

NATIONAL
ARCHIVES
MICROFILM
PUBLICATION

IMAGE EVALUATION TEST TARGET (QA-3)

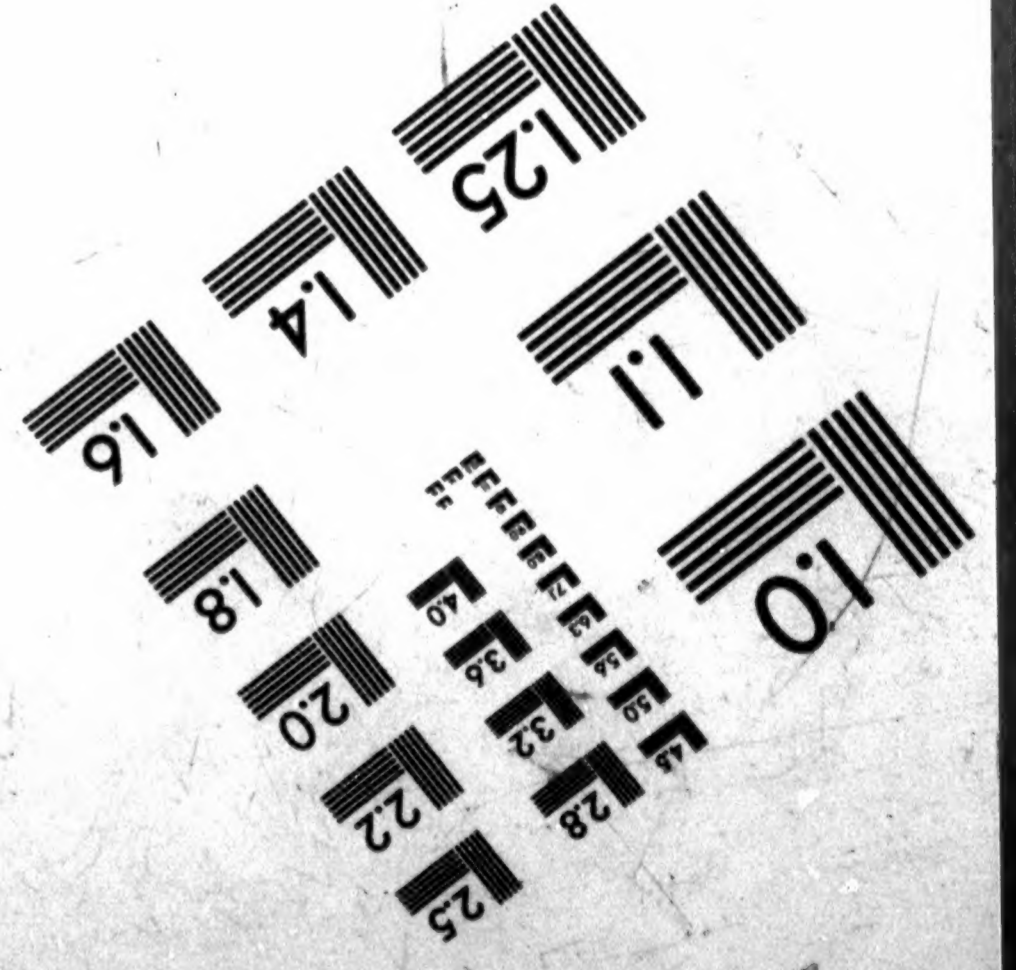
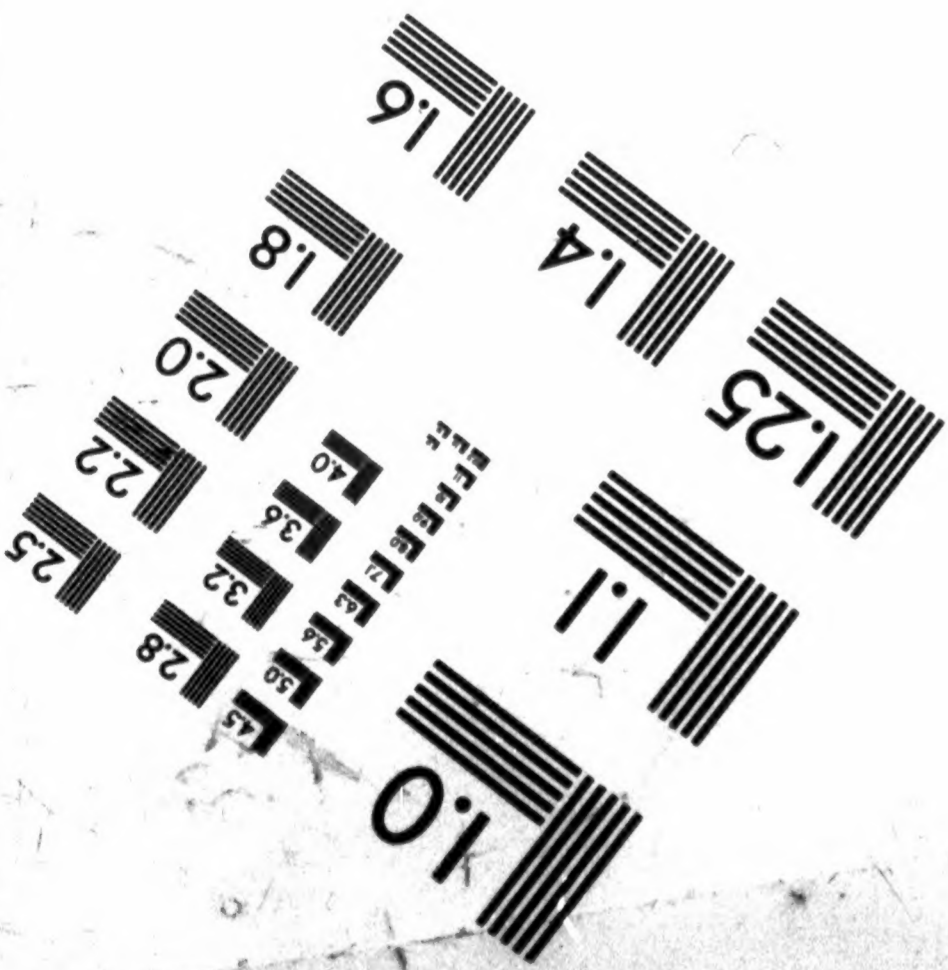
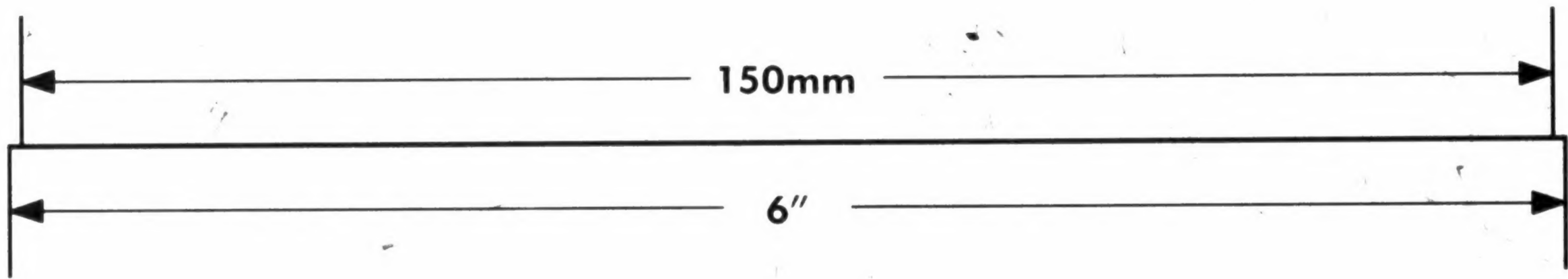
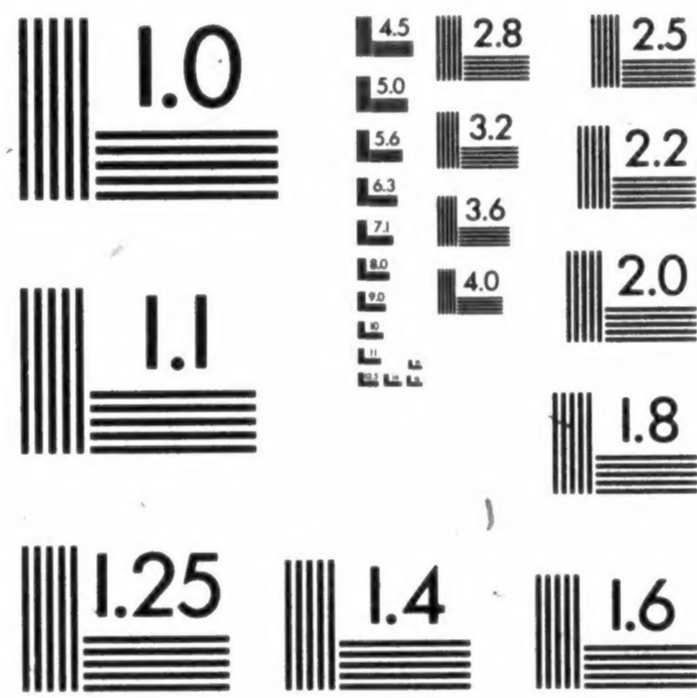
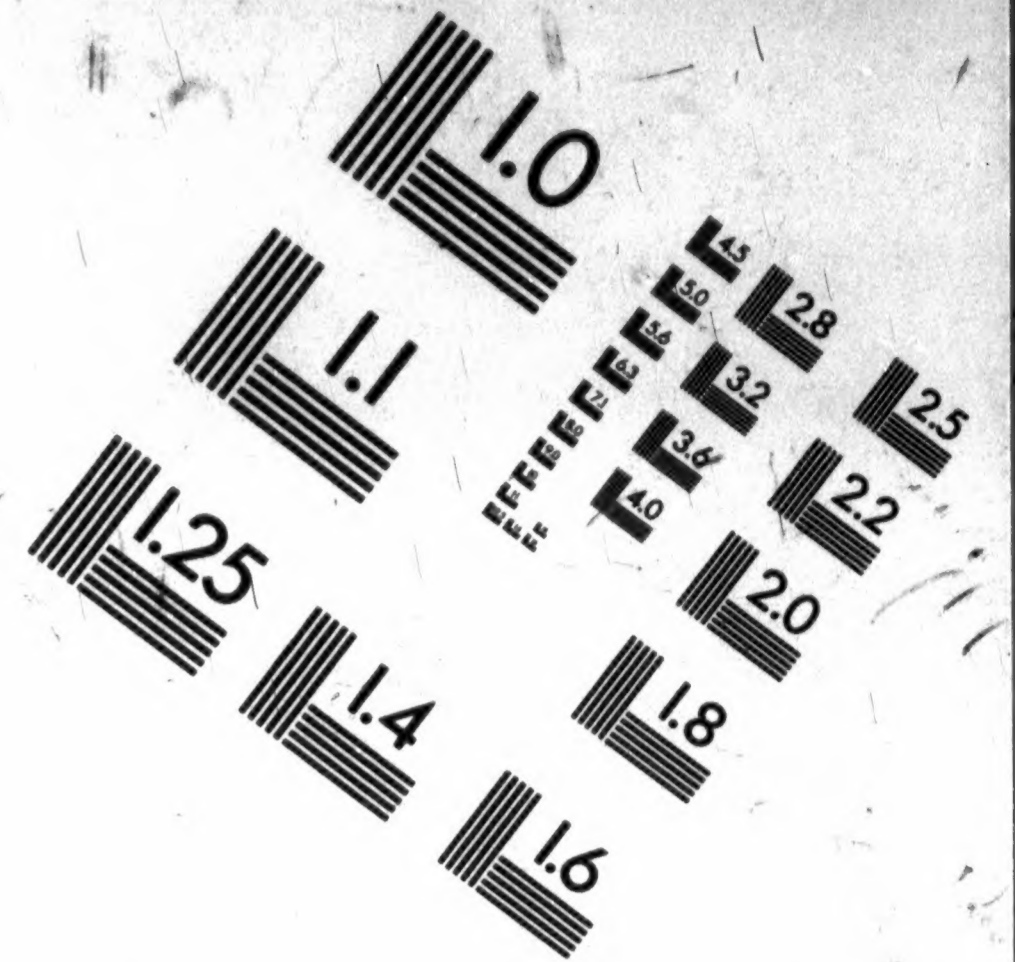
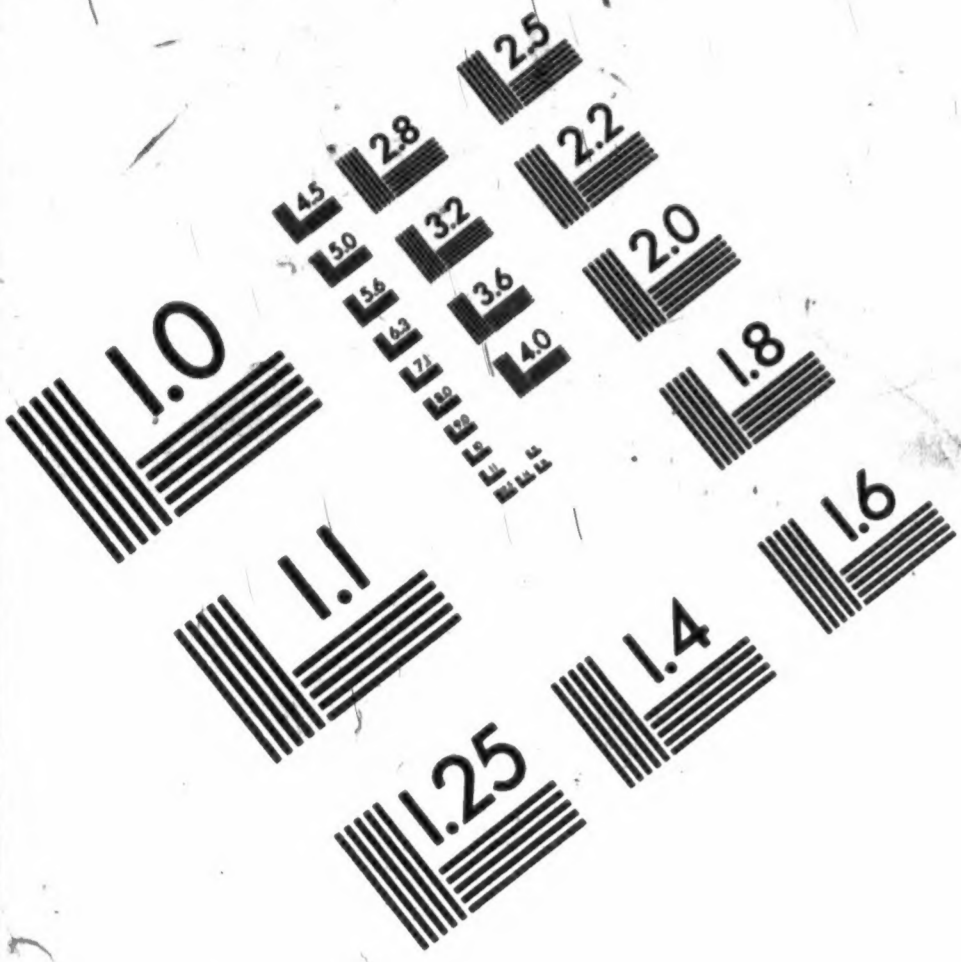

APPLIED IMAGE, Inc
1653 East Main Street
Rochester, NY 14609 USA
Phone: 716/482-0300
Fax: 716/288-5989

© 1993, Applied Image, Inc., All Rights Reserved

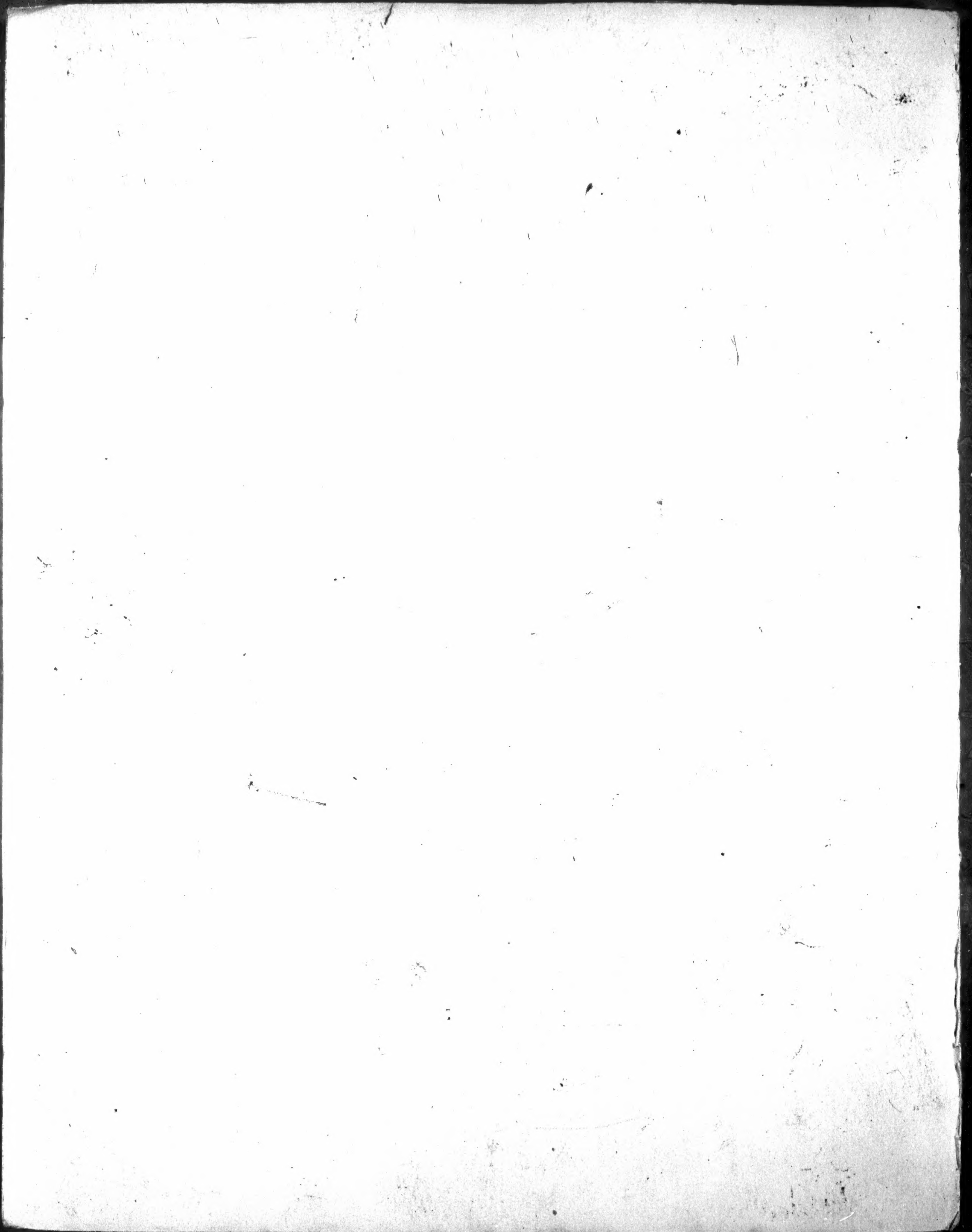

National Archives at College Park



8601 Adelphi Road College Park MD 20740-6001

J PROCTOR

OPERATOR

CAMERA

5-11-99

Z-3

DATE FILMED

REDUCTION RATIO

2461-0576-014-02

10

FILM EMULSION NUMBER

M1820

106

PROJECT NUMBER

ROLL NUMBER

MICROCOPY

1820

ROLL

106

M1820

**COMPILED MILITARY SERVICE RECORDS OF
VOLUNTEER UNION SOLDIERS WHO SERVED WITH THE
UNITED STATES COLORED TROOPS:
2d Through 7th Colored Infantry, Including
3d Tennessee Volunteers (African Descent)
6th Louisiana Infantry (African Descent)
7th Louisiana Infantry (African Descent)**

Introduction written by Budge Weidman, Project Manager

Records prepared for microfilming by volunteers of
the Civil War Conservation Corps

Pat Alfredson	Sue Goward*	Peggy Pratt
Phyllis Altrogge	Bert Greenstein	Ray Puzio
Kenneth Ashton	Anne Greenwood	Sylvia Scott
Sue Barnard*	Jim Harris	Lynn Shearouse
Rex Bowser	Walter Hayden	Charles Spencer
Ann N. Brown	Mary Hayden	Mary Stack-Dunne
Jerry Brown	Pat Ikonen	Ben Stearns
Robert Budway	Dick Ives	Bill Stormer*
Randy Caldwell	Sarah Jaffe	Pat Sullivan
Mary Ann Castellana*	Barbara Kemp	Gorman Tidball*
Mary Lou Cole	Bev Manypenny	John Toole
Giovanni Croce	Frank Masterson	Maryellen Toole
B. H. Custer	Joe Mazur	Dean Warner
Bob Denney	Kathleen McCarthy	Melody Warner
Earl Dunn	Catherine McManus	Milt Weatherhead
Yvette Fallin	Ben Miles	Russ Weidman
Maria Flesher	Dave Murray	Robert Young
Naomi Glass	Mary Poggioli	

Team leaders are indicated by the asterisk.

National Archives and Records Administration
Washington, DC
1999

INTRODUCTION

On the 116 rolls of this microfilm publication, M1820, are reproduced the compiled military service records of volunteer Union soldiers belonging to the 2d through the 7th United States Colored Infantry units, including the 3d Tennessee Volunteers (African Descent) and the 6th and 7th Louisiana Infantries (African Descent). These units were part of the United States Colored Troops (USCT). The USCT included 7 numbered cavalry regiments; 13 numbered artillery regiments plus 1 independent battery; 144 numbered infantry regiments; Brigade Bands Nos. 1 & 2 (Corps d'Afrique and US Colored Troops); Powell's Regiment Colored Infantry; Southard's Company Colored Infantry; Quartermaster Detachment; Pioneer Corps, 1st Division, 16th Army Corps; Pioneer Corps, Cavalry Division, 16th Army Corps; Unassigned Company A Colored Infantry; and Unassigned USCT. There are also miscellaneous service cards arranged alphabetically by surname at the end of the unit records. The records reproduced are part of the Records of the Adjutant General's Office, 1780's-1917, Record Group (RG) 94.

Background

United States Colored Troops

Since the time of the American Revolution, African Americans have volunteered to serve their country in time of war. The Civil War was no exception. Official sanction was the difficulty. In the fall of 1862 there were four Union regiments of African Americans raised in New Orleans, LA: the 1st, 2d, and 3d Louisiana Native Guard, and the 1st Louisiana Heavy Artillery (African Descent). The 1st South Carolina Infantry (African Descent) was not officially organized until January 1863; however, three companies of the regiment were on coastal expeditions as early as November 1862. The 1st Kansas Colored Infantry was not mustered into Federal service until January 1863, even though the regiment had already participated in the action at Island Mound, MO, on October 27, 1862. These early unofficial regiments received little Federal support, but they showed the strength of the African American soldier's desire to fight for freedom.

The first official authorization to employ African Americans in Federal service was the Second Confiscation and Militia Act of July 17, 1862. This act allowed President Abraham Lincoln "to receive [African Americans] into the service of the United States, for the purpose of constructing entrenchments, or performing camp service, or any other labor, or any military or naval service for which they may be found competent." The President did not authorize use of African Americans in combat, however, until issuance of the Emancipation Proclamation on January 1, 1863.

In late January 1863 Governor John Andrew of Massachusetts received permission to raise a regiment of African American soldiers. The pace of organizing additional regiments was very slow. In March Secretary of War Edwin M. Stanton sent Gen. Lorenzo Thomas to the lower Mississippi Valley to recruit free and

contraband African Americans. Thomas was given broad authority. He was to explain the administration's policy regarding African American soldiers and recruit volunteers to raise and command them. Stanton wanted all officers of such units to be white, but that policy was softened to allow African American surgeons and chaplains. By the end of the war, in addition to the chaplains and surgeons, there were 87 African American officers. Thomas's endeavor was very successful, and on May 22, 1863, the Bureau of Colored Troops was established to coordinate and organize regiments from all parts of the country. Created under War Department General Order No. 143, the bureau was responsible for handling "all matters relating to the organization of Colored Troops." The bureau was directly under the Adjutant General's Office and its procedures and rules were specific and strict. All African American regiments were now to be designated United States Colored Troops (USCT). At this time there were some African American regiments with state names and a few regiments in the Department of the Gulf designated as Corps d'Afrique. The Corps d'Afrique units ultimately became numbered regiments in the USCT. The 54th and 55th Massachusetts Infantries (Colored), the 5th Massachusetts Cavalry (Colored), the 29th Connecticut Infantry (Colored), the 6th and 7th Louisiana Infantries (African Descent), the 3d Tennessee Volunteers (African Descent), and the 1st South Carolina Volunteers (Colored) retained their number and state designations.

To facilitate recruiting in the states of Maryland, Missouri, Tennessee, and eventually Kentucky, the War Department issued General Order No. 329 on October 3, 1863. Section 6 of the order stated that if any citizen should offer his or her slave for enlistment into the military service, that person would, "if such slave be accepted, receive from the recruiting officer a certificate thereof, and become entitled to compensation for the service or labor of said slave, not exceeding the sum of three hundred dollars, upon filing a valid deed of manumission and of release, and making satisfactory proof of title." For this reason, some records of manumission are contained in the compiled service records reproduced in this publication.

The USCT fought in 39 major engagements and over 400 lesser ones. Sixteen African American soldiers received the Congressional Medal of Honor. As it was in other units, the death toll from disease was very high in the USCT. Deaths from disease and battle totaled 37,000. The last regiment of the USCT was mustered out of Federal service in December 1867.

Important sources for information about African American units in the Civil War are the War Department's *The War of the Rebellion: A Compilation of the Official Records of the Union and Confederate Armies* (Washington, DC: 1880-1901; reprinted Harrisburg, PA, 1971 and 1985) and the Navy Department's *The War of the Rebellion: A Compilation of the Official Records of the Union and Confederate Navies* (Washington, DC: 1874-1922; reprinted Harrisburg, PA, 1971 and 1985). These multivolume works contain reports of operations and other official correspondence.

2d United States Colored Infantry

This regiment was organized at Arlington, VA, from June 23 to November 11, 1863, to serve 3 years. During its existence, the regiment served in New Orleans, LA, and Ship Island, MI. In 1864 the unit moved to Key West and participated in operations on the west coast of Florida. On February 20, 1865, Companies D and I took part in the attack on Fort Myers, FL. Subsequent service took place in the District of Florida until the regiment was mustered out on January 5, 1866.

3d United States Colored Infantry

This regiment was organized at Camp William Penn, Philadelphia, PA, from August 3 to 10, 1863, to serve 3 years. The regiment participated in the siege of Fort Wagner, SC, and operations against Charleston, SC. In 1864 the unit moved to Jacksonville, FL, and maintained duty in the area until being mustered out October 31, 1865.

3d Tennessee Volunteers (African Descent)

This regiment was organized in the spring of 1864 in Memphis, TN, for the defense of that city. Most of the men were transferred to the 7th United States Colored Heavy Artillery, which was redesignated the 11th United States Colored Infantry (New) on January 23, 1865. There are service records pertaining to the officers and men in the 3d Tennessee Volunteers as well as in the 11th United States Colored Infantry (New).

4th United States Colored Infantry

The regiment was organized at Baltimore, MD, July 15 to September 1, 1863, to serve 3 years. The unit participated in actions in Virginia at Bermuda Hundred, Petersburg, Dutch Gap, and Chaffin's Farm. In North Carolina the regiment took part in the battle and capture of Fort Fisher, Sugar Loaf Hill, and the city of Wilmington. In these actions the regiment sustained losses of 355 officers and men wounded, missing, or killed. The regiment was mustered out of service May 6, 1866.

5th United States Colored Infantry

This regiment was organized at Camp Delaware, OH, from August 6, 1863, to January 15, 1864, to serve 3 years. In Virginia the regiment served at Norfolk and Portsmouth and participated in major battles at Petersburg, Chaffin's Farm, and Fair Oaks. The regiment took part in the capture of Fort Fisher and the city of Wilmington in North Carolina. Its remaining service took place in North Carolina until it was mustered out on September 20, 1865.

6th United States Colored Infantry

This regiment was organized at Camp William Penn, Philadelphia, PA, from July 28 to September 12, 1863, to serve 3 years. The unit participated in battles at Chaffin's Farm, Williamsburg, and Petersburg in Virginia and at Sugar Loaf Hill, NC. During these actions the regiment sustained losses of 237 killed, wounded, or missing. The regiment was mustered out September 20, 1865.

6th Louisiana Infantry (African Descent)

This regiment was organized for 60 days in New Orleans, LA, on July 4, 1863. The unit served at New Orleans and was mustered out August 13, 1863.

7th United States Colored Infantry

This regiment was organized at Baltimore, MD, from September 26 to November 12, 1863, to serve 3 years. The unit served in Virginia, Florida, and South Carolina. It was mustered out of service October 13, 1866.

7th Louisiana Infantry (African Descent)

This regiment was organized for 60 days in New Orleans, LA, on July 10, 1863. It served in New Orleans until it was mustered out on August 6, 1863.

Records Description

Compiled service records consist of a jacket-envelope for each soldier, labeled with his name, rank, unit, and card numbers. The compilation of service records of Union soldiers began in 1890 under the direction of Col. Fred C. Ainsworth, head of the Record and Pension Office of the Adjutant General's Office, Department of War. Information from muster rolls, regimental returns, descriptive books, and other records was copied verbatim onto cards. A separate card was prepared each time an individual name appeared on a document. These cards were numbered on the back, and these numbers were entered onto the outside jacket containing the cards. The carded information was verified by a separated operation of comparison; great care was taken to ensure that the cards were accurate.

A typical jacket contains card abstracts of entries found in original records relating to the soldier and original documents relating solely to that soldier. Examples of the latter include enlistment papers, substitute certificates, casualty sheets, death reports, prisoner-of-war memorandums, and correspondence. Unique to the records of the USCT are deeds of manumission, oaths of allegiance, proof of ownership, certificates of monetary award, and bills of sale. These items appear most frequently in units recruited in the border states of Kentucky, Missouri, and Maryland. These states remained in the Union but were slave states. Jackets and cards include a section labeled "bookmark," which was reserved for cross-references to other records relating to the individual or his unit. The service records are

arranged by arm of service, thereunder numerically by regiment or independent battalion or company, and thereunder alphabetically by name of the soldier. Records for officers are interfiled alphabetically by name with the records of enlisted men. If an individual served in more than one unit, which was typical for USCT officers, there will be a separate service record for each unit in which he served.

The unjacketed miscellaneous cards were accumulated by the War Department with the expectation that they would be incorporated in individual compiled service records. This expectation was never fulfilled, however, because either insufficient or contradictory information made it impossible to associate the cards or papers with a particular soldier's service records.

Related Records

Among the records of the Adjutant General's Office in the National Archives are many of the original records that were abstracted or "carded" by the Record and Pension Office. These include the individual unit's muster rolls, returns, and descriptive books. Other series in RG 94 that contain information relating to volunteer Union soldiers who served with the USCT include carded records relating to Union staff officers, carded medical records of volunteer Union soldiers, unbound and bound regimental records and "record of events" cards. The regimental records of the 54th Massachusetts Infantry (Colored) have been reproduced as Microfilm Publication M1659, *Records of the Fifty-fourth Massachusetts Infantry Regiment (Colored), 1863-1865*.

The "record of events" cards include information copied from the unit's muster rolls and returns. They show the stations of the field and staff and the companies of the regiment at the time the muster roll or return was prepared and sometimes mention battles, skirmishes, or other activities in which the regiment participated. The cards have been reproduced as Microfilm Publication M594, *Compiled Records Showing Service of Military Units in Volunteer Union Organizations*.

Record Group 94 also includes a card index for the USCT, reproduced as Microfilm Publication M589, *Index to Compiled Military Service Records of Volunteer Union Soldiers Who Served with U.S. Colored Troops*, which may be used to locate the regiment of a USCT soldier. An index card gives the name of the soldier and his rank, as well as the unit in which he served; sometimes there is a cross-reference to his service in other units or organizations. The National Archives is continually producing microfilm publications of volunteer Union compiled military service records. A complete listing of finished publications can be found in the National Archives *Microfilm Resources for Research: A Comprehensive Catalog*, which is available online at <http://www.nara.gov>.

The records of the Colored Troops Division, within RG 94, include division correspondence and records relating to recruiting, the appointment of officers, and the slave or free status of individuals, as well as a compilation of historical extracts

NATIONAL ARCHIVES MICROFILM PUBLICATIONS

and official papers concerning the military service of African Americans from the colonial period through the Civil War entitled *The Negro in the Military Service of the United States, 1639-1886*. This compilation is reproduced as Microfilm Publication M858. The records of the Bounty and Claims Division, also in RG 94, include correspondence of the division and records relating to bounties and claims paid to loyal owners of slaves by the Slave Claims Commissions of Delaware, Kentucky, Maryland, Missouri, Tennessee, and West Virginia.

If a soldier applied for a pension, the pension application case file may be among the Records of the Veterans Administration (RG 15). Indexes to the pension applications have been reproduced as Microfilm Publications T288, *General Index to Pension Files, 1861-1934*, and T289, *Organizational Index to Pension Files of Veterans Who Served Between 1861 and 1900*.

If a soldier or officer was tried before a general court-martial or if an individual or his unit was the subject of a court of inquiry or military commission, transcripts of those proceedings may be among the Records of the Office of the Judge Advocate General (Army) (RG 153). The registers to the proceedings have been reproduced as Microfilm Publication M1105, *Registers of the Records of the Proceedings of the U.S. Army General Courts-Martial, 1809-1890*.

Other record groups having information pertaining to the USCT include Records of the Bureau of Refugees, Freedmen, and Abandoned Lands (RG 105); Records of the Provost Marshal General's Bureau (Civil War) (RG 110); Records of the Accounting Officers of the Department of the Treasury (RG 217); and Records of U.S. Army Continental Commands, 1821-1920 (RG 393).

Holdings of the National Archives relating to the Civil War are outlined in Kenneth W. Munden and Henry Putnam Beers, *Guide to Federal Archives Relating to the Civil War* (Washington, DC: National Archives, 1962) and Henry Putnam Beers, *Guide to the Archives of the Government of the Confederate States of America* (Washington, DC: National Archives, 1968), which were reprinted as *The Union* (1986) and *The Confederacy* (1986).

ROLL LIST

Roll Description

2d United States Colored Infantry

- 1 Abram, Abraham - Bell, Daniel A.
- 2 Bell, Henry - Brown, Thomas
- 3 Brown, William - Clark, Moses
- 4 Clark, Stephen - Downing, Dennis
- 5 Downs, John - Gavin, Benjamin
- 6 Gibbs, Paton - Haskins, Iverson
- 7 Hasler, William - Jenkins, Charles
- 8 Johnson, Albert - Kratzenberg, Augusta
- 9 Kratzenberg, Charles - Miller, Thomas
- 10 Mills, John Q. - Pettis, Alfred
- 11 Pettis, Frank - Russ, Charles
- 12 Russell, Charles - Spindle, James E.
- 13 Sprague, Benedict - Thoroughgood, Miles E.
- 14 Thornson, Charles H. - West, James
- 15 West, Nimrod - Woodson, William
- 16 Woodward, George G. - Young, William A.

2d United States Colored Infantry Miscellaneous Service Cards

- 16 Ackis, George - Young, Samuel

3d United States Colored Infantry

- 17 Abbot, Charles S. - Bohlen, John
- 18 Bond, Charles - Clemens, William
- 19 Clemmons, Joseph - Fernow, Edward B. F.
- 20 Fields, Alfred - Harmon, William K.
- 21 Harris, George - Jackson, Frederick
- 22 Jackson, George - LaCount, Charles J.
- 23 Ladson, Thomas - Miller, Henry
- 24 Miller, John - Preslin, Stephen
- 25 Preston, Joseph - Shorter, Daniel
- 26 Shorter, John W. - Thompson, George A.
- 27 Thompson, John - Williams, Edward
- 28 Williams, Enoch - Young, William H.

3d United States Colored Infantry Miscellaneous Service Cards

- 29 Abbott, Chas. - Wright, Lorenzo

3d Tennessee Volunteers (African Descent)

30 Ady, George - Young, Samuel

4th United States Colored Infantry

31 Abney, Richard - Bass, James
 32 Batsom, David - Brown, Stephen R.
 33 Brown Uriah - Cherry, Thomas
 34 Chew, Josiah - Davis, Jeremiah
 35 Davis, John H. J. - Ellis, John J.
 36 Emery, Enoch - Gray, James
 37 Grayson, Noble - Hause, William
 38 Hawkins, Alexander - Jackson, John
 39 Jackson, John Daniel - Jones, John
 40 Jones, John Robert - Linthicum, Dennis C.
 41 Linthicum, George L. - Mercer, Benjamin F.
 42 Mickens, Thomas H. - Novel, Charles
 43 Odiorne George G. - Reynolds, S. Walter
 44 Rezin, George F. - Seymour, George W.
 45 Seymour, Thomas - Stockett, Samuel
 46 Stokes, George E. W. - Veal, Charles
 47 Viney, Richard - Willett, James
 48 Williams, Adam - Zimmons, Charles

4th United States Colored Infantry Miscellaneous Service Cards

49 Adams, James O. - Juricks, Jacob
 50 Kane, Chas. - Zook, Gray

5th United States Colored Infantry

51 Adams, John - Black, Edward
 52 Blackburn, Daniel - Brown, James
 53 Brown, J. R. - Coleman, James
 54 Coleman, Thornton - Duckwilder, Clayburn
 55 Dudley, George - Gilson, James
 56 Glasgow, James - Herse, Jerry
 57 Hervit, John - Johnson, Arthur B.
 58 Johnson, Charles - Lett, William
 59 Levis, Hezekiah - McFarland, Allen
 60 McFarland, John - Page, David
 61 Page, Isaiah - Rider, William H.
 62 Ridgeway, John - Sloan, Samuel
 63 Sly, William - Teeters, Charles
 64 Teeters, Henry W. - Walker, William
 65 Walker, Willis - Winters, James

66 Winters, Oscar - Zimmerman, Henry

5th United States Colored Infantry Miscellaneous Service Cards

66 Alexander, Arthur - Kyser, Henry

67 Ladd, Andrew - Young, Thomas

6th United States Colored Infantry

68 Abraham, Jacob - Bolier, Abram

69 Boo, David - Carey, Walter

70 Carr, William - Davis, Peter

71 Davis, Robert - Fiderman, William C.

72 Field, Edward - Gustus, John R.

73 Guy, William - Hopkins, James

74 Hosfield, Lewis M. - Johnson, John Henry

75 Johnson, John W. - Lemon, George

76 Lett, Nelson - Miller, John

77 Miller, Lawson L. - Pierce, Alfred B.

78 Pierce, George - Ruff, Jacob

79 Russell, Lloyd - Smith, William H.

80 Snowden, Henry - Van Clief, Emanuel

81 Van Vrankin, William H. - Wilson, Anthony

82 Wilson, Charles - Young, John

6th United States Colored Infantry Miscellaneous Service Cards

82 Abrams, Jacob - Furgerson, Henry

83 Gadsby, John - Young, Richard

6th Louisiana Infantry (African Descent)

84 Aaron, Koff - Chevarre, Ernest

85 Cheveau, Auguste - Guimiase, Julian

86 Gusman, Thomas - Meyer, Wilson

87 Michael, Louis - Sorza, Antoine

88 Span, Octavus - Zenon, Aristide

7th United States Colored Infantry

89 Abraham, John - Bardy, Joseph

90 Bargus, James J. - Bowyer, Littleton

91 Bowzer, Emory - Bundick, Henry

92 Burden, Daniel - Chase, Henry

93 Chase, Isaac - Crawford, George W.

94 Cray, Charles M. - Drummond, William

NATIONAL ARCHIVES MICROFILM PUBLICATIONS

- 95 Dumpson, George - Gale, Joseph
- 96 Gamby, Charles - Griffin, Charles W.
- 97 Griffin, George E. - Hazelton, William
- 98 Hearn, William E. - Jackson, George H.
- 99 Jackson, Henry - Johnson, Samuel
- 100 Johnson, Stephen - Landsell, William
- 101 Lane, William - Melvin, Sime
- 102 Merrill, Lewis - Nichols, Lloyd
- 103 Noonan, William F. - Purnell, James
- 104 Purnell, John H. - Russell, Thomas
- 105 Russum, Alexander - Smith, James R.
- 106 Smith, James W. - Taylor, Daniel
- 107 Taylor, Levin H. - Vaughn, John H.
- 108 Veasey, Edward - Whitman, Moses P.
- 109 Whittica, James - Wright, John Wesley
- 110 Wright, Joseph - Young, Thomas

7th United States Colored Infantry Miscellaneous Service Cards

- 110 Adams, Gilbert - Kutchumber, Jacob
- 111 Landon, Perry H. - Young, Stephen

7th Louisiana Infantry (African Descent)

- 112 Able, Alfred - Colar, Manuel
- 113 Cole, Arnold - Holland, John C.
- 114 Holland, Jules - Myers, Victor
- 115 Narcisse, James - Swails, George A.
- 116 Sylvester, Joseph - Zoodrick, Dick

7th Louisiana Infantry (African Descent) Miscellaneous Service Cards

- 116 Allen, Charles - Whittey, Hiram C.

NATIONAL ARCHIVES MICROFILM PUBLICATIONS

Microfilm Publication M1820

COMPILED MILITARY SERVICE RECORDS OF VOLUNTEER UNION
SOLDIERS WHO SERVED WITH THE UNITED STATES COLORED TROOPS:
2d Through 7th United States Colored Infantry, Including 3d Tennessee Volunteers
(African Descent), 6th Louisiana Infantry (African Descent), 7th Louisiana Infantry
(African Descent)

Roll 106

7th United States Colored Infantry

Smith, James W. - Taylor, Daniel

NATIONAL ARCHIVES AND RECORDS ADMINISTRATION

1236

Smith James W.

Co A, 7 U.S. Col'd Inf.

Private

Private

CARD NUMBERS.

1	6298912	26
2	6289499	27
3	6289601	28
4	6289695	29
5	6289491	30
6	6289883	31
7	6289983	32
8	6290085	33
9	6290182	34
10	6290272	35
11	6290359	36
12	6290449	37
13	6290534	38
14	6290613	39
15	6290691	40
16	6290765	41
17	6290838	42
18	9066603	43
19	43152388	44
20		45
21		46
22		47
23		48
24		49
25		50

Book Mark:

See also

D. 3093798 and WD
S. P. O. m. m. Cf. 1415788-9-20-20 RSC

Star for P. O. rec. to stations
and wounds 1/20/23.

P. O. D. C. 415788 - Return for record of
any other James W. Smith Co. 7th Regt. 114th ILL.
1/23

S

7

U.S.C.T.

James H. Smith

Co. 3, 7 Reg't U.S. Col'd Inf.

Appears on

Company Descriptive Book

of the organization named above.

DESCRIPTION.

Age 34 years; height 5 feet 5 inches.

Complexion *Blk*

Eyes *Blu*; hair *Curly*

Where born *Balti, Md*

Occupation *Laborer*

ENLISTMENT.

When *Jan. 6*, 1864.

Where *Baltimore, Md.*

By whom ; term *3* y'rs.

Remarks: *Drafted from 5th Sub. Dist 2^d Dist Md.*

J. Brown

S | 7 | U.S.C.T.

James N. Smith

Appears with rank of *Private* on
Muster and Descriptive Roll

of Detachment of drafted men forwarded
for U.S.C.T.

x Co. F, 7th Regt. Roll dated
Baltimore, Md. Jan. 12, 1864.

Where born *Maryland*
Age *34* y'rs; occupation *Laborer*

Drafted and mustered in:

When *Jan. 6*, 1864.

Where *Balt^o. Md.*

Enrollment district *2 Dist. Md.*

Period *3* years.

Eyes *Black*; hair *Black*

Complexion *Black*; height *5 ft. 3 in.*

Bounty paid \$ *100*; due \$ *100*

Clothing account:

Last settled _____, 186 ; drawn since \$ *28* ^{*10*}/_{*100*}

Date of commencement of service *Jan. 6*, 1864.

Company to which assigned _____

Remarks: *Colored man, drafted from
5 Sub Dist. 2 Dist. Md., Nov. 27, '63.*

x From margin of roll.

Book mark: _____

W. W. Hibbard

(356m)

Copyist.

| | | | | | **U.S.C.T.**

James W. Smith
Priv., Co. I, 7 Reg't U. S. Col'd Inf'y

Age 32 years.

Appears on a

Detachment Muster-in Roll

of the organization named above. Roll dated
Baltimore, Md., Apr. 18, 1865.

Muster-in to date *Jan. 16, 1864.*

Joined for duty and enrolled:

When *Dec. 22, 1863.*

Where *Baltimore, Md.*

Period 3 years.

Valuation of horse, \$ 100

Valuation of horse equipments, \$ 100

Remarks: *Drafted*

Book mark: _____

Beck
Copyist.

S. 1

7

U.S.C.T.

James W. Smith

Pvt., Co. F, 7 Reg't U. S. Col'd Infantry.

Appears on

Company Muster Roll

for *Jan. & Feb.*, 1864

Joined for duty and enrolled:

When *Jan 6.*, 1864*

Where *Baltimore C. Md.* *

Period years.*

Present or absent *Present*

Stoppage, \$ 100 for

Due Gov't \$ 100 for

Remarks: *Joined for duty
Jan 16. 1864.*

* See enrollment on card from muster-in-roll.

Book mark:

(858c)

J. H. Miller
Copyist.

S

7

U.S.C.T.

James H. Smith
Pvt., Co. F, 7 Reg't U. S. Col'd Infantry.

Appears on

Company Muster Roll

for *March & April*, 1864.

Joined for duty and enrolled:

When *May 6th*, 1864.*

Where *Baltimore Md* *

Period *3* years.*

Present or absent *Present*

Stoppage, \$ *100* for

Due Gov't \$ *100* for

Remarks:

* See enrollment on card from muster-in roll.

Book mark: _____

(358c)

J. C. Miller
Copyist.

S | **7** | **U.S.C.T.**

James H. Smith
Pvt, Co. F, 7 Reg't U. S. Col'd Infantry.

Appears on

Company Muster Roll

for *May & June*....., 186*4*.*

Joined for duty and enrolled:

When *May 6th*....., 186*4*.*

Where *Baltimore Co Md*.....*

Period *3* years.*

Present or absent *Absent*

Stoppage, \$ *100* for.....

Due Gov't \$ *100* for.....

Remarks: *Stop for one letter
& scales - Sick at Jack
Sawills Md*

* See enrollment on card from muster-in roll.

Book mark:.....

(858c)

J. H. Miller
Copyist.

S

7

U.S.C.T.

James H. Smith

Pvt, Co. F, 7 Reg't U.S. Col'd Infantry.

Appears on

Company Muster Roll

for July & Aug, 1864

Joined for duty and enrolled:

When Jan 6, 1864*

Where Baltimore, Md.*

Period 3 years.*

Present or absent Present

Stoppage, \$ 100 for

Due Gov't \$ 100 for

Remarks: Stopped for
1 Letter Pr. Scale

* See enrollment on card from muster-in roll.

Book mark:

W. H. [Signature]

(858c)

Copyist.

S | **7** | **U.S.C.T.**

James W. Smith

Private, Co. F, 7 Reg't U. S. Col'd Infantry.

Appears on

Company Muster Roll

for *Sept. and Oct.*, 1864.

Joined for duty and enrolled:

When *Jan'y 6*, 1864.*

Where *Baltimore, Md.* *

Period *3* years.*

Present or absent *Present.*

Stoppage, \$ *100* for _____

Due Gov't \$ *100* for _____

Remarks: _____

* ~~See~~ See enrollment on card from muster-in roll.

Book mark: _____

Keefe

S. 1

7

U.S.C.T.

James W. Smith
Private, Co. F, 7 Reg't U. S. Col'd Infantry.

Appears on

Company Muster Roll

for *Nov. and Dec., 1864*

Joined for duty and enrolled:

When *Jan 6*, 1864.*

Where *Baltimore Md.**

Period *3* years.*

Present or absent *Present*

Stoppage, \$ *100* for

Due Gov't \$ *100* for

Remarks:

* See enrollment on card from muster-in roll.

Book mark: _____

Keefe

S | **7** | **U.S.C.T.**

James W. Smith

Private, Co. F, 7 Reg't U. S. Col'd Infantry.

Appears on

Company Muster Roll

for *Jan. 5 Feb.*, 1865.

Joined for duty and enrolled:

When *Sep 27*, 1863.*

Where *Baltimore* *

Period *3* years.*

Present or absent *Present*

Stoppage, \$ *100* for

Due Gov't \$ *100* for

Remarks:

* ~~43~~ See enrollment on card from muster-in roll.

Book mark: -----

Keeper
----- Copyist.

S | **7** | **U.S.C.T.**

James W. Smith
Private Co. F, 7 Reg't U. S. Col'd Infantry.

Appears on

Company Muster Roll

for *Mar. & Apr.*, 186*5*.

Joined for duty and enrolled:

When *Jan. 6*, 186*4*.*

Where *Baltimore Co., Md.* *

Period *3* years.*

Present or absent *Present*

Stoppage, \$ *100* for

Due Gov't \$ *100* for

Remarks: _____

* See enrollment on card from muster-in roll.

Book mark: _____

(358c)

Keefer
Copyist.

S | **7** | **U.S.C.T.**

James W. Smith

Private, Co. F, 7 Reg't U. S. Col'd Infantry.

Appears on

Company Muster Roll

for *May and June*, 1865.

Joined for duty and enrolled:

When *Jan 6*, 186*4*.*

Where *Baltimore* *

Period *3* years.*

Present or absent *Present*

Stoppage, \$ *100* for

Due Gov't \$ *100* for

Remarks: *To be stopped for
1 Shelter Tent Piece
Wrench and Stiper*

* See enrollment on card from muster-in roll.

Book mark:

Keefe

S | **7** | **U.S.C.T.**

James W. Smith
Private, Co. F, 7 Reg't U. S. Col'd Infantry.

Appears on

Company Muster Roll

for *July and Aug.*, 186*5*.

Joined for duty and enrolled:

When *Jan. 6*, 186*4**

Where *Baltimore Co. Md.**

Period *3* years.*

Present or absent *Present*

Stoppage, \$ *100* for

Due Gov't \$ *100* for

Remarks:

* See enrollment on card from muster-in roll.

Book mark: -----

Keeper.
(358c) Copyist.

S 7 U.S.C.T.

James W. Smith
Priv., Co. F, 7 Reg't U. S. Col'd *Infy*

Appears on

Company Muster Roll

for *Sept. & Oct.* 186*3*.

Joined for duty and enrolled:

When *Jan. 6*, 186*4*.*

Where *Baltimore Co., Md.* *

Period *3* years.*

Present or absent *Present.*

Stoppage, \$ $\frac{26}{100}$ for *Ordnance.*

Due Gov't, \$ $\frac{100}{100}$ for

Valuation of horse, \$ $\frac{100}{100}$

Valuation of horse equipments, \$ $\frac{100}{100}$

Remarks: _____

*~~See~~ See enrollment on card from muster-in roll.

Book-mark: _____

Keefe
Copist.

S

7

U.S.C.T.

James H. Smith

Capt., Co. F, 7 Reg't U. S. Col'd Infantry.

Appears on

Company Muster Roll

for Nov. & Dec., 1865.

Joined for duty and enrolled:

When Jan. 6, 1864.*

Where Baltimore, Md.*

Period 3 years.*

Present or absent Present.

Stoppage, \$ 100 for

Due Gov't \$ 100 for

Remarks: Stop for
ordnance 26 cts.

* See enrollment on card from muster-in roll.

Book mark:

Brooks

(858c)

Copyist.

S 7 U.S.C.T.

James W. Smith
Co. F, 7 Reg't U. S. Col'd Infantry.

Appears on

Company Muster Roll

for *Jan. + Feb.*, 1866.

Joined for duty and enrolled:

When *Jan. 6*, 1864.*

Where *Baltimore Md.**

Period *3* years.*

Present or absent *Present*

Stoppage, \$ *100* for

Due Gov't \$ *100* for

Remarks:

* See enrollment on card from muster-in-roll.

Book mark: _____

Brooke
(858c) Copyist.

S | 7 | **U.S.C.T.**

James V. Smith
Pvt., Co. F, 7 Reg't U. S. Col'd Infantry.

Appears on

Company Muster Roll

for Mar. & Apr., 1866.

Joined for duty and enrolled:

When Jan. 6, 1864.*

Where Baltimore Md. *

Period 3 years.*

Present or absent Present

Stoppage, \$ 100 for

Due Gov't \$ 100 for

Remarks:

* See enrollment on card from muster-in roll.

Book mark: 5000

Brooks
Copyist.

S | 7 | **U.S.C.T.**

James H. Smith
Pl., Co. F, 7 Reg't U. S. Col'd Infantry.

Appears on

Company Muster Roll

for May & June, 1866.

Joined for duty and enrolled:

When Jan. 6, 1864.*

Where Baltimore Md.*

Period 3 years.*

Present or absent Present

Stoppage, \$ 100 for _____

Due Gov't \$ 100 for _____

Remarks: _____

NEXT ROLL ON FILE MUSTER OUT.

* See enrollment on card from muster-in roll.

Book mark: _____

(858c)

Brooks

Copyist.

S. | 7 | U.S.C.T.

James H. Smith
Pvt., Co. I., 7 Reg't U. S. Col'd Infantry.

Appears on Co. Muster-out Roll, dated
Indianola, Texas, Oct. 13, 1866.

Muster-out to date Oct. 13, 1866.

Last paid to June 30, 1866.

Clothing account:

Last settled....., 186 ; drawn since \$.....¹⁰⁰

Due soldier \$.....¹⁰⁰; due U. S. \$.....¹⁸/₁₀₀

Am't for cloth'g in kind or money adv'd \$.....¹⁰⁰

Due U. S. for arms, equipments, &c., \$.....¹⁰⁰

Bounty paid \$.....¹⁰⁰; due \$.....¹⁰⁰

Remarks: Joined Co.
Jan'y 16, 64.

Book mark: V68P 1/69. O.V. 10P. 223. 69.

Brooks,

NA 23

1237

Smith John L

Co H, 7 U.S. Col'd Inf.

2nd Lieutenant 2nd Lieutenant

CARD NUMBERS.

1	6298415	26
2	6293502	27
3	6293596	28
4	6293690	29
5	6293848	30
6	6292092	31
7	6292150	32
8	6292208	33
9	6292256	34
10	6294161	35
11	6292304	36
12	9428724	37
13		38
14		39
15		40
16		41
17		42
18		43
19		44
20		45
21		46
22		47
23		48
24		49
25		50

Book Mark:

See also 9a. "Pa Vols 4 186 Pa Vols

(S. 725-093 P.O. M. & M.)
S. 765-280 P.O. M. & M.)

S | *117* | **U.S.C.T.**

Geo L Smith
2^d Lt., Co....., *7* Reg't U. S. Col'd Inf.

Appears on

Regimental Descriptive Book

(List of Commissioned Officers)

of the regiment named above.

Rank *2^d Lt.*

Date of appointment *May 20* 1865.

Remarks: *Appointed 2^d Lieut 7th*
U.S.C.T. by the President U
States. Mustered July 9/65

Hardy

S | 7th | U.S.C.T.

John L Smith

2^d Lt, Co., 7 Reg't U. S. Col'd Infantry.

Age 28 years.

Appears on an

Individual Muster-in Roll

of the organization named above. Roll dated

Indianola, Texas, Aug 14, 1865.

Muster-in to date July 9, 1865.

Joined for duty and enrolled:

When July 9th, 1865.

Where Indianola Texas

Period 3 years.

Remarks: Citizen appointment
Promoted 2^d Lt. vice
Brown promoted.

Book mark :

C. S. Rozzell

(336)

Copyist.

S

7

U.S.C.T.

John L. Smith

2^d Lieut, Co. H, 7 Reg't U. S. Col'd Infantry.

Appears on

Company Muster Roll

for *July and Aug*, 1865.

Present or absent *absent*

Stoppage, \$ *100* for

Due Gov't, \$ *100* for

Remarks: *Act. as Commissary at
Post Hosp. Indiana's Tex by A.C. No 86
Hd. Qrs 1st Corps Indiana's Tex Aug 11. 65*

Book mark:

N. H. Merrill

S

7

U.S.C.T.

John L. Smith

2^d Lieut, Co. H, 7 Reg't U. S. Col'd Infantry.

Appears on

Company Muster Roll

for *Sept and Oct*, 1865.

Present or absent *Absent*

Stoppage, \$ *100* for

Due Gov't, \$ *100* for

Remarks: *Detached as Commissary at
Post Hosp. Indianola Texas by D.O. No 86
Hd. Qrs.*

Book mark:

N N Merrill

S

7

U.S.C.T.

John L. Smith

2^d Lieut, Co. H, 7 Reg't U. S. Col'd Infantry.

Appears on

Company Muster Roll

for *Jan. & Feb.*, 1866.

Present or absent

Stoppage, \$ 100 for

Due Gov't, \$ 100 for

Remarks: *Transferred to Co. G. 7 U.S.C.T. per Reg't order. No -*

Book mark:

J. J. Kearney

(858)

Copyist

NARA 31

1 | 7 | U.S.C.T.

John L. Smith
2nd Lieut, Co. G, 7 Reg't U. S. Col'd Infantry.

Appears on

Company Muster Roll

for Jan & Feb, 1866.

Present or absent Absent

Stoppage, \$ 100 for

Due Gov't, \$ 100 for

Remarks: assigned to Co "G"
per P.O. 17 Hd qrs 7th
U.S.C.T. Feb 18/66 On
Special duty with
lev H.

Book mark:

Radzick

(858)

Copyist

Q

7

U.S.C.T.

John L. Smith

2nd Lieut, Co. G, 7 Reg't U. S. Col'd Infantry.

Appears on

Company Muster Roll

for *Mar & Apr*, 1866.

Present or absent *absent*

Stoppage, \$ *100* for

Due Gov't, \$ *100* for

Remarks: *On special duty with Co H.*

Book mark:

Hadfield

(858)

Copyist

S | **7** | **U.S.C.T.**

John L Smith

2 *Serjeant*, Co. G, 7 Reg't U. S. Col'd Infantry.

Appears on

Company Muster Roll

for *May & June*, 186*6*

Present or absent *Absent*

Stoppage, \$ *100* for

Due Gov't, \$ *100* for

Remarks: *On special duty with Co H*

Book mark:

Hadfield

A

7

U.S.C.T.

John L. Smith

2 Lieut, Co. G, 7 Reg't U. S. Col'd Infantry.

Appears on

Company Muster Roll

for July & Aug, 1866

Present or absent absent

Stoppage, \$ 100 for

Due Gov't, \$ 100 for

Remarks: Entitled to extra pay for comdg Co "H" in Mar & Apr & Co D during the months of June July & Aug 1866. On duty with Co D

Book mark:

Hadfield

(858)

Copist

J | **7** | **U.S.C.T.**

John L. Smith

2^d Lieut, Co. *H*, 7 Reg't U. S. Col'd Inf.

Appears on **Co. Muster-out Roll**, dated
Indianola, Tex., *Oct. 13*, 1866 .
Muster-out to date _____, 186 .
Last paid to *never paid while in Co.*, 186 .

Clothing account:

Last settled _____, 186 ; drawn since \$ _____ 100
Due soldier \$ _____ 100; due U. S. \$ _____ 100
Am't for cloth'g in kind or money adv'd \$ _____ 100

Due U. S. for arms, equipments, &c., \$ _____ 100
Bounty paid \$ _____ 100; due \$ _____ 100

Remarks: *App't & 2^d Lieut. 7 U.S.C.T.*
by President U.S. May 30. '65. Joined
for duty July 9. '65. Mustered same day
Assig'd to Co. H. 7 U.S.C.T. Transf'd to Co.
G. 7 U.S.C.T. Feb. 19. '66

Book mark: _____

(361) _____ *J. J. Kearney* Copyist.

1

7

U.S.C.T.

John L. Smith

2nd Lieut Co. G, 7 Reg't U. S. Col'd Infantry.

Appears on Co. Muster-out Roll, dated Indianola Texas, Oct 13, 1866.

Muster-out to date Oct 13, 1866.

Last paid to June 30, 1866.

Clothing account:

Last settled....., 186 ; drawn since \$ 100

Due soldier \$ 100; due U. S. \$ 100

Am't for cloth'g in kind or money adv'd \$ 100

Due U. S. for arms, equipments, &c., \$ 100

Bounty paid \$ 100; due \$ 100

Remarks: Entered service at Philadelphia Pa in 90th P.V. Oct 15/61 discharged on Surgeons certificate of disability Dec 14. 63. Re enlisted in 186th P.V. March 26 1864 His (over)

Book mark:

Hadfield

97 97 97

JAN. 21

6292304

416814

charged June 1st 1865 to
 accept appointment as
 2nd Lieut. 7th U.S. Inf. joined
 Regiment July 9 1865
 mustered same day and
 assigned to Co H trans
 ferred to Co G Feb 19 1866
 service continuous
 since March 26 1864
 muster out to remain
 South Extra pay due
 for command Co H
 for March & April 1866
 & for command Co D
 June July & Aug 1866

1238

Smith John S.

Co K, 7 U.S. Col'd Inf.

Private Private

CARD NUMBERS.

1	6296038	26
2	6296136	27
3	6296235	28
4	6296334	29
5	6296433	30
6	6296524	31
7	6296617	32
8	6296692	33
9	6296782	34
10	6296888	35
11	6296996	36
12	6297101	37
13	6297198	38
14	6297294	39
15	6297380	40
16	6297463	41
17	6297536	42
18	6297610	43
19	6297749	44
20	9067104	45
21	33225783	46
22		47
23		48
24		49
25		50

Book Mark: S399 - Vol 4 R.C. J. 1866

See also

S. 11 7 U.S.C.T.

John S. Smith

, Co. K, 7 Reg't U. S. Col'd Inf.

Appears on

Company Descriptive Book

of the organization named above.

DESCRIPTION.

Age 22 years; height 5 feet 5 inches.

Complexion *Mulatto*

Eyes *Blue*; hair *Black*

Where born *Beconnae, Virginia*

Occupation *Farmer*

ENLISTMENT.

When *Nov. 21*, 1863.

Where *Beil Haven*

By whom *Col. W. Binney*; term *3* y'rs.

Remarks: *Mustered into serv. at Camp Stanton, Ches. Co. Md. by Lt. Col. Haskell, Nov. 12. 63. Died Mar. 14. 1865; place unknown. received communication of his death Aug. 21. 66.*

A. J. White

A 7 U.S.C.T.

John S. Smith

Privt., Co. K, 7 Reg't U. S. Col'd Inf.

Age 21 years.

Appears on

Company Muster-in Roll

of the organization named above. Roll dated Camp Stanton Charles Co., Va., Nov. 12, 1863.

Muster-in to date Nov. 12, 1863

Joined for duty and enrolled:

When Nov. 4, 1863.

Where Accomac, Va.

Period 3 years.

Remarks:

Book mark:

D. M. Kennedy Copyist.

I | 7 | U.S.C.T.

John S. Smith
Privt., Co. K, 7 Reg't U. S. Col'd Infantry.

Appears on

Company Muster Roll

for Nov. 12 to Dec 31, 1863.

Present or absent Present.

Stoppage, \$ 100 for

Due Gov't, \$ 100 for

Remarks: Enlistment Premium
\$ 2 00 dollars due.

Book mark:

D. M. Kennedy
Copyist.

A | **7** | **U.S.C.T.**

John A Smith
Privt., Co. K, 7 Reg't U. S. Col'd Infantry.

Appears on

Company Muster Roll

for *Jan.* ~~or~~ *Feb.*, 186 *4*

Present or absent *Present.*

Stoppage, \$ *100* for

Due Gov't, \$ *100* for

Remarks:

Book mark: *258*

D. M. Kennedy

(258)

Copist.

S

7

U.S.C.T.

John S. Smith
Privt., Co. K, 7 Reg't U. S. Col'd Infantry.

Appears on

Company Muster Roll

for *Nov* & *Apr.*, 1864.

Present or absent *Present*

Stoppage, \$ 100 for

Due Gov't, \$ 100 for

Remarks:

Book mark:

D. M. Kennedy

(358)

Copyist.

S

7

U.S.C.T.

John S. Smith
Privt, Co. K, 7 Reg't U. S. Col'd Infantry.

Appears on

Company Muster Roll

for *May & June*, 186*4*

Present or absent *Present*

Stoppage, \$ *100* for

Due Gov't, \$ *100* for

Remarks:

Book mark:

D. M. Kennedy

S | 7 | U.S.C.T.

John Smith
Pot. Co. K, 7 Reg't U.S.C.T.

Appears on

Hospital Muster Roll

of U. S. A. General Hospital,

at Fort Monroe, Va.,

for Sept. & Oct., 1864.

Attached to hospital :

When _____, 186 .

How employed _____

Last paid by Maj. _____

to _____, 186 .

Bounty paid \$ 100 ; due \$ 100

Present or absent Present.

Remarks : No descriptive list

Contraband Section (Hampton)

Book mark :

Armstrong
Copyist.

S | *4* | **U.S.C.T.**
John S. Smith
Privt, Co. K, 4 Reg't U.S. Col'd Inf.

Appears on

Company Muster Roll

for *Sept. v. Oct.*, 18*64*

Present or absent *Absent*

Stoppage, \$ *100* for

Due Gov't, \$ *100* for

Remarks: *Sick in hospital*
Fortress Monroe Aug. 11th 64

Book mark:

L. M. Kennedy

(858)

Copyist

S

7

U.S.C.T.

John S. Smith

Pvt

, Co. K, 7 Reg't U. S. Col'd Infantry.

Appears on

Company Muster Roll

for *Nov & Dec*, 186*4*

Present or absent *Absent*

Stoppage, \$ *100* for

Due Gov't, \$ *100* for

Remarks: *Absent Sick Hosp. Fort
Mons since Aug. 11, 64.*

Book mark:

Leary

Copyist.

S

7

U.S.C.T.

John S. Smith

Priv, Co. K, 7 Reg't U. S. Col'd Infantry.

Appears on

Company Muster Roll

for *Jan + Feb*, 1865.

Present or absent *Absent*

Stoppage, \$ *100* for

Due Gov't, \$ *100* for

Remarks: *Absent sick since Aug. 11. 64. pay due soldier for 6 mos. (fr. May to Oct. due.)*

Book mark:

(358)

Leary
Copyist.

S

7

U.S.C.T.

John S. Smith

Priv, Co. K, 7 Reg't U. S. Col'd Infantry.

Appears on

Company Muster Roll

for *March & April*, 1865.

Present or absent *Absent*

Stoppage, \$ 100 for

Due Gov't, \$ 100 for

Remarks: *Sick in hospital since Aug. 11. 65.*

Book mark:

Sear
Copyist.

S. | 7 | U.S.C.T.

John S. Smith

Priv, Co. K, 7 Reg't U. S. Col'd Infantry.

Appears on

Company Muster Roll

for *July and Aug*, 1865.

Present or absent *Absent*

Stoppage, \$ *100* for

Due Gov't, \$ *100* for

Remarks: *In hospital since Aug. 11. 64.*

Book mark:

Searcy

Copyist.

S

7

U.S.C.T.

John F. Smith

Priv, Co. K, 7 Reg't U. S. Col'd Infantry.

Appears on

Company Muster Roll

for *Sept + Oct*, 1865

Present or absent *Absent*

Stoppage, \$ *100* for

Due Gov't, \$ *100* for

Remarks: *In Abs since Aug. 11. 1865*

Book mark:

Seary
Copyist.

(858)

S | 7 | U.S.C.T.

John T. Smith

Priv, Co. K, 7 Reg't U. S. Col'd Infantry.

Appears on

Company Muster Roll

for *Nov & Dec*, 1865.

Present or absent *Absent*

Stoppage, \$ *100* for

Due Gov't, \$ *100* for

Remarks: *In Hosp. since Aug 11. 65.*

Book mark:

258 *Scary*

S

7

U.S.C.T.

John T. Smith
Priv., Co. K, 7 Reg't U. S. Col'd Infantry.

Appears on

Company Muster Roll

for *Jan. & Feb.*, 1866

Present or absent *Absent*

Stoppage, \$ *100* for

Due Gov't, \$ *100* for

Remarks *In Hosp. since*
Aug. 11. 1865 -

Book mark:

Paradise

(358)

Copyist.

S | 7 | U.S.C.T.

John J. Smith
Priv, Co. K, 7 Reg't U. S. Col'd Infantry.

Appears on

Company Muster Roll

for *Mich. & Apl.*, 186*6*

Present or absent *Absent*

Stoppage, \$ *100* for

Due Gov't, \$ *100* for

Remarks: *Sick in Hosp. since*
Aug. 11. 65.

Book mark:

Randall

S

7

U.S.C.T.

John T. Smith
Capt., Co. K, 7 Reg't U. S. Col'd Infantry.

Appears on

Company Muster Roll

for May & June, 1866

Present or absent Absent

Stoppage, \$ 100 for

Due Gov't, \$ 100 for

Remarks: Sick in Hospital
since Aug. 11. 65

Book mark: Died March 14th 1865.
See S. 399, Vol. 4, R.E.G. 1866

Randall

(358)

Copyist.

S

7

U.S.C.T.

John F. Smith
Pat., Co. K, 7 Reg't U. S. Col'd Infantry.

Appears on

Company Muster Roll

for July & Aug., 1866

Present or absent

Stoppage, \$ 100 for

Due Gov't, \$ 100 for

Remarks: Died March 14, 65,
received notification
July 31, 66

Book mark:

Randall

Copyist.

S | 7 | U.S.C.T.

John T. Smith
Pot., Co. K., 7 Reg't U. S. Col'd Inf.

Appears on Co. Muster-out Roll, dated
Indianola, Texas, Oct. 13, 1866.

Muster-out to date _____, 186 .

Last paid to Feb. 29, 1864 .

Clothing account:

Last settled _____, 186 ; drawn since \$ _____ 100

Due soldier \$ _____ 100; due U. S. \$ _____ 100

Am't for cloth'g in kind or money adv'd \$ _____ 100

Due U. S. for arms, equipments, &c., \$ _____ 100

Bounty paid \$ _____ 100; due \$ _____ 100

Remarks: Died March 14, 1865.
Place & cause unknown.

Book mark: 2nd And. 5452, Nov. 14/67
F. S.

Randall

Smith, John J

P, Co. N, 7 Reg't U.S.C. Inf.

3 Enclosures.

Bed Cards	Descriptive Lists
Burial Records	Final Statements /
Certs. of Dis. for Discharge	Furloughs
C. M. Charges	Med. Des. Lists
Med. Certificates	Orders

Other papers relating to—

Admission to Hosp'l	Furlough
Casualty Sheet (Officer's) X2	Med. Examination
Confinement	Misc. Information
Contracts	Pay or Clothing
Death or Effects 2 2	Personal Reports
Desertions	Rank
Discharge from Hosp'l	Transfer to Hosp'l
Discharge from Service	Transfer to V. R. C.
Duty	Transportation

Smith, John T

P K

WAR 69
War Department

Adjutant General's Office.

July 31, 1866

Brig Gen. James Shaw Jr
Comdg 4th U.S.C.T.

General.

In reply to your
letter of the 27th inst relative to absent enlisted
men of your regiment I have the honor to
inform you that—

John T. Smith Co. K. died Mar 14, 1865,

Very Respectfully
Yours Obedt Servt
(Sgd) J. W. Taggard
Asst Adj Gen

Official "Extract"
A. H. C. Brown
1st Lieut & Capt 7th U.S.C.T.

Extract from Act of Congress.

SEC. 12. And be it further enacted, That the fees of agents and attorneys for making out and causing to be executed the papers necessary to establish a claim for a pension, bounty, and other allowance before the Pension Office, under this act, shall not exceed the following rates: For making out and causing to be duly executed a declaration by the applicant, with the necessary affidavits, and forwarding the same to the Pension Office, with the requisite correspondence, ten dollars; which sum shall be received by such agent or attorney in full for all services in obtaining such pension, and shall not be demanded or received, in whole or in part, until such pension shall be obtained; and the sixth and seventh sections of an act entitled "An act to grant pensions," approved July [fourth,] eighteen hundred and sixty-two, are hereby repealed.

SEC. 13. And be it further enacted, That any agent or attorney who shall, directly or indirectly, demand or receive any greater compensation for his services under this act than is prescribed in the preceding section of this act, or who shall contract or agree to prosecute any claim for a pension, bounty, or other allowance under this act, on the condition that he shall receive a per centum upon any portion of the amount of such claim, or who shall wrongfully withhold from a pensioner or other claimant the whole or any part of the pension or bounty allowed and due to such pensioner or claimant, shall be deemed guilty of a high misdemeanor, and, upon conviction thereof, shall, for every such offense, be fined not exceeding one hundred dollars, or imprisoned at hard labor not exceeding one year, or both, according to the circumstances and aggravations of the offense.

Approved July 4, 1864.

NOTE 10.—If any soldier is charged a higher fee than that allowed by the above act, he should report the fact and the name of the agent to the Adjutant General, in order that steps may be taken to have the same refunded.

ADJUTANT GENERAL'S OFFICE

Sept 24 1865

Duplicate with Inventory of C. A. G.

FINAL STATEMENT

OF

Co. K

7th Reg't of U.S. C.T.

VOLUNTEERS.

Rec'd March 14/65

NOTE 1.—Two of these certificates (or duplicates) are to be given to each Volunteer Soldier or drafted man who may be discharged without being mustered out (Final Statements are never given to men mustered out of service,) that he may at once receive from the Paymaster the pay, &c. due him, and the captain or other COMMISSIONED officer commanding the company will certify to the act of the delivery of the duplicate certificates; with these certificates the Soldier is "entitled to" his discharge, and should also present his discharge to the Paymaster to have the payment endorsed on it. The discharge is to be given back to the Soldier by the Paymaster; the latter only retaining as his vouchers the duplicate certificates.

NOTE 2.—If the Soldier is entitled to pay for the use of his horse, the Company Commander will certify to that fact on the back of both these final statements, and also to the time he has pay due for having been so mounted on his own horse.

NOTE 3.—When a Soldier is furnished with final statements, his descriptive list, if he has one, should be taken up by the officer who gives the Soldier these statements, and endorsed with a statement to this effect by the officer. The endorsement should exhibit a full statement of the time for which the Soldier was allowed pay on his final statements, the clothing account, and all other charges against him or in his favor, so as to comprise a complete exhibit of his account. It will then be transmitted to the Company Commander of the Soldier, who will enter all the data necessary to a full understanding of the Soldier's account on the muster roll upon which the Soldier's discharge is reported. The descriptive list will then be destroyed. The object of this is, that the remaining portion of the Soldier's account may be settled upon the receipt of these muster rolls, and the Soldier receive any pay or allowances that may be due him at the time of his discharge, and which may not appear on his last final statements from the fact that his descriptive list is incomplete. These accounts for back pay, &c., are settled by the 2d Auditor of the Treasury Department.

NOTE 4.—Charges for loss or injury to ordnance, horse equipments, and other miscellaneous charges, should appear under the heading of "Other Stoppages."

NOTE 5.—Bounty paid by State authorities, and not by the United States, will not be entered on this statement.

NOTE 6.—Amounts due the Suttler and Laundress must be entered on the muster roll on which the discharge, death, desertion, &c., is reported, as well as on the final statement, otherwise the amount cannot be collected from the United States.

NOTE 7.—This blank will be used for deceased volunteers and drafted men, as well as for others.

NOTE 8.—When a Soldier dies in hospital or on detached service, his descriptive list, if he has one, should be sent with his final statements, in duplicate, to the Adjutant General, Washington, D.C.

NOTE 9.—If the soldier is a drafted man or substitute, the space for time, &c., of enrolled, should contain only the words "drafted or substitute," as the case may be. If the Soldier is a "VETERAN," (or RECRUIT,) the words "as a veteran," (or "recruit,") as the case may be, should be interlined after the words "mustered into the service of the U.S." A statement of all the installments of "Veteran or Recruit Bounty" RECEIVED by the Soldier must be made on the back of each final statement.

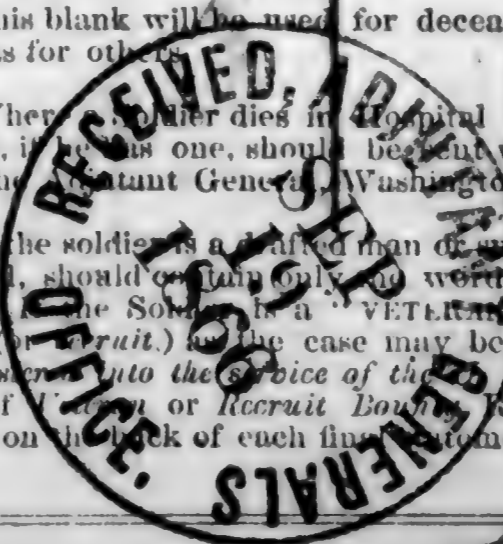

Enson, R. H. [Signature]

I certify, on honor, that John T. Smith, a Private of
Captain C. L. Bunnick Company H of the 7th Regiment of U. S. Colored Troops
VOLUNTEERS, of the State of _____, born in Accomac, Va., State
of Virginia, aged 22 years; 5 feet 5 inches high; Mulatto complexion,
Black eyes, Black hair, and by occupation a Farmer, who joined for service
and was enrolled (see Note 9) on the 4 day of November, 1863, at Camp Stanton, Md.
by Col. W. Bissell, for the period of Three years, and mustered into
the service of the United States on the 12th day of November, 1863, at
Camp Stanton, Md. by St. Col. Haskell; and having served
HONESTLY and FAITHFULLY with his Company to the present date, is now entitled to a
DISCHARGE by reason of Death. He died March 14 65. Place unknown.

Case: Unknown (received notification of his death ad. Gen. Off. War Dept.)
The said John T. Smith was last paid by Paymaster

Maj. Howell, to include the 31st day of December, 1864, and
has pay due him from that time to the present date; he is entitled to pay and subsistence for
TRAVELING to place of enrollment, and whatever other allowances are authorized to volunteer
soldiers, drafted men, or militia, so discharged. He has received from the United States **CLOTHING**
amounting to Seven $\frac{74}{100}$ dollars, since the 31st day of October,
1864, when his clothing account was last settled. ~~He has received from the United States~~
~~_____ dollars advanced **FOUNDED**.~~

~~There is to be stopped from him, on account of the State of _____, or other~~
~~authorities, for **CLOTHING**, &c., received on entering service, _____ dollars, and~~
~~for other stoppages, viz:~~

~~_____ dollars~~
He has been furnished with **TRANSPORTATION** in kind from the place of his discharge to
_____; and he has been **SUBSISTED** for **TRAVELING** to his
place of enrollment, up to the _____, 186-.

He is indebted to _____, **SUTLER**, _____ dollars.

He is indebted to _____, **LAUNDRESS**, _____ dollars.

Given in Duplicate, at Fort Lincoln, Texas, this 31 day
of August, 1866.

Chas. L. Bunnick
Capt. U. S. C. T.
Commanding Company.

Copy sent for to R.C. June 2/66

CASUALTY SHEET

No. _____

John Smith

of Company *K*

7th Regiment of *Walsh's*
State Volunteers.

NATURE OF CASUALTY.

Died Mar. 14 1865.

Never belonged to the
7th Regt. U.S.C. I. see
S 364. Vol. 4. R.C. I. 1864

MARR 64
CASUALTY SHEET.

Name: John Smith
Rank: _____ Company: K Regiment: 7th
Arm: U.S. Artillery State: _____
Nature of Casualty: Death

CAUSE OF CASUALTY—(NAME OF DISEASE, &c.)

BY WHOM DISCHARGED.

DEGREE OF DISABILITY.

FROM WHAT SOURCE THIS INFORMATION WAS OBTAINED.

S-341, Vol. 4, R. C. J., 1866,

BY WHOM CERTIFIED.

J. Simons
Brig. Gen. U.S.A. Med. Dir.

DATE OF DISCHARGE, DEATH, &c.

March 14 1865,

PLACE OF DISCHARGE, DEATH, &c.

U.S. Genl. Hospital
Fort Monroe, Va.,

REMARKS

No further information can be obtained in this case from hospital records, see letter
Pro. of C. of Ad + P. in act
for \$30⁰⁰ sent 2^d Auditor
July 3, 1866,

James Decker
Clerk.

2 photos sent for HQ July 31, 66
Sept 28/66

CASUALTY SHEET

No. _____

John T. Smith

Priv of Company *K*

7th Regiment of *W.V. I.*

State Volunteers.

NATURE OF CASUALTY.

Died Mar 14, 65

CASUALTY SHEET.

Name: John F. Smith

Rank: Priv Company: K Regiment: 4th

Arm: Regt. C.T. State: _____

Nature of Casualty: Death

CAUSE OF CASUALTY—(NAME OF DISEASE, &c.)

BY WHOM DISCHARGED.

DEGREE OF DISABILITY.

FROM WHAT SOURCE THIS INFORMATION WAS OBTAINED.

S. 399, Vol. 4, R.C.S., 1866

BY WHOM CERTIFIED.

J. Jimms Col. Col. 11th
Med. Dir. Dept. Va

REMARKS.

No final papers can be obtained from Med. Dir. Va

DATE OF DISCHARGE, DEATH, &c.

Mar. 14, 1865,

PLACE OF DISCHARGE, DEATH, &c.

Va

James DeLoach

Clerk.

John S. Smith

De R. G. Webb

Adjutant General's Office,

COLORED TROOPS BRANCH,

July 18, 1877

Mr. Ellul Vol. K C. T., 187

Wanted in the case of John S. or John J. Smith, Co. K.,
7 Reg't U.S.C.T., information as to cause and
place of death.
MOR. of Co. states he died Mar. 14/65.

Respectfully,

Wm. Anderson
a Chief Clerk.

Adjutant General's Office, D. B.

Div. Records Discontinued Comd's. &c
July 26th, 1877

Vol. J C. T., 187
Reply in case of John J. Smith Co. K,
7 Reg't U.S.C.T.

(Name appears also as John S. Smith.)
Co. Descriptive book: Died Mar. 14th 1865; Cause and place
unknown. - Rec'd Com: of his death Aug. 24 '66.

Co. Morning Rep. book shows Aug 11 '64: sent to Hospital
at Fort Monroe.
He had Clothing drawn at that Hospital
in Nov. 1864.

No evidence relative to cause & place of death.
There are no Registers of Deaths of Dept. Va., or Ft. Monroe in file.

W.F.

Smith Lewis

Co I, 7 U.S. Col'd Inf.

Private

Private

CARD NUMBERS.

1	6278993	26
2	6294854	27
3	6294947	28
4	6295050	29
5	6295150	30
6	6295249	31
7	6295347	32
8	6295438	33
9	6295516	34
10	6295602	35
11	6295675	36
12	6295745	37
13	6295819	38
14	6295890	39
15	6279022	40
16	9066978	41
17	43155700	42
18		43
19		44
20		45
21		46
22		47
23		48
24		49
25		50

Book Mark:

See also

2020

Apper

of the

Age

Comp

Eyes

Where

Occup

Where

Where

By w

Rem

to

2020

2020

==

1239

Smith Lewis

Co I, 7 U.S. Col'd Inf.

Private

Private

CARD NUMBERS.

1	6278993	26
2	6294854	27
3	6294947	28
4	6295050	29
5	6295150	30
6	6295249	31
7	6295347	32
8	6295438	33
9	6295516	34
10	6295602	35
11	6295675	36
12	6295745	37
13	6295819	38
14	6295890	39
15	6279022	40
16	9066978	41
17	43155700	42
18		43
19		44
20		45
21		46
22		47
23		48
24		49
25		50

Book Mark:

See also

I. 7 U.S.C.T.

Levin Smith

Co. G, 7 Reg't U. S. Col'd Inf.

Appears on Company Descriptive Book of the organization named above.

DESCRIPTION.

Age 20 years; height 5 feet 5 1/2 inches.

Complexion *Griff*

Eyes *Hazel*; hair *Blk.*

Where born *Talbot, Maryland*

Occupation *Farmer*

ENLISTMENT.

When *Sept. 26*, 1864.

Where *Baltimore, Md.*

By whom *Capt. Blumenberg*; term *3* y'rs.

Remarks: *Substitute, assigned to Co. G. 21. 1864.*

Mustered in at Balt. Md. Sept. 26. 64. by Capt. Blumenberg.

U.S. Miller
Coryist.

S | 7 | U.S.C.T.

Levin Smith

....., Co., 7 Reg't U. S. Col'd Infantry.

Age 20 years.

Appears on a

Detachment Muster-in Roll

of the organization named above. Roll dated

Baltimore, Md., Sept. 27, 1864.

Muster-in to date Sept. 27, 1864.

Joined for duty and enrolled:

When Sept. 26, 1864.

Where Baltimore, Md.

Period 3 years.

Remarks: Substitute

Book mark:

(837)

Beck
Copyist.

S. Smith *msc*

Seven Smith

Appears with rank of _____ on _____

Muster and Descriptive Roll

of *Detachment of US Substitute*
Drafted men forwarded to Col
J M Bowman. Roll dated
Camp Bradford, Oct 2, 1864.

Where born *Virginia*

Age *20* years; occupation *laborer*

When enlisted *Sept 26*, 186 .

Where enlisted *Balto, Md.*

For what period enlisted *3* years.

Eyes *Blk* ; hair *Woolly*

Complexion *Brown*, height *5 ft. 4 in.*

When mustered in *Sept 26*, 186 .

Where mustered in _____

Bounty paid \$ _____; due \$ _____

Clothing account:

Last settled _____, 186 ; drawn since \$ *24* ^{*79*} _{*100*}

Date of first muster _____, 186 .

Company to which assigned _____

Remarks: *Substitute for*
William H Knight,
3rd Dist Md.

Book mark : _____

(356m)

Copyist.

J. M. Law

S

7

U.S.C.T.

Leavon Smith

Pvt, Co. 1, 7 Reg't U. S. Col'd Infantry.

Appears on

Company Muster Roll

for Sept & Oct, 1864.

Present or absent Present

Stoppage, \$ 100 for

Due Gov't, \$ 100 for

Remarks: Recruit from Depot. Joined for duty Oct. 21, 1864.

Book mark:

(358)

J.B. Gage

Copyist.

S

7

U.S.C.T.

Levin Smith

Priv., Co. I, 7 Reg't U. S. Col'd Infantry.

Appears on

Company Muster Roll

for Nov. & Decr., 1864

Present or absent Present

Stoppage, \$ 100 for

Due Gov't, \$ 100 for

Remarks:

Recruit joined from depot to Co. for duty. Oct. 21, 1864.

Book mark:

A. Maher

(358)

Copyist.

S

7

U.S.C.T.

Levin Smith

Priv, Co. I, 7 Reg't U. S. Col'd Infantry.

Appears on

Company Muster Roll

for *Jan'y, + Feby,* 1865.

Present or absent *Present*

Stoppage, \$ *100* for

Due Gov't, \$ *100* for

Remarks:

Book mark:

D. Mahser

(358)

Copyist.

S

7

U.S.C.T.

Levin Smith

Priv, Co. I, 7 Reg't U. S. Col'd Infantry.

Appears on

Company Muster Roll

for *March & April*, 1865.

Present or absent *Present*

Stoppage, \$ *100* for

Due Gov't, \$ *100* for

Remarks:

Book mark:

D. Maher

Copyist.

(358)

S

7

U.S.C.T.

Lewis Smith

Priv, Co. 1, 7 Reg't U. S. Col'd Infantry.

Appears on,

Company Muster Roll

for *May + June*, 1865.

Present or absent *Present*

Stoppage, \$ *100* for

Due Gov't, \$ *100* for

Remarks:

Book mark:

D. Maher
Copyist.

S

7

U.S.C.T.

Lewis Smith

Priv, Co. I, 7 Reg't U. S. Col'd Infantry.

Appears on

Company Muster Roll

for *July & Aug.*, 1865.

Present or absent *Present*

Stoppage, \$ *100* for

Due Gov't, \$ *02* for *C & G, Equipage*

" " *23¢* " *Ordinance, &c.*

Remarks:

Book mark:

D. Maher

Copyist.

(358)

S

7

U.S.C.T.

Lewis Smith

Pvt, Co. 1, 7 Reg't U. S. Col'd Infantry.

Appears on

Company Muster Roll

for *Sept. & Oct.*, 1865.

Present or absent *Present*

Stoppage, \$ 100 for

Due Gov't, \$ 23 for *Ordnance, &c.*

" " 24 " *C. & G. Equipage*

Remarks:

Book mark:

D. Mahser

Copyist.

(358)

S

7

U.S.C.T.

Levin Smith

Priv., Co. I, 7 Reg't U. S. Col'd Infantry.

Appears on

Company Muster Roll

for Nov. + Decr., 1865.

Present or absent Present.

Stoppage, \$ 100 for

Due Gov't, \$ 23/100, for Ordn., &c.

" " 20. " C & G Equipage

Remarks:

Book mark:

D. Maher

Copyist.

(358)

8

7

U.S.C.T.

Levin Smith

Private, Co. I, 7 Reg't U. S. Col'd Infantry.

Appears on

Company Muster Roll

for Jan + Feb, 1866

Present or absent Present

Stoppage, \$ 100 for

Due Gov't, \$ 100 for

Remarks:

Book mark:

Sabine
Copyist.

(358)

S

7

U.S.C.T.

Levin Smith

Pr, Co. I, 7 Reg't U. S. Col'd Infantry.

Appears on

Company Muster Roll

for Mar & Apr, 1866.

Present or absent Present.

Stoppage, \$ 100 for

Due Gov't, \$ 100 for

Remarks:

Book mark:

Sabine

Copyist.

(858)

8

7

U.S.C.T.

Levin Smith

Pr, Co. I, 7 Reg't U. S. Col'd Infantry.

Appears on

Company Muster Roll

for Oct 28 to June 30, 1866.

Present or absent Not stated.

Stoppage, \$ 100 for

Due Gov't, \$ 100 for

Remarks:

Book mark:

Levine

(858)

Copyist.

8

7

U.S.C.T.

Levin Smith

Priv., Co. I, 7 Reg't U. S. Col'd Infantry.

Appears on

Company Muster Roll

for July + Aug, 1866.

Present or absent Present.

Stoppage, \$ 100 for

Due Gov't, \$ 100 for

Remarks:

Book mark:

250875

Satine

(858)

Copyist.

S | *7* | U.S.C.T.

Levin Smith

Appears with rank of on
**Muster and Descriptive Roll of a Detach-
ment of Drafted Men and Substitutes
forwarded**

for the *7* Reg't U. S. Col'd Inf. Roll dated
Baltimore, Md, Sept. 27, 1864.

Where born *Va.*

Age *20* years; occupation *Laborer*

Drafted and mustered in:

When *Sept. 26,* 1864.

Where *Batts. Md*

Period *3* years.

Eyes *Blk*; hair *Blk*

Complexion *Brn.*; height *5 ft 6 in.*

Paid bounty and advance pay, \$ *100*

Bounty due \$ *100*

Where credited

Company to which assigned

Remarks: *Substitute for Wm H.
Knight 3rd Dist Md*

Book mark:

J. M. Family

S

7

U.S.C.T.

Levin Smith
Pvt, Co *D*, 7 Reg't U. S. Col'd Infantry.

Appears on **Co. Muster-out Roll**, dated
Indianola, Tenn
October, 13, 1866.

Muster-out to date *Oct. 13*, 1866.

Last paid to *June 30*, 1866.

Clothing account:

Last settled....., 186 ; drawn since \$..... 100

Due soldier \$ *9 26*/₁₀₀; due U. S. \$..... 100

Am't for cloth'g in kind or money adv'd \$..... 100

Due U. S. for arms, equipments, &c., \$ *6* 100

Bounty paid \$..... 100; due \$..... 100

Remarks *Joined co. for duty*
Oct 21, '64.
Retains one O.P. musket
& set of accoutrements for
G.O. 101, War Dept. May
30, '65.

Book mark:

Sabine

Smith, Leven

Co. _____ Reg't *USC I*

2 Enclosures.

Bed Cards	Final Statements
Burial Records	Furloughs or L. of A.
Certs. of Dis. for Discharge	Med. Certificates
C. M. Charges	Med. Des. Lists
Descriptive Lists	Orders
Discharge Certificates	Pris. of War Record
Enlistment Papers	Resignations

Other papers relating to—

Admission to Hosp'l	Furlough or L. of A.
Casualty Sheet	Med. Examination
Confinement	Misc. Information
Contracts	Pay or Clothing
Death or Effects	Personal Reports
Desertion	Rank
Discharge from Hosp'l	Transfer to Hosp'l
Discharge from Service	Transfer to V. R. C.
Duty	Transportation

DECLARATION OF SUBSTITUTE.

I, Seven Smith Col desiring to ENLIST in the Army of the United States, for THREE YEARS, **Do declare**, That I am Twenty years and _____ months of age; that I have never been discharged from the United States service on account of disability or by sentence of a court martial; and I know of no impediment to my serving honestly and faithfully as a soldier for three years.

GIVEN at Baltimore the 26th day of Sept 1864

WITNESS:

Wm James Seven Smith
mark

Colored 21

No. 292

Seven Smith

Enlisted at Baltimore

As Substitute for

Wm St.rough

On the 26th day of Sept 1864

By

Wm St.rough

Capt J. Plumbe

William Brooks

Thos F. Muddoch

Board of Enrollment,

2nd Div. of Md



SUBSTITUTE
VOLUNTEER ENLISTMENT.

STATE OF Maryland City TOWN OF Baltimore



I, Leven Smith col born in the State of Virginia, aged Twenty years, and by occupation a Labourer

Do HEREBY ACKNOWLEDGE to have agreed with William A. Knight Esq., of 12 Hill St 15th Ward Baltimore City State of Maryland

to become his **SUBSTITUTE** in the Military Service, for a sufficient consideration paid and delivered to me, on the Twenty Sixth day of September, 1864; and having thus agreed with said William A. Knight, I DO HEREBY ACKNOWLEDGE to have enlisted this Twenty Sixth day of September 1864, to serve as a **Soldier** in the **Army of the United States of America**, for the period of **THREE YEARS**, unless sooner discharged by proper authority: I do also agree to accept such bounty, pay, rations, and clothing, as are, or may be, established by law for soldiers. And I do solemnly swear that I will bear true and faithful allegiance to the **United States of America**; that I will serve them honestly and faithfully against all their enemies or opposers whomsoever; and that I will observe and obey the orders of the President of the United States, and the orders of the Officers appointed over me, according to the Rules and Articles of War.

SWORN and subscribed to, at Baltimore this 26th day of September 1864 BEFORE Capt L. Humber Co. Mar 3rd Dist Md

Leven Smith
mark

We certify, on honor, That we have carefully examined the above-named Volunteer Substitute agreeably to the Regulations, and that, in our opinion, he is free from all bodily defects and mental infirmity which would in any way disqualify him from performing the duties of a soldier; that he was entirely sober when enlisted; that he is of lawful age, (not under 18 years;) and that, in accepting him as duly qualified to perform the duties of an able-bodied soldier, and as a Substitute in lieu of William A Knight ^{Enrolled} drafted in 15th Ward Baltimore Md July, 1863, we have strictly observed the Regulations which govern in such cases. This soldier has Black eyes Shaggy hair, Brown complexion; is 5 feet 6 1/4 inches high.

Wm A. Humber
Provost Marshal.
William Brooks
Commissioner of Board.
Wm D. Mumford
Surgeon of Board.

Board of Enrollment of 3d Dist. of Maryland

DECLARATION OF SUBSTITUTE.

x, Leven Smith desiring to ENLIST in the Army of the United States, for THREE YEARS, **Do declare**, That I am Twenty years and _____ months of age; that I have never been discharged from the United States service on account of disability or by sentence of a court martial; and I know of no impediment to my serving honestly and faithfully as a soldier for three years.

GIVEN at Baltimore
the 26th day of Sept 1864

WITNESS:

Wm Gains Leven ^{his} Smith
enoch

No. 297

21

Leven Smith

Enlisted at Baltimore

As Substitute for

Wm St. Knight

On the 26th day of Sept 1864

By

Wm St. Knight

Capt G. Plumbe

William Brooks

Thos F. Murchick

Board of Enrollment,

3rd Div. of Md

Herbold Snyder & Co

SUBSTITUTE VOLUNTEER ENLISTMENT.

STATE OF *Maryland* CITY TOWN OF *Baltimore*



I, *Lucas Smith* born in the State of *Virginia*, aged *Twenty* years, and by occupation a *Labourer*

Do HEREBY ACKNOWLEDGE to have agreed with *Wm H Knight*, Esq., of *15 Hill st*

15th Ward, Baltimore City, State of Maryland

to become his **SUBSTITUTE** in the Military Service, for a sufficient consideration paid and delivered to me, on the *Twenty Sixth* day of *September*, 186*4*; and having thus agreed with said *Wm H Knight*

I DO HEREBY ACKNOWLEDGE to have enlisted this *Twenty Sixth* day of *September* 186*4*, to serve as a **Soldier** in the **Army of the United States of America**, for the period of **THREE YEARS**, unless sooner discharged by proper authority: I do also agree to accept such bounty, pay, rations, and clothing, as are, or may be, established by law for soldiers. And I do solemnly swear that I will bear true and faithful allegiance to the **United States of America**; that I will serve them honestly and faithfully against all their enemies or opposers whomsoever; and that I will observe and obey the orders of the President of the United States, and the orders of the Officers appointed over me, according to the Rules and Articles of War.

SWORN and subscribed to, at *Baltimore* this *26th* day of *September* 186*4*

Lucas Smith
mark

BEFORE *Capt L Blumentberg*
3rd Mar 3rd Dist Md

We certify, on honor, That we have carefully examined the above-named Volunteer Substitute agreeably to the Regulations, and that, in our opinion, he is free from all bodily defects and mental infirmity which would in any way disqualify him from performing the duties of a soldier; that he was entirely sober when enlisted; that he is of lawful age, (not under 18 years;) and that, in accepting him as duly qualified to perform the duties of an able-bodied soldier, and as a Substitute in lieu of *Wm H Knight*, drafted in *15 Ward Balt city Md* *July* 186*3*, we have strictly observed the Regulations which govern in such cases. This soldier has *Blue* eyes, *Wavy* hair, *Fair* complexion; is *5* feet *6 1/4* inches high.

Wm H Blumentberg
Provost Marshal

William Brooks
Commissioner of Board.

J. P. Mumford
Surgeon of Board.

Board of Enrollment of *3rd* Dist. of *Maryland*

1240

Smith Littleton J.

Co G, 7 U.S. Col'd Inf.

Sergeant | *Sergeant*

CARD NUMBERS.

1	6290904	26
2	6291008	27
3	6291109	28
4	6291297	29
5	6291395	30
6	6291492	31
7	6291589	32
8	6291648	33
9	6291746	34
10	6291808	35
11	6291825	36
12	6291898	37
13	6291969	38
14	6292033	39
15	6292096	40
16	6292154	41
17	6292212	42
18	6292260	43
19	6292307	44
20	9066631	45
21		46
22		47
23		48
24		49
25		50

Book Mark:

See also

COMPTON

S-2099749. ~~And. W. 20.~~

S | 7 | U.S.C.T.

Thomas L. Smith
Serg't, Co. G, 7 Reg't U.S. Col'd Inf.

Appears on .

Company Descriptive Book

of the organization named above.

○ DESCRIPTION.

Age *25* years; height *5* feet *4 3/4* inches.

Complexion *Grippy*

Eyes *Blue*; hair *Curly*

Where born *Worcester, Md.*

Occupation .

ENLISTMENT.

When *Nov 1*, 186 .

Where *Worcester*

By whom *Col. W. Birney*; term *3* y'rs.

Remarks: *Reduced to Rank*
Major 23 " 64, for incompeten
cy. Mustered into Service
Nov 5. 63 by Col W. Birney
at Benedict, Md.

J. Brown
Copyist.

S | 7 | U.S.C.T.

Littleton I. Smith

Sergh., Co. *G*, 7 Reg't U. S. Col'd Inf.

Age *23* years.

Appears on

Company Muster-in Roll

of the organization named above. Roll dated

Camp Stanton, Charles Co., Md., Nov. 5, 1863.

Muster-in to date *Nov. 5, 1863.*

Joined for duty and enrolled:

When *Nov. 1*, 1863.

Where *Worchester, Md.*

Period *3* years.

Remarks:

Book mark:

(356)

Sandy
Cpyist.

S

7

U.S.C.T.

Littleton J. Smith

Sergh., Co. G, 7 Reg't U. S. Col'd Infantry.

Appears on

Company Muster Roll

for *Nov. 5 to Dec. 31*, 1863.

Present or absent *Present*

Stoppage, \$ *100* for

Due Gov't, \$ *100* for

Remarks: *Premium for en-*
listment \$2.00 (due)

Book mark:

(858)

Sandoz
Coppist

S

7

U.S.C.T.

Littleton T. Smith

Serjt., Co. G, 7 Reg't U. S. Col'd Infantry.

Appears on

Company Muster Roll

for Jan & Feby, 1864.

Present or absent Present

Stoppage, \$ 100 for

Due Gov't, \$ 100 for

Remarks:

Book mark:

Sandy
Copyist

(858)

G

7

U.S.C.T.

Littleton J Smith

Priv., Co. G, 7 Reg't U. S. Col'd Infantry.

Appears on

Company Muster Roll

for *March & Apr.*, 1864.

Present or absent *Present.*

Stoppage, \$ *100* for

Due Gov't, \$ *100* for

Remarks: *Reduced to the ranks March 23, 1864, for disobedience of orders.*

Book mark:

Sando
Coryist

(858)

S

7

U.S.C.T.

Littleton J. Smith

Priv., Co. G, 7 Reg't U. S. Col'd Infantry.

Appears on

Company Muster Roll

for *May & June*, 1864.

Present or absent *Absent*

Stoppage, \$ *100* for

Due Gov't, \$ *100* for

Remarks: *Sick in Hospital,
Jacksonville, Fla.*

Book mark:

Sandoy
Cpyist

(858)

S

7

U.S.C.T.

Littleton T. Smith

Priv., Co. G, 7 Reg't U. S. Col'd Infantry.

Appears on

Company Muster Roll

for *July & Aug.*, 1864.

Present or absent *Present.*

Stoppage, \$ *100* for

Due Gov't, \$ *100* for

Remarks: *Free on or before
April 19th, 1861.*

Book mark: *100*

(858)

Sandoz
Copyist

G

7

U.S.C.T.

Littleton I Smith

Priv., Co. G, 7 Reg't U. S. Col'd Infantry.

Appears on

Company Muster Roll

for Sept. 7 Oct. , 1864.

Present or absent Absent

Stoppage, \$ 100 for

Due Gov't, \$ 100 for

Remarks: Absent-sick.

Free on or before Apr. 19, 1864.

Book mark:

(858)

Sandoz
Copyist

S | **7** | **U.S.C.T.**

Littleton T. Smith

Prd, Co. G, 7 Reg't U. S. Col'd Infantry.

Appears on

Company Muster Roll

for *Nov & Dec*, 186*4*

Present or absent *Present*

Stoppage, \$ *100* for

Due Gov't, \$ *100* for

Remarks:

Book mark:

(858)

J. W. Ames

Copyist

S | **7** | **U.S.C.T.**

Littellon J. Smith

Pvt., Co. G, 7 Reg't U. S. Col'd Infantry.

Appears on

Company Muster Roll

for *Jan'y & Feb'y*, 186*5*.

Present or absent *Present*

Stoppage, \$ *100* for

Due Gov't, \$ *100* for

Remarks:

Stop for 1 Haversack

Book mark:

(858)

J. W. Ames

Copyst

S | 7 | U.S.C.T.

Littleton J. Smith

Pvt., Co. G, 7 Reg't U. S. Col'd Infantry.

Appears on

Company Muster Roll

for *March & April*, 186*5*!

Present or absent *Present*

Stoppage, \$ *100* for

Due Gov't, \$ *100* for

Remarks:

Book mark:

(858)

J. W. Ames

Copyist

S | 7 | U.S.C.T.

Littleton, Smith

Sgt., Co. G, 7 Reg't U. S. Col'd Infantry.

Appears on

Company Muster Roll

for *May + June*, 186*5*

Present or absent *Present*

Stoppage, \$ *100* for

Due Gov't, \$ *100* for

Remarks: *Promoted from Pvt
to Corp'l May 2^d/65 pr. S.O,
44 Hd Qrs, 7 U.S. C. 9, 6
Sgt. from Corp'l May 2^d/65*

Book mark:

J. W. Ames

(858)

Copyist

S 7 U.S.C.T.

Littleton J. Smith

Sgt., Co. G, 7 Reg't U. S. Col'd Infantry.

Appears on

Company Muster Roll

for July & Aug, 1860.

Present or absent Present

Stoppage, \$ 100 for

Due Gov't, \$ 100 for

Remarks:

Book mark:

(858)

J. W. Jones

Copyist

S

7

U.S.C.T.

Littleton T. Smith

Sgt., Co. G, 7 Reg't U. S. Col'd Infantry.

Appears on

Company Muster Roll

for *Sept. & Oct.*, 186*5*.

Present or absent *Present*

Stoppage, \$ 100 for

Due Gov't, \$ 100 for

Remarks:

Book mark:

(858)

J. W. Cross

Copyist

S | 7 | U.S.C.T.

Littleton F. Smith

Sgt, Co. G, 7 Reg't U. S. Col'd Infantry.

Appears on

Company Muster Roll

for *Nov. + Dec.*, 186*2*.

Present or absent *Present*

Stoppage, \$ *100* for

Due Gov't, \$ *100* for

Remarks:

Book mark:

J. W. Cross

(858)

Copyist

J

7

U.S.C.T.

Littleton Smith

sqt, Co. G, 7 Reg't U. S. Col'd Infantry.

Appears on

Company Muster Roll

for Jan + Feb, 1866.

Present or absent Present

Stoppage, \$ 100 for

Due Gov't, \$ 100 for

Remarks:

Book mark:

Hadfield

(858)

Copyist

NARA 119

A | **7** | **U.S.C.T.**

Littleton P. Smith

Sgt, Co. G, 7 Reg't U. S. Col'd Infantry.

Appears on

Company Muster Roll
for *Mar & Apr*, 1866.

Present or absent *Present*

Stoppage, \$ *100* for

Due Gov't, \$ *100* for

Remarks: *On det service
per S.O. No 56 Hdqrs
Post Victoria Texas
Mar 19. 66*

Book mark:

Hadfield

(858)

Copyist

A | **7** | **U.S.C.T.**

Littleton T. Smith

spt, Co. G, 7 Reg't U. S. Col'd Infantry.

Appears on

Company Muster Roll

for *May to June*, 1866.

Present or absent *Present*

Stoppage, \$ *100* for

Due Gov't, \$ *100* for

Remarks: *On det service per
so. 56 Hd qrs Post
Victoria Texas Mar 19/66*

Book mark:

Hadfield

A

7

U.S.C.T.

Littleton T. Smith

Sgt; Co. G, 7 Reg't U. S. Col'd Infantry.

Appears on

Company Muster Roll

for July & Aug, 1866.

Present or absent Present

Stoppage, \$ 100 for

Due Gov't, \$ 100 for

Remarks: On det service per
SO 56 H & qrs Post
Victoria Texas Mar 19/66

Book mark:

Hadfield

(858)

Copyist

Littleton T. Smith

Sgt, Co. *G*, 7 Reg't U. S. Col'd Infantry.

Appears on **Co. Muster-out Roll**, dated

Indianola Texas *Oct 13*, 1866.

Muster-out to date

Oct 13, 1866.

Last paid to

June 30, 1866.

Clothing account:

Last settled....., 1866; drawn since \$.....¹⁰⁰

Due soldier \$ *29*^{*48*}/₁₀₀; due U. S. \$.....¹⁰⁰

Am't for cloth'g in kind or money adv'd \$.....¹⁰⁰

Due U. S. for arms, equipments, &c., \$.....¹⁰⁰

Bounty paid \$.....¹⁰⁰; due \$ *100*/₁₀₀

Remarks: *Joined original organization promoted Corporal May 2 1865 promoted Sergeant May 21 1865*

Book mark: *V 184 P 191.74*

Hadfield

1241

Smith Oliver

Co F, 7 U.S. Col'd Inf.

Sergeant Private

CARD NUMBERS.

1	6289131	26
2	6289232	27
3	6289402	28
4	6289498	29
5	6289599	30
6	6289694	31
7	6289790	32
8	6289882	33
9	6289982	34
10	6290084	35
11	6290181	36
12	6290271	37
13	6290358	38
14	6290448	39
15	6290533	40
16	6290612	41
17	6290690	42
18	6290764	43
19	6290837	44
20	S. 269. R.C.T. 67.	45
21	9066595	46
22		47
23		48
24		49
25		50

Book Mark: S 269 - Vol 5 - R.C. J. 1867

See also

100

100

100

100

100

100

100

100

100

100

100

100

100

100

100

100

100

100

100

100

100

100

100

100

100

100

100

100

100

100

100

100

100

100

100

100

100

100

100

100

100

100

100

100

1241

Smith Oliver

Co F, 7 U.S. Col'd Inf.

Sergeant | Private

CARD NUMBERS.

1	6289131	26
2	6289232	27
3	6289402	28
4	6289498	29
5	6289599	30
6	6289694	31
7	6289790	32
8	6289882	33
9	6289982	34
10	6290084	35
11	6290181	36
12	6290271	37
13	6290358	38
14	6290448	39
15	6290533	40
16	6290612	41
17	6290690	42
18	6290764	43
19	6290837	44
20	S. 269. R.C.T. 67.	45
21	9066595	46
22		47
23		48
24		49
25		50

Book Mark: S 269 - Vol 5 - R.C. J. 1867

See also

S 738047 2 and
Rep 366520.
S1985338 Pomom

WARREN 115

S | **7** | **U.S.C.T.**

Oliver Smith
....., Co. *D*....., 7 Reg't U.S. Col'd Inf.

Appears on
Company Descriptive Book
of the organization named above.

DESCRIPTION.

Age *23* years; height *5* feet *9* inches.
Complexion *Dark*
Eyes *Blue*; hair *Curly*
Where born *Balto, Md.*
Occupation *Farmer*

ENLISTMENT.

When *Sept 24*....., 186*3*.
Where *Baltimore, Md.*
By whom *Col W. King*; term *3* y'rs.

Remarks: *Mustered Sept 30*
1863, by Col W. King.
Appointed Sergt, Sept
24 1863. Reduced to the
rank of private for incompetency
Dec 28 1863.

.....
.....
.....

Oliver Smith

S | 7 | U.S.C.T.

Oliver Smith

Serjt, Co. *H*, 7 Reg't U. S. Colored Inf.

Age *23* years.

Appears on

Company Muster-in Roll

of the organization named above. Roll dated

Baltimore Md Sept 30, 186 *3*.

Muster-in to date *Sept 30*, 186 *3*.

Joined for duty and enrolled:

When *Sept 24*, 186 *3**

Where *Harford Co Md* *

Period *3* years.*

Remarks:
.....
.....
.....
.....
.....

*Muster-in roll shows enrollment of all men of this company as of same date. See enrollment on subsequent card or cards.

Book mark :

Let Hill
Copyist.

S. | 7 | U.S.C.T.

Olive Smith

Sgt, Co. F, 7 Reg't U. S. Col'd Infantry.

Appears on

Company Muster Roll

for *Sept. 30 to Octo 31*, 186*3*.

Joined for duty and enrolled:

When *Sept 27*, 186*3*.*

Where *Hanford C. Cal* *

Period *3* years.*

Present or absent *Present*

Stoppage, \$ *100* for _____

Due Gov't \$ *100* for _____

Remarks: _____

* See enrollment on card from muster-in roll.

Book mark: _____

J. A. Miller
Copyist.

S | 7 | U.S.C.T.

Oliver Smith

Plt, Co. F, 7 Reg't U. S. Col'd Infantry.

Appears on

Company Muster Roll

for *Nov. & Dec.*, 186 *3*.

Joined for duty and enrolled:

When *Sept. 2nd*, 186 *3*.*

Where *Harford Co Md.* *

Period *3* years.*

Present or absent *Present.*

Stoppage, \$ *100* for

Due Gov't \$ *100* for

Remarks: - *Reduced to the rank of private for insubordination. - Stopped for 1 pr scales.*

* See enrollment on card from muster-in roll.

Book mark:

(358c)

W. H. ...
Copyist.

117 U.S.C.T.

Cleves Smith

Pvt., Co. F, 7 Reg't U. S. Col'd Infantry.

Appears on

Company Muster Roll

for *Jan & Feb.*, 1864.

Joined for duty and enrolled:

When *Sept 27.*, 1863.*

Where *Harford Co. Md.* *

Period years.*

Present or absent *Present*

Stoppage, \$ 100 for

Due Gov't \$ 100 for

Remarks:

.....
.....
.....
.....

* ~~See~~ See enrollment on card from muster-in roll.

Book mark:

(358c)

John H. ...
Copyist.

S | 7 | U.S.C.T.

Oliver Smith

Plt, Co. F, 7 Reg't U. S. Col'd Infantry.

Appears on

Company Muster Roll

for *March & April*, 1864.

Joined for duty and enrolled:

When *Sept. 27*, 1863.*

Where *Hagerstown, Md.**

Period *3* years.*

Present or absent *Present*

Stoppage, \$ *100* for

Due Gov't \$ *100* for

Remarks: *Stop for haversack.*

* See enrollment on card from muster-in roll.

Book mark:

(858c)

J. C. Hill
Copyist.

S | **7** | **U.S.C.T.**

Oliver Smith

Pvt., Co. F, 7 Reg't U. S. Col'd Infantry.

Appears on

Company Muster Roll

for *May & June*, 186*4*.

Joined for duty and enrolled:

When *Sept 27*, 186*3*.*

Where *Hanford Co. Md* *

Period *3* years.*

Present or absent *Present*

Stoppage, \$ *100* for

Due Gov't \$ *100* for

Remarks:

* ~~See~~ See enrollment on card from muster-in roll.

Book mark: -----

J. C. Hill
Copyist.

S 7 U.S.C.T.

Oliver Smith

Pvt, Co. F, 7 Reg't U. S. Col'd Infantry.

Appears on

Company Muster Roll for July, Aug, 1864.

Joined for duty and enrolled:

When Sept 27, 1863.*

Where Harwood, Md.*

Period 3 years.*

Present or absent Absent

Stoppage, \$ 100 for

Due Gov't \$ 100 for

Remarks: Absent wounded since Aug 15, 64

* See enrollment on card from muster-in roll.

Book mark:

W. H. H. H.

S 1. 7 U.S.C.T.

Oliver Smith

Private, Co. F, 7 Reg't U. S. Col'd Infantry.

Appears on

Company Muster Roll

for *Sept. 2nd Oct.*, 1864.

Joined for duty and enrolled:

When *Sept. 27*, 1863.*

Where *Hartford Co., Md* *

Period *3* years.*

Present or absent *Absent*

Stoppage, \$ *100* for

Due Gov't \$ *100* for

Remarks: *Absent wounded since Aug. 13, '64.*

* See enrollment on card from muster-in roll.

Book mark:

Keefe

S | 7 | U.S.C.T.

Oliver Smith

Private Co. F, 7 Reg't U. S. Col'd Infantry.

Appears on

Company Muster Roll

for *Nov. and Dec.*, 1864.

Joined for duty and enrolled:

When *Sept 27*, 1863.*

Where *Harford Co., Md.* *

Period *3* years.*

Present or absent *Absent*

Stoppage, \$ *100* for

Due Gov't \$ *100* for

Remarks: *Absent wounded since Aug 18, 64.*

* See enrollment on card from muster-in roll.

Book mark:

Keefe

S | **7** | **U.S.C.T.**

Oliver Smith

Private Co. F, 7 Reg't U. S. Col'd Infantry.

Appears on

Company Muster Roll

for *Jan & Feb*, 1865.

Joined for duty and enrolled:

When *Sep. 27*, 1863.*

Where *Harford Co., Md.* *

Period *3* years.*

Present or absent *Absent*

Stoppage, \$ *100* for

Due Gov't \$ *100* for

Remarks: *Absent wounded since Aug. 13, 65*

* See enrollment on card from muster-in roll.

Book mark:

(358c)

Keefe Copyist.

S | **7** | **U.S.C.T.**

Oliver Smith

Private, Co. F, 7 Reg't U. S. Col'd Infantry.

Appears on

Company Muster Roll

for *Mar. & Apr.*, 186*3*.

Joined for duty and enrolled:

When *Sep. 27*, 186*3*.*

Where *Harford Co., Md.* *

Period *3* years.*

Present or absent *Absent*

Stoppage, \$ *100* for

Due Gov't \$ *100* for

Remarks: *Absent wounded since Aug. 15th 64*

* See enrollment on card from muster-in roll.

Book mark:

Keefe
Copyist.

S | **7** | **U.S.C.T.**

Oliver Smith

Private, Co. F, 7 Reg't U. S. Col'd Infantry.

Appears on

Company Muster Roll

for *May and June*, 1863.*

Joined for duty and enrolled:

When *Sep. 27*, 1863.*

Where *Harford* *

Period *3* years.*

Present or absent *Absent*

Stoppage, \$ *100* for

Due Gov't \$ *100* for

Remarks: *Absent wounded since Aug 15th 1864.*

* See enrollment on card from muster-in roll.

Book mark:

Keefe
Copyist.

S | 7 | U.S.C.T.

Oliver Smith

Private Co. F, 7 Reg't U. S. Col'd Infantry.

Appears on

Company Muster Roll

for *July and Aug.*, 1865.

Joined for duty and enrolled:

When *Sep. 27*, 1863.*

Where *Harford Co., Md.* *

Period *3* years.*

Present or absent *Absent*

Stoppage, \$ *100* for

Due Gov't \$ *100* for

Remarks: *Absent wounded since Aug. 15, 65 at New York.*

* See enrollment on card from muster-in roll.

Book mark:

Keefe

817

U.S.C.T.

Oliver Smith
Priv., Co. F, 7 Reg't U. S. Col'd Infy

Appears on

Company Muster Roll

for Sept & Oct 1863.

Joined for duty and enrolled:

When Sept. 27, 1863.*

Where Harford Co., Md. *

Period 3 years.*

Present or absent Absent

Stoppage, \$ 100 for

Due Gov't, \$ 100 for

Valuation of horse, \$ 100

Valuation of horse equipments, \$ 100

Remarks: Wounded, absent, in
New York since Aug.
14, 64.

* See enrollment on card from muster-in roll.

Book-mark :

Keeper
Copyist.

8 | 7 | U.S.C.T.

Oliver Smith

Priv., Co. F, 7 Reg't U. S. Col'd Infantry.

Appears on

Company Muster Roll

for *Nov. & Dec.*, 1865.

Joined for duty and enrolled:

When *Sept. 27*, 1863.*

Where *Harford, Md.* *

Period *3* years.*

Present or absent *Absent*

Stoppage, \$ *100* for

Due Gov't \$ *100* for

Remarks: *Wounded in
Hosp. N.Y. Harbor
since Aug. 14, 64.*

* See enrollment on card from muster-in roll.

Book mark:

Brooke

8. 1 7 U.S.C.T.

Oliver Smith

Reg't, Co. F, 7 Reg't U. S. Col'd Infantry.

Appears on

Company Muster Roll

for Jan. & Feb., 1866

Joined for duty and enrolled:

When Sept. 27, 1863.*

Where Harford Co., Md. *

Period 3 years.*

Present or absent Absent.

Stoppage, \$ 100 for

Due Gov't \$ 100 for

Remarks: Wounded in Hospital. (N.Y. Harbor) Since Aug. 14, 1864.

* See enrollment on card from muster-in roll.

Book mark:

Brooker

S. 7 U.S.C.T.

Oliver Smith
Pvt., Co. F, 7 Reg't U. S. Col'd Infantry.

Appears on

Company Muster Roll
for Mar. & April, 1866.

Joined for duty and enrolled:

When Sept. 27, 1863.*

Where Harford, Md. *

Period 3 years.*

Present or absent Absent.

Stoppage, \$ 100 for

Due Gov't \$ 100 for

Remarks: Wounded and
in Hosp. N. Y. Harbor
since Aug. 14th, 1864.

* See enrollment on card from muster-in roll.

Book mark:

Brooke
Coryist.

S 7 U.S.C.T.

Oliver Smith
Pt., Co. F, 7 Reg't U. S. Col'd Infantry.

Appears on

Company Muster Roll

for May + June, 1866.

Joined for duty and enrolled:

When Sept. 27, 1863.*

Where Herford, Md. *

Period 3 years.*

Present or absent Absent

Stoppage, \$ 100 for

Due Gov't \$ 100 for

Remarks: Wounded and in
Hosp. N. D. Harbor
since Aug. 14, 1864.

NEXT ROLL ON FILE MUSTER OUT.

* See enrollment on card from muster-in roll.

Book mark:

Brooks

S | 7 | U.S.C.T.

Oliver Smith
Capt, Co. F, 7 Reg't U. S. Col'd Infantry.

Appears on Co. Muster-out Roll, dated
Indianola, Texas, Oct. 13, 1866.

Muster-out to date _____, 186 .
Last paid to Apr. 30, 186U.

Clothing account:

Last settled _____, 186 ; drawn since \$ _____ 100
Due soldier \$ 149³⁷/₁₀₀; due U. S. \$ _____ 100
Am't for cloth'g in kind or money adv'd \$ _____ 100
Due U. S. for arms, equipments, &c., \$ _____ 100
Bounty paid \$ _____ 100; due \$ 100 100

Remarks: Joined Co. at
original organization.
Wounded Kingland Road
Va. Aug. 13, 64 sent to Hosp.
Port Monroe Va. transferred
to Hosp. Davids Island
N. Harbor there when
Book mark: 2269 Vol. 5 R.C.P. 1867 ^(over)

Brooker

JAN. 21

6290837

W18910

Last heard from.
No discharge
furnished.

S | 7 U.S.C.T.

Oliver Smith,

Priv., Co. F, 7 Reg't U.S.C.T.

NOTATION.

Book mark: S. 269 (R.C.T.) 1867.

War Department,

Record and Pension Division,

Washington, May 23, 1891.

Investigation fails to elicit any further information relative to this soldier.

A. G. Neuhart.

Smith, Oliver

P, Co. 7, 7 Reg't U.S. Inf.

Enclosures.

Bed Cards	Final Statements
Burial Records	Furloughs or L. of A.
Certs. of Dis. for Discharge	Med. Certificates
C. M. Charges	Med. Des. Lists
Descriptive Lists	Orders
Discharge Certificates	Pris. of War Record
Enlistment Papers	Resignations

Other papers relating to—

Admission to Hosp'l	Furlough or L. of A.
Casualty Sheet 2	Med. Examination
Confinement	Misc. Information
Contracts	Pay or Clothing
Death or Effects	Personal Reports
Desertion	Rank
Discharge from Hosp'l	Transfer to Hosp'l
Discharge from Service	Transfer to V. R. C.
Duty	Transportation

151

121



CASUALTY SHEET
OF WOUNDED.

Clair Smith

Co Company *G.*

7th Regiment of *Inf*

Volunteers at the battle of _____

Aug 14/64

CASUALTY SHEET.

Name, *Oliver Smith*
 Rank, *Pat*, Company *F*, Regiment, *7th*
 Arm, *Infy* State, *Ore*
 Place of casualty, *Not stated*
 Nature of casualty, *wounded Reside*
 Date of casualty, *Aug 14/64*

FROM WHAT SOURCE THIS INFORMATION WAS OBTAINED.

Report of Killed, Wounded, and Missing of the _____ Regiment,
Shaw's Brigade, _____ Division, _____ Corps, dated _____
 Signed *A. P. Steuchhold*
Surg 8th Ore Inf. Chf Med Off.
Shaw's Brig
Ind 50 L. P. No. 8.

A. J. Logan
 Clerk.

08/2/80

157
(2)

CASUALTY SHEET
OF WOUNDED.

Oliver Smith

Private Company A

7 Regiment of USCB

Volunteers at the battle of Meas Deep

Bottom Va, Aug 14/64.

MARR 142

CASUALTY SHEET.

Name, Oliver Smith
Rank, Private, Company F, Regiment, 17th
Arm, uscs, State, _____
Place of casualty, Co "Head Neck Bottom Va" Ind 20 No 119)
Nature of casualty, Wounded R Side
Date of casualty, Aug 14th 1864

FROM WHAT SOURCE THIS INFORMATION WAS OBTAINED.

Report of Killed, Wounded, and Missing of the _____ Regiment.

Brigade, _____ Division, _____ Corps, dated _____
List of Killed and Wounded in Brigade
of Colored Troops, 10th Army Corps, Commanded
by Col Shaw 7th uscs.
(Signed) A. P. Reichhold Surgeon 8th uscs Chief
Med Officer Shaw's Brigade

Ind 50 & no 68

W. F. Thompson

Clerk.

1890 143

1242
Smith William
Co C, 7 U.S. Col'd Inf.

Private Private

CARD NUMBERS.

1	6283632	26
2	6283733	27
3	6283833	28
4	6283931	29
5	6284032	30
6	6284129	31
7	6284224	32
8	6284319	33
9	6284394	34
10	6284503	35
11	6284602	36
12	6284709	37
13	6284811	38
14	6284903	39
15	6284991	40
16	6285075	41
17	6285139	42
18	6285211	43
19	6285265	44
20	6285321	45
21	9066230	46
22		47
23		48
24		49
25		50

Book Mark:

See also

7 U.S.C.T.

William Smith

Co. B, 7 Reg't U.S. Col'd Inf.

Appears on Company Descriptive Book

of the organization named above.

DESCRIPTION.

Age 29 years; height 5 feet 4 inches.

Complexion Black.

Eyes Black; hair Curly.

Where born Dorchester, Md.

Occupation Farmer.

ENLISTMENT.

When Sept. 23, 1863.

Where Baltimore.

By whom Col. W. Binney; term 3 y'rs.

Remarks: Murdered at Baltimore Md. Sept. 26, 63, by Col. W. Binney.

W. Smith

S | 7 | U.S.C.T.

William Smith.
Prov., Co. C, 7 Reg't U. S. Colored Inf.

Age 29 years.

Appears on

Company Muster-in Roll

of the organization named above. Roll dated
Baltimore, Md., Sept. 26, 1863.

Muster-in to date Sept. 26, 1863

Joined for duty and enrolled:

When Sept. 23, 1863*

Where Dorchester Co., Md. *

Period 3 years.*

Remarks: _____

*Muster-in roll shows enrollment of all men of this company as of same date. See enrollment on subsequent card or cards.

Book mark: _____

(356c)

Callaway
Copyist.

8 | 7 | U.S.C.T.

William Smith,

Private, Co. C, 7 Reg't U. S. Col'd Infantry.

Appears on

Company Muster Roll
for Sept 26 to Oct. 31, 1863.

Joined for duty and enrolled:

When Sept. 23, 1863.*

Where Rochester Co. Md. *

Period 3 years.*

Present or absent Absent

Stoppage, \$ 100 for

Due Gov't \$ 100 for

Remarks: Detached on recruiting
service Oct. 29, 63.

* See enrollment on card from muster-in roll.

Book mark:

Caraway
(358c) Copyist.

8 | 7 | U.S.C.T.

William Smith
Priv., Co. C, 7 Reg't U. S. Col'd Infantry.

Appears on

Company Muster Roll
for Nov. & Dec., 1863

Joined for duty and enrolled:

When Sept. 23, 1863*

Where Dorchester Co., Md. *

Period 3 years.*

Present or absent Present

Stoppage, \$ 100 for

Due Gov't \$ 100 for

Remarks:

* See enrollment on card from muster-in roll.

Book mark:

(358c)

Calloway
Copyist.

S | 7 | U.S.C.T.

William Smith

Priv., Co. C, 7 Reg't U. S. Col'd Infantry.

Appears on

Company Muster Roll

for January Feby, 1864

Joined for duty and enrolled:

When Sept. 23, 1863*

Where Dorchester Co, Md. *

Period 3 years.*

Present or absent Present,

Stoppage, \$ 100 for

Due Gov't \$ 100 for

Remarks Stop for our knapsack,

* See enrollment on card from muster-in roll.

Book mark:

Calloway

(358c)

Copyist.

S | 7 | U.S.C.T.

William Smith,

Priv, Co. C, 7 Reg't U. S. Col'd Infantry.

Appears on

Company Muster Roll

for Nov^{and} Apl, 1864.

Joined for duty and enrolled:

When Sept. 23, 1863*

Where Dorchester Co. Md. *

Period 3 years.*

Present or absent Present

Stoppage, \$ 100 for

Due Gov't \$ 100 for

Remarks: Stop for one cauteer

* See enrollment on card from muster-in roll.

Book mark: -----

Callaway

8 | 7 | U.S.C.T.

William Smith.

Priv, Co. C, 7 Reg't U. S. Col'd Infantry.

Appears on

Company Muster Roll

for May and June, 1864.

Joined for duty and enrolled:

When Sept. 23, 1863

Where Rochester Co. Md. *

Period 3 years.*

Present or absent Present.

Stoppage, \$ 100 for

Due Gov't \$ 100 for

Remarks:

* See enrollment on card from muster-in roll.

Book mark:

Callaway.

S 17

U.S.C.T.

William Smith
Priv. Co. B, 7 Reg't U. S. Col'd Inf.

Appears on

Company Muster Roll

for July and Aug. 1864

Joined for duty and enrolled:

When Sept. 23, 1863*

Where Dorchester Co. Md. *

Period 3 years.*

Present or absent Present

Stoppage, \$ 100 for

Due Gov't, \$ 100 for

Valuation of horse, \$ 100

Valuation of horse equipments, \$ 100

Remarks:

* See enrollment on card from muster-in roll.

Book-mark:

Calloway

S | **7** | **U.S.C.T.**

William Smith
Priv., Co. C, 7 Reg't U. S. Col'd Infantry.

Appears on
Company Muster Roll
for *Sept. & Oct.*, 1864.

Joined for duty and enrolled:
When *Sept. 23*, 1864.*
Where *Worcester* *
Period *3* years.*

Present or absent *Present*
Stoppage, \$ *100* for
Due Gov't \$ *100* for

Remarks:

* ~~43~~ See enrollment on card from muster-in roll.

Book mark: _____

M. M. Murphy
(358c) Copyist.

S | **7** | **U.S.C.T.**

William Smith
Priv., Co. C, 7 Reg't U. S. Col'd Infantry.

Appears on

Company Muster Roll
for *Nov. & Dec.*, 1864.

Joined for duty and enrolled:

When *Sept. 23*, 1863.*

Where *Dorchester* *

Period *3* years.*

Present or absent *Present*

Stoppage, \$ *100* for

Due Gov't \$ *100* for

Remarks:

* See enrollment on card from muster-in roll.

Book mark: -----

M. M. Murphy

S | 7 | U.S.C.T.

William Smith
Pvt., Co. C, 7 Reg't U. S. Col'd Infantry.

Appears on

Company Muster Roll
for Jan. & Feb., 1865.

Joined for duty and enrolled:

When Sept. 23rd, 1863.*

Where Dorchester Co., Md.*

Period 3 years.*

Present or absent Present

Stoppage, \$ 100 for

Due Gov't \$ 100 for

Remarks:

* See enrollment on card from muster-in roll.

Book mark:

M. M. Murphy
(358c) Copyist.

S | **7** | **U.S.C.T.**

William Smith
Pvt., Co. C, 7 Reg't U. S. Col'd Infantry.

Appears on

Company Muster Roll
for *Mar. & Apr.*, 186*5*.*

Joined for duty and enrolled:

When *Sept. 23*, 186*3*.*

Where *Dorchester**

Period *3* years.*

Present or absent *Present*

Stoppage, \$ *100* for

Due Gov't \$ *100* for

Remarks:

* ~~See~~ See enrollment on card from muster-in roll.

Book mark: -----

(358c)

M. M. Murphy

Copyist.

S | **7** | **U.S.C.T.**

William Smith

Sgt., Co. C, 7 Reg't U. S. Col'd Infantry.

Appears on

Company Muster Roll

for *May & June*, 186*5*.

Joined for duty and enrolled:

When *Sept. 23rd*, 186*3*.*

Where *Dorchester* *

Period *3* years.*

Present or absent *Present*

Stoppage, \$ *100* for

Due Gov't \$ *100* for

Remarks:

* See enrollment on card from muster-in roll.

Book mark: -----

M. M. Murphy

S | **7** | **U.S.C.T.**

William Smith
Priv., Co. C, 7 Reg't U. S. Col'd Infantry.

Appears on

Company Muster Roll

for *July & Aug.*, 186*5*.

Joined for duty and enrolled:

When *Sept. 23rd*, 186*3*.*

Where *Dorchester* *

Period *3* years.*

Present or absent *Present*

Stoppage, \$ *100* for

Due Gov't \$ *100* for

Remarks:

* See enrollment on card from muster-in roll.

Book mark: -----

(258c)

M. M. Murphy
Copyist.

S | **7** | **U.S.C.T.**

William Smith

Priv., Co. C, 7 Reg't U. S. Col'd Infantry.

Appears on
Company Muster Roll
for *Sept. 7 Oct.*, 186*3*

Joined for duty and enrolled:
When *Sept. 23*, 186*3*.*
Where *Worcester, Ind.**
Period *3* years.*

Present or absent *Present*

Stoppage, \$ *100* for

Due Gov't \$ *100* for

Remarks:

* See enrollment on card from muster-in roll.

Book mark: _____

M. M. Murphy
(258c) Copyist.

S. | 7 | U.S.C.T.

William Smith
Pvt., Co. C, 7 Reg't U. S. Col'd Infantry.

Appears on

Company Muster Roll

for Nov & Dec, 1863

Joined for duty and enrolled:

When Sept. 23, 1863

Where Lancaster Ind.*

Period 3 years.*

Present or absent Present

Stoppage, \$ 100 for

Due Gov't \$ 100 for

Remarks:

* See enrollment on card from muster-in roll.

Book mark:

Saperz

S. | **7** | **U.S.C.T.**

William Smith

Ort, Co. C, 7 Reg't U. S. Col'd Infantry.

Appears on

Company Muster Roll
for *Jan x Feb*, 186 *6*

Joined for duty and enrolled:

When *Sept. 23*, 186 *3**

Where *Dorchester Md.**

Period *3* years.*

Present or absent *Present*

Stoppage, \$ *100* for

Due Gov't \$ *100* for

Remarks:

* ~~See~~ See enrollment on card from muster-in roll.

Book mark: -----

Lopez

S. | 7 | U.S.C.T.

William Smith

Prt, Co. C, 7 Reg't U. S. Col'd Infantry.

Appears on

Company Muster Roll

for March & April, 1866

Joined for duty and enrolled:

When Sept 23, 1863

Where Dorchester Md.*

Period 3 years.*

Present or absent Present.

Stoppage, \$ 100 for

Due Gov't \$ 100 for

Remarks:

* See enrollment on card from muster-in roll.

Book mark: -----

Lopez
Copyist.

S. | 7 | U.S.C.T.

William Smith
Pr, Co. C, 7 Reg't U. S. Col'd Infantry.

Appears on

Company Muster Roll
for May & June, 1866

Joined for duty and enrolled:

When Sept. 25, 1863*

Where Rochester Md. *

Period 3 years.*

Present or absent Present.

Stoppage, \$ 100 for

Due Gov't \$ 100 for

Remarks:

* See enrollment on card from muster-in roll.

Book mark:

Lopez.

S. 7 U.S.C.T.

William Smith

Co. C, 7 Reg't U. S. Col'd Infantry.

Appears on

Company Muster Roll

for July & Aug, 1866

Joined for duty and enrolled:

When Sept. 25, 1863

Where Worcester Md.

Period 3 years.*

Present or absent Present

Stoppage, \$ 100 for

Due Gov't \$ 100 for

Remarks:

* See enrollment on card from muster-in roll.

Book mark:

Lopez

S | 7 | U.S.C.T.

William Smith

Pvt, Co. C, 7 Reg't U. S. Col'd Infantry.

Appears on Co. Muster-out Roll, dated
Indianola Texas, Oct 13, 1866.

Muster-out to date Oct. 13, 1866.

Last paid to June 30, 1866.

Clothing account:

Last settled....., 186 ; drawn since \$..... 100

Due soldier \$ ⁴²/₁₀₀ ⁶⁴ ; due U. S. \$..... 100

Am't for cloth'g in kind or money adv'd \$..... 100

Due U. S. for arms, equipments, &c., \$..... 100

Bounty paid \$..... 100 ; due \$ ~~100~~ ¹⁰⁰

Remarks: Joined Co. at
original organization.

Book mark: V. 177. P. 96. 73. 287. 865.

Lopez

Smith, William

P. Co. 7 U.S.C. Inf. Reg't

Enclosures.

Bed Cards	Descriptive Lists
Burial Records	Final Statements
Certs. of Dis. for Discharge	Furloughs
C. M. Charges	Med. Des. Lists
Med. Certificates	Orders

Other papers relating to—

Admission to Hosp'l	Furlough
Casualty Sheet (Officer's)	Med. Examination
Confinement	Misc. Information
Contracts	Pay or Clothing
Death or Effects	Personal Reports
Desertions	Rank
Discharge from Hosp'l	Transfer to Hosp'l
Discharge from Service	Transfer to V. R. C.
Duty	Transportation
	Slave claim /

MICROFILM PUBLICATION M 1849

COMPILED MILITARY SERVICE RECORDS
OF VOLUNTEER UNION SOLDIERS WHO SERVED WITH
THE UNITED STATES COLORED TROOPS (USCT)
7TH REGIMENT OF INFANTRY

PERSONAL PAPERS' TARGET SHEET

PLEASE NOTE THE CHECKED INFORMATION ABOUT THE PERSONAL PAPERS IN
THIS FILE:

- NO PERSONAL PAPERS WERE FOUND IN THIS FILE WHEN THE
RECORDS WERE ARRANGED FOR MICROFILMING.
- 3 PERSONAL PAPER(S) FOUND IN THIS FILE WHEN THE RECORDS
WERE ARRANGED FOR MICROFILMING.

P. No. 54. P. C.

*Care Wallace & Melbourne
Cambridge Md*

No. 914

APPLICATION OF

Wm. H. Radcliff

OF

Dorchester Co. Md

For Compensation for Service of Slave,

Wm. Smith

Enlisted in 7th Regiment

Dorchester Co. Md
U. S. Colored Troops, Co. C.

Received, March 9 1864.

COMPENSATION *Refused*

Septem 26th 1864,

because the claimant has been
disloyal.

Thos. Simmons
President, Bd. Claiming

Recd. A. G. O. October 2. 1865.

EVIDENCE OF TITLE.

I. William H. Radcliffe, of Dorchester
County, Md., do solemnly swear that William Smith

who has been enlisted in the _____ Regiment, U. S. Colored Troops,
Co. _____; is my slave for life; (his term of service expiring on
the _____ day of _____ 186 _____); and that

I became possessed of him by Purchase, in the month
of January, eighteen hundred and fifty five. And I

do further swear that I have not purchased said slave from any person or persons disloyal
to the Government of the United States, with the object of obtaining compensation for
the same; and furthermore, that I have no agency for obtaining compensation for any per-
son or persons but such as, to my knowledge, are loyal citizens of the United States.

March 2nd 1864.
Wm H Radcliff

STATE OF MARYLAND,

Dorchester County, to wit:

On this *2nd* day of *March* in the year 1864,

before me, the subscriber, a Justice of the Peace of the State and County aforesaid, personally appeared *William H. Radcliffe* and took, signed, and acknowledged the oaths preceding; and further made oath, in due form of law, that all the statements made in this application are, to the best of *his* knowledge and belief, strictly true.

Also personally appeared before me *John M. Beckwith* and *John M. Beckwith*, loyal citizens of the United States, residents of *Dorchester County*, well acquainted with the said *William H. Radcliffe*, and in no manner interested in the prosecution of this claim, and made oath, in due form of law, that the said *William H. Radcliffe* is the owner of the slave *William Smith*, as a fact of public notoriety; that they believe all the statements herein made by *him*, in reference thereto, are correct, and that *he* is unquestionably loyal to the Government of the United States. Witness their signatures:

John M. Beckwith

J. M. Beckwith

Sworn before

H. J. Winterbottom Justice of the Peace.

STATE OF MARYLAND,

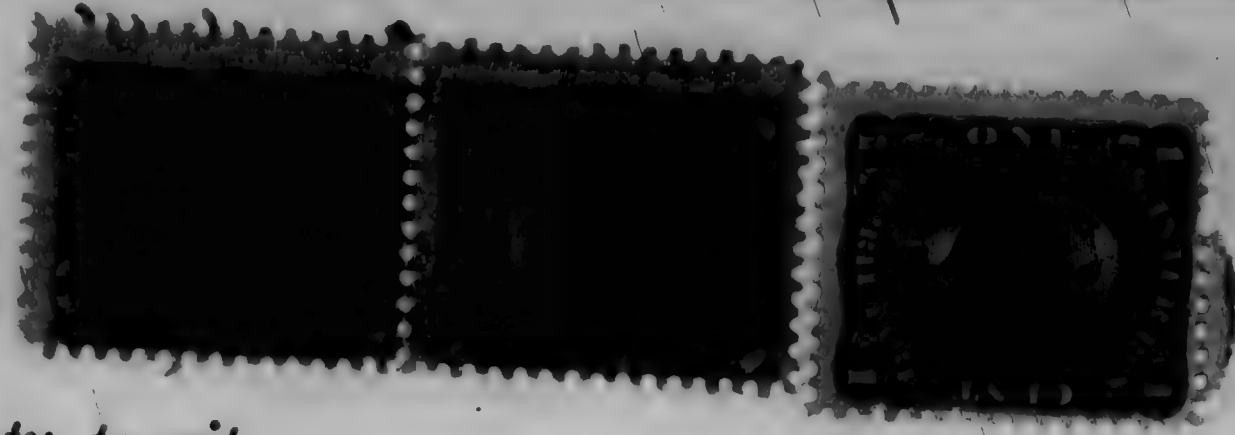

Dorchester County, to wit:

I, *Francis J. Henry*, Clerk of the Circuit Court for

Dorchester County, do hereby certify that *A. D. Winterbottom, Esquire*,

before whom the foregoing affidavits were made, was, at the time of signing the same, a

Justice of the Peace for the County and State aforesaid, duly commissioned and sworn;

and that his signature thereto is genuine, and that full faith and credit should be given to

his official acts.

Witness my hand and the seal of said Court, this *twenty sixth* day of

September, A. D. 1864.

F. J. Henry, CLERK.

914

A.

No. 914

CLAIMANT'S CERTIFICATE.

I, William H. Radcliffe a loyal citizen, and a resident
of District No 7, County of Dorchester, State of
Maryland, hereby claim compensation, under the provisions of
General Orders, No. 329, 1863, for my slave William Smith
enlisted _____ 186 , at Cambrian Md
by _____ in the _____
Regiment U. S. Colored Troops, Co. _____ ; certificate of which enlistment, and a
descriptive list, as required, accompany this application.

In proof of my loyalty to the Constitution and Government of the United States, I
present the accompanying oath, which I have taken, signed, and acknowledged, to be filed
with this application, in accordance with requirement of said General Orders.

Wm H Radcliff

March 2nd 1864.

B.

OATH OF ALLEGIANCE.

I, William H. Radcliffe, do solemnly swear that I have never joined, or been concerned in, any insurrection or rebellion; that I have never borne arms against the United States; that I have never given any aid, countenance, counsel, or encouragement to any person or persons engaged, or whom I had reason to believe were about to engage, in insurrection, rebellion, or armed hostility against the United States; that I have neither sought, nor accepted, nor attempted to exercise the functions of any office, civil or military, nor to perform any service whatever, under any authority or pretended authority in hostility to the United States; that I have not yielded a voluntary support to any insurrection, rebellion, or pretended government, authority, power, or constitution within the United States hostile thereto. And I do further swear that, to the best of my knowledge and ability, I have supported and defended, and will continue to support and defend, the United States against all enemies, foreign and domestic; and that I have supported, defended, and obeyed, and will continue to support, defend, and obey, the Constitution and laws of the United States; that I will bear true faith and allegiance to the same; and that I take this oath freely, without any mental reservation or purpose of evasion: So help me God.

Wm H Radcliffe

Sworn to and subscribed before me, at Cambridge
this 2nd day of March 1864.



H. J. Wintertottum
Justice of the Peace

C.

I present herewith evidence of my title to the slave William
Smith enlisted as aforesaid, and in consideration of the sum of
 _____ by me received, I hereby covenant and
 agree with the United States, that I, my heirs, executors, or assigns, shall never hereafter make
 or enforce any claim to the labor or services of said slave; and pledge myself to execute
 a valid Deed of Manumission and Release of all my claims to service forever of said
William Smith to be filed with the Board of Claims
 now in session at _____

Wm H. Riddell

March 3^d, 1864.



State of Maryland }
Dorchester County, Md. } I hereby certify that the foregoing is
true and correct Copy of the original deed of Manumission
now on file in my office for record among the Chatter Records
for Dorchester County.

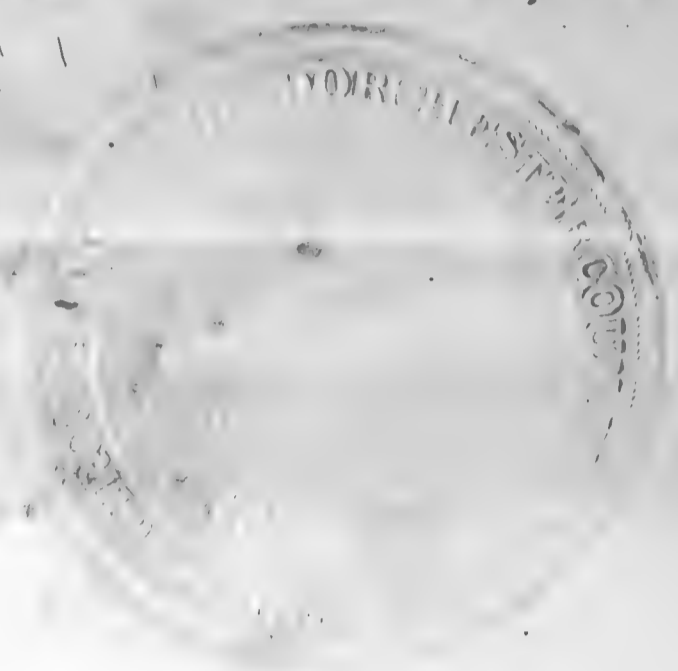

In testimony whereof I have subscribed my
name and affix the seal of the Circuit Court
for Dorchester County this 15th day of May
1864.



T. J. Henry Clerk.

PL

h14

E.

DEED OF MANUMISSION AND RELEASE OF SERVICE.

Whereas my slave W^m Smith has enlisted in the service of the United States: now, in consideration thereof, I, William H. Radcliff, of Derchester county, State of Maryland, do hereby, in consideration of said enlistment, manumit, set free, and release the above-named William Smith from all service due me; his freedom to commence from the 23^d day of September 1863, the date of his enlistment as aforesaid in the 7th Regiment of Colored Troops, in the service of the United States. &c. &c.

Witness my hand and seal, this 16th day of May, 1864.

W^m H. Radcliff



Witness:

A. J. Winterbottom
W^m Kirby
Ethel Wolford

Derchester County,

U.S. Stamp 5 cts

State of Maryland May 16, 1864.

Before me appeared this day William H. Radcliff, and acknowledged the above Deed of Manumission and Release of Service to be his free act and deed.

A. J. Winterbottom J.P.

Smith William

Co *E*, 7 U.S. Col'd Inf

Corporal | *Sergeant*

CARD NUMBERS.

1	6287221	26
2	6287322	27
3	6287423	28
4	6287524	29
5	6287617	30
6	6287714	31
7	6287810	32
8	6287902	33
9	6287996	34
10	6288093	35
11	6288192	36
12	6288365	37
13	6288464	38
14	6288559	39
15	6288587	40
16	6288680	41
17	6288766	42
18	6288848	43
19	6288931	44
20	6289011	45
21	9066482	46
22		47
23		48
24		49
25		50

Book Mark:

See also

S

7

U.S.C.T.

William Smith

, Co. E, 7 Reg't U. S. Col'd Inf.

Appears on

Company Descriptive Book

of the organization named above.

DESCRIPTION.

Age 33 years; height 5 feet 6 inches.

Complexion *Wheat*

Eyes *Black*; hair *Curly*

Where born *Kent, Md.*

Occupation *Farmer*

ENLISTMENT.

When *Sept 2nd*, 1863.

Where *Baltimore*

By whom *Col Wm Perry*, term *3* y'rs.

Remarks: *Appointed Corp'l Dec 30 1863.*

In the engagement on John's Island S.C. July 9 1864. Also at Deep Bottom Va. Aug 14 1864. Promoted to Serg't S.C. No. 35 16th Q. Y. U.S.C.I. March 18 1864. Reduced to Rank's S.C. No. 49 16th Q. Y. U.S.C.I. June 11 1865. Promoted to Serg't S.C. No. 106 16th Q. Y. U.S.C.I. Indiana Tex, Nov 7 1865, vice Brown discharged.

J. Brown

S | 7 | U.S.C.T.

William Smith
Corp., Co. E, 7 Reg't U. S. Colored Inf.

Age 33 years.

Appears on

Company Muster-in Roll

of the organization named above. Roll dated

Baltimore Md. Sept. 30, 1863.

Muster-in to date

Sept. 30, 1863.

Joined for duty and enrolled:

When

Sept. 27, 1863.*

Where

Kent Co. Md. *

Period

3 years.*

Remarks:

*Muster-in roll shows enrollment of all men of this company as of same date. See enrollment on subsequent card or cards.

Book mark:

J. C. Rankin

(356c)

Copyist.

S | 7 | U.S.C.T.

William Smith
Corp., Co. E, 7 Reg't U. S. Col'd Infantry.

Appears on

Company Muster Roll
for Sept 30/63 to Oct. 31, 1863.

Joined for duty and enrolled:

When Sept 27, 1863.*

Where Kent Ind. *

Period 3 years.*

Present or absent Absent.

Stoppage, \$ 100 for

Due Gov't \$ 100 for

Remarks: On detached serv-
ice at Baltimore Ind.

* See enrollment on card from muster-in roll.

Book mark: -----

W. A. Rankin
(358c) Copyist.

S | 7 | U.S.C.T.

William Smith
Corp., Co. E, 7 Reg't U. S. Col'd Infantry

Appears on

Company Muster Roll
for Nov. & Dec., 1863.

Joined for duty and enrolled:

When Sept. 27, 1863.

Where Kent.

Period 3 years.*

Present or absent Absent.

Stoppage, \$ 100 for

Due Gov't \$ 100 for

Remarks: Detached ser-
vice recruiting at
Baltimore Md. by
order Col. W. Birney
Oct. 27, 1863.

* See enrollment on card from muster-in roll.

Book mark:

J. A. Rankin,
Copyist.

S | **7** | **U.S.C.T.**

William Smith
Cop., Co. E, 7 Reg't U. S. Col'd Infantry.

Appears on

Company Muster Roll

for *Jan. & Feb.*, 1864

Joined for duty and enrolled:

When *Sept 27*, 1863.*

Where *Kent.* *

Period *8* years.*

Present or absent *Present.*

Stoppage, \$ *100* for

Due Gov't \$ *100* for

Remarks: *Returned from
recruiting service
Jan. 3, 1864.*

* See enrollment on card from muster-in roll.

Book mark:

A. C. Rankin
Copyist.

S

7

U.S.C.T.

William Smith

Sgt., Co. E, 7 Reg't U. S. Col'd Infantry.

Appears on

Company Muster Roll

for Mar. & Apr., 1864.

Joined for duty and enrolled:

When Sept. 27, 1863.*

Where Kent Co. Md.*

Period 3 years.*

Present or absent Present.

Stoppage, \$ 100 for

Due Gov't \$ 100 for

Remarks: Promoted Ser-
geant Per Reg't Order
No. 34 dated Hd. Qrs
7th U.S.C.T. Jacksonville
Fla. Mch. 17. 1864.

* See enrollment on card from muster-in roll.

Book mark:

E. A. Rankin

(358c)

Copyist.

S | 7 | U.S.C.T.

William Smith

Sgt., Co. E, 7 Reg't U. S. Col'd Infantry.

Appears on

Company Muster Roll

for Dated June 30, 1864.

Joined for duty and enrolled:

When Sept. 27, 1863.*

Where Kent Co. Md.*

Period years.*

Present or absent Present.

Stoppage, \$ 100 for

Due Gov't \$ 100 for

Remarks:

* See enrollment on card from muster-in roll.

Book mark:

E. P. Rankin
Copyist.

S 7 U.S.C.T.

William Smith

Sgt, Co. E, 7 Reg't U. S. Col'd Infantry.

Appears on

Company Muster Roll

for *Jul. & Aug.*, 1864

Joined for duty and enrolled:

When *Sept 27*, 1863*

Where *Kent.**

Period *3* years.*

Present or absent *Present*

Stoppage, \$ *100* for

Due Gov't \$ *100* for

Remarks: *Free on or before Apr. 19th 1861.*

* See enrollment on card from muster-in roll.

Book mark: -----

C. A. Rankin

S. | 7 | U.S.C.T.

William Smith

Sergt., Co. E, 7 Reg't U. S. Col'd Infantry.

Appears on

Company Muster Roll

for Sept & Oct, 1864.

Joined for duty and enrolled:

When Sept 27, 1863.*

Where 1st Lt. Co. Md. *

Period 2 1/2 years.*

Present or absent Absent

Stoppage, \$ 100 for

Due Gov't \$ 100 for

Remarks: Free on or before April 19 1864. Appointed from Corp'l March 17 50. At 55. Ad. 2nd 7 U.S.C. Detached 50. At 10. Ad. 2nd. 1. "Prig. 3" Du. 10" A. C. One

* See enrollment on card from muster-in roll.

Book mark: Over!

S. Thompson

JAN. 20

6287902

1891

*difference of pay between
Capt. & Sgt. and
Capt. & Sgt. according to
respective appointments*

S. | 7 | U.S.C.T.

William Smith

Sgt., Co. E, 7 Reg't U. S. Col'd Infantry.

Appears on

Company Muster Roll

for Nov & Dec, 1864.

Joined for duty and enrolled:

When Sept 27, 1863.*

Where Cent Co Ind.*

Period 3 years.*

Present or absent Present

Stoppage, \$ 100 for

Due Gov't \$ 100 for

Remarks: Appointed Sergeant
S.O. 55, Hd. Qrs. 7th U.S.C.
March 17/64. Had
drawn Sergeants pay since
May 1/64. Face on, or
before April 19/64, & had

* See enrollment on card from muster-in roll.

Book mark:

C. Thompson (over)

JAN. 20

6287996

018910

*back pay due as such
from enlistment.*

S. | 7 | U.S.C.T.

William Smith

Sgt., Co. E, 7 Reg't U. S. Col'd Infantry.

Appears on

Company Muster Roll

for *Jan & Feb.*, 186*5*.

Joined for duty and enrolled:

When *Sept 27*, 186*3*.*

Where *Kent*.*

Period *2* years.*

Present or absent *Present*

Stoppage, \$ *100* for

Due Gov't \$ *100* for

Remarks: *Stop for transportation on furlough from Balt Md, to Elkton Md \$ 1.05*

* See enrollment on card from muster-in-roll.

Book mark:

A. Thompson

S.

7

U.S.C.T.

William Smith

Serjt, Co. E, 7 Reg't U. S. Col'd Infantry.

Appears on

Company Muster Roll

for *March + April*, 1865.

Joined for duty and enrolled:

When *Sept 27*, 1863.*

Where *Cent*

Period *2* years.*

Present or absent *Present*

Stoppage, \$ *100* for

Due Gov't \$ *100* for

Remarks: *Top for transportation furnished on Furlough from Baltimore to Easton Md 7/25*

* See enrollment on card from muster-in roll.

Book mark:

S. Thompson

D. | **7** | **U.S.C.T.**

William Smith

Co., Co. E, 7 Reg't U. S. Col'd Infantry.

Appears on

Company Muster Roll

for *May & June*, 186*3*.

Joined for duty and enrolled:

When *Sept 27*, 186*3*.*

Where *Cent*.*

Period *2* years.*

Present or absent *Present*

Stoppage, \$ *100* for

Due Gov't \$ *100* for

Remarks: *Reduced to rank of*
Son Capt S.O. No. 47.
Ad. 27. 11. 6. 11. 6. 11. 6.
11/65. Exp for transportation
on freight from Baltimore to
Easton Md 7. 1. 65

* See enrollment on card from muster-in roll.

Book mark:

H. Thompson

C. | **7** | **U.S.C.T.**

William Smith

Cpl., Co. E, 7 Reg't U. S. Col'd Infantry.

Appears on

Company Muster Roll

for *July & Aug.*, 1865.

Joined for duty and enrolled:

When *Sept. 27*, 1863.*

Where *Green Ann Co. Md.**

Period *3* years.*

Present or absent *Present*

Stoppage, \$ *100* for

Due Gov't \$ *100* for *3*

Remarks:

* See enrollment on card from muster-in roll.

Book mark: -----

C. Thompson
(358c) Copyist.

S. | **7** | **U.S.C.T.**

William Smith
Cpl., Co. E, 7 Reg't U. S. Col'd Infantry.

Appears on

Company Muster Roll

for *Sept Oct*, 186*0*.

Joined for duty and enrolled:

When *Sept 27*, 186*0*.*

Where *Lucen Ann Co, Md.* *

Period *8* years.*

Present or absent *Present*

Stoppage, \$ *100* for

Due Gov't \$ *100* for

Remarks: *Sept Fort. Harpersack*

* ~~See~~ See enrollment on card from muster-in roll.

Book mark: _____

C. Thompson

S | 7 | U.S.C.T.

William Smith

Sgt., Co. E, 7 Reg't U. S. Col'd Infantry.

Appears on

Company Muster Roll

for Nov & Dec, 1865.

Joined for duty and enrolled:

When Sept. 27, 1863.*

Where Queen Ann Co., Md.*

Period 3 years.*

Present or absent Present

Stoppage, \$ 95 for Car & G. Equipage

Due Gov't \$ 100 for

Remarks Promoted from Pvt. to Sgt. per S.O. No. 106 Md. Grs. 7 U.S. Col'd Inf. Indiana & Texas Nov 7, 1865.

* See enrollment on card from muster-in roll.

Book mark:

(358c)

Jno J Bell Copyist.

S | **7** | **U.S.C.T.**

William Smith

Sgt, Co. E, 7 Reg't U. S. Col'd Infantry.

Appears on

Company Muster Roll

for *Jan. & Feb*, 186*6*.

Joined for duty and enrolled:

When *Sept. 27*, 186*3**

Where *Green Anna Co. Md**

Period *3* years.*

Present or absent *Present*

Stoppage, \$ *100* for

Due Gov't \$ *100* for

Remarks:

* ~~See~~ See enrollment on card from muster-in roll.

Book mark: -----

Geo J. Bell Jr
(358c) Copyist.

S | 7 | U.S.C.T.

William Smith

Sgt, Co. E, 7 Reg't U. S. Col'd Infantry.

Appears on

Company Muster Roll

for March & April, 1866

Joined for duty and enrolled:

When Sept. 27, 1866?

Where Queen Anne Co., Md.

Period 3 years.*

Present or absent Present

Stoppage, \$ 100 for

Due Gov't \$ 100 for

Remarks:

* See enrollment on card from muster-in roll.

Book mark: -----

(358c)

Geo F. Bree
Copyist.

S | **7** | **U.S.C.T.**

William Smith

Sgt, Co. E, 7 Reg't U. S. Col'd Infantry.

Appears on

Company Muster Roll

for *May & June*, 186*6*.

Joined for duty and enrolled:

When *Sept 27*, 186*3*.*

Where *Queen Ann Co., Md.**

Period *3* years.*

Present or absent *Present*

Stoppage, \$ *100* for

Due Gov't \$ *100* for

Remarks:

* See enrollment on card from muster-in roll.

Book mark: _____

Wm H. Wells
(358c) Copyist.

S | **7** | **U.S.C.T.**

William Smith

Sgt, Co. E, 7 Reg't U. S. Col'd Infantry.

Appears on

Company Muster Roll

for *July & Aug*, 186*6*.

Joined for duty and enrolled:

When *Sept. 27*, 186*3*.*

Where *Queen Ann Co, Md.* *

Period *3* years.*

Present or absent *Present*,

Stoppage, \$ *100* for

Due Gov't \$ *100* for

Remarks:

* ~~45~~ See enrollment on card from muster-in roll.

Book mark:

J. J. Bell
Copyist.

S | 7 | U.S.C.T.

William Smith
Sgt, Co. C, 7 Reg't U. S. Col'd Infantry.

Appears on Co. Muster-out Roll, dated
Indianola, Texas, Oct. 13, 1866.

Muster-out to date Oct. 13, 1866.

Last paid to June 30, 1866.

Clothing account:

Last settled....., 186 ; drawn since \$..... 100

Due soldier \$ 28 ⁴² / 100; due U. S. \$..... 100

Am't for cloth'g in kind or money adv'd \$..... 100

Due U. S. for arms, equipments, &c., \$..... 100

Bounty paid \$..... 100; due \$ 100 / 100

Remarks: Joined for duty at original
organization Appointed Corporal
S.O. No. 77 Hd. Qrs. 7th U.S. Inf.
Dec. 30, 1863 Promoted Sergeant
S.O. No. 35 Hd. Qrs. 7th U.S. Inf.
Mch. 18, 1864 Reduced to ranks
S.O. No. 49 Hd. Qrs. 7th U.S. Inf.
over

Book mark:

Geo. H. Bell Jr

JAN. 20

6289011

#18910

June 11, 1865. Promoted
to Sergeant from Private
S.O. No. 106 Reg. Gre.
7. U.S.C. Nov. 7, 1865.

1244

Smith William D.

Co G, 7 U.S. Col'd Inf.

Captain Captain

CARD NUMBERS.

1	6278916	26
2	6291004	27
3	6291105	28
4	6291209	29
5	6291308	30
6	6291407	31
7	6291505	32
8	6291605	33
9	6291405	34
10	6291458	35
11	6291819	36
12	6291892	37
13	6291963	38
14	6292028	39
15	6292090	40
16	6292148	41
17	6292206	42
18	6292254	43
19	6292302	44
20	7347637	45
21	9428682	46
22	9066027	47
23	8909-00-1863	48
24	43224948	49
25	43226845	50

Book Mark: 909- C. J. 82
8909-00-1863

See also

RFP 370807 (Rem)

RFP 394293

RFP 504414

RFP 505294

M.A. 2501078 P.O.M.M.

S | 7 | U.S.C.T.

William V. Smith
Capt, Co. *G*, 7 Reg't U.S. Col'd Inf.

Appears on
Company Descriptive Book

of the organization named above.

DESCRIPTION.

Age *23* years; height *5* feet *10* inches.

Complexion *Light*

Eyes *Grey*; hair *Brown*

Where born *Boston, Mass.*

Occupation *Clerk*

ENLISTMENT.

When, 186 .

Where

By whom; term y'rs.

Remarks: *Appointed by order*
of President of U. S.
Oct 8" 1863. Joined for
duty and enlisted into
U. S. Service by Col H.
Benny, at Baltimore,
Md., Oct 21" 63.

J. Brown

S | *7* | **U.S.C.T.**

Wm Smith

Capt., Co....., *7* Reg't U. S. Col'd Inf.

Appears on

Regimental Descriptive Book

(List of Commissioned Officers)

of the regiment named above.

Rank *Captain*

Date of appointment *Oct 8* 186*3*

Remarks: *Born in the state of Mass
and a resident of said state
entered the service of U.S. as a
2nd Lieut of 44 Regt Mass Inf
Aug 26/61. Was mustered into
service of 7. U.S.C.T Oct 23, 1863*

M. Fairley

S | 7th | U.S.C.T.

William V Smith

Capt, Co., 7 Reg't U. S. Col'd Infantry.

Age 23 years.

Appears on an

Individual Muster-in Roll

of the organization named above. Roll dated

Baltimore Md, Oct-21, 1863.

Muster-in to date Oct-21, 1863.

Joined for duty and enrolled:

When Oct-21, 1863.

Where Baltimore Md

Period 3 years. or during the war

Remarks: Assigned to Co. G
7th U.S.C.T.

Book mark: 8202-07-1863

C. S. Rogzelle

(336)

Copyist.

S

7

U.S.C.T.

William W Smith

Capt., Co. G, 7 Reg't U. S. Col'd Infantry.

Appears on

Company Muster Roll

for *Nov 5 to Dec 31*, 1863.

Present or absent *Absent*

Stoppage, \$ *100* for

Due Gov't, \$ *100* for

Remarks: *Joined for duty Oct 21st, 1863, by order of Col. Wm. Birney. Detached recently at Baltimore, Dec 29th, 1863.*

Book mark:

Sandy
Copyist

(858)

S

7

U.S.C.T.

William V. Smith

Capt., Co. G, 7 Reg't U. S. Col'd Infantry.

Appears on

Company Muster Roll

for Jan. & Feby., 1864.

Present or absent Absent

Stoppage, \$ 100 for

Due Gov't, \$ 100 for

Remarks: Returned to duty from Baltimore (Recruiting service) Jan. 16, 1864. Detached as A. A. A. Genl. at Brig. 148. Qrs. Feb. 16, 1864, by order Gen. Birney.

Book mark:

Sandy
Copyist

(858)

7 no. 00
1 Brig. | U.S.C.T.

William V. Smith

A. A. G. Rank Capt., 1 Brig. Reg't U.S.C.T.

Appears on

Field and Staff Muster Roll

for Jan. & Feb., 1864.

Present or absent present

Stoppage, \$ 100 for

Due Gov't, \$ 100 for

Valuation of horse, \$ 100

Valuation of horse equipments, \$ 100

Remarks: Detached from
Co. G. 7 U.S.C.T. as Act.
Asst. Adj. General by
Special Orders No. 41
Par VII. Hd. Qrs. Camp
Stanton dated Feb. 16,
1864.

NEXT ROLL ON FILE, JUN 1864

Book mark:

N. C. Taylor

S

7

U.S.C.T.

William V. Smith

Capt., Co. G, 7 Reg't U. S. Col'd Infantry.

Appears on

Company Muster Roll

for *Mch. & Apr.*, 1864.

Present or absent *Present*

Stoppage, \$ *100* for

Due Gov't, \$ *100* for

Remarks:

Book mark:

Sandoy
Copyist

S

7

U.S.C.T.

William V. Smith.

Capt., Co. G, 7 Reg't U. S. Col'd Infantry.

Appears on

Company Muster Roll

for *May & June*; 1864.

Present or absent *Present.*

Stoppage, \$ 100 for

Due Gov't, \$ 100 for

Remarks:

Book mark:

(858)

Sandoz
Cpyist

S

7

U.S.C.T.

William V. Smith

Capt., Co. G, 7 Reg't U. S. Col'd Infantry.

Appears on

Company Muster Roll

for *July & Aug.*, 186*4*.

Present or absent *Present*.

Stoppage, \$ *100* for

Due Gov't, \$ *100* for

Remarks: *Stop for two waist belt plates, seven canteen box belt plates, eight bayonets, one waist belt.*

Book mark:

Sandoy

Copyist

(858)

S

7

U.S.C.T.

William V. Smith

Capt., Co. G, 7 Reg't U. S. Col'd Infantry.

Appears on

Company Muster Roll

for Sept. & Oct., 1864.

Present or absent Absent

Stoppage, \$ 100 for

Due Gov't, \$ 100 for

Remarks: Wounded on the 29th Sept and in Cheesepark Hospital until Oct 12, 1864.

Absent with leave for 30 days, S. O. No. 286, Hd. Qrs. Dept. Va. & N. C., dated October 12, 1864.

Book mark:

Sandoz Copyist

S

7

U.S.C.T.

William V. Smith

Capt., Co. G, 7 Reg't U. S. Col'd Infantry.

Appears on

Company Muster Roll

for *Nov. + Dec.*, 186*4*

Present or absent *Absent*

Stoppage, \$ *100* for

Due Gov't, \$ *100* for

Remarks:

*Wounded Sept. 29, 64
in Hospital since
that time.*

Book mark:

J. W. Chaves
(858) Copyist

S

7

U.S.C.T.

William J. Smith

Capt., Co. G, 7 Reg't U. S. Col'd Infantry.

Appears on

Company Muster Roll

for *Jan'y + Feby*, 186*5*.

Present or absent *Absent*

Stoppage, \$ *100* for

Due Gov't, \$ *100* for

Remarks:

*Absent with leave
S.O. No. 201 Dept of 10
Feby 14/65*

Book mark:

J. W. Jones

(858)

Copyist

S | **7** | **U.S.C.T.**

William V. Smith

Capt., Co. G, 7 Reg't U. S. Col'd Infantry.

Appears on

Company Muster Roll

for *March & April*, 186*5*!

Present or absent *Absent*

Stoppage, \$ *100* for

Due Gov't, \$ *100* for

Remarks:

*Absent sick leave
S.O. No. 28 Dept. War Feb'y
24, 1865*

Book mark:

J. W. Chaves
(858) Copyist

S | 7 | U.S.C.T.

William S. Smith

Capt, Co. G, 7 Reg't U. S. Col'd Infantry.

Appears on

Company Muster Roll

for May + June, 1865.

Present or absent Absent

Stoppage, \$ 100 for

Due Gov't, \$ 100 for

Remarks:

Absent with leave for
S.O. 140 Hd Quarters Dept,
Va, May 24/65.

Book mark:

J. W. Thine Copyist

(858)

S

7

U.S.C.T.

William V. Smith
Capt, Co. G, 7 Reg't U. S. Col'd Infantry.

Appears on

Company Muster Roll

for *July + Aug*, 1865!

Present or absent *Absent*

Stoppage, \$ *100* for

Due Gov't, \$ *100* for

Remarks:

*On Det. Service as
Ordnance Officer 1st Brig 2^d
Div. 2^d A. per S.O. 63 Hd. Qrs.
1st Brig 2^d Div 25th A. C. Aug.
18/63*

Book mark:

J. W. Jones

(858)

Copyist

S | **7** | **U.S.C.T.**

William V. Smith
Capt, Co. G, 7 Reg't U. S. Col'd Infantry.

Appears on

Company Muster Roll

for *Sept. & Oct.*, 186*5*.

Present or absent *Absent*

Stoppage, \$ *100* for

Due Gov't, \$ *100* for

Remarks:

*On Det service as Ordnance
Officer 1st Brig 2^d Div 25
AC, per S.O. 63 Hd Qrs,
1st Brig 2^d Hd Qrs, Div, 25
AC, Aug, 18/65,*

Book mark:

J. W. Cross
(858) Copyist

S | **7** | **U.S.C.T.**

William V. Smith
Capt, Co. G, 7 Reg't U. S. Col'd Infantry.

Appears on

Company Muster Roll

for *Nov. + Dec.*, 1865.

Present or absent *Absent*

Stoppage, \$ *100* for

Due Gov't, \$ *100* for

Remarks:

*Det on Genl Court Martial
per S.O. 106 Hd. qrs. Dept
of Louisiana New Orleans
La. Nov. 4/65 pd for the
months of Oct. 1865 by
O. J. Sweeney pay master
U. S. A.*

Book mark:

(858)

J. W. Ames

Copyist

S | 7 | **U.S.C.T.**

William Smith

Capt., Co. G, 7 Reg't U. S. Col'd Infantry.

Appears on

Company Muster Roll

for Jan - Feb, 1866.

Present or absent Absent

Stoppage, \$ 100 for

Due Gov't, \$ 100 for

Remarks: Det on Genl Court
Martial per SO 126
As grs Dept of Louisiana
New Orleans La Nov 4/65

Book mark:

Hadfield

J | **7** | **U.S.C.T.**

William V Smith

Capt, Co. G, 7 Reg't U. S. Col'd Infantry.

Appears on

Company Muster Roll

for *Mar & Apr*, 186 *6*

Present or absent *Absent*

Stoppage, \$ *100* for

Due Gov't, \$ *100* for

Remarks: *Det on Genl Court Martial per SO 106 Hd qrs Dept of Louisiana New Orleans La Nov 4.65*

Book mark:

Hadfield

A | **7** | **U.S.C.T.**

William V Smith

Capt., Co. G, 7 Reg't U. S. Col'd Infantry.

Appears on

Company Muster Roll

for *May - June*, 186 *6*

Present or absent *absent*

Stoppage, \$ *100* for

Due Gov't, \$ *100* for

Remarks: *On leave of absence
per DO 122 Hd qrs mil
Div of the Gulf New Orleans
La June 4 1866*

Book mark:

Hadfield

1866 224

A | . 7 | **U.S.C.T.**

William Smith

Capt, Co. G, 7 Reg't U. S. Col'd Infantry.

Appears on

Company Muster Roll

for *July & aug*, 1866.

Present or absent *absent*

Stoppage, \$ *100* for

Due Gov't, \$ *100* for

Remarks: *Absent sick at Indianola Texas*

Book mark: _____

(858)

Ladfield

Copyist

William V. Smith
 Capt, Co. *G*, 7 Reg't U. S. Col'd Infantry.

Appears on **Co. Muster-out Roll**, dated
Indianola Texas, Oct 13, 1866.

Muster-out to date *Oct 13, 1866*.

Last paid to *May 3, 1866*.

Clothing account:

Last settled....., 186 ; drawn since \$..... 100

Due soldier \$..... 100; due U. S. \$..... 100

Am't for cloth'g in kind or money adv'd \$..... 100

Due U. S. for arms, equipments, &c., \$..... 100

Bounty paid \$..... 100; due \$..... 100

Remarks: *appointed Capt of*
U.S. A. Oct 8 1863 mus-
tered Oct 22/63 and as
signed to be absent
wounded from Sept 27
1864 to July 9 1865 detached
as ordnance officer for
over
 Book mark: *909 C. T. 82 407*
(over)

Hadfield

JAN. 21

6292302

1891

PO 177 Hd qrs lent. Dist
Texas Det on G. C. M. for
P. O. no 106 Hd qrs dept
La Nov 4 1865 absent
with 50 days leave for
PO 122 Hd qrs mil Div
Ist. June 4 1866 service
continuous

Book Mark:— G. C. M.

S 1 7 U.S.C.T.

William Vincent Smith
Capt. 7 Regt. U.S. Colored Troops.

Appears on

General Order

No. 65, dated War Department, Adjutant Gen-
eral's Office, June 22, 1867.

Appointed to be

Major

BY BREVET

in the Volunteer Force, Army of the United
States, for meritorious
services

To date from Oct. 27, 1865.

A. D. Moser

S | 7 U.S.C.T.

William Vincent Smith
Capt 7 Regt U.S. Cold Troops

Appears on

General Order

No. 67, dated War Department, Adjutant Gen-
eral's Office, July 16, 1867.

Appointed to be

Lieutenant Colonel

BY BREVET

in the Volunteer Force, Army of the United
States, for gallant and merito-
rious services

To date from Oct 27, 1865.

J. Williams
(400) **Copyist.**

S 1 7 base

William U. Smith

, Co. , 7 Reg USCY

NOTATION.

909-CY-188 with
Book mark: S 202-CY-1863

Record and Pension Office,

WAR DEPARTMENT,

Washington, April 5, 1898

Service also alleged in
44 Mass Inf and
18 Mass Inf.

Smith, Wm - V -

Capt, Co. G, 7 Reg't USCT.

1 ~~4~~ Enclosures.

Bed Cards	Descriptive Lists
Burial Records	Final Statements
Certs. of Dis. for Discharge	Furloughs
C. M. Charges	Med. Des. Lists
Med. Certificates 9	Orders 1

Other papers relating to—

Admission to Hosp'l	Furlough 3
Casualty Sheet (Officer's)	Med. Examination
Confinement	Misc. Information 4
Contracts	Pay or Clothing
Death or Effects	Personal Reports
Descriptions	Rank
Discharge from Hosp'l	Transfer to Hosp'l
Discharge from Service	Transfer to V. R. C.
Duty	Transportation

MICROFILM PUBLICATION M 1849

COMPILED MILITARY SERVICE RECORDS
OF VOLUNTEER UNION SOLDIERS WHO SERVED WITH
THE UNITED STATES COLORED TROOPS (USCT)
7TH REGIMENT OF INFANTRY

PERSONAL PAPERS' TARGET SHEET

PLEASE NOTE THE CHECKED INFORMATION ABOUT THE PERSONAL PAPERS IN
THIS FILE:



NO PERSONAL PAPERS WERE FOUND IN THIS FILE WHEN THE
RECORDS WERE ARRANGED FOR MICROFILMING.



20 PERSONAL PAPER(S) FOUND IN THIS FILE WHEN THE RECORDS
WERE ARRANGED FOR MICROFILMING.

S. 65. Lt L. A. B. Holt
Telegram.

Fort Monroe, Oct. 8, 1864.

W. E. Townsend

Requests leave of absence
for Capt: Wm V Smith
Coly. 4th U.S.C.S.

Note - In Telegram of
Oct. 7th to Mr.
W. E. Townsend,
A. W. Foster
a. a. g.

Very truly
Recd Wm. B. Oct. 8, 1864

Office U. S. Military Telegraph,
WAR DEPARTMENT.

The following Telegram received at Washington, 11:50 A. M. Oct 8 1864.

From Fort Monroe Oct 8 1864.

Brig Genl E D Townsend a a Genl
Capt Wm V Smith Co
of seventh (7) U S Colored troops is
able to leave hospital please send
leave of absence for him
W E Townsend

23 Cal



Major Foster Capt. I. is badly
wounded & ought to have a
sick leave - D. W. E. Townsend
went down to take him to his
home in Boston. Can it be arranged
here? E D T

U.S. Genl. Hosp
Fortune Mountain
October 9th 1864

E. M. Chellan U.S.A.
In charge Hospital

Certificate of Disability
in case of Capt. W. V. Smith
Co. G. 7th U.S. C. T.

Wm. Smith Capt. Co. G. 7th U.S. C. T. having
applied for a certificate on which to ground an
application for leave of absence, I do hereby certify
that I have carefully examined this Officer and
find that he is suffering from a Gun shot
Wound flesh of right Elbow and Gun shot wound
(flesh) of left shoulder received in action -

And that in consequence thereof he is in
my opinion, unfit for duty. I further declare
my belief that he will not be able to resume his
duties in a less period than thirty days -

Dated at
W. S. Gen. Hoop
Fortress Monroe Va
Officers Division
October 9th 1864

St. M. L. L. L.
Asst. Surgeon U. S. Army
In Charge Hospital

334-1864
S. S. of *Ermyles* Oct 11 1864
Fortress Monroe Va
October 9th 1864

Capt W. V. Smith Co. G.
7th U.S.C.T.

Requesting leave of
Absence for thirty days

Granted ~~not~~
on Surg certificate

286-7-1864

Rec'd M. D. O. B. Mans. 7th Oct 11 1864

1864 Oct. 11 1864

Medical Directors Office
Depts Va & N. C. in the field Oct 11th 1864
Respectfully forwarded
recommended to favorable
consideration

W. G. Buckley
Surg. U.S.A.
Actg. Med. Director

Rec'd M. D. O. Dept. Va & N. C. field Oct 11th 1864

W. V. Smith
Capt. 7th U.S.C.T.

U.S. General Hospital
Fortuez Monroe Va.
October 9th 1864

Major R. S. Davis
Asst. Adjt. Genl.
Sir

I have the honor to
request a Leave of Absence for twenty days
grounded upon the accompanying Surgeons
Certificate -

Yours
Very Respectfully
Wm. V. Smith

Wm. V. Smith
Capt. Co G. 7th U.S. Col. Inf.

523-449-101, after first use. 5 Dr. 10th
Nov 5. 1864

Order Council of
Col. Comdy 1st Reg.
3rd Div. 10th Ab.

Calls attention to the fact
that all the officers of the 7th Reg.
who participated in the charge
on Fort Gilmer on 29th Sept.
have been mentioned in Gen's
orders, with the exception of
Capt. W. V. Smith 7th Reg. Inf.
Captain Smith has always
proved himself to be a faithful
& gallant officer. And in the
charge above mentioned he
was wounded three times
before quitting the field &c.

(15)



file

A. J. C. 200, 8th Div.
No. 3rd Div. 10th Ab. Nov. 7. 1864

No. 3rd Div. 10th Ab.

November 7. 1864.

Approved and resp. forward-
ed. The gallant conduct of Cap-
tain W. V. Smith, 7th U. S. C. I.,
in the assault on Fort Gilmer, Sep-
tember 29th, 1864, is fully proved
by numerous witnesses. He merits
a mention in Gen. Orders.

Wm. Birney,
Brig. General (Inf)

Head Quarters 10th Ab.
Lutherfield Va. Nov. 7
(L. B. 2577)

Respectfully forwarded.

A. A. Ames,
Brig. Genl.

NARA 239
7
Wd Liz 1st Brigade
3^d Div U.C. Nov. 5. 1864.

Capt M. Bailey.
A.A. Genl.

Sir.

I have this day seen
the order from Wd Liz Dept Va & N.C. dated
Oct 11. 1864. Containing list of promotions and
honorable mention for meritorious conduct.

All the officers of the Companies of the 7th U.S.C.I.
who participated in the charge were mentioned
with one exception, Capt Wm Vincent Smith,
and I take the liberty of calling the attention
of the General Com^d to the omission believe-
ing that it must have been accidental.

Capt Smith has always proved himself both
in camp and in the field a competent, faith-
ful and gallant officer. On the 29th of Sept
while leading his company he was twice woun-
ded and still pressed on, untill he received
the third, when he fell and was carried to
the rear. He has ^{since} been in hospital

and I fear will long be a great sufferer.

I am Sir

Very respectfully

Your Obedt Servt.

James Shaw

Coe Comdy.

I

S. 214, P.O. # 1865.

U.S. Gen: Hospital

Fort Monroe Va. Feb: 10: 1865.

E. M. Blewett - Asst: Surgeon - U.S.A.

Certificate of Disability in case of Captain
Wm V. Smith - Co: 6 - 4th U.S. I. L.

Captain Wm J. Smith - Co: G - 1st U.S.C.S. having applied for a certificate on which to base an application for leave of absence. I do hereby certify that I have carefully examined this Officer and find him suffering from gun shot wounds of right elbow and left shoulder, received in action. And that in consequence thereof he is, in my opinion unfit for duty. I further declare my belief that he will not be able to resume his duties in a less period than twenty days. Said Officer is sufficiently convalescent to bear transportation.

U. S. General Hospital }
St. Louis, Mo Feb: 16th 1865.

E. M. Collins
Lieut: Surgeon, U.S.A.
On charge Hospital.

Ms V Smith
Capt. 7th U.S.C. I.

H. Q. Dept of Va Army of James

In the field. Va. Feb 14th 1865.

Special Order
No 45 (Extract)

Leaves of absence to go out of the
Dept are hereby granted to the following named
Officers ~~is~~ on Surgeons Certificate of disability
from wounds received in action
Captain W. B. Smith, 7th W. S. C. (for 20) days.

By Command of Maj Gen Ord
15d) E. B. Smith
A. A. G.
Official
J. B. Evans,
Capt Am A. A. G.

Recd H. Q. 25th Div 28th Feb 16th 1865.

Wm V. Smith
Capt. G. Y. U. S. A.

1 Dr. Ameyres

Recorded

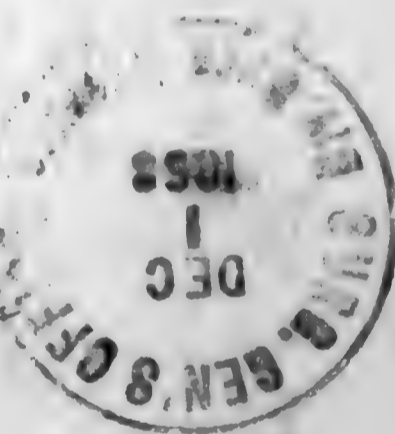

Captain W^m J. Smith

Co. G of the 7th

Regiment U. S. Col^d 60th having applied for a certificate on which to ground an application

for leave of absence, I do hereby certify that I have carefully examined this officer and find that* he is
invalided in Boston Mass. suffering from excision of
right humerus (lower third) the result of a gun shot wound
received at the Siege of Petersburg Va. Sep^r 26th 1865. Wound
still tender and painful. Period of recovery uncertain.

Date of original leave July 24, for twenty days -

And that in consequence thereof, he is, in my opinion, unfit for duty. I further declare my belief that he
will not be able to resume his duties in a less period than † Twenty days, from March 19th 1865
and is unable to travel without incurring the risk of permanent disability.

Left Dep^t 28. 1865 -

Dated at Boston, this 17th day of March 1865.

Approved

A. M. M. Loren

Surgeon Major
Medical Director

Wm Hall A. S. U. S. G.

* Here the nature of the disease, wound, or disability, is to be fully stated, and the period during which the officer has suffered under its effects.

† Here state, candidly and explicitly, the opinion as to the period which will probably elapse before the officer will be able to resume his duties. Where there is no reason to expect a recovery, or when the prospect of a recovery is distant and uncertain, it must be so stated.

[This certificate to be made out in triplicate.]

I. 28. 1865.

Boston, Mass.
March 17 1865.

W. V. Smith
Captain 4th U. S. C. Troops.

Forwards Surgeons
certificate of disability.

Recd N. C. March 20 1865.

Captain *Wm J. Smith*

Co. *G* of the *7th*

Regiment *U.S. Col. 70th*

having applied for a certificate on which to ground an application

for leave of absence, I do hereby certify that I have carefully examined this officer and find that* *he is*
invalided in Boston Mass. suffering from excision of
right humerus (lower third) the result of a gun shot wound
received at the siege of Petersburg Sept. 29. 1865. Wound still
tender and painful. Period of recovery uncertain.

Date of Original leave February 14. 1865 for thirty days:

And that in consequence thereof, he is, in my opinion, unfit for duty. I further declare my belief that he

will not be able to resume his duties in a less period than† *thirty* days, *from Mar 19. 65*

and is unable to travel without incurring the risk of permanent disability.

Sgt. Dep^t February 28. 1865.

Dated at *Boston*, this *17th* day of *March* 1865

Approved

A. M. Cullen
Surgeon U.S.A.
Medical Director

Wm. D. Hall *Adj. S. U.S.A.*

* Here the nature of the disease, wound, or disability, is to be fully stated, and the period during which the officer has suffered under its effects.

† Here state, candidly and explicitly, the opinion as to the period which will probably elapse before the officer will be able to resume his duties. Where there is no reason to expect a recovery, or when the prospect of a recovery is distant and uncertain, it must be so stated.

Wm. V. Smith
Capt. G. Y. U. S. C. V.

1 Dir Annapolis



Recorded.

Cap^t. Wm V. Smith

Co. G. of the 7th

Regiment U. S. Cal^d. Vol^s

having applied for a certificate on which to ground an application

for leave of absence, I do hereby certify that I have carefully examined this officer and find that* he is
invalided in Boston Mass. suffering from division of
right humerus (lower third) the result of a gun shot
wound received at the siege of Petersburg Va. Sept^r
29th 1864. Arm still painful and tender. Period of recovery
uncertain. Date of original loss July 24th 65. for many days.

And that in consequence thereof, he is, in my opinion, unfit for duty. I further declare my belief that he

will not be able to resume his duties in a less period than†

Twenty days, from April 8th 65.

and is unable to travel without incurring the risk of permanent disability.

Left Dept. July 28th 1865.

Dated at

Boston

, this

7th

day of

April 1865.

Approved

A. M. Carey

Surgeon U. S. A.

Medical Director

Wm. D. Hall A. A. S. M. D.

* Here the nature of the disease, wound, or disability, is to be fully stated, and the period during which the officer has suffered under its effects.

† Here state, candidly and explicitly, the opinion as to the period which will probably elapse before the officer will be able to resume his duties. Where there is no reason to expect a recovery, or when the prospect of a recovery is distant and uncertain, it must be so stated.

936. 22 LAB. 1865.

Boston. Mass.

April 7th 1865.

Capt Wm S Smith.
7th U. S. G. U. T.

Certificate of disability

Recd at 0 a.m. 10th 65

Capt. Amos V. Smith

Co. C of the 7th

Regiment U.S. Col. Vols. having applied for a certificate on which to ground an application for leave of absence, I do hereby certify that I have carefully examined this officer and find that*

he is invalided in Boston, Mass. suffering from excision of right humerus (lower third) the result of a gun shot wound received at the siege of Petersburg. Va. Sep 29/1864 - arm still painful and tender. Period of recovery uncertain. Date of original leave Feb 24/65 - for twenty days.

And that in consequence thereof, he is, in my opinion, unfit for duty. I further declare my belief that he will not be able to resume his duties in a less period than†

Twenty days, from April 8/65

and is unable to travel without incurring the risk of permanent disability.

Left Dept. July 28th 1865.

Dated at *Boston*, this *7th* day of *April 1865.*

approved

A. M. M. Loren
Surgeon U.S.A.
Medical Director

Wm. D. Ball A.A.S. U.S.A.

* Here the nature of the disease, wound, or disability, is to be fully stated, and the period during which the officer has suffered under its effects.

† Here state, candidly and explicitly, the opinion as to the period which will probably elapse before the officer will be able to resume his duties. Where there is no reason to expect a recovery, or when the prospect of a recovery is distant and uncertain, it must be so stated.

S. 42. 1865.

Boston, Mass.

April 27 1865.

Capt. Wm V. Smith
7th U. S. Colored Troops.

Surgeon's certificate

Recd A.G.O. 2 May 1. 1865.

Captain W^m V. Smith

Regiment Mass. Col. 50th Co. I of the 7th
having applied for a certificate on which to ground an application

for leave of absence, I do hereby certify that I have carefully examined this officer and find that* he is
invalided in Boston, Mass., suffering from excision
of right humerus (lower third) the result of a gun shot
wound received at the Siege of Petersburg 8th Sept 29 1864.
Wound still troublesome. Period of recovery uncertain.
Original leave dated Feb. 24 1865.

And that in consequence thereof, he is, in my opinion, unfit for duty. I further declare my belief that he
will not be able to resume his duties in a less period than Twenty days, from April 28/65
and is unable to travel without incurring the risk of permanent disability.

Dated at

Boston

, this 27th day of April 1865.

Approved,

A. M. M. Loren
Surgeon, U.S.A.
Medical Director.

Wm. P. Hooker
W^m Surg Genl. Mass

* Here the nature of the disease, wound, or disability, is to be fully stated, and the period during which the officer has suffered under its effects.

† Here state, candidly and explicitly, the opinion as to the period which will probably elapse before the officer will be able to resume his duties. Where there is no reason to expect a recovery, or when the prospect of a recovery is distant and uncertain, it must be so stated.

[This certificate to be made out in triplicate.]

NARA 255
M.D. Q^o 7th Regt Troops
Camp "Lincoln," Va May 22

Grange Henry
Asst. Surgeon 7th Regt. T.

Surgeon's Certificate on
which to ground an appli-
cation for Leave of Absence
on the part of Capt. Wm. H.
Smith, 7th Regt. T.

Camp 7, Regiment U.S.C.
1st Brigade 2d Div, 25th Ab.
22^d May 1865

Captain William V. Smith. 7th Regt
U.S.C. having applied for a certificate on
which to ground, an application for leave of
absence. I do hereby certify that I have carefully
examined this officer and find that he
suffers from "Necrosis of the ulna" the result
of a gun shot wound, received on the 29th
September 1864. His right arm is swollen
and at present useless. and that in consequence
thereof he is in my opinion unfit for duty
I further declare my belief that he will not
be able to resume his duties in a less period
than thirty days — I consider a change of
climate necessary for the more speedy

care of the deceased man, and in order
to save his life

Henry Prange
Asst Surgeon in charge
of 7th Regt WCT

No. 50 (copy) 1st Brig 2nd Div

Camp Lincoln Va
May 22nd 1865

Smith W. V.

Capt. T. M. G. S.
A. S. L. C. 1st Brig 2nd Div 24th Regt

Requests a leave of absence
of 30 days based on Surgeon's
Certificate of ^{physical} disability

One Enclosure.

Grant

S. O. 140 May 24.
2

Smith 1st Brig 2nd Div
25th Regt.

Co. 7th Regt. 5th Div
MAY 23 1865

Adj. Gen. 1st Brig 2nd Div 20th ac
Camp Lincoln, Va. May 22nd 65

Respectfully forwarded

W. Barry

Co. 8th Regt 1st Brig
2nd Div
May 22/65
Respectfully forwarded

James Shaw for
copy used
etc.

L. 85-25th ab. 1865
A. S. L. C. 1st Brig 2nd Div

Camp Lincoln Va.

May 23rd 1865.

Respectfully forwarded
Approved.

G. W. Taylor

Major General Commanding

W. T. Smith
Capt. 7th Mass

76th Inf^y 1st Brig. 2nd Div. 25th A.C.
May 2nd 1865

Maj: L. L. Wheeler
A. A. Gil 25th A.C.

Major:

I have the honor to request a leave of absence of thirty days, to go north (Mass.) on account of poor health. Would respectfully call attention to the enclosed Surgeons certificate.

Very Respectfully
Your obt-Servt-

Wm V. Smith
Capt. 7th N.S.C. & A. S. Co
1st Brig 2nd Div. 25th A.C.

Wm J. Smith
Capt. 7th U.S. C. I.

WAR 261
Hd. Qrs Dept of War
Army of the James
Richmond, Va. May 24 1868

Special Order
No 140

Leaves of absence to go out of
the Dept are hereby granted to the following
named officers.

Capt H. V. Smith ^{Atty. Gen.} U.S.C.T. for 30 days

Official
R. G. Shannon
A. A. G.

By Command of Maj Gen Ord
S. C. Mearns
A. A. G.

Recd May 29 1868

WAR 262
Hd Quarters Mil Div of the Gulf.
New Orleans Oct 28th 1863.

Sheridan, P. H.
Maj Genl Comd.
By George Lee.
A. A. Genl.

Issues S. O. No 91
Capt W. V. Smith 7th U.
S. Colored Inf being unfit
for field duty is hereby
ordered to report to Maj
Genl E. R. S. Canby. For
assignment to light duty.

Filed 12/1/93

Head Quarters Military Division of the Gulf
Special Orders }
No 91 }
New Orleans La. October 28th 1865

Extract

11th — Captain Wm W. Smith 4th U. S. Colored Infantry being unfit for service in the field is hereby ordered to report to Major General E. K. S. Canby, commanding Department of Louisiana for assignment to light duty.

By Command of Major General P. N. Sheridan
George Lee,
Official Byron Porter, Assistant-Adjutant-General
Capt ad. ls.

~~201 of 1865~~
U. S. Gen. Supt.
S. 214, ~~1865~~
Fort Monroe, Va. 9-1865

Wm V. Smith. Capt. Co. 4th U.S. I. S.

Application for Leave of Absence
No 451 Feb 14. 1865

Wm V. Smith, Capt. Co. 4th U.S. I. S.
11th February 1865.

Copy forwarded, approved,
(and enclosure)
John H. Sweeney
Asst Surg U.S.A.
Act Asst Med Dir
Dept of War.

Wm V. Smith, Army of James
In the field 7th 13th July 65

Respectfully forwarded
and approved

Wm V. Smith
Surg. Major
13th Med. Director
Recd. Wm V. Smith 12th July 65
Wm V. Smith, Va. 11 Feb 1865



Wm V. Smith
Capt. 7th U.S. I. S.

Wm V. Smith

NARA 265
Office Division
U. S. General Hospital
Fortress Monroe Va.
February 9th 1866-

Colonel -

I have the honor to make application for a
Grant of Absence, based on the accompanying Surgeon's Certificate
of Disability -

Very respectfully
Your obedt. servt -
William W. Smith
Capt: Co: 5th U.S.C.S.

Deut - Col: E. W. Smith.
Asst: Adjutant General
Department of Virginia -

MS 5165
New Orleans, La.

May 31 / 11

S 129 La 1813

D. O. June 2nd 1866

Smith. Mar. T.

Capt. 7th U.S. C. G.

File

Requests to be
relieved from duty
in this Department
of Louisiana

Hq. Ins Dept. La
New Orleans May 31/11

Respectfully forwarded
approved

A. J. Smith
Acty May 31
1866

NARA 267
New Orleans, La.

May 3. - 1866

Lieut Nathaniel Burbank
Actg. Asst. Adjt. Genl.
Lieutenant,

I would respectfully
request to be relieved from temporary
duty in this Department.

I am a member of a
General Court Mutual Company in this
City - by S. D. No. 87. par 2. Department
of Louisiana.

I am, Lieutenant
Very respectfully,
Your obedient servant
William V. Smith
Capt U. S. C. I.

S. S. Adams
50 Days

50 days

Request to be
of advance for
days, with
to apply for an
of thirty days -

Smith, H. T.
Capt. U.S.A.

Wm. S. Adams, Jr.
New Orleans, La.
June 4th 1844

DRB. 3" 169
New Orleans, La.
June 4th 1866.

Smith, H. V.

Capt. U.S.A.

Request - leave
of absence for twenty
days with permission
to apply for an extension
of thirty days -

50 days

S. J. [unclear] 66
50 Day

NARA 269
New Orleans, La.
June 4th 1861.

Lieut. Col. George Lee
Apt. Adjt. Genl.
Division of the Gulf
Colonel.

I have the honor to apply
for leave of absence for twenty days
with permission to apply for an extension
of thirty days, on account of sickness
in my family at home and urgent
private business.

I have not had a leave
of absence for a year.

I have the honor to be, Colonel

Very respectfully

Your obedient servant
William V. Smith
Capt. U.S.A.

S. Y. W. LAB. 1866

Boston. Mass. July 17th 1866.

William T. Smith
Capt. 4th U. S. C. Troop

Surgeons certificate.

12
file

Rec'd. ass. July 19th 1866

William J. Smith Capt. Co. G of the Seventh
Regiment U.S.C.A. having applied for a certificate on which to ground an application

for leave of absence, I do hereby certify that I have carefully examined this officer, and find that*

He is suffering from functional derangement of the
Liver accompanied by loss of appetite wakefulness &
debility

And that, in consequence thereof, he is, in my opinion, unfit for duty. I further declare my belief that he
will not be able to resume his duties in a less period than† Twenty days, from July. 24/06
and is unable to travel without incurring the risk of permanent disability.

Dated at Boston Mass, this 17th day of July 1866

Approved: A. M. Lawrence Surgeon U.S.A. Medical Director
W. E. Townsend
a. e. S. J. C. J. A.

* Here the nature of the disease, wound, or disability, is to be fully stated, and the period during which the officer has suffered under its effects.

† Here state, candidly and explicitly, the opinion as to the period which will probably elapse before the officer will be able to resume his duties. Where there is no reason to expect a recovery, or when the prospect of a recovery is distant and uncertain, it must be so stated.

[This certificate to be made out in triplicate.]

NEW ORLEANS, LA.
NOV 2^a 1866
L. P. S. 93-94.

Smith W. V.

Capt 7th U.S. Col. Troop.

Requests to be
furnished with
transportation from
New Orleans, La. to
Baltimore, Md.

See Special Order No 1, 66

Fee - S. O. Jan. 1, 66 -

New Orleans, La
November 2^d /66

Lt Col J. S. Crosby
A. A. Genl.
Dept of Gulf.
Colonel.

I have the honor to state that on the departure of my Regt from Texas to the place of its disbandment at Baltimore Md. I was left behind sick at Post Hospital being unable to travel. I have the honor therefore to request transportation from this City to Baltimore Md.

I certify on honor that I may not be mustered out to remain South and that I have not been furnished with transportation for transportation.

I have the honor to be,

Very respectfully, Your obedient Servant
William T. Smith
Capt 7th U.S. Col Troops

1245

Snowden Benjamin

Co. C, 7 U.S. Col'd Inf.

Private Private

CARD NUMBERS.

1	6278882	26
2	6278996	27
3	6284598	28
4	6284707	29
5	6284809	30
6	6284902	31
7	6284990	32
8	6285074	33
9	6285154	34
10	6285363	35
11	6299528	36
12	9066234	37
13		38
14		39
15		40
16		41
17		42
18		43
19		44
20		45
21		46
22		47
23		48
24		49
25		50

Book Mark:

See also

A 1407 503 - *Quinn*

S

7

U.S.C.T.

Benjamin Snowden

, Co. *C*, 7 Reg't U.S. Col'd Inf.

Appears on

Company Descriptive Book

of the organization named above.

DESCRIPTION.

Age *39* years; height *5* feet *1/2* inches.

Complexion *Black*,

Eyes *Black*; hair *Black*

Where born *Howard, Alabama*

Occupation *Laborer*.

ENLISTMENT.

When *March 4*, 1865.

Where *Ellicott, Mills.*

By whom *Capt Holland*; term *1* y'rs.

Remarks: *Substitute for Dr. A. G.*

Luthean 5" Dist. Del.

*Mustered out by reason
of expiration of term of
service at Indianola Texas,
March 4, 66.*

J. Smith

0 1 7 U.S.C.T.

Benjamin Snowden
Bat., Co., 7 Reg't U. S. Col'd

Age 39 years.

Appears on a

Detachment Muster-in Roll

of the organization named above. Roll dated
Baltimore Md., Mch 16, 1865.

Muster-in to date Mch 7, 1865.

Joined for duty and enrolled:

When Mch 4, 1865.

Where S. Mills, Md.

Period 1 years.

Valuation of horse, \$ 100

Valuation of horse equipments, \$ 100

Remarks: *Substituted*

Book mark:

Hammond

7 Reg^x U.S.C.T.

Benjamin Snowden
Appears with rank of Private on

Muster and Descriptive Roll of a Detachment of Substitutes forwarded

for the 7 Reg't U. S. Col'd Inf. Roll dated
Baltimore Md, March 16, 1865

Where born Hoboken

Age 39 y'rs; occupation Laborer

When enlisted March 4th, 1865

Where enlisted E Mills

For what period enlisted one years.

Eyes Blue; hair Blue

Complexion Brown; height 5 ft. 5 1/2 in.

When mustered in _____, 1865

Where mustered in _____

Bounty paid \$ 100; due \$ 100

Where credited _____

Company to which assigned _____

Remarks: Substitute for
Dr. A. J. Lithcum
5th Dist Md.

Book mark: _____

(339) J. Scherley Copyist

S | 7 | U.S.C.T.

Benjamin Snowden
Sgt., Co. C, 7 Reg't U. S. Col'd Infantry.

Appears on

Company Muster Roll
for Mar. 7 Apr. 1865.

Joined for duty and enrolled:

When Mar. 4th, 1865.*

Where Howard Co. *

Period one years.*

Present or absent Present

Stoppage, \$ 100 for

Due Gov't \$ 100 for

Remarks: Joined Co. Mar. 18th
1865

* See enrollment on card from muster-in roll.

Book mark:

M. M. Murphy
(358c) Copyist.

S | **7** | **U.S.C.T.**

Benjamin Snowden
Priv., Co. C, 7 Reg't U. S. Col'd Infantry.

Appears on

Company Muster Roll

for *May 7 June*, 1865.

Joined for duty and enrolled:

When *Mar. 4*, 1865.*

Where *Howard**

Period *one* years.*

Present or absent *Present*

Stoppage, \$ *100* for

Due Gov't \$ *100* for

Remarks: *joined Co. Mar. 18/65*

* See enrollment on card from muster-in roll.

Book mark:

M. M. Murphy

S | 7 | U.S.C.T.

Benjamin Snowden
Sgt., Co. C, 7 Reg't U. S. Col'd Infantry.

Appears on

Company Muster Roll

for July & Aug., 1865.

Joined for duty and enrolled:

When Mar. 4, 1865.*

Where Howard *

Period one years.*

Present or absent Present

Stoppage, \$ 1.00 for

Due Gov't \$ 1.00 for

Remarks: Due the soldier
U. S. Army \$5.25.00

* See enrollment on card from muster-in roll.

Book mark:

M. M. Murphy
Copyist.

S

7

U.S.C.T.

Benjamin Snowden
Priv., Co. C, 7 Reg't U. S. Col'd Infantry.

Appears on

Company Muster Roll
for Sept. & Oct., 1865.

Joined for duty and enrolled:

When Mar. 4", 1865.*

Where Ellicott Mills, Md. *

Period one years.*

Present or absent Present

Stoppage, \$ 100 for

Due Gov't \$ 100 for

Remarks: Due the soldier
U. S. Bounty \$525.00

* See enrollment on card from muster-in roll.

Book mark:

(358c)

M. M. Murphy
Copyist.

S. | 7 | U.S.C.T.

Benjamin Sworden
Pr., Co. C, 7 Reg't U. S. Col'd Infantry.

Appears on

Company Muster Roll

for Nov & Dec, 1865.

Joined for duty and enrolled:

When Mch 4, 1865*

Where Elliott's Mill *

Period 3 years.*

Present or absent Present.

Stoppage, \$ 100 for

Due Gov't \$ 100 for

Remarks Due the soldier
U.S. Bounty \$ 52.50

* See enrollment on card from muster-in roll.

Book mark:

(858c) Lopez Copyist.

MARR 294

S. | **7** | **U.S.C.T.**

Benjamin Snodden

Prvt., Co. C, 7 Reg't U. S. Col'd Infantry.

Appears on

Company Muster Roll

for *Jan & Feb*, 186*6*

Joined for duty and enrolled:

When *March 4*, 186*5**

Where *Ellicott's Mill**

Period *1* years.*

Present or absent *Present.*

Stoppage, \$ *100* for

Due Gov't \$ *100* for

Remarks:

* ~~45~~ See enrollment on card from muster-in roll.

Book mark: *Muster out on file*

(358c)

Lopez.

Copyist.

S | 7 | U.S.C.T.

Benjamin Swordon
Pr, Co. C, 7 Reg't U. S. Col'd Infantry.

Appears on

Company Muster Roll

for *Mich + Apl*, 1866

Joined for duty and enrolled:

When *Mich. 4*, 1865*

Where *Ellicott's Mill**

Period *1* years*

Present or absent

Stoppage, \$ *100* for

Due Gov't \$ *100* for

Remarks: *Discharged by reason of expiration of term of service*

* See enrollment on card from muster-in roll.

Book mark:

(358c)

Lopez
Copyist.

S | 7 | U.S.C.T.

Benjamin Snowdon
Pr't, Co. *C*, 7 Reg't U. S. Col'd Infantry.

Appears on **Co. Muster-out Roll**, dated
Indianola Texas, Oct 13, 1866.

Muster-out to date _____, 186 .
Last paid to *Dec 31*, 186 *5*.

Clothing account:

Last settled _____, 186 ; drawn since \$ _____ 100
Due soldier \$ _____ 100; due U. S. \$ _____ 100
Am't for cloth'g in kind or money adv'd \$ _____ 100
Due U. S. for arms, equipments, &c., \$ _____ 100
Bounty paid \$ _____ 100; due \$ _____ 100

Remarks: *Mustered out at*
Indianola Texas Mar. 4
'66 at expiration of term.

Book mark: *332-33*

(361) *Lopez* Copyist.

S 7 U.S.C.T.

Benjamin Snowden,
Capt., Co. C, 7th Reg't U. S. Col'd Infantry.

Appears on a

Detachment Muster-out Roll

of the organization named above. Roll dated

Victoria Texas Mar. 4, 1866.

Muster-out to date Mar. 4, 1866.

Last paid to Dec. 31, 1865

Clothing account:

Last settled _____, 1866 ; drawn since \$ _____ 100

Due soldier \$11 ⁰³/₁₀₀; due U. S. \$ _____ 100

Am't for cloth'g in kind or money adv'd \$ _____ 100

Due U. S. for arms, equipments, &c., \$ _____ 100

Bounty paid \$None 100 due \$None 100

Remarks: Entered the service as
a substitute for D. A. S.
Lutheran 5" Dist Det.
Mustered out by reason
of expiration of term of
service. (over)

Book mark: _____

(349)

Jenkins
Copyist.

JAN. 20

6279528

1891

Entitled to travel-time,
and subsistence to
place of destination
from Indianola Texas.

1246

Snowden John

Co *G*, 7 U.S. Col'd Inf.

Corporal | *Corporal*

CARD NUMBERS.

1	6290919	26
2	6291017	27
3	6291118	28
4	6291296	29
5	6291394	30
6	6291493	31
7	6291590	32
8	6291703	33
9	6291803	34
10	62919259	35
11	6291875	36
12	6291944	37
13	6292012	38
14	6292041	39
15	6292103	40
16	6292161	41
17	6292219	42
18	6292267	43
19	6292315	44
20	9066714	45
21		46
22		47
23		48
24		49
25		50

Book Mark:

See also

R + P 39.4293

S. 1 4 U.S.C.T.

John Snowden
Co. G, 7 Reg't U.S. Col'd Inf.

Appears on
Company Descriptive Book
of the organization named above.

DESCRIPTION.

Age 21 years; height 5 feet 4 1/2 inches.

Complexion *Blk*

Eyes *Blk*; hair *Curly*

Where born *Charles Mt*

Occupation *Farmer*

ENLISTMENT.

When *Oct 2*, 186 .

Where *Calvert*

By whom *Col W. Perry*; term *3* y'rs.

Remarks: *Promoted Corporal
Nov 1863. Reduced to
rank of Pvt 23rd Oct.
incompetency. Missing
in action Sept 29th 64.
A prisoner of war until
March 65- returned to duty.
Mustered into service Nov
5th 63 by Col Wm. Perry at
Benedict Mt.*

J. Brown

S

7

U.S.C.T.

John Snowden

Corp., Co. *G*, 7 Reg't U. S. Col'd Inf.

Age *21* years.

Appears on

Company Muster-in Roll

of the organization named above. Roll dated

Camp Stanton, Charles Co., Md., Nov. 5, 1863.

Muster-in to date

Nov. 5, 1863.

Joined for duty and enrolled:

When *Oct. 21*, 1863.

Where *Calvert Md.*

Period *3* years.

Remarks:

Book mark:

Sandy

Oppt.

(856)

S

7

U.S.C.T.

John Snowden
Capt., Co. G, 7 Reg't U. S. Col'd Infantry.

Appears on

Company Muster Roll

for *Nov. 5 to Dec. 31*, 1863.

Present or absent *Present*

Stoppage, \$ *100* for

Due Gov't, \$ *100* for

Remarks: *Premium for en-*
listment \$2.00 (due).

Book mark:

(858)

Sandoz
Cpyist

S | 7 | U.S.C.T.

John Snowden
Corp., Co. G, 7 Reg't U. S. Col'd Infantry.

Appears on

Company Muster Roll

for *Jan. 7* *Feby*, 186 *4*.

Present or absent *Present*

Stoppage, \$ 100 for

Due Gov't, \$ 100 for

Remarks:

Book mark:

(858)

Sandoz
Copyist

S | 7 | U.S.C.T.

John Snowden

Priv., Co. G, 7 Reg't U. S. Col'd Infantry.

Appears on

Company Muster Roll

for *Mch. & Apr.*, 1864

Present or absent *Present*

Stoppage, \$ *100* for

Due Gov't, \$ *100* for

Remarks: *Reduced to the ranks March 23, 1864, for disobedience of orders.*

Book mark:

(858)

Sandoy
Copyist

S

7

U.S.C.T.

John Snowden
Priv., Co. G, 7 Reg't U. S. Col'd Infantry.

Appears on

Company Muster Roll

for May & June, 1864.

Present or absent Present.

Stoppage, \$ 100 for

Due Gov't, \$ 100 for

Remarks:

Book mark:

Sandoz.
Copyist

S | 7 | U.S.C.T.

John Snowden
Priv., Co. G, 7 Reg't U. S. Col'd Infantry.

Appears on

Company Muster Roll

for *July & Aug.*, 1864.

Present or absent *Present.*

Stoppage, \$ 100 for

Due Gov't, \$ 100 for

Remarks:

Book mark:

(858)

Gandog.
Copyist

G

7

U.S.C.T.

John Snowden
Priv., Co. G, 7 Reg't U. S. Col'd Infantry.

Appears on

Company Muster Roll

for *Sept. & Oct.*, 1864.

Present or absent *Absent*

Stoppage, \$ *100* for

Due Gov't, \$ *100* for

Remarks: *Missing in action*
Sept. 29", 1864.

Book mark:

J. J. Jandoz
Spyist

(858)

J

7

U.S.C.T.

John Snowdon
Pr, Co. G, 7 Reg't U. S. Col'd Infantry.

Appears on

Company Muster Roll

for *Nov + Dec*, 186 *4*

Present or absent

Stoppage, \$ 100 for

Due Gov't, \$ 100 for

Remarks:

Missing in action
Sept. 29, 64 + Omitted
to be dropped

Roll for Mar & Apr 65-
month on which name
appears

Book mark:

(858)

J. W. [Signature]

Copyist

S | **7** | **U.S.C.T.**

John Snowden
Pvt, Co. G, 7 Reg't U. S. Col'd Infantry.

Appears on

Company Muster Roll

for *March & April*, 186*2*.

Present or absent *Absent*

Stoppage, \$ *100* for

Due Gov't, \$ *100* for

Remarks:

*Gained from missing
in action absent with
leave,*

Book mark:

J. W. Ames
(858) Copyist

S | 7

U.S.C.T.

John Snowden
Prt, Co. G, 7 Reg't U. S. Col'd Infantry.

Appears on a

Detachment Muster Roll

of the organization named above

for *March & Apr*, 1865.

Station *Camp Parole, Annapolis, Md.*

Present or absent *Present*

Stoppage, \$ *100* for

Due Gov't, \$ *100* for

Remarks:

Book mark:

L. Y. Spann

S

7

U.S.C.T.

John Snowden
Private, Co. G, 7 Reg't U. S. Col'd Infantry.

Appears on

Company Muster Roll

for *May & June*, 186*2*

Present or absent *Present*

Stoppage, \$ *100* for

Due Gov't, \$ *100* for

Remarks:

*Stop for transportation
while on furlough \$1.00
Pd. \$32.00 by Wm. R. J.
Stevens Mar. 17/68.*

Book mark:

(858)

J. W. Case

Copyist

S | **7** | **U.S.C.T.**

John Snawden

Plt, Co. G, 7 Reg't U. S. Col'd Infantry.

Appears on

Company Muster Roll

for *July + Aug*, 1865.

Present or absent *Present*

Stoppage, \$ 100 for

Due Gov't, \$ 100 for

Remarks:

Book mark:

H. W. True

(858)

Copyist

S 7 U.S.C.T.

John Snowden
Sgt., Co. G, 7 Reg't U. S. Col'd Infantry.

Appears on

Company Muster Roll

for Sept + Oct, 1865

Present or absent Present

Stoppage, \$ 100 for

Due Gov't, \$ 100 for

Remarks:

Book mark:

J. W. Lives
(858) Copyist

MARR 385

S | 7 | U.S.C.T.

John Snowden
Capt, Co. G, 7 Reg't U. S. Col'd Infantry.

Appears on

Company Muster Roll

for *Nov. + Dec.*, 1865.

Present or absent *Present*

Stoppage, \$ *100* for

Due Gov't, \$ *100* for

Remarks:

*Appointed Capt from
Private per S.O. 106 Ad.
quos 7th U.S. C. I. Nov.
7/65.*

Book mark:

(858)

J. S. Snow

Copyist

S | 7 | U.S.C.T.

John Snowden
Cap, Co. G, 7 Reg't U. S. Col'd Infantry.

Appears on

Company Muster Roll

for Jan, Feb, 1866

Present or absent Present

Stoppage, \$ 100 for

Due Gov't, \$ 100 for

Remarks: Stop for Haver sack & lantern

Book mark:

Madgill

MARR 3 1867

A

7

U.S.C.T.

John Snowden
Co. G, 7 Reg't U. S. Col'd Infantry.

Appears on

Company Muster Roll

for *Mar & Apr*, 186*6*.

Present or absent *Present*

Stoppage, \$ *100* for

Due Gov't, \$ *100* for

Remarks:

Book mark: _____

Hadfield

(858)

Copyist

A

7

U.S.C.T.

John Snowden
Corp., Co. G, 7 Reg't U. S. Col'd Infantry.

Appears on

Company Muster Roll

for *May & June*, 1866.

Present or absent *Present*

Stoppage, \$ *100* for

Due Gov't, \$ *100* for

Remarks:

Book mark:

Hadfield

(858)

Copyist

S

7

U.S.C.T.

John Snowden

Corp, Co. G, 7 Reg't U. S. Col'd Infantry.

Appears on

Company Muster Roll

for *July & Aug*, 186*6*.

Present or absent *Present*

Stoppage, \$ *100* for

Due Gov't, \$ *100* for

Remarks:

Book mark:

Hadfield

(858)

Copyist

7 | **U.S.C.T.**

John Snowden

Capt, Co. *G*, 7 Reg't U. S. Col'd Infantry.

Appears on **Co. Muster-out Roll**, dated
Indianola Texas Oct 13, 1866 .

Muster-out to date *Oct 13*, 1866 .

Last paid to *June 30*, 1866 .

Clothing account:

Last settled....., 186 ; drawn since \$..... 100

Due soldier \$ *21*^{*46*}/₁₀₀; due U. S. \$..... 100

Am't for cloth'g in kind or money adv'd \$..... 100

Due U. S. for arms, equipments, &c., \$..... 100

Bounty paid \$..... 100; due \$ *150* 100

Remarks: *joined original organization promoted Corporal November 7 1865 absent wounded in the hands of the enemy from September 29 1864 to February 5 1865*

Book mark: *V. 164 P 266, 73*

Madgill

Snowden John
 P, Co. *G*, *7* Reg't *1st Inf*
 Enclosures.

Bed Cards	Final Statements
Burial Records	Furloughs or L. of A.
Certs. of Dis. for Discharge	Med. Certificates
C. M. Charges	Med. Des. Lists
Descriptive Lists	Orders
Discharge Certificates	Pris. of War Record /
Enlistment Papers	Resignations

Other papers relating to—

Admission to Hosp'l	Furlough or L. of A.
Casualty Sheet	Med. Examination
Confinement	Misc. Information
Contracts	Pay or Clothing
Death or Effects	Personal Reports
Desertion	Rank
Discharge from Hosp'l	Transfer to Hosp'l
Discharge from Service	Transfer to V. R. C.
Duty	Transportation

MEMORANDUM FROM PRISONER OF WAR RECORDS.

No. _____

(This blank to be used only in the arrangement of said records.)

NAME.	RANK.	ORGANIZATION.				INFORMATION OBTAINED FROM—				
		No. of Reg't.	State.	Arm of Service.	Co.	Records of—	Vol.	Page.	Vol.	Page.
<i>Snowden</i>				<i>Inf</i>		<i>OR</i>	<i>22</i>	<i>174</i>	<i>10</i>	<i>282</i>
<i>Snowden John P.</i>	<i>7</i>	<i>U. S.</i>	<i>CT.</i>	<i>Co.</i>	<i>OR</i>	<i>33</i>	<i>241</i>	<i>32</i>	<i>49</i>	
						<i>no</i>	<i>29</i>	<i>288</i>	<i>69</i>	<i>57</i>

Captured at *Deep Bottom* *Sept. 29*, 1864, confined at *Richmond, Va.*, *Sept 29*, 1864.
Sent to Salisbury N.C. Nov 24 64

Admitted to Hospital at _____
 where he died _____, 186____, of *confined at Goldsboro N.C.*
 Paroled at *N. C. Ferry N.C. Mar 4*, 1865; reported at *Camp Parole, Md.*, *March 14*, 1865.

R 3
ls. mar 13. 65
 Copied by *A. J. Owen*
slan owned by Maggie Snowden Belmont Co Md

(Record continued.)

Furloughed *men 18*, 1865, for *3* days; returned *Apr 18*, 1865;
deserted *To Regt May 3.65*, 1865

Adjutant General's Office,

, 18

This is accepted as referring to

Co. _____, Reg't _____

and records will be corrected accordingly.

Assistant Adjutant Gen'l.

MEMORANDUM FROM PRISONER OF WAR Copied by _____

1	6285 1000	
2	6285 000	
3	6285 700	
4	6285 800	
5	6287 194	
6	9066331	31
7		32
8		33
9		34
10		35
11		36
12		37
13		38
14		39
15		40
16		41
17		42
18		43
19		44
20		45
21		46
22		47
23		48
24		49
25		50

Book Mark:

See also

S

7

U.S.C.T.

Joseph Solson
Pot, Co. *D*, 7 Reg't U. S. Colored Inf.

Age *32* years.

Appears on

Company Muster-in Roll

of the organization named above. Roll dated

Baltimore Md., Sep 29, 186*3*.

Muster-in to date

Sep 29, 186*3*

Joined for duty and enrolled:

When *Sept 26*, 186*3*.*

Where *Queen Ann Co. Md.**

Period *3* years.*

Remarks:

*Muster-in roll shows enrollment of all men of this company as of same date. See enrollment on subsequent card or cards.

Book mark: *N. No. 97*

R. S. Shelton

S

7

U.S.C.T.

Joseph Salson
Col

, Co. D, 7 Reg't U. S. Col'd Infantry.

Appears on

Company Muster Roll

for from Sept 29. to Oct 31., 1863.

Joined for duty and enrolled:

When Sept 26, 1863.*

Where Queen Ann Co., Md.*

Period 3 years.*

Present or absent Present

Stoppage, \$ 100 for

Due Gov't \$ 100 for

Remarks:

* See enrollment on card from muster-in roll.

Book mark:

R B Shelton

(358c)

Copyist.

5

7

U.S.C.T.

Joseph Solson
Priv, Co. D, 7 Reg't U. S. Col'd Infantry.

Appears on

Company Muster Roll

for Nov & Dec, 1863.

Joined for duty and enrolled:

When Sept 26, 1863.*

Where Queen Ann Md.*

Period 3 years.*

Present or absent Present

Steppage, \$ 100 for

Due Gov't \$ 100 for

Remarks:

* See enrollment on card from muster-in roll.

Book mark:

R. S. Shelton

NARA 319

S | **7** | **U.S.C.T.**

Joseph Solson

Priv, Co. D, 7 Reg't U. S. Col'd Infantry.

Appears on

Company Muster Roll
for *Jan & Feb*, 1864.

Joined for duty and enrolled:

When *Sept 26*, 1863.*

Where *Queen Ann Md* *

Period *3* years.*

Present or absent -----

Stoppage, \$ *100* for -----

Due Gov't \$ *100* for -----

Remarks: *Died in hospital at
Benedict Md. Jan. 14, 64.
Final statement not rendered.*

* See enrollment on card from muster-in roll.

Bookmark: *V. 1 P 23 68*

Comptroller

R B Shelton

7

U.S.C.T.

Joseph Solsan

Plt., Co. *D.*, 7 Reg't U. S. Col'd Infantry.

Appears on **Co. Muster-out Roll**, dated
Indianola Texas, Oct 13, 186*6*.

Muster-out to date _____, 186 .

Last paid to *Dec 31*, 186*3*.

Clothing account:

Last settled _____, 186 ; drawn since \$ _____ ¹⁰⁰

Due soldier \$ _____ ¹⁰⁰; due U. S. \$ _____ ¹⁰⁰

Am't for cloth'g in kind or money adv'd \$ _____ ¹⁰⁰

Due U. S. for arms, equipments, &c., \$ _____ ¹⁰⁰

Bounty paid \$ _____ ¹⁰⁰; due \$ _____ ¹⁰⁰

Remarks: *Died at Benedict Md.*

Jan. 14. 64. of fever.

Final statements forwarded

Mch. 2-64.

Book mark: *V. 90. P. 145. 69. V. 1. P. 23. 68.*

P. V. 20. P. 189. 71. J.S.

Heard

Bolson, Joseph

P, Co. *D.*

7 Reg't U. S. C. Inf.

3 Enclosures.

Bed Cards.....	Descriptive Lists.....
Burial Records.....	Final Statements /.....
Certs. of Dis. for Discharge.....	Furloughs.....
C. M. Charges.....	Med. Des. Lists.....
Med. Certificates.....	Orders.....

Other papers relating to—

Admission to Hosp'l.....	Furlough.....
Casualty Sheet (Officer's).....	Med. Examination.....
Confinement.....	Misc. Information.....
Contracts.....	Pay or Clothing.....
Death or Effects /.....	Personal Reports.....
Desertions.....	Rank.....
Discharge from Hosp'l.....	Transfer to Hosp'l.....
Discharge from Service.....	Transfer to V. R. C.....
Duty.....	Transportation.....
	<i>Slave claim /</i>

MICROFILM PUBLICATION M 1849

COMPILED MILITARY SERVICE RECORDS
OF VOLUNTEER UNION SOLDIERS WHO SERVED WITH
THE UNITED STATES COLORED TROOPS (USCT)
7TH REGIMENT OF INFANTRY

PERSONAL PAPERS' TARGET SHEET

PLEASE NOTE THE CHECKED INFORMATION ABOUT THE PERSONAL PAPERS IN
THIS FILE:

- NO PERSONAL PAPERS WERE FOUND IN THIS FILE WHEN THE
RECORDS WERE ARRANGED FOR MICROFILMING.
- 8 PERSONAL PAPER(S) FOUND IN THIS FILE WHEN THE RECORDS
WERE ARRANGED FOR MICROFILMING.

Hergemath

102

1864
MAR 24

We the undersigned being
well acquainted with, Maria
Louise Hergemather and
knowing her actions and
sentiments hereby certify that
throughout the continuance of
of the Rebellion she was unquestion-
ably loyal to the Government
of the United States

Union Magistrate	G. W. Handy
Pro of Proo Master	Wm E. Bryan
Union Constable	Chas W. Kelley
Union Farmer	Wm H. Rice
Friend	Wm H. Ford
Spencer Dr. Rev	E. P. Jump

F.

CERTIFICATE OF AWARD OF THE BOARD OF CLAIMS.

Office of the Board of Claims
For Slaves Enlisted in the Service of the United States,

No 944

Baltimore Md.,

October 7th, 1865.

\$300-

We hereby certify, that Maria L. Sdergenrather, of Queen Anne's county, State of Maryland, having proved, under oath, her loyalty to the Constitution and Government of the United States, and established her title as to the ownership of Joseph Solson, a slave enlisted at Baltimore Md., on the 26th day of September, 1863, by Col. Wm. Binney, in the service of the United States, in the 7th Regiment of Colored Troops, Co. D, and having filed a valid Deed of Manumission and Release of Service of said slave, is entitled to the sum of Three Hundred dollars, which has been awarded to her by this Board as a remuneration for all claim to the future labor or service of said slave, under the provision of General Orders, War Department, No. 329, 1863.

Thos. Simmons, President of the Board.

Saml. Jones, Member of the Board.

Wm. W. Rop, Member of the Board.

To Col. C. W. Foster,

Chief of the Bureau for the
Organization of Colored Troops, Washington, D. C.

I hereby Certify, that the within is truly Copied
from Liber S. E. D. No. 1. one of the Land Records of
Queen Annes County.

In Testimony whereof. Thereto Sub-
scribe my name and the Seal of the
Circuit Court for Queen Annes County
Affix. this 19th day of March 1864
Samuel E. Dyott Clarke



13/10
11/11

NARA 327

Queen Annes County, to Wit. Be it remembered
that on the Nineteenth day of March in the year
of our Lord one Thousand Eight Hundred and Sixty
four, the following Deed of Manumission was
brought to be recorded to Wit;

Deed of manumission and release of Service.

Whereas my slave Joseph Tolson has enlisted in the
service of the United States; now, in consideration thereof,
I Maria L Hergenrather of Queen Annes County, State
of Maryland, do hereby, in consideration of said enlist-
ment, manumit, set free, and release the above-na-
med Joseph Tolson from all Service due me; his
Freedom to Commence from the 29th September 1863 the
date of his enlistment as aforesaid in the 7th Regiment
of Colored Troops, in the Service of the United States,

Witness my hand and Seal this Eleventh day of March
1864,

M. L. Hergenrather 

Witness:

Alas. S. Reed

Geo. W. Hollowfield

Charles W. Kelley

Queen Annes County,

State of Maryland Mar 11th 1864
11

Before me appeared this day Maria L Hergenrather and
acknowledged the above Deed of Manumission and release
of Service to be his free act and deed.

G. W. Handy J.P. 

State of Maryland Queen Annes County to Wit;

Deceptive List
of
Joseph Solson
on
Mm. - Megeurathu
No. 97.

A. S. O. Oct 17 '65.
I certify that the name
of Joseph Solson is borne
on the muster in Roll of
Co. D. 1st U. S. Inf. in
this Office. It is stated on
said Roll that he was
enrolled in Queenstown
Md.

Ed. Saggard
U. S. Army
M. D.

VOLUNTEER DESCRIPTIVE LIST and Account of Pay and Clothing of

No.	NAMES.	RANK.	DESCRIPTION.						WHERE BORN.		OCCUPATION.	ENROLLMENT (For Drafted Men.)	
			Years of age.	Eyes.	Hair.	Complexion.	Feet.	Inches.	State or Kingdom.	Town or county.		When	Where (Town and State)
	Joseph Solen		32	Blk	Curly	Blk	5	7	Mass	Queen Anne	Tasman	1863 Sept 26	Queen Anne

NOTES.

- 1..The amount of any extra pay for which the soldier may be mustered, or for which he may be entitled to Hospital Steward, etc., and which may be still due him, must be carefully noted.
- 2..In the column headed "BOUNTY PAID," must be entered the whole amount hitherto paid him; in that of "BOUNTY DUE," the whole amount yet due him. Bounty paid by State authorities, and not by the United States, will not be entered on this statement.
- 3..Stoppages for loss or damage done to arms, or other public property, must be noted, and the articles, and particular damage to each, specified. When stoppages are due, under sentence of a Court Martial, a transcript of the same must be entered here; and the amount already stopped must be carefully stated.
- 4..In every case of desertion, the date, and that of delivery, or apprehension, must be given, together with a correct transcript of the order of sentence or pardon.
- 5..A careful settlement of the man's CLOTHING ACCOUNT must be made, to date, and the amount DUE TO, or FROM him must be precisely stated.
- 6..Should the man have been engaged in any action or skirmish, it must be mentioned, together with date and place. A full and particular mention will be made of any wounds he may have received in action, or other injury, whilst in the line of his duty.
- 7..If the soldier is entitled to pay for the time he has been absent, and also to the time he has been mustered, he must certify to that fact on this list, and also to the time he has pay due for having been so mounted on his own horse.
- 8..When a soldier is furnished with final statements, his descriptive list, if he has one, should be taken up by the officer who gives the soldier these statements, and endorsed with a statement to that effect by the officer. This endorsement should exhibit a full statement of the time for which the soldier was allowed pay on his final statements, the clothing account, and all other charges against him or in his favor, so as to comprise a complete exhibit of his account. It will then be transmitted to the company commander of the soldier, who will enter all the data necessary to a full understanding of the soldier's account on the muster roll upon which the soldier's discharge is reported. The descriptive list will then be destroyed. The object of this is, that the remaining portion of the soldier's account may be settled upon the receipt of these muster rolls, and the soldier receive any pay or allowances that may be due him at the time of his discharge, and which may not appear on his final statements from the fact that his descriptive list is incomplete. These accounts for back pay, &c., are settled by the 2d Auditor of the Treasury Dep't.
- 9..Where a soldier dies in Hospital or on detached service, his descriptive list should be sent with his final statements to the Second Auditor, Washington, D. C.
- 10..Men drafted will be considered as mustered in from the draft, and will be mustered for pay on the usual rolls for the draft. On the same line as the soldier's name, under the heading "Duty and Enrolled,"—Commencement of First Payment by the heading "When Mustered in," will be given the date when drafted, or, if a substitute, when enlisted, (substitute must be given the place from which drafted, (or where enlisted;) under the heading "By whom Mustered in," will be given the name of the officer enlisting him. (When enlisted by the name of the Provost Marshal of the Enrollment District, State of Massachusetts.) Or if a name of the officer enlisting him. (When enlisted by the name of the Provost Marshal of the Enrollment District, State of Massachusetts.)
- 11..A separate descriptive list should, as a general rule, be given to each man, and must, in all cases, be signed by COMMISSIONER of the Enrollment District, and not by enlisted men acting as such.

[A. G. O. No. 93.]

Clothing of

Recruits in 4th U.S.C.T.

ENROLLED. (For Drafted Men, see note 10.)			MUSTERED IN. (For Drafted Men, see note 10.)				LAST PAID.		BOUNTY.	
When	Where (Town and State.)	By whom.	When	Where (Town and State.)	By whom. (In the case of drafted men, from what enrollment district.)	Period.	By paymaster.	To what time.	Paid \$ (See note 2.)	Due \$ (See note 2.)
1863 Sept 26	Queen Anne	Ed W. Barry	1862 Sept 29	Benedict	Ed W. Barry	Three years or upwards	—	—	—	—

... should be sent with his final statement in duplicate to the Auditor, Washington, D. C. ... will be considered as mustered in from the date of their ... will be mustered for pay on the usual rolls for Volunteers. ... line as the soldier's name, under the heading "Joined for ... rolled.—Commencement of First Payment by Time," will ... word drafted, or substitute, as the case may be; and under ... "When Mustered in," will be given the date when the sol- ... ed, or, if a substitute, when enlisted, (substitutes, under the ... Act, are mustered in by enlistment;) under "Where Mus- ... will be given the place from which drafted, (or if a substitute, ... ed,) under the heading "By whom Mustered in," will be ... o. of the Enrollment District from which he was drafted, ... te to which it belongs, thus: 4th D. Mass. (meaning 4th ... District, State of Massachusetts.) Or if a substitute, the ... officer enlisting him. (When enlisted by Board of Enroll- ... ms of the Provost Marshal of the Enrollment District.) ... scriptive list should, as a general rule, be given for each man. ... at must, in all cases, be signed by COMMISSIONED officers; ... el men acting as such.

I CERTIFY that the above is a correct transcript from the Records of this Regt.

from Maryland in U.S. Colored Troops

STATION: Benedict, Md
DATE: February 8th 1864

M. B. ...
Brigade ...
M...

100

whom. to whom drafted (See note 1.)	Period.	LAST PAID.		BOUNTY.		REMARKS
		By paymaster.	To what time.	Paid \$ (See note 2.)	Due \$ (See note 2.)	
<i>Wm Birney</i>	<i>Three years or during the war</i>	<i>—</i>	<i>—</i>	<i>—</i>	<i>—</i>	<i>Co H. 1st USCT Given to M. J. Hergensatter</i>

... transcript from the Records of *this Genl. Rendezvous of Recruits*
U.S. Colored Troops

and
1864

Wm Birney,
Brig Genl. U.S. Army
 Commanding the Company
Mustering Officer

St. Feb 97. R. Cl.
St. No. R. V.
No. 102

Queenston Rd

APPLICATION OF

Maria S. Heyer-sher

Queen Annis Lewis

For Compensation for Service of Slave,

Joseph Salmon

Enlisted in Seventh Regiment

U. S. Colored Troops, Co. L.

Received, February 13 1864.

COMPENSATION AWARDED,

October 2nd 1865

Three Hundred Dollars.

Wm. Simmons
President Board Claims

CHECK

Stave for gift of paper
Recd. at. Oct 9. 1865.

STATE OF MARYLAND

EVIDENCE OF TITLE.

I, Maria Louise Hergemather of Queen Anne
 County, Md., do solemnly swear that Joseph Salem
 who has been enlisted in the Seventh Regiment, U. S. Colored Troops,
 Co. I.; is my slave for Life; (his term of service expiring on
 the day of 186;) and that
 I became possessed of him by Inheritance from my father, James Embert, in the month
 of December, eighteen hundred and fifty seven. And I
 do further swear that I have not purchased said slave from any person or persons disloyal
 to the Government of the United States, with the object of obtaining compensation for
 the same; and furthermore, that I have no agency for obtaining compensation for any per-
 son or persons but such as, to my knowledge, are loyal citizens of the United States.

Maria L. Hergemather
February 4. 1864.

STATE OF MARYLAND,

Queen Anne's County, to wit:

On this Fourth day of February in the year 1864,

before me, the subscriber, a Justice of the Peace of the State and County aforesaid, personally appeared Maria L. Heyamather, and took, signed, and acknowledged the oaths preceding, and further made oath, in due form of law, that all the state-

ments made in this application are, to the best of her knowledge and belief, strictly true. Also personally appeared before me Wm. H. Crofts and

Geo. DeRochebrune, loyal citizens of the United States, residents of

Queenstown Md, well acquainted with the said Maria L.

Heyamather, and in no manner interested in the prosecution of this

claim, and made oath, in due form of law, that the said Maria L. Heyamather

is the owner of the slave Joseph Solomon, as a fact of public noto-

riety; that they believe all the statements herein made by her, in reference

thereto, are correct, and that she is unquestionably loyal to the Government of

the United States. Witness their signatures:

Wm. H. Crofts
Geo. DeRochebrune
Justice of the Peace. Seal

G. W. Hardy



STATE OF MARYLAND,



Queen Annis County, to wit:

I, *Saml E Dyott*, Clerk of the Circuit Court for *Queen Annis* County, do hereby certify that *J W Handy J.P.*,

before whom the foregoing affidavits were made, was, at the time of signing the same, a Justice of the Peace for the County and State aforesaid, duly commissioned and sworn; and that his signature thereto is genuine, and that full faith and credit should be given to his official acts.

Witness my hand and the seal of said Court, this *4th* day of *February*, A. D. 1864.

Saml E Dyott CLERK.

A.

No. 102 CLAIMANT'S CERTIFICATE.

I, Maria L. Hergemather a loyal citizen, and a resident
of Greenstown, County of Queen Anne's, State of
Maryland, hereby claim compensation, under the provisions of
General Orders, No. 329, 1863, for my slave Joseph Solomon
enlisted September 26th 1863, at Queen Anne's Landing
by Capt. Robert W. King in the Seventh
Regiment U. S. Colored Troops, Co. D; certificate of which enlistment, and a
descriptive list, as required, accompany this application.

In proof of my loyalty to the Constitution and Government of the United States, I
present the accompanying oath, which I have taken, signed, and acknowledged, to be filed
with this application, in accordance with requirement of said General Orders.

Maria L. Hergemather.

July 4 1864.

B.

OATH OF ALLEGIANCE.

I, *Maria L. Heigenmatter*, do solemnly swear that I have never joined, or been concerned in, any insurrection or rebellion; that I have never borne arms against the United States; that I have never given any aid, countenance, counsel, or encouragement to any person or persons engaged, or whom I had reason to believe were about to engage, in insurrection, rebellion, or armed hostility against the United States; that I have neither sought, nor accepted, nor attempted to exercise the functions of any office, civil or military, nor to perform any service whatever, under any authority or pretended authority in hostility to the United States; that I have not yielded a voluntary support to any insurrection, rebellion, or pretended government, authority, power, or constitution within the United States hostile thereto. And I do further swear that, to the best of my knowledge and ability, I have supported and defended, and will continue to support and defend, the United States against all enemies, foreign and domestic; and that I have supported, defended, and obeyed, and will continue to support, defend, and obey, the Constitution and laws of the United States; that I will bear true faith and allegiance to the same; and that I take this oath freely, without any mental reservation or purpose of evasion: So help me God.

Maria L. Heigenmatter

Sworn to and subscribed before me, at *Queens town*
 this *4th* day of *February* 186*4*.



G W Hardy

Justice of the Peace

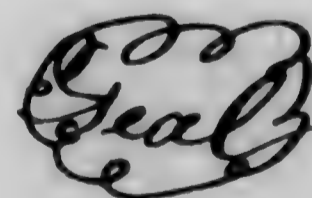

C. 1



I present herewith evidence of my title to the slave Joseph Solun
 _____ enlisted as aforesaid, and in consideration of the sum of
 _____ by me received, I hereby covenant and
 agree with the United States, that I, my heirs, executors, or assigns, shall never hereafter make
 or enforce any claim to the labor or services of said slave; and pledge myself to execute
 a valid Deed of Manumission and Release of all my claims to service forever of said
Joseph Solun to be filed with the Board of Claims
 now in session at Baltimore Md

Maria L. Hergemather

July 11, 1864

Recd from Div of Discontinued
Commands!

ARTICLES OF WAR.

ART. 95. When any non-commissioned officer or soldier shall die, or be killed in the service of the United States, the then commanding officer of the troop or company shall, in the presence of two other commissioned officers, take an account of what effects he died possessed of, above his arms and accoutrements, and transmit the same to the office of the Department of War, which said effects are to be accounted for, and paid to the representatives of such deceased non-commissioned officer or soldier. And in case any of the officers, so authorized to take care of the effects of deceased officers and soldiers, should, before they have accounted to their representatives for the same, have occasion to leave the regiment or post, by preferment or otherwise, they shall, before they be permitted to quit the same, deposit in the hands of the commanding officer, or of the assistant military agent, all the effects of such deceased non-commissioned officers and soldiers, in order that the same may be secured for, and paid to, their respective representatives.

ARMY REGULATIONS—EDITION OF 1861.

DECEASED SOLDIERS.

Par. 152. Inventories of the effects of deceased non-commissioned officers and soldiers, required by the 95th Article of War, will be forwarded to the Adjutant General, by the commander of the company to which the deceased belonged, and a duplicate of the same to the colonel of the regiment. Final statements of pay, clothing, &c., will be sent with the inventories. When a soldier dies at a post or station absent from his company, it will be the duty of his immediate commander to furnish the required inventory, and, at the same time, to forward to the commanding officer of the company to which the soldier belonged, a report of his death, specifying the date, place, and cause; to what time he was last paid, and the money or other effects in his possession at the time of his decease; which report will be noted on the next muster-roll of the company to which the man belonged. Each inventory will be endorsed, "Inventory of the effects of _____, late of company (—) _____ regiment of _____, who died at _____, the _____ day of _____, 186—." If a legal representative receive the effects, it will be stated in the report. If the soldier leave no effects, the fact will be reported.

Par. 153. Should the effects of a deceased non-commissioned officer or soldier not be administered upon within a short period after his decease, they shall be disposed of by a Council of Administration, under the authority of the commanding officer of the post, and the proceeds deposited with the Paymaster, to the credit of the United States, until they shall be claimed by the legal representatives of the deceased.

Par. 154. In all such cases of sales by the Council of Administration, a statement in detail, or account of the proceeds, duly certified by the Council and commanding officer, accompanied by the Paymaster's receipt for the proceeds, will be forwarded by the commanding officer to the Adjutant General. The statement will be endorsed, "Report of the proceeds of the effects of _____, late of company (—) _____ regiment of _____, who died at _____, the _____ day of _____, 186—."

NOTE 1.—The effects in all cases, when called for, should be turned over to the legal representative, without further authority from the Adjutant General. When the effects are turned over to the relatives of the deceased before these inventories are sent to the Adjutant General, their receipts therefor should be attached to the inventories. In all other cases, one copy will be sent with a letter of transmittal direct to the Adjutant General, and a duplicate retained by the officer.

NOTE 2.—Particular care should be taken to take receipts in duplicate from the Paymaster for any funds turned over to him; one copy should be sent direct to the Adjutant General and one retained by the officer.

INVENTORY OF THE EFFECTS

Filed August 20, 1865

Joseph Salsum

Late of Company "D"

11th Reg't of U.S.C.V.

Volunteers, who died at Camp Stanton Md,

on the 14 day of January 1864.



349

Inventory of the effects of Joseph Solon late
 a Private of Captain Thos. McLearty Company D of
 the 7 Regiment of Rescol Traps Volunteers, who was enrolled as
 a Private at Baltimore in the State of Maryland on
 the 26 day of September 1863, and mustered into the service of the United
 States as a Private on the 29 day of September 1863, at Baltimore
 in Company D, 7 Regiment of Rescol Traps Volunteers, to serve Three
 years or during the war; he was born in Dunn Run Co in the State
 of Maryland; he was 32 years of age, 5 feet 9 inches
 high, Griff complexion, Blk eyes, Curly hair, and by occupation, when enrolled,
 a Farmer; he died in Hospital at
Benedit Mel on the 14 day of January 1864, by
 reason of Diarrhoe

INVENTORY.						
ARTICLES.	No.	ARTICLES.	No.	ARTICLES.	No.	
Hats		Pairs trousers		Knapsacks		
Caps		Pairs flannel drawers				
Forage caps		Pairs cotton drawers				
Great coats	1	Flannel shirts	2			
Uniform coats	1	Cotton shirts				
Uniform jackets		Pairs boots				
Flannel sack coats		Pairs shoes				
Blouses		Pairs socks	1	MONEY.	Specie	\$
Stable frocks		Blankets	1		Notes	\$
Fatigue overalls		Haversacks				

I CERTIFY, ON HONOR, that the above inventory comprises all the effects of
Joseph Solon, deceased, and that the effects are in the hands
 of Capt Thos McLearty at Camp Stanton Mel
 to be disposed of by a Council of Administration.

(DUPLICATES.)

STATION: Camp Stanton Mel

DATE: Jan. 14 1864

[A. G. O. No. 104.]

Thos. McLearty
Capt Thos McLearty
 Commanding the Company.

J 161 126

FINAL STATEMENT

D.
OF

Joseph Nelson
Reg't of *1st Regt*

VOLUNTEERS.

Discharged January 14 1864

NOTE 1.—Two of these certificates (or duplicates) are to be given to each Volunteer Soldier or drafted man who may be discharged previously to the discharge of his company, that he may at once receive from the Paymaster the pay, &c., due him, and the captain or other COMMISSIONED officer commanding the company will certify to the act of the delivery of the duplicate certificates; on these certificates the Soldier is "entitled to" his discharge, and should also present his discharge to the Paymaster to have the payment endorsed on it. The discharge is to be given back to the Soldier by the Paymaster; the latter only retaining as his voucher the duplicate certificates.

NOTE 2.—If the Soldier is entitled to pay for the use of his horse, the Company Commander will certify to that fact on the back of both these final statements, and also to the time he has pay due for having been so mounted on his own horse.

NOTE 3.—When a Soldier is furnished with final statements, his descriptive list, if he has one, should be taken up by the officer who gives the Soldier these statements, and endorsed with a statement to this effect by the officer. This endorsement should exhibit a full statement of the time for which the Soldier was allowed pay on his final statements, the clothing account, and all other charges against him or in his favor, so as to comprise a complete exhibit of his account. It will then be transmitted to the company commander of the Soldier, who will enter all the data necessary to a full understanding of the Soldier's account on the muster roll upon which the Soldier's discharge is reported. The descriptive list will then be destroyed. The object of this is, that the remaining portion of the Soldier's account may be settled upon the receipt of these muster rolls, and the Soldier receive any pay or allowances that may be due him at the time of his discharge, and which may not appear on his final statements from the fact that his descriptive list is incomplete. These accounts for back pay, &c., are settled by the 2d Auditor of the Treasury Department.

NOTE 4.—Charges for loss or injury to ordnance, horse equipments, and other miscellaneous charges, should appear under the heading of "Other Stoppages."

NOTE 5.—Bounty paid by State authorities, and not by the United States, will not be entered on this statement.

NOTE 6.—Amounts due the Sutler and Laundress must be entered on the muster roll on which the discharge, death, desertion, &c., is reported, as well as on the final statement, otherwise the amount cannot be collected from the United States.

NOTE 7.—This blank will be used for deceased volunteers and drafted men, as well as for others.

NOTE 8.—Where a Soldier dies in Hospital or on detached service, his descriptive list, if he has one, should be sent with his final statements, in duplicate, to the Second Auditor, Washington, D. C.

ADJUTANT GENERAL'S OFFICE.
March 8th 1864
Duplicate with inventory sent 2d Auditor.

Ans. v. A. R. of Gen.

I certify, on honor, that Joseph Sobon a Private of
Captain Thos. M. Carley Company (D) of the 11th Regiment of W.V. Troops
VOLUNTEERS, of the State of MD, born in Dunn Am Co, State
of Maryland, aged 32 years; 5 feet 9 inches high; Fair complexion,
Blk eyes, Curly hair, and by occupation a Gardner, having joined the company on
its original organization at Baltimore Md, and enrolled in it at the muster into
the service of the United States at Baltimore Md, on the 29th day
of September, 1863, (or was mustered in service as a recruit, by
....., at, on the day of,
186 , or was drafted and mustered into the service of the United States from the
Enrollment District of the State of, at,
on the day of, 186 ,) to serve in the Regiment, for
the term of Three Years; and having served HONESTLY and
FAITHFULLY with his Company in 7th Regt. U.S. Troops to the present date, is now
entitled to a **DISCHARGE** by reason of Death

(For date of death see Inventory - Jan 14th 64 - etc.)

The said Joseph Sobon was last paid by Paymaster
Maj. Nelson to include the day of, 186 , and has
pay due him from that time to the present date; he is entitled to pay and subsistence for
TRAVELING to place of enrollment, and whatever other allowances are authorized to volunteer
soldiers, drafted men, or militia, so discharged. He has received from the United States **CLOTHING**
amounting to Thirty-Eigh 36 dollars, since the 29th day of September,
1863, when his clothing account was last settled. He has received from the United States
100 dollars advanced **BOUNTY**.

There is to be stopped from him, on account of the State of, or other
authorities, for **CLOTHING**, &c, received on entering service, dollars; and
for other stoppages, viz:

..... dollars.
He has been furnished with **TRANSPORTATION** in kind from the place of his discharge to
.....; and he has been **SUBSISTED** for **TRAVELING** to his
place of enrollment, up to the, 186 .

He is indebted to, **SUTLER**, dollars.
He is indebted to, **LAUNDRESS**, dollars.

Given in Duplicate, at Camp Stanton Md, this 14th day
of January, 1864.

Thos. M. Carley
Capt. 7th U.S. Troops
Commanding Company.

1248

Somers George

Co 10, 7 U.S. Col'd Inf.

Private Private

CARD NUMBERS.

1	6278868	26
2	6279093	27
3	6286455	28
4	6286545	29
5	6286633	30
6	6286718	31
7	6286792	32
8	6286869	33
9	6286945	34
10	6287141	35
11	6279426	36
12	9066340	37
13		38
14		39
15		40
16		41
17		42
18		43
19		44
20		45
21		46
22		47
23		48
24		49
25		50

Book Mark:

See also

S | 7 | U.S.C.T.

George Somers
Co. *D*, 7 Reg't U.S. Col'd Inf.

Appears on
Company Descriptive Book
of the organization named above.

DESCRIPTION.

Age *32* years; height *5* feet *2 1/2* inches.
Complexion *Black*
Eyes *Black*; hair *Black*
Where born *Delaware*
Occupation _____

ENLISTMENT.

When *March 4*, 186*5*.
Where *Wilmington*
By whom *Capt. Alden*; term *1* y'rs.

Remarks: *Drafted from*
5th Mass. Col. Del.
Discharged March
4, 1866, by reason of ex-
piration of term of service.

J. P. Brown
Coryist.

NARA 945

S | *7* | **U.S.C.T.**

George Somers

Pri, Co., *7* Reg't U. S. Col'd Infantry.

Age *32* years.

Appears on a

Detachment Muster-in Roll

of the organization named above. Roll dated

Baltimore, Md., Mar. 16, 1865.

Muster-in to date *Mar. 10,* 1865.

Joined for duty and enrolled:

When *Mar. 4*, 1865.

Where *Wilmington*

Period *1* years.

Remarks: *Drafted*

Book mark: _____

(887)

Beck
Copyist.

S | *7* | **U.S.C.T.**

George Somers

Appears with rank of _____ on
**Muster and Descriptive Roll of a Detach-
ment of Drafted Men and Substitutes
forwarded**

for the *7* Reg't U. S. Col'd Inf. Roll dated
Baltimore Md. Mch 11, 1865.

Where born *Delaware*

Age *22* years; occupation *Labourer*

Drafted and mustered in:

When *Mch 4*, 186*5*

Where *Wilmington*

Period *1* years.

Eyes *Blk*; hair *Blk*

Complexion *Blk*; height *5 ft. 7 in.*

Paid bounty and advance pay, \$ *100*

Bounty due \$ *100*

Where credited _____

Company to which assigned _____

Remarks: *Drafted from Sussex
Co. Delaware*

Book mark: _____

J. McFarley
(340) Copyist

S 7 U.S.C.T.

George Somers
Priv., Co. D, 7 Reg't U. S. Col'd Infantry.

Appears on

Company Muster Roll

for *March & April*, 1865.

Joined for duty and enrolled:

When *March 4*, 1865.*

Where *Sussex Co. Del.* *

Period *1* years.*

Present or absent *Present*

Stoppage, \$ *100* for

Due Gov't \$ *100* for

Remarks: *Joined Company*
March 18 1865

* See enrollment on card from muster-in roll.

Book mark:

(358c) *J. H. Neal* Copyist.

1865 340

S | **7** | **U.S.C.T.**

George Summers
Priv., Co. D, 7 Reg't U. S. Col'd Infantry.

Appears on

Company Muster Roll

for *May & June*, 1865.

Joined for duty and enrolled:

When *March 4*, 1865.*

Where *Sussex Del.* *

Period *1* years.*

Present or absent *Present*

Stoppage, \$ *100* for

Due Gov't \$ *100* for

Remarks:

* See enrollment on card from muster-in roll.

Book mark: -----

E. D. Neale

(358c) Copyist.

S | **7** | **U.S.C.T.**

George Summers
Private, Co. D, 7 Reg't U. S. Col'd Infantry.

Appears on

Company Muster Roll

for *July & Aug.*, 1865.

Joined for duty and enrolled:

When *March 4*, 1865.*

Where *Amesbury Del* *

Period *1* years.*

Present or absent *Present*

Stoppage, \$ *100* for

Due Gov't \$ *100* for

Remarks:

* ~~See~~ See enrollment on card from muster-in roll.

Book mark: -----

(358c) *J.M. Neal* Copyist.

A **7** **U.S.C.T.**

George Summere
Priv., Co. D, 7 Reg't U. S. Col'd Infantry.

Appears on

Company Muster Roll

for *Sept. & Oct.*, 1865.

Joined for duty and enrolled:

When *March 4*, 1865.*

Where *Sussex Del* *

Period *1* years.*

Present or absent *Present*

Stoppage, \$ *100* for

Due Gov't \$ *100* for

Remarks:

* See enrollment on card from muster-in roll.

Book mark: -----

J. W. Neals
(358c) *J. W. Neals* Copyist.

NARA 351

7 | U.S.C.T.

George Summers

Priv, Co. D, 7 Reg't U. S. Col'd Infantry.

Appears on

Company Muster Roll

for *Nov. & Dec*, 1865.

Joined for duty and enrolled:

When *Mich 4*, 1865.*

Where *Severex Del*, *

Period *1* years.*

Present or absent *Present*

Stoppage, \$ *100* for

Due Gov't \$ *50* for *C. & G. Equipage*,
100

Remarks:

* See enrollment on card from muster-in roll.

Book mark:

Hearst

8 | 7 | U.S.C.T.

George Somers
Pvt., Co. D, 7 Reg't U. S. Col'd Infantry.

Appears on

Company Muster Roll

for Jan'y & Feby, 1866.

Joined for duty and enrolled:

When Mich 4, 1865.*

Where Sussun Del *

Period 1 years.*

Present or absent Present

Stoppage, \$ 100 for

Due Gov't \$ 100 for

Remarks:

* See enrollment on card from muster-in roll.

Book mark: -----

(358c) Hearst Copyist.

S | **7** | **U.S.C.T.**

George Somers
Prvt, Co. D, 7 Reg't U. S. Col'd Infantry.

Appears on

Company Muster Roll

for *Mch & Apl*, 1866.

Joined for duty and enrolled:

When *Mch 4*, 1865.*

Where *Sussur Del* *

Period *1* years*

Present or absent _____

Stoppage, \$ *100* for _____

Due Gov't \$ *100* for _____

Remarks: *Discharged Mch 4, 1866*
by reason of expiration of
term of service. Discharge
and Muster out rolls given.

* See enrollment on card from muster-in roll.

Book mark: _____

Hearst

S | 7 | U.S.C.T.
George Somers
Private Co. D, 7 Reg't U. S. Col'd Inf

Appears on an

Individual Muster-out Roll

of the organization named above. Roll dated

Victoria Texas Mar. 4, 1866.

Muster-out to date Mar. 4, 1866.

Last paid to Dec 31, 1865.

Clothing account:

Last settled....., 186 ; drawn since \$..... 100

Due soldier \$..... 100; due U. S. \$..... 40
100

Am't for cloth'g in kind or money adv'd \$..... 100

Due U. S. for arms, equipments, &c., \$..... 100

Bounty paid \$..... 100; due \$..... 100

Remarks: Joined the Compa-
ny for duty March
18, 1865. No further
military history.
This man mustered
out by reason of ex-

Book mark: (over)

E H Lipscombe

JAN. 20

6279426

AL8910

Expiration of term
of service.

Entitled to travel=
time and subsistence
to place of general
rendevous, from
Port Lavaca Texas

S

7

U.S.C.T.

George Somers

Priv, Co. *D*, 7 Reg't U. S. Col'd Infantry.

Appears on **Co. Muster-out Roll**, dated *Indianola Texas, Oct 13, 1866*.

Muster-out to date _____, 186 .

Last paid to *Dec 31, 1866*.

Clothing account:

Last settled _____, 186 ; drawn since \$ _____ 100

Due soldier \$ _____ 100; due U. S. \$ _____ 100

Am't for cloth'g in kind or money adv'd \$ _____ 100

Due U. S. for arms, equipments, &c., \$ _____ 100

Bounty paid \$ _____ 100; due \$ _____ 100

Remarks: *Discharged at Victoria, Texas, Mo. 4. 66. reason Expiration term of service.*

Book mark: *M.O.R. on file.*

Hearst

1249

Somerville John

Co I, 7 U.S. Col'd Inf.

Private Private

CARD NUMBERS.

1	6294376	26
2	6294279	27
3	6294476	28
4	6294576	29
5	6294670	30
6	6294762	31
7	6294852	32
8	6294944	33
9	6295047	34
10	6295147	35
11	6295246	36
12	6295344	37
13	6295436	38
14	6295515	39
15	6295604	40
16	6295677	41
17	6295747	42
18	6295821	43
19	6295893	44
20	9066973	45
21		46
22		47
23		48
24		49
25		50

Book Mark:

See also

MARA 350

S. 1966031 10 m 9m

S. | 7 | U.S.C.T.

John Sumerville
Co. G, 7 Reg't U.S. Col'd Inf.

Appears on
Company Descriptive Book
of the organization named above.

DESCRIPTION.

Age 22 years; height 5 feet 3 inches.
Complexion *Dark*
Eyes *Blue*; hair *Dark*
Where born *St. Marys, Md.*
Occupation *Farmer*

ENLISTMENT.

When *Oct. 21*, 1863.
Where *St. Marys, Md.*
By whom *Chas. Wm. Binney*; term 3 y'rs.

Remarks: *Murdered in at Camp Stanton Md. Nov. 5. 63. by Lt. Col. Haskelle.*
On recruiting service from Jan. 9. 64. to Feb. 8. 64.
Ab. sick from Sept. 12. 64. to Jan. 65.
Det. Oct. 12. 65. to Oct. 65.

J. F. White.

S | 7 | U.S.C.T.

John Somerville
Pvt., Co. I, 7 Reg't U. S. Col'd Inf.

Age 22 years.

Appears on

Company Muster-in Roll

of the organization named above. Roll dated

Camp Stanton
Charles Co., Md., Nov. 5, 1863.

Muster-in to date *Nov. 5, 1863.*

Joined for duty and enrolled:

When *Oct. 21*, 186 .

Where *St. Mary, Md.*

Period *3* years.

Remarks:.....
.....
.....
.....
.....
.....

Book mark:.....

J. B. Gage

S | 7 | U.S.C.T.

John Somerville

Pvt, Co. 1, 7 Reg't U. S. Col'd Infantry.

Appears on

Company Muster Roll

for *from Nov. 5 to Dec. 31*, 186*3*.

Present or absent *Present*

Stoppage, \$ *100* for

Due Gov't, \$ *100* for

Remarks: *Enlistment premium
\$2.00 due.*

Book mark:

J. B. Gage

(358)

Copyist.

S

7

U.S.C.T.

John Somerville
Priv, Co. I, 7 Reg't U. S. Col'd Infantry.

Appears on

Company Muster Roll

for *Jan & Feb*, 1864

Present or absent *Present*

Stoppage, \$ *100* for

Due Gov't, \$ *100* for

Remarks: *Enlistment premium \$2.00 due. On recruiting service Jan 29 to Feb. 8/64.*

Inserted by Camp

Book mark:

J.B. Gage

(358)

Copyist.

S | 7 | U.S.C.T.

John Somerville
Pvt, Co. I, 7 Reg't U. S. Col'd Infantry.

Appears on

Company Muster Roll

for Mch & Apr, 1864.

Present or absent Present

Stoppage, \$ 100 for

Due Gov't, \$ 100 for

Remarks:

Book mark:

(358)

J B Gage Copyist.

S | 7 | U.S.C.T.

John Somerville
Prvt., Co. I, 7 Reg't U. S. Col'd Infantry.

Appears on

Company Muster Roll

for *May & June*, 1864.

Present or absent *Present*

Stoppage, \$ *100* for

Due Gov't, \$ *100* for

Remarks:

Book mark:

(358)

J. B. Gage
Copyist.

S | 7 | U.S.C.T.

John Somerville
Priv., Co. I, 7 Reg't U. S. Col'd Infantry.

Appears on

Company Muster Roll

for July & Aug, 1864.

Present or absent Present

Stoppage, \$ 100 for

Due Gov't, \$ 100 for

Remarks:

Book mark:

(358)

J. B. Page
Copyist.

S

7

U.S.C.T.

John Somerville
Pot, Co. I, 7 Reg't U. S. Col'd Infantry.

Appears on

Company Muster Roll

for Sept & Oct, 1864

Present or absent Absent

Stoppage, \$ 100 for

Due Gov't, \$ 100 for

Remarks: Sick since Sept. 12,
1864 in Hosp. Stop for
1 Bugle complete

Book mark:

J. B. Gage
Copyist.

S | 7 | U.S.C.T.

John Somerville
Priv, Co. I, 7 Reg't U. S. Col'd Infantry.

Appears on

Company Muster Roll

for *Nov, & Decr.*, 1864.

Present or absent: *Absent*

Stoppage, \$ *100* for

Due Gov't, \$ *100* for

Remarks:

*Absent sick: In the field, Va, since
Sept. 12, 1864.
Deduct Money Value of one
Bugle Complete.*

Book mark:

D. Mahor

NARA 368

S

7

U.S.C.T.

John Somerville

Priv, Co. I, 7 Reg't U. S. Col'd Infantry.

Appears on

Company Muster Roll

for *Jan'y. & Feby.*, 1865.

Present or absent *Present*

Stoppage, \$ *100* for

Due Gov't, \$ *100* for

Remarks:

Book mark:

D. Maher
Copyist.

(358)

S

7

U.S.C.T.

John Somerville

Priv., Co. I, 7 Reg't U. S. Col'd Infantry.

Appears on

Company Muster Roll

for March & April, 1865.

Present or absent Present

Stoppage, \$ 100 for

Due Gov't, \$ 100 for

Remarks:

Charge for One Bugle Complete

Book mark:

D. Maher
Copyist.

(358)

S | 7 | U.S.C.T.

John Somerville
Priv, Co. I, 7 Reg't U. S. Col'd Infantry.

Appears on

Company Muster Roll

for *May + June*, 1865.

Present or absent *Present*

Stoppage, \$ *100* for

Due Gov't, \$ *100* for

Remarks:

Book mark:

D. Maher

S | 7 | U.S.C.T.

John Somerville
Priv, Co. I, 7 Reg't U. S. Col'd Infantry.

Appears on

Company Muster Roll

for *July & Aug.*, 186*3*.

Present or absent: *Present*

Stoppage, \$..... 100 for

Due Gov't, \$..... 100 for

Remarks:.....
.....
.....
.....
.....
.....
.....
.....
.....
.....

Book mark:.....
.....

D. Maher

S

7

U.S.C.T.

John Somerville
Priv, Co. I, 7 Reg't U. S. Col'd Infantry.

Appears on

Company Muster Roll

for *Sept. & Oct.*, 1865.

Present or absent *Present*

Stoppage, \$ *100* for

Due Gov't, \$ *6* ^{*52*}/_{*100*} for *C. & G. Equipage*

Remarks:

Book mark:

D. Mahser
Copyist.

S

7

U.S.C.T.

John Sommerville

Priv., Co. I, 7 Reg't U. S. Col'd Infantry.

Appears on

Company Muster Roll

for Nov. + Decr., 1865.

Present or absent Present.

Stoppage, \$ 100 for

Due Gov't, \$ 6 ⁵²/₁₀₀ for C. & G. Equipage

Remarks:

Book mark:

D. Maher

Copyist.

S | 7 | U.S.C.T.

John Somerville

Private, Co. I, 7 Reg't U. S. Col'd Infantry.

Appears on

Company Muster Roll

for Jan + Feb, 1866.

Present or absent Present.

Stoppage, \$ 100 for

Due Gov't, \$ 100 for

Remarks:

Book mark:

Sabine

Copyist.

S

7

U.S.C.T.

John Somerville

Private, Co. I, 7 Reg't U. S. Col'd Infantry.

Appears on

Company Muster Roll

for Mar + Apr, 1866.

Present or absent Absent.

Stoppage, \$ 100 for

Due Gov't, \$ 100 for

Remarks: Det. S.O. go. Hodges. 7 users
And Tex Oct. 12, '65.

Book mark:

SECRET

Satine

Copyist.

(358)

8

7

U.S.C.T.

John Somerville

Private, Co. I, 7 Reg't U. S. Col'd Infantry.

- Appears on

Company Muster Roll

for Feb 28 to June 30, 1866.

Present or absent

Stoppage, \$ 100 for

Due Gov't, \$ 100 for

Remarks: Det. S.O. go Hodges. 7th U.S.C.T. Ind. Tex. Oct. 12, 65.

Book mark:

Sarime

Copyist.

S

7

U.S.C.T.

John Somerville

Private, Co. I, 7 Reg't U. S. Col'd Infantry.

Appears on

Company Muster Roll

for July + Aug, 1866.

Present or absent Absent.

Stoppage, \$100 for

Due Gov't, \$100 for

Remarks: Detached SO, order No. 90 Hdqrs. 7th U.S.C.T. Ind. Tex. Oct. 12, '65.

To forfeit two dollars (\$2) of monthly pay by sentence S.O.C. com'd by SO. 2, Hdqrs. 7th U.S.C.T. May 22, '66.

Book mark:

Sabine

Copyist.

(358)

S

7

U.S.C.T.

John Somerville
Pvt., Co. *D*, 7 Reg't U. S. Col'd Infantry.

Appears on **Co. Muster-out Roll**, dated
Indianola, Texas,
October, 13, 1866.

Muster-out to date *Oct. 13*, 1866.

Last paid to *June 21*, 1866.

Clothing account:

Last settled....., 186 ; drawn since \$..... 100

Due soldier \$ *28⁹⁹* 100; due U. S. \$..... 100

Am't for cloth'g in kind or money adv'd \$..... 100

Due U. S. for arms, equipments, &c., \$..... 100

Bounty paid \$..... 100; due \$ *100* 100

Remarks: *Joined co. at original organization.*

*On det. service per S.O. No. 5, Hdqrs. Post, Indianola, Tex. Jan. 6, '66 to Oct. 3, '66.**

**As it appears.*

Book mark *V. 186 P. 255, 74.*

Sabine.

1250

Somerwell Samuel

Co I, 7 U.S. Col'd Inf.

Private

Private

CARD NUMBERS.

1	6294278	26
2	6294374	27
3	6294475	28
4	6294575	29
5	6294669	30
6	6294761	31
7	6294850	32
8	6294943	33
9	6295046	34
10	6295146	35
11	6295245	36
12	6295343	37
13	6295435	38
14	6295514	39
15	6295605	40
16	6295678	41
17	6295748	42
18	6295822	43
19	6295892	44
20	9066972	45
21		46
22		47
23		48
24		49
25		50

Book Mark:

See also

S

7

U.S.C.T.

Samuel Somersville

Co. D, 7 Reg't U. S. Col'd Inf.

Appears on

Company Descriptive Book

of the organization named above.

DESCRIPTION.

Age *32* years; height *5* feet *6 1/2* inches.

Complexion *Dark*.

Eyes *Dark*; hair *Dark*.

Where born *St. Mary, Md.*

Occupation *Farmer*.

ENLISTMENT.

When *Oct. 22*, 186 *3*.

Where *St. Mary, Md.*

By whom *Ed. Wm. Biney*; term *3* y'rs.

Remarks: *Mustered in at Camp Stanton, Md. Nov. 5. 63. by Lt. Col. Haskell.*

J. F. White

S | 7 | U.S.C.T.

Samuel Somerwell

Priv., Co. I, 7 Reg't U. S. Col'd Inf.

Age 32 years.

Appears on

Company Muster-in Roll

of the organization named above. Roll dated
Camp Stanton, Charles Co., Md., Nov. 5, 1863.

Muster-in to date Nov. 5, 1863

Joined for duty and enrolled:

When Oct. 22, 1863

Where St. Mary, Md.

Period 3 years.

Remarks:

Book mark:

J. B. Gage

S

7

U.S.C.T.

Samuel Somerwell

Priv., Co. I, 7 Reg't U. S. Col'd Infantry.

Appears on

Company Muster Roll

for from Nov. 5 to Dec. 31, 1863

Present or absent Present

Stoppage, \$ 100 for

Due Gov't, \$ 100 for

Remarks: Enlistment premium \$2.00 due

Book mark:

(858)

J. B. Gage

Copyist.

S

7

U.S.C.T.

Samuel Somerwell

Priv, Co. I, 7 Reg't U. S. Col'd Infantry.

Appears on

Company Muster Roll

for Jan & Feb, 1864.

Present or absent Present

Stoppage, \$ 100 for

Due Gov't, \$ 100 for

Remarks: Enlistment premium \$2.00 due

Book mark:

J B Gage Copyist.

(358)

S | 7 | U.S.C.T.

Samuel Somerwell

Pvt, Co. I, 7 Reg't U. S. Col'd Infantry.

Appears on

Company Muster Roll

for Mch & Apr, 1864

Present or absent Present

Stoppage, \$ 100 for

Due Gov't, \$ 100 for

Remarks:

Book mark:

(358)

J.B. Gage

Copyist.

S 7 U.S.C.T.

Samuel Somerwell

Priv., Co. I, 7 Reg't U. S. Col'd Infantry.

Appears on

Company Muster Roll

for May & June, 1864

Present or absent Present

Stoppage, \$ 100 for

Due Gov't, \$ 100 for

Remarks:

Book mark:

J. B. Gage

(358)

Copyist.

S

7

U.S.C.T.

Samuel Somerwell

Private, Co. I, 7 Reg't U. S. Col'd Infantry.

Appears on

Company Muster Roll

for July & Aug, 1864.

Present or absent Present

Stoppage, \$ 100 for

Due Gov't, \$ 100 for

Remarks: Stop pay for one Knapsack & one Haversack.

Book mark:

J. B. Gage

(358)

Copyist.

S

7

U.S.C.T.

Samuel Somerwell
Pvt, Co. I, 7 Reg't U. S. Col'd Infantry.

Appears on

Company Muster Roll

for Sept & Oct., 1864

Present or absent Present

Stoppage, \$ 100 for

Due Gov't, \$ 100 for

Remarks: Stop for 1 Knapsack

Book mark:

(358)

J. B. Gage
Copyist.

S. | 7 | U.S.C.T.

Samuel Somerwell

Priv, Co. I, 7 Reg't U. S. Col'd Infantry.

Appears on

Company Muster Roll

for *Nov. + Decr.*, 1864

Present or absent *Present*

Stoppage, \$ *100* for

Due Gov't, \$ *100* for *one Knapsack.*

Remarks:

Book mark:

D. Maher

(358)

Copyist.

S

7

U.S.C.T.

Samuel Somerwell

Priv., Co. I, 7 Reg't U. S. Col'd Infantry.

Appears on

Company Muster Roll

for *Jan'y. + Feby.*, 1865.

Present or absent *Present*

Stoppage, \$ *100* for

Due Gov't, \$ *100* for

Remarks:

Book mark:

D. Maher

(358)

Copyist.

S

7

U.S.C.T.

Samuel Somerwell

Priv, Co. I, 7 Reg't U. S. Col'd Infantry.

Appears on

Company Muster Roll

for March & April, 1865.

Present or absent Present

Stoppage, \$ 100 for

Due Gov't, \$ 100 for

Remarks:

Book mark:

D. Maher

Copyist.

(358)

S | 7 | U.S.C.T.

Samuel Somerswell.

Priv, Co. I, 7 Reg't U. S. Col'd Infantry.

Appears on

Company Muster Roll

for *May + June*, 1865.

Present or absent *Present*

Stoppage, \$ *100* for

Due Gov't, \$ *100* for

Remarks:

Charge for One Bugle, Complete.

Book mark:

A. Maher

S

7

U.S.C.T.

Samuel Somerwell

Priv., Co. I, 7 Reg't U. S. Col'd Infantry.

Appears on

Company Muster Roll

for July & Aug., 1865.

Present or absent Present

Stoppage, \$ 100 for

Due Gov't, \$ 100 for

Remarks:

Ab. sick at Indianola, Texas
since Aug. 4, '65.

Book mark:

D. Mahor

Copyist.

S

7

U.S.C.T.

Samuel Somerwell.

Priv, Co. I, 7 Reg't U. S. Col'd Infantry.

Appears on

Company Muster Roll

for Sept. & Oct., 1865.

Present or absent Present

Stoppage, \$ 100 for

Due Gov't, \$ 100 for

Remarks:

Book mark:

D. Maher

Copyist.

S

7

U.S.C.T.

Samuel Sommerwell

Priv, Co. I, 7 Reg't U. S. Col'd Infantry.

Appears on

Company Muster Roll

for Nov. + Decr., 1865.

Present or absent Present

Stoppage, \$ 100 for

Due Gov't, \$ 100 for

Remarks:

Book mark:

D. Maher
Copyist.

S

7

U.S.C.T.

Samuel Somerwell

Private, Co. I, 7 Reg't U. S. Col'd Infantry.

Appears on

Company Muster Roll

for Jan + Feb, 1866.

Present or absent Present.

Stoppage, \$ 100 for

Due Gov't, \$ 100 for

Remarks:

Book mark:

Sabine Copyist.

S

7

U.S.C.T.

Samuel Somerwell

Private, Co. I, 7 Reg't U. S. Col'd Infantry.

Appears on

Company Muster Roll

for Mar + Apr, 1866.

Present or absent Present.

Stoppage, \$ 100 for

Due Gov't, \$ 100 for

Remarks:

Book mark:

(358)

Sarine

Copyist.

8

7

U.S.C.T.

Samuel Somerwell

Private, Co. I, 7 Reg't U. S. Col'd Infantry.

Appears on

Company Muster Roll

for Feb. 28 to June 30, 1866.

Present or absent Not stated.

Stoppage, \$ 100 for

Due Gov't, \$ 100 for

Remarks:

Book mark:

Sabine

Copyist.

(858)

S

7

U.S.C.T.

Samuel Somerwell

Private, Co. I, 7 Reg't U. S. Col'd Infantry.

Appears on

Company Muster Roll

for July + Aug, 1866.

Present or absent Present.

Stoppage, \$ 100 for

Due Gov't, \$ 100 for

Remarks:

Book mark:

322221

Sabine

Copyist.

(358)

S | 7 | U.S.C.T.

Samuel Summerwell
Pvt, Co D, 7 Reg't U. S. Col'd Infantry.

Appears on **Co. Muster-out Roll**, dated
Indianola Texas
October 13, 1866.

Muster-out to date *Oct. 13*, 1866.

Last paid to *June 30*, 1866.

Clothing account:

Last settled....., 186 ; drawn since \$..... 100

Due soldier \$ ~~24~~²² 100; due U. S. \$..... 100

Am't for cloth'g in kind or money adv'd \$..... 100

Due U. S. for arms, equipments, &c., \$ *6* 100

Bounty paid \$..... 100; due \$ *100* 100

Remarks: *Joined co. at ori-*
ginal organization.
Retains one R. Co. muster
set of account records
per G.O. 10, War Dept.
May 30, '65.

Book mark:

Sabine

1251

Southron James

Co *G*, 7 U.S. Col'd Inf.

Private

Private

CARD NUMBERS.

1	6290990	26
2	6291087	27
3	6291189	28
4	6291293	29
5	6291391	30
6	6291489	31
7	6291604	32
8	6292420	33
9	9066713	34
10		35
11		36
12		37
13		38
14		39
15		40
16		41
17		42
18		43
19		44
20		45
21		46
22		47
23		48
24		49
25		50

Book Mark: *E. B.* ¹²/₃₁₁

See also

MARR 491

S 1 7 | **U.S.C.T.**

James + Sathron
....., Co. *G*, *7* Reg't U.S. Col'd *Inf*

Appears on
Company Descriptive Book
of the organization named above.

DESCRIPTION.

Age *25* years; height *5* feet *4 1/4* inches.

Complexion *Rex*

Eyes *Rex*; hair *Curly*

Where born *St Mary, Md.*

Occupation *Farmer*

ENLISTMENT.

When *Oct 26*, 186 .

Where *St Mary*

By whom *Col W. Bony*; term *3* y'rs.

Remarks: *Did in Salisbury
North Carolina Peters-
burg Va.*

** As it is on book.*

(3830)

J. Brown
.....
C

Copyist.

S | 7 | U.S.C.T.

James Sothoron
Privt, Co. G, 7 Reg't U. S. Col'd Inf.

Age 35 years.

Appears on

Company Muster-in Roll

of the organization named above. Roll dated
Camp Stanton, Charles Co., Md, Nov 5, 1863.

Muster-in to date Nov. 5, 1863.

Joined for duty and enrolled:

When Oct. 26, 1863.

Where St. Mary, Md.

Period 3 years.

Remarks:

Book mark:

(856)

Sarsby
Copyist.

S

7

U.S.C.T.

James Sothorow

Priv., Co. G, 7 Reg't U. S. Col'd Infantry.

Appears on

Company Muster Roll

for *Nov. 5 to Dec. 31*, 1863.

Present or absent *Present*

Stoppage, \$ *100* for

Due Gov't, \$ *100* for

Remarks: *Premium for enlistment \$2.00 (due)*

Book mark: *1000000000*

(858)

Sandy
Cpyist

S

7

U.S.C.T.

James Sothoron

Priv., Co. G, 7 Reg't U. S. Col'd Infantry.

Appears on

Company Muster Roll

for *Jan. & Feby.*, 186*4*.

Present or absent *Present*

Stoppage, \$ *100* for

Due Gov't, \$ *100* for

Remarks:

Book mark:

(858)

Sandoz
Copyist

S

7

U.S.C.T.

James Sathorow

Priv., Co. G, 7 Reg't U. S. Col'd Infantry.

Appears on

Company Muster Roll

for *Mch. & Apr.*, 1864.

Present or absent *Present*

Stoppage, \$ *100* for

Due Gov't, \$ *100* for

Remarks:

Book mark: *100:100*

(858)

Saidg
Copyist

G

7

U.S.C.T.

James Sothorow

Priv., Co. G, 7 Reg't U. S. Col'd Infantry.

Appears on

Company Muster Roll

for *May & June*, 1864.

Present or absent *Absent*

Stoppage, \$ *100* for

Due Gov't, \$ *100* for

Remarks: *Sick in Jacksonville since June 28, 1864.*

Book mark:

Sandoz
Cpyist

(858)

S

7

U.S.C.T.

James Sothorow
Private, Co. G, 7 Reg't U. S. Col'd Infantry.

Appears on

Company Muster Roll

for *July & Aug.*, 1864.

Present or absent *Present*

Stoppage, \$ 100 for

Due Gov't, \$ 100 for

Remarks:

Book mark:

(858)

Saidy
Copyist

NARA 499

S 7 U.S.C.T.

James Southron
Priv., Co. G, 7 Reg't U. S. Col'd Infantry.

Appears on

Company Muster Roll

for *Sept & Oct.*, 1864.

Present or absent _____

Stoppage, \$ _____ 100 for _____

Due Gov't, \$ _____ 100 for _____

Remarks: *Unofficially reported
that he died in Hospital
during the month of Sept,
1864.*

Book mark: *Died Sept 9, 1864. E.B. 311.*

(858)

Saidoz
Copyist

S

7

U.S.C.T.

James Southron
Pot, Co. *4*, 7 Reg't U. S. Col'd Infantry.

Appears on **Co. Muster-out Roll**, dated *Indianola Texas, Oct 13, 1866*.

Muster-out to date _____, 186 .

Last paid to *April 30, 1864*.

Clothing account:

Last settled _____, 186 ; drawn since \$ 100

Due soldier \$ 100; due U. S. \$ 100

Am't for cloth'g in kind or money adv'd \$ 100

Due U. S. for arms, equipments, &c., \$ 100

Bounty paid \$ 100; due \$ 100

Remarks: *Died of disease at US Hospital Bermuda Hundred Va September 2 1864 final statements**

* Roll torn

Book mark: *C. S. ego Died*
nr

Hadfield

JAN. 21

6292420

123910

rep 9/64 E.B. 12/311

Bothron, James A.

P, Co. - *7* Reg't **U. S. C. Inf.**

3 Enclosures.

Bed Cards.....	Descriptive Lists.....
Burial Records.....	Final Statements.....
Certs. of Dis. for Discharge.....	Furloughs.....
C. M. Charges.....	Med. Des. Lists.....
Med. Certificates.....	Orders.....

Other papers relating to—

Admission to Hosp'l.....	Furlough.....
Casualty Sheet (Officer's) <i>/</i>	Med. Examination.....
Confinement.....	Misc. Information.....
Contracts.....	Pay or Clothing.....
Death or Effects <i>/</i>	Personal Reports.....
Desertions.....	Rank.....
Discharge from Hosp'l.....	Transfer to Hosp'l.....
Discharge from Service.....	Transfer to V. R. C.....
Duty.....	Transportation.....
	<i>Slave claim /</i>

MICROFILM PUBLICATION M 1849

COMPILED MILITARY SERVICE RECORDS
OF VOLUNTEER UNION SOLDIERS WHO SERVED WITH
THE UNITED STATES COLORED TROOPS (USCT)
7TH REGIMENT OF INFANTRY

PERSONAL PAPERS' TARGET SHEET

PLEASE NOTE THE CHECKED INFORMATION ABOUT THE PERSONAL PAPERS IN
THIS FILE:

- NO PERSONAL PAPERS WERE FOUND IN THIS FILE WHEN THE
RECORDS WERE ARRANGED FOR MICROFILMING.
- 5 PERSONAL PAPER(S) FOUND IN THIS FILE WHEN THE RECORDS
WERE ARRANGED FOR MICROFILMING.

[OFFICE ENDORSEMENT.]

War Department,

ADJUTANT GENERAL'S OFFICE,

May 8th, 1874

The death of James Southron
Private, Co. G, 7th Regt U. S.
Colored Troops, is reported as follows:

- On Company Muster Roll, 1864
- For Sept 1st, 1864, September 1st, 1864
- Company Muster-out Roll, September 1st, 1864
- Company Descriptive Book, 1864
- Company Morning Reports, 1864
- Soldier's Final Statement, 1864
- Soldier's Record of Death and Interment, 1864
- Soldier's Inventory of Effects, 1864
- Soldier's Certificate of Disability for Discharge, 1864
- Soldier's Individual Muster-out Roll, 1864
- Regimental Return, 1864
- For Sept 1st, 1864, 1864
- Regimental Quarterly Returns, 1864
- Regimental Descriptive Book, 1864

By Surgeon General, (C. S.) Sept 9th, 1864, is held to be the correct date, and the Company Muster Roll will be amended accordingly.

Thomas M. Seward
Assistant Adjutant General.
Noted H. M.

Muster on Roll.

162-137

CASUALTY SHEET

No. 6212

James Southron

Priv of Company "G"

7 Regiment of U. S. C.

State Volunteers.

NATURE OF CASUALTY

Killed Sept 21st 1864

Ernest R. H. Coan

CASUALTY SHEET.

Name: *James Southorn*
Rank: *Private* Company: *"G"* Regiment: *"7"*
Arm: *U.S. Col's Troops* State: _____
Nature of Casualty: *Death*

CAUSE OF CASUALTY—(NAME OF DISEASE, &c.)

Diarrhea
Ch. Dysentery

DEGREE OF DISABILITY.

BY WHOM CERTIFIED.

William V. Smith
Capt. Comdr Co

DATE OF DISCHARGE, DEATH, &c.

Sept 2, 1861

PLACE OF DISCHARGE, DEATH, &c.

Bermuda Hundred Va.

BY WHOM DISCHARGED.

FROM WHAT SOURCE THIS INFORMATION WAS OBTAINED.

Co. Muster Out Roll

REMARKS.

A. P. Ball
Clerk.

EVIDENCE OF TITLE.

I, Ignatius Simms of St Mary's County Maryland, do solemnly swear that James A. Sotheron who has been enlisted in the 7th Regiment, U. S. Colored Troops, Co. ...; was my Slave for Life at the time of said enlistment; and that I became possessed of him by Inheritance in the month of January eighteen hundred and fifty three. And I do further swear that I have not purchased said Slave from any person or persons disloyal to the Government of the United States, with the object of obtaining compensation for the same: and furthermore, that I have no agency for obtaining compensation for any person or persons but such as to my knowledge are loyal citizens of the United States.

Sworn and subscribed before



Ignatius Simms
H. Adams
Justice of the Peace.

STATE OF MARYLAND,

County, to wit:

On this nineteenth day of January in the year 1867 before me, the subscriber, a Justice of the Peace of the State and County aforesaid, personally appeared Francis M. Williams and Richard Long loyal citizens of the United States, residents of St. Mary's County and in no manner interested in the prosecution of this claim, and made oath in due form of law, that the said Ignatius Simms was the owner of the Slave James A. Sotheron as a fact of public notoriety; that they believe all the statements made by him in reference to said Slave are correct.

Witness their Signatures



Francis M. Williams
Richard Long
H. Adams
Justice of the Peace.

Sworn and subscribed before

And I Hereby do Certify, That Francis M. Williams and Richard Long are citizens of St. Mary's County, in good repute, and that their statements, under oath, are entitled to full faith and credit.

H. Adams
Justice of the Peace.

EVIDENCE OF LOYALTY.

STATE OF MARYLAND,

County, to wit:

On this 18th day of January in the year 1867 before me, the subscriber, a Justice of the Peace of the State and County aforesaid, personally appeared Francis M. Williams a resident of St. Mary's County, State of Maryland and Richard Long a resident of St. Mary's County, State of Maryland having first been duly sworn, upon their oaths declare that they reside respectively in St. Mary's County, State of Maryland and ...; that they are personally acquainted with Ignatius Simms claimant for compensation for his Slave James A. Sotheron under the Acts of Congress of February 24, 1864, and July 28, 1866, and that they know that said claimant hath firmly and faithfully maintained his allegiance and adherence to the Government of the United States, by defending its cause against the Government of the so-called Confederate States of America, in all suitable and practicable ways, and according to his ability and opportunity; they also swear that they have themselves maintained a like adherence and allegiance to the Government of the United States, and that they have no interest in said claim.

Sworn and Subscribed before



Francis M. Williams
Richard Long
H. Adams
Justice of the Peace.

STATE OF MARYLAND,

Saint Mary's County, to wit:

I, John A. Camaliero Clerk of the Circuit Court for Saint Mary's County, do hereby certify that H. Adams before whom the foregoing affidavits were made, was, at the time of signing the same, a Justice of the Peace for the County and State aforesaid, duly commissioned and sworn; and that his signature thereto is genuine, and that full faith and credit should be given to his official acts.

WITNESS my hand and the Seal of said Court, this 21st day of January A. D. 1867.

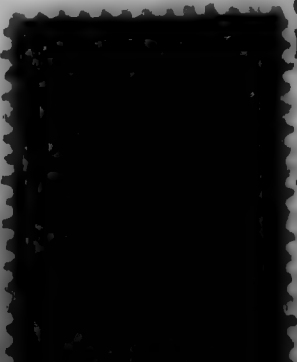

John A. Camaliero
Clerk.

NO 59 4 10

RECEIVED, ADJUTANT GENERAL'S
OFFICE.
FEB 9
1867

RECEIVED
FEB 9 1867

R.O.F.A.
No 2848

Vol A Bermuda Arms Co

WAR DEPARTMENT,

ADJUTANT GENERAL'S OFFICE,

WASHINGTON,

January 12, 1867.

SIR:

Final Statements in the cases of deceased soldiers are required to be sent to the Adjutant General's Office in duplicate, with one copy of the Inventory of Effects. The Descriptive List should also be sent to this Office in cases where the soldier was absent from his Company at the time of his death. Where there were no effects, it should be so stated on a blank Inventory, properly signed.

Certificates of Disability should be sent in duplicate. Special care should be taken that the date of discharge and signature of the discharging officer should be affixed.

No of the Final Statement or Inventory, has been received in the case of *James Southorn Private*, of Co. "G", "7" Regiment of *U.S. 5th* Volunteers, whose papers were forwarded to this Office. You will please forward the missing papers without delay.

I have the honor to be, sir,

Very respectfully,

Your obedient servant,

*Died Sept. 2 1864
Bermuda Hundred, Va.*

F. C. Hazard

Assistant Adjutant General.

(110)

~~COMMANDING OFFICER~~

J. J. Woodward
a.s.u.s.a.

Information from Co. Muster-Out Roll

a.f.B.

MODEL FOR SET OF PAPER

FORM 1.—FINAL STATEMENT.

I CERTIFY, ON HONOR, that *John Smith*, a Private of Captain J. Brown's Company, (A,) of the 1st Regiment of Pennsylvania Volunteers, of the State of Pennsylvania, born in Pittsburg, State of Pennsylvania, aged 21 years, 5 feet 10 inches high, light complexion, blue eyes, dark hair, and by occupation a Farmer, having joined the Company on its original organization at Pittsburg, and enrolled in it at the muster into the service of the United States at Pittsburg, on the 1st day of July, 1861, (or was mustered in service as a recruit, by _____, at _____, on the _____ day of _____, 186—, or was drafted and mustered into the service of the United States from the _____ Enrollment District of the State of _____, at _____, on the _____ day of _____, 186—,) to serve in the Regiment for the term of Three Years, and having served *honestly* and *faithfully* with his Company in the field to the present date, is now entitled to a DISCHARGE by reason of death. Died in Regimental Hospital, Fort Brown, Texas, December 31, 1863, of typhoid fever.

The said John Smith was last paid by Paymaster Major Morse, to include the 31st day of October, 1863, and has pay due him from that time to the present date. He is entitled to pay and subsistence for *traveling* to place of enrollment, and whatever other allowances are authorized to volunteer soldiers, drafted men, or militia, so discharged. He has received from the United States *clothing* amounting to 20.00 dollars, since the 31st day of December, 1862, when his clothing account was last settled. He has received from the United States 25.00 dollars advanced *bounty*.

There is to be stopped from him on account of the State of _____, or other authorities, for *clothing*, &c., received on entering service, nothing, .00 dollars; and for other stoppages, viz: nothing, .00 dollars. He has been furnished with *no transportation* in kind from the place of his discharge to _____; and he has not been *subsisted* for *traveling* to his place of enrollment up to the _____, 186—.

He is indebted to _____, Sutler, _____ .00 dollars.

He is indebted to _____, Laundress, _____ .00 dollars.

GIVEN, IN DUPLICATE, at Fort Brown, Texas, this 31st day of December, 1863.

JAMES BROWN,
Captain Co. A, 1st Penn. Vols.,
Commanding Company.

FORM 2.

INVENTORY of the effects of John Smith, late a Private of Captain J. Brown's Company, (A,) of the 1st Regiment of Pennsylvania Volunteers, who was enrolled as a Private at Pittsburg, in the State of Pennsylvania, on the 1st day of July, 1861, and mustered into the service of the United States as a Private on the 1st day of July, 1861, at Pittsburg, in Company A, 1st Regiment of Pennsylvania Volunteers, to serve three years or during the war. He was born in Pittsburg, in the State of Pennsylvania; he was 21 years of age, 5 feet 10 inches high, light complexion, blue eyes, dark hair, and by occupation, when enrolled, a Farmer. He died in Regimental Hospital, at Fort Brown, Texas, on the 31st day of December, 1863, of typhoid fever.

INVENTORY.					
ARTICLES.	No.	ARTICLES.	No.	ARTICLES.	No.
Hats.....		Pairs trousers.....		Knapsacks.....	
Caps.....		Pairs flannel drawers.....			
Forage caps.....		Pairs cotton drawers.....			
Great coats.....	1	Flannel shirts.....	1	Watch, silver.....	1
Uniform coats.....		Cotton shirts.....			
Uniform jackets.....		Pairs boots.....			
Flannel sack coats.....		Pairs shoes.....			
Blouses.....		Pairs socks.....			
Stable frocks.....		Blankets.....			
Fatigue overalls.....		Haversacks.....			
				MONEY.	
				Specie.....	\$2 00
				Notes.....	\$50 00

I CERTIFY, ON HONOR, that the above inventory comprises all the effects of Private John Smith, deceased, and that the effects are in the hands of Captain J. Brown, at Fort Brown, Texas, to be disposed of by a Council of Administration, except the money, which has been turned over to Major Wm. C. Morse, Paymaster, U. S. Army, whose receipt is hereto annexed.*

STATION: Fort Brown, Texas.

DATE: December 31, 1863.

(Duplicates.)

JAMES BROWN,
Captain Co. A, 1st Penn. Vols.,
Commanding the Company.

*NOTE.—If the effects have been turned over to relatives of deceased, so state on certificate, instead of "in the hands of Captain," &c., and give the names of the persons, and their relation to the deceased person.

FORM 3.—HEIR'S RECEIPT FOR EFFECTS.

RECEIVED of Captain John Brown, Company A, 1st Regiment of Pennsylvania Volunteers, the following effects of Private John Smith, late of Company A, 1st Regiment of Pennsylvania Volunteers, now deceased, which I claim as his wife:

1 great coat, 1 flannel shirt, 1 silver watch, fifty dollars in notes, and two dollars in specie.

MARY SMITH.

FORM 4.—PAYMASTER'S RECEIPT FOR MONEY.

RECEIVED, this 31st day of December, 1863, at Fort Brown, Texas, of Captain James Brown, of Company A, 1st Pennsylvania Volunteers, fifty dollars in Treasury notes and two dollars in specie, the property of the late Private John Smith, of Company A, 1st Pennsylvania Volunteers, who died at Fort Brown, Texas, on the 31st day of December, 1863.

WM. C. MORSE, Paymaster, U. S. A.

RS FOR A DECEASED SOLDIER.

FORM 5.—PROCEEDINGS OF A COUNCIL OF ADMINISTRATION,

Convened at Fort Brown, Texas, pursuant to Orders, No. 1, dated Post Headquarters, Fort Brown, Texas, January 2, 1864—consisting of Captain James Keith, Company C, 1st Pennsylvania Volunteers; Captain John Brown, Company D, 1st Pennsylvania Volunteers; and Lieutenant William Roe, Company E, 1st Pennsylvania Volunteers—for the purpose of disposing of the effects of the late John Smith, of Company A, 1st Pennsylvania Volunteers:

The Council found that the effects consisted of the following articles. They were ordered to be sold at auction, which was accordingly done, and the amount set opposite the articles respectively obtained, for which the receipt of the Paymaster is annexed:

AT AUCTION.		
1 shirt	brought.....	\$1 00
1 great coat	".....	2 50
1 silver watch	".....	25 00
		\$28 50

JAMES KEITH,
Capt. Co. C, 1st Penn. Vols., President.
WILLIAM ROE,
Lieut. Co. E, 1st Penn. Vols., Recorder.

APPROVED:
JOHN SANDERS,
Colonel 1st Penn. Vols.,
Commanding Post.

FORM 6.—PAYMASTER'S RECEIPT.

RECEIVED from Captain John Brown, Company A, 1st Pennsylvania Volunteers, at Fort Brown, Texas, January 10, 1864, twenty-eight dollars and fifty cents, the result of the sale of the effects of the late Private John Smith, of Company A, 1st Pennsylvania Volunteers.

WM. C. MORSE, Paymaster U. S. Army.

ARTICLES OF WAR.

ART. 95. When any non-commissioned officer or soldier shall die, or be killed in the service of the United States, the then commanding officer of the troop or company shall, in the presence of two other commissioned officers, take an account of what effects he died possessed of, above his arms and accoutrements, and transmit the same to the office of the Department of War, which said effects are to be accounted for, and paid to the representatives of such deceased non-commissioned officer or soldier. And in case any of the officers, so authorized to take care of the effects of deceased officers and soldiers, should, before they have accounted to their representatives for the same, have occasion to leave the regiment or post, by preferment or otherwise, they shall, before they be permitted to quit the same, deposit in the hands of the commanding officer, or of the assistant military agent, all the effects of such deceased non-commissioned officers and soldiers, in order that the same may be secured for, and paid to, their respective representatives.

DIRECTIONS.

NOTE 1.—One copy of the inventories of the effects of deceased non-commissioned officers and soldiers, required by the 95th Article of War, will be forwarded to the Adjutant General, by the commander of the company to which the deceased belonged, and a duplicate of the same to the colonel of the regiment. Final statements of pay, clothing, &c., in duplicate, will be sent to the Adjutant General with one copy of the inventory. Both inventory and final statements should be forwarded, as a general rule, through Regimental Headquarters. When a soldier dies at a post or station absent from his company, it will be the duty of his immediate commander to furnish, direct to the Adjutant General, the required inventory and final statements, and, at the same time, to forward to the commanding officer of the company to which the soldier belonged, a report of his death, specifying the date, place, and cause; to what time he was last paid, and the money or other effects in his possession at the time of his decease; which report will be noted on the next muster roll of the company to which the man belonged. Each inventory will be endorsed "Inventory of the effects of _____, late of company _____, regiment of _____, who died at _____ the _____ day of _____, 186-." If a legal representative receive the effects, it will be stated in the report. If the soldier leave no effects, the fact will be reported on the blank for inventory.

NOTE 2.—Should the effects of a deceased non-commissioned officer or soldier not be administered upon within a short period after his decease, they shall be disposed of by a Council of Administration under the authority of the commanding officer of the post, and the proceeds deposited with the Paymaster, to the credit of the United States, until they shall be claimed by the legal representatives of the deceased. This should be done according to Forms 5 and 6, and one copy of each sent to the Adjutant General. No copy of the order convening the board is required, the approval of the commanding officer being sufficient.

NOTE 3.—In all such cases of sales by the Council of Administration, a statement in detail, or account of the proceeds duly certified by the Council and commanding officer, (Form 5,) accompanied by the Paymaster's receipt of the proceeds, will be forwarded by the commanding officer to the Adjutant General. The statement will be endorsed "Report of the proceeds of the effects of _____, late of company _____, regiment of _____, who died at _____ the _____ day of _____, 186-."

NOTE 4.—The effects in all cases, when called for, should be turned over to the legal representative, without further authority from the Adjutant General. When the effects are turned over to the relatives of the deceased before these inventories are sent to the Adjutant General, their receipts therefor should be attached to the inventories. In all other cases, one copy will be sent with a letter of transmittal direct to the Adjutant General, and a duplicate retained by the officer.

NOTE 5.—Particular care should be taken to take receipts in duplicate from the Paymaster for any funds turned over to him; one copy should be sent direct to the Adjutant General, and one retained by the officer.

NOTE 6.—Where a soldier dies in hospital or on detached service, his descriptive list, if he has one, should be sent with his final statements, in duplicate, to the Adjutant General, Washington, D. C.

NOTE 7.—Form 1 will be forwarded in duplicate to the Adjutant General, through Regimental Headquarters, as soon as possible after the death of the soldier, accompanied by one copy of Forms 2 and 3, or 4, as the case may require. A duplicate of the inventory (Form 2) should be retained until the articles are finally disposed of.

NOTE 8.—The papers for each man should be made SEPARATELY for each man, and, when possible, fastened together. This is especially necessary, and must be done in all cases. The papers cannot be properly disposed of at the Adjutant General's Office unless this is done, and must be returned for correction.

NOTE 9.—Where there are no line officers, as for instance, a general hospital without a line officer to command the guard, the Council of Administration may be made up from other commissioned officers, in the same way as prescribed for line officers.

NOTE 10.—Where a soldier dies away from his company or regiment, and the officer having charge of him cannot furnish Final Statements by reason of not being able to obtain a Descriptive List, he should notify the regimental or company commander, (giving him full particulars as to history and description of the man, as far as possible,) whose duty it will then be, in such case, to furnish the necessary papers from the best data he can obtain.

ny

Surgeon General's Office,

Record and Pension Division,

Feb 9th 1867

Respectfully returned to Asst Adjt

Genl J. W. Saggard A. G. C.

It appears from the records of Field

Hosp (supposed to be 10th & 24th Corps)
near Petersburg Va. Pirate James
on file in this Office, that

Sutherland Co. G. 7 Regt U.S. C. I

(supposed to be the soldier referred
to within) was admitted with
Chronic Diarrhoea Sept 3. 1864
and died in that Hospital

(cause not given) Sept 9. 1864.

No evidence on file from which
Final Statements or Inventory

can be prepared.

By Order of the Surgeon General

J. H. Woodruff

Bot. Major and Asst. Surg. U. S. A.

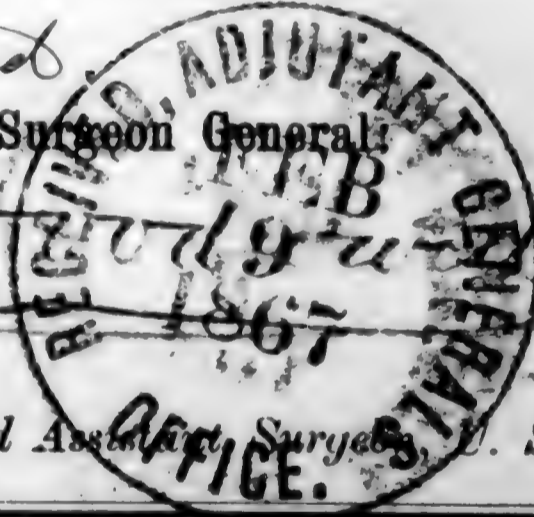

2848

H. B.

WAR DEPARTMENT,

ADJUTANT GENERAL'S OFFICE,

Washington, Feb 26th 1867.

Respectfully returned to the
Commission for the State of

Maryland

with the information that there is
~~no record of enlistment or service.~~

The letter of this Co. must be given before
evidence of enrollment, and Muster in
can be furnished.

Freeman

Adj. Adjt. Genl.

W.H.A.

S. 189 Ind.

Sulthorn

Endorsement.

No. 189

APPLICATION OF

Ignatius Finnes
OF

St Mary County

for compensation for service of slave,

James A. Atterton

enlisted , 1863,

in Co. 7 Regiment

U. S. Colored Troops.

Received *Feb 10* , 1867.

Compensation awarded,

..... , 186

Dollars.

President Board of Claims.

P. O. ADDRESS OF CLAIMANT:

Monacis
Almy
Baltimore
md

CLAIM FOR COMPENSATION FOR ENLISTED SLAVE.

No.

I, *Ignatius Simms* a loyal citizen, and a resident of *St Mary's*, County of *Hayland*, State of *Hayland*, hereby claim compensation, under the provisions of Section 24, Act approved February 24, 1864, and Section 2, Act approved July 28, 1866, for my slave *James A. Johnson*, enlisted 1863, at *Benedict*, by *Ignatius Simms*, in the *7* Regiment U. S. Colored Troops, Co.; certificate of which enlistment and a descriptive list, as required, accompany this application.

In proof of my loyalty to the Constitution and Government of the United States, I present the accompanying oath, which I have taken, signed and acknowledged; to be filed with this application, in accordance with requirement of General Orders, No. 329, 1863, War Department, Adjutant General's Office.

Ignatius Simms

January 16th, 1867.

OATH OF ALLEGIANCE.

I, *Ignatius Simms*, the owner and claimant, do solemnly swear that the foregoing claim is a just and true claim due to me as master and owner of the said slave, and that the facts alleged in said claim in respect to the draft or enlistment (*as the case may be*) of said slave into the military service of the United States are true. And I do further swear that I have never joined, or been concerned in, any insurrection or rebellion; that I have never borne arms against the United States; that I have never given any aid, countenance, counsel or encouragement to any person or persons engaged, or whom I had reason to believe were about to engage, in insurrection, rebellion or armed hostility against the United States; that I have neither sought, nor accepted, nor attempted to exercise the functions of any office, civil or military, nor to perform any service whatever, under any authority or pretended authority in hostility to the United States; that I have not yielded a voluntary support to any insurrection, rebellion or pretended government, authority, power or constitution within the United States hostile thereto. And I do further swear that, to the best of my knowledge and ability, I have supported and defended, and will continue to support and defend, the United States against all enemies, foreign and domestic; and that I have supported, defended and obeyed, and will continue to support, defend and obey, the Constitution and laws of the United States; that I will bear true faith and allegiance to the same; and that I take this oath freely, without any mental reservation or purpose of evasion: So help me God.

Ignatius Simms

Sworn to and subscribed before me, at *Home*, this *16th* day of *January*, 1867.

W. L. Davis
Justice of the Peace



1252

Sparks George Washington

Co *F*, 7 U.S. Col'd Inf.

Private

Private

CARD NUMBERS.

1	6289204	26
2	6289303	27
3	6289398	28
4	6289500	29
5	6289602	30
6	6289696	31
7	6289792	32
8	6289885	33
9	6289984	34
10	6290077	35
11	6290174	36
12	6290296	37
13	6290898	38
14	9066596	39
15		40
16		41
17		42
18		43
19		44
20		45
21		46
22		47
23		48
24		49
25		50

Book Mark:

See also

NARA 425

S | 7 | U.S.C.T.
George H. Sparks
Co. *B*, 7 Reg't U.S. Col'd Inf.

Appears on
Company Descriptive Book
of the organization named above.

DESCRIPTION.

Age *31* years; height *5* feet *4* inches.
Complexion *Rose*
Eyes *Blue*; hair *Curly*
Where born *Caroline, Md.*
Occupation *Farmer*

ENLISTMENT.

When *Sept 24*, 186*3*
Where *Baltimore Md.*
By whom *Col. W. Birney* term *3* y'rs.

Remarks: *Mustered Sept 30,*
1863, by Col Wm. Birney.
Killed in Hospital at
Manassas, Va., April
20, 1865.

W. Brown
Copyist.

S | 7 | U.S.C.T.

George Washington Spatke
Sgt., Co. F., 7 Reg't U. S. Colored Inf.

Age *21* years.

Appears on

Company Muster-in Roll

of the organization named above. Roll dated

Baltimore Md., Sept 30, 1863.

Muster-in to date *Sept. 30, 1863.*

Joined for duty and enrolled:

When *Sept 24*, 186*3*.*

Where *Kent Co. Md.* *

Period *3* years.*

Remarks:
.....
.....
.....
.....
.....

* Muster-in roll shows enrollment of all men of this company as of same date. See enrollment on subsequent card or cards.

Book mark :

(356c)

J. A. Spitzer
Corrpt.

S | **7** | **U.S.C.T.**

George Washington Sparks
Sgt, Co. F, 7 Reg't U. S. Col'd Infantry.

Appears on

Company Muster Roll

for *Sept 30. to Oct 31.*, 186 *3*.

Joined for duty and enrolled:

When *Sept 27.*, 186 *3*.*

Where *Kent Co Md.* *

Period *3* years.*

Present or absent *Absent*

Stoppage, \$ *100* for

Due Gov't \$ *100* for

Remarks: *Sick sent hospital*
at River Damack's Bal-
timore Md.

* See enrollment on card from muster-in roll.

Book mark: _____

(858c)

J. Schmitt
Copyist.

S | **7** | **U.S.C.T.**

George W. Sparks
Sgt., Co. F, 7 Reg't U. S. Col'd Infantry.

Appears on

Company Muster Roll

for *Nov. & Dec.*, 186*3*.

Joined for duty and enrolled:

When *Sept. 27*, 186*3*.*

Where *Kent Co. Md* *

Period *3* years.*

Present or absent *Present.*

Stoppage, \$ *100* for

Due Gov't \$ *100* for

Remarks: *- Not paid since enlistment.*

* See enrollment on card from muster-in roll.

Book mark:

(858c)

C. H. Miller
Copyist.

1863 499

7

U.S.C.T.

George W. Sparks
Sgt., Co. F, 7 Reg't U. S. Col'd Infantry.

Appears on

Company Muster Roll

for *Jan. & Feb.*, 186*4**

Joined for duty and enrolled:

When *Sept 24*, 186*3**
Where *Kent Co. Md.**

Period _____ years.*

Present or absent *Present*

Stoppage, \$ 100 for _____

Due Gov't \$ 100 for _____

Remarks: _____

* See enrollment on card from muster in roll.

Book mark: _____

(858c)

J. A. Miller
Copyist.

S | **7** | **U.S.C.T.**

George W. Sparks
Plt, Co. F, 7 Reg't U. S. Col'd Infantry.

Appears on

Company Muster Roll

for *March, & April*, 186*4*

Joined for duty and enrolled:

When *Sept 24*, 186*3*.*

Where *Kent Co. Md* *

Period *3* years.*

Present or absent *Present*

Stoppage, \$ *100* for

Due Gov't \$ *100* for

Remarks:

* See enrollment on card from muster-in roll.

Book mark: -----

(358c)

J. A. Miller
Copyist.

A 7 U.S.C.T.

George W. Sparks
Pvt., Co. F, 7 Reg't U. S. Col'd Infantry.

Appears on

Company Muster Roll

for *May & June*, 186*4*.

Joined for duty and enrolled:

When *Sept. 27*, 186*3*.*

Where *Ant Co. Md* *

Period *3* years.*

Present or absent *Present*

Stoppage, \$ *100* for

Due Gov't \$ *100* for

Remarks:

* ~~See~~ See enrollment on card from muster-in roll.

Book mark: _____

(358c)

J. E. Miller
Copyist.

S | 7 | U.S.C.T.

George W. Sparks
Pvt, Co. F, 7 Reg't U. S. Col'd Infantry.

Appears on

Company Muster Roll
for July & Aug, 1864.

Joined for duty and enrolled:

When Sept 27, 1864.*

Where Kent Co. Md.*

Period 3 years.*

Present or absent Present

Stoppage, \$ 100 for

Due Gov't \$ 100 for

Remarks:

* See enrollment on card from muster-in roll.

Book mark:

W. H. ... Copyist.

S | **7** | **U.S.C.T.**

George W. ^{pauper} Smith

Private, Co. F, 7 Reg't U. S. Col'd Infantry.

Appears on

Company Muster Roll

for *Septnd Oct.*, 186*4*.

Joined for duty and enrolled:

When *Sept. 27*, 186*4*.*

Where *Kent Co., Md.*.*

Period *3* years.*

Present or absent *Absent*

Stoppage, \$ *100* for

Due Gov't \$ *100* for

Remarks: *In Hosp. sick since
Sep. 29, '64.*

** Corrected by S. A. Wight*

* See enrollment on card from muster-in roll.

Book mark:

Keefe

S | **7** | **U.S.C.T.**

George W. Sparks

Private, Co. F, 7 Reg't U. S. Col'd Infantry.

Appears on

Company Muster Roll

for *Nov. and Dec.*, 1864.

Joined for duty and enrolled:

When *Sep. 27*, 1863.*

Where *Kent Co., Md.* *

Period *3* years.*

Present or absent *Absent*

Stoppage, \$ *100* for

Due Gov't \$ *100* for

Remarks: *In Hosp. wounded since Sept. 29, 64*

* See enrollment on card from muster-in roll.

Book mark:

Keeper

S | **7** | **U.S.C.T.**

George W. Sparks

Private, Co. F, 7 Reg't U. S. Col'd Infantry.

Appears on

Company Muster Roll

for *Jan. & Feb.*, 1865.

Joined for duty and enrolled:

When *Sep 27*, 1865.*

Where *Kent Co., Md.* *

Period *3* years.*

Present or absent *Present*

Stoppage, \$ *100* for

Due Gov't \$ *100* for

Remarks:

* See enrollment on card from muster-in roll.

Book mark: _____

(858c)

Keefe

Copyist.

S | **7** | **U.S.C.T.**

George W. Sparks

Private, Co. F, 7 Reg't U. S. Col'd Infantry.

Appears on

Company Muster Roll

for *Mar.* *Apr.* , 186*5*.

Joined for duty and enrolled:

When *Sep. 27*, 186*3*.*

Where *Kent Co., Md.* *

Period *3* years.*

Present or absent *Absent*

Stoppage, \$ *100* for

Due Gov't \$ *100* for

Remarks: *Absent sick since March 10th 65*

* ~~See~~ See enrollment on card from muster-in roll.

Book mark: -----

Keefe

(858c) Copyist.

S | **7** | **U.S.C.T.**

George W. Sparks

Private, Co. F, 7 Reg't U. S. Col'd Infantry.

Appears on

Company Muster Roll

for *May and June*, 186*5*.

Joined for duty and enrolled:

When *Sep. 27*, 186*3*.*

Where *Kent Co., Md.* *

Period *2* years.*

Present or absent

Stoppage, \$ *100* for

Due Gov't \$ *100* for

Remarks: *Died in U.S. Gen Hosp. Fortress Monroe, Va March 20 1865 of Typhoid Fever.*

* See enrollment on card from muster-in roll.

Book mark: *Also. Died in U.S. Gen (over)*

(858c)

Keeper
Copyist.

JAN. 20

6290296

1891

Hosp. Fortres Monroe Va,
Apr. 20, 1865. see endant
on F. S. 8654 24th Apr.
Apr 9/68. 11. 2. 67, 2. And
July 29th 68.

S | 7 | U.S.C.T.

George H. Sparks
Pvt., Co. F, 7 Reg't U. S. Col'd Infantry.

Appears on Co. Muster-out Roll, dated
Indiana, Texas, Oct 13, 1866.

Muster-out to date 186 .

Last paid to 186 .

Clothing account:

Last settled....., 186 ; drawn since \$..... 100

Due soldier \$..... 100; due U. S. \$..... 100

Am't for cloth'g in kind or money adv'd \$..... 100

Due U. S. for arms, equipments, &c., \$..... 100

Bounty paid \$..... 100; due \$..... 100

Remarks: Died in Hospital
Fort Monroe, Va.
Apr. 20, 65.

Book mark: V33P106/- 86542a.
168 over

Brivoke

JAN. 21

6290898

18910

Apr. 9 '68. 294.547.
P.S.

Sparks, George A.
 P, Co. F, 7 Reg't U. S. C. Inf.

2 Enclosures.

Bed Cards	Descriptive Lists
Burial Records	Final Statements /
Certs. of Dis. for Discharge	Furloughs
C. M. Charges	Med. Des. Lists
Med. Certificates	Orders

Other papers relating to—

Admission to Hosp'l	Furlough
Casualty Sheet (Officer's) /	Med. Examination
Confinement	Misc. Information
Contracts	Pay or Clothing
Death or Effects	Personal Reports
Desertions	Rank
Discharge from Hosp'l	Transfer to Hosp'l
Discharge from Service	Transfer to V. R. C.
Duty	Transportation

162

CASUALTY SHEET
OF WOUNDED.

Geo W Sparks

Private Company "F"

7th Regiment of W. S. C. I.

Volunteers at the battle of Chapin's

Farm, Va., Sept 29 & 30.

1864

CASUALTY SHEET.

Name, Geo W Sparks
Rank, Private, Company "A", Regiment, 7th
Arm, U. S. L. T., State, _____
Place of casualty, Chapeins Farm, Va.

Nature of casualty, Wounded

Date of casualty, Sept 29 + 30 1864

FROM WHAT SOURCE THIS INFORMATION WAS OBTAINED.

Report of Killed, Wounded, and Missing of the _____ Regiment,
_____ Brigade, _____ Division, _____ Corps, dated _____
List of casualties in the 7th U. S. L. Troops, on the
29 + 30 of Sept / 64, at Chapeins Farm, Va.
Sgd. Slewellyn P. Haskell
First Lieut Leonard

Ind 50 S no 63.

J. P. Prosser

Clerk.

The Descriptive Book of Co. I,
 7th U.S.C. reports under Register of
 Deaths Geo. W. Sparks Pvt. Died at
 Fortres Monroe Va April 20th 1865.
 Cause unknown. Descriptive roll of
 Company reports him as having died
 in Hospital at Fortres Monroe Va
 same date. The morning report book
 of Company. It is not on file
 with the records of the 7th U.S.C.

Record Room
 A.C. Dec. 24th 1868
 J. H. A. B.

On cert for 56 July 1864
See cert for 66 Nov 16 1864
F.

FINAL STATEMENT

Private George W. Sparks
2nd Reg't of U.S. Troops

VOLUNTEERS.

Died March 25th 1865

NOTE 1.—Two of these certificates (or duplicates) are to be given to each Volunteer Soldier or drafted man who may be discharged previously to the discharge of his company, that he may at once receive from the Paymaster the pay, &c., due him, and the captain or other COMMISSIONED officer commanding the company will certify to the act of the delivery of the duplicate certificates; on these certificates the Soldier is "entitled to" his discharge, and should also present his discharge to the Paymaster to have the payment endorsed on it. The discharge is to be given back to the Soldier by the Paymaster; the latter only retaining as his voucher the duplicate certificates.

NOTE 2.—If the Soldier is entitled to pay for the use of his horse, the Company Commander will certify to that fact on the back of both these final statements, and also to the time he has pay due for having been so mounted on his own horse.

NOTE 3.—When a Soldier is furnished with final statements, his descriptive list, if he has one, should be taken up by the officer who gives the Soldier these statements, and endorsed with a statement to this effect by the officer. This endorsement should exhibit a full statement of the time for which the Soldier was allowed pay on his final statements, the clothing account, and all other charges against him or in his favor, so as to comprise a complete exhibit of his account. It will then be transmitted to the Company Commander of the Soldier, who will enter all the data necessary to a full understanding of the Soldier's account on the muster roll upon which the Soldier's discharge is reported. The descriptive list will then be destroyed. The object of this is, that the remaining portion of the Soldier's account may be settled upon the receipt of these muster rolls, and the Soldier receive any pay or allowances that may be due him at the time of his discharge, and which may not appear on his final statements from the fact that his descriptive list is incomplete. These accounts for back pay, &c., are settled by the 2d Auditor of the Treasury Department.

NOTE 4.—Charges for loss or injury to ordnance, horse equipments, and other miscellaneous charges, should appear under the heading of "Other Stoppages."

NOTE 5.—Bounty paid by State authorities, and not by the United States, will not be entered on this statement.

NOTE 6.—Amounts due the Sattler and Laundress must be entered on the muster roll on which the discharge, death, desertion, &c., is reported, as well as on the final statement, otherwise the amount cannot be collected from the United States.

NOTE 7.—This blank will be used for deceased volunteers and drafted men, as well as for others.

NOTE 8.—Where a Soldier dies in Hospital or on detached service; his descriptive list, if he has one, should be sent with his final statements, in duplicate, to the Adjutant General, Washington, D. C.

Enson R. Cas.

Adjutant General's Office
Washington, D.C., Dec. 31st 1864

3 B roll 6 Page 458.

All rolls and papers whereon is noted the death of George W. Sparks, late Private Company "F" 2nd U.S. Colored Troops, will be made to show that he died in Hospital at Fortress Monroe, Va April 30th 1865.

Thomas M. Gruent
Asst. Adj. General
A.G.

Noted on Muster Roll
Jan 4 1865
See Letter Jan 8 69 to 2nd Auditor Treasury Dept.

ADJUTANT GENERAL'S OFFICE
Jan 10 1866
Duplicate with Inventory sent 2d Auditor.

I certify on honor, that George W. Sparks Private of
 Captain L. O. Omme's Company (A) of the 1st Regiment of U.S. Troops,
VOLUNTEERS, of the State of _____, born in Caroline Co., State
 of Mo., aged 27 years; 5 feet 5 inches high; Blk complexion,
Blk eyes, Curly hair, and by occupation a Farmer, having joined the company on
 its original organization at Baltimore Md., and enrolled in it at the muster into
 the service of the United States at Baltimore Md., on the 30th day
 of Sept., 1863, (or was mustered in service as a recruit, by _____
 _____, at _____, on the _____ day of _____,
 186 , or was drafted and mustered into the service of the United States from the _____
 Enrollment District of the State of _____, at _____,
 on the _____ day of _____, 186), to serve in the Regiment, for
 the term of Three Years: and having served HONESTLY and
 FAITHFULLY with his Company in Florida Va. to the present date, is now

entitled to a **DISCHARGE** by reason of Death in hospital at
Ft. Monroe Va. April 20th 1864 - as per Certificate Book and M.O. No.

The said George W. Sparks was last paid by Paymaster
Haj. McConnell to include the 30th day of April, 1864 and has
 pay due him from that time to the present date; he is entitled to pay and subsistence for
TRAVELING to place of enrollment, and whatever other allowances are authorized to volunteer
 soldiers, drafted men, or militia, so discharged. He has received from the United States **CLOTHING**
 amounting to 45 ⁵⁷ ~~100~~ dollars, since the 30 day of Sept.,
 1864, when his clothing account was last settled. He has received from the United States
100 dollars advanced **BOUNTY**.

There is to be stopped from him, on account of the State of _____, or other
 authorities, for **CLOTHING**, 24 ¹⁸ ~~100~~ dollars; and
 for other stoppages, viz: _____

_____ dollars.

He has been furnished with **TRANSPORTATION** in kind from the place of his discharge to
 _____; and he has been **SUBSISTED** for **TRAVELING** to his
 place of enrollment, up to the _____, 186 .

He is indebted to _____, **SUTLER**, _____ dollars.

He is indebted to _____, **LAUNDRESS**, _____ dollars.

Given in Duplicate, at Near City Point, Va., this 11 day
 of May, 1865.

J. M. Caff
1st Lt. U.S.A.
 Commanding Company.

Discharged April 20th 1864

1253

Sparks Henry

Co A, 7 U.S. Col'd Inf.

Private

Private

CARD NUMBERS.

1	6280794	26
2	6280894	27
3	6280995	28
4	6281095	29
5	6281191	30
6	6281284	31
7	6281375	32
8	6281460	33
9	6281543	34
10	6281624	35
11	6281706	36
12	9065964	37
13	43152950	38
14		39
15		40
16		41
17		42
18		43
19		44
20		45
21		46
22		47
23		48
24		49
25		50

Book Mark:

See also

S-3091518 And W D

54

MARR 449

S | 7 | U.S.C.T.

Henry Sparks
....., Co. *A*, 7 Reg't U.S. Col'd Inf.

Appears on

Company Descriptive Book

of the organization named above.

DESCRIPTION.

Age *26* years; height *5* feet *5 1/2* inches.

Complexion *Brown*

Eyes *Blk.*; hair *Blk.*

Where born *Virginia*

Occupation *Laborer.*

ENLISTMENT.

When *Dec. 19*, 186*4*

Where *Washington D.C.*

By whom _____; term *3* y'rs.

Remarks: *Substitute.*

*Mustered Dec. 19, 64,
by Capt. H. Putnam.*

H. Smith

S 1 7 U.S.C.T.

Henry Sparks

Appears with rank of 1st on

Muster and Descriptive Roll

of Detachment of men
drafted forwarded.

Unassigned Regt U.S.C.T. Roll dated
Washington D.C Dec 21, 1864.

Where born Va.

Age 26 y'rs; occupation Laborer

Drafted and mustered in:

When Dec. 19, 1864.

Where Washington, D.C.

Enrollment district 3^d Sub. Dist. D.C.

Period 3 years.

Eyes Brown; hair Black

Complexion Brown; height 5 ft. 5 1/2 in.

Bounty paid \$ 100; due \$ 100

Clothing account:

Last settled _____, 1864; drawn since \$ 18 34/100

Date of commencement of service Dec 19, 1864.

Company to which assigned _____

Remarks: Substitute for
John H. Seiffert 3^d Sub.
Dist. D.C. Not entitled
to bounty.

Book mark: _____

R. W. Fish

517 U.S.C.T.

Henry Sparks

Pvt., Co. A, 7 Reg't U. S. Col'd Infantry.

Appears on

Company Muster Roll

for Jan. & Feb., 1865.

Joined for duty and enrolled:

When Dec. 19, 1864.*

Where Washington, D.C.*

Period 3 years.*

Present or absent Present

Stoppage, \$ 100 for

Due Gov't \$ 100 for

Remarks: Recruit from depot.

(Mustered in Dec 19-64)

* See enrollment on card from muster-in roll.

Book mark:

(858c)

Conard

Copyist.

S. 7

U.S.C.T.

Henry Sparks
Pvt., Co. A, 7 Reg't U. S. Col'd Infantry.

Appears on

Company Muster Roll

for Mch + Apl , 1865.

Joined for duty and enrolled:

When Dec. 19 , 1864.*

Where Washington, D.C. *

Period 3 years.*

Present or absent Present

Stoppage, \$ 100 for

Due Gov't \$ 100 for

Remarks: Recruit from Depot

* See enrollment on card from muster-in roll.

Book mark:

(858c)

 Conard
Copyist.

S | 7 | U.S.C.T.

Henry Sparkes
Pot., Co. A, 7 Reg't U. S. Col'd Infantry.

Appears on

Company Muster Roll

for May & June, 1865.

Joined for duty and enrolled:

When Dec. 19, 1864.*

Where Washington *

Period 3 years.*

Present or absent Present

Stoppage, \$ 100 for

Due Gov't \$ 100 for

Remarks: Recruit from Depot. Charge
1 Screw driver & 1 wiper.

* See enrollment on card from muster-in roll.

Book mark:

(358c)

Conard
Copyist.

S | 7 | U.S.C.T.

Henry Sparks
Pvt., Co. A, 7 Reg't U. S. Col'd Infantry.

Appears on

Company Muster Roll

for July & Aug, 1865.

Joined for duty and enrolled:

When Dec. 19, 1864.*

Where Washington *

Period 3 years.*

Present or absent * Present

Stoppage, \$ 100 for

Due Gov't \$ 100 for

Remarks: Absent sick since Aug 25, 1865, Indianola, Tex.

* Name appears in "Present" column

* See enrollment on card from muster-in roll.

Book mark:

(358c)

Conard
Copyist.

S 7 U.S.C.T.

Henry Sparks
Pat, Co. A, 7 Reg't U. S. Col'd Infantry.

Appears on

Company Muster Roll

for Sept. & Oct., 1865.

Joined for duty and enrolled:

When Dec. 19, 1864.*

Where Washington *

Period 3 years.*

Present or absent Absent

Stoppage, \$ 100 for

Due Gov't \$ 100 for

Remarks: Absent sick since Sept.
21/65.

* See enrollment on card from muster-in roll.

Book mark:

(358c)

Conard
Copyist.

S 7 U.S.C.T.

Henry Sparks
Co. A, 7 Reg't U. S. Col'd Infantry.

Appears on

Company Muster Roll
for Nov & Dec, 1865.

Joined for duty and enrolled:

When Dec 19, 1864*

Where Washington, D.C.*

Period 3 years.*

Present or absent Present

Stoppage, \$ 100 for

Due Gov't \$ 100 for

Remarks:

* See enrollment on card from muster-in roll.

Book mark:

(358c) Mowry J. Copyist.

S 7 U.S.C.T.

Henry Sparks
Priv. Col. A, 7 Reg't U. S. Col'd Infantry.

Appears on
Company Muster Roll
for Jan & Feb, 1866.

Joined for duty and enrolled:
When Dec 19, 1864.*
Where Washington, D.C.*
Period 3 years.*

Present or absent Present
Stoppage, \$ 13/100 for Advance
Due Gov't \$ 100 for

Remarks:

* See enrollment on card from muster-in roll.

Book mark: _____

(858c) Henry J. Copyist.

17 U.S.C.T.

Henry Sparks
Co. A, 7 Reg't U. S. Col'd Infantry.

Appears on

Company Muster Roll

for March & April, 1866.

Joined for duty and enrolled:

When Dec 19, 1864*

Where Washington, D.C.*

Period 3 years.*

Present or absent Present

Stoppage, \$ 100 for

Due Gov't \$ 100 for

Remarks:

* See enrollment on card from muster-in roll.

Book mark: _____

(858c)

Henry J.
Copyist.

S. 1

7

U.S.C.T.

Henry Sparks

Pri, Co. A, 7 Reg't U. S. Col'd Infantry.

Appears on

Company Muster Roll

for May & June, 1866.

Joined for duty and enrolled:

When Dec 19, 1864*

Where Washington, D.C.*

Period 3 years.*

Present or absent Present

Stoppage, \$ 100 for

Due Gov't \$ 100 for

Remarks:

* See enrollment on card from muster-in roll.

Book mark:

(858c)

Mowry J. Copyist.

S | 7 | U.S.C.T.

³ Henry Sparks

Pri, Co. A, 7 Reg't U. S. Col'd Infantry.

Appears on

Company Muster Roll

for July & Aug, 1866.

Joined for duty and enrolled:

When Dec. 19, 1864.*

Where Washington, D.C.*

Period 3 years.*

Present or absent Present

Stoppage, \$ 100 for

Due Gov't \$ 100 for

Remarks:

* See enrollment on card from muster-in roll.

Book mark:

Henry Sparks Copyist.

S | 7 | U.S.C.T.

Henry Sparks
Pri, Co. A, 7 Reg't U. S. Col'd Infantry.

Appears on Co. Muster-out Roll, dated
Indiana, Dec. 13, 1866.

Muster-out to date Oct 13, 1866.

Last paid to June 30, 1866.

Clothing account:

Last settled....., 186 ; drawn since \$ 100

Due soldier \$ 100; due U. S. \$ 4 88/100

Am't for cloth'g in kind or money adv'd \$ 100

Due U. S. for arms, equipments, &c., \$ 6 00/100

Bounty paid \$ none 100; due \$ 100

Remarks: Joined Co. Jan. 10/65.
Substitute for John H.
Support. Retains 1 Enfield
rifled musket & set of accoutre-
ments, per G.O. 101, War Dept
May 30/65.

Book mark: V222 F232 75

(361)

Murray, Jr.
Copyist.

1254

Spaulding Harlan
Co *E*, 7 U.S. Col'd Inf.

Captain | *Captain*
CARD NUMBERS.

1	6278720	26
2	6287307	27
3	6287408	28
4	6287509	29
5	6287610	30
6	6287707	31
7	6287804	32
8	6287896	33
9	6287990	34
10	6288087	35
11	6288188	36
12	6288289	37
13	6288389	38
14	6288486	39
15	6288581	40
16	6288674	41
17	6288760	42
18	6288843	43
19	6288926	44
20	6289006	45
21	9428683	46
22	9205-CT-1863	47
23	43224963	48
24	43226847	49
25		50

Book Mark: { 925 - C. J. 82
 { 9205-CT-1863.

See also 44 N. of. Inf.

Q. 9, 1313628

S | 7 | **U.S.C.T.**

Harlan Spaulding
Capt., Co., 7 Reg't U. S. Col'd Inf.

Appears on

Regimental Descriptive Book

(List of Commissioned Officers)

of the regiment named above.

Rank Capt.

Date of appointment Oct 10 1863

Remarks: Born in the State of New
York and a resident of said
State entered the service of U.S.
as a private of 44th New York
Infy. vol. Sept 17/63 was
mustered into the service of 7th
U.S.C.T. Oct 21 1863

In ten engagements with the
44th N.Y. vols. In nine engage-
ments with the 7th U.S.C.T.

A Fairley
 Copyist.

S. | 7th | U.S.C.T.

Harlan P Spaulding
Capt., Co. 7 Reg't U. S. Col'd Infantry.

Age 24 years.

Appears on an

Individual Muster-in Roll

of the organization named above. Roll dated

Baltimore Md, Oct-21, 1863.

Muster-in to date Oct-21, 1863.

Joined for duty and enrolled:

When Oct-21, 1863.

Where Baltimore Md

Period 3 years. or during the war

Remarks: Assigned to Co
E. Seventh U.S. C
Troops

Book mark :

C. S. Rozzell

(836)

Copyist.

S | 7 | U.S.C.T.

Harlan P. Spaulding
Capt., Co. E, 7 Reg't U. S. Col'd Infantry.

Appears on

Company Muster Roll

for *Sept. 30/63 to Oct. 31*, 1863.

Joined for duty and enrolled:

When....., 186 .*

Where*

Period..... years.*

Present or absent *Present.*

Stoppage, \$ 100 for.....

Due Gov't \$ 100 for.....

Remarks: *Appointed by the*
President Oct. 10th 1863.
Accepted Oct. 19th 1863.

* See enrollment on card from muster-in roll.

Book mark:.....

L. C. Rankin

S | 7 | U.S.C.T.

Harlan P. Spaulding
Capt., Co. E, 7 Reg't U. S. Col'd Infantry

Appears on

Company Muster Roll

for *Nov. & Dec.*, 1863.

Joined for duty and enrolled:

When *October 10*, 1863.

Where *Washington D.C.*

Period years.*

Present or absent *Present.*

Stoppage, \$ *100* for

Due Gov't \$ *100* for

Remarks: *Joined for
duty by order Col.
Wm. Birney Oct. 21,
1863*

* See enrollment on card from muster-in roll.

Book mark:

A. E. Rankin

(358c)

Copyist.

S | 7 | U.S.C.T.

Harlan P. Spaulding
Capt., Co. E, 7 Reg't U. S. Col'd Infantry.

Appears on

Company Muster Roll

for Jan. + Feb., 1864.

Joined for duty and enrolled:

When Oct. 10, 1863.*

Where Washington D.C.*

Period years.*

Present or absent Present.

Stoppage, \$ 100 for

Due Gov't \$ 100 for

Remarks:
.....
.....
.....
.....
.....

* See enrollment on card from muster-in roll.

Book mark:

E. C. Rankin
(358c) Copyist.

S | 7 | U.S.C.T.

Hailan P. Spaulding
Capt., Co. E, 7 Reg't U. S. Col'd Infantry.

Appears on

Company Muster Roll
for *Mar. & Apr.*, 1864.

Joined for duty and enrolled:

When *Oct. 10*, 1863.*

Where *Washington D.C.**

Period years.*

Present or absent *Present*

Stoppage, \$ *100* for

Due Gov't \$ *100* for

Remarks:

* See enrollment on card from muster-in roll.

Book mark:

E. E. Rankin
Copyist.

S | 7 | U.S.C.T.

Harlan P. Spaulding
Capt., Co. E, 7 Reg't U. S. Col'd Infantry.

Appears on

Company Muster Roll

for *Dated June 30*, 1864.

Joined for duty and enrolled:

When *Oct. 10*, 1863.*

Where *Washington D.C.*

Period years.*

Present or absent *Absent.*

Stoppage, \$ *100* for

Due Gov't \$ *100* for

Remarks: *Sick in Camp*
at Jacksonville
June 2^d 1864.

* See enrollment on card from muster-in roll.

Book mark:

(358c)

E. A. Rankin

Copyist.

S | **7** | **U.S.C.T.**

Hurlam P. Spaulding
Capt., Co. E, 7th Reg't U. S. Col'd Infantry.

Appears on

Company Muster Roll

for *Jul. & Aug.*, 1864.

Joined for duty and enrolled:

When *Oct. 10*, 1863.*

Where *Washington D.C.**

Period years.*

Present or absent *Present*

Stoppage, \$ *100* for

Due Gov't \$ *100* for

Remarks:

* See enrollment on card from muster-in roll.

Book mark:

A. P. Rankin
Copyist.

O.S.

7

U.S.C.T.

Nathan P. Spaulding
Captain, Co. E, 7 Reg't U. S. Col'd Infantry.

Appears on

Company Muster Roll

for *Sept & Oct*, 1864.

Joined for duty and enrolled:

When *Oct 10*, 1863.*

Where *Washington D.C.**

Period years.*

Present or absent *Present*

Stoppage, \$ *100* for

Due Gov't \$ *100* for

Remarks: *Top for actions drawn
in the month of Sept - of St. Anthony -
A.C.S. 7/11/70*

* See enrollment on card from muster-in roll.

Book mark:

S. Thompson

(358c)

Copyist.

S. 7 U.S.C.T.

Nelson L. Spaulding
Captain, Co. E, 7 Reg't U. S. Col'd Infantry.

Appears on

Company Muster Roll

for Nov + Dec, 1864.

Joined for duty and enrolled:

When Oct 10, 1863.

Where Washington D.C.

Period years.*

Present or absent Present.

Stoppage, \$ 100 for

Due Gov't \$ 100 for

Remarks:

* See enrollment on card from muster-in roll.

Book mark:

Thompson

S.

7

U.S.C.T.

Warlan P. Spaulding

Capt., Co. E, 7 Reg't U. S. Col'd Infantry.

Appears on

Company Muster Roll

for *Jan & Feb.*, 1865.

Joined for duty and enrolled:

When *Oct 10th*, 1863.*

Where *Washington D.C.* *

Period years.*

Present or absent *Present*

Stoppage, \$ 100 for

Due Gov't \$ 100 for

Remarks:

.....
.....
.....
.....

* See enrollment on card from muster-in roll.

Book mark:

S. Thompson

S. | **7** | **U.S.C.T.**

Harlan P Spaulding
Captain, Co. E, 7 Reg't U. S. Col'd Infantry.

Appears on

Company Muster Roll

for *March & April*, 186*5*.

Joined for duty and enrolled:

When *Oct 10*, 186*3*.*

Where *Washington D.C.* *

Period years.*

Present or absent *Present*

Stoppage, \$ *100* for

Due Gov't \$ *100* for

Remarks:

* See enrollment on card from muster-in roll.

Book mark:

E. Thompson

S. 1 | **7** | **U.S.C.T.**

William L. Spaulding
Captain, Co. E, 7 Reg't U. S. Col'd Infantry.

Appears on

Company Muster Roll

for *May & June*, 186*5*.

Joined for duty and enrolled:

When *Oct 10*, 186*3*.*

Where *Washington, D.C.* *

Period years.*

Present or absent *Present*

Stoppage, \$ *100* for

Due Gov't \$ *100* for

Remarks:

* See enrollment on card from muster-in roll.

Book mark:

W. L. Spaulding

A

7

U.S.C.T.

William R. Spaulding
Captain, Co. E, 7 Reg't U. S. Col'd Infantry.

Appears on

Company Muster Roll

for *July & Aug.*, 186*5*.

Joined for duty and enrolled:

When *Oct 10*, 186*3*.*

Where *Washington D.C.* *

Period years.*

Present or absent *Present*

Stoppage, \$ *100* for

Due Gov't \$ *100* for

Remarks: *Commanding Detach-*
ment 7th U. S. C. I. at
Matagorda, Texas July
7 '65

* See enrollment on card from muster-in roll.

Book mark:

J. Thompson

7 U.S.C.T.

Orlan & Chaulding
Captain, Co. E, 7 Reg't U. S. Col'd Infantry.

Appears on

Company Muster Roll

for *Sept + Oct*, 186*5*.

Joined for duty and enrolled:

When *Sept 10th*, 186*5*.*

Where *Washington D.C.* *

Period years.*

Present or absent *Present*

Stoppage, \$ *100* for

Due Gov't \$ *100* for

Remarks: *Commanding Det. 7th*
U.S.C.T. at Matagorda, Texas.

* See enrollment on card from muster-in roll.

Book mark:

W. Thompson

S | 7 | U.S.C.T.

Harlan P Spaulding
Capt, Co. E, 7 Reg't U. S. Col'd Infantry.

Appears on

Company Muster Roll

for Nov & Dec, 1865.

Joined for duty and enrolled:

When Oct 10, 1863.*

Where Washington, D.C.*

Period years.*

Present or absent Absent

Stoppage, \$ 100 for

Due Gov't \$ 100 for

Remarks Det. as Pro Mar
Indianola, Tex per S.O.
No. 153 Hed. Gns.
U.S. forces Indian Tex
Dec 25, 1865.

* See enrollment on card from muster-in roll.

Book mark:

(358c)

Jno J Bell Jr
Copyist.

NARA 499
Harlan P Spaulding
Capt. 4th N. S. C. I.

Leave.

1865.

See weekly report
of Brig. Gen. C. A.
Heckman Comdg.

25th A. C.

S | 7 | U.S.C.T.

Harlan P Spaulding
Capt., Co. E, 7 Reg't U. S. Col'd Infantry.

Appears on

Company Muster Roll

for Jan, & Feb, 1866.

Joined for duty and enrolled:

When Oct. 10, 1863.*

Where Washington, DC.*

Period years.*

Present or absent Absent

Stoppage, \$ 100 for

Due Gov't \$ 100 for

Remarks: Set as Pro Man
Indianola, Texas per SO.
No. 153 Hdqrs U.S. Forces
Indianola, Tex. Dec 25, 1865

* See enrollment on card from muster-in roll.

Book mark:

J. H. Bull
(358c) Copyist.

S

7

U.S.C.T.

Harlan P. Spaulding
Capt, Co. E, 7 Reg't U. S. Col'd Infantry

Appears on

Company Muster Roll

for March & April, 1866.

Joined for duty and enrolled:

When Oct. 10, 1863.*

Where Washington, D.C.*

Period 3 years.*

Present or absent Absent.

Stoppage, \$ 100 for

Due Gov't \$ 100 for

Remarks Commanding Post
Victoria, Texas per
S.O. No. 39. Hd Qrs
Cent Dist of Tex.
San Antonio, Tex
February 27, 1866.

* See enrollment on card from muster-in roll.

Book mark:

Geo J. Bull

(358c)

Copyright

S | 7 | U.S.C.T.

Harlan P Spaulding
Capt, Co. E, 7 Reg't U. S. Col'd Infantry.

Appears on

Company Muster Roll

for May & June, 1866.

Joined for duty and enrolled:

When Oct. 10, 1863.*

Where Washington, D.C.*

Period years.*

Present or absent Absent

Stoppage, \$ 100 for

Due Gov't \$ 100 for

Remarks: Commanding Post
Victoria, Tex per S. O.
No. 39 145. G. S. Comd
Dist. of Texas -
San Antonio, Tex
Feb. 27, 1866.

* See enrollment on card from muster-in roll.

Book mark:

(358c) *[Signature]* Copyist.

S | 7 | U.S.C.T.

Harlow P. Spaulding
Capt, Co. E, 7 Reg't U. S. Col'd Infantry

Appears on

Company Muster Roll

for July & Aug, 1866.

Joined for duty and enrolled:

When Oct 10, 1863.

Where Washington, D.C.

Period years.*

Present or absent Absent.

Stoppage, \$ 100 for

Due Gov't \$ 100 for

Remarks Commanding Post
Victoria Tex per SO No. 39
Head Quarters Central
District of Texas.
San Antonio Tex Feb. 27,
1866.

* See enrollment on card from muster-in roll.

Book mark:

(358c)

Geo Bell
Copyist.

S | **7** | **U.S.C.T.**

Warlan P Spaulding
Capt. C., Co. *C.*, 7 Reg't U. S. Col'd Infantry.

Appears on **Co. Muster-out Roll**, dated
Indianola, Texas, Oct 13, 1866

Muster-out to date *Oct. 13, 1866*

Last paid to *Aug. 31, 1866*

Clothing account:

Last settled....., 186 ; drawn since \$..... 100

Due soldier \$..... 100; due U. S. \$..... 100

Am't for cloth'g in kind or money adv'd \$..... 100

Due U. S. for arms, equipments, &c., \$..... 100

Bounty paid \$..... 100; due \$..... 100

Remarks *Entered service as private*
Co. A. 44th N.Y.S.V. Sept. 17, 1861
Promoted Corporal. Mich. 4, 1863.
Discharged to accept promotion
Oct. 2^d, 1863 - Appointed Capt
7th U.S.C.T. by the President
U.S. Oct. 10, 1863. Joined the

Book mark: *925-C.T. 62 over*

Jno Bull

JAN. 20

6289006

AL891A

Regt. ^{9th} mustered
into service as Capt
Oct. 21, 1863. Service
continuous since
original enlistment
at Albany, N.Y.
Sept. 17, 1861

Stop for seventy nine
cap letters "E"

Twenty seven Bugles
& Eagles, Seventy eight
numbers # 2, 64

S 1 7 U.S.C.T.

Harlan P. Spaulding
Capt. 7 Regt. U.S. Colored Troops

Appears on

General Order

No. 65, dated War Department, Adjutant Gen-
eral's Office, June 22, 1867.

Appointed to be

Major

BY BREVET

in the Volunteer Force, Army of the United
States, for gallant and
meritorious conduct
and services during
the war

To date from March 13, 1865.

O. D. Moser

S 1 7 | U.S.C.T.

Harlan P. Spaulding
Capt 7 Regt. U.S. Cold Troops

Appears on

General Order

No. 67, dated War Department, Adjutant Gen-
eral's Office, July 16, 1867.

Appointed to be

Lieutenant Colonel

BY BREVET

in the Volunteer Force, Army of the United
States, for gallant and merito-
rious services

To date from mch 13, 1865.

(400) J. M. Williams Copyist.

S. 7th Wc 5th

Harlan P. Spaulding
Captain, Co. E., 7th Reg't Wc Troops

NOTATION.

Book mark: 925 - Co. E. - 1862
S. 205. Co. E. 1863

War Department,

Adjutant General's Office,

Washington, December 10th, 1887.

See also Co. A. #4. Wc 705

A. M. Muzzy Copyist.

Spaulding, Harlan P.

Capt., Co. -----, Reg't. *Mc Inf*

 ----- **9** Enclosures.

Bed Cards	Final Statements
Burial Records	Furloughs or L. of A.
Certs. of Dis. for Discharge	Med. Certificates
C. M. Charges	Med. Des. Lists
Descriptive Lists	Orders
Discharge Certificates	Pris. of War Record
Enlistment Papers	Resignations

Other papers relating to—

Admission to Hosp'l	Furlough or L. of A. <i>2</i>
Casualty Sheet	Med. Examination
Confinement	Misc. Information <i>2</i>
Contracts	Pay or Clothing
Death or Effects	Personal Reports
Desertion	Rank
Discharge from Hosp'l	Transfer to Hosp'l
Discharge from Service	Transfer to V. R. C.
Duty	Transportation
.....

MICROFILM PUBLICATION M 1849

COMPILED MILITARY SERVICE RECORDS
OF VOLUNTEER UNION SOLDIERS WHO SERVED WITH
THE UNITED STATES COLORED TROOPS (USCT)
7TH REGIMENT OF INFANTRY

PERSONAL PAPERS' TARGET SHEET

PLEASE NOTE THE CHECKED INFORMATION ABOUT THE PERSONAL PAPERS IN
THIS FILE:

- NO PERSONAL PAPERS WERE FOUND IN THIS FILE WHEN THE
RECORDS WERE ARRANGED FOR MICROFILMING.
- 3 PERSONAL PAPER(S) FOUND IN THIS FILE WHEN THE RECORDS
WERE ARRANGED FOR MICROFILMING.

Evidence in S. 37/64 Mr. Des. Mich.
Sept

my reason for asking you
 are because I had a dispute
 with a man about the
 price of provisions in the
 army at government
 price. & I wish to settle it
 & told him I would ask you
 as you had to buy your own
 provisions & they were furnish-
 ed to you at first cost
 or at whole sale cost,
 He said he did not believe
 that you could buy your
 sugar or flour any cheaper
 than we could here at the
 retail price. please let
 me know the price of every
 thing, mothers health continues
 poor & she wants to see you
 very much she wrote you
 about the time I wrote last
 & it is time you got it.
 no more at present
 Frank

Springville

Sunday Jan 10th / 64

Dear Brother

Luzeem has just
 been to the office & returned with
 a letter from you. I have been
 looking for one from you for
 a long time & was happy to
 hear from you again. but I
 had been thinking that I should
 see you here on furlough
 after you had been mustered
 for pay, but you seem ^{to think}
 you wont come. I have
 to inform you of the death
 of Putnam ~~B~~ Bolder, he died
 very sudden on Friday the
~~8th~~ 8th inst of Spotted Fever
 & sister Hattie & little Genie
 are both very sick with
 the same complaint & are
 not expected to live. I wish

you could get a furlough & come
 home immediately as you
 may not have an opportunity
 of seeing Hattie alive if you
 do not come soon. Jacobs
 health is poor & they have
 had hard times there this
 winter. Putnam came over
 here on Newyears day after
 mother to go over & help take
 care of Hattie but mothers
 health was poor & Lorraine
 went over with him & on
 the next monday he was
 taken sick & died the Friday
 following. Horace has gone
 over there today & if they are
 not any better I shall take
 mother & go over myself
 tomorrow when Horace
 comes back. Lorraine
 came back yesterday &
 they thought Hattie was gone

MAR 495
better, but since they did not
think would lie.

Well I have been very busy
since I wrote last to you, we
have 14 Cutters nearly done
& they are about half spoken
for already & I think we could
have sold them all if we
could had them done two
weeks ago. You say in this
letter to mother that you
have need a letter from
me that you have not heard
I want you to let me know
what you think of what I
wrote you about in my
last if you cant come
home write me all about it
I should like you to tell
me what it costs you
for provisions by the pound
how ^{much} for flour per lb & how
much for sugar & every
thing else

Head Qrs 7th U.S.C. Troops
January 20. 1864

S. 37. 1864

Harlan P. Spalding Capt
7th U.S.C.T.

Application for ten days
leave of absence.

One enclosure

Received Feb. 2/64

See G.O. No. 25, Par. 5. —/64

Head Qrs. 7th U.S.C.T.
Camp Stanton Jan. 20/64

Approved & respectfully
forwarded

James Shaw
Col

Head Quarters, Camp
Stanton, Jan. 20, 1864.

Approved and respectfully
forwarded.

Wm Birney,
Brig. General U.S.V.

(U.S. 4)

Camp Stanton Jan 20th 1864

Lieutenant

I have the honor to request
a leave of absence to go to Springfield Ohio N.Y.
of ten days for the following reasons
To see a sister
who is very sick and not expected to live and to attend
to important private business

Very Respectfully
Your obedient servant

J. R. Lockwood
Capt 7th U.S.C.V.

Harlan P. Spaulding
Capt 60th 7th U.S.C.V.

Post Victoria Texas.
September 9th 1866
~~MR S. J. J.~~
Spaulding, Nathan P.
Capt Geo "E" of 1st Regt.

Requests leave of absence of
ten days to visit Matamoros
Texas. Regt Mustered Out

H. L. Post Victoria, Tex
September 9/66

Respectfully forwarded
Approved -

Wm T. Smith
Capt 7th Regt 5th Div. Army.

LRB S. 56
MR S. J. J. Sept 14/66

E. H. B. p. 182 No 248
Head Quarters

Sub District of San Antonio
San Antonio Tex.
Sep. 14th 1866

Respectfully forwarded
Approved

L. T. Brewster
Oct 17th 1866
Br. Maj. Genl
Comd'g.

LRB S. 56
Head Quarters Dist of Texas
Galveston Sept 24/66

Respectfully forwarded
to Depart Hd. Qrs
Approved

Geo. W. My.
Br. Maj. Genl
Comd'g.

Post Victoria Texas
Sept 9th 1866.

Lieut. O. M. Mitchel.

A. A. G.

Lieutenant

I have the honor to request
leave of absence for ten days for the purpose of
visiting Matagorda Texas. on private business
1st Lieut John S. Evans is serving with my lieut
and it will therefore be no detriment to the
service.

Very Respectfully

Your Obedt Servt

Wesley P. Spaulding.

Capt 1st Regt 2nd Div.

Company A. 9th Regt.

1255 Daniel L
Spence Daniel
Co Hd, 7 U.S. Col'd Inf.

2nd Lieutenant 2nd Lieutenant

CARD NUMBERS.

1	6278718	26
2	6294965	27
3	6295066	28
4	6295167	29
5	6295267	30
6	6295363	31
7	6295456	32
8	6295544	33
9	6295614	34
10	6295689	35
11	6295760	36
12	6294160	37
13	6295833	38
14	9428716	39
15		40
16		41
17		42
18		43
19		44
20		45
21		46
22		47
23		48
24		49
25		50

Book Mark: 3081- C. J. 82

See also 62 Ohio Vol

PAP 419638

A 1877961 P.O. Murray

MS 114 5654

2 | 7 | **U.S.C.T.**

Daniel L. Spiece

2 Lt, Co. 7 Reg't U. S. Col'd Inf.

Appears on
Regimental Descriptive Book
(List of Commissioned Officers)

of the regiment named above.

Rank 2 Lt.

Date of appointment Nov 23 1864.

Remarks: Appointed 2 Lt by Maj
Gen Butler, Mustered Nov 30
64 Entered service April 17/61
as Corporal in 17. Ohio vols
Born in Ohio & Residence
Ohio

M. Farley
Copyst.

S | 7th U.S.C.T.

Daniel Spice

2^d Lt., Co. 7 Reg't U. S. Col'd Infantry.

Age 24 years.

Appears on an

Individual Muster-in Roll

of the organization named above. Roll dated

Chapins Farm Va, Jan 11, 1865.

Muster-in to date Nov 30, 1864.

Joined for duty and enrolled:

When Nov 30, 1864.

Where Chapins Farm Va

Period 3 years.

Remarks: This Officer was a Corporal in the 62^d Ohio Vols and is promoted to be a Second Lieutenant in the 7th Regt U. S. C. T. (vice 2^d Lt. A. K. Long promoted over)

Book mark :

C. S. Rozzell

(336)

Copyist.

JAN. 20

6278718

1891*

by virtue of a provisional
commission from Maj.
Gen Butler dated
November 23- 1864-

S

7

U.S.C.T.

Daniel Spice

2^d Lieut, Co. I, 7 Reg't U. S. Col'd Infantry.

Appears on

Company Muster Roll

for Jan'y. & Feb'y. 1865.

Present or absent Present

Stoppage, \$ 100 for

Due Gov't, \$ 100 for

Remarks:

Assigned to Co. for duty Decr. 28, '64.
S. O. N^o 113. H. D. 2^d Reg. 7th U.S. C. I.
Stop for two (2) rations in Jan'y & two (2)
rations in February.

Book mark:

D. Mahor

(358)

Copyist.

S

7

U.S.C.T.

Daniel Spiece

2^d Lieut, Co. I, 7 Reg't U. S. Col'd Infantry.

Appears on

Company Muster Roll

for *March + April*, 1865.

Present or absent *not stated*.

Stoppage, \$ 100 for

Due Gov't, \$ 100 for

Remarks:

*Assigned to Co. Decr. 28. '64, S.O. 113.
H. Drs. 7th, U.S.C. I. Two rations
drawn in kind during Jan'y. Feby.
& March 1865.*

Book mark:

D. Maher

(358)

Copyist.

S

7

U.S.C.T.

Daniel Spiece

2^d Lieut., Co. I, 7 Reg't U. S. Col'd Infantry.

Appears on

Company Muster Roll

for *May & June*, 186*5*.

Present or absent *Present*

Stoppage, \$ *100* for

Due Gov't, \$ *100* for

Remarks:

Book mark:

D. Maher

(358)

Copyist.

S | 7 | U.S.C.T.

Daniel Spiece

2^d Lieut., Co. I, 7 Reg't U. S. Col'd Infantry.

Appears on

Company Muster Roll

for July & Aug., 1865.

Present or absent Present

Stoppage, \$ 100 for

Due Gov't, \$ 100 for

Remarks:

Book mark:

D. Moates Copyist.

S

7

U.S.C.T.

Daniel Spiece

2^d Lieut, Co. I, 7 Reg't U. S. Col'd Infantry.

Appears on

Company Muster Roll

for Sept. + Oct., 1865.

Present or absent Present

Stoppage, \$ 100 for

Due Gov't, \$ 100 for

Remarks:

Book mark:

D. Maher

Copyist.

S

7

U.S.C.T.

Daniel Spiece

2^d Lieut, Co. I, 7 Reg't U. S. Col'd Infantry.

Appears on

Company Muster Roll

for Nov. + Decr., 1865.

Present or absent Present

Stoppage, \$ 100 for

Due Gov't, \$ 100 for

Remarks:

Book mark:

D. Maher

(358)

Copyist.

S

7

U.S.C.T.

Daniel Spruce

2^d Lt Co. I, 7 Reg't U. S. Col'd Infantry.

Appears on

Company Muster Roll

for *Jan Feb*, 1866.

Present or absent *Present.*

Stoppage, \$ *100* for

Due Gov't, \$ *100* for

Remarks:

Book mark:

Sabine
Copyist.

(358)

8

7

U.S.C.T.

David Spieci

Co. I, 7 Reg't U. S. Col'd Infantry.

Appears on

Company Muster Roll

for Mar + Apr, 1866.

Present or absent Present.

Stoppage, \$ 100 for

Due Gov't, \$ 100 for

Remarks:

Book mark:

(358)

Sabine

Copyist.

S

7

U.S.C.T.

Daniel Spivee

2^d Lt., Co. I, 7 Reg't U. S. Col'd Infantry.

Appears on

Company Muster Roll

for Feb. 28 to June 30, 1866.

Present or absent Not stated

Stoppage, \$ 100 for

Due Gov't, \$ 100 for

Remarks:

Book mark:

Savine

MAR 5 14

S

7

U.S.C.T.

Daniel L. Spice

B Co., Co. I, 7 Reg't U. S. Col'd Infantry.

Appears on

Company Muster Roll

for July + Aug, 1866.

Present or absent Present.

Stoppage, \$ 100 for

Due Gov't, \$ 100 for

Remarks:

Book mark:

(858)

Sabine Copyist.

S | 7 | U.S.C.T.

Daniel L. Spiece
2^d Co. I., 7 Reg't U. S. Col'd Infantry.

Appears on **Co. Muster-out Roll** dated
Indianola, Texas
October 13, 1866.

Muster-out to date *Oct. 13*, 1866.

Last paid to *June 30*, 1866.

Clothing account:

Last settled....., 186 ; drawn since \$.....¹⁰⁰

Due soldier \$.....¹⁰⁰; due U. S. \$.....¹⁰⁰

Am't for cloth'g in kind or money adv'd \$.....¹⁰⁰

Due U. S. for arms, equipments, &c., \$.....¹⁰⁰

Bounty paid \$.....¹⁰⁰; due \$.....¹⁰⁰

Remarks *Entered service as*
priv., Co. E, 17th O. Inf't.,
19th Apr. '61. Mustered out
by reason of expiration
of service, Aug. 17, '61.
Enlisted as priv., Co. D,
62^d O.V.I., Sep. 12, '61 over
Book mark *3081 C.D. 82.*

Sabine
Copyist.

JAN. 21

6295833

18910

Promoted corp, July 11, '63.
Discharged Jan. 1, '64, by
reason of re-enlistment
as a veteran in Co. D, 62
O.V.S., Jan. 1, '64. Ap-
pointed 2^d Lt., 7th U.S.C.T.,
Nov. 23, '64. Joined regt.
Must^d in and assigned
to Co. H, 7th U.S.C.T., Nov. 30,
'64. Transferred to Co. I,
Dec. 28, '64. On detached
service at Cox's Landing,
Va., from Mar. 23, '65, to
May 5, '65. Service con-
tinuous from Sep. 12, '61,
to Oct. 13, '66. Enlisted at
Somerset, O., Apr. 19, '61.
Mustered out to receive
final payment in the
South per G.O. 10 Hdqrs,
Mil. Div. Gulf, N. Orleans,
La., Aug. 14, '65.

G | **7** | **U.S.C.T.**

Daniel Speice

2^d Lieut, Co. *No. 7*, 7 Reg't U. S. Col'd Inf.

Appears on **Co. Muster-out Roll**, dated
Indianola, Tex, *Oct. 13*, 1866 .

Muster-out to date, 186 .

Last paid to *never paid while in Co.*, 186 .

Clothing account:

Last settled, 186 ; drawn since \$ 100

Due soldier \$ 100; due U. S. \$ 100

Am't for cloth'g in kind or money adv'd \$ 100

Due U. S. for arms, equipments, &c., \$ 100

Bounty paid \$ 100; due \$ 100

Remarks: *Appt'd 2^d Lieut 7 U.S.C.T. by*
Major Genl Butler, Nov. 3. '64 joined for
duty Nov. 30. '64 Must'd in same day
Assig'd to Co. H. 7 U.S.C.T. Transf'd to
Co. I. 7 U.S.C.T. Dec. 28. '64

Book mark:

(861)

J. J. Kearney
(Copist.)

1256

Spence James

Co I, 7 U.S. Col'd Inf.

Private

Private

CARD NUMBERS.

1	6294274	26
2	6294372	27
3	6294472	28
4	6294572	29
5	6294666	30
6	6294758	31
7	6294849	32
8	6294941	33
9	6295044	34
10	6295144	35
11	6295243	36
12	6295341	37
13	6295433	38
14	6295512	39
15	6295600	40
16	6295673	41
17	6295743	42
18	6295817	43
19	6295888	44
20	9066969	45
21		46
22		47
23		48
24		49
25		50

Book Mark:

See also

2666128. POM

S. 1 7 U.S.C.T.

James Inence
Co. D, 7 Reg't U. S. Col'd Inf.

Appears on
Company Descriptive Book
of the organization named above.

DESCRIPTION.

Age 36 years; height 5 feet 5 3/4 inches.
Complexion Dark.
Eyes Blk.; hair Blk.
Where born Worcester, Md.
Occupation Farmer.

ENLISTMENT.

When Oct. 21, 1863.
Where Worcester, Md.
By whom Col. Wm. Birney; term 3 y'rs.

Remarks: Mustered in at Camp Stanton, Md. Nov. 5. 63. by Lt. Col. Haskell.
Det. as nurse in Hosp. since Jan. 1. 64. to Feb. 64.

J. B. White.

S | 7 | U.S.C.T.

James Spence

Pvt, Co. I, 7 Reg't U. S. Col'd Inf.

Age 36 years.

Appears on

Company Muster-in Roll

of the organization named above. Roll dated
Camp Stanton, Charles Co., Md., Nov. 5, 1863.

Muster-in to date Nov. 5, 1863

Joined for duty and enrolled:

When Oct. 31, 1863

Where Worcester, Md.

Period 3 years.

Remarks:

Book mark:

(856)

J. B. Gage

Copyist.

S | 7 | U.S.C.T.

James Spence
Priv

Co. I, 7 Reg't U. S. Col'd Infantry.

Appears on

Company Muster Roll

for from Nov. 5 to Dec 31, 1863.

Present or absent Present

Stoppage, \$ 100 for

Due Gov't, \$ 100 for

Remarks: Enlistment premium
\$2.00 due.

Book mark:

J. B. Gage

S

7

U.S.C.T.

James Spence

Priv, Co. I, 7 Reg't U. S. Col'd Infantry.

Appears on

Company Muster Roll

for *Jan* *Feb*, 186*4*.

Present or absent *Present*

Stoppage, \$ *100* for

Due Gov't, \$ *100* for

Remarks: *Enlistment premium \$2.00 due. Nurse in Hospital detached since Jan 1, /64.*

Book mark:

J.B. Gage

(358)

Copyist.

S | 7 | U.S.C.T.

James Spence

Pvt, Co. I, 7 Reg't U. S. Col'd Infantry.

Appears on

Company Muster Roll

for *Mich & Apr*, 1864

Present or absent *Absent*

Stoppage, \$ *100* for

Due Gov't, \$ *100* for

Remarks: *Stoppage for one bayonet (Enfield) - Sick in Genl Hosptl, Jacksonville, Fla. since April 29, 1864. Des. List sent.*

Book mark:

J B Gage

S | 7 | U.S.C.T.

James Spence

Priv., Co. I, 7 Reg't U. S. Col'd Infantry.

Appears on

Company Muster Roll

for May & June, 1864

Present or absent Present

Stoppage, \$ 100 for

Due Gov't, \$ 100 for

Remarks: Charge for 1 Enfield Bayonet

Book mark:

J.B. Gage

Copyist.

S | 7 | U.S.C.T.

James Spence
Pvt., Co. I, 7 Reg't U. S. Col'd Infantry.

Appears on

Company Muster Roll

for July & Aug, 1864

Present or absent Present

Stoppage, \$ 100 for

Due Gov't, \$ 100 for

Remarks: Stop for one Bayonet
(Enfield)

Book mark:

(358)

J.B. Gage
Copyist.

S | 7 | U.S.C.T.

James Spence
Priv., Co. I, 7 Reg't U. S. Col'd Infantry.

Appears on

Company Muster Roll
for Sept & Oct, 1864.
Present or absent Present

Stoppage, \$ 100 for

Due Gov't, \$ 100 for

Remarks:

Book mark:

(358)

J.B. Gage Copyist.

S

7

U.S.C.T.

James Spence

Priv., Co. I, 7 Reg't U. S. Col'd Infantry.

Appears on

Company Muster Roll

for *Nov. + Decr.*, 1864.

Present or absent *Present*

Stoppage, \$ *100* for

Due Gov't, \$ *100* for

Remarks:

Book mark:

D. Maher

Copyist.

S | 7 | U.S.C.T.

James Spence.
Priv., Co. I, 7 Reg't U. S. Col'd Infantry.

Appears on

Company Muster Roll

for Jan'y. + Feby., 1865.

Present or absent Present

Stoppage, \$ 100 for

Due Gov't, \$ 100 for

Remarks:

Book mark:

D. Mahor
Copyist.

S

7

U.S.C.T.

James Spence

Priv., Co. I, 7 Reg't U. S. Col'd Infantry.

Appears on

Company Muster Roll

for March & April, 1865.

Present or absent Present

Stoppage, \$ 100 for

Due Gov't, \$ 100 for

Remarks:

Book mark:

D. Mahser

Copyist.

(358)

S

7

U.S.C.T.

James Spence

Priv, Co. I, 7 Reg't U. S. Col'd Infantry.

Appears on

Company Muster Roll

for *May + June*, 1865.

Present or absent *Present*

Stoppage, \$ 100 for

Due Gov't, \$ 100 for

Remarks:

Book mark:

D. Maher

Copyist.

(358)

S

7

U.S.C.T.

James Spence

Priv, Co. I, 7 Reg't U. S. Col'd Infantry.

Appears on

Company Muster Roll

for *July & Aug.*, 1865.

Present or absent *Present*

Stoppage, \$ *100* for

Due Gov't, \$ *100* for

Remarks:

Book mark:

D. Mahor
Copyist.

S

7

U.S.C.T.

James Spence
Priv, Co. I, 7 Reg't U. S. Col'd Infantry.

Appears on

Company Muster Roll

for *Sept. & Oct.*, 1865.

Present or absent *Present*

Stoppage, \$ 100 for

Due Gov't, \$ 25 for *C. & G. Equipage*

Remarks:

Book mark:

D. Maher
Copyist.

(358)

MAR 5 1865

S

7

U.S.C.T.

James Spense

Priv, Co. I, 7 Reg't U. S. Col'd Infantry.

Appears on

Company Muster Roll

for *Nov. & Decr.*, 1865.

Present or absent *Present*

Stoppage, \$ 100 for

Due Gov't, \$ 25 for *C. & G. Equipage*

Remarks:

Book mark:

D. Maher

Copyist.

(358)

S

7

U.S.C.T.

James Spence

Private, Co. I, 7 Reg't U. S. Col'd Infantry.

Appears on

Company Muster Roll

for Jan + Feb, 1866.

Present or absent Credit.

Stoppage, \$ 100 for

Due Gov't, \$ 100 for

Remarks:

Book mark:

Sabine

Copyist.

MARR 53A

S

7

U.S.C.T.

James Spence

Private, Co. I, 7 Reg't U. S. Col'd Infantry.

Appears on

Company Muster Roll

for Mar + Apr, 1866.

Present or absent Present.

Stoppage, \$ 100 for

Due Gov't, \$ 100 for

Remarks:

Book mark:

Satine

Copyist.

(858)

S

7

U.S.C.T.

James Spence

Private, Co. I, 7 Reg't U. S. Col'd Infantry.

Appears on

Company Muster Roll

for Jan 28 to June 30, 1866.

Present or absent Not stated.

Stoppage, \$ 100 for

Due Gov't, \$ 100 for

Remarks:

Book mark:

Sabine

Copyist.

8

7

U.S.C.T.

James Spence

Private, Co. I, 7 Reg't U. S. Col'd Infantry.

Appears on

Company Muster Roll

for July + Aug, 1866.

Present or absent Present.

Stoppage, \$ 100 for

Due Gov't, \$ 100 for

Remarks:

Book mark:

Sabine

Copyist.

S

7

U.S.C.T.

James Spence
Pvt, Co. *F*, 7 Reg't U. S. Col'd Infantry.

Appears on Co. Muster-out Roll dated
Indianola Texas
October, 13, 1866.

Muster-out to date *Oct. 13*, 1866.

Last paid to *June 30*, 1866.

Clothing account:

Last settled....., 186 ; drawn since \$.....¹⁰⁰

Due soldier \$ *24*⁹¹/₁₀₀; due U. S. \$.....¹⁰⁰

Am't for cloth'g in kind or money adv'd \$.....¹⁰⁰

Due U. S. for arms, equipments, &c., \$ *6* ¹⁰⁰

Bounty paid \$.....¹⁰⁰; due \$ *100* ¹⁰⁰

Remarks: *Joined co. at ori-*
ginal organization.
Retains one R. M. M. set
set of accoutrements
per G.O. 101, War Dept.,
May 30, '65.

Book mark:

Sabine

1257

Spence Lot

Co *L*, 7 U.S. Col'd Inf.

Private | *Private*

CARD NUMBERS.

1	6294276	26
2	6294379	27
3	6294473	28
4	6294573	29
5	6294667	30
6	6294759	31
7	6294848	32
8	6294881	33
9	6294974	34
10	6295074	35
11	6295175	36
12	6295272	37
13	6295432	38
14	6295511	39
15	6295599	40
16	6295672	41
17	6295742	42
18	6295816	43
19	6295950	44
20	9066970	45
21		46
22		47
23		48
24		49
25		50

Book Mark: _____

See also _____

S. | 7 | U.S.C.T.

1st Spence
Co. G, 7 Reg't U.S. Col'd Inf.

Appears on
Company Descriptive Book
of the organization named above.

DESCRIPTION.

Age 29 years; height 5 feet 5 3/4 inches.
Complexion *Suff.*
Eyes *Dark*; hair *Dark*.
Where born *Worcester, Md.*
Occupation *Farmer*.

ENLISTMENT.

When *Oct. 31.*, 1863.
Where *Worcester, Md.*
By whom *Ch. Wm. Birney*; term *3* y'rs.

Remarks: *Mustered in at Camp Stanton
Md. Nov. 5. 63 by Lt. Col. Haskell.
Appointed Corp. Dec. 5. 63.
Appointed Serj. July 14. 65.
Reduced to ranks Sept
9. 65.
Det. Mar. 17. 66 to Sept. 5. 66.
Died at Post Hosp.
Sept. 5. 66, Indianola, Texas of
disease.*

J. E. White
Copyist.

S | 7 | U.S.C.T.

Lt Spence

Pvt, Co. I, 7 Reg't U. S. Col'd Inf.

Age 29 years.

Appears on

Company Muster-in Roll

of the organization named above. Roll dated
Camp Stanton, Md., Nov 5, 1863
Charles Co., Md., Nov 5, 1863

Muster-in to date Nov 5, 1863

Joined for duty and enrolled:

When Oct 31, 1863

Where Worcester, Md.

Period 3 years.

Remarks:

Book mark:

J B Gage

S

7

U.S.C.T.

Lot Spence

Priv, Co. I, 7 Reg't U. S. Col'd Infantry.

Appears on

Company Muster Roll

for *from Nov. 5 to Dec. 31*, 1863.

Present or absent *Present*

Stoppage, \$ *100* for

Due Gov't, \$ *100* for

Remarks: *Enlistment premium
\$2.00 due.*

Book mark: .

J.B. Gage

(358)

Copyist.

S

7

U.S.C.T.

Lot Spence

Priv, Co. I, 7 Reg't U. S. Col'd Infantry.

Appears on

Company Muster Roll

for *Jan & Feb*, 1864.

Present or absent *Present*

Stoppage, \$ *100* for

Due Gov't, \$ *100* for

Remarks: *Enlistment premium
\$2.00 due*

Book mark:

J B Gage

(358)

Copyist.

NARA 545

S | 7 | U.S.C.T.

Lot Spence

Pvt, Co. I, 7 Reg't U. S. Col'd Infantry.

Appears on

Company Muster Roll

for Mch & Apr, 1864.

Present or absent Present

Stoppage, \$ 100 for

Due Gov't, \$ 100 for

Remarks:

Book mark:

(858)

J.B. Gage

Copyist.

S | 7 | U.S.C.T.

List Spence

Priv, Co. I, 7 Reg't U. S. Col'd Infantry.

Appears on

Company Muster Roll

for *May & June*, 1864.

Present or absent *Present*

Stoppage, \$ *100* for

Due Gov't, \$ *100* for

Remarks:

Book mark:

J. B. Gage

(358)

Copyist.

S | 7 | U.S.C.T.

Lot Spence

Priv, Co. I, 7 Reg't U. S. Col'd Infantry.

Appears on

Company Muster Roll

for *July & Aug*, 186*4*

Present or absent *Present*

Stoppage, \$ *100* for

Due Gov't, \$ *100* for

Remarks:

Book mark:

(858)

J. B. Sage
Copyist.

S | 7 | U.S.C.T.

Lot Spence
Pvt., Co. I, 7 Reg't U. S. Col'd Infantry.

Appears on

Company Muster Roll
for Sept & Oct, 1864.
Present or absent Present

Stoppage, \$ 100 for

Due Gov't, \$ 100 for

Remarks: Stop for 1 Knapsack
& 1 Haversack.

Book mark:

(358)

J.B. Gage
Copyist.

S

7

U.S.C.T.

Lot Spence

Corpl, Co. 1, 7 Reg't U. S. Col'd Infantry.

Appears on

Company Muster Roll

for *Nov. & Decr.*, 1864.

Present or absent *Present*

Stoppage, \$ *100* for *one Knapsack & one Haversack*

Due Gov't, \$ *100* for

Remarks:

Appointed Corpl. Decr. 5, 1864

Book mark:

A. Maher
Copyist.

(358)

S

7

U.S.C.T.

Lot Spence

Corpl, Co. I, 7 Reg't U. S. Col'd Infantry.

Appears on

Company Muster Roll

for *Jan'y. + Feby.*, 1865.

Present or absent *Present*

Stoppage, \$ *100* for

Due Gov't, \$ *100* for

Remarks:

*Appointed Corpl Dec. 5. 64. S. O. No 107.
H. 2nd 7th. U.S.C.T.*

Book mark:

D. Maher
Copyist.

S

7

U.S.C.T.

Lot Spence

Corpl, Co. I, 7 Reg't U. S. Col'd Infantry.

Appears on

Company Muster Roll

for *March + April*, 1865.

Present or absent *Present*

Stoppage, \$ *100* for

Due Gov't, \$ *100* for

Remarks:

*Appointed Corpl. Decr. 5. 64. S.O. 107.
H. D. 7th U.S.C.T.*

Book mark:

D. Mahon

(358)

Copyist.

S

7

U.S.C.T.

Lot Spence

Corpl, Co. I, 7 Reg't U. S. Col'd Infantry.

Appears on

Company Muster Roll

for *May + June*, 1865.

Present or absent *Presents*

Stoppage, \$ *100* for

Due Gov't, \$ *100* for

Remarks:

Book mark:

D. Mahser
Copyist.

S

7

U.S.C.T.

Lot Spence

Serq't, Co. I, 7 Reg't U. S. Col'd Infantry.

Appears on

Company Muster Roll

for July & Aug., 1865.

Present or absent Present

Stoppage, \$ 100 for

Due Gov't, \$ 100 for

Remarks:

Appointed Serq't July 14 '65. S.O. 56. H.P.
Drs. 7th. U.S. C.T. - From Corp'l.

Book mark:

D. Maher

(358)

Copyist.

S

7

U.S.C.T.

Lot Spence

Priv, Co. I, 7 Reg't U. S. Col'd Infantry.

Appears on

Company Muster Roll

for *Sept. + Oct.*, 1865.

Present or absent *Present*

Stoppage, \$ *100* for

Due Gov't, \$ *100* for

Remarks:

Reduced from Sergt. Sept. 9. '65.

Book mark:

D. Maher
Copyist.

(358)

S

7

U.S.C.T.

Lot Spence

Priv, Co. I, 7 Reg't U. S. Col'd Infantry.

Appears on

Company Muster Roll

for *Nov. & Decr*, 1865.

Present or absent *Present*

Stoppage, \$ *100* for

Due Gov't, \$ *100* for

Remarks:

Reduced from Sergt. Sept. 9, 1865.

Book mark:

D. Maher

(358)

Copyist.

S | 7 | U.S.C.T.

Loe Spence

Priv., Co. I, 7 Reg't U. S. Col'd Infantry.

Appears on

Company Muster Roll

for Jan. + Feb, 1866.

Present or absent Pres.

Stoppage, \$ 100 for

Due Gov't, \$ 100 for

Remarks:

Book mark:

Sabine Copyist.

8

7

U.S.C.T.

Lot Spence

Part, Co. I, 7 Reg't U. S. Col'd Infantry.

Appears on

Company Muster Roll

for Mar + Apr, 1866.

Present or absent Absent.

Stoppage, \$ 100 for

Due Gov't, \$ 100 for

Remarks: Det. 80. 10 Hedges. Post-
And. Tex. Mar. 17, '66.

Book mark:

Sabine

Copyist.

8

7

U.S.C.T.

Lor Spence

Part, Co. I, 7 Reg't U. S. Col'd Infantry.

Appears on

Company Muster Roll

for Feb 28th to June 30, 1866.

Present or absent

Stoppage, \$ 100 for

Due Gov't, \$ 100 for

Remarks: Det. S. O. 10 Hdqrs. Post
Ind. Tex. Mar. 17, '66.

Book mark:

Sabine

Copyist.

(858)

8

7

U.S.C.T.

Lot Spence

Private, Co. I, 7 Reg't U. S. Col'd Infantry.

Appears on

Company Muster Roll

for July + Aug, 1866.

Present or absent Absent.

Stoppage, \$ 100 for

Due Gov't, \$ 100 for

Remarks: Detached S.O. order No. 10, Hodges, Post Ind. Tex, Mar. 17, '66.

Book mark:

Sabine Copyist.

S | 7 | U.S.C.T.

Lot Spruce

Co., 7 Reg't U. S. Col'd Infantry.

Appears on **Co. Muster-out Roll**, dated
Indianola, Texas
October, 13, 1866.

Muster-out to date _____, 1866.

Last paid to *June 30*, 1866.

Clothing account:

Last settled _____, 1866 ; drawn since \$ _____ 100

Due soldier \$ _____ 100 ; due U. S. \$ _____ 100

Am't for cloth'g in kind or money adv'd \$ _____ 100

Due U. S. for arms, equipments, &c., \$ _____ 100

Bounty paid \$ _____ 100 ; due \$ _____ 100

Remarks: *Died.*

Appointed corp, Dec. 5, '64. Appointed sergt, July 14, '65; reduced to ranks, Sep. 9, '65.

On det. service per S.O. No. 10, Hager Post, Ind.

Book mark: *PR 15 P 86, 69.*

Satine
Copyist.

JAN. 21

6295950

1891*

Indianola, Tex., Mch. 17, '66,
till decease from cholera
at Indianola, Tex., Sep.
5, '66.

Final papers sent
A.G.O., Oct. 3, '66.

Spence, Lot

P. I., Co. 7 Reg't U. S. C. Inf.

2 Enclosures.

Bed Cards	Descriptive Lists
Burial Records	Final Statements /
Certs. of Dis. for Discharge	Furloughs
C. M. Charges	Med. Des. Lists
Med. Certificates	Orders

Other papers relating to—

Admission to Hosp'l	Furlough
Casualty Sheet (Officer's)	Med. Examination
Confinement	Misc. Information
Contracts	Pay or Clothing
Death or Effects /	Personal Reports
Desertions	Rank
Discharge from Hosp'l	Transfer to Hosp'l
Discharge from Service	Transfer to V. R. C.
Duty	Transportation

Extract from Act of Congress.

SEC. 12. *And be it further enacted,* That the fees of agents and attorneys for making out and causing to be executed the papers necessary to establish a claim for a pension, bounty, and other allowance before the Pension Office, under this act, shall not exceed the following rates: For making out and causing to be duly executed a declaration by the applicant, with the necessary affidavits, and forwarding the same to the Pension Office, with the requisite correspondence, ten dollars; which sum shall be received by such agent or attorney in full for all services in obtaining such pension, and shall not be demanded or received, in whole or in part, until such pension shall be obtained; and the sixth and seventh sections of an act entitled "An act to grant pensions," approved July [fourteenth,] eighteen hundred and sixty-two, are hereby repealed.

SEC. 13. *And be it further enacted,* That any agent or attorney who shall, directly or indirectly, demand or receive any greater compensation for his services under this act than is prescribed in the preceding section of this act, or who shall contract or agree to prosecute any claim for a pension, bounty, or other allowance under this act, on the condition that he shall receive a per centum upon any portion of the amount of such claim, or who shall wrongfully withhold from a pensioner or other claimant the whole or any part of the pension or claim allowed and due to such pensioner or claimant, shall be deemed guilty of a high misdemeanor, and, upon conviction thereof, shall, for every such offense, be fined not exceeding three hundred dollars, or imprisoned at hard labor not exceeding two years, or both, according to the circumstances and aggravations of the offense.

Approved July 4, 1864.

NOTE. 10.—If any soldier is charged a higher fee than that allowed by the above act, he should report the fact and the name of the agent to the Adjutant General, in order that steps may be taken to have the same refunded.

ADJUTANT GENERAL'S OFFICE

Oct 18th 1866

Duplicate with [unclear]

FINAL STATEMENT. 37

OF

Private [unclear] Co.,
7th Reg't of [unclear]
VOLUNTEERS.
Aid Sept 5th 1866

NOTE 1.—Two of these certificates (or duplicates) are to be given to each Volunteer Soldier or drafted man who may be discharged without being mustered out (Final Statements are never given to men mustered out of service,) that he may at once receive from the Paymaster the pay, &c., due to him, and the captain or other COMMISSIONED officer commanding the company will certify to the act of the delivery of the duplicate certificates; with these certificates the Soldier is "entitled to" his discharge, and should also present his discharge to the Paymaster to have the payment endorsed on it. The discharge is to be given back to the Soldier by the Paymaster; the latter only retaining as his vouchers the duplicate certificates.

NOTE 2.—If the Soldier is entitled to pay for the use of his horse, the Company Commander will certify to that fact on the back of both these final statements, and also to the time he has pay due for having been so mounted on his own horse.

NOTE 3.—When a Soldier is furnished with final statements, his descriptive list, if he has one, should be taken up by the officer who gives the Soldier these statements, and endorsed with a statement to this effect by the officer. The endorsement should exhibit a full statement of the time for which the Soldier was allowed pay on his final statements, the clothing account, and all other charges against him or in his favor, so as to comprise a complete exhibit of his account. It will then be transmitted to the Company Commander of the Soldier, who will enter all the data necessary to a full understanding of the Soldier's account on the muster roll upon which the Soldier's discharge is reported. The descriptive list will then be destroyed. The object of this is, that the remaining portion of the Soldier's account may be settled upon the receipt of these muster rolls, and the Soldier receive any pay or allowances that may be due him at the time of his discharge, and which may not appear on his last final statements from the fact that his descriptive list is incomplete. These accounts for back pay, &c., are settled by the 2d Auditor of the Treasury Department.

NOTE 4.—Charges for loss or injury to ordnance, horse equipments, and other miscellaneous charges, should appear under the heading of "Other Stoppages."

NOTE 5.—Bounty paid by State authorities, and not by the United States, will not be entered on this statement.

NOTE 6.—Amounts due the Sutler and Laundress must be entered on the muster roll on which the discharge, death, desertion, &c., is reported, as well as on the final statement, otherwise the amount cannot be collected from the United States.

NOTE 7.—This blank will be used for deceased volunteers and drafted men, as well as for others.

NOTE 8.—Where a Soldier dies in Hospital or in detached service, his descriptive list, if he has one, should be sent with his final statements, in duplicate, to the Adjutant General, Washington.

NOTE 9.—If the soldier is a drafted man or substitute, the space for time, &c., of enrolled, should contain only the words *drafted or substitute*, as the case may be. If the Soldier is a "VETERAN," (or RECRUIT,) the words *as a veteran*, (or *recruit*,) as the case may be, should be interlined after the words *mustered into the service of the U. S.* A statement of all the installments of Veteran or Recruit BOUNTY RECEIVED by the Soldier must be made on the back of each final statement.

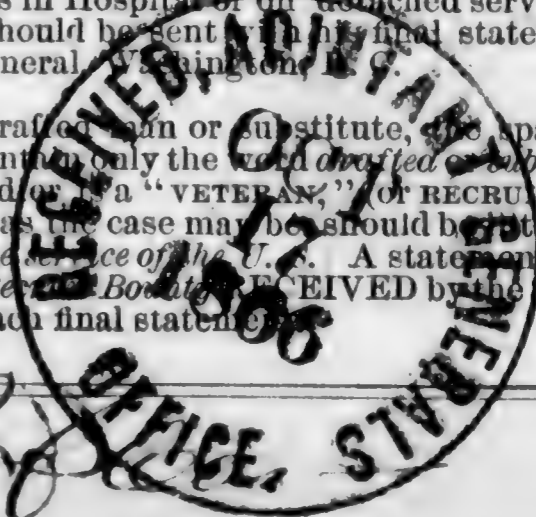

[Handwritten signature and name]

I certify, on honor, that Lot Spence, a Private of
 Captain C. G. Peeples's Company (I) of the 7th Regiment of U.S. Colored Troops
Volunteers, of the State of _____, born in Worcester State
 of Maryland, aged 29 years; 5 feet 5 1/2 inches high; Fair complexion,
Dark eyes, Dark hair, and by occupation a Farmer, who joined for service
 and was enrolled (see Note 9) on the 31 day of October, 1863, at Worcester Md
 by Col. W. Birney, for the period of Three years, and mustered into
 the service of the United States on the 5th day of November, 1863, at
Camp Stanton Md, by St. Col. Haskell; and having served
HONESTLY and **FAITHFULLY** with his Company to the present date, is now entitled to a
DISCHARGE by reason of Death from Cholera at Post Hosp.
Indianola Tex. Sep. 3. 1866.

The said Lot Spence was last paid by Paymaster
Maj. Matthews to include the 30th day of June, 1866, and
 has pay due him from that time to the present date; he is entitled to pay and subsistence for
TRAVELING to place of enrollment, and whatever other allowances are authorized to volunteer
 soldiers, drafted men, or militia, so discharged. He has received from the United States **CLOTHING**
 amounting to _____ dollars, since the 5th day of September,
 1866, when his clothing account was last settled. He has received from the United States
_____ dollars advanced **BOUNTY**. One Soldier for clothing sixty
three dollars and five cents
 There is to be stopped from him, on account of the State of _____, or other
 authorities, for **CLOTHING**, &c., received on entering service, _____ dollars; and
 for other stoppages, viz: _____
_____ dollars.

He has been furnished with **TRANSPORTATION** in kind from the place of his discharge to
_____; and he has been **Subsisted** for **Traveling** to his
 place of enrollment, up to the _____, 1866.

He is indebted to _____, **Sutler**, _____ dollars.
 He is indebted to _____, **Laundress**, _____ dollars.

Given in Duplicate, at Indianola Texas, this third day
 of October, 1866.

C. G. Peeples
Capt. 7th U.S.C.T.
 Commanding Company.

NARA 565

1866 37

J. G. on file

ARTICLES OF WAR.

INVENTORY OF THE EFFECTS

H. M.

OF

Priv. Sgt. Spencer

Late of Company *I*

7th Reg't of *U. S. Cavalry*

Volunteers, who died at *Indianola Texas*

on the *5* day of *September* 1866

ART. 95. When any non-commissioned officer or soldier shall die, or be killed in the service of the United States, the then commanding officer of the troop or company shall, in the presence of two other commissioned officers, take an account of what effects he died possessed of, above his arms and accoutrements, and transmit the same to the office of the Department of War, which said effects are to be accounted for, and paid to the representatives of such deceased non-commissioned officer or soldier. And in case any of the officers, so authorized to take care of the effects of deceased officers and soldiers, should, before they have accounted to their representatives for the same, have occasion to leave the regiment or post, by preferment or otherwise, they shall, before they be permitted to quit the same, deposit in the hands of the commanding officer, or of the assistant military agent, all the effects of such deceased non-commissioned officers and soldiers, in order that the same may be secured for, and paid to, their respective representatives.

DIRECTIONS.

NOTE 1.—One copy of the inventories of the effects of deceased non-commissioned officers and soldiers, required by the 95th Article of War, will be forwarded to the Adjutant General, by the commander of the company to which the deceased belonged, and a duplicate of the same to the colonel of the regiment. Final statements of pay, clothing, &c., in duplicate, will be sent to the Adjutant General with one copy of the inventory. Both inventory and final statements should be forwarded, as a general rule, through Regimental Headquarters. When a soldier dies at a post or station absent from his company, it will be the duty of his immediate commander to furnish, direct to the Adjutant General, the required inventory and final statements, and, at the same time, to forward to the commanding officer of the company to which the soldier belonged, a report of his death, specifying the date, place, and cause; to what time he was last paid, and the money or other effects in his possession at the time of his decease; which report will be noted on the next muster roll of the company to which the man belonged. Each inventory will be endorsed, "Inventory of the effects of ———, late of company (—) ——— regiment of ———, who died at ———, the ——— day of ———, 186—." If a legal representative receive the effects, it will be stated in the report. If the soldier leave no effects, the fact will be reported on the blank for inventory.

NOTE 2.—Should the effects of a deceased non-commissioned officer or soldier not be administered upon within a short period after his decease, they shall be disposed of by a Council of Administration, under the authority of the commanding officer of the post, and the proceeds deposited with the Paymaster, to the credit of the United States, until they shall be claimed by the legal representatives of the deceased.

NOTE 3.—In all such cases of sales by the Council of Administration, a statement in detail, or account of the proceeds duly certified by the Council and commanding officer, (Form 5,) accompanied by the Paymaster's receipt for the proceeds, will be forwarded by the commanding officer to the Adjutant General. The statement will be endorsed, "Report of the proceeds of the effects of ———, late of company (—) ——— regiment of ———, who died at ———, the ——— day of ———, 186—."

NOTE 4.—The effects in all cases, when called for, should be turned over to the legal representative, without further authority from the Adjutant General. When the effects are turned over to the relatives of the deceased before these inventories are sent to the Adjutant General, their receipts therefor should be attached to the inventories. In all other cases, one copy will be sent with a letter of transmittal direct to the Adjutant General, and a duplicate retained by the officer.

NOTE 5.—Particular care should be taken to take receipts in duplicate from the Paymaster for any funds turned over to him; one copy should be sent direct to the Adjutant General and one retained by the officer.

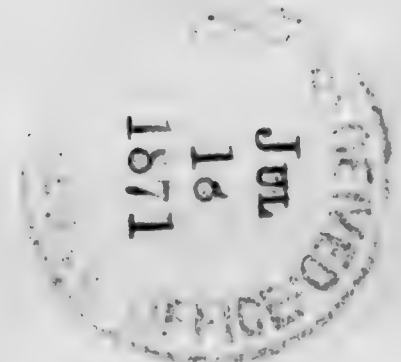

Inventory of the effects of Let Spence late
a Private of Captain C. G. Peoples Company I of
the 4th Regiment of M. S. Colored Troops Volunteers, who was enrolled as
a Private at Worcester in the State of Maryland on
the 31 day of October 1863, and mustered into the service of the United
States as a Private on the 5th day of November 1863, at Camp Stanton Md.
in Company I, 4th Regiment of M. S. Colored Troops Volunteers, to serve three
years or during the war; he was born in Worcester in the State
of Maryland; he was 29 years of age, 5 feet 5 3/4 inches
high, Wet complexion, Dark eyes, Dark hair, and by occupation, when enrolled,
a Farmer; he died in Post Hospital, at
Indiana Lee on the 5th day of September 1866, by
reason of Cholera

INVENTORY.					
ARTICLES.	No.	ARTICLES.	No.	ARTICLES.	No.
Hats.....		Pairs trousers.....		Knapsacks.....	
Caps.....		Pairs flannel drawers.....			
Forage Caps.....		Pairs cotton drawers.....			
Great coats.....		Flannel shirts.....	3		3
Uniform coats.....		Cotton shirts.....	3		3
Uniform jackets.....		Pairs boots.....	2		2
Flannel sack coats.....		Pairs shoes.....	2		2
Blouses.....		Pairs socks.....			
Stable frocks.....		Blankets.....	2	MONEY.	
Fatigue overalls.....		Haversacks.....		Specie.....	\$ 3
				Notes.....	\$

I CERTIFY, ON HONOR, that the above inventory comprises all the effects of Let Spence, deceased, and that the effects are in the hands of _____ at _____ to be disposed of by a Council of Administration.

(DUPLICATES.)

C. G. Peoples
Capt. 4th M. S. C. T.
 Commanding the Company.

STATION: Indiana Lee

DATE: Oct. 3. 1866

1258

Spencer James

Co *H* 7 U.S. Col'd Inf.

Private

Private

CARD NUMBERS.

1	6296036	26
2	6296134	27
3	6296233	28
4	6296335	29
5	6296431	30
6	6296543	31
7	6297460	32
8	9067102	33
9	279-CJ-1878	34
10		35
11		36
12		37
13		38
14		39
15		40
16		41
17		42
18		43
19		44
20		45
21		46
22		47
23		48
24		49
25		50

Book Mark: E. B. 502 Y 279 C. J. 78

See also

S. 7 U.S.C.T.

James Spence

Co. 3^d, 7 Reg't U. S. Col'd Inf.

Appears on

Company Descriptive Book

of the organization named above.

DESCRIPTION.

Age 18 years; height 5 feet 5 1/2 inches.

Complexion Mulatto.

Eyes Gray; hair Black.

Where born Worcester, Maryland.

Occupation Farmer.

ENLISTMENT.

When Nov. 4, 1863.

Where Snow Hill

By whom Col. W. G. Bixey; term 3 y'rs.

Remarks: Mustered into serv. at
Camp Stanton, Chap. Co. Md.
by Lt. Col. Huskell, Nov. 12. 63.
Missing in action
at Johns Island, S.C. July
9. 64.

A. J. White.

A | **7** | **U.S.C.T.**

James Spencer
Pvt., Co. K, 7 Reg't U. S. Col'd Inf.

Age *18* years.

Appears on

Company Muster-in Roll

of the organization named above. Roll dated
Camp Stanton
Charles Co. Md., Nov. 12, 1863.

Muster-in to date *Nov. 12, 1863*

Joined for duty and enrolled:

When *Nov 14*, 1863.

Where *Worcester Md.*

Period *3* years.

Remarks: _____

Book mark: _____

D. M. Kennedy
Copyist.

A | **7** | **U.S.C.T.**

James Spence
Privt, Co. K, 7 Reg't U. S. Col'd Infantry.

Appears on

Company Muster Roll

for *Nov. 12 to Dec 31*, 186*3*.

Present or absent *Present*

Stoppage, \$ *100* for

Due Gov't, \$ *100* for

Remarks: *Enlistment premium*
2 02 dollars due.

Book mark:

D. M. Kennedy

A | **7** | **U.S.C.T.**

James Spence
Privt, Co. K, 7 Reg't U. S. Col'd Infantry.

Appears on

Company Muster Roll

for *Jan.* v. *Feb.*, 1864.

Present or absent *Present.*

Stoppage, \$ *100* for

Due Gov't, \$ *100* for

Remarks:

Book mark:

W. H. Kennedy
Coptist.

A

7

U.S.C.T.

James Spence

Privt., Co. K, 7 Reg't U. S. Col'd Infantry.

Appears on

Company Muster Roll

for *Me. v. Apl.*, 1864

Present or absent *Present*

Stoppage, \$ 100 for

Due Gov't, \$ 100 for

Remarks:

Book mark:

D. M. Kennedy
Copyist.

S | **7** | **U.S.C.T.**

James Spence
Privt., Co. K, 7 Reg't U.S. Col'd Infantry.

Appears on

Company Muster Roll

for *May* *v. June*, 1864.

Present or absent *Present*

Stoppage, \$ *100* for

Due Gov't, \$ *100* for

Remarks:

Book mark:

D. M. Kennedy
Copyist.

A | **7** | **U.S.C.T.**

James Spence
Privt, Co. K, 7 Reg't U. S. Col'd Infantry.

Appears on

Company Muster Roll
for *July & Aug.*, 1864.

Present or absent

Stoppage, \$ 100 for

Due Gov't, \$ 100 for

Remarks: *Missing in action*
July 9th 1864

Book mark:

D. M. Kennedy
(358) Copyist.

S | 7 | U.S.C.T.

James Spencer
Pot., Co. K, 7 Reg't U. S. Col'd Inf.

Appears on Co. Muster-out Roll, dated
Indianola Texas, Oct 13, 1866.

Muster-out to date _____, 186 .

Last paid to Feb 29, 1864.

Clothing account:

Last settled _____, 186 ; drawn since \$ _____ 100

Due soldier \$ _____ 100; due U. S. \$ _____ 100

Am't for cloth'g in kind or money adv'd \$ _____ 100

Due U. S. for arms, equipments, &c., \$ _____ 100

Bounty paid \$ _____ 100; due \$ _____ 100

Remarks: A prisoner of War
since Sept. 29, 64. Missing
in action.

Book mark: U.S.P. 101/68. - 2" Aud.
9128. apl. 25. 1868. - P.O. 40. P. 153. 77.
(over)

Randall

JAN. 21

6297760

1891

Bookmark: Missing in
action at Johns Island,
S.C. July 9th/64, E.B. $\frac{12}{502}$
249. C.G. 78.

G. J. 7. 7205.
James Spence
Co. H, 7. Regt. 7205.

NOTATION.

EB 12/502
Book mark: 279. C. S. 1878.

War Department,
Adjutant General's Office,

Washington, *Friday* 15, 1878.

Missing in action at John's
Island, S.C.

[Empty ruled lines for additional text]

(438) J. L. Robinson Copyist.

1259
Spinney Robert M.

Co D, B, 7 U.S. Col'd Inf.

2nd Lieutenant | 1st Lieutenant

CARD NUMBERS.

1	6285831	26
2	6285931	27
3	6286028	28
4	6286122	29
5	6286218	30
6	6286319	31
7	6286386	32
8	6286565	33
9	6282748	34
10	6282847	35
11	6282941	36
12	6283035	37
13	6283124	38
14	6283198	39
15	6283269	40
16	6283340	41
17	6287149	42
18	6283409	43
19	6278717	44
20	6279429	45
21	6278719	46
22	0428712	47
23	2-198-03-1864	48
24	43227356	49
25		50

Book Mark: 2-198-03-1864

See also 13 n. H. vols

RP 394 293.

S. 1448804 P.O. M. M.

N.R. 752428

S. 2389543 P.O. M. M.

M. A. 1091422

S | 7th | U.S.C.T.

Robert-M Spinney

2^d Lt., Co., 7 Reg't U. S. Col'd Infantry.

Age 25 years.

Appears on an

Individual Muster-in Roll

of the organization named above. Roll dated

Hilton Head S.C. Mch 14, 1864.

Muster-in to date March 10, 1864.

Joined for duty and enrolled:

When March 10, 1864.

Where Hilton Head S.C.

Period 3 years.

Remarks: This Officer was Ser-
 quant in 13th A. H. Vols,
 is promoted 2^d Lieut-
 vice Charles L Barn-
 mark (promoted) by
 commission from the

Book mark: S-198-07-1864

C. S. Rogzelle

(336)

Copyist.

JAN. 20

6278717

1891

*Let- of war dated
February 26-1864.*

S | 7th | U.S.C.T.

Robert M Spinney
1st Lt., Co. 7 Reg't U. S. Col'd Infantry.

Age 25 years.

Appears on an

Individual Muster-in Roll

of the organization named above. Roll dated

New Orleans La, June 22, 1865.

Muster-in to date May 30, 1865.

Joined for duty and enrolled:

When May 30, 1865.

Where New Orleans La

Period 3 years.

Remarks: This Officer was
Sergeant in the 13th N.
H Vols. Appointed 2^d
Lieut - 7th Regt - U. S. C.
Infantry. March 10 - 1864.
Promoted 1st Lieut - Co B
our

Book mark :

C. S. Rozzell

JAN. 20

6278719

1891*

*Same Night - vice David
S. Mack promoted.*

REG 594

S | 7 | **U.S.C.T.**

Robert M. Spinner
2^d Lt., Co. 7, 7 Reg't U. S. Col'd Inf.

Appears on
Regimental Descriptive Book
(List of Commissioned Officers)

of the regiment named above.

Rank 2^d Lt.

Date of appointment Mar 10 1864.

Remarks: Appointed 2^d Lieut. by the
President U. States
Promoted 1st Lieut. May 16/45
by Maj Gen Ord

Maisley Copyist.

S

7

U.S.C.T.

Robert M Spinney

2nd Sg., Co. D, 7 Reg't U. S. Col'd Infantry.

Appears on

Company Muster Roll

for March & April, 1864.

Joined for duty and enrolled:

When March 10, 1864.*

Where Washington D.C.*

Period 3 years.*

Present or absent Present

Stoppage, \$ 100 for

Due Gov't \$ 100 for

Remarks: Assigned to Compa-
ny March 10, 1864 pr.
Special O. No. 32, dated
Regimental Hd Qrs. Mar.
10 1864.

(Mustered in Mar 10-64)

* See enrollment on card from muster-in roll.

Book mark:

R. B. Shelton

(358c)

Copyist.

5

7

U.S.C.T.

Robert M. Spinney
2nd St., Co. D, 7 Reg't U. S. Col'd Infantry.

Appears on

Company Muster Roll

for May & June, 1864.

Joined for duty and enrolled:

When March 10, 1864.*

Where Washington D.C.*

Period 3 years.*

Present or absent Present

Stoppage, \$ 100 for

Due Gov't \$ 100 for

Remarks:

* See enrollment on card from muster-in roll.

Book mark:

R. B. Shelton

(358c)

Copyist.

S | **7** | **U.S.C.T.**

Robert M Spinney
2nd St, Co. D, 7 Reg't U. S. Col'd Infantry.

Appears on

Company Muster Roll
for *July & Aug*, 1864.

Joined for duty and enrolled:

When *Mich 10*, 1864*
Where *Washington D.C.**
Period *3* years.*

Present or absent *Present*

Stoppage, \$ *100* for

Due Gov't \$ *100* for

Remarks:

* See enrollment on card from muster-in roll.

Book mark: -----

R B Shelton
(358c) Copyist.

S | **7** | **U.S.C.T.**

Robert M. Spinney
2^d Lieut, Co. D, 7 Reg't U. S. Col'd Infantry.

Appears on

Company Muster Roll

for *Sept. & Oct*, 1864.

Joined for duty and enrolled:

When *March 10*, 1864*

Where *Washington D.C.**

Period *3* years.*

Present or absent *absent*

Stoppage, \$ *100* for

Due Gov't \$ *100* for

Remarks: *Missing in ac-*
tion Sept. 29th 1864

* See enrollment on card from muster-in roll.

Book mark:

F. H. Neale

S | **7** | **U.S.C.T.**

Robert A. Spirney
2^d Lieut, Co. D, 7 Reg't U. S. Col'd Infantry.

Appears on

Company Muster Roll

for *Nov. & Dec.*, 1864.

Joined for duty and enrolled:

When *March 10*, 1864.*

Where *Washington D.C.* *

Period *3* years.*

Present or absent *absent*

Steppage, \$ *100* for

Due Gov't \$ *100* for

Remarks: *Missing in action*
Sept. 29th 1864.
Supposed to be prisoner
of war

* See enrollment on card from muster-in roll.

Book mark:

(358c) *F. W. Neal* Copyist.

A

7

U.S.C.T.

Robert A. Spinney
Lieut., Co: D, 7 Reg't U. S. Col'd Infantry.

Appears on

Company Muster Roll

for *Jan'y & Feb*, 1865.

Joined for duty and enrolled:

When *March 10*, 1864.*

Where *Washington D.C.* *

Period *3* years.*

Present or absent *absent*

Stoppage, \$ *100* for

Due Gov't \$ *100* for

Remarks: *Missing in action*
Sept. 29 - 1864. Supposed
to be prisoner of war.

* See enrollment on card from muster-in roll.

Book mark:

(358c)

E. D. Meals

Copyist.

S | 7 | U.S.C.T.

Robert M. Spinney
1st Lt, Co. B, 7 Reg't U. S. Col'd Infantry.

Appears on

Company Muster Roll
for Feb 28 to June 30, 1865.

Joined for duty and enrolled:

When May 30, 1865.*

Where Washington, DC.*

Period 3 years.*

Present or absent Present

Stoppage, \$ 100 for

Due Gov't \$ 100 for

Remarks: Promoted from 2nd Lt, Co D. to 1st Lt. & assigned Co B, May 30th, 1865. Regt (20) 48 Mustered at New Orleans. La June 22/65 (over)

* See enrollment on card from muster-in roll.

Book mark:

Wooler
(358c) Copyist.

JAN. 20

6282748

1891

to take effect May
30, 1865, Pay due
for increase Com-
mutation, month
of March 1865 and
2nd Lt. Co D. Due
for commanding
Co. B. for June
1865

NARA 599

S | **7** | **U.S.C.T.**

Robert M. Spivey
2^d Lt., Co. D, 7 Reg't U. S. Col'd Infantry.

Appears on

Company Muster Roll

for *March & April*, 186*5*.

Joined for duty and enrolled:

When *March 10*, 186*4*.*

Where *Washington D.C.* *

Period *3* years.*

Present or absent *Present*

Stoppage, \$ *100* for

Due Gov't \$ *100* for

Remarks: *Reported for duty*
with Co. April 12th 1865,
from missing in action Sept
29 - 1864

* See enrollment on card from muster-in roll.

Book mark: _____

R. D. Neal
(358c) Copyist.

S

7

U.S.C.T.

Robert M. Sperry
2^d Lieut, Co. D, 7 Reg't U. S. Col'd Infantry.

Appears on

Company Muster Roll

for *May & June*, 1865.

Joined for duty and enrolled:

When *March 10*, 1865.*

Where *Washington D.C.* *

Period *3* years.*

Present or absent.....

Stoppage, \$ *100* for.....

Due Gov't \$ *100* for.....

Remarks: *Transferred.*
Promoted to 1st Lieut.
& transferred to Co. B. 4th U.S.
C.T. May 29 - 1865
Due the increase pay for
the month of March 1865.

* See enrollment on card from muster-in roll.

Book mark:.....

E. H. Neale

(358c)

Copyist.

S | 7 | U.S.C.T.

Robert M. Spinney
1st Lt, Co. B, 7 Reg't U. S. Col'd Infantry.

Appears on

Company Muster Roll
for July & Aug, 1865.

Joined for duty and enrolled:

When May 30, 1865.*

Where Washington, D.C.*

Period 3 years.*

Present or absent Present

Stoppage, \$ 100 for

Due Gov't \$ 100 for

Remarks:

* See enrollment on card from muster-in roll.

Book mark:

(358c) *W. D. ...* Copyist.

S | 7 | U.S.C.T.

Robert M. Spinney
pt Lt, Co. B, 7 Reg't U. S. Col'd Infantry.

Appears on

Company Muster Roll
for Sept Oct, 1865.

Joined for duty and enrolled:

When May 30, 1865.*

Where Washington, DC.*

Period 3 years.*

Present or absent Present

Stoppage, \$ 100 for

Due Gov't \$ 100 for

Remarks: Responsibility
money due for Com-
manding Co "B" Sept
& Oct 1865

* See enrollment on card from muster-in roll.

Book mark:

(358c) W. H. R. Copyist.

8 | 7 | U.S.C.T.

Robert M. Spunney
1st Lt, Co. B, 7 Reg't U. S. Col'd Infantry.

Appears on

Company Muster Roll

for Nov + Dec, 1865.

Joined for duty and enrolled:

When May 30, 1865.*

Where Washington, DC.*

Period 3 years.*

Present or absent Present

Stoppage, \$ 100 for

Due Gov't \$ 100 for

Remarks: Responsibility
money due for Comd
Co "B" for the months
Sept. Oct. Nov + Dec
1865

* See enrollment on card from muster-in roll.

Book mark:

(358c) W. D. D. O. G. Copyist.

S | 7 | U.S.C.T.

Robert M Spinnery
1st Sg, Co. B, 7 Reg't U. S. Col'd Infantry.

Appears on

Company Muster Roll

for Jan'y and Feb, 1866

Joined for duty and enrolled:

When May 30, 1865.*

Where Washington D.C. *

Period 3 years.*

Present or absent Present

Stoppage, \$ 100 for _____

Due Gov't \$ 100 for _____

Remarks: Special duty with
Co F. since Feb. 16/66
pay due for command
of Co B. from Dec. 31/65
to Feb. 16/66 pay due for
command of Co F. from that time

* See enrollment on card from muster-in roll.

Book mark: _____

A. Holbrook

(358c)

Copyist.

S | 7 | U.S.C.T.

Robert M. Spurney
1st Ch., Co. B, 7 Reg't U. S. Col'd Infantry.

Appears on

Company Muster Roll

for Mich + apl., 1866.

Joined for duty and enrolled:

When May 30, 1865.*

Where Washington DC *

Period 3 years.*

Present or absent absent

Stoppage, \$ 100 for

Due Gov't \$ 100 for

Remarks: absent with
leave since Apr. 3 - 1866
S.O. 20 Post due to
Texas Apr. 2 1866

* See enrollment on card from muster-in roll.

Book mark:

Holbrook

S | 7 | U.S.C.T.

Robert M. Spencey
124th, Co. B, 7 Reg't U. S. Col'd Infantry.

Appears on

Company Muster Roll

for May + June, 1866

Joined for duty and enrolled:

When May 30, 1865.*

Where Washington D.C.*

Period 3 years.*

Present or absent Present

Stoppage, \$ 100 for

Due Gov't \$ 100 for

Remarks: Reported for duty of
66 days leave of absence June
8 - 1866 - 20 days half pay
stopped on May. Payment by
Major Turner Due for Company
Co B. from Dec. 31 - 1865 to

* See enrollment on card from muster-in roll.

Book mark:

Stolbrook

(358c) Orly

Copyist.

JAN. 20

6283259

1891A

Feb 16-1866 + Co F from
Feb 16-1866 to march 16 1866
+ Co. B. for month of
June - 1866

S | 7 | U.S.C.T.

Robert M. Spencey
1st Sg., Co. B, 7 Reg't U. S. Col'd Infantry.

Appears on

Company Muster Roll

for July and Aug, 1866.

Joined for duty and enrolled:

When May 30, 1866.*

Where Washington D.C.*

Period 3 years.*

Present or absent Present

Stoppage, \$ 100 for

Due Gov't \$ 100 for

Remarks: Due for commanding
Co B for months of July
and Aug. 1866

* See enrollment on card from muster-in roll.

Book mark:

Holbrook

(358c)

Copyist.

S | *7* | U.S.C.T.

Robert M. Spunney
2nd Lt, Co. D, 7 Reg't U. S. Col'd Inf

Appears on an

Individual Muster-out Roll

of the organization named above. Roll dated
New Orleans La June 22, 1865-

Muster-out to date *May 29, 1865-*

Last paid to *Apr 30, 1865-*

Clothing account:

Last settled....., 186 ; drawn since \$..... 100

Due soldier \$..... 100; due U. S. \$..... 100

Am't for cloth'g in kind or money adv'd \$..... 100

Due U. S. for arms, equipments, &c., \$..... 100

Bounty paid \$..... 100; due \$..... 100

Remarks: *Mustered out for
promotion Co. "B" same
Regiment vice David
S Mack promoted.
Muster out to date
May 29th 1865-*

Book mark:

E H Lipscombe

NARR 654

S | 7 | U.S.C.T.

Robert M. Spinner
1st Lt., Co. B., 7 Reg't U. S. Col'd Infantry.

Appears on **Co. Muster-out Roll**, dated
Indianola Texas, Oct 13, 1866 .

Muster-out to date *Oct 13*, 1866 .

Last paid to *June 30*, 1866 .

Clothing account:

Last settled....., 186 ; drawn since \$..... 100

Due soldier \$..... 100; due U. S. \$..... 100

Am't for cloth'g in kind or money adv'd \$..... 100

Due U. S. for arms, equipments, &c., \$..... 100

Bounty paid \$..... 100; due \$..... 100

Remarks: *Entered U. S. service at
Portsmouth N. H. Aug 21-1862
in 13th N. H. V. Discharged Feb. 29
1864 to accept appointment as 2^d Lt. of
U. S. C. I. Joined Regiment for duty
at Hilton Head S. C. Mch 8-1864
assigned to Co. D. & mustered Mch 10*

Book mark: *408CT. 86 - 1,024CT-82*

Holbrook
(361) *over* Copyist.

JAN. 20

6283409

1891

1864 absent a furlough war
from Sep. 29-1864 to Feb. 22-
1865 Promoted 1st Lt. & assigned
to Co. B. May 30-1865. mustered
June 22-1865- Responsibility
money due for command of
Co. B. for July & Aug. 1865
July August & September
1866 mustered out to remain
south pursuant to General
order no 10 dated Ad Brs.
Mil. Div. Gulf Aug. 14-1865-
Due for decrease of commutation
of Rations from 30[¢] to
20[¢] for March 1865 service
continuous since Aug. 21-62

S

7

U.S.C.T.

Robert M. Spinney
2nd Lieut. Co. D, 7 Reg't U. S. Col'd Infantry.

Appears on **Co. Muster-out Roll**, dated
Indianola Texas, Oct 13, 1866.

Muster-out to date _____, 186 .

Last paid to May 29, 1865.

Clothing account:

Last settled _____, 186 ; drawn since \$ _____ 100

Due soldier \$ _____ 100; due U. S. \$ _____ 100

Am't for cloth'g in kind or money adv'd \$ _____ 100

Due U. S. for arms, equipments, &c., \$ _____ 100

Bounty paid \$ _____ 100; due \$ _____ 100

Remarks: joined for duty at Hilton
Head S. C. Mch. 10-64. Absent a
prisoner in the hands of the
enemy from Sept 29-64 to Feb.
22-65. Rejoined Co. Apl 12-65. Pro-
moted 1st Lieut. by the President U.S. and
transferred to Co. B. 7 U.S.C.T. May 29-65;

Book mark: _____

Hearst

17 U.S.C.
Robert M. Skinner
Co., 7 Reg't U.S.C.

NOTATION.

1024-CJ-1882 with
Book mark: J-198-CJ-1864

War Department,

Adjutant General's Office,

Washington, Oct 3, 1883

See also L.K. 13 A. N. V.

S 1 7 12567

Robert M. Spinney

1st Lt 7 Regt U.S. Cold Troops

Appears on

General Order

No. 67, dated War Department, Adjutant General's Office, July 16, 1867.

Appointed to be

Captain

BY BREVET

in the Volunteer Force, Army of the United States, for gallant and meritorious Conduct in the attack on Fort Gilmer

To date from March 13, 1865.

J. M. Williams

(400)

Copyist.

Spinney Robert M.
 2 Lt, Co. H, 7 Reg't 21st Inf
 Enclosures.

Bed Cards	Final Statements
Burial Records	Furloughs or L. of A.
Certs. of Dis. for Discharge	Med. Certificates
C. M. Charges	Med. Des. Lists
Descriptive Lists	Orders 2
Discharge Certificates	Pris. of War Record
Enlistment Papers	Resignations

Other papers relating to—

Admission to Hosp'l	Furlough or L. of A. 3
Casualty Sheet	Med. Examination
Confinement	Misc. Information /
Contracts	Pay or Clothing
Death or Effects	Personal Reports
Desertion	Rank
Discharge from Hosp'l	Transfer to Hosp'l
Discharge from Service	Transfer to V. R. C.
Duty	Transportation

NARA 612
MICROFILM PUBLICATION M 1849

COMPILED MILITARY SERVICE RECORDS
OF VOLUNTEER UNION SOLDIERS WHO SERVED WITH
THE UNITED STATES COLORED TROOPS (USCT)
7TH REGIMENT OF INFANTRY

PERSONAL PAPERS' TARGET SHEET

PLEASE NOTE THE CHECKED INFORMATION ABOUT THE PERSONAL PAPERS IN
THIS FILE:

- NO PERSONAL PAPERS WERE FOUND IN THIS FILE WHEN THE
RECORDS WERE ARRANGED FOR MICROFILMING.
- 10 PERSONAL PAPER(S) FOUND IN THIS FILE WHEN THE RECORDS
WERE ARRANGED FOR MICROFILMING.

MEMORANDUM FROM PRISONER OF WAR RECORDS.

No. 198

(This blank to be used only in the arrangement of said records.)

NAME.	RANK.	ORGANIZATION.				INFORMATION OBTAINED FROM—				
		No. of Reg't.	State.	Arm of Service.	Co.	Records of—	Vol.	Page.	Vol.	Page.
<i>Roll</i>						<i>Mis</i>	<i>35</i>	<i>134</i>		
						<i>O & Ex</i>	<i>9</i>	<i>307</i>		
						<i>C. P. Md</i>	<i>4</i>	<i>66</i>	<i>81</i>	<i>201</i>

Spinney Robert M 2 Lt 7 W.S. C.T. D

Captured at *Fort Gilmore Va Sept 29*, 1864, ^{*Prnt from Le hafus Farm*} confined at Richmond, Va., *Sept 29*, 1864.
Sent to *Salisbury N.C. Oct 2/64*. Returned *Feb 18/65*

Admitted to Hospital at _____
where he died _____, 1865, *In camp at Richmond Va. Feby 19. 65*

Paroled at *James Riv Va Feb 22*, 1865; reported at Camp Parole, Md., _____, 1865.
admt to Hospel Div No 1 Annapolis Md Feb 23/65. granted leave of absence

Copied by _____ *over*

(Record continued.)

Furloughed _____, 186 , for _____ days; returned _____, 186 ;
deserted _____, 186 ;

March 1/65. S.O. 102. Is rept to C.P. nearest Regt. Retd April 15/65
exchd and sent to Regt. date not given - sent to Regt apr 3/65

Borne on Rolls as Robert M Spinney Co. D. 7 W.D. C.T.

Pens case afft Woodward Dec 2. 87

Copied by

[Signature]

Adjutant General's Office,

Nov 27 1867

This is accepted as referring to

[Signature]

[Signature]

to S. D. S.

and records will be corrected accordingly.

[Signature]

Assistant Adjutant Gen'l.

[Signature]

Robert M. Spruay mustered in as 2d Lieut
7th Regt U.S.C.T. March 11, 1864. On Return of
that Regt for the month of January 1865, he is reported
"Missing in Action since Sept 29, 1864"
W.S.

Co. B. 177 - 1865
D 570 (V. 87) 85,
Annapolis Md
Feb 23 1865
G. 15, C. R. A. B. 1865,
R. M. Spinney
2nd Lt. 7th U.S. C.T.

Applies for a Leave of
Absence of Thirty (30)
days as Paroled prison-
er. Recd 547

Head Quarters Camp Parole
Near Annapolis Md
February 24. 1865.
Approved, and respect-
fully forwarded to Post Brig
Genl. W. Hoffman. U.S.A.
Commissary General of
Prisoners. Washington D.C.

Annapolis
F. D. Small
Col 3rd Regt V. R. Co.
Commanding Post &c
Received A.G.O. 1st March 1865

248
183 G. (C.C. 41) July 24/65
was Depart.
Adjutant General's Office,
March 1. 1865
Respectfully referred
to Col. C. W. Foster,
A.A.G.
This Application
is approved, by the
Commissary Gener-
al of Prisoners, in
endorsement of the
28th ultimo.
Thomson
Adj. Adjutant General.

Notes: Veto Sp. No 102
of March 20th 1865. A.G. Office

Annapolis Md
Feb. 23rd 1865-

Col. A. R. Root.

Quid. Parole Camp

I have the honor to apply
for a leave of absence of thirty (30)
days, being a Paroled prisoner of war. I
enlisted, as Private in the 13th N. H. Vols.
Sept. 29th 1862. - Was Mustered as 2nd Lt.
in the 7th U. S. Col. Troops, March 10th
1864. - Was captured Sept. 29th 1864. in
an assault on Fort. Gilmer, defenses
of Richmond. - Was Paroled Feb. 22nd 1865.

Very respectfully
Your Obedt. Servant
Robert M. Spurney
2nd Lieut - 7th U. S. (I)

MEMORANDUM FROM PRISONER OF WAR RECORDS.

No. _____

(This blank to be used only in the arrangement of said records.)

NAME.	RANK.	ORGANIZATION.				INFORMATION OBTAINED FROM—				
		No. of Reg't.	State.	Arm of Service.	Co.	Records of—	Vol.	Page.	Vol.	Page.
<i>Spinnecy R. W.</i>	<i>2d Lt.</i>	<i>4</i>	<i>U.S.G.T.</i>	<i>0</i>	<i>10</i>	<i>Wash. Div. No. 1 Roll</i>	<i>131</i>	<i>2.</i>	<i>8</i>	

Captured at *Fort Gillmore, Va. Sept 29*, 1864, confined at Richmond, Va., _____, 186 .

Admitted to Hospital at _____

where he died _____, 186 , of _____

Paroled at *Ashburn Landing, Va. Feb 20*, 1865; reported at *Camp Parole, Md., Wash. Div. No. 1 Roll Feb 23*, 1865.

Copied by *Wash*

66 of D. L. a. B. 1866
Forismouth
May 2. 1866
W. (B.) 260. Aug. 1866
Spinney Robert A
1st Lt. 11809

Requests an extension
to leave of absence.

Approved
By command of
Lieut. General
E. S. Parker
Prot. Col., Mil. Sec.
Hqrs. Army
May 7. '66.

HEAD QUARTERS
RECEIVED MAY 5 1866

Rec'd. ago. May 4. 1866.

Adj't Gen W. S
I respectfully
submit this applica-
tion to you &
ask for it a favor-
able consideration
according to the law
of the Army, the
grounds for the
furlough, would
be sufficient & I hope
it is at under our
law. I have the
honor to be your
Obedt Servt
Charles Dawson
4. May. 1866

Please send your
answer to me
- W
even sent
May 7. 66

Adj't. Gen's. Office,
Bureau for Colored Troops,
May 4th 1866.
Respectfully submitted
to Lieutenant General
H. S. Grant, Command-
ing Army of the
United States
Lew. Foster
a. a. Gen's. Regt.

Note
In A. O.
no 212, Par 2, my
of 1866, and
letter of May 9,
1866 to be in div-
ision
file

Portsmouth N.H.
May 2nd 1888

Sir

I have the honor to request an extension of twenty (20) days to a leave of absence granted by, S.C. 59, Headquarters Dept of Army, W.S.C. 18, Headquarters 1st Div of the 1st Army which expires May 22nd 1888. For the following reasons I came north for the purpose of fulfilling a marriage engagement, and being delayed on the road, have not time to make necessary arrangements in season to report at the expiration of my present leave. With this statement of my case I would respectfully request your earliest attention.

I am Sir very respectfully

Your Obedt Servant
Robert M. Spinney
1521 7th St. N.H.

Adjutant General U.S.A.
Washington D.C.

Official Address
Robert M. Spinney
Portsmouth

N.H.

NARR 619

SPECIAL ORDERS, } HEADQUARTERS OF THE ARMY,
No. 212. } ADJUTANT GENERAL'S OFFICE,
Washington, May 8th, 1866

(Extract.)

* * * * *

2. The leave of absence granted 1st Lieutenant *R. M. Spinney*, 7th U. S. Colored Troops, in Special Orders, No. 59, of March 16th, 1866, Headquarters, Department of Texas, and extended by Special Orders, No. 78, Headquarters, Military Division of the Gulf, of April 6th, 1866, is hereby further extended twenty days.

* * * * *

By command of Lieutenant-General Grant :

E. D. TOWNSEND,

Assistant Adjutant General.

OFFICIAL:

Assistant Adjutant General.

General Breck,

Spinner R. M.
L. 701. S. C. 7,

E

✓

SPECIAL ORDERS, } HEADQUARTERS OF THE ARMY,
No. 212. } ADJUTANT GENERAL'S OFFICE,
Washington, May 8th, 1866.

(Extract.)

* * * * *
2. The leave of absence granted 1st Lieutenant R. M. Spinney, 7th
U. S. Colored Troops, in Special Orders, No. 59, of March 16th, 1866,
Headquarters, Department of Texas, and extended by Special Orders,
No. 78, Headquarters, Military Division of the Gulf, of April 6th, 1866,
is hereby further extended twenty days.

* * * * *
By command of Lieutenant-General Grant :

E. D. TOWNSEND,
Assistant Adjutant General.

OFFICIAL:

Assistant Adjutant General.

Colonel Foster.

SPECIAL ORDERS, } HEADQUARTERS OF THE ARMY,
No. 212. } ADJUTANT GENERAL'S OFFICE,
Washington, May 8th, 1866.

(Extract.)

* * * * *

2. The leave of absence granted 1st Lieutenant *R. M. Spinney*, 7th U. S. Colored Troops, in Special Orders, No. 59, of March 16th, 1866, Headquarters, Department of Texas, and extended by Special Orders, No. 78, Headquarters, Military Division of the Gulf, of April 6th, 1866, is hereby further extended twenty days.

* * * * *

By command of Lieutenant-General Grant :

E. D. TOWNSEND,

Assistant Adjutant General.

OFFICIAL:

E. D. Townsend
Assistant Adjutant General.

Paymaster General
u/a

War Department,

ADJUTANT GENERAL'S OFFICE,

Washington, May 9th 1866.

Charles Robinson Esq,
Treasury Department,
Washington, D.C.

Sir,

In reply to your endorsement of the 4th instant, on the application of 1st Lieutenant R. M. Spinney, 4th U. S. Colored Troops, for an extension of his leave of absence, I have respectfully to inform you that an order has this day been sent by mail to the address of that Officer, extending his leave of absence as requested.

Very Respectfully,
(over)

Your Obedient Servant,
A. F. Ruckelshaus

Assist. Adj. General Vols.

(S. C. C. S. L. A. J. 1866)

Opened by mistake.

Adjutant General's Office
OFFICIAL BUSINESS.

1861
Chas. Beck

C. R. Dennis

Assistant Adjutant General.

Charles Dennis Esq.
~~Treasury Department~~
Washington D.C.

Coburn Bureau



Cold Spring

CHICAGO
MAY 10
1871

CHICAGO
MAY 10
1871

REGISTERED

CHICAGO
MAY 10
1871

1260
Staats Richard
Co G, 7 U.S. Col'd Inf.

Private | Private

CARD NUMBERS.

1	6278772	26
2	6279021	27
3	6291586	28
4	6291646	29
5	6291744	30
6	6291806	31
7	6291878	32
8	6291947	33
9	6292015	34
10	6292088	35
11	6292363	36
12	6279506	37
13	9066736	38
14		39
15		40
16		41
17		42
18		43
19		44
20		45
21		46
22		47
23		48
24		49
25		50

Book Mark:

See also

S | 7 | U.S.C.T.

Richard Staats
Co. G, 7 Reg't U.S. Col'd Inf

Appears on
Company Descriptive Book
of the organization named above.

DESCRIPTION.

Age 18 years; height 5 feet 5 inches.
Complexion *Wex*
Eyes *Blue*; hair *Wex*
Where born *Worcester Co. Md.*
Occupation *Farmer*

ENLISTMENT.

When *Sept 20*, 1864.
Where *Wilmington, Del*
By whom *Capt. Wilmer*; term *1* y'rs

Remarks: *Substitute. Mustered out of service. Mustered into service Sept 20 '64 by Capt. Wilmer at Wilmington Del. See Register of Discharged - Discharged Dec 6 '65 at Indianola, Tex. by expiration of service.*

(3830) *J. Brown* Copyist.

S | 7 | U.S.C.T.

Richard Staats

Co., 7 Reg't U. S. Col'd Infantry.

Age 18 years.

Appears on a

Detachment Muster-in Roll

of the organization named above. Roll dated

Baltimore, Md., Sept 27, 1864.

Muster-in to date Sept. 27, 1864.

Joined for duty and enrolled:

When Sept. 20, 1864.

Where Wilmington, Del.

Period 1 years.

Remarks: Substitute

Book mark:

Beck

(837)

Copyist.

S 1 7 U.S.C.T.

Richard Starts

Appears with rank of on

Muster and Descriptive Roll of a Detachment of Drafted Men and Substitutes forwarded

for the 7 Reg't U. S. Col'd Inf. Roll dated
Baltimore, Md Sept 27 1864.

Where born Del

Age 18 years; occupation Laborer.

Drafted and mustered in:

When Sept. 20, 1864

Where Wil. Del.

Period 1 years.

Eyes Blk; hair Blk

Complexion Blk; height 5 ft. 3 in.

Paid bounty and advance pay, \$ 100

Bounty due \$ 100

Where credited

Company to which assigned

Remarks: Substitute for John
Vangesal, Wil. Del.

Book mark:

(340)

J. M. Fairly
Copyist

G | 7 | U.S.C.T.

Richard Staats

Privt., Co. G, 7 Reg't U. S. Col'd Infantry.

Appears on

Company Muster Roll

for Sept. & Oct., 1864.

Present or absent Present

Stoppage, \$ 100 for

Due Gov't, \$ 100 for

Remarks: Joined for duty Oct.
23^d, 1864.

Book mark:

Sandoz
Copyist

S | **7** | **U.S.C.T.**

Richard Staats
Plt., Co. G, 7 Reg't U. S. Col'd Infantry.

Appears on

Company Muster Roll

for *Nov & Dec*, 186*4*.

Present or absent *Present*

Stoppage, \$ 100 for

Due Gov't, \$ 100 for

Remarks:

Book mark: _____

J. W. Clues
(858) Copyist

S | 7 | U.S.C.T.

Richard Staab

Pvt., Co. G, 7 Reg't U. S. Col'd Infantry.

Appears on

Company Muster Roll

for Jan'y & Feby, 1865.

Present or absent Present

Stoppage, \$ 100 for

Due Gov't, \$ 100 for

Remarks:

Book mark:

J. W. Child
(858) Copyist

S | **7** | **U.S.C.T.**

Richard Staats

Pr., Co. G, 7 Reg't U. S. Col'd Infantry.

Appears on

Company Muster Roll

for *March & April*, 1862.

Present or absent *Present*

Stoppage, \$ *100* for

Due Gov't, \$ *100* for

Remarks:

Book mark:

J. W. Ames

(858)

Copyist

S | **7** | **U.S.C.T.**

Richard Staats
Pvt., Co. G, 7 Reg't U. S. Col'd Infantry.

Appears on

Company Muster Roll

for *May + June*, 186*5!*

Present or absent *Present*

Stoppage, \$ 100 for

Due Gov't, \$ 100 for

Remarks:

Book mark:

J. W. Ames
(858) Copyist

S

7

U.S.C.T.

Richard Staats

Pvt., Co. G, 7 Reg't U. S. Col'd Infantry.

Appears on

Company Muster Roll

for *July & Aug*, 186*3*.

Present or absent *Present*

Stoppage, \$ *100* for

Due Gov't, \$ *100* for

Remarks:

Book mark:

J. W. Thomas

(858)

Copyist

S

7

U.S.C.T.

Richard Staats

Sgt., Co. G, 7 Reg't U. S. Col'd Infantry.

Appears on

Company Muster Roll

for *Sept. + Oct*, 186*2*.

Present or absent *Absent*

Stoppage, \$ *100* for

Due Gov't, \$ *100* for

Remarks:

Absent at Indianola Texas awaiting M.O. of service.

Book mark:

J. W. [Signature]

(858)

Copyist

S | 7 | U.S.C.T.

Richard Haats

Pvt., Co. G, 7 Reg't U. S. Col'd Infantry.

Appears on

Company Muster Roll

for *Nov + Dec*, 1865.

Present or absent _____

Stoppage, \$ _____ 100 for _____

Due Gov't, \$ _____ 100 for _____

Remarks: _____

*M.O. of service by reason
of expiration of term of
service at Indianola Texas
Dec. 6/65.*

Book mark: _____

(858)

J. W. [Signature]

Copyist

A

7

U.S.C.T.

Richard Staats

Pvt, Co. *G*, 7 Reg't U. S. Col'd Infantry.

Appears on **Co. Muster-out Roll**, dated *Indianola Texas, Oct 13*, 1866.

Muster-out to date _____, 1866.

Last paid to *June 30*, 1865.

Clothing account:

Last settled _____, 1866 ; drawn since \$ _____ 100

Due soldier \$ _____ 100 ; due U. S. \$ _____ 100

Am't for cloth'g in kind or money adv'd \$ _____ 100

Due U. S. for arms, equipments, &c., \$ _____ 100

Bounty paid \$ _____ 100 ; due \$ _____ 100

Remarks: *Discharged by reason of expiration of term of service at Indianola Texas December 6 1865*

Book mark: *M O on file*

Hadfield

S 17 U.S.C.T.

Richard Hunt,
Co. G, 7 Reg't U. S. Col'd Infantry.

Appears on a

Detachment Muster-out Roll

of the organization named above. Roll dated

Victoria Texas, Dec 6, 1863.

Muster-out to date *Dec. 6, 1863.*

Last paid to *June 30, 1863*

Clothing account:

Last settled 186 ; drawn since \$ ¹⁰⁰

Due soldier \$ ¹⁰⁰; due U. S. \$ *15* ¹⁵ ₁₀₀

Am't for cloth'g in kind or money adv'd \$ ¹⁰⁰

Due U. S. for arms, equipments, &c., \$ *6* ⁰⁰ ₁₀₀

Bounty paid \$ *None* ¹⁰⁰ due \$ *None* ¹⁰⁰

Remarks: *The person for whom he entered the service is not known. Joined for duty Oct. 21. 1864.*

Retained Springfield Rifled Musket (over)

Book mark:

Jenkins
Copyist.

JAN. 20

6279506

#1681a

and equipments.
No further Military
history. Mustered out
by reason of expiration
of term of service.

Awaiting muster
out till date on
account of absence of
Mustering officer. Has
performed the regular
duty of a soldier until
this date. Entitled to
travel - time, subsistence
and transportation to
place of enlistment.

The company to which these men
were attached is stationed at Matagorda Texas a distance of over
Eighty (80) miles from this post
(Victoria) but owing to poor commu-
nication and the detention of
of the mail by storms etc. these
rolls were not rec^d for examination
and signature until this date.

Stafford Jacob
Co B, 7 U.S. Col'd Inf.

Private | Private

CARD NUMBERS.

1	6283629	26
2	6283730	27
3	6283830	28
4	6283928	29
5	6284029	30
6	6284126	31
7	6284221	32
8	6284317	33
9	6284392	34
10	6284501	35
11	6284623	36
12	6285413	37
13	9066227	38
14		39
15		40
16		41
17		42
18		43
19		44
20		45
21		46
22		47
23		48
24		49
25		50

Book Mark: E. B. 12-
219

See also

A. 165398.3 and att. 5

165398

S

7

U.S.C.T.

Jacob Stafford

, Co. *C*, 7 Reg't U.S. Col'd Inf.

Appears on

Company Descriptive Book

of the organization named above.

DESCRIPTION.

Age *20* years; height *5* feet *3 1/2* inches.

Complexion *Black*

Eyes *Black*; hair *Black*.

Where born *Orchard, Md.*

Occupation *Farmer*.

ENLISTMENT.

When *Sept. 23*, 1863.

Where *Baltimore*,

By whom *Col. W. Binney*; term *3* y'rs.

Remarks: *Mustered at Baltimore Md. Sept. 24, 63, by Col. W. Binney. Died at U. S. Gen. Hosp. Balt. Md. of Erysipelas March 8, 65.*

J. Smith

S | 7 | U.S.C.T.

Jacob Stafford
Private, Co. *C*, 7 Reg't U.S. Colored Inf.

Age *20* years.

Appears on

Company Muster-in Roll

of the organization named above. Roll dated
Baltimore, Md, Sept. 26, 1863

Muster-in to date *Sept. 26, 1863*

Joined for duty and enrolled:

When *Sept. 23, 1863*

Where *Dorchester Co, Md. **

Period *3* years.*

Remarks: _____

*Muster-in roll shows enrollment of all men of this company as of same date. See enrollment on subsequent card or cards.

Book mark: _____

Callaway

8 | 7 | U.S.C.T.

Jacob Stafford,
Priv., Co. C, 7 Reg't U. S. Col'd Infantry.

Appears on

Company Muster Roll
for Sept 26 to Oct. 31, 1863

Joined for duty and enrolled:

When Sept. 23, 1863*

Where Rochester Co, N.Y. *

Period 3 years.*

Present or absent Present

Stoppage, \$ 100 for

Due Gov't \$ 100 for

Remarks:

* See enrollment on card from muster-in roll.

Book mark:

(358c)

Greenway
Copyist.

8 | 7 | U.S.C.T.

Jacob Stafford
Priv., Co. C, 7 Reg't U. S. Col'd Infantry.

Appears on

Company Muster Roll

for Nov & Dec, 1863.

Joined for duty and enrolled:

When Sept. 23, 1863.*

Where Dorchester Co. Md.*

Period 3 years.*

Present or absent Present

Stoppage, \$ 100 for

Due Gov't \$ 100 for

Remarks:

* See enrollment on card from muster-in roll.

Book mark:

(358c) *Lawson* Copyist.

8 | 7 | U.S.C.T.

Jacob Stafford

Pvt, Co. C, 7 Reg't U. S. Col'd Infantry.

Appears on

Company Muster Roll

for *Jan'y and Feb'y*, 1864

Joined for duty and enrolled:

When *Sept. 23*, 1863.*

Where *Dorchester Co. Md.* *

Period *3* years.*

Present or absent *Present*

Stoppage, \$ *100* for

Due Gov't \$ *100* for

Remarks: *Stop for one knapsack*

* See enrollment on card from muster-in roll.

Book mark:

Callaway

S | 7 | U.S.C.T.

Jacob Stafford
Priv, Co. C, 7 Reg't U. S. Col'd Infantry.

Appears on

Company Muster Roll
for *Nov⁴ to Apr*, 1864.

Joined for duty and enrolled:

When *Sept. 23*, 1863*

Where *Dorchester Co. Md.* *

Period *3* years.*

Present or absent *Present,*

Stoppage, \$ *100* for

Due Gov't \$ *100* for

Remarks:

* See enrollment on card from muster-in roll.

Book mark:-----

Brewer
Copyist.

8 | 7 | U.S.C.T.

Jacob Stafford.
Pvt, Co. C, 7 Reg't U. S. Col'd Infantry.

Appears on

Company Muster Roll
for May to June, 1864

Joined for duty and enrolled:

When Sept. 23, 1863*

Where Dorchester, Md.*

Period 3 years.*

Present or absent Present

Stoppage, \$ 100 for

Due Gov't \$ 100 for

Remarks:

* See enrollment on card from muster-in roll.

Book mark:

(358c)

Copyist.

Calloway

817

U.S.C.T.

Jacob Stafford
Pvt, Co. C, 7 Reg't U. S. Col'd Inf.

Appears on

Company Muster Roll

for July and Aug. 1864.

Joined for duty and enrolled:

When Sept. 23, 1863.*

Where Dorchester Co., Md. *

Period 3 years.*

Present or absent Absent

Stoppage, \$ 100 for

Due Gov't, \$ 100 for

Valuation of horse, \$ 100

Valuation of horse equipments, \$ 100

Remarks: Sent to Hospital
Wounded, Aug. 24, 64.

* See enrollment on card from muster-in roll.

Book-mark:

Calloway
Copist.

S | 7 | U.S.C.T.

Jacob Stafford
Pvt., Co. C, 7 Reg't U. S. Col'd Infantry.

Appears on

Company Muster Roll
for Sept. & Oct., 1864.

Joined for duty and enrolled:

When Sept. 23, 1863.*
Where Worcester*
Period 3 years.*

Present or absent

Stoppage, \$ 100 for

Due Gov't \$ 100 for

Remarks: Wounded in action
and sent to Hosp.
Aug. 14

* See enrollment on card from muster-in roll.

Book mark:

M. W. Murphy
Copyist.

S

7

U.S.C.T.

Jacob Stafford
Priv., Co. C, 7 Reg't U. S. Col'd Infantry.

Appears on

Company Muster Roll

for Nov. & Dec., 1864.

Joined for duty and enrolled:

When Sept. 23, 1863.*

Where Worcester *

Period 3 years.*

Present or absent

Stoppage, \$ 100 for

Due Gov't \$ 100 for

Remarks:

Wounded and sent to Hosp. Aug. 14/64

* See enrollment on card from muster-in roll.

Book mark:

M. W. Murphy

(358c)

Copyist.

S | 7 | U.S.C.T.

Jacob Stafford
Priv., Co. C, 7, Reg't U. S. Col'd Infantry.

Appears on

Company Muster Roll
for Jan. & Feb., 1865.

Joined for duty and enrolled:

When Sept. 23rd, 1863.*

Where Worcester Co., Md.*

Period 3 years.*

Present or absent Absent

Stoppage, \$ 100 for

Due Gov't \$ 100 for

Remarks: Wounded in
action Sept. 29th / 64
In Hosp. at Wm. Kern's
Manoir, Balt., Md.

* See enrollment on card from muster-in roll.

Book mark:

M. M. Murphy
(358c) Copyist.

J | **7** | **U.S.C.T.**

Jacob Stafford
Pvt., Co. C, 7 Reg't U. S. Col'd Infantry.

Appears on

Company Muster Roll
for *Mar. 7 Apr.*, 186*5*.

Joined for duty and enrolled:

When *Sept. 23*, 186*3*.*

Where *Worcester* *

Period *3* years.*

Present or absent

Stoppage, \$ *100* for

Due Gov't \$ *100* for

Remarks: *Died Mar. 12/65*
Grant Rector Hosp.
of Emmons

Inserted by Comparer

* See enrollment on card from muster-in roll.

Book mark: *Died Mch 8/65 213 1/2*
219

M. M. Murphy
(358c) Copyist.

S 1 7 U.S.C.T.

Jacob Stafford
Pr't. Co, Co. 7 Reg't U. S. Col'd Infantry.

Appears on Co. Muster-out Roll, dated
Indianola Texas, Oct. 13, 1866.

Muster-out to date _____, 1866.

Last paid to Aug 31, 1864.

Clothing account:

Last settled _____, 1866 ; drawn since \$ 100

Due soldier \$ 100 ; due U. S. \$ 100

Am't for cloth'g in kind or money adv'd \$ 100

Due U. S. for arms, equipments, &c., \$ 100

Bounty paid \$ 100 ; due \$ 100

Remarks: Died at Baltimore
Mar 8 '65 of Erysipelas.
Final statements sent
to A. G. O. Apl. 30 '65.

Book mark: 768 P. 18. 69 J. S.

(361) Lopez Copyist.

Stafford Jacob
P. Co. 7 Reg't U.S.C.

4 Enclosures.

Bed Cards	Descriptive Lists
Burial Records	2 Final Statements ✓
Certs. of Dis. for Discharge	Furloughs
C. M. Charges	Med. Des. Lists
Med. Certificates	Orders

Other papers relating to—

Admission to Hosp'l	Furlough
Casualty Sheet (Officer's)	Med. Examination
Confinement	Misc. Information
Contracts	Pay or Clothing
Death or Effects /	Personal Reports
Descriptions	Rank
Discharge from Hosp'l	Transfer to Hosp'l
Discharge from Service	Transfer to V. R. C.
Duty	Transportation
	Slave claim 1

MICROFILM PUBLICATION M 1849

COMPILED MILITARY SERVICE RECORDS
OF VOLUNTEER UNION SOLDIERS WHO SERVED WITH
THE UNITED STATES COLORED TROOPS (USCT)
7TH REGIMENT OF INFANTRY

PERSONAL PAPERS' TARGET SHEET

PLEASE NOTE THE CHECKED INFORMATION ABOUT THE PERSONAL PAPERS IN
THIS FILE:

- NO PERSONAL PAPERS WERE FOUND IN THIS FILE WHEN THE
RECORDS WERE ARRANGED FOR MICROFILMING.
- 4 PERSONAL PAPER(S) FOUND IN THIS FILE WHEN THE RECORDS
WERE ARRANGED FOR MICROFILMING.

1113 N 111
1865
West General Hospital
McKim Mansion
Baltimore March 10th 1865

L. W. Read
Surgeon Dept of
Incharge

Transmits Record of Death
and Testament of Private
Jacob Stafford Co '6' 4th Regt.

One Enclosure

Recd Mid. Dept. Md. 11th 1865

Jacob Stafford
Co '6' 4th U.S.C.T.

Wpa, General Hospital
No 2100 Mansion
Baltimore, Md, March 11th 1865.

Lieut Col Saml B Lawrence
Asst. Adj. General 8th A. C.
Colonel.

I have the honor to transmit "Record of
Death & Interment" of Private Jacob Stafford Co 'C'
7th U.S. C. Troops who died at this Hospital March 8th 1865

Very respectfully
Your Obedt Servant
W. H. Hall
Surgeon U.S.A.
In charge of Hospital.

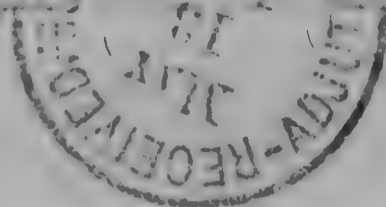

Jacob Stafford
W.C.

7th U.S. Col^d Troop
Adjutant General, U. S. Army.

Recd March 9, 1865.

COPY OF RECORD

FOR THE

ADJUTANT GENERAL, U. S. ARMY.

No. 2.

RECORD OF DEATH AND INTERMENT.

Name and number of person interred,	<i>Jacob Stafford</i>	
Number and locality of the grave . . .	<i>Laurel Cemetery</i>	
Hospital number of the deceased . . .	<i>1044</i>	
Regiment, rank, and company . . .	<i>Private "C" 7th U. S. C. Troops</i>	
Residence before enlistment		
Conjugal condition, (and if married,)	<i>Single</i>	
the residence of the widow) . . . }		
Nativity	<i>Maryland</i>	
Age of deceased	<i>20 Years</i>	
Cause of death	<i>Erysipelas.</i>	
References and remarks }		
Date of death	<i>March 8th 1865</i>	
Date of burial	<i>March 9th 10, o. c. A. M.</i>	<i>1865.</i>

[A duplicate of this Record has been forwarded to the Sexton, and another remains at this Hospital.]

To *Lieut Col S. B. Lawrence*
Asst ADJUTANT GENERAL.

SIR:

It becomes my duty to inform you that the person above described died at this Hospital as herein stated; and that it is desired his remains should be interred with the usual military honors.

Respectfully,

[Signature]
Surgeon U. S. Army
In charge of Hospital

MILITARY HOSPITAL, *McHenry Mansion Baltimore*

This copy of Record is to be transmitted to the Adjutant General at Washington immediately after the place of burial and the number of the grave have been ascertained and registered. The above notification is to remain attached.

HOSPITAL RECORD,

SUBJECT TO THE

ORDER OF THE SURGEON GENERAL
UNITED STATES ARMY.

Jacob Stafford
4th W.S. C. I. Pvt "C"

Mar 8th/65
McKiins Bldg
Balto Md

No. 1.

RECORD OF DEATH AND INTERMENT.

Name and number of person interred,	<i>Jacob Stafford</i>	
Number and locality of the grave . . .	<i>Laurel Cemetery</i>	
Hospital number of the deceased . . .	<i>1044.</i>	
Regiment, rank, and company . . .	<i>Pri Co. 7th U. S. C. Troops</i>	
Residence before enlistment		
Conjugal condition, (and if married, } the residence of the widow) . . . }	<i>Single</i>	
Nativity	<i>Maryland</i>	
Age of deceased	<i>20</i>	
Cause of death	<i>Erysipilas (face)</i>	
References and remarks }		
Date of death	<i>March 8th 1865</i>	
Date of burial	<i>March 9th 10 o.c. A.M</i>	<i>1865.</i>

Duplicates sent to the Adjutant General of the United States Army, and to the Sexton of the Cemetery.

Memoranda:

List of Effects.
1 Pt Coat (Suff), - 1 Pr Pants (Suff), - 1 Blouse
1 Cap, - 1 Pr Shoes, - 1 Humpack, - 1 W. Blanket.
Final Statements & Inventory of Effects
sent to A.S.O. & Co Camp Mich 10th 1865

S. No. 102 N. C.

No. 944

APPLICATION OF

Caleb Shepherd

Dorchester Co. Md

For Compensation for Service of Slave,

Isaac Stafford

Enlisted in Seventh Regiment ^{Sept 23} 7th

U. S. Colored Troops, Co. C

Received, March 9 1864.

COMPENSATION

Refused

September 18th 1865

This claim is rejected ~~because~~ because
Caleb Shepherd has been discharged.

Thos. Simmons
President Board of Claims

Recd. A. G. C. Sept. 25. 1865.

Care. Wallace & Millburn
Care. Wallace & Millburn

STATE OF MARYLAND

EVIDENCE OF TITLE.

I, Caleb Shepherd, of Dorchester
 County, Md., do solemnly swear that Jacob S Fufford
 who has been enlisted in the Seventh Regiment, U. S. Colored Troops,
 Co. C; is my slave for life; (his term of service expiring on
 the _____ day of _____ 186 _____;) and that
 I became possessed of him by his birth, in the month
 of about, eighteen hundred and forty four. And I
 do further swear that I have not purchased said slave from any person or persons disloyal
 to the Government of the United States, with the object of obtaining compensation for
 the same; and furthermore, that I have no agency for obtaining compensation for any per-
 son or persons but such as, to my knowledge, are loyal citizens of the United States.

March 1st 1864. C Shepherd



STATE OF MARYLAND,

Dorchester County, to wit:

On this *first* day of *March* in the year 1864,

before me, the subscriber, a Justice of the Peace of the State and County aforesaid, personally appeared *Calib Shepherd*, and took, signed, and acknowledged the oaths preceding; and further made oath, in due form of law, that all the statements made in this application are, to the best of *his* knowledge and belief, strictly true.

Also personally appeared before me *E. W. LeCompte* and *John T. Jackson*, loyal citizens of the United States, residents of *Dorchester Co. Md*, well acquainted with the said *Calib Shepherd*, and in no manner interested in the prosecution of this claim, and made oath, in due form of law, that the said *Calib Shepherd* is the owner of the slave *Paunt Stuffer*, as a fact of public notoriety; that they believe all the statements herein made by *him*, in reference thereto, are correct, and that *he* is unquestionably loyal to the Government of the United States. Witness their signatures:

E. W. LeCompte
John T. Jackson

Swoorn before

H. J. Winterbottom Justice of the Peace.

STATE OF MARYLAND,

County, to wit:

I, _____, Clerk of the Circuit Court for

_____ County, do hereby certify that _____,

before whom the foregoing affidavits were made, was, at the time of signing the same, a

Justice of the Peace for the County and State aforesaid, duly commissioned and sworn;

and that his signature thereto is genuine, and that full faith and credit should be given to

his official acts.

Witness my hand and the seal of said Court, this _____ day of

_____, A. D. 1864.

CLERK.

A.

No. 9421 CLAIMANT'S CERTIFICATE.

I, Calhoun Sheppard a loyal citizen, and a resident
of Cambridge, County of Dorchester, State of
Maryland, hereby claim compensation, under the provisions of
General Orders, No. 329, 1863, for my slave Isaac Sheppard
enlisted Sept. 23rd 1863, at Balto Md
by Col. Wm Birney in the Seventh
Regiment U. S. Colored Troops, Co. C; certificate of which enlistment, and a
descriptive list, as required, accompany this application.

In proof of my loyalty to the Constitution and Government of the United States, I
present the accompanying oath, which I have taken, signed, and acknowledged, to be filed
with this application, in accordance with requirement of said General Orders.

March 1st 1864.

Calhoun Sheppard Guardian

B.

OATH OF ALLEGIANCE.

I, Caleb Shephard, do solemnly swear that I have never joined, or been concerned in, any insurrection or rebellion; that I have never borne arms against the United States; that I have never given any aid, countenance, counsel, or encouragement to any person or persons engaged, or whom I had reason to believe were about to engage, in insurrection, rebellion, or armed hostility against the United States; that I have neither sought, nor accepted, nor attempted to exercise the functions of any office, civil or military, nor to perform any service whatever, under any authority or pretended authority in hostility to the United States; that I have not yielded a voluntary support to any insurrection, rebellion, or pretended government, authority, power, or constitution within the United States hostile thereto. And I do further swear that, to the best of my knowledge and ability, I have supported and defended, and will continue to support and defend, the United States against all enemies, foreign and domestic; and that I have supported, defended, and obeyed, and will continue to support, defend, and obey, the Constitution and laws of the United States; that I will bear true faith and allegiance to the same; and that I take this oath freely, without any mental reservation or purpose of evasion: So help me God.

C. Shephard Guardian

Sworn to and subscribed before me, at Cambridge
this 1st day of March 1864.

H. J. Winterbottom
Justice of the Peace

C.

I present herewith evidence of my title to the slave Jacob
Stafford enlisted as aforesaid, and in consideration of the sum of
three hundred dollars which when by me received, I hereby covenant and
agree with the United States, that I, my heirs, executors, or assigns, shall never hereafter make
or enforce any claim to the labor or services of said slave; and pledge myself to execute
a valid Deed of Manumission and Release of all my claims to service forever of said
Jacob Stafford to be filed with the Board of Claims
now in session at Balto. Md.

W. Shephard guardian

March 18th, 1864.



[OFFICE ENDORSEMENT.]

War Department,

ADJUTANT GENERAL'S OFFICE,

January 29, 1871

The death of *Jacob Stafford*
Co. C, 7 Reg't U. S.
Colored Troops, is reported as follows:

- On Company Muster Roll.
- For *March 1st, 1865, March 1st, 1865*
- Company Muster-out Roll.
- March 8th, 1865*
- Company Descriptive Book., 186
- Company Morning Reports., 186
- Soldier's Final Statement.
- March 8th, 1865*
- Soldier's Record of Death and Interment.
- March 8, 1865*
- Soldier's Inventory of Effects., 186
- Soldier's Certificate of Disability for Discharge., 186
- Soldier's Individual Muster-out Roll., 186
- Regimental Return.
- For *March, 1865, March 8, 1865*
- Regimental Quarterly Returns *1st Qr 65*
- March 8, 1865*
- Regimental Descriptive Book., 186
- By Surgeon General.
- (*March 8, 1865*), 186

March 8, 1865, is held to be the correct date, and the Company Muster Roll will be amended accordingly.

Thomas M. Stewart
Adjutant General
EB 12 March 12
219 Noted 26th

6-108

FINAL STATEMENT

OF

Private Jacob Stafford, Co 'C'

7th Reg't of U.S.C. Troops

VOLUNTEERS.

Disch March 5th 1865

A.G.O.
Disc List sent 2^d Amd.
7th

A.G.O. Sept. 6, 1865.
P.C. old inv. & R.M. & recy.
for \$1.50 sent to 2^d Amd.
U.S.

NOTE 1.—Two of these certificates (or duplicates) are to be given to each Volunteer Soldier or drafted man who may be discharged previously to the discharge of his company that he may at once receive from the Paymaster the pay &c. due him and the captain or other COMMISSIONED officer commanding the company will certify to the act of the delivery of the duplicate certificates, on these certificates the Soldier is "entitled to" his discharge and should also present his discharge to the Paymaster to have the payment endorsed on it. The discharge is to be given back to the Soldier by the Paymaster; the latter only retaining as his voucher the duplicate certificates.

NOTE 2.—If the Soldier is entitled to pay for the use of his horse, the Company Commander will certify to that fact on the back of both these final statements, and also to the time he has pay due for having been so mounted on his own horse.

NOTE 3.—When a Soldier is furnished with final statements, his descriptive list, if he has one, should be taken up by the officer who gives the Soldier these statements and endorsed with a statement to this effect by the officer. This endorsement should exhibit a full statement of the time for which the Soldier was allowed pay on his final statements, the clothing account, and all other charges against him, or in his favor, so as to comprise a complete exhibit of his account. It will then be transmitted to the company commander of the Soldier who will enter all the data necessary to a full understanding of the Soldier's account on the muster roll upon which the Soldier's discharge is reported. The descriptive list will then be destroyed. The object of this is, that the remaining portion of the Soldier's account may be settled upon the receipt of these muster rolls, and the Soldier receive any pay or allowances that may be due him at the time of his discharge and which may not appear on his final statements from the fact that his descriptive list is incomplete. These accounts for back pay, &c., are settled by the 2d Auditor of the Treasury Department.

NOTE 4.—Charges for loss or injury to ordnance, horse equipments, and other miscellaneous charges, should appear under the heading of "Other Stoppages."

NOTE 5.—Bounty paid by State authorities, and not by the United States, will not be entered on this statement.

NOTE 6.—Amounts due the Sutler and Laundress must be entered on the muster roll on which the discharge, death, desertion, &c., is reported, as well as on the final statement, otherwise the amount cannot be collected from the United States.

NOTE 7.—This blank will be used for deceased volunteers and drafted men, as well as for others.

NOTE 8.—Where a Soldier dies in Hospital or on detached service, his descriptive list, if he has one, should be sent with his final statements, in duplicate, to the Adjutant General, Washington, D. C.

ADJUTANT GENERAL'S OFFICE.
Mar 15th 1865.
Duplicate with Inventory sent 2^d Auditor.

Anton J. Hoffmann

I certify, on honor, that Jacob Stafford a Private of
 Captain A. H. Cheney's Company (6th) of the 7th Regiment of Volunteers
VOLUNTEERS, of the State of _____, born in Rockwell Co., State
 of Maryland, aged 21 years; 5 feet 3 1/2 inches high; Black complexion,
Black eyes Black hair, and by occupation a Farmer, having joined the company on
 its original organization at _____, and enrolled in it at the muster into
 the service of the United States at Baltimore Md., on the Twenty-third day
 of September, 1863, (or was mustered in service as a recruit, by Col. Wm. W.
Birney, at Baltimore Md., on the Twenty-sixth day of September,
 1863, or was drafted and mustered into the service of the United States from the _____
 Enrollment District of the State of _____, at _____,
 on the _____ day of _____, 186-), to serve in the Regiment, for
 the term of Three Years: and having served HONESTLY and
 FAITHFULLY with his Company in _____ to the present date, is now

entitled to a **DISCHARGE** by reason of Death from Erysipelas
He died at McKim's Mansion Hospital Baltimore Md. March 8th 1865

The said Jacob Stafford was last paid by Paymaster
Maj. M. C. Conwell to include the Thirtieth day of April, 1864, and has
 pay due him from that time to the present date; he is entitled to pay and subsistence for
 TRAVELING to place of enrollment, and whatever other allowances are authorized to volunteer
 soldiers, drafted men, or militia, so discharged. He has received from the United States **CLOTHING**
 amounting to \$ 81. 86 dollars, since the _____ day of _____,
 186-, when his clothing account was last settled. He has received from the United States
 _____ dollars advanced **BOUNTY**.

There is to be stopped from him, on account of the State of _____, or other
 authorities, for **CLOTHING, &c.**, received on entering service, _____ dollars; and
 for other stoppages, viz: To be stopped for Transportation \$ 5.00.

_____ dollars.
 He has been furnished with TRANSPORTATION in kind from the place of his discharge to
 _____; and he has been SUBSISTED for TRAVELING to his
 place of enrollment, up to the _____, 186-.

He is indebted to _____, **SUTLER**, _____ dollars.
 He is indebted to _____, **LAUNDRESS**, _____ dollars.

Given in Duplicate, at McKim's Mansion Hospital Balt. Md., this 10th day
 of March, 1865.

Wm. A. Surgeon
In charge of McKim's Hospital
 Commanding Company

1262

Stafford Josiah

Co. F, 7 U.S. Col'd Inf.

Private | Private

CARD NUMBERS.

1	6289205	26
2	6289326	27
3	6279561	28
4	6290905	29
5	9066597	30
6		31
7		32
8		33
9		34
10		35
11		36
12		37
13		38
14		39
15		40
16		41
17		42
18		43
19		44
20		45
21		46
22		47
23		48
24		49
25		50

Book Mark:

See also

81877471 PONTON

D. 235-8382 P.O. RITA

D-3078428-P.O. VFF.

1863

S | **7** | **U.S.C.T.**

Josiah Stafford
....., Co. *3*, 7 Reg't U.S. Col'd Inf.

Appears on
Company Descriptive Book
of the organization named above.

DESCRIPTION.

Age *22* years; height *5* feet *4* inches.
Complexion *R*.....
Eyes *R*.....; hair *Curly*
Where born *Charleston, Md.*
Occupation *Farmer*

ENLISTMENT.

When *Sept 24*....., 186*3*
Where *Baltimore, Md.*
By whom *Col St. Birney*; term *3* y'rs.

Remarks: *Mustered Sept 30,*
1863. by Col Wm. Birney.
Discharged Oct 24 1863
from 1 Birney Barracks
Baltimore, Md.

.....
J. Brown
.....

S | 7 | U.S.C.T.

Joseph Stafford
Capt, Co. *F*, 7 Reg't U. S. Colored Inf.

Age *22* years.

Appears on

Company Muster-in Roll

of the organization named above. Roll dated

Baltimore Md, Sept 30, 1863.

Muster-in to date *Sept 30, 1863.*

Joined for duty and enrolled:

When *Sept 27*, 186*3*.*

Where *Dorchester Co. Md.* *

Period *3* years.*

Remarks:
.....
.....
.....
.....
.....

*Muster-in roll shows enrollment of all men of this company as of same date: See enrollment on subsequent card or cards.

Book mark :
.....
.....

John Miller
Quartermaster

A | **7** | **U.S.C.T.**

Josiah Stafford

Plt., Co. F, 7 Reg't U. S. Col'd Infantry.

Appears on

Company Muster Roll

for *Sept 30 to Oct 31st*, 186*3*.

Joined for duty and enrolled:

When *Sept 27th*, 186*3*.*

Where *Dorchester Co. Md.* *

Period *3* years.*

Present or absent.....

Stoppage, \$ *100* for.....

Due Gov't \$ *100* for.....

Remarks: *Deserted Oct 24th*
1863.

* ~~See~~ See enrollment on card from muster-in roll.

Book mark:.....

J. A. Miller
Copyist.

S. 4

U.S.C.T.

Josiah Stafford

Priv., Co. *F 4* Reg't U. S. Col'd Infantry.

Appears on

Descriptive List of Deserters

dated *Feb. 8th*, 1864.

Deserted:

When *October 24*, 1863.

Where *Baltimore, Md.*

Arrested:

When _____, 186 .

Where _____

Remarks:

Book mark:

(851)

J. Smith

Copist.

S | 7 | U.S.C.T.

Josiah Stafford
Pt., Co. P, 7 Reg't U. S. Col'd Infantry.

Appears on Co. Muster-out Roll, dated
Indianola, Texas, Oct. 13, 1866 .

Muster-out to date 186 .

Last paid to 186 .

Clothing account:

Last settled....., 186 ; drawn since \$..... 100

Due soldier \$..... 100; due U. S. \$..... 100

Am't for cloth'g in kind or money adv'd \$..... 100

Due U. S. for arms, equipments, &c., \$..... 100

Bounty paid \$..... 100; due \$..... 100

Remarks: Deserted at
Birney Barracks,
Baltimore, Md. Oct 24,
'63.

Book mark :

Brooks

1263

Stafford Lewis

Co C, 7 U.S. Col'd Inf.

Private

Private

CARD NUMBERS.

1	6283680	26
2	6283731	27
3	6283831	28
4	6284030	29
5	6284127	30
6	6284222	31
7	6284316	32
8	6284391	33
9	6284500	34
10	6284600	35
11	6284728	36
12	6285414	37
13	9066228	38
14		39
15		40
16		41
17		42
18		43
19		44
20		45
21		46
22		47
23		48
24		49
25		50

Book Mark E.B. $\frac{12}{222}$

See also

S. 1687925 and W.D.

A 1969504 and W.D.

51979005 and W.D.

P. 1992927 and W.D.

7 U.S.C.T.

Lewis Stafford

Co. C, 7 Reg't U.S. Col'd Inf.

Appears on Company Descriptive Book of the organization named above.

DESCRIPTION.

Age 20 years; height 5 feet 3 1/2 inches.

Complexion Black.

Eyes Black; hair Curly.

Where born Dorchester, Md.

Occupation Farmer.

ENLISTMENT.

When Sept. 23, 1863.

Where Baltimore.

By whom Col. W. Boney; term 3 y'rs.

Remarks: Mustered at Baltimore Md. Sept. 26, 63, by Col. Whinery. A prisoner of War fr. Sept. 29, 64. Died in Confederate Hospital Salisbury, Md., Dec. 14, 64.

J. G. Smith

MARR 635

S | 7 | U.S.C.T.

Lewis, Stafford.
Priv., Co. C, 7 Reg't U. S. Colored Inf.

Age 21 years.

Appears on

Company Muster-in Roll

of the organization named above. Roll dated
Baltimore, Md. Sept. 26, 1863

Muster-in to date Sept. 26, 1863

Joined for duty and enrolled:

When Sept. 23, 1863

Where Dorchester Co. Md. *

Period 3 years.*

Remarks:

*Muster-in roll shows enrollment of all men of this company as of same date. See enrollment on subsequent card or cards.

Book mark:

Calceway
Copyist.

8 | 7 | U.S.C.T.

Lewis Stafford

Prov, Co. C, 7 Reg't U. S. Col'd Infantry.

Appears on

Company Muster Roll for Sept. 26 to Oct. 31, 1863

Joined for duty and enrolled:

When Sept. 23, 1863.*

Where Dorchester Co., Md. *

Period 3 years.*

Present or absent Present,

Stoppage, \$ 100 for

Due Gov't \$ 100 for

Remarks:

* See enrollment on card from muster-in roll.

Book mark:

Callaway

S | **7** | **U.S.C.T.**

Lewis Stafford
Prob, Co. C, 7 Reg't U. S. Col'd Infantry.

Appears on

Company Muster Roll
for *Nov. 4th Dec. 1st*, 1863

Joined for duty and enrolled:

When *Sept. 23*, 1863*

Where *Dorchester Co. Md.**

Period *3* years.*

Present or absent *Present*

Stoppage, \$ *100* for

Due Gov't \$ *100* for

Remarks:

* See enrollment on card from muster-in roll.

Book mark: -----

Callaway

8 | 7 | U.S.C.T.

Lewis Stafford

Priv., Co. C, 7 Reg't U. S. Col'd Infantry.

Appears on

Company Muster Roll
for January Feby, 1864.

Joined for duty and enrolled:

When Sept. 23, 1863.*

Where Dorchester Co. Md. *

Period 3 years.*

Present or absent Present.

Stoppage, \$ 100 for

Due Gov't \$ 100 for

Remarks: Stop for one Knapsack.

* See enrollment on card from muster-in roll.

Book mark:

Callaway

8 | 7 | U.S.C.T.

Lewis Stafford.

Priv, Co. C, 7 Reg't U. S. Col'd Infantry.

Appears on

Company Muster Roll

for *March and April*, 1864.

Joined for duty and enrolled:

When *Sept. 23*, 1863*

Where *Dorchester Co, Md.* *

Period *3* years.*

Present or absent *Present*.

Stoppage, \$ *100* for

Due Gov't \$ *100* for

Remarks: *Stop for one Housack.*

* See enrollment on card from muster-in roll.

Book mark:

Chesway

S | **7** | **U.S.C.T.**

Lewis Stafford
Pvt, Co. C, 7 Reg't U. S. Col'd Infantry.

Appears on

Company Muster Roll
for *May/June*, 186*4*

Joined for duty and enrolled:

When *Sept. 23*, 186*3**

Where *Dochester Co. Md.**

Period *3* years.*

Present or absent *Present.*

Stoppage, \$ *100* for

Due Gov't \$ *100* for

Remarks:

* See enrollment on card from muster-in roll.

Book mark: -----

Careaway
(358c) Copyist.

8 | 7

U.S.C.T.

Lewis Stafford
Privt, Co. C, 7 Reg't U. S. Col'd Inf

Appears on

Company Muster Roll
for July and Aug 1864

Joined for duty and enrolled:

When Sept. 23, 1863*

Where Donchester Co. Md. *

Period 3 years.*

Present or absent Present.

Stoppage, \$ 100 for

Due Gov't, \$ 100 for

Valuation of horse, \$ 100

Valuation of horse equipments, \$ 100

Remarks:

* See enrollment on card from muster-in roll.

Book-mark:

Creedway

S | **7** | **U.S.C.T.**

Beris Stafford
Priv., Co. C, 7 Reg't U. S. Col'd Infantry.

Appears on

Company Muster Roll
for *Sept. & Oct.*, 186*4*.

Joined for duty and enrolled:

When *Sept. 23^d*, 186*3*.*

Where *Borchester* *

Period *3* years.*

Present or absent *Absent*

Stoppage, \$ *100* for

Due Gov't \$ *100* for

Remarks: *Wounded and sent to Hosp. Sept. 29^d*

* See enrollment on card from muster-in roll.

Book mark:

M. M. Murphy
(858c) Copyist.

S | 7 | U.S.C.T.

Lewis Stafford
Priv., Co. C, 7 Reg't U. S. Col'd Infantry.

Appears on

Company Muster Roll
for Nov. & Dec., 1864.

Joined for duty and enrolled:

When Sept. 23, 1863.*

Where Worcester *

Period 3 years.*

Present or absent Absent

Stoppage, \$ 100 for

Due Gov't \$ 100 for

Remarks: Wounded and
sent to Hosp. Sept.
29/64

* See enrollment on card from muster-in roll.

Book mark:

M. M. Murphy
(358c) Copyist.

S | **7** | **U.S.C.T.**

Lewis Stafford
Priv., Co. C, 7 Reg't U. S. Col'd Infantry.

Appears on

Company Muster Roll

for *Jan. & Feb.*, 186*5*.

Joined for duty and enrolled:

When *Sept. 23*, 186*3*.*

Where *Worcester Co. Ind.* *

Period *3* years.*

Present or absent *Absent*

Stoppage, \$ *100* for

Due Gov't \$ *100* for

Remarks: *Wounded in
action Sept. 29/64
In Hosp. since - local
ity unknown*

* See enrollment on card from muster-in roll.

Book mark:

M. M. Murphy

S | 7 | U.S.C.T.

Lewis Stafford
Priv., Co. C, 7 Reg't U. S. Col'd Infantry.

Appears on

Company Muster Roll
for *Mar. & Apr.*, 186*5*.

Joined for duty and enrolled:

When *Sept. 23*", 186*3*.*

Where *Dorchester* *

Period *3* years.*

Present or absent *Absent*

Stoppage, \$ *100* for

Due Gov't \$ *100* for

Remarks: *Wounded Sept. 29/64. In Hosp. locality unknown*

* See enrollment on card from muster-in roll.

Book mark: *Died at Cover*

M. M. Murphy

JAN. 20

6284600

AT 6810

Salisbury, N. C. while a
Prisoner of War Dec. 29/64
see evidence in Final
Statement Form

S | 7 | U.S.C.T.

Lewis Stafford
Pvt., Co. C, 7 Reg't U. S. Col'd Infantry.

Appears on

Company Muster Roll
for May 7 June, 1865.

Joined for duty and enrolled:

When Sept. 23, 1863.*

Where Dorchester *

Period 3 years.*

Present or absent

Stoppage, \$ 100 for

Due Gov't \$ 100 for

Remarks: Taken Prisoner
Sept. 29/64 in front
of Richmond. Died
in Confederate Prison
Salisbury, N.C. Months of
Dec. Final State. (over)

* See enrollment on card from muster-in roll.

Book mark: Died Dec. 30, '64 of Pneumonia E. 13223¹²

(258c)

M. M. Murphy
Copyist.

JAN. 20

6284728

018910

ments sent (May 18/65.
Information received of
Sergt. Jenkins, a Paroled
Prisoner.

S. 1 7 U.S.C.T.

Lewis Stafford
Pt. Co. C, 7 Reg't U. S. Col'd Infantry.

Appears on Co. Muster-out Roll, dated
Indianola Texas, Oct. 13, 1866.

Muster-out to date _____, 186 .

Last paid to *Apr. 30*, 1864.

Clothing account:

Last settled _____, 186 ; drawn since \$ _____ 100

Due soldier \$ _____ 100; due U. S. \$ _____ 100

Am't for cloth'g in kind or money adv'd \$ _____ 100

Due U. S. for arms, equipments, &c., \$ _____ 100

Bounty paid \$ _____ 100; due \$ _____ 100

Remarks: *Captured Sept. 29 '64. Died at Salisbury N.C. Dec. 14 '64 of Diarrhoea. Final statements sent to a.g.o. Dec. 3 '65.*

Book mark: *V68 Pg. 69. F.S.*

(361) *Lopez* Copyist.
(over)

JAN. 20

6285414

018910

Died Dec. 30 '64 of
Pneumonia I.B. 222.

Stafford, Lewis

Co. C, 7th Reg't U.S.C. Inf.

3 Enclosures.

Bed Cards	Final Statements 2
Burial Records	Furloughs or L. of A.
Certs. of Dis. for Discharge	Med. Certificates
C. M. Charges	Med. Des. Lists
Descriptive Lists	Orders
Discharge Certificates	Pris. of War Record 2
Enlistment Papers	Resignations

Other papers relating to—

Admission to Hosp'l	Furlough or L. of A.
Casualty Sheet 2	Med. Examination
Confinement	Misc. Information 1
Contracts	Pay or Clothing
Death or Effects 1	Personal Reports
Desertion	Rank
Discharge from Hosp'l	Transfer to Hosp'l
Discharge from Service	Transfer to V. R. C.
Duty	Transportation

MICROFILM PUBLICATION M 1849

COMPILED MILITARY SERVICE RECORDS
OF VOLUNTEER UNION SOLDIERS WHO SERVED WITH
THE UNITED STATES COLORED TROOPS (USCT)
7TH REGIMENT OF INFANTRY

PERSONAL PAPERS' TARGET SHEET

PLEASE NOTE THE CHECKED INFORMATION ABOUT THE PERSONAL PAPERS IN
THIS FILE:

- NO PERSONAL PAPERS WERE FOUND IN THIS FILE WHEN THE
RECORDS WERE ARRANGED FOR MICROFILMING.
- 8 PERSONAL PAPER(S) FOUND IN THIS FILE WHEN THE RECORDS
WERE ARRANGED FOR MICROFILMING.

A.

No. 945 CLAIMANT'S CERTIFICATE.

I, Caleb Shepherd a loyal citizen, and a resident
of Cambridge, County of Dorchester, State of
Maryland, hereby claim compensation, under the provisions of
General Orders, No. 329, 1863, for my slave Lewis Stafford
enlisted Sept. 23rd 1864, at Balto. Md.
by Cpl. Wm. Birney in the Seventh
Regiment U. S. Colored Troops, Co. C; certificate of which enlistment, and a
descriptive list, as required, accompany this application.

In proof of my loyalty to the Constitution and Government of the United States, I
present the accompanying oath, which I have taken, signed, and acknowledged, to be filed
with this application, in accordance with requirement of said General Orders.

C. Shepherd

March 1st 1864.

B.

OATH OF ALLEGIANCE.

I, Caleb Shepherd, do solemnly swear that I have never joined, or been concerned in, any insurrection or rebellion; that I have never borne arms against the United States; that I have never given any aid, countenance, counsel, or encouragement to any person or persons engaged, or whom I had reason to believe were about to engage, in insurrection, rebellion, or armed hostility against the United States; that I have neither sought, nor accepted, nor attempted to exercise the functions of any office, civil or military, nor to perform any service whatever, under any authority or pretended authority in hostility to the United States; that I have not yielded a voluntary support to any insurrection, rebellion, or pretended government, authority, power, or constitution within the United States hostile thereto. And I do further swear that, to the best of my knowledge and ability, I have supported and defended, and will continue to support and defend, the United States against all enemies, foreign and domestic; and that I have supported, defended, and obeyed, and will continue to support, defend, and obey, the Constitution and laws of the United States; that I will bear true faith and allegiance to the same; and that I take this oath freely, without any mental reservation or purpose of evasion: So help me God.

C. Shepherd

Sworn to and subscribed before me, at Cambridge }
 this 1st day of March 1864.

H. S. Winterbottom
Justice of the Peace



C.

I present herewith evidence of my title to the slave Lewis
Stafford enlisted as aforesaid, and in consideration of the sum of
three hundred dollars which when by me received, I hereby covenant and
agree with the United States, that I, my heirs, executors, or assigns, shall never hereafter make
or enforce any claim to the labor or services of said slave; and pledge myself to execute
a valid Deed of Manumission and Release of all my claims to service forever of said
Lewis Stafford to be filed with the Board of Claims
now in session at Balto. Md.

G. Shepherd

1st March 1864.



J. W. P. P. C.

No. 945

APPLICATION OF

Leah Shepherd

OF

Dorchester Co. Md.

For Compensation for Service of Slave,

Lewis Stafford

Enlisted in Seventh Regiment

U. S. Colored Troops, Co. C.

Received, March 9 1864.

COMPENSATION ~~AWARDED~~ Refused

September 18th 1865.

This claim is rejected because
Leah Shepherd has been dis-
loyal.

Thos. Simmons

Presid & Bd. Claims

Recd. H. G. Sept. 25. 1865.

Care Wallace & Milborne Cambridge

MSA 786

NARA 797

STATE OF MARYLAND

EVIDENCE OF TITLE.

I, Calist Shepherd, of Dorchester
County, Md., do solemnly swear that Lewis Stapp
who has been enlisted in the Seventh Regiment, U. S. Colored Troops,
Co. C; is my slave for life; (his term of service expiring on
the _____ day of _____ 186 _____;) and that
I became possessed of him by his birth, in the month
of about, eighteen hundred and forty three. And I
do further swear that I have not purchased said slave from any person or persons disloyal
to the Government of the United States, with the object of obtaining compensation for
the same; and furthermore, that I have no agency for obtaining compensation for any per-
son or persons but such as, to my knowledge, are loyal citizens of the United States.

March 1st - 1864. C. Shepherd

5

211 1 1 1864

MARR 799

STATE OF MARYLAND,

Dorchester County, to wit:

On this *first* day of *March* in the year 1864,

before me, the subscriber, a Justice of the Peace of the State and County aforesaid, personally appeared *Calib Shephard*, and took, signed, and acknowledged the oaths preceding; and further made oath, in due form of law, that all the statements made in this application are, to the best of *his* knowledge and belief, strictly true.

Also personally appeared before me *E. W. LeCompte* and *John T. Jackson*, loyal citizens of the United States, residents of *Dorchester Co. Md*, well acquainted with the said *Calib Shephard*, and in no manner interested in the prosecution of this claim, and made oath, in due form of law, that the said *Calib Shephard* is the owner of the slave *Lewis Stafford*, as a fact of public notoriety; that they believe all the statements herein made by *him*, in reference thereto, are correct, and that *he* is unquestionably loyal to the Government of the United States. Witness their signatures:

Sworn before

E. W. LeCompte
John T. Jackson

H. T. Winterbottom Justice of the Peace.

STATE OF MARYLAND,

County, to wit:

I, _____, Clerk of the Circuit Court for

_____ County, do hereby certify that _____,

before whom the foregoing affidavits were made, was, at the time of signing the same, a

Justice of the Peace for the County and State aforesaid, duly commissioned and sworn;

and that his signature thereto is genuine, and that full faith and credit should be given to

his official acts.

Witness my hand and the seal of said Court, this _____ day of

_____, A. D. 1864.

CLERK.

Inventory of the
Effects of Private late
Lewis Stafford of Company "C" 7th Regiment
U. S. C. Troops who died in
Confederate Prison Salisbury N. C.
December 1865



Inventory of the effects of Private Lewis Stafford of Capt George R. Sherman's Co "C" of the 7th Regiment U. S. C. Troops was enlisted by Col Barney of the 2nd U. S. C. Troops at Baltimore on the 23rd day of September 1863 to serve for three years was born in Dorchester County in the state of Maryland is 20 years of age 5 feet $\frac{3}{4}$ inches high Black complexion Black eyes Curly hair by occupation a waiter Died in Salisbury North Carolina in the month of December date unknown. Cause unknown.

Inventory

Effects of Private Lewis Stafford of Co "C" none

I certify on honor that the above Inventory of the Deceased Private Lewis Stafford is a correct one.

Camp Lincoln Va
May 8/65

Sylvester Eler
2nd Lieut
Commanding the Co.

In Pratt
Held upok
from Prison
from records

Repry

M. Woodward

July 30, 77

main

Sub-report

Repry

sup

[OFFICE ENDORSEMENT.]

War Department,

ADJUTANT GENERAL'S OFFICE,

January 31, 187*7*

The death of *Levis Stafford*
Cot., Co. *C*, of Reg't U. S.
Colored *Troops*, is reported as follows:

- On Company Muster Roll
For *May-June*, 1865, *December*, 186
- Company Muster-out Roll.
Dec. 14, 186*4*
- Company Descriptive Book.
Primer of War Reports, 186
- ~~Company Morning Reports:~~
Number 304 "Primer", 186
- Soldier's Final Statement.
December 19, 186*4*
- Soldier's Record of Death and Interment.
....., 186*4*
- Soldier's Inventory of Effects.
December, 186*4*
- Soldier's Certificate of Disability for Discharge.
....., 186
- Soldier's Individual Muster-out Roll.
....., 186
- Regimental Return.
For *June*, 1865, *Dec 10*, 186*4*
- Regimental Quarterly Returns. *2nd Q^r 1865*
December 18, 186*5*
- Regimental Descriptive Book.
....., 186

By Surgeon General.

(*Dec 30*) *of Primmer*, 186
and some health 186*4* is held to be
the correct date, and the Company Muster
Roll will be amended accordingly.

Thomas M. Sargent
Adjutant General
E. B. 1123 Noted H.M. Noted on Key

FINAL STATEMENT

OF

Stafford
Private Lewis Stafford

7 Reg't of *U. S. C. S.*

VOLUNTEERS.

Died Dec 19 " 1864

NOTE 1.—Two of these certificates (or duplicates) are to be given to each Volunteer Soldier or drafted man who may be discharged previously to the discharge of his company, that he may at once receive from the Paymaster the pay, &c., due him, and the captain or other COMMISSIONED officer commanding the company will certify to the act of the delivery of the duplicate certificates, on these certificates the Soldier is "entitled to" his discharge and should also present his discharge to the Paymaster to have the payment endorsed on it. The discharge is to be given back to the Soldier by the Paymaster; the latter only retaining as his voucher the duplicate certificates.

NOTE 2.—If the Soldier is entitled to pay for the use of his horse, the Company Commander will certify to that fact on the back of both these final statements, and also to the time he has pay due for having been so mounted on his own horse.

NOTE 3.—When a Soldier is furnished with final statements, his descriptive list, if he has one, should be taken up by the officer who gives the Soldier these statements and endorsed with a statement to this effect by the officer. This endorsement should exhibit a full statement of the time for which the Soldier was allowed pay on his final statements, the clothing account and all other charges against him or in his favor, so as to comprise a complete exhibit of his account. It will then be transmitted to the company commander of the Soldier who will enter all the data necessary to a full understanding of the Soldier's account on the muster roll upon which the Soldier's discharge is reported. The descriptive list will then be destroyed. The object of this is, that the remaining portion of the Soldier's account may be settled upon the receipt of these muster rolls, and the Soldier receive any pay or allowances that may be due him at the time of his discharge and which may not appear on his final statements from the fact that his descriptive list is incomplete. These accounts for back pay &c., are settled by the 2d Auditor of the Treasury Department.

NOTE 4.—Charges for loss or injury to ordnance, horse equipments, and other miscellaneous charges, should appear under the heading of "Other Stoppages."

NOTE 5.—Bounty paid by State authorities, and not by the United States, will not be entered on this statement.

NOTE 6.—Amounts due the Sutler and Laundress must be entered on the muster roll on which the discharge, death, desertion, &c., is reported, as well as on the final statement, otherwise the amount cannot be collected from the United States.

NOTE 7.—This blank will be used for deceased volunteers and drafted men, as well as for others.

NOTE 8.—Where a Soldier dies in Hospital or on detached service, his descriptive list, if he has one, should be sent with his final statements, in duplicate, to the Adjutant General, Washington, D. C.

ADJUTANT GENERAL'S OFFICE
Apl 4 " 1866
Duplicate with Inventory sent to Auditor

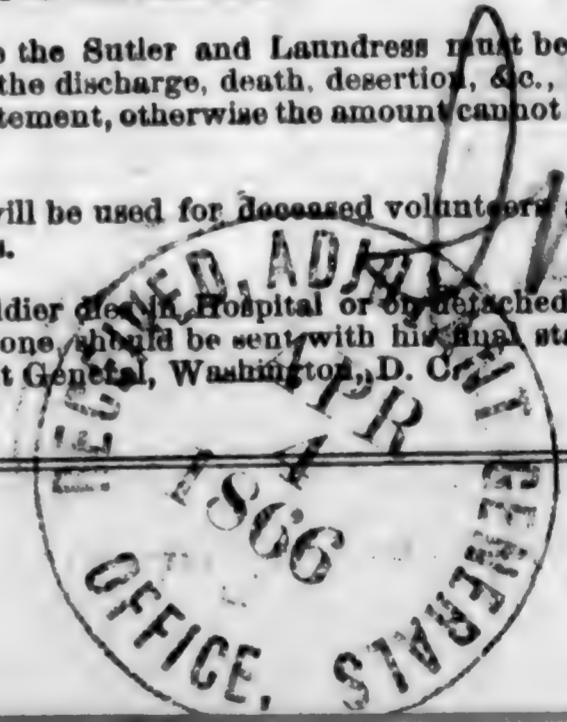

I certify, on honor, that Louis Stafford a Private of
 Captain Sherman Company (2) of the 1st Regiment of U.S.C.
VOLUNTEERS, of the State of Maryland, born in Dorchester, State
 of Maryland, aged 20 years; 5 feet 3 1/2 inches high; Blk. complexion,
Blk. eyes, Curly hair, and by occupation a Wagoner, having joined the company on
 its original organization at Baltimore, and enrolled in it at the muster into
 the service of the United States at _____, on the 23rd day
 of September, 1863, (or was mustered in service as a recruit, by Capt Wm
Barney, at Baltimore, on the 26 day of September,
 1863, or was drafted and mustered into the service of the United States from the
 Enrollment District of the State of _____, at _____,
 on the _____ day of _____, 1863) to serve in the Regiment, for
 the term of Three Years; and having served HONESTLY and
 FAITHFULLY with his Company in the 1st Regt to the present date, is now
 entitled to a **DISCHARGE** by reason of Death in Salisbury
M.C. as prisoner of War December 19th 1864

The said Private Louis Stafford was last paid by Paymaster
May MacConel to include the 30 day of April, 1864, and has
 pay due him from that time to the present date; he is entitled to pay and subsistence for
TRAVELING to place of enrollment, and whatever other allowances are authorized to volunteer
 soldiers, drafted men, or militia, so discharged. He has received from the United States **CLOTHING**
 amounting to twelve 12 29 dollars, since the 10 day of May;
 1864, when his clothing account was last settled. He has received from the United States
 _____ dollars advanced **BOUNTY**.

There is to be stopped from him, on account of the State of _____, or other
 authorities, for **CLOTHING**, &c., received on entering service, _____ dollars; and
 for other stoppages, viz: _____

_____ dollars.
 He has been furnished with **TRANSPORTATION** in kind from the place of his discharge to
 _____; and he has been **SUBSISTED** for **TRAVELING** to his
 place of enrollment, up to the _____, 1864.

He is indebted to _____, **SUTLER**, _____ dollars.
 He is indebted to _____, **LAUNDRESS**, _____ dollars.

Given in Duplicate, at Indianola Texas, this 22 day
 of March, 1866.

Sydney E. Coler
1st Lieut C
 Commanding Company. C.

163 128

FINAL STATEMENT

OF
Private Lewis Stafford
Co. 7th
25th Reg't of N.Y.C. Troops

VOLUNTEERS.

Private Stafford

NOTE 1.—Two of these certificates (or duplicates) are to be given to each Volunteer Soldier or drafted man who may be discharged previously to the discharge of his company, that he may at once receive from the Paymaster the pay, &c., due him, and the captain or other COMMISSIONED officer commanding the company will certify to the act of the delivery of the duplicate certificates; on these certificates the Soldier is "entitled to" his discharge, and should also present his discharge to the Paymaster to have the payment endorsed on it. The discharge is to be given back to the Soldier by the Paymaster; the latter only retaining as his voucher the duplicate certificates.

NOTE 2.—If the Soldier is entitled to pay for the use of his horse, the Company Commander will certify to that fact on the back of both these final statements, and also to the time he has pay due for having been so mounted on his own horse.

NOTE 3.—When a Soldier is furnished with final statements, his descriptive list, if he has one, should be taken up by the officer who gives the Soldier these statements, and endorsed with a statement to this effect by the officer. This endorsement should exhibit a full statement of the time for which the Soldier was allowed pay on his final statements, the clothing account, and all other charges against him or in his favor, so as to comprise a complete exhibit of his account. It will then be transmitted to the Company Commander of the Soldier, who will enter all the data necessary to a full understanding of the Soldier's account on the muster roll upon which the Soldier's discharge is reported. The descriptive list will then be destroyed. The object of this is, that the remaining portion of the Soldier's account may be settled upon the receipt of these muster rolls, and the Soldier receive any pay or allowances that may be due him at the time of his discharge, and which may not appear on his final statements from the fact that his descriptive list is incomplete. These accounts for back pay, &c., are settled by the 2d Auditor of the Treasury Department.

NOTE 4.—Charges for loss or injury to ordnance, horse equipments, and other miscellaneous charges, should appear under the heading of "Other Stoppages."

NOTE 5.—Bounty paid by State authorities, and not by the United States, will not be entered on this statement.

NOTE 6.—Amounts due the Sutler and Landress must be entered on the muster roll on which the discharge, death, desertion, &c., is reported, as well as on the final statement, otherwise the amount cannot be collected from the United States.

NOTE 7.—This blank will be used for deceased volunteers and drafted men, as well as for others.

NOTE 8.—Where a Soldier dies in Hospital or on detached service, his descriptive list, if he has one, should be sent with his final statements, in duplicate, to the Adjutant General, Washington, D. C.

ADJUTANT GENERAL'S OFFICE

July 21 1865

Duplicate with Inventory sent 2d Auditor.

Carson D. Ross
GEN'L'S OFFICE

I certify, on honor, that Lewis Stafford a Private of
 Captain George P. Sherman Company (C) of the 17th Regiment of W. P. Co. Troops
~~VOLUNTEERS~~, of the State of Maryland, born in Dorchester Co., State
 of Maryland, aged 20 years; 5 feet 3 1/2 inches high; Blk complexion,
Blk eyes, Curly hair, and by occupation a Waiter, having joined the company on
 its original organization at Baltimore, and enrolled in it at the muster into
 the service of the United States at Baltimore, on the 23rd day
 of September, 1863, (or was mustered in service as a recruit, by Colonel
Pirney, at Baltimore, on the 26th day of September,
 1863, ~~or was drafted and mustered into the service of the United States from the~~
~~Enrollment District of the State of~~ at
~~on the~~ day of 186) to serve in the Regiment, for
 the term of Three years; and having served HONESTLY and
 FAITHFULLY with his Company in until his capture Sep 29/64 to the present date, is now
 entitled to a **DISCHARGE** by reason of Death by confinement in
Confederate Prison in Salisbury North Carolina December 19/64

The said Lewis Stafford was last paid by Paymaster
Hammond to include the 31st day of August, 1864, and has
~~pay due him from that time to the present date; he is entitled to pay and subsistence for~~
~~TRAVELING~~ to place of enrollment, and whatever other allowances are authorized to volunteer
~~soldiers, drafted men, or militia, so discharged.~~ He has received from the United States **CLOTHING**
 amounting to \$3 29 cts 100 dollars, since the 31st day of August,
 1864, when his clothing account was last settled. ~~He has received from the United States~~
~~100 dollars advanced BOUNTY.~~

~~There is to be stopped from him, on account of the State of~~ or other
~~authorities, for CLOTHING, &c., received on entering service,~~ 100 dollars; and
~~for other stoppages, viz:~~

~~100 dollars.~~
~~He has been furnished with TRANSPORTATION in kind from the place of his discharge to~~
~~place of enrollment, up to the~~ ; and he has been **SUBSISTED** for **TRAVELING** to his
~~place of enrollment, up to the~~ ;

~~He is indebted to~~ SUTLER, 100 dollars.
~~He is indebted to~~ LAUNDRESS, 100 dollars.

Given in Duplicate, at Camp Lincoln near City Point Va, this 18th day
 of May, 1865.

Sylvester C. Lee
2nd Lieut
 Commanding Company. "C"

163
1864

Dup

FINAL STATEMENT

H.M.

OF
Private Lewis Stafford
Co. C. Reg't of W. I. Col Troops.

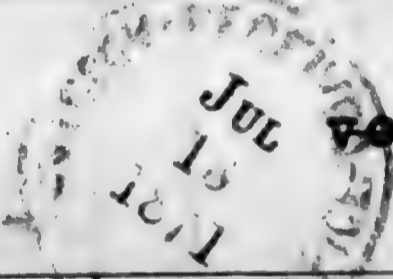

VOLUNTEERS.

NOTE 1.—Two of these certificates (or duplicates) are to be given to each Volunteer Soldier or drafted man who may be discharged previously to the discharge of his company, that he may at once receive from the Paymaster the pay, &c., due him, and the captain or other COMMISSIONED officer commanding the company will certify to the act of the delivery of the duplicate certificates; on these certificates the Soldier is "entitled to" his discharge, and should also present his discharge to the Paymaster to have the payment endorsed on it. The discharge is to be given back to the Soldier by the Paymaster; the latter only retaining as his voucher the duplicate certificates.

NOTE 2.—If the Soldier is entitled to pay for the use of his horse, the Company Commander will certify to that fact on the back of both these final statements, and also to the time he has pay due for having been so mounted on his own horse.

NOTE 3.—When a Soldier is furnished with final statements, his descriptive list, if he has one, should be taken up by the officer who gives the Soldier these statements, and endorsed with a statement to this effect by the officer. This endorsement should exhibit a full statement of the time for which the Soldier was allowed pay on his final statements, the clothing account, and all other charges against him or in his favor, so as to comprise a complete exhibit of his account. It will then be transmitted to the Company Commander of the Soldier, who will enter all the data necessary to a full understanding of the Soldier's account on the muster roll upon which the Soldier's discharge is reported. The descriptive list will then be destroyed. The object of this is, that the remaining portion of the Soldier's account may be settled upon the receipt of these muster rolls, and the Soldier receive any pay or allowances that may be due him at the time of his discharge, and which may not appear on his final statements from the fact that his descriptive list is incomplete. These accounts for back pay, &c., are settled by the 2d Auditor of the Treasury Department.

NOTE 4.—Charges for loss or injury to ordnance, horse equipments, and other miscellaneous charges, should appear under the heading of "Other Stoppages."

NOTE 5.—Bounty paid by State authorities, and not by the United States, will not be entered on this statement.

NOTE 6.—Amounts due the Sutler and Laundress must be entered on the muster roll on which the discharge, death, desertion, &c., is reported, as well as on the final statement, otherwise the amount cannot be collected from the United States.

NOTE 7.—This blank will be used for deceased volunteers and drafted men, as well as for others.

NOTE 8.—Where a Soldier dies in Hospital or on detached service, his descriptive list, if he has one, should be sent with his final statements, in duplicate, to the Adjutant General, Washington, D. C.

I certify, on honor, that Lewis Stafford Private of
 Captain Geo. R. Sherman's Company (B) of the 7th Regiment of W. G. Troops
~~VOLUNTEERS~~, of the State of Maryland, born in Dorchester Co., State
 of Maryland, aged 20 years; 5 feet 2 inches high; Blk complexion,
Blk eyes, Curly hair, and by occupation a Waiter, having joined the company on
 its original organization at Baltimore, and enrolled in it at the muster into
 the service of the United States at Baltimore, on the 23rd day
 of September, 1863, (or was mustered in service ~~by~~ by Colonel
W. Birney, at Baltimore, on the 26th day of September,
 1863, or was drafted and mustered into the service of the United States from the
 Enrollment District of the State of _____, at _____,
 on the _____ day of _____, 186____,) to serve in the Regiment, for
 the term of Three Years: and having served HONESTLY and
 FAITHFULLY with his Company in until his capture Sept 13/64 to the present date, is now
 entitled to a **DISCHARGE** by reason of Death by confinement in Confederate
Poison in Salisbury N. C. December 16/64

The said Lewis Stafford was last paid by Paymaster
Heammond to include the 31st day of August, 1864, and has
~~paid due him from that time to the present date; he is entitled to pay and subsistence for~~
~~TRAVELING~~ to place of enrollment, and whatever other allowances are authorized to volunteer
~~soldiers, drafted men, or militia, so discharged.~~ He has received from the United States **CLOTHING**
 amounting to \$ 3.29^{cts} 100 dollars, since the 31st day of August,
 1864, when his clothing account was last settled. ~~He has received from the United States~~
~~_____ dollars advanced BOUNTY.~~

~~There is to be stopped from him, on account of the State of _____, or other~~
~~authorities, for CLOTHING, &c, received on entering service, _____ dollars; and~~
~~for other stoppages, viz:~~

~~_____ dollars.~~
~~He has been furnished with TRANSPORTATION in kind from the place of his discharge to~~
~~_____ ; and he has been SUBSISTED for TRAVELING to his~~
~~place of enrollment, up to the _____, 186____.~~

~~He is indebted to _____, SUTLER, _____ dollars.~~
~~He is indebted to _____, LAUNDRESS, _____ dollars.~~

Given in Duplicate, at Camp Lincoln near City Point, this 18 day
 of May 18th, 1865.

Sylvester Eder
2nd Lieut
 Commanding Company, "C"

MEMORANDUM FROM PRISONER OF WAR RECORDS.

No. _____

(This blank to be used only in the arrangement of said records.)

NAME.	RANK.	ORGANIZATION.				INFORMATION OBTAINED FROM—				
		No. of Reg't.	State.	Arm of Service.	Co.	Records of—	Vol.	Page.	Vol.	Page.
<i>L</i> <i>Stafford Lewis</i>	<i>P</i>	<i>5</i>	<i>U.S. Negro</i>	<i>Inf</i>	<i>6</i>	<i>W. R.</i>	<i>29</i>	<i>288</i>	<i>69</i>	<i>58</i>
		<i>7</i>	<i>U.S.C.T.</i>				<i>5</i>	<i>68</i>	<i>12</i>	<i>180</i>
							<i>12</i>	<i>247</i>		

Captured at *Chapins Farm Va* *Sept. 29*, 1864; brought from _____, and confined at Richmond, Va., *Sept. 29*, 1864, *Sent to Salisbury Mo. Nov. 24, 1864 - Slave, owned by Capt Sheppard, Cambridge, Md.*

Admitted to Hospital at *Salisbury Mo. Dec 29* 1864; treated for _____

Where he died *Dec. 30*, 1864; of *Pneumonia*

Paroled at _____, 186 ; reported at _____, 186 .

881
147

[OVER.]

(Record continued.)

Furloughed _____, 186 , for _____ days; returned _____, 186 ;
deserted _____, 186 ;

Adjutant General's Office,

_____, 18

This is accepted as referring to _____

Co. _____, _____ Reg't,

and records will be corrected accordingly.

Assistant Adjutant Gen'l.

Copied by *A - 1/26/99*

Prisoners of War Records

Show L Stafford Co

- 7th U.S.C. I died Jan'y

15. 65 at Salisbury N.C

Capture not given.

B.H.S. 1. 30. 77

For Transfer of July 15/65.

CASUALTY SHEET

No. _____

L. Stafford

of Company _____

2nd Regiment of U.C.V.

State Volunteers.

NATURE OF CASUALTY.

Death

Died at Salisbury
N.C. Jan'y 15th 1865

Page 26 - 8
Salisbury
Records

CASUALTY SHEET

Name: L. Stafford

Rank: _____ Company: _____ Regiment: 7th

Arm: Inftry State: N. C.

Nature of Casualty: Death

CAUSE OF CASUALTY—(NAME OF DISEASE, &c.)

BY WHOM DISCHARGED.

DEGREE OF DISABILITY.

FROM WHAT SOURCE THIS INFORMATION WAS OBTAINED.

BY WHOM CERTIFIED.

Col. Maj. W. F. Hartz
A. A. G.

Roll furnished by
Comy Genl. of Insurers

REMARKS.

DATE OF DISCHARGE, DEATH, &c.

Jan'y 15th 1865.

PLACE OF DISCHARGE, DEATH, &c.

Salisbury N.C.

G. W. Clark

Clerk.

[Large handwritten signature]

NARA 725

Prisoner of War Records
How. Lewis. Stafford
Co. "C" 5th W. Negro Inftry
captured at Chapins Farm
Va. Sept. 29. 64. Confined
at Richmond Va same
day and was sent to
Salisbury N.C. Nov 24. 64
Lewis. Stafford or Shafford
Co. "C" 7th W. I. was admitted
to Hospital at Salisbury
N.C. Dec 29. 64 and died
there Dec 30. 64 of "Pneumonia"
M. S. 1. 30. 77

CASUALTY SHEET

No. _____

Lewis Stafford

of Company *B*

7 Regiment of *U. S. Colored Troops*

State Volunteers.

NATURE OF CASUALTY.

Death

*Died at Salisbury Hospital
of Pneumonia Dec 30. 1864
Page 43 - Salisbury Hospital Record*

CASUALTY SHEET

Name: *Lewis Stafford*

Rank: _____ Company: *6* Regiment: *9*

Arm: _____ State: *United States Col Troops*

Nature of Casualty: *Death*

CAUSE OF CASUALTY—(NAME OF DISEASE, &c.)

Pneumonia

BY WHOM DISCHARGED.

FROM WHAT SOURCE THIS INFORMATION WAS OBTAINED.

Roll furnished by Comd'g Gen'l of Prisoners.

DEGREE OF DISABILITY.

BY WHOM CERTIFIED.

Bot. Major W. J. Harty a/c

REMARKS.

DATE OF DISCHARGE, DEATH, &c.

December 30 1864

PLACE OF DISCHARGE, DEATH, &c.

Salisbury Hospital N.C.

[Signature]
Clerk.

(170)

J.M.C.

1264

Stafford Robert

Co A, 7 U.S. Col'd Inf.

Private

Private

CARD NUMBERS.

1	6279896	26
2	6279997	27
3	6280098	28
4	6280197	29
5	6280301	30
6	6280398	31
7	6280493	32
8	6280588	33
9	6280688	34
10	6280787	35
11	6280887	36
12	6280989	37
13	6281089	38
14	6281185	39
15	6281278	40
16	6281389	41
17	6281729	42
18	9065957	43
19		44
20		45
21		46
22		47
23		48
24		49
25		50

Book Mark:

See also

4898338PO KKM

S

7

U.S.C.T.

Robert Stafford

Co. A, 7 Reg't U.S. Col'd Inf.

Appears on

Company Descriptive Book

of the organization named above.

DESCRIPTION.

Age 27 years; height 5 feet 5 inches.

Complexion Blk.

Eyes Blk.; hair Curly.

Where born Dorchester, Md.

Occupation Farmer.

ENLISTMENT.

When Sept. 23d, 1863.

Where Baltimore.

By whom Col. W. Binney; term 3 y'rs.

Remarks: Mustered Sept. 26, 1863.
Discharged from Hicks
U. S. A. Gen. Hospital Baltimore
Md. January 22d. 1866, on
Surgeon's Certificate of Disa-
bility.

J. H. Smith

5111 NARA 751
S | 7 | U.S.C.T.

Robert Stafford
Pvt., Co. A, 7 Reg't U. S. Colored Inf.

Age 27 years.

Appears on

Company Muster-in Roll

of the organization named above. Roll dated
Baltimore Md. Sept. 26, 1863.

Muster-in to date Sept. 26, 1863.

Joined for duty and enrolled:

When Sept. 23, 1863.*

Where Dorchester Co. Md. *

Period 3 years.*

Remarks:.....
.....
.....
.....
.....

*Muster-in roll shows enrollment of all men of this company as of same date. See enrollment on subsequent card or cards.

Book mark :.....

Daggett

S | 7 | U.S.C.T.

Robert Stafford
Pvt., Co. A, 7 Reg't U. S. Col'd Infantry.

Appears on

Company Muster Roll

for *from Sept. 26 to Oct. 31, 1863.*

Joined for duty and enrolled:

When *Sept. 23*, 1863.*

Where *Dorchester Co. Md.* *

Period *3* years.*

Present or absent *Absent.*

Stoppage, \$ *100* for

Due Gov't \$ *100* for

Remarks: *Detached on recruiting service in St. Mary's Co. Md.*

* See enrollment on card from muster-in roll.

Book mark:

Daggett
(858c) Copyist.

B

7

U.S.C.T.

Robert Stafford
Pvt, Co. A, 7 Reg't U. S. Col'd Infantry.

Appears on

Company Muster Roll

for Nov. & Dec., 1863.

Joined for duty and enrolled:

When Sept. 23, 1863.*

Where Dorchester Co. Md. *

Period 3 years.*

Present or absent Absent.

Stoppage, \$ 100 for

Due Gov't \$ 100 for

Remarks: Detached recruiting
by order of Col. W. Birney
Dec. 1st Enlistment
premium of \$2.00 due.

* See enrollment on card from muster-in roll.

Book mark:

(358c)

Daggett

Copyist.

S | *7* | U.S.C.T.

Robert Stafford

Priv., Co. A, 7 Reg't U. S. Col'd Infantry.

Appears on

Company Muster Roll

for *Jan. & Feb.*, 1864.

Joined for duty and enrolled:

When *Sept. 23*, 1863.*

Where *Worcester Co. Md.* *

Period *3* years.*

Present or absent *Present.*

Stoppage, \$ *100* for

Due Gov't \$ *100* for

Remarks: *Enlistment premium due.*

* See enrollment on card from muster-in roll.

Book mark:

Daggett

S | 7 | U.S.C.T.

Robert Stafford

Pvt., Co. A, 7 Reg't U. S. Col'd Infantry.

Appears on

Company Muster Roll

for *Mar. & Apr.*, 1864.

Joined for duty and enrolled:

When *Sept. 23*, 1863.*

Where *Worcester Co. Ind.* *

Period *3* years.*

Present or absent *Present.*

Stoppage, \$ *100* for _____

Due Gov't \$ *100* for _____

Remarks: _____

* See enrollment on card from muster-in roll.

Book mark: _____

Daggett

S | 7 | **U.S.C.T.**

Robert Stafford

Pvt., Co. A, 7 Reg't U. S. Col'd Infantry.

Appears on

Company Muster Roll

for *May & June*, 1864.

Joined for duty and enrolled:

When *Sept. 23*, 1863.*

Where *Dorchester Co. Md.* *

Period *3* years.*

Present or absent *Present*

Stoppage, \$ *100* for

Due Gov't \$ *100* for

Remarks:

* See enrollment on card from muster-in roll.

Book mark:

Gaggett

S | 7 | U.S.C.T.

Robert Stafford
Pvt., Co. A, 7 Reg't U. S. Col'd Infantry.

Appears on

Company Muster Roll

for July & Aug., 1864.

Joined for duty and enrolled:

When Sept. 23, 1863.*

Where Dorchester Co. Md.*

Period 3 years.*

Present or absent Present.

Stoppage, \$ 100 for

Due Gov't \$ 100 for

Remarks: Stop for One Haversack

* See enrollment on card from muster-in roll.

Book mark:

Daggett

S | 7 | U.S.C.T.

Robert Stafford

Pvt., Co. A, 7 Reg't U. S. Col'd Infantry.

Appears on

Company Muster Roll

for Sept. & Oct., 1864.

Joined for duty and enrolled:

When Sept. 23, 1863.*

Where Dorchester *

Period _____ years.*

Present or absent Present.

Stoppage, \$ 100 for _____

Due Gov't \$ 100 for _____

Remarks: Stop for one set of metallic scales, Corp'l.

* See enrollment on card from muster-in roll.

Book mark: _____

(358c)

Leonard
Copyist.

S | 7 | U.S.C.T.

Robert Stafford

Pvt., Co. A, 7 Reg't U. S. Col'd Infantry.

Appears on

Company Muster Roll

for Nov. & Dec., 1864.

Joined for duty and enrolled:

When Sept. 23, 1863.*

Where Dorchester, Md. *

Period 3 years.*

Present or absent Absent.

Stoppage, \$ 100 for

Due Gov't \$ 100 for

Remarks: Stop for one set of metallic scales Sick in Hosp. since Dec. 13, 1864.

* See enrollment on card from muster-in roll.

Book mark:

(858c)

Leonard Copyist.

S 1 7 U.S.C.T.

Robert Stafford

Priv., Co. A, 7 Reg't U. S. Col'd Infantry.

Appears on

Company Muster Roll

for Jan & Feb., 1865.

Joined for duty and enrolled:

When Sept. 23, 1863.*

Where Dorchester, Md.*

Period 3 years.*

Present or absent Present

Stoppage, \$ 100 for

Due Gov't \$ 100 for

Remarks:

[Empty lines for remarks]

* See enrollment on card from muster-in roll.

Book mark:

[Empty line for book mark]

(858c)

Leonard Copyist.

5 | 7 | U.S.C.T.

Robert Stafford
Pvt., Co. A, 7 Reg't U. S. Col'd Infantry.

Appears on

Company Muster Roll

for Mich & Apr., 1865.

Joined for duty and enrolled:

When Sept. 23, 1863.*

Where Dorchester*

Period 3 years.*

Present or absent Present

Stoppage, \$ 100 for

Due Gov't \$ 100 for

Remarks:

* See enrollment on card from muster-in roll.

Book mark:

(858c)

Conard
Copyist.

S | 7 | U.S.C.T.

Robt. Stafford
Pvt., Co. A, 7 Reg't U. S. Col'd Infantry.

Appears on

Company Muster Roll

for May & June, 1865.

Joined for duty and enrolled:

When Sept 23, 1863.*

Where Dorchester.*

Period 3 years.*

Present or absent Not stated.

Stoppage, \$ 100 for

Due Gov't \$ 100 for

Remarks:

* See enrollment on card from muster-in roll.

Book mark:

(358c) Leonard Copyist.

S

7

U.S.C.T.

Robert Stafford

Priv., Co. A, 7 Reg't U. S. Col'd Infantry.

Appears on

Company Muster Roll

for July & Aug., 1865.

Joined for duty and enrolled:

When Sept 23, 1863.*

Where Dorchester *

Period years.*

Present or absent Absent

Stoppage, \$ 100 for

Due Gov't \$ 100 for

Remarks: Absent sick since May 10, 1865.

* See enrollment on card from muster-in roll.

Book mark:

Conrad

(358c)

Copyist.

S | 7 | U.S.C.T.

Robert Stafford

Priv., Co. A, 7 Reg't U. S. Col'd Infantry.

Appears on

Company Muster Roll

for Sept. & Oct., 1865.

Joined for duty and enrolled:

When Sept 23, 1863.*

Where Dorchester *

Period 3 years.*

Present or absent Absent

Stoppage, \$ 100 for

Due Gov't \$ 100 for

Remarks: Absent sick since May 10/65. Paid by Maj. Pulsifer for May & June /65, \$32.

* See enrollment on card from muster-in roll.

Book mark:

(858c)

Conard

Copyist.

S 1 7 U.S.C.T.

Robert Stafford
Pi, Co. A, 7 Reg't U. S. Col'd Infantry.

Appears on

Company Muster Roll
for Nov & Dec, 1865.

Joined for duty and enrolled:

When Sep 23, 1863.*

Where Dorchester Co. Md.*

Period 3 years.*

Present or absent Absent

Stoppage, \$ 100 for

Due Gov't \$ 100 for

Remarks: Absent sick since
May 10 65. Paid for
May & June 65, by Maj.
Pelejer.

* See enrollment on card from muster-in roll.

Book mark:

(858c)

Mowry J.
Copyist.

S 7 U.S.C.T.

Robert Stafford
Pri. Co. A, 7 Reg't U. S. Col'd Infantry.

Appears on

Company Muster Roll
for *Jan & Feb*, 186*6*.

Joined for duty and enrolled:

When *Sep 23*, 186*3*.*

Where *Smockester, Md.* *

Period *3* years.*

Present or absent

Stoppage, \$ *100* for

Due Gov't \$ *100* for

Remarks: *Discharged from*
Wicks Gen. Hosp. Baltz.
Md. June 22/66 on Surg
Cert. of Disability. Final
statement given. Paid
for May & June 1865 by
(over)

* See enrollment on card from muster-in roll.

Book mark:

(858c)

Murray Jr
Coppist.

JAN. 20

6281389

ALB91*

Maj. Lelsifer.

S 1 7 U.S.C.T.

Robert Stafford
Pri., Co. A, 7 Reg't U. S. Col'd Infantry.

Appears on Co. Muster-out Roll, dated
Indianola, Tex., Oct 13, 1866.

Muster-out to date 186 .
Last paid to 186 .

Clothing account:

Last settled 186 ; drawn since \$ 100
Due soldier \$ 100 ; due U. S. \$ 100
Am't for cloth'g in kind or money adv'd \$ 100

Due U. S. for arms, equipments, &c., \$ 100

Bounty paid \$ 100 ; due \$ 100

Remarks: Discharged from
"Hicks" Gen. Hosp. Balt.
Md., on Surg's Cert. of
Disability Jan. 22/66.

Book mark

(361)

Mowry Jr. Copyist.

Stafford, Robt.

P. Co. a, 7 Reg't U S C T.

8 Enclosures.

Bed Cards	Descriptive Lists
Burial Records	Final Statements
Certs. of Dis. for Discharge	Furloughs
C. M. Charges	Med. Des. Lists
Med. Certificates	Orders

Other papers relating to—

Admission to Hosp'l	Furlough
Casualty Sheet (Officer's)	Med. Examination
Confinement	Misc. Information
Contracts	Pay or Clothing 5
Death or Effects	Personal Reports
Desertions	Rank
Discharge from Hosp'l	Transfer to Hosp'l
Discharge from Service	Transfer to V. R. C.
Duty	Transportation

Hicks U.S.A. Gen. Hosp.

Baltimore, Md. Jan 22, 1866

Thos. S. W.
Surg. U.S. Vols.

Notification of Discharge of Private
Robt. Stafford, Co. "A," 7th U.S.C.A.
Jan. 22^d, 1866, on Surgeon's Certif-
icate of Disability, & Final
Statement - Given.

(Recd. Feby. 24th, 1866)

Hicks, U. S. Army General Hospital,
BALTIMORE, MD.

Jan 22, 1866

Sir:

I have to inform you that Robt. Stafford of your
company was discharged from service this day on Surgeon's
Certificate of Disability, and final statements given.

Very Respectfully,

Your Obedient Servant,

Theo. Lind

Surgeon U. S. A.

In charge of Hospital.

Commanding Officer

Co. A, 7th Regt. Inf. C. S.

(Recd. Feb. 24th 1866)

Stafford, Robert

P-a

Pay

NARA 753

U. S. General Hospital,

Fortress Monroe, Va., Aug. 10th, 1865.

Commanding Officer,

Co. A, my Regt. U.S.A.

Sir:

You are hereby notified that Robert Stafford, a
Private of your Company, has been paid at this Hospital, for the
months of May and June, 1865, (\$32.00.) by Major Pulsifer, U. S. A.

By Order of the Surgeon in charge:

Very Respectfully,

Your Obedient Servant,

Robert Cullen

2d LIEUT. VET. RES. CORPS,
& MILITARY ASSISTANT.

✓ S. 42, Reg. of Dis. 5
1866

NOTE 1.

The company commander will here add a statement of all the facts known to him concerning the disease or wound, or cause of disability of the soldier; the time, place, manner, and all the circumstances under which the injury occurred, or disease originated or appeared; the duty, or service, or situation of the soldier at the time the injury was received or disease contracted, stating particularly whether the injury was received or the disease contracted in the line of his duty; and whatever other facts may aid a judgment as to the cause, immediate or remote, of the disability, and the circumstances attending it.

When the facts are not known to the company commander, the certificate of any officer, or affidavit of other person having such knowledge, will be appended—as the surgeon in charge of a hospital, the officer commanding a detachment of recruits, &c., &c.

NOTE 2.

When a probable cause for pension, special care must be taken to state the degree of disability—as *1, 2, &c.*, &c.; to describe particularly the disability, wound, or disease; the extent of which it deprives him of the use of any limb or faculty, or affects his health, strength, activity, constitution, or capacity to labor or earn his subsistence. The surgeon will add, from his knowledge of the facts and circumstances, and from the evidence in the case, his professional opinion of the cause or origin of the disability. In the case of discharges by Medical Inspectors, the last paragraph will state that the "discharge was given by consent of the soldier, after a personal examination, and for disability, the nature, degree, and origin of which are correctly described in the within certificate."

Par. 1260 Regulations, Edit. 1861.
Medical officers, in giving certificates of disability, are to take particular care in all cases that have not been under their charge; and especially in epilepsy, convulsions, chronic rheumatism, derangement of the urinary organs, ophthalmia, ulcers, or any obscure disease liable to be feigned or purposely produced; and in no case shall such certificate be given until after sufficient time and examination to detect any attempt at deception.

DIRECTIONS.

This certificate will be made out in duplicate by the soldier's company commander, or other officer commanding the separate detachment to which he belongs, and sent by him to the surgeon who has charge of the hospital where the soldier is sick. The surgeon will then fill out and sign the surgeon's certificate, and forward these papers to the regimental, detachment, or post commander, who will forward them, with his action endorsed thereon, through the proper channel, to his division commander; or, if the troops are not attached to a division, to his corps, department, or other commander or officer to whom the authority to discharge enlisted men may be specially delegated.

These certificates, after having received the action of the highest authority to which they are required to be sent, will be returned through the same channel to the regimental, post, or detachment commander, who will, if the discharge is authorized by the endorsement of the proper authority, sign the soldier's discharge, and the last certificate on this paper; see that the soldier is furnished with the proper final statements in duplicate, and forward BOTH of these certificates direct to the Adjutant General United States Army, at Washington, D. C.; they will not, under any circumstances, be given to the hands of the soldier.

CERTIFICATE OF DISABILITY FOR DISCHARGE

IN THE CASE OF

Robert Stafford
a *Private* Co. *A*
7th, Reg't of *Inf.*

MEDICAL DIRECTOR'S OFFICE

MIDDLE MILITARY DEPT.

Baltimore, Md. Jan. 13, 1866.

APPROVED.

J. Simpson
Bvt. Col. and Surg. U. S. A.
Medical Director.

HEAD-QUARTERS MIDDLE MILITARY DEPARTMENT

Baltimore, Md., Jan. 13, 1866.

To be discharged

BY COMMAND OF MAJOR GENERAL HANCOCK!

Wm. Mung
Asst. Adj. Genl.

*Extract furnished 2^d
auditor April 1st 1868*

RECEIVED
1866
J. M. H.

Received (A. G. Office) 1866
Arthur W. Rogers

ADJUTANT GENERAL'S OFFICE

Jan 24 1866

Duplicate sent the Pension Office.

ARMY OF THE UNITED STATES
CERTIFICATE
OF DISABILITY FOR DISCHARGE.



Private Robert Stafford, of Captain _____
Company, (A) of the 7th _____ Regiment of the United States
Col. Vols was enlisted by Col. William Birney _____ of
the _____ Regiment of _____ at _____ Md.
on the 23d day of September, 1863, to serve three years; he was born
in _____ in the State of _____, is twenty seven
years of age, _____ feet _____ inches high, _____ complexion, _____ eyes,
_____ hair, and by occupation when enlisted a _____ During the last two
months said soldier has been unfit for duty 10 days.*

STATION: Hicks Genl Hosp Balto Md
DATE: Jan 13 1864

Thos. Sims
Surgeon U. S. Vols
Commanding Company Hosp

I CERTIFY, that I have carefully examined the said Robert Stafford
of Captain _____ Company, and find him incapable of performing the duties of a
soldier because of † Chronic inflammation with obstruction of
left lachrymal duct, following an attack of con-
=junctivitis consequent on exposure in line of duty
October 1864 near Fort Harrison Va
Disability one fourth (1/4)

Thos. Sims
Surgeon. *rs*
In chg

DISCHARGED, this twenty second day of January, 1864, at Hicks Genl
Hosp Balto Md

Thos. Sims
Surgeon. *rs*
Commanding the Regt Hosp

The Soldier desires to be addressed at

Town Cambridge County Dorset State Md

* See Note 1 on the back of this. † See Note 2 on the back of this.

Robert Stafford

"Quartermaster's Department."

U. S. A. General Hospital,

Hicks

No. 251.

Baltimore, Md., November 23rd 1865.

Clothing has been drawn this day by *Robert Stafford*, a private
of Co. A, *7th Reg't 26 S. C. Y. Inf.* without
Descriptive List, Money value, *\$ 7.00* Dollars.

Official,
Wm. M. McNeill
Brig. Maj. Asst. Surg. U. S. A.
1st Lieut. V. M. O. & Military Assistant
Executive Officer *To Surgeon in Charge.*

Wm. M. McNeill
Hospital, General U. S. A.,
In Charge of Quartermaster's Depart.

12

Hospital Number 1292

Name Robt. Stafford

Age 29 Nativity Md

Married or ~~single~~ to be Stafford

Residence Beekmantown Md

Post Office address of } Cornersville
wife or nearest relative. } Md

Rank Pr Co. A. 7th Regiment Md. C. S.
U. S. A.

When admitted Oct. 28, 63

From what source Fort Monroe

Diagnosis: (In surgical cases, state explicitly
seat and character of wound or injury.)

Obstruction of ^{left} nasal
duct

Hicks G. H.
Baltimore, Md.

R

On what occasion wounded _____

Date _____

Nature of missile or weapon _____

TREATMENT.

[HERE NOTE IMPORTANT COMPLICATIONS AND ALL OPERATIONS.]

RESULT AND DATE.

Discharged from service Jan 22nd

Pay Department, U. S. A.,

Norfolk Sept 1, 1865

Paymaster of the 7 Regt USCT

I have this day paid Robt Stafford

Co. A, \$ 22, in full from May 1 1865

to June 30 1865.

J G Pulsifer
Paymaster U. S. A.

Stafford, Robert

Pa

[Faint, illegible handwriting]

**U. S. GENERAL HOSPITAL,
Fortress Monroe, Va.,**

Sept 11th, 1865.

COMMANDING OFFICER

Co. *A* 7th Regt. *Wle Troops*

Sir

I have to report that *Robert Stafford* of your Company, has received the following Clothing at this Hospital.

ARTICLES.	No.	VALUE.	
		Dolls.	Cts
CAP,.....			
GREAT COAT,.....			
FLANNEL SACK COAT,.....			
BLANKET,			
UNIFORM COAT,.....			
TROUSERS,.....			
<i>(1)</i> SHIRTS,.....	<i>2</i>	<i>2</i>	<i>82</i>
<i>(2)</i> DRAWERS,.....	<i>3</i>	<i>3</i>	<i>20</i>
BOOTEES, Prs.,.....			
BOOTS, Prs.,.....			
<i>(1)</i> STOCKINGS, Prs.,.....	<i>100</i>	<i>00</i>	<i>48</i>

You are respectfully requested to acknowledge the receipt of this communication.

Very Respectfully, Yours Lt. Genl.

Robert Stafford

LIEUT. VET. RESERVE CORPS.

Will Asst

Stafford, Robert
D-A

764

U. S. GENERAL HOSPITAL,
Fortress Monroe, Va.

July 11th 1865.

COMMANDING OFFICER

Co. A, 7th Regt. U. S. C. Troops

Sir

I have to Report that Robert Stafford
of your Company, has received the following Clothing at this Hospital.

ARTICLES.	No.	VALUE.	
		DOLLS.	CTS.
CAP,			
GREAT COAT,			
FLANNEL SACK COAT,			
BLANKET,			
UNIFORM COAT,			
TROWSERS,			
SHIRTS,			
DRAWERS,			
(// BOOTEES, Prs.,	one	2	70
BOOTS, Prs.,			
(// STOCKINGS, Prs.,	one		48
			18

You are respectfully requested to acknowledge the receipt of this communication.

Very Respectfully, Your Obedt. Servt.

Robert A. Cullen

LIEUT. VET. RESERVE CORPS,
AND A. A. Q. M.

1265

Stanley Alexander W.

Co B, 7 U.S. Col'd Inf.

Private

Private

CARD NUMBERS.

1	6281848	26
2	6281946	27
3	6282047	28
4	6282145	29
5	6282244	30
6	6282343	31
7	6282433	32
8	62833337	33
9	9066090	34
10		35
11		36
12		37
13		38
14		39
15		40
16		41
17		42
18		43
19		44
20		45
21		46
22		47
23		48
24		49
25		50

Book Mark:

See also

AWD. 739302-8/4/20 - mc
cy. 201 -

S

7

U.S.C.T.

Alexander W. Stanley

Co. B, 7 Reg't U.S. Col'd Inf.

Appears on

Company Descriptive Book

of the organization named above.

DESCRIPTION.

Age 19 years; height 5 feet 9 inches.

Complexion Black

Eyes Black; hair curly.

Where born Dorchester, Md.

Occupation Farmer.

ENLISTMENT.

When Sept. 26, 1863.

Where Baltimore, Md.

By whom Col. W. Binney; term 3 yrs.

Remarks: Killed on the 28 day of Aug. 1864 while on duty in the trenches before Petersburg Va. Mustered Sept. 26, 63, by Col. Wm. Binney.

(383a)

J. Smith

Copyist.

7 | U.S.C.T.

Alexander M. Stanley,
Private, Co. B., 7 Reg't U. S. Colored Inf.

Age 19 years.

Appears on

Company Muster-in Roll

of the organization named above. Roll dated

Baltimore Md., Sept 26, 1869.

Muster-in to date Sept 26, 1869.

Joined for duty and enrolled:

When Sept 23, 1869.*

Where Dorchester Co. Md.*

Period 2 years.*

Remarks:

*Muster-in roll shows enrollment of all men of this company as of same date. See enrollment on subsequent card or cards.

Book mark:

(356c)

J. B. Cray Copyist.

7 U.S.C.T.

Alexander W. Stanley
Priv. Co. B, 7 Reg't U. S. Col'd Infantry.

Appears on

Company Muster Roll

for Sept 26th to Oct 9th, 1863.

Joined for duty and enrolled:

When Sept 26th, 1863.*

Where Dochester Co. Md.*

Period 3 years.*

Present or absent Present

Stoppage, \$ 100 for

Due Gov't \$ 100 for

Remarks:

* See enrollment on card from muster-in roll.

Book mark:

(358c)

J. S. Carey Copyist.

S. | 7 | U.S.C.T.

Alexander W. Stanley
Privt, Co. B, 7 Reg't U. S. Col'd Infantry.

Appears on

Company Muster Roll

for Nov & Dec, 1863.

Joined for duty and enrolled:

When Sept 23, 1863.*

Where Dorchester.*

Period 3 years.*

Present or absent Absent

Stoppage, \$ 100 for

Due Gov't \$ 100 for

Remarks: Enlistment premium
\$2.00 due

Detached on recruiting
service Nov. 12"

* See enrollment on card from muster-in roll.

Book mark:

(358c)

J. G. Casey

Copist.

S. | 7 | U.S.C.T.

Alexander M. Stanley
Privt., Co. B, 7 Reg't U. S. Col'd Infantry.

Appears on

Company Muster Roll

for Jan & Feb., 1864.

Joined for duty and enrolled:

When Sept 23", 1863.*

Where Dorchester.*

Period 9 years.*

Present or absent Present.

Stoppage, \$ 100 for

Due Gov't \$ 100 for

Remarks: Returned from recruit-
-ing service Jan 3" 1864
\$2 Enlistment premium due

* See enrollment on card from muster-in roll.

Book mark:

(858c)

J. G. Casey Copyist.

S.

7

U.S.C.T.

Alexander W. Stensley

Privt, Co. B, 7 Reg't U. S. Col'd Infantry.

Appears on

Company Muster Roll

for *Arch & apr*, 186*4*.

Joined for duty and enrolled:

When *Sept 23*, 186*3*.*

Where *Dorchester Ind*.*

Period *3* years.*

Present or absent *Present*.

Stoppage, \$ *100* for

Due Gov't \$ *100* for

Remarks:

* See enrollment on card from muster-in roll.

Book mark:

J. S. Curry

(358c)

Copyist.

S.

7

U.S.C.T.

Alexander W. Stanley
Privt, Co. B, 7 Reg't U. S. Col'd Infantry.

Appears on

Company Muster Roll

for *May & June*, 186*4*.

Joined for duty and enrolled:

When *Sept 23rd*, 186*9*.*

Where *Dorchester Ind*.*

Period *2* years.*

Present or absent *Absent*.

Stoppage, \$ *100* for

Due Gov't \$ *100* for

Remarks: *On detached service since*
June 24 64. I. O. No. 67. Reg.
H. d. 24.

* See enrollment on card from muster-in roll.

Book mark:

(358c)

J. B. Casey

Copyist.

774

A. 7.

U.S.C.T.

Alexander W. Stanley
Privt., Co. B., 7 Reg't U. S. Col'd *Inf*

Appears on

Company Muster Roll

for *July & Aug*, 1864.

Joined for duty and enrolled:

When *Sept 23*, 1863.*

Where *Dorchester, Ind.**

Period years.*

Present or absent.....

Stoppage, \$ 100 for.....

Due Gov't, \$ 100 for.....

Remarks: *Killed on picket Aug. 28. 64.*

No statements given.

* See enrollment on card from muster-in roll.

Book mark:.....

(358c)

J. S. Gray

Copyist.

S | 7 | U.S.C.T.

Alexander W. ~~Stacy~~
Pr., Co. B, 7 Reg't U. S. Col'd Infantry.

Appears on Co. Muster-out Roll, dated
Indianola Tex, Oct 13, 1864.

Muster-out to date _____, 186 .

Last paid to Apr. 30, 1864.

Clothing account:

Last settled _____, 186 ; drawn since \$ _____ 100

Due soldier \$ _____ 100; due U. S. \$ _____ 100

Am't for cloth'g in kind or money adv'd \$ _____ 100

Due U. S. for arms, equipments, &c., \$ _____ 100

Bounty paid \$ _____ 100; due \$ _____ 100

Remarks: Killed on Picket
before Petersburg Va. Aug 28
1864 - final statement rendered
Sep. 4 - 1864

Book mark: V90P. 153.69
4524 - 1850

A. Johnson

Stanley, Alexander W.

P. B., Co.

7 Reg't

U.S.C. Inf

H

Enclosures.

Bed Cards	Descriptive Lists
Burial Records	Final Statements <i>2</i>
Certs. of Dis. for Discharge	Furloughs
C. M. Charges	Med. Des. Lists
Med. Certificates	Orders

Other papers relating to—

Admission to Hosp'l	Furlough
Casualty Sheet (Officer's)	Med. Examination
Confinement	Misc. Information <i>1</i>
Contracts	Pay or Clothing
Death or Effects <i>2</i>	Personal Reports
Desertions	Rank
Discharge from Hosp'l	Transfer to Hosp'l
Discharge from Service	Transfer to V. R. C.
Duty	Transportation

Received of 1st Lieut Charles S. Bjornmark.
Co. B. 7th Regt. U.S. Col. Troops. the following effects
of Private Alexander W. Stanley late of Co. B. 7th
Regt. U.S. Col. Troops. now deceased, which I claim as his
next heir.

1. uniform coat. 1. uniform jacket. 1. Pair of Flannel Draw
ers. 1 flannel shirt and \$9.70. in notes.

Camp near Petersburg, Va.

Aug. 29th 1864.

Witness

Rufell Hall

2nd Lt - 7th U.S. Col. Troops.

William H. Stanley
mark

ARTICLES OF WAR.

ART. 95. When any non-commissioned officer or soldier shall die, or be killed in the service of the United States, the then commanding officer of the troop or company shall, in the presence of two other commissioned officers, take an account of what effects he died possessed of, above his arms and accoutrements, and transmit the same to the office of the Department of War, which said effects are to be accounted for, and paid to the representatives of such deceased non-commissioned officer or soldier. And in case any of the officers, so authorized to take care of the effects of deceased officers and soldiers, should, before they have accounted to their representatives for the same, have occasion to leave the regiment or post, by preferment or otherwise, they shall, before they be permitted to quit the same, deposit in the hands of the commanding officer, or of the assistant military agent, all the effects of such deceased non-commissioned officers and soldiers, in order that the same may be secured for, and paid to, their respective representatives.

ARMY REGULATIONS—EDITION OF 1861.

DECEASED SOLDIERS.

Par. 152. Inventories of the effects of deceased non-commissioned officers and soldiers, required by the 95th Article of War, will be forwarded to the Adjutant General, by the commander of the company to which the deceased belonged, and a duplicate of the same to the colonel of the regiment. Final statements of pay, clothing, &c., will be sent with the inventories. When a soldier dies at a post or station absent from his company, it will be the duty of his immediate commander to furnish the required inventory, and, at the same time, to forward to the commanding officer of the company to which the soldier belonged, a report of his death, specifying the date, place, and cause; to what time he was last paid, and the money or other effects in his possession at the time of his decease; which report will be noted on the next muster roll of the company to which the man belonged. Each inventory will be endorsed, "Inventory of the effects of _____, late of company (—) _____ regiment of _____, who died at _____, the _____ day of _____, 186—." If a legal representative receive the effects, it will be stated in the report. If the soldier leave no effects, the fact will be reported.

Par. 153. Should the effects of a deceased non-commissioned officer or soldier not be administered upon within a short period after his decease, they shall be disposed of by a Council of Administration, under the authority of the commanding officer of the post, and the proceeds deposited with the Paymaster, to the credit of the United States, until they shall be claimed by the legal representatives of the deceased.

Par. 154. In all such cases of sales by the Council of Administration, a statement in detail, or account of the proceeds, duly certified by the Council and commanding officer, accompanied by the Paymaster's receipt for the proceeds, will be forwarded by the commanding officer to the Adjutant General. The statement will be endorsed, "Report of the proceeds of the effects of _____, late of company (—) _____ regiment of _____, who died at _____, the _____ day of _____, 186—."

NOTE 1.—The effects in all cases, when called for, should be turned over to the legal representative, without further authority from the Adjutant General. When the effects are turned over to the relatives of the deceased before these inventories are sent to the Adjutant General, their receipts therefor should be attached to the inventories. In all other cases, one copy will be sent with a letter of transmittal direct to the Adjutant General, and a duplicate retained by the officer.

NOTE 2.—Particular care should be taken to take receipts in duplicate from the Paymaster for any funds turned over to him; one copy should be sent direct to the Adjutant General and one retained by the officer.

INVENTORY OF THE EFFECTS

OF

Priv. Alexander W. Stanley

Late of Company *B*

7th Reg't of U. S. Col. Troops

Volunteers, who died at in the trenches near Petersburg Va on the 28 day of August 1864.



Inventory of the effects of Alexander W. Hamby late
 a Private of Captain Lewis Edward Weld's Company "B" of
 the 7th Regiment of U. S. Col Troops Volunteers, who was enrolled as
 a Private at Baltimore in the State of Maryland on
 the 24th day of September 1863, and mustered into the service of the United
 States as a Private on the 24th day of September 1863, at Baltimore, Md
 in Company "B", 7th Regiment of U. S. Col Troops volunteers, to serve three
 years or during the war; he was born in Dorchester County in the State
 of Maryland; he was 19 years of age, 5 feet 9 inches
 high, Black complexion, Black eyes, Curly hair, and by occupation, when enrolled,
 a Farmer; he died in the action trenches, at
before Petersburg, Va on the 28th day of August 1864, by
 reason of acute wound being shot.

INVENTORY.					
ARTICLES.	No.	ARTICLES.	No.	ARTICLES.	No.
Hats.....		Pairs trousers.....		Knapsacks.....	
Caps.....		Pairs flannel drawers.....	/		
Forage caps.....		Pairs cotton drawers.....			
Great coats.....		Flannel shirts.....	/		
Uniform coats.....	/	Cotton shirts.....			
Uniform jackets.....	/	Pairs boots.....			
Flannel sack coats.....		Pairs shoes.....			
Blouses.....		Pairs socks.....			
Stable frocks.....		Blankets.....			
Fatigue overalls.....		Haversacks.....			
				MONEY.	
				Specie.....	\$
				Notes.....	\$ 9.70

I CERTIFY, ON HONOR, that the above inventory comprises all the effects of Alexander W. Hamby, late a private of Co. B, 7th U.S. Col Troops, deceased, and that the effects are in the hands of Private William Hamby, Co. B, 7th U.S. Col Troops at Camp near Petersburg, Va who is the next heir to deceased to be disposed of by a Council of Administration.

(DUPLICATES.)

Charles J. Bussard
 1st Lieut. 7th U. S. Col Troops
 Commanding the Company.

STATION: Camp near Petersburg, Va

DATE: September 4th 1864

1864

164

FINAL STATEMENT

Dub
OF *H. M.*

Pvt. Alexander W. Stanley

Co. B. 7th Reg't of U. S. Col. Troops

VOLUNTEERS.

NOTE 1.—Two of these certificates (or duplicates) are to be given to each volunteer soldier who may be discharged previously to the discharge of his company, that he may at once receive from the Paymaster the pay, &c., due him, and the captain or other officer commanding the company will certify to the act of the delivery of the duplicate certificates; on these certificates the Soldier is "entitled to" his discharge, and should also present his discharge to the Paymaster to have the payment endorsed on it. The discharge is to be given back to the Soldier by the Paymaster; the latter only retaining as his voucher the duplicate certificates.

NOTE 2.—If the Soldier is entitled to pay for the use of his horse, the Company Commander will certify to that fact, and also to the time he has pay due for having been so mounted on his own horse.

NOTE 3.—Amounts due the Sutler and Laundress must be entered on the Muster Roll on which the death, desertion, &c., is reported, as well as on the final statement, otherwise the amount cannot be collected from the United States.

NOTE 4.—This blank will be used for deceased volunteers as well as others.



I certify, on honor, that Alexander W. Stanley a Private of
 Captain Levi Lyman Wells' Company (B) of the 7th Regiment of Col. Troops
VOLUNTEERS, of the State of U. S., born in Dorchester Co., State
 of Maryland, aged 19 years; 5 feet 9 inches high; Wack complexion,
Wack eyes, Curly hair, and by occupation a Farmer, having joined the company on
 its original organization at Baltimore, Md., and enrolled in it at the muster into
 the service of the United States at Baltimore, Md., on the twenty sixth day
 of September, 1863, (or was mustered in service as a recruit, by Capt. W.
Brissey, at Baltimore, Md., on the twenty sixth day of September,
 1863, to serve in the Regiment,) for the term of three years or during the war:
 and having served **HONESTLY** and **FAITHFULLY** with his Company in 7th Reg U.S. & T
 to the present date, is now entitled to a **DISCHARGE** by reason of Death.

And Alexander W. Stanley was killed while on duty in the trenches before
Petersburg, Va. August 28th 1864

The said Alexander W. Stanley was last paid by Paymaster
M. B. Connel to include the 30th day of April, 1864, and has
 pay due him from that time to the present date; he is entitled to pay and subsistence for
TRAVELING to place of enrollment and whatever other allowances are authorized to volunteer
 soldiers, or militia, so discharged. He has received Fifty 150 / 100 dollars,
 advanced by the United States on account of **CLOTHING**.

There is to be stopped from him, on account of the State of _____, or other
 authorities for **CLOTHING, &c.**, received on entering service, _____ / 100 dollars; also,
 for expenses of **SUBSISTENCE** for **TRAVELING** from place of enrollment to the place of rendezvous,
 amounting to _____ / 100 dollars: and on account of the United States for **EXTRA**
CLOTHING received in kind from _____ and for other
 stoppages, viz:

_____ amounting to _____ / 100 dollars;
 and he has been **SUBSISTED** for **TRAVELING** to his place of enrollment, up to the _____
 _____, 186- .

He is indebted to _____, **SUTLER**, _____ / 100 dollars
 He is indebted to _____, **LAUNDRESS**, _____ / 100 dollars.

Given in Duplicate, at Camp near Petersburg, this 1st day of September, 1864.

Charles L. Bismarck
 1st Lieut. 7th U. S. Col. Troops

 Commanding Company.

A.G.O.
Inspect. for effects sent
to 2^d Auditor,
B.

✓ 164 129
FINAL STATEMENT

OF

Private Alexander W. Stanley
Co. B. 7th Reg't of U.S. Col. Troops

VOLUNTEERS.

Disch. Aug 25th 1864

NOTE 1.—Two of these certificates (or duplicates) are to be given to each volunteer soldier who may be discharged previously to the discharge of his company, that he may at once receive from the Paymaster the pay, &c., due him, and the captain or other officer commanding the company will certify to the act of the delivery of the duplicate certificates; on these certificates the Soldier is "entitled to" his discharge, and should also present his discharge to the Paymaster to have the payment endorsed on it. The discharge is to be given back to the Soldier by the Paymaster; the latter only retaining as his voucher the duplicate certificates.

NOTE 2.—If the Soldier is entitled to pay for the use of his horse, the Company Commander will certify to that fact, and also to the time he has pay due for having been so mounted on his own horse.

NOTE 3.—Amounts due the Sutler and Laundress must be entered on the Muster Roll on which the death, desertion, &c., is reported, as well as on the final statement, otherwise the amount cannot be collected from the United States.

NOTE 4.—This blank will be used for deceased volunteers as well as others.

ADJUTANT GENERAL'S OFFICE.

Sept 13th 1864

Duplicate with Inventory sent 2d Auditor.

Wm. V. ...
RECEIVED
ADJUTANT GENERAL'S OFFICE
SEP 13 1864

I certify, on honor, that Alexander W. Stanley a Private of
 Captain Lewis Leonard Weld's Company (B) of the 7th Regiment of Col. Troops
VOLUNTEERS, of the State of M. S., born in Dorchester Co., State
 of Maryland, aged 19 years; 5 feet 9 inches high; Black complexion,
Black eyes, Curly hair, and by occupation a Farmer, having joined the company on
 its original organization at Baltimore, Md., and enrolled in it at the muster into
 the service of the United States at Baltimore, Md., on the twenty sixth day
 of September, 1863, (or was mustered in service as a recruit, by Col. W.
Birney, at Baltimore, Md. on the twenty sixth day of September,
 1863, to serve in the Regiment,) for the term of three years or during the war.
 and having served **HONESTLY** and **FAITHFULLY** with his Company in 7th Regt. U. S. C. T.
 to the present date, is now entitled to a **DISCHARGE** by reason of Death.

Said Alexander W. Stanley was killed while on duty in the trenches
before Petersburg, Va. August 28th 1864.

The said Alexander W. Stanley was last paid by Paymaster
Maj. B. McConnell to include the 30th day of April, 1864, and has
 pay due him from that time to the present date; he is entitled to pay and subsistence for
TRAVELING to place of enrollment and whatever other allowances are authorized to volunteer
 soldiers, or militia, so discharged. He has received Fifty 150 / 100 ²²/₁₀₀ dollars,
 advanced by the United States on account of **CLOTHING**.

There is to be stopped from him, on account of the State of _____, or other
 authorities for **CLOTHING, &c.**, received on entering service, _____ ¹⁰⁰/₁₀₀ dollars; also,
 for expenses of **SUBSISTENCE** for **TRAVELING** from place of enrollment to the place of rendezvous,
 amounting to _____ ¹⁰⁰/₁₀₀ dollars: and on account of the United States for **EXTRA**
CLOTHING received in kind from _____ and for other
 stoppages, viz:

_____ amounting to _____ ¹⁰⁰/₁₀₀ dollars;

and he has been **SUBSISTED** for **TRAVELING** to his place of enrollment, up to the _____
 _____, 186-.

~~He is indebted to _____, **BUTLER**, _____ ¹⁰⁰/₁₀₀ dollars.~~

~~He is indebted to _____, **LAUNDRESS**, _____ ¹⁰⁰/₁₀₀ dollars.~~

Given in Duplicate, at Camp near Petersburg, this 1th day of September, 1864.

Charles L. Bismont
 1st Lieut. 7th U. S. C. T.

Commanding Company.

Stanley Algy
Co *F*, 7 U.S. Col'd Inf.

Corporal | *Private*

CARD NUMBERS.

1	6289139	26
2	6289240	27
3	6289341	28
4	6289439	29
5	6289543	30
6	6289697	31
7	6289793	32
8	6289884	33
9	6289985	34
10	6290080	35
11	6290177	36
12	6290273	37
13	6290360	38
14	6290471	39
15	6290869	40
16	6279427	41
17	9066598	42
18		43
19		44
20		45
21		46
22		47
23		48
24		49
25		50

Book Mark:

See also

S2217649 po. in

S

7

U.S.C.T.

Algy Stanley

Co. G, 7 Reg't U.S. Col'd Inf.

Appears on

Company Descriptive Book

of the organization named above.

DESCRIPTION.

Age 30 years; height 5 feet 6 1/2 inches.

Complexion *Rose*

Eyes *Blue*; hair *Curly*

Where born *Worcester, Mass.*

Occupation *Farmer*

ENLISTMENT.

When *Sept 27*, 1863.

Where *Baltimore, Md.*

By whom *Col. W. B. Biny*; term *3* y'rs.

Remarks: *Mustered Sept 30, 1863 by Col Wm Biny. Promoted corporal Sept 24, 1863. Reduced to the ranks for disobedience of orders June 13, 1864. Mustered out of service at Ft. Monroe Va. June 6, 1865.*

J. Brown

S | **7** | **U.S.C.T.**

Alger Stanley
Corpl, Co. *A*, 7 Regt U. S. Colored Inf.

Age *30* years.

Appears on

Company Muster-in Roll

of the organization named above. Roll dated

Baltimore Md Sept 30, 1863.

Muster-in to date *Sept 30, 1863.*

Joined for duty and enrolled:

When *Sept 27*, 186 *3*.*

Where *Dorchester Co. Md* *

Period *3* years.*

Remarks:
.....
.....
.....
.....
.....

*Muster-in roll shows enrollment of all men of this company as of same date. See enrollment on subsequent card or cards.

Book mark: *L. H. 9. 11. 11.*

J. S. Miller
Coryist.

S 7 U.S.C.T.

Algy Stanley

Capt, Co. F, 7 Reg't U. S. Col'd Infantry.

Appears on

Company Muster Roll

for *Sept 30 to Oct. 31*, 186*3*.

Joined for duty and enrolled:

When *Sept. 27*, 186*3*.*

Where *Dorchester Co. Md* *

Period *3* years.*

Present or absent *Present*

Stoppage, \$ *100* for

Due Gov't \$ *100* for

Remarks:

* See enrollment on card from muster-in roll.

Book mark:

[Signature]
Copyist.

S | 7 | U.S.C.T.

Algy Stanley

Capt., Co. F, 7 Reg't U. S. Col'd Infantry.

Appears on

Company Muster Roll

for *for 7 Dec*, 186 *3*.

Joined for duty and enrolled:

When *Sept 27*, 186 *3*.*

Where *Dorchester Co. Md.* *

Period *3* years.*

Present or absent *Present*

Stoppage, \$ *100* for

Due Gov't \$ *100* for

Remarks:

* ~~See~~ See enrollment on card from muster-in roll.

Book mark: -----

(358c)

[Signature]
Copyist.

S | **7** | **U.S.C.T.**

Algy Stanley

Corpl, Co. F, 7 Reg't U. S. Col'd Infantry.

Appears on

Company Muster Roll
for *Sent Feb* -----, 186*4*.

Joined for duty and enrolled:

When *Sept 27* -----, 186*3*.*

Where *Dorchester Co. c. Md* -----*

Period ----- years.*

Present or absent *Present* -----

Stoppage, \$ ----- *100* for -----

Due Gov't \$ ----- *100* for -----

Remarks: -----

* See enrollment on card from muster-in roll.

Book mark: -----

C. H. Miller

Copyist.

S | **7** | **U.S.C.T.**

Algy Stanley

Capt, Co. F, 7 Reg't U. S. Col'd Infantry.

Appears on

Company Muster Roll

for *March & April*, 186*4*.

Joined for duty and enrolled:

When *Sept 24th*, 186*3*.*

Where *Durham Co. N.C.* *

Period *3* years.*

Present or absent *Present*

Stoppage, \$ *100* for

Due Gov't \$ *100* for

Remarks: -----

* ~~See~~ See enrollment on card from muster-in roll.

Book mark: -----

J. C. Miller

(358c) Copyist.

S

7

U.S.C.T.

Angus Stanley

Sgt., Co. F, 7 Reg't U. S. Col'd Infantry.

Appears on

Company Muster Roll

for *May & June*, 186*4*.

Joined for duty and enrolled:

When *Sept. 27*, 186*3*.*

Where *Dorchester, Mass.* *

Period *3* years.*

Present or absent *Present*

Stoppage, \$ *100* for

Due Gov't \$ *100* for

Remarks: *Stop for one letter
bugle, scales & buttons.*

* See enrollment on card from muster-in roll.

Book mark:

(858c)

E. H. [Signature]
Copyist.

S 7 U.S.C.T.

Algy Stanley
Pvt, Co. F, 7 Reg't U. S. Col'd Infantry.

Appears on

Company Muster Roll
for July & Aug, 1864.

Joined for duty and enrolled:

When Sept 27, 1864.*

Where Dorchester Co. Md.*

Period 3 years.*

Present or absent Absent

Stoppage, \$ 100 for

Due Gov't \$ 100 for

Remarks: Stopped for
letter, Bugle, Pr.
Scales, bawteen
Absent wounded
since Aug 25/64

* See enrollment on card from muster-in roll.

Book mark:

Wooler

S |

7

U.S.C.T.

Algy Stanley

Private, Co. F, 7 Reg't U. S. Col'd Infantry.

Appears on

Company Muster Roll

for *Sept. and Oct.*, 1864.

Joined for duty and enrolled:

When *Sept. 27*, 1864.*

Where *Dorchester Co. Md.* *

Period *2* years.*

Present or absent *Absent*

Stoppage, \$ *100* for

Due Gov't \$ *100* for

Remarks: *Absent wounded since Aug. 25, '64 Stopped for 1 letter, 1 bugle, 1 canteen 1 pr sculis.*

* See enrollment on card from muster-in roll.

Book mark:

Keefe

S | 7 | U.S.C.T.

Algy Stanley
Private, Co. F, 7 Reg't U. S. Col'd Infantry.

Appears on

Company Muster Roll

for Nov. 3rd Dec., 1864.

Joined for duty and enrolled:

When Sept. 27, 1863.*

Where Dorchester Co., Md.*

Period 3 years.*

Present or absent Absent.

Stoppage, \$ 100 for _____

Due Gov't \$ 100 for _____

Remarks: Absent wounded
since Aug. 28, 64. Stopped
for 1 letter, 1 bugle, 1 scalpa,
1 canteen.

* See enrollment on card from muster-in roll.

Book mark: _____

Keefe

S | **7** | **U.S.C.T.**

Algy Stanley
Private, Co. F, 7 Reg't U. S. Col'd Infantry.

Appears on

Company Muster Roll

for *Jan. & Feb.*, 186*5*.

Joined for duty and enrolled:

When *Sep. 27*, 186*3*.*

Where *Dorchester Co., Md.*.*

Period *2* years.*

Present or absent *Absent*

Stoppage, \$ *100* for

Due Gov't \$ *100* for

Remarks: *In Hosp. wounded since Aug. 25, 64. Transportation while on furlough Balto, Md. 3.44*

* See enrollment on card from muster-in roll.

Book mark:

Keefe Copyist.

S | **7** | **U.S.C.T.**

Algy Stanley
Private, Co. F, 7 Reg't U. S. Col'd Infantry.

Appears on

Company Muster Roll

for *Mar. & Apr*, 1865.

Joined for duty and enrolled:

When *Sep. 27*, 1863.*

Where *Dorchester Co., Md.* *

Period *2* years.*

Present or absent *Absent*

Stoppage, \$ *100* for

Due Gov't \$ *100* for

Remarks: *Absent sick since
March 27th 65. Stopped for
transportation Balto \$6.44.*

* See enrollment on card from muster-in roll.

Book mark:

(358c)

Keefe

Copyist.

S | **7** | **U.S.C.T.**

Algy Stanley

Private, Co. F, 7 Reg't U. S. Col'd Infantry.

Appears on

Company Muster Roll

for *May and June*, 1865.

Joined for duty and enrolled:

When *Sept. 27*, 1863.*

Where *Dorchester* *

Period *2* years.*

Present or absent *Absent*

Stoppage, \$ *100* for

Due Gov't \$ *100* for

Remarks: *Absent sick since
May 22, 65.*

* See enrollment on card from muster-in roll.

Book mark:

Keefe

S | **7** | **U.S.C.T.**

Algy Stanley
Private, Co. F, 7 Reg't U. S. Col'd Infantry.

Appears on

Company Muster Roll

for *July and Aug.*, 1863.

Joined for duty and enrolled:

When *Sep. 27*, 1863.*

Where *Dorchester Co., Md.* *

Period *3* years.*

Present or absent *Absent*

Stoppage, \$ *100* for

Due Gov't \$ *100* for

Remarks: *Absent sick at
Fortress Monroe, Va. since
May 22, 65.*

* See enrollment on card from muster-in roll.

Book mark:

Keefe

S 7 | U.S.C.T.

Algy Stanley
Priv., Co. *F*, *7* Reg't U. S. Col'd *Infy*

Appears on

Company Muster Roll

for *Sept. & Oct.* 186*3*.

Joined for duty and enrolled:

When *Sept. 27*, 186*3*.*

Where *Dorchester Co., Md.* *

Period *3* years.*

Present or absent

Stoppage, \$ *100* for

Due Gov't, \$ *100* for

Valuation of horse, \$ *100*

Valuation of horse equipments, \$ *100*

Remarks: *Discharged from U.S. Gen. Hosp. Fort Monroe, Va. June 6. 65 by order War Dept.*

* See enrollment on card from muster-in roll.

Book-mark :

(358c)

Keefe

Copyist.

S | 7 | **U.S.C.T.**

Algy Stanley
Private, Co. *F*, 7 Reg't U. S. Col'd *Inf*

Appears on an

Individual Muster-out Roll

of the organization named above. Roll dated

Fort Monroe Va June 6, 1865 -

Muster-out to date *June 6*, 1865 -

Last paid to *Dec 31*, 1864 -

Clothing account:

Last settled *Sep 30*, 1864; drawn since \$.....100

Due soldier \$.....100; due U. S. \$.....100

Am't for cloth'g in kind or money adv'd \$ *27.90* / 100

Due U. S. for arms, equipments, &c., \$.....100

Bounty paid \$.....100; due \$.....100

Remarks: *Mustered out*
by Order War Dept
Dated May 3^d 1865
Patient in U. S. Genl,
Hospital
Fort Monroe Va.

Book mark:

E H Lipscombe

Copyist.

S | **7** | **U.S.C.T.**

Algy Stanley
Co. F, Co. *F*, 7 Reg't U. S. Col'd Infantry.

Appears on **Co. Muster-out Roll**, dated *Indiana, Texas, Oct 13*, 1866 .

Muster-out to date _____, 186 .

Last paid to _____, 186 .

Clothing account:

Last settled _____, 186 ; drawn since \$ _____ 100

Due soldier \$ _____ 100 ; due U. S. \$ _____ 100

Am't for cloth'g in kind or money adv'd \$ _____ 100

Due U. S. for arms, equipments, &c., \$ _____ 100

Bounty paid \$ _____ 100 ; due \$ _____ 100

Remarks: *Discharged for*
disability at Ft. Monroe
Va. June 6, 65.

Book mark: *Lt 49 Md. Co. 34 P. 217.75*
(over)

Brooks,

JAN. 21

6290869

#1891*

M.C. on file.

Le compte. Mrs J
 _____, Co. _____, *7* Reg't: *Mc Inf*
 ----- **Enclosures.**

- | | |
|------------------------------------|----------------------------|
| Bed Cards | Final Statements |
| Burial Records | Furloughs or L. of A. |
| Certs. of Dis. for Discharge | Med. Certificates |
| C. M. Charges | Med. Des. Lists |
| Descriptive Lists | Orders |
| Discharge Certificates | Pris. of War Record |
| Enlistment Papers | Resignations |

Other papers relating to—

- | | |
|------------------------------|---------------------------------------|
| Admission to Hosp'l | Furlough or L. of A. |
| Casualty Sheet | Med. Examination |
| Confinement | Misc. Information |
| Contracts | Pay or Clothing |
| Death or Effects | Personal Reports |
| Desertion | Rank |
| Discharge from Hosp'l | Transfer to Hosp'l |
| Discharge from Service | Transfer to V. R. C. |
| Duty | Transportation |
| | <i>Glenn</i>
<i>Glenn</i> <i>2</i> |

MICROFILM PUBLICATION M.1849

COMPILED MILITARY SERVICE RECORDS
OF VOLUNTEER UNION SOLDIERS WHO SERVED WITH
THE UNITED STATES COLORED TROOPS (USCT)
7TH REGIMENT OF INFANTRY

PERSONAL PAPERS' TARGET SHEET

PLEASE NOTE THE CHECKED INFORMATION ABOUT THE PERSONAL PAPERS IN
THIS FILE:

- NO PERSONAL PAPERS WERE FOUND IN THIS FILE WHEN THE
RECORDS WERE ARRANGED FOR MICROFILMING.
- 2 PERSONAL PAPER(S) FOUND IN THIS FILE WHEN THE RECORDS
WERE ARRANGED FOR MICROFILMING.

STATE OF MARYLAND,

County, to wit:

On this twenty eight day of December in the year 1866 before me, the subscriber, a Justice of the Peace of the State and County aforesaid, personally appeared Solomon J. Wilson and William C. Littleton loyal citizens of the United States, residents of Dorchester Co. Md. and in no manner interested in the prosecution of this claim, and made oath in due form of law, that the said Thomas J. Secombe was the owner of the Slave Alexy Stanley as a fact of public notoriety; that they believe all the statements made by him in reference to said Slave are correct.

Witness their Signatures,

Solomon J. Wilson
Wm C Littleton
H. J. Wintrobotten
Justice of the Peace.

Sworn and subscribed before

And I Hereby do Certify, That the said Solomon J. Wilson and William C. Littleton are citizens of Dorchester County, in good repute, and that their statements, under oath, are entitled to full faith and credit.

H. J. Wintrobotten
Justice of the Peace.



EVIDENCE OF TITLE.

I *Thomas J. Leompfe* of *Dorchester County* Maryland, do solemnly swear that *Algy Stanley* who has been enlisted in the *7th* Regiment, U. S. Colored Troops, Co. *H*; was my Slave for *Life* at the time of said enlistment; and that I became possessed of him by *Inheritance* in the month of *May* eighteen hundred and *thirty seven*. And I do further swear that I have not purchased said Slave from any person or persons disloyal to the Government of the United States, with the object of obtaining compensation for the same; and furthermore, that I have no agency for obtaining compensation for any person or persons but such as to my knowledge are loyal citizens of the United States.

Sworn and subscribed before

Thos J. Leompfe
H. S. Winterbottom
Justice of the Peace.

STATE OF MARYLAND,
County, to wit:

On this *twentieth* day of *December* in the year 1866 before me, the subscriber, a Justice of the Peace of the State and County aforesaid, personally appeared *Thomas P. Vinton* a resident of *Dorchester* County, State of *Maryland* and *John T. Jackson* a resident of *Dorchester* County, State of *Maryland* having first been duly sworn, upon their oaths declare that they reside respectively in *Dorchester* County, State of *Maryland* and *Dorchester* County, State of *Maryland*; that they are personally acquainted with *Thomas J. Leompfe* claimant for compensation for *his* Slave *Algy Stanley* under the Acts of Congress of February 24, 1864, and July 28, 1866, and that they know that said "claimant hath firmly and faithfully maintained *his* allegiance and adherence to the Government of the United States, by defending its cause against the Government of the so-called Confederate States of America, in all suitable and practicable ways, and according to *his* ability and opportunity;" they also swear that they have themselves maintained a like adherence and allegiance to the Government of the United States, and they have no interest in said claim.

Sworn and subscribed before

Thomas P. Vinton
John T. Jackson
H. S. Winterbottom
Justice of the Peace.

STATE OF MARYLAND,
Dorchester County, to wit:

I *Francis J. Henry* Clerk of the Circuit Court for *Dorchester* County, do hereby certify that *H. S. Winterbottom, Esq.* before whom the foregoing affidavits were made, was, at the time of signing the same, a Justice of the Peace for the County and State aforesaid, duly commissioned and sworn; and that his signature thereto is genuine, and that full faith and credit should be given to his official acts.

Witness my hand and the Seal of said Court, this *twentieth* day of *December* A. D. 1866.

Francis J. Henry
Clerk.

WAR 999
War Department,

ADJUTANT GENERAL'S OFFICE,

Washington, Jan. 28th 1867.

Respectfully returned to the
Commission for the State of
Maryland, with the informa-
tion that Alay S. Simley
was enlisted at Dorchester Md.
Sept 27th 1863. and was
mustered in as Corp' in Co. F 7th
U. S. C. I. Sept 30th 1863.

U. S. G. Ind.

[Signature]

Asst. Adj't General.

W.B.

Endorsement.

No. 79

APPLICATION OF

Thos B LeCompte

OF

Dorchester Co

for compensation for service of slave,

Algn. Stanley

enlisted Sept 27, 1863,

in F Co. Seventh 7th Regiment

U. S. Colored Troops.

Received Jan 20, 1869.

Compensation awarded,

, 186

Dollars.

President Board of Claims.

P. O. ADDRESS OF CLAIMANT:

as follows
Filed by John C. Holland
31 N. Calvert St. Baltimore

CLAIM FOR COMPENSATION FOR ENLISTED SLAVE.

No. _____

I, Thomas I. Le Compte a loyal citizen, and a resident
of Cambridge, County of Dorchester, State of
Maryland, hereby claim compensation, under the provisions of
Section 24, Act approved February 24, 1864, and Section 2, Act approved July 28, 1866, for
my slave Algy Stanley, enlisted September 27
1863, at Pennock, Dorchester Co. Md., by Gen. W. Burney
, in the Seventh (7th) Regiment U. S. Colored Troops,
Co. A; certificate of which enlistment and a descriptive list, as required, accompany
this application.

In proof of my loyalty to the Constitution and Government of the United States, I present
the accompanying oath, which I have taken, signed and acknowledged; to be filed with this
application, in accordance with requirement of General Orders, No. 329, 1863, War Depart-
ment, Adjutant General's Office.

Thos I. Le Compte

December 20th, 1866.

OATH OF ALLEGIANCE.

I, Thomas I. Le Compte, the owner and claimant, do solemnly swear
that the foregoing claim is a just and true claim due to me as master and owner of the said
slave, and that the facts alleged in said claim in respect to the draft or enlistment (*as the case
may be*) of said slave into the military service of the United States are true. And I do
further swear that I have never joined, or been concerned in, any insurrection or rebellion; that
I have never borne arms against the United States; that I have never given any aid, countenance,
counsel or encouragement to any person or persons engaged, or whom I had reason to believe
were about to engage, in insurrection, rebellion or armed hostility against the United States;
that I have neither sought, nor accepted, nor attempted to exercise the functions of any office,
civil or military, nor to perform any service whatever, under any authority or pretended
authority in hostility to the United States; that I have not yielded a voluntary support to any
insurrection, rebellion or pretended government, authority, power or constitution within the
United States hostile thereto. And I do further swear that, to the best of my knowledge and
ability, I have supported and defended, and will continue to support and defend, the United
States against all enemies, foreign and domestic; and that I have supported, defended and
obeyed, and will continue to support, defend and obey, the Constitution and laws of the United
States; that I will bear true faith and allegiance to the same; and that I take this oath freely,
without any mental reservation or purpose of evasion: So help me God.

Thos I. Le Compte

Sworn to and subscribed before me, at Cambridge,
this 20th day of December, 1866.

Wm. P. Winterbottom
Justice of the Peace



1267

Stanley Andrew
Co A, 7 U.S. Col'd Inf.

Private Private

CARD NUMBERS.

1	6289206	26
2	6289304	27
3	6289399	28
4	6289501	29
5	6289603	30
6	6289698	31
7	6289794	32
8	6289886	33
9	6289986	34
10	6290106	35
11	6290870	36
12	9066599	37
13		38
14		39
15		40
16		41
17		42
18		43
19		44
20		45
21		46
22		47
23		48
24		49
25		50

Book Mark: E.B. $\frac{12}{777}$

See also

S

7

U.S.C.T.

Andrew Stanley

Co. *G*, 7 Reg't U.S. Col'd Inf.

Appears on

Company Descriptive Book

of the organization named above.

DESCRIPTION.

Age *18* years; height *5* feet *5* inches.

Complexion *Rex*

Eyes *Rex*; hair *Curly*

Where born *Woochiston, Md.*

Occupation *Farmer*

ENLISTMENT.

When *Sept 24*, 1863.

Where *Baltimore, Md.*

By whom *Col. W. Binny*; term *3* y'rs.

Remarks: *Mustered Sept 30, 1863, by Col. W. Binny. Discharged for disability from U.S. Gen. Hosp'l David's Island, N.Y. Notice paid Feb 6 1865.*

W. Binny

S | 7 | U.S.C.T.

Andrew Stanley
3rd, Co *A*, 7 Reg't U. S. Colored Inf.

Age *18* years.

Appears on

Company Muster-in Roll

of the organization named above. Roll dated

Baltimore Md, Sept. 30, 1863.

Muster-in to date *Sept. 30, 1863.*

Joined for duty and enrolled:

When *Sept. 27*, 186*3*.*

Where *Lancaster Co. Md* *

Period *3* years.*

Remarks:
.....
.....
.....
.....
.....

*Muster-in roll shows enrollment of all men of this company as of same date. See enrollment on subsequent card or cards.

Book mark :

L. A. Hill
Copyist.

S | 7 | U.S.C.T.

Andrew Stanley
Plt., Co. F, 7 Reg't U. S. Col'd Infantry.

Appears on

Company Muster Roll
for *Sept 30 to Octo 31*, 186*3*.

Joined for duty and enrolled:

When *Sept 27*, 186*3*.*

Where *Dorchester Co. Md.* *

Period *3* years.*

Present or absent *Present*

Stoppage, \$ *100* for

Due Gov't \$ *100* for

Remarks:

* ~~See~~ See enrollment on card from muster-in roll.

Book mark: _____

(858c)

J. A. Miller
Copyist.

1863

S | **7** | **U.S.C.T.**

Andrew Stanley
Sgt, Co. F, 7 Reg't U. S. Col'd Infantry.

Appears on
Company Muster Roll
for *Nov & Dec*, 186 *3*.

Joined for duty and enrolled:
When *Sept 27*, 186 *3*.*
Where *Dorchester Co. Md* *
Period *3* years.*

Present or absent *Present*

Stoppage, \$ *100* for

Due Gov't \$ *100* for

Remarks: ** Detached (Service)*
at Annapolis by order Col
Primer Dec 21 1863

** as it appears on Roll*

* See enrollment on card from muster-in roll.

Book mark:

(358c) *J. H. Miller*
Copyist.

A 7 U.S.C.T.

Andrew Stanley
Pot., Co. F, 7 Reg't U. S. Col'd Infantry.

Appears on

Company Muster Roll

for *Jan & Feb*, 1864

Joined for duty and enrolled:

When *Sept 24*, 1863.*

Where *Dorchester Co. Md.**

Period..... years.*

Present or absent *Present*

Stoppage, \$ *100* for.....

Due Gov't \$ *100* for.....

Remarks: *Stopped for 1 Rank*
roll

* See enrollment on card from muster-in roll.

Book mark:.....

John Miller
Copyist.

S | 7 | U.S.C.T.

Andrew Stanley

Sgt, Co. F, 7 Reg't U. S. Col'd Infantry.

Appears on

Company Muster Roll

for *March to April*, 1864.

Joined for duty and enrolled:

When *Sept 27*, 1863.*

Where *Dorchester Co. Md.* *

Period *3* years.*

Present or absent *Present*

Stoppage, \$ *100* for

Due Gov't \$ *100* for

Remarks:

* ~~45~~ See enrollment on card from muster-in roll.

Book mark: _____

J. C. Miller
Copyist.

S 1 7 U.S.C.T.

Andrew Stanley
Pvt., Co. F, 7 Reg't U. S. Col'd Infantry.

Appears on

Company Muster Roll
for July & Aug, 1864.

Joined for duty and enrolled:

When Sept 27, 1864*

Where Dorchester Co. Md.*

Period 3 years.*

Present or absent Present

Stoppage, \$ 100 for

Due Gov't \$ 100 for

Remarks: Stopped for 1
Buyle, Pr. Scales

* See enrollment on card from muster-in roll.

Book mark:

W. S. [Signature]

S | **7** | **U.S.C.T.**

Andrew Stanley

Private, Co. F, 7 Reg't U. S. Col'd Infantry.

Appears on

Company Muster Roll

for *Sept^{2nd} Oct*, 1864.

Joined for duty and enrolled:

When *Sept. 27*, 1863.*

Where *Dorchester Co. Md* *

Period *3* years.*

Present or absent *Absent*

Stoppage, \$ *100* for

Due Gov't \$ *100* for

Remarks *Absent wounded since Sept. 29, 64. Stopped for 1 letter, 1 bugle, 1 pr scales.*

* ~~See~~ See enrollment on card from muster-in roll.

Book mark:

Keefe
Copyist.

(358c)

S. | 7 | U.S.C.T.

Andrew Stanley
Priv, Co. I, 7 Reg't U. S. Col'd Inf.

Appears on

Company Muster Roll

for Nov & Dec 1864.

Joined for duty and enrolled:

When Sept. 27, 1863.*

Where Poochester Co, Md. *

Period 3 years.*

Present or absent Absent

Stoppage, \$ 100 for

Due Gov't, \$ 100 for

Valuation of horse, \$ 100

Valuation of horse equipments, \$ 100

Remarks: Absent wounded
since Sept. 29th 64, stopped
for 1 letter, 1 angle,
1 scale, 1 cauteer.

* See enrollment on card from muster-in roll.

Book-mark: His Feb. 10th 64 No. 5. 329.

(359c)

Wm French
Comptroller

Copyist.

7 U.S.C.T.

Andrew Stanley

Private, Co. F, 7 Reg't U. S. Col'd Infantry.

Appears on

Company Muster Roll

for Jan. & Feb., 1865.

Joined for duty and enrolled:

When Sep 27, 1863.*

Where Dorchester Co., Md.*

Period 3 years.*

Present or absent

Stoppage, \$ 100 for

Due Gov't \$ 100 for

Remarks: Discharged from
De Camp Gen Hospital,
David's Island N.Y. Jan'y
27th 1865 upon Surgeon's
certificate of disability from
wounds received Sep 29 '64

* See enrollment on card from muster-in roll.

Book mark:

Keefe

(358c)

Copyist.

S. | 7 | U.S.C.T.

Andrew Stanley
Pvt., Co. F, 7 Reg't U. S. Col'd Infantry.

Appears on Co. Muster-out Roll, dated
Indianola, Texas, Dec 13, 1866.

Muster-out to date _____, 186 .

Last paid to _____, 186 .

Clothing account:

Last settled _____, 186 ; drawn since \$ 100

Due soldier \$ 100 ; due U. S. \$ 100

Am't for cloth'g in kind or money adv'd \$ 100

Due U. S. for arms, equipments, &c., \$ 100

Bounty paid \$ 100 ; due \$ 100

Remarks: Discharged for
disability at Davids
Island N.Y. Harbor.
Notice received
Feb. 6-60.

Book mark: C. H. - Discharged June

Brooks

JAN. 21

6290870

1.8910

27/65. E. B. $\frac{12}{297}$.

Stanley, Andrew

P. Co. F.

7 Reg't U. S. C. Inf.

3 Enclosures.

Bed Cards.....	Descriptive Lists.....
Burial Records.....	Final Statements.....
Certs. of Dis. for Discharge /	Furloughs.....
C. M. Charges.....	Med. Des. Lists.....
Med. Certificates.....	Orders.....

Other papers relating to—

Admission to Hosp'l.....	Furlough.....
Casualty Sheet (Officer's) 2	Med. Examination.....
Confinement.....	Misc. Information /
Contracts.....	Pay or Clothing.....
Death or Effects.....	Personal Reports.....
Desertions.....	Rank.....
Discharge from Hosp'l.....	Transfer to Hosp'l.....
Discharge from Service.....	Transfer to V. R. C.....
Duty.....	Transportation.....

MICROFILM PUBLICATION M 1849

COMPILED MILITARY SERVICE RECORDS
OF VOLUNTEER UNION SOLDIERS WHO SERVED WITH
THE UNITED STATES COLORED TROOPS (USCT)
7TH REGIMENT OF INFANTRY

PERSONAL PAPERS' TARGET SHEET

PLEASE NOTE THE CHECKED INFORMATION ABOUT THE PERSONAL PAPERS IN
THIS FILE:

- NO PERSONAL PAPERS WERE FOUND IN THIS FILE WHEN THE
RECORDS WERE ARRANGED FOR MICROFILMING.

- 9 PERSONAL PAPER(S) FOUND IN THIS FILE WHEN THE RECORDS
WERE ARRANGED FOR MICROFILMING.

1425.
Jas A Sheerman
given to.
Jas Carron

A.

No. 425 CLAIMANT'S CERTIFICATE.

I, James A. Sherman a loyal citizen, and a resident of the _____ County of Dorchester, State of Maryland, hereby claim compensation, under the provisions of General Orders, No. 329, 1863, for my slave Andrew Stanley enlisted ^{September 30th} ~~Oct. 24th~~, 1863, at Birney Barracks by Col. William Birney in the Seventh Regiment U. S. Colored Troops, Co. F.; certificate of which enlistment, and a descriptive list, as required, accompany this application.

In proof of my loyalty to the Constitution and Government of the United States, I present the accompanying oath, which I have taken, signed, and acknowledged, to be filed with this application, in accordance with requirement of said General Orders.

James A. Sherman

February 20th 1864.

B.

OATH OF ALLEGIANCE.

I, James N. Sherman, do solemnly swear that I have never joined, or been concerned in, any insurrection or rebellion; that I have never borne arms against the United States; that I have never given any aid, countenance, counsel, or encouragement to any person or persons engaged, or whom I had reason to believe were about to engage, in insurrection, rebellion, or armed hostility against the United States; that I have neither sought, nor accepted, nor attempted to exercise the functions of any office, civil or military, nor to perform any service whatever, under any authority or pretended authority in hostility to the United States; that I have not yielded a voluntary support to any insurrection, rebellion, or pretended government, authority, power, or constitution within the United States hostile thereto. And I do further swear that, to the best of my knowledge and ability, I have supported and defended, and will continue to support and defend, the United States against all enemies, foreign and domestic; and that I have supported, defended, and obeyed, and will continue to support, defend, and obey, the Constitution and laws of the United States; that I will bear true faith and allegiance to the same; and that I take this oath freely, without any mental reservation or purpose of evasion: So help me God.

James N. Sherman

Sworn to and subscribed before me, at East New Market
this 20th day of February 1864.

Conrad Bayley J.P.



C.

I present herewith evidence of my title to the slave Andrew Stanley, — enlisted as aforesaid, and in consideration of the sum of Three hundred dollars by me received, I hereby covenant and agree with the United States, that I, my heirs, executors, or assigns, shall never hereafter make or enforce any claim to the labor or services of said slave; and pledge myself to execute a valid Deed of Manumission and Release of all my claims to service forever of said Andrew Stanley to be filed with the Board of Claims now in session at Baltimore

James N. Sherman

July, 20th, 1864.

Correct
In 16.

* Des list in No 424
P. O. & New Market Md
No. 425 No. 97 R. V. 30
1865

P. O. & New Market Md

APPLICATION OF

James N. Sherman

OF

Dorchester County, Maryland

For Compensation for Service of Slave,

Andrew Stanley

Enlisted in Seventh Regiment

U. S. Colored Troops, Co. F.

Received, Feb 26th 1864.

COMPENSATION AWARDED,

January 27th 1865

Three Hundred Dollars.

Thos. Simmons

President Board of Claims

954 R. V.

Compensation

Recd. A. G. I. January 29. 1865

EVIDENCE OF TITLE.

I. *James N. Sherman*, of *Dorchester* County, Md., do solemnly swear that *Andrew Stanley* who has been enlisted in the *seventh* Regiment, U. S. Colored Troops, Co. *F.*; is my slave for *life* ; (~~his term of service expiring on the _____ day of _____ 186~~;) and that I became possessed of him by *his birth, his mother being my slave*, ~~in the month of _____ or about the year~~, eighteen hundred and *forty five*. And I do further swear that I have not purchased said slave from any person or persons disloyal to the Government of the United States, with the object of obtaining compensation for the same; and furthermore, that I have no agency for obtaining compensation for any person or persons but such as, to my knowledge, are loyal citizens of the United States.

James N. Sherman

February 20th 1864.

STATE OF MARYLAND.

Borchester County, to wit:



On this 20th day of February in the year 1864,

before me, the subscriber, a Justice of the Peace of the State and County aforesaid, personally appeared *James N. Sherman*, and took, signed, and acknowl-

edged the oaths preceding; and further made oath, in due form of law, that all the state-ments made in this application are, to the best of *his* knowledge and belief, strictly

true. Also personally appeared before me *James R. Donoh* and

Major S. Fletcher, loyal citizens of the United States, residents of

Borchester County, well acquainted with the said *James N. Sherman*, and in no manner interested in the prosecution of this

claim, and made oath, in due form of law, that the said *James N. Sherman*

is the owner of the slave *Andrew Stanley*, as a fact of public noto-

riety; that they believe all the statements herein made by *him*, in reference

thereto, are correct, and that *he* is unquestionably loyal to the Government of

the United States. Witness their signatures:

M. S. Fletcher
James R. Donoh

Enoch Bayley Justice of the Peace.

STATE OF MARYLAND,

Dorchester County, to wit:

I, *Francis J. Army*, Clerk of the Circuit Court for *Dorchester* County, do hereby certify that *Euseb Dugley*,

before whom the foregoing affidavits were made, was, at the time of signing the same, a Justice of the Peace for the County and State aforesaid, duly commissioned and sworn; and that his signature thereto is genuine, and that full faith and credit should be given to his official acts.

Witness my hand and the seal of said Court, this *22nd* day of

February, A. D. 1864.



F. J. Army CLERK.

State of Maryland, Dorchester County, to wit;

I hereby certify, that the within and foregoing is a true and correct copy of the original Deed of Manumission and Release of Service now on file in my office, to be enrolled among the Chattel Record Books for Dorchester County.

In testimony whereof, I hereunto subscribe my name and affix the seal of the Circuit Court for Dorchester County, this 9th, day of May, Anno Domini 1864.

Francis J. Henry, Clerk.



Deed of Manumission,
James N. Sherman,
To
Andrew Stanley.

M.C.

E.

Deed of Manumission and Release of Service.

Whereas my slave Andrew Stanley has enlisted in the service of the United States: now, in consideration thereof, I, James N. Sherman, of Dorchester County, State of Maryland, do hereby, in consideration of said enlistment, manumit, set free, and release the above-named Andrew Stanley from all service due me; his freedom to commence from the 30th day of September, 1863, the date of his enlistment as aforesaid in the seventh Regiment of Colored Troops, in the service of the United States.

Witness my hand and seal, this ninth day of May, 1864.

Witness: James N. Sherman *Seal*

W. M. Bride.....

J. P. Fountain.....

Josiah Carroll.....

Dorchester County,

State of Maryland, May 9th, 1864.

Before me appeared this day James N. Sherman, and acknowledged the above Deed of Manumission and Release of Service to be his free act and deed.

Josiah Carroll, J.P.

161

CASUALTY SHEET
OF WOUNDED.

Andrew Stanley

Private Company C⁷,
A

4th Regiment of W.S.C.V.

Volunteers at the battle of Chapin

Flam. Va Sept 29

T 30/67

CASUALTY SHEET.

Name, Andrew Stanley
 Rank, Private, Company 'F', Regiment, 7'
 Arm, U. S. C. I., State, _____
 Place of casualty, Chapins Farm, Va.
 Nature of casualty, Wounded
 Date of casualty, Sept 29 + 30 / 61

FROM WHAT SOURCE THIS INFORMATION WAS OBTAINED.

Report of Killed, Wounded, and Missing of the _____ Regiment,
 Brigade, _____ Division, _____ Corps, dated _____
List of casualties in the U. S. C. I. on the 29 +
30 of Sept / 61, at Chapins Farm, Va.
(Sgd) Stewellyn A. Harker
Suit case bound
Ind vs S. No 63.

W. Brown

Clerk.

WAR 838

[OFFICE ENDORSEMENT.]

War Department,

ADJUTANT GENERAL'S OFFICE,

April 17th, 1877

The discharge of Andrew Stanley, Co. "F", 4th Reg't U. S. Colored Troops, is reported as follows:

- On Company Muster Roll. For Jan & Feb 1865, January 1, 1865
- Company Muster-out Roll. No date, 1865
- Company Descriptive Book. 1865
- Company Morning Reports. 1865
- Soldier's Final Statement. 1865
- Soldier's Record of Death and Interment. 1865
- Soldier's Inventory of Effects. 1865
- Soldier's Certificate of Disability for Discharge. 1865
- Soldier's Individual Muster-out Roll. January 1st, 1865
- Regimental Return. For August, 1865, January 1, 1865
- Regimental Quarterly Returns. 1865
- Regimental Descriptive Book. 1865
- By Surgeon General. 1865

() January 27th, 1865, is held to be the correct date, and the Company Muster-out Roll will be amended accordingly.

Thomas M. Seward

Assistant Adjutant General.

C 13 12 297 Noted on key. Noted on key.

Letter to Adjutant General

NOTE 1.

The company commander will here add a statement of all the facts known to him concerning the disease or wound, or cause of disability of the soldier; the time, place, manner, and all the circumstances under which the injury occurred, or disease originated or appeared; the duty, or service, or situation of the soldier at the time the injury was received or disease contracted, stating particularly whether the injury was received or the disease contracted in the line of his duty; and whatever other facts may aid a judgment as to the cause, immediate or remote, of the disability, and the circumstances attending it.

When the facts are not known to the company commander, the certificate of any officer, or affidavit of other person having such knowledge, will be appended—as the surgeon in charge of a hospital, the officer commanding a detachment of recruits, &c., &c.

NOTE 2.

When a probable case for pension, special care must be taken to state the degree of disability—as $\frac{1}{2}$, $\frac{1}{4}$, &c., &c.; to describe particularly the disability, wound, or disease; the extent of which it deprives him of the use of any limb or faculty, or affects his health, strength, activity, constitution, or capacity to labor or earn his subsistence. The surgeon will add, from his knowledge of the facts and circumstances, and from the evidence in the case, his professional opinion of the cause or origin of the disability. In the case of discharges by Medical Inspectors, the last paragraph will state that the "discharge was given by consent of the soldier, after a personal examination, and for disability, the nature, degree, and origin of which are correctly described in the within certificate."

Par. 1260 Regulations, Edit. 1861.

Medical officers, in giving certificates of disability, are to take particular care in all cases that have not been under their charge; and especially in epilepsy, convulsions, chronic rheumatism, derangement of the urinary organs, ophthalmia, ulcers, or any obscure disease liable to be feigned or purposely produced; and in no case shall such certificate be given until after sufficient time and examination to detect any attempt at deception.

DIRECTIONS.

This certificate will be made out in duplicate by the soldier's company commander, or other officer commanding the separate detachment to which he belongs, and sent by him to the surgeon who has charge of the hospital where the soldier is sick. The surgeon will then fill out and sign the surgeon's certificate, and forward these papers to the regimental, detachment, or post commander, who will forward them, with his action endorsed thereon, through the proper channel, to his division commander; or, if the troops are not attached to a division, to his corps, department, or other commander or officer to whom the authority to discharge enlisted men may be specially delegated.

These certificates, after having received the action of the highest authority to which they are required to be sent, will be returned through the same channel to the regimental, post, or detachment commander, who will, if the discharge is authorized by the endorsement of the proper authority, sign the soldier's discharge, and the proper final statements in duplicate, and forward BOTH of these certificates direct to the Adjutant General United States Army, at Washington, D. C.; they will not, under any circumstances, be given to the hands of the soldier.

ADJUTANT GENERAL'S OFFICE

Duplicate sent the Pension Office.

J. P. 41. R. of Dis. 1865. 42

CERTIFICATE OF DISABILITY FOR DISCHARGE

IN THE CASE OF

Andrew Stanley
a Private Co. F

Reg't of A. S. C. Troops

APPROVED

Wm. Sloan

Surgeon, U. S. A.,

Medical Director Dep't of the East

HEADQUARTERS DEPARTMENT OF THE EAST,

NEW YORK CITY, Jan. 21st, 1865.

To be discharged.

BY COMMAND OF MAJOR GENERAL DIX:

Wm. Sloan

Capt. and A. D. C., A. A. A. G.

Received (A. G. Office) [Circular Stamp: ADJUTANT GENERAL'S OFFICE] [Handwritten: J. P. 41. R. of Dis. 1865. 42]

ARMY OF THE UNITED STATES CERTIFICATE OF DISABILITY FOR DISCHARGE.



Private Andrew Stanley, of Captain J. H. Deardon's Company, (D) of the Seventh Regiment of the United States held Joseph was enlisted by Col Wm Birney of the _____ Regiment of _____ at _____ on the twenty seventh day of September, 1863, to serve three years; he was born in _____ in the State of Maryland, is nineteen years of age, five feet five inches high, black complexion, black eyes, curly hair, and by occupation when enlisted a Farmer. During the last two months said soldier has been unfit for duty 60 days.*

Debar's Genl. Hosp'l
STATION: Davids Island N.Y. H
DATE: January 14 1865

Warren Webster
Asst Surgeon U.S.A.
Commanding Company Hosp'l

I CERTIFY, that I have carefully examined the said Private Andrew Stanley of Captain J. H. Deardon's Company, and find him incapable of performing the duties of a soldier because of a gunshot wound of thigh, received in action at Church Hill Va. Sep 22, 1863 and producing permanent contraction of flexor muscles. Degree of disability - one third. He is a negro, and therefore not a subject for the draft by Warren Webster

Asst Surgeon U.S.A.
In charge

DISCHARGED, this twenty seventh day of January, 1865, at Debar's Genl. Hospital Davids Island N.Y. H.

Warren Webster
Asst Surgeon U.S.A.
Commanding the Reg't Hosp'l

The Soldier desires to be addressed at

Town Cambridge County Dorset State Md

* See Note 1 on the back of this. † See Note 2 on the back of this.

CASUALTY SHEET

No. _____

Andrew Stanley
_____ of Company *D*
7 Regiment of *U. S. C. V.*
State Volunteers.

NATURE OF CASUALTY

Discharged Jan 27. 65



NARA 942
CASUALTY SHEET.

Name: *Andrew Stanley*
Rank: *Pvt* Company: *F* Regiment: *7*
Arm: *Inf* State: *U.S.A.*
Nature of Casualty: *Discharge*

CAUSE OF CASUALTY—(NAME OF DISEASE, &C.)

Disability

DEGREE OF DISABILITY.

BY WHOM CERTIFIED.

Warren Webster

Asst Surg USA

DATE OF DISCHARGE, DEATH, &c.

Jan'y 27. 65

PLACE OF DISCHARGE, DEATH, &c.

David's Island N.Y.N.

BY WHOM DISCHARGED.

FROM WHAT SOURCE THIS INFORMATION WAS OBTAINED.

*Roll No 39. De Camp
Hosp. Recds.*

REMARKS.

A. D. Bailie

Clerk.

SSS

F.

CERTIFICATE OF AWARD OF THE BOARD OF CLAIMS.

Office of the Board of Claims
for Slaves Enlisted in the Service of the United States,

445

Baltimore Md.

\$300-

January 28th 1863.

We hereby certify, that James N. Sherman, of Dorchester county, State of Maryland, having proved, under oath, his loyalty to the Constitution and Government of the United States, and established his title as to the ownership of Andrew Stanley, a slave enlisted at Birney Barracks, on the 30th day of September, 1863, by Col. Wm. Birney, in the service of the United States, in the 7th Regiment of Colored Troops, Co. F, and having filed a valid Deed of Manumission and Release of Service of said slave, is entitled to the sum of Three Hundred dollars, which has been awarded to him by this Board as a remuneration for all claim to the future labor or service of said slave, under the provision of General Orders, War Department, No. 329, 1863.

Thos. Immons, President of the Board.

L. E. Staughen, Member of the Board.

Wm. Jones, Member of the Board.

To Col. C. W. Foster,

Chief of the Bureau for the
Organization of Colored Troops, Washington, D. C.

S. No. 97. S. 7.

No. .

ABSTRACT OF DISBURSEMENTS.

....., 186 .

James N. Sherman

Dollars *300* 100.

Paid , 186 .

The United States,

To *James A. Sherman* Dr.

		DOLLARS.	CENTS.
<i>1865.</i> <i>January 28th</i>	For amount awarded him by the Board of Claims, in consideration of the enlistment of <i>Andrew Stanley</i> in the <i>7th Regt. U.S. Col. Troops</i>	<i>300</i>	<i>00</i>
<i>Total \$</i>		<i>300</i>	<i>00</i>

I CERTIFY that the above account is correct and just; that the name of *Andrew Stanley* is borne on the muster-in rolls of the *7th Regt. U.S. Col. Troops*; and that the above amount was awarded by the Board of which *Thomas Simmon Esq.* is President, said award being in accordance with section 24 of the act entitled "An act to amend an act entitled 'An act for enrolling and calling out the national forces, and for other purposes,'" approved Feb. 24, 1864.

Assistant Adjutant General.

RECEIVED _____, 186 , of *Capt. A. F. Rockwell, A.A.G. Vol*
dollars and _____ cents, in full of the above account.

James A. Sherman

(SIGNED DUPLICATES.)

G. No 97. P. 7

No. _____

ABSTRACT OF DISBURSEMENTS.

....., 186 .

James N. Sherman

Dollars *300* 100.

Paid , 186 .

The United States,

To James A. Sherman Dr.

		DOLLARS.	CENTS.
1865.	January 28 th		
For amount awarded him by the Board of Claims, in consideration of the enlistment of Andrew Stanley in the 7 th Regt U.S. Col ^d Troops		300	00
Total \$		300	00

I CERTIFY that the above account is correct and just; that the name of Andrew Stanley is borne on the muster-in rolls of the 7th Regt U.S. Col^d Troops; and that the above amount was awarded by the Board of which Thomas Simmons Esq is President, said award being in accordance with section 24 of the act entitled "An act to amend an act entitled 'An act for enrolling and calling out the national forces, and for other purposes,'" approved Feb. 24, 1864.

Assistant Adjutant General.

RECEIVED _____, 186 _____, of Capt^d A. J. Rockwell a. a. g. v. l. dollars and _____ cents, in full of the above account.

James A. Sherman

(SIGNED DUPLICATES.)

1268

Stanley Goldbury
 Co. 10, 7 U.S. Col'd Inf.

Private | Private

CARD NUMBERS.

1	6285498	26
2	6285599	27
3	6285696	28
4	6285801	29
5	6285904	30
6	6286028	31
7	6287197	32
8	9066325	33
9		34
10		35
11		36
12		37
13		38
14		39
15		40
16		41
17		42
18		43
19		44
20		45
21		46
22		47
23		48
24		49
25		50

Book Mark:

See also

S

7

U.S.C.T.

Goldborough Stanley

Co. D, 7 Reg't U.S. Col'd Inf.

Appears on

Company Descriptive Book

of the organization named above.

DESCRIPTION.

Age 18 years; height 5 feet 8 1/2 inches.

Complexion Black

Eyes Black; hair Curly

Where born Worcester, Md.

Occupation Farmer

ENLISTMENT.

When Sept 26, 1863.

Where Worcester

By whom ; term y'rs.

Remarks: died at hospital at Jacksonsville, Fla May 3, 1864. Mustered Sep 29 1863.

A. Brown

S | **7** | **U.S.C.T.**

Goldsbury Stanley
Pvt, Co. *D*, 7 Reg't U. S. Colored Inf.

Age *18* years.

Appears on

Company Muster-in Roll

of the organization named above. Roll dated

Baltimore Md, *Sep 29*, 1863.

Muster-in to date *Sep. 29*, 1863.

Joined for duty and enrolled:

When *Sept 26*, 1863.*

Where *Dorchester Co. Md.**

Period *3* years.*

Remarks:

*Muster-in roll shows enrollment of all men of this company as of same date. See enrollment on subsequent card or cards.

Book mark:

R. S. Shelton

(356c)

Copyist.

D

7

U.S.C.T.

Goldshun Stanley

Pvt., Co. D, 7 Reg't U. S. Col'd Infantry.

Appears on

Company Muster Roll

for from Sept 29 to Oct 31, 1863

Joined for duty and enrolled:

When Sept 26, 1863.*

Where Dorchester Co. Md.*

Period 3 years.*

Present or absent Present

Stoppage, \$ 100 for

Due Gov't \$ 100 for

Remarks:

[Empty lines for remarks]

* See enrollment on card from muster-in roll.

Book mark:

R. S. Shelton

(358c)

Copyist.

S

7

U.S.C.T.

Goldsbury Stanley

Pvt, Co. D, 7 Reg't U. S. Col'd Infantry.

Appears on

Company Muster Roll

for *Nov + Dec*, 1863.

Joined for duty and enrolled:

When *Sept 26*, 1863*

Where *Dorchester Md**

Period *3* years.*

Present or absent *Present*

Stoppage, \$ *100* for

Due Gov't \$ *100* for

Remarks:

* See enrollment on card from muster-in roll.

Book mark:

R S Shelton

(358c)

Copyist.

S

7

U.S.C.T.

Goldsbury Stanley
Pvt, Co. D, 7 Reg't U. S. Col'd Infantry.

Appears on

Company Muster Roll

for Jan'y & Feby, 1864.

Joined for duty and enrolled:

When Sept 26, 1863*

Where Dorchester Md *

Period 3 years.*

Present or absent Present

Stoppage, \$ 100 for

Due Gov't \$ 100 for

Remarks:

* See enrollment on card from muster-in roll.

Book mark:-----

R S Shelton

(358c)

Copyist.

S | 7 | U.S.C.T.

Goldsbury Stanley
Pvt, Co. D, 7 Reg't U. S. Col'd Infantry.

Appears on

Company Muster Roll
for *Mehe Apl*, 1864.

Joined for duty and enrolled:

When *Sept 26*, 1863.*

Where *Dorchester Md.**

Period *3* years.*

Present or absent *Absent*

Stoppage, \$ *100* for

Due Gov't \$ *100* for

Remarks: *Sic in Hospital
Jacksonville Fla.*

* See enrollment on card from muster-in roll.

Book mark:

R S Shelton

S | **7** | **U.S.C.T.**

Goldsbury Stanley
Pvt, Co. D, 7 Reg't U. S. Col'd Infantry.

Appears on

Company Muster Roll

for *May & June*, 1864.

Joined for duty and enrolled:

When *Sept 26*, 186 *B*.*

Where *Dorchester Co. Md.**

Period *3* years.*

Present or absent _____

Stoppage, \$ *100* for _____

Due Gov't \$ *100* for _____

Remarks: *Died in Jacksonville*
Fla June 3rd 1864.
Final statement rendered.

* See enrollment on card from muster-in roll.

Book mark: _____

R S Shelton

S | 7 | U.S.C.T.

Goldsbury Stanley
Pvt., Co. *D*, 7 Reg't U. S. Col'd Infantry.

Appears on **Co. Muster-out Roll**, dated
Indianola Texas, Oct 13, 186*6*.

Muster-out to date _____, 186 .

Last paid to *Feb 29*, 186*4*.

Clothing account:

Last settled _____, 186 ; drawn since \$ _____ ¹⁰⁰

Due soldier \$ _____ ¹⁰⁰; due U. S. \$ _____ ¹⁰⁰

Am't for cloth'g in kind or money adv'd \$ _____ ¹⁰⁰

Due U. S. for arms, equipments, &c., \$ _____ ¹⁰⁰

Bounty paid \$ _____ ¹⁰⁰; due \$ _____ ¹⁰⁰

Remarks: *Died at Jacksonville Fla. May 3. 64. Cause unknown. Final statements forwarded May 20. 64.*

Book mark: *FS*

Heard

Stanley, Goldsberry

P, Co. D., 7 Regt U.S.C. Inf.

2 Enclosures.

Bed Cards.....	Descriptive Lists.....
Burial Records.....	Final Statements..... /
Certs. of Dis. for Discharge.....	Furloughs.....
C. M. Charges.....	Med. Des. Lists.....
Med. Certificates.....	Orders.....

Other papers relating to—

Admission to Hosp'l.....	Furlough.....
Casualty Sheet (Officer's).....	Med. Examination.....
Confinement.....	Misc. Information.....
Contracts.....	Pay or Clothing.....
Death or Effects.....	Personal Reports.....
Desertions.....	Rank.....
Discharge from Hosp'l.....	Transfer to Hosp'l.....
Discharge from Service.....	Transfer to V. R. C.....
Duty.....	Transportation.....
	Slave claim /

MICROFILM PUBLICATION M 1849

COMPILED MILITARY SERVICE RECORDS
OF VOLUNTEER UNION SOLDIERS WHO SERVED WITH
THE UNITED STATES COLORED TROOPS (USCT)
7TH REGIMENT OF INFANTRY

PERSONAL PAPERS' TARGET SHEET

PLEASE NOTE THE CHECKED INFORMATION ABOUT THE PERSONAL PAPERS IN
THIS FILE:

- NO PERSONAL PAPERS WERE FOUND IN THIS FILE WHEN THE
RECORDS WERE ARRANGED FOR MICROFILMING.
- 7 PERSONAL PAPER(S) FOUND IN THIS FILE WHEN THE RECORDS
WERE ARRANGED FOR MICROFILMING.

A.

No. 700

CLAIMANT'S CERTIFICATE.

I, William A. Sullivan a loyal citizen, and a resident of Cambridge, County of Dorchester, State of Maryland, hereby claim compensation, under the provisions of General Orders, No. 329, 1863, for my slave Goldborough Stanley enlisted Sept. 26th 1863, at Cambridge, by Col. Wm Birney, in the 7th Regiment U. S. Colored Troops, Co. D.; certificate of which enlistment, and a descriptive list, as required, accompany this application.

In proof of my loyalty to the Constitution and Government of the United States, I present the accompanying oath, which I have taken, signed, and acknowledged, to be filed with this application, in accordance with requirement of said General Orders.

W. A. Sullivan

February 22nd 1864.

x See No 699.

NARA 86A

B.

OATH OF ALLEGIANCE.

I, William A. Sullivan, do solemnly swear that I have never joined, or been concerned in, any insurrection or rebellion; that I have never borne arms against the United States; that I have never given any aid, countenance, counsel, or encouragement to any person or persons engaged, or whom I had reason to believe were about to engage, in insurrection, rebellion, or armed hostility against the United States; that I have neither sought, nor accepted, nor attempted to exercise the functions of any office, civil or military, nor to perform any service whatever, under any authority or pretended authority in hostility to the United States; that I have not yielded a voluntary support to any insurrection, rebellion, or pretended government, authority, power, or constitution within the United States hostile thereto. And I do further swear that, to the best of my knowledge and ability, I have supported and defended, and will continue to support and defend, the United States against all enemies, foreign and domestic; and that I have supported, defended, and obeyed, and will continue to support, defend, and obey, the Constitution and laws of the United States; that I will bear true faith and allegiance to the same; and that I take this oath freely, without any mental reservation or purpose of evasion: So help me God.

W. A. Sullivan

Sworn to and subscribed before me, at Cambridge }
this 22nd day of February 1864. }

H. L. Winterbottom

Justice of the Peace



NARA 861
C.

I present herewith evidence of my title to the slave Goldborough Stanley
enlisted as aforesaid, and in consideration of the sum of
three hundred dollars which when by me received, I hereby covenant and
agree with the United States, that I, my heirs, executors, or assigns, shall never hereafter make
or enforce any claim to the labor or services of said slave; and pledge myself to execute
a valid Deed of Manumission and Release of all my claims to service forever of said
Goldborough Stanley to be filed with the Board of Claims
now in session at Baltimore, Md.

W. A. Sullivan

22nd Feb^y, 1864.

For a certificate see No. 699
S. No. 21. A. G. O. J. 1864
No. 700 No. 48

APPLICATION

William A. Subin

OF

Dorchester Co. Md

For Compensation for Service of Slave,

Goldsbury Stanley

Enlisted in Seventh Regiment

U. S. Colored Troops, Co. D

Received: March 2^d 1863.

COMPENSATION AWARDED,

May 3rd 1864.

Three Hundred Dollars.

J. F. Street

Treasr Bd of Claims.

Paid by Col. Sullivan

S. O. A. G. O.

Rec^d A. G. O. May 8. 1864.

War Department
A. G. O. Washington
June 8. 1864.

Respectfully returned for
evidence that the bounty due
the recruit from the state of
Maryland has been paid.

In order

R. T. Dana
Capt Adj't Genl U. S. A.

Rec^d back A. G. O. Sept. 13. 1864

EVIDENCE OF TITLE.

I. *William A. Sullivan*, of *Dorchester*
County, Md., do solemnly swear that *Goldborough Stanley*
who has been enlisted in the *7th* Regiment, U. S. Colored Troops,
Co. *D.*; is my slave for *life*; (his term of service expiring on
the _____ day of _____ 186 _____;) and that
I became possessed of him by *will of Henry Sullivan*, in the month
of _____, eighteen hundred and *fifty nine*. And I
do further swear that I have not purchased said slave from any person or persons disloyal
to the Government of the United States, with the object of obtaining compensation for
the same; and furthermore, that I have no agency for obtaining compensation for any per-
son or persons but such as, to my knowledge, are loyal citizens of the United States.

W. A. Sullivan

February 22nd 1864.

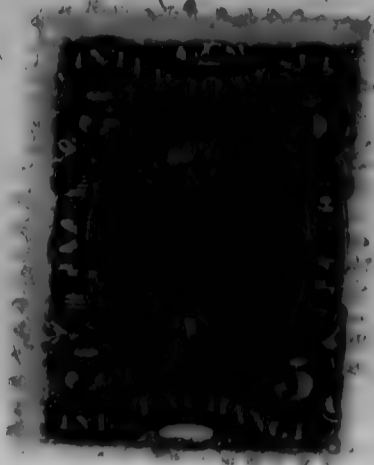

STATE OF MARYLAND,

Dorchester County, to wit:

On this *22nd* day of *February* in the year 1864,

before me, the subscriber, a Justice of the Peace of the State and County aforesaid, per-

sonally appeared *William A. Sullivan*, and took, signed, and acknowl-

edged the oaths preceding; and further made oath, in due form of law, that all the state-

ments made in this application are, to the best of *his* knowledge and belief, strictly

true. Also personally appeared before me *William Thomas* and

Joseph Bradshaw, loyal citizens of the United States, residents of

Dorchester County, well acquainted with the said *William*

A. Sullivan, and in no manner interested in the prosecution of this

claim, and made oath, in due form of law, that the said *William A. Sullivan*

is the owner of the slave *Goldborough Stanley*, as a fact of public noto-

riety; that they believe all the statements herein made by *him*, in reference

thereto, are correct, and that *he* is unquestionably loyal to the Government of

the United States. Witness their signatures:

William Thomas
Joseph Bradshaw

Swoon before

H. J. Winterbottom Justice of the Peace.

STATE OF MARYLAND,

Dorchester County, to wit:

I, *Francis J. Henry*, Clerk of the Circuit Court for

Dorchester County, do hereby certify that *A. J. Winterbottom*,

before whom the foregoing affidavits were made, was, at the time of signing the same, a Justice of the Peace for the County and State aforesaid, duly commissioned and sworn; and that his signature thereto is genuine, and that full faith and credit should be given to his official acts.

Witness my hand and the seal of said Court, this *23rd* day of

April, A. D. 1864.

F. J. Henry CLERK.



State of Maryland

Dorchester County, Sec: 3 I hereby certify that the within is a true and correct copy of the original deed of allanmission now on file in my office for Record among the Chattel Records for Dorchester County.

In testimony whereof I hereunto subscribe my name and affix the seal of the Circuit Court for Dorchester County this 14th day of April Anno Domini 1866

J. J. Army Clerk

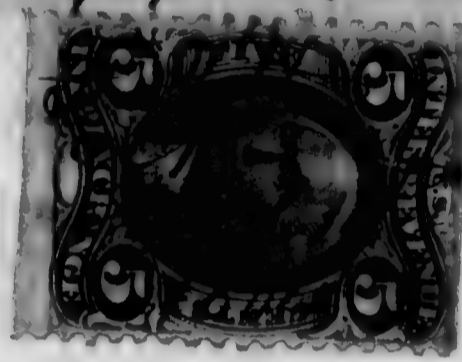

Wm. Sullivan
to
Gordon King
700

Wm Sullivan
12.8.66

E.

DEED OF MANUMISSION AND RELEASE OF SERVICE.

Whereas my slave Goldstorough Stanly has enlisted in the service of the United States: now, in consideration thereof, I, William A. Sullivan of Dorchester county, State of Maryland, do hereby, in consideration of said enlistment, manumit, set free, and release the above-named Goldstorough Stanly from all service due me; his freedom to commence from the Sept. 26th 1863, the date of his enlistment as aforesaid in the 7th Regiment of Colored Troops, in the service of the United States.

Witness my hand and seal, this 12th day of April, 1864.

W. A. Sullivan



Witness:

William Thomas

Wm Kinly

H. J. Winterbottom

Dorchester County,

State of Maryland, 1864. April 12th.

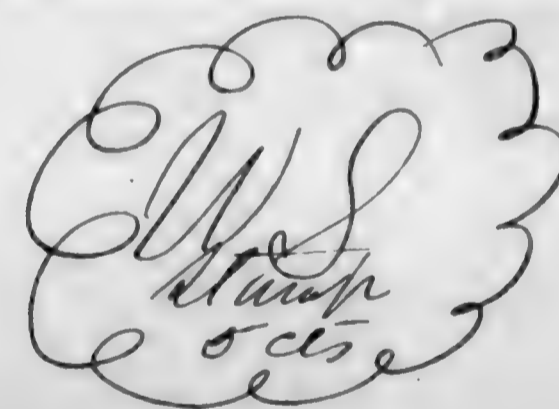

Before me appeared this day William A. Sullivan, and acknowledged the above Deed of Manumission and Release of Service to be his free act and deed.

H. J. Winterbottom J.P.

⁻²⁻
Final statement ~~of 165~~ ^{of 165}
Brevet Gatesburg Steady
4th U.S. Milit. Troops.

Died May 3rd 1862.

ADJUTANT GENERAL'S OFFICE.
June 9th 1864
Duplicate with Inventory sent 2d Auditor.

Subscribed
G. W. R. of Gatesburg
Recd: W. D. June 11th 1864.

NARA 869

I certify on honor that Goldsbury Stanly a private of
Captain Thomas M. Carty, Company "D" 7th Regt. U.S.C. Troop, born in
Dorchester Co. Maryland, age 18, 5 feet 8 1/2 inches high, Black complexion,
Black eyes, curly hair, & by occupation a Farmer, having joined the Company
in its original organization at Baltimore & enrolled in its
muster into the service of the United States at Baltimore on the
26th Day of September 1863. To serve in the Regiment for the term
of three years or during the war: and having served Manfully & Faithfully
with his Company in the 7th U.S.C. Troop to the present day: is now
entitled to a Discharge by reason of Death.

The said Private Goldsbury Stanly was last payed by Major, Lockwood,
D. include the 29th Day of February 1864 & has pay due him from that
date to the present date.

He has received from the United States, Clothing amounting to
43 dollars, since the 26th Day of September 1863. At time of entering the
service

(The Deceased had no effects)

GIVEN in Duplicate at Jacksonville, Florida this the 3rd day of May,
1864

Thos. M. Carty

Capt 7th U.S.C. Troop

Commanding Co "D"

F.

CERTIFICATE OF AWARD OF THE BOARD OF CLAIMS.

Office of the Board of Claims
For Slaves Enlisted in the Service of the United States,

Baltimore Md

May 3d, 1864

No 64

\$300-

We hereby certify, that *William A. Sullivan*, of *Dorchester* county, State of *Maryland*, having proved, under oath, *his* loyalty to the Constitution and Government of the United States, and established *his* title as to the ownership of *Goldsbury Stanley*, a slave enlisted at *Dorchester County Md*, on the *26th* day of *September* 1863, by *Col Wm. Birney*, in the service of the United States, in the *Seventh* Regiment of Colored Troops, *Co. D*, and having filed a valid Deed of Manumission and Release of Service of said slave, is entitled to the sum of *Three Hundred* dollars, which has been awarded to *him* by this Board as a remuneration for all claim to the future labor or service of said slave, under the provision of General Orders, War Department, No. 329, 1863.

J. Street, President of the Board.

W. Johnson, Member of the Board.

L. C. Stranglin, Member of the Board.

To *Maj. C. W. Foster*,

Chief of the Bureau for the

Organization of Colored Troops, Washington, D. C.

W. A. Sullivan
48.

No. .

ABSTRACT OF DISBURSEMENTS.

....., 186 .

William A. Sullivan

Dollars *300* ⁰⁰/₁₀₀

Paid, 186 .

The United States,

To William A. Sullivan Dr.

186 .		DOLLARS.	CENTS.
	For amount awarded him by the Board of Claims, in consideration of the enlistment of <u>Goldsbury Stanley</u> in the <u>7th Reg't U. S. Colored Troops</u>	300	00
	Total \$	300	00

I CERTIFY that the above account is correct and just; that the name of Goldsbury Stanley is borne on the muster-in rolls of the 7th Reg't U. S. Colored Troops; and that the above amount was awarded by the Board of which S. F. Street is President, said award being in accordance with section 24 of the act entitled "An act to amend an act entitled 'An act for enrolling and calling out the national forces, and for other purposes,'" approved Feb. 24, 1864.

Assistant Adjutant General.

RECEIVED _____, 186 , of Capt S. G. Benedict, A. A. G. Col.
Three Hundred dollars and _____ cents, in full of the above account.

W. A. Sullivan

(SIGNED DUPLICATES.)

48.

No. .

ABSTRACT OF DISBURSEMENTS.

....., 186 .

William A. Sullivan

Dollars *300* ⁰⁰/₁₀₀

Paid , 186 .

The United States,

To William A. Sullivan Dr.

186 .	For amount awarded him by the Board of Claims, in consideration of the enlistment of <u>Goldsbury Stanley</u> in the <u>7th Regt U. S. Colored Troop</u>	DOLLARS.	CENTS.
		300	00
Total \$		300	00

I CERTIFY that the above account is correct and just; that the name of Goldsbury Stanley is borne on the muster-in rolls of the 7th Regt U. S. Colored Troop; and that the above amount was awarded by the Board of which S. F. Street Esq is President, said award being in accordance with section 24 of the act entitled "An act to amend an act entitled 'An act for enrolling and calling out the national forces, and for other purposes,'" approved Feb. 24, 1864.

Assistant Adjutant General.

RECEIVED _____, 186 , of Capt G. Benedict, A. A. G. Col Three Hundred dollars and _____ cents, in full of the above account.

W. A. Sullivan

(SIGNED DUPLICATES.)

Stanley Harrison
Co H, 7 U.S. Col'd Inf.

Private | Private

CARD NUMBERS.

1	6292509	26
2	6292606	27
3	6292708	28
4	6292809	29
5	6292905	30
6	6292996	31
7	6293087	32
8	6293187	33
9	6293283	34
10	6293381	35
11	6293478	36
12	6293575	37
13	6293662	38
14	6293747	39
15	6293882	40
16	6293905	41
17	6293949	42
18	6294051	43
19	6294120	44
20	9066845	45
21		46
22		47
23		48
24		49
25		50

Book Mark:

See also:

NARA 876

21050464 P.O. mm Retd.

8 1 7 U.S.C.T.

Harrison Stanley

Co. K, 7 Reg't U.S. Col'd Inf.

Appears on

Company Descriptive Book

of the organization named above.

DESCRIPTION.

Age 19 years; height 5 feet 3/4 inches.

Complexion Black

Eyes Black; hair Black.

Where born Dorchester, Maryland.

Occupation

ENLISTMENT.

When Oct. 15, 1862

Where Dorchester

By whom Col. W. Boney; term 3 y'rs.

Remarks: Mustered Nov. 5, 1863
by Lt. Col. Haskell

H. G. White

A | **7** | **U.S.C.T.**

Harrison Stanley
Pt., Co. *H*, 7 Reg't U. S. Col'd Inf.

Age *19* years.

Appears on

Company Muster-in Roll

of the organization named above. Roll dated

Gt. Austin Charles Co. Md., *Nov. 5*, 1863.

Muster-in to date *Nov. 5*, 1863

Joined for duty and enrolled:

When *Oct. 15*, 1863.

Where *Dorchester Md.*

Period *3* years.

Remarks: _____

Book mark: _____

Steele

7

U.S.C.T.

Harrison Stanley
H, Co. H, 7 Reg't U. S. Col'd Infantry.

Appears on

Company Muster Roll

for *Nov & Dec*, 1863.

Present or absent *Present*

Stoppage, \$ *100* for

Due Gov't, \$ *100* for

Remarks: *Due \$2 enlistment premium*

Book mark:

Steel

A.

7

U.S.C.T.

Harrison Stanley,

P., Co. H, 7 Reg't U. S. Col'd Infantry.

Appears on

Company Muster Roll

for *Jan. and Feb.*, 1864.

Present or absent *Present*

Stoppage, \$ *100* for

Due Gov't, \$ *100* for

Remarks:

Book mark:

Steele

J. | 7

U.S.C.T.

Harrison Stanley

P., Co. H, 7 Reg't U. S. Col'd Infantry.

Appears on

Company Muster Roll

for Mch. + Apr. 1864

Present or absent Present

Stoppage, \$ 100 for

Due Gov't, \$ 100 for

Remarks:

Book mark:

Steel

A. | 7 | U.S.C.T.

Marrison Stanley,
Ch., Co. H, 7 Reg't U. S. Col'd Infantry.

Appears on

Company Muster Roll

for *May & June*, 1864.

Present or absent *Absent*

Stoppage, \$ *100* for

Due Gov't, \$ *100* for

Remarks: *On detached
service at Man-
assas per S.O.
no. 67 Dist Hd
Apr. June 28*

Book mark:

Steele

S.

7

U.S.C.T.

Harrison Stanley

D., Co. H, 7 Reg't U. S. Col'd Infantry.

Appears on

Company Muster Roll

for *July & Aug.*, 1864.

Present or absent *Present*

Stoppage, \$ *100* for

Due Gov't, \$ *100* for

Remarks:

Book mark: *1000000000*

Steite

A.

7

U.S.C.T.

Harrison Stanley,
Pl., Co. H, 7 Reg't U. S. Col'd Infantry.

Appears on

Company Muster Roll

for Sept. & Oct., 1864.

Present or absent Present

Stoppage, \$ 100 for

Due Gov't, \$ 100 for

Remarks:

Book mark:

Stute

A

7

U.S.C.T.

Stanley Harrison

Private, Co. H, 7 Reg't U. S. Col'd Infantry.

Appears on

Company Muster Roll

for *Nov. and Dec*, 1861.

Present or absent *Present*

Stoppage, \$ *100* for

Due Gov't, \$ *100* for

Remarks: *Stop for 1 Carb. box Plate
gren pling & wiper*

Book mark:

N. H. Merrill

(858)

Copyist

S

7

U.S.C.T.

Harrison Stanley

Par Co. H, 7 Reg't U. S. Col'd Infantry.

Appears on

Company Muster Roll

for *Jan and Feb.*, 1865.

Present or absent *Present*

Stoppage, \$ *100* for

Due Gov't, \$ *100* for

Remarks:

Book mark:

H. H. Merrill

S | **7** | **U.S.C.T.**

Harrison Stanley

Priv, Co. H, 7 Reg't U. S. Col'd Infantry.

Appears on

Company Muster Roll

for *March and April*, 1865 .

Present or absent *Present*

Stoppage, \$ *100* for

Due Gov't, \$ *100* for

Remarks:

Book mark:

N. H. Merrill

(858)

Copyist

A

7

U.S.C.T.

Harison Stanley

Private, Co. H, 7 Reg't U. S. Col'd Infantry.

Appears on

Company Muster Roll

for *May and June*, 1865.

Present or absent *Present*

Stoppage, \$ *100* for

Due Gov't, \$ *100* for

Remarks:

Book mark:

H. H. Merrill

A

7

U.S.C.T.

Harrison Stanley

Priv, Co. H, 7 Reg't U. S. Col'd Infantry.

Appears on

Company Muster Roll

for *July and Aug*, 1865.

Present or absent *Present*

Stoppage, \$ *100* for

Due Gov't, \$ *100* for

Remarks:

Book mark:

N. H. Merrill

(858)

Copyist

J | 7 | **U.S.C.T.**

Harrison Stanley

Priv, Co. H, 7 Reg't U. S. Col'd Infantry.

Appears on

Company Muster Roll

for *Sept and Oct.*, 1863.

Present or absent *Present*

Stoppage, \$ *95* for *Org Equip.*

Due Gov't, \$ *100* for

Remarks:

Book mark:

N. H. Merrill

S

7

U.S.C.T.

Harrison Stanley

Priv, Co. H, 7 Reg't U. S. Col'd Infantry.

Appears on

Company Muster Roll

for *Nov. and Dec*, 1865.

Present or absent *Present*

Stoppage, \$ *95* for *C.G. Equip*

Due Gov't, \$ *100* for

Remarks:

Book mark:

N. H. Merrill

S.

7

U.S.C.T.

Harrison Stanley

Prvt, Co. H, 7 Reg't U. S. Col'd Infantry.

Appears on

Company Muster Roll

for Jan. & Feb., 1866.

Present or absent Present

Stoppage, \$ 100 for

Due Gov't, \$ 100 for

Remarks:

Book mark:

J. J. Kearney

Copyist

(858)

S.

7

U.S.C.T.

Henry Stanley

Capt, Co. H, 7 Reg't U. S. Col'd Infantry.

Appears on

Company Muster Roll

for *March & April*, 186*b.*

Present or absent *Present*

Stoppage, \$ *100* for

Due Gov't, \$ *100* for

Remarks:

Book mark:

J. J. Kearney

(858)

Copyist

S.

7

U.S.C.T.

Harrison Stanley

Prf, Co. H, 7 Reg't U. S. Col'd Infantry.

Appears on

Company Muster Roll

for *May & June*, 1866.

Present or absent *Present*

Stoppage, \$ *100* for

Due Gov't, \$ *100* for

Remarks: *Stop Ten Dollars for Sentence of C. Court*

Book mark:

(855)

J. J. Kearney

Copyist

4 | 7 | **U.S.C.T.**

Harrison Stanley

Pr, Co. H, 7 Reg't U. S. Col'd Infantry.

Appears on

Company Muster Roll

for July & Aug, 1866.

Present or absent Present

Stoppage, \$ 100 for

Due Gov't, \$ 100 for

Remarks:

Book mark:

(858)

J. J. Kearney

Copyist

J. | **7** | **U.S.C.T.**

Harrison Stanley

Pvt, Co. *26*, 7 Reg't U. S. Col'd Infantry.

Appears on **Co. Muster-out Roll**, dated *Indianola, Tex*, *Oct. 13*, 1866 .

Muster-out to date *Oct. 13*, 1866 .

Last paid to *June 30*, 1866 .

Clothing account:

Last settled....., 186 ; drawn since \$.....¹⁰⁰

Due soldier \$ *23* ^{*43*}/₁₀₀; due U. S. \$.....¹⁰⁰

Am't for cloth'g in kind or money adv'd \$.....¹⁰⁰

Due U. S. for arms, equipments, &c., \$.....¹⁰⁰

Bounty paid \$.....¹⁰⁰; due \$ *100* ¹⁰⁰

Remarks: *Joined at Orig'l Organizⁿ*

Book mark: *V. 64 P. 83. 73*

J. J. Kearney
Copyist.

Stanley, Harrison

P, Co. *26*, 7 Reg't U.S.C. Inf.

2 Enclosures.

Bed Cards.....	Descriptive Lists.....
Burial Records.....	Final Statements.....
Certs. of Dis. for Discharge.....	Furloughs.....
C. M. Charges.....	Med. Des. Lists.....
Med. Certificates.....	Orders.....

Other papers relating to—

Admission to Hosp'l.....	Furlough.....
Casualty Sheet (Officer's).....	Med. Examination.....
Confinement.....	Misc. Information <i>2</i>
Contracts.....	Pay or Clothing.....
Death or Effects.....	Personal Reports.....
Desertions.....	Rank.....
Discharge from Hosp'l.....	Transfer to Hosp'l.....
Discharge from Service.....	Transfer to V. R. C.....
Duty.....	Transportation.....

MARR 875

MICROFILM PUBLICATION M 1849

COMPILED MILITARY SERVICE RECORDS
OF VOLUNTEER UNION SOLDIERS WHO SERVED WITH
THE UNITED STATES COLORED TROOPS (USCT)
7TH REGIMENT OF INFANTRY

PERSONAL PAPERS' TARGET SHEET

PLEASE NOTE THE CHECKED INFORMATION ABOUT THE PERSONAL PAPERS IN
THIS FILE:

- NO PERSONAL PAPERS WERE FOUND IN THIS FILE WHEN THE
RECORDS WERE ARRANGED FOR MICROFILMING.
- 7 PERSONAL PAPER(S) FOUND IN THIS FILE WHEN THE RECORDS
WERE ARRANGED FOR MICROFILMING.

A.

No. 699

CLAIMANT'S CERTIFICATE.

I, William A. Sullivan a loyal citizen, and a resident
of Cambridge, County of Dorchester, State of
Maryland, hereby claim compensation, under the provisions of
General Orders, No. 329, 1863, for my slave Harrison Stanley
enlisted November 15th 1863, at Cambridge
by Col Wm Birney in the Seventh
Regiment U. S. Colored Troops, Co. H; certificate of which enlistment, and a
descriptive list, as required, accompany this application.

In proof of my loyalty to the Constitution and Government of the United States, I
present the accompanying oath, which I have taken, signed, and acknowledged, to be filed
with this application, in accordance with requirement of said General Orders.

W A SullivanFebruary 22nd 1864.

B.

OATH OF ALLEGIANCE.

I, William A. Sullivan, do solemnly swear that I have never joined, or been concerned in, any insurrection or rebellion; that I have never borne arms against the United States; that I have never given any aid, countenance, counsel, or encouragement to any person or persons engaged, or whom I had reason to believe were about to engage, in insurrection, rebellion, or armed hostility against the United States; that I have neither sought, nor accepted, nor attempted to exercise the functions of any office, civil or military, nor to perform any service whatever, under any authority or pretended authority in hostility to the United States; that I have not yielded a voluntary support to any insurrection, rebellion, or pretended government, authority, power, or constitution within the United States hostile thereto. And I do further swear that, to the best of my knowledge and ability, I have supported and defended, and will continue to support and defend, the United States against all enemies, foreign and domestic; and that I have supported, defended, and obeyed, and will continue to support, defend, and obey, the Constitution and laws of the United States; that I will bear true faith and allegiance to the same; and that I take this oath freely, without any mental reservation or purpose of evasion: So help me God.

W. A. Sullivan

Sworn to and subscribed before me, at Cambridge
this 22nd day of February 1864. }

H. L. Winterbottom

Justice of the Peace



C.

I present herewith evidence of my title to the slave Harrison Stanley
enlisted as aforesaid, and in consideration of the sum of
three hundred dollars which when by me received, I hereby covenant and
agree with the United States, that I, my heirs, executors, or assigns, shall never hereafter make
or enforce any claim to the labor or services of said slave; and pledge myself to execute
a valid Deed of Manumission and Release of all my claims to service forever of said
Harrison Stanley to be filed with the Board of Claims
now in session at Baltimore, Md.

W. A. Gulwam

22nd Feb. 1864

S. W. D. C. T. 1864. 67
No. 699 No. 47

APPLICATION OF

William A. Sullivan

OF

Dorchester Co. Md

For Compensation for Service of Slave,

Harrison Buntley

Enlisted in Seventh Regiment

U. S. Colored Troops, Co. H.

Received, March 2^d 1863

COMPENSATION AWARDED,

May 3rd 1864.

Three Hundred Dollars.

J. Street

Trust Bd of Claims.

Filed by Col Sullivan

J. G. A. U.

Rec^d. A. G. O. May 8. 1864.

Received March 30. 67

War Department
A. G. O. Washington D. C.
June 2. 1864

Respectfully returned for evidence
that the bounty due the recruit
from the State of Maryland has
been paid.

By order:

L. P. [Signature]
Capt. Adj. Genl
U. S. A.

Rec^d back A. G. O. Sept. 13. 1864

EVIDENCE OF TITLE.

I, *William A. Sullivan*, of *Dorchester*
 County, Md., do solemnly swear that *Harrison Stanley*
 who has been enlisted in the *7th* Regiment, U. S. Colored Troops,
 Co. *H*; is my slave for *life*; (his term of service expiring on
 the _____ day of _____ 186 _____;) and that
 I became possessed of him by *will of Henry Sullivan*, in the month
 of _____, eighteen hundred and *fifty nine*. And I
 do further swear that I have not purchased said slave from any person or persons disloyal
 to the Government of the United States, with the object of obtaining compensation for
 the same; and furthermore, that I have no agency for obtaining compensation for any per-
 son or persons but such as, to my knowledge, are loyal citizens of the United States.

W. A. Sullivan

February 22nd, 1864.

STATE OF MARYLAND,



Dorchester County, to wit:

On this *22nd* day of *February* in the year 1864,

before me, the subscriber, a Justice of the Peace of the State and County aforesaid, personally appeared *William A. Sullivan*, and took, signed, and acknowl-

edged the oaths preceding; and further made oath, in due form of law, that all the statements made in this application are, to the best of *his* knowledge and belief, strictly

true. Also personally appeared before me *William Thomas* and

Joseph Bradshaw, loyal citizens of the United States, residents of *Dorchester County*, well acquainted with the said *William*

A. Sullivan, and in no manner interested in the prosecution of this

claim, and made oath, in due form of law, that the said *William A. Sullivan*

is the owner of the slave *Harrison Stanley*, as a fact of public noto-

riety; that they believe all the statements herein made by *him*, in reference

thereto, are correct, and that *he* is unquestionably loyal to the Government of

the United States. Witness their signatures:

William Thomas

Joseph Bradshaw

Sworn before

H. P. Winterbottom Justice of the Peace.

STATE OF MARYLAND,

Dorchester County, to wit:

I, *Francis Henry*, Clerk of the Circuit Court for *Dorchester* County, do hereby certify that *H. S. Winterbottom*

before whom the foregoing affidavits were made, was, at the time of signing the same, a Justice of the Peace for the County and State aforesaid, duly commissioned and sworn; and that his signature thereto is genuine, and that full faith and credit should be given to his official acts.

Witness my hand and the seal of said Court, this *23rd* day of *April*, A. D. 1864.

F. B. Henry CLERK.



State of Maryland 3

Dorchester County, Sct: 3 I hereby certify that the within is a true and correct Copy of the Original Deed of Manumission now on file in my office for Record among the Chattel Records for Dorchester County.

In testimony whereof I hereto subscribe my name and affix the Seal of the Circuit Court for Dorchester County this 14th day of April Anno Domini 1844

H. B. Army Ck



Wm, Sullivan

to
Harrison Stanley

~~707~~ 699

E.

DEED OF MANUMISSION AND RELEASE OF SERVICE.

Whereas my slave Harrison Stanley has enlisted in the service of the United States: now, in consideration thereof, I, William A. Sullivan, of Dorchester county, State of Maryland, do hereby, in consideration of said enlistment, manumit, set free, and release the above-named Harrison Stanley from all service due me; his freedom to commence from the 15th November 1863, the date of his enlistment as aforesaid in the 7th Regiment of Colored Troops, in the service of the United States.

Witness my hand and seal, this 12th day of April, 1864.

W. A. Sullivan



Witness:

William Thomas

W. Kirby

H. J. Winterbottom

Dorchester County,

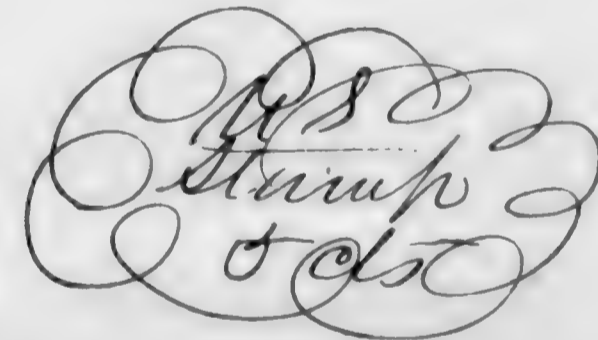

State of Maryland, 1864. April 12th

Before me appeared this day William A. Sullivan and acknowledged the above Deed of Manumission and Release of Service to be his free act and deed.

H. J. Winterbottom J.P.

F.

CERTIFICATE OF AWARD OF THE BOARD OF CLAIMS.

8062

Office of the Board of Claims
For Slaves Enlisted in the Service of the United States,

Baltimore Md.

May 4th 1864

\$300-

We hereby certify, that William A. Sullivan, of Dorchester county, State of Maryland, having proved, under oath, his loyalty to the Constitution and Government of the United States, and established his title as to the ownership of Harrison Stanley, a slave enlisted at Dorchester County Md., on the 15th day of November 1863, by Col. Wm. Birney, in the service of the United States, in the Seventh Regiment of Colored Troops, Co. A, and having filed a valid Deed of Manumission and Release of Service of said slave, is entitled to the sum of Three Hundred dollars, which has been awarded to him by this Board as a remuneration for all claim to the future labor or service of said slave, under the provision of General Orders, War Department, No. 329, 1863.

J. Streeter, President of the Board.

Thos. Ammons, Member of the Board.

L. E. Staughen, Member of the Board.

To Maj. C. W. Foster,

Chief of the Bureau for the
Organization of Colored Troops, Washington, D. C.

47.

No. .

ABSTRACT OF DISBURSEMENTS.

....., 186 .

William A. Sullivan

Dollars *300* ^{*00*}/_{*100*}.

Paid , 186 .

The United States,

To William A. Sullivan Dr.

186		DOLLARS.	CENTS.
	For amount awarded him by the Board of Claims, in consideration of the enlistment of <u>Harrison Stanley</u> in the <u>7th Regt U. S. Colored Troops</u>	300	00
	Total \$	300	00

I CERTIFY that the above account is correct and just; that the name of Harrison Stanley is borne on the muster-in rolls of the 7th Regt U.S. Colored Troops; and that the above amount was awarded by the Board of which S. F. Streets Esq is President, said award being in accordance with section 24 of the act entitled "An act to amend an act entitled 'An act for enrolling and calling out the national forces, and for other purposes,'" approved Feb. 24, 1864.

Assistant Adjutant General.

RECEIVED _____, 186 , of Capt. L. G. Benedict, A. A. G. Col Three Hundred dollars and _____ cents, in full of the above account.

W. A. Sullivan

(SIGNED DUPLICATES.)

Sullivan
#7

No. . .

ABSTRACT OF DISBURSEMENTS.

....., 186 .

William A. Sullivan

Dollars *300* $\frac{00}{100}$

Paid, 186 .

The United States,

To William A. Sullivan Dr.

186	For amount awarded him by the Board of Claims, in consideration of the enlistment of <i>Harrison Stanley</i> in the <i>7th Regt U. S. Colored Troops</i>	DOLLARS.	CENTS.
		300	00
<i>Total \$</i>		300	00

I CERTIFY that the above account is correct and just; that the name of *Harrison Stanley* is borne on the muster-in rolls of the *7th Regt U. S. Colored Troops*; and that the above amount was awarded by the Board of which *S. H. Street* is President, said award being in accordance with section 24 of the act entitled "An act to amend an act entitled 'An act for enrolling and calling out the national forces, and for other purposes,'" approved Feb. 24, 1864.

Assistant Adjutant General.

RECEIVED _____, 186 , of *Capt. G. Benedict, A. A. G. Col.*
Three Hundred dollars and _____ cents, in full of the above account.

W. A. Sullivan

(SIGNED DUPLICATES.)

1
Warren Stanley
Co. H. 7th USCT

NARA 914

Adjutant General's Office,

COLORED TROOPS BRANCH,

June 4, 1877

Vol. 1 C. T., 187
Wanted in the case of Garrison Stanley, Co. 10.
"Reg't U.S. information as to trial of F.O.C.
"M.R. Mar & June 1866" Stop 10.00 w/ sentence F.O.C.

Respectfully,

R. A. Woodward
Chief Clerk.

Per JH

Adjutant General's Office,

Wis. Record discontinued Comd's
June 11th, 1877

Vol. 1 C. T., 187
Reply in case of Garrison Stanley, Co. 10.
7 Reg't U.S.C.T.

Regt. Guard Rep. book shows. Confined June 15 '66
for disob. of orders. - Released June 19 '66. -
Not promulgated in Orders of Regt.

Records of Post Indianola Col. Shaw Comdg' for
June - July 1866 are not on file.

Col. Shaw approved all F.O.C.M. 7'6. S.C.T. in
said period

Stanley James H.
Co D, 7 U.S. Col'd Inf.

Private Private

CARD NUMBERS.

1	6285598	26
2	6285695	27
3	6285800	28
4	6285903	29
5	6286001	30
6	6286098	31
7	6286190	32
8	6286259	33
9	6286305	34
10	6286456	35
11	6286544	36
12	6286632	37
13	6286717	38
14	6286790	39
15	6286868	40
16	6286928	41
17	6286994	42
18	6287046	43
19	6287102	44
20	9066322	45
21		46
22		47
23		48
24		49
25		50

Book Mark:

See also

8832 581. 2. And. p. d. 1000

S

7

U.S.C.T.

James H. Stanley
....., Co. *A*, 7 Reg't U.S. Col'd Inf.

Appears on

Company Descriptive Book

of the organization named above.

DESCRIPTION.

Age *21* years; height *5* feet *2* inches.

Complexion *Black*

Eyes *Black*; hair *Curly*

Where born *Dorchester, Md.*

Occupation *Farmer*

ENLISTMENT.

When *Sept 26*, 1863.

Where *Dorchester*

By whom *Ed. H. Binney*; term *3* y'rs.

Remarks: *Mustered Sep 29 63.*

.....
.....
.....
.....
.....
.....
.....
.....

J. Brown

5 | 7 | U.S.C.T.

James H. Stanley
Priv., Co. D, 7 Reg't U. S. Colored Inf.

Age 27 years.

Appears on

Company Muster-in Roll

of the organization named above. Roll dated

Baltimore Md, Sep. 29, 1863.

Muster-in to date

Sep. 29, 1863.

Joined for duty and enrolled:

When Sept 26, 1863

Where Dorchester Co. Md.

Period 3 years.*

Remarks:

*Muster-in roll shows enrollment of all men of this company as of same date. See enrollment on subsequent card or cards.

Book mark:

R. S. Shelton

(356c)

Copyist.

5 | 7 | **U.S.C.T.**

James S Stanley
 Pvt , Co. D, 7 Reg't U. S. Col'd Infantry.

Appears on

Company Muster Roll

for from Sept 29. to Oct 31, 1863.

Joined for duty and enrolled:

When Sept 26, 1863.*

Where Dorchester Co., Md.*

Period 3 years.*

Present or absent Present

Stoppage, \$ 100 for _____

Due Gov't \$ 100 for _____

Remarks: _____

* ~~See~~ See enrollment on card from muster-in roll.

Book mark: _____

R S Shetton

(358c)

Copyist.

5 | 7 | U.S.C.T.

James H. Stanley
Priv., Co. D, 7 Reg't U. S. Col'd Infantry.

Appears on

Company Muster Roll

for Apr & Dec, 1863.

Joined for duty and enrolled:

When Sept 26, 1863*

Where Dorchester Md.*

Period 3 years.*

Present or absent Present

Steppage, \$ 100 for

Due Gov't \$ 100 for

Remarks:

* See enrollment on card from muster-in roll.

Book mark:

R. S. Shelton

S | **7** | **U.S.C.T.**

James H Stanley
Pvt, Co. D, 7 Reg't U. S. Col'd Infantry.

Appears on

Company Muster Roll

for *Jan'y & Feb'y*, 1864.

Joined for duty and enrolled:

When *Sept 26*, 186 *3**

Where *Dorchester Md* *

Period *3* years.*

Present or absent *Present*

Stoppage, \$ *100* for

Due Gov't \$ *100* for

Remarks:

* ~~See~~ See enrollment on card from muster-in roll.

Book mark:

R B Shelton

S | 7 | U.S.C.T.

James H Stanley
Priv, Co. D, 7 Reg't U. S. Col'd Infantry.

Appears on

Company Muster Roll
for *March Apl*, 1864

Joined for duty and enrolled:

When *Sept 26*, 1863*

Where *Dorchester Md**

Period *3* years.*

Present or absent *Present*

Stoppage, \$ *100* for

Due Gov't \$ *100* for

Remarks:

* See enrollment on card from muster-in roll.

Book mark: -----

(358c)

R B Shelton

Copyist.

S

7

U.S.C.T.

James H. Stanley
Capt, Co. D, 7 Reg't U. S. Col'd Infantry.

Appears on

Company Muster Roll

for May & June, 1864.

Joined for duty and enrolled:

When Sept 26, 1863.*

Where Dorchester Co., Md. *

Period 3 years.*

Present or absent Present

Stoppage, \$ 100 for

Due Gov't \$ 100 for

Remarks:

* See enrollment on card from muster-in roll.

Book mark:

R. S. Shelton

S

7

U.S.C.T.

James M Stanley

Pvt, Co. D, 7 Reg't U. S. Col'd Infantry.

Appears on

Company Muster Roll

for July & Aug, 1864.

Joined for duty and enrolled:

When Sept 26, 1863*

Where Dorchester Md *

Period 3 years.*

Present or absent Present

Stoppage, \$ 100 for

Due Gov't \$ 100 for

Remarks:

Blank lines for remarks

* See enrollment on card from muster-in roll.

Book mark:

R S Shelton

(358c)

Copyist.

S

7

U.S.C.T.

James H. Stanley
Private, Co. D, 7 Reg't U. S. Col'd Infantry.

Appears on

Company Muster Roll

for *Sept. & Oct.*, 186*4*

Joined for duty and enrolled:

When *Sept. 26*, 186*3*.*

Where *Dorchester* *

Period *3* years.*

Present or absent *Present*

Steppage, \$ *100* for

Due Gov't \$ *100* for

Remarks:

* See enrollment on card from muster-in roll.

Book mark: -----

(358c)

J. D. Neale

Copyist.

S | **7** | **U.S.C.T.**

James A. Stanley
Private, Co. D, 7 Reg't U. S. Col'd Infantry.

Appears on

Company Muster Roll

for *Nov. & Dec.*, 1864.

Joined for duty and enrolled:

When *Sept. 26*, 1863.*

Where *Dorchester* *

Period *3* years.*

Present or absent *Present*

Stoppage, \$ *100* for

Due Gov't \$ *100* for

Remarks:

* See enrollment on card from muster-in roll.

Book mark: _____

(358c) *J. W. Neal* Copyist.

S | 7 | **U.S.C.T.**

James A. Stanley
Private, Co. D, 7 Reg't U. S. Col'd Infantry.

Appears on

Company Muster Roll

for Jan'y & Feb, 1865.

Joined for duty and enrolled:

When Sept 26, 1863.*

Where Dorchester Co.*

Period 3 years.*

Present or absent absent

Stoppage, \$ 100 for

Due Gov't \$ 100 for

Remarks: On det. Service
since Feb. 23 - 65 per S.O.
No. 46 dated Hd Qrs 2^d
Div. 25 A.C. Feb 23 -
65 Stop 1 canteen

* See enrollment on card from muster-in roll.

Book mark: _____

(358c) F. D. Neals Copyist.

S | 7 | U.S.C.T.

James A. Stanley
Priv., Co. D, 7 Reg't U. S. Col'd Infantry.

Appears on

Company Muster Roll

for *Mich & April*, 1865.

Joined for duty and enrolled:

When *Sept. 26*, 1863.*

Where *Norchester Co. Md.**

Period *3* years.*

Present or absent *Absent.*

Stoppage, \$ *100* for

Due Gov't \$ *100* for

Remarks: *Det. S.O. 46*
2^d Div. 25th Corps Feb. 25-
1865 Stop / canteen

* See enrollment on card from muster-in roll.

Book mark:

F. D. Neale
(358c) Copyist.

A 7 U.S.C.T.

James H. Stanley
Priv., Co. D, 7 Reg't U. S. Col'd Infantry.

Appears on

Company Muster Roll

for May & June, 1865.

Joined for duty and enrolled:

When Sept. 26, 1865.*

Where Kent Ind. *

Period 3 years.*

Present or absent Present

Stoppage, \$ 100 for

Due Gov't \$ 100 for

Remarks: Stop for one screw
drive & cone wrench

* See enrollment on card from muster-in roll.

Book mark:

(358c)

J. H. Neale

Copyist.

1865

S 7 U.S.C.T.

James H. Stanley
Priv., Co. D, 7 Reg't U. S. Col'd Infantry.

Appears on

Company Muster Roll

for *July & Aug.*, 1865.

Joined for duty and enrolled:

When *Sept. 26*, 1865.*

Where *Kent Md.* *

Period *3* years.*

Present or absent *Present*

Stoppage, \$ *100* for

Due Gov't \$ *100* for

Remarks: *Stop for*
or advance \$1.79

* See enrollment on card from muster-in roll.

Book mark:

F. W. Neal
(358c) Copyist.

7 U.S.C.T.

James A. Stanley
Co. D, 7 Reg't U. S. Col'd Infantry.

Appears on

Company Muster Roll

for Sept. 8. Oct., 1863.

Joined for duty and enrolled:

When Sept. 26, 1863.*

Where Kent Md. *

Period 3 years.*

Present or absent Present

Stoppage, \$ 100 for

Due Gov't \$ 100 for

Remarks:

* See enrollment on card from muster-in roll.

Book mark:

(358c) F. W. Neal Copyist.

S

7

U.S.C.T.

James H. Stanley
Pvt, Co. D, 7 Reg't U. S. Col'd Infantry.

Appears on

Company Muster Roll

for Nov. & Dec, 1865.

Joined for duty and enrolled:

When Sept 26, 1863.*

Where Kent Md *

Period 3 years.*

Present or absent Present

Stoppage, \$ 100 for

Due Gov't \$ 100 for

Remarks:

* See enrollment on card from muster-in roll.

Book mark:

Heard

S

7

U.S.C.T.

James H. Stanley

Pvt, Co. D, 7 Reg't U. S. Col'd Infantry.

Appears on

Company Muster Roll

for Jan'y & Feby, 1866.

Joined for duty and enrolled:

When Sept 26, 1863.*

Where Kent Md *

Period 3 years.*

Present or absent Absent

Stoppage, \$ 100 for

Due Gov't \$ 100 for

Remarks: Det. in O.M. Dept. J.O. No. 4
Dated 4th Co. Sub. Dist. Victoria Tex.
Indianola Tex. Jan 24. 1864.

* See enrollment on card from muster-in roll.

Book mark:

Hearst

8 | 7 | U.S.C.T.

James H. Stanley
Pvt., Co. D, 7 Reg't U. S. Col'd Infantry.

Appears on

Company Muster Roll

for Mch & Apl , 1866.

Joined for duty and enrolled:

When Sept 26 , 1863.*

Where Kent Md *

Period 3 years.*

Present or absent Present

Stoppage, \$ 100 for

Due Gov't \$ 100 for

Remarks:

* See enrollment on card from muster-in roll.

Book mark:-----

 Hearst
(358c) Copyist.

8 | 7 | **U.S.C.T.**

James H. Stanley
Pvt, Co. D, 7 Reg't U. S. Col'd Infantry.

Appears on

Company Muster Roll

for *May & June*, 186*6*.

Joined for duty and enrolled:

When *Sept 26*, 1863.*

Where *Kent Md* *

Period *3* years.*

Present or absent *Present*

Stoppage, \$ *100* for

Due Gov't \$ *100* for

Remarks:

* See enrollment on card from muster-in roll.

Book mark: _____

Heard

S. | 7 | U.S.C.T.

James H. Stanley
Sgt., Co. D, 7 Reg't U. S. Col'd Infantry.

Appears on

Company Muster Roll

for July & Aug, 1866.

Joined for duty and enrolled:

When Sept 26, 1863.*

Where Kent, Md.*

Period 3 years.*

Present or absent Present

Stoppage, \$ 100 for

Due Gov't \$ 100 for

Remarks:

* See enrollment on card from muster-in roll.

Book mark:

Heard
(358c) Copyist.

S

7

U.S.C.T.

James H. Stanley

Priv., Co. D, 7 Reg't U. S. Col'd Infantry.

Appears on Co. Muster-out Roll, dated Indianola Texas, Oct 13, 1866.

Muster-out to date Oct 13, 1866.

Last paid to June 30, 1866.

Clothing account:

Last settled....., 186 ; drawn since \$ 100

Due soldier \$ 100; due U. S. \$ 37 66/100

Am't for cloth'g in kind or money adv'd \$ 100

Due U. S. for arms, equipments, &c., \$ 78/100

Bounty paid \$ 100; due \$ 100 00/100

Remarks: joined at original organization. Stop for one C.B. Plate & Belt and one U.B. Plate 78'

Book mark :

Heard

Stanley, James H.

P, Co. D.

7 Reg't U.S.C. In:

Enclosures.

- | | |
|-----------------------------------|------------------------|
| Bed Cards..... | Descriptive Lists..... |
| Burial Records..... | Final Statements..... |
| Certs. of Dis. for Discharge..... | Furloughs..... |
| C. M. Charges..... | Med. Des. Lists..... |
| Med. Certificates..... | Orders..... |

Other papers relating to—

- | | |
|---------------------------------|--------------------------|
| Admission to Hosp'l..... | Furlough..... |
| Casualty Sheet (Officer's)..... | Med. Examination..... |
| Confinement..... | Misc. Information..... |
| Contracts..... | Pay or Clothing..... |
| Death or Effects..... | Personal Reports..... |
| Desertions..... | Rank..... |
| Discharge from Hosp'l..... | Transfer to Hosp'l..... |
| Discharge from Service..... | Transfer to V. R. C..... |
| Duty..... | Transportation..... |
| | Slave claim 1 |

MICROFILM PUBLICATION M 1849

COMPILED MILITARY SERVICE RECORDS
OF VOLUNTEER UNION SOLDIERS WHO SERVED WITH
THE UNITED STATES COLORED TROOPS (USCT)
7TH REGIMENT OF INFANTRY

PERSONAL PAPERS' TARGET SHEET

PLEASE NOTE THE CHECKED INFORMATION ABOUT THE PERSONAL PAPERS IN
THIS FILE:

- NO PERSONAL PAPERS WERE FOUND IN THIS FILE WHEN THE
RECORDS WERE ARRANGED FOR MICROFILMING.

- 7 PERSONAL PAPER(S) FOUND IN THIS FILE WHEN THE RECORDS
WERE ARRANGED FOR MICROFILMING.

A.

No. 424 CLAIMANT'S CERTIFICATE.

I, James N. Sherman a loyal citizen, and a resident of the County of Dorchester, State of Maryland, hereby claim compensation, under the provisions of General Orders, No. 329, 1863, for my slave James H. Stanley enlisted Sept. 26th ~~Oct. 20th~~ 1863, at Birney Barracks by Col. William Birney in the Seventh Regiment U. S. Colored Troops, Co. D.; certificate of which enlistment, and a descriptive list, as required, accompany this application.

In proof of my loyalty to the Constitution and Government of the United States, I present the accompanying oath, which I have taken, signed, and acknowledged, to be filed with this application, in accordance with requirement of said General Orders.

James N. Sherman

February 20th 1864

B.

OATH OF ALLEGIANCE.

I, James N. Sherman, do solemnly swear that I have never joined, or been concerned in, any insurrection or rebellion; that I have never borne arms against the United States; that I have never given any aid, countenance, counsel, or encouragement to any person or persons engaged, or whom I had reason to believe were about to engage, in insurrection, rebellion, or armed hostility against the United States; that I have neither sought, nor accepted, nor attempted to exercise the functions of any office, civil or military, nor to perform any service whatever, under any authority or pretended authority in hostility to the United States; that I have not yielded a voluntary support to any insurrection, rebellion, or pretended government, authority, power, or constitution within the United States hostile thereto. And I do further swear that, to the best of my knowledge and ability, I have supported and defended, and will continue to support and defend, the United States against all enemies, foreign and domestic; and that I have supported, defended, and obeyed, and will continue to support, defend, and obey, the Constitution and laws of the United States; that I will bear true faith and allegiance to the same; and that I take this oath freely, without any mental reservation or purpose of evasion: So help me God.

James N. Sherman

Sworn to and subscribed before me, at East New Market

this 20th day of February 1864.

Emory Bayley, J.P.



NARA 942
C.

I present herewith evidence of my title to the slave James Henry Stanley — enlisted as aforesaid, and in consideration of the sum of three hundred dollars by me received, I hereby covenant and agree with the United States, that I, my heirs, executors, or assigns, shall never hereafter make or enforce any claim to the labor or services of said slave; and pledge myself to execute a valid Deed of Manumission and Release of all my claims to service forever of said James Henry Stanley to be filed with the Board of Claims now in session at Baltimore

James W. Sherman

Feb. 20th, 1864

Correct. Th. H.

J. No. 8. D. C. T. 1865.

No. 424 1/2 90. P. V. 10

APPLICATION OF

James N. Sherman

OF

Dorchester County, Maryland

For Compensation for Service of Slave,

James H. Stanley

Enlisted in Seventh Regiment

U. S. Colored Troops, Co. D.

Received, Feb 26th 1864.

COMPENSATION AWARDED,

January 27th 1865

Three Hundred Dollars.

Thos. Simmons
President Board of Claims

J. S. A. H.

Recd. at G. O. January 29. 1865

7

P.O. & Newmarket Md

EVIDENCE OF TITLE.

I, *James N. Sherman*, of *Lorchester* County, Md., do solemnly swear that *James Henry Stanley* who has been enlisted in the *seventh* Regiment, U. S. Colored Troops, Co. *D.*; is my slave for *life*; (~~his term of service expiring on the~~ ~~day of~~ ~~186~~;) and that I became possessed of him by ~~his birth, his mother being my slave, in the month of~~ *in or about the year* eighteen hundred and *seventy three*. And I do further swear that I have not purchased said slave from any person or persons disloyal to the Government of the United States, with the object of obtaining compensation for the same; and furthermore, that I have no agency for obtaining compensation for any person or persons but such as, to my knowledge, are loyal citizens of the United States.

James N. Sherman

February 20th 1864



STATE OF MARYLAND,

Dorchester County, to wit:

On this *20th* day of *February* in the year 1864,

before me, the subscriber, a Justice of the Peace of the State and County aforesaid, personally appeared *James N. Sherman*, and took, signed, and acknowledged the oaths preceding; and further made oath, in due form of law, that all the state-

ments made in this application are, to the best of *his* knowledge and belief, strictly

true. Also personally appeared before me *James R. Donoho* and

Major S. Fletcher, loyal citizens of the United States, residents of

said County, well acquainted with the said *James*

N. Sherman, and in no manner interested in the prosecution of this

claim, and made oath, in due form of law, that the said *James N. Sherman*

is the owner of the slave *James Henry Stanley*, as a fact of public noto-

riety; that they believe all the statements herein made by *him*, in reference

thereto, are correct, and that *he* is unquestionably loyal to the Government of

the United States. Witness their signatures:

M. S. Fletcher
James R. Donoho

Enoch Bayley Justice of the Peace.



STATE OF MARYLAND,

Dorchester County, to wit:

I, *H. J. Army*, Clerk of the Circuit Court for

Dorchester County, do hereby certify that *Enoch Bayley*

before whom the foregoing affidavits were made, was, at the time of signing the same, a

Justice of the Peace for the County and State aforesaid, duly commissioned and sworn;

and that his signature thereto is genuine, and that full faith and credit should be given to

his official acts.

Witness my hand and the seal of said Court, this *22nd* day of

February, A. D. 1864.

H. J. Army CLERK.

State of Maryland, Dorchester County, Court;

I hereby certify, that the within and foregoing is a true (and) correct copy of the original Deed of Manumission and Release of Service, now on file in my office, to be enrolled among the Chattel Record Books for Dorchester County.



In testimony whereof, I hereunto subscribe my name and affix the seal of the Circuit Court for Dorchester County, this 9th day of May, in the year of our Lord 1864.



Francis J. Henry, Clerk,

132

Deed of Manumission,
James N. Sherman,
Esq.,
James H. Stanley.

NARA 948
E.

Deed of Manumission and Release of Service,

Whereas my slave James A. Stanley has enlisted in the service of the United States: now, in consideration thereof, I, James N. Sherman, of Dorchester County, State of Maryland, do hereby, in consideration of said enlistment, manumit, set free, and release the above-named James A. Stanley from all service due me; his freedom to commence from the 26th day of September 1863, the date of his enlistment as aforesaid in the seventh Regiment of Colored Troops, in the service of the United States.

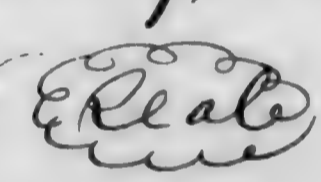
Witness my hand and seal this ninth day of May, 1864.
Witness James N. Sherman 

..... W. M. Bird.

..... J. P. Fountain,

..... Josiah Carroll.

Dorchester County,

State of Maryland, May 9th, 1864.

Before appeared this day James N. Sherman, and acknowledged the above Deed of Manumission and Release of Service to be his free act and deed.

Josiah Carroll, J.P.

424 & 425

N.Y.C. Feb 2^d 1863.

Andrew Stanley Co "F" 7th U.S.C.T.

James H Stanley "D" "

I certify that the above names
are borne on the Muster-in Rolls
of the companies set opposite their
respective names. It is stated
on said Rolls that they were
enrolled at Rochester N.Y.
G.H.R.

Wm. Hayward
A. S. Surg.

Rec^d from
Col. Purroy for
two Slaves Andrew
& Jim 1863

Birney Barracks
Oct 20. 1863

This is to Certify that Andrew Stanley Co. I,
7th W. S. C. I. & James H. Stanley, Co. D. same Regt.
representing themselves to be Slaves of James
A. Sherman of Dorchester Co. Md. have been
by me mustered into the Service of the
United States.

William Birney,
Colonel 2^d U.S.C. I.
Mustering Officer.

James A. Sherman, East New Market
Dorchester Co.

F.

CERTIFICATE OF AWARD OF THE BOARD OF CLAIMS.

Office of the Board of Claims
For Slaves Enlisted in the Service of the United States,

Baltimore Md

January 28th 1863.

No 444

\$300

We hereby certify, that James N. Sherman, of
Dorchester county, State of Maryland,
having proved, under oath, his loyalty to the Constitution and
Government of the United States, and established his title
as to the ownership of James S. Stanley, a slave enlisted
at Birney Barracks, on the 26th day of September,
1863, by Col. G. M. Birney, in the service of the
United States, in the 7th Regiment of Colored Troops,
Co. D, and having filed a valid Deed of Manumission and Release
of Service of said slave, is entitled to the sum of Three Hundred
dollars, which has been awarded to him by this Board as a
remuneration for all claim to the future labor or service of said slave,
under the provision of General Orders, War Department, No. 329,
1863.

Thos. Simmons, President of the Board.

L. E. Stauffer, Member of the Board.

Wm. J. Fox, Member of the Board.

To Col. C. W. Foster,

Chief of the Bureau for the
Organization of Colored Troops, Washington, D. C.

S. No. 96 R. 7

No. .

ABSTRACT OF DISBURSEMENTS.

....., 186 .

James A. Sherman

Dollars *300* 100.

Paid , 186 .

S. No. 96 R. 7

No. .

ABSTRACT OF DISBURSEMENTS.

....., 186 .

James N. Sherman

Dollars *300* 100.

Paid , 186 .

The United States,

To *James N. Sherman* Dr.

		DOLLARS,	CENTS.
<i>1865.</i> <i>January 28th</i>	For amount awarded him by the Board of Claims, in consideration of the enlistment of <i>James N. Stanley</i> in the <i>7th Regt U.S. Col. Troops</i>	<i>300</i>	<i>00</i>
<i>Total \$</i>		<i>300</i>	<i>00</i>

I CERTIFY that the above account is correct and just; that the name of *James N. Stanley* is borne on the muster-in rolls of the *7th Regt. U.S. Col. Troops*; and that the above amount was awarded by the Board of which *Thomas Timmon Esq.* is President, said award being in accordance with section 24 of the act entitled "An act to amend an act entitled 'An act for enrolling and calling out the national forces, and for other purposes,'" approved Feb. 24, 1864.

Assistant Adjutant General.

RECEIVED _____, 186 _____, of *Capt. A. F. Rockwell. A.A. Gvt.*
 _____ dollars and _____ cents, in full of the above account.

James N. Sherman

(SIGNED DUPLICATES.)

James N. Sherman

No. _____

ABSTRACT OF DISBURSEMENTS.

....., 186 .

James N. Sherman

Dollars *300* 100.

Paid , 186 .

The United States,

To James N. Sherman Dr.

		DOLLARS.	CENTS.
1865. January 28 th	For amount awarded him by the Board of Claims, in consideration of the enlistment of <u>James H Stanley</u> in the <u>7th Regt U.S. Col^d Troops</u>	300	00
Total \$		300	00

I CERTIFY that the above account is correct and just; that the name of James H Stanley is borne on the muster-in rolls of the 7th Regt U.S. Col^d Troops; and that the above amount was awarded by the Board of which Thomas Simmons Esq is President, said award being in accordance with section 24 of the act entitled "An act to amend an act entitled 'An act for enrolling and calling out the national forces, and for other purposes,'" approved Feb. 24, 1864.

Assistant Adjutant General.

RECEIVED _____, 186 , of Capt A. F. Rockwell A.A.G.Vols.
 _____ dollars and _____ cents, in full of the above account.

James N. Sherman

(SIGNED DUPLICATES.)

127

Stanley Lawrence

Co E, 7 U.S. Col'd Inf.

Sergeant

Sergeant

CARD NUMBERS.

1	6287210	26
2	6287311	27
3	6287412	28
4	6287513	29
5	6287614	30
6	6287711	31
7	6287808	32
8	6287900	33
9	6287994	34
10	6288091	35
11	6288190	36
12	6288292	37
13	6288392	38
14	6288489	39
15	6288584	40
16	6288677	41
17	6288763	42
18	6288846	43
19	6288929	44
20	6289009	45
21	9066480	46
22		47
23		48
24		49
25		50

Book Mark:

See also

S | **7** | **U.S.C.T.**

Lawrence Stanley
....., Co. *E*., 7 Reg't U.S. Col'd Inf.

Appears on
Company Descriptive Book
of the organization named above.

DESCRIPTION.

Age *22* years; height *5* feet *6* inches.

Complexion *Black*

Eyes *Black*; hair *Curly*

Where born *Dorchester, Md.*

Occupation *Farmer*

ENLISTMENT.

When *Sept 24*, 186*3*.

Where *Baltimore*

By whom *Col Wm Boney*; term *3* y'rs.

Remarks: *Appointed Sergeant*
Dec 30. 1863. In the engage-
ment on Johns Island, S.C.
July 9. 1864. Also at Deep Bot-
ton, Va. Aug 14. 1864.

.....
.....
.....
.....

J. J. Brown
(3830) **Copyist.**

S | **7** | **U.S.C.T.**

Lawrence Stanley
Sgt., Co. *E.*, 7 Reg't U. S. Colored Inf.
Age *22* years.

Appears on

Company Muster-in Roll

of the organization named above. Roll dated
Baltimore Md., Sept. 30, 1863.

Muster-in to date *Sept. 30, 1863.*

Joined for duty and enrolled:

When *Sept. 27, 1863.**

Where *Dorchester Co. Md.**

Period *3* years.*

Remarks :
.....
.....
.....
.....
.....

*Muster-in roll shows enrollment of all men of this company as of same date. See enrollment on subsequent card or cards.

Book mark :
.....

E. E. Rankin

S | 7 | U.S.C.T.

Lawrence Stanley
Sgt., Co. E, 7 Reg't U. S. Col'd Infantry.

Appears on

Company Muster Roll

for Sept. 30/63 to Oct. 31, 1863.

Joined for duty and enrolled:

When Sept. 27, 1863.*

Where Dorchester Md. *

Period 3 years.*

Present or absent Absent.

Stoppage, \$ 100 for

Due Gov't \$ 100 for

Remarks: On detached service at Baltimore Md.

* See enrollment on card from muster-in roll.

Book mark:

J. E. Rankin

MAR 9 1863

S | 7 | U.S.C.T.

Lawrence Stanley
Sgt., Co. E, 7 Reg't U. S. Col'd Infantry

Appears on

Company Muster Roll

for Nov. & Dec., 1863

Joined for duty and enrolled:

When Sept. 27, 1863.*

Where Dorchester Co. Md.*

Period 3 years.*

Present or absent Absent.

Stoppage, \$ 100 for

Due Gov't \$ 100 for

Remarks: Detached service at Baltimore Md. recruiting by order Col. W. Birney Oct. 27, 1863.

* See enrollment on card from muster-in roll.

Book mark:

E. A. Rankin,

S | 7 | U.S.C.T.

Lawrence Stanley
Sgt., Co. E, 7 Reg't U. S. Col'd Infantry.

Appears on

Company Muster Roll

for Jan & Feb., 1864

Joined for duty and enrolled:

When Sept 27, 1863.*

Where Dorchester Co. Md.*

Period 3 years.*

Present or absent Present.

Stoppage, \$ 100 for

Due Gov't \$ 100 for

Remarks: Returned from
recruiting service
Jan. 3, 1864.

* See enrollment on card from muster-in roll.

Book mark:

E. E. Rankin

S | 7 | U.S.C.T.

Lawrence Stanley
Sgt., Co. E, 7 Reg't U. S. Col'd Infantry.

Appears on

Company Muster Roll

for Mar & Apr., 1864

Joined for duty and enrolled:

When Sept. 27, 1863

Where Dorchester Co. Md.

Period 3 years.*

Present or absent Present

Stoppage, \$ 100 for

Due Gov't \$ 100 for

Remarks:

* See enrollment on card from muster-in roll.

Book mark:

D. A. Rankin

S | 7 | U.S.C.T.

Lawrence Stanley
Sgt., Co. E, 7 Reg't U. S. Col'd Infantry.

Appears on

Company Muster Roll

for Dated June 30, 1864.

Joined for duty and enrolled:

When Sept. 27, 1863.*

Where Dorchester Co. Md.*

Period years.*

Present or absent Present.

Stoppage, \$ 100 for

Due Gov't \$ 100 for

Remarks: Stop for one
Haversack and
Canteen.

* See enrollment on card from muster-in roll.

Book mark:

E. E. Rankin
Copyist.

S | **7** | **U.S.C.T.**

Lawrence Stanley
Sgt., Co. E, 7 Reg't U. S. Col'd Infantry.

Appears on

Company Muster Roll

for *Jul. + Aug.*, 186*4*.

Joined for duty and enrolled:

When *Sept. 27*, 186*3*.*

Where *Dorchester Co. Md.* *

Period *3* years.*

Present or absent *Present.*

Stoppage, \$ *100* for

Due Gov't \$ *100* for

Remarks: *Stop for one*
Ball screw wiper
vic. Haversack &
Leanteen

* ~~See~~ See enrollment on card from muster-in roll.

Book mark: _____

E. E. Rankin

NOV 9 1865

O.S.

7

U.S.C.T.

Lawrence Stanley

Sergeant, Co. E, 7 Reg't U. S. Col'd Infantry.

Appears on

Company Muster Roll

for *Sept + Oct*, 186 *4*

Joined for duty and enrolled:

When *Sept 27*, 186 *3*.*

Where *Dorchester Co Md* *

Period *3* years.* *or during the war*

Present or absent *Present*

Stoppage, \$ *100* for

Due Gov't \$ *100* for

Remarks:

* ~~See~~ See enrollment on card from muster-in roll.

Book mark: -----

E. Thompson

S. | 7 | U.S.C.T.

Lawrence Stanley

Serjt., Co. E, 7 Reg't U. S. Col'd Infantry.

Appears on

Company Muster Roll

for Nov & Dec, 1864.

Joined for duty and enrolled:

When Sept 27, 1863.

Where Dorchester Co Md.

Period 7 years.*

Present or absent Present

Stoppage, \$ 100 for

Due Gov't \$ 100 for

Remarks: Stop for Naversack & Canteen

* See enrollment on card from muster-in roll.

Book mark:

E. Thompson

S. | **7** | **U.S.C.T.**

Lawrence Stanley
Sergt; Co. E, 7 Reg't U. S. Col'd Infantry.

Appears on

Company Muster Roll

for *Jan to Feb*, 186*5*.

Joined for duty and enrolled:

When *Sept 27*, 186*3*.*

Where *Dorchester Co Md* *

Period *3* years.*

Present or absent *Present*

Stoppage, \$ *100* for

Due Gov't \$ *100* for

Remarks: *Stop for Service*

* See enrollment on card from muster-in roll.

Book mark: -----

Thompson

MAR 9 1865

7 U.S.C.T.

Laurence Stanley
Supt., Co. E, 7 Reg't U. S. Col'd Infantry.

Appears on

Company Muster Roll

for March-April, 1865.

Joined for duty and enrolled:

When Sept 27, 1863.*

Where Berkeley Co Md.*

Period 7 years.*

Present or absent Present

Stoppage, \$ 100 for

Due Gov't \$ 100 for

Remarks: Stop for screwdriver.

* See enrollment on card from muster-in roll.

Book mark:

Thompson

S. 1 **7** **U.S.C.T.**

Lawrence Stanley
Sergeant, Co. E, 7 Reg't U. S. Col'd Infantry.

Appears on

Company Muster Roll

for *May June*, 186*5*.

Joined for duty and enrolled:

When *Sept-27*, 186*5*.*

Where *Dorchester @ Md.*.*

Period *3* years.*

Present or absent *Present*

Stoppage, \$ *100* for

Due Gov't \$ *100* for

Remarks: *Left for 1. & crew driver*

* See enrollment on card from muster-in roll.

Book mark:

E. Thompson

1865

251

7

U.S.C.T.

Lawrence Stanley

Sergt; Co. E, 7 Reg't U. S. Col'd Infantry.

Appears on

Company Muster Roll

for *July & Aug -*, 186*5*.

Joined for duty and enrolled:

When *Sept-27*, 186*3*.*

Where *Inchester Md* *

Period *2* years.*

Present or absent *Present*

Stoppage, \$ *100* for

Due Gov't \$ *100* for

Remarks:

* See enrollment on card from muster-in roll.

Book mark: -----

A. Thompson

(358c)

Copyist.

7

U.S.C.T.

James Stanley

Sergt.; Co. E, 7 Reg't U. S. Col'd Infantry.

Appears on

Company Muster Roll

for *Sept + Oct.*, 186*5*.

Joined for duty and enrolled:

When *Sept 27th*, 186*3*.*

Where *Archives Co. Md.**

Period *2* years.*

Present or absent *Present*

Stoppage, \$ *100* for

Due Gov't \$ *100* for

Remarks: *Stop for 4 oversack,
+ Anteen.*

* See enrollment on card from muster-in roll.

Book mark:

J. Thompson

Copyist.

S |

7

U.S.C.T.

Lawrence Stanley

Sgt., Co. E, 7 Reg't U. S. Col'd Infantry.

Appears on

Company Muster Roll

for Nov. & Dec., 1865.

Joined for duty and enrolled:

When Sept. 27, 1863.*

Where Dorchester Co., Md.*

Period 3 years.*

Present or absent Present.

Stoppage, \$ 1⁶⁰/₁₀₀ for C. & G. Equipage

Due Gov't \$ 1⁰⁰/₁₀₀ for

Remarks:

* See enrollment on card from muster-in roll;

Book mark:

J. W. Bell, Jr.

(358c)

Copyist.

S | 7 | U.S.C.T.

Lawrence Stanley

Sergt, Co. E, 7 Reg't U. S. Col'd Infantry.

Appears on

Company Muster Roll

for Jan. + Feb, 1866

Joined for duty and enrolled:

When Sept. 27, 1863.*

Where Dorchester Co., Md. *

Period 3 years.*

Present or absent Present

Stoppage, \$ 100 for

Due Gov't \$ 100 for

Remarks:

* See enrollment on card from muster-in roll.

Book mark:

(358c) Jno J Bell Jr Copyist.

S | 7 | U.S.C.T.

Lawrence Stanley
Sgt., Co. E, 7 Reg't U. S. Col'd Infantry

Appears on

Company Muster Roll

for March & April, 1866.

Joined for duty and enrolled:

When Sept 27, 1863.*

Where Norchester Co., Md.*

Period 3 years.*

Present or absent Absent

Stoppage, \$ 100 for

Due Gov't \$ 100 for

Remarks: Absent sick since
March 9, 1866 at
Post Hospital
Indianola, Texas.

* See enrollment on card from muster-in roll.

Book mark: _____

(358c)

Geo. H. Bell
Compt.

S | 7 | U.S.C.T.

Lawrence Stanley
Sgt., Co. E, 7 Reg't U. S. Col'd Infantry.

Appears on

Company Muster Roll

for May + June, 1866.

Joined for duty and enrolled:

When Sept. 27, 1863.*

Where Dorchester Co., Md.*

Period 3 years.*

Present or absent Absent

Stoppage, \$ 100 for

Due Gov't \$ 100 for

Remarks: Absent sick at
Post Hospital
Indianola, Tex. May 12, 1866.

* See enrollment on card from muster-in roll.

Book mark:

(358c)

J. J. Bell Jr
Copyist.

S | 7 | U.S.C.T.

Lawrence Stanley
Sgt, Co. E, 7 Reg't U. S. Col'd Infantry.

Appears on

Company Muster Roll

for July & Aug, 1864.

Joined for duty and enrolled:

When Sept 27, 1863.

Where Dorchester Co., Md.*

Period 3 years.*

Present or absent Absent.

Stoppage, \$ 100 for

Due Gov't \$ 100 for

Remarks: Absent sick at
Post Hospital,
Indianola, Tex. Since
May 12, 1866.

* See enrollment on card from muster-in roll.

Book mark:

(358c) J. J. Ball Jr. Copyist.

S | 7 | U.S.C.T.

Lawrence Stanley
Sgt., Co. C, 7 Reg't U. S. Col'd Infantry.

Appears on Co. Muster-out Roll, dated
Indiantola, Texas Oct 13, 1866.

Muster-out to date Oct. 13, 1866.

Last paid to June 30, 1866.

Clothing account:

Last settled....., 186 ; drawn since \$..... 100

Due soldier \$ 36²¹/₁₀₀; due U. S. \$..... 100

Am't for cloth'g in kind or money adv'd \$..... 100

Due U. S. for arms, equipments, &c., \$..... 100

Bounty paid \$..... 100; due \$ (111) 100

Remarks: Joined for duty at
original organization. Appointed
Sergeant S. O. No. 77 Red. Yrs.
7 Yrs. Dec. 30, 1863.
Stop for one Pick Axe and
handle \$ 1.66

Book mark U. 184 P. 96 - 74 - 412 - 122

(361) *J. B. Bell* Copyist.

1272

Stanley William

Co E., 7 U.S. Col'd Inf.

Private Private

CARD NUMBERS.

1	6287287	26
2	6287388	27
3	6287486	28
4	6287587	29
5	6287688	30
6	6287784	31
7	6287880	32
8	6287911	33
9	6288005	34
10	6288102	35
11	6288267	36
12	6288366	37
13	6288465	38
14	6288560	39
15	6288650	40
16	6288740	41
17	6288826	42
18	6288906	43
19	6288989	44
20	6289069	45
21	9066481	46
22		47
23		48
24		49
25		50

Book Mark:

See also

M. A. 926574

S | **7** | **U.S.C.T.**

William Stanley
....., Co. *E*, 7 Reg't U. S. Col'd Inf.

Appears on
Company Descriptive Book
of the organization named above.

DESCRIPTION.

Age *23* years; height *5* feet *5 3/4* inches.

Complexion *Black*

Eyes *Black*; hair *Curly*

Where born *Dorchester, Md*

Occupation *Farmer*

ENLISTMENT.

When *Sept 24*, 186*3*.

Where *Baltimore*

By whom *Col W. P. Riney*; term *3* y'rs.

Remarks: *Appointed Sergeant*
Dec 30. 1863 *corporal*
Oct 14. 1864. In the engage-
ment at Deep Bottom, Va.
Aug 14. 1864. Reduced
to ranks S. O. No. 26 1/2 B.
U. S. C. I. Mech. 17. 1865.

**As it is on book.*

J. Brown

S | 7 | U.S.C.T.

William Stanley
Priv., Co. E, 7 Reg't U. S. Colored Inf.

Age 23 years.

Appears on

Company Muster-in Roll

of the organization named above. Roll dated

Baltimore Md. Sept. 30, 1863.

Muster-in to date Sept. 30, 1863.

Joined for duty and enrolled:

When Sept. 27, 1863.*

Where Dorchester Co. Md. *

Period 3 years.*

Remarks:

*Muster-in roll shows enrollment of all men of this company as of same date. See enrollment on subsequent enlistment cards.

Book mark:

A. E. Rankin

S 7 U.S.C.T.

William Stanley
Pvt., Co. E, 7 Reg't U. S. Col'd Infantry.

Appears on

Company Muster Roll
for Sept. 24/63 to Oct. 31, 1863.

Joined for duty and enrolled:

When Sept. 27, 1863.*

Where Dorchester Md.*

Period 3 years.*

Present or absent Present

Stoppage, \$ 100 for

Due Gov't \$ 100 for

Remarks:

* See enrollment on card from muster-in roll.

Book mark:

E. B. Rankin
Copyist.

1863

S | 7 | U.S.C.T.

William Stanley
Pvt., Co. E, 7 Reg't U. S. Col'd Infantry.

Appears on

Company Muster Roll

for Nov. & Dec., 1863.

Joined for duty and enrolled:

When Sept. 27, 1863.*

Where Dorchester, *

Period 3 years.*

Present or absent Present

Stoppage, \$ 100 for

Due Gov't \$ 100 for

Remarks:

* See enrollment on card from muster-in roll.

Book mark:

C. E. Rankin
Copyist.

S | 7 | U.S.C.T.

William Stanley
Pvt, Co. E, 7 Reg't U. S. Col'd Infantry.

Appears on

Company Muster Roll
for Jan. & Feb., 1864.

Joined for duty and enrolled:

When Sept 27, 1863.*

Where Dorchester.*

Period 3 years.*

Present or absent Present.

Stoppage, \$ 100 for

Due Gov't \$ 100 for

Remarks:

* See enrollment on card from muster-in roll.

Book mark:

E. E. Rankin,
Copyist.

S | **7** | **U.S.C.T.**

William Stanley
Prvt., Co. E, 7 Reg't U. S. Col'd Infantry.

Appears on

Company Muster Roll
for *Mar. & Apr.*, 1864

Joined for duty and enrolled:

When *Sept. 27*, 1863.*

Where *Dorchester*.*

Period *3* years.*

Present or absent *Present*

Stoppage, \$ *100* for

Due Gov't \$ *100* for

Remarks:

* See enrollment on card from muster-in roll.

Book mark: -----

A. C. Rankin
(358c) Copyist.

S | 7 | U.S.C.T.

Wm Stanley
Pvt., Co. E, 7 Reg't U. S. Col'd Infantry.

Appears on

Company Muster Roll

for Dated June 30, 1864

Joined for duty and enrolled:

When Sept. 27, 1863.*

Where Dorchester Co. Md.*

Period years.*

Present or absent Absent.

Stoppage, \$ 100 for

Due Gov't \$ 100 for

Remarks: Left in Camp
at Jacksonville
Florida June 28th
1864.

* See enrollment on card from muster-in roll.

Book mark:

A. E. Rankin

817

U.S.C.T.

William Stanley
Reg't, Co. E, 7 Reg't U. S. Col'd Inf'ty

Appears on

Company Muster Roll

for Jul. & Aug. 1864.

Joined for duty and enrolled:

When Sept. 27, 1863.*

Where Dorchester *

Period 3 years.*

Present or absent Present

Stoppage, \$ 100 for

Due Gov't, \$ 100 for

Valuation of horse, \$ 100

Valuation of horse equipments, \$ 100

Remarks: ~~Stop for one~~
wrench.

x As it appears on Roll.

* See enrollment on card from muster-in roll.

Book-mark :

E. P. Rankin

(358c)

Copist.

01

7

U.S.C.T.

William Stanley
Cnpl, Co. E, 7 Reg't U. S. Col'd Infantry.

Appears on

Company Muster Roll

for Sept + Oct, 1864.

Joined for duty and enrolled:

When Sept 27th, 1863.*

Where Dorchester*

Period 3 years.*

Present or absent Present

Stoppage, \$ 100 for

Due Gov't \$ 100 for

Remarks: Appointed Cnpl S.O. No -
Ad. Ord. 7 "U.S.C.T. dated Oct 4"
1864. Due from date of appointment
difference of pay between Cavalry
& Infantry

* See enrollment on card from muster-in roll.

Book mark:

C. Thompson

S.

7

U.S.C.T.

William Stanley
Capt., Co. E, 7 Reg't U. S. Col'd Infantry.

Appears on

Company Muster Roll

for Nov to Dec, 1864.

Joined for duty and enrolled:

When Sept 27, 1863.*

Where Dorchester Md.*

Period 3 years.*

Present or absent Present

Stoppage, \$ 100 for

Due Gov't \$ 100 for

Remarks Stop for 1. Haversack

* See enrollment on card from muster-in roll.

Book mark

E. Thompson

S.

7

U.S.C.T.

William Stanley
Capt., Co. E, 7 Reg't U. S. Col'd Infantry.

Appears on

Company Muster Roll

for *Jan + Feb*, 1865.

Joined for duty and enrolled:

When *Sept 27*, 1863.*

Where *Dorchester**

Period years.*

Present or absent *Present*

Stoppage, \$ 100 for

Due Gov't \$ 100 for

Remarks *Stop for Screw Driver
& Pipe.*

* See enrollment on card from muster-in roll.

Book mark:

S. Thompson

S. | 7 | U.S.C.T.

William Stanley
Pte, Co. E, 7 Reg't U. S. Col'd Infantry

Appears on

Company Muster Roll
for March & April, 1860.

Joined for duty and enrolled:

When Sept 27, 1860.

Where Dorchester

Period 9 years.*

Present or absent. Present

Stoppage, \$ 100 for

Due Gov't \$ 100 for

Remarks: Stop for 1. Sore & driven,
Wiper Reduced to ranks
from Corp'l S.O. No. 26. Hd
2nd 7th U.S.C.T. March 26/65.

* See enrollment on card from muster-in roll.

Book mark:

S. Thompson

(358c)

Copyist.

S.

7

U.S.C.T.

William C. Tautley
(Capt), Co. E, 7 Reg't U. S. Col'd Infantry.

Appears on

Company Muster Roll

for *May & June*, 1865.

Joined for duty and enrolled:

When *May 27*, 1863.*

Where *Dorchester* *

Period *2* years.*

Present or absent *Present*

Stoppage, \$ *100* for

Due Gov't \$ *100* for

Remarks: *Reduced to ranks from*
Capt S.O. No. 26, Hd Qrs
7th U.S.C.T. March 26/65
1st for 1st Squad driver & Wiper

* See enrollment on card from muster-in roll.

Book mark:

S. Thompson

01 | 7 | U.S.C.T.

William Stanley
Cpt, Co. E, 7 Reg't U. S. Col'd Infantry.

Appears on

Company Muster Roll

for July & Aug., 1865.

Joined for duty and enrolled:

When Sept-27, 1863.*

Where Dorchester Md *

Period 3 years.*

Present or absent Present

Stoppage, \$ 100 for

Due Gov't \$ 100 for

Remarks:

* See enrollment on card from muster-in roll.

Book mark:

S. Thompson

488994

S. | **7** | **U.S.C.T.**

William Stanley

Sgt, Co. E, 7 Reg't U. S. Col'd Infantry.

Appears on

Company Muster Roll

for *Sept & Oct*, 186*5*.

Joined for duty and enrolled:

When *Sept 27th*, 186*3*.*

Where *Crochester Co. Md.* *

Period *2* years.*

Present or absent *Present*

Stoppage, \$ *100* for

Due Gov't \$ *100* for

Remarks *Staff for 1. Haversack,
1. Canteen, 1. piece Shelter
Tent.*

* See enrollment on card from muster-in roll.

Book mark:

S. Thompson

S | 7 | U.S.C.T.

William Stanley
Prk, Co. E, 7 Reg't U. S. Col'd Infantry.

Appears on

Company Muster Roll

for Nov. & Dec, 1865.

Joined for duty and enrolled:

When Sept 27, 1863.*

Where Dorchester Co., Md.*

Period 3 years.*

Present or absent Present.

Stoppage, \$ 6 ⁵⁰/₁₀₀ for C. & G. Equipage.

Due Gov't \$ 100 for

Remarks:

* See enrollment on card from muster-in roll.

Book mark: -----

S

7

U.S.C.T.

William Stanley,
Pvt, Co. E, 7 Reg't U. S. Col'd Infantry.

Appears on

Company Muster Roll

for Jan. & Feb, 1866.

Joined for duty and enrolled:

When Sept. 27, 1863.*

Where Worcester Co., Md.*

Period 3 years.*

Present or absent Present

Stoppage, \$ 100 for

Due Gov't \$ 100 for

Remarks:

* See enrollment on card from muster-in roll.

Book mark:

(358c)

Wm J Bell Jr

Copyist.

S

7

U.S.C.T.

William Stanley
Trk, Co. E, 7 Reg't U. S. Col'd Infantry.

Appears on

Company Muster Roll

for *Mch. + Apl*, 186*4*.

Joined for duty and enrolled:

When *Sept. 27*, 186*3*.*

Where *Orchestertown, Ind.*.*

Period *3* years.*

Present or absent *Present*.

Stoppage, \$ *100* for

Due Gov't \$ *100* for

Remarks: *Stop for*
1 Canton.

* See enrollment on card from muster-in roll.

Book mark:

(358c)

J. H. Bell Jr
Compt.

S | 7 | U.S.C.T.

William Stanley
Priv., Co. E, 7 Reg't U. S. Col'd Infantry.

Appears on

Company Muster Roll

for May + June, 1866

Joined for duty and enrolled:

When Sept 27, 1863.*

Where Dorchester Co., Md.*

Period 3 years.*

Present or absent Present.

Stoppage, \$ 65 for 100 for 60 G. Equipage

Due Gov't \$ 100 for

Remarks:

* See enrollment on card from muster-in roll.

Book mark:

(358c) J. J. Bell Jr. Copyist.

S | 7 | U.S.C.T.

William Stanley
Pvt, Co. E, 7 Reg't U. S. Col'd Infantry.

Appears on

Company Muster Roll

for July & Aug, 1866.

Joined for duty and enrolled:

When Sept. 27, 1863.*

Where Dorchester Co., Md.*

Period 3 years.*

Present or absent Present

Stoppage, \$ 100 for

Due Gov't \$ 100 for

Remarks:

* See enrollment on card from muster-in roll.

Book mark:

(358c) Jno J. Bell Jr Copyist.

S | 7 | U.S.C.T.

William Stanley
Sgt, Co. E, 7 Reg't U. S. Col'd Infantry.

Appears on Co. Muster-out Roll, dated
Indiavola Texas, Oct. 13, 1866.

Muster-out to date Oct. 13, 1866.

Last paid to June 30, 1866.

Clothing account:

Last settled....., 186 ; drawn since \$..... 100

Due soldier \$ ⁰¹ / 100; due U. S. \$..... 100

Am't for cloth'g in kind or money adv'd \$..... 100

Due U. S. for arms, equipments, &c., \$..... 100

Bounty paid \$..... 100; due \$ 100 100

Remarks: Joined for duty at original
organization. Promoted to Corp'l
S. C. no 85, Hd Qrs 7th U. S. I.
Oct. 5, 1864. Reduced to
rank S. C. no. 26 Hd Qrs
7th U. S. I. Mech 27, 1865.

Book mark N. 145 - P. 131 - 72.

(361) Jno Bell Copyist.

Stanley, William
P. E.

, Co. *E*, 7 Reg' U. S. C. Inf.

Enclosures.

Bed Cards	Descriptive Lists
Burial Records	Final Statements
Certs. of Dis. for Discharge	Furloughs
C. M. Charges	Med. Des. Lists
Med. Certificates	Orders

Other papers relating to—

Admission to Hosp'l	Furlough
Casualty Sheet (Officer's)	Med. Examination
Confinement	Misc. Information
Contracts	Pay or Clothing
Death or Effects	Personal Reports
Desertions	Rank
Discharge from Hosp'l	Transfer to Hosp'l
Discharge from Service	Transfer to V. R. C.
Duty	Transportation
	<i>Slave claim</i>

MICROFILM PUBLICATION M 1849

COMPILED MILITARY SERVICE RECORDS
OF VOLUNTEER UNION SOLDIERS WHO SERVED WITH
THE UNITED STATES COLORED TROOPS (USCT)
7TH REGIMENT OF INFANTRY

PERSONAL PAPERS' TARGET SHEET

PLEASE NOTE THE CHECKED INFORMATION ABOUT THE PERSONAL PAPERS IN
THIS FILE:

- NO PERSONAL PAPERS WERE FOUND IN THIS FILE WHEN THE
RECORDS WERE ARRANGED FOR MICROFILMING.
- 2 PERSONAL PAPER(S) FOUND IN THIS FILE WHEN THE RECORDS
WERE ARRANGED FOR MICROFILMING.

C. No. 05. P. H.

No. 941

APPLICATION OF

David M. Corkran

Dorchester Co. Md.

For Compensation for Service of Slave,

William Stanley

Enlisted in Seventh Regiment

U. S. Colored Troops, Co. E.

Received, March 9 1864.

COMPENSATION ~~Refused~~

Sept 18 1865.

The claimant has been ~~found~~ disloyal.

Thos. Finmore

Presid. Bd. Claims

Recd. G. O. Sept. 25. 1865.

Care McCleave
Williams

EVIDENCE OF TITLE.

I. David Mc Corkran, of Dorchester
 County, Md., do solemnly swear that William Stanley
 who has been enlisted in the Seventh **Regiment**, U. S. Colored Troops,
 Co. E; is my slave for life; (his term of service expiring on
 the _____ day of _____ 186 _____;) and that
 I became possessed of him by in right of my wife, in the month
 of about, eighteen hundred and forty eight. And I
 do further swear that I have not purchased said slave from any person or persons disloyal
 to the Government of the United States, with the object of obtaining compensation for
 the same; and furthermore, that I have no agency for obtaining compensation for any per-
 son or persons but such as, to my knowledge, are loyal citizens of the United States.

David Mc Corkran

February 29th 1864.

MAR 1865



STATE OF MARYLAND,

Dorchester County, to wit:

On this *29th* day of *February* in the year 1864,

before me, the subscriber, a Justice of the Peace of the State and County aforesaid, personally appeared *David M. Corkran*, and took, signed, and acknowledged the oaths preceding; and further made oath, in due form of law, that all the statements made in this application are, to the best of *his* knowledge and belief, strictly true.

Also personally appeared before me *Joseph R. Stewart* and *Rubin W. Hall*, loyal citizens of the United States, residents of *Dorchester County*, well acquainted with the said *David M. Corkran*, and in no manner interested in the prosecution of this claim, and made oath, in due form of law, that the said *David M. Corkran* is the owner of the slave *William Stanley*, as a fact of public notoriety; that they believe all the statements herein made by *him*, in reference thereto, are correct, and that *he* is unquestionably loyal to the Government of the United States. Witness their signatures:

Joseph R. Stewart
Rubin W. Hall

Sworn before

H. J. Winterbottom Justice of the Peace.

STATE OF MARYLAND,

..... County, to wit:

I,, Clerk of the Circuit Court for

..... County, do hereby certify that

before whom the foregoing affidavits were made, was, at the time of signing the same, a Justice of the Peace for the County and State aforesaid, duly commissioned and sworn ; and that his signature thereto is genuine, and that full faith and credit should be given to his official acts.

Witness my hand and the seal of said Court, this day of

....., A. D. 1864.

.....
CLERK.

MAR 1867

A.

No. 941

CLAIMANT'S CERTIFICATE.

I, David M. Corkran a loyal citizen, and a resident
of United States, County of Dorchester, State of
Maryland, hereby claim compensation, under the provisions of
General Orders, No. 329, 1863, for my slave William Stanley
enlisted Sept 27th 1863, at Balto. Md.
by Col. Wm Birney in the Seventh
Regiment U. S. Colored Troops, Co. E; certificate of which enlistment, and a
descriptive list, as required, accompany this application.

In proof of my loyalty to the Constitution and Government of the United States, I
present the accompanying oath, which I have taken, signed, and acknowledged, to be filed
with this application, in accordance with requirement of said General Orders.

David M. Corkran

February 29th 1864.

7
A

B.



OATH OF ALLEGIANCE.

I, David M. Corkran, do solemnly swear that I have never joined, or been concerned in, any insurrection or rebellion; that I have never borne arms against the United States; that I have never given any aid, countenance, counsel, or encouragement to any person or persons engaged, or whom I had reason to believe were about to engage, in insurrection, rebellion, or armed hostility against the United States; that I have neither sought, nor accepted, nor attempted to exercise the functions of any office, civil or military, nor to perform any service whatever, under any authority or pretended authority in hostility to the United States; that I have not yielded a voluntary support to any insurrection, rebellion, or pretended government, authority, power, or constitution within the United States hostile thereto. And I do further swear that, to the best of my knowledge and ability, I have supported and defended, and will continue to support and defend, the United States against all enemies, foreign and domestic; and that I have supported, defended, and obeyed, and will continue to support, defend, and obey, the Constitution and laws of the United States; that I will bear true faith and allegiance to the same; and that I take this oath freely, without any mental reservation or purpose of evasion: So help me God.

David M. Corkran

Sworn to and subscribed before me, at Cambridge
 this 29th day of February 1864.

H. S. Winterbottom
Justice of the Peace

C.

I present herewith evidence of my title to the slave Wm Stanley
 enlisted as aforesaid, and in consideration of the sum of
three hundred dollars, which were by me received, I hereby covenant and
 agree with the United States, that I, my heirs, executors, or assigns, shall never hereafter make
 or enforce any claim to the labor or services of said slave; and pledge myself to execute
 a valid Deed of Manumission and Release of all my claims to service forever of said
William Stanley to be filed with the Board of Claims
 now in session at Balto. Md.

David McConaughy

....., 186 .



1275

Stansbury Lewis

Co B, 7 U.S. Col'd Inf.

Private Private

CARD NUMBERS.

1	6281849	26
2	6281947	27
3	6282048	28
4	6282146	29
5	6282245	30
6	6282344	31
7	6282438	32
8	6282529	33
9	6282628	34
10	6282728	35
11	6282826	36
12	6282924	37
13	6283016	38
14	6283099	39
15	6283184	40
16	6283257	41
17	6283329	42
18	6283399	43
19	6283467	44
20	9066091	45
21		46
22		47
23		48
24		49
25		50

Book Mark:

See also

S 1129709 - 0000
M. S. 1061468
S. 2500453 Point
S 2761009 And ud

S | **7** | **U.S.C.T.**

Lewis Stansbury

Co. *B*, 7 Reg't U.S. Col'd Inf.

Appears on

Company Descriptive Book

of the organization named above.

DESCRIPTION.

Age *25* years; height *5* feet *7 1/2* inches.

Complexion *Griff*.

Eyes *Black*; hair *Curly*.

Where born *Queen Ann, Md.*

Occupation *Fanner*.

ENLISTMENT.

When *Sept. 16*, 186*3*.

Where *Baltimore, Md.*

By whom *Col. W. Binney*; term *3* y'rs.

Remarks: *Mustered Sept. 26, 63,*
by Col. Wm. Binney.

J. Smith

L | **7** | **U.S.C.T.**

Lewis Stansbury
Privt., Co. *B.*, 7 Reg't U. S. Colored Inf.

Age *25* years.

Appears on

Company Muster-in Roll

of the organization named above. Roll dated

Baltimore Ind., *Sept 26*, 1863.

Muster-in to date *Sept 26*, 1863.

Joined for duty and enrolled:

When *Sept 3*, 1863.*

Where *Queen Ann Co. Ind.**

Period *3* years.*

Remarks: _____

*Muster-in roll shows enrollment of all men of this company as of same date. See enrollment on subsequent card or cards.

Book mark: _____

(356c) *J. S. Casey* Copyist.

S.

7

U.S.C.T.

Lewis Stansbury

Privt., Co. B, 7 Reg't U. S. Col'd Infantry.

Appears on

Company Muster Roll

for Sept 26" to Oct 31" , 1863.

Joined for duty and enrolled:

When Sept 26" , 1863.*

Where Green Anna Co. Ind. *

Period 3 years.*

Present or absent Present

Stoppage, \$ 100 for

Due Gov't \$ 100 for

Remarks:

* See enrollment on card from muster-in roll.

Book mark:

(358c)

J. S. Camp

Copyist.

7 | **U.S.C.T.**

Lewis Stansbury
Private, Co. B, 7 Reg't U. S. Col'd Infantry.

Appears on

Company Muster Roll

for Nov & Dec, 1867 .

Joined for duty and enrolled:

When Sept 23, 1867 .*

Where Queen Ann .*

Period 3 years.*

Present or absent Present

Stoppage, \$ 100 for

Due Gov't \$ 100 for

Remarks: Enlistment premium
\$2.00 due

* See enrollment on card from muster-in roll.

Book mark:

(358c) J. G. Casey Copyist.

S. | 7 | **U.S.C.T.**

Lewis Stansbury

Privt, Co. B, 7 Reg't U. S. Col'd Infantry.

Appears on

Company Muster Roll

for Jan 4 Feb, 1864.

Joined for duty and enrolled:

When Sept 23, 1863.*

Where Queen Ann.*

Period 9 years.*

Present or absent Present

Stoppage, \$ 100 for

Due Gov't \$ 100 for

Remarks: \$2.00 Enlistment pre-
mium due

* See enrollment on card from muster-in roll.

Book mark: _____

(358c)

J. S. Casey Copyist.

S.

7

U.S.C.T.

Lewis Stansbury

Privt, Co. B, 7 Reg't U. S. Col'd Infantry.

Appears on

Company Muster Roll

for *March & April*, 1864.

Joined for duty and enrolled:

When *Sept 23*, 1862.*

Where *Queen Anne Md* *

Period *3* years.*

Present or absent *Present*.

Stoppage, \$ *100* for

Due Gov't \$ *100* for

Remarks:

* See enrollment on card from muster-in roll.

Book mark: -----

(358c)

J. S. Casey

Copyist.

L | 7 | **U.S.C.T.**

Lewis Stansbury
Privt, Co. B, 7 Reg't U. S. Col'd Infantry.

Appears on

Company Muster Roll

for May & June, 1864.

Joined for duty and enrolled:

When Sept 23, 1863.*

Where Queen Anne Md.*

Period 3 years.*

Present or absent Present

Stoppage, \$ 100 for

Due Gov't \$ 100 for

Remarks:

* See enrollment on card from muster-in roll.

Book mark: _____

(358c) J. S. Casey Copyist.

A. | 7.

U.S.C.T.

Lewis Stansbury

Privt, Co. D, 7 Reg't U.S. Col'd Inf't.

Appears on

Company Muster Roll

for July & Aug, 1864.

Joined for duty and enrolled:

When Sept 23, 1863.*

Where Queen Ann, Ind.*

Period years.*

Present or absent Present.

Stoppage, \$ 100 for

Due Gov't, \$ 100 for

Remarks:

* See enrollment on card from muster-in roll.

Book mark:

J. S. Casey

8 | 7 | **U.S.C.T.**

Lewis Stansbury
Pvt, Co. B, 7 Reg't U. S. Col'd Infantry.

Appears on

Company Muster Roll

for Sept & Oct, 1864.

Joined for duty and enrolled:

When Sept 23, 1863.*

Where Queen Ann. Md.*

Period 3 years.*

Present or absent Present

Stoppage, \$ 100 for _____

Due Gov't \$ 100 for _____

Remarks: _____

* ~~See~~ See enrollment on card from muster-in roll.

Book mark: _____

(858c) Woblog Copyist.

5 | 7 | **U.S.C.T.**

Lewis Stansbury

Pvt, Co. B, 7 Reg't U. S. Col'd Infantry.

Appears on

Company Muster Roll

for Nov & Dec, 1864.

Joined for duty and enrolled:

When Sept 23, 1863.*

Where Queen Ann. Md.*

Period 3 years.*

Present or absent Present

Stoppage, \$ 100 for _____

Due Gov't \$ 100 for _____

Remarks: _____

* See enrollment on card from muster-in roll.

Book mark: _____

W. A. [Signature]

8 | 7 | U.S.C.T.

Lewis Stansbury
Pvt, Co. B, 7 Reg't U. S. Col'd Infantry.

Appears on

Company Muster Roll
for Jan & Feb, 1865.

Joined for duty and enrolled:

When Sept 23, 1863.*

Where Queen Ann, Md.*

Period 3 years.*

Present or absent Present

Stoppage, \$ 100 for

Due Gov't \$ 100 for

Remarks:

* See enrollment on card from muster-in roll.

Book mark: -----

(358c) W. Stoz Copyist.

8 | 7 | U.S.C.T.

Lewis Stansbury
Pvt, Co. B, 7 Reg't U. S. Col'd Infantry.

Appears on

Company Muster Roll
for Feb 28 to June 30, 1865.

Joined for duty and enrolled:

When Sept 23, 1863.*

Where Queen Ann Co. Md.*

Period 3 years.*

Present or absent Present

Stoppage, \$ 100 for

Due Gov't \$ 100 for

Remarks:

* See enrollment on card from muster-in roll.

Book mark:

(358c) [Signature] Copyist.

S | 7 | **U.S.C.T.**

Lewis Hansbury
Privt, Co. B, 7 Reg't U. S. Col'd Infantry.

Appears on

Company Muster Roll
for July Aug, 1865.

Joined for duty and enrolled:

When Sept 23, 1863.*

Where Queen Ann. Md.*

Period 3 years.*

Present or absent Present

Stoppage, \$ 100 for _____

Due Gov't \$ 100 for _____

Remarks: _____

* See enrollment on card from muster-in roll.

Book mark: _____

(358c) W. D. [Signature] Copyist.

S | 7 | U.S.C.T.

Lewis Stanbury
Pvt., Co. B, 7 Reg't U. S. Col'd Infantry.

Appears on

Company Muster Roll

for Sept & Oct, 1865.

Joined for duty and enrolled:

When Sept 23, 1863.*

Where Queen Ann Co. Md.*

Period 2 years.*

Present or absent Present

Stoppage, \$ 100 for

Due Gov't \$ 100 for

Remarks: Det. Com. Dept
20. 79. 7th US C. I.,
Sept 14, 1865

* See enrollment on card from muster-in roll.

Book mark:

W. S. Log

S 1 7 U.S.C.T.

Lewis Stansbery
Pvt, Co. B, 7 Reg't U. S. Col'd Infantry.

Appears on

Company Muster Roll
for Nov & Dec, 1865

Joined for duty and enrolled:

When Sept 23, 1865*

Where I Ann Co. Md.*

Period 3 years.*

Present or absent Present

Stoppage, \$ 100 for

Due Gov't \$ 100 for

Remarks:

* See enrollment on card from muster-in roll.

Book mark:

Woblog
Copyist.

S | **7** | **U.S.C.T.**

Lewis Stansbury
Pvt, Co. B, 7 Reg't U. S. Col'd Infantry.

Appears on

Company Muster Roll

for *Jan'y and Feb*, 186 *6*.

Joined for duty and enrolled:

When *Sept 23*, 186 *3*.*

Where *Green am Co met* *

Period *3* years.*

Present or absent *Present*

Stoppage, \$ *100* for

Due Gov't \$ *100* for

Remarks:

* See enrollment on card from muster-in roll.

Book mark: -----

Holbrook
(358c) Copyist.

S | 7 | U.S.C.T.

Lewis Staebury

In Co. B, 7 Reg't U. S. Col'd Infantry.

Appears on

Company Muster Roll

for Mch + apr, 1866

Joined for duty and enrolled:

When Sep 23, 1863*

Where Green Anna Md *

Period 3 years.*

Present or absent Present

Stoppage, \$ 100 for

Due Gov't \$ 100 for

Remarks:

* See enrollment on card from muster-in roll.

Book mark:

Holbrook Copyist.

1863

S | **7** | **U.S.C.T.**

Lewis Hansburg
Pr, Co. B, 7 Reg't U. S. Col'd Infantry.

Appears on

Company Muster Roll
for *May and June*, 186 *6*.

Joined for duty and enrolled:

When *Sep 23*, 186 *3**

Where *Green am co reg* *

Period *3* years.*

Present or absent *Present*

Stoppage, \$ *100* for

Due Gov't \$ *100* for

Remarks:

* See enrollment on card from muster-in roll.

Book mark: _____

Holbrook
(358c) Copyist.

S | 7 | U.S.C.T.

Lewis Staunbury
In, Co. B, 7 Reg't U. S. Col'd Infantry.

Appears on

Company Muster Roll
for July and Aug, 1864.

Joined for duty and enrolled:

When Sep. 23, 1863.*

Where Queen Anne to md. *

Period 3 years.*

Present or absent Present

Stoppage, \$ 100 for

Due Gov't \$ 100 for

Remarks:

* See enrollment on card from muster-in roll.

Book mark:

(358c) *Stalworth* Copyist.

S

7

U.S.C.T.

Levis Staunbury
Co. D, 7 Reg't U. S. Col'd Infantry.

Appears on **Co. Muster-out Roll**, dated
Indiana Tex, Oct 13, 1866.

Muster-out to date *Oct 13*, 1866.

Last paid to *June 30*, 1866.

Clothing account:

Last settled....., 186 ; drawn since \$..... 100

Due soldier \$ *32 ⁴⁷ / 100*; due U. S. \$..... 100

Am't for cloth'g in kind or money adv'd \$..... 100

Due U. S. for arms, equipments, &c., \$..... 6 100

Bounty paid \$..... 100; due \$ *100* 100

Remarks: *Found original organ-
ization Retain's Esfield
Rifled musket + complete set
of accoutrements for 4 e.
101 War Dept.
May 30 - 1865*

Book mark: *V. 177. P 239 73*

Hobbs

1274

Stephens George H

Co G, 7 U.S. Col'd Inf.

Private

Private

CARD NUMBERS.

1	6278744	26
2	6291191	27
3	6291295	28
4	6291393	29
5	6291491	30
6	6291588	31
7	6291647	32
8	6291745	33
9	6291807	34
10	6291879	35
11	6291958	36
12	6292418	37
13	9066734	38
14		39
15		40
16		41
17		42
18		43
19		44
20		45
21		46
22		47
23		48
24		49
25		50

Book Mark:

See also

S 1 2 | **U.S.C.T.**

George W. Stephens
Co. *4*, *7* Reg't U.S. Col'd *Inf.*

Appears on
Company Descriptive Book
of the organization named above.

DESCRIPTION.

Age *22* years; height *5* feet *4 3/4* inches.
Complexion *Griff*
Eyes *Blue*; hair *Curly*
Where born *Kent, Mo.*
Occupation *Farmer*

ENLISTMENT.

When *Jan 16*, 186*4*
Where *Kent*
By whom *Genl Will B. King*; term *3* y'rs.

Remarks: *See Register of Deaths - Killed accidentally July 6. 65, at Indianola, Tex.*

J. Brown **Copyist.**

MAR 1864

S | 7

U.S.C.T.

George H. Stephens

, Co. G, 7 Reg't U. S. Col'd Infantry.

Age 22 years.

Appears on a

Detachment Muster-in Roll

of the organization named above. Roll dated

Benedict, Md., Jan. 16, 1864.

Muster-in to date Jan. 16, 1864.

Joined for duty and enrolled:

When Jan. 16, 1864.

Where Kent

Period 3 years.

Remarks:

Book mark:

(837)

W. Beck
Copyist.

S

7

U.S.C.T.

George H. Stevens.

Priv., Co. G, 7 Reg't U. S. Col'd Infantry.

Appears on

Company Muster Roll

for *Jan & Feby.*, 1864.

Present or absent *Present*

Stoppage, \$ *100* for

Due Gov't, \$ *100* for

Remarks: *joined as recruit
Jan. 16th, 1864.*

Book mark:

(858)

Sandoy
Copyist

S

7

U.S.C.T.

George H. Stephens

Priv., Co. G, 7 Reg't U. S. Col'd Infantry.

Appears on

Company Muster Roll

for *Mch & Apr.*, 1864.

Present or absent *Present*

Stoppage, \$ 100 for

Due Gov't, \$ 100 for

Remarks:

Book mark:

(858)

Sandy
Copyist

I | 7 | U.S.C.T.

Geo. W. Stephens.

Priv., Co. G, 7 Reg't U. S. Col'd Infantry.

Appears on

Company Muster Roll

for May & June, 1864.

Present or absent Present.

Stoppage, \$ 100 for

Due Gov't, \$ 100 for

Remarks:

Book mark:

(858)

Sandoz
Cpyist

G

7

U.S.C.T.

George W Stephens
Priv., Co. G, 7 Reg't U. S. Col'd Infantry.

Appears on

Company Muster Roll

for July & Aug., 1864.

Present or absent Absent.

Stoppage, \$ 100 for

Due Gov't, \$ 100 for

Remarks: Detailed as Teamster, S.O. No. 1, 1 Brig., 2 Div., 10 Army Corp, Aug 14/64.

Book mark:

Sandoy

Copyist

(858)

I

7

U.S.C.T.

George W. Stevens.
Priv., Co. G, 7 Reg't U. S. Col'd Infantry.

Appears on

Company Muster Roll

for *Sept. & Oct*, 1864.

Present or absent *Absent*

Stoppage, \$ *100* for

Due Gov't, \$ *100* for

Remarks: *Detached teamster*
S.O. No. 1, Hd. qrs. 1st Bng.,
3d. Divis., 10 Corps, Aug.
14, 1864.

Book mark:

(858)

Sandy
copyist

S | **7** | **U.S.C.T.**

George H. Stephen
Pvt., Co. G, 7 Reg't U. S. Col'd Infantry.

Appears on

Company Muster Roll

for *Nov & Dec*, 186*4*

Present or absent *Present*

Stoppage, \$ *100* for

Due Gov't, \$ *100* for

Remarks:

Book mark:

(858)

J. W. Lewis

Copyist

S

7

U.S.C.T.

George H. Stephens
Pvt., Co. G, 7 Reg't U. S. Col'd Infantry.

Appears on

Company Muster Roll

for *Jan'y & Feby*, 1865.

Present or absent *Present*

Stoppage, \$ *100* for

Due Gov't, \$ *100* for

Remarks:

Det. as Tender Aug 1864
S.O. 1 Hd Co. 3rd Div 10
Co.

Book mark:

(858)

J. W. [Signature]

Copyist

J

7

U.S.C.T.

George H. Stevens

Pvt., Co. G, 7 Reg't U. S. Col'd Infantry.

Appears on

Company Muster Roll

for *March + April*, 186*5*.

Present or absent *Present*

Stoppage, \$ 100 for

Due Gov't, \$ 100 for

Remarks:

*Det. as transfer S.O., 12
1st. Brig. 2nd Div. Reg. 15th
1862 10 A. C.*

Book mark:

J. C. Cross

(858)

Copist

S

7

U.S.C.T.

George W. Stevens
Pvt., Co. G, 7 Reg't U. S. Col'd Infantry.

Appears on

Company Muster Roll

for *May + June*, 186 *51*

Present or absent *Absent*

Stoppage, \$ *100* for

Due Gov't, \$ *100* for

Remarks:

*Det. as teamster per S.O.
12th Brig, 3rd Div, 10th AC
Aug 13, 64*

Book mark:

J. W. [Signature]

(858)

Copyist

S

7

U.S.C.T.

George Stephens

Pvt., Co. G, 7 Reg't U. S. Col'd Infantry.

Appears on

Company Muster Roll

for *July + Aug.*, 1865.

Present or absent

Stoppage, \$ 100 for

Due Gov't, \$ 100 for

Remarks:

*Accidentally killed at Indianola
Texas July 6/65 Final
Statement to A.G.O.*

Book mark:

J. W. True

(858)

Copyist

1 | 7 | **U.S.C.T.**

George H. Stephens
Pot, Co. G, 7 Reg't U. S. Col'd Infantry.

Appears on **Co. Muster-out Roll**, dated *Indianola Texas Oct 13*, 1866.

Muster-out to date _____, 186 .
Last paid to *Dec 31*, 1864 .

Clothing account:

Last settled _____, 186 ; drawn since \$ _____ 100
Due soldier \$ _____ 100 ; due U. S. \$ _____ 100
Am't for cloth'g in kind or money adv'd \$ _____ 100

Due U. S. for arms, equipments, &c., \$ _____ 100

Bounty paid \$ _____ 100 ; due \$ _____ 100

Remarks: *Killed July 6 1865*
accidentally at Indian
ola Texas final statements
*rendered **

* *Roll from*

Book mark: *F. S.*

Hadfield

Stephens, Gen. H.

P., Co. G, 7 Reg't W.C. Inf

Enclosures.

Bed Cards	Final Statements /
Burial Records	Furloughs or L. of A.
Certs. of Dis. for Discharge	Med. Certificates
C. M. Charges	Med. Des. Lists
Descriptive Lists	Orders
Discharge Certificates	Pris. of War Record
Enlistment Papers	Resignations

Other papers relating to—

Admission to Hosp'l	Furlough or L. of A.
Casualty Sheet	Med. Examination
Confinement	Misc. Information
Contracts	Pay or Clothing
Death or Effects	Personal Reports
Desertion	Rank
Discharge from Hosp'l	Transfer to Hosp'l
Discharge from Service	Transfer to V. R. C.
Duty	Transportation

Extract from Act of Congress.

SEC. 12. *And be it further enacted,* That the fees of agents and attorneys for making out and causing to be executed the papers necessary to establish a claim for a pension, bounty, and other allowance before the Pension Office, under this act, shall not exceed the following rates: For making out and causing to be duly executed a declaration by the applicant, with the necessary affidavits, and forwarding the same to the Pension Office, with the requisite correspondence, ten dollars; which sum shall be received by such agent or attorney in full for all services in obtaining such pension, and shall not be demanded or received, in whole or in part, until such pension shall be obtained; and the sixth and seventh sections of an act entitled "An act to grant pensions," approved July [fourteenth,] eighteen hundred and sixty-two, are hereby repealed.

SEC. 13. *And be it further enacted,* That any agent or attorney who shall, directly or indirectly, demand or receive any greater compensation for his services under this act than is prescribed in the preceding section of this act, or who shall contract or agree to prosecute any claim for a pension, bounty, or other allowance under this act, on the condition that he shall receive a per centum upon any portion of the amount of such claim, or who shall wrongfully withhold from a pensioner or other claimant the whole or any part of the pension or claim allowed and due to such pensioner or claimant, shall be deemed guilty of a high misdemeanor, and, upon conviction thereof, shall, for every such offense, be fined not exceeding three hundred dollars, or imprisoned at hard labor not exceeding two years, or both, according to the circumstances and aggravations of the offense.

Approved July 4, 1864.

NOTE 10.—If any soldier is charged a higher fee than that allowed by the above act, he should report the fact and the name of the agent to the Adjutant General, in order that steps may be taken to have the same refunded.

ADJUTANT GENERAL'S OFFICE.

For 17 1865

Duplicate with Inventory sent 2d Auditor.

✓ *109*
FINAL STATEMENT

OF

George H. Stephens

7 Reg't of U.S. Col. Troops

VOLUNTEERS.

Alms July 6 1865

NOTE 1.—Two of these certificates (or duplicates) are to be given to each Volunteer Soldier or drafted man who may be discharged without being mustered out, (Final Statements are never given to men mustered out of service,) that he may at once receive from the Paymaster the pay, &c., due him, and the captain or other COMMISSIONED officer commanding the company will certify to the act of the delivery of the duplicate certificates; with these certificates the Soldier is "entitled to" his discharge, and should also present his discharge to the Paymaster to have the payment endorsed on it. The discharge is to be given back to the Soldier by the Paymaster; the latter only retaining as his vouchers the duplicate certificates.

NOTE 2.—If the Soldier is entitled to pay for the use of his horse, the Company Commander will certify to that fact on the back of both these final statements, and also to the time he has pay due for having been so mounted on his own horse.

NOTE 3.—When a Soldier is furnished with final statements, his descriptive list, if he has one, should be taken up by the officer who gives the Soldier these statements, and endorsed with a statement to this effect by the officer. The endorsement should exhibit a full statement of the time for which the Soldier was allowed pay on his final statements, the clothing account, and all other charges against him or in his favor, so as to comprise a complete exhibit of his account. It will then be transmitted to the Company Commander of the Soldier, who will enter all the data necessary to a full understanding of the Soldier's account on the muster roll upon which the Soldier's discharge is reported. The descriptive list will then be destroyed. The object of this is, that the remaining portion of the Soldier's account may be settled upon the receipt of these muster rolls, and the Soldier receive any pay or allowances that may be due him at the time of his discharge, and which may not appear on his last final statements from the fact that his descriptive list is incomplete. These accounts for back pay, &c., are settled by the 2d Auditor of the Treasury Department.

NOTE 4.—Charges for loss or injury to ordnance, horse equipments, and other miscellaneous charges, should appear under the heading of "Other Stoppages."

NOTE 5.—Bounty paid by State authorities, and not by the United States, will not be entered on this statement.

NOTE 6.—Amounts due the Sutler and Laundress must be entered on the muster roll on which the discharge, death, desertion, &c., is reported, as well as on the final statement, otherwise the amount cannot be collected from the United States.

NOTE 7.—This blank will be used for deceased volunteers and drafted men, as well as for others.

NOTE 8.—Where a Soldier dies in Hospital or on detached service, his descriptive list, if he has one, should be sent with his final statements, in duplicate, to the Adjutant General, Washington, D. C.

NOTE 9.—If the soldier is a drafted man or substitute, the space for those, &c., of enrolled, should contain only the word *drafted* or *substitute*, as the case may be. If the Soldier is a "VETERAN," (or RECRUIT,) the words *as a veteran*, (or *recruit*,) as the case may be, should be interlined after the words *mustered into the service of the U. S.* A statement of all the installments of *Veteran* or *Recruit* Bounty RECEIVED by the Soldier must be made on the back of each final statement.

C. W. Stephens
Nov 17 1865
of Co 7th

NOV 1864

I certify, on honor, that George H Stephens, Private of
 Captain Wm V Smith's Company (5) of the 7 Regiment of W S Col, 2nd
VOLUNTEERS, of the State of Maryland, born in Kent Co, State
 of Maryland, aged 22 years; 5 feet 4 1/2 inches high; Gruff complexion,
Black eyes, Curlly hair, and by occupation a Farmer, who joined for service
 and was enrolled (see Note 9) on the 16th day of Jan, 1864, at Chas Co Ind
 by Genl Wm Birney, for the period of 3 years, and mustered into
 the service of the United States on the 10th day of January, 1864, at
Carls Co Ind, by Genl Wm Birney; and having served
HONESTLY and **FAITHFULLY** with his Company to the present date, is now entitled to a
DISCHARGE by reason of Accidentally Killed at
Indianola Texas, July 6th 1865

The said George H Stephens was last paid by Paymaster
Maj' M Smith, to include the 31st day of December, 1864, and
 has pay due him from that time to the present date; he is entitled to pay and subsistence for
TRAVELING to place of enrollment, and whatever other allowances are authorized to volunteer
 soldiers, drafted men, or militia, so discharged. He has received from the United States **CLOTHING**
 amounting to 5 68 ¹⁰⁰ dollars, since the 15 day of Nov,
 1864, when his clothing account was last settled. He has received from the United States
100 dollars advanced **BOUNTY**.

There is to be stopped from him, on account of the State of _____, or other
 authorities, for **CLOTHING**, &c., received on entering service, _____ ¹⁰⁰ dollars; and
 for other stoppages, viz: _____

_____ ¹⁰⁰ dollars.
 He has been furnished with **TRANSPORTATION** in kind from the place of his discharge to
 _____; and he has been **SUBSISTED** for **TRAVELING** to his
 place of enrollment, up to the _____, 186 .

He is indebted to _____, **SUTLER**, _____ ¹⁰⁰ dollars.
 He is indebted to _____, **LAUNDRESS**, _____ ¹⁰⁰ dollars.

Given in Duplicate, at Matagorda Texas, this 25th day
 of October, 1865.

A. F. Long
1st Lieut Co. 87th U.S.C.S.
 Commanding Company.

1275

Stephens Thomas
Co I, 7 U.S. Col'd Inf.

Private | Private

CARD NUMBERS.

1	6278771	26
2	6279020	27
3	6289889	28
4	6289988	29
5	6290086	30
6	6290183	31
7	6290275	32
8	6290386	33
9	6290871	34
10	6279428	35
11	9066604	36
12	4315572	37
13		38
14		39
15		40
16		41
17		42
18		43
19		44
20		45
21		46
22		47
23		48
24		49
25		50

Book Mark:

See also

S. 2293807. P.O. M & W,
N. C. Com. Phil Pa 5/22/25

S

7

U.S.C.T.

Thomas Stevens

Co. 2, 7 Reg't U. S. Col'd Inf.

Appears on

Company Descriptive Book

of the organization named above.

DESCRIPTION.

Age 22 years; height 5 feet 4 1/2 inches.

Complexion *Rex*

Eyes *Rex*; hair *Curly*

Where born *Wilmington, Del.*

Occupation *Laborer*

ENLISTMENT.

When *Sept 29*, 1864

Where *Wilmington*

By whom *Capt. Palmer*; term *1* y'rs

Remarks: *Substitute for Henry Stevens Wilmington, Del. Mustered into service at Ft. Monroe, Va. by order Sec of War May 26 1865.*

J. D. Brown

S | *7* | **U.S.C.T.**

Thomas Stevens

....., Co., *7* Reg't U. S. Col'd Infantry.

Age *22* years.

Appears on a

Detachment Muster-in Roll

of the organization named above. Roll dated

Baltimore, Md., Sept. 27, 1864.

Muster-in to date *Sept. 27, 1864.*

Joined for duty and enrolled:

When *Sept. 29, 1864.*

Where *Wilmington, Del.*

Period *1* years.

Remarks: *Substitute*

Book mark:

Beck
Copyst.

7 | 7 | U.S.C.T.

Thomas Stephens

Appears with rank of _____ on
**Muster and Descriptive Roll of a Detach-
ment of Drafted Men and Substitutes
forwarded**

for the 7 Reg't U. S. Col'd Inf. Roll dated
Baltimore, Md., Sept 27, 1864.

Where born *Del.*

Age 22 years; occupation *Labourer*

Drafted and mustered in:

When *Sept 29*, 1864

Where *Wil. Del.*

Period 7 years.

Eyes *Blk*; hair *Blk*

Complexion *Blk*; height 5 ft. 4 in.

Paid bounty and advance pay, \$ 100

Bounty due \$ 100

Where credited _____

Company to which assigned _____

Remarks: *Substitute for Henry
Stephens. Wil. Del.*

Book mark: _____

(340)

J. M. Fairly
Clerk

S | **7** | **U.S.C.T.**

Thomas Stevens

Private, Co. F, 7 Reg't U. S. Col'd Infantry.

Appears on

Company Muster Roll

for *Sept and Oct*, 1864.

Joined for duty and enrolled:

When *Sept 29*, 1864.*

Where *Arlington D.C.**

Period *1* years.*

Present or absent *Present*

Stoppage, \$ *100* for

Due Gov't \$ *100* for

Remarks: *Joined a recruit Oct. 21st 64.*

* See enrollment on card from muster-in roll.

Book mark:

Keifer

S | I | uscs

Thomas Stephens

Appears with rank of _____ on

Muster and Descriptive Roll

of Detachment of US Substitutes
& Drafted men forwarded to

Col S. M. Bowman . Roll dated
Camp Bradford, Oct 2, 1864.

Where born Delaware

Age 22 years; occupation Laborer

When enlisted Sept 29, 186 .

Where enlisted Wilmington

For what period enlisted 1 years.

Eyes Blk ; hair Blk

Complexion Blk ; height 5 ft. 4 1/2 in.

When mustered in Sept 24, 186 .

Where mustered in _____

Bounty paid \$ 100; due \$ 100

Clothing account:

Last settled _____, 186 ; drawn since \$ 1836 / 100

Date of first muster _____, 186 .

Company to which assigned _____

Remarks: Sub. for Henry Stephens
Wilmington Del.

Book mark : _____

J. W. McLean

S | 7 | U.S.C.T.

Thomas Stevens

Private, Co. F, 7 Reg't U. S. Col'd Infantry.

Appears on

Company Muster Roll

for *Nov. 3rd Dec.*, 1864.

Joined for duty and enrolled:

When *Sept. 29*, 1864.*

Where *Wilmington Del.* *

Period *1* years.*

Present or absent *Present*

Stoppage, \$ *100* for

Due Gov't \$ *100* for

Remarks: *Joined a Recruit
Oct. 21, 64.*

* See enrollment on card from muster-in roll.

Book mark:

(358c)

Keefe

Copyist.

S 1

7

U.S.C.T.

Thomas Stevens

Private, Co. F, 7 Reg't U. S. Col'd Infantry.

Appears on

Company Muster Roll

for *Jan. & Feb.*, 1865.

Joined for duty and enrolled:

When *Sep 29*, 1863.*

Where *Washington D.C.* *

Period *7* years.*

Present or absent *Present*

Stoppage, \$ *100* for

Due Gov't \$ *100* for

Remarks:

* See enrollment on card from muster-in roll.

Book mark: -----

(358c)

Keefe

Copyist.

S

7

U.S.C.T.

Thomas Stevens

Private, Co. F, 7 Reg't U. S. Col'd Infantry.

Appears on

Company Muster Roll

for Mar. & Apr., 1865.

Joined for duty and enrolled:

When Sep. 29, 1864.*

Where Wilmington, Del. *

Period 1 years.*

Present or absent Present.

Stoppage, \$ 100 for

Due Gov't \$ 100 for

Remarks:

* See enrollment on card from muster-in roll.

Book mark:

Keefe

(358c)

Copyist.

A | **7** | **U.S.C.T.**

Thomas Stevens

Private, Co. F, 7 Reg't U. S. Col'd Infantry.

Appears on

Company Muster Roll

for *May and June*, 1865.

Joined for duty and enrolled:

When *Sep. 29*, 1864.*

Where *Wilmington Del.* *

Period *1* years.*

Present or absent *Absent*

Stoppage, \$ *100* for

Due Gov't \$ *100* for

Remarks: *Absent sick since May 11, 65. To be stopped for 1 canteen and paper.*

* See enrollment on card from muster-in roll.

Book mark:

Keeper

S | **7** | **U.S.C.T.**

Thomas Stevens

Private, Co. F, 7 Reg't U. S. Col'd Infantry.

Appears on

Company Muster Roll

for *July and Aug*, 1865.

Joined for duty and enrolled:

When *Sep. 29*, 1864.*

Where *Wilmington Del.* *

Period *1* years.*

Present or absent

Stoppage, \$ *100* for

Due Gov't \$ *100* for

Remarks: *Discharged from
U.S. Gen. Hosp. Fortress
Monroe, Va. May 26, 65 by
order Secy of War.*

* See enrollment on card from muster-in roll.

Book mark:

(858c)

Keefe

Copyist.

NARRATIVE

S | 7 | U.S.C.T.

Thomas Stevens
Privt, Co. F, 7 Reg't U. S. Col'd Inf

Appears on an

Individual Muster-out Roll

of the organization named above. Roll dated
Fort Monroe Va May 26, 1865-

Muster-out to date *May 26, 1865-*

Last paid to *Dec 31, 1864.*

Clothing account:

Last settled *Sept 29, 1864*; drawn since \$..... 100

Due soldier \$..... 100; due U. S. \$..... 100

Am't for cloth'g in kind or money adv'd \$ *45.88* / 100

Due U. S. for arms, equipments, &c., \$..... 100

Bounty paid \$..... 100; due \$..... 100

Remarks: *Mustered out
by order of War
Department dated
May 3rd 1865
Patient in U. S.
Gen. Hosp't Fortress*

Book mark: *(over)*

(348) *E H Sepcombe*
Copyist.

JAN. 20

6279428

1891

Monroe Va.

S. | 7 | U.S.C.T.

Thomas Stephens
Co. F., 7 Reg't U. S. Col'd Infantry.

Appears on Co. Muster-out Roll, dated
Indiana, Ind., Oct. 13, 1866 .

Muster-out to date, 186 .

Last paid to, 186 .

Clothing account:

Last settled, 186 ; drawn since \$ 100

Due soldier \$ 100 ; due U. S. \$ 100

Am't for cloth'g in kind or money adv'd \$ 100

Due U. S. for arms, equipments, &c., \$ 100

Bounty paid \$ 100 ; due \$ 100

Remarks: Discharged by
order of Sec. of War at
Pt. Monroe Va.
May 26 - '65.

Book mark 3675-90-M. O. on file.

Brooks.

Stevens, Thomas
 , Co. , 7 Reg't U.S.C.I.

2 Enclosures.

Bed Cards	Final Statements
Burial Records	Furloughs or L. of A.
Certa. of Dis. for Discharge	Med. Certificates
C. M. Charges	Med. Des. Lists
Descriptive Lists	Orders
Discharge Certificates	Pris. of War Record
Enlistment Papers 2	Resignations

Other papers relating to—

Admission to Hosp'l	Furlough or L. of A.
Casualty Sheet	Med. Examination
Confinement	Misc. Information
Contracts	Pay or Clothing
Death or Effects	Personal Reports
Desertion	Rank
Discharge from Hosp'l	Transfer to Hosp'l
Discharge from Service	Transfer to V. R. C.
Duty	Transportation

DECLARATION OF SUBSTITUTE.

I, Thomas Stevens (Col) desiring to ENLIST in the Army of the United States, for ~~THREE YEARS~~ ^{one}, Do declare, That I am twenty two years and _____ months of age; that I have never been discharged from the United States service on account of disability or by sentence of a court martial; and I know of no impediment to my serving honestly and faithfully as a soldier for ~~three~~ ^{one} year.

GIVEN at Wilmington the 24th day of Sept. 1864

WITNESS:

L. E. Mahes Thomas Stevens
Wm

21-9/64
No. 49

Thomas Stevens (Col)
Enlisted at Wilmington

As Substitute for
Henry Stevens (Col)

On the 24th day of Sept., 1864

By

Edmund Wickham
J. C. Walker
H. J. Fisher

Board of Enrollment,
Dir. of Wet

SUBSTITUTE VOLUNTEER ENLISTMENT.

STATE OF

TOWN OF

Delaware



Wilmington

I, Thomas Stevens (Col) born in the State of Delaware, aged twenty-two years, and by occupation a labourer

Do HEREBY ACKNOWLEDGE to have agreed with Henry Stevens (Col) Esq., of West Duck Creek Ad Kent County Delaware

to become his SUBSTITUTE in the Military Service, for a sufficient consideration paid and delivered to me, on the twenty-fourth day of Sept, 1864, and having thus agreed with said Henry Stevens, I DO HEREBY ACKNOWLEDGE to have enlisted this twenty-fourth day of Sept, 1864, to serve as a Soldier in the Army of the United States of America, for the period

of ~~THREE YEARS~~

unless sooner discharged by proper authority: I do also agree to accept such bounty, pay, rations, and clothing, as are, or may be, established by law for soldiers. And I do solemnly swear that I will bear true and faithful allegiance to the United States of America; that I will serve them honestly and faithfully against all their enemies or opposers whomsoever; and that I will observe and obey the orders of the President of the United States, and the orders of the Officers appointed over me, according to the Rules and Articles of War.

SWORN and subscribed to, at Wilmington

this 24th day of Sept, 1864

BEFORE

Thomas Stevens

[Signature]

We certify, on honor, That we have carefully examined the above-named Volunteer Substitute agreeably to the Regulations, and that, in our opinion, he is free from all bodily defects and mental infirmity which would in any way disqualify him from performing the duties of a soldier; that he was entirely sober when enlisted; that he is of lawful age, (not under 18 years;) and that, in accepting him as duly qualified to perform the duties of an able-bodied soldier, and as a Substitute in lieu of Henry Stevens (Col) Co. Del. Sept 19, 1864, we have strictly observed the Regulations which govern in such cases. This soldier has blue eyes, black hair, fair complexion, is 5 feet 4 1/2 inches high.

[Signature]

Provost Marshal

[Signature]

Commissioner of Board

[Signature]

Surgeon of Board

Board of Enrollment of Army Dist. of Delaware

DECLARATION OF SUBSTITUTE.

I, Thomas Stevens (sub) desiring to ENLIST in the Army of the United States, for ~~THREE~~ ^{one} YEARS, Do declare, That I am 22 years and _____ months of age; that I have never been discharged from the United States service on account of disability or by sentence of a court martial; and I know of no impediment to my serving honestly and faithfully as a soldier for ~~three~~ ^{one} years.

GIVEN at Wilmington Del the 24 day of September 1864

WITNESS:

R. E. Mules Thomas Stevens
his mark

9/64

No. _____

Thomas Stevens (sub)

Enlisted at Wilmington

As Substitute for

Henry Stone

On the 24 day of Sept, 1864

By

John Wilson

W. C. Blake

W. G. Fisher

Board of Enrollment.

Disc. of Del.

SUBSTITUTE
VOLUNTEER ENLISTMENT.

STATE OF

TOWN OF



Delaware
I, Thomas Stevens (son) born in the State
of Delaware, aged twenty two years, and by
occupation a laborer

DO HEREBY ACKNOWLEDGE to have agreed with
Henry Stevens (son), Esq., of West Duke
Creek Hundred, Kent County, Delaware
to become his **SUBSTITUTE** in the Military Service, for a sufficient consideration paid and
delivered to me, on the twenty fourth day of September, 1864,
and having thus agreed with said Henry Stevens I DO HEREBY
ACKNOWLEDGE to have enlisted this twenty fourth day of September
1864, to serve as a **Soldier** in the **Army of the United States of America**, for the period
~~of THREE YEARS~~, unless sooner discharged by proper authority: I do also agree to accept such
bounty, pay, rations, and clothing, as are, or may be, established by law for soldiers. And I do
solemnly swear that I will bear true and faithful allegiance to the **United States of America**;
that I will serve them honestly and faithfully against all their enemies or opposers whomsoever:
and that I will observe and obey the orders of the President of the United States, and the orders
of the Officers appointed over me, according to the Rules and Articles of War.

four

SWORN and subscribed to, at Wilmington

this 24 day of Sept 1864

BEFORE

[Signature]
[Signature]
[Signature]

Thomas Stevens
[Signature]

We certify, on honor, That we have carefully examined the above-named Volunteer Substitute
agreeably to the Regulations, and that, in our opinion, he is free from all bodily defects and mental infirmity
which would in any way disqualify him from performing the duties of a soldier; that he was entirely sober
when enlisted; that he is of lawful age, (not under 18 years;) and that, in accepting him as duly qualified to
perform the duties of an able-bodied soldier, and as a Substitute in lieu of Henry Stevens

Co. Del. Sep 19, 1864, we have strictly observed the Regulations which govern
in such cases. This soldier has blue eyes, black hair, black complexion; is 5 feet 4 1/2
inches high.

[Signature]
Provost Marshal.

[Signature]
Commissioner of Board.

[Signature]
Surgeon of Board.

Board of Enrollment of Eng. Dist. of Delaware

1276

Stephens Thomas

Co I, 7 U.S. Col'd Inf.

Private | *Private*

CARD NUMBERS.

1	6294277	26
2	6294395	27
3	6294474	28
4	6294574	29
5	6294668	30
6	6294760	31
7	6294849	32
8	6294942	33
9	6295045	34
10	6295145	35
11	6295244	36
12	6295342	37
13	6295434	38
14	6295513	39
15	6295601	40
16	6295674	41
17	6295744	42
18	6295818	43
19	6295889	44
20	9066971	45
21		46
22		47
23		48
24		49
25		50

Book Mark:

See also

S. 1

7

U.S.C.T.

Thomas Stephens

Co. G, 7 Reg't U. S. Col'd Inf.

Appears on

Company Descriptive Book

of the organization named above.

DESCRIPTION.

Age 22 years; height 5 feet 5 1/4 inches.

Complexion *Blk.*

Eyes *Blk.*; hair *Blk.*

Where born *Somerset, Md.*

Occupation *Farmer.*

ENLISTMENT.

When *Oct. 30.*, 1863.

Where *Forester.*

By whom *Ch. Wm. Birney*; term *3* y'rs.

Remarks: *Enlisted in at Camp Stanton, Md. Nov. 5. 63. by Lt. Col. Haskele.*

J. F. White

S | 7 | U.S.C.T.

Thomas Stephens

Pvt., Co. I, 7 Reg't U. S. Col'd Inf.

Age 22 years.

Appears on

Company Muster-in Roll

of the organization, named above. Roll dated

Camp Stanton, Charles Co., Md., Nov. 5, 1863.

Muster-in to date Nov. 5, 1863

Joined for duty and enrolled:

When Oct. 30, 1863

Where Worcester, Md

Period 3 years.

Remarks:

Book mark:

J. B. Gage

Copyist.

S

7

U.S.C.T.

Thomas Stephens

Pvt., Co. I, 7 Reg't U. S. Col'd Infantry.

Appears on

Company Muster Roll

for from Nov. 5 to Dec. 31, 1863.

Present or absent Present

Stoppage, \$ 100 for

Due Gov't, \$ 100 for

Remarks: Enlistment premium \$2.00 due

Book mark:

J. B. Gage

(358)

Copyist.

S | 7 | U.S.C.T.

Thomas Stephens,
Pvt., Co. I, 7 Reg't U. S. Col'd Infantry.

Appears on

Company Muster Roll

for Jan & Feb, 1864.
Present or absent Present

Stoppage, \$ 100 for

Due Gov't, \$ 100 for

Remarks: Enlistment premium
\$2.00 due

Book mark:

J.B. Gage
Copyist.

MAR 10 1874

S | 7 | U.S.C.T.

Thomas Stephens
Pvt., Co. I, 7 Reg't U. S. Col'd Infantry.

Appears on

Company Muster Roll

for *March & April*, 186*4*.

Present or absent *Present*

Stoppage, \$ *100* for

Due Gov't, \$ *100* for

Remarks:

Book mark:

(358)

J. B. Gage
Copyist.

S | 7 | U.S.C.T.

Thomas Stephens

Pvt., Co. I, 7 Reg't U. S. Col'd Infantry.

Appears on

Company Muster Roll

for May & June, 1864.

Present or absent Absent

Stoppage, \$ 100 for

Due Gov't, \$ 100 for

Remarks: Sick at Jacksonville, Fla. since June 28, 1864

Book mark:

J. B. Gage

Copyist.

S 7 U.S.C.T.

Thomas Stephens
Pvt, Co. I, 7 Reg't U. S. Col'd Infantry.

Appears on

Company Muster Roll

for July & Aug, 1864.

Present or absent Absent

Stoppage, \$ 100 for

Due Gov't, \$ 100 for

Remarks: Sick in Hosptl, at
Fort Monroe, Va., since Aug.
11, 1864

Book mark:

(358)

J. B. Gage
Copyist.

S | 7 | U.S.C.T.

Thomas Stephens

Priv., Co. I, 7 Reg't U. S. Col'd Infantry.

Appears on

Company Muster Roll

for Sept & Oct., 1864.

Present or absent Present

Stoppage, \$ 100 for

Due Gov't, \$ 100 for

Remarks:

Book mark:

J.B. Gage

Copyist.

S | 7 | U.S.C.T.

Thomas Stephens

Priv., Co. I, 7 Reg't U. S. Col'd Infantry.

Appears on

Company Muster Roll

for *Nov. & Decr.*, 1864.

Present or absent *Present*

Stoppage, \$ 100 for

Due Gov't, \$ 100 for

Remarks:

Book mark:

D. Maher

S

7

U.S.C.T.

Thomas Stephens

Priv, Co. I, 7 Reg't U. S. Col'd Infantry.

Appears on

Company Muster Roll

for *Jan'y. + Feby.*, 1865.

Present or absent *Present*

Stoppage, \$ 100 for

Due Gov't, \$ 100 for

Remarks:

Book mark:

D. Maher
Copyist.

S

7

U.S.C.T.

Thomas Stephens

Priv, Co. I, 7 Reg't U. S. Col'd Infantry.

Appears on

Company Muster Roll

for *March & April*, 1865.

Present or absent *Present*

Stoppage, \$..... 100 for

Due Gov't, \$..... 100 for

Remarks:.....

Book mark:.....

A. Maher
Copyist.

(358)

S | 7 | U.S.C.T.

Thomas Stephens

Priv, Co. 1, 7 Reg't U. S. Col'd Infantry.

Appears on

Company Muster Roll

for *May & June*, 1865.

Present or absent *Present*

Stoppage, \$ *100* for

Due Gov't, \$ *100* for

Remarks:

Book mark:

D. Maher
Copyist.

MAR 1865

S

7

U.S.C.T.

Thomas Stephens

Priv, Co. I, 7 Reg't U. S. Col'd Infantry.

Appears on

Company Muster Roll

for July + August, 1865.

Present or absent Present

Stoppage, \$ 100 for

Due Gov't, \$ 02/100, for C + G Equipage

4 23¢ " Ordnance &c.

Remarks:

Book mark:

D. Maher

(358)

Copyist.

S

7

U.S.C.T.

Thomas Stephens

Priv., Co. I, 7 Reg't U. S. Col'd Infantry.

Appears on

Company Muster Roll

for *Sept. & Oct.*, 1865.

Present or absent *Present*

Stoppage, \$ *100* for

Due Gov't, \$ *23*/₁₀₀ for *Ordnance, &c.*

" " *5¢* for *C. & G. Equipage*

Remarks:

Book mark:

D. Maher
Copyist.

S

7

U.S.C.T.

Thomas Stephens

Priv., Co. I, 7 Reg't U. S. Col'd Infantry.

Appears on

Company Muster Roll

for Nov. + Decr., 1865.

Present or absent Present

Stoppage, \$ 100 for

Due Gov't, \$ 23/100 for Ordnance, &c.

" " 50 C. & G. Equipage

Remarks:

Book mark:

D. Maher

(358)

Copyist.

8

7

U.S.C.T.

Thomas Stephen

Pr, Co. I, 7 Reg't U. S. Col'd Infantry.

Appears on

Company Muster Roll

for Jan + Feb, 1866

Present or absent Present

Stoppage, \$ 100 for

Due Gov't, \$ 100 for

Remarks:

Book mark:

Sabine

Copyist.

(858)

S

7

U.S.C.T.

Thomas Stephens

Private, Co. I, 7 Reg't U. S. Col'd Infantry.

Appears on

Company Muster Roll

for Mar & Apr, 1866.

Present or absent Present.

Stoppage, \$ 100 for

Due Gov't, \$ 100 for

Remarks:

Book mark:

Sabine

Copyist.

8

7

U.S.C.T.

Thomas Stephens

Private, Co. I, 7 Reg't U. S. Col'd Infantry.

Appears on

Company Muster Roll

for Oct 28 to June 30, 1866.

Present or absent not stated.

Stoppage, \$ 100 for

Due Gov't, \$ 100 for

Remarks:

Book mark:

Sabine

Copyist.

8

7

U.S.C.T.

Thomas Stephens

Private, Co. I, 7 Reg't U. S. Col'd Infantry.

Appears on

Company Muster Roll

for July + Aug, 1866.

Present or absent Present.

Stoppage, \$ 100 for

Due Gov't, \$ 100 for

Remarks:

Book mark:

Satine Copyist.

S

7

U.S.C.T.

Thomas Stephens
Pr., Co. *S*, 7 Reg't U. S. Col'd Infantry.

Appears on **Co. Muster-out Roll**, dated
Indianola, Texas
October 13, 1866.

Muster-out to date *Oct. 13*, 1866.

Last paid to *June 30*, 1866.

Clothing account:

Last settled....., 186 ; drawn since \$..... 100

Due soldier \$ *58*⁷⁰/₁₀₀; due U. S. \$..... 100

Am't for cloth'g in kind or money adv'd \$..... 100

Due U. S. for arms, equipments, &c., \$..... 100

Bounty paid \$..... 100; due \$ *100* 100

Remarks: *Joined co. at ori-*
ginal organization.

Book mark: *V. 68 P. 71, 73.*

Sabine

Stevens, Thomas -

B, Co. I, 7 Reg't USCT

Enclosures.

Bed Cards	Descriptive Lists
Burial Records	Final Statements
Certs. of Dis. for Discharge	Furloughs
C. M. Charges	Med. Des. Lists
Med. Certificates	Orders

Other papers relating to—

Admission to Hosp'l	Furlough
Casualty Sheet (Officer's)	Med. Examination
Confinement	Misc. Information
Contracts	Pay or Clothing
Death or Effects	Personal Reports
Desertions	Rank
Discharge from Hosp'l	Transfer to Hosp'l
Discharge from Service	Transfer to V. R. C.
Duty	Transportation

TREATMENT.

[HERE NOTE IMPORTANT COMPLICATIONS AND ALL OPERATIONS.]

R.
Ung. Hydr. Nitrat. ʒi
Adeps — ʒi Mos
S. apply morning & evening

R. Pills Quinine pro ʒa —
No XX. S. 2 — 3 times a day,

RESULT AND DATE.

Returned to duty
Sept 17th 1864.

Wm M. Keeney a. a. s.

MAR 1864

Hospital Number 3503.

Name Thomas Stevens
Age 24 Nativity Stevens County N. C.
Married or Single Married
Residence Penick Armory Co. N. C.
Post Office address of wife or nearest relative. Malinda Stevens

Rank Priv. Co. I. Regiment 7 U.S. Col.

When admitted August 17, 1864.
From what source Hospital Home No.

Diagnosis: (in surgical cases state explicitly seat and character of wound or injury.)

Cutaneous Eription & Weakness of Breast

Summit House G. H. Philadelphia, Pa.

On what occasion wounded.....
Date.....
Nature of missile or weapon.....

1277

Steward Benjamin

Co *A*, 7 - U.S. Col'd Inf.

Private | Private

CARD NUMBERS.

1	6289207	26
2	6289305	27
3	6289400	28
4	6289502	29
5	6289604	30
6	6289699	31
7	6289795	32
8	6289887	33
9	6289987	34
10	6290078	35
11	6290175	36
12	6290274	37
13	6290361	38
14	6290450	39
15	6290535	40
16	6290614	41
17	6290692	42
18	6290766	43
19	6290839	44
20	9066600	45
21		46
22		47
23		48
24		49
25		50

Book Mark: _____

See also _____

0192802, POMK M

MAR 10 1865

S | 7 | U.S.C.T.

Benjamin Steward
Co. *F*, 7 Reg't U. S. Col'd Inf.

Appears on
Company Descriptive Book
of the organization named above.

DESCRIPTION.

Age *21* years; height *5* feet *4* inches.

Complexion *Rufous*

Eyes *Blue*; hair *Curly*

Where born *Kent, Md.*

Occupation *Farmer*

ENLISTMENT.

When *Sept 27*, 1863.

Where *Baltimore, Md.*

By whom *Col W. Birney*; term *3* y'rs.

Remarks: *Mustered Sept 30,*
1863, by Col W. Birney.

(3830)

J. Brown

Copyst.

S | **7** | **U.S.C.T.**

Benjamin Howard
Pvt. Co. F, 7 Reg't U. S. Colored Inf.

Age *21* years.

Appears on

Company Muster-in Roll

of the organization named above. Roll dated

Baltimore Md Sept 30, 186*3*.

Muster-in to date *Sept 30*, 186*3*.

Joined for duty and enrolled:

When *Sept 24*" , 186*3*.*

Where *Kent Co Md* *

Period *3* years.*

Remarks:
.....
.....
.....
.....
.....

*Master-in roll shows enrollment of all men of this company as of same date. See enrollment on subsequent card or cards.

Book mark :
.....
.....

L. A. Miller
Print.

MAR 1897

A | **7** | **U.S.C.T.**

Benjamin Steward
Plt., Co. F, 7 Reg't U. S. Col'd Infantry.

Appears on

Company Muster Roll
for *Sept. 30 to Oct 31*, 186*3*.

Joined for duty and enrolled:

When *Sept. 27*, 186*3*.*

Where *Kent Co. Md* *

Period *3* years.*

Present or absent *Present*

Stoppage, \$ *100* for _____

Due Gov't \$ *100* for _____

Remarks: _____

* See enrollment on card from muster-in roll.

Book mark: _____

(358c)

John Miller
Copyist.

S

7

U.S.C.T.

Benjamin Steward
Co. F, 7 Reg't U. S. Col'd Infantry.

Appears on

Company Muster Roll

for *Nov. & Dec.*, 186 *3*.

Joined for duty and enrolled:

When *Sept 27*, 186 *3*.*

Where *Kent Co. Md* *

Period *3* years.*

Present or absent *Present*

Stoppage, \$ *100* for

Due Gov't \$ *100* for

Remarks:

* See enrollment on card from muster-in roll.

Book mark: _____

(358c)

J. C. Hill
Copyist.

S | **7** | **U.S.C.T.**

Benjamin Steward
Pat., Co. F, 7 Reg't U. S. Col'd Infantry.

Appears on

Company Muster Roll

for *Jan & Feb.*, 186*4*.

Joined for duty and enrolled:

When *Sept 24.*, 186*3*.*

Where *Kent Co Md* *

Period..... years.*

Present or absent *Present*

Stoppage, \$.....*100* for.....

Due Gov't \$.....*100* for.....

Remarks:
.....
.....
.....
.....
.....

* See enrollment on card from muster-in roll.

Book mark:.....

John Miller
Copyist.

S 7 U.S.C.T.

Benjamin Steward

Pvt., Co. F, 7 Reg't U. S. Col'd Infantry.

Appears on

Company Muster Roll

for *March & April*, 186*4*.

Joined for duty and enrolled:

When *Sept 27*, 186*3*.*

Where *Kent Co. Md* *

Period *3* years.*

Present or absent *Present*

Stoppage, \$ *100* for

Due Gov't \$ *100* for

Remarks:

* ~~45~~ See enrollment on card from muster-in roll.

Book mark: -----

(358c)

Joseph Miller
Copyist.

A 7 U.S.C.T.

Benjamin Howard

Plt, Co. F, 7 Reg't U. S. Col'd Infantry.

Appears on

Company Muster Roll

for *May & June*, 186*4*

Joined for duty and enrolled:

When *Sept 27*, 186*3*.*

Where *Kent. Co. Md* *

Period *3* years.*

Present or absent *Present*

Stoppage, \$ *100* for

Due Gov't \$ *100* for

Remarks: *Stop for one letter figure bugles, scales, & shelter tent.*

* See enrollment on card from muster-in roll.

Book mark:

John Miller
Copyist.

S

7

U.S.C.T.

Benjamin Steward
Pvt, Co. F, 7 Reg't U. S. Col'd Infantry.

Appears on

Company Muster Roll
for July & Aug, 1864.

Joined for duty and enrolled:

When Sept 27, 1864

Where Kent Co. Md *

Period 3 years.*

Present or absent Present

Stoppage, \$ 100 for

Due Gov't \$ 100 for

Remarks: Stopped for
1 better Buyle
Pr. Scales, Figure
1/2 shelter tent
Free on or before
Apr 19/61

* See enrollment on card from muster-in roll.

Book mark:

W. B. H. C.

(358c)

Copyist.

MAR 11 1863

S | **7** | **U.S.C.T.**

Benjamin Steward
Private, Co. F, 7 Reg't U. S. Col'd Infantry.

Appears on

Company Muster Roll

for *Sept. and Oct.*, 186*3*.

Joined for duty and enrolled:

When *Sept. 27*, 186*3*.*

Where *Kent Co., Md.* *

Period *2* years.*

Present or absent *Present.*

Stoppage, \$ *100* for

Due Gov't \$ *100* for

Remarks:

* See enrollment on card from muster-in roll.

Book mark: -----

Keefe
Copyist.

S | **7** | **U.S.C.T.**

Benjamin Steward
Private, Co. F, 7 Reg't U. S. Col'd Infantry.

Appears on

Company Muster Roll

for *Nov^{2nd} Dec.*, 186*4*.

Joined for duty and enrolled:

When *Sept. 27*, 186*3*.*

Where *Kent Co., Md* *

Period *3* years.*

Present or absent *Present*

Stoppage, \$ *100* for

Due Gov't \$ *100* for

Remarks:

* ~~See~~ See enrollment on card from muster-in roll.

Book mark: -----

(358c)

Keeper

Copyist.

S | **7** | **U.S.C.T.**

Benjamin Steward
Private, Co. F, 7 Reg't U. S. Col'd Infantry.

Appears on

Company Muster Roll

for *Jan. 5 Feb.*, 186*5*.

Joined for duty and enrolled:

When *Sep. 27*, 186*3*.*

Where *Kent Co., Md* *

Period *3* years.*

Present or absent *Present*

Stoppage, \$ *100* for

Due Gov't \$ *100* for

Remarks:

* See enrollment on card from muster-in roll.

Book mark: _____

(358c)

Keefe

Copyist.

S | **7** | **U.S.C.T.**

Benjamin Steward

Private, Co. F, 7 Reg't U. S. Col'd Infantry.

Appears on

Company Muster Roll

for *Mar. & Apr.*, 1865.

Joined for duty and enrolled:

When *Sep. 27*, 1863.*

Where *Kent Co., Md.**

Period *2* years.*

Present or absent *Present*.

Stoppage, \$ *100* for

Due Gov't \$ *100* for

Remarks:

* ~~See~~ See enrollment on card from muster-in roll.

Book mark: -----

(358c)

Keefer

Copyist.

S

7

U.S.C.T.

Benjamin Steward

Private, Co. F, 7 Reg't U. S. Col'd Infantry.

Appears on

Company Muster Roll

for *May and June*, 1865.

Joined for duty and enrolled:

When *Sept. 27*, 1863.*

Where *Kent*.*

Period *2* years.*

Present or absent *Present*

Stoppage, \$ *100* for

Due Gov't \$ *100* for

Remarks: *To be stopped for 1
Shelter Tent Piece and
1 Wiper.*

* See enrollment on card from muster-in roll.

Book mark:

Keefe

S | **7** | **U.S.C.T.**

Benjamin Stewards

Private, Co. F, 7 Reg't U. S. Col'd Infantry.

Appears on

Company Muster Roll

for *July and Aug.*, 1865.

Joined for duty and enrolled:

When *Sep. 27*, 1865.*

Where *Kent Co., Md* *

Period *3* years.*

Present or absent *Present*

Stoppage, \$ *100* for

Due Gov't \$ *100* for

Remarks:

* See enrollment on card from muster-in roll.

Book mark: -----

(358c)

Keefe
Copyist.

S 7 | **U.S.C.T.**

Benjamin Steward
Priv., Co. F, 7 Reg't U. S. Col'd Infy

Appears on

Company Muster Roll

for Sept. & Oct. 1868.

Joined for duty and enrolled:

When Sept. 27, 1868.*

Where Kent Co., Md. *

Period 3 years.*

Present or absent Present

Stoppage, \$ 100 for

Due Gov't, \$ 100 for

Valuation of horse, \$ 100

Valuation of horse equipments, \$ 100

Remarks: _____

*~~See~~ See enrollment on card from muster-in roll.

Book-mark: _____

(35c) Keefe Copyist.

S. | 7 | U.S.C.T.

Benjamin Steward
Prvt., Co. F, 7 Reg't U. S. Col'd Infantry.

Appears on

Company Muster Roll

for *Nov. & Dec.*, 1865.

Joined for duty and enrolled:

When *Sept. 27*, 1863.*

Where *Kent, Md.* *

Period *3* years.*

Present or absent *Present*

Stoppage, \$ *100* for

Due Gov't \$ *100* for

Remarks:

* See enrollment on card from muster-in roll.

Book mark: -----

(858c)

Brooks

Copyist.

S. 1 7 U.S.C.T.

Benjamin Steward
Priv., Co. F, 7 Reg't U. S. Col'd Infantry.

Appears on

Company Muster Roll

for Jan. + Feb., 1866.

Joined for duty and enrolled:

When Sept. 27, 1863.*

Where Kent Co, Ind.*

Period 3 years.*

Present or absent Present.

Stoppage, \$ 100 for _____

Due Gov't \$ 100 for _____

Remarks: _____

* See enrollment on card from muster-in roll.

Book mark: _____

Brooks

81

7

U.S.C.T.

Benjamin Steward
Pvt., Co. F, 7 Reg't U. S. Col'd Infantry.

Appears on

Company Muster Roll

for Mar. & April, 1866.

Joined for duty and enrolled:

When Sept. 27, 1863.*

Where Kent, Md.*

Period 3 years.*

Present or absent Present

Stoppage, \$ 100 for

Due Gov't \$ 100 for

Remarks:

* See enrollment on card from muster-in roll.

Book mark:

(858c)

Brooker

Copyist.

S. 1 7 U.S.C.T.

Benjamin Steward
Pvt., Co. F, 7 Reg't U. S. Col'd Infantry.

Appears on

Company Muster Roll

for May + June, 1866.

Joined for duty and enrolled:

When Sept. 27, 1863.*

Where Kent, Md. *

Period 3 years.*

Present or absent Present,

Stoppage, \$ 100 for

Due Gov't \$ 100 for

Remarks:

NEXT ROLL ON FILE MUSTER OUT.

* See enrollment on card from muster-in roll.

Book mark:

(858c)

Brooks

Copyist.

S | 7 | U.S.C.T.

Benjamin Steward
Priv., Co. F., 7 Reg't U. S. Col'd Infantry.

Appears on **Co. Muster-out Roll**, dated
Indiana, Texas, Oct 13, 1866 .

Muster-out to date Oct. 13, 1866 .

Last paid to June 30, 1866 .

Clothing account:

Last settled....., 186 ; drawn since \$.....¹⁰⁰

Due soldier \$ 1 0⁹²/₁₀₀; due U. S. \$.....¹⁰⁰

Am't for cloth'g in kind or money adv'd \$.....¹⁰⁰

Due U. S. for arms, equipments, &c., \$.....¹⁰⁰

Bounty paid \$.....¹⁰⁰; due \$ 1 00¹⁰⁰

Remarks: Joined Co. at
original
organization

Book mark: 333625

Brooks
Copyist.

1278

Steward David

Co G, 7 U.S. Col'd Inf.

Private

Private

CARD NUMBERS.

1	6290988	26
2	6291085	27
3	6291187	28
4	6291291	29
5	6291389	30
6	6291487	31
7	6291584	32
8	6291700	33
9	6291804	34
10	6291876	35
11	6291945	36
12	6292013	37
13	6292074	38
14	6292137	39
15	6292187	40
16	6292245	41
17	6292291	42
18	6292339	43
19	9066711	44
20		45
21		46
22		47
23		48
24		49
25		50

Book Mark:

See also

R+Q 394293

MAR 11 1867

S 1 2 U.S.C.T.

David Steward
Co. G, 2 Reg't U.S. Col'd Inf

Appears on
Company Descriptive Book
of the organization named above.

DESCRIPTION.

Age 24 years; height 5 feet 4 1/2 inches.
Complexion Mulatto
Eyes Black; hair curly
Where born Somerset, Md.
Occupation Waiter

ENLISTMENT.

When Nov 1, 186 .
Where Worcester
By whom Col. H. Burns; term 3 y'rs.

Remarks: Mustered into Service Nov 5 '63 by Col. Wm. Burns at Benedict, Md. Severely wounded in the charge on Ft. Gilmer Va. Sept 29 '64.

* As it is on book

(383g)

J. J. Brown
Copyist.

S | 7 | U.S.C.T.

David Steward

Priv., Co. G, 7 Reg't U. S. Col'd Inf.

Age 24 years.

Appears on

Company Muster-in Roll

of the organization named above. Roll dated

Camp Stanton, Charles Co, Md. Nov. 5, 1863.

Muster-in to date Nov. 5, 1863.

Joined for duty and enrolled:

When Nov. 1, 1863.

Where Worcester, Md.

Period 3 years.

Remarks:

Book mark: P.VII P120 '69.

Sandoz
Cpyist.

S

7

U.S.C.T.

David Stewart

Priv., Co. G, 7 Reg't U. S. Col'd Infantry.

Appears on

Company Muster Roll

for Nov. 5 to Dec. 31, 1863.

Present or absent Present

Stoppage, \$ 100 for

Due Gov't, \$ 100 for

Remarks: Premium for enlistment \$2.00 (due).

Book mark:

Sandoz
Copyist

(858)

S . 7 U.S.C.T.

David Stewart
Priv., Co. G, 7 Reg't U. S. Col'd Infantry.

Appears on

Company Muster Roll

for Jan. & Feby, 1864.

Present or absent Present

Stoppage, \$ 100 for

Due Gov't, \$ 100 for

Remarks:

Book mark:

(858)

Sandoz
Copyist

S

7

U.S.C.T.

David Steward

Priv., Co. G, 7 Reg't U. S. Col'd Infantry.

Appears on

Company Muster Roll

for Mch & Apr., 1864.

Present or absent Present

Stoppage, \$ 100 for

Due Gov't, \$ 100 for

Remarks:

Book mark: [illegible]

Sandoz

Copyst

(858)

S

7

U.S.C.T.

David Steward

Priv., Co. G, 7 Reg't U. S. Col'd Infantry.

Appears on

Company Muster Roll

for May & June, 1864.

Present or absent Present

Stoppage, \$ 100 for

Due Gov't, \$ 100 for

Remarks:

Book mark:

Sandoz
Copyist

(858)

S

7

U.S.C.T.

David Stewart

Priv., Co. G, 7 Reg't U. S. Col'd Infantry.

Appears on

Company Muster Roll

for July & Aug., 1864.

Present or absent Present

Stoppage, \$ 100 for

Due Gov't, \$ 100 for

Remarks:

Book mark:

53798

Sandoz

Copyist

(858)

S

7

U.S.C.T.

David Steward

Priv., Co. G, 7 Reg't U. S. Col'd Infantry.

Appears on

Company Muster Roll

for *Sept & Oct.*, 186*4*.

Present or absent *Absent*.

Stoppage, \$ *100* for

Due Gov't, \$ *100* for

Remarks: *Missing in ac-
tion Sept. 29", 1864.*

Book mark:

Sandoz
Copyist

(858)

S | **7** | **U.S.C.T.**

David Steward

Pat., Co. G, 7 Reg't U. S. Col'd Infantry.

Appears on

Company Muster Roll

for *Nov. & Dec.*, 1864.

Present or absent

Stoppage, \$ 100 for

Due Gov't, \$ 100 for

Remarks:

*Missing in action
Sept. 29, 64 & omitted
to be dropped.*

*Roll for Mar & Apr 65-
next on which name
appears*

Book mark:

J. W. Lewis
(858) Copyist

J | 7 | U.S.C.T.

David Steward

PA, Co. G, 7 Reg't U. S. Col'd Infantry.

Appears on

Company Muster Roll

for *Web & Camp*, 186 *5*

Present or absent *Present*

Stoppage, \$ *100* for

Due Gov't, \$ *100* for

Remarks:

Gained from missing in action

Book mark:

(858)

J. W. Ames

Copyist

S 7 U.S.C.T.

David Steward

Pvt., Co. G, 7 Reg't U. S. Col'd Infantry.

Appears on

Company Muster Roll

for May & June, 1865.

Present or absent Absent

Stoppage, \$ 100 for

Due Gov't, \$ 100 for

Remarks:

Absent sick since
May 9/65

Book mark:

J. W. [Signature]

(858)

Copyist

S

7

U.S.C.T.

David Steward

Pvt., Co. G, 7 Reg't U. S. Col'd Infantry.

Appears on

Company Muster Roll

for *July & Aug*, 1865.

Present or absent *Absent*

Stoppage, \$ 100 for

Due Gov't, \$ 100 for

Remarks:

Absent sick since May 2/65

Book mark:

J. W. Jones

(858)

Copyst

7 U.S.C.T.

David Stewart

Pt, Co. G, 7 Reg't U. S. Col'd Infantry.

Appears on

Company Muster Roll

for Sept. + Oct., 1865

Present or absent Present

Stoppage, \$ 100 for

Due Gov't, \$ 100 for

Remarks:

Book mark:

J. W. Jones

(858)

Copyist

S

7

U.S.C.T.

David Steward

Pvt., Co. G, 7 Reg't U. S. Col'd Infantry.

Appears on

Company Muster Roll

for Nov. + Dec., 1865.

Present or absent Present

Stoppage, \$ 100 for

Due Gov't, \$ 100 for

Remarks:

Book mark:

J. W. Ames

(858)

Copyist

S

7

U.S.C.T.

David Steward

Pot, Co. G, 7 Reg't U. S. Col'd Infantry.

Appears on

Company Muster Roll

for Jan & Feb, 1866

Present or absent Present

Stoppage, \$ 100 for

Due Gov't, \$ 100 for

Remarks: Stop for Havers
sack & canteen

Book mark:

Headfield

(858)

Copyist

S

7

U.S.C.T.

David Steward

Pvt, Co. G, 7 Reg't U. S. Col'd Infantry.

Appears on

Company Muster Roll

for *Mar & Apr*, 186*6*.

Present or absent *Present*

Stoppage, \$ *100* for

Due Gov't, \$ *100* for

Remarks:

Book mark:

Hadfield

(858)

Copyist

MAR 11 1866

A | 7 | U.S.C.T.

David Steward

Pvt., Co. G, 7 Reg't U. S. Col'd Infantry.

Appears on

Company Muster Roll

for May & June, 1866.

Present or absent Present

Stoppage, \$ 100 for

Due Gov't, \$ 100 for

Remarks:

Book mark:

Hadfield

(858)

Copyist

A | 7 | U.S.C.T.

David Steward

Pvt., Co. G, 7 Reg't U. S. Col'd Infantry.

Appears on

Company Muster Roll

for July & Aug, 1866.

Present or absent Present

Stoppage, \$ 100 for

Due Gov't, \$ 100 for

Remarks:

Book mark:

Hudgins

1864 195

J

7

U.S.C.T.

David Steward

Pvt, Co. G., 7 Reg't U. S. Col'd Infantry.

Appears on Co. Muster-out Roll, dated Indianola Texas Oct 13, 1866.

Muster-out to date Oct 13, 1866.

Last paid to June 30, 1866.

Clothing account:

Last settled....., 186 ; drawn since \$ 100

Due soldier \$ 12 ⁶⁷/₁₀₀; due U. S. \$ 100

Am't for cloth'g in kind or money adv'd \$ 100

Due U. S. for arms, equipments, &c., \$ 100

Bounty paid \$ 100; due \$ 100 ¹⁰⁰/₁₀₀

Remarks: Joined original organization absent wounded in the hands of the enemy from September 29 1864 to April 18 1865

Book mark: P 11 P 12069 v 208 (over)

Hadfield

JAN. 21

6292339

018910

P 140 74

Steward, David

P, Co. _____, *7* Reg't *1st Inf*

_____ **Enclosures.**

Bed Cards	Final Statements
Burial Records	Furloughs or L. of A. /
Certs. of Dis. for Discharge	Med. Certificates
C. M. Charges	Med. Des. Lists
Descriptive Lists	Orders
Discharge Certificates	Pris. of War Record
Enlistment Papers	Resignations

Other papers relating to—

Admission to Hosp'l	Furlough or L. of A.
Casualty Sheet	Med. Examination
Confinement	Misc. Information
Contracts	Pay or Clothing
Death or Effects	Personal Reports
Desertion	Rank
Discharge from Hosp'l	Transfer to Hosp'l
Discharge from Service	Transfer to V. R. C.
Duty	Transportation
.....

Headquarters Dept of So
Richmond Va

May 25th 1865

Furlough granted for
Thirty (30) days.

By Command of
Major Genl

A. R. Foster
A. R. Foster

Enclosure 4.

David Stewart

See Letter of Brig. Genl.

R. H. Jackson

Acty. 2. 2nd Div. 4th Reg. July 6th 1865

David Stewart

To all whom it may Concern:

Extract from Army Regulations,
edition 1861.

Par. 190. Furloughs will be granted only by the commanding officer of the post, or the commanding officer of the regiment actually quartered with it. Furloughs may be prohibited at the discretion of the officer in command.

Par. 191. Soldiers on furlough shall not take with them their arms or accoutrements.

The bearer hereof, David Steward
Private of Captain William V. Smith's Company of the 7th
 Regiment of United States Colored Troops
 aged 24 years, 5 feet 4 1/2 inches high, Mulatto complexion, Black
 eyes, Curly hair, and by profession a Waiter; born in the State
 of Maryland, and enlisted at Worcester Co in
 the State of Maryland, on the 1st day of November
 eighteen hundred and Seventy Three, to serve for the period of 3 years or during war is hereby
 permitted to go to Newtown, in the County of Worcester Co,
 State of Maryland, he having received a **FURLOUGH** from the
 _____ day of _____, to the _____ day of _____,
 at which period he will rejoin his Company or Regiment at Mar City Point Va,
 or wherever it then may be, **OR BE CONSIDERED A DESERTER.**

Subsistence has been furnished to said _____, to the _____
 day of _____, and pay to the 30th day of April 1864,
 both inclusive.

1279

Steward George

Co. 6, 7 U.S. Col'd Inf.

Private Corporal

CARD NUMBERS.

1	6283631	26
2	6283732	27
3	6283832	28
4	6283930	29
5	6284031	30
6	6284128	31
7	6284223	32
8	6284318	33
9	6284393	34
10	6284502	35
11	6284607	36
12	6284708	37
13	6284810	38
14	6284927	39
15	6285081	40
16	9066229	41
17		42
18		43
19		44
20		45
21		46
22		47
23		48
24		49
25		50

Book Mark: E. B. ¹²/₂₁₇

See also

NARA 14

S | **7** | **U.S.C.T.**

George Steward
....., Co. *C*....., 7 Reg't U. S. Col'd Inf.

Appears on
Company Descriptive Book
of the organization named above.

DESCRIPTION.

Age *21* years; height *5* feet *4* inches.

Complexion *Griff*

Eyes *Black*; hair *Curly*.

Where born *Talbot, Md.*

Occupation *Farmer.*

ENLISTMENT.

When *Sept. 16*....., 186 *3*.

Where *Baltimore,*

By whom *Col. W. Binney*; term *3* y'rs.

Remarks: *Mustered at Baltimore*
Md. Sept. 26, 63, by Col W.
Binney, Died at Genl. Hosp.
Corps De Afrique, New Orleans
July 21, 65.

J. Smith

8 | 7 | U.S.C.T.

George Steward
Prov, Co. *C*, 7 Reg't U. S. Colored Inf.

Age *21* years.

Appears on

Company Muster-in Roll

of the organization named above, Roll dated
Baltimore, Md. Sept. 26, 186*3*

Muster-in to date *Sept. 26*, 186*3*

Joined for duty and enrolled:

When *Sept. 23*, 186*3**

Where *Talbot Co, Md.* *

Period *3* years.*

Remarks:

* Muster-in roll shows enrollment of all men of this company as of same date. See enrollment on subsequent card or cards.

Book mark:

Collaway

(356c)

Copyist.

8 | 7 | U.S.C.T.

George Steward.

Priv., Co. C, 7 Reg't U. S. Col'd Infantry.

Appears on

Company Muster Roll
for Sept. 26 to Oct. 31, 1863.

Joined for duty and enrolled:

When Sept. 23, 1863*

Where Talbot Co. Md. *

Period 3 years.*

Present or absent Absent

Stoppage, \$ 100 for

Due Gov't \$ 100 for

Remarks: Detached on recruiting
service Oct. 29. 1863.

* See enrollment on card from muster-in roll.

Book mark:

Callaway

(358c)

Copyist.

S 1

7

U.S.C.T.

George Steward

Priv., Co. C, 7 Reg't U. S. Col'd Infantry.

Appears on

Company Muster Roll

for Nov & Dec, 1863

Joined for duty and enrolled:

When Sept. 23, 1863*

Where Talbot Co., Md. *

Period 3 years.*

Present or absent Present.

Stoppage, \$ 100 for

Due Gov't \$ 100 for

Remarks:

* See enrollment on card from muster-in roll.

Book mark:

Calloway

8 | 7 | U.S.C.T.

George Steward
Pvt, Co. C, 7 Reg't U. S. Col'd Infantry.

Appears on

Company Muster Roll
for Jan'y and July, 1864.

Joined for duty and enrolled:

When Sept. 23, 1863*

Where Talbot Co. Md. *

Period 3 years.*

Present or absent Present

Stoppage, \$ 100 for

Due Gov't \$ 100 for

Remarks: Stop for on Knapsack

* See enrollment on card from muster-in roll.

Book mark:

(358c)

Calloway

Copyist.

8 | 7 | U.S.C.T.

George Steward

Priv., Co. C, 7 Reg't U. S. Col'd Infantry.

Appears on

Company Muster Roll

for Mch and Apl, 1864.

Joined for duty and enrolled:

When Sept. 23, 1863*

Where Talbot Co. Md. *

Period 3 years.*

Present or absent Present,

Stoppage, \$ 100 for

Due Gov't \$ 100 for

Remarks: Stop for our knapsack & canteen.

* See enrollment on card from muster-in roll.

Book mark:

Callaway

8 | 7 | U.S.C.T.

George Steward
Priv, Co. C, 7 Reg't U. S. Col'd Infantry.

Appears on

Company Muster Roll
for May/June, 1864

Joined for duty and enrolled:

When Sept. 23, 1863*

Where Talbot Co. Md. *

Period 3 years.*

Present or absent Present

Stoppage, \$ 100 for

Due Gov't \$ 100 for

Remarks:

* See enrollment on card from muster-in roll.

Book mark:

(358c)

Calloway Copyist.

8 | 7 | U.S.C.T.

George Stewards
Pvt, Co. *B*, 7 Reg't U. S. Col'd *Inf*

Appears on

Company Muster Roll
for *July and Aug*, 1864.

Joined for duty and enrolled:

When *Sept. 23*, 186*3*

Where *Talbot Co, Md**

Period *3* years.*

Present or absent *Present*

Stoppage, \$ *100* for

Due Gov't, \$ *100* for

Valuation of horse, \$ *100*

Valuation of horse equipments, \$ *100*

Remarks:

* See enrollment on card from muster-in roll.

Book-mark:

Callaway

S | **7** | **U.S.C.T.**

George Steward
Pvt., Co. C, 7 Reg't U. S. Col'd Infantry.

Appears on

Company Muster Roll
for *Sept. & Oct.*, 186*4*.

Joined for duty and enrolled:

When *Sept. 23*, 186*3*.*

Where *Tullahoma* *

Period *3* years.*

Present or absent *Present*

Stoppage, \$ *100* for

Due Gov't \$ *100* for

Remarks:

* See enrollment on card from muster-in roll.

Book mark: _____

W. M. Murphy
(358c) Copyist.

S. | 7 | U.S.C.T.

George Steward
Prof., Co. C, 7 Reg't U. S. Col'd Infantry.

Appears on

Company Muster Roll

for *Nov. & Dec.*, 1864.

Joined for duty and enrolled:

When *Sept. 23rd*, 1863.*

Where *Talbot* *

Period *3* years.*

Present or absent *Present*

Stoppage, \$ *100* for

Due Gov't \$ *100* for

Remarks:

* See enrollment on card from muster-in roll.

Book mark: _____

M. M. Murphy
(358c) Copyist.

S | **7** | **U.S.C.T.**

George Steward
Priv., Co. C, 7 Reg't U. S. Col'd Infantry.

Appears on

Company Muster Roll
for *Jan. & Feb.*, 186*3*.

Joined for duty and enrolled:

When *Sept. 23*, 186*3*.*

Where *Talbot Co., Md.* *

Period *3* years.*

Present or absent *Present*

Stoppage, \$ *100* for

Due Gov't \$ *100* for

Remarks:

* See enrollment on card from muster-in roll.

Book mark: _____

M. M^c Murphy
(358c) Copyist.

1863

S | 7 | U.S.C.T.

George Steward
Priv., Co. C, 7 Reg't U. S. Col'd Infantry.

Appears on

Company Muster Roll
for *Mar. & Apr.*, 186*3*.

Joined for duty and enrolled:

When *Sept. 23*, 186*3*.*

Where *Tulbot* *

Period *3* years.*

Present or absent. *Absent*

Stoppage, \$ *100* for

Due Gov't \$ *100* for

Remarks: *Det. per S. O.*
No. 39 R. & B. 2 Div.
25 Corps Apr. 22/65
Stop. for wife

* See enrollment on card from muster-in roll.

Book mark:

M. H. Murphy
(358c) Copyist.

J | **7** | **U.S.C.T.**

George Steward

Sgt., Co. C, 7 Reg't U. S. Col'd Infantry.

Appears on

Company Muster Roll
for *May & June*, 1865.

Joined for duty and enrolled:

When *Sept. 23*, 1863.*

Where *Talbot* *

Period *3* years.*

Present or absent *Absent*

Stoppage, \$ *100* for

Due Gov't \$ *100* for

Remarks: *Sent to Hosp.*
New Orleans June 21/65.
Stop. for Curper

* See enrollment on card from muster-in roll.

Book mark:

M. M. Murphy
(858c) Copyist.

S | 7 | U.S.C.T.

George Steward

Priv., Co. C, 7 Reg't U. S. Col'd Infantry.

Appears on

Company Muster Roll

for July & Aug., 1865.

Joined for duty and enrolled:

When Sept. 23rd, 1863.*

Where Fallot *

Period 3 years.*

Present or absent Absent

Stoppage, \$ 100 for

Due Gov't \$ 100 for

Remarks: Sent to Hosp. June 21/65

* See enrollment on card from muster-in roll.

Book mark:

M. M. Murphy

S | 7 | U.S.C.T.

George Steward

Priv., Co. C, 7 Reg't U. S. Col'd Infantry.

Appears on

Company Muster Roll
for *Sept. 7 Oct.*, 186*5*.

Joined for duty and enrolled:

When *Sept. 16*, 186*3*.*

Where *Tulbot, Ind.* *

Period *3* years.*

Present or absent

Stoppage, \$ *100* for

Due Gov't \$ *100* for

Remarks: *Died at Hosp. Corps d' Afrique New Orleans, La. July 21/65. Final statements rendered*

* See enrollment on card from muster-in roll.

Book mark: *Died July 4/65 - E.B. 12/217*

M. M. Murphy
(258c) Copyist.

S. | 7 | U.S.C.T.

George Steward

Compl. Co., 7 Reg't U. S. Col'd Infantry.

Appears on Co. Muster-out Roll, dated Indianola Texas, Oct. 13, 1866.

Muster-out to date _____, 1866 .

Last paid to Dec 31, 1864.

Clothing account:

Last settled _____, 1866 ; drawn since \$ _____ 100

Due soldier \$ _____ 100 ; due U. S. \$ _____ 100

Am't for cloth'g in kind or money adv'd \$ _____ 100

Due U. S. for arms, equipments, &c., \$ _____ 100

Bounty paid \$ _____ 100 ; due \$ _____ 100

Remarks: Died at New Orleans July 21 '65 of Scurvy. Final statements sent to Ayo. Aug 10/65.

Book mark: Died July 4/65

Lopez (over) Copyist.

JAN. 20

6285381

018910

*E.B. 1917. 197. 1880
2244. 1881 F.S.*

Steward, George

P. Co. C., 7 Reg't U.S.C. Inf.

3 Enclosures.

Bed Cards.....	Descriptive Lists.....
Burial Records..... /	Final Statements..... /
Certs. of Dis. for Discharge.....	Furloughs.....
C. M. Charges.....	Med. Des. Lists.....
Med. Certificates.....	Orders.....

Other papers relating to—

Admission to Hosp'l.....	Furlough.....
Casualty Sheet (Officer's).....	Med. Examination.....
Confinement.....	Misc. Information.....
Contracts.....	Pay or Clothing.....
Death or Effects..... /	Personal Reports.....
Desertions.....	Rank.....
Discharge from Hosp'l.....	Transfer to Hosp'l.....
Discharge from Service.....	Transfer to V. R. C.....
Duty.....	Transportation.....

FINAL STATEMENT

OF

Private Georg Steward
7th Reg't of U.S.C.T.

VOLUNTEERS.

Died July 4th 1865

NOTE 1.—Two of these certificates (or duplicates) are to be given to each Volunteer Soldier or drafted man who may be discharged previously to the discharge of his company that he may at once receive from the Paymaster the pay, &c., due him and the captain or other COMMISSIONED officer commanding the company will certify to the act of the delivery of the duplicate certificates, on these certificates the Soldier is "entitled to" his discharge, and should also present his discharge to the Paymaster to have the payment endorsed on it. The discharge is to be given back to the Soldier by the Paymaster; the latter only retaining as his voucher the duplicate certificates.

NOTE 2.—If the Soldier is entitled to pay for the use of his horse, the Company Commander will certify to that fact on the back of both these final statements, and also to the time he has pay due for having been so mounted on his own horse.

NOTE 3.—When a Soldier is furnished with final statements, his descriptive list, if he has one, should be taken up by the officer who gives the Soldier these statements and endorsed with a statement to this effect by the officer. This endorsement should exhibit a full statement of the time for which the Soldier was allowed pay on his final statements, the clothing account, and all other charges against him or in his favor, so as to comprise a complete exhibit of his account. It will then be transmitted to the company commander of the Soldier, who will enter all the data necessary to a full understanding of the Soldier's account on the muster roll upon which the Soldier's discharge is reported. The descriptive list will then be destroyed. The object of this is that the remaining portion of the Soldier's account may be settled upon the receipt of these muster rolls, and the Soldier receive any pay or allowances that may be due him at the time of his discharge, and which may not appear on his final statements from the fact that his descriptive list is incomplete. These accounts for back pay, &c., are settled by the 2d Auditor of the Treasury Department.

NOTE 4.—Charges for loss or injury to ordnance, horse equipments, and other miscellaneous charges, should appear under the heading of "Other Stoppages."

NOTE 5.—Bounty paid by State authorities, and not by the United States, will not be entered on this statement.

NOTE 6.—Amounts due the Suttler and Laundress must be entered on the muster roll on which the discharge, death, desertion, &c., is reported, as well as on the final statement, otherwise the amount cannot be collected from the Government.

NOTE 7.—This blank will be used for deceased volunteers and drafted men, as well as for others.

NOTE 8.—Where a Soldier dies in Hospital or on detached service, his descriptive list, if he has one, should be sent with his final statements, in duplicate, to the Adjutant General, Washington, D. C.

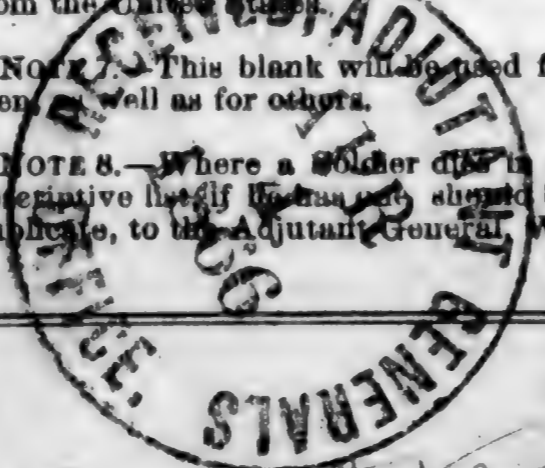

Dr. J. M. ...
Adj. Gen. ...

[OFFICE ENDORSEMENT.]

War Department,

ADJUTANT GENERAL'S OFFICE,

January 29, 1877

The death of Georg Steward
Cpl., Co. D, 7th Reg't U. S.
Colored Troops, is reported as follows:

- On Company Muster Roll. For Sept & Oct, 1865, July 21, 1865
- Company Muster-out Roll. July 21, 1865
- Company Descriptive Book. 186
- Company Morning Reports. 186
- Soldier's Final Statement. July 21, 1865
- Soldier's Record of Death and Interment. July 21, 1865
- Soldier's Inventory of Effects. 186
- Soldier's Certificate of Disability for Discharge. 186
- Soldier's Individual Muster-out Roll. 186
- Regimental Return. For 1865, 186
- Regimental Quarterly Returns. 186
- Regimental Descriptive Book. 186
- By Surgeon General. 186

July 4, 1865, is held to be the correct date, and the Company Muster Roll will be amended accordingly.

Thomas M. ...
Adj. Gen.
Noted

A.G.O. Dec 27/65
P.O. of Adm. & P.M.
sent for 1.30 sent 2nd U.S.

ADJUTANT GENERAL'S OFFICE
Apr 4th 1866
Duplicate with Inventory sent 2^d Auditor.

MARCH 1865

I certify, on honor, that George Steward a Private of
Captain Sherman's Company (B) of the 7th Regiment of U.S.C.T.
VOLUNTEERS, of the State of Maryland, born in Talbot, State
of Maryland, aged 24 years; 5 feet 4 3/4 inches high; Fair complexion,
Blue eyes, Curly hair, and by occupation a Farmer, having joined the company on
its original organization at Baltimore, and enrolled in it at the muster into
the service of the United States at Baltimore, on the 16th day
of September, 1863, (or was mustered in service as a recruit, by Col Wm
Burns, at Baltimore, on the 26 day of September,
1863; or was drafted and mustered into the service of the United States from the
Enrollment District of the State of _____, at _____
on the _____ day of _____, 1863) to serve in the Regiment, for
the term of three Years : and having served HONESTLY and
FAITHFULLY with his Company in 7th Regt to the present date, is now
entitled to a **DISCHARGE** by reason of Death Death July 4th 1865
in the U.S. General Hospital New Orleans La.

The said Private George Steward was last paid by Paymaster
Wm J. Smith to include the 31st day of December, 1864, and has
pay due him from that time to the present date; he is entitled to pay and subsistence for
TRAVELING to place of enrollment, and whatever other allowances are authorized to volunteer
soldiers, drafted men, or militia, so discharged. He has received from the United States **CLOTHING**
amounting to fourty five ¹⁴/₁₀₀ dollars, since the 10th day of October,
1864, when his clothing account was last settled. He has received from the United States
100 dollars advanced **BOUNTY**.

There is to be stopped from him, on account of the State of _____, or other
authorities, for **CLOTHING, &c.**, received on entering service, _____ dollars; and
for other stoppages, viz: _____

_____ dollars.
He has been furnished with **TRANSPORTATION** in kind from the place of his discharge to
_____ ; and he has been **SUBSISTED** for **TRAVELING** to his
place of enrollment, up to the _____, 186 .

He is indebted to _____, **BUTLER**, _____ dollars.

He is indebted to _____, **LAUNDRESS**, _____ dollars.

Given in Duplicate, at Indianola Texas, this 20th day
of March, 1865.

Sebastian Elder
1st Lieutenant
Commanding Company. Co

DEPARTMENT OF THE ARMY
OFFICE OF THE ADJUTANT GENERAL
COPY OF RECORD

FOR THE

ADJUTANT GENERAL U. S. ARMY.

[Faint, illegible text]

[Faint, illegible text]

[Faint, illegible text]



[Faint, illegible text]

No. 2.

RECORD OF DEATH AND INTERMENT.

Name and number of person interred,	<i>George Steward</i>	
Number and locality of the grave, -		
Hospital number of the deceased, -	<i>6099</i>	
Regiment, Rank, and Company, - -	<i>7th U. S. Infantry Corporal "B"</i>	
Residence before enlistment, - - -		
Conjugal condition (and if married,) the residence of the widow,)		
Cause of death,)	<i>Pneumonia</i>	
Age of the deceased, - - - - -		
Nativity, - - - - -		
References and Remarks, - -)		
Date of death and burial, - - -	<i>July 4th 1865</i>	186

[A duplicate of this Record has been forwarded to the Sexton, and the other remains at this Hospital.]

To *Adj. Genl. U. S. Army*
SIR:

It becomes my duty to inform you that the person above described died at this Hospital as herein stated: and that it is desired his remains should be interred with the usual military honors.

Respectfully,

F. E. Piquette
Surgeon U. S. Army
Col. Infantry
in charge

MILITARY HOSPITAL, *Corps d'Aspique N. Orleans*
La.

This copy of Record is to be transmitted to the Adjutant General at Washington immediately after the place of burial and the number of the grave have been ascertained and registered. The above notification is to remain attached.

ARTICLES OF WAR.

ART. 95. When any non-commissioned officer or soldier shall die, or be killed in the service of the United States, the then commanding officer of the troop or company shall, in the presence of two other commissioned officers, take an account of what effects he died possessed of, above his arms and accoutrements, and transmit the same to the office of the Department of War, which said effects are to be accounted for, and paid to the representatives of such deceased non-commissioned officer or soldier. And in case any of the officers, so authorized to take care of the effects of deceased officers and soldiers, should, before they have accounted to their representatives for the same, have occasion to leave the regiment or post, by preferment or otherwise, they shall, before they be permitted to quit the same, deposit in the hands of the commanding officer, or of the assistant military agent, all the effects of such deceased non-commissioned officers and soldiers, in order that the same may be secured for, and paid to, their respective representatives.

ARMY REGULATIONS—EDITION OF 1861.

DECEASED SOLDIERS.

Par. 152. Inventories of the effects of deceased non-commissioned officers and soldiers, required by the 95th Article of War, will be forwarded to the Adjutant General, by the commander of the company to which the deceased belonged, and a duplicate of the same to the colonel of the regiment. Final statements of pay, clothing, &c., will be sent with the inventories. When a soldier dies at a post or station absent from his company, it will be the duty of his immediate commander to furnish the required inventory, and, at the same time, to forward to the commanding officer of the company to which the soldier belonged, a report of his death, specifying the date, place, and cause; to what time he was last paid, and the money or other effects in his possession at the time of his decease; which report will be noted on the next muster-roll of the company to which the man belonged. Each inventory will be endorsed, "Inventory of the effects of _____, late of company (—) _____ regiment of _____, who died at _____, the _____ day of _____, 186—." If a legal representative receive the effects, it will be stated in the report. If the soldier leave no effects, the fact will be reported.

Par. 153. Should the effects of a deceased non-commissioned officer or soldier not be administered upon within a short period after his decease, they shall be disposed of by a Council of Administration, under the authority of the commanding officer of the post, and the proceeds deposited with the Paymaster, to the credit of the United States, until they shall be claimed by the legal representatives of the deceased.

Par. 154. In all such cases of sales by the Council of Administration, a statement in detail, or account of the proceeds, duly certified by the Council and commanding officer, accompanied by the Paymaster's receipt for the proceeds, will be forwarded by the commanding officer to the Adjutant General. The statement will be endorsed, "Report of the proceeds of the effects of _____, late of company (—) _____ regiment of _____, who died at _____, the _____ day of _____, 186—."

NOTE 1.—The effects in all cases, when called for, should be turned over to the legal representative, without further authority from the Adjutant General. When the effects are turned over to the relatives of the deceased before these inventories are sent to the Adjutant General, their receipts therefor should be attached to the inventories. In all other cases, one copy will be sent with a letter of transmittal direct to the Adjutant General, and a duplicate retained by the officer.

NOTE 2.—Particular care should be taken to take receipts in duplicate from the Paymaster for any funds turned over to him; one copy should be sent direct to the Adjutant General and one retained by the officer.

Behind no Descriptive List

INVENTORY OF THE EFFECTS

OF

Corp. George Stennard

Late of Company "C"

7th Reg't of U.S. Col. Infy.

Volunteers, who died at New Orleans La.

on the 4th day of July 1865.

MAR 15 1864

Inventory of the effects of George Steward late
 a Corporal of Captain _____ Company "C" of
 the 7th Regiment of M.S. Col. Say, Volunteers, who was enrolled as
 a _____ at _____ in the State of _____ on
 the _____ day of _____ 186 , and mustered into the service of the United
 States as a _____ on the _____ day of _____ 186 , at _____
 in Company _____, _____ Regiment of _____ Volunteers, to serve _____
 years or during the war; he was born in _____ in the State
 of _____; he was _____ years of age, _____ feet _____ inches
 high, _____ complexion, _____ eyes, _____ hair, and by occupation, when enrolled,
 a _____; he died in Camp of Agrienne U.S. Gen. Hosp., at
New Orleans La. on the 4th day of July 1865, by
 reason of Pneumonia.

INVENTORY.					
ARTICLES.	No.	ARTICLES.	No.	ARTICLES.	No.
Hats		Pairs trousers		Knapsacks	1
Caps		Pairs flannel drawers		<u>Camblet</u>	1
Forage caps		Pairs cotton drawers			
Great coats	1	Flannel shirts	1		
Uniform coats		Cotton shirts			
Uniform jackets		Pairs boots			
Flannel sack coats		Pairs shoes	1		
Blouses		Pairs socks			
Stable frocks		Blankets <u>Rubber</u>	1	MONEY. Specie	\$
Fatigue overalls		Haversacks	1	Notes	\$

I CERTIFY, ON HONOR, that the above inventory comprises all the effects of Corporal
George Steward, deceased, and that the effects are in the hands
 of Surgeon in Charge at Camp of Agrienne U.S. Gen. Hosp.
New Orleans La. to be disposed of by a Council of Administration.

(DUPLICATES.)

STATION: New Orleans La.

 Commanding the Company.

DATE: July 4th 1865

1280
Steward Lloyd
Co A, 7 U.S. Col'd Inf.

Private Private

CARD NUMBERS.

1	6285501	26
2	6285602	27
3	6285699	28
4	6285827	29
5	6287196	30
6	9066327	31
7		32
8		33
9		34
10		35
11		36
12		37
13		38
14		39
15		40
16		41
17		42
18		43
19		44
20		45
21		46
22		47
23		48
24		49
25		50

Book Mark:

See also

D. 3021857 and wd

S | **7** | **U.S.C.T.**

Lloyd Stewart
Co. *D*, 7 Reg't U.S. Col'd Inf.

Appears on
Company Descriptive Book
of the organization named above.

DESCRIPTION.

Age *24* years; height *5* feet *10 1/2* inches.
Complexion *Briff*
Eyes *Black*; hair *Curly*
Where born *Queen Ann. Md*
Occupation *Farmer*

ENLISTMENT.

When *Sept 20*, 186*3*.
Where *Queen Ann*
By whom *Col. M. Birney*; term *3* y'rs.

Remarks: *Wid. at hosp.*
Pennsylv. Md. Feb
19. 1864. Mustered Sep
29. 63.

J. Brown

S | 7 | U.S.C.T.

Lloyd Steward
Priv., Co. D, 7 Reg't U. S. Colored Inf.

Age 24 years.

Appears on

Company Muster-in Roll

of the organization named above. Roll dated

Baltimore Md, Sept. 29, 1863.

Muster-in to date Sept. 29, 1863.

Joined for duty and enrolled:

When Sept 26, 1863*

Where Queen Ann Cr. Md.*

Period 3 years.*

Remarks:

*Muster-in roll shows enrollment of all men of this company as of same date. See enrollment on subsequent card or cards.

Book mark:

R. S. Lett

8

7

U.S.C.T.

Lloyd Steward

Private, Co. D, 7 Reg't U. S. Col'd Infantry.

Appears on

Company Muster Roll

for from Sept 29 to Oct 31, 1863

Joined for duty and enrolled:

When Sept 2 to , 1863

Where Queen Ann Co. Md.

Period 3 years.*

Present or absent Present

Stoppage, \$ 100 for

Due Gov't \$ 100 for

Remarks:

* See enrollment on card from muster-in roll.

Book mark:

R B Shelton

(358c)

Copyist.

S | 7 | U.S.C.T.

Lloyd Steward
Priv, Co. D, 7 Reg't U. S. Col'd Infantry.

Appears on

Company Muster Roll
for Nov + Dec, 1863

Joined for duty and enrolled:

When Sept 26, 1863*

Where Queen Ann md.*

Period 3 years.*

Present or absent Present

Stoppage, \$ 100 for

Due Gov't \$ 100 for

Remarks: Stop for 1. Haversack.

* ~~See~~ See enrollment on card from muster-in roll.

Book mark: -----

R S Shelton

(358c)

Copyist.

S

7

U.S.C.T.

Lloyd Steward,
Priv, Co. D, 7 Reg't U. S. Col'd Infantry.

Appears on

Company Muster Roll

for *January & February*, 1864.

Joined for duty and enrolled:

When *Sept 26*, 1863.*

Where *Queen Ann Md* *

Period *3* years.*

Present or absent

Stoppage, \$ *100* for

Due Gov't \$ *100* for

Remarks: *Died in hospital at*
Benedict Md. Feb. 19. 64.
Final Statement not render-
ed.

* See enrollment on card from muster-in roll.

Book mark:

R S Shelton

MAY 17 1863

S | 7 | U.S.C.T.

Lloyd Steward

Priv., Co. D, 7 Reg't U. S. Col'd Infantry.

Appears on **Co. Muster-out Roll**, dated
Indianola Texas, Oct 13, 1863.

Muster-out to date _____, 186 .

Last paid to *Dec 31, 1863* .

Clothing account:

Last settled _____, 186 ; drawn since \$ _____ 100

Due soldier \$ _____ 100; due U. S. \$ _____ 100

Am't for cloth'g in kind or money adv'd \$ _____ 100

Due U. S. for arms, equipments, &c., \$ _____ 100

Bounty paid \$ _____ 100; due \$ _____ 100

Remarks: *Died at Camp Stanton*

Md. Nov. 9. 63. Pneumonia.

Final statements forwarded Mch.

2. 64.

Book mark: *V. 33. P. 167/68. F.S.*
(over)

Heast

JAN. 20

6287196

1891*

L.G.O. Died Feby 19. 1864. at
Camp Stanton Md. of Typhoid
Pneumonia. see Enderut. on
F.d.

Steward, Lloyd

P, Co. D, 7 Regt. U. S. C. Inf.

2 Enclosures.

Bed Cards	Descriptive Lists
Burial Records	Final Statements /
Certs. of Dis. for Discharge	Furloughs
C. M. Charges	Med. Des. Lists
Med. Certificates	Orders

Other papers relating to—

Admission to Hosp'l	Furlough
Casualty Sheet (Officer's)	Med. Examination
Confinement	Misc. Information
Contracts	Pay or Clothing
Death or Effects /	Personal Reports
Desertions	Rank
Discharge from Hosp'l	Transfer to Hosp'l
Discharge from Service	Transfer to V. R. C.
Duty	Transportation

The Description Book of Co. D
7th U.S. reports under Registrar of
Deaths Lloyd Steward Pvt. - Died
at Camp Stanton, Md. Feby. 19. 1864.
cause Pneumonia, Final statements for-
warded March 2 1864. Under description
roll of Co. he is reported as having
died at Hosp. Benedict Md. same date
Under remarks of morning report book
for Feby. 19. 1864 he is reported died
at Hosp. at Benedict, Md. of Typhoid
Fever

✓ 166 - 5 - 181
FINAL STATEMENT

OF
Lloyd S. Steward
Reg't of U.S. C. Troops

VOLUNTEERS.
Sub February 19th 1864

NOTE 1.—Two of these certificates (or duplicates) are to be given to each Volunteer Soldier or drafted man who may be discharged previously to the discharge of his company, that he may at once receive from the Paymaster the pay, &c., due him, and the captain or other COMMISSIONED officer commanding the company will certify to the act of the delivery of the duplicate certificates; on these certificates the Soldier is "entitled to" his discharge, and should also present his discharge to the Paymaster to have the payment endorsed on it. The discharge is to be given back to the Soldier by the Paymaster; the latter only retaining as his voucher the duplicate certificates.

NOTE 2.—If the Soldier is entitled to pay for the use of his horse, the Company Commander will certify to that fact on the back of both these final statements, and also to the time he has pay due for having been so mounted on his own horse.

NOTE 3.—When a Soldier is furnished with final statements, his descriptive list, if he has one, should be taken up by the officer who gives the Soldier these statements, and endorsed with a statement to this effect by the officer. This endorsement should exhibit a full statement of the time for which the Soldier was allowed pay on his final statements, the clothing account, and all other charges against him or in his favor, so as to comprise a complete exhibit of his account. It will then be transmitted to the company commander of the Soldier, who will enter all the data necessary to a full understanding of the Soldier's account on the muster roll upon which the Soldier's discharge is reported. The descriptive list will then be destroyed. The object of this is, that the remaining portion of the Soldier's account may be settled upon the receipt of these muster rolls, and the Soldier receive any pay or allowances that may be due him at the time of his discharge, and which may not appear on his final statements from the fact that his descriptive list is incomplete. These accounts for back pay, &c., are settled by the 2d Auditor of the Treasury Department.

NOTE 4.—Charges for loss or injury to ordnance, horse equipments, and other miscellaneous charges, should appear under the heading of "Other Stoppages."

NOTE 5.—Bounty paid by State authorities, and not by the United States, will not be entered on this statement.

NOTE 6.—Amounts due the Sutler and Laundress must be entered on the muster roll on which the discharge, death, desertion, &c., is reported, as well as on the final statement, otherwise the amount cannot be collected from the United States.

NOTE 7.—This blank will be used for deceased volunteers and drafted men, as well as for others.

NOTE 8.—Where a Soldier dies in Hospital or on detached service, his descriptive list, if he has one, should be sent with his final statements, in duplicate, to the Second Auditor, Washington, D. C.

Chas. W. Roflan

Adjutant General's Office
Washington D.C., Dec. 31, 1888.
E. 3rd Reg. 458.
All rolls and papers where
on is noted the death of
Lloyd S. Steward, late Pri-
vate Company "D" 4th U.S. Col-
ored Troops, will be made
to show that he died at
Camp Stanton, Md, Febru-
ary 19th 1864, of Typhoid
Pneumonia.

Thomas M. Fugent
Asst Adj't General

See letter of Jan 8. to 2nd Au-
ditor Treasury Dept.
Noted on D. O. Roll
Jan 4. 189
W. J. F.

ADJUTANT GENERAL'S OFFICE.
March 8th 1864
Duplicate with Inventory sent 2d Auditor.

I certify, on honor, that Gloyd Steward a Private of
 Captain Thos. M. Carthy Company (D) of the 7 Regiment of USC Troops
VOLUNTEERS, of the State of _____, born in Queen Anne's, State
 of Maryland, aged 24 years; 5 feet 10 1/2 inches high; Griff complexion,
Blk eyes, Curly hair, and by occupation a Farmer, having joined the company on
 its original organization at Baltimore Md, and enrolled in it at the muster into
 the service of the United States at Baltimore Md, on the 29th day
 of September, 1862, (or was mustered in service as a recruit, by _____
 _____, at _____, on the _____ day of _____,
 186 _____, or was drafted and mustered into the service of the United States from the
 Enrollment District of the State of _____, at _____,
 on the _____ day of _____, 186 _____,) to serve in the Regiment, for
 the term of Three Years: and having served HONESTLY and
 FAITHFULLY with his Company in the 7th USC Troops to the present date, is now
 entitled to a **DISCHARGE** by reason of Death

Made ill for January & February 1864, Camp description & name left in last of
death by February 19th 1864, cause typhoid pneumonia.
 The said Gloyd Steward was last paid by Paymaster

Maj. Malone to include the 31 day of December, 1863, and has
 pay due him from that time to the present date; he is entitled to pay and subsistence for
TRAVELING to place of enrollment, and whatever other allowances are authorized to volunteer
 soldiers, drafted men, or militia, so discharged. He has received from the United States **CLOTHING**
 amounting to Fifty-three 24/₁₀₀ dollars, since the 29th day of September,
 1863, when his clothing account was last settled. He has received from the United States
 _____ 100 dollars advanced **BOUNTY**.

There is to be stopped from him, on account of the State of _____, or other
 authorities, for **CLOTHING**, &c, received on entering service, _____ 100 dollars; and
 for other stoppages, viz: _____
 _____ 100 dollars.

He has been furnished with **TRANSPORTATION** in kind from the place of his discharge to
 _____; and he has been **SUBSISTED** for **TRAVELING** to his
 place of enrollment, up to the _____, 186 _____.

He is indebted to _____, **SUTLER**, _____ 100 dollars.
 He is indebted to _____, **LAUNDRESS**, _____ 100 dollars.

Given in Duplicate, at Camp Stanton Md, this 19 day
 of February, 1864.

Thos. M. Carthy
Capt. 7th USC Troops
 Commanding Company.

ARTICLES OF WAR.

ART. 95. When any non-commissioned officer or soldier shall die, or be killed in the service of the United States, the then commanding officer of the troop or company shall, in the presence of two other commissioned officers, take an account of what effects he died possessed of, above his arms and accoutrements, and transmit the same to the office of the Department of War, which said effects are to be accounted for, and paid to the representatives of such deceased non-commissioned officer or soldier. And in case any of the officers, so authorized to take care of the effects of deceased officers and soldiers, should, before they have accounted to their representatives for the same, have occasion to leave the regiment or post, by preferment or otherwise, they shall, before they be permitted to quit the same, deposit in the hands of the commanding officer, or of the assistant military agent, all the effects of such deceased non-commissioned officers and soldiers, in order that the same may be secured for, and paid to, their respective representatives.

ARMY REGULATIONS—EDITION OF 1861.

DECEASED SOLDIERS.

Par. 152. Inventories of the effects of deceased non-commissioned officers and soldiers, required by the 95th Article of War, will be forwarded to the Adjutant General, by the commander of the company to which the deceased belonged, and a duplicate of the same to the colonel of the regiment. Final statements of pay, clothing, &c., will be sent with the inventories. When a soldier dies at a post or station absent from his company, it will be the duty of his immediate commander to furnish the required inventory, and, at the same time, to forward to the commanding officer of the company to which the soldier belonged, a report of his death, specifying the date, place, and cause; to what time he was last paid, and the money or other effects in his possession at the time of his decease; which report will be noted on the next muster-roll of the company to which the man belonged. Each inventory will be endorsed, "Inventory of the effects of _____, late of company (—) _____ regiment of _____, who died at _____, the _____ day of _____, 186—." If a legal representative receive the effects, it will be stated in the report. If the soldier leave no effects, the fact will be reported.

Par. 153. Should the effects of a deceased non-commissioned officer or soldier not be administered upon within a short period after his decease, they shall be disposed of by a Council of Administration, under the authority of the commanding officer of the post, and the proceeds deposited with the Paymaster, to the credit of the United States, until they shall be claimed by the legal representatives of the deceased.

Par. 154. In all such cases of sales by the Council of Administration, a statement in detail, or account of the proceeds, duly certified by the Council and commanding officer, accompanied by the Paymaster's receipt for the proceeds, will be forwarded by the commanding officer to the Adjutant General. The statement will be endorsed, "Report of the proceeds of the effects of _____, late of company (—) _____ regiment of _____, who died at _____, the _____ day of _____, 186—."

NOTE 1.—The effects in all cases, when called for, should be turned over to the legal representative, without further authority from the Adjutant General. When the effects are turned over to the relatives of the deceased before these inventories are sent to the Adjutant General, their receipts therefor should be attached to the inventories. In all other cases, one copy will be sent with a letter of transmittal direct to the Adjutant General, and a duplicate retained by the officer.

NOTE 2.—Particular care should be taken to take receipts in duplicate from the Paymaster for any funds turned over to him; one copy should be sent direct to the Adjutant General and one retained by the officer.

*Recd from Div of discontinued
Commands*

INVENTORY OF THE EFFECTS

Filed August 20, 1875
OF

Lloyd Steward

Late of Company *D*

7th Reg't of *M. C. I.*

Volunteers, who died at _____

on the *19* day of *February* 186*7*.



Inventory of the effects of Lloyd Steward late
a Private of Captain Thos. McLearty Company D of
the 7 Regiment of U.S. Colored Troops Volunteers, who was enrolled as
a Private at Baltimore in the State of Maryland on
the 29 day of September 1863, and mustered into the service of the United
States as a Private on the 29 day of September 1863, at Baltimore
in Company D, 7 Regiment of U.S. Colored Troops Volunteers, to serve Three
years or during the war; he was born in Queen Anne Co in the State
of Maryland; he was 24 years of age, 5 feet 10 1/2 inches
high, Fair complexion, Blk eyes, Curly hair, and by occupation, when enrolled,
a Farmer; he died in Benedict Hospital at
Benedict Md on the 19 day of Febry 1864, by
reason of disease

INVENTORY.					
ARTICLES.	No.	ARTICLES.	No.	ARTICLES.	No.
Hats		Pairs trowsers	<u>1</u>	Knapsacks	<u>1</u>
Caps		Pairs flannel drawers	<u>1</u>	<u>Gun</u>	<u>1</u>
Forage caps	<u>1</u>	Pairs cotton drawers			
Great coats	<u>1</u>	Flannel shirts	<u>3</u>		
Uniform coats		Cotton shirts			
Uniform jackets		Pairs boots			
Flannel sack coats	<u>2</u>	Pairs shoes			
Blouses		Pairs socks			
Stable frocks		Blankets			
Fatigue overalls		Haversacks	<u>1</u>		
				MONEY.	
				Specie	\$
				Notes	<u>\$2.00</u>

I CERTIFY, ON HONOR, that the above inventory comprises all the effects of
Lloyd Steward, deceased, and that the effects are in the hands
of Capt. Thos. McLearty at Camp Stanton Md
to be disposed of by a Council of Administration.

(DUPLICATES.)

STATION: Camp Stanton Md

DATE: Febry 19th 1864

[A. G. O. No. 104.]

Thos. McLearty
Capt. 7th U.S. Colored Troops
Commanding the Company.

1281

Steward Stephen

Co G, 7 U.S. Col'd Inf.

Private

Private

CARD NUMBERS.

1	6290989	26
2	6291086	27
3	6291188	28
4	6291292	29
5	6291390	30
6	6291488	31
7	6291585	32
8	6291701	33
9	6292417	34
10	9066712	35
11		36
12		37
13		38
14		39
15		40
16		41
17		42
18		43
19		44
20		45
21		46
22		47
23		48
24		49
25		50

Book Mark:

See also

J. 609966 - P.O. M & M

S 1 7

U.S.C.T.

Stephen Steward
Co. G, 7 Reg't U.S. Col'd Inf

Appears on

Company Descriptive Book

of the organization named above.

DESCRIPTION.

Age 19 years; height 5 feet 4 inches.

Complexion *Blk*

Eyes *Blk*; hair *curly*

Where born *Dorchester, Md.*

Occupation *Farmer*

ENLISTMENT.

When *Oct 15*, 186 .

Where *Dorchester*

By whom *Col. H. Pomy*; term *3* y'rs.

Remarks: *Lied in prison
at Salisbury, Md.*

* *As it is on book.*

(383g)

J. Brown
Copyist.

S | 7 | U.S.C.T.

Stephen Steward

Priv., Co. G, 7 Reg't U. S. Col'd Inf.

Age 19 years.

Appears on

Company Muster-in Roll

of the organization named above. Roll dated
Camp Stanton, Charles Co., Md., Nov. 5, 1863.

Muster-in to date Nov. 5, 1863.

Joined for duty and enrolled:

When Oct. 15, 1863.

Where Dorchester, Md.

Period 3 years.

Remarks:

Book mark:

(856)

Sandoz
Copyist.

S

7

U.S.C.T.

Stephen Steward.

Priv., Co. G, 7 Reg't U. S. Col'd Infantry.

Appears on

Company Muster Roll

for Nov. 5 to Dec. 31, 1863.

Present or absent Present

Stoppage, \$ 100 for

Due Gov't, \$ 100 for

Remarks: Premium for enlistment \$2.00 (due).

Book mark:

Sando Copyist

(858)

S

7

U.S.C.T.

Stephen Steward

Priv., Co. G, 7 Reg't U. S. Col'd Infantry.

Appears on

Company Muster Roll

for *Jan. & Feby.*, 1864.

Present or absent *Present*

Stoppage, \$ *100* for

Due Gov't, \$ *100* for

Remarks:

Book mark:

Sandoz

Copyist

(858)

S

7

U.S.C.T.

Stephen Steward.

Priv., Co. G, 7 Reg't U. S. Col'd Infantry.

Appears on

Company Muster Roll,

for *Mch. & Apr.*, 1864.

Present or absent *Present.*

Stoppage, \$ 100 for

Due Gov't, \$ 100 for

Remarks:

Book mark: *30501*

(858)

Sandoz
Copyist

S

7

U.S.C.T.

Stephen Steward

Priv., Co. G, 7 Reg't U. S. Col'd Infantry.

Appears on

Company Muster Roll.

for May & June, 1864.

Present or absent Present.

Stoppage, \$ 100 for

Due Gov't, \$ 100 for

Remarks:

Book mark:

Sandoz Copyist

(358)

S

7

U.S.C.T.

Stephen Stewart

Priv., Co. G, 7 Reg't U. S. Col'd Infantry.

Appears on

Company Muster Roll

for *July & Aug.*, 186*4*.

Present or absent *Present*

Stoppage, \$ *100* for

Due Gov't, \$ *100* for

Remarks:

Book mark:

Sandoz
Copyist

G | 7 | U.S.C.T.

Stephen Steward

Priv., Co. G, 7 Reg't U. S. Col'd Infantry.

Appears on

Company Muster Roll

for Sept. & Oct., 1864.

Present or absent Absent.

Stoppage, \$ 100 for

Due Gov't, \$ 100 for

Remarks: Missing in action
Sept. 29th, 1864.

Book mark: 300-357

(858)

Sandoz
Copyist

S | 7 | U.S.C.T.

Stephen Steward
Pvt., Co. G, 7 Reg't U. S. Col'd Infantry.

Appears on

Company Muster Roll

for Nov. & Dec., 1864

Present or absent

Stoppage, \$ 100 for

Due Gov't, \$ 100 for

Remarks:

Missing action Sept. 29
64 & Omitted to be
dropped.

Book mark:

J. W. Ames
(858) Copyist

A

7

U.S.C.T.

Stephen Steward

Pot, Co. *G*, 7 Reg't U. S. Col'd Infantry.

Appears on **Co. Muster-out Roll**, dated *Indianola Texas Oct 13*, 1866.

Muster-out to date _____, 186 .

Last paid to *April 30*, 1864 .

Clothing account:

Last settled _____, 186 ; drawn since \$ _____ 100

Due soldier \$ _____ 100 ; due U. S. \$ _____ 100

Am't for cloth'g in kind or money adv'd \$ _____ 100

Due U. S. for arms, equipments, &c., \$ _____ 100

Bounty paid \$ _____ 100 ; due \$ _____ 100

Remarks: *Died at Salisbury N.C. while prisoner of War final statements rendered**

* *Roll Form*

Book mark *apl 18.68 2^d and 9003*

over

Ladfield

NR 91 192

JAN. 21

6292417

ALB910

301.332

Stewart, Steve

P, Co. G

7
3

Reg't 11th Inf.

Enclosures.

Bed Cards	Final Statements
Burial Records	Furloughs or L. of A.
Certs. of Dis. for Discharge	Med. Certificates
C. M. Charges	Med. Des. Lists
Descriptive Lists	Orders
Discharge Certificates	Pris. of War Record /
Enlistment Papers	Resignations

Other papers relating to—

Admission to Hosp'l	Furlough or L. of A.
Casualty Sheet /	Med. Examination
Confinement	Misc. Information /
Contracts	Pay or Clothing
Death or Effects	Personal Reports
Desertion	Rank
Discharge from Hosp'l	Transfer to Hosp'l
Discharge from Service	Transfer to V. R. C.
Duty	Transportation

MEMORANDUM FROM PRISONER OF WAR RECORDS.

No. 473

(This blank to be used only in the arrangement of said records.)

NAME.	RANK.	ORGANIZATION.				INFORMATION OBTAINED FROM—			
		No. of Reg't.	State.	Arm of Service.	Co.	Records of—	Vol.	Page.	Vol.
<i>Stewart Steve.</i>	<i>P</i>	<i>17</i>	<i>U.S.C.T.</i>		<i>D</i>	<i>Mid.</i>	<i>39 288</i>	<i>69</i>	<i>57</i>

Captured at *Chapin's Farm, Va.* *Sept. 29, 1864*, confined at *Richmond, Va.*, *Sept. 29, 1864*.
Sent to Salisbury, N.C., Oct. 24, 1864.

Admitted to Hospital at *no record of death*

where he died _____, 186____, of _____

Paroled at _____, 186____; reported at *Camp Parole, Md.*, _____, 186____.

Slave owned by Mrs. R. Nicols Dorchester Md

Copied by _____

(Record continued.)

Furloughed _____, 186 , for _____ days; returned _____, 186 ;
deserted _____, 186 ;

Cancelled as Stephen Steward, Co. G. 1st U.S.C.T.

Cousin Gen. Woodward July 20 83

Rice N.Y.

Copied by

J.H. Med.

July 17/83

Adjutant General's Office,

, 18

This is accepted as referring to

Co. _____,

Reg't, _____

and records will be corrected accordingly.

Assistant Adjutant Gen'l.

MAR 1 1867

Surgeon General's Office,

Record and Pension Division,

August 9th, 1867.

Respectfully returned to *Asst. Surg.*

Genl. F. W. Taggart, U. S. A.

The death-records of this Office furnish no information in this case.

Records of Regt. 3^d of Salisbury, N. C., furnish no evidence.

BY ORDER OF THE SURGEON GENERAL:

J. J. Woodward

*3^d P.
G. W. F.*

Brevet Lt. Col. and Asst. Surgeon, U. S. A. (49)

R. of A., Vol. 7 No. 2273

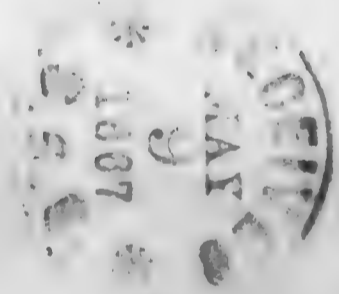

NARA 1197

WAR DEPARTMENT,

ADJUTANT GENERAL'S OFFICE,

WASHINGTON, *May 7*, 186*7*.

SIR:

Final Statements in the cases of deceased soldiers are required to be sent to the Adjutant General's Office in duplicate, with one copy of the Inventory of Effects. The Descriptive List should also be sent to this Office in cases where the soldier was absent from his Company at the time of his death. Where there were no effects, it should be so stated on a blank Inventory, properly signed.

Certificates of Disability should be sent in duplicate. Special care should be taken that the date of discharge and signature of the discharging officer should be affixed.

No of the Final Statement *Or* Inventory, has been received in the case of *Stephen Steward, Private*, of Co. *G*, *7* Regiment of *U.S. 6th Troop* Volunteers, whose papers were forwarded to this Office. You will please forward the missing papers without delay.

I have the honor to be, sir,

Very respectfully,

Your obedient servant,

Wm. H. Wood
Salisbury, N.C.

F. W. Hayward

Assistant Adjutant General.
(110)

~~COMMANDING OFFICER~~

J. J. Woodward
assnsd.

a.f.B.

FOR A DECEASED SOLDIER.

FORM 5.—PROCEEDINGS OF A COUNCIL OF ADMINISTRATION,

Convened at Fort Brown, Texas, pursuant to Orders, No. 1, dated Post Headquarters, Fort Brown, Texas, January 2, 1864—consisting of Captain James Keith, Company C, 1st Pennsylvania Volunteers; Captain John Brown, Company D, 1st Pennsylvania Volunteers; and Lieutenant William Roe, Company E, 1st Pennsylvania Volunteers—for the purpose of disposing of the effects of the late John Smith, of Company A, 1st Pennsylvania Volunteers:

The Council found that the effects consisted of the following articles. They were ordered to be sold at auction, which was accordingly done, and the amount set opposite the articles respectively obtained, for which the receipt of the Paymaster is annexed:

AT AUCTION.

1 shirt	brought.....	\$1 00
1 great coat	“.....	2 50
1 silver watch	“.....	25 00
		\$28 50

JAMES KEITH,

Capt. Co. C, 1st Penn. Vols., President.

WILLIAM ROE,

Lieut. Co. E, 1st Penn. Vols., Recorder.

APPROVED:

JOHN SANDERS,
Colonel 1st Penn. Vols.,
Commanding Post.

FORM 6.—PAYMASTER'S RECEIPT.

RECEIVED from Captain John Brown, Company A, 1st Pennsylvania Volunteers, at Fort Brown, Texas, January 10, 1864, twenty-eight dollars and fifty cents, the result of the sale of the effects of the late Private John Smith, of Company A, 1st Pennsylvania Volunteers.

WM. C. MORSE, Paymaster U. S. Army.

ARTICLES OF WAR.

ART. 95. When any non-commissioned officer or soldier shall die, or be killed in the service of the United States, the then commanding officer of the troop or company shall, in the presence of two other commissioned officers, take an account of what effects he died possessed of, above his arms and accoutrements, and transmit the same to the office of the Department of War, which said effects are to be accounted for, and paid to the representatives of such deceased non-commissioned officer or soldier. And in case any of the officers, so authorized to take care of the effects of deceased officers and soldiers, should, before they have accounted to their representatives for the same, have occasion to leave the regiment or post, by preferment or otherwise, they shall, before they be permitted to quit the same, deposit in the hands of the commanding officer, or of the assistant military agent, all the effects of such deceased non-commissioned officers and soldiers, in order that the same may be secured for, and paid to, their respective representatives.

DIRECTIONS.

NOTE 1.—One copy of the inventories of the effects of deceased non-commissioned officers and soldiers required by the 95th Article of War, will be forwarded to the Adjutant General, by the commander of the company to which the deceased belonged, and a duplicate of the same to the colonel of the regiment. Final statements of pay, clothing, &c., in duplicate, will be sent to the Adjutant General with one copy of the inventory. Both inventory and final statements should be forwarded, as a general rule, through Regimental Headquarters. When a soldier dies at a post or station absent from his company, it will be the duty of his immediate commander to furnish, direct to the Adjutant General, the required inventory and final statements, and, at the same time, to forward to the commanding officer of the company to which the soldier belonged, a report of his death, specifying the date, place, and cause; to what time he was last paid, and the money or other effects in his possession at the time of his decease; which report will be noted on the next muster roll of the company to which the man belonged. Each inventory will be endorsed "Inventory of the effects of ———, late of company (—) ——— regiment of ———, who died at ——— the ——— day of ———, 186—." If a legal representative receive the effects, it will be stated in the report. If the soldier leave no effects, the fact will be reported on the blank for inventory.

NOTE 2.—Should the effects of a deceased non-commissioned officer or soldier not be administered upon within a short period after his decease, they shall be disposed of by a Council of Administration under the authority of the commanding officer of the post, and the proceeds deposited with the Paymaster, to the credit of the United States, until they shall be claimed by the legal representatives of the deceased. This should be done according to Forms 5 and 6, and one copy of each sent to the Adjutant General. No copy of the order convening the board is required, the approval of the commanding officer being sufficient.

NOTE 3.—In all such cases of sales by the Council of Administration, a statement in detail, or account of the proceeds duly certified by the Council and commanding officer, (Form 5,) accompanied by the Paymaster's receipt of the proceeds, will be forwarded by the commanding officer to the Adjutant General. The statement will be endorsed "Report of the proceeds of the effects of ———, late of company (—) ——— regiment of ———, who died at ——— the ——— day of ———, 186—."

NOTE 4.—The effects in all cases, when called for, should be turned over to the legal representative, without further authority from the Adjutant General. When the effects are turned over to the relatives of the deceased before these inventories are sent to the Adjutant General, their receipts therefor should be attached to the inventories. In all other cases, one copy will be sent with a letter of transmittal direct to the Adjutant General, and a duplicate retained by the officer.

NOTE 5.—Particular care should be taken to take receipts in duplicate from the Paymaster for any funds turned over to him; one copy should be sent direct to the Adjutant General, and one retained by the officer.

NOTE 6.—Where a soldier dies in hospital or on detached service, his descriptive list, if he has one, should be sent with his final statements, in duplicate, to the Adjutant General, Washington, D. C.

NOTE 7.—Form 1 will be forwarded in duplicate to the Adjutant General, through Regimental Headquarters, as soon as possible after the death of the soldier, accompanied by one copy of Forms 2 and 3, or 4, as the case may require. A duplicate of the inventory (Form 2) should be retained until the articles are finally disposed of.

NOTE 8.—The papers for each man should be made SEPARATELY for each man, and, when possible, fastened together. This is especially necessary, and must be done in all cases. The papers cannot be properly disposed of at the Adjutant General's Office unless this is done, and must be returned for correction.

NOTE 9.—Where there are no line officers, as, for instance, a general hospital without a line officer to command the guard, the Council of Administration may be made up from other commissioned officers, in the same way as prescribed for line officers.

NOTE 10.—Where a soldier dies away from his company or regiment, and the officer having charge of him cannot furnish Final Statements by reason of not being able to obtain a Descriptive List, he should notify the regimental or company commander, (giving him full particulars as to history and description of the man, as far as possible,) whose duty it will then be, in such case, to furnish the necessary papers from the best data he can obtain.

169

Sent for May 7. 63

CASUALTY SHEET

No. Complete

Stephen Steward

Private of Company "G"

7 Regiment of USVP

State Volunteers.

NATURE OF CASUALTY.

Killed

CASUALTY SHEET.

Name: Stephen Steward

Rank: Private Company: "G" Regiment: 7th

Arm: U.S. Cold Troop State: _____

Nature of Casualty: Death

CAUSE OF CASUALTY—(NAME OF DISEASE, &c.)

BY WHOM DISCHARGED.

FROM WHAT SOURCE THIS INFORMATION WAS OBTAINED.

DEGREE OF DISABILITY.

Gov. Muster out Roll.

BY WHOM CERTIFIED.

W. V. Smith

Capt. Comd'g Co.

DATE OF DISCHARGE, DEATH, &c.

REMARKS.

(Prisoner of war)

PLACE OF DISCHARGE, DEATH, &c.

Salisbury, N.C.

A. J. Ball

Clerk.

1282

1282
Stout Henry
Co. A, 7 U.S. Col'd Inf.

Private | *Private*

CARD NUMBERS.

1	6279901	26
2	6280002	27
3	6280103	28
4	6280202	29
5	6280306	30
6	6280403	31
7	6280498	32
8	6280593	33
9	6280693	34
10	6280792	35
11	6280892	36
12	6280993	37
13	6281093	38
14	6281189	39
15	6281282	40
16	6281373	41
17	6281458	42
18	6281541	43
19	6281622	44
20	6281704	45
21	9065962	46
22		47
23		48
24		49
25		50

Book Mark:

See also

S.2038290 P.O.m.m

MAR 12 1864

S | **7** | **U.S.C.T.**

Henry Stout
....., Co. *W*, 7 Reg't U.S. Col'd Inf.

Appears on
Company Descriptive Book
of the organization named above.

DESCRIPTION.

Age *22* years; height *5* feet *5 3/4* inches.
Complexion *ruff*.
Eyes *Bro.*; hair *curly*
Where born *Queen Ann, Md.*
Occupation *Farmer*.

ENLISTMENT.

When *Sept. 23d.*, 186*3*.
Where *Baltimore*.
By whom *Capt. M Binny*; term *3* y'rs.
Remarks: *Descriptive List sent to*
Hospital Indianola Texas
July 13, 65.
Mustered Sept. 26, 63.

(383g)

J. Smith,
.....
Copyist.

S | 7 | U.S.C.T.

Henry Stout
Pt., Co. *a*, 7 Reg't U. S. Colored Inf.

Age *22* years.

Appears on

Company Muster-in Roll

of the organization named above. Roll dated
Baltimore Md., Sept. 26, 1863.

Muster-in to date *Sept. 26, 1863.*

Joined for duty and enrolled:

When *Sept. 23*, 1863.*

Where *Queen Anne Co. Md.**

Period *3* years.*

Remarks:

EdMuster-in roll shows enrollment of all men of this company as of same date. See enrollment on subsequent card or cards.

Book mark:

Dayett

S | 7 | U.S.C.T.

Henry Stout
Pvt; Co. A, 7 Reg't U. S. Col'd Infantry.

Appears on

Company Muster Roll

for ~~June~~ Sept. 26 to Oct. 31, 1862.

Joined for duty and enrolled:

When Sept. 23, 1862.*

Where Queen Ann Co. Md. *

Period 3 years.*

Present or absent Absent.

Stoppage, \$ 100 for

Due Gov't \$ 100 for

Remarks: Detached on recruiting service in Calvert Co. Md.

* See enrollment on card from muster-in roll.

Book mark:

Daggett
(358c) Copyist.

S | 7 | U.S.C.T.

Henry Stout

Prvt., Co. A, 7 Reg't U. S. Col'd Infantry.

Appears on

Company Muster Roll

for Nov. & Dec., 1863.

Joined for duty and enrolled:

When Sept. 23, 1863.*

Where Queen Anne Co., Md. *

Period 3 years.*

Present or absent Absent

Stoppage, \$ 100 for

Due Gov't \$ 100 for

Remarks: Detached recruiting by order of Col. W. Birney Dec. 1st Enlistment premium due.

* See enrollment on card from muster-in roll.

Book mark:

Daggett

5 | 7 | U.S.C.T.

Henry Stout
Priv., Co. A, 7 Reg't U. S. Col'd Infantry.

Appears on

Company Muster Roll

for Jan. & Feb., 1864.

Joined for duty and enrolled:

When Sept. 23, 1863.*

Where Queen Ann Co. Md.*

Period 3 years.*

Present or absent Present.

Stoppage, \$ 100 for

Due Gov't \$ 100 for

Remarks: Joined from Recruiting
Feb. 5th 1864
Enlistment premium due.

* See enrollment on card from muster-in roll.

Book mark:

Gazette

S. | 7 | U.S.C.T.

Henry Stout
Pvt., Co. A, 7 Reg't U. S. Col'd Infantry.

Appears on

Company Muster Roll
for Mar. & Apr., 1864.

Joined for duty and enrolled:

When Sept. 23, 1863.*

Where Queen Ann Co., Md.*

Period 9 years.*

Present or absent Absent.

Stoppage, \$ 100 for

Due Gov't \$ 100 for

Remarks: Absent sick in
Genl. Hospital Jacksonville
Fla. since March 22 1864.

* See enrollment on card from muster-in roll.

Book mark:

Gaggett
(358c) Copyist.

S | **7** | **U.S.C.T.**

Henry Stout

Prs., Co. A, 7 Reg't U. S. Col'd Infantry.

Appears on

Company Muster Roll

for *May & June*, 1864.

Joined for duty and enrolled:

When *Sept. 23*, 1863.*

Where *Queen Anne Co. Md.**

Period *3* years.*

Present or absent *Present.*

Stoppage, \$ *100* for

Due Gov't \$ *100* for

Remarks: _____

* ~~42~~ See enrollment on card from muster-in roll.

Book mark: _____

Daggett

8

7

U.S.C.T.

Henry Stout

Pvt., Co. A, 7 Reg't U. S. Col'd Infantry.

Appears on

Company Muster Roll

for July & Aug., 1864.

Joined for duty and enrolled:

When Sept. 23, 1863.*

Where Queen Ann Co. Md. *

Period 3 years.*

Present or absent Present.

Stoppage, \$ 100 for

Due Gov't \$ 100 for

Remarks:

* See enrollment on card from muster-in roll.

Book mark:

Laggett

S

7

U.S.C.T.

Henry Stout

Priv., Co. A, 7 Reg't U. S. Col'd Infantry.

Appears on

Company Muster Roll

for Sept. & Oct., 1864.

Joined for duty and enrolled:

When Sept. 23, 1863.*

Where Queen Ann *

Period 3 years.*

Present or absent Present

Stoppage, \$ 100 for

Due Gov't \$ 100 for

Remarks: Stop for one set of metallic scales, Corp's

* See enrollment on card from muster-in roll.

Book mark:

(858c)

Edward Copyist.

S | 7 | U.S.C.T.

Henry Stout
Pvt., Co. A, 7 Reg't U. S. Col'd Infantry.

Appears on

Company Muster Roll

for Nov. & Dec., 1864.

Joined for duty and enrolled:

When Sept. 23, 1863.*

Where Queen Ann, Md.*

Period 3 years.*

Present or absent Present.

Stoppage, \$ 100 for

Due Gov't \$ 100 for

Remarks: Stop for one set of metallic scales.

* See enrollment on card from muster-in roll.

Book mark:

(358c)

Leonard
Copyist.

S. 1 7 U.S.C.T.

Henry Stout
Pvt., Co. A, 7 Reg't U. S. Col'd Infantry.

Appears on

Company Muster Roll

for Jan & Feb., 1865.

Joined for duty and enrolled:

When Sept. 23, 1863.*

Where Queen Ann, Md.*

Period 3 years.*

Present or absent Present.

Stoppage, \$ 100 for

Due Gov't \$ 100 for

Remarks:

* See enrollment on card from muster-in roll.

Book mark:

(858c) Leonard Copyist.

S | 7 | U.S.C.T.

Henry Stout

Pat., Co. A, 7 Reg't U. S. Col'd Infantry.

Appears on

Company Muster Roll

for Mch. & Apl., 1865.

Joined for duty and enrolled:

When Sept 23, 1863.*

Where Queen Ann.*

Period 3 years.*

Present or absent Present.

Stoppage, \$ 100 for

Due Gov't \$ 100 for

Remarks:

* See enrollment on card from muster-in roll.

Book mark:

(358c)

Leonard Copyist.

S | 7 | U.S.C.T.

Henry Stout
Pvt, Co. A, 7 Reg't U. S. Col'd Infantry.

Appears on

Company Muster Roll

for May & June, 1865.

Joined for duty and enrolled:

When Sept. 23, 1863.*

Where Queen Ann *

Period 3 years.*

Present or absent Present.

Stoppage, \$ 100 for

Due Gov't \$ 100 for

Remarks: Charge 1 Screw driver & 1
Wiper.

* See enrollment on card from muster-in roll.

Book mark:

S | 7 | U.S.C.T.

Henry Stout
Pvt, Co. A, 7 Reg't U. S. Col'd Infantry.

Appears on

Company Muster Roll

for July & Aug., 1865.

Joined for duty and enrolled:

When Sept 23, 1863.*

Where Queen Ann.*

Period years.*

Present or absent * Present

Stoppage, \$ 100 for

Due Gov't \$ 100 for

Remarks: Absent sick since July 3, 1865, Indianola, Tex.

* Name appears in "Present" column

* See enrollment on card from muster-in roll.

Book mark:

Edward
Copyist.

S 7 U.S.C.T.

Henry Stout
Pvt., Co. A, 7 Reg't U. S. Col'd Infantry.

Appears on

Company Muster Roll

for Sept. & Oct., 1865.

Joined for duty and enrolled:

When Sept. 23, 1863.*

Where Queen Anne's.*

Period 3 years.*

Present or absent Present

Stoppage, \$ 100 for

Due Gov't \$ 100 for

Remarks:

* See enrollment on card from muster-in roll.

Book mark:

(358c)

Conard
Copyist.

MAR 21 1865

S | **7** | **U.S.C.T.**

Henry Stark
Pi, Co. A, 7 Reg't U. S. Col'd Infantry.

Appears on

Company Muster Roll
for *Nov & Dec*, 186*5*.

Joined for duty and enrolled:

When *Sept 23*, 186*3*.*

Where *Queen Ann Co. Md.* *

Period *3* years.*

Present or absent *Present*

Stoppage, \$ *100* for

Due Gov't \$ *100* for

Remarks:

* ~~See~~ See enrollment on card from muster-in roll.

Book mark: _____

(358c)

Henry J. Copyist.

S 1 7 U.S.C.T.

Henry Stort
B., Co. A, 7 Reg't U. S. Col'd Infantry.

Appears on

Company Muster Roll
for Jan & Feb, 1866

Joined for duty and enrolled:

When Sep 23, 1863.*

Where Queen Ann Co. Md.*

Period 3 years.*

Present or absent Present

Stoppage, \$ 65 for le & GB

Due Gov't \$ 100 for _____

Remarks: _____

* See enrollment on card from muster-in roll.

Book mark: _____

(358c)

Mowry Jr.
Cpyist.

81 7 U.S.C.T.

Henry Stout
Pri, Co. A, 7 Reg't U. S. Col'd Infantry.

Appears on

Company Muster Roll

for Nov & Dec, 1866.

Joined for duty and enrolled:

When Sep 23, 1863.*

Where Queen Ann Co. Md.*

Period 3 years.*

Present or absent Present

Stoppage, \$ 100 for

Due Gov't \$ 100 for

Remarks:

* See enrollment on card from muster-in roll.

Book mark:

Henry J. Stout
Copyist.

S 1 7 U.S.C.T.

Henry Stou
Co. A, 7 Reg't U. S. Col'd Infantry.

Appears on

Company Muster Roll

for May & June, 1866.

Joined for duty and enrolled:

When Sep 23, 1863.*

Where Queen Ann Co. Md.*

Period 3 years.*

Present or absent Present

Stoppage, \$ 100 for

Due Gov't \$ 100 for

Remarks: To forfeit 1 month pay
by sentence of G. C. Court
June 10/66

* See enrollment on card from muster-in roll.

Book mark:

(858c)

Henry J. Copyist.

1863

7 U.S.C.T.

Henry Stout

Co. A 7 Reg't U. S. Col'd Infantry.

Appears on

Company Muster Roll

for July 7 Aug., 1866.

Joined for duty and enrolled:

When Sep 23, 1863.*

Where New Am Co Ind.*

Period 3 years.*

Present or absent Present

Stoppage, \$ 100 for

Due Gov't \$ 100 for

Remarks: To forfeit to the U.S. one month's pay by sentence of Field Officers Court Jun 10/66

* See enrollment on card from muster-in roll.

Book mark:

Mowry J. Copyist.

(858c)

RECORDED

S 1 7 U.S.C.T.

Henry Stout
Pri, Co. A, 7 Reg't U. S. Col'd Infantry.

Appears on **Co. Muster-out Roll**, dated
Indianola, Tex., Oct 13, 1866.

Muster-out to date Oct 13, 1866.

Last paid to Apr 30, 1866.

Clothing account:

Last settled....., 186 ; drawn since \$.....¹⁰⁰

Due soldier \$ 11⁰⁴/₁₀₀; due U. S. \$.....¹⁰⁰

Am't for cloth'g in kind or money adv'd \$.....¹⁰⁰

Due U. S. for arms, equipments, &c., \$.....¹⁰⁰

Bounty paid \$ None ¹⁰⁰; due \$ 100⁰⁰/₁₀₀

Remarks: Joined Orig. Reg'n.
No forfeit one months
pay; by sentence of Field
Officers Court June 10/66

Book mark:.....

Henry J. Stout
Adjut.

Stuart Henry
P. Co. 7, *Reg't 1st Inf*
3 Enclosures.

Bed Cards	Final Statements
Burial Records	Furloughs or L. of A.
Certs. of Dis. for Discharge	Med. Certificates
C. M. Charges	Med. Des. Lists
Descriptive Lists	Orders
Discharge Certificates	Pris. of War Record
Enlistment Papers	Resignations

Other papers relating to—

Admission to Hosp'l	Furlough or L. of A.
Casualty Sheet. <i>3</i>	Med. Examination
Confinement	Misc. Information
Contracts	Pay or Clothing
Death or Effects	Personal Reports
Desertion	Rank
Discharge from Hosp'l	Transfer to Hosp'l
Discharge from Service	Transfer to V. R. C.
Duty	Transportation
.....

CASUALTY SHEET
OF WOUNDED.

Stout
Henry Stout
Private Company A
7 Regiment of M.S.P.

Volunteers at the battle of near Dupo
Battone, Va. Aug 14, 64.

CASUALTY SHEET.

Name, *Henry Stout*
Rank, *Private*, Company *A*, Regiment, *7th*
Arm, *USCT*, State, _____
Place of casualty, _____

Nature of casualty, *wounded, Right leg, slight*

Date of casualty, *Aug 13th 1864*

FROM WHAT SOURCE THIS INFORMATION WAS OBTAINED.

Report of Killed, Wounded, and Missing of the _____ Regiment.
Brigade, _____ Division, _____ Corps, dated _____

List of killed and wounded in Brigade of Colored Troops, 10th Army Corps, commanded by Col Shaw 7th USCT.

*(Signed) A.P. Reichhold Surgeon 8th USCT
Chief Med officer Shaws Brigade.*

Ind 50d 4068

W.F. Thompson

Clerk.

150

(3)



CASUALTY SHEET
OF WOUNDED.

Terry Stout

Private Company *A*

7th Regiment of *Infantry*

Volunteers at the battle of

Aug 13/64

CASUALTY SHEET.

Name, *Henry Stoul*
 Rank, *Sgt* Company *A*, Regiment, *7th*
 Arm, *Infy*, State, *MS*
 Place of casualty, *Not stated*
 Nature of casualty, *wounded, right leg slight*
 Date of casualty, *Aug 13th 1864*

FROM WHAT SOURCE THIS INFORMATION WAS OBTAINED.

Report of Killed, Wounded, and Missing of the _____ Regiment,
Shaw's Brigade, _____ Division, _____ Corps, dated _____
 Signed *A. P. Hechheld* Surg
8th MS Infy Chf. Med. Off.
Shaw's Brig.
Ind 50. L. P. 3. No 68.

A. P. Logan
 Clerk.
7/31/80

150
(2)

CASUALTY SHEET
OF WOUNDED.

Henry Stout

Privat Company W

7 Regiment of U.S.C.T.

Volunteers at the battle of near Deep
Bottom Va, Aug. 14/64.

CASUALTY SHEET.

Name, Henry Stuart
 Rank, Pvt, Company A, Regiment, 7
 Arm, USC, State, _____
 Place of casualty, near Deep Bottom Va
 Nature of casualty, Wounded
 Date of casualty, August 14, 1864

FROM WHAT SOURCE THIS INFORMATION WAS OBTAINED.

Report of Casualties
~~Killed, Wounded, and Missing~~ of the 7 Regiment,
 Brigade, _____ Division, _____ Corps, dated USC 13th to 20
Aug 64, during engagement. Not dated or signed.
Ind 30 No 119.

R. C. Jones.
 Clerk.

1283

Stout John

Co F, 7 U.S. Col'd Inf.

Private

Private

CARD NUMBERS.

1	6289208	26
2	6289306	27
3	6289403	28
4	6289503	29
5	6289605	30
6	6289700	31
7	6289796	32
8	6289888	33
9	6289989	34
10	6290079	35
11	6290176	36
12	6290276	37
13	6290363	38
14	6290452	39
15	6290536	40
16	6290633	41
17	6290899	42
18	9066601	43
19		44
20		45
21		46
22		47
23		48
24		49
25		50

Book Mark: 1997- C.J. 84

See also

S | **7** | **U.S.C.T.**

John Stout
....., Co. *G*, 7 Reg't U. S. Col'd Inf.

Appears on
Company Descriptive Book
of the organization named above.

DESCRIPTION.

Age *21* years; height *5* feet *8 1/2* inches.

Complexion *Blk*

Eyes *Blk*; hair *Curly*

Where born *Kent, Md.*

Occupation *Fanner*

ENLISTMENT.

When *Sept 27*, 1863.

Where *Baltimore, Md.*

By whom *Col. W. Birney*; term *3* y'rs.

Remarks: *Mustered Sept 30 1863*
by Col. Wm. Birney. Died
at Jacksonville, Fla. Aug
10 1864, Chronic Diarrhoea.
Notice of death received.
Buried at Ft. Monroe,
Va. during the summer of
1865.

J. J. Brown
.....
Copist.

S | **7** | **U.S.C.T.**

John C. Stout.
Pat, Co. *C*, 7 Reg't U. S. Colored Inf.

Age *21* years.

Appears on

Company Muster-in Roll

of the organization named above. Roll dated

Baltimore Md. Sept 30, 186*3*.*

Muster-in to date *Sept. 30*, 186*3*.*

Joined for duty and enrolled:

When *Sept. 27*, 186*3*.*

Where *Kent Co. Md.* *

Period *3* years.*

Remarks: _____

*Muster-in roll shows enrollment of all men of this company as of same date. See enrollment on subsequent card or cards.

Book mark: _____

J. A. Miller
Supt.

S | **7** | **U.S.C.T.**

John H. Hunt

Pvt, Co. F, 7 Reg't U. S. Col'd Infantry.

Appears on

Company Muster Roll

for *Sept. 30. to Octo. 31.*, 186*3*.

Joined for duty and enrolled:

When *Sept. 27.*, 186*3*.*

Where *Hunt Co. Md* *

Period *3* years.*

Present or absent *Present*

Stoppage, \$ *100* for

Due Gov't \$ *100* for

Remarks:

* See enrollment on card from muster-in roll.

Book mark: _____

C. J. Miller
Copyist.

S | **7** | **U.S.C.T.**

Ed. Stout

Plt, Co. F, 7 Reg't U. S. Col'd Infantry.

Appears on

Company Muster Roll
for *Nov & Dec*, 186 *3*.

Joined for duty and enrolled:

When *Sept 27*, 186 *3*.*

Where *Kent Co. Md* *

Period *3* years.*

Present or absent *Present*

Stoppage, \$ *100* for -----

Due Gov't \$ *100* for -----

Remarks: *Stopped for one cap
bugle.*

* ~~See~~ See enrollment on card from muster-in roll.

Book mark: -----

J. H. Miller
Copyist.

S. A. 7 U.S.C.T.

Frank Stout
Sub, Co. F, 7 Reg't U. S. Col'd Infantry.

Appears on

Company Muster Roll

for *Jan. & Feb.*, 1864

Joined for duty and enrolled:

When *Sept 27.*, 1863.*

Where *Kent Co Md* *

Period..... years.*

Present or absent *Present*

Stoppage, \$ 100 for.....

Due Gov't \$ 100 for.....

Remarks:
.....
.....
.....
.....
.....

* See enrollment on card from muster-in roll.

Book mark:.....

C. J. H. H. H.
Copyist.

NARA 1200

S | **7** | **U.S.C.T.**

John Stout
Pl., Co. F, 7 Reg't U. S. Col'd Infantry.

Appears on
Company Muster Roll
for *March & April*, 186*4*.

Joined for duty and enrolled:
When *Sept 27*, 186*3*. *
Where *New Co. Md.* *
Period *3* years.*

Present or absent *Present.*

Stoppage, \$ *100* for _____

Due Gov't \$ *100* for _____

Remarks: *Stop for Laversack
& Canteen*

* ~~See~~ See enrollment on card from muster-in roll.

Book mark: _____

(358c) _____
J. C. Miller
Copyist.

S 7 U.S.C.T.

John Stout
Co. F, 7 Reg't U. S. Col'd Infantry.

Appears on

Company Muster Roll

for *May & June*, 186*4*.

Joined for duty and enrolled:

When *Sept 27*, 186*3*.*

Where *Frank Co. Md* *

Period *3* years.*

Present or absent *Present*

Stoppage, \$ *100* for

Due Gov't \$ *100* for

Remarks: *Stop for one letter*
figure & for scales

* See enrollment on card from muster-in roll.

Book mark:

J. C. [Signature]
Copyist.

S 1 7 U.S.C.T.

John Stout
Prt, Co. F, 7 Reg't U. S. Col'd Infantry.

Appears on
Company Muster Roll
for July & Aug, 1864.

Joined for duty and enrolled:
When Sept 27, 1863.*
Where Kent Co. Mo.*
Period 3 years.*

Present or absent Absent

Stoppage, \$ 100 for

Due Gov't \$ 100 for

Remarks: Stop for 1
Letter, Figure Pr.
Scales. Absent
Sick since Aug.
14/64

* See enrollment on card from muster-in roll.

Book mark:

w. d. d. o. r.

NA 991 241

S | 7

U.S.C.T.

John Stout
Private, Co. F, 7 Reg't U. S. Col'd Infy

Appears on

Company Muster Roll

for Sept. & Oct., 1864.

Joined for duty and enrolled:

When Sept. 27, 1863.*

Where Kent Co., Md.*

Period 3 years.*

Present or absent Absent

Stoppage, \$ 100 for

Due Gov't, \$ 100 for

Remarks: Absent wounded since Sept 29, 64. Stopped for 1 letter, 1 figure, 1 pr. scales & 1 piece shelter tent.

* See enrollment on card from muster-in roll.

Book mark:

Keefe.

(358c)

Copyst.

S | 7 | U.S.C.T.

John Stout
Private, Co. F, 7 Reg't U. S. Col'd Infantry.

Appears on

Company Muster Roll

for *Nov. 3rd Dec., 1864.*

Joined for duty and enrolled:

When *Sept. 27, 1863.**

Where *Kent Co., Md.**

Period years.*

Present or absent *Absent*

Stoppage, \$ 100 for

Due Gov't \$ 100 for

Remarks: *Absent wounded since Sep. 29th 64. Stopped for 1 letter, 1 bugle, 1 scales, 1 piece shelter tent.*

* See enrollment on card from muster-in roll.

Book mark:

Keefe

S | **7** | **U.S.C.T.**

John Stout
Private, Co. F, 7 Reg't U. S. Col'd Infantry.

Appears on

Company Muster Roll

for *Jan. & Feb.*, 1865.

Joined for duty and enrolled:

When *Sep. 27*, 1863.*

Where *Kent Co., Md.**

Period *9* years.*

Present or absent *Present.*

Stoppage, \$ *100* for

Due Gov't \$ *100* for

Remarks:

* See enrollment on card from muster-in roll.

Book mark: _____

Keefe

Copyist.

S

7

U.S.C.T.

John Stout

Private, Co. F, 7 Reg't U. S. Col'd Infantry.

Appears on

Company Muster Roll

for *Mar. 5 Apr*, 1865.

Joined for duty and enrolled:

When *Sep. 27*, 1863.*

Where *Kent Co., Md.* *

Period *3* years.*

Present or absent *Present*.

Stoppage, \$ *100* for

Due Gov't \$ *100* for

Remarks:

* See enrollment on card from muster-in roll.

Book mark: -----

(858c)

Keefe

Copyist.

J | *7* | U.S.C.T.

John Stout

Private, Co. F, 7 Reg't U. S. Col'd Infantry.

Appears on

Company Muster Roll

for *May and June*, 186*5*.

Joined for duty and enrolled:

When *Sep. 27*, 186*3*.*

Where *Kent*.*

Period *3* years.*

Present or absent *Absent*.

Stoppage, \$ *100* for

Due Gov't \$ *100* for

Remarks: *Absent sick since May 20th 1865. To be stopped for 1 Wiper^{2nd} 1 Cart. Box Blt. Plate.*

* See enrollment on card from muster-in roll.

Book mark:

Keefe
(858c) Copyist.

NA 991 244

S | **7 -** | **U.S.C.T.**

John Stout

Private, Co. F, 7 Reg't U. S. Col'd Infantry.

Appears on

Company Muster Roll

for *July and Aug.*, 1865.

Joined for duty and enrolled:

When *Sep. 27*, 1863.*

Where *Kent Co., Md.**

Period *3* years.*

Present or absent *Absent*

Stoppage, \$ *100* for

Due Gov't \$ *100* for

Remarks: *Absent sick at
Fortress Monroe, Va since
May 30, 65. Stopped for
Ordinance 29^x*

** Bull torn.*

* See enrollment on card from muster-in roll.

Book mark:

Keefe

S | 7

U.S.C.T.

John Stout
Priv., Co. F, 7 Reg't U. S. Col'd Inf'y

Appears on

Company Muster Roll

for Sept. & Oct. 1865.

Joined for duty and enrolled:

When Sept. 27, 1863.*

Where Kent Co., Md. *

Period 3 years.*

Present or absent Absent.

Stoppage, \$ 1 ⁵/₁₀₀ for Ordnance

Due Gov't, \$ ¹⁰⁰/₁₀₀ for

Valuation of horse, \$ ¹⁰⁰/₁₀₀

Valuation of horse equipments, \$ ¹⁰⁰/₁₀₀

Remarks: Sick at Fortress
Monroe since May 30th
1865.

*See enrollment on card from muster-in roll.

Book-mark :

Keefe
Copyist.

8 | 7 | U.S.C.T.

John Stout
Pet., Co. F, 7 Reg't U. S. Col'd Infantry.

Appears on

Company Muster Roll

for Nov. & Dec., 1863.

Joined for duty and enrolled:

When Sept. 27, 1863.*

Where Kent Dnd. *

Period 3 years.*

Present or absent Absent

Stoppage, \$ 100 for

Due Gov't \$ 100 for

Remarks: Sick Fortress
Monroe Va. May 30, 63.
Stop for ordnance
\$1.05.

* See enrollment on card from muster-in roll.

Book mark:

Brubaker

S. 1 7 U.S.C.T.

John Stewart
Capt., Co. F, 7 Reg't U. S. Col'd Infantry.

Appears on

Company Muster Roll

for Jan. + Feb., 1866

Joined for duty and enrolled:

When Sept. 27, 1863.*

Where Kent Co., Md. *

Period 3 years.*

Present or absent

Stoppage, \$ 100 for

Due Gov't \$ 100 for

Remarks: Drowned near
Pt. Monroe Va.
Notice received
Feb. 10-1866

* See enrollment on card from muster-in roll.

Book mark 8931.2a Apl 15/68

Browke Copyist.

MAR 12 1866

S | 7 | U.S.C.T.

John Stout
Capt., Co. F., 7 Reg't U. S. Col'd Infantry.

Appears on Co. Muster-out Roll, dated
Indianda, Texas, Oct 13, 1866.

Muster-out to date _____, 186 .

Last paid to _____, 186 .

Clothing account:

Last settled _____, 186 ; drawn since \$ _____ 100

Due soldier \$ _____ 100 ; due U. S. \$ _____ 100

Am't for cloth'g in kind or money adv'd \$ _____ 100

Due U. S. for arms, equipments, &c., \$ _____ 100

Bounty paid \$ _____ 100 ; due \$ _____ 100

Remarks: Wounded at Ft.
Monroe Va. during
the summer of 1865.

Book mark: Als. Dep't 10/65 - see
(over)

Brooks.

NR 91 251

JAN. 21

6290899

616816

Cas. sheet + cir. letter
 on file. 8931. 2a. App. 15/28.
 313.277 1997 C.S. 84.
 F.S.

Stout,
Stout, John
P. Co. F., 7 Reg't Med Inf.

Enclosures.

- | | |
|------------------------------------|----------------------------|
| Bed Cards | Final Statements |
| Burial Records | Furloughs or L. of A. |
| Certs. of Dis. for Discharge | Med. Certificates |
| C. M. Charges | Med. Des. Lists |
| Descriptive Lists | Orders |
| Discharge Certificates | Pris. of War Record |
| Enlistment Papers | Resignations |

Other papers relating to—

- | | |
|------------------------------|---------------------------|
| Admission to Hosp'l | Furlough or L. of A. |
| Casualty Sheet | Med. Examination |
| Confinement | Misc. Information |
| Contracts | Pay or Clothing |
| Death or Effects | Personal Reports |
| Desertion | Rank |
| Discharge from Hosp'l | Transfer to Hosp'l |
| Discharge from Service | Transfer to V. R. C. |
| Duty | Transportation |

Hospital Number 4686 5th

Name John George Stans

Age 22 Nativity German

Married or Single Single

Residence Kent-C-Md

Post Office address of wife or nearest relative David Stans

Kent-C-Md

Rank Private Co. F. Regiment 7th Regt

When admitted Oct 1864

From what source Fortress Monroe

Diagnosis: (in surgical cases state explicitly seat and character of wound or injury.)

Gravel - W -

Right Arm

fever. Summit House G. H. Philadelphia, Pa.

On what occasion wounded Aug 13th

Date Aug 29 - 64

Nature of missile or weapon Rifle

MARR 1254

TREATMENT.

[HERE NOTE IMPORTANT COMPLICATIONS AND ALL OPERATIONS.]

Cold water dressing.

Returned to duty
Feb. 10 1865
C. M. Porter

RESULT AND DATE.

Healed
Transferred to Guard
Nov 21/54

H. A. D. M.
a. b. c.
—

149

CASUALTY SHEET
OF WOUNDED.

John Stout
Pat Company A,

7th Regiment of U. S. C. T.

Volunteers at the battle of Chapins

Farm Va. Sept 29,

+ 30/62

CASUALTY SHEET.

Name, John Stout
 Rank, Private, Company 'F', Regiment, 1st
 Arm, U. S. C. I., State, _____
 Place of casualty, Chapins Farm, Va.

Nature of casualty, Wounded
 Date of casualty, Sept 29 + 30 / 64

FROM WHAT SOURCE THIS INFORMATION WAS OBTAINED.

Report of Killed, Wounded, and Missing of the _____ Regiment,
 Brigade, _____ Division, _____ Corps, dated _____
List of casualties in the 1st U. S. C. I. on the 29
+ 30 of Sept / 64, at Chapins Farm, Va.
(Sgd) Lemuel H. Haskell
Sir Robert Lewis
Quid 50 J no 63

W. P. Broome
 Clerk.

WAR DEPARTMENT,
Surgeon General's Office,

RECORD AND PENSION DIVISION,

Washington, D. C.,

July 12th, 1884

(TRANSCRIPT FROM RECORDS.)

It appears from the records filed in this Office, that Priv. John Stout, C. F., 4th U. S. C. T's, was admitted to G. H., Ft. Monroe, Va., Dec. 6, '64, from field, with S. F. W. right arm, upper third, wounded at Deep Bottom, Sept. 29, '64, and transferred to G. H., Dec. 15, '64. - Was admitted to Summit House G. H., West Philadelphia, Pa., Dec. 18, '64, from Fortcas. Monroe, (name: John Stout,) with deep shot wound right arm, wounded at Deep Bottom, Sept. 29, '64, and returned to duty Feb. 10, '65. - Was admitted to G. H., Ft. Monroe, Va., May 30, '65, from Point of Rocks, (name: John Stout,) with S. F. W. right arm, flesh wounded at Deep Bottom, Dec. 29, '64, and died Sept. 9, or 10, '65; cause: Accidental drowning.

By order of the Surgeon General:

D. I. Pope

Asst. Surgeon U. S. Army.
(108)

VOL _____

NO 307.269

Per _____

(NOTE.—This transcript should not be detached from the accompanying papers. If additional information is desired relative to the case, the papers should accompany the application therefor.)

A. B. S.

1997 Q. 1. 1884

July 12. 1884

John Stout,
late Pot. Co. 7th; 7th U.S.C.A.

Surgeon General re-
turns A.G.O. commu-
nication of May 14th
84. with report on
case of.

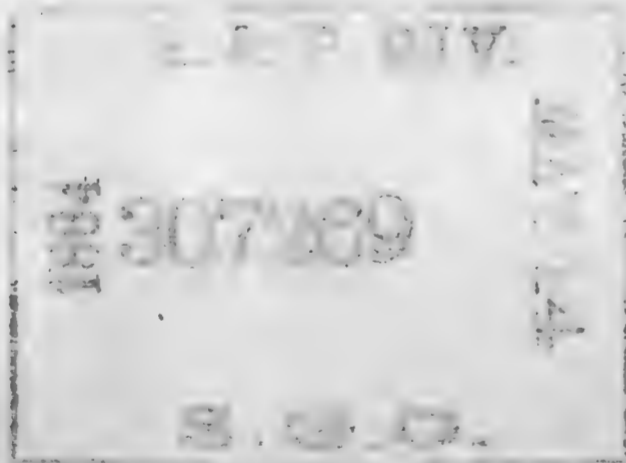

WAR DEPARTMENT,
Surgeon General's Office,
Record and Pension Division,

Washington, D. C., July 12, 1884

Respectfully returned to the Adjutant General, U. S.

Army, with report enclosed.

BY ORDER OF THE SURGEON GENERAL:

[Handwritten Signature]

Assistant Surgeon, U. S. A.
(80)

[Handwritten Initials]

Noted d.l.

War Department,

ADJUTANT GENERAL'S OFFICE,

Washington, D. C., May 14th, 1864.

Sir:

I have the honor to inform you that John Stout
Private, Co. 2, 7th Reg't U.S. Colored Troops
 Volunteers, is reported on the muster-rolls of that Company for the months
 from June 30th '65 to Dec 31, 1865, as follows:

"Absent sick at Fort Monroe Va. since
 May 30 '65"; Abs for Jan'y + Feb'y 1866
 "Drowned near Ft. Monroe Va."

and to request that you furnish this Office with such information relative to
 this soldier as the records of your office may afford.

Very respectfully,

Your obedient servant,

O. W. Benjamin
 Assistant Adjutant General.
 (253.)

The Surgeon General
 U. S. Army

AM

This is given out for the M. O. R. Regts
Sept. 3. 1865
Complete
CASUALTY SHEET

No. _____

John Stults
_____ of Company *D*
_____ of *7th* Regiment of *Miss. C. T.*
State Volunteers.

NATURE OF CASUALTY.

Died Sept. 10. 1865.

Ans. M. O. R. Regts.

MAR 26 1865

CASUALTY SHEET.

Name: John Stultz
 Rank: Priv Company: F Regiment: 7th
 Arm: U.S.C.P. State: _____
 Nature of Casualty: Death

CAUSE OF CASUALTY—(NAME OF DISEASE, &c.)

BY WHOM DISCHARGED.

FROM WHAT SOURCE THIS INFORMATION WAS OBTAINED.

DEGREE OF DISABILITY.

Roll of Honor Pg 46
Hampton & Ft Monroe, Va,

BY WHOM CERTIFIED.

REMARKS.

James M. Moore
A. J. M.

DATE OF DISCHARGE, DEATH, &c.

Sept. 10, 1865

PLACE OF DISCHARGE, DEATH, &c.

Buried Hampton, Va

James Beckwith
 Clerk.

Medical Director's Office,
Dept. of the Potomac,
Richmond Va. Sept 24. 1866.

Respectfully returned.
It appears from records
of the late U. S. Genl Hospital
Drt Monroe, that the within
named soldier died at
said Hospital from Drowning
Sept 10th 1865.

There are no Inventories
on file ^{for that month,} nor any data
from which Final
Statements can be furnished.

J. S. Lewis
Drt Col. U. S. Army
Medical Director

WAR DEPARTMENT,

ADJUTANT GENERAL'S OFFICE,

WASHINGTON, *Sept. 3^d*, 1866.

SIR:

Final Statements in the cases of deceased soldiers are required to be sent to the Adjutant General's Office in duplicate, with one copy of the Inventory of Effects. The Descriptive List should also be sent to this Office in cases where the soldier was absent from his Company at the time of his death. Where there were no effects, it should be so stated on a blank Inventory, properly signed.

Certificates of Disability should be sent in duplicate. Special care should be taken that the date of discharge and signature of the discharging officer should be affixed.

As of the Final Statement *or* Inventory, has been received in the case of *Priv. John Stults*, of Co. *F*, *7th* Regiment of *V. S. C. T.* Volunteers, whose papers were forwarded to this Office. You will please forward the missing papers without delay.

I have the honor to be, sir,

Very respectfully,

Your obedient servant,

*Reported on Burial
Records Died Sept. 10. 1865,
Buried Hampton, Va.*

F. W. Hayward

Assistant Adjutant General.

~~COMMANDING OFFICER~~

Medical Director. Dept. Potomac

*If you cannot furnish final papers please give date,
place, and cause of death, if possible,
J. B.*

MODEL FOR SET OF PAPER

FORM 1.—FINAL STATEMENT.

I CERTIFY, ON HONOR, that *John Smith*, a Private of Captain *J. Brown's* Company, (A,) of the 1st Regiment of Pennsylvania Volunteers, of the State of Pennsylvania, born in *Pittsburg*, State of Pennsylvania, aged 21 years, 5 feet 10 inches high, light complexion, blue eyes, dark hair, and by occupation a Farmer, having joined the Company on its original organization at *Pittsburg*, and enrolled in it at the muster into the service of the United States at *Pittsburg*, on the 1st day of July, 1861, (or was mustered in service as a recruit, by _____, at _____, on the _____ day of _____, 186—, or was drafted and mustered into the service of the United States from the _____ Enrollment District of the State of _____, at _____, on the _____ day of _____, 186—,) to serve in the Regiment for the term of Three Years, and having served *honestly* and *faithfully* with his Company in the field to the present date, is now entitled to a DISCHARGE by reason of death. Died in Regimental Hospital, Fort Brown, Texas, December 31, 1863, of typhoid fever.

The said *John Smith* was last paid by Paymaster Major *Morse*, to include the 31st day of October, 1863, and has pay due him from that time to the present date. He is entitled to pay and subsistence for *traveling* to place of enrollment, and whatever other allowances are authorized to volunteer soldiers, drafted men, or militia, so discharged. He has received from the United States *clothing* amounting to 20.00 dollars, since the 31st day of December, 1862, when his clothing account was last settled. He has received from the United States 25.00 dollars advanced *bounty*.

There is to be stopped from him on account of the State of _____, or other authorities, for *clothing*, &c., received on entering service, nothing, 00 dollars; and for other stoppages, viz: nothing, 00 dollars. He has been furnished with no *transportation* in kind from the place of his discharge to _____; and he has not been *subsisted* for *traveling* to his place of enrollment up to the _____, 186—.

He is indebted to _____, *Sutler*, _____ 00 dollars.
 He is indebted to _____, *Laundress*, _____ 00 dollars.

GIVEN, IN DUPLICATE, at Fort Brown, Texas, this 31st day of December, 1863.

JAMES BROWN,
Captain Co. A, 1st Penn. Vols.,
Commanding Company.

FORM 2.

INVENTORY of the effects of *John Smith*, late a Private of Captain *J. Brown's* Company, (A,) of the 1st Regiment of Pennsylvania Volunteers, who was enrolled as a Private at *Pittsburg*, in the State of Pennsylvania, on the 1st day of July, 1861, and mustered into the service of the United States as a Private on the 1st day of July, 1861, at *Pittsburg*, in Company A, 1st Regiment of Pennsylvania Volunteers, to serve three years or during the war. He was born in *Pittsburg*, in the State of Pennsylvania; he was 21 years of age, 5 feet 10 inches high, light complexion, blue eyes, dark hair, and by occupation, when enrolled, a Farmer. He died in Regimental Hospital, at Fort Brown, Texas, on the 31st day of December, 1863, of typhoid fever.

INVENTORY.					
ARTICLES.	No.	ARTICLES.	No.	ARTICLES.	No.
Hats.....		Pairs trousers.....		Knapsacks.....	
Caps.....		Pairs flannel drawers.....			
Forage caps.....		Pairs cotton drawers.....		Watch, silver.....	1
Great coats.....	1	Flannel shirts.....	1		
Uniform coats.....		Cotton shirts.....		MONEY.	
Uniform jackets.....		Pairs boots.....		Specie.....	\$2 00
Flannel sack coats.....		Pairs shoes.....		Notes.....	\$50 00
Blouses.....		Pairs socks.....			
Stable frocks.....		Blankets.....			
Fatigue overalls.....		Haversacks.....			

I CERTIFY, ON HONOR, that the above inventory comprises all the effects of Private *John Smith*, deceased, and that the effects are in the hands of Captain *J. Brown*, at Fort Brown, Texas, to be disposed of by a Council of Administration, except the money which has been turned over to Major *Wm. C. Morse*, Paymaster, U. S. Army, whose receipts are hereto annexed.

STATION: Fort Brown, Texas.
 DATE: December 31, 1863.
 (Duplicates.)

JAMES BROWN,
Captain Co. A, 1st Penn. Vols.,
Commanding the Company.

*NOTE.—If the effects have been turned over to relatives of deceased, so state on certificate, instead of "in the hands of Captain," &c., and give the names of the persons, and their relation to the deceased person.

FORM 3.—HEIR'S RECEIPT FOR EFFECTS.

RECEIVED of Captain *John Brown*, Company A, 1st Regiment of Pennsylvania Volunteers, the following effects of Private *John Smith*, late of Company A, 1st Regiment of Pennsylvania Volunteers, now deceased, which I claim as his wife:
 1 great coat, 1 flannel shirt, 1 silver watch, fifty dollars in notes, and two dollars in specie.

MARY SMITH.

FORM 4.—PAYMASTER'S RECEIPT FOR MONEY.

RECEIVED, this 31st day of December, 1863, at Fort Brown, Texas, of Captain *James Brown*, of Company A, 1st Pennsylvania Volunteers, fifty dollars in Treasury notes and two dollars in specie, the property of the late Private *John Smith*, of Company A, 1st Pennsylvania Volunteers, who died at Fort Brown, Texas, on the 31st day of December, 1863.

WM. C. MORSE, Paymaster, U. S. A.

RS FOR A DECEASED SOLDIER.

FORM 5.—PROCEEDINGS OF A COUNCIL OF ADMINISTRATION,

Convened at Fort Brown, Texas, pursuant to Orders, No. 1, dated Post Headquarters, Fort Brown, Texas, January 2, 1864—consisting of Captain James Keith, Company C, 1st Pennsylvania Volunteers; Captain John Brown, Company D, 1st Pennsylvania Volunteers; and Lieutenant William Roe, Company E, 1st Pennsylvania Volunteers—for the purpose of disposing of the effects of the late John Smith, of Company A, 1st Pennsylvania Volunteers:

The Council found that the effects consisted of the following articles. They were ordered to be sold at auction, which was accordingly done, and the amount set opposite the articles respectively obtained, for which the receipt of the Paymaster is annexed:

AT AUCTION.		
1 shirt	brought.....	\$1 00
1 great coat	“.....	2 50
1 silver watch	“.....	25 00
		<hr/>
		\$28 50

JAMES KEITH,
Capt. Co. C, 1st Penn. Vols., President.
WILLIAM ROE,
Lieut. Co. E, 1st Penn. Vols., Resorder.

APPROVED:
JOHN SANDERS,
Colonel 1st Penn. Vols.,
Commanding Post.

FORM 6.—PAYMASTER'S RECEIPT.

RECEIVED from Captain John Brown, Company A, 1st Pennsylvania Volunteers, at Fort Brown, Texas, January 10, 1864, twenty-eight dollars and fifty cents, the result of the sale of the effects of the late Private John Smith, of Company A, 1st Pennsylvania Volunteers.

WM. C. MORSE, Paymaster U. S. Army.

ARTICLES OF WAR.

ART. 95. When any non-commissioned officer or soldier shall die, or be killed in the service of the United States, the then commanding officer of the troop or company shall, in the presence of two other commissioned officers, take an account of what effects he died possessed of, above his arms and accoutrements, and transmit the same to the office of the Department of War, which said effects are to be accounted for, and paid to the representatives of such deceased non-commissioned officer or soldier. And in case any of the officers, so authorized to take care of the effects of deceased officers and soldiers, should, before they have accounted to their representatives for the same, have occasion to leave the regiment or post, by preferment or otherwise, they shall, before they be permitted to quit the same, deposit in the hands of the commanding officer, or of the assistant military agent, all the effects of such deceased non-commissioned officers and soldiers, in order that the same may be secured for, and paid to, their respective representatives.

DIRECTIONS.

NOTE 1.—One copy of the inventories of the effects of deceased non-commissioned officers and soldiers, required by the 95th Article of War, will be forwarded to the Adjutant General, by the commander of the company to which the deceased belonged, and a duplicate of the same to the colonel of the regiment. Final statements of pay, clothing, &c., in duplicate, will be sent to the Adjutant General with one copy of the inventory. Both inventory and final statements should be forwarded, as a general rule, through Regimental Headquarters. When a soldier dies at a post or station absent from his company, it will be the duty of his immediate commander to furnish, direct to the Adjutant General, the required inventory and final statements, and, at the same time, to forward to the commanding officer of the company to which the soldier belonged, a report of his death, specifying the date, place, and cause: to what time he was last paid, and the money or other effects in his possession at the time of his decease; which report will be noted on the next page of the inventory. Each inventory will be endorsed "Inventory of the effects of _____, late of company _____, _____ regiment of _____, who died at _____, _____, 186—."

NOTE 2.—Should the effects of a deceased non-commissioned officer or soldier not be administered upon within a short period after his decease, they shall be disposed of by a Council of Administration under the authority of the commanding officer of the post, and the proceeds deposited with the Paymaster, to the credit of the United States, until they shall be claimed by the legal representatives of the deceased. This should be done according to Forms 5 and 6, and one copy of each sent to the Adjutant General. No copy of the order convening the board is required, the approval of the commanding officer being sufficient.

NOTE 3.—In all such cases of sales by the Council of Administration, a statement in detail, or account of the proceeds duly certified by the Council and commanding officer, (Form 5,) accompanied by the Paymaster's receipt of the proceeds, will be forwarded by the commanding officer to the Adjutant General. The statement will be endorsed "Report of the proceeds of the effects of _____, late of company _____, _____ regiment of _____, who died at _____ the _____ day of _____, 186—."

NOTE 4.—The effects in all cases, when called for, should be turned over to the legal representative, without further authority from the Adjutant General. When the effects are turned over to the relatives of the deceased before these inventories are sent to the Adjutant General, their receipts therefor should be attached to the inventories. In all other cases, one copy will be sent with a letter of transmittal direct to the Adjutant General, and a duplicate retained by the officer.

NOTE 5.—Particular care should be taken to take receipts in duplicate from the Paymaster for any funds turned over to him; one copy should be sent direct to the Adjutant General, and one retained by the officer.

NOTE 6.—Where a soldier dies in hospital or on detached service, his descriptive list, if he has one, should be sent with his final statements, in duplicate, to the Adjutant General, Washington, D. C.

NOTE 7.—Form 1 will be forwarded in duplicate to the Adjutant General, through Regimental Headquarters, as soon as possible after the death of the soldier, accompanied by one copy of Forms 2 and 3, or 4, as the case may require. A duplicate of the inventory (Form 2) should be retained until the articles are finally disposed of.

NOTE 8.—The papers for each man should be made SEPARATELY for each man, and, when possible, fastened together. This is especially necessary, and must be done in all cases. The papers cannot be properly disposed of at the Adjutant General's Office unless this is done, and must be returned for correction.

NOTE 9.—Where there are no line officers, as for instance, a general hospital without a line officer to command the guard, the Council of Administration may be made up from other commissioned officers, in the same way as prescribed for line officers.

NOTE 10.—Where a soldier dies away from his company or regiment, and the officer having charge of him cannot furnish Final Statements by reason of not being able to obtain a Descriptive List, he should notify the regimental or company commander, (giving him full particulars as to history and description of the man, as far as possible,) whose duty it will then be, in such case, to furnish the necessary papers from the best data he can obtain.

Medical Director Office,
Dept of the Potomac.
Richmond Va Oct 5, 1866.

Respectfully returned.
It appears the within named
soldier died at U.S. Gen.
Hospital Ft Monroe Va Sept:
10th 1865, of (Drowned).

There are no Inventories
for that month on file,
nor any data from
which Final Statement
can be furnished.

A. S. Lewis

Brig Col. U. S. Army
Medical Director

T. J. M.

T-79 1100-DB-430-66

NARA 1267

WAR DEPARTMENT,

ADJUTANT GENERAL'S OFFICE,

WASHINGTON, *Sept 28th*, 186*6*.

SIR:

Final Statements in the cases of deceased soldiers are required to be sent to the Adjutant General's Office in duplicate, with one copy of the Inventory of Effects. The Descriptive List should also be sent to this Office in cases where the soldier was absent from his Company at the time of his death. Where there were no effects, it should be so stated on a blank Inventory, properly signed.

Certificates of Disability should be sent in duplicate. Special care should be taken that the date of discharge and signature of the discharging officer should be affixed.

No of the Final Statement *No* Inventory, has
been received in the case of *John Stout*, of
Co. *"F"*, *7th* Regiment of *U. S. C. Corps* Volunteers, whose papers
were forwarded to this Office. You will please forward the missing papers without delay.

I have the honor to be, sir,

Very respectfully,

Your obedient servant,

W. H. Hazard

Assistant Adjutant General.
(110)

~~COMMANDING OFFICER~~

Medical Director

Dept of the Potomac

Asst. Surgeon of 1865. U. S. Genl. Hosp. Fort Monroe, Va.
Ordn. Council of Advn & Paymaster recd received.

RA

MODEL FOR SET OF PAPER

FORM 1.—FINAL STATEMENT.

I CERTIFY, ON HONOR, that John Smith, a Private of Captain J. Brown's Company, (A.) of the 1st Regiment of Pennsylvania Volunteers, of the State of Pennsylvania, born in Pittsburg, State of Pennsylvania, aged 21 years, 5 feet 10 inches high, light complexion, blue eyes, dark hair, and by occupation a Farmer, having joined the Company on its original organization at Pittsburg, and enrolled in it at the muster into the service of the United States at Pittsburg, on the 1st day of July, 1861, (or was mustered in service as a recruit, by ———, at ———, on the ——— day of ———, 186—, or was drafted and mustered into the service of the United States from the ——— Enrollment District of the State of ———, at ———, on the ——— day of ———, 186—,) to serve in the Regiment for the term of Three Years, and having served *honestly and faithfully* with his Company in the field to the present date, is now entitled to a DISCHARGE by reason of death. Died in Regimental Hospital, Fort Brown, Texas, December 31, 1863, of typhoid fever.

The said John Smith was last paid by Paymaster Major Morse, to include the 31st day of October, 1863, and has pay due him from that time to the present date. He is entitled to pay and subsistence for *traveling* to place of enrollment, and whatever other allowances are authorized to volunteer soldiers, drafted men, or militia, so discharged. He has received from the United States *clothing* amounting to 20⁰⁰/₁₀₀ dollars, since the 31st day of December, 1862, when his clothing account was last settled. He has received from the United States 25⁰⁰/₁₀₀ dollars advanced *bounty*.

There is to be stopped from him on account of the State of ———, or other authorities, for *clothing, &c.*, received on entering service, nothing, ⁰⁰/₁₀₀ dollars; and for other stoppages, viz: nothing, ⁰⁰/₁₀₀ dollars. He has been furnished with no *transportation* in kind from the place of his discharge to ———; and he has not been *subsisted* for *traveling* to his place of enrollment up to the ———, 186—.

He is indebted to ———, Sutler, ⁰⁰/₁₀₀ dollars.

He is indebted to ———, Laundress, ⁰⁰/₁₀₀ dollars.

GIVEN, IN DUPLICATE, at Fort Brown, Texas, this 31st day of December, 1863.

JAMES BROWN,
Captain Co. A, 1st Penn. Vols.,
Commanding Company.

FORM 2.

INVENTORY of the effects of John Smith, late a Private of Captain J. Brown's Company, (A.) of the 1st Regiment of Pennsylvania Volunteers, who was enrolled as a Private at Pittsburg, in the State of Pennsylvania, on the 1st day of July, 1861, and mustered into the service of the United States as a Private on the 1st day of July, 1861, at Pittsburg, in Company A, 1st Regiment of Pennsylvania Volunteers, to serve three years or during the war. He was born in Pittsburg, in the State of Pennsylvania; he was 21 years of age, 5 feet 10 inches high, light complexion, blue eyes, dark hair, and by occupation, when enrolled, a Farmer. He died in Regimental Hospital, at Fort Brown, Texas, on the 31st day of December, 1863, of typhoid fever.

INVENTORY.						
ARTICLES.	No.	ARTICLES.	No.	ARTICLES.	No.	
Hats.....		Pairs trowsers.....		Knapsacks.....		
Caps.....		Pairs flannel drawers.....				
Forage caps.....		Pairs cotton drawers.....		Watch, silver.....	1	
Great coats.....	1	Flannel shirts.....	1			
Uniform coats.....		Cotton shirts.....		MONEY.		
Uniform jackets.....		Pairs boots.....			Specie.....	\$2 00
Flannel sack coats.....		Pairs shoes.....				
Blouses.....		Pairs socks.....			Notes.....	\$50 00
Stable frocks.....		Blankets.....				
Fatigue overalls.....		Haversacks.....				

I CERTIFY, ON HONOR, that the above inventory comprises all the effects of Private John Smith, deceased, and that the effects are in the hands of Captain J. Brown, at Fort Brown, Texas, to be disposed of by a Council of Administration, except the money, which has been turned over to Major Wm. C. Morse, Paymaster, U. S. Army, whose receipt is hereto annexed.*

STATION: Fort Brown, Texas.

DATE: December 31, 1863.

(Duplicates.)

JAMES BROWN,
Captain Co. A, 1st Penn. Vols.,
Commanding the Company.

*NOTE.—If the effects have been turned over to relatives of deceased, so state on certificate, instead of "In the hands of Captain," &c., and give the names of the persons, and their relation to the deceased person.

FORM 3.—HEIR'S RECEIPT FOR EFFECTS.

RECEIVED of Captain John Brown, Company A, 1st Regiment of Pennsylvania Volunteers, the following effects of Private John Smith, late of Company A, 1st Regiment of Pennsylvania Volunteers, now deceased, which I claim as his wife:

1 great coat, 1 flannel shirt, 1 silver watch, fifty dollars in notes, and two dollars in specie.

MARY SMITH.

FORM 4.—PAYMASTER'S RECEIPT FOR MONEY.

RECEIVED, this 31st day of December, 1863, at Fort Brown, Texas, of Captain James Brown, of Company A, 1st Pennsylvania Volunteers, fifty dollars in Treasury notes and two dollars in specie, the property of the late Private John Smith, of Company A, 1st Pennsylvania Volunteers, who died at Fort Brown, Texas, on the 31st day of December, 1863.

WM. C. MORSE, Paymaster, U. S. A.

RS FOR A DECEASED SOLDIER.

FORM 5.—PROCEEDINGS OF A COUNCIL OF ADMINISTRATION,

Convened at Fort Brown, Texas, pursuant to Orders, No. 1, dated Post Headquarters, Fort Brown, Texas, January 2, 1864—consisting of Captain James Keith, Company C, 1st Pennsylvania Volunteers; Captain John Brown, Company D, 1st Pennsylvania Volunteers; and Lieutenant William Roe, Company E, 1st Pennsylvania Volunteers—for the purpose of disposing of the effects of the late John Smith, of Company A, 1st Pennsylvania Volunteers:

The Council found that the effects consisted of the following articles. They were ordered to be sold at auction, which was accordingly done, and the amount set opposite the articles respectively obtained, for which the receipt of the Paymaster is annexed:

AT AUCTION.

1 shirt	brought.....	\$1 00
1 great coat	“	2 50
1 silver watch	“	25 00
		\$28 50

JAMES KEITH,
Capt. Co. C, 1st Penn. Vols., President.
 WILLIAM ROE,
Lieut. Co. E, 1st Penn. Vols., Recorder.

APPROVED: JOHN SANDERS,
Colonel 1st Penn. Vols.,
Commanding Post.

FORM 6.—PAYMASTER'S RECEIPT.

RECEIVED from Captain John Brown, Company A, 1st Pennsylvania Volunteers, at Fort Brown, Texas, January 10, 1864, twenty-eight dollars and fifty cents, the result of the sale of the effects of the late Private John Smith, of Company A, 1st Pennsylvania Volunteers.

WM. C. MORSE, *Paymaster U. S. Army.*

ARTICLES OF WAR.

ART. 95. When any non-commissioned officer or soldier shall die, or be killed in the service of the United States, the then commanding officer of the troop or company shall, in the presence of two other commissioned officers, take an account of what effects he died possessed of, above his arms and accoutrements, and transmit the same to the office of the Department of War, which said effects are to be accounted for, and paid to the representatives of such deceased non-commissioned officer or soldier. And in case any of the officers, so authorized to take care of the effects of deceased officers and soldiers, should, before they have accounted to their representatives for the same, have occasion to leave the regiment or post, by preferment or otherwise, they shall, before they be permitted to quit the same, deposit in the hands of the commanding officer, or of the assistant military agent, all the effects of such deceased non-commissioned officers and soldiers, in order that the same may be secured for, and paid to, their respective representatives.

DIRECTIONS.

NOTE 1.—One copy of the inventories of the effects of deceased non-commissioned officers and soldiers, required by the 95th Article of War, will be forwarded to the Adjutant General, by the commander of the company to which the deceased belonged, and a duplicate of the same to the colonel of the regiment. Final statements of pay, clothing, &c., in duplicate, will be sent to the Adjutant General with one copy of the inventory. Both inventory and final statements should be forwarded, as a general rule, through Regimental Headquarters. When a soldier dies at a post or station absent from his company, it will be the duty of his immediate commander to furnish, direct to the Adjutant General, the required inventory and final statements, and, at the same time, to forward to the commanding officer of the company to which the soldier belonged, a report of his death, specifying the date, place, and cause; to what time he was last paid, and the money or other effects in his possession at the time of his decease; which report will be noted on the next muster roll of the company to which the man belonged. Each inventory will be endorsed "Inventory of the effects of _____, late of company (—), _____ regiment of _____, who died at _____ the _____ day of _____, 186—." If a legal representative receive the effects, it will be stated in the report. If the soldier leave no effects, the fact will be reported on the blank for inventory.

NOTE 2.—Should the effects of a deceased non-commissioned officer or soldier not be administered upon within a short period after his decease, they shall be disposed of by a Council of Administration under the authority of the commanding officer of the post, and the proceeds deposited with the Paymaster, to the credit of the United States, until they shall be claimed by the legal representatives of the deceased. This should be done according to Forms 5 and 6, and one copy of each sent to the Adjutant General. No copy of the order convening the board is required, the approval of the commanding officer being sufficient.

NOTE 3.—In all such cases of sales by the Council of Administration, a statement in detail, or account of the proceeds duly certified by the Council and commanding officer, (Form 5,) accompanied by the Paymaster's receipt of the proceeds, will be forwarded by the commanding officer to the Adjutant General. The statement will be endorsed "Report of the proceeds of the effects of _____, late of company (—), _____ regiment of _____, who died at _____ the _____ day of _____, 186—."

NOTE 4.—The effects in all cases, when called for, should be turned over to the legal representative, without further authority from the Adjutant General. When the effects are turned over to the relatives of the deceased before these inventories are sent to the Adjutant General, their receipts therefor should be attached to the inventories. In all other cases, one copy will be sent with a letter of transmittal direct to the Adjutant General, and a duplicate retained by the officer.

NOTE 5.—Particular care should be taken to take receipts in duplicate from the Paymaster for any funds turned over to him; one copy should be sent direct to the Adjutant General, and one retained by the officer.

NOTE 6.—Where a soldier dies in hospital or on detached service, his descriptive list, if he has one, should be sent with his final statements, in duplicate, to the Adjutant General, Washington, D. C.

NOTE 7.—Form 1 will be forwarded in duplicate to the Adjutant General, through Regimental Headquarters, as soon as possible after the death of the soldier, accompanied by one copy of Forms 2 and 3, or 4, as the case may require. A duplicate of the inventory (Form 2) should be retained until the articles are finally disposed of.

NOTE 8.—The papers for each man should be made SEPARATELY for each man, and, when possible, fastened together. This is especially necessary, and must be done in all cases. The papers cannot be properly disposed of at the Adjutant General's Office unless this is done, and must be returned for correction.

NOTE 9.—Where there are no line officers, as for instance, a general hospital without a line officer to command the guard, the Council of Administration may be made up from other commissioned officers, in the same way as prescribed for line officers.

NOTE 10.—Where a soldier dies away from his company or regiment, and the officer having charge of him cannot furnish Final Statements by reason of not being able to obtain a Descriptive List, he should notify the regimental or company commander, (giving him full particulars as to history and description of the man, as far as possible,) whose duty it will then be, in such case, to furnish the necessary papers from the best data he can obtain.

(OFFICE INDORSEMENT.)

War Department,

ADJUTANT GENERAL'S OFFICE,

July 18th, 1864.

The death of Pvt John Stout, Co. A, 7th Reg't U. S. Colored Troops, is reported as follows:

On Company Muster Roll. For Jan & July 1866, no date, 1866.

Company Muster-out Roll. No date, 1866.

Company Descriptive Book. Died Aug 10, 1864. Chronic diarrhoea. Jacksonville. Drowned summer 1865. Holloway, 1866.

Company Morning Reports. Not on file, 1866.

Soldier's Final Statement. Not on file, 1866.

Soldier's Record of Death and Interment. Not on file, 1866.

Soldier's Inventory of Effects. Not on file, 1866.

Soldier's Certificate of Disability for Discharge. Not on file, 1866.

Soldier's Individual Muster-out Roll. Not on file, 1866.

Regimental Return. For Feb'y 1866, no date, 1866.

Regimental Quarterly Returns. No date, 1866.

Regimental Descriptive Book. Drowned at Holloway, Summer 1865.

By Surgeon General Simons Medical Director Dept of the Potomac (Oct 1/66), 1865.

Sept 10th, 1865, is held to be the correct date, and the Company Muster Roll will be amended accordingly.

[Signature]

Assistant Adjutant General.

[Signature] L.B. 16/473 Noted etc.

[Handwritten notes]
... 10, 66
... 1866
... 1866

CASUALTY SHEET

No. P.C. No. 17/66
John Shouk

Private of Company F

7th Regiment of U.S. Troops

State Volunteers.

NATURE OF CASUALTY.

Died Summer of 1865
Regt mustered out...
officer. Batts.
U.S. Sec
S. 617, Vol. 4, D.C. 3, 1866.

A.G. O. Dec 4th 1866
A.C. of Adm & P. M. rec'd
for 3. 20 sent 2nd Aug. 1866
Ant. on R. of Cas.

CASUALTY SHEET.

Name: John Shoup
 Rank: Priv Company: D Regiment: 4th
 Arm: Wife Corps State: _____
 Nature of Casualty: Deaths

CAUSE OF CASUALTY—(NAME OF DISEASE, &c.)

Drowned,

DEGREE OF DISABILITY.

BY WHOM CERTIFIED.

O. E. Pratt,
Lt Col.

DATE OF DISCHARGE, DEATH, &c.

Summer of 1865

PLACE OF DISCHARGE, DEATH, &c.

St. Marys Va.

BY WHOM DISCHARGED.

FROM WHAT SOURCE THIS INFORMATION WAS OBTAINED.

City Recd. D. Goldens
March 31st 1865

REMARKS.

O. D. Cole

Clerk.

Eng in Regt 3rd Regt

NARA 272

1284

Stugen Williams

Co , 7 U.S. Col'd Inf.

Private

CARD NUMBERS.

1	26
2	27
3 <i>see Stugen</i>	28 <i>William</i>
4	29
5	30
6	31
7	32
8	33
9	34
10	35
11	36
12	37
13	38
14	39
15	40
16	41
17	42
18	43
19	44
20	45
21	46
22	47
23	48
24	49
25	50

Book Mark:

See also

1285

Straitman Henry

Co *D*, 7 U.S. Col'd Inf.

Private

Private

CARD NUMBERS.

1	6294275	26
2	6294371	27
3	6294471	28
4	6294571	29
5	6294665	30
6	6294756	31
7	6294845	32
8	6294939	33
9	6295051	34
10	6295151	35
11	6295250	36
12	6295361	37
13	6295951	38
14	9066968	39
15		40
16		41
17		42
18		43
19		44
20		45
21		46
22		47
23		48
24		49
25		50

Book Mark: *E. B. Vol 8 - P 418*

See also

I. | 7 | U.S.C.T.

Henry Stratton
Co. D, 7 Reg't U.S. Col'd Inf.

Appears on
Company Descriptive Book
of the organization named above.

DESCRIPTION.

Age 33 years; height 5 feet 3 1/4 inches.

Complexion *Dark*.

Eyes *Dark*; hair *Dark*.

Where born *Calvert, Md.*

Occupation *Farmer*.

ENLISTMENT.

When *Oct. 23*, 1863.

Where *Calvert, Md.*

By whom *Col. Wm. Birney*; term *3* y'rs.

Remarks: *Mustered in at Camp Stanton, Md. Nov. 5. 63. by Lt. Col. Haskell. Died at Gardiamola Texas, July 12. 65. of disease.*

J. J. White

S | 7 | U.S.C.T.

Henry Straitnin
Pvt, Co. D, 7 Reg't U. S. Col'd Inf.

Age 33 years.

Appears on

Company Muster-in Roll

of the organization named above. Roll dated
Camp Stanton, Charles Co., Md., Nov. 5, 1863.

Muster-in to date Nov. 5, 1863

Joined for duty and enrolled:

When Oct. 23, 1863

Where Calvert, Md.

Period 3 years.

Remarks:

Book mark:

J. B. Gage
Copyist.

S

7

U.S.C.T.

Henry Straitner

Pvt, Co. I, 7 Reg't U. S. Col'd Infantry.

Appears on

Company Muster Roll

for from Nov. 5 to Dec. 31, 1863

Present or absent Present

Stoppage, \$ 100 for

Due Gov't, \$ 100 for

Remarks: Enlistment premium \$2.00 due

Book mark:

J B Gage

(358)

Copyist.

S | 7 | U.S.C.T.

Henry Straitman

Priv., Co. I, 7 Reg't U. S. Col'd Infantry.

Appears on

Company Muster Roll

for Jan & Feb, 1864.

Present or absent Present

Stoppage, \$ 100 for

Due Gov't, \$ 100 for

Remarks: Enlistment premium \$2.00 due

Book mark:

J B Gage

S | 7 | U.S.C.T.

Henry Straitnin

Pvt, Co. I, 7 Reg't U. S. Col'd Infantry.

Appears on

Company Muster Roll

for Mch & Apr, 1864.

Present or absent Present

Stoppage, \$ 100 for

Due Gov't, \$ 100 for

Remarks:

Book mark:

(358)

J. B. Yage

Copyist.

WAR 1279

S | 7 | U.S.C.T.

Henry Straitnin
Pvt, Co. I, 7 Reg't U. S. Col'd Infantry.

Appears on

Company Muster Roll

for May & June, 1864

Present or absent Present

Stoppage, \$ 100 for

Due Gov't, \$ 100 for

Remarks:

Book mark:

(358)

J. B. Gage
Copyist.

S | 7 | U.S.C.T.

Henry Straitner
Pot, Co. I, 7 Reg't U. S. Col'd Infantry.

Appears on

Company Muster Roll

for July & Aug, 1864

Present or absent Present

Stoppage, \$ 100 for

Due Gov't, \$ 100 for

Remarks:

Book mark:

(358)

J B Gage

Copyist.

S | 7 | U.S.C.T.

Henry Straitnin
Priv, Co. I, 7 Reg't U. S. Col'd Infantry.

Appears on

Company Muster Roll

for Sept & Oct, 1864

Present or absent Present

Stoppage, \$ 100 for

Due Gov't, \$ 100 for

Remarks: Stop for 1 Knapsack
& 1 Haversack.

Book mark:

JOB Gage Copyist.

S | 7 | U.S.C.T.

Henry Straitino

Priv, Co. I, 7 Reg't U. S. Col'd Infantry.

Appears on

Company Muster Roll

for *Nov. & Decr.*, 1864.

Present or absent *Present*

Stoppage, \$ 100 for

Due Gov't, \$ 100 for *One Knapsack & One Haversack.*

Remarks:

Book mark:

D. Maher

Copyist.

S

7

U.S.C.T.

Henry Stratton
Priv, Co. I, 7 Reg't U. S. Col'd Infantry.

Appears on

Company Muster Roll

for *Jan'y. + Feby.*, 1865.

Present or absent *Present*

Stoppage, \$ *100* for

Due Gov't, \$ *100* for

Remarks:

Book mark:-----

(358)

D. Maher
Copyist.

S | 7 | U.S.C.T.

Henry Stratton
Priv., Co. I, 7 Reg't U. S. Col'd Infantry.

Appears on

Company Muster Roll

for March + April, 1865.

Present or absent Present

Stoppage, \$ 100 for

Due Gov't, \$ 100 for

Remarks:

Book mark:

(358)

D. Mahor
Copyist.

S

7

U.S.C.T.

Henry Straitsman

Priv, Co. I, 7 Reg't U. S. Col'd Infantry.

Appears on

Company Muster Roll

for *May + June*, 1865.

Present or absent *Present*

Stoppage, \$ 100 for

Due Gov't, \$ 100 for

Remarks:

Book mark:

D. Maher

Copyist.

S

7

U.S.C.T.

Henry Strautiner

Priv, Co. I, 7 Reg't U. S. Col'd Infantry.

Appears on

Company Muster Roll

for *July & Aug.*, 1865.

Present or absent

Stoppage, \$ 100 for

Due Gov't, \$ 100 for

Remarks:

*Died at Indianola, Texas of Bronchitis
July 12, '65. Final Statement + Inventory
sent to A.S.O. July 14, 1865.*

Book mark: *151.950; 2^o Aud. 7.556, Feb. 6, '68.*

D. Maher
Copyist.

(858)

NARA 1287

S

7

U.S.C.T.

Henry Straitman

Co. C, 7 Reg't U. S. Col'd Infantry.

Appears on **Co. Muster-out Roll**, dated
Indianola, Texas,
October, 13, 1866.

Muster-out to date _____, 186 .

Last paid to *Dec. 31*, 1864.

Clothing account:

Last settled _____, 186 ; drawn since \$ _____ 100

Due soldier \$ _____ 100 ; due U. S. \$ _____ 100

Am't for cloth'g in kind or money adv'd \$ _____ 100

Due U. S. for arms, equipments, &c., \$ _____ 100

Bounty paid \$ _____ 100 ; due \$ _____ 100

Remarks: *List of bronchitis,*
at Indianola, Tex. July
11, '65. Final papers
sent N.Y.C. July 14, '65.

Book mark: *7111 P160 70.*
12 JS EB 7d 8 P418
7519500

Sabine

(361)

Copyist.

Straitman, Henry

P. Co. I., 7 Reg't U. S. C. Inf.

2 Enclosures.

Bed Cards	Descriptive Lists
Burial Records	Final Statements
Certs. of Dis. for Discharge	Furloughs
C. M. Charges	Med. Des. Lists
Med. Certificates	Orders

Other papers relating to—

Admission to Hosp'l	Furlough
Casualty Sheet (Officer's)	Med. Examination
Confinement	Misc. Information
Contracts	Pay or Clothing
Death or Effects	Personal Reports
Desertions	Rank
Discharge from Hosp'l	Transfer to Hosp'l
Discharge from Service	Transfer to V. R. C.
Duty	Transportation

8-112
FINAL STATEMENT

OF

Dr. Henry Strauss
 2¹⁵ Reg't of *W. A. C.*
 Dis'd July 12th 1865.

VOLUNTEERS.

NOTE 1.—Two of these certificates (or duplicates) are to be given to each Volunteer Soldier or drafted man who may be discharged without being mustered out (Final Statements are never given to men mustered out of service,) that he may at once receive from the Paymaster the pay, &c. due him, and the captain or other COMMISSIONED officer commanding the company will certify to the act of the delivery of the duplicate certificates; with these certificates the Soldier is "enrolled to" his discharge, and should also present his discharge to the Paymaster to have the payment endorsed on it. The discharge is to be given back to the Soldier by the Paymaster; the latter only retaining as his vouchers the duplicate certificates.

NOTE 2.—If the Soldier is entitled to pay for the use of his horse, the Company Commander will certify to that fact on the back of both these final statements, and also to the time he has pay due for having been so mounted on his own horse.

NOTE 3.—When a Soldier is furnished with final statements, his descriptive list, if he has one, should be taken up by the officer who gives the Soldier these statements, and endorsed with a statement to this effect by the officer. The endorsement should exhibit a full statement of the time for which the Soldier was allowed pay on his final statements, the clothing account, and all other charges against him or in his favor, so as to comprise a complete exhibit of his account. It will then be transmitted to the Company Commander of the Soldier, who will enter all the data necessary to a full understanding of the Soldier's account on the muster roll upon which the Soldier's discharge is reported. The descriptive list will then be destroyed. The object of this is, that the remaining portion of the Soldier's account may be settled upon the receipt of these muster rolls, and the Soldier receive any pay or allowances that may be due him at the time of his discharge, and which may not appear on his last final statements from the fact that his descriptive list is incomplete. These accounts for back pay, &c., are settled by the 2d Auditor of the Treasury Department.

NOTE 4.—Charges for loss or injury to ordnance, horse equipments, and other miscellaneous charges, should appear under the heading of "Other Stoppages."

NOTE 5.—Bounty paid by State authorities, and not by the United States, will not be entered on this statement.

NOTE 6.—Amounts due the Sutler and Laundress must be entered on the muster roll on which the discharge, death, desertion, &c., is reported, as well as on the final statement, otherwise the amount cannot be collected from the United States.

NOTE 7.—This blank will be used for deceased volunteers and drafted men, as well as for others.

NOTE 8.—Where a Soldier dies in Hospital or on detached service, his descriptive list, if he has one, should be sent with his final statements, in duplicate, to the Adjutant General, Washington, D. C.

NOTE 9.—If the soldier is a drafted man or substitute, the space for time, &c., or enrolled, should contain only the word *drafted* or *substitute*, as the case may be. If the Soldier is a "VETERAN," (or RECRUIT,) the words as a *veteran*, (or *recruit*) as the case may be, should be interlined after the words *mustered into the service of the U. S.* A statement of all the installments of Veteran or Recruit Bounty RECEIVED by the Soldier must be made on the back of each final statement.

Henry Strauss

Extract from Act of Congress.

SEC. 12. And be it further enacted, That the fees of agents and attorneys for making out and causing to be executed the papers necessary to establish a claim for a pension, bounty, and other allowance before the Pension Office, under this act, shall not exceed the following rates: For making out and causing to be duly executed a declaration by the applicant, with the necessary affidavits, and forwarding the same to the Pension Office, with the requisite correspondence, ten dollars; which sum shall be received by such agent or attorney in full for all services in obtaining such pension, and shall not be demanded or received, in whole or in part, until such pension shall be obtained; and the sixth and seventh sections of an act entitled "An act to grant pensions," approved July [fourteenth,] eighteen hundred and sixty-two, are hereby repealed.

SEC. 13. And be it further enacted, That any agent or attorney who shall, directly or indirectly, demand or receive any greater compensation for his services under this act than is prescribed in the preceding section of this act, or who shall contract or agree to prosecute any claim for a pension, bounty, or other allowance under this act, on the condition that he shall receive a per centum upon any portion of the amount of such claim, or who shall wrongfully withhold from a pensioner or other claimant the whole or any part of the pension or claim allowed and due to such pensioner or claimant, shall be deemed guilty of a high misdemeanor, and, upon conviction thereof, shall, for every such offense, be fined not exceeding three hundred dollars, or imprisoned at hard labor not exceeding two years, or both, according to the circumstances and aggravations of the offense.

Approved July 4, 1864.

NOTE 10.—If any soldier is charged a higher fee than that allowed by the above act, he should report the fact and the name of the agent to the Adjutant General, in order that steps may be taken to have the same refunded.

ADJUTANT GENERAL'S OFFICE.

August 3rd 1865

Duplicate with Inventory sent 2d Auditor.

Adjutant General's Office
Washington D.C., March 4, 1870

A. D. vol. 8. P. 418

The Muster Out Roll of Company *D* 7th U.S. Colored Troops, reports the death of Private *Henry Straizer* July 11th 1865.

The Muster Roll of the company for July and August 1865, and the Final Statement of the soldier report date of death July 12, 1865.

The latter date (July twelfth 1865,) is held to be correct and the company Muster Out Roll will be amended accordingly.

H. A. Atchison
 Private Colonel U.S.A.
 Inelig Bureau Col 4th Corps

Edw
W. H. M.

In letter of

March 18, 1870

W. H. M.

I certify, on honor, that Henry Straitman, a Private of
 Captain C. G. Teeple's Company (D) of the 7th Regiment of U. S. C. Troops
VOLUNTEERS, of the State of Maryland, born in Calvert, State
 of Maryland, aged 33 years; 5 feet 5¹/₄ inches high, Dark complexion,
Blue eyes, Blue hair, and by occupation a Farmer, who joined for service
 and was enrolled (see Note 9) on the 23rd day of October, 1863, at Calvert Md
 by Col. Wm. Binney, for the period of Three years, and mustered into
 the service of the United States on the 5th day of November, 1863, at
Camp Staunton by Lt. Col. Haswell; and having served
 HONESTLY and FAITHFULLY with his Company to the present date, is now entitled to a
DISCHARGE by reason of Death caused by Bronchitis
at Indianola Texas, July 12th 1865

The said Private Henry Straitman was last paid by Paymaster
Maj. G. N. Smith, to include the 31st day of December, 1864, and
 has pay due him from that time to July 12. 1865 ~~the present date~~; he is entitled to pay and subsistence for
TRAVELING to place of enrollment, and whatever other allowances are authorized to volunteer
 soldiers, drafted men, or militia, so discharged. He has received from the United States **CLOTHING**
 amounting to 55 ⁵⁵/₁₀₀ dollars, since the 1st day of November,
 1864 when his clothing account was last settled. He has received from the United States
100 dollars advanced **BOUNTY**.

There is to be stopped from him, on account of the State of _____, or other
 authorities, for **CLOTHING**, &c., received on entering service, _____ ¹⁰⁰ dollars; and
 for other stoppages, viz: _____

_____ ¹⁰⁰ dollars.
 He has been furnished with **TRANSPORTATION** in kind from the place of his discharge to
 _____; and he has been **SUBSISTED** for **TRAVELING** to his
 place of enrollment, up to the _____, 186 .

He is indebted to _____, **SUTLER**, _____ ¹⁰⁰ dollars.

He is indebted to _____, **LAUNDRESS**, _____ ¹⁰⁰ dollars.

Given in Duplicate, at Indianola Texas, this 14th day
 of July, 1865.

C. G. Teeple

Inventory of the effects of Henry Straitman late
 a Private of Captain C. G. Seiple's Company D of
 the 7th Regiment of U. S. Colored Troops Volunteers, who was enrolled as
 a Private at Calvert in the State of Maryland on
 the 23rd day of October 1863, and mustered into the service of the United
 States as a Private on the 5th day of November 1863, at Camp Cranston
 in Company D, 7th Regiment of U. S. Colored Troops Volunteers, to serve three
 years or during the war; he was born in Calvert in the State
 of Maryland; he was 23 years of age, 5 feet 5⁴/₄ inches
 high, Dark complexion, BLK eyes, BLK hair, and by occupation, when enrolled,
 a Farmer; he died in Post Hospital, at
Indianola Texas on the 12th day of July 1865, by
 reason of Bronchitis

INVENTORY.					
ARTICLES.	No.	ARTICLES.	No.	ARTICLES.	No.
Hats.....		Pairs trousers.....		Knapsacks.....	
Caps.....		Pairs flannel drawers.....			
Forage caps.....		Pairs cotton drawers.....			
Great coats.....	1	Flannel shirts.....			
Uniform coats.....		Cotton shirts.....			
Uniform jackets.....		Pairs boots.....			
Flannel sack coats.....		Pairs shoes.....	1		
Blouses.....		Pairs socks.....			
Stable frocks.....		Blankets.....		MONEY.	
Fatigue overalls.....		Haversacks.....		Specie.....	\$
				Notes.....	\$

I CERTIFY, ON HONOR, that the above inventory comprises all the effects of private
Henry Straitman late 7th U.S.C.T., deceased, and that the effects are in the hands
 of A. H. Gross & H. Johnson Private U.S.C.T. at Indianola Texas
who received them as nephews to be disposed of by a Council of Administration
of deceased and his heirs.

(DUPLICATES.)

STATION: Indianola Texas

DATE: July 14th 1865

[A. G. O. No. 104.]

C. G. Seiple
Capt
 Commanding the Company.

(Over)

128
Summers George

Co H, 7 U.S. Col'd Inf.

CARD NUMBERS.

1	26
2	27
3	28 <i>see Summers George</i>
4	29
5	30
6	31
7	32
8	33
9	34
10	35
11	36
12	37
13	38
14	39
15	40
16	41
17	42
18	43
19	44
20	45
21	46
22	47
23	48
24	49
25	50

Book Mark:

See also

1287.

Susker George

Co C, 7 U.S. Col'd Inf.

Private Private

CARD NUMBERS.

1	6283633	26
2	6283734	27
3	6283834	28
4	6283932	29
5	6284033	30
6	6284139	31
7	6285418	32
8	9066231	33
9		34
10		35
11		36
12		37
13		38
14		39
15		40
16		41
17		42
18		43
19		44
20		45
21		46
22		47
23		48
24		49
25		50

Book Mark:

See also

S

7

U.S.C.T.

George Susker

, Co. *C*, 7 Reg't U.S. Col'd Inf.

Appears on

Company Descriptive Book

of the organization named above.

DESCRIPTION.

Age *24* years; height *5* feet *4 3/4* inches.

Complexion *briff*.

Eyes *Black*; hair *Curly*.

Where born *Talbot, Md.*

Occupation *Farmer*.

ENLISTMENT.

When *Sept. 21*, 186*3*.

Where *Baltimore*.

By whom *Cot. W. Binney*; term *3* y'rs.

Remarks: *Mustered at Baltimore Md. Sept. 20, 63, by Col. W. Binney. Died at Hospital Jacksonville Fla. of Diphtheria, May 25, 64.*

W. Smith

8 | 7 | U.S.C.T.

George Susker,
Privt, Co. C, 7 Reg't U. S. Colored Inf.

Age 24 years.

Appears on

Company Muster-in Roll

of the organization named above. Roll dated

Baltimore, Md., Sept. 26, 1863

Muster-in to date

Sept. 26, 1863

Joined for duty and enrolled:

When

Sept. 23, 1863

Where

Falbat Co., Md. *

Period

3 years.*

Remarks:

*Muster-in roll shows enrollment of all men of this company as of same date. See enrollment on subsequent card or cards.

Book mark:

Callaway

(356c)

Corist.

NOV 12 1867

S | 7 | U.S.C.T.

George Dusker.
Priv., Co. C, 7 Reg't U. S. Col'd Infantry.

Appears on

Company Muster Roll

for *Sept. 26 to Oct. 31*, 1863.

Joined for duty and enrolled:

When *Sept. 23*, 1863*

Where *Talbot Co. Md.**

Period *3* years.*

Present or absent *Absent.*

Stoppage, \$ *100* for

Due Gov't \$ *100* for

Remarks: *Detached on recruiting service Oct. 29. 63.*

* See enrollment on card from muster-in roll.

Book mark:

Carraway

(358c) Copyist.

S | 7 | U.S.C.T.

George Susker,
Priv., Co. C, 7 Reg't U. S. Col'd Infantry.

Appears on

Company Muster Roll
for Nov and Dec, 1863.

Joined for duty and enrolled:

When Sept. 23, 1863*

Where Calvert Co., Md. —*

Period 3 years.*

Present or absent Present

Stoppage, \$ 100 for

Due Gov't \$ 100 for

Remarks:

* See enrollment on card from muster-in roll.

Book mark:

(358c)

Calloway

Copyist.

8 | 7 | U.S.C.T.

George Susker,
Priv., Co. C, 7 Reg't U. S. Col'd Infantry.

Appears on

Company Muster Roll
for *Jan'y and Feby*, 1864.

Joined for duty and enrolled:

When *Sept. 23*, 1863*

Where *Talbot Co. Md.**

Period *3* years.*

Present or absent *Present*

Stoppage, \$ *100* for

Due Gov't \$ *100* for

Remarks:

* See enrollment on card from muster-in roll.

Book mark:-----

Calloway
(358c) Copyist.

S | **7** | **U.S.C.T.**

George Susker

Priv, Co. C, 7 Reg't U. S. Col'd Infantry.

Appears on

Company Muster Roll

for *March and April*, 1864.

Joined for duty and enrolled:

When *Sept. 23*, 1863.*

Where *Talbot Co. Md.* *

Period *3* years.*

Present or absent *Present*

Stoppage, \$ *100* for

Due Gov't \$ *100* for

Remarks:

* See enrollment on card from muster-in roll.

Book mark:

Callaway

S

7

U.S.C.T.

George Susker

Privt, Co. C, 7 Reg't U. S. Col'd Infantry.

Appears on

Company Muster Roll

for *May & June*, 1864.

Joined for duty and enrolled:

When *Sept. 23*, 186*3**

Where *Talbot Co. Md.**

Period *3* years.*

Present or absent

Stoppage, \$ *100* for

Due Gov't \$ *100* for

Remarks: *Died in Hospital
Jacksonville of Diarrhea
May 25, 1864. Final
Statements sent to the
A. G. O.*

* See enrollment on card from muster-in roll.

Book mark:

(358c)

Calloway
Copyist.

S 1 7 U.S.C.T.

George Susker
Co. C, 7 Reg't U. S. Col'd Infantry.

Appears on Co. Muster-out Roll, dated
Indianola Texas, Oct. 13, 1866.

Muster-out to date _____, 186 .
Last paid to Feb. 28, 1864.

Clothing account:

Last settled _____, 186 ; drawn since \$ _____ 100

Due soldier \$ _____ 100; due U. S. \$ _____ 100

Am't for cloth'g in kind or money adv'd \$ _____ 100

Due U. S. for arms, equipments, &c., \$ _____ 100

Bounty paid \$ _____ 100; due \$ _____ 100

Remarks: Died at Jackson-
ville, Fla. May 25 '64
of Diarrhoea. Final
statements sent to
a.g.o.

Book mark: V33, P23, 68 F.S.

(361) _____ Lopez. Copyist.

Busker, George

P, Co. *C*, **7** Reg't U.S.C. Inf.

3 Enclosures.

Bed Cards.....	Descriptive Lists.....
Burial Records.....	Final Statements..... <i>2</i>
Certs. of Dis. for Discharge.....	Furloughs.....
C. M. Charges.....	Med. Des. Lists.....
Med. Certificates.....	Orders.....

Other papers relating to—

Admission to Hosp'l.....	Furlough.....
Casualty Sheet (Officer's).....	Med. Examination.....
Confinement.....	Misc. Information.....
Contracts.....	Pay or Clothing.....
Death or Effects..... <i>/</i>	Personal Reports.....
Desertions.....	Rank.....
Discharge from Hosp'l.....	Transfer to Hosp'l.....
Discharge from Service.....	Transfer to V. R. C.....
Duty.....	Transportation.....

Inventory of the effects of
Private Dewey Parker
 Co. "B" 11th U.S. Col. Troops
 who died at Jacksonville Fla.
May 22nd 1864

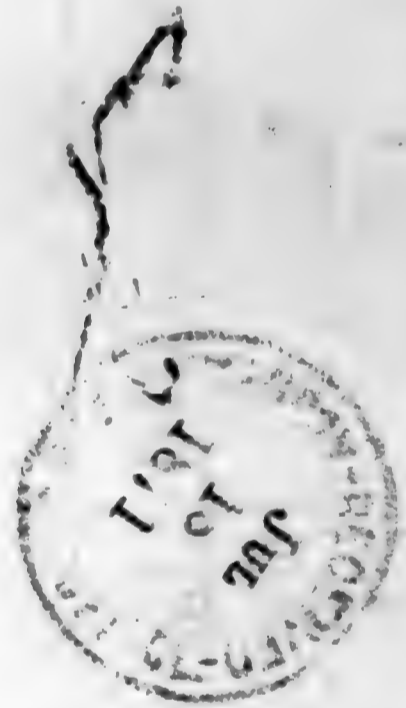

Inventories of the effects of George Dasher, late a Private of Captain
 Julius A. Weiss' Company "B" of the 7th Regiment of United States
 Colored Troops. George Dasher was enlisted by Col. W^m Birney
 of the 2^d Regiment of United States Colored Troops at Baltimore Md.
 on the 16th day of September 1862 to serve three years or during the war;
 he was born in Talbot County in the State of Maryland, is 24 years of
 age & feet 4³/₄ inches high. Gruff complexion black eyes curly
 hair and by occupation when enlisted a farmer; he died in General
 Hospital at Jacksonville Fla. on the 23rd day of May 1864 by reason of Diarrhoea

Inventories

Articles		Articles	
Remapsacks	1	Rubber Blankets	1
Hooversacks	1	Wool Blankets	1
Canteens	1	Shoes	1
Great Coats	1	Pants	1
Channel Sack Coats	1		
Shirts	1	Money	
Drawers	1	Specie	\$ 0.00
Caps	1	Notes	\$ 0.00

I certify on honor that the above inventory comprises all the
 effects of Private George Dasher deceased. And that the effects are
 in my hands to be disposed of by a Council of Administration

W.A. Cheney 1st Lieut
 7th U.S.C. Troops
 Comdy. Co. "B"

Jacksonville Fla.
 May 26th 1864

168 137

Final Statement
of
Private George Inker
Co. B "7" U.S.C. Troops
May 26th 1864

Recd May 25th 1864

ADJUTANT GENERAL'S OFFICE
C. S. Carson
Duplicate with Inventory sent to Adjutant
Sept 24th 1864
D. B. [Signature]

I certify, on honor that George Suster a Private of Captain Julius A. Weiss, Company "C" 7th Regiment of United States Colored Troops, born in Talbot County State of Maryland, aged 24 years, 2 feet 4³/₄ inches high; griff complexion. Black eyes curly hair and by occupation a farmer, having joined the company on its original organization at Baltimore Md. and enrolled in it at the muster into the service of the United States at Baltimore Md. on the 26th day of September 1864 for the term of three years or during the war, and having served honestly and faithfully with his company in the 7th Regt. U.S.C. Troops to the present date is now entitled to a discharge by reason of death.

Died May 25th 1864
 (see printing)

The said Private George Suster was last paid by Maj. Hookwood, to include the 29th day of February 1864 and has pay due him from that time to the present date

He has received from the United States nothing to the amount of Fifty-min⁷⁰ dollars since the 26th day of September 1863. the time of entering the service

W. L. Murray
 7th Series 7th U.S.C. Troops
 Cavalry, Co. "C"

Jacksonville Fla
 May 26th 1864

1864

168

Final Statements

Dr. J. H. Kelly
Private Surgeon

Co. "I" 1st U.S. Cavalry

May 26th 1864

MAR 13 1864

I certify on honor that George Suster a Private
of Captains J. A. Weiss Company "C" 7th Regiment
of United States Colored Troops born in Talbot
County State of Maryland, aged 24 years, 5 feet
4³/₄ inches high; grizz complexion, black eyes
curly hair and by occupation a farmer, having
joined the company on its original organization
at Baltimore Md. and enrolled in it at the muster
into the service of the United States at Baltimore
Md. on the 26th day of September 1864 for the term of
three years or during the war, and having served
honestly and faithfully with his company in the
7th Reg. U.S. Col. Troops to the present date is entitled
to a discharge by reason of death

The said Private George Suster was last paid
by Maj. A. Wood to include the 29th day of February
1864 and has pay due him from that time to the
present date

He has received from the United States clothing
to the amount of Fifty nine ⁷⁰/₁₀₀ dollars since the
26th day of September 1863 the time of entering the
service

Jacksonville Fla.
May 26th 1864

W. H. Murray
1st Lieut. W. M. C. Troops
Comdg. Co. "C"

1288

Sutton Jacob

Co B, 7 U.S. Col'd Inf.

Private Corporal

CARD NUMBERS.

1	6281850	26
2	6281948	27
3	6282049	28
4	6282147	29
5	6282246	30
6	6282345	31
7	6282439	32
8	6282530	33
9	6282629	34
10	6282729	35
11	6282827	36
12	6282925	37
13	6282985	38
14	6283049	39
15	6283136	40
16	6283209	41
17	6283280	42
18	6283349	43
19	6283420	44
20	9066092	45
21		46
22		47
23	1	48
24		49
25		50

Book Mark:

See also

S. 2024349 P.O. in -
S 2457891 And W.D.
S. 2682383 And W.D.

S

7

U.S.C.T.

Jacob Sutton

, Co. B, 7 Reg't U.S. Col'd Inf.

Appears on

Company Descriptive Book

of the organization named above.

DESCRIPTION.

Age 22 years; height 5 feet 7 1/2 inches.

Complexion Black.

Eyes Black; hair curly

Where born Fallot, Md.

Occupation Farmer.

ENLISTMENT.

When Sept. 21, 1863.

Where Baltimore, Md.

By whom Col. W. Binney; term 3 y'rs.

Remarks: Mustered Sept. 24, 63,

by Col. Wm. Binney.

Promoted to Corporal Sept.

19, 1865.

J. Smith,

(3830)

Copyist.

A | 7 | U.S.C.T.

Jacob Sutton,
Privt., Co. B., 7 Reg't U. S. Colored Inf.

Age 22 years.

Appears on

Company Muster-in Roll

of the organization named above. Roll dated

Baltimore Ind., Sept 26, 1863.

Muster-in to date Sept 26, 1863.

Joined for duty and enrolled:

When Sept 29, 1863.*

Where Fallst Co. Ind.*

Period 3 years.*

Remarks:

*Muster-in roll shows enrollment of all men of this company as of same date. See enrollment on subsequent card or cards.

Book mark:

(356e) J. B. Casey Copyist.

S.

7

U.S.C.T.

Jacob Sutton
Privt, Co. B, 7 Reg't U. S. Col'd Infantry.

Appears on

Company Muster Roll

for *Sept 26" to Oct 31"*, 186*9*.

Joined for duty and enrolled:

When *Sept 26"*, 186*9*.*

Where *Talbot Co. Md* *

Period *3* years.*

Present or absent *Present*.

Stoppage, \$ *100* for

Due Gov't \$ *100* for

Remarks:

* See enrollment on card from muster-in roll.

Book mark: -----

(358c)

J. G. ...

Copyist.

A. 7 U.S.C.T.

Jacob Sutton
Privt, Co. B, 7 Reg't U. S. Col'd Infantry.

Appears on

Company Muster Roll

for Nov & Dec, 1863.

Joined for duty and enrolled:

When Sept 23, 1863.*

Where Gallat.*

Period 3 years.*

Present or absent Present

Stoppage, \$ 100 for

Due Gov't \$ 100 for

Remarks: Enlistment premium
\$2.00 due.

* See enrollment on card from muster-in roll.

Book mark:

(358c)

J. S. Gray

Copyist.

S.

7

U.S.C.T.

Jacob Sutter

Privt, Co. B, 7 Reg't U. S. Col'd Infantry.

Appears on

Company Muster Roll

for *Jan & Feb.*, 1864.

Joined for duty and enrolled:

When *Sept 23.*, 1862.*

Where *Talbot.**

Period *2* years.*

Present or absent *Present.*

Stoppage, \$ *100* for

Due Gov't \$ *100* for

Remarks: *\$2.00 Enlistment pre-
mium due*

* See enrollment on card from muster-in roll.

Book mark:

(358c)

J. S. Casey

Copyist.

L.

7

U.S.C.T.

Jacob Sutton

Privt, Co. B, 7 Reg't U. S. Col'd Infantry.

Appears on

Company Muster Roll

for *March & April*, 1864.

Joined for duty and enrolled:

When *Sept 23*, 1863.*

Where *Talbot And**

Period *9* years.*

Present or absent *Present*.

Stoppage, \$ *100* for

Due Gov't \$ *100* for

Remarks:

* See enrollment on card from muster-in roll.

Book mark: _____

(358c)

J. C. King

Copyist.

S. | 7 | U.S.C.T.

Jacob Sutton
Pvt., Co. B, 7 Reg't U. S. Col'd Infantry.

Appears on

Company Muster Roll

for May & June, 1864.

Joined for duty and enrolled:

When Sept 23, 1864.*

Where Talbot, Md.*

Period 3 years.*

Present or absent Absent

Stoppage, \$ 100 for

Due Gov't \$ 100 for

Remarks: Sick at Jacksonville,
Fla since June 27, 64.

* See enrollment on card from muster-in roll.

Book mark: _____

(358c)

J. B. Casey Copyist.

A 1 7

U.S.C.T.

Jacob Sutton

Privt, Co. B, 7 Reg't U. S. Col'd Inft.

Appears on

Company Muster Roll

for July & Aug, 1864

Joined for duty and enrolled:

When Sept 23, 1863 *

Where Gallat, Md. *

Period years. *

Present or absent Present

Stoppage, \$ 100 for

Due Gov't, \$ 100 for

Remarks: Stop 1 Knapsack

* See enrollment on card from muster-in roll.

Book mark:

J. G. Carey

S | 7 | U.S.C.T.

Jacob Sutton

Priv., Co. B, 7 Reg't U. S. Col'd Infantry.

Appears on

Company Muster Roll

for Sept & Oct, 1864.

Joined for duty and enrolled:

When Sept 23, 1863.*

Where Talbot. Md.*

Period 3 years.*

Present or absent Present

Stoppage, \$ 100 for

Due Gov't \$ 100 for

Remarks: Stop 1 Haversack

* See enrollment on card from muster-in roll.

Book mark:

(358c) [Signature] Copyist.

S | 7 | U.S.C.T.

Jacob Sutton
Pvt, Co. B, 7 Reg't U. S. Col'd Infantry.

Appears on

Company Muster Roll
for Nov, Dec, 1864.

Joined for duty and enrolled:

When Sept 23, 1863.*

Where Galbot, Md.*

Period 3 years.*

Present or absent Present

Stoppage, \$ 100 for

Due Gov't \$ 100 for

Remarks: Stopped for
Haversack

* See enrollment on card from muster-in roll.

Book mark:

(858c) Wooler Copyist.

S | 7 | U.S.C.T.

Jacob Sutton
Pvt, Co. B, 7 Reg't U. S. Col'd Infantry.

Appears on

Company Muster Roll
for Jan & Feb, 1865.

Joined for duty and enrolled:

When Sept 23, 1863.*

Where Talbot Md *

Period 3 years.*

Present or absent Present

Stoppage, \$ 100 for

Due Gov't \$ 100 for

Remarks:

* See enrollment on card from muster-in roll.

Book mark:-----

(358c) *W. S. [Signature]* Copyist.

S

7

U.S.C.T.

Jacob Sutton

Prst, Co. B, 7 Reg't U. S. Col'd Infantry.

Appears on

Company Muster Roll

for Feb 28 to June 30, 1865.

Joined for duty and enrolled:

When Sept 23, 1863.*

Where Galbot Co. Ind *

Period 3 years.*

Present or absent Present

Stoppage, \$ 100 for

Due Gov't \$ 100 for

Remarks:

* See enrollment on card from muster-in roll.

Book mark:

W. H. [Signature]

S | 7 | U.S.C.T.

Jacob Sutton
Private, Co. B, 7 Reg't U. S. Col'd Infantry.

Appears on

Company Muster Roll
for July & Aug, 1865.

Joined for duty and enrolled:

When Sept 23, 1863.*

Where Talbot Co. Md *

Period 3 years.*

Present or absent Present

Stoppage, \$ 100 for

Due Gov't \$ 100 for

Remarks:

* See enrollment on card from muster-in roll.

Book mark: -----

(358c) W. D. Doe Copyist.

S | 7 | U.S.C.T.

Jacob Sutton
Copt., Co. B, 7 Reg't U. S. Col'd Infantry.

Appears on

Company Muster Roll
for Sept & Oct, 1865.

Joined for duty and enrolled:

When Sept 23, 1863.*

Where Talbot Co. Md *

Period 3 years.*

Present or absent Present

Stoppage, \$ 100 for

Due Gov't \$ 100 for

Remarks: Promoted to
Corporal, Sept 19
1865. Regt. 20. 85

* See enrollment on card from muster-in roll.

Book mark:

(358c) W. H. Log Copyist.

8 | 7 | U.S.C.T.

Jacob Sutton
Cnpl, Co. B, 7 Reg't U. S. Col'd Infantry.

Appears on

Company Muster Roll
for Nov & Dec, 1865.

Joined for duty and enrolled:

When Sept 23, 1863.*

Where Talbot Co., Md.*

Period 3 years.*

Present or absent Present

Stoppage, \$ 100 for

Due Gov't \$ 100 for

Remarks: Promoted to
Cnpl pr. O.O. No 85
dated H & M. 7 us.
C.T. Sept 19, 1865

* See enrollment on card from muster-in roll.

Book mark:

(358c)

W. H. [Signature]

Copist.

S | 7 | U.S.C.T.

Jacob Sutton
Corpl, Co. B, 7 Reg't U. S. Col'd Infantry.

Appears on

Company Muster Roll

for *Jamies and Det*, 186*6*

Joined for duty and enrolled:

When *sep 23*, 186*6**

Where *Haltott loo md**

Period *3* years.*

Present or absent *Present*

Stoppage, \$ *100* for

Due Gov't \$ *100* for

Remarks:

* See enrollment on card from muster-in roll.

Book mark:

Holbrook
Copyist.

S | 7 | U.S.C.T.

Jacob Sutton
Corpl, Co. B, 7 Reg't U. S. Col'd Infantry.

Appears on

Company Muster Roll

for Mch + apl, 1866.

Joined for duty and enrolled:

When Sep 23, 1863.*

Where Falbot md *

Period 3 years.*

Present or absent Present

Stoppage, \$ 100 for

Due Gov't \$ 100 for

Remarks:

* See enrollment on card from muster-in roll.

Book mark:

Holbrook

S | 7 | U.S.C.T.

Jacob Sutton
Corp, Co. B, 7 Reg't U. S. Col'd Infantry.

Appears on

Company Muster Roll

for May + June, 1864

Joined for duty and enrolled:

When Sep 23, 1863*

Where Feltot Co md *

Period 3 years.*

Present or absent Present

Stoppage, \$ 100 for

Due Gov't \$ 100 for

Remarks:

* See enrollment on card from muster-in roll.

Book mark:

Holbrook
(358c) Copyist.

S | 7 | U.S.C.T.

Jacob Sutton
Comp., Co. B, 7 Reg't U. S. Col'd Infantry.

Appears on

Company Muster Roll

for July and Aug, 1866.

Joined for duty and enrolled:

When Sep. 23, 1863*

Where Tallahassee, Fla. *

Period 3 years.*

Present or absent Present

Stoppage, \$ 100 for

Due Gov't \$ 100 for

Remarks:

* See enrollment on card from muster-in roll.

Book mark:

(358c) *Holbrook* Copyist.

S

7

U.S.C.T.

Jacob Sutton

Corp, Co. B, 7 Reg't U. S. Col'd Infantry.

Appears on Co. Muster-out Roll, dated

Indiavola Texas, Oct 13, 1866.

Muster-out to date Oct 13, 1866.

Last paid to June 30, 1866.

Clothing account:

Last settled....., 186 ; drawn since \$ 100

Due soldier \$ 44 ¹⁶/₁₀₀; due U. S. \$ 100

Am't for cloth'g in kind or money adv'd \$ 100

Due U. S. for arms, equipments, &c., \$ 6 ⁰⁰/₁₀₀

Bounty paid \$ 100; due \$ 100 ⁰⁰/₁₀₀

Remarks: Issued original organization
Private from muster in to Sept
19 1865 - then Corporal & date
Wm's Esfield muster (Rifled)
& complete set of accounts mustered
no. 101 was Dept. May 30 1865

Book mark V 164 P 221.73.443061

A. Johnson

(361)

Copyist.

Sutton Jacob

, Co.

9 Reg't U. S. C. I

1 Enclosures.

Bed Cards	Final Statements
Burial Records	Furloughs or L. of A
Certs. of Dis. for Discharge	Med. Certificates
C. M. Charges	Med. Des. Lists
Descriptive Lists	Orders
Discharge Certificates	Pris. of War Record
Enlistment Papers	Resignations

Other papers relating to—

Admission to Hosp'l	Furlough or L. of A
Casualty Sheet	Med. Examination
Confinement	Misc. Information
Contracts	Pay or Clothing
Death or Effects	Personal Reports
Desertion	Rank
Discharge from Hosp'l	Transfer to Hosp'l
Discharge from Service	Transfer to V. R. C.
Duty	Transportation
	Slave Papers 1

MICROFILM PUBLICATION M 1849

COMPILED MILITARY SERVICE RECORDS
OF VOLUNTEER UNION SOLDIERS WHO SERVED WITH
THE UNITED STATES COLORED TROOPS (USCT)
7TH REGIMENT OF INFANTRY

PERSONAL PAPERS' TARGET SHEET

PLEASE NOTE THE CHECKED INFORMATION ABOUT THE PERSONAL PAPERS IN
THIS FILE:

- NO PERSONAL PAPERS WERE FOUND IN THIS FILE WHEN THE
RECORDS WERE ARRANGED FOR MICROFILMING.
- 6 PERSONAL PAPER(S) FOUND IN THIS FILE WHEN THE RECORDS
WERE ARRANGED FOR MICROFILMING.

845,

Sent to Leonard
March 30th/65

A.

No. 845

CLAIMANT'S CERTIFICATE.

I, Charles Lowndes a loyal citizen, and a resident
of Talbot, County of Ad., State of
Maryland, hereby claim compensation, under the provisions of
General Orders, No. 329, 1863, for my slave Jacob Vinton
enlisted September 26th, 1863 at Benedict
by Col. Wm Birney in the seventh
Regiment U. S. Colored Troops, Co. B.; certificate of which enlistment, and a
descriptive list, as required, accompany this application.

In proof of my loyalty to the Constitution and Government of the United States, I
present the accompanying oath, which I have taken, signed, and acknowledged, to be filed
with this application, in accordance with requirement of said General Orders.

Charles Lowndes

March 5th 1864.

MAR 13 1864

B.

OATH OF ALLEGIANCE.

I, Charles Lozandes, do solemnly swear that I have never joined, or been concerned in, any insurrection or rebellion; that I have never borne arms against the United States; that I have never given any aid, countenance, counsel, or encouragement to any person or persons engaged, or whom I had reason to believe were about to engage, in insurrection, rebellion, or armed hostility against the United States; that I have neither sought, nor accepted, nor attempted to exercise the functions of any office, civil or military, nor to perform any service whatever, under any authority or pretended authority in hostility to the United States; that I have not yielded a voluntary support to any insurrection, rebellion, or pretended government, authority, power, or constitution within the United States hostile thereto. And I do further swear that, to the best of my knowledge and ability, I have supported and defended, and will continue to support and defend, the United States against all enemies, foreign and domestic; and that I have supported, defended, and obeyed, and will continue to support, defend, and obey, the Constitution and laws of the United States; that I will bear true faith and allegiance to the same; and that I take this oath freely, without any mental reservation or purpose of evasion: So help me God.

Charles Lozandes

Sworn to and subscribed before me, at Easton Md
this 5th day of March 1864.



W. H. Thepauis
J. P.

C.

I present herewith evidence of my title to the slave Jacob Sutton
 enlisted as aforesaid, and in consideration of the sum of
 by me received, I hereby covenant and
 agree with the United States, that I, my heirs, executors, or assigns, shall never hereafter make
 or enforce any claim to the labor or services of said slave; and pledge myself to execute
 a valid Deed of Manumission and Release of all my claims to service forever of said
Jacob Sutton to be filed with the Board of Claims
 now in session at Baltimore

Charles Lowndes

March 5th, 1864.

L. No. 28. N. C.
L. No. 33. R. V.

No. 845

APPLICATION OF

Charles Lowndes

of
Talbot County

For Compensation for Service of Slave,

Jacob Sutton

Enlisted in 7th Regiment

U. S. Colored Troops, Co. B.

Received, March 8th 1864.

COMPENSATION AWARDED,

April 8th 1865

Three Hundred Dollars.

Thos. Simmons
President Board of Claims

Re Ex
Sec. Contract April 18. 1865.

March 30. 67

EVIDENCE OF TITLE.

I, Charles Londer, of Talbot
 County, Md., do solemnly swear that Jacob Sutton
 who has been enlisted in the Seventh Regiment, U. S. Colored Troops,
 Co. B.; is my slave for life; (his term of service expiring on
 the _____ day of _____ 186 _____;) and that
 I became possessed of him by birth, in the month
 of _____, eighteen hundred and forty two. And I
 do further swear that I ~~have~~ not purchased said slave from any person or persons disloyal
 to the Government of the United States, with the object of obtaining compensation for
 the same; and furthermore, that I have no ~~agency~~ agency for obtaining compensation for any per-
 son or persons but such as, to my knowledge, are loyal citizens of the United States.

Charles Londer

March 3rd 1864.

STATE OF MARYLAND,

Talbot County, to wit:

On this *fifth* day of *March* in the year 1864,

before me, the subscriber, a Justice of the Peace of the State and County aforesaid, personally appeared *Charles Lounds*, and took, signed, and acknowledged the oaths preceding; and further made oath, in due form of law, that all the statements made in this application are, to the best of *his* knowledge and belief, strictly true.

Also personally appeared before me *Henry M. Nicols* and *W. J. Harcisty*, loyal citizens of the United States, residents of *Talbot County*, well acquainted with the said *Charles Lounds*, and in no manner interested in the prosecution of this claim, and made oath, in due form of law, that the said *Charles Lounds* is the owner of the slave *Jacob Sutton*, as a fact of public notoriety; that they believe all the statements herein made by *him*, in reference thereto, are correct, and that *he* is unquestionably loyal to the Government of the United States. Witness their signatures:

W. H. [Signature]

H. M. Nicols
W. J. Harcisty
Justice of the Peace.

STATE OF MARYLAND,

Talbot County, to wit:

I, *Samuel T. Hopkins*, Clerk of the Circuit Court for

Talbot County, do hereby certify that *Wendell Shepard Esq*

before whom the foregoing affidavits were made, was, at the time of signing the same, a

Justice of the Peace for the County and State aforesaid, duly commissioned and sworn;

and that his signature thereto is genuine, and that full faith and credit should be given to

his official acts.

Witness my hand and the seal of said Court, this *fifth* day of

March, A. D. 1864.

Samuel T. Hopkins CLERK.

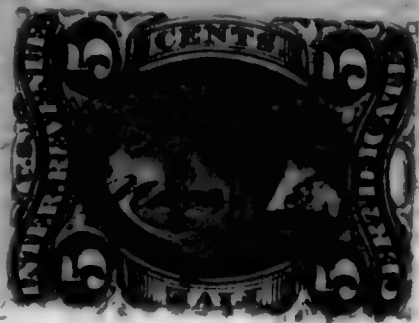

Charles Townes
to
Jacob Sutton

Copy. Manuscript.

MAR 13 1864

E.
DEED OF MANUMISSION AND RELEASE OF SERVICE.

WHEREAS, my slave *Jacob Sutton* has enlisted
in the service of the United States : now in consideration thereof, I *Charles Lowndes*
of Talbot County, State of Maryland, do hereby, in consideration
of said enlistment, manumit, set free, and release the above named *Jacob Sutton*
from all service due me; his freedom to commence from the *21st* day of
September 1862, the date of his enlistment as aforesaid in the *7th* Regiment of Colored
Troops, in the service of the United States, *Co. "B."*

Witness my hand and seal, this *21st* day of *May* 1864.

WITNESS: *Charles Lowndes* {SEAL.}
Chas. H. Gibson
Philemon F. Kennard
W. H. Shepard

TALBOT COUNTY, STATE OF MARYLAND, _____ 1864.
Before me appeared this day *Charles Lowndes* and acknowledg-
ed the above Deed of Manumission and Release from Service to be his free act and deed.

W. H. Shepard J.P.

STATE OF MARYLAND, TALBOT COUNTY, SCT :
I hereby certify that the foregoing is truly taken and copied from the original Manumission
this day filed for record in the office of Clerk of the Circuit Court for Talbot County.
In Testimony whereof I hereto set my hand and affix the seal of the said Court this
25th day of *March* A. D. 1864.



Saml. T. Hopkins Clerk
Circuit Court for Talbot County.

F.

CERTIFICATE OF AWARD OF THE BOARD OF CLAIMS.

No. 5213

Office of the Board of Claims
For Slaves Enlisted in the Service of the United States,

Baltimore Md.

April 15th, 1865.

f300-

We hereby certify, that Charles Loundes, of Falbot county, State of Maryland, having proved, under oath, his loyalty to the Constitution and Government of the United States, and established his title as to the ownership of Jacob Sutton, a slave enlisted at Falbot County Md. on the 21st day of September, 1863, by Col. Wm. Birney, in the service of the United States, in the 7th Regiment of Colored Troops, Co. B., and having filed a valid Deed of Manumission and Release of Service of said slave, is entitled to the sum of Three hundred dollars, which has been awarded to him by this Board as a remuneration for all claim to the future labor or service of said slave, under the provision of General Orders, War Department, No. 329, 1863.

Thos. Simmons, President of the Board.

L. E. Strangford, Member of the Board.

Wm. Rogers, Member of the Board.

To Col. C. W. Foster,

Chief of the Bureau for the
Organization of Colored Troops, Washington, D. C.

T. No. 33. N. V.

No. .

ABSTRACT OF DISBURSEMENTS.

....., 186 .

Charles Lourdes

Dollars *300* 100.

Paid , 186 .

The United States,

To Charles Lowndes Dr.

1867		DOLLARS.	CENTS.
April 15 th	For amount awarded him by the Board of Claims, in consideration of the enlistment of <u>Jacob Sutton</u> in the <u>7th Regt U.S. Col. Troops</u>	300	00
Total \$		300	00

I CERTIFY that the above account is correct and just; that the name of Jacob Sutton is borne on the muster-in rolls of the 7th Regt. U.S. Col. Troops; and that the above amount was awarded by the Board of which Thos. Finnon Esq. is President, said award being in accordance with section 24 of the act entitled "An act to amend an act entitled 'An act for enrolling and calling out the national forces, and for other purposes,'" approved Feb. 24, 1864.

Assistant Adjutant General.

RECEIVED _____, 186 , of Major A. F. Rockwell a. a. s. v. s. dollars and _____ cents, in full of the above account.

Charles Lowndes

(SIGNED DUPLICATES.)

L. M. Chesbrough

No. .

ABSTRACT OF DISBURSEMENTS.

....., 186 .

Charles Loomis

Dollars *300* .
100.

Paid , 186 .

The United States,

To Charles Lowndes Dr.

		DOLLARS.	CENTS.
1865.	For amount awarded him by the Board of Claims, in consideration		
April 15 th	of the enlistment of <i>Jacob Sutton</i>		
	in the <i>7th Reg^t U.S. Col. Troops</i>	<i>300</i>	<i>00</i>
<i>Total. \$</i>		<i>300</i>	<i>00</i>

I CERTIFY that the above account is correct and just; that the name of *Jacob Sutton* is borne on the muster-in rolls of the *7th Reg^t U.S. Col. Troops*; and that the above amount was awarded by the Board of which *Thos. Simmons Esq.* is President, said award being in accordance with section 24 of the act entitled "An act to amend an act entitled 'An act for enrolling and calling out the national forces, and for other purposes,'" approved Feb. 24, 1864.

Assistant Adjutant General.

RECEIVED _____, 186 _____, of *Major W.F. Rockwell a.a.g. vts*
 _____ dollars and _____ cents, in full of the above account.

Charles Lowndes

(SIGNED DUPLICATES.)

1289
 Sutton Solomon

Co. 6, 7 U.S. Col'd Inf.

Private

Private

CARD NUMBERS.

1	6283634	26
2	6283735	27
3	6283835	28
4	6283933	29
5	6284034	30
6	6284130	31
7	6284225	32
8	6284320	33
9	6284395	34
10	6284504	35
11	6284603	36
12	6284710	37
13	6284812	38
14	6284904	39
15	6284992	40
16	6285076	41
17	6285140	42
18	6285212	43
19	6285266	44
20	6285322	45
21	9066232	46
22		47
23		48
24		49
25		50

Book Mark:

See also

82808261awnd

S | 7 | U.S.C.T.

Samuel
Solomon Sutton
....., Co. *C*, 7 Reg't U. S. Col'd Inf.

Appears on
Company Descriptive Book
of the organization named above.

DESCRIPTION.

Age *40* years; height *5* feet *4 1/2* inches.
Complexion *Black*.
Eyes *Black*; hair *Curly*
Where born *Saltov, Md.*
Occupation *Farmer*.

ENLISTMENT.

When *Sept. 21*, 186*3*.
Where *Baltimore*.
By whom *Ced. W. Binney*; term *3* y'rs.
Remarks: *Mustered at Baltimore*
Md. Sept. 26, 63, by Ced. W. Binney.

+ See on book

J. Smith

8 | 7 | U.S.C.T.

Salomon Sutton,
Prov. Co. C, 7 Reg't U. S. Colored Inf.

Age *40* years.

Appears on

Company Muster-in Roll

of the organization named above. Roll dated

Baltimore, Md., Sept. 26, 186*3*

Muster-in to date

Sept. 26, 186*3*

Joined for duty and enrolled:

When *Sept. 23*, 186*3**

Where *Talbot Co., Md.* *

Period *3* years.*

Remarks:

*Muster-in roll shows enrollment of all men of this company as of same date. See enrollment on subsequent card or cards.

Book mark:

(356c)

Crewey
Copyst.

S | 7 | **U.S.C.T.**

Salomon Sutton,

Privt, Co. C, 7 Reg't U. S. Col'd Infantry.

Appears on

Company Muster Roll
for Sept 26 to Oct 31, 1863

Joined for duty and enrolled:

When Sept. 23, 1863*

Where Talbot Co, Md. *

Period 3 years.*

Present or absent Absent

Stoppage, \$ 100 for

Due Gov't \$ 100 for

Remarks: Detached on recruiting service Oct. 29. 1863.

* See enrollment on card from muster-in roll.

Book mark: _____

(358c)

Cassaway
Copyist.

S | 7 | U.S.C.T.

Salomon Sutton,

Pvt, Co. C, 7 Reg't U. S. Col'd Infantry.

Appears on

Company Muster Roll

for Nov 1863, 1863

Joined for duty and enrolled:

When Sept. 23, 1863*

Where Talbot Co. Md. *

Period 3 years.*

Present or absent Present

Stoppage, \$ 100 for

Due Gov't \$ 100 for

Remarks:

* See enrollment on card from muster-in roll.

Book mark:-----

Calloway

S | 7 | U.S.C.T.

Salomon Sutton,
Priv, Co. C, 7 Reg't U. S. Col'd Infantry.

Appears on

Company Muster Roll
for Jan^y and Feby, 1864.

Joined for duty and enrolled:

When Sept. 23, 1863.*

Where Talbot Co. Md. *

Period 3 years.*

Present or absent Present,

Stoppage, \$ 100 for

Due Gov't \$ 100 for

Remarks:

* ~~See~~ See enrollment on card from muster-in roll.

Book mark: _____

Callaway

S | 7 | U.S.C.T.

Salomon Sutton.

Priv, Co. C, 7 Reg't U. S. Col'd Infantry.

Appears on

Company Muster Roll

for *March and April*, 1864.

Joined for duty and enrolled:

When *Sept. 23*, 1863.*

Where *Talbot Co., Md.* *

Period *3* years.*

Present or absent *Present*

Stoppage, \$ *100* for

Due Gov't \$ *100* for

Remarks: *Stop for our knapsack and Haversack.*

* See enrollment on card from muster-in roll.

Book mark:

Calloway.

S | 7 | U.S.C.T.

Salomon Sutton

Pvt, Co. C, 7 Reg't U. S. Col'd Infantry.

Appears on

Company Muster Roll

for May 18 June, 1864.

Joined for duty and enrolled:

When Sept. 23, 1863*

Where Falbot Co. Md.*

Period 3 years.*

Present or absent Present.

Stoppage, \$ 100 for

Due Gov't \$ 100 for

Remarks:

* See enrollment on card from muster-in roll.

Book mark:

Ballouway

S 7 U.S.C.T.

Solomon Sutton,
Privt, Co. C, 7 Reg't U. S. Col'd Inf.

Appears on

Company Muster Roll
for July²⁴ Aug 1864.

Joined for duty and enrolled:

When Sept. 23, 1863*

Where Talbot Co., Md.*

Period 3 years.*

Present or absent Present.

Stoppage, \$ 100 for

Due Gov't, \$ 100 for

Valuation of horse, \$ 100

Valuation of horse equipments, \$ 100

Remarks:

* See enrollment on card from muster-in roll.

Book-mark:

Calloway

7 U.S.C.T.

Solomon Sutton
Pvt; Co. C, 7 Reg't U. S. Col'd Infantry.

Appears on

Company Muster Roll
for Sept. & Oct., 1864.

Joined for duty and enrolled:

When Sept. 23rd, 1863.*

Where Talbot *

Period 3 years.*

Present or absent Present

Stoppage, \$ 100 for

Due Gov't \$ 100 for

Remarks:

* See enrollment on card from muster-in roll.

Book mark:

M. M. Murphy
Copyist.

(358c)

S | **7** | **U.S.C.T.**

Solomon Sutton
Priv., Co. C, 7 Reg't U. S. Col'd Infantry.

Appears on

Company Muster Roll
for *Nov. & Dec.*, 1864.

Joined for duty and enrolled:

When *Sept. 23rd*, 1864.*

Where *Talbot* *

Period *3* years.*

Present or absent *Present*

Stoppage, \$ *100* for

Due Gov't \$ *100* for

Remarks:

* See enrollment on card from muster-in roll.

Book mark: -----

M. M. Murphy
(358c) Copyist.

S | 7 | U.S.C.T.

Solomon Sutton

Priv., Co. C, 7 Reg't U. S. Col'd Infantry.

Appears on

Company Muster Roll

for Jan. & Feb., 1865.

Joined for duty and enrolled:

When Sept. 23, 1863.*

Where Gallop Co., (Ind.) *

Period 3 years.*

Present or absent Present

Stoppage, \$ 100 for

Due Gov't \$ 100 for

Remarks:

* See enrollment on card from muster-in roll.

Book mark:

M. M. Murphy

(358c)

Copyist.

S

7

U.S.C.T.

Solomon Sutton

Priv., Co. C, 7 Reg't U. S. Col'd Infantry.

Appears on

Company Muster Roll

for *Mar. + Apr.*, 186 *5*!

Joined for duty and enrolled:

When *Sept. 23*, 186 *3*.*

Where *Fallot* *

Period *3* years.*

Present or absent *Present*

Stoppage, \$ *100* for

Due Gov't \$ *100* for

Remarks:

.....
.....
.....
.....
.....

* See enrollment on card from muster-in roll.

Book mark:

M. M. Murphy

1863

S | 7 | U.S.C.T.

Solomon Sutton

Pvt., Co. C, 7 Reg't U. S. Col'd Infantry.

Appears on

Company Muster Roll
for May 7 June, 1863.

Joined for duty and enrolled:

When Sept. 23, 1863.*

Where Tallot *

Period 3 years.*

Present or absent Present

Stoppage, \$ 100 for

Due Gov't \$ 100 for

Remarks:

* See enrollment on card from muster-in roll.

Book mark:

M. M. Murphy

(358c)

Copyist.

S | 7 | U.S.C.T.

Solomon Sutton

Priv., Co. C, 7 Reg't U. S. Col'd Infantry.

Appears on

Company Muster Roll

for *July & Aug.*, 186*5*.

Joined for duty and enrolled:

When *Sept. 23*, 186*5*.*

Where *Tullot* *

Period *3* years.*

Present or absent *Present*

Stoppage, \$ *100* for

Due Gov't \$ *100* for

Remarks:

* See enrollment on card from muster-in roll.

Book mark: -----

(258c)

Mr. M. Murphy Copyist.

S | 7 | U.S.C.T.

Solomon Sutton
Priv., Co. C, 7 Reg't U. S. Col'd Infantry.

Appears on

Company Muster Roll
for Sept. 7 Oct. 1865.

Joined for duty and enrolled:

When Sept. 21, 1863.*

Where Tulbot, Md.*

Period 3 years.*

Present or absent Present

Stoppage, \$ 100 for

Due Gov't \$ 100 for

Remarks:

* See enrollment on card from muster-in roll.

Book mark:

M. M. Murphy
(858c) Copyist.

NARA 1356

S. 7 U.S.C.T.

Solomon Sutton

Private, Co. C, 7 Reg't U. S. Col'd Infantry.

Appears on

Company Muster Roll

for Nov. & Dec, 1865

Joined for duty and enrolled:

When Sept. 21, 1863

Where Talbot Md. *

Period 3 years.*

Present or absent Present.

Stoppage, \$ 100 for

Due Gov't \$ 100 for

Remarks:

* See enrollment on card from muster-in roll.

Book mark:

Saper

S. 7 U.S.C.T.

Solomon Sutton
Pvt, Co. C, 7 Reg't U. S. Col'd Infantry.

Appears on

Company Muster Roll
for Jan & Feb, 1866

Joined for duty and enrolled:

When Sept. 21, 1863*

Where Gallop Md.*

Period 3 years.*

Present or absent Present

Stoppage, \$ 18 for Ordnance

Due Gov't \$ 100 for

Remarks:

* See enrollment on card from muster-in roll.

Book mark:

(858c) Lopez Copyist.

S. | **7** | **U.S.C.T.**

Solomon Sutton
Gr, Co. C, 7 Reg't U. S. Col'd Infantry.

Appears on

Company Muster Roll
for *March & April*, 186*6*

Joined for duty and enrolled:

When *Sept. 21*, 186*6*

Where *Talbot Md.**

Period *3* years.*

Present or absent *Present.*

Stoppage, \$ *100* for

Due Gov't \$ *100* for

Remarks:

* See enrollment on card from muster-in roll.

Book mark: -----

Lopez
Copyist.

S. 7 U.S.C.T.

Solomon Sutton
Private, Co. C, 7 Reg't U. S. Col'd Infantry.

Appears on

Company Muster Roll
for May & June, 1866

Joined for duty and enrolled:

When Sept. 21, 1863*

Where Tolbot Md *

Period 3 years.*

Present or absent Present.

Stoppage, \$ 100 for

Due Gov't \$ 100 for

Remarks:

* See enrollment on card from muster-in roll.

Book mark:

Lopez Copyist.

S. 1 7 U.S.C.T.

Solomon Sutton
Pr, Co. C, 7 Reg't U. S. Col'd Infantry.

Appears on

Company Muster Roll
for July & Aug, 1866

Joined for duty and enrolled:

When Sept. 21, 1863

Where Tolbot Md.*

Period 3 years.*

Present or absent Present,

Stoppage, \$ 100 for

Due Gov't \$ 100 for

Remarks:

* See enrollment on card from muster-in roll.

Book mark:

Lopez Copyist.

S. | 7 | U.S.C.T.

Solomon Sutton
Pvt, Co. B, 7 Reg't U. S. Col'd Infantry.

Appears on Co. Muster-out Roll, dated
Indianola Texas Oct 13, 1866.

Muster-out to date Oct 13, 1866.

Last paid to June 30, 1866

Clothing account:

Last settled....., 186 ; drawn since \$..... 100

Due soldier \$ ^{43 33}/₁₀₀; due U. S. \$..... 100

Am't for cloth'g in kind or money adv'd \$..... 100

Due U. S. for arms, equipments, &c., \$..... 100

Bounty paid \$..... 100; due \$ ¹⁰⁰/₁₀₀

Remarks: Joined Co. at orig-
organization.

Book mark: V1639138.73

Soper

1290

Sutton William

Co D, 7 U.S. Col'd Inf.

Private Private

CARD NUMBERS.

1	6283506	26
2	6285687	27
3	6285704	28
4	6285806	29
5	6285909	30
6	6286006	31
7	6286104	32
8	6286199	33
9	6286309	34
10	6287198	35
11	9066332	36
12	B529-REC-65	37
13		38
14		39
15		40
16		41
17		42
18		43
19		44
20		45
21		46
22		47
23		48
24		49
25		50

Book Mark: B529-REC-1865.

See also

S. 215-8431 Roman

AP 687450

S | 7 | U.S.C.T.

William Sutton
Co. D, 7 Reg't U.S. Col'd Inf.

Appears on
Company Descriptive Book
of the organization named above.

DESCRIPTION.

Age 23 years; height 5 feet 9 3/4 inches.

Complexion *Rex*

Eyes *Rex*; hair *Curly*

Where born *Talbot Co. Md.*

Occupation *Farmer*

ENLISTMENT.

When *Sept - 26*, 1863.

Where *Talbot*

By whom *Ed. M. Poincy*; term *3* y'rs.

Remarks: *Missing in action
Sept 29th 63. Mustered
out 29th 63. Died while
a prisoner of war at
Richmond, Va. Oct 64.*

J. J. Brown
(3830) Copyist.

D | 7 | U.S.C.T.

William Sutton
Priv, Co. D, 7 Reg't U. S. Colored Inf.

Age 23 years.

Appears on

Company Muster-in Roll

of the organization named above. Roll dated

Baltimore Md., Sep 29 1863.

Muster-in to date Sep 29, 1863.

Joined for duty and enrolled:

When Sept 26, 1864.*

Where Talbot Co., Md. *

Period 3 years.*

Remarks:

*Muster-in roll shows enrollment of all men of this company as of same date. See enrollment on subsequent card or cards.

Book mark: B. 529 - REC - 1865.

R. S. Shelton

S | **7** | **U.S.C.T.**

William Sutton
Pvt, Co. D, 7 Reg't U. S. Col'd Infantry.

Appears on

Company Muster Roll

for *from Sept 29 to Oct 31*, 186*3*.

Joined for duty and enrolled:

When *Sept 26*, 186*3**

Where *Talbot Co, Md.**

Period *3* years.*

Present or absent *Present*

Stoppage, \$ *100* for

Due Gov't \$ *100* for

Remarks:

* See enrollment on card from muster-in roll.

Book mark:

R S Shelton

(358c)

Copyist.

8 | 7 | U.S.C.T.

William Sutton

Private, Co. D, 7 Reg't U. S. Col'd Infantry.

Appears on

Company Muster Roll

for Nov + Dec, 1863

Joined for duty and enrolled:

When Sept 16, 1863*

Where Talbot Md *

Period 3 years.*

Present or absent Present

Stoppage, \$ 100 for

Due Gov't \$ 100 for

Remarks:

* See enrollment on card from muster-in roll.

Book mark:

R B Shelton

(358c)

Copyist.

6

7

U.S.C.T.

William Sutton
Priv, Co. D, 7 Reg't U. S. Col'd Infantry.

Appears on

Company Muster Roll

for Jan & Feb, 1864.

Joined for duty and enrolled:

When Sept 26, 1863.*

Where Queen Ann Md *

Period 0 years.*

Present or absent Present

Stoppage, \$ 100 for

Due Gov't \$ 100 for

Remarks:

* See enrollment on card from muster-in roll.

Book mark:

R. S. Shelton

(358c)

Copyist.

1869 1379

D | 7 | U.S.C.T.

William Sutton

Priv, Co. D, 7 Reg't U. S. Col'd Infantry.

Appears on

Company Muster Roll

for *March Apl*, 1864.

Joined for duty and enrolled:

When *Sept 26*, 1863*

Where *Talbot Md.**

Period *3* years.*

Present or absent *Present*

Stoppage, \$ *100* for

Due Gov't \$ *100* for

Remarks:

* See enrollment on card from muster-in roll.

Book mark: _____

R. S. Shelton

(358c)

Copyist.

S | 7 | U.S.C.T.

William Sutton

Pvt, Co. D, 7 Reg't U. S. Col'd Infantry.

Appears on

Company Muster Roll

for May & June, 1864.

Joined for duty and enrolled:

When Sept. 26, 1863.*

Where Talbot Co. Md. *

Period 3 years.*

Present or absent Present

Stoppage, \$ 100 for

Due Gov't \$ 100 for

Remarks:

* See enrollment on card from muster-in roll.

Book mark:

R S Shelton

(358c)

Copyist.

5 | 7 | **U.S.C.T.**

William Sutton
Pvt, Co. D, 7 Reg't U. S. Col'd Infantry.

Appears on

Company Muster Roll

for July & Aug, 1864.

Joined for duty and enrolled:

When Sept 26, 1863*

Where Talbot Md.*

Period 3 years.*

Present or absent Present

Stoppage, \$ 100 for _____

Due Gov't \$ 100 for _____

Remarks: _____

* See enrollment on card from muster-in roll.

Book mark: _____

R S Shelton
(358c) Copyist.

NOV 1864

7 | **U.S.C.T.**

William Sutton
Private, Co. D, 7 Reg't U. S. Col'd Infantry.

Appears on

Company Muster Roll

for Sept. & Oct., 1864.

Joined for duty and enrolled:

When Sept. 26, 1863.*

Where Fallot *

Period 3 years.*

Present or absent absent

Stoppage, \$ 100 for

Due Gov't \$ 100 for

Remarks: Missing in action
Sept. 29th 1864

* See enrollment on card from muster-in roll.

Book mark: _____

(358c)

W. M. Cook
Copyist.

S

7

U.S.C.T.

William Sutton

Private, Co. D, 7 Reg't U. S. Col'd Infantry.

Appears on

Company Muster Roll

for Nov. & Dec., 1864

Joined for duty and enrolled:

When Sept. 26, 1863.*

Where Tallot *

Period 3 years.*

Present or absent absent

Steppage, \$ 100 for

Due Gov't \$ 100 for

Remarks: Missing in action
Sept 29 1864

* See enrollment on card from muster-in roll.

Book mark: 23. 2nd and Nov. 2/65
over

E. N. Neale

(358c)

Copyist.

JAN. 20

6286309

018910

Pension 111.857

S | 7 | U.S.C.T.

William Sutton

Pr, Co. *D*, 7 Reg't U. S. Col'd Infantry.

Appears on **Co. Muster-out Roll**, dated *Indianola Texas*, *Oct 13*, 1866.

Muster-out to date _____, 186 .

Last paid to *Apr 30*, 1864.

Clothing account:

Last settled _____, 186 ; drawn since \$ _____ 100

Due soldier \$ _____ 100 ; due U. S. \$ _____ 100

Am't for cloth'g in kind or money adv'd \$ _____ 100

Due U. S. for arms, equipments, &c., \$ _____ 100

Bounty paid \$ _____ 100 ; due \$ _____ 100

Remarks: *Died at Richmond, Va. Oct 5. 64. while a prisoner of war. Final statements forwarded June 20. /65.*

Book mark: *116.857. C.S.*

Heard

1896
S 7 U.S.C.G.

William Sutton
Priv., Co. D, 7th Reg't U.S.C.I.

NOTATION.

Book mark: B 529 R.C.G. 1865.

Record and Pension Office,

WAR DEPARTMENT,

Washington, May 7th, 1902

It has this day (May 7th, 1902)

been determined by this Department from the records that the above named soldier died January 15, 1865, in hospital at Salisbury, North Carolina, while a prisoner of war, and that so much of the record as shows his death on October 7, 1864, in hospital at Richmond, Virginia, is erroneous.

W. M. Gibson

Empty header box with vertical lines

Sutton, Wm

P, Co. *D*, **7** Reg't **U. S. C. Inf.**

J Enclosures.

Bed Cards.....	Descriptive Lists.....
Burial Records.....	Final Statements.....
Certs. of Dis. for Discharge.....	Furloughs.....
C. M. Charges.....	Med. Des. Lists.....
Med. Certificates.....	Orders.....

P of 9 years 1

Other papers relating to—

Admission to Hosp'l.....	Furlough.....
Casualty Sheet (Officer's)..... /	Med. Examination.....
Confinement.....	Misc. Information..... <i>6</i>
Contracts.....	Pay or Clothing.....
Death or Effects.....	Personal Reports.....
Desertions.....	Rank.....
Discharge from Hosp'l.....	Transfer to Hosp'l.....
Discharge from Service.....	Transfer to V. R. C.....
Duty.....	Transportation.....

MAR 1988

847

A.

No. 847

CLAIMANT'S CERTIFICATE.

I, Charles Lowndes a loyal citizen, and a resident
of near Easton, County of Talbot, State of
Maryland, hereby claim compensation, under the provisions of
General Orders, No. 329, 1863, for my slave William Dutton
enlisted Sept. 29th 1863, at Benedict
by Col. Wm. Birney in the seventh
Regiment U. S. Colored Troops, Co. D; certificate of which enlistment, and a
descriptive list, as required, accompany this application.

In proof of my loyalty to the Constitution and Government of the United States, I
present the accompanying oath, which I have taken, signed, and acknowledged, to be filed
with this application, in accordance with requirement of said General Orders.

Charles Lowndes

March 5th 1864.

B.

OATH OF ALLEGIANCE.

I, Charles Lowndes, do solemnly swear that I have never joined, or been concerned in, any insurrection or rebellion; that I have never borne arms against the United States; that I have never given any aid, countenance, counsel, or encouragement to any person or persons engaged, or whom I had reason to believe were about to engage, in insurrection, rebellion, or armed hostility against the United States; that I have neither sought, nor accepted, nor attempted to exercise the functions of any office, civil or military, nor to perform any service whatever, under any authority or pretended authority in hostility to the United States; that I have not yielded a voluntary support to any insurrection, rebellion, or pretended government, authority, power, or constitution within the United States hostile thereto. And I do further swear that, to the best of my knowledge and ability, I have supported and defended, and will continue to support and defend, the United States against all enemies, foreign and domestic; and that I have supported, defended, and obeyed, and will continue to support, defend, and obey, the Constitution and laws of the United States; that I will bear true faith and allegiance to the same; and that I take this oath freely, without any mental reservation or purpose of evasion: So help me God.

Charles Lowndes

Sworn to and subscribed before me, at Eastern Md
this 5th day of March 1864

W. H. Shepard
S. L. P.

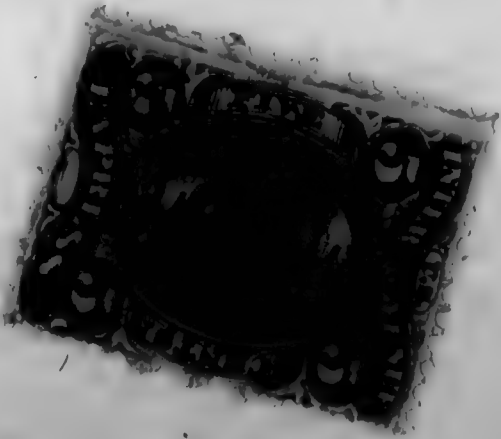

C.

I present herewith evidence of my title to the slave William Dutton
 enlisted as aforesaid, and in consideration of the sum of
 by me received, I hereby covenant and
 agree with the United States, that I, my heirs, executors, or assigns, shall never hereafter make
 or enforce any claim to the labor or services of said slave; and pledge myself to execute
 a valid Deed of Manumission and Release of all my claims to service forever of said
William Dutton to be filed with the Board of Claims
 now in session at Baltimore

Charles Gordon

March 5th, 1864.

Concord

L. No 30, R. 1845
L. No 35 R. 1.
No. 847

APPLICATION OF

Charles Lowndes

Falbot County

For Compensation for Service of Slave,

Wm. Sutton

Enlisted in 7th Regiment

U. S. Colored Troops, Co. D.

Received, March 8th 1864.

COMPENSATION AWARDED,

April 8th 1864

Three Hundred Dollars.

Thos. Simmons
President Board of Claims

Re Ex,
Concord

Recd. F. G. O. April 12. 1865.

STATE OF MARYLAND

EVIDENCE OF TITLE.

I, Charles Lowndes, of Talbot
County, Md., do solemnly swear that William Cotton
who has been enlisted in the seventh Regiment, U. S. Colored Troops,
Co. D, ; is my slave for life ; (his term of service expiring on
the _____ day of _____ 186 _____) and that
I became possessed of him by gift, in the month
of _____, eighteen hundred and forty one. And I
do further swear that I have not purchased said slave from any person or persons disloyal
to the Government of the United States, with the object of obtaining compensation for
the same ; and furthermore, that I have no agency for obtaining compensation for any per-
son or persons but such as, to my knowledge, are loyal citizens of the United States.

Charles Lowndes

March 5th 1864.

STATE OF MARYLAND,

Talbot County, to wit:

On this fifth day of March in the year 1864,

before me, the subscriber, a Justice of the Peace of the State and County aforesaid, personally appeared Charles Loands, and took, signed, and acknowledged the oaths preceding; and further made oath, in due form of law, that all the statements made in this application are, to the best of his knowledge and belief, strictly true.

Also personally appeared before me Henry M. Nicols and W. J. Handley, loyal citizens of the United States, residents of Talbot County, well acquainted with the said Charles Loands, and in no manner interested in the prosecution of this claim, and made oath, in due form of law, that the said Charles Loands is the owner of the slave William Sutton, as a fact of public notoriety; that they believe all the statements herein made by him, in reference thereto, are correct, and that he is unquestionably loyal to the Government of the United States. Witness their signatures:

[Signature]

H. M. Nicols
W. J. Handley
Justice of the Peace.

STATE OF MARYLAND,

Talbot County, to wit:
I, *Samuel Hopkins*, Clerk of the Circuit Court for
Talbot County, do hereby certify that *William H. Shepard Esq*

before whom the foregoing affidavits were made, was, at the time of signing the same, a Justice of the Peace for the County and State aforesaid, duly commissioned and sworn; and that his signature thereto is genuine, and that full faith and credit should be given to his official acts.

Witness my hand and the seal of said Court, this *fifth* day of
March, A. D. 1864.

Sam Hopkins CLERK.

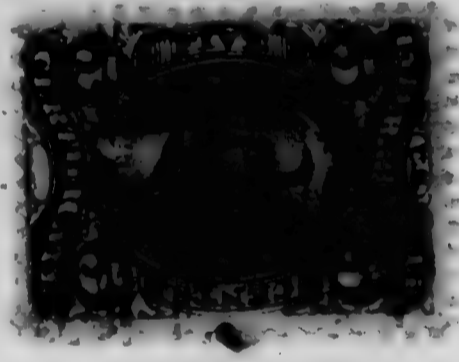

MEMORANDUM FROM PRISONER OF WAR RECORDS.

No. _____

(This blank to be used only in the arrangement of said records.)

NAME.	RANK.	ORGANIZATION.				INFORMATION OBTAINED FROM—				
		No. of Reg't.	State.	Arm of Service.	Co.	Records of	Vol.	Page.	Vol.	Page.
<i>Sutton William P</i>	<i>P</i>	<i>7</i>	<i>Negro</i>	<i>Sec 50th D</i>		<i>Miss Record</i>	<i>39</i>	<i>280/2</i>		
							<i>12</i>	<i>246</i>		

Captured at *Ft Harrison Va*, *Sept 30*, 1864; brought from _____, and confined at Richmond, Va., *Oct 2*, 1864. *Remark Died Oct 7/64*

Admitted to Hospital at *Salisbury Me*, 186 ; treated for *date not stated*

Where he died *January 15*, 1865; of *cause not given*

Paroled at _____, 186 ; reported at _____, 186 .

2158.431 R.P. 4. 24.0 2

2 for Sandford, Co July 15/66 114
2 p. s. rd _____ Sept 28/66
R.C. No. 17, 66.

CASUALTY SHEET

No. _____
Wm Sutton
_____ of Company B
7 Regiment of U.S. G. T.
~~State Volunteers.~~
Not on Rolls of Co B

NATURE OF CASUALTY.

Death
Prison Salisbury, N.C.
Jan 15. 1865
E. 25. Vol. 3 R.C. 5. 1866
refd to R.C. April 7. 1866
Don't mention of cert. records
with chief must officer,
Bull. Mod. Ser
S. 617. Vol. 4 R.C. 5. 1866-
Page 25, 8
Salisbury Records
Ans. m. v. 170 & 171

NARA 390

CASUALTY SHEET

Name: James Sutton

Rank: _____ Company: C Regiment: 7

Arm: _____ State: W. S. C. T.

Nature of Casualty: _____

CAUSE OF CASUALTY—(NAME OF DISEASE, &c.)

BY WHOM DISCHARGED.

DEGREE OF DISABILITY.

FROM WHAT SOURCE THIS INFORMATION WAS
OBTAINED.

BY WHOM CERTIFIED.

Col. Maj. H. T. Hartz
A. S. G.

Roll furnished by Hansen
of Paris

REMARKS.

DATE OF DISCHARGE, DEATH, &c.

Jan 15, 1865

PLACE OF DISCHARGE, DEATH, &c.

Salisbury, W. C.

J. H. Keane

Clerk.

[Large handwritten signature]

NARA 1399

Charles Lowndes

to

William Sutton

Copy Transmission

E.

DEED OF MANUMISSION AND RELEASE OF SERVICE.

WHEREAS, my slave *Wm. Sutton* has enlisted in the service of the United States : now in consideration thereof, I *Charles Soundes* of Talbot County, State of Maryland, do hereby, in consideration of said enlistment, manumit, set free, and release the above named *Wm. Sutton* from all service due me; his freedom to commence from the *26th* *September 1863*, the date of his enlistment as aforesaid in the *7th* Regiment of Colored Troops, in the service of the United States. *Co. D.*

Witness my hand and seal, this *21st* day of *May* 1864.

WITNESS: *Charles Soundes* {SEAL} *Chas. A. Gibson*

Philmon J. Kennard
W. H. Shepard

TALBOT COUNTY, STATE OF MARYLAND, _____ 1864.

Before me appeared this day *Capt Charles Soundes* and acknowledged the above Deed of Manumission and Release from Service to be his free act and deed.

W. H. Shepard J.P.

STATE OF MARYLAND, TALBOT COUNTY, SCT :

I hereby certify that the foregoing is truly taken and copied from the original Manumission this day filed for record in the office of Clerk of the Circuit Court for Talbot County.

In Testimony whereof I hereto set my hand and affix the seal of the said Court this *25th* day of *March* A. D. 1864.



Saml. J. Hopkins Clerk
Circuit Court for Talbot County.

F.

CERTIFICATE OF AWARD OF THE BOARD OF CLAIMS.

No 5745

\$300-

Office of the Board of Claims
For Slaves Enlisted in the Service of the United States,

Baltimore Md,

April 15th, 1865.

We hereby certify, that Charles Lounds, of Fallot county, State of Maryland, having proved, under oath, his loyalty to the Constitution and Government of the United States, and established his title as to the ownership of William Sutton, a slave enlisted at Fallot County Md, on the 24th day of September, 1863, by Col. Wm. Birney, in the service of the United States, in the 7th Regiment of Colored Troops, Co. D, and having filed a valid Deed of Manumission and Release of Service of said slave, is entitled to the sum of Three Hundred dollars, which has been awarded to him by this Board as a remuneration for all claim to the future labor or service of said slave, under the provision of General Orders, War Department, No. 329, 1863.

Thos. Ginnons President of the Board.
L. E. Strougher Member of the Board.
Wm. Rogers Member of the Board.

To Col. C. W. Foster,

Chief of the Bureau for the
Organization of Colored Troops, Washington, D. C.

L. No. 35. P. 1.

No. .

ABSTRACT OF DISBURSEMENTS.

....., 186 .

Charles Lowndes

Dollars *300* 100.

Paid, 186 .

The United States,

To Charles Lowndes Dr.

1865.		DOLLARS.	CENTS.
April 15 th	For amount awarded him by the Board of Claims, in consideration of the enlistment of <u>Wm. Sutton</u> in the <u>7th Regt U.S. Col. Troops</u>	300	00
Total \$		300	00

I CERTIFY that the above account is correct and just; that the name of Wm Sutton is borne on the muster-in rolls of the 7th Regt U.S. Col. Troops; and that the above amount was awarded by the Board of which Thos. Simmons Esq is President, said award being in accordance with section 24 of the act entitled "An act to amend an act entitled 'An act for enrolling and calling out the national forces, and for other purposes,'" approved Feb. 24, 1864.

Assistant Adjutant General.

RECEIVED _____, 186 , of Major A. F. Rockwell a. a. c. vol. dollars and _____ cents, in full of the above account.

Charles Lowndes

(SIGNED DUPLICATES.)

J. Chas. Lewis

No. _____

ABSTRACT OF DISBURSEMENTS.

....., 186 .

Charles Lowndes

Dollars *300* 100.

Paid , 186 .

The United States,

To Charles Lowndes Dr.

1865.		DOLLARS.	CENTS.
April 15 th	For amount awarded him by the Board of Claims, in consideration of the enlistment of <u>Wm. Sutton</u> in the <u>7th Regt U.S. Col. Troops</u>	300	00
Total \$		300	00

I CERTIFY that the above account is correct and just; that the name of Wm Sutton is borne on the muster-in rolls of the 7th Regt U.S. Col. Troops; and that the above amount was awarded by the Board of which Hon. Simmons Esq. is President, said award being in accordance with section 24 of the act entitled "An act to amend an act entitled 'An act for enrolling and calling out the national forces, and for other purposes,'" approved Feb. 24, 1864.

Assistant Adjutant General.

RECEIVED _____, 186 _____, of Major A.F. Rockwell a. a. S. vols.
 _____ dollars and _____ cents, in full of the above account.

Charles Lowndes

(SIGNED DUPLICATES.)

1291
Swan Jackson

Co. A, 7 U.S. Col'd Inf.

Private Private

CARD NUMBERS.

1	6279877	26
2	6279998	27
3	6280099	28
4	6280198	29
5	6280302	30
6	6280399	31
7	6280494	32
8	6280589	33
9	6280689	34
10	6280788	35
11	6280888	36
12	6280990	37
13	6281090	38
14	6281186	39
15	6281279	40
16	6281370	41
17	6281455	42
18	6281538	43
19	6281619	44
20	6281701	45
21	9065958	46
22		47
23		48
24		49
25		50

Book Mark:

See also

1291

Swan Jackson

Co A, 7 U.S. Col'd Inf.

Private Private

CARD NUMBERS.

1	6279897	26
2	6279998	27
3	6280099	28
4	6280198	29
5	6280302	30
6	6280399	31
7	6280494	32
8	6280589	33
9	6280689	34
10	6280788	35
11	6280888	36
12	6280990	37
13	6281090	38
14	6281186	39
15	6281279	40
16	6281370	41
17	6281455	42
18	6281538	43
19	6281619	44
20	6281701	45
21	9065958	46
22		47
23		48
24		49
25		50

Book Mark:

See also

MAR 14 1957

S. 704.225 P.O. WITH

1863 499

S | 7 | U.S.C.T.

Jackson Swan

, Co. *A*, 7 Reg't U.S. Col'd Inf.

Appears on
Company Descriptive Book

of the organization named above.

DESCRIPTION.

Age *24* years; height *5* feet *6 3/4* inches.

Complexion *Blk.*

Eyes *Blk.*; hair *Curly*

Where born *Baltimore.*

Occupation *Farmer.*

ENLISTMENT.

When *Sept. 23d.*, 186*3*.

Where *Baltimore.*

By whom *Col. Winney*; term *3* y'rs.

Remarks: *Mustered Sept. 26, 1863.*

J. G. Smith

S | 7 | U.S.C.T.

Jackson Swan
Pvt., Co. *A*, 7 Reg't U. S. Colored Inf.

Age *27* years.

Appears on

Company Muster-in Roll

of the organization named above. Roll dated
Baltimore Md. Sept 26, 1863.

Muster-in to date *Sept. 26, 1863.*

Joined for duty and enrolled:

When *Sept. 23*, 1863.*

Where *Queen Ann Co. Md.**

Period *3* years.*

Remarks:
.....
.....
.....
.....
.....

*Muster-in roll shows enrollment of all men of this company as of same date. See enrollment on subsequent card or cards.

Book mark :

Daggett

S 1

7

U.S.C.T.

Jackson Swan

Pvt., Co. A, 7 Reg't U. S. Col'd Infantry.

Appears on

Company Muster Roll

for from Sept. 26 to Oct. 31, 1863.

Joined for duty and enrolled:

When Sept. 23, 1863.*

Where Queen Ann Co. Md.*

Period 3 years.*

Present or absent Absent

Stoppage, \$ 100 for

Due Gov't \$ 100 for

Remarks: Detached on recruiting service in St Mary's Co. Md.

* See enrollment on card from muster-in roll.

Book mark:

Daggett

(358c)

Copyist.

S | 7 | U.S.C.T.

Jackson Swan
Pvt., Co. A, 7 Reg't U. S. Col'd Infantry.

Appears on

Company Muster Roll
for Nov. & Dec., 1863.

Joined for duty and enrolled:

When Sept. 23, 1863.*

Where Queen Ann Co. Md. *

Period 1 1/2 years.*

Present or absent Present

Stoppage, \$ 100 for

Due Gov't \$ 100 for

Remarks: Enlistment premium
of \$2.00 due.

* See enrollment on card from muster-in roll.

Book mark:

(358c) Daggett Copyist.

S | 7 | U.S.C.T.

Jackson Swan
Pvt., Co. A, 7 Reg't U. S. Col'd Infantry.

Appears on

Company Muster Roll

for Jan. & Feb., 1864.

Joined for duty and enrolled:

When Sept. 23, 1863.*

Where Queen Ann Co., Md.*

Period 3 years.*

Present or absent Present.

Stoppage, \$ 100 for

Due Gov't \$ 100 for

Remarks: Enlistment premium
due.

* See enrollment on card from muster-in roll.

Book mark:

Dargrett

5 | 7 | U.S.C.T.

Jackson Swan
Pvt., Co. A, 7 Reg't U. S. Col'd Infantry.

Appears on

Company Muster Roll
for *Mar. & Apr.*, 1864.

Joined for duty and enrolled:

When *Sept. 23*, 1863.*

Where *Queen Ann Co. Md.**

Period *3* years.*

Present or absent *Present.*

Stoppage, \$ *100* for

Due Gov't \$ *100* for

Remarks:

* ~~45~~ See enrollment on card from muster-in roll.

Book mark: -----

Gaggett
(358c) Copyist.

S | 7 | U.S.C.T.

Jackson Swan

Priv., Co. A, 7 Reg't U. S. Col'd Infantry.

Appears on

Company Muster Roll

for May & June, 1864.

Joined for duty and enrolled:

When Sept. 23, 1863.*

Where Queen Ann Leo. Ind. *

Period 3 years.*

Present or absent Present.

Stoppage, \$ 100 for

Due Gov't \$ 100 for

Remarks:

[Empty lines for remarks]

* See enrollment on card from muster-in roll.

Book mark:

Gaggett

8 | 7 | U.S.C.T.

Jackson Swan
Prvt., Co. A, 7 Reg't U. S. Col'd Infantry.

Appears on

Company Muster Roll

for *July + Aug.*, 1864.

Joined for duty and enrolled:

When *Sept. 23*, 1863.*

Where *Baltimore Co. Md.* *

Period *3* years.*

Present or absent *Present.*

Stoppage, \$ *100* for

Due Gov't \$ *100* for

Remarks:

* ~~43~~ See enrollment on card from muster-in roll.

Book mark: _____

Daggett
(358c) Copyist.

S | 7 | U.S.C.T.

Jackson Swan
Pvt., Co. A, 7 Reg't U. S. Col'd Infantry.

Appears on

Company Muster Roll
for Sept. & Oct., 1864.

Joined for duty and enrolled:

When Sept. 23, 1863.*

Where Baltimore*

Period _____ years.*

Present or absent Present.

Stoppage, \$ 100 for _____

Due Gov't \$ 100 for _____

Remarks: Stop for one set of metallic
scales, Corp'l's

* See enrollment on card from muster-in roll.

Book mark: _____

(858c)

Leonard
Copyist.

5 | 7 | U.S.C.T.

Jackson Swan
Pvt., Co. A, 7 Reg't U. S. Col'd Infantry.

Appears on

Company Muster Roll

for Nov. & Dec., 1864.

Joined for duty and enrolled:

When Sept. 23, 1863.*

Where Baltimore*

Period 3 years.*

Present or absent Present.

Stoppage, \$ 100 for

Due Gov't \$ 100 for

Remarks: Stop for one set of me-
tallic scales.

* See enrollment on card from muster-in roll.

Book mark:

Conard
Copyist.

517 U.S.C.T.

Jackson Swan
Pvt., Co. A, 7 Reg't U. S. Col'd Infantry.

Appears on

Company Muster Roll

for Jan & Feb., 1865.

Joined for duty and enrolled:

When Sept 23, 1863.*

Where Baltimore, Md.*

Period 3 years.*

Present or absent Present.

Stoppage, \$ 100 for

Due Gov't \$ 100 for

Remarks:

* See enrollment on card from muster-in roll.

Book mark:

(358c)

Leonard
Copyist.

S 7 U.S.C.T.

Jackson Swan

Pvt., Co. A, 7 Reg't U. S. Col'd Infantry.

Appears on

Company Muster Roll

for Mch. & Apr., 1865.

Joined for duty and enrolled:

When Sept. 23, 1863.*

Where Baltimore *

Period 3 years.*

Present or absent Absent

Stoppage, \$ 100 for

Due Gov't \$ 100 for

Remarks: Sick in Hospital since April 1/65.

* See enrollment on card from muster-in roll.

Book mark:

(358c)

Conard Copyist.

MAR 14 1863

S | 7 | U.S.C.T.

Jackson Swan

Plt., Co. A, 7 Reg't U. S. Col'd Infantry.

Appears on

Company Muster Roll

for May & June, 1865.

Joined for duty and enrolled:

When Sept. 23, 1863.*

Where Baltimore*

Period 3 years.*

Present or absent Present.

Stoppage, \$ 100 for

Due Gov't \$ 100 for

Remarks:

* See enrollment on card from muster-in roll.

Book mark:

(858c)

Leonard Copyist.

S 1 7 U.S.C.T.

Jackson Swan

Priv., Co. A, 7 Reg't U. S. Col'd Infantry.

Appears on

Company Muster Roll

for July & Aug, 1865.

Joined for duty and enrolled:

When Sept. 23, 1863.*

Where Baltimore*

Period years.*

Present or absent Present.

Stoppage, \$ 100 for

Due Gov't \$ 67/100 for G & S. E.

Remarks:

* See enrollment on card from muster-in roll.

Book mark:

(358c) Leonard Copyist.

517 U.S.C.T.

Jackson Swan
Pvt., Co. A, 7 Reg't U. S. Col'd Infantry.

Appears on

Company Muster Roll

for Sept. & Oct., 1865.

Joined for duty and enrolled:

When Sept. 23, 1863.*

Where Baltimore.*

Period 3 years.*

Present or absent Present

Stoppage, \$ 100 for

Due Gov't \$ 69/100 for B. & S. S.

Remarks:

* See enrollment on card from muster-in roll.

Book mark:

Conard

Copyist.

(358c)

S 1 7 U.S.C.T.

Jackson Swan
Pi, Co. A, 7 Reg't U. S. Col'd Infantry.

Appears on

Company Muster Roll
for Nov. & Dec., 1865.

Joined for duty and enrolled:

When Sep 23, 1863.*

Where Baltimore Co. Md.*

Period 3 years.*

Present or absent Present

Stoppage, \$ 100 for

Due Gov't \$ 134 100 for Capt Union Equipage

Remarks:

* See enrollment on card from muster-in roll.

Book mark:

(358c)

Mowry, J. Copyist.

7

U.S.C.T.

Jackson Swan
Co. A, 7 Reg't U. S. Col'd Infantry.

Appears on

Company Muster Roll

for *Jan & Feb*, 1866.

Joined for duty and enrolled:

When *Sep 23*, 1863.*

Where *Baltimore Co. Md.**

Period *3* years.*

Present or absent *Present*

Stoppage, \$ *100* for

Due Gov't \$ *100* for

Remarks:

* See enrollment on card from muster-in roll.

Book mark: _____

(858c)

Swan
Copy

1863 425

S | **7** | **U.S.C.T.**

Jackson Swan
Co. A, 7 Reg't U. S. Col'd Infantry.

Appears on

Company Muster Roll

for *Nov 5 - Dec 1866*, 1866.

Joined for duty and enrolled:

When *Sep 23*, 1863.*

Where *Baltimore Co. Md.**

Period *3* years.*

Present or absent *Present*

Stoppage, \$ *100* for

Due Gov't \$ *100* for

Remarks:

* See enrollment on card from muster-in roll.

Book mark: -----

(358c)

Henry J. Copyist.

S | 7 | U.S.C.T.

Jackson from
Pi., Co. A, 7 Reg't U. S. Col'd Infantry.

Appears on

Company Muster Roll

for May & June, 1866.

Joined for duty and enrolled:

When Sep 23, 1863.*

Where Balt. Co. Md.*

Period 3 years.*

Present or absent Present

Stoppage, \$ 100 for

Due Gov't \$ 100 for

Remarks:

* See enrollment on card from muster-in roll.

Book mark:

Thomas J. Copyist.

7

U.S.C.T.

J
Jackson Swan
Pri, Co. A, 7 Reg't U. S. Col'd Infantry.

Appears on

Company Muster Roll

for *July & Aug*, 186*6*.

Joined for duty and enrolled.

When *Sep 23*, 186*5*.*

Where *Balto. Co. Md* *

Period *3* years.*

Present or absent *Present*

Stoppage, \$ *100* for

Due Gov't \$ *100* for

Remarks:

* ~~40~~ See enrollment on card from muster-in roll.

Book mark:

(358c)

Mowry J.
Copyist.

S 1 7 U.S.C.T.

Jackson Swan
Pr, Co. A, 7 Reg't U. S. Col'd Infantry.

Appears on Co. Muster-out Roll, dated
Mananala, Tex, Oct 13, 1866 .

Muster-out to date Oct. 13, 1866 .

Last paid to June 30, 1866 .

Clothing account:

Last settled....., 186 ; drawn since \$ 100

Due soldier \$ 21 ⁵⁵/₁₀₀; due U. S. \$ 100

Am't for cloth'g in kind or money adv'd \$ 100

Due U. S. for arms, equipments, &c., \$ 6 ⁰⁰/₁₀₀

Bounty paid \$ none ⁰⁰/₁₀₀; due \$ 100 ⁰⁰/₁₀₀

Remarks: Joined Orig. Organ
Retains 1 Springfield rifled
Musket & set of accoutrements
per G.O. of War Dept May
30/65.

Book mark: V 152 P 34 73

Mowry, J.
Copyist.

Swann, Jackson

P. A., Co.

7

Reg't U. S. C. Inf.

Enclosures.

Bed Cards	Descriptive Lists
Burial Records	Final Statements
Certs. of Dis. for Discharge	Furloughs
C. M. Charges	Med. Des. Lists
Med. Certificates	Orders

Other papers relating to—

Admission to Hosp'l	Furlough
Casualty Sheet (Officer's)	Med. Examination
Confinement	Misc. Information
Contracts	Pay or Clothing
Death or Effects	Personal Reports
Desertions	Rank
Discharge from Hosp'l	Transfer to Hosp'l
Discharge from Service	Transfer to V. R. C.
Duty	Transportation
	<i>Slave claim /</i>

MICROFILM PUBLICATION M 1849

COMPILED MILITARY SERVICE RECORDS
OF VOLUNTEER UNION SOLDIERS WHO SERVED WITH
THE UNITED STATES COLORED TROOPS (USCT)
7TH REGIMENT OF INFANTRY

PERSONAL PAPERS' TARGET SHEET

PLEASE NOTE THE CHECKED INFORMATION ABOUT THE PERSONAL PAPERS IN
THIS FILE:

- NO PERSONAL PAPERS WERE FOUND IN THIS FILE WHEN THE
RECORDS WERE ARRANGED FOR MICROFILMING.

- 3 PERSONAL PAPER(S) FOUND IN THIS FILE WHEN THE RECORDS
WERE ARRANGED FOR MICROFILMING.

E. No. 16. L. Cl

Street air P.O.
No. 431

APPLICATION OF

Ann Emory

OF

Baltimore County

For Compensation for Service of Slave,

Jackson Swann

Enlisted in Seventh Regiment

U. S. Colored Troops, Co. A.

Received, Feb 26th 1864.

COMPENSATION ~~AWARDED~~ Refused

Aug 1st 1865.

Rejected for reasons ~~stated~~ stated
on claim No 430.

Thos. Simmons
Presid. Bd. Claims

Filed by

John S. Munday

Sept. 1. 1865 August 7. 1865.

NARA 1492

EVIDENCE OF TITLE.

I. Ann Emory, of Baltimore
County, Md., do solemnly swear that Jackman Swann
who has been enlisted in the Seventh Regiment, U. S. Colored Troops;
Co. A; is my slave for life; (~~his term~~ of service expiring on
the _____ day of _____ 186 _____;) and that
I became possessed of him by the Will of Elyah Bosley, ind? in the month
of _____, eighteen hundred and _____. And I
do further swear that I have not purchased said slave from any person or persons disloyal
to the Government of the United States, with the object of obtaining compensation for
the same; and furthermore, that I have no agency for obtaining compensation for any per-
son or persons but such as, to my knowledge, are loyal citizens of the United States.

Ann Emory
February 11th 1864.

John S. Curtis

STATE OF MARYLAND.

Baltimore County, to wit:

On this Eleventh day of February in the year 1864,

before me, the subscriber, a Justice of the Peace of the State and County aforesaid, personally appeared

Ann Emory, and took, signed, and acknowledged the oaths preceding; and further made oath, in due form of law, that all the statements made in this application are, to the best of her knowledge and belief, strictly true.

Also personally appeared before me James G. Stansbury and Thomas H. Stansbury, loyal citizens of the United States, residents of Baltimore County, well acquainted with the said Ann Emory, and in no manner interested in the prosecution of this claim, and made oath, in due form of law, that the said Ann Emory is the owner of the slave Jackson Swann, as a fact of public notoriety; that they believe all the statements herein made by her, in reference thereto, are correct, and that she is unquestionably loyal to the Government of the United States. Witness their signatures:

James G. Stansbury and Thomas H. Stansbury, loyal citizens of the United States, residents of Baltimore County, well acquainted with the said Ann Emory, and in no manner interested in the prosecution of this claim, and made oath, in due form of law, that the said Ann Emory is the owner of the slave Jackson Swann, as a fact of public notoriety; that they believe all the statements herein made by her, in reference thereto, are correct, and that she is unquestionably loyal to the Government of the United States. Witness their signatures:

James G. Stansbury and Thomas H. Stansbury, loyal citizens of the United States, residents of Baltimore County, well acquainted with the said Ann Emory, and in no manner interested in the prosecution of this claim, and made oath, in due form of law, that the said Ann Emory is the owner of the slave Jackson Swann, as a fact of public notoriety; that they believe all the statements herein made by her, in reference thereto, are correct, and that she is unquestionably loyal to the Government of the United States. Witness their signatures:

James G. Stansbury and Thomas H. Stansbury, loyal citizens of the United States, residents of Baltimore County, well acquainted with the said Ann Emory, and in no manner interested in the prosecution of this claim, and made oath, in due form of law, that the said Ann Emory is the owner of the slave Jackson Swann, as a fact of public notoriety; that they believe all the statements herein made by her, in reference thereto, are correct, and that she is unquestionably loyal to the Government of the United States. Witness their signatures:

James G. Stansbury and Thomas H. Stansbury, loyal citizens of the United States, residents of Baltimore County, well acquainted with the said Ann Emory, and in no manner interested in the prosecution of this claim, and made oath, in due form of law, that the said Ann Emory is the owner of the slave Jackson Swann, as a fact of public notoriety; that they believe all the statements herein made by her, in reference thereto, are correct, and that she is unquestionably loyal to the Government of the United States. Witness their signatures:

W. Sean Stout

John S. Cooter

James G. Stansbury
Thomas H. Stansbury

Justice of the Peace.

MDR 1434

STATE OF MARYLAND,

Baltimore County, to wit:

I, *John H. Longnecker*, Clerk of the Circuit Court for
Baltimore County, do hereby certify that *John S. Curtis Esq*

before whom the foregoing affidavits were made, was, at the time of signing the same, a
Justice of the Peace for the County and State aforesaid, duly commissioned and sworn;
and that his signature thereto is genuine, and that full-faith and credit should be given to
his official acts.

Witness my hand and the seal of said Court, this *twenty seventh* day of
February, A. D. 1864.

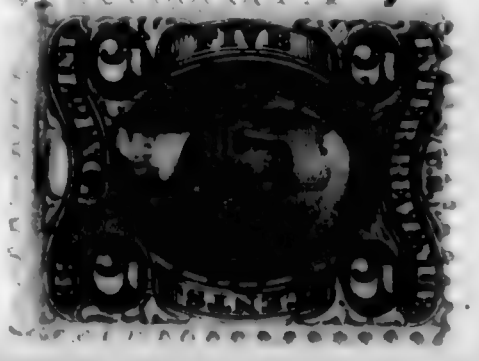

John H. Longnecker CLERK.

2131

A.

No. 431

CLAIMANT'S CERTIFICATE.

I, Ann Emory a loyal citizen, and a resident
of Baltimore, County of the State of
Maryland, hereby claim compensation, under the provisions of
General Orders, No. 329, 1863, for my slave Jackson Sudan
enlisted October 1863, at Baltimore
by Gen^e William Borney in the seventh
Regiment U. S. Colored Troops, Co. A; certificate of which enlistment, and a
descriptive list, as required, accompany this application.

In proof of my loyalty to the Constitution and Government of the United States, I
present the accompanying oath, which I have taken, signed, and acknowledged, to be filed
with this application, in accordance with requirement of said General Orders.

Ann Emory

February 21st 1864

John S Curles

B.

OATH OF ALLEGIANCE.

I, Ann Emory, do solemnly swear that I have never joined, or been concerned in, any insurrection or rebellion; that I have never borne arms against the United States; that I have never given any aid, countenance, counsel, or encouragement to any person or persons engaged, or whom I had reason to believe were about to engage, in insurrection, rebellion, or armed hostility against the United States; that I have neither sought, nor accepted, nor attempted to exercise the functions of any office, civil or military, nor to perform any service whatever, under any authority or pretended authority in hostility to the United States; that I have not yielded a voluntary support to any insurrection, rebellion, or pretended government, authority, power, or constitution within the United States hostile thereto. And I do further swear that, to the best of my knowledge and ability, I have supported and defended, and will continue to support and defend, the United States against all enemies, foreign and domestic; and that I have supported, defended, and obeyed, and will continue to support, defend, and obey, the Constitution and laws of the United States; that I will bear true faith and allegiance to the same; and that I take this oath freely, without any mental reservation or purpose of evasion: So help me God.

Ann Emory

Sworn to and subscribed before me, at Glenn Manor }

this 11th day of February 1864.

John S. Curtis

5-cts
Stamp
10 years

C.

I present herewith evidence of my title to the slave _____
 _____ enlisted as aforesaid, and in consideration of the sum of
 _____ by me received, I hereby covenant and
 agree with the United States, that I, my heirs, executors, or assigns, shall never hereafter make
 or enforce any claim to the labor or services of said slave; and pledge myself to execute
 a valid Deed of Manumission and Release of all my claims to service forever of said
 _____ to be filed with the Board of Claims
 now in session at _____

John Emory

5th _____, 186 .
John Emory
per Seal

50 ct Stamp -

E.

MS.
Stamp
57 cts

DEED OF MANUMISSION AND RELEASE OF SERVICE.

Whereas my slave Jackson Brown has enlisted in the service of the United States: now, in consideration thereof, I, Ann Emory, of Baltimore county, State of Maryland, do hereby, in consideration of said enlistment, manumit, set free, and release the above-named Jackson Brown from all service due me; his freedom to commence from the fifth of October 1863, the date of his enlistment as aforesaid in the 7th Regiment of Colored Troops, in the service of the United States.

Witness my hand and seal, this Twenty third day of May, 1864

Ann Emory



Witness:

Alley M. Morrison
John L. Howard
Henry W. Morrison

Baltimore County,

State of Maryland May, 1864.

MS.
Stamp
5 cts

Before me appeared this day Ann Emory and acknowledged the above Deed of Manumission and Release of Service to be his free act and deed.

Henry W. Morrison
cl k

Recorded on the 24th day of May 1864 and Examined
 Per John H. Longnecker, Clk.

State of Maryland, Baltimore County, to wit:
 I here by certify, that the within is a
 true copy of the Original now of Record in the Office
 of the Clerk of the Circuit Court for Baltimore County,
 In Testimony whereof, I here to set my
 hand and ~~and~~ affix the seal of the
 Circuit Court for Baltimore County this
 24th day of May A. D. 1864.
 John H. Longnecker
 Clerk of the Circuit Court for Baltimore County.



1292

Swan Nicholas

Co — , 7 U.S. Col'd Inf.

CARD NUMBERS.

1	6279110	26
2		27
3		28
4		29
5		30
6		31
7		32
8		33
9		34
10		35
11		36
12		37
13		38
14		39
15		40
16		41
17		42
18		43
19		44
20		45
21		46
22		47
23		48
24		49
25		50

Book Mark:

See also

S. | 7 | U.S.C.T.

Nicholas Swan

Appears with rank of _____ on
Muster and Descriptive Roll of a Detach-
ment of Drafted Men and Substitutes
forwarded

for the 7 Reg't U. S. Col'd Inf. Roll dated
Baltimore Md, Apr, 1865

Where born Cambridge Md

Age 21 years; occupation Laborer

~~Enlisted~~

Drafted and mustered in:

When March 24, 1865

Where E. Mills, Md

Period 1 years.

Eyes Blk; hair Blk

Complexion Blk; height 5 ft. 6 in.

Paid bounty and advance pay, \$ 100

Bounty due \$ 100

Where credited _____

Company to which assigned _____

Remarks Sub for Charles Foster
Sub Dist. of Cong. D. Md
Not taken up on muster Roll of
Book mark: Right

J. M. Fauley Copyist

1293

Eye Thomas
Co *L*, 7 U.S. Col'd Inf.

Private | *Corporal*

CARD NUMBERS.

1	6289209	26
2	6289307	27
3	6289404	28
4	6289504	29
5	6289606	30
6	6289701	31
7	6279292	32
8	6289797	33
9	6289890	34
10	6289990	35
11	6290081	36
12	6290178	37
13	6290277	38
14	6290362	39
15	6290451	40
16	6290489	41
17	6290569	42
18	6290648	43
19	6290721	44
20	6290795	45
21	9066602	46
22		47
23		48
24		49
25		50

Book Mark *L72-V10.C.7.73*

See also

P.O. Mil. 64/125353, 4/4/19 W.B.

S | **7** | **U.S.C.T.**

Thomas Sizer
....., Co. *G*, 7 Reg't U.S. Col'd Inf.

Appears on
Company Descriptive Book
of the organization named above.

DESCRIPTION.

Age *24* years; height *5* feet *9* inches.

Complexion *Rex*

Eyes *Blue*; hair *Curly*

Where born *Worcester, Ms.*

Occupation *Farmer*

ENLISTMENT.

When *Sept 24*, 186*3*.

Where *Baltimore, Md.*

By whom *Ed W. Pinney*; term *3* y'rs.

Remarks: *Mustered Sept 30 1863*
by Col Wm Pinney. Promoted
Corpl Dec 11 1865.

J. Brown Copyist.

S | 7 | U.S.C.T.

Thomas Hope
Pvt., Co *F*, 7 Reg't U. S. Colored Inf.

Age *24* years.

Appears on

Company Muster-in Roll

of the organization named above. Roll dated

Baltimore Md Sept. 30, 1863.

Muster-in to date *Sept. 30, 1863.*

Joined for duty and enrolled:

When *Sept. 27*, 186*3*.*

Where *Dorchester Co. Md.* *

Period *3* years.*

Remarks:
.....
.....
.....
.....
.....

*Muster-in roll shows enrollment of all men of this company as of same date. See enrollment on subsequent card or cards.

Book mark :

.....
.....
John H. ...
.....

WAR 1447

S 7 U.S.C.T.

Thomas Sipe
Pvt., Co. F, 7 Reg't U. S. Col'd Infantry.

Appears on
Company Muster Roll
for *Sept 30 to Octo 31*, 186*3*.

Joined for duty and enrolled:
When *Sept 27*, 186*3*. *
Where *Dorchester Co. Md* *
Period *3* years. *

Present or absent *Present*

Stoppage, \$ *100* for

Due Gov't \$ *100* for

Remarks:

* ~~42~~ See enrollment on card from muster-in roll.

Book mark: -----

(858c) *J. A. Miller*
Copyist.

S. | **7** | **U.S.C.T.**

Thomas Sipe

Priv. Co. F, 7 Reg't U. S. Col'd Infantry.

Appears on

Company Muster Roll

for *Nov. & Dec.*, 186 *3*.

Joined for duty and enrolled:

When *Sept. 27.*, 186 *3*.*

Where *Doniphan Co. Mo.* *

Period *3* years.*

Present or absent *Present*

Stoppage, \$ *100* for

Due Gov't \$ *100* for

Remarks: *Stopped for one for scales*

* See enrollment on card from muster-in roll.

Book mark:

(858c)

C. H. Hill
Copyist.

S 1 7 U.S.C.T.

Thomas Sipe

Plt., Co. F, 7 Reg't U. S. Col'd Infantry.

Appears on

Company Muster Roll

for *Jan & Feb*, 1864.

Joined for duty and enrolled:

When *Sept 27*, 1863.*

Where *Dorchester Co. Md.* *

Period _____ years.*

Present or absent *Present*

Stoppage, \$ 100 for _____

Due Gov't \$ 100 for _____

Remarks: _____

* See enrollment on card from muster-in roll.

Book mark: _____

C. S. Sipe
Copyist.

S | 7 | U.S.C.T.

Thomas Sipe

Pat, Co. F, 7 Reg't U. S. Col'd Infantry.

Appears on

Company Muster Roll

for *March & April*, 1864.

Joined for duty and enrolled:

When *Sept 27*, 1863.*

Where *Lancaster Co. Md* *

Period *3* years.*

Present or absent *Present*

Stoppage, \$ *100* for

Due Gov't \$ *100* for

Remarks:

* See enrollment on card from muster-in roll.

Book mark: _____

John Miller
Copyist.

S | **7** | **U.S.C.T.**

Thomas Sipe

Sgt., Co. F, 7 Reg't U. S. Col'd Infantry.

Appears on

Company Muster Roll

for *May & June*, 186*4*.

Joined for duty and enrolled:

When *Sept 27*, 186*3*.*

Where *Dorchester Co. Md.* *

Period *3* years.*

Present or absent *Absent*

Stoppage, \$ *100* for

Due Gov't \$ *100* for

Remarks: *Detained as Pioneer
June 10th*

* ~~See~~ See enrollment on card from muster-in roll.

Book mark: _____

[Signature]
Copyist.

S 7 | U.S.C.T.

Thomas Syle
Port, Co., 7 Reg't U. S. Col'd Infantry.

Appears on a

Detachment Muster Roll

of the organization named above

for May & June, 1864.

Station Jacksonville, Fla.

Present or absent Present

Stoppage, \$ 100 for

Due Gov't, \$ 100 for

Remarks: "F" 7 U.S.C.T. J.

Book mark :

L. Y. Sparr

S 1. 7 U.S.C.T.

Thomas Lye
Pvt, Co. F, 7 Reg't U. S. Col'd Infantry.

Appears on

Company Muster Roll
for July, Aug, 1864.

Joined for duty and enrolled:

When Sept 27, 1863.*

Where Dorchester Co. Md.*

Period 3 years.*

Present or absent Present

Stoppage, \$ 100 for

Due Gov't \$ 100 for

Remarks: Stop for 1
canteen

* See enrollment on card from muster-in roll.

Book mark:

W. H. B. C. Copyist.

1864
S | 7 | U.S.C.T.

Thomas Sage

Private, Co. F, 7 Reg't U. S. Col'd Infantry.

Appears on

Company Muster Roll

for *Sept and Oct*, 1864.

Joined for duty and enrolled:

When *Sept 27*, 1863.*

Where *Dorchester Co., Md.**

Period *3* years.*

Present or absent *Absent.*

Stoppage, \$ *100* for

Due Gov't \$ *100* for

Remarks *In Hosp. wounded since Oct. 28 '64.*

* See enrollment on card from muster-in roll.

Book mark:

(858c)

Keefer.

Copyist.

S 1

7

U.S.C.T.

Thomas Lipe

Private, Co. F, 7 Reg't U. S. Col'd Infantry.

Appears on

Company Muster Roll

for *Nov. and Dec.*, 1864.

Joined for duty and enrolled:

When *Sept. 27*, 1863.*

Where *Dorchester Co., Md.* *

Period *3* years.*

Present or absent *Absent*

Stoppage, \$ *100* for

Due Gov't \$ *100* for

Remarks: *Absent wounded since Oct. 28, 64.*

* ~~45~~ See enrollment on card from muster-in roll.

Book mark:

Keefe

(358c)

Copyist.

S 1 | **7** | **U.S.C.T.**

Thomas Lye

Private Co. F, 7 Reg't U. S. Col'd Infantry.

Appears on

Company Muster Roll

for *Jan. 1 Feb.*, 1865.

Joined for duty and enrolled:

When *Sep 27*, 1863.*

Where *Dorchester Co., Md.* *

Period *3* years.*

Present or absent *Present*

Stoppage, \$ *100* for

Due Gov't \$ *100* for

Remarks:

* See enrollment on card from muster-in roll.

Book mark: _____

Keefe

(858c) Copyist.

S | **7** | **U.S.C.T.**

Thomas Sze

Private, Co. F, 7 Reg't U. S. Col'd Infantry.

Appears on

Company Muster Roll

for *Mar. & Apr.*, 1865.

Joined for duty and enrolled:

When *Sep 27*, 1863.*

Where *Dorchester Co., Md.**

Period *2* years.*

Present or absent *Present*

Stoppage, \$ *100* for

Due Gov't \$ *100* for

Remarks:

* See enrollment on card from muster-in roll.

Book mark: _____

(858c) *Kaefer* Copyist.

I

7

U.S.C.T.

Thomas Sizer

Private, Co. F, 7 Reg't U. S. Col'd Infantry.

Appears on

Company Muster Roll

for *May and June*, 1865.

Joined for duty and enrolled:

When *Sep. 27*, 1865.*

Where *Dorchester* *

Period *3* years.*

Present or absent *Present*.

Stoppage, \$ *100* for

Due Gov't \$ *100* for

Remarks: *To be stopped for 1
Wrench and 1 Paper.*

* See enrollment on card from muster-in roll.

Book mark:

(358c)

Keefe

Copyist.

S | **7** | **U.S.C.T.**

Thomas Sze

Private, Co. F, 7 Reg't U. S. Col'd Infantry.

Appears on

Company Muster Roll

for *July and Aug*, 1863.

Joined for duty and enrolled:

When *Sep. 27*, 1863.*

Where *Dorchester Co., Md.**

Period *3* years.*

Present or absent *Present*

Stoppage, \$ *100* for

Due Gov't \$ *100* for

Remarks:

* ~~See~~ See enrollment on card from muster-in roll.

Book mark: _____

(858c)

Keefe

Copyist.

S 7 | U.S.C.T.

Thomas Lye
Priv., Co. *F*, *7* Reg't U. S. Col'd *Infy*

Appears on

Company Muster Roll

for *Sept. & Oct.* 186*3*.

Joined for duty and enrolled:

When *Sept. 27*, 186*3*.*

Where *Dorchester Co., Md.**

Period *3* years.*

Present or absent *Present*

Stoppage, \$ *100* for

Due Gov't, \$ *100* for

Valuation of horse, \$ *100*

Valuation of horse equipments, \$ *100*

Remarks:

*~~See~~ See enrollment on card from muster-in roll.

Book-mark:

Keefe
Copyist.

S | 7 | U.S.C.T.

Thomas Surr

Cpl., Co. F, 7 Reg't U. S. Col'd Infantry.

Appears on

Company Muster Roll

for Nov. & Dec., 1865.

Joined for duty and enrolled:

When Sept. 27, 1863.*

Where Kent County, Md. *

Period 3 years.*

Present or absent Present.

Stoppage, \$ 100 for

Due Gov't \$ 100 for

Remarks: Promoted Corporal Dec. 11, 65.

* See enrollment on card from muster-in roll.

Book mark:

Brooke

S. 1 7 U.S.C.T.

Thomas Sye
Cpl., Co. F, 7 Reg't U. S. Col'd Infantry.

Appears on

Company Muster Roll

for Jan. + Feb., 1866.

Joined for duty and enrolled:

When Sept. 27, 1863.*

Where Worcester Co., Md. *

Period 3 years.*

Present or absent Present

Stoppage, \$ 100 for

Due Gov't \$ 100 for

Remarks:

* See enrollment on card from muster-in roll.

Book mark:

(358c)

Brooke
Copyist.

S 1 7 | **U.S.C.T.**

Thomas Dye

File, Co. F, 7 Reg't U. S. Col'd Infantry.

Appears on

Company Muster Roll

for *March + April*, 1866.

Joined for duty and enrolled:

When *Sept. 27*, 1863.*

Where *Worcester, Md.**

Period *3* years.*

Present or absent *Present*

Stoppage, \$ *100* for

Due Gov't \$ *100* for

Remarks:

* See enrollment on card from muster-in roll.

Book mark: _____

Brooks

(858c)

Copyist.

S. | 7 | U.S.C.T.

Thomas Dye
Cpl., Co. F, 7 Reg't U. S. Col'd Infantry.

Appears on

Company Muster Roll

for May + June, 1866.

Joined for duty and enrolled:

When Sept. 27, 1863.*

Where Rochester, Md. *

Period 3 years.*

Present or absent Present.

Stoppage, \$ 100 for

Due Gov't \$ 100 for

Remarks:

NEXT ROLL ON FILE MUSTER OUT.

* See enrollment on card from muster-in roll.

Book mark:

Perover

D | **7** | **U.S.C.T.**

Thomas Sye
Cpl., Co. *F*, 7 Reg't U. S. Col'd Infantry.

Appears on **Co. Muster-out Roll**, dated
Indianola Texas, Oct. 13, 1866.

Muster-out to date *Oct. 13, 1866*.

Last paid to *June 30, 1866*.

Clothing account:

Last settled....., 186 ; drawn since \$..... 100

Due soldier \$ *25³³* 100; due U. S. \$..... 100

Am't for cloth'g in kind or money adv'd \$..... 100

Due U. S. for arms, equipments, &c., \$..... 100

Bounty paid \$..... 100; due \$ *100* 100

Remarks: *Joined Co. at original organization promoted Dec. 11. 65. Wounded at Harbystown Road Va. Oct. 28. '64.*

Book mark: *V. 65 P. 103. 73.*
L72 V. 10. C. 73. P. 12 P. 92. 69.

Brooks

Sgt. Thomas

P. Co. 7.

Reg't *1st Inf*

Enclosures.

Bed Cards	Final Statements
Burial Records	Furloughs or L. of A.
Certs. of Dis. for Discharge	Med. Certificates
C. M. Charges	Med. Des. Lists
Descriptive Lists	Orders
Discharge Certificates	Pris. of War Record
Enlistment Papers	Resignations

Other papers relating to—

Admission to Hosp'l	Furlough or L. of A.
Casualty Sheet. /	Med. Examination
Confinement	Misc. Information
Contracts	Pay or Clothing
Death or Effects	Personal Reports
Desertion	Rank
Discharge from Hosp'l	Transfer to Hosp'l
Discharge from Service	Transfer to V. R. C.
Duty	Transportation

160

CASUALTY SHEET
OF WOUNDED.

Thomas Sye

Private Company F

7 Regiment of U.S.C.

Volunteers at the battle of _____

Oct 28 - 1864

CASUALTY SHEET.

Name, Thomas Dye
 Rank, Private, Company F, Regiment, 7th
 Arm, U.S.A., State, _____
 Place of casualty, _____

Nature of casualty, Wounded

Date of casualty, Oct 28th 1864

FROM WHAT SOURCE THIS INFORMATION WAS OBTAINED.

Report of Killed, Wounded, and Missing of the _____ Regiment,
 _____ Brigade, _____ Division, _____ Corps, dated _____
List of casualties in the 7th Regt U.S. Col. Troops in
the action of Oct 27th & 28th 1864.
 (Signed) Llewellyn F. Haskell
Lt Col Comd'g Regt

Ind 50 L no 59

W. F. Thompson

Clerk.

¹²⁹⁴
Tabor, Philip

Co *H*, 7 U.S. Col'd Inf.

Private | Private

CARD NUMBERS.

1	6 2 7 9 0 2 6	26
2	6 2 7 8 7 7 7	27
3	6 2 8 9 8 9 4	28
4	6 2 8 9 9 4 3	29
5	6 2 9 0 0 9 3	30
6	6 2 9 0 1 8 4	31
7	6 2 9 0 2 8 0	32
8	6 2 9 0 3 6 7	33
9	6 2 9 0 4 7 3	34
10	6 2 9 0 9 0 0	35
11	9 0 8 6 6 1 2	36
12	4 3 1 5 5 7 0 5	37
13		38
14		39
15		40
16		41
17		42
18		43
19		44
20		45
21		46
22		47
23		48
24		49
25		50

Book Mark:

See also:

Last child 2mg 12/15/95

J | **7** | **U.S.C.T.**

Phillip Talbot

, Co. *G*, 7 Reg't U. S. Col'd Inf.

Appears on
Company Descriptive Book
of the organization named above.

DESCRIPTION.

Age *20* years; height *5* feet *7* inches.

Complexion *Wk*

Eyes *Wk*; hair *Curly*

Where born *Balti, Md.*

Occupation *Farmer*

ENLISTMENT.

When *Sept 2^d*, 186*4*.

Where *Baltimore, Md.*

By whom *Capt Cathcart*, term *1* y'rs.

Remarks: *Drafted. Died*
in Hospital at Indian-
ola, Tex, Sept 2^d 65.
of Scorbatic.

F. B. Brown
Copist.

7 | 7 | U.S.C.T.

Philip Falbot

Appears with rank of _____ on
**Muster and Descriptive Roll of a Detach-
ment of Drafted Men and Substitutes
forwarded**

for the 7 Reg't U. S. Col'd Inf. Roll dated
Baltimore Md., Sept 27, 1864.

Where born Md.

Age 20 years; occupation Farmer.

Drafted and mustered in:

When Sept. 27, 1864.

Where Baltimore Md.

Period years.

Eyes Blk; hair Blk

Complexion Blk; height 5 ft. 9 in.

Paid bounty and advance pay, \$ 100

Bounty due \$ 100

Where credited _____

Company to which assigned _____

Remarks: Drafted 2nd Dist. Md.

Book mark: _____

J. M. Family Copyist

1473

9 | 7

U.S.C.T.

Philip Talbot

....., Co., 7 Reg't U. S. Col'd Infantry.

Age *20* years.

Appears on a

Detachment Muster-in Roll

of the organization named above. Roll dated

Baltimore, Md., Sept. 27, 1864.

Muster-in to date *Sept. 27, 1864.*

Joined for duty and enrolled:

When *Sept. 27*, 1864.

Where *Baltimore, Md.*

Period *1* years.

Remarks: *Drafted*

Book mark:

W Beck

Copyist.

(837)

J | 7 | uscb

Philip Talbot

Appears with rank of _____ on

Muster and Descriptive Roll

of Detachment of US Substitutes
& Drafted men forwarded to
Col. S. M. Bowman Roll dated
Camp Bradford, Oct 2, 1864.

Where born Maryland

Age 20 years; occupation Farmer

When enlisted Sept 27, 186 .

Where enlisted Balto. Md

For what period enlisted 1 years.

Eyes Blk ; hair Blk

Complexion Blk ; height 5 ft. 7 in.

When mustered in Sept. 27, 186 .

Where mustered in _____

Bounty paid \$ 100; due \$ 100

Clothing account:

Last settled _____, 186 ; drawn since \$ 3/15/100

Date of first muster _____, 186 .

Company to which assigned _____

Remarks: Drafted man 2nd.
Dist., Md -

Book mark : _____

J. W. Clew

7

7

U.S.C.T.

Philip Talbot

Private, Co. F, 7 Reg't U. S. Col'd Infantry.

Appears on

Company Muster Roll

for *Sept and Oct.*, 1864.

Joined for duty and enrolled:

When *Sept. 27*, 1864.*

Where *Baltimore, Md.* *

Period *1* years.*

Present or absent *Present*

Stoppage, \$ *100* for

Due Gov't \$ *100* for

Remarks: *Joined a Recruit
Oct. 21" 64.*

* See enrollment on card from muster-in roll.

Book mark:

Keefex

7

7

U.S.C.T.

Philip Talbot

Private, Co. F, 7 Reg't U. S. Col'd Infantry.

Appears on

Company Muster Roll

for Nov^{2nd} Dec., 1864.

Joined for duty and enrolled:

When Sep 27, 1864.*

Where Baltimore *

Period 3 years.*

Present or absent Present

Stoppage, \$ 100 for

Due Gov't \$ 100 for

Remarks: Joined a recruit
Oct. 21 '64.

* See enrollment on card from muster-in roll.

Book mark:

(358c)

Keefe

Copyist.

7

7

U.S.C.T.

Philip Falbot

Private Co. F, 7 Reg't U. S. Col'd Infantry.

Appears on

Company Muster Roll

for *Jan. 1 Feb.*, 1865.

Joined for duty and enrolled:

When *Sept 27*, 1864.*

Where *Baltimore*.*

Period *1* years.*

Present or absent *Present*.

Stoppage, \$ *100* for

Due Gov't \$ *100* for

Remarks:

* See enrollment on card from muster-in roll.

Book mark: _____

Keeper

(358c) Copyist.

J | 7 | U.S.C.T.

Philip Falbot

Private, Co. F, 7 Reg't U. S. Col'd Infantry.

Appears on

Company Muster Roll

for *Mar. & Apr.*, 1865.

Joined for duty and enrolled:

When *Sep. 27*, 1864.*

Where *Baltimore* *

Period *1* years.*

Present or absent *Present.*

Stoppage, \$ *100* for

Due Gov't \$ *100* for

Remarks:

* ~~See~~ See enrollment on card from muster-in roll.

Book mark: _____

(358c)

Keefe

Copyist.

7 | 7 | **U.S.C.T.**

Philip Falbot

Private, Co. F, 7 Reg't U. S. Col'd Infantry.

Appears on

Company Muster Roll

for *May and June*, 1865.

Joined for duty and enrolled:

When *Sep. 27*, 1864.*

Where *Baltimore* *

Period *1* years.*

Present or absent *Present*

Stoppage, \$ *100* for

Due Gov't \$ *100* for

Remarks: *To be stopped for
1 canteen, 1 Haversack,
1 Wiper and 1 Cart Box Plt.
Plate.*

* See enrollment on card from muster-in roll.

Book mark:

(858c)

Keefer

Copyist.

F | 7 | U.S.C.T.

Philip Falbot

Private Co. F, 7 Reg't U. S. Col'd Infantry.

Appears on

Company Muster Roll

for July and Aug., 1865.

Joined for duty and enrolled:

When Sept. 27, 1864.*

Where Baltimore Co., Md. *

Period 1 years.*

Present or absent Present

Stoppage, \$ 100 for

Due Gov't \$ 100 for

Remarks:

* See enrollment on card from muster-in roll.

Book mark: _____

(358c) Keeper Copyist.

7 | 7 | U.S.C.T.

Philip Talbot
Priv., Co. F, 7 Reg't U. S. Col'd Infy

Appears on

Company Muster Roll

for Sept. & Oct. 1865.

Joined for duty and enrolled:

When Sept. 27, 1864.*

Where Baltimore Co., Md. *

Period 1 years.*

Present or absent

Stoppage, \$ 100 for

Due Gov't, \$ 100 for

Valuation of horse, \$ 100

Valuation of horse equipments, \$ 100

Remarks: Died of Scorbutois at
Indianola, Tex. Sept. 2,
1865. Final statements for-
warded. Stop for over)

* See enrollment on card from muster-in roll.

Book-mark: 2d And. 5788, Nov. 26, 1867.

Keeper

(358c)

Copist.

JAN. 20

6290473

1891

*to and G. E. 770
Stop for Ordinance 120*

27 | 7 | U.S.C.T.

Phillip Cabot
Co. F, 7 Reg't U. S. Col'd Infantry.

Appears on Co. Muster-out Roll, dated
Indianola, Texas, Oct. 13, 1866.

Muster-out to date 186 .

Last paid to 186 .

Clothing account:

Last settled 186 ; drawn since \$ 100

Due soldier \$ 100 ; due U. S. \$ 100

Am't for cloth'g in kind or money adv'd \$ 100

Due U. S. for arms, equipments, &c., \$ 100

Bounty paid \$ 100 ; due \$ 100

Remarks: died of Scorbitis
at Indianola, Tx, Sep. 2,
66.

Book mark: 2^d ind. 575-8, 1st 26,
(over)

Brivko

JAN. 21

6290900

1.8910

1867. F.S.

Talbot, Phillip

P, Co. F, 7 Regt. U. S. C. Inf.

2 Enclosures.

Bed Cards	Descriptive Lists
Burial Records	Final Statements
Certs. of Dis. for Discharge	Furloughs
C. M. Charges	Med. Des. Lists
Med. Certificates	Orders

Other papers relating to—

Admission to Hosp'l	Furlough
Casualty Sheet (^{Priv.} Officer's)	Med. Examination
Confinement	Misc. Information
Contracts	Pay or Clothing
Death or Effects	Personal Reports
Desertions	Rank
Discharge from Hosp'l	Transfer to Hosp'l
Discharge from Service	Transfer to V. R. C.
Duty	Transportation

Extract from Act of Congress.

SEC. 12. And be it further enacted, That the fees of agents and attorneys for making out and causing to be executed the papers necessary to establish a claim for a pension, bounty, and other allowance before the Pension Office, under this act, shall not exceed the following rates: For making out and causing to be duly executed a declaration by the applicant, with the necessary affidavits, and forwarding the same to the Pension Office, with the requisite correspondence, ten dollars; which sum shall be received by such agent or attorney in full for all services in obtaining such pension, and shall not be demanded or received, in whole or in part, until such pension shall be obtained; and the sixth and seventh sections of an act entitled "An act to grant pensions," approved July [fourteenth,] eighteen hundred and sixty-two, are hereby repealed.

SEC. 13. And be it further enacted, That any agent or attorney who shall, directly or indirectly, demand or receive any greater compensation for his services under this act than is prescribed in the preceding section of this act, or who shall contract or agree to prosecute any claim for a pension, bounty, or other allowance under this act, on the condition that he shall receive a per centum upon any portion of the amount of such claim, or who shall wrongfully withhold from a pensioner or other claimant the whole or any part of the pension or claim allowed and due to such pensioner or claimant, shall be deemed guilty of a high misdemeanor, and, upon conviction thereof, shall, for every such offense, be fined not exceeding three hundred dollars, or imprisoned at hard labor not exceeding two years, or both, according to the circumstances and aggravations of the offense.

Approved July 4, 1864.

NOTE 10.—If any soldier is charged a higher fee than that allowed by the above act, he should report the fact and the name of the agent to the Adjutant General, in order that steps may be taken to have the same refunded.

A. J. C. Mch 3, 66
P. M. quit for \$94.
Dead 2^d Aug, 1864.

ADJUTANT GENERAL'S OFFICE
March 3^d 1866
Duplica's with inventory sent 2d Auditor.

FINAL STATEMENT 115

or
Pr. Phillip Talbot Co. I.
7th Reg't of U. S. C. Troops

VOLUNTEERS.

Dead Sept 2^d 65

NOTE 1.—Two of these certificates (or duplicates) are to be given to each Volunteer Soldier or drafted man who may be discharged without being mustered out. (Final Statements are never given to men mustered out of service.) that he may at once receive from the Paymaster the pay, &c., due him, and the captain or other COMMISSIONED officer commanding the company will certify to the act of the delivery of the duplicate certificates; with these certificates the Soldier is "entitled to" his discharge, and should also present his discharge to the Paymaster to have the payment endorsed on it. The discharge is to be given back to the Soldier by the Paymaster; the latter only retaining as his vouchers the duplicate certificates.

NOTE 2.—If the Soldier is entitled to pay for the use of his horse, the Company Commander will certify to that fact on the back of both these final statements, and also to the time he has pay due for having been so mounted on his own horse.

NOTE 3.—When a Soldier is furnished with final statements, his descriptive list, if he has one, should be taken up by the officer who gives the Soldier these statements, and endorsed with a statement to this effect by the officer. The endorsement should exhibit a full statement of the time for which the Soldier was allowed pay on his final statements, the clothing account, and all other charges against him or in his favor, so as to comprise a complete exhibit of his account. It will then be transmitted to the Company Commander of the Soldier, who will enter all the data necessary to a full understanding of the Soldier's account on the muster roll upon which the Soldier's discharge is reported. The descriptive list will then be destroyed. The object of this is, that the remaining portion of the Soldier's account may be settled upon the receipt of these muster rolls, and the Soldier receive any pay or allowances that may be due him at the time of his discharge, and which may not appear on his last final statements from the fact that his descriptive list is incomplete. These accounts for back pay, &c., are settled by the 2d Auditor of the Treasury Department.

NOTE 4.—Charges for loss or injury to ordnance, horse equipments, and other miscellaneous charges, should appear under the heading of "Other Stoppages."

NOTE 5.—Bounty paid by State authorities, and not by the United States, will not be entered on this statement.

NOTE 6.—Amounts due the Sutler and Laundress must be entered on the muster roll on which the discharge, death, desertion, &c., is reported, as well as on the final statement, otherwise the amount cannot be collected from the United States.

NOTE 7.—This blank will be used for deceased volunteers and drafted men, as well as for others.

NOTE 8.—Where a Soldier dies in Hospital or on detached service, his descriptive list, if he has one, should be sent with his final statements, in duplicate, to the Adjutant General, Washington, D. C.

NOTE 9.—If the soldier is a drafted man or substitute, the space for time, &c., of enrolled, should contain only the word *drafted* or *substitute*, as the case may be. If the Soldier is a "VETERAN," (or RECRUIT,) the words as a *veteran*, (or *recruit*;) as the case may be, should be interlined after the words *mustered into the service of the U. S. A.* A statement of all the installments of *Veteran* or *Recruit* bounty RECEIVED by the Soldier must be made on the back of each final statement.

Adj. Gen. O. J. ...
1866

I certify, on honor, that Phillip Talbot, a Private of
 Captain Geo. R. Sherman's Company (F) of the 7th Regiment of W. Col. Troops
VOLUNTEERS, of the State of Maryland, born in Baltimore, State
 of Maryland, aged 20 years; 5 feet 7 inches high; Blk complexion,
Blk eyes, Blk hair, and by occupation a Farmer, who joined for service
 and was enrolled (see Note 9) on the 27 day of Sept, 1864, at Baltimore Md
 by Capt. Cathcart, for the period of One years, and mustered into
 the service of the United States on the 27th day of Sept, 1864, at
Baltimore Md, by Capt; and having served
HONESTLY and **FAITHFULLY** with his Company to the present date, is now entitled to a
DISCHARGE by reason of Death

Disch. Talbot 27-1865.

The said Private Phillip Talbot was last paid by Paymaster
May Tinsdell, to include the 30th day of June, 1866, and
 has pay due him from that time to the present date; he is entitled to pay and subsistence for
TRAVELING to place of enrollment, and whatever other allowances are authorized to volunteer
 soldiers, drafted men, or militia, so discharged. He has received from the United States **CLOTHING**
 amounting to Sixteen ⁰³/₁₀₀ dollars, since the 1st day of May 1865,
 1865, when his clothing account was last settled. He has received from the United States
 _____ ⁰⁰/₁₀₀ dollars advanced **BOUNTY**.

There is to be stopped from him, on account of the State of _____, or other
 authorities, for **CLOTHING**, &c., received on entering service, _____ ⁰⁰/₁₀₀ dollars; and
 for other stoppages, viz: Camp and Garrison Equipage # 4.70
for Ordnance # 20
 _____ ⁰⁰/₁₀₀ dollars.

He has been furnished with **TRANSPORTATION** in kind from the place of his discharge to
 _____; and he has been **SUBSISTED** for **TRAVELING** to his
 place of enrollment, up to the _____, 186 .

He is indebted to _____, **SUTLER**, _____ ⁰⁰/₁₀₀ dollars.

He is indebted to _____, **LAUNDRESS**, _____ ⁰⁰/₁₀₀ dollars.

Given in Duplicate, at Indianola Texas, this 12th day
 of February, 1866.

C. H. C. Brown
1st Lieut. 7th U. S. C. T.
 Commanding Company. F.

CASUALTY SHEET

No.

Philip Sabot

Priv of Company *"D"*

7th Regiment of *U.S.C.V.*

State Volunteers.

NATURE OF CASUALTY.

Killed Sept 2, 1865.

CASUALTY SHEET.

Name: Philip Talbot
 Rank: Private Company: "F" Regiment: 7th
 Arm: U.S. Col's Troop State: _____
 Nature of Casualty: Death

CAUSE OF CASUALTY—(NAME OF DISEASE, &c.)

Scurbutis

BY WHOM DISCHARGED.

FROM WHAT SOURCE THIS INFORMATION WAS OBTAINED.

Co. Muster Roll
Oct. 1865

DEGREE OF DISABILITY.

BY WHOM CERTIFIED.

W. H. Brown
1st Lieut. Comd'g Co.

DATE OF DISCHARGE, DEATH, &c.

Sept. 21, 1865

PLACE OF DISCHARGE, DEATH, &c.

Indianola, Texas

REMARKS.

A. B. Ball
Clerk.

¹²⁹⁵
Soney William

Co D, 7 U.S. Col'd Inf.

Private | Sergeant,

CARD NUMBERS.

1	26
2	27
3	28
4 See Soney,	29 William H.
5	30
6	31
7	32
8	33
9	34
10	35
11	36
12	37
13	38
14	39
15	40
16	41
17	42
18	43
19	44
20	45
21	46
22	47
23	48
24	49
25	50

Book Mark:

See also

¹²⁹⁵
Taylor, Benjamin

Co C, 7 U.S. Col'd Inf.

Private

Private

CARD NUMBERS.

1	6278986	26
2	6278839	27
3	6284606	28
4	6284713	29
5	6284815	30
6	6284906	31
7	6284994	32
8	6285078	33
9	6285155	34
10	6285368	35
11	6279520	36
12	9066242	37
13		38
14		39
15		40
16		41
17		42
18		43
19		44
20		45
21		46
22		47
23		48
24		49
25		50

Book Mark:

See also

81705-278 PO. m. in
S-275-7782 Am. N. 12
A 2806591 " " "

J | **7** | **U.S.C.T.**

Benjamin Taylor

, Co. *C*, 7 Reg't U.S. Col'd Inf.

Appears on

Company Descriptive Book

of the organization named above.

DESCRIPTION.

Age *27* years; height *5* feet *8* inches.

Complexion *bruff*.

Eyes *Black*; hair *Black*.

Where born *Md.*

Occupation *Farmer*.

ENLISTMENT.

When *Mar. 10*, 186*5*.

Where *Baltimore*

By whom *Ed. Bowman*; term *1* y'rs.

Remarks: *Mustered at Baltimore Md. Mar. 10, 65 by Gt. B. R. Rykes*
Mustered out by reason of expiration
of term of service at Galveston Texas,
Mar. 9, 66.

J. Smith

T 7 U.S.C.T.

Benjamin Taylor

Appears with rank of _____ on _____

Muster and Descriptive Roll of a Detachment of U. S. Vols. forwarded

for the 7 Reg't U. S. Col'd Infantry. Roll dated
Baltimore Md March 10, 1865.

Where born *Anne Arundel Co Md*

Age *27* yrs; occupation *Farmer*

When enlisted *Mar 10*, 1865.

Where enlisted *Baltimore Md*

For what period enlisted *1* years.

Eyes *Blk*; hair *Blk*

Complexion *Griffe*; height *5* ft. *8* in.

When mustered in *Mar 10*, 1865.

Where mustered in *Baltimore Md*

Bounty paid \$ *100*; due \$ *100*

Where credited _____

Company to which assigned _____

Remarks : _____

Book mark : _____

G. W. Deadrick

9

7

U.S.C.T.

Benjamin Taylor

Prn, Co *7* Reg't U. S. Col'd Infantry.

Age *27* years.

Appears on a

Detachment Muster-in Roll

of the organization named above. Roll dated

Baltimore, Md., Mar. 16, 186*3*.

Muster-in to date *Mar. 11*, 186*3*.

Joined for duty and enrolled:

When *Mar 10*, 186*3*.

Where *Baltimore, Md.*

Period *1* years.

Remarks: *Enlisted*

Book mark:

(837)

Beck
Copyist.

G | **7** | **U.S.C.T.**

Benjamin Taylor
Priv., Co. C, 7 Reg't U. S. Col'd Infantry.

Appears on

Company Muster Roll
for *Mar. & Apr.*, 186 *5**

Joined for duty and enrolled:

When *Mar. 10*, 186 *5**

Where

Period *one* years.*

Present or absent *Present*

Stoppage, \$ *100* for

Due Gov't \$ *100* for

Remarks: *Joined Co. Mar.*
18/65

* See enrollment on card from muster-in roll.

Book mark:

M. M. Murphy
(858c) Copyist.

T | **7** | **U.S.C.T.**

Benjamin Taylor
Bob, Co. C, 7 Reg't U. S. Col'd Infantry.

Appears on

Company Muster Roll
for *May & June*, 186*5*.

Joined for duty and enrolled:

When *Mar. 10*" , 186*5*.*

Where*

Period *one* years.*

Present or absent *Present*

Stoppage, \$ *100* for

Due Gov't \$ *100* for

Remarks: *joined Co. Mar. 18/65*

* See enrollment on card from muster-in roll.

Book mark:

M. M. Murphy

(258c)

Copyist.

J

7

U.S.C.T.

Benjamin Taylor
Priv., Co. C, 7 Reg't U. S. Col'd Infantry.

Appears on

Company Muster Roll

for *July & Aug.*, 1865.

Joined for duty and enrolled:

When *Mar. 10*, 1865.*

Where *Antietam* *

Period *one* years.*

Present or absent *Present*

Stoppage, \$ *100* for

Due Gov't \$ *100* for

Remarks:

* See enrollment on card from muster-in roll.

Book mark:

W. M. Murphy

(858c)

Copyist.

J

7

U.S.C.T.

Benjamin Taylor
Prof., Co. C, 7 Reg't U. S. Col'd Infantry.

Appears on

Company Muster Roll
for *Sept. & Oct.*, 1865.

Joined for duty and enrolled:

When *Mar. 10*, 1865.*

Where *Baltimore, Md.* *

Period *one* years.*

Present or absent *Present*

Stoppage, \$ *100* for

Due Gov't \$ *100* for

Remarks:

* ~~See~~ See enrollment on card from muster-in roll.

Book mark: -----

M. M. Murphy
(258c) Copyist.

NARA 1500

J | **7** | **U.S.C.T.**

Benjamin Taylor
Pr, Co. C, 7 Reg't U. S. Col'd Infantry.

Appears on

Company Muster Roll

for *Nov. & Dec.*, 186*5*

Joined for duty and enrolled:

When *March 10*, 186*5**

Where *Baltimore Md.*

Period *3* years.*

Present or absent *Present*

Stoppage, \$ *100* for

Due Gov't \$ *100* for

Remarks:

* ~~45~~ See enrollment on card from muster-in roll.

Book mark: -----

Lopez
(258c) Copyist.

J

7

U.S.C.T.

Benjamin Taylor
Pr, Co. C, 7 Reg't U. S. Col'd Infantry.

Appears on

Company Muster Roll
for Jan x Feb, 1866

Joined for duty and enrolled:

When March 10, 1865*

Where Baltimore Md.*

Period 1 year.*

Present or absent Present.

Stoppage, \$ 18/100 for Ordnance.

Due Gov't \$ 100 for

Remarks:

* See enrollment on card from muster-in roll.

Book mark: Muster out on file

(858c)

Lopez
Copyist.

J

7

U.S.C.T.

Benjamin Taylor
Prp, Co. C, 7 Reg't U. S. Col'd Infantry.

Appears on

Company Muster Roll

for *March x April*, 186 *6*

Joined for duty and enrolled:

When *March 10*, 186 *5**

Where *Baltimore Md**

Period *1* year*

Present or absent

Stoppage, \$ *100* for

Due Gov't \$ *100* for

Remarks: *Discharged by reason of expiration of term of service.*

* See enrollment on card from muster-in roll.

Book mark:

Lopez

7

U.S.C.T.

Benjamin Taylor,
Sub, Co. *C*, *7* Reg't U. S. Col'd Infantry.

Appears on a

Detachment Muster-out Roll

of the organization named above. Roll dated

Galveston Texas Mar. 9, 1866.

Muster-out to date *Mar. 4,* 1866.

Last paid to *Dec. 31,* 1865

Clothing account:

Last settled 186 ; drawn since \$ 100

Due soldier \$ *7* ⁰⁰/₁₀₀ ; due U. S. \$ 100

Am't for cloth'g in kind or money adv'd \$ 100

Due U. S. for arms, equipments, &c., \$ 100

Bounty paid \$ *None* 100 due \$ *100* ⁰⁰/₁₀₀

Remarks: *Recruit. Mustered out by reason of expiration of term of service.*

Book mark:

(349)

Jenkins

Copyist.

NARA 1984

I. | 7 | U.S.C.T.

Benjamin Taylor
Ist, Co., *C*, 7 Reg't U. S. Col'd Infantry.

Appears on **Co. Muster-out Roll**, dated
Indianola Texas Oct. 13, 1866.

Muster-out to date 186 .

Last paid to *Dec 1*, 1865.

Clothing account:

Last settled....., 186 ; drawn since \$.....¹⁰⁰

Due soldier \$.....¹⁰⁰; due U. S. \$.....¹⁰⁰

Am't for cloth'g in kind or money adv'd \$.....¹⁰⁰

Due U. S. for arms, equipments, &c., \$.....¹⁰⁰

Bounty paid \$.....¹⁰⁰; due \$.....¹⁰⁰

Remarks: *Mustered out at
Galveston Texas Mar. 9
'66 at expiration of term.*

Book mark:.....

Sopez

¹²⁹⁷
Taylor, Charles

Co D, 7 U.S. Col'd Inf.

Private | Private

CARD NUMBERS.

1	6294283	26
2	6294379	27
3	6294479	28
4	6294579	29
5	6294673	30
6	6294765	31
7	6294856	32
8	6294949	33
9	6295052	34
10	6295152	35
11	6295251	36
12	6295348	37
13	6295440	38
14	6295518	39
15	6295607	40
16	6295680	41
17	6295750	42
18	6295824	43
19	6295895	44
20	6295956	45
21	9066979	46
22	J-36-054871	47
23		48
24		49
25		50

Book Mark: J-36-054871
CN - vol 9 - p. - 278.

See also

J | 7 | U.S.C.T.

Charles Taylor

Priv, Co. *D*, 7 Reg't U. S. Col'd Inf.

Age *21* years.

Appears on

Company Muster-in Roll

of the organization named above. Roll dated
Camp Stanton, Charles Co., Md, *Nov. 5*, 186*3*.

Muster-in to date *Nov. 5*, 186*3*

Joined for duty and enrolled:

When *Oct. 22*, 186 .

Where *Calvert, Md*

Period *3* years.

Remarks:
•

Book mark: *S. 771. Md.*

(856)

J. B. Gage

Copyist.

NOV 15 1863

J | 7 | U.S.C.T.

Charles Taylor
Pvt, Co. I, 7 Reg't U. S. Col'd Infantry.

Appears on

Company Muster Roll

for from Nov. 5 to Dec. 31, 1863.

Present or absent Present

Stoppage, \$ 100 for

Due Gov't, \$ 100 for

Remarks: Enlistment premium
\$2.00 due

Book mark:

J. B. Enge

(358)

Copyist.

J

7

U.S.C.T.

Charles Taylor
Pvt, Co. I, 7 Reg't U. S. Col'd Infantry.

Appears on

Company Muster Roll

for Jan & Feb, 1864.

Present or absent Present

Stoppage, \$ 100 for

Due Gov't, \$ 100 for

Remarks: Enlistment premium
\$2.00 due.

Book mark:

J.B. Gage

Copyist.

(358)

J

7

U.S.C.T.

Charles Taylor
Pvt., Co. I, 7 Reg't U. S. Col'd Infantry.

Appears on

Company Muster Roll

for *Mich & Apr*, 1864.

Present or absent *Present*

Stoppage, \$ *100* for

Due Gov't, \$ *100* for

Remarks:

Book mark:

J.B. Gage

(358)

Copyist.

T

7

U.S.C.T.

Charles Taylor

Priv, Co. I, 7 Reg't U. S. Col'd Infantry.

Appears on

Company Muster Roll

for *May & June*, 1864.

Present or absent *Present*

Stoppage, \$ *100* for

Due Gov't, \$ *100* for

Remarks: *Charge for 1 Cartridge
Box belt Plate, 1 pr. Shoulder
Scales & 1 canteen*

Book mark:

J. B. Gage

(358)

Copyist.

7

7

U.S.C.T.

Charles Taylor

Private, Co. I, 7 Reg't U. S. Col'd Infantry.

Appears on

Company Muster Roll

for July & Aug, 1864

Present or absent Present

Stoppage, \$ 100 for

Due Gov't, \$ 100 for

Remarks: Stop pay for one Knapsack, 1 Haversack, 1 Canteen, & 1 Cartridge Box Belt Plate.

Book mark:

J. B. Edge

(858)

Copyist.

J

7

U.S.C.T.

Charles Taylor

Pvt, Co. I, 7 Reg't U. S. Col'd Infantry.

Appears on

Company Muster Roll

for Sept & Oct, 1864

Present or absent Present

Stoppage, \$ 100 for

Due Gov't, \$ 100 for

Remarks: Stop for 1 Knapsack

Book mark:

J B Gage

(858)

Copyist.

T

7

U.S.C.T.

Charles Taylor

Priv., Co. I, 7 Reg't U. S. Col'd Infantry.

Appears on

Company Muster Roll

for *Nov. + Decr.*, 1864.

Present or absent *Present*

Stoppage, \$ *100* for

Due Gov't, \$ *100* for *one Knapsack.*

Remarks:

Book mark:

D. Maher

(358)

Copyist.

T

7

U.S.C.T.

Charles Taylor

Priv., Co. I, 7 Reg't U. S. Col'd Infantry.

Appears on

Company Muster Roll

for *Jan'y. & Feby.*, 1865.

Present or absent *Present*

Stoppage, \$.....100 for

Due Gov't, \$.....100 for

Remarks:

Book mark;

D. Maher
Copyist.

(358)

T

7

U.S.C.T.

Charles Taylor

Priv, Co. I, 7 Reg't U. S. Col'd Infantry.

Appears on

Company Muster Roll

for *March + April*, 1865.

Present or absent *Present*

Stoppage, \$ *100* for

Due Gov't, \$ *100* for

Remarks:

Book mark:

D. Maher

S

7

U.S.C.T.

Charles Taylor

Priv., Co. I, 7 Reg't U. S. Col'd Infantry.

Appears on

Company Muster Roll

for *May & June*, 1865.

Present or absent *Present*

Stoppage, \$ *100* for

Due Gov't, \$ *100* for

Remarks:

Book mark:

D. Mahser

(358)

Copyist.

T

7

U.S.C.T.

Charles Taylor
Priv., Co. 1, 7 Reg't U. S. Col'd Infantry.

Appears on

Company Muster Roll

for July & Aug., 1865.

Present or absent Present

Stoppage, \$ 100 for

Due Gov't, \$ $\frac{23}{100}$, for Ordnance, &c.

Remarks:

Book mark:

D. Maher

Copyist.

T

7

U.S.C.T.

Charles Taylor

Priv, Co. I, 7 Reg't U. S. Col'd Infantry.

Appears on

Company Muster Roll

for *Sept. & Oct.*, 1865.

Present or absent *Present*

Stoppage, \$ *100* for

Due Gov't, \$ $\frac{23}{100}$ for *Ordnance, &c.*

Remarks:

Book mark:

D. Maher

(358)

Copyist.

J

7

U.S.C.T.

Charles Taylor

Priv, Co. I, 7 Reg't U. S. Col'd Infantry.

Appears on

Company Muster Roll

for *Nov. + Decr.*, 1865.

Present or absent *Present*

Stoppage, \$ 100 for

Due Gov't, \$ $\frac{23}{100}$ for *Ordna, &c.*

Remarks:

Book mark:

D. Maker
Copyist.

J

7

U.S.C.T.

Charles Taylor

Private, Co. I, 7 Reg't U. S. Col'd Infantry.

Appears on

Company Muster Roll

for Jan + Feb, 1866.

Present or absent Present.

Stoppage, \$ 100 for

Due Gov't, \$ 100 for

Remarks:

Book mark:

Savine

Copyist.

J

7

U.S.C.T.

Charles Taylor

Pr Co. I, 7 Reg't U. S. Col'd Infantry.

Appears on

Company Muster Roll

for Mar + Apr, 1866.

Present or absent Present.

Stoppage, \$ 100 for

Due Gov't, \$ 100 for

Remarks:

Book mark:

Sabine

Copyist.

J

7

U.S.C.T.

Charles Taylor

Private, Co. I, 7 Reg't U. S. Col'd Infantry.

Appears on

Company Muster Roll

for Jan 28th to June 30, 1860.

Present or absent Not stated.

Stoppage, \$ 100 for

Due Gov't, \$ 100 for

Remarks:

Book mark:

Sabine

Copyist.

(358)

J

7

U.S.C.T.

Charles Taylor

Private, Co. I, 7 Reg't U. S. Col'd Infantry.

Appears on

Company Muster Roll

for July & Aug, 1862.

Present or absent Present.

Stoppage, \$ 1.00 for

Due Gov't, \$ 1.00 for

Remarks:

Book mark

502833

Sabine

Copyist.

(358)

T

7

U.S.C.T.

Charles Taylor

Prvt, Co *B*, 7 Reg't U. S. Col'd Infantry.

Appears on **Co. Muster-out Roll**, dated *Indianola, Texas*
October 13, 1866.

Muster-out to date _____, 1866 .

Last paid to *June 30*, 1866 .

Clothing account:

Last settled _____, 1866 ; drawn since \$ _____ 100

Due soldier \$ *27* ^{*22*}/₁₀₀; due U. S. \$ _____ 100

Am't for cloth'g in kind or money adv'd \$ _____ 100

Due U. S. for arms, equipments, &c., \$ _____ 100

Bounty paid \$ _____ 100; due \$ *100* 100

Remarks: *Joined co. at original organization.*

+ Died since completion of rolls.

+ The entire entry, excepting this remark, is canceled by line thro' it.

Book mark *T 36 T 9 CT 1871*

Sabine

T

7

U.S.C.T.

Charles Taylor
Pvt, Co *D*, 7 Reg't U. S. Col'd Infantry.

Appears on **Co. Muster-out Roll**, dated
Indianola Texas
October, '13, 1866.

Muster-out to date _____, 186 .

Last paid to *June 30*, 1866 .

Clothing account:

Last settled _____, 186 ; drawn since \$ _____ 100

Due soldier \$ _____ 100; due U. S. \$ _____ 100

Am't for cloth'g in kind or money adv'd \$ _____ 100

Due U. S. for arms, equipments, &c., \$ _____ 100

Bounty paid \$ _____ 100; due \$ _____ 100

Remarks: *Died of Cholera,*
at Indianola, Texas,
Oct. 10, '66. Final
papers sent A.G.O.,
Oct. 9, '66.

Died since completion
of rolls.

Book mark: *739 P 96 68.*
S 171 Ma. P 17 P 19, 71.
over

Sabine

Copyist.

1891526

JAN. 21

6295956

18914

*Died Oct. 8, '66. G.B. Vol.
9, P. 278.*

J. | 7 | U.S.C.T.

Charles Taylor

, Co. I, 7 Reg't U. S. Col'd Inf.

Appears on

Company Descriptive Book

of the organization named above.

DESCRIPTION.

Age 21 years; height 5 feet 5 inches.

Complexion Blk.

Eyes Blk.; hair Blk.

Where born Calvert, Md.

Occupation Farmer.

ENLISTMENT.

When Oct. 22, 1863.

Where Calvert, Md.

By whom Ed. Wm. Birney; term 3 y'rs.

Remarks: Murdered in at Camp Stanton, Md. Nov. 5. 63. by Lt. Col. Haskell. Died of Epidemic Cholera at Indianola, Texas Oct. 8. 65.

J. G. White

J T U.S.A.

Charles Taylor
Co. D, 7 Reg't Inf. C.S.

NOTATION.

Book mark: J 36, C.S. 1871

Record and Pension Office,

WAR DEPARTMENT.

This book mark refers only to a report from the medical records, made by the Surgeon General to the Adjutant General, relative to the above-named man. As the medical records have since been carded, no transcript of this report is made hereon.

(491)

F. E. Schellenger
Copyist.

Taylor, Charles

P, Co. I, 7 Regt U. S. C. Inf.

3 Enclosures.

Bed Cards.....	Descriptive Lists.....
Burial Records.....	Final Statements..... /
Certs. of Dis. for Discharge.....	Furloughs.....
C. M. Charges.....	Med. Des. Lists.....
Med. Certificates.....	Orders.....

Other papers relating to—

Admission to Hosp'l.....	Furlough.....
Casualty Sheet (Officer's)..... /	Med. Examination.....
Confinement.....	Misc. Information.....
Contracts.....	Pay or Clothing.....
Death or Effects..... /	Personal Reports.....
Desertions.....	Rank.....
Discharge from Hosp'l.....	Transfer to Hosp'l.....
Discharge from Service.....	Transfer to V. R. C.....
Duty.....	Transportation.....

MICROFILM PUBLICATION M 1849

COMPILED MILITARY SERVICE RECORDS
OF VOLUNTEER UNION SOLDIERS WHO SERVED WITH
THE UNITED STATES COLORED TROOPS (USCT)
7TH REGIMENT OF INFANTRY

PERSONAL PAPERS' TARGET SHEET

PLEASE NOTE THE CHECKED INFORMATION ABOUT THE PERSONAL PAPERS IN
THIS FILE:

- NO PERSONAL PAPERS WERE FOUND IN THIS FILE WHEN THE
RECORDS WERE ARRANGED FOR MICROFILMING.
- 6 PERSONAL PAPER(S) FOUND IN THIS FILE WHEN THE RECORDS
WERE ARRANGED FOR MICROFILMING.

Edorsement of
loyalty.

Balto Dec 7 1864

Board of Claims,

Gentlemen,

It is due to Mr Lewis
Sarah M^{rs} Skinner of Calvert County Maryland
~~Ely~~ to state that I have reason to believe her
to be loyal to the United States, has
taken to my knowledge the oath of Allegi-
ance, and I never heard of her render-
ing any "aid or comfort" to the enemy.

I shall be pleased to learn that she
may be successful in obtaining the
usual compensation for her slaves taken
for the use of the Government.

Very respectfully &

Thos. H. Linnard

Bible House 75 Fayette Street
Balto.

—v—

Extract from Act of Congress.

SEC. 12. And be it further enacted, That the fees of agents and attorneys for making out and causing to be executed the papers necessary to establish a claim for a pension, bounty, and other allowance before the Pension Office, under this act, shall not exceed the following rates: For making out and causing to be duly executed a declaration by the applicant, with the necessary affidavits, and forwarding the same to the Pension Office, with the requisite correspondence, ten dollars; which sum shall be received by such agent or attorney in full for all services in obtaining such pension, and shall not be demanded or received, in whole or in part, until such pension shall be obtained; and the sixth and seventh sections of an act entitled "An act to grant pensions," approved July [fourteenth,] eighteen hundred and sixty-two, are hereby repealed.

SEC. 13. And be it further enacted, That any agent or attorney who shall, directly or indirectly, demand or receive any greater compensation for his services under this act than is prescribed in the preceding section of this act, or who shall contract or agree to prosecute any claim for a pension, bounty, or other allowance under this act, on the condition that he shall receive a per centum upon any portion of the amount of such claim, or who shall wrongfully withhold from a pensioner or other claimant the whole or any part of the pension or claim allowed and due to such pensioner or claimant, shall be deemed guilty of a high misdemeanor, and, upon conviction thereof, shall, for every such offense, be fined not exceeding three hundred dollars, or imprisoned at hard labor not exceeding two years, or both, according to the circumstances and aggravations of the offense.

Approved July 4, 1864.

NOTE 10.—If any soldier is charged a higher fee than that allowed by the above act, he should report the fact and the name of the agent to the Adjutant General, in order that steps may be taken to have the same refunded.

FINAL STATEMENT.

-I- 39

OF

Charles Taylor Private
7th Reg't of No. 1. Co. Troops

Volunteers.
Died Oct 8th 1866

NOTE 1.—Two of these certificates (or duplicates) are to be given to each Volunteer Soldier or drafted man who may be discharged without being mustered out (Final Statements are never given to men mustered out of service) that he may at once receive from the Paymaster the pay, &c., due to him, and the captain or other commissioned officer commanding the company will certify to the act of the delivery of the duplicate certificates; with these certificates the Soldier is "entitled to" his discharge, and should also present his discharge to the Paymaster to have the payment endorsed on it. The discharge is to be given back to the Soldier by the Paymaster; the latter only retaining as his vouchers the duplicate certificates.

NOTE 2.—If the Soldier is entitled to pay for the use of his horse, the Company Commander will certify to that fact on the back of both these final statements, and also to the time he has pay due for having been so mounted on his own horse.

NOTE 3.—When a Soldier is furnished with final statements, his descriptive list, if he has one, should be taken up by the officer who gives the Soldier these statements, and endorsed with a statement to this effect by the officer. The endorsement should exhibit a full statement of the time for which the Soldier was allowed pay on his final statements, the clothing account, and all other charges against him or in his favor, so as to comprise a complete exhibit of his account. It will then be transmitted to the Company Commander of the Soldier, who will enter all the data necessary to a full understanding of the Soldier's account on the muster roll upon which the Soldier's discharge is reported. The descriptive list will then be destroyed. The object of this is, that the remaining portion of the Soldier's account may be settled upon the receipt of these muster rolls, and the Soldier receive any pay or allowances that may be due him at the time of his discharge, and which may not appear on his last final statements from the fact that his descriptive list is incomplete. These accounts for back pay, &c., are settled by the 2d Auditor of the Treasury Department.

NOTE 4.—Charges for loss or injury to ordnance, horse equipments, and other miscellaneous charges, should appear under the heading of "Other Stoppages."

NOTE 5.—Bounty paid by State authorities, and not by the United States, will not be entered on this statement.

NOTE 6.—Amounts due the Sutler and Laundress must be entered on the muster roll on which the discharge, death, desertion, &c., is reported, as well as on the final statement, otherwise the amount cannot be collected from the United States.

NOTE 7.—This blank will be used for deceased volunteers and drafted men, as well as for others.

NOTE 8.—Where a Soldier dies in Hospital or on detached service, his descriptive list, if he has one, should be sent with his final statements, in duplicate, to the Adjutant General, Washington, D. C.

NOTE 9.—If the soldier is a drafted man or substitute, the space for time, &c., of enrolled, should contain only the words "drafted or substitute," as the case may be. If the soldier is a "VETERAN" (OR RECRUIT,) the words "as a veteran (or recruit)," as the case may be, should be interlined after the words "enrolled into the service of the U. S." A statement of all the installments of Veteran or Recruit BOUNTY RECEIVED by the Soldier must be made on the back of each final statement.

Adjutant General's Office
Washington, D. C.
Oct 24 1866

Adjutant General's Office
Washington, D. C. March 7, 1871.

E. B. vol. 9, p. 278.
The Muster Out Roll of Co. 2nd U.S. Troops reports the death of Private Charles Taylor October 10, 1866.

The Final Statement of the soldier and the records of the Surgeon General's Office (A. 36 vol. 9, & p. 1841) report date of death Oct. 8, 1866.

The latter date (October eighth 1866) is held to be correct and the Company Muster Out Roll will be amended accordingly.

Thurman D. Fessenden
Assist. Adjt. General

Filed
7th

In letter of March 7, 1871 to General

ADJUTANT GENERAL'S OFFICE
Oct 24 1866
Duplicate with Inventory sent 2d Auditor.

I certify, on honor, that Charles Taylor, a Private of
 Captain Charles L. Teeple's Company (I) of the Seventh Regiment of No. 1 Colored Troops
Volunteers, of the State of _____, born in Calvert County State
 of Maryland, aged 21 years; 5 feet 5 inches high; Black complexion,
Black eyes, Black hair, and by occupation a Farmer, who joined for service
 and was enrolled (see Note 9) on the 22 day of October, 1863, at Calvert, Md.
 by Col. W. Birney, for the period of Three years, and mustered into
 the service of the United States on the Fifth day of November, 1863, at
Camp Stanton, Md., by St. Col. Haskell; and having served
HONESTLY and **FAITHFULLY** with his Company to the present date, is now entitled to a
DISCHARGE by reason of Death from Epidemic Cholera, at Indianola,
Texas Oct 8th 1866.

The said Charles Taylor was last paid by Paymaster
Maj. Underwood, to include the 30th day of June, 1866, and
 has pay due him from that time to the present date; he is entitled to pay and subsistence for
TRAVELING to place of enrollment, and whatever other allowances are authorized to volunteer
 soldiers, drafted men, or militia, so discharged. He has received from the United States **CLOTHING**
 amounting to _____ dollars, since the _____ day of _____,
 1866, when his clothing account was last settled. He has received from the United States
 _____ dollars advanced **BOUNTY**. Due Soldier for clothing Twenty Seven Dollars
and Twenty two cents. \$27.22
 There is to be stopped from him, on account of the State of _____, or other
 authorities, for **CLOTHING**, &c., received on entering service, _____ dollars; and
 for other stoppages, viz: _____

_____ dollars.
 He has been furnished with **TRANSPORTATION** in kind from the place of his discharge to
 _____; and he has been **Subsisted** for **Traveling** to his
 place of enrollment, up to the _____, 1866.

He is indebted to _____, **Sutler**, _____ dollars.
 He is indebted to _____, **Laundress**, _____ dollars.

Given in Duplicate, at Indianola, Texas, this 9th day
 of October, 1866.

E. G. Teeple
 Capt. 7th No. 1. Col. Tro.
 Commanding Company.

ARTICLES OF WAR.

ART. 95. When any non-commissioned officer or soldier shall die, or be killed in the service of the United States, the then commanding officer of the troop or company shall, in the presence of two other commissioned officers, take an account of what effects he died possessed of, above his arms and accoutrements, and transmit the same to the office of the Department of War, which said effects are to be accounted for, and paid to the representatives of such deceased non-commissioned officer or soldier. And in case any of the officers, so authorized to take care of the effects of deceased officers and soldiers, should, before they have accounted to their representatives for the same, have occasion to leave the regiment or post, by preferment or otherwise, they shall, before they be permitted to quit the same, deposit in the hands of the commanding officer, or of the assistant military agent, all the effects of such deceased non-commissioned officers and soldiers, in order that the same may be secured for, and paid to, their respective representatives.

DIRECTIONS.

NOTE 1.—One copy of the inventories of the effects of deceased non-commissioned officers and soldiers, required by the 95th Article of War, will be forwarded to the Adjutant General, by the commander of the company to which the deceased belonged, and a duplicate of the same to the colonel of the regiment. Final statements of pay, clothing, &c., in duplicate, will be sent to the Adjutant General with one copy of the inventory. Both inventory and final statements should be forwarded, as a general rule, through Regimental Headquarters. When a soldier dies at a post or station absent from his company, it will be the duty of his immediate commander to furnish, direct to the Adjutant General, the required inventory and final statements, and, at the same time, to forward to the commanding officer of the company to which the soldier belonged, a report of his death, specifying the date, place, and cause; to what time he was last paid, and the money or other effects in his possession at the time of his decease; which report will be noted on the next muster roll of the company to which the man belonged. Each inventory will be endorsed, "Inventory of the effects of — — —, late of company (—) — — — regiment of — — —, who died at — — —, the — — — day of — — —, 186—." If a legal representative receive the effects, it will be stated in the report. If the soldier leave no effects, the fact will be reported on the blank for inventory.

NOTE 2.—Should the effects of a deceased non-commissioned officer or soldier not be administered upon within a short period after his decease, they shall be disposed of by a Council of Administration, under the authority of the commanding officer of the post, and the proceeds deposited with the Paymaster, to the credit of the United States, until they shall be claimed by the legal representatives of the deceased.

NOTE 3.—In all such cases of sales by the Council of Administration, a statement in detail, or account of the proceeds duly certified by the Council and commanding officer, (Form 5.) accompanied by the Paymaster's receipt for the proceeds, will be forwarded by the commanding officer to the Adjutant General. The statement will be endorsed, "Report of the proceeds of the effects of — — —, late of company (—) — — — regiment of — — —, who died at — — —, the — — — day of — — —, 186—."

NOTE 4.—The effects in all cases, when called for, should be turned over to the legal representative, without further authority from the Adjutant General. When the effects are turned over to the relatives of the deceased before these inventories are sent to the Adjutant General, their receipts therefor should be attached to the inventories. In all other cases, one copy will be sent with a letter of transmittal direct to the Adjutant General, and a duplicate retained by the officer.

NOTE 5.—Particular care should be taken to take receipts in duplicate from the Paymaster for any funds turned over to him; one copy should be sent direct to the Adjutant General and one retained by the officer.

1866 39

F. S. on file,
INVENTORY OF THE EFFECTS

Hill.

OF

Charles Taylor

Late of Company *D*

7 Reg't of *U. S.*

Volunteers, who died at *Sierrita, Tex.*

on the *8* day of *October* 1866.



Inventory of the effects of Charles Taylor late
 a Private of Captain Charles G. Telfer Company I of
 the Seventh Regiment of U.S. Colored Troops Volunteers, who was enrolled as
 a Private at Calvert, Md in the State of Maryland on
 the 22 day of October 1863, and mustered into the service of the United
 States as a Private on the 5th day of November 1863, at Camp Stanton, Md.
 in Company I, 7th Regiment of U.S. Colored Troops Volunteers, to serve Three
 years or during the war; he was born in Calvert County in the State
 of Maryland; he was 21 years of age, 5 feet 5 inches
 high, Black complexion, Black eyes, Black hair, and by occupation, when enrolled,
 a Farmer; he died in Post Hospital, at
Indianapolis, Texas on the _____ day of October 1866, by
 reason of Cholera (Epidemic) at Indianapolis Texas, Oct. 8th 1866.

INVENTORY.					
ARTICLES.	No.	ARTICLES.	No.	ARTICLES.	No.
Hats.....		Pairs trousers.....		Knapsacks.....	
Caps.....		Pairs flannel drawers.....			
Forage Caps.....		Pairs cotton drawers.....			
Great coats.....		Flannel shirts.....			
Uniform coats.....		Cotton shirts.....			
Uniform jackets.....		Pairs boots.....			
Flannel sack coats.....		Pairs shoes.....			
Blouses.....		Pairs socks.....			
Stable frocks.....		Blankets.....			
Fatigue overalls.....		Haversacks.....			
				MONEY.	
				Specie.....	\$
				Notes.....	\$

I CERTIFY, ON HONOR, that the above inventory comprises all the effects of _____
 _____, deceased, and that the effects are in the hands
 of _____ at _____
 _____ to be disposed of by a Council of Administration.

(DUPLICATES.)

STATION: Indianapolis Texas

Capt. G. W. S. S.
 Commanding the Company.

DATE: October 9th 1866

EVIDENCE OF TITLE.

I, Sarah M Skinner of Calvert County, Maryland, do solemnly swear that Charles Taylor who has been enlisted in the 7th Regiment, U. S. Colored Troops, Co. 1st; was my Slave for life at the time of said enlistment; and that I became possessed of him by Parole List in the month of August eighteen hundred and Forty four. And I do further swear that I have not purchased said Slave from any person or persons disloyal to the Government of the United States, with the object of obtaining compensation for the same; and furthermore, that I have no agency for obtaining compensation for any person or persons but such as to my knowledge are loyal citizens of the United States.

Sarah M Skinner

Sworn and subscribed before

Wm H Talbot J P Justice of the Peace

STATE OF MARYLAND,

Calvert County, to wit:

On this Eleventh day of January in the year 1867 before me, the subscriber, a Justice of the Peace of the State and County aforesaid, personally appeared Elizabeth Lyons and Dr John R Quinn loyal citizens of the United States, residents of Calvert County, Md and in no manner interested in the prosecution of this claim, and made oath in due form of law, that the said Sarah M Skinner was the owner of the Slave Charles Taylor as a fact of public notoriety; that they believe all the statements made by her in reference to said Slave are correct.

Witness their Signatures,

Sworn and subscribed before

Elizabeth Lyons Dr John R Quinn Justice of the Peace

And I Hereby do Certify, That the said Elizabeth Lyons and Dr John R Quinn are citizens of Calvert County, in good repute, and that their statements, under oath, are entitled to full faith and credit.

Wm H Talbot J P Justice of the Peace

EVIDENCE OF LOYALTY.

STATE OF MARYLAND,

Calvert County, to wit:

On this Eleventh day of January in the year 1867 before me, the subscriber, a Justice of the Peace of the State and County aforesaid, personally appeared Elizabeth Lyons a resident of Calvert County, State of Maryland and Dr John R Quinn a resident of Calvert County, State of Maryland having first been duly sworn, upon their oaths declare that they reside respectively in Calvert County, State of Maryland and that they are personally acquainted with Sarah M Skinner claimant for compensation for her Slave Charles Taylor under the Acts of Congress of February 24, 1864, and July 28, 1866, and that they know that said claimant hath firmly and faithfully maintained her allegiance and adherence to the Government of the United States, by defending its cause against the Government of the so-called Confederate States of America, in all suitable and practicable ways, and according to her ability and opportunity; they also swear that they have themselves maintained a like adherence and allegiance to the Government of the United States, and that they have no interest in said claim.

Sworn and Subscribed before

Elizabeth Lyons Dr John R Quinn Justice of the Peace

STATE OF MARYLAND,

Calvert County, to wit:

I, Dennis B. Dwyer, Clerk of the Circuit Court for Calvert County, do hereby certify that Henry H Talbot, Justice of the Peace for the County and State aforesaid, duly commissioned and sworn; and that his signature thereto is genuine, and that full faith and credit should be given to his official acts.

Witness my hand and the Seal of said Court, this twelfth day of January A. D. 1867

Dennis B. Dwyer Clerk

NARA 1539

STATE OF MARYLAND, Calvert County, to wit;

I HEREBY certify that *Henry J. Salcott* Esquire, before whom the above affidavits were made, and who has thereto subscribed his name, was at the time of so doing, a Justice of the Peace of the said State, in and for Calvert County aforesaid, duly elected, commissioned and sworn, and that to all acts done by him in that capacity, full faith and credit are due and ought to be given, as well in Courts of Justice as thereout.

In testimony whereof I hereunto subscribe my name and affix the

seal of the Circuit Court for Calvert County this *12th*
day of *January* 18*67*

Dennis B. Dixon, Clerk of the

Circuit Court for Calvert County.



1867

Endorsement.

No. 171

APPLICATION OF

Sarah M Skinner

OF

Calvert Co. Md

for compensation for service of slave,

Charles Taylor

enlisted Oct 22, 1863,

in I. Co. Seventh Regiment

U. S. Colored Troops.

Received

July 24, 1867

Compensation awarded,

186

Dollars.

President Board of Claims.

P. O. ADDRESS OF CLAIMANT:

F P Stevens

Baerova

War Department,

ADJUTANT GENERAL'S OFFICE,

Washington, April 12th 1867.

Respectfully returned to the Commission for the State of Md. with the information that Charles Taylor

was enlisted at Calvert Co. Md. Oct 22nd 1863. and was mustered in as Pvt. in Co. "I" 7th Regt. U. S. Col. Troops 5/16/63

J. W. Hazard

Asst. Adj't General.

States, in the

to the approval of the provisions of Section 24, 28, 1866.

To

Chief of the B. Organizat

CLAIM FOR COMPENSATION FOR ENLISTED SLAVE.

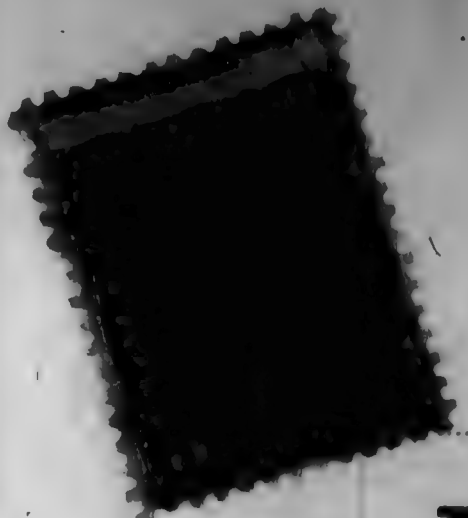

I, Sarah M Skinner a loyal citizen, and a resident of 2^d Election district, County of Seavers, State of Maryland, hereby claim compensation, under the provisions of Section 24, Act approved February 24, 1864, and Section 2, Act approved July 28, 1866, for my slave Charles Taylor, enlisted Oct 22^d 1863, at Camp Stanton Benedict, by Gen Am Birney, in the Seventh Regiment U. S. Colored Troops, Co. D; certificate of which enlistment and a descriptive list, as required, accompany this application.

In proof of my loyalty to the Constitution and Government of the United States, I present the accompanying oath, which I have taken, signed and acknowledged; to be filed with this application, in accordance with requirement of General Orders, No. 329, 1863, War Department, Adjutant General's Office.

Sarah M Skinner

11th Jan, 1867.

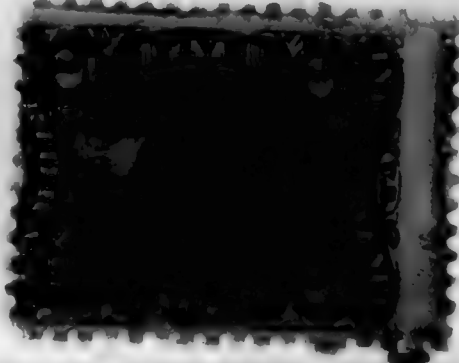

OATH OF ALLEGIANCE.

I, Sarah M Skinner, the owner and claimant, do solemnly swear that the foregoing claim is a just and true claim due to me as master and owner of the said slave, and that the facts alleged in said claim in respect to the draft or enlistment (as the case may be) of said slave into the military service of the United States are true. And I do further swear that I have never joined, or been concerned in, any insurrection or rebellion; that I have never borne arms against the United States; that I have never given any aid, countenance, counsel or encouragement to any person or persons engaged, or whom I had reason to believe were about to engage, in insurrection, rebellion or armed hostility against the United States; that I have neither sought, nor accepted, nor attempted to exercise the functions of any office, civil or military, nor to perform any service whatever, under any authority or pretended authority in hostility to the United States; that I have not yielded a voluntary support to any insurrection, rebellion or pretended government, authority, power or constitution within the United States hostile thereto. And I do further swear that, to the best of my knowledge and ability, I have supported and defended, and will continue to support and defend, the United States against all enemies, foreign and domestic; and that I have supported, defended and obeyed, and will continue to support, defend and obey, the Constitution and laws of the United States; that I will bear true faith and allegiance to the same; and that I take this oath freely, without any mental reservation or purpose of evasion: So help me God.

Sarah M Skinner

Sworn to and subscribed before me, at Prince,
Geoduck this 11th day of January, 1867.
Wm H. Scholtz, J. P.

1298

Taylor, Daniel

Co D, 7 U.S. Col'd Inf.

Private

Sergeant

CARD NUMBERS.

1	6 2 9 4 2 8 5	26
2	6 2 9 4 3 8 1	27
3	6 2 9 4 4 8 1	28
4	6 2 9 4 5 8 0	29
5	6 2 9 4 6 7 4	30
6	6 2 9 4 7 6 3	31
7	6 2 9 4 8 5 5	32
8	6 2 9 4 9 4 8	33
9	6 2 9 4 9 7 7	34
10	6 2 9 5 0 7 7	35
11	6 2 9 5 1 7 8	36
12	6 2 9 5 2 7 5	37
13	6 2 9 5 3 6 8	38
14	6 2 9 5 4 6 1	39
15	6 2 9 5 5 4 9	40
16	6 2 9 5 6 2 2	41
17	6 2 9 5 6 9 4	42
18	6 2 9 5 7 6 7	43
19	6 2 9 5 8 3 8	44
20	9 0 6 6 9 8 1	45
21		46
22		47
23		48
24		49
25		50

Book Mark:

See also

MAP 1549

S 64465-2 Ps. off
D. 2664367 *of m m*

Q

549
S. | 7 | U.S.C.T.

Daniel Taylor

, Co. G, 7 Reg't U. S. Col'd Inf.

Appears on

Company Descriptive Book

of the organization named above.

DESCRIPTION.

Age 19 years; height 5 feet 5 1/2 inches.

Complexion *Suff.*

Eyes *Blk.*; hair *Blk.*

Where born *Worcester, Md.*

Occupation *Farmer.*

ENLISTMENT.

When *Nov. 2*, 1863.

Where *Accomac, Va.*

By whom *Col. Wm. Birney*; term 3 y'rs.

Remarks: *Mustered in at Camp Stanton, Md. Nov. 5. 63. by Lt. Col. Haskelle.*

Appointed Corp. Nov 11. 63.

At sick at Beaufort, from Mar. 9. 64. to Aug. 64.

Appointed Sergt. Sept. 11. 65.

J. D. White.

1544

I | 7 | U.S.C.T.

Daniel Taylor

Pvt, Co. I, 7 Reg't U. S. Col'd Inf.

Age 19 years.

Appears on

Company Muster-in Roll

of the organization named above. Roll dated
Camp Stanton
Charles Co., Md, Nov. 5, 1863.

Muster-in to date Nov. 5, 1863

Joined for duty and enrolled:

When Nov. 2, 1863

Where Acomac, Va.

Period 3 years.

Remarks:

Book mark:

J. B. Gage

(856)

Copyist.

7

7

U.S.C.T.

Daniel Taylor

Pvt., Co. I, 7 Reg't U. S. Col'd Infantry.

Appears on

Company Muster Roll

for from Nov. 5, to Dec 31, 1863

Present or absent Present

Stoppage, \$ 100 for

Due Gov't, \$ 100 for

Remarks: Enlistment premium \$2.00 due

Book mark:

J. B. Gage

Copyist.

(358)

7 | 7 | U.S.C.T.

Daniel Taylor

Pvt., Co. I, 7 Reg't U. S. Col'd Infantry.

Appears on

Company Muster Roll

for Jan & Feb, 1864.

Present or absent Present

Stoppage, \$ 100 for

Due Gov't, \$ 100 for

Remarks: Enlistment premium \$2.00 due

Book mark:

J.B. Gage

Copyist.

J

7

U.S.C.T.

Daniel Taylor

Pvt

Co. I, 7 Reg't U. S. Col'd Infantry.

Appears on

Company Muster Roll

for *Mch & Apr*, 1864.

Present or absent *Absent*

Stoppage, \$ 100 for

Due Gov't, \$ 100 for

Remarks: *Stoppage for one
knapsack. Sick in Genl.
Hosp., Beaufort S.C., since
Mar. 9, 1864. Descrip. List sent.*

Book mark:

J B Gage

(358)

Copyist.

J | **7** | **U.S.C.T.**

Daniel Taylor

Pvt, Co. I, 7 Reg't U. S. Col'd Infantry.

Appears on

Company Muster Roll

for *May & June*, 1864.

Present or absent *Absent*

Stoppage, \$ *100* for

Due Gov't, \$ *100* for

Remarks: *Sick at Beaufort since
May 9, 1864 - Charge for 1
Bayonet.*

Book mark: *58022*

(358)

J B Gage
Copyist.

T | **7** | **U.S.C.T.**

Daniel Taylor

Prvt, Co. I, 7 Reg't U. S. Col'd Infantry.

Appears on

Company Muster Roll

for *July & Aug*, 186*4*.

Present or absent *Present*

Stoppage, \$ *100* for

Due Gov't, \$ *100* for

Remarks: *Stop pay for one
knapsack & one Bayonet.*

Book mark:

J. B. Gage

(858)

Copyist.

J | **7** | **U.S.C.T.**

Daniel Taylor
Pvt, Co. I, 7 Reg't U. S. Col'd Infantry.

Appears on

Company Muster Roll

for *Sept & Oct*, 186 *4*

Present or absent *Present*

Stoppage, \$ *100* for

Due Gov't, \$ *100* for

Remarks: *Stop for 1 Knapsack & 1 Haversack*

Book mark:

J B Gage

Copyist.

T

7

U.S.C.T.

Daniel Taylor

Priv, Co. I, 7 Reg't U. S. Col'd Infantry.

Appears on

Company Muster Roll

for *Nov. + Decr.*, 1864.

Present or absent *Present*

Stoppage, \$ *100* for

Due Gov't, \$ *100* for *One Knapsack, + One Haversack,*

Remarks:

Book mark:

D. Mahor
Copyist.

D

7

U.S.C.T.

Daniel Taylor

Corpl., Co. I, 7 Reg't U. S. Col'd Infantry.

Appears on

Company Muster Roll

for *Jan'y. & Feby.*, 1865.

Present or absent *Present*

Stoppage, \$ *100* for

Due Gov't, \$ *100* for

Remarks:

*Appointed Corpl. Feby 11. 65. S. O. No. 14. H. -
Drs. 7th U. S. C. T.*

Book mark:

D. Maher

(358)

Copyist.

D

7

U.S.C.T.

Daniel Taylor

Corpl, Co. I, 7 Reg't U. S. Col'd Infantry.

Appears on

Company Muster Roll

for *March & April*, 1865.

Present or absent *Present*

Stoppage, \$ 100 for

Due Gov't, \$ 100 for

Remarks:

*Appointed Corpl. Feby. 11. 65. S.O. 14,
H. 2. 7. U.S.C.T. From Private*

Book mark:

D. Maher

Copyist.

P

7

U.S.C.T.

Daniel Taylor
Corpl, Co. I, 7 Reg't U. S. Col'd Infantry.

Appears on

Company Muster Roll

for *May & June*, 1865.

Present or absent *Present*

Stoppage, \$ *100* for

Due Gov't, \$ *100* for

Remarks:

Appointed Corpl. Feby 11. '65. S.O. 14.

Book mark:

D. Mahor

(358)

Copyist.

T

7

U.S.C.T.

Daniel Taylor

Corpl., Co. I, 7 Reg't U. S. Col'd Infantry.

Appears on

Company Muster Roll

for July + Aug., 1865.

Present or absent Present

Stoppage, \$ 100 for

Due Gov't, \$ 67/100 for C. & G. Equipage

Remarks:

Appointed Corpl. Feby. 11. 65. S. O. 14.
H. 2rs. 7th. U.S.C.T. From Priv.

Book mark:

D. Maher

Copyist.

(358)

T

7

U.S.C.T.

Daniel Taylor

Serjt, Co. I, 7 Reg't U. S. Col'd Infantry.

Appears on

Company Muster Roll

for *Sept. + Oct.*, 1865.

Present or absent *Present*

Stoppage, \$ *100* for

Due Gov't, \$ *69* for *C + G, Equipage*.

Remarks:

*Appointed Serjt. Sept. 11. 65. S. O. 81,
H. Des. 7th U.S.C.T. - From Corpel.*

Book mark:

D. Maher
Copyist.

(358)

MAR 15 1867

T

7

U.S.C.T.

Daniel Taylor

Serqt, Co. I, 7 Reg't U. S. Col'd Infantry.

Appears on

Company Muster Roll

for *Nov. + Decr.*, 1865.

Present or absent *Present*

Stoppage, \$ *100* for

Due Gov't, \$ *69* for *C. & H. Equipage*

Remarks:

Book mark:

D. Maher

Copyist.

(358)

T | 7 | U.S.C.T.

Daniel Taylor

Cpl, Co. I, 7 Reg't U. S. Col'd Infantry.

Appears on

Company Muster Roll

for *Jan + Feb*, 186*6*.

Present or absent... *Present*

Stoppage, \$..... *100* for

Due Gov't, \$..... *100* for

Remarks:.....
.....
.....
.....
.....
.....
.....
.....
.....
.....
.....
.....

Book mark:.....
.....

(358)

Sabine
Copyist.

J

7

U.S.C.T.

Daniel Taylor

Sgt., Co. I, 7 Reg't U. S. Col'd Infantry.

Appears on

Company Muster Roll

for Mar. + Apr., 1866.

Present or absent Present.

Stoppage, \$ 100 for

Due Gov't, \$ 100 for

Remarks:

Book mark:

Sabine

Copyist.

NOV 1869

J

7

U.S.C.T.

Daniel Taylor

Sgt., Co. I, 7 Reg't U. S. Col'd Infantry.

Appears on

Company Muster Roll

for Oct. 28 to June 30, 1866.

Present or absent Not stated

Stoppage, \$ 100 for

Due Gov't, \$ 100 for

Remarks:

Book mark:

Sabine Copyist.

(358)

J

7

U.S.C.T.

Daniel Taylor

Sgt., Co. I, 7 Reg't U. S. Col'd Infantry.

Appears on

Company Muster Roll

for July & Aug, 1866.

Present or absent Present.

Stoppage, \$ 100 for

Due Gov't, \$ 100 for

Remarks:

Book mark:

Sabine

Copyist.

T

7

U.S.C.T.

Daniel Taylor

Sgt, Co I, 7 Reg't U. S. Col'd Infantry.

Appears on Co. Muster-out Roll, dated

Indianola, Md.,
October 13, 1866.

Muster-out to date Oct. 13, 1866.

Last paid to June 30, 1866.

Clothing account:

Last settled....., 186 ; drawn since \$..... 100

Due soldier \$ 12 79 100; due U. S. \$..... 100

Am't for cloth'g in kind or money adv'd \$..... 100

Due U. S. for arms, equipments, &c., \$ 6 100

Bounty paid \$..... 100; due \$ 100 100

Remarks: *Joined co. at original organization.*

Appointed corpl, Feb. 11, '65. Appointed sergt, Sep. 11, '65. Absent sick at Beaufort, S.C., from over

300.637/80

Book mark: *V. 171, P. 292, 73.*

Sabine

JAN. 21

6295838

ALB910

Mar. 9, '64, to Aug. '64.
Retains one S. P. un-
der act of accountment
per G. O. 101 War Dept.,
May 30, '65.

1299

Taylor, Daniel

Co *K*, 7 U.S. Col'd Inf.

Private

Private

CARD NUMBERS.

1	6296042	26
2	6296155	27
3	6297730	28
4	9067111	29
5		30
6		31
7		32
8		33
9		34
10		35
11		36
12		37
13		38
14		39
15		40
16		41
17		42
18		43
19		44
20		45
21		46
22		47
23		48
24		49
25		50

Book Mark:

See also

J. | 7 | U.S.C.T.

David Taylor

Co. K, 7 Reg't U.S. Col'd Inf.

Appears on
Company Descriptive Book
of the organization named above.

DESCRIPTION.

Age 19 years; height 5 feet 3 3/4 inches.

Complexion Black

Eyes Black; hair Black.

Where born Accomac, Virginia.

Occupation Steamer.

ENLISTMENT.

When Nov. 4, 1863.

Where Drummondtown

By whom W. H. Birney; term 3 y'rs.

Remarks: Mustered into serv. at
Camp Stanton, Chas. Co.
Md. by Lt. Col. Laskell.
Nov. 12. 63.

Died at Camp Hosp.
Benedict, Md. Dec. 15. 63.

Cause: Congestive Chills.

A. J. White

7 | U.S.C.T.

Daniel Taylor
Privt, Co K, 7 Reg't U. S. Col'd Inf.

Age 19 years.

Appears on

Company Muster-in Roll

of the organization named above. Roll dated
Camp Stanton
Charles Co. Md., Nov. 12, 1863.

Muster-in to date Nov. 12, 1863

Joined for duty and enrolled:

When Nov 4, 1863.

Where Accomac Va.

Period 3 years.

Remarks:

Book mark:

D. M. Kennedy
Copyist.

Y | **7** | **U.S.C.T.**

Daniel Taylor
Privt, Co. K, 7 Reg't U. S. Col'd Infantry.

Appears on

Company Muster Roll

for *Nov. 12 to Dec 31*, 186*3*.

Present or absent _____

Stoppage, \$ _____ *100* for _____

Due Gov't, \$ _____ *100* for _____

Remarks: *Died in Hospital*
in Comp. Dec 15 1863.
Enlistment Premium \$2.00
two dollars due.

Book mark: _____

D. M. Kennedy

G

7

U.S.C.T.

Daniel Taylor
Pot., Co. *K*, 7 Reg't U. S. Col'd Inf.

Appears on Co. Muster-out Roll, dated
Indianola, Texas, Oct. 13, 1866.

Muster-out to date _____, 186 .

Last paid to *paydne from Muster* 186 .

Clothing account:

Last settled _____, 186 ; drawn since \$ _____ 100

Due soldier \$ _____ 100; due U. S. \$ _____ 100

Am't for cloth'g in kind or money adv'd \$ _____ 100

Due U. S. for arms, equipments, &c., \$ _____ 100

Bounty paid \$ _____ 100; due \$ _____ 100

Remarks: *Died in Hosp. at Camp*
Stanton, Md. Dec. 15. 1863, of
Congestive Chills, Final
Statements rendered Dec.
18" 1863

Book mark: *F. S.*

Taylor, Daniel

P, Co. K, 7 Reg't U. S. C. Inf.

6 Enclosures.

Bed Cards	Descriptive Lists
Burial Records	Final Statements <i>2</i>
Certs. of Dis. for Discharge	Furloughs
C. M. Charges	Med. Des. Lists
Med. Certificates	Orders

Other papers relating to—

Admission to Hosp'l	Furlough
Casualty Sheet (Officer's)	Med. Examination
Confinement	Misc. Information
Contracts	Pay or Clothing
Death or Effects <i>3</i>	Personal Reports
Desertions	Rank
Discharge from Hosp'l	Transfer to Hosp'l
Discharge from Service	Transfer to V. R. C.
Duty	Transportation

ARTICLES OF WAR.

ART. 95. When any non-commissioned officer or soldier shall die, or be killed in the service of the United States, the then commanding officer of the troop or company shall, in the presence of two other commissioned officers, take an account of what effects he died possessed of, above his arms and accoutrements, and transmit the same to the office of the Department of War, which said effects are to be accounted for, and paid to the representatives of such deceased non-commissioned officer or soldier. And in case any of the officers, so authorized to take care of the effects of deceased officers and soldiers, should, before they have accounted to their representatives for the same, have occasion to leave the regiment or post, by preferment or otherwise, they shall, before they be permitted to quit the same, deposit in the hands of the commanding officer, or of the assistant military agent, all the effects of such deceased non-commissioned officers and soldiers, in order that the same may be secured for, and paid to, their respective representatives.

ARMY REGULATIONS—EDITION OF 1861.

DECEASED SOLDIERS.

Par. 152. Inventories of the effects of deceased non-commissioned officers and soldiers, required by the 95th Article of War, will be forwarded to the Adjutant General, by the commander of the company to which the deceased belonged, and a duplicate of the same to the colonel of the regiment. Final statements of pay, clothing, &c., will be sent with the inventories. When a soldier dies at a post or station absent from his company, it will be the duty of his immediate commander to furnish the required inventory, and, at the same time, to forward to the commanding officer of the company to which the soldier belonged, a report of his death, specifying the date, place, and cause; to what time he was last paid, and the money or other effects in his possession at the time of his decease; which report will be noted on the next muster-roll of the company to which the man belonged. Each inventory will be endorsed, "Inventory of the effects of _____, late of company (—) _____ regiment of _____, who died at _____, the _____ day of _____, 186—." If a legal representative receive the effects, it will be stated in the report. If the soldier leave no effects, the fact will be reported.

Par. 153. Should the effects of a deceased non-commissioned officer or soldier not be administered upon within a short period after his decease, they shall be disposed of by a Council of Administration, under the authority of the commanding officer of the post, and the proceeds deposited with the Paymaster, to the credit of the United States, until they shall be claimed by the legal representatives of the deceased.

Par. 154. In all such cases of sales by the Council of Administration, a statement in detail, or account of the proceeds, duly certified by the Council and commanding officer, accompanied by the Paymaster's receipt for the proceeds, will be forwarded by the commanding officer to the Adjutant General. The statement will be endorsed, "Report of the proceeds of the effects of _____, late of company (—) _____ regiment of _____, who died at _____, the _____ day of _____, 186—."

NOTE 1.—The effects in all cases, when called for, should be turned over to the legal representative, without further authority from the Adjutant General. When the effects are turned over to the relatives of the deceased before these inventories are sent to the Adjutant General, their receipts therefor should be attached to the inventories. In all other cases, one copy will be sent with a letter of transmittal direct to the Adjutant General, and a duplicate retained by the officer.

NOTE 2.—Particular care should be taken to take receipts in duplicate from the Paymaster for any funds turned over to him; one copy should be sent direct to the Adjutant General and one retained by the officer.

INVENTORY OF THE EFFECTS

OF

Daniel Taylor

Late of Company *"H"*

4th Reg't of *N.S. Cold's Troop*

Volunteers, who died at *Camp Stanton,*

on the *16th* day of *December* 1863.



Inventory of the effects of Daniel Taylor late
 a Private of Captain Chas. L. Rice Company "H" of
 the 7th Regiment of U.S. Col'd Troops Volunteers, who was enrolled as
 a Private at _____ in the State of _____ on
 the 4 day of November 1863, and mustered into the service of the United
 States as a Private on the 12th day of November 1863, at Camp Stanton
 in Company H, 7th Regiment of U.S. Col'd Troops Volunteers, to serve Three
 years or during the war; he was born in Accomack County in the State
 of Virginia; he was 19 years of age, 5 feet 3 1/2 inches
 high, Black complexion, Black eyes, Black hair, and by occupation, when enrolled,
 a Farmer; he died in Hospital in
Camp on the 16th day of December 1863, by
 reason of Congestive Chills

INVENTORY.					
ARTICLES.	No.	ARTICLES.	No.	ARTICLES.	No.
Hats		Pairs trousers		Knapsacks	
Caps		Pairs flannel drawers	1		
Forage caps	1	Pairs cotton drawers			
Great coats	1	Flannel shirts	1		
Uniform coats	1	Cotton shirts			
Uniform jackets		Pairs boots			
Flannel sack coats		Pairs shoes	1		
Blouses		Pairs socks	1		
Stable frocks		Blankets	1		
Fatigue overalls		Haversacks <u>Painted Rubber</u>	1		
				MONEY.	
				Specie	\$
				Notes	\$

I CERTIFY, ON HONOR, that the above inventory comprises all the effects of Daniel Taylor, deceased, and that the effects are in the hands of Capt. Chas. L. Rice at Camp Stanton to be disposed of by a Council of Administration.

(DUPLICATES.)

STATION: Camp Stanton Ind,
 DATE: Dec 21 1863

Chas. L. Rice
Capt. U.S.A.
 Commanding the Company.

NARA 1572

ARTICLES OF WAR.

ART. 95. When any non-commissioned officer or soldier shall die, or be killed in the service of the United States, the then commanding officer of the troop or company shall, in the presence of two other commissioned officers, take an account of what effects he died possessed of, above his arms and accoutrements, and transmit the same to the office of the Department of War, which said effects are to be accounted for, and paid to the representatives of such deceased non-commissioned officer or soldier. And in case any of the officers, so authorized to take care of the effects of deceased officers and soldiers, should, before they have accounted to their representatives for the same, have occasion to leave the regiment or post, by preferment or otherwise, they shall, before they be permitted to quit the same, deposit in the hands of the commanding officer, or of the assistant military agent, all the effects of such deceased non-commissioned officers and soldiers, in order that the same may be secured for, and paid to, their respective representatives.

ARMY REGULATIONS—EDITION OF 1861.

DECEASED SOLDIERS.

Par. 152. Inventories of the effects of deceased non-commissioned officers and soldiers, required by the 95th Article of War, will be forwarded to the Adjutant General, by the commander of the company to which the deceased belonged, and a duplicate of the same to the colonel of the regiment. Final statements of pay, clothing, &c., will be sent with the inventories. When a soldier dies at a post or station absent from his company, it will be the duty of his immediate commander to furnish the required inventory, and, at the same time, to forward to the commanding officer of the company to which the soldier belonged, a report of his death, specifying the date, place, and cause; to what time he was last paid, and the money or other effects in his possession at the time of his decease; which report will be noted on the next muster-roll of the company to which the man belonged. Each inventory will be endorsed, "Inventory of the effects of _____, late of company (—) _____ regiment of _____, who died at _____, the _____ day of _____, 186—." If a legal representative receive the effects, it will be stated in the report. If the soldier leave no effects, the fact will be reported.

Par. 153. Should the effects of a deceased non-commissioned officer or soldier not be administered upon within a short period after his decease, they shall be disposed of by a Council of Administration, under the authority of the commanding officer of the post, and the proceeds deposited with the Paymaster, to the credit of the United States, until they shall be claimed by the legal representatives of the deceased.

Par. 154. In all such cases of sales by the Council of Administration, a statement in detail, or account of the proceeds, duly certified by the Council and commanding officer, accompanied by the Paymaster's receipt for the proceeds, will be forwarded by the commanding officer to the Adjutant General. The statement will be endorsed, "Report of the proceeds of the effects of _____, late of company (—) _____ regiment of _____, who died at _____, the _____ day of _____, 186—."

NOTE 1.—The effects in all cases, when called for, should be turned over to the legal representative, without further authority from the Adjutant General. When the effects are turned over to the relatives of the deceased before these inventories are sent to the Adjutant General, their receipts therefor should be attached to the inventories. In all other cases, one copy will be sent with a letter of transmittal direct to the Adjutant General, and a duplicate retained by the officer.

NOTE 2.—Particular care should be taken to take receipts in duplicate from the Paymaster for any funds turned over to him; one copy should be sent direct to the Adjutant General and one retained by the officer.

INVENTORY OF THE EFFECTS

OF

Daniel Taylor
Late of Company "A"

7th
21st Reg't of U.S. Col'd Troops

Volunteers, who died at *Camp Hunterdon*

on the *16th* day of *December* 1863.



Inventory of the effects of Daniel Taylor late
 a Private of Captain Chas. Le Rife Company "K" of
 the 7th Regiment of Vol. Artillery Volunteers, who was enrolled as
 a Private at _____ in the State of _____ on
 the 4 day of November 1863, and mustered into the service of the United
 States as a Private on the 12th day of November 1863, at Camp Stanton Va.
 in Company "K", 7th Regiment of Vol. Artillery Volunteers, to serve Three
 years or during the war; he was born in Acorn in the State
 of Virginia; he was 39 years of age, 5 feet 3 3/4 inches
 high, Black complexion, Blue eyes, Black hair, and by occupation, when enrolled,
 a Farmer; he died in Hopewell, at
Camp Stanton Va. on the 15th day of December 1863, by
 reason of Congestive Chills

INVENTORY.					
ARTICLES.	No.	ARTICLES.	No.	ARTICLES.	No.
Hats		Pairs trousers		Knapsacks	
Caps		Pairs flannel drawers	1		
Forage caps	1	Pairs cotton drawers	1		
Great coats	1	Flannel shirts	1		
Uniform coats	1	Cotton shirts			
Uniform jackets		Pairs boots			
Flannel sack coats		Pairs shoes	1		
Blouses		Pairs socks	1		
Stable frocks		Blankets	1		
Fatigue overalls		<u>1</u> <u>Printed Blusser</u>	1		
				MONEY.	
					Specie
				Notes	\$

I CERTIFY, ON HONOR, that the above inventory comprises all the effects of Daniel Taylor, deceased, and that the effects are in the hands of Capt. Charles Le Rife at Camp Stanton Va. Charles Le Rife to be disposed of by a Council of Administration.

(DUPLICATES.)

STATION: Camp Stanton Va.

DATE: Dec 21st 1863

Chas. Le Rife
Capt. 7th Vol. Artillery
 Commanding the Company.

ARTICLES OF WAR.

ART. 95. When any non-commissioned officer or soldier shall die, or be killed in the service of the United States, the then commanding officer of the troop or company shall, in the presence of two other commissioned officers, take an account of what effects he died possessed of, above his arms and accoutrements, and transmit the same to the office of the Department of War, which said effects are to be accounted for, and paid to the representatives of such deceased non-commissioned officer or soldier. And in case any of the officers, so authorized to take care of the effects of deceased officers and soldiers, should, before they have accounted to their representatives for the same, have occasion to leave the regiment or post, by preferment or otherwise, they shall, before they be permitted to quit the same, deposit in the hands of the commanding officer, or of the assistant military agent, all the effects of such deceased non-commissioned officers and soldiers, in order that the same may be secured for, and paid to, their respective representatives.

ARMY REGULATIONS—EDITION OF 1861.

DECEASED SOLDIERS.

Par. 152. Inventories of the effects of deceased non-commissioned officers and soldiers, required by the 95th Article of War, will be forwarded to the Adjutant General, by the commander of the company to which the deceased belonged, and a duplicate of the same to the colonel of the regiment. Final statements of pay, clothing, &c., will be sent with the inventories. When a soldier dies at a post or station absent from his company, it will be the duty of his immediate commander to furnish the required inventory, and, at the same time, to forward to the commanding officer of the company to which the soldier belonged, a report of his death, specifying the date, place, and cause; to what time he was last paid, and the money or other effects in his possession at the time of his decease; which report will be noted on the next muster-roll of the company to which the man belonged. Each inventory will be endorsed, "Inventory of the effects of _____, late of company (—) _____ regiment of _____, who died at _____, the _____ day of _____, 186—." If a legal representative receive the effects, it will be stated in the report. If the soldier leave no effects, the fact will be reported.

Par. 153. Should the effects of a deceased non-commissioned officer or soldier not be administered upon within a short period after his decease, they shall be disposed of by a Council of Administration, under the authority of the commanding officer of the post, and the proceeds deposited with the Paymaster, to the credit of the United States, until they shall be claimed by the legal representatives of the deceased.

Par. 154. In all such cases of sales by the Council of Administration, a statement in detail, or account of the proceeds, duly certified by the Council and commanding officer, accompanied by the Paymaster's receipt for the proceeds, will be forwarded by the commanding officer to the Adjutant General. The statement will be endorsed, "Report of the proceeds of the effects of _____, late of company (—) _____ regiment of _____, who died at _____, the _____ day of _____, 186—."

NOTE 1.—The effects in all cases, when called for, should be turned over to the legal representative, without further authority from the Adjutant General. When the effects are turned over to the relatives of the deceased before these inventories are sent to the Adjutant General, their receipts therefor should be attached to the inventories. In all other cases, one copy will be sent with a letter of transmittal direct to the Adjutant General, and a duplicate retained by the officer.

NOTE 2.—Particular care should be taken to take receipts in duplicate from the Paymaster for any funds turned over to him; one copy should be sent direct to the Adjutant General and one retained by the officer.

INVENTORY OF THE EFFECTS

OF

Daniel Taylor

Late of Company *14th*

7th Reg't of *U.S. Artillery*

Volunteers, who died at *Camp Streator*

on the *12th* day of *December* 1863.

INVENTORY

Inventory of the effects of Daniel Taylor late
a Private of Captain Chas. S. Rice Company "H" of
the 7th Regiment of N. S. Col. Grays Volunteers, who was enrolled as
a Private at _____ in the State of _____ on
the 4th day of November 1863, and mustered into the service of the United
States as a Private on the 12th day of November 1863, at Camp Stanton Md
in Company "H", 7th Regiment of N. S. Col. Grays Volunteers, to serve Three
years or during the war; he was born in Accomack in the State
of Virginia; he was 19 years of age, 6' feet 8 $\frac{1}{2}$ inches
high, Black complexion, Black eyes, Black hair, and by occupation, when enrolled,
a Farmer; he died in Hospital at
Camp Stanton Md on the 16th day of December 1863, by
reason of Congestive Chills

INVENTORY.									
ARTICLES.	No.	ARTICLES.	No.	ARTICLES.	No.				
Hats		Pairs trousers		Knapsacks					
Caps		Pairs flannel drawers	1						
Forage caps	1	Pairs cotton drawers							
Great coats	1	Flannel shirts	1						
Uniform coats	1	Cotton shirts							
Uniform jackets		Pairs boots		<table border="1" style="width: 100%; border-collapse: collapse;"> <tr> <td rowspan="2" style="text-align: center; vertical-align: middle;">MONEY.</td> <td style="text-align: right;">Specie</td> <td style="text-align: center;">\$</td> </tr> <tr> <td style="text-align: right;">Notes</td> <td style="text-align: center;">\$</td> </tr> </table>	MONEY.	Specie	\$	Notes	\$
MONEY.	Specie	\$							
	Notes	\$							
Flannel sack coats		Pairs shoes	1						
Blouses	1	Pairs socks	1						
Stable frocks		Blankets	1						
Fatigue overalls		Blankets <u>Painted Rubber</u>	1						

I CERTIFY, ON HONOR, that the above inventory comprises all the effects of _____
Daniel Taylor, deceased, and that the effects are in the hands
of Chas. S. Rice Capt., at Camp Stanton Md
to be disposed of by a Council of Administration.

(DUPLICATES.)

STATION: Camp Stanton Md

DATE: Dec 31st 1863

Chas. S. Rice
Co. "H" 7th Regt. N. S. Col. Grays
Capt. Commanding the Company.

1869

29

FINAL STATEMENT

Duplicate
OF
H.M.

Daniel Taylor

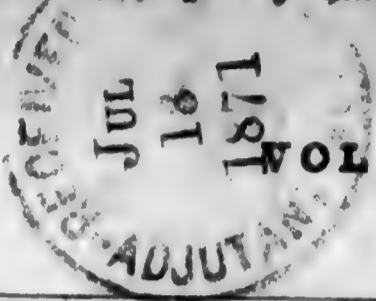
Late of Co. "B"
7th Reg't of U.S. Col'd Grps

VOLUNTEERS.

NOTE 1.—Two of these certificates (or duplicates) are to be given to each Volunteer Soldier or drafted man who may be discharged previously to the discharge of his company, that he may at once receive from the Paymaster the pay, &c., due him, and the captain or other COMMISSIONED officer commanding the company will certify to the act of the delivery of the duplicate certificates; on these certificates the Soldier is "entitled to" his discharge, and should also present his discharge to the Paymaster to have the payment endorsed on it. The discharge is to be given back to the Soldier by the Paymaster; the latter only retaining as his voucher the duplicate certificates.

NOTE 2.—If the Soldier is entitled to pay for the use of his horse, the Company Commander will certify to that fact on the back of both these final statements, and also to the time he has pay due for having been so mounted on his own horse.

NOTE 3.—When a Soldier is furnished with final statements, his descriptive list, if he has one, should be taken up by the officer who gives the Soldier these statements, and endorsed with a statement to this effect by the officer. This endorsement should exhibit a full statement of the time for which the Soldier was allowed pay on his final statements, the clothing account, and all other charges against him or in his favor, so as to comprise a complete exhibit of his account. It will then be transmitted to the company commander of the Soldier, who will enter all the data necessary to a full understanding of the Soldier's account on the muster roll upon which the Soldier's discharge is reported. The descriptive list will then be destroyed. The object of this is, that the remaining portion of the Soldier's account may be settled upon the receipt of these muster rolls, and the Soldier receive any pay or allowances that may be due him at the time of his discharge, and which may not appear on his final statements from the fact that his descriptive list is incomplete. These accounts for back pay, &c., are settled by the 2d Auditor of the Treasury Department.

NOTE 4.—Charges for loss or injury to ordnance, horse equipments, and other miscellaneous charges, should appear under the heading of "Other Stoppages."

NOTE 5.—Bounty paid by State authorities, and not by the United States, will not be entered on this statement.

NOTE 6.—Amounts due the Sutler and Laundress must be entered on the muster list on which the discharge, death, desertion, &c., is reported, as well as on the final statement, otherwise the amount cannot be collected from the United States.

NOTE 7.—This blank will be used for deceased volunteers and drafted men, as well as for others.

NOTE 8.—Where a Soldier dies in Hospital or on detached service, his descriptive list, if he has one, should be sent with his final statements, in duplicate, to the Second Auditor, Washington, D. C.

I certify, on honor, that Daniel Taylor, late a Private of
 Captain Chas. Rice Company (K) of the 7th Regiment of 40th Col. Inf.
~~VOLUNTEERS~~ of the State of _____, born in Alabama, State
 of Virginia, aged 19 years; 5 feet 3 3/4 inches high; Black complexion,
Black eyes, Black hair, and by occupation a Farmer, having joined the company on
 its original organization at Camp Stanton Ind. and enrolled in it at the muster into
 the service of the United States at Camp Stanton Ind. on the 12th day
 of November, 1863, (or was mustered in service as a recruit, by _____
 _____, at _____, on the Fourth day of November
 1863, or was drafted and mustered into the service of the United States from the _____
 Enrollment District of the State of _____, at _____,
 on the _____ day of _____, 186 .) to serve in the Regiment, for
 the term of Three years or during the war; and having served **HONESTLY** and
FAITHFULLY with his Company in _____ to the present date, is now
 entitled to a **DISCHARGE** by reason of Death

The said Daniel Taylor ^{Has never received} was last paid by Paymaster
any pay to include the _____ day of _____, 186 , and has
 pay due him from ^{the date of enlistment} _____ to the present date; he is entitled to pay and subsistence for
TRAVELING to place of enrollment, and whatever other allowances are authorized to volunteer
 soldiers, drafted men, or militia, so discharged. He has received from the United States **CLOTHING**
 amounting to (23.22) thirty three dollars since the 4th day of November
 1863, when his clothing account was last settled. He has received from the United States
 _____ dollars advanced **BOUNTY**.

There is to be stopped from him, on account of the State of _____, or other
 authorities, for **CLOTHING**, &c, received on entering service, _____ dollars; and
 for other stoppages, viz: _____

_____ dollars.
 He has been furnished with **TRANSPORTATION** in kind from the place of his discharge to
 _____; and he has been **SUBSISTED** for **TRAVELING** to his
 place of enrollment, up to the _____, 186 .

He is indebted to _____, **SUTLER**, _____ dollars.
 He is indebted to _____, **LAUNDRESS**, _____ dollars.

Given in Duplicate, at Camp Stanton Ind., this 21st day
 of December, 1863.

Chas. Rice
 Co. K. 7th Regt. I. S. C. I.
 Capt., Commanding Company.

1863

63

FINAL STATEMENT

Dup^{of} +

Donald Taylor
Sgt of Co 17th
705 Reg't of Inf. Col'd Troops

1871
1871
1871
VOLUNTEERS.

NOTE 1.—Two of these certificates (or duplicates) are to be given to each Volunteer Soldier or drafted man who may be discharged previously to the discharge of his company, that he may at once receive from the Paymaster the pay, &c., due him, and the captain or other COMMISSIONED officer commanding the company will certify to the act of the delivery of the duplicate certificates; on these certificates the Soldier is "entitled to" his discharge, and should also present his discharge to the Paymaster to have the payment endorsed on it. The discharge is to be given back to the Soldier by the Paymaster; the latter only retaining as his voucher the duplicate certificates.

NOTE 2.—If the Soldier is entitled to pay for the use of his horse, the Company Commander will certify to that fact on the back of both these final statements, and also to the time he has pay due for having been so mounted on his own horse.

NOTE 3.—When a Soldier is furnished with final statements, his descriptive list, if he has one, should be taken up by the officer who gives the Soldier these statements, and endorsed with a statement to this effect by the officer. This endorsement should exhibit a full statement of the time for which the Soldier was allowed pay on his final statements, the clothing account, and all other charges against him or in his favor, so as to comprise a complete exhibit of his account. It will then be transmitted to the company commander of the Soldier, who will enter all the data necessary to a full understanding of the Soldier's account on the muster roll upon which the Soldier's discharge is reported. The descriptive list will then be destroyed. The object of this is, that the remaining portion of the Soldier's account may be settled upon the receipt of these muster rolls, and the Soldier receive any pay or allowances that may be due him at the time of his discharge, and which may not appear on his final statements from the fact that his descriptive list is incomplete. These accounts for back pay, &c., are settled by the 2d Auditor of the Treasury Department.

NOTE 4.—Charges for loss or injury to ordnance, horse equipments, and other miscellaneous charges, should appear under the heading of "Other Stoppages."

NOTE 5.—Bounty paid by State authorities, and not by the United States, will not be entered on this statement.

NOTE 6.—Amounts due the Sutler and Laundress must be entered on the muster roll on which the discharge, death, desertion, &c., is reported, as well as on the final statement, otherwise the amount cannot be collected from the United States.

NOTE 7.—This blank will be used for deceased volunteers and drafted men, as well as for others.

NOTE 8.—Where a Soldier dies in Hospital or on detached service, his descriptive list, if he has one, should be sent with his final statements, in duplicate, to the Second Auditor, Washington, D. C.

I certify, on honor, that Daniel Taylor a Private of
 Captain Charles Rice Company (K) of the 1st Regiment of W. Va. Cold Grps
VOLUNTEERS, of the State of West Virginia, born in Beersville, State
 of Virginia, aged 19 years; 5 feet 3 1/2 inches high; Black complexion,
Black eyes, Black hair, and by occupation a Farmer, having joined the company on
 its original organization at Camp Stanton Md, and enrolled in it at the muster into
 the service of the United States at Camp Stanton Md, on the 12th day
 of November, 1868, (or was mustered in service as a recruit, by
 _____, at _____, on the Fourth day of November,
 1868, or was drafted and mustered into the service of the United States from the _____
 Enrollment District of the State of _____, at _____,
 on the _____ day of _____, 186 ,) to serve in the Regiment, for
 the term of Three years or during the war, and having served **HONESTLY** and
FAITHFULLY with his Company in 1st Regt W. Va. C. G. to the present date, is now
 entitled to a **DISCHARGE** by reason of Death

The said Daniel Taylor ~~has never received~~ was last paid by Paymaster
 _____ on _____ day of _____, 186 , and has
 pay due him from that time to the present date; he is entitled to pay and subsistence for
TRAVELING to place of enrollment, and whatever other allowances are authorized to volunteer
 soldiers, drafted men, or militia, so discharged. He has received from the United States **CLOTHING**
 amounting to 22.19 dollars since the _____ day of _____,
 186 , when his clothing account was last settled. He has received from the United States
 _____ dollars advanced **BOUNTY**.

There is to be stopped from him, on account of the State of _____, or other
 authorities, for **CLOTHING**, &c., received on entering service, _____ dollars; and
 for other stoppages, viz: _____

_____ dollars.
 He has been furnished with **TRANSPORTATION** in kind from the place of his discharge to
 _____; and he has been **SUBSISTED** for **TRAVELING** to his
 place of enrollment, up to the _____, 186 .

He is indebted to _____, **SUTLER**, _____ dollars.
 He is indebted to _____, **LAUNDRESS**, _____ dollars.

Given in Duplicate, at Camp Stanton Md, this 31st day
 of December, 1868.

Charles Rice
 Co. "K" 1st Regt. W. Va. Cold Grps
 Capt. Commanding Company.

Adm. Sept 29. 1863
Prof C of Adm. and
P. m. rec for 11. 36
sent 2d. Aud
H.

ADJUTANT GENERAL'S OFFICE,

Feb 11th 1864

Duplicate, with Inventory, sent 2d

Auditor.

✓ 29
FINAL STATEMENT

OF

Daniel Taylor
Sgt of Co 196th
7th Reg't of U.S. Col'd Troops

VOLUNTEERS.

Dec 15/63

NOTE 1.—Two of these certificates (or duplicates) are to be given to each Volunteer Soldier or drafted man who may be discharged previously to the discharge of his company, that he may at once receive from the Paymaster the pay, &c., due him, and the captain or other COMMISSIONED officer commanding the company will certify to the act of the delivery of the duplicate certificates; on these certificates the Soldier is "entitled to" his discharge, and should also present his discharge to the Paymaster to have the payment endorsed on it. The discharge is to be given back to the Soldier by the Paymaster; the latter only retaining as his voucher the duplicate certificates.

NOTE 2.—If the Soldier is entitled to pay for the use of his horse, the Company Commander will certify to that fact on the back of both these final statements, and also to the time he has pay due for having been so mounted on his own horse.

NOTE 3.—When a Soldier is furnished with final statements, his descriptive list, if he has one, should be taken up by the officer who gives the Soldier these statements, and endorsed with a statement to this effect by the officer. This endorsement should exhibit a full statement of the time for which the Soldier was allowed pay on his final statements, the clothing account, and all other charges against him or in his favor, so as to comprise a complete exhibit of his account. It will then be transmitted to the company commander of the Soldier, who will enter all the data necessary to a full understanding of the Soldier's account on the muster roll upon which the Soldier's discharge is reported. The descriptive list will then be destroyed. The object of this is, that the remaining portion of the Soldier's account may be settled upon the receipt of these muster rolls, and the Soldier receive any pay or allowances that may be due him at the time of his discharge, and which may not appear on his final statements from the fact that his descriptive list is incomplete. These accounts for back pay, &c., are settled by the 2d Auditor of the Treasury Department.

NOTE 4.—Charges for loss or injury to ordnance, horse equipments, and other miscellaneous charges, should appear under the heading of "Other Stoppages."

NOTE 5.—Bounty paid by State authorities, and not by the United States, will not be entered on this statement.

NOTE 6.—Amounts due the Sutler and Laundress must be entered on the muster roll on which the discharge, death, desertion, &c., is reported, as well as on the final statement, otherwise the amount cannot be collected from the United States.

NOTE 7.—This blank will be used for deceased volunteers and drafted men, as well as for others.

NOTE 8.—Where a Soldier dies in Hospital or on detached service, his descriptive list, if he has one, should be sent with his final statements, in duplicate, to the Second Auditor, Washington, D. C.

Edson T. Roof

NARA 1581

I certify, on honor, that Daniel Taylor a Private of
 Captain Chas. L. Rice Company "K" of the 7th Regiment of N.S. Col. Inf.
VOLUNTEERS, of the State of _____, born in Acorn, State
 of Virginia, aged 19 years; 5' feet 8 1/2 inches high; Black complexion,
Black eyes, Black hair, and by occupation a Farmer, having joined the company on
 its original organization at Camp Stanton Va., and enrolled in it at the muster into
 the service of the United States at Camp Stanton Va., on the 12th day
 of November, 1863, (or was mustered in service as a recruit, by
 _____, at _____, on the fourth day of November
 1863, or was drafted and mustered into the service of the United States from the
 Enrollment District of the State of _____, at _____,
 on the _____ day of _____, 186) to serve in the Regiment, for
 the term of Three years or during the war; and having served **HONESTLY** and
FAITHFULLY with his Company in _____ to the present date, is now
 entitled to a **DISCHARGE** by reason of Death

The said Daniel Taylor ^{has never received} was last paid by Paymaster
 _____ ^{any} 200 dollars to include the _____ day of _____, 186 , and has
 pay due him from that time to the present date; he is entitled to pay and subsistence for
TRAVELING to place of enrollment, and whatever other allowances are authorized to volunteer
 soldiers, drafted men, or militia, so discharged. He has received from the United States **CLOTHING**
 amounting to \$6.72 ^{Twenty six dollars seventy two cts} dollars, since the fourth day of November,
 1863, when his clothing account was last settled. He has received from the United States
 _____ dollars advanced **BOUNTY**.

There is to be stopped from him, on account of the State of _____, or other
 authorities, for **CLOTHING**, &c, received on entering service, _____ dollars; and
 for other stoppages, viz: _____

_____ dollars.
 He has been furnished with **TRANSPORTATION** in kind from the place of his discharge to
 _____; and he has been **SUBSISTED** for **TRAVELING** to his
 place of enrollment, up to the _____, 186 .

He is indebted to _____, **SUTLER**, _____ dollars.
 He is indebted to _____, **LAUNDRESS**, _____ dollars.

Given in Duplicate, at Camp Stanton Va., this 31st day
 of December, 1863.

Chas. L. Rice
C. "K" 7th N.S. Co. I.
Capt. Commanding Company.

MICROCOPY

1820

ROLL

106

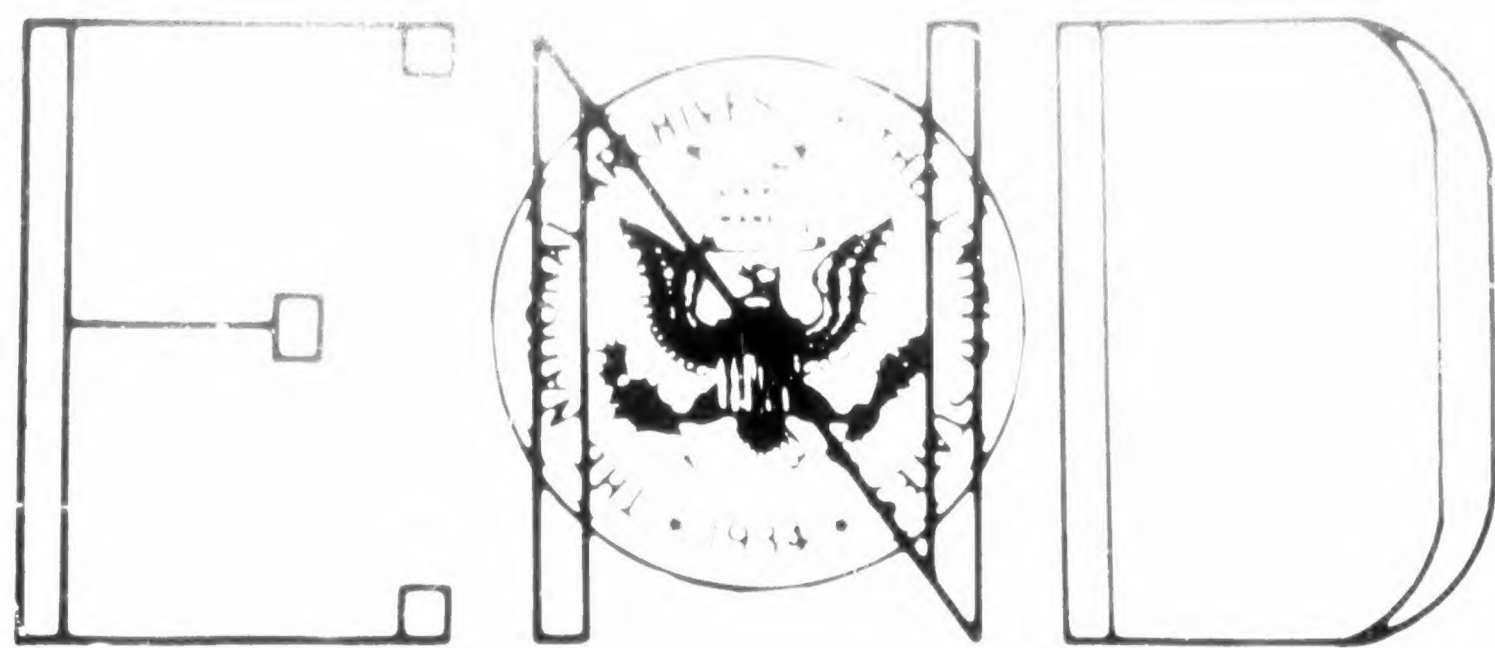
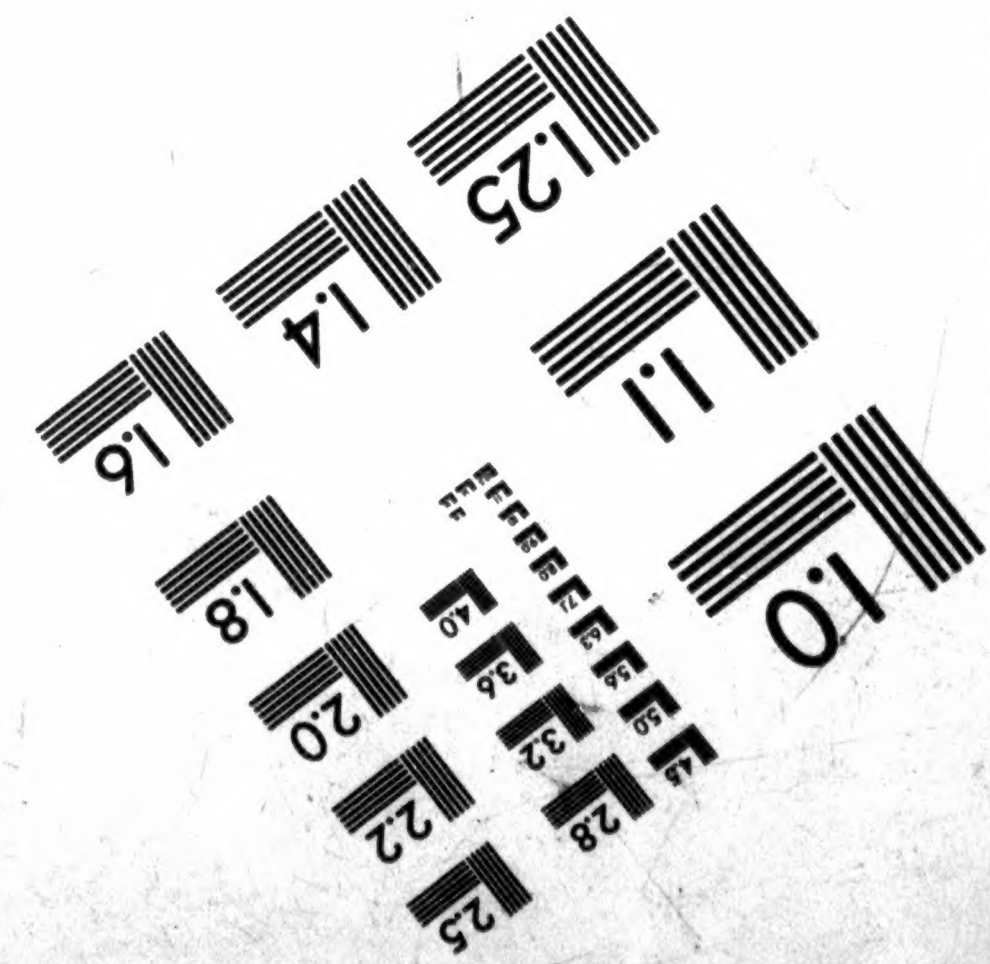
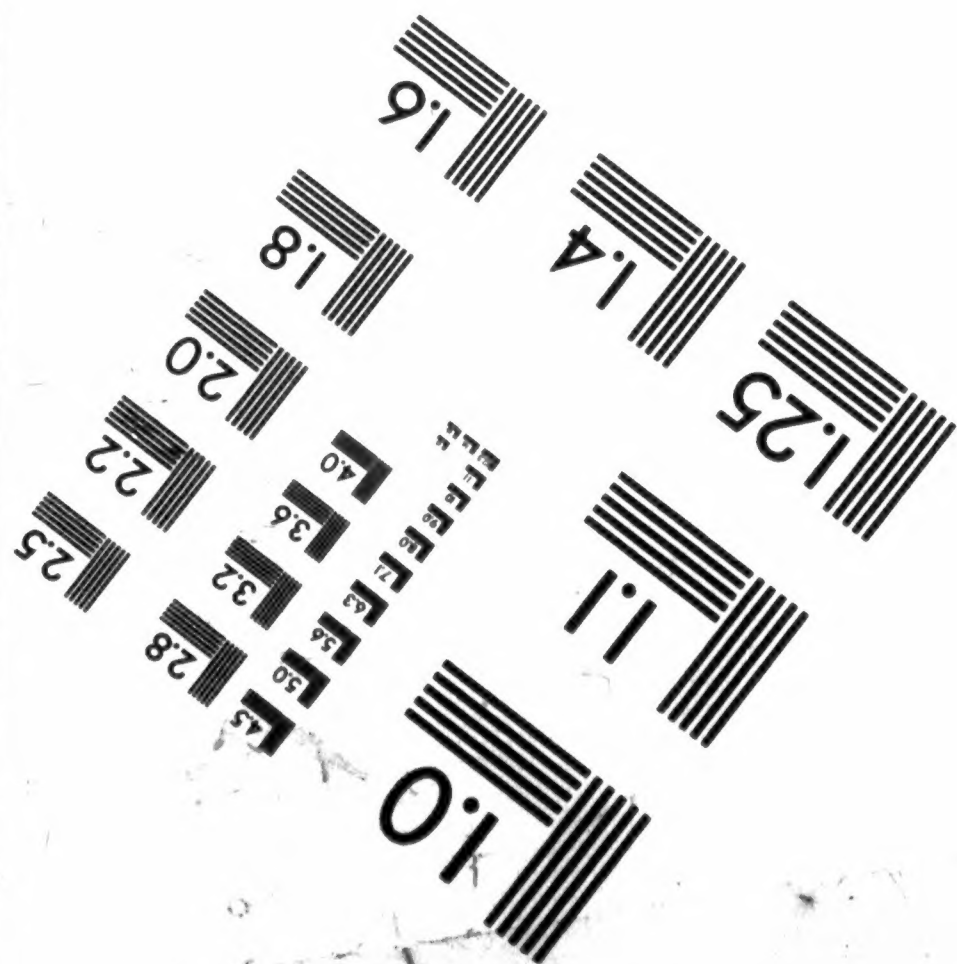
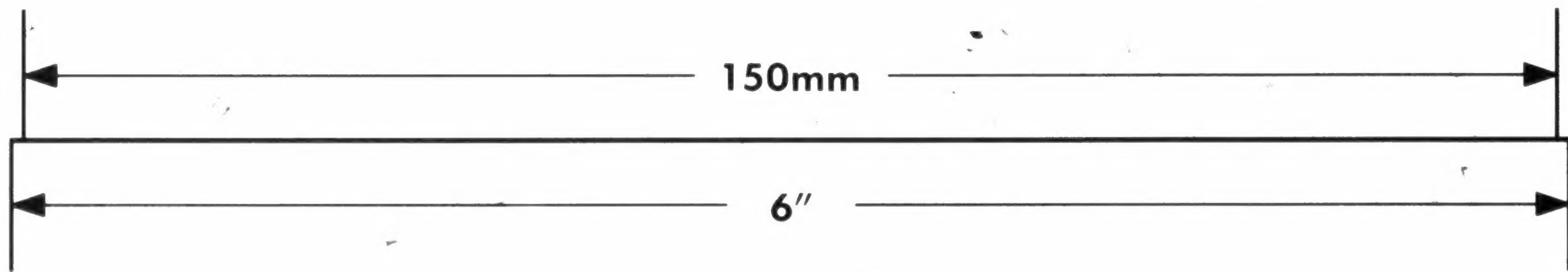
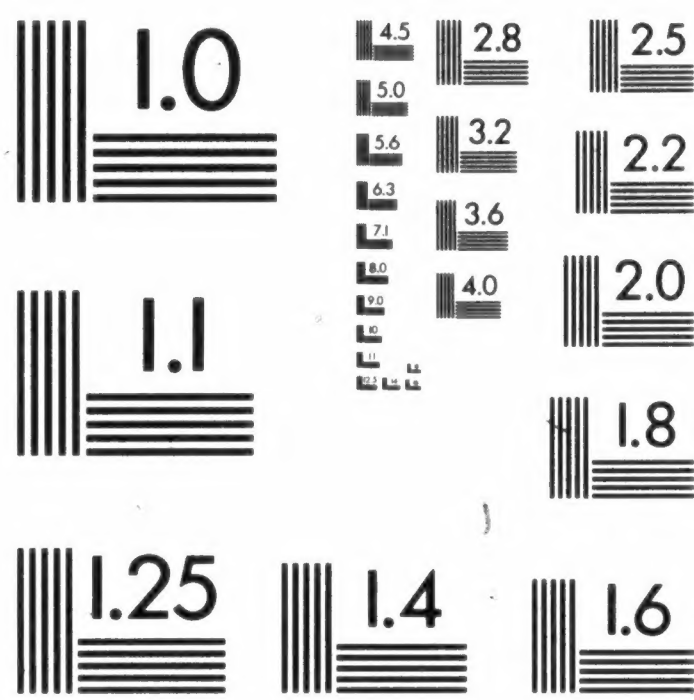
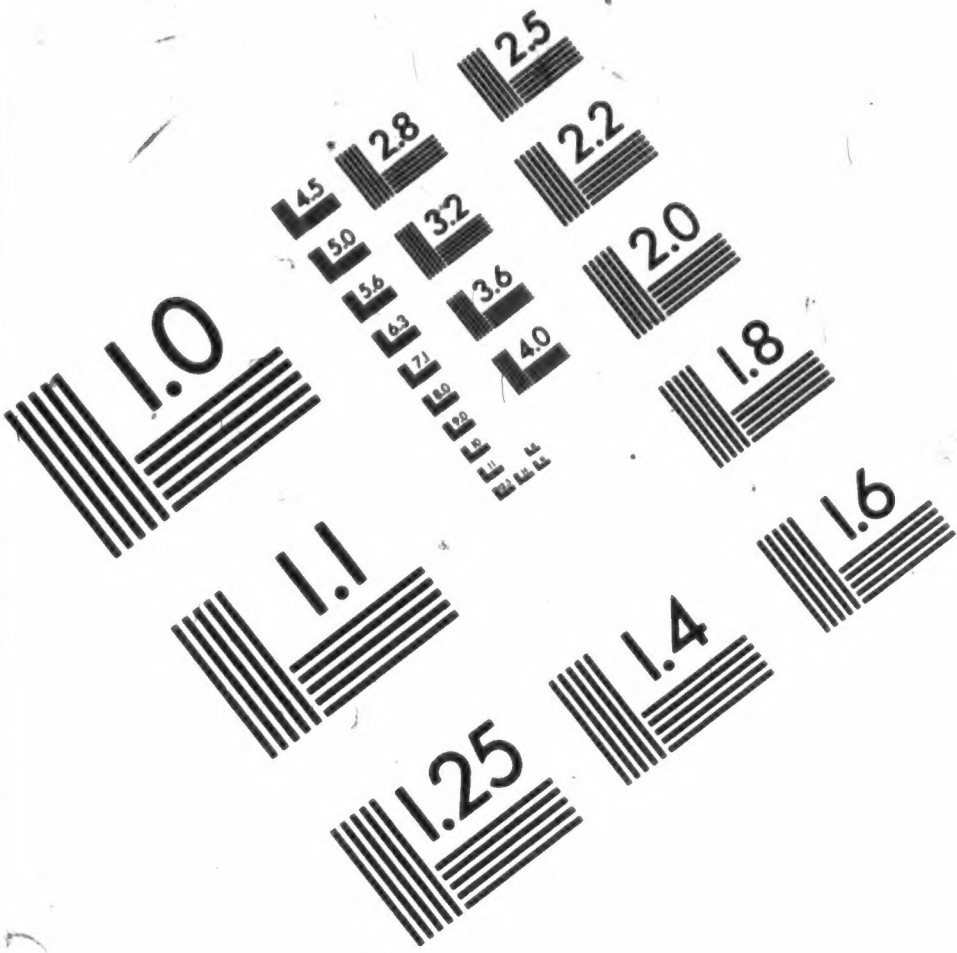

IMAGE EVALUATION
TEST TARGET (QA-3)



APPLIED IMAGE, Inc
1653 East Main Street
Rochester, NY 14609 USA
Phone: 716/482-0300
Fax: 716/288-5989

© 1993, Applied Image, Inc., All Rights Reserved

THE END

PLEASE

REWIND