

NATIONAL
ARCHIVES
MICROFILM
PUBLICATIONS

IMAGE EVALUATION TEST TARGET (QA-3)

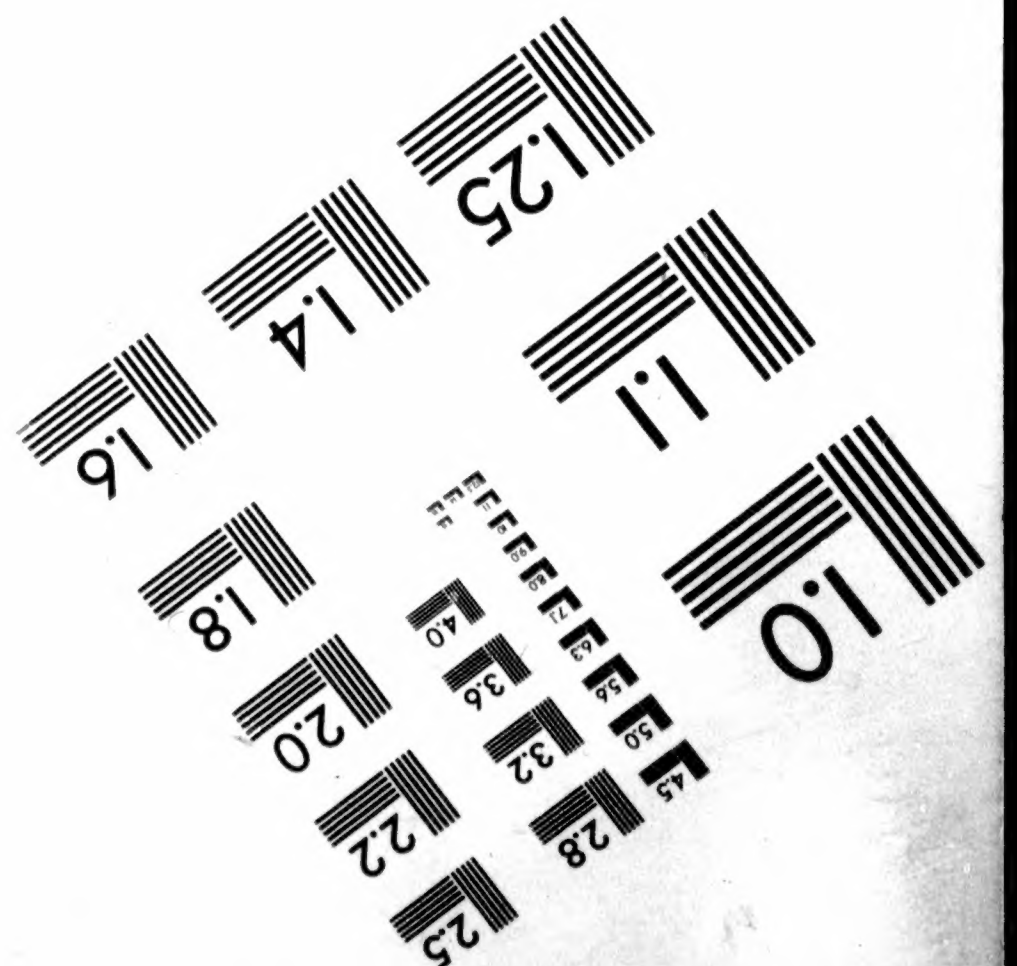
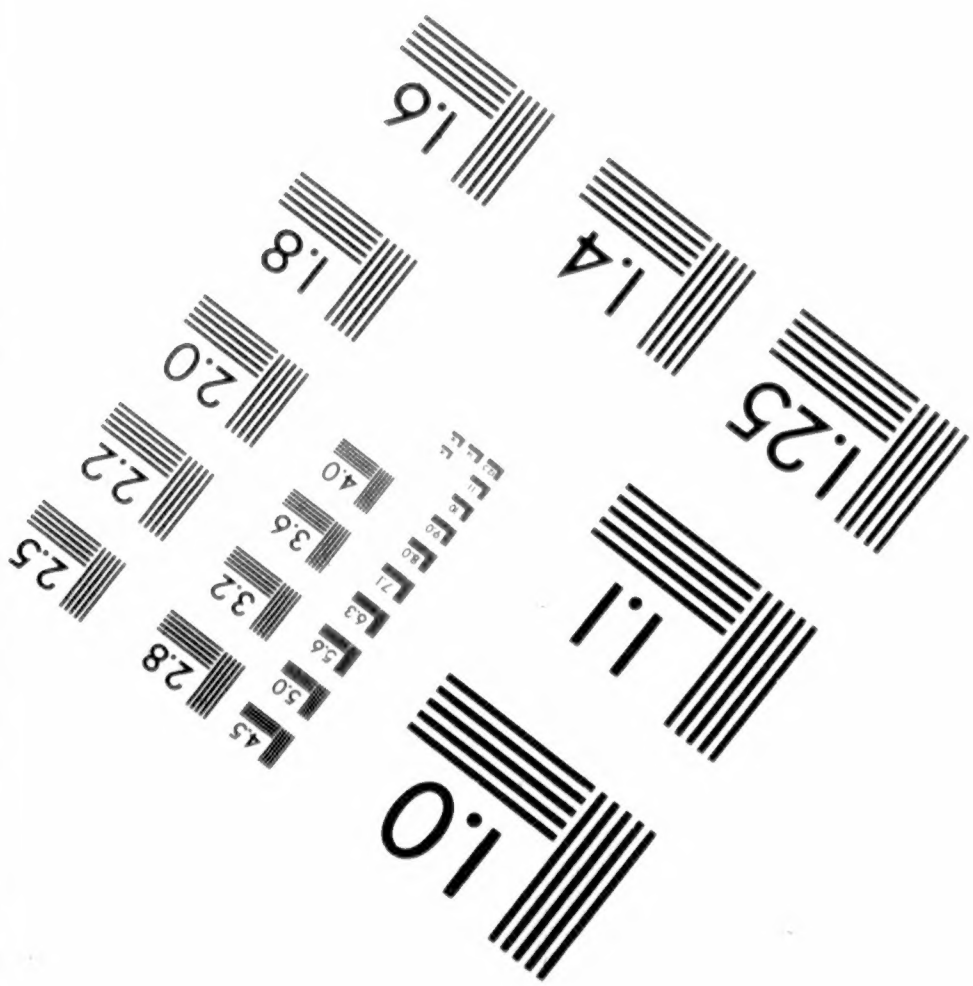
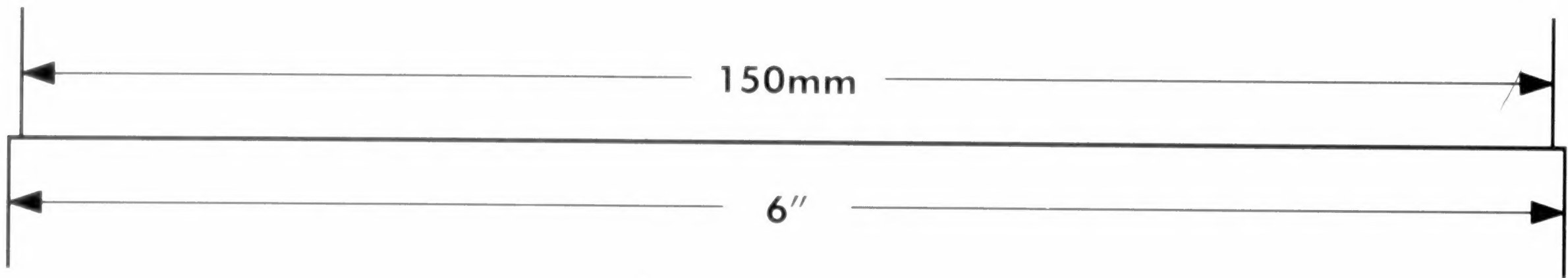
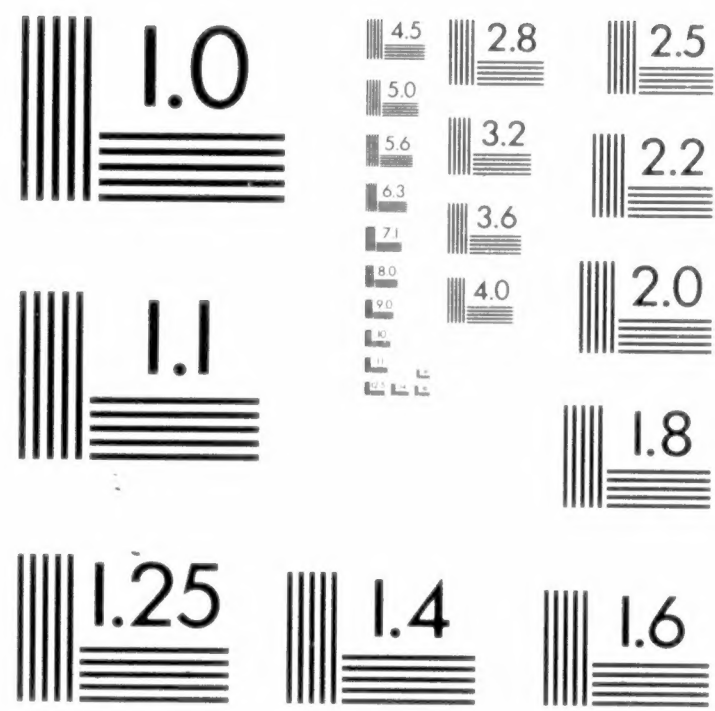
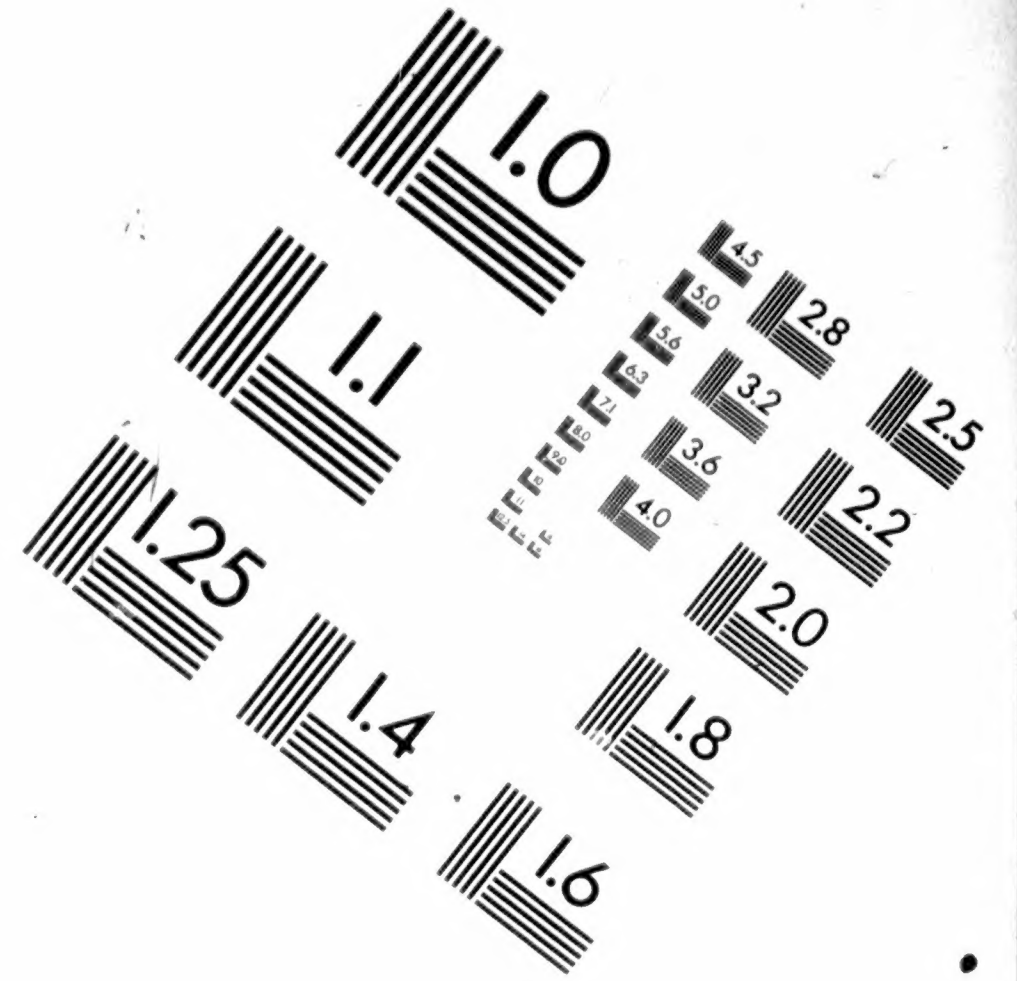
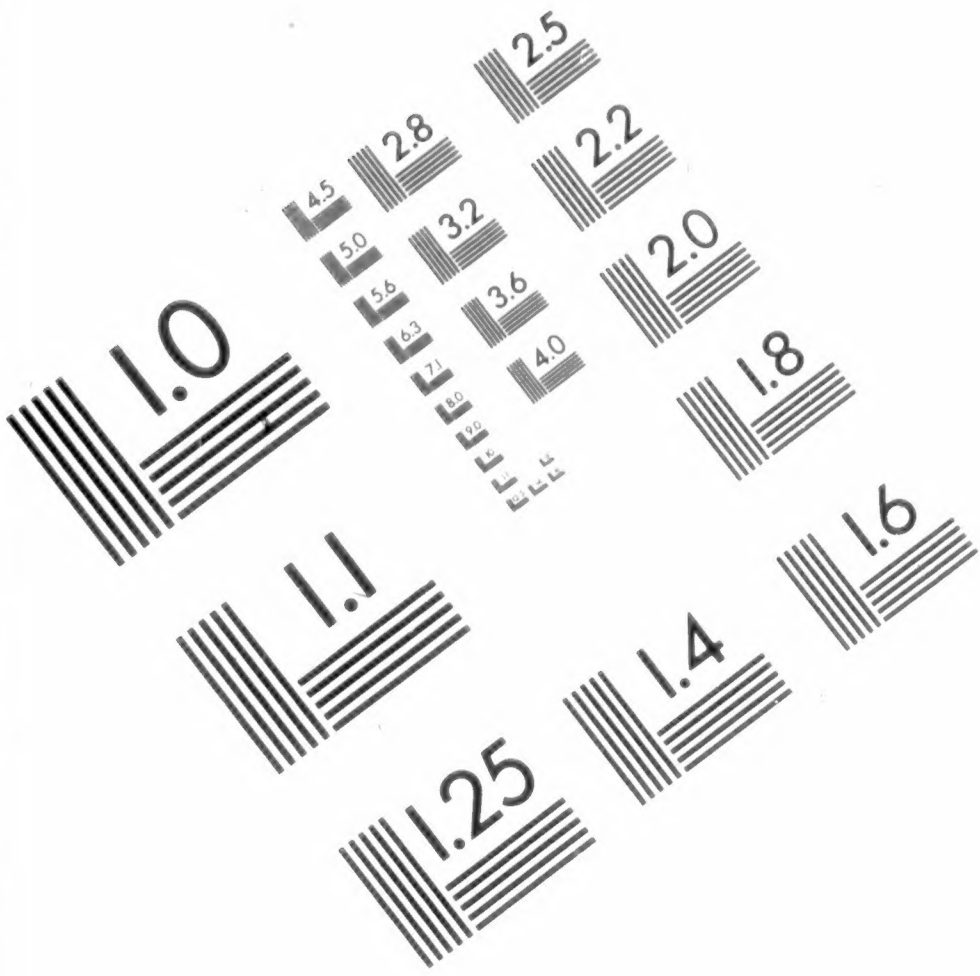

APPLIED IMAGE Inc
 1653 East Main Street
 Rochester, NY 14609 USA
 Phone: 716/482-0300
 Fax: 716/288-5989

© 1993, Applied Image, Inc., All Rights Reserved

National Archives at College Park



8601 Adelphi Road College Park MD 20740-6001

Sieh Loreta Z-1

OPERATOR

CAMERA

15, Aug. 2000 10-16

DATE FILMED

REDUCTION RATIO

2461-0598-013-01 Kodak

FILM EMULSION NUMBER

M1821 34

PROJECT NUMBER

ROLL NUMBER

MICROCOPY

1

8

2

1

ROLL

3

4

NATIONAL ARCHIVES AND RECORDS ADMINISTRATION
MICROFILM PUBLICATIONS

M1821

COMPILED MILITARY SERVICE RECORDS OF
VOLUNTEER UNION SOLDIERS WHO SERVED WITH THE
UNITED STATES COLORED TROOPS: Infantry Organizations
8th through 13th including the 11th (new)

Introduction by Budge Weidman
Regimental histories by Michael F. Knight

Records prepared for microfilming by volunteers of
the Civil War Conservation Corps

Budge Weidman, Project Manager

| | | |
|----------------------|-------------------|------------------|
| Pat Alfredson | Naomi Glass | Dave Murray |
| Phyllis Altrogge | Sue Goward* | Mary Poggioli |
| Kenneth Ashton | Bert Greenstein | Peggy Pratt |
| Sue Barnard* | Anne Greenwood | Ray Puzio |
| Rex Bowser | Jim Harris | Sylvia Scott |
| Ann N. Brown | Walter Hayden | Lynn Shearouse |
| Jerry Brown | Mary Hayden | Charles Spencer |
| Robert Budway | Pat Ikonen | Mary Stack-Dunne |
| Randy Caldwell | Dick Ives | Ben Stearns |
| Mary Ann Castellana* | Sarah Jaffe | Bill Stormer* |
| Mary Lou Cole | Gale Kaufmann | Pat Sullivan |
| Steve Cowan | Barbara Kemp | Gorman Tidball* |
| Giovanni Croce | Bev Manypenny | John Toole |
| B. H. Custer | Frank Masterson | Maryellen Toole |
| Bob Denney | Joe Mazur | Dean Warner |
| Earl Dunn | Kathleen McCarthy | Melody Warner |
| Yvette Fallin | Catherine McManus | Milt Weatherhead |
| Maria Flesher | Ben Miles | Robert Young |

Russ Weidman, Deputy Project Manager

Team leaders are indicated by the asterisk.

National Archives and Records Administration
Washington, DC
2000

NATIONAL ARCHIVES AND RECORDS ADMINISTRATION
MICROFILM PUBLICATIONS

INTRODUCTION

On the 109 rolls of this microfilm publication, M1821, are reproduced the compiled military service records of volunteer Union soldiers belonging to the 8th through the 13th infantry units, including the 11th (new) organized for service with the United States Colored Troops (USCT). The USCT included 7 numbered cavalry regiments; 13 numbered artillery regiments plus 1 independent battery; 144 numbered infantry regiments; Brigade Bands Nos. 1 & 2 (Corps d'Afrique and US Colored Troops); Powell's Regiment Colored Infantry; Southard's Company Colored Infantry; Quartermaster Detachment; Pioneer Corps, 1st Division, 16th Army Corps; Pioneer Corps, Cavalry Division, 16th Army Corps; Unassigned Company A Colored Infantry; and Unassigned USCT. There are also miscellaneous service cards arranged alphabetically by surname at the end of the unit records. The records reproduced are part of the Records of the Adjutant General's Office, 1780's-1917, Record Group (RG) 94.

Background

Since the time of the American Revolution, African Americans have volunteered to serve their country in time of war. The Civil War was no exception. Official sanction was the difficulty. In the fall of 1862 there were four Union regiments of African Americans raised in New Orleans, LA: the 1st, 2nd, and 3rd Louisiana Native Guard, and the 1st Louisiana Heavy Artillery (African Descent). The 1st South Carolina Infantry (African Descent) was not officially organized until January 1863; however, three companies of the regiment were on coastal expeditions as early as November 1862. The 1st Kansas Colored Infantry was not mustered into Federal service until January 1863, even though the regiment had already participated in the action at Island Mound, MO, on October 27, 1862. These early unofficial regiments received little Federal support, but they showed the strength of the African American soldier's desire to fight for freedom.

The first official authorization to employ African Americans in Federal service was the Second Confiscation and Militia Act of July 17, 1862 (12 Stat. 592). This act allowed President Abraham Lincoln "to employ as many persons of African descent as he may deem necessary and proper for the suppression of this rebellion, and for this purpose he may organize and use them in such manner as he may judge best for the public welfare." The use of African Americans met with varying reactions and treatment. In the trans-Mississippi West, they saw some combat, while in the Department of Tennessee and in the South they were frequently assigned fatigue work. In the East, they drew both combat and fatigue duty. The President did not authorize use of African Americans in combat, however, until issuance of the Emancipation Proclamation on January 1, 1863.

NATIONAL ARCHIVES AND RECORDS ADMINISTRATION
MICROFILM PUBLICATIONS

In late January 1863, Gov. John Andrew of Massachusetts received permission to raise a regiment of African American soldiers. Because the pace of organizing additional regiments was very slow, Secretary of War Edwin M. Stanton sent Gen. Lorenzo Thomas to the lower Mississippi Valley in March to recruit free and contraband African Americans. Thomas was given broad authority. He was to explain the administration's policy regarding African American soldiers and recruit volunteers to raise and command them. Stanton wanted all officers of such units to be white, but that policy was softened to allow African American surgeons and chaplains. By the end of the war, in addition to the chaplains and surgeons, there were 87 African American officers. Thomas's endeavor was very successful, and on May 22, 1863, the Bureau of Colored Troops was established to coordinate and organize regiments from all parts of the country. Created under War Department General Order No. 143, the bureau was responsible for handling "all matters relating to the organization of Colored Troops." The bureau was directly under the Adjutant General's Office, and its procedures and rules were specific and strict. All African American regiments were now to be designated United States Colored Troops (USCT). At this time there were some African American regiments with state names and a few regiments in the Department of the Gulf designated as Corps d'Afrique. The Corps d'Afrique units ultimately became numbered regiments in the USCT. The 54th and 55th Massachusetts Infantries (Colored), the 5th Massachusetts Cavalry (Colored), the 29th Connecticut Infantry (Colored), the 6th and 7th Louisiana Infantries (African Descent), the 3rd Tennessee Volunteer Infantry (African Descent), and the 1st South Carolina Volunteers (Colored) retained their numbers and state designations, but served under the Bureau of Colored Troops.

To facilitate recruiting in the states of Maryland, Missouri, Tennessee, and eventually Kentucky, the War Department issued General Order No. 329 on October 3, 1863. Section 6 of the order stated that if any citizen should offer his or her slave for enlistment into the military service, that person would, "if such slave be accepted, receive from the recruiting officer a certificate thereof, and become entitled to compensation for the service or labor of said slave, not exceeding the sum of three hundred dollars, upon filing a valid deed of manumission and of release, and making satisfactory proof of title." For this reason, some records of manumission are contained in the compiled service records reproduced in this publication.

The USCT fought in 39 major engagements and over 400 lesser ones. Sixteen African American soldiers received Medals of Honor. As it was in other units, the death toll from disease was very high in the USCT. Deaths from disease and battle totaled 37,000. The last regiment of the USCT was mustered out of Federal service in December 1867.

Important sources for information about African American units in the Civil War

NATIONAL ARCHIVES AND RECORDS ADMINISTRATION
MICROFILM PUBLICATIONS

are the War Department's *The War of the Rebellion: A Compilation of the Official Records of the Union and Confederate Armies* (Washington, DC: 1880-1901; reprinted Harrisburg, PA 1971 and 1985) and the Navy Department's *The War of the Rebellion; A Compilation of the Official Records of the Union and Confederate Navies* (Washington, DC: 1874-1922; reprinted Harrisburg, PA 1971 and 1985). These multivolume works contains reports of operations and other official correspondence.

8th United States Colored Infantry

This regiment was organized from November to December 31, 1863, at Camp William Penn, PA. In February 1864 the regiment was ordered to Jacksonville, Florida, where it joined General Gilmore's ill-fated Florida expedition. The 8th USCT was engaged heavily at Olustee on February 20, 1864, and sustained heavy casualties. The regiment fought with great distinction despite never having fired its weapons before this battle. From February to August the regiment continued to serve in Florida on fatigue and fortification duty, as well as reconnaissance duty. In August the regiment was ordered to the trenches outside of Petersburg where it served until September 28. On September 29, 1864, the 8th USCT fought near Chaffin's Farm, Fort Gilmore, and in October, the Darby Town Road. Following these engagements, the regiment returned to the trenches around Petersburg until the city fell in April 1865. Following the fall of Petersburg, the 8th USCT was ordered to Texas, where they mustered out in December 1865.

9th United States Colored Infantry

This regiment was organized at Camp Stanton, Benedict, Maryland, from November 11 to December 31, 1863, for 3 years' service. In March of 1864 the regiment was ordered to Hilton Head, South Carolina, for fatigue duty and reconnaissance on John Island. The regiment joined the 3rd Division, 10th Army Corps, at Deep Bottom, Virginia, and was stationed in the trenches at Petersburg from July to September. On September 29 and 30, 1864, the 9th USCT fought at Fort Gilmore near Chaffin's Farm. In 2 days of fighting the regiment suffered 113 men and officers killed or wounded. The regiment was engaged in skirmishes at Darby Town Road on October 10 and at New Market Road on October 27. From November 1864 until April 1865 the regiment was posted in the trenches before Fort Harrison. The 9th USCT marched into Richmond on April 3, 1865, with, "Drums beating colors flying [and] men singing the John Brown Hymn-Gloria in Excelsis." In July the regiment was moved to Brownsville, Texas, where it remained until September 1866. The 9th was ordered to Louisiana in October and mustered out at New Orleans, November 26, 1866.

NATIONAL ARCHIVES AND RECORDS ADMINISTRATION
MICROFILM PUBLICATIONS

10th United States Colored Infantry

This regiment was formed between November and December 1863 at Camp Craney Island, Virginia, for 3 years' service. In May, the 10th USCT moved to Fort Powhatan aboard the famous steamer *Planter*. On May 24, 1864, the 10th USCT skirmished with Fitzhugh Lee's force at Wilson's Wharf. The regiment was posted to picket duty on the right of Federal lines before Petersburg in June 1864. From August 1864 to March 1865 the regiment provided guard duty at City Point, Virginia. On April 3, 1865, the 10th USCT marched into Richmond, Virginia. Beginning in July 1865, the regiment was stationed in Corpus Christie, Texas, where it remained until it mustered out in May 1866.

11th United States Colored Infantry (Old)

This regiment was organized from October 31 to December 31, 1863, at Fort Smith, Arkansas, from men recruited by Captain J. M. Steele (formerly of the 12th Kansas Volunteers). From January to July 1864 the regiment performed guard and escort duty out of Fort Smith. On August 24, 1864, a Rebel cavalry force consisting of 300-400 whites and Indians attacked the regiment, consisting of 260 men organized into companies "A" through "E." The regiment was able to repulse three cavalry charges before the enemy withdrew. On September 19, 1864, the 11th USCT skirmished against General Ganos's rebel forces. On January 24, 1865, the regiment attacked and routed Colonel Newton's rebel regiment at Bogg's Mills, Arkansas, capturing a large amount of horses and equipment. The 11th USCT (old) was stationed at Little Rock in February, at which time it was consolidated with the 112th USCT and the 113th USCT (old) to form the 113th USCT (new).

11th United States Colored Infantry (New)

This regiment was organized from June through August 1863, as the 1st Regiment Alabama Siege Artillery. During its years of active service, the regiment was reorganized several times. In January 1864, the regiment was stationed at Fort Pickering, Memphis, Tennessee, when it was consolidated into the 1st Tennessee Heavy Artillery (in accordance with Special Order 25). The regiment served on fatigue duty at Fort Pickering until early March, when it was reorganized, along with several Negro pioneer companies, into the 6th USCT Heavy Artillery. The regiment was ordered to Fort Pillow, Tennessee, where it was attacked on March 12, 1864, by the forces of Nathaniel Bedford Forrest. After the fort surrendered, over half the regiment was lost in the ensuing massacre by Forrest's forces. Following the Ft. Pillow massacre, the remains of the regiment returned to Ft. Pickering where it was reorganized as the 7th USCT Heavy Artillery. On January 23, 1865, the regiment was consolidated with several Negro pioneer companies and

NATIONAL ARCHIVES AND RECORDS ADMINISTRATION
MICROFILM PUBLICATIONS

designated as the 11th USCT (new). The 11th USCT served on picket and fatigue duty in Memphis until it was mustered out on January 12, 1866.

12th United States Colored Infantry

This regiment was organized at Elk Bridge and Nashville, Tennessee, in August 1863. On December 15 and 16, 1864, the regiment participated in the Battle of Nashville. The regiment participated in the pursuit of General John Bell Hood's army to Decatur, Alabama. Following this expedition, the 12th USCT guarded the Nashville and Northwestern Railroad against guerilla attacks until it mustered out in January 1866.

13th United States Colored Infantry

This regiment was organized at Camp Mussy, Tennessee, in November 1863. From December 1864 until December 1865, the 13th USCT was responsible for guarding a section of the Nashville and Northwestern Railroad. The regiment participated in the Battle of Nashville on December 15 and 16, 1864. On the second day, the 13th USCT participated in several attacks on rebel positions, including the assault on Overton Hill. In January 1865, the regiment joined the pursuit of the remnants of General John Bell Hood's army to Decatur, Alabama. The regiment was returned to picket duty along the Nashville and Northwestern railroad for the rest of the year until it mustered out on January 10, 1866.

Records Description

Compiled service records consist of a jacket-envelope for each soldier, labeled with his name, rank, unit, and card numbers. The compilation of service records of Union soldiers began in 1890 under the direction of Col. Fred C. Ainsworth, head of the Record and Pension Office of the Adjutant General's Office, Department of War. Information from muster rolls, regimental returns, descriptive books, and other records was copied verbatim onto cards. A separate card was prepared each time an individual name appeared on a document. These cards were numbered on the back, and these numbers were entered onto the outside jacket containing the cards. The carded information was verified by a separated operation of comparison; great care was taken to ensure that the cards were accurate.

A typical jacket contains card abstracts of entries found in original records relating to the soldier and original documents relating solely to that soldier. Examples of the latter include enlistment papers, substitute certificates, casualty sheets, death reports, prisoner-of-war memorandums, and correspondence. Unique to the records

NATIONAL ARCHIVES AND RECORDS ADMINISTRATION
MICROFILM PUBLICATIONS

of the USCT are deeds of manumission, oaths of allegiance, proof of ownership, certificates of monetary award, and bills of sale. These items appear most frequently in units recruited in the border states of Kentucky, Missouri, and Maryland. These states remained in the Union but were slave states. Jackets and cards include a section labeled "bookmark," which was reserved for cross-references to other records relating to the individual or his unit. The service records are arranged by arm of service, thereunder numerically by regiment or independent battalion or company, and thereunder alphabetically by name of the soldier. Records for officers are interfiled alphabetically by name with the records of enlisted men. If an individual served in more than one unit, which was typical for USCT officers, there will be a separate service record for each unit in which he served.

The unjacketed miscellaneous cards were accumulated by the War Department with the expectation that they would be incorporated in individual compiled service records. The expectation was never fulfilled, however, because either insufficient or contradictory information made it impossible to associate the cards or papers with a particular soldier's service record.

Related Records

Among the records of the Adjutant General's Office in the National Archives are many of the original records that were abstracted or "carded" by the Record and Pension Office. These include the individual unit's muster rolls, returns, and descriptive books. Other series in RG 94 that contain information relating to volunteer Union soldiers who served with the USCT include carded records relating to Union staff officers, carded medical records of volunteer Union soldiers, unbound and bound regimental records, and "record of events" cards. The regimental records of the 54th Massachusetts Infantry (Colored) have been reproduced as Microfilm Publication M1659, *Records of the Fifty-fourth Massachusetts Infantry Regiment (Colored), 1863-1865*.

The "record of events" cards include information copied from the unit's muster rolls and returns. They show the stations of the field and staff and of the companies of the regiment at the time the muster roll or return was prepared and sometimes mention battles, skirmishes, or other activities in which the regiment participated. The cards have been reproduced as Microfilm Publication M594, *Compiled Records Showing Service of Military Units in Volunteer Union Organizations*.

Record Group 94 also includes a card index for the USCT, reproduced as Microfilm Publication M589, *Index to Compiled Military Service Records of Volunteer Union Soldiers Who Served with U.S. Colored Troops*, which may be used to locate the regiment of USCT personnel. An index card gives the name of the soldier and his

NATIONAL ARCHIVES AND RECORDS ADMINISTRATION
M I C R O F I L M P U B L I C A T I O N S

rank, as well as the unit in which he served; sometimes there is a cross-reference to his service in other units or organizations. The National Archives is continually producing microfilm publications of volunteer Union compiled military service records. A complete listing of finished publications can be found in the National Archives *Microfilm Resources for Research: A Comprehensive Catalog*, which is available online at www.nara.gov.

The Records of the Colored Troops Division, within RG 94, include division correspondence and records relating to recruiting, the appointment of officers, and the slave or free status of individuals as well as a compilation of historical extracts and official papers concerning the military service of African Americans from the colonial period through the Civil War entitled *The Negro in the Military Service of the United States 1639-1886*. This compilation is reproduced as Microfilm Publication M858. The Records of the Bounty and Claims Division, also in RG 94, include correspondence of the division and records relating to bounties and claims paid to loyal owners of slaves by the Slave Claims Commissions of Delaware, Kentucky, Maryland, Missouri, Tennessee, and West Virginia.

If a soldier applied for a pension, the pension application case file may be among the Records of the Veterans Administration (RG 15). Indexes to the pension applications have been reproduced as Microfilm Publication T288, *General Index to Pension Files, 1861-1934*, and T289, *Organizational Index to Pension Files of Veterans Who Served Between 1861 and 1900*.

If a soldier or officer was tried before a general court-martial or if an individual or his unit was the subject of a court of inquiry or military commission, transcripts of the proceedings may be among the Records of the Office of the Judge Advocate General (Army) (RG 153). The registers to the proceedings have been reproduced as Microfilm Publication M1105, *Registers of the Records of the Proceedings of the U.S. Army General Courts-Martial, 1809-1890*.

Other record groups having information pertaining to the USCT include Records of the Bureau of Refugees, Freedmen, and Abandoned Lands (RG 105); Records of the Provost Marshal General's Bureau (Civil War) (RG 110); Records of the Accounting Officers of the Department of the Treasury (RG 217); and Records of U.S. Army Continental Commands, 1821-1920 (RG 393).

Holdings of the National Archives relating to the Civil War are outlined in Kenneth W. Munden and Henry Putnam Beers, *Guide to Federal Archives Relating to the Civil War* (Washington, DC: National Archives, 1962) and Henry Putnam Beers, *Guide to the Archives of the Government of the Confederate States of America* (Washington, DC: National Archives, 1968), which were reprinted as *The Union* (1986) and *The Confederacy* (1986).

NATIONAL ARCHIVES AND RECORDS ADMINISTRATION
MICROFILM PUBLICATIONS

ROLL LIST

Roll Description

8th United States Colored Infantry

1. Adams, Edward – Benedict, Thomas
2. Bennett, Jackson – Brown, Thomas
3. Brown, William – Clafford, John S.
4. Clapp, David C. – Davis, Noah
5. Davis, William – Fields, John
6. Finch, Edmunds – Hall, Irwin
7. Hall, Jacob – Holly, William
8. Hooker, Joseph – Johnson, John
9. Johnson, Joseph – Locke, Isaac B.
10. Lockwood, Harrison – Mitchel, Ambrose
11. Mitchell, Cleo – Phelps, Daniel
12. Phelps, Joseph – Rogers, Norman
13. Roland, Spencer – Smith, Thomas B.
14. Smith, William – Timbrook, James
15. Tippitt, Samuel – Whitaker, Alexander
16. White, David – Young, John

8th United States Colored Infantry, Miscellaneous Service Cards

17. Adams, John – Junks, James E.
18. Keith, Henry – Zinn, Alfred D.

9th United States Colored Infantry

19. Acty, Robert – Bell, Custis
20. Bell, Franklin – Brown, Elijah
21. Brown, Franklin – Churn, Walter
22. Claggett, Franklin – Cox, William
23. Crawford, Henry – Dennis, Joshua
24. Dennis, Littleton – Elzy, George
25. Ennels, John – Gale, Francis
26. Gale, James – Hamlin, Noah
27. Harmon, George – Henry, Isaac
28. Henry, Isaiah – James, Minus
29. James, Richard – Kemer, William
30. Kett, Teagle – Mapp, Alfred
31. Mapp, Bennett – Morris, Peter P.
32. Morris, Richard – Pinckett, Robert

NATIONAL ARCHIVES AND RECORDS ADMINISTRATION
MICROFILM PUBLICATIONS

Roll Description

- 33. Pinckett, Sandy – Purnell, Moses H.
- 34. Purnell, Noah – Rutter, William
- 35. Ryaer, Leven – Smith, George
- 36. Smith, Henry – Thomas, Henry
- 37. Thomas, John H. – Wainwright Alfred
- 38. Wales, Benjamin – White, Horace
- 39. White, Isaac – Young, James
Bayley, Thomas: Board of Examination Proceedings

9th United States Colored Infantry, Miscellaneous Service Cards

- 40. Adams, Robert – Long, Josephus
- 41. Maccle, Joseph – Young, Henry

10th United States Colored Infantry

- 42. Ackleboro, Jacob – Booker, Arthur
- 43. Booker, Henry – Carter, William
- 44. Casten, Abraham – Dennis, John
- 45. Dennison, Peter – Forman, Charles
- 46. Forman, Edinborough – Hitchcock, Henry M.
- 47. Hodges, Moses – Jones, Levi
- 48. Jones, Robert – McKenzie, George H.
- 49. Mears, George – Pleasants, Norman
- 50. Pleasants, Sterling – Savage, Joseph
- 51. Savoy, Thos. – Spady, Joseph
- 52. Sparrow, Edward – Van de Sande, George
- 53. Vaughn, George – Wilkins, Melville
- 54. Wilkins, Robert – Young, Levens

10th United States Colored Infantry, Miscellaneous Service Cards

- 55. Adams, Charles – Young, Laws

11th United States Colored Infantry (Old)

- 56. Adams, Amos – Falkner, Jacob
- 57. Falkner, James – Mayo, Isaac
- 58. McAfee, Daniel – Tadlock, Silas
- 59. Tadlock, William – Youngblood, Hayes

NATIONAL ARCHIVES AND RECORDS ADMINISTRATION
MICROFILM PUBLICATIONS

| <u>Roll</u> | <u>Description</u> |
|-------------|---|
| | 11th United States Colored Infantry (Old), Miscellaneous Service Cards |
| 59. | Adams, Luther – Yager, Peter G. |
| | 11th United States Colored Infantry (New) |
| 60. | Abbo, Sunum – Bell, Robert |
| 61. | Bell, Taylor – Buckner, Charles |
| 62. | Bufford, Jackson – Collins, Lewis |
| 63. | Collins, Robert – Dyson, Richard |
| 64. | Ebanson, Albert – Gallin, Joseph |
| 65. | Gardner, Mathew – Harris, Charles |
| 66. | Harris, Dennis – Hyman, Samuel |
| 67. | Ingrum, Wesley – King Parker |
| 68. | Kirby, George – McCauley, Albert |
| 69. | McCauley, Bergess – Moss, Edmond |
| 70. | Motley, Nathan – Patty, Henry |
| 71. | Payden, Nelson – Rogers, Aaron |
| 72. | Rogers, Barry – Smith, Lewis |
| 73. | Smith, Malcom F. – Tolliver, Richard |
| 74. | Tonston, Alexander – Warren, Nelson |
| 75. | Washburn, Luther J. – Williams, Isaac |
| 76. | Williams, Jackson – Young Willis |
| | 11th United States Colored Infantry (New), Miscellaneous Service Cards |
| 77. | Abbott, Daniel – Young, William |
| | 12th United States Colored Infantry |
| 78. | Abnerathy, John H. – Benson, Albert |
| 79. | Benson, Edmond – Burton, Grank |
| 80. | Butler, Cooper – Cooper, Washington |
| 81. | Copelan, Moses – Eazell, James |
| 82. | Eddington, James – Gardner, Dennis |
| 83. | Gardner, John – Helm, Claibourne |
| 84. | Helm, James – Jennygin, Reuben |
| 85.* | Jennyson, Addison – Lewis, Franklin |
| 86. | Lewis, George – McNerrie, William |
| 87. | McNorris, Robert – Parrem, Henry |

NATIONAL ARCHIVES AND RECORDS ADMINISTRATION
MICROFILM PUBLICATIONS

Roll Description

- 88. Patten, David – Roads, Henry
- 89. Roads, William – Stieger, Arthur
- 90. Stiger, Arthur – Walters, Jerry
- 91. Ward, Asbury – Young, Peter

12th United States Colored Infantry, Miscellaneous Service Cards

- 92. Abernathy, Essic – Youngman, John

13th United States Colored Infantry

- 93. Abb, Peter – Batson, Edward
- 94. Batson, James – Caldwell, Isaac
- 95. Caldwell, Mack – Cornell, John
- 96. Cornell, William – Edmondson, Charles
- 97. Edwards, Emanuel – Gather, Frank
- 98. George, William – Hardin, Lewis
- 99. Hardin, Robert – Hughes, Noah
- 100. Hunter, Allen D. – Jourdan, Thomas
- 101. Joyce, John – Mathews, Hiram
- 102. Mathews, James – Monroe, Jim
- 103. Montgomery, William – Parsons, Oliver
- 104. Pate, Andrew – Robertson, Willis
- 105. Robinson, Alias – Smith, George W.
- 106. Smith, James – Thorp, John H.
- 107. Thorpe, Alonzo – Webster, Martin
- 109. Webster, Washington – Zingear, Abraham

13th United States Colored Infantry, Miscellaneous Service Cards

- 109. Adams, Alfred – Zelner, Josiah

NATIONAL ARCHIVES AND RECORDS ADMINISTRATION
MICROFILM PUBLICATIONS

Microfilm Publication M1821

COMPILED MILITARY SERVICE RECORDS OF VOLUNTEER UNION
SOLDIERS WHO SERVED WITH THE UNITED STATES COLORED
TROOPS: Infantry Organizations 8th through 13th including the 11th (new)

Roll 34

9th United States Colored Infantry

Purnell, Noah – Rutter, William

917
Purnell. Noah

Co B, 9 U.S. Col'd Inf.

Private Private

CARD NUMBERS.

| | | |
|----|---------|----|
| 1 | 6304408 | 26 |
| 2 | 6304507 | 27 |
| 3 | 6304607 | 28 |
| 4 | 6304714 | 29 |
| 5 | 6304813 | 30 |
| 6 | 6304907 | 31 |
| 7 | 6305003 | 32 |
| 8 | 6305099 | 33 |
| 9 | 6305198 | 34 |
| 10 | 6305295 | 35 |
| 11 | 6305393 | 36 |
| 12 | 6305480 | 37 |
| 13 | 6305568 | 38 |
| 14 | 6305652 | 39 |
| 15 | 6305725 | 40 |
| 16 | 6305796 | 41 |
| 17 | 6305864 | 42 |
| 18 | 6305951 | 43 |
| 19 | 6305138 | 44 |
| 20 | 9068803 | 45 |
| 21 | | 46 |
| 22 | | 47 |
| 23 | | 48 |
| 24 | | 49 |
| 25 | | 50 |

Book Mark: EB 811 P160

See also

SP 9 U.S.C.T.

Noah Sumrell
 , Co. C , 9 Reg't U. S. Col'd Inf.

Appears on
Company Descriptive Book
 of the organization named above.

DESCRIPTION.

Age 21 years; height 5 feet 8 7/8 inches.
 Complexion Dark
 Eyes Black; hair Black
 Where born Worcester, Md.
 Occupation Farmer

ENLISTMENT.

When Oct 31 , 1862
 Where Snow Hill; Worcester, Md
 By whom Col. Wm Burney; term 3 y'rs.
 Remarks: Died at Brownsville
 Tex. of Cholera Aug.
 24, 1866.

(383a) *E. L. Shannon* Copyist.

P

9

U.S.C.T.

Noah Purnell

Pvt., Co. C, 9 Reg't U. S. Col'd Infantry.

Age 21 years.

Appears on

Company Muster-in Roll

of the organization named above. Roll dated

Camp Stanton Charles Co Md Nov 11, 1863.

Muster-in to date Nov 11, 1863

Joined for duty and enrolled:

When Oct 31, 1863.

Where Worcester Md

Period 3 years.

Remarks:

Book mark:

(356)

J. G. Whitt
Copyist.

P

9

U.S.C.T.

Noah Purnell

Pat, Co. C, 9 Reg't U. S. Col'd Infantry.

Appears on

Company Muster Roll

for From Nov 11th to Dec 31, 1863.

Present or absent Absent

Stoppage, \$ 100 for

Due Gov't, \$ 100 for

Remarks: \$2 Rec Prem due
* On det. serv. recruit-
ing by order Col. Wm.
Birney S.O. No. 20 Dec.
20. 63 since Dec. 21. 63.

* Inserted by comparison

Book mark:

G. H. H. H.

Copyist

(358)

P

9

U.S.C.T.

Noah Purnell

Plt, Co. C, 9 Reg't U. S. Col'd Infantry.

Appears on

Company Muster Roll

for Jan & Feb, 1864.

Present or absent Present

Stoppage, \$ 100 for

Due Gov't, \$ 100 for

Remarks: 2 Reet Prem due

Book mark:

(858)

M. D. White Copyist

P | **9** | **U.S.C.T.**

Noah Purnell

Plt, Co. C, 9 Reg't U. S. Col'd Infantry.

Appears on

Company Muster Roll

for *March & April*, 186*4*.

Present or absent *Present*

Stoppage, \$ *100* for

Due Gov't, \$ *100* for

Remarks:

Book mark:

(358)

H. A. Wiley
Copyist

P

9

U.S.C.T.

Noah Purnell

Put, Co. C, 9 Reg't U. S. Col'd Infantry.

Appears on

Company Muster Roll

for May & June, 1864.

Present or absent Present

Stoppage, \$ 100 for

Due Gov't, \$ 100 for

Remarks: App. Ordinance 1st Waper 20th
Wagon driver 23rd / Tompion 02nd
45th

Book mark:

(358)

J. G. A. [Signature]
Copist

P 9 U.S.C.T.

Noah Purnell

Pvt, Co. C, 9 Reg't U. S. Col'd Infantry.

Appears on

Company Muster Roll

for July & Aug, 1864.

Present or absent absent

Stoppage, \$ 100 for

Due Gov't, \$ 100 for

Remarks Absent with since Aug 13/64. Free on or before April 19/61

Book mark:

(358)

Copyist

P

9

U.S.C.T.

Noah Purnell

Pvt, Co. C, 9 Reg't U. S. Col'd Infantry.

Appears on

Company Muster Roll

for *Sep & Oct*, 186⁴.

Present or absent *Present*

Stoppage, \$ 100 for

Due Gov't, \$ 100 for

Remarks:

Book mark:

(358)

W. A. White
Copyist

P | **9** | **U.S.C.T.**

Noah Purnell

Pvt, Co. C, 9 Reg't U. S. Col'd Infantry.

Appears on

Company Muster Roll

for *Nov & Dec*, 1864.

Present or absent *Present*

Stoppage, \$ *100* for

Due Gov't, \$ *100* for

Remarks:

Book mark:

(358)

W. J. Whely
Copyist

P | 9 | **U.S.C.T.**

Noah Purnell

Pvt, Co. C, 9 Reg't U. S. Col'd Infantry.

Appears on

Company Muster Roll

for Jan & Feb, 1865.

Present or absent Present

Stoppage, \$ 100 for

Due Gov't, \$ 100 for

Remarks:

Book mark: _____

(358) A. J. Anderson Copyist

P

9

U.S.C.T.

Noah Purnell

Pat., Co. C, 9 Reg't U. S. Col'd Infantry.

Appears on

Company Muster Roll

for *March & April*, 1865.

Present or absent *Present*

Stoppage, \$ 100 for

Due Gov't, \$ 100 for

Remarks:

Book mark:

A. J. Anderson

(358)

Copyist

P | 9 | U.S.C.T.

Noah Purnell

Cpt., Co. C, 9 Reg't U. S. Col'd Infantry.

Appears on

Company Muster Roll

for Dec 31/64 to June 30, 1865.

Present or absent Present

Stoppage, \$ 100 for

Due Gov't, \$ 100 for

Remarks:

Book mark:

A. J. Anderson

P

9

U.S.C.T.

Noah Purnell

Pvt, Co. C, 9 Reg't U. S. Col'd Infantry.

Appears on

Company Muster Roll

for *July & Aug*, 1865.

Present or absent *Present*

Stoppage, \$ *100* for

Due Gov't, \$ *100* for

Remarks:

Book mark:

A. J. Anderson

P | **9** | **U.S.C.T.**

Noah Purnell

Plt, Co. C, 9 Reg't U. S. Col'd Infantry.

Appears on

Company Muster Roll

for *June 30 to Oct 31*, 1865.

Present or absent *Present*

Stoppage, \$ *100* for

Due Gov't, \$ *100* for

Remarks:

Book mark:

A. J. Anderson
Copyist

P | 9 | U.S.C.T.

Noah Purnell

Pvt., Co. C, 9 Reg't U. S. Col'd Infantry.

Appears on

Company Muster Roll

for June 30 to Dec 31, 1865.

Present or absent Present

Stoppage, \$ 100 for

Due Gov't, \$ 100 for

Remarks:

Book mark:

A. J. Anderson

9 | U.S.C.T.

Noah Purnell

Private, Co. C, 9 Reg't U. S. Col'd Infantry.

Appears on

Company Muster Roll

for Jan & Feb, 1864.

Present or absent Present

Stoppage, \$ 100 for

Due Gov't, \$ 100 for

Remarks:

Book mark:

(358) A. J. Anderson Copyist

C

9

U.S.C.T.

Neal Purcell

Purcell, Co. C, 9 Reg't U. S. Col'd Infantry.

Appears on

Company Muster Roll

for *Apr 1866*, 1866

Present or absent *Present*

Stoppage, \$ 100 for

Due Gov't, \$ 100 for

Remarks:

Book mark:

(358)

Emilio
Copyist

P

9

U.S.C.T.

Joel Currier

Private, Co. C, 9 Reg't U. S. Col'd Infantry.

Appears on

Company Muster Roll

for *May 1st* June, 1866.

Present or absent *Present*

Stoppage, \$ 100 for

Due Gov't, \$ 100 for

Remarks:

Book mark:

(358)

A. M. Currier

Copyist

R | **9** | **U.S.C.T.**

Asah Purcell

Purcell, Co. C, 9 Reg't U. S. Col'd Infantry.

Appears on

Company Muster Roll

for *July 1866*, 186*6*.

Present or absent

Stoppage, \$ *100* for

Due Gov't, \$ *100* for

Remarks: *Died of Cholera at
Gainesville Texas Aug 24
'66*

Book mark: *5006, 2^d Col. Oct 12 / 67*

(358)

Quinn
Copyist

2

9

U.S.C.T.

Amos Purcell

Private, Co. *C*, 9 Reg't U. S. Col'd Infantry.

Appears on **Co. Muster-out Roll**, dated *Nov. 26*, 186*6*.

Muster-out to date _____, 186 .

Last paid to _____, 186 .

Clothing account:

Last settled _____, 186 ; drawn since \$ _____ 100

Due soldier \$ _____ 100; due U. S. \$ _____ 100

Am't for cloth'g in kind or money adv'd \$ _____ 100

Due U. S. for arms, equipments, &c., \$ _____ 100

Bounty paid \$ _____ 100; due \$ _____ 100

Remarks: *found at org. orgⁿ*
Died of Cholera at Brunswick
Dec 24 - Aug 24 / 1864. Sent to 1000.

Book mark: *Died Aug 24 / 1864 EB VII 0160*
sub. 2^d and Oct 12 / 67. PV 34P 124. 721, I. S.

(361)

J. Francis
Copyist.

Purnell, Noah

P, Co. C, 9 Reg't U.S.C. Inf

2 Enclosures.

| | |
|------------------------------|--------------------|
| Bed Cards | Descriptive Lists |
| Burial Records | Final Statements / |
| Certs. of Dis. for Discharge | Furloughs |
| C. M. Charges | Med. Des. Lists |
| Med. Certificates | Orders |

Other papers relating to—

| | |
|----------------------------|----------------------|
| Admission to Hosp'l | Furlough |
| Casualty Sheet (Officer's) | Med. Examination |
| Confinement | Misc. Information |
| Contracts | Pay or Clothing |
| Death or Effects / | Personal Reports |
| Desertions | Rank |
| Discharge from Hosp'l | Transfer to Hosp'l |
| Discharge from Service | Transfer to V. R. C. |
| Duty | Transportation |

*Recd from Div. of Discontinued
Commands; Filed Aug 26/75-*

ARTICLES OF WAR.

ART. 95. When any non-commissioned officer or soldier shall die, or be killed in the service of the United States, the then commanding officer of the troop or company shall, in the presence of two other commissioned officers, take an account of what effects he died possessed of, above his arms and accoutrements, and transmit the same to the office of the Department of War, which said effects are to be accounted for, and paid to the representatives of such deceased non-commissioned officer or soldier. And in case any of the officers, so authorized to take care of the effects of deceased officers and soldiers, should, before they have accounted to their representatives for the same, have occasion to leave the regiment or post, by preferment or otherwise, they shall, before they be permitted to quit the same, deposit in the hands of the commanding officer, or of the assistant military agent, all the effects of such deceased non-commissioned officers and soldiers, in order that the same may be secured for, and paid to, their respective representatives.

ARMY REGULATIONS—EDITION OF 1863.

DECEASED SOLDIERS.

Par. 152. Inventories of the effects of deceased non-commissioned officers and soldiers, required by the 95th Article of War, will be forwarded to the Adjutant General, by the commander of the company to which the deceased belonged, and a duplicate of the same to the colonel of the regiment. Final statements of pay, clothing, &c., in duplicate, will be sent to the Adjutant General with one copy of the inventory. When a soldier dies at a post or station absent from his company, it will be the duty of his immediate commander to furnish the required inventory and final statements, and, at the same time, to forward to the commanding officer of the company to which the soldier belonged, a report of his death, specifying the date, place, and cause; to what time he was last paid, and the money or other effects in his possession at the time of his decease; which report will be noted on the next muster roll of the company to which the man belonged. Each inventory will be endorsed, "Inventory of the effects of _____, late of company (—) _____ regiment of _____, who died at _____, the _____ day of _____, 186—." If a legal representative receive the effects, it will be stated in the report. If the soldier leave no effects, the fact will be reported.

Par. 153. Should the effects of a deceased non-commissioned officer or soldier not be administered upon within a short period after his decease, they shall be disposed of by a Council of Administration, under the authority of the commanding officer of the post, and the proceeds deposited with the Paymaster, to the credit of the United States, until they shall be claimed by the legal representatives of the deceased.

Par. 154. In all such cases of sales by the Council of Administration, a statement in detail, or account of the proceeds, duly certified by the Council and commanding officer, accompanied by the Paymaster's receipt for the proceeds, will be forwarded by the commanding officer to the Adjutant General. The statement will be endorsed, "Report of the proceeds of the effects of _____, late of company (—) _____ regiment of _____, who died at _____, the _____ day of _____, 186—."

NOTE 1.—The effects in all cases, when called for, should be turned over to the legal representative, without further authority from the Adjutant General. When the effects are turned over to the relatives of the deceased before these inventories are sent to the Adjutant General, their receipts therefor should be attached to the inventories. In all other cases, one copy will be sent with a letter of transmittal direct to the Adjutant General, and a duplicate retained by the officer.

NOTE 2.—Particular care should be taken to take receipts in duplicate from the Paymaster for any funds turned over to him; one copy should be sent direct to the Adjutant General and one retained by the officer.

INVENTORY OF THE EFFECTS

OF

Buss. Noah Burwell

Late of Company *C*

9th Reg't of *11th Corps*

Volunteers, who died at *Brownville Texas*

on the *24* day of *August* 186*6*.



Inventory of the effects of Noah Sumrell late
 a Private of ^{late} Captain Marshall M. Phelps Company C of
 the 9th Regiment of 21st 6th Group Volunteers, who was enrolled as
 a Privt. at Maester in the State of Maryland on
 the 31st day of October 1863, and mustered into the service of the United
 States as a Privt. on the 11th day of November 1863, at Benedict
 in Company C, 9th Regiment of 21st 6th Group Volunteers, to serve 3
 years or during the war; he was born in Maester in the State
 of Maryland; he was 23 years of age, 5 feet 2 inches
 high, Fair complexion, Blue eyes, Bluish hair, and by occupation, when enrolled,
 a Farmer; he died in Brownsville Texas, at
in the Co Quarters on the 27th day of August 1866, by
 reason of Cholera

| INVENTORY. | | | | | |
|-------------------------|-----|----------------------------|-----|----------------|-------------|
| ARTICLES. | No. | ARTICLES. | No. | ARTICLES. | No. |
| Hats..... | | Pairs trousers..... | | Knapsacks..... | |
| Caps..... | | Pairs flannel drawers..... | | | |
| Forage Caps..... | | Pairs cotton drawers..... | | | |
| Great coats..... | | Flannel shirts..... | | | |
| Uniform coats..... | | Cotton shirts..... | | | |
| Uniform jackets..... | | Pairs boots..... | | | |
| Flannel sack coats..... | | Pairs shoes..... | | | |
| Blouses..... | | Pairs socks..... | | | |
| Sable frocks..... | | Blankets..... | | | |
| Fatigue overalls..... | | Haversacks..... | | | |
| | | | | MONEY. | |
| | | | | | Specie..... |
| | | | | Notes..... | \$ |

I CERTIFY, ON HONOR, that the above inventory comprises all the effects of Noah Sumrell, deceased, and that the effects are in the hands
~~of~~ he left no effects at _____
 to be disposed of by a Council of Administration.

(DUPLICATES.)

STATION: Brownsville Texas

DATE: September 10 1866

[A. G. O. No. 104.]

Henry Dabman
Sept 9 1866
 Commanding the Company.

[OFFICE INDORSEMENT.]

War Department,

ADJUTANT GENERAL'S OFFICE,

August 31, 1874.

The death of Puto Noah
Cunnell, Co. E, 9th Reg't U. S.
Colored Troops, is reported as follows:

- On Company Muster Roll. For July^{1st} & Augt., 1866, Augt. 24, 1866
- Company Muster-out Roll. August 24, 1866
- Company Descriptive Book. , 1866
- Company Morning Reports. , 1866
- Soldier's Final Statement. August 24, 1866
- Soldier's Record of Death and Interment. , 1866
- Soldier's Inventory of Effects. , 1866
- Soldier's Certificate of Disability for Discharge. , 1866
- Soldier's Individual Muster-out Roll. , 1866
- Regimental Return. For , 1866 , 1866
- Regimental Quarterly Returns. , 1866
- Regimental Descriptive Book. , 1866
- By Surgeon General. , 1866

(August 24, 1866) is held to be the correct date, and the Company Muster Roll will be amended accordingly.

Noted
H. J. Thomas
Assistant Adjutant General.

160.

FINAL STATEMENT

OF

Puto Noah Cunnell Co. E
9th Reg't of Col Troops

VOLUNTEERS.

NOTE 1.—Two of these certificates (or duplicates) are to be given to each Volunteer Soldier or drafted man who may be discharged without being mustered out (Final Statements are never given to men mustered out of service.) that he may at once receive from the Paymaster the pay, &c., due him, and the captain or other COMMISSIONED officer commanding the company will certify to the act of the delivery of the duplicate certificates; with these certificates the Soldier is "entitled to" his discharge, and should also present his discharge to the Paymaster to have the payment endorsed on it. The discharge is to be given back to the Soldier by the Paymaster; the latter only retaining as his vouchers the duplicate certificates.

NOTE 2.—If the Soldier is entitled to pay for the use of his horse, the Company Commander will certify to that fact on the back of both these final statements, and also to the time he has pay due for having been so mounted on his own horse.

NOTE 3.—When a Soldier is furnished with final statements, his descriptive list, if he has one, should be taken up by the officer who gives the Soldier these statements, and endorsed with a statement to this effect by the officer. The endorsement should exhibit a full statement of the time for which the Soldier was allowed pay on his final statements, the clothing account, and all other charges against him or in his favor, so as to comprise a complete exhibit of his account. It will then be transmitted to the Company Commander of the Soldier, who will enter all the data necessary to a full understanding of the Soldier's account on the muster roll upon which the Soldier's discharge is reported. The descriptive list will then be destroyed. The object of this is, that the remaining portion of the Soldier's account may be settled upon the receipt of these muster rolls, and the Soldier receive any pay or allowances that may be due him at the time of his discharge, and which may not appear on his last final statements from the fact that his descriptive list is incomplete. These accounts for back pay, &c., are settled by the 2d Auditor of the Treasury Department.

NOTE 4.—Charges for loss or injury to ordnance, horse equipments, and other miscellaneous charges, should appear under the heading of "Other Stoppages."

NOTE 5.—Bounty paid by State authorities, and not by the United States, will not be entered on this statement.

NOTE 6.—Amount due the Sutler and Laundress must be entered on the back of the final statement, if the discharge, death, desertion, &c., is reported, as in the United States.

NOTE 7.—This blank may be used for deceased volunteers and drafted men, as well as for others.

NOTE 8.—Where a Soldier dies in Hospital or on detached service, his descriptive list, if he has one, should be sent with his final statements, in duplicate, to the Adjutant General, Washington, D. C.

NOTE 9.—If the soldier is a drafted man or substitute, the space for time, &c., at enrolment, should contain only the word *drafted* or *substitute*, as the case may be. If the Soldier is a "VETERAN," (or RECRUIT,) the words as a *veteran*, (or *recruit*.) as the case may be, should be interlined after the words *mustered into the service of the U. S.* A statement of all the installments of *Veteran* or *Recruit* Bounty RECEIVED by the Soldier must be made on the back of each final statement.

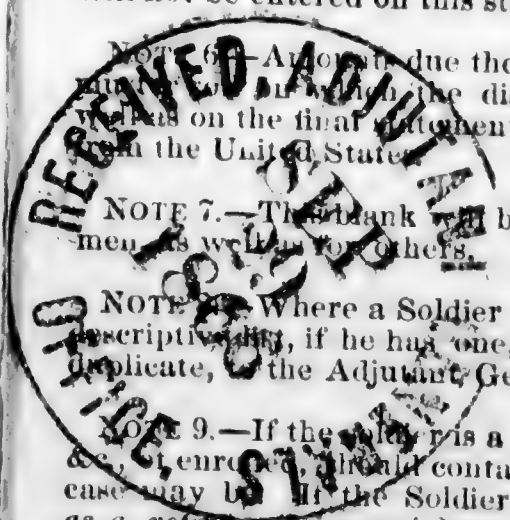

Handwritten signature and date: 6th, 1874

FINAL STATEMENT

46
OF
Pvt. Noah Russell Co. C
9th Reg't of N.Y. Troops
Aud. Aug 24 1861
VOLUNTEERS.

NOTE 1.—Two of these certificates (or duplicates) are to be given to each Volunteer Soldier or drafted man who may be discharged without being mustered out (Final Statements are never given to men mustered out of service.) that he may at once receive from the Paymaster the pay, &c., due him, and the captain or other COMMISSIONED officer commanding the company will certify to the act of the delivery of the duplicate certificates; with these certificates the Soldier is "entitled to" his discharge, and should also present his discharge to the Paymaster to have the payment endorsed on it. The discharge is to be given back to the Soldier by the Paymaster; the latter only retaining as his vouchers the duplicate certificates.

NOTE 2.—If the Soldier is entitled to pay for the use of his horse, the Company Commander will certify to that fact on the back of both these final statements, and also to the time he has pay due for having been so mounted on his own horse.

NOTE 3.—When a Soldier is furnished with final statements, his descriptive list, if he has one, should be taken up by the officer who gives the Soldier these statements, and endorsed with a statement to this effect by the officer. The endorsement should exhibit a full statement of the time for which the Soldier was allowed pay on his final statements, the clothing account, and all other charges against him or in his favor, so as to comprise a complete exhibit of his account. It will then be transmitted to the Company Commander of the Soldier, who will enter all the data necessary to a full understanding of the Soldier's account on the muster roll upon which the Soldier's discharge is reported. The descriptive list will then be destroyed. The object of this is, that the remaining portion of the Soldier's account may be settled upon the receipt of these muster rolls, and the Soldier receive any pay or allowances that may be due him at the time of his discharge, and which may not appear on his last final statements from the fact that his descriptive list is incomplete. These accounts for back pay, &c., are settled by the 2d Auditor of the Treasury Department.

NOTE 4.—Charges for loss or injury to ordnance, horse equipments, and other miscellaneous charges, should appear under the heading of "Other Stoppages."

NOTE 5.—Bounty paid by State authorities, and not by the United States, will not be entered on this statement.

NOTE 6.—Amounts due the Sutler and Laundress must be entered on the final statement, when the discharge, death, desertion, &c., is reported, as well as on the final statement, otherwise the amount cannot be collected from the United States.

NOTE 7.—This blank may be used for deceased volunteers and drafted men, as well as for others.

NOTE 8.—Where a Soldier dies in Hospital or on detached service, his descriptive list, if he has one, should be sent with his final statements, in duplicate, to the Adjutant General, Washington, D. C.

NOTE 9.—If the Soldier is a drafted man or substitute, the space for time, &c., entered on the final statement should contain only the word *drafted* or *substitute*, as the case may be. If the Soldier is a "VETERAN," (or RECRUIT,) the words *as a veteran*, (or *recruit*.) as the case may be, should be interlined after the words *mustered into the service of the U. S.* A statement of all the installments of *Veteran* or *Recruit* Bounty RECEIVED by the Soldier must be made on the back of each final statement.

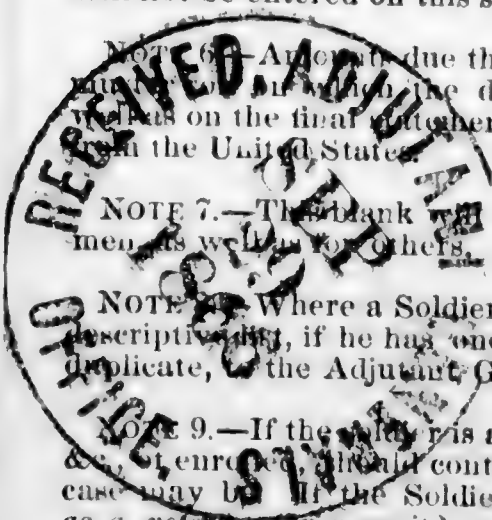

Wm. M. ...
Capt. ...

ADJUTANT GENERAL'S OFFICE
Sept 29 1861
Duplicate with Inventory sent 2d Auditor.

I certify, on honor, that Thomas Sumner, a Private of late
 Captain A. K. Phelps Company (6) of the 9th Regiment of 21st Mass
VOLUNTEERS, of the State of Maine, born in Lucas, State
 of Maine, aged 23 years; 5 feet 1 inches high; Dun complexion,
Black eyes, Black hair, and by occupation a Farmer, who joined for service
 and was enrolled (see Note 9) on the 31st day of October, 1863, at Marble Hill
 by Col Geo Bonner, for the period of 3 years, and mustered into
 the service of the United States on the 11th day of November, 1863, at
Burdick Hill, by Lt Col Eastell; and having served

HONESTLY and FAITHFULLY with his Company to the present date, is now entitled to a
DISCHARGE by reason of Death. Died in Camp at
Brunswick Me on 24th 1866 (11 yrs)

The said Private Keith Sumner was last paid by Paymaster
Geo. Underwood, to include the 30th day of June, 1866, and
 has pay due him from that time to the present date; he is entitled to pay and subsistence for
TRAVELING to place of enrollment, and whatever other allowances are authorized to volunteer
 soldiers, drafted men, or militia, so discharged. He has received from the United States **CLOTHING**
 amounting to Twenty-six 96 100 dollars, since the 31st day of October,
 1863, when his clothing account was last settled. He has received from the United States
100 dollars advanced **BOUNTY**.

There is to be stopped from him, on account of the State of _____, or other
 authorities, for **CLOTHING**, &c., received on entering service, _____ 100 dollars; and
 for other stoppages, viz: _____
 _____ 100 dollars.

He has been furnished with **TRANSPORTATION** in kind from the place of his discharge to
 _____; and he has been **SUBSISTED** for **TRAVELING** to his
 place of enrollment, up to the _____, 186 .

He is indebted to _____, **SUTLER**, _____ 100 dollars.
 He is indebted to _____, **LAUNDRESS**, _____ 100 dollars.

Given in Duplicate, at Brunswick Me, this 10th day
 of September, 1866.

Henry Johnson
1st Lieut 9th Mass Troops
 Commanding Company.

⁹¹⁸
Purnell, Peter

Co E, 9 U.S. Col'd Inf.

Private | Private

CARD NUMBERS.

| | | |
|----|---------|----|
| 1 | 6305094 | 26 |
| 2 | 6308191 | 27 |
| 3 | 6308298 | 28 |
| 4 | 6308402 | 29 |
| 5 | 6308502 | 30 |
| 6 | 6308599 | 31 |
| 7 | 6308697 | 32 |
| 8 | 6308798 | 33 |
| 9 | 6308896 | 34 |
| 10 | 6308994 | 35 |
| 11 | 6309089 | 36 |
| 12 | 6309178 | 37 |
| 13 | 6309267 | 38 |
| 14 | 6309353 | 39 |
| 15 | 6309433 | 40 |
| 16 | 6309509 | 41 |
| 17 | 6309584 | 42 |
| 18 | 6309656 | 43 |
| 19 | 6309727 | 44 |
| 20 | 6309797 | 45 |
| 21 | 9068919 | 46 |
| 22 | | 47 |
| 23 | | 48 |
| 24 | | 49 |
| 25 | | 50 |

Book Mark:

See also

S. 1693477 P.O. Wm
R. Misc. No. 1103135-3/22/18 = Y.H.L.

A. M. Hamner
Esq

P | 9 | U.S.C.T.

Peter Purnell

, Co. E, 9 Reg't U. S. Col'd Inf.

Appears on
Company Descriptive Book
of the organization named above.

DESCRIPTION.

Age 40 years; height 5 feet 4/4 inches.

Complexion *Blk*

Eyes *Blk*; hair *Blk*

Where born *Worcester Co Md*

Occupation *Laborer*

ENLISTMENT.

When *Nov 10*, 1863.

Where *Worcester Co Md*

By whom *Wm Birney*; term *3* y'rs.
Col + Mustng Officer

Remarks:
** Descriptive list furnished Nov 30 - 65 -
Discharged with
the Regt - Nov 26 - 1866 -*

+ All appears on book

C. S. Rogge

P

9

U.S.C.T.

Peter Purnell

Pri., Co. E, 9 Reg't U. S. Col'd Infantry.

Age 40 years.

Appears on

Company Muster-in Roll

of the organization named above. Roll dated

Camp Stanton Charles Co, Md Nov 17, 1863.

Muster-in to date Nov 17, 1863

Joined for duty and enrolled:

When Nov 10, 1863.

Where Worcester Md

Period 3 years.

Remarks:

Book mark:

C. C. Parker

(356)

Copyist.

P

9

U.S.C.T.

Peter Purnell

Pri , Co. E, 9 Reg't U. S. Col'd Infantry.

Appears on

Company Muster Roll

for Nov 15 to Dec 31, 1863.

Present or absent Present

Stoppage, \$ 100 for

Due Gov't, \$ 100 for

Remarks: detailed as Co
Teamster Two dollars
Recruits Premium due

Book mark:

C. C. Parker

P | 9 | U.S.C.T.

Peter Purnell

Pri, Co. E, 9 Reg't U. S. Col'd Infantry.

Appears on

Company Muster Roll

for *Jan + Feb*, 1864.

Present or absent *Present*

Stoppage, \$ *100* for

Due Gov't, \$ *100* for

Remarks: *Two dollars Recruits*

Premium due

Book mark:

C. C. Parker

P | 9 | U.S.C.T.

Peter Purnell

Pri, Co. E, 9 Reg't U. S. Col'd Infantry.

Appears on

Company Muster Roll

for Mar + Apr, 1864.

Present or absent Present

Stoppage, \$ 100 for

Due Gov't, \$ 100 for

Remarks: Two dollars Recruits premium due

Book mark:

C. C. Parker

P

9

U.S.C.T.

Peter Purnell

Pri . Co. E, 9 Reg't U. S. Col'd Infantry.

Appears on

Company Muster Roll

for May & June, 1864.

Present or absent Present

Stoppage, \$ 100 for

Due Gov't, \$ 100 for

Remarks:

Book mark:

C. C. Parker

(358)

Copist.

P | 9 | U.S.C.T.

Peter Purnell

Pri, Co. E, 9 Reg't U. S. Col'd Infantry.

Appears on

Company Muster Roll

for July + Aug, 1864.

Present or absent Present

Stoppage, \$ 100 for

Due Gov't, \$ 100 for

Remarks: Free on or before Apr 15 - 1861

Book mark:

C. C. Parker

P | 9 | U.S.C.T.

Peter Purnell

Pri, Co. E, 9 Reg't U. S. Col'd Infantry.

Appears on

Company Muster Roll

for Sept + Oct, 1864.

Present or absent Present

Stoppage, \$ 100 for

Due Gov't, \$ 100 for

Remarks: Free on or before Apr 19/61

Book mark:

C. C. Parker

P

9

U.S.C.T.

Peter Purnell

Pat. Co. E, 9 Reg't U. S. Col'd Infantry.

Appears on

Company Muster Roll

for Nov & Dec, 1864

Present or absent Present

Stoppage, \$ 100 for

Due Gov't, \$ 100 for

Remarks: Free on or before
Apr 19-61.

Book mark:

J. E. Neteman Copyist.

(358)

P | 9 | U.S.C.T.

Peter Purnell

Sgt, Co. E, 9 Reg't U. S. Col'd Infantry.

Appears on

Company Muster Roll

for *Jany & Liby*, 1865

Present or absent *Present*

Stoppage, \$ *100* for

Due Gov't, \$ *100* for

Remarks:

Book mark:

J. E. Noteman
Copyist.

P

9

U.S.C.T.

Peter Purnell

Pat, Co. E, 9 Reg't U. S. Col'd Infantry.

Appears on

Company Muster Roll

for March & April, 1865.

Present or absent Absent

Stoppage, \$ 100 for

Due Gov't, \$ 100 for

Remarks: Ate Service in I M

Sept for S.O. no 32 Fed

Dis g'd 23.65

Book mark:

H. E. Moteman

(358)

Copyist.

P | 9 | U.S.C.T.

Peter Purnell

Pat, Co. E, 9 Reg't U. S. Col'd Infantry.

Appears on

Company Muster Roll

for *Dec 31, 64 to June 30, 1865.*

Present or absent *Absent*

Stoppage, \$ 100 for

Due Gov't, \$ 100 for

Remarks: *On detc serv in 2nd Regt
pr S.O. #32 Feb 23rd to 25th
Mar 23rd 1865,*

Book mark: _____

H. E. Noteman

P | 9 | U.S.C.T.

Peter Purnell

Pat, Co. E, 9 Reg't U. S. Col'd Infantry.

Appears on

Company Muster Roll

for July & Augt, 1865.

Present or absent Present

Stoppage, \$ 100 for

Due Gov't, \$ 100 for

Remarks: On detached service in D.M. Sept per S.O. no 32 Vol Des 9th US Col March 23, 65. Stopped for Ordnance 20. etc

Book mark:

J. E. Neteman Copyist.

(P) | 9 | U.S.C.T.

Peter Purnell

Pat, Co. E, 9 Reg't U. S. Col'd Infantry.

Appears on

Company Muster Roll

for June 30 to Oct 31, 1865

Present or absent Present

Stoppage, \$ 100 for

Due Gov't, \$ 20/100 for Ord

Remarks: Let Ser J. M. Dept
S.C. no. 32 Fed Dr. 2569
March 23. 65

Book mark:

H. E. Meteman

(858)

Copyist.

P | **9** | **U.S.C.T.**

Peter Jurnell

Pat, Co. E, 9 Reg't U. S. Col'd Infantry.

Appears on

Company Muster Roll

for *June 30 to Dec 31, 1865*

Present or absent *Present*

Stoppage, \$ *100* for

Due Gov't, \$ *20* for *ord*

Remarks: *Let Serv. Ac. no 32*
Had Dis 9 U.S.C.T.
March 24, 65

Book mark:

H. E. Wetman

(358)

Copyist.

9

U.S.C.T.

....., Co. E, 9 Reg't U. S. Col'd Infantry.

Appears on

Company Muster Roll

for, 186 .

Present or absent

Stoppage, \$.....100 for

Due Gov't, \$.....100 for

Remarks:

Book mark:

9

U.S.C.T.

....., Co. E, 9 Reg't U. S. Col'd Infantry.

Appears on

Company Muster Roll

for:, 186..

Present or absent

Stoppage, \$.....100 for

Due Gov't, \$.....100 for

Remarks:

Book mark:

9

U.S.C.T.

....., Co. E, 9 Reg't U. S. Col'd Infantry.

Appears on

Company Muster Roll

for, 186 .

Present or absent

Stoppage, \$ 100 for

Due Gov't, \$ 100 for

Remarks:

Book mark:

9

U.S.C.T.

John J. ...

... , Co. E, 9 Reg't U. S. Col'd Infantry.

Appears on

Company Muster Roll

for *1863*, 186 .

Present or absent *Present*

Stoppage, \$ *100* for

Due Gov't, \$ *100* for

Remarks:

Book mark:

John J. ...

9

U.S.C.T.

....., Co. E, 9 Reg't U. S. Col'd Infantry.

Appears on

Company Muster Roll

for 186 .

Present or absent

Stoppage, \$ 100 for

Due Gov't, \$ 100 for

Remarks:

Book mark:

9

U.S.C.T.

Wm. J. ...

....., Co., 9 Reg't U. S. Col'd Infantry.

Appears on **Co. Muster-out Roll**, dated

Jan 10 1864, 186*4*.

Muster-out to date *Jan 10*, 186*4*.

Last paid to *Jan 10*, 186*4*.

Clothing account:

Last settled....., 186 ; drawn since \$..... 100

Due soldier \$..... / 100; due U. S. \$..... 100

Am't for cloth'g in kind or money adv'd \$..... 100

Due U. S. for arms, equipments, &c., \$..... 100

Bounty paid \$..... 100: due \$..... 100

Remarks: *Wm. J. ...*
... ..
... ..
... ..
... ..

Book mark: *...*

Purnell, Peter
 P, Co. G, 9 Reg't U S C Inf.

2 Enclosures.

| | |
|------------------------------------|-------------------------|
| Bed Cards | Descriptive Lists |
| Burial Records | Final Statements |
| Certs. of Dis. for Discharge | Furloughs |
| C. M. Charges | Med. Des. Lists |
| Med. Certificates | Orders 2 |

Other papers relating to—

| | |
|----------------------------------|---------------------------|
| Admission to Hosp'l | Furlough |
| Casualty Sheet (Officer's) | Med. Examination |
| Confinement | Misc. Information |
| Contracts | Pay or Clothing |
| Death or Effects | Personal Reports |
| Desertions | Rank |
| Discharge from Hosp'l | Transfer to Hosp'l |
| Discharge from Service | Transfer to V. R. C. |
| Duty | Transportation |

Hodges G. M. W.S. Co. B.
Dec. 30/83

Col. Shub. Bayley

Special Order No. 59

Returning Peter
Russell to duty
with his Co.

Peter Russell

Adjpts 4th U. S. C. B.
Dec. 30/68

Special Order
No. 53

Peter Purmill of Co. "E." is hereby
relieved from duty as Quartermaster as his
report to Capt. Ridley

By order of
Thos. Bayley
Col. Comdg Regt

Official,
C. W. Money
1st Lt. & Adj. Adjt.

Headquarters 9th U. S. C. S.
Dec. 28/63

1st Col. S. C. Armstrong
Company Regt.

Special Order No.
150

Detailing Private Peter
Purnell as Recruit.

Peter Purnell

Hedgers 9th U. S. Cold Troops
Dec. 28, 1869

Special Order
No. 50

Private Peter Purnell of Co "G."
9th U. S. C. T. is hereby detailed as Regt
Teamster

By order of
S. C. Armstrong
Lieut Col. Commanding Regt

Official
C. H. Murey
1st Lieut & Act. Adj't.

⁹¹⁹
Purnell, Saco

Co G, 9 U.S. Col'd Inf.

Private | Private

CARD NUMBERS.

| | | |
|----|---------|----|
| 1 | 6311739 | 26 |
| 2 | 6311833 | 27 |
| 3 | 6311936 | 28 |
| 4 | 6312036 | 29 |
| 5 | 6312131 | 30 |
| 6 | 6312225 | 31 |
| 7 | 6312317 | 32 |
| 8 | 6312410 | 33 |
| 9 | 6312501 | 34 |
| 10 | 6312589 | 35 |
| 11 | 6312675 | 36 |
| 12 | 6312777 | 37 |
| 13 | 6300394 | 38 |
| 14 | 6313325 | 39 |
| 15 | 9069158 | 40 |
| 16 | | 41 |
| 17 | | 42 |
| 18 | | 43 |
| 19 | | 44 |
| 20 | | 45 |
| 21 | | 46 |
| 22 | | 47 |
| 23 | | 48 |
| 24 | | 49 |
| 25 | | 50 |

Book Mark:

See also

S: 1041058 Pomm.

A. M. Shannon
Esq

9 | 9 | U.S.C.T.

Isaac Purnell

....., Co. G, 9 Reg't U. S. Col'd Inf.

Appears on
Company Descriptive Book

of the organization named above.

DESCRIPTION.

Age 21 years; height 5 feet 3 inches.

Complexion Black

Eyes Black; hair Wool

Where born Worcester, Md.

Occupation Farm h.

ENLISTMENT.

When Nov. 18....., 1863

Where 5 m. from { Berlin,
Worcester,

By whom Col Wm. Binney term 3 y'rs.

Remarks: Strong rebel
Isaac Purnell.
Slave for life
Discharged. Muster-
ed out while absent
sick Ft. Monroe,
Va., June 4/65. Noti-
fication from A.G.O.

X As appears.

W. M. Jackson

P | 9 | U.S.C.T.

Saco Purnell
Pvt, Co. *G*, 9 Reg't U. S. Col'd Infantry.

Age *21* years.

Appears on

Company Muster-in Roll

of the organization named above. Roll dated
Camp Stanton
Charles Co Md., *Nov 23*, 1863.

Muster-in to date *Nov 23*, 1863

Joined for duty and enrolled:

When *Nov 18*, 1863.

Where *Worcester Md.*

Period *3* years.

Remarks:
.....
.....
.....
.....
.....
.....

Book mark:

B. Banoll

P

9

U.S.C.T.

Saco Purnell

Pvt, Co. G, 9 Reg't U. S. Col'd Infantry.

Appears on

Company Muster Roll

for *Nov 23 to Dec 31*, 1863.

Present or absent *Present*

Stoppage, \$ *100* for

Due Gov't, \$ *100* for

Remarks *\$2 Recruiting premium due. Sick in quarters.*

Book mark:

E. Carroll

P | **9** | **U.S.C.T.**

Saco Purnell

Pvt, Co. G, 9 Reg't U. S. Col'd Infantry.

Appears on

Company Muster Roll

for *Jan'y + Feb*, 1864.

Present or absent *Present*

Stoppage, \$ *100* for

Due Gov't, \$ *100* for

Remarks: *\$ 2⁰⁰/₁₁ Recruiting premium due.*

Book mark:

E. Carroll

P

9

U.S.C.T.

Saco Funnell

Pvt, Co. G, 9 Reg't U. S. Col'd Infantry.

Appears on

Company Muster Roll

for *March & April*, 1864.

Present or absent *Present*

Stoppage, \$ 100 for

Due Gov't, \$ 100 for

Remarks:

Book mark:

E. B. Carroll

(858)

Copist.

P

9

U.S.C.T.

Saco Funnell

Pvt, Co. G, 9 Reg't U. S. Col'd Infantry.

Appears on

Company Muster Roll

for *May & June*, 1864.

Present or absent *Present*

Stoppage, \$ 100 for

Due Gov't, \$ 100 for

Remarks:

Book mark:

E. C. Carroll

J

9

U.S.C.T.

Sacco Furnell

Pvt, Co. G, 9 Reg't U. S. Col'd Infantry.

Appears on

Company Muster Roll

for *July & Aug*, 1864.

Present or absent *Present*

Stoppage, \$ *100* for

Due Gov't, \$ *100* for

Remarks:

Book mark:

E. Carroll

(858)

Copyist.

P

9

U.S.C.T.

Sacco Purnell

Pvt, Co. G, 9 Reg't U. S. Col'd Infantry.

Appears on

Company Muster Roll

for *Sept & Oct*, 1864.

Present or absent *Present*

Stoppage, \$ *100* for

Due Gov't, \$ *100* for

Remarks:

Book mark:

E. Carroll

P

9

U.S.C.T.

Saco Tunell
Private, Co. G, 9 Reg't U. S. Col'd Infantry.

Appears on

Company Muster Roll

for *Nov, & Dec,*, 1864.

Present or absent *Present*

Stoppage, \$ *100* for

Due Gov't, \$ *100* for

Remarks: *See Det. Service*
as Provost Guard per
S.O. No. 5 Hdqrs 2nd Brig
3rd Div. 25th A.C. Dec 7/64

Book mark:

M. M. Warren

P

9

U.S.C.T.

Sacco Purnell
Private, Co. G, 9 Reg't U. S. Col'd Infantry.

Appears on

Company Muster Roll

for Jan. & Feb., 1865.

Present or absent Present

Stoppage, \$ 100 for

Due Gov't, \$ 100 for

Remarks: Detached Service

S. O. No. 5 H. L. 2nd Brig
3rd Div. 25th A. C. Dec. 7/64

Book mark:

M. W. Warren

(858)

Copist.

P

9

U.S.C.T.

Saca Purnell
Private, Co. G, 9 Reg't U. S. Col'd Infantry.

Appears on

Company Muster Roll

for *Mar. & April*, 186*5*.

Present or absent *Present*

Stoppage, \$ *100* for

Due Gov't, \$ *100* for

Remarks:

Book mark:

M. W. Hansen

P

9

U.S.C.T.

Saco Purnell
Priv., Co. G, 9 Reg't U. S. Col'd Infantry.

Appears on

Company Muster Roll

for Dec, 31/64 to June 30, 1865.

Present or absent Absent

Stoppage, \$ 100 for

Due Gov't, \$ 100 for

Remarks: Abs sick since
May 13. 65 Stop Kupsek
\$ 3.10

Book mark:

M. W. Warren

(358)

Copist.

J | 9 | U.S.C.T.

Saco Turnell

Pvt., Co. G, 9 Reg't U. S. Col'd Infantry.

Appears on

Company Muster Roll

for *July & Aug.*, 1865.

Present or absent

Stoppage, \$ 100 for

Due Gov't, \$ 100 for

Remarks: *Discharged by ord
Ward Dept. May 3. 65-
Ft. Monroe Va. June 4
65-Stop Kup \$3.70*

Book mark:

M. M. Warren

P | *9* U.S.C.T.

Saco Purnell

Pri, Co. *4*, *9* Reg't U. S. Col'd Infantry.

Appears on a

Detachment Muster-out Roll

of the organization named above. Roll dated

St. Maurice, Va., June 4, 1865.

Muster-out to date *June 4, 1865.*

Last paid to *Dec 31, 1864*

Clothing account:

Last settled *Apr 31, 1864*, drawn since \$ *30* ^{*68*} _{*100*}

Due soldier \$ 100; due U. S. \$ 100

Am't for cloth'g in kind or money adv'd \$ 100

Due U. S. for arms, equipments, &c., \$ 100

Bounty paid \$ 100 due \$ 100

Remarks: *Mustered out by order of War Dept dated May 3^d 65. Patient U. S. Genl Hoop St. Maurice, Va.*

Book mark: _____

(349) *J. B. Brown* Copyist.

P | 9 | U.S.C.T.

Saco Purnell
 Priv., Co. G, 9 Reg't U. S. Col'd Infantry.

Appears on **Co. Muster-out Roll**, dated
 New Orleans La. Nov. 26, 1866.

Muster-out to date _____, 186 .

Last paid to _____, 186 .

Clothing account:

Last settled _____, 186 ; drawn since \$ _____ 100

Due soldier \$ _____ 100; due U. S. \$ _____ 100

Am't for cloth'g in kind or money adv'd \$ _____ 100

Due U. S. for arms, equipments, &c., \$ _____ 100

Bounty paid \$ _____ 100; due \$ _____ 100

Remarks: *Joined at origl. orgn.
 Discharged June 4, '65
 Fk. Monroe Va. Tel Order
 A. S. C. May 3, '65.*

Book mark: _____

(861) *C. E. McLaughlin*
 Copyist.

⁹²⁰
Purnell, Severon

Co G, 9 U.S. Col'd Inf.

Private | Private

CARD NUMBERS.

| | | |
|----|--------------|----|
| 1 | 63 11740 | 26 |
| 2 | 63 11834 | 27 |
| 3 | 63 11937 | 28 |
| 4 | 63 12037 | 29 |
| 5 | 63 12132 | 30 |
| 6 | 63 12226 | 31 |
| 7 | 63 12318 | 32 |
| 8 | 63 12411 | 33 |
| 9 | 63 12502 | 34 |
| 10 | 63 12590 | 35 |
| 11 | 63 12676 | 36 |
| 12 | 63 12778 | 37 |
| 13 | 63 128396 | 38 |
| 14 | 63 13326 | 39 |
| 15 | 9069 159 | 40 |
| 16 | P-16807-1871 | 41 |
| 17 | | 42 |
| 18 | | 43 |
| 19 | | 44 |
| 20 | | 45 |
| 21 | | 46 |
| 22 | | 47 |
| 23 | | 48 |
| 24 | | 49 |
| 25 | | 50 |

Book Mark: P 168 or 9. 16. P. 71

See also

P | 9 | U.S.C.T.

Sevon Russell

Co. G, 9 Reg't U.S. Col'd Inf.

Appears on

Company Descriptive Book

of the organization named above.

DESCRIPTION.

Age 26 years; height 5 feet 5/8 inches.

Complexion Not very black

Eyes Black; hair Wool

Where born Worcester, Md.

Occupation Farmer

ENLISTMENT.

When Nov. 18, 1863

Where Snow Hill, Worcester

By whom Col. W. Binney; term 3 y'rs.

Remarks: Free.

Co. Cook

Mustered out while absent sick at Norfolk, Va. June 10/65.

M. Jackson

(383)

Copyist.

P

9

U.S.C.T.

Sevon Purnell

Pvt, Co. *G*, 9 Reg't U. S. Col'd Infantry.

Age *26* years.

Appears on

Company Muster-in Roll

of the organization named above. Roll dated

Camp Stanton
Charles Co Md., *Nov 23*, 1863.

Muster-in to date *Nov 23*, 1863

Joined for duty and enrolled:

When *Nov 18*, 1863.

Where *Worcester Md.*

Period *3* years.

Remarks:
.....
.....
.....
.....
.....

Book mark:

E. Barroll

P

9

U.S.C.T.

Servon Purnell

Pot, Co. G, 9 Reg't U. S. Col'd Infantry.

Appears on

Company Muster Roll

for *Nov 23 to Dec 31*, 1863.

Present or absent *Absent*

Stoppage, \$ *100* for

Due Gov't, \$ *100* for

Remarks *\$2.00 Recruiting premiums
due. On recruiting service since
Dec 20. Post order No 92.*

Book mark:

E. B. Carroll

P

9

U.S.C.T.

Purnell Sevron

Pvt, Co. G, 9 Reg't U. S. Col'd Infantry.

Appears on

Company Muster Roll

for *Jan'y + Feb*, 1864.

Present or absent *Present*

Stoppage, \$ *100* for

Due Gov't, \$ *100* for

Remarks: *Daily duty as Co. Cook
\$2.00, Recruiting premium due*

Book mark:

E. C. Carroll

P

9

U.S.C.T.

Servon Purnell
Pvt, Co. G, 9 Reg't U. S. Col'd Infantry.

Appears on

Company Muster Roll

for *March & April*, 1864.

Present or absent *Present*

Stoppage, \$ *100* for

Due Gov't, \$ *100* for

Remarks: *Daily duty as Cook.*

Book mark: _____

E. C. Carroll

(858)

Copist.

P

9

U.S.C.T.

Severon Purnell

Pvt, Co. G, 9 Reg't U. S. Col'd Infantry.

Appears on

Company Muster Roll

for *May + June*, 1864.

Present or absent *Present*

Stoppage, \$ *100* for

Due Gov't, \$ *100* for

Remarks: *Daily duty as Co. Cook*

Book mark:

E. B. Carroll

P

9

U.S.C.T.

Servon Purnell
Pot, Co. G, 9 Reg't U. S. Col'd Infantry.

Appears on

Company Muster Roll

for *July + Aug*, 1864.

Present or absent *Present*

Stoppage, \$ 100 for

Due Gov't, \$ 100 for

Remarks: *Free on or before April 19, 1861.*

Book mark: _____

E. Carroll

(858)

Copyist.

P

9

U.S.C.T.

Severn Purnell
Pvt, Co. G, 9 Reg't U. S. Col'd Infantry.

Appears on

Company Muster Roll

for *Sept & Oct*, 1864.

Present or absent *Present*

Stoppage, \$ *100* for

Due Gov't, \$ *100* for

Remarks: *Daily duty as cook*
Free on or before April 19. 61

Book mark:

E. B. Carroll

(858)

Copyist.

P

9

U.S.C.T.

Severon Curwell
Private, Co. G, 9 Reg't U. S. Col'd Infantry.

Appears on

Company Muster Roll

for *Nov & Dec*, 1864

Present or absent *Present*

Stoppage, \$ *100* for

Due Gov't, \$ *100* for

Remarks: *All daily duty as
Co. Cook. Free on
or before April 19/61*

Book mark:

M. M. Warren

(858)

Copist.

P

9

U.S.C.T.

Sworn Turnell
Private, Co. G, 9 Reg't U. S. Col'd Infantry.

Appears on

Company Muster Roll

for *Jan. & Feb.*, 1865.

Present or absent *Private*

Stoppage, \$ *100* for

Due Gov't, \$ *100* for

Remarks: *Co Cook since*
*Jan. 12 1864 *~~1st~~ 2nd Brig.*

** as appears on Roll*

Book mark: _____

M. W. Tharion

P

9

U.S.C.T.

Suron Turnell
Private, Co. G, 9 Reg't U. S. Col'd Infantry.

Appears on

Company Muster Roll

for *Mar. & April*, 1865.

Present or absent *Present*

Stoppage, \$ 100 for

Due Gov't, \$ 100 for

Remarks: *Daily Duty as Co
Cook since Jan. 1. 64*

Book mark:

M. W. Warren

P

9

U.S.C.T.

Swson Purcell
Priv., Co. G, 9 Reg't U. S. Col'd Infantry.

Appears on

Company Muster Roll

for *Dec. 31/64 to June 30, 1865*

Present or absent

Absent

Stoppage, \$ 100 for

Due Gov't, \$ 100 for

Remarks:

*Abs. sick since
May 22 - 65
Stop \$4.58 (transfer
on furlough)*

Book mark:

M. M. Warren

P

9

U.S.C.T.

Sorsore Russell
Priv., Co. G, 9 Reg't U. S. Col'd Infantry.

Appears on

Company Muster Roll

for *July & Aug.*, 1865.
Present or absent

Stoppage, \$ 100 for

Due Gov't, \$ 100 for

Remarks: *Discharged by ord
War Dept May 3, 65
Norfolk Va. June 10, 65
Free on or bef Apr 19/61
no bounty yet rec'd. \$100.00
due Stop \$4.58 transp'tn*

Book mark *Discharged June 7, 1865 (over)*

M. M. Warren

(858)

Copist.

P. 168 Wg C.J. 71

JAN. 21

6312778
018913

P | 9 - U.S.C.T.

Severin Purnell
Pri, Co. G, 9 Reg't U. S. Col'd Infantry.

Appears on a

Detachment Muster-out Roll

of the organization named above. Roll dated
Norfolk, Va. June 4, 1865.
Muster-out to date June 14, 1865.
Last paid to Dec 31, 1864

Clothing account:

Last settled Oct 31, 1864; drawn since \$ 17 ²⁵/₁₀₀

Due soldier \$ 100; due U. S. \$ 100

Am't for cloth'g in kind or money adv'd \$ 100

Due U. S. for arms, equipments, &c., \$ 100

Bounty paid \$ 100 due \$ 100

Remarks: Discharged from Balfour
Gen Hosp'l Portsmouth, Va.
order of War Dept May
3, '65. No account of Bounty
on des' list.

Book mark: V. 129. P. 138. 74.

(349) *J. Brown* Copist.

P | 9 | U.S.C.T.

~~Devon~~ Purnell
 Priv., Co. G, 9 Reg't U. S. Col'd Infantry.

Appears on **Co. Muster-out Roll**, dated
 New Orleans La., Nov. 26, 1866.

Muster-out to date _____, 186 .

Last paid to _____, 186 .

Clothing account:

Last settled _____, 186 ; drawn since \$ _____ 100

Due soldier \$ _____ 100; due U. S. \$ _____ 100

Am't for cloth'g in kind or money adv'd \$ _____ 100

Due U. S. for arms, equipments, &c., \$ _____ 100

Bounty paid \$ _____ 100; due \$ _____ 100

Remarks: *Joined at orig. orgn.*
Discharged June 10, '65.
Norfolk Va. Fel. Order A.G.O
May 3, '65.

** corrected by Shannon*

Book mark: *V. 129. P. 138. 71. Dis-*
charged June 7, 1865 P. 168 V. 9.
C. J. 71

C. E. McLaughlin

(861)

Copyist.

P 19 U.S.A.
Serron Purcell
Co. 9, 9 Reg't U.S.A.

NOTATION.

Book mark: P 168-6.7.1871

War Department,

Adjutant General's Office,

Washington, Oct 26, 1871.

Discharged June 7 1865

Sumell, Vernon
 _____, Co. _____, Reg't *9 U.S.C.T.*

----- / ----- **Enclosures.**

| | |
|------------------------------------|----------------------------|
| Bed Cards | Final Statements |
| Burial Records | Furloughs or L. of A. |
| Certs. of Dis. for Discharge | Med. Certificates |
| C. M. Charges | Med. Des. Lists |
| Descriptive Lists | Orders |
| Discharge Certificates | Pris. of War Record |
| Enlistment Papers | Resignations |

Other papers relating to—

| | |
|------------------------------|---------------------------|
| Admission to Hosp'l | Furlough or L. of A. |
| Casualty Sheet | Med. Examination |
| Confinement | Misc. Information / |
| Contracts | Pay or Clothing |
| Death or Effects | Personal Reports |
| Desertion | Rank |
| Discharge from Hosp'l | Transfer to Hosp'l |
| Discharge from Service | Transfer to V. R. C. |
| Duty | Transportation |

NARA 93

Levon Furnell
9th N. S. C. S.

Furlough

1865.

See letter of Capt.
Wm Cook, Comd'g-

25 A. C.

⁹²¹
Purnell, Stephen

Co A, 9 U.S. Col'd Inf.

Private | Private

CARD NUMBERS.

| | | |
|----|---------|----|
| 1 | 6300804 | 26 |
| 2 | 6300904 | 27 |
| 3 | 6301004 | 28 |
| 4 | 6301106 | 29 |
| 5 | 6301203 | 30 |
| 6 | 6301297 | 31 |
| 7 | 6301389 | 32 |
| 8 | 6301487 | 33 |
| 9 | 6301587 | 34 |
| 10 | 6301685 | 35 |
| 11 | 6301781 | 36 |
| 12 | 6301872 | 37 |
| 13 | 6301960 | 38 |
| 14 | 6302052 | 39 |
| 15 | 6302129 | 40 |
| 16 | 6302199 | 41 |
| 17 | 6302271 | 42 |
| 18 | 6302339 | 43 |
| 19 | 6302404 | 44 |
| 20 | 6302473 | 45 |
| 21 | 9068592 | 46 |
| 22 | | 47 |
| 23 | | 48 |
| 24 | | 49 |
| 25 | | 50 |

Book Mark:

See also

8634402 P.O. 90
81765277 P.O. m. m.

81934439, And. W.A.
81940473 And. W.A.
O.Y. 1530683

A.M. Shannon
E.A.

P | 9 | U.S.C.T.

Stephen Piornell

, Co. A, 9 Reg't U. S. Col'd Inf.

Appears on

Company Descriptive Book

of the organization named above.

DESCRIPTION.

Age 19 years; height 5 feet 6 1/2 inches.

Complexion Dark

Eyes Brown; hair Black

Where born Worcester, Md

Occupation Farmer

ENLISTMENT.

When Nov 2nd, 1863

Where Benedict

By whom Col. Quincy; term 3 y'rs.

Remarks: mustered out with Regt Nov 26/66

M. A. ...

P | 9 | U.S.C.T.

Stephen Furnell
Priv, Co. *A*, 9 Reg't U. S. Col'd Infantry.

Age *19* years.

Appears on

Company Muster-in Roll

of the organization named above. Roll dated

Camp Stanton Ches. Co. Md. Nov. 11, 186*3*.

Muster-in to date *Nov. 11*, 186*3*

Joined for duty and enrolled:

When *Nov. 1*, 186*3*.

Where *Worcester Md*

Period *3* years.

Remarks:

Book mark:

W B Ferguson

P | 9 | U.S.C.T.

Stephen Purcell
Civ, Co. A, 9 Reg't U. S. Col'd Infantry.

Appears on

Company Muster Roll

for *Nov. 11* to *Dec. 31*, 1863.

Present or absent *Absent*

Stoppage, \$ 100 for

Due Gov't, \$ 100 for

Remarks: *Recruit premium due*

Absent recruit's service special order No. 90 Hd. Qrs. Camp Stanton Dec. 20 1863.

Book mark:

W. B. Ferguson

(858)

Copyist

P | 9 | U.S.C.T.

Stephen Purnell
Priv, Co. A, 9 Reg't U. S. Col'd Infantry.

Appears on

Company Muster Roll

for *Jan. & Feb.*, 1864.

Present or absent *Present*

Stoppage, \$ *100* for

Due Gov't, \$ *100* for

Remarks: *\$ recruit premium due.*

Book mark:

W. H. Ferguson

(858)

Copyist

P

9

U.S.C.T.

Stephen Cornell
Priv, Co. A, 9 Reg't U. S. Col'd Infantry.

Appears on

Company Muster Roll

for *March & April*, 186*4*.

Present or absent *Present*

Stoppage, \$ *100* for

Due Gov't, \$ *100* for

Remarks:

Book mark: -----

(358)

W. H. Ferguson

Copyist

P

9

U.S.C.T.

Stephen Purcell

Priv, Co. A, 9 Reg't U. S. Col'd Infantry.

Appears on

Company Muster Roll

for *May & June*, 1864.

Present or absent *Present*

Stoppage, \$ *100* for

Due Gov't, \$ *100* for

Remarks:

Book mark:

W. B. Ferguson

(358)

Copyist

P | **9** | **U.S.C.T.**

Stephen Purcell
Priv, Co. A, 9 Reg't U. S. Col'd Infantry.

Appears on

Company Muster Roll

for *July & Aug.*, 186*4*.

Present or absent *Present*

Stoppage, \$ *100* for

Due Gov't, \$ *100* for

Remarks: *Waiter to Capt. Thompson*

Book mark:

(358)

W. B. Ferguson
Copyist

P | 9 | U.S.C.T.

Stephen Purnell
Priv., Co. A, 9 Reg't U. S. Col'd Infantry.

Appears on

Company Muster Roll

for *Sept. & Oct.*, 1864.

Present or absent *Absent*

Stoppage, \$ 100 for

Due Gov't, \$ 100 for

Remarks: *Absent wounded*
since Sept. 29th 64.

Book mark:

W. B. Ferguson
Copyist

9 | **U.S.C.T.**

Stephen Purcell
Pvt, Co. *A*, 9 Reg't U. S. Col'd Infantry.

Appears on

Company Muster Roll

for *Nov. 7*, 186*4*

Present or absent *Absent*

Stoppage, \$ *100* for

Due Gov't, \$ *100* for

Remarks: *Absent wounded*
since Sept. 29/64

Book mark: _____

W. B. Ferguson

C

9

U.S.C.T.

Stephen Curnell

C, Co. A, 9 Reg't U. S. Col'd Infantry.

Appears on

Company Muster Roll

for *Jany & Oby*, 1865.

Present or absent *Absent*

Stoppage, \$ *100* for

Due Gov't, \$ *100* for

Remarks: *Absent wounded since Sept 29th 1864*

Book mark: *33-332*

W. C. Maxwell

(358)

Copyist

9

U.S.C.T.

John ...
...
... Co. A, 9 Reg't U. S. Col'd Infantry.

Appears on

Company Muster Roll

for *March 1864*, 1864.

Present or absent *present*

Stoppage, \$ *100* for

Due Gov't, \$ *100* for

Remarks: *Account sick since*
March 29, 1864. \$ 100.00 (Due)
pay due ...

Book mark

A. E. Howard

(858)

Copyist

9

U.S.C.T.

Stephen Linnell
Co. A, 9 Reg't U. S. Col'd Infantry.

Appears on

Company Muster Roll

for *Stephen Linnell*, 186

Present or absent *absent*

Stoppage, \$ 100 for

Due Gov't, \$ 100 for

Remarks: *absent wounded*
since Sept 21st by order
soldier's office back

Book mark:

Stephen Linnell

(858)

Copyist

C

9

U.S.C.T.

John J. ...

... Co. A, 9 Reg't U. S. Col'd Infantry.

Appears on

Company Muster Roll

for *July & Aug*, 186*4*.

Present or absent *Present*

Stoppage, \$ *100* for

Due Gov't, \$ *100* for

Remarks: *... from June 1864*
... Dec 1864

Book mark:

John J. ...

P

9

U.S.C.T.

Stephen Cunnell

Priv, Co. A, 9 Reg't U. S. Col'd Infantry.

Appears on

Company Muster Roll

for *Jun 30 to Oct 31*, 1865.

Present or absent *Present*

Stoppage, \$ *100* for

Due Gov't, \$ *100* for

Remarks: *Due W.D. \$100.00
not paid from June 30/64
to Dec. 31/64*

Book mark:

W. G. Howser

(858)

Copyist

9

9

U.S.C.T.

Stephen Cornell

Co., Co. A, 9 Reg't U. S. Col'd Infantry.

Appears on

Company Muster Roll

for *June 30th Dec 31*, 186*5*.

Present or absent *present*

Stoppage, \$ *100* for

Due Gov't, \$ *100* for

Remarks: *Due 50.00*

*twice paid in July Aug
Sept, October, October,
November & December, 1864*

Book mark:

W. G. Thrope

J | **9** | **U.S.C.T.**

John B. ...
..., Co. A, 9 Reg't U. S. Col'd Infantry.

Appears on

Company Muster Roll

for *Jan & Feb*, 186*6*.

Present or absent *Present*.

Stoppage, \$ *100* for

Due Gov't, \$ *100* for

Remarks:

Book mark:

H. B. ...

P

9

U.S.C.T.

Stephen Purnell

Pvt., Co. A, 9 Reg't U. S. Col'd Infantry.

Appears on

Company Muster Roll

for *Month April*, 186*4*.

Present or absent *Present*

Stoppage, \$ *100* for

Due Gov't, \$ *100* for

Remarks:

Book mark:

ENCLOSURE

Dregan

P

9

U.S.C.T.

Stephen Purnell
Co. A, 9 Reg't U. S. Col'd Infantry.

Appears on

Company Muster Roll

for July & Aug, 1866.

Present or absent Present

Stoppage, \$ 100 for

Due Gov't, \$ 100 for

Remarks: Set Service for I.C.
No 179 Wd Burr & P.G. July
23, 66

Book mark

Breyer

(358)

Copyist

P | **9** | **U.S.C.T.**

Stephen Purnell
P, Co. A, 9 Reg't U. S. Col'd Infantry.

Appears on

Company Muster Roll

for *Sept + Oct*, 186*6*.

Present or absent *Present*

Stoppage, \$ *100* for

Due Gov't, \$ *100* for

Remarks: *Daily duty Pioneer*

Book mark:

Dreyer

P | 9 | U.S.C.T.

Stephen Purcell

Pr, Co. *A*, 9 Reg't U. S. Col'd Infantry.

Appears on **Co. Muster-out Roll**, dated

New Orleans La. Nov 26, 1864.

Muster-out to date *Nov 26*, 1864.

Last paid to *Aug 31*, 1864.

Clothing account:

Last settled 186 ; drawn since \$ 100

Due soldier \$ *22*^{*58*} 100; due U. S. \$ 100

Am't for cloth'g in kind or money adv'd \$ 100

Due U. S. for arms, equipments, &c., \$ *0* 100

Ordinary
Bounty paid *None* 100; due \$ *700* 100

Remarks *(Due under act of Cong July 26, 66 §110) Joined at Argt Aug 3. / Muster and acc'ts returned.*

Book mark: *V64 P 54 - 73*

(861)

Bryer

Copyist.

Curnell, Stephen.

Co. *A*, *9* Reg't *U.S. 6. I.*

3

Enclosures.

| | |
|------------------------------------|----------------------------|
| Bed Cards | Final Statements |
| Burial Records | Furloughs or L. of A. |
| Certs. of Dis. for Discharge | Med. Certificates |
| C. M. Charges | Med. Des. Lists |
| Descriptive Lists | Orders |
| Discharge Certificates | Pris. of War Record |
| Enlistment Papers | Resignations |

Other papers relating to—

| | |
|------------------------------|---------------------------|
| Admission to Hosp'l | Furlough or L. of A. |
| Casualty Sheet | Med. Examination |
| Confinement | Misc. Information |
| Contracts | Pay or Clothing |
| Death or Effects | Personal Reports |
| Desertion | Rank |
| Discharge from Hosp'l | Transfer to Hosp'l |
| Discharge from Service | Transfer to V. R. C. |
| Duty | Transportation |

MICROFILM PUBLICATION M 1851

COMPILED MILITARY SERVICE RECORDS
 OF VOLUNTEER UNION SOLDIERS WHO SERVED WITH
 THE UNITED STATES COLORED TROOPS (USCT)
 9TH REGIMENT OF INFANTRY

PERSONAL PAPERS' TARGET SHEET

PLEASE NOTE THE CHECKED INFORMATION ABOUT THE PERSONAL PAPERS IN
 THIS FILE:

- NO PERSONAL PAPERS WERE FOUND IN THIS FILE WHEN THE RECORDS WERE ARRANGED FOR MICROFILMING.
- 5 PERSONAL PAPER(S) FOUND IN THIS FILE WHEN THE RECORDS WERE ARRANGED FOR MICROFILMING.

A.

No. CLAIMANT'S CERTIFICATE.

I, George C. Purnell a loyal citizen, and a resident
of Worcester, County of the, State of
Maryland, hereby claim compensation, under the provisions of
General Orders, No. 329, 1863, for my slave Stephen Purnell
enlisted Nov 14 1863, at Benedict
by Col. Wm Purnell in the 9th
Regiment U. S. Colored Troops, Co. D; certificate of which enlistment, and a
descriptive list, as required, accompany this application.

In proof of my loyalty to the Constitution and Government of the United States, I
present the accompanying oath, which I have taken, signed, and acknowledged, to be filed
with this application, in accordance with requirement of said General Orders.

George C. Purnell

Feb 25th 1864.

B.

OATH OF ALLEGIANCE.

I, George C. Cornell, do solemnly swear that I have never joined, or been concerned in, any insurrection or rebellion; that I have never borne arms against the United States; that I have never given any aid, countenance, counsel, or encouragement to any person or persons engaged, or whom I had reason to believe were about to engage, in insurrection, rebellion, or armed hostility against the United States; that I have neither sought, nor accepted, nor attempted to exercise the functions of any office, civil or military, nor to perform any service whatever, under any authority or pretended authority in hostility to the United States; that I have not yielded a voluntary support to any insurrection, rebellion, or pretended government, authority, power, or constitution within the United States hostile thereto. And I do further swear that, to the best of my knowledge and ability, I have supported and defended, and will continue to support and defend, the United States against all enemies, foreign and domestic; and that I have supported, defended, and obeyed, and will continue to support, defend, and obey, the Constitution and laws of the United States; that I will bear true faith and allegiance to the same; and that I take this oath freely, without any mental reservation or purpose of evasion: So help me God.

George C. Cornell

Sworn to and subscribed before me, at Berlin
 this 25th day of Feb 1864. }



L. D. Powell
Justice of the peace

1864

C.

I present herewith evidence of my title to the slave Stephen Purcell
 _____ enlisted as aforesaid, and in consideration of the sum of
 _____ by me received, I hereby covenant and
 agree with the United States, that I, my heirs, executors, or assigns, shall never hereafter make
 or enforce any claim to the labor or services of said slave; and pledge myself to execute
 a valid Deed of Manumission and Release of all my claims to service forever of said
Stephen Purcell to be filed with the Board of Claims
 now in session at Baltimore

George C. Purcell

July 25th, 1864.



G. No. 25. A. 11.

No. 378

APPLICATION OF

George C. Purnell

OF

Minister Co. Md.

For Compensation for Service of Slave,

Stephen Purnell

Enlisted in 91st Regiment

U. S. Colored Troops, Co. C.

Received, March 1 1864.

COMPENSATION ~~AWARDED~~ Refused

August 17th 1864

For reasons endorsed on ~~Document~~
Claim No. 376.

Thos. Simmons
Presidt. Bd. Clms

Recd. S. C. August 21. 1864.

1864

DECLARATION TO STATE

EVIDENCE OF TITLE.

I, George C. Purnell, of Worcester County, Md., do solemnly swear that Stephen Purnell who has been enlisted in the 91st Regiment, U. S. Colored Troops, Co. D; is my slave for life; (his term of service expiring on the _____ day of _____ 186____;) and that I became possessed of him by inheritance of my father, in the month of _____, eighteen hundred and _____. And I do further swear that I have not purchased said slave from any person or persons disloyal to the Government of the United States, with the object of obtaining compensation for the same; and furthermore, that I have no agency for obtaining compensation for any person or persons but such as, to my knowledge, are loyal citizens of the United States.

George C. Purnell

 _____ 1864.

STATE OF MARYLAND,

Mercer County, to wit:

On this *15th* day of *Feb.* in the year 1864,

before me, the subscriber, a Justice of the Peace of the State and County aforesaid, personally appeared *George C. Purcell*, and took, signed, and acknowledged the oaths preceding; and further made oath, in due form of law, that all the statements made in this application are, to the best of *his* knowledge and belief, strictly true.

Also personally appeared before me *Jacob P. Henry* and *Wm B. Robin*, loyal citizens of the United States, residents of *Mercer County*, well acquainted with the said *George C. Purcell*, and in no manner interested in the prosecution of this claim, and made oath, in due form of law, that the said *George C. Purcell* is the owner of the slave *Stephen Purcell*, as a fact of public notoriety; that they believe all the statements herein made by *him*, in reference thereto, are correct, and that *he* is unquestionably loyal to the Government of the United States. Witness their signatures:



G. Purcell

Jacob P. Henry
William B. Robin
Justice of the Peace.

E.

DEED OF MANUMISSION AND RELEASE OF SERVICE.

Whereas my slave Stephen Powell has enlisted in the service of the United States: now, in consideration thereof, I, George C. Powell, of Worcester county, State of Maryland, do hereby, in consideration of said enlistment, manumit, set free, and release the above-named Stephen Powell from all service due me; his freedom to commence from the _____, the date of his enlistment as aforesaid in the _____ Regiment of Colored Troops, in the service of the United States.

Witness my hand and seal, this 30 day of April 1864.

George C. Powell



Witness:

L. D. Powell

Isaac B. Powell

Worcester County,
State of Maryland, 1864.

Before me appeared this day George C. Powell and acknowledged the above Deed of Manumission and Release of Service to be his free act and deed.

L. D. Powell J.P.

Chas. Rev.
55
L. D. Powell
1864

State of Maryland, Worcester County, to wit:

I George W. Richardson, Clerk of the Circuit Court for Worcester County, hereby certify that the foregoing is a true copy of the original now on file and of record in this Office.

In testimony whereof, I hereunto subscribe my name and affix the seal of the said Circuit Court, this fourth day of May, Anno Domini, Eighteen Hundred and Sixty four.



George W. Richardson

W. G. R.

576
579

W. G. R.

115

CASUALTY SHEET
OF WOUNDED.*Stephen Purnell**Private* Company *A**9* Regiment of *USCA*Volunteers at the battle of *Chapin's Farm**T. a. + assault on Fort Gilmer**Sept 29 + 30 / 64*

CASUALTY SHEET.

Name, *Stephen Purnell*
 Rank, *Private*, Company *A*, Regiment, *9th*
 Arm, *U.S.A.*, State, _____
 Place of casualty, *Chapins Farm Va. + assault on Fort
 Gilmer. Ind 41 no 691*
 Nature of casualty, *Wounded - Nature 3*
 Date of casualty, *Sept 29 + 30/64*

FROM WHAT SOURCE THIS INFORMATION WAS OBTAINED

Report of *Killed, Wounded, and Missing* of the _____ Regiment,
 _____ Brigade, _____ Division, _____ Corps, dated _____
List of wounded in 9th U.S.A.
(Signed) Edwin S. Babcock
Capt 9th U.S.A. Comd'g Regt
 Endorsed: *List of Casualties in 9th U.S.A. Sept*
29th & 30th 1864
Ind 502 no 67

W. F. Thompson
 Clerk.

Hd. Qrs Dist. Rio Grande
 Brownsville, Texas
 July 23rd 1866

Special Order
 No 179. C4 35

Detailing Lt.
 Stephen Durnell, Co. F, 9th
 U.S.A. to report for duty to
 Lieut. Hamilton A.S.G. ord. off.

Recd H. J. G. U.S.A. July 24th 1866

Headquarters District of the Rio Grande,

Brownsville, Texas, July 23, 1866.

SPECIAL ORDERS, }
No. 179. }

(EXTRACT.)

* * * * *
III. Private Stephen Purnell, Co. A, 9th U. S. C. T., is detached from his Regiment, and will report for duty, without delay, to Lieut. J. M. Hamilton, 9th U. S. C. T., Acting Ordnance Officer, Brownsville, Texas; in place of Private Isaac Spencer, Co. H, 117th U. S. C. T., who will at once rejoin his Regiment.
* * * * *

By ORDER OF BREVET MAJOR GENERAL GETTY :

D. D. WHEELER,
Assistant Adjutant General.

OFFICIAL

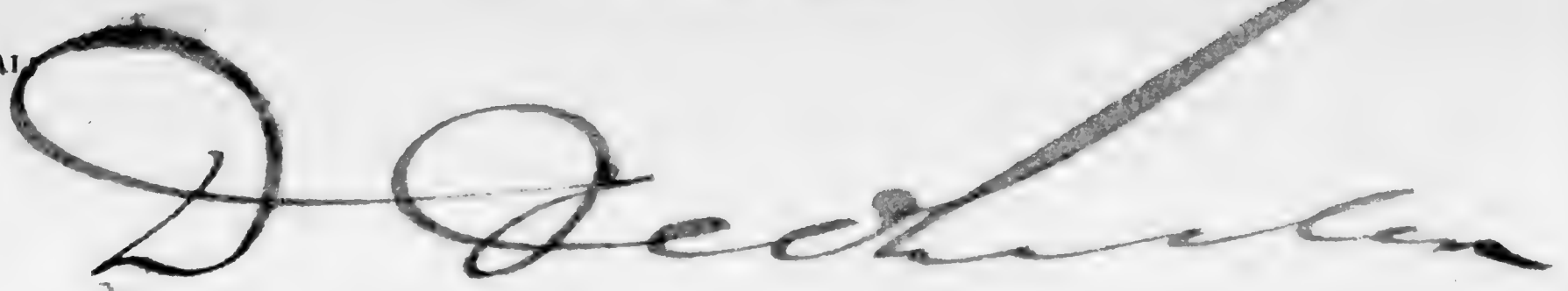

Assistant Adjutant General.

636 / 15501

⁹²²
Purnell, Stephen
Co D, 9 U.S. Col'd Inf.

Private | Private

CARD NUMBERS.

| | | |
|----|---------|----|
| 1 | 6306242 | 26 |
| 2 | 6306314 | 27 |
| 3 | 6306416 | 28 |
| 4 | 6306520 | 29 |
| 5 | 6306620 | 30 |
| 6 | 6306717 | 31 |
| 7 | 6306817 | 32 |
| 8 | 6306913 | 33 |
| 9 | 6307015 | 34 |
| 10 | 6307116 | 35 |
| 11 | 6307214 | 36 |
| 12 | 6307339 | 37 |
| 13 | 6300392 | 38 |
| 14 | 6307994 | 39 |
| 15 | 9068467 | 40 |
| 16 | | 41 |
| 17 | | 42 |
| 18 | | 43 |
| 19 | | 44 |
| 20 | | 45 |
| 21 | | 46 |
| 22 | | 47 |
| 23 | | 48 |
| 24 | | 49 |
| 25 | | 50 |

Book Mark:

See also

L1825-94120mm
Headstone Case 5/31/39, tea

J. M. Shannon
Esq.

P | 9 | U.S.C.T.

Stephen Purnell,

, Co. D, 9 Reg't U. S. Col'd Inf.

Appears on
Company Descriptive Book
of the organization named above.

DESCRIPTION.

Age 19 years; height 5 feet 5 3/4 inches.

Complexion Dark;

Eyes Dark; hair Dark;

Where born Worcester Md,

Occupation Farmer.

ENLISTMENT.

When Nov. 10, 1863.

Where Berlin Md,

By whom Col. Birney; term 3 y'rs.

Remarks: Discharged at Ft Monroe June 4/65 on Surg's Certificate of Disability Wounded at Deep Bottom Va, Aug. 13/64.

x As it appears on descriptive Book,

Pol,

P

9

U.S.C.T.

Stephen Purnell
Pvt, Co. *D*, 9 Reg't U. S. Col'd Infantry.

Age *19* years.

Appears on

Company Muster-in Roll

of the organization named above. Roll dated

C. Stanton, Chas. Co. Md. Nov 14, 1863

Muster-in to date *Nov 14, 1863*

Joined for duty and enrolled:

When *Nov 10*, 186 *3*

Where *Worcester Md.*

Period *3* years.

Remarks:

Book mark:-----

J. E. Parks

P | **9** | **U.S.C.T.**

Stephen Purnell

2 Put, Co. D, 9 Reg't U. S. Col'd Infantry.

Appears on

Company Muster Roll

for *from Nov. 14 to Dec. 31, 1863*

Present or absent *Present*

Stoppage, \$ 100 for

Due Gov't, \$ 100 for

Remarks: *\$ 200 recruits premium due*

Book mark: _____

J. E. Parks

(858)

Copyist

P

9

U.S.C.T.

Stephen Cornell

Priv, Co. D, 9 Reg't U. S. Col'd Infantry.

Appears on

Company Muster Roll

for *Jan & Feb*, 1864

Present or absent *Present*

Stoppage, \$ *100* for

Due Gov't, \$ *100* for

Remarks: *Two dollars
recruits premium
due.*

Book mark:

J. E. Parks

(858)

Copyist

P | **9** | **U.S.C.T.**

Stephen Purnell

Priv, Co. D, 9 Reg't U. S. Col'd Infantry.

Appears on

Company Muster Roll

for *Mar, & Apr*, 186 *4*.

Present or absent *Present*

Stoppage, \$ *100* for

Due Gov't, \$ *100* for

Remarks:

Book mark: _____

J. E. Purke
Copyist

(858)

C

9

U.S.C.T.

Stephen Russell

Priv, Co. D, 9 Reg't U. S. Col'd Infantry.

Appears on

Company Muster Roll

for *May & June*, 1864.

Present or absent *Present*

Stoppage, \$ *100* for

Due Gov't, \$ *100* for

Remarks:

Book mark: _____

H. E. Parks

(858)

Copyist

P

9

U.S.C.T.

Stephen Cornell
Priv, Co. D, 9 Reg't U. S. Col'd Infantry.

Appears on

Company Muster Roll

for *July & Aug*, 1864

Present or absent *absent*

Stoppage, \$ *100* for

Due Gov't, \$ *100* for

Remarks: *Stop for one (1)*
can been absent
sick in Gen Hosp.
in consequence of
wound received in
action near
Deep Bottom Va.
Aug, 14th 1864.

Book mark:

A. E. Parks

(858)

Copyist

P | **9** | **U.S.C.T.**

Stephen Sumell

Priv Co. D, 9 Reg't U. S. Col'd Infantry.

Appears on

Company Muster Roll

for *Sep, Oct*, 1864.

Present or absent *absent*

Stoppage, \$ *100* for

Due Gov't, \$ *100* for

Remarks: *absent sick*
in Gen Hays' on
account of
wounds received
in action near
Deep Bottom Va.
Aug. 14 - 1864

Book mark:

J. E. Ruick

(358)

Copyist

P

9

U.S.C.T.

Stephen Cornell

Priv, Co. D, 9 Reg't U. S. Col'd Infantry.

Appears on

Company Muster Roll

for *Nov, 1864*, 1864.

Present or absent *Absent*

Stoppage, \$ *100* for

Due Gov't, \$ *100* for

Remarks: *abs. wounded since Aug. 16-1864*

Book mark:

J. E. Ruck

(358)

Copyist

P

9

U.S.C.T.

Stephen Purnell

Co., Co. D, 9 Reg't U. S. Col'd Infantry.

Appears on

Company Muster Roll

for *Jan & Feb*, 1865.

Present or absent *Absent*

Stoppage, \$ *100* for

Due Gov't, \$ *100* for

Remarks: *Absent wounded*

since Aug 16/64.

The difference between \$7. & \$13. per month is due the soldier from Jan 1/64 to Apr 30/64

Book mark:

J M Harmon

(858)

Copyist

P | 9 | U.S.C.T.

Stephen Purcell
Capt., Co. D, 9 Reg't U. S. Col'd Infantry.

Appears on

Company Muster Roll

for *Mar & Apr*, 1865.

Present or absent *Present*

Stoppage, \$ *100* for

Due Gov't, \$ *100* for

Remarks: *Stop 1 Knapsack
1 Haversack 1 Can
teen. The difference
bet. \$7 & \$13 per month
is due this soldier
from Jan 1/64 to Apr
30/64*

Book mark:

J M Harmon

(358)

Copyist

P 9 U.S.C.T.

Stephen Purnell
Prvt., Co. D, 9 Reg't U. S. Col'd Infantry.

Appears on

Company Muster Roll

for Dec 31/64 to June 30, 1865.

Present or absent Absent

Stoppage, \$ 100 for

Due Gov't, \$ 100 for

Remarks: Absent Sick in
hospital since May 15.
Stop for 1 Knapsack,
1 Haversack 1 Canteen
The difference bet \$ 7.
7 & \$ 13. per month is
due this soldier from
Jan 1/64 to Dec 30/64.

Book mark:

J. M. Harmon

P | 9 | U.S.C.T.

Stephen Purnell
Pvt., Co. D, 9 Reg't U. S. Col'd Infantry.

Appears on

Company Muster Roll

for Dec 31/64 to June 30, 1865.

Present or absent

Stoppage, \$ 100 for

Due Gov't, \$ 100 for

Remarks: The difference
bet. \$4 & \$13 per month
is due this soldier from
Jan'y 1/64 to April 30/64.
Stop for 1 Knapsack -
1 Haversack & Canteen.
Mustered out June 4/65
at Ft. Monroe Va per
order War Dept. dated
May 3/65

Book mark:

J. M. Harwood

P | 9 U.S.C.T.

Stephen Purnell
 Pri, Co., Reg't U. S. Col'd Infantry.

Appears on a
Detachment Muster-out Roll
 of the organization named above. Roll dated
 Fort Monroe, Va, June 4, 1865.
 Muster-out to date June 4, 1865.
 Last paid to Oct 31, 1864

Clothing account:
 Last settled ^{never settled} 186 ; drawn since \$ 85 ²⁹/₁₀₀
 Due soldier \$ 100; due U. S. \$ 100
 Am't for cloth'g in kind or money adv'd \$ 100

Due U. S. for arms, equipments, &c., \$ 100
 Bounty paid \$ 100 due \$ 100

Remarks: Due 26.00 for one
 Snapsack, Haversack, Canteen.
 Due him difference between \$7.00
 and \$13.00 per month from Jan
 1, 1864. Mustered out by order
 of War Dept dated May 3rd 1865.
 (over)

Book mark: 425. 424.

(349) *J. P. Brown*
 Copyist.

WAR 147

JAN. 21

6300392

AT 8910

*Patient in U.S. Embassy
Jh. Monroe, Va.*

P. | 9 | U.S.C.T.

Stephen Purnell

Pvt, Co. *D*, 9 Reg't U. S. Col'd Infantry.

Appears on **Co. Muster-out Roll**, dated
New Orleans La., 26th, 186*6*.

Muster-out to date _____, 186 .

Last paid to _____, 186 .

Clothing account:

Last settled _____, 186 ; drawn since \$ _____ 100

Due soldier \$ _____ 100; due U. S. \$ _____ 100

Am't for cloth'g in kind or money adv'd \$ _____ 100

Due U. S. for arms, equipments, &c., \$ _____ 100

Bounty paid \$ _____ 100; due \$ _____ 100

Remarks: *Discharged*
Joined at original orgn!
Co. D. 9th Regt. U. S. Col'd Inf. June
1865, at Ft. Monroe Va.

Book mark: *425.424*

G. E. Dayton

(361)

Copyist.

Parnell Steven

Part, Co. D, 9 Reg't U.S.C. Inf

2 Enclosures.

| | |
|------------------------------------|----------------------------|
| Bed Cards | Final Statements |
| Burial Records | Furloughs or L. of A. |
| Certs. of Dis. for Discharge | Med. Certificates |
| C. M. Charges | Med. Des. Lists |
| Descriptive Lists | Orders |
| Discharge Certificates | Pris. of War Record |
| Enlistment Papers | Resignations |

Other papers relating to—

| | |
|------------------------------|---------------------------|
| Admission to Hosp'l | Furlough or L. of A. |
| Casualty Sheet..... 2 | Med. Examination |
| Confinement | Misc. Information |
| Contracts | Pay or Clothing |
| Death or Effects | Personal Reports |
| Desertion | Rank |
| Discharge from Hosp'l | Transfer to Hosp'l |
| Discharge from Service | Transfer to V. R. C. |
| Duty | Transportation |

114

(2)

CASUALTY SHEET
OF WOUNDED.

Steven Parnell

Priv Company D

9 Regiment of USCP

Volunteers at the battle of _____

August 14/64

CASUALTY SHEET.

Name, *Steven Parnell*
Rank, *Private*, Company *D*, Regiment, *9th*
Arm, *U.S.A.*, State,
Place of casualty,

Nature of casualty, *Wounded, locality of wound,*
not known
Date of casualty, *Aug 14th 1864*

FROM WHAT SOURCE THIS INFORMATION WAS OBTAINED.

Report of *Killed, Wounded, and Missing* of the _____ Regiment,
Brigade, _____ Division, _____ Corps, dated _____
List of Killed and wounded in Brigade of
Colored Troops, 10th Army Corps, commanded
by Col Shaw 7th U.S.C.
(Signed) A.P. Reichhold, Surgeon 8th U.S.C. Chief
Med Officer, Shaw's Brigade.

Ind 50 L no 68

W.F. Thompson

Clerk

114

(2)

CASUALTY SHEET
OF WOUNDED.

Steven Parnell

Privat Company *A*

9th Regiment of *U.S.C.T.*

Volunteers at the battle of

Aug 14/64

CASUALTY SHEET.

Name, *Seren Parnell*
 Rank, *Priv*, Company *A*, Regiment, *9th*
 Arm, *Infy*, State, *U.S.C.T.*
 Place of casualty, *Not stated*
 Nature of casualty, ~~wounded~~, *Not known*
 Date of casualty, *Aug 14th 1864*

FROM WHAT SOURCE THIS INFORMATION WAS OBTAINED

Report of Killed, Wounded, and Missing of the _____ Regiment,
Shaw Brigade, _____ Division, _____ Corps, dated _____
 Signed *A. P. Nichhald* Surg
8th U.S.C.T. Chf. Med Off.
Shaw Brig
Ind 50 L P. 1. No 68.

A. P. Logan
 Clerk
7/30/80

9236
Purnell, Theodore

Co E, 9 U.S. Col'd Inf.

Private | Private

CARD NUMBERS.

| | | |
|----|---------|----|
| 1 | 6308095 | 26 |
| 2 | 6308192 | 27 |
| 3 | 6308299 | 28 |
| 4 | 6308403 | 29 |
| 5 | 6308503 | 30 |
| 6 | 6308600 | 31 |
| 7 | 6308698 | 32 |
| 8 | 6308799 | 33 |
| 9 | 6308897 | 34 |
| 10 | 6308995 | 35 |
| 11 | 6309090 | 36 |
| 12 | 6309179 | 37 |
| 13 | 6309268 | 38 |
| 14 | 6309354 | 39 |
| 15 | 6309434 | 40 |
| 16 | 6309510 | 41 |
| 17 | 6309585 | 42 |
| 18 | 6309657 | 43 |
| 19 | 6309728 | 44 |
| 20 | 6309798 | 45 |
| 21 | 9068920 | 46 |
| 22 | | 47 |
| 23 | | 48 |
| 24 | | 49 |
| 25 | | 50 |

Book Mark:

See also

S. 663318 P.O.M. - 2 M.
St. 1288801 P.O. aff

A. M. Shannon
Esq

P | 9 | U.S.C.T.

Theodore Parnell

, Co. E, 9 Reg't U. S. Col'd Inf.

Appears on

Company Descriptive Book

of the organization named above.

DESCRIPTION.

Age 27 years; height 5 feet 3/4 inches.

Complexion *Blk*

Eyes *Blk*; hair *Blk*

Where born *Worcester Co Md*

Occupation *Laborer*

ENLISTMENT.

When *Nov 10*, 1863.

Where *Worcester Co Md*

By whom *Wm Birney*; term *3* y'rs.
Col & mustering officer

Remarks:

*Discharged with
the Regt - Nov 26 - 1866*

C. S. Pozzelle

P | 9 | U.S.C.T.

Theodore Purnell
Pri, Co. E, 9 Reg't U. S. Col'd Infantry.

Age 27 years.

Appears on

Company Muster-in Roll

of the organization named above. Roll dated

Camp Stanton Charles Co, Md Nov 17, 1863.

Muster-in to date Nov 17, 1863

Joined for duty and enrolled:

When Nov 10, 1863.

Where Worcester Md

Period 3 years.

Remarks:

Book mark:

C. L. Parker

P

9

U.S.C.T.

Theodore Purnell

Private, Co. E, 9 Reg't U. S. Col'd Infantry.

Appears on

Company Muster Roll

for Nov 17 to Dec 31, 1863.

Present or absent Present

Stoppage, \$ 100 for

Due Gov't, \$ 100 for

Remarks: Two Dollars Recruits Premium due

Book mark:

C. L. Parker

P

9

U.S.C.T.

Theodore Purnell

Pri, Co. E, 9 Reg't U. S. Col'd Infantry.

Appears on

Company Muster Roll

for Jan + Feb, 1864.

Present or absent Present

Stoppage, \$ 100 for

Due Gov't, \$ 100 for

Remarks: Two Dollars Recruits Premium due

Book mark:

C. C. Parker

(358)

Copyist.

P

9

U.S.C.T.

Theodore Purnell

Pri, Co. E, 9 Reg't U. S. Col'd Infantry.

Appears on

Company Muster Roll

for Mar + Apr, 1864.

Present or absent Present

Stoppage, \$ 100 for

Due Gov't, \$ 100 for

Remarks: Two dollars Recruits premium due

Book mark:

C. C. Parker

(358)

Copyist.

P | 9 | U.S.C.T.

Theodore Purnell

Private, Co. E, 9 Reg't U. S. Col'd Infantry.

Appears on

Company Muster Roll

for May & June, 1864.

Present or absent Present

Stoppage, \$ 100 for

Due Gov't, \$ 100 for

Remarks: Stop for 1 screw driven

23

Book mark:

C. C. Parker

P

9

U.S.C.T.

Theodore Purnell

Pri, Co. E, 9 Reg't U. S. Col'd Infantry.

Appears on

Company Muster Roll

for July + Aug, 1864.

Present or absent Absent

Stoppage, \$ 100 for

Due Gov't, \$ 100 for

Remarks: Absent sick in Genl Hospital since Aug 8 - 1864

Book mark:

C. B. Parker

(858)

Copist.

P

9

U.S.C.T.

Theodore Purnell

Pri, Co. E, 9 Reg't U. S. Col'd Infantry.

Appears on

Company Muster Roll

for *Sept + Oct*, 1864.

Present or absent *Present*

Stoppage, \$ 100 for

Due Gov't, \$ 100 for

Remarks:

Book mark:

C. C. Parker

P | 9 | U.S.C.T.

Theodore Purnell

1st Co. E, 9 Reg't U. S. Col'd Infantry.

Appears on

Company Muster Roll

for *Nov & Dec*, 1864.

Present or absent *Absent*

Stoppage, \$ *100* for

Due Gov't, \$ *100* for

Remarks *Absent sick in
Gen Hospital since
Dec 25, 64*

Book mark: _____

J. E. Neteman Copyist.

(858)

P | 9 | U.S.C.T.

Theodore Purnell

Pat, Co. E, 9 Reg't U. S. Col'd Infantry.

Appears on

Company Muster Roll

for *Jan'y & Feby*, 1865.

Present or absent *Present*

Stoppage, \$ 100 for

Due Gov't, \$ 100 for

Remarks: *Stop for Transportation
7 1/2 Dollars.*

Book mark:

H. E. Neteman

(358)

Copyist.

P

9

U.S.C.T.

Theodore Lunnell

Plt, Co. E, 9 Reg't U. S. Col'd Infantry.

Appears on

Company Muster Roll

for March & April, 1865.

Present or absent Present

Stoppage, \$ 100 for

Due Gov't, \$ 100 for

Remarks: Stop for Transportation
9 16/100 Dollars.

Book mark:

H. E. Neteman

(858)

Copyist.

P | 9 | U.S.C.T.

Theodore Purnell
Sgt., Co. E, 9 Reg't U. S. Col'd Infantry.

Appears on

Company Muster Roll

for *Dec 31, 64 to June 30, 1865*

Present or absent *Present*

Stoppage, \$ *100* for

Due Gov't, \$ *100* for

Remarks: *Stop for Trans \$ 7 16*

Book mark: _____

J. E. Meteman
Copyist.

P | 9 | U.S.C.T.

Medea Linnell

Pat, Co. E, 9 Reg't U. S. Col'd Infantry.

Appears on

Company Muster Roll

No. of *July & Augt*, 1865.

Present or absent *Present*

Stoppage, \$ *100* for

Due Gov't, \$ *100* for

Remarks: *Stoped for Ordinance 24 cts*

Book mark:

H. E. Weteman

(858)

Copyist.

P | **9** | **U.S.C.T.**

Theodore Purnell

Plt, Co. E, 9 Reg't U. S. Col'd Infantry.

Appears on

Company Muster Roll

for *June 30 to Oct 31, 1865*

Present or absent *Present*

Stoppage, \$ *100* for

Due Gov't, \$ *22* for *Ord*

Remarks:

Book mark:

A. E. Wetman

(858)

Copyist.

P | **9** | **U.S.C.T.**

Theodore Purnell

Pat, Co. E, 9 Reg't U. S. Col'd Infantry.

Appears on

Company Muster Roll

for *June 30 to Dec 31, 1865.*

Present or absent *Present*

Stoppage, \$ 100 for

Due Gov't, \$ 22 100 for *ord*

Remarks:

Book mark:

J. C. Noteman
Copyist.

9

U.S.C.T.

....., Co. E, 9 Reg't U. S. Col'd Infantry.

Appears on

Company Muster Roll

for, 186.....

Present or absent

Stoppage, \$.....100 for

Due Gov't, \$.....100 for

Remarks:

Book mark:

P. | **9** | **U.S.C.T.**

[Faint handwritten text]

..... Co. E, 9 Reg't U. S. Col'd Infantry.

Appears on

Company Muster Roll

for , 186 .

Present or absent

Stoppage, \$ 100 for

Due Gov't, \$ 100 for

Remarks:

.....
.....
.....
.....
.....
.....
.....
.....
.....
.....
.....
.....

Book mark:

.....

9

U.S.C.T.

[Faint handwritten text]

....., Co. E, 9 Reg't U. S. Col'd Infantry.

Appears on

Company Muster Roll

for, 186 .

Present or absent

Stoppage, \$ 100 for

Due Gov't, \$ 100 for

Remarks:

Book mark:

9

U.S.C.T.

....., Co. E, 9 Reg't U. S. Col'd Infantry.

Appears on

Company Muster Roll

for, 186 ..

Present or absent

Stoppage, \$.....100 for

Due Gov't, \$.....100 for

Remarks:

Book mark:

9

U.S.C.T.

[Handwritten signature]

....., Co. E, 9 Reg't U. S. Col'd Infantry.

Appears on

Company Muster Roll

for 186 .

Present or absent

Stoppage, \$ 100 for

Due Gov't, \$ 100 for

Remarks:

Book mark:

9

U.S.C.T.

....., Co....., 9 Reg't U. S. Col'd Infantry.

Appears on **Co. Muster-out Roll**, dated

....., 186.....

Muster-out to date 186.....

Last paid to 186.....

Clothing account:

Last settled....., 186.....; drawn since \$..... 100

Due soldier \$..... 100; due U. S. \$..... 100

Am't for cloth'g in kind or money adv'd \$..... 100

Due U. S. for arms, equipments, &c., \$..... 100

Bounty paid \$..... 100; due \$..... 100

Remarks:

.....
.....
.....
.....

Book mark: *V. 20. P. 18. 12*

⁹²⁴
Purnell, William E

Co F, 9 U.S. Col'd Inf.

Private | Corporal

CARD NUMBERS.

| | | |
|----|---------|----|
| 1 | 6309944 | 26 |
| 2 | 6310037 | 27 |
| 3 | 6310146 | 28 |
| 4 | 6310251 | 29 |
| 5 | 6310350 | 30 |
| 6 | 6310448 | 31 |
| 7 | 6310544 | 32 |
| 8 | 6310641 | 33 |
| 9 | 6310738 | 34 |
| 10 | 6310835 | 35 |
| 11 | 6310928 | 36 |
| 12 | 6311011 | 37 |
| 13 | 6311099 | 38 |
| 14 | 6311136 | 39 |
| 15 | 6311210 | 40 |
| 16 | 6311282 | 41 |
| 17 | 6311352 | 42 |
| 18 | 6311421 | 43 |
| 19 | 6311486 | 44 |
| 20 | 6311551 | 45 |
| 21 | 9069041 | 46 |
| 22 | | 47 |
| 23 | | 48 |
| 24 | | 49 |
| 25 | | 50 |

Book Mark:

See also

S 948651-POff6

S 2097512 ~~some~~

J. M. Shannon

Edw

P | 9 | U.S.C.T.

William E. Purnell

, Co. 7, 9 Reg't U. S. Col'd Inf.

Appears on
Company Descriptive Book
of the organization named above.

DESCRIPTION.

Age 18 years; height 5 feet 6 1/2 inches.

Complexion Dark

Eyes Black; hair Black

Where born Worcester Maryland

Occupation Farmer

ENLISTMENT.

When Nov 18, 1863.

Where Newark Worcester Co. Me.

By whom Lt Wm Perry; term Three yrs.

Remarks: Promoted Corporal Nov
1864 - 1089-9 Lt 67
Mustered out with Regt
Nov 26 1864

L. B. Sawyer

P

9

U.S.C.T.

William E. Purnell
Priv, Co. 7, 9 Reg't U. S. Col'd Infantry.

Age 18 years.

Appears on

Company Muster-in Roll

of the organization named above. Roll dated

Charles Co. Md., Nov 23, 1863.

Muster-in to date Nov 28, 1863

Joined for duty and enrolled:

When Nov. 18, 1863.

Where Worcester Md.

Period 3 years.

Remarks:

Book mark:

Martin

P | 9 | U.S.C.T.

William E. Purcell

Priv., Co. F, 9 Reg't U. S. Col'd Infantry.

Appears on

Company Muster Roll

for Nov. 23 to Dec 31, 1863.

Present or absent Present

Stoppage, \$ 100 for

Due Gov't, \$ 100 for

Remarks: \$2.00 Recruit
Premium due.

Book mark:

Martin

P | **9** | **U.S.C.T.**

William E. Punell
Priv, Co. F, 9 Reg't U. S. Col'd Infantry.

Appears on

Company Muster Roll

for *Jan Feb*, 186*4*.

Present or absent *Present*

Stoppage, \$ *100* for

Due Gov't, \$ *100* for

Remarks: *\$200 Recruit*
Arrears due.

Book mark:

Martin

P

9

U.S.C.T.

William E. Purnell
Priv., Co. *F*, 9 Reg't U. S. Col'd Infantry.

Appears on

Company Muster Roll

for *Mch & apr*, 186 *4*

Present or absent *present*

Stoppage, \$ *100* for

Due Gov't, \$ *100* for

Remarks: *Stopped for one*
screw driver

Book mark:

Banes

P

9

U.S.C.T.

William E. Purcell

Priv, Co. F, 9 Reg't U. S. Col'd Infantry.

Appears on

Company Muster Roll

for May & June, 1864.

Present or absent Present

Stoppage, \$ 100 for

Due Gov't, \$ 100 for

Remarks:

Book mark:

Martin

P | 9 | U.S.C.T.

William E Purcell
Priv, Co. F, 9 Reg't U. S. Col'd Infantry.

Appears on

Company Muster Roll

for July & Aug, 1864.

Present or absent Present

Stoppage, \$ 100 for

Due Gov't, \$ 100 for

Remarks: Free Apr. 19/61.

Book mark:

Martin

9 | **U.S.C.T.**

William E. Purnell
Priv, Co. 4, 9 Reg't U. S. Col'd Infantry.

Appears on

Company Muster Roll

for Sept Oct, 1864.

Present or absent Present

Stoppage, \$ 100 for

Due Gov't, \$ 100 for

Remarks: Full on or before
Apr. 19, 1861.

Book mark: _____

Martin

P | 9 | U.S.C.T.

William E. Sumell

Priv, Co. F, 9 Reg't U. S. Col'd Infantry.

Appears on

Company Muster Roll

for *Nov. & Dec*, 1864.

Present or absent *Present*

Stoppage, \$ *100* for

Due Gov't, \$ *100* for

Remarks: *Taken on d*
before Apr. 19/61
Due the difference
between seven dollars
per month and thirteen
dollars per month
from enlistment

Book mark:

E. Thornton

(858)

Copyist

P | 9 | U.S.C.T.

William E. Lunnell
Priv, Co. F, 9 Reg't U. S. Col'd Infantry.

Appears on

Company Muster Roll

for *Jan. to Feb*, 186*5*.

Present or absent *Present*

Stoppage, \$ *100* for

Due Gov't, \$ *100* for

Remarks:

Book mark:

E. L. Shannon

(358)

Copyist

P

9

U.S.C.T.

William C. Sumell

Priv, Co. F, 9 Reg't U. S. Col'd Infantry.

Appears on

Company Muster Roll

for *May & June*, 1865.

Present or absent *Present*

Stoppage, \$ 100 for

Due Gov't, \$ 100 for

Remarks: *Stop for screw
driver & tampon \$0.25*

Book mark:

Ed. Shannon

(858)

Copyist

I | **9** | **U.S.C.T.**

William E. Sumell
Priv, Co. F, 9 Reg't U. S. Col'd Infantry.

Appears on

Company Muster Roll

for *July Aug*, 1865.

Present or absent *Present*

Stoppage, \$ *100* for

Due Gov't, \$ *100* for

Remarks:

Book mark:

E. L. Hanson

P **9** **U.S.C.T.**
William E. Purnell
Put, Co. F, 9 Reg't U. S. Col'd Infantry.

Appears on

Company Muster Roll
for *June 30 to Oct 31*, 1865.
Present or absent *Present*

Stoppage, \$ *100* for

Due Gov't, \$ *100* for

Remarks:

Book mark: *587708*

P. A. Ward
(358) Copyist

F

9

U.S.C.T.

William E. Funnell
Capt, Co. "F", 9 Reg't U. S. Col'd Infantry.

Appears on

Company Muster Roll

for *June 30 to Dec 31, 1865.*

Present or absent *Present*

Stoppage, \$ *100* for

Due Gov't, \$ *100* for

Remarks: *Promoted from
private, sr. S.C. 1864
par. 4, Hd Qrs. 9th U.S. C.I.
Nov. 1/65.*

Book mark: *Present*

J. A. [Signature]

P | 9 | U.S.C.T.

William E. Purnell
Corp, Co. F, 9 Reg't U. S. Col'd Infantry.

Appears on

Company Muster Roll

for Jan. & Feb., 1866.

Present or absent present

Stoppage, \$ 100 for

Due Gov't, \$ 100 for

Remarks:

Book mark:

(358) J. E. Nichol Copyist

P

9

U.S.C.T.

William E. Purnell
Coop, Co. F, 9 Reg't U. S. Col'd Infantry.

Appears on

Company Muster Roll

for *Mch. & Apl.*, 186*6*.

Present or absent *present*

Stoppage, \$ *100* for

Due Gov't, \$ *100* for

Remarks:

Book mark:

(358) *J. E. Nichol* Copyist

P | 9 | U.S.C.T.

William E. Purnell
Capt, Co. F, 9 Reg't U. S. Col'd Infantry.

Appears on

Company Muster Roll

for May & June, 1866.

Present or absent present

Stoppage, \$ 100 for

Due Gov't, \$ 100 for

Remarks: Stop for Cartridge
box belt plate, screw
driver and wiper 35¢

Book mark:

(358) J. E. Nichol Copyist

2

P | 9 | U.S.C.T.

William E. Russell
Capt, Co. F, 9 Reg't U. S. Col'd Infantry.

Appears on

Company Muster Roll

for July & Aug., 1866.

Present or absent present

Stoppage, \$ 100 for

Due Gov't, \$ 100 for

Remarks:

Book mark:

(358) J. E. Nichol Copyist

P

9

U.S.C.T.

William E. Purnell
Corp, Co. F, 9 Reg't U. S. Col'd Infantry.

Appears on

Company Muster Roll

for *Sep. & Oct.*, 186 *6*

Present or absent *present*

Stoppage, \$ *100* for

Due Gov't, \$ *100* for

Remarks:

Book mark:

(358)

J. E. Nichol
Copyist

P | 9 | U.S.C.T.

William E. Purnell
Corp, Co. *F.*, 9 Reg't U. S. Col'd Infantry.

Appears on **Co. Muster-out Roll**, dated
New Orleans, La., Nov. 26, 1866.

Muster-out to date *Nov. 26,* 1866.

Last paid to *Aug. 31,* 1866.

Clothing account:

Last settled....., 186 ; drawn since \$..... 100

Due soldier \$ *25*^{*71*}/₁₀₀; due U. S. \$..... 100

Am't for cloth'g in kind or money adv'd \$..... 100

Due U. S. for arms, equipments, &c., \$..... 100

Bounty paid \$ *None* 100; due \$ *100*^{*00*}/₁₀₀

Remarks: *Joined at Original*
Orgn.

Priv't to Feb. 1/65

Book mark :

(861)

J. E. Nichol

Copyist.

⁹²⁵
Purnell, William H

Co E, 9 U.S. Col'd Inf.

Private

Private

CARD NUMBERS.

| | | |
|----|---------|----|
| 1 | 6308096 | 26 |
| 2 | 6308193 | 27 |
| 3 | 6308300 | 28 |
| 4 | 6308404 | 29 |
| 5 | 6308504 | 30 |
| 6 | 6308601 | 31 |
| 7 | 6308699 | 32 |
| 8 | 6308800 | 33 |
| 9 | 6308898 | 34 |
| 10 | 6308996 | 35 |
| 11 | 6309091 | 36 |
| 12 | 6309180 | 37 |
| 13 | 6309269 | 38 |
| 14 | 6309355 | 39 |
| 15 | 6309453 | 40 |
| 16 | 6309854 | 41 |
| 17 | 9068922 | 42 |
| 18 | | 43 |
| 19 | | 44 |
| 20 | | 45 |
| 21 | | 46 |
| 22 | | 47 |
| 23 | | 48 |
| 24 | | 49 |
| 25 | | 50 |

Book Mark:

See also

P | **9** | **U.S.C.T.**

William H Purnell

....., Co. *E*, 9 Reg't U. S. Col'd Inf.

Appears on
Company Descriptive Book
of the organization named above.

DESCRIPTION.

Age *18* years; height *5* feet *3 3/4* inches.

Complexion *Blk*

Eyes *Blk*; hair *Blk*

Where born *Worcester Co Md*

Occupation *Laborer*

ENLISTMENT.

When *Nov 10*, 186*3*.

Where *Worcester Co Md*

By whom *Wm Birney* term *3* y'rs.
Col + Mustering Officer

Remarks:
*Died at-Post-Hos-
pital Brownsville Texas
Jan 16-1866. Descriptive
list sent to Hospital.*

C. S. Rozzell

P | 9 | U.S.C.T.

William H Purnell
Pri, Co. E, 9 Reg't U. S. Col'd Infantry.

Age 18 years.

Appears on

Company Muster-in Roll

of the organization named above. Roll dated

Camp Stanton Charles Co, Md Nov 17, 1863 .

Muster-in to date Nov 17, 1863

Joined for duty and enrolled:

When Nov 10, 1863 .

Where Worcester Md

Period 3 years.

Remarks:
.....
.....
.....
.....
.....

Book mark:.....

C C Parker

P | 9 | U.S.C.T.

William H. Purnell

Pri, Co. E, 9 Reg't U. S. Col'd Infantry.

Appears on

Company Muster Roll

for *Nov 17 to Dec 31*, 1868.

Present or absent *Present*

Stoppage, \$ *100* for

Due Gov't, \$ *100* for

Remarks: *Two Dollars Recruits
Premium due*

Book mark:.....

C. C. Parker

P | 9 | U.S.C.T.

William H. Purnell

Pi, Co. E, 9 Reg't U. S. Col'd Infantry.

Appears on

Company Muster Roll

for *Jan + Feb*, 1864.

Present or absent *Present*

Stoppage, \$ 100 for

Due Gov't, \$ 100 for

Remarks: *Two Dollars Recruits
Premium due*

Book mark: _____

C. C. Parker

(858)

Copyist.

P

9

U.S.C.T.

William H. Purnell

Pri , Co. E, 9 Reg't U. S. Col'd Infantry.

Appears on

Company Muster Roll

for Mar + Apr , 1864.

Present or absent Present

Stoppage, \$ 100 for

Due Gov't, \$ 100 for

Remarks: on daily duty as Pioneer
Stop for 1 pr scales 1 esp Bugle
1 Letter E
Two dollars Recruits premium
due

Book mark:

C. A. Parker

P

9

U.S.C.T.

William H. Purnell

Pri, Co. E, 9 Reg't U. S. Col'd Infantry.

Appears on

Company Muster Roll

for *May & June*, 1864.

Present or absent *Absent*

Stoppage, \$ 100 for

Due Gov't, \$ 100 for

Remarks: *In detached service
on Gun Boat "John Adams"
since June 16 - 1864*

Book mark:

C. C. Barker

(858)

Copyist.

P

9

U.S.C.T.

William H. Purnell

Pri, Co. E, 9 Reg't U. S. Col'd Infantry.

Appears on

Company Muster Roll

for July & Aug, 1864.

Present or absent Present

Stoppage, \$ 100 for

Due Gov't, \$ 100 for

Remarks:

Book mark:

C. C. Parker

(858)

Copyist.

P

9

U.S.C.T.

William H. Purnell

Pri, Co. E, 9 Reg't U. S. Col'd Infantry.

Appears on

Company Muster Roll

for Sept + Oct, 1864.

Present or absent Present

Stoppage, \$ 100 for

Due Gov't, \$ 100 for

Remarks:

Book mark:

C. C. Parker

(858)

Copyist.

P

9

U.S.C.T.

William H. Purnell

Det. Co. E, 9 Reg't U. S. Col'd Infantry.

Appears on

Company Muster Roll

for *Nov & Dec*, 186*4*.

Present or absent *Present*

Stoppage, \$ 100 for

Due Gov't, \$ 100 for

Remarks:

Book mark:

H. E. Noteman

(358)

Copyist.

P | 9 | U.S.C.T.

William H. Purnell

Pvt, Co. E, 9 Reg't U. S. Col'd Infantry.

Appears on

Company Muster Roll

for *Jany & Selby*, 1865

Present or absent *Present*

Stoppage, \$ 100 for

Due Gov't, \$ 100 for

Remarks:

Book mark:

J. E. Wetman Copyist.

P | 9 | U.S.C.T.

William H. Furnell

Sgt, Co. E, 9 Reg't U. S. Col'd Infantry.

Appears on

Company Muster Roll

for *March & April*, 1865.

Present or absent *Present*

Stoppage, \$ *100* for

Due Gov't, \$ *100* for

Remarks:

Book mark:

J. E. Noteman
Copyist.

(858)

P

9

U.S.C.T.

William H. Purnell

Pat, Co. E, 9 Reg't U. S. Col'd Infantry.

Appears on

Company Muster Roll

for *Dec 31, 64 to June 30, 1865.*

Present or absent *Present*

Stoppage, \$ 100 for

Due Gov't, \$ 100 for

Remarks:

Book mark:

H. E. Meteman
Copyist.

(358)

P | 9 | U.S.C.T.

William H. Gurnell

Pat, Co. E, 9 Reg't U. S. Col'd Infantry.

Appears on

Company Muster Roll

for *July & Augt*, 1865.

Present or absent *Present*

Stoppage, \$ 100 for

Due Gov't, \$ 100 for

Remarks: *Stoped for Ordnance 45 cts*
One Haversack 95 cts

Book mark: _____

(858)

H. B. Noteman
Copyist.

P

9

U.S.C.T.

William H. Purnell

Pat, Co. E, 9 Reg't U. S. Col'd Infantry.

Appears on

Company Muster Roll

for June 30 to Oct 31, 1865.

Present or absent Present

Stoppage, \$ 100 for

Due Gov't, \$ 45/100 for ord

Remarks:

Book mark:

H. E. Wetman

(858)

Copyist.

P | **9** | **U.S.C.T.**

William H. Lunnell
Sgt, Co. E, 9 Reg't U. S. Col'd Infantry.

Appears on

Company Muster Roll

for *June 30 to Dec 31, 1865.*

Present or absent *Present*

Stoppage, \$ 100 for

Due Gov't, \$ 45 *and*
100 for

Remarks:

Book mark:

H. E. Wetman
Copyist.

9

U.S.C.T.

[Faint handwritten text]

....., Co. E, 9 Reg't U. S. Col'd Infantry.

Appears on

Company Muster Roll

for, 186

Present or absent

Stoppage, \$ 100 for

Due Gov't, \$ 100 for

Remarks: *[Handwritten notes]*

Book mark:

(A) | 9 | U.S.C.T.

William H. ...

..., Co. ..., 9 Reg't U. S. Col'd Infantry.

Appears on Co. Muster-out Roll, dated *June 10th, 1866*.

Muster-out to date _____, 186 .

Last paid to _____, 186 .

Clothing account:

Last settled _____, 186 ; drawn since \$ _____ 100

Due soldier \$ _____ 100; due U. S. \$ _____ 100

Am't for cloth'g in kind or money adv'd \$ _____ 100

Due U. S. for arms, equipments, &c., \$ _____ 100

Bounty paid \$ _____ 100; due \$ _____ 100

Remarks: *Discharged ...*

Book mark: *72*

...
(861) Copyist.

Purnell, William H.

P, Co. E, 9 Reg't U.S.C. Inf.

4 Enclosures.

| | |
|------------------------------|--------------------|
| Bed Cards | Descriptive Lists |
| Burial Records | Final Statements / |
| Certs. of Dis. for Discharge | Furloughs |
| C. M. Charges | Med. Des. Lists |
| Med. Certificates | Orders |

Other papers relating to—

| | |
|----------------------------|----------------------|
| Admission to Hosp'l | Furlough |
| Casualty Sheet (Officer's) | Med. Examination |
| Confinement | Misc. Information |
| Contracts | Pay or Clothing |
| Death or Effects 3 | Personal Reports |
| Desertions | Rank |
| Discharge from Hosp'l | Transfer to Hosp'l |
| Discharge from Service | Transfer to V. R. C. |
| Duty | Transportation |

Extract from Act of Congress.

SEC. 12. *And be it further enacted,* That the fees of agents and attorneys for making out and causing to be executed the papers necessary to establish a claim for a pension, bounty, and other allowance before the Pension Office, under this act, shall not exceed the following rates: For making out and causing to be duly executed a declaration by the applicant, with the necessary affidavits, and forwarding the same to the Pension Office, with the requisite correspondence, ten dollars; which sum shall be received by such agent or attorney in full for all services in obtaining such pension, and shall not be demanded or received, in whole or in part, until such pension shall be obtained; and the sixth and seventh sections of an act entitled "An act to grant pensions," approved July [fourteenth,] eighteen hundred and sixty-two, are hereby repealed.

SEC. 13. *And be it further enacted,* That any agent or attorney who shall, directly or indirectly, demand or receive any greater compensation for his services under this act than is prescribed in the preceding section of this act, or who shall contract or agree to prosecute any claim for a pension, bounty, or other allowance under this act, on the condition that he shall receive a per centum upon any portion of the amount of such claim, or who shall wrongfully withhold from a pensioner or other claimant the whole or any part of the pension or claim allowed and due to such pensioner or claimant, shall be deemed guilty of a high misdemeanor, and, upon conviction thereof, shall, for every such offense, be fined not exceeding three hundred dollars, or imprisoned at hard labor not exceeding two years, or both, according to the circumstances and aggravations of the offense.

Approved July 4, 1864.

NOTE 10.—If any soldier is charged a higher fee than that allowed by the above act, he should report the fact and the name of the agent to the Adjutant General, in order that steps may be taken to have the same refunded.

Adj. G. March 5th 1866
Recd List sent 2^d

ADJUTANT GENERAL'S OFFICE
March 5th 1866
Duplicate with Inventory sent 2d Auditor.

FINAL STATEMENT

OF

William H. Purcell

7 Reg't of Inf Colords

VOLUNTEERS.

Dec Jan'y 15th 66

NOTE 1.—Two of these certificates (or duplicates) are to be given to each Volunteer Soldier or drafted man who may be discharged without being mustered out (Final Statements are never given to men mustered out of service,) that he may at once receive from the Paymaster the pay, &c., due him, and the captain or other COMMISSIONED officer commanding the company will certify to the act of the delivery of the duplicate certificates; with these certificates the Soldier is "entitled to" his discharge, and should also present his discharge to the Paymaster to have the payment endorsed on it. The discharge is to be given back to the Soldier by the Paymaster; the latter only retaining as his vouchers the duplicate certificates.

NOTE 2.—If the Soldier is entitled to pay for the use of his horse, the Company Commander will certify to that fact on the back of both these final statements, and also to the time he has pay due for having been so mounted on his own horse.

NOTE 3.—When a Soldier is furnished with final statements, his descriptive list, if he has one, should be taken up by the officer who gives the Soldier these statements, and endorsed with a statement to this effect by the officer. The endorsement should exhibit a full statement of the time for which the Soldier was allowed pay on his final statements, the clothing account, and all other charges against him or in his favor, so as to comprise a complete exhibit of his account. It will then be transmitted to the Company Commander of the Soldier, who will enter all the data necessary to a full understanding of the Soldier's account on the muster roll upon which the Soldier's discharge is reported. The descriptive list will then be destroyed. The object of this is, that the remaining portion of the Soldier's account may be settled upon the receipt of these muster rolls, and the Soldier receive any pay or allowances that may be due him at the time of his discharge, and which may not appear on his last final statements from the fact that his descriptive list is incomplete. These accounts for back pay, &c., are settled by the 2d Auditor of the Treasury Department.

NOTE 4.—Charges for loss or injury to ordnance, horse equipments, and other miscellaneous charges, should appear under the heading of "Other Stoppages."

NOTE 5.—Bounty paid by State authorities, and not by the United States, will not be entered on this statement.

NOTE 6.—Amounts due the Sutler and Laundress must be entered on the muster roll on which the discharge, death, desertion, &c., is reported, as well as on the final statement, otherwise the amount cannot be collected from the United States.

NOTE 7.—This blank will be used for deceased volunteers and drafted men, as well as for others.

NOTE 8.—Where a Soldier dies in Hospital or on detached service, his descriptive list, if he has one, should be sent with his final statements, in duplicate, to the Adjutant General, Washington, D. C.

NOTE 9.—If the soldier is a drafted man or substitute, the space for time, &c., of enrolled, should contain only the word *drafted* or *substitute*, as the case may be. If the Soldier is a "VETERAN," (or RECRUIT,) the words *as a veteran*, (or *recruit*;) as the case may be, should be interlined after the words *mustered into the service of the U. S.* A statement of all the installments of *Veteran* or *Recruit Bounty RECEIVED* by the Soldier must be made on the back of each final statement.

Wilson
MAR 5 1866
OFFICE OF THE ADJUTANT GENERAL

1863

I certify, on honor, that William H. Sumell, a Private of
 Captain A. D. Learned Company (E) of the 9 Regiment of 11th Regt of
VOLUNTEERS, of the State of _____, born in Worcester Co., State
 of Maryland, aged 18 years; 5 feet 3 3/4 inches high; Black complexion,
Black hair, and by occupation a Laborer, who joined for service
 and was enrolled (see Note 9) on the 10 day of November, 1863, at Worcester Co. Md.
 by Cot William B. Boney, for the period of Three years, and mustered into
 the service of the United States on the 17 day of November, 1863, at
Camp Stanton Md. by Cot Wm Boney; and having served
 HONESTLY and FAITHFULLY with his Company to the present date, is now entitled to a
DISCHARGE by reason of Death

The said William H. Sumell was last paid by Paymaster
Maj Brewsant, to include the 30 day of June, 1865, and
 has pay due him from that time to the present date; he is entitled to pay and subsistence for
 TRAVELING to place of enrollment, and whatever other allowances are authorized to volunteer
 soldiers, drafted men, or militia, so discharged. He has received from the United States **CLOTHING**
 amounting to Twenty three 13 dollars, since the 31 day of October,
 1863, when his clothing account was last settled. He has received from the United States
100 dollars advanced **BOUNTY**.

There is to be stopped from him, on account of the State of _____, or other
 authorities, for **CLOTHING, &c.**, received on entering service, _____ 100 dollars; and
 for other stoppages, viz: Slip for clothing Overdrawn
at last settlement Twelve 12 Slip for ordnance
cost 45cts Total 1 Twelve 12 100 dollars.

He has been furnished with **TRANSPORTATION** in kind from the place of his discharge to
 _____; and he has been **SUBSISTED** for **TRAVELING** to his
 place of enrollment, up to the _____, 186 .

He is indebted to _____, **SUTLER**, _____ 100 dollars.

He is indebted to _____, **LAUNDRESS**, _____ 100 dollars.

Given in Duplicate, at Post Hospital Brownsville Tex this 16 day
 of January, 1866.

A. C. Brewsant
 Surgeon 11th Regt of
 Commanding Company
 in charge Hospital

Discharge of

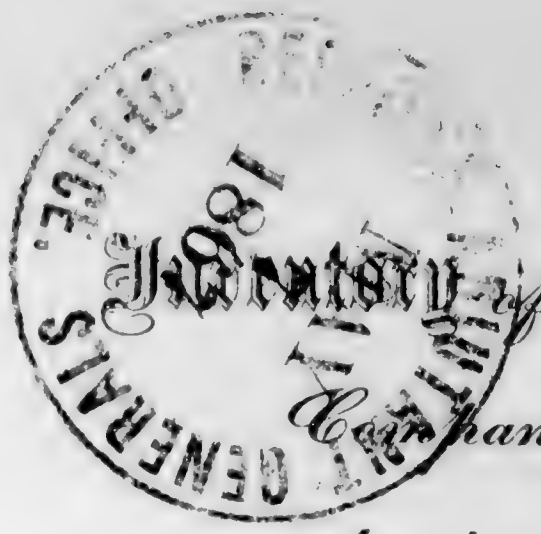

Inventory of the effects of *Wm. H. Purnell Private*
Company E, 9th Regiment U.S.C.T.
 who died in the *Brownsville U.S. General Hospital*

January 16, 1866 of *Chronic Diarrhoea*

| | | | |
|--------------------|---|-------------------------------|---|
| CAPS | | BLANKETS. <i>Rubber</i> | / |
| DRESS COATS | | KNAPSACKS | / |
| OVERCOATS | | CANTEENS | / |
| JACKETS | | HAVERSACKS | / |
| TROUSERS | | MUSKETS | |
| SHIRTS | | BAYONETS | |
| DRAWERS | / | CARTRIDGE BOX | |
| BOOTS, pairs | | BELT | . |
| SHOES, pairs | | MONEY | |
| STOCKINGS | / | | |

E. Fowler
Capt + Asst Surg U.S.A.
In Charge.

INVENTORY

OF THE EFFECTS OF

Wm. H. Purnell Private

Late of *Company E, 9th Regiment*

U.S.C.T., who died
 at *Brownsville Texas General*

Hospital *January 16,*
 1866.

U. S. Army General Hospital,

....., 186

Commanding Officer, Company,

..... Regiment

I have to inform you

that of your Company died in this

Hospital on of

I enclose his Descriptive List, with Pay and Clothing Account,
and Inventory of his effects.

Very respectfully, yours, &c.,

.....

Surgeon U. S.,

In charge of General Hospital

No. 35 of

Inventory of the effects of Priv. Wm H Burnell
Company E, 9th Regiment U.S. A.
who died in the Brownsville Post Hospital
January 16th, 1866.

| | | | |
|----------------------|---|------------------------|---|
| CAPS | | BLANKETS. rubber | / |
| DRESS COATS | | KNAPSACKS | / |
| OVERCOATS | | CANTEENS | / |
| JACKETS | | HIVERSACKS | / |
| TROUSERS | | MUSKETS | |
| SHIRTS | | BAYONETS | |
| DRAWERS pair | / | CARTRIDGE BOX | |
| BOOTS, pairs | | BELT | |
| SHOES, pairs | | MONEY | |
| STOCKINGS pair | / | | |

J. L. R. Rammone
Surgeon in Charge
In Charge

INVENTORY

OF THE EFFECTS OF

Priv. Wm H Burnell

Late of Company E, 9th Regiment

W. H. Burnell, who died
at Brownsville Tex. General Hospital

Hospital
January 16th,
1866.



No. 357.

Inventory of the effects of Priv. Wm H Purnell
Company B, 9th Regiment USA
who died in the Brownsville Post General Hospital
January 16th, 1866

| | | | |
|-----------------------------|---|-------------------------------|---|
| CAPS | | BLANKETS. <u>rubber</u> | / |
| DRESS COATS | | KNAPSACKS | / |
| OVERCOATS | | CANTEENS | / |
| JACKETS | | Haversacks | / |
| TROUSERS | | MUSKETS | |
| SHIRTS | | BAYONETS | |
| DRAWERS <u>pair</u> | / | CARTRIDGE BOX | |
| BOOTS, pairs | | BELT | |
| SHOES, pairs | | MONEY | |
| STOCKINGS <u>pair</u> | / | | |

W. B. Ransom
Surgeon 14th USA
In charge

INVENTORY

OF THE EFFECTS OF

Priv. Wm H Purnell

Late of Company B, 9th Regiment

W. H. Purnell, who died
at Brownsville Post General Hospital

January 16th
1866.

See
A. Purnell
9th. S. C. Troop



⁸²⁶
Purnell, Gedrick A

Co A, 9 U.S. Col'd Inf.

Private Private

CARD NUMBERS.

| | | |
|----|---------|----|
| 1 | 6313437 | 26 |
| 2 | 6313536 | 27 |
| 3 | 6313637 | 28 |
| 4 | 6313741 | 29 |
| 5 | 6313839 | 30 |
| 6 | 6313934 | 31 |
| 7 | 6314025 | 32 |
| 8 | 6314130 | 33 |
| 9 | 6314230 | 34 |
| 10 | 6314324 | 35 |
| 11 | 6314417 | 36 |
| 12 | 6314496 | 37 |
| 13 | 6314578 | 38 |
| 14 | 6314650 | 39 |
| 15 | 6314714 | 40 |
| 16 | 6314777 | 41 |
| 17 | 6314837 | 42 |
| 18 | 6314897 | 43 |
| 19 | 6314956 | 44 |
| 20 | 6315084 | 45 |
| 21 | 9069265 | 46 |
| 22 | | 47 |
| 23 | | 48 |
| 24 | | 49 |
| 25 | | 50 |

Book Mark:

See also

9 U.S.C.T.

Frederick A. Purnell
Co. *F.*, 9 Reg't U. S. Col'd Inf.

Appears on
Company Descriptive Book
of the organization named above.

DESCRIPTION.

Age *22* years; height *5* feet *10* inches.
Complexion *Black*
Eyes *Black*; hair *Black*
Where born *North Maryland*
Occupation *Farm*

ENLISTMENT.

When *Nov 18*, 186*3*.
Where *Newark, Worcester Co. Md.*
By whom *Col. W. Spring*; term *1* y'rs.

Remarks: *Description list furnished*
Aug. 7, 1865.
Did at Sedgwick Co. Gen.
Dept. Granville, La. Nov. 1864.
of Asiatic India.

Casey
(383g) Copyist.

P. 9 U.S.C.T.

Jeddick A. Cornell
Print Co. *H*, 9 Reg't U. S. Col'd Infantry.

Age *22* years.

Appears on

Company Muster-in Roll

of the organization named above. Roll dated

Camp Stanton, Charles Co., Maryland, *Nov. 23*, 186*3*.

Muster-in to date *Nov. 23*, 186*3*

Joined for duty and enrolled:

When *Nov. 18*, 186*3*.

Where *Worcester, Md.*

Period *3* years.

Remarks:
.....
.....
.....
.....
.....

Book mark:

O. J. Markle
(356) Copyist.

O

9

U.S.C.T.

Jeddick A. Ornell
Private, Co. H, 9 Reg't U. S. Col'd Infantry.

Appears on

Company Muster Roll

for *Nov. 23 to Dec. 31, 1863.*

Present or absent *Present.*

Stoppage, \$ *100* for

Due Gov't, \$ *100* for

Remarks: *\$2 Recruits premium due.*
Sick in Quarters

Book mark:

O. J. Markle.

(358)

Copyist.

WAR 23

P

9

U.S.C.T.

Jeddick A. Purnell
Private, Co. H, 9 Reg't U. S. Col'd Infantry.

Appears on

Company Muster Roll

for *Jan. + Feb.*, 1864.

Present or absent *Present.*

Stoppage, \$ *100* for

Due Gov't, \$ *100* for

Remarks: *Stop for one Haversack*
\$2 Reemits premium due.

Book mark:

(358)

O. J. Markle,

Copyist.

O

9

U.S.C.T.

Jedrick A. Snell

Private, Co. H, 9 Reg't U. S Col'd Infantry.

Appears on

Company Muster Roll

for *March + April*, 1864.

Present or absent *Present*

Stoppage, \$ *100* for

Due Gov't, \$ *100* for

Remarks:

Book mark:

O. J. Markle,

(358)

Copyist.

Q

9

U.S.C.T.

Zeddick A. Purcell
Private, Co. H, 9 Reg't U. S Col'd Infantry.

Appears on

Company Muster Roll

for *May + June*, 1864.

Present or absent *Present.*

Stoppage, \$ *100* for

Due Gov't, \$ *100* for

Remarks:

Book mark:

O. J. Markle,

(358)

Copyist.

P | **9** | **U.S.C.T.**

Jeddo A. Purnell
Private, Co. H, 9 Reg't U. S Col'd Infantry.

Appears on

Company Muster Roll

for *July & August*, 1864.

Present or absent *Absent*.

Stoppage, \$ *100* for

Due Gov't, \$ *100* for

Remarks: *In Gen. Hospital from
Wounds received in Act. Aug. 16,
1864 Deep Bottom, Va. Stop for
one month.*

Book mark:

O. J. Markle,
(358) Copied.

P

9

U.S.C.T.

Jeddie A. Cornell

Private, Co. H, 9 Reg't U. S. Col'd Infantry.

Appears on

Company Muster Roll

for Sept. & Oct., 1864

Present or absent Absent

Stoppage, \$ 100 for

Due Gov't, \$ 100 for

Remarks: Absent Wounded Deep Bottom, Va., Aug. 16, 1864. Stop for 1 Quarter.

Book mark:

J. Markle

(358)

Copyist.

P

9

U.S.C.T.

Ruddie W. Purnell
Priv., Co. H, 9 Reg't U. S. Col'd Infantry.

Appears on

Company Muster Roll

for *Nov. & Dec.*, 1864.

Present or absent *Present*

Stoppage, \$ *100* for

Due Gov't, \$ *100* for

Remarks: *Wounded at Deep Bottom Aug. 16. Returned to duty Nov. 29. Stop once Haversack and canteen. A deficiency of seven dollars per month and thirteen dollars per month is due from Jan. 1, 1864 to April 30, 1864*

Book mark:

A. L. Ames

(358)

Copyist.

O | 9 | U.S.C.T.

Eddie A. Purnell
Priv., Co. H, 9 Reg't U. S. Col'd Infantry.

Appears on

Company Muster Roll

for *Jan. + Feb.*, 1865.

Present or absent *Present*

Stoppage, \$ 100 for

Due Gov't, \$ 100 for

Remarks:

Book mark:

A. L. Ames

P

9

U.S.C.T.

Zeddie A. Purnell

Priv., Co. H, 9 Reg't U. S. Col'd Infantry.

Appears on

Company Muster Roll

for *Mch. & April*, 1865.

Present or absent *Absent*

Stoppage, \$ *100* for

Due Gov't, \$ *100* for

Remarks: *Guard at Field
Hosp. S. O. No. 33 Hd.
ers. 9 U. S. C. I. March
24/65*

Book mark:

A. L. Ames

(358)

Copyist.

P

9

U.S.C.T.

Jeddick A. Purnell
Priv., Co. H, 9 Reg't U. S. Col'd Infantry.

Appears on

Company Muster Roll

for *Dec. 31, 1864 to June 30, 1865.*

Present or absent *Absent*

Stoppage, \$ *100* for

Due Gov't, \$ *100* for

Remarks: *Det. Sear. Field Hosp.*
S.O. No. 33, Hd. Qrs. 9th U.S.C.I.
March 24/65

Book mark:

J. L. Arue

(358)

Copyist.

P

9

U.S.C.T.

Jeddick A. Purnell

Priv., Co. H, 9 Reg't U. S. Col'd Infantry.

Appears on

Company Muster Roll

for July & Aug., 1865.

Present or absent Absent

Stoppage, \$ 100 for

Due Gov't, \$ 100 for

Remarks: Ditch & serv. Field Hosp. S.O. 33 Hd. Qrs. 9th U.S.C. March 24, 1865.

Book mark:

A. L. Ames

P

9

U.S.C.T.

Geddick A. Purnell
Priv., Co. H, 9 Reg't U. S. Col'd Infantry.

Appears on

Company Muster Roll

for June 30 to Oct. 31, 1865.

Present or absent Absent

Stoppage, \$ 100 for

Due Gov't, \$ 100 for

Remarks: Detach & service
P.H. Brownsville S.O. 33
Ad. Drs. 9th U.S. C.T. Mch.
25/65

Book mark:

A. L. Ames

(358)

Copyist.

P

9

U.S.C.T.

Giddie A. Purnell

Priv., Co. H, 9 Reg't U. S. Col'd Infantry.

Appears on

Company Muster Roll

for June 30 to Dec. 31, 1865.

Present or absent Absent

Stoppage, \$ 57 100 for Ordnance & 65cts. for Camp & Gen. Equip.

Due Gov't, \$ 100 for

Remarks: Post Hosp. Guard per S.O. No. 33, Hd. Qrs. 9th U.S.C.T. Mch. 24/65

Book mark:

A. L. Ames

P

9

U.S.C.T.

Zeddie A. Purnell
Privt., Co. H, 9 Reg't U. S. Col'd Infantry.

Appears on

Company Muster Roll

for *Jan. & Feb.*, 186*6*.

Present or absent *Present.*

Stoppage, \$ *100* for

Due Gov't, \$ *100* for

Remarks: *Stop for Haversack 95cts*
launter 65 cents.

Book mark:

B. Bradin

P | 9 | U.S.C.T.

Jedrick A. Purnell
Private, Co. H, 9 Reg't U. S. Col'd Infantry.

Appears on

Company Muster Roll

for *March & April*, 186*6*.

Present or absent *Present*.

Stoppage, \$ *100* for

Due Gov't, \$ *100* for

Remarks: *Stop or one Wipers, one
Screw Driver, one Cone Wrench,
one Cartridge Box Belt & one
Cart. Box Belt plate, & one Bayonet
Scabbard \$1.34.*

Book mark:

R. Braden

P

9

U.S.C.T.

Zedrick A. Purnell
Privt, Co. H, 9 Reg't U. S. Col'd Infantry.

Appears on

Company Muster Roll

for *May & June*, 186*6*.

Present or absent *Present*.

Stoppage, \$ *100* for

Due Gov't, \$ *100* for

Remarks:

x

Book mark:

R. Bradis

P.

9

U.S.C.T.

Zedrick A. Purnell
Privt, Co. H, 9 Reg't U. S. Col'd Infantry.

Appears on

Company Muster Roll

for *July & August*, 186*6*.

Present or absent *Present*

Stoppage, \$ *100* for

Due Gov't, \$ *100* for

Remarks:

Book mark:

R. Bradin

P | 9 | U.S.C.T.

Zeddick Purnell
Privt, Co. H, 9 Reg't U. S. Col'd Infantry.

Appears on

Company Muster Roll

for *Sept. & Oct*, 186 *6*.

Present or absent *Present*.

Stoppage, \$ *100* for

Due Gov't, \$ *100* for

Remarks:

Book mark:

R. Bradin

P. | 9 | U.S.C.T.

Yedick A. Purnell
Privt, Co. '26", 9 Reg't U. S. Col'd Infantry.

Appears on **Co. Muster-out Roll**, dated
New Orleans, La., Nov. 26, 1864.

Muster-out to date _____, 186 .

Last paid to _____, 186 .

Clothing account:

Last settled _____, 186 ; drawn since \$ _____ 100

Due soldier \$ _____ 100; due U. S. \$ _____ 100

Am't for cloth'g in kind or money adv'd \$ _____ 100

Due U. S. for arms, equipments, &c., \$ _____ 100

Bounty paid \$ _____ 100; due \$ _____ 100

Remarks: *Joined at Original organiza-*
tion. Died at U.S. Genl Hosp't Green-
sville, La. Nov. 4/64 of Cholera.

Book mark: *P. V. 27. P. 124. 73. F. S. 4878*
2^d Aud. Aug. 19/67.

R. Bradley

(861)

Copyist.

Parnell, Zeddick a
 Co. H, 9 Reg't U. S. C. Inf.

4 Enclosures.

| | |
|------------------------------------|-------------------------|
| Bed Cards | Descriptive Lists |
| Burial Records / | Final Statements / |
| Certs. of Dis. for Discharge | Furloughs |
| C. M. Charges | Med. Des. Lists |
| Med. Certificates | Orders |

Other papers relating to—

| | |
|---|---------------------------|
| Admission to Hosp'l | Furlough |
| Casualty Sheet (^{Priv} Officer's) / | Med. Examination |
| Confinement | Misc. Information |
| Contracts | Pay or Clothing |
| Death or Effects | Personal Reports |
| Desertions | Rank |
| Discharge from Hosp'l | Transfer to Hosp'l |
| Discharge from Service | Transfer to V. R. C. |
| Duty | Transportation |

MICROFILM PUBLICATION M 1851

COMPILED MILITARY SERVICE RECORDS
OF VOLUNTEER UNION SOLDIERS WHO SERVED WITH
THE UNITED STATES COLORED TROOPS (USCT)
9TH REGIMENT OF INFANTRY

PERSONAL PAPERS' TARGET SHEET

PLEASE NOTE THE CHECKED INFORMATION ABOUT THE PERSONAL PAPERS IN
THIS FILE:

- NO PERSONAL PAPERS WERE FOUND IN THIS FILE WHEN THE
RECORDS WERE ARRANGED FOR MICROFILMING.
- 5 PERSONAL PAPER(S) FOUND IN THIS FILE WHEN THE RECORDS
WERE ARRANGED FOR MICROFILMING.

Exp. 10/10/64

CASUALTY SHEET

No. _____

Frederick A. Pennell

Private of Company *"A"*

9th Regiment of *U.S.C.V.*

State Volunteers.

NATURE OF CASUALTY.

Died Nov 4 "1864

NARA 259
CASUALTY SHEET.

Name: *Meddick A. Pennell*
Rank: *Pat. Co.* Company: *"H"* Regiment: *9th*
Arm: *U. S. Troop* State: _____
Nature of Casualty: *Death*

CAUSE OF CASUALTY—(NAME OF DISEASE, &c.)

Cholera

DEGREE OF DISABILITY.

BY WHOM CERTIFIED.

G. M. Pennell
Supt. Ch. Comd'g

DATE OF DISCHARGE, DEATH, &c.
November 4th 1866

PLACE OF DISCHARGE, DEATH, &c.
Sedgwick U. S. Genl. Hosp.
Greenville, La.

BY WHOM DISCHARGED.

FROM WHAT SOURCE THIS INFORMATION WAS OBTAINED.

Gr. list of dead Soldiers for 4th 1866

REMARKS.

"These List furnished Surgeon"

G. M. Kenney
Clerk.



Post Hospital
Quincy, Ill. La. Aug 7 1867

Dear Sir,

I have the honor to forward herewith enclosed final statements & inventories of effects in the case of Frederick W. Merrill late a private of Co. 20th U. S. C. I. who died at the Sedgwick Post Hospital March 25th 1867.

Very respectfully,
Wm. H. Smith
S. H. Armstrong
Adj. Surg. Gen. & Asst. Dir. Gen. Hosp.
Quincy

Adj. Surg. U. S. A.
Washington
D. C.

Extract from Act of Congress.

SEC. 12. And be it further enacted, That the fees of agents and attorneys for making out and causing to be executed the papers necessary to establish a claim for a pension, bounty, and other allowance before the Pension Office, under this act, shall not exceed the following rates: For making out and causing to be duly executed a declaration by the applicant, with the necessary affidavits, and forwarding the same to the Pension Office, with the requisite correspondence, ten dollars; which sum shall be received by such agent or attorney in full for all services in obtaining such pension, and shall not be demanded or received, in whole or in part, until such pension shall be obtained; and the sixth and seventh sections of an act entitled "An act to grant pensions," approved July [fourteenth,] eighteen hundred and sixty-two, are hereby repealed.

SEC. 13. And be it further enacted, That any agent or attorney who shall, directly or indirectly, demand or receive any greater compensation for his services under this act than is prescribed in the preceding section of this act, or who shall contract or agree to prosecute any claim for a pension, bounty, or other allowance under this act, on the condition that he shall receive a per centum upon any portion of the amount of such claim, or who shall wrongfully withhold from a pensioner or other claimant the whole or any part of the pension or claim allowed and due to such pensioner or claimant, shall be deemed guilty of a high misdemeanor, and, upon conviction thereof, shall, for every such offense, be fined not exceeding three hundred dollars, or imprisoned at hard labor not exceeding two years, or both, according to the circumstances and aggravations of the offense.

Approved July 4, 1864.

NOTE. 10.—If any soldier is charged a higher fee than that allowed by the above act, he should report the fact and the name of the agent to the Adjutant General, in order that steps may be taken to have the same refunded.

FINAL STATEMENT.

OF

Yonick A. Parrell
9th Reg't of U. S. C. Infantry

VOLUNTEERS.

Rec'd Jan 16 1864

NOTE 1.—Two of these certificates (or duplicates) are to be given to each Volunteer Soldier or drafted man who may be discharged without being mustered out (Final Statements are never given to men mustered out of service,) that he may at once receive from the Paymaster the pay, &c. due to him, and the captain or other COMMISSIONED officer commanding the company will certify to the act of the delivery of the duplicate certificates; with these certificates the Soldier is "entitled to" his discharge, and should also present his discharge to the Paymaster to have the payment endorsed on it. The discharge is to be given back to the Soldier by the Paymaster; the latter only retaining as his vouchers the duplicate certificates.

NOTE 2.—If the Soldier is entitled to pay for the use of his horse, the Company Commander will certify to that fact on the back of both these final statements, and also to the time he has pay due for having been so mounted on his own horse.

NOTE 3.—When a Soldier is furnished with final statements, his descriptive list, if he has one, should be taken up by the officer who gives the Soldier these statements, and endorsed with a statement to this effect by the officer. The endorsement should exhibit a full statement of the time for which the Soldier was allowed pay on his final statements, the clothing account, and all other charges against him or in his favor, so as to comprise a complete exhibit of his account. It will then be transmitted to the Company Commander of the Soldier, who will enter all the data necessary to a full understanding of the Soldier's account on the muster roll upon which the Soldier's discharge is reported. The descriptive list will then be destroyed. The object of this is, that the remaining portion of the Soldier's account may be settled upon the receipt of these muster rolls, and the Soldier receive any pay or allowances that may be due him at the time of his discharge, and which may not appear on his last final statements from the fact that his descriptive list is incomplete. These accounts for back pay, &c., are settled by the 2d Auditor of the Treasury Department.

NOTE 4.—Charges for loss or injury to ordnance, horse equipments, and other miscellaneous charges, should appear under the heading of "Other Stoppages."

NOTE 5.—Bounty paid by State authorities, and not by the United States, will not be entered on this statement.

NOTE 6.—Amounts due the Sutler and Laundress must be entered on the muster roll, and the charge, death, desertion, &c., is reported, as well as on this statement, otherwise the amount cannot be collected from the United States.

NOTE 7.—This blank will be used for deceased volunteers and drafted men, as well as for others.

NOTE 8.—Where a Soldier dies in hospital or on detached service, his descriptive list, if he has one, should be sent with his final statements, in duplicate, to the Adjutant General, Washington, D. C.

NOTE 9.—If the soldier is a drafted man or substitute, the space for time, &c., if collected, should contain only the word *drafted* or *substitute*, as the case may be. If the soldier is a "VETERAN," (or RECRUIT,) the words *as a veteran*, (or *as a recruit*), as the case may be, should be interlined after the words *mustered into the service of the U. S.* A statement of all the installments of *Veteran or Recruit Bounty RECEIVED* by the Soldier must be made on the back of each final statement.

also Jan 16 1864
Rec'd with inventory
ADJUTANT GENERAL
Jan 16 1864
Duplicate with Inventory sent to Adj. Gen.

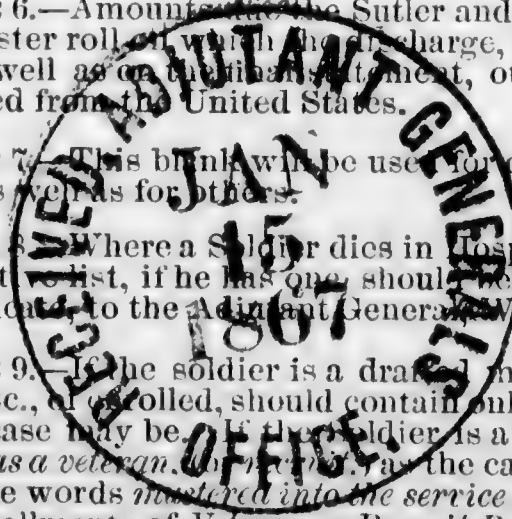

William A. R. [unclear]

I certify, on honor, that Fredrick A. Pennell, a Private of
 Captain S. H. Rhoades Company (No) of the 9th Regiment of U. S. C. Infantry
Volunteers, of the State of Maryland, born in Norcross State
 of Maryland, aged 22 years; 5 feet 10 inches high; Black complexion,
Black eyes, Black hair, and by occupation a Farmer, who joined for service
 and was enrolled (see Note 9) on the 18th day of November, 1863, at Yemassee Md
 by Col. Wm. B. Burney, for the period of Three years, and mustered into
 the service of the United States on the 23rd day of November, 1863; at
Benedick Md, by Col. Wm. B. Burney; and having served

HONESTLY and **FAITHFULLY** with his Company to the present date, is now entitled to a
DISCHARGE by reason of death at Soldiers Club Hospital
November 24th 1864 of Cholera

The said Fredrick A. Pennell was last paid by Paymaster
Wm. Underwood, to include the 20th day of June, 1864, and
 has pay due him from that time to the present date; he is entitled to pay and subsistence for
TRAVELING to place of enrollment, and whatever other allowances are authorized to volunteer
 soldiers, drafted men, or militia, so discharged. He has received from the United States **CLOTHING**
 amounting to 41.84 dollars, since the 31st day of October,
 1864, when his clothing account was last settled. He has received from the United States
100 dollars advanced **BOUNTY**.

There is to be stopped from him, on account of the State of _____, or other
 authorities, for **CLOTHING**, &c., received on entering service, _____ dollars; and
 for other stoppages, viz: One hundred and twenty five dollars
 _____ dollars.

He has been furnished with **TRANSPORTATION** in kind from the place of his discharge to
 _____; and he has been **Subsisted** for **Traveling** to his
 place of enrollment, up to the _____, 1864.

He is indebted to _____, **Sutler**, _____ dollars.
 He is indebted to _____, **Laundress**, _____ dollars.

Given in Duplicate, at Rich. Hospital Annapolis, this 1st day
 of January 1864.

[Signature]
Col. Wm. B. Burney
 Commanding Company of 9th U. S. C. Infantry

COPY OF RECORD

FOR THE

ADJUTANT GENERAL, U. S. ARMY.



No. 2.

RECORD OF DEATH AND INTERMENT.

| | | |
|--------------------------------------|-------|---|
| Name and number of person interred, | - - - | Widdick A. Parnell |
| Number and locality of the Grave, | - - - | Square No. 13. Grave No. 79. |
| Hospital number of the deceased, | - - - | 511 |
| Regiment, rank and company, | - - - | Regt. Co. H. 9 th U.S. C. Infantry |
| Residence before enlistment, | - - - | Berlin Md. |
| Conjugal condition, (and if married, | - - - | Single |
| The residence of the widow, | - - - | W. Parnell Berlin Md. |
| Cause of death, | - - - | Cholera |
| Age of the deceased, | - - - | 22 |
| Nativity, | - - - | Md. |
| References and remarks, | - - - | |
| Date of death and burial, | - - - | Nov. 4 th 1864 |

To *Adj. Gen. H. A. C.*
Washington D.C.

SIR:

It becomes my duty to inform you that the person above described died at this Hospital as herein stated, and that it is desired his remains should be interred with the usual Military honors.

Respectfully,
[Signature]
 Bat. Lt. Col. V. Wash. SURGEON, U. S. ARMY.

Sedgwick
 MILITARY HOSPITAL, *Greenville Pa*
Nov 4th 1864

In charge

Dear Sir,

Respectfully returned with
 the information and pertinent state-
 ments of the Government in the case
 of ~~Medical~~ Albert ~~Parnell~~, known as
 Albert Parnell, were forwarded
January 18, 1877 and consequently
 could not have reached their
 destination Jan. 24 (the time at
 which this letter was dated)

J. H. Farnsworth

Belmont, Mass. Feb. 1, 1877
 Chicago

⁹²⁷
Pye George W.
Co *K* 9 U.S. Col'd Inf.

Private | *Private*

CARD NUMBERS.

| | | |
|----|---------|----|
| 1 | 6316905 | 26 |
| 2 | 6317002 | 27 |
| 3 | 6317105 | 28 |
| 4 | 6317207 | 29 |
| 5 | 6317329 | 30 |
| 6 | 6318410 | 31 |
| 7 | 9069486 | 32 |
| 8 | | 33 |
| 9 | | 34 |
| 10 | | 35 |
| 11 | | 36 |
| 12 | | 37 |
| 13 | | 38 |
| 14 | | 39 |
| 15 | | 40 |
| 16 | | 41 |
| 17 | | 42 |
| 18 | | 43 |
| 19 | | 44 |
| 20 | | 45 |
| 21 | | 46 |
| 22 | | 47 |
| 23 | | 48 |
| 24 | | 49 |
| 25 | | 50 |

Book Mark:

See also

P | **9** | **U.S.C.T.**

George H. Lyle

, Co. *H*, 9 Reg't U. S. Col'd Inf.

Appears on

Company Descriptive Book

of the organization named above.

DESCRIPTION.

Age *40* years; height *5* feet *10* inches.

Complexion *Dark*

Eyes *Dark*; hair *Black*

Where born *Charles Md.*

Occupation *Wood-cutter*

ENLISTMENT.

When *Nov. 26*, 186 *3*

Where *Benedict*

By whom *Wm. Purney*; term *3* y'rs.

Remarks: *Died in Genl Hosp't.*
at Beaufort S. C. June 6/64
of Hydrops Pericardii,
Received notice of his death
June 21/64. Final statements
forwarded June 21/64

J. M. Purney

P

9

U.S.C.T.

George W. Pye
Pri, Co. K, 9 Reg't U. S. Col'd Infantry.

Age 40 years.

Appears on

Company Muster-in Roll

of the organization named above. Roll dated

Charles Co. Md, Nov 30, 1863.

Muster-in to date Nov 30, 1863

Joined for duty and enrolled:

When Nov. 26, 1863.

Where Charles Md.

Period 3 years.

Remarks:

Book mark:

O. G. Smith

(356)

Copyist.

P

9

U.S.C.T.

George W. Pye
Pri, Co. K, 9 Reg't U. S. Col'd Infantry.

Appears on

Company Muster Roll

for *Nov & Dec*, 1863.

Present or absent *Present*

Stoppage, \$ 100 for

Due Gov't, \$ 100 for

Remarks: *\$2.00 Recruit Premium*
Due

Book mark:

W. Smith

(358)

Copyist

P | **9** | **U.S.C.T.**

George W. Pye
Pri, Co. K, 9 Reg't U. S. Col'd Infantry.

Appears on

Company Muster Roll
for *Jan & Feb*, 186*4*.

Present or absent *Present*

Stoppage, \$ *100* for

Due Gov't, \$ *100* for

Remarks: *\$2.00 Recruit*
Premium Due

Book mark:

O. G. Smith

(358)

Copyist

P

9

U.S.C.T.

George W. Pye
Pri Co. K, 9 Reg't U. S. Col'd Infantry.

Appears on

Company Muster Roll

for Mch & April, 1864.

Present or absent Absent

Stoppage, \$ 100 for

Due Gov't, \$ 100 for

Remarks: Absent sick at
Beaufort S.C. since
April 8 - 1864.

Book mark:

O. G. Smith

P | **9** | **U.S.C.T.**

George W. Pye
Pri, Co. K, 9 Reg't U. S. Col'd Infantry.

Appears on

Company Muster Roll

for *May & June*, 1864.

Present or absent

Stoppage, \$ *100* for

Due Gov't, \$ *100* for

Remarks: *Died in Gen
Hospl at Beaufort
S.C. June 6/64 of
Hydrop Pericardis*

Book mark:

C. G. Smith

(358)

Copyist

P | 9 | U.S.C.T.

George W. Pye
Priv., Co. *A*, 9 Reg't U. S. Col'd Infantry.

Appears on **Co. Muster-out Roll**, dated
New Orleans, La., Nov. 26, 186*6*.

Muster-out to date _____, 186 .

Last paid to _____, 186 .

Clothing account:

Last settled _____, 186 ; drawn since \$ _____ 100

Due soldier \$ _____ 100; due U. S. \$ _____ 100

Am't for cloth'g in kind or money adv'd \$ _____ 100

Due U. S. for arms, equipments, &c., \$ _____ 100

Bounty paid \$ _____ 100; due \$ _____ 100

Remarks: *Joined at original
 organization. Died at
 Gen. Hosp. Beaufort, S.C.
 June 6, 1864.*

Book mark: *312.223.540.1884.F.S.*

(861)

N. C. Taylor

Copyist.

Page, George W.

P, Co. K, 9 Reg't U.S.C. Inf.

2 Enclosures.

| | |
|------------------------------|--------------------|
| Bed Cards | Descriptive Lists |
| Burial Records | Final Statements / |
| Certs. of Dis. for Discharge | Furloughs |
| C. M. Charges | Med. Des. Lists |
| Med. Certificates | Orders |

Other papers relating to—

| | |
|----------------------------|----------------------|
| Admission to Hosp'l | Furlough |
| Casualty Sheet (Officer's) | Med. Examination |
| Confinement | Misc. Information |
| Contracts | Pay or Clothing |
| Death or Effects / | Personal Reports |
| Desertions | Rank |
| Discharge from Hosp'l | Transfer to Hosp'l |
| Discharge from Service | Transfer to V. R. C. |
| Duty | Transportation |

ARTICLES OF WAR.

ART. 95. When any non-commissioned officer or soldier shall die, or be killed in the service of the United States, the then commanding officer of the troop or company shall, in the presence of two other commissioned officers, take an account of what effects he died possessed of, above his arms and accoutrements, and transmit the same to the office of the Department of War, which said effects are to be accounted for, and paid to the representatives of such deceased non-commissioned officer or soldier. And in case any of the officers, so authorized to take care of the effects of deceased officers and soldiers, should, before they have accounted to their representatives for the same, have occasion to leave the regiment or post, by preferment or otherwise, they shall, before they be permitted to quit the same, deposit in the hands of the commanding officer, or of the assistant military agent, all the effects of such deceased non-commissioned officers and soldiers, in order that the same may be secured for, and paid to, their respective representatives.

ARMY REGULATIONS—EDITION OF 1861.

DECEASED SOLDIERS.

Par. 152. Inventories of the effects of deceased non-commissioned officers and soldiers, required by the 95th Article of War, will be forwarded to the Adjutant General, by the commander of the company to which the deceased belonged, and a duplicate of the same to the colonel of the regiment. Final statements of pay, clothing, &c., will be sent with the inventories. When a soldier dies at a post or station absent from his company, it will be the duty of his immediate commander to furnish the required inventory, and, at the same time, to forward to the commanding officer of the company to which the soldier belonged, a report of his death, specifying the date, place, and cause; to what time he was last paid, and the money or other effects in his possession at the time of his decease; which report will be noted on the next muster roll of the company to which the man belonged. Each inventory will be endorsed, "Inventory of the effects of _____, late of company (—) _____ regiment of _____, who died at _____, the _____ day of _____, 186—." If a legal representative receive the effects, it will be stated in the report. If the soldier leave no effects, the fact will be reported.

Par. 153. Should the effects of a deceased non-commissioned officer or soldier not be administered upon within a short period after his decease, they shall be disposed of by a Council of Administration, under the authority of the commanding officer of the post, and the proceeds deposited with the Paymaster, to the credit of the United States, until they shall be claimed by the legal representatives of the deceased.

Par. 154. In all such cases of sales by the Council of Administration, a statement in detail, or account of the proceeds, duly certified by the Council and commanding officer, accompanied by the Paymaster's receipt for the proceeds, will be forwarded by the commanding officer to the Adjutant General. The statement will be endorsed, "Report of the proceeds of the effects of _____, late of company (—) _____ regiment of _____, who died at _____, the _____ day of _____, 186—."

NOTE 1.—The effects in all cases, when called for, should be turned over to the legal representative, without further authority from the Adjutant General. When the effects are turned over to the relatives of the deceased before these inventories are sent to the Adjutant General, their receipts therefor should be attached to the inventories. In all other cases, one copy will be sent with a letter of transmittal direct to the Adjutant General, and a duplicate retained by the officer.

NOTE 2.—Particular care should be taken to take receipts in duplicate from the Paymaster for any funds turned over to him; one copy should be sent direct to the Adjutant General and one retained by the officer.

Kept from Div. of discontinued
Commands Filed Aug 24, 1875
INVENTORY OF THE EFFECTS

OF
George W. Pyle
Late of Company H
9 Reg't of U.S.C. Troops
Volunteers, who died at W. Va. Camp
on the 6 day of June 1864



Inventory of the effects of George W. Pize late
 a Private of Captain Wendell & Mills Company 12 of
 the 9th Regiment of N.S.C. Troops Volunteers, who was enrolled as
 a Private at Charles Co. in the State of Maryland on
 the 26 day of November 1863, and mustered into the service of the United
 States as a Private on the 30 day of Nov. 1863, at Sanford Md
 in Company 7, 9 Regiment of N.S.C. Volunteers, to serve 3
 years or during the war; he was born in Charles Co. in the State
 of Maryland; he was 40 years of age, 5 feet 10 inches
 high, Blk. complexion, Blk eyes, Blk hair, and by occupation, when enrolled,
 a Wood Cutter; he died in U.S. Genl Hospital No 6 at
Sanford Md. on the 6 day of June 1864, by
 reason of Mydops Pericardis

| INVENTORY. | | | | | |
|-------------------------|-----|----------------------------|-----|----------------|-----|
| ARTICLES. | No. | ARTICLES. | No. | ARTICLES. | No. |
| Hats..... | | Pairs trousers..... | 2 | Knapsacks..... | 1 |
| Caps..... | | Pairs flannel drawers..... | | | |
| Forage caps..... | | Pairs cotton drawers..... | 2 | | |
| Great coats..... | 1 | Flannel shirts..... | 2 | | |
| Uniform coats..... | 1 | Cotton shirts..... | | | |
| Uniform jackets..... | | Pairs boots..... | 1 | | |
| Flannel sack coats..... | | Pairs shoes..... | 1 | | |
| Blouses..... | 1 | Pairs socks..... | | | |
| Stable frocks..... | | Blankets..... | 1 | MONEY. | |
| Fatigue overalls..... | | Haversacks..... | 1 | Specie..... | \$ |
| | | | | Notes..... | \$ |

I CERTIFY, ON HONOR, that the above inventory comprises all the effects of Private
George W. Pize, deceased, and that the effects are in the hands
 of W. M. Kirk Asst. Surg. U.S. at Hospital No. 6
Sanford Md. to be disposed of by a Council of Administration.

(DUPLICATES.)
 STATION :
 DATE :
 [A. G. O. No. 104.]

I certify that the above is a true and correct copy of the effects of the above named soldier as they were found in the hands of the commanding officer of the company to which he belonged.

W. M. Kirk
Asst. Surg. U.S.
 Commanding the Company.

Wendell & Mills
 In Charge of

Faint handwritten notes in the left margin.

✓ *62K 108*
FINAL STATEMENT

OF
George W. Pru
9th Reg't of *Vol. Co. Troops*

VOLUNTEERS.

Out June 6 '184

NOTE 1.—Two of these certificates (or duplicates) are to be given to each Volunteer Soldier or drafted man who may be discharged previously to the discharge of his company, that he may at once receive from the Paymaster the pay, &c., due him, and the captain or other COMMISSIONED officer commanding the company will certify to the act of the delivery of the duplicate certificates; on these certificates the Soldier is "entitled to" his discharge, and should also present his discharge to the Paymaster to have the payment endorsed on it. The discharge is to be given back to the Soldier by the Paymaster; the latter only retaining as his voucher the duplicate certificates.

NOTE 2.—If the Soldier is entitled to pay for the use of his horse, the Company Commander will certify to that fact on the back of both these final statements, and also to the time he has pay due for having been so mounted on his own horse.

NOTE 3.—When a Soldier is furnished with final statements, his descriptive list, if he has one, should be taken up by the officer who gives the Soldier these statements, and endorsed with a statement to this effect by the officer. This endorsement should exhibit a full statement of the time for which the Soldier was allowed pay on his final statements, the clothing account, and all other charges against him or in his favor, so as to comprise a complete exhibit of his account. It will then be transmitted to the company commander of the Soldier, who will enter all the data necessary to a full understanding of the Soldier's account on the muster roll upon which the Soldier's discharge is reported. The descriptive list will then be destroyed. The object of this is, that the remaining portion of the Soldier's account may be settled upon the receipt of these muster rolls, and the Soldier receive any pay or allowances that may be due him at the time of his discharge, and which may not appear on his final statements from the fact that his descriptive list is incomplete. These accounts for back pay, &c., are settled by the 2d Auditor of the Treasury Department.

NOTE 4.—Charges for loss or injury to ordnance, horse equipments, and other miscellaneous charges, should appear under the heading of "Other Stoppages."

NOTE 5.—Bounty paid by State authorities, and not by the United States, will not be entered on this statement.

NOTE 6.—Amounts due the Soldier and Landress must be entered on the muster roll on which the discharge, death, desertion, &c., is reported, as well as on the final statement, otherwise the amount cannot be collected from the United States.

NOTE 7.—This blank will be used for deceased volunteers and drafted men, as well as for others.

NOTE 8.—Where a Soldier dies in hospital or on detached service, his descriptive list, if he has one, should be sent with his final statements, in duplicate, to the 2d Auditor, Washington, D. C.

ADJUTANT GENERAL'S OFFICE.
Nov 21 1864
Duplicate with inventory sent 2d Auditor.

RECEIVED
ADJUTANT GEN'L'S OFFICE
NOV 21 1864
Carroll

I certify, on honor, that George W. Page a Private of
 Captain W. H. Mills Company (K) of the 9th Regiment of U.S.C.
VOLUNTEERS, of the State of Maryland, born in Charles Co., State
 of Maryland, aged 40 years; 5 feet 10 inches high; Blk. complexion,
Blk. eyes, Blk. hair, and by occupation a Wood Cutter, having joined the company on
 its original organization at Camp Stanton, Md., and enrolled in it at the muster into
 the service of the United States at Camp Stanton, Md., on the 30 day
 of Nov., 1863, (or was mustered in service as a recruit, by
 _____, at _____, on the _____ day of _____,
 186 , or was drafted and mustered into the service of the United States from the _____
 Enrollment District of the State of _____, at _____,
 on the _____ day of _____, 186), to serve in the Regiment, for
 the term of 3 yrs or they wa: and having served **HONESTLY** and
FAITHFULLY with his Company in Camp Stanton to the present date, is now
 entitled to a **DISCHARGE** by reason of Drunk died in U.S. Genl
Hoop, Md. Co. Dec 6th 1864

The said George W. Page was last paid by Paymaster
Maj. Malme to include the 31st day of U.S.C., 1863, and has
 pay due him from that time to the death; he is entitled to pay and subsistence for
TRAVELING to place of enrollment, and whatever other allowances are authorized to volunteer
 soldiers, drafted men, or militia, so discharged. He has received from the United States **CLOTHING**
 amounting to 35.68 dollars, since the his enlistment day of _____
 186 , when his clothing account was last settled. He has received from the United States
 _____ dollars advanced **BOUNTY**.

There is to be stopped from him, on account of the State of _____, or other
 authorities, for **CLOTHING, &c.**, received on entering service, _____ dollars; and
 for other stoppages, viz: _____
 _____ dollars.
 He has been furnished with **TRANSPORTATION** in kind from the place of his discharge to
 _____; and he has been **SUBSISTED** for **TRAVELING** to his
 place of enrollment, up to the _____, 186 .

He is indebted to _____, **SUTLER**, _____ dollars.
 He is indebted to _____, **LAUNDRESS**, _____ dollars.

Given in Duplicate, at Chapin's Farm Va, this 6 day
 of Nov., 1864.

Wm. H. Mills
Capt. K Co. 9th U.S.C.
 Commanding Company.

928

Quinn James

Co *G*, **9** U.S. Col'd Inf.

Captain | *Private*

CARD NUMBERS.

| | | |
|----|---------|----|
| 1 | 6311675 | 26 |
| 2 | 6311835 | 27 |
| 3 | 6311938 | 28 |
| 4 | 6312038 | 29 |
| 5 | 6312133 | 30 |
| 6 | 6312227 | 31 |
| 7 | 6312319 | 32 |
| 8 | 6312412 | 33 |
| 9 | 6312503 | 34 |
| 10 | 6312591 | 35 |
| 11 | 6312677 | 36 |
| 12 | 6312756 | 37 |
| 13 | 6312838 | 38 |
| 14 | 6312910 | 39 |
| 15 | 6312979 | 40 |
| 16 | 6313047 | 41 |
| 17 | 6313114 | 42 |
| 18 | 6300216 | 43 |
| 19 | 6313178 | 44 |
| 20 | 6300287 | 45 |
| 21 | 6313239 | 46 |
| 22 | 6313301 | 47 |
| 23 | 9069160 | 48 |
| 24 | | 49 |
| 25 | | 50 |

Book Mark: _____

See also _____

2760904 - P. Off

5795900 P. Off

5833790 P. Off

5987380 - P. Off

W. L. Patton
E

2 | 9 | U.S.C.T.

James Quinn^x

Co. G, 9 Reg't U.S. Col'd Inf.

Appears on Company Descriptive Book

of the organization named above.

DESCRIPTION.

Age 22 years; height 5 feet 5 3/8 inches.

Complexion Not very black

Eyes Black; hair Wool

Where born Worcester, Md.

Occupation Farmer

ENLISTMENT.

When Nov. 18, 1863

Where Newtown Worcester

By whom Col. W. B. Biny, term 3 y'rs.

Remarks: Strong? rebel (Traitor) William Quinn.

Since 35 Reduced to ranks (for deserting his post & sleeping on guard) from Corporal (over) & free since 35 X As appears.

M. Jackson

MAY. 11

9069160

* 1891 *

Carpenter, Ostler
Mustered out with
Regt Nov. 26, 1866.

Q

9

U.S.C.T.

James Quin
Capt., Co. *G*, 9 Reg't U. S. Col'd Infantry.

Age *22* years.

Appears on

Company Muster-in Roll

of the organization named above. Roll dated
Camp Stanton
Charles Co. Md., *Nov 23*, 1863.

Muster-in to date *Nov 23*, 1863

Joined for duty and enrolled:

When *Nov 18*, 1863.

Where *Somerset Md.*

Period *3* years.

Remarks:

Book mark:

E. Barroll

Q

9

U.S.C.T.

James Quin

, Co. G, 9 Reg't U. S. Col'd Infantry.

Appears on

Company Muster Roll

for Nov 23 to Dec 31, 1863.

Present or absent Absent

Stoppage, \$ 100 for

Due Gov't, \$ 100 for

Remarks \$2⁰⁰ Recruiting premium
due. On recruiting service
since Dec 20. Post order No 92
Redeemed from capt. Dec 25
By order of Lt Col Armstrong

Book mark:

E. B. Carroll

Q | 9 | U.S.C.T.

James Quin
Pvt., Co. G, 9 Reg't U. S. Col'd Infantry.

Appears on

Company Muster Roll

for *Jan'y + Feb*, 1864.

Present or absent *Present*

Stoppage, \$ 100 for

Due Gov't, \$ 100 for

Remarks: *\$2⁰⁰/₁₀₀ Recruiting premium due.*

Book mark:

E. C. Carroll

Q

9

U.S.C.T.

James Quin
Pvt, Co. G, 9 Reg't U. S. Col'd Infantry.

Appears on

Company Muster Roll

for *March + April*, 1864.

Present or absent *Absent*

Stoppage, \$ *100* for

Due Gov't, \$ *100* for

Remarks: *Absent in Small Pox
Hospital at Hilton Head S.C.
Since April 13.*

Book mark:

E. C. Carroll

(858)

Copyst.

Q

9

U.S.C.T.

James Quin
Priv, Co. G, 9 Reg't U. S. Col'd Infantry.

Appears on

Company Muster Roll

for *May + June*, 1864.

Present or absent *Absent*

Stoppage, \$ 100 for

Due Gov't, \$ 100 for

Remarks: *Absent in Genl. Hosp'l. Since*
June 28th.

Book mark:

E. Carroll

Q

9

U.S.C.T.

James Quin
Priv, Co. G, 9 Reg't U. S. Col'd Infantry.

Appears on

Company Muster Roll

for *July + Aug.*, 1864.

Present or absent *Absent*

Stoppage, \$ *100* for

Due Gov't, \$ *100* for

Remarks: *Absent sick in Gen'l Hosp'l*
Since Aug. 18-64.

Book mark:

E. Carroll

Q

9

U.S.C.T.

James Quin
Priv, Co. G, 9 Reg't U. S. Col'd Infantry.

Appears on

Company Muster Roll

for *Sept + Oct*, 1864.

Present or absent *Absent*

Stoppage, \$ *100* for

Due Gov't, \$ *100* for

Remarks: *Absent sick since
Sept 10, 64.*

Book mark:

E. B. Carroll

L | 9 | U.S.C.T.

James Quinn
Private, Co. G, 9 Reg't U. S. Col'd Infantry.

Appears on

Company Muster Roll

for Nov. & Dec., 1864.

Present or absent Present

Stoppage, \$ 100 for

Due Gov't, \$ 100 for

Remarks:

Book mark:

W. M. Warren

L

9

U.S.C.T.

James Quinn
Private, Co. G, 9 Reg't U. S. Col'd Infantry.

Appears on

Company Muster Roll

for *Jan, & Feb.*, 1865

Present or absent *Present*

Stoppage, \$ 100 for

Due Gov't, \$ 100 for

Remarks:

Book mark:

W. M. Warren

Q

9

U.S.C.T.

James Linn
Private, Co. G, 9 Reg't U. S. Col'd Infantry.

Appears on

Company Muster Roll

for *Mar. & April*, 186*5*

Present or absent *Present*

Stoppage, \$ *100* for

Due Gov't, \$ *100* for

Remarks:

Book mark:

M. M. Warren

2

9

U.S.C.T.

James Quinn
Priv., Co. G, 9 Reg't U. S. Col'd Infantry.

Appears on

Company Muster Roll

for *Dec 31/64 to June 30, 1865.*

Present or absent *Present*

Stoppage, \$ 100 for

Due Gov't, \$ 100 for

Remarks: *Stop Kupsek #310*

Book mark:

W. M. Warren

2 | 9 | U.S.C.T.

James Quinn
Priv., Co. G, 9 Reg't U. S. Col'd Infantry.

Appears on

Company Muster Roll

for *July & Aug.*, 1865.

Present or absent *Present*

Stoppage, \$ 100 for

Due Gov't, \$ 100 for

Remarks:

Book mark:

M. M. Hassen

2

9

U.S.C.T.

James Linn
Priv., Co. G, 9 Reg't U. S. Col'd Infantry.

Appears on

Company Muster Roll

for *June 30 to Oct. 31*, 1865.

Present or absent. *Present*

Stoppage, \$ 100 for

Due Gov't, \$ 100 for

Remarks:

Book mark:

W. M. Warren

L | 9 | U.S.C.T.

James Quinn
Priv., Co. G, 9 Reg't U. S. Col'd Infantry.

Appears on

Company Muster Roll

for June 30 to Dec. 31, 1865.

Present or absent Present

Stoppage, \$ 100 for

Due Gov't, \$ 100 for

Remarks Stop Cont. 65-65

Book mark:

M. M. Stassen

2

9

U.S.C.T.

James Quin
Priv.

Co. G, 9 Reg't U. S. Col'd Infantry.

Appears on

Company Muster Roll

for Jan. & Feb., 1866.

Present or absent Present

Stoppage, \$ 100 for

Due Gov't, \$ 100 for

Remarks:

Book mark:

C. E. M. Laughlin
Copt. ist.

(858)

2 | 9 | U.S.C.T.

James Quin
Priv., Co. G, 9 Reg't U. S. Col'd Infantry.

Appears on

Company Muster Roll

for Mar. & Apr., 1866.

Present or absent Present

Stoppage, \$ 100 for

Due Gov't, \$ 100 for

Remarks: Stop C. & G. 950.

Book mark:

C. E. M. Laughlin

2 | 9 | U.S.C.T.

James Quin
Priv., Co. G, 9 Reg't U. S. Col'd Infantry.

Appears on

Company Muster Roll

for May + June, 1866.

Present or absent Absent

Stoppage, \$ 4 / 100 for

Due Gov't, \$ 100 for

Remarks: Det. Serv. 2 M.
Dept. S. O. 84 Dist. R. G.
Mar. 31/66.

Book mark:

b. E. McLaughlin

26 | 9

U.S.C.T.

James Quinn
Pvt, Co. *G, 9* Reg't U. S. Col'd Inf.

Appears on a

Detachment Muster Roll

of the organization named above

for *May and June*, 186*4*

Station *Brownville, Tex.*

Present or absent *Present.*

Stoppage, \$ *100* for

Due Gov't, \$ *100* for

Remarks:

Book mark:

(244)

J. J. Smith

Copyist.

2

9

U.S.C.T.

James Quinn

Priv., Co. G, 9 Reg't U. S. Col'd Infantry.

Appears on

Company Muster Roll

for July & Aug., 1866.

Present or absent Absent

Stoppage, \$ 100 for

Due Gov't, \$ 100 for

Remarks: Det. Service 2 M.
D. Dis Rio Grande
S. O # 84. Mar. 31, 1866.

Book mark:

G. E. M. Laughlin

(858)

Copist.

21 9

U.S.C.T.

James Quinn
Reg't U. S. Col'd Inf.

Appears on a

Detachment Muster Roll

of the organization named above

for *July and Aug.*, 186*6*.

Station *Brownsville, Texas.*

Present or absent *Present.*

Stoppage, \$ *100* for

Due Gov't, \$ *100* for

Remarks: *Detached by special
Orders No. 184, Ad. G. O.,
Series 1866.*

Book mark:

(244)

J. J. Smith

Copyist.

21

9

U.S.C.T.

James Quinn
Priv

, Co. G, 9 Reg't U. S. Col'd Infantry.

Appears on

Company Muster Roll

for Sep. + Oct., 1866.

Present or absent Present

Stoppage, \$ 100 for

Due Gov't, \$ 100 for

Remarks:

Book mark:

C. E. M. Laughlin

(858)

Copist.

21 | 9 | U.S.C.T.

James Quinn
 Priv., Co. G, 9 Reg't U. S. Col'd Infantry.

Appears on **Co. Muster-out Roll**, dated
 New Orleans La. Nov. 26, 1866.

Muster-out to date Nov. 26, 1866.

Last paid to Aug. 31, 1866.

Clothing account:

Last settled _____, 186 ; drawn since \$ _____ 100

Due soldier \$ ^{36²⁹}/₁₀₀; due U. S. \$ _____ 100

Am't for cloth'g in kind or money adv'd \$ _____ 100

Due U. S. for arms, equipments, &c., \$ ^{6⁰⁰}/₁₀₀

Ordinary
 ^ Bounty paid \$ *now* 100; due \$ 100 100 *

Remarks: *Joined at orig. orgn.
 Corp. to Dec. 5, '63. Retains
 1 musket & acc'tnts.
 * Bounty due under Act
 of Congress of July 26, '66,
 100.*

Book mark: *V. 168. P. 212. 73.*

C. E. M. Laughlin
 (861) Copyist.

Quinn, James

P, Co. *G*, *9* Reg't **U. S. C. Inf.**

5 Enclosures.

| | |
|------------------------------------|-------------------------|
| Bed Cards | Descriptive Lists |
| Burial Records | Final Statements |
| Certs. of Dis. for Discharge | Furloughs |
| C. M. Charges | Med. Des. Lists |
| Med. Certificates | Orders <i>3</i> |

Other papers relating to—

| | |
|----------------------------------|----------------------------------|
| Admission to Hosp'l | Furlough |
| Casualty Sheet (Officer's) | Med. Examination |
| Confinement | Misc. Information <i>/</i> |
| Contracts | Pay or Clothing |
| Death or Effects | Personal Reports |
| Desertions | Rank |
| Discharge from Hosp'l | Transfer to Hosp'l |
| Discharge from Service | Transfer to V. R. C. |
| Duty | Transportation |

Slave Claim 1

MICROFILM PUBLICATION M 1851

COMPILED MILITARY SERVICE RECORDS
OF VOLUNTEER UNION SOLDIERS WHO SERVED WITH
THE UNITED STATES COLORED TROOPS (USCT)
9TH REGIMENT OF INFANTRY

PERSONAL PAPERS' TARGET SHEET

PLEASE NOTE THE CHECKED INFORMATION ABOUT THE PERSONAL PAPERS IN
THIS FILE:

- NO PERSONAL PAPERS WERE FOUND IN THIS FILE WHEN THE
RECORDS WERE ARRANGED FOR MICROFILMING.
- 10 PERSONAL PAPER(S) FOUND IN THIS FILE WHEN THE RECORDS
WERE ARRANGED FOR MICROFILMING.

sec. 5763

~~Original Order~~

~~Copy of Order~~

Chs 244

Reducing Corp. Income tax
to the extent

W. A. McArthur
As Acty. Adm'r

Head Quarters 9th U.S.C.T.
Benedict Md Dec 5th 1863

Special Order
Regimental Order

No 24

Corporal Quinn of
Co. B. 9th Regt. U.S.C. Troops
having been guilty of deserting
his guard party on the night
of the 3^d inst is hereby reduced
to the ranks.

W. A. Huntley
St & Acty Adjt.

By order of
S. C. Armstrong
Lt. Col. Comdg

MAN 38

Ed. J. ...
Nov 3, 1865

p. end ...
Nov 230

James
Shanting ...
Nov 4, 1865

Deposited to Co. Comdr

Recd. ...
Nov 4, 1865

Adj Gen's Office
Nov 20th 1863

Special Orders
(No 234)

Relieving Private Quinn
Co G from Special Duty at
Dw H^q W^g

Recd in 4th S.C. Nov 20th 1863

Head Quarters First Division,

Twenty Fifth Army Corps,

Brownsville, Texas. Nov. 20, 1865.

Special Orders,

No. 234

(EXTRACT.)

Private James Quinn
"G" Company 9th Inf. G. Troops. is hereby
relieved from special duty at these Head
quarters, and will at once report to his
Regiment for duty.

By Order of Brevet Maj. Gen. Giles A. Smith.

ad Hare

Asst. Adj't. General.

Comdg Officer
"G" Co. 9th Inf. G. T.

Ms. 270.

WAR 385

EVIDENCE OF TITLE.

I, William Quinn, of Princeton
County, Md., do solemnly swear that James Quinn
who has been enlisted in the 9th Regiment, U. S. Colored Troops,
Co. D; is my slave for 16 years; (his term of service expiring on
the 1st day of January 1866;) and that
I became possessed of him by bring him in my possession in the month
of December, eighteen hundred and 1860. And I
do further swear that I have not purchased said slave from any person or persons disloyal
to the Government of the United States, with the object of obtaining compensation for
the same; and furthermore, that I have no agency for obtaining compensation for any per-
son or persons but such as, to my knowledge, are loyal citizens of the United States.

William Quinn
February 15th 1866.



STATE OF MARYLAND,

Worcester

County, to wit:

On this *15th* day of *February* in the year 1864,

before me, the subscriber, a Justice of the Peace of the State and County aforesaid, personally appeared *William Quinn*, and took, signed, and acknowledged the oaths preceding; and further made oath, in due form of law, that all the statements made in this application are, to the best of *his* knowledge and belief, strictly true.

William Quinn

Also personally appeared before me *Wm H. Merrill* and *Thos A Williams*, loyal citizens of the United States, residents of *Worcester*, well acquainted with the said *William Quinn*, and in no manner interested in the prosecution of this claim, and made oath, in due form of law, that the said *William Quinn* is the owner of the slave *James Quinn*, as a fact of public notoriety; that they believe all the statements herein made by *him*, in reference thereto, are correct, and that *he* is unquestionably loyal to the Government of the United States. Witness their signatures:

Wm H Merrill
Thos A Williams

Wm H Merrill Justice of the Peace.

STATE OF MARYLAND,

Lewis County, to wit:

I, *Cynthia R. Fountain*, Clerk of the Circuit Court for

Lewis County, do hereby certify that *William A. Hartman*

before whom the foregoing affidavits were made, was, at the time of signing the same, a Justice of the Peace for the County and State aforesaid, duly commissioned and sworn; and that his signature thereto is genuine, and that full faith and credit should be given to his official acts.

Witness my hand and the seal of said Court, this *Sixteenth* day of

January, A. D. 1864.



Cynthia Fountain CLERK.

A.

A.

No. 837 CLAIMANT'S CERTIFICATE.

I, William Lumm, a loyal citizen, and a resident of ... County of Worcester, State of ... hereby claim compensation, under the provisions of General Orders, No. 329, 1863, for my slave ... enlisted ... 1863 at ... by ... in the ... Regiment U. S. Colored Troops, Co. ... ; certificate of which enlistment, and a descriptive list, as required, accompany this application.

In proof of my loyalty to the Constitution and Government of the United States, I present the accompanying oath, which I have taken, signed, and acknowledged, to be filed with this application, in accordance with requirement of said General Orders.

William Lumm

February 15th 1864.



B.

OATH OF ALLEGIANCE.

I, William Quinn, do solemnly swear that I have never joined, or been concerned in, any insurrection or rebellion; that I have never borne arms against the United States; that I have never given any aid, countenance, counsel, or encouragement to any person or persons engaged, or whom I had reason to believe were about to engage, in insurrection, rebellion, or armed hostility against the United States; that I have neither sought, nor accepted, nor attempted to exercise the functions of any office, civil or military, nor to perform any service whatever, under any authority or pretended authority in hostility to the United States; that I have not yielded a voluntary support to any insurrection, rebellion, or pretended government, authority, power, or constitution within the United States hostile thereto. And I do further swear that, to the best of my knowledge and ability, I have supported and defended, and will continue to support and defend, the United States against all enemies, foreign and domestic; and that I have supported, defended, and obeyed, and will continue to support, defend, and obey, the Constitution and laws of the United States; that I will bear true faith and allegiance to the same; and that I take this oath freely, without any mental reservation or purpose of evasion: So help me God.

William Quinn

Sworn to and subscribed before me, at New Town
this 10th day of September 1864. }

William T. Miller
Justice of the Peace



1864

C.

I present herewith evidence of my title to the slave James
Sum enlisted as aforesaid, and in consideration of the sum of
 _____ by me received, I hereby covenant and
 agree with the United States, that I, my heirs, executors, or assigns, shall never hereafter make
 or enforce any claim to the labor or services of said slave; and pledge myself to execute
 a valid Deed of Manumission and Release of all my claims to service forever of said
James Sum to be filed with the Board of Claims
 now in session at Baltimore

William Sum

February 10th, 1864.

F.

CERTIFICATE OF AWARD OF THE BOARD OF CLAIMS.

Office of the Board of Claims
For Slaves Enlisted in the Service of the United States,

Baltimore Md,

October 8th, 1864

\$300-

We hereby certify, that William Quinn, of Worcester county, State of Maryland, having proved, under oath, his loyalty to the Constitution and Government of the United States, and established his title as to the ownership of James Quinn, a slave enlisted at Worcester County Md on the 18th day of November 1863, by Col. Wm. Birney, in the service of the United States, in the 9th Regiment of Colored Troops, Co. G., and having filed a valid Deed of Manumission and Release of Service of said slave, is entitled to the sum of Three Hundred dollars, which has been awarded to him by this Board as a remuneration for all claim to the future labor or service of said slave, under the provision of General Orders, War Department, No. 329, 1863.

Thos. Simons, President of the Board.
L. E. Strong, Member of the Board.
Wm. T. Jones, Member of the Board.

To Col. W. Norton,

Chief of the Bureau for the

Organization of Colored Troops, Washington, D. C.

in my Office. If you have any more copies of the original and so on

In testimony whereof I hereunto subscribe my name and affix the seal of the said Circuit Court, this twenty fifth day of March Anno Domini Eighteen hundred and sixty four.

Geo. S. Richardson Clk.



110 Duin 837
to
James

Clarks Certip. 1/5-1

E.

DEED OF MANUMISSION AND RELEASE OF SERVICE.

Whereas my slave James Quinn has enlisted in the service of the United States: now, in consideration thereof, I, William Quinn, of Worcester county, State of Maryland, do hereby, in consideration of said enlistment, manumit, set free, and release the above-named James Quinn from all service due me; his freedom to commence from the 18th of March 1863, the date of his enlistment as aforesaid in the ninth Regiment of Colored Troops, in the service of the United States.

Witness my hand and seal, this 21st day of March, 1864.

79

William Quinn



Witness:

C. W. B. Marshall

William F. Minkerson

Verin Atkinson

Worcester County,

State of Maryland, 1864.

Before me appeared this day William Quinn, and acknowledged the above Deed of Manumission and Release of Service to be his free act and deed.

Inter. Revenue

5c

William F. Minkerson
Justice of the Peace

State of Maryland, Worcester County, to wit:

I, George N. Richardson, Clerk of the Circuit Court for Worcester County, hereby certify that the within is a true copy of the original now on file in my Office.

In testimony whereof I hereunto subscribe my name and affix the seal of the said Circuit Court, this, twenty fifth day of March Anno Domini Eighteen hundred and sixty four.

Geo. N. Richardson Clk.



1100
6
837
Clerk's Office
1864

2.

No. .

ABSTRACT OF DISBURSEMENTS.

....., 186 .

William Quinn

Dollars *300* ⁰⁰/₁₀₀

Paid, 186 .

The United States,

To William Quinn Dr.

| 1864 | | DOLLARS. | CENTS. |
|-------------|---|----------|--------|
| October 8th | For amount awarded him by the Board of Claims, in consideration | | |
| | of the enlistment of James Quinn | | |
| | in the 9th Regt U.S. Col'd Troops | 300 | 00 |
| | | Total \$ | 300 00 |

I CERTIFY that the above account is correct and just; that the name of James Quinn is borne on the muster-in rolls of the 9th Regt U.S. Colored Troops; and that the above amount was awarded by the Board of which Tho. S. Timmons Esq. is President, said award being in accordance with section 24 of the act entitled "An act to amend an act entitled 'An act for enrolling and calling out the national forces, and for other purposes,'" approved Feb. 24, 1864.

Assistant Adjutant General.

RECEIVED _____, 186 _____, of Cap Sely, Baudick, A.A.G., Col. _____ dollars and _____ cents, in full of the above account.

(SIGNED DUPLICATES.)

William Quinn

1861

2.

No. .

ABSTRACT OF DISBURSEMENTS.

....., 186 .

William Quinn

Dollars *300* ^{*00*}/_{*100*}

Paid , 186 .

v
James Durr,
Post Coly.
9th St.

Mr Ellertson

1877

Adjutant General's Office,

COLORED TROOPS BRANCH,

April 12th, 1877

Mr Ellersbrook Vol.

C. T., 187

Wanted in the case of James Quinn, Privt, Co. G,
9th Reg't U.S. Troops Cause of Reduction.

W. R. Form. Ogr to Dec 3/63. Replaced him Reduced from Corporal Dec.
25 by order Lt Col Armstrong."

Respectfully,

A. A. Woodward
Chief Clerk.
Per J. H. Palmer

WPS

Adjutant General's Office,

Div. Records Discontinued Comd's &c
April 16th, 1877

Vol. C. T., 187

Reply in case of James Quinn, Co. G,
9th Reg't U. S. C. T.

Co. Descriptive book: App'td Corp'l. Nov. 23 '1863.
Reduced to the ranks, for deserting his post, sleeping on guard
pr. Regtl. Order of Dec. 5 '1863.

Regtl. Order book: Reduced to the ranks (from Corp'l.) for
deserting his guard party on night of the 3rd inst. pr
S.O. No. 24 Regtl. H^q. Dec. 5 '1863.

W.F.

(Dec. 5 '63 is the correct date.)

537

A. G. O., Oct. 11th 1864.

Declare that the name of James Quin
is borne on the muster-roll of Co. G,
7th Regt. U. S. C. Troops on file in this
Office, & that he was enrolled in
Somerset Co., Md.

J. G.

J. W. Taggart

A. A. Coul. Tol.

State of Maryland Worcester County
S.S.

Personally appeared before me William Quinn
of Worcester County Maryland and made oath
that Adam Quinn a man of African descent
about five feet eight inches high of very dark
mulatto complexion about thirty two years of age
and supposed to be enlisted in the United States
Infantry Troops is a slave for life under the
laws of the State of Maryland.

And also James Quinn a man of African
descent nearly of Black complexion and about five
feet eight inches high about twenty three years
of age.

And also Ephraim Quinn a man of
African descent about five feet seven inches high
dark complexion and about eighteen years of
age both also supposed to be enlisted in the
United States Infantry Troops are slaves for
a term of years. The former having twelve
years to serve and the latter seventeen years to
serve under the laws of the State of Maryland.

William Quinn
Sworn to and subscribed before me at
New Town this 23^d day of January A. D. 1864

William T. McKerson
Justice of the Peace

Where a soldier dies
list, if he has one,
to the Second Auditor
Men drafted will be
and will be mustered
same line as the soldier
Enrolled.—Comment
the word drafted, &
given the date when
in," will be given to
whom Mustered in,
from which he was
4th D. Mass.; (mean
setts.)
A separate descripti
man.
Descriptive lists must
not be enlisted men

VOLUNTEER DESCRIPTIVE LIST and ~~Account of Pay and Clothing~~ of *James Quinn Company 9th Regt*

| No. | NAMES. | RANK. | DESCRIPTION. | | | | | WHERE BORN. | | OCCUPATION. | ENROLLED. (For Drafted Men, see note 10.) | | | MUSTERED IN. (For Drafted Men, see note 10.) | | | | LAST PAID. |
|-----|--------------------|-------|---------------|------------|-------------|-------------|----------|--------------|-------------------|------------------|--|---------------|-----------------------------|---|-----------------|-----------------------------|--|------------|
| | | | Years of age. | Eyes. | Hair. | Complexion. | Feet. | Inches. | State or Kingdom. | | Town or county. | When. | Where. (Town and State.) | By whom. | When. | Where. (Town and State.) | By whom. (In the case of drafted men, from what enrollment district.) | |
| 1 | <i>James Quinn</i> | | <i>22</i> | <i>Blk</i> | <i>Wool</i> | <i>Dark</i> | <i>5</i> | <i>5 7/8</i> | <i>Ms</i> | <i>Worcester</i> | <i>Farmer</i> | <i>Nov 18</i> | <i>Worcester</i> | <i>Nov 28</i> | <i>Benedict</i> | <i>Col W. D. Denny</i> | <i>from books of Bureau Mass</i> | |

NOTES.

the soldier may be mustered, ex. *er, &c.*, and which may be *will*
must be entered the *whole amount*
"DUE," the *whole amount yet due*
and not by the United States,
or other *public property*, must
lar *damage* to each, specified.
of a Court Martial, a *transcript*
amount *already stopped*, must
delivery, or *apprehension*, must be
of the order of *sentence or pardon*.
ACCOUNT *must be made, to date,*
be precisely stated.
action, or *skirmish*, it must be
A *full and particular mention*
received in *action*, or other

7. If the soldier is entitled to pay for the use of his horse, the company commander will certify to that fact on this list, and also to the time he has pay due for having been so mounted on his own horse.
8. When a soldier is furnished with final statements, his descriptive list, if he has one, should be taken up by the officer who gives the soldier these statements, and endorsed with a statement to this effect by the officer. This endorsement should exhibit a full statement of the time for which the soldier was allowed pay on his final statements, the clothing account, and all other charges against him or in his favor, so as to comprise a complete exhibit of his account. It will then be transmitted to the company commander of the soldier, who will enter all the data necessary to a full understanding of the soldier's account on the muster roll upon which the soldier's discharge is reported. The descriptive list will then be destroyed. The object of this is, that the remaining portion of the soldier's account may be settled upon the receipt of these muster rolls, and the soldier receive any pay or allowances that may be due him at the time of his discharge, and which may not appear on his final statements from the fact that his descriptive list is incomplete. These accounts for back pay, &c., are settled by the 2d Auditor of the Treasury Department.

9. Where a soldier dies in Hospital or on detached service, his descriptive list, if he has one, should be sent with his final statements, in duplicate, to the Second Auditor, Washington, D. C.
10. Men drafted will be considered as mustered in from the date of their draft, and will be mustered for pay on the usual rolls for Volunteers. On the same line as the soldier's name, under the heading "Joined for Duty and Enrolled.—Commencement of First Payment by Time," will be written the word *drafted*, and under the heading "When Mustered in" will be given the date when the soldier was drafted; under "Where Mustered in," will be given the place from which drafted; under the heading "By whom Mustered in," will be given the No. of the Enrollment District from which he was drafted, and the State to which it belongs, thus: *4th D. Mass.*; (meaning 4th Enrollment District, State of Massachusetts.)
11. A separate descriptive list should, as a general rule, be given for each man.
12. Descriptive lists must, in all cases, be signed by COMMISSIONED officers; not by enlisted men acting as such.

I CERTIFY that the above is a correct transcript from the Records

Recruits from Mansfield for 1863

STATION: *Benedict Ind*

DATE: _____

Company of 9th U.S. Colored Troop

| MUSTERED IN. (For Drafted Men, see note 10.) | | | LAST PAID. | | BOUNTY. | | REMARKS. |
|---|--|-----------------------------------|---------------|---------------|--------------------------|-------------------------|---|
| Where. (Town and State.) | By whom. (In the case of drafted men, from what enrollment district.) | Period. | By paymaster. | To what time. | Paid \$ (See note 2.) | Due \$ (See note 2.) | |
| 29. Benedict | Col W. D. Emory | from orders of Bureau MAY 1864 | — | — | — | — | Co. G 9th U.S.C.T. Given to Rev. Mr. Quinn Keaton ms |

at the above is a correct transcript from the Records of this Genl Rendezvous of
from Maryland for U.S. Colored Troop

Benedict Lds

Wm Bivens,
 Brig. General U.S.A.
 Commanding the Company
 U.S. Rec. Office

929
Rain, William E.

Co F, 9 U.S. Col'd Inf.

Private Private

CARD NUMBERS.

| | | |
|----|---------|----|
| 1 | 6309945 | 26 |
| 2 | 6310038 | 27 |
| 3 | 6310147 | 28 |
| 4 | 6310253 | 29 |
| 5 | 6310351 | 30 |
| 6 | 6310449 | 31 |
| 7 | 6310545 | 32 |
| 8 | 6310642 | 33 |
| 9 | 6310742 | 34 |
| 10 | 6310839 | 35 |
| 11 | 6310932 | 36 |
| 12 | 6311015 | 37 |
| 13 | 6311103 | 38 |
| 14 | 6311182 | 39 |
| 15 | 6311253 | 40 |
| 16 | 6311327 | 41 |
| 17 | 6311394 | 42 |
| 18 | 6311462 | 43 |
| 19 | 6311528 | 44 |
| 20 | 6311592 | 45 |
| 21 | 9069042 | 46 |
| 22 | | 47 |
| 23 | | 48 |
| 24 | | 49 |
| 25 | | 50 |

Book Mark:

See also

R | 9 | U.S.C.T.

William E. Rain

, Co. F, 9 Reg't U. S. Col'd Inf.

Appears on

Company Descriptive Book

of the organization named above.

DESCRIPTION.

Age 19 years; height 5 feet 8 inches.

Complexion Dark

Eyes Black; hair Black

Where born Hovestri, Maryland

Occupation Farmer

ENLISTMENT.

When Nov 11, 1863.

Where Berlin Hovestri Co Md

By whom Col Wm Berner; term Thirty rs.

Remarks: Mustered out with Regt Nov 24 - 1864

L. B. Sawyer

R | 9 | U.S.C.T.

William E. Rain
Priv, Co. F, 9 Reg't U. S. Col'd Infantry.

Age 19 years.

Appears on

Company Muster-in Roll

of the organization named above. Roll dated

Charles Co. Md., Nov 23, 1863.

Muster-in to date Nov 23, 1863

Joined for duty and enrolled:

When Nov 11, 1863.

Where Worcester Md.

Period 3 years.

Remarks:

Book mark:

Martin

P | **9** | **U.S.C.T.**

William E. Rain
Priv., Co. F, 9 Reg't U. S. Col'd Infantry.

Appears on

Company Muster Roll

for *Nov. 23, to Dec 31*, 186*3*.

Present or absent *Present*

Stoppage, \$ *100* for

Due Gov't, \$ *100* for

Remarks: *4200 Recruit*
Prem. due.

Book mark:

Martin

R | 9 | U.S.C.T.

William E. Rain

Pvt, Co. F, 9 Reg't U. S. Col'd Infantry.

Appears on

Company Muster Roll

for Jan & Feb, 1864

Present or absent Present

Stoppage, \$ 100 for

Due Gov't, \$ 100 for

Remarks: \$2.00 Recruit
Pen. due.

Book mark:

Martin

R

9

U.S.C.T.

William E. Rair
Priv, Co. F, 9 Reg't U. S. Col'd Infantry.

Appears on

Company Muster Roll

for Mar + Apr, 1864.

Present or absent Present

Stoppage, \$ 100 for

Due Gov't, \$ 100 for

Remarks:

Book mark:

Martin

R | 9 | U.S.C.T.

William E. Rain
Priv, Co. F, 9 Reg't U. S. Col'd Infantry.

Appears on

Company Muster Roll

for May & June, 1864.

Present or absent Present

Stoppage, \$ 100 for

Due Gov't, \$ 100 for

Remarks:

Book mark:

Martin

R | 9 | U.S.C.T.

William E. Rain

Priv, Co. F, 9 Reg't U. S. Col'd Infantry.

Appears on

Company Muster Roll

for July & Aug, 1864

Present or absent Present

Stoppage, \$ 100 for

Due Gov't, \$ 100 for

Remarks:

Book mark:

Martin

R. | 9 | U.S.C.T.

William E. Rain
Priv., Co. 4, 9 Reg't U. S. Col'd Infantry.

Appears on

Company Muster Roll

for Sep + Oct, 1864.

Present or absent Absent

Stoppage, \$ 100 for

Due Gov't, \$ 100 for

Remarks: Absent sick
since Sep. 28, 1864.

Book mark:

Martin

R | 9 | U.S.C.T.

William E. Rain

Priv, Co. F, 9 Reg't U. S. Col'd Infantry.

Appears on

Company Muster Roll

for Nov. + Dec, 1864.

Present or absent Absent

Stoppage, \$ 100 for

Due Gov't, \$ 100 for

Remarks: Absent sick since Sept 28/64. Due the difference between seven dollars per month and thirteen dollars per month from Jan. 1/64 to Apr. 1/64

Book mark:

E. L. Thornton

R | 9 | U.S.C.T.

William E. Rain
Priv, Co. F, 9 Reg't U. S. Col'd Infantry.

Appears on

Company Muster Roll

for Jan & Feb, 1865.

Present or absent Present

Stoppage, \$ 100 for

Due Gov't, \$ 100 for

Remarks:

Book mark:

E. Shannon

(358)

Copyist

R

9

U.S.C.T.

William E. Rain

Priv, Co. F, 9 Reg't U. S. Col'd Infantry.

Appears on

Company Muster Roll

for March & Apr, 1865

Present or absent Present

Stoppage, \$ 100 for

Due Gov't, \$ 100 for

Remarks:

Book mark:

E. H. Stanton

R | 9 | U.S.C.T.

William C. Rain
Priv, Co. F, 9 Reg't U. S. Col'd Infantry.

Appears on

Company Muster Roll

for May & June, 1865.

Present or absent Present

Stoppage, \$ 100 for

Due Gov't, \$ 100 for

Remarks: Stop for screw driver,
wiper & tomahawk \$0.45

Book mark:

E. L. Shannon

R

9

U.S.C.T.

William E. Rain
Priv, Co. F, 9 Reg't, U. S. Col'd Infantry.

Appears on

Company Muster Roll

for July & Aug., 1865.

Present or absent Present

Stoppage, \$ 100 for

Due Gov't, \$ 100 for

Remarks:

Book mark:

E. L. Shannon

(358)

Copyist

R . 9 U.S.C.T.
William E. Rain
Put, Co. F, 9 Reg't U. S. Col'd Infantry.

Appears on

Company Muster Roll
for *June 30 to Oct 31*, 1865.
Present or absent *Present*

Stoppage, \$ *100* for

Due Gov't, \$ *100* for

Remarks:

Book mark: *330422*

O. A. Ward

R | **9** | **U.S.C.T.**
William E. Rain
Plt, Co. *"F"*, 9 Reg't U. S. Col'd Infantry.

Appears on

Company Muster Roll

for *June 30 to Dec 31*, 1865.

Present or absent *Absent*

Stoppage, \$ *100* for

Due Gov't, \$ *100* for

Remarks: *Temporarily absent on daily duty in order of Col. Thos. Parkey, Comdr. Bris.*

Book mark: _____

A. A. Ward

R

9

U.S.C.T.

William E. Rain

PO, Co. F, 9 Reg't U. S. Col'd Infantry.

Appears on

Company Muster Roll

for Jan. & Feb., 1866.

Present or absent Present

Stoppage, \$ 100 for

Due Gov't, \$ 100 for

Remarks:

Book mark:

J. E. Nichol Copyist

(358)

R | 9 | U.S.C.T.

William E. Rain
Pvt, Co. F, 9 Reg't U. S. Col'd Infantry.

Appears on

Company Muster Roll

for *Mch. & Apl.*, 1866.

Present or absent *present*

Stoppage, \$ 100 for

Due Gov't, \$ 100 for

Remarks:

Book mark:

(358) *J. E. Nichol* Copyist

R | 9 | U.S.C.T.

William E. Rain
Pot, Co. F, 9 Reg't U. S. Col'd Infantry.

Appears on

Company Muster Roll

for May & June, 1866.

Present or absent present

Stoppage, \$ 100 for

Due Gov't, \$ 100 for

Remarks: Stop for Cartridge
box belt plate and
wiper 17¢

Book mark:

(358) J. E. Nichol Copyist

R

9

U.S.C.T.

William E. Rain

POV, Co. F, 9 Reg't U. S. Col'd Infantry.

Appears on

Company Muster Roll

for July & Aug., 1866.

Present or absent present

Stoppage, \$ 100 for

Due Gov't, \$ 100 for

Remarks:

Book mark:

(358) J. E. Nichol Copyist

R | 9 | U.S.C.T.

William E. Rain
Private, Co. F, 9 Reg't U. S. Col'd Infantry.

Appears on

Company Muster Roll

for Sep. & Oct., 1866.

Present or absent present

Stoppage, \$ 100 for

Due Gov't, \$ 100 for

Remarks:

Book mark:

(358) J. E. Nichol Copyist

R | 9 | U.S.C.T.

William Rain

Pvt, Co. *F*, 9 Reg't U. S. Col'd Infantry.

Appears on **Co. Muster-out Roll**, dated *New Orleans, La, Nov. 26, 1866.*

Muster-out to date *Nov. 26, 1866.*

Last paid to *Aug. 31, 1866.*

Clothing account:

Last settled....., 186 ; drawn since \$..... 100

Due soldier \$..... 100; due U. S. \$ *4* ⁵⁵/₁₀₀

Am't for cloth'g in kind or money adv'd \$..... 100

Due U. S. for arms, equipments, &c., \$..... 100

Bounty paid \$ *None* 100; due \$ *100* ⁰⁰/₁₀₀

Remarks: *Joined at Original Orgn.*

Book mark: *V. 186 P. 212 - 74*
(over)

(861)

J. E. Nichol

Copyist.

WARA 047

JAN. 21

6311592

01891*

281,402

Rayne, Wm E

P, Co. D,

9 Reg U.S.C. Inf.

2 Enclosures.

| | |
|------------------------------|-------------------|
| Bed Cards | Descriptive Lists |
| Burial Records | Final Statements |
| Certs. of Dis. for Discharge | Furloughs |
| C. M. Charges | Med. Des. Lists |
| Med. Certificates | Orders |

Other papers relating to—

| | |
|----------------------------|----------------------|
| Admission to Hosp'l | Furlough / |
| Casualty Sheet (Officer's) | Med. Examination |
| Confinement | Misc. Information |
| Contracts | Pay or Clothing |
| Death or Effects | Personal Reports |
| Desertions | Rank |
| Discharge from Hosp'l | Transfer to Hosp'l |
| Discharge from Service | Transfer to V. R. C. |
| Duty | Transportation |
| | Save claim 1 |

MICROFILM PUBLICATION M1851

COMPILED MILITARY SERVICE RECORDS
OF VOLUNTEER UNION SOLDIERS WHO SERVED WITH
THE UNITED STATES COLORED TROOPS (USCT)
9TH REGIMENT OF INFANTRY

PERSONAL PAPERS' TARGET SHEET

PLEASE NOTE THE CHECKED INFORMATION ABOUT THE PERSONAL PAPERS IN
THIS FILE:

- NO PERSONAL PAPERS WERE FOUND IN THIS FILE WHEN THE
RECORDS WERE ARRANGED FOR MICROFILMING.
- 4 PERSONAL PAPER(S) FOUND IN THIS FILE WHEN THE RECORDS
WERE ARRANGED FOR MICROFILMING.

A.

No. 1060

CLAIMANT'S CERTIFICATE.

I, W. D. Pitts Agent for Mrs C. H. Mayne, a loyal citizen, and a resident
of Washington, County of the, State of
Maryland, hereby claim compensation, under the provisions of
General Orders, No. 329, 1863, for my slave Mrs C. H. Mayne
enlisted Jan 25th, 1863, at Baltimore
by Col. Am. Bennett, in the 9
Regiment U. S. Colored Troops, Co. F; certificate of which enlistment, and a
descriptive list, as required, accompany this application.

In proof of my loyalty to the Constitution and Government of the United States, I
present the accompanying oath, which I have taken, signed, and acknowledged, to be filed
with this application, in accordance with requirement of said General Orders.

W. D. Pitts Agent

March 2, 1864

B.

OATH OF ALLEGIANCE.

I, *Mr. D. Pitts Agur*, do solemnly swear that I have never joined, or been concerned in, any insurrection or rebellion; that I have never borne arms against the United States; that I have never given any aid, countenance, counsel, or encouragement to any person or persons engaged, or whom I had reason to believe were about to engage, in insurrection, rebellion, or armed hostility against the United States; that I have neither sought, nor accepted, nor attempted to exercise the functions of any office, civil or military, nor to perform any service whatever, under any authority or pretended authority in hostility to the United States; that I have not yielded a voluntary support to any insurrection, rebellion, or pretended government, authority, power, or constitution within the United States hostile thereto. And I do further swear that, to the best of my knowledge and ability, I have supported and defended, and will continue to support and defend, the United States against all enemies, foreign and domestic; and that I have supported, defended, and obeyed, and will continue to support, defend, and obey, the Constitution and laws of the United States; that I will bear true faith and allegiance to the same; and that I take this oath freely, without any mental reservation or purpose of evasion: So help me God.

D. Pitts Agur

Sworn to and subscribed before me, at *Boston*
 this *2nd* day of *March*, 1864. }

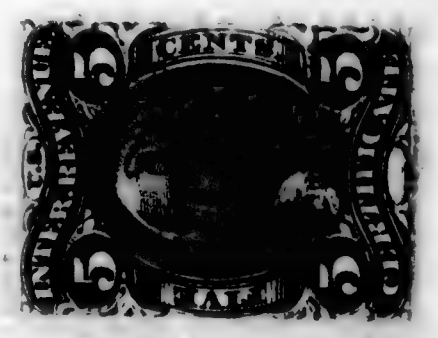

S. D. Russell
 Justice of the Peace

C.

I present herewith evidence of my title to the slave Wm. C. Haynes
 enlisted as aforesaid, and in consideration of the sum
 of by me received, I hereby covenant and
 agree with the United States, that I, my heirs, executors, or assigns, shall never hereafter make
 or enforce any claim to the labor or services of said slave; and pledge myself to execute
 a valid Deed of Manumission and Release of all my claims to service forever of said
Wm. C. Haynes to be filed with the Board of Claims
 now in session at Baltimore

Wm. C. Haynes

March 27, 1864.



C. 10. 11. G. W.

No. 1060

APPLICATION OF

Bevin

Wm. D. Pitts Agent for Wm. C. Rayne

OF

Monrovia County

For Compensation for Service of Slave,

Wm. C. Rayne

Enlisted in 7th Regiment

U. S. Colored Troops, Co. F.

Received, March 11 1864.

COMPENSATION ~~AWARDED~~ Refused

September 28, 1865

Wm. D. Pitts is disloyal, and has failed to establish the loyalty of Wm. C. Rayne, or his authority to act as agent. The claim should have been made by Wm. Rayne.

Wm. J. F. Johnson
President Bd. Claims

Wm. D. Pitts
Sept 28, 1865

EVIDENCE OF TITLE.

I, *Wm. D. Pettis Agent for Wm. C. Bayne*, of *Worcester* County, Md., do solemnly swear that *Wm. J. Bayne* who has been enlisted in the *9th* Regiment, U. S. Colored Troops, Co. *Wm. C. Bayne*; is my slave for *life*; (his term of service expiring on the *-----* day of *-----* 186*5*;) and that I became possessed of him by *Descent under his mother's Estate*, in the month of *-----*, eighteen hundred and *-----*. And I do further swear that I have not purchased said slave from any person or persons disloyal to the Government of the United States, with the object of obtaining compensation for the same; and furthermore, that I have no agency for obtaining compensation for any person or persons but such as, to my knowledge, are loyal citizens of the United States.

Wm. D. Pettis 186*4*.

STATE OF MARYLAND.

Worcester County, to wit:

On this *7th* day of *March* in the year 1864,

before me, the subscriber, a Justice of the Peace of the State and County aforesaid, personally appeared *Mr. D. Pitts apt for Mr. C. Payne*, and took, signed, and acknowledged the oaths preceding; and further made oath, in due form of law, that all the state-

ments made in this application are, to the best of *his* knowledge and belief, strictly

true. Also personally appeared before me *James Whaley* and

Deot John H. Taylor, loyal citizens of the United States, residents of

Worcester County, well acquainted with the said *Mr. D. Pitts apt for Mr. C. Payne*

, and in no manner interested in the prosecution of this

claim, and made oath, in due form of law, that the said *Mr. D. Pitts apt for Mr. C. Payne*

is the owner of the slave *Mr. C. Payne*, as a fact of public noto-

riety: that they believe all the statements herein made by *him*, in reference

thereto, are correct, and that *he* is unquestionably loyal to the Government of

the United States. Witness their signatures:

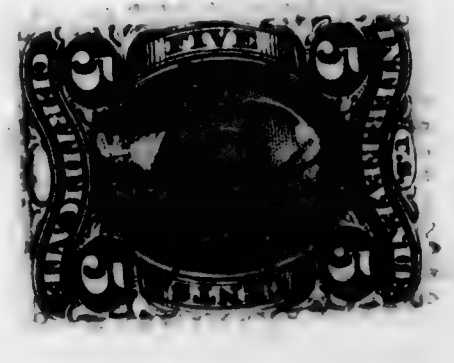

James Whaley
John H. Taylor

J. H. [unclear] Justice of the Peace.

STATE OF MARYLAND,

Worcester

County, to wit:

I, *George A. Richardson*

, Clerk of the Circuit Court for

Worcester County, do hereby certify that *S. D. Powell Esq.*

before whom the foregoing affidavits were made, was, at the time of signing the same, a Justice of the Peace for the County and State aforesaid, duly commissioned and sworn; and that his signature thereto is genuine, and that full faith and credit should be given to his official acts.

Witness my hand and the seal of said Court, this

eighth

day of

March

, A. D. 1864.

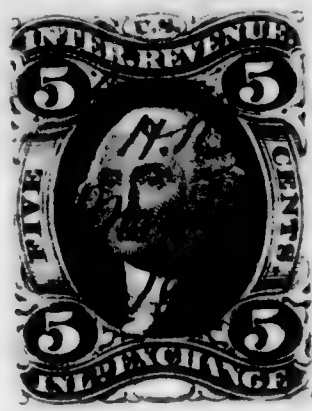

Geo. A. Richardson

CLERK.

E.B. 154.

6.3. P.2/1.

72

To all whom it may Concern:

Extract from Army Regulations, edition 1861.

Par. 190. Furloughs will be granted only by the commanding officer of the post, or the commanding officer of the regiment actually quartered with it. Furloughs may be prohibited at the discretion of the officer in command. Par. 191. Soldiers on furlough shall not take with them their arms or accoutrements.

The bearer hereof, William E. Rain, private of Captain Wm Royal's "F" Company of the 9th Regiment of U.S. Colored Troops aged 19 years, 5 feet 8 inches high, dark complexion, black eyes, black hair, and by profession a farmer; born in the County of Worcester Md., and enlisted at Berlin Worcester County in the State of Maryland, on the 11th day of November eighteen hundred and sixty three, to serve for the period of three years, is hereby permitted to go to Berlin, in the County of Worcester, State of Maryland, he having received a FURLOUGH from the day of to the day of, at which period he will rejoin his Company or Regiment at or wherever it then may be, OR BE CONSIDERED A DESERTER.

Subsistence has been furnished to said, to the day of, and pay to the day of, both inclusive.

Given under my hand, at, this day of, 18.

Commanding the Reg't.

Mr. [unclear]

PARA 35

VOLUNTEER DESCRIPTIVE LIST and Account of Pay and Clothing of

A Recruit in 9th U.S.C.

NOTES: 1. The amount of any extra pay for which the soldier may be mustered, ex. gr. as Acting Hospital Steward, as Saddler, &c., and which may be still due him, must be carefully noted.
2. In the column headed "BOUNTY PAID," must be entered the whole amount hitherto paid him; in that of "BOUNTY DUE," the whole amount yet due him.
3. Stoppages for loss or damage done to arms, or other public property, must be noted, and the articles, and particular damage to each specified.
4. When stoppages are due, under sentence of a Court Martial, a transcript of the same must be entered here; and the amount already stopped, must be carefully stated.

NOTES: 5. In every case of desertion, the date, and that of delivery, or apprehension, must be entered.
6. A careful settlement of the man's CLOTHING ACCOUNT must be made, to date.
7. Should the man have been engaged in any action, or skirmish, it must be mentioned.
8. A full and particular mention will be made of any wounds he may have received.

| No. | NAMES. | RANK. | DESCRIPTION. | | | | | | WHERE BORN. | | OCCUPATION. | ENROLLED. | | | MUSTERED. | | | |
|-----|------------------------|-------|---------------|------------|------------|-------------|----------|----------|-------------------|-----------------|---------------|-------------|--------------------------|-------------------|-------------|--------------------------|-------------------|-------------|
| | | | Years of age. | Eyes. | Hair. | Complexion. | Feet. | Inches. | State or Kingdom. | Town or county. | | When. | Where. (Town and State.) | By whom. | When. | Where. (Town and State.) | By whom. | Period. |
| 1 | <i>William E. Rain</i> | | <i>19</i> | <i>Blk</i> | <i>Blk</i> | <i>Dark</i> | <i>3</i> | <i>8</i> | <i>N.C.</i> | <i>Muste</i> | <i>Farmer</i> | <i>1863</i> | <i>Muste</i> | <i>C. W. Biny</i> | <i>1863</i> | <i>Benedict</i> | <i>C. W. Biny</i> | <i>1864</i> |

State of Maryland

I CERTIFY that the above is a correct transcript from the Records of *this 9th U.S.C.*

STATION: *Benedict Dist* } *Troops*

DATE: *February 20th 1864*

HERALD

in 9th U.S.C.

...sertion, the date, and that of delivery, or apprehension, must be given, together with a correct transcript of the order of sentence, or pardon.
...of the man's CLOTHING ACCOUNT must be made, to date, and the amount DUE TO, or FROM him must be precisely stated.
...ave been engaged in any action, or skirmish, it must be mentioned, together with date and place.
...ular mention will be made of any wounds he may have received in action, or other injury, whilst in the line of his duty.

| MUSTERED. | | | | LAST PAID. | | BOUNTY. | | REMARKS. |
|-------------|-----------------------------|-------------------|--------------------|---------------|---------------|--------------------------|-------------------------|---|
| When. | Where. (Town and State.) | By whom. | Period. | By paymaster. | To what time. | Paid \$ (See note 2.) | Due \$ (See note 2.) | |
| <i>1863</i> | <i>Benedict</i> | <i>Co W Denny</i> | <i>Three years</i> | <i>---</i> | <i>---</i> | <i>---</i> | <i>---</i> | <i>Co F 9th U.S.C.</i> <i>Sent to Mr Pitt</i> <i>for Mr Rayne</i> |

Sent Rendezvous of Recruits from Maryland for U.S. Colonel
Wm B. Denny
Brig. Genl. U.S. Army
Mustering Office

⁹³⁰
Rayfield. Simon

Co *B*, 9 U.S. Col'd Inf.

Private | Private

CARD NUMBERS.

| | | |
|----|---------|----|
| 1 | 6304409 | 26 |
| 2 | 6304508 | 27 |
| 3 | 6304608 | 28 |
| 4 | 6304715 | 29 |
| 5 | 6304814 | 30 |
| 6 | 6304908 | 31 |
| 7 | 6305004 | 32 |
| 8 | 6305101 | 33 |
| 9 | 6305200 | 34 |
| 10 | 6305297 | 35 |
| 11 | 6305395 | 36 |
| 12 | 6305575 | 37 |
| 13 | 6306103 | 38 |
| 14 | 6300391 | 39 |
| 15 | 9068804 | 40 |
| 16 | | 41 |
| 17 | | 42 |
| 18 | | 43 |
| 19 | | 44 |
| 20 | | 45 |
| 21 | | 46 |
| 22 | | 47 |
| 23 | | 48 |
| 24 | | 49 |
| 25 | | 50 |

Book Mark: _____

See also _____

51169670 P.O. M. Y. U.
S 1773-975 - Ant. v. A
P 1900471 R. U. S. P.

S. S. Douglas
2

R | 9 | U.S.C.T.

Simon Rayfield
Co. C, 9 Reg't U. S. Col'd Inf.

Appears on

Company Descriptive Book

of the organization named above.

DESCRIPTION.

Age 20 years; height 5 feet $6\frac{1}{2}$ inches.

Complexion Black

Eyes Black; hair Black

Where born Accomac, Va.

Occupation Boatman

ENLISTMENT.

When Nov. 4, 1863

Where Drummond Island, Accomac, Va.

By whom Col. Wm. Burney; term 3 y'rs.

Remarks: Descriptive List sent
May 12, 1865. Mustered
out by order of War de-
partment on Aug. 20
certificate of disability
June 3rd 1865.

E. L. Shaubert

N | 9 | U.S.C.T.

Simon Rayfield
Pvt., Co. *C*, 9 Reg't U. S. Col'd Infantry.

Age *20* years.

Appears on

Company Muster-in Roll

of the organization named above. Roll dated
Camp Stanton Charles Col'd Nov 11, 1863.

Muster-in to date *Nov 11*, 1863

Joined for duty and enrolled:

When *Nov 4*, 1863.

Where *Acornac Va*

Period *3* years.

Remarks:

Book mark:

W. H. L. H.
Copyst.

R

9

U.S.C.T.

Simon Rayfield

Pvt, Co. C, 9 Reg't U. S. Col'd Infantry.

Appears on

Company Muster Roll

for *From Nov 11th to Dec 31st*, 1863.

Present or absent *Present*

Stoppage, \$ 100 for

Due Gov't, \$ 100 for

Remarks: *\$2 Rec Rem due*

Book mark:

(358)

W. J. Hill
Copyist

R | 9 | U.S.C.T.

Simon Rayfield
Plt, Co. C, 9 Reg't U. S. Col'd Infantry.

Appears on

Company Muster Roll

for *Jany & Seley*, 186⁴.

Present or absent *Present*

Stoppage, \$ 100 for

Due Gov't, \$ 100 for

Remarks: *#2 Reg't Rem due*

Book mark:

(858)

G. J. Whitt
Copyist

R | **9** | **U.S.C.T.**

Simon Rayfield

Pvt., Co. C, 9 Reg't U. S. Col'd Infantry.

Appears on

Company Muster Roll

for *Mar & April*, 186*4*.

Present or absent *Present*

Stoppage, \$ *100* for

Due Gov't, \$ *100* for

Remarks:

Book mark:

(858)

W. D. Kelly
Coryist

R

9

U.S.C.T.

Simon Rayfield

Pat, Co. C, 9 Reg't U. S. Col'd Infantry.

Appears on

Company Muster Roll

for *May & June*, 1864.

Present or absent *Present*

Stoppage, \$ 100 for

Due Gov't, \$ 100 for

Remarks:

Book mark:

(358)

J. G. White
Copyist

R 9 U.S.C.T.

Simon Rayfield

Plt, Co. C, 9 Reg't U. S. Col'd Infantry.

Appears on

Company Muster Roll

for July & Aug, 1864.

Present or absent Present

Stoppage, \$ 100 for

Due Gov't, \$ 100 for

Remarks: Free on or before April 19/61

Book mark:

(358)

J. D. White Copyist

R

9

U.S.C.T.

Simon Rayfield

Pvt, Co. C, 9 Reg't U. S. Col'd Infantry.

Appears on

Company Muster Roll

for *Sep & Oct*, 1864.

Present or absent *Absent*

Stoppage, \$ 100 for

Due Gov't, \$ 100 for

Remarks: *Absent wounded since Sep 29/64. Free on or before April 19/61*

Book mark:

(358)

M. P. H. G.
Copyist

R | **9** | **U.S.C.T.**

Simon Rayfield
Pvt., Co. C, 9 Reg't U. S. Col'd Infantry.

Appears on

Company Muster Roll

for *Nov & Dec*, 1864.

Present or absent *Absent*

Stoppage, \$ *100* for

Due Gov't, \$ *100* for

Remarks: *Absent wounded*
since Sep 29/64

Book mark:

(358)

V. G. Kelly
Copyist

R | 9 | U.S.C.T.

Simon Rayfield

Private, Co. C, 9 Reg't U. S. Col'd Infantry.

Appears on

Company Muster Roll

for *Jan - Feb*, 1865.

Present or absent *Absent*

Stoppage, \$ *100* for

Due Gov't, \$ *100* for

Remarks: *Absent wounded since Sept 29th 64*

Book mark:

A. J. Anderson

R

9

U.S.C.T.

Simon Rayfield

Private, Co. C, 9 Reg't U. S. Col'd Infantry.

Appears on

Company Muster Roll

for *March & April*, 1865.

Present or absent *Absent*

Stoppage, \$ *100* for

Due Gov't, \$ *100* for

Remarks: *Absent wounded since Sept 29th 64.*

Book mark: _____

A. J. Anderson

R | 9 U.S.C.T.

Simon Rayfield
Pri, Co. 6, 9 Reg't U. S. Col'd Infantry.

Appears on a
Detachment Muster-out Roll
of the organization named above. Roll dated
Norfolk Va. June 3, 1865.
Muster-out to date June 3, 1865.
Last paid to Dec 31, 1864

Clothing account:
Last settled ^{never settled} 186 ; drawn since \$ 9/34 100
Due soldier \$ 100; due U. S. \$ 100
Am't for cloth'g in kind or money adv'd \$ 100

Due U. S. for arms, equipments, &c., \$ 100
Bounty paid \$ 100 due \$ 100

Remarks: Discharged from Balfour
Genl Hoopie in obedience to orders
of the War Dept dated May 3 1865.
No account of Bounty descrip-
tive List.

Book mark:

J. Brown
(349) Copyist.

R

9

U.S.C.T.

Simon Rayfield

Priv, Co. C, 9 Reg't, U. S. Col'd Infantry.

Appears on

Company Muster Roll

for *Dec 31 64 to June 31*, 1865.

Present or absent *Absent*

Stoppage, \$ *100* for

Due Gov't, \$ *100* for

Remarks: *Absent wounded since Sept 29 1864.*

Book mark:

A. J. Anderson

(358)

Copyist

R | 9 | U.S.C.T.

Simon Rayfield

Pvt, Co. C, 9 Reg't U. S. Col'd Infantry.

Appears on

Company Muster Roll

for *July & Aug*, 1865.

Present or absent

Stoppage, \$ 100 for

Due Gov't, \$ 100 for

Remarks: *Discharged by order War Dept dated May 3^d 1865 at U.S. Mt Norfolk, Va. June 3^d 1865*

Book mark: *8357.2nd. Mar 24/68. PV. 8. P 46. 69. — Pm. 5 Apr 2/66*

A. J. Anderson

R

9

U.S.C.T.

Simon Mayfield
Private, Co. "C", 9 Reg't U. S. Col'd Infantry.

Appears on **Co. Muster-out Roll**, dated

New Haven, Conn., Nov 26 1866.

Muster-out to date _____, 186 .

Last paid to _____, 186 .

Clothing account:

Last settled _____, 186 ; drawn since \$ _____ 100

Due soldier \$ _____ 100; due U. S. \$ _____ 100

Am't for cloth'g in kind or money adv'd \$ _____ 100

Due U. S. for arms, equipments, &c., \$ _____ 100

Quantity paid \$ _____ 100; due \$ _____ 100

Remarks: *Joined at regt. orgn
Discharged in Genl. Hosp. Va.
(Northville) June 3/65*

Book mark: *V. 54, P. 139, 69; 830 2^d Aug 2nd 24
1999, 1878, P. 48, P. 46, 69 68*

(361)

Finios

Copyist.

Rayfield, Samuel
D. Co. C, 9 Reg't U.S.C. Inf

1 Enclosures.

| | |
|------------------------------------|----------------------------|
| Bed Cards | Final Statements |
| Burial Records | Furloughs or L. of A |
| Certs. of Dis. for Discharge | Med. Certificates |
| C. M. Charges | Med. Des. Lists |
| Descriptive Lists | Orders |
| Discharge Certificates | Pris. of War Record |
| Enlistment Papers | Resignations |

Other papers relating to—

| | |
|------------------------------|----------------------------|
| Admission to Hosp'l | Furlough or L. of A |
| Casualty Sheet | Med. Examination |
| Confinement | Misc. Information |
| Contracts | Pay or Clothing |
| Death or Effects | Personal Reports |
| Desertion | Rank |
| Discharge from Hosp'l | Transfer to Hosp'l |
| Discharge from Service | Transfer to V. R. C. |
| Duty | Transportation |

132

CASUALTY SHEET
OF WOUNDED.

Samuel Rayfield

Private Company C

9 Regiment of U.S.C.V.

Volunteers at the battle of Chapuis

Farm. Va. - assault on Fort

Gilmer - Sept 29 + 30/64.

CASUALTY SHEET.

Name, *Samuel Rayfield*
Rank, *Private*, Company *"E"*, Regiment, *9th*
Arm, *USC^A*, State,
Place of casualty, *"Chapins Farm Va. + Assault on Fort
Gilmer" - (Ind 41 no 69)*
Nature of casualty, *wounded, nature S*
Date of casualty, *Sept 29 + 30/64*

FROM WHAT SOURCE THIS INFORMATION WAS OBTAINED.

Report (of Killed, Wounded, and Missing) of the _____ Regiment,

Brigade, _____ Division, _____ Corps, dated _____
List of Wounded of 9th USC^A
(Signed) Edwin S. Babcock
Capt 9th USC^A Comdg Regt
Endorsed: List of Casualties in 9th USC^A Sept
29th + 30th 1864
Ind 50 & no 67

W F Thompson

Clerk.

.931

Rayfield, Solomon

Co *H*, 9 U.S. Col'd Inf.

Private | Private

CARD NUMBERS.

| | | |
|----|---------|----|
| 1 | 6313438 | 26 |
| 2 | 6313537 | 27 |
| 3 | 6313638 | 28 |
| 4 | 6313742 | 29 |
| 5 | 6313840 | 30 |
| 6 | 6313935 | 31 |
| 7 | 6314026 | 32 |
| 8 | 6314131 | 33 |
| 9 | 6314231 | 34 |
| 10 | 6314325 | 35 |
| 11 | 6314418 | 36 |
| 12 | 6314529 | 37 |
| 13 | 6315049 | 38 |
| 14 | 9264266 | 39 |
| 15 | | 40 |
| 16 | | 41 |
| 17 | | 42 |
| 18 | | 43 |
| 19 | | 44 |
| 20 | | 45 |
| 21 | | 46 |
| 22 | | 47 |
| 23 | | 48 |
| 24 | | 49 |
| 25 | | 50 |

Book Mark:

See also

p. 1775196 answered

01940479 answered

2
1940479

R | 9 | U.S.C.T.

Solomon Rayfield
....., Co. *H*, 9 Reg't U. S. Col'd Inf.

Appears on
Company Descriptive Book
of the organization named above.

DESCRIPTION.

Age *25* years; height *5* feet *7*/₄ inches.
Complexion *Chesnut*
Eyes *Black*; hair *Black*
Where born *Accomac Virginia*
Occupation *Cytmann*

ENLISTMENT.

When *Nov. 7*....., 1863.
Where *Dummond Town Accomac Va*
By whom *Col. Biny*; term *3* y'rs.
Remarks: *Discharged on Surgeons certificate of Disability June 28 1865.*

Casey

P

9

U.S.C.T.

Soloman Rayfield
Private, Co. H, 9 Reg't U. S. Col'd Infantry.

Age 28 years.

Appears on

Company Muster-in Roll

of the organization named above. Roll dated
Camp Stanton, Charles Co., Maryland, Nov. 23, 1863.

Muster-in to date Nov. 23, 1863

Joined for duty and enrolled:

When Nov. 7, 1863.

Where Accomac, Va.

Period 3 years.

Remarks:

Book mark:

O. J. Markle,

(356)

Copyst.

R | **9** | **U.S.C.T.**

Solomon Rayfield
Private, Co. H, 9 Reg't U.S. Col'd Infantry.

Appears on

Company Muster Roll

for *Nov. 23 to Dec. 31, 1863.*

Present or absent *Present.*

Stoppage, \$ *100* for

Due Gov't, \$ *100* for

Remarks: *\$2 Recruits premium due.*

Book mark:

O. J. Markle.

P | **9** | **U.S.C.T.**

Solomon Ruffield
Private, Co. H, 9 Reg't U. S. Col'd Infantry.

Appears on

Company Muster Roll

for *Jan. + Feb.*, 1864.

Present or absent *Present.*

Stoppage, \$ *100* for

Due Gov't, \$ *100* for

Remarks: *Recruits Premium due.*

Book mark:

O. J. Markle

R | 9 | U.S.C.T.

Samuel Ryfield
Private, Co. H, 9 Reg't U.S. Col'd Infantry.

Appears on

Company Muster Roll

for *March & April*, 1864.

Present or absent *Present.*

Stoppage, \$ *100* for

Due Gov't, \$ *100* for

Remarks:

Book mark:

O. J. Markle,

P

9

U.S.C.T.

Solomon Payfield
Private, Co. H, 9 Reg't U. S. Col'd Infantry.

Appears on

Company Muster Roll

for *May & June*, 1864.

Present or absent *Present.*

Stoppage, \$ *100* for

Due Gov't, \$ *100* for

Remarks:

Book mark:

O. J. Markle

R | 9 | U.S.C.T.

Solomon Rayfield
Private, Co. H, 9 Reg't U. S Col'd Infantry.

Appears on

Company Muster Roll

for *July & August*, 1864.

Present or absent *Present.*

Stoppage, \$ *100* for

Due Gov't, \$ *100* for

Remarks: *Free on leave before April 14, 1861.*

Book mark:

(358)

C. J. Markle,
Coyist.

R | **9** | **U.S.C.T.**

Solomon Payfield
Private, Co. H, 9 Reg't U. S. Col'd Infantry.

Appears on

Company Muster Roll

for *Sept. + Oct.*, 1864.

Present or absent *Absent.*

Stoppage, \$ *100* for

Due Gov't, \$ *100* for

Remarks: *Absent Wounded Sept. 23,*
1864 in a charge on Fort Gilmer,
Lawrence Hill, Va.

Book mark: *462 Dis. Apl. 21, 66 B. E. S.*

O. J. Markle,

(358)

Copyist.

R | 9 | U.S.C.T.

Solomon Rayfield
Priv., Co. H, 9 Reg't U. S. Col'd Infantry.

Appears on

Company Muster Roll

for Nov. & Dec., 1864.

Present or absent Absent

Stoppage, \$ 1.00 for

Due Gov't, \$ 1.00 for

Remarks: Absent. Wounded
Sept. 29, 1864, in a
charge on Fort Gilman
Laird Hill Va.
The difference between
20.00 Dollars per month
and 10.00 Dollars
per month is due from
Jan. 1, 1864 to April 30,
1864

Book mark:

A. L. Ames

R | 9 | U.S.C.T.

Solomon Rayfield
 Priv., Co. H, 9 Reg't U. S. Col'd Infantry.

Appears on

Company Muster Roll

for Jan. + Feb., 1865.

Present or absent Absent

Stoppage, \$ 100 for

Due Gov't, \$ 100 for

Remarks: Absent sick in
 Balfour U.S.A. Gen. Hosp.
 Portsmouth Va. since
 Sept. 29/64

The difference between
 \$7 + \$13 per month is due
 this soldier from Jan. 1
 to April 30/64

Book mark:

A. L. Ames

R | 9 | U.S.C.T.

Solomon Rayfield
Priv., Co. H, 9 Reg't U. S. Col'd Infantry.

Appears on

Company Muster Roll

for Mch. & April, 1865.

Present or absent Absent

Stoppage, \$ 100 for

Due Gov't, \$ 100 for

Remarks: The difference
between \$7 + \$13 per
month due this sol-
dier from Jan. 1 to
April 30/64
Absent sick since
Sept. 29/64

Book mark:

A. L. Ames

R | **9** | **U.S.C.T.**

Solomon Payfield
Priv., Co. H, 9 Reg't U. S. Col'd Infantry.

Appears on

Company Muster Roll

for *Dec. 31, 1864* to *June 30, 1865*.

Present or absent *Absent*

Stoppage, \$ *100* for

Due Gov't, \$ *100* for

Remarks: *Diff. between \$7 &*
\$13 per mo. due this
Soldier from Jan. 1 to
April 30, 64
Absent sick since
Sept. 29, 64

Book mark:

F. L. Ames

R

9

U.S.C.T.

Solomon Rayfield
Priv., Co. H, 9 Reg't U. S. Col'd Infantry.

Appears on

Company Muster Roll

for July & Aug., 1865.

Present or absent

Stoppage, \$ 100 for

Due Gov't, \$ 100 for

Remarks: Discharged June 28, 65, David's Island N.Y. Surg. Certificate. Back pay due \$24.00

Book mark: June 26/66 P.M. G. 875

A. L. Ames

(358)

Copyist.

R. | 9 | U.S.C.T.

Solomon Rayfield
 Private, Co. "H", 9 Reg't U. S. Col'd Infantry.

Appears on **Co. Muster-out Roll**, dated
New Orleans, La., Nov 26, 1864.

Muster-out to date 186 .
 Last paid to 186 .

Clothing account:

Last settled 186 ; drawn since \$ 100
 Due soldier \$ 100; due U. S. \$ 100
 Am't for cloth'g in kind or money adv'd \$ 100

Due U. S. for arms, equipments, &c., \$ 100
 Bounty paid \$ 100; due \$ 100

Remarks: *joined at Original organization. Discharged per Surg. Genl. of disability, June 28/65; at U.S. Genl. Hosp't Davids Island, N.Y. U.*

Book mark: *U. 54, P. 127, 69, C. D.*

(861) *R. Bradin* Copyist.

Rayfield, Solomon

P, Co. H, 9 Reg't U. S. C. Inf.

3 Enclosures.

| | |
|--------------------------------------|-------------------------|
| Bed Cards | Descriptive Lists |
| Burial Records | Final Statements |
| Certs. of Dis. for Discharge / | Furloughs |
| C. M. Charges | Med. Des. Lists |
| Med. Certificates | Orders |

Other papers relating to—

| | |
|------------------------------------|----------------------------|
| Admission to Hosp'l | Furlough |
| Casualty Sheet (Officer's) 2 | Med. Examination |
| Confinement | Misc. Information |
| Contracts | Pay or Clothing |
| Death or Effects | Personal Reports |
| Desertions | Rank |
| Discharge from Hosp'l | Transfer to Hosp'l |
| Discharge from Service | Transfer to V. R. C. |
| Duty | Transportation |

131

CASUALTY SHEET
OF WOUNDED.

*Solomon Rayfield**Private* Company *76**9* Regiment of *USC*Volunteers at the battle of *Chapin's Farm**in* *2nd* *assault* *on* *Pt* *Gilmer**Sept 29 & 30 1864.*

CASUALTY SHEET.

Name, Solomon Rayfield
 Rank, Private, Company A, Regiment, 9th
 Arm, U.S.A., State,
 Place of casualty, "Chapins Point Va and assault on
 Fort Gilmer" Ind 41 No 69.
 Nature of casualty, Wounded - Nature S
 Date of casualty, Sept 29 & 30 1864.

FROM WHAT SOURCE THIS INFORMATION WAS OBTAINED

Report of Killed, Wounded, and Missing of the _____ Regiment,
 Brigade, _____ Division, _____ Corps, dated _____
List of Wounded of 9th U.S.A.
(Signed) Edwin S. Babcock
Capt 9th U.S.A. Comdg Regt
Endorsed: List of Casualties in 9th U.S.A. Sept
29th & 30th 1864
Ind 50 L No 67

W. F. Thompson
 Clerk.

CASUALTY SHEET

No.

Solomon Rayfield

Private of Company *H*

9 Regiment of *N.C.S.*

State Volunteers.

NATURE OF CASUALTY.

Discharged June 28 1865



WARA 482

CASUALTY SHEET.

Name: *Solomon Rayfield*
Rank: *Private* Company: *H* Regiment: *9*
Arm: _____ State: *N.S.C.T.*
Nature of Casualty: *Discharge*

CAUSE OF CASUALTY—(NAME OF DISEASE, &c.)

Disability

DEGREE OF DISABILITY.

BY WHOM CERTIFIED.

Warren Webster

apt Surg N.S.A. Comd Hospital

DATE OF DISCHARGE, DEATH, &c.

June 28-1865

PLACE OF DISCHARGE, DEATH, &c.

Delcamp General Hospital

BY WHOM DISCHARGED.

FROM WHAT SOURCE THIS INFORMATION WAS OBTAINED.

Delcamp General Hospital

Davias Island N.Y. June 30. 1865
(Roll 31) REMARKS.

J. J. Davidson

Clerk.

G. S. O. of Dis, 40,
1165

CERTIFICATE OF DISABILITY FOR DISCHARGE

IN THE CASE OF

Saloman Rayfield
a Private Co. H.

9th Reg't of U.S.T.

APPROVED
Spencer Sloan
Surgeon, U.S.A.,
Medical Director Dept of the East

HEADQUARTERS DEPARTMENT OF THE EAST,
NEW YORK CITY, June 22d, 1865.

To be discharged.

BY COMMAND OF MAJOR GENERAL DIX:

J. L. Cook
Capt. and A. D. C., A. A. A. G.

Received (A. G. Office) _____, 1865

Enk on Roflas

NOTE 1.

The company commander will here add a statement of all the facts known to him concerning the disease or wound, or cause of disability of the soldier; the time, place, manner, and all the circumstances under which the injury occurred, or disease originated or appeared; the duty, or service, or situation of the soldier at the time the injury was received or disease contracted, stating particularly whether the injury was received or the disease contracted in the line of his duty; and whatever other facts may aid a judgment as to the cause, immediate or remote, of the disability, and the circumstances attending it.

When the facts are not known to the company commander, the certificate of any officer, or affidavit of other person having such knowledge, will be appended—as the surgeon in charge of a hospital, the officer commanding a detachment of recruits, &c., &c.

NOTE 2.

When a probable case for pension, special care must be taken to state the degree of disability—as 1/2, 3/4, &c., &c.; to describe particularly the disability, wound, or disease; the extent of which it deprives him of the use of any limb or faculty, or affects his health, strength, activity, constitution, or capacity to labor or earn his subsistence. The surgeon will add, from his knowledge of the facts and circumstances, and from the evidence in the case, his professional opinion of the cause or origin of the disability. In the case of discharges by Medical Inspectors, the last paragraph will state that the "discharge was given by consent of the soldier, after a personal examination, and for disability, the nature, degree, and origin of which are correctly described in the within certificate."

Par. 1260 Regulations, Edit 1861.

Medical officers, in giving certificates of disability, are to take particular care in all cases that have not been under their charge; and especially in epilepsy, convulsions, chronic rheumatism, derangement of the urinary organs, ophthalmia, ulcers, or any obscure disease liable to be feigned or purposely produced; and in no case shall such certificate be given until after sufficient time and examination to detect any attempt at deception.

DIRECTIONS.

This certificate will be made out in duplicate by the soldier's company commander, or other officer commanding the separate detachment to which he belongs, and sent by him to the surgeon who has charge of the hospital where the soldier is sick. The surgeon will then fill out and sign the surgeon's certificate, and forward these papers to the regimental, detachment, or post commander, who will forward them, with his action endorsed thereon, through the proper channel, to his division commander, or, if the troops are not attached to a division, to his corps, department, or other commander or officer to whom the authority to discharge enlisted men may be specially delegated.

These certificates, after having received the action of the highest authority to which they are required to be sent, will be returned through the same channel to the regimental, post, or detachment commander, who will, if the discharge is authorized by the endorsement of the proper authority, sign the soldier's discharge, and the last certificate on this paper; see that the soldier is furnished with the proper final statements in duplicate, and forward BOTH of these certificates to the Adjutant General United States Army, at Washington, D. C.; they will not, under any circumstances, be given

ADJUTANT GENERAL'S OFFICE
July 15. 1865.
Duplicate sent the Pension Office.

ARMY OF THE UNITED STATES
CERTIFICATE
OF DISABILITY FOR DISCHARGE

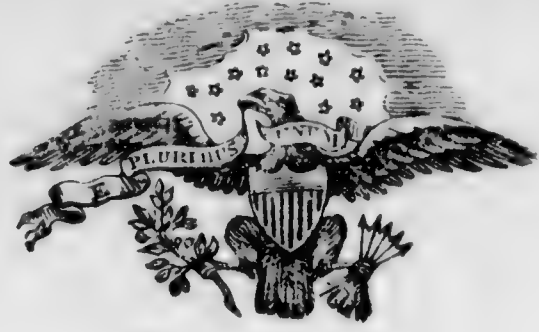

Private Solomon Rayfield, of Captain 2^d Lieut. John S. Mansur Company, (26.) of the 9th Regiment of the United States Old Troops was enlisted by Col. W. Birney of the 9th Regiment of at Drummondstown on the seventh day of November, 1863, to serve three years; he was born in Accomac in the State of Virginia, is twenty eight years of age, five feet eleven inches high, Chestnut complexion, Black eyes, Black hair, and by occupation when enlisted a Oysterman. During the last two months said soldier has been unfit for duty 60 days.*

Discharged in accordance with order of War Dept. A.G.O. May 3/1865.

De Camp Hospital
STATION: David's Island, N.Y.
DATE: June 19, 1865

Warren Webster
Asst. Surg. M.D.
Commanding Company Hosp.

I CERTIFY, that I have carefully examined the said Soloman Rayfield of Captain John S. Mansur Company, and find him incapable of performing the duties of a soldier because of gunshot wound of right foot fracturing metatarsal bones, received in action at Chapin's Farm 29 Sept 1864. Degree of disability - one half. Not fit to be enlisted in Vet Res Corps.

Warren Webster
Asst. Surgeon. M.D.

DISCHARGED, this 28th day of June, 1865, at De Camp Genl. Hospital David's Island, N.Y.

Warren Webster
Asst. Surgeon M.D.
Commanding the Regt. Hosp.

The Soldier desires to be addressed at
Town Eastern Shore County _____ State Maryland

* See Note 1 on the back of this. † See Note 2 on the back of this

932

Redley, Alexander

Co F, 9 U.S. Col'd Inf.

Private

Private

CARD NUMBERS.

| | | |
|----|---------|----|
| 1 | 6309946 | 26 |
| 2 | 6310039 | 27 |
| 3 | 6310079 | 28 |
| 4 | 6310184 | 29 |
| 5 | 6310285 | 30 |
| 6 | 6310385 | 31 |
| 7 | 6310482 | 32 |
| 8 | 6310575 | 33 |
| 9 | 6310741 | 34 |
| 10 | 6310838 | 35 |
| 11 | 6310931 | 36 |
| 12 | 6311014 | 37 |
| 13 | 6311102 | 38 |
| 14 | 6311181 | 39 |
| 15 | 6311267 | 40 |
| 16 | 6311659 | 41 |
| 17 | 9069043 | 42 |
| 18 | | 43 |
| 19 | | 44 |
| 20 | | 45 |
| 21 | | 46 |
| 22 | | 47 |
| 23 | | 48 |
| 24 | | 49 |
| 25 | | 50 |

Book Mark:

See also

R

9

U.S.C.T.

Alexander Redkey

, Co. F, 9 Reg't U. S. Col'd Inf.

Appears on

Company Descriptive Book

of the organization named above.

DESCRIPTION.

Age 30 years; height 5 feet 6 1/4 inches.

Complexion Dark

Eyes Brown; hair Black

Where born Washington Maryland

Occupation Gardener

ENLISTMENT.

When Nov 14, 1863.

Where Holland's Bluff Calvert Md

By whom Col Wm Barry; term 3 yrs.

Remarks: Promoted to Capt by S.O. No 22

Jan 23-1864 Hd Qrs 9th Me I

Reduced to ranks by S.O. No 13 orders

9th Me I July 1-1865 Aid in

Regt Hays Brownsville Tex

July 16-1867 - when rec'd.

July 18 - Descriptive List

forwarded July 19-

H B Barry

R. | 9 | U.S.C.T.

Alexander Redley
Priv, Co. F, 9 Reg't U. S. Col'd Infantry.

Age 30 years.

Appears on

Company Muster-in Roll

of the organization named above. Roll dated

Charles Co. Md. Nov 23, 1863.

Muster-in to date Nov 23 1863

Joined for duty and enrolled:

When Nov. 16, 1863.

Where Calvert Md.

Period 3 years.

Remarks:

Book mark:

Martin

R. | 9 | U.S.C.T.

Alexander Redley

Private, Co. F, 9 Reg't U. S. Col'd Infantry.

Appears on

Company Muster Roll

for Nov 23 to Dec 31, 1863.

Present or absent Present

Stoppage, \$ 100 for

Due Gov't, \$ 100 for

Remarks: \$2.00 Arrear
Arrear. due.

Book mark:

Martin

R

9

U.S.C.T.

Alexander Redley
Corp., Co. F, 9 Reg't U. S. Col'd Infantry.

Appears on

Company Muster Roll

for Jan & Feb, 1864.

Present or absent Present

Stoppage, \$ 100 for

Due Gov't, \$ 100 for

Remarks: Promoted to
Corp. by special
order No. 22. Jan. 23.
Col. Thos Bayley.
\$2.00. Recruit Premium
" due -

Book mark: 50582

Martin

R. | 9 | U.S.C.T.

Alexander Redley
Corp, Co. F, 9 Reg't U. S. Col'd Infantry.

Appears on

Company Muster Roll

for Mar. & Apr., 1864.

Present or absent Present

Stoppage, \$ 100 for

Due Gov't, \$ 100 for

Remarks:

Book mark:

Martin

R | 9 U.S.C.T.

Alexander Redley
loop, Co. F, 9 Reg't U. S. Col'd Infantry.

Appears on

Company Muster Roll

for May & June, 1864.

Present or absent Present

Stoppage, \$ 100 for

Due Gov't, \$ 100 for

Remarks: Stopped for one
Catdg. Box belt & Catdg.
Box Belt Plate & Canteen

Book mark:

Martin

R | 9 | U.S.C.T.

Alexander Redley
Corp, Co. F, 9 Reg't U. S. Col'd Infantry.

Appears on

Company Muster Roll

for July + Aug, 1864.

Present or absent Absent

Stoppage, \$ 100 for

Due Gov't, \$ 100 for

Remarks: Absent sick
in Gen. Hosp.
Since Aug. 8/64.

Book mark:

Martin

R. 1 9 U.S.C.T.

Alexander Redley
Corp; Co. 7, 9 Reg't U. S. Col'd Infantry.

Appears on

Company Muster Roll

for Sep. & Oct, 1864.

Present or absent Absent

Stoppage, \$ 100 for

Due Gov't, \$ 100 for

Remarks: Absent sick
in U. S. Gen. Hosp.
since Aug. 8. 1864.

Book mark:

Martin

R | **9** | **U.S.C.T.**

Alexander Redley
Capt, Co. F, 9 Reg't U. S. Col'd Infantry.

Appears on

Company Muster Roll

for *Nov. & Dec*, 1864.

Present or absent *Absent*

Stoppage, \$ *100* for

Due Gov't, \$ *100* for

Remarks: *Absent sick*
since Dec. 30, 1864
Due the difference be-
tween seven dollars per
month and thirteen dollars
per month from Jan. 1, 1864
to Apr. 30/64

Book mark:

E. L. Thornton

R | 9 | U.S.C.T.

Alexander Ridley
Priv, Co. F, 9 Reg't U. S. Col'd Infantry.

Appears on

Company Muster Roll

for *Jan. 5 Feb*, 1865.

Present or absent *Absent*

Stoppage, \$ *100* for

Due Gov't, \$ *100* for

Remarks: *Reduced to ranks from*
Corpl. pr so no. 13 Reg 2nd 9"
U.S.C.T. Feb. 1/65. Absent sick
since Jan. 27/65. Has "back
pay due", the difference between
thirteen dollars per month and
seven dollars per month from
Jan. 1, 1864 to Apr 30/64

Book mark:

E. L. Harbison

R | 9 | U.S.C.T.

Alexander Ridley
 Priv., Co. F, 9 Reg't U. S. Col'd Infantry.

Appears on

Company Muster Roll

for March to April, 1865.

Present or absent Present

Stoppage, \$ 100 for

Due Gov't, \$ 100 for

Remarks: Back pay due. Re-
duced from Corp'l. Feb 1/65.
Due the difference between
(13) thirteen dollars per
month and (7) seven dollars
per month from Jan. 1, 1864
to Apr. 30/65

Book mark: _____

E. Hasbun

R | 9 | U.S.C.T.

Alexander Ardley
Priv., Co. F, 9 Reg't U. S. Col'd Infantry.

Appears on

Company Muster Roll

for May & June, 1865.

Present or absent Present

Stoppage, \$ 100 for

Due Gov't, \$ 100 for

Remarks: Reduced from Corp. Feb. 1, 1865. Stop for 3 cartridge box belts & plates & tom-tom \$1.58. Back pay due, - the difference between (13) thirteen dollars per month and (7) seven dollars per month from Jan. 1, 1864 to Apr 30/64.

Book mark:

E. L. Shannon

(858)

Copyist

R

9

U.S.C.T.

Alexander Redley
Priv, Co. F, 9 Reg't U. S. Col'd Infantry.

Appears on

Company Muster Roll

for July & Aug, 1865

Present or absent Present

Stoppage, \$ 100 for

Due Gov't, \$ 100 for

Remarks:

Book mark:

E. L. Shannon

(358)

Copyist

R | 9 | U.S.C.T.

Alexander Redley
Put, Co. F, 9 Reg't U. S. Col'd Infantry.

Appears on

Company Muster Roll

for June 30 to Oct 31, 1865.

Present or absent Present

Stoppage, \$ 100 for

Due Gov't, \$ 100 for

Remarks:

Book mark:

D. A. Ward

R | 9 | U.S.C.T.

Alexander Redley
Lieut, Co. "F", 9 Reg't U. S. Col'd Infantry.

Appears on

Company Muster Roll

for June 30 to Dec 31, 1865.

Present or absent Absent

Stoppage, \$ 100 for

Due Gov't, \$ 100 for

Remarks: Absent sick
since Dec. 29/65.

Book mark:

D. A. Ward

R | 9 | U.S.C.T.

Alexander Redley
Private, Co. F, 9 Reg't U. S. Col'd Infantry.

Appears on

Company Muster Roll

for Jan. & Feb., 1866.

Present or absent

Stoppage, \$ 100 for

Due Gov't, \$ 100 for

Remarks: Died in Post
Hosptl. at Brownsville,
Texas Jan. 16/66. of
disease. Descriptive
list furnished.

Book mark:

(358) J. E. Nichol Copyist

R | 9 | U.S.C.T.

Alexander Redley
 Pvt., Co. F., 9 Reg't U. S. Col'd Infantry.

Appears on **Co. Muster-out Roll**, dated
New Orleans, La., Nov. 26, 1866.

Muster-out to date _____, 186 .

Last paid to _____, 186 .

Clothing account:

Last settled _____, 186 ; drawn since \$ _____ 100

Due soldier \$ _____ 100; due U. S. \$ _____ 100

Am't for cloth'g in kind or money adv'd \$ _____ 100

Due U. S. for arms, equipments, &c., \$ _____ 100

Bounty paid \$ _____ 100; due \$ _____ 100

Remarks: *joined at Original*
Company, Ind. to Jan. 23/64
Capt. from Jan 23/64 to Feb. 1/65
Died of disease Jan. 16/66 at
Gen. Hosp. Brunswick, Tex.
Final statements forwarded.

Book mark: *F. S.*

(361) *J. E. Nichol* Copyist.

Redley, Alexander
P. Co. 74, 9 Reg't U. S. C. Inf
See Riddell's, Alex.

B Enclosures.

| | |
|------------------------------------|----------------------------|
| Bed Cards | Final Statements / |
| Burial Records | Furloughs or L. of A |
| Certs. of Dis. for Discharge | Med. Certificates |
| C. M. Charges | Med. Des. Lists |
| Descriptive Lists | Orders |
| Discharge Certificates | Pris. of War Record |
| Enlistment Papers | Resignations |

Other papers relating to—

| | |
|------------------------------|----------------------------|
| Admission to Hosp'l | Furlough or L. of A |
| Casualty Sheet / | Med. Examination |
| Confinement | Misc. Information / |
| Contracts | Pay or Clothing |
| Death or Effects 3 | Personal Reports |
| Desertion | Rank |
| Discharge from Hosp'l | Transfer to Hosp'l |
| Discharge from Service | Transfer to V. R. C. |
| Duty | Transportation |

Extract from Act of Congress.

SEC. 12. And be it further enacted, That the fees of agents and attorneys for making out and causing to be executed the papers necessary to establish a claim for a pension, bounty, and other allowance before the Pension Office, under this act, shall not exceed the following rates: For making out and causing to be duly executed a declaration by the applicant, with the necessary affidavits, and forwarding the same to the Pension Office, with the requisite correspondence, ten dollars: which sum shall be received by such agent or attorney in full for all services in obtaining such pension, and shall not be demanded or received, in whole or in part, until such pension shall be obtained; and the sixth and seventh sections of an act entitled "An act to grant pensions," approved July [fourteenth.] eighteen hundred and sixty-two, are hereby repealed.

SEC. 13. And be it further enacted, That any agent or attorney who shall, directly or indirectly, demand or receive any greater compensation for his services under this act than is prescribed in the preceding section of this act, or who shall contract or agree to prosecute any claim for a pension, bounty, or other allowance under this act, on the condition that he shall receive a per centum upon any portion of the amount of such claim, or who shall wrongfully withhold from a pensioner or other claimant the whole or any part of the pension or claim allowed and due to such pensioner or claimant, shall be deemed guilty of a high misdemeanor, and, upon conviction thereof, shall, for every such offense, be fined not exceeding three hundred dollars, or imprisoned at hard labor not exceeding two years, or both, according to the circumstances and aggravations of the offense.

Approved July 4, 1864.

NOTE 10.—If any soldier is charged a higher fee than that allowed by the above act, he should report the fact and the name of the agent to the Adjutant General, in order that steps may be taken to have the same refunded.

A. G. W. March 5/1866
Base List sent 2/11/66

ADJUTANT GENERAL'S OFFICE.
March 5th 1866
Duplicate with inventory sent 2d Auditor.

FINAL STATEMENT

See Alex Reddleton

OF

Alexander Reddleton
Reg't of Rifled

VOLUNTEERS.

Died Jan'y 16th 1866

NOTE 1.—Two of these certificates (or duplicates) are to be given to each Volunteer Soldier or drafted man who may be discharged without being mustered out (Final Statements are never given to men mustered out of service,) that he may at once receive from the Paymaster the pay, &c., due him, and the captain or other COMMISSIONED officer commanding the company will certify to the act of the delivery of the duplicate certificates; with these certificates the Soldier is "entitled to" his discharge, and should also present his discharge to the Paymaster to have the payment endorsed on it. The discharge is to be given back to the Soldier by the Paymaster; the latter only retaining as his vouchers the duplicate certificates.

NOTE 2.—If the Soldier is entitled to pay for the use of his horse, the Company Commander will certify to that fact on the back of both these final statements, and also to the time he has pay due for having been so mounted on his own horse.

NOTE 3.—When a Soldier is furnished with final statements, his descriptive list, if he has one, should be taken up by the officer who gives the Soldier these statements, and endorsed with a statement to this effect by the officer. The endorsement should exhibit a full statement of the time for which the Soldier was allowed pay on his final statements, the clothing account, and all other charges against him or in his favor, so as to comprise a complete exhibit of his account. It will then be transmitted to the Company Commander of the Soldier, who will enter all the data necessary to a full understanding of the Soldier's account on the muster roll upon which the Soldier's discharge is reported. The descriptive list will then be destroyed. The object of this is, that the remaining portion of the Soldier's account may be settled upon the receipt of these muster rolls, and the Soldier receive any pay or allowances that may be due him at the time of his discharge, and which may not appear on his last final statements from the fact that his descriptive list is incomplete. These accounts for back pay, &c., are settled by the 2d Auditor of the Treasury Department.

NOTE 4.—Charges for loss or injury to ordnance, horse equipments, and other miscellaneous charges, should appear under the heading of "Other Stoppages."

NOTE 5.—Bounty paid by State authorities, and not by the United States, will not be entered on this statement.

NOTE 6.—Amounts due the Sutler and Laundress must be entered on the muster roll on which the discharge, death, desertion, &c., is reported, as well as on the final statement, otherwise the amount cannot be collected from the United States.

NOTE 7.—This blank will be used for deceased volunteers and drafted men, as well as for others.

NOTE 8.—Where a Soldier dies in Hospital or on detached service, his descriptive list, if he has one, should be sent with his final statements, in duplicate, to the Adjutant General, Washington, D. C.

NOTE 9.—If the soldier is a drafted man or substitute, the space for time, &c., of enrolled, should contain only the word *drafted* or *substitute*, as the case may be. If the Soldier is a "VETERAN," (or RECRUIT,) the words *as a veteran*, (or *recruit*,) as the case may be, should be interlined after the words *mustered into the service of the U. S. A.* Payment of all the installments of *Veteran* or *Recruit* Bounty RECEIVED by the Soldier must be made on the back of each final statement.

RECEIVED
MAR 5 1866
Adj. Gen. 1866

MAR 45

I certify, on honor, that Alexander Redley, a Private of
 Captain Wm Royal Company (D) of the 7 Regiment of 1st Drum
VOLUNTEERS, of the State of _____, born in Washington, State
 of Maryland, aged 30 years; 5 feet 6 1/4 inches high; Dark complexion.
Brown eyes, Black hair, and by occupation a Gardener, who joined for service
 and was enrolled (see Note 9) on the 16 day of November, 1863, at Holland Cliff
 by Col Wm Birney, for the period of Three years, and mustered into
 the service of the United States on the 23 day of November, 1863, at
Camp Stanton Md., by Col Wm Birney; and having served
 HONESTLY and FAITHFULLY with his Company to the present date, is now entitled to a
DISCHARGE by reason of Death

The said Alexander Redley was last paid by Paymaster
Maj Lorenz, to include the 31 day of June, 1867, and
 has pay due him from that time to the present date; he is entitled to pay and subsistence for
TRAVELING to place of enrollment, and whatever other allowances are authorized to volunteer
 soldiers, drafted men, or militia, so discharged. He has received from the United States **CLOTHING**
 amounting to Thirty four 05/100 dollars, since the 31 day of October,
 1866, when his clothing account was last settled. He has received from the United States
_____ _____/100 dollars advanced **BOUNTY**.

There is to be stopped from him, on account of the State of _____, or other
 authorities, for **CLOTHING, &c.**, received on entering service, _____ 100 dollars; and
 for other stoppages, viz: Stop for clothing overdrawn
at last settlement Fourteen 22/100 dollars.

He has been furnished with **TRANSPORTATION** in kind from the place of his discharge to
 _____; and he has been **SUBSISTED** for **TRAVELING** to his
 place of enrollment, up to the _____, 186_____.

He is indebted to _____, **SUTLER**, _____ 100 dollars.
 He is indebted to _____, **LAUNDRESS**, _____ 100 dollars.

Given in Duplicate, at Post Hospital Annapolis Md., this 15 day
 of January, 1868.

C. E. Peardon
Surgeon 1st Lt.
Commanding Company
In charge Hospital

Discharge of Alexander Redley
 1868

CASUALTY SHEET.

Name: *Alexander Riddleton*

Rank: _____ Company: *"F"* Regiment: *9th*

Arm: *U. S. Troops* State: _____

Nature of Casualty: *Death*

CAUSE OF CASUALTY—(NAME OF DISEASE, &c.)

BY WHOM DISCHARGED.

FROM WHAT SOURCE THIS INFORMATION WAS OBTAINED.

DEGREE OF DISABILITY.

*Pro Council of Adm
E 104. Vol 2 P. 3 1866.*

BY WHOM CERTIFIED.

*Lewis Pomm
Col. 117th U. S. Inf. Regt.*

DATE OF DISCHARGE, DEATH, &c.

REMARKS.
*U. S. C. Oct 11th 1866
P. M. sent
for P. O. 100
sent 2nd Aug.*

PLACE OF DISCHARGE, DEATH, &c.

*Cast Hospital
Pomerville Texas.*

A. M. Kenney
Clerk.

Inventory of the effects of Alexander Riddley
 Company *F*, *9* Regiment *U.S. Troops*
 who died in the *Post* ~~Camp~~ *Hospital Brownsville*
Texas January *16*, 186*6*.

| | | | |
|--------------------|---|---------------------|---|
| CAPS | / | BLANKETS | |
| DRESS COATS | / | KNAPSACKS | / |
| OVERCOATS | | CANTEENS | / |
| JACKETS | | HAVERSACKS | / |
| TROUSERS | | MUSKETS | |
| SHIRTS | | BAYONETS | |
| DRAWERS | | CARTRIDGE BOX | |
| BOOTS, pairs | | BELT | |
| SHOES, pairs | / | MONEY | |
| STOCKINGS | | <i>Blouse</i> | / |

Said Soldier was buried ^{pay or} nothing while in service of the Hospital

*W. B. Brown Dir. of Ascertainment
 Commanding, 1st Dec. Brig. 26/65*

INVENTORY

OF THE EFFECTS OF

Alexander Riddley

Late of Company *F*, *9* Regiment
U.S. Troops who died
 at *Post* ~~Camp~~
Hospital Brownsville Texas
 186*6*.



U. S. Army ^{Post} General Hospital,

Brownsville Texas Jan 16, 1866.

Commanding Officer, F Company,

9th Regiment *Reforested Troops*

I have to inform you

that Alexander Riddle of your Company died in this Hospital on this 16 day of January 1866 of Chronic Dysentery

I enclose his ~~Descriptive List, with Pay and Clothing Account,~~

~~and~~ Inventory of his effects. D

Very respectfully, yours, &c.,

Wm White

A. A. Surgeon U. S. A.,

~~In charge of General Hospital~~

Executive Officer

433 433

Inventory of the effects of *Alexander Riddleton Pinali*
Company *F*, *9th* Regiment *U.S.A.*
who died in the *Post* *General Hospital Brownsville*
Texas *Jan 16*, 1865. of *Chronic Dysentery.*

| | | | |
|--------------------------------------|---|---------------------|---|
| CAPS | / | BLANKETS | |
| DRESS COATS | / | KNAPSACKS | / |
| OVERCOATS | | CANTEENS | / |
| JACKETS <i>Blank Sack Coat</i> | / | HIVERSACKS | / |
| TROUSERS | | MUSKETS | |
| SHIRTS | | BAYONETS | |
| DRAWERS | | CARTRIDGE BOX | |
| BOOTS, pairs | | BELT | |
| SHOES, pairs | / | MONEY | |
| STOCKINGS | | | |

E. Cowles
Capt & Asst. Surgeon *U.S.A.*
In charge.

6017

INVENTORY

OF THE EFFECTS OF

Pinali Alexander Riddleton

Late of Company *F*, *9th* Regiment
U.S.A., who died
at *Brownsville, Texas*
Hospital *January 16*,
1865.

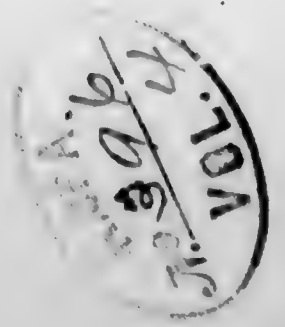
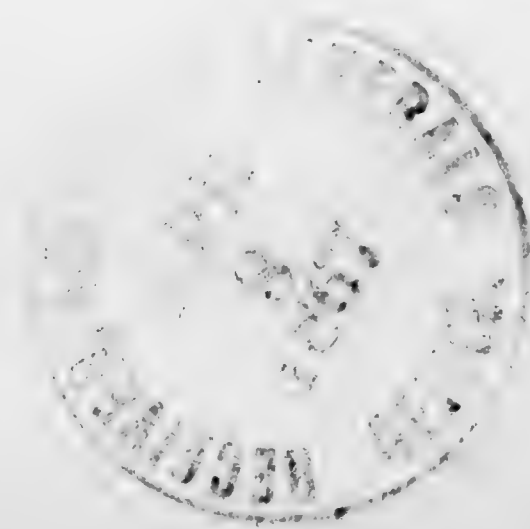

4999 431

No. 341.

Inventory of the effects of Private Alexander Riddleton
Company *F*, 9th Regiment U.S. C.S.
who died in the Barranville's General Hospital

January 16th, 1864
Ironia Dessevery

| | | | |
|--------------------|---|---------------------|---|
| CAPS | / | BLANKETS | |
| DRESS COATS | / | KNAPSACKS | / |
| OVERCOATS | | CANTEENS | / |
| JACKETS | | HIVERSACKS | / |
| TROUSERS | | MUSKETS | |
| SHIRTS | | BAYONETS | |
| DRAWERS | | CARTRIDGE BOX | |
| BOOTS, pairs | | BELT | |
| SHOES, pairs | / | MONEY | |
| STOCKINGS | | <i>Blouse</i> | / |

U.S.A. Dec 15 '66
Inventory with receipt

J. B. Radmore
Surgeon 114th U.S. I.
In charge.

INVENTORY

OF THE EFFECTS OF *A. Riddleton*

Private Alexander Riddleton

Late of Company *F*, 9th Regiment

U.S. C.S., who died
at *Barranville's* General Hospital

Hospital *January 16th*
1864.

See Alex. Rodley -



Ant. M. Collins

✓
 Alexander Redley.
 Prov Co. T.
 9th Regt. T.

Mr Ewerbrook

Adjutant General's Office,

COLORED TROOPS BRANCH,

March 30th, 1877

Mr Ellerbrook Vol.

C. T., 187

Wanted in the case of Alexander Redley 1st, Co. F.,
9th Reg't U.S. Troops. Cause of Reduction.

M. R. for Jan'y & Feb'y. 1865. Reports him Reduced to ranks
from Capt. per order 13. Hd Qrs 9th Feb'y 1865."

Respectfully,

MRB.

R. A. Woodward
Chief Clerk.

In St. Haden

Adjutant General's Office,

Div. of Discontinued Service

April 6, 1877

Vol. C. T., 187

Reply in case of Alexander Redley, Co. "F",
9th Reg't U. S. C. Troops.

Ord. Dis 9th U. S. C. Troops
Feb'y. 1st 1865

Special Orders }
No 13. } Extract

Corporal Alexander Redley reduced
to the ranks for inefficiency
Ref Order of Adl Thomas Baylis
Sgt S. G. Rhodes
1st Lt. Acting Adj.

apl 6.77 1877

Reed, Enoch ⁸³³

Co A, 9 U.S. Col'd Inf.

Private | Private

CARD NUMBERS.

| | | |
|----|---------|----|
| 1 | 6300805 | 26 |
| 2 | 6300905 | 27 |
| 3 | 6301006 | 28 |
| 4 | 6301108 | 29 |
| 5 | 6301205 | 30 |
| 6 | 6301299 | 31 |
| 7 | 6301391 | 32 |
| 8 | 6301491 | 33 |
| 9 | 6301591 | 34 |
| 10 | 6301689 | 35 |
| 11 | 6301785 | 36 |
| 12 | 6301876 | 37 |
| 13 | 6301962 | 38 |
| 14 | 6302054 | 39 |
| 15 | 6302131 | 40 |
| 16 | 6302204 | 41 |
| 17 | 6302276 | 42 |
| 18 | 6302344 | 43 |
| 19 | 6302409 | 44 |
| 20 | 6302478 | 45 |
| 21 | 9068597 | 46 |
| 22 | | 47 |
| 23 | | 48 |
| 24 | | 49 |
| 25 | | 50 |

Book Mark: R. 25. V. 9. C. 872

See also

SC 43817 P.O. aff

A 1963873 P.O. aff

S-2108419 P.O. aff

2
Lynch 3.5

P | **9** | **U.S.C.T.**

Cruck Reed

....., Co. *A*, 9 Reg't U. S. Col'd Inf.

Appears on
Company Descriptive Book
of the organization named above.

DESCRIPTION.

Age *25* years; height *5* feet *6* inches.

Complexion *Dark*

Eyes *Brown*; hair *Blk*

Where born *Accomac Va*

Occupation *Farmer*

ENLISTMENT.

When *Nov 7*, 186 *3*

Where *Benedict*

By whom *Col Birney*; term *3* y'rs.

Remarks: *mustered out
with Regt Nov 26/66*

J. A. Schooley

R | **9** | **U.S.C.T.**

Ernest Reed
Priv, Co. *A*, 9 Reg't U. S. Col'd Infantry.

Age *25* years.

Appears on

Company Muster-in Roll

of the organization named above. Roll dated

Camp Stanton Ches. Md. Nov. 11, 186*3*.

Muster-in to date *Nov. 11*, 186*3*

Joined for duty and enrolled:

When *Nov. 7*, 186*3*.

Where *Acornae Va.*

Period *3* years.

Remarks:

.....
.....
.....
.....
.....
.....

Book mark:

.....

W. P. Ferguson

R **9 U.S.C.T.**

Enoch Reed
Priv, Co. A, 9 Reg't U. S. Col'd Infantry.

Appears on

Company Muster Roll

for *Nov. 11" to Dec. 31"*, 1863.

Present or absent *Present*

Stoppage, \$ *100* for

Due Gov't, \$ *100* for

Remarks: *Recruit premium due.*

Book mark:

W. P. Ferguson

A | **9** | **U.S.C.T.**

Onoch Reed
Priv, Co. A, 9 Reg't U. S. Col'd Infantry.

Appears on

Company Muster Roll

for *Jan & Feb.*, 1864.

Present or absent *Present*

Stoppage, \$ *100* for

Due Gov't, \$ *100* for

Remarks: *\$2 recruit premium due.*

Book mark:

W. H. Ferguson

A 9 U.S.C.T.

Onoch Reed
Pr, Co. A. 9 Reg't U. S. Col'd Infantry.

Appears on

Company Muster Roll

for *March & April*, 186*4*.

Present or absent *Present*

Stoppage, \$ *100* for

Due Gov't, \$ *100* for

Remarks:

Book mark: _____

(358)

W.B. Ferguson

Copyist

R

9

U.S.C.T.

Enoch Reed

Priv, Co. A, 9 Reg't U. S. Col'd Infantry.

Appears on

Company Muster Roll

for *May & June*, 1864.

Present or absent *Present*

Stoppage, \$ *100* for

Due Gov't, \$ *100* for

Remarks:

Book mark:

W. P. Ferguson

(358)

Copyist

9 U.S.C.T.

Croch Reed

Priv, Co. A, 9 Reg't U. S. Col'd Infantry.

Appears on

Company Muster Roll

for *July & Aug.*, 1864.

Present or absent *Present*

Stoppage, \$ 100 for

Due Gov't, \$ 100 for

Remarks:

Book mark:

W. B. Ferguson

(858)

Copist

R | **9** | **U.S.C.T.**

Enoch Reed
Priv, Co. A, 9 Reg't U. S. Col'd Infantry.

Appears on

Company Muster Roll

for *Sept. & Oct.*, 1864.

Present or absent *Absent*

Stoppage, \$ 100 for

Due Gov't, \$ 100 for

Remarks: *Absent wounded*
since Sept. 21" '64.

Book mark:

W. B. Ferguson

(358)

Copyist

R 9 U.S.C.T.

Onch Reed
Co. A, 9 Reg't U. S. Col'd Infantry.

Appears on

Company Muster Roll

for *Nov. - Dec.*, 186*4*

Present or absent *Present*

Stoppage, \$ *100* for

Due Gov't, \$ *100* for

Remarks: *W. S. Grant's*
Ad. Gen. U. S. A. dated
Ad. Gen. 2^d Div. 2^d Reg't
25th U. S. Col. Dec. 7th 64

Book mark:

W. S. Grant

R

9

U.S.C.T.

Enoch Reed
Co., Co. A, 9 Reg't U. S. Col'd Infantry.

Appears on

Company Muster Roll

for *Jany & Greby*, 1865.

Present or absent *present*

Stoppage, \$ 100 for

Due Gov't, \$ 100 for

Remarks:

Book mark:

39022307

W. G. Mowler

(358)

Copyist

9

U.S.C.T.

James J. [unclear]

[unclear], Co. A, 9 Reg't U. S. Col'd Infantry.

Appears on

Company Muster Roll

for *March - April*, 186*2*.

Present or absent *Present*

Stoppage, \$ *100* for

Due Gov't, \$ *100* for

Remarks: *Detached as a cook
Guard post near [unclear]
2nd Reg't April 1862*

Book mark:

W. G. [unclear]

14 | **9** | **U.S.C.T.**

Simon Reed

Co., Co. A, 9 Reg't U. S. Col'd Infantry.

Appears on

Company Muster Roll

for *May 1864*, 186*4*.

Present or absent *Present*

Stoppage, \$ *100* for

Due Gov't, \$ *100* for

Remarks: *sub. ser. in Co. A
9th Regt. U.S. Col'd Inf.
April 26, 1864*

Book mark:

W. B. [Signature]
Copyist

9

U.S.C.T.

James M. ...

..., Co. A, 9 Reg't U. S. Col'd Infantry.

Appears on

Company Muster Roll

for *July 1862*, 1862.

Present or absent *Present*

Stoppage, \$ *100* for

Due Gov't, \$ *100* for

Remarks:

Book mark: _____

James M. ...

Q | 9 | U.S.C.T.

Enoch Reed

Co. A, Co. A, 9 Reg't U. S. Col'd Infantry.

Appears on

Company Muster Roll

for *June 30 & Oct 31*, 1865.

Present or absent *Present*

Stoppage, \$ *100* for

Due Gov't, \$ *100* for

Remarks:

Book mark:

W. C. Mower

(858)

Copyist

9

U.S.C.T.

James H. [unclear]

Co. H, Co. A, 9 Reg't U. S. Col'd Infantry.

Appears on

Company Muster Roll

for *Jan 30 to Dec 31*, 186*0*.

Present or absent *present*

Stoppage, \$ *100* for *insurance*

House Cash

Due Gov't, \$ *100* for

Remarks:

Book mark:

W. H. [unclear]

R

9

U.S.C.T.

Enoch Wood

Co. A, Co. A, 9 Reg't U. S. Col'd Infantry.

Appears on

Company Muster Roll

for *Jan - Feb*, 186.

Present or absent *Present*

Stoppage, \$ *100* for

Due Gov't, \$ *100* for

Remarks:

Book mark:

Wm. M. ...

(858)

Copyist

R

9

U.S.C.T.

Enoch Reed

Pl, Co. A, 9 Reg't U. S. Col'd Infantry.

Appears on

Company Muster Roll

for *March-April*, 186*6*.

Present or absent *Present*

Stoppage, \$ *100* for

Due Gov't, \$ *100* for

Remarks:

Book mark:

Boyer

R

9

U.S.C.T.

Enoch Reed

Pr, Co. A, 9 Reg't U. S. Col'd Infantry.

Appears on

Company Muster Roll

for *May & June*, 186*6*.

Present or absent *Present*

Stoppage, \$ *100* for

Due Gov't, \$ *100* for

Remarks:

Book mark:

Beyer

R

9

U.S.C.T.

Enoch Reed

Pr, Co. A, 9 Reg't U. S. Col'd Infantry.

Appears on

Company Muster Roll

for *July + Aug*, 186*6*.

Present or absent *Present*

Stoppage, \$ *00* ^{*4*} *100* for *Cap letters*
bugles + numbers

Due Gov't, \$ *100* for

Remarks:

Book mark:

Bryer

R

9

U.S.C.T.

Enoch Reed

Pvt, Co. A, 9 Reg't U. S. Col'd Infantry.

Appears on

Company Muster Roll

for *Sept + Oct*, 186*6*.

Present or absent *Present*

Stoppage, \$ *100* for

Due Gov't, \$ *100* for

Remarks:

Book mark: *305508*

Dregin

(358)

Copyist

R | 9 | U.S.C.T.

Emoch Reed
Pt., Co. *A*, 9 Reg't U. S. Col'd Infantry.

Appears on **Co. Muster-out Roll**, dated
New Orleans La, Jan 24, 1864.

Muster-out to date *Jan 24*, 1864.

Last paid to *Aug 31*, 1864.

Clothing account:

Last settled _____, 186 ; drawn since \$ 100

Due soldier \$ ⁵¹ / 100; due U. S. \$ 100

Am't for cloth'g in kind or money adv'd \$ 100

Due U. S. for arms, equipments, &c., \$ *0* 100

Ordinary
Bounty paid \$ *100* 100; due \$ *100* 100

Remarks: *(Due under act of Aug July 24 1864) Formed at org. camp of Exchanges at New Orleans to with view to payment without return to state 1 Muster and reenforcements returned*

(as on Roll) P 218 P 183, 71 V. 165 P 44-73

Book mark *(R 25 2 90 7 72*

Boeger

Reed, Ervock

P, Co. A, 9 Regt U.S.C. Inf.

1 Enclosures.

| | |
|------------------------------|-------------------|
| Bed Cards | Descriptive Lists |
| Burial Records | Final Statements |
| Certs. of Dis. for Discharge | Furloughs |
| C. M. Charges | Med. Des. Lists |
| Med. Certificates | Orders |

Other papers relating to—

| | |
|----------------------------|----------------------|
| Admission to Hosp'l | Furlough |
| Casualty Sheet (Officer's) | Med. Examination |
| Confinement | Misc. Information |
| Contracts | Pay or Clothing |
| Death or Effects | Personal Reports |
| Desertions | Rank |
| Discharge from Hosp'l | Transfer to Hosp'l |
| Discharge from Service | Transfer to V. R. C. |
| Duty | Transportation |

Have Claim 1

NARA 450
MICROFILM PUBLICATION M 1851

COMPILED MILITARY SERVICE RECORDS
OF VOLUNTEER UNION SOLDIERS WHO SERVED WITH
THE UNITED STATES COLORED TROOPS (USCT)
9TH REGIMENT OF INFANTRY

PERSONAL PAPERS' TARGET SHEET

PLEASE NOTE THE CHECKED INFORMATION ABOUT THE PERSONAL PAPERS IN
THIS FILE:

- NO PERSONAL PAPERS WERE FOUND IN THIS FILE WHEN THE
RECORDS WERE ARRANGED FOR MICROFILMING.
- 12 PERSONAL PAPER(S) FOUND IN THIS FILE WHEN THE RECORDS
WERE ARRANGED FOR MICROFILMING.

Accomac Co. N. C.

Dec 2nd 1863

To all whom it may concern:

I hereby certify that the Rev Eruch Reed warmly supported the Union Candidate for a seat in the Convention from this county; that he was at that time warmly and zealously Union.

He neither voted for nor against the ratification of the ordinance of Secession. Since then, my knowledge in regard to his position is not very extensive. So far as I know he has departed himself as a loyal citizen.

Edward H. Shoad

I have interviewed Mr. Reed and he has not returned my sample to require it, and not being a qualified voter, did not for that reason vote either way.

E. H. S.

NARA 469

HEAD QUARTERS,

First Separate Brigade, 8th Army Corps,

Drummondtown, Va., Dec 27 1863.

Rev. Enoch Reed is known to me as a respect-
table citizen of Accomac Co. Va for some time
a clergyman of the Episcopal Church in
Ohio. He is represented to me as conserva-
tive in his political views and adher-
ing to the Union men
of Accomac. So far as my own knowledge
extends I know nothing to disturb my
confidence in his right views & actions.

Henry H. Lockwood

Brig Gen Condy

To all whom it may concern
 I have known the Rev Emack Reed of
 Accomac Co, E. Shore intimately & well
 for years & especially just before the act
 of secession & ever since & from all that
 I know or have reason to believe
 He has always been & now is faithful
 & Loyal to the Union Constitution &
 Government of the United States

Thos. Hall Nelson Senator
 Elected from the 1st district
 Drummond Down Dec, 4, 1863 Virginia

A. Rep. Dec: 7 '63

I have no hesitation in endorsing the loyalty of the Rev. Enoch Reed, of the County of Accomac.

I make this endorsement of him after such inquiry as has satisfied me that I have done right in certifying to his loyalty.

I am credibly informed that he was actually opposed to secession, and to the ordinance of secession, and that his walk and conversation have been uniformly those of a

Union man. And
from quite a cor-
respondence with
him, I am firmly
of the opinion that
he is heartily at-
tached to Union of
the States. His at-
tention to me all
breath the most
devoted loyalty.

Wm. Legar.

Point Breeze Dec., 24th 1853,
 Mr. Bee

Dear Sir: I recollect a
 conversation, at the Court House
 between you and myself a
 short time before the vote
 was taken in Va. on the
 ratification of the Ordinance
 of Secession, at which time
 you requested me to make
 a speech against it

Respectfully yours,

(Attraction

West in Reed

NARA 465

HEAD QUARTERS,
Department of Virginia and North Carolina.

Fort Monroe, March 9th 186

Sir

I am directed by
the Major Genl Comdg to say in
reply to your note, that he feels
grateful for your kind consider-
ation.

The whole permit system has
been abolished, and your other
suggestions shall have due
attention

I am Very Resply
Fred Martin
Capt U.S.A.

Mr Enoch Reed
Aberdeen

A.

No. 329

CLAIMANT'S CERTIFICATE.

I, Emmel Reed a loyal citizen, and a resident
of near Louisa, County of Accomack, State of
Virginia, hereby claim compensation, under the provisions of
General Orders, No. 329, 1863, for my slave: Emmel Reed and Peter Reed
enlisted September 7th 1863, at Benedict, Maryland
by Col. Wm. Binney in the Company I, 9th
Regiment U. S. Colored Troops, Co A; certificate of which enlistment, and a
descriptive list, as required, accompany this application.

In proof of my loyalty to the Constitution and Government of the United States, I
present the accompanying oath, which I have taken, signed, and acknowledged, to be filed
with this application, in accordance with requirement of said General Orders.

Emmel Reed

February 24th 1864.

B.

OATH OF ALLEGIANCE.

I, Enoch Reed, do solemnly swear that I have never joined, or been concerned in, any insurrection or rebellion; that I have never borne arms against the United States; that I have never given any aid, countenance, counsel, or encouragement to any person or persons engaged, or whom I had reason to believe were about to engage, in insurrection, rebellion, or armed hostility against the United States; that I have neither sought, nor accepted, nor attempted to exercise the functions of any office, civil or military, nor to perform any service whatever, under any authority or pretended authority in hostility to the United States; that I have not yielded a voluntary support to any insurrection, rebellion, or pretended government, authority, power, or constitution within the United States hostile thereto. And I do further swear that, to the best of my knowledge and ability, I have supported and defended, and will continue to support and defend, the United States against all enemies, foreign and domestic; and that I have supported, defended, and obeyed, and will continue to support, defend, and obey, the Constitution and laws of the United States; that I will bear true faith and allegiance to the same; and that I take this oath freely, without any mental reservation or purpose of evasion: So help me God.

Enoch Reed

Sworn to and subscribed before me, at Drummond }
Town this 24th day of February 186 4

Jacob M. Rops J.P.



C.

I present herewith evidence of my title to the slave: Peter H Enoch Reed
 _____ enlisted as aforesaid, and in consideration of the sum of
 _____ by me received, I hereby covenant and
 agree with the United States, that I, my heirs, executors, or assigns, shall never hereafter make
 or enforce any claim to the labor or services of said slave; and pledge myself to execute
 a valid Deed of Manumission and Release of all my claims to service forever of said
 Slave Peter Reed Enoch Reed to be filed with the Board of Claims
 now in session at Baltimore Md

_____ Enoch Reed

 Accmack Co Va , 1864

NARA 479

EVIDENCE OF TITLE.

I, Enoch Reed, of Accomack
Va.
County, ~~Acc.~~, do solemnly swear that Enoch Reed and Peter Reed
~~had~~
who ~~has~~ been enlisted in the 9th Regiment, U. S. Colored Troops,
Cos. A & B; ~~is~~ ^{is} my slave for this life; ~~his~~ ^{this} term of service expiring ~~on~~
~~the~~ next ~~day~~ ^{day} of Sept. 1864; and that
I became possessed of ~~him~~ ^{them} by marriage, in the month
of May, 4th day thereof, eighteen hundred and thirty-eight. And I
do further swear that I have not purchased said slave from any person or persons disloyal
to the Government of the United States, with the object of obtaining compensation for
the same; and furthermore, that I have no agency for obtaining compensation for any per-
son or persons but such as, to my knowledge, are loyal citizens of the United States.

Enoch Reed

Sworn to before me the 24 Feb 1864.

Jacob M. Prop. Justice of the Peace

STATE OF ~~MARYLAND~~ *Virginia*

Accomac County, to wit:

On this *the 24th* day of *February* in the year 1864,

before me, the subscriber, a Justice of the Peace of the State and County aforesaid, personally appeared *Enoch Reed*, and took, signed, and acknowledged the oaths preceding; and further made oath, in due form of law, that all the statements made in this application are, to the best of *his* knowledge and belief, strictly true.

William H. Board

Also personally appeared before me *Law M. Rofs* and *Abel T. Johnson*, loyal citizens of the United States, residents of *Accomac County Virginia*, well acquainted with the said *Enoch Reed*, and in no manner interested in the prosecution of this

claim, and made oath, in due form of law, that the said *Enoch Reed* is the owner of the slave ~~Enoch Reed~~ *Enoch Reed*, as a fact of public notoriety; that they believe all the statements herein made by *Enoch Reed* in reference thereto, are correct, and that *he* is unquestionably loyal to the Government of the United States. Witness their signatures:

W. H. Board
A. T. Johnson

Law M. Rofs Justice of the Peace.



Virginia

STATE OF ~~MARYLAND~~

Accomack County, to wit:

I, *John B. Dilworth*, Clerk of the ~~Circuit~~ *County* Court for *Accomack* County, do hereby certify that *Jacob M. Pop*,

before whom the foregoing affidavits were made, was, at the time of signing the same, a Justice of the Peace for the County and State aforesaid, duly commissioned and sworn; and that his signature thereto is genuine, and that full faith and credit should be given to his official acts.

Witness my hand and the seal of said Court, this *24th* day of *February*, A. D. 1864.

J. B. Dilworth CLERK.



F.

CERTIFICATE OF AWARD OF THE BOARD OF CLAIMS.

Office of the Board of Claims
For Slaves Enlisted in the Service of the United States,

710114-

Baltimore Md.

\$300

May 21st 1864

We hereby certify, that Enoch Reed, of Accomack county, State of Virginia, having proved, under oath, his loyalty to the Constitution and Government of the United States, and established his title as to the ownership of Enoch Reed, a slave enlisted at Accomack County Va., on the 7th day of November, 1863, by Col. Wm. Birney, in the service of the United States, in the ninth Regiment of Colored Troops, Co. A., and having filed a valid Deed of Manumission and Release of Service of said slave, is entitled to the sum of Three Hundred dollars, which has been awarded to him by this Board as a remuneration for all claim to the future labor or service of said slave, under the provision of General Orders, War Department, No. 329, 1863.

J. Street, President of the Board.
Thos. Simmons, Member of the Board.
S. E. Strangher, Member of the Board.

To Maj. C. W. Foster,
Chief of the Bureau for the
Organization of Colored Troops, Washington, D. C.

11.

No. .

ABSTRACT OF DISBURSEMENTS.

....., 186 .

Enoch Reed

Dollars *300* ^{*00*}/_{*100*}

Paid , 186 .

WAR 475

The United States,

To *Enoch Reed* Dr.

| 186 . | DOLLARS. | CENTS. |
|--|---------------|-----------|
| For amount awarded him by the Board of Claims, in consideration of the enlistment of <i>Enoch Reed</i> in the <i>9th Regt U. S. Colored Troops</i> | <i>300</i> | <i>00</i> |
| | \$ <i>300</i> | <i>00</i> |

I CERTIFY that the above account is correct and just; that the name of *Enoch Reed* is borne on the muster-in rolls of the *9th Regt U. S. Colored Troops*; and that the above amount was awarded by the Board of which *S. F. Street* Esq. is President, said award being in accordance with section 24 of the act entitled "An act to amend an act entitled 'An act for enrolling and calling out the national forces, and for other purposes,'" approved Feb. 24, 1864.

Assistant Adjutant General.

RECEIVED
Three Hundred , 186 , of *Capt. G. Benedict A. G. V. S.* dollars and *—* cents, in full of the above account.
Enoch Reed

(SIGNED DUPLICATES.)

10.

No. .

ABSTRACT OF DISBURSEMENTS.

....., 186 .

Enoch Reid

Dollars *300* ⁰⁰/₁₀₀

Paid , 186 .

The United States,

To *Enoch Reed* Dr.

| 186 . | DOLLARS. | CENTS. |
|---|------------|-----------|
| For amount awarded him by the Board of Claims, in consideration of the enlistment of <i>Enoch Reed</i> in the <i>9th Regt U. S. Colored Troops</i> | <i>300</i> | <i>00</i> |
| <i>Total</i> \$ | <i>300</i> | <i>00</i> |

I CERTIFY that the above account is correct and just; that the name of *Enoch Reed* is borne on the muster-in rolls of the *9th Regt U. S. Colored Troops*; and that the above amount was awarded by the Board of which *S. F. Street* is President, said award being in accordance with section 24 of the act entitled "An act to amend an act entitled 'An act for enrolling and calling out the national forces, and for other purposes,'" approved Feb. 24, 1864.

Assistant Adjutant General.

RECEIVED _____, 186 , of *Capt S. G. Benedict, A. A. G. Vol*
Three Hundred dollars and _____ cents, in full of the above account.

Enoch Reed

(SIGNED DUPLICATES.)

E.

DEED OF MANUMISSION AND RELEASE OF SERVICE.

Whereas my slave Enoch Reed has enlisted in the service of the United States: now, in consideration thereof, I, Enoch Reed, of Accomac county, State of Virginia, do hereby, in consideration of said enlistment, manumit, set free, and release the above-named Enoch Reed from all service due me; his freedom to commence from the Seventh November 1863, the date of his enlistment as aforesaid in the Ninth Regiment of Colored Troops, in the service of the United States.

Witness my hand and seal, this 27th day of April, 1864

Enoch Reed 

Witness:

Louis A. Samart
J. Peters
W. W. Carter

Baltimore City
County

State of Maryland, 1864.

Before me appeared this day Enoch Reed and acknowledged the above Deed of Manumission and Release of Service to be his free act and deed.

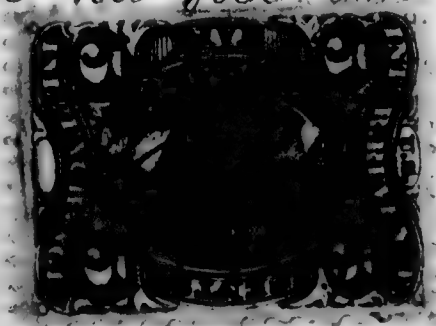

John Mace
Superior Court Baltimore City

Accomack County Court Clerks Office May 13th 1864

This Deed of Manumission from Enoch Reese
to his Slave Enock, together with the Certificate
of Acknowledgment thereof, thereto annexed
was this day received by me in the clerks office
and admitted to record.

Just J. B. Ailworth C. C. C.

State of Virginia Accomack County to wit:

I do hereby Certify that the foregoing Deed together
with the Certificate thereof, thereto Annexed, is recorded
in the Clerks office of Accomack County Court.

In Testimony whereof I have hereunto
subscribed my name and affixed
the seal of said Court this 14th day of
May 1864.

J. B. Ailworth C. C. C.



Reed, Joseph T. ⁹³⁴

Co G, 9 U.S. Col'd Inf.

Private Private

CARD NUMBERS.

| | | |
|----|---------|----|
| 1 | 6311741 | 26 |
| 2 | 6311860 | 27 |
| 3 | 6313357 | 28 |
| 4 | 9069161 | 29 |
| 5 | | 30 |
| 6 | | 31 |
| 7 | | 32 |
| 8 | | 33 |
| 9 | | 34 |
| 10 | | 35 |
| 11 | | 36 |
| 12 | | 37 |
| 13 | | 38 |
| 14 | | 39 |
| 15 | | 40 |
| 16 | | 41 |
| 17 | | 42 |
| 18 | | 43 |
| 19 | | 44 |
| 20 | | 45 |
| 21 | | 46 |
| 22 | | 47 |
| 23 | | 48 |
| 24 | | 49 |
| 25 | | 50 |

Book Mark:

See also

R | **9** | **U.S.C.T.**

Joseph T. Reed

....., Co. *G*, 9 Reg't U.S. Col'd Inf.

Appears on

Company Descriptive Book

of the organization named above.

DESCRIPTION.

Age *19* years; height *5* feet *3* inches.

Complexion *Yellow*

Eyes *Black*; hair *Wool*

Where born

Occupation *Farm h.*

ENLISTMENT.

When *Nov. 20*, 186*3*.

Where *Forest Mary, St. Mary.*

By whom *Col. Wm. Biney*; term *3* y'rs.

Remarks: *Free*

Died in hosp at Benedict.

M. Jackson

(3837)

Compt.

R

9

U.S.C.T.

Joseph J. Reed
Pot, Co. G, 9 Reg't U. S. Col'd Infantry.

Age 19 years.

Appears on

Company Muster-in Roll

of the organization named above. Roll dated
Camp Stanton
Charles Co Md, Nov 23, 1863.

Muster-in to date Nov 23, 1863

Joined for duty and enrolled:

When Nov 20, 1863.

Where St Mary Md.

Period 3 years.

Remarks:

Book mark:

E. B. Carroll

R

9

U.S.C.T.

Joseph T. Reed
Pot., Co. G, 9 Reg't U. S. Col'd Infantry.

Appears on

Company Muster Roll

for *Nov 23 to Dec 31*, 1863.

Present or absent

Stoppage, \$ 100 for

Due Gov't, \$ 100 for

Remarks: *Died at Hospl. Dec 3.
Final statements forwarded Jan 2nd.
\$ 2⁰⁰/₁₀₀ Recruiting premium due*

Book mark:

E. B. Carroll

R | 9 | U.S.C.T.

Joseph T. Reed
 Priv., Co. E., 9 Reg't U. S. Col'd Infantry.

Appears on **Co. Muster-out Roll**, dated
 New Orleans, La. Nov. 26, 1866.

Muster-out to date 186 .
 Last paid to 186 .

Clothing account:

Last settled 186 ; drawn since \$ 100

Due soldier \$ 100; due U. S. \$ 100

Am't for cloth'g in kind or money adv'd \$ 100

Due U. S. for arms, equipments, &c., \$ 100

Bounty paid \$ 100; due \$ 100

Remarks: *joined at origl. orgn.*
Died Dec. 3, '63, Benedict Md.

Book mark *2747.1882*

(361) *C. E. M. Laughlin* Copyist.

Reed, Joseph T.

P, Co. G, 9 Reg U.S.C. Inf.

2 Enclosures.

| | |
|------------------------------|-------------------|
| Bed Cards | Descriptive Lists |
| Burial Records | Final Statements |
| Certs. of Dis. for Discharge | Furloughs |
| C. M. Charges | Med. Des. Lists |
| Med. Certificates | Orders |

Other papers relating to—

| | |
|----------------------------|----------------------|
| Admission to Hosp'l | Furlough |
| Casualty Sheet (Officer's) | Med. Examination |
| Confinement | Misc. Information |
| Contracts | Pay or Clothing |
| Death or Effects | Personal Reports |
| Desertions | Rank |
| Discharge from Hosp'l | Transfer to Hosp'l |
| Discharge from Service | Transfer to V. R. C. |
| Duty | Transportation |

FINAL STATEMENT

OF

Joseph T. Reed

9th Reg't of U. S. I.

VOLUNTEERS.

Rec'd Dec 3/63

NOTE 1.—Two of these certificates (or duplicates) are to be given to each Volunteer Soldier or drafted man who may be discharged previously to the discharge of his company, that he may at once receive from the Paymaster the pay, &c., due him, and the captain or other COMMISSIONED officer commanding the company will certify to the act of the delivery of the duplicate certificates; on these certificates the Soldier is "entitled to" his discharge, and should also present his discharge to the Paymaster to have the payment endorsed on it. The discharge is to be given back to the Soldier by the Paymaster; the latter only retaining as his voucher the duplicate certificates.

NOTE 2.—If the Soldier is entitled to pay for the use of his horse, the Company Commander will certify to that fact on the back of both these final statements, and also to the time he has pay due for having been so mounted on his own horse.

NOTE 3.—When a Soldier is furnished with final statements, his descriptive list, if he has one, should be taken up by the officer who gives the Soldier these statements, and endorsed with a statement to this effect by the officer. This endorsement should exhibit a full statement of the time for which the Soldier was allowed pay on his final statements, the clothing account, and all other charges against him or in his favor, so as to comprise a complete exhibit of his account. It will then be transmitted to the company commander of the Soldier, who will enter all the data necessary to a full understanding of the Soldier's account on the muster roll upon which the Soldier's discharge is reported. The descriptive list will then be destroyed. The object of this is, that the remaining portion of the Soldier's account may be settled upon the receipt of these muster rolls, and the Soldier receive any pay or allowances that may be due him at the time of his discharge, and which may not appear on his final statements from the fact that his descriptive list is incomplete. These accounts for back pay, &c., are settled by the Auditor of the Treasury Department.

NOTE 4.—Charges for loss or injury to ordnance, horse equipments, and other miscellaneous charges, should appear under the heading of "Other Stoppages."

NOTE 5.—Bounty paid by State authorities, and not by the United States, will not be entered on this statement.

NOTE 6.—Amounts due the Sutler and Laundress must be entered on the muster roll on which the discharge, death, desertion, &c., is reported, as well as on the final statement, otherwise the amount cannot be collected from the United States.

NOTE 7.—This blank will be used for deceased volunteers and drafted men, as well as for others.

NOTE 8.—Where a Soldier dies in Hospital or on detached service, his descriptive list, if he has one, should be sent with his final statements, in duplicate, to the Second Auditor, Washington, D. C.

Received by Office Jan 6/64

April 26 1864

Duplicates with Inventory sent 2d Auditor.

I certify, on honor, that Joseph J. Reed a private of
 Captain William Cook's Company (6) of the 9th Regiment of U. S. C. I
VOLUNTEERS, of the State of (unknown), born in (unknown), State
 of unknown, aged 19 years; 5 feet 3 inches high; medial complexion,
grey eyes, ^{not very woolly} hair, and by occupation a (unknown) having joined the company on
 its original organization at Camp Stanton Md. and enrolled in it at the muster into
 the service of the United States at Camp Stanton Md., on the 23d day
 of November, 1863, (~~or was mustered in service as a recruit, by~~
 _____, at _____, on the _____ day of _____,
 1863, or was drafted and mustered into the service of the United States from the
 Enrollment District of the State of _____, at _____,
 on the _____ day of _____, 1863;) to serve in the Regiment, for
 the term of 3 years or longer: and having served **HONESTLY** and
FAITHFULLY with his Company in Maryland to the present date, is now
 entitled to a **DISCHARGE** by reason of death.

The said Joseph J. Reed was last paid by Paymaster
 _____ to include the _____ day of _____ 1863 and has
 pay due him from ^{Nov 20th (date of his enrolment at Forest Wharf Md.) to Dec 3d (date of his death)} that time to the present date; he is entitled to pay and subsistence for
^{besides \$2.00 recruiting prem.} TRAVELING to place of enrollment, and whatever other allowances are authorized to volunteer
 soldiers, drafted men, or militia, so discharged. ^{He has received from the United States Clothing} He has received from the United States **CLOTHING**
 amounting to twenty-nine ⁴⁵ ~~100~~ dollars, since the _____ day of _____,
 1863, when his clothing account was last settled. He has received from the United States
 _____ ~~100~~ dollars advanced **BOUNTY**.

There is to be stopped from him, on account of the State of _____, or other
 authorities, for **CLOTHING**, &c., received on entering service, _____ dollars; and
 for other stoppages, viz: _____

_____ dollars.
 He has been furnished with **TRANSPORTATION** in kind from the place of his discharge to
 _____; and he has been **SUBSISTED** for **TRAVELING** to his
 place of enrollment, up to the _____, 1863.

He is indebted to _____, **SUTLER**, _____ dollars.
 He is indebted to _____, **LAUNDRESS**, _____ dollars.

Given in Duplicate, at Camp Stanton Md., this 31 day
 of January, 1864.

William Cook

Captain

 Commanding Company.

ARTICLES OF WAR.

ART. 95. When any non-commissioned officer or soldier shall die, or be killed in the service of the United States, the then commanding officer of the troop or company shall, in the presence of two other commissioned officers, take an account of what effects he died possessed of, above his arms and accoutrements, and transmit the same to the office of the Department of War, which said effects are to be accounted for, and paid to the representatives of such deceased non-commissioned officer or soldier. And in case any of the officers, so authorized to take care of the effects of deceased officers and soldiers, should, before they have accounted to their representatives for the same, have occasion to leave the regiment or post, by preference or otherwise, they shall, before they be permitted to quit the same, deposit in the hands of the commanding officer, or of the assistant military agent, all the effects of such deceased non-commissioned officers and soldiers, in order that the same may be secured for, and paid to, their respective representatives.

ARMY REGULATIONS—EDITION OF 1861.

DECEASED SOLDIERS.

Par. 152. Inventories of the effects of deceased non-commissioned officers and soldiers, required by the 95th Article of War, will be forwarded to the Adjutant General, by the commander of the company to which the deceased belonged, and a duplicate of the same to the colonel of the regiment. Final statements of pay, clothing, &c., will be sent with the inventories. When a soldier dies at a post or station absent from his company, it will be the duty of his immediate commander to furnish the required inventory, and, at the same time, to forward to the commanding officer of the company to which the soldier belonged, a report of his death, specifying the date, place, and cause; to what time he was last paid, and the money or other effects in his possession at the time of his decease; which report will be noted on the next muster roll of the company to which the man belonged. Each inventory will be endorsed, "Inventory of the effects of _____, late of company (—) _____ regiment of _____, who died at _____, the _____ day of _____, 186—." If a legal representative receive the effects, it will be stated in the report. If the soldier leave no effects, the fact will be reported.

Par. 153. Should the effects of a deceased non-commissioned officer or soldier not be administered upon within a short period after his decease, they shall be disposed of by a Council of Administration, under the authority of the commanding officer of the post, and the proceeds deposited with the Paymaster, to the credit of the United States, until they shall be claimed by the legal representatives of the deceased.

Par. 154. In all such cases of sales by the Council of Administration, a statement in detail, or account of the proceeds, duly certified by the Council and commanding officer, accompanied by the Paymaster's receipt for the proceeds, will be forwarded by the commanding officer to the Adjutant General. The statement will be endorsed, "Report of the proceeds of the effects of _____, late of company (—) _____ regiment of _____, who died at _____, the _____ day of _____, 186—."

NOTE 1.—The effects in all cases, when called for, should be turned over to the legal representative, without further authority from the Adjutant General. When the effects are turned over to the relatives of the deceased before these inventories are sent to the Adjutant General, their receipts therefor should be attached to the inventories. In all other cases, one copy will be sent with a letter of transmittal direct to the Adjutant General, and a duplicate retained by the officer.

NOTE 2.—Particular care should be taken to take receipts in duplicate from the Paymaster for any funds turned over to him; one copy should be sent direct to the Adjutant General and one retained by the officer.

1863

INVENTORY OF THE EFFECTS

Received from _____
Commanded _____
Joseph _____

Late of Company _____

9th Reg't of U. S. C. S.

Volunteers who died at Benedict Md

on the 30 day of Dec, 1863.

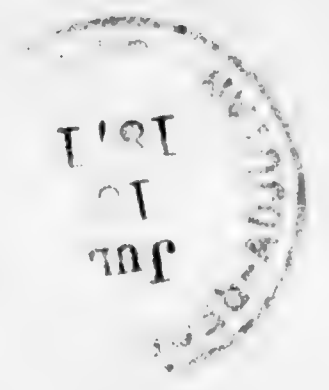

Inventory of the effects of Joseph T. Reed late
a Private of Captain William Cook's Company 6 of
the 9th Regiment of U. S. C. T. Volunteers, who was enrolled as
a recruit at Forest Wharf in the State of Md. on
the 20th day of November 1863, and mustered into the service of the United
States as a private on the 23d day of November 1863, at Camp Santowick
in Company 9, 9th Regiment of U. S. C. T. Volunteers, to serve 3
years or during the war; he was born in (unknown) in the State
of (unknown); he was 19 years of age, 5 feet 3 inches
high, yellow complexion, black eyes, black hair, and by occupation, when enrolled,
a farm hand; he died in hospital, at
Benedict Md on the 3d day of December 1863, by
reason of (disease unknown)

| INVENTORY. | | | | | |
|-------------------------|-----|----------------------------|-----|----------------|-----|
| ARTICLES. | No. | ARTICLES. | No. | ARTICLES. | No. |
| Hats..... | | Pairs trousers..... | | Knapsacks..... | |
| Caps..... | | Pairs flannel drawers..... | | | |
| Forage caps..... | | Pairs cotton drawers..... | | | |
| Great coats..... | | Flannel shirts..... | | | |
| Uniform coats..... | | Cotton shirts..... | | | |
| Uniform jackets..... | | Pairs boots..... | | | |
| Flannel sack coats..... | | Pairs shoes..... | | | |
| Blouses..... | | Pairs socks..... | | | |
| Stable frocks..... | | Blankets..... | | MONEY. | |
| Fatigue overalls..... | | Haversacks..... | | Specie..... | \$ |
| | | | | Notes..... | \$ |

I CERTIFY, ON HONOR, that the above inventory comprises all the effects of
....., deceased, and that the effects are in the hands
of at
..... to be disposed of by a Council of Administration.

(DUPLICATES.)

STATION: Hilton Head S.C. William Cook
Capt 9th U. S. C. T.
Commanding the Company.
DATE: Apr. 9th 1864

Reed, Peter

Co E, 9 U.S. Col'd Inf.

Private Private

CARD NUMBERS.

| | | |
|----|---------|----|
| 1 | 6308097 | 26 |
| 2 | 6308194 | 27 |
| 3 | 6308301 | 28 |
| 4 | 6308405 | 29 |
| 5 | 6308505 | 30 |
| 6 | 6308606 | 31 |
| 7 | 6308703 | 32 |
| 8 | 6308804 | 33 |
| 9 | 6308921 | 34 |
| 10 | 6309860 | 35 |
| 11 | 9068923 | 36 |
| 12 | | 37 |
| 13 | | 38 |
| 14 | | 39 |
| 15 | | 40 |
| 16 | | 41 |
| 17 | | 42 |
| 18 | | 43 |
| 19 | | 44 |
| 20 | | 45 |
| 21 | | 46 |
| 22 | | 47 |
| 23 | | 48 |
| 24 | | 49 |
| 25 | | 50 |

Book Mark: EB. 12/274.

See also

S 716 016 P.O. 9/11/47
#11767892 Aud. W.D.

E.S. Dwyer
→

R | 9 | U.S.C.T.

Peter Reed

, Co. E, 9 Reg't U. S. Col'd Inf.

Appears on

Company Descriptive Book

of the organization named above.

DESCRIPTION.Age 30 years; height 5 feet 4 $\frac{3}{4}$ inches.Complexion *Blk*Eyes *Blk*; hair *Blk*Where born *Accomac Co Va*Occupation *Laborer***ENLISTMENT.**When *Nov 10*, 1863.Where *Accomac Co Va*By whom *Wm Birney*; term *3* y'rs.
*Col + Mustering Officer*Remarks: *Died*

at Point of Rocks Hospital Va Feb 4-1865. Inventory and Final Statements forwarded Feb 11 1865 - Inventory, one Knapsack, one Haversack, one Canteen, one Cap, one Gt-coat, one Uniform coat,

C. S. Rozzell

R | 9 | U.S.C.T.

Peter Reed

Pri, Co. E, 9 Reg't U. S. Col'd Infantry.

Age 30 years.

Appears on

Company Muster-in Roll

of the organization named above, Roll dated

Camp Stanton Charles Co, Md Nov 17, 1863.

Muster-in to date Nov 17, 1863

Joined for duty and enrolled:

When Nov 10, 1863.

Where Accomac Va

Period 3 years.

Remarks:

Book mark:

C. Barker

R | 9 | U.S.C.T.

Peter Reed

Private, Co. E, 9 Reg't U. S. Col'd Infantry.

Appears on

Company Muster Roll

for Nov 17 to Dec 31, 1863.

Present or absent Present

Stoppage, \$ 100 for

Due Gov't, \$ 100 for

Remarks: Two Dollars Recruits

Premium Due

Book mark:

C. C. Parker

(858)

Copyist.

R | 9 | U.S.C.T.

Peter Reed

Private, Co. E, 9 Reg't U. S. Col'd Infantry.

Appears on

Company Muster Roll

for Jan + Feb, 1864.

Present or absent Present

Stoppage, \$ 100 for

Due Gov't, \$ 100 for

Remarks: Two Dollars Recruits Premium Due

Book mark:

C. Parker

R

9

U.S.C.T.

Peter Reed

Pri, Co. E, 9 Reg't U. S. Col'd Infantry.

Appears on

Company Muster Roll

for *Mar + Apr*, 1864.

Present or absent *Present*

Stoppage, \$ *100* for

Due Gov't, \$ *100* for

Remarks: *Two dollars Recruits premium due*

Book mark:

C. C. Parker

(358)

Copyist.

R

9

U.S.C.T.

Peter Reed

Private, Co. E, 9 Reg't U. S. Col'd Infantry.

Appears on

Company Muster Roll

for May - June, 1864.

Present or absent Present

Stoppage, \$ 100 for

Due Gov't, \$ 100 for

Remarks:

Book mark:

C. C. Parker

(358)

Copyist.

R | 9 | U.S.C.T.

Peter Reed

Pr, Co. E, 9 Reg't U. S. Col'd Infantry.

Appears on

Company Muster Roll

for July & Aug, 1864.

Present or absent Present

Stoppage, \$ 100 for

Due Gov't, \$ 100 for

Remarks:

Book mark:

C. C. Parker

R | 9 | U.S.C.T.

Peter Rud

Pr, Co. E, 9 Reg't U. S. Col'd Infantry.

Appears on

Company Muster Roll

for Sept + Oct, 1864.

Present or absent Present

Stoppage, \$ 100 for

Due Gov't, \$ 100 for

Remarks:

Book mark:

C. C. Parker

R | 9 | U.S.C.T.

Peter Reed

Plt, Co. E, 9 Reg't U. S. Col'd Infantry.

Appears on

Company Muster Roll

for Nov & Dec, 1864.

Present or absent Absent

Stoppage, \$ 100 for

Due Gov't, \$ 100 for

Remarks Absent sick in Gen Hospital since Dec 20-64

Book mark:

H. E. Noteman Copyist.

R | 9 | U.S.C.T.

Peter Reed

Pat., Co. E, 9 Reg't U. S. Col'd Infantry.

Appears on

Company Muster Roll

for *May & Selby*, 1865.

Present or absent

Stoppage, \$ 100 for

Due Gov't, \$ 100 for

Remarks: *Lied in Hospital
Pt of Rocks Sac of Typhoid
Fever Feb 14-65 Inventory
and Final Statements forwarded
Feb 11, 1865.*

Book mark: *Lied Feb 4, 65 E 13 274¹²*

J. C. Meteman
(358) copyist.

9

U.S.C.T.

....., Co....., 9 Reg't U. S. Col'd Infantry.

Appears on **Co. Muster-out Roll**, dated

....., 186.....

Muster-out to date 186 ..

Last paid to 186 ..

Clothing account:

Last settled....., 186 ; drawn since \$..... 100

Due soldier \$..... 100; due U. S. \$..... 100

Am't for cloth'g in kind or money adv'd \$..... 100

Due U. S. for arms, equipments, &c., \$..... 100

Bounty paid \$..... 100; due \$..... 100

Remarks:

.....

.....

.....

.....

.....

Book mark:

.....

.....

Reed, Peter

P, Co. *E*, **9** *U. S. C. Inf.*
Reg't

4 Enclosures.

| | |
|-----------------------------------|-------------------------|
| Bed Cards..... | Descriptive Lists..... |
| Burial Records..... | Final Statements..... / |
| Certs. of Dis. for Discharge..... | Furloughs..... |
| C. M. Charges..... | Med. Des. Lists..... |
| Med. Certificates..... | Orders..... |

Other papers relating to—

| | |
|---------------------------------|--------------------------|
| Admission to Hosp'l..... | Furlough..... |
| Casualty Sheet (Officer's)..... | Med. Examination..... |
| Confinement..... | Misc. Information..... |
| Contracts..... | Pay or Clothing..... |
| Death or Effects..... / | Personal Reports..... |
| Desertions..... | Rank..... |
| Discharge from Hosp'l..... | Transfer to Hosp'l..... |
| Discharge from Service..... | Transfer to V. R. C..... |
| Duty..... | Transportation..... |

Inventory of Effects! Slave Claim!

MICROFILM PUBLICATION M 1851

COMPILED MILITARY SERVICE RECORDS
OF VOLUNTEER UNION SOLDIERS WHO SERVED WITH
THE UNITED STATES COLORED TROOPS (USCT)
9TH REGIMENT OF INFANTRY

PERSONAL PAPERS' TARGET SHEET

PLEASE NOTE THE CHECKED INFORMATION ABOUT THE PERSONAL PAPERS IN
THIS FILE:

- NO PERSONAL PAPERS WERE FOUND IN THIS FILE WHEN THE
RECORDS WERE ARRANGED FOR MICROFILMING.
- 10 PERSONAL PAPER(S) FOUND IN THIS FILE WHEN THE RECORDS
WERE ARRANGED FOR MICROFILMING.

A.

No. 1,003. CLAIMANT'S CERTIFICATE.

I, Enoch Reed, a loyal citizen, and a resident
of near Locustville, County of Accomac, State of
Virginia, hereby claim compensation, under the provisions of
General Orders, No. 329, 1863, for my slave Peter Reed
enlisted November tenth, 1863, at Sumner's Barracks
by Col. William Simey, in the ninth
Regiment U. S. Colored Troops, Co. V.; certificate of which enlistment, and a
descriptive list, as required, accompany this application.

In proof of my loyalty to the Constitution and Government of the United States, I
present the accompanying oath, which I have taken, signed, and acknowledged, to be filed
with this application, in accordance with requirement of said General Orders.

Enoch Reed

Given at Camp March 4th 1864 J.P.

B.

OATH OF ALLEGIANCE.

I, Emmeh Reed, do solemnly swear that I have never joined, or been concerned in, any insurrection or rebellion; that I have never borne arms against the United States; that I have never given any aid, countenance, counsel, or encouragement to any person or persons engaged, or whom I had reason to believe were about to engage, in insurrection, rebellion, or armed hostility against the United States; that I have neither sought, nor accepted, nor attempted to exercise the functions of any office, civil or military, nor to perform any service whatever, under any authority or pretended authority in hostility to the United States; that I have not yielded a voluntary support to any insurrection, rebellion, or pretended government, authority, power, or constitution within the United States hostile thereto. And I do further swear that, to the best of my knowledge and ability, I have supported and defended, and will continue to support and defend, the United States against all enemies, foreign and domestic; and that I have supported, defended, and obeyed, and will continue to support, defend, and obey, the Constitution and laws of the United States; that I will bear true faith and allegiance to the same; and that I take this oath freely, without any mental reservation or purpose of evasion: So help me God.

Emmeh Reed

Sworn to and subscribed before me, at Wilmington }
 on this the 4th day of March, 1864.

Jacob M. Ross J.P.



C.

I present herewith evidence of my title to the slave Peter Reed
 _____ enlisted as aforesaid, and in consideration of the sum
 of _____ by me received, I hereby covenant and
 agree with the United States, that I, my heirs, executors, or assigns, shall never hereafter make
 or enforce any claim to the labor or services of said slave; and pledge myself to execute
 a valid Deed of Manumission and Release of all my claims to service forever of said
Peter Reed to be filed with the Board of Claims
 now in session at Baltimore

Wm Reed

4th March, 1864



Accepted for filing
I. No. 25. D. C. T. 1864

No. 1003 No. 2

APPLICATION OF

Enoch Reed

OF

Loenestille, Accomac Co. Va

For Compensation for Service of Slave,

Peter Reed

Enlisted in *9th* Regiment

U. S. Colored Troops, Co. *B*

Received, *March 10th* 1864.

COMPENSATION AWARDED,

May 20th - 1864.

Three Hundred Dollars.

J. Street

President Bd of Claims.

Received
Recd. A. G. O. May 23. 1864

March 30. 1864

STATE OF VIRGINIA

EVIDENCE OF TITLE.

I, Emilio Reed, of Accomac
 County, Virginia, do solemnly swear that Peter Reed
 who has been enlisted in the Ninth Regiment, U. S. Colored Troops,
 Co. I; is my slave for Life; (his term of service expiring on
 the _____ day of his death, ~~186~~;) and that
 I became possessed of him by Marriage, in the month
 of May ^{the 4 day}, eighteen hundred and Thirty Eight. And I
 do further swear that I have not purchased said slave from any person or persons disloyal
 to the Government of the United States, with the object of obtaining compensation for
 the same; and furthermore, that I have no agency for obtaining compensation for any per-
 son or persons but such as, to my knowledge, are loyal citizens of the United States.

Emilio Reed

Accomac Co. V. A. March 1864.

MAR 3 1864

Virginia,
STATE OF MARYLAND,

Accomac County County, to wit:

On this *the fourth* day of *March*, in the year 1864,

before me, the subscriber, a Justice of the Peace of the State and County aforesaid, personally appeared *Enoch Reed*, and took, signed, and acknowl-

edged the oaths preceding, and further made oath, in due form of law, that all the statements made in this application are, to the best of *his* knowledge and belief, strictly

true. Also personally appeared before me *W. H. Cord* and

Abel S. Johnson, loyal citizens of the United States, residents of

Accomac County, well acquainted with the said *Enoch Reed*

, and in no manner interested in the prosecution of this claim, and made oath, in due form of law, that the said *Enoch Reed*

is the owner of the slave *Peter Reed*, as a fact of public noto-

riety: that they believe all the statements herein made by *Enoch Reed*, in reference

thereto, are correct, and that *E. Reed* is unquestionably loyal to the Government of

the United States. Witness their signatures:

William H. Cord
Abel S. Johnson



Jacob H. Rees Justice of the Peace.

MAR 5 11

23

STATE OF ~~MARYLAND~~, *Virginia*

Accomack County, to wit:

I, *J. B. Alworth*, Clerk of the Circuit Court for *Accomack* County, do hereby certify that *Jacob M. Hyslop*,

before whom the foregoing affidavits were made, was, at the time of signing the same, a Justice of the Peace for the County and State aforesaid, duly commissioned and sworn; and that his signature thereto is genuine, and that full faith and credit should be given to his official acts.

Witness my hand and the seal of said Court, this *5th* day of *March*, A. D. 1864.

J. B. Alworth CLERK.



E. Reed

No. .

ABSTRACT OF DISBURSEMENTS.

....., 186 .

Enoch Reed

Dollars *300* ^{*00*}/₁₀₀

Paid , 186 .

NARA 513

The United States,

To *Enoch Reed* Dr.

186 .

For amount awarded him by the Board of Claims, in consideration

of the enlistment of *Peter Reed*

in the *9th Reg't U. S. Colored Troops*

DOLLARS. CENTS.

300 00

Total \$ 300 00

I CERTIFY that the above account is correct and just; that the name of *Peter Reed* is borne on the muster-in rolls of the *9th Reg't U.S. Colored Troops*; and that the above amount was awarded by the Board of which *S. J. Strickland Esq* is President, said award being in accordance with section 24 of the act entitled "An act to amend an act entitled 'An act for enrolling and calling out the national forces, and for other purposes,'" approved Feb. 24, 1864.

Assistant Adjutant General.

RECEIVED

Three Hundred

, 186 , of *Capt S. J. Benedict A. A. G. Vol. 1*, dollars and _____ cents, in full of the above account.

Enoch Reed

(SIGNED DUPLICATES.)

9

No. .

ABSTRACT OF DISBURSEMENTS.

....., 186 .

Enoch Rud

Dollars *300* ^{*00*}/_{*100*}

Paid , 186 .

The United States,

To *Enoch Reed* Dr.

| 186 . | DOLLARS. | CENTS. |
|---|------------|-----------|
| For amount awarded him by the Board of Claims, in consideration of the enlistment of <i>Peter Reed</i> in the <i>9th Regt U.S. Colored Troops</i> | <i>300</i> | <i>00</i> |
| <i>Total \$</i> | <i>300</i> | <i>00</i> |

I CERTIFY that the above account is correct and just; that the name of *Peter Reed* is borne on the muster-in rolls of the *9th Regt U.S. Colored Troops*; and that the above amount was awarded by the Board of which *S. F. Street* is President, said award being in accordance with section 24 of the act entitled "An act to amend an act entitled 'An act for enrolling and calling out the national forces, and for other purposes,'" approved Feb. 24, 1864.

Assistant Adjutant General.

RECEIVED _____, 186 , of *Cap L. G. Benedict A. A. G. W. G.* dollars and _____ cents, in full of the above account.

Enoch Reed

(SIGNED DUPLICATES.)

E.

DEED OF MANUMISSION AND RELEASE OF SERVICE.

Whereas my slave Peter Reed has enlisted in the service of the United States: now, in consideration thereof, I, Enoch Reed, of Accomac county, State of Virginia, do hereby, in consideration of said enlistment, manumit, set free, and release the above-named Peter Reed from all service due me; his freedom to commence from the Tenth of November 1863, the date of his enlistment as aforesaid in the Ninth Regiment of Colored Troops, in the service of the United States.

Witness my hand and seal, this 27th day of April, 1864

Enoch Reed 

Witness:

Louis A. Jamieson
J. P. Thomas
W. W. Carter

Baltimore City
County

State of Maryland, 1864.

Before me appeared this day Enoch Reed, and acknowledged the above Deed of Manumission and Release of Service to be his free act and deed.

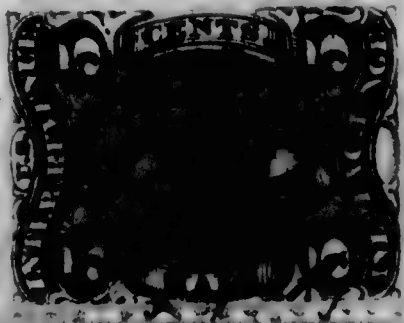

Alford Macer, Clerk
Superior Court Baltimore City

Accomack County Court-Clerks office May 13th 1864
 This Deed of Manumission from Enoch Reed to
 his Slave Peter, together with the Certificate thereof
 thereto annexed, was this day received by me in
 the Clerks office and admitted to record.

J. B. Milwirth C. C.

State of Virginia, Accomack County to wit:
 I do hereby Certify that the foregoing Deed together
 with the Certificate thereof, thereto annexed, is recorded
 in the Clerks office of Accomack County Court.

In Testimony whereof I have hereunto
 subscribed my name and affixed
 the Seal of said Court this 14th day
 of May A.D. 1864.

J. B. Milwirth C. C.

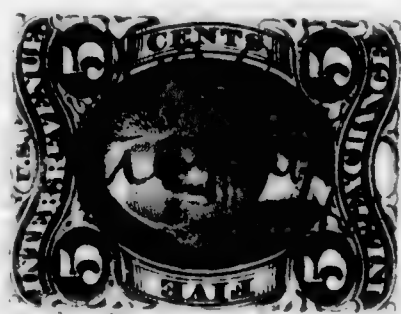

F.

CERTIFICATE OF AWARD OF THE BOARD OF CLAIMS.

70115

Office of the Board of Claims
For Slaves Enlisted in the Service of the United States,

\$800-

Baltimore Md.

May 21st 1864

We hereby certify, that Enoch Reed, of Accomack county, State of Virginia, having proved, under oath, his loyalty to the Constitution and Government of the United States, and established his title as to the ownership of Peter Reed, a slave enlisted at Accomack County Va. on the 10th day of November, 1863, by Col. Wm. Birney, in the service of the United States, in the Ninth Regiment of Colored Troops, Co. E, and having filed a valid Deed of Manumission and Release of Service of said slave, is entitled to the sum of Three Hundred dollars, which has been awarded to him by this Board as a remuneration for all claim to the future labor or service of said slave, under the provision of General Orders, War Department, No. 329, 1863.

J. F. Street

President of the Board.

Wm. Timmons

Member of the Board.

S. C. Stranghn

Member of the Board.

To Maj. C. W. Foster,

Chief of the Bureau for the

Organization of Colored Troops, Washington, D. C.

[OFFICE ENDORSEMENT.]

War Department,

ADJUTANT GENERAL'S OFFICE,

March 16, 1865
The South Carolina State
Reed, Co. C, 9th Reg't U. S.
Colored Troops, is reported as follows:

On Company Muster Roll,
For January, February 1865, February 14, 1865.

Company Muster-out Roll,
February 4, 1865.

Company Descriptive Book,
186

Company Morning Reports,
186

Soldier's Final Statement,
February 4, 1865.

Soldier's Record of Death and Interment,
1865.

Soldier's Inventory of Effects,
February 4, 1865.

Soldier's Certificate of Disability for Discharge,
1865.

Soldier's Individual Muster-out Roll,
1865.

Regimental Return,
For February, 1865, February 4, 1865.

Regimental Quarterly Returns,
February 4, 1865.

Regimental Descriptive Book,
1865.

By Surgeon General,
February 4, 1865, is held to be

the correct date, and the Company Muster
Roll will be amended accordingly.

Thomas M. Stewart
Assistant Adjutant General.

75
FINAL STATEMENT

OF

Perer Reed
9th Reg't of Colored Troops

VOLUNTEERS.

NOTE 1.—Two of these certificates (or duplicates) are to be given to each Volunteer Soldier and a third man who may be discharged without being mustered out (Final statements are never given to men mustered out of service,) that he may once receive from the Paymaster the pay, &c., due him, and the captain or other COMMISSIONED officer commanding the company will certify to the act of the delivery of the duplicate certificates; with these certificates the Soldier is "entitled to" his discharge, and should also present his discharge to the Paymaster to have the payment endorsed on it. The discharge is to be given back to the Soldier by the Paymaster; the latter only retaining as his vouchers the duplicate certificates.

NOTE 2.—If the Soldier is entitled to pay for the use of his horse, the Company Commander will certify to that fact on the back of both these final statements, and also to the time he has pay due for having been so mounted on his own horse.

NOTE 3.—When a Soldier is furnished with final statements, his descriptive list, if he has one, should be taken up by the officer who gives the Soldier these statements, and endorsed with a statement to this effect by the officer. The endorsement should exhibit a full statement of the time for which the Soldier was allowed pay on his final statements, the clothing account, and all other charges against him or in his favor, so as to comprise a complete exhibit of his account. It will then be transmitted to the Company Commander of the Soldier, who will enter all the data necessary to a full understanding of the Soldier's account on the muster roll upon which the Soldier's discharge is reported. The descriptive list will then be destroyed. The object of this is, that the remaining portion of the Soldier's account may be settled upon the receipt of these muster rolls, and the Soldier receive any pay or allowances that may be due him at the time of his discharge, and which may not appear on his last final statements from the fact that his descriptive list is incomplete. These accounts for back pay, &c., are settled by the 2d Auditor of the Treasury Department.

NOTE 4.—Charges for loss or injury to ordnance, horse equipments, and other miscellaneous charges, should appear under the heading of "Other Stoppages."

NOTE 5.—Bounty paid by State authorities, and not by the United States, will not be entered on this statement.

NOTE 6.—Amounts due the Sutler and Laundress must be entered on the muster roll on which the discharge, death, desertion, &c., is reported, as well as on the final statement, otherwise the amount cannot be collected from the United States.

NOTE 7.—This blank will be used for deceased volunteers and drafted men, as well as for others.

NOTE 8.—Where a Soldier dies in Hospital or on detached service, his descriptive list, if he has one, should be sent with his final statements, in duplicate, to the Adjutant General, Washington, D. C.

NOTE 9.—If the soldier is a drafted man or substitute, the space for time, &c., of enrollment, should contain only the word "drafted" or "substitute," as the case may be. If the Soldier is a "VETERAN," (or RECRUIT,) the words "as a veteran," (or recruit,) as the case may be, should be interlined after the words "mustered into the service of the U. S." A statement of all the installments of Veteran or Recruit Bounty RECEIVED by the Soldier must be made on the back of each final statement.

Perer Reed

Co. 1st Regt. 11th Me.
1st S 20 24th Me.

FINAL STATEMENT

OF

75
Perer Reed
4th Reg't of 11th Me.

VOLUNTEERS.

Must July 15 1865.

NOTE 1.—Two of these certificates (or duplicates) are to be given to each Volunteer Soldier or drafted man who may be discharged without being mustered out (Final statements are never given to men mustered out of service,) that he may at once receive from the Paymaster the pay, &c., due him, and the captain or other COMMISSIONED officer commanding the company will certify to the act of the delivery of the duplicate certificates; with these certificates the Soldier is "entitled to" his discharge, and should also present his discharge to the Paymaster to have the payment endorsed on it. The discharge is to be given back to the Soldier by the Paymaster; the latter only retaining as his vouchers the duplicate certificates.

NOTE 2.—If the Soldier is entitled to pay for the use of his horse, the Company Commander will certify to that fact on the back of both these final statements, and also to the time he has pay due for having been so mounted on his own horse.

NOTE 3.—When a Soldier is furnished with final statements, his descriptive list, if he has one, should be taken up by the officer who gives the Soldier these statements, and endorsed with a statement to this effect by the officer. The endorsement should exhibit a full statement of the time for which the Soldier was allowed pay on his final statements, the clothing account, and all other charges against him or in his favor, so as to comprise a complete exhibit of his account. It will then be transmitted to the Company Commander of the Soldier, who will enter all the data necessary to a full understanding of the Soldier's account on the muster roll upon which the Soldier's discharge is reported. The descriptive list will then be destroyed. The object of this is, that the remaining portion of the Soldier's account may be settled upon the receipt of these muster rolls, and the Soldier receive any pay or allowances that may be due him at the time of his discharge, and which may not appear on his last final statements from the fact that his descriptive list is incomplete. These accounts for back pay, &c., are settled by the 2d Auditor of the Treasury Department.

NOTE 4.—Charges for loss or injury to ordnance, horse equipments, and other miscellaneous charges, should appear under the heading of "Other Stoppages."

NOTE 5.—Bounty paid by State authorities, and not by the United States, will not be entered on this statement.

NOTE 6.—Amounts due the Sutler and Landdress must be entered on the muster roll on which the discharge, death, desertion, &c., is reported, as well as on the final statement, otherwise the amount cannot be collected from the United States.

NOTE 7.—This blank will be used for deceased volunteers and drafted men, as well as for others.

NOTE 8.—Where a Soldier dies in Hospital or on detached service, his descriptive list, if he has one, should be sent with his final statements, in duplicate, to the Adjutant General, Washington, D. C.

NOTE 9.—If the soldier is a drafted man or substitute, the space for time, &c., of enrolled, should contain only the word *drafted* or *substitute*, as the case may be. If the Soldier is a "VETERAN," (or RECRUIT,) the words as a *veteran*, (or *recruit*.) as the case may be, should be interlined after the words *mustered into the service of the U. S.* A statement of all the installments of *Veteran or Recruit Bounty RECEIVED* by the Soldier must be made on the back of each final statement.

Perer Reed
Adj. Gen.

ADJUTANT GENERAL'S OFFICE

July 15 1865

Duplicate with Inventory sent 2d Auditor.

I certify, on honor, that Peter Reed, a private of
 Captain D. G. Risley's Company (E) of the 9th Regiment of U.S. Colored
VOLUNTEERS, of the State of _____, born in Accomac Co., State
 of Virginia, aged 30 years; 5 feet 4 3/4 inches high; Black complexion,
Black eyes, Black hair, and by occupation a Laborer, who joined for service
 and was enrolled (see Note 9) on the 10 day of November, 1863, at Accomac Co
 by Col William Birney, for the period of Three years, and mustered into
 the service of the United States on the 17th day of November, 1863, at
Camp Stanton Md., by Colonel William Birney; and having served
 HONESTLY and FAITHFULLY with his Company to the present date, is now entitled to a
DISCHARGE by reason of Death. He died at Point of Rocks

hospital of Typho Malarial Fever on the 4th day of February 1865

The said Peter Reed was last paid by Paymaster
Major Hammond, to include the 31st day of August, 1864, and
 has pay due him from that time to the present date; he is entitled to pay and subsistence for
TRAVELING to place of enrollment, and whatever other allowances are authorized to volunteer
 soldiers, drafted men, or militia, so discharged. He has received from the United States **CLOTHING**
 amounting to Fifty two $\frac{90}{100}$ dollars, since the 10th day of November,
 1863, when his clothing account was last settled. He has received from the United States
but seven $\frac{00}{100}$ dollars ~~advanced BOUNTY~~ per month for service prior to April 30 1864

There is to be stopped from him, on account of the State of _____, or other
 authorities, for **CLOTHING, &c.**, received on entering service, nothing $\frac{00}{100}$ dollars; and
 for other stoppages, viz: One Knapsack one Haversack and
one canteen

Three $\frac{27}{100}$ dollars.
 He has been furnished with **TRANSPORTATION** in kind from the place of his discharge to
 _____; and he has been **SUBSISTED** for **TRAVELING** to his
 place of enrollment, up to the _____, 186 .

He is indebted to _____, **SUTLER**, _____ $\frac{00}{100}$ dollars.
 He is indebted to _____, **LAUNDRESS**, _____ $\frac{00}{100}$ dollars.

Given in Duplicate, at Camp of the 9th U.S. Col. Troop, this 11 day
 of February, 1865.

George O Murray
1st Lt 9th U.S. Col. T.
 Commanding Company. E

ARTICLES OF WAR.

ART. 95. When any non-commissioned officer or soldier shall die or be killed in the service of the United States, the then commanding officer of the troop or company shall, in the presence of two other commissioned officers, take an account of what effects he died possessed of, also his arms and accoutrements, and transmit the same to the office of the Department of War, which said effects are to be accounted for, and paid to the representatives of such deceased non-commissioned officer or soldier. And in case any of the officers, so authorized to take care of the effects of deceased officers and soldiers, should, before they have accounted to their representatives for the same, have occasion to leave the regiment or post, by preferment or otherwise, they shall, before they be permitted to quit the same, deposit in the hands of the commanding officer, or of the assistant military agent, all the effects of such deceased non-commissioned officers and soldiers, in order that the same may be secured for, and paid to, their respective representatives.

ARMY REGULATIONS—EDITION OF 1861.

DECEASED SOLDIERS.

Par. 152. Inventories of the effects of deceased non-commissioned officers and soldiers, required by the 95th Article of War, will be forwarded to the Adjutant General, by the commander of the company to which the deceased belonged, and a duplicate of the same to the colonel of the regiment. Final statements of pay, clothing, &c., will be sent with the inventories. When a soldier dies at a post or station absent from his company, it will be the duty of his immediate commander to furnish the required inventory, and, at the same time, to forward to the commanding officer of the company to which the soldier belonged, a report of his death, specifying the date, place, and cause; to what time he was last paid, and the money or other effects in his possession at the time of his decease; which report will be noted on the next muster roll of the company to which the man belonged. Each inventory will be endorsed, "Inventory of the effects of _____, late _____ company (—) _____ regiment of _____, who died at _____, the _____ day of _____, 186—." If a legal representative receive the effects, it will be stated in the report. If the soldier leave no effects, the fact will be reported.

Par. 153. Should the effects of a deceased non-commissioned officer or soldier not be administered upon within a short period after his decease, they shall be disposed of by a Council of Administration, under the authority of the commanding officer of the post, and the proceeds deposited with the Paymaster, to the credit of the United States, until they shall be claimed by the legal representatives of the deceased.

Par. 154. In all such cases of sales by the Council of Administration, a statement in detail, or account of the proceeds, duly certified by the Council and commanding officer, accompanied by the Paymaster's receipt for the proceeds, will be forwarded by the commanding officer to the Adjutant General. The statement will be endorsed, "Report of the proceeds of the effects of _____, late of company (—) _____ regiment of _____, who died at _____, the _____ day of _____, 186—."

NOTE 1.—The effects in all cases, when called for, should be turned over to the legal representative, without further authority from the Adjutant General. When the effects are turned over to the relatives of the deceased before these inventories are sent to the Adjutant General, their receipts therefor should be attached to the inventories. In all other cases, one copy will be sent with a letter of transmittal direct to the Adjutant General, and a duplicate retained by the officer.

NOTE 2.—Particular care should be taken to take receipts in duplicate from the Paymaster for any funds turned over to him; one copy should be sent direct to the Adjutant General and one retained by the officer.

INVENTORY OF THE EFFECTS

OF

Peter U. Reed

Late of Company "C"

9th Reg't of U. S. Colored

Volunteers, who died at Point of Rocks, Pa

on the 4th day of February 1865.



Inventory of the effects of Peter Reed late
 a private of Captain Douglas G. Risley's Company "E" of
 the 9th Regiment of U.S. Colored Volunteers, who was enrolled as
 a private at Accomac Co in the State of Virginia on
 the 10th day of November 1863, and mustered into the service of the United
 States as a private on the 17 day of November 1863, at Camp Stanton Md
 in Company "E", 9th Regiment of U.S. Colored Volunteers, to serve three
 years or during the war; he was born in Accomac County in the State
 of Virginia; he was 30 years of age, 5 feet 4 3/4 inches
 high, Black complexion, Black eyes, Black hair, and by occupation, when enrolled,
 a laborer; he died in Hospital, at
Point, Rocks Va on the 4 day of February 1865, by
 reason of Typho Malarial Fever,

| INVENTORY. | | | | | |
|-------------------------|-----|----------------------------|-----|--------------------|-----|
| ARTICLES. | No. | ARTICLES. | No. | ARTICLES. | No. |
| Hats..... | | Pairs trousers..... | | Knapsacks..... | / |
| Caps..... | | Pairs flannel drawers..... | | <u>Coats</u> | / |
| Forage caps..... | / | Pairs cotton drawers..... | | | |
| Great coats..... | / | Flannel shirts..... | | | |
| Uniform coats..... | / | Cotton shirts..... | | | |
| Uniform jackets..... | | Pairs boots..... | | | |
| Flannel sack coats..... | | Pairs shoes..... | | | |
| Blouses..... | | Pairs socks..... | | | |
| Stable frocks..... | | Blankets..... | | | |
| Fatigue overalls..... | | Haversacks..... | / | | |
| | | | | MONEY. | |
| | | | | Specie..... | \$ |
| | | | | Notes..... | \$ |

I CERTIFY, ON HONOR, that the above inventory comprises all the effects of Peter
Reed late private of Co. "E" 9th U.S.C.V. deceased, and that the effects are in the hands
 of The Executive Officer at Hospital point of
Rocks Va to be disposed of by a Council of Administration.

(DUPLICATES.)

STATION: In the Field Va

DATE: February 11-1865

Geo O Murray
Lt 9th U.S.C.V.
 Commanding the Company.

ARTICLES OF WAR.

ART. 95. When any non-commissioned officer or soldier shall die, or be killed in the service of the United States, the then commanding officer of the troop or company shall, in the presence of two other commissioned officers, take an account of what effects he died possessed of, above his arms and accoutrements, and transmit the same to the office of the Department of War, which said effects are to be accounted for, and paid to the representatives of such deceased non-commissioned officer or soldier. And in case any of the officers, so authorized to take care of the effects of deceased officers and soldiers, should, before they have accounted to their representatives for the same, have occasion to leave the regiment or post, by preferment or otherwise, they shall, before they be permitted to quit the same, deposit in the hands of the commanding officer, or of the assistant military agent, all the effects of such deceased non-commissioned officers and soldiers, in order that the same may be secured for, and paid to, their respective representatives.

ARMY REGULATIONS—EDITION OF 1863.

DECEASED SOLDIERS.

Par. 152. Inventories of the effects of deceased non-commissioned officers and soldiers, required by the 95th Article of War, will be forwarded to the Adjutant General, by the commander of the company to which the deceased belonged, and a duplicate of the same to the colonel of the regiment. Final statements of pay, clothing, &c., in duplicate, will be sent to the Adjutant General with one copy of the inventory. When a soldier dies at a post or station absent from his company, it will be the duty of his immediate commander to furnish the required inventory and final statements, and, at the same time, to forward to the commanding officer of the company to which the soldier belonged, a report of his death, specifying the date, place, and cause; to what time he was last paid, and the money or other effects in his possession at the time of his decease; which report will be noted on the next muster roll of the company to which the man belonged. Each inventory will be endorsed, "Inventory of the effects of _____, late of company (—) _____ regiment of _____, who died at _____, the _____ day of _____, 186—." If a legal representative receive the effects, it will be stated in the report. If the soldier leave no effects, the fact will be reported.

Par. 153. Should the effects of a deceased non-commissioned officer or soldier not be administered upon within a short period after his decease, they shall be disposed of by a Council of Administration, under the authority of the commanding officer of the post, and the proceeds deposited with the Paymaster, to the credit of the United States, until they shall be claimed by the legal representatives of the deceased.

Par. 154. In all such cases of sales by the Council of Administration, a statement in detail, or account of the proceeds, duly certified by the Council and commanding officer, accompanied by the Paymaster's receipt for the proceeds, will be forwarded by the commanding officer to the Adjutant General. The statement will be endorsed, "Report of the proceeds of the effects of _____, late of company (—) _____ regiment of _____, who died at _____, the _____ day of _____, 186—."

NOTE 1.—The effects in all cases, when called for, should be turned over to the legal representative, without further authority from the Adjutant General. When the effects are turned over to the relatives of the deceased before these inventories are sent to the Adjutant General, their receipts therefor should be attached to the inventories. In all other cases, one copy will be sent with a letter of transmittal direct to the Adjutant General, and a duplicate retained by the officer.

NOTE 2.—Particular care should be taken to take receipts in duplicate from the Paymaster for any funds turned over to him; one copy should be sent direct to the Adjutant General and one retained by the officer.

INVENTORY OF THE EFFECTS

OF

Peter Reed

Late of Company *E*

9 Reg't of *W. V. I.*

Volunteers, who died at *St. of Rocky Mts. Hospital*
on the *4* day of *February* 186*6*.

An Inventory of the effects
complete

This Inventory filed
Sept 20 1900

HSD

Inventory of the effects of Peter Reed late
a Private of Captain _____ Company E of
the 9th Regiment of Co. S. C. I. Volunteers, who was enrolled as
a _____ at _____ in the State of _____ on
the _____ day of _____ 1865, and mustered into the service of the United
States as a _____ on the _____ day of _____ 1865, at _____
in Company _____, _____ Regiment of _____ Volunteers, to serve _____
years or during the war; he was born in _____ in the State
of _____; he was _____ years of age, _____ feet _____ inches
high, _____ complexion, _____ eyes, _____ hair, and by occupation, when enrolled,
a _____; he died in Point of Rocks, Md., at
Point of Rocks, Md. on the 4th day of February 1865, by
reason of Egyptic Mal Fever

| INVENTORY. | | | | | |
|-------------------------|-----|----------------------------|-----|----------------------|-----|
| ARTICLES. | No. | ARTICLES. | No. | ARTICLES. | No. |
| Hats..... | | Pairs trousers..... | | Knapsacks..... | / |
| Caps..... | | Pairs flannel drawers..... | | <u>Canteen</u> | / |
| Forage caps..... | / | Pairs cotton drawers..... | | | |
| Great coats..... | / | Flannel shirts..... | | | |
| Uniform coats..... | / | Cotton shirts..... | | | |
| Uniform jackets..... | | Pairs boots..... | | | |
| Flannel sack coats..... | | Pairs shoes..... | | | |
| Blouses..... | | Pairs socks..... | | | |
| Stable frocks..... | | Blankets..... | | | |
| Fatigue overalls..... | | Haversacks..... | / | | |
| | | | | MONEY. | |
| | | | | Specie..... | \$ |
| | | | | Notes..... | \$ |

I CERTIFY, ON HONOR, that the above inventory comprises all the effects of Pat.
Peter Reed, deceased, and that the effects are in the hands
of Surg. H. B. Fowler at Point of Rocks, Md.
_____ to be disposed of by a Council of Administration.

(DUPLICATES.)

STATION: Point of Rocks, Md.
DATE: February 5 1865

H. B. Fowler
Surg. 12th W. V. Regt.
Commanding the Company.
In Charge

936
Reynolds, James A
Co F, 9 U.S. Col'd Inf.

Private Private

CARD NUMBERS.

| | | |
|----|---------|----|
| 1 | 6299977 | 26 |
| 2 | 6310643 | 27 |
| 3 | 6310743 | 28 |
| 4 | 6310840 | 29 |
| 5 | 6310933 | 30 |
| 6 | 6311016 | 31 |
| 7 | 6311118 | 32 |
| 8 | 6300363 | 33 |
| 9 | 6311621 | 34 |
| 10 | 9069082 | 35 |
| 11 | | 36 |
| 12 | | 37 |
| 13 | | 38 |
| 14 | | 39 |
| 15 | | 40 |
| 16 | | 41 |
| 17 | | 42 |
| 18 | | 43 |
| 19 | | 44 |
| 20 | | 45 |
| 21 | | 46 |
| 22 | | 47 |
| 23 | | 48 |
| 24 | | 49 |
| 25 | | 50 |

Book Mark:

See also

S-1007452-P.O. MRM
D1873644 P O aff

S 1873642 P O aff

S 3024035-P.O. RM

C. E. Doughty

ca

R | 9 | U.S.C.T.
James A Reynolds
Co. F, 9 Reg't U. S. Col'd Inf.

Appears on
Company Descriptive Book
of the organization named above.

DESCRIPTION.

Age 20 years; height 5 feet 4 inches.
Complexion Black
Eyes Black; hair Black
Where born Virginia
Occupation Farmer

ENLISTMENT.

When Oct 3, 1864.
Where Baltimore Md
By whom Capt Castner; term One yrs.
Remarks: Discharged Oct 10-1864 at Brownsville Tex & granted term of service

L B Singer
Copyist.

R. | 7 | **U.S.C.T.**

James A. Reynolds.

Appears with rank of _____ on

Muster and Descriptive Roll of a Detachment of Drafted Men and Substitutes forwarded

for the 9 Reg't U. S. Col'd Inf. Roll dated

Baltimore Md Oct 7, 1864.

Where born va.

Age 20 years; occupation farmer

~~enlisted~~

~~Drafted~~ and mustered in:

When Oct 3 1864.

Where Baltimore

Period one years

Eyes blk; hair blk

Complexion blk; height 5 ft. 4 in.

Paid bounty and advance pay, \$ 100

Bounty due \$ 100

Where credited _____

Company to which assigned _____

Remarks: Substitute for Edward E. Frazier 2 Dist Md.

Book mark: By G. D. Dougherty

A. H. Pratt

9

Roll 1005

James A. Reynolds

Appears with rank of _____ on _____

Muster and Descriptive Roll

of Detachment of US Substitutes
Drafted men turned over to
Col. S. M. Bowman. Roll dated
Camp Bradford, Md, Oct 12, 1864.

Where born Virginia

Age 20 years; occupation Farmhand

When enlisted Oct 3, 186 .

Where enlisted Balto, Md

For what period enlisted 1 years.

Eyes Blk; hair Blk

Complexion Blk; height 5 ft. 4 in.

When mustered in Oct. 3, 186 .

Where mustered in _____

Bounty paid \$ 100; due \$ 100

Clothing account:

Last settled _____, 186 ; drawn since \$ 29 10/100

Date of first muster _____, 186 .

Company to which assigned _____

Remarks: Substitute for
Edward E. Frazier, 2nd Dist.
Md.

Book mark : _____

J D McCaw

R | 9 | U.S.C.T.

James A. Reynolds
 Priv., Co. F, 9 Reg't U. S. Col'd Infantry.

Appears on

Company Muster Roll

for Nov. & Dec., 1864.

Present or absent Present

Stoppage, \$ 100 for

Due Gov't, \$ 100 for

Remarks: Recruit assigned
 from depot. Due
 the difference between
 seven dollars per month
 and thirteen dollars
 per month from Jan. 1
 1864 to Apr 30, 1864

Book mark:

E. Thosman

R

9

U.S.C.T.

James A. Reynolds
Priv., Co. F, 9 Reg't U. S. Col'd Infantry.

Appears on

Company Muster Roll

for Jan. & Feb., 1865.

Present or absent Present

Stoppage, \$ 100 for

Due Gov't, \$ 100 for

Remarks:

Book mark:

E. L. Stanton

R | 9 | U.S.C.T.

James A. Reynolds
Priv, Co. F, 9 Reg't U. S. Col'd Infantry.

Appears on

Company Muster Roll

for March & Apr, 1865

Present or absent Present

Stoppage, \$ 100 for

Due Gov't, \$ 100 for

Remarks:

Book mark: 2

E. L. Tharnton

R | 9 | U.S.C.T.

James A. Reynolds
Priv., Co. F, 9 Reg't U. S. Col'd Infantry.

Appears on

Company Muster Roll

for *May & June*, 1865.

Present or absent *Present*

Stoppage, \$ *100* for

Due Gov't, \$ *100* for

Remarks: *Stop for reserve
driver, super & companion
\$0.45.*

Book mark:

E. L. Shannon

R | 9 | U.S.C.T.

James A. Reynolds
Priv, Co. F, 9 Reg't U. S. Col'd Infantry.

Appears on

Company Muster Roll

for July & Aug, 1865.

Present or absent Present

Stoppage, \$ 100 for

Due Gov't, \$ 100 for

Remarks:

Book mark:

E. L. Shaw

(358)

Copist

R

9

U.S.C.T.

James A. Reynolds
Put, Co. F, 9 Reg't U. S. Col'd Infantry.

Appears on

Company Muster Roll

for *June 30 to Oct 31*, 1865.

Present or absent.....

Stoppage, \$.....100 for.....

Due Gov't, \$.....100 for.....

Remarks: *Discharged Oct 19/65*
at Brownsville, Texas,
on expiration of service.

Book mark: *Discharged Oct 9/65. E.B.*
12/284.

D. A. Ward

(358)

Copyist

R. 1 9 U.S.C.T.

James A. Reynolds
Inf^{try}, Co. 5, 9 Reg't U. S. Col'd Inf.

Appears on an

Individual Muster-out Roll

of the organization named above. Roll dated
Brownsville Tex, Oct 1, 1865.

Muster-out to date Oct 6, 1865.

Last paid to June 30, 1865.

Clothing account:

Last settled....., 186 ; drawn since ^{since enlistment} \$ 65 ⁶³/₁₀₀

Due soldier \$ 100; due U. S. \$ 100

Am't for cloth'g in kind or money adv'd \$ 100

Due U. S. for arms, equipments, &c., \$ 100

Bounty paid \$ 100; due \$ 100

Remarks: No evidence on the Company
Records of his having received any
bounty. x Bounty due to G.O.
No 224 War Dept series 164 \$100.00

Mustered by reason of expiration of term of service.
x As appears on Roll.

Book mark:

W. O. Chance

R | 9 | U.S.C.T.

James H. Reynolds
Pr, Co. *F*, 9 Reg't U. S. Col'd Infantry.

Appears on **Co. Muster-out Roll**, dated
New Orleans, La., Nov. 26, 1866.

Muster-out to date _____, 186 .
 Last paid to _____, 186 .

Clothing account:

Last settled _____, 186 ; drawn since \$ _____ 100

Due soldier \$ _____ 100; due U. S. \$ _____ 100

Am't for cloth'g in kind or money adv'd \$ _____ 100

Due U. S. for arms, equipments, &c., \$ _____ 100

Bounty paid \$ _____ 100; due \$ _____ 100

Remarks: *Joined as Substitute*
Discharged Oct. 10/65 at
Brownsville, Tex. by
reason of expiration of
term of service.

Book mark: *Discharged Oct. 6/65*
(over)

(861) *J. E. Nichol* Copyist.

JAN. 21

6311621

1891

E. B. $\frac{12}{2.84}$

Reynolds, James A.
Pri, Co. 7, 9 Reg U. S. C. Inf.

2 Enclosures.

| | |
|------------------------------------|-------------------------|
| Bed Cards | Descriptive Lists |
| Burial Records | Final Statements |
| Certs. of Dis. for Discharge | Furloughs |
| C. M. Charges | Med. Des. Lists |
| Med. Certificates | Orders |

EP

Other papers relating to—

| | |
|----------------------------------|----------------------------|
| Admission to Hosp'l | Furlough |
| Casualty Sheet (Officer's) | Med. Examination |
| Confinement | Misc. Information / |
| Contracts | Pay or Clothing |
| Death or Effects | Personal Reports |
| Desertions | Rank |
| Discharge from Hosp'l | Transfer to Hosp'l |
| Discharge from Service / | Transfer to V. R. C. |
| Duty | Transportation |

MICROFILM PUBLICATION M1851

COMPILED MILITARY SERVICE RECORDS
OF VOLUNTEER UNION SOLDIERS WHO SERVED WITH
THE UNITED STATES COLORED TROOPS (USCT)
9TH REGIMENT OF INFANTRY

PERSONAL PAPERS' TARGET SHEET

PLEASE NOTE THE CHECKED INFORMATION ABOUT THE PERSONAL PAPERS IN
THIS FILE:

- NO PERSONAL PAPERS WERE FOUND IN THIS FILE WHEN THE
RECORDS WERE ARRANGED FOR MICROFILMING.
- 3 PERSONAL PAPER(S) FOUND IN THIS FILE WHEN THE RECORDS
WERE ARRANGED FOR MICROFILMING.

DECLARATION OF SUBSTITUTE.

I, James C Reynolds desiring to ENLIST in the Army of the United States, for THREE YEARS, **Do declare**, That I am Twenty years and _____ months of age; that I have never been discharged from the United States service on account of disability or by sentence of a court martial; and I know of no impediment to my serving honestly and faithfully as a soldier for ^{me} ~~three~~ years.

GIVEN at Ball's Mill the 3rd day of October 1864

WITNESS Wm Taylor James C Reynolds
Wm Taylor *James C Reynolds*

01

No. _____

James C Reynolds Recd

Enlisted at Ball's Mill

As Substitute for

William E. Thayer

On the 3rd day of Oct, 1864.

By

Robert Matthews

Genl J. Chapman

J. Pitt Ward

Board of Enrollment,
Dist. of Me

(No. 39.)

SUBSTITUTE VOLUNTEER ENLISTMENT.

STATE OF

TOWN OF

Virginia



Baltimore

I, James A Reynolds born in the State of Virginia, aged twenty years, and by occupation a Farmer Do HEREBY ACKNOWLEDGE to have agreed with Edward E. Frazier, Esq., of 3rd Dist

2nd Dist Maryland to become his **SUBSTITUTE** in the Military Service, for a sufficient consideration paid and delivered to me, on the third day of October, 1864 and having thus agreed with said Edward E. Frazier, I DO HEREBY ACKNOWLEDGE to have enlisted this third day of October 1864 to serve as a **Soldier** in the **Army of the United States of America**, for the period of **THREE YEARS**, unless sooner discharged by proper authority: I do also agree to accept such bounty, pay, rations, and clothing, as are, or may be, established by law for soldiers. And I do solemnly swear that I will bear true and faithful allegiance to the **United States of America**; that I will serve them honestly and faithfully against all their enemies or opposers whomsoever; and that I will observe and obey the orders of the President of the United States, and the orders of the Officers appointed over me, according to the Rules and Articles of War.

SWORN and subscribed to, at Baltimore this 3rd day of Oct 1864 BEFORE Robert G. Gathens James A. Reynolds Cap & Prov Mar 2nd Dist Md

We certify, on honor, That we have carefully examined the above-named Volunteer Substitute agreeably to the Regulations, and that, in our opinion, he is free from all bodily defects and mental infirmity which would in any way disqualify him from performing the duties of a soldier; that he was entirely sober when enlisted; that he is of lawful age, (not under 18 years;) and that, in accepting him as duly qualified to perform the duties of an able-bodied soldier, and as a Substitute in lieu of Edward E. Frazier Enrolled for Draft, drafted in 3rd Dist 2nd Dist Md, 1864, we have strictly observed the Regulations which govern in such cases. This soldier has black eyes, black hair, black complexion; is 5 feet 11 inches high.

Robert G. Gathens
Cap & Provost Marshal

Genl A. Chapman
Commissioner of Board

J. Robt. Ward
Surgeon of Board

Board of Enrollment of 2nd Dist of Maryland

James A Reynolds,
~~Port Co St 9th Dec~~

Mr Ellbrook,

noted

to be
sent

Adjutant General's Office,

COLORED TROOPS BRANCH,

March 20th, 1877

Mr. Ellertson.

Vol. C. T., 187

Wanted in the case of James Reynolds, Co. F,
9th Reg't U.S. Troops.

Record of trial re
Reg't Ret'n for Sept 1865. Report him "Absent in confinement
awaiting trial Sept. 1865."

Respectfully,

W. A. Woodward,
Chief Clerk.

In H. A. L. S. O.

Adjutant General's Office,

Div of Discontinued Cases

April 6, 1877

Vol. C. T., 187

Reply in case of James A. Reynolds, Co. "F",
9th Reg't U. S. C. Troops.

"Main Report B. Co. Sept. 14th 1865 Report
him "confined at Brownsville Texas."
Reg't B. Co. Dec. B. Co. Report him mustered
out by reason of term of service at
Brownsville Texas October 10th 1865."
Reg't B. Co. records furnish no evidence
of return to duty or trial.

MS

46677 B. 16

[OFFICE]

War Department,

ADJUTANT GENERAL'S OFFICE,

March 24, 1871

The Discharge of Private James
C. Reynolds, Co. G, 9th Regt U. S.
Colored Troops, is reported as follows:

- On Company Muster Roll.
For Muster October, 1865, October 10, 1865
- Company Muster-out Roll.
October 10, 1865
- Company Descriptive Book., 1865
- Company Morning Reports., 1865
- Soldier's Final Statement., 1865
- Soldier's Record of Death and Interment., 1865
- Soldier's Inventory of Effects., 1865
- Soldier's Certificate of Disability for Discharge., 1865
- Soldier's Individual Muster-out Roll.
October 6, 1865
- Regimental Return.
For October, 1865, October 6, 1865
- Regimental Quarterly Returns., 1865
- Regimental Descriptive Book., 1865
- By Surgeon General.
() 1865

See Attention to Discharge of Private Reynolds

the correct date, and the Company Muster Roll will be amended accordingly.

Thomas M. Swann

Assistant Adjutant General.

Wm. C. Hall

[Faint handwritten notes]

⁹³⁷
Rhodes, Stephen H

Co D. H. 9 U.S. Col'd Inf.

Lieutenant | Captain

CARD NUMBERS.

| | | | |
|----|---------|----|---------------|
| 1 | 6299930 | 26 | 6314970 |
| 2 | 6306245 | 27 | 9428823 |
| 3 | 6306345 | 28 | 9428843 |
| 4 | 6306450 | 29 | 9428853 |
| 5 | 6306550 | 30 | R-109-01-1863 |
| 6 | 6306650 | 31 | |
| 7 | 6306750 | 32 | |
| 8 | 6306845 | 33 | |
| 9 | 6306946 | 34 | |
| 10 | 6307981 | 35 | |
| 11 | 6300558 | 36 | |
| 12 | 6300571 | 37 | |
| 13 | 6300585 | 38 | |
| 14 | 6300599 | 39 | |
| 15 | 6300613 | 40 | |
| 16 | 6300627 | 41 | |
| 17 | 6300642 | 42 | |
| 18 | 6300655 | 43 | |
| 19 | 6300724 | 44 | |
| 20 | 6300364 | 45 | |
| 21 | 6299931 | 46 | |
| 22 | 6314731 | 47 | |
| 23 | 6314792 | 48 | |
| 24 | 6314853 | 49 | |
| 25 | 6314912 | 50 | |

Book Mark: 1572.C.T.8a-1846 C.T.87.
R-109-01-1863

See also 349 mass fols

S 2135-135 P.O. MTH

G. E. Dwyer

R | *9* | U.S.C.T.

Stephen H. Rhodes

1st Lt., Co., *9* Reg't U. S. Col'd Inf.

Appears on

Regimental Descriptive Book
(List of Commissioned Officers)

of the regiment named above.

Rank *1st Lieut*

Date of appointment *Nov 5*, 1863.

Remarks: *# Sergeant* ~~*Private*~~ *311* Mass.

Inf. Wounded at Deep Bottom Aug 16/64.

App'd Capt 9 U.S. Ct
Jan 1/65.

App't Capt. Feb 21/66.

Promoted Capt 9 U.S. Ct.

Feb 21. 1866, by order of
the President

See on back

Harmon

1619 U.S.C.T.

Stephen D. Rhodes
1st Lt., Co. "A" Reg't U. S. Col'd Infantry.

Age 24 years.

Appears on an

Individual Muster-in Roll

of the organization named above. Roll dated
Charles Co., Md., Nov 22, 1863.

Muster-in to date Nov 22, 1863.

Joined for duty and enrolled:

When Nov 22, 1863

Where Camp Sigourney Md

Period 3 years.

Remarks: Assigned to Co.
"A" U.S.C.I.

Book mark: R-109-07-1863

W. D. [Signature]
Copyist.

R | 9 | U.S.C.T.

Stephen H. Rhodes
1st Lieut., Co. D, 9 Reg't U. S. Col'd Infantry.

Appears on

Company Muster Roll

for *period* *Nov. 14* " to *Dec. 31*, 1863.

Present or absent *Present*

Stoppage, \$ *100* for

Due Gov't, \$ *100* for

Remarks: *Appointment dated*
was *Sept* *Nov. 5* - 1863
joined for duty per
special order No 5
dated *Nov 77* - 1863.
Hogers. Camp. Stanton
Mo.

Book mark:

J. E. Parks

(358)

Copyist

R | 9 | U.S.C.T.

Stephen A. Rhodes
1st Lt., Co. D, 9 Reg't U. S. Col'd Infantry.

Appears on

Company Muster Roll

for *Jan, & Feb.*, 186 *4*

Present or absent *Present*

Stoppage, \$ *100* for

Due Gov't, \$ *100* for

Remarks: *absent with*
leave eight days
per special order
no. 16 dated Hdqrs
Middle Dept. Baltimore
MD Jan 19th - 1864.
absent without leave
one day Feb. 2nd 1864.

Book mark: _____

J. E. Purke

(858)

Copyist

R

9

U.S.C.T.

Stephen H. Rhodes
1st Lt., Co. D, 9 Reg't U. S. Col'd Infantry.

Appears on

Company Muster Roll

for *Mar Paper*, 186 *4*

Present or absent *Present*

Stoppage, \$ *100* for

Due Gov't, \$ *100* for

Remarks:

Book mark:

J. E. Purke

(858)

Copyist

R

9

U.S.C.T.

Stephen H. Rhodes
1st Lt., Co. D, 9 Reg't U. S. Col'd Infantry.

Appears on

Company Muster Roll

for May & June, 1864

Present or absent absent

Stoppage, \$ 100 for

Due Gov't, \$ 100 for

Remarks: absent with
leave (8) eight days
per special order No
16, dated Hager, Middle
Sept. on detached ser-
vice per special or-
der No. 126 dated Hg.
ago, Beauford S.C.,
June 15 " 1864.

Book mark:

J. E. Parks
Copyist

9

U.S.C.T.

Stephen H. Rhodes
1st Lt., Co. D, 9 Reg't U. S. Col'd Infantry.

Appears on

Company Muster Roll

for *July & Aug.*, 1864.

Present or absent *absent*

Stoppage, \$ *100* for

Due Gov't, \$ *100* for

Remarks: *absent sick in*
Gen Hays' in conse-
quence of wound
received in action
near Deep Bottom
Val. Aug. 10 1864.

Book mark:

J. E. Parks

(858)

Copyist

R | 9 | U.S.C.T.

Stephen H. Rhodes
1st Lt., Co. D, 9 Reg't, U. S. Col'd Infantry.

Appears on

Company Muster Roll

for Sep & Oct, 1864

Present or absent Present

Stoppage, \$ 100 for

Due Gov't, \$ 100 for

Remarks: Absent sick
in Gen Hosp. of
wounds received in
action near Deep
Cotton Va Aug 16-1864
Returned Oct 12, 1864
present sick

Book mark:

J. E. Rourke

(358)

Copyist

R | 9 | U.S.C.T.

Stephen H. Rhodes
1st Lt., Co. D, 9 Reg't U. S. Col'd Infantry.

Appears on

Company Muster Roll

for Nov. 1st Dec., 1864

Present or absent Present

Stoppage, \$ 100 for

Due Gov't, \$ 100 for

Remarks: Acting Adjutant
per Field order
since Oct. 17, 1864

Book mark:

J. E. Rupp

(358)

Copyist

R

9

U.S.C.T.

Stephen H. Rhodes

1st Lt., Co. D, 9 Reg't U. S. Col'd Infantry.

Appears on

Company Muster Roll

for Jan'y & Feb'y, 1865.

Present or absent Absent

Stoppage, \$ 100 for

Due Gov't, \$ 100 for

Remarks: Accepted Adjt
9th U.S.C.T. per Ser.
No. 14. Hd Qrs. 9th U.S.C.T.
dated Feb'y 1865.

Book mark:

J. M. Harmon

(358)

Copyist

R. | 9 | U.S.C.T.

Stephen H. Rhodes

1st Lt., Co. D, 9 Reg't U. S. Col'd Infantry.

Appears on Co. Muster-out Roll, dated New Orleans La, 26th Nov, 1866.

Muster-out to date _____, 186 .

Last paid to _____, 186 .

Clothing account:

Last settled _____, 186 ; drawn since \$ _____ 100

Due soldier \$ _____ 100; due U. S. \$ _____ 100

Am't for cloth'g in kind or money adv'd \$ _____ 100

Due U. S. for arms, equipments, &c., \$ _____ 100

Bounty paid \$ _____ 100; due \$ _____ 100

Remarks: Lost.

Joined at original
company, App'd Adj't
Feb 1/65.

Book mark: 1572 C.F. 80 = 1846 C.F. 87

G. E. Dayton

(861)

Copyist.

P. 1 U.S.C.T.

Stephen H. Rhodes

Rank *Adj.*, 4. Reg't U. S. Col'd Infantry.

Appears on

Field and Staff Muster Roll

for *Jan & Feb.*, 1865.

Present or absent *Present*

Stoppage, \$ 100 for

Due Gov't, \$ 100 for

Valuation of horse, \$ 100

Valuation of horse equipments, \$ 100

Remarks: *Appointed Adjutant*
since Stewart detached
to rank as such from
the first day of January
1865 for 80 Days Reg't
of U.S.C.I. Feb 6, 1865. Stop
in lieu of rations for the month
of Jan & Feb, 1865.

**As entry appears on Roll*

Book mark:

W. Kelley
Compt.

P *4* **U.S.C.T.**

Stephen B. Rhodes

Rank *Adj*, *9* Reg't U. S. Col'd Infantry.

Appears on

Field and Staff Muster Roll

for *March* *April*, 186*5*.

Present or absent *Present*

Stoppage, \$ *100* for

Due Gov't, \$ *100* for

Valuation of horse, \$ *100*

Valuation of horse equipments, \$ *100*

Remarks:

Book mark:

(357)

Wiley
Capt

U.S.C.T.

John W. Miller

Rank *1st Lt.*, *9* Reg't U. S. Col'd Infantry.

Appears on

Field and Staff Muster Roll

for *March 1865*, 186 *5*

Present or absent *Present*

Stoppage, \$ *100* for

Due Gov't, \$ *100* for

Valuation of horse, \$ *100*

Valuation of horse equipments, \$ *100*

Remarks:

Book mark:

Miller

S. I. P. **U.S.C.T.**

William H. Parker

Rank *Co. 1st*, Reg't U. S. Col'd Infantry.

Appears on

Field and Staff Muster Roll

for *July & Aug*, 186*5*.

Present or absent *Present*

Stoppage, \$ *100* for

Due Gov't, \$ *100* for

Valuation of horse, \$ *100*

Valuation of horse equipments, \$ *100*

Remarks:

Book mark:

(357)

W. Parker
Copyist

R 1 9

U.S.C.T.

Stephen H. Rhodes

Rank *Adj.*, 1st Reg't U. S. Col'd Infantry.

Appears on

Field and Staff Muster Roll

for *Nov 1st Dec*, 1865.

Present or absent *Present*

Stoppage, \$ 100 for

Due Gov't, \$ 100 for

Valuation of horse, \$ 100

Valuation of horse equipments, \$ 100

Remarks:

Book mark:

W. Kelly
C. P. 1865

R. 9 U.S.C.T.

Stephen H. Rhodes

Rank *Adj. G.* Reg't U. S. Col'd Infantry.

Appears on

Field and Staff Muster Roll

for *Jan & Feb.*, 1866.

Present or absent *Present*

Stoppage, \$ *100* for

Due Gov't, \$ *100* for

Valuation of horse, \$ *100*

Valuation of horse equipments, \$ *100*

Remarks:

Book mark:

W. Kelley
Adj. Gt.

R | **U.S.C.T.**

Stephen H. Rhodes

Rank *adj.*, Reg't U. S. Col'd Inf.

Appears on
Field and Staff Muster-out Roll

of the organization named above. Roll dated

Southwestern Pa., *Jan 1st*, 186*6*.

Muster-out to date _____, 186*6*.

Last paid to _____, 186*6*.

Clothing account:

Last settled _____, 186*6* ; drawn since \$ _____ 100

Due soldier \$ _____ 100; due U. S. \$ _____ 100

Am't for cloth'g in kind or money adv'd \$ _____ 100

Due U. S. for arms, equipments, &c., \$ _____ 100

Bounty paid \$ _____ 100; due \$ _____ 100

Remarks: *arrived at my unit in
asst. Co. app. 1st adj.
Jan'y 1, 1865. Discharged &
accept promotion in the same
Regt. March 12, 1866*

Book mark : _____

Mellor
Copyist.

U.S.C.T.

R. J. ...
...

Co. H, 1st Reg't U. S. Col'd Infantry.

Age *27* years.

Appears on an

Individual Muster-in Roll

of the organization named above. Roll dated
Brownsville Texas, March 13, 1866.

Muster-in to date *March 13*, 1866.

Joined for duty and enrolled:

When *March 13*, 1866.

Where *Brownsville Texas*

Period *3* years.

Remarks: *Presented for mustering as*
Adjutant "Co. H" 1st Reg't U.S. Col'd Inf.
Commission from Sec. of War dated
March 12 Office *Brownsville Texas*
Mustered out as "1st Lieutenant" U.S.
dated March 12, 1866.

Book mark :

R. J. ...

R | 9 | **U.S.C.T.**

Stephen A. Rhodes
Capt, Co., 9 Reg't U. S. Col'd Inf.

Appears on

Regimental Descriptive Book

(List of Commissioned Officers)

of the regiment named above.

Rank Capt

Date of appointment Feb 21, 1866

Remarks: Promoted from
1st Lt. 9th U.S. Ct.
mustered as Capt March
15/66

.....
.....
.....
.....
.....
.....
.....
.....
.....
.....

Harmon

R | 9 | **U.S.C.T.**

Stephen F. Rhodes
 1st Lt. Asst., Co. _____, 9th Reg't U. S. Col'd Inf't.

Appears on an

Individual Muster-out Roll

of the organization named above. Roll dated

Brownsville, Tex., March 12, 1866.

Muster-out to date March 12, 1866.

Last paid to Jan 31, 1866.

Clothing account:

Last settled _____, 1866 ; drawn since \$ _____ 100

Due soldier \$ _____ 100; due U. S. \$ _____ 100

Am't for cloth'g in kind or money adv'd \$ _____ 100

Due U. S. for arms, equipments, &c., \$ _____ 100

Bounty paid \$ _____ 100; due \$ _____ 100

Remarks: Promoted to Capt. Co. H^o 9th
 U.S.C.T. by virtue of commission
 from Sec of War dated February
 21st, 1866 vice Crawville, dismissed
 Mustered in as Captain Co. H.
 Same Regt to date March 13, 1866.

Book mark: _____

W. O. Chance

(348)

Copyist.

A | *9* | **U.S.C.T.**

Stephen H. Rhodes

Adjt, *Co*, *9* Reg't U. S. Col'd Inf.

Appears on

Regimental Descriptive Book

(List of Commissioned Officers)

of the regiment named above.

Rank *Adjt*

Date of appointment *Jan'y 1*, 1865.

Remarks: *Adjtd Adjt 9*
Ms. Ct. by order of
Col Thomas Bayler
Jan'y 1. 1865.

Appointed Capt Feb 21/1865
promoted to Capt gas.
C. T. by order of the Presi-
dent of the U.S. and
mustered in as such
Mar 13/1866.

Harmon

A. 4 U.S.C.T.

Stephen H Rhodes

Rank *Adj*, *9* Reg't U. S. Col'd Infantry.

Appears on

Field and Staff Muster Roll

for *Mich & Apr*, 186*6*.

Present or absent

Stoppage, \$ *100* for

Due Gov't, \$ *100* for

Valuation of horse, \$ *100*

Valuation of horse equipments, \$ *100*

Remarks: *Promoted to Capt 9
US C.I. & assigned to Co
Genl. O No 23 The 9th US
C.I. March 14 1866*

Book mark:

Wiley

R. | 9 | U.S.C.T.

Stephen H. Rhodes

Capt, Co. H, 9 Reg't U. S. Col'd Infantry.

Appears on

Company Muster Roll

for *March & April*, 186*6*.

Present or absent *Present*

Stoppage, \$ *100* for

Due Gov't, \$ *100* for

Remarks: *Promoted from 1st Lt. and
Adj. 9th U. S. C. I. to be Capt 9th
U. S. C. I. by order of the President
of the United States, July 21/66.*

Book mark :

R. Bradin

R. | 9 | U.S.C.T.

Stephen H. Rhodes.
Capt., Co. H, 9 Reg't U. S. Col'd Infantry.

Appears on

Company Muster Roll

for *May & June*, 186*6*.

Present or absent *Present.*

Stoppage, \$ *100* for

Due Gov't, \$ *100* for

Remarks: *On Gen. Court Martial*
per S. O. No. 137, 26th Cos. Separate
Brigade, Dist of the Rio Grande
June 20/66. Was absent sick
from May 4 to June 4/66.

Book mark:

R. Bradin

R. | 9 | U.S.C.T.

Stephen H. Rhoads
Capt., Co. H, 9 Reg't U. S. Col'd Infantry.

Appears on

Company Muster Roll

for July & Aug., 1864.

Present or absent Present.

Stoppage, \$ 100 for

Due Gov't, \$ 100 for

Remarks:

Book mark:

R. Prædix

R

9

U.S.C.T.

Stephen H. Rhodes

Capt., Co. *H*, 9 Reg't U. S. Col'd Infantry.

Appears on

Company Muster Roll

for *Sept & Oct*, 186*6*

Present or absent *Present*

Stoppage, \$ *100* for

Due Gov't, \$ *100* for

Remarks:

Book mark:

(358)

Fitz

Copyist.

compr.

Stephen H. Rhodes.
Capt., Co. "26", 9 Reg't U. S. Col'd Infantry.
 Appears on **Co. Muster-out Roll**, dated
New Orleans La., *Nov. 26th*, 1864.
 Muster-out to date *Nov. 26*, 1864.
 Last paid to *Aug. 31*, 1864.

Clothing account:
 Last settled....., 186 ; drawn since \$..... 100
 Due soldier \$..... 100; due U. S. \$..... 100
 Am't for cloth'g in kind or money adv'd \$..... 100

Due U. S. for arms, equipments, &c., \$..... 100
 Bounty paid \$..... 100; due \$..... 100

Remarks: *First entered the service as private Co. A. 34th Mass. Vol. Inf. June 10/62; first mustered into service at Worcester, Mass. Promoted to Corp'l & Sergt. Disch'd Nov. /62 to accept appointment as 1st Lieut in 9th U. S. C. I. Mustered as such*
 • Book mark: *423 b. T. 86. - 2. 818. b. T. 82.*

(over)

(861) *R. Brudin*
 Copyist.

JAN. 22

6314970

18910

Nov. 22/63. Wounded in action at Dup
Bottom, Va. Aug. 16/64. Appointed Adj't
Jan. 1/65. Promoted to Capt. Co. 26th 9th
W. S. C. I. March 22/66. Extra 8 months
pay (proper) due. Pay due for responsi-
-bility of Co. Property since Aug. 31/66.
Service continuous. ⁺ Discharge
given at New Orleans, La. with
view to payment without returning
to State

⁺ As it appears on Roll.

R 1 9 U.S.C.T.

Stephen H. Rhodes

, Co., 9 Reg't U.S.C.T.

NOTATION.

1572-23-1660 with

Book mark: R 109. C.T. / 103

War Department,

Adjutant General's Office,

Washington, Apr 13, 18 81.

See also Co. A. 34 Mass V

L. C. Casey
Sergeant.

Rhodes, Stephen H.
1st
Advt. Co., *9* Reg't *U. S. C. Inf.*

6 Enclosures.

| | |
|------------------------------------|----------------------------|
| Bed Cards | Final Statements |
| Burial Records | Furloughs or L. of A |
| Certs. of Dis. for Discharge | Med. Certificates |
| C. M. Charges | Med. Des. Lists |
| Descriptive Lists | Orders <i>J</i> |
| Discharge Certificates | Pris. of War Record |
| Enlistment Papers | Resignations |

Other papers relating to—

| | |
|------------------------------|----------------------------|
| Admission to Hosp'l | Furlough or L. of A |
| Casualty Sheet | Med. Examination |
| Confinement | Misc. Information |
| Contracts | Pay or Clothing |
| Death or Effects | Personal Reports |
| Desertion | Rank |
| Discharge from Hosp'l | Transfer to Hosp'l |
| Discharge from Service | Transfer to V. R. C. |
| Duty | Transportation |

MICROFILM PUBLICATION M 1851

COMPILED MILITARY SERVICE RECORDS
OF VOLUNTEER UNION SOLDIERS WHO SERVED WITH
THE UNITED STATES COLORED TROOPS (USCT)
9TH REGIMENT OF INFANTRY

PERSONAL PAPERS' TARGET SHEET

PLEASE NOTE THE CHECKED INFORMATION ABOUT THE PERSONAL PAPERS IN
THIS FILE:

- NO PERSONAL PAPERS WERE FOUND IN THIS FILE WHEN THE
RECORDS WERE ARRANGED FOR MICROFILMING.
- 8 PERSONAL PAPER(S) FOUND IN THIS FILE WHEN THE RECORDS
WERE ARRANGED FOR MICROFILMING.

Special Order
No. 2
Nov. 24, '53

Rhode
St

Detachment of Rhode
for Special Duty
M. J. Whinnety
at & St. 1853



Head Quarters 9th U. S. Col. I.
Nov 24. 1863

Special Order
No. 2.

Pursuant to Special Order
No. 7. Head Quarters Camp Stanton dated Nov 24. 1863.
St. Rhodis will immediately report to Col Birney
for duty

W. A. Muntler
St & Acty Adjnt

By order of
S. C. Armstrong
St. Col. Conroy

U. S. Forces, District of Beaufort.

Headquarters, Beaufort, S. C., *Nov 15th 1864.*

Special Orders }
No 126

I. *1st Lt Stephen H Rhodes Co D 9th U S C Troop*
is hereby detailed to assist Capt L M Metcalf, *33rd U S Troop*
Acting Provost Marshal to superintend the organization
and drill of the Militia of this command in accordance
with the requirements of *Par 17*. General Orders No. 82
current series Dept of the South.

By order of
Genl Geo B. Saxton
Stuart M. Payton
A. A. Gould

26^d of Beaufort S.C.

June 30. 1861

S.O. No 138

Relieve Lieut Rhodes from super-
intending the organization and
drill of the Militia of the District
of Beaufort

U. S. Forces, Port Royal Island,

Headquarters, Beaufort, S. C., June 30th 1864.

SPECIAL ORDERS, }

No. 138

That 1st Lieut Stephen H. Rhodes Co^y "20"
9th U.S. Inf. detached by virtue of Part I Special
Orders 126. to superintend the organization
and drill of the Militia of this District is
hereby relieved. He will report forthwith for
duty with his company and regiment

BY ORDER OF

BRIG.-GEN. RUFUS SAXTON

Stephen Taylor

Asst. Adjt. General.

commanding Officer 4th U.S. Inf.
 through 1st Div Camp of Instruction

B. 915 Beaufort S.C.
June 15th 1864

S.O. No 126

Detail in Rhode's assist-Capt-Metcalf
det'd Provost-Marshal organizing & drilling the
Militia.

Stephen H. Rhodes

Lt.

Order

U.S. Army Post Royal Island

Co's gss Beaufort S.C. June 15th 1864

Special Order }
no 126

II 1st Lieut Stephen H. Rhodes Co D 9th U.S.C. Troops hereby
detached to assist Capt L.W. Motcaly 33rd U.S.C. Troops acting
Provost Marshal to superintend the organization and drill of the Militia
of the command in accordance with the requirements of For VI
General Orders no 82 current series Dept of the South.
Lieut Rhodes will report forthwith to Capt Motcaly for further in-
structions.

By Order of
Brig Gen. Rufus Saxton
Stuart M. Taylor,
Asst Adj't General.

Official
Geo. H. Evans
1st Lieut - Acting Adj't.

Head Quarters First Division,

Twenty Fifth Army Corps,

Brownsville, Texas, February 4, 1866.

Special Orders,

No. 17

(EXTRACT.)

1. ~~1st~~ ^{et} ~~1st~~ ^{Adjutant} Lieut. S. H. Rhodes,
of the 1st U.S. Troops, is hereby relieved from
duty with this Regiment, and will report
to Major W. L. Radmore, Surgeon in charge
of Post Hospital, for duty without delay.

By Order of ~~Brigadier Maj. Gen. Giles A. Smith.~~

Col. J. H. Perkins,

Comdg. Officer,

1st U.S. Troops.

C. B. Fessenden,

Capt. 9th U.S. Inf.,
Actg. Post Adj. General.

MB. 53 p. 12,

Hq. 1st Div. 20th A. C.
Feb'y 4, 1866.

S.O. 1
17.

S. H. Rhodes
9th U.S. C. Troops.

Head Quarters First Division,

Twenty Fifth Army Corps,

Brownsville, Texas, February 4, 1866.

Special Orders,

No. 17

(EXTRACT.)

Adj't
 1st Lieut. S. H. Rhodes
 of the U.S. Troops, is hereby relieved from
 duty with his Regiment, and will report
 to Major C. C. Radburn, Surgeon in charge
 of Post Hospital, for duty without delay.



By Order of ~~Brigadier Maj. Gen. Giles A. Smith,~~
 Col. C. C. Radburn

Col. S. G. Brown / C. C. Radburn
 Comdg. D. P. H. of 25-AC, / Capt. 9th U.S. Inf. Adj't. General.

Wm. H. D. W. 25 to 6
Feb 24 / 1866

Special Order
No. 18

John W. ...
...
...

Rec'd 11 1865 Feb 6 1866

Head Quarters First Division,

Twenty Fifth Army Corps,

Brownsville, Texas, February 3, 1866,

Special Orders,

No. 18.

(EXTRACT.)

To — 1st Lieut. G. Adjt. S. H. Rhodes
of U. S. G. Troops, is hereby relieved
from duty at Post Hospital, and will
report to this Regiment, for duty without
delay.

* * * * *

By Order of ~~Brevet Maj. Gen. Giles A. Smith~~

Col. G. Perkins

~~L. B. Fessenden~~

~~Capt. G. A. ...~~
Adj. G. Adjt. General.

G. O.

of U. S. G. Troops,

Hd. qrs. U. S. Forces
Brownsville, Texas,
April 18th 1856

Special Orders
No. 15

Detaching
Capt. J. C. Rhodes of the
3^d Co. Troop on Special
Duty to drain a Lagoon.

John H. Rhodes

See also...

Head Quarters U. S. Forces
Brownsville, Texas
April 18th 1866,

Special Order 1

To - 15

Captain Stephen C. Rhodes
9th U. S. C. Troops is hereby detailed on Special
duty for the purpose of superintending the
draining of the Lagoon near the Ordnance
Storehouse.

Capt. Rhodes will report to
these Head Quarters without delay
for instructions

By Order of Col. G. B. Brown
(Lieut.) Geo. Potwin
1st Lieut. & a. a. a. c.

Head Quarters 9th U. S. C. T.
Brownsville, Texas April 18th 1866.

In Official Copy

Solomon F. Fargues

1st Lieut. & Adjutant 9th U. S. T.

938
Rice, Alexander

Co B, 9 U.S. Col'd Inf.

Corporal | Corporal

CARD NUMBERS.

| | | |
|----|---------|----|
| 1 | 6302556 | 26 |
| 2 | 6302657 | 27 |
| 3 | 6302758 | 28 |
| 4 | 6302861 | 29 |
| 5 | 6302962 | 30 |
| 6 | 6303060 | 31 |
| 7 | 6303157 | 32 |
| 8 | 6303253 | 33 |
| 9 | 6303419 | 34 |
| 10 | 6303514 | 35 |
| 11 | 6303609 | 36 |
| 12 | 6303690 | 37 |
| 13 | 6303779 | 38 |
| 14 | 6303815 | 39 |
| 15 | 6303890 | 40 |
| 16 | 6303962 | 41 |
| 17 | 6304086 | 42 |
| 18 | 6304305 | 43 |
| 19 | 9068699 | 44 |
| 20 | | 45 |
| 21 | | 46 |
| 22 | | 47 |
| 23 | | 48 |
| 24 | | 49 |
| 25 | | 50 |

Book Mark: E.B.V. p. 180.

See also

Rev. 528724.

D. 1671339 And No 5

A. E. Doughty

2

P | 9 | U.S.C.T.

Alexander Price

....., Co. B, 9 Reg't U. S. Col'd Inf.

Appears on

Company Descriptive Book

of the organization named above.

DESCRIPTION.

Age 21 years; height 5 feet 7/2 inches.

Complexion Light

Eyes Dark; hair Black

Where born Calvert, Md,

Occupation Farmer

ENLISTMENT.

When Oct 1 1863

Where Belle Creek, Calvert, Md,

By whom Col. W. Birney term 3 y'rs.

Remarks: In action with
Co. at John's Island, SC,
Deep Bottom, Va, &
Chapin's Farm, Va,
Died May 4/64

C. R. Owen

R | 9 | U.S.C.T.

Alexander Rice
Copl, Co. *B*, 9 Reg't U. S. Col'd Infantry.

Age *21* years.

Appears on

Company Muster-in Roll

of the organization named above. Roll dated
Camp Stanton Charles Co. Md. Nov 11, 1863.

Muster-in to date *Nov 11, 1863*

Joined for duty and enrolled:

When *Oct 23*, 1863.

Where *Calvert Md*

Period *3* years.

Remarks:

Book mark:

S. Dineen

R

9

U.S.C.T.

Alexander Rice

Capt, Co. B, 9 Reg't U. S. Col'd Infantry.

Appears on

Company Muster Roll

for *Nov 11 to Dec 31*, 1863.

Present or absent *Present*

Stoppage, \$ *100* for

Due Gov't, \$ *100* for

Remarks: *Two dollars recruit
premium due.*

Book mark:

S. Urman

(358)

Copyist

R | 9 | U.S.C.T.

Alexander Rice
Copl., Co. B, 9 Reg't U. S. Col'd Infantry.

Appears on

Company Muster Roll

for *Jany & Feby*, 1864
Present or absent *Present*

Stoppage, \$ 100 for

Due Gov't, \$ 100 for

Remarks: *Two dollars recruit
premium due.*

Book mark:

S. Dinean

(358)

Copyist

R

9

U.S.C.T.

Alexander Rice

Capt, Co. B, 9 Reg't U. S. Col'd Infantry.

Appears on

Company Muster Roll

for *Mich & Apl*, 1864.

Present or absent *Present*

Stoppage, \$ 100 for

Due Gov't, \$ 100 for

Remarks:

Book mark:

S. Duneau

(358)

Copyist

R

9

U.S.C.T.

Alexander Rice

Capt., Co. B, 9 Reg't U. S. Col'd Infantry.

Appears on

Company Muster Roll

for May & June, 1864

Present or absent Present

Stoppage, \$ 100 for

Due Gov't, \$ 100 for

Remarks Stop for one Canteen

Book mark:

S. Dimean

(358)

Copyist

R

9

U.S.C.T.

Alexander Rice

Corpl, Co. B, 9 Reg't U. S. Col'd Infantry.

Appears on

Company Muster Roll

for *July & Aug*, 1864.

Present or absent *Present*

Stoppage, \$ *100* for

Due Gov't, \$ *100* for

Remarks:

Book mark:

S. Linnear

(358)

Copyist

R

9

U.S.C.T.

Alexander Rice

Capt., Co. B, 9 Reg't U. S. Col'd Infantry.

Appears on

Company Muster Roll

for *Sept & Oct*, 1864.

Present or absent *Present*

Stoppage, \$ 100 for

Due Gov't, \$ 100 for

Remarks:

Book mark:

J. Duncan

(358)

Copyist

R

9

U.S.C.T.

Alexander Rice

Copl., Co. B, 9 Reg't U. S. Col'd Infantry.

Appears on

Company Muster Roll

for Nov & Dec, 1864.

Present or absent Present

Stoppage, \$ 100 for

Due Gov't, \$ 100 for

Remarks:

Book mark:

S. Duncan

(358)

Copyist

H.P.

9

U.S.C.T.

Alexander Rice
Sgt., Co. B, 9 Reg't U. S. Col'd Infantry.

Appears on

Company Muster Roll

for *Jan & Feb*, 1865

Present or absent *present*

Stoppage, \$ 100 for

Due Gov't, \$ 100 for

Remarks: *Reduced to rank*
by S. O. no 22 H. S.
9. U. S. C. T. Feb. 21, 65.

Book mark:

Harpur

(358)

Copyist

P | **9** | **U.S.C.T.**

Alexander Rice
Priv, Co. B, 9 Reg't U. S. Col'd Infantry.

Appears on

Company Muster Roll
for *Mar & Apr*, 1865.

Present or absent *present*

Stoppage, \$ *100* for

Due Gov't, \$ *100* for

Remarks: *Reduced to ranks*
from corporal per
S.O. 22 H 29, U.S. C. T. Feb 21/65.

Book mark: _____

B. C. Harper

(358)

Copyist

R.P.

9

U.S.C.T.

Alexander Rice

Priv, Co. B, 9 Reg't U. S. Col'd Infantry.

Appears on

Company Muster Roll

for *Dec. 31/64 to June 30, 1865.*

Present or absent *present*

Stoppage, \$ *100* for

Due Gov't, \$ *100* for

Remarks: *Reduced to
Ranks from Corp
S. C. No. 22 Hd Qrs
9th U. S. C. I. Feb. 21/65.*

Book mark:

(358)

Harpes

Copyist

R.P. | **9** | **U.S.C.T.**

Alexander Rice
Pvt., Co. B, 9 Reg't U. S. Col'd Infantry.

Appears on
Company Muster Roll
for *June 30/65 to Oct 31, 1865.*
Present or absent *present*

Stoppage, \$ *100* for

Due Gov't, \$ *100* for

Remarks:

Book mark: _____

Harpes.

(358) Copyist

R.

9

U.S.C.T.

Alexander Rice
Corp., Co. B, 9 Reg't U. S. Col'd Infantry.

Appears on

Company Muster Roll

for June 30/65 to Dec 31, 1865.

Present or absent present

Stoppage, \$ 100 for

Due Gov't, \$ 100 for

Remarks:

Book mark:

(858)

Harpur
Copyist

R.P.

9

U.S.C.T.

Alexander Rice
Corp, Co. B, 9 Reg't U. S. Col'd Infantry.

Appears on

Company Muster Roll

for Jan & Feb, 1866.

Present or absent absent

Stoppage, \$ 100 for

Due Gov't, \$ 100 for

Remarks: Sick in Hospt
Brownsville Texas
since Jan. 6, 1866.

Book mark:

P. C. Harper
Copyist

(358)

R

9

U.S.C.T.

Alexander Rice
Capt., Co. B, 9 Reg't U. S. Col'd Infantry.

Appears on

Company Muster Roll

for *March & April*, 1866.

Present or absent *Absent*

Stoppage, \$ 100 for

Due Gov't, \$ 100 for

Remarks: *Absent sick
 since Jan 6/66 in
 Fort Hospital
 Brownville*

Book mark:

F. C. Dickerson

(858)

Copyist

R | 9 | U.S.C.T.

Alexander Rice
Capt., Co. B, 9 Reg't U. S. Col'd Infantry.

Appears on

Company Muster Roll

for May & June, 1866.

Present or absent

Stoppage, \$ 100 for

Due Gov't, \$ 100 for

Remarks: At post Hoop
Brownsville Texas May
5/66

Book mark: At May 4/66 -
Ch. Diabara E.B.T. P-183. 1/4/88

(358)

J. C. Jones
Company

R. | 9 | U.S.C.T.

Alexander Rice
Capt., Co. B, 9 Reg't U. S. Col'd Infantry.

Appears on Co. Muster-out Roll, dated
New Orleans La, Nov 26, 1866.

Muster-out to date _____, 186 .

Last paid to _____, 186 .

Clothing account:

Last settled _____, 186 ; drawn since \$ _____ 100

Due soldier \$ _____ 100; due U. S. \$ _____ 100

Am't for cloth'g in kind or money adv'd \$ _____ 100

Due U. S. for arms, equipments, &c., \$ _____ 100

Bounty paid \$ _____ 100; due \$ _____ 100

Remarks: *Joined at Origin at
Ogans Corp to Feb 2/65
Priv to Nov 1/65.
Died in Hspt Brownville
Tex. May 4/66.*

Book mark: *2d And 6426 Jan 9
over*

F. C. Dickerson.

JAN. 21

6304305

01891*

68 V161. P. 17.73 7.8.

Rice, Alexander

Corp, Co. *B*, **9** Regt. **U. S. C. Inf.**

2 Enclosures.

| | |
|-----------------------------------|---------------------------------|
| Bed Cards..... | Descriptive Lists..... |
| Burial Records..... | Final Statements <i>/</i> |
| Certs. of Dis. for Discharge..... | Furloughs..... |
| C. M. Charges..... | Med. Des. Lists..... |
| Med. Certificates..... | Orders..... |

Other papers relating to—

| | |
|---------------------------------|----------------------------------|
| Admission to Hosp'l..... | Furlough..... |
| Casualty Sheet (Officer's)..... | Med. Examination..... |
| Confinement..... | Misc. Information <i>/</i> |
| Contracts..... | Pay or Clothing..... |
| Death or Effects..... | Personal Reports..... |
| Desertions..... | Rank..... |
| Discharge from Hosp'l..... | Transfer to Hosp'l..... |
| Discharge from Service..... | Transfer to V. R. C..... |
| Duty..... | Transportation..... |
| | |

RAAH 621
MICROFILM PUBLICATION M 1851

COMPILED MILITARY SERVICE RECORDS
OF VOLUNTEER UNION SOLDIERS WHO SERVED WITH
THE UNITED STATES COLORED TROOPS (USCT)
9TH REGIMENT OF INFANTRY

PERSONAL PAPERS' TARGET SHEET

PLEASE NOTE THE CHECKED INFORMATION ABOUT THE PERSONAL PAPERS IN
THIS FILE:

- NO PERSONAL PAPERS WERE FOUND IN THIS FILE WHEN THE
RECORDS WERE ARRANGED FOR MICROFILMING.
- 3 PERSONAL PAPER(S) FOUND IN THIS FILE WHEN THE RECORDS
WERE ARRANGED FOR MICROFILMING.

[OFFICE ENDORSEMENT.]

War Department,

ADJUTANT GENERAL'S OFFICE,

187

The Death of *Col. Alexander Rice*, Co. I., 9th Reg't U. S. Colored Troops, is reported as follows:

On Company Muster Roll For *May June*, 1866, *May 3rd*, 1866, Company Muster-out Roll *May 11th*, 1866.

Company Descriptive Book, 186

Company Morning Reports, 186

Soldier's Final Statement, 186

Soldier's Record of Death and Interment, *May 11th*, 1866

Soldier's Inventory of Effects, 186

Soldier's Certificate of Disability for Discharge, 186

Soldier's Individual Muster-out Roll, 186

Regimental Return, For *May*, 1866, *May 11th*, 1866, Regimental Quarterly Returns, *May 4th*, 1866.

Regimental Descriptive Book, 186

By Surgeon General, 186

May 4th, 1866, is held to be the correct date, and the Company Muster Roll will be amended accordingly.

Thomas M. Vincent
Assistant Adjutant General.

613 15 July 1866

FINAL STATEMENT

OF

Co 13
Captain Alexander Rice
9th Reg't of U.S. Troops

VOLUNTEERS.

Dec May 4th 1866

NOTE 1.—Two of these certificates (or duplicates) are to be given to each Volunteer Soldier or drafted man who may be discharged without being mustered out (Final Statements are never given to men mustered out of service.) that he may at once receive from the Paymaster the pay, &c., due to him, and the captain or other commissioned officer commanding the company will certify to the act of the delivery of the duplicate certificates; with these certificates the Soldier is "entitled to" his discharge, and should also present his discharge to the Paymaster to have the payment endorsed on it. The discharge is to be given back to the Soldier by the Paymaster; the latter only retaining as his vouchers the duplicate certificates.

NOTE 2.—If the Soldier is entitled to pay for the use of his horse, the Company Commander will certify to that fact on the back of both these final statements, and also to the time he has pay due for having been so mounted on his own horse.

NOTE 3.—When a Soldier is furnished with final statements, his descriptive list, if he has one, should be taken up by the officer who gives the Soldier these statements, and endorsed with a statement to this effect by the officer. The endorsement should exhibit a full statement of the time for which the Soldier was allowed pay on his final statements, the clothing account, and all other charges against him or in his favor, so as to comprise a complete exhibit of his account. It will then be transmitted to the Company Commander of the Soldier, who will enter all the data necessary to a full understanding of the Soldier's account on the muster roll upon which the Soldier's discharge is reported. The descriptive list will then be destroyed. The object of this is, that the remaining portion of the Soldier's account may be settled upon the receipt of these muster rolls, and the Soldier receive any pay or allowances that may be due him at the time of his discharge, and which may not appear on his last final statements from the fact that his descriptive list is incomplete. These accounts for back pay, &c., are settled by the 2d Auditor of the Treasury Department.

NOTE 4.—Charges for loss or injury to ordnance, horse equipments, and other miscellaneous charges, should appear under the heading of "Other Stoppages."

NOTE 5.—Bounty paid by State authorities, and not by the United States, will not be entered on this statement

NOTE 6.—Amounts due the Sutler and Laundress must be entered on the muster roll on which the discharge, death, desertion, &c., is reported, as well as on the final statement, otherwise the amount cannot be collected from the United States.

NOTE 7.—This blank will be used for deceased volunteers and drafted men, as well as for others.

NOTE 8.—Where a Soldier dies in Hospital or on detached service, his descriptive list, if he has one, should be sent with his final statements, in duplicate, to the Adjutant General, Washington, D. C.

NOTE 9.—If the soldier is a drafted man or substitute, the space for time, &c., of enrolled, should contain only the word *drafted* or *substitute*, as the case may be. If the soldier is a "volunteer," (OR RECRUIT,) the words *as a veteran* (or *recruit*) as the case may be, should be interlined after the words *enrolled* into the service of the U. S. A statement of all the installments of *Veteran or Recruit Bounty RECEIVED* by the Soldier must be made on the back of each final statement.

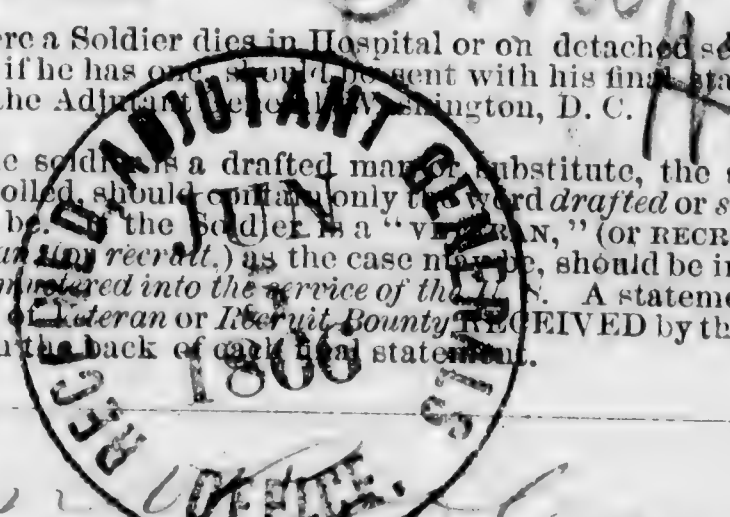

Arthur

1866

papers necessary to establish a claim for a pension, bounty, and other allowance before the Pension Office, under this act, shall not exceed the following rates: For making out and causing to be duly executed a declaration by the applicant, with the necessary affidavits, and forwarding the same to the Pension Office, with the requisite correspondence, ten dollars: which sum shall be received by such agent or attorney in full for all services in obtaining such pension, and shall not be demanded or received, in whole or in part, until such pension shall be obtained; and the sixth and seventh sections of an act entitled "An act to grant pensions," approved July [fourteenth,] eighteen hundred and sixty-two, are hereby repealed.

SEC. 13. And be it further enacted, That any agent or attorney who shall, directly or indirectly, demand or receive any greater compensation for his services under this act than is prescribed in the preceding section of this act, or who shall contract or agree to prosecute any claim for a pension, bounty, or other allowance under this act, on the condition that he shall receive a per centum upon any portion of the amount of such claim, or who shall wrongfully withhold from a pensioner or other claimant the whole or any part of the pension or claim allowed and due to such pensioner or claimant, shall be deemed guilty of a high misdemeanor, and, upon conviction thereof, shall, for every such offense, be fined not exceeding three hundred dollars, or imprisoned at hard labor not exceeding two years, or both, according to the circumstances and aggravations of the offense.

Approved July 4, 1864.

NOTE. 10.—If any soldier is charged a higher fee than that allowed by the above act, he should report the fact and the name of the agent to the Adjutant General, in order that steps may be taken to have the same refunded.

Adj. G. June 5th 1866
Recd. Adj. Gen. Office

ADJUTANT GENERAL'S OFFICE
June 5th 1866
Duplicate with Inventory sent 2d Auditor.

Co 13
FINAL STATEMENT.

OF

Corporal Alexander Rice
9th Regt of U.S. Troops

VOLUNTEERS.

Died May 4th 1866

NOTE 1.—Two of these certificates (or duplicates) are to be given to each Volunteer Soldier or drafted man who may be discharged without being mustered out (Final Statements are never given to men mustered out of service.) that he may at once receive from the Paymaster the pay, &c., due to him, and the captain or other COMMISSIONED officer commanding the company will certify to the act of the delivery of the duplicate certificates; with these certificates the Soldier is "entitled to" his discharge, and should also present his discharge to the Paymaster to have the payment endorsed on it. The discharge is to be given back to the Soldier by the Paymaster; the latter only retaining as his vouchers the duplicate certificates.

NOTE 2.—If the Soldier is entitled to pay for the use of his horse, the Company Commander will certify to that fact on the back of both these final statements, and also to the time he has pay due for having been so mounted on his own horse.

NOTE 3.—When a Soldier is furnished with final statements, his descriptive list, if he has one, should be taken up by the officer who gives the Soldier these statements, and endorsed with a statement to this effect by the officer. The endorsement should exhibit a full statement of the time for which the Soldier was allowed pay on his final statements, the clothing account, and all other charges against him or in his favor, so as to comprise a complete exhibit of his account. It will then be transmitted to the Company Commander of the Soldier, who will enter all the data necessary to a full understanding of the Soldier's account on the muster roll upon which the Soldier's discharge is reported. The descriptive list will then be destroyed. The object of this is, that the remaining portion of the Soldier's account may be settled upon the receipt of these muster rolls, and the Soldier receive any pay or allowances that may be due him at the time of his discharge, and which may not appear on his last final statements from the fact that his descriptive list is incomplete. These accounts for back pay, &c., are settled by the 2d Auditor of the Treasury Department.

NOTE 4.—Charges for loss or injury to ordnance, horse equipments, and other miscellaneous charges, should appear under the heading of "Other Stoppages."

NOTE 5.—Bounty paid by State authorities, and not by the United States, will not be entered on this statement.

NOTE 6.—Amounts due the Sutler and Laundress must be entered on the muster roll on which the discharge, death, desertion, &c., is reported, as well as on the final statement, otherwise the amount cannot be collected from the United States.

NOTE 7.—This blank will be used for deceased volunteers and drafted men, as well as for others.

NOTE 8.—Where a Soldier dies in Hospital or on detached service, his descriptive list, if he has one, should be sent with his final statements, in duplicate, to the Adjutant General, Washington, D. C.

NOTE 9.—If the soldier is a drafted man or substitute, the space for time, &c., of enrolled, should contain only the word *drafted* or *substitute*, as the case may be. If the soldier is a "VOLUNTEER," (or RECRUIT,) the words *as a veteran* (or *recruit*), as the case may be, should be interlined after the words *mustered into the service of the U.S.* A statement of all the installments of *Veteran or Recruit Bounty RECEIVED* by the Soldier must be made on the back of each final statement.

Dirby
ADJUTANT GENERAL'S OFFICE
RECEIVED
JUN 5 1866

Adj. Gen. Office

I certify, on honor, that Alexander Rice, a Corporal of Lieut. C. B. Fullington Company (B) of the 9th Regiment of Inf. Co. 500th Volunteers, of the State of Maryland, born in Caroline County State of Maryland, aged 24 years; 5 feet 7 1/2 inches high; Light complexion, Black eyes, Black hair, and by occupation a Farmer, who joined for service and was enrolled (see Note 9) on the 23^d day of October, 1863, at Walvert County by Col. Bonnet, for the period of Three years, and mustered into the service of the United States on the Eleventh 11th day of November, 1863, at Camp Stanton Md by Lt. Col. Hoakwell; and having served

HONESTLY and **FAITHFULLY** with his Company to the present date, is now entitled to a **DISCHARGE** by reason of

Death May 4th 1864 of
Charlie Dinkens, Post Hospital, Brownsville Texas.

The said Corporal Alexander Rice was last paid by Paymaster Major Heiviland, to include the 21st day of February, 1866, and has pay due him from that time to the present date; he is entitled to pay and subsistence for **TRAVELING** to place of enrollment, and whatever other allowances are authorized to volunteer soldiers, drafted men, or militia, so discharged. He has received from the United States **CLOTHING** amounting to Fifty five \$45.00 dollars, since the 21st day of October, 1865, when his clothing account was last settled. He has received from the United States 100 dollars advanced **BOUNTY**.

There is to be stopped from him, on account of the State of _____, or other authorities, for **CLOTHING**, &c., received on entering service, _____ dollars; and for other stoppages, viz: _____

_____ dollars.
He has been furnished with **TRANSPORTATION** in kind from the place of his discharge to _____; and he has been **Subsisted** for **Traveling** to his place of enrollment, up to the _____, 186 .

He is indebted to _____, **Sutler**, _____ dollars.
He is indebted to _____, **Laundress**, _____ dollars.

Given in Duplicate, at Post Hospital Brownsville Texas, this 7th day of Nov 1866.

Joel Moore

July 17th 1866
Commanding Company.
In charge

Alexander Ricci.

Corpl. Co. B.

9th U.S. T.

Mr. Ellertson.

Adjutant General's Office,

COLORED TROOPS BRANCH,

December 18th, 1876.

Vol. _____

C. T., 187

Wanted in the case of Alexander Rice, Corp., Co. B,

9th Reg't U.S.C. Troops

Cause of reduction.

For San't. J. J. reports him Reduced to the rank of private for S.O. 22^d.
Ad. Gen. 9th U.S.C. Troops, July 21/65.

Respectfully,

E. H. Woodward

Chief Clerk.

J. J. Patton

Adjutant General's Office,

Div. of Discontinued Commands,
Dec. 22^d, 1876.

Vol. _____

C. T., 187

Reply in case of Alexander Rice, Corp., Co. B,

9th Reg't U.S.C. Troops

S. O. 22^d 9th U.S.C. Troops, 1865 shows
him "reduced to rank for want of
energy and intelligence".

S. O. 22^d

Dec. 22, '76.

M. C. [Signature]

¹⁹³⁹
Rice, Presby

Co D, 9 U.S. Col'd Inf.

Private

Private

CARD NUMBERS.

| | | |
|----|-------------|----|
| 1 | 6299979 | 26 |
| 2 | 6306916 | 27 |
| 3 | 6307018 | 28 |
| 4 | 6307147 | 29 |
| 5 | 6308015 | 30 |
| 6 | 9068474 | 31 |
| 7 | 844-05-1878 | 32 |
| 8 | 43155794 | 33 |
| 9 | | 34 |
| 10 | | 35 |
| 11 | | 36 |
| 12 | | 37 |
| 13 | | 38 |
| 14 | | 39 |
| 15 | | 40 |
| 16 | | 41 |
| 17 | | 42 |
| 18 | | 43 |
| 19 | | 44 |
| 20 | | 45 |
| 21 | | 46 |
| 22 | | 47 |
| 23 | | 48 |
| 24 | | 49 |
| 25 | | 50 |

Book Mark: 844-05-1878

See also

R | 9 | U.S.C.T.

Frisbie Rice,

....., Co. *H*, 9 Reg't U. S. Col'd Inf.

Appears on

Company Descriptive Book

of the organization named above.

DESCRIPTION.

Age *39* years; height *5* feet *7 3/4* inches.

Complexion *Chestnut;*

Eyes *Blue*; hair *Black,*

Where born *Kent Md.*

Occupation *Laborer,*

ENLISTMENT.

When *Sept. 20*....., 1864.

Where *Easton Md.*

By whom *Capt. Stafford*; term *1* y'rs.

Remarks: *Sept. 30/64 mustered
drafted. Died March 30/65
at Pt of Rocks. Final
Statements & Inventory fur-
nished.*

Pol

R. | 9 | U.S.C.T.

Frisby Rice

Appears with rank of _____ on
**Muster and Descriptive Roll of a Detach-
ment of Drafted Men and Substitutes
forwarded**

for the *9* Reg't U. S. Col'd Inf. Roll dated
Baltimore Md Oct 7, 1864.

Where born *Kent Co Md.*

Age *39* years; occupation *laborer*

~~Drafted~~ ^{*enlisted*} and mustered in:

When *Sept 20, 1864.*

Where *Easton*

Period *one* years

Eyes *blk*; hair *blk*

Complexion *chestnut*; height *5 ft. 7 3/4 in.*

Paid bounty and advance pay, \$ *100*

Bounty due \$ *100*

Where credited _____

Company to which assigned _____

Remarks: *Drafted 1st Dist Md.
By S. S. Dougherty*

Book mark: _____

A. Pratt

9

Ro | | *uscg*

Frisby Rice

Appears with rank of _____ on _____

Muster and Descriptive Roll

of *Detachment of US Substitutes*

Drafted men turned over to

Col. S. M. Bowman. Roll dated
Camp Bradford, Md, Oct 12, 1864.

Where born *Kent Co, Maryland*

Age *39* years; occupation *Laborer*

When enlisted *Sept. 20*, 186 .

Where enlisted *Easton*

For what period enlisted *1* years.

Eyes *Blk*; hair *Blk*

Complexion *Chestnut*; height *5 ft. 7³/₄ in.*

When mustered in *Sept. 20*, 186 .

Where mustered in _____

Bounty paid \$ 100; due \$ 100

Clothing account:

Last settled _____, 186 ; drawn since \$ *18³⁶*/100

Date of first muster _____, 186 .

Company to which assigned _____

Remarks: *Drafted man / St. Dist. Md.*

Book mark : _____

Wm Law

R | 9 | U.S.C.T.

Frisby Rice.
Pvt, Co. D, 9 Reg't U. S. Col'd Infantry.

Appears on

Company Muster Roll

for Nov, Dec, 1864.

Present or absent Present

Stoppage, \$ 100 for

Due Gov't, \$ 100 for

Remarks: Shop for one
haversack. Recruit
joined from Depot.

Book mark:

J. E. Burke

(358)

Copyist

R | **9** | **U.S.C.T.**

Frisby Rice

Priv., Co. D, 9 Reg't U. S. Col'd Infantry.

Appears on

Company Muster Roll

for *Jan'y & Feby*, 1865.

Present or absent *Present*

Stoppage, \$ 100 for

Due Gov't, \$ 100 for

Remarks:

Book mark:

W. Harmon

(358)

Copyist

R 9 U.S.C.T.

Frisbie Rice

Pvt., Co. D, 9 Reg't U. S. Col'd Infantry.

Appears on

Company Muster Roll

for *Mar & Apr*, 1865.

Present or absent.....

Stoppage, \$ 100 for.....

Due Gov't, \$ 100 for.....

Remarks: *Wid in Hosp at
Pt. of Rocks Pa. of
Chronic Diarrhoea
Mar 31/65 - Due a.c.
James Sutter \$9.00
Stop for 1 Knapsack 1.
Haversack 1 Canteen
1/2 Shelter tent.*

Book mark: *152,179 Oct 25/67
7763 2'a. Feb 25/68.*

Co. 9. U.S.C.T.

Fresbie Rice

Reg't U. S. Col'd Infantry.
Co. D, 9th

Appears on **Co. Muster-out Roll**, dated
New Orleans La. Dec 100, 1866.

Muster-out to date _____, 186 .

Last paid to _____, 186 .

Clothing account:

Last settled _____, 186 ; drawn since \$ _____ 100

Due soldier \$ _____ 100; due U. S. \$ _____ 100

Am't for cloth'g in kind or money adv'd \$ _____ 100

Due U. S. for arms, equipments, &c., \$ _____ 100

Bounty paid \$ _____ 100; due \$ _____ 100

Remarks: Joined as Recruit,
Died of disease at Pt of Rocks, dtd,
30/65

Book mark: 152.179 Oct 25/67
(over.)

(361)

G. E. Dayton

Copyist.

RRR 635

JAN. 21

6308015

018910

Bk. Mch. conts

7/6 3 Land F.S.

Feb 25/68

844 C. T. '78

Died March 31/65 E.B.

12
526

R. 9 U.S.C.
Frisbie Rice
Co. D, 9 Reg't U.S.C.

NOTATION.

Book mark: 844-CF-1878.

Record and Pension Office.

WAR DEPARTMENT.

This book mark refers only to a report from the medical records, made by the Surgeon General to the Adjutant General, relative to the above-named man. As the medical records have since been carded, no transcript of this report is made hereon.

(491) Wm E Newman Copyist.

Rice, Frisbie

P, Co. D. I. 9 Regt. S. C. Inf.

4 Enclosures.

| | |
|------------------------------|--------------------|
| Bed Cards | Descriptive Lists |
| Burial Records | Final Statements 2 |
| Certs. of Dis. for Discharge | Furloughs |
| C. M. Charges | Med. Des. Lists |
| Med. Certificates | Orders |

Other papers relating to—

| | |
|----------------------------|----------------------|
| Admission to Hosp'l | Furlough |
| Casualty Sheet (Officer's) | Med. Examination |
| Confinement | Misc. Information |
| Contracts | Pay or Clothing |
| Death or Effects / | Personal Reports |
| Desertions | Rank |
| Discharge from Hosp'l | Transfer to Hosp'l |
| Discharge from Service | Transfer to V. R. C. |
| Duty | Transportation |
| Inventory of Effects 1 | |

MICROFILM PUBLICATION M1851

COMPILED MILITARY SERVICE RECORDS
OF VOLUNTEER UNION SOLDIERS WHO SERVED WITH
THE UNITED STATES COLORED TROOPS (USCT)
9TH REGIMENT OF INFANTRY

PERSONAL PAPERS' TARGET SHEET

PLEASE NOTE THE CHECKED INFORMATION ABOUT THE PERSONAL PAPERS IN
THIS FILE:

- NO PERSONAL PAPERS WERE FOUND IN THIS FILE WHEN THE
RECORDS WERE ARRANGED FOR MICROFILMING.
- 5 PERSONAL PAPER(S) FOUND IN THIS FILE WHEN THE RECORDS
WERE ARRANGED FOR MICROFILMING.

Receipt from Div. of discontinued
Commands Filed Aug 26/75
INVENTORY OF THE EFFECTS

ARTICLES OF WAR.

ART. 95. When any non-commissioned officer or soldier shall die, or be killed in the service of the United States, the then commanding officer of the troop or company shall, in the presence of two other commissioned officers, take an account of what effects he died possessed of, above his arms and accoutrements, and transmit the same to the office of the Department of War, which said effects are to be accounted for, and paid to the representatives of such deceased non-commissioned officer or soldier. And in case any of the officers, so authorized to take care of the effects of deceased officers and soldiers, should, before they have accounted to their representatives for the same, have occasion to leave the regiment or post, by preferment or otherwise, they shall, before they be permitted to quit the same, deposit in the hands of the commanding officer, or of the assistant military agent, all the effects of such deceased non-commissioned officers and soldiers, in order that the same may be secured for, and paid to, their respective representatives.

ARMY REGULATIONS—EDITION OF 1861.
DECEASED SOLDIERS.

Par. 152. Inventories of the effects of deceased non-commissioned officers and soldiers, required by the 95th Article of War, will be forwarded to the Adjutant General, by the commander of the company to which the deceased belonged, and a duplicate of the same to the colonel of the regiment. Final statements of pay, clothing, &c., will be sent with the inventories. When a soldier dies at a post or station absent from his company, it will be the duty of his immediate commander to furnish the required inventory, and, at the same time, to forward to the commanding officer of the company to which the soldier belonged, a report of his death, specifying the date, place, and cause; to what time he was last paid, and the money or other effects in his possession at the time of his decease; which report will be noted on the next muster roll of the company to which the man belonged. Each inventory will be endorsed, "Inventory of the effects of _____, late of company (—) _____ regiment of _____, who died at _____, the _____ day of _____, 186—." If a legal representative receive the effects, it will be stated in the report. If the soldier leave no effects, the fact will be reported.

Par. 153. Should the effects of a deceased non-commissioned officer or soldier not be administered upon within a short period after his decease, they shall be disposed of by a Council of Administration, under the authority of the commanding officer of the post, and the proceeds deposited with the Paymaster, to the credit of the United States, until they shall be claimed by the legal representatives of the deceased.

Par. 154. In all such cases of sales by the Council of Administration, a statement in detail, or account of the proceeds, duly certified by the Council and commanding officer, accompanied by the Paymaster's receipt for the proceeds, will be forwarded by the commanding officer to the Adjutant General. The statement will be endorsed, "Report of the proceeds of the effects of _____, late of company (—) _____ regiment of _____, who died at _____, the _____ day of _____, 186—."

NOTE 1.—The effects in all cases, when called for, should be turned over to the legal representative, without further authority from the Adjutant General. When the effects are turned over to the relatives of the deceased before these inventories are sent to the Adjutant General, their receipts therefor should be attached to the inventories. In all other cases, one copy will be sent with a letter of transmittal direct to the Adjutant General, and a duplicate retained by the officer.

NOTE 2.—Particular care should be taken to take receipts in duplicate from the Paymaster for any funds turned over to him; one copy should be sent direct to the Adjutant General and one retained by the officer.

OF

Private Prishia Rice

Late of Company *D*

9th Reg't of *10th Corps*

Volunteers, who died at *Pl. of Rockwell*

on the *1st* day of *April* 186*5*.



Inventory of the effects of Ernie Rice late
 a Private of Captain C. W. Murray Company D of
 the 9th Regiment of Infantry Volunteers, who was enrolled as
 a Private at Kent Co. in the State of Del. on
 the 1st day of Sept 1865, and mustered into the service of the United
 States as a Private on the 30 day of September 1865, at Canton Md
 in Company D, 9th Regiment of Infantry Volunteers, to serve One
 years or during the war; he was born in Kent Co. Del. in the State
 of Maryland; he was 39 years of age, 5 feet 7³/₄ inches
 high, Whitish complexion, Blk eyes, Blk hair, and by occupation, when enrolled,
 a Laborer; he died in Hospital, at
Point of Rocks Va on the 1st day of April 1865; by
 reason of Chronic Diarrhea.

| INVENTORY. | | | | | |
|-------------------------|-----|----------------------------|-----|----------------|-----|
| ARTICLES. | No. | ARTICLES. | No. | ARTICLES. | No. |
| Hats..... | | Pairs trousers..... | | Knapsacks..... | |
| Caps..... | | Pairs flannel drawers..... | | | |
| Forage caps..... | | Pairs cotton drawers..... | | | |
| Great coats..... | | Flannel shirts..... | | | |
| Uniform coats..... | | Cotton shirts..... | | | |
| Uniform jackets..... | | Pairs boots..... | | | |
| Flannel sack coats..... | | Pairs shoes..... | | | |
| Blouses..... | | Pairs socks..... | | | |
| Stable frocks..... | | Blankets..... | | MONEY. | |
| Fatigue overalls..... | | Haversacks..... | | Specie..... | \$ |
| | | | | Notes..... | \$ |

I CERTIFY, ON HONOR, that the above inventory comprises all the effects of Ernie Rice, deceased, and that the effects are in the hands of _____ at _____ to be disposed of by a Council of Administration.

(DUPLICATES.)

STATION: Richmond Va

DATE: April 6, 1865

C. W. Murray
Capt 9th Infantry
 Commanding the Company.

ARTICLES OF WAR.

ART. 95. When any non-commissioned officer or soldier shall die, or be killed in the service of the United States, the then commanding officer of the troop or company shall, in the presence of two other commissioned officers, take an account of what effects he died possessed of, above his arms and accoutrements, and transmit the same to the office of the Department of War, which said effects are to be accounted for, and paid to the representatives of such deceased non-commissioned officer or soldier. And in case any of the officers, so authorized to take care of the effects of deceased officers and soldiers, should, before they have accounted to their representatives for the same, have occasion to leave the regiment or post, by preferment or otherwise, they shall, before they be permitted to quit the same, deposit in the hands of the commanding officer, or of the assistant military agent, all the effects of such deceased non-commissioned officers and soldiers, in order that the same may be secured for, and paid to, their respective representatives.

DIRECTIONS.

NOTE 1.—One copy of the inventories of the effects of deceased non-commissioned officers and soldiers, required by the 95th Article of War, will be forwarded to the Adjutant General, by the commander of the company to which the deceased belonged, and a duplicate of the same to the colonel of the regiment. Final statements of pay, clothing, &c., in duplicate, will be sent to the Adjutant General with one copy of the inventory. Both inventory and final statements should be forwarded, as a general rule, through Regimental Headquarters. When a soldier dies at a post or station absent from his company, it will be the duty of his immediate commander to furnish, direct to the Adjutant General, the required inventory and final statements, and, at the same time, to forward to the commanding officer of the company to which the soldier belonged, a report of his death, specifying the date, place, and cause; to what time he was last paid, and the money or other effects in his possession at the time of his decease; which report will be noted on the next muster roll of the company to which the man belonged. Each inventory will be endorsed, "Inventory of the effects of _____, late of company _____, regiment of _____, who died at _____, the _____ day of _____, 186-." If a legal representative receive the effects, it will be stated in the report. If the soldier leave no effects, the fact will be reported on the blank for inventory.

NOTE 2.—Should the effects of a deceased non-commissioned officer or soldier not be administered upon within a short period after his decease, they shall be disposed of by a Council of Administration, under the authority of the commanding officer of the post, and the proceeds deposited with the Paymaster, to the credit of the United States, until they shall be claimed by the legal representatives of the deceased.

NOTE 3.—In all such cases of sales by the Council of Administration, a statement in detail, or account of the proceeds duly certified by the Council and commanding officer, (Form 5.) accompanied by the Paymaster's receipt for the proceeds, will be forwarded by the commanding officer to the Adjutant General. The statement will be endorsed, "Report of the proceeds of the effects of _____, late of company _____, regiment of _____, who died at _____, the _____ day of _____, 186-."

NOTE 4.—The effects in all cases, when called for, should be turned over to the legal representative, without further authority from the Adjutant General. When the effects are turned over to the relatives of the deceased before these inventories are sent to the Adjutant General, their receipts therefor should be attached to the inventories. In all other cases, one copy will be sent with a letter of transmittal direct to the Adjutant General, and a duplicate retained by the officer.

NOTE 5.—Particular care should be taken to take receipts in duplicate from the Paymaster for any funds turned over to him; one copy should be sent direct to the Adjutant General and one retained by the officer.

INVENTORY OF THE EFFECTS

OF

Frank Rice

Late of Company *D*

9 Reg't of *U. S. A.*

Volunteers, who died at *P. R. H.*

on the *11* day of *March* 186*5*.

Filed Sept 26 - 1900
Duplicate on file shows
death April 1 - 1865
This inventory appears to
have been made at the
Hospital

H. J.

Inventory of the effects of Lewis Rice late
a Private of Captain _____ Company "40" of
the 9th Regiment of Vol. Inf. Volunteers, who was enrolled as
a _____ at _____ in the State of _____ on
the _____ day of _____ 1864, and mustered into the service of the United
States as a _____ on the _____ day of _____ 1864, at _____
in Company _____, Regiment of _____ Volunteers, to serve _____
years or during the war; he was born in _____ in the State
of Mo.; he was 22 years of age, _____ feet _____ inches
high, _____ complexion, _____ eyes, _____ hair, and by occupation, when enrolled,
a _____; he died in Point of Rocks, Pa., at
Point of Rocks, Pa. on the 31st day of March 1865, by
reason of Chronic Diarrhea

| INVENTORY. | | | | | |
|-------------------------|-----|----------------------------|-----|----------------|-----|
| ARTICLES. | No. | ARTICLES. | No. | ARTICLES. | No. |
| Hats..... | | Pairs trousers..... | | Knapsacks..... | |
| Caps..... | | Pairs flannel drawers..... | | | |
| Forage caps..... | | Pairs cotton drawers..... | | | |
| Great coats..... | | Flannel shirts..... | | | |
| Uniform coats..... | | Cotton shirts..... | | | |
| Uniform jackets..... | | Pairs boots..... | | | |
| Flannel sack coats..... | | Pairs shoes..... | | | |
| Blouses..... | | Pairs socks..... | | | |
| Stable frocks..... | | Blankets..... | | | |
| Fatigue overalls..... | | Haversacks..... | | | |
| | | | | MONEY. | |
| | | | | Specie..... | \$ |
| | | | | Notes..... | \$ |

I CERTIFY, ON HONOR, that the above inventory comprises all the effects of _____
_____, deceased, and that the effects are in the hands
of _____ at _____
_____ to be disposed of by a Council of Administration.

(DUPLICATES.)

STATION: Point of Rocks, Pa.
DATE: April 1, 1865

H. E. Foster
Surgeon 12th W. V. Inf.
Commanding the Company.
In charge

1865

186576

FINAL STATEMENT

Joseph H. Hill
Private Irish Rifles

9 Reg't of *11th Corps*

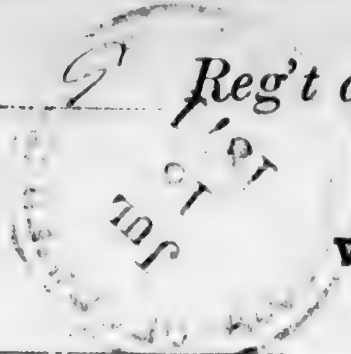

VOLUNTEERS.

NOTE 1.—Two of these certificates (or duplicates) are to be given to each Volunteer Soldier or drafted man who may be discharged without being mustered out (Final Statements are never given to men mustered out of service,) that he may at once receive from the Paymaster the pay, &c., due him, and the captain or other COMMISSIONED officer commanding the company will certify to the act of the delivery of the duplicate certificates; with these certificates the Soldier is "entitled to" his discharge, and should also present his discharge to the Paymaster to have the payment endorsed on it. The discharge is to be given back to the Soldier by the Paymaster; the latter only retaining as his vouchers the duplicate certificates.

NOTE 2.—If the Soldier is entitled to pay for the use of his horse, the Company Commander will certify to that fact on the back of both these final statements, and also to the time he has pay due for having been so mounted on his own horse.

NOTE 3.—When a Soldier is furnished with final statements, his descriptive list, if he has one, should be taken up by the officer who gives the Soldier these statements, and endorsed with a statement to this effect by the officer. The endorsement should exhibit a full statement of the time for which the Soldier was allowed pay on his final statements, the clothing account, and all other charges against him or in his favor, so as to comprise a complete exhibit of his account. It will then be transmitted to the Company Commander of the Soldier, who will enter all the data necessary to a full understanding of the Soldier's account on the muster roll upon which the Soldier's discharge is reported. The descriptive list will then be destroyed. The object of this is, that the remaining portion of the Soldier's account may be settled upon the receipt of these muster rolls, and the Soldier receive any pay or allowances that may be due him at the time of his discharge, and which may not appear on his last final statements from the fact that his descriptive list is incomplete. These accounts for back pay, &c., are settled by the 2d Auditor of the Treasury Department.

NOTE 4.—Charges for loss or injury to ordnance, horse equipments, and other miscellaneous charges, should appear under the heading of "Other Stoppages."

NOTE 5.—Bounty paid by State authorities, and not by the United States, will not be entered on this statement.

NOTE 6.—Amounts due the Sutler and Laundress must be entered on the muster roll on which the discharge, death, desertion, &c., is reported, as well as on the final statement, otherwise the amount cannot be collected from the United States.

NOTE 7.—This blank will be used for deceased volunteers and drafted men, as well as for others.

NOTE 8.—Where a Soldier dies in Hospital or on detached service, his descriptive list, if he has one, should be sent with his final statements, in duplicate, to the Adjutant General, Washington, D. C.

NOTE 9.—If the soldier is a drafted man or substitute, the space for time, &c., of enrolled, should contain only the word *drafted* or *substitute*, as the case may be. If the Soldier is a "VETERAN," (or RECRUIT,) the words *as a veteran*, (or *recruit*;) as the case may be, should be interlined after the words *mustered into the service of the U. S.* A statement of all the installments of *Veteran* or *Recruit Bounty RECEIVED* by the Soldier must be made on the back of each final statement.

I certify, on honor, that Frisbie Rice, a Private of
 Captain C. W. Murray's Company (D) of the 9th Regiment of W. Va. Troops
VOLUNTEERS, of the State of _____, born in Kent Co, State
 of Maryland, aged 39 years; 5 feet 7 1/2 inches high; Chast complexion,
Black eyes, Black hair, and by occupation a Laborer, who joined for service
 and was enrolled (see Note 9) on the Drafted day of _____, 1864, at _____
 by _____, for the period of One years, and mustered into
 the service of the United States on the 30 day of September, 1864, at
Easton Md., by Capt Safford; and having served
HONESTLY and FAITHFULLY with his Company to the present date, is now entitled to a
DISCHARGE by reason of Death.

The said Frisbie Rice was last paid by Paymaster _____
 to include the _____ day of _____, 1864, and
 has pay due him from ^{date of must} ~~that time~~ to the present date; he is entitled to pay and subsistence for
TRAVELING to place of enrollment, and whatever other allowances are authorized to volunteer
 soldiers, drafted men, or militia, so discharged. He has received from the United States **CLOTHING**
 amounting to 25- 86/100 dollars, since the _____ day of Must,
 1864, when his clothing account was last settled. He has received from the United States
 _____ 100 dollars advanced **BOUNTY**.

There is to be stopped from him, on account of the State of _____, or other
 authorities, for **CLOTHING, &c.**, received on entering service, _____ 100 dollars; and
 for other stoppages, viz: One Knapsack, One Haversack, One Canteen
and One Piece Shelter Tent.
 _____ 100 dollars.

He has been furnished with **TRANSPORTATION** in kind from the place of his discharge to
 _____; and he has been **SUBSISTED** for **TRAVELING** to his
 place of enrollment, up to the _____, 1864.

He is indebted to Amos S. Jones, **SUTLER**, _____ 7 100 dollars.
 He is indebted to _____, **LAUNDRESS**, _____ 100 dollars.

Given in Duplicate, at Richmond Va, this 6 day
 of April, 1865.

C. W. Murray
Capt 9th W. Va. Troops
 Commanding Company.

[OFFICE ENDORSEMENT.]

War Department,

ADJUTANT GENERAL'S OFFICE,

April 9th, 1878
The Quaker of South Carolina
Rice, Co D, 9th Reg't U. S.
Colored Troops, is reported as follows:

On Company Muster Roll.
For Jan. 1st 1865, Mar 31, 1865

Company Muster-out Roll.
Mar 30, 1865

Company Descriptive Book. 1866

Company Morning Reports. 1866

Soldier's Final Statement. Mar 31, 1865

Soldier's Record of Death and Interment. 1866

Soldier's Inventory of Effects. April 1, 1865

Soldier's Certificate of Disability for Discharge. 1866

Soldier's Individual Muster-out Roll. 1866

Regimental Return. For April 1, 1865, Mar 31, 1865

Regimental Quarterly Returns. Mar 31, 1865

Regimental Descriptive Book. 1866

By Surgeon General. (844,978) March 31, 1865

March 31, 1865, is held to be
the correct date, and the Company Muster-out
Roll will be amended accordingly.

Am. D. Cook

Assistant Adjutant General.

613 12
9445-536 Vallet

FINAL STATEMENT

OF

Pvt Josiah Rice
9th Reg't of U. S. Colored Troops.

VOLUNTEERS.

NOTE 1.—Two of these certificates (or duplicates) are to be given to each Volunteer Soldier or drafted man who may be discharged without being mustered out (Final Statements are never given to men mustered out of service,) that he may at once receive from the Paymaster the pay, &c., due him, and the captain or other COMMISSIONED officer commanding the company will certify to the act of the delivery of the duplicate certificates; with these certificates the Soldier is "entitled to" his discharge, and should also present his discharge to the Paymaster to have the payment endorsed on it. The discharge is to be given back to the Soldier by the Paymaster; the latter only retaining as his vouchers the duplicate certificates.

NOTE 2.—If the Soldier is entitled to pay for the use of his horse, the Company Commander will certify to that fact on the back of both these final statements, and also to the time he has pay due for having been so mounted on his own horse.

NOTE 3.—When a Soldier is furnished with final statements, his descriptive list, if he has one, should be taken up by the officer who gives the Soldier these statements, and endorsed with a statement to this effect by the officer. The endorsement should exhibit a full statement of the time for which the Soldier was allowed pay on his final statements, the clothing account, and all other charges against him or in his favor, so as to comprise a complete exhibit of his account. It will then be transmitted to the Company Commander of the Soldier, who will enter all the data necessary to a full understanding of the Soldier's account on the muster roll upon which the Soldier's discharge is reported. The descriptive list will then be destroyed. The object of this is, that the remaining portion of the Soldier's account may be settled upon the receipt of these muster rolls, and the Soldier receive any pay or allowances that may be due him at the time of his discharge, and which may not appear on his last final statements from the fact that his descriptive list is incomplete. These accounts for back pay, &c., are settled by the 24 Auditor of the Treasury Department.

NOTE 4.—Charges for loss or injury to ordnance, horse equipments, and other miscellaneous charges, should appear under the heading of "Other Stoppages."

NOTE 5.—Bounty paid by State authorities, and not by the United States, will not be entered on this statement.

NOTE 6.—Amounts due the Sutler and Laundress must be entered on the muster roll on which the discharge, death, desertion, &c., is reported, as well as on the final statement, otherwise the amount cannot be collected from the United States.

NOTE 7.—This blank will be used for deceased volunteers and drafted men, as well as for others.

NOTE 8.—Where a Soldier dies in Hospital or on detached service, his descriptive list, if he has one, should be sent with his final statements, in duplicate, to the Adjutant General, Washington, D. C.

NOTE 9.—If the soldier is a drafted man or substitute, the space for time, &c., of enrolled, should contain only the word *drafted* or *substitute*, as the case may be. If the Soldier is a "VETERAN," (or RECRUIT,) the words as a *veteran*, (or *recruit*), as the case may be, should be interlined after the words *mustered into the service of the U. S.* A statement of all the installments of *Veteran* or *Recruit Bounty* RECEIVED by the Soldier must be made on the back of each final statement.

Am. D. Cook

FINAL STATEMENT

OF

Pvt Josiah Rice
9th Reg't of U.S. Inf.

VOLUNTEERS.

NOTE 1.—Two of these certificates (or duplicates) are to be given to each Volunteer Soldier or drafted man who may be discharged without being mustered out (Final Statements are never given to men mustered out of service,) that he may at once receive from the Paymaster the pay, &c., due him, and the captain or other COMMISSIONED officer commanding the company will certify to the act of the delivery of the duplicate certificates; with these certificates the Soldier is "entitled to" his discharge, and should also present his discharge to the Paymaster to have the payment endorsed on it. The discharge is to be given back to the Soldier by the Paymaster; the latter only retaining as his vouchers the duplicate certificates.

NOTE 2.—If the Soldier is entitled to pay for the use of his horse, the Company Commander will certify to that fact on the back of both these final statements, and also to the time he has pay due for having been so mounted on his own horse.

NOTE 3.—When a Soldier is furnished with final statements, his descriptive list, if he has one, should be taken up by the officer who gives the Soldier these statements, and endorsed with a statement to this effect by the officer. The endorsement should exhibit a full statement of the time for which the Soldier was allowed pay on his final statements, the clothing account, and all other charges against him or in his favor, so as to comprise a complete exhibit of his account. It will then be transmitted to the Company Commander of the Soldier, who will enter all the data necessary to a full understanding of the Soldier's account on the muster roll upon which the Soldier's discharge is reported. The descriptive list will then be destroyed. The object of this is, that the remaining portion of the Soldier's account may be settled upon the receipt of these muster rolls, and the Soldier receive any pay or allowances that may be due him at the time of his discharge, and which may not appear on his last final statements from the fact that his descriptive list is incomplete. These accounts for back pay, &c., are settled by the 2d Auditor of the Treasury Department.

NOTE 4.—Charges for loss or injury to ordnance, horse equipments, and other miscellaneous charges, should appear under the heading of "Other Stoppages."

NOTE 5.—Bounty paid by State authorities, and not by the United States, will not be entered on this statement.

NOTE 6.—Amounts due the Sutler and Laundress must be entered on the muster roll on which the discharge, death, desertion, &c., is reported, as well as on the final statement, otherwise the amount cannot be collected from the United States.

NOTE 7.—This blank will be used for deceased volunteers and drafted men, as well as for others.

NOTE 8.—Where a Soldier dies in Hospital or on detached service, his descriptive list, if he has one, should be sent with his final statements, in duplicate, to the Adjutant General, Washington, D. C.

NOTE 9.—If the soldier is a drafted man or substitute, the space for time, &c., of enrolled, should contain only the word *drafted* or *substitute*, as the case may be. If the Soldier is a "VETERAN," (or RECRUIT,) the words as a *veteran*, (or *recruit*,) as the case may be, should be interlined after the words *mustered into the service of the U.S.A.* A statement of all the installments of *Veteran* or *Recruit* *Bounty* RECEIVED by the Soldier must be made on the back of each final statement.

ADJUTANT GENERAL'S OFFICE.

Apr 22 1865

Duplicate with Inventory sent 2d Auditor.

Wm. R. ...

⁹⁴⁰
 Richards, Jenkins H.

Co D, 9 U.S. Col'd Inf.

Private | Private

CARD NUMBERS.

| | | |
|----|---------|----|
| 1 | 6306243 | 26 |
| 2 | 6306315 | 27 |
| 3 | 6306417 | 28 |
| 4 | 6306521 | 29 |
| 5 | 6306621 | 30 |
| 6 | 6306718 | 31 |
| 7 | 6306818 | 32 |
| 8 | 6306917 | 33 |
| 9 | 6307019 | 34 |
| 10 | 6307118 | 35 |
| 11 | 6307217 | 36 |
| 12 | 6307308 | 37 |
| 13 | 6307397 | 38 |
| 14 | 6307489 | 39 |
| 15 | 6307563 | 40 |
| 16 | 6307643 | 41 |
| 17 | 6307722 | 42 |
| 18 | 6307800 | 43 |
| 19 | 6307880 | 44 |
| 20 | 6307957 | 45 |
| 21 | 9068471 | 46 |
| 22 | | 47 |
| 23 | | 48 |
| 24 | | 49 |
| 25 | | 50 |

Book Mark:

See also

A. 127 05-5-8
A. 233785-8 P.O. Pitt

C.S. Dougherty

78

9

U.S.C.T.

James W. Richards

, Co. *D*, 9 Reg't U. S. Col'd Inf.

Appears on

Company Descriptive Book

of the organization named above.

DESCRIPTION.

Age *21* years; height *5* feet *6* inches.

Complexion *Dark;*

Eyes *Dark;* hair *Dark.*

Where born *Somerset Md.,*

Occupation *Farmer.*

ENLISTMENT.

When *Nov. 11*, 186*3*.

Where *Newark Ma.,*

By whom *Col. Binney*; term *3* y'rs.

Remarks: *Discharged with
Rept Nov. 26/66.*

Poly

R

9

U.S.C.T.

Jenkins A. Richards
Co. C, 9 Reg't U. S. Col'd Infantry.

Age *21* years.

Appears on

Company Muster-in Roll

of the organization named above. Roll dated

C. Stanton, Ches. Co. Md., Nov 14, 1863

Muster-in to date *Nov. 14, 1863*

Joined for duty and enrolled:

When *Nov. 11*, 186 *3*

Where *Somerset Md.*

Period *3* years.

Remarks: _____

Book mark: _____

J. C. Parks

(356)

Copyist.

R | **9** | **U.S.C.T.**

Jenkins H. Richards
Pvt, Co. D, 9 Reg't U. S. Col'd Infantry.

Appears on

Company Muster Roll

for *from Nov 14* to *Dec 31*, 186 *3*

Present or absent *Present*

Stoppage, \$ *100* for

Due Gov't, \$ *100* for

Remarks: *\$200 recruits*
premium due

Book mark:

J. E. Parks

(358)

Copyist

R

9

U.S.C.T.

Jenkins H. Richards
Priv, Co. D, 9 Reg't U. S. Col'd Infantry.

Appears on

Company Muster Roll

for *Jan & Feb*, 1864.

Present or absent *Present*

Stoppage, \$ *100* for

Due Gov't, \$ *100* for

Remarks: *Two dollars*
recruits premium
due.

Book mark: _____

J. E. Ruck

(858)

Copyist

R

9

U.S.C.T.

Jenkins H. Richards

Priv, Co. D, 9 Reg't U. S. Col'd Infantry.

Appears on

Company Muster Roll

for *Mar & Apr*, 186 *4*

Present or absent *Present*

Stoppage, \$ *100* for

Due Gov't, \$ *100* for

Remarks:

Book mark:

J. E. Burke

(358)

Copyist

R | 9 | U.S.C.T.

Jenkins H. Richards
Cpt., Co. D, 9 Reg't U. S. Col'd Infantry.

Appears on

Company Muster Roll

for May & June, 1864.

Present or absent Present

Stoppage, \$ 100 for

Due Gov't, \$ 100 for

Remarks:

Book mark:

(358)

J. E. Parks

Copyist

R

9

U.S.C.T.

Jenkins H. Richards
Priv., Co. D, 9 Reg't U. S. Col'd Infantry.

Appears on

Company Muster Roll

for *July Aug*, 1864

Present or absent *Present*

Stoppage, \$ *100* for

Due Gov't, \$ *100* for

Remarks: *Map for one O*
Quapsack, one O
knivesack, one
O can beer

Book mark:

J. E. Burke

(358)

Copyist

P | 9 | U.S.C.T.

Jenkins H. Richards
Priv, Co. D, 9 Reg't U. S. Col'd Infantry.

Appears on

Company Muster Roll

for *Sept, Oct*, 186 *4*

Present or absent *Present*

Stoppage, \$ 100 for

Due Gov't, \$ 100 for

Remarks:

Book mark: _____

(858)

A. E. Ruck

Copyist

P

9

U.S.C.T.

Jenkins H. Richards
Priv, Co. D, 9 Reg't U. S. Col'd Infantry.

Appears on

Company Muster Roll

for *Nov. 1864*, 186 *4*

Present or absent *Present*

Stoppage, \$ *100* for

Due Gov't, \$ *100* for

Remarks: *Stop for one*
haversack.

Book mark: _____

J. E. Parks

R | 9 | U.S.C.T.

Jenkins A. Richards
Plt., Co. D, 9 Reg't U. S. Col'd Infantry.

Appears on

Company Muster Roll

for *Mar 1865*, 1865.

Present or absent *Present*

Stoppage, \$ *100* for

Due Gov't, \$ *100* for

Remarks: *Stop for 1 bayo-*
net, scabbard

Book mark: _____

J. M. Harmon

(358)

Copyist

R | 9 | U.S.C.T.

Jenkins A Richards
Capt., Co. D, 9 Reg't U. S. Col'd Infantry.

Appears on

Company Muster Roll

for Dec 31/64 to June 30, 1865.

Present or absent Present

Stoppage, \$ 100 for

Due Gov't, \$ 100 for

Remarks: Stop for bayonet
scabbard.

Book mark:

J. M. Harmon

R | 9 | U.S.C.T.

Jenkins A Richards
Pvt., Co. D, 9 Reg't U. S. Col'd Infantry.

Appears on

Company Muster Roll

for Dec 31/64 to Aug 31, 1865.

Present or absent Present

Stoppage, \$ 100 for

Due Gov't, \$ 100 for

Remarks: Stop for 1 bayonet
not scabbard

Book mark:

J. M. Harrison

R

9

U.S.C.T.

Jenkins H Richards

Priv, Co. D, 9 Reg't U. S. Col'd Infantry.

Appears on

Company Muster Roll

for *June 30/65 to Oct 31*, 186*5*.

Present or absent *Present*

Stoppage, \$ *100* for

Due Gov't, \$ *100* for

Remarks:

Book mark:

J M Harmon

(858)

Copyist

R

9

U.S.C.T.

Jenkins A. Richards

Priv., Co. D, 9 Reg't U. S. Col'd Infantry.

Appears on

Company Muster Roll

for June 30/65 to Dec 31, 1865.

Present or absent Absent

Stoppage, \$ 100 for

Due Gov't, \$ 0, 08/100 for ord.

Remarks: Order per. as
Wood Cutter, Mem.
order of U.S.C.T. Nov
7/65

Book mark:

J. M. Harmon

(858)

Copyist

R 9 U.S.C.T.

Justin A. Richards
Plt., Co. D, 9 Reg't U. S. Col'd Infantry.

Appears on

Company Muster Roll

for *Jan & Feb*, 186*6*.

Present or absent *Present*

Stoppage, \$ 100 for

Due Gov't, \$ 100 for

Remarks:

Book mark: -----

M. Harmon

No. 9 U.S.C.T.

Jenkins H. Richards
Priv., Co. D, 9 Reg't U. S. Col'd Infantry.

Appears on

Company Muster Roll

for *March & April*, 1866

Present or absent *present*

Stoppage, \$ 100 for

Due Gov't, \$ 100 for

Remarks:

Book mark:

G. E. Dayton

(358)

Copyist

No. | 9 | U.S.C.T.

Jenkins H. Richards
Plt, Co. D, 9 Reg't U. S. Col'd Infantry.

Appears on

Company Muster Roll

for *May + June*, 186*6*

Present or absent *Present*

Stoppage, \$ *100* for

Due Gov't, \$ *100* for

Remarks:

Book mark:

G. E. Dayton

(858)

Copyist

Ro. | 9 | U.S.C.T.

Jenkins H. Richards
Priv, Co. D, 9 Reg't U. S. Col'd Infantry.

Appears on

Company Muster Roll

for July + Aug, 1866

Present or absent present

Stoppage, \$ 100 for

Due Gov't, \$ 100 for

Remarks:

Book mark:

G. E. Dayton

(858)

Copyist

R.

9

U.S.C.T.

Jenkins H. Richards

Priv., Co. D, 9 Reg't U. S. Col'd Infantry.

Appears on

Company Muster Roll

for Sep + Oct, 1866

Present or absent present

Stoppage, \$ 100 for

Due Gov't, \$ 100 for

Remarks:

Book mark:

G. E. Dayton

(858)

Copyist

R. | 9 | U.S.C.T.

Jenkins H. Richards
Priv., Co. *D*, 9 Reg't U. S. Col'd Infantry.

Appears on **Co. Muster-out Roll**, dated
New Orleans La. 26 Nov, 1866.

Muster-out to date *26 Nov*, 1866.

Last paid to *31 Aug*, 1866.

Clothing account:

Last settled _____, 186 ; drawn since \$ _____ 100

Due soldier \$ *16³⁴* / 100; due U. S. \$ _____ 100

Am't for cloth'g in kind or money adv'd \$ _____ 100

Due U. S. for arms, equipments, &c., \$ *6⁰⁰* / 100

ordinary Bounty paid \$ *none* / 100; due \$ *100⁰⁰* x / 100

Remarks: *Joined at original*
organs;

Stop for (1.) Musketsell
of accounts retained.

x *Bounty due under Act of Con-*
gress of only 28/66 \$ 100⁰⁰

Book mark: *U. 181 P. 183. 74 d*

G. E. Dayton

⁹⁴¹
Ridley, Alexander

Co F, 9 U.S. Col'd Inf.

CARD NUMBERS.

| | |
|----|----|
| 1 | 26 |
| 2 | 27 |
| 3 | 28 |
| 4 | 29 |
| 5 | 30 |
| 6 | 31 |
| 7 | 32 |
| 8 | 33 |
| 9 | 34 |
| 10 | 35 |
| 11 | 36 |
| 12 | 37 |
| 13 | 38 |
| 14 | 39 |
| 15 | 40 |
| 16 | 41 |
| 17 | 42 |
| 18 | 43 |
| 19 | 44 |
| 20 | 45 |
| 21 | 46 |
| 22 | 47 |
| 23 | 48 |
| 24 | 49 |
| 25 | 50 |

see Ridley Alexander

Book Mark:

See also

Riley, Henry

Co A, 9 U.S. Col'd Inf.

Private Private

CARD NUMBERS.

| | | |
|----|----------|----|
| 1 | 6313443 | 26 |
| 2 | 63133-42 | 27 |
| 3 | 6313643 | 28 |
| 4 | 6313747 | 29 |
| 5 | 6313845 | 30 |
| 6 | 6313941 | 31 |
| 7 | 6314031 | 32 |
| 8 | 6314136 | 33 |
| 9 | 6314236 | 34 |
| 10 | 6314330 | 35 |
| 11 | 6314423 | 36 |
| 12 | 6314501 | 37 |
| 13 | 6314583 | 38 |
| 14 | 631465-5 | 39 |
| 15 | 6314719 | 40 |
| 16 | 631478- | 41 |
| 17 | 6314842 | 42 |
| 18 | 6314902 | 43 |
| 19 | 6314961 | 44 |
| 20 | 6315017 | 45 |
| 21 | 9069271 | 46 |
| 22 | | 47 |
| 23 | | 48 |
| 24 | | 49 |
| 25 | | 50 |

Book Mark:

See also

S. 740430 P.C. aff
S 817149 P.O. aff

C. E. Doughty

No. 9 U.S.C.T.

Henry Riley

Co. B, 9 Reg't U. S. Col'd Inf.

Appears on Company Descriptive Book of the organization named above.

DESCRIPTION.

Age 25 years; height 5 feet 11 1/2 inches.

Complexion Black.

Eyes Black; hair Black.

Where born Accomac, Virginia

Occupation Farmer.

ENLISTMENT.

When Nov 1863.

Where Accomac, Virginia

By whom W. B. Boring; term 3 y'rs.

Remarks: Discharged Nov 1864 for ill health. Served in the Dept. of the Gulf.

C. A. Boring

P

9

U.S.C.T.

Henry Riley
Private, Co. H, 9 Reg't U. S. Col'd Infantry.

Age *25* years.

Appears on

Company Muster-in Roll

of the organization named above, Roll dated

Camp Stanton, Charles ^{*Maryland*} *Nov. 23*, 1863.

Muster-in to date *Nov. 23*, 1863

Joined for duty and enrolled:

When *Nov. 7*, 1863.

Where *Accomac, Va.*

Period *3* years.

Remarks:
.....
.....
.....
.....
.....
.....
.....

Book mark:

(356)

O. J. Markle,
Copyist.

P

9

U.S.C.T.

Henry Riley

Private, Co. H, 9 Reg't U. S. Col'd Infantry.

Appears on

Company Muster Roll

for Nov. 23 to Dec. 31, 1863.

Present or absent Present.

Stoppage, \$ 100 for

Due Gov't, \$ 100 for

Remarks: \$2 Recruits premium due.

Book mark:

O. J. Markle.

(358)

Copyist.

P

9

U.S.C.T.

Henry Riley

Private, Co. H, 9 Reg't U. S. Cav'd Infantry.

Appears on

Company Muster Roll

for Jan. + Feb., 1864.

Present or absent Present.

Stoppage, \$ 100 for

Due Gov't, \$ 100 for

Remarks: \$2 Recruits premium due.

Book mark:

O. J. Markle,

(358)

Copyist.

R

9

U.S.C.T.

Henry Riley

Private, Co. H, 9 Reg't U. S. Col'd Infantry.

Appears on

Company Muster Roll

for *March & April*, 1864.

Present or absent *Present*

Stoppage, \$ *100* for

Due Gov't, \$ *100* for

Remarks:

Book mark:

O. J. Markle

(358)

Copyist.

R | 9 | U.S.C.T.

Henry Riley
Private, Co. H, 9 Reg't U. S. Col'd Infantry.

Appears on

Company Muster Roll

for *May & June*, 1864.

Present or absent *Present.*

Stoppage, \$ *100* for

Due Gov't, \$ *100* for

Remarks: *no shoulder scales.*

Book mark:

O. J. Markle

R

9

U.S.C.T.

Henry Riley

Private, Co. H, 9 Reg't U. S. Col'd Infantry.

Appears on

Company Muster Roll

for July + August, 1864.

Present or absent present.

Stoppage, \$ 100 for

Due Gov't, \$ 100 for

Remarks:

Book mark:

O. J. Markle

(358)

Copyist.

P

9

U.S.C.T.

Henry Riley

Private, Co. H, 9 Reg't U. S. Col'd Infantry.

Appears on

Company Muster Roll

for Sept. & Oct., 1864

Present or absent Present.

Stoppage, \$ 100 for

Due Gov't, \$ 100 for

Remarks:

Book mark:

O. J. Markle
Copyist.

R | **9** | **U.S.C.T.**

Henry Riley
Priv., Co. *H*, 9 Reg't U. S. Col'd Infantry.

Appears on

Company Muster Roll

for *Nov. & Dec.*, 186*4*

Present or absent *Present*

Stoppage, \$ *100* for

Due Gov't, \$ *100* for

Remarks: *The difference between Seven Dollars per month and Thirteen Dollars per month is due from Jan. 16 to April 30 1864*

Book mark:

H. Ames

R | **9** | **U.S.C.T.**

Henry Riley
Priv., Co. H, 9 Reg't U. S. Cav'd Infantry.

Appears on

Company Muster Roll

for *Jan. + Feb.*, 1865.

Present or absent *Present*

Stoppage, \$ *100* for

Due Gov't, \$ *100* for

Remarks:

Book mark:

A. L. Ames

R | 9 | U.S.C.T.

Henry Riley
Priv., Co. H, 9 Reg't U. S. Col'd Infantry.

Appears on

Company Muster Roll

for Mch. & April, 1863.

Present or absent Present

Stoppage, \$ 100 for

Due Gov't, \$ 100 for

Remarks:

Book mark:

A. L. Ames

R | 9 | U.S.C.T.

Henry Piler
Private, Co. H, 9 Reg't U. S. Col'd Infantry.

Appears on

Company Muster Roll

for Dec 31, 1864 to June 30, 1865.

Present or absent Present

Stoppage, \$ 1.00 for

Due Gov't, \$ 1.00 for

Remarks: Stop for one month
prior, one piece

x Appears on prior
rolls as Riley.

Book mark:

H. Ames

R

9

U.S.C.T.

Henry Riley
Priv., Co. H, 9 Reg't U. S. Col'd Infantry.

Appears on

Company Muster Roll

for July & Aug., 1865.

Present or absent Present

Stoppage, \$ 100 for

Due Gov't, \$ 100 for

Remarks:

Book mark:

A. L. Ames

(358)

Copyist.

R | 9 | U.S.C.T.
Henry Riley
Priv., Co. H, 9 Reg't U. S. Col'd Infantry.

Appears on

Company Muster Roll

for June 30 to Oct. 31, 1865.

Present or absent Present

Stoppage, \$ 100 for

Due Gov't, \$ 100 for

Remarks:

Book mark:

A. L. Ames

R

9

U.S.C.T.

Henry Riley

Priv., Co. H, 9 Reg't U. S. Col'd Infantry.

Appears on

Company Muster Roll

for June 30 to Dec. 31, 1865.

Present or absent Present

Stoppage, \$ 100 for ⁶⁹ Ordnance

Due Gov't, \$ 100 for

Remarks:

Book mark:

A. L. Jones

(358)

Copyist.

R. | 9 | U.S.C.T.

Henry Riley
Privt, Co. H, 9 Reg't U. S. Col'd Infantry.

Appears on

Company Muster Roll

for *Jan. & Feb.*, 186 *6*.

Present or absent *Present*.

Stoppage, \$ *100* for

Due Gov't, \$ *100* for

Remarks:

Book mark: _____

R. Braden

R. | 9 | U.S.C.T.

Henry Riley
Privt, Co. H, 9 Reg't U. S. Col'd Infantry.

Appears on

Company Muster Roll

for *March & April*, 186*6*.

Present or absent *Present*

Stoppage, \$ *100* for

Due Gov't, \$ *100* for

Remarks:

Book mark: _____

R. Braden

R. | 9 | U.S.C.T.

Henry Riley.
Privt, Co. H, 9 Reg't U. S. Col'd Infantry.

Appears on

Company Muster Roll

for May & June, 1866.

Present or absent Present

Stoppage, \$ 100 for

Due Gov't, \$ 100 for

Remarks:

Book mark:

R. Bradin

R. | 9 | U.S.C.T.

Henry Riley
Priv., Co. H, 9 Reg't U. S. Col'd Infantry.

Appears on

Company Muster Roll

for *July & Aug*, 186 *6*.

Present or absent *Present*

Stoppage, \$ 100 for

Due Gov't, \$ 100 for

Remarks:

Book mark:

R. Braden

R.

9

U.S.C.T.

Henry Riley

Private, Co. "H", 9 Reg't U. S. Col'd Infantry.

Appears on **Co. Muster-out Roll**, dated

New Orleans, La., Nov. 26, 1864.

Muster-out to date *Nov. 26, 1864*.

Last paid to *Aug. 31, 1864*.

Clothing account:

Last settled....., 186 ; drawn since \$..... 100

Due soldier \$ *34* ^{*50*}/₁₀₀; due U. S. \$..... 100

Am't for cloth'g in kind or money adv'd \$..... 100

Due U. S. for arms, equipments, &c., \$ *6* 100

Ordinary
Bounty paid \$..... 100; due \$ *30* 100

Remarks: *Bounty due under act of Congress of July 26/64 \$100. Failed at Iniquial Organization Stop for one S. R. Mousket & Accouterments Retained.*

Book mark: *V. 167, P. 98, 73.*

R. Braden

(861)

Copyist.

Riley, Henry

P. Co. H, 9 Regt. U. S. C. Inf.

Enclosures.

| | |
|------------------------------|-------------------|
| Bed Cards | Descriptive Lists |
| Burial Records | Final Statements |
| Certs. of Dis. for Discharge | Furloughs |
| C. M. Charges | Med. Des. Lists |
| Med. Certificates | Orders |

Other papers relating to—

| | |
|----------------------------|----------------------|
| Admission to Hosp'l | Furlough |
| Casualty Sheet (Officer's) | Med. Examination |
| Confinement | Misc. Information |
| Contracts | Pay or Clothing |
| Death or Effects | Personal Reports |
| Desertions | Rank |
| Discharge from Hosp'l | Transfer to Hosp'l |
| Discharge from Service | Transfer to V. R. C. |
| Duty | Transportation |

Save Claim 1

MICROFILM PUBLICATION M 1851

COMPILED MILITARY SERVICE RECORDS
OF VOLUNTEER UNION SOLDIERS WHO SERVED WITH
THE UNITED STATES COLORED TROOPS (USCT)
9TH REGIMENT OF INFANTRY

PERSONAL PAPERS' TARGET SHEET

PLEASE NOTE THE CHECKED INFORMATION ABOUT THE PERSONAL PAPERS IN
THIS FILE:

- NO PERSONAL PAPERS WERE FOUND IN THIS FILE WHEN THE
RECORDS WERE ARRANGED FOR MICROFILMING.
- 7 PERSONAL PAPER(S) FOUND IN THIS FILE WHEN THE RECORDS
WERE ARRANGED FOR MICROFILMING.

A.S.H.
August 13, 1864
Examined & found correct,
T.H.

Prof. Sneed Supersubscribed
No. 1422 - No. 24.

APPLICATION

OF
Raymond Riley Senr.
OF
Drummond Tomp, Acconiae Co Va
For Compensation for Service of Slave,

Henry Riley
Enlisted in *9th* Regiment
U. S. Colored Troops, Co. *H.*
Received, *Apr 23d* 1864.

COMPENSATION AWARDED,

July 28th 1864.
Three Hundred Dollars.
T. J. Street
President Board of Claims
No Bounties due

Raymond Riley Senr.
1000
6/25/64

MAR 6 1864

STATE OF ^{Virginia} MARYLAND,

Accomack County, to wit:

On this ninth day of April in the year 1864,

before me, the subscriber, a Justice of the Peace of the State and County aforesaid, personally appeared Raymond Riley (son), and took, signed, and acknowledged the oaths preceding; and further made oath, in due form of law, that all the statements made in this application are, to the best of his knowledge and belief, strictly true.

Also personally appeared before me John D. Tyler Henry A. Leatherbury and _____, loyal citizens of the United States, residents of

Accomack Va, well acquainted with the said Raymond Riley son, and in no manner interested in the prosecution of this claim, and made oath, in due form of law, that the said Raymond Riley (son) is the owner of the slave Henry Riley, as a fact of public notoriety; that they believe all the statements herein made by R. Riley (son) in reference thereto, are correct, and that S. Riley is unquestionably loyal to the Government of the United States. Witness their signatures:

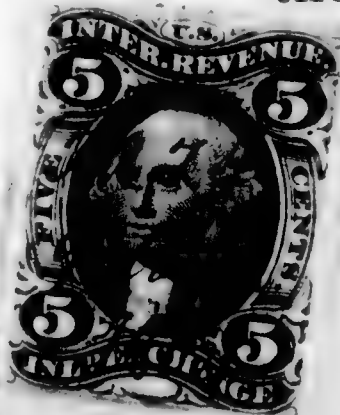

John D. Tyler
H. A. Leatherbury
J. A. J. Payne Justice of the Peace.

MAR 28 1864

Virginia
STATE OF ~~MARYLAND~~

Accomack County, to wit:

I, *Wm. B. Alworth*, Clerk of the ~~Circuit~~ *Circuit* Court for *Accomack* County, do hereby certify that *Judge A. T. Jones*

before whom the foregoing affidavits were made, was, at the time of signing the same, a Justice of the Peace for the County and State aforesaid, duly commissioned and sworn; and that his signature thereto is genuine, and that full faith and credit should be given to his official acts.

Witness my hand and the seal of said Court, this *13th* day of *April*, A. D. 1864.

W. B. Alworth, CLERK.



A.

No. 1422.

CLAIMANT'S CERTIFICATE.

I, Raymond Riley (son), a loyal citizen, and a resident
of Accomack, County of Accomack, State of
Virginia, hereby claim compensation, under the provisions of
General Orders, No. 329, 1863, for my slave Henry Riley
enlisted November 7th, 1863, at Drummond Town Accomack
by Col. Wm Binney, in the Co. H. 9th U. S. Col. Troops
Regiment U. S. Colored Troops, Co. H; certificate of which enlistment, and a
descriptive list, as required, accompany this application.

In proof of my loyalty to the Constitution and Government of the United States, I
present the accompanying oath, which I have taken, signed, and acknowledged, to be filed
with this application, in accordance with requirement of said General Orders.

April the 2th, 1864

Raymond Riley (son)

B.

OATH OF ALLEGIANCE.

I, *Raymond Riley (Sen)*, do solemnly swear that I have never joined, or been concerned in, any insurrection or rebellion; that I have never borne arms against the United States; that I have never given any aid, countenance, counsel, or encouragement to any person or persons engaged, or whom I had reason to believe were about to engage, in insurrection, rebellion, or armed hostility against the United States; that I have neither sought, nor accepted, nor attempted to exercise the functions of any office, civil or military, nor to perform any service whatever, under any authority or pretended authority in hostility to the United States; that I have not yielded a voluntary support to any insurrection, rebellion, or pretended government, authority, power, or constitution within the United States hostile thereto. And I do further swear that, to the best of my knowledge and ability, I have supported and defended, and will continue to support and defend, the United States against all enemies, foreign and domestic; and that I have supported, defended, and obeyed, and will continue to support, defend, and obey, the Constitution and laws of the United States; that I will bear true faith and allegiance to the same; and that I take this oath freely, without any mental reservation or purpose of evasion: So help me God.

Raymond Riley

Sworn to and subscribed before me, at *Onancock Va.*
this *9th* day of *April*, 1864.

Jully A. J. Jones J.P.



C.

I present herewith evidence of my title to the slave Henry Riley
enlisted as aforesaid, and in consideration of the sum
of Three Hundred Dollars by me received, I hereby covenant and
agree with the United States, that I, my heirs, executors, or assigns, shall never hereafter make
or enforce any claim to the labor or services of said slave; and pledge myself to execute
a valid Deed of Manumission and Release of all my claims to service forever of said
Henry Riley to be filed with the Board of Claims
now in session at Baltimore Md

April 9th, 1864.

Raymond Riley son



E.

DEED OF MANUMISSION AND RELEASE OF SERVICE.

Whereas my slave Henry Riley has enlisted in the service of the United States: now, in consideration thereof, I, Raymond Riley Jr, of Accomack County, State of Virginia, do hereby, in consideration of said enlistment, manumit, set free, and release the above-named Henry Riley from all service due me; his freedom to commence from the 7th day of November 1863, the date of his enlistment as aforesaid in the 54th Regiment of Colored Troops, in the service of the United States.

Witness my hand and seal, this 31st day of May 1864

Raymond Riley
SEAL.

Witness:

E. B. Napier
E. W. Robatson
John E. Taylor

Accomack County,

State of Virginia, 1864

Before me appeared this day Raymond Riley Jr. and acknowledged the above Deed of Manumission and Release of Service to be his free act and deed.

Jully N. Joynes J.P.

State of Virginia
Accomack County, to-wit:

1796

I John B. Kilworth, Clerk of Accomack County Court, do hereby Certify that this Deed of Manumission from Raymond Riley to his slave Henry Riley is a true Copy of together with the Certificate of Acknowledgment & one ^{at the City of one} now of record in the Clerk's Office said Court.

In Testimony whereof I have hereunto set my hand and affixed the seal of said Court this 14th day of June A.D. 1864.



John B. Kilworth, C. C.

Accomack County Clerk's Office June 11 1796
This Deed of Manumission from Raymond Riley to
his slave Henry Riley together with the Certificate of
Acknowledgment & one ^{at the City of one} now of record in the Clerk's
Office said Court. I have hereunto set my hand and affixed the seal of
said Court this 14th day of June A.D. 1864.
John B. Kilworth, C. C.

F.

CERTIFICATE OF AWARD OF THE BOARD OF CLAIMS.

Office of the Board of Claims
For Slaves Enlisted in the Service of the United States,

Calverton Md.

July 30th, 1864

112
\$300-

We hereby certify, that *Raymond Riley*, of
Aceona R county, State of *Virginia*,
having proved, under oath, *his* loyalty to the Constitution and
Government of the United States, and established *his* title
as to the ownership of *Henry Riley*, a slave enlisted
at *Drummers Town Va.*, on the *7th* day of *November*,
1863, by *Col. Wm. Birney*, in the service of the
United States, in the *ninth* Regiment of Colored Troops,
Co. A, and having filed a valid Deed of Manumission and Release
of Service of said slave, is entitled to the sum of *Three Hundred*
dollars, which has been awarded to *him* by this Board as a
remuneration for all claim to the future labor or service of said slave,
under the provision of General Orders, War Department, No. 329,
1863.

J. Street, President of the Board.

Thos. Jamieson, Member of the Board.

L. C. Straughn, Member of the Board.

To *Maj. W. Foster*,

Chief of the Bureau for the

Organization of Colored Troops, Washington, D. C.

24

No. .

ABSTRACT OF DISBURSEMENTS.

....., 186 .

Raymond Riley

Dollars *300* $\frac{00}{100}$

Paid , 186 .

789

The United States,

To *Raymond Riley* Dr.

| 1864. | | DOLLARS. | CENTS. |
|-----------------------------|---|----------------|-----------|
| <i>July 30th</i> | For amount awarded him by the Board of Claims, in consideration | | |
| | of the enlistment of <i>Henry Riley</i> | | |
| | in the <i>9th Regt U. S. Colored Troops</i> | <i>300</i> | <i>00</i> |
| <i>Total</i> | | <i>\$ 300.</i> | <i>00</i> |

I CERTIFY that the above account is correct and just; that the name of *Henry Riley* is borne on the muster-in rolls of the *9th Regt U. S. Colored Troops*; and that the above amount was awarded by the Board of which *S. F. Shurtz* is President, said award being in accordance with section 24 of the act entitled "An act to amend an act entitled 'An act for enrolling and calling out the national forces, and for other purposes,'" approved Feb. 24, 1864.

Assistant Adjutant General.

RECEIVED *October*, 1864, of *Capt G. Benedict, A. A. S. Col*
Three Hundred dollars and _____ cents, in full of the above account.

Raymond Riley

(SIGNED DUPLICATES.)

Witness
Geo. C. Tyler
 U. S. Coll. Dist. Rev.

27

No. .

ABSTRACT OF DISBURSEMENTS.

....., 186 .

Raymond Riley

Dollars *300* ^{cc}/₁₀₀

Paid , 186 .

The United States,

To *Raymond Riley* Dr.

| 1864 | | DOLLARS. | CENTS. |
|------------------|---|------------|-----------|
| <i>July 30th</i> | For amount awarded him by the Board of Claims, in consideration | | |
| | of the enlistment of <i>Henry Riley</i> | | |
| | in the <i>9th Regt U. S. Colored Troops</i> | <i>300</i> | <i>00</i> |
| <i>Total \$</i> | | <i>300</i> | <i>00</i> |

I CERTIFY that the above account is correct and just; that the name of *Henry Riley* is borne on the muster-in rolls of the *9th Regt U. S. Colored Troops*; and that the above amount was awarded by the Board of which *S. W. Stuelow Esq* is President, said award being in accordance with section 24 of the act entitled "An act to amend an act entitled 'An act for enrolling and calling out the national forces, and for other purposes,'" approved Feb. 24, 1864.

Assistant Adjutant General.

RECEIVED *October*, 1864, of *Raymond Riley*, *Three Hundred* dollars and *00* cents, in full of the above account.

Raymond Riley

(SIGNED DUPLICATES.)

Witness
Geo. L. Tyler
 U. S. Col. Int. Rev.

1722

A. D. Aug 13, 1864

I certify that the name of
Henry Riley is borne on the
muster-roll of Comp'y 2d
9th Regt U.S.C. Troops - as filed
in this office
(M.A.)

J. W. Tizzard
Act. Secy

VOLUNTEER DESCRIPTIVE LIST and Account of Pay and Clothing of *A. Recruit of U. S. Colored Troops*

| No. | NAMES. | RANK. | DESCRIPTION. | | | | | WHERE BORN. | | OCCUPATION. | ENROLLED. (For Drafted Men, see note 10.) | | | MUSTERED IN. (For Drafted Men, see note 10.) | | | | LAST P By paymaster. |
|-----|--------------------|-------|---------------|-------------|-------------|-------------|-----------------|-------------|-------------------|---------------|--|----------------|-----------------------------|---|-----------------|-----------------------------|--|-------------------------|
| | | | Years of age. | Eyes. | Hair. | Complexion. | Feet. | Inches. | State or Kingdom. | | Town or county. | When. | Where. (Town and State.) | By whom. | When. | Where. (Town and State.) | By whom. (In the case of drafted men, from what enrollment district.) | |
| | <i>Henry Riley</i> | | <i>25</i> | <i>Blk.</i> | <i>Blk.</i> | <i>Blk.</i> | <i>5 10 1/2</i> | <i>10</i> | <i>10</i> | <i>Farmer</i> | <i>Nov 7th</i> | <i>Accomac</i> | <i>Col. Wm. B. Mumby</i> | <i>Nov 23rd</i> | <i>Benedict</i> | <i>C. W. Mumby</i> | <i>From June or during the war</i> | |

NOTES.

- 1..The amount of any extra pay for which the soldier may be mustered, ex. gr. as Acting Hospital Steward, as Saddler, &c., and which may be still due him, must be carefully noted.
- 2..In the column headed "BOUNTY PAID," must be entered the whole amount hitherto paid him; in that of "BOUNTY DUE," the whole amount yet due him. Bounty paid by State authorities, and not by the United States, will not be entered on this statement.
- 3..Stoppages for loss or damage done to arms, or other public property, must be noted, and the articles, and particular damage to each, specified. When stoppages are due, under sentence of a Court Martial, a transcript of the same must be entered here; and the amount already stopped, must be carefully stated.
- 4..In every case of desertion, the date, and that of delivery, or apprehension, must be given, together with a correct transcript of the order of sentence or pardon.
- 5..A careful settlement of the man's CLOTHING ACCOUNT must be made, to date, and the amount DUE TO, or FROM him must be precisely stated.
- 6..Should the man have been engaged in any action or skirmish, it must be mentioned, together with date and place. A full and particular mention will be made of any wounds he may have received in action, or other injury, whilst in the line of his duty.
- 7..If the soldier is entitled to pay for use of his horse, the company commander will certify to that fact on his own horse.
- 8..When a soldier is furnished with statements, his descriptive list, if he has one, should be taken up by the officer who gives the soldier these statements, and endorsed with a statement to this effect by the officer. This endorsement should exhibit a full statement of the time for which the soldier was allowed pay on his account, and all other charges against him in his favor, so as to comprise a complete exhibit of his account. It will then be transmitted to the company commander of the soldier, who will enter all the data necessary to a full understanding of the soldier's account on the muster roll upon which the soldier's discharge is reported. The descriptive list will then be destroyed. The object of this is that the remaining portion of the soldier's account may be settled by the receipt of these muster rolls, and the soldier receive any pay allowances that may be due him at the time of his discharge, and that they may not appear on his final statements from the fact that his descriptive list is incomplete. These accounts for back pay, &c., are settled by the 2d Auditor of the Treasury Department.
- 9..Where a soldier dies in Hospital or on detached service, his descriptive list, if he has one, should be sent with his final statements, in duplicate, to the Second Auditor, Washington, D. C.
- 10..Men drafted will be considered as mustered in from the date of their draft, and will be mustered for pay on the usual rolls for Volunteers. On the same line as the soldier's name, under the heading "Joined for Duty and Enrolled,—Commencement of First Payment by Time," will be written the word *drafted*; and under the heading "When Mustered in" will be given the date when the soldier was drafted; under "Where Mustered in," will be given the place from which drafted; under the heading "By whom Mustered in," will be given the No. of the Enrollment District from which he was drafted, and the State to which it belongs, thus: *4th D. Mass.*; (meaning 4th Enrollment District, State of Massachusetts.)
- 11..A separate descriptive list should, as a general rule, be given for each man.
- 12..Descriptive lists must, in all cases, be signed by COMMISSIONED officers; not by enlisted men acting as such.

I CERTIFY that the above is a correct transcript from the Records
State of Maryland for U. S. C. Troops

STATION: *Benedict, Md.*
 DATE: *February 1st 1864*

1st U. S. Colored Troop

| MUSTERED IN. (For Drafted Men, see note 10.) | | | | LAST PAID. | | BOUNTY. | | REMARKS. |
|---|-----------------------------|--|--------------------------------------|---------------|---------------|--------------------------|-------------------------|---|
| En. <i>3</i> | Where. (Town and State.) | By whom. (In the case of drafted men, from what enrollment district.) | Period. | By paymaster. | To what time. | Paid \$ (See note 2.) | Due \$ (See note 2.) | |
| <i>23rd</i> | <i>Benedict, Md.</i> | <i>Col. Wm. Birney</i> | <i>Three years or during the war</i> | — | — | — | — | <i>Co. H. 9th U. S. Colored Troop given to Raymond Riley</i> |

that the above is a correct transcript from the Records of *This Genl. Rendezvous for recruits from the*
of Maryland for U. S. C. Troops

Benedict, Md.
February 1st 1864

Wm Birney,
Regt. Genl. U. S. A.
Commanding the Company
W. S. Mustering Officer

⁹⁴³
Risley, Douglas G.

Co E, 9 U.S. Col'd Inf.

Captain | Captain

CARD NUMBERS.

| | | |
|----|---------|----|
| 1 | 6299932 | 26 |
| 2 | 6308121 | 27 |
| 3 | 6308222 | 28 |
| 4 | 6308325 | 29 |
| 5 | 6308426 | 30 |
| 6 | 6308527 | 31 |
| 7 | 6308627 | 32 |
| 8 | 6308724 | 33 |
| 9 | 6308825 | 34 |
| 10 | 6308925 | 35 |
| 11 | 6309020 | 36 |
| 12 | 6309114 | 37 |
| 13 | 6309206 | 38 |
| 14 | 6309814 | 39 |
| 15 | 9428832 | 40 |
| 16 | | 41 |
| 17 | | 42 |
| 18 | | 43 |
| 19 | | 44 |
| 20 | | 45 |
| 21 | | 46 |
| 22 | | 47 |
| 23 | | 48 |
| 24 | | 49 |
| 25 | | 50 |

Book Mark: 424. e. r 86

See also

R | 9 | U.S.C.T.

Douglas G. Risley
 Capt, Co. 9, Reg't U. S. Col'd Inf.

Appears on

Regimental Descriptive Book

(List of Commissioned Officers)

of the regiment named above.

Rank *Capt*

Date of appointment *Nov 5*, 1863.

Remarks: *Private 9, Ind. Inf*
Wounded at Fort Gil-
mer. Sept 29/64. Mus.
out & honor, dis chgd. by
S.O. 435, Ex. 17, War Dept
Clgo Washington Aug 8,
1865, to take effect
May 15, 1865 on account
of his services being no
longer required, and phys-
ical disability from wounds
recd in action

Harmon

R. I. G. U.S.C.T.

Wm. S. G. Gist
Co. 1, 9th Reg't U. S. Col'd Infantry.

Age 26 years.

Appears on an

Individual Muster-in Roll

of the organization named above. Roll dated
Sept. 27, 1863
Cherokee Co. Mo.

Muster-in to date Nov. 27, 1863.

Joined for duty and enrolled:

When Nov. 27, 1863

Where Cherokee Co. Mo.

Period 3 years.

Remarks: Assigned to Co. "E"
Nov. 27, 1863

Book mark :

Wm. S. G. Gist

R

9

U.S.C.T.

Douglas G. Risley
Capt, Co. E, 9 Reg't U. S. Col'd Infantry.

Appears on

Company Muster Roll

for *Nov 17 to Dec 31*, 1863.

Present or absent *Present*

Stoppage, \$ *100* for

Due Gov't, \$ *100* for

Remarks: *Assigned to Co E for S.O.*
No 12 dated Nov 27 - 1863
Hd Qrs Camp Stanton Md
Signed W. Birney Col and Mus-
tering Officer joined for duty
Nov 27 - 1863

Book mark:

C. C. Parker

(858)

Copyist.

R

9

U.S.C.T.

Douglas G. Risley

Capt, Co. E, 9 Reg't U. S. Col'd Infantry.

Appears on

Company Muster Roll

for Jan + Feb, 1864.

Present or absent Present

Stoppage, \$ 100 for

Due Gov't, \$ 100 for

Remarks:

Book mark:

C. C. Parker

(358)

Copyist.

R

9

U.S.C.T.

Douglas G. Risley

Capt, Co. E, 9 Reg't U. S. Col'd Infantry.

Appears on

Company Muster Roll

for *Mar + Apr*....., 1864.

Present or absent *Present*.....

Stoppage, \$.....100 for.....

Due Gov't, \$.....100 for.....

Remarks:.....

Book mark:.....

C. C. Parker

R

9

U.S.C.T.

Douglas G. Risley

Capt, Co. E, 9 Reg't U. S. Col'd Infantry.

Appears on

Company Muster Roll

for *May & June*, 1864.

Present or absent *Present*

Stoppage, \$ *100* for

Due Gov't, \$ *100* for

Remarks:

Book mark:

C. C. Parker

(358)

Copyist.

R | 9 | U.S.C.T.

Douglas G. Risley
Capt, Co. E, 9 Reg't U. S. Col'd Infantry.

Appears on

Company Muster Roll

for July - Aug, 1864.

Present or absent Absent

Stoppage, \$ 100 for

Due Gov't, \$ 100 for

Remarks: Absent on sick
leave since Aug. 9th 1864
for S.O. No 286 Hd Qrs Dept
of the South dated Aug. 1-1864

Book mark:

C. C. Parker

R

9

U.S.C.T.

Douglas G. Risley
Capt, Co. E, 9 Reg't U. S. Col'd Infantry.

Appears on

Company Muster Roll

for *Sept + Oct*, 1864.

Present or absent *Absent*

Stoppage, \$ 100 for

Due Gov't, \$ 100 for

Remarks: *Wounded in action and sent to US Gen Hospital Front Monroe Sep 29/64*

Book mark: *Dis. Feb 16/64*

C. C. Parker

(358)

Copyist.

R | 9 | U.S.C.T.

Douglas G. Risley
Capt, Co. E, 9 Reg't U. S. Col'd Infantry.

Appears on

Company Muster Roll

for Nov & Dec, 1864.

Present or absent Absent

Stoppage, \$ 100 for

Due Gov't, \$ 100 for

Remarks: Wounded in action
and sent to US Genl
Hospital Fort Monroe
Sept 29-1864

Book mark:

J. E. Weteman
(858) Copyist.

R | 9 | U.S.C.T.

Douglas S. Risley
Capt, Co. E, 9 Reg't U. S. Col'd Infantry.

Appears on

Company Muster Roll

for *Jan'y & Feb'y*, 1865

Present or absent *Absent*

Stoppage, \$ 100 for

Due Gov't, \$ 100 for

Remarks: *Absent in Genl Hospital*
wounded in action
Sept 29th 1862.

Book mark: _____

H. E. Weteman
(358) Copyist.

R | 9 | U.S.C.T.

Douglas G. Risley
Capt, Co. E, 9 Reg't U. S. Col'd Infantry.

Appears on

Company Muster Roll

for March & April, 1865.

Present or absent Absent

Stoppage, \$ 100 for

Due Gov't, \$ 100 for

Remarks: Reported Absent
without leave Mar 25, 65
Certificate of Disability
Rec'd Mar 25th 65,

Book mark ::

J. E. Moteman
Copyist.

R | **9** | **U.S.C.T.**

Douglas G. Risley
Capt, Co. E, 9 Reg't U. S. Col'd Infantry.

Appears on

Company Muster Roll

for *Dec 31, 64 to June 30, 1865*

Present or absent *Absent*

Stoppage, \$ 100 for

Due Gov't, \$ 100 for

Remarks: *Reported absent without leave Mar 25, 65 Certificate of disability rec'd mch 25/65*

Book mark: _____

(858)

J. E. Meteman Copyist.

R | 9 | U.S.C.T.

Douglas I. Risley
Capt., Co. E, 9 Reg't U. S. Col'd Infantry.

Appears on

Company Muster Roll

for July & Augt, 1865.

Present or absent Absent

Stoppage, \$ 100 for

Due Gov't, \$ 100 for

Remarks: Reported Absent without
leave since mar 25, 65
Certificate of disability received
March 25/65

Book mark:

J. E. Noteman
Copyist.

R | **9** | **U.S.C.T.**

Donald S. Risley
Capt, Co. E, 9 Reg't U. S. Col'd Infantry.

Appears on

Company Muster Roll

for *June 30 to Oct 31*, 1865.

Present or absent _____

Stoppage, \$ _____ 100 for _____

Due Gov't, \$ _____ 100 for _____

Remarks: *Mustered out of U.S. Service May 15th 1865*

Book mark: _____

H. E. Meteman
(858) Copyist.

B. | **9** | **U.S.C.T.**

Company G
1st, Co. *...*, 9 Reg't U. S. Col'd Infantry.

Appears on **Co. Muster-out Roll**, dated
..., *...*, 186*...*.

Muster-out to date , 186 .

Last paid to , 186 .

Clothing account:

Last settled....., 186 ; drawn since \$ 100

Due soldier \$ 100; due U. S. \$ 100

Am't for cloth'g in kind or money adv'd \$ 100

Due U. S. for arms, equipments, &c., \$ 100

Bounty paid \$ 100; due \$ 100

Remarks: *...*
...
...
...

Book mark: *H. 24. 2. 4. 26.*

...

Risley, Douglas G
 Capt., 9 Regt. S. C. Inf.

Harris, E. B. 15 Enclosures.

| | |
|------------------------------|-------------------|
| Bed Cards | Descriptive Lists |
| Burial Records | Final Statements |
| Certs. of Dis. for Discharge | Furloughs |
| C. M. Charges | Med. Des. Lists |
| Med. Certificates | Orders 3 |

Other papers relating to—
 Post 1

| | |
|----------------------------|----------------------|
| Admission to Hosp'l | Furlough 3 |
| Casualty Sheet (Officer's) | Med. Examination |
| Confinement | Misc. Information 2 |
| Contracts | Pay or Clothing |
| Death or Effects | Personal Reports |
| Desertions | Rank |
| Discharge from Hosp'l | Transfer to Hosp'l |
| Discharge from Service | Transfer to V. R. C. |
| Duty | Transportation |

Record and Pension Office,

WAR DEPARTMENT.

The slip hereto attached is a stub from
a "Pass Book", Headquarters Department
of Washington.

No. 1045R
Name ~~John P. Kirby~~
Reg't, 9 Reg't, Col
Reason: Alexandria
and Return
Recommended by Capt. Camp
Date Nov 24 '11
Expires, 25.2.12
1563

ADJUTANT GENERAL'S OFFICE,

Sept 10, 1870

Case of Douglas G. Risley
late Capt 9th U.S.C.T.R. 7th 10. C. P. S. A. B. 1865Chg Comdr Bureau
Sept 10. 70

Mr Woodward

Please furnish for
Retiring Board in New York
Certificates in the Case of
this Officer who was
wounded Sept 29/64
& was absent on acct of
wounds until May 15,
65. when he was dis-
charged

Respy

C Brown

Special Order
No 27
Dec. 10th 1863.

Detailing 1000
for duty at West Point

Wm. S. Brewster
Adj. & Secy. Adj. G.

L. G. Risley

Head Quarters 9th U.S. C.

Dec 10th 1863

Special Order
No 24

Pursuant to Special Order No 46
Head Quarters Camp Stanton, dated Dec 10, 1863
Capt. D. G. Risley will report with his company
immediately for duty to Col. Birney

C. W. Huntley
Adj. Gen.

By order of
S. L. Armstrong

J. B. G. R. 198. 1864

Adj. Genl. Med. Dir.
 Fort, Beaufort, SC
 July 15, 1864

The Board having ex-
 amined Douglas G. Pasley
 Capt. Co E. 9th U.S.C.P.
 approves the within cer-
 tificate & recommends
 that a leave of absence
 be granted him.

for Vice Utter
 Surgeon 56 U.S.C.P.
 Post Surgeon
 Pres. Med. Dir. Fort

Charles H. G. Linn
 Surgeon 26 U.S.C.P.
 & recorder Med-
 ical Board.

Capt. Angler G. Risley "Co. E." 9th Regt.
 U. S. C. I. having applied for a Certificate
 on which to ground an application for a
 leave of absence,

I do hereby Certify that I have
 carefully examined this officer and find that
 he is suffering from Chronic Diarrhea, which
 has already continued three months, having
 been induced by fatigue and exposure in service
 and now aggravated by the peculiar influences
 of this season and climate - and that
 in consequence thereof he is in my opinion
 unfit for duty and a change of locality
 is necessary in order to preserve his life.

I further declare my belief that he
 will not be able to resume his duties in a
 less period than thirty days.

Given at

Beaufort S. C.

This 26th day of June 1864.

E. M. Pease

Surgeon 9th U. S. C. I.

No. 100 Dept of the South
August 1st 1864

P. O. No 286

Grant leave of absence for 30 days
to Capt. D. G. Risley 9th U.S. Col.

D. G. Risley

R. A. G. B. J. G. W. Aug 2nd 64

HEADQUARTERS, Department of the South,

HILTON HEAD, S. C., *August 1st* 1864.

SPECIAL ORDERS, }

No. 286 } *

*
* Leave of absence for thirty days, on
Surgeons Certificate of disability is hereby granted
to the following named officers.

Co. Congras & Riley 9th U. S. C. T.

* * * *

By Command of Major-General J. G. POSTER,

W. H. M. Sawyer

Capt. & Asst. Adj. Gen'l.

C. O. 9th U. S. C. T.

U. S. Gen: Supt:-
Fort Monroe Va:-
Dec: 24th 1862

E. M. Keenan, U.S.A.-
Surgeon in Charge-

Certificate of Disability in case of Capt:
W. S. Risley - 9th U.S. Col.

Capt. D. G. Risley 1st U.S.C.T. having applied for a certificate on which to base an application for Leave of Absence, I do hereby certify that I have carefully examined this Officer and find him suffering from gun shot wound of right shoulder, received in action, and that in consequence thereof he is in my opinion unfit for duty, I further declare my belief that he will not be able to resume his duties in a less period than twenty days. Said Officer is sufficiently convalescent to bear transportation.

U.S. General Hospital }
Fortress Monroe Va. Dec 24th 64: }

E. S. Williams
Asst. Surgeon, U.S. Army -
In Charge.

Bob [unclear]
U. S. Gen: H. [unclear]
no 10 ✓ James Monroe Va.
December 24th 64

D. G. Risley
Capt. 9th U.S.C.

Risley, Douglas G -
Capt. 9th U.S.C.

Application for Leave of Absence -

M.D. Dept. 8th and No. 6a,
In the file of Dec. 31/64

Respy. forwarded
Approved

Geo. Tuckley
Surgeon Col.
actg. Med. Director

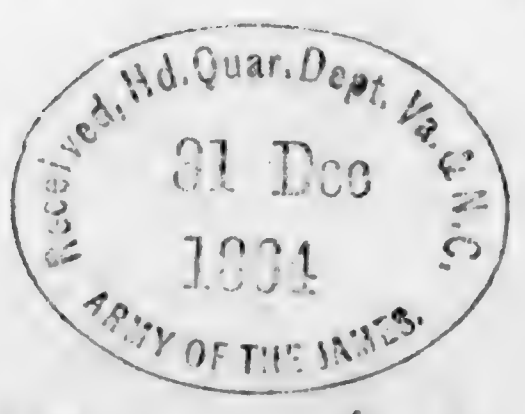

Recd M.D. Ad. S. Dec 31/64

Officers Division
U. S. General Hospital
Fortress Monroe Va.
December 24th 1864.

Colonel -

I have the honor to make application for a Leave of
Absence, based on the accompanying Surgeon's Certificate of Disability.

Very respectfully,
Your obedt. servant -
Douglas S. Roisley
Capt: 9th U.S.C.

Lieut-Col: E. W. Smith -
Asst: Adjt: General -
Departments of Va. and N.C.

Surgens Certificate
of Capt D G Piser
for 30 days



Captain Douglas G. Risley of the 9th Regiment of U.S. Dragoon, having applied for a certificate on which to ground an application for an extension of a leave of absence, I hereby certify that I have carefully examined this officer and find him suffering from gun-shot wound in right arm, causing fracture, and excision of humerus of six inches, the rifle ball being lodged under the scapula against the ribs, causing much irritation and pain. This wound was received at "Chapins Farm" front of Richmond Va Sept 29th 1864, and that in consequence thereof he is unfit for duty and unable to travel. I further declare my belief that he will not be able to resume his duties for a less period than thirty days: I therefore recommend that such extension of his leave be granted him.

D. H. Keay M.D.

Witness at Elberton Ga,
this 27th day of April 1865.

Personally appeared before me a Notary Public in & for the State of Georgia a reputable Physician practicing in the town and county of Elberton that the above certificate is correct according to the best of his knowledge and belief.

Elberton Ga
April 4th 1865

R. N. Prush

There is no U.S.A. Dragoon in this place.

R. N. Prush

Surgeon Certificate
for Capt. Rialy



Richard [illegible]

Captain Douglas G. Risley of the 9th Regiment of
U.S. Colored Troops having applied for a certificate on
which to ground an application for an extension of
leave of absence, I ~~submit~~ hereby certify that I
have carefully examined the said officer and find him
suffering from effect of gun shot wound in right
arm, Excision of humerus of right arm of six inches,
and that the debility resulting from his wound is such
as to prevent his traveling; and I further declare that
in my opinion he will not be able to resume his
duties for a less period than Thirty (30) days; I
therefore recommend that an extension of his leave
be granted him.

Wound received in engagement at "Shapiro's Farm"
front of Richmond Va. Sept. 29th 1864.

D. H. Runyan M.D.

Subscribed and sworn to before me a
Notary Public in and for the County of
~~Richmond~~ Elbert Ind^a the 4th day of March 1865.

R. K. Brush
Notary Public

I certify that the above said D. H.
Runyan is a practicing Physician
in this County and vicinity.

R. K. Brush

There is no M.D. Surgeon in this place.

R. K. Brush

MEMORANDUM FROM PRISONER OF WAR RECORDS.

No. _____

(This blank to be used only in the arrangement of said records.)

| NAME. | RANK. | ORGANIZATION. | | | | INFORMATION OBTAINED FROM— | | | |
|---------------------|-------------|---------------|-----------|-----------------|-----------------|----------------------------|------------|-------|------|
| | | No. of Reg't. | State. | Arm of Service. | Co. | Records of— | Vol. | Page. | Vol. |
| <i>Bisby, P. G.</i> | <i>Capt</i> | <i>9.</i> | <i>US</i> | <i>CT.</i> | <i>CS.P. Md</i> | <i>81</i> | <i>291</i> | | |

Captured at _____, 186 , confined at Richmond, Va., _____, 186 .

Admitted to Hospital at _____

where he died _____, 186 , of _____

Paroled at _____, 186 ; reported at Camp Parole, Md., _____, 186 .

Sent to Hospital No. 1. Annapolis Md for medical treatment May 4 1865

Copied by *1727*

Pisley, Douglas G
 Capt. 9" U.S.C. 7

11774 743

2

Copy C. A. 1865

SPECIAL ORDERS, } WAR DEPARTMENT,
No. 425. } ADJUTANT GENERAL'S OFFICE,
Washington, August 8th, 1865.

(Extract.)

* * * * *
12. Under the provisions of General Orders, No. 82, May 6th, 1865, from this Office, Captain *Douglas G. Risley*, 9th U. S. Colored Troops, is hereby mustered out and honorably discharged the service of the United States, to take effect May 15th, 1865, on account of his services being no longer required, and physical disability from wounds received in action. He will receive no final payments, until he has satisfied the Pay Department that he is not indebted to the Government.

* * * * *

By order of the Secretary of War :

E. D. TOWNSEND,
Assistant Adjutant General.

OFFICIAL:

Assistant Adjutant General.

Charles Foster

War Department
A. G. O. August 8th 1865

Special Orders
No 425 S

Discharging
Capt. Douglas B. Resley
7th U. S. Colored Troops



12/11/1865

SPECIAL ORDERS, }
No. 425. }

WAR DEPARTMENT,
ADJUTANT GENERAL'S OFFICE,
Washington, August 8th, 1865.

(Extract.)

* * * * *

12. Under the provisions of General Orders, No. 82, May 6th, 1865, from this Office, Captain *Douglas G. Ristey*, 9th U. S. Colored Troops, is hereby mustered out and honorably discharged the service of the United States, to take effect May 15th, 1865, on account of his services being no longer required, and physical disability from wounds received in action. He will receive no final payments, until he has satisfied the Pay Department that he is not indebted to the Government.

* * * * *

By order of the Secretary of War :

E. D. TOWNSEND,

Assistant Adjutant General.

OFFICIAL:



Assistant Adjutant General.

*Co 9th U.S. Colored Troops
Gov. Dept of North Carolina*

Camp of 9th U.S. (I.)
J. B. G. R. July 26 1864

Philip K. Masten
Capt 9th U.S. (I.)

Apply for leave of absence
for thirty days on surgeons
(anticipation of disability)

Head Qrs. 9th U.S.C.,
July 3rd 1864

Approved & Respectfully
forWARDED.

There are now eight line
officers for duty in this
Regt and none absent on leave.

Wm. C. Armstrong
Lieut. Col. 9th U.S.C.

30 days.

See Par. X S. 4. 255
Aug. 1st 1864

Head Qrs. 9th U.S.C. July 26 1864

W. D. S. Jones
District of Beaufort
Beaufort S.C.
July 26. 1864

Respectfully returned -
the number of Field &
Staff officers present for
duty should be given.
Also number of officers on
detached service - and
number of officers left with
the company if the request
is granted.

By order of
Brig. Gen. J. M. Foster
Hon. Wm. Pugh
A.D.C.

W. D. S. Jones
Head Qrs. 9th U.S.C.
July 28. 1864

Respectfully re-forwarded.
There are four Field & Staff officers
present - for duty.
Two Field & Staff and two line officers
are on detached service.
Twenty eight line officers are on duty
with the regiment. And 1st Lt. L. N.
Shedd will be left with the Company
if this request is granted.

L. M. Bennett
Major 9th U.S.C.
Com'g Regt.

Headquarters W. D. Jones
District of Beaufort
Beaufort S.C.
July 28. 1864
E. B. 1101 (2) D. B. 1864
Respectfully forwarded

Edward C. Pollee
Brig. Surgeon
Commanding

HEADQUARTERS, Dept of the South
July 29th 64

Respectfully referred to the Medi-
cal Director D.D. for recommenda-
tion

By Command of
Maj. Gen. J. M. Foster
W. H. Sanger
Asst. Adjt. Gen.



Head Qrs. 9th U.S.C. July 28 1864

715- *Mud. Dir. Office*
Pitts. Wash. D. C.
July 20-1884

Respectfully forwarded

Approved

W. H. Lyons

Surg. U.S.A.
and. Mud. Dir. D.C.



9999 754

Camp of G. U. S. Troops

Beaufort, Fla.

July 1st 1864

ii.

I have the honor to apply for leave of absence for a period of thirty days, for the following reason,

Surgeon's Certificate of Disability -

Very respectfully

Your Obedt Servt

Walter G. Rieley
Capt G. U. S. A.

W. M. Harris
1st Lt. 1st Regt. Fla. Cav.

Department of the South
Wilmington, N. C.

W. S. G.

Capt., Co. -----, *9* Reg't *U.S.A.*

Leave of Absence Papers

(File mark: *R 10* C. T. L. A. B., 186*5*.)

Cannot be found on Leave of Absence File. Investigation shows that the papers were disposed of as indicated below:

Returned -----

Filed with -----

L. G. for Ret. 1865

W. S. G.

Leave of Absence
transferred to
Personal Paperfiles

⁹⁴⁴
Rivers, Spencer

Co *b*, 9 U.S. Col'd Inf.

Private

Private

CARD NUMBERS.

| | | |
|----|-------------|----|
| 1 | 6299978 | 26 |
| 2 | 6305105 | 27 |
| 3 | 6305204 | 28 |
| 4 | 6305301 | 29 |
| 5 | 6305399 | 30 |
| 6 | 6305485 | 31 |
| 7 | 6305600 | 32 |
| 8 | 6300427 | 33 |
| 9 | 6306104 | 34 |
| 10 | 9068847 | 35 |
| 11 | 148-05-1847 | 36 |
| 12 | 43155799 | 37 |
| 13 | | 38 |
| 14 | | 39 |
| 15 | | 40 |
| 16 | | 41 |
| 17 | | 42 |
| 18 | | 43 |
| 19 | | 44 |
| 20 | | 45 |
| 21 | | 46 |
| 22 | | 47 |
| 23 | | 48 |
| 24 | | 49 |
| 25 | | 50 |

Book Mark: O.A. 12/209. 148-05-1847

See also

B776708 - Po 90
D1471379 - P.O. man

C. S. Dougherty
2

R | 9 | U.S.C.T.

Spencer Rivers

, Co. C, 9 Reg't U. S. Col'd Inf.

Appears on

Company Descriptive Book

of the organization named above.

DESCRIPTION.

Age 24 years; height 5 feet 5 inches.

Complexion Black

Eyes Black; hair Black

Where born Sussex Co., Va.

Occupation Laborer

ENLISTMENT.

When Sept 26, 1864.

Where Ellicott Mills

By whom Capt. Holland; term 1 yr.

Remarks: Substitute
Mustered out by reason
of expiration of term
of service Sept. 28. 1865.

E. L. Johnson

9
B | 11505
Spencer Rivers

Appears with rank of _____ on _____

Muster and Descriptive Roll

of *Detachments of U.S. Substitutes*
& *Drafted men turned over to*

Col. J. M. Bowman Roll dated
Camp Bradford Md Oct 12, 1864.

Where born *Sussex Co. Virginia*

Age *21* years; occupation *Laborer*

When enlisted *Sept 26*, 186 .

Where enlisted *Ellicotts Mills*

For what period enlisted *1* years.

Eyes *Blk* ; hair *Blk*

Complexion *Blk* ; height *5 ft. 5 in.*

When mustered in *Sept 26*, 186 .

Where mustered in _____

Bounty paid \$ _____ *100*; due \$ _____ *100*

Clothing account:

Last settled _____, 186 ; drawn since \$ *27.92*/*100*

Date of first muster _____, 186 .

Company to which assigned _____

Remarks: *Substitute for Charles*
Carroll, 5th Dist, Mdr.

Book mark : _____

W. M. Caw

R. | 9 | U.S.C.T.

Spencer Rivers

Appears with rank of _____ on
**Muster and Descriptive Roll of a Detach-
 ment of Drafted Men and Substitutes**
 forwarded

for the *9* Reg't U. S. Col'd Inf. Roll dated
Baltimore Md, Oct 7, 1864.

Where born *Sussex Co. Va.*

Age *27* years; occupation *laborer*

* *Enlisted*
~~Drafted~~ and mustered in:

When *Sept 26, 1864.*

Where *E. Mills*

Period *one* years

Eyes *blk*; hair *blk*

Complexion *blk*; height *5* ft. *5* in.

Paid bounty and advance pay, \$ 100

Bounty due \$ 100

Where credited _____

Company to which assigned _____

Remarks: *Substitute for Charles*

Carroll 3d Dist Md.

* *By G. E. Dougherty*
 Book mark: _____

G. L. Pratt

R

9

U.S.C.T.

Spencer Rivers

Plt, Co. C, 9 Reg't U. S. Col'd Infantry.

Appears on

Company Muster Roll

for *Nov & Dec*, 1864

Present or absent *Present*

Stoppage, \$ 100 for

Due Gov't, \$ 100 for

Remarks: *Assigned to Co. per verbal order Capt H. S. Thompson Comdg 9 U.S.C.I. Nov 1/64.*

Book mark:

(858)

W. H. H. H.
Copyist



R | **9** | **U.S.C.T.**

Spencer Rivers
Co, Co. C, 9 Reg't U. S. Col'd Infantry.

Appears on

Company Muster Roll

for *Jan to Feb*, 186*5*.

Present or absent *Present*

Stoppage, \$ *100* for

Due Gov't, \$ *100* for

Remarks:

Book mark:

A J Anderson

Q | **9** | **U.S.C.T.**

Spencer Rivers

Priv, Co. C, 9 Reg't U. S. Col'd Infantry.

Appears on

Company Muster Roll

for *March & April*, 1865:

Present or absent *Present*

Stoppage, \$ *100* for

Due Gov't, \$ *100* for

Remarks:

Book mark:

A. J. Anderson

R

9

U.S.C.T.

Spencer Rivers

Pat, Co. C, 9 Reg't U. S. Col'd Infantry.

Appears on

Company Muster Roll

for *Dec 31/64 to June 30*, 1865.

Present or absent *Present*

Stoppage, \$ *100* for

Due Gov't, \$ *100* for

Remarks:

Book mark:

A. J. Anderson

Q

9

U.S.C.T.

Spencer Rivers

Cvt, Co. C, 9 Reg't U. S. Col'd Infantry.

Appears on

Company Muster Roll

for *July & Aug*, 186*5*.

Present or absent *Present*

Stoppage, \$ *100* for

Due Gov't, \$ *100* for

Remarks:

Book mark:

A. J. Anderson

(858)

Copyist

R

9

U.S.C.T.

Spencer Rivers

Pvt, Co. C, 9 Reg't U. S. Col'd Infantry.

Appears on

Company Muster Roll

for *June 30 to Oct 31*, 1865.

Present or absent

Stoppage, \$ 100 for

Due Gov't, \$ 100 for

Remarks: *Mustered out by reason of expiration of term of service Sept 28, 1865*

Book mark: *Dischⁿ Sept 29/65 1482.12 A&O. Co. 77 E.B. 209*

A. J. Anderson

R | 9

U.S.C.T.

Spencer River

Pri, Co. *6*, *9* Reg't U. S. Col'd Infantry.

Appears on a

Detachment Muster-out Roll

of the organization named above. Roll dated

Brownsville Tex., Sept 29, 1865.

Muster-out to date *Sept 29, 1865.*

Last paid to *June 30, 1865*

Clothing account:

Last settled 186 ; ^{mo. in} drawn since \$ *102* ²⁸ 100

Due soldier \$ 100 ; due U. S. \$ 100

Am't for cloth'g in kind or money adv'd \$ 100

Due U. S. for arms, equipments, &c., \$ 100

Bounty paid \$ 100 due \$ *100* 100

Remarks: *Was received no bounty since entering the service.*

Stop for Gun & Equipments \$6.00, retained as per Circular 24 Affd. War Dept June 10 1865. Mustered out by reason of expiration term of service.

Book mark :

J. Brown (over)

(349)

Copist.

JAN. 21

6300427

18910

*\$100 Bondy due under G.O
224 H. Dept Series 1894.*

V.P.

9

U.S.C.T.

Francis Rivers

Private, Co. "C", 9 Reg't U. S. Col'd Infantry.

Appears on **Co. Muster-out Roll**, dated
New Orleans, La., Nov 26, 1866.

Muster-out to date _____, 186 .

Last paid to _____, 186 .

Clothing account:

Last settled _____, 186 ; drawn since \$ 100

Due soldier \$ 100; due U. S. \$ 100

Am't for cloth'g in kind or money adv'd \$ 100

Due U. S. for arms, equipments, &c., \$ 100

Money paid \$ 100; due \$ 100

Remarks: *Joined as recruit
Discharged on expiration of term
at Brownsville, Texas, Sept 28/65
F.S. Given.*

Book mark: *Discharged Sept 29/65*

148. V 12 A. 90. C. 9. 774 E. B. 12/209

Francis

R | 9. | U. S. C. J.

Spencer Rivers

, Co. C, 9th Reg't U. S. C. J.

NOTATION.

E. B. 12-209.

Book mark: 148-C-J-1877

War Department,

Adjutant General's Office,

Washington, Jan'y 20, 1877.

Mustered out September 29,
1865.

M. Allen

⁹⁴⁵
Roach, Benjamin

Co H, 9 U.S. Col'd Inf.

Private | Private

CARD NUMBERS.

| | | |
|----|---------|----|
| 1 | 63/3439 | 26 |
| 2 | 63/3538 | 27 |
| 3 | 63/3669 | 28 |
| 4 | 63/5085 | 29 |
| 5 | 9069267 | 30 |
| 6 | | 31 |
| 7 | | 32 |
| 8 | | 33 |
| 9 | | 34 |
| 10 | | 35 |
| 11 | | 36 |
| 12 | | 37 |
| 13 | | 38 |
| 14 | | 39 |
| 15 | | 40 |
| 16 | | 41 |
| 17 | | 42 |
| 18 | | 43 |
| 19 | | 44 |
| 20 | | 45 |
| 21 | | 46 |
| 22 | | 47 |
| 23 | | 48 |
| 24 | | 49 |
| 25 | | 50 |

Book Mark: EB. 17. 205

See also

P. | 9 | U.S.C.T.

Benjamin Roach

, Co. *H*, 9 Reg't U. S. Col'd Inf.

Appears on

Company Descriptive Book

of the organization named above.

DESCRIPTION.

Age *23* years; height *5* feet, *0* inches.

Complexion *Black*

Eyes *Black*; hair *Black*

Where born *Somerset, Maryland.*

Occupation *Farmer.*

ENLISTMENT.

When *Oct 23*, 186*3*.

Where *Princetown, Somerset Co. Md.*

By whom *Col. M. Birney*; term *3* y'rs.

Remarks: *Declined Hospital at
Sunderland, Md. Jan 2, 1864
of Consumption.*

Case

R | **9** | **U.S.C.T.**

Benjamin Roach
 Private, Co. *H*, 9 Reg't U. S. Col'd Infantry.

Age *20* years.

Appears on

Company Muster-in Roll

of the organization named above. Roll dated

Camp Stanton, Charles Co., Maryland, *Nov. 23*, 186*3*.

Muster-in to date *Nov. 23*, 186*3*

Joined for duty and enrolled:

When *Oct. 23*, 186*3*.

Where *Somerset, Md.*

Period *3* years.

Remarks:

Book mark:

O. J. Markle

R

9

U.S.C.T.

Benjamin Roach
Private, Co. H, 9 Reg't U. S. Col'd Infantry.

Appears on

Company Muster Roll

for Nov. 23 to Dec. 31, 1863.

Present or absent Present.

Stoppage, \$ 100 for

Due Gov't, \$ 100 for

Remarks: \$2 Recruits Premium due.
Detached Service Hospital
Nurse since 14, 63.

Book mark:

O. J. Markle

R

9

U.S.C.T.

Benjamin Roach

Private, Co. H, 9 Reg't U. S Col'd Infantry.

Appears on

Company Muster Roll

for *Jan. + Feb.*, 1864.

Present or absent

Stoppage, \$ 100 for

Due Gov't, \$ 100 for

Remarks: *Died in hospital at
Camp Stanton, Md. Feb. 13, 1864
of Consumption. Final statements
and Inventory forwarded. no effects.
\$2.00 Recruits premium due.*

Book mark:

O. J. Markle

R

9

U.S.C.T.

Benjamin Roach.

Private, Co. "26", 9 Reg't U. S. Col'd Infantry.

Appears on **Co. Muster-out Roll**, dated

New Orleans, La., *Nov. 26th*, 1864.

Muster-out to date _____, 186 .

Last paid to _____, 186 .

Clothing account:

Last settled _____, 186 ; drawn since \$ _____ 100

Due soldier \$ _____ 100; due U. S. \$ _____ 100

Am't for cloth'g in kind or money adv'd \$ _____ 100

Due U. S. for arms, equipments, &c., \$ _____ 100

Bounty paid \$ _____ 100; due \$ _____ 100

Remarks: *Joined at original organization, Died at Post Hospital Benedict, Md. Jan. 31/64 of consumption.*

Book mark: *2^d Aud. Jan. 27/68. K.S. Died (over)*

R. Bradin

(861)

Copyist.

JAN. 22

6315085

Q1891*

at Post Hosp'l Benedict, Md. Feb. 13/64
F. S. E. B. $\frac{12}{303}$.

Roach, Benjamin

, Co. H, 9 Reg't S. C. Inf.

5

Enclosures.

| | |
|-----------------------------------|-------------------------|
| Bed Cards..... | Descriptive Lists..... |
| Burial Records..... | Final Statements..... 3 |
| Certs. of Dis. for Discharge..... | Furloughs..... |
| C. M. Charges..... | Med. Des. Lists..... |
| Med. Certificates..... | Orders..... |

Other papers relating to—

| | |
|---------------------------------|--------------------------|
| Admission to Hosp'l..... | Furlough..... |
| Casualty Sheet (Officer's)..... | Med. Examination..... |
| Confinement..... | Misc. Information..... |
| Contracts..... | Pay or Clothing..... |
| Death or Effects..... / | Personal Reports..... |
| Desertions..... | Rank..... |
| Discharge from Hosp'l..... | Transfer to Hosp'l..... |
| Discharge from Service..... | Transfer to V. R. C..... |
| Duty..... | Transportation..... |

Save Claim 1

MICROFILM PUBLICATION M 1851

COMPILED MILITARY SERVICE RECORDS
OF VOLUNTEER UNION SOLDIERS WHO SERVED WITH
THE UNITED STATES COLORED TROOPS (USCT)
9TH REGIMENT OF INFANTRY

PERSONAL PAPERS' TARGET SHEET

PLEASE NOTE THE CHECKED INFORMATION ABOUT THE PERSONAL PAPERS IN
THIS FILE:

- NO PERSONAL PAPERS WERE FOUND IN THIS FILE WHEN THE
RECORDS WERE ARRANGED FOR MICROFILMING.
- 10 PERSONAL PAPER(S) FOUND IN THIS FILE WHEN THE RECORDS
WERE ARRANGED FOR MICROFILMING.

WAR 789

[OFFICE ENDORSEMENT.]

War Department,

ADJUTANT GENERAL'S OFFICE,

April 28th, 1874
The Death of *Sir Benjamin*
Roach, Co. *H*, 9th Reg't U. S.
Colored *Troop*, is reported as follows:

On Company Muster Roll
For *Jan'y Feb'y*, 1864, *February 13th*, 1864
Company Muster-out Roll.
Company Descriptive Book.

Company Morning Reports. 186

Soldier's Final Statement. 186

Soldier's Record of Death and Interment. *February 13th*, 1864

Soldier's Inventory of Effects. 186

Soldier's Certificate of Disability for Discharge. *February 13th*, 1864

Soldier's Individual Muster-out Roll. 186

Regimental Returns. 186

For *February*, 1864, *February 13th*, 1864
Regimental Quarterly Returns.

Regimental Descriptive Book. *February 13th*, 1864

By Surgeon General. 186

February 13th, 1864, is held to be
the correct date, and the Company Muster
Roll will be amended accordingly.

Thomas M. Seward

Assistant Adjutant General.

C13 303

Noted 26th

FINAL STATEMENT

OF

Benjamin Roach

Reg't of *U. S. Colored Troops*

VOLUNTEERS.

Due Feb'y 13th 1864

NOTE 1.—Two of these certificates (or duplicates) are to be given to each Volunteer Soldier or drafted man who may be discharged previously to the discharge of his company, that he may at once receive from the Paymaster the pay, &c., due him, and the captain or other COMMISSIONED officer commanding the company will certify to the act of the delivery of the duplicate certificates; on these certificates the Soldier is "entitled to" his discharge, and should also present his discharge to the Paymaster to have the payment endorsed on it. The discharge is to be given back to the Soldier by the Paymaster; the latter only retaining as his voucher the duplicate certificates.

NOTE 2.—If the Soldier is entitled to pay for the use of his horse, the Company Commander will certify to that fact on the back of both these final statements, and also to the time he has pay due for having been so mounted on his own horse.

NOTE 3.—When a Soldier is furnished with final statements, his descriptive list, if he has one, should be taken up by the officer who gives the Soldier these statements, and endorsed with a statement to this effect by the officer. This endorsement should exhibit a full statement of the time for which the Soldier was allowed pay on his final statements, the clothing account, and all other charges against him or in his favor, so as to comprise a complete exhibit of his account. It will then be transmitted to the company commander of the Soldier's account, who will enter all the data necessary to a full understanding of the Soldier's account on the muster roll upon which the Soldier's discharge is reported. The descriptive list will then be destroyed. The object of this is, that the remaining portion of the Soldier's account may be settled upon the receipt of these muster rolls, and the Soldier receive any pay or allowances that may be due him at the time of his discharge, and which may not appear on his final statements from the fact that his descriptive list is incomplete. These accounts for back pay, &c., are settled by the 2d Auditor of the Treasury Department.

NOTE 4.—Charges for loss or injury to ordnance, horse equipments, and other miscellaneous charges, should appear under the heading of "Other Stoppages."

NOTE 5.—Bounty paid by State authorities, and not by the United States, will not be entered on this statement.

NOTE 6.—Amounts due the Soldier and Landress must be entered on the muster roll on which the discharge, death, desertion, &c., is reported, as well as on the final statement, otherwise the amount cannot be collected from the United States.

NOTE 7.—This blank will be used for deceased volunteers and drafted men, as well as for others.

NOTE 8.—Where a Soldier dies in Hospital or on detached service, his descriptive list, if he has one, should be sent with his final statements, in duplicate, to the Second Auditor, Washington, D. C.

Continued on next page

I certify, on honor, that Benjamin Roach a Private of
 Captain Oren H. Granville's Company (16) of the 9th Regiment of U.S. Colored Troops
VOLUNTEERS, of the State of _____, born in Somerset Co., State
 of Maryland, aged 23 years; 5 feet 10 $\frac{1}{2}$ inches high; Black complexion,
Black eyes, Black hair, and by occupation a Farmer, having joined the company on
 its original organization at Princes Ann Md, and enrolled in it at the muster into
 the service of the United States at Benedict Md, on the 23rd day
 of November, 1863, (or was mustered in service as a recruit, by Col. W. Birney
2nd U.S.C.T. Mustering Officer, on the _____ day of _____,
 186____, or was drafted and mustered into the service of the United States from the
 Enrollment District of the State of _____, at _____,
 on the _____ day of _____, 186____) to serve in the Regiment, for
 the term of Three years or during: and having served **HONESTLY** and
FAITHFULLY with his Company in his capacity as private to the present date, is now
 entitled to a **DISCHARGE** by reason of Death,

The said Benjamin Roach was last paid by Paymaster
Maj. Malone to include the 31st day of December, 1863, and has
 pay due him from that time to the present date; he is entitled to pay and subsistence for
TRAVELING to place of enrollment, and whatever other allowances are authorized to volunteer
 soldiers, drafted men, or militia, so discharged. He has received from the United States **CLOTHING**
 amounting to 32 $\frac{27}{100}$ dollars, since the 23rd day of October,
 1863, when his clothing account was last settled. He has received from the United States
 _____ dollars advanced **BOUNTY**.

There is to be stopped from him, on account of the State of _____, or other
 authorities, for **CLOTHING**, &c., received on entering service, _____ dollars; and
 for other stoppages, viz:

He leaves no effects whatever,
 _____ dollars.

He has been furnished with **TRANSPORTATION** in kind from the place of his discharge to
 _____; and he has been **SUBSISTED** for **TRAVELING** to his
 place of enrollment, up to the _____, 186____.

He is indebted to _____, **SUTLER**, _____ dollars.

He is indebted to _____, **LAUNDRESS**, _____ dollars.

Given in Duplicate, at Camp Stanton Md, this 15th day
 of Feb, 1864.

Oren H. Granville
Captain

Commanding Company.

1864

FINAL STATEMENT

Dup

Stephen Cook Co. H.

9th Reg't of *U. S. Troops*

1871
1871
1871
VOLUNTEERS.

NOTE 1.—Two of these certificates (or duplicates) are to be given to each Volunteer Soldier or drafted man who may be discharged previously to the discharge of his company, that he may at once receive from the Paymaster the pay, &c., due him, and the captain or other COMMISSIONED officer commanding the company will certify to the act of the delivery of the duplicate certificates; on these certificates the Soldier is "entitled to" his discharge, and should also present his discharge to the Paymaster to have the payment endorsed on it. The discharge is to be given back to the Soldier by the Paymaster; the latter only retaining as his voucher the duplicate certificates.

NOTE 2.—If the Soldier is entitled to pay for the use of his horse, the Company Commander will certify to that fact on the back of both these final statements, and also to the time he has pay due for having been so mounted on his own horse.

NOTE 3.—When a Soldier is furnished with final statements, his descriptive list, if he has one, should be taken up by the officer who gives the Soldier these statements, and endorsed with a statement to this effect by the officer. This endorsement should exhibit a full statement of the time for which the Soldier was allowed pay on his final statements, the clothing account, and all other charges against him or in his favor, so as to comprise a complete exhibit of his account. It will then be transmitted to the company commander of the Soldier, who will enter all the data necessary to a full understanding of the Soldier's account on the muster roll upon which the Soldier's discharge is reported. The descriptive list will then be destroyed. The object of this is, that the remaining portion of the Soldier's account may be settled upon the receipt of these muster rolls, and the Soldier receive any pay or allowances that may be due him at the time of his discharge, and which may not appear on his final statements from the fact that his descriptive list is incomplete. These accounts for back pay, &c., are settled by the 2d Auditor of the Treasury Department.

NOTE 4.—Charges for loss or injury to ordnance, horse equipments, and other miscellaneous charges, should appear under the heading of "Other Stoppages."

NOTE 5.—Bounty paid by State authorities, and not by the United States, will not be entered on this statement.

NOTE 6.—Amounts due the Sutler and Laundress must be entered on the muster roll on which the discharge, death, desertion, &c., is reported, as well as on the final statement, otherwise the amount cannot be collected from the United States.

NOTE 7.—This blank will be used for deceased volunteers and drafted men, as well as for others.

NOTE 8.—Where a Soldier dies in Hospital or on detached service, his descriptive list, if he has one, should be sent with his final statements, in duplicate, to the Second Auditor, Washington, D. C.

I certify, on honor, that Benjamin Roach a private of
 Captain Oren H. Granville Company (H) of the 4th Regiment of U. S. Troops
VOLUNTEERS, of the State of _____, born in Sanneville, State
 of Maryland, aged 23 years; 5 feet 10 1/2 inches high; Black complexion,
Black eyes, Black hair, and by occupation a Farmer; having joined the company on
 its original organization at Princeton, and enrolled in it at the muster into
 the service of the United States at Benedict on the 23 day
 of November, 1863, (or was mustered in service as a recruit, by Col. W. Birney
2^d U. S. Troop, Mustering Officer day of _____,
 186____, or was drafted and mustered into the service of the United States from the
 Enrollment District of the State of _____, at _____,
 on the _____ day of _____, 186____) to serve in the Regiment, for
 the term of three years or during the war; and having served **HONESTLY** and
FAITHFULLY with his Company in his capacity as private to the present date, is now
 entitled to a **DISCHARGE** by reason of Death

The said Benjamin Roach was last paid by Paymaster
Major Malcom to include the 31st day of December 1863, and has
 pay due him from that time to the present date; he is entitled to pay and subsistence for
TRAVELING to place of enrollment, and whatever other allowances are authorized to volunteer
 soldiers, drafted men, or militia, so discharged. He has received from the United States **CLOTHING**
 amounting to 32 1/100 dollars, since the 23 day of October,
 1863, when his clothing account was last settled. He has received from the United States
 _____ dollars advanced **BOUNTY**.

There is to be stopped from him, on account of the State of _____, or other
 authorities, for **CLOTHING**, &c., received on entering service, _____ dollars; and
 for other stoppages, viz:

He leaves no Effects
 _____ dollars.

He has been furnished with **TRANSPORTATION** in kind from the place of his discharge to
 _____; and he has been **SUBSISTED** for **TRAVELING** to his
 place of enrollment, up to the _____, 186____.

He is indebted to _____, **SUTLER**, _____ dollars.
 He is indebted to _____, **LAUNDRESS**, _____ dollars.

Given in Duplicate, at Camp Stanton, this 15th day
 of July, 1864.

Oren H. Granville
Captain
 Commanding Company.

1864 sent for Mr. O. G.

FINAL STATEMENT

Duplicate

of

9th Reg't of U. S. Troops

9th Vol. VOLUNTEERS.

NOTE 1.—Two of these certificates (or duplicates) are to be given to each Volunteer Soldier or drafted man who may be discharged previously to the discharge of his company, that he may at once receive from the Paymaster the pay, &c., due him, and the captain or other COMMISSIONED officer commanding the company will certify to the act of the delivery of the duplicate certificates; on these certificates the Soldier is "entitled to" his discharge, and should also present his discharge to the Paymaster to have the payment endorsed on it. The discharge is to be given back to the Soldier by the Paymaster; the latter only retaining as his voucher the duplicate certificates.

NOTE 2.—If the Soldier is entitled to pay for the use of his horse, the Company Commander will certify to that fact on the back of both these final statements, and also to the time he has pay due for having been so mounted on his own horse.

NOTE 3.—When a Soldier is furnished with final statements, his descriptive list, if he has one, should be taken up by the officer who gives the Soldier these statements, and endorsed with a statement to this effect by the officer. This endorsement should exhibit a full statement of the time for which the Soldier was allowed pay on his final statements, the clothing account, and all other charges against him or in his favor, so as to comprise a complete exhibit of his account. It will then be transmitted to the company commander of the Soldier, who will enter all the data necessary to a full understanding of the Soldier's account on the muster roll upon which the Soldier's discharge is reported. The descriptive list will then be destroyed. The object of this is, that the remaining portion of the Soldier's account may be settled upon the receipt of these muster rolls, and the Soldier receive any pay or allowances that may be due him at the time of his discharge, and which may not appear on his final statements from the fact that his descriptive list is incomplete. These accounts for back pay, &c., are settled by the 2d Auditor of the Treasury Department.

NOTE 4.—Charges for loss or injury to ordnance, horse equipments, and other miscellaneous charges, should appear under the heading of "Other Stoppages."

NOTE 5.—Bounty paid by State authorities, and not by the United States, will not be entered on this statement.

NOTE 6.—Amounts due the Sutler and Laundress must be entered on the muster roll on which the discharge, death, desertion, &c., is reported, as well as on the final statement, otherwise the amount cannot be collected from the United States.

NOTE 7.—This blank will be used for deceased volunteers and drafted men, as well as for others.

NOTE 8.—Where a Soldier dies in Hospital or on detached service, his descriptive list, if he has one, should be sent with his final statements, in duplicate, to the Second Auditor, Washington, D. C.

I certify, on honor, that Benjamin Roach a private of
 Captain McGraville's Company (H) of the 9th Regiment of U.S.C. Troops
VOLUNTEERS, of the State of _____, born in Dorchester Co., State
 of Maryland, aged 23 years; 5 feet 10 1/2 inches high; Black complexion,
Black eyes, Black hair, and by occupation a Farmer, having joined the company on
 its original organization at Princes Ann Md, and enrolled in it at the muster into
 the service of the United States at Benedict Md, on the 23rd day
 of November, 1863, (or was mustered in service as a recruit, by Capt W. Binney
2nd U.S.C. Troop, assisting officer, on the _____ day of _____,
 1863, or was drafted and mustered into the service of the United States from the
 Enrollment District of the State of _____, at _____,
 on the _____ day of _____, 1863) to serve in the Regiment, for
 the term of Three Years or during the war: and having served **HONESTLY** and
FAITHFULLY with his Company in his capacity as private to the present date, is now
 entitled to a **DISCHARGE** by reason of Death

The said Benjamin Roach was last paid by Paymaster
Maj. Bellator to include the 31st day of December, 1863, and has
 pay due him from that time to the present date; he is entitled to pay and subsistence for
TRAVELING to place of enrollment, and whatever other allowances are authorized to volunteer
 soldiers, drafted men, or militia, so discharged. He has received from the United States **CLOTHING**
 amounting to 32 7/8 dollars, since the 23rd day of October,
 1863, when his clothing account was last settled. He has received from the United States
 _____ dollars advanced **BOUNTY**.

There is to be stopped from him, on account of the State of _____, or other
 authorities, for **CLOTHING**, &c., received on entering service, _____ dollars; and
 for other stoppages, viz: _____

_____ dollars.
 He has been furnished with **TRANSPORTATION** in kind from the place of his discharge to
 _____; and he has been **SUBSISTED** for **TRAVELING** to his
 place of enrollment, up to the _____, 1863.

He is indebted to _____, **SUTLER**, _____ dollars.

He is indebted to _____, **LAUNDRESS**, _____ dollars.

Given in Duplicate, at Camp Stanton Md, this 15th day
 of February, 1864.

Oren H. Graville
Captain
 Commanding Company.

ARTICLES OF WAR.

ART. 95. When any non-commissioned officer or soldier shall die, or be killed in the service of the United States, the then commanding officer of the troop or company shall, in the presence of two other commissioned officers, take an account of what effects he died possessed of, above his arms and accoutrements, and transmit the same to the office of the Department of War, which said effects are to be accounted for, and paid to the representatives of such deceased non-commissioned officer or soldier. And in case any of the officers, so authorized to take care of the effects of deceased officers and soldiers, should, before they have accounted to their representatives for the same, have occasion to leave the regiment or post, by preferment or otherwise, they shall, before they be permitted to quit the same, deposit in the hands of the commanding officer, or of the assistant military agent, all the effects of such deceased non-commissioned officers and soldiers, in order that the same may be secured for, and paid to, their respective representatives.

ARMY REGULATIONS—EDITION OF 1861.

DECEASED SOLDIERS.

Par. 152. Inventories of the effects of deceased non-commissioned officers and soldiers, required by the 95th Article of War, will be forwarded to the Adjutant General, by the commander of the company to which the deceased belonged, and a duplicate of the same to the colonel of the regiment. Final statements of pay, clothing, &c., will be sent with the inventories. When a soldier dies at a post or station absent from his company, it will be the duty of his immediate commander to furnish the required inventory, and, at the same time, to forward to the commanding officer of the company to which the soldier belonged, a report of his death, specifying the date, place, and cause; to what time he was last paid, and the money or other effects in his possession at the time of his decease; which report will be noted on the next muster-roll of the company to which the man belonged. Each inventory will be endorsed, "Inventory of the effects of _____, late of company (—) _____ regiment of _____, who died at _____, the _____ day of _____, 186—." If a legal representative receive the effects, it will be stated in the report. If the soldier leave no effects, the fact will be reported.

Par. 153. Should the effects of a deceased non-commissioned officer or soldier not be administered upon within a short period after his decease, they shall be disposed of by a Council of Administration, under the authority of the commanding officer of the post, and the proceeds deposited with the Paymaster, to the credit of the United States, until they shall be claimed by the legal representatives of the deceased.

Par. 154. In all such cases of sales by the Council of Administration, a statement in detail, or account of the proceeds, duly certified by the Council and commanding officer, accompanied by the Paymaster's receipt for the proceeds, will be forwarded by the commanding officer to the Adjutant General. The statement will be endorsed, "Report of the proceeds of the effects of _____, late of company (—) _____ regiment of _____, who died at _____, the _____ day of _____, 186—."

NOTE 1.—The effects in all cases, when called for, should be turned over to the legal representative, without further authority from the Adjutant General. When the effects are turned over to the relatives of the deceased before these inventories are sent to the Adjutant General, their receipts therefor should be attached to the inventories. In all other cases, one copy will be sent with a letter of transmittal direct to the Adjutant General, and a duplicate retained by the officer.

NOTE 2.—Particular care should be taken to take receipts in duplicate from the Paymaster for any funds turned over to him; one copy should be sent direct to the Adjutant General and one retained by the officer.

INVENTORY OF THE EFFECTS

OF

Private Benjamin Cook

Late of Company H

9th Reg't of U. S. Troops

Volunteers, who died at Camp Stanton

on the 13 day of July 1861.

Inventory of the effects of Benjamin Roach late
a private of Captain O. H. Grenville's Company H of
the 9th Regiment of U. S. C. Troops Volunteers, who was enrolled as
a private at Princess Ann in the State of Maryland on
the 23rd day of October 1863, and mustered into the service of the United
States as a private on the 23 day of November 1863, at Benedict
in Company H, 9th Regiment of U. S. C. Troops Volunteers, to serve three
years or during the war; he was born in Somerset Co in the State
of Maryland; he was 23 years of age, 5 feet 10 1/2 inches
high, Black complexion, Black eyes, Black hair, and by occupation, when enrolled,
a Farmer; he died in Hospital at
Camp Stanton on the 13th day of February 1864, by
reason of Consumption

| INVENTORY. <i>No Effects</i> | | | | | | | |
|------------------------------|-----|-----------------------------|-----|-----------------|-----|--------------|----|
| ARTICLES. | No. | ARTICLES. | No. | ARTICLES. | No. | | |
| Hats | 0 | Pairs trousers | 0 | Knapsacks | | | |
| Caps | 0 | Pairs flannel drawers | 0 | | | | |
| Forage caps | 0 | Pairs cotton drawers | 0 | | | | |
| Great coats | 0 | Flannel shirts | 0 | | | | |
| Uniform coats | 0 | Cotton shirts | 0 | | | | |
| Uniform jackets | 0 | Pairs boots | 0 | | | | |
| Flannel sack coats | 0 | Pairs shoes | 0 | | | | |
| Blouses | 0 | Pairs socks | 0 | | | | |
| Stable frocks | 0 | Blankets | 0 | | | | |
| Fatigue overalls | 0 | Haversacks | 0 | | | | |
| | | | | | | MONEY. | |
| | | | | | | Specie | \$ |
| | | | | Notes | \$ | | |

I CERTIFY, ON HONOR, that the above inventory comprises all the effects of Private Benjamin
Roach Co. H of U. S. C. Troops, deceased, and that ^{he leaves in} ~~the~~ effects are in the hands
of _____ at _____
_____ to be disposed of by a Council of Administration.

(DUPLICATES.)

Oren H. Grenville
Captain
Commanding the Company.

STATION : _____

DATE : _____

A.

No. 742

CLAIMANT'S CERTIFICATE.

I, John D. Sudler a loyal citizen, and a resident
of the, County of Somerset, State of
Maryland, hereby claim compensation, under the provisions of
General Orders, No. 329, 1863, for my slave Benjamin Roach
enlisted mid Oct 23rd 1863, at Princess Anne
by Col Wm - Minney in the Ninth
Regiment U. S. Colored Troops, Co. H; certificate of which enlistment, and a
descriptive list, as required, accompany this application.

In proof of my loyalty to the Constitution and Government of the United States, I
present the accompanying oath, which I have taken, signed, and acknowledged, to be filed
with this application, in accordance with requirement of said General Orders.

John D. Sudler

March 2^d 1864

B.

OATH OF ALLEGIANCE.

I, John P. Ardler, do solemnly swear that I have never joined, or been concerned in, any insurrection or rebellion; that I have never borne arms against the United States; that I have never given any aid, countenance, counsel, or encouragement to any person or persons engaged, or whom I had reason to believe were about to engage, in insurrection, rebellion, or armed hostility against the United States; that I have neither sought, nor accepted, nor attempted to exercise the functions of any office, civil or military, nor to perform any service whatever, under any authority or pretended authority in hostility to the United States; that I have not yielded a voluntary support to any insurrection, rebellion, or pretended government, authority, power, or constitution within the United States hostile thereto. And I do further swear that, to the best of my knowledge and ability, I have supported and defended, and will continue to support and defend, the United States against all enemies, foreign and domestic; and that I have supported, defended, and obeyed, and will continue to support, defend, and obey, the Constitution and laws of the United States; that I will bear true faith and allegiance to the same; and that I take this oath freely, without any mental reservation or purpose of evasion: So help me God.

John P. Ardler

Sworn to and subscribed before me, at Princess Anne }
 this 2^d day of Marche 1864 }

Isaac Gibbons
 Justice of the peace



Ms. A. 9. 2. 1. 1. 1.

C.

I present herewith evidence of my title to the slave Benjamin Roach
 enlisted as aforesaid, and in consideration of the sum of
 by me received, I hereby covenant and
 agree with the United States, that I, my heirs, executors, or assigns, shall never hereafter make
 or enforce any claim to the labor or services of said slave; and pledge myself to execute
 a valid Deed of Manumission and Release of all my claims to service forever of said
Benjamin Roach to be filed with the Board of Claims
 now in session at Baltimore City Md

John T. Sudler

March 2^d, 1864

L. S. 121. A. B.
G. 10 140 A. 1
No. 742

March 1862

APPLICATION OF

John D. Sudder

OF

Somerset County

For Compensation for Service of Slave,

Benj'n Roach

Enlisted in 9th Regiment

U. S. Colored Troops, Co. H.

Received, March 4th 1864.

COMPENSATION AWARDED,

October 17th 1865

Three Hundred Dollars.

Thos. Finmore

President Bd. Claims

Recd. T. H. October 21. 1865.

EVIDENCE OF TITLE.

I. *John D. Sudler*, of *Somerset*
County, Md., do solemnly swear that *Benjamin Roach*
who has been enlisted in the *ninth* Regiment, U. S. Colored Troops,
Co. *H*; is my slave for *life*; (~~his term of service expiring on~~
~~the~~ ~~day of~~ ~~186~~;) and that
I became possessed of him by *Birth*, ~~in the month~~
~~of~~, eighteen hundred and *forty four*. And I
do further swear that I have not purchased said slave from any person or persons disloyal
to the Government of the United States, with the object of obtaining compensation for
the same; and furthermore, that I have no agency for obtaining compensation for any per-
son or persons but such as, to my knowledge, are loyal citizens of the United States.

John D. Sudler

Marche 2^d 1864.

STATE OF MARYLAND,

Somerset County, to wit: .

On this *Second* day of *March* in the year 1864,

before me, the subscriber, a Justice of the Peace of the State and County aforesaid, personally appeared *John D. Sudler*, and took, signed, and acknowl-

edged the oaths preceding; and further made oath, in due form of law, that all the statements made in this application are, to the best of *his* knowledge and belief, strictly

true. Also personally appeared before me *Littleton Longden* and

William A. Fisher, loyal citizens of the United States, residents of

Somerset County, well acquainted with the said *John D.*

Sudler, and in no manner interested in the prosecution of this

claim, and made oath, in due form of law, that the said *John D. Sudler*

is the owner of the slave *Benjamin Roach*, as a fact of public noto-

riety; that they believe all the statements herein made by *him*, in reference

thereto, are correct, and that *he* is unquestionably loyal to the Government of

the United States. Witness their signatures:

Littleton Longden
W. A. Fisher



Isaac Gibbons

Justice of the Peace.

STATE OF MARYLAND,

Somerset

County, to wit:

I, *Levin Woolford*

, Clerk of the Circuit Court for

Somerset

County, do hereby certify that

Isaac Gibbons Esquire

before whom the foregoing affidavits were made, was, at the time of signing the same, a Justice of the Peace for the County and State aforesaid, duly commissioned and sworn; and that his signature thereto is genuine, and that full faith and credit should be given to his official acts.

Witness my hand and the seal of said Court, this

Second —

day of

March

, A. D. 1864.

Levin Woolford

CLERK.

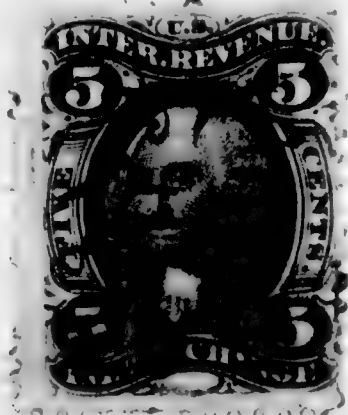

F.

CERTIFICATE OF AWARD OF THE BOARD OF CLAIMS.

No 1035

Office of the Board of Claims
For Slaves Enlisted in the Service of the United States,

Baltimore Md.

October 18th, 1865.

\$ 300-

We hereby certify, that John D. Sudler of Somerset county, State of Maryland, having proved, under oath, his loyalty to the Constitution and Government of the United States, and established his title as to the ownership of Benjamin Roach, a slave enlisted at Somerset County Md., on the 23^d day of October, 1863, by Col. Wm. Birney, in the service of the United States, in the 7th Regiment of Colored Troops, Co. H, and having filed a valid Deed of Manumission and Release of Service of said slave, is entitled to the sum of Three Hundred dollars, which has been awarded to him by this Board as a remuneration for all claim to the future labor or service of said slave, under the provision of General Orders, War Department, No. 329, 1863.

Thos. J. Simons, President of the Board.

James Rogers, Member of the Board.

Wm. H. Sp, Member of the Board.

To Col. C. M. Foster,

Chief of the Bureau for the
Organization of Colored Troops, Washington, D. C.

ARRR 797
S. No. 143. R. 1.

No. .

ABSTRACT OF DISBURSEMENTS.

....., 186 .

Sudler, John D.

Dollars *300* 100.

Paid , 186 .

The United States,

To *John D Judler Dr.*

| | | DOLLARS. | CENTS. |
|---|---|------------|-----------|
| <i>1865.</i> <i>Oct. 18th</i> | For amount awarded him by the Board of Claims, in consideration of the enlistment of <i>Benjamin Roach</i> in the <i>9th Regt U.S. Col. Troops</i> | <i>300</i> | <i>00</i> |
| <i>Total \$</i> | | <i>300</i> | <i>00</i> |

I CERTIFY that the above account is correct and just; that the name of *Benjamin Roach* is borne on the muster-in rolls of the *9th Regt U.S. Col. Troops*, and that the above amount was awarded by the Board of which *Thos. Mummon Esq.* is President, said award being in accordance with section 24 of the act entitled "An act to amend an act entitled 'An act for enrolling and calling out the national forces, and for other purposes,'" approved Feb. 24, 1864.

Assistant Adjutant General.

RECEIVED

, 186 , of *Major W.F. Rockwell a. a. g. vol.*
dollars and _____ cents, in full of the above account.

Int. [unclear]

John F. Judler

(SIGNED DUPLICATES.)

E. No. 143. C. 1.

No. .

ABSTRACT OF DISBURSEMENTS.

....., 186 .

Sudler John D.

Dollars *300* - 100.

Paid , 186 .

The United States,

To *John D. Sudler* Dr.

| | | DOLLARS. | CENTS. |
|----------------------------|--|------------|-----------|
| <i>Oct 18th</i> | For amount awarded him by the Board of Claims, in consideration of the enlistment of <i>Benjamin Roach</i> in the <i>9th Regt. U.S. Col. Troops</i> | <i>300</i> | <i>00</i> |
| <i>Total</i> | | <i>300</i> | <i>00</i> |

I CERTIFY that the above account is correct and just; that the name of *Benjamin Roach* is borne on the muster-in rolls of the *9th Regt. U.S. Col. Troops* and that the above amount was awarded by the Board of which *John Summons Esq.* is President, said award being in accordance with section 24 of the act entitled "An act to amend an act entitled 'An act for enrolling and calling out the national forces, and for other purposes,'" approved Feb. 24, 1864.

Assistant Adjutant General.

RECEIVED _____, 186____, of *Major A. F. Beckwell* a/c *ad. g. v. l.* dollars and _____ cents, in full of the above account.

(SIGNED DUPLICATES.)

John D. Sudler

NAAR 881

Public Court House
April 1/1891

E

Deed of Manumission & Release of Service

Whereas my slave Benjamin Roach has enlisted in the service of the United States now in consideration thereof I John D. Sudler of Somerset County State of Maryland do hereby in consideration of said enlistment manumit set free and release the above named Benjamin Roach from all service due me his freedom to Commence from the 23rd day of October 1863 the date of his enlistment as aforesaid in the 9th Regiment of Colored Troops in the service of the United States witness my hand and Seal the 22nd day of March 1864

Witness
 Littleton Claywell
 Isaac Gibbons
 Wm. J. Lanford

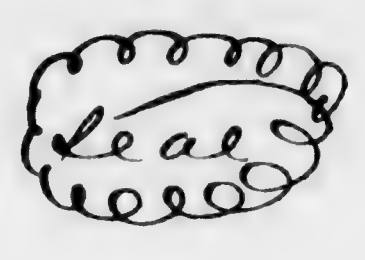
John D. Sudler 

Somerset County, State of Maryland 1864 Before me appeared this day John D. Sudler and acknowledged the above deed of Manumission and Release of Service to be his free act and deed

Before Isaac Gibbons, J. P.

State of Maryland Somerset County to wit:
 I Lewis Woodford Clerk of the Circuit Court for Somerset County aforesaid hereby certify that Isaac Gibbons Esquire before whom the above acknowledgment appears to have been made and whose name is thereto subscribed was at the time the same bears date one of the justices of the peace of the State of Maryland in and for Somerset County aforesaid duly Commissioned and sworn - In testimony whereof I hereunto subscribe

my name and affix the Seal of the said Circuit Court
this 22^d day of March 1864



Levin Woolford clk

State of Maryland Somerset County Del:

I hereby certify that the foregoing is truly
Copied from the Original now on file and of record in the
Office of the Clerk of the Circuit Court for Somerset County
in and for the State aforesaid

In testimony whereof I hereunto sub-
scribe my name and affix the seal of
the said Circuit Court, this 22^d day
of March Anno Domini 1864



Levin Woolford clk

Roach, Hope⁹⁴⁶

Co K 9 U.S. Col'd Inf.

Private Private

CARD NUMBERS.

| | | |
|----|----------|----|
| 1 | 6316906 | 26 |
| 2 | 6317103 | 27 |
| 3 | 6317106 | 28 |
| 4 | 6317208 | 29 |
| 5 | 6317303 | 30 |
| 6 | 6317397 | 31 |
| 7 | 6317485- | 32 |
| 8 | 6317575- | 33 |
| 9 | 6317654 | 34 |
| 10 | 6317739 | 35 |
| 11 | 6317815- | 36 |
| 12 | 6317886 | 37 |
| 13 | 6317958 | 38 |
| 14 | 6318018 | 39 |
| 15 | 6318075- | 40 |
| 16 | 6318133 | 41 |
| 17 | 6318189 | 42 |
| 18 | 6318242 | 43 |
| 19 | 6318293 | 44 |
| 20 | 6318344 | 45 |
| 21 | 9069487 | 46 |
| 22 | | 47 |
| 23 | | 48 |
| 24 | | 49 |
| 25 | | 50 |

Book Mark:

See also

D. 1294521 P.O. Mon
S-2086815 P.O. Mon

G. E. Doughty
2

R | 9 | U.S.C.T.

Hope Rouch
Co. *K*, 9 Reg't U. S. Col'd Inf.

Appears on
Company Descriptive Book
of the organization named above.

DESCRIPTION.

Age *26* years; height *6* feet *1/2* inches.
Complexion *Mulatto*
Eyes *Dr. Brown*; hair *Black*
Where born *Somerset Md.*
Occupation *Farmer*

ENLISTMENT.

When *Nov. 26*, 186*3*.
Where *Anna Mersick*
By whom *Capt. Wm. Boring*; term *3* y'rs.

Remarks:
*In the engagement on Johns
Island S. C. July. 9/64
Discharged with Regt.*

J. W. Smith
(383g) Copyist.

R | 9 | U.S.C.T.

Hope Roach
Pri., Co. K., 9 Reg't U. S. Col'd Infantry.

Age 26 years.

Appears on

Company Muster-in Roll

of the organization named above. Roll dated
Charles Co Md Nov 30, 1863.

Muster-in to date Nov 30, 1863.

Joined for duty and enrolled:

When Nov 26, 1863.

Where Somerset Md

Period 3 years.

Remarks:
.....
.....
.....
.....
.....
.....

Book mark:

C. G. Smith

R | **9** | **U.S.C.T.**

Hope Roach
Pri, Co. K, 9 Reg't U. S. Col'd Infantry.

Appears on

Company Muster Roll

for *Nov & Dec*, 1863.

Present or absent *Present*

Stoppage, \$ *100* for

Due Gov't, \$ *100* for

Remarks: *\$200 Recruit Premium*
Due

Book mark:

C. G. Smith

9 U.S.C.T.

Hope Roach

Pr, Co. K, 9 Reg't U. S. Col'd Infantry.

Appears on

Company Muster Roll

for Jan & Feb, 1864

Present or absent Present

Stoppage, \$ 100 for

Due Gov't, \$ 100 for

Remarks: \$2.00 Recruit-Premium Due

Book mark:

O. G. Smith

R | 9 | U.S.C.T.

Hope Roach

Pri , Co. K, 9 Reg't U. S. Col'd Infantry.

Appears on

Company Muster Roll

for *March & April*, 1864

Present or absent *Present*

Stoppage, \$ *100* for

Due Gov't, \$ *100* for

Remarks: *Stop for one pair of Metalic Scales*

Book mark:

O. Y. Smith

(858)

Copyist

R

9

U.S.C.T.

Hope Roach

Pri, Co. K, 9 Reg't U. S. Col'd Infantry.

Appears on

Company Muster Roll

for May & June, 1864

Present or absent Present

Stoppage, \$ 100 for

Due Gov't, \$ 100 for

Remarks:

Book mark:

[Signature]

(358)

Copyist

R | 9 | U.S.C.T.

Hope Roach
Pri, Co. K, 9 Reg't U. S. Col'd Infantry.

Appears on

Company Muster Roll

for July & Aug., 1864.

Present or absent Present

Stoppage, \$ 100 for

Due Gov't, \$ 100 for

Remarks:

Book mark:

A. G. Smith

(858)

Copyist

R | 9 | U.S.C.T.

Hope Roach
Pri, Co. K, 9 Reg't U. S. Col'd Infantry.

Appears on

Company Muster Roll

for Sept & Oct, 1864.

Present or absent Present

Stoppage, \$ 100 for

Due Gov't, \$ 100 for

Remarks: Due the differences
between \$7.00 per mo.
& \$13.00 per mo. from
Jan. 1st to Apr. 30/64.

Book mark:

O G Smith

R | 9 | U.S.C.T.

Hope Roach
Priv, Co. K, 9 Reg't U. S. Col'd Infantry.

Appears on

Company Muster Roll
for *Nov Dec*, 1864

Present or absent *Present*

Stoppage, \$ 100 for

Due Gov't, \$ 100 for

Remarks:

Book mark:

G W Deabrick

S

9

U.S.C.T.

Hope Roach
Priv, Co. K, 9 Reg't U. S. Col'd Infantry.

Appears on

Company Muster Roll

for *Jan & Feb*, 1865.

Present or absent *Present*

Stoppage, \$ *100* for

Due Gov't, \$ *100* for

Remarks:

Book mark:

G W Deadrick

R | 9 | U.S.C.T.

Hope Beach
Priv., Co. K, 9 Reg't U. S. Col'd Infantry.

Appears on

Company Muster Roll

for *May to Apr*, 1865.

Present or absent *Present*

Stoppage, \$ *100* for

Due Gov't, \$ *100* for

Remarks:

Book mark:

G W Deadrick

R | **9** | **U.S.C.T.**

Hope Roach
Priv, Co. K, 9 Reg't U. S. Col'd Infantry.

Appears on

Company Muster Roll

for *Dec 31/64 to June 30, 1865.*

Present or absent *Present*

Stoppage, \$ 100 for

Due Gov't, \$ 100 for

Remarks: *Stop for transportation while on furlough*
\$358
\$3700

Book mark:

G W Dearick

(358)

Copied

R | 9 | U.S.C.T.

Hope Roach

Priv., Co. K, 9 Reg't U. S. Col'd Infantry.

Appears on

Company Muster Roll

for *July & Aug*, 1863.

Present or absent *Present*

Stoppage, \$ *100* for

Due Gov't, \$ *100* for

Remarks:

Book mark:

G. W. Deadrick

A | **9** | **U.S.C.T.**

Walter Roach

Priv, Co. K, 9 Reg't U. S. Col'd Infantry.

Appears on

Company Muster Roll

for *Sept Oct*, 186*5*.

Present or absent *Present*

Stoppage, \$ 100 for

Due Gov't, \$ 100 for

Remarks:

Book mark:

G W Deadrick

R 9 U.S.C.T.

Wesley Roach

Priv, Co. K, 9 Reg't U. S. Col'd Infantry.

Appears on

Company Muster Roll

for *June 30/63 to Dec 31*, 1863.

Present or absent *Present*

Stoppage, \$ *100* for

Due Gov't, \$ *100* for

Remarks:

Book mark:

G W Deabrick

R

9

U.S.C.T.

Hope Roach
Priv., Co. K, 9 Reg't U. S. Col'd Infantry.

Appears on

Company Muster Roll

for *Jan. and Feb.*, 186*6*.

Present or absent *Present*

Stoppage, \$ *100* for

Due Gov't, \$ *100* for

Remarks:

Book mark:

J. C. Taylor

(358)

Copyist

R

9

U.S.C.T.

Hope Roach
Prvt., Co. K, 9 Reg't U. S. Col'd Infantry.

Appears on

Company Muster Roll

for *Mar. and Apr.*, 1866.

Present or absent *Present*

Stoppage, \$ *100* for

Due Gov't, \$ *100* for

Remarks *Stop for ordnance*
34¢.

Book mark:

D. C. Taylor

(358)

Copyist

R

9

U.S.C.T.

Hope Roach
Pvt., Co. K, 9 Reg't U. S. Col'd Infantry.

Appears on

Company Muster Roll

for *May and June, 1866*

Present or absent *Present*

Stoppage, \$ *100* for

Due Gov't, \$ *100* for

Remarks:

Book mark:

(358)

A. C. Taylor

Copyist

R | 9 | U.S.C.T.

Hope Roach
Priv., Co. K, 9 Reg't U. S. Col'd Infantry.

Appears on

Company Muster Roll

for *July and Aug.*, 186*6*.

Present or absent *Present*

Stoppage, \$ 100 for

Due Gov't, \$ 100 for

Remarks:

Book mark:

J. C. Taylor

R

9

U.S.C.T.

Hope Roach
Pvt., Co. K, 9 Reg't U. S. Col'd Infantry.

Appears on

Company Muster Roll

for *Sep. and Oct.*, 186*6*.

Present or absent *Present*

Stoppage, \$ *100* for

Due Gov't, \$ *100* for

Remarks:

Book mark:

P. C. Taylor

(858)

Copyist

R | 9 | U.S.C.T.

Hope Roach
Put., Co. *K*, 9 Reg't U. S. Col'd Infantry.

Appears on **Co. Muster-out Roll**, dated
New Orleans, La., Nov. 26, 1866.

Muster-out to date *Nov. 26*, 1866.

Last paid to *Aug. 31*, 1866.

Clothing account:

Last settled _____, 186 ; drawn since \$ _____ 100

Due soldier \$ *75* ¹⁰⁰; due U. S. \$ _____ 100

Am't for cloth'g in kind or money adv'd \$ _____ 100

Due U. S. for arms, equipments, &c., \$ *6* ¹⁰⁰

Ordinary
 Bounty paid \$ *none* ¹⁰⁰; due \$ *100* ¹⁰⁰ +

Remarks: *Bounty due under Act of Congress of July 26, 1866, \$100. Joined at original organization. Stop one S.R.M. and set of accoutrements retained.*

Book mark: *V. 114. P. 477. 70. 287. 482.*

(861) *J. C. Taylor* Copyist.

Roach, Hope
 , Co. K, 9 Reg't U.S.C. Inf

1 Enclosures.

| | |
|------------------------------------|----------------------------|
| Bed Cards | Final Statements |
| Burial Records | Furloughs or L. of A |
| Certs. of Dis. for Discharge | Med. Certificates |
| C. M. Charges | Med. Des. Lists |
| Descriptive Lists | Orders |
| Discharge Certificates | Pris. of War Record |
| Enlistment Papers | Resignations |

Other papers relating to—

| | |
|------------------------------|-----------------------------|
| Admission to Hosp'l | Furlough or L. of A / |
| Casualty Sheet | Med. Examination |
| Confinement | Misc. Information |
| Contracts | Pay or Clothing |
| Death or Effects | Personal Reports |
| Desertion | Rank |
| Discharge from Hosp'l | Transfer to Hosp'l |
| Discharge from Service | Transfer to V. R. C. |
| Duty | Transportation |

Hope Roach.
"K," 9th U.S.C.T.

Furlough.

1865

See letter of 1st Lt.
C. P. Goodyear, Comdg.

25.A.6.

Roach, William ⁹⁴⁷

Co B, 9 U.S. Col'd Inf.

Private | Private

CARD NUMBERS.

| | | |
|----|---------|----|
| 1 | 6304611 | 26 |
| 2 | 6304718 | 27 |
| 3 | 6304817 | 28 |
| 4 | 6304910 | 29 |
| 5 | 6305007 | 30 |
| 6 | 6305104 | 31 |
| 7 | 6305203 | 32 |
| 8 | 6305300 | 33 |
| 9 | 6305398 | 34 |
| 10 | 6305484 | 35 |
| 11 | 6305571 | 36 |
| 12 | 6305655 | 37 |
| 13 | 6305728 | 38 |
| 14 | 6305799 | 39 |
| 15 | 6305867 | 40 |
| 16 | 6300200 | 41 |
| 17 | 6305933 | 42 |
| 18 | 6300262 | 43 |
| 19 | 6305999 | 44 |
| 20 | 6306004 | 45 |
| 21 | 9068836 | 46 |
| 22 | | 47 |
| 23 | | 48 |
| 24 | | 49 |
| 25 | | 50 |

Book Mark:

See also

P 1098332 P.O. Mtn

G.S. Doughty
2

R | 9 | U.S.C.T.

William Roach

, Co. C, 9 Reg't U. S. Col'd Inf.

Appears on

Company Descriptive Book

of the organization named above.

DESCRIPTION.

Age 19 years; height 5 feet 8 1/2 inches.

Complexion Black

Eyes Black; hair Black

Where born Somersa, Md

Occupation Waterman

ENLISTMENT.

When Jan'y 18, 1864.

Where Potatoes Neck, Somerset Co., Md

By whom Col. W. Burney; term 3 y'rs.

Remarks: Discharged with
Regt. Nov. 26. 1866.

E. L. Shanton

R

9

U.S.C.T.

William Roach

Det., Co. C, 9 Reg't U. S. Col'd Infantry.

Appears on

Company Muster Roll

for Jan & Feb, 1864.

Present or absent Present

Stoppage, \$ 100 for

Due Gov't, \$ 100 for

Remarks: Sick in Quarters
#2 Recd Prem due

Book mark:

(858)

M. A. Kelly
Copyist

R | 9 | U.S.C.T.

William Roach

PA, Co. C, 9 Reg't U. S. Col'd Infantry.

Appears on

Company Muster Roll

for *Mar & April*, 1864.

Present or absent *Present*

Stoppage, \$ 100 for

Due Gov't, \$ 100 for

Remarks:

Book mark:

M. White
Copyist

R

9

U.S.C.T.

William Roach

Plt, Co. C, 9 Reg't U. S. Col'd Infantry.

Appears on

Company Muster Roll

for *May & June*, 1864.

Present or absent *Present*

Stoppage, \$ 100 for

Due Gov't, \$ 100 for

Remarks:

Book mark:

(358)

J. G. White
Copyist

R | 9 | U.S.C.T.

William Roach

Pat, Co. C, 9 Reg't U. S. Col'd Infantry.

Appears on

Company Muster Roll

for July & Aug, 1864.

Present or absent absent

Stoppage, \$ 100 for

Due Gov't, \$ 100 for

Remarks: Wounded at Deep Bottom Va Aug 16/64

Book mark:

(358)

Y. D. Wiley
Copyist

R | 9 | U.S.C.T.

William Roach

1st, Co. C, 9 Reg't U. S. Col'd Infantry.

Appears on

Company Muster Roll

for Sep & Oct, 1864.

Present or absent Absent

Stoppage, \$ 100 for

Due Gov't, \$ 100 for

Remarks: Absent wounded since Aug 16/64

Book mark:

(358)

J. D. Hill Copyist

R | 9 | U.S.C.T.

William Roach

Pvt, Co. C, 9 Reg't U. S. Col'd Infantry.

Appears on

Company Muster Roll

for *Nov & Dec*, 1864.

Present or absent *Present*

Stoppage, \$ 100 for

Due Gov't, \$ 100 for

Remarks:

Book mark:

(358)

J. G. Thibault
Copyist

R

9

U.S.C.T.

William Roach

Pvt., Co. C, 9 Reg't U. S. Col'd Infantry.

Appears on

Company Muster Roll

for *Jan - Feb*, 1865.

Present or absent *Present*

Stoppage, \$ 100 for

Due Gov't, \$ 100 for

Remarks:

Book mark:

A. J. Anderson

Q | 9 | U.S.C.T.

William Roach

Pat, Co. C, 9 Reg't U. S. Col'd Infantry.

Appears on

Company Muster Roll

for March & April, 1865.

Present or absent Present

Stoppage, \$ 100 for

Due Gov't, \$ 100 for

Remarks: Present Guard at the
grs 2 Brig. 1st Div. 25th a.c. for S.O.
No 42. 16 days. 9th U.S. 67. April 6/65

Book mark:

A J Anderson

R | **9** | **U.S.C.T.**

William Roach

Cpt, Co. C, 9 Reg't U. S. Col'd Infantry.

Appears on

Company Muster Roll

for *Dec 31/64 to June 30*, 1865.

Present or absent *Present*

Stoppage, \$ *100* for

Due Gov't, \$ *100* for

Remarks: *An Det. Serv. for S.O. No 42
No. 2, 9th U.S.C.I. Apr 25, 1865*

Book mark:

A. J. Anderson

R | 9 | U.S.C.T.

William Roach

Plt, Co. C, 9 Reg't U. S. Col'd Infantry.

Appears on

Company Muster Roll

for *July & Aug*, 1865.

Present or absent *Present*

Stoppage, \$ 100 for

Due Gov't, \$ 100 for

Remarks: *On det serv in S.C. No. 42 76 & 9 U.S.G.I. April 25 1865.*

Book mark:

A.J. Anderson

R | **9** | **U.S.C.T.**

William Roach

Co, Co. C, 9 Reg't U. S. Col'd Infantry.

Appears on

Company Muster Roll

for *June 30 to Oct 31*, 1865.

Present or absent *Present*

Stoppage, \$ *100* for

Due Gov't, \$ *100* for

Remarks:

Book mark:

A. J. Anderson

R

9

U.S.C.T.

William Rouch

Pvt, Co. C, 9 Reg't U. S. Col'd Infantry.

Appears on

Company Muster Roll

for Jun 30 to Dec 31, 1865.

Present or absent Present

Stoppage, \$ 100 for

Due Gov't, \$ 100 for

Remarks:

Book mark:

A. J. Anderson

2 | 9 | U.S.C.T.

William Roach

Capt, Co. C, 9 Reg't U. S. Col'd Infantry.

Appears on

Company Muster Roll

for Jan & Feb, 1864.

Present or absent absent

Stoppage, \$ 100 for

Due Gov't, \$ 100 for

Remarks: det serv pr S.C. 2 1/2 yrs
Dis 25 a.c. Jan 22 '66.

* Name in Column "Names Present" Canceled
by line drawn through it.

Book mark:

A. J. Anderson

R | **9** | **U.S.C.T.**

William (Wm) C. Pouch
Private, Co. C, 9 Reg't U. S. Col'd Infantry.

Appears on

Company Muster Roll

for *John W. Pouch*, 186 *6*

Present or absent *Present*

Stoppage, \$ *100* for

Due Gov't, \$ *100* for

Remarks:

Book mark:

Francis

9

9

U.S.C.T.

William Voach

Serjeant, Co. C, 9 Reg't U. S. Col'd Infantry.

Appears on

Company Muster Roll

for *May & June*, 1866.

Present or absent *Absent*

Stoppage, \$ 100 for

Due Gov't, \$ 100 for

Remarks: *Det. service at G. M.
Sep. 22 56. Hd Qrs. 1st
Br. 9 March 3 66*

Book mark:

Francis

R | *9* **U.S.C.T.**

William Roach
Pr., Co. *C*, *9* Reg't U. S. Col'd Inf.

Appears on a
Detachment Muster Roll

of the organization named above
for *May and June*, 186*6*.
Station *Brownsville, Texas.*
Present or absent *Present.*

Stoppage, \$ *100* for

Due Gov't, \$ *100* for

Remarks:
.....
.....
.....
.....
.....

Book mark :

J. G. Smith,
(244) Copyist.

P | **9** | **U.S.C.T.**

William Poach

Private, Co. C, 9 Reg't U. S. Col'd Infantry.

Appears on

Company Muster Roll

for *July 4th 1866*, 186*6*.

Present or absent *Present*

Stoppage, \$ *100* for

Due Gov't, \$ *100* for

Remarks: *Det in 9th Dept
for 50.58 Hrs L.R. G.
March 3rd 66*

Book mark:

(358)

Amos
Copyist

R 9 U.S.C.T.

William Roach

Pvt., Co. *C*, *4* Reg't U. S. Col'd Inf.

Appears on a

Detachment Muster Roll

of the organization named above

for *July & Aug.*, 186 *4*.

Station *Brownsville, Tex.*

Present or absent *Present.*

Stoppage, \$ *100* for

Due Gov't, \$ *100* for

Remarks: *Detained by special orders*
No. 58 Hd. Qrs. I. R. G. Lewis
1864.

Book mark:

(344)

J. J. Smith

Copyist.

N.

9

U.S.C.T.

William Roach

Private, Co. C, 9 Reg't U. S. Col'd Infantry.

Appears on

Company Muster Roll

for *Sept 1/10* *Oct*, 186*6*.

Present or absent *Present*

Stoppage, \$ *100* for

Due Gov't, \$ *04*/*100* for *Brass*

Ornaments

Remarks:

Book mark:

Amicos

R. | 9 | U.S.C.T.

William Roach
Smith, Co. 'C', 9 Reg't U. S. Col'd Infantry.

Appears on **Co. Muster-out Roll**, dated
New Orleans, La., Nov 25, 1866.

Muster-out to date *Nov 25, 1866.*

Last paid to *Aug 31, 1866.*

Clothing account:

Last settled 186 ; drawn since \$ 100

Due soldier \$ *61 32* / 100; due U. S. \$ 100

Am't for cloth'g in kind or money adv'd \$ 100

Due U. S. for arms, equipments, &c., \$ *04* / 100

Ordinary
 Bounty paid \$ *None* / 100; due \$ *300* / 100

Remarks: *joined as recruit*

Stop for 1 Bu gle letter number

*Ag 18. Enrolled Jan 18. by Somerset
 Ad - 3 yrs. det' Jan 23. by Benedict & Co*

Inserted by comparers.

Book mark: *V180 P 210.74.*
At 131. Md.

R. Smith

Roach, William

P, Co. *C*, *9* Regt. *U. S. C. Inf.*

3

Enclosures.

| | |
|-----------------------------------|------------------------|
| Bed Cards..... | Descriptive Lists..... |
| Burial Records..... | Final Statements..... |
| Certs. of Dis. for Discharge..... | Furloughs..... |
| C. M. Charges..... | Med. Des. Lists..... |
| Med. Certificates..... | Orders <i>3</i> |

Other papers relating to—

| | |
|---|---------------------------|
| Admission to Hosp'l..... | Furlough..... |
| Casualty Sheet (Officer's) <i>2</i> | Med. Examination..... |
| Confinement..... | Misc. Information..... |
| Contracts..... | Pay or Clothing..... |
| Death or Effects..... | Personal Reports..... |
| Desertions..... | Rank..... |
| Discharge from Hosp'l..... | Transfer to Hosp'l..... |
| Discharge from Service..... | Transfer to V. R. C. |
| Duty..... | Transportation..... |

Star Claim 1

MICROFILM PUBLICATION M 1851

COMPILED MILITARY SERVICE RECORDS
OF VOLUNTEER UNION SOLDIERS WHO SERVED WITH
THE UNITED STATES COLORED TROOPS (USCT)
9TH REGIMENT OF INFANTRY

PERSONAL PAPERS' TARGET SHEET

PLEASE NOTE THE CHECKED INFORMATION ABOUT THE PERSONAL PAPERS IN
THIS FILE:

- NO PERSONAL PAPERS WERE FOUND IN THIS FILE WHEN THE
RECORDS WERE ARRANGED FOR MICROFILMING.
- 8 PERSONAL PAPER(S) FOUND IN THIS FILE WHEN THE RECORDS
WERE ARRANGED FOR MICROFILMING.

133
(2)

CASUALTY SHEET
OF WOUNDED.

Wm Roach

Private Company Co

9 Regiment of USCA

Volunteers at the battle of _____

August 16th / 64

CASUALTY SHEET.

Name, *Wm Roach*
 Rank, *Private*, Company *6*, Regiment, *9th*
 Arm, *U.S.A.*, State,
 Place of casualty,
 Nature of casualty, *Wounded - Left Shoulder*
 Date of casualty, *Aug 16th 1864*

FROM WHAT SOURCE THIS INFORMATION WAS OBTAINED.

Report of Killed, Wounded, and Missing of the _____ Regiment,
 _____ Brigade, _____ Division, _____ Corps, dated *List of Killed*
and wounded in Brigade of Colored Troops, 10th
Army Corps, commanded by Col Shaw 7th U.S.A.
(Signed) A.P. Reichhold Surgeon 8th U.S.A.
Chief Med Officer Shaws Brigade

Ind 502 no 68

W F Thompson

Clerk

Head Qrs 3rd Army Corps
No 267 1865

Special Orders
No 286

Detailing Sgt Wm Fuch
Co C in P. No 1

Recd at HQ Nov 27th 1865

Headquarters Twenty-fifth Army Corps,

ASSISTANT ADJUTANT GENERAL'S OFFICE.

IN THE FIELD, TEXAS, *November 28th* 1865.

SPECIAL ORDERS,)

No. *288*)

(Extract.)

1. Private *William Kueh*
Co. "C" 9th U.S. Col. Troops, is hereby detailed
for duty in the Quartermaster Department, and
will report to *Sicut E. R. Cooper*, 11th U. S. Col.
Troops, Acting Assistant Quartermaster at these
Headquarters, without delay.

*

*

*

BY COMMAND OF MAJOR GENERAL WENTZEL:

J. G. L.

Assistant Adjutant General.

Comdg. Off. 9th U.S.C.T.

(Am. Genl. Smith.)

M.B. 2831

Ltd
11th Jan 112nd Dr 25th 6
Jan 22 1866

Special Orders
12

Detailing Private W^m
Peach Co "E" in Dr 25th 6

Rec^d 9th 11th 5th 6th Jan 22nd 1866

MAR 27 1866

Head Quarters First Division,

Twenty Fifth Army Corps,

Brownsville, Texas, January 27th, 1866.

Special Orders,

No. 12.

(EXTRACT.)

Company 1... Private William Beach
 of Company A U.S. Troops, is hereby
 detailed of duty in the Quartermaster's
 Department of 1st Division 25th A.C. and will at
 once report to Captain H. E. Richardson A.
 A. G. M., for duty.

* * * * *

By Order of ~~Brig~~ Maj. Gen. Giles A. Smith.

Attest

Asst. Adj't. General.

O. O.

of U.S. Troops.

The 1st Regt. H. 2.

M. B. 34 p. 8.

Adj. 1st Div., 23rd A.C.,
Jan'y 22^d, 1866.

S.O. 1
12.

William Roach

9th U.S.C. Troops

WAR 66

Head Quarters First Division,

Twenty Fifth Army Corps,

Brownsville, Texas, January 22, 1866.

Special Orders,

No. 12.

(EXTRACT.)

1 _____ Private William C. Jack
 of Company of U.S. Troops, is hereby
 detailed for duty in the Quartermaster
 Department of 1st Division, S.A.C., and will
 report to Captain S. L. Richard
 U.S.A., for duty.

* * * * *

By Order of ~~Private~~ Maj. Gen. Giles A. Smith.

Adams J.

Asst. Adj't. General.

Maj. Gen. H. H. Hildreth
 S.A.C.

Received

133

12

CASUALTY SHEET
OF WOUNDED.

Wm Rouch

1st Company *C*

9th Regiment of *Inf*

Volunteers at the battle of

Aug 16/64

CASUALTY SHEET.

Name, *Wm Roach*
Rank, *Priv*, Company *C*, Regiment, *9th*
Arm, *Infy*, State, *Miss*
Place of casualty, *Not stated*
Nature of casualty, *wounded, left shoulder*
Date of casualty, *Aug 16th / 64*

FROM WHAT SOURCE THIS INFORMATION WAS OBTAINED

Report of Killed, Wounded, and Missing of the _____ Regiment,
Shaw's Brigade, _____ Division, _____ Corps, dated _____
Signed *A. R. Steinhilberd*, Surg
8th Miss Infy, Chf Med Off.
Shaw's Brig
Ind 50. L. P. 2. Nos.

A. J. Logan
Clerk.
7/30/80

MAR 26 1864

Endorsement.

No. 131

APPLICATION OF

Aljah Whittington
OF
Somerset Co. Md.
for compensation for service of slave,
William Roach
enlisted *Jan. 18th*, 1864
in *C. Co. Ninth* Regiment
U. S. Colored Troops.

Received *July 13*, 186*7*
Compensation awarded,
_____, 186____

Dollars.

President Board of Claims.

P. O. ADDRESS OF CLAIMANT:

Princeps Ann
Somerset Co.
Md.
Filed by *Wm. Daniel.*

War Department,

ADJUTANT GENERAL'S OFFICE,

Washington, Jan 26 1867.

Respectfully returned to the
Commission for the State of
Maryland, with the informa-
tion that *William Roach*
was enlisted at *Somerset Co. Md.*
June 18th 1864 and was
mustered in as a *private in Co.*
C⁹ 26. S. C. T. June 22nd 1864

131. ind.
H. B. V.

H. B. V.

Asst. Adj't General.

States, in the _____ Regiment of Colored Troops, Co. _____, the sum of _____ dollars has been awarded to _____ by this Board, subject to the approval of the Secretary of War, as a compensation for the said slave, under the provisions of Section 24, Act approved February 24, 1864, and Section 2, Act approved July 28, 1866.

STATE OF AWARD OF THE BOARD OF CLAIMS.

OFFICE OF THE BOARD OF CLAIMS,

For Slaves Enlisted or Drafted in the Service of the United States,



_____, 186____ .
that _____, of
_____, county, State of _____,
ath, _____ loyalty to the Constitution and Government of the United
_____ title to the ownership of _____
_____, a slave enlisted or drafted (as the case may be) and mustered at
_____, on the _____ day of _____,
_____, in the service of the United
States, in the _____ Regiment of Colored Troops, Co. _____, the sum of _____ dollars has been awarded to _____ by this Board, subject to the approval of the Secretary of War, as a compensation for the said slave, under the provisions of Section 24, Act approved February 24, 1864, and Section 2, Act approved July 28, 1866.
_____, President of the Board.
_____, Member of the Board.
_____, Member of the Board.

To _____
Chief of the Bureau for the
Organization of Colored Troops, Washington, D. C.



CLAIM FOR COMPENSATION FOR ENLISTED SLAVE.

No.

I, *Aljah Whittington* a loyal citizen, and a resident of *Maryland*, County of *Somerset*, State of *Maryland*, hereby claim compensation, under the provisions of Section 24, Act approved February 24, 1864, and Section 2, Act approved July 28, 1866, for my slave *William Roach*, enlisted *January 20 1864*, in *Somerset County*, by *Gen. Burney*, in the *Ninth* Regiment U. S. Colored Troops, Co. *C*; certificate of which enlistment and a descriptive list, as required, accompany this application.

In proof of my loyalty to the Constitution and Government of the United States, I present the accompanying oath, which I have taken, signed and acknowledged; to be filed with this application, in accordance with requirement of General Orders, No. 329, 1863, War Department, Adjutant General's Office.

Aljah Whittington

3 day June, 1867.



OATH OF ALLEGIANCE.

I, *Aljah Whittington*, the owner and claimant, do solemnly swear that the foregoing claim is a just and true claim due to me as master and owner of the said slave, and that the facts alleged in said claim in respect to the draft or enlistment (*as the case may be*) of said slave into the military service of the United States are true. And I do further swear that I have never joined, or been concerned in, any insurrection or rebellion; that I have never borne arms against the United States; that I have never given any aid, countenance, counsel or encouragement to any person or persons engaged, or whom I had reason to believe were about to engage, in insurrection, rebellion or armed hostility against the United States; that I have neither sought, nor accepted, nor attempted to exercise the functions of any office, civil or military, nor to perform any service whatever, under any authority or pretended authority in hostility to the United States; that I have not yielded a voluntary support to any insurrection, rebellion or pretended government, authority, power or constitution within the United States hostile thereto. And I do further swear that, to the best of my knowledge and ability, I have supported and defended, and will continue to support and defend, the United States against all enemies, foreign and domestic; and that I have supported, defended and obeyed, and will continue to support, defend and obey, the Constitution and laws of the United States; that I will bear true faith and allegiance to the same; and that I take this oath freely, without any mental reservation or purpose of evasion: So help me God.

Aljah Whittington

Sworn to and subscribed before me, at *his office*, } *Wm. Dorsey J. P.*
this *3* day of *June*, 1867.

I certify that said Aljah Whittington again appeared before me and signed the Oath of Allegiance, which had been omitted to be done.

Wm. Dorsey J. P.

Office of the Adjutant General
Washington, D.C.

Cooper, Eph B.
Adj. Gen.

Requests that Private Wm
Roach Co's 9th Regt
be sent for duty in
San. Dep't 25th A.C.

25th A.C.



HEADQUARTERS, TWENTY-FIFTH ARMY CORPS,

IN THE FIELD, ... 1865.

9-68-1865
25th A. C., 1865.

Respectfully referred to,
Adj. Gen. ...
Adj. Gen. ...
Adj. Gen. ...

[Signature]
BY COMMAND OF MAJOR GEN'L G. WEITZEL.
[Signature]
Assistant Adjutant General.

Office of the Adj. Gen. 25th A.C.
Brownsville Tex or New York.
E. B. Cooper
Respectfully referred to
Adj. Gen. E. B. Cooper
Adj. Gen. 25th Army Corps
who will please state for
what duty this man is
required.
Private Cooper is also

reminded that all official
communication
relating with the Adj. Gen.
should pass through this
office.
[Signature]
Maj. Gen. of the 25th Army Corps

Office of the Adj. Gen. 25th A.C.
November 20, 1865

Respectfully forwarded
through Office Chief of
Mr. 25 A.C. with information
that this man is
required to assist in
the Blacksmith Shop
E. B. Cooper
Adj. Gen.

Office of Genl 25th A.C.
Brownsville Texas
E.B. - 8-25-65
Respectfully returned
Approved.

W. D. Jones
Maj. Genl. of Genl
25th Army Corps

Head Quarters 25th Army Corps
In the field Brownsville Texas
9th Co. I. B. 25th A. C.
Respectfully referred to the
Commanding Officer of the
know if he has any objection
to this man being detailed

by order of Major Genl. *W. D. Jones*
D. Jackson
Adj. Genl.

H. 2, 900. 5. 6. 7.
Brownsville, Tex.
Nov. 23rd, '65.

Respectfully returned.
This regiment has already
191 enlisted men detached
to only 414 present. With
the details for fatigue and
guard-duty as heavy as
they now are, I do not
think the interests of the
service would be subverted
by still further dimin-
ishing its numbers.

William Cook
Capt. U. S. A.
Commandy.

Head Quarters 1st Div. 1st Div. 25th A.C.
Brownsville, Texas
Nov. 23rd, 1865.

Respectfully forwarded
Thomas M. ...
Col. 9th Regt. S.
Commandy.

E.B. 620 p. 25-9.

117

Head Quarters 1st Div. 25th A.C.
Brownsville Texas
Nov. 24 - 1865

Respectfully forwarded

P. W. Smith

Adj. Maj. Genl.

Public the ...

Red back 114 Dec 17 25 200. 1124. 45

Head Quarters Division 25 A. C.
Brownsville Texas
Novemb. 22nd 1865

Respectfully transmitted

By order of
Pvt Maj. Gen. Giles A. Smith
Adj. Gen.
Major J. A. A. B.

Head Quarters 1st Div. 1st Div. 25th A. C.
Brownsville, Texas,
Nov. 22nd 1865.

Respectfully transmitted.

By Order of
Col. Thos. Bayley
Capt. J. Hamilton
Capt. J. A. A. B.
G. 3.618 / p. 255.

Recd. at Head Quarters 25 A. C. 11/22 - 1865

Office A. A. G. M.
Head Quarters 25th Army Corps
November 20. 1865.

Lieut. Col. D. D. Wheeler.

A. A. General 25. A.
Colonel:

I have the honor to request
that Private William Roach Co. C. 9th W. S.
Cold Troop, be detailed for duty in Q. M. Dept.
25th Army Corps, and ordered to report to this office
as soon as practicable.

I have the honor to be,

Colonel,

Very Respectfully,

Yours Obedt. Servt.

Eph. D. Cooper

1st Lt. A. A. G. M.

Amb Corps 1st Div. 25th Army Corps

EVIDENCE OF TITLE.

I, Aljah Whittington of Somerset County, Maryland, do solemnly swear that William Roach who has been enlisted in the 9th Regiment, U. S. Colored Troops, Co. C; was my Slave for life at the time of said enlistment; and that I became possessed of him by purchase in the month of _____ eighteen hundred and _____. And I do further swear that I have not purchased said Slave from any person or persons disloyal to the Government of the United States, with the object of obtaining compensation for the same: and furthermore, that I have no agency for obtaining compensation for any person or persons but such as to my knowledge are loyal citizens of the United States.

Sworn and subscribed before

Aljah Whittington
Wm. Dorsey
 Justice of the Peace.

STATE OF MARYLAND, Somerset County, to wit:

On this _____ day of _____ in the year 1867 before me, the subscriber, a Justice of the Peace of the State and County aforesaid, personally appeared Wm. Muir & Robt. H. Jones and _____ loyal citizens of the United States, residents of Somerset County, Md. and in no manner interested in the prosecution of this claim, and made oath in due form of law, that the said Aljah Whittington was the owner of the Slave William Roach as a fact of public notoriety; that they believe all the statements made by _____ in reference to said Slave are correct.

Witness their Signatures,

William Muir
Robt. H. Jones
Wm. Dorsey
 Justice of the Peace.

Sworn and subscribed before

And I Hereby do Certify, That the said Wm. Muir and Robt. H. Jones are citizens of Somerset County, in good repute, and that their statements, under oath, are entitled to full faith and credit.

Wm. Dorsey
 Justice of the Peace.

EVIDENCE OF LOYALTY.

STATE OF MARYLAND, Somerset County, to wit:

On this 9th day of January in the year 1867 before me, the subscriber, a Justice of the Peace of the State and County aforesaid, personally appeared Wm. Muir _____ a resident of Somerset County, State of Maryland and Robt. H. Jones a resident of Somerset County, State of Maryland having first been duly sworn, upon their oaths declare that they reside respectively in the aforesaid County, State of Maryland and _____ County, State of _____; that they are personally acquainted with the said Aljah Whittington, claimant for compensation for his Slave William Roach under the Acts of Congress of February 24, 1864, and July 28, 1866, and that they know that said "claimant hath firmly and faithfully maintained his allegiance and adherence to the Government of the United States, by defending its cause against the Government of the so-called Confederate States of America, in all suitable and practicable ways, and according to his ability and opportunity;" they also swear that they have themselves maintained a like adherence and allegiance to the Government of the United States, and that they have no interest in said claim.

Sworn and Subscribed before

William Muir
Robt. H. Jones
Wm. Dorsey
 Justice of the Peace.

STATE OF MARYLAND, _____ County, to wit:

I, Levin Woodford Clerk of the Circuit Court for Somerset County, do hereby certify that William Dorsey Esq. before whom the foregoing affidavits were made, was, at the time of signing the same, a Justice of the Peace for the County and State aforesaid, duly commissioned and sworn; and that his signature thereto is genuine, and that full faith and credit should be given to his official acts.

WITNESS my hand and the Seal of said Court, this third day of January A. D. 1867

Levin Woodford
 Clerk.

948
 Robbins, Cesar

Co D, 9 U.S. Col'd Inf.

Corporal | Sergeant

CARD NUMBERS

| | | |
|----|---------|----|
| 1 | 6306154 | 26 |
| 2 | 6306253 | 27 |
| 3 | 6306353 | 28 |
| 4 | 6306458 | 29 |
| 5 | 6306558 | 30 |
| 6 | 6306656 | 31 |
| 7 | 6306756 | 32 |
| 8 | 6306851 | 33 |
| 9 | 6306953 | 34 |
| 10 | 6307055 | 35 |
| 11 | 6307155 | 36 |
| 12 | 6307334 | 37 |
| 13 | 6307985 | 38 |
| 14 | 6300418 | 39 |
| 15 | 9068473 | 40 |
| 16 | | 41 |
| 17 | | 42 |
| 18 | | 43 |
| 19 | | 44 |
| 20 | | 45 |
| 21 | | 46 |
| 22 | | 47 |
| 23 | | 48 |
| 24 | | 49 |
| 25 | | 50 |

Book Mark:

See also

R | 9 | U.S.C.T.

Caesar Robins,

, Co. D, 9 Reg't U. S. Col'd Inf.

Appears on

Company Descriptive Book

of the organization named above.

DESCRIPTION.

Age 23 years; height 5 feet 7 inches.

Complexion *Dark*

Eyes *Dark*; hair *Dark*.

Where born *Worcester Ma.*

Occupation *Farmer*.

ENLISTMENT.

When *Nov. 11*, 1863.

Where *Berlin Ma.*

By whom *Col. Birney*; term *3* y'rs.

Remarks: *App'd Corp'l Nov. 11/63
Promoted to Sgt July
24/64, Mustered out per
order of the War Dept at
Fort Monroe Va. June
19/65.*

Pol

R | 9 | U.S.C.T.

Cesar Robbins
corp, Co. H, 9 Reg't U. S. Col'd Infantry.

Age 23 years.

Appears on

Company Muster-in Roll

of the organization named above. Roll dated

L. Stanton, Chas. Co. Md. Nov 14, 1863.

Muster-in to date Nov 14, 1863

Joined for duty and enrolled:

When Nov 11, 1863

Where Worcester Md

Period 3 years.

Remarks:
.....
.....
.....
.....
.....
.....

Book mark:

A. E. Burke

R

9

U.S.C.T.

Cesar Robins

Corp, Co. D, 9 Reg't U. S. Col'd Infantry.

Appears on

Company Muster Roll

for ~~from~~ *Nov 14* to *Dec 31*, 1863.

Present or absent *Present*

Stoppage, \$ *100* for

Due Gov't, \$ *100* for

Remarks: *\$200 recruits premium due*

Book mark:

J. C. Burke

(858)

Copyist

R

9

U.S.C.T.

Caesar Robins

corp, Co. D, 9 Reg't U. S. Col'd Infantry.

Appears on

Company Muster Roll

for Jan & Feb, 1864

Present or absent Present

Stoppage, \$ 100 for

Due Gov't, \$ 100 for

Remarks: Two dollars re-
cruits premium due

Book mark:

J. E. Parks

(858)

Copyist

R | **9** | **U.S.C.T.**

Caesar Robins

Corp, Co. D, 9 Reg't U. S. Col'd Infantry.

Appears on

Company Muster Roll

for *Mar 1864*, 186 4.

Present or absent *Present*

Stoppage, \$ *100* for

Due Gov't, \$ *100* for

Remarks:

Book mark:

J. E. Parks

(858)

Copyist

P

9

U.S.C.T.

Cesar Robinson

Corp, Co. D, 9 Reg't U. S. Col'd Infantry.

Appears on

Company Muster Roll

for *May & June*, 1864.

Present or absent *Present*

Stoppage, \$ *100* for

Due Gov't, \$ *100* for

Remarks:

Book mark:

F. E. Parks

(858)

Copyist

R | 9 | U.S.C.T.

Cesar Robins

Serjt., Co. D, 9 Reg't U. S. Col'd Infantry.

Appears on

Company Muster Roll

for *July & Aug.*, 1864.

Present or absent *Present*

Stoppage, \$ 100 for

Due Gov't, \$ 100 for

Remarks: *Stop for one D
knapsack. Promoted
from Corp. per special
order No. 85, dated
Adgns. 9th M.S.C. 2,
July 24 - 1864*

Book mark: _____

J. E. Parks

(858)

Copyist

R | 9 | U.S.C.T.

Cesar Robins
Serg't, Co. D, 9 Reg't U. S. Col'd Infantry.

Appears on

Company Muster Roll

for Sep, Oct, 1864.

Present or absent Present

Stoppage, \$ 100 for

Due Gov't, \$ 100 for

Remarks:

Book mark:

J. E. Parks

(858)

Copyist

R | 9 | **U.S.C.T.**

Caesar Robbins

Sgt, Co. D, 9 Reg't U. S. Col'd Infantry.

Appears on

Company Muster Roll

for *Nov, & Dec*, 186 *4*

Present or absent *Present*

Stoppage, \$ 100 for

Due Gov't, \$ 100 for

Remarks:

Book mark: -----

J. E. Burke

R | 9 | U.S.C.T.

Caesar Robbins
Sgt., Co. D, 9 Reg't U. S. Col'd Infantry.

Appears on

Company Muster Roll

for *Jan & Feb*, 186*J.*

Present or absent *Present*

Stoppage, \$ *100* for

Due Gov't, \$ *100* for

Remarks:

Book mark:

J. M. Harmon

R | 9 | U.S.C.T.

Caesar Robins
Sgt, Co. D, 9 Reg't U. S. Col'd Infantry.

Appears on

Company Muster Roll

for Mar & Apr, 1865.

Present or absent Present

Stoppage, \$ 100 for

Due Gov't, \$ 100 for

Remarks: Stop for 1 Can- teen

Book mark: _____

W. Vernon

R | 9 | U.S.C.T.

Caesar Robins

Sgt, Co. D, 9 Reg't U. S. Col'd Infantry.

Appears on

Company Muster Roll

for Dec 31/64 to June 30, 1865.

Present or absent Absent

Stoppage, \$ 100 for

Due Gov't, \$ 100 for

Remarks: Absent Sick in
Hosp. since May 16/65,
Stop for 1 Quarter

Book mark:

J. M. Harmon

R | 9 | U.S.C.T.

Caesar Robins

Sgt, Co. D, 9 Reg't U. S. Col'd Infantry.

Appears on

Company Muster Roll

for Dec 31/64 to Aug 31, 1865.

Present or absent

Stoppage, \$ 100 for

Due Gov't, \$ 100 for

Remarks: Mustered out June 19/65 at Ft. Monroe Va per order War Dept. dated May 3/65. Stop for 1 Canton

Book mark:

J. M. Harmon

R | 9 U.S.C.T.

Clair Robins
Sgt., Co. 10, 9 Reg't U. S. Col'd Infantry.

Appears on a
Detachment Muster-out Roll
of the organization named above. Roll dated
Pt. Monroe, Va., June 19, 1865.
Muster-out to date June 19, 1865.
Last paid to Dec 31, 1864

Clothing account:
Last settled Oct 31, 1864; drawn since \$ 02 100
Due soldier \$ 100; due U. S. \$ 100
Am't for cloth'g in kind or money adv'd \$ 100

Due U. S. for arms, equipments, &c., \$ 100
Bounty paid \$ 100 due \$ 100

Remarks: Due U. S. for one
canteen. Mustered out
by order of War Dept dated
May 3, 1865. Patient in
Inf. Gen. Hospital Pt. Monroe, Va.

Book mark: 45-85 P.M. May 23/66.

(349) J. T. Brown Copyist.

R. | 9 | U.S.C.T.

Cesar Robins

Sgt., Co. A, 9 Reg't U. S. Col'd Infantry.

Appears on **Co. Muster-out Roll**, dated
New Orleans La; Dec 10, 1866.

Muster-out to date _____, 186 .

Last paid to _____, 186 .

Clothing account:

Last settled _____, 186 ; drawn since \$ _____ 100

Due soldier \$ _____ 100; due U. S. \$ _____ 100

Am't for cloth'g in kind or money adv'd \$ _____ 100

Due U. S. for arms, equipments, &c., \$ _____ 100

Bounty paid \$ _____ 100; due \$ _____ 100

Remarks: *Discharged.*

*Joined at original organz;
Co. A to July 24/64
at 6.00 per order W.D. June
19/65 at Fort Monroe Va*

Book mark : _____

G. E. Dayton

Robbins, Cleaver

Inf, Co. D., 9 Regt. U.S.C. Inf.

See

Birch, Geo. C.

Enclosures.

- | | |
|------------------------------|-------------------|
| Bed Cards | Descriptive Lists |
| Burial Records | Final Statements |
| Certs. of Dis. for Discharge | Furloughs |
| C. M. Charges | Med. Des. Lists |
| Med. Certificates | Orders |

Other papers relating to—

- | | |
|----------------------------|----------------------|
| Admission to Hosp'l | Furlough |
| Casualty Sheet (Officer's) | Med. Examination |
| Confinement | Misc. Information |
| Contracts | Pay or Clothing |
| Death or Effects | Personal Reports |
| Desertions | Rank |
| Discharge from Hosp'l | Transfer to Hosp'l |
| Discharge from Service | Transfer to V. R. C. |
| Duty | Transportation |

Save Claim 1

MICROFILM PUBLICATION M 1851

COMPILED MILITARY SERVICE RECORDS
OF VOLUNTEER UNION SOLDIERS WHO SERVED WITH
THE UNITED STATES COLORED TROOPS (USCT)
9TH REGIMENT OF INFANTRY

PERSONAL PAPERS' TARGET SHEET

PLEASE NOTE THE CHECKED INFORMATION ABOUT THE PERSONAL PAPERS IN
THIS FILE:

- NO PERSONAL PAPERS WERE FOUND IN THIS FILE WHEN THE
RECORDS WERE ARRANGED FOR MICROFILMING.
- 6 PERSONAL PAPER(S) FOUND IN THIS FILE WHEN THE RECORDS
WERE ARRANGED FOR MICROFILMING.

War Department
A. G. O. October 9. 1864
Respectfully returned to
you the seal of the Circuit Court
for Worcester County affixed to
the Deed of Manumission.

By order:
J. G. Bennett
Capt. 1st Regt. Col. Vols.
U. S. A.
J. No. 14. D. C. T. 1864
Office of Board of Claims
Baltimore Oct. 26/64

Respectfully returned with the seal
of the Circuit Court for Worcester
County, affixed to the deed of
Manumission, as requested.
Thos. Simmons
Presid. Bd. Claims

Rec'd back, A. G. O. Oct. 27/64

J. No. 14. D. C. T. 1864
No. 302 No. 19

P.O. Berlin
Worcester Co

APPLICATION OF

For Compensation for Service of Slave,

Enlisted in U. S. Colored Troops, Co.

Received, Feb 23d 1864.

COMPENSATION AWARDED,

June 18th 1864.

Three Hundred Dollars.

Thos. Simmons
Presid. Bd. of Claims

Payment
A. G. O. Oct. 11. 1864

Approved March 30 67

EVIDENCE OF TITLE.

I, William B. [unclear], of [unclear]
 County, Md., do solemnly swear that [unclear]
 who has been enlisted in the [unclear] Regiment, U. S. Colored Troops,
 Co. D; is my slave for [unclear]; (~~this term of service expiring on~~
~~the~~ ~~day of~~ ~~186~~;) and that
 I became possessed of him by [unclear], in the month
 of August, eighteen hundred and [unclear]. And I
 do further swear that I have not purchased said slave from any person or persons disloyal
 to the Government of the United States, with the object of obtaining compensation for
 the same; and furthermore, that I have no agency for obtaining compensation for any per-
 son or persons but such as, to my knowledge, are loyal citizens of the United States.

William B. [unclear]

February 17th 1864

MAR 29

STATE OF MARYLAND,

Washington County, to wit:

On this *September* day of *1864* in the year 1864, before me, the subscriber, a Justice of the Peace of the State and County aforesaid, personally appeared *William C. ...*, and took, signed, and acknowledged the oaths preceding; and further made oath, in due form of law, that all the statements made in this application are, to the best of *his* knowledge and belief, strictly true.

Also personally appeared before me *Joseph ...* and *John ...*, loyal citizens of the United States, residents of *Berlin, Worcester Co.*, well acquainted with the said *...*, and in no manner interested in the prosecution of this claim, and made oath, in due form of law, that the said *...* is the owner of the slave *...*, as a fact of public notoriety; that they believe all the statements herein made by *...*, in reference thereto, are correct, and that *...* is unquestionably loyal to the Government of the United States. Witness their signatures:



Joseph ...
John ...
Justice of the Peace.

STATE OF MARYLAND,

Howard County, to wit:

I, *George St. Richardson*, Clerk of the Circuit Court for *Howard* County, do hereby certify that *William R. Palmer*, before whom the foregoing affidavits were made, was, at the time of signing the same, a Justice of the Peace for the County and State aforesaid, duly commissioned and sworn; and that his signature thereto is genuine, and that full faith and credit should be given to his official acts.

Witness my hand and the seal of said Court, this *nineteenth* day of *February*, A. D. 1864.



Geo. H. Richardson CLERK.

E.

DEED OF MANUMISSION AND RELEASE OF SERVICE.

Whereas, my slave Caesar Robin's has enlisted in the service of the United States: now, in consideration thereof, I, Wm B. Robin's, of Worcester county, State of Maryland, do hereby, in consideration of said enlistment, manumit, set free, and release the above named Caesar Robin's from all service due me; his freedom to commence from the eleventh day of November, the date of his enlistment as aforesaid in the ninth Regiment of Colored Troops, in the service of the United States.

Witness my hand and seal, this ninth day of May 1864.

William B. Robin's



Witness:

William C. Gladden

G. E. Bowen

Worcester County,

State of Maryland, 1864.

Before me appeared this day Wm B. Robin's and acknowledged the above Deed of Manumission and Release of Service to be his free act and deed.

Daniel P. Russell J.P.

State of Maryland, Worcester County, to wit:

I, George N. Richardson Clerk of the Circuit Court for Worcester County, hereby certify that the above is a true copy of the original, now on file in my office for record.

In Testimony whereof, I hereunto subscribe my name and affix the seal of the said Circuit Court, this nineteenth day of May, Anno Domini eighteen hundred and sixty-four.



Geo. N. Richardson Clerk.

Hol

ters and Stationers, 218 Market St., Phila.

F.

CERTIFICATE OF AWARD OF THE BOARD OF CLAIMS.

Office of the Board of Claims
For Slaves Enlisted in the Service of the United States,

Baltimore Md.

October 8th, 1864

5
\$300-

We hereby certify, that William B. Robbins, of Proctor county, State of Maryland, having proved, under oath, his loyalty to the Constitution and Government of the United States, and established his title as to the ownership of Cesar Robbins, a slave enlisted at Proctor County Md, on the 11th day of November 1863, by Chas. Birney, in the service of the United States, in the 9th Regiment of Colored Troops, Co. D, and having filed a valid Deed of Manumission and Release of Service of said slave, is entitled to the sum of Three Hundred dollars, which has been awarded to him by this Board as a remuneration for all claim to the future labor or service of said slave, under the provision of General Orders, War Department, No. 329, 1863.

Mrs. Simmons, President of the Board.
L. E. Stranghan Member of the Board.
James Jones, Member of the Board.

To Col. W. Fort,

Chief of the Bureau for the
Organization of Colored Troops, Washington, D. C.

A.

No. 302

CLAIMANT'S CERTIFICATE.

I, William P. Yellin a loyal citizen, and a resident
of Worcester, County of Worcester, State of
Massachusetts, hereby claim compensation, under the provisions of
General Orders, No. 329, 1863, for my slave Harriet Bellin
enlisted Nov 11th 1863, at Worcester
by William P. Yellin in the 5th
Regiment U. S. Colored Troops, Co. I; certificate of which enlistment, and a
descriptive list, as required, accompany this application.

In proof of my loyalty to the Constitution and Government of the United States, I
present the accompanying oath, which I have taken, signed, and acknowledged, to be filed
with this application, in accordance with requirement of said General Orders.

William P. Yellin

1863 1863.

B.

OATH OF ALLEGIANCE.



I, William Wallace, do solemnly swear that I have never joined, or been concerned in, any insurrection or rebellion; that I have never borne arms against the United States; that I have never given any aid, countenance, counsel, or encouragement to any person or persons engaged, or whom I had reason to believe were about to engage, in insurrection, rebellion, or armed hostility against the United States; that I have neither sought, nor accepted, nor attempted to exercise the functions of any office, civil or military, nor to perform any service whatever, under any authority or pretended authority in hostility to the United States; that I have not yielded a voluntary support to any insurrection, rebellion, or pretended government, authority, power, or constitution within the United States hostile thereto. And I do further swear that, to the best of my knowledge and ability, I have supported and defended, and will continue to support and defend, the United States against all enemies, foreign and domestic; and that I have supported, defended, and obeyed, and will continue to support, defend, and obey, the Constitution and laws of the United States; that I will bear true faith and allegiance to the same; and that I take this oath freely, without any mental reservation or purpose of evasion: So help me God.

William Wallace

Sworn to and subscribed before me, at _____ }
 this _____ day of _____ 1864. }

William Wallace

Notary Public



C.

I present herewith evidence of my title to the slave William
W. W. W. enlisted as aforesaid, and in consideration of the sum of
..... by me received, I hereby covenant and
agree with the United States, that I, my heirs, executors, or assigns, shall never hereafter make
or enforce any claim to the labor or services of said slave; and pledge myself to execute
a valid Deed of Manumission and Release of all my claims to service forever of said
..... to be filed with the Board of Claims
now in session at Baltimore Md

William W. W.

February 17, 1864.



W. B. Smith

No. _____

ABSTRACT OF DISBURSEMENTS.

....., 186 .

William B. Smith

Dollars *300* ^{*00*}/₁₀₀

Paid , 186 .

Approved by W. B. Smith

The United States,

To *William B. Robbins* Dr.

| 1864 | | DOLLARS. | CENTS. |
|--------------------|--|------------|-----------|
| <i>October 8th</i> | For amount awarded him by the Board of Claims, in consideration of the enlistment of <i>Cesar Robbins</i> in the <i>9th Reg't U. S. Col'd Troops</i> | <i>300</i> | <i>00</i> |
| <i>Total \$</i> | | <i>300</i> | <i>00</i> |

I CERTIFY that the above account is correct and just; that the name of *Cesar Robbins* is borne on the muster-in rolls of the *9th Reg't U. S. Colored Troops*; and that the above amount was awarded by the Board of which *Thos. Simmons Esq* is President, said award being in accordance with section 24 of the act entitled "An act to amend an act entitled 'An act for enrolling and calling out the national forces, and for other purposes,'" approved Feb. 24, 1864.

Assistant Adjutant General.

RECEIVED _____, 186 , of *Capt S. G. Benedict, A. A. G., Col.*,
dollars and _____ cents, in full of the above account.

(SIGNED DUPLICATES.)

William B. Robbins

19

No. .

ABSTRACT OF DISBURSEMENTS.

....., 186 .

William B. Robin

Dollars *300* $\frac{00}{100}$.

Paid , 186 .

William B. Robin

The United States,

To William B. Robbins Dr.

1864

October 20th

For amount awarded him by the Board of Claims, in consideration

of the enlistment of *Cesar Robbins*

in the *9th Regt U.S. Colored Troops*

DOLLARS. CENTS.

300 00

Total \$ 300. 00

I CERTIFY that the above account is correct and just; that the name of *Cesar Robbins* is borne on the muster-in rolls of the *9th Regt U.S. Colored Troops*; and that the above amount was awarded by the Board of which *Thos. Simmons* is President, said award being in accordance with section 24 of the act entitled "An act to amend an act entitled 'An act for enrolling and calling out the national forces, and for other purposes,'" approved Feb. 24, 1864.

Assistant Adjutant General.

RECEIVED

, 186 , of *Wm G. Benedict, A, A, G, Col.*
dollars and cents, in full of the above account.

(SIGNED DUPLICATES.)

William B. Robbins

302.

A. A. C. Oct. 11th 1864.

I certify that the name of Caesar Robbins
is borne on the Muster-roll of Co. D, 9th
Regt. U. S. C. Troop in file in this office, &
that he was enrolled in Worcester Co. Mass.

J. R.

Geo. Saggard

A. A. Capt. 10th.

Descriptive List
of
Casey Robins
for
Wm B. Robbins

302

Wm B. Robbins
1300
Chicago Ill
1887

VOLUNTEER DESCRIPTIVE LIST and Account of Pay and Clothing of

A. Powell - U. S. A.

| No. | NAMES | RANK. | DESCRIPTION. | | | | | WHERE BORN. | | OCCUPATION. | ENROLLED. (For Drafted Men, see note 10.) | | | MUSTERED IN. (For Drafted Men, see note 10.) | | | | LAST P. |
|-----|----------------------|-------|---------------|----------|----------|-------------|-----------|-------------|-------------------|---------------|--|-------------------|-----------------------------|---|----------------|-----------------------------|--|---------|
| | | | Years of age. | Eyes. | Hair. | Complexion. | Feet. | Inches. | State or Kingdom. | | Town or county. | When. | Where. (Town and State.) | By whom. | When. | Where. (Town and State.) | By whom. (In the case of drafted men, from what enrollment district.) | |
| | <i>Cesar Robbins</i> | | <i>23</i> | <i>G</i> | <i>C</i> | <i>W</i> | <i>57</i> | <i> Md</i> | <i>Frederick</i> | <i>Farmer</i> | <i>Nov, 11</i> | <i>Providence</i> | <i>Oct. 14</i> | <i>Benedict</i> | <i>Oct. 14</i> | <i>Bing</i> | <i>3 yrs</i> | |

NOTES.

- The amount of any extra pay for which the soldier may be mustered, *ex. gr. as Acting Hospital Steward, as Saddler, &c.*, and which may be still due him, must be carefully noted.
- In the column headed "BOUNTY PAID," must be entered the whole amount hitherto paid him; in that of "BOUNTY DUE," the whole amount yet due him. Bounty paid by State authorities, and not by the United States, will not be entered on this statement.
- Stoppages for loss or damage done to arms, or other public property, must be noted, and the articles, and particular damage to each, specified. When stoppages are due, under sentence of a Court Martial, a transcript of the same must be entered here; and the amount already stopped, must be carefully stated.
- In every case of desertion, the date, and that of delivery, or apprehension, must be given, together with a correct transcript of the order of sentence or pardon.
- A careful settlement of the man's CLOTHING ACCOUNT must be made, to date, and the amount DUE TO, or FROM him must be precisely stated.
- Should the man have been engaged in any action or skirmish, it must be mentioned, together with date and place. A full and particular mention will be made of any wounds he may have received in action, or other injury, whilst in the line of his duty.
- If the soldier is entitled to pay for the use of his horse, the company commander will certify to that fact on this list, and also to the time he has pay due for having been so mounted on his own horse.
- When a soldier is furnished with final statements, his descriptive list, if he has one, should be taken up by the officer who gives the soldier these statements, and endorsed with a statement to this effect by the officer. This endorsement should exhibit a full statement of the time for which the soldier was allowed pay on his final statements, the clothing account, and all other charges against him or in his favor, so as to comprise a complete exhibit of his account. It will then be transmitted to the company commander of the soldier, who will enter all the data necessary to a full understanding of the soldier's account on the muster roll upon which the soldier's discharge is reported. The descriptive list will then be destroyed. The object of this is, that the remaining portion of the soldier's account may be settled upon the receipt of these muster rolls, and the soldier receive any pay or allowances that may be due him at the time of his discharge, and which may not appear on his final statements from the fact that his descriptive list is incomplete. These accounts for back pay, &c., are settled by the 2d Auditor of the Treasury Dep't.
- Where a soldier dies in Hospital or on detached service, his descriptive list, if he has one, should be sent with his final statements, in duplicate, to the Second Auditor, Washington, D. C.
- Men drafted will be considered as mustered in from the date of their draft, and will be mustered for pay on the usual rolls for Volunteers. On the same line as the soldier's name, under the heading "Joined for Duty and Enrolled.—Commencement of First Payment by Time," will be written the word *drafted*, or *substitute*, as the case may be; and under the heading "When Mustered in" will be given the date when the soldier was drafted, or, if a substitute, when enlisted. (substitutes, under the Enrollment Act, are mustered in by enlistment;) under "Where Mustered in," will be given the place from which drafted, (or if a substitute, where enlisted;) under the heading "By whom Mustered in," will be given the No. of the Enrollment District from which he was drafted, and the State to which it belongs, thus: *4th D. Mass.*; (meaning 4th Enrollment District, State of Massachusetts.) Or if a substitute, the name of the officer enlisting him. (When enlisted by Board of Enrollment, the name of the Provost Marshal of the Enrollment District.)
- A separate descriptive list should, as a general rule, be given for each man.
- Descriptive lists must, in all cases, be signed by COMMISSIONED officers; not by enlisted men acting as such.

I CERTIFY that the above is a correct transcript from the Record

from the State of Maryland for

STATION:

Benedict Md

DATE:

February 18 1864

1864

U.S.C.

| MUSTERED IN. (For Drafted Men, see note 10.) | | | LAST PAID. | | BOUNTY. | | REMARKS |
|---|--|---------|---------------|---------------|--------------------------|-------------------------|--|
| Where. (Town and State.) | By whom. (In the case of drafted men, from what enrollment district.) | Period. | By paymaster. | To what time. | Paid \$ (See note 2.) | Due \$ (See note 2.) | |
| 4 Benedict Md | Wm B. Pilling | 3 yrs | | | | | Co D 9 th U.S.C., for William B. Pilling |

That the above is a correct transcript from the Records of This Genl. Rendezvous of Recruits
State of Maryland for U.S.C.

Benedict Md
February 18 1864

Wm B. Pilling,
Brig Genl. U.S. Vols
Commanding the Company.
U.S. Mustering Officer

9490
Robbins, Elijah

Co G, 9 U.S. Col'd Inf.

Private Private

CARD NUMBERS.

| | | |
|----|----------|----|
| 1 | 6311742 | 26 |
| 2 | 6311836 | 27 |
| 3 | 6311939 | 28 |
| 4 | 6312039 | 29 |
| 5 | 6312134 | 30 |
| 6 | 6312228 | 31 |
| 7 | 6312320 | 32 |
| 8 | 6312413 | 33 |
| 9 | 6312504 | 34 |
| 10 | 6312592 | 35 |
| 11 | 6312678 | 36 |
| 12 | 6312757 | 37 |
| 13 | 6312839 | 38 |
| 14 | 6312911 | 39 |
| 15 | 6312980 | 40 |
| 16 | 6313048 | 41 |
| 17 | 6313115- | 42 |
| 18 | 6313179 | 43 |
| 19 | 6313248 | 44 |
| 20 | 6313302 | 45 |
| 21 | 9068162 | 46 |
| 22 | | 47 |
| 23 | | 48 |
| 24 | | 49 |
| 25 | | 50 |

Book Mark:

See also

S. 2012363 P.O. in m

G. E. Doughty
2

A | **9** | **U.S.C.T.**

Elijah Robbins

....., Co. *G*, 9 Reg't U. S. Col'd Inf.

Appears on

Company Descriptive Book

of the organization named above.

DESCRIPTION.

Age *18* years; height *5* feet *5/8* inches.

Complexion *Black*

Eyes *Black*; hair *Wool*

Where born *Worcester, Md.*

Occupation *Farm h*

ENLISTMENT.

When *Nov. 18*, 18*63*.

Where *St. Pover's (prop Sine-
pupent) Worcester.*

By whom *Col. Wm. Biney*; term *3* y'rs.

Remarks: *Free
Mustered out into
Regt. Nov. 26, 1866.*

M. Jackson

R | 9 | U.S.C.T.

Elijah Robbins
Pvt, Co. *G*, 9 Reg't U. S. Col'd Infantry.

Age *18* years.

Appears on

Company Muster-in Roll

of the organization named above. Roll dated
Camp Stanton
Charles Co Md., *Nov 23*, 1863.

Muster-in to date *Nov 23*, 1863

Joined for duty and enrolled:

When *Nov 18*, 1863.

Where *Worcester Md.*

Period *3* years.

Remarks:

Book mark: -----

E. Carroll

R

9

U.S.C.T.

Elijah Robbins
Priv, Co. G, 9 Reg't U. S. Col'd Infantry.

Appears on

Company Muster Roll

for *Nov 23 to Dec 31*, 186*3*.

Present or absent *Present*

Stoppage, \$ *100* for

Due Gov't, \$ *100* for

Remarks: *\$2.00 Recruiting premium due*

Book mark: _____

E. Carroll

R

9

U.S.C.T.

Elijah Robbins

Pvt, Co. G, 9 Reg't U. S. Col'd Infantry.

Appears on

Company Muster Roll

for *Jan'y & Feb*, 1864.

Present or absent *Present*

Stoppage, \$ *100* for

Due Gov't, \$ *100* for

Remarks: *\$2⁰⁰/₁₀₀ Recruiting premium due.*

Book mark:

E. B. Carroll

R

9

U.S.C.T.

Elijah Robbins
Pvt, Co. G, 9 Reg't U. S. Col'd Infantry.

Appears on

Company Muster Roll

for *March & April*, 1864.

Present or absent *Present*

Stoppage, \$ *100* for

Due Gov't, \$ *100* for

Remarks:

Book mark:

E. Carroll

R

9

U.S.C.T.

Elijah Robbins
Pvt., Co. G, 9 Reg't U. S. Col'd Infantry.

Appears on

Company Muster Roll

for *May & June*, 1864.

Present or absent *Present*

Stoppage, \$ *100* for

Due Gov't, \$ *100* for

Remarks:

Book mark:

E. Carroll

R

9

U.S.C.T.

Elijah Robins
 Pvt , Co. G, 9 Reg't U. S. Col'd Infantry.

Appears on

Company Muster Roll

for *July & Aug.*, 1864.

Present or absent *Present*.

Stoppage, \$ 100 for

Due Gov't, \$ 100 for

Remarks: *Free on or before April*
19, 61.

Book mark: _____

E. Carroll

R

9

U.S.C.T.

Elijah Robins

Pvt, Co. G, 9 Reg't U. S. Col'd Infantry.

Appears on

Company Muster Roll

for *Sept & Oct*, 1864.

Present or absent *Present*

Stoppage, \$ 100 for

Due Gov't, \$ 100 for

Remarks: *Free on or before April 19, 1861.*

Book mark: _____

E. Carroll

R

9

U.S.C.T.

Clajah Robin
Private, Co. G, 9 Reg't U. S. Col'd Infantry.

Appears on

Company Muster Roll

for *Nov. & Dec.*, 1864.

Present or absent*

Stoppage, \$ 100 for

Due Gov't, \$ 100 for

Remarks: *Absent sick since*
Dec. 11/64 Free on or
before April 19/61

* *Amount cancelled in Presence*
column

Book mark:

M. M. Warren

R

9

U.S.C.T.

Elijah Robbins
Private, Co. G, 9 Reg't U. S. Col'd Infantry.

Appears on

Company Muster Roll

for *Jan. & Feb.*, 1865

Present or absent *Absent*

Stoppage, \$ 100 for

Due Gov't, \$ 100 for

Remarks: *Absent sick since*
Dec, 1st 1864
Free on or by Apr. 19/61

Book mark:

W. M. Warren

R

9

U.S.C.T.

Elijah Robbins
Private, Co. G, 9 Reg't U. S. Col'd Infantry.

Appears on

Company Muster Roll

for *Mar. & April*, 186*5*.

Present or absent *Present*

Stoppage, \$ *100* for

Due Gov't, \$ *100* for

Remarks: *Free on or bef. Ap. 19.*
61

Book mark:

W. M. Warren

R

9

U.S.C.T.

Chajah Robbins

Pvt., Co. G, 9 Reg't U. S. Col'd Infantry.

Appears on

Company Muster Roll

for Dec. 31/64 to June 30, 1865.

Present or absent Present

Stoppage, \$ 100 for

Due Gov't, \$ 100 for

Remarks: Stop Kupsack 3.10
Canteen 65. Free on or
bef ap 19/61
diff. bet \$7 & \$13 per
mo due soldier from
enlistment to Ap 30/64

Book mark:

M. M. Hansen

R

9

U.S.C.T.

Elijah Robbins
Priv., Co. G, 9 Reg't U. S. Col'd Infantry.

Appears on

Company Muster Roll

for *July & Aug.*, 1865.

Present or absent *Present*

Stoppage, \$ 100 for

Due Gov't, \$ 100 for

Remarks: *Stop Conteen 95*

Book mark: *100*

W. M. Warren

(358)

Copist.

A

9

U.S.C.T.

Elijah Robbins
Pvt., Co. G, 9 Reg't U. S. Col'd Infantry.

Appears on

Company Muster Roll

for *June 30 to Oct. 31*, 1865

Present or absent *Present*

Stoppage, \$ *100* for

Due Gov't, \$ *100* for

Remarks: *Stop fourteen 65*

Book mark:

M. M. Warren

R

9

U.S.C.T.

Elijah Robbins
Priv., Co. G, 9 Reg't U. S. Col'd Infantry.

Appears on

Company Muster Roll

for *June 30 to Dec. 31*, 1865.

Present or absent *Present*

Stoppage, \$ *100* for

Due Gov't, \$ *100* for

Remarks: *Stop 2 Camp \$1.30*

Book mark:

M. M. Warren

R

9

U.S.C.T.

Elijah Robbins
Pot., Co. G, 9 Reg't U. S. Col'd Infantry.

Appears on

Company Muster Roll

for Jan & Feb., 1866.

Present or absent Present

Stoppage, \$ 100 for

Due Gov't, \$ 100 for

Remarks:

Book mark:

C. E. M. Laughlin

(858)

Copist.

R

9

U.S.C.T.

Elijah Robbins
Priv., Co. G, 9 Reg't U. S. Col'd Infantry.

Appears on

Company Muster Roll

for Mar. + Apr., 1866.

Present or absent Present

Stoppage, \$ 100 for

Due Gov't, \$ 100 for

Remarks: Stop order 72.

Book mark:

C. E. M. Laughlin

R

9

U.S.C.T.

Elijah Robbins
Priv., Co. G, 9 Reg't U. S. Col'd Infantry.

Appears on

Company Muster Roll

for May & June, 1866.

Present or absent Present

Stoppage, \$ $\frac{4}{100}$ for

Due Gov't, \$ $\frac{100}{100}$ for

Remarks:

Book mark:

C. E. M. Laughlin

R | 9 | U.S.C.T.

Elijah Robbins
Priv., Co. G, 9 Reg't U. S. Col'd Infantry.

Appears on

Company Muster Roll

for July & Aug., 1866.

Present or absent Present

Stoppage, \$ 100 for B.Y.E. 3.10

Ord. .16

Due Gov't, \$ 100 for

Remarks:

Book mark:

B. E. M. Laughlin

(858)

Copist.

R | 9 | U.S.C.T.

Elizah Robbins
Priv., Co. G, 9 Reg't U. S. Col'd Infantry.

Appears on

Company Muster Roll

for Sep. 9 Oct., 1866

Present or absent Present

Stoppage, \$ 100 for

Due Gov't, \$ 100 for

Remarks:

Book mark:

C. E. M. Laughlin

R | 9 | U.S.C.T.

Elijah Robbins
 Priv., Co. G, 9 Reg't U. S. Col'd Infantry.

Appears on Co. Muster-out Roll, dated
 New Orleans La. Nov. 26, 1866.

Muster-out to date Nov. 26, 1866.

Last paid to Aug. 31, 1866.

Clothing account:

Last settled....., 186 ; drawn since \$ 100

Due soldier \$ 100; due U. S. \$ 153
 100

Am't for cloth'g in kind or money adv'd \$ 100

Due U. S. for arms, equipments, &c., \$ 6⁰⁰/₁₀₀

Ordinary
 Bounty paid \$ None 100; due \$ 100 100 *

Remarks: Joined at origl. orgn.

Retains 1 musket & acc'ts.

* Bounty due under Act of
 Congress of July 26, '66, 100.

Book mark: 2234, 1881

C. E. McLaughlin

950

Robbins, George

Co F, 9 U.S. Col'd Inf.

Private | Private

CARD NUMBERS.

| | | |
|----|---------|----|
| 1 | 6299933 | 26 |
| 2 | 6310041 | 27 |
| 3 | 6310149 | 28 |
| 4 | 6310254 | 29 |
| 5 | 6310353 | 30 |
| 6 | 6310451 | 31 |
| 7 | 6310547 | 32 |
| 8 | 6310645 | 33 |
| 9 | 6310745 | 34 |
| 10 | 6310842 | 35 |
| 11 | 6310935 | 36 |
| 12 | 6311018 | 37 |
| 13 | 6311105 | 38 |
| 14 | 6311184 | 39 |
| 15 | 6311255 | 40 |
| 16 | 6311329 | 41 |
| 17 | 6311396 | 42 |
| 18 | 6311464 | 43 |
| 19 | 6311529 | 44 |
| 20 | 6311593 | 45 |
| 21 | 9069064 | 46 |
| 22 | | 47 |
| 23 | | 48 |
| 24 | | 49 |
| 25 | | 50 |

Book Mark:

See also

S 2899 543 and w 2

C. E. Doughty
2

P | **9** | **U.S.C.T.**

George Robbins
Co. *F*, 9 Reg't U. S. Col'd Inf.

Appears on
Company Descriptive Book
of the organization named above.

DESCRIPTION.

Age *18* years; height *5* feet *8* inches.
Complexion *Dark*
Eyes *Brown*; hair *Black*
Where born *Morristown Maryland*
Occupation *Laborer*

ENLISTMENT.

When *Nov 10*, 1863.
Where *Berlin Morristown Ind*
By whom *Capt J. P. Halden* term *three* yrs.
Remarks: *Detached by S O No 5*
Detached Sept 6-64 Hdqrs
Mustered out with Regt
Nov 24 - 1866

L B Singer
Copyist.

R. 4 U.S.C.T.

George Robbins

19th Reg't U. S. Col'd Infantry.

Age 15 years.

Appears on an

Individual Muster-in Roll

of the organization named above. Roll dated
Camp Steadman, Charles Co. Md., Dec. 26, 1863.

Muster-in to date Dec. 26, 1863.

Joined for duty and enrolled:

When Nov. 10, 1863.

Where Berlin Md.

Period 3 years.

Remarks: Assigned to Co "F"
9th U.S.C.T.

Book mark:

W. R. Houston

R. | 9 | U.S.C.T.

George Robbier
Priv., Co. F, 9 Reg't U. S. Col'd Infantry.

Appears on

Company Muster Roll

for Nov 23 to Dec 31, 1863.

Present or absent Present

Stoppage, \$ 100 for

Due Gov't, \$ 100 for

Remarks: \$2.00 Recruit
Pen. due.

Book mark:

Martin

R | 9 | U.S.C.T.

George Robbins
Priv, Co. F, 9 Reg't U. S. Col'd Infantry.

Appears on

Company Muster Roll

for Jan Feb, 1864

Present or absent Present

Stoppage, \$ 100 for

Due Gov't, \$ 100 for

Remarks: 200 Recruit
Precedue.

Book mark:

Martin

A | **9** | **U.S.C.T.**

George Robbins
Priv, Co. F, 9 Reg't U. S. Col'd Infantry.

Appears on

Company Muster Roll

for *Mar & Apr*, 186*4*.

Present or absent *Present*

Stoppage, \$ *100* for

Due Gov't, \$ *100* for

Remarks: *Stopped for our
wiper.*

Book mark:

Martin

R | 9 | U.S.C.T.

George Robbins
Priv, Co. F, 9 Reg't U. S. Col'd Infantry.

Appears on

Company Muster Roll

for May & June, 1864.

Present or absent Present.

Stoppage, \$ 100 for

Due Gov't, \$ 100 for

Remarks:

Book mark:

Martin

R | 9 | U.S.C.T.

George Roffin
Priv., Co. F, 9 Reg't U. S. Col'd Infantry.

Appears on

Company Muster Roll

for *July + Aug.*, 1864.

Present or absent *Present*

Stoppage, \$ *100* for

Due Gov't, \$ *100* for

Remarks:

Book mark:

Martin

R. 1 9 U.S.C.T.

George Robbins
Priv, Co. F, 9 Reg't U. S. Col'd Infantry.

Appears on

Company Muster Roll

for Sep & Oct, 1864

Present or absent Present

Stoppage, \$ 100 for

Due Gov't, \$ 100 for

Remarks:

Book mark:

Martin

R | 9 | U.S.C.T.

George Robbins
 Priv., Co. F, 9 Reg't U. S. Col'd Infantry.

Appears on

Company Muster Roll

for Nov. & Dec., 1864.

Present or absent Absent

Stoppage, \$ 100 for

Due Gov't, \$ 100 for

Remarks: On detached
service as guard for
ammunition train
so. to 5th Reg 2nd Tex
Brig. 3 Div. 10 A.C.
Sept. 6/64. Due the differ
ence between seven dollars
per month & thirteen dollars per
month from Jan. 1/64 to
Apr. 30/64

Book mark:

E. L. Thorton

A | **9** | **U.S.C.T.**

George Robins
Priv, Co. F, 9 Reg't U. S. Col'd Infantry.

Appears on

Company Muster Roll

for *Jan. to Feb*, 1865.

Present or absent *Present*

Stoppage, \$ *100* for

Due Gov't, \$ *100* for

Remarks: *On detcho service
in Ord. Train pt S.O.
No. 5 - 1st Reg. 1st Brig. 3
Dist 10th abo. Sept 6/64*

Book mark:

E. Stanton

R | 9 | U.S.C.T.

George Robbins
Priv, Co. F, 9 Reg't U. S. Col'd Infantry.

Appears on

Company Muster Roll

for March to April, 1865.

Present or absent Absent

Stoppage, \$ 100 for

Due Gov't, \$ 100 for

Remarks: On detached service in
Ord. Train for No. 5 Reg.
Pro. 1 Brig. 3 Div. 10 Ar.
Sept. 6/64.

Book mark:

E. H. Stanton

R | **9** | **U.S.C.T.**

George Robbins
Priv, Co. F, 9 Reg't U. S. Col'd Infantry.

Appears on

Company Muster Roll

for *May & June*, 1865.

Present or absent *Present*

Stoppage, \$ 100 for

Due Gov't, \$ 100 for

Remarks:

Book mark:

E. L. Thomson

A | **9** | **U.S.C.T.**

George Robbins
Priv, Co. F, 9 Reg't U. S. Col'd Infantry.

Appears on

Company Muster Roll

for *July & Aug*, 1865.

Present or absent *Present*

Stoppage, \$ *100* for

Due Gov't, \$ *100* for

Remarks:

Book mark:

E. L. Hanson

R

9

U.S.C.T.

George Robbins
Private, Co. F, 9 Reg't U. S. Col'd Infantry.

Appears on

Company Muster Roll

for June 30 to Oct 31, 1865.

Present or absent Present

Stoppage, \$ 100 for

Due Gov't, \$ 100 for

Remarks:

Book mark:

P. A. Ward

R | **9** | **U.S.C.T.**
George Robbins
Out, Co. *F*, 9 Reg't U. S. Col'd Infantry.

Appears on

Company Muster Roll

for *June 30 to Dec 31*, 1865.

Present or absent *Present*

Stoppage, \$ *100* for

Due Gov't, \$ *100* for

Remarks:

Book mark:

D. A. Ward

R | 9 | U.S.C.T.

George Robbins
PT, Co. F, 9 Reg't U. S. Col'd Infantry.

Appears on

Company Muster Roll

for Jan. & Feb., 1866.

Present or absent present

Stoppage, \$ 100 for

Due Gov't, \$ 100 for

Remarks:

Book mark:

(858) J. E. Nichol Copyist

R | 9 | U.S.C.T.

George Robbins

Pvt, Co. F, 9 Reg't U. S. Col'd Infantry.

Appears on

Company Muster Roll

for *Mch. & Apl.*, 1866.

Present or absent *present*

Stoppage, \$ 100 for

Due Gov't, \$ 100 for

Remarks:

Book mark:

(358)

J. E. Nichol

Copyist

R | 9 | U.S.C.T.

George Robbins

POV, Co. F, 9 Reg't U. S. Col'd Infantry.

Appears on

Company Muster Roll

for *May & June*, 186*6*.

Present or absent *present*

Stoppage, \$ *100* for

Due Gov't, \$ *100* for

Remarks: *Stop for Cartridge
box belt plate, screw
driver & wiper 35¢*

Book mark:

(358) *J. E. Nichol* Copyist

R

9

U.S.C.T.

George Robbins

Private, Co. F, 9 Reg't U. S. Col'd Infantry.

Appears on

Company Muster Roll

for July & Aug., 1866.

Present or absent present

Stoppage, \$ 100 for

Due Gov't, \$ 100 for

Remarks:

Book mark:

(358) J.E. Nichol Copyist

R | 9 | U.S.C.T.

George Robbins
Pot, Co. F, 9 Reg't U. S. Col'd Infantry.

Appears on

Company Muster Roll

for Sep. & Oct., 1866.

Present or absent present

Stoppage, \$ 100 for

Due Gov't, \$ 100 for

Remarks:

Book mark:

(358)

J. E. Nichol
Copyist

R | 9 | U.S.C.T.

George Robbins
 Pvt., Co. F., 9 Reg't U. S. Col'd Infantry.

Appears on **Co. Muster-out Roll**, dated
New Orleans, La, Nov. 26, 1866.

Muster-out to date *Nov. 26*, 1866.

Last paid to *Aug. 31*, 1866.

Clothing account:

Last settled....., 186 ; drawn since \$..... 100

Due soldier \$ *10* ^{*03*}/₁₀₀; due U. S. \$..... 100

Am't for cloth'g in kind or money adv'd \$..... 100

Due U. S. for arms, equipments, &c., \$..... 100

Bounty paid \$ *None* 100; due \$ *100* ^{*00*}/₁₀₀

Remarks: *Joined at Original*
Orgn.

Book mark: *V. 173, P. 219-73*
(over)

(861) *J. E. Nichol* Copyist.

NARA 952

448, 1880

JAN. 21

6311593

018910

951

Robbins, Henry

Co *E*, 9 U.S. Col'd Inf.

Private | *Private*

CARD NUMBERS.

| | | |
|----|---------|----|
| 1 | 6308098 | 26 |
| 2 | 6308195 | 27 |
| 3 | 6308302 | 28 |
| 4 | 6308406 | 29 |
| 5 | 6308506 | 30 |
| 6 | 6308604 | 31 |
| 7 | 6308701 | 32 |
| 8 | 6308802 | 33 |
| 9 | 6308900 | 34 |
| 10 | 6308998 | 35 |
| 11 | 6300073 | 36 |
| 12 | 6309093 | 37 |
| 13 | 6300108 | 38 |
| 14 | 6309182 | 39 |
| 15 | 6300140 | 40 |
| 16 | 6309271 | 41 |
| 17 | 6300155 | 42 |
| 18 | 6309357 | 43 |
| 19 | 6309436 | 44 |
| 20 | 6309512 | 45 |
| 21 | 6309587 | 46 |
| 22 | 6309659 | 47 |
| 23 | 6309729 | 48 |
| 24 | 6309799 | 49 |
| 25 | 9068974 | 50 |

Book Mark: _____

See also _____

S. 1508063 P. O. M. M.
S. 2031713 P. O. M. M.

S. S. Dwyer
2

R | 9 | U.S.C.T.

Henry Robbins

, Co. E, 9 Reg't U. S. Col'd Inf.

Appears on

Company Descriptive Book

of the organization named above.

DESCRIPTION.

Age 21 years; height 5 feet 3/2 inches.

Complexion Blk

Eyes Blk; hair Blk

Where born Worcester Co Md

Occupation Laborer

ENLISTMENT.

When Nov 10, 1863.

Where Worcester Co Md

By whom Wm Birney; term 3 y'rs.
Col + Mustering Officer

Remarks:

Discharged with
the Regt - Nov 26 - 1864

C. J. Rogzall

R

9

U.S.C.T.

Henry Robbins

Pvt., Co. E, 9 Reg't U. S. Col'd Infantry.

Age 21 years.

Appears on

Company Muster-in Roll

of the organization named above. Roll dated

Camp Stanton Charles Co, Md Nov 17, 1863.

Muster-in to date Nov 17, 1863

Joined for duty and enrolled:

When Nov 10, 1863.

Where Worcester Md

Period 3 years.

Remarks:

Book mark:

C. C. Parker

R | 9 | U.S.C.T.

Henry Robbins

Pr, Co. E, 9 Reg't U. S. Col'd Infantry.

Appears on

Company Muster Roll

for *Nov 17 to Dec 31*, 1863.

Present or absent *Present*

Stoppage, \$ *100* for

Due Gov't, \$ *100* for

Remarks: *Two dollars Recruits*

Premium due

Book mark:

C. C. Barker

R | 9 | U.S.C.T.

Henry Robbins

Private, Co. E, 9 Reg't U. S. Col'd Infantry.

Appears on

Company Muster Roll

for Jan + Feb, 1864.

Present or absent Present

Stoppage, \$ 100 for

Due Gov't, \$ 100 for

Remarks: Two Dollars Recruits Premium Due

Book mark:

C. C. Parker

R | 9 | U.S.C.T.

Henry Robbins

Pri, Co. E, 9 Reg't U. S. Col'd Infantry.

Appears on

Company Muster Roll

for Mar & Apr, 1864.

Present or absent Present

Stoppage, \$ 100 for

Due Gov't, \$ 100 for

Remarks: Two dollar Recruits premium due

Book mark:

C. C. Parker

R 9 U.S.C.T.

Henry Robbins

Private, Co. E, 9 Reg't U. S. Col'd Infantry.

Appears on

Company Muster Roll

for May & June, 1864.

Present or absent Absent

Stoppage, \$ 100 for

Due Gov't, \$ 100 for

Remarks: On detached service on Gun Boat "John Adams" since June 16 - 1864

Book mark:

C. C. Parker

R

9

U.S.C.T.

Henry Robbins

Pri, Co. E, 9 Reg't U. S. Col'd Infantry.

Appears on

Company Muster Roll

for *July & Aug*, 1864.

Present or absent *Present*

Stoppage, \$ 100 for

Due Gov't, \$ 100 for

Remarks:

Book mark:

Ch Parker

(858)

Copyist.

R | 9 | U.S.C.T.

Henry Robbins

Private, Co. E, 9 Reg't U. S. Col'd Infantry.

Appears on

Company Muster Roll

for Sept + Oct, 1864.

Present or absent Present

Stoppage, \$ 100 for

Due Gov't, \$ 100 for

Remarks:

Book mark:

C. C. Parker

(858)

Copyist.

R

9

U.S.C.T.

Henry Robbins

Plat. Co. E, 9 Reg't U. S. Col'd Infantry.

Appears on

Company Muster Roll

for *Nov & Dec*, 1864.

Present or absent *Present*

Stoppage, \$ 100 for

Due Gov't, \$ 100 for

Remarks:

Book mark:

H. E. Noteman

(858)

Copyist.

R | 9 | U.S.C.T.

Henry Robbins
Pot, Co. E, 9 Reg't U. S. Col'd Infantry.

Appears on

Company Muster Roll

for *Jany & Liby*, 1865.

Present or absent *Absent*

Stoppage, \$ 100 for

Due Gov't, \$ 100 for

Remarks: *Act Service with
Ambulance Corps for
S.C. no 10 2nd Regt 9th US Col
Jan 25th 65,*

Book mark:

J. E. Wetman
(858) Copyist.

R | 9 | U.S.C.T.

Henry Robbins
Capt, Co. E, 9 Reg't U. S. Col'd Infantry.

Appears on

Company Muster Roll

for March & April, 1865.

Present or absent Absent

Stoppage, \$ 100 for

Due Gov't, \$ 100 for

Remarks: Aetc Service with
Ambulance Corps for S.O.
No 10 Fed Drs 9th Dist.
Jan 25. 1865

Book mark:

J. E. Noteman

R | 9th | U.S.C.T.

Henry Robbins

Rk, Co. *E*, Reg't U. S. Col'd Infantry.

Appears on a

Detachment Muster Roll

of the organization named above

for *March and April*, 1865.

Station *Near Petersburg, Va.*

Present or absent *Present*

Stoppage, \$ 100 for

Due Gov't, \$ 100 for

Remarks:

Book mark:

R

9

U.S.C.T.

Henry Robbins

Pat, Co. E, 9 Reg't U. S. Col'd Infantry.

Appears on

Company Muster Roll

for Dec 31, 64 to June 30, 1865.

Present or absent Absent

Stoppage, \$ 100 for

Due Gov't, \$ 100 for

Remarks On duty serv with Amb Corps pr S. #10 Fed Res 9th U.S. I. Aug 25th 1865

Book mark:

J. E. Noteman

(358)

Copyist.

R | 9th U.S.C.T.

Henry Robins

Pvt., Co. *E*, *9th* Reg't U. S. Col'd Infantry.

Appears on a

Detachment Muster Roll

of the organization named above

for *May and June*, 1865.

Station *White's Ranch, Texas.*

Present or absent *Present*

Stoppage, \$ 100 for

Due Gov't, \$ 100 for

Remarks:

Book mark:

(344)

Jas. V. Kearny
Copyist.

R | **9** | **U.S.C.T.**

Henry Robins
Pat, Co. E, 9 Reg't U. S. Col'd Infantry.

Appears on

Company Muster Roll

for *July & Augt*, 186*5*.

Present or absent *Absent*

Stoppage, \$ *100* for

Due Gov't, \$ *100* for

Remarks *On detached service*
in Amb Corps per SO
no 10 Hd Qrs 9 USCS
Jan 25, 65

Book mark:

H. E. Metemian
Copyist.

R | 9th U.S.C.T.

Henry Robins

Pvt, Co. *E*, *9* Reg't U. S. Col'd Infantry.

Appears on a

Detachment Muster Roll

of the organization named above

for *July and August*, 1865.

Station *Brownsville, Texas.*

Present or absent *Present*

Stoppage, \$ 100 for

Due Gov't, \$ 100 for

Remarks:

Book mark:

R

9

U.S.C.T.

Henry Robbins

Plat, Co. E, 9 Reg't U. S. Col'd Infantry.

Appears on

Company Muster Roll

for June 30 to Oct 31, 1865.

Present or absent Absent

Stoppage, \$ 100 for

Due Gov't, \$ *95 100 for 648

" " *20 100 " 000

Remarks: Let Serv Amk Corp
S.O. no 10. Fed Reg 9" 26863
Jan 25, 65

* As it appears on roll cancelled

Book mark:

J. E. Moteman

(858)

Copyist.

R | 9th U.S.C.T.

Henry Robin

Rk, Co., *9th* Reg't U. S. Col'd Inf.

Appears on a

Detachment Muster Roll

of the organization named above

for *Sept and Oct*, 1865.

Station *Brownville, Texas.*

Present or absent *Present*

Stoppage, \$ *100* for

Due Gov't, \$ *100* for

Remarks:

Book mark:

Jas. V. Kearney

R | 9 | U.S.C.T.

Henry Robbins
Priv., Co. E, 9 Reg't U. S. Col'd Infantry.

Appears on

Company Muster Roll

for June 30 to Dec 31, 1865

Present or absent Present

Stoppage, \$ 100 for

Due Gov't, \$ 100 for

Remarks: Act Service Amb
Corp S.C. no 10 16d Ins
9 U.S.C. June 13, 65

Book mark:

(858)

H. E. Weteman
Copyist.

9

U.S.C.T.

Co. E, 9 Reg't U. S. Col'd Infantry.

Appears on

Company Muster Roll

for _____, 1866.

Present or absent _____

Stoppage, \$ _____ 100 for _____

Due Gov't, \$ _____ 100 for _____

Remarks: _____

Book mark: _____

11

9

U.S.C.T.

....., Co. E, 9 Reg't U. S. Col'd Infantry.

Appears on

Company Muster Roll

for, 186 .

Present or absent

Stoppage, \$.....100 for

Due Gov't, \$.....100 for

Remarks:

Book mark:

9

U.S.C.T.

....., Co. E, 9 Reg't U. S. Col'd Infantry.

Appears on

Company Muster Roll

for, 186 ..

Present or absent

Stoppage, \$ 100 for

Due Gov't, \$ 100 for

Remarks:

Book mark:

9

U.S.C.T.

James L. ...

..., Co. E, 9 Reg't U. S. Col'd Infantry.

Appears on

Company Muster Roll

for ..., 186 .

Present or absent

Stoppage, \$ 100 for

Due Gov't, \$ 100 for

Remarks:

Book mark:

W. J. ... | **9** | **U.S.C.T.**

Company Muster Roll

..., Co. E, 9 Reg't U. S. Col'd Infantry.

Appears on

Company Muster Roll

for *...*, 186 *...*

Present or absent *...*

Stoppage, \$ 100 for *...*

Due Gov't, \$ 100 for *...*

Remarks: *...*

Book mark: *...*

J. 1 | **9** | **U.S.C.T.**

Henry [unclear]
....., Co., 9 Reg't U. S. Col'd Infantry.

Appears on **Co. Muster-out Roll**, dated
....., *.....*, 186*0*.

Muster-out to date *.....*, 186*0*.

Last paid to *.....*, 186*0*.

Clothing account:

Last settled....., 186*0* ; drawn since \$..... *100*

Due soldier \$..... *100*; due U. S. \$..... *100*

Am't for cloth'g in kind or money adv'd \$..... *100*

Due U. S. for arms, equipments, &c., \$..... *100*

Bounty paid \$..... *100*; due \$..... *100*

Remarks: *.....*
.....
.....
.....

Book mark: *M. S. [unclear]*

Robins, Henry

P, Co. E, 9 Regt U. S. C. Inf.

Enclosures.

- | | |
|-----------------------------------|------------------------|
| Bed Cards..... | Descriptive Lists..... |
| Burial Records..... | Final Statements..... |
| Certs. of Dis. for Discharge..... | Furloughs..... |
| C. M. Charges..... | Med. Des. Lists..... |
| Med. Certificates..... | Orders..... |

Other papers relating to—

- | | |
|---------------------------------|--------------------------|
| Admission to Hosp'l..... | Furlough..... |
| Casualty Sheet (Officer's)..... | Med. Examination..... |
| Confinement..... | Misc. Information..... |
| Contracts..... | Pay or Clothing..... |
| Death or Effects..... | Personal Reports..... |
| Desertions..... | Rank..... |
| Discharge from Hosp'l..... | Transfer to Hosp'l..... |
| Discharge from Service..... | Transfer to V. R. C..... |
| Duty..... | Transportation..... |
| | <i>Slave Claim 1</i> |

MICROFILM PUBLICATION M 1851

COMPILED MILITARY SERVICE RECORDS
OF VOLUNTEER UNION SOLDIERS WHO SERVED WITH
THE UNITED STATES COLORED TROOPS (USCT)
9TH REGIMENT OF INFANTRY

PERSONAL PAPERS' TARGET SHEET

PLEASE NOTE THE CHECKED INFORMATION ABOUT THE PERSONAL PAPERS IN
THIS FILE:

- NO PERSONAL PAPERS WERE FOUND IN THIS FILE WHEN THE
RECORDS WERE ARRANGED FOR MICROFILMING.
- 6 PERSONAL PAPER(S) FOUND IN THIS FILE WHEN THE RECORDS
WERE ARRANGED FOR MICROFILMING.

A.

No. 1131 CLAIMANT'S CERTIFICATE.

I, Andania Robins, a loyal citizen, and a resident of Worcester, County of the, State of Maryland, hereby claim compensation, under the provisions of General Orders, No. 329, 1863, for my slave Henry Robins enlisted Nov 1, 1863, at Worcester by Col Wm Berry, in the 9th Regiment U. S. Colored Troops, Co. E; certificate of which enlistment, and a descriptive list, as required, accompany this application.

In proof of my loyalty to the Constitution and Government of the United States, I present the accompanying oath, which I have taken, signed, and acknowledged, to be filed with this application, in accordance with requirement of said General Orders.

Andania Robins

March 11th, 1864.

B.

OATH OF ALLEGIANCE.

I, Andruia Robin, do solemnly swear that I have never joined, or been concerned in, any insurrection or rebellion; that I have never borne arms against the United States; that I have never given any aid, countenance, counsel, or encouragement to any person or persons engaged, or whom I had reason to believe were about to engage, in insurrection, rebellion, or armed hostility against the United States; that I have neither sought, nor accepted, nor attempted to exercise the functions of any office, civil or military, nor to perform any service whatever, under any authority or pretended authority in hostility to the United States; that I have not yielded a voluntary support to any insurrection, rebellion, or pretended government, authority, power, or constitution within the United States hostile thereto. And I do further swear that, to the best of my knowledge and ability, I have supported and defended, and will continue to support and defend, the United States against all enemies, foreign and domestic; and that I have supported, defended, and obeyed, and will continue to support, defend, and obey, the Constitution and laws of the United States; that I will bear true faith and allegiance to the same; and that I take this oath freely, without any mental reservation or purpose of evasion: So help me God.

Andruia Robin

Sworn to and subscribed before me, at Berlin }
 this 11th day of March, 1864.

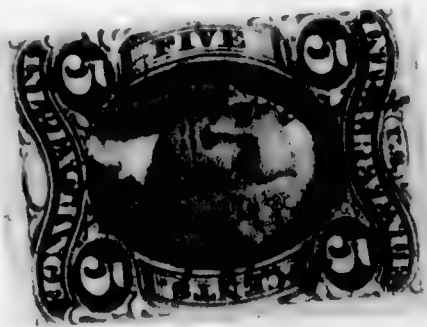

A. D. P. ...
Justice of the Peace

C.

I present herewith evidence of my title to the slave Henry
Robins enlisted as aforesaid, and in consideration of the sum
of _____ by me received, I hereby covenant and
agree with the United States, that I, my heirs, executors, or assigns, shall never hereafter make
or enforce any claim to the labor or services of said slave; and pledge myself to execute
a valid Deed of Manumission and Release of all my claims to service forever of said
Henry Robins to be filed with the Board of Claims
now in session at Baltimore



March 11, 1864.

A. G. C. Cal. 2464
Examined & found correct

R.O. Berlin
Norcester Co. No. 2

A. G. C. Cal. 2464

No. 1181

APPLICATION OF

William Andrew Robins

OF

Amherst's 2nd

For Compensation for Service of Slave,

Henry Robins

Enlisted in _____ Regiment

U. S. Colored Troops, Co. *D*.

Received, *March 16* 1864.

COMPENSATION AWARDED,

October 15th 1864.

Three Hundred Dollars.

*Thos. Simmons
Pres B. of Claims*

*for a lost Slave
for a lost Slave
Boston*

Baymont

Recd. A. G. C. Cal. 2464

EVIDENCE OF TITLE.

I, *Andaria Robin*, of *Montgomery* County, Md., do solemnly swear that *Henry Robin* who has been enlisted in the *9th* Regiment, U. S. Colored Troops, Co. *E*; is my slave for *Life*; (his term of service expiring on the *1st* day of *1864*;) and that I became possessed of him ~~by~~ *he was born mine*, in the month of *1863*, eighteen hundred and *63*. And I do further swear that I have not purchased said slave from any person or persons disloyal to the Government of the United States, with the object of obtaining compensation for the same; and furthermore, that I have no agency for obtaining compensation for any person or persons but such as, to my knowledge, are loyal citizens of the United States.

Andaria Robin
March 11 1864.

STATE OF MARYLAND.

Harwood County, to wit:

On this *14th* day of *October* in the year 1864,

before me, the subscriber, a Justice of the Peace of the State and County aforesaid, personally appeared *Andania Robinson*, and took, signed, and acknowledged the oaths preceding; and further made oath, in due form of law, that all the statements made in this application are, to the best of *her* knowledge and belief, strictly true.

Also personally appeared before me *George W. ...* and *...*, loyal citizens of the United States, residents of *Harwood County*, well acquainted with the said *Andania Robinson*, and in no manner interested in the prosecution of this

claim, and made oath, in due form of law, that the said *Andania Robinson* is the owner of the slave *Henry Robinson*, as a fact of public notoriety: that they believe all the statements herein made by *her*, in reference thereto, are correct, and that *she* is unquestionably loyal to the Government of

the United States. Witness their signatures:



George W. ...
...

Justice of the Peace.

STATE OF MARYLAND,

Worcester County, to wit:

I, *George A. Richardson*, Clerk of the Circuit Court for

Worcester County, do hereby certify that *J. D. Powell Esq.*

before whom the foregoing affidavits were made, was, at the time of signing the same, a Justice of the Peace for the County and State aforesaid, duly commissioned and sworn; and that his signature thereto is genuine, and that full faith and credit should be given to his official acts.

Witness my hand and the seal of said Court, this *fourteenth* day of

March, A. D. 1864.



Geo. A. Richardson

CLERK.

...

Audasia Robin
to
Henry-

E

Deed of Manumission and release of Service

Whereas my slave Henry Robins has enlisted in the Service of the United States
Now, in Consideration thereof, S. Andasia Robins of Worcester County State of
Maryland, do hereby, in Consideration of said Enlistment, manumit, set
free, and release the above-named Henry Robins from all Service due
me, his freedom to commence from the _____ the date of his enlistment as
aforesaid in the 9th Regiment of Colored Troops. in the Service
of the United States.

Witness
L. D. Powell
James B. Sumrell

Witness My hand and seal, this 30 day of April 1864

Andasia Robins 

Worcester County State of Maryland 1864 April 30

Before me appeared this day Andasia
Robins and acknowledged the above Deed of Manumission and release of Service to
be his free act and deed

L. D. Powell J.P.

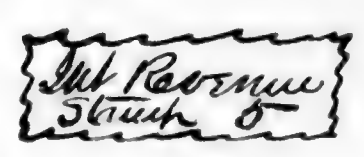

State of Maryland Worcester County to Wit:

I, George A. Richardson, Clerk of the Circuit Court for Worcester County
hereby, Certify that the above is a true copy of the Original now on file in this Office for record

In testimony whereof I herewith subscribe my name and affix
the seal of the said Circuit Court, this fourth day of May Anno
Domini Eighteen Hundred and Sixty four

Geo. A. Richardson Clerk

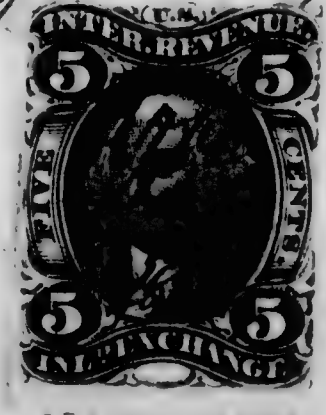

F.

CERTIFICATE OF AWARD OF THE BOARD OF CLAIMS.

Office of the Board of Claims
 For Slaves Enlisted in the Service of the United States,

Baltimore Md.

October 15th, 1864.

no 27
 \$300

We hereby certify, that Mrs. Ananias Robins, of
 Worcester county, State of Maryland,
 having proved, under oath, her loyalty to the Constitution and
 Government of the United States, and established her title
 as to the ownership of Henry Robins, a slave enlisted
 at Worcester County Md, on the 10th day of November,
 1863, by Col. Wm Birney, in the service of the
 United States, in the 9th Regiment of Colored Troops,
 Co. E, and having filed a valid Deed of Manumission and Release
 of Service of said slave, is entitled to the sum of Three Hundred
 dollars, which has been awarded to her by this Board as a
 remuneration for all claim to the future labor or service of said slave,
 under the provision of General Orders, War Department, No. 329,
 1863.

Thos. Simmons, President of the Board.
 S. E. Strayhorn, Member of the Board.
 Wm. H. Ray, Member of the Board.

To Col C. W. Foster,

Chief of the Bureau for the
 Organization of Colored Troops, Washington, D. C.

Payment of the amount due
the decedent in this case may be
made to F. G. & Jas. P. Summitt
executors of his last will & testament.

(Sgd.) J. M. Broadhead
Compt.

2d Compt. Office Sept. 28. 1865.
A. G. O. January 22. 1866.
Official:
A. F. Rockwell
A. G. O.

A. G. O. T. R. No. 31

No. .

ABSTRACT OF DISBURSEMENTS.

....., 186 .
Andasia Robins

Dollars 300 ⁰⁰/₁₀₀

Paid , 186 .

The United States,

To Andasia Robbins Dr.

| 1864 | For amount awarded ^{her} him by the Board of Claims, in consideration | DOLLARS. | CENTS. |
|--------------|---|----------|--------|
| October 15th | of the enlistment of <u>Henry Robbins</u> in the <u>9th Regt U. S. Cold Troop</u> | 300 | 00 |
| | - | Total \$ | 300 00 |

I CERTIFY that the above account is correct and just; that the name of Henry Robbins is borne on the muster-in rolls of the 9th Regt U. S. Cold Troop; and that the above amount was awarded by the Board of which Thos Simmons Esq is President, said award being in accordance with section 24 of the act entitled "An act to amend an act entitled 'An act for enrolling and calling out the national forces, and for other purposes,'" approved Feb. 24, 1864.

W. Suggard
Assistant Adjutant General.

RECEIVED
Thos Simmons, 186 , of Capt G. Benedict, A. A. G. 80th dollars and _____ cents, in full of the above account.

J. R. Funnell
James R. Funnell

(SIGNED DUPLICATES.)

Maryland, Sec.

U. S. R.
Stamp
\$9.50
on will



The State of Maryland.

To all Persons to whom these Presents shall come, Greeting:
Know ye, that the last Will and Testament of Andasia Robins late of Worcester County, deceased, hath in due form of law been exhibited, proved and recorded, in the Office of the Register of Wills for Worcester County, a copy of which is to these presents annexed, and administration of all the Goods, Chattels and credits of the deceased, is hereby granted and committed unto Francis J. Pinnell and James R. Pinnell Executors by the said will appointed.

Witness: Wm H. Merrill Esquire, Chief Judge of the Orphans Court for Worcester County, this 9th day of December Anno Domini, 1864.

Est E. Hubbell R. W., W. County

The State of Maryland, Worcester County, Sec.

The subscriber Register of Wills for Worcester County doth hereby certify that it appears by the Records in his office, that Letters of Administration of all the Goods, chattels, and credits of Andasia Robins, deceased, were on the 9th day of Decer. in the year of our Lord, one thousand eight hundred and sixty four granted and committed unto Francis J. Pinnell and James R. Pinnell the Executors by the last Will and testament of the deceased appointed.

In testimony whereof, I hereunto subscribe my name and affix the seal of my Office this 18th day of January in the year of our Lord Eighteen hundred and sixty five.



Est, E. Hubbell Reg. Wills for Worcester County

Maryland Sec.

I William H. Merrill Presiding Judge of the Orphans Court for Worcester County, in the State aforesaid, do certify, that the aforesaid Attestation of E. Hubbell Register of Wills for said County is in due form and by the proper Officer. Given under my hand at the Tower of Snow Hill this day of January in the year of Our Lord Eighteen hundred and sixty five.



Wm H. Merrill

Payment of the amount due the
deceased in this case may be made
to S. J. & Jas. P. Surrall, executors
of his last will & testament.

(Sgd) G. M. Brodhead
Compt.

2d Compt. Office, Sept. 20. 1865.
A. S. O. January 20. 1866.

Official,
A. F. Rockwell
A. S. O.

R. V. O. C. T. R. No. 31

No. .

ABSTRACT OF DISBURSEMENTS.

....., 186 .

Andasia Robins

Dollars 310 ⁰⁰/₁₀₀

Paid, 186 .

MAR 9 1864

The United States,

To *Andasia Robbins* Dr.

| | | DOLLARS. | CENTS. |
|---------------------|--|------------|-----------|
| 1864 | For amount awarded ^{to} him by the Board of Claims, in consideration | | |
| <i>October 15th</i> | of the enlistment of <i>Henry Robbins</i> | | |
| | in the <i>9th Regt U. S. Col'd Troop</i> | <i>300</i> | <i>00</i> |
| <i>Total \$</i> | | <i>300</i> | <i>00</i> |

I CERTIFY that the above account is correct and just; that the name of *Henry Robbins* is borne on the muster-in rolls of the *9th Regt U. S. Col'd Troop*; and that the above amount was awarded by the Board of which *Thos. Timmony Esq* is President, said award being in accordance with section 24 of the act entitled "An act to amend an act entitled 'An act for enrolling and calling out the national forces, and for other purposes,'" approved Feb. 24, 1864.

Geo. Suggard
Assistant Adjutant General.

RECEIVED *Three hundred*, 186, of *Capt. G. Remondet, C. A. G. V. S.* dollars and _____ cents, in full of the above account.

G. J. Purnell
James R. Purnell

(SIGNED DUPLICATES.)

Maryland, Sc.

M. S. R.
Stamps
\$9.50
On Will



The State of Maryland.

To all Persons to whom these Presents shall come Greeting:
Know ye, that the last Will and Testament of Andasia Robins, late of Worcester County, deceased, hath in due form of law been exhibited, proved and recorded in the Office of the Register of Wills for Worcester County, a copy of which is to these presents annexed, and Administration of all the Goods, Chattels and credits of the deceased, is hereby granted, and committed unto Francis J. Pennell and James R. Pennell Executors by the said Will appointed.

Witness: Wm H. Memill Esquire, Chief Judge of the Orphans Court for Worcester County, this 9th day of December Anno Domini 1864.

Est E. Hubbell R. W., W. County.

The State of Maryland, Worcester County Sc.

The subscriber Register of Wills for Worcester County doth hereby certify that it appears by the Records in his Office that Letters of Administration of all the Goods, Chattels, and credits of Andasia Robins, deceased, were on the 9th day of December in the year of our Lord One thousand eight hundred and sixty four granted and committed unto Francis J. Pennell and James R. Pennell the Executors by the last Will and Testament of the deceased appointed.

In testimony whereof, I humbly subscribe my name and affix the seal of my Office this 18th day of January in the year of our Lord Eighteen hundred and sixty five.



Est E. Hubbell Reg. Wills for Worcester County.

Maryland Sc.

I Wm H. Memill Presiding Judge of the Orphans Court for Worcester County in the State aforesaid, do Certify, that the foregoing attestation of E. Hubbell Register of Wills for said County is in due form and by the proper Officer. Given under my hand at the Town of Snow Hill this day of January in the year of our Lord Eighteen hundred and sixty five.



Wm H. Memill

95-2
 Robbins, Isaac

Co H, 9 U.S. Col'd Inf.

Private | Private

CARD NUMBERS.

| | | |
|----|---------|----|
| 1 | 6313440 | 26 |
| 2 | 6313539 | 27 |
| 3 | 6313639 | 28 |
| 4 | 6313743 | 29 |
| 5 | 6313841 | 30 |
| 6 | 6313936 | 31 |
| 7 | 6314027 | 32 |
| 8 | 6314132 | 33 |
| 9 | 6314232 | 34 |
| 10 | 6314326 | 35 |
| 11 | 6314419 | 36 |
| 12 | 6314497 | 37 |
| 13 | 6314579 | 38 |
| 14 | 6314651 | 39 |
| 15 | 6314715 | 40 |
| 16 | 6314778 | 41 |
| 17 | 6314838 | 42 |
| 18 | 6314898 | 43 |
| 19 | 6314957 | 44 |
| 20 | 6315013 | 45 |
| 21 | 9069268 | 46 |
| 22 | | 47 |
| 23 | | 48 |
| 24 | | 49 |
| 25 | | 50 |

Book Mark:

See also

N^o 1 | **9** | **U.S.C.T.**

Isaac Robbins

....., Co. *H*, 9 Reg't U. S. Col'd Inf.

Appears on

Company Descriptive Book

of the organization named above.

DESCRIPTION.

Age *20* years; height *5* feet *10 1/4* inches.

Complexion *Black*

Eyes *Black*; hair *Black*

Where born *Moravia, Maryland*

Occupation *Farmer*

ENLISTMENT.

When *Nov. 18*....., 1863.

Where *Berlin, Moravia Co. Ind.*

By whom *Col. W. Birney*; term *3* y'rs.

Remarks: *Discharged Nov. 26/66
for S. C. No. 68. Co. D. Dept. of
the Gulf.*

Casy

R

9

U.S.C.T.

Isaac Robbins
Private, Co. H, 9 Reg't U. S. Col'd Infantry.

Age 20 years.

Appears on

Company Muster-in Roll

of the organization named above. Roll dated

Camp Stanton, ^{Maryland} Charles Co. Nov. 23, 1863.

Muster-in to date Nov. 23, 1863

Joined for duty and enrolled:

When Nov. 18, 1863.

Where Worcester, Md.

Period 3 years.

Remarks:

Book mark:

O. J. Markle,
Copyist.

P

9

U.S.C.T.

Isaac Robbins

Private, Co. H, 9 Reg't U. S. Col'd Infantry.

Appears on

Company Muster Roll

for Nov. 23 to Dec. 31, 1863.

Present or absent Present.

Stoppage, \$ 100 for

Due Gov't, \$ 100 for

Remarks: \$2 Reemits premium due.

Book mark:

O. J. Markle

R

9

U.S.C.T.

Isaac Robbins
Private, Co. H, 9 Reg't U. S Col'd Infantry.

Appears on

Company Muster Roll

for Jan. + Feb., 1864.

Present or absent Present.

Stoppage, \$ 100 for

Due Gov't, \$ 100 for

Remarks: \$2 Recruits premium due.

Book mark:

O. Markle,

R

9

U.S.C.T.

Isaac Robbins

Private, Co. H, 9 Reg't U. S Col'd Infantry.

Appears on

Company Muster Roll

for March & April, 1864.

Present or absent Present.

Stoppage, \$ 100 for

Due Gov't, \$ 100 for

Remarks:

Book mark:

O. J. Markle

P | **9** | **U.S.C.T.**

Isaac Robbins
Private, Co. H, 9 Reg't U. S Col'd Infantry.

Appears on

Company Muster Roll

for *May + June*, 1864.

Present or absent *A. Present.*

Stoppage, \$ *100* for

Due Gov't, \$ *100* for

Remarks: *Stop for shoulder scales.*

Book mark:

(358)

O. J. Markle,
Capt.

R | 9 | U.S.C.T.

James Robbins
Private, Co. H, 9 Reg't U. S Col'd Infantry.

Appears on

Company Muster Roll

for *July & August*, 1864.

Present or absent *Present*

Stoppage, \$ 100 for

Due Gov't, \$ 100 for

Remarks: *Free man before April 17, 1861.*

Book mark:

O. J. Markle

R

9

U.S.C.T.

Isaac Robbins

Private, Co. H, 9 Reg't U. S. Col'd Infantry.

Appears on

Company Muster Roll

for Sept. & Oct., 1864

Present or absent Present

Stoppage, \$ 100 for

Due Gov't, \$ 100 for

Remarks: Free on or before April 19, 1861.

Book mark:

O. J. Markle

R | 9 | U.S.C.T.

Isaac Robbins

Priv., Co. H, 9 Reg't U. S. Col'd Infantry.

Appears on

Company Muster Roll

for Nov. & Dec., 1864

Present or absent Present

Stoppage, \$ 100 for

Due Gov't, \$ 100 for

Remarks: Free on or before April 19, 1861. Stop for one Haversack one Canteen The difference between one Dollar per month and Three Dollars per month is due from enlistment to April 30 1864

Book mark:

A. L. Ames

R | **9** | **U.S.C.T.**

Isaac Robbins 1st

Priv., Co. H, 9 Reg't U. S. Col'd Infantry.

Appears on

Company Muster Roll

for *Jan. & Feb.*, 1865.

Present or absent *Present*

Stoppage, \$ *100* for

Due Gov't, \$ *100* for

Remarks:

Book mark:

A. L. Ames

R | 9 | U.S.C.T.

Isaac Robbins 1st

Priv., Co. H, 9 Reg't U. S. Col'd Infantry.

Appears on

Company Muster Roll

for Mch. & Apr, 1865.

Present or absent Present

Stoppage, \$ 100 for

Due Gov't, \$ 100 for

Remarks:

Book mark:

A. L. Ames

R | 9 | U.S.C.T.

Isaac Robbins
Priv., Co. H, 9 Reg't U. S. Col'd Infantry.

Appears on

Company Muster Roll

for Dec. 31, 1864 to June 30, 1865.

Present or absent Present

Stoppage, \$ 100 for

Due Gov't, \$ 100 for

Remarks: Stop for one
month

Book mark:

A. L. Ames

R | 9 | U.S.C.T.

Isaac Robbins
Priv., Co. H, 9 Reg't U. S. Col'd Infantry.

Appears on

Company Muster Roll

for July & Aug., 1865.

Present or absent Present

Stoppage, \$ 100 for

Due Gov't, \$ 100 for

Remarks: Stop for Ord-
nance 96 cts.

Book mark:

A. L. Ames

R | 9 | U.S.C.T.

Isaac Robbins

Priv., Co. H, 9 Reg't U. S. Col'd Infantry.

Appears on

Company Muster Roll

for June 30 to Dec. 31, 1865.

Present or absent Present

Stoppage, \$ 96 100 for Ordnance &

Scts. for Camp & Gar. Equip.

Due Gov't, \$ 100 for

Remarks: Stop for Springfield R. Musket & set of Equipments Complete \$23.45

Book mark:

A. L. Ames

R.

9

U.S.C.T.

Isaac Robins 1st

Prith, Co. H, 9 Reg't U. S. Col'd Infantry.

Appears on

Company Muster Roll

for Jan. & Feb., 1866.

Present or absent Present.

Stoppage, \$ 100 for

Due Gov't, \$ 100 for

Remarks:

Book mark:

R. Prith

R. | 9 | U.S.C.T.

Isaac Robbins 1st

Privt., Co. H, 9 Reg't U. S. Col'd Infantry.

Appears on

Company Muster Roll

for March & April, 1864.

Present or absent Present.

Stoppage, \$ 100 for

Due Gov't, \$ 100 for

Remarks: On daily duty in Reg't
Q. M. Dept.

Book mark:

R. Braden

R,

9

U.S.C.T.

Isaac Robins 1st

Privt, Co. H, 9 Reg't U. S. Col'd Infantry.

Appears on

Company Muster Roll

for May & June, 1864.

Present or absent Present,

Stoppage, \$ 100 for

Due Gov't, \$ 100 for

Remarks: On daily duty in Reg't
Q. M. Dept.

Book mark:

R. Broadie

R. | 9 | U.S.C.T.

Issued Robbins 1st

Pratt, Co. H, 9 Reg't U. S. Col'd Infantry.

Appears on

Company Muster Roll

for July & August, 1866.

Present or absent Present.

Stoppage, \$ 100 for

Due Gov't, \$ 100 for

Remarks: On Daily duty in
Regtl. 2. M Dept.

Book mark:

R. Braden

R,

9

U.S.C.T.

Isaac Robbins, 1st

Prick, Co. H, 9 Reg't U. S. Col'd Infantry.

Appears on

Company Muster Roll

for Sept & Oct., 1864.

Present or absent Present

Stoppage, \$ 100 for

Due Gov't, \$ 100 for

Remarks: Daily duty in Regt. 2nd Dept.

Book mark:

R. Bradin

R. | 9 | U.S.C.T.

Isaac Robbins 1st

Privt, Co. *H*, 9 Reg't U. S. Col'd Infantry.

Appears on **Co. Muster-out Roll**, dated
New Orleans, La., Nov. 26, 1866.

Muster-out to date *Nov. 26, 1866.*

Last paid to *Aug. 21, 1866.*

Clothing account:

Last settled....., 186 ; drawn since \$..... 100

Due soldier \$ *49* ^{*66*}/₁₀₀; due U. S. \$..... 100

Am't for cloth'g in kind or money adv'd \$..... 100

Due U. S. for arms, equipments, &c., \$..... 100

Ordinary
Bounty paid \$..... 100; due \$ *100* 100

Remarks: *Bounty due under act of Congress of July 26/69 \$100. Joined at Original Organization.*

Book mark :

R. Bradlee

953
Robbins, Isaac (2)

Co H, 9 U.S. Col'd Inf.

Private

Private

CARD NUMBERS.

| | | |
|----|---------|----|
| 1 | 63/3441 | 26 |
| 2 | 63/3540 | 27 |
| 3 | 63/3640 | 28 |
| 4 | 63/3744 | 29 |
| 5 | 63/3842 | 30 |
| 6 | 63/3937 | 31 |
| 7 | 63/4028 | 32 |
| 8 | 63/4133 | 33 |
| 9 | 63/4233 | 34 |
| 10 | 63/4327 | 35 |
| 11 | 63/4420 | 36 |
| 12 | 63/4498 | 37 |
| 13 | 63/4580 | 38 |
| 14 | 63/4652 | 39 |
| 15 | 63/4716 | 40 |
| 16 | 63/4779 | 41 |
| 17 | 63/4839 | 42 |
| 18 | 63/4899 | 43 |
| 19 | 63/4958 | 44 |
| 20 | 63/5014 | 45 |
| 21 | 9069269 | 46 |
| 22 | | 47 |
| 23 | | 48 |
| 24 | | 49 |
| 25 | | 50 |

Book Mark:

See also

501 | 9 | U.S.C.T.

Isaac Robbins 2nd
Co. H., 9 Reg't U. S. Col'd Inf.

Appears on

Company Descriptive Book

of the organization named above.

DESCRIPTION.

Age *14* years; height *4* feet *9* inches.

Complexion *Black*

Eyes *Black*; hair *Black*

Where born *Maryland*

Occupation *Farmer*

ENLISTMENT.

When *Nov. 1861*, 186

Where *Berlin, Somerset Co. Md.*

By whom *Col. W. B. Boney*; term *3* y'rs.

Remarks: *Discharged Nov. 24 66.*
for ill. No. 10. Co. H. Dept. of
the Gulf.

Carey

R

9

U.S.C.T.

Isaac Robbins
Private, Co. H., 9 Reg't U. S. Col'd Infantry.

Age 20 years.

Appears on

Company Muster-in Roll

of the organization named above. Roll dated
Camp Stanton, Charles Co., Maryland, Nov. 23, 1863.

Muster-in to date Nov. 23, 1863

Joined for duty and enrolled:

When Nov. 18, 1863.

Where Worcester, Md.

Period 3 years.

Remarks:

Book mark:

O. J. Markle

R

9

U.S.C.T.

Isaac Robbins 25
Private, Co. H, 9 Reg't U. S. Col'd Infantry.

Appears on

Company Muster Roll

for Nov. 23 to Dec. 31, 1863

Present or absent Present

Stoppage, \$ 100 for

Due Gov't, \$ 100 for

Remarks: #2 Recruits Premium due.

Book mark:

O. J. Markle,

R

9

U.S.C.T.

Isaac Robbins 2^d

Private, Co. H, 9 Reg't U. S. Col'd Infantry.

Appears on

Company Muster Roll

for Jan. + Feb., 1864

Present or absent Present.

Stoppage, \$ 100 for

Due Gov't, \$ 100 for

Remarks: \$0. Recruits premium due.

daily duty as drummer.

Book mark:

O. J. Markle

(358)

Copyist.

R

9

U.S.C.T.

Samuel Robbins 2^d

Private, Co. H, 9 Reg't U. S Col'd Infantry.

Appears on

Company Muster Roll

for March & April, 1864

Present or absent Present

Stoppage, \$ 100 for

Due Gov't, \$ 100 for

Remarks:

Book mark:

O. J. Markle

R | **9** | **U.S.C.T.**

Isaac Robbins 2^d
Private, Co. H, 9 Reg't U. S Col'd Infantry.

Appears on

Company Muster Roll

for *May + June*, 1864.

Present or absent *Absent.*

Stoppage, \$ *100* for

Due Gov't, \$ *100* for

Remarks: *On Det. Ser. on gunboat*
John Adams since June 24,
1864 - per order of Lt. Col.
J. C. Armstrong Comd. Regt.

Book mark:

(358)

O. J. Markle,
Copyist.

R | **9** | **U.S.C.T.**

Jesse Robbins
Private, Co. H, 9 Reg't U. S Col'd Infantry.

Appears on

Company Muster Roll

for *July & August*, 1864.

Present or absent *Present*

Stoppage, \$ *100* for

Due Gov't, \$ *100* for

Remarks:

Book mark:

O. J. Markle,
Copyist.

P

9

U.S.C.T.

Isaac Robbins 2
Private, Co. H, 9 Reg't U. S. Col'd Infantry.

Appears on

Company Muster Roll

for Sept. & Oct., 1864.

Present or absent Present.

Stoppage, \$ 100 for

Due Gov't, \$ 100 for

Remarks:

Book mark:

O. J. Markle,

R | 9 | U.S.C.T.

Isaac Robbins 2nd
Priv., Co. H, 9 Reg't U. S. Col'd Infantry.

Appears on

Company Muster Roll

for Jan. & Feb., 1865.

Present or absent Present

Stoppage, \$ 100 for

Due Gov't, \$ 100 for

Remarks: Due the U.S. for
1 Canton \$0.65

Book mark:

A. L. Ames

R

9

U.S.C.T.

Isaac Robbins 2nd
Priv., Co. H, 9 Reg't U. S. Col'd Infantry.

Appears on

Company Muster Roll

for Mch. & Aprl, 1865.

Present or absent Present

Stoppage, \$ 100 for

Due Gov't, \$ 100 for

Remarks: Due the U.S. for
one Canteen \$0.65
Stop for one Drum
complete, one Drum
Sling, one pr. Sticks, &
one set Drum Snare

Book mark:

A. L. Ames

R | **9** | **U.S.C.T.**

Isaac Robbins 2^d

Priv., Co. H, 9 Reg't U. S. Col'd Infantry.

Appears on

Company Muster Roll

for *Dec. 31, 56 to June 30, 1865.*

Present or absent *Present*

Stoppage, \$ *100* for

Due Gov't, \$ *100* for

Remarks: *Stop for me Can-
teen, one Drum Com-
plets, one Drum skin,
one per sticks one set
Drum snare.*

Book mark:

A. L. Jones

R | **9** | **U.S.C.T.**

Isaac Robbins 2^d
Priv., Co. H, 9 Reg't U. S. Col'd Infantry.

Appears on

Company Muster Roll

for *July & Aug.*, 1865.

Present or absent *Present*

Stoppage, \$ *100* for

Due Gov't, \$ *100* for

Remarks:

Book mark:

H. Ames

R | 9 | U.S.C.T.

Isaac Robbins 2^d
Priv., Co. H, 9 Reg't U. S. Col'd Infantry.

Appears on

Company Muster Roll

for June 30 to Oct. 31, 1865.

Present or absent Present

Stoppage, \$ 100 for

Due Gov't, \$ 100 for

Remarks:

Book mark:

A. L. Ames

R

9

U.S.C.T.

Isaac Robbins 2nd

Priv., Co. H, 9 Reg't U. S. Col'd Infantry.

Appears on

Company Muster Roll

for June 30 to Dec. 31, 1865.

Present or absent Present

Stoppage, \$ 100 for

Due Gov't, \$ 100 for

Remarks:

Book mark:

A. L. Arice

(358)

Copyist.

R, | 9 | U.S.C.T.

Isaac Robbins 2^d

Privt, Co. H, 9 Reg't U. S. Col'd Infantry.

Appears on

Company Muster Roll

for Jan. & Feb., 1864.

Present or absent Present

Stoppage, \$ 100 for

Due Gov't, \$ 100 for

Remarks:

Book mark:

R. Bradis

R. | 9 | U.S.C.T.

Isaac Robbins 2^d

Privt, Co. H, 9 Reg't U. S. Col'd Infantry.

Appears on

Company Muster Roll

for March & April, 1866.

Present or absent Present

Stoppage, \$ 100 for

Due Gov't, \$ 100 for

Remarks: On daily duty as musician

Book mark:

R. Braden

R. | 9 | U.S.C.T.

Isaac Robbins, 2^d
Privat, Co. H, 9 Reg't U. S. Col'd Infantry.

Appears on

Company Muster Roll

for *May & June*, 186 *6*.

Present or absent *Present*.

Stoppage, \$ *100* for

Due Gov't, \$ *100* for

Remarks: *On daily duty as New-*
sician.

Book mark:

R. Bradin

R.

9

U.S.C.T.

Isaac Robbins 2^d

Prvt, Co. H, 9 Reg't U. S. Col'd Infantry.

Appears on

Company Muster Roll

for July & Aug., 1864.

Present or absent Absent.

Stoppage, \$ 100 for

Due Gov't, \$ 100 for

Remarks: Stop one Drum Case,
Absent in confinement at Military
prison Brownsville Texas.

Book mark:

R. Pradin

R

9

U.S.C.T.

Isaac Robbins 2^d

Privt, Co. H, 9 Reg't U. S. Col'd Infantry.

Appears on

Company Muster Roll

for Sept. & Oct. , 1864.

Present or absent Absent.

Stoppage, \$ 100 for

Due Gov't, \$ 100 for

Remarks: Absent sick in U.S.G. Hospital Greenville La, since Oct. 21/64. Stop for one canteen & 1 Drum stick carriage \$1.15.

Book mark:

R. Braden

R.

9

U.S.C.T.

Isaac Robbins 2^d

Park, Co. '26", 9 Reg't U. S. Col'd Infantry.

Appears on **Co. Muster-out Roll**, dated

New Orleans, La, Nov. 26th 1864.

Muster-out to date *Nov. 26, 1864*.

Last paid to *Oct. 31, 1864*.

Clothing account:

Last settled....., 186 ; drawn since \$..... 100

Due soldier \$ *3* ^{*82*}/₁₀₀; due U. S. \$..... 100

Am't for cloth'g in kind or money adv'd \$..... 100

Due U. S. for arms, equipments, &c., \$ *5* ^{*15*}/₁₀₀

Ordinary
Bounty paid \$..... 100; due \$ *100* 100

Remarks: *Joined at Original organization. Stop for one Canton & Drumstick carriage. Stop for one Musician's sword & sword Belt, & Plate Double Frog retained.*

Book mark:

R. Braden

Robbins, Isaac, 2^d
D. H. 9 Reg't *U.S.C. Inf*

Enclosures.

| | |
|------------------------------------|----------------------------|
| Bed Cards | Final Statements |
| Burial Records | Furloughs or L. of A |
| Certs. of Dis. for Discharge | Med. Certificates |
| C. M. Charges | Med. Des. Lists |
| Descriptive Lists | Orders |
| Discharge Certificates | Pris. of War Record |
| Enlistment Papers | Resignations |

Other papers relating to—

| | |
|------------------------------|----------------------------------|
| Admission to Hosp'l | Furlough or L. of A |
| Casualty Sheet | Med. Examination |
| Confinement | Misc. Information <i>/</i> |
| Contracts | Pay or Clothing |
| Death or Effects | Personal Reports |
| Desertion | Rank |
| Discharge from Hosp'l | Transfer to Hosp'l |
| Discharge from Service | Transfer to V. R. C. |
| Duty | Transportation |

v

Isaac Robbins And
Comate C. H.
Gruyer T.

Mr Ellsworth

Adjutant General's Office,

COLORED TROOPS BRANCH,

April 24th, 1877

Mr. Ellerbrook.

Vol. C. T., 187

Wanted in the case of Isaac Robbins 2nd Pmt, Co. H,
9th Reg't U. S. C. Troops. Record of Trial. &c.

M.R. for July & Aug/66 reports him absent in confinement at
Military Prison Brownsville Texas.

Respectfully,

L. A. Woodward
Chief Clerk.

J. J. Halson

M.P.S.

Adjutant General's Office,

Div. Records discontinued Comd's &c
May 1st, 1877

Vol. C. T., 187

Reply in case of Isaac Robbins 2nd Pmt., Co. A,
9th Reg't U. S. C. T.

Co. Mg. Rep. book shows July 5th 1866: Placed in arrest on the 1st of July.
Sept. 2nd '66: Returned from absent in arrest & report to duty. On daily duty as Musician

No evidence relative to trial. - G.M. Order book of Dist. Rio Grande and
Records of Mil. Prison Brownsville, are not in file.

W.S.

Robbins, Jenkins ⁹⁵⁴
 Co F, 9 U.S. Col'd Inf.

Corporal | Corporal

CARD NUMBERS.

| | | |
|----|---------|----|
| 1 | 6309874 | 26 |
| 2 | 6309974 | 27 |
| 3 | 6310169 | 28 |
| 4 | 6111629 | 29 |
| 5 | 9069045 | 30 |
| 6 | | 31 |
| 7 | | 32 |
| 8 | | 33 |
| 9 | | 34 |
| 10 | | 35 |
| 11 | | 36 |
| 12 | | 37 |
| 13 | | 38 |
| 14 | | 39 |
| 15 | | 40 |
| 16 | | 41 |
| 17 | | 42 |
| 18 | | 43 |
| 19 | | 44 |
| 20 | | 45 |
| 21 | | 46 |
| 22 | | 47 |
| 23 | | 48 |
| 24 | | 49 |
| 25 | | 50 |

Book Mark:

See also

R | 9 | U.S.C.T.

Jenkins Robbins
 , Co. F, 9 Reg't U. S. Col'd Inf.

Appears on
Company Descriptive Book
 of the organization named above.

DESCRIPTION.

Age 27 years; height 5 feet 8 5/8 inches.
 Complexion Dark
 Eyes Black; hair Black
 Where born Worcester Maryland
 Occupation Farmer

ENLISTMENT.

When Nov 18, 1863
 Where Berlin Worcester Co Ind
 By whom Lt W. M. Perry; term three y'rs.
 Remarks: Mustered in as Corp. in
 2nd Regt of Heavy Artillery
 Ind. July 5, 1864 of disease

H. B. Singer
 Copyist.

R. 9 U.S.C.T.

Jenkins Robbins
 Corp., Co. F, 9 Reg't U. S. Col'd Infantry.

Age 27 years.

Appears on

Company Muster-in Roll

of the organization named above. Roll dated

Charles Md, Nov 23, 1863.

Muster-in to date Nov 23, 1863

Joined for duty and enrolled:

When Nov. 18, 1863.

Where Worcester Md.

Period 3 years.

Remarks:

Book mark:

Martin

R | 9 U.S.C.T.

Jenkins Robbins
Corp, Co. F, 9 Reg't U. S. Col'd Infantry.

Appears on

Company Muster Roll

for Nov. 23 to Dec 31, 1863.

Present or absent Present

Stoppage, \$ 100 for

Due Gov't, \$ 100 for

Remarks: \$2.00 Recruit
Premium due.

Book mark:

Martin

R | **9** | **U.S.C.T.**

Jenkins Robbins
Cozf, Co. F, 9 Reg't U. S. Col'd Infantry.

Appears on

Company Muster Roll

for *Jan + Feb*, 1864.

Present or absent

Stoppage, \$ *100* for

Due Gov't, \$ *100* for

Remarks: *Died at Benedict*
of disease; Jan. 5.
1864. Inventory
and final statement
forwarded.
\$200 Recruit Premium
due.

Book mark: *7250, 2d A. Jan 28, 68. 148, 860.*
Wr. 6. D.

Martin

R | 9 | U.S.C.T.

Jenkins Robbins
Cap., Co. *F.*, 9 Reg't U. S. Col'd Infantry.

Appears on **Co. Muster-out Roll**, dated
New Orleans, Lou, Nov. 26, 1866.

Muster-out to date _____, 186 .

Last paid to _____, 186 .

Clothing account:

Last settled _____, 186 ; drawn since \$ _____ 100

Due soldier \$ _____ 100; due U. S. \$ _____ 100

Am't for cloth'g in kind or money adv'd \$ _____ 100

Due U. S. for arms, equipments, &c., \$ _____ 100

Bounty paid \$ _____ 100; due \$ _____ 100

Remarks: *Joined at Original*
Orgn.
Died of disease Jan. 5/64
at Benedict Md. Final
statements forwarded.

Book mark: *148,800*

(over)

(361) *J. E. Nichol* Copyist.

ARRIVAL

JAN. 21

6311629

el8810

V. 12, P. 55-70

25-8, 85-9

F. S.

Robbins, Jenkins

P, Co. *F*, **9** Reg' **U.S.C. Inf.**

Qu

Bailey, John

Enclosures.

| | |
|------------------------------|---------------------------|
| Bed Cards | Descriptive Lists |
| Burial Records | Final Statements <i>/</i> |
| Certs. of Dis. for Discharge | Furloughs |
| C. M. Charges | Med. Des. Lists |
| Med. Certificates | Orders |

Other papers relating to—

| | |
|----------------------------|----------------------|
| Admission to Hosp'l | Furlough |
| Casualty Sheet (Officer's) | Med. Examination |
| Confinement | Misc. Information |
| Contracts | Pay or Clothing |
| Death or Effects | Personal Reports |
| Desertions | Rank |
| Discharge from Hosp'l | Transfer to Hosp'l |
| Discharge from Service | Transfer to V. R. C. |
| Duty | Transportation |

✓ *110*

FINAL STATEMENT

OF

Gentle Robbins
9th Reg't of U. S. Colored

VOLUNTEERS.

NOTE 1.—Two of these certificates (or duplicates) are to be given to each Volunteer Soldier or drafted man who may be discharged previously to the discharge of his company, that he may at once receive from the Paymaster the pay, &c., due him, and the captain or other COMMISSIONED officer commanding the company will certify to the act of the delivery of the duplicate certificates; on these certificates the Soldier is "entitled to" his discharge, and should also present his discharge to the Paymaster to have the payment endorsed on it. The discharge is to be given back to the Soldier by the Paymaster; the latter only retaining as his voucher the duplicate certificates.

NOTE 2.—If the Soldier is entitled to pay for the use of his horse, the Company Commander will certify to that fact on the back of both these final statements, and also to the time he has pay due for having been so mounted on his own horse.

NOTE 3.—When a Soldier is furnished with final statements, his descriptive list, if he has one, should be taken up by the officer who gives the Soldier these statements, and endorsed with a statement to this effect by the officer. This endorsement should exhibit a full statement of the time for which the Soldier was allowed pay on his final statements, the clothing account, and all other charges against him or in his favor, so as to comprise a complete exhibit of his account. It will then be transmitted to the company commander of the Soldier, who will enter all the data necessary to a full understanding of the Soldier's account on the muster roll upon which the Soldier's discharge is reported. The descriptive list will then be destroyed. The object of this is, that the remaining portion of the Soldier's account may be settled upon the receipt of these muster rolls, and the Soldier receive any pay or allowances that may be due him at the time of his discharge, and which may not appear on his final statements from the fact that his descriptive list is incomplete. These accounts for back pay, &c., are settled by the 2d Auditor of the Treasury Department.

NOTE 4.—Charges for loss or injury to ordnance, horse equipments, and other miscellaneous charges, should appear under the heading of "Other Stoppages."

NOTE 5.—Bounty paid by State authorities, and not by the United States, will not be entered on this statement.

NOTE 6.—Amounts due the Stryker and Laundress must be entered on the muster roll on which the discharge, death, desertion, &c., is reported, as well as on the final statement, otherwise the amount cannot be collected from the United States.

NOTE 7.—This blank will be used for deceased volunteers and drafted men, as well as for others.

NOTE 8.—Where a Soldier dies in Hospital or on detached service, his descriptive list, if he has one, should be sent with his final statements, in duplicate, to the Second Auditor, Washington, D. C.

ADJUTANT GENERAL'S OFFICE
March 11th
Duplicate with Inventory sent 2d

Erwin P. Rogers

I certify, on honor, that Jenkins Robbins Corporal of
 Captain William Royal's Company (No. 4) of the 11th Regiment of U.S. Colored
VOLUNTEERS, of the State of Massachusetts, born in Ware, State
 of Mass. Cont., aged 27 years; 5 feet 9 inches high; Dark complexion,
Blue eyes, Dark hair, and by occupation a Farmer, having joined the company on
 its original organization at Camp Beantown, and enrolled in it at the muster into
 the service of the United States at Camp Beantown, on the Twenty third day
 of November, 1863, (or was mustered in service as a recruit, by
 _____, at _____, on the _____ day of _____,
 186 , or was drafted and mustered into the service of the United States from the _____
 Enrollment District of the State of _____, at _____,
 on the _____ day of _____, 186 .) to serve in the Regiment, for
 the term of Three years during the War: and having served HONESTLY and
 FAITHFULLY with his Company in the capacity of Corporal to the present date, is now
 entitled to a **DISCHARGE** by reason of Discharge

Paid June 5, 1864
 100 dollars

The said _____ was last paid by Paymaster
 _____ to include the _____ day of _____, 186 , and has
 pay due him from ~~that time~~ ^{in arrears} to the present date; he is entitled to pay and subsistence for
TRAVELING to place of enrollment, and whatever other allowances are authorized to volunteer
 soldiers, drafted men, or militia, so discharged. He has received from the United States **CLOTHING**
 amounting to One ²⁷ dollars, since the 27th day of November,
 1863, when his clothing account was last settled. He has received from the United States
 _____ ¹⁰⁰ dollars advanced **BOUNTY**.

There is to be stopped from him, on account of the State of United States or other
 authorities, for **CLOTHING**, &c., received on entering service, Twenty ²⁰ dollars; and
 for other stoppages, viz: one hundred and one
dollars _____ ¹⁰⁰ dollars.

He has been furnished with **TRANSPORTATION** in kind from the place of his discharge to
 _____; and he has been **SUBSISTED** for **TRAVELING** to his
 place of enrollment, up to the _____, 186 .

He is indebted to _____, **SUTLER**, _____ dollars.
 He is indebted to _____, **LAUNDRESS**, _____ dollars.

Given in Duplicate, at Camp Beantown, this 6th day
 of January, 1864.

William Royal
Capt. U.S.C.
 Commanding Company.

Robbins, Thomas

Co G, 9 U.S. Col'd Inf.

Private Private

CARD NUMBERS.

| | | |
|----|---------|----|
| 1 | 63/1743 | 26 |
| 2 | 63/1837 | 27 |
| 3 | 63/1871 | 28 |
| 4 | 63/1972 | 29 |
| 5 | 63/2068 | 30 |
| 6 | 63/2163 | 31 |
| 7 | 63/2321 | 32 |
| 8 | 63/2414 | 33 |
| 9 | 63/2505 | 34 |
| 10 | 63/2593 | 35 |
| 11 | 63/2679 | 36 |
| 12 | 63/2779 | 37 |
| 13 | 63/2327 | 38 |
| 14 | 63/0365 | 39 |
| 15 | 9069/63 | 40 |
| 16 | | 41 |
| 17 | | 42 |
| 18 | | 43 |
| 19 | | 44 |
| 20 | | 45 |
| 21 | | 46 |
| 22 | | 47 |
| 23 | | 48 |
| 24 | | 49 |
| 25 | | 50 |

Book Mark:

See also

ARRIVED

S. 680805 P. C. aff
S 1016291 - Po p. d. med
S 2138195 P. C. M. M.

C. S. Donnelly
2

R | 9 | U.S.C.T.

Thos. Robbins

....., Co. *G*, 9 Reg't U. S. Col'd Inf.

Appears on

Company Descriptive Book

of the organization named above.

DESCRIPTION.

Age *29* years; height *5* feet *5 1/4* inches.

Complexion *Black*

Eyes *Black*; hair *Wool*.

Where born *Worcester, Md.*

Occupation *Farm h.*

ENLISTMENT.

When *Nov. 18*....., 1863

Where *Berlin, Worcester.*

By whom *Col. Wm. Biney*, term *3* y'rs.

Remarks: *Free.*

Made Corp from private. Promoted to Serg't. Reduced to ranks for inefficiency & disobedience of orders.

Discharged by order War Department.

M. Jackson

R

9

U.S.C.T.

Thomas Robbins

Pr't, Co. G, 9 Reg't U. S. Col'd Infantry.

Age 29 years.

Appears on

Company Muster-in Roll

of the organization named above. Roll dated

Camp Stanton
Charles Co Md., Nov 23, 1863.

Muster-in to date

Nov 23, 1863

Joined for duty and enrolled:

When Nov 18, 1863.

Where Worcester Md.

Period 3 years.

Remarks:

Book mark:

E. B. Carroll

R

9

U.S.C.T.

Thomas Robbins

Pvt., Co. G, 9 Reg't U. S. Col'd Infantry.

Appears on

Company Muster Roll

for Nov 23 to Dec 31, 1863.

Present or absent Absent

Stoppage, \$ 100 for

Due Gov't, \$ 100 for

Remarks: \$2.00 Recruiting premium
Dec. 1. On recruiting service
since Dec 20. Post order No 92

Book mark:

E. G. Carroll

R

9

U.S.C.T.

Thomas Robbins
Corpl., Co. G, 9 Reg't U. S. Col'd Infantry.

Appears on

Company Muster Roll

for Jan'y + Feb, 1864.

Present or absent Present

Stoppage, \$ 100 for

Due Gov't, \$ 100 for

Remarks: Appointed Corpl. Feb 12.
SO No. 36. Hd. qrs. 9 U.S.C.T.
\$ 2.00 Recruiting premium due

Book mark:

E. C. Carroll

R

9

U.S.C.T.

Thomas Robbins
Capt., Co. G, 9 Reg't U. S. Col'd Infantry.

Appears on

Company Muster Roll

for March & April, 1864.

Present or absent Present

Stoppage, \$ 100 for

Due Gov't, \$ 100 for

Remarks:

Book mark:

E. Carroll

R

9

U.S.C.T.

Thomas Robbins
Srpt., Co. G, 9 Reg't U. S. Col'd Infantry.

Appears on

Company Muster Roll

for *May & June*, 1864.

Present or absent *Present*

Stoppage, \$ *100* for

Due Gov't, \$ *100* for

Remarks: *Promoted from Corp.*
SO. 75. June 9th. Hd. qrs. 9th.
W.S.C.T.

Book mark:

E. Carroll

R

9

U.S.C.T.

Thomas Robins
Sgt., Co. G, 9 Reg't U. S. Col'd Infantry.

Appears on

Company Muster Roll

for July & Aug, 1864.

Present or absent Present

Stoppage, \$ 100 for

Due Gov't, \$ 100 for

Remarks: Free on or before April 19-61

Book mark:

E. Carroll

R

9

U.S.C.T.

Thomas Robins

Priv., Co. G, 9 Reg't U. S. Col'd Infantry.

Appears on

Company Muster Roll

for Sept & Oct, 1864.

Present or absent Present.

Stoppage, \$ 100 for

Due Gov't, \$ 100 for

Remarks: Reduced from Supt. SO No 7, dated Hd. qrs. 9 W. S. I. Oct 16, 1864, Free on or before April 19, 1861, Stop for Hapsack & 2 great Coat Straps

Book mark:

E. C. Carroll

R

9

U.S.C.T.

Thomas Robin
Private, Co. G, 9 Reg't U. S. Col'd Infantry.

Appears on

Company Muster Roll

for Nov. & Dec., 1864.

Present or absent Present

Stoppage, \$ 100 for

Due Gov't, \$ 100 for

Remarks: Reduced from
Sergeant, S. O. No 7 Ad-202
9th U.S. C. I. Oct. 16/64
Free on or before April
19/64 Stop knapsack
Two Great Coat Straps

Book mark:

W. M. Warren

R

9

U.S.C.T.

Thomas Robbins
Private, Co. G, 9 Reg't U. S. Col'd Infantry.

Appears on

Company Muster Roll

for Jan. & Feb., 1865.

Present or absent Present

Stoppage, \$ 100 for

Due Gov't, \$ 100 for

Remarks:

Book mark:

M. W. Warren

R

9

U.S.C.T.

Thomas Robbins
Private, Co. G, 9 Reg't U. S. Col'd Infantry.

Appears on

Company Muster Roll

for *Mar. & Aprie*, 1865.

Present or absent *Present*

Stoppage, \$ 100 for

Due Gov't, \$ 100 for

Remarks:

Book mark:

W. M. Massen

R

9

U.S.C.T.

Thomas Robbins
Priv., Co. G, 9 Reg't U. S. Col'd Infantry.

Appears on

Company Muster Roll

for Dec. 31/64 to June 30, 1865.

Present or absent Absent

Stoppage, \$ 100 for

Due Gov't, \$ 100 for

Remarks: Abs. sick since
May 30 65

Book mark:

W. M. Warren

R

9

U.S.C.T.

Thomas Robbins
Priv., Co. G, 9 Reg't U. S. Col'd Infantry.

Appears on

Company Muster Roll

for July & Aug., 1865.

Present or absent

Stoppage, \$ 100 for

Due Gov't, \$ 100 for

Remarks: Discharged by ord
War Dept. of May 3, 65
June 14, 65 Ft Monroe, Va.
Rec on or bef. Apr 19, 66
no bounty yet rec'd \$100.00
due.

Book mark: 5730 Pmly June 11, 66 T.

M. Mark Warren

R 1 9 U.S.C.T.

Thomas Robbins
out, Co. *4*, *a* Reg't U. S. Col'd *1st*

Appears on an

Individual Muster-out Roll

of the organization named above. Roll dated

Fort Monroe, Va, *June 14*, 1865.

Muster-out to date *June 14*, 1865.

Last paid to *Dec 31*, 1864.

Clothing account:

Last settled *Oct 31*, 1864; drawn since \$ *100*

Due soldier \$ *100*; due U. S. \$ *100*

Am't for cloth'g in kind or money adv'd \$ *38* ^{*68*}/_{*100*}

Due U. S. for arms, equipments, &c., \$ *100*

Bounty paid \$ *100*; due \$ *100*

Remarks: *Mustered out by Order*
War Dept. dated May 3rd 1865.
Patient in U.S. Genl. Hospital
Fort Monroe, Va.

Book mark: _____

W. O. Chance

R 9 | U.S.C.T.

Thomas Robbins
 Priv., Co. G., 9 Reg't U. S. Col'd Infantry.

Appears on **Co. Muster-out Roll**, dated
 New Orleans La., Nov. 26, 1866.

Muster-out to date _____, 186 .

Last paid to _____, 186 .

Clothing account:

Last settled _____, 186 ; drawn since \$ _____ 100

Due soldier \$ _____ 100; due U. S. \$ _____ 100

Am't for cloth'g in kind or money adv'd \$ _____ 100

Due U. S. for arms, equipments, &c., \$ _____ 100

Bounty paid \$ _____ 100; due \$ _____ 100

Remarks: *Joined at origl. regt.*

*Discharged June 14, '65, Ft
 Monroe Va. Tel. Order Ad. M. May 3,
 '65. - Priv. to Feb. 12, '64. Corp. to
 June 9, '64. Sergt. to Oct. 16, '64.*

Book mark: *V. 54. P. 131. 64.*

V. 162. P. 77. 73

C. E. M. Laughlin

(861)

Copyist.

Robbins, Thomas
D. G. 9 Reg't *U.S.C. Inf.*
 , Co. ,

Enclosures.

| | |
|------------------------------------|----------------------------|
| Bed Cards | Final Statements |
| Burial Records | Furloughs or L. of A |
| Certs. of Dis. for Discharge | Med. Certificates |
| C. M. Charges | Med. Des. Lists |
| Descriptive Lists | Orders |
| Discharge Certificates | Pris. of War Record |
| Enlistment Papers | Resignations |

Other papers relating to—

| | |
|------------------------------|----------------------------|
| Admission to Hosp'l | Furlough or L. of A |
| Casualty Sheet | Med. Examination |
| Confinement | Misc. Information |
| Contracts | Pay or Clothing |
| Death or Effects | Personal Reports |
| Desertion | Rank |
| Discharge from Hosp'l | Transfer to Hosp'l |
| Discharge from Service | Transfer to V. R. C. |
| Duty | Transportation |

NARA 1974

Adjutant General's Office,

COLORED TROOPS BRANCH,

April 13th, 1877

Mr Ellersbrook Vol.

C. T., 187

Wanted in the case of Thomas Robbins, Co. G,
9th Reg't U.S.C. Cause of Reduction.

MR. J. M. Sept 10/64 reports him Reduced from Sergt.
pers Oct 7. Had in Reg't. Oct 16/64.

Respectfully,

W. A. Woodward
Chief Clerk.

J. H. Halson

Adjutant General's Office,

Records & Discontinued Com'd's &c.

April 16, 1877

Vol. C. T., 187

Reply in case of Thomas Robbins, Co. G,
9th Reg't U.S.C.

Co. Order Book. Reduced to the ranks, (from Sergt.)
for general inefficiency and disob. of orders, per
S.O. No. 7 Reg't. 14th Qr. Oct. 18, 1864.

W.F.

MR

⁹⁵⁶
Roberts, David

Co A, 9 U.S. Col'd Inf.

Private Private

CARD NUMBERS.

| | | |
|----|---------|----|
| 1 | 6300806 | 26 |
| 2 | 6300906 | 27 |
| 3 | 6300943 | 28 |
| 4 | 6301044 | 29 |
| 5 | 6301139 | 30 |
| 6 | 6301236 | 31 |
| 7 | 6301331 | 32 |
| 8 | 6301422 | 33 |
| 9 | 6301524 | 34 |
| 10 | 6301602 | 35 |
| 11 | 6301718 | 36 |
| 12 | 6301814 | 37 |
| 13 | 6301909 | 38 |
| 14 | 6302003 | 39 |
| 15 | 6302083 | 40 |
| 16 | 6302158 | 41 |
| 17 | 6302229 | 42 |
| 18 | 6302345 | 43 |
| 19 | 6302410 | 44 |
| 20 | 6302479 | 45 |
| 21 | 9068598 | 46 |
| 22 | | 47 |
| 23 | | 48 |
| 24 | | 49 |
| 25 | | 50 |

Book Mark:

See also

MAR 1976

D 2201506 a.o. m m
D. 2208053 P.O. Ritt
R.P. 743655

S-2658523 - Aud. WD

S. S. Doughty
2

9

U.S.C.T.

David Coler

, Co. A, 9 Reg't U. S. Col'd Inf.

Appears on

Company Descriptive Book

of the organization named above.

DESCRIPTION.

Age 20 years; height 5 feet 6 inches.

Complexion Fair

Eyes Brown; hair Black

Where born Somersct Md

Occupation Farmer

ENLISTMENT.

When Oct 21, 1863

Where Benedict

By whom Col Berney; term 3 y'rs.

Remarks: Promoted to Corp July 26/64
Promoted to Sgt May 31/64. Reduced to the ranks p. L. M. order Aug 16/66
Mustered out with Regt Nov 26/66

J. H. Kelley

R

9

U.S.C.T.

David Roberts
Civ, Co. *A*, 9 Reg't U. S. Col'd Infantry.

Age *20* years.

Appears on

Company Muster-in Roll

of the organization named above. Roll dated

Camp Stanton Ches. Co. Md. Nov. 11", 1863.

Muster-in to date

Nov. 11", 1863

Joined for duty and enrolled:

When

Oct. 21"

, 1863.

Where

Somerset Md.

Period

3

years.

Remarks:

Book mark:

23708

(356)

W. H. Ferguson

Copyist.

R

9

U.S.C.T.

David Roberts

Priv., Co. A, 9 Reg't U. S. Col'd Infantry.

Appears on

Company Muster Roll

for Nov. 11" to Dec. 31", 1863.

Present or absent Present

Stoppage, \$ 100 for

Due Gov't, \$ 100 for

Remarks: \$2 Recruit premium due

Book mark:

W B Ferguson

R 9 U.S.C.T.

David Roberts
Corp, Co. A, 9 Reg't U. S. Col'd Infantry.

Appears on

Company Muster Roll

for Jan. & Feb., 1864.

Present or absent Present

Stoppage, \$ 100 for

Due Gov't, \$ 100 for

Remarks: \$ 2 recruit premium due.

Promoted Corp'l.
Special order No. 42
Hd. Qrs. 9th U. S. C. I.
dated Feb. 26th 1864.

Book mark:

M. P. Ferguson

P | **9** **U.S.C.T.**

David Roberts
Corp, Co. A, 9 Reg't U. S. Col'd Infantry.

Appears on

Company Muster Roll

for *March & April*, 186*4*.

Present or absent *+*

Stoppage, \$ *100* for

Due Gov't, \$ *100* for

Remarks: *Absent on duty service*
Special order No. 7 Hd. Qrs
Provost Guard Hilton Head
S.C. April 28th 1864 at
Jacksonville Fla.

Name appears in column
of names present with a
line drawn through it.

Book mark:

W. Ferguson

R 9 U.S.C.T.

David Roberts
Serjt, Co. A, 9 Reg't U. S. Col'd Infantry.

Appears on

Company Muster Roll

for *May & June*, 1864.

Present or absent *Present*

Stoppage, \$ *100* for

Due Gov't, \$ *100* for

Remarks: *Promoted to Serjt.*
Special order No. 68
Ad. 2nd 9th U.S.C.I.
dated May 21st 1864

Book mark:

W. Ferguson

R

9

U.S.C.T.

David Roberts
Supt, Co. A, 9 Reg't U. S. Col'd Infantry.

Appears on

Company Muster Roll

for *July & Aug.*, 1864.

Present or absent *Present*

Stoppage, \$ 100 for

Due Gov't, \$ 100 for

Remarks:

Book mark:

W. B. Ferguson

(858)

Copyist

2 | **9** | **U.S.C.T.**

David Roberts
Sergt, Co. A, 9 Reg't U. S. Col'd Infantry.

Appears on

Company Muster Roll

for *Sept. & Oct.*, 1864.

Present or absent *Present*

Stoppage, \$ *100* for

Due Gov't, \$ *100* for

Remarks:

Book mark: -----

W. B. Ferguson
(858) Copyist

R

9

U.S.C.T.

David Roberts

Sgt, Co. *A*, 9 Reg't U. S. Col'd Infantry.

Appears on

Company Muster Roll

for *Nov. + Dec.*, 1864.

Present or absent *Present*

Stoppage, \$ *100* for

Due Gov't, \$ *100* for

Remarks:

Book mark:

W. B. Stevenson

47 | **9** | **U.S.C.T.**

Dwight Roberts
Sgt, Co. A, 9 Reg't U. S. Col'd Infantry.

Appears on

Company Muster Roll

for *Jan & Feb*, 186*5*.

Present or absent *Present*

Stoppage, \$ *100* for

Due Gov't, \$ *100* for

Remarks:

Book marks *999999*

W. G. Mowser
Copyist

B

9

U.S.C.T.

Dwight Rose

Sgt., Co. A, 9 Reg't U. S. Col'd Infantry.

Appears on

Company Muster Roll

for *Mar & April*, 1857.

Present or absent *Present*

Stoppage, \$ 100 for

Due Gov't, \$ 100 for

Remarks: *Stop for transportation while on furlough \$3.58*

Book mark:

W E Mowbray

(358)

Copyist

CF

9

U.S.C.T.

Louis Couette

Couette, Co. A, 9 Reg't U. S. Col'd Infantry.

Appears on

Company Muster Roll

for *March 1864*, 186*4*.

Present or absent *Present*

Stoppage, \$ *100* for

Due Gov't, \$ *100* for

Remarks: *See list on page*

attached \$3.00

Book mark:

(858)

Copyist

1 | **9** | **U.S.C.T.**

John Doe

John Doe, Co. A, 9 Reg't U. S. Col'd Infantry.

Appears on

Company Muster Roll

for *June 1864*, 186*4*.

Present or absent *Present*

Stoppage, \$ *100* for

Due Gov't, \$ *100* for

Remarks:

Book mark:

R

9

U.S.C.T.

David Roberts

sgt, Co. A, 9 Reg't U. S. Col'd Infantry.

Appears on

Company Muster Roll

for *Jun 30* to *Oct 31*, 186*5*.

Present or absent *present*

Stoppage, \$ *100* for

Due Gov't, \$ *100* for

Remarks:

Book mark:

W. J. Browner

9 **U.S.C.T.**

David Roberts

Sgt, Co. A, 9 Reg't U. S. Col'd Infantry.

Appears on

Company Muster Roll

for *Jun 30* dated *3*, 186*5*.

Present or absent *present*

Stoppage, \$ *37* / *100* for *Ordinance*

Stores lost

Due Gov't, \$ *100* for

Remarks: *Due the credit the*
difference between \$13.00
per month and \$17.00 from
July 1st 64 to April 30th 64

Book mark:

W. E. Roberts

9

U.S.C.T.

James G. ...

..., Co. A, 9 Reg't U. S. Col'd Infantry.

Appears on

Company Muster Roll

for ..., 186.

Present or absent

Stoppage, \$ 100 for

Due Gov't, \$ 100 for

Remarks:

Book mark:

James G. ...

R

9

U.S.C.T.

David Roberts

Serje, Co. A, 9 Reg't U. S. Col'd Infantry.

Appears on

Company Muster Roll

for March - April, 1866.

Present or absent Present

Stoppage, \$ 100 for

Due Gov't, \$ 100 for

Remarks Stop for paper and 1
screw driver & cone wrench
25 cts.

Book mark:

Greger

R

9

U.S.C.T.

David Roberts

Sgt, Co. A, 9 Reg't U. S. Col'd Infantry.

Appears on

Company Muster Roll

for May + June, 1864.

Present or absent Present

Stoppage, \$ 100 for

Due Gov't, \$ 100 for

Remarks:

Book mark

Breyer

R

9

U.S.C.T.

David Roberts

Co. A, 9 Reg't U. S. Col'd Infantry.

Appears on

Company Muster Roll

for July & Aug, 1866.

Present or absent Absent

Stoppage, \$ 100 for

Due Gov't, \$ 100 for

Remarks: Reduced to the ranks from sergt for G.O. M.O. No 22 Hed Huss & R. G. Aug 16, 66. Stop \$10. per month for same order, Absent in arrears

Book marks:

Bryer

R

9

U.S.C.T.

David Roberts

Co. A, 9 Reg't U. S. Col'd Infantry.

Appears on

Company Muster Roll

for Sept & Oct, 1864.

Present or absent Present

Stoppage, \$ 100 for

Due Gov't, \$ 100 for

Remarks Stop (sentence & G.M.) \$10.00 per month in confinement

Book mark:

Breyer

R | 9 | U.S.C.T.

David Roberts

Co. A, 9 Reg't U. S. Col'd Infantry.

Appears on **Co. Muster-out Roll**, dated
New Orleans La. Jan 24, 1864.

Muster-out to date *Nov 24*, 1864.

Last paid to *Aug 31*, 1864.

Clothing account:

Last settled _____, 186 ; drawn since \$ 100

Due soldier \$ *30* ⁹¹ 100; due U. S. \$ 100

Am't for cloth'g in kind or money adv'd \$ 100

Due U. S. for arms, equipments, &c., \$ 100

Ordinary Bounty paid \$ *none* 100; due \$ *114* ^x 100

Remarks: *(Due under act of May July 24, 65 § 1102) Joined at Capt. org. Private to Feb 24, 64 Capt. to May 24, 64 Sergt. to Aug 16, 66 Stop as per sentence of G. O. M. § 1107 per M.*

Book mark: *P 164 P 278, 73*

Breyer

Roberts, David
 Co. A, 9 Reg't U.S.C. Inf.

1 Enclosures.

| | |
|------------------------------------|----------------------------|
| Bed Cards | Final Statements |
| Burial Records | Furloughs or L. of A |
| Certs. of Dis. for Discharge | Med. Certificates |
| C. M. Charges | Med. Des. Lists |
| Descriptive Lists | Orders |
| Discharge Certificates | Pris. of War Record |
| Enlistment Papers | Resignations |

Other papers relating to—

| | |
|------------------------------|----------------------------|
| Admission to Hosp'l | Furlough or L. of A |
| Casualty Sheet | Med. Examination |
| Confinement | Misc. Information .. / |
| Contracts | Pay or Clothing |
| Death or Effects | Personal Reports |
| Desertion | Rank |
| Discharge from Hosp'l | Transfer to Hosp'l |
| Discharge from Service | Transfer to V. R. C. |
| Duty | Transportation |

16

David Roberts.
Private Co. A. 9th Regt. I. I.

Mr. Ellbrook.

Adjutant General's Office,

COLORED TROOPS BRANCH,

Mr Ellerbrook

November 16th 1876

Vol.

C. T., 187

Wanted in the case of

9th Reg't U.S.C.T.

David Roberts, Private, Co. A,

Record of Trial &c.

M.R. for July & Aug. 1866. Upon him "Reduced to the ranks from sergeant for G.O.M. No 22 Hd Qrs Dist Rio Grande Aug. 16/66. Sept 10. per month per same order Abuse in arrest."

Respectfully,

A.B.S.

W. A. Woodward,

Chief Clerk.

In J. H. Hatten

Adjutant General's Office,

, 187

Vol.

C. T., 187

Reply in case of

9th Reg't U.S.C.T.

David Roberts

Co. "A",

Hd. Qrs. Dist. of Rio Grande Brownsville Texas. August 16th 1866. G. O. M. No. 22.

David Roberts Sgt. Co. "A" 9th U.S.C.T. Charge. Conduct prejudicial to good order and military discipline. Finding Guilty Sentence. To be reduced to the ranks, to forfeit ten (10) dollars per month of his monthly pay for the remainder of his term of service and to be confined at hard labor for the same period at such place as the

(over)

Commanding General may direct,
Approved, and Military Prison at
Brownsville Texas designated as
place of confinement.
By order of
Col. May. Genl. Getty.

Nov. 20 76. P.D.

⁹⁵⁷
Robertson, Frederick

Co K, 9 U.S. Col'd Inf.

Private | Private

CARD NUMBERS.

| | | |
|----|---------|----|
| 1 | 6316907 | 26 |
| 2 | 6317124 | 27 |
| 3 | 6317107 | 28 |
| 4 | 6317209 | 29 |
| 5 | 6317304 | 30 |
| 6 | 6317398 | 31 |
| 7 | 6317486 | 32 |
| 8 | 6317576 | 33 |
| 9 | 6317655 | 34 |
| 10 | 6317740 | 35 |
| 11 | 6317816 | 36 |
| 12 | 6317887 | 37 |
| 13 | 6317959 | 38 |
| 14 | 6318019 | 39 |
| 15 | 6318076 | 40 |
| 16 | 6318134 | 41 |
| 17 | 6318190 | 42 |
| 18 | 6318243 | 43 |
| 19 | 6300303 | 44 |
| 20 | 6318294 | 45 |
| 21 | 6318345 | 46 |
| 22 | 9069498 | 47 |
| 23 | | 48 |
| 24 | | 49 |
| 25 | | 50 |

Book Mark:

See also

MAR 11 1933

S. 774849 P.O. U.S.M.

C. E. Doughty

R | **9** | **U.S.C.T.**

Frederick Robertson

, Co. *K*, 9 Reg't U. S. Col'd Inf.

Appears on

Company Descriptive Book

of the organization named above.

DESCRIPTION.

Age *22* years; height *5* feet *8 1/2* inches.

Complexion *Black*

Eyes *Dark*; hair *Black*

Where born *Queen Anne's Md.*

Occupation *Oysterman*

ENLISTMENT.

When *Nov 24*, 186 *3*

Where *Baltimore*

By whom *Capt William Binig*; term *3* y'rs.

Remarks:

*Descriptive list forwarded to
Genl. Saph Aug 13/64
Dischgd with Regt*

J. V. Ames

R | 9 | U.S.C.T.

Frederick Robertson
Pri, Co. K, 9 Reg't U.S. Col'd Infantry.

Age 22 years.

Appears on

Company Muster-in Roll

of the organization named above. Roll dated
Charles Co. Md, Nov 30, 1863.

Muster-in to date Nov 30, 1863

Joined for duty and enrolled:

When Nov. 24, 1863.

Where Queen Ann Md

Period 3 years.

Remarks:

Book mark:

O. G. Smith

R

9

U.S.C.T.

Frederick Robertson
Opi, Co. K, 9 Reg't U. S. Col'd Infantry.

Appears on

Company Muster Roll

for *Nov & Dec*, 1863.

Present or absent *Present*

Stoppage, \$ *100* for

Due Gov't, \$ *100* for

Remarks: *\$2.00 Recruit Premium*
due

Book mark:

O. Smith

(858)

Copyist

R | 9 | U.S.C.T.

Frederick Robertson
Pri, Co. K, 9 Reg't U. S. Col'd Infantry.

Appears on

Company Muster Roll

for Jan & Feb, 1864

Present or absent Present

Stoppage, \$ 100 for

Due Gov't, \$ 100 for

Remarks: \$200 Recruit
Premium Due

Book mark:

A. Smith

R | 9 | U.S.C.T.

Frederick Robertson
Pri, Co. K, 9 Reg't U. S. Col'd Infantry.

Appears on

Company Muster Roll

for 10th April, 1864.

Present or absent Present

Stoppage, \$ 100 for

Due Gov't, \$ 100 for

Remarks: Stop for one Haversack

Book mark:

Ch Smith

R | **9** | **U.S.C.T.**

Frederick Robertson
Pii , Co. K, 9 Reg't U. S. Col'd Infantry.

Appears on

Company Muster Roll

for *May & June* , 1864.

Present or absent *Present*

Stoppage, \$ 100 for _____

Due Gov't, \$ 100 for _____

Remarks:

Book mark: _____

Oliver

(858)

Copyist

K | **9** | **U.S.C.T.**

Fredrick Robertson
Pri , Co. K, 9 Reg't U. S. Col'd Infantry.

Appears on

Company Muster Roll

for *July & Aug* , 1864.

Present or absent *Present*

Stoppage, \$ *100* for

Due Gov't, \$ *100* for

Remarks: *Stop for one*
Haversack

Book mark:

O. G. Smith

L | 9 | U.S.C.T.

Fredrick Robertson
Pi, Co. K, 9 Reg't U. S. Col'd Infantry.

Appears on

Company Muster Roll

for Sept & Oct, 1864

Present or absent Present

Stoppage, \$ 100 for

Due Gov't, \$ 100 for

Remarks: Due the difference
between \$7.00 per mo. &
\$9.00 per mo. from Jan
1st to Apr. 30/64.

Book mark:

Og Smith

P

9

U.S.C.T.

Frederick Robertson
Priv, Co. K, 9 Reg't U. S. Col'd Infantry.

Appears on

Company Muster Roll

for *Nov & Dec*, 1864.

Present or absent *Present*

Stoppage, \$ *100* for

Due Gov't, \$ *100* for

Remarks:

Book mark:

G W Deadrick
Copyist

(858)

B 9 U.S.C.T.

Frederick Robertson
Priv, Co. K, 9 Reg't U. S. Col'd Infantry.

Appears on

Company Muster Roll

for *Jan & Feb*, 1865.

Present or absent *Present*

Stoppage, \$ 100 for

Due Gov't, \$ 100 for

Remarks: *On Det. Ser. as Provost*
Guard SO No 21 dated 25 Dec
9 26 36 5 Feb 17/65

Book mark:

G W Deadrick

B | **9** | **U.S.C.T.**

Fredrick Robertson
Priv, Co. K, 9 Reg't U. S. Col'd Infantry.

Appears on

Company Muster Roll

for *Mar & Apr*, 1865.

Present or absent *Present*

Stoppage, \$ *100* for

Due Gov't, \$ *100* for

Remarks:

Book mark: -----

G W Deadrick

P | **9** | **U.S.C.T.**

Frederick Robertson

Priv, Co. K, 9 Reg't U. S. Col'd Infantry.

Appears on

Company Muster Roll

for *Dec 31/64 to June 30*, 1865.

Present or absent *Present*

Stoppage, \$ *100* for

Due Gov't, \$ *100* for

Remarks: *In arrest awaiting trial since June 15/65*

Book mark:

G W Deadrick

G | **9** | **U.S.C.T.**

Frederick Robertson
Priv, Co. K, 9 Reg't U. S. Col'd Infantry.

Appears on

Company Muster Roll
for *July & Aug*, 186*5*.

Present or absent *Absent*

Stoppage, \$ *100* for

Due Gov't, \$ *100* for

Remarks: *Absent in confinement awaiting trial*

Book mark:

G W Deadrick

R | **9** | **U.S.C.T.**

Frederick Robertson
Priv, Co. K, 9 Reg't U. S. Col'd Infantry.

Appears on

Company Muster Roll

for *Sept & Oct*, 1865.

Present or absent *Present*

Stoppage, \$ 100 for

Due Gov't, \$ 100 for

Remarks:

Book mark:

G W Deadrick

(858)

Copyist

R | 9 | U.S.C.T.

Frederick Robinson
Priv., Co. K, 9 Reg't U. S. Col'd Infantry.

Appears on

Company Muster Roll

for June 30/63 to Dec 31, 1863.

Present or absent Present

Stoppage, \$ 100 for

Due Gov't, \$ 100 for

Remarks:

Book mark:

G W Deadrick

(858)

Copyist

R

9

U.S.C.T.

Frederick Robertson
Out., Co. K, 9 Reg't U. S. Col'd Infantry.

Appears on

Company Muster Roll

for *Jan. and Feb.*, 1866.

Present or absent *Present*

Stoppage, \$ 100 for

Due Gov't, \$ 100 for

Remarks:

Book mark:

P. C. Taylor

(358)

Copyist

R

9

U.S.C.T.

Frederick Robertson
Pvt., Co. K, 9 Reg't U. S. Col'd Infantry.

Appears on

Company Muster Roll

for *Mar. and Apr.*, 1866.

Present or absent *Present*

Stoppage, \$ *100* for

Due Gov't, \$ *100* for

Remarks *Stop for ordnance*
24¢. Stop for one
canteen 65¢, total
89¢.

Book mark:

(858)

J. C. Taylor

Copyist

R

9

U.S.C.T.

Frederick Robertson
Pvt., Co. K, 9 Reg't U. S. Col'd Infantry.

Appears on

Company Muster Roll

for *May and June*, 186*6*

Present or absent *Present*

Stoppage, \$ 100 for

Due Gov't, \$ 100 for

Remarks:

Book mark:

J. C. Taylor

(358)

Copyist

R

9

U.S.C.T.

Frederick Robertson
Pvt., Co. K, 9 Reg't U. S. Col'd Infantry.

Appears on

Company Muster Roll

for July and Aug., 1866.

Present or absent Absent

Stoppage, \$ 100 for

Due Gov't, \$ 100 for

Remarks: Detached in
I. M. Dept. S. O. 31 Hd.
U. S. Forces July
12, 1866.

Book mark:

F. C. Taylor

(358)

Copyist

R | *9* **U.S.C.T.**

Fredrick Robinson

Sr., Co. *K*, *9* Reg't U. S. Col'd Inf.

Appears on a

Detachment Muster Roll

of the organization named above

for *July & Aug.*, 186*6*.

Station *Brownsville, Tex.*

Present or absent *Present.*

Stoppage, \$ *100* for

Due Gov't, \$ *100* for

Remarks: *Detained by special order No. 140 Hd. Qu. A. P. D. Series 1866.*

Book mark :

J. Smith

R

9

U.S.C.T.

Frederick Robertson
Pvt., Co. K, 9 Reg't U. S. Col'd Infantry.

Appears on

Company Muster Roll

for *Sept. and Oct.*, 1866.

Present or absent *Present*

Stoppage, \$ 100 for

Due Gov't, \$ 100 for

Remarks:

Book mark:

F. C. Taylor

(858)

Copyist

R | 9 | U.S.C.T.

Frederick Robertson
Pvt., Co. K, 9 Reg't U. S. Col'd Infantry.

Appears on Co. Muster-out Roll, dated
New Orleans, La., Nov. 26, 1866.

Muster-out to date Nov. 26, 1866.

Last paid to Aug. 31, 1866.

Clothing account:

Last settled _____, 1866 ; drawn since \$ 100

Due soldier \$ 100; due U. S. \$ 162 / 100

Am't for cloth'g in kind or money adv'd \$ 100

Due U. S. for arms, equipments, &c., \$ 100

Ordinary bounty paid \$ none; due \$ 100 100 +

Remarks: Bounties due under
Act of Congress of July 26,
1866, \$100. Joined at orig-
inal organization.

Book mark: V. 163. P. 215. 73.

(361)

P. C. Taylor

Copyist.

⁹⁵⁸⁶
Robertson, Morris

Co C, 9 U.S. Col'd Inf.

Private | Private

CARD NUMBERS.

| | | |
|----|---------|----|
| 1 | 6304410 | 26 |
| 2 | 6304509 | 27 |
| 3 | 6304609 | 28 |
| 4 | 6304716 | 29 |
| 5 | 6304815 | 30 |
| 6 | 6304909 | 31 |
| 7 | 6305005 | 32 |
| 8 | 6305102 | 33 |
| 9 | 6305201 | 34 |
| 10 | 6305298 | 35 |
| 11 | 6305396 | 36 |
| 12 | 6305482 | 37 |
| 13 | 6305569 | 38 |
| 14 | 6305653 | 39 |
| 15 | 6305726 | 40 |
| 16 | 6305797 | 41 |
| 17 | 6305865 | 42 |
| 18 | 6305952 | 43 |
| 19 | 6306139 | 44 |
| 20 | 9068805 | 45 |
| 21 | | 46 |
| 22 | | 47 |
| 23 | | 48 |
| 24 | | 49 |
| 25 | | 50 |

Book Mark: E.B-12-210

See also

R | 9 | U.S.C.T.

Norman Robertson
 , Co. C, 9 Reg't U. S. Col'd Inf.

Appears on

Company Descriptive Book
 of the organization named above.

DESCRIPTION.

Age 41 years; height 5 feet 8 1/2 inches.

Complexion Black

Eyes Black; hair Black

Where born St. Mary, Md.

Occupation Carpenter

ENLISTMENT.

When Oct 23, 1863

Where Equiana Farm, St. Mary, Md

By whom Col. Wm Birney; term 3 y'rs.

Remarks: Died at Brownsville, Tex. of cholera Aug. 20th 1866. Inventory & final statements sent Sept. 10th 1866.

E. L. Horton

R

9

U.S.C.T.

Morris Robertson

Plt, Co *C*, 9 Reg't U. S. Col'd Infantry.

Age *41* years.

Appears on

Company Muster-in Roll

of the organization named above. Roll dated

Camp Stanton Charles Co Md Nov 11, 1863.

Muster-in to date *Nov 11, 1863*

Joined for duty and enrolled:

When *Oct 23rd*, 1863.

Where *St Marys Md*

Period *3* years.

Remarks:

Book mark:

W. A. White
Copyist.

R

9

U.S.C.T.

Morris Robertson

Private, Co. C, 9 Reg't U. S. Col'd Infantry.

Appears on

Company Muster Roll

for From Nov 11th To Dec 31st, 1863.

Present or absent Present

Stoppage, \$ 100 for

Due Gov't, \$ 100 for

Remarks: #2 Rec Rem due
Owed serv. as Carpenter
Date & Order not known

Book mark:

(358)

Copyist

R

9

U.S.C.T.

Morris Robertson

Plt, Co. C, 9 Reg't U. S. Col'd Infantry.

Appears on

Company Muster Roll

for *Jaw & Seby*, 186⁴.

Present or absent *Present*

Stoppage, \$ 100 for

Due Gov't, \$ 100 for

Remarks: *#2 Reg't Prem due*

Book mark:

(358)

J. J. White
Copyist

R

9

U.S.C.T.

Morris Robertson

Plt, Co. C, 9 Reg't U. S. Col'd Infantry.

Appears on

Company Muster Roll

for *Mar & April*, 186*4*.

Present or absent *Present*

Stoppage, \$..... 100 for.....

Due Gov't, \$..... 100 for.....

Remarks:.....

Book mark:.....

(358)

Y. H. Hill
Copyist

R

9

U.S.C.T.

Morris Robertson

Pat, Co. C, 9 Reg't U. S. Col'd Infantry.

Appears on

Company Muster Roll

for May & June, 1864.

Present or absent Present

Stoppage, \$ 100 for

Due Gov't, \$ 100 for

Remarks: My Ordnance Ticket 2^{ds}

Book mark:

(358)

Yedhul Copyist

R

9

U.S.C.T.

Morris Robertson

Plt, Co. C, 9 Reg't U. S. Col'd Infantry.

Appears on

Company Muster Roll

for *July & Aug*, 186*4*.

Present or absent *Absent*

Stoppage, \$ *100* for

Due Gov't, \$ *100* for

Remarks *Absent sick since Aug 13/64.*

Book mark:

(358)

H. J. White
Copyist

R | **9** | **U.S.C.T.**

Morris Robertson

Co, Co. C, 9 Reg't U. S. Col'd Infantry.

Appears on

Company Muster Roll

for *Sep & Oct*, 186*4*.

Present or absent *Present*

Stoppage, \$ *100* for

Due Gov't, \$ *100* for

Remarks:

Book mark:

V. J. Kelly
Copyist

R | 9 | U.S.C.T.

Morris Robertson

Private, Co. C, 9 Reg't U. S. Col'd Infantry.

Appears on

Company Muster Roll

for *Nov & Dec*, 1864.

Present or absent *Present*

Stoppage, \$ 100 for

Due Gov't, \$ 100 for

Remarks:

Book mark:

(358)

W. H. H. H.
Copyist

R | 9 | U.S.C.T.

Morris Robertson

Cvt, Co. C, 9 Reg't U. S. Col'd Infantry.

Appears on

Company Muster Roll

for *Jan - Feb*, 1865.

Present or absent *Present*

Stoppage, \$ *100* for

Due Gov't, \$ *100* for

Remarks:

Book mark:

A J Anderson

R

9

U.S.C.T.

Morris Robertson

Pvt, Co. C, 9 Reg't U. S. Col'd Infantry.

Appears on

Company Muster Roll

for *March & April*, 186*2*.

Present or absent *Present*

Stoppage, \$ *100* for

Due Gov't, \$ *100* for

Remarks:

Book mark:

A J Anderson

A | **9** | **U.S.C.T.**

Morris Robinson

Cvt, Co. C, 9 Reg't U. S. Col'd Infantry.

Appears on

Company Muster Roll

for *Dec 31/64 to June 30*, 1865.

Present or absent *Present*

Stoppage, \$ *100* for

Due Gov't, \$ *100* for

Remarks:

Book mark:

A. J. Anderson

Q | 9 | U.S.C.T.

James Robertson

Cpt, Co. C, 9 Reg't U. S. Col'd Infantry.

Appears on

Company Muster Roll

for *July & Aug*, 1865.

Present or absent *Present*

Stoppage, \$ 100 for

Due Gov't, \$ 100 for

Remarks:

Book mark:

A. J. Anderson

R

9

U.S.C.T.

Morris Robertson

Pvt, Co. C, 9 Reg't U. S. Col'd Infantry.

Appears on

Company Muster Roll

for *June 30 to Oct 31*, 1865.

Present or absent *Present*

Stoppage, \$ *100* for

Due Gov't, \$ *100* for

Remarks:

Book mark:

A. J. Anderson

(358)

Copyist

R | 9 | U.S.C.T.

Amos Robertson

Priv, Co. C, 9 Reg't U. S. Col'd Infantry.

Appears on

Company Muster Roll

for *June 27 to Dec 31*, 1865.

Present or absent *Present*

Stoppage, \$ *100* for

Due Gov't, \$ *100* for

Remarks:

Book mark:

A. J. Anderson

R | 9 | U.S.C.T.

Morris Robertson
Capt, Co. C, 9 Reg't U. S. Col'd Infantry.

Appears on

Company Muster Roll

for *Jan & Feb*, 186*6*.

Present or absent *Present*

Stoppage, \$ *100* for

Due Gov't, \$ *100* for

Remarks:

Book mark:

A. J. Anderson
(358) Copyist

9 | **U.S.C.T.**

Morris Robertson
Private, Co. C, 9 Reg't U. S. Col'd Infantry.

Appears on

Company Muster Roll

for *Feb 11*, 186*6*.

Present or absent *Present*

Stoppage, \$ 100 for

Due Gov't, \$ 100 for

Remarks:

Book mark:

L. M. ...

(P) | **9** | **U.S.C.T.**

Charles Valbertson
Private, Co. C, 9 Reg't U. S. Col'd Infantry.

Appears on

Company Muster Roll

for *May / June*, 186*6*

Present or absent *Present*

Stoppage, \$ 100 for

Due Gov't, \$ 100 for

Remarks: *Daily duty as Private*

Book mark:

(358)

Francis

Copyist

(V.) | 9 | U.S.C.T.

Morris Robertson
Private, Co. C, 9 Reg't U. S. Col'd Infantry.

Appears on

Company Muster Roll

for *July & Aug.*, 186*6*.

Present or absent

Stoppage, \$ 100 for

Due Gov't, \$ 100 for

Remarks: *Sir of Chatham at
Brownsville Texas Aug 25 '66*

Inserted by compiler

Book mark: *142.931.*

Finco

R. | 9 | U.S.C.T.

Morris Cybertean
Private, Co. C, 9 Reg't U. S. Col'd Infantry.

Appears on Co. Muster-out Roll, dated
New Orleans, La., Nov 1865.

Muster-out to date 186 .

Last paid to 186 .

Clothing account:

Last settled 186 ; drawn since \$ 100

Due soldier \$ 100; due U. S. \$ 100

Am't for cloth'g in kind or money adv'd \$ 100

Due U. S. for arms, equipments, &c., \$ 100

Bounty paid \$ 100: due \$ 100

Remarks: joined at New Orleans
Sailed at New Orleans
Dec 25/65 S.D. sent to Regt

Book mark: Co. C, S. O. 74 B. V. 1864-1865
142.981: F. S. Sailed Aug 25/66. E. B. 12/210

(861)

D. J. Morris

Copyist.

Robertson, Morris
Co. C, 9 Reg't U.S.C. Inf

5- Enclosures.

| | |
|------------------------------|----------------------|
| Bed Cards | Final Statements / |
| Burial Records | Furloughs or L. of A |
| Certs. of Dis. for Discharge | Med. Certificates |
| C. M. Charges | Med. Des. Lists |
| Descriptive Lists | Orders 2 |
| Discharge Certificates | Pris. of War Record |
| Enlistment Papers | Resignations |

Other papers relating to—

| | |
|------------------------|----------------------|
| Admission to Hosp'l | Furlough or L. of A |
| Casualty Sheet | Med. Examination |
| Confinement | Misc. Information / |
| Contracts | Pay or Clothing |
| Death or Effects / | Personal Reports |
| Desertion | Rank |
| Discharge from Hosp'l | Transfer to Hosp'l |
| Discharge from Service | Transfer to V. R. C. |
| Duty | Transportation |

Morris Robertson.
C. 9th
~~10th~~ No. S. C. C.

Furlough

1865

See letter of Capt.
H. M. Phelps 9th
No. S. C. C.

25 A. C.

Comd. U.S. Frigate
March 11th 1844.

S. C. No. 59.

Detail in Robertson at Algiers.

Head Quarters Binney's Brigade
 Beaufort S. C. March 11th 1866

Special Order
 No 59 }

I Private Morris Robinson Co C
 9th U. S. C. T. is hereby detailed for duty at these Head
 Quarters & will report immediately with eight days
 uncooked rations & in heavy marching order

By order of Brig Gen Wm Binney
 Lewis Edward Wood
 Capt & A. A. A. G.

WAR 152
Hd Qrs 1st Brig 1st Div 25th Ab.
Brownsville Texas Oct 7th 1865

Special Orders
No - 4

Private Morris Robinson, Co. "C,"

9th U.S. is hereby detailed for duty in the Quarter
Master Dept of this Brig and will report to
Lt. C. P. Goodyear A.A.Q.M. for duty at once

By order of
Col. John Bayley
9th U.S. Comdg
C. B. Fessenden
Adjutant and A.A.Q.M.

PARA 153

1866

51

J. J. ...
INVENTORY OF THE EFFECTS

ARTICLES OF WAR.

ART. 95. When any non-commissioned officer or soldier shall die, or be killed in the service of the United States, the then commanding officer of the troop or company shall, in the presence of two other commissioned officers, take an account of what effects he died possessed of, above his arms and accoutrements, and transmit the same to the office of the Department of War, which said effects are to be accounted for, and paid to the representatives of such deceased non-commissioned officer or soldier. And in case any of the officers, so authorized to take care of the effects of deceased officers and soldiers, should, before they have accounted to their representatives for the same, have occasion to leave the regiment or post, by preferment or otherwise, they shall, before they be permitted to quit the same, deposit in the hands of the commanding officer, or of the assistant military agent, all the effects of such deceased non-commissioned officers and soldiers, in order that the same may be secured for, and paid to, their respective representatives.

ARMY REGULATIONS—EDITION OF 1863.

DECEASED SOLDIERS.

Par. 152. Inventories of the effects of deceased non-commissioned officers and soldiers, required by the 95th Article of War, will be forwarded to the Adjutant General, by the commander of the company to which the deceased belonged, and a duplicate of the same to the colonel of the regiment. Final statements of pay, clothing, &c., in duplicate, will be sent to the Adjutant General with one copy of the inventory. When a soldier dies at a post or station absent from his company, it will be the duty of his immediate commander to furnish the required inventory and final statements, and, at the same time, to forward to the commanding officer of the company to which the soldier belonged, a report of his death, specifying the date, place, and cause; to what time he was last paid, and the money or other effects in his possession at the time of his decease; which report will be noted on the next muster roll of the company to which the man belonged. Each inventory will be endorsed, "Inventory of the effects of _____, late of company (—) _____ regiment of _____, who died at _____, the _____ day of _____, 186—." If a legal representative receive the effects, it will be stated in the report. If the soldier leave no effects, the fact will be reported.

Par. 153. Should the effects of a deceased non-commissioned officer or soldier not be administered upon within a short period after his decease, they shall be disposed of by a Council of Administration, under the authority of the commanding officer of the post, and the proceeds deposited with the Paymaster, to the credit of the United States, until they shall be claimed by the legal representatives of the deceased.

Par. 154. In all such cases of sales by the Council of Administration, a statement in detail, or account of the proceeds, duly certified by the Council and commanding officer, accompanied by the Paymaster's receipt for the proceeds, will be forwarded by the commanding officer to the Adjutant General. The statement will be endorsed, "Report of the proceeds of the effects of _____, late of company (—) _____ regiment of _____, who died at _____, the _____ day of _____, 186—."

NOTE 1.—The effects in all cases, when called for, should be turned over to the legal representative, without further authority from the Adjutant General. When the effects are turned over to the relatives of the deceased before these inventories are sent to the Adjutant General, their receipts therefor should be attached to the inventories. In all other cases, one copy will be sent with a letter of transmittal direct to the Adjutant General, and a duplicate retained by the officer.

NOTE 2.—Particular care should be taken to take receipts in duplicate from the Paymaster for any funds turned over to him; one copy should be sent direct to the Adjutant General and one retained by the officer.



OF
Lieut. Morris Robertson
Late of Company *C*
9th Reg't of *U.S.C.*
Volunteers, who died at *Savannah Ga.*
on the *23rd* day of *August* 1866.

Inventory of the effects of Henry Johnson late
 a Private of Captain Bartholomew Phelps Company C of
 the 9th Regiment of 21st Co Troops Volunteers, who was enrolled as
 a Private at St. Mary in the State of Maryland on
 the 23rd day of October 1863, and mustered into the service of the United
 States as a Private on the 11th day of November 1863, at Baltimore Md
 in Company L, 9th Regiment of 21st Co Volunteers, to serve 3
 years or during the war; he was born in Umanac in the State
 of Virginia; he was 43 years of age, 5 feet 8 inches
 high, Black complexion, Black eyes, Black hair, and by occupation, when enrolled,
 a Tanner; he died in Brownsville Texas, at
in the Co Quarters on the 25th day of August 1866, by
 reason of Cholera

| INVENTORY. | | | | | |
|-------------------------|-----|----------------------------|-----|---|-----------|
| ARTICLES. | No. | ARTICLES. | No. | ARTICLES. | No. |
| Hats..... | | Pairs trousers..... | | Knapsacks..... | 1 |
| Caps..... | | Pairs flannel drawers..... | | <i>The deceased disposed of his money before he died, to a relation, Sergt. Robt C. Cole Co. C. 9th Regt whose receipt for the same is in my possession the sum</i> | |
| Forage Caps..... | | Pairs cotton drawers..... | | | |
| Great coats..... | | Flannel shirts..... | | | |
| Uniform coats..... | | Cotton shirts..... | | | |
| Uniform jackets..... | | Pairs boots..... | | | |
| Flannel sack coats..... | | Pairs shoes..... | | | |
| Blouses..... | | Pairs socks..... | | | |
| Sable frocks..... | | Blankets..... | | | |
| Fatigue overalls..... | | Haversacks..... | | | |
| | | | | | |
| | | | | Specie..... | \$ 136.00 |
| | | | | Notes..... | \$ |

I CERTIFY, ON HONOR, that the above inventory comprises all the effects of Henry Johnson, deceased, and that the effects ~~are in the hands~~
~~of~~ were destroyed for fear of infection
~~to be disposed of by a Council of Administration.~~

(DUPLICATES.)

STATION: Brownsville Texas

DATE: September 10th 1866

Henry Johnson
Lieut 9th Co Troops
 Commanding the Company.

WAR 1865

[OFFICE ENDORSEMENT.]

War Department,

ADJUTANT GENERAL'S OFFICE,

The Death of *Pvt. Morris Robertson*, Co. C, 9th Reg't U. S. Colored Troops, is reported as follows:

- On Company Muster Roll, For *July 1866*, *Aug 25th*, 1866
- Company Muster-out Roll, *Aug 25*, 1865
- Company Descriptive Book, 186
- Company Morning Reports, 186
- Soldier's Final Statement, *Aug 25th*, 1866
- Soldier's Record of Death and Interment, 186
- Soldier's Inventory of Effects, 186
- Soldier's Certificate of Disability for Discharge, 186
- Soldier's Individual Muster-out Roll, 186
- Regimental Return, For *August*, 1866, *August 25th*, 1866
- Regimental Quarterly Returns, *Aug 25th*, 1866
- Regimental Descriptive Book, 186

By Surgeon General, *(Aug 25)*, 1866, is held to be the correct date, and the Company Muster Roll will be amended accordingly.

Thomas M. Sargent
Assistant Adjutant General.
See letter to *2d Auditor*
July 31, 1877
Noted

FINAL STATEMENT 51

OF

Pvt. Morris Robertson
in Co. C Reg't of *25th*

VOLUNTEERS.

NOTE 1.—Two of these certificates (or duplicates) are to be given to each Volunteer Soldier or drafted man who may be discharged without being mustered out (Final Statements are never given to men mustered out of service) that he may at once receive from the Paymaster the pay, &c., due him, and the captain or other COMMISSIONED officer commanding the company will certify to the act of the delivery of the duplicate certificates; with these certificates the Soldier is "entitled to" his discharge, and should also present his discharge to the Paymaster to have the payment endorsed on it. The discharge is to be given back to the Soldier by the Paymaster; the latter only retaining as his vouchers the duplicate certificates.

NOTE 2.—If the Soldier is entitled to pay for the use of his horse, the Company Commander will certify to that fact on the back of both these final statements, and also to the time he has pay due for having been so mounted on his own horse.

NOTE 3.—When a Soldier is furnished with final statements, his descriptive list, if he has one, should be taken up by the officer who gives the Soldier these statements, and endorsed with a statement to this effect by the officer. The endorsement should exhibit a full statement of the time for which the Soldier was allowed pay on his final statements, the clothing account, and all other charges against him or in his favor, so as to comprise a complete exhibit of his account. It will then be transmitted to the Company Commander of the Soldier, who will enter all the data necessary to a full understanding of the Soldier's account on the muster roll upon which the Soldier's discharge is reported. The descriptive list will then be destroyed. The object of this is, that the remaining portion of the Soldier's account may be settled upon the receipt of these muster rolls, and the Soldier receive any pay or allowances that may be due him at the time of his discharge, and which may not appear on his last final statements from the fact that his descriptive list is incomplete. These accounts for back pay, &c., are settled by the 2d Auditor of the Treasury Department.

NOTE 4.—Charges for loss or injury to ordnance, *arms*, and other miscellaneous charges, should appear upon the heading of "Other Stoppages."

NOTE 5.—Bounty paid by State authorities, and not by the United States, will not be entered on this statement.

NOTE 6.—Amounts due the Sutler and Land Agent must be entered on the muster roll on which the discharge, death, desertion, &c., is reported, well as on the final statement, otherwise the amount cannot be collected from the United States.

NOTE 7.—This blank will be used for deceased volunteers and drafted men, as well as for others.

NOTE 8.—Where a Soldier dies in Hospital or on detached service, his descriptive list, if he has one, should be sent with his final statements, in duplicate, to the Adjutant General, Washington, D. C.

NOTE 9.—If the soldier is a drafted man or substitute, the space for time, &c., or enrolled, should contain only the word *drafted* or *substitute*, as the case may be. If the Soldier is a "VETERAN," (or RECRUIT,) the words *as a veteran*, (or *recruit*) as the case may be, should be interlined after the words *mustered into the service of the U. S.* A statement of all the instalments of *Veteran* or *Recruit* Bounty RECEIVED by the Soldier must be made on the back of each final statement.

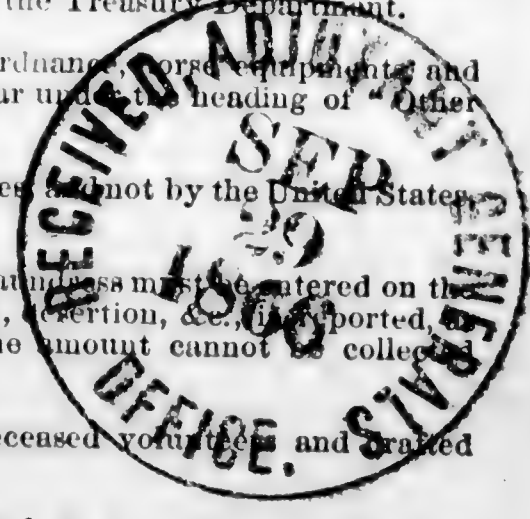

William H. ...

MAR 1866

FINAL STATEMENT 51

OF

Private
Rich. Henry Robinson

Co. G Reg't of *25th*

VOLUNTEERS.

Ad. Gen. Aug 25 1866

NOTE 1.—Two of these certificates (or duplicates) are to be given to each Volunteer Soldier or drafted man who may be discharged without being mustered out (Final Statements are never given to men mustered out of service,) that he may at once receive from the Paymaster the pay, &c., due him, and the captain or other COMMISSIONED officer commanding the company will certify to the act of the delivery of the duplicate certificates; with these certificates the Soldier is "entitled to" his discharge, and should also present his discharge to the Paymaster to have the payment endorsed on it. The discharge is to be given back to the Soldier by the Paymaster; the latter only retaining as his vouchers the duplicate certificates.

NOTE 2.—If the Soldier is entitled to pay for the use of his horse, the Company Commander will certify to that fact on the back of both these final statements, and also to the time he has pay due for having been so mounted on his own horse.

NOTE 3.—When a Soldier is furnished with final statements, his descriptive list, if he has one, should be taken up by the officer who gives the Soldier these statements, and endorsed with a statement to this effect by the officer. The endorsement should exhibit a full statement of the time for which the Soldier was allowed pay on his final statements, the clothing account, and all other charges against him or in his favor, so as to comprise a complete exhibit of his account. It will then be transmitted to the Company Commander of the Soldier, who will enter all the data necessary to a full understanding of the Soldier's account on the muster roll upon which the Soldier's discharge is reported. The descriptive list will then be destroyed. The object of this is, that the remaining portion of the Soldier's account may be settled upon the receipt of these muster rolls, and the Soldier receive any pay or allowances that may be due him at the time of his discharge, and which may not appear on his last final statements from the fact that his descriptive list is incomplete. These accounts for back pay, &c., are settled by the 2d Auditor of the Treasury Department.

NOTE 4.—Charges for loss or injury to ordnance, accoutrements, and other miscellaneous charges, should appear under the heading of "Other Stoppages."

NOTE 5.—Bounty paid by State authorities, and not by the United States, will not be entered on this statement.

NOTE 6.—Amounts due the Sutler and Land Agent must be entered on the muster roll on which the discharge, death, desertion, &c., is reported, as well as on the final statement, otherwise the amount cannot be collected from the United States.

NOTE 7.—This blank will be used for deceased volunteers and drafted men, as well as for others.

NOTE 8.—Where a Soldier dies in Hospital or on detached service, his descriptive list, if he has one, should be sent with his final statements, in duplicate, to the Adjutant General, Washington, D. C.

NOTE 9.—If the soldier is a drafted man or substitute, the space for time, &c., or enrolled, should contain only the word *drafted* or *substitute*, as the case may be. If the Soldier is a "VETERAN," (or RECRUIT,) the words *as a veteran*, (or *recruit*,) as the case may be, should be interlined after the words *mustered into the service of the U. S.* A statement of all the instalments of *Veteran* or *Recruit* Bounty RECEIVED by the Soldier must be made on the back of each final statement.

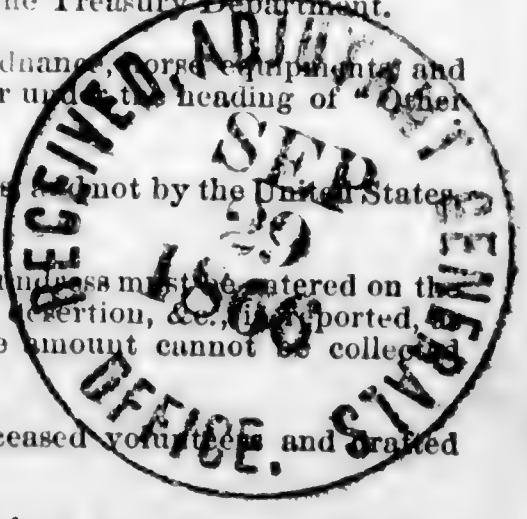

Edwin V. ...

ADJUTANT GENERAL'S OFFICE
Sept 29 1866
Duplicate with Inventory sent 2d Auditor.

I certify, on honor, that Maris Robertson, a Private of
 late Captain H. H. Poles Company (C) of the 9th Regiment of US 65
VOLUNTEERS, of the State of Maryland, born in Accomac, State
 of Virginia, aged 43 years; 5 feet 8 inches high; Black complexion,
Blue eyes, Black hair, and by occupation a Tanner, who joined for service
 and was enrolled (see Note 9) on the 23rd day of October, 1863, at St. Mary
 by Col. B. B. Perry, for the period of 3 years, and mustered into
 the service of the United States on the 11th day of November, 1863, at
Baltimore Md., by James K. Smith; and having served

HONESTLY and FAITHFULLY with his Company to the present date, is now entitled to a
DISCHARGE by reason of Death. Died of Cholera at
Baltimore Md. June 30 1866 (C. G. P.)

The said Maris Robertson was last paid by Paymaster
Andrew ..., to include the 30th day of June, 1866, and
 has pay due him from that time to the present date; he is entitled to pay and subsistence for
TRAVELING to place of enrollment, and whatever other allowances are authorized to volunteer
 soldiers, drafted men, or militia, so discharged. He has received from the United States **CLOTHING**
 amounting to Twenty $\frac{16}{100}$ dollars, since the 31st day of October,
 1863, when his clothing account was last settled. He has received from the United States
 $\frac{100}{100}$ dollars advanced **BOUNTY**.

There is to be stopped from him, on account of the State of _____, or other
 authorities, for **CLOTHING, &c.**, received on entering service, $\frac{100}{100}$ dollars; and
 for other stoppages, viz: _____

 _____ $\frac{100}{100}$ dollars.

He has been furnished with **TRANSPORTATION** in kind from the place of his discharge to
 _____; and he has been **SUBSISTED** for **TRAVELING** to his
 place of enrollment, up to the _____, 186 .

He is indebted to _____, **SUTLER**, $\frac{100}{100}$ dollars.
 He is indebted to _____, **LAUNDRESS**, $\frac{100}{100}$ dollars.

Given in Duplicate, at Baltimore Md., this 10th day
 of September, 1866.

Henry Dubois
Lieut. Col.
 Commanding Company.

959
 Robinson, Edward

Co B, 9 U.S. Col'd Inf.

Private

Private

CARD NUMBERS.

| | | |
|----|----------|----|
| 1 | 6299980 | 26 |
| 2 | 6303342 | 27 |
| 3 | 6303420 | 28 |
| 4 | 6303575 | 29 |
| 5 | 6303610 | 30 |
| 6 | 6303691 | 31 |
| 7 | 6303797 | 32 |
| 8 | 6304298 | 33 |
| 9 | 6350368 | 34 |
| 10 | 4068731 | 35 |
| 11 | 43155768 | 36 |
| 12 | | 37 |
| 13 | | 38 |
| 14 | | 39 |
| 15 | | 40 |
| 16 | | 41 |
| 17 | | 42 |
| 18 | | 43 |
| 19 | | 44 |
| 20 | | 45 |
| 21 | | 46 |
| 22 | | 47 |
| 23 | | 48 |
| 24 | | 49 |
| 25 | | 50 |

Book Mark: E.B.V. 12. p. 193.

See also

5662, 588 P090
S. 1313254, P.O. m. m.
U.S. Vet Bureau 1/23/30 Jewel

C. E. Dwyer
2

R 1 9 U.S.C.T.

Edmund Robinson

Co. B, 9 Reg't U. S. Col'd Inf.

Appears on

Company Descriptive Book

of the organization named above.

DESCRIPTION.

Age 17 years; height 5 feet 3 inches.

Complexion *Blk*

Eyes *Blk*; hair *Blk*

Where born *Dobson*

Occupation *Dobson*

ENLISTMENT.

When *Sept. 27*, 1864.

Where *Wilmington*

By whom *Capt. Wilcox*; term 1 y'rs.

Remarks: *Dis charged on account of expiration of time*

C. Owen

R. | 9. | **U.S.C.T.**

Edward Robinson

Appears with rank of _____ on
**Muster and Descriptive Roll of a Detach-
ment of Drafted Men and Substitutes**
forwarded

for the 9. Reg't U. S. Col'd Inf. Roll dated
Baltimore Md Oct 7, 1864.

Where born Del

Age 19 years; occupation labour

~~Drafted~~ Enlisted and mustered in:

When Sept 29, 1864.

Where Wil Del

Period one years

Eyes blk; hair blk

Complexion blk; height 5 ft. 5 in.

Paid bounty and advance pay, \$ 100

Bounty due \$ 100

Where credited _____

Company to which assigned _____

Remarks: Substitute for Clayton

Robinson Wil Del.

+ P. S. Smith ev.
Book mark: _____

A. P. Pratt

B1 9 USC

Edward Robinson

Appears with rank of _____ on _____

Muster and Descriptive Roll

of Detachment of US Substitutes
& Drafted men turned over to
Col A M Bowman Roll dated
Camp Bradford Ms, Oct 12, 1864

Where born Delaware

Age 19 years; occupation Laborer

When enlisted Sept 29, 1864

Where enlisted Wilmington

For what period enlisted _____ years.

Eyes Blk; hair Blk

Complexion Black; height 5 ft. 5 in.

When mustered in Sept 29, 1864

Where mustered in _____

Bounty paid \$ _____; due \$ _____

Clothing account:
Last settled _____, 1864; drawn since \$ 1836

Date of first muster _____, 1864

Company to which assigned _____

Remarks: Substitute for
Clayton Robinson
Wilmington Del

Book mark : _____

F M Law
Copyist

(356m)

R | 9 | U.S.C.T.

Edward Robinson
Priv, Co. *B*, 9 Reg't U. S. Col'd Infantry.

Appears on

Company Muster Roll

for *Nov & Dec*, 186*4*

Present or absent *Present*

Stoppage, \$ *100* for

Due Gov't, \$ *100* for

Remarks: *joined as recruit from Depot*

Book mark: _____

(358) *S. Linnear* Copyist.

R.

9

U.S.C.T.

Edward Robinson
Priv., Co. B, 9 Reg't U. S. Col'd Infantry.

Appears on

Company Muster Roll

for *Jan & Feb*, 1865.

Present or absent *present*

Stoppage, \$ *100* for

Due Gov't, \$ *100* for

Remarks:

Book mark:

B. E. Harper

(358)

Copyist

R. | **9** | **U.S.C.T.**

Edward Robinson
Pvt., Co. B, 9 Reg't U. S. Col'd Infantry.

Appears on

Company Muster Roll

for *Mar & Apr*, 1865.

Present or absent *present*

Stoppage, \$ *100* for

Due Gov't, \$ *100* for

Remarks:

Book mark:

(358)

Harpes Copyist

R.

9

U.S.C.T.

Edward Robinson

Pvt., Co. B, 9 Reg't U. S. Col'd Infantry.

Appears on

Company Muster Roll

for *Dec 31/64 to June 30, 1865.*

Present or absent *present*

Stoppage, \$ *100* for

Due Gov't, \$ *100* for

Remarks:

Book mark:

(358)

Harpes
Copyist

R. | **9** | **U.S.C.T.**

Edward Robinson
Co. *B*, 9 Reg't U. S. Col'd Infantry.

Appears on

Company Muster Roll

for *July & Aug*, 186*5*

Present or absent *present*

Stoppage, \$ *100* for

Due Gov't, \$ *100* for

Remarks:

Book mark:

Warpes

R.

9

U.S.C.T.

Edward Robinson

Pvt., Co. B, 9 Reg't U. S. Col'd Infantry.

Appears on

Company Muster Roll

for *June 30/65 to Oct. 31, 1865.*

Present or absent

Stoppage, \$ 100 for

Due Gov't, \$ 100 for

Remarks: *Discharged by reason of expiration of term of service Sept 29th 1865.*

Book marks:

Hasper.

R. | 9 | U.S.C.T.

Edward Robinson,

Priv., Co. *B.*, 9 Reg't U. S. Col'd Infantry.

Appears on **Co. Muster-out Roll**, dated
New Orleans La Nov 26, 1866 .

Muster-out to date _____, 186 .

Last paid to _____, 186 .

Clothing account:

Last settled _____, 186 ; drawn since \$ _____ 100

Due soldier \$ _____ 100; due U. S. \$ _____ 100

Am't for cloth'g in kind or money adv'd \$ _____ 100

Due U. S. for arms, equipments, &c., \$ _____ 100

Bounty paid \$ _____ 100; due \$ _____ 100

Remarks: *joined as substitute*
Disch'd by reason
expiration term of service
Sept. 28/65.

Book mark: *Discharged Sept 29/65*
over

F. L. Dickerson,

JAN. 21

6304298

01891*

E. B. V. 12, P. 183

ARRA1170

R | 9

U.S.C.T.

Edward Robison
 Pvt., Co. B; 9 Reg't U. S. Col'd Inf.

Appears on an

Individual Muster-out Roll

of the organization named above. Roll dated

Brownsville, Tex. Sept 29, 1865.

Muster-out to date Sept 29, 1865.

Last paid to June 30, 1865.

Clothing account:

Last settled....., 186 ; drawn since ^{enlistment} \$ 67 50 / 100

Due soldier \$ 100; due U. S. \$ 100

Am't for cloth'g in kind or money adv'd \$ 100

Due U. S. for arms, equipments, &c., \$ 100

Bounty paid \$ 100; due \$ 100

Remarks: Mustered out by reason
 of expiration term of service.
 \$100. Bounty due under G.O.
 War Dept No 224 Series 1864.

Book mark:

W. H. Chance

Robinson, Edward
 P. Co. B, 9 Reg't U.S.C. Inf.

1 Enclosures.

| | |
|------------------------------------|----------------------------|
| Bed Cards | Final Statements |
| Burial Records | Furloughs or L. of A |
| Certs. of Dis. for Discharge | Med. Certificates |
| C. M. Charges | Med. Des. Lists |
| Descriptive Lists | Orders |
| Discharge Certificates | Pris. of War Record |
| Enlistment Papers | Resignations |

Other papers relating to—

| | |
|------------------------------|----------------------------|
| Admission to Hosp'l | Furlough or L. of A |
| Casualty Sheet | Med. Examination |
| Confinement | Misc. Information / |
| Contracts | Pay or Clothing |
| Death or Effects | Personal Reports |
| Desertion | Rank |
| Discharge from Hosp'l | Transfer to Hosp'l |
| Discharge from Service | Transfer to V. R. C. |
| Duty | Transportation |

[OFFICE ENDORSEMENT.]

War Department,

ADJUTANT GENERAL'S OFFICE,

....., 187

The *Discharge* of *Private Edward Robinson*, Co. D., *9th* Reg't U. S. Colored *Troops*, is reported as follows:

On Company Muster Roll. For *Sept + Oct*, 1865, *Sept. 29th*, 1865

Company Muster-out Roll. *Sept. 28th*, 1865

Company Descriptive Book.

....., 186

Company Morning Reports.

....., 186

Soldier's Final Statement.

....., 186

Soldier's Record of Death and Interment.

....., 186

Soldier's Inventory of Effects.

....., 186

Soldier's Certificate of Disability for Discharge.

....., 186

Soldier's Individual Muster-out Roll.

Sept. 29th, 1865

Regimental Return.

For *Sept.*, 1865, *Sept. 28th*, 1865

Regimental Quarterly Returns.

....., 186

Regimental Descriptive Book.

....., 186

By Surgeon General.

....., 186

Sept 29, 1865, is held to be the correct date, and the Company Muster Roll will be amended accordingly.

Roma M. Sweet
Assistant Adjutant General.
11/3/65

960
 Robinson, Joseph

Co I, 9 U.S. Col'd Inf.

Private Private

CARD NUMBERS.

| | | |
|----|---------|----|
| 1 | 6315170 | 26 |
| 2 | 6315270 | 27 |
| 3 | 6315394 | 28 |
| 4 | 6316794 | 29 |
| 5 | 9069386 | 30 |
| 6 | | 31 |
| 7 | | 32 |
| 8 | | 33 |
| 9 | | 34 |
| 10 | | 35 |
| 11 | | 36 |
| 12 | | 37 |
| 13 | | 38 |
| 14 | | 39 |
| 15 | | 40 |
| 16 | | 41 |
| 17 | | 42 |
| 18 | | 43 |
| 19 | | 44 |
| 20 | | 45 |
| 21 | | 46 |
| 22 | | 47 |
| 23 | | 48 |
| 24 | | 49 |
| 25 | | 50 |

Book Mark:

See also

R. | 9 | U.S.C.T.

Joseph Robinson,

, Co. I, 9 Reg't U. S. Col'd Inf.

Appears on

Company Descriptive Book

of the organization named above.

DESCRIPTION.

Age 20 years; height 5 feet 4 1/2 inches.

Complexion Light

Eyes Blue; hair Black

Where born Somerset, Md.

Occupation Farmer

ENLISTMENT.

When Nov. 22, 1863.

Where Tussock, Somerset, Md.

By whom Col. Birney; term 3 y'rs.

Remarks: Discharged Feb. 10/64.

D. Mastie

R | 9 | U.S.C.T.

Joseph Robinson
No. , Co. *D* , 9 Reg't U. S. Col'd Infantry.

Age *40* years.

Appears on

Company Muster-in Roll

of the organization named above. Roll dated
Camp Stanton Charles Co Md, Nov, 25 , 1863.

Muster-in to date *Nov, 25* , 1863

Joined for duty and enrolled:

When *Nov 22* , 1863.

Where *Somerville Md*

Period *3* years.

Remarks:

Book mark:

(356)

J. E. Chapin

Copyist.

R

9

U.S.C.T.

Joseph Robinson

Pro, Co. I, 9 Reg't U. S. Col'd Infantry.

Appears on

Company Muster Roll

for from Nov. 25 to Dec 31, 1863

Present or absent Present

Stoppage, \$ 100 for

Due Gov't, \$ 100 for

Remarks: \$2 Recruit Prem. due

Book mark:

J. Chapin

R | 9 | U.S.C.T.

Joseph Robinson
Pvt., Co. I, 9 Reg't U. S. Col'd Infantry.

Appears on

Company Muster Roll

for Jan & Feb, 1864.

Present or absent

Stoppage, \$ 100 for

Due Gov't, \$ 100 for

Remarks: Disch'd Feb. 14/64 by order of
Brig. Gen. Lockwood Comd'g Middle Dept.
by reason of disability. Discharge &
Statute given. \$2 Rec. Prom. due.

Book mark: Disch'd Feb. 14/64, L.B. 35-3¹²

J. E. Chapin

No. 9 U.S.C.T.

Joseph Robinson

Priv., Co. J, 9 Reg't U. S. Col'd Infantry.

Appears on Co. Muster-out Roll, dated New Orleans, La., Oct 10, 1866.

Muster-out to date, 1866

Last paid to, 1866

Clothing account:

Last settled, 1866; drawn since \$100

Due soldier \$100; due U. S. \$100

Am't for cloth'g in kind or money adv'd \$100

Due U. S. for arms, equipments, &c., \$100

Bounty paid \$100; due \$100

Remarks: Joined at original organz; Discharged as Sny Capt Dis Feb 9/64

Book mark: C.D. Discharged (100ms.)

G. E. Dayton

WARREN 1964

JAN. 22

6316796

018910

B. M.

Febry 16/64 L. B. $\frac{12}{353}$

Robinson, Joseph

P, Co. I, 9 Reg't U. S. C. Inf.

2 Enclosures.

| | |
|------------------------------|-------------------|
| Bed Cards | Descriptive Lists |
| Burial Records | Final Statements |
| Certs. of Dis. for Discharge | Furloughs |
| C. M. Charges | Med. Des. Lists |
| Med. Certificates | Orders |

Other papers relating to—

| | |
|----------------------------|----------------------|
| Admission to Hosp'l | Furlough |
| Casualty Sheet (Officer's) | Med. Examination |
| Confinement | Misc. Information |
| Contracts | Pay or Clothing |
| Death or Effects | Personal Reports |
| Desertions | Rank |
| Discharge from Hosp'l | Transfer to Hosp'l |
| Discharge from Service | Transfer to V. R. C. |
| Duty | Transportation |

Slave Claim 1

MICROFILM PUBLICATION M.1851

COMPILED MILITARY SERVICE RECORDS
OF VOLUNTEER UNION SOLDIERS WHO SERVED WITH
THE UNITED STATES COLORED TROOPS (USCT)
9TH REGIMENT OF INFANTRY

PERSONAL PAPERS' TARGET SHEET

PLEASE NOTE THE CHECKED INFORMATION ABOUT THE PERSONAL PAPERS IN
THIS FILE:

NO PERSONAL PAPERS WERE FOUND IN THIS FILE WHEN THE
RECORDS WERE ARRANGED FOR MICROFILMING.

6 PERSONAL PAPER(S) FOUND IN THIS FILE WHEN THE RECORDS
WERE ARRANGED FOR MICROFILMING.

A.

No. 137

CLAIMANT'S CERTIFICATE.

I, J. A. Willing adm. J. A. Willing a loyal citizen, and a resident
of Dorchester, County of Somerset, State of
Maine, hereby claim compensation, under the provisions of
General Orders, No. 329, 1863, for ~~the~~ ^{Robinson} slave of Josiah or Joseph Willing alias
enlisted November 23 1863, at Camp Stanton
by Col Wm. Birney in the 1st
Regiment U. S. Colored Troops, Co. I; certificate of which enlistment, and a
descriptive list, as required, accompany this application.

In proof of my loyalty to the Constitution and Government of the United States, I
present the accompanying oath, which I have taken, signed, and acknowledged, to be filed
with this application, in accordance with requirement of said General Orders.

James A. Willing
adm.

February 11 1864

B.

OATH OF ALLEGIANCE.

I, *Jas. A. Milling adm.*, do solemnly swear that I have never joined, or been concerned in, any insurrection or rebellion; that I have never borne arms against the United States; that I have never given any aid, countenance, counsel, or encouragement to any person or persons engaged, or whom I had reason to believe were about to engage, in insurrection, rebellion, or armed hostility against the United States; that I have neither sought, nor accepted, nor attempted to exercise the functions of any office, civil or military, nor to perform any service whatever, under any authority or pretended authority in hostility to the United States; that I have not yielded a voluntary support to any insurrection, rebellion, or pretended government, authority, power, or constitution within the United States hostile thereto. And I do further swear that, to the best of my knowledge and ability, I have supported and defended, and will continue to support and defend, the United States against all enemies, foreign and domestic; and that I have supported, defended, and obeyed, and will continue to support, defend, and obey, the Constitution and laws of the United States; that I will bear true faith and allegiance to the same; and that I take this oath freely, without any mental reservation or purpose of evasion: So help me God.

James A. Milling

Sworn to and subscribed before me, at *Baltimore* }
 this *11* day of *February* 186*4* }

Jos W Stake
 Justice of the Peace



[Faint, illegible text at the bottom of the page, possibly a signature or stamp.]

1864

C.

I present herewith evidence of my title to the slave Isiah ^{Robinson}
Joseph Willing ^{alias} enlisted as aforesaid, and in consideration of the sum of
..... by me received, I hereby covenant and
agree with the United States, that I, my heirs, executors, or assigns, shall never hereafter make
or enforce any claim to the labor or services of said slave; and pledge myself to execute
a valid Deed of Manumission and Release of all my claims to service forever of said
Isiah or Joseph Willing ^{Robinson} ^{alias} to be filed with the Board of Claims
now in session at Baltimore Md

James A. S. Willing
 JAS
 Willing

Feb 11, 1864

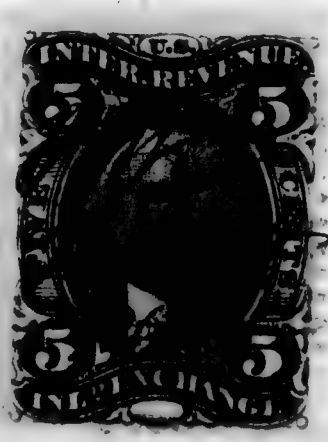

1864
November 27th
Examined & found correct,
J. H.
[Faint illegible text]

11 51
No. 137
APPLICATION OF
D. A. J. Willing adm.
OF
Somerset County
For Compensation for Service of Slave,
alias Robinson
Josiah or Joseph Willing
Enlisted in 11th Regiment
U. S. Colored Troops, Co. D.
Received, February 13th 1864.
COMPENSATION AWARDED,
November 14th 1864.
Three Hundred Dollars.
Thos. Simmons
President Board of Claims
Nov. 20 1864

P.O. Gaspin
Somerset

March 30. 64

EVIDENCE OF TITLE.

I, J. A. J. Milling, adm^r of Mr. J. S. Milling dec^d, of Somerset
County, Md., do solemnly swear that Josiah, or Joseph ~~Willing~~, alias
Joseph Robinson
who has been enlisted in the Smith Regiment, U. S. Colored Troops,
Co. I; is ~~the~~ slave for life of the estate (his term of service expiring on
the ~~Willing dec^d~~ day of 186;) and that
he became possessed of him by purchase, in the month
of _____, eighteen hundred and _____. And I
do further swear that I have not purchased said slave from any person or persons disloyal
to the Government of the United States, with the object of obtaining compensation for
the same; and furthermore, that I have no agency for obtaining compensation for any per-
son or persons but such as, to my knowledge, are loyal citizens of the United States.

James A. J. Milling
February 11 1864

STATE OF MARYLAND,

Baltimore City, County, to wit:

On this *11th* day of *February* in the year 1864,

before me, the subscriber, a Justice of the Peace of the State and County aforesaid, personally appeared *Isaac J. Willing adm. of W. J. Willing decd.*, and took, signed, and acknowledged the oaths preceding; and further made oath, in due form of law, that all the statements made in this application are, to the best of *his* knowledge and belief, strictly true.

Also personally appeared before me *John Turner* and *Wm. Walter*, loyal citizens of the United States, residents of *Somerset County*, well acquainted with the said *Isaac J. Willing*, and in no manner interested in the prosecution of this claim, and made oath, in due form of law, that the said *Isaac J. Willing, at his death* ^{*alias Robinson*} ~~was~~ the owner of the slave *Isiah or Joseph Willing*, as a fact of public notoriety; that they believe all the statements herein made by *him*, in reference thereto, are correct, and that *he* is unquestionably loyal to the Government of the United States. Witness their signatures:

Is W Blake

John Turner
Wm Walter

Justice of the Peace.



State of Maryland, Baltimore City, Sct:

I HEREBY CERTIFY, That *Joseph M. Blake* Esquire, before whom the annexed affidavit

is made, and who has thereto subscribed his name, was at the time of so doing a Justice of the Peace of the State of Maryland, in and for the City of Baltimore, duly commissioned and sworn.



IN TESTIMONY WHEREOF, I hereto set my hand and affix the seal of the Superior Court of Baltimore City, this *13th* day of *February* A. D. 186*4*

Alford Mace
Clerk of the Superior Court of Baltimore City.

NOV 1864

F.

CERTIFICATE OF AWARD OF THE BOARD OF CLAIMS.

Office of the Board of Claims
For Slaves Enlisted in the Service of the United States,

Catonsville Md

November 17th, 1864

\$ 300

We hereby certify, that *James A. Milling, Adm^r*, of *Somerset* county, State of *Maryland*, having proved, under oath, *his* loyalty to the Constitution and Government of the United States, and established *his* title as to the ownership of *Joseph Robinson*, a slave enlisted at *Somerset County Md*, on the *22^d* day of *November*, 1863, by *Col. E. Wm. Birney*, in the service of the United States, in the *9th* Regiment of Colored Troops, Co. *D*, and having filed a valid Deed of Manumission and Release of Service of said slave, is entitled to the sum of *Three Hundred* dollars, which has been awarded to *him* by this Board as a remuneration for all claim to the future labor or service of said slave, under the provision of General Orders, War Department, No. 329, 1863.

Thos. Simmons, President of the Board.

L. C. Strang, Member of the Board.

Samuel Jones, Member of the Board.

To *Col. C. W. Foster*,

Chief of the Bureau for the
Organization of Colored Troops, Washington, D. C.

[OFFICE ENDORSEMENT.]

War Department,

ADJUTANT GENERAL'S OFFICE,

Dec 16, 1864

The Discharge of Pvt Joseph Robinson, Co. I, 9th Reg't U.S. Colored Troops, is reported as follows:

- On Company Muster Roll, For ~~Jan'y 1st~~, 1864, ~~Feb'y 14th~~, 1864
 - Company Muster out Roll, February 9, 1864
 - Company Descriptive Book, 186
 - Company Morning Reports, 186
 - Soldier's Final Statement, 186
 - Soldier's Record of Death and Interment, 186
 - Soldier's Inventory of Effects, 186
 - Soldier's Certificate of Disability for Discharge, February 10, 1864
 - Soldier's Individual Muster out Roll, 186
 - Regimental Return, For February, 1864, February 11, 1864
 - Regimental Quarterly Returns, 186
 - Regimental Descriptive Book, 186
 - By Surgeon General, 186
- Feb'y 16, 1864 is held to be the correct date, and the Company Muster Rolls will be amended accordingly.

L. B. 353 Assistant Adjutant General. Noted J. H.

R. 34. R. of Dis 1864 C.

CERTIFICATE OF DISABILITY FOR DISCHARGE

IN THE CASE OF

Joseph Robinson a private Co. I Ninth Reg't of U.S.C.T.

No. 1119 9th U.S.C.T. Camp Stanton Feb'y 1864

Respectfully forwarded this 9th day of Feb'y 1864

Head Qm. Camp, Stanton Md. February 9, 1864

Approved and respectfully forwarded.

Wm. Binney, Brig. Genl. U.S.A. Camp Stanton

Received (A. G. Office) 186 MEDICAL DIRECTOR'S OFFICE, Middle Dept., 8th Army Corps, Baltimore, Md., February 12, 1864. APPROVED. Surgeon, U.S.A. Medical Director.

Headquarters, Middle Dept, Bal., Md., Feb'y 15, 1864

To be discharged By Command of Major General Max Hoodless Captain

ADJUTANT GENERAL'S OFFICE

March 7, 1864

Duplicate sent the Pension Office.

J. A. J. Milling
to
J. Robinson

Mounty Club issued
at the time

Deed of Manumission and Release of Service

alias Robinson

Whereas the slave Joseph Robutson has enlisted in the service of the United States, now in consideration thereof I James A. J. Willing of Somerset County State of Maryland do hereby in consideration of said enlistment manumit, set free and release the above named Joseph Robutson from all service due the heirs of Wm. J. L. Willing dec'd his freedom to commence from the 22nd of November 1863 the date of his enlistment as aforesaid in the ninth Regiment of Colored Troops in the service of the United States Witness my hand and seal this 26th day of February 1864

Witness
John M. Dougherty
C. C. Donohoe

James A. J. Willing admsr 

State of Maryland Somerset County 1864 before me appeared this day James A. J. Willing and acknowledged the above deed of manumission and release of service to be his free act and deed

State of Maryland Somerset County to wit Joseph E. Lynch J. P.

I Levin Woolford clerk of the Circuit Court for Somerset County aforesaid hereby certify that Joseph E. Lynch Esquire before whom the above acknowledgment appears to have been made and whose name is



thereunto subscribed, was at the time the same bears date one of the justices of the peace of the state of Maryland in and for Somerset County aforesaid duly commissioned and sworn

That his signature thereto is genuine & for testimony whereof
I hereunto subscribe my name and affix the seal of the said
Circuit Court this 8 day of March 1864

Levin Woolford clk

State of Maryland Somerset County Set:

I hereby certify that the foregoing is truly
Copied from the Original now on file and of record in the office
of the Clerk of the Circuit Court for Somerset County in and for
the State aforesaid & for testimony whereof I hereunto sub-

scribe my name and affix the seal
of the said Circuit Court this 8th day
of March Anno Domini 1864

Levin Woolford clk



MARK 1864
That his signature thereto is genuine & In testimony whereof
I hereunto subscribe my name and affix the seal of the said
Circuit Court this 8 day of March 1864

Levin Woolford clk

State of Maryland Somerset County Set:

I hereby certify that the foregoing is truly
Copied from the Original now on file and of records in the office
of the Clerk of the Circuit Court for Somerset County in and for
the State aforesaid & In testimony whereof I hereunto sub-

scribe my name and affix the seal
of the said Circuit Court this 8th day
of March Anno Domini 1864

Levin Woolford clk



137

24
Co. D, 9th U.S. CT
Wm. Miller

Robinson Joseph

A. G. O. Nov. 21st 1864,
I certify that the name of
Joseph Robinson is borne on
the Muster-roll of Co. D
9th U.S. Cavalry, on file at
this Office. It is
stated on said roll that
he was enrolled as Private 101
T. M.

E. W. Saggard
Adj. Genl.

VOLUNTEER DESCRIPTIVE LIST and Account of Pay and Clothing of

A recruit in 9th U.S.C.T.

| No. | NAMES. | RANK. | DESCRIPTION. | | | | | WHERE BORN. | | OCCUPATION. | ENROLLED OR ENLISTED. (For Drafted Men, see note 10.) | | | MUSTERED IN. (For Drafted Men, see note 10.) | | | | LAST PAID. | | | |
|-----|------------------------|-------|---------------|------------|------------|--------------|----------------------|-------------------|-----------------|-----------------|--|-----------------------------|---------------|---|-----------------------------|--|---------------|----------------|------------------|--|--|
| | | | Years of age. | Eyes. | Hair. | Complexion. | HEIGHT. Feet. In. | State or Kingdom. | Town or county. | | When. | Where. (Town and State.) | By whom. | When. | Where. (Town and State.) | By whom. (In the case of drafted men, from what enrollment district.) | Period. | By paymaster. | To | | |
| 1 | <i>Robinson Joseph</i> | | <i>40</i> | <i>Blk</i> | <i>Blk</i> | <i>Light</i> | <i>5</i> | <i>4 1/2</i> | <i>MD</i> | <i>Somerset</i> | <i>Farmer</i> | <i>1863</i> | <i>Apr 22</i> | <i>Somerset</i> | <i>C. Birney</i> | <i>1863</i> | <i>Apr 22</i> | <i>Conduct</i> | <i>C. Birney</i> | | |

REMARKS.

NOTES.

- The amount of any extra pay for which the soldier may be mustered, *ex. gr.* as Acting Hospital Steward, as Saddler, &c., and which may be still due him, must be carefully noted.
- In the column headed "BOUNTY PAID," must be entered the whole amount *hitherto* paid him; in that of "BOUNTY DUE," the whole amount yet due him. Bounty paid by State authorities, and not by the United States, will not be entered on this statement.
- Stoppages for loss or damage done to arms, or other public property, must be noted, and the articles, and particular damage to each, specified. When stoppages are due, under sentence of a Court Martial, a transcript of the same must be entered here; and the amount already stopped, must be carefully stated.
- In every case of desertion, the date, and that of delivery, or apprehension, must be given, together with a correct transcript of the order of sentence or pardon.
- A careful settlement of the man's CLOTHING ACCOUNT must be made, to date, and the amount DUE TO, or FROM him must be precisely stated.
- Should the man have been engaged in any action or skirmish, it must be mentioned, together with date and place. A full and particular mention will be made of any wounds he may have received in action, or other injury, whilst in the line of his duty.
- If the soldier is entitled to pay for the use of his horse, the company commander will certify to that fact on this list, and also to the time he has pay due for having been so mounted on his own horse.
- When a soldier is furnished with final statements, his descriptive list, if he has one, should be taken up by the officer who gives the soldier these statements, and endorsed with a statement to this effect by the officer. This endorsement should exhibit a full statement of the time for which the soldier was allowed pay on his final statements, the clothing account, and all other charges against him or in his favor, so as to comprise a complete exhibit of his account. It will then be transmitted to the company commander of the soldier, who will enter all the data necessary to a full understanding of the soldier's account on the muster roll upon which the soldier's discharge is reported. The descriptive list will then be destroyed. The object of this is, that the remaining portion of the soldier's account may be settled upon the receipt of these muster rolls, and the soldier receive any pay or allowances that may be due him at the time of his discharge, and which may not appear on his final statements from the fact that his descriptive list is incomplete. These accounts for back pay, &c., are settled by the 2d Auditor of the Treasury Dep't.
- Where a soldier dies in Hospital or on detached service, his descriptive list, if he has one, should be sent with his final statements, in duplicate, to the Adjutant General, Washington, D. C.
- Men drafted will be considered as mustered in from the date of their draft, and will be mustered for pay on the usual rolls for Volunteers. On the same line as the soldier's name, under the heading "Joined for Duty and Enrolled.—Commencement of First Payment by Time," will be written the word *drafted*, or *substitute* as the case may be; and under the heading "When Mustered in" will be given the date when the soldier was drafted, or, if a substitute, when enlisted, (substitutes, under the Enrollment Act, are mustered in by enlistment;) under "Where Mustered in," will be given the place from which drafted, (or if a substitute, where enlisted;) under the heading "By whom Mustered in," will be given the No. of the Enrollment District from which he was drafted, and the State to which it belongs, *as: 4th D. Mass.*; (meaning 4th Enrollment District, State of Massachusetts.) Or if a substitute, the name of the officer enlisting him. When enlisted by Board of Enrollment, the name of the Provost Marshal of the Enrollment District.)
- A separate descriptive list should, as general rule, be given for each man.
- Descriptive lists must, in all cases, be signed by COMMISSIONED officers; not by enlisted men acting as such.

I CERTIFY that the above is a correct transcript from the Records of

from Maryland for U.S. Colored Troops

STATION *Baltimore Md.*

DATE: *October 16th 64*

*James B. ...
Capt 31st Regt. 6th*

WARREN

9th U.S.C.

| MUSTERED IN. (For Drafted Men, see note 10.) | | | LAST PAID. | | BOUNTY. | | CLOTHING ACCOUNT. | |
|---|--|---------|---------------|---------------|--------------------------|--------|--------------------------|--|
| Where. (Town and State.) | By whom. (In the case of drafted men, from what enrollment district.) | Period. | By paymaster. | To what time. | Paid \$ (See note 2.) | Due \$ | Date of last settlement. | Total money value of clothing drawn since last settlement. |
| | Pennedict C. Berry | | | | | | 60 A 9th U.S.C. | |

J. M. Melling

That the above is a correct transcript from the Records of this Great Rendezvous of Recruits
Maryland for U.S. Colored Troops

By Command of
S. M. Bowman
Capt. 84th Penn Vols
Commanding the Company.

Baltimore Md.
October 16th 64

James Butler
Capt 51st U.S.C.
Chf Mustg and Recr Officer
of U.S. Colored Troops for Md.

961
Robinson, Leve

Co K, 9 U.S. Col'd Inf.

Private | Private

CARD NUMBERS.

| | | |
|----|---------|----|
| 1 | 63/6908 | 26 |
| 2 | 63/7005 | 27 |
| 3 | 63/7108 | 28 |
| 4 | 63/7210 | 29 |
| 5 | 63/7305 | 30 |
| 6 | 63/7399 | 31 |
| 7 | 63/7487 | 32 |
| 8 | 63/7577 | 33 |
| 9 | 63/7636 | 34 |
| 10 | 63/7742 | 35 |
| 11 | 63/7817 | 36 |
| 12 | 63/7907 | 37 |
| 13 | 63/8378 | 38 |
| 14 | 63/8406 | 39 |
| 15 | 9069489 | 40 |
| 16 | | 41 |
| 17 | | 42 |
| 18 | | 43 |
| 19 | / | 44 |
| 20 | | 45 |
| 21 | | 46 |
| 22 | | 47 |
| 23 | | 48 |
| 24 | | 49 |
| 25 | | 50 |

Book Mark:

See also

LIBRARY

8739473- Report
J 1033883- 2land.
D. 1193299 P.O. m...

G. E. Doughty
2

B | **9** | **U.S.C.T.**

Levi Robertson

....., Co. *B*, 9 Reg't U. S. Col'd Inf.

Appears on

Company Descriptive Book

of the organization named above.

DESCRIPTION.

Age *30* years; height *5* feet *6* inches.

Complexion *Black*

Eyes *Grey*; hair *Black*

Where born *Somerset Md.*

Occupation *Oysterman*

ENLISTMENT.

When *Nov 26*, 186 *3*

Where *White Haven*

By whom *Capt. Wm. Boring*; term *3* y'rs.

Remarks:

Dischd.

J. W. Ames

R | 9 | U.S.C.T.

Levi Robinson
Pri, Co. K, 9 Reg't U. S. Col'd Infantry.

Age 30 years.

Appears on

Company Muster-in Roll

of the organization named above. Roll dated

Charles Co. Md, Nov 30, 1863.

Muster-in to date Nov 30, 1863

Joined for duty and enrolled:

When Nov 26, 1863.

Where Somerset Md

Period 3 years.

Remarks:

Book mark:

C. G. Smith

R | **9** | **U.S.C.T.**

Levi Robinson
Ovi, Co. K, 9 Reg't U. S. Col'd Infantry.

Appears on

Company Muster Roll

for *Nov & Dec*, 1863.

Present or absent *Present*

Stoppage, \$ *100* for

Due Gov't, \$ *100* for

Remarks: *\$2.00 Recruit Premium*
Due

Book mark:

C. G. Smith

B | **9** | **U.S.C.T.**

Levi Robinson

Pri, Co. K, 9 Reg't U. S. Col'd Infantry.

Appears on

Company Muster Roll

for *Jan & Feb*, 1864.

Present or absent *Present*

Stoppage, \$ *100* for

Due Gov't, \$ *100* for

Remarks: *\$200 Recruit
Premium Due*

Book mark:

O. G. Smith

(358)

Copyist

R | **9** | **U.S.C.T.**

Levi Robinson

Pri, Co. K, 9 Reg't U. S. Col'd Infantry.

Appears on

Company Muster Roll

for *March & April*, 186*4*

Present or absent *Present*

Stoppage, \$ *100* for

Due Gov't, \$ *100* for

Remarks: *Stop for our Haversack*

Book mark:

Oes Smith

R | **9** | **U.S.C.T.**

Levi Robinson

Pvt, Co. K, 9 Reg't U. S. Col'd Infantry.

Appears on

Company Muster Roll

for *May & June*, 1864.

Present or absent *Absent*

Stoppage, \$ *100* for

Due Gov't, \$ *100* for

Remarks: *Absent sick at
Beaufort SC since
June 11-1864*

Book mark:

O. G. Smith

R | 9 | U.S.C.T.

Levi Robinson
Pri., Co. K, 9 Reg't U. S. Col'd Infantry.

Appears on

Company Muster Roll

for July & Aug, 1864

Present or absent Present

Stoppage, \$ 100 for

Due Gov't, \$ 100 for

Remarks: Stop for one
Canteen

Book mark:

O. G. Smith

R | **9** | **U.S.C.T.**

Levi Robinson
Pri, Co. *K*, 9 Reg't U. S. Col'd Infantry.

Appears on

Company Muster Roll

for *Sept & Oct*, 186*4*

Present or absent *Present*

Stoppage, \$ *100* for

Due Gov't, \$ *100* for

Remarks: *Due the difference*
between \$7.00 per mo.
& \$13.00 per mo. from
Jan. 1 to Apr. 30/64.

Book mark: _____

O. G. Smith

R

9

U.S.C.T.

Levi Robinson

Priv, Co. K, 9 Reg't U. S. Col'd Infantry.

Appears on

Company Muster Roll

for Nov & Dec, 1864

Present or absent Present

Stoppage, \$ 100 for

Due Gov't, \$ 100 for

Remarks:

Book mark:

G W Deabrick
Copyist

(858)

B

9

U.S.C.T.

Levi Robinson

Priv, Co. K, 9 Reg't U. S. Col'd Infantry.

Appears on

Company Muster Roll

for *Jan Feb*, 1863.

Present or absent *Present*

Stoppage, \$ *100* for

Due Gov't, \$ *100* for

Remarks:

Book mark:

G W Deadrick

(858)

Copyist

R

9

U.S.C.T.

Levi Robinson

Priv, Co. K, 9 Reg't U. S. Col'd Infantry.

Appears on

Company Muster Roll

for *May & Apr*, 1865.

Present or absent *Present*

Stoppage, \$ *100* for

Due Gov't, \$ *100* for

Remarks: *Stop for transportation while on furlough & 3.58/100*

Book mark:

G W Deadrick

(858)

Copyist

R | 9

U.S.C.T.

Levi Robinson

Pri, Co. K, 9 Reg't U. S. Col'd Infantry.

Appears on a

Detachment Muster-out Roll

of the organization named above. Roll dated

Fort Monroe, Va., June 13, 1865.

Muster-out to date

June 13, 1865.

Last paid to

Dec 31, 1864

Clothing account:

Last settled *Oct 31, 1864*; drawn since \$ *30*⁶⁵/₁₀₀

Due soldier \$ *100*; due U. S. \$ *100*

Am't for cloth'g in kind or money adv'd \$ *100*

Due U. S. for arms, equipments, &c., \$ *100*

Bounty paid \$ *100* due \$ *100*

Remarks: *Rec'd U. S. for transportation \$ 31.58. Mustered out by War Dept. dated May 3rd 1865. Patient U. S. Gen Hospital Fort Monroe, Va.*

**As it is on roll.*

Book mark: *282.071.*

(349)

J. S. Brown

Copyist.

P. | 9 | U.S.C.T.

Levi Robinson

Priv., Co. K, 9 Reg't U. S. Col'd Infantry.

Appears on

Company Muster Roll

for Dec 31/64 to June 30, 1865.

Present or absent Absent

Stoppage, \$ 100 for

Due Gov't, \$ 100 for

Remarks: Absent sick since May 20 1865 Stop for transportation while on furlough \$3 58/100

Book mark:

G W Deabrick

(858)

Copyist

K 9 U.S.C.T.

Levi Robinson
Priv, Co. K, 9 Reg't U. S. Col'd Infantry.

Appears on

Company Muster Roll

for July - Aug, 1865.

Present or absent

Stoppage, \$ 100 for

Due Gov't, \$ 100 for

Remarks: Mustered out of service
at Ft Monroe Va June 13/65 By
order War Dept
Stop \$ 3 ⁵⁸/₁₀₀ for transportation
while on furlough

Book mark:

G W Deavrick

(858)

Copyist

R | 9 | U.S.C.T.

Levi Robinson
Pvt., Co. *K*, 9 Reg't U. S. Col'd Infantry.

Appears on **Co. Muster-out Roll**, dated
New Orleans, La., Nov. 26, 1866.

Muster-out to date _____, 186 .
 Last paid to _____, 186 .

Clothing account:

Last settled _____, 186 ; drawn since \$ _____ 100

Due soldier \$ _____ 100; due U. S. \$ _____ 100

Am't for cloth'g in kind or money adv'd \$ _____ 100

Due U. S. for arms, equipments, &c., \$ _____ 100

Bounty paid \$ _____ 100; due \$ _____ 100

Remarks: *Joined at original
 organization. Discharged
 June 13, 1865 at Ft. Monroe,
 Va. by order War Dept.*

Book mark: *282.071*

(861)

D. C. Taylor

Copyist.

Robinson, Levi

P, Co. K, 9 Regt U.S.C. Inf.

2 Enclosures.

| | |
|------------------------------|-------------------|
| Bed Cards | Descriptive Lists |
| Burial Records | Final Statements |
| Certs. of Dis. for Discharge | Furloughs |
| C. M. Charges | Med. Des. Lists |
| Med. Certificates | Orders / |

Other papers relating to—

| | |
|----------------------------|----------------------|
| Admission to Hosp'l | Furlough |
| Casualty Sheet (Officer's) | Med. Examination |
| Confinement | Misc. Information |
| Contracts | Pay or Clothing |
| Death or Effects | Personal Reports |
| Desertions | Rank |
| Discharge from Hosp'l | Transfer to Hosp'l |
| Discharge from Service | Transfer to V. R. C. |
| Duty | Transportation |

Have Claim 1

MICROFILM PUBLICATION M 1851

COMPILED MILITARY SERVICE RECORDS
OF VOLUNTEER UNION SOLDIERS WHO SERVED WITH
THE UNITED STATES COLORED TROOPS (USCT)
9TH REGIMENT OF INFANTRY

PERSONAL PAPERS' TARGET SHEET

PLEASE NOTE THE CHECKED INFORMATION ABOUT THE PERSONAL PAPERS IN
THIS FILE:

- NO PERSONAL PAPERS WERE FOUND IN THIS FILE WHEN THE
RECORDS WERE ARRANGED FOR MICROFILMING.
- 5 PERSONAL PAPER(S) FOUND IN THIS FILE WHEN THE RECORDS
WERE ARRANGED FOR MICROFILMING.

Hdqrs 9th U. S. Co. B
Jan: 1/84

Col. John Bayley

Special Order No. 1

Detailing Levi Robertson
Co. K. as teamster

Reg't 9th U. S. C. Troopers
Jan. 1, 1864

Special Orders
No. 1

Private Levi Robertson of Co
"K" is hereby detailed as right
teamster. He will report for duty to
Q. M. Beebe tomorrow morning.

By order of

Thomas Beatty

Col. Comd'g Reg't

Official

E. W. M. M. M.

1st Lt. Adj't

A.

No. CLAIMANT'S CERTIFICATE.

I, William Catlin a loyal citizen, and a resident
of Hyack, County of Bonner, State of
Maine, hereby claim compensation, under the provisions of
General Orders, No. 329, 1863, for my slave Levi Robinson
enlisted November 26 1863, at Camp Stanton
by Col. Tom. Birney in the ninth
Regiment U. S. Colored Troops, Co. K; certificate of which enlistment, and a
descriptive list, as required, accompany this application.

In proof of my loyalty to the Constitution and Government of the United States, I
present the accompanying oath, which I have taken, signed, and acknowledged, to be filed
with this application, in accordance with requirement of said General Orders.

William Catlin W.C.

February 20th 1864

B.

OATH OF ALLEGIANCE.

I, William Catlin, do solemnly swear that I have never joined, or been concerned in, any insurrection or rebellion; that I have never borne arms against the United States; that I have never given any aid, countenance, counsel, or encouragement to any person or persons engaged, or whom I had reason to believe were about to engage, in insurrection, rebellion, or armed hostility against the United States; that I have neither sought, nor accepted, nor attempted to exercise the functions of any office, civil or military, nor to perform any service whatever, under any authority or pretended authority in hostility to the United States; that I have not yielded a voluntary support to any insurrection, rebellion, or pretended government, authority, power, or constitution within the United States hostile thereto. And I do further swear that, to the best of my knowledge and ability, I have supported and defended, and will continue to support and defend, the United States against all enemies, foreign and domestic; and that I have supported, defended, and obeyed, and will continue to support, defend, and obey, the Constitution and laws of the United States; that I will bear true faith and allegiance to the same; and that I take this oath freely, without any mental reservation or purpose of evasion: So help me God.

William Catlin
Treasurer

Sworn to and subscribed before me, at Baltimore
 this 10th day of February 1864

John W. Donovan
Justice of the Peace



C.

I present herewith evidence of my title to the slave Levi
Robinson enlisted as aforesaid, and in consideration of the sum of
..... by me received, I hereby covenant and
agree with the United States, that I, my heirs, executors, or assigns, shall never hereafter make
or enforce any claim to the labor or services of said slave; and pledge myself to execute
a valid Deed of Manumission and Release of all my claims to service forever of said
Levi Robinson, to be filed with the Board of Claims
now in session at Baltimore Md,

William Catlin W. C.

February 20th, 186 4



E.

DEED OF MANUMISSION AND RELEASE OF SERVICE.

Whereas my slave Levi Robinson has enlisted in the service of the United States: now, in consideration thereof, I, William Cattan, of Somerset county, State of Maryland, do hereby, in consideration of said enlistment, manumit, set free, and release the above-named Levi Robinson from all service due me; his freedom to commence from the 26th day November 1863, the date of his enlistment as aforesaid in the ninth Regiment of Colored Troops, in the service of the United States.

Witness my hand and seal, this 11th day of May, 1864.

William Cattan



Witness:

M H Taylor
L E Walter
J E Lynch
Somerset County,

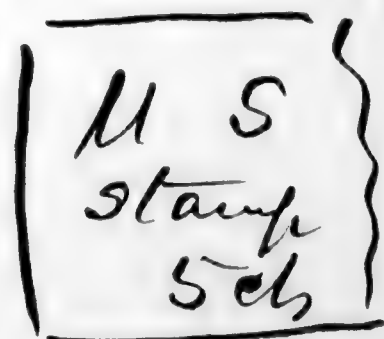

State of Maryland May 11th, 1864.

Before me appeared this day William Cattan, and acknowledged the above Deed of Manumission and Release of Service to be his free act and deed.

Joseph E Lynch J.P.
Justice of the Peace

Maryland Somerset County I do hereby certify that the within is
truly Copied from the Original on file and of record in the office of the
Clerk of the Circuit Court for Somerset County

In testimony whereof I hereunto subscribe
my name and affix the Seal of the said
Circuit Court this 26th day of May
Anno Domini 1864

Levin Woolford clk



Sealed

1864

~~Levin Woolford~~
1864
Levin Woolford

H. J. 58. 21. 11

No. 352,

APPLICATION OF

William Cattan

OF

Lyackin, Somerset County

For Compensation for Service of Slave,

Levi Robinson

Enlisted in *Wish* Regiment

U. S. Colored Troops, Co. *K.*

Received, *Feb 24* 1864.

COMPENSATION ~~was~~ Refused

August 8th 1865

Dallas.

Thos. Timmons

President Board of Claims

*This claim is rejected for reasons en-
dorsed on claims No. 168.*

Thos. Timmons
President Board of Claims

Recd. G. C. August 14. 1865.

no. 352. 11. 11. 11.

EVIDENCE OF TITLE.

I, William Catlin, of Somerset
 County, Md., do solemnly swear that Levi Robinson
 who has been enlisted in the Ninth Regiment, U. S. Colored Troops,
 Co. K ; is my slave for life ; (~~his term of service expiring on~~
~~the~~ day of ~~186~~) and that
 I became possessed of him by purchase , in the month
 of September , eighteen hundred and forty nine . And I
 do further swear that I have not purchased said slave from any person or persons disloyal
 to the Government of the United States, with the object of obtaining compensation for
 the same; and furthermore, that I have no agency for obtaining compensation for any per-
 son or persons but such as, to my knowledge, are loyal citizens of the United States.

February 20th 1864.

William Catlin v. c.

Somerset County }
 STATE OF MARYLAND, }

~~Baltimore City~~ County, to wit:

On this seventeenth day of February in the year 1864,
 before me, the subscriber, a Justice of the Peace of the State and County aforesaid, personally appeared William Catlin, and took, signed, and acknowledged the oaths preceding; and further made oath, in due form of law, that all the statements made in this application are, to the best of his knowledge and belief, strictly true.

Also personally appeared before me Alfred S. Nezieh and ~~Joseph E. Parsons~~ and Robert E. Parsons, loyal citizens of the United States, residents of Somerset County, well acquainted with the said William Catlin, and in no manner interested in the prosecution of this claim, and made oath, in due form of law, that the said William Catlin is the owner of the slave Levi Robinson, as a fact of public notoriety; that they believe all the statements herein made by him, in reference thereto, are correct, and that he is unquestionably loyal to the Government of the United States. Witness their signatures:

Alfred S. Nezieh
Robert E. Parsons

John W. Anderson Justice of the Peace.

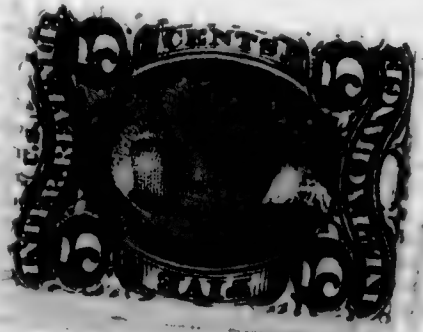

STATE OF MARYLAND,

Somerset County
~~Baltimore City~~ to wit:

I, *Alfred Mace*, Clerk of the *Superior* ~~Circuit~~ Court for *Somerset County*
~~Baltimore City~~, do hereby certify that

before whom the foregoing affidavits were made, was, at the time of signing the same, a Justice of the Peace for the County and State aforesaid, duly commissioned and sworn; and that his signature thereto is genuine, and that full faith and credit should be given to his official acts.

Witness my hand and the seal of said Court, this *Seventeenth* day of

February, A. D. 1864.

CLERK.

State of Maryland Somerset County to wit:

I *Levin Woolford* Clerk of the Circuit Court for Somerset County do hereby certify that *John W. D. Anderson Esquire* before whom the foregoing affidavits were made, was, at the time of signing the same, a justice of the peace for the County and State aforesaid duly Commissioned and Sworn; and that his signature thereto is genuine, and that full faith and Credit should be given to his official acts witness my hand and the seal of said Court this *twentieth* day of *February* A. D. 1864

Levin Woolford CLK



White Haven Feb 2nd 1864

General Binney Dear Sir

Allow me to ask you the second time for a descriptive list of my slave Levi Robertson, when I wrote to you first I wrot his name Sougherty but since that time I have seen his name on the Muster Roll that is before the Commissioners at Baltimore and he calls himself Levi Robertson ~~he is~~ ~~a member of company~~ he is about 28 years of age 5 feet 6 inches high

Respectfully yours William Catlin

State of Maryland Somerset County On this the 25th February 1864 before me the Subscriber, a Justice of the Peace In and for said County personally appeared William Catlin and made oath on the holy Evangelly of almighty God that the above described man is his slave for life

P.S. Sworn before Joseph P. Lynch Col J. M. Bowman Dear Sir

Above you have a description of my slave which I sent to Gen^l Binney and it has been sent back with instructions to send it to you. therefore I hope you will send me a description list
Respectfully yours William Catlin

[A. G. O. No. 93.]

9. Where a soldier dies in Hospital or on detached service, his descriptive list should be given for each man. 10. A separate descriptive list should, as a general rule, be given for each man. 11. Descriptive lists must, in all cases, be signed by COMMISSIONED OFFICERS; not by enlisted men acting as such.

DATE: March

VOLUNTEER DESCRIPTIVE LIST and Account of Pay and Clothing of

William Catlin

VOLUNTEER DESCRIPTIVE LIST and Account of Pay and Clothing of

A Recruit 9th U.S.

| No. | NAMES. | RANK. | DESCRIPTION. | | | | | WHERE BORN. | | OCCUPATION. | ENROLLED OR ENLISTED. (For Drafted Men, see note 10.) | | | MUSTERED IN. (For Drafted Men, see note 10.) | | | | LAST |
|-----|----------------------|-------|---------------|-------------|------------|-------------|----------------------|-------------------|-----------------|----------------|--|-----------------------------|-----------------|---|-----------------------------|--|-----------------------|------|
| | | | Years of age. | Eyes. | Hair. | Complexion. | HEIGHT. Feet. In. | State or Kingdom. | Town or county. | | When. | Where. (Town and State.) | By whom. | When. | Where. (Town and State.) | By whom. (In the case of drafted men, from what enrollment district.) | Period. | |
| | <i>Levi Robinson</i> | | <i>30</i> | <i>Gray</i> | <i>Blk</i> | <i>Dark</i> | <i>56</i> | <i>Ind</i> | <i>Somerset</i> | <i>Captain</i> | <i>1863</i> | <i>Nov 26</i> | <i>Somerset</i> | <i>Ed Perry</i> | <i>1863</i> | <i>Nov 30</i> | <i>Benedict Perry</i> | |

REMARKS.

NOTES.

amount of any extra pay for which the soldier may be mustered, ex. as Acting Hospital Steward, as Saddler, &c., and which may be still be him, must be carefully noted.
 The column headed "BOUNTY PAID," must be entered the whole amount thereto paid him; in that of "BOUNTY DUE," the whole amount yet due him. Bounty paid by State authorities, and not by the United States, will not be entered on this statement.
 Stoppages for loss or damage done to arms, or other public property, must be noted, and the articles, and particular damage to each, specified. When stoppages are due, under sentence of a Court Martial, a transcript of the same must be entered here; and the amount already stopped must be carefully stated.
 In every case of desertion, the date, and that of delivery, or apprehension, must be given, together with a correct transcript of the order of sentence or pardon. A full settlement of the man's CLOTHING ACCOUNT must be made, to date, and the amount DUE TO, or FROM him must be precisely stated.
 If the man have been engaged in any action or skirmish, it must be mentioned, together with date and place. A full and particular mention will be made of any wounds he may have received in action, or other injury, whilst in the line of his duty.

7..If the soldier is entitled to pay for the use of his horse, the company commander will certify to that fact on this list, and also to the time he has pay due for having been so mounted on his own horse.
 8..When a soldier is furnished with final statements, his descriptive list, if he has one, should be taken up by the officer who gives the soldier these statements, and endorsed with a statement to this effect by the officer. This endorsement should exhibit a full statement of the time for which the soldier was allowed pay on his final statements, the clothing account, and all other charges against him or in his favor, so as to comprise a complete exhibit of his account. It will then be transmitted to the company commander of the soldier, who will enter all the data necessary to a full understanding of the soldier's account on the muster roll upon which the soldier's discharge is reported. The descriptive list will then be destroyed. The object of this is, that the remaining portion of the soldier's account may be settled upon the receipt of these muster rolls, and the soldier receive any pay or allowances that may be due him at the time of his discharge, and which may not appear on his final statements from the fact that his descriptive list is incomplete. These accounts for back pay, &c., are settled by the 2d Auditor of the Treasury Dept.
 9..Where a soldier dies in Hospital or on detached service, his descriptive

list, if he has one, should be sent with his final statements, in duplicate, to the Adjutant General, Washington, D. C.
 10..Men drafted will be considered as mustered in from the date of their draft, and will be mustered for pay on the usual rolls for Volunteers. On the same line as the soldier's name, under the heading "Joined for Duty and Enrolled.—Commencement of First Payment by Time," will be written the word *drafted*, or *substitute*, as the case may be; and under the heading "When Mustered in," will be given the date when the soldier was drafted, or, if a substitute, when enlisted, (substitutes, under the Enrollment Act, are mustered in by enlistment.) Under "Where Mustered in," will be given the place from which drafted, (or if a substitute, where enlisted.) Under the heading "By whom Mustered in," will be given the No. of the Enrollment District from which he was drafted, and the State to which it belongs, thus: *4th D. Mass.*; (meaning 4th Enrollment District, State of Massachusetts.) Or if a substitute, the name of the officer enlisting him. (When enlisted by Board of Enrollment, the name of the Provost Marshal of the Enrollment District.)
 11..A separate descriptive list should, as a general rule, be given for each man.
 12..Descriptive lists must, in all cases, be signed by COMMISSIONED officers; not by enlisted men acting as such.

I CERTIFY that the above is a correct transcript from the Records

from Maryland for U.S. Colored Troops

STATION:

Baltimore Md

DATE:

March 16th 1864

Co. K 9th U.S.C.T.

| MUSTERED IN. (For Drafted Men, see note 10.) | | | | LAST PAID. | | BOUNTY. | | CLOTHING ACCOUNT. | |
|---|-----------------------------|--|---------|---------------|---------------|--------------------------|-------------------------|---------------------------------|--|
| No. | Where. (Town and State.) | By whom. (In the case of drafted men, from what enrollment district.) | Period. | By paymaster. | To what time. | Paid \$ (See note 2.) | Due \$ (See note 2.) | Date of last settlement. | Total money value of clothing drawn since last settlement. |
| 123 30 | Benedict | Ed. Berney | | | | | | Co. K. 9 th U.S.C.T. | |
| | | | | | | | | Mr. Castle | |

That the above is a correct transcript from the Records of this Genl. Rendezvous of Recruits Maryland for U.S. Colored Troops

Baltimore Md
March 16th 1864

J. M. Brannon
Capt. 84th Pa. Vol.
Commanding the Company
Chief, Recr. S. Muster, Office
of U.S. Colored Troops, for Md.

962

Rogers, James

Co B, 9 U.S. Col'd Inf.

Private | Corporal

CARD NUMBERS.

| | | |
|----|---------|----|
| 1 | 6302629 | 26 |
| 2 | 6302729 | 27 |
| 3 | 6302831 | 28 |
| 4 | 6302932 | 29 |
| 5 | 6303032 | 30 |
| 6 | 6303130 | 31 |
| 7 | 6303164 | 32 |
| 8 | 6303259 | 33 |
| 9 | 6303357 | 34 |
| 10 | 6303455 | 35 |
| 11 | 6303550 | 36 |
| 12 | 6303642 | 37 |
| 13 | 6303733 | 38 |
| 14 | 6303811 | 39 |
| 15 | 6303886 | 40 |
| 16 | 6303958 | 41 |
| 17 | 6304027 | 42 |
| 18 | 6304097 | 43 |
| 19 | 6304165 | 44 |
| 20 | 6304230 | 45 |
| 21 | 9068700 | 46 |
| 22 | | 47 |
| 23 | | 48 |
| 24 | | 49 |
| 25 | | 50 |

Book Mark:

See also

1659107 } P.O. aff'd
1659132 }

2
Lynch

R | 9 | U.S.C.T.

James Rogers

....., Co. B, 9 Reg't U. S. Col'd Inf.

Appears on

Company Descriptive Book

of the organization named above.

DESCRIPTION.

Age 23 years; height 5 feet 6 3/4 inches.

Complexion Dark

Eyes Dark; hair Dark

Where born Accomac, Va.

Occupation Sailor

ENLISTMENT.

When Nov. 7, 1865

Where near Accomac, Va.

By whom E. W. Kinney term 2 y'rs.

Remarks: He enlisted to Corp'l.
Sept. 1, 1864. In action
with Co. at John's G'd,
S. C.; Deep Bottom, Va;
and Chapin's Farm, Va.
Slightly wounded in
latter action.
Mustered out with
Regt. Nov. 26/66.

E. W. Kinney

R

9

U.S.C.T.

James Rogers

Priv, Co. *B*, 9 Reg't U. S. Col'd Infantry.

Age *25* years.

Appears on

Company Muster-in Roll

of the organization named above. Roll dated

Camp Stanton Charles Co. Md. Nov 11, 1863.

Muster-in to date *Nov 11*, 1863

Joined for duty and enrolled:

When *Nov 7*, 1863.

Where *Acomac Va*

Period *3* years.

Remarks:

Book mark:

S. Duncan

R

9

U.S.C.T.

James Rogers

Plt, Co. B, 9 Reg't U. S. Col'd Infantry.

Appears on

Company Muster Roll

for *Nov 11 to Dec 31*, 1863.

Present or absent *Present*

Stoppage, \$ *100* for

Due Gov't, \$ *100* for

Remarks: *Two dollars recruit premium due*

Book mark:

S. Duncan

(358)

Copyist

R

9

U.S.C.T.

James Rogers
Pvt., Co. B, 9 Reg't U. S. Col'd Infantry.

Appears on

Company Muster Roll

for James & Selby, 1864.

Present or absent Present

Stoppage, \$ 100 for

Due Gov't, \$ 100 for

Remarks Two dollars recruit
premium due

Book mark:

S. Duncan

(858)

Copyist

R | 9 | U.S.C.T.

James Rogers
Priv, Co. B, 9 Reg't U. S. Col'd Infantry.

Appears on

Company Muster Roll

for *Mich + Apl*, 1864.

Present or absent *Present*

Stoppage, \$ 100 for

Due Gov't, \$ 100 for

Remarks:

Book mark:

S. Urman

(358)

Copyist

R | **9** | **U.S.C.T.**

James Rogers
Priv, Co. B, 9 Reg't U. S. Col'd Infantry.

Appears on

Company Muster Roll

for *May & June*, 186*4*

Present or absent *Present*

Stoppage, \$ *100* for

Due Gov't, \$ *100* for

Remarks:

Book mark: _____

S. Humeau

R

9

U.S.C.T.

James Rogers

Priv, Co. B, 9 Reg't U. S. Col'd Infantry.

Appears on

Company Muster Roll

for *July & Aug*, 1864.

Present or absent *Present*

Stoppage, \$ 100 for

Due Gov't, \$ 100 for

Remarks:

Book mark:

S. Linnear

(358)

Copyist

R

9

U.S.C.T.

James Rogers
Co. B, 9 Reg't U. S. Col'd Infantry.

Appears on

Company Muster Roll

for Sept & Oct, 1864.

Present or absent Present

Stoppage, \$ 100 for

Due Gov't, \$ 100 for

Remarks Promoted to Co. B
for S.O. No. 97 Hd Qrs 9th U.S.
C.I. Sept 7, 1864 stop for
one canteen

Book mark:

S. Dimean

R

9

U.S.C.T.

James Rogers

Coupl, Co. B, 9 Reg't U. S. Col'd Infantry.

Appears on

Company Muster Roll

for Nov & Dec, 1864.

Present or absent Present

Stoppage, \$ 100 for

Due Gov't, \$ 100 for

Remarks: Promoted to Coupl for
S.O. No. 97 Hd Qrs 9 U.S.C.I.
Sept. 7. 64
stop for one (1) Canteen

Book mark:

J. Duncan

R.

9

U.S.C.T.

James Rogers
Corpl, Co. B, 9 Reg't U. S. Col'd Infantry.

Appears on

Company Muster Roll

for Jan & Feb, 1865.

Present or absent present

Stoppage, \$ 100 for

Due Gov't, \$ 100 for

Remarks: Stop for one
consec

Book mark:

Harper.

R **9** **U.S.C.T.**

James Rogers
Corpl, Co. B, 9 Reg't U. S. Col'd Infantry.

Appears on

Company Muster Roll

for *Mar & Apr*, 1865.

Present or absent *present*

Stoppage, \$ *100* for

Due Gov't, \$ *100* for

Remarks: *Stop for one canteen.*

Book mark:

(358)

Harper
Copyist

R.

9

U.S.C.T.

James Rodgers
Corp, Co. B, 9 Reg't U. S. Col'd Infantry.

Appears on

Company Muster Roll

for *Dec 31/64 to June 30, 1865.*

Present or absent *present*

Stoppage, \$ *100* for

Due Gov't, \$ *100* for

Remarks: *Stop for*
one quarter

Book mark:

B. E. Harper

(358)

Copyist

R.

9

U.S.C.T.

James Rogers
Corp, Co. B, 9 Reg't U. S. Col'd Infantry.

Appears on

Company Muster Roll

for *July & Aug*, 1865.

Present or absent *present*.

Stoppage, \$ *100* for

Due Gov't, \$ *100* for

Remarks:

Book mark:

Harper

R.P.

9

U.S.C.T.

Gas. Rogers
Corp, Co. B, 9 Reg't U. S. Col'd Infantry.

Appears on

Company Muster Roll

for *June 30/65 to Dec 31, 1865.*

Present or absent *present*

Stoppage, \$ *100* for

Due Gov't, \$ *100* for

Remarks:

Book mark:

Hasper

(358)

Copyist

R.

9

U.S.C.T.

James Rogers
Corp, Co. B, 9 Reg't U. S. Col'd Infantry.

Appears on

Company Muster Roll

for

Jan & Feb

, 1866.

Present or absent

present

Stoppage, \$ 100 for

Due Gov't, \$ 100 for

Remarks:

Book mark:

Harper

R. | 9 | U.S.C.T.

James Rogers
Corpl., Co. B, 9 Reg't U. S. Col'd Infantry.

Appears on

Company Muster Roll
for *March & April*, 1866.

Present or absent *Present.*

Stoppage, \$ *100* for

Due Gov't, \$ *100* for

Remarks:

Book mark:

F. C. Dickerson.

R. | 9 | U.S.C.T.

James Rogers,
Capt., Co. B, 9 Reg't U. S. Col'd Infantry.

Appears on

Company Muster Roll

for *May & June*, 1866.

Present or absent *Present.*

Stoppage, \$ 100 for

Due Gov't, \$ 100 for

Remarks:

Book mark:

F. C. Dickerson.

R.

9

U.S.C.T.

James Rogers
Co. B, 9 Reg't U. S. Col'd Infantry.

Appears on

Company Muster Roll

for *July & Aug.*, 1866.

Present or absent *Present*

Stoppage, \$ *4*/*100* for *Camp & Garrison*

Equipage.

Due Gov't, \$ *100* for

Remarks:

Book mark: *52-1000*

G. C. Dickerson,

R

9

U.S.C.T.

James Rogers
Coopl, Co. B, 9 Reg't U. S. Col'd Infantry.

Appears on

Company Muster Roll

for *Sept. & Oct.*, 1866.

Present or absent *Present*

Stoppage, \$ *100* for

Due Gov't, \$ *100* for

Remarks:

Book mark: *320-28*

F. C. Dickerson

(358)

Copyist

R. | 9 | U.S.C.T.

James Rogers
 Corp'l, Co. B., 9 Reg't U. S. Col'd Infantry.

Appears on **Co. Muster-out Roll**, dated
New Orleans La. Nov. 26, 1866.

Muster-out to date *Nov. 26*, 1866.

Last paid to *Aug 31*, 1866.

Clothing account:

Last settled....., 186 ; drawn since \$ 100

Due soldier \$ *7* ²⁴/₁₀₀; due U. S. \$ 100

Am't for cloth'g in kind or money adv'd \$ 100

Due U. S. for arms, equipments, &c., \$ *6* 100

Bounty paid \$ *9* 100; due \$ *100* 100

Remarks: *Joined at Original*
Organ. in to Sept 7-65.
Stop for 1 month &
Set accoutrements,
(retained.)

\$100. Bounty under act of
 Book mark: *V-125: P 297-73* ^{order.}

F. C. Dickerson.

WARREN 255

JAN. 21

6304230

1891

*Congress amend July
2d. 1866.*

Rogers, James
 Corp, Co. *B 9*, Reg't *U.S.C. Inf.*

Enclosures.

| | |
|------------------------------------|----------------------------|
| Bed Cards | Final Statements |
| Burial Records | Furloughs or L. of A. |
| Certs. of Dis. for Discharge | Med. Certificates |
| C. M. Charges | Med. Des. Lists |
| Descriptive Lists | Orders |
| Discharge Certificates | Pris. of War Record |
| Enlistment Papers | Resignations |

Other papers relating to—

| | |
|------------------------------|---------------------------|
| Admission to Hosp'l | Furlough or L. of A. |
| Casualty Sheet | Med. Examination |
| Confinement | Misc. Information |
| Contracts | Pay or Clothing |
| Death or Effects | Personal Reports |
| Desertion | Rank |
| Discharge from Hosp'l | Transfer to Hosp'l |
| Discharge from Service | Transfer to V. R. C. |
| Duty | Transportation |

128

CASUALTY SHEET
OF WOUNDED.

James Rogers
Corporal Company *B*
9 Regiment of *USCA*

Volunteers at the battle of *Chapin's*

Farm Va + assault on

Fort Gilmer Sept 29+30/64

CASUALTY SHEET.

Name, James Rogers
 Rank, Corporal, Company B, Regiment, 9th
 Arm, U.S.A., State, _____
 Place of casualty, "Chapins Farm Va. + assault on Fort
 Gilmer" Ina 41 no 69.
 Nature of casualty, Wounded - Nature S
 Date of casualty, Sept 29 + 30 / 64

FROM WHAT SOURCE THIS INFORMATION WAS OBTAINED.

Report of Killed, Wounded, and Missing of the _____ Regiment,
 _____ Brigade, _____ Division, _____ Corps, dated _____
List of Wounded of 9th U.S.A.
(Sigid) Edwin S. Babcock
Capt 9th U.S.A. Comdg Regt
Endorsed: List of Casualties in 9th U.S.A.
Sept 29th & 30th 1864.
Ina 50 L no 67

W. F. Thompson
 Clerk.

⁹⁶³
Rogers, Robin

Co. D, 9 U.S. Col'd Inf.

Private | Private

CARD NUMBERS.

| | | |
|----|---------|----|
| 1 | 6306158 | 26 |
| 2 | 6306316 | 27 |
| 3 | 6306418 | 28 |
| 4 | 6306522 | 29 |
| 5 | 6306622 | 30 |
| 6 | 6306719 | 31 |
| 7 | 6306819 | 32 |
| 8 | 6306918 | 33 |
| 9 | 6307020 | 34 |
| 10 | 6307120 | 35 |
| 11 | 6307218 | 36 |
| 12 | 6307309 | 37 |
| 13 | 6307398 | 38 |
| 14 | 6307483 | 39 |
| 15 | 6307564 | 40 |
| 16 | 6307644 | 41 |
| 17 | 6307723 | 42 |
| 18 | 6307801 | 43 |
| 19 | 6307881 | 44 |
| 20 | 6307958 | 45 |
| 21 | 9068472 | 46 |
| 22 | | 47 |
| 23 | | 48 |
| 24 | | 49 |
| 25 | | 50 |

Book Mark:

See also

P. 140 234/A 0. aff

S. P. Douglas
2

WAR 1861
R | 9 | U.S.C.T.

Robin Rogers,

, Co. D, 9 Reg't U. S. Col'd Inf.

Appears on

Company Descriptive Book

of the organization named above.

DESCRIPTION.

Age 19 years; height 5 feet 7 1/2 inches.

Complexion Light;

Eyes Dark; hair Dark.

Where born Northampton va.

Occupation Farmer.

ENLISTMENT.

When Nov. 11, 1863.

Where Eastville.

By whom Col. Birney; term 3 y'rs.

Remarks: Discharged with
Regt Nov. 26/66.

A | **9** | **U.S.C.T.**

Robin Rogers
But, Co. *N*, 9 Reg't U. S. Col'd Infantry.

Age *19* years.

Appears on

Company Muster-in Roll

of the organization named above. Roll dated
C. Stanton, Ches. Co. Md. Nov. 14, 1863.

Muster-in to date *Nov. 14, 1863*

Joined for duty and enrolled:

When *Nov. 11*, 186 *3*

Where *Northampton Va.*

Period *3* years.

Remarks:
.....
.....
.....
.....
.....

Book mark:

J. E. Parks

R

9

U.S.C.T.

Robin Rogers

Pvt, Co. D, 9 Reg't U. S. Col'd Infantry.

Appears on

Company Muster Roll

for *from Nov 14* to *Dec 31*, 186 *3*

Present or absent *Present*

Stoppage, \$ *100* for

Due Gov't, \$ *100* for

Remarks: *\$ 2.00 recruits premium due*

Book mark:

F. E. Parks

(858)

Copyist

R

9

U.S.C.T.

Robin Rogers

Co., Co. D, 9 Reg't U. S. Col'd Infantry.

Appears on

Company Muster Roll

for *Jan & Feb*, 1864.

Present or absent *Present*

Stoppage, \$ *100* for

Due Gov't, \$ *100* for

Remarks: *Two dollars recruits premium due.*

Book mark:

F. E. Parks

(858)

Copyist

R | 9 | U.S.C.T.

Robin Rogers

Priv., Co. D, 9 Reg't U. S. Col'd Infantry.

Appears on

Company Muster Roll

for Mar Apr, 1864

Present or absent absent

Stoppage, \$ 100 for

Due Gov't, \$ 100 for

Remarks: Detailed as guard for prisoners going from Hilton Head S.C. to Jacksonville Fla.

Book mark:

J. E. Parks

P

9

U.S.C.T.

Robin Rogers

Priv, Co. D, 9 Reg't U. S. Col'd Infantry.

Appears on

Company Muster Roll

for *May & June*, 186*4*.

Present or absent *Present*

Stoppage, \$ *100* for

Due Gov't, \$ *100* for

Remarks:

Book mark:

J. E. Rucke

(858)

Copyist

R

9

U.S.C.T.

Robin Rogers

Co. D, 9 Reg't U. S. Col'd Infantry.

Appears on

Company Muster Roll

for *July 1867*, 1867

Present or absent *Present*

Stoppage, \$ *100* for

Due Gov't, \$ *100* for

Remarks: *Shop for one (1) Knapsack & one (1) Haversack.*

Book mark:

J. C. Parks

(358)

Copyist

R | **9** | **U.S.C.T.**

Robin Rogers
Priv, Co. D, 9 Reg't U. S. Col'd Infantry.

Appears on

Company Muster Roll

for *Sept, & Oct.*, 186 *4*

Present or absent *Present*

Stoppage, \$ *100* for

Due Gov't, \$ *100* for

Remarks:

Book mark: _____

J. E. Purke
Copyist

A | **9** | **U.S.C.T.**

Robin Rogers
Priv, Co. D, 9 Reg't U. S. Col'd Infantry.

Appears on

Company Muster Roll

for *Nov, 1864*, 186 *4*

Present or absent *Present*

Stoppage, \$ *100* for

Due Gov't, \$ *100* for

Remarks: *Stop for one*
Knapsack,

Book mark:

J. E. Rucke

(358)

Copyist

R **9** **U.S.C.T.**

Robbie Rogers
Plt., Co. D, 9 Reg't U. S. Col'd Infantry.

Appears on

Company Muster Roll

for *Jan & Feb*, 1865.

Present or absent *Present*

Stoppage, \$ *100* for

Due Gov't, \$ *100* for

Remarks:

Book mark:

J. M. Harmon

R | 9 | U.S.C.T.

Robin Rogers

Pvt., Co. D, 9 Reg't U. S. Col'd Infantry.

Appears on

Company Muster Roll

for *Mar 1865*, 1865.

Present or absent *Absent*.

Stoppage, \$ *100* for

Due Gov't, \$ *100* for

Remarks: *Absent in Con-*

*finement Service Mch
1865. Stop for 1
bayonet scabbard*

Book mark:

W. Harmon

R | 9 | U.S.C.T.

Robin Rogers
Pvt., Co. D, 9 Reg't U. S. Col'd Infantry.

Appears on

Company Muster Roll

for Dec 31/64 to June 30, 1865.

Present or absent Absent.

Stoppage, \$ 100 for

Due Gov't, \$ 100 for

Remarks Absent in confinement since Mar. 16/65
Stop for 1 bayonet
scabbard.

Book mark:

J. M. Garrison

R | 9 U.S.C.T.

Robin Rogers
Pvt., Co. D, 9 Reg't U. S. Col'd Infantry.

Appears on

Company Muster Roll

for Dec 31/64 to Dec 31, 1865.

Present or absent *Absent*

Stoppage, \$ 100 for

Due Gov't, \$ 100 for

Remarks: *Sentenced by Gen
Ch. Mer. Order no 32 Hd
Qr. 1st Div. 25 A.C. Apr 17
1865. to be confined at
hard labor on Govt. work
for the period of six months
& to forfeit to the U.S.
\$10. per mo. of his month-
ly pay during the term
of his sentence.
Stop for 1 bayonet scabbard.*

Book mark:

J. M. Harwood

R

9

U.S.C.T.

Robbin Rogers

Pvt., Co. D, 9 Reg't U. S. Col'd Infantry.

Appears on

Company Muster Roll

for June 30/65 to Oct 31, 1865.

Present or absent Present

Stoppage, \$ 100 for

Due Gov't, \$ 100 for

Remarks: Due us for 1 bayonet scabbard 56 ct.

Book mark:

J. M. Harmon

R

9

U.S.C.T.

Robbie Rogers

Prvt., Co. D, 9 Reg't U. S. Col'd Infantry.

Appears on

Company Muster Roll

for June 30/65 to Dec 31, 1865.

Present or absent Present

Stoppage, \$ 100 for

Due Gov't, \$ 100 for ord

Remarks:

Book mark:

(358)

J. M. Harmon

Copyist

R | **9** | **U.S.C.T.**

Robin Rodgers
Prvt., Co. D, 9 Reg't U. S. Col'd Infantry.

Appears on

Company Muster Roll

for *Jan'y & Feb'y*, 186 *6*

Present or absent *Present*

Stoppage, \$ *100* for

Due Gov't, \$ *100* for

Remarks:

Book mark:

J. M. Harmon

No. 9 U.S.C.T.

Robin Rogers
Private, Co. D, 9 Reg't U. S. Col'd Infantry.

Appears on

Company Muster Roll

for March + April, 1866.

Present or absent present.

Stoppage, \$ 100 for

Due Gov't, \$ 100 for

Remarks:

Book mark:

G. E. Dayton

R. | **9** | **U.S.C.T.**

Robin Rogers
Plt, Co. D, 9 Reg't U. S. Col'd Infantry.

Appears on

Company Muster Roll

for *May + June*, 186 *6*

Present or absent *Present*

Stoppage, \$ *100* for

Due Gov't, \$ *100* for

Remarks:

Book mark:

G. E. Dayton

R. 9 U.S.C.T.

Robert Rogers
Co., Co. D, 9 Reg't U. S. Col'd Infantry.

Appears on

Company Muster Roll

for *July & Aug*, 186*6*

Present or absent *present.*

Stoppage, \$ *100* for

Due Gov't, \$ *100* for

Remarks:

Book mark: _____

G. E. Dayton

R.

9

U.S.C.T.

Robin Rogers
Pat, Co. D, 9 Reg't U. S. Col'd Infantry.

Appears on

Company Muster Roll

for *Sep + Oct*, 1866.

Present or absent *present.*

Stoppage, \$ *100* for

Due Gov't, \$ *100* for

Remarks:

Book mark:

G. E. Dayton

(358)

Copyist

P. | 9 | U.S.C.T.

Robin Rogers

Regt. Co. D, 9 Reg't U. S. Col'd Infantry.

Appears on **Co. Muster-out Roll**, dated *New Orleans La. 26th Mo*, 1866,

Muster-out to date *26th Mo*, 1866,

Last paid to *31 Aug*, 1866,

Clothing account:

Last settled _____, 1866; drawn since \$ _____ 100

Due soldier \$ *42 83* 100; due U. S. \$ _____ 100

Am't for cloth'g in kind or money adv'd \$ _____ 100

Due U. S. for arms, equipments, &c., \$ *6 00* 100

ordinary none Bounty paid \$ *none* 100; due \$ *100 00* 100 x

Remarks: *Joined at original*

organz;

*Stop for (1) Muskets and
sett accounts retained*

*x Bounty due under Act of
Congress of July 2nd 1866 \$ 100 00*

Book mark: *V221 P. 291. 75*

G. E. Dayton

Rogers, Robin
 Co. D, 9 Reg't U.S. Inf

2 Enclosures.

| | |
|------------------------------------|----------------------------|
| Bed Cards | Final Statements |
| Burial Records | Furloughs or L. of A |
| Certs. of Dis. for Discharge | Med. Certificates |
| C. M. Charges <i>/</i> | Med. Des. Lists |
| Descriptive Lists | Orders |
| Discharge Certificates | Pris. of War Record |
| Enlistment Papers | Resignations |

Other papers relating to—

| | |
|------------------------------|----------------------------------|
| Admission to Hosp'l | Furlough or L. of A |
| Casualty Sheet | Med. Examination |
| Confinement | Misc. Information <i>/</i> |
| Contracts | Pay or Clothing |
| Death or Effects | Personal Reports |
| Desertion | Rank |
| Discharge from Hosp'l | Transfer to Hosp'l |
| Discharge from Service | Transfer to V. R. C. |
| Duty | Transportation |

MICROFILM PUBLICATION M.1851

COMPILED MILITARY SERVICE RECORDS
OF VOLUNTEER UNION SOLDIERS WHO SERVED WITH
THE UNITED STATES COLORED TROOPS (USCT)
9TH REGIMENT OF INFANTRY

PERSONAL PAPERS' TARGET SHEET

PLEASE NOTE THE CHECKED INFORMATION ABOUT THE PERSONAL PAPERS IN
THIS FILE:

- NO PERSONAL PAPERS WERE FOUND IN THIS FILE WHEN THE
RECORDS WERE ARRANGED FOR MICROFILMING.
- 3 PERSONAL PAPER(S) FOUND IN THIS FILE WHEN THE RECORDS
WERE ARRANGED FOR MICROFILMING.

Charge and
Specification
preferred against
Robt Rogers Coe

Charge and Specification preferred against
Private Robin Rogers Co D 9th N S C Troops

Charge - Sleeping on Post

Specification. That Private Robin Rogers Co
Dth 9th N S C Troops having been duly posted
as a sentinal was found asleep on his
Post - between the hours of six and seven
A. M.

This at the Camp of the 9th N S C Troops
On or about - the 13th day of March 1863

Witnesses

A. Rhodes Adj. 9th N S C T

Jelley Floyd Sgt. Co E 9th N S C T

A. Rhodes

1st Lt. Adj. 9th N S C T

9th N S C Troops

✓
Robin Rogers
Print Co. D. G. & Co.

Mr. Everett

Adjutant General's Office,

COLORED TROOPS BRANCH,

February 9th, 1877

Mr. Ellersbrook Vol.

C. T., 187

Wanted in the case of Robin Rogers, Priv., Co. G.,
9th Reg't U.S.C.T.

Record of Trial &c.

M.P. from February 28th to June 30th 65. Report him "Absent in Confinement since March 16, 1865." and
M.P. for July & August. Absent without leave. Sentenced for G.C.M.O. No. 32, H.C. 1, Div. 25, A.C. Apr. 17/65.
To be confined at hard labor on Gov't Works for the period of six months "and to forfeit to the U.S.
the amount of his monthly pay during the term of his sentence."

Respectfully,

W. A. Woodward,
Chief Clerk.

J. H. Halson

Adjutant General's Office,

Record Room

February 14th, 1877

Vol. C. T., 187

Reply in case of Robin Rogers, Co. "D",
9th Reg't U.S.C.T.

G.C.M.O. No. 32 H.C. 1 Div. 25 A.C. Apr. 17th 1865.

Charge - Sleeping on Post

Sentence - To be confined at hard labor on some Gov't Fort-
ification to be designated by the Comdg Genl for six months
and to forfeit ten dollars per month of his monthly pay
for during the term of his sentence.

Approved - Fort Norfolk designated as place of conf.

G. C.

Head Quarters in the Field
 Va of 1st Div 25th A.C.

Apr 17, 1865.
 Gen Court Martial Order No 30

Proceedings & findings of
 the Gen Court Martial in
 the case of Private Robin
 Rogers Co "D." 9th Regt. U.S.C.

Apr 17th 1865.

Headquarters 1st Div 25th A.C.

In the field No

Apr 17th 1865

General Court Martial Orders }
 No — 32 }

Before a General Court Martial which convened at Head Quarters 1st Div 25th A.C. on the 17th day of March 1865 pursuant to Special Orders No 69 Part II dated Head Quarters 1st Div 25th A.C. In the field No March 16th 1865 and of which Col Pratt 36th U.S.C.T. is President were arraigned and tried.

6th Private Robin Rogers Co "D" 9th Regt U.S.C.T.
Charges

Sleeping on Post

To which charge the accused pleaded "Not Guilty"
 The Court after mature deliberation upon the evidence adduced find the accused of the charge "Guilty" and do therefore sentence him Private Robin Rogers Co "D" 9th Regt U.S.C.T. to be confined at Hard Labor on some Government Fortification to be designated by the Commanding General for the period of six months and to forfeit to the United States ten dollars per month of his monthly pay during the term of his sentence.

7th Private George Marshal Co "K" 43rd Regt U.S.C.T.
Charge

Desertion.

To which charge the accused pleaded "Not Guilty".
 The Court after mature deliberation upon the evidence adduced find the accused of the charge "Guilty" and do therefore sentence him Privat George Marshall Co "K" 43rd Regt U.S.C.T. To be confined at Hard Labor on some Government Fortification for the period of two years and to forfeit to the United States ten dollars per month of his monthly pay during the term of sentence.

The proceedings finding^g and sentence in the case of Private Robert Rogers Co "D" 9th U.S.C.T. are approved except that portion of the proceedings where the Court takes upon itself the power to excuse an absent member. The Court should know that the authority organizing the Court alone can excuse a member or take him away from his duty in the Court. The sentence will be duly carried into effect at Fort Norfolk Va as provided in orders from the Headquarters of the Department. The Court should have designated the place of execution of such a sentence as directed in the orders referred to.

The proceedings finding^g and sentence in the case of Privat George Marshall Co "K" 43rd U.S.C.T. are approved. The sentence owing to the recommendation of the Court is annulled and Privat Marshall will be restored to duty.

The Court seems to have neglected in this case
 to call out testimony to which the prisoners state-
 ment was a sufficient clue.

By Command of
 Brig Major Genl. Kautz
 W-Tomborlu.

Official.
 W-Tomborlu.
 a. a. g.

a. a. g.

¹⁶⁴
Roley, George

Co. H, 9 U.S. Col'd Inf.

Private | Private

CARD NUMBERS.

| | | |
|----|---------|----|
| 1 | 6313442 | 26 |
| 2 | 6313541 | 27 |
| 3 | 6313641 | 28 |
| 4 | 6313745 | 29 |
| 5 | 6313843 | 30 |
| 6 | 6313938 | 31 |
| 7 | 6314029 | 32 |
| 8 | 6314134 | 33 |
| 9 | 6314234 | 34 |
| 10 | 6314328 | 35 |
| 11 | 6314421 | 36 |
| 12 | 6314499 | 37 |
| 13 | 6314581 | 38 |
| 14 | 6314653 | 39 |
| 15 | 6314717 | 40 |
| 16 | 6314780 | 41 |
| 17 | 6314840 | 42 |
| 18 | 6314900 | 43 |
| 19 | 6314959 | 44 |
| 20 | 6315015 | 45 |
| 21 | 9069270 | 46 |
| 22 | | 47 |
| 23 | | 48 |
| 24 | | 49 |
| 25 | | 50 |

Book Mark:

See also

J. 088235 P.C. GH

C. S. Douglas
2

(R) | 9 | U.S.C.T.

George Haley

, Co. *H*, 9 Reg't U. S. Col'd Inf.

Appears on

Company Descriptive Book

of the organization named above.

DESCRIPTION.

Age *21* years; height *5* feet *11* inches.

Complexion *Black*

Eyes *Black*; hair *Black*

Where born *Accomac, Virginia*

Occupation *Seaman*

ENLISTMENT.

When *Nov. 1st*, 186*3*.

Where *Camp Hull, Accomac, Va.*

By whom *Col. M. Steiner*; term *3* y'rs.

Remarks: *Descriptive list found
at July 27th 1864*

*Discharged Nov. 4th
from S. C. No. 6, U. S. Dept of
the Gulf.*

Carey

P

9

U.S.C.T.

George Roley
Private, Co. H, 9 Reg't U. S. Col'd Infantry.

Age 21 years.

Appears on

Company Muster-in Roll

of the organization named above Roll dated

Camp Stanton, Charles Co., Maryland, Nov. 23, 1863.

Muster-in to date Nov. 23, 1863

Joined for duty and enrolled:

When Nov. 7, 1863.

Where Accomac, Va.

Period 3 years.

Remarks:

Book mark:

O. J. Markle,

R

9

U.S.C.T.

George Raley

Private, Co. H, 9 Reg't U. S. Col'd Infantry.

Appears on

Company Muster Roll

for Nov. 23 to Dec. 31, 1863.

Present or absent Present.

Stoppage, \$ 100 for

Due Gov't, \$ 100 for

Remarks: \$2 Recruits premium due.

Book mark:

O. J. Markle

P | **9** | **U.S.C.T.**

George Roley
Private, Co. H, 9 Reg't U. S. Col'd Infantry.

Appears on

Company Muster Roll

for *Jan. + Feb.*, 1864.

Present or absent *Present.*

Stoppage, \$ *100* for

Due Gov't, \$ *100* for

Remarks: *Stop for one Knapsack and one Haversack. \$2 Reenlist premium due.*

Book mark:

O. J. Markle,

R

9

U.S.C.T.

George Roley

Private, Co. H, 9 Reg't U. S. Col'd Infantry.

Appears on

Company Muster Roll

for *March & April*, 1864.

Present or absent *Present.*

Stoppage, \$ *100* for

Due Gov't, \$ *100* for

Remarks:

Book mark:

O. J. Markle,

R | 9 | U.S.C.T.

George Foley
Private, Co. H, 9 Reg't U. S Col'd Infantry.

Appears on

Company Muster Roll

for *May & June*, 1864.

Present or absent *Present.*

Stoppage, \$ *100* for

Due Gov't, \$ *100* for

Remarks: *Stop for shoulder scales.*

Book mark:

O. J. Markle.

R

9

U.S.C.T.

George Roley

Private, Co. H, 9 Reg't U.S. Col'd Infantry.

Appears on

Company Muster Roll

for July + August, 1864.

Present or absent Present.

Stoppage, \$ 100 for

Due Gov't, \$ 100 for

Remarks:

Book mark:

O. J. Markle

P

9

U.S.C.T.

George Rolley

Private, Co. H, 9 Reg't U. S. Col'd Infantry.

Appears on

Company Muster Roll

for Sept. + Oct., 1864

Present or absent Present

Stoppage, \$ 100 for

Due Gov't, \$ 100 for

Remarks:

Book mark:

O. J. Markle

(358)

Copyist.

B | 9 | U.S.C.T.

George Colley
Priv., Co. H, 9 Reg't U. S. Col'd Infantry.

Appears on

Company Muster Roll

for Nov. & Dec., 1864.

Present or absent Present

Stoppage, \$ 100 for

Due Gov't, \$ 100 for

Remarks: The difference
between 50 and 100
dollars per month and
50 dollars per
month is due from
Jan., 54 to April 3,
54

Book mark:

H. Amos

R | **9** | **U.S.C.T.**

George Polley
Priv., Co. H, 9 Reg't U. S. Col'd Infantry.

Appears on

Company Muster Roll

for *Jan. & Feb.*, 1865.

Present or absent *Present*

Stoppage, \$ *100* for

Due Gov't, \$ *100* for

Remarks:

Book mark:

A. L. Arce

R | **9** | **U.S.C.T.**
George Polley
Priv., Co. H, 9 Reg't U. S. Col'd Infantry.

Appears on

Company Muster Roll

for *Mch. & Apr.*, 1865.

Present or absent *Present*

Stoppage, \$ 100 for

Due Gov't, \$ 100 for

Remarks:

Book mark:

A. L. Ames

R | **9** | **U.S.C.T.**

George Coley
Priv., Co. H, 9 Reg't U. S. Col'd Infantry.

Appears on

Company Muster Roll

for *Dec. 31, 1864 to June 30, 1865.*

Present or absent *Present*

Stoppage, \$ *100* for

Due Gov't, \$ *100* for

Remarks: *Stop for one*
month.

Book mark:

A. Amis

B | **9** | **U.S.C.T.**

George Coley
Priv., Co. H, 9 Reg't U. S. Col'd Infantry.

Appears on

Company Muster Roll

for *July & Aug.*, 1865.

Present or absent *Absent*

Stoppage, \$ *100* for

Due Gov't, \$ *100* for

Remarks: *Absent sick since July 16, 1865*

Book mark :

A. L. Ames

B | 9 | U.S.C.T.

George Roley
Priv., Co. H, 9 Reg't U. S. Col'd Infantry.

Appears on

Company Muster Roll

for June 30 to Oct 31, 1865.

Present or absent Absent

Stoppage, \$ 100 for

Due Gov't, \$ 100 for

Remarks: Absent sick since
~~Aug. 16/65~~ July 16/65

X Not appear on roll.

Book mark:

H. Ames

R

9

U.S.C.T.

George Rolley
Priv., Co. H, 9 Reg't U. S. Col'd Infantry.

Appears on

Company Muster Roll

for June 30 to Dec. 31, 1865.

Present or absent Absent

Stoppage, \$ 100 for

Due Gov't, \$ 100 for

Remarks: Post Hosp. Guard
per S. O. No. 224, Hd.
Irs. 1st Div. 25 Ac.
Nov. 2nd, 1865

Book marks:

A. L. Ames

R. | 9 | U.S.C.T.

George Rolley
Privt, Co. H, 9 Reg't U. S. Col'd Infantry.

Appears on

Company Muster Roll

for *Jan. & Feb*, 186 *6*

Present or absent *Absent*

Stoppage, \$ *100* for

Due Gov't, \$ *100* for

Remarks: *On det. service Post-hospital per S. O. No. 50. Hd Qrs Dist of the Rio Grand, Feb. 21st 1866.*

Book mark:

R. Bradin

R. | 9 | U.S.C.T.

George Roley
Privt., Co. H, 9 Reg't U. S. Col'd Infantry.

Appears on

Company Muster Roll

for *March & April*, 186*4*.

Present or absent *Absent*.

Stoppage, \$ *100* for

Due Gov't, \$ *100* for

Remarks: *On detached service
at Post Hosp'l per S.O. No. 50. 2nd
Qrs. Dist of the Rio Grande Feb 21/64*

Book mark:

R. Bradin

R

9

U.S.C.T.

George Paley

Priv., Co. H, 9 Reg't U. S. Col'd Infantry.

Appears on

Company Muster Roll

for *May + June*, 186*6*

Present or absent *Absent*

Stoppage, \$ *100* for

Due Gov't, \$ *100* for

Remarks: *On det. service at Post Hospital per SO No. 50. Hd. Qrs. Dist. of the Rio Grande, Feb. 21, 1866.*

Book mark:

(358)

Fitz
Camp.

R. | 9 | U.S.C.T.

George Roloy
Prin, Co. H, 9 Reg't U. S. Col'd Infantry.

Appears on

Company Muster Roll

for *July & Aug.*, 186*6*.

Present or absent *Absent*.

Stoppage, \$ *100* for

Due Gov't, \$ *100* for

Remarks: *On det. Service at Post,
Hospital per S.O. No. 50, Med. Dep.
Dist Rio Grande, Feb. 21/66.*

Book mark:

R. Bradin

R.

9

U.S.C.T.

George Roley,
Privt., Co. H, 9 Reg't U. S. Col'd Infantry.

Appears on

Company Muster Roll

for *Sept. & Oct.*, 186 *6*.

Present or absent *Present.*

Stoppage, \$ *100* for

Due Gov't, \$ *100* for

Remarks:

Book mark:

R. Braden

(358)

Copyist.

R | 9 | U.S.C.T.

George Raley.
Priv., Co. *H.*, 9 Reg't U. S. Col'd Infantry.

Appears on **Co. Muster-out Roll**, dated
New Orleans, La., Nov. 26, 186*6.*
 Muster-out to date *Nov. 26,* 186*6.*
 Last paid to *June 30,* 186*6.*

Clothing account:

Last settled....., 186 ; drawn since \$..... 100
 Due soldier \$ *26* ^{*30*}/₁₀₀; due U. S. \$..... 100
 Am't for cloth'g in kind or money adv'd \$..... 100

Due U. S. for arms, equipments, &c., \$..... 100
Ordinary
 Bounty paid \$..... 100; due \$ *100* 100

Remarks: *Bounty due under act
 of Congress of July 26/66 \$100
 paid at Original Organization.*

Book mark: *2164 P. 234. 73. 262. 860*

(861) *R. Bradin.* Copyist.

965
Roley, Samuel

Co F, 9 U.S. Col'd Inf.

Private | Corporal

CARD NUMBERS.

| | | |
|----|---------|----|
| 1 | 6309947 | 26 |
| 2 | 6310040 | 27 |
| 3 | 6310148 | 28 |
| 4 | 6310253 | 29 |
| 5 | 6310352 | 30 |
| 6 | 6310450 | 31 |
| 7 | 6310546 | 32 |
| 8 | 6310644 | 33 |
| 9 | 6310744 | 34 |
| 10 | 6310841 | 35 |
| 11 | 6310934 | 36 |
| 12 | 6311017 | 37 |
| 13 | 6311104 | 38 |
| 14 | 6311183 | 39 |
| 15 | 6311254 | 40 |
| 16 | 6311328 | 41 |
| 17 | 6311395 | 42 |
| 18 | 6311463 | 43 |
| 19 | 6311488 | 44 |
| 20 | 6311533 | 45 |
| 21 | 9069044 | 46 |
| 22 | | 47 |
| 23 | | 48 |
| 24 | | 49 |
| 25 | | 50 |

Book Mark:

See also

S. 733 712 P.O. '90
S1216414 - P.O. MEM

42 Douglas
2

R | 9 | U.S.C.T.

Samuel Raley
Co. F, 9 Reg't U. S. Col'd Inf.

Appears on
Company Descriptive Book
of the organization named above.

DESCRIPTION.

Age 20 years; height 5 feet 7 1/8 inches.
Complexion Dark
Eyes Brown; hair Black
Where born Worcester, Massachusetts
Occupation Farmer

ENLISTMENT.

When Nov 16, 1863.
Where Sandy Hill, Worcester Co. Mass.
By whom Col. Wm. B. Smith; term three y'rs.
Remarks Promoted Corporal 10
65 Oct 24 64. 9 M 6 J

Mustered out North Reg't
Nov 26 1864

L. B. Singer

R | 9 | U.S.C.T.

Samuel Roley
Priv, Co. F, 9 Reg't U. S. Col'd Infantry.

Age 20 years.

Appears on

Company Muster-in Roll

of the organization named above. Roll dated

Charles Co. Md., Nov 23, 1863.

Muster-in to date Nov 23, 1863

Joined for duty and enrolled:

When Nov. 16, 1863.

Where Worcester Md.

Period 3 years.

Remarks:

Book mark:

Martin

R. | 9 | U.S.C.T.

Samuel Coley

Priv, Co. F, 9 Reg't U. S. Col'd Infantry.

Appears on

Company Muster Roll

for Nov. 23, to Dec 31, 1863.

Present or absent Present

Stoppage, \$ 100 for

Due Gov't, \$ 100 for

Remarks: \$200 Recruit
Oren. due.

Book mark:

Martin

R | 9 | U.S.C.T.

Samuel Roley
Priv, Co. F, 9 Reg't U. S. Col'd Infantry.

Appears on

Company Muster Roll

for Jan & Feb, 1864

Present or absent Present

Stoppage, \$ 100 for

Due Gov't, \$ 100 for

Remarks: \$2.00 Recruit
Arre. due.

Book mark:

Martin

R | 9 U.S.C.T.

Samuel Roley
Priv, Co. F, 9 Reg't U. S. Col'd Infantry.

Appears on

Company Muster Roll

for Mar. & Apr., 1864

Present or absent Present

Stoppage, \$ 100 for

Due Gov't, \$ 100 for

Remarks:

Book mark:

Martin

R | 9 | U.S.C.T.

Samuel Roley
Priv, Co. F, 9 Reg't U. S. Col'd Infantry.

Appears on

Company Muster Roll

for *May & June, 1864.*

Present or absent *Present*

Stoppage, \$ *100* for

Due Gov't, \$ *100* for

Remarks:

Book mark:

Martin

R | 9 | U.S.C.T.

Samuel Roley
Priv, Co. F, 9 Reg't U. S. Col'd Infantry.

Appears on

Company Muster Roll

for July & Aug, 1864.

Present or absent Present

Stoppage, \$ 100 for

Due Gov't, \$ 100 for

Remarks:

Book mark:

Martin

R | 9 | U.S.C.T.

Samuel Raley
Priv, Co. F, 9 Reg't U. S. Col'd Infantry.

Appears on

Company Muster Roll

for Sep + Oct, 1864

Present or absent Present

Stoppage, \$ 100 for

Due Gov't, \$ 100 for

Remarks:

Book mark:

Martin

R | 9 | U.S.C.T.

Samuel Roley
Priv, Co. F, 9 Reg't U. S. Col'd Infantry.

Appears on

Company Muster Roll

for Nov. & Dec, 1864.

Present or absent Present

Stoppage, \$ 100 for

Due Gov't, \$ 100 for

Remarks: Due the difference
between seven dol-
lars per month and
thirteen dollars per
month from ^{Jan. 1/64 to} ~~Apr~~ 3/64

Book mark:

E. L. Thornton

R | 9 | U.S.C.T.

Samuel Roley
Priv, Co. F, 9 Reg't U. S. Col'd Infantry.

Appears on

Company Muster Roll

for Jan. to Feb, 1865.

Present or absent Present

Stoppage, \$ 100 for

Due Gov't, \$ 100 for

Remarks:

Book mark:

E. L. Hampton

R | **9** | **U.S.C.T.**

Samuel Roley
Priv, Co. F, 9 Reg't U. S. Col'd Infantry.

Appears on

Company Muster Roll

for *Mech to Apr*, 1865.

Present or absent *Present*

Stoppage, \$ *100* for

Due Gov't, \$ *100* for

Remarks:

Book mark:

E. L. Hasbun

R | 9 | U.S.C.T.

Samuel Raley
Priv, Co. F, 9 Reg't U. S. Col'd Infantry.

Appears on

Company Muster Roll

for May & June, 1865.

Present or absent Absent

Stoppage, \$ 100 for

Due Gov't, \$ 100 for

Remarks: On Detach service
as Hqs guard pr S.O.
No. 41. Hqs 9th U.S. C.T.
Apr 25, 1865. Stop for
compr \$0.02.

Book mark:

E. L. Thomson

R | 9 | U.S.C.T.

Samuel Foley
Priv, Co. F, 9 Reg't U. S. Col'd Infantry.

Appears on

Company Muster Roll

for July & Aug, 1865.

Present or absent Present

Stoppage, \$ 100 for

Due Gov't, \$ 100 for

Remarks:

Book mark:

E. L. Harrison

R 9 U.S.C.T.

Samuel Roley
 Put, Co. F, 9 Reg't U. S. Col'd Infantry.

Appears on

Company Muster Roll

for June 30 to Oct 31, 1865.

Present or absent Absent

Stoppage, \$ 100 for

Due Gov't, \$ 100 for

Remarks: In det'd service as
 foot orderly at Hd Qrs.
 1st Brig, 1st Div, 25 A.C.
 pr. S.O. No 41, Hd Qrs.
 9th U. S. C. I. Apr 25/65.

Book mark:

P. A. Grant

9

U.S.C.T.

7
Samuel Kaley
Co. "H", 9 Reg't U. S. Col'd Infantry.

Appears on

Company Muster Roll

for *June 30 to Sep 30*, 1865.

Present or absent *Present*

Stoppage, \$ *100* for

Due Gov't, \$ *100* for

Remarks:

Book mark:

A. A. [Signature]

R | 9 | U.S.C.T.

Samuel Roley
Pvt, Co. F, 9 Reg't U. S. Col'd Infantry.

Appears on

Company Muster Roll

for Jan. & Feb., 1866.

Present or absent present

Stoppage, \$ 100 for

Due Gov't, \$ 100 for

Remarks:

Book mark:

(858) J. E. Nichol Copyist

R

9

U.S.C.T.

Samuel Roley

Private, Co. F, 9 Reg't U. S. Col'd Infantry.

Appears on

Company Muster Roll

for Mch. & Apl., 1866.

Present or absent present

Stoppage, \$ 100 for

Due Gov't, \$ 100 for

Remarks:

Book mark:

J. E. Nichol Copyist

(358)

R | 9 | U.S.C.T.

Samuel Roley
Private, Co. F, 9 Reg't U. S. Col'd Infantry.

Appears on

Company Muster Roll

for May & June, 1866.

Present or absent present

Stoppage, \$ 100 for

Due Gov't, \$ 100 for

Remarks:

Book mark:

(358) J.E. Nichol Copyist

R | 9 | U.S.C.T.

Samuel Roley

Pvt, Co. F, 9 Reg't U. S. Col'd Infantry.

Appears on

Company Muster Roll

for July & Aug, 1866.

Present or absent present

Stoppage, \$ 100 for

Due Gov't, \$ 100 for

Remarks:

Book mark:

(358) J. E. Nichol Copyist

R | 9 | U.S.C.T.

Samuel Roley
Capt, Co. F, 9 Reg't U. S. Col'd Infantry.

Appears on

Company Muster Roll

for Sep. & Oct., 1866.

Present or absent present

Stoppage, \$ 100 for

Due Gov't, \$ 100 for

Remarks: Promoted from
Priv. pr. S.O. No. 68,
Ad. Ins. 9th U.S. C. I.
Oct. 26/66

Book mark:

(358) J. E. Nichol Copyist

R | 9 | U.S.C.T.

Samuel Roley
Corp, Co. *F.*, 9 Reg't U. S. Col'd Infantry.

Appears on **Co. Muster-out Roll**, dated
New Orleans, La., Nov. 26, 1866.

Muster-out to date *Nov. 26,* 1866.

Last paid to *Aug. 31,* 1866.

Clothing account:

Last settled....., 186 ; drawn since \$..... 100

Due soldier \$ *1*^{*74*}/₁₀₀; due U. S. \$..... 100

Am't for cloth'g in kind or money adv'd \$..... 100

Due U. S. for arms, equipments, &c., \$ *6*^{*00*}/₁₀₀

Bounty paid \$ *None* 100; due \$ *100*^{*00*}/₁₀₀

Remarks: *Joined at Original*
Orgn.

Prick to Oct. 2. 1866

Stop for me S. R. M. & set
acctmts. retained

Book mark: *V. 163, P. 97 - 73*

(861) *J. E. Nichol* Copyist.

Polley, Samuel
Cmp., Co. 4, 9 Reg't U.S.C. Inf

1 **Enclosures.**

| | |
|------------------------------------|----------------------------|
| Bed Cards | Final Statements |
| Burial Records | Furloughs or L. of A |
| Certs. of Dis. for Discharge | Med. Certificates |
| C. M. Charges | Med. Des. Lists |
| Descriptive Lists | Orders |
| Discharge Certificates | Pris. of War Record |
| Enlistment Papers | Resignations |

Other papers relating to—

| | |
|------------------------------|----------------------------------|
| Admission to Hosp'l | Furlough or L. of A |
| Casualty Sheet | Med. Examination |
| Confinement | Misc. Information <i>/</i> |
| Contracts | Pay or Clothing |
| Death or Effects | Personal Reports |
| Desertion | Rank |
| Discharge from Hosp'l | Transfer to Hosp'l |
| Discharge from Service | Transfer to V. R. C. |
| Duty | Transportation |

Samuel Poley
Capt. Co. F.
9th Regt.

Mr. Euerbrook

Adjutant General's Office,

COLORED TROOPS BRANCH,

March 23rd, 1877

Mr. Ellersbrook. Vol.

C. T., 187

Wanted in the case of

Samuel Raley, Corp. Co. "F",
9th Reg't U. S. Col. Troops.

Missing about 3 if dead.

Reg't Retn. for Feb. 1866. Reports him "Absent without leave."

Respectfully,

H. A. Woodward,
Chief Clerk.

J. J. Halton

Adjutant General's Office,

Div. of Discontinued Commands.

March 31st, 1877

Vol.

C. T., 187

Reply in case of

Samuel Raley Corp., Co. "F",
9th Reg't U. S. Col. Troops.

More. Report of Reg't. Report him "Absent without leave" March 9. 66 "On detached service." Time of absence without leave not stated. No evidence of trial with report and records. Dy. Order of Rio Grande not on file. ^{and} Dy. Order restoring him to duty.

March 31. 77. 12. 26

966
Rover, Elby

Co H, 9 U.S. Col'd Inf.

Private

Private

CARD NUMBERS.

| | | |
|----|---------|----|
| 1 | 63/3642 | 26 |
| 2 | 63/3746 | 27 |
| 3 | 63/3844 | 28 |
| 4 | 63/3939 | 29 |
| 5 | 63/4030 | 30 |
| 6 | 63/4135 | 31 |
| 7 | 63/4235 | 32 |
| 8 | 63/4329 | 33 |
| 9 | 63/4422 | 34 |
| 10 | 63/4500 | 35 |
| 11 | 63/4582 | 36 |
| 12 | 63/4654 | 37 |
| 13 | 63/4718 | 38 |
| 14 | 63/4781 | 39 |
| 15 | 63/4841 | 40 |
| 16 | 63/4901 | 41 |
| 17 | 63/4960 | 42 |
| 18 | 63/5016 | 43 |
| 19 | 9069295 | 44 |
| 20 | | 45 |
| 21 | | 46 |
| 22 | | 47 |
| 23 | | 48 |
| 24 | | 49 |
| 25 | | 50 |

Book Mark:

See also

Q. 1418245 P. O. O. M. M.

C. E. Doughty
2

8 | 9 | U.S.C.T.

Rosier Elly

, Co. H., 9 Reg't U. S. Col'd Inf.

Appears on

Company Descriptive Book

of the organization named above.

DESCRIPTION.

Age 23 years; height 5 feet 8 inches.

Complexion Black

Eyes Black; hair Black

Where born Sun Run, Maryland

Occupation Farmer

ENLISTMENT.

When Jan 17, 1864

Where Sun Run, Ind.

By whom Brig Genl W. B. Biny term 3 y'rs.

Remarks: Descriptive Lists for-

warded March 14, 1866

Discharged Nov. 24, 1866

for S. O. U. S. Dept. of the

Gulf.

W. B. Biny

R

9

U.S.C.T.

Elby Rosier

Private, Co. H, 9 Reg't U. S. Col'd Infantry.

Appears on

Company Muster Roll

for *Jan. + Feb.*, 1864.

Present or absent *Present.*

Stoppage, \$ *100* for

Due Gov't, \$ *100* for

Remarks: *Recruit joined from depot.
\$2 Recruits premium due.*

Book mark:

O. J. Markle,

(358)

Copyist.

R

9

U.S.C.T.

Elby Rosier

Private, Co. H, 9 Reg't U. S Col'd Infantry.

Appears on

Company Muster Roll

for *March + April*, 1864.

Present or absent *Present.*

Stoppage, \$ *100* for

Due Gov't, \$ *100* for

Remarks:

Book mark:

O. J. Markle

R | 9 | U.S.C.T.

Elby Rosier

Private, Co. H, 9 Reg't U. S Col'd Infantry.

Appears on

Company Muster Roll

for *May & June*, 1864.

Present or absent *Present.*

Stoppage, \$ *100* for

Due Gov't, \$ *100* for

Remarks:

Book mark:

O. J. Markle,

P | **9** | **U.S.C.T.**

Elby Rosier
Private, Co. H, 9 Reg't U. S. Col'd Infantry.

Appears on

Company Muster Roll

for *July + August*, 1864.

Present or absent *Absent.*

Stoppage, \$ *100* for

Due Gov't, \$ *100* for

Remarks: *Sick in U. S. G. Hospital,*
Beaufort, S. C., since Aug. 2, 1864.

Book mark: _____

O. J. Markle,

R 9 U.S.C.T.

Ebby Rosier

Private, Co. H, 9 Reg't U. S. Col'd Infantry.

Appears on

Company Muster Roll

for Sept. + Oct., 1864

Present or absent Absent

Stoppage, \$ 100 for

Due Gov't, \$ 100 for

Remarks: Absent sick in U.S.A.G. Hospital, Beaufort, S.C., since July 2, 1864

Book mark:

O. J. Markle,

R | 9 | U.S.C.T.

Elby Rosier

Civil, Co. H, 9 Reg't U. S. Col'd Infantry.

Appears on

Company Muster Roll

for Nov. & Dec., 1864

Present or absent Absent

Stoppage, \$ 100 for

Due Gov't, \$ 100 for

Remarks: Absent: last heard from in U.S. Hospital, Beaufort S.C. July 2, 1864. The difference between seven Dollars per month and thirteen Dollars per month is due from Jan. 1, 1864 to April 30, 1864.

Book mark:

J. L. Ames

R | 9 | U.S.C.T.

Elby Rossier
Private, Co. H, 9 Reg't U. S. Col'd Infantry.

Appears on

Company Muster Roll

for Dec. 31, 1864 to June 30, 1865.

Present or absent Present

Stoppage, \$ 100 for

Due Gov't, \$ 100 for

Remarks: Stop for me
Lieber

Book mark:

J. L. Arnes

R | 9 | U.S.C.T.

Elby Rosier
Priv Co. H, 9 Reg't U. S. Col'd Infantry.

Appears on

Company Muster Roll

for *Jan. & Feb.*, 1865.

Present or absent *Present*

Stoppage, \$ *100* for

Due Gov't, \$ *100* for

Remarks:

Book mark:

A. L. Ames

R | **9** | **U.S.C.T.**

Elby Rosier
Privt, Co. H, 9 Reg't U. S. Col'd Infantry.

Appears on

Company Muster Roll

for *Mch. & Apl.*, 1865.

Present or absent *Present*

Stoppage, \$ *100* for

Due Gov't, \$ *100* for

Remarks:

Book mark:

A. L. Ames

R | **9** | **U.S.C.T.**
Elby Rosier
Privat, Co. H, 9 Reg't U. S. Col'd Infantry.

Appears on

Company Muster Roll

for *June 30 to Oct 31*, 1865.

Present or absent *Present*

Stoppage, \$ *100* for

Due Gov't, \$ *100* for

Remarks:

Book mark:

A. L. Ames

R | **9** | **U.S.C.T.**

Elby Rosier
Priv., Co. H, 9 Reg't U. S. Col'd Infantry.

Appears on

Company Muster Roll

for *June 30 to Dec. 31*, 1865.

Present or absent *Present*

Stoppage, \$ *100* for

Due Gov't, \$ *100* for

Remarks:

Book mark:

A. L. Ames

R | **9** | **U.S.C.T.**

Elby Rossier
Priv. Co. H, 9 Reg't U. S. Col'd Infantry.

Appears on

Company Muster Roll

for *July & Aug.*, 1865.

Present or absent *Present*

Stoppage, \$ *100* for

Due Gov't, \$ *100* for

Remarks:

Book mark:

A. L. Ames

R.

9

U.S.C.T.

Elby Rosier

Privt., Co. H, 9 Reg't U. S. Col'd Infantry.

Appears on

Company Muster Roll

for *Jan. & Feb.*, 186 *6*

Present or absent *Present*

Stoppage, \$ *100* for

Due Gov't, \$ *100* for

Remarks:

Book mark:

R. Braden

R₁

9

U.S.C.T.

Elby Rosier
Privt., Co. H, 9 Reg't U. S. Col'd Infantry.

Appears on

Company Muster Roll

for *March & April*, 1866.

Present or absent *Absent*.

Stoppage, \$ *100* for

Due Gov't, \$ *100* for

Remarks: *Detached service with*
asst. Company of Muskets per & O.
No. 66. Hd. Qrs. Dist of the Rio
Grande March 12/66.

Book mark:

R. Braden

R. | 9 | U.S.C.T.

Elby Rosier,
Prnt, Co. H, 9 Reg't U. S. Col'd Infantry.

Appears on

Company Muster Roll

for *May & June*, 186 *6*.

Present or absent *Absent.*

Stoppage, \$ *100* for

Due Gov't, \$ *100* for

Remarks: *On det. service with asst.*
com. of subsistence per S.O. No.
66, Hd. Qrs. Dist. of the Rio Grande
March 12/66.

Book mark:

R. Braden

R

9

U.S.C.T.

Olby Pasier
Pol., Co. 26, 9 Reg't U. S. Col'd Infantry.

Appears on

Company Muster Roll

for *July & Aug.*, 186*6*.

Present or absent *Absent*

Stoppage, \$ *100* for

Due Gov't, \$ *100* for

Remarks: *On det. service
with Det. Com'y of
Musters, per S.O. Noble
Ad. List of the Rio
Grande, Mex. 12/66*

Book mark: _____

(358)

Fitz
Copyist.
Carupr.

R. | 9 | U.S.C.T.

Elby Rosier
Print., Co. H, 9 Reg't U. S. Col'd Infantry.

Appears on

Company Muster Roll

for *Sept. & Oct.*, 186*6*.

Present or absent *Present.*

Stoppage, \$ *100* for

Due Gov't, \$ *100* for

Remarks:

Book mark:

R. Bradin

R | 9 | U.S.C.T.

Elby Rosier

Privt, Co. *H*, 9 Reg't U. S. Col'd Infantry.

Appears on **Co. Muster-out Roll**, dated

New Orleans La, *Nov 26*, 1864 .

Muster-out to date *Nov 26*, 1864 .

Last paid to *June 30*, 1864 .

Clothing account:

Last settled....., 186 ; drawn since \$..... 100

Due soldier \$ *53* ^{*5*}/₁₀₀; due U. S. \$..... 100

Am't for cloth'g in kind or money adv'd \$..... 100

Due U. S. for arms, equipments, &c., \$..... 100

Bounty paid \$..... 100; due \$ *300* 100

Remarks: *Joined as Recruit.*

Ag. 23 - Enrolled Jan. 17. 64

Queen Ann. Id. Mpi Jan 22. 64

Benedict 3m.

Book mark: *U. G. P. 134. 64*

R. Bradin

Posier, Albert
P., Co. *H*, *9* Reg't *U.S.C. Reg*

2 Enclosures.

| | |
|------------------------------------|----------------------------|
| Bed Cards | Final Statements |
| Burial Records | Furloughs or L. of A |
| Certs. of Dis. for Discharge | Med. Certificates |
| C. M. Charges | Med. Des. Lists |
| Descriptive Lists | Orders |
| Discharge Certificates | Pris. of War Record |
| Enlistment Papers | Resignations |

Other papers relating to—

| | |
|------------------------------|----------------------------|
| Admission to Hosp'l | Furlough or L. of A |
| Casualty Sheet | Med. Examination |
| Confinement | Misc. Information |
| Contracts | Pay or Clothing |
| Death or Effects | Personal Reports |
| Desertion | Rank |
| Discharge from Hosp'l | Transfer to Hosp'l |
| Discharge from Service | Transfer to V. R. C. |
| Duty | Transportation |
| | <i>Star claim 1</i> |

MICROFILM PUBLICATION M 1851

COMPILED MILITARY SERVICE RECORDS
OF VOLUNTEER UNION SOLDIERS WHO SERVED WITH
THE UNITED STATES COLORED TROOPS (USCT)
9TH REGIMENT OF INFANTRY

PERSONAL PAPERS' TARGET SHEET

PLEASE NOTE THE CHECKED INFORMATION ABOUT THE PERSONAL PAPERS IN
THIS FILE:

- NO PERSONAL PAPERS WERE FOUND IN THIS FILE WHEN THE
RECORDS WERE ARRANGED FOR MICROFILMING.
- 6 PERSONAL PAPER(S) FOUND IN THIS FILE WHEN THE RECORDS
WERE ARRANGED FOR MICROFILMING.

7



EVIDENCE OF TITLE.

I. *William H Foster*, of *Queen Anne* County, Md., do solemnly swear that ~~John~~ ^{Edgar} *Rogers* who has been enlisted in the *Ninth (9th)* Regiment, U. S. Colored Troops, Co. *H*; is my slave for *life*; (~~his term of service expiring on the~~ *day of* *186*;) and that I became possessed of ~~him~~ ^{them} by *their mother being my slave at* ^{the time of their birth} in the month of *1864*, ~~eighteen hundred and~~. And I do further swear that I have not purchased said slave from any person or persons disloyal to the Government of the United States, with the object of obtaining compensation for the same; and furthermore, that I have no agency for obtaining compensation for any person or persons but such as, to my knowledge, are loyal citizens of the United States.

W. H. Foster

Jan'y 30th 1864.

STATE OF MARYLAND,

Queen Anne County, to wit: ,

On this thirtieth day of January in the year 1864,

before me, the subscriber, a Justice of the Peace of the State and County aforesaid, per-

sonally appeared William H Foster, and took, signed, and acknowl-

edged the oaths preceding; and further made oath, in due form of law, that all the state-

ments made in this application are, to the best of his knowledge and belief, strictly

true. Also personally appeared before me Elijah Purvis and

Barclay Brown, loyal citizens of the United States, residents of

Indersville, well acquainted with the said William

H Foster, and in no manner interested in the prosecution of this

claim, and made oath, in due form of law, that the said William H Foster

is the owner of the slaves ^{Elber} ~~Robert~~ ~~Rogier~~ ~~Henry~~ ~~Boyer~~, as a fact of public noto-

riety: that they believe all the statements herein made by him, in reference

thereto, are correct, and that he is unquestionably loyal to the Government of

the United States. Witness their signatures:



A. D. Sallaway

Elijah Purvis
Barclay Brown
Justice of the Peace.

MAR 13 1867

STATE OF MARYLAND,

Queen Anne County, to wit:

I, *Saml. E. Dyott*, Clerk of the Circuit Court for *Queen Anne* County, do hereby certify that *A. P. Hollaway*

before whom the foregoing affidavits were made, was, at the time of signing the same, a Justice of the Peace for the County and State aforesaid, duly commissioned and sworn; and that his signature thereto is genuine, and that full faith and credit should be given to his official acts.

Witness my hand and the seal of said Court, this

6th day of

February, A. D. 1864.

Saml. E. Dyott CLERK.



7/20 82

4

A.

No. 82

CLAIMANT'S CERTIFICATE.

I, William C Foster a loyal citizen, and a resident
of Queen Anne, County of the, State of
Maryland, hereby claim compensation, under the provisions of
General Orders, No. 329, 1863, for my slave's Albert Royer *alias Elby Rosier*
enlisted Jan'y 17th 1864 at Millington
by Ser't A. N. Bugbee in the ~~nineteenth~~ 9th
Regiment U. S. Colored Troops, Co. H; certificate of which enlistment, and a
descriptive list, as required, accompany this application. (See Extra Rolls)

In proof of my loyalty to the Constitution and Government of the United States, I
present the accompanying oath, which I have taken, signed, and acknowledged, to be filed
with this application, in accordance with requirement of said General Orders.

W. C. Foster

Jan'y 30th 1864.

B.

OATH OF ALLEGIANCE.

I, William H. Foster, do solemnly swear that I have never joined, or been concerned in, any insurrection or rebellion; that I have never borne arms against the United States; that I have never given any aid, countenance, counsel, or encouragement to any person or persons engaged, or whom I had reason to believe were about to engage, in insurrection, rebellion, or armed hostility against the United States; that I have neither sought, nor accepted, nor attempted to exercise the functions of any office, civil or military, nor to perform any service whatever, under any authority or pretended authority in hostility to the United States; that I have not yielded a voluntary support to any insurrection, rebellion, or pretended government, authority, power, or constitution within the United States hostile thereto. And I do further swear that, to the best of my knowledge and ability, I have supported and defended, and will continue to support and defend, the United States against all enemies, foreign and domestic; and that I have supported, defended, and obeyed, and will continue to support, defend, and obey, the Constitution and laws of the United States; that I will bear true faith and allegiance to the same; and that I take this oath freely, without any mental reservation or purpose of evasion: So help me God.

W. H. Foster

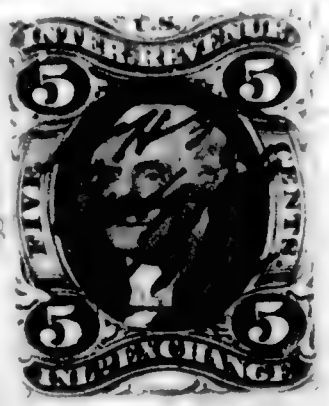

Sworn to and subscribed before me, at Indiansville }
 this 30th day of July 1864 }

A. P. Callaway
 Justice of the Peace

C.

I present herewith evidence of my title to the slave Albert Royer
alias Elby Rosier enlisted as aforesaid, and in consideration of the sum of
100 *Hundred dollars* by me received, I hereby covenant and
 agree with the United States, that I, my heirs, executors, or assigns, shall never hereafter make
 or enforce any claim to the labor or services of said slave; and pledge myself to execute
 a valid Deed of Manumission and Release of all my claims to service forever of said
Albert Royer *alias Elby Rosier* to be filed with the Board of Claims
 now in session at Washington Md

W. C. Foster

Jan 30th, 1864.

8

Queen Anne's County Court: Be it remembered that on the sixth day of August in the year of our Lord one thousand eight hundred and sixty four, the following Deed of Manumission was brought to be recorded to wit:

Deed of Manumission and Release of Service

Whereas my slave ^{alias Elby Royer} Elbert Royer, has enlisted in the service of the United States now, in consideration thereof, I, William H. Foster of Queen Anne's County, State of Maryland do hereby in consideration of said enlistment, manumit, set free, and release the above named Elbert Royer, from all service due me: his freedom to commence from the date of his enlistment aforesaid in the Regiment of Colored Troops in the service of the United States, Ninth Regiment, United States Colored Troops, Co No.

Witness my hand and seal this 6th day of August 1864

U.S. States
5 cents
W.H.F.
Aug 6. 1864
Internal
Revenue

Witness
A.P. Sallaway
C. Greer

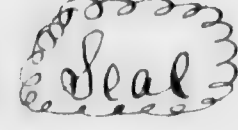
W. H. Foster 

U.S. States
5 cents
A.P.S.
Aug 6. 1864
Internal
Revenue

Queen Anne's County State of Maryland 1864, 6th August: Before me appeared this day William H. Foster and acknowledged the above Deed of Manumission and Release of Service to be his free act and deed.

A. P. Sallaway J.P.

State of Maryland Queen Anne's County Court: I hereby certify that the above is truly copied from Liber S. C. C. Vol folio 307 a land record book of Queen Anne's County.

In testimony whereof, I hereto subscribe my name and affix the seal of the Circuit Court for Queen Anne's County this 8th day of August A.D. 1864



Samuel C. Ozell Clerk

F.

CERTIFICATE OF AWARD OF THE BOARD OF CLAIMS.

Office of the Board of Claims
For Slaves Enlisted in the Service of the United States,

Baltimore Md.

November 5th, 1864

294
/ 300

We hereby certify, that William N. Foster, of Queen Anne's county, State of Maryland, having proved, under oath, his loyalty to the Constitution and Government of the United States, and established his title as to the ownership of Elly Rozier, a slave enlisted at Queen Anne's County Md. on the 17th day of January 1864, by Gen Wm Birney, in the service of the United States, in the 9th Regiment of Colored Troops, Co. H., and having filed a valid Deed of Manumission and Release of Service of said slave, is entitled to the sum of Three Hundred dollars, which has been awarded to him by this Board as a remuneration for all claim to the future labor or service of said slave, under the provision of General Orders, War Department, No. 329, 1863.

Thos. Simmons, President of the Board.
L. E. Staughn, Member of the Board.
Edms. Jones, Member of the Board.

To Col. W. Foster,

Chief of the Bureau for the
Organization of Colored Troops, Washington, D. C.

61 de San Antonio de 1. ande
L. & Co. Office
San Antonio, Texas,
Nov 12th 1855

J. C. M.
(E. R.)

Delivered, Private
Letter from San Antonio, Tex. to
the Major to Capt. J. E. ...

Headquarters District of the Rio Grande,
Assistant Adjutant General's Office,

Brownsville, Texas, March 13th 1865.

SPECIAL ORDERS,
NO.)

(EXTRACT)

By Order of Brevet Major General Getty:
Col. 4th U.S. Col. Scurry, is detached from
his Regiment and will report at once for
duty to Capt. J. C. Gaskwood, 11th U.S. Col.
Troops, Asst. Com. Army of Mexico, Depart-
ment of Texas.

By Order of Brevet Major General Getty:

Assistant Adjutant General.

Col. 4th U.S. Col.
Wm. C. Scurry

82.

A. S. D. Nov. 9, 1864

I certify that the name of Elby
Rozier is borne on a Muster-
roll of recruits for 9th Regt
U. S. Colored Troops - on file, in this
office. It is stated on same roll
that he was enrolled at Queen Anne
Md

M. A.

F. W. Saggart
A. S. Gen'l

VOLUNTEER DESCRIPTIVE LIST and Account of Pay and Clothing of

A recruit in 9th U.S.C.

| No. | NAMES. | RANK. | DESCRIPTION. | | | | | WHERE BORN. | | OCCUPATION. | ENROLLED OR ENLISTED. (For Drafted Men, see note 10.) | | | MUSTERED IN. (For Drafted Men, see note 10.) | | | | LAST PAID. | |
|-----|-------------------|-------|---------------|------------|------------|--------------|----------------------|-------------------|-----------------|----------------|--|-----------------------------|-----------------|---|-----------------------------|--|---------|---------------|-----------|
| | | | Years of age. | Eyes. | Hair. | Complexion. | HEIGHT. Feet. In. | State or Kingdom. | Town or county. | | When. | Where. (Town and State.) | By whom. | When. | Where. (Town and State.) | By whom. (In the case of drafted men, from what enrollment district.) | Period. | By paymaster. | T. |
| 1 | <i>Roger Elby</i> | | <i>23</i> | <i>Blk</i> | <i>Blk</i> | <i>Light</i> | <i>5-1</i> | <i>Mass</i> | <i>Quincy</i> | <i>Farmers</i> | <i>Jan 17 64</i> | <i>Quincy Mass</i> | <i>W. Brown</i> | <i>Jan 22 64</i> | <i>Tellurville</i> | <i>W. Brown</i> | | | <i>Co</i> |

REMARKS.

NOTES.

- The amount of any extra pay for which the soldier may be mustered, *ex. gr.* as Acting Hospital Steward, as Saddler, &c., and which may be still due him, must be carefully noted.
- In the column headed "BOUNTY PAID," must be entered the whole amount hitherto paid him; in that of "BOUNTY DUE," the whole amount yet due him. Bounty paid by State authorities, and not by the United States, will not be entered on this statement.
- Stoppages for loss or damage done to arms, or other public property, must be noted, and the articles, and particular damage to each, specified. When stoppages are due, under sentence of Court Martial, a transcript of the same must be entered here; and the amount already stopped must be carefully stated.
- In every case of desertion, the date, and that of delivery, or apprehension, must be given, together with a correct transcript of the order of sentence or pardon.
- A careful settlement of the man's CLOTHING ACCOUNT must be made, to date, and the amount DUE TO, or FROM him must be precisely stated.
- Should the man have been engaged in any action, or skirmish, it must be mentioned, together with date and place. A full and particular mention will be made of any wounds he may have received in action, or other injury, whilst in the line of his duty.
- If the soldier is entitled to pay for the use of his horse, the company commander will certify to that fact on this list, and also to the time he has pay due for having been so mounted on his own horse.
- When a soldier is furnished with final statements, his descriptive list, if he has one, should be taken up by the officer who gives the soldier these statements, and endorsed with a statement to this effect by the officer. This endorsement should exhibit a full statement of the time for which the soldier was allowed pay on his final statements, the clothing account, and all other charges against him or in his favor, so as to comprise a complete exhibit of his account. It will then be transmitted to the company commander of the soldier, who will enter all the data necessary to a full understanding of the soldier's account on the muster roll upon which the soldier's discharge is reported. The descriptive list will then be destroyed. The object of this is, that the remaining portion of the soldier's account may be settled upon the receipt of these muster rolls, and the soldier receive any pay or allowances that may be due him at the time of his discharge, and which may not appear on his final statements from the fact that his descriptive list is incomplete. These accounts for back pay, &c., are settled by the 3d Auditor of the Treasury D. P. T.
- Where a soldier dies in Hospital or on detached service, his descriptive list, if he has one, should be sent with his final statements, in duplicate, to the Adjutant General, Washington, D. C.
- Men drafted will be considered as mustered in from the date of their draft, and will be mustered for pay on the usual rolls for Volunteers. On the same line as the soldier's name, under the heading "Joined for Duty and Enrolled.—Commencement of First Payment by Time," will be written the word *drafted*, or *substitute*, as the case may be; and under the heading "When Mustered in," will be given the date when the soldier was drafted, or, if a substitute, when enlisted, (substitutes, under the Enrollment Act, are mustered in by enlistment;) under "Where Mustered in," will be given the place from which drafted, (or, if a substitute, where enlisted,) under the heading "By whom Mustered in," will be given the No. of the Enrollment District from which he was drafted, and the State to which it belongs, thus: *4th D. Mass.* (meaning 4th Enrollment District, State of Massachusetts.) Or, if a substitute, the name of the officer enlisting him. (When enlisted by Board of Enrollment, the name of the Provost Marshal of the Enrollment District.)
- A separate descriptive list should, as a general rule, be given for each man.
- Descriptive lists must, in all cases, be signed by COMMISSIONED officers; not by enlisted men acting as such.

I CERTIFY that the above is a correct transcript from the Records

from Maryland for U.S.C. Troops

STATION: *Tellurville Mass*

DATE: *October 16 64*

Account on 9th U.S.C.T.

| MUSTERED IN. (For Drafted Men, see note 10.) | | | | LAST PAID. | | COUNTY. | | CLOTHING ACCOUNT. | |
|---|-----------------------------|--|---------|---------------|--------------------------------|--------------------------|-------------------------|-------------------------------|--|
| When. | Where. (Town and State.) | By whom. In the case of drafted men, from what enrollment district. | Period. | By paymaster. | To what time. | Paid \$ (See note 2.) | Due \$ (See note 2.) | Date of last settle- ment. | Total money value of clothing drawn since last settlement. |
| Jan 21 1864 | Pellum | William | | William | Co 16 9 th U.S.C.T. | | | | |

CERTIFY that the above is a correct transcript from the Records of Pellum, Maryland for U.S.C.T. Troops

STATION: Pellum Md
DATE: October 16 1864

William
Commanding the Company.

James Butler
Capt 30th U.S.C.T.

1969
Ross, Edmund

Co B, 9 U.S. Col'd Inf.

Private Private

CARD NUMBERS.

| | | |
|----|---------|----|
| 1 | 6304411 | 26 |
| 2 | 6304510 | 27 |
| 3 | 6304610 | 28 |
| 4 | 6304717 | 29 |
| 5 | 6304816 | 30 |
| 6 | 6304911 | 31 |
| 7 | 6305006 | 32 |
| 8 | 6305103 | 33 |
| 9 | 6305202 | 34 |
| 10 | 6305299 | 35 |
| 11 | 6305397 | 36 |
| 12 | 6305483 | 37 |
| 13 | 6305570 | 38 |
| 14 | 6305654 | 39 |
| 15 | 6305727 | 40 |
| 16 | 6305798 | 41 |
| 17 | 6305866 | 42 |
| 18 | 6305932 | 43 |
| 19 | 6305998 | 44 |
| 20 | 6306063 | 45 |
| 21 | 9068806 | 46 |
| 22 | | 47 |
| 23 | | 48 |
| 24 | | 49 |
| 25 | | 50 |

Book Mark: 397.c.r.79

See also

MAR 1988

D1354334 - P.O. Mum

C. E. Douglas
2

R | 9 | U.S.C.T.

Edmund Ross

, Co. C, 9 Reg't U. S. Col'd Inf.

Appears on
Company Descriptive Book
of the organization named above.

DESCRIPTION.

Age 27 years; height 5 feet 8 7/8 inches.

Complexion Black

Eyes Black; hair Black

Where born Accomac, Va.

Occupation Farmer

ENLISTMENT.

When Nov. 3, 1863

Where In. from Edmund, Accomac, Va.

By whom Col. W. B. Parney; term 3 y'rs.

Remarks: Discharged with
Regt. Nov. 26 1866.

E. L. Shannon

R | 9 | U.S.C.T.

Edmund Ross

Co. C, 9 Reg't U. S. Col'd Infantry.

Age *22* years.

Appears on

Company Muster-in Roll

of the organization named above. Roll dated

Camp Stanton Charles Co. Md Nov 11, 1863.

Muster-in to date *Nov 11, 1863*

Joined for duty and enrolled:

When *Nov 3rd*, 1863.

Where *Accomac Va*

Period *3* years.

Remarks:

Book mark: *Ma 397.62.79.*

R

9

U.S.C.T.

Edmund Ross

Pat, Co. C, 9 Reg't U. S. Col'd Infantry.

Appears on

Company Muster Roll

for From Nov 11th to Dec 31, 1863.

Present or absent Present

Stoppage, \$ 100 for

Due Gov't, \$ 100 for

Remarks: \$2 Rec Rem due

Book mark:

(858)

Y. G. Whely
Copyist

R | 9 | U.S.C.T.

Edmund Ross

Pvt, Co. C, 9 Reg't U. S. Col'd Infantry.

Appears on

Company Muster Roll

for Jan & Feby, 1864.

Present or absent Present

Stoppage, \$ 100 for

Due Gov't, \$ 100 for

Remarks: \$2 Rec't Prem due

Book mark:

(858)

W. J. Kelly Copyist

R | 9 | U.S.C.T.

Edmund Ross

Plt, Co. C, 9 Reg't U. S. Col'd Infantry.

Appears on

Company Muster Roll

for *Mar & April*, 1864.

Present or absent *Present*

Stoppage, \$ 100 for

Due Gov't, \$ 100 for

Remarks:

Book mark: *3307.4.1864*

V. J. White
Copyist

R

9

U.S.C.T.

Edmund Ross

Private, Co. C, 9 Reg't U. S. Col'd Infantry.

Appears on

Company Muster Roll

for May & June, 1864.

Present or absent Present

Stoppage, \$ 100 for

Due Gov't, \$ 100 for

Remarks:

Book mark:

J. G. Whitt Copyist

R

9

U.S.C.T.

Edmund Ross

Pvt, Co. C, 9 Reg't U. S. Col'd Infantry.

Appears on

Company Muster Roll

for July & Aug, 1864.

Present or absent Absent

Stoppage, \$ 100 for

Due Gov't, \$ 100 for

Remarks Absent in arrest at Beaufort S.C. since June 21/64.

Book mark:

(358)

Y. J. White Copyist

R

9

U.S.C.T.

Edmund Ross

Pvt, Co. C, 9 Reg't U. S. Col'd Infantry.

Appears on

Company Muster Roll

for Nov & Dec, 1864.

Present or absent Present

Stoppage, \$ 100 for

Due Gov't, \$ 100 for

Remarks:

Book mark:

(358)

E. J. Wiley
Copyist

R

9

U.S.C.T.

Edmund Rago

Pvt, Co. C, 9 Reg't U. S. Col'd Infantry.

Appears on

Company Muster Roll

for *Dec 31/64 to June 30*, 1865.

Present or absent *Present*

Stoppage, \$ *100* for

Due Gov't, \$ *100* for

Remarks:

Book mark:

A. J. Anderson

R | 9 | U.S.C.T.

Edmund Rojo
Priv, Co. C, 9 Reg't U. S. Col'd Infantry.

Appears on

Company Muster Roll

for *Jan - Feb*, 1865.

Present or absent *Present*

Stoppage, \$ 100 for

Due Gov't, \$ 100 for

Remarks:

Book mark:

A. J. Anderson

R | 9 | U.S.C.T.

Edmund Ruff
Privt., Co. C, 9 Reg't U. S. Col'd Infantry.

Appears on

Company Muster Roll

for *March & April*, 1865.

Present or absent *Present*

Stoppage, \$ 100 for

Due Gov't, \$ 100 for

Remarks:

Book mark:

A J Anderson

R | 9 | U.S.C.T.

Edmund Rapp

Pvt., Co. C, 9 Reg't U. S. Col'd Infantry.

Appears on

Company Muster Roll

for Jan 30 to Oct 31, 1865.

Present or absent Absent

Stoppage, \$ 100 for

Due Gov't, \$ 100 for

Remarks: Absent sick since
Sept 1st 1865

Book mark: _____

A. J. Anderson

R

9

U.S.C.T.

Edmund Rap

Cpl., Co. C, 9 Reg't U. S. Col'd Infantry.

Appears on

Company Muster Roll

for June 21 to Dec 31, 1865.

Present or absent Present

Stoppage, \$ $\frac{38}{100}$ for *Ordinance*

Due Gov't, \$ 100 for

Remarks: Present sick since Sept 1st 1865

Book mark:

A. J. Anderson

12 | **9** | **U.S.C.T.**

Edmund Kays

Co. C, Co. C, 9 Reg't U. S. Col'd Infantry.

Appears on

Company Muster Roll

for July & Aug, 1865.

Present or absent Present

Stoppage, \$ 100 for

Due Gov't, \$ 100 for

Remarks:

Book mark:

A. J. Anderson

2 | **9** | **U.S.C.T.**

Emmanuel Rops
Plt, Co. C, 9 Reg't U. S. Col'd Infantry.

Appears on

Company Muster Roll

for *Jan & Feb*, 186*6*.

Present or absent *absent*

Stoppage, \$ *100* for

Due Gov't, \$ *100* for

Remarks: *Not sent for S.C. 5076² Ans*
List of the Plt Grand Feb 21, 66

Book mark:

A. J. Anderson

V. | 9 | U.S.C.T.

Edmund Ross
Private, Co. C, 9 Reg't U. S. Col'd Infantry.

Appears on

Company Muster Roll

for *March / Apr*, 186*6*.

Present or absent *Absent*

Stoppage, \$ _____ 100 for _____

Due Gov't, \$ _____ 100 for _____

Remarks: *Det. Service, Capt. Vospit.
for S.O. 30. W^d Grd. Dist
Rio Grande, July 2/1866*

Book mark: _____

Amico

(V) | 9 | U.S.C.T.

Edmund Voss

Private, Co. C, 9 Reg't U. S. Col'd Infantry.

Appears on

Company Muster Roll

for May 1 June, 1866

Present or absent Absent

Stoppage, \$ 100 for

Due Gov't, \$ 100 for

Remarks: Det. served at Post Hospital for S.O. 05. Ad. On Dist. W. G. by 21 06

Book mark:

(358)

Francis

Copyist

R

9

U.S.C.T.

Edmund Ross

Company, Co. C, 9 Reg't U. S. Col'd Infantry.

Appears on

Company Muster Roll

for *July and Aug.*, 1866.

Present or absent *Absent*

Stoppage, \$ 100 for

Due Gov't, \$ 100 for

Remarks: *Set in Cust. Hosp.
for 20.50. Wd. yrs. N. Y.
July 21 1866*

Book mark:

Edmund S

V. | **9** | **U.S.C.T.**

Edmund Ross
Private, Co. C, 9 Reg't U. S. Col'd Infantry.

Appears on

Company Muster Roll
for *Sept 1* *Oct*, 186*6*

Present or absent *Present*

Stoppage, \$ *100* for

Due Gov't, \$ *100* for *of Brass*

Quantities

Remarks:

Book mark:

Francis
Copyist

R. | 9 | U.S.C.T.

Admiral Russ

Private, Co. C, 9 Reg't U. S. Col'd Infantry.

Appears on Co. Muster-out Roll, dated New Orleans, La., Dec. 20, 1866.

Muster-out to date Nov. 26, 1866.

Last paid to Aug. 3, 1866.

Clothing account:

Last settled _____, 1866; drawn since \$ 100

Due soldier \$ 100; due U. S. \$ 100

Am't for cloth'g in kind or money adv'd \$ 100

Due U. S. for arms, equipments, &c., \$ 100

Bounty paid \$ 100; due \$ 100

Remarks: found at orig. org. Stop for Masket & set of Equipments, 1 Bugle letter & number. Bounty due under the Act of Congress July 26/66. 100

Book mark: V. 163, P. 112, 73

Francis Copyist.

Ross, Emanuel
Co. C 9 Reg't U.S.C. Inf

1 Enclosures.

| | |
|------------------------------------|----------------------------|
| Bed Cards | Final Statements |
| Burial Records | Furloughs or L. of A |
| Certs. of Dis. for Discharge | Med. Certificates |
| C. M. Charges | Med. Des. Lists |
| Descriptive Lists | Orders |
| Discharge Certificates | Pris. of War Record |
| Enlistment Papers | Resignations |

Other papers relating to—

| | |
|------------------------------|----------------------------|
| Admission to Hosp'l | Furlough or L. of A |
| Casualty Sheet | Med. Examination |
| Confinement | Misc. Information 1 |
| Contracts | Pay or Clothing |
| Death or Effects | Personal Reports |
| Desertion | Rank |
| Discharge from Hosp'l | Transfer to Hosp'l |
| Discharge from Service | Transfer to V. R. C. |
| Duty | Transportation |

✓
Edmund Rob.
First Co. C. 9th
Regt.

Mr Ellertson

NARR 1484

Adjutant General's Office,

COLORED TROOPS BRANCH,

January 16th, 1877

Mr Ellerbrook

Vol.

C. T., 187

Wanted in the case of Edmund Ross, Priv., Co. C,
9th Reg't U.S.C. Troops

Record of trial re

M.A. for July + Aug. 64. reports him "Arrested at Beaufort S.C. since
June 21. 1864." and Regt. Det. for Aug. 64. "In Confinement at
Beaufort S.C."

Respectfully,

M.B.S.

L. A. Woodward
Chief Clerk.
In H. Patton

Adjutant General's Office,

Record Room

Jan. 25th, 1877.

Vol.

C. T., 187

Reply in case of Edmund Ross, Co. "C",
9th Reg't U.S.C.

No evidence of trial, with Regt. 3^d Div.
10th A.C. or Dept. South Records.

S.B.

⁴⁶⁸
Ross, Jerome

Co H, 9 U.S. Col'd Inf.

Private | Private

CARD NUMBERS.

| | | |
|----|----------|----|
| 1 | 6300027 | 26 |
| 2 | 6314137 | 27 |
| 3 | 6314237 | 28 |
| 4 | 6314331 | 29 |
| 5 | 6314424 | 30 |
| 6 | 6314526 | 31 |
| 7 | 6300366 | 32 |
| 8 | 6315050 | 33 |
| 9 | 9069310 | 34 |
| 10 | 43155827 | 35 |
| 11 | | 36 |
| 12 | | 37 |
| 13 | | 38 |
| 14 | | 39 |
| 15 | | 40 |
| 16 | | 41 |
| 17 | | 42 |
| 18 | | 43 |
| 19 | | 44 |
| 20 | | 45 |
| 21 | | 46 |
| 22 | | 47 |
| 23 | | 48 |
| 24 | | 49 |
| 25 | | 50 |

Book Mark:

See also

R | **9** | **U.S.C.T.**

J. James (P. J.)
_____, Co. *H*, 9 Reg't U. S. Col'd Inf.

Appears on
Company Descriptive Book
of the organization named above.

DESCRIPTION.

Age *24* years; height *5* feet *10* inches.
Complexion *Black*
Eyes *Black*; hair *Black*.
Where born *Virginia*
Occupation *Tavern*

ENLISTMENT.

When *Oct. 10*, 186*4*.
Where *Wilmington*
By whom *Capt. [illegible]*; term *1* y'rs.

Remarks: *Descriptive list forwarded
ad. May 9th 1865 to
H. [illegible] at [illegible]
H. [illegible] June 1st 1865 by
order of Sec. of War.*

**As borne on Descriptive Book*

C. [illegible]
(383g) Copyist.

R. | 9 | U.S.C.T.

Jerome Ross.

Appears with rank of _____ on

Muster and Descriptive Roll of a Detachment of Drafted Men and Substitutes forwarded

for the *9* Reg't U. S. Col'd Inf. Roll dated *Baltimore Md, Oct 15, 1864.*

Where born *Va.*

Age *34* years; occupation *laborer*

Enlisted
~~Drafted~~ and mustered in:

When *Oct 12, 1864.*

Where *Wilmington*

Period *one* years

Eyes *black*; hair *black*

Complexion *black*; height *5'10* in.

Paid bounty and advance pay, \$ 100

Bounty due \$ 100

Where credited _____

Company to which assigned _____

Remarks: *Drafted man Wilmington Del.*

Book mark: _____

By C. E. Dougherty - es
H. Pratt

B | ⁹ | *mees*

Jerome Ross

Appears with rank of _____ on _____

Muster and Descriptive Roll

of *Detachment of US substitutes*
& *Drafted men forwarded to*

Col J M Bowman Roll dated
Camp Bradford Md Oct 20, 1864.

Where born *Virginia*

Age *24* years; occupation *Labourer*

When enlisted *Oct. 12*, 186 .

Where enlisted *Wilmington*

For what period enlisted *1* years.

Eyes *Blk*; hair *Blk*

Complexion *Blk*; height *5 ft. 10 in.*

When mustered in *Oct 12*, 186 .

Where mustered in _____

Bounty paid \$ _____ ¹⁰⁰; due \$ _____ ¹⁰⁰

Clothing account:

Last settled _____, 186 ; drawn since \$ ¹⁶³/₁₀₀

Date of first muster _____, 186 .

Company to which assigned _____

Remarks: *Drafted man,*
Wilmington Del.

Book mark : _____

J W M Caw

21 | 9 | U.S.C.T.

Jerome Ross
Priv., Co. H, 9 Reg't U. S. Col'd Infantry.

Appears on

Company Muster Roll
for *Nov. & Dec.*, 186*4*
Present or absent *Present*

Stoppage, \$ *100* for

Due Gov't, \$ *100* for

Remarks: *Paid due from date of enrollment. The difference between seven Dollars per month and thirteen Dollars per month is due from Jan. 5 to April 30, 1864*

Book mark:

J. L. Ames

R | 9 | U.S.C.T.

Jerome Ross
Priv., Co. H, 9 Reg't U. S. Col'd Infantry.

Appears on

Company Muster Roll

for Dec. 31, 1864 to June 30, 1865.

Present or absent Absent

Stoppage, \$ 100 for

Due Gov't, \$ 100 for

Remarks: Absent sick
since May 2nd 1865

Book mark:

J. A. Ames

R | 9 | U.S.C.T.

Jerome Ross
Priv., Co. H, 9 Reg't U. S. Col'd Infantry.

Appears on

Company Muster Roll

for *Jan. & Feb.*, 1865.

Present or absent *Present*

Stoppage, \$ *100* for

Due Gov't, \$ *100* for

Remarks:

Book mark:

A. L. Ames

R | **9** | **U.S.C.T.**

Jerome Ross
Priv., Co. H, 9 Reg't U. S. Col'd Infantry.

Appears on

Company Muster Roll

for *March & April*, 1865.

Present or absent *Present*

Stoppage, \$ *100* for

Due Gov't, \$ *100* for

Remarks:

Book mark:

A. L. Ames

R | 9 | **U.S.C.T.**

Ernest Ross
 S
 out, Co. F, 9 Reg't U. S. Col'd *inf.*

Appears on an

Individual Muster-out Roll

of the organization named above. Roll dated

Fort Monroe Va June 7, 1865.

Muster-out to date *June 7*, 1865.

Last paid to *Dec 31*, 1864.

Clothing account:

Last settled ^{*never settled.*} *x*, 186 ; drawn since \$ 100

Due soldier \$ 100; due U. S. \$ 100

Am't for cloth'g in kind or money adv'd \$ *53* ^{*05*}/₁₀₀

Due U. S. for arms, equipments, &c., \$ 100

Bounty paid \$ 100; due \$ 100

Remarks: *Mustered out by order
 War Dept dated May 3, 1865
 Patient in U.S. Genl Hospital
 Fort Monroe, Va.*

Book mark:

M. O'Chane

R | 9 | U.S.C.T.

Jerome Rofs
Priv., Co. H, 9 Reg't U. S. Col'd Infantry.

Appears on

Company Muster Roll

for *July & Aug.*, 1865.

Present or absent

Stoppage, \$ 100 for

Due Gov't, \$ 100 for

Remarks: *Discharged June 7, '65, Fort Monroe, Va. Q. V. Dept.*

Book mark:

A. L. Ames

R. | 9 | U.S.C.T.

Jerome Ross.
Privt., Co. "26", 9 Reg't U. S. Col'd Infantry.

Appears on **Co. Muster-out Roll**, dated
New Orleans, La., Nov. 26, 1864.

Muster-out to date _____, 186 .

Last paid to _____, 186 .

Clothing account:

Last settled _____, 186 ; drawn since \$ _____ 100

Due soldier \$ _____ 100; due U. S. \$ _____ 100

Am't for cloth'g in kind or money adv'd \$ _____ 100

Due U. S. for arms, equipments, &c., \$ _____ 100

Bounty paid \$ _____ 100; due \$ _____ 100

Remarks: *joined as Recruit. Disch'd*
June 7/65. while absent sick at
U.S. Genl. Hosp't, Fortress Monroe
was by order of War Dept.

Book mark : _____

R. Braxton

⁹⁶⁹
Roxbury, George

Co I, 9 U.S. Col'd Inf.

Private | Private

CARD NUMBERS.

| | | |
|----|---------|----|
| 1 | 6315171 | 26 |
| 2 | 6315271 | 27 |
| 3 | 6315370 | 28 |
| 4 | 6315473 | 29 |
| 5 | 6315571 | 30 |
| 6 | 6315684 | 31 |
| 7 | 6316820 | 32 |
| 8 | 9069387 | 33 |
| 9 | | 34 |
| 10 | | 35 |
| 11 | | 36 |
| 12 | | 37 |
| 13 | | 38 |
| 14 | | 39 |
| 15 | | 40 |
| 16 | | 41 |
| 17 | | 42 |
| 18 | | 43 |
| 19 | | 44 |
| 20 | | 45 |
| 21 | | 46 |
| 22 | | 47 |
| 23 | | 48 |
| 24 | | 49 |
| 25 | | 50 |

Book Mark:

See also

1999 14 17

S. 923130 P.O. W. 2M.

C. E. Douglas
2

Re | 9 | U.S.C.T.

George Roxbury,
 , Co. *I*, 9 Reg't U. S. Col'd Inf.

Appears on

Company Descriptive Book
 of the organization named above.

DESCRIPTION.

Age *28* years; height *5* feet *4 1/4* inches.

Complexion - *Light*

Eyes *Brown*; hair *Black*

Where born *Somerset, Md.*

Occupation *Farmer*

ENLISTMENT.

When *March 22*, 186*3*.

Where *Quantico, Somerset, Md.*

By whom *Col. Birney*; term *3* y'rs.

Remarks: *Killed in action
 near Strawberry Plain, Va,
 Aug. 15/64.*

Plastic
 Copyist.

R 9 U.S.C.T.

George Roxbury
Co. D, 9 Reg't U. S. Col'd Infantry.

Age 28 years.
Appears on

Company Muster-in Roll

of the organization named above. Roll dated
Capt. Stanton Charles Co. Md. Nov. 25, 1863.
Muster-in to date Nov. 25, 1863

Joined for duty and enrolled:

When Nov. 22, 1863

Where Somerset Md.

Period 3 years.

Remarks:
.....
.....
.....
.....
.....

Book mark:

(356) J. E. Chapin Copyist.

R 9 U.S.C.T.

George Roxbury

Co. I, 9 Reg't U. S. Col'd Infantry.

Appears on

Company Muster Roll

for from Nov. 25 to Dec 31, 1863.

Present or absent Present

Stoppage, \$ 100 for

Due Gov't, \$ 100 for

Remarks: \$25 Recruit Prem. due

Book mark:

J. E. Chapin

R | 9 | U.S.C.T.

George Roxbury

Pr, Co. I, 9 Reg't U. S. Col'd Infantry.

Appears on

Company Muster Roll

for *Jan & Feb.*, 1864.

Present or absent *Present*

Stoppage, \$ *100* for

Due Gov't, \$ *100* for

Remarks: *Ar Rec. Pm. due.*

Book mark:

J. Chapin

R | **9** | **U.S.C.T.**

George Roxbury
Pro, Co. I, 9 Reg't U. S. Col'd Infantry.

Appears on

Company Muster Roll

for *Mex & Am.*, 1864.

Present or absent *Present*

Stoppage, \$ 100 for

Due Gov't, \$ 100 for

Remarks:

Book mark:

J. E. Chapin

R | 9 | U.S.C.T.

George Roxbury

Pr, Co. I, 9 Reg't U. S. Col'd Infantry.

Appears on

Company Muster Roll

for May & June, 1864.

Present or absent Present

Stoppage, \$ 100 for

Due Gov't, \$ 100 for

Remarks:

Book mark:

J. E. Chapin

R

9

U.S.C.T.

George Roxbury

Co. I, 9 Reg't U. S. Col'd Infantry.

Appears on

Company Muster Roll

for July & Aug, 1864.

Present or absent

Stoppage, \$ 100 for

Due Gov't, \$ 100 for

Remarks: Killed in a skirmish near Strawberry Plain Aug 16/64. Died prior to Aug 19/64.

Book mark: Aug 2 '78 Jan 8 '74

J. E. Chapin

R. | 9 | U.S.C.T.

George Roxbury
Fit, Co. *V*, 9 Reg't U. S. Col'd Infantry.

Appears on **Co. Muster-out Roll**, dated
New Orleans La; 26th, 186*6*.

Muster-out to date _____, 186 .

Last paid to _____, 186 .

Clothing account:

Last settled _____, 186 ; drawn since \$ _____ 100

Due soldier \$ _____ 100; due U. S. \$ _____ 100

Am't for cloth'g in kind or money adv'd \$ _____ 100

Due U. S. for arms, equipments, &c., \$ _____ 100

Bounty paid \$ _____ 100; due \$ _____ 100

Remarks: *Joined at original*
organiz; Killed in action
Aug 16/64. I + F.S. forward
Sep 7/64.

Book mark: *P. U. 11, P. 191, 69 = 510. 1878 P. 5*

G. E. Dayton

(361)

Copyist.

Roxbury, George

P, Co. *I*, **9** Reg' U.S.C. Inf.

² Enclosures.

| | |
|-----------------------------------|-------------------------|
| Bed Cards..... | Descriptive Lists..... |
| Burial Records..... | Final Statements..... / |
| Certs. of Dis. for Discharge..... | Furloughs..... |
| C. M. Charges..... | Med. Des. Lists..... |
| Med. Certificates..... | Orders..... |

Other papers relating to—

| | |
|---|--------------------------|
| Admission to Hosp'l..... | Furlough..... |
| Casualty Sheet (<i>Pri</i> Officer's)..... / | Med. Examination..... |
| Confinement..... | Misc. Information..... |
| Contracts..... | Pay or Clothing..... |
| Death or Effects..... | Personal Reports..... |
| Desertions..... | Rank..... |
| Discharge from Hosp'l..... | Transfer to Hosp'l..... |
| Discharge from Service..... | Transfer to V. R. C..... |
| Duty..... | Transportation..... |

130

CASUALTY SHEET

No.
George Robinson
Private of Company Cp.
9th Regiment of N. S. V.
State Volunteers.

NATURE OF CASUALTY.

Killed

CASUALTY SHEET.

Name: George Roxbury
Rank: Private Company: A Regiment: 9
Arm: U. S. C. T. State: _____

Nature of Casualty: Killed

CAUSE OF CASUALTY—(NAME OF DISEASE, &c.)

BY WHOM DISCHARGED.

DEGREE OF DISABILITY.

FROM WHAT SOURCE THIS INFORMATION WAS OBTAINED.

BY WHOM CERTIFIED.

as attested in the 9th U.S. Troops,
August 15, 1864,
REMARKS.

Geo H. Evans
1st & 2nd Regt 9th U.S. T.
DATE OF DISCHARGE, DEATH, &c.
August 15, 1864
PLACE OF DISCHARGE, DEATH, &c.

Disc 50 I no 60.

H. P. Brown
Clerk.
(170.)

[OFFICE ENDORSEMENT.]

War Department,

ADJUTANT GENERAL'S OFFICE,

187
The Death of *Priv. George Rowbury*, Co. 9th Reg't U.S. Colored Troops, is reported as follows:

On Company Muster Roll. *August 10, 1864*
For *July August, 1864, August 6, 1864*
Company Muster-out Roll.

✓ Company Descriptive Book. *August 15, 1864*

✓ Company Morning Reports. *No record*, 186

Soldier's Final Statement. *August 15, 1864*

Soldier's Record of Death and Interment. 186

Soldier's Inventory of Effects. 186

Soldier's Certificate of Disability for Discharge. 186

Soldier's Individual Muster-out Roll. 186

Regimental Returns. *August 15, 1864*
For *August, 1864, August 15, 1864*
Regimental Quarterly Returns. *August 15, 1864*

✓ Regimental Descriptive Book. *August 10, 1864*

By Surgeon General. 186

(*Aug 16*) 186 *is held to be the correct date, and the Company Muster Roll will be amended accordingly.*

Assistant Adjutant General.

FINAL STATEMENT

OF

Priv. George Rowbury
9th Reg't of U.S.C.T.

VOLUNTEERS

Aug 15 1864

NOTE 1.—Two of these certificates (or duplicates) are to be given to each Volunteer Soldier or drafted man who may be discharged previously to the discharge of his company, that he may at once receive from the Paymaster the pay, &c., due him, and the captain or other COMMISSIONED officer commanding the company will certify to the act of the delivery of the duplicate certificates; on these certificates the Soldier is "entitled to" his discharge, and should also present his discharge to the Paymaster to have the payment encoursed on it. The discharge is to be given back to the Soldier by the Paymaster; the latter only retaining as his voucher the duplicate certificates.

NOTE 2.—If the Soldier is entitled to pay for the use of his horse, the Company Commander will certify to that fact on the back of both these final statements, and also to the time he has pay due for having been so mounted on his own horse.

NOTE 3.—When a Soldier is furnished with final statements, his descriptive list, if he has one, should be taken up by the officer who gives the Soldier these statements, and endorsed with a statement to this effect by the officer. This endorsement should exhibit a full statement of the time for which the Soldier was allowed pay on his final statements, the clothing account, and all other charges against him or in his favor, so as to comprise a complete exhibit of his account. It will then be transmitted to the company commander of the Soldier, who will enter all the data necessary to a full understanding of the Soldier's account on the muster roll upon which the Soldier's discharge is reported. The descriptive list will then be destroyed. The object of this is, that the remaining portion of the Soldier's account may be settled upon the receipt of these muster rolls, and the Soldier receive any pay or allowances that may be due him at the time of his discharge, and which may not appear on his final statements from the fact that his descriptive list is incomplete. These accounts for back pay, &c., are settled by the 2d Auditor of the Treasury Department.

NOTE 4.—Charges for loss or injury to ordnance, horse equipments, and other miscellaneous charges, should appear under the heading of "Other Stoppages."

NOTE 5.—Bounty paid by State authorities, and not by the United States, will not be entered on this statement.

NOTE 6.—Amounts due the Sutler and Laundress must be entered on the muster roll on which the discharge, death, desertion, &c., is reported, as well as on the final statement, otherwise the amount cannot be collected from the United States.

NOTE 7.—This blank will be used for deceased volunteers and drafted men, as well as for others.

NOTE 8.—Where a Soldier dies in Hospital or on detached service, his descriptive list, if he has one, should be sent with his final statements, in duplicate, to the Second Auditor, Washington, D. C.

Wm. Rowbury

I certify, on honor, that George Roxbury a Private of
 Captain W. B. Brewster's Company (2^d) of the 7th Regiment of U.S.C.
VOLUNTEERS, of the State of _____, born in Somerset Co., State
 of Maryland, aged 40 years; 5 feet 4 1/2 inches high; Light complexion,
Brown eyes, Blk hair, and by occupation a Farmer, having joined the company on
 its original organization at Benedict Md, and enrolled in it at the muster into
 the service of the United States at Benedict Md, on the 25th day
 of November 1863, (or was mustered in service as a recruit, by Col. W. B. Brewster
Brewster, at Benedict Md on the 28th day of November
 1863, or was drafted and mustered into the service of the United States from the
 Enrollment District of the State of _____, at _____,
 on the _____ day of _____, 1863.) to serve in the Regiment, for
 the term of Three years or the War; and having served **HONESTLY** and
FAITHFULLY with his Company in the 7th U.S.C. to the present date, is now
 entitled to a **DISCHARGE** by reason of Death caused by gunshot
wound through the breast

(At cert. camp. 13-11-64
 Benedict Md)

The said Private George Roxbury was last paid by Paymaster
May P. Dye to include the 30th day of June, 1864, and has
 pay due him from that time to the present date; he is entitled to pay and subsistence for
TRAVELING to place of enrollment, and whatever other allowances are authorized to volunteer
 soldiers, drafted men, or militia, so discharged. He has received from the United States **CLOTHING**
 amounting to 40 ⁴⁰/₁₀₀ dollars, since the date day of Enrollment,
 1863, when his clothing account was last settled. He has received from the United States
no ^{no}/₁₀₀ dollars advanced **BOUNTY**.

There is ~~to be stopped~~ from him, on account of the State of _____, or other
 authorities, for ~~CLOTHING, &c.~~, received on entering service, _____ ¹⁰⁰/₁₀₀ dollars; and
 for other stoppages, viz: _____

_____ ¹⁰⁰/₁₀₀ dollars.
 He has been furnished with **TRANSPORTATION** in kind from the place of his discharge to
 _____; and he has been **SUBSISTED** for **TRAVELING** to his
 place of enrollment, up to the _____, 1864.

~~He is indebted to _____, SUTLER, _____ ¹⁰⁰/₁₀₀ dollars.~~
~~He is indebted to _____, LAUNDRESS, _____ ¹⁰⁰/₁₀₀ dollars.~~

Given in Duplicate, at St. Petersburg Fla., this 7th day
 of Sept, 1864.

Emulus S. Harris
2nd Lt 9th U.S.C.

 Commanding Company.

⁹⁷⁰
Roxbury, Matthew

Co K 9 U.S. Col'd Inf.

Private | Private

CARD NUMBERS.

| | | |
|----|---------|----|
| 1 | 6316909 | 26 |
| 2 | 6317006 | 27 |
| 3 | 6317109 | 28 |
| 4 | 6317211 | 29 |
| 5 | 6317306 | 30 |
| 6 | 6317400 | 31 |
| 7 | 6317488 | 32 |
| 8 | 6317578 | 33 |
| 9 | 6317657 | 34 |
| 10 | 6317741 | 35 |
| 11 | 6317818 | 36 |
| 12 | 6317910 | 37 |
| 13 | 6318380 | 38 |
| 14 | 6300367 | 39 |
| 15 | 9069490 | 40 |
| 16 | | 41 |
| 17 | | 42 |
| 18 | | 43 |
| 19 | | 44 |
| 20 | | 45 |
| 21 | | 46 |
| 22 | | 47 |
| 23 | | 48 |
| 24 | | 49 |
| 25 | | 50 |

Book Mark:

See also

ROP 336159 - aff.

51151 - P.O. number

5101607 P.O. aff.

D. 1380374 P.O. aff.

J. 257799 - P.O. aff.

D. 2514697 And N. G.

C. E. Doughty

R | **9** | **U.S.C.T.**

Matthew Roxbury

....., Co. *H*, 9 Reg't U. S. Col'd Inf.

Appears on

Company Descriptive Book

of the organization named above.

DESCRIPTION.

Age *21* years; height *5* feet *6³/₄* inches.

Complexion *Black*

Eyes *Brown*; hair *Black*

Where born *Somerset Mass.*

Occupation *Sailor*

ENLISTMENT.

When *Nov 26*, 186*3*.

Where *Salisbury*

By whom *Capt Wm Birney*, term *3* y'rs.

Remarks:

In the engagement on John's Island S. C. July 9/64 Drowned.

R

9

U.S.C.T.

Matthew Roxbeezy
Pri, Co. K, 9 Reg't U. S. Col'd Infantry.

Age 21 years.

Appears on

Company Muster-in Roll

of the organization named above. Roll dated

Charles Co. Md, Nov 30, 1863.

Muster-in to date Nov 30, 1863

Joined for duty and enrolled:

When Nov 26, 1863.

Where Somerset Md

Period 3 years.

Remarks:

Book mark:

C. G. Smith

R | **9** **U.S.C.T.**

Matthew Foxbury
Pri, Co. K, 9 Reg't U. S. Col'd Infantry.

Appears on

Company Muster Roll

for *Nov & Dec*, 1863.

Present or absent *Present*

Stoppage, \$ *100* for

Due Gov't, \$ *100* for

Remarks: *\$2.00 Recruit Premium*
Due

Book mark:

O. Smith

(858)

Copyist

R | 9 | U.S.C.T.

Matthew Roxbury
Pri, Co. K, 9 Reg't U. S. Col'd Infantry.

Appears on

Company Muster Roll

for Jan & Feb, 1864

Present or absent Present

Stoppage, \$ 100 for

Due Gov't, \$ 100 for

Remarks: \$2.00 Recruit
Premium Due

Book mark:

Oliver Smith

R 9 U.S.C.T.

Matthew Roxbury

Pri, Co. K, 9 Reg't U. S. Col'd Infantry.

Appears on

Company Muster Roll

for Mich & April, 1864

Present or absent Present

Stoppage, \$ 100 for

Due Gov't, \$ 100 for

Remarks:

Book mark:

O. G. Smith

R | **9** | **U.S.C.T.**

Matthew Roxbury
Ori , Co. K, 9 Reg't U. S. Col'd Infantry.

Appears on

Company Muster Roll

for *July & Aug* , 186*4*.

Present or absent *Present*

Stoppage, \$ *100* for

Due Gov't, \$ *100* for

Remarks: *Free on or before*
Apr. 19 - 1861.

Book mark :

O. Smith

R 1 9 U.S.C.T.

Matthew Roxbury
Private, Co. K, 9 Reg't U. S. Col'd Infantry.

Appears on

Company Muster Roll

for Sept & Oct, 1864

Present or absent Present

Stoppage, \$ 100 for

Due Gov't, \$ 100 for

Remarks: Free on or before
Apr. 19/61.
Due the difference
between \$7.00 pay. mo. &
\$13.00 pay. mo. from
enlistment to April
30/64

Book mark:

C. G. Smith

R 9 U.S.C.T.

Matthew Roxbury
Priv., Co. K, 9 Reg't U. S. Col'd Infantry.

Appears on

Company Master Roll

for Nov & Dec, 1864

Present or absent Present

Stoppage, \$ 100 for

Due Gov't, \$ 100 for

Remarks: Free on or before

Apr 19/61

Book mark:

G W Deodrick

(858)

Copyist

R

9

U.S.C.T.

Matthew Roxbury

Priv., Co. K, 9 Reg't U. S. Col'd Infantry.

Appears on

Company Muster Roll

for Dec 31/64 to June 30, 1865.

Present or absent Absent

Stoppage, \$ 100 for

Due Gov't, \$ 100 for

Remarks: Absent sick since May 30 1865

Book mark:

G W Deadrick

(858)

Copyist

R | 9 | U.S.C.T.

Matthew Roxbury
Priv., Co. K, 9 Reg't U. S. Col'd Infantry.

Appears on

Company Muster Roll

for *May - Apr.*, 1865.

Present or absent *Present*

Stoppage, \$ *100* for

Due Gov't, \$ *100* for

Remarks:

Book mark:

G W Deadrick

(858)

Copyist

3 9 U.S.C.T.

Matthew Roxbury
Sgt., Co. K, 9 Reg't U. S. Col'd Inf.

Appears on an

Individual Muster-out Roll

of the organization named above. Roll dated

St. Monroe, Va. June 24., 1865.

Muster-out to date June 24., 1865.

Last paid to , 186 .

Clothing account:

Last settled Oct 3, 1864; drawn since \$ 100

Due soldier \$ 100; due U. S. \$ 100

Am't for cloth'g in kind or money adv'd \$ 45 ⁺³ 100

Due U. S. for arms, equipments, &c., \$ 100

Bounty paid \$ 100; due \$ 100

Remarks: Accountable for knapsack, Haversack and canteen. Mustered out by order of War Dept. dated May 31, 1865. Present in U.S. Gen. Hospital St. Monroe, Va.

Book mark:

Mochanic

(248)

Copyist.

2

P. 1

9

U.S.C.T.

Matthew Rosbury
Priv., Co. K, 9 Reg't U. S. Col'd Infantry.

Appears on

Company Muster Roll

for *July & Aug*, 1865.

Present or absent

Stoppage, \$ 100 for

Due Gov't, \$ 100 for

Remarks:

*Mustered out of service
at Ft Monroe Va June 24/65
By order War Dept*

Book mark:

G. W. Peabody

(358)

Copyist

R | 9 | U.S.C.T.

Matthew Roxbury
Out., Co. K, 9 Reg't U. S. Col'd Infantry.

Appears on **Co. Muster-out Roll**, dated
New Orleans, La. Nov 26, 1866.

Muster-out to date _____, 186 .
Last paid to _____, 186 .

Clothing account:

Last settled _____, 186 ; drawn since \$ _____ 100

Due soldier \$ _____ 100; due U. S. \$ _____ 100

Am't for cloth'g in kind or money adv'd \$ _____ 100

Due U. S. for arms, equipments, &c., \$ _____ 100

Bounty paid \$ _____ 100; due \$ _____ 100

Remarks: *Joined at original
organization. Discharged
June 24, 1865 at Ft. Monroe, Va.
by order War Dept.*

Book mark: *288.141.*

(361)

J. C. Taylor

Copyist.

⁹⁷¹
Royal, William

Co F, 9 U.S. Col'd Inf.

Captain

Captain

CARD NUMBERS.

| | | |
|----|----------|----|
| 1 | 6299934 | 26 |
| 2 | 6309964 | 27 |
| 3 | 6310066 | 28 |
| 4 | 6310172 | 29 |
| 5 | 6310273 | 30 |
| 6 | 6310373 | 31 |
| 7 | 6310470 | 32 |
| 8 | 6310564 | 33 |
| 9 | 6310666 | 34 |
| 10 | 6310766 | 35 |
| 11 | 6310860 | 36 |
| 12 | 6310952 | 37 |
| 13 | 6311043 | 38 |
| 14 | 6311122 | 39 |
| 15 | 6311196 | 40 |
| 16 | 6311269 | 41 |
| 17 | 6311348 | 42 |
| 18 | 6311409 | 43 |
| 19 | 6311475 | 44 |
| 20 | 6311540 | 45 |
| 21 | 9428835 | 46 |
| 22 | 73227145 | 47 |
| 23 | | 48 |
| 24 | | 49 |
| 25 | | 50 |

Book Mark: 3066-C.T.82

See also

Q. 2411675 POWITM
8970 995 817 4.57 RMB
/13

Q. 8. 2007/13

R

9

U.S.C.T.

William Royal
Capt, Co. F, 9 Reg't U. S. Col'd Infantry.

Appears on

Company Muster Roll

for Nov. 23, to Dec 31, 1863.

Present or absent Present

Stoppage, \$ 100 for

Due Gov't, \$ 100 for

Remarks: Appointed Nov. 14, 1863. Mustered in by Col. Birney and assigned by Special Order No. 12. Nov. 27.

Book mark:

W. Martin

(358)

Copist

R. L. C.

U.S.C.T.

William Royal
Capt, Co. 4 Reg't U. S. Col'd Infantry.
Age 22 years.

Appears on an

Individual Muster-in Roll

of the organization named above. Roll dated
Camp Stanton
Charles C. Md, Nov 27, 1863.

Muster-in to date Nov 27, 1863.

Joined for duty and enrolled:

When Nov. 27, 1863.

Where Camp Stanton Md

Period 3 years.

Remarks: assigned to 10th
U.S.C.T.

Book mark :

W. D. Johnston

R | 9 | U.S.C.T.

William Royal
Capt, Co. F, 9 Reg't U. S. Col'd Infantry.

Appears on

Company Muster Roll

for Jan & Feb, 1864

Present or absent Present

Stoppage, \$ 100 for

Due Gov't, \$ 100 for

Remarks:

Book mark:

Martin

R | 9 | U.S.C.T.

William Royal
Capt, Co. F, 9 Reg't U. S. Col'd Infantry.

Appears on

Company Muster Roll

for *Mar & Apr.*, 1864.

Present or absent *Present*

Stoppage, \$ *100* for

Due Gov't, \$ *100* for

Remarks:

Book mark:

W. H. Martin

(358)

Copyist

R. | 9 | U.S.C.T.

William Royal
Capt, Co. F, 9 Reg't U. S. Col'd Infantry.

Appears on

Company Muster Roll

for *May + June*, 1864.

Present or absent *Present*

Stoppage, \$ *100* for

Due Gov't, \$ *100* for

Remarks:

Book mark:

W. Martin

R | 9 | U.S.C.T.

William Royal
Capt, Co. F, 9 Reg't U. S. Col'd Infantry.

Appears on

Company Muster Roll

for July & Aug, 1864.

Present or absent Absent

Stoppage, \$ 100 for

Due Gov't, \$ 100 for

Remarks: Absent sick
in Gen. Hosp. at
Ft Monroe Va.
since Aug. 14, 1864.

Book mark:

Wartie

R. | 9 | U.S.C.T.

William Royal
Capt., Co. F, 9 Reg't U. S. Col'd Infantry.

Appears on

Company Muster Roll

for Sep. & Oct., 1864.

Present or absent Present

Stoppage, \$ 100 for

Due Gov't, \$ 100 for

Remarks: Returned from
Absent sick at
Fort Mowbray, Va.
Sep. 5, 1864. Absent
sick at Base Hosp.
10th A. C. from Sept.
30 to Oct. 22, 1864.

Book mark:

Martin

R | 9 | U.S.C.T.

William Royal
Capt., Co. F, 9 Reg't U. S. Col'd Infantry.

Appears on

Company Muster Roll

for *Nov. Dec*, 1864.

Present or absent *Present*

Stoppage, \$ *100* for

Due Gov't, \$ *100* for

Remarks: *In arrest per*
S.O. No. 26 Hd Qrs.
9th U.S.C.T. Dec. 26,
1864.

Book mark:

E. L. Harrison

(358)

Copyist

R

9

U.S.C.T.

William Royal
Capt, Co. F, 9 Reg't U. S. Col'd Infantry.

Appears on

Company Muster Roll

for Jan. & Feb, 1865.

Present or absent Absent

Stoppage, \$ 100 for

Due Gov't, \$ 100 for

Remarks: Absent with leave
from Dec. 25, 25th a/c,
since Feb. 26, 1865. \$10
Ten dollars per month
due for the months of
Jan. & Feb. 1865 for re-
sponsibility of Company.

Book mark:

E. L. Thornton

(358)

Copyist

R | **9** | **U.S.C.T.**

William Royal
Capt, Co. F, 9 Reg't U. S. Col'd Infantry.

Appears on

Company Muster Roll

for *March Apr*, 1865.

Present or absent *Present*

Stoppage, \$ *100* for

Due Gov't, \$ *100* for

Remarks: *Ten dollars per month due for responsibility of Co. for the months of Jan. & Feb. 1865.*

Book mark:

E. Thasman

R 9 U.S.C.T.

William Royal
Capt, Co. F, 9 Reg't U. S. Col'd Infantry.

Appears on

Company Muster Roll

for May & June, 1865.

Present or absent Present

Stoppage, \$ 100 for

Due Gov't, \$ 100 for

Remarks:

Book mark:

E. L. Shannon

(358)

Copyist

R

9

U.S.C.T.

William Royal
Capt, Co. F, 9 Reg't U. S. Col'd Infantry.

Appears on

Company Muster Roll

for July to Aug, 1865.

Present or absent Present

Stoppage, \$ 100 for

Due Gov't, \$ 100 for

Remarks:

Book mark:

E. L. Shannon

R | 9 | U.S.C.T.

William Royal
Capt, Co. F, 9 Reg't U. S. Col'd Infantry.

Appears on

Company Muster Roll

for June 30 to Oct 31, 1865.

Present or absent Present

Stoppage, \$ 100 for

Due Gov't, \$ 100 for

Remarks:

Book mark:

D. A. Ward
Copyist

1865

K | **9** | **U.S.C.T.**
William Royal
Capt, Co. *F*, 9 Reg't U.S. Col'd Infantry.

Appears on

Company Muster Roll

for *June 30 to Dec 31*, 186*5*.

Present or absent *Present*

Stoppage, \$ *100* for

Due Gov't, \$ *100* for

Remarks:

Book mark:

J. A. Ward

R

9

U.S.C.T.

William Royal
Capt., Co. F, 9 Reg't U. S. Col'd Infantry.

Appears on

Company Muster Roll

for Jan. & Feb., 1866.

Present or absent present

Stoppage, \$ 100 for

Due Gov't, \$ 100 for

Remarks:

Book mark: 22155

(858)

J. E. Nichol
Copyist

R | 9 | U.S.C.T.

William Royal
Capt, Co. F, 9 Reg't U. S. Col'd Infantry.

Appears on

Company Muster Roll

for *Mch. & Apl.*, 1866.

Present or absent *Present*

Stoppage, \$ *100* for

Due Gov't, \$ *100* for

Remarks: *On G. C. M. pr*
S.O. No. 83 Hd. Qrs.
Dept. of Texas Apl.
20/66

Book mark:

J. E. Nichol
(358) Copyist

R | 9 | U.S.C.T.

William Royal
Capt, Co. F, 9 Reg't U. S. Col'd Infantry.

Appears on

Company Muster Roll

for May & June, 1866.

Present or absent Present

Stoppage, \$ 100 for

Due Gov't, \$ 100 for

Remarks:

Book mark: vr

(858) J. E. Nichol Copyist

R | 9 | U.S.C.T.

William Royal
Capt., Co. F, 9 Reg't U. S. Col'd Infantry.

Appears on

Company Muster Roll

for *July & Aug.*, 1866.

Present or absent *present*

Stoppage, \$ 100 for

Due Gov't, \$ 100 for

Remarks:

Book mark: 44730

(358) *J. E. Nichol* Copyist

R | 9 | U.S.C.T.

William Royal
Capt, Co. F, 9 Reg't U. S. Col'd Infantry.

Appears on

Company Muster Roll

for *Sep. & Oct.*, 1866.

Present or absent *present*

Stoppage, \$ 100 for

Due Gov't, \$ 100 for

Remarks:

Book mark:

(358)

J. E. Nichol
Copyist

R | 9 | U.S.C.T.

William Royal
Capt., Co. F., 9 Reg't U. S. Col'd Infantry.

Appears on **Co. Muster-out Roll**, dated
New Orleans, La., Nov. 26, 1866.

Muster-out to date *Nov. 26, 1866.*

Last paid to *Aug. 31, 1866.*

Clothing account:

Last settled....., 186 ; drawn since \$..... 100

Due soldier \$..... 100; due U. S. \$..... 100

Am't for cloth'g in kind or money adv'd \$..... 100

Due U. S. for arms, equipments, &c., \$..... 100

Bounty paid \$..... 100; due \$..... 100

Remarks: *First enlisted as*
Priv. Co. E " 44th N.Y.V.
at Albany N.Y. Aug. 14/62
& mustered into service
as such at Albany
N.Y. Sep. 25/62

Book mark: *3, 66, 6, 7 - 8 2*
(over)

(861) *J. E. Nichol* Copyist.

JAN. 21

6311540

1891

Appointed Capt.
9th U.S.C. T. Nov. 14/63
Service continuous.

Three months pay
(proper) due, and ten
dollars per month
for responsibility of
Co. "F" 9th U.S.C. T.
since Aug. 31/66.

R | 9 U.S.C.T.

William Royal
Capt 9 Regt U.S. Cold Troops

Appears on

General Order

No 67, dated War Department, Adjutant Gen-
eral's Office, July 16, 1867.

Appointed to be

Major

BY BREVET

in the Volunteer Force, Army of the United
States, for gallant and meritorious
services at the battles of John's
Island S.C. Fussell's Mills
and Fort Harrison Va.

To date from March 13, 1865.

(400) J. M. Williams Copyist.

Royal, William
 Capt., Co. F, 9 Reg't U.S.C. Inf

6 Enclosures.

| | |
|------------------------------|----------------------|
| Bed Cards | Final Statements |
| Burial Records | Furloughs or L. of A |
| Certs. of Dis. for Discharge | Med. Certificates |
| C. M. Charges 2 | Med. Des. Lists ✓ |
| Descriptive Lists | Orders 4 |
| Discharge Certificates | Pris. of War Record |
| Enlistment Papers | Resignations |

Other papers relating to—

| | |
|------------------------|----------------------|
| Admission to Hosp'l | Furlough or L. of A |
| Casualty Sheet | Med. Examination |
| Confinement | Misc. Information / |
| Contracts | Pay or Clothing |
| Death or Effects | Personal Reports |
| Desertion | Rank |
| Discharge from Hosp'l | Transfer to Hosp'l |
| Discharge from Service | Transfer to V. R. C. |
| Duty | Transportation |

NRH1475
MICROFILM PUBLICATION M 1851

COMPILED MILITARY SERVICE RECORDS
OF VOLUNTEER UNION SOLDIERS WHO SERVED WITH
THE UNITED STATES COLORED TROOPS (USCT)
9TH REGIMENT OF INFANTRY

PERSONAL PAPERS' TARGET SHEET

PLEASE NOTE THE CHECKED INFORMATION ABOUT THE PERSONAL PAPERS IN
THIS FILE:

- NO PERSONAL PAPERS WERE FOUND IN THIS FILE WHEN THE
RECORDS WERE ARRANGED FOR MICROFILMING.
- 7 PERSONAL PAPER(S) FOUND IN THIS FILE WHEN THE RECORDS
WERE ARRANGED FOR MICROFILMING.

MAN 477

Head, Masters 9th U. S. C.

In the field on Dec 25th 1864

Special Orders
No 30

Capt Wm Royal 9th U. S. C.
having been guilty of disobedience of orders
is hereby placed under arrest.

By Command of
Lieut Col David Torrance
A. Rhodes
1st Lieut & Acty. Adjt.

Deposited
Dec 26 1860

to Mr. C.

Placing Capt. Royal
in Charge

Mr. Royal

1st Lt. 9th W.S.C. Troops
In the Field on Dec 26 1864

Special Orders
No 36

In compliance with
instructions received from Hd Qrs 2^d Brig 3^d
Division 3^d Army Corps Captain William Royal
9th W.S.C. Troops is hereby placed under arrest
with ~~the~~ privilege of the Camp

By Order of
Lt. Col. David Torrance
Comdg 9th W.S.C. Troops
J. H. Rhodes
1st Lt. 9th W.S.C. Troops

Adj. Gen 9th Army Corps
February 23rd 1865

Special Order
No 53

Granting Leave of Absence
for 25 days to Capt Royal

Capt Royal

Adj. Gen 9th & C Troops
In the File of Feb 26th 1865

Capt Royal is first reported
absent with leave Feb 26 1865

S. P. Rhodes
Adj. Gen 9th & C Troops

Recd Adj. Gen 9th hsc 7 Feb 24th 1865

11th Regt 3^d Army Corps
 Army of the James
 In the Field Va. February 23^d 1865

Special Orders }
 1005 013 } (Extract)

Leaves of Absence to go out of the
 Department is hereby granted to the following
 named Officers

via
 Capt. William Royal 9th A S C Troops
 for twenty five (25) days

By Order of Major Genl. Witzel
 (Signed) D D Wheeler
 A A G

Official
 A Rhodes
 9th A S C

Hed. q. 8th Dec. 25th A. C.

General Orders

No. 2

Tannam 12/1/65

Proceedings of a Court
Martial in case of
Capt Wm Royal 17th Dec 65

Wm Royal

General Order
 1st Division, 25th N.C.
 In the Field Va. Nov 19th 1864.

General Order
 (No. — 5)

I. Order General Court martial. which
 occurred at Ft. G. M. B. 1st Division, 25th N.C.
 pursuant to General Order No. 19, dated Dec. 20th 1864.
 Ft. G. M. B. 1st Division, 25th N.C. and of which T. Co.
 2nd Regt. 25th N.C. is present was arranged &
 tried.

Capt. Wm. Royal, 25th N.C.

Change. Distribution of Orders.

Specification In this that be the said Capt. Wm. Royal
 being an commanding E. Company 2nd Regiment N.C.
 Co. 2. did cause the post pieces in said Company to be
 discharged between the hours of seven & twelve meridian
 instead of causing the same to be discharged between
 the hours of ten & seven A.M. as directed in a circular
 order dated, Ft. G. M. B. 25th N.C. among the forces.
 In the Field, Va. Dec 14th 1864.

1 1
 This at Camp of the 9th Regt. W. B. I. in the Field
 W. B. on the 25th day of December 1854.
 To which charges and Specification the accused pleaded
"Not Guilty"

The Court having minutely considered the evidence
 adduced for the accused. Capt. Wm. Royal. 9th W. B. I.
 b. 7. Not Guilty, and so therefore acquitted him.
 The Court would most respectfully call the attention
 of the commanding General to the impropriety of
 Officers performing Duties against a Commissioned
 Officer without the best proof of evidence to be obtained
 with the Army -

Wm. C. C. Dr. Cook.
 Wm. M. W. B. I.
 President Court. W. B. I.

Wm. C. C. Dr. Cook.
 Wm. M. W. B. I.
 Judge Advocate.

Proceedings of a C. C.
Martial in case
of Capt Wm Royal,

Trial of Capt Royal
By Court Martial

Royal, Wm
Exp-9-M-8 ET

Place of printing 28th Ave.
In the State of New York 1865
A. C. 102

It brings a public indignity and unmerited reproach upon the aggrieved officer, - and it deprives the Regiment for a considerable time of the much-needed services of a Company commander, beside setting a noxious example of mis-rule.

If on the other hand - Lt. Col. Torrance acted without definite motive, he deserves censure for adopting so grave a course, without duly weighing the consequences.

Justice to the accused demands that his acquittal and this reprimand upon Lt. Col. Torrance, be as widely known, as was the unarranted arrest of Capt. Royal.

This order will therefore be published before every regiment in this Division, and will be recorded in the Regimental and all the Company Books of the 9th U.S.C.T.

Regimental Commanders are charged with the execution of this order.

By Command of Brig. Genl. Edw. A. Wild.

R. W. Allen

1st Lieut 36th U.S.C.T.

A. A. A. G.

The proceedings and finding in this case are approved.
Capt. Wm. Royal 9th U. S. C. T. is honorably discharged from
arrest, and will return to duty.

In reviewing the record of proceedings in this case,
the Senl. Comd^y is struck with the course taken by Lt. Col.
David Torrance, 29th Conn. Col^o Vol^s then Comd^y the
9th U. S. C. T., in preferring charges against Capt. Royal,
unsupported by an iota of evidence, and then appearing
before the Court as a witness in the case, but apparently in
total ignorance of what he had done, and of his own
grounds of action.

If Lt. Col. Torrance had any motive, it must have
been either a desire to fritter away the valuable time of
the Court, or a malicious desire to injure the accused by a
long arrest, with the discredit necessarily accompanying
it. The former action would be highly reprehensible.
But, as the Court martial do not bring against Lt.
Col. Torrance any charge of "contempt of court" the
Commanding General is constrained to believe that he
was instigated by malice against Capt. Royal.
This way of showing malice deserves the strongest censure,
both as affecting the good of the service, and the
rights of the individual.

This at Camp of the 9th Regt. U. S. C. T. in the field. V^o
on the 26th day of December 1864.

To which charge and Specification the accused pleaded
"Not Guilty"

The Court having maturely considered the evidence adduced
find the accused Capt. Wm. Royal 9th U. S. C. Troops
"Not Guilty" and do therefore acquit him.

The Court would most respectfully call the attention
of the Commanding General to the impropriety of Officers
preferring charges against a Commissioned Officer without
the least proof of evidence to substantiate the charge.

By Edmund De Buckle
Major 118th U. S. C. Troops
& President Court Martial

Marvin Patterson

1st Lieut 22nd U. S. C.

Judge Advocate.

Head Qrs 1st Div. 25th A.C.
 In the Field V^o January 12th 1865.

General Orders
 No. = 2

Before General Court Martial, which convened at Head Quarters 2nd Brigade 1st Division 25th A.C. pursuant to Special Orders No 19 dated Dec 22nd 1864. Hd. Qrs 1st (then 2nd) Division 25th A.C. and of which Lt. Col. Lewis S. Weld 41st U.S. C. Troops is President was arraigned and tried:

Capt W^m Royal 9th U.S. Col^d Troops

Charge. Disobedience of Orders.

Specification. In this that he the said Captain W^m Royal being in command of Est Company Ninth Regiment United States Colored Troops did cause the four pieces in said Company to be discharged between the hours of eleven and twelve meridian, instead of causing the same to be discharged, between the hours of ten and eleven A.M. as directed in a Circular order dated "Head Quarters" 25th Army Corps Army of the James In the field V^o Dec. 14th 1864.

Charge and Specification

Against Capt. Royal

Yth N^o S^o Troops

Charges and Specifications preferred Against
 Captain William Royal, Sixth Regt. U.S. Col'd Troops

Charge Disobedience of Orders—

Specification

In this that he the said Captain
 William Royal being in command of
 F Company, Sixth Regiment United States
 Colored Troops did cause the fowl prices in
 said Company to be discharged between the
 hours of eleven and twelve Meridian, instead
 of causing the same to be discharged between
 the hours of ten and eleven A. M., as directed
 in a circular Order dated "Head Quarters 25th
 Army Corps Army of the James In the Field
 Vol Dec 14" 1864."

This At
 Camp of the 9th Regt. U.S.C.T. in the field Va
 on the 26th Day of December 1864

Witnesses

| | |
|---|-------------------------------------|
| David Torrance | David Torrance |
| St. Col. 39 Com'd Co | St. Col. 29 Com'd Col'd Bols |
| Henry Clay | Commanding 9 th U.S.C.T. |
| 1 st Sgt. Co 39 th U.S.C.T. | Officer preferring Charges |

✓
William Royal
Capt Co F
9th Regt T.

Mr Beerbrook

WAR 495
Adjutant General's Office,

COLORED TROOPS BRANCH,

March 2nd, 1877

Mr. Clark Vol.

C. T., 1877

Wanted in the case of

William Royal Capt., Co. F,

9th Reg't U.S.C. Troops.

Cause of arrest & record of trial.

Report of Dec. 10th. Report from parent with remark. In
Arrest person of Hd. In. 9th Reg't. Dec. 26th 1874?

Respectfully,

R. A. Woodward
Chief Clerk.
In J. Jackson

Adjutant General's Office,

March 27, 1877

Vol.

C. T., 1877

Reply in case of

Reg't

U.S.C. Troops.

William Royal Capt., Co. F,

1007
C. T. 1877. Dec. 26th 1874. Report from parent with remark. In
Arrest person of Hd. In. 9th Reg't. Dec. 26th 1874?
Records of 3rd Reg't. 5th Div. 35th AC. fail to show cause of
arrest and records of 2nd Reg't. 1st Div. 35th AC. do not furnish any
information relative to his release &c

972
Rec. Henry

Co *I*, 9 U.S. Col'd Inf.

Private | *Private*

CARD NUMBERS.

| | | |
|----|------------------------|----|
| 1 | 6315172 | 26 |
| 2 | 6315272 | 27 |
| 3 | 6315369 | 28 |
| 4 | 6315474 | 29 |
| 5 | 6315572 | 30 |
| 6 | 6315663 | 31 |
| 7 | 6315757 | 32 |
| 8 | 6315849 | 33 |
| 9 | 6315940 | 34 |
| 10 | 6316029 | 35 |
| 11 | 6316119 | 36 |
| 12 | 6316282 | 37 |
| 13 | 6316250 | 38 |
| 14 | 6316364 | 39 |
| 15 | 6316438 | 40 |
| 16 | 6316589 | 41 |
| 17 | 6316580 | 42 |
| 18 | 6316644 | 43 |
| 19 | 6316721 | 44 |
| 20 | 6316822 | 45 |
| 21 | 9069388 | 46 |
| 22 | <i>Rec. P. 435,514</i> | 47 |
| 23 | | 48 |
| 24 | | 49 |
| 25 | | 50 |

Book Mark: *Rec. P. 435,514*

See also

S 1171618 Audubon
Rep 435514

G. E. Doughty
21

T. 1 9 U.S.C.T.

Henry Ruel,
 Co. D, 9 Reg't U. S. Col'd Inf.

Appears on

Company Descriptive Book
 of the organization named above.

DESCRIPTION.

Age 20 years; height 5 feet 1 1/2 inches.

Complexion *Dark*

Eyes *Blk*; hair *Blk*

Where born *Accomac, Va.*

Occupation *Farmer*

ENLISTMENT.

When *Nov. 7*, 1863.

Where *Poor House, Accomac, Va.*

By whom *Col. Birney*; term *3* y'rs.

Remarks: *Died in Reg't Hosp.
 Sept. 10/64.*

Hastie
 Copyist.

R | 9 | U.S.C.T.

Henry Rice
Private, Co. C, 9 Reg't U. S. Col'd Infantry.

Age 20 years.

Appears on

Company Muster-in Roll

of the organization named above. Roll dated

Camp Stanton, Va., Nov. 25, 1863.

Muster-in to date Nov. 25, 1863

Joined for duty and enrolled:

When Nov. 27, 1863

Where Accomac Va

Period 3 years.

Remarks:

Book mark: R.P. 435,514.

J. E. Chapin

R

9

U.S.C.T.

Henry Rue

Pvt, Co. I, 9 Reg't U. S. Col'd Infantry.

Appears on

Company Muster Roll

for *from Nov. 25 to Dec 31*, 1863.

Present or absent *Present*

Stoppage, \$ *100* for

Due Gov't, \$ *100* for

Remarks: *\$2 Recruit Pems due*

Book mark:

J. E. Chapin

R | 9 | U.S.C.T.

Henry Rue

Pr, Co. I, 9 Reg't U. S. Col'd Infantry.

Appears on

Company Muster Roll

for *Jan + Feb*, 1864.

Present or absent *Present*

Stoppage, \$ *100* for

Due Gov't, \$ *100* for

Remarks: *\$2 Rec. Prem. due.*

Book mark:

J. E. Chapin

R

9

U.S.C.T.

Henry Rue

Pvt, Co. I, 9 Reg't U. S. Col'd Infantry.

Appears on

Company Muster Roll

for *McK & Apr*, 1864.

Present or absent *Present*

Stoppage, \$ *100* for

Due Gov't, \$ *100* for

Remarks:

Book mark:

J. E. Napier

R

9

U.S.C.T.

Henry Rue

Pro, Co. I, 9 Reg't U. S. Col'd Infantry.

Appears on

Company Muster Roll

for *May + June*, 1864.

Present or absent *Present*

Stoppage, \$ *100* for

Due Gov't, \$ *100* for

Remarks:

Book mark:

J. E. Casper

R

9

U.S.C.T.

Almon

at, Co. I, 9 Reg't U. S. Col'd Infantry.

Appears on

Company Muster Roll

for *July & Aug*, 1864.

Present or absent *Present*

Stoppage, \$ *100* for

Due Gov't, \$ *100* for

Remarks:

Book mark:

J. C. Chapin

R

9

U.S.C.T.

Henry Rue

25, Co. I, 9 Reg't U. S. Col'd Infantry.

Appears on

Company Muster Roll

for *Sept & Oct*, 186 *4*

Present or absent *absent*

Stoppage, \$ *100* for

Due Gov't, \$ *100* for

Remarks: *Absent since Sept 22, 64
sent to hospital*

Book mark:

J. E. Chapin

R. 9 U.S.C.T.

Henry True
D. *True*, Co. I, 9 Reg't U. S. Col'd Infantry.

Appears on

Company Muster Roll

for *Nov & Dec*, 1864.

Present or absent *Absent*.

Stoppage, \$ *100* for

Due Gov't, \$ *100* for

Remarks: *Absent sick since
Oct 22^d, 64. Sent to Hospital.*

Book mark:

W. O. Chance

R. 9 U.S.C.T.

Henry Rue

Priv., Co. I, 9 Reg't U. S. Col'd Infantry.

Appears on

Company Muster Roll

for Jan & Feb, 1865.

Present or absent Present

Stoppage, \$ 100 for

Due Gov't, \$ 100 for

Remarks:

Book mark:

no chance

R

9

U.S.C.T.

Henry Rue

Tow, Co. I, 9 Reg't U. S. Col'd Infantry.

Appears on

Company Muster Roll

for Mar & Apr, 1865.

Present or absent Present

Stoppage, \$ 100 for

Due Gov't, \$ 100 for

Remarks: Shop for one axe & helve.

Book mark:

no chance

R

9

U.S.C.T.

Henry Rue

Sriv, Co. I, 9 Reg't U. S. Col'd Infantry.

Appears on

Company Muster Roll

for From Dec 31/64 to June 30, 1865.

Present or absent Present

Stoppage, \$ 100 for

Due Gov't, \$ 100 for

Remarks: Stop for one axe and Helve.

Book mark:

mochance

R

9

U.S.C.T.

Henry True

Priv., Co. I, 9 Reg't U. S. Col'd Infantry.

Appears on

Company Muster Roll

for July & Aug, 1865.

Present or absent Present.

Stoppage, \$ 100 for

Due Gov't, \$ 100 for

Remarks:

Book mark:

No chance

R. 9 U.S.C.T.

Henry Rue

Priv, Co.-I, 9 Reg't U. S. Col'd Infantry.

Appears on

Company Muster Roll

for from June 30 to Oct 31, 1865.

Present or absent Present.

Stoppage, \$ 100 for

Due Gov't, \$ 100 for

Remarks:

Book mark:

no chance

R

9

U.S.C.T.

Henry Rue

Private, Co. I, 9 Reg't U. S. Col'd Infantry.

Appears on

Company Muster Roll

for From June 30 to Dec 31, 1865.

Present or absent Present

Stoppage, \$ 100 for

Due Gov't, \$ 100 for

Remarks:

Book mark:

Mochance

R | 9 | U.S.C.T.

Henry Rose
Pvt, Co. I, 9 Reg't U. S. Col'd Infantry.

Appears on

Company Muster Roll

for *Jan'y 4 to Feb'y*, 1866.

Present or absent *present*

Stoppage, \$ 100 for

Due Gov't, \$ 100 for

Remarks:

Book mark:

(358)

J. Ryan
Copyist

B

9

U.S.C.T.

Henry Bone

Priv, Co. I, 9 Reg't U. S. Col'd Infantry.

Appears on

Company Muster Roll

for *March 3 to April*, 1866.

Present or absent *present*

Stoppage, \$ *100* for

Due Gov't, \$ *100* for

Remarks: *Stop for one C. B. Bell
Plate, one Tompkins \$ 11/100*

Book mark:

(358)

J. Brown
Copyist

H

9

U.S.C.T.

Henry Bone
Pvt, Co. I, 9 Reg't U. S. Col'd Infantry.

Appears on

Company Muster Roll

for *May to June*, 186*6*.

Present or absent *present*

Stoppage, \$ *100* for

Due Gov't, \$ *100* for

Remarks:

Book mark:

(358)

J. Brown
Copyist

76

9

U.S.C.T.

Henry Tom
Pvt, Co. I, 9 Reg't U. S. Col'd Infantry.

Appears on

Company Muster Roll

for *July & Aug*, 1860.

Present or absent *present*

Stoppage, \$ 100 for

Due Gov't, \$ 100 for

Remarks:

Book mark:

(358)

[Signature]
Copyist

R | **9** | **U.S.C.T.**

Henry Rome
Pvt, Co. I, 9 Reg't U. S. Col'd Infantry.

Appears on

Company Muster Roll

for *Sept & Oct*, 1866.

Present or absent

Stoppage, \$ 100 for

Due Gov't, \$ 100 for

Remarks: *Died in Reg't Hospital
Brownsville Tex Sept 10. 66
Inventory & P.S. sent Sept
10. 66*

Book mark:

(358)

J. J. [Signature]
Copyist

R. | 9 | U.S.C.T.

Henry Rue

Regt, Co. I, 9 Reg't U. S. Col'd Infantry.

Appears on Co. Muster-out Roll, dated
New Orleans La: 26th Nov, 1866.

Muster-out to date 186 .

Last paid to 186 .

Clothing account:

Last settled 186 ; drawn since \$ 100

Due soldier \$ 100; due U. S. \$ 100

Am't for cloth'g in kind or money adv'd \$ 100

Due U. S. for arms, equipments, &c., \$ 100

Bounty paid \$ 100; due \$ 100

Remarks: *Joined at original
organy. Died Sept
16/68. Dr T. S. forward
ed.*

Book mark: *P. 20. 168. 71.*

G. E. Dayton

(861)

Copyist.

R. 1 9 U.S.P.S.

Henry Rue
Priv., Co. B, 9 Reg't U.S.P.S.

NOTATION.

Book mark: R. P. # 35514

Record and Pension Office,

WAR DEPARTMENT,

Washington Dec. 16, 1895.

It has this day Dec. 16, 1895

been determined by this Department from records on file and evidence furnished by the Auditor for the War Dept., that this man was enrolled Nov. 22, 1863.

A. G. N.

Rue, Henry

P, Co. *I*,

9

Reg't

U. S. C. Inf.

2 Enclosures.

| | |
|------------------------------|-------------------|
| Bed Cards | Descriptive Lists |
| Burial Records | Final Statements |
| Certs. of Dis. for Discharge | Furloughs |
| C. M. Charges | Med. Des. Lists |
| Med. Certificates | Orders |

Other papers relating to—

| | |
|----------------------------|----------------------|
| Admission to Hosp'l | Furlough |
| Casualty Sheet (Officer's) | Med. Examination |
| Confinement | Misc. Information |
| Contracts | Pay or Clothing |
| Death or Effects | Personal Reports |
| Desertions | Rank |
| Discharge from Hosp'l | Transfer to Hosp'l |
| Discharge from Service | Transfer to V. R. C. |
| Duty | Transportation |

Extract from Act of Congress.

SEC. 12. And be it further enacted, That the fees of agents and attorneys for making out and causing to be executed the papers necessary to establish a claim for a pension, bounty, and other allowance before the Pension Office, under this act, shall not exceed the following rates: For making out and causing to be duly executed a declaration by the applicant, with the necessary affidavits, and forwarding the same to the Pension Office, with the requisite correspondence, ten dollars; which sum shall be received by such agent or attorney in full for all services in obtaining such pension, and shall not be demanded or received, in whole or in part, until such pension shall be obtained; and the sixth and seventh sections of an act entitled "An act to grant pensions," approved July [fourteenth,] eighteen hundred and sixty-two, are hereby repealed.

SEC. 13. And be it further enacted, That any agent or attorney who shall, directly or indirectly, demand or receive any greater compensation for his services under this act than is prescribed in the preceding section of this act, or who shall contract or agree to prosecute any claim for a pension, bounty, or other allowance under this act, on the condition that he shall receive a per centum upon any portion of the amount of such claim, or who shall wrongfully withhold from a pensioner or other claimant the whole or any part of the pension or claim allowed and due to such pensioner or claimant, shall be deemed guilty of a high misdemeanor, and, upon conviction thereof, shall, for every such offense, be fined not exceeding three hundred dollars, or imprisoned at hard labor not exceeding two years, or both, according to the circumstances and aggravations of the offense.

Approved July 4, 1864.

NOTE 10.—If any soldier is charged a higher fee than that allowed by the above act, he should report the fact and the name of the agent to the Adjutant General, in order that steps may be taken to have the same refunded.

July 4 1864
782 2012 U.S. Army
Adjutant General's Office

ADJUTANT GENERAL'S OFFICE
Sept 29 1864
Duplicate with Inventory sent to Paymaster.

53
FINAL STATEMENT.

OF

Priv. Henry Rue
9th Reg't of U. S. C. T.

Acid Sept 1864
VOLUNTEERS.

NOTE 1.—Two of these certificates (or duplicates) are to be given to each Volunteer Soldier or drafted man who may be discharged without being mustered out (Final Statements are never given to men mustered out of service) that he may at once receive from the Paymaster the pay, &c., due to him, and the captain or other commissioned officer commanding the company will certify to the act of the delivery of the duplicate certificates; with these certificates the Soldier is "entitled to" his discharge, and should also present his discharge to the Paymaster to have the payment endorsed on it. The discharge is to be given back to the Soldier by the Paymaster; the latter only retaining as his vouchers the duplicate certificates.

NOTE 2.—If the Soldier is entitled to pay for the use of his horse, the Company Commander will certify to that fact on the back of both these final statements, and also to the time he has pay due for having been so mounted on his own horse.

NOTE 3.—When a Soldier is furnished with final statements, his descriptive list, if he has one, should be taken up by the officer who gives the Soldier these statements, and endorsed with a statement to this effect by the officer. The endorsement should exhibit a full statement of the time for which the Soldier was allowed pay on his final statements, the clothing account, and all other charges against him or in his favor, so as to comprise a complete exhibit of his account. It will then be transmitted to the Company Commander of the Soldier, who will enter all the data necessary to a full understanding of the Soldier's account on the muster roll upon which the Soldier's discharge is reported. The descriptive list will then be destroyed. The object of this is, that the remaining portion of the Soldier's account may be settled upon the receipt of these muster rolls, and the Soldier receive any pay or allowances that may be due him at the time of his discharge, and which may not appear on his last final statements from the fact that his descriptive list is incomplete. These accounts for back pay, &c., are settled by the 2d Auditor of the Treasury Department.

NOTE 4.—Charges for loss or injury to ordnance, horse equipments, and other miscellaneous charges, should appear under the heading of "Other Stoppages."

NOTE 5.—Bounty paid by State authorities, and not by the United States, will not be entered on this statement.

NOTE 6.—Amounts due the Sutler, and address must be entered on the muster roll on which the discharge, death, desertion, &c., is reported, as well as on the final statement, otherwise the amount cannot be collected from the United States.

NOTE 7.—This blank will be used in the discharge of volunteers and drafted men, as well as for others.

NOTE 8.—Where a Soldier dies in Hospital or in detached service, his descriptive list, if he has one, should be sent with his final statements, in duplicate, to the Adjutant General, Washington, D. C.

NOTE 9.—If the soldier is a drafted man or substitute, the space for time, &c., of enrolled, should contain only the word *drafted* or *substitute*, as the case may be. If the Soldier is a "VETERAN," (or RECRUIT,) the words *as a veteran*, (or *recruit*.) as the case may be, should be interlined after the words *mustered into the service of the U. S.* A statement of all the installments of *Veteran or Recruit Bounty* RECEIVED by the Soldier must be made on the back of each final statement.

RECEIVED, ADJUTANT GENERAL'S OFFICE, SEP 29 1864

Henry Rue

I certify, on honor, that Henry Rue, a Private of
Captain C. B. Fassenden Jr Company (D) of the 9th Regiment of U. S. C.
Volunteers, of the State of _____, born in Accomac State
of Virginia, aged 20 years; 5 feet 11 1/2 inches high; Fair complexion,
Blue eyes, Blue hair, and by occupation a Farmer, who joined for service
and was enrolled (see Note 9) on the 7th day of November, 1863, at Peor House
by Col Wm Bann, for the period of Three years, and mustered into
the service of the United States on the 25th day of November, 1863, at
Camp Stanton, Md., by Col Wm Bann; and having served
HONESTLY and **FAITHFULLY** with his Company to the present date, is now entitled to a
DISCHARGE by reason of Death Cholera Sept 10th 1866
Regt Hosp. Brownsville Texas

The said Private Henry Rue was last paid by Paymaster
Maj Underwood, to include the 30th day of June, 1866, and
has pay due him from that time to the present date; he is entitled to pay and subsistence for
TRAVELING to place of enrollment, and whatever other allowances are authorized to volunteer
soldiers, drafted men, or militia, so discharged. He has received from the United States **CLOTHING**
amounting to 54 ⁵⁶/₁₀₀ dollars, since the 31st day of October,
1865, when his clothing account was last settled. He has received from the United States
_____ ^{_____}/₁₀₀ dollars advanced **BOUNTY**.

There is to be stopped from him, on account of the State of _____, or other
authorities, for **CLOTHING**, &c., received on entering service, _____ ^{_____}/₁₀₀ dollars; and
for other stoppages, viz: _____

_____ ^{_____}/₁₀₀ dollars.
He has been furnished with **TRANSPORTATION** in kind from the place of his discharge to
_____ ; and he has been **Subsisted** for **Traveling** to his
place of enrollment, up to the _____, 186 .

He is indebted to _____, **Sutler**, _____ ^{_____}/₁₀₀ dollars.

He is indebted to _____, **Laundress**, _____ ^{_____}/₁₀₀ dollars.

Given in Duplicate, at Brownsville Texas, this 10th day
of September, 1866.

C. B. Fassenden Jr
Capt C. B. 9th U. S. C. V.
Commanding Company.

ARTICLES OF WAR.

ART. 95. When any non-commissioned officer or soldier shall die, or be killed in the service of the United States, the then commanding officer of the troop or company shall, in the presence of two other commissioned officers, take an account of what effects he died possessed of, above his arms and accoutrements, and transmit the same to the office of the Department of War, which said effects are to be accounted for, and paid to the representatives of such deceased non-commissioned officer or soldier. And in case any of the officers, so authorized to take care of the effects of deceased officers and soldiers, should, before they have accounted to their representatives for the same, have occasion to leave the regiment or post, by preferment or otherwise, they shall, before they be permitted to quit the same, deposit in the hands of the commanding officer, or of the assistant military agent, all the effects of such deceased non-commissioned officers and soldiers, in order that the same may be secured for, and paid to, their respective representatives.

DIRECTIONS.

NOTE 1.—One copy of the inventories of the effects of deceased non-commissioned officers and soldiers, required by the 95th Article of War, will be forwarded to the Adjutant General, by the commander of the company to which the deceased belonged, and a duplicate of the same to the colonel of the regiment. Final statements of pay, clothing, &c., in duplicate, will be sent to the Adjutant General with one copy of the inventory. Both inventory and final statements should be forwarded, as a general rule, through Regimental Headquarters. When a soldier dies at a post or station absent from his company, it will be the duty of his immediate commander to furnish, direct to the Adjutant General, the required inventory and final statements, and, at the same time, to forward to the commanding officer of the company to which the soldier belonged, a report of his death, specifying the date, place, and cause; to what time he was last paid, and the money or other effects in his possession at the time of his decease; which report will be noted on the next muster roll of the company to which the man belonged. Each inventory will be endorsed, "Inventory of the effects of _____, late of company (—) _____ regiment of _____, who died at _____, the _____ day of _____, 186—." If a legal representative receive the effects, it will be stated in the report. If the soldier leave no effects, the fact will be reported on the blank for inventory.

NOTE 2.—Should the effects of a deceased non-commissioned officer or soldier not be administered upon within a short period after his decease, they shall be disposed of by a Council of Administration, under the authority of the commanding officer of the post, and the proceeds deposited with the Paymaster, to the credit of the United States, until they shall be claimed by the legal representatives of the deceased.

NOTE 3.—In all such cases of sales by the Council of Administration, a statement in detail, or account of the proceeds duly certified by the Council and commanding officer, (Form 5,) accompanied by the Paymaster's receipt for the proceeds, will be forwarded by the commanding officer to the Adjutant General. The statement will be endorsed, "Report of the proceeds of the effects of _____, late of company (—) _____ regiment of _____, who died at _____, the _____ day of _____, 186—."

NOTE 4.—The effects in all cases, when called for, should be turned over to the legal representative, without further authority from the Adjutant General. When the effects are turned over to the relatives of the deceased before these inventories are sent to the Adjutant General, their receipts therefor should be attached to the inventories. In all other cases, one copy will be sent with a letter of transmittal direct to the Adjutant General, and a duplicate retained by the officer.

NOTE 5.—Particular care should be taken to take receipts in duplicate from the Paymaster for any funds turned over to him; one copy should be sent direct to the Adjutant General and one retained by the officer.

1866
52
F. J. ... file
INVENTORY OF THE EFFECTS

OF

Sir Henry Rue

Late of Company 9

 9th Reg't of U. S. C. T.

Volunteers, who died at Brownsville Texas

on the 10th day of September 1866.

1866
SEP 11
1866

INVENTORY

Inventory of the effects of Henry Rue late
a Private of Captain C. B. Fessenden Jr. Company I of
the 9th Regiment of U. S. Colored Volunteers, who was enrolled as
a Private at Farm House in the State of Virginia on
the 7th day of November 1863, and mustered into the service of the United
States as a Private on the 25th day of November 1863, at Camp Stanton, Md.
in Company I, 9th Regiment of U. S. Colored Volunteers, to serve Three
years or during the war; he was born in Accomac in the State
of Virginia; he was 20 years of age, 5 feet 1 1/2 inches
high, Griff complexion, BRN eyes, BRN hair, and by occupation, when enrolled,
a Farmer; he died in Regt Hospital, at
Brownsville Texas on the 10th day of September 1866, by
reason of Cholera

| INVENTORY. | | | | | | |
|-------------------------|-----|-----------------------------|-----|----------------|--------|----------------|
| ARTICLES. | No. | ARTICLES. | No. | ARTICLES. | No. | |
| Hats..... | | Pairs trousers..... | / | Knapsacks..... | | |
| Caps..... | | Pairs flannel drawers..... | / | | | |
| Forage caps..... | | Pairs cotton drawers..... | | | | |
| Great coats..... | / | Flannel shirts..... | / | | | |
| Uniform coats..... | / | Cotton shirts..... | | | | |
| Uniform jackets..... | | Pairs boots..... | | | | |
| Flannel sack coats..... | / | Pairs shoes..... | / | | | |
| Blouses..... | | Pairs socks..... | 2 | | | |
| Stable frocks..... | | Blankets..... <u>Rubber</u> | / | | MONEY. | Specie..... \$ |
| Fatigue overalls..... | | Haversacks..... | | | | Notes..... \$ |

I CERTIFY, ON HONOR, that the above inventory comprises all the effects of Private
Henry Rue, deceased, and that the effects are in the hands
of Capt C. B. Fessenden Jr. at Brownsville
Texas to be disposed of by a Council of Administration.

(DUPLICATES.)

STATION: Brownsville, Texas

DATE: Sept 10. 1866

[A. G. O. No. 164.]

C. B. Fessenden Jr.
Capt - Co I 9th U.S.C.
Commanding the Company.

973
Rutter, William

Co K, 9 U.S. Col'd Inf.

Privates | Private

CARD NUMBERS. /

| | | |
|----|---------|----|
| 1 | 6317110 | 26 |
| 2 | 6317212 | 27 |
| 3 | 6317307 | 28 |
| 4 | 6317401 | 29 |
| 5 | 6317489 | 30 |
| 6 | 6317579 | 31 |
| 7 | 6317658 | 32 |
| 8 | 6317743 | 33 |
| 9 | 6317819 | 34 |
| 10 | 6317888 | 35 |
| 11 | 6317960 | 36 |
| 12 | 6318020 | 37 |
| 13 | 6318077 | 38 |
| 14 | 6318135 | 39 |
| 15 | 6318191 | 40 |
| 16 | 6318244 | 41 |
| 17 | 6318295 | 42 |
| 18 | 6318346 | 43 |
| 19 | 9167522 | 44 |
| 20 | 9069517 | 45 |
| 21 | | 46 |
| 22 | | 47 |
| 23 | | 48 |
| 24 | | 49 |
| 25 | | 50 |

Book Mark:

See also

P. 144 2716 P.C. aff.
S 1878614 P.M.M.

C. R. Daugherty
2

R | 9 | U.S.C.T.

William Rutter

, Co. K, 9 Reg't U. S. Col'd Inf.

Appears on

Company Descriptive Book

of the organization named above.

DESCRIPTION.

Age 30 years; height 5 feet 7 1/2 inches.

Complexion *Cruddy*

Eyes *Black*; hair *Black*

Where born *Cecil Md.*

Occupation *Farmer*

ENLISTMENT.

When *Jan, 17*, 1864.

Where *Cecil Md.*

By whom *Wm. Spurr*; term 3 y'rs.

Remarks: *Joined Co. as recruit
from Depot Jan. 17/64
Discharged with Regt.*

S. L. Ames

R | **9** | **U.S.C.T.**

** William Rutter*

, Co. *H*, 9 Reg't U. S. Col'd Inf.

Appears on

Company Descriptive Book

of the organization named above.

DESCRIPTION.

Age *30* years; height . . . feet . . . inches.

Complexion *Mulatto*

Eyes *Black*; hair *Black*

Where born *Cecil*

Occupation *Farmer*

ENLISTMENT.

When *Jan'y 17*, 186 *4*

Where

By whom *Genl Wm Birney*; term *3* y'rs.

Remarks:

*Junior Co. as a recruit
Jan'y 17, 64.*

** Entire entry cancelled by
this account through*

J. W. Ames

R

9

U.S.C.T.

William Rutter

Pri, Co. K, 9 Reg't U. S. Col'd Infantry.

Appears on

Company Muster Roll

for *Jan & Feb*, 186*4*

Present or absent *Present*

Stoppage, \$ *100* for

Due Gov't, \$ *100* for

Remarks: *\$2.00 Recruit -
Premium Due*

Book mark:

O. G. Smith

(358)

Copyist

R

9

U.S.C.T.

William Rutter
Pri, Co. K, 9 Reg't U. S. Col'd Infantry.

Appears on

Company Muster Roll

for *March & April*, 1864.

Present or absent *Present*

Stoppage, \$ *100* for

Due Gov't, \$ *100* for

Remarks: *Stop for one ^{pair} Metallic
seals & two Cap bugles*

Book mark:

O. Smith

(358)

Copyist

R | **9** | **U.S.C.T.**

William Rutter
Pii , Co. K, 9 Reg't U. S. Col'd Infantry.

Appears on

Company Muster Roll

for *May & June* , 186*4*.

Present or absent *Present*

Stoppage, \$ *100* for

Due Gov't, \$ *100* for

Remarks:

Book mark:

O. G. Smith

R

9

U.S.C.T.

William Rutter

Pri, Co. K, 9 Reg't U. S. Col'd Infantry.

Appears on

Company Muster Roll

for July & Aug, 1864.

Present or absent Present

Stoppage, \$ 100 for

Due Gov't, \$ 100 for

Remarks: Stop for 5 Knapsacks & 1 Haversack

Book mark:

C. G. Smith

R | 9 | U.S.C.T.

William Rutter
Pri, Co. K, 9 Reg't U. S. Col'd Infantry.

Appears on

Company Muster Roll

for Sept & Oct, 1864

Present or absent Absent

Stoppage, \$ 100 for

Due Gov't, \$ 100 for

Remarks: On detached
service as teamster
since Sept. 70/64 by
order of Brig Gen Blinn
Due the difference between
\$7.00 per mo. & \$13.00 per mo.
from Jan. 1 to Apr 30/64.

Book mark:

O. Smith

R | 9 | U.S.C.T.

William Sutter
Priv., Co. K, 9 Reg't U. S. Col'd Infantry.

Appears on

Company Muster Roll

for Nov & Dec, 1864

Present or absent Absent

Stoppage, \$ 100 for

Due Gov't, \$ 100 for

Remarks: On detached service
as teamster since Sept 10
/64 By order of Maj Gen Remy
as per SO No 117 dated Hd Qrs
10 ab Sept 5/64

Book mark:

G W Deabrick

(858)

Copyist

P | **9** | **U.S.C.T.**

William Rutter

Priv, Co. K, 9 Reg't U. S. Col'd Infantry.

Appears on

Company Muster Roll

for *Dec 31/64 to June 30, 1865.*

Present or absent *Present*

Stoppage, \$ *100* for

Due Gov't, \$ *100* for

Remarks: *Det or transfer in Lt
Order Reg't No 14 dated Feb 20
9 U.S.C.T. Feb 6/65*

+ as it appears on roll

Book mark:

G W Deadrick

(858)

Copyist

K | **9** | **U.S.C.T.**

William Rutter
Priv, Co. K, 9 Reg't U. S. Col'd Infantry.

Appears on

Company Muster Roll

for *Jan & Feb*, 1865.

Present or absent *Present*

Stoppage, \$ *100* for

Due Gov't, \$ *100* for

Remarks: *On Det. Ser. as teamster*
in Lt. Art. Brig. 80 No 14 Satd
Ad. Ser. 9th C.T. Feb 6/65

Book mark:

G. W. Deadrick

(858)

Copyist

R | 9 | U.S.C.T.

William Rutter
Priv, Co. K, 9 Reg't U. S. Col'd Infantry.

Appears on

Company Muster Roll

for *Mar - Apr*, 1865.

Present or absent *Absent*

Stoppage, \$ *100* for

Due Gov't, \$ *100* for

Remarks: *Detached as Gunster*
At Army Bury since Feb 6/65
SO No 54 Hd Qrs 9 USCT
dated Feb 6/65

Book mark:

G W Deadrick

R | **9** | **U.S.C.T.**

William Rutter
Prin, Co. K, 9 Reg't U. S. Col'd Infantry.

Appears on

Company Muster Roll

for *June 30/63 to Dec 31*, 1865.

Present or absent *Present*

Stoppage, \$ *100* for

Due Gov't, \$ *100* for

Remarks:

Book mark:

G W Deavrick

(858)

Copyist

R | **9** | **U.S.C.T.**

William Rutter
Priv, Co. K, 9 Reg't U. S. Col'd Infantry.

Appears on

Company Muster Roll

for *July & Aug*, 186*5*.

Present or absent *Present*

Stoppage, \$ *100* for

Due Gov't, \$ *100* for

Remarks:

Book mark:

G W Deadrick

(858)

Copyist

R

9

U.S.C.T.

William Ruyter
Priv, Co. K, 9 Reg't U. S. Col'd Infantry.

Appears on

Company Muster Roll

for *Sept - Oct*, 186*3*.

Present or absent: *Present*.

Stoppage, \$ *100* for

Due Gov't, \$ *100* for

Remarks:

Book mark:

G W Deabrick

(358)

Copyist

R

9

U.S.C.T.

William Rutter
Int., Co. K, 9 Reg't U. S. Col'd Infantry.

Appears on

Company Muster Roll

for *Jan. and Feb.*, 186*6*.

Present or absent *Present*

Stoppage, \$ *100* for

Due Gov't, \$ *100* for

Remarks:

Book mark:

J. C. Taylor

(358)

Copyist

R

9

U.S.C.T.

William Rutter
Put, Co. K, 9 Reg't U. S. Col'd Infantry.

Appears on

Company Muster Roll

for *May and June*, 1866.

Present or absent *Present*

Stoppage, \$ 100 for

Due Gov't, \$ 100 for

Remarks:

Book mark:

P. C. Taylor

(358)

Copyist

R

9

U.S.C.T.

William Rutter
Priv., Co. K, 9 Reg't U. S. Col'd Infantry.

Appears on

Company Muster Roll

for *July and Aug*, 186*6*.

Present or absent *Present*

Stoppage, \$ *100* for

Due Gov't, \$ *100* for

Remarks:

Book mark:

J. C. Taylor

(358)

Copyst

R | 9 | U.S.C.T.

William Rutter
Priv., Co. K, 9 Reg't U. S. Col'd Infantry.

Appears on

Company Muster Roll

for *Sep. and Oct.*, 186*6*.

Present or absent *Present*

Stoppage, \$ 100 for

Due Gov't, \$ 100 for

Remarks:

Book mark:

(358)

P. C. Taylor

Copyist

R | 9 | U.S.C.T.

William Putter
Pvt., Co. K, 9 Reg't U. S. Col'd Infantry.

Appears on Co. Muster-out Roll, dated
New Orleans, La., Nov. 26, 1866.

Muster-out to date Nov. 26, 1866.

Last paid to Aug. 31, 1866.

Clothing account:

Last settled _____, 1866; drawn since \$ 100

Due soldier \$ 10 ⁹⁶/₁₀₀; due U. S. \$ 100

Am't for cloth'g in kind or money adv'd \$ 100

Due U. S. for arms, equipments, &c., \$ ⁹⁵/₁₀₀

Ordinary
Bounty paid \$ none ¹⁰⁰/₁₀₀; due \$ 300 ¹⁰⁰/₁₀₀ +

Remarks: ⁺ Bounty due under
Act of Congress of July 26,
1866, none. Joined as re-
cruit. Stop one havers-
sack.

ag. 30 - Enrolled Jan. 17. 64 Cecil Mt
24th Inf Jan. 22. 64 Benedict

Book mark: 3360.1878. 399.779.

D. C. Taylor

MICROCOPY

1821

34

IMAGE EVALUATION TEST TARGET (QA-3)

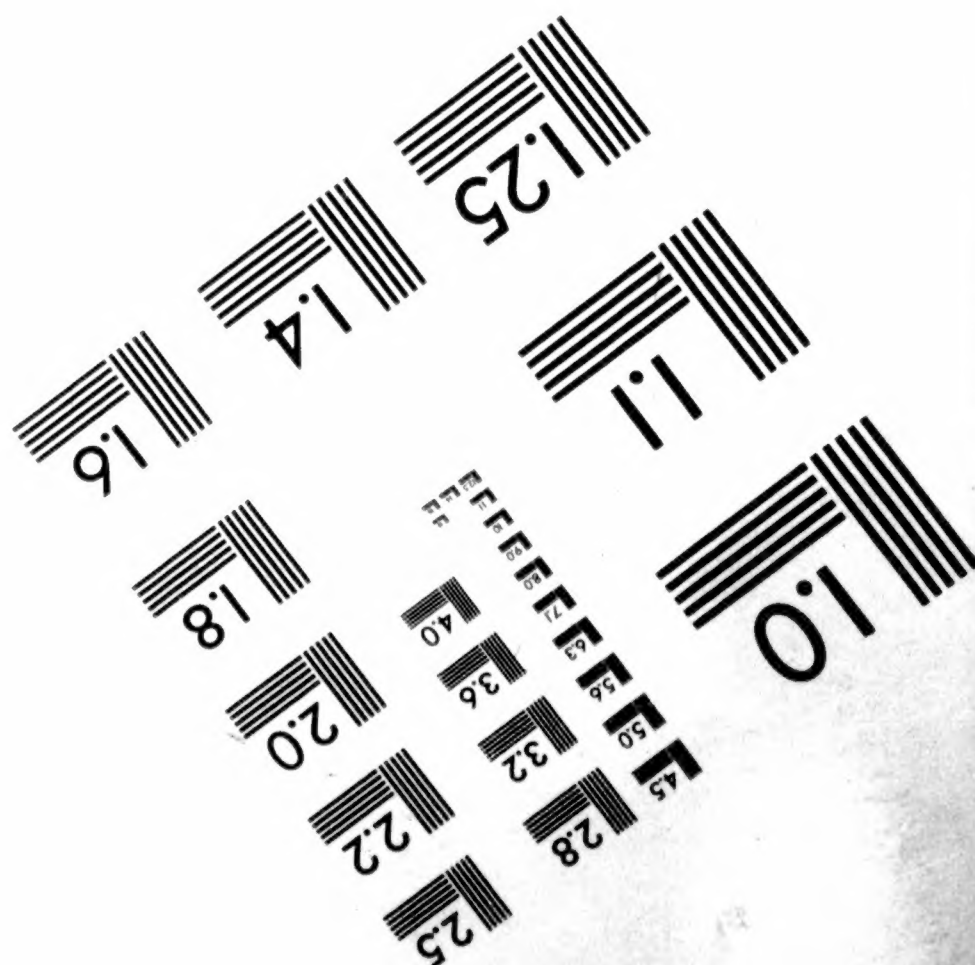
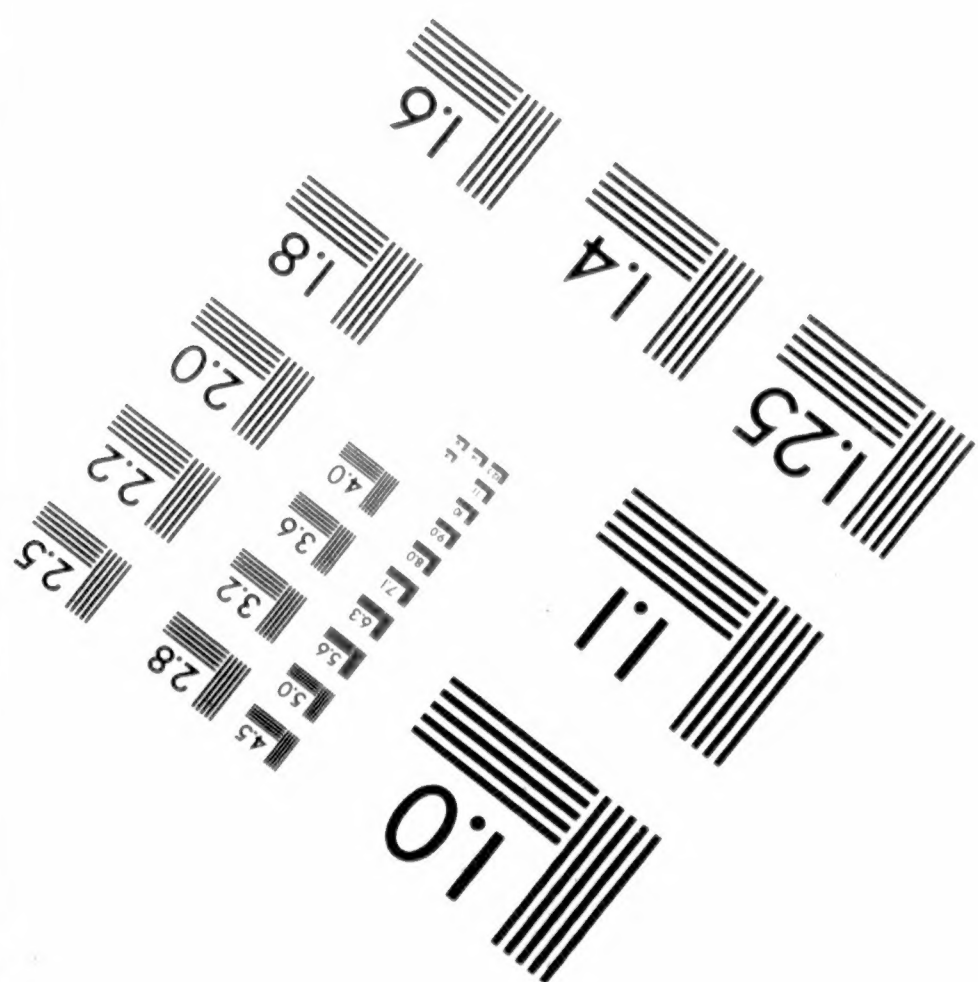
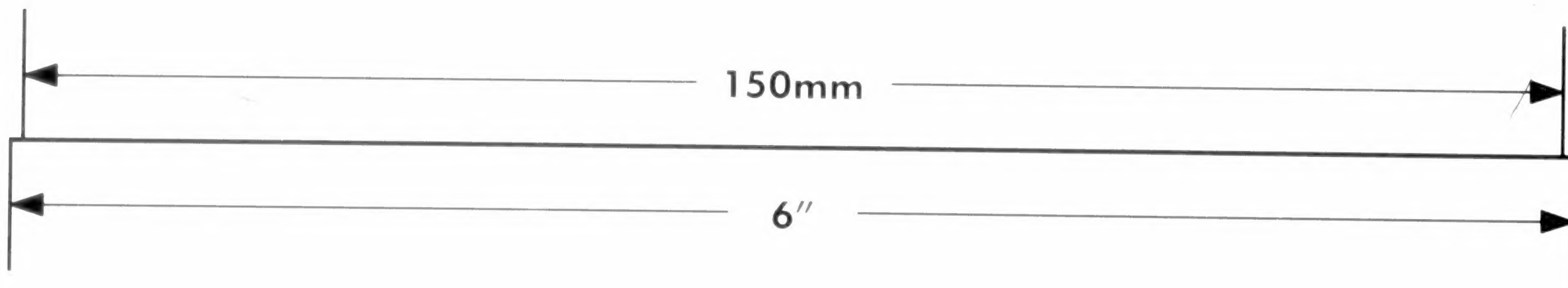
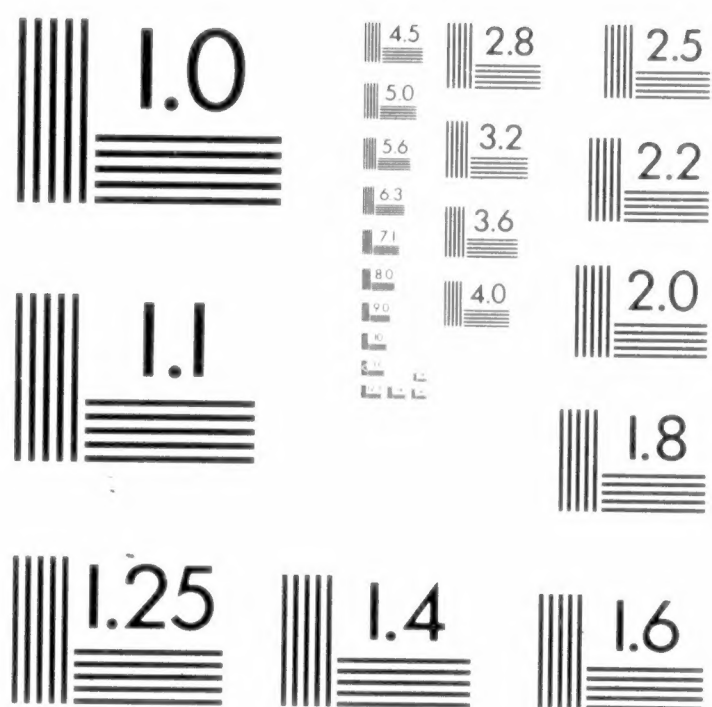
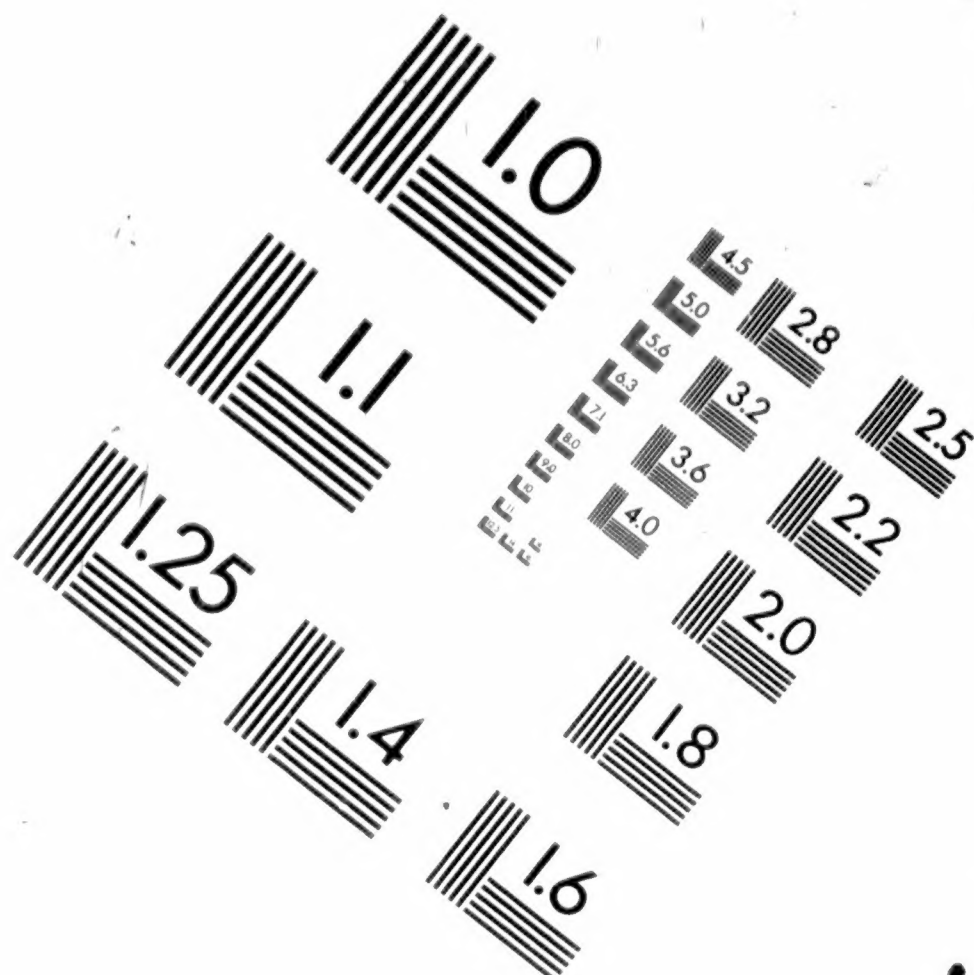
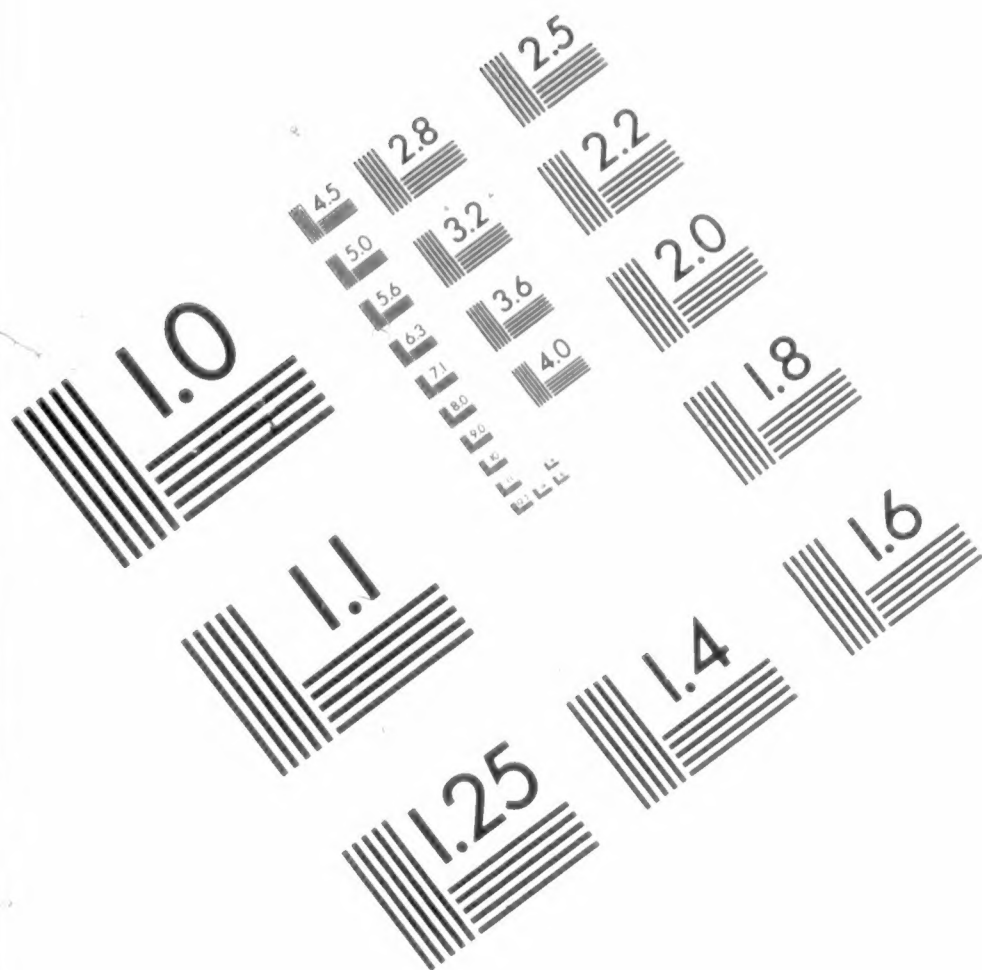

APPLIED IMAGE, Inc.
 1653 East Main Street
 Rochester, NY 14609 USA
 Phone: 716/482-0300
 Fax: 716/288-5989

© 1993, Applied Image, Inc., All Rights Reserved

THE END

PLEASE

REWIND