

ONAL

LIVES

FILM

ATIONS

**NATIONAL
ARCHIVES
MICROFILM
PUBLICATIONS**

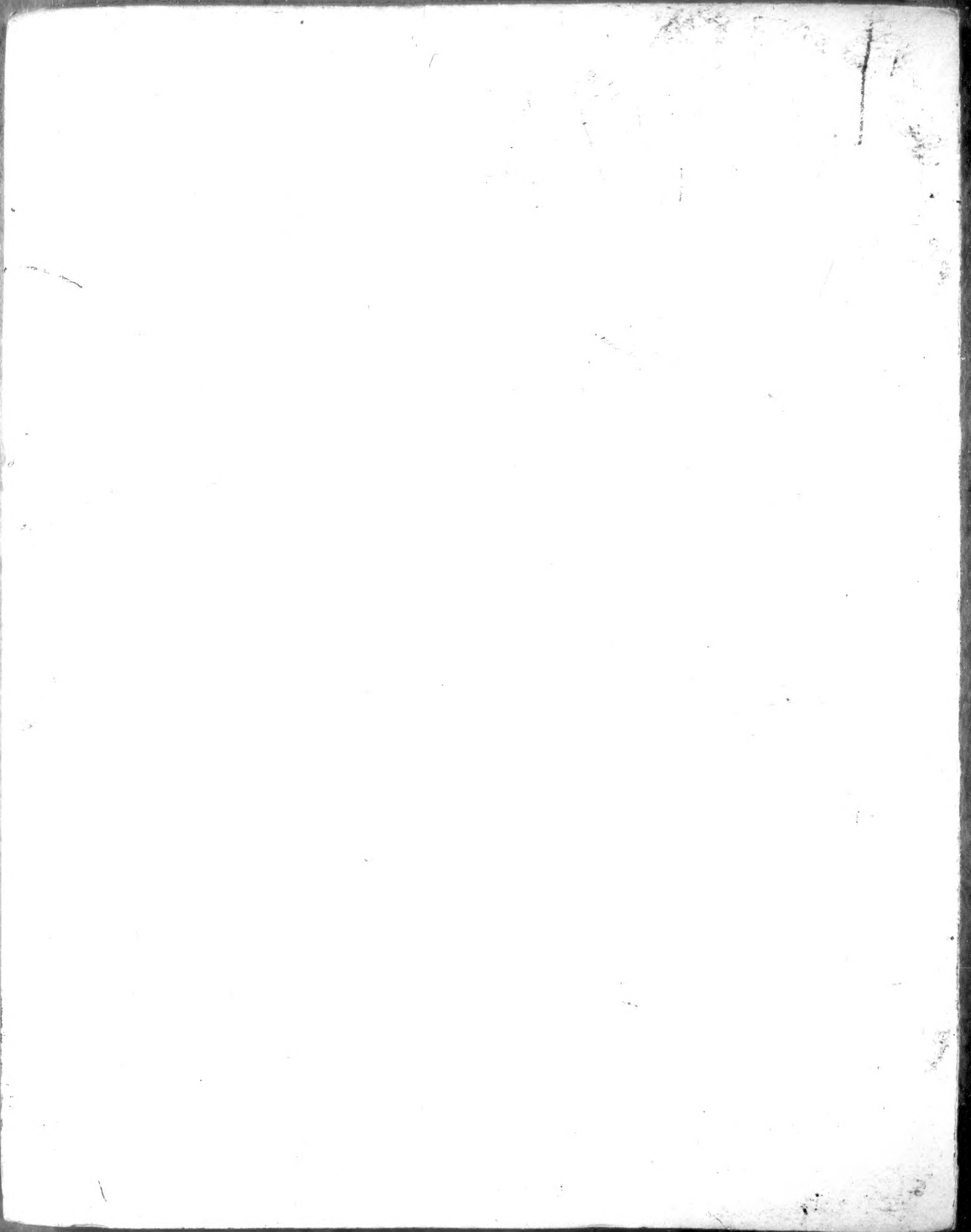
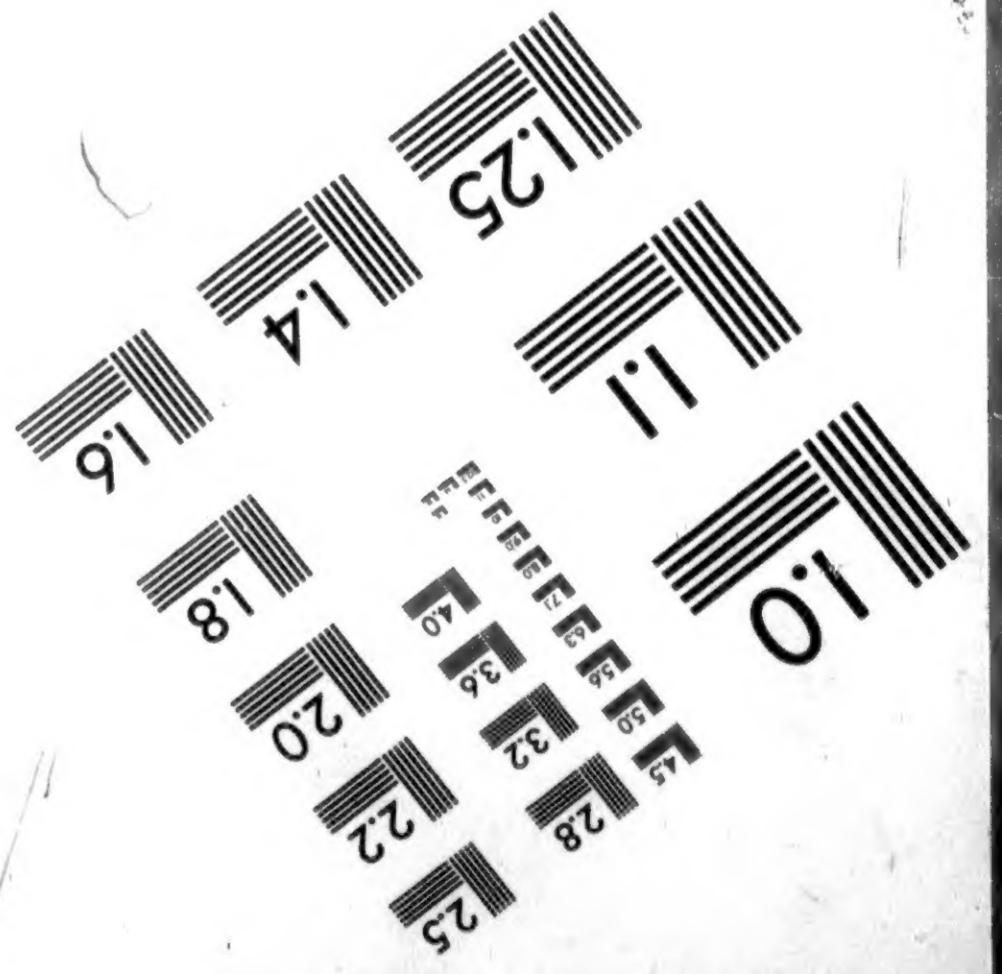
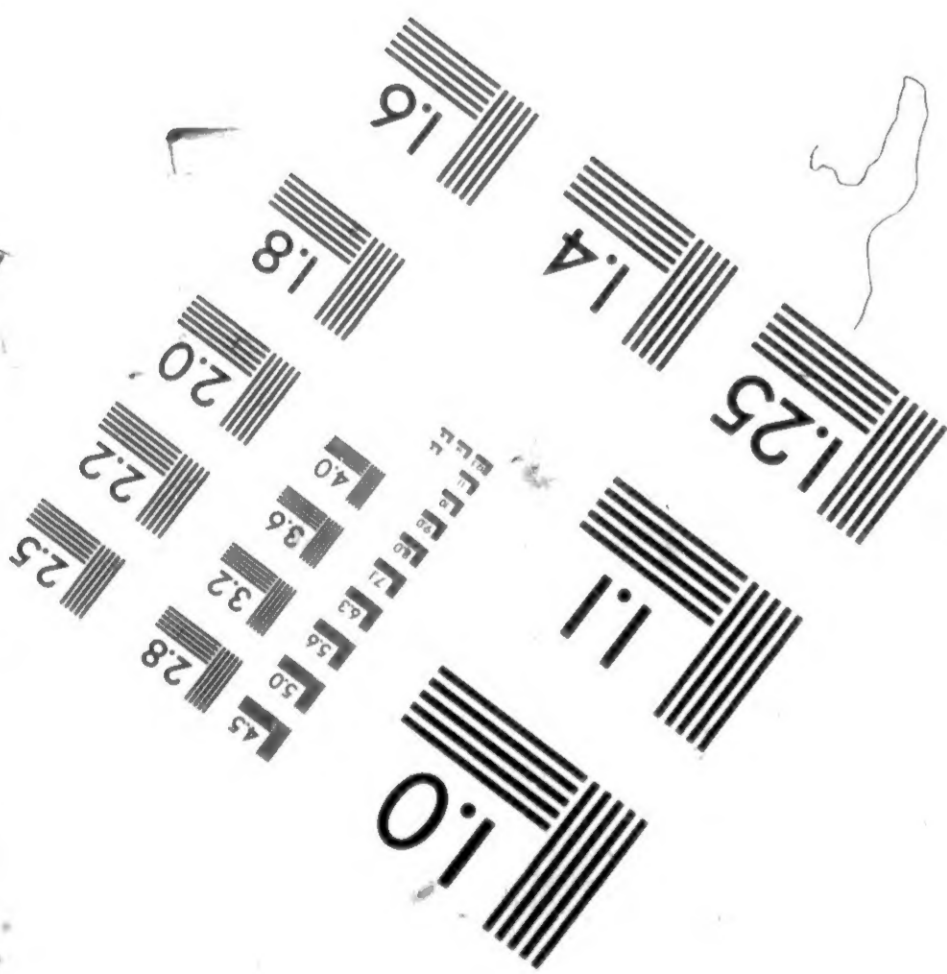
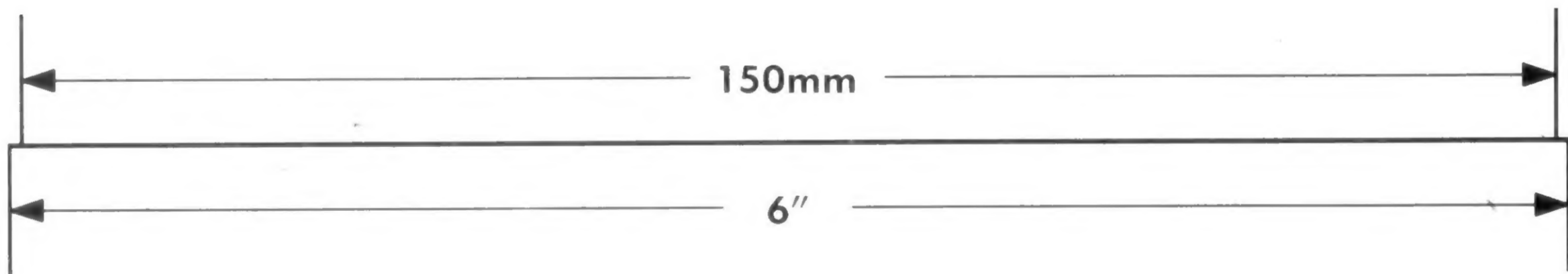
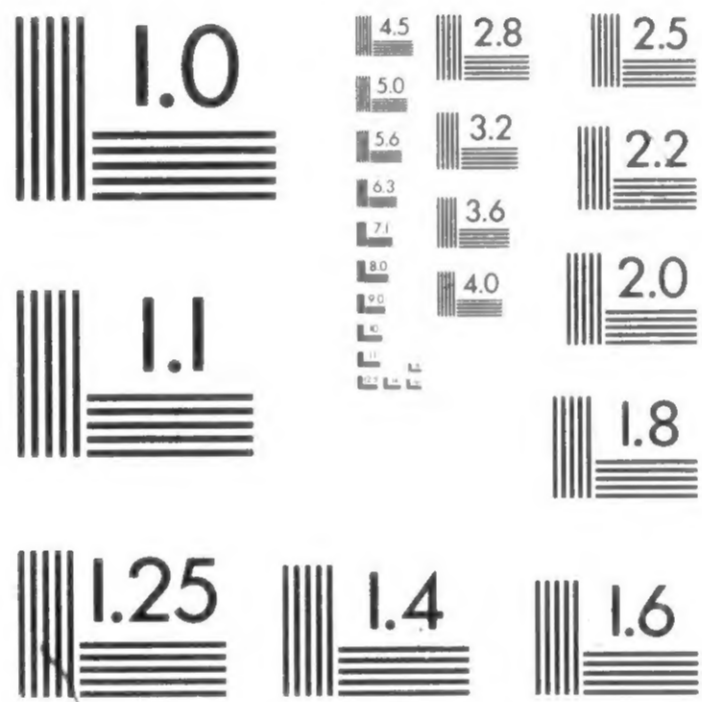
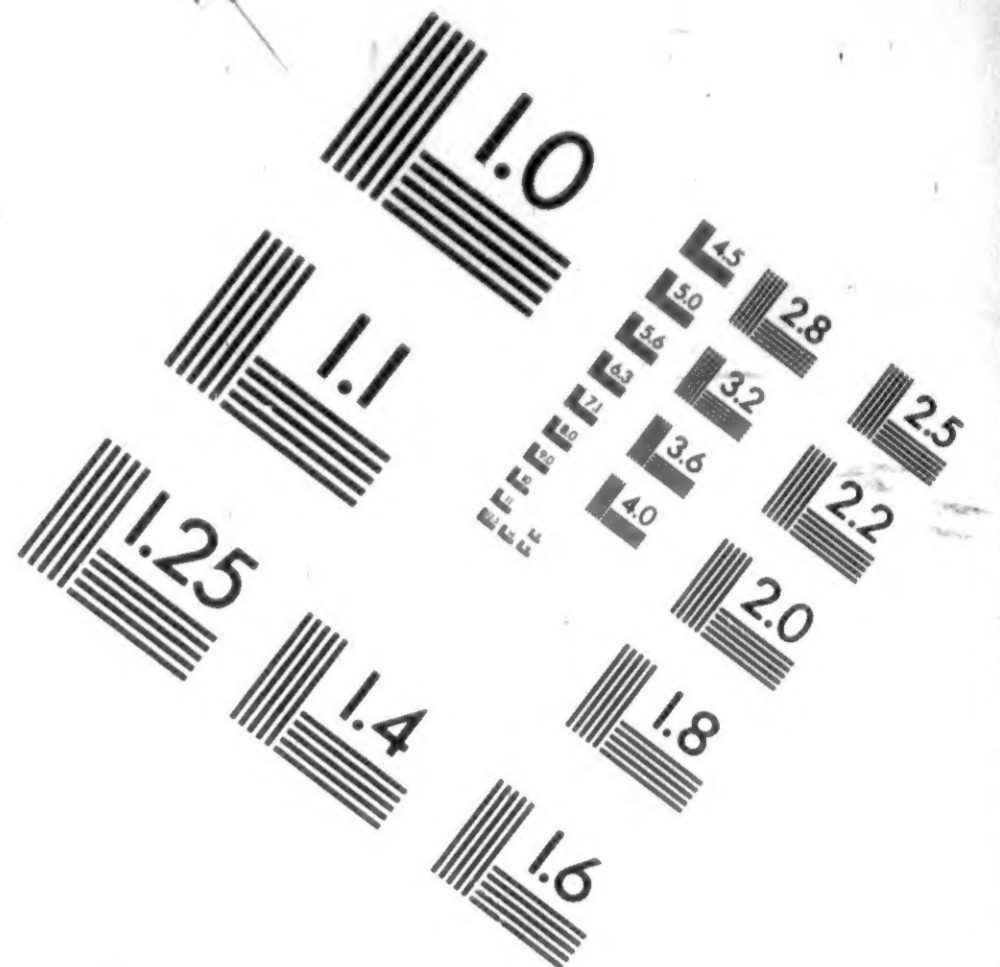
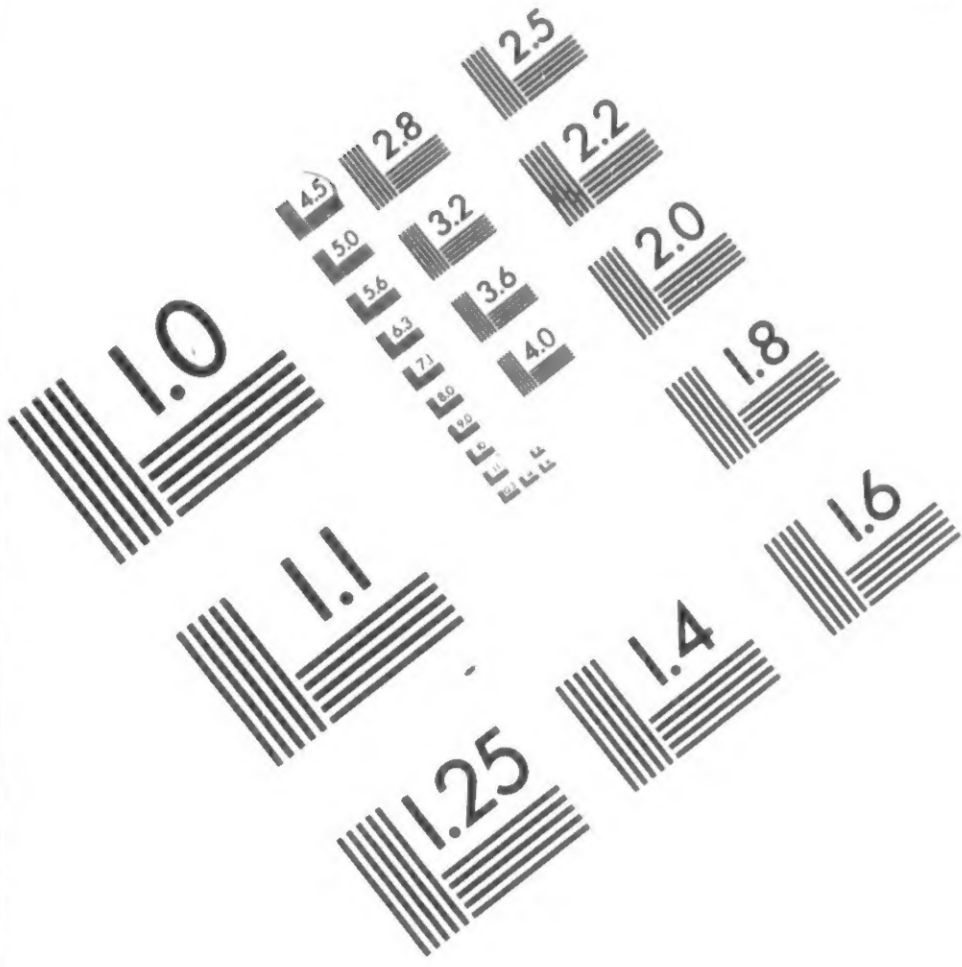

IMAGE EVALUATION TEST TARGET (QA-3)



APPLIED IMAGE, Inc
 1653 East Main Street
 Rochester, NY 14609 USA
 Phone: 716/482-0300
 Fax: 716/288-5989

© 1993, Applied Image, Inc., All Rights Reserved

National Archives at College Park



8601 Adelphi Road College Park MD 20740-6001

T.D

Z-4

OPERATOR

CAMERA

9-19-00

10X

DATE FILMED

REDUCTION RATIO

2461-581-011-0

FILM EMULSION NUMBER

1821

602

PROJECT NUMBER

ROLL NUMBER

MICROCOPY

M

1521

2011

62

NATIONAL ARCHIVES AND RECORDS ADMINISTRATION
MICROFILM PUBLICATIONS

INTRODUCTION

On the 109 rolls of this microfilm publication, M1821, are reproduced the compiled military service records of volunteer Union soldiers belonging to the 8th through the 13th infantry units, including the 11th (new) organized for service with the United States Colored Troops (USCT). The USCT included 7 numbered cavalry regiments; 13 numbered artillery regiments plus 1 independent battery; 144 numbered infantry regiments; Brigade Bands Nos. 1 & 2 (Corps d'Afrique and US Colored Troops); Powell's Regiment Colored Infantry; Southard's Company Colored Infantry; Quartermaster Detachment; Pioneer Corps, 1st Division, 16th Army Corps; Pioneer Corps, Cavalry Division, 16th Army Corps; Unassigned Company A Colored Infantry; and Unassigned USCT. There are also miscellaneous service cards arranged alphabetically by surname at the end of the unit records. The records reproduced are part of the Records of the Adjutant General's Office, 1780's-1917, Record Group (RG) 94.

Background

Since the time of the American Revolution, African Americans have volunteered to serve their country in time of war. The Civil War was no exception. Official sanction was the difficulty. In the fall of 1862 there were four Union regiments of African Americans raised in New Orleans, LA: the 1st, 2nd, and 3rd Louisiana Native Guard, and the 1st Louisiana Heavy Artillery (African Descent). The 1st South Carolina Infantry (African Descent) was not officially organized until January 1863; however, three companies of the regiment were on coastal expeditions as early as November 1862. The 1st Kansas Colored Infantry was not mustered into Federal service until January 1863, even though the regiment had already participated in the action at Island Mound, MO, on October 27, 1862. These early unofficial regiments received little Federal support, but they showed the strength of the African American soldier's desire to fight for freedom.

The first official authorization to employ African Americans in Federal service was the Second Confiscation and Militia Act of July 17, 1862 (12 Stat. 592). This act allowed President Abraham Lincoln "to employ as many persons of African descent as he may deem necessary and proper for the suppression of this rebellion, and for this purpose he may organize and use them in such manner as he may judge best for the public welfare." The use of African Americans met with varying reactions and treatment. In the trans-Mississippi West, they saw some combat, while in the Department of Tennessee and in the South they were frequently assigned fatigue work. In the East, they drew both combat and fatigue duty. The President did not authorize use of African Americans in combat, however, until issuance of the Emancipation Proclamation on January 1, 1863.

NATIONAL ARCHIVES AND RECORDS ADMINISTRATION
MICROFILM PUBLICATIONS

In late January 1863, Gov. John Andrew of Massachusetts received permission to raise a regiment of African American soldiers. Because the pace of organizing additional regiments was very slow, Secretary of War Edwin M. Stanton sent Gen. Lorenzo Thomas to the lower Mississippi Valley in March to recruit free and contraband African Americans. Thomas was given broad authority. He was to explain the administration's policy regarding African American soldiers and recruit volunteers to raise and command them. Stanton wanted all officers of such units to be white, but that policy was softened to allow African American surgeons and chaplains. By the end of the war, in addition to the chaplains and surgeons, there were 87 African American officers. Thomas's endeavor was very successful, and on May 22, 1863, the Bureau of Colored Troops was established to coordinate and organize regiments from all parts of the country. Created under War Department General Order No. 143, the bureau was responsible for handling "all matters relating to the organization of Colored Troops." The bureau was directly under the Adjutant General's Office, and its procedures and rules were specific and strict. All African American regiments were now to be designated United States Colored Troops (USCT). At this time there were some African American regiments with state names and a few regiments in the Department of the Gulf designated as Corps d'Afrique. The Corps d'Afrique units ultimately became numbered regiments in the USCT. The 54th and 55th Massachusetts Infantries (Colored), the 5th Massachusetts Cavalry (Colored), the 29th Connecticut Infantry (Colored), the 6th and 7th Louisiana Infantries (African Descent), the 3rd Tennessee Volunteer Infantry (African Descent), and the 1st South Carolina Volunteers (Colored) retained their numbers and state designations, but served under the Bureau of Colored Troops.

To facilitate recruiting in the states of Maryland, Missouri, Tennessee, and eventually Kentucky, the War Department issued General Order No. 329 on October 3, 1863. Section 6 of the order stated that if any citizen should offer his or her slave for enlistment into the military service, that person would, "if such slave be accepted, receive from the recruiting officer a certificate thereof, and become entitled to compensation for the service or labor of said slave, not exceeding the sum of three hundred dollars, upon filing a valid deed of manumission and of release, and making satisfactory proof of title." For this reason, some records of manumission are contained in the compiled service records reproduced in this publication.

The USCT fought in 39 major engagements and over 400 lesser ones. Sixteen African American soldiers received Medals of Honor. As it was in other units, the death toll from disease was very high in the USCT. Deaths from disease and battle totaled 37,000. The last regiment of the USCT was mustered out of Federal service in December 1867.

Important sources for information about African American units in the Civil War

NATIONAL ARCHIVES AND RECORDS ADMINISTRATION
MICROFILM PUBLICATIONS

are the War Department's *The War of the Rebellion: A Compilation of the Official Records of the Union and Confederate Armies* (Washington, DC: 1880-1901; reprinted Harrisburg, PA 1971 and 1985) and the Navy Department's *The War of the Rebellion; A Compilation of the Official Records of the Union and Confederate Navies* (Washington, DC: 1874-1922; reprinted Harrisburg, PA 1971 and 1985). These multivolume works contains reports of operations and other official correspondence.

8th United States Colored Infantry

This regiment was organized from November to December 31, 1863, at Camp William Penn, PA. In February 1864 the regiment was ordered to Jacksonville, Florida, where it joined General Gilmore's ill-fated Florida expedition. The 8th USCT was engaged heavily at Olustee on February 20, 1864, and sustained heavy casualties. The regiment fought with great distinction despite never having fired its weapons before this battle. From February to August the regiment continued to serve in Florida on fatigue and fortification duty, as well as reconnaissance duty. In August the regiment was ordered to the trenches outside of Petersburg where it served until September 28. On September 29, 1864, the 8th USCT fought near Chaffin's Farm, Fort Gilmore, and in October, the Darby Town Road. Following these engagements, the regiment returned to the trenches around Petersburg until the city fell in April 1865. Following the fall of Petersburg, the 8th USCT was ordered to Texas, where they mustered out in December 1865.

9th United States Colored Infantry

This regiment was organized at Camp Stanton, Benedict, Maryland, from November 11 to December 31, 1863, for 3 years' service. In March of 1864 the regiment was ordered to Hilton Head, South Carolina, for fatigue duty and reconnaissance on John Island. The regiment joined the 3rd Division, 10th Army Corps, at Deep Bottom, Virginia, and was stationed in the trenches at Petersburg from July to September. On September 29 and 30, 1864, the 9th USCT fought at Fort Gilmore near Chaffin's Farm. In 2 days of fighting the regiment suffered 113 men and officers killed or wounded. The regiment was engaged in skirmishes at Darby Town Road on October 10 and at New Market Road on October 27. From November 1864 until April 1865 the regiment was posted in the trenches before Fort Harrison. The 9th USCT marched into Richmond on April 3, 1865, with, "Drums beating colors flying [and] men singing the John Brown Hymn-Gloria in Excelsis." In July the regiment was moved to Brownsville, Texas, where it remained until September 1866. The 9th was ordered to Louisiana in October and mustered out at New Orleans, November 26, 1866.

NATIONAL ARCHIVES AND RECORDS ADMINISTRATION
MICROFILM PUBLICATIONS

10th United States Colored Infantry

This regiment was formed between November and December 1863 at Camp Craney Island, Virginia, for 3 years' service. In May, the 10th USCT moved to Fort Powhatan aboard the famous steamer *Planter*. On May 24, 1864, the 10th USCT skirmished with Fitzhugh Lee's force at Wilson's Wharf. The regiment was posted to picket duty on the right of Federal lines before Petersburg in June 1864. From August 1864 to March 1865 the regiment provided guard duty at City Point, Virginia. On April 3, 1865, the 10th USCT marched into Richmond, Virginia. Beginning in July 1865, the regiment was stationed in Corpus Christie, Texas, where it remained until it mustered out in May 1866.

11th United States Colored Infantry (Old)

This regiment was organized from October 31 to December 31, 1863, at Fort Smith, Arkansas, from men recruited by Captain J. M. Steele (formerly of the 12th Kansas Volunteers). From January to July 1864 the regiment performed guard and escort duty out of Fort Smith. On August 24, 1864, a Rebel cavalry force consisting of 300-400 whites and Indians attacked the regiment, consisting of 260 men organized into companies "A" through "E." The regiment was able to repulse three cavalry charges before the enemy withdrew. On September 19, 1864, the 11th USCT skirmished against General Ganos's rebel forces. On January 24, 1865, the regiment attacked and routed Colonel Newton's rebel regiment at Bogg's Mills, Arkansas, capturing a large amount of horses and equipment. The 11th USCT (old) was stationed at Little Rock in February, at which time it was consolidated with the 112th USCT and the 113th USCT (old) to form the 113th USCT (new).

11th United States Colored Infantry (New)

This regiment was organized from June through August 1863, as the 1st Regiment Alabama Siege Artillery. During its years of active service, the regiment was reorganized several times. In January 1864, the regiment was stationed at Fort Pickering, Memphis, Tennessee, when it was consolidated into the 1st Tennessee Heavy Artillery (in accordance with Special Order 25). The regiment served on fatigue duty at Fort Pickering until early March, when it was reorganized, along with several Negro pioneer companies, into the 6th USCT Heavy Artillery. The regiment was ordered to Fort Pillow, Tennessee, where it was attacked on March 12, 1864, by the forces of Nathaniel Bedford Forrest. After the fort surrendered, over half the regiment was lost in the ensuing massacre by Forrest's forces. Following the Ft. Pillow massacre, the remains of the regiment returned to Ft. Pickering where it was reorganized as the 7th USCT Heavy Artillery. On January 23, 1865, the regiment was consolidated with several Negro pioneer companies and

NATIONAL ARCHIVES AND RECORDS ADMINISTRATION
MICROFILM PUBLICATIONS

designated as the 11th USCT (new). The 11th USCT served on picket and fatigue duty in Memphis until it was mustered out on January 12, 1866.

12th United States Colored Infantry

This regiment was organized at Elk Bridge and Nashville, Tennessee, in August 1863. On December 15 and 16, 1864, the regiment participated in the Battle of Nashville. The regiment participated in the pursuit of General John Bell Hood's army to Decatur, Alabama. Following this expedition, the 12th USCT guarded the Nashville and Northwestern Railroad against guerilla attacks until it mustered out in January 1866.

13th United States Colored Infantry

This regiment was organized at Camp Mussy, Tennessee, in November 1863. From December 1864 until December 1865, the 13th USCT was responsible for guarding a section of the Nashville and Northwestern Railroad. The regiment participated in the Battle of Nashville on December 15 and 16, 1864. On the second day, the 13th USCT participated in several attacks on rebel positions, including the assault on Overton Hill. In January 1865, the regiment joined the pursuit of the remnants of General John Bell Hood's army to Decatur, Alabama. The regiment was returned to picket duty along the Nashville and Northwestern railroad for the rest of the year until it mustered out on January 10, 1866.

Records Description

Compiled service records consist of a jacket-envelope for each soldier, labeled with his name, rank, unit, and card numbers. The compilation of service records of Union soldiers began in 1890 under the direction of Col. Fred C. Ainsworth, head of the Record and Pension Office of the Adjutant General's Office, Department of War. Information from muster rolls, regimental returns, descriptive books, and other records was copied verbatim onto cards. A separate card was prepared each time an individual name appeared on a document. These cards were numbered on the back, and these numbers were entered onto the outside jacket containing the cards. The carded information was verified by a separated operation of comparison; great care was taken to ensure that the cards were accurate.

A typical jacket contains card abstracts of entries found in original records relating to the soldier and original documents relating solely to that soldier. Examples of the latter include enlistment papers, substitute certificates, casualty sheets, death reports, prisoner-of-war memorandums, and correspondence. Unique to the records

NATIONAL ARCHIVES AND RECORDS ADMINISTRATION
MICROFILM PUBLICATIONS

of the USCT are deeds of manumission, oaths of allegiance, proof of ownership, certificates of monetary award, and bills of sale. These items appear most frequently in units recruited in the border states of Kentucky, Missouri, and Maryland. These states remained in the Union but were slave states. Jackets and cards include a section labeled "bookmark," which was reserved for cross-references to other records relating to the individual or his unit. The service records are arranged by arm of service, thereunder numerically by regiment or independent battalion or company, and thereunder alphabetically by name of the soldier. Records for officers are interfiled alphabetically by name with the records of enlisted men. If an individual served in more than one unit, which was typical for USCT officers, there will be a separate service record for each unit in which he served.

The unjacketed miscellaneous cards were accumulated by the War Department with the expectation that they would be incorporated in individual compiled service records. The expectation was never fulfilled, however, because either insufficient or contradictory information made it impossible to associate the cards or papers with a particular soldier's service record.

Related Records

Among the records of the Adjutant General's Office in the National Archives are many of the original records that were abstracted or "carded" by the Record and Pension Office. These include the individual unit's muster rolls, returns, and descriptive books. Other series in RG 94 that contain information relating to volunteer Union soldiers who served with the USCT include carded records relating to Union staff officers, carded medical records of volunteer Union soldiers, unbound and bound regimental records, and "record of events" cards. The regimental records of the 54th Massachusetts Infantry (Colored) have been reproduced as Microfilm Publication M1659, *Records of the Fifty-fourth Massachusetts Infantry Regiment (Colored), 1863-1865*.

The "record of events" cards include information copied from the unit's muster rolls and returns. They show the stations of the field and staff and of the companies of the regiment at the time the muster roll or return was prepared and sometimes mention battles, skirmishes, or other activities in which the regiment participated. The cards have been reproduced as Microfilm Publication M594, *Compiled Records Showing Service of Military Units in Volunteer Union Organizations*.

Record Group 94 also includes a card index for the USCT, reproduced as Microfilm Publication M589, *Index to Compiled Military Service Records of Volunteer Union Soldiers Who Served with U.S. Colored Troops*, which may be used to locate the regiment of USCT personnel. An index card gives the name of the soldier and his

NATIONAL ARCHIVES AND RECORDS ADMINISTRATION
MICROFILM PUBLICATIONS

rank, as well as the unit in which he served; sometimes there is a cross-reference to his service in other units or organizations. The National Archives is continually producing microfilm publications of volunteer Union compiled military service records. A complete listing of finished publications can be found in the National Archives *Microfilm Resources for Research: A Comprehensive Catalog*, which is available online at www.nara.gov.

The Records of the Colored Troops Division, within RG 94, include division correspondence and records relating to recruiting, the appointment of officers, and the slave or free status of individuals as well as a compilation of historical extracts and official papers concerning the military service of African Americans from the colonial period through the Civil War entitled *The Negro in the Military Service of the United States 1639-1886*. This compilation is reproduced as Microfilm Publication M858. The Records of the Bounty and Claims Division, also in RG 94, include correspondence of the division and records relating to bounties and claims paid to loyal owners of slaves by the Slave Claims Commissions of Delaware, Kentucky, Maryland, Missouri, Tennessee, and West Virginia.

If a soldier applied for a pension, the pension application case file may be among the Records of the Veterans Administration (RG 15). Indexes to the pension applications have been reproduced as Microfilm Publication T288, *General Index to Pension Files, 1861-1934*, and T289, *Organizational Index to Pension Files of Veterans Who Served Between 1861 and 1900*.

If a soldier or officer was tried before a general court-martial or if an individual or his unit was the subject of a court of inquiry or military commission, transcripts of the proceedings may be among the Records of the Office of the Judge Advocate General (Army) (RG 153). The registers to the proceedings have been reproduced as Microfilm Publication M1105, *Registers of the Records of the Proceedings of the U.S. Army General Courts-Martial, 1809-1890*.

Other record groups having information pertaining to the USCT include Records of the Bureau of Refugees, Freedmen, and Abandoned Lands (RG 105); Records of the Provost Marshal General's Bureau (Civil War) (RG 110); Records of the Accounting Officers of the Department of the Treasury (RG 217); and Records of U.S. Army Continental Commands, 1821-1920 (RG 393).

Holdings of the National Archives relating to the Civil War are outlined in Kenneth W. Munden and Henry Putnam Beers, *Guide to Federal Archives Relating to the Civil War* (Washington, DC: National Archives, 1962) and Henry Putnam Beers, *Guide to the Archives of the Government of the Confederate States of America* (Washington, DC: National Archives, 1968), which were reprinted as *The Union* (1986) and *The Confederacy* (1986).

NATIONAL ARCHIVES AND RECORDS ADMINISTRATION
MICROFILM PUBLICATIONS

ROLL LIST

Roll Description

8th United States Colored Infantry

1. Adams, Edward – Benedict, Thomas
2. Bennett, Jackson – Brown, Thomas
3. Brown, William – Clafford, John S.
4. Clapp, David C. – Davis, Noah
5. Davis, William – Fields, John
6. Finch, Edmunds – Hall, Irwin
7. Hall, Jacob – Holly, William
8. Hooker, Joseph – Johnson, John
9. Johnson, Joseph – Locke, Isaac B.
10. Lockwood, Harrison – Mitchel, Ambrose
11. Mitchell, Cleo – Phelps, Daniel
12. Phelps, Joseph – Rogers, Norman
13. Roland, Spencer – Smith, Thomas B.
14. Smith, William – Timbrook, James
15. Tippitt, Samuel – Whitaker, Alexander
16. White, David – Young, John

8th United States Colored Infantry, Miscellaneous Service Cards

17. Adams, John – Junks, James E.
18. Keith, Henry – Zinn, Alfred D.

9th United States Colored Infantry

19. Acty, Robert – Bell, Custis
20. Bell, Franklin – Brown, Elijah
21. Brown, Franklin – Churn, Walter
22. Claggett, Franklin – Cox, William
23. Crawford, Henry – Dennis, Joshua
24. Dennis, Littleton – Elzy, George
25. Ennels, John – Gale, Francis
26. Gale, James – Hamlin, Noah
27. Harmon, George – Henry, Isaac
28. Henry, Isaiah – James, Minus
29. James, Richard – Kemer, William
30. Kett, Teagle – Mapp, Alfred
31. Mapp, Bennett – Morris, Peter P.
32. Morris, Richard – Pinckett, Robert

NATIONAL ARCHIVES AND RECORDS ADMINISTRATION
MICROFILM PUBLICATIONS

Roll Description

- 33. Pinckett, Sandy – Purnell, Moses H.
 - 34. Purnell, Noah – Rutter, William
 - 35. Ryaer, Leven – Smith, George
 - 36. Smith, Henry – Thomas, Henry
 - 37. Thomas, John H. – Wainwright Alfred
 - 38. Wales, Benjamin – White, Horace
 - 39. White, Isaac – Young, James
- Bayley, Thomas: Board of Examination Proceedings

9th United States Colored Infantry, Miscellaneous Service Cards

- 40. Adams, Robert – Long, Josephus
- 41. Maccle, Joseph – Young, Henry

10th United States Colored Infantry

- 42. Ackleboro, Jacob – Booker, Arthur
- 43. Booker, Henry – Carter, William
- 44. Casten, Abraham – Dennis, John
- 45. Dennison, Peter – Forman, Charles
- 46. Forman, Edinborough – Hitchcock, Henry M.
- 47. Hodges, Moses – Jones, Levi
- 48. Jones, Robert – McKenzie, George H.
- 49. Mears, George – Pleasants, Norman
- 50. Pleasants, Sterling – Savage, Joseph
- 51. Savoy, Thos. – Spady, Joseph
- 52. Sparrow, Edward – Van de Sande, George
- 53. Vaughn, George – Wilkins, Melville
- 54. Wilkins, Robert – Young, Levens

10th United States Colored Infantry, Miscellaneous Service Cards

- 55. Adams, Charles – Young, Laws

11th United States Colored Infantry (Old)

- 56. Adams, Amos – Falkner, Jacob
- 57. Falkner, James – Mayo, Isaac
- 58. McAfee, Daniel – Tadlock, Silas
- 59. Tadlock, William – Youngblood, Hayes

NATIONAL ARCHIVES AND RECORDS ADMINISTRATION
MICROFILM PUBLICATIONS

<u>Roll</u>	<u>Description</u>
	11th United States Colored Infantry (Old), Miscellaneous Service Cards
59.	Adams, Luther – Yager, Peter G.
	11th United States Colored Infantry (New)
60.	Abbo, Sunum – Bell, Robert
61.	Bell, Taylor – Buckner, Charles
62.	Bufford, Jackson – Collins, Lewis
63.	Collins, Robert – Dyson, Richard
64.	Ebanson, Albert – Gallin, Joseph
65.	Gardner, Mathew – Harris, Charles
66.	Harris, Dennis – Hyman, Samuel
67.	Ingrum, Wesley – King Parker
68.	Kirby, George – McCauley, Albert
69.	McCauley, Bergess – Moss, Edmond
70.	Motley, Nathan – Patty, Henry
71.	Payden, Nelson – Rogers, Aaron
72.	Rogers, Barry – Smith, Lewis
73.	Smith, Malcom F. – Tolliver, Richard
74.	Tonston, Alexander – Warren, Nelson
75.	Washburn, Luther J. – Williams, Isaac
76.	Williams, Jackson – Young Willis
	11th United States Colored Infantry (New), Miscellaneous Service Cards
77.	Abbott, Daniel – Young, William
	12th United States Colored Infantry
78.	Abnerathy, John H. – Benson, Albert
79.	Benson, Edmond – Burton, Grank
80.	Butler, Cooper – Cooper, Washington
81.	Copelan, Moses – Eazell, James
82.	Eddington, James – Gardner, Dennis
83.	Gardner, John – Helm, Claibourne
84.	Helm, James – Jennygin, Reuben
85.	Jennyson, Addison – Lewis, Franklin
86.	Lewis, George – McNerrie, William
87.	McNorris, Robert – Parrem, Henry

NATIONAL ARCHIVES AND RECORDS ADMINISTRATION
MICROFILM PUBLICATIONS

<u>Roll</u>	<u>Description</u>
88.	Patten, David – Roads, Henry
89.	Roads, William – Stieger, Arthur
90.	Stiger, Arthur – Walters, Jerry
91.	Ward, Asbury – Young, Peter
12th United States Colored Infantry, Miscellaneous Service Cards	
92.	Abernathy, Essic – Youngman, John
13th United States Colored Infantry	
93.	Abb, Peter – Batson, Edward
94.	Batson, James – Caldwell, Isaac
95.	Caldwell, Mack – Cornell, John
96.	Cornell, William – Edmondson, Charles
97.	Edwards, Emanuel – Gather, Frank
98.	George, William – Hardin, Lewis
99.	Hardin, Robert – Hughes, Noah
100.	Hunter, Allen D. – Jourdan, Thomas
101.	Joyce, John – Mathews, Hiram
102.	Mathews, James – Monroe, Jim
103.	Montgomery, William – Parsons, Oliver
104.	Pate, Andrew – Robertson, Willis
105.	Robinson, Alias – Smith, George W.
106.	Smith, James – Thorp, John H.
107.	Thorpe, Alonzo – Webster, Martin
109.	Webster, Washington – Zingear, Abraham
13th United States Colored Infantry, Miscellaneous Service Cards	
109.	Adams, Alfred – Zelner, Josiah

NATIONAL ARCHIVES AND RECORDS ADMINISTRATION
MICROFILM PUBLICATIONS

Microfilm Publication M1821

COMPILED MILITARY SERVICE RECORDS OF VOLUNTEER UNION
SOLDIERS WHO SERVED WITH THE UNITED STATES COLORED
TROOPS: Infantry Organizations 8th through 13th including the 11th (new)

Roll 62

11th United States Colored Infantry (New)

Bufford, Jackson – Collins, Lewis

214

Gifford Jackson

Co F, 11 U.S. Col'd Inf.

(New Organization.)

Private

Private

CARD NUMBERS.

1	6322706	26
2	6329936	27
3	6330026	28
4	6330116	29
5	6330198	30
6	6330272	31
7	6330343	32
8	6330415	33
9	6330479	34
10	6330547	35
11	6330623	36
12	6330694	37
13	6330766	38
14	6330831	39
15	9072102	40
16		41
17		42
18		43
19		44
20		45
21		46
22		47
23		48
24		49
25		50

Book Mark: _____

See also _____

S-935077-2d. and. P.D.
S-1146848-Pompano

B | 11 (new) U.S.C.T.

Jackson Buford
(new)
Co. F, 11 Reg't U.S. Col'd Inf.

Appears on

Company Descriptive Book

of the organization named above.

DESCRIPTION.

Age 18 years height 5 feet 3 inches.

Complexion Bk

Eyes; Bk hair Bk

Where born Charleston, S.C.

Occupation

ENLISTMENT.

When Jan. 13- , 1864.

Where Ft. Pickens

By whom J. S. Kappner; term 3 y'rs.

Remarks:

F. A. Wright

B

11 (New).

U.S.C.T.

Jackson Buford

Appears with rank of Pri on

Muster and Descriptive Rolls of Detachments of U. S. Vols. forwarded

for the 11 Reg't U. S. Col'd Inf. Roll dated

Memphis Tenn, Mar 1, 1864.

Where born S. Carolina

Age 18 y'rs; occupation

When enlisted Jan 13, 1864.

Where enlisted F1-Pickering

For what period enlisted 3 years.

Eyes black; hair black

Complexion black; height 5 ft. 3 in.

When mustered in Feb 24, 1864.

Where mustered in F1 Pickering

Bounty paid \$ 100; due \$ 100

Where credited

Company to which assigned F

Remarks:

Book mark:

Ashley

23

11 (New).

U.S.C.T.

Jackson Bufert
Pvt., Co. F, 1 Battalion, 1 Reg't Tenn. H. Art'y.†

Age years.

Appears on

Company Muster Roll*

for Jan 11 to Mch 1, 1864.

Joined for duty and enrolled:

When Jan 3, 1864.

Where Ft Pickering

Period 3. years

Mustered in:

When Feb 24, 1864.

Where Memphis

Present or absent Present

Stoppage, \$ 100 for

Due Gov't, \$ 100 for

Remarks:

† This organization subsequently became Co. F, 11 Reg't U. S. Colored Infantry (New).

* First current roll. No muster-in roll of this company on file.

Book mark:

3333 Rose

73

11 (New).

U.S.C.T.

Jackson Buford
Capt, Co. F, 6 Reg't U. S. Col'd H. Art'y.*

Appears on

Company Muster Roll

for *Michl Apl*, 1864.

Present or absent *Present*

Stoppage, \$ 100 for

Due Gov't, \$ 100 for

Remarks:

* This organization subsequently became Co. F, 11 Reg't U. S. Colored Infantry (New).

Book mark:

Rose

B | **11** (New). **U.S.C.T.**

Jackson Buppens
Sgt, Co. F, 7 Reg't U. S. Col'd H. Art'y.*

Appears on

Company Muster Roll

for *May to June*, 186*4*.

Present or absent *Present*

Stoppage, \$ _____ 100 for _____

Due Gov't, \$ _____ 100 for _____

Remarks: _____

* This organization subsequently became Co. F, 11 Reg't U. S. Colored Infantry (New).

Book mark: _____

75 | 11 (New). | U.S.C.T.

Jackson Street
Pat., Co. F, 7 Reg't U. S. Col'd H. Art'y.*

Appears on

Company Muster Roll

for July and Aug, 1861

Present or absent Present

Stoppage, \$ 100 for

Due Gov't, \$ 100 for

Remarks:

* This organization subsequently became Co. F, 11 Reg't U. S. Colored Infantry (New).

Book mark:

B | **11** (New). | **U.S.C.T.**

Jackson Duffens
Sgt, Co. F, 7 Reg't U. S. Col'd H. Art'y.*

Appears on

Company Muster Roll

for *Sept Oct*, 186*4*

Present or absent *Present*

Stoppage, \$ *100* for

Due Gov't, \$ *100* for

Remarks:

* This organization subsequently became Co. F, 11 Reg't U. S. Colored Infantry (New).

Book mark:

75 | 11 (New). | U.S.C.T.

Jackson Bufford
Sgt., Co. F, 7 Reg't U. S. Col'd H. Art'y.*

Appears on

Company Muster Roll

for Nov and Dec, 1864.

Present or absent Present

Stoppage, \$ 100 for

Due Gov't, \$ 100 for

Remarks:

* This organization subsequently became Co. F, 11 Reg't U. S. Colored Infantry (New).

Book mark:

Rose

P

11 (New)

U.S.C.T.

Jackson Bufford

Priv, Co. F, 11 Reg't U. S. Col'd Inf. (New).

Appears on

Company Muster Roll

for *Jan & Feb*, 186*5*.

Present or absent *Present*

Stoppage, \$ *100* for

Due Gov't, \$ *100* for

Remarks: *On daily duty as
Drummer since Feb. 1, 1865.*

Book mark:

Spucher

S

11 (New)

U.S.C.T.

Jackson Gufford

Pot, Co. F, 11 Reg't U. S. Col'd Inf. (New).

Appears on

Company Muster Roll

for *March & Apr*, 186*5*.

Present or absent *Present*

Stoppage, \$ *100* for

Due Gov't, \$ *100* for

Remarks: *On daily duty as
Musician in Regtl. Band.*

Book mark:

Spencer

Q

11 (New)

U.S.C.T.

Jackson
Port, Co. F, 11 Reg't U. S. Col'd Inf. (New).

Appears on

Company Muster Roll

for *May 1st June*, 1865.

Present or absent *Present*

Stoppage, \$ *100* for

Due Gov't, \$ *100* for

Remarks: *On duty as summoned*

Book mark:

Spencer

B 11 (New) U.S.C.T.

Jackson Clifford
Priv., Co. F, 11 Reg't U. S. Col'd Inf. (New).

Appears on

Company Muster Roll

for *July & Aug*, 1865.

Present or absent *Present*

Stoppage, \$ *100* for

Due Gov't, \$ *100* for

Remarks:

Book mark:

Spuehu

P 11 (New) U.S.C.T.

Jackson Bufford
Pvt, Co. F, 11 Reg't U. S. Col'd Inf. (New).

Appears on

Company Muster Roll

for *Sept & Oct*, 1865.

Present or absent *Present*

Stoppage, \$ *100* for

Due Gov't, \$ *2* ^{*20*}/_{*100*} for *C - GE*

Remarks:

Book mark:

Spencer

P

11 (New) U.S.C.T.

Jackson Rufford

Plt, Co. F, 11 Reg't U. S. Col'd Inf. (New).

Appears on

Company Muster Roll

for *Mr + Me*, 1865.

Present or absent *Present*

Stoppage, \$ *100* for

Due Gov't, \$ *2*^{*20*}/_{*100*} for *C + G Equip.*

Remarks:

.....
.....
.....
.....
.....
.....
.....
.....
.....
.....

Book mark:

Record
Copyist.

P

11 (New). U.S.C.T.

Jackson Dufford

Pt. F, 11 Reg't U. S. Col'd Inf. (New).

Appears on Co. Muster-out Roll, dated *Memphis Tenn Jan 12*, 1866.

Muster-out to date *Jan 12*, 1866.

Last paid to *June 30*, 1865.

Clothing account:

Last settled _____, 186 ; drawn since \$ _____ 100

Due soldier \$ _____ 100; due U. S. \$ _____ ³⁶ 100

Am't for cloth'g in kind or money adv'd \$ _____ 100

Due U. S. for arms, equipments, &c., \$ _____ 100

Bounty paid \$ _____ 100; due \$ _____ 100

Remarks: *Due U.S. for C, & G, & P 2²⁶*

Book mark: *1716-83-7.210164.*

69-

Reed

(361)

Copyist.

215

Burford Perry Jordan

Co F, 11 U.S. Col'd Inf.

(New Organization.)

Private

CARD NUMBERS.

1	6 3 2 2 7 0 5	26
2	6 3 2 9 9 3 7	27
3	6 3 3 0 0 2 5	28
4	6 3 3 0 1 1 5	29
5	6 3 3 0 1 9 7	30
6	6 3 3 0 2 7 1	31
7	6 3 3 0 3 4 4	32
8	6 3 3 0 4 1 4	33
9	6 3 3 0 4 7 8	34
10	6 3 3 0 5 4 6	35
11	6 3 3 0 6 2 2	36
12	6 3 3 0 6 9 3	37
13	6 3 3 0 7 6 5	38
14	6 3 3 0 8 3 0	39
15	9 0 7 2 1 0 1	40
16		41
17		42
18		43
19		44
20		45
21		46
22		47
23		48
24		49
25		50

Book Mark:

See also

B | 11 (new) U.S.C.T.

Jerry Buford
(new)
Co. F, 11 Reg't U.S. Col'd Inf.

Appears on

Company Descriptive Book

of the organization named above.

DESCRIPTION.

Age 23 years height 5 feet 9½ inches.

Complexion Bk

Eyes; Bk hair Bk

Where born Halifax - Va.

Occupation

ENLISTMENT.

When Jan. 11, 1864.

Where Ft. Pickens

By whom J. G. Kappner ; term 3 y'rs.

Remarks:

F. A. Winger

B

11 (New). U.S.C.T.

Jerrey Buford

Appears with rank of *Pr* on

Muster and Descriptive Rolls of Detachments of U. S. Vols. forwarded

for the *11* Reg't U. S. Col'd *Inf* Roll dated

Memphis Tenn, *Mar 1*, 1864.

Where born *Halifax Co Virginia*

Age *23* y'rs; occupation

When enlisted *Jan 11*, 1864.

Where enlisted *Ft Pickering*

For what period enlisted *3* years.

Eyes *black*; hair *black*

Complexion *black*; height ft. in.

When mustered in *Feb 24*, 1864.

Where mustered in *Ft Pickering*

Bounty paid \$ *100*; due \$ *100*

Where credited

Company to which assigned *F*

Remarks:

Book mark:

Ashley

73

11 (New).

U.S.C.T.

Jerry Buford
Pvt., Co. F, 6 Reg't U. S. Col'd H. Art'y.*

Appears on

Company Muster Roll

for *March* *April*, 1864.

Present or absent *Present*

Stoppage, \$ *100* for

Due Gov't, \$ *100* for

Remarks: *Company Cook*

* This organization subsequently became Co. F, 11 Reg't U. S. Colored Infantry (New).

Book mark:

Rose

18

11 (New).

U.S.C.T.

James Buppard
*Co. F, 7 Reg't U. S. Col'd H. Art'y.**

Appears on

Company Muster Roll

for *May to June*, 186*1*

Present or absent *Present*

Stoppage, \$ *100* for

Due Gov't, \$ *100* for

Remarks: *On daily duty as*
Co. Co. R. I.

* This organization subsequently became Co. F, 11 Reg't U. S. Colored Infantry (New).

Book mark:

James

TJ | **11 (New).** | **U.S.C.T.**

James Buggs
Sgt., Co. F, 7 Reg't U. S. Col'd H. Art'y.*

Appears on

Company Muster Roll

for *July and Aug*, 186*4*.

Present or absent *Present*

Stoppage, \$ *100* for

Due Gov't, \$ *100* for

Remarks: *On daily duties*
in Co. F.

* This organization subsequently became Co. F, 11 Reg't U. S. Colored Infantry (New).

Book mark: _____

11

11 (New).

U.S.C.T.

Jerry Buffard
Sgt, Co. F, 7 Reg't U. S. Col'd H. Art'y.*

Appears on

Company Muster Roll

for *Sept Oct*, 186*4*.

Present or absent *Present*

Stoppage, \$ *100* for

Due Gov't, \$ *100* for

Remarks:

* This organization subsequently became Co. F, 11 Reg't U. S. Colored Infantry (New).

Book mark:

Present

B

11 (New).

U.S.C.T.

Jourdan Buffin
Sgt., Co. F, 7 Reg't U. S. Col'd H. Art'y.*

Appears on

Company Muster Roll

for *Nov and Dec*, 1864.

Present or absent *Present*

Stoppage, \$ *100* for

Due Gov't, \$ *100* for

Remarks:

* This organization subsequently became Co. F, 11 Reg't U. S. Colored Infantry (New).

Book mark:

Page 1

S | **11** (New) | **U.S.C.T.**

Louisa Bufford
Plt, Co. F, 11 Reg't U. S. Col'd Inf. (New).

Appears on

Company Muster Roll

for *Jan & Feb*, 186*5*.

Present or absent *Present*

Stoppage, \$ *100* for

Due Gov't, \$ *1* ^{*53*}/_{*100*} for *Ordinance*

Remarks: *On daily duty as Reg'tal*
transfer since Feb. 6, O.O. #28.
H. Q. 11" M.C. Infy.

Book mark:

Spencer

S

11 (New)

U.S.C.T.

Lawrence Bufford
Port, Co. F, 11 Reg't U. S. Col'd Inf. (New).

Appears on

Company Muster Roll

for *March & Apr*, 1865.

Present or absent *Present*

Stoppage, \$ *100* for

Due Gov't, \$ *100* for

Remarks: *On daily duty as*
Regimental Quartermaster

Book mark:

Spencer

B

11 (New)

U.S.C.T.

Sourdan Bufford
Pot., Co. F, 11 Reg't U. S. Col'd Inf. (New).

Appears on

Company Muster Roll

for *May & June*, 186*5*.

Present or absent

Present

Stoppage, \$ *2* $\frac{40}{100}$ for *Advance*

Due Gov't, \$ $\frac{100}{100}$ for

Remarks:

Book mark: *...*

Spencer

6

11 (New)

U.S.C.T.

Jordan Bifford
Priv, Co. F, 11 Reg't U. S. Col'd Inf. (New).

Appears on

Company Muster Roll

for *July & Aug*, 1865.

Present or absent *Present*

Stoppage, \$ *2* $\frac{45}{100}$ for *Ordnaues*

Due Gov't, \$ $\frac{100}{100}$ for

Remarks:

Book mark:

Spencer

S 11 (New) U.S.C.T.

Jordan Bufford
Pat, Co. F, 11 Reg't U. S. Col'd Inf. (New).

Appears on

Company Muster Roll

for *Sept & Oct*, 186*5*.

Present or absent *Present*

Stoppage, \$ *100* for

Due Gov't, \$ *10* for *Ordinance*

Remarks:

Book mark:

Spencer

P

11 (New) U.S.C.T.

Jordan Bufford
Pr, Co. F, 11 Reg't U. S. Col'd Inf. (New).

Appears on

Company Muster Roll

for *Nov + Dec*, 1865.

Present or absent *Present*

Stoppage, \$ *100* for

Due Gov't, \$ *100* for *Ordinance*

Remarks:

Book mark:

Deer
Copyist.

D

11 (New). U.S.C.T.

London Bufford

Plt, *F*, 11 Reg't U. S. Col'd Inf. (New).

Appears on Co. Muster-out Roll, dated

Memphis Tenn Jan 12, 1866.

Muster-out to date

Jan 12, 1866.

Last paid to

James, 1865.

Clothing account:

Last settled 186 ; drawn since \$ 100

Due soldier \$ 100; due U. S. \$ *11*^{*49*}/₁₀₀

Am't for cloth'g in kind or money adv'd \$ 100

Due U. S. for arms, equipments, &c., \$ 100

Bounty paid \$ 100; due \$ 100

Remarks *Due U. S. for ord. 10*

Book mark: *1570-1883*

W. W. W.

(861)

Copyist.

216

Buford. Solomon

Co *E*, 11 U.S. Col'd Inf.

(New Organization.)

Private

Private

CARD NUMBERS.

1	6322602	26
2	6330948	27
3	6331095	28
4	6331985	29
5	9072206	30
6		31
7		32
8		33
9		34
10		35
11		36
12		37
13		38
14		39
15		40
16		41
17		42
18		43
19		44
20		45
21		46
22		47
23		48
24		49
25		50

Book Mark:

See also

B

11 (New) U. S. C. T.

Salmon Buford

Co. G, 11 Reg't U. S. Col'd Inf. (New)

Appears on

Company Descriptive Book

of the organization named above.

DESCRIPTION.

Age 44 years height 5 feet 6 inches.

Complexion Black

Eyes; Blue hair Blue

Where born Shelby Co. Ala

Occupation Laborer

ENLISTMENT.

When Jan 12, 1864.

Where Fort Pickens

By whom Capt Kappner; term 3 y'rs.

Remarks: Died in Small Pox Hospital at Memphis Tenn March 12/64.

* Final statement given

* Entered by Compr.

A. J. Anderson

B

11 (New). U.S.C.T.

Solomon Buford

Appears with rank of Pri on

Muster and Descriptive Rolls of Detachments of U. S. Vols. forwarded

for the 11 Reg't U. S. Col'd Inf. Roll dated

Memphis Tenn Feb 2, 1864.

Where born Shelby Co Ala

Age 44 y'rs; occupation

When enlisted Jan 12, 1864.

Where enlisted Fort-Pickering

For what period enlisted 3 years.

Eyes Black; hair Black

Complexion Black; height 5 ft. 6 in.

When mustered in Feb 4, 1864.

Where mustered in Fort-Pickering

Bounty paid \$ 100; due \$ 100

Where credited

Company to which assigned

Remarks:

Book mark:

Ashley

B

11 (New). U.S.C.T.

Solomon Buford

Sgt, Co. E, 1 Battalion, 1 Reg't Tenn. H. Art'y.†

Age years.

Appears on

Company Muster Roll*

for Feb 4 to 29, 1864

Joined for duty and enrolled:

When Jan 12, 1864

Where Fort Pickering

Period 3 years.

Mustered in:

When Feb 4, 1864

Where Fort Pickering

Present or absent Present

Stoppage, \$ 100 for

Due Gov't \$ 100 for

Remarks:

† This organization subsequently became Co. G, 11 Reg't U. S. Colored Infantry (New).

* First current roll. No muster-in roll of this company on file. This roll shows enrollment of all men of this company as of same date. See enrollment on subsequent card or cards.

Book mark:

Sallade

B | 11 (New). | U.S.C.T.

Solomon Buford
Pat, Co. G, 6 Reg't U. S. Col'd H. Art'y.†

Appears on

Company Muster Roll

for *March & April*, 186*4*

Joined for duty and enrolled:

When *Jan 12*, 186*4**

Where *Ft Pickens**

Period *3* years.*

Present or absent.....

Stoppage, \$ *100* for

Due Gov't \$ *100* for

Remarks: *died in small Pox
Hospital at Memphis Tenn
March 12, 1864*

* This organization subsequently became Co. G, 11 Reg't U. S. Colored Infantry (New).

* ~~See~~ See enrollment on card from first current roll.

Book mark: *141.347*

Ballade
Copyist.

B. 11 (New). U.S.C.T.

Solomon Bedford,

Priv. G., 11 Reg't U. S. Col'd Inf. (New).

Appears on Co. Muster-out Roll, dated

Memphis T., Jan. 12, 1866.

Muster-out to date _____, 1866.

Last paid to Rec'd, no pay 1866.

Clothing account:

Last settled _____, 1866; drawn since \$ 100

Due soldier \$ 100; due U. S. \$ 100

Am't for cloth'g in kind or money adv'd \$ 100

Due U. S. for arms, equipments, &c., \$ 100

Bounty paid \$ 100; due \$ 100

Remarks: Died at Memphis

T. Mch. 12, 1864.

Final statement for
wished.

Book mark: 141, 337 Ben

W. M. M. M.

Pouford, Solomon
A, Co. *Reg* 11 U.S.C. Inf.

6 Enclosures.

Bed Cards	Descriptive Lists
Burial Records	Final Statements <i>3</i>
Certs. of Dis. for Discharge	Furloughs
C. M. Charges	Med. Des. Lists
Med. Certificates	Orders

Other papers relating to—

Admission to Hosp'l	Furlough
Casualty Sheet (Officer's)	Med. Examination
Confinement	Misc. Information
Contracts	Pay or Clothing
Death or Effects <i>3</i>	Personal Reports
Desertions	Rank
Discharge from Hosp'l	Transfer to Hosp'l
Discharge from Service	Transfer to V. R. C.
Duty	Transportation

ARTICLES OF WAR.

ART. 95. When any non-commissioned officer or soldier shall die, or be killed in the service of the United States, the then commanding officer of the troop or company shall, in the presence of two other commissioned officers, take an account of what effects he died possessed of, above his arms and accoutrements, and transmit the same to the office of the Department of War, which said effects are to be accounted for, and paid to the representatives of such deceased non-commissioned officer or soldier. And in case any of the officers, so authorized to take care of the effects of deceased officers and soldiers, should, before they have accounted to their representatives for the same, have occasion to leave the regiment or post, by preferment or otherwise, they shall, before they be permitted to quit the same, deposit in the hands of the commanding officer, or of the assistant military agent, all the effects of such deceased non-commissioned officers and soldiers, in order that the same may be secured for, and paid to, their respective representatives.

ARMY REGULATIONS—EDITION OF 1861.

DECEASED SOLDIERS.

Par. 152. Inventories of the effects of deceased non-commissioned officers and soldiers, required by the 95th Article of War, will be forwarded to the Adjutant General, by the commander of the company to which the deceased belonged, and a duplicate of the same to the colonel of the regiment. Final statements of pay, clothing, &c., will be sent with the inventories. When a soldier dies at a post or station absent from his company, it will be the duty of his immediate commander to furnish the required inventory, and, at the same time, to forward to the commanding officer of the company to which the soldier belonged, a report of his death, specifying the date, place, and cause; to what time he was last paid, and the money or other effects in his possession at the time of his decease; which report will be noted on the next muster-roll of the company to which the man belonged. Each inventory will be endorsed, "Inventory of the effects of _____, late of company (—) _____ regiment of _____, who died at _____, the _____ day of _____, 186—." If a legal representative receive the effects, it will be stated in the report. If the soldier leave no effects, the fact will be reported.

Par. 153. Should the effects of a deceased non-commissioned officer or soldier not be administered upon within a short period after his decease, they shall be disposed of by a Council of Administration, under the authority of the commanding officer of the post, and the proceeds deposited with the Paymaster, to the credit of the United States, until they shall be claimed by the legal representatives of the deceased.

Par. 154. In all such cases of sales by the Council of Administration, a statement in detail, or account of the proceeds, duly certified by the Council and commanding officer, accompanied by the Paymaster's receipt for the proceeds, will be forwarded by the commanding officer to the Adjutant General. The statement will be endorsed, "Report of the proceeds of the effects of _____, late of company (—) _____ regiment of _____, who died at _____, the _____ day of _____, 186—."

NOTE 1.—The effects in all cases, when called for, should be turned over to the legal representative, without further authority from the Adjutant General. When the effects are turned over to the relatives of the deceased before these inventories are sent to the Adjutant General, their receipts therefor should be attached to the inventories. In all other cases, one copy will be sent with a letter of transmittal direct to the Adjutant General, and a duplicate retained by the officer.

NOTE 2.—Particular care should be taken to take receipts in duplicate from the Paymaster for any funds turned over to him; one copy should be sent direct to the Adjutant General and one retained by the officer.

*Recd from Div. of Discontinued
Commands*

INVENTORY OF THE EFFECTS

Filed, Sept. 20, 1875
OF

Private Solomon Bradford

Late of Company C

4th Reg't of Ala Sup Art

Volunteers, who died at Memphis Tenn

on the 12th day of March 1864.



Inventory of the effects of Salomon Buford late
 a Private of Captain John B. Mullers Company C of
 the 1st Regiment of Ala. Sig. Art Volunteers, who was enrolled as
 a Private at Memphis in the State of Tennessee on
 the 12th day of January 1864, and mustered into the service of the United
 States as a Private on the 14th day of February 1864, at Fort Pickering
 in Company C, 1st Regiment of Tenn. Sig. Art Volunteers, to serve three
 years or during the war; he was born in Shelby County in the State
 of Alabama; he was 44 years of age, 5 feet 6 inches
 high, Black complexion, Black eyes, Black hair, and by occupation, when enrolled,
 a Laborer; he died in Small's Hospital at
Memphis Tenn on the 17th day of March 1864, by
 reason of small pox

INVENTORY.					
ARTICLES.	No.	ARTICLES.	No.	ARTICLES.	No.
Hats		Pairs trousers	1	Knapsacks	
Caps		Pairs flannel drawers			
Forage caps		Pairs cotton drawers	2		
Great coats	1	Flannel shirts	2		
Uniform coats		Cotton shirts			
Uniform jackets		Pairs boots			
Flannel sack coats		Pairs shoes			
Blouses		Pairs socks			
Stable frocks		Blankets			
Fatigue overalls		Haversacks			
				MONEY.	
				Specie	\$
				Notes	\$

I CERTIFY, ON HONOR, that the above inventory comprises all the effects of Private
Salomon Buford, deceased, and that the effects are in the hands
 of his heirs at Memphis Tenn
 to be disposed of by a Council of Administration.

(DUPLICATES.)

Nath Reed 1st Lieut

STATION: Fort Pickering Tenn

Commanding the Company.

DATE: March 19th 1864

ARTICLES OF WAR.

ART. 95. When any non-commissioned officer or soldier shall die, or be killed in the service of the United States, the then commanding officer of the troop or company shall, in the presence of two other commissioned officers, take an account of what effects he died possessed of, above his arms and accoutrements, and transmit the same to the office of the Department of War, which said effects are to be accounted for, and paid to the representatives of such deceased non-commissioned officer or soldier. And in case any of the officers, so authorized to take care of the effects of deceased officers and soldiers, should, before they have accounted to their representatives for the same, have occasion to leave the regiment or post, by preferment or otherwise, they shall, before they be permitted to quit the same, deposit in the hands of the commanding officer, or of the assistant military agent, all the effects of such deceased non-commissioned officers and soldiers, in order that the same may be secured for, and paid to, their respective representatives.

ARMY REGULATIONS—EDITION OF 1861.

DECEASED SOLDIERS.

Par. 152. Inventories of the effects of deceased non-commissioned officers and soldiers, required by the 95th Article of War, will be forwarded to the Adjutant General, by the commander of the company to which the deceased belonged, and a duplicate of the same to the colonel of the regiment. Final statements of pay, clothing, &c., will be sent with the inventories. When a soldier dies at a post or station absent from his company, it will be the duty of his immediate commander to furnish the required inventory, and, at the same time, to forward to the commanding officer of the company to which the soldier belonged, a report of his death, specifying the date, place, and cause; to what time he was last paid, and the money or other effects in his possession at the time of his decease; which report will be noted on the next muster-roll of the company to which the man belonged. Each inventory will be endorsed, "Inventory of the effects of _____, late of company (—) _____ regiment of _____, who died at _____, the _____ day of _____, 186—." If a legal representative receive the effects, it will be stated in the report. If the soldier leave no effects, the fact will be reported.

Par. 153. Should the effects of a deceased non-commissioned officer or soldier not be administered upon within a short period after his decease, they shall be disposed of by a Council of Administration, under the authority of the commanding officer of the post, and the proceeds deposited with the Paymaster, to the credit of the United States, until they shall be claimed by the legal representatives of the deceased.

Par. 154. In all such cases of sales by the Council of Administration, a statement in detail, or account of the proceeds, duly certified by the Council and commanding officer, accompanied by the Paymaster's receipt for the proceeds, will be forwarded by the commanding officer to the Adjutant General. The statement will be endorsed, "Report of the proceeds of the effects of _____, late of company (—) _____ regiment of _____, who died at _____, the _____ day of _____, 186—."

NOTE 1.—The effects in all cases, when called for, should be turned over to the legal representative, without further authority from the Adjutant General. When the effects are turned over to the relatives of the deceased before these inventories are sent to the Adjutant General, their receipts therefor should be attached to the inventories. In all other cases, one copy will be sent with a letter of transmittal direct to the Adjutant General, and a duplicate retained by the officer.

NOTE 2.—Particular care should be taken to take receipts in duplicate from the Paymaster for any funds turned over to him; one copy should be sent direct to the Adjutant General and one retained by the officer.

C. G.

INVENTORY OF THE EFFECTS

OF

Wm. J. Brown

Late of Company *D*

Reg't of *1st Regt Art*

Volunteers, who died at *Sumner's*

on the *11th* day of *July* 186*1*.



Company G 1st Batt 1st Reg of Art. U.S. Head Quarters U.S. Ordnance Dept. Memphis Tenn.

Inventory of the effects of Solomon Buford late
 a Private of Captain John B. Mullers Company G of
 the 1st Regiment of Artillery Volunteers, who was enrolled as
 a Private at Memphis in the State of Tennessee on
 the 12th day of January 1864, and mustered into the service of the United
 States as a Private on the 4th day of February 1864, at Fort Pickering
 in Company G 1st Batt 1st Regiment of Tenn Heavy Art Volunteers, to serve 3
 years or during the war; he was born in Shelby County in the State
 of Alabama; he was 44 years of age, 5 feet 6 inches
 high, Black complexion, Black eyes, Black hair, and by occupation, when enrolled,
 a Laborer; he died in Small Pox Hospital, at
Memphis Tenn on the 12th day of March 1864, by
 reason of Disease

INVENTORY.					
ARTICLES.	No.	ARTICLES.	No.	ARTICLES.	No.
Hats		Pairs trousers	1	Knapsacks	
Caps		Pairs flannel drawers			
Forage caps		Pairs cotton drawers	2		
Great coats	1	Flannel shirts	2		
Uniform coats		Cotton shirts			
Uniform jackets		Pairs boots			
Flannel sack coats		Pairs shoes			
Blouses		Pairs socks			
Stable frocks		Blankets		MONEY.	
Fatigue overalls		Haversacks		Specie	\$
				Notes	\$

I CERTIFY, ON HONOR, that the above inventory comprises all the effects of Solomon
Buford, deceased, and that the effects are in the hands
 of his heirs at Memphis Tenn
 to be disposed of by a Council of Administration

(DUPLICATES.)

STATION: Fort Pickering Tenn Wash. Beece Law's
Co. G - 1st Reg Art Drago Comd
 Commanding the Company.

DATE: March 23rd 1864

V Co - G

42

FINAL STATEMENT

OF

Private Samuel Buford

14 Reg't of Ala Sigs Art

740 Co S 11th Regt
VOLUNTEERS.

Died March 12 - 1864

NOTE 1.—Two of these certificates (or duplicates) are to be given to each volunteer soldier who may be discharged previously to the discharge of his company, that he may at once receive from the Paymaster the pay, &c., due him, and the captain or other officer commanding the company will certify to the act of the delivery of the duplicate certificates; on these certificates the Soldier is "entitled to" his discharge, and should also present his discharge to the Paymaster to have the payment endorsed on it. The discharge is to be given back to the Soldier by the Paymaster; the latter only retaining as his voucher the duplicate certificates.

NOTE 2.—If the Soldier is entitled to pay for the use of his horse, the Company Commander will certify to that fact, and also to the time he has pay due for having been so mounted on his own horse.

NOTE 3.—Amounts due the Sutler and Laundress must be entered on the Muster Roll on which the death, desertion, &c., is reported, as well as on the final statement, otherwise the amount cannot be collected from the United States.

NOTE 4.—This blank will be used for deceased volunteers as well as others.

ADJUTANT GENERAL'S OFFICE
June 22^d 1864
Duplicate with Inventory sent 2d Auditor.



Ent on R of Co

I certify, on honor, that Solomon Buford a Private of
Captain John B. Mullers Company (B) of the 1st Regiment of Ala Regt
VOLUNTEERS, of the State of _____, born in Shelby Co, State
of Alabama, aged 44 years; 5 feet 6 inches high; Black complexion,
Black eyes, Black hair, and by occupation a Laborer, having joined the company on
its original organization at Fort Pickens Tenn, and enrolled in it at the muster into
the service of the United States at Fort Pickens, on the 4th day
of February, 1864, (or was mustered in service as a recruit, by _____
at _____, on the _____ day of _____,
1864, to serve in the Regiment,) for the term of three years
and having served **HONESTLY** and **FAITHFULLY** with his Company in Fort Pickens
to the ^{12th of March 1864} present date, is now entitled to a **DISCHARGE** by reason of Death in
hospital March 12th 1864

The said Solomon Buford has drawn no pay was last paid by Paymaster
_____ to include the _____ day of _____, 1864, and has
pay due him from that time to the present date; he is entitled to pay and subsistence for
TRAVELING to place of enrollment and whatever other allowances are authorized to volunteer
soldiers, or militia, so discharged. He has received _____ dollars,
advanced by the United States on account of **CLOTHING**.

There is to be stopped from him, on account of the State of _____, or other
authorities for **CLOTHING**, &c., received on entering service, _____ dollars; also,
for expenses of **SUBSISTENCE** for **TRAVELING** from place of enrollment to the place of rendezvous,
amounting to _____ dollars: and on account of the United States for **EXTRA**
CLOTHING received in kind from _____ and for other
stoppages, viz:

He has drawn clothing
since enlistment amounting to twenty one ²¹ dollars;
and he has been **SUBSISTED** for **TRAVELING** to his place of enrollment, up to the _____
_____, 1864.

He is indebted to _____, **SUTLER**, _____ dollars.

He is indebted to _____, **LAUNDRESS**, _____ dollars.

Given in Duplicate, at Fort Pickens, this 18th day of March, 1864.

Nath Reed 1st Lieut
1st Ala Regt
Commanding Company.

FINAL STATEMENT

OF

Private Salomon G. Ford

17th Reg't of 18th Ind. Inf.

VOLUNTEERS.

NOTE 1.—Two of these certificates (or duplicates) are to be given to each volunteer soldier who may be discharged previously to the discharge of his company, that he may at once receive from the Paymaster the pay, &c., due him, and the captain or other officer commanding the company will certify to the act of the delivery of the duplicate certificates; on these certificates the Soldier is "entitled to" his *discharge*, and should also present his discharge to the Paymaster to have the payment endorsed on it. The discharge is to be given back to the Soldier by the Paymaster; the latter only retaining as his voucher the duplicate certificates.

NOTE 2.—If the Soldier is entitled to pay for the use of his horse, the Company Commander will certify to that fact, and also to the time he has pay due for having been so mounted on his own horse.

NOTE 3.—Amounts due the Sutler and Laundress must be entered on the Muster Roll on which the death, desertion, &c., is reported, as well as on the final statement, otherwise the amount cannot be collected from the United States.

NOTE 4.—This blank will be used for deceased volunteers as well as others.



I certify, on honor, that Solomon Buford a Private of
Captain Johul Mullers Company (G) of the 7th Regiment of U.S. Col Art Regt
VOLUNTEERS, of the State of _____, born in Shelby Co. State
of Alabama, aged 44 years; 5 feet 6 inches high; Black complexion,
Black eyes, Black hair, and by occupation a Laborer, having joined the company on
its original organization at Fort Pickens Term, and enrolled in it at the muster into
the service of the United States at Fort Pickens Term, on the 4th day
of February, 1864, (or was mustered in service as a recruit, by _____
at _____, on the _____ day of _____,
186 , to serve in the Regiment,) for the term of Three Years
and having served **HONESTLY** and **FAITHFULLY** with his Company in Fort Pickens
to the ^{12th of March} present date, is now entitled to a **DISCHARGE** by reason of Discharge in Hospital
by reason of Small Pox

The said Solomon Buford has drawn his pay was last paid by Paymaster
_____ to include the _____ day of _____, 186 , and has
pay due him from that time to the present date; he is entitled to pay and subsistence for
TRAVELING to place of enrollment and whatever other allowances are authorized to volunteer
soldiers, or militia, so discharged. He has received _____ dollars,
advanced by the United States on account of **CLOTHING**.

There is to be stopped from him, on account of the State of _____, or other
authorities for **CLOTHING**, &c., received on entering service, _____ dollars; also,
for expenses of **SUBSISTENCE** for **TRAVELING** from place of enrollment to the place of rendezvous,
amounting to _____ dollars: and on account of the United States for **EXTRA**
CLOTHING received in kind from _____ and for other
stoppages, viz:

The said Solomon Buford has drawn
Clothing since enlistment amounting to twenty one ¹³/₁₀₀ dollars;
and he has been **SUBSISTED** for **TRAVELING** to his place of enrollment, up to the _____
_____, 186 .

He is indebted to _____, **SUTLER**, _____ dollars.
He is indebted to _____, **LAUNDRESS**, _____ dollars.

Given in Duplicate, at Fort Pickens, this 18th day of March, 1864.

Nathaniel Reed 1st Lieut
7th U.S. Colored Art Regt
Commanding Company.

1864 G.
Sub 261

FINAL STATEMENT

OF

Final Statement

1st Reg't of 11th 21st 26th (New)

VOLUNTEERS.

Complete

NOTE 1.—Two of these certificates (or duplicates) are to be given to each volunteer soldier who may be discharged previously to the discharge of his company, that he may at once receive from the Paymaster the pay, &c., due him, and the captain or other officer commanding the company will certify to the act of the delivery of the duplicate certificates; on these certificates the Soldier is "entitled to" his discharge, and should also present his discharge to the Paymaster to have the payment endorsed on it. The discharge is to be given back to the Soldier by the Paymaster; the latter only retaining as his voucher the duplicate certificates.

NOTE 2.—If the Soldier is entitled to pay for the use of his horse, the Company Commander will certify to that fact, and also to the time he has pay due for having been so mounted on his own horse.

NOTE 3.—Amounts due the Sutler and Laundress must be entered on the Muster Roll on which the death, desertion, &c., is reported, as well as on the final statement, otherwise the amount cannot be collected from the United States.

NOTE 4.—This blank will be used for deceased volunteers as well as others.



I certify, on honor, that Solomon Buford a Private of
Captain John B. Mullers Company (G) of the 14 Regiment of Ala. Heavy Art
VOLUNTEERS, of the State of _____, born in Shelby Co., State
of Alabama, aged 44 years; 5 feet 6 inches high; Black complexion,
Black eyes, Black hair, and by occupation a Laborer, having joined the company on
its original organization at Memphis Tenn, and enrolled in it at the muster into
the service of the United States at Fort Pickering, on the 4th day
of February, 1864, (or was mustered in service as a recruit, by _____
at _____, on the _____ day of _____,
186 , to serve in the Regiment,) for the term of three years
and having served **HONESTLY** and **FAITHFULLY** with his Company in Fort Pickering
to the present date, is now entitled to a **DISCHARGE** by reason of Death in
Hospital March 12th 1864
Hospital March 12th 1864

The said Solomon Buford has received no pay was last paid by Paymaster
_____ to include the _____ day of _____, 186 , and has
pay due him from that time to the present date; he is entitled to pay and subsistence for
TRAVELING to place of enrollment and whatever other allowances are authorized to volunteer
soldiers, or militia, so discharged. He has received _____ dollars,
advanced by the United States on account of **CLOTHING**.

There is to be stopped from him, on account of the State of _____, or other
authorities for **CLOTHING**, &c., received on entering service, _____ dollars; also,
for expenses of **SUBSISTENCE** for **TRAVELING** from place of enrollment to the place of rendezvous,
amounting to _____ dollars: and on account of the United States for **EXTRA**
CLOTHING received in kind from _____ and for other
stoppages, viz:

He has drawn clothing
amounting to twenty three 13 dollars;
and he has been **SUBSISTED** for **TRAVELING** to his place of enrollment, up to the _____
_____, 186 .

He is indebted to _____, **SUTLER**, _____ dollars.

He is indebted to _____, **LAUNDRESS**, _____ dollars.

Given in Duplicate, at Fort Pickering, this 23rd day of March, 1864.

Wm. H. Peace & Geo. W. Case
Co. J. 10th Ala. Heavy Art
Commanding Company.

Receipt for the sum of
Twenty Five Dollars

Received at Memphis Tenn
on the 23rd day of March 1864 of 1st Lieut
Nathaniel Reed Company Co. "G" 1st Ala. Siege
Art, the following articles of clothing, the property
of Solomon Buford deceased. Viz, one ~~pair~~ pair of
wool pair drawers two shirts, one pair trousers

Mary^{her}_{mark} Buford

217

Bunch Henry

Co C, 11 U.S. Col'd Inf.

(New Organization.)

Private

Private

CARD NUMBERS.

1	6322781	26
2	6326780	27
3	6326804	28
4	6323222	29
5	6329411	30
6	9071316	31
7	9071421	32
8		33
9		34
10		35
11		36
12		37
13		38
14		39
15		40
16		41
17		42
18		43
19		44
20		45
21		46
22		47
23		48
24		49
25		50

Book Mark:

See also

P

11 (new) U. S. C. T.

Henry Bunch
Co. *C*, 11 Reg't U. S. Col'd Inf. *(new)*

Appears on

Company Descriptive Book

of the organization named above.

DESCRIPTION.

Age *20* years height *5* feet *8* inches.

Complexion *yellow*

Eyes; *gray* hair *black*

Where born *Portland Me*

Occupation *laborer*

ENLISTMENT.

When *July 11*, 186*4*

Where *Memphis*

By whom *M. J. Smith*; term *3* y'rs.

Remarks:

Hollbrook

S

11 (new) U.S.C.T.

Henry Smith

Co. *B*, 11 Reg't U.S. Col'd Inf. *(new)*

Appears on

Company Descriptive Book

of the organization named above.

DESCRIPTION.

Age *20* years height *5* feet *8* inches.

Complexion *Yellow*

Eyes; *Gray* hair *Black*

Where born *Portland Key*

Occupation *Laborer*

ENLISTMENT.

When *July 11*, 186 *4*

Where *Memphis Tenn*

By whom *W. J. Smith*; term *3* y'rs.

Remarks: *Deserted*

.....
.....
.....
.....
.....
.....
.....
.....
.....

Shalbrook

B

11 (New).

U.S.C.T.

Henry Bunch

Appears with rank of *Pri* on

Muster and Descriptive Rolls of Detachments of U. S. Vols. forwarded

for the *7th U.S. Col'd Inf* Reg't U. S. Col'd *Inf* Roll dated

Memphis Tenn, July 11, 1864.

Where born *Portland Kentucky*

Age *20* y'rs; occupation *Laborer*

When enlisted *July 11*, 1864.

Where enlisted *Memphis Tenn*

For what period enlisted *3* years.

Eyes *Grey*; hair *black*

Complexion *yellow*; height *5* ft. *8* in.

When mustered in *July 11*, 1864.

Where mustered in *Memphis*

Bounty paid \$ *100*; due \$ *100*

Where credited

Company to which assigned *C*

Remarks: *Joined as Recruit*

Book mark:

Ashley

B

11 (New).

U.S.C.T.

Henry Bunch

Posi, Co. C, 7 Reg't U. S. Col'd H. Art'y.*

Appears on

Company Muster Roll

for July & Aug, 1864

Present or absent *absent*

Stoppage, \$ 100 for

Due Gov't, \$ 100 for

Remarks: *Enlisted in Company July 11, 1864. Absent with sick-leave since July 13, 1864.*

* This organization subsequently became Co. C, 11 Reg't U. S. Col'd Infantry (New).

Book mark :

A Neal

B | 11 (New). | U.S.C.T.

Henry Bunch
Pri, Co. C, 7 Reg't U. S. Col'd H. Art'y.*

Appears on

Company Muster Roll

for July & Aug, 1864

Present or absent

Stoppage, \$ 100 for

Due Gov't, \$ 100 for

Remarks: Deserted from
Fort Pickens
July 13, 1864

* This organization subsequently became Co. C, 11 Reg't U. S. Col'd Infantry (New).

Book mark :

Priest
Copyist.

B | 11-11-64 | U.S.C.T.

Henry Bunch
Pot, Co. 6 // (U.S.C.H.A.) (new)
Reg't U. S. Col'd Infantry

Appears on

Descriptive List of Deserters
Ft. Pickering
dated Memphis Tenn. July 31, 1864.

Deserted:

When July 13, 1864

Where Memphis

Arrested:

When _____, 186 .

Where _____

Remarks: _____

Book mark: _____

W.H. Bogan

B

11 (New).

U.S.C.T.

Henry Bunch

Pat Co. C, 11 Reg't U. S. Col'd Inf. (New).

Appears on Co. Muster-out Roll, dated

Memphis, Tenn. Jan 12, 1866.

Muster-out to date _____, 186 .

Pay due from Enrollment, 186 .
Last paid to _____, 186 .

Clothing account:

Last settled _____, 186 ; drawn since \$ _____ 100

Due soldier \$ _____ 100 ; due U. S. \$ _____ 100

Am't for cloth'g in kind or money adv'd \$ _____ 100

Due U. S. for arms, equipments, &c., \$ _____ 100

Bounty paid \$ _____ 100 ; due \$ _____ 100

Remarks: Wounded from Ft. Pickens Tenn. July 13/64

Book mark : _____

S. W. Williams

(361)

Copyist.

218

Bunton, Peter

Co A.M., 11 U.S. Col'd Inf.

(New Organization.)

Private

Private

CARD NUMBERS.

1	6335-670	26
2	6335-764	27
3	6335-840	28
4	6335-907	29
5	6335-966	30
6	6324-332	31
7	6324612	32
8	6324681	33
9	6324746	34
10	6324814	35
11	9070870	36
12	9072884	37
13	9072980	38
14		39
15		40
16		41
17		42
18		43
19		44
20		45
21		46
22		47
23		48
24		49
25		50

Book Mark:

See also

S 76,3980 P.O. 90

S-917986 - P.O. - M.Y. Inc

A 184853.8 P.O. aff

B

11 (New) U. S. C. T.

Peter Burnton

, Co. A, 11 Reg't U. S. Col'd Inf. (New)

Appears on

Company Descriptive Book

of the organization named above.

DESCRIPTION.

Age 20 years height 5 feet 2 1/2 inches.

Complexion dark

Eyes; Blk hair Blk

Where born Mississippi

Occupation Farmer

ENLISTMENT.

When Apr 1, 1864

Where Memphis

By whom Capt. Eyster; term 3 yrs.

Remarks: Transferred from Co. M. late 7 U. S. C. A. Regt. Spl Order No. 119 dated H. Q. Dist West. Tenn. Memphis Tenn. May 8. 1865.

Hearst

B.

11th Reg't U.S.C.T.

Peter Buntor,
(New)
Co. B, 11 Reg't U.S. Col'd Inf.

Appears on

Company Descriptive Book

of the organization named above.

DESCRIPTION.

Age 20 years height 5 feet 2 1/2 inches.

Complexion *dk*

Eyes; *blk* hair *blk*

Where born *Miss.*

Occupation *farmer*

ENLISTMENT.

When *1 Apr*, 186*4*

Where *Memphis*

By whom *Capt Cyster*; term *3* y'rs.

Remarks: *Transfd to Co "A"*

Dayton,

B. | **11^(New) U.S.C.T.**

Peter Buntow,
(New)
Co. *M*, 11 Reg't U.S. Col'd Inf.

Appears on
Company Descriptive Book
of the organization named above.

DESCRIPTION.

Age *20* years height *5* feet *2 1/2* inches.

Complexion *black*

Eyes; *black* hair *black*

Where born *unknown Miss.*

Occupation *farmer.*

ENLISTMENT.

When *1 April*, 186*4*

Where *Memphis.*

By whom *Capt Eyston*; term *3* y'rs.

Remarks:

Dayton,
Copyright.

B | 11 (New) | U.S.C.T.

Peter Buntow
Prvt, Co. M, 7 Reg't U. S. Col'd H. Art'y.*

Appears on

Company Muster Roll

for July + Aug., 1864.

Present or absent Present

Stoppage, \$ 100 for

Due Gov't, \$ 100 for

Remarks: Assigned to Co. by
S.O. No. 116, Sec. War,
dated July 6, 1864.

* This organization subsequently became Co. M, 11 Reg't U. S. Colored Infantry (New).

Book mark:

P. Pool

B | 11 (New) | U.S.C.T.

Peter Bunton

Priv., Co. M, 7 Reg't U. S. Col'd H. Art'y.*

Appears on

Company Muster Roll

for Sept & Oct, 1864

Present or absent Present

Stoppage, \$ 100 for

Due Gov't, \$ 100 for

Remarks: Stop for one
Haversack .67.

* This organization subsequently became Co. M, 11 Reg't U. S. Colored Infantry (New).

Book mark:

P. Pool,

B | **11** (New) | **U.S.C.T.**

Peter Burton

Pr, Co. M, 7 Reg't U. S. Col'd H. Art'y.*

Appears on

Company Muster Roll

for *Nov + Dec*, 1864

Present or absent *Present*

Stoppage, \$ *100* for

Due Gov't, \$ *100* for

Remarks: *Stop for one Haversack. 67. Stopped on Aug. Muster + Pay Roll. Stop for one Haversack. 67.*

* This organization subsequently became Co. M, 11 Reg't U. S. Colored Infantry (New).

Book mark: _____

J Pool,

(358)

Copyist.

B

11 (New).

U.S.C.T.

Peter Bunton

Pat

, Co. M, 11 Reg't U. S. Col'd Inf. (New).

Appears on

Company Muster Roll

for *Jan'y + Feb'y*, 186*5*.

Present or absent *Present*

Stoppage, \$ *100* for

Due Gov't, \$ *100* for

Remarks: *Stop for two hours*
\$ 1.34 Charged on last
roll.

Book mark: *32500*

Washington

B

11 (New). U.S.C.T.

Peter Bunton

Pat, Co. M, 11 Reg't U. S. Col'd Inf. (New).

Appears on

Company Muster Roll

for March - April, 1864.

Present or absent Present

Stoppage, \$ 100 for

Due Gov't, \$ 100 for

Remarks:

Book mark:

Washington

B. | 11 (New). | U.S.C.T.

Peter Bunton

Pvt, Co. A, 11 Reg't U. S. Col'd Inf. (New).

Appears on

Company Muster Roll

for *May & June*, 1865.

Present or absent *Present*.

Stoppage, \$ *100* for

Due Gov't, \$ *100* for

Remarks:

*Transferred from
Co. M. S. C. No. 94 dated
Ad. gres. Dist. West Tenn.*

Book mark:

A. H. Reed

(358)

Copyist

B. | 11 (New). U.S.C.T.

Peter Bunton

Priv, Co. A, 11 Reg't U.S. Col'd Inf. (New).

Appears on

Company Muster Roll

for July & Aug., 1865.

Present or absent Present.

Stoppage, \$ 100 for

Due Gov't, \$ 100 for

Remarks:

Book mark:

A. W. Reed

(858)

Copyist

B. | 11 (New). | U.S.C.T.

Wt Benton
Wt, Co. A, 11 Reg't U. S. Col'd Inf. (New).

Appears on

Company Muster Roll

for Wt & O.L., 1865.

Present or absent Present

Stoppage, \$ 100 for release

Due Gov't, \$ 100 for

Remarks:

Book mark:

Hoyberger

B | 11 (New). | U.S.C.T.

10 + 3 months

Plt, Co. A, 11 Reg't U.S. Col'd Inf. (New).

Appears on

Company Muster Roll

for *Nov & Dec*, 1865.

Present or absent *Present*

Stoppage, \$ *100* for *absence*

100

Due Gov't, \$ *100* for

Remarks:

Book mark:

Hoyberg

B | 11 (New), U.S.C.T.

Peter Bunton

R, A, 11 Reg't U. S. Col'd Inf. (New).

Appears on Co. Muster-out Roll, dated

Memphis Tenn, Jan'y 12, 1866.

Muster-out to date Jan'y June 12, 1866.

Last paid to June 30 1865.

Clothing account:

Last settled, 186 ; drawn since \$ 100

Due soldier \$ 100; due U. S. \$ 100

Am't for cloth'g in kind or money adv'd \$ 100

Due U. S. for arms, equipments, &c., \$ 100

Bounty paid \$ 100; due \$ 59.²⁴/₁₀₀

Remarks: Due U.S. for Ordnance
53 cts Due U.S. for Land G. & E
95 cts Transferred from
Co. M. (late 7th U.S. C. A. Hy)
per Spl O. No 119 dated 26th
Apr. Dist West. Tenn. May 8/65
(over)

Book mark N. 5-6 C. 210. 09

x Corrected Oct 24/93 H. A. J.

Hoyberger

JAN. 22

6324814

AT 18914

Spl. order No. 97 76th Qrs.
11th U.S. C. D. 10th May '65
Emb. April '64 + muscid Apr '64
Memphis, Tenn. 3 yrs. Age 20

219

Burden John

Co E, 11 U.S. Col'd Inf.

(New Organization.)

Private

Private

CARD NUMBERS.

1	6322825	26
2	6329458	27
3	6329523	28
4	6329598	29
5	6329678	30
6	6329741	31
7	6329801	32
8	9071894	33
9		34
10		35
11		36
12		37
13		38
14		39
15		40
16		41
17		42
18		43
19		44
20		45
21		46
22		47
23		48
24		49
25		50

Book Mark:

See also

A
A-3108797 And. W. 00

B | 11 (new) U.S.C.T.

John Burden
, Co. E, 11 Reg't U. S. Col'd Inf. (new)

Appears on
Company Descriptive Book
of the organization named above.

DESCRIPTION.

Age 21 years, height 5 feet 5 inches.

Complexion *Beau*

Eyes *Beau*; hair *Beau*

Where born *Miss*

Occupation *Boatman*

ENLISTMENT.

When *March 4*, 1865.

Where *Memphis Tenn*

By whom *Capt Campbell*; term *3* y'rs.

Remarks: *Mustered in as a substitute for 3 yrs for C. W. McCord a citizen of Memphis Tenn and credited to Memphis Shelby Co Tenn under the draft authorized by Serial Order No 4 Hdqrs. Genl Div. W. Miss*

Houston

MAY. 11

9071894

* 1891 *

Dated Jan 8th 1865 N.
O. La.

Assigned to duty
in Co. E 11th U. S. C.
Col. Duffin per Special
Order No 66 dated
Std. G. S. 11th U. S. C.
Memphis Tenn
March 17th 1865

B 11 (New). U.S.C.T.

John Burden

Appears with rank of *Pvt* on

Muster and Descriptive Rolls of Detachments of U. S. Vols. forwarded

for the *11* Reg't U. S. Col'd. *Left* Roll dated

Memphis Tenn, *Mich 9th*, 1865.

Where born *Miss*.

Age *21* y'rs; occupation *Boatman*

When enlisted *March 9th*, 1865.

Where enlisted *Memphis Tenn*.

For what period enlisted *3* years.

Eyes *Black*; hair *Black*

Complexion *Black*; height *5* ft. *5* in.

When mustered in *March 9th*, 1865.

Where mustered in *Memphis Tenn*.

Bounty paid \$ *00* *100*; due \$ *00* *100*

Where credited

Company to which assigned

Remarks: *Mustered in as a substitute for 3 yrs. for C. H. McCoy a citizen of Memphis Tenn and credited to Memphis Shelby Co.*

Book mark: *(over)*

Rhette

JAN. 22

6322825

018914

Rem's Cont.

Term. under the draft
authorized by Genl Order
No. 4 Hd Qrs Mil Div W. Miss
dated Jan'y 8 '65 N.C. La.

B

11 (New).

U.S.C.T.

John Burdett
Co. E, Co. E, 11 Reg't U. S. Col'd Inf. (New).

Appears on

Company Muster Roll

for *March & April*, 1865

Present or absent *Present*

Stoppage, \$ *100* for

Due Gov't, \$ *100* for

Remarks: *joined a Sub-*
stitute.

Book mark:

Lowry

(858)

Copyist.

B

11 (New).

U.S.C.T.

John Burden
Plt, Co. E, 11 Reg't U. S. Col'd Inf. (New).

Appears on

Company Muster Roll

for *May & June*, 1865.

Present or absent *Present*

Stoppage, \$ *100* for

Due Gov't, \$ *100* for

Remarks:

Book mark: _____

(858)

Lowry

Copyist.

D | **11 (New).** | **U.S.C.T.**

John Burden
Pvt, Co. E, 11 Reg't U. S. Col'd Inf. (New).

Appears on

Company Muster Roll

for *July & Aug., 1865.*

Present or absent *Present*

Stoppage, \$ *100* for

Due Gov't, \$ *100* for

Remarks:

Book mark:

(858)

Lowry

Copyist.

B | 11 (New). | U.S.C.T.

John Burden
Co. E, 11 Reg't U. S. Col'd Inf. (New).

Appears on

Company Muster Roll

for Sept. & Oct., 1865.

Present or absent Present

Stoppage, \$ 100 for

Due Gov't, \$ 100 for

Remarks:

Book mark:

(858)

Lawry

Copyist.

A | 11 (New). | U.S.C.T.

John Burden
Priv, Co. E, 11 Reg't U. S. Col'd Inf. (New).

Appears on

Company Muster Roll

for *Nov. & Dec*, 1865.

Present or absent *Present*

Stoppage, \$ *100* for

Due Gov't, \$ *22* / *100* for *ordnance*

Remarks:

Book mark: _____

Valentine

B.

11 (New).

U.S.C.T.

John Burden

Priv. Co. E., 11 Reg't U. S. Col'd Inf. (New).

Appears on **Co. Muster-out Roll**, dated

Memphis Tenn. Jan 12, 1866 .

Muster-out to date *Jan 12, 1866 .*

Last paid to *June 30, 1865 .*

Clothing account:

Last settled 186 ; drawn since \$ 100

Due soldier \$ 100; due U. S. \$ *11* ⁰⁶/₁₀₀

Am't for cloth'g in kind or money adv'd \$ 100

Due U. S. for arms, equipments, &c., \$ ²²/₁₀₀

Bounty paid \$ 100; due \$ 100

Remarks:

*First installment of
bounty due \$ 100.⁰⁰*

Book mark:

Valentine

Burden, John -
 P, Co. E 11 U.S.C. Inf.
 Reg't

3 Enclosures.

Bed Cards	Descriptive Lists
Burial Records	Final Statements
Certs. of Dis. for Discharge	Furloughs
C. M. Charges	Med. Des. Lists
Med. Certificates	Orders

E.P.P. 2

Other papers relating to—

Admission to Hosp'l	Furlough
Casualty Sheet (Officer's)	Med. Examination
Confinement	Misc. Information
Contracts	Pay or Clothing
Death or Effects	Personal Reports
Desertions	Rank
Discharge from Hosp'l	Transfer to Hosp'l
Discharge from Service	Transfer to V. R. C.
Duty	Transportation

NOTE 1.—This blank will be used for both enlistments and re-enlistments—enlistment of veterans, &c., &c., in the volunteer service. They will be made out in duplicate in all cases—one to accompany the recruiting return of the superintendent (not the recruiting officer) to the Adjutant General, and one to accompany the accounts of the officer who pays bounty, &c. The Regiment and Company in which the soldier last served should be given on the back.

NOTE 2.—An enlistment holds to service. A muster-in must, in all cases, precede payment of pay, bounty, pension, &c. A muster-in roll must, in all cases, be filed in the Adjutant General's Office as evidence of muster-in. The mustering officer, commissary, or assistant commissary of musters, as the case may be, will countersign both enlistments as having mustered the soldier into the service of the United States before either of them is given to the disbursing officer.

DECLARATION OF RECRUIT.

X, _____, desiring to VOLUNTEER as a Soldier in the Army of the United States, for the term of THREE YEARS, Do Declare, That I am _____ years and _____ months of age; that I have never been discharged from the United States service on account of disability or by sentence of a court martial, or by order before the expiration of a term of enlistment; and I know of no impediment to my serving honestly and faithfully as a soldier for three years.

GIVEN at _____

the _____ day of _____

Witness:

John P. Burdick
mark

11-10-65
John P. Burdick
Adj. Gen.

Discharged _____, 18 _____

Reg't of _____

enlistment; last served in Company () _____

Volunteered at _____
March 5th 1865
By *Capt. W. Campbell*
1st Regiment of *W. Va. Cav.*

CONSENT IN CASE OF MINOR.

I, _____, Do CERTIFY, That I am the _____ of _____; that the said _____ is _____ years of age; and I do hereby freely give my CONSENT to his volunteering as a SOLDIER in the ARMY OF THE UNITED STATES for the period of THREE YEARS.

GIVEN at _____

the _____ day of _____

Witness:

C. W. McCoy furnished

VOLUNTEER ENLISTMENT.

STATE OF

TOWN OF

Tennessee

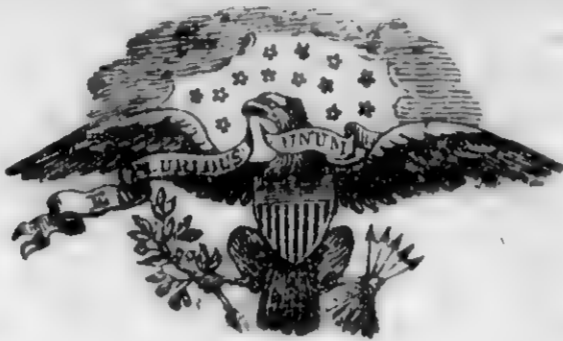

Murphy

I, *John Burden*, born in _____, in the State of *Mississippi*, aged *21* years, and by occupation a *Boatman*, Do HEREBY ACKNOWLEDGE to have volunteered this *9th* day of *March*, 1865, to serve as a **Soldier** in the **Army of the United States of America**, for the period of **THREE YEARS**, unless sooner discharged by proper authority: Do also agree to accept such bounty, pay, rations, and clothing, as are, or may be, established by law for volunteers. And I, *John Burden*, do solemnly swear, that I will bear true faith and allegiance to the **United States of America**, and that I will serve them honestly and faithfully against all their enemies or opposers whomsoever; and that I will observe and obey the orders of the President of the United States, and the orders of the officers appointed over me, according to the Rules and Articles of War.

Sworn and subscribed to, at *Murphy Tenn* this *9* day of *March*, 1865, *John Burden* BEFORE *Wm. C. M. D. W. Tenn*

I CERTIFY, ON HONOR, That I have carefully examined the above-named Volunteer, agreeably to the General Regulations of the Army, and that, in my opinion, he is free from all bodily defects and mental infirmity, which would in any way disqualify him from performing the duties of a soldier.

L. B. Brown Surgeon Major 118th Ill. Inf. Vol. *James Hamilton* Surgeon 120th Ill. Inf. Vol. *Wm. C. M. D. W. Tenn* Board of Enrollments

I CERTIFY, ON HONOR, That I have minutely inspected the Volunteer *John Burden* previously to his enlistment, and that he was entirely sober when enlisted; that, to the best of my judgment and belief, he is of lawful age; and that, in accepting him as duly qualified to perform the duties of an able-bodied soldier, I have strictly observed the Regulations which govern the recruiting service. This soldier has *Blue* eyes, *Blue* hair, *Blue* complexion, is *5* feet *2* inches high.

Wm. C. M. D. W. Tenn *Capt. S. ...* Regiment of *9th ...* Volunteers, RECRUITING OFFICER.

(A. G. O. No. 74 & 76.)

Mustered into the service of the United States, for three years or during the war, from the date of enlistment, in Co. *...* of the *11th* Regiment of *...* Volunteers, on the *9th* day of *March*, 1865, at *Murphy Tenn*

DECLARATION OF RECRUIT.

*, _____, desiring to VOLUNTEER as a Soldier in the Army of the United States, for the term of THREE YEARS, Do Declare, That I am _____ years and _____ months of age; that I have never been discharged from the United States service on account of disability or by sentence of a court martial, or by order before the expiration of a term of enlistment; and I know of no impediment to my serving honestly and faithfully as a soldier for three years.

GIVEN at _____ the _____ day of _____

Witness:

John S. Birdeau
mark

NOTE 1.—This blank will be used for both enlistments and re-enlistments—enlistment of veterans, &c., &c., in the volunteer service. They will be made out in duplicate in all cases—one to accompany the recruiting return of the superintendent (not the recruiting officer) to the Adjutant General, and one to accompany the accounts of the officer who pays bounty, &c. The Regiment and Company in which the soldier last served should be given on the back.

NOTE 2.—An enlistment holds to service. A muster-in must, in all cases, precede payment of pay, bounty, pension, &c. A muster-in roll must, in all cases, be filed in the Adjutant General's Office as evidence of muster-in. The mustering officer, commissary, or assistant commissary of musters, as the case may be, will countersign both enlistments as having mustered the soldier into the service of the United States before either of them is given to the disbursing officer.

APR 1867. This must be countersigned by the Adjutant General of the United States.

Discharged _____, 18 .

enlistment; last served in Company ()
Reg't of _____

No. _____
Volunteered at _____
March 9th, 1865.
By *Capt. W. Campbell*
1st Regiment of *W. S. Latta's Regt.*

CONSENT IN CASE OF MINOR.

I, _____, Do CERTIFY, That I am the _____ of _____; that the said _____ is _____ years of age; and I do hereby freely give my CONSENT to his volunteering as a SOLDIER in the ARMY OF THE UNITED STATES for the period of THREE YEARS.

GIVEN at _____ the _____ day of _____

Witness:

VOLUNTEER ENLISTMENT.

STATE OF

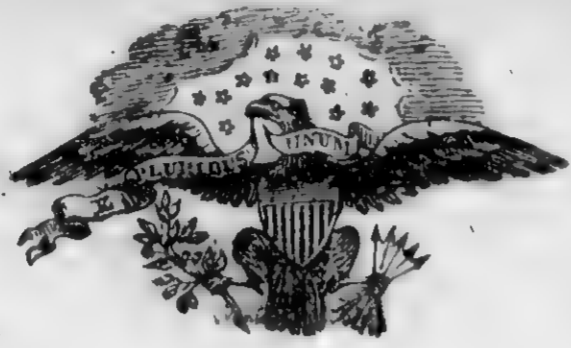

TOWN OF

Tennessee

Memphis

I, *John Bursden*, born in _____, in the State of *Mississippi*, aged *21* years, and by occupation a *Boatman*, Do HEREBY ACKNOWLEDGE to have volunteered this *9th* day of *March*, 1865, to serve as a **Soldier** in the **Army of the United States of America**, for the period of **THREE YEARS**, unless sooner discharged by proper authority: Do also agree to accept such bounty, pay, rations, and clothing, as are, or may be, established by law for volunteers. And I, *John Bursden*, do solemnly swear, that I will bear true faith and allegiance to the **United States of America**, and that I will serve them honestly and faithfully against all their enemies or opposers whomsoever; and that I will observe and obey the orders of the President of the United States, and the orders of the officers appointed over me, according to the Rules and Articles of War.

Sworn and subscribed to, at *Memphis Tenn* this *9* day of *March*, 1865, BEFORE *Wm. C. M. D. W. Tenn* *John Bursden* mark

I CERTIFY, ON HONOR, That I have carefully examined the above-named Volunteer, agreeably to the General Regulations of the Army, and that, in my opinion, he is free from all bodily defects and mental infirmity, which would in any way disqualify him from performing the duties of a soldier.

Wm. Keay Lt. 120th Regt. Ill. Vol. Inf.
President of Board of Enrollments
Orvil Smith Major 3rd U. S. L. G.
Wm. C. M. D. W. Tenn
Jas. Hamilton Surg. 120th Regt. Ill. Vol. Inf.
EXAMINING SURGEONS
Wm. C. M. D. W. Tenn
Board of Enrollments

I CERTIFY, ON HONOR, That I have minutely inspected the Volunteer _____ previously to his enlistment, and that he was entirely sober when enlisted; that, to the best of my judgment and belief, he is of lawful age; and that, in accepting him as duly qualified to perform the duties of an able-bodied soldier, I have strictly observed the Regulations which govern the recruiting service. This soldier has _____ eyes, _____ hair, _____ complexion, is _____ feet _____ inches high.

Wm. C. M. D. W. Tenn
Capt 9th Regiment of Iowa Infantry Volunteers,
RECRUITING OFFICER.

(A. G. O. No. 74 & 76.)

Mustered into the service of the United States, for three years or during the war, from date of enlistment, in Company _____ Regiment of *9th Regt. Ill. Vol. Inf.* on the *9* day of *March*, 1865, at *Memphis Tenn*

Wm. C. M. D. W. Tenn
Capt 9th Regt. Ill. Vol. Inf.

W^d 2^d 11th of Feb Light
March 17th 1863

Special Order
No 66

Private John Brown
a Recruit, assigned
to Co "D" for duty

Duty

Head Quarters M. C. S. Cold Light.
Memphis Tenn. March 17th 1863.

Special Order,
No 66

John Burden a Recruit, mustered
into Service March 9th 1863, at Memphis Tenn, and
assigned to this Regiment, is hereby assigned to Co
M. C. S. Cold Light, and will report without delay
to Comdg Officer of Co E M. C. S. Cold Light.

By Order of

W. D. Turner Col

Comdg Regiment
S. F. Denton

Adj't.

To Comdg Officer
Co E M. C. S. Cold Light

220

Burgess, Armstead

Co B, 11 U.S. Col'd Inf.

(New Organization.)

Private

Private

CARD NUMBERS.

1	6325026	26
2	6325134	27
3	6325242	28
4	6325346	29
5	6325448	30
6	6325569	31
7	6325881	32
8	6325961	33
9	6326033	34
10	6326102	35
11	6326159	36
12	9070944	37
13	9071081	38
14		39
15		40
16		41
17		42
18		43
19		44
20		45
21		46
22		47
23		48
24		49
25		50

Book Mark:

See also

S642056 - C. G. S.

S-4095156 P.O. member

S. 2015016 P.O. mil. (P. order)

S 2109484 P.O. aff

S 2110939 P.O. aff.

P.O. misc IC 1074018 5/4/14 M.S.

B

11 (New) U.S.C.T.

Armstead Burgess

Co. (New), 11 Reg't U.S. Col'd Inf.

Appears on

Company Descriptive Book

of the organization named above.

DESCRIPTION.

Age 17 years height 5 feet 9 inches.

Complexion Black

Eyes; Black hair Black

Where born Franklin, Alabama

Occupation Laborer

ENLISTMENT.

When Aug 17, 1863.

Where Corinth, Miss

By whom Capt. Baker; term 3 yrs.

Remarks: Missing in action at Fort Pillow, Tenn April 12 1864. Final statements forwarded July 12 1864 returned from prison and joined his Co May 19/65.

T. A. Sibley

B

11 (new) U.S.C.T.

Amos Burgess

Co. B, 11 Reg't U.S. Col'd Inf. (New)

Appears on

Company Descriptive Book

of the organization named above.

DESCRIPTION.

Age 17 years height 5 feet 9 inches.

Complexion Black

Eyes; Black hair Black

Where born Frankton Alabama

Occupation Laborer

ENLISTMENT.

When Aug 17, 1863.

Where Corinth Miss

By whom Capt Baker; term 3 y'rs.

Remarks: Missing in action at Fort Pillow April 12, 1864.

M. A. Aisley

B | **11** (New). | **U.S.C.T.**

Amstead Burgess
Im, Co. *B*, 1 Reg't Ala, Siege Art'y.*

Age *17* years.

Appears on

Company Muster-in Roll

of the organization named above. Roll dated

Corinth, Miss, Sep 7, 1863.

Muster-in to date *Sep 7*, 1863

Joined for duty and enrolled:

When *Aug 17*, 1863.

Where *Corinth, Miss*

Period *3* years.

Remarks:

* This organization subsequently became Co. *B*, 11 Reg't U. S. Colored Infantry (New).

Book mark: -----

Al Deunan
Copyist.

R | **11 (New).** | **U.S.C.T.**

Armistead Burgess
Mr., Co. B, 1 Reg't Ala. Siege Art'y.*

Appears on

Company Muster Roll

for *Sept & Oct*, 1863.

Present or absent *Present*

Stoppage, \$ *100* for

Due Gov't, \$ *100* for

Remarks:

* This organization subsequently became Co. B, 11 Reg't U.S. Col'd Infantry (New).

Book mark:

M. J. ...
Copyist.

B

11 (New).

U.S.C.T.

Arrested Burgess
Pr., Co. B, 4 Battalion, 1 Reg't Tenn. H. Art'y.*

Appears on

Company Muster Roll

for *Jan. and Feb.*, 1864.

Present or absent *Present.*

Stoppage, \$ *100* for

Due Gov't, \$ *100* for

Remarks:

*This organization subsequently became Co. B, 11 Reg't U. S. Col'd Infantry (New).

Book mark:

A. O. Gilbert

B

11 (New).

U.S.C.T.

Amstead Burgess
Prv., Co. B, 6 Reg't U. S. Col'd H. Art'y.*

Appears on

Company Muster Roll

for

Feb. and Apr., 1864.

Present or absent

Absent.

Stoppage, \$

100 for

Due Gov't, \$

100 for

Remarks:

Missing since
Battle of Fort Pillow
Apr. 12, '64.

Roll June 65 next on which name appears.

*This organization subsequently became Co. B, 11 Reg't U. S. Col'd
Infantry (New).

Book mark:

H. Gilbert

(358)

Copyist.

B

11 (New)

U.S.C.T.

Armostad Burgess
Pr., Co. B, 7 Reg't U. S. Col'd H. Art'y.*

Appears on

Company Muster Roll

for *May and June*, 1863.

Present or absent

Stoppage, \$ 100 for

Due Gov't, \$ 100 for

Remarks: *Missing in ac-*
tion since Apr. 12,
'64 at Ft. Pillow, Tenn

*This organization subsequently became Co. B, 11 Reg't U. S. Col'd Infantry (New).

Book mark:

H. O. Gilbert

B

11 (New).

U.S.C.T.

Armeded Burges

Co. B, 11 Reg't U. S. Col'd Inf. (New).

Appears on

Company Muster Roll

for *May & June*, 1865

Present or absent *Present*

Stoppage, \$ 100 for

Due Gov't, \$ 100 for

Remarks: *Returned from Missing in action at Ft. Pillow. May 19, 1865*

Book mark :

W. Sayre

(353)

Copyist.

B

11 (New). U.S.C.T.

Armstead Burgess

Priv, Co. B, 11 Reg't U. S. Col'd Inf. (New).

Appears on

Company Muster Roll

for *July & Aug*, 186 *5*.

Present or absent *Absent*

Stoppage, \$ *100* for

Due Gov't, \$ *2*^{*14*} *100* for *Ord*

Remarks *Absent in ar-
rest in Irving Block
Memphis, Tenn.*

Book mark :

W. N. Payne

B

11 (New). U.S.C.T.

Arnstead Burgess
Priv, Co. B, 11 Reg't U. S. Col'd Inf. (New).

Appears on

Company Muster Roll

for *Sept. & Oct.*, 186*4*.

Present or absent *Present*

Stoppage, \$ *2*^{*34*} *100* for *Advance*

Due Gov't, \$ *100* for

Remarks:

Book mark:

Murphy

B

11 (New).

U.S.C.T.

Armstead Burgess

Prvt, Co. B, 11 Reg't U. S. Col'd Inf. (New).

Appears on

Company Muster Roll

for *Nov. 9 Dec.*, 186*5*.

Present or absent *Present*

Stoppage, \$ *2* ^{*39*}/_{*100*} for *Oldman*

Due Gov't, \$ *100* for

Remarks:

Book mark:

Murphy

B

11 (New). U.S.C.T.

Armed Burges

Co. B, 11 Reg't U. S. Col'd Inf. (New).

Appears on Co. Muster-out Roll, dated

Memphis Ten., Jan. 12, 1866.

Muster-out to date

Jan. 12, 1866.

Last paid to

Dec 31, 1865.

Clothing account:

Last settled 186 ; drawn since \$ 100

Due soldier \$ 100 ; due U. S. \$ ^{42 79} 100

Am't for cloth'g in kind or money adv'd \$ 100

Due U. S. for arms, equipments, &c., \$ 100

Bounty paid \$ 100 ; due \$ 100

Remarks: *due U. S. for advance*
\$2.39

Book mark: *P.S.*

Murphy

(361)

Copyist.

Burgess, Armstead -

P. B., Co. **11**

Reg't **U. S. C. Inf.**

5 Enclosures.

Bed Cards	Descriptive Lists
Burial Records	Final Statements <i>2</i>
Certs. of Dis. for Discharge	Furloughs
C. M. Charges	Med. Des. Lists
Med. Certificates	Orders

Other papers relating to—

Admission to Hosp'l	Furlough
Casualty Sheet (Officer's)	Med. Examination
Confinement	Misc. Information <i>/</i>
Contracts	Pay or Clothing
Death or Effects	Personal Reports
Desertions	Rank
Discharge from Hosp'l	Transfer to Hosp'l
Discharge from Service	Transfer to V. R. C.
Duty	Transportation
<i>ref w 2</i>	

1864 Sub No. 43

FINAL STATEMENT

OF

First Amended Surgeon
Co. B, 7th Reg't of U.S.C. Art. Army

VOLUNTEERS.

NOTE 1.—Two of these certificates (or duplicates) are to be given to each Volunteer Soldier or drafted man who may be discharged previously to the discharge of his company, that he may at once receive from the Paymaster the pay, &c., due him, and the captain or other COMMISSIONED officer commanding the company will certify to the act of the delivery of the duplicate certificates; on these certificates the Soldier is "entitled to" his discharge, and should also present his discharge to the Paymaster to have the payment endorsed on it. The discharge is to be given back to the Soldier by the Paymaster; the latter only retaining as his voucher the duplicate certificates.

NOTE 2.—If the Soldier is entitled to pay for the use of his horse, the Company Commander will certify to that fact on the back of both these final statements, and also to the time he has pay due for having been so mounted on his own horse.

NOTE 3.—When a Soldier is furnished with final statements, his descriptive list, if he has one, should be taken up by the officer who gives the Soldier these statements, and endorsed with a statement to this effect by the officer. This endorsement should exhibit a full statement of the time for which the Soldier was allowed pay on his final statements, the clothing account, and all other charges against him or in his favor, so as to comprise a complete exhibit of his account. It will then be transmitted to the company commander of the Soldier, who will enter all the data necessary to a full understanding of the Soldier's account on the muster roll upon which the Soldier's discharge is reported. The descriptive list will then be destroyed. The object of this is, that the remaining portion of the Soldier's account may be settled upon the receipt of these muster rolls, and the Soldier receive any pay or allowances that may be due him at the time of his discharge, and which may not appear on his final statements from the fact that his descriptive list is incomplete. These accounts for back pay, &c., are settled by the 2d Auditor of the Treasury Department.

NOTE 4.—Charges for loss or injury to ordnance, horse equipments, and other miscellaneous charges, should appear under the heading of "Other Stoppages."

NOTE 5.—Bounty paid by State authorities, and not by the United States, will not be entered on this statement.

NOTE 6.—Amounts due the Sutler and Laundress must be entered on the muster roll on which the discharge, death, desertion, &c., is reported, as well as on the final statement, otherwise the amount cannot be collected from the United States.

NOTE 7.—This blank will be used for deceased volunteers and drafted men, as well as for others.

NOTE 8.—Where a Soldier dies in Hospital or on detached service, his descriptive list, if he has one, should be sent with his final statements, in duplicate, to the Second Auditor, Washington, D. C.

JUL 21 1871

I certify, on honor, that Amstead Burgess of
Captain John H. Paine Company (B) of the 7th Regiment of U.S.C. Art. Inf.
VOLUNTEERS, of the State of _____, born in Maule, State
of Alabama, aged 17 years; 5 feet 9 inches high; Black complexion,
Black eyes, Black hair, and by occupation a Laborer, having joined the company on
its original organization at Cornith Miss, and enrolled in it at the muster into
the service of the United States at Cornith Miss, on the 7 day
of Sept, 1863, (or was mustered in service as a recruit, by _____
at _____, on the _____ day of _____
186 , or was drafted and mustered into the service of the United States from the _____
Enrollment District of the State of _____, at _____,
on the _____ day of _____, 186), to serve in the Regiment, for

the term of Three years: and having served **HONESTLY** and
FAITHFULLY with his Company in The field to the present date, is now
entitled to a **DISCHARGE** by reason of Missing in action since April
12-1864, at Fort Pillow Tenn supposed to have been killed.

The said Amstead Burgess was last paid by Paymaster
Wm. Dolman to include the 31st day of December, 1863, and has
pay due him from that time to the present date; he is entitled to pay and subsistence for
TRAVELING to place of enrollment, and whatever other allowances are authorized to volunteer
soldiers, drafted men, or militia, so discharged. He has received from the United States **CLOTHING**
amounting to _____ dollars, since the _____ day of _____,
186 , when his clothing account was last settled. He has received from the United States
_____ dollars advanced **BOUNTY**.

There is to be stopped from him, on account of the State of _____, or other
authorities, for **CLOTHING, &c.**, received on entering service, _____ dollars; and
for other stoppages, viz: Cannot give the amount of clothing
drawn the company clothing broken up at Fort Pillow
Tenn April 12 1864 Cannot procure any in interest _____ dollars.

He has been furnished with **TRANSPORTATION** in kind from the place of his discharge to
_____ ; and he has been **SUBSISTED** for **TRAVELING** to his
place of enrollment, up to the _____, 186 .

He is indebted to _____, **SUTLER**, _____ dollars.
He is indebted to _____, **LAUNDRESS**, _____ dollars.

Given in Duplicate, at Fort Pickens Tenn, this 10 day
of April, 1864.

Wallis A. Field
2nd Lt 7-U.S.C. Art-Inf
Commanding Company. B

A. G. O. No. 95-First.]

Effects lost at Fort Pillow
Tenn April 12 - 1864

Co. B

43

FINAL STATEMENT

OF
Sgt. Samuel Burgess

Co. B 7th Regt of U.S.C. Artillery

7th U.S.C. Artillery
VOLUNTEERS.

April 12 1864

NOTE 1.—Two of these certificates (or duplicates) are to be given to each Volunteer Soldier or drafted man who may be discharged previously to the discharge of his company, that he may at once receive from the Paymaster the pay, &c., due him, and the captain or other COMMISSIONED officer commanding the company will certify to the act of the delivery of the duplicate certificates; on these certificates the Soldier is "entitled to" his discharge, and should also present his discharge to the Paymaster to have the payment endorsed on it. The discharge is to be given back to the Soldier by the Paymaster; the latter only retaining as his voucher the duplicate certificates.

NOTE 2.—If the Soldier is entitled to pay for the use of his horse, the Company Commander will certify to that fact on the back of both these final statements, and also to the time he has pay due for having been so mounted on his own horse.

NOTE 3.—When a Soldier is furnished with final statements, his descriptive list, if he has one, should be taken up by the officer who gives the Soldier these statements, and endorsed with a statement to this effect by the officer. This endorsement should exhibit a full statement of the time for which the Soldier was allowed pay on his final statements, the clothing account, and all other charges against him or in his favor, so as to comprise a complete exhibit of his account. It will then be transmitted to the company commander of the Soldier, who will enter all the data necessary to a full understanding of the Soldier's account on the muster roll upon which the Soldier's discharge is reported. The descriptive list will then be destroyed. The object of this is, that the remaining portion of the Soldier's account may be settled upon the receipt of these muster rolls, and the Soldier receive any pay or allowances that may be due him at the time of his discharge, and which may not appear on his final statements from the fact that his descriptive list is incomplete. These accounts for back pay, &c., are settled by the 2d Auditor of the Treasury Department.

NOTE 4.—Charges for loss or injury to ordnance, horse equipments, and other miscellaneous charges, should appear under the heading of "Other Stoppages."

NOTE 5.—Bounty paid by State authorities, and not by the United States, will not be entered on this statement.

NOTE 6.—Amounts due the Sutler and Laundress must be entered on the muster roll on which the discharge, death, desertion, &c., is reported, as well as on the final statement, otherwise the amount cannot be collected from the United States.

NOTE 7.—This blank will be used for deceased volunteers and drafted men, as well as for others.

NOTE 8.—Where a Soldier dies in Hospital or on detached service, his descriptive list, if he has one, should be sent with his final statements, in duplicate, to the Second Auditor, Washington, D. C.

ADJUTANT GENERAL'S OFFICE.

July 18th 1864

Duplicate with Inventory sent 2d Auditor.

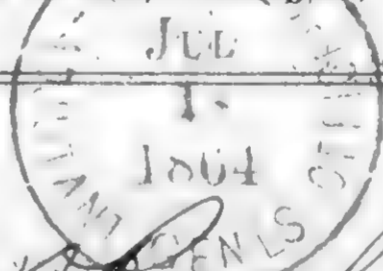

Ent on R. P. Co.

I certify, on honor, that Armed Aid Surgeon Private of
Captain John H. Bowen Company (B) of the 7 Regiment of U.S.C. Art 14th
VOLUNTEERS, of the State of _____, born in Franklin, State
of Alabama, aged 17 years; 5 feet 9 inches high; Black complexion,
Black eyes, Black hair, and by occupation a Laborer, having joined the company on
its original organization at South Miss, and enrolled in it at the muster into
the service of the United States at South Miss, on the 7th day
of Sept, 1863, (or was mustered in service as a recruit, by _____
at _____, on the _____ day of _____,
1863, or was drafted and mustered into the service of the United States from the _____
Enrollment District of the State of _____, at _____,
on the _____ day of _____, 1863), to serve in the Regiment, for
the term of Three Years: and having served HONESTLY and
FAITHFULLY with his Company in The field to the present date, is now
entitled to a **DISCHARGE** by reason of Wounding in action since
April 12 - 1864 supposed to have been killed

The said Private Armed Aid Surgeon was last paid by Paymaster
Wm. Dolman to include the 31st day of Dec, 1863, and has
pay due him from that time to the present date; he is entitled to pay and subsistence for
TRAVELING to place of enrollment, and whatever other allowances are authorized to volunteer
soldiers, drafted men, or militia, so discharged. He has received from the United States **CLOTHING**
amounting to _____ dollars, since the _____ day of _____,
1863, when his clothing account was last settled. He has received from the United States
_____ dollars advanced **BOUNTY**.

There is to be stopped from him, on account of the State of _____, or other
authorities, for **CLOTHING, &c.**, received on entering service, _____ dollars; and
for other stoppages, viz: Cannot give the amount of clothing
drawn the company clothing took was lost at Fort Pillow
from April 12, 1864, cannot give any more _____ dollars.

He has been furnished with **TRANSPORTATION** in kind from the place of his discharge to
_____ ; and he has been **SUBSISTED** for **TRAVELING** to his
place of enrollment, up to the _____, 1863.

He is indebted to _____, **SUTLER**, _____ dollars.
He is indebted to _____, **LAUNDRESS**, _____ dollars.

Given in Duplicate, at Fort Pickens Tenn, this 10 day
of July, 1864

Walter H. Spield
2d Lieut 7- U.S.C. Art 14th
Commanding Company. B

A. G. O. No. 95-First.)

Effects lost at Fort Pillow
from April 12, 1864

MEMORANDUM FROM PRISONER OF WAR RECORDS.

No. _____

(This blank to be used only in the arrangement of said records.)

INFORMATION OBTAINED FROM—

NAME.	RANK:	ORGANIZATION.				Records of—			
		No. of Reg't.	State.	Arm of Service.	Co.	Vol.	Page.	Vol.	Page.
<i>Sergeant Amstead</i>		<i>11.</i>	<i>Wisc</i>	<i>B</i>					

Captured at _____, 186 ; brought from _____, and confined at Richmond, Va., _____, 186 .

Admitted to Hospital at _____, 186 ; treated for _____

Where he died _____, 186 ; of _____

Paroled at _____, 186 ; reported at _____, 186 .

(Record continued.)

Furloughed , 186 , for days; returned , 186 ;
deserted , 186 ;

Adjutant General's Office,

This is accepted as referring to

, 18

Co. , Reg't,

and records will be corrected accordingly.

Assistant Adjutant Gen'l.

3-287

Copied by

Amstean Burgess
Pot. Co B 11th USC 9

Ellenbrook

Adjutant General's Office,

COLORED TROOPS BRANCH,

Mr Ellertson

Jan 6th, 1877

Vol. C. T., 187

Wanted in the case of Armstead Burgess Pvt, Co. "O",
11th Reg't U.S.C.T. (Col) Caused and period
of confinement - and record of trial -

Arrest in Irving Block Memphis Tenn
MB for July & August 1865 and RR for Sept 1865

Wife

Respectfully,

W. U. Woodward
Chief Clerk
J. H. Heston

Adjutant General's Office,

, 187

Vol. C. T., 187

Reply in case of _____, Co. _____,

Reg't

Register of Prisoners, Pro Man Memphis Tenn,
"Armstead Burgess Co. B" 11th U.S.C.T., confined
Aug 30/65 by Genl Smith, until further orders,
released by order Genl J. D. Smith Oct 16/65 "

Name not borne in S.O. Dist Wash Tenn Oct 15th or 16th 65

Common Rept dated Sept 1/65 - "Armstead Burgess
confined in Irving Block Memphis Tenn "

No remarks on mon Repts for Oct 65, relative
to Burgess,

E. H. Adams 7/77

Statement of Service Reference Slip.

Office Plusion

Claim No. 1074018

Arnstead Burgess
(Name.)

, Co. B, 11 Reg't USC Inf

To Arch Div. May 4, 1914

For Record of trial or
other action,

Johnson
J.H.

RRSec.

Record of "Federal soldier
confined in Irving Military
Prison, Memphis, Tenn.
shows:

Aug. 30, 1865

Arnstead Burgess, Co. B.

11 U.S. C. Inf.

By Col. Turner.

Until further orders.

No record of charges or date of
release found.

Harley
J.H.

Statement furnished 5/4, 1914

J.H.

221

Burnett, Aaron

Co *11*, 11 U.S. Col'd Inf.

(New Organization.)

Private

Private

CARD NUMBERS.

1	6334013	26
2	6334104	27
3	6334207	28
4	6334301	29
5	6334379	30
6	6334452	31
7	6334521	32
8	6334590	33
9	6334661	34
10	6334736	35
11	6334807	36
12	6334873	37
13	6334936	38
14	9072520	39
15		40
16		41
17		42
18		43
19		44
20		45
21		46
22		47
23		48
24		49
25		50

Book Mark:

See also

B | 11 (Ken) U.S.C.T.

Sam Burnett

Co. K, 11 Reg't U.S. Col'd Inf. (Ken)

Appears on

Company Descriptive Book

of the organization named above.

DESCRIPTION.

Age 27 years height 5 feet 5 inches.

Complexion Blk

Eyes; Blk hair Blk

Where born Va

Occupation Farmer

ENLISTMENT.

When Mich n, 1864.

Where Memphis

By whom L. J. Washburn term 3 y'rs.

Remarks:

Bryer

B

11 (New). U.S.C.T.

Jaron Burnett

Art, Co. *K*, 6 Reg't U. S. Col'd H. Art'y. †

Appears on

Company Muster-in and Descriptive Roll

of the organization named above. Roll dated *Fort Pickens*
Memphis, Tenn., *April 2*, 1864.

Where born *Virginia*

Age *27* y'rs; occupation *Farmer*

When enlisted *March 1*, 1864.*

Where enlisted *Memphis, Tenn.*

For what period enlisted *3* years.

Eyes *Black*; hair *Black*

Complexion *Black*; height *5 ft. 5 in.*

When mustered in *March 1*, 1864.*

Where mustered in

Bounty paid \$ *100*; due \$ *100*

Where credited *Camargo, Miss.*

Company to which assigned

Remarks:

† This organization subsequently became Co. *K*, 11 Reg't U. S. Colored Infantry (New).

* Muster in roll shows enrollment and muster-in of this company as of same date. See enrollment on subsequent card or cards.

Book mark:

Rockster

B | 11 (New). | U.S.C.T.

Baron Burnett
(Pot, Co. K, 6 Reg't U. S. Col'd H. Art'y.†

Appears on

Company Muster Roll

for Feb 2 to Apr 30, 1864.

Joined for duty and enrolled:

When March 1, 1864.*

Where Memphis, Tenn.*

Period 3 years.*

Present or absent Present

Stoppage, \$ 100 for

Due Gov't \$ 100 for

Remarks:

† This organization subsequently became Co. K, 11 Reg't U. S. Colored Infantry (New).

* See enrollment on card from muster-in roll.

Book mark:

Rochester

B | **11** (New). | **U.S.C.T.**

Alon Burnett
Cpt, Co. K, 7 Reg't U. S. Col'd H. Art'y.†

Appears on

Company Muster Roll

for *May & June*, 186*4*.

Joined for duty and enrolled:

When *March 1*, 186*4*.*

Where *Memphis Tenn.* *

Period *3* years.*

Present or absent *Present*

Stoppage, \$ *100* for

Due Gov't \$ *100* for

Remarks :

†This organization subsequently became Co. K, 11 Reg't U. S. Col'd Infantry (New).

* ~~See~~ See enrollment on card from muster-in roll.

Book mark :

Recheater

B

11 (New).

U.S.C.T.

Aaron Burnett

Pvt, Co. K, 7 Reg't U. S. Col'd H. Art'y.†

Appears on

Company Muster Roll

for July & Aug., 1864.

Joined for duty and enrolled:

When March 1, 1864.*

Where Memphis, Tenn. *

Period 3 years.*

Present or absent Present

Stoppage, \$ 100 for

Due Gov't \$ 100 for

Remarks:

†This organization subsequently became Co. K, 11 Reg't U. S. Col'd Infantry (New).

* See enrollment on card from muster-in roll.

Book mark:

Rochester

29

11 (New). U.S.C.T.

Arson Burnett
Pot, Co. K, 7 Reg't U. S. Col'd H. Art'y.†

Appears on

Company Muster Roll

for Sept Oct, 1864

Joined for duty and enrolled:

When Mar. 1, 1864.*

Where Memphis, Tenn. *

Period 3 years.*

Present or absent Present

Stoppage, \$ 100 for

Due Gov't \$ 100 for

Remarks:

†This organization subsequently became Co. K, 11 Reg't U. S. Col'd Infantry (New).
* See enrollment on card from muster-in roll.

Book mark: _____

Proctor

B

11 (New).

U.S.C.T.

Aaron Burnett

Pvt., Co. K, 7 Reg't U. S. Col'd H. Art'y.†

Appears on

Company Muster Roll

for Apr + Dec, 1864.

Joined for duty and enrolled:

When March 1st, 1864.*

Where Memphis *

Period 3 years.*

Present or absent Present

Stoppage, \$ 100 for

Due Gov't \$ 100 for

Remarks: Due U.S. for one
Screw driver and one
Wiper and one Haver-
sack

†This organization subsequently became Co. K, 11 Reg't U. S. Col'd Infantry (New).

* See enrollment on card from muster-in roll.

Book mark:

Rockwater

B | 11 (New). U.S.C.T.

Baron Burnett

Pvt., Co. K, 11 Reg't U. S. Col'd Inf. (New).

Appears on

Company Muster Roll

for Jan & Febr, 1865.

Joined for duty and enrolled:

When March 1, 1864.*

Where Memphis Tenn

Period 3 years.*

Present or absent present

Stoppage, \$ $\frac{43}{100}$ for Ordnance Lost

Due Gov't, \$ $\frac{100}{100}$ for

Remarks: Due Ad. for one
haversack

* See enrollment on card from muster-in roll.

Book mark:

Wm L Allen

3

11 (New). U.S.C.T.

Carroll Burnett

Art., Co. K, 11 Reg't U. S. Col'd Inf. (New).

Appears on

Company Muster Roll

for Mar & Apr, 1865.

Joined for duty and enrolled:

When March, 1865.*

Where Alexandria Tenn

Period 3 years.*

Present or absent present

Stoppage, \$ 45/100 for 1/2 day

Due Gov't, \$ 100 for

Remarks:

* See enrollment on card from muster-in roll.

Book mark:

Am L Allen

3

11 (New).

U.S.C.T.

Baron Burnett

Co. K, 11 Reg't U. S. Col'd Inf. (New).

Appears on

Company Muster Roll

for May 1861

Joined for duty and enrolled:

When March 1861

Where Memphis

Period 3 years.*

Present or absent present

Stoppage, \$ 45 for 100 for 12 days

Due Gov't, \$ 100 for

Remarks:

* See enrollment on card from muster-in roll.

Book mark:

A. Allen

B 11 (New). U.S.C.T.

Aaron Burnett

1st, Co. K, 11 Reg't U. S. Col'd Inf. (New).

Appears on

Company Muster Roll

for *July & Aug*, 1865.

Joined for duty and enrolled:

When *March*, 1864.*

Where *Memphis* *

Period *3* years.*

Present or absent *present*

Stoppage, \$ *100* for

Due Gov't, \$ *45* *100* for *Provision*

" " *65* *100* " *C. & Car. Equip*

Remarks: *Added for one
haversack.*

* See enrollment on card from muster-in roll.

Book mark:

A. Allen

I 11 (New). U.S.C.T.

Raaron Burnett

Priv., Co. K, 11 Reg't U. S. Col'd Inf. (New).

Appears on

Company Muster Roll

for *Sept & Oct*, 1865.

Joined for duty and enrolled:

When *March 1*, 1864.*

Where *Memphis* *

Period *3* years.*

Present or absent *absent*

Stoppage, \$ *1.00* for *Expenses*

Due Gov't, \$ *1.26* for *Gratuities*

Remarks: *In military prison
Fort Pickens*

* See enrollment on card from muster-in roll.

Book mark:

R. Allen

73 11 (New). U.S.C.T.

Aaron Burnett

Butt, Co. K, 11 Reg't U. S. Col'd Inf. (New).

Appears on

Company Muster Roll

for Nov. & Dec. , 1865.

Joined for duty and enrolled:

When Mar. 1 , 1864*

Where Memphis *

Period 3 years.*

Present or absent Present

Stoppage, \$ 1 26 for Ordnances

Due Gov't, \$ 1 60 for b. b. & g. &.

Remarks:

* See enrollment on card from muster-in roll.

Book mark:

Hammer

B | 11 (New). | U.S.C.T.

Aron Bennett

Pvt, K, 11 Reg't U. S. Col'd Inf. (New).

Appears on Co. Muster-out Roll, dated
Memphis, Tenn., Jan 12, 1866.

Muster-out to date Jan 12, 1866.

Last paid to June 30, 1865.

Clothing account:

Last settled _____, 186 ; drawn since \$ _____ 100

Due soldier \$ _____ 100; due U. S. \$ 29 ⁵⁹/₁₀₀

Am't for cloth'g in kind or money adv'd \$ _____ 100

Due U. S. for arms, equipments, &c., \$ 7 ²⁶/₁₀₀

Bounty paid \$ _____ 100; due \$ _____ 100

Remarks: Due U.S. for lo. b. & eqs.
Equipage \$ 1.60

Book mark : _____

(361)

Hammer

Copyist.

Burnett Aaron

P, Co. K, 11 Reg't U. S. I

Enclosures.

Bed Cards	Final Statements
Burial Records	Furloughs or L. of A.
Certs. of Dis. for Discharge	Med. Certificates
C. M. Charges	Med. Des. Lists
Descriptive Lists	Orders
Discharge Certificates	Pris. of War Record
Enlistment Papers	Resignations

Other papers relating to—

Admission to Hosp'l	Furlough or L. of A.
Casualty Sheet	Med. Examination
Confinement	Misc. Information
Contracts	Pay or Clothing
Death or Effects	Personal Reports
Desertion	Rank
Discharge from Hosp'l	Transfer to Hosp'l
Discharge from Service	Transfer to V. R. C.
Duty	Transportation

Clara Russell,

Adjutant General's Office,

COLORED TROOPS BRANCH,

Mr. Ellersbrook

June 28th, 1877

Vol. C. T., 187

Wanted in the case of Clarou Burnett Pvt., Co. "K",
11th Reg't U.S.C. Troops Cause opened of confinement
and whether tried -

Absent "In Military Prison Fort Pickens"
MAR Sept-Oct 1865 Present for duty - M R
Nov 08 Dec 1865 (If confined by G.O. 103 Sept 24 '65
Copy of order need not be given)

H.J.G.

Respectfully,

Le A. Woodward
Chief Clerk

P. J. Haeson

Adjutant General's Office,

Div of Discontinued Commands

July 6th, 1877

Vol. C. T., 187

Reply in case of Clarou Burnett, Co. "K",
11th Reg't U.S.C. Troops

Mar. Report Book date Oct. 7th 1865. Shows
him "Sent to Stockade for disobedience of Orders."
Nov. 2nd 1865 Shows him "Returned from Stockade."
Records of Military Prison Fort Pickens Reports
him "Received Oct. 7th 1865. Charge Absence without
leave. Sentence By Order No. 103. 30 days. Oct. 7. 1865.
Sentence Expires Nov. 6th 1865. Released By order of Genl Smith Oct. 9th 65.
No evidence of trial

soft C. 7-6-77 R. 26

222

Burnett, Henry

Co K, 11 U.S. Col'd Inf.

(New Organization.)

Private

Private

CARD NUMBERS.

1	6334014	26
2	6334105	27
3	6334213	28
4	6334354	29
5	6335013	30
6	9072522	31
7		32
8		33
9		34
10		35
11		36
12		37
13		38
14		39
15		40
16		41
17		42
18		43
19		44
20		45
21		46
22		47
23		48
24		49
25		50

Book Mark:

See also

B | 11 (new) U.S.C.T.

Henry Burnett

, Co. K, 11 Reg't U.S. Col'd Inf. (new)

Appears on

Company Descriptive Book

of the organization named above.

DESCRIPTION.

Age 22 years height 5 feet 5 inches.

Complexion Blk

Eyes; Blk hair Blk

Where born Aberdeen Miss

Occupation Farmer

ENLISTMENT.

When Mich 1st, 1864.

Where Memphis

By whom Lt Washburn, term 3 y'rs.

Remarks: absent sick in
Heister Hospital since
June 18. 1864.

* Inserted by compr

Brewer

3

11 (New).

U.S.C.T.

Henry Burnett

Art. Co. K, 6 Reg't U. S. Col'd H. Art'y.†

Appears on

Company Muster-in and Descriptive Roll
of the organization, named above. Roll dated

Fort Pickens
Memphis, Tenn., April 2, 1864.

Where born Mississippi

Age 22 y'rs; occupation Farmer

When enlisted March 1, 1864*

Where enlisted Memphis, Tenn.

For what period enlisted 3 years.

Eyes Black; hair Black

Complexion Black; height 5 ft. 5 in.

When mustered in March 1, 1864*

Where mustered in

Bounty paid \$ 100; due \$ 100

Where credited Warden, Morris Co.,
Miss.

Company to which assigned

Remarks:

† This organization subsequently became Co. K, 11 Reg't U. S. Colored Infantry (New).

* Muster in roll shows enrollment and muster-in of this company as of same date. See enrollment on subsequent card or cards.

Book mark:

Proctor

B | 11 (New). | U.S.C.T.

Henry Burnett
Sgt., Co. K, 6 Reg't U. S. Col'd H. Art'y.†

Appears on

Company Muster Roll
for April to Oct 30, 1864.

Joined for duty and enrolled:

When March 1, 1864.*

Where Memphis, Tenn. *

Period 9 years.*

Present or absent Present

Stoppage, \$ 100 for

Due Gov't \$ 100 for

Remarks: Sick in Quarters

† This organization subsequently became Co. K, 11 Reg't U. S. Colored Infantry (New).

* See enrollment on card from muster-in roll.

Book mark:

Proctor

B | 11 (New). | U.S.C.T.

Henry Burnett
Pvt., Co. K, 7 Reg't U. S. Col'd H. Art'y.†

Appears on

Company Muster Roll

for *May & June*, 186*4*

Joined for duty and enrolled:

When *March 1*, 186*4*.*

Where *Memphis, Tenn.* *

Period *3* years.*

Present or absent *Absent*

Stoppage, \$ *100* for

Due Gov't \$ *100* for

Remarks *Absent sick in
Webster Hosptl. since
June 19. 1864*

†This organization subsequently became Co. K, 11 Reg't U. S. Col'd Infantry (New).

* See enrollment on card from muster-in roll.

Book mark:

Recruiter

B

11 (New). U.S.C.T.

Henry Burnette
Sgt

Co. K, 7 Reg't U. S. Col'd H. Art'y.†

Appears on

Company Muster Roll

for July & Aug, 1864.

Joined for duty and enrolled:

When March 1, 1864.*

Where Memphis, Tenn. *

Period 3 years.*

Present or absent.

Stoppage, \$ 100 for

Due Gov't \$ 100 for

Remarks: Died Webster Gen's Hosp.
July 4, 1864 of disease

†This organization subsequently became Co. K, 11 Reg't U. S. Col'd Infantry (New).

* See enrollment on card from muster-in roll.

Book mark: PV 4 P. 50, 68

Proctor

B | 11 (New). | U.S.C.T.

Henry Burnett
Pvt, K 11 Reg't U. S. Col'd Inf. (New).

Appears on Co. Muster-out Roll, dated
Memphis, Tenn, Jan 12, 1866.

Muster-out to date _____, 186 .

Last paid to Apr. 30, 1864.

Clothing account:

Last settled _____, 186 ; drawn since \$ _____ 100

Due soldier \$ _____ 100; due U. S. \$ _____ 100

Am't for cloth'g in kind or money adv'd \$ _____ 100

Due U. S. for arms, equipments, &c., \$ _____ 100

Bounty paid \$ _____ 100; due \$ _____ 100

Remarks: Died July 14/64 in
Hobbs' Gen'l Hospital

Book mark: F.S. Died July 4/64 G.B.V.
Over

(361)

Hammer

Copyist.

JAN. 23

6335013

☆1891☆

10 P. 325

P. V. 4. P. 56. 68.

V. 154. P. 102. 73

Burnett, Henry -

P, Co. R, **U**: **U. S. C. Inf.**

2 Enclosures.

Bed Cards	Descriptive Lists
Burial Records	Final Statements /
Certs. of Dis. for Discharge	Furloughs
C. M. Charges	Med. Des. Lists
Med. Certificates	Orders

Other papers relating to—

Admission to Hosp'l	Furlough
Casualty Sheet (Officer's)	Med. Examination
Confinement	Misc. Information
Contracts	Pay or Clothing
Death or Effects /	Personal Reports
Desertions	Rank
Discharge from Hosp'l	Transfer to Hosp'l
Discharge from Service	Transfer to V. R. C.
Duty	Transportation

Inventory of the effects of *Private Henry Barrett,*
Company "K" 2nd Regiment U.S. Army, Art. Cadet,
who died in the U.S. General Hospital Memphis
Tenn. July 4th 1864.

CAPS.....	BLANKETS.....
DRESS COATS.....	KNAPSACKS.....
OVERCOATS.....	CANTEENS.....
JACKETS.....	HIVERSACKS.....
TROUSERS.....	MUSKETS.....
SHIRTS.....	BAYONETS.....
DRAWERS.....	CARTRIDGE BOX.....
BOOTS, prs.....	BELT.....
SHOES, prs.....	MONEY.....
STOCKINGS.....	

1864 sub 44
 No. 101

Inventory
 of the effects of *Private*
Henry Barrett,
 late of *Co. "K" 2nd Regiment*
U.S. Army, Art. Cadet, who died
at the U.S. General
Hospital Memphis Tenn. July 4th
 1864.

JUL
 12
 1871

Webster U. S. Army General Hospital,

Memphis, Tenn. July 4th 1864.

Commanding Officer ^{11th} Co. Company,

7th Regt. U. S. Army Art. Caval.

I have to inform you
that Henry Burnett of your Company, died
in this hospital on the 4th day of July 1864,
of Chronic Diarrhoea

~~I inclose his descriptive list, with pay and clothing account,
and inventory of his effects. He had no effects.~~

Very respectfully yours, &c.,

A. T. Shaw

Surgeon U. S. Army, &c.

In charge of General Hospital.

✓ Henry Burnett 44
7th U. S. H. A. (Cavalry)
7th U. S. "K"
Died July 4th 1864
11th U. S. "K"

War Department
Adjutant General's Office
May 6th 1873.

The Muster - Out Roll of
Co. K. 11th U. S. C. Troops reports
that Private Henry Burnett of
that Company died July 14th 1864

The Co. Muster - Roll, however,
for July & August 1864, as also the
Soldier's Final Statement, give July
4th 1864 as the date of death.

The latter date - (July 4th 1864) -
is held to be correct, and the Co. Muster
- Out Roll will be amended accordingly.

Thoma M. G. present
E. B. 10
325 Assistant Adjutant General
Noted 2/11
See letter to 2d and
of May 17 1873

ADJUTANT GENERAL'S OFFICE.

Aug 3rd 1864

Duplicate with Inventory sent 2d Auditor.

Enthorn & Rofle.

Final Statements
CERTIFICATE

TO BE GIVEN TO VOLUNTEERS AT THE TIME OF THEIR DISCHARGE TO ENABLE THEM TO RECEIVE THEIR PAY, Etc.

I Certify, On honor that *Henry Burnett* a *Private*
of *Captain W. B. Colburn* Company (*B Co*) of the *Seventh*
Regiment of *W. Henry Art.* Volunteers, of the State of *Colorado* born in
State of *Mississippi* aged *25* years; *5*" feet *3*"
inches high; *Black* complexion, *Black* eyes, *Black* hair, and
by occupation a *Farmer*, was enrolled or enlisted at *Memphis Tennessee*
March 1 1864 and mustered in service by *Capt. Williams* at
Memphis Tennessee on the *2*" day of *April* 1864 to serve in
the Regiment for the term of three years; and having served honestly and faithfully with his Company in
the field to the present date, is now entitled to a discharge by reason of *Death*

*State particularly the cause of discharge; if for disability, whether the disability existed prior to the date of muster, or was contracted after.]

He was killed in action at General Hospital Memphis Tennessee on the 4th day of July 1864 in service of the Union.

The said *Henry Burnett* was last paid by Paymaster to include the _____ day of _____

186 , and has pay due him from that time to the present date, and also pay for the use of his _____ (having been mounted during the time) and he is entitled to pay and subsistence for traveling to to place of enrollment, and whatever other allowances are authorized to volunteer soldiers, or militia, so discharged.

He has received Clothing from the United States, not paid for, amounting to *535.50* dollars.

He has received Clothing from the State of _____ not paid for, amounting to _____ dollars.

He is entitled to Clothing pay from the *First* day of *March* 1864 to the time of discharge *Death*.

He is indebted for other stoppages than above *for loss of Equipments &c*

He has been subsisted for traveling to his place of enrollment, up to the _____ 186

He is indebted to _____ Sutler, *Seven (7) 1/2* dollars.

GIVEN in duplicates at *Memphis Tennessee* this *25*" day of *July* 1864

A. J. Shaw
Surgeon C. S. Brown *Inf. 2d Regt* *in Charge* Commanding Company.

NOTE.—Two of these certificates (or duplicates) are to be given to each volunteer soldier who may be discharged previously to the discharge of his company, that he may at once receive from the Paymaster the pay, etc., due him, and the captain or other officer commanding the company, will certify to the act of the delivery of the duplicate certificates; on these certificates the soldier is "entitled to" his discharge, and should also present his discharge to the Paymaster to have the payment endorsed on it. The discharge is to be given back to the Soldier by the Paymaster:—the latter only retaining as his voucher the duplicate certificates.

NOTE.—When Descriptive Roll has been given to a Soldier, no Final Certificate should be given until he returns his Descriptive Roll.

227

Burnett Hernton

Co D., 11 U.S. Col'd Inf.

(New Organization.)

Private

Private

CARD NUMBERS.

1	6327476	26
2	6327551	27
3	6327631	28
4	6327735	29
5	6327819	30
6	6327942	31
7	6328677	32
8	9071533	33
9	9071694	34
10		35
11		36
12		37
13		38
14		39
15		40
16		41
17		42
18		43
19		44
20		45
21		46
22		47
23		48
24		49
25		50

Book Mark:

See also

S 2318576 and N.D.
RTP779061

B

11 (new) U.S.C.T.

Hernton Burnett

(new)
Co. D, 11 Reg't U.S. Col'd Inf.

Appears on

Company Descriptive Book

of the organization named above.

DESCRIPTION.

Age 29 years height feet inches.

Complexion Black

Eyes; Black hair Black

Where born

Occupation

ENLISTMENT.

When Oct 17, 1863.

Where Ft. Haystack, Tenn.

By whom D. Carson ; term 3 y'rs.

Remarks Missing in action at Fort
Pillar April 12th 1864.

Carson

B

11 (New) U.S.C.T.

Hernton Burnett

Co. *D*, 11 Reg't U.S. Col'd Inf. (New)

Appears on

Company Descriptive Book

of the organization named above.

DESCRIPTION.

Age years height feet inches.

Complexion

Eyes; hair

Where born

Occupation

ENLISTMENT.

When , 186 ..

Where

By whom ; term y'rs.

Remarks:

W. J. ...
Cypriat.

B

11 (New).

U.S.C.T.

Horton Burnett

Pvt., Co. D, 1 Reg't Ala. Art'y.*

Age 22 years.

Appears on

Company Muster-in Roll

of the organization named above. Roll dated

Corinth Miss, Oct 27, 1863.

Muster-in to date

Oct 27, 1863

Joined for duty and enrolled:

When

Oct 17

, 1863.

Where

La Fayette Tenn

Period

3

years.

Remarks:

* This organization subsequently became Co. D, 11 Reg't U. S. Colored Infantry (New).

Book mark:

Leger

B

11 (New).

U.S.C.T.

Horton Burnett

H, Co. D, 1 Reg't Ala. Siege Art'y.*

Appears on

Company Muster Roll

for *from Enlistment to Oct 31, 1863.*

Present or absent *Present*

Stoppage, \$ *100* for

Due Gov't, \$ *100* for

Remarks: *Has never
drawn pay.*

*This organization subsequently became Co. D, 11 Reg't U. S. Col'd Infantry (New).

Book mark :

Leeger

B 11 (New). U.S.C.T.

Hazleton Burnett
Priv, Co. D, 1 Reg't Ala. Siege Art'y.*

Appears on

Company Muster Roll

for *Nov & Dec*, 186*3*.

Present or absent *Present*

Stoppage, \$ *100* for

Due Gov't, \$ *100* for

Remarks:

*This organization subsequently became Co. D, 11 Reg't U. S. Col'd Infantry (New).

Book mark:

(358)

Leger

Copist.

B

11 (New). U.S.C.T.

Clinton Bennett

PT, Co. D, 4 Battalion, 1 Reg't Tenn. H. Art'y.*

Appears on

Company Muster Roll

for *Jan + Feb*, 1864.

Present or absent *Present*

Stoppage, \$ *100* for

Due Gov't, \$ *100* for

Remarks:

* This organization subsequently became Co. D, 11 Reg't U. S. Colored Infantry (New).

Book mark:

Legis

B. | **11** (New) | **U.S.C.T.**

Victor Burnett

Co., Co. D, 7 Reg't U. S. Col'd H. Art'y.*

Appears on

Company Muster Roll

for *Mar. & Apr.*, 186*4*.

Present or absent *Absent*.

Stoppage, \$ *100* for

Due Gov't, \$ *100* for

Remarks: *Miping in action
at Fort Pillow April
12, 1864.*

*This organization subsequently became Co. D, 11 Reg't U. S. Col'd Infantry (New).

Book mark: _____

B. J. Cooke
(858) Copyist.

B. | 11 (New) | U.S.C.T.

Houston Burnett

Cpt., Co. D, 7 Reg't U. S. Col'd H. Art'y.*

Appears on

Company Muster Roll

for *May + June*, 186*4*.

Present or absent *Absent.*

Stoppage, \$ *100* for

Due Gov't, \$ *100* for

Remarks: *Miping in action
at Fort Pillow since
April 12, 1864.*

*This organization subsequently became Co. D, 11 Reg't U. S. Col'd Infantry (New).

Book mark:

B. J. Cooke
(358) Copyist.

B | 11 (New). U.S.C.T.

Hernton Burnett

Co. D, 11 Reg't U. S. Col'd Inf. (New).

Appears on Co. Muster-out Roll, dated
Memphis Tenn, Jan. 12, 1866.

Muster-out to date _____, 186 .

Last paid to *Dec 31*, 186 *3*.

Clothing account:

Last settled _____, 186 ; drawn since \$ _____ 100

Due soldier \$ _____ 100; due U. S. \$ _____ 100

Am't for cloth'g in kind or money adv'd \$ _____ 100

Due U. S. for arms, equipments, &c., \$ _____ 100

Bounty paid \$ _____ 100; due \$ _____ 100

Remarks: *Missing in action*
& all records destroyed
at Ft. Pillow Apr. 12. 64.
All that were not killed
were carried into slav
very by their captors.

Book mark : _____

(861)

Hedgus
Copyist.

Burnett, Thornton

P, Co. D, 11, U. S. C. Inf. Reg't

3 Enclosures.

Bed Cards	Descriptive Lists
Burial Records	Final Statements 2
Certs. of Dis. for Discharge	Furloughs
C. M. Charges	Med. Des. Lists
Med. Certificates	Orders

Other papers relating to—

Admission to Hosp'l	Furlough
Casualty Sheet (Officer's)	Med. Examination
Confinement	Misc. Information
Contracts	Pay or Clothing
Death or Effects /	Personal Reports
Desertions	Rank
Discharge from Hosp'l	Transfer to Hosp'l
Discharge from Service	Transfer to V. R. C.
Duty	Transportation

V *45.*
FINAL STATEMENT

OF

Hurston Burnett

Reg't of *U.S. Col. Hy.*

71st New
VOLUNTEERS.

Disch April 12 1864

NOTE 1.—Two of these certificates (or duplicates) are to be given to each Volunteer Soldier or drafted man who may be discharged previously to the discharge of his company, that he may at once receive from the Paymaster the pay, &c., due him, and the captain or other COMMISSIONED officer commanding the company will certify to the act of the delivery of the duplicate certificates; on these certificates the Soldier is "entitled to" his discharge, and should also present his discharge to the Paymaster to have the payment endorsed on it. The discharge is to be given back to the Soldier by the Paymaster; the latter only retaining as his voucher the duplicate certificates.

NOTE 2.—If the Soldier is entitled to pay for the use of his horse, the Company Commander will certify to that fact on the back of both these final statements, and also to the time he has pay due for having been so mounted on his own horse.

NOTE 3.—When a Soldier is furnished with final statements, his descriptive list, if he has one, should be taken up by the officer who gives the Soldier these statements, and endorsed with a statement to this effect by the officer. This endorsement should exhibit a full statement of the time for which the Soldier was allowed pay on his final statements, the clothing account, and all other charges against him or in his favor, so as to comprise a complete exhibit of his account. It will then be transmitted to the company commander of the Soldier, who will enter all the data necessary to a full understanding of the Soldier's account on the muster roll upon which the Soldier's discharge is reported. The descriptive list will then be destroyed. The object of this is, that the remaining portion of the Soldier's account may be settled upon the receipt of these muster rolls, and the Soldier receive any pay or allowances that may be due him at the time of his discharge, and which may not appear on his final statements from the fact that his descriptive list is incomplete. These accounts for back pay, &c., are settled by the 2d Auditor of the Treasury Department.

NOTE 4.—Charges for loss or injury to ordnance, horse equipments, and other miscellaneous charges, should appear under the heading of "Other Stoppages."

NOTE 5.—Bounty paid by State authorities, and not by the United States, will not be entered on this statement.

NOTE 6.—Amounts due the Sutler and Laundress must be entered on the muster roll on which the discharge, death, desertion, &c., is reported, as well as on the final statement, otherwise the amount cannot be collected from the United States.

NOTE 7.—This blank will be used for deceased volunteers and drafted men, as well as for others.

NOTE 8.—Where a Soldier dies in Hospital or on detached service, his descriptive list, if he has one, should be sent with his final statements, in duplicate, to the Second Auditor, Washington, D. C.

ADJUTANT GENERAL'S OFFICE
July 18 1864
Duplicate with Inventory sent 2d Auditor.

Eubank & Co

I certify, on honor, that Hurnton Burnett a Private of
Captain J Carson Company (3), of the 7th Regiment of U.S. Col. A. Hays
VOLUNTEERS, of the State of _____, born in _____; State
of _____, aged 22 years; _____ feet _____ inches high; Black complexion,
Black eyes, Black hair, and by occupation a _____, having joined the company on
its original organization at La Fayette Tenn, and enrolled in it at the muster into
the service of the United States at Corinth, on the Twenty Seventh day
of October, 1863, (or was mustered in service as a recruit, by _____
at _____, on the _____ day of _____,
186 , or was drafted and mustered into the service of the United States from the _____
Enrollment District of the State of _____, at _____,
on the _____ day of _____, 186) to serve in the Regiment, for
the term of Three years unless soon discharged and having served HONESTLY and
FAITHFULLY with his Company in The Field to the present date, is now
entitled to a **DISCHARGE** by reason of Missing in action at Fort Pillow
Apr 12th 1864 Supposed to be killed

The said Hurnton Burnett was last paid by Paymaster
Map Dolman to include the thirty first day of December, 1863, and has
pay due him from that time to the present date, he is entitled to pay and subsistence for
TRAVELING to place of enrollment, and whatever other allowances are authorized to volunteer
soldiers, drafted men, or militia, so discharged. He has received from the United States **CLOTHING**
amounting to _____ dollars, since the _____ day of _____,
186 , when his clothing account was last settled. He has received from the United States
_____ dollars advanced **BOUNTY**.

There is to be stopped from him, on account of the State of _____, or other
authorities, for **CLOTHING**, &c., received on entering service, _____ dollars; and
for other stoppages, viz: The Book & Papers of the Co. were all lost
in action at Fort Pillow Apr 12th 1864
unable to tell _____ dollars.
He has been furnished with TRANSPORTATION in kind from the place of his discharge to
_____ ; and he has been SUBSISTED for TRAVELING to his
place of enrollment, up to the _____, 186 .

He is indebted to _____, **SUTLER**, _____ dollars.

He is indebted to _____, **LAUNDRESS**, _____ dollars.

Given in Duplicate, at Fort Pickering, this 21st day
of June, 1864.

W. B. Nelson Major

U.S. Col. A. Hays

Commanding Company

1861 Sup 45

FINAL STATEMENT

OF

Hurston Burnett

2d
Reg't of U. S. C. A. *1st*

VOLUNTEERS.

NOTE 1.—Two of these certificates (or duplicates) are to be given to each Volunteer Soldier or drafted man who may be discharged previously to the discharge of his company, that he may at once receive from the Paymaster the pay, &c., due him, and the captain or other COMMISSIONED officer commanding the company will certify to the act of the delivery of the duplicate certificates; on these certificates the Soldier is "entitled to" his discharge, and should also present his discharge to the Paymaster to have the payment endorsed on it. The discharge is to be given back to the Soldier by the Paymaster; the latter only retaining as his voucher the duplicate certificates.

NOTE 2.—If the Soldier is entitled to pay for the use of his horse, the Company Commander will certify to that fact on the back of both these final statements, and also to the time he has pay due for having been so mounted on his own horse.

NOTE 3.—When a Soldier is furnished with final statements, his descriptive list, if he has one, should be taken up by the officer who gives the Soldier these statements, and endorsed with a statement to this effect by the officer. This endorsement should exhibit a full statement of the time for which the Soldier was allowed pay on his final statements, the clothing account, and all other charges against him or in his favor, so as to comprise a complete exhibit of his account. It will then be transmitted to the company commander of the Soldier, who will enter all the data necessary to a full understanding of the Soldier's account on the muster roll upon which the Soldier's discharge is reported. The descriptive list will then be destroyed. The object of this is, that the remaining portion of the Soldier's account may be settled upon the receipt of these muster rolls, and the Soldier receive any pay or allowances that may be due him at the time of his discharge, and which may not appear on his final statements from the fact that his descriptive list is incomplete. These accounts for back pay, &c., are settled by the 2d Auditor of the Treasury Department.

NOTE 4.—Charges for loss or injury to ordnance, horse equipments, and other miscellaneous charges, should appear under the heading of "Other Stoppages."

NOTE 5.—Bounty paid by State authorities, and not by the United States, will not be entered on this statement.

NOTE 6.—Amounts due the Sutler and Laundress must be entered on the muster roll on which the discharge, death, desertion, &c., is reported, as well as on the final statement, otherwise the amount cannot be collected from the United States.

NOTE 7.—This blank will be used for deceased volunteers and drafted men, as well as for others.

NOTE 8.—Where a Soldier dies in Hospital or on detached service, his descriptive list, if he has one, should be sent with his final statements, in duplicate, to the Second Auditor, Washington, D. C.

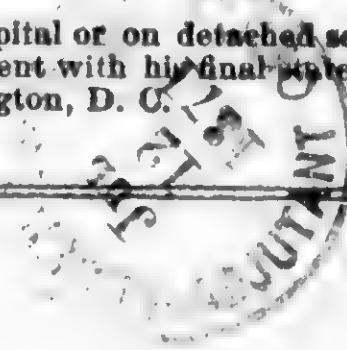

I certify, on honor, that Hurston Birneth Private of
 Captain D. Carson Company (D) of the 7th Regiment of U.S. Col, Ky
VOLUNTEERS, of the State of _____, born in _____, State
 of _____, aged 22 years; _____ feet _____ inches high; Black complexion,
Black eyes, Black hair, and by occupation a _____, having joined the company on
 its original organization at La Fayette Tenn, and enrolled in it at the muster into
 the service of the United States at Corinth Miss, on the Twenty day
 of October, 1863, (or was mustered in service as a recruit, by _____
 _____, at _____, on the _____ day of _____,
 186 , or was drafted and mustered into the service of the United States from the _____
 Enrollment District of the State of _____, at _____,
 on the _____ day of _____, 186) to serve in the Regiment, for
 the term of Three years unless sooner discharged and having served **HONESTLY** and
FAITHFULLY with his Company in The Field to the present date, is now
 entitled to a **DISCHARGE** by reason of Moving in action at Fort
Pillow Apr 12th 1864 supposed to be killed

The said Hurston Birneth was last paid by Paymaster
Map Dalmon to include the Third day of December, 1863, and has
 pay due him from that time to the present date; he is entitled to pay and subsistence for
TRAVELING to place of enrollment, and whatever other allowances are authorized to volunteer
 soldiers, drafted men, or militia, so discharged. He has received from the United States **CLOTHING**
 amounting to _____ dollars, since the _____ day of _____,
 186 , when his clothing account was last settled. He has received from the United States
 _____ dollars advanced **BOUNTY**.

There is to be stopped from him, on account of the State of _____, or other
 authorities, for **CLOTHING**, &c, received on entering service, _____ dollars; and
 for other stoppages, _____: The Books & Papers of the Col were
lost in action at Fort Pillow Apr 12th 1864
unable to tell _____ dollars.
 He has been furnished with **TRANSPORTATION** in kind from the place of his discharge to
 _____; and he has been **SUBSISTED** for **TRAVELING** to his
 place of enrollment, up to the _____, 186 .

He is indebted to _____, **SUTLER**, _____ dollars.

He is indebted to _____, **LAUNDRESS**, _____ dollars.

Given in Duplicate, at Fort Pickens, this 21st day
 of June, 1864.

D. Carson

7th U.S. Col, Ky

Commanding Company

ARTICLES OF WAR.

ART. 95. When any non-commissioned officer or soldier shall die, or be killed in the service of the United States, the then commanding officer of the troop or company shall, in the presence of two other commissioned officers, take an account of what effects he died possessed of, above his arms and accoutrements, and transmit the same to the office of the Department of War, which said effects are to be accounted for, and paid to the representatives of such deceased non-commissioned officer or soldier. And in case any of the officers, so authorized to take care of the effects of deceased officers and soldiers, should, before they have accounted to their representatives for the same, have occasion to leave the regiment or post, by preferment or otherwise, they shall, before they be permitted to quit the same, deposit in the hands of the commanding officer, or of the assistant military agent, all the effects of such deceased non-commissioned officers and soldiers, in order that the same may be secured for, and paid to, their respective representatives.

ARMY REGULATIONS—EDITION OF 1863.

DECEASED SOLDIERS.

Par. 152. Inventories of the effects of deceased non-commissioned officers and soldiers, required by the 95th Article of War, will be forwarded to the Adjutant General, by the commander of the company to which the deceased belonged, and a duplicate of the same to the colonel of the regiment. Final statements of pay, clothing, &c., in duplicate, will be sent to the Adjutant General with one copy of the inventory. When a soldier dies at a post or station absent from his company, it will be the duty of his immediate commander to furnish the required inventory and final statements, and, at the same time, to forward to the commanding officer of the company to which the soldier belonged, a report of his death, specifying the date, place, and cause; to what time he was last paid, and the money or other effects in his possession at the time of his decease; which report will be noted on the next muster roll of the company to which the man belonged. Each inventory will be endorsed, "Inventory of the effects of _____, late of company (—) _____ regiment of _____, who died at _____, the _____ day of _____, 186—." If a legal representative receive the effects, it will be stated in the report. If the soldier leave no effects, the fact will be reported.

Par. 153. Should the effects of a deceased non-commissioned officer or soldier not be administered upon within a short period after his decease, they shall be disposed of by a Council of Administration, under the authority of the commanding officer of the post, and the proceeds deposited with the Paymaster, to the credit of the United States, until they shall be claimed by the legal representatives of the deceased.

Par. 154. In all such cases of sales by the Council of Administration, a statement in detail, or account of the proceeds, duly certified by the Council and commanding officer, accompanied by the Paymaster's receipt for the proceeds, will be forwarded by the commanding officer to the Adjutant General. The statement will be endorsed, "Report of the proceeds of the effects of _____, late of company (—) _____ regiment of _____, who died at _____, the _____ day of _____, 186—."

NOTE 1.—The effects in all cases, when called for, should be turned over to the legal representative, without further authority from the Adjutant General. When the effects are turned over to the relatives of the deceased before these inventories are sent to the Adjutant General, their receipts therefor should be attached to the inventories. In all other cases, one copy will be sent with a letter of transmittal direct to the Adjutant General, and a duplicate retained by the officer.

NOTE 2.—Particular care should be taken to take receipts in duplicate from the Paymaster for any funds turned over to him; one copy should be sent direct to the Adjutant General and one retained by the officer.

INVENTORY OF THE EFFECTS

OF

Hurnton Burnett

Late of Company *D*

7th Reg't of *U.S. C.A. (Gy)*

Volunteers, who died at *Fort Pillow*

on the *12* day of *April* 186*4*.



Inventory of the effects of Hurston Burnett late
 a Private of Captain Delos Carson Company "D" of
 the Seventh Regiment of U.S. C.A., Ky. Volunteers, who was enrolled as
 a Private at La Fayette in the State of Tenn on
 the 11th day of October 1863, and mustered into the service of the United
 States as a Private on the 27th day of October 1863, at Corinth Ms
 in Company D, 7th Regiment of U.S. C.A., Ky. Volunteers, to serve Three
 years or during the war; he was born in _____ in the State
 of _____; he was 22 years of age, _____ feet _____ inches
 high, black complexion, black eyes, black hair, and by occupation, when enrolled,
 a _____; he died in slipping in action, at
Fort Pickens on the 12th day of April 1864, by
 reason of Supposed to have killed

INVENTORY.					
ARTICLES.	No.	ARTICLES.	No.	ARTICLES.	No.
Hats.....		Pairs trousers.....		Knapsacks.....	
Caps.....		Pairs flannel drawers.....			
Forage caps.....		Pairs cotton drawers.....			
Great coats.....		Flannel shirts.....			
Uniform coats.....		Cotton shirts.....			
Uniform jackets.....		Pairs boots.....			
Flannel sack coats.....		Pairs shoes.....			
Blouses.....		Pairs socks.....			
Stable frocks.....		Blankets.....		MONEY	
Fatigue overalls.....		Haversacks.....		Specie.....	\$
				Notes.....	\$

I CERTIFY, ON HONOR, that the above inventory comprises all the effects of _____
 _____, deceased, and that the effects are in the hands
 of Lo D in action at Fort Pickens April 12/64
 _____ to be disposed of by a Council of Administration.

(DUPLICATES.)
 STATION: Fort Pickens
 DATE: June 27th 1864
W. Blodgett 7th U.S. C.A., Ky.
 Commanding the Company.

224 Jackson
Burnett. Jack

Coal, 11 U.S. Col'd Inf.

(New Organization.)

Private Private

CARD NUMBERS.

1	6322762	26
2	6333146	27
3	6333235	28
4	6333318	29
5	6333395	30
6	6333471	31
7	6333551	32
8	6333623	33
9	6333695	34
10	6333770	35
11	6333840	36
12	6333907	37
13	9072481	38
14		39
15		40
16		41
17		42
18		43
19		44
20		45
21		46
22		47
23		48
24		49
25		50

Book Mark:

See also

B

11 (New) U. S. C. T.

Jackson Burnett
(New)
Co. D, 11 Reg't U. S. Col'd Inf.

Appears on

Company Descriptive Book

of the organization named above.

DESCRIPTION.

Age 20 years height 5 feet 5 inches.

Complexion Black

Eyes; Black hair Black

Where born Mississippi

Occupation Farmer

ENLISTMENT.

When March, 1864

Where Memphis Tenn.

By whom Slaughter; term 3 y'rs.

Remarks:

Forrest
Copied.

B | 11 (New). | U.S.C.T.

Jackson Burnett

Appears with rank of *Pri* on

Muster and Descriptive Rolls of Detachments of U. S. Vols. forwarded

for the *7 U.S.C.A.* Reg't U. S. Col'd *Inf.* Roll dated

Memphis Tenn, *June 29*, 1864.

Where born *Mississippi*

Age *20* y'rs; occupation *Farmer*

When enlisted *March 1*, 1864.

Where enlisted *Memphis Tenn*

For what period enlisted *3* years.

Eyes *Black*; hair *Black*

Complexion *Black*; height *5* ft. *5* in.

When mustered in *June 29*, 1864.

Where mustered in *Memphis Tenn*

Bounty paid \$ *100*; due \$ *100*

Where credited

Company to which assigned

Remarks: *Joined as Recruit*

Book mark:

Ashley

J

11 (New).

U.S.C.T.

Jack Burnett

Priv., Co. I, 7 Reg't U. S. Col'd H. Art'y.†

Appears on

Company Muster Roll

for *May & June*, 1864.

Joined for duty and enrolled:

When *1st Mar.*, 1864.*

Where *Fremont Tenn.**

Period *3* years.*

Present or absent *present*

Stoppage, \$ *100* for

Due Gov't, \$ *100* for

Remarks:

†This organization subsequently became Co. I, 11 Reg't U. S. Col'd Infantry (New).

* See enrollment on card from muster-in roll.

Book mark:

Milliken

G | **11** (New). | **U.S.C.T.**

Jack Burnett
Priv., Co. I, 7 Reg't U. S. Col'd H. Art'y.†

Appears on

Company Muster Roll

for *July + Aug't*, 1864.

Joined for duty and enrolled:

When *1st Mar.*, 1864.*

Where *Memphis Tenn.**

Period *3* years.*

Present or absent *Not stated*

Stoppage, \$ *100* for

Due Gov't, \$ *100* for

Remarks: *Stop for one haversack
& one canteen lost or destroyed.*

†This organization subsequently became Co. I, 11 Reg't U. S. Col'd Infantry (New).
* See enrollment on card from muster-in roll.

Book mark: _____

Milliken
Copyist.

P

11 (New). U.S.C.T.

Jack Burnett

Private, Co. I, 7 Reg't U. S. Col'd H. Art'y.†

Appears on

Company Muster Roll

for *Sept. & Oct.*, 1864.

Joined for duty and enrolled:

When *1st Mar.*, 1864.*

Where *Memphis Tenn.**

Period *3* years.*

Present or absent *present*

Stoppage, \$ *100* for

Due Gov't, \$ *100* for

Remarks:

†This organization subsequently became Co. I, 11 Reg't U. S. Col'd Infantry (New).

* See enrollment on card from muster-in roll.

Book mark:

Milliken

B

11 (New). U.S.C.T.

Jack Burnett

Priv., Co. I, 7 Reg't U. S. Col'd H. Art'y.†

Appears on

Company Muster Roll

for *Nov & Dec.*, 1864.

Joined for duty and enrolled:

When *12th Mar.*, 1864.*

Where *Memphis Tenn.* *

Period *3* years.*

Present or absent *present*

Stoppage, \$ *100* for

Due Gov't, \$ *100* for

Remarks: _____

†This organization subsequently became Co. I, 11 Reg't U. S. Col'd Infantry (New).
* See enrollment on card from muster-in roll.

Book mark: _____

Milliken

B | 11 (New) | U.S.C.T.

Jack Burnett

Private, Co. I, 11 Reg't U. S. Col'd Inf. (New.)
Appears on

Company Muster Roll

for *Jan + Febr*, 1865.

Joined for duty and enrolled:

When *March 1*, 1864.*

Where *Memphis Tenn.* *

Period *3* years.*

Present or absent *Present*

Stoppage, \$ *100* for

Due Gov't \$ *100* for

Remarks:

* See enrollment on card from muster-in roll.

Book mark:

M. A. Michaels

B | 11 (New) | U.S.C.T.

Jack Burnett

Private Co. I, 11 Reg't U. S. Col'd Inf. (New.)
Appears on

Company Muster Roll

for March & Apr., 1865.

Joined for duty and enrolled:

When March 1, 1864.*

Where Memphis Tenn.*

Period 3 years.*

Present or absent Present

Stoppage, \$ 100 for

Due Gov't \$ 100 for

Remarks:

* See enrollment on card from muster-in roll.

Book mark:

M. A. Michaels
Copyist.

D | 11 (New) | U.S.C.T.

Jack Burnett

Private, Co. I, 11 Reg't U. S. Col'd Inf. (New.)
Appears on

Company Muster Roll

for *May & June*, 186*5*.

Joined for duty and enrolled:

When *March 1*, 186*4*.*

Where *Memphis Tenn.* *

Period *3* years.*

Present or absent *Present*

Stoppage, \$ *100* for

Due Gov't \$ *100* for

Remarks:

* See enrollment on card from muster-in roll.

Book mark:

M.A. Michaels

(358c)

Copyist.

B | 11 (New) | U.S.C.T.

Jack Burnett

Private, Co. I, 11 Reg't U. S. Col'd Inf. (New.)

Appears on

Company Muster Roll

for *July & Aug*, 186*5*.

Joined for duty and enrolled:

When *March 1*, 186*4*.*

Where *Memphis Tenn* *

Period *3* years.*

Present or absent *Present*.

Stoppage, \$ *100* for

Due Gov't \$ *100* for

Remarks:

* See enrollment on card from muster-in roll.

Book mark:

(358c)

M. A. Michaels

Copyist.

B | 11 (New) | U.S.C.T.

Jack Burnett

Private, Co. I, 11 Reg't U. S. Col'd Inf. (New.)
Appears on

Company Muster Roll

for Sept & Oct, 1865.

Joined for duty and enrolled:

When March, 1864.*

Where Memphis Tenn *

Period 3 years.*

Present or absent Present

Stoppage, \$ 100 for

Due Gov't \$ 100 for

Remarks: Stop for 1 Screw D & C 7/11
1 Tompion & Wiper 4/5-2

* See enrollment on card from muster-in roll.

Book mark:

M. A. Michaels

(358c)

Copyist.

B

11 (New)

U.S.C.T.

Jack Burnett

Priv., Co. I, 11 Reg't U. S. Col'd Inf. (New.)
Appears on

Company Muster Roll

for *Nov. and Dec.*, 1865.

Joined for duty and enrolled:

When *1 March*, 1864.*

Where *Memphis Tenn.**

Period *3* years.*

Present or absent *Present*

Stoppage, \$ *100* for

Due Gov't \$ *100* for

Remarks:

* See enrollment on card from muster-in roll.

Book mark:

D. P. Webster

B | 11 (New). U.S.C.T.

Jaesl Burnett

Priv. ad., 11 Reg't U. S. Col'd Inf. (New).

Appears on Co. Muster-out Roll, dated *Memphis Tenn Jan 12*, 1866.

Muster-out to date *Jan 12*, 1866.

Last paid to *June 30*, 1865.

Clothing account:

Last settled....., 186 ; drawn since \$..... 100

Due soldier \$..... 100; due U. S. \$ *3*, ^{*53*}/₁₀₀

Am't for cloth'g in kind or money adv'd \$..... 100

Due U. S. for arms, equipments, &c., \$ *45* / ¹⁰⁰

Bounty paid \$..... 100; due \$..... 100

Remarks:

Book mark:

D. S. Webster

225

Burnett, John

Co H, 11 U.S. Col'd Inf.

(New Organization.)

Private

Corporal

CARD NUMBERS.

1	6322817	26
2	6332447	27
3	6332505	28
4	6332558	29
5	6332632	30
6	6332704	31
7	6332775	32
8	6332840	33
9	9072376	34
10		35
11		36
12		37
13		38
14		39
15		40
16		41
17		42
18		43
19		44
20		45
21		46
22		47
23		48
24		49
25		50

Book Mark:

See also

Δ 175553 Downer

51850693 P.O. Downer

MA. 1236771

S 2845627 and WP

P.O. No. of: 1063575 Mar 22/13
RUB

3 | **11 (New) U.S.C.T.**

John Bennett
....., Co. *H*, 11 Reg't U.S. Col'd Inf. *(New)*

Appears on

Company Descriptive Book

of the organization named above.

DESCRIPTION.

Age *27* years height *5* feet *7* inches.

Complexion *Black*

Eyes; *Black* hair *Black*

Where born *Memphis Miss*

Occupation *Steamboatman*

ENLISTMENT.

When *Jan 27*, 186*5*.

Where *Memphis Tenn*

By whom *J. G. McQueen*, term *3* y'rs.

Remarks:

J. G. McQueen
Coptist

B

11 (New).

U.S.C.T.

John Bennett

Appears with rank of Priv. on

Muster and Descriptive Rolls of Detachments of U. S. Vols. forwarded

(7 U.S.C.A.)
for the 11 Reg't U. S. Col'd Inf. Roll dated

Memphis Tenn. Jan. 27, 1865.

Where born Monroe Co. Miss.

Age 22 y'rs; occupation Steamboatman

When enlisted Jan. 22^d, 1865.

Where enlisted Memphis Tenn.

For what period enlisted 3 years.

Eyes Black; hair Black

Complexion Black; height 5 ft. 7 in.

When mustered in Jan. 22^d, 1865.

Where mustered in Memphis Tenn.

Bounty paid \$ 100; due \$ 100

Where credited Memphis, Shelby Co. Tenn.

Company to which assigned A,

Remarks:

Book mark:

Phelps

B. | 11 (New). | U.S.C.T.

John Burnett

Pl., H, 11 Reg't U. S. Col'd Inf. (New).

Appears on

Company Muster Roll

for *Jan. & Feb.*, 1865.

Present or absent *Present*

Stoppage, \$ *100* for

Due Gov't, \$ *100* for

Remarks:

Book mark:

Heawling

D. | 11 (New). | U.S.C.T.

John Barnett
Pr., H, 11 Reg't U. S. Col'd Inf. (New).

Appears on

Company Muster Roll

for *Mar. & Apr. 1865.*

Present or absent *Present*

Stoppage, \$ *100* for

Due Gov't, \$ *100* for

Remarks:

Book mark:

(858)

Hawling

Copyist.

B. | 11 (New). | U.S.C.T.

John Burnett
Corpl., H, 11 Reg't U. S. Col'd Inf. (New).

Appears on

Company Muster Roll

for *July & Aug.*, 1865.

Present or absent *Present.*

Stoppage, \$ *43* for *Ord. &*

Ord. stones lost.

Due Gov't, \$ *100* for

Remarks:

Book mark:

Hessling

B. | 11 (New). | U.S.C.T.

John Burnett
Cmpt., H, 11 Reg't U. S. Col'd Inf. (New).

Appears on

Company Muster Roll

for *Sept. & Oct.*, 1865.

Present or absent *Present*

Stoppage, \$ *43* for *Ordn.* &

Ordn. stores lost.

Due Gov't, \$ *100* for

Remarks: *Stoppage of \$2.00*
for transportation from
Memphis to Corinth

Book mark:

Maxwell

B

11 (New).

U.S.C.T.

John Burnett
Corpl, H, 11 Reg't U. S. Col'd Inf. (New).

Appears on

Company Muster Roll

for *Nov & Dec*, 1865.

Present or absent *Present*

Stoppage, \$ *43* for *Ordnance*

Due Gov't, \$ *100* for

Remarks:

*Stoppage of \$200 for trans-
portation furnished*

Book mark:

M. E. Meary
Coyt.

B

11 (New). U.S.C.T.

John Burnett
Corp H, 11 Reg't U. S. Col'd Inf. (New).

Appears on Co. Muster-out Roll, dated
Memphis Tenn Jan 12, 1866.

Muster-out to date June 12, 1866.

Last paid to June 30, 1866.

Clothing account:

Last settled _____, 186 ; drawn since \$ 100

Due soldier \$ 20 90¹⁰⁰; due U. S. \$ 100

Am't for cloth'g in kind or money adv'd \$ 100

Due U. S. for arms, equipments, &c., \$ 43¹⁰⁰

Bounty paid \$ 100; due \$ 100

Remarks:

Stopage of \$2.00 for transp-
-ortation furnished 1st
-installment of Bounty due \$100

Book mark:

W. E. Creamy
Copyist.

226

Burnett Joseph

Co H, 11 U.S. Col'd Inf.

(New Organization.)

Private

Corporal

CARD NUMBERS.

1	6332004	26
2	6332103	27
3	6332185	28
4	6332263	29
5	6332326	30
6	6332389	31
7	6332446	32
8	6332582	33
9	6332664	34
10	6332639	35
11	6332711	36
12	6332777	37
13	6332843	38
14	9072294	39
15		40
16		41
17		42
18		43
19		44
20		45
21		46
22		47
23		48
24		49
25		50

Book Mark:

See also

Ø 1310432 P0 m + m

D | **11 (New) U.S.C.T.**

Joseph Burnett
....., Co. *H*, **11 Reg't U.S. Col'd Inf.** *(New)*

Appears on
Company Descriptive Book
of the organization named above.

DESCRIPTION.

Age *40* years height *5* feet *9 1/2* inches.
Complexion *Black*
Eyes; *Black* hair *Black*
Where born *Susumbia Ala*
Occupation *farmer*

ENLISTMENT.

When *Feb 24*, 186 *7*
Where *Memphis Tenn*
By whom *J. M. Raven*; term *3* y'rs.

Remarks:
.....
.....
.....
.....
.....

J. E. Purke

(9)

11 (New).

U.S.C.T.

Joseph Burnett

(Pt.) Co. H, 6 Reg't U. S. Col'd H. Art'y.*

Appears on

Battery Muster-in and Descriptive Roll

of the organization named above. Roll dated

Memphis, Tenn. April 2, 1864.

Where born Tusculum, Ala.

Age 40 y'rs; occupation Farmer

When enlisted Feb. 24, 1864.

Where enlisted Memphis, Tenn.

For what period enlisted 3 years.

Eyes Blk; hair Blk

Complexion Blk; height 5 ft. 7 1/2 in.

When mustered in Feb. 24, 1864.

Where mustered in Memphis, Tenn.

Bounty paid \$ 100; due \$ 100

Where credited

Battery to which assigned

Remarks:

* This organization subsequently became Co. H, 11 Reg't U. S. Colored Infantry (New).

Book mark:

(356g)

Wagner

Copyist.

Q

11 (New). U.S.C.T.

Joseph Summitt
P.M.

, Co. H, 6 Reg't U. S. Col'd H. Art'y.*

Appears on

Company Muster Roll

for 2^d to 30th Apl, 1864.

Present or absent Present.

Stoppage, \$ 100 for

Due Gov't, \$ 100 for

Remarks:

*This organization subsequently became Co. H, 11 Reg't U. S. Col'd Infantry (New).

Book mark:

Wagner

C

11 (New).

U.S.C.T.

Joseph Burnett

Pvt., Co. H, 7 Reg't U. S. Col'd H. Art'y.*

Appears on

Company Muster Roll

for *May 7 June*, 1864.

Present or absent *Present*

Stoppage, \$ *100* for

Due Gov't, \$ *100* for

Remarks:

*This organization subsequently became Co. H, 11 Reg't U. S. Col'd Infantry (New).

Book mark:

J.A. Wagner

9

11 (New).

U.S.C.T.

Joseph Burnett
Cvt., Co. H, 7 Reg't U. S. Col'd H. Art'y.*

Appears on

Company Muster Roll

for July & Aug., 1864.

Present or absent Present.

Stoppage, \$ 100 for

Due Gov't, \$ 100 for

Remarks:

*This organization subsequently became Co. H, 11 Reg't U. S. Col'd Infantry (New).

Book mark:

Wagner

B

11 (New).

U.S.C.T.

Joseph Burnett
AW

, Co. H, 7 Reg't U. S. Col'd H. Art'y.*

Appears on

Company Muster Roll

for *Sept & Oct.*, 186 *4*

Present or absent *Present.*

Stoppage, \$ *100* for

Due Gov't, \$ *100* for

Remarks:

*This organization subsequently became Co. H, 11 Reg't U. S. Col'd Infantry (New).

Book mark:

J. H. Wagner

(9)

11 (New).

U.S.C.T.

Joseph O. Bennett
Pvt.

, Co. H, 7 Reg't U. S. Col'd H. Art'y.*

Appears on

Company Muster Roll

for *Nov. & Dec.*, 1864.

Present or absent *Present.*

Stoppage, \$ *100* for

Due Gov't, \$ *100* for

Remarks:

*This organization subsequently became Co. H, 11 Reg't U. S. Col'd Infantry (New).

Book mark:

J. H. W. Agnew
Copyist

B. | 11 (New). | U.S.C.T.

Joseph Bennett
M., H, 11 Reg't U. S. Col'd Inf. (New).

Appears on

Company Muster Roll

for *Jan. & Feb.*, 186 5.

Present or absent *Present*

Stoppage, \$ *100* for

Due Gov't, \$ *100* for

Remarks:

Book mark:

Hausling

B. | 11 (New). | U.S.C.T.

Joseph Burnett
Pot., H, 11 Reg't U. S. Col'd Inf. (New).

Appears on

Company Muster Roll

for Mar. & Apr., 1865.

Present or absent Present

Stoppage, \$ 100 for _____

Due Gov't, \$ 100 for _____

Remarks: _____

Book mark: _____

(858)

Maestling
Copyist.

B. | 11 (New). | U.S.C.T.

Joseph Burnett
Co., H, 11 Reg't U. S. Col'd Inf. (New).

Appears on

Company Muster Roll

for *May & June*, 186*5*.

Present or absent *Present*

Stoppage, \$ *100* for

Due Gov't, \$ *100* for

Remarks:

Book mark:

Kearney

B. | 11 (New). | U.S.C.T.

Joseph Burnett
Vol., H, 11 Reg't U. S. Col'd Inf. (New).

Appears on

Company Muster Roll

for *July & Aug*, 186 *5*.

Present or absent *Present*

Stoppage, \$ *100* for

Due Gov't, \$ *100* for

Remarks:

Book mark:

Hawthorn

B. | 11 (New). | U.S.C.T.

Joseph Burnett
Co., H, 11 Reg't U. S. Col'd Inf. (New).

Appears on

Company Muster Roll

for Sept. & Oct., 1865.

Present or absent Present

Stoppage, \$ 100 for

Due Gov't, \$ 100 for

Remarks:

Book mark:

Hawesling

B

11 (New).

U.S.C.T.

Joseph Burnett
Corp, H, 11 Reg't U. S. Col'd Inf. (New).

Appears on

Company Muster Roll

for Nov & Dec, 1865.

Present or absent Present

Stoppage, \$ 100 for

Due Gov't, \$ 100 for

Remarks:

Book mark:

(858)

McMurry
Copyist.

B

11 (New). U.S.C.T.

Joseph Burnett
Corp, H, 11 Reg't U. S. Col'd Inf. (New).

Appears on Co. Muster-out Roll, dated
Memphis News Jan 12, 1866.

Muster-out to date Jan 12, 1866.

Last paid to June 30, 1865.

Clothing account:

Last settled....., 186 ; drawn since \$..... 100

Due soldier \$..... 100; due U. S. \$ 4 78 100

Am't for cloth'g in kind or money adv'd \$..... 100

Due U. S. for arms, equipments, &c., \$..... 100

Bounty paid \$..... 100; due \$..... 100

Remarks:

Appointed from Pvt Nov 1/65

Book mark N. 23 P 227. 68.

(361)

M. E. Meany
Copyist.

227

Burns, William

Co H, 11 U.S. Col'd Inf.

(New Organization.)

Private

Private

CARD NUMBERS.

1	6332002	26
2	6332171	27
3	6332154	28
4	6332930	29
5	9072291	30
6		31
7		32
8		33
9		34
10		35
11		36
12		37
13		38
14		39
15		40
16		41
17		42
18		43
19		44
20		45
21		46
22		47
23		48
24		49
25		50

Book Mark:

See also

Co | **11** *(new)* **U.S.C.T.**

William Oliver
(new)
Co *H* 11 Reg't U.S. Col'd Inf.

Appears on
Company Descriptive Book
of the organization named above.

DESCRIPTION.

Age *18* years height *5* feet *4* inches.

Complexion *Black*

Eyes; *Black* hair *Black*

Where born *Memphis Tenn*

Occupation *farmer*

ENLISTMENT.

When *Feb 24*, 186*4*.

Where *Memphis Tenn*

By whom *J. M. Raven* term *3* y'rs.

Remarks: *Deserted from*
Fort Pickens Tenn,
April 27th 1864

J. E. Purke

9

11 (New).

U.S.C.T.

William Burns

Pvt., Co. H, 6 Reg't U. S. Col'd H. Art'y.*

Appears on

Company Muster Roll

for 2^d to 30th Apl., 1864.

Present or absent

Stoppage, \$ 100 for

Due Gov't, \$ 100 for

Remarks Deserted from Pt.
Pickering Tenn April 26 1864

*This organization subsequently became Co. H, 11 Reg't U. S. Col'd Infantry (New).

Book mark :

(358)

Wagner

Copyist.

B | 11/16/64 U.S.C.T.

William Burns
Pvt, Co. H, 11 (6 U.S.C.H.A.) (new)
Reg't U. S. Col'd Infantry

Appears on

Descriptive List of Deserters
Ft. Pickering
dated *Memphis Tenn. April 30*, 1864.

Deserted:

When *April 22*, 1864.

Where *Ft. Pickering*

Arrested:

When _____, 186 .

Where _____

Remarks: _____

Book mark: _____

(351)

W. H. Bogan Copyist.

B

11 (New). U.S.C.T.

William Burns
Co. H, 11 Reg't U. S. Col'd Inf. (New).

Appears on Co. Muster-out Roll, dated
Memphis Tenn Jan 12, 1866.

Muster-out to date _____, 186 .

Last paid to _____, 186 .

Pay due from Enrollment

Clothing account:

Last settled _____, 186 ; drawn since \$ _____ 100

Due soldier \$ _____ 100; due U. S. \$ _____ 100

Am't for cloth'g in kind or money adv'd \$ _____ 100

Due U. S. for arms, equipments, &c., \$ _____ 100

Bounty paid \$ _____ 100; due \$ _____ 100

Remarks:

Deserted from F. McKerny
Apr 22/64

Book mark : _____

(361)

M. E. Bueary
Copyist.

228

Buttson, Albert

Co I, 11 U.S. Col'd Inf.

Private

CARD NUMBERS.

1	26
2	27
3	28
4	29
5	30
6	31
7	32
8	33
9	34
10	35
11	36
12	37
13	38
14	39
15	40
16	41
17	42
18	43
19	44
20	45
21	46
22	47
23	48
24	49
25	50

Book Mark:

See also

229 martin
Caffee, Marton

Co B, 11 U.S. Col'd Inf.

(New Organization.)

Private Private

CARD NUMBERS.

1	6324975	26
2	6325059	27
3	6325215	28
4	6323125	29
5	6325-5-45	30
6	6325-629	31
7	6325-663	32
8	6325-705	33
9	6325-764	34
10	6325-827	35
11	6325-899	36
12	6325-978	37
13	6326047	38
14	6326143	39
15	6326302	40
16	9091053	41
17		42
18		43
19		44
20		45
21		46
22		47
23		48
24		49
25		50

Book Mark:

See also

11

11 (New) U.S.C.T.

Martin Kupper

(New)
Co. 11, 11 Reg't U. S. Col'd Inf.

Appears on

Company Descriptive Book

of the organization named above.

DESCRIPTION.

Age 20 years; height 5 feet 8 inches.

Complexion Fair

Eyes Blue; hair Blue

Where born Unknown

Occupation Soldier

ENLISTMENT.

When July 4, 1865

Where Corinth Miss

By whom Capt Baker; term 3 y'rs.

Remarks: Died at Fort Hospital Fort
Corinth Miss Dec 16 1865 of
Inflammation of the lungs

Fairley

6 | 11 (New). | U.S.C.T.

Marion Coates

Priv., Co. B, 1 Battalion Ala. Siege Art'y.*

Age 23 years.

Appears on

Company Muster-in Roll

of the organization named above. Roll dated

Comdt. Miss Aug 20, 1863.

Muster-in to date Aug 20, 1863.

Joined for duty and enrolled:

When July 14, 1863.

Where Comdt. Miss

Period 3 years.

Remarks:

* This organization subsequently became Co. B, 11 Reg't U. S. Colored Infantry (New).

Book mark:

J. S. [Signature]

6 | 11 (New). | U.S.C.T.

Morton Coffee

Prin, Co. B, 1 Reg't Ala. Siege Art'y.*

Appears on

Company Muster Roll

for from Enlistment to Aug 31, 1863.

Present or absent Present

Stoppage, \$ 100 for

Due Gov't, \$ 100 for

Remarks:

* This organization subsequently became Co. B, 11 Reg't U. S. Col'd Infantry (New).

Book mark:

[Signature]

X | 11 (New). | U.S.C.T.

Morton Coffee
Pvt., Co. B, 1 Reg't Ala. Siege Art'y.*

Appears on

Company Muster Roll

for Sept & Oct, 1863.

Present or absent

Stoppage, \$ 100 for

Due Gov't, \$ 100 for

Remarks: Deserted at
Cormick Mills
Oct 4' 1863

Filed with Morton Coffee
next appears on Roll for
May & June 1864

* This organization subsequently became Co. B, 11 Reg't U.S. Col'd Infantry (New).

Book mark:

J. A. Leonard

6 | 11 New U.S.C.T.

Morton Caffu
Pvt, Co. B 11 Reg't U. S. Col'd Infantry (new)

Appears on

Descriptive List of Deserters

dated Corinth Miss. Nov. 30, 1863.

Deserted:

When Oct. 4, 1863.

Where Corinth Miss.

Arrested:

When _____, 186 .

Where _____

Remarks: _____

Book mark: _____

(351)

W. H. Bogan

Copyist.

No

11 (New)

U.S.C.T.

Martin Kaffu

Co. B, 7 Reg't U. S. Col'd H. Art'y.*

Appears on

Company Muster Roll

for May and June, 1864.

Present or absent Present.

Stoppage, \$ 100 for

Due Gov't, \$ 100 for

Remarks: Taken up from
desertion Apr. 11, '64.

*This organization subsequently became Co. B, 11 Reg't U. S. Col'd
Infantry (New).

Book mark:

H. O. Gilbert

No | **11** (New) | **U.S.C.T.**

Martin Kaffre
Co., Co. B, 7 Reg't U. S. Col'd H. Art'y.*

Appears on

Company Muster Roll

for *July and Aug.*, 1864.

Present or absent *Absent.*

Stoppage, \$ *100* for

Due Gov't, \$ *100* for

Remarks: *In confinement.*
All pay proper stop-
ped to May 1, '64 by
sentence of Gen. Court
Martial.

*This organization subsequently became Co. B, 11 Reg't U. S. Col'd Infantry (New).

Book mark:

H. O. Gilbert

No. | **11** (New) | **U.S.C.T.**

Martin Kasse
Private, Co. B, 7 Reg't U. S. Col'd H. Art'y.*

Appears on

Company Muster Roll

for *Sept. and Oct.*, 1864.

Present or absent *Absent.*

Stoppage, \$ 100 for

Due Gov't, \$ 100 for

Remarks: *In confinement
all pay proper stop-
ped to May, '64 by
sentence of Genl. C.M.*

*This organization subsequently became Co. B, 11 Reg't U. S. Col'd Infantry (New).

Book mark:

H. O'Gilbert

K 11 (New) U.S.C.T.

Martin Kaffre
Pr., Co. B, 7 Reg't U. S. Col'd H. Art'y.*

Appears on

Company Muster Roll

for *Nov. and Dec.*, 186*4*.

Present or absent *Present.*

Stoppage, \$ *100* for

Due Gov't, \$ *100* for

Remarks: *All pay proper stopped to May 1, '64 by sentence of Gen. Court Martial.*

*This organization subsequently became Co. B, 11 Reg't U. S. Col'd Infantry (New).

Book mark:

A. O. Gilbert

K | **11 (New).** | **U.S.C.T.**

Martin Koffee

Pvt, Co. B, 11 Reg't U. S. Col'd Inf. (New).

Appears on

Company Muster Roll

for *Jan & Feb*, 1865.

Present or absent *Present*

Stoppage, \$ *100* for

Due Gov't, \$ *100* for

Remarks: *All pay proper
stopped to May 1st
1864 by sentence
of Gen. Court Mar-
tial*

Book mark :

W. W. Sayre

K | 11 (New). | U.S.C.T.

Martin Koffee
Pvt, Co. B, 11 Reg't U. S. Col'd Inf. (New).

Appears on

Company Muster Roll

for *Moh Cape*, 1865.

Present or absent *Present*

Stoppage, \$ 100 for

Due Gov't, \$ 100 for

Remarks: *Stop for 2 over-coat straps 12 cts*

Book mark :

W. Wrayne

K

11 (New). U.S.C.T.

Martin Kaffee

Pr, Co. B, 11 Reg't U. S. Col'd Inf. (New).

Appears on

Company Muster Roll

for (May of June), 1865.

Present or absent Present

Stoppage, \$ 100 for

Due Gov't, \$ 12/100 for Cage

Remarks :

Book mark :

(358)

W. W. Sawyer

Copyist.

K | 11 (New). | U.S.C.T.

Martin Kaffee
Pvt, Co. B, 11 Reg't U. S. Col'd Inf. (New).

Appears on

Company Muster Roll

for July & Aug, 1865.

Present or absent

Absent

Stoppage, \$ 100 for

Due Gov't, \$ 100 for

Remarks:

Absent in arrest
in Irving Block, Mem-
phis, Tenn.

Book mark :

W. A. Payne
Copyist.

H | **11** (New). | **U.S.C.T.**

Martin Kaffer
Pvt, Co. B, 11 Reg't U. S. Col'd Inf. (New).

Appears on

Company Muster Roll

for *Sept 1st*, 186*4*.

Present or absent *absent*

Stoppage, \$ *100* for

Due Gov't, \$ *100* for

Remarks: *On confinement at Fort Pickens, Military Prison.*

Book mark:

Murphy

K | 11 (New). | **U.S.C.T.**

Martin Kaffer
Pvt, Co. B, 11 Reg't U. S. Col'd Inf. (New).

Appears on

Company Muster Roll

for Nov. to Dec., 1865.

Present or absent

Stoppage, \$ 100 for

Due Gov't, \$ 100 for

Remarks: Died at General Hospital, Memphis Tenn.

Book mark: Died Dec. 16/65. C.R. 205-121559

Murphy

K 11 (new) | U.S.C.T.

Martin Kaffe

Priv., Co. B, 11 Reg't U. S. Col'd

Appears on Co. Muster-out Roll, dated
Memphis Tenn, Jan 12, 1866

Muster-out to date _____, 186

Last paid to Feb 28, 1865

Clothing account:

Last settled _____, 186 ; drawn since \$ 100

Due soldier \$ 100; due U. S. \$ 100

Am't for cloth'g in kind or money adv'd \$ 100

Due U. S. for arms, equipments, &c., \$ 100

Bounty paid \$ 100; due \$ 100

Remarks: Died at Memphis Tenn
Dec 16, 1865

Book mark: 121, 559 P.S.

(361)

Murphy

Copyist.

Kappe, Martin

D, Co. D

// Reg't U.S. Inf.

7

Enclosures.

Bed Cards	Final Statements	2
Burial Records	Furloughs or L. of A	
Certs. of Dis. for Discharge	Med. Certificates	
C. M. Charges	Med. Des. Lists	
Descriptive Lists	Orders	/
Discharge Certificates	Pris. of War Record	
Enlistment Papers	Resignations	

Other papers relating to—

Admission to Hosp'l	Furlough or L. of A	
Casualty Sheet	Med. Examination	/
Confinement	Misc. Information	/
Contracts	Pay or Clothing	
Death or Effects	Personal Reports	2
Desertion	Rank	
Discharge from Hosp'l	Transfer to Hosp'l	
Discharge from Service	Transfer to V. R. C.	
Duty	Transportation	

Coffey, Martin

P. B.

Adm. to H.

7

SPECIAL ORDERS,
No. 310.

HEAD-QUARTERS,
DISTRICT OF WEST TENNESSEE,
Memphis Tenn. December 15th, 1865.

[Extract.]

* * * * *

2 On the recommendation of J. N. Sharp, Acting Assistant Surgeon,
the following named prisoner at Fort Pickering, will be admitted to the
Post Hospital for treatment:

Private Martin Coffy, Company "B," 11th U. S. colored Infantry.

* * * * *

BY ORDER OF BREVET MAJOR GENERAL J. E. SMITH,

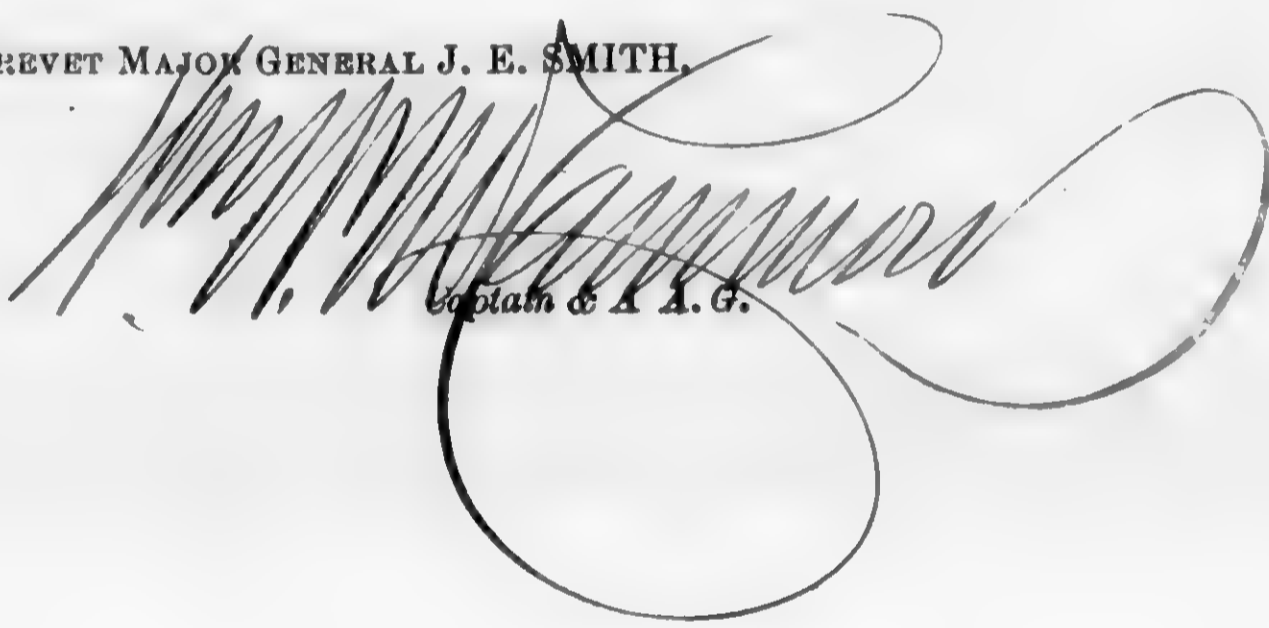

John E. Smith
Captain & A. A. G.

Comdy. Officer 2073

Info. sent for to G. C. Feb 2/87

CASUALTY SHEET, See No. 5-2
partisan

No.

Martin Coffee

Priv of Company "B"

11th Regiment of U.S. Troops

State Volunteers.

NATURE OF CASUALTY.

.....

Cut on Rifle

CASUALTY SHEET.

Name: *Marthin Coffey*

Rank: *Private*

Company: *"B"*

Regiment: *11th*

Arm: *W. G. Troops*

State: _____

Nature of Casualty: _____

Death

CAUSE OF CASUALTY—(NAME OF DISEAS

Disease

BY WHOM DISCHARGED.

FROM WHAT SOURCE THIS INFORMATION WAS
OBTAINED.

Col. R. W. Goldens
10 Dec 31st 1865

DEGREE OF DISABILITY.

REMARKS.

BY WHOM CERTIFIED.

W. J. Schellor de Ruol
Major

DATE OF DISCHARGE, DEATH, &c.

Dec 16th 1865

PLACE OF DISCHARGE, DEATH, &c.

Memphis Tenn

B. D. Crook

Clerk.

(119)

Miss Chief Musty Office
Memphis
Tenn

Extract from Act of Congress.

SEC. 12. *And be it further enacted*, That the fees of agents and attorneys for making out and causing to be executed the papers necessary to establish a claim for a pension, bounty, and other allowance before the Pension Office, under this act, shall not exceed the following rates: For making out and causing to be duly executed a declaration by the applicant, with the necessary affidavits, and forwarding the same to the Pension Office, with the requisite correspondence, ten dollars; which sum shall be received by such agent or attorney in full for all services in obtaining such pension, and shall not be demanded or received, in whole or in part, until such pension shall be obtained; and the sixth and seventh sections of an act entitled "An act to grant pensions," approved July [fourteenth,] eighteen hundred and sixty-two, are hereby repealed.

SEC. 13. *And be it further enacted*, That any agent or attorney who shall, directly or indirectly, demand or receive any greater compensation for his services under this act than is prescribed in the preceding section of this act, or who shall contract or agree to prosecute any claim for a pension, bounty, or other allowance under this act, on the condition that he shall receive a per centum upon any portion of the amount of such claim, or who shall wrongfully withhold from a pensioner or other claimant the whole or any part of the pension or claim allowed and due to such pensioner or claimant, shall be deemed guilty of a high misdemeanor, and, upon conviction thereof, shall, for every such offense, be fined not exceeding three hundred dollars, or imprisoned at hard labor not exceeding two years, or both, according to the circumstances and aggravations of the offense.

Approved July 4, 1864.

NOTE. 10.—If any soldier is charged a higher fee than that allowed by the above act, he should report the fact and the name of the agent to the Adjutant General, in order that steps may be taken to have the same refunded.

1865 FINAL STATEMENT 62

OF

Charles Kaffer
Reg't of 1st Reg't of
VOLUNTEERS.

NOTE 1.—Two of these certificates (or duplicates) are to be given to each Volunteer Soldier or drafted man who may be discharged without being mustered out (Final Statements are never given to men mustered out of service) that he may at once receive from the Paymaster the pay, &c., due to him, and the captain or other COMMISSIONED officer commanding the company will certify to the act of the delivery of the duplicate certificates; with these certificates the Soldier is "entitled to" his discharge, and should also present his discharge to the Paymaster to have the payment endorsed on it. The discharge is to be given back to the Soldier by the Paymaster; the latter only retaining as his vouchers the duplicate certificates.

NOTE 2.—If the Soldier is entitled to pay for the use of his horse, the Company Commander will certify to that fact on the back of both these final statements, and also to the time he has pay due for having been so mounted on his own horse.

NOTE 3.—When a Soldier is furnished with final statements, his descriptive list, if he has one, should be taken up by the officer who gives the Soldier these statements, and endorsed with a statement to this effect by the officer. The endorsement should exhibit a full statement of the time for which the Soldier was allowed pay on his final statements, the clothing account, and all other charges against him or in his favor, so as to comprise a complete exhibit of his account. It will then be transmitted to the Company Commander of the Soldier, who will enter all the data necessary to a full understanding of the Soldier's account on the muster roll upon which the Soldier's discharge is reported. The descriptive list will then be destroyed. The object of this is, that the remaining portion of the Soldier's account may be settled upon the receipt of these muster rolls, and the Soldier receive any pay or allowances that may be due him at the time of his discharge, and which may not appear on his last final statements from the fact that his descriptive list is incomplete. These accounts for back pay, &c., are settled by the 2d Auditor of the Treasury Department.

NOTE 4.—Charges for loss or injury to ordnance, horse equipments, and other miscellaneous charges, should appear under the heading of "Other Stoppages."

NOTE 5.—Bounty paid by State authorities, and not by the United States, will not be entered on this statement.

NOTE 6.—Amounts due the Sutler and Laundress must be entered on the muster roll on which the discharge, death, desertion, &c., is reported, as well as on the final statement, otherwise the amount cannot be collected from the United States.

NOTE 7.—This blank will be used for deceased volunteers and drafted men, as well as for others.

NOTE 8.—Where a Soldier dies in Hospital or on detached service, his descriptive list, if he has one, should be sent with his final statements, in duplicate, to the Adjutant General, Washington, D. C.

NOTE 9.—If the soldier is a drafted man or substitute, the space for time, &c., of enrolled, should contain only the word *drafted* or *substitute*, as the case may be. If the Soldier is a "VETERAN," (OR RECRUIT,) the words *as a veteran*, (or *recruit*.) as the case may be, should be interlined after the words *mustered into the service of the U. S.* A statement of all the installments of *Veteran or Recruit Bounty RECEIVED* by the Soldier must be made on the back of each final statement.

I certify, on honor, that Charles Kaffer, a Private of
 Captain Wm. W. May Company (B) of the 11th Regiment of W.C. Kelly
Volunteers, of the State of _____, born in _____ State
 of _____, aged _____ years; _____ feet _____ inches high; Black complexion,
Black eyes, Black hair, and by occupation a Laborer, who joined for service
 and was enrolled (see Note 9) on the 4th day of July, 1863, at base of ship
 by Captain Baker, for the period of Three years, and mustered into
 the service of the United States on the fourth day of August, 1863, at
base of ship, by Sgt. Hoffman; and having served
HONESTLY and **FAITHFULLY** with his Company to the present date, is now entitled to a
DISCHARGE by reason of Death, having died at Post Hospital
December 16th 1865 of Inflammation of the Lungs

The said Private Charles Kaffer was last paid by Paymaster
Wm. W. May, to include the 25th day of February, 1865, and
 has pay due him from that time to the present date; he is entitled to pay and subsistence for
TRAVELING to place of enrollment, and whatever other allowances are authorized to volunteer
 soldiers, drafted men, or militia, so discharged. He has received from the United States **CLOTHING**
 amounting to Twenty four ⁵⁰/₁₀₀ dollars, since the 25th day of February,
 1865, when his clothing account was last settled. He has received from the United States
 _____ ¹⁰⁰/₁₀₀ dollars advanced **BOUNTY**.

There is to be stopped from him, on account of the State of _____, or other
 authorities, for **CLOTHING**, &c., received on entering service, _____ ¹⁰⁰/₁₀₀ dollars; and
 for other stoppages, viz: _____

_____ ¹⁰⁰/₁₀₀ dollars.
 He has been furnished with **TRANSPORTATION** in kind from the place of his discharge to
 _____; and he has been **Subsisted** for **Traveling** to his
 place of enrollment, up to the _____, 1865.

He is indebted to S. M. Catchon, **Sutler**, Twenty ²/₁₀₀ dollars.
 He is indebted to _____ **Laundress**, _____ ¹⁰⁰/₁₀₀ dollars.

Given in Duplicate, at Chaplin's Linn, this 16th day
 of December, 1865.

Wm. W. May
Capt. W. C. Kelly
 Commanding Company.

Inventory of the effects of
 Company Regiment
 who died in the General Hospital
 , 186.....

CAPS	BLANKETS
OVERCOATS	CANTEENS
JACKETS	HAVERSACKS
TROUSERS	MUSKETS
SHIRTS	BAYONETS
DRAWERS	CARTRIDGE BOX
BOOTS, pairs	BELT
SHOES, pairs	MONEY
STOCKINGS	

*Recd from Dir of Discontinued
 Commands*

Filed Sept 16, 1875

INVENTORY

OF THE EFFECTS OF

Martin Blake

Late of Company B, 11th Regiment
M. C. Kelly, who died
 at *Chickadee* General
 Hospital December 16th

1865.

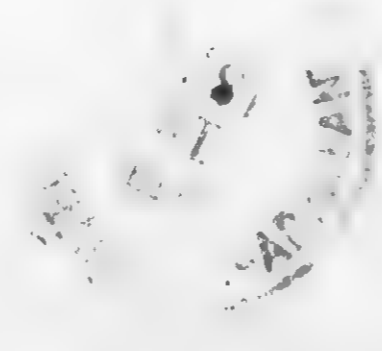

Office ^{Post} U. S. Army General Hospital,
Fort Pickens Tenn. December 16th, 1865.

Commanding Officer, Company, 'B'
11th Regiment U.S. Infantry

I have to inform you
that Martin Coffy Private of your Company died in this
Hospital on the 16th inst of
Inflammation of the lungs.

~~I enclose his Descriptive List, with Pay and Clothing Accounts,
and Inventory of his effects.~~

Very respectfully, yours, &c.,

A. D. Pinkens

Asst. Surgeon U. S. A. ^{Post} ~~General~~ Hospital
In charge of

I know nothing of deceased's effects or descrip-
tive list.

ARTICLES OF WAR.

ART. 95. When any non-commissioned officer or soldier shall die, or be killed in the service of the United States, the then commanding officer of the troop or company shall, in the presence of two other commissioned officers, take an account of what effects he died possessed of, above his arms and accoutrements, and transmit the same to the office of the Department of War, which said effects are to be accounted for, and paid to the representatives of such deceased non-commissioned officer or soldier. And in case any of the officers, so authorized to take care of the effects of deceased officers and soldiers, should, before they have accounted to their representatives for the same, have occasion to leave the regiment or post, by preferment or otherwise, they shall, before they be permitted to quit the same, deposit in the hands of the commanding officer, or of the assistant military agent, all the effects of such deceased non-commissioned officers and soldiers, in order that the same may be secured for, and paid to, their respective representatives.

DIRECTIONS.

NOTE. 1.—One copy of the inventories of the effects of deceased non-commissioned officers and soldiers, required by the 95th Article of War, will be forwarded to the Adjutant General, by the commander of the company to which the deceased belonged, and a duplicate of the same to the colonel of the regiment. Final statements of pay, clothing, &c., in duplicate, will be sent to the Adjutant General with one copy of the inventory. Both inventory and final statements should be forwarded, as a general rule, through Regimental Headquarters. When a soldier dies at a post or station absent from his company, it will be the duty of his immediate commander to furnish, direct to the Adjutant General, the required inventory and final statements, and, at the same time, to forward to the commanding officer of the company to which the soldier belonged, a report of his death, specifying the date, place, and cause; to what time he was last paid, and the money or other effects in his possession at the time of his decease; which report will be noted on the next muster roll of the company to which the man belonged. Each inventory will be endorsed, "Inventory of the effects of _____, late of company _____, regiment of _____, who died at _____, the _____ day of _____, 186-." If a legal representative receive the effects, it will be stated in the report. If the soldier leave no effects, the fact will be reported on the blank for inventory.

NOTE. 2.—Should the effects of a deceased non-commissioned officer or soldier not be administered upon within a short period after his decease, they shall be disposed of by a Council of Administration, under the authority of the commanding officer of the post, and the proceeds deposited with the Paymaster, to the credit of the United States, until they shall be claimed by the legal representatives of the deceased.

NOTE. 3.—In all such cases of sales by the Council of Administration, a statement in detail, or account of the proceeds duly certified by the Council and commanding officer, (Form 5,) accompanied by the Paymaster's receipt for the proceeds, will be forwarded by the commanding officer to the Adjutant General. The statement will be endorsed, "Report of the proceeds of the effects of _____, late of company _____, regiment of _____, who died at _____, the _____ day of _____, 186-."

NOTE. 4.—The effects in all cases, when called for, should be turned over to the legal representative, without further authority from the Adjutant General. When the effects are turned over to the relatives of the deceased before these inventories are sent to the Adjutant General, their receipts therefor should be attached to the inventories. In all other cases, one copy will be sent with a letter of transmittal direct to the Adjutant General, and a duplicate retained by the officer.

NOTE. 5.—Particular care should be taken to take receipts in duplicate from the Paymaster for any funds turned over to him; one copy should be sent direct to the Adjutant General and one retained by the officer.

INVENTORY OF THE EFFECTS

OF

Private Martin Kapp
 Late of Company B
 11th Reg't of *Mt. Light*
 Volunteers, who died at *Smith's Lea*
 on the 16th day of *December* 186-.



Inventory of the effects of Martin Kuffe late
 a Private of Captain Wm. S. [unclear] Company B of
 the 11th Regiment of M.C. Infantry Volunteers, who was enrolled as
 a Recruit at Leitchfield in the State of Mississippi on
 the fourth day of July 1863, and mustered into the service of the United
 States as a Recruit on the 20th day of August 1863, at Corinth Miss
 in Company B, 1st Regiment of Ala. Reg. Vol. Volunteers, to serve Three
 years or during the war; he was born in _____ in the State
 of _____; he was 5' years of age, _____ feet _____ inches
 high, black complexion, black eyes, black hair, and by occupation, when enrolled,
 a Sabotier; he died in Mad Hospital, at
Memphis Tenn on the 16th day of December 1865, by
 reason of Inflammation of the Lung

INVENTORY.

ARTICLES.	No.	ARTICLES.	No.	ARTICLES.	No.
Hats.....		Pairs trousers.....		Knapsacks.....	
Caps.....		Pairs flannel drawers.....			
Forage caps.....		Pairs cotton drawers.....			
Great coats.....		Flannel shirts.....			
Uniform coats.....		Cotton shirts.....			
Uniform jackets.....		Pairs boots.....			
Flannel sack coats.....		Pairs shoes.....			
Blouses.....		Pairs socks.....		MONEY.	Specie..... \$
Stable frocks.....		Blankets.....			Notes..... \$
Fatigue overalls.....		Haversacks.....			

I CERTIFY, ON HONOR, that the above inventory comprises all the effects of Private Martin Kuffe
"B" Co 11th M.C. Infantry, deceased, and that the effects are in the hands
as reported to me by the Surgeon in charge
 to be disposed of by a Council of Administration.

(DUPLICATES.)

STATION: Memphis Tenn
 DATE: December 19th 1865

Wm. S. [unclear]
Capt B Co 11th M.C. Infy
 Commanding the Company.

[OFFICE ENDORSEMENT.]

War Department,

ADJUTANT GENERAL'S OFFICE,

January 14, 1877

The death of *Private Martin Kaff*, Co. *C*, *11th* Reg't U. S. Colored *(see new)*, is reported as follows:

- On Company Muster Roll. For *Nov 16th*, 1865, *no date*, 186
- Company Muster-out Roll. *Dec 16th*, 1865
- Company Descriptive Book. 186
- Company Morning Reports. 186
- Soldier's Final Statement. *Dec 16th*, 1865
- Soldier's Record of Death and Interment. 186
- Soldier's Inventory of Effects. 186
- Soldier's Certificate of Disability for Discharge. 186
- Soldier's Individual Muster-out Roll. 186
- Regimental Return. For *Dec 16th*, 1865, *Dec 16th*, 1865
- Regimental Quarterly Returns *As per Soldier's Dec 16th*, 1865
- Regimental Descriptive Book. 186

By Surgeon General.

(*Dec 16*) 1865, is held to be the correct date, and the Company Muster Roll will be amended accordingly.

Thoma M. Sargent
See letter to *Adj. Auditor*
Adj. Auditor
January 31, 1877
Adj. Auditor

C. B.
FINAL STATEMENT *52*

OF

Private Martin Kaff C B
11th Reg't of *McPherson*

VOLUNTEERS.

NOTE 1.—Two of these certificates (or duplicates) are to be given to each Volunteer Soldier or drafted man who may be discharged without being mustered out (Final Statements are never given to men mustered out of service,) that he may at once receive from the Paymaster the pay, &c., due to him, and the captain or other COMMISSIONED officer commanding the company will certify to the act of the delivery of the duplicate certificates; with these certificates the Soldier is "entitled to" his discharge, and should also present his discharge to the Paymaster to have the payment endorsed on it. The discharge is to be given back to the Soldier by the Paymaster; the latter only retaining as his vouchers the duplicate certificates.

NOTE 2.—If the Soldier is entitled to pay for the use of his horse, the Company Commander will certify to that fact on the back of both these final statements, and also to the time he has pay due for having been so mounted on his own horse.

NOTE 3.—When a Soldier is furnished with final statements, his descriptive list, if he has one, should be taken up by the officer who gives the Soldier these statements, and endorsed with a statement to this effect by the officer. The endorsement should exhibit a full statement of the time for which the Soldier was allowed pay on his final statements, the clothing account, and all other charges against him or in his favor, so as to comprise a complete exhibit of his account. It will then be transmitted to the Company Commander of the Soldier, who will enter all the data necessary to a full understanding of the Soldier's account on the muster roll upon which the Soldier's discharge is reported. The descriptive list will then be destroyed. The object of this is, that the remaining portion of the Soldier's account may be settled upon the receipt of these muster rolls, and the Soldier receive any pay or allowances that may be due him at the time of his discharge, and which may not appear on his last final statements from the fact that his descriptive list is incomplete. These accounts for back pay, &c., are settled by the 2d Auditor of the Treasury Department.

NOTE 4.—Charges for loss or injury to ordnance, horse equipments, and other miscellaneous charges, should appear under the heading of "Other Stoppages."

NOTE 5.—Bounty paid by State authorities, and not by the United States, will not be entered on this statement.

NOTE 6.—Amounts due the Sutler and Laundress must be entered on the muster roll on which the discharge, death, desertion, &c., is reported, as well as on the final statement, otherwise the amount cannot be collected from the United States.

NOTE 7.—This blank will be used for deceased volunteers and drafted men, as well as for others.

NOTE 8.—Where a Soldier dies in Hospital or on detached service, his descriptive list, if he has one, should be sent with his final statements, in duplicate, to the Adjutant General, Washington, D. C.

NOTE 9.—If the soldier is a drafted man or substitute, the space for time, &c., of enrolled, should contain only the word *drafted* or *substitute*, as the case may be. If the Soldier is a "VETERAN," (or RECRUIT,) the words *as a veteran*, (or *recruit*,) as the case may be, should be interlined after the words *mustered into the service of the U. S.* A statement of all the installments of *Veteran or Recruit Bounty RECEIVED* by the Soldier must be made on the back of each final statement.

Out on office

6. B. 52
FINAL STATEMENT

OF

Private Martin Kalf C B
11th Reg't of N.Y. Infy

VOLUNTEERS.

NOTE 1.—Two of these certificates (or duplicates) are to be given to each Volunteer Soldier of drafted man who may be discharged without being mustered out (Final Statements are never given to men mustered out of service,) that he may at once receive from the Paymaster the pay, &c., due to him, and the captain or other COMMISSIONED officer commanding the company will certify to the act of the delivery of the duplicate certificates; with these certificates the Soldier is "entitled to" his discharge, and should also present his discharge to the Paymaster to have the payment endorsed on it. The discharge is to be given back to the Soldier by the Paymaster; the latter only retaining as his vouchers the duplicate certificates.

NOTE 2.—If the Soldier is entitled to pay for the use of his horse, the Company Commander will certify to that fact on the back of both these final statements, and also to the time he has pay due for having been so mounted on his own horse.

NOTE 3.—When a Soldier is furnished with final statements, his descriptive list, if he has one, should be taken up by the officer who gives the Soldier these statements, and endorsed with a statement to this effect by the officer. The endorsement should exhibit a full statement of the time for which the Soldier was allowed pay on his final statements, the clothing account, and all other charges against him or in his favor, so as to comprise a complete exhibit of his account. It will then be transmitted to the Company Commander of the Soldier, who will enter all the data necessary to a full understanding of the Soldier's account on the muster roll upon which the Soldier's discharge is reported. The descriptive list will then be destroyed. The object of this is, that the remaining portion of the Soldier's account may be settled upon the receipt of these muster rolls, and the Soldier receive any pay or allowances that may be due him at the time of his discharge, and which may not appear on his last final statements from the fact that his descriptive list is incomplete. These accounts for back pay, &c., are settled by the 2d Auditor of the Treasury Department.

NOTE 4.—Charges for loss or injury to ordnance, horse equipments, and other miscellaneous charges, should appear under the heading of "Other Stoppages."

NOTE 5.—Bounty paid by State authorities, and not by the United States, will not be entered on this statement.

NOTE 6.—Amounts due the Sutler and Laundress must be entered on the muster roll on which the discharge, death, desertion, &c., is reported, as well as on the final statement, otherwise the amount cannot be collected from the United States.

NOTE 7.—This blank will be used for deceased volunteers and drafted men, as well as for others.

NOTE 8.—Where a Soldier dies in Hospital or on detached service, his descriptive list, if he has one, should be sent with his final statements, in duplicate, to the Adjutant General, Washington, D. C.

NOTE 9.—If the soldier is a drafted man or substitute, the space for time, &c., of enrolled, should contain only the word *drafted* or *substitute*, as the case may be. If the Soldier is a "VETERAN," (or RECRUIT,) the words *as a veteran*, (or *recruit*,) as the case may be, should be interlined after the words *mustered into the service of the U. S.* A statement of all the installments of *Veteran or Recruit Bounty RECEIVED* by the Soldier must be made on the back of each final statement.

and attorneys for making out and causing to be executed the papers necessary to establish a claim for a pension, bounty, and other allowance before the Pension Office, under this act, shall not exceed the following rates: For making out and causing to be duly executed a declaration by the applicant, with the necessary affidavits, and forwarding the same to the Pension Office, with the requisite correspondence, ten dollars; which sum shall be received by such agent or attorney in full for all services in obtaining such pension, and shall not be demanded or received, in whole or in part, until such pension shall be obtained; and the sixth and seventh sections of an act entitled "An act to grant pensions," approved July [fourteenth,] eighteen hundred and sixty-two, are hereby repealed.

SEC. 13. *And be it further enacted,* That any agent or attorney who shall, directly or indirectly, demand or receive any greater compensation for his services under this act than is prescribed in the preceding section of this act, or who shall contract or agree to prosecute any claim for a pension, bounty, or other allowance under this act, on the condition that he shall receive a per centum upon any portion of the amount of such claim, or who shall wrongfully withhold from a pensioner or other claimant the whole or any part of the pension or claim allowed and due to such pensioner or claimant, shall be deemed guilty of a high misdemeanor, and, upon conviction thereof, shall, for every such offense, be fined not exceeding three hundred dollars, or imprisoned at hard labor not exceeding two years, or both, according to the circumstances and aggravations of the offense.

Approved July 4, 1864.

NOTE. 10.—If any soldier is charged a higher fee than that allowed by the above act, he should report the fact and the name of the agent to the Adjutant General, in order that steps may be taken to have the same refunded.

ADJUTANT GENERAL'S OFFICE

Dec 27th 1865

Duplicate with inventor sent 2d Auditor

Can be used after

I certify, on honor, that Martin Kaffer, a Private of
Captain Paul Whitney Company (B) of the 11th Regiment of Ill^o Infantry
Volunteers, of the State of _____, born in _____ State
of _____, aged _____ years; _____ feet _____ inches high; Blk complexion,
Blk eyes, Blk hair, and by occupation a Laborer, who joined for service
and was enrolled (see Note 9) on the 4th day of July, 1863, at Ceranto Miss
by Capt Baker, for the period of Three years, and mustered into
the service of the United States on the 20th day of August, 1863, at
Ceranto Miss, by Steffen; and having served
HONESTLY and **FAITHFULLY** with his Company to the present date, is now entitled to a
DISCHARGE by reason of being died in Post Hospital at Memphis Tenn
December 16th 1865 of inflammation of the Lung

The said Private Martin Kaffer was last paid by Paymaster
Whitney, to include the 25th day of February, 1865, and
has pay due him from that time to the present date; he is entitled to pay and subsistence for
TRAVELING to place of enrollment, and whatever other allowances are authorized to volunteer
soldiers, drafted men, or militia, so discharged. He has received from the United States **CLOTHING**
amounting to Twentyfour $\frac{50}{100}$ dollars, since the 28th day of February,
1865, when his clothing account was last settled. He has received from the United States
 $\frac{00}{100}$ dollars advanced **BOUNTY**.

There is to be stopped from him, on account of the State of _____, or other
authorities, for **CLOTHING**, &c., received on entering service, $\frac{00}{100}$ dollars; and
for other stoppages, viz: _____

_____ $\frac{00}{100}$ dollars.
He has been furnished with **TRANSPORTATION** in kind from the place of his discharge to
_____ ; and he has been **Subsisted** for **Traveling** to his
place of enrollment, up to the _____, 1865.

He is indebted to John Cutchman, **Sutler**, Twenty $\frac{00}{100}$ dollars.
He is indebted to _____ **Laundress**, $\frac{00}{100}$ dollars.
Given in Duplicate, at Memphis Tenn, this 16th day
of December, 1865.

Paul Whitney
Capt 11th Ill^o Infy
Commanding Company.

Martin Coffee or Kaffee

Det. Co. B. 11th USC. 7 (new)

Ellerbrook

Adjutant General's Office,

COLORED TROOPS BRANCH,

Mr Ellertson

July 16th, 1877

Vol. C. T., 187

Wanted in the case of Martin Coffee (Coffee) Pvt. Co. B,
11th Reg't U.S.C. Troops (new) 1st Record of trial - 2^d Cause of
Confinement and whether true - 1st "In confinement all pay & allowances
stopped to May 1st 64 by authority of Govt" - M.R. from June 30-64
to Oct 31-64 - 2nd "Absent in arrest in Irving Black Memphis Tenn -
& in confinement at Fort Pickering Mil Prison - M.R. rolls July 2 Aug
& Sept & Oct 1865 -"

Respectfully,

L. A. Woodward
Chief Clerk.
J. H. Dalton

Adjutant General's Office,

, 187

Vol. C. T., 187

Reply in case of _____, Co. _____

Reg't Hd Qrs Dist of Memphis
G.O. #27 - Memphis Tenn June 18/64.
9. Put Martin Coffee Co's B 7th arty Ky
Charge Desertion - "xxx did leave his company
on or about the 4 day of Oct 1863, at Corinth Miss.
xxx and did remain absent until taken up by the
Cavalry forces, near Memphis Tenn, on or about
Apr 11/64 -"

Verdict - Guilty.
Sentence - "xxx to forfeit all pay & allowances
(except the value of clothing drawn) due him before the
1st day of May 1864, and to be placed at hard labor in
Fort Pickering for the period of six months"
- approved

Register of Prisoners confined at Fort Pickering Tenn -
Martin Coffee, 7 arty Ky, Confined May 26/64,
date of release not

As shown Rept dated May 31/64, "Martin Coffee returned
to Co from desertion Apr 11/64"
Dec 5/64 "xxx released from confinement & for duty"

Hd Qrs Dist of Mem Tenn
G.O. #107 - Memphis Tenn Oct 25/65
11. Martin Coffey Co's B "11th arty Ky
Charge - Desertion - Verdict - Guilty -
"xxx to be confined at hard labor for the period of
four months, in Fort Pickering Mil
Prison, Memphis Tenn"
- approved

Register of Prisoners Pro near Memphis Tenn
Martin Coffey Co's B "11th U.S.C.T., Confined Aug 30/65
by Genl Smith, until further orders, sent to Fort
Pickering, for execution of sentence Oct 30/65 -"

Register of Prisoners confined at Fort Pickering Tenn,
Shows him confined Oct 25/65 for mutiny by G.O.
109, for 4 months, sentence expires Feb
30/66 - sent to Hospital Feb 23/66."

C.H.A. Jan 20/77

Respectfully returned for reexamination of "Register
of prisoners confined at Fort Pickens" as to date this man
was sent to Hospital - Records of this office show that
Martin Coffey "died in Post Hospital Fort Pickens
Dec 16th 1865 of Inflammation of the lungs"

Feb 3^d 1877 -

Respectfully

E. A. Woodward,

Sur J. S. Patton

to come as given
by Prison Register -

E. A. Woodward, Feb 9/77

Martin Coffey - Staffer

Art. Co. B. 11th Regt. C. I. (new)

Ellenbrook

230

Louison Hardin

Co A, 11 U.S. Col'd Inf.

(New Organization.)

Private

Private

CARD NUMBERS.

1		26
2		27
3	<i>Louison</i>	28 <i>Hardin</i>
4		29
5		30
6		31
7		32
8		33
9		34
10		35
11		36
12		37
13		38
14		39
15		40
16		41
17		42
18		43
19		44
20		45
21		46
22		47
23		48
24		49
25		50

Book Mark: *6-105-V-10-69-74*

See also

231

Baison Samuel

Co A, 11 U.S. Col'd Inf.

(New Organization.)

Private Private

CARD NUMBERS.

1		26
2		27
3	<i>Baison Samuel</i>	28
4		29
5		30
6		31
7		32
8		33
9		34
10		35
11		36
12		37
13		38
14		39
15		40
16		41
17		42
18		43
19		44
20		45
21		46
22		47
23		48
24		49
25		50

Book Mark:

See also

232)

Caldwell, Edward

Co B, 11 U.S. Col'd Inf.

(New Organization.)

Private

Corporal

CARD NUMBERS.

1	6325027	26
2	6325139	27
3	6325247	28
4	6325335	29
5	6325437	30
6	6325565	31
7	6326207	32
8	9070894	33
9	9070913	34
10	9071085	35
11		36
12		37
13		38
14		39
15		40
16		41
17		42
18		43
19		44
20		45
21		46
22		47
23		48
24		49
25		50

Book Mark:

See also

6

11 (New) U. S. C. T.

Edward Caldwell

Co. B, 11 Reg't U. S. Col'd Inf. (New)

Appears on
Company Descriptive Book
of the organization named above.

DESCRIPTION.

Age 20 years height 5 feet 8 inches.

Complexion Black

Eyes; Black hair Black

Where born Louisville Kentucky

Occupation Laborer

ENLISTMENT.

When July 4, 1863.

Where Louisville Miss.

By whom Baker; term 3 yrs.

Remarks: Missing in Action at
Fort Pillow Apr. 12 1864

A. Fairley

6 | 11th | U.S.C.T.

Edward Caldwell
....., Co. ^(New)....., 11 Reg't U.S. Col'd Inf.

Appears on

Company Descriptive Book

of the organization named above.

DESCRIPTION.

Age 20 years height 5 feet 8 inches.

Complexion Black

Eyes; Black hair Black

Where born Harrods Co. Kentucky

Occupation Laborer

ENLISTMENT.

When July 14, 1863.

Where Corinth, Miss.

By whom Baker; term 2 y'rs.

Remarks: Missing in action at Battle
of Fort Pillow April 12, 1864

A. Farley
Copyist.

6 | 11 (h.w) | U.S.C.T.

Edward Subwell
....., Co. K, 11 Reg't U.S. Col'd Inf. (h.w)

Appears on
Company Descriptive Book
of the organization named above.

DESCRIPTION.

Age 20 years height 5 feet 8 inches.

Complexion Black

Eyes; Black hair Black

Where born Perry Co. Kentucky

Occupation Laborer

ENLISTMENT.

When July 14, 1863.

Where Corinth Miss.

By whom Capt. Baker ; term 3 y'rs.

Remarks: Missing in action at Fort
Pelloue Tenn. April 12 1864 final
statements forwarded July 12 1864

Handley

Co. | 11 (New). | U.S.C.T.

Edward Caldwell

Priv., Co. B, 1 Reg't Ala. Siege Art'y.*

Age 20 years.

Appears on

Company Muster-in Roll

of the organization named above. Roll dated

Cornick, Miss, Sep 7, 1863.

Muster-in to date Sep 7, 1863

Joined for duty and enrolled:

When July 14, 1863.

Where Cornick, Miss.

Period 3 years.

Remarks:

* This organization subsequently became Co. B, 11 Reg't U. S. Colored Infantry (New).

Book mark:

Handwritten signature

11 (New). U.S.C.T.

Edward Caldwell

Co. B, 1 Reg't Ala. Siege Art'y.*

Appears on

Company Muster Roll

for September, 1863.

Present or absent Present

Stoppage, \$ 100 for

Due Gov't, \$ 100 for

Remarks:

* This organization subsequently became Co. B, 11 Reg't U.S. Col'd Infantry (New).

Book mark:

Copyist.

Lo | 11 (New). | U.S.C.T.

Edward Caldwell

Private, Co. B, 1 Reg't Ala. Siege Art'y.*

Appears on

Company Muster Roll

for Nov + Dec, 1863.

Present or absent Present

Stoppage, \$ 100 for

Due Gov't, \$ 100 for

Remarks:

* This organization subsequently became Co. B, 11 Reg't U.S. Col'd Infantry (New).

Book mark:

J. L. Leonard

11 (New). U.S.C.T.

Edward Caldwell
Capt, Co. B, 4 Battalion, 1 Reg't Tenn. H. Art'y.*

Appears on

Company Muster Roll
for Jan. and Feb., 1864.
Present or absent Present.

Stoppage, \$ 100 for

Due Gov't, \$ 100 for

Remarks: Promoted to Capt.
Feb. 29, '64.

*This organization subsequently became Co. B, 11 Reg't U. S. Col'd Infantry (New).

Book mark:

W. O. Gilbert

C | **11** (New). | **U.S.C.T.**

Edward Caldwell
Corpl., Co. B, 6 Reg't U. S. Col'd H. Art'y.*

Appears on

Company Muster Roll
for *Mch. and Apr.*, 186*4*.

Present or absent *Absent*

Stoppage, \$ *100* for

Due Gov't, \$ *100* for

Remarks: *Missing since
Battle of Ft. Pillow
Apr. 12/64.*

*This organization subsequently became Co. B, 11 Reg't U. S. Col'd Infantry (New).

Book mark: *162,652*

M. O'Gillich

6 | 11 (New) | U.S.C.T.

Edward Caldwell
Co. B, 7 Reg't U. S. Col'd H. Art'y.*

Appears on

Company Muster Roll

for *May and June*, 1864.

Present or absent

Stoppage, \$ 100 for

Due Gov't, \$ 100 for

Remarks: *Missing in ac-*
tion since Apr. 12,
'64 at Ft. Pillow, Tenn.

*This organization subsequently became Co. B, 11 Reg't U. S. Col'd Infantry (New).

Book mark:

N. O. Gilbert

C

11 (New). U.S.C.T.

Edward Caldwell

Cospl, B, 11 Reg't U. S. Col'd Inf. (New).

Appears on Co. Muster-out Roll, dated

Memphis Tenn, Jan 12, 1866 .

Muster-out to date _____, 186 .

Last paid to Dec 31, 1863 .

Clothing account:

Last settled _____, 186 ; drawn since \$ _____ 100

Due soldier \$ _____ 100 ; due U. S. \$ _____ 100

Am't for cloth'g in kind or money adv'd \$ _____ 100

Due U. S. for arms, equipments, &c., \$ _____ 100

Bounty paid \$ _____ 100 ; due \$ _____ 100

Remarks: Missing in action at
Port Pillow Tenn April 12
1864.

Book mark: 162, 652, V, 230, P, 48, 76 F.S.

(361)

Murphy

Copyist.

Caldwell, Edward

Cop^l Co. B, 11 Reg't U. S. Inf.

2 Enclosures.

Bed Cards	Descriptive Lists
Burial Records	Final Statements 2
Certs. of Dis. for Discharge	Furloughs
C. M. Charges	Med. Des. Lists
Med. Certificates	Orders

Other papers relating to—

Admission to Hosp'l	Furlough
Casualty Sheet (Officer's)	Med. Examination
Confinement	Misc. Information
Contracts	Pay or Clothing
Death or Effects	Personal Reports
Desertions	Rank
Discharge from Hosp'l	Transfer to Hosp'l
Discharge from Service	Transfer to V. R. C.
Duty	Transportation

Co. B *44*
✓
FINAL STATEMENT

OF
Co. B. Claude Williams, U.S.
7 Reg't of *U.S. Army*
7th U.S. Cavalry
VOLUNTEERS.
Discharge April 12, 1864

NOTE 1.—Two of these certificates (or duplicates) are to be given to each Volunteer Soldier or drafted man who may be discharged previously to the discharge of his company, that he may at once receive from the Paymaster the pay, &c., due him, and the captain or other COMMISSIONED officer commanding the company will certify to the act of the delivery of the duplicate certificates; on these certificates the Soldier is "entitled to" his discharge, and should also present his discharge to the Paymaster to have the payment endorsed on it. The discharge is to be given back to the Soldier by the Paymaster; the latter only retaining as his voucher the duplicate certificates.

NOTE 2.—If the Soldier is entitled to pay for the use of his horse, the Company Commander will certify to that fact on the back of both these final statements, and also to the time he has pay due for having been so mounted on his own horse.

NOTE 3.—When a Soldier is furnished with final statements, his descriptive list, if he has one, should be taken up by the officer who gives the Soldier these statements, and endorsed with a statement to this effect by the officer. This endorsement should exhibit a full statement of the time for which the Soldier was allowed pay on his final statements, the clothing account, and all other charges against him or in his favor, so as to comprise a complete exhibit of his account. It will then be transmitted to the company commander of the Soldier, who will enter all the data necessary to a full understanding of the Soldier's account on the muster roll upon which the Soldier's discharge is reported. The descriptive list will then be destroyed. The object of this is, that the remaining portion of the Soldier's account may be settled upon the receipt of these muster rolls, and the Soldier receive any pay or allowances that may be due him at the time of his discharge, and which may not appear on his final statements from the fact that his descriptive list is incomplete. These accounts for back pay, &c., are settled by the 2d Auditor of the Treasury Department.

NOTE 4.—Charges for loss or injury to ordnance, horse equipments, and other miscellaneous charges, should appear under the heading of "Other Stoppages."

NOTE 5.—Bounty paid by State authorities, and not by the United States, will not be entered on this statement.

NOTE 6.—Amounts due the Sutler and Laundress must be entered on the muster roll on which the discharge, death, desertion, &c., is reported, as well as on the final statement, otherwise the amount cannot be collected from the United States.

NOTE 7.—This blank will be used for deceased volunteers and drafted men, as well as for others.

NOTE 8.—Where a Soldier dies in Hospital or on detached service, his descriptive list, if he has one, should be sent with his final statements, in duplicate, to the Second Auditor, Washington, D. C.

ADJUTANT GENERAL'S OFFICE.
July 18th 1864
Duplicate with Inventory sent 2d Auditor.

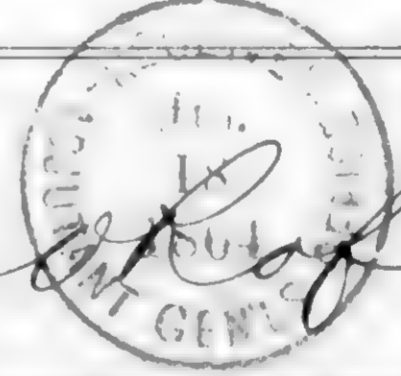
Emerson

I certify, on honor, that Edward Caldwell a Corporal of
 Captain Wm H. Gable Company (2) of the 7 Regiment of U.S.C. Art-Inf
VOLUNTEERS, of the State of _____, born in Homer Co, State
 of Kentucky, aged 20 years; 5 feet 8 inches high; Black complexion,
Black eyes, Black hair, and by occupation a Laborer, having joined the company on
 its original organization at Carruth Miss, and enrolled in it at the muster into
 the service of the United States at Carruth Miss, on the 7 day
 of Sept, 1863, (or was mustered in service as a recruit, by _____
 _____, at _____, on the _____ day of _____,
 186 , or was drafted and mustered into the service of the United States from the _____
 Enrollment District of the State of _____, at _____,
 on the _____ day of _____, 186), to serve in the Regiment, for
 the term of Three years: and having served **HONESTLY** and
FAITHFULLY with his Company in The field to the present date, is now
 entitled to a **DISCHARGE** by reason of Missing in action since
April 12-1864, supposed to have been killed

The said Capt. Edward Caldwell was last paid by Paymaster
Wm J. Dolman to include the 31st day of Dec, 1863, and has
 pay due him from that time to the present date; he is entitled to pay and subsistence for
TRAVELING to place of enrollment, and whatever other allowances are authorized to volunteer
 soldiers, drafted men, or militia, so discharged. He has received from the United States **CLOTHING**
 amounting to _____ dollars, since the _____ day of _____,
 186 , when his clothing account was last settled. He has received from the United States
 _____ dollars advanced **BOUNTY**.

There is to be stopped from him, on account of the State of _____, or other
 authorities, for **CLOTHING**, &c., received on entering service, _____ dollars; and
 for other stoppages, viz: Cannot give the amount of clothing drawn
the Company clothing lost at Fort Pillow from
April 12-1864, cannot procure any vouchers _____ dollars.

He has been furnished with **TRANSPORTATION** in kind from the place of his discharge to
 _____; and he has been **SUBSISTED** for **TRAVELING** to his
 place of enrollment, up to the _____, 186 .

He is indebted to _____, **SUTLER**, _____ dollars.
 He is indebted to _____, **LAUNDRESS**, _____ dollars.

Given in Duplicate, at Fort Henry Tenn, this 10 day
 of July, 1864

Wm H. Gable
2d Lt U.S.C. Art-Inf
 Commanding Company 2

[A. G. O. No. 95—First.]

Effects lost in battle at Fort Pillow

1864 Sep 26 M. 47
FINAL STATEMENT

OF

Capt Edward Paulding Co. B
7th Reg't of 150th Inf. Army

VOLUNTEERS.

NOTE 1.—Two of these certificates (or duplicates) are to be given to each Volunteer Soldier or drafted man who may be discharged previously to the discharge of his company, that he may at once receive from the Paymaster the pay, &c., due him, and the captain or other COMMISSIONED officer commanding the company will certify to the act of the delivery of the duplicate certificates; on these certificates the Soldier is "entitled to" his discharge, and should also present his discharge to the Paymaster to have the payment endorsed on it. The discharge is to be given back to the Soldier by the Paymaster; the latter only retaining as his voucher the duplicate certificates.

NOTE 2.—If the Soldier is entitled to pay for the use of his horse, the Company Commander will certify to that fact on the back of both these final statements, and also to the time he has pay due for having been so mounted on his own horse.

NOTE 3.—When a Soldier is furnished with final statements, his descriptive list, if he has one, should be taken up by the officer who gives the Soldier these statements, and endorsed with a statement to this effect by the officer. This endorsement should exhibit a full statement of the time for which the Soldier was allowed pay on his final statements, the clothing account, and all other charges against him or in his favor, so as to comprise a complete exhibit of his account. It will then be transmitted to the company commander of the Soldier, who will enter all the data necessary to a full understanding of the Soldier's account on the muster roll upon which the Soldier's discharge is reported. The descriptive list will then be destroyed. The object of this is, that the remaining portion of the Soldier's account may be settled upon the receipt of these muster rolls, and the Soldier receive any pay or allowances that may be due him at the time of his discharge, and which may not appear on his final statements from the fact that his descriptive list is incomplete. These accounts for back pay, &c., are settled by the 2d Auditor of the Treasury Department.

NOTE 4.—Charges for loss or injury to ordnance, horse equipments, and other miscellaneous charges, should appear under the heading of "Other Stoppages."

NOTE 5.—Bounty paid by State authorities, and not by the United States, will not be entered on this statement.

NOTE 6.—Amounts due the Sutler and Laundress must be entered on the muster roll on which the discharge, death, desertion, &c., is reported, as well as on the final statement, otherwise the amount cannot be collected from the United States.

NOTE 7.—This blank will be used for deceased volunteers and drafted men, as well as for others.

NOTE 8.—Where a Soldier dies in Hospital or on detached service, his descriptive list, if he has one, should be sent with his final statements, in duplicate, to the Second Auditor, Washington, D. C.

JUL 12 1871

I certify, on honor, that Edward Caldwell a corporal of
 Captain John H. Baker Company (2) of the 7 Regiment of U.S.C. Artillery
VOLUNTEERS, of the State of _____, born in Harvey Lee, State
 of Kentucky, aged 20 years; 5 feet 8 inches high; Black complexion,
Black eyes, Black hair, and by occupation a Laborer, having joined the company on
 its original organization at Cornith Miss, and enrolled in it at the muster into
 the service of the United States at Cornith Miss, on the 7th day
 of Sept, 1863, (or was mustered in service as a recruit, by _____
 _____, at _____, on the _____ day of _____,
 1863, or was drafted and mustered into the service of the United States from the _____
 Enrollment District of the State of _____, at _____,
 on the _____ day of _____, 1863;) to serve in the Regiment, for
 the term of Three years; and having served **HONESTLY** and
FAITHFULLY with his Company in The field to the present date, is now
 entitled to a **DISCHARGE** by reason of Wounding in action since April
12-1864 at Fort Pillow Tenn. supposed to have been killed

The said Edward Caldwell was last paid by Paymaster
Wm. Dolman to include the 31st day of Dec, 1863, and has
 pay due him from that time to the present date; he is entitled to pay and subsistence for
TRAVELING to place of enrollment, and whatever other allowances are authorized to volunteer
 soldiers, drafted men, or militia, so discharged. He has received from the United States **CLOTHING**
 amounting to _____ dollars, since the _____ day of _____,
 1863, when his clothing account was last settled. He has received from the United States
 _____ dollars advanced **BOUNTY**.

There is to be stopped from him, on account of the State of _____, or other
 authorities, for **CLOTHING**, &c., received on entering service, _____ dollars; and
 for other stoppages, viz: Cannot give the amount of clothing
drawn the Company Clothing book was lost at Ft Pillow
Tenn April 12-1864. Cannot procure any inventories _____ dollars.

He has been furnished with **TRANSPORTATION** in kind from the place of his discharge to
 _____; and he has been **SUBSISTED** for **TRAVELING** to his
 place of enrollment, up to the _____, 1863.

He is indebted to _____, **SUTLER**, _____ dollars.
 He is indebted to _____, **LAUNDRESS**, _____ dollars.

Given in Duplicate, at Fort Pickering Tenn, this 10 day
 of July, 1864

Walter H. Tipton

2^d Lieut 7th U.S.C. Artillery
 Commanding Company B.

[A. G. O. No. 95—First.]

Effects lost at Fort Pillow Tenn
April 12-1864

233

Campbell, John

Co A, 11 U.S. Col'd Inf.

(New Organization.)

Private

Private

CARD NUMBERS.

1	6323527	26
2	6323615	27
3	6323705	28
4	6323808	29
5	6323912	30
6	6324018	31
7	6324150	32
8	6324861	33
9	9070814	34
10	9070800	35
11		36
12		37
13		38
14		39
15		40
16		41
17		42
18		43
19		44
20		45
21		46
22		47
23		48
24		49
25		50

Book Mark:

See also

6 | **11 (New) U. S. C. T.**

John Campbell
....., Co. A, 11 Reg't U. S. Col'd Inf. ^(New)

Appears on
Company Descriptive Book
of the organization named above.

DESCRIPTION.

Age 19 years height feet inches.

Complexion Blk

Eyes; Blk hair Blk

Where born

Occupation

ENLISTMENT.

When June 16, 1863.

Where Corinth Miss

By whom Lt. Bischoff; term 3 y'rs.

Remarks: Wiping after battle
at Fort Pillow, Tenn.
Apr 12. 1864.

Heart

C | 11 | U.S.C.T.

John Campbell

, Co. A., 11 Reg't U.S. Col'd Inf.

Appears on

Company Descriptive Book

of the organization named above.

DESCRIPTION.

Age 19 years height . . . feet . . . inches.

Complexion *Blk*

Eyes; *Blk* hair *Blk*

Where born

Occupation *Farmer*

ENLISTMENT.

When *June 16*, 1863.

Where *Corinth, Miss.*

By whom *Lt. Bischoff*; term *3* y'rs.

Remarks: *Missing after battle
at Fort Pillow, Tenn.
Apr 12-64.*

Hearst

C

11 (New).

U.S.C.T.

John Campbell

1000, Co. A, 1 Reg't Ala. Siege Art'y.*

Age 19 years.

Appears on

Company Muster-in Roll

of the organization named above. Roll dated

Cornith Miss, June 20, 1863.

Muster-in to date June 20, 1863

Joined for duty and enrolled:

When June 10, 1863

Where Cornith Miss

Period 3 years.

Remarks:

* This organization subsequently became Co. , 11 Reg't U. S. Colored Infantry (New).

Book mark:

Howse

C

11 (New).

U.S.C.T.

John Campbell

Sgt., Co. A, 1 Reg't Ala. Siege Art'y.*

Appears on

Company Muster Roll

for June 20 to 30, 1863

Present or absent present

Stoppage, \$ 1.00 for

Due Gov't, \$ 1.00 for

Remarks:

*This organization subsequently became Co. A, 11 Reg't U. S. Colored Infantry (New).

Book mark:

House

C | 11 (New). | U.S.C.T.

John Campbell
Pvt., Co. A, 1 Reg't Ala. Siege Art'y.*

Appears on

Company Muster Roll

for July and August, 1863

Present or absent present

Stoppage, \$ 100 for

Due Gov't, \$ 100 for

Remarks:

To pay for one canteen

*This organization subsequently became Co. A, 11 Reg't U. S. Colored Infantry (New).

Book mark:

Howe

C

11 (New). U.S.C.T.

John Campbell
Sgt, Co. A, 1 Reg't Ala. Siege Art'y.*

Appears on

Company Muster Roll

for July and August, 1863

Present or absent Present

Stoppage, \$ 100 for

Due Gov't, \$ 100 for

Remarks:

To pay for one Carter

*This organization subsequently became Co. A, 11 Reg't U. S. Colored Infantry (New).

Book mark:

House

C

11 (New).

U.S.C.T.

John Campbell

Priv., Co. A, 1 Reg't Ala. Siege Art'y.*

Appears on

Company Muster Roll

for Sept. and Oct., 1863

Present or absent Present

Stoppage, \$ 100 for

Due Gov't, \$ 100 for

Remarks:

*This organization subsequently became Co. A, 11 Reg't U. S. Colored Infantry (New).

Book mark:

House

C

11 (New).

U.S.C.T.

John Campbell

Pat., Co. A, 1 Reg't Ala. Siege Art'y.*

Appears on

Company Muster Roll

for Nov. and Dec., 1863

Present or absent Present

Stoppage, \$ 100 for

Due Gov't, \$ 100 for

Remarks:

*This organization subsequently became Co. A, 11 Reg't U. S. Colored Infantry (New).

Book mark:

House

6 | 11 (New). | U.S.C.T.

John Campbell
Pvt., Co. A, 4 Batt'n, 1 Reg't Tenn. H. Art'y.*

Appears on

Company Muster Roll

for *Jan'y & Feby*, 1864.

Present or absent *Present*

Stoppage, \$ 100 for

Due Gov't, \$ 100 for

Remarks:

* This organization subsequently became Co. A, 11 Reg't U. S. Colored Infantry (New).

Book mark:

6

11 (New).

U.S.C.T.

John Campbell

Co. A, 6 Reg't U. S. Col'd H. Art'y.*

Appears on

Company Muster Roll

for March & April, 1864.

Present or absent absent

Stoppage, \$ 100 for

Due Gov't, \$ 100 for

Remarks: Missing after Battle at Fort Pillow from April 12-1864

* This organization subsequently became Co. A, 11 Reg't U. S. Colored Infantry (New).

Book mark:

Rosenbaum

C | 11 (New). U.S.C.T.

John Campbell

Co. A, 11 Reg't U. S. Col'd Inf. (New).

Appears on **Co. Muster-out Roll**, dated
Memphis Tenn. Jan'y 12 1866 .

Muster-out to date _____, 186 .

Last paid to *Dec 31*, 1863 .

Clothing account:

Last settled _____, 186 ; drawn since \$ _____ 100

Due soldier \$ _____ 100 ; due U. S. \$ _____ 100

Am't for cloth'g in kind or money adv'd \$ _____ 100

Due U. S. for arms, equipments, &c., \$ _____ 100

Bounty paid \$ _____ 100 ; due \$ _____ 100

Remarks: *Missing in action at
Ft. Pillow Tenn. 12th aprl '64*

Book mark: *V. 15 P. 25. 68. 1219-75*

IS.

Hoyberger

(361)

Copyist.

Campbell, John -
P, Co. A, **U** Regt. S. C. Inf.

Enclosures.

Bed Cards	Descriptive Lists
Burial Records	Final Statements /
Certs. of Dis. for Discharge	Furloughs
C. M. Charges	Med. Des. Lists
Med. Certificates	Orders

Other papers relating to—

Admission to Hosp'l	Furlough
Casualty Sheet (Officer's)	Med. Examination
Confinement	Misc. Information
Contracts	Pay or Clothing
Death or Effects	Personal Reports
Desertions	Rank
Discharge from Hosp'l	Transfer to Hosp'l
Discharge from Service	Transfer to V. R. C.
Duty	Transportation

6-A ✓ 48.

FINAL STATEMENT

W. C. Brown

Route John Campbell

2^d Reg't of U.S. Col. Art. Heavy
State 6th U.S. Col. Art.

VOLUNTEERS.

NOTE 1.—Two of these certificates (or duplicates) are to be given to each Volunteer Soldier or drafted man who may be discharged previously to the discharge of his company, that he may at once receive from the Paymaster the pay, &c., due him, and the captain or other COMMISSIONED officer commanding the company will certify to the act of the delivery of the duplicate certificates; on these certificates the Soldier is "entitled to" his discharge, and should also present his discharge to the Paymaster to have the payment endorsed on it. The discharge is to be given back to the Soldier by the Paymaster; the latter only retaining as his voucher the duplicate certificates.

NOTE 2.—If the Soldier is entitled to pay for the use of his horse, the Company Commander will certify to that fact on the back of both these final statements, and also to the time he has pay due for having been so mounted on his own horse.

NOTE 3.—When a Soldier is furnished with final statements, his descriptive list, if he has one, should be taken up by the officer who gives the Soldier these statements, and endorsed with a statement to this effect by the officer. This endorsement should exhibit a full statement of the time for which the Soldier was allowed pay on his final statements, the clothing account, and all other charges against him or in his favor, so as to comprise a complete exhibit of his account. It will then be transmitted to the company commander of the Soldier, who will enter all the data necessary to a full understanding of the Soldier's account on the muster roll upon which the Soldier's discharge is reported. The descriptive list will then be destroyed. The object of this is, that the remaining portion of the Soldier's account may be settled upon the receipt of these muster rolls, and the Soldier receive any pay or allowances that may be due him at the time of his discharge, and which may not appear on his final statements from the fact that his descriptive list is incomplete. These accounts for back pay, &c., are settled by the 2d Auditor of the Treasury Department.

NOTE 4.—Charges for loss or injury to ordnance, horse equipments, and other miscellaneous charges, should appear under the heading of "Other Stoppages."

NOTE 5.—Bounty paid by State authorities, and not by the United States, will not be entered on this statement.

NOTE 6.—Amounts due the Sutler and Laundress must be entered on the muster roll on which the discharge, death, desertion, &c., is reported, as well as on the final statement, otherwise the amount cannot be collected from the United States.

NOTE 7.—This blank will be used for deceased volunteers and drafted men, as well as for others.

NOTE 8.—Where a Soldier dies in Hospital or on detached service, his descriptive list, if he has one, should be sent with his final statements, in duplicate, to the Adjutant General, Washington, D. C.

ADJUTANT GENERAL'S OFFICE.

July 18th 1864
Duplicate with Inventory sent 2d Auditor

Ent on R of Co

I certify, on honor, that John Campbell, a Private of
Captain C. J. Eberstein Company (A) of the 7 Regiment of Vol. Inf. Regt. N.Y.
VOLUNTEERS, of the State of _____, born in _____, State
of _____, aged 19 years; _____ feet _____ inches high; Dark complexion,
Blue eyes, Black hair, and by occupation a _____, having joined the company on
its original organization at Camp #4 Mass, and enrolled in it at the muster into
the service of the United States at Camp #4 Mass, on the Sixteenth day
of June, 1863, (or was mustered in service as a recruit, by _____
at _____, on the _____ day of _____,
1863, or was drafted and mustered into the service of the United States from the _____
Enrollment District of the State of _____, at _____,
on the _____ day of _____, 1863,) to serve in the Regiment, for

the term of Three years unless sooner discharged and having served **HONESTLY** and
FAITHFULLY with his Company in the field to the present date, is now
entitled to a **DISCHARGE** by reason of Missing after Battle of Fort Pickens
from April 12 1864 Supposed to be killed

The said Private John Campbell was last paid by Paymaster
Myrdalman to include the 31st day of December, 1863, and has
pay due him from that time to the present date; he is entitled to pay and subsistence for
TRAVELING to place of enrollment, and whatever other allowances are authorized to volunteer
soldiers, drafted men, or militia, so discharged. He has received from the United States **CLOTHING**
amounting to _____ dollars, since the _____ day of _____,
1863, when his clothing account was last settled. He has received from the United States
_____ dollars advanced **BOUNTY**.

There is to be stopped from him, on account of the State of _____, or other
authorities, for **CLOTHING**, &c., received on entering service, _____ dollars; and
for other stoppages, viz: Camp #4 Mass, all Messy & at Fort Pickens
from April 12 1864 Rendering it impossible for me
to give the amount of Clothing _____ dollars.

He has been furnished with **TRANSPORTATION** in kind from the place of his discharge to
_____ ; and he has been **SUBSISTED** for **TRAVELING** to his
place of enrollment, up to the _____, 1863.

He is indebted to C. R. Grigg, **SUTLER**, _____ dollars.
He is indebted to _____, **LAUNDRESS**, _____ dollars.

Given in Duplicate, at Fort Pickens from, this 22^d day
of June, 1864.

H. B. Martin
2^d Lieut
Commanding Company.

234

Campbell, Newton

Co A, 11 U.S. Col'd Inf.

(New Organization.)

Private

Private

CARD NUMBERS.

1	6323523	26
2	6323614	27
3	6323706	28
4	6323809	29
5	6323913	30
6	6324019	31
7	6324110	32
8	6322960	33
9	6324211	34
10	6324247	35
11	6324284	36
12	6324328	37
13	6324394	38
14	6324459	39
15	6324534	40
16	6324613	41
17	6324683	42
18	6324748	43
19	6324816	44
20	9070572	45
21	9070610	46
22	9070761	47
23		48
24		49
25		50

Book Mark:

See also

S. 21,13200 P.O. Off.
S-2179827 P.O. Off.
A2688695 a u r t

C | 11 (New) U. S. C. T.

Newton Campbell
(New)
Co. A, 11 Reg't U. S. Col'd Inf.

Appears on
Company Descriptive Book
of the organization named above.

DESCRIPTION.

Age 31 years height 5 feet 9 inches.

Complexion Blk

Eyes; Blk hair Blk

Where born Madison, Ala.

Occupation Waggoner.

ENLISTMENT.

When June 1, 1863.

Where Corinth Miss

By whom Capt. Booth; term 3 y'rs.

Remarks:
.....
.....
.....
.....
.....
.....
.....
.....
.....
.....

Hearst

C | **11 (New) U. S. C. T.**

Newton Campbell
....., Co A, 11 Reg't U. S. Col'd Inf. ^(New.)

Appears on

Company Descriptive Book

of the organization named above.

DESCRIPTION.

Age 31 years height 5 feet 9 inches.

Complexion Blk

Eyes; Blk hair Blk

Where born Madison Ala.

Occupation Wagoner.

ENLISTMENT.

When June 1, 1863.

Where Corinth Miss.

By whom Capt J. J. Booth, term 3 y'rs.

Remarks:

.....
.....
.....
.....
.....
.....
.....
.....

Hearst

C | 11 (new) U. S. C. T.

Newton Campbell
(New)
Co. A., 11 Reg't U. S. Col'd Inf.

Appears on

Company Descriptive Book

of the organization named above.

DESCRIPTION.

Age 31 years height 5 feet 9 inches.

Complexion Blk

Eyes; Blk hair Blk

Where born Madison, Ala.

Occupation Wagoner.

ENLISTMENT.

When June 1, 1863.

Where Corinth Miss

By whom Capt. Booth; term 3 y'rs.

Remarks:

.....
.....
.....
.....
.....
.....
.....
.....

Hearse

C

11 (New).

U.S.C.T.

Denton Campbell

ser, Co. A, 1 Reg't Ala. Siege Art'y.*

Age 31 years.

Appears on

Company Muster-in Roll

of the organization named above. Roll dated

Corinth Miss June 20, 1863

Muster-in to date June 20, 1863

Joined for duty and enrolled:

When June 1, 1863

Where Corinth Miss

Period 3 years.

Remarks:

* This organization subsequently became Co. , 11 Reg't U. S. Colored Infantry (New).

Book mark:

House

C | 11 (New). | U.S.C.T.

Norton Campbell

Pvt., Co. A, 1 Reg't Ala. Siege Art'y.*

Appears on

Company Muster Roll

for June 20 to 30, 1863.

Present or absent Present

Stoppage, \$ 100 for

Due Gov't, \$ 100 for

Remarks:

*This organization subsequently became Co. A, 11 Reg't U. S. Colored Infantry (New).

Book mark:

House

C | 11 (New). | U.S.C.T.

Norton Campbell
Pvt, Co. A, 1 Reg't Ala. Siege Art'y.*

Appears on

Company Muster Roll

for *July and Aug.*, 1863.

Present or absent *Present*

Stoppage, \$ *100* for

Due Gov't, \$ *100* for

Remarks:

*This organization subsequently became Co. A, 11 Reg't U. S. Colored Infantry (New).

Book mark:

House

C

11 (New).

U.S.C.T.

Newton Campbell

Prvt., Co. A, 1 Reg't Ala. Siege Art'y.*

Appears on

Company Muster Roll

for Sept. and Oct., 1862

Present or absent Present

Stoppage, \$ 100 for

Due Gov't, \$ 100 for

Remarks:

*This organization subsequently became Co. A, 11 Reg't U. S. Colored Infantry (New).

Book mark:

House

C

11 (New).

U.S.C.T.

Junston Campbell
Pat, Co. A, 1 Reg't Ala. Siege Art'y.*

Appears on

Company Muster Roll

for *Nov. and Dec*, 186 *3*

Present or absent *Present*

Stoppage, \$ *100* for

Due Gov't, \$ *100* for

Remarks:

On daily duty Teamster

*This organization subsequently became Co. A, 11 Reg't U. S. Colored Infantry (New).

Book mark:

House

6 | 11 (New). | U.S.C.T.

Newton Campbell

Pol., Co. A, 4 Batt'n, 1 Reg't Tenn. H. Art'y.*

Appears on

Company Muster Roll

for *Jan'y & Feby*, 1864.

Present or absent *Present*

Stoppage, \$ *100* for

Due Gov't, \$ *100* for

Remarks: *On special duty in
Co. 5th, Sept for S.O. 2109
dated Hd Qrs Fort Pickering
Jan'y 17/64*

* This organization subsequently became Co. A, 11 Reg't U. S. Colored Infantry (New).

Book mark :

(358)

Rosenblum
Copyst.

6

11 (New).

U.S.C.T.

Newton Campbell
Pot., Co. A, 6 Reg't U. S. Col'd H. Art'y.*

Appears on

Company Muster Roll

for *March & April*, 1864.

Present or absent *Present*

Stoppage, \$ *100* for

Due Gov't, \$ *100* for

Remarks: *detailed as teamster
in Regiment per S.O. No
dated April 25-1864*

* This organization subsequently became Co. A, 11 Reg't U. S. Colored Infantry (New).

Book mark :

Rosenbaum

C. M. (new) U.S.C.T.

Newton Campbell
61st Regt N. S. C. Infy.)
Priv., Co. 6 Reg't U. S. Col'd Hqs. Art.

Appears on a

Detachment Muster Roll

of the organization named above

for *Mch. + Apl.*, 1864.

Station *Fort Pickering, Tenn.*

Present or absent *Present*

Stoppage, \$ 100 for

Due Gov't, \$ 100 for

Remarks: *Detailed as teamster
in regiment.*

Book mark:

Philipsen

6

11 (New).

U.S.C.T.

Newton Campbell

Pvt., Co. A, 7 Reg't U. S. Col'd H. Art'y.*

Appears on

Company Muster Roll

for *May & June*, 1864.

Present or absent

Stoppage, \$ 100 for

Due Gov't, \$ 100 for

Remarks: *detailed as Teamster
in Regiment - for S.O. No
dated April 25-1864*

*This organization subsequently became Co. A, 11 Reg't U. S. Colored Infantry (New).

Book mark :

Rosenbaum

6

11 (New).

U.S.C.T.

Newton Campbell

Pvt, Co. A, 7 Reg't U. S. Col'd H. Art'y.*

Appears on

Company Muster Roll

for

to aug 31, 1864.

Present or absent

Not Stated

Stoppage, \$

100 for

Due Gov't, \$

100 for

Remarks:

*This organization subsequently became Co. A, 11 Reg't U. S. Colored Infantry (New).

Book mark:

Rosenbaum
Coptist.

6 11 (New). U.S.C.T.

Newton Campbell
Pvt., Co. A, 7 Reg't U. S. Col'd H. Art'y.*

Appears on

Company Muster Roll

for Sept- & Oct, 1864.

Present or absent Not Stated

Stoppage, \$ 100 for

Due Gov't, \$ 100 for

Remarks:

*This organization subsequently became Co. A, 11 Reg't U. S. Colored Infantry (New).

Book mark:

Rosenbaum
Copyst.

6 | 11 (New). | U.S.C.T.

Newton Campbell

Privt., Co. A, 7 Reg't U. S. Col'd H. Art'y.*

Appears on

Company Muster Roll

for *Nov & Dec*, 1864.

Present or absent *Present*

Stoppage, \$..... 100 for

Due Gov't, \$..... 100 for

Remarks :

*This organization subsequently became Co. A, 11 Reg't U. S. Colored Infantry (New).

Book mark :

Rosenbaum
Copyst.

C. | 11 (New). | U.S.C.T.

Newton Campbell
Priv., Co. A, 11 Reg't U. S. Col'd Inf. (New).

Appears on

Company Muster Roll

for Jan. & Feb., 1865.

Present or absent Present.

Stoppage, \$.100 for

Due Gov't, \$ 1.00 for

Remarks:

On duty with R.
Q. M. per. Spe. No. 10
Hd. Qrs. 8th U. S. C. A. Hy.
Jan'y 19/65.

Book mark:

A. W. Reed

(358)

Copyist

C. | **11** (New). | **U.S.C.T.**

Newton Campbell,
Pvt., Co. A, 11 Reg't U. S. Col'd Inf. (New).

Appears on

Company Muster Roll

for *Mar. & Apr.*, 1865.

Present or absent *Present.*

Stoppage, \$ *100* for

Due Gov't, \$ *100* for

Remarks: *On duty with the*
R. I. M. per. S. O. No. 10,
dated Hd. qrs. 7th U. S.
Arty. Hq., Jan'y 19/65.

Book mark:

A. H. Reed

C. | **11** (New). | **U.S.C.T.**

Newton Campbell,
Privt, Co. A, 11 Reg't U. S. Col'd Inf. (New).

Appears on

Company Muster Roll

for *May & June*, 186*5*.

Present or absent *Present.*

Stoppage, \$ *100* for

Due Gov't, \$ *100* for

Remarks: *Detailed wagon*
Master Sgt. S.O. No. 10.
Lost Haversack, two
great coat straps.

Book mark:

A. M. Reed,

C., 11 (New). U.S.C.T.

Newton Campbell
Pvt., Co. A, 11 Reg't U.S. Col'd Inf. (New).

Appears on

Company Muster Roll
for *July & Aug.*, 186*5*.
Present or absent *Present*

Stoppage, \$ *100* for

Due Gov't, \$ *100* for

Remarks: *On duty with*
R. C. M. S. Co. No. 10 Hd.
Qrs. 11 U. S. C. Infy. Lost
one Haversack
Due U. S. for C. & G.
Eq. 95 cts.

Book mark:

N. W. Reed

(358)

Copyist

C

11 (New).

U.S.C.T.

Newton Campbell

Pl., Co. A, 11 Reg't U.S. Col'd Inf. (New).

Appears on

Company Muster Roll

for *Sept. & Oct.*, 1865.

Present or absent *Present*

Stoppage, \$ *20* ^{*10*} *100* for *Cont.*

Due Gov't, \$ *100* for

Remarks: *On daily duty at
Tregon - Muster in R.
of M. Sept.*

Book mark:

Hoyberger

C | 11 (New). | U.S.C.T.

Newton Campbell

Pl, Co. A, 11 Reg't U. S. Col'd Inf. (New).

Appears on

Company Muster Roll

for *Nov & Dec*, 1865.

Present or absent *Present*

Stoppage, \$ *25* 100 for *6.00*

Due Gov't, \$ *100* for

Remarks: *in duty at
regt Muster in R. 4th
1865*

Book mark:

Hayberger

C | 11 (New). U.S.C.T.

Newton Campbell

B. A., 11 Reg't U. S. Col'd Inf. (New).

Appears on Co. Muster-out Roll, dated

Memphis Tenn; Jan'y 17 1866.

Muster-out to date *Jan'y 17 1866.*

Last paid to *June 30 1865.*

Clothing account:

Last settled....., 186 ; drawn since \$..... 100

Due soldier \$ *14*^{*73*}..... 100; due U. S. \$..... 100

Am't for cloth'g in kind or money adv'd \$..... 100

Due U. S. for arms, equipments, &c., \$..... 100

Bounty paid \$..... 100; due \$..... 100

Remarks: *Due U. S. for C. and G. E.;
95 Cts*

Book mark :

(361)

Hoyberger

Copyist.

1235

Campbell, Henry

Co L, 11 U.S. Col'd Inf.

(New Organization.)

Private

Private

CARD NUMBERS.

1	6335037	26
2	6335125	27
3	6335281	28
4	9070790	29
5		30
6		31
7		32
8		33
9		34
10		35
11		36
12		37
13		38
14		39
15		40
16		41
17		42
18		43
19		44
20		45
21		46
22		47
23		48
24		49
25		50

Book Mark:

See also

6

11 (new) U.S.C.T.

Henry Campbell
(new)
, Co. 2, 11 Reg't U.S. Col'd Inf.

Appears on

Company Descriptive Book

of the organization named above.

DESCRIPTION.

Age 18 years height 5 feet 5 inches.

Complexion *Blk*

Eyes; *Blk* hair *Blk*

Where born *Lawrence Co. Ala.*

Occupation *Farmer*

ENLISTMENT.

When *March 1st, 1864.*

Where *Memphis Tenn.*

By whom *Serg. E. Crouk etc.*; term *3* y'rs.

Remarks: *Died in Regt Hoopl
at Fort Pickering Memphis
Tenn. June 14th 1864 by
reason of disease.*

D. M. Kennedy
Copyst.

C

11 (New).

U.S.C.T.

Henry Canble

Pvt, Co. I, 6 Reg't U. S. Col'd H. Art'y.†

Appears on

Company Muster-in and Descriptive Roll
of the organization named above. Roll dated

Fort Pickens, Memphis, Tenn April 2, 1864.

Where born *Lawrence, Alabama,*

Age *18* y'rs; occupation *Farmer.*

When enlisted *March 1, 1864.**

Where enlisted *Memphis, Tenn,*

For what period enlisted *3* years.

Eyes *Black*; hair *black*

Complexion *black*, height *5 ft. 5 in.*

When mustered in *April 2, 1864.*

Where mustered in *Fort Pickens, Memphis, Tenn,*

Bounty paid \$ *100*; due \$ *100*

Where credited

Company to which assigned

Remarks:

† This organization subsequently became Co. I, 11 Reg't U. S. Colored Infantry (New).

* Muster-in roll shows enrollment of all men of this company as of same date. See enrollment on subsequent card or cards.

Book mark:

(356d)

[Signature]

Copyist.

C | 11 (New). | U.S.C.T.

Henry Campbell

First, Co. *L*, 6 Reg't U. S. Col'd H. Art'y.†

Appears on

Company Muster Roll

for *Mich & Spé*, 1864.

Joined for duty and enrolled:

When *March*, 1864.*

Where *Memphis, Tenn.**

Period *3* years.*

Present or absent *Present*

Stoppage, \$ *100* for

Due Gov't \$ *100* for

Remarks:

† This organization subsequently became Co. *L*, 11 Reg't U. S. Colored Infantry (New).

* See enrollment on card from muster-in roll.

Book mark:

C | 11 (New). | U.S.C.T.

Henry Campbell

Co., Co. L, 7 Reg't U. S. Col'd H. Art'y.†

Appears on

Company Muster Roll

for *May June*, 1864*

Joined for duty and enrolled:

When *March*, 1864*

Where *Memphis, Tenn.**

Period *3* years.*

Present or absent

Stoppage, \$ *100* for

Due Gov't, \$ *100* for

Remarks:

Died at Roll Camp at Fort Pickens, Memphis, Tenn, June 14, 64, by reason of disease no. CO. M. O. R.

†This organization subsequently became Co. L, 11 Reg't U. S. Col'd Infantry (New).

* See enrollment on card from muster-in roll.

Book mark:

Campbell Henry

P. Co. L.

11 Reg' U. S. C. Inf.

✓ Enclosures.

Bed Cards	Descriptive Lists
Burial Records	Final Statements /
Certs. of Dis. for Discharge	Furloughs
C. M. Charges	Med. Des. Lists
Med. Certificates	Orders

Other papers relating to—

Admission to Hosp'l	Furlough
Casualty Sheet (Officer's) <i>Priv.</i> /	Med. Examination
Confinement	Misc. Information
Contracts	Pay or Clothing
Death or Effects	Personal Reports
Desertions	Rank
Discharge from Hosp'l	Transfer to Hosp'l
Discharge from Service	Transfer to V. R. C.
Duty	Transportation

FINAL STATEMENT

OF

Private Henry Campbell

J. H. Reg't of *W. S. Cal. Art. (Reg.)*

VOLUNTEERS.

NOTE 1.—Two of these certificates (or duplicates) are to be given to each volunteer soldier who may be discharged previously to the discharge of his company, that he may at once receive from the Paymaster the pay, &c., due him, and the captain or other officer commanding the company will certify to the act of the delivery of the duplicate certificates; on these certificates the Soldier is "entitled to" his discharge, and should also present his discharge to the Paymaster to have the payment endorsed on it. The discharge is to be given back to the Soldier by the Paymaster; the latter only retaining as his voucher the duplicate certificates.

NOTE 2.—If the Soldier is entitled to pay for the use of his horse, the Company Commander will certify to that fact, and also to the time he has pay due for having been so mounted on his own horse.

NOTE 3.—Amounts due the Sutler and Laundress must be entered on the Muster Roll on which the death, desertion, &c., is reported, as well as on the final statement, otherwise the amount cannot be collected from the United States.

NOTE 4.—This blank will be used for deceased volunteers as well as others.

ADJUTANT GENERAL'S OFFICE

Aug 12 1861

Inventory sent 2d Auditor.



I certify, on honor, that Private Henry Campbell Captain _____ Company (I) of the 2^d Regiment of W. S. Colored Inf. Regt VOLUNTEERS, of the State of _____, born in Lawrence State of Alabama, aged 18 years; 5 feet 5 inches high; Black complexion, Black eyes, Black hair, and by occupation a Farmer, having joined the company on its original organization at Memphis Tennessee, and enrolled in it at the muster into the service of the United States at Memphis Tennessee, on the first day of March, 1864, (or was mustered in service as a recruit, by _____, at _____, on the _____ day of _____, 1864, to serve in the Regiment,) for the term of _____ and having served **HONESTLY** and **FAITHFULLY** with his Company in Said Regiment to the present date, is now entitled to a **DISCHARGE** by reason of Death Death _____ June 12th 1864

The said Henry Campbell has Pay due from date of enlistment was last paid by Paymaster _____ to include the 1st day of March, 1864, and has pay due him from that time to the present date; he is entitled to pay and subsistence for **TRAVELING** to place of enrollment and whatever other allowances are authorized to volunteer soldiers, or militia, so discharged. He has received _____ dollars, advanced by the United States on account of **CLOTHING**.

There is to be stopped from him, on account of the State of _____, or other authorities for **CLOTHING**, &c., received on entering service, _____ dollars; also, for expenses of **SUBSISTENCE** for **TRAVELING** from place of enrollment to the place of rendezvous, amounting to _____ dollars: and on account of the United States for **EXTRA CLOTHING** received in kind from _____ and for other stoppages, viz:

_____ amounting to _____ dollars; and he has been **SUBSISTED** for **TRAVELING** to his place of enrollment, up to the _____, 1864.

He is indebted to C. R. Guggs, **SUTLER**, _____ dollars.
 He is indebted to _____, **LAUNDRESS**, _____ dollars.

Given in Duplicate, at _____, this _____ day of _____, 1864.

*The above named
has no effects*

Richard A. Mates 2^d Lieut. Co. C
W. S. Colored Inf. Regt
 Commanding Company. S

Approved by the Chief Clerk
Dep of War Dec 30/65. 49

CASUALTY SHEET

No.

Henry Campbell
Private of Company "D"

7th Regiment of U.S. A.V.

State Volunteers. New York

NATURE OF CASUALTY.

Went missing

Emerson R. Co.

CASUALTY SHEET.

Name: *Henry Campbell*
Rank: *Sgt* Company: *D* Regiment: *4*
Arm: *U.S.A.* State: *N.Y.*
Nature of Casualty: *Disease*

CAUSE OF CASUALTY—(NAME OF DISEASE, &c.)

BY WHOM DISCHARGED.

Disease

FROM WHAT SOURCE THIS INFORMATION WAS OBTAINED.

DEGREE OF DISABILITY.

*From Cert of Capt Solts
for Gen Eng of June 30/64*

BY WHOM CERTIFIED.

REMARKS.

*W.D. Hunter
Col Comd Regt*

DATE OF DISCHARGE, DEATH, &c.

June 14. 1864

PLACE OF DISCHARGE, DEATH, &c.

Windsor, Tenn

J.H. Hoffer
Clerk.

236

Canada Sham

Co E, 11 U.S. Col'd Inf.

(New Organization.)

Private Private

CARD NUMBERS.

1	6328719	26
2	6328780	27
3	6328861	28
4	6328961	29
5	6329064	30
6	6329150	31
7	6329236	32
8	6329312	33
9	6329388	34
10	6329498	35
11	6329893	36
12	9071950	37
13	9071791	38
14		39
15		40
16		41
17		42
18		43
19		44
20		45
21		46
22		47
23		48
24		49
25		50

Book Mark:

See also

6 | 1 (New) **U. S. C. T.**

Isaac Canada
(New)
....., Co. 8, 11 Reg't U. S. Col'd Inf.

Appears on
Company Descriptive Book
of the organization named above.

DESCRIPTION.

Age 23 years height 5 feet 7 inches.

Complexion Dark

Eyes; Black hair Black

Where born Miss.

Occupation

ENLISTMENT.

When Oct 21, 1863.

Where La Grange Tenn

By whom Capt Craig; term 3 y'rs.

Remarks:
.....
.....
.....
.....
.....
.....
.....
.....
.....
.....

Houston

C | 11 (new) **U. S. C. T.**

Isham Canada
(new)
....., Co. E, 11 Reg't U. S. Col'd Inf.

Appears on

Company Descriptive Book

of the organization named above.

DESCRIPTION.

Age 25 years height 5 feet 7 inches.

Complexion Dark

Eyes; Black hair Black

Where born Mississippi

Occupation

ENLISTMENT.

When Oct 21, 1863

Where Lagrange Tenn

By whom J. H. Craig term 3 y'rs.

Remarks: Sentenced by
Gen'l Court Martial
to forfeit two months
of his Pay proper
and to be placed
at hard labor on
the Fortifications
at Fort Pickens
for two months for
over

Houston

MAY. 11

9071791

* 1861 *

leaving his Post
while on duty
per Genl Order
no 6. Dated 14d. Apr
1865. Died in Regiments
Hospital April 21
1865 of Dropsy at
Memphis Tenn.

6 | **11** (New) | **U.S.C.T.**

Iskham Canada
Pri, Co. *E*, 1 Reg't Ala. Siege Art'y.*

Age *25* years.

Appears on

Company Muster-in Roll

of the organization named above. Roll dated

Cornth Miss, *Dec 9*, 1863.

Muster-in to date *Dec 9*, 1863.

Joined for duty and enrolled:

When *Oct 21*, 1863

Where *La Grange*

Period *3* years.

Remarks:
.....
.....
.....
.....
.....
.....

*This organization subsequently became Co. *E*, 11 Reg't U. S. Colored Infantry (New).

Book mark:.....
.....

Sumner

C

11 (New).

U.S.C.T.

Sham Canada

Pvt., Co. E, 1 Reg't Ala. Siege Art'y.*

Appears on

Company Muster Roll

for *Enrollment to Dec. 31.*, 1863.

Present or absent *Absent.*

Stoppage, \$ *100* for

Due Gov't, \$ *100* for

Remarks: *Absent without leave since Dec. 29. 63.*

*This organization subsequently became Co. E, 11 Reg't U. S. Col'd Infantry (New).

Book mark :

Lewis

Copist.

C

11 (New).

U.S.C.T.

Isam Canada

Priv, Co. E, 4 Battalion, 1 Reg't Tenn. H. Art'y.*

Appears on

Company Muster Roll

for *Jan. & Feb.*, 1864.

Present or absent *Present*

Stoppage, \$ *100* for

Due Gov't, \$ *100* for

Remarks:

* This organization subsequently became Co. E, 11 Reg't U. S. Colored Infantry (New).

Book mark:

Lewis

C | **11** (New). | **U.S.C.T.**

Iskum Canada

Priv....., Co. E, 6 Reg't U. S. Col'd H. Art'y.*

Appears on

Company Muster Roll

for..... *Mich & Apè* , 1864.

Present or absent *Present.*

Stoppage, \$ *100* for

Due Gov't, \$ *100* for.....

Remarks :

.....

.....

.....

.....

.....

.....

.....

.....

.....

.....

* This organization subsequently became Co. E, 11 Reg't U. S. Colored Infantry (New).

Book mark :

Lewis
Copyist.

6

11 (New).

U.S.C.T.

Isham Canada

Priv, Co. E, 7 Reg't U. S. Col'd H. Art'y.*

Appears on

Company Muster Roll

for May & June, 1864

Present or absent absent

Stoppage, \$ 100 for

Due Gov't, \$ 100 for

Remarks: Confined in Guard House for disobedience of orders.

* This organization subsequently became Co. E, 11 Reg't U. S. Colored Infantry (New).

Book mark:

Crenshaw

C | 11 (New). | U.S.C.T.

Isham Canada
Priv, Co. E, 7 Reg't U. S. Col'd H. Art'y.*

Appears on

Company Muster Roll

for *July & Aug.*, 186 *4*.

Present or absent *Present*

Stoppage, \$ 100 for

Due Gov't, \$ 100 for

Remarks:

* This organization subsequently became Co. E, 11 Reg't U. S. Colored Infantry (New).

Book mark:

Crenshaw

Co | **11** (New). | **U.S.C.T.**

Isham Canada

Priv, Co. E, 7 Reg't U. S. Col'd H. Art'y.*

Appears on

Company Muster Roll

for *Sept. & Oct.*, 186*4*.

Present or absent *Present*

Stoppage, \$ *100* for

Due Gov't, \$ *100* for

Remarks: *Stop for one canteen
& Haversack #112.*

* This organization subsequently became Co. E, 11 Reg't U. S. Colored Infantry (New).

Book mark: _____

Crenshaw

C | **11** (New). | **U.S.C.T.**

Isham Canada

Priv, Co. E, 7 Reg't U. S. Col'd H. Art'y.*

Appears on

Company Muster Roll

for *Nov. & Dec.*, 186 *4*

Present or absent *Absent*

Stoppage, \$ *100* for

Due Gov't, \$ *100* for

Remarks: *In arrest since Dec. 11/64. Stop for one canteen & one haversack.*

* This organization subsequently became Co. E, 11 Reg't U. S. Colored Infantry (New).

Book mark: *5-2-64*

Crenshaw

C | 11 (New). | U.S.C.T.

Sham Canada

Co. E, 11 Reg't U. S. Col'd Inf. (New).

Appears on

Company Muster Roll

for Jan & Feb, 1865

Present or absent Absent

Stoppage, \$ 100 for

Due Gov't, \$ 100 for

Remarks: Stop for Canteen
& 1 Haversack.

In Military Prison await-
ing sentence of G.C.M.

Book mark:

Lowry

C | 11 (New). | U.S.C.T.

Asham Canada
Prov., Co. E, 11 Reg't U. S. Col'd Inf. (New).

Appears on

Company Muster Roll

for *Mich & Apr*, 1865

Present or absent

Stoppage, \$ 100 for

Due Gov't, \$ 100 for

Remarks: *Died of Dropsy in
Reg. Hospital, Apr. 2/65.
Stop two months pay prop-
er in obedience of
G.C.M. per G.O. No. 6
dated Hd. Qrs. Dist. W.
Term. Feb. 2/65.*

Book mark: *P.V. 1. P. 96-68.*

(858)

Lowry

Copyist.

C | 11 (New). | U.S.C.T.

Isham Canada

Priv Co. E, 11 Reg't U. S. Col'd Inf. (New).

Appears on **Co. Muster-out Roll**, dated

Memphis Tenn. Jan 12, 1866.

Muster-out to date _____, 186 .

Last paid to *Aug 31, 1864.*

Clothing account:

Last settled _____, 186 ; drawn since \$ _____ 100

Due soldier \$ _____ 100 ; due U. S. \$ _____ 100

Am't for cloth'g in kind or money adv'd \$ _____ 100

Due U. S. for arms, equipments, &c., \$ _____ 100

Bounty paid \$ _____ 100 ; due \$ _____ 100

Remarks:

*Died Apr 21/65 at Reg
Hosp. Memphis Tenn
Dropsy*

Book mark: *P. 1. P. 96. 68 1. 230. P. 90. 76. 1693. 1883*

Valentine

(361)

Copyist.

Canada Ishaw

D, Co. E, 11 Reg't U. S. C. I

4 Enclosures.

Bed Cards	Final Statements 2
Burial Records	Furloughs or L. of A
Certs. of Dis. for Discharge	Med. Certificates
C. M. Charges	Med. Des. Lists
Descriptive Lists	Orders
Discharge Certificates	Pris. of War Record
Enlistment Papers	Resignations

Other papers relating to—

Admission to Hosp'l	Furlough or L. of A
Casualty Sheet	Med. Examination
Confinement	Misc. Information /
Contracts	Pay or Clothing
Death or Effects	Personal Reports
Desertion	Rank
Discharge from Hosp'l	Transfer to Hosp'l
Discharge from Service	Transfer to V. R. C.
Duty /	Transportation

No. 2^d Lt. Fort-Préserving
April 2ⁿ 1864

Private Johann Comada
release from Military
Prison term of Pen-
tence having expired

~~No. 1000~~ Headquarters Fort Pickering,

Fort Pickering, Tenn., April 2 1865.

Commanding Officer

Camp B of 11th Regt. of U. S. Col. Inftry

Sir:

You are hereby notified that

Ischem Canidy

Of your command, was this day released from
Military Prison, term of Sentence having expired,
and is returned to you under proper guard.

By Order of COL. I. G. KAPPNER,

H. C. Wyckoff

Supt. and Provost Marshal.

W. S. Clerk

14
Gen. E.

FINAL STATEMENT

OF

Prince-Wham Canada
Co. E 11th Reg't of U. S. Col. Infantry

VOLUNTEERS.

NOTE 1.—Two of these certificates (or duplicates) are to be given to each Volunteer Soldier or drafted man who may be discharged previously to the discharge of his company, that he may at once receive from the Paymaster the pay, &c., due him, and the captain or other COMMISSIONED officer commanding the company will certify to the act of the delivery of the duplicate certificates; on these certificates the Soldier is "entitled to" his discharge, and should also present his discharge to the Paymaster to have the payment endorsed on it. The discharge is to be given back to the Soldier by the Paymaster; the latter only retaining as his voucher the duplicate certificates.

NOTE 2.—If the Soldier is entitled to pay for the use of his horse, the Company Commander will certify to that fact on the back of both these final statements, and also to the time he has pay due for having been so mounted on his own horse.

NOTE 3.—When a Soldier is furnished with final statements, his descriptive list, if he has one, should be taken up by the officer who gives the Soldier these statements, and endorsed with a statement to this effect by the officer. This endorsement should exhibit a full statement of the time for which the Soldier was allowed pay on his final statements, the clothing account, and all other charges against him or in his favor, so as to comprise a complete exhibit of his account. It will then be transmitted to the company commander of the Soldier, who will enter all the data necessary to a full understanding of the Soldier's account on the muster roll upon which the Soldier's discharge is reported. The descriptive list will then be destroyed. The object of this is, that the remaining portion of the Soldier's account may be settled upon the receipt of these muster rolls, and the Soldier receive any pay or allowances that may be due him at the time of his discharge, and which may not appear on his final statements from the fact that his descriptive list is incomplete. These accounts for back pay, &c., are settled by the 2d Auditor of the Treasury Department.

NOTE 4.—Charges for loss or injury to ordnance, horse equipments, and other miscellaneous charges, should appear under the heading of "Other Stoppages."

NOTE 5.—Bounty paid by State authorities, and not by the United States, will not be entered on this statement.

NOTE 6.—Amounts due the Sutler and Laundress must be entered on the muster roll on which the discharge, death, desertion, &c., is reported, as well as on the final statement, otherwise the amount cannot be collected from the United States.

NOTE 7.—This blank will be used for deceased volunteers and drafted men, as well as for others.

NOTE 8.—Where a Soldier dies in Hospital or on detached service, his descriptive list, if he has one, should be sent with his final statements, in duplicate, to the Adjutant General, Washington, D. C.

ADJUTANT GENERAL'S OFFICE.

May 9th 1865.

Duplicate with Inventory sent 2d Auditor.

Ent on R of Co

I certify, on honor, that Sham Canada a Private of
Captain Geo W Leaville Company (E) of the 11th Regiment of U S Col Infy
VOLUNTEERS, of the State of U S, born in _____, State
of Miss, aged 26 years; 5 feet 7 inches high; Dark complexion,
Blau eyes, Blau hair, and by occupation a Farmer, having joined the company on
its original organization at Covint Miss, and enrolled in it at the muster into
the service of the United States at Covint Miss, on the 19th day
of December, 1863, (or was mustered in service as a recruit, by Genl Meagher
U S Col Infy, at Covint Miss, on the 19th day of December
1863, or was drafted and mustered into the service of the United States from the _____
Enrollment District of the State of _____, at _____,
on the _____ day of _____, 186) to serve in the Regiment, for
the term of Three _____: and having served **HONESTLY** and

FAITHFULLY with his Company in the 11th U S Col Infy to the present date, is now
entitled to a **DISCHARGE** by reason of Death from Dropsy, in
rec^d Miss on the 21st day of April 1865

The said Sham Canada was last paid by Paymaster
Way Smith to include the 21st day of August, 1864, and has
pay due him from that time to the present date; he is entitled to pay and subsistence for
TRAVELING to place of enrollment, and whatever other allowances are authorized to volunteer
soldiers, drafted men, or militia, so discharged. He has received from the United States **CLOTHING**
amounting to Fifty five $\frac{81}{100}$ dollars, since Oct 21 1863 date of enrollment
186 , when his clothing account was last settled. He has received from the United States
 $\frac{100}{100}$ dollars advanced **BOUNTY**.

There is to be stopped from him, on account of the State of _____, or other
authorities, for **CLOTHING**, &c. received on entering service, _____ $\frac{100}{100}$ dollars; and
for other stoppages, viz: Stop two months pay proper in obedience
to Sentence of Genl Court martial, from Genl Order No 6 dated
Jan 21st Dis. West Tenn Feb 5th 1865 _____ $\frac{100}{100}$ dollars.

He has been furnished with **TRANSPORTATION** in kind from the place of his discharge to
_____; and he has been **SUBSISTED** for **TRAVELING** to his
place of enrollment, up to the _____, 186 .

He is indebted to Clark & Gregg, **SUTLER**, Five $\frac{100}{100}$ dollars.
He is indebted to _____, **LAUNDRESS**, _____ $\frac{100}{100}$ dollars.

Given in Duplicate, at Memphis Tenn, this 20th day
of April, 1865.

Geo W Leaville Capt
11th U S Col Infy
Commanding Company, "E"

1865-

June 14
20 M

FINAL STATEMENT

OF

Private Isham Bernada

Co "C" 11th Reg't of U. S. Col. Infantry

VOLUNTEERS.

NOTE 1.—Two of these certificates (or duplicates) are to be given to each Volunteer Soldier or drafted man who may be discharged previously to the discharge of his company, that he may at once receive from the Paymaster the pay, &c., due him, and the captain or other COMMISSIONED officer commanding the company will certify to the act of the delivery of the duplicate certificates; on these certificates the Soldier is "entitled to" his discharge, and should also present his discharge to the Paymaster to have the payment endorsed on it. The discharge is to be given back to the Soldier by the Paymaster; the latter only retaining as his voucher the duplicate certificates.

NOTE 2.—If the Soldier is entitled to pay for the use of his horse, the Company Commander will certify to that fact on the back of both these final statements, and also to the time he has pay due for having been so mounted on his own horse.

NOTE 3.—When a Soldier is furnished with final statements, his descriptive list, if he has one, should be taken up by the officer who gives the Soldier these statements, and endorsed with a statement to this effect by the officer. This endorsement should exhibit a full statement of the time for which the Soldier was allowed pay on his final statements, the clothing account, and all other charges against him or in his favor, so as to comprise a complete exhibit of his account. It will then be transmitted to the company commander of the Soldier, who will enter all the data necessary to a full understanding of the Soldier's account on the muster roll upon which the Soldier's discharge is reported. The descriptive list will then be destroyed. The object of this is, that the remaining portion of the Soldier's account may be settled upon the receipt of these muster rolls, and the Soldier receive any pay or allowances that may be due him at the time of his discharge, and which may not appear on his final statements from the fact that his descriptive list is incomplete. These accounts for back pay, &c., are settled by the 2d Auditor of the Treasury Department.

NOTE 4.—Charges for loss or injury to ordnance, horse equipments, and other miscellaneous charges, should appear under the heading of "Other Stoppages."

NOTE 5.—Bounty paid by State authorities, and not by the United States, will not be entered on this statement.

NOTE 6.—Amounts due the Sutler and Laundress must be entered on the muster roll on which the discharge, death, desertion, &c., is reported, as well as on the final statement, otherwise the amount cannot be collected from the United States.

NOTE 7.—This blank will be used for deceased volunteers and drafted men, as well as for others.

NOTE 8.—Where a Soldier dies in Hospital or on detached service, his descriptive list, if he has one, should be sent with his final statements, in duplicate, to the Adjutant General, Washington, D. C.

1865
JUN 14
70 M

I certify, on honor, that Sham Canada a Private of
Captain Geo. W. Carlisle Company (C) of the 11th Regiment of U.S. Col. Infy
VOLUNTEERS, of the State of U.S., born in _____, State
of Miss., aged 26 years; 5 feet 7 inches high; Dark complexion,
Black eyes, Black hair, and by occupation a Farmer, having joined the company on
its original organization at Merwinth Miss., and enrolled in it at the muster into
the service of the United States at Merwinth Miss., on the Ninth day
of December, 1863, (or was mustered in service as a recruit, by J. H. ...
at Merwinth Miss. on the Ninth day of December,
1863, or was drafted and mustered into the service of the United States from the _____
Enrollment District of the State of _____, at _____,
on the _____ day of _____, 1863), to serve in the Regiment, for
the term of Three years: and having served **HONESTLY** and
FAITHFULLY with his Company in the 11th U.S. Col. Infy, to the present date, is now
entitled to a **DISCHARGE** by reason of Death from Dropsy in Reg.
Wasp on the 21st day of Jan. 1865

The said Sham Canada was last paid by Paymaster
Geo. Smith to include the 27th day of August, 1864, and has
pay due him from that time to the present date; he is entitled to pay and subsistence for
TRAVELING to place of enrollment, and whatever other allowances are authorized to volunteer
soldiers, drafted men, or militia, so discharged. He has received from the United States **CLOTHING**
amounting to Fifty five ^{\$} dollars, since the Oct 21st 1863 ^{date of enrollment} day of _____,
1863, when his clothing account was last settled. He has received from the United States
100 dollars advanced **BOUNTY**.

There is to be stopped from him, on account of the State of _____, or other
authorities, for **CLOTHING**, &c., received on entering service, _____ dollars; and
for other stoppages, viz: Pay two months for absence for obedience
to sentence of Gen'l Court martial per Gen'l Order
No 6 dated 10th Dec 1864 _____ dollars.
He has been furnished with **TRANSPORTATION** in kind from the place of his discharge to
_____; and he has been **SUBSISTED** for **TRAVELING** to his
place of enrollment, up to the _____, 1864.

He is indebted to Clark R. Grog, **SUTLER**, Two dollars.
He is indebted to _____, **LAUNDRESS**, _____ dollars.

Given in Duplicate, at Memphis Tenn, this 30 day
of April, 1865.

Geo. W. Carlisle
11th U.S. Col. Infy
Commanding Company. "C"

Vertical handwritten notes on the left margin, including the name "Sham Canada" and other illegible scribbles.

Isham Canada

Pat. Co. E. 11th W.C.T. (new)

Ellerbrook

Adjutant General's Office,

COLORED TROOPS BRANCH,

Mr Ellersbrook

April 13, 1877

Vol. C. T., 187

Wanted in the case of Isham Canada Private, Co. "E", 11th Reg't U.S.C. Troops (new) 1st Period (Absent and whether tried - 2nd whether tried - 3rd Record of Trial - (1st Absent without leave since Dec 29th 1863 M.R. Organization to Dec 31. 63. Pr for duty M.R. June & Feby 64 (2nd) Absent "Confined in guard house for disobedience of orders" M.R. May & June 64. Pr for duty M.R. July & Aug 64 (3rd) "Died April 21. 65 - Stop two months pay proper + + + + G.O. No. 6 Ad 2nd Dist West Tenn Feby 2. 1865."

Respectfully,

R. A. Woodward Chief Clerk.

In J. Halton

Adjutant General's Office,

Div. Records Discontinued Comd &c April 17, 1877.

Vol. C. T., 187

Reply in case of Isham Canada Pt. Co. E, 11th Reg't U.S.C.T.

Co. Descript. book: furnished by G.M. To be conf. 2 M. of profit 2 M. pay &c for G.O. No. 6 Dist. W. Tenn. Feb. 2 '65. - Died of Dropsy in Regt Hosp. April 21 '65. - Co. Mg. Report book Dec. 24 '63: Absent without leave May 28 '64: sent to Mil. Prison. - July 6 '64 Ret'd from Prison. Aug. 26 '64: Absent without leave - Aug 27: Returned from Absent without leave. Dec. 13 '64: Confined in Mil. Prison. - Ap. 2 '65: Released from Conf't. Records Pro. Mas. Memphis: Confined Dec. 13 '64. Sentenced to 2 M. h. labor from Feb. 2 '65, Released Ap. 2 '65. (Dist. W. Tenn.) 11th Qn. Dist. W. Tenn. Feb. 2 1865. G.O. 6. Charge: Leaving his Post before regularly relieved - Finding "Guilty". Sentence: To forfeit his pay proper for 2 months & be placed on the fortification Pt. Pickering for 2 M. Approved.

Vertical note: No evidence, relationship period of absence in Dec. 63 to Jan. or Feb. 64. also no evidence of trial in Dec. 63. Prison records for Pickering for 1864 incomplete.

Handwritten initials or mark.

237
Canfield, Justus

Co C, 11 U.S. Col'd Inf.

(New Organization.)

1st Lieutenant / 2nd Lieutenant

CARD NUMBERS.

1	6322321	26
2	6334193	27
3	6334287	28
4	6334363	29
5	6334436	30
6	6334506	31
7	6334575	32
8	6334644	33
9	6334720	34
10	6334791	35
11	6334857	36
12	63349210	37
13	6565-C.P.-1864	38
14	42738219	39
15	42738253	40
16	40767468	41
17		42
18		43
19		44
20		45
21		46
22		47
23		48
24		49
25		50

Book Mark: { 6. 106. V. 10. 69. 73
6. 565-C.P.-1864

See also

17585202 P.C. aff.

S. 2960 406 Audw

AS. 1688423

~~S. 3082649. P.P. Ret.~~

C 11 (New) U.S.C.T.

Justus Greenfield
1st, Co., 1st Reg't U. S. Col'd Infantry.

Age 24 years.

Appears on an

Individual Muster-in Roll

of the organization named above. Roll dated

Memphis Tenn June 20, 1864.

Muster-in to date March 1, 1864.

Joined for duty and enrolled:

When March 1, 1864.

Where Memphis Tenn.

Period 1 years.

Remarks: Promoted to First
Lieut 7th Colored Art. Heavy
from Private Co. B. 2. Iowa
Army by S.O. 87. Dated
Memphis Tenn. May 16. 1864.
Signed L. Thomas, A. G. U. S. A.

Book mark: C. 565 - C.T. - 1864. (over)

J. Warner

(336)

Copyist.

JAN. 22

6322321

ALB91*

*Must be in to date from
March 1, 1864 per S.O. 85
dated Natchez Miss. Oct.
24, 1865*

C

11 (New).

U.S.C.T.

Justus Sanfield
1st Lt., Co. K, 7 Reg't U. S. Col'd H. Art'y.†

Appears on

Company Muster Roll

for *May & June*, 1864.

Joined for duty and enrolled:

When *March 1*, 1864.*

Where *Memphis, Tenn.* *

Period *3* years.*

Present or absent *Present*

Stoppage, \$ *100* for

Due Gov't \$ *100* for

Remarks: *In settling as an*
enlisted man in final statements
there was made a stoppage of
Twenty six dollars being the
pay for the months of March &
April 1864 as the Muster-in
-over

†This organization subsequently became Co. K, 11 Reg't U. S. Col'd Infantry (New).

* See enrollment on card from muster-in roll.

Book mark: _____

Rochester

(358c)

Copyist.

JAN. 23

6334193

21891a

Roll as 1st Y. date
Back to March 1st 1864

C 11 (New). U.S.C.T.

Justus Canfield
Private Co. K, 7 Reg't U. S. Col'd H. Art'y.†

Appears on

Company Muster Roll

for July & Aug, 1864.

Joined for duty and enrolled:

When March 1, 1864.*

Where Memphis, Tenn.*

Period 3 years.*

Present or absent Present

Stoppage, \$ 100 for

Due Gov't \$ 100 for

Remarks: All settlement as an
Enlisted man on final statements
there was made a stoppage of
Twenty six dollars being
the pay for the months of March
& April 1864 as the Muster-roll
over

†This organization subsequently became Co. K, 11 Reg't U. S. Col'd
Infantry (New).

* See enrollment on card from muster-in roll.

Book mark:

Arrester

JAN. 23

6334287

018910

*the 1st Lieut. is dated
back to March 1. 1864*

C | 11 (New). | U.S.C.T.

Justus Canfield
Feb 11, Co. K, 7 Reg't U. S. Col'd H. Art'y.†

Appears on

Company Muster Roll

for *Sep & Oct*, 186*H*.

Joined for duty and enrolled:

When *Mar. 1*, 186*H*.*

Where *Memphis, Tenn* *

Period *3* years.*

Present or absent. *Absent*

Stoppage, \$ *100* for

Due Gov't \$ *100* for

Remarks: *Absent Sick*

†This organization subsequently became Co. K, 11 Reg't U. S. Col'd Infantry (New).

* See enrollment on card from muster-in roll.

Book mark: _____

Proquest

C | 11 (New). | U.S.C.T.

Justus Canfield
Private, Co. K, 7 Reg't U. S. Col'd H. Art'y.†

Appears on

Company Muster Roll

for *Mr. & Mrs. [unclear]*, 1864.

Joined for duty and enrolled:

When *March 1st*, 1864.*

Where *Memphis, Tenn.**

Period *3* years.*

Present or absent *Present*

Stoppage, \$ *100* for

Due Gov't \$ *100* for

Remarks: *Present Sick*

†This organization subsequently became Co. K, 11 Reg't U. S. Col'd Infantry (New).

* See enrollment on card from muster-in roll.

Book mark:

Reedster

C | 11 (New). U.S.C.T.

Justin Campfield

1st Lt, Co. K, 11 Reg't U. S. Col'd Inf. (New).

Appears on

Company Muster Roll

for *Jan & Febr*, 1865.

Joined for duty and enrolled:

When *March 1*, 1864.*

Where *Memphis Tenn*

Period *3* years.*

Present or absent *present*

Stoppage, \$ *100* for

Due Gov't, \$ *100* for

Remarks: *On Special Duty
for S. Oct 8 Hd. Qrs 7th Arty.
C Arty Ky since Jan 17/65*

* See enrollment on card from muster-in roll.

Book mark:

Am Allen

C | **11 (New). U.S.C.T.**

Justus Campbell

1st Lt, Co. K, 11 Reg't U. S. Col'd Inf. (New).

Appears on

Company Muster Roll

for *Mar & Apr*, 1865.

Joined for duty and enrolled:

When *March*, 1864.*

Where *Memphis Tenn*

Period *3* years.*

Present or absent *present*

Stoppage, \$ *100* for

Due Gov't, \$ *100* for

Remarks: *In Special Duty Comd'g Co 'D' is entitled to \$10 per month for responsibility for ordnance and (over)*

* See enrollment on card from muster-in roll.

Book mark:

Spd Allen

JAN. 23

6334575

1891

ordnance stores per S.
O. 198, Hd. Qrs. 7th Med. C.
Arty. Jan 17/65.

Co. 1 11 1 U.S.

J. Canfield
1st Lieut. Co. K. 11th U.S. Col. Inftry

Return

of Fort Pickering, Tenn.,
for the month of May, 1865,
dated May 31, 1865,
shows the following with regard to the person
named above :

Post or station

Remarks: Post. Discharged
May 10, 1865, per Special
orders No. 193, War Dept.
dated April 8, 1865.

Book mark :

C. J. Harris
Copyist.

11

11 (New). U.S.C.T.

James [unclear]

Co. K, 11 Reg't U. S. Col'd Inf. (New).

Appears on

Company Muster Roll

for *May 1*, 186*4*.

Joined for duty and enrolled:

When *May 1*; 186*4*.*

Where *Hempstead* *

Period *3* years.*

Present or absent *absent*

Stoppage, \$ *100* for

Due Gov't, \$ *100* for

Remarks: *Absent with leave since June 3rd, 65*

* See enrollment on card from muster-in roll.

Book mark:

H. Allen

Co. 1 11 1 U.S.

J. Canfield
1st Lieut. 11th U.S. Col'd Inf'ty

Return

of Fort Pickering, Tenn.,

for the month of June, 1865,

dated June 30, 1865,

shows the following with regard to the person
named above :

Post or station _____

Remarks: Gained. Restored
to duty by S.O. No. 275, Par.
22 dated War Dept. Adjo.
Washington, June 3, 1865.

Book mark : _____

(546)

C. J. Harris

Copyist.

C 11 (New). U.S.C.T.

Justus Embred

1st Lt., Co. K, 11 Reg't U. S. Col'd Inf. (New).

Appears on

Company Muster Roll

for *July & Aug*, 1865.

Joined for duty and enrolled:

When *March*, 1864*

Where *Memphis**

Period *3* years.*

Present or absent *absent*

Stoppage, \$ *100* for

Due Gov't, \$ *100* for

Remarks: *absent with leave*

* See enrollment on card from muster-in roll.

Book mark:

W. A. Allen

C. 11 (New). U.S.C.T.

Justus Campbell
1st Lt., Co. K, 11 Reg't U. S. Col'd Inf. (New).

Appears on

Company Muster Roll

for... *Sept & Oct*, 1865.

Joined for duty and enrolled:

When... *March 1*, 1864.*

Where... *Memphis* *

Period *3* years.*

Present or absent... *present*

Stoppage, \$... 100 for

Due Gov't, \$... 100 for

Remarks: *Present in arrest*

* See enrollment on card from muster-in roll.

Book mark:

J. H. Allen

6 | 11 (New) | U.S.C.T.

Justus Langfeld

121, Co. K 11 Reg't U. S. Col'd Inf. (New.)
Appears on

Company Muster Roll

for Nov. & Dec., 1865

Joined for duty and enrolled:

When Mar. 1, 1864.*

Where Memphis *

Period 3 years.*

Present or absent

Stoppage, \$ 100 for

Due Gov't \$ 100 for

Remarks: Present in
custody. See Recapitula-
tion

* See enrollment on card from muster-in roll.

Book mark: 254010

Hammer

Justus Canfield
Lieut., Co. K, 11 Reg't U. S. Col'd Inf. (New.)

Appears on Returns as follows:

June 1864 - (7 U. S. Col'd Inf. Art'y) June 21, '64, Ft. Pickering, Reported as 1 Lieut. Co. K

Present assigned to duty by Spec Order No. 17, Ad. Dis. 7 U. S. C. A. N.Y. June 21, '64

July 1864 - Present assigned to duty per Spec Order No. 17, Ad. Dis. 7 U. S. C. Art'y Navy.

Aug. & Sept 1864 - Present.

Oct. 1864 - Absent with leave.

Nov. & Dec. 1864 - Present sick.

Jan'y 1865 - Present on Special duty Comdg Co. D. (over)

Book mark:

O. J. Taylor.

JAN. 23.

40767468

1899.

Febry to April 1865 - Present on
Special duty Comd'g Co.
I. (U.S. Col'd Inf. New).

May 1865 - Discharged, May 10. '65.
per S.O. No. 193 War Dept.
dated April 28. '65.

June 1865 - Restored to Com'd
per S.O. 275 War Dept.

June 3, 1865 - Absent
with leave.

July & Aug 1865 - Absent with leave

Sept. 1865 - Present, Returned
under arrest by order from
Sec. of War.

Oct. & Dec. 1865 - Present in arrest.

60

11 (New).

U.S.C.T.

Justus Banfield

Org. K

11 Reg't U. S. Col'd Inf. (New).

Appears on Co. Muster-out Roll, dated

Memphis, Tenn., Jan 12, 1866.

Muster-out to date _____, 1866.

Last paid to Feb 28 1865.

Clothing account:

Last settled _____, 1866; drawn since \$ 100

Due soldier \$ 100; due U. S. \$ 100

Am't for cloth'g in kind or money adv'd \$ 100

Due U. S. for arms, equipments, &c., \$ 100

Bounty paid \$ 100; due \$ 100

Remarks: Absent in arrest awaiting trial by Gen'l Martial

Book mark: 6.106. v. 10. b. 5. 73

Over

Hammer

JAN. 25

6334920

018910

2394 - c. 5/83 .

5-475 - P. m. ls. June 8/66

C. 111

U.S.A.

Justus Canfield
1st St., Co. K, 11 Reg't U.S.A. Inf.
(recd)

NOTATION.

Book mark: C. 565 - C. J. 1894

Record and Pension Office,

WAR DEPARTMENT,

Washington, May 18, 1894.

It has this day (May 18, 1894)

been determined by this Department from the records that this officer was finally discharged from the service May 9, 1865, by the operation of S.O. 193, par. 51, April 28, 1865, N.O., A.G.O. on an adverse report of a military board convened under the provisions of Sec. 10, of the act of Congress approved July 22, 1861; and that so much of S.O. 275, par. 22, June 3, 1865, N.O., A.G.O., as undertakes to

A. G. M.

revoke said so. no. 193,
and restore this officer
to his command, and
so much of I.O. 81, Feb.
21, 1866, W.D., A.G.O., as
undertakes to muster
him out of service to
take effect Dec. 23, 1865,
are void, and of no
effect.

See also Co. B, 2 Iowa
Cav.

Canfield, Justus -
 Lt., Co. K + I, 11 U. S. C. Inf.
 Reg't

23 Enclosures.

Bed Cards	Descriptive Lists
Burial Records	Final Statements
Certs. of Dis. for Discharge	Furloughs
C. M. Charges 2	Med. Des. Lists
Med. Certificates 1	Orders 10

Other papers relating to—

Admission to Hosp'l	Furlough 1
Casualty Sheet (Officer's)	Med. Examination
Confinement	Misc. Information 10
Contracts	Pay or Clothing
Death or Effects	Personal Reports
Desertions	Rank
Discharge from Hosp'l	Transfer to Hosp'l
Discharge from Service	Transfer to V. R. C.
Duty	Transportation

MICROFILM PUBLICATION M 1853

COMPILED MILITARY SERVICE RECORDS
OF VOLUNTEER UNION SOLDIERS WHO SERVED WITH
THE UNITED STATES COLORED TROOPS (USCT)
11TH REGIMENT OF INFANTRY-NEW ORGANIZATION

PERSONAL PAPERS' TARGET SHEET

PLEASE NOTE THE CHECKED INFORMATION ABOUT THE PERSONAL PAPERS IN
THIS FILE:

NO PERSONAL PAPERS WERE FOUND IN THIS FILE WHEN THE
RECORDS WERE ARRANGED FOR MICROFILMING.

25 PERSONAL PAPER(S) FOUND IN THIS FILE WHEN THE RECORDS
WERE ARRANGED FOR MICROFILMING.

Canfield, Justus

1st Lt - K

Order

Head Quarters 11th U.S. Infantry
Memphis Tenn May 27th 1865

Special Order
No 35

III. 1st Lieut. Justin Campbell Co "E" 11th
U.S. Infy. Company Co "D" 11th U.S. Infy. is hereby placed in
arrest with the limits of camp, pending charges, for dis-
obedience of orders, and relieved from Company Co "D"
11th U.S. Infy. and will turn over all Ordnance, Ordnance
Stores, Clothing, Cap and Garrison Equipage and all other
public property now in his possession, as Company Officer
Co "D" 11th U.S. Infy. to 2nd Lieut. John C. Mully Co "D" 11th U.S. Infy.
the proper receipts and Quittances will be prepared
and exchanged

By Order of Col
W. D. Burns Comdr. Regt.
B. F. Dehart

St. J. Adjt.

To Company Officer of Co "E"
11th U.S. Infy.

Canfield 9.

Et -

Comp

Canfield 9.

St -

Conf-

#360 J. D. 1865.

Head-Quarters Fort Pickering,
Memphis Tenn May 1865.

Col. W. D. Turner
Comdg 11th W. I. Infantry
Memphis Tenn

Colonel!

Your report of the 29th ult. stating
that Lieut. A. Gausfield of your Regiment,
has disobeyed instructions in regard to not
receiving money from enlisted Men, has
been received and laid before the General com-
manding.

He directs that this Officer be placed
under arrest and that you cause Charges
to be preferred against him, without delay.

By Order, Col. J. A. Kaffner
J. M. Mather
Capt. A. S. G.

Charges and Specifications
against Lieutenant Justus Canfield,
Co. "K," 11th U.S.C. Infantry.

Charge 1st;- Disobedience of orders.

Specification 1st;- Du This, That 1st Lt.
Justus Canfield Co. "K," 11th U.S.C. Inf.
did, contrary to Special Order No. 264.
Dist. of Memphis, dated Oct. 30th, 1864.-
borrow from the enlisted men of this
Regiment, (11th U.S.C. I.) certain sums
of money to wit:

Corporal James Cook Co. "I." - \$80. 00.

Corporal Beverly Young Co. "I." - \$100. 00.

Corporal Joe Harris Co. "I." - \$40. 00.

Squire Watson Co. "K." \$80. 00.

This in violation of the above Special
order No. 264. at the camp of the 11th U.
S.C. Inf., Memphis Tenn., on or about
May 8th 1865.

Specification 2^d;- Du This, That Lieut
Justus Canfield Co. "K," 11th U.S.C. Inf.
did borrow from Corp'l Joe Harris, Co. "I."
11th U.S.C. Inf., and other enlisted men of
his Regiment, various sums of money
with the intention of defrauding them
of the same. He, Lieutenant Justus
Canfield Co. "K," 11th U.S.C. Inf., having
absented himself from his Regiment
since May 8th 1865. having violated his
word pledged to repay said enlisted
men the various sums borrowed.

from them, at a short period.
This at the Camp of the 11th U.S. Inf.
near Memphis Tenn., on or about
May 8th 1865.

Charge 2^d. - Conduct unbecoming
an officer and a gentleman.

Specification 1st. - In this, that Lieut.
Justus Gaufield Co. "H." 11th U.S. Inf.
did borrow one hundred dollars
(\$100.00.) from Beverly (Young Co. "I." 11th
U.S. Inf. promising to pay ^{him} one
hundred and ten dollars (\$110.00.) in
three weeks from date. That Lieut.
Justus Gaufield Co. "H." 11th U.S. Inf.
did not pay him in the specified time,
and has failed to do so at all; but
did tender his resignation, not
intending to return to his Regiment, or
to pay his just indebtedness either to
the enlisted men, the Sutter, or his br.
officers, to whom he is indebted. This
at the Camp of the 11th U.S. Inf.
Memphis Tenn. on or about the 8th of
May 1865.

Charge 3^d. - Conduct prejudicial
to good order and military discipline.

Specification 1st. - In this that Lieut.
Justus Gaufield Co. "H." 11th U.S. Inf.
did destroy his influence as an officer
over the enlisted men of his Company

and others in the regiment by borrowing
money from, and otherwise trading
with, them and thus, in a manner,
placing himself on an equality with
said enlisted men. This at Camp of
The 11th U.S. Co. Inf. on or about May 8th 1865

Col. 11th U.S. Co. Inf.
Comd'g Regt.

Witnesses

Canfield, Justus

Lt. N

C. M. Chys

Charges and Specifications against
Lieutenant Justus Caufield, Co. "K" 11th
U. S. C. Inf.

Charge 1st; Disobedience of orders.

Specification 1st; In this, That 1st Lieut.
Justus Caufield, Co. "K" 11th U. S. C. Inf.
did, contrary to Special Order No. 264, Dist
of Memphis, dated Oct 30th 1864, borrow
from the enlisted men of this regiment
(11th U. S. C. Inf.) certain sums of money,
to wit:

Corporal James Cook, Co. "I" \$80.00.

Corporal Beverly Young, Co. "I" \$100.00.

Corporal Joel Harris, Co. "I" \$40.00.

Squire Watson, Co. "K" \$80.00.

This in violation of the above Special Order
No. 264, at the Camp of the 11th U. S. C. Inf.
Memphis Tenn. on or about May 8th 1865.

* Specification 2nd; In this, That Lieut.
Justus Caufield, Co. "K" 11th U. S. C. Inf.
did borrow from Corporal Joel Harris
Co. "I" 11th U. S. C. Inf. and other enlisted men
of his regiment, various sums of
money with the intention of defrauding
them of the same. He, Lieutenant
Justus Caufield, Co. "K" 11th U. S. C. Inf.
having absented himself from his
regiment since May 8th 1865, having
violated his word pledged to repay said
enlisted men the various sums
borrowed from them, at a short period.

This at The Camp of the 11th U. S. Inf. near Memphis Tenn. on or about May 8th 1865.

Charge 2^d: Conduct unbecoming an officer and a gentleman.

* Specification 1st: In this, That Lieutenant Justus Canfield Co. "K" 11th U. S. Inf. did borrow One Hundred dollars (\$100.00) from Beverly Young Co. "I" 11th U. S. Inf. promising to pay him One Hundred and Ten dollars (\$110.00.) in three weeks from date. That Lieutenant Justus Canfield, Co. "K" 11th U. S. Inf. did not pay him in the specified time, and has failed to do so at all; but did tender his resignation, not intending to return to his regiment or to pay his just indebtedness either to the enlisted men, the sutler, or his brother officers, to whom he is indebted. This at the Camp of the 11th U. S. Inf. near Memphis Tenn. on or about the 8th of May 1865.

Charge 3^d: Conduct prejudicial to good order and military discipline.

Specification : In this, That Lieut. Justus Canfield, Co. "K" 11th U. S. Inf. did destroy his influence as an officer over the enlisted men of his Company and others in the regiment by borrowing money from, and otherwise trading,

with said enlisted men, thereby placing
himself on an equality with them
from obligation. This at Camp
of the 11th U.S. Co. Infantry on or about
the 8th of May 1865.

Col. 11th U.S. Co. Infy
Commanding Regt.

Witness.

Campfield, Julius -
D.R.

C. M. Chapman

St. Augustus Canfield
In Acct. with
D P Barr

July 3rd 1863

For 4 months rent of
Photograph Gallery in West
Pickering Memphis Tenn.

At \$30.00 per month \$120.00

So Canfield you
will please pay the
above account to
Col Turner and this
shall be your receipt for
the same
D P Barr

Vicksburg Miss
July 9th 1866.

Col Sumner.
11th U.S. Col 15th Regt
Gen

Enclosed
you will please find
an account of the
in favor of G. P. Barr. Genl
House rent in Fort Bakerina
at \$30 per month. If the Genl
says he did not occupy the
house four months let him
pay you for what time he
did occupy it. If collected
please send per Express to G. P.
Barr Paducah Ky.

Mr Barr sent me the accou
nt to give to you. But owing
to my Regiment leaving so

sudden. I could not call
and see you personally, as I
wished to do.

I am Col Very Respectfully

Your Obedt Servt

J. M. Van Fleet

Q. M. Fergat

5-11-1864

P. O. Address Alexander

La

March 1st Iowa

Iowa July 1965

Comdy Officer 11th U.S.C.I.
Dear Sir I heri with I end
my resignation for your
approval. Circumstances
are such with me that it
is imposable for me to rejoin
the regt. My health is very
poor and I came home in good
faith and have gone into busin
and it will be a great sacrifice
for me to break up and come
Back, under the circumstances
it is my duty to my self &
also to my family for me to
remain at home I therefore
most respectfully ask that
you give a good endorsement
on the enclosed resignation
and forward the same

through the military channel
and oblige your.

If I were to report
to the regt. I could not do any
duty on account of my impaired
health. Please answer this
and give the prospects in
regard to my papers & allow
the regt.

I am Sir very respectfully
your Obedient Servant
Justus Canfield
1st Lieut 11th U.S.C.

N. E. 383. O. W. Tom. 1. No. 3.

War Department
Adj. Genl's Office
August 31. 1865.
Washington D. C.

War Department
F. H. Taggard A. A. S. Col.

Directs Genl Pope County.
Dept of Missouri, to assist
J. J. Justice, Campbell 114
Inf. Col. Inf. and send under
proper guard to Memphis Tenn
to report to the Genl County.
D. W. Tom for trial by
court Marshal for absence
without leave.

(Official Copy)

Recd & qm D. W. S. Apr. 15. 1865

37 / 11 / 1865

War Department,
Adjutant General's Office,
Washington D.C. Aug. 31. 1865.

Major General John Pope,
Commanding Department of the Missouri,
Fort Leavenworth, Kansas,
General.

I am
directed by the Secretary of War to instruct
you to cause 1st Lieutenant Justus Curfield,
11th U. S. Colored Troops, now supposed to
be at his home at Marshall, Iowa, to be
arrested and sent under proper guard to
Memphis, Tennessee, to report to the Com-
manding General District of West Tennessee,
for trial by Court Martial or Military
Commission for absence without leave, defraud-
ing enlisted men, and disobedience of

Order.

I have the honor to be,

Very Respectfully,

Your Obedient Servant,

(Signed)

F. W. Saggard

U. S. Genl. Vols.

Official Copy as previously furnished for
the information of Commanding General District
of West Tennessee, Memphis, Tennessee.

F. W. Saggard

U. S. Genl. Vols.

Miss Alice M. Jones

Washington D.C. Aug. 31. 1863.

Dear Miss Alice
I received your letter
of the 21st inst.

Directs that John Justice Span-

ford 11th Reg. U.S. Colored Troops

be arrested at Washington

D.C. to be arrested and sent to

Memphis Tenn. for trial ^{before} the C.M.

for absence without leave, &c.

11th U.S.C.T.

Alice

Kan Department,
Adjutant General's Office,
Washington, August 31st 1865,

Major General John Pope,
Comd'g Department of Missouri,
Fort Leavenworth, Kansas,
General:-

I am directed
by the Secretary of War, to instruct
you to cause 1st Lieutenant Justus
Canfield, 11th U.S. Col and Troop now
supposed to be at his home at Marshall-
town, Iowa, to be arrested and sent
under proper guard to Memphis
Tennessee, to report to the Comman-
ding General, District of West
Tennessee for trial by Court Martial
or Military Commission for absence
(over)

without liars, defrauding enlisted
men, and disobedience of orders.

I have the honor to,

Very Respectfully,

Your Obedient Servant,

Geo. Sargent

(U. S. Army)

(C. 121, Feb. 5, A. T. 1865.)

1
Campfield justus

Lt

Order

New Orleans 11th U.S. Infy
Memphis Tenn Sept 23rd 1865

Special Orders
No 169 } Extract

21 22 23 24 25
The Sergeant Justus Conyild 11th U.S. Infy
having reported at the Det. Co under
arrest in compliance with S.O. 239
Det. Co Dist West Tenn, of date Sept 23rd 1865
will remain in arrest in his quarters in
Camp,

26 27 28 29 30
My Command
To Comdg Officer
Co 15th U.S. Infy

~~Col. J. D. Turner~~
~~J. H. Denton~~
S. J. Denton

Canfield, Foster,
Et.

SPECIAL ORDERS,
No. 239.

HEAD-QUARTERS,
DISTRICT OF WEST TENNESSEE,
Memphis, Tenn., September 23d, 1863

EXTRACT.

* * * * *

2 Lieutenant Justus Canfield, 11th United States colored Infantry, having reported at these Head Quarters under arrest, will report at once to the Commanding Officer of his Regiment, and remain in arrest in his Quarters in Camp.

* * * * *

BY ORDER OF BREVET MAJOR GENERAL J. E. SMITH,
W. H. MORGAN,
Brevet Brigadier General and Assistant Adjutant General.

OFFICIAL.

W. H. Morgan
Captain & A. A. G.

*Col Turner
Comd. 11th Reg. Col Inf.*

Canfield justus

Et.

SPECIAL ORDERS,
No 317

HEAD-QUARTERS,
DISTRICT OF WEST TENNESSEE,
Memphis Tenn. December 23d, 1865.

[*Extract.*]

1 Justus Canfield, First Lieutenant 11th U. S. colored Infantry, is hereby released from arrest with permission to return to his home to await the orders of the War Department in his case. Before leaving this city, he will report his Post Office address to Colonel E. R. Wiley, Acting Judge Advocate, District West Tennessee.

* * * * *

BY ORDER OF BREVET MAJOR GENERAL J. E. SMITH.

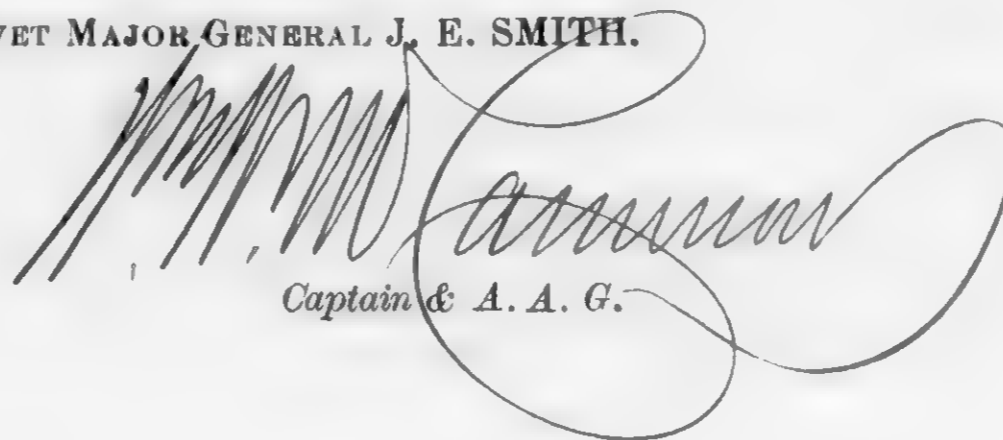
Captain & A. A. G.

County Officers "Ref Col Capt"

Copy of opinion of Judge Advocate
General.

D. 20. Vol. 3. C. D. 1866.

War Department,
Bureau of Military Justice,
February 13th 1866.

Respectfully returned to the Adjutant
General.

Sit. Major Genl. John E. Smith, writes
to the Dept. asking advice in the matter
of the arrest and trial of Sicut Justice
Canfield, 11th U. S. Col^d Infantry.

Sicut Canfield it appears was examined
by a Board of Officers convened for
that purpose Jan^y 30th 1865 and upon the
adverse report was discharged from service,
but was reinstated and restored to rank
June 30th 1865.

July 6th following, he tendered his resignation, which was not accepted. He was subsequently arrested by order of the Secretary of War, and sent to Memphis, for trial. He was accordingly arraigned before Ct. Martial, put in a plea denying jurisdiction, and the Court sustained the plea. The proceedings were disapproved by Genl. Smith, who ordered the accused to be detained in arrest for further trial on the same charges.

Dec. 13th Lieut. Canfield, being in poor health and utterly without means, the writer permitted him to go home, where he now is, and requests what shall be done.

There can be no doubt of the correctness of the course adopted by Genl. Smith in disapproving the sentence of the Court.

The tender of resignation by Lt. Canfield was in fact an acceptance of his re-issu statement.

The offenses of which he was accused consisted of borrowing money from enlisted men, and a failure to pay them. These offenses, though purely military, derived their criminality not only from the fact they were committed in violation of discipline and military law, but more especially from the abuse of the powers of an officer, exercised in plundering the men whose protection and care were among the most sacred of his obligations.

Though a trial by Ct. Martial could not result in any sentence or order which would restore the money taken from the victims of such discreditable practices, still it would seem to be an act of injustice to

permit this officer to leave the service
with an honorable discharge without a
judicial determination of the grave
accusations brought against.

(Signed) J. Holt.

Judge Adv. General.

War Dept. A. S. C.

February 27, 1866.

Official:

Geo. S. Sargent
Asst. Adjt. Genl. Col.

War Department,

ADJUTANT GENERAL'S OFFICE,

Washington, February 21st, 1866.

Special Orders,

No. 87.

(Extract)

* * * * *

5. 1st Lieutenant Justus Canfield, 11th U.S. Colored Troops, having tendered his resignation, is hereby mustered out of the service of the United States to take effect December 23rd 1865, with the condition that he shall receive no final payments, until he shall satisfy the Pay Department that he is not indebted to the Government, and that he has restored to the following named enlisted men of his regiment, or to the Pay Department, the amounts set opposite their respective names, the same having been obtained by him from said men as a loan.

(over)

Corporal James Cook, Company I; \$80.

Corporal Beverly Young, Company I; \$100.

Corporal Joe Harris, Company I; \$40.

Private Squire Watson, Company K; \$80.

* * * * *

By order of the Secretary of War,
(Signed) E. D. Townsend,

Assistant Adjutant General,

War Dept. A.S.O.

Feb 24th 1866.

Officials;

A. F. Ruckwell

a. a. Genl. Volg.

Campbell, District
11-7-66

May Genl. Geo. H. Thomas

Camp Hill in Tenn

War Department,

ADJUTANT GENERAL'S OFFICE,

Washington, Feb^y 24[#], 1866.

Major General George W. Thomas,

Commanding Military Division of the Tennessee,

Head Quarters, Nashville, Tenn.,

General:-

I have respectfully to acknowledge the receipt of letter of December 29[#] 1865, from Brevet Major General John E. Smith, Commanding District of West Tennessee in the case of 1st Lieutenant Justus Canfield 11th W. S. Colored Troops, forwarded under cover of your endorsement of the 8th ultimo.

In reply I am directed to enclose for your information an official copy of the opinion of the Judge Advocate General together with a copy of Special Order from this office in
(over)

the case with the request that you will
cause copies of the same to be forwarded to
General Smith

In view of the fact that Lieutenant
Canfield is now at his home in Iowa, and
that the regiment to which Canfield belongs
has been mustered out, it was not deemed
expedient to order him back to Memphis
for trial.

I have the honor to be,

Very Respectfully,

Your obedient servant.

L. W. Foster

a. agent. 304.

SPECIAL ORDERS, }
No. 81. }

WAR DEPARTMENT,
ADJUTANT GENERAL'S OFFICE,
Washington, February 21st, 1866.

(Extract.)

* * * * *
✓ 5. 1st Lieutenant *Justus Canfield*, 11th U. S. Colored Troops, having rendered his resignation, is hereby mustered out of the service of the United States, to take effect December 23d, 1865, with condition that he shall receive no final payments, until he shall satisfy the Pay Department that he is not indebted to the Government, and that he has restored to the following named enlisted men of his regiment, or to the Pay Department, the amounts set opposite their respective names, the same having been obtained by him from said men as a loan:—

Corporal *James Cook*, Company "I," \$80.
Corporal *Beverly Young*, Company "I," \$100.
Corporal *Joe Hanis*, Company "I," \$40.
Private *Squire Watson*, Company "K," \$80.

* * * * *

By order of the Secretary of War:

E. D. TOWNSEND,
Assistant Adjutant General.

OFFICIAL:

Assistant Adjutant General.

Wm. S. Foster

104
L. Justus Canfield
11th N. S. C. T.

~~not found~~

SPECIAL ORDERS, }
No. 81.

WAR DEPARTMENT,
ADJUTANT GENERAL'S OFFICE,
Washington, February 21st, 1866.

(Extract.)

* * * * *
5. 1st Lieutenant *Justus Canfield*, 11th U. S. Colored Troops, having
tendered his resignation, is hereby mustered out of the service of the
United States, to take effect December 23d, 1865, with condition that
he shall receive no final payments, until he shall satisfy the Pay
Department that he is not indebted to the Government, and that he has
restored to the following named enlisted men of his regiment, or to the
Pay Department, the amounts set opposite their respective names, the
same having been obtained by him from said men as a loan:—

Corporal *James Cook*, Company "I," \$20.
Corporal *Beverly Young*, Company "I," \$100.
Corporal *Joe Hanis*, Company "I," \$40.
Private *Squire Watson*, Company "K," \$20.

* * * * *
By order of the Secretary of War:

E. D. TOWNSEND,
Assistant Adjutant General.

OFFICIAL:

Assistant Adjutant General.

21/25 C.P. 1866

John W. ...

21, 1866

James Cook

Campfield, Justus

1st Lt. 11th U.S.C.S.

Coby

3

SPECIAL ORDERS,
No. 81.

WAR DEPARTMENT,
ADJUTANT GENERAL'S OFFICE,
Washington, February 21st, 1866.

(Extract.)

* * * * *
5. 1st Lieutenant *Justus Canfield*, 11th U. S. Colored Troops, having rendered his resignation, is hereby mustered out of the service of the United States, to take effect December 23d, 1865, with condition that he shall receive no final payments, until he shall satisfy the Pay Department that he is not indebted to the Government, and that he has restored to the following named enlisted men of his regiment, or to the Pay Department, the amounts set opposite their respective names, the same having been obtained by him from said men as a loan:—

- Corporal *James Cook*, Company "I," \$80.
- Corporal *Beverly Young*, Company "I," \$100.
- Corporal *Joe Hanis*, Company "I," \$40.
- Private *Squire Watson*, Company "K," \$80.

By order of the Secretary of War:

E. D. TOWNSEND,
Assistant Adjutant General.

OFFICIAL:

Assistant Adjutant General.

Wm. T. Felt

Canfield, Justus -

1st Lt

Rank

Adjutant General's Office

Washington, D. C., July 12th 1864.

Sir:

I have the honor to inform you that the muster into service of Justus Canfield as a 1st Lieutenant in the Seventh Regiment of U. S. C. Art. (Reg.) Volunteers, made by Lieut. P. Meagher Act, Commissary of Musters 16th Army Corps on the Twentieth day of June, ^{to date from March 1st 1864} 1864, is accepted at this Office; but, on account of errors, as stated below, it can only date from June 20th, 1864, which is accordingly fixed as the date from which it shall take effect.

The following are the errors: The affidavit required in such cases, does not accompany the Roll

I am, sir, very respectfully,

Your obedient servant,

(Signed) J. W. Saggard

Assistant Adjutant General. Vol.

To Commanding Officer

7th U. S. C. Art. (Reg.) for his information and guidance

Official copy furnished ⁽⁷⁸⁾ Lieut. P. Meagher Act. Comy. Musters 16th Army Corps

A. B.

Memphis Tenn

J. W. Saggard
A. A. G. Vol.

Justus Caufield, a First Lieutenant in the 7th U. S. Col'd. Art. (Heavy), having applied for a certificate wherein to base an application for leave of absence, I hereby certify that I have carefully examined this officer, and find him much debilitated by a long continued and stubborn attack of Bilious Intermittent Fever.

He is, in my opinion, unfit for duty; and will not be able to resume his duties in a less period of time than sixty days.

In my opinion, he requires an immediate change to a more northerly latitude and climate to save life, or prevent permanent disability.

Dated at Memphis, Tenn.

This 13th day of Oct^r 1864

Reese P. Kendall,

Surg. 7th U. S. C. A. (Heavy)

in Fort Pickens

Appended a personal Examination.

Geo. S. Keegan, M.D.

Surg. in Charge of the Hospital

11.3. 114 1.9
A-C 222/21057/1864

Quarters Co. No. 7th U.S.C.A. Reg.
Fort Pickering. Oct 13th 1864

118, G. R. B. "C" Regt
Canfield, Justice 1st Dist Co No
7th U.S. Cavalry.

Make application for leave of
absence for 30 days, from
October 15th to 14th 1864.

in inclosure

200

See S. O. 67 - 111

Recd 4th U.S. Oct 13/64

Head Qrs Fort Pickering Oct 13 1864
Recd H. Q. & M. Oct 14 1864

114 111 111 111

Head Quarters 7th U.S. Cavalry
Fort Pickering Memphis Oct 13th 1864

Respectfully forwarded
Approved

J. M. D. Baker
Superintendent 7th U.S. Cavalry

Head Quarters Fort Pickering
Fort Pickering 14th October 1864

Respectfully forwarded
and approved

J. H. Kappner
Capt U.S. Cavalry (Heavy)
Company Fort

Head Quarters District Memphis
Memphis Tenn Oct 14th 1864

Respectfully forwarded
Approved

R. W. Brockland
Brig General.

Recd H. Q. Dist. No. 1
Memphis Oct 13th 64

Approved
S. J. Grant
Act Med Director

Quarters Co. No. 7th U.S.C.A. Heavy,
Fort Pickering Memphis Oct 13th 1864.

Major W. H. Morgan
At A Genl. Dist. West Tenn.

Major:

I have the honor
to request a leave of absence for 20. days, for reasons
set forth in accompanying Surgeons Certificate.

I am Major

With respect &c.

Justus Canfield
1st Lieut. Co. No. 7th U.S.C.A. Heavy,

Headquarters, District of Memphis, }
MEMPHIS, TENN., OCT. 30, 1864. }

Special Orders,)

No. 264.)

PAR. V. * * * * *

Officers of Colored Regiments are prohibited from borrowing or receiving money from the enlisted men of such Regiments, and all Officers who have heretofore borrowed or received money from such enlisted men will immediately return the same.

Commanding Officers of Colored Regiments will take measures for the safe keeping of such money of the enlisted men of their commands as is not needed for the immediate use of themselves or families; the money to be deposited in a safe depository, to be drawn as needed or required by the owners.

By order of Brig. Gen'l R. P. BUCKLAND,

ALF. G. TUTHER,

Capt. and Acting Ass't Adj't Gen'l.

OFFICIAL:

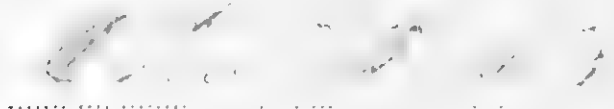
A. A. A. Gen'l.

Justus C. Angell,

Adjutant General's Office,

COLORED TROOPS BRANCH,

Mr Ellertson

June 27th, 1877

Vol. C. T., 187

Wanted in the case of Justus Canfield 1st Co. "K",
11th Reg't U. S. C. Troops (new) Cause of arrest and
Record of trial - M. R. for Nov 1865 - reports him
"Present in Arrest" - & M. O. Roll of Co. reports - "Absent
in arrest awaiting trial by Lt C M."

A. G.

Respectfully,

W. A. Woodward
Chief Clerk.

W. J. Halston

Adjutant General's Office,

Division of Discontinued Bonds

July 5, 1877

Vol. C. T., 187

Reply in case of Justus Canfield, Co. "K",
11th Reg't U. S. C. Troops
Reg'tl & Des. Book report him Rest to
Comd for S. O. 275 since 1865. M. Dept June 3. '65, on file,

20 of DC 5-77 A. G.

Papers relating
to Justus Campfield,
about 1811 "W. & C. Liberty,

Canfield Justice
1st, Co., 11 Reg't *12th*

Resignation Papers

(File mark: *P. 111* C. T. R. B., 1864)

Cannot be found on Resignation File. Investigation shows that the papers were disposed of as indicated below:

Returned _____

Filed with ~~*C. T. R. B. 1864*~~

vide C. T. R. B. file 3 (a) 434

**Resignation papers
transferred to
Personal Paper files**

Sanitchie Abner

Co *G*, 11 U.S. Col'd Inf.

(New Organization.)

Private

Private

CARD NUMBERS.

1	26
2	27
3	<i>In Sanitchie Abner</i>
4	29
5	30
6	31
7	32
8	33
9	34
10	35
11	36
12	37
13	38
14	39
15	40
16	41
17	42
18	43
19	44
20	45
21	46
22	47
23	48
24	49
25	50

Book Mark:

See also

238

Sanitchie Abner

Co *G*, 11 U.S. Col'd Inf.

(New Organization.)

Private

Private

CARD NUMBERS.

1	26
2	27
3	<i>In Sanitchie Abner</i>
4	29
5	30
6	31
7	32
8	33
9	34
10	35
11	36
12	37
13	38
14	39
15	40
16	41
17	42
18	43
19	44
20	45
21	46
22	47
23	48
24	49
25	50

Book Mark:

See also

239

Cannady, Peter

Co *H*, 11 U.S. Col'd Inf.

(New Organization.)

Private | *Corporal*

CARD NUMBERS.

1	6332008	26
2	6332097	27
3	6332181	28
4	6332259	29
5	6332320	30
6	6332380	31
7	6332437	32
8	6332494	33
9	6332552	34
10	6332627	35
11	6332700	36
12	6332770	37
13	6332836	38
14		39
15		40
16		41
17		42
18		43
19		44
20		45
21		46
22		47
23		48
24		49
25		50

Book Mark:

See also

5822525 P.O. aff.
5822799 P.O. aff.
51313758 Pomson

D: 2107199. P.O. Ref

D-2962142. And. N.A.

AS. V.B. 7/6/28₂

6 | **11** ^(New) **U.S.C.T.**

Peter Comrad
....., Co. 6 ^(New) 11 Reg't U.S. Col'd Inf.

Appears on

Company Descriptive Book

of the organization named above.

DESCRIPTION.

Age 23 years height 5 feet 7 1/2 inches.

Complexion yellow

Eyes; Black hair Black

Where born Mason Ky

Occupation farmer

ENLISTMENT.

When Feb 24, 1864.

Where Memphis Tenn

By whom J. J. McQueen, term 3 y'rs.

Remarks:

J. E. Rusk

C | 11 (New). | U.S.C.T.

Peter *Cumrod*
Pvt., Co. H, 6 Reg't U. S. Col'd H. Art'y.*

Appears on

Battery Muster-in and Descriptive Roll

of the organization named above. Roll dated

Richering Memphis Tenn. (Apr. 2, 1864)

Where born *(Massou. Ind. Ky.)*

Age *23* y'rs; occupation *Farmer*

When enlisted *Feb. 24, 1864*

Where enlisted *Memphis Tenn.*

For what period enlisted *3* years.

Eyes *Blk*; hair *Blk*

Complexion *Yellow*; height *5 ft. 7 1/2 in.*

When mustered in *Feb. 24, 1864*

Where mustered in *Memphis, Tenn.*

Bounty paid \$ *100*; due \$ *100*

Where credited

Battery to which assigned

Remarks:

* This organization subsequently became Co. H, 11 Reg't U. S. Colored Infantry (New).

Book mark:

(Magnus)

(356g)

Copyist.

6 | **11 (New).** | **U.S.C.T.**

Peter Cannady
Corpl., Co. H, 6 Reg't U. S. Col'd H. Art'y.*

Appears on

Company Muster Roll

for *2^d to 30th Apl.*, 1864.

Present or absent *Present.*

Stoppage, \$ *100* for

Due Gov't, \$ *100* for

Remarks *Appointed Corpl*
from Pvt. per S. O. no.
dated Ad. Drs. 6th W.S. Army.
Arty. Apl 29/64.

*This organization subsequently became Co. II, 11 Reg't U. S. Col'd Infantry (New).

Book mark :

Wagner

b | **11 (New).** | **U.S.C.T.**

Peter Hannady
Cooper, Co. H, 7 Reg't U. S. Col'd H. Art'y.*

Appears on

Company Muster Roll

for *May & June*, 1864.

Present or absent *Present.*

Stoppage, \$ *100* for

Due Gov't, \$ *100* for

Remarks:

*This organization subsequently became Co. H, 11 Reg't U. S. Col'd Infantry (New).

Book mark: _____

J. H. Wagner

10 | 11 (New). | U.S.C.T.

Peter Bamady
Co. H, 7 Reg't U. S. Col'd H. Art'y.*

Appears on

Company Muster Roll

for July 7 (Aug), 1864.

Present or absent Present.

Stoppage, \$ 100 for

Due Gov't, \$ 100 for

Remarks:

*This organization subsequently became Co. H, 11 Reg't U. S. Col'd Infantry (New).

Book mark:

Wagner
Copyist

b | **11** (New). | **U.S.C.T.**

Peter Cannady
Copple, Co. H, 7 Reg't U. S. Col'd H. Art'y.*

Appears on

Company Muster Roll

for *Sept. 7 Oct.*, 186*4*.

Present or absent *Present.*

Stoppage, \$ *100* for

Due Gov't, \$ *100* for

Remarks:

*This organization subsequently became Co. H, 11 Reg't U. S. Col'd Infantry (New).

Book mark: -----

C. H. Wagner

6 | **11** (New). | **U.S.C.T.**

Peter Kennedy
Copple, Co. H, 7 Reg't U. S. Col'd H. Art'y.*

Appears on

Company Muster Roll

for *Nov & Dec.*, 1864.

Present or absent *Present*

Stoppage, \$ 100 for

Due Gov't, \$ 100 for

Remarks:

*This organization subsequently became Co. H, 11 Reg't U. S. Col'd Infantry (New).

Book mark:

P. A. Wagner

C. | 11 (New). | U.S.C.T.

Peter Cannady
Copt., H, 11 Reg't U. S. Col'd Inf. (New).

Appears on

Company Muster Roll

for *Jan. & Feb.*, 1865.

Present or absent *Present*

Stoppage, \$ *100* for

Due Gov't, \$ *100* for

Remarks:

Book mark:

Accounting

C. | 11 (New). | U.S.C.T.

Peter Cunnady
Co. H, 11 Reg't U. S. Col'd Inf. (New).

Appears on

Company Muster Roll

for *Mar. & Apr., 1865.*

Present or absent *Present*

Stoppage, \$ *100* for

Due Gov't, \$ *100* for

Remarks:

Book mark:

(858)

Hessling

Copyist.

C. | 11 (New). | U.S.C.T.

Peter Cumady
Coopl., H, 11 Reg't U. S. Col'd Inf. (New).

Appears on

Company Muster Roll

for *May & June, 1865*

Present or absent *Present*

Stoppage, \$ *100* for

Due Gov't, \$ *100* for

Remarks:

Book mark: *...*

(858)

Hawking

Copyist.

C. | 11 (New). | U.S.C.T.

Peter Cannady
Corpl., H, 11 Reg't U. S. Col'd Inf. (New).

Appears on

Company Muster Roll

for *July & Aug.*, 1865.

Present or absent *Present.*

Stoppage, \$ *43* / *100* for *Ord. &*

Ord. stores loan.

Due Gov't, \$ *100* for

Remarks:

Book mark:

Hausling

C. | 11 (New). | U.S.C.T.

Peter Cannady
Corpl., H, 11 Reg't U. S. Col'd Inf. (New).

Appears on

Company Muster Roll

for *Sept. & Oct., 1865*

Present or absent *Present*

Stoppage, \$ *43* / *100* for *Arcl. &*

Arcl. stones lost.

Due Gov't, \$ *100* for

Remarks:

Book mark:

C | **11** (New). | **U.S.C.T.**

Peter Camady
Corp, H, 11 Reg't U. S. Col'd Inf. (New).

Appears on

Company Muster Roll

for *Nov 4 Dec*, 1865.

Present or absent *Present*

Stoppage, \$ *43* / *100* for *ordnance*

Due Gov't, \$ *100* for

Remarks:

Book mark:

M. E. Camady

C | 11 (New). U.S.C.T.

Peter Barnady
Corp A, 11 Reg't U. S. Col'd Inf. (New).

Appears on Co. Muster-out Roll, dated
Memphis Tenn June 12, 1866.

Muster-out to date June 12, 1866.

Last paid to June 30, 1865.

Clothing account:

Last settled 186 ; drawn since \$ 100

Due soldier \$ 6²⁷/₁₀₀; due U. S. \$ 100

Am't for cloth'g in kind or money adv'd \$ 100

Due U. S. for arms, equipments, &c., \$ ⁴³/₁₀₀

Bounty paid \$ 100; due \$ 100

Remarks:

Book mark: 432-497

(361)

McCreary
Copyist.

739-a

Cannon William

Co. F, // U. S. Col'd Inf.
(New Organization.)

CARD NUMBERS.

1	26
2	27
3	28
4	29
5	30
6	31
7	32
8	33
9	34
10	35
11	36
12	37
13	38
14	39
15	40
16	41
17	42
18	43
19	44
20	45
21	46
22	47
23	48
24	49
25	50

Reference envelope,

Number of personal papers herein.....

Book Mark :

See also Pioneer Corps, Cold, Cav.
Div. 16 A. C.

2401

Loare William

Co *Mrd*, 11 U.S. Col'd Inf.

(New Organization.)

Private

Private

CARD NUMBERS.

1		26	
2		27	
3	<i>In Carr</i>	28	<i>William</i>
4		29	
5		30	
6		31	
7		32	
8		33	
9		34	
10		35	
11		36	
12		37	
13		38	
14		39	
15		40	
16		41	
17		42	
18		43	
19		44	
20		45	
21		46	
22		47	
23		48	
24		49	
25		50	

Book Mark ..

See also

241

Carutchie, Abner

Co G, 11 U.S. Col'd Inf.

(New Organization.)

Private

Private

CARD NUMBERS.

1	26
2	
3	<i>Carutchie, Abner</i>
4	29
5	30
6	31
7	32
8	33
9	34
10	35
11	36
12	37
13	38
14	39
15	40
16	41
17	42
18	43
19	44
20	45
21	46
22	47
23	48
24	49
25	50

Book Mark:

See also

242

Parcutchie, William

Co G, 11 U.S. Col'd Inf.

(New Organization.)

Private

Private

CARD NUMBERS.

1	6 3 2 2 6 0 7	26
2	6 3 3 0 9 5 3	27
3	6 3 3 1 0 3 9	28
4	6 3 3 1 1 2 7	29
5	6 3 3 1 2 1 2	30
6	6 3 3 1 2 9 7	31
7	6 3 3 1 3 7 6	32
8	6 3 3 1 4 5 9	33
9	6 3 3 1 5 4 3	34
10	6 3 3 1 6 8 0	35
11	6 3 3 1 9 7 7	36
12	9 0 7 2 2 1 8	37
13		38
14		39
15		40
16		41
17		42
18		43
19		44
20		45
21		46
22		47
23		48
24		49
25		50

Book Mark: *END 12/829*

See also

S. 1669067 Auto. 200

A. 1761815 auto. 17. 22.

6

11 (New) U. S. C. T.

William Carnitahie

(New)

Co. G, 11 Reg't U. S. Col'd Inf.

Appears on

Company Descriptive Book

of the organization named above.

DESCRIPTION.

Age 30 years height 5 feet 4 inches.

Complexion Black

Eyes; Blue hair Black

Where born Richmond Va

Occupation Laborer

ENLISTMENT.

When Jan 12, 1864.

Where Fort Pickens

By whom Col. Kappner; term 3 y'rs.

Remarks: Discharged June 13/65
for disability by order of Maj
Genl E. J. Smith

A. J. Anderson

6

11 (New).

U.S.C.T.

William Careutchie

Appears with rank of *Pri* on

Muster and Descriptive Rolls of Detachments of U. S. Vols. forwarded

for the *11* Reg't U. S. Col'd *Inf* Roll dated

Memphis Tenn, *Feb 2*, 1864.

Where born *Richmond Co Va*

Age *30* y'rs; occupation

When enlisted *Jan 12*, 1864.

Where enlisted *Fort-Pickering*

For what period enlisted *3* years.

Eyes *black*; hair *black*

Complexion *black*; height *5* ft. *4* in.

When mustered in *Feb 4*, 1864.

Where mustered in *Fort-Pickering*

Bounty paid \$ *100*; due \$ *100*

Where credited

Company to which assigned

Remarks:

Book mark

Ashley

6 | 11 (New). U.S.C.T.

William Barntchie

Pvt, Co. E, 1 Battalion, 1 Reg't Tenn. H. Art'y.†

Age years.

Appears on

Company Muster Roll*

for Feb 4 to 29, 1864.

Joined for duty and enrolled:

When Jan 12, 1864.

Where Fort Pickering

Period 3 years.

Mustered in:

When Feb 4, 1864.

Where Fort Pickering

Present or absent Present

Stoppage, \$ 100 for

Due Gov't \$ 100 for

Remarks:

† This organization subsequently became Co. G, 11 Reg't U. S. Colored Infantry (New).

* First current roll. No muster-in roll of this company on file. This roll shows enrollment of all men of this company as of same date. See enrollment on subsequent card or cards.

Book mark:

(358b)

Ballade

Copyist.

6 | 11 (New). | U.S.C.T.

William Barritchie
Pvt, Co. G, 6 Reg't U. S. Col'd H. Art'y.†

Appears on

Company Muster Roll

for Feb & Apr, 1864.

Joined for duty and enrolled:

When Jan 12, 1864.*

Where Ht Pickering *

Period 3 years.*

Present or absent Present

Stoppage, \$ 100 for

Due Gov't \$ 100 for

Remarks: Sick in Quarters

* This organization subsequently became Co. G, 11 Reg't U. S. Colored Infantry (New).

* See enrollment on card from first current roll.

Book mark:

Sallade

6 | 11 (New). | U.S.C.T.
William Carntehie
1st, Co. G, 7 Reg't U. S. Col'd H. Art'y.†

Appears on

Company Muster Roll

for May & June, 1864

Joined for duty and enrolled:

When Jan 12, 1864.*

Where Ft Pickens *

Period 3 years.*

Present or absent Present

Stoppage, \$ 100 for

Due Gov't, \$ 100 for

Remarks: On daily duty as
company cook

† This organization subsequently became Co. G, 11 Reg't U. S. Colored Infantry (New).
* See enrollment on card from first current roll.

Book mark: _____

Ballade
Copyist.

5 | 11 (New). | U.S.C.T.

William Carnithee

Private, Co. G, 7 Reg't U. S. Col'd H. Art'y.†

Appears on

Company Muster Roll

for July & Aug, 1864.

Joined for duty and enrolled:

When Jan 12, 1864.*

Where Ft. Pickens *

Period 3 years.*

Present or absent Present

Stoppage, \$ 100 for

Due Gov't, \$ 100 for

Remarks: _____

† This organization subsequently became Co. G, 11 Reg't U. S. Colored Infantry (New).
* See enrollment on card from first current roll.

Book mark: _____

Sullivan

6 | 11 (New). | U.S.C.T.

William Carntene
Sgt, Co. G, 7 Reg't U. S. Col'd H. Art'y.†

Appears on

Company Muster Roll

for Sgt Coct, 1864.

Joined for duty and enrolled:

When Jan 12, 186 .*

Where Ft. Pickens *

Period 2 years.*

Present or absent Present

Stoppage, \$ 100 for

Due Gov't, \$ 100 for

Remarks: On duty as
Company Cook

† This organization subsequently became Co. G, 11 Reg't U. S. Colored Infantry (New).

* See enrollment on card from first current roll.

Book mark: _____

Dallade

11 (New). U.S.C.T.

William Carnteris
1st, Co. G, 7 Reg't U. S. Col'd H. Art'y.†

Appears on

Company Muster Roll

for *Nov & Dec*, 1864.

Joined for duty and enrolled:

When *Jan 12*, 1864.*

Where *Fort Pickens* *

Period *3* years.*

Present or absent *Present*

Stoppage, \$ *100* for

Due Gov't, \$ *100* for

Remarks:

† This organization subsequently became Co. G, 11 Reg't U. S. Colored Infantry (New).

* See enrollment on card from first current roll.

Book mark:

Sullivan

C. | **11** (New). | **U.S.C.T.**

William Carnitchie

Pvt., Co. G, 11 Reg't U. S. Col'd Inf. (New).

Appears on

Company Muster Roll
for *Jan & Feb*, 186*5*.

Joined for duty and enrolled:

When *Jan 12*, 186*4*.*

Where *Ft. Pickering*, *

Period *3* years.*

Present or absent *Present*

Stoppage, \$ *100* for

Due Gov't \$ *100* for

Remarks:

* ~~See~~ See enrollment on card from first current roll.

Book mark:

(358c)

Ramsey

Copyist.

6

11 (New).

U.S.C.T.

William Cornitchie

Pvt., Co. G, 11 Reg't U. S. Col'd Inf. (New).

Appears on

Company Muster Roll

for Mar & Apr, 1865.

Joined for duty and enrolled:

When Jan 12, 1865.*

Where Ft Pickering.*

Period 3 years.*

Present or absent Present.

Stoppage, \$ 100 for

Due Gov't \$ 1 60/100 for

Remarks:

* Name appears in column of Names Present as William Cornitchie.

* See enrollment on card from first current roll.

Book mark:

Ramsey

(358c)

Copyst.

C. | 11 (New). | U.S.C.T.

William Carnitchie
Pot, Co. G, 11 Reg't U. S. Col'd Inf. (New).

Appears on

Company Muster Roll

for *May & June*, 186*5*.

Joined for duty and enrolled:

When *Jan 12*, 186*4*.*

Where *Ft Pickering*. *

Period *3* years.*

Present or absent */*

Stoppage, \$ *100* for

Due Gov't \$ *160* / *100* for

Remarks: *Dischard. and final statements given.*

* See enrollment on card from first current roll.

Book mark: *Discharged June 13/65.*
E. B. 12
329

(358c)

Ramsey
Cpyist.

C, 11 (New). U.S.C.T.

William Canitchie

Priv., Co., 11 Reg't U. S. Col'd Inf. (New).

Appears on Co. Muster-out Roll, dated

Memphis T. Jan 12, 1866.

Muster-out to date _____, 186 .

Last paid to Feb 28, 1865.

Clothing account:

Last settled _____, 186 ; drawn since \$ 100

Due soldier \$ 100; due U. S. \$ 100

Am't for cloth'g in kind or money adv'd \$ 100

Due U. S. for arms, equipments, &c., \$ 100

Bounty paid \$ 100; due \$ 100

Remarks: Disch'd for Disability

June 1865, per order Maj. Gen. E. E. Smith.

Book mark: Disch'd June 13/65.

EW. 12/229.

Carnitchie, William

P, Co. G, 11 U. S. C. Inf.
Reg't

Enclosures.

Bed Cards	Descriptive Lists
Burial Records	Final Statements
Certs. of Dis. for Discharge	Furloughs
C. M. Charges	Med. Des. Lists
Med. Certificates	Orders

Other papers relating to—

Admission to Hosp'l	Furlough
Casualty Sheet (Officer's)	Med. Examination
Confinement	Misc. Information
Contracts	Pay or Clothing
Death or Effects	Personal Reports
Desertions	Rank
Discharge from Hosp'l	Transfer to Hosp'l
Discharge from Service	Transfer to V. R. C.
Duty	Transportation

[OFFICE ENDORSEMENT.]

War Department,

ADJUTANT GENERAL'S OFFICE,

May 21st, 1871

The discharge of Wm. Carnitchie
Carnitchie Co. G, 11 Reg't U.S.

Colored Sp. (mul.), is reported as follows:

On Company Muster Roll.
For May, 1865, no date, 1865

Company Muster-out Roll.
June 18th, 1865

Company Descriptive Book. 1865

Company Morning Reports. 1865

Soldier's Final Statement. 1865

Soldier's Record of Death and Interment. 1865

Soldier's Inventory of Effects. 1865

Soldier's Certificate of Disability for Discharge. 1865

Soldier's Individual Muster-out Roll. 1865

Regimental Return. 1865

For June, 1865, June 13, 1865

Regimental Quarterly Returns. 1865

Regimental Descriptive Book. 1865

By Surgeon General. 1865

(June 13th), 1865, is held to be

the correct date, and the Company Muster

Roll will be amended accordingly.

Thomas W. Sargent
Assistant Adjutant General.
Noted &c.

See letter to D. B. = 126 = 1865

C. S. 14. 2. W. 2. 1865
11
CERTIFICATE OF DISABILITY FOR DISCHARGE
IN THE CASE OF
Wm. Carnitchie
a Private of Co. G
11th Reg't of U.S.

HEAD QUARTERS DIST. WEST TENNESSEE,
MEMPHIS TENN., June 11th, 1865.
TO BE DISCHARGED.
BY ORDER OF BREVET MAJOR GENERAL J. E. SMITH.
J. E. Smith
Brevet Brig. Gen'l & Asst. Adj. Gen'l.
Discharged in pursuance of instructions received from Maj. Gen'l
GEO. H. THOMAS, Commanding Department of the Cumberland.

Received (A. G. Office) _____, 1865
En on O. R. [unclear]

D. B. = 126 = 1865
Office Surgeon in Charge
Dist West Tenn
Memphis Tenn June 9th 1865
Approved
R. F. Swallow
Surgeon 11th Reg't
Surgeon in Chief D.W.T.

Head Quarters 11. W. S. C. Inf
Memphis Tenn June 13th
Respectfully forwarded
Office A. G. W. S. A.
Gen. L. Fausch
Maj. 11. W. S. C.
Comdr.

The company commander will here add a statement of all the facts known to him concerning the disease or wound, or cause of disability of the soldier; the time, place, manner, and all the circumstances under which the injury occurred, or disease originated or appeared; the duty, or service, or situation of the soldier at the time the injury was received or disease contracted, stating particularly whether the injury was received or the disease contracted in the line of his duty; and whatever other facts may aid a judgment as to the cause, immediate or remote, of the disability, and the circumstances attending it.

When the facts are not known to the company commander, the certificate of any officer, or affidavit of other person having such knowledge, will be appended—as the surgeon in charge of a hospital, the officer commanding a detachment of recruits, &c., &c.

NOTE 2.

When a probable case for pension, special care must be taken to state the degree of disability—as $\frac{1}{2}$, $\frac{3}{4}$, &c., &c.; to describe particularly the disability, wound, or disease the extent of which it deprives him of the use of any limb or faculty, or affects his health, strength, activity, constitution, or capacity to labor or earn his subsistence. The surgeon will add, from his knowledge of the facts and circumstances, and from the evidence in the case, his professional opinion of the cause or origin of the disability. In the case of discharges by Medical Inspectors, the last paragraph will state that the "discharge was given by consent of the soldier, after a personal examination, and for disability, the nature, degree, and origin of which are correctly described in the within certificate."

Par. 1260 Regulations, Edit. 1861.

Medical officers, in giving certificates of disability, are to take particular care in all cases that have not been under their charge; and especially in epilepsy, convulsions, chronic rheumatism, derangement of the urinary organs, ophthalmia, ulcers, or any obscure disease liable to be feigned or purposely produced; and in no case shall such certificate be given until after sufficient time and examination to detect any attempt at deception.

DIRECTIONS.

This certificate will be made out in duplicate by the soldier's company commander, or other officer commanding the separate detachment to which he belongs, and sent by him to the surgeon who has charge of the hospital where the soldier is sick. The surgeon will then fill out and sign the surgeon's certificate, and forward these papers to the regimental, detachment, or post commander, who will forward them, with his action endorsed thereon, through the proper channel, to his division commander; or, if the troops are not attached to a division, to his corps, department, or other commander or officer to whom the authority to discharge enlisted men may be specially delegated.

These certificates, after having received the action of the highest authority to which they are required to be sent, will be returned through the same channel to the regimental, post, or detachment commander, who will, if the discharge is authorized by the endorsement of the proper authority, sign the soldier's discharge, and the last certificate on this paper; see that the soldier is furnished with the proper final statements in duplicate, and forward BOTH of these certificates direct to the Adjutant General United States Army, at Washington, D. C.; they will not, under any circumstances, be given into the hands of the soldier.

ADJUTANT GENERAL'S OFFICE

June 28. 1865

Duplicate sent the Pension Office.

CERTIFICATE OF DISABILITY FOR DISCHARGE

6. 8. 14. 2. 21. 0. 1865
11
IN THE CASE OF
No. 73 Prof. Dix,
William Comstock
a Private of Co. "G"
11th Reg't of Ill. Inf.

HEAD QUARTERS DIST. WEST TENNESSEE,

MEMPHIS TENN., June 11. 1865.

TO BE DISCHARGED.

BY ORDER OF BREVET MAJOR GENERAL J. E. SMITH.

Wm. M. ...
Brevet Brig. Gen'l & Asst. Adj. Gen'l.

Discharged in pursuance of instructions received from Maj. Gen'l GEO. H. THOMAS, Commanding Department of the Cumberland.

Received (A. G. Office) 1865

En on

Wm. M. ...

D. B. = 126 = 1865

Office Surgeon in Charge
Dist West Tenn
Memphis Tenn June 9th 1865

Approved

R. F. Swallow

Surgeon 11th Ill. Inf.
Surgeon in Chief D. W. T.

Head Quarters 11. 22 S. C. Inf
Memphis Tenn. June 12th

Respectfully forwarded
Office A. G. U. S. A.

Gen. L. Fausch
Maj. 11. 22 S. C. Inf
Comd'g

ARMY OF THE UNITED STATES
CERTIFICATE
OF DISABILITY FOR DISCHARGE.

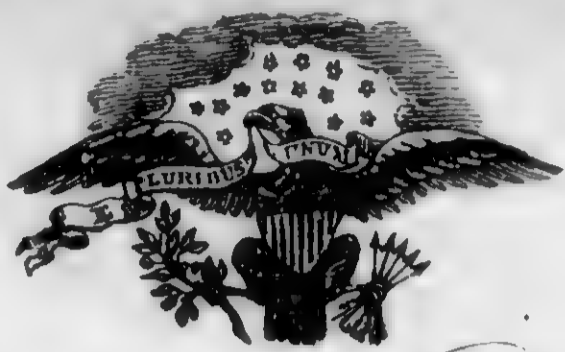

William Barnitchev a *Private*, of Captain *Nathaniel*
Reed's Company, (*G*) of the *49th* Regiment of the United States
Col. J. G. Reynolds was enlisted by *Col. J. G. Reynolds* of
the *3rd* Regiment of *Artillery* at *Fort Pickens, Tampa*
on the *19th* day of *January*, 186*5*, to serve *3* years; he was born
in *Richmond Co.* in the State of *Alabama*, is *39*
years of age, *5* feet *4* inches high, *Wheat* complexion, *Black* eyes,
Black hair, and by occupation when enlisted a *Laborer*. During the last two
months said soldier has been unfit for duty *54* days.* *Cause Chronic Rheuma-*
tism, Inflamed Limbs, Groinache, & traps and
entirely worthless as a Soldier. (Substance)
found to exist.

STATION: *Memphis, Tenn*
DATE: *May 24 1865*

William Reed
Captain
Commanding Company.

I CERTIFY, that I have carefully examined the said *William Barnitchev*
of Captain *Nathaniel Reed's* Company, and find him incapable of performing the duties of a
soldier because of *with deformity,*
and old age - being above 45 years of age. This condition
existed prior to enlistment.

Refused for Return on Reserve Corps.
Reason of his ability: One Hand.
Reed, J. H. Kendall
Surgeon 11th U.S. G. Inf. Surgeon. *in cas*

DISCHARGED, this *Fifth 13* day of *June*, 186*5*, at *Memphis*
Tennessee
Geo. L. Saddock
Major 11th U.S. Inf.
Commanding the Reg't.

The Soldier desires to be addressed at
Town _____ County _____ State _____

* See Note 1 on the back of this. † See Note 2 on the back of this

Approved & respectfully forwarded
Wm. A. Standish
May 11. 1865
Infy
Comdy.

Approved
on
General
Recommendation
of
Major
Geo. L. Saddock
11th U.S. Inf.
May 24 1865
Chap. & Co. 7th

243

Carlisle Gabriel

Co E, 11 U.S. Col'd Inf.

(New Organization.)

Private Private

CARD NUMBERS.

1	6335039	26
2	6335126	27
3	6335212	28
4	6335309	29
5	6335380	30
6	6335453	31
7	6335588	32
8	6329529	33
9	6329605	34
10	6329685	35
11	6329748	36
12	6329808	37
13	9071877	38
14	9072792	39
15		40
16		41
17		42
18		43
19		44
20		45
21		46
22		47
23		48
24		49
25		50

Book Mark:

See also

6 | 11 (new) U.S.C.T.

Gabrial Carlial

, Co. E, 11 Reg't U. S. Col'd Inf. (new)

Appears on

Company Descriptive Book

of the organization named above.

DESCRIPTION.

Age 25 years; height 5 feet 7 inches.

Complexion (Beck)

Eyes (Beck); hair (Beck)

Where born (Memphis Miss)

Occupation (Lammer)

ENLISTMENT.

When (Mch) 1864.

Where (Memphis Tenn)

By whom (Sgt Conklin); term 3 y'rs.

Remarks: Transferred from Co L May 11 1865 per D.O. No 21. Hd. Qrs 11th U.S. C. I. May 10-65

(Handwritten signature)

C

11 (new) U. S. C. T.

Gabriel Carlile

(new)
Co. C, 11 Reg't U. S. Col'd Inf.

Appears on

Company Descriptive Book

of the organization named above.

DESCRIPTION.

Age 25 years height 5 feet 4 inches.

Complexion

Blk

Eyes;

Blk

hair

Blk

Where born

Monroe Co. Miss

Occupation

Farmer

ENLISTMENT.

When

March 1st, 1864.

Where

Memphis Tenn.

By whom

Serg. E. Croukleton ; term 3 y'rs.

Remarks:

G. M. Kennedy

(338g)

Copist.

C

11 (New). U.S.C.T.

Fabrial Carlile

Privt, Co. L, 6 Reg't U. S. Col'd H. Art'y.†

Appears on

Company Muster-in and Descriptive Roll
of the organization named above. Roll dated

Fort Pickering, April 2, 1864.

Where born *Monroe Co, Mississippi,*

Age *25* y'rs; occupation *Farmer*

When enlisted *March 1, 1864.**

Where enlisted. *Memphis, Tenn.*

For what period enlisted *3* years.

Eyes *dark*; hair *black*

Complexion *black*; height *5 ft. 7 in.*

When mustered in *April 2, 1864.*

Where mustered in *Fort Pickering, Memphis, Tenn.*

Bounty paid \$ *100*; due \$ *100*

Where credited.....

Company to which assigned.....

Remarks:

† This organization subsequently became Co. L, 11 Reg't U. S. Colored Infantry (New).

* Muster-in roll shows enrollment of all men of this company as of same date. See enrollment on subsequent card or cards.

Book mark:

(256d)

[Signature]

Copyist.

C

11 (New).

U.S.C.T.

Fabrial Carlile

Co. L, 6 Reg't U. S. Col'd H. Art'y.†

Appears on

Company Muster Roll

for *Nov 1864*, 1864.

Joined for duty and enrolled:

When *March*, 1864.*

Where *Memphis Tenn* *

Period *3* years.*

Present or absent. *Present*

Stoppage, \$ *100* for

Due Gov't \$ *100* for

Remarks :

† This organization subsequently became Co. *L*, 11 Reg't U. S. Colored Infantry (New).

* See enrollment on card from muster-in roll.

Book mark :

C | **11** (New). | **U.S.C.T.**

Fabrial Carlile

Priv, Co. L, 7 Reg't U. S. Col'd H. Art'y. †

Appears on

Company Muster Roll

for *May & June*, 186*4**

Joined for duty and enrolled:

When *March*, 186*4**

Where *Memphis, Tenn**

Period *3* years.*

Present or absent *Present*

Stoppage, \$ *100* for

Due Gov't, \$ *100* for

Remarks:

†This organization subsequently became Co. L, 11 Reg't U. S. Col'd Infantry (New).

* See enrollment on card from muster-in-roll.

Book mark:

[Signature]

C

11 (New).

U.S.C.T.

Gabriel Carlile

Priv., Co. L, 7 Reg't U. S. Col'd H. Art'y.†

Appears on

Company Muster Roll

for July 10 Aug, 1864.

Joined for duty and enrolled:

When March, 1864.*

Where Memphis, Tenn. *

Period 3 years.*

Present or absent Present

Stoppage, \$ 100 for

Due Gov't, \$ 100 for

Remarks:

†This organization subsequently became Co. L, 11 Reg't U. S. Col'd Infantry (New).

* See enrollment on card from muster-in roll.

Book mark:

W. H. ...

C 11 (New). U.S.C.T.

Gabriel Cantile
Priv, Co. L, 7 Reg't U. S. Col'd H. Art'y.†

Appears on

Company Muster Roll

for Sept & Oct, 1864

Joined for duty and enrolled:

When March 1, 1864*

Where Memphis, Tenn. *

Period 3 years.*

Present or absent Present

Stoppage, \$ 100 for

Due Gov't, \$ 100 for

Remarks:

†This organization subsequently became Co. L, 11 Reg't U. S. Col'd Infantry (New).

* See enrollment on card from muster-in roll.

Book mark:

C | 11 (New). | U.S.C.T.

Gabriel Carlile

Put, Co. L, 7 Reg't U. S. Col'd H. Art'y.†

Appears on

Company Muster Roll

for *Nov & Dec*, 1864.

Joined for duty and enrolled:

When *March*, 1864.*

Where *Memphis, Tenn**

Period *3* years.*

Present or absent *Present*

Stoppage, \$ *100* for

Due Gov't, \$ *100* for

Remarks:

†This organization subsequently became Co. L, 11 Reg't U. S. Col'd Infantry (New).

* See enrollment on card from muster-in roll.

Book mark:

None

Ce | 11 (New) | U.S.C.T.

Gabriel Costial

Priv., Co. L, 11 Reg't U. S. Col'd Infantry.

Appears on

Company Muster Roll

or Jan & Feb, 1865.

joined for duty and enrolled:

When March 1", 1864.*

Where Memphis, Tenn.*

Period 3 years.*

Present or absent Present

Stoppage, \$ 100 for

Due Gov't \$ 100 for

Remarks:

* See enrollment on card from muster-in roll.

Book mark:

S.W. Williams

C | 11 (New) | U.S.C.T.

Gabriel Castial
Private, Co. L, 11 Reg't U. S. Col'd Infantry.

Appears on

Company Muster Roll
for Dated April 30, 1865.

Joined for duty and enrolled:

When March 1, 1864.*

Where Memphis, Tenn.*

Period 3 years.*

Present or absent Present

Stoppage, \$ 100 for

Due Gov't \$ 100 for

Remarks:

* See enrollment on card from muster-in roll.

Book mark:

J. W. Williams

C | 11 (New). | U.S.C.T.

Gabrial Carlial
Cook, Co. E, 11 Reg't U. S. Col'd Inf. (New).

Appears on

Company Muster Roll

for *May June*, 1865.

Present or absent *Present*

Stoppage, \$ *100* for

Due Gov't, \$ *100* for

Remarks: *Transferred from
Co. "L" May 11/65.*

*On daily duty as Co. Cook.
Stop for ordnance 43¢.*

Book mark:

Lowry

C | 11 (New). | U.S.C.T.

Gabriel Carlisle
Sgt, Co. E, 11 Reg't U. S. Col'd Inf. (New).

Appears on

Company Muster Roll

for July & Aug, 1865.

Present or absent Present

Stoppage, \$ 100 for

Due Gov't, \$ 100 for

Remarks: On daily duty as
Co. Cook.
Stop for Ordnance 43¢.

Book mark:

(858)

Lowry

Copyist.

6 | 11 (New). | U.S.C.T.

Gabrial Carlial
Cook, Co. E, 11 Reg't U. S. Col'd Inf. (New).

Appears on

Company Muster Roll

for *Sep. & Oct.*, 1865.

Present or absent *Present*

Stoppage, \$ *100* for

Due Gov't, \$ *100* for

Remarks: *In daily duty*
as Co. Cook.

Book mark: _____

(858)

Lovvy

Copyist.

C | 11 (New). | U.S.C.T.

Gabrial Carliat
Priv., Co. E, 11 Reg't U. S. Col'd Inf. (New).

Appears on

Company Muster Roll

for *c Nov. & Dec*, 1865.

Present or absent *Present*

Stoppage, \$ *100* for

Due Gov't, \$ *100* for

Remarks:

Book mark:

Valentine

C

11 (New).

U.S.C.T.

Gabrial Carrial

Priv Co. E, 11 Reg't U. S. Col'd Inf. (New).

Appears on Co. Muster-out Roll, dated

Memphis Tenn. Jan 12, 1866.

Muster-out to date Jan 12, 1866.

Last paid to June 30, 1865.

Clothing account:

Last settled 186 ; drawn since \$ 100

Due soldier \$ 100; due U. S. \$ 2 23 / 100

Am't for cloth'g in kind or money adv'd \$ 100

Due U. S. for arms, equipments, &c., \$ 100

Bounty paid \$ 100; due \$ 100

Remarks:

Book mark:

Valentine

²⁴
Carlisle George H.
Co *E*, 11 U.S. Col'd Inf.

(New Organization.)

1st Lieutenant Captain

CARD NUMBERS.

1	6328704	26
2	6328764	27
3	6328830	28
4	6323072	29
5	6322322	30
6	6328930	31
7	6329033	32
8	6329119	33
9	6329206	34
10	6329284	35
11	6329361	36
12	6329431	37
13	6329499	38
14	6329576	39
15	6329656	40
16	6329719	41
17	6329779	42
18	9428945	43
19	R.P. 423363	44
20		45
21		46
22		47
23		48
24		49
25		50

Book Mark: 1831-69-84
R.P. 423363

See also

A. 774531- P.O. 90

S-2006028 P.O. m

M. 810 29263

6

U.S.C.T.

George W. Carlisle

Co. 11 Reg't U. S. Col'd Inf.

Appears on

Regimental Descriptive Book

(List of Commissioned Officers)

of the regiment named above.

Rank 1st Lieut

Date of appointment 186

Remarks:

Holbrook

6 | 11 (New). | U.S.C.T.

George W. Carlisle

1st Lieut, Co. E, 1 Reg't Ala. Siege Art'y.*

Age 28 years.

Appears on

Company Muster-in Roll

of the organization named above. Roll dated

Corinth Miss, Dec 7, 1863.

Muster-in to date Dec 7, 1863

Joined for duty and enrolled:

When Nov 16, 1863

Where Corinth

Period 3 years.

Remarks: Appointed from Private of Co. J. Smith Ill. Cav. to 1st Lieut of Co. E. 1 Ala. Siege Artillery

* This organization subsequently became Co. C. 11 Reg't U. S. Colored Infantry (New).

Book mark: 610422203

Leumurr

C | **11** (New). | **U.S.C.T.**

George W. Carlisle
1 Lt., Co. E, 1 Reg't Ala. Siege Art'y.*

Appears on

Company Muster Roll

for Enrollment to Dec. 31, 1868.

Present or absent Present.

Stoppage, \$ 100 for

Due Gov't, \$ 100 for

Remarks: Appointed 1 Lt. of Co. E.
1 Ala. Sige Artillery of A. D.
from 9th Regt. Ill. Cav. in
accordance with Special order
No. 17. dated Hd. Qrs. L. W.
16 A.C. Corinth. Miss. Nov. 16. 63.

*This organization subsequently became Co. E, 11 Reg't U. S. Col'd Infantry (New).

Book mark : _____

6

11 (New).

U.S.C.T.

George W. Carlisle

1st, Co. E, 4 Battalion, 1 Reg't Tenn. H. Art'y.*

Appears on

Company Muster Roll

for *Jan. & Feb.*, 1864.

Present or absent *Present.*

Stoppage, \$ *100* for

Due Gov't, \$ *100* for

Remarks: *In command of the
Company since its
organization.*

* This organization subsequently became Co. E, 11 Reg't U. S. Colored Infantry (New).

Book mark: _____

Lewis

Copysist.

C | 11 (New) | U.S.C.T.

George W. Carlisle
1st Lieut., Co. E, 11th Reg't U. S. Col'd Infantry. (4th Ala. Siege Arty of A. D.)

Appears on an

Individual Muster-out Roll

of the organization named above. Roll dated

Memphis, Tenn., Mar. 18, 1864.

Muster-out to date Mar. 16, 1864.

Last paid to Dec. 31, 1863.

Clothing account:

Last settled....., 186 ; drawn since \$..... 100

Due soldier \$..... 100; due U. S. \$..... 100

Am't for cloth'g in kind or money adv'd \$..... 100

Due U. S. for arms, equipments, &c., \$..... 100

Bounty paid \$..... 100; due \$..... 100

Remarks: Mustered out for promotion to
Captain of Company "E" 1st Alabama
Siege Artillery of A. D. in compli-
ance with Special Order No. 31 dat-
ed Feb. 20. U. S. C. Troops. Vicksburg, Miss.
Mar. 1864 by order of the Secretary of War

Book mark:

Shull

4 11 (new) U.S.C.T.

George W. Carlisle
Capt, Co. 1 Ala Siege Artillery
Reg't U. S. Col'd Infantry.

Age 28 years.

Appears on an

Individual Muster-in Roll

of the organization named above. Roll dated

Memphis Tenn, *March 17*, 1864.

Muster-in to date *March 17*, 1864.

Joined for duty and enrolled:

When *March 5*, 1864.

Where *Memphis Tenn*

Period *3* years.

Remarks: *Appointed Capt of
Co. E. 1 Ala. Siege Art.
A.S. in S.O. 31 dated
Hd Qrs. U.S. C. Troops.
Vicksburg Miss. March
8, 1864 to date from
(over)*

Book mark :

J. Walker

C | (New) | U.S.C.T.

George W. Carlisle
1st Lieut., Co. E, 11th (1st Ala. Siege Arty. of A.D.)
Reg't U. S. Col'd Infantry.

Appears on an

Individual Muster-out Roll

of the organization named above. Roll dated

Memphis, Tenn., Mar. 18, 1864.

Muster-out to date Mar. 16, 1864.

Last paid to Dec. 31, 1863.

Clothing account:

Last settled....., 186 ; drawn since \$..... 100

Due soldier \$..... 100; due U. S. \$..... 100

Am't for cloth'g in kind or money adv'd \$..... 100

Due U. S. for arms, equipments, &c., \$..... 100

Bounty paid \$..... 100; due \$..... 100

Remarks: Mustered out for promotion to
Captain of Company "E" 1st Alabama
Siege Artillery of A. D. in compli-
ance with Special Order No. 31 dat-
ed Ad. Dep. U. S. C. Proprs. Vicksburg, Miss
Mar. 1864 by order of the Secretary of War
over

Book mark:

Shull

JAN. 22

6323072

418914

*Signed L. Thomas Adjutant
General*

4 11 (new) U.S.C.T.

George W. Carlisle
Capt, Co. 11, 1 Ala Siege Art. U.S. Reg't U. S. Col'd Infantry.

Age 28 years.

Appears on an

Individual Muster-in Roll

of the organization named above. Roll dated
Memphis Tenn, *March 17*, 1864.

Muster-in to date *March 17*, 1864.

Joined for duty and enrolled:

When *March 5*, 1864.

Where *Memphis Tenn*

Period *3* years.

Remarks: *Appointed Capt of
Co. E. 1 Ala. Siege art.
Art. in S.O. 31 dated
4th Dec. U.S. C. Troops.
Vicksburg Miss. March
8, 1864 to date from
(over)*

Book mark :

J. Walker

JAN. 22

6322322

018910

issued by order of
The Secretary of War.
Signed, L. Thomas
Adjutant

6

11 (New).

U.S.C.T.

George W. Carlisle

Capt., Co. E, 6 Reg't U. S. Col'd H. Art'y.*

Appears on

Company Muster Roll

for Mch & Apl, 1864.

Present or absent Present.

Stoppage, \$ 100 for

Due Gov't, \$ 100 for

Remarks: Promoted Capt. per Special Order No. 31. dated Hd. Qrs. U.S.C.I. Vicksburg. Miss. Mch. 8. 64. Signed L. Thomas. Adjt. Gen. U.S.A. Pay due for Com'g the Comp'y since Jan. 1. 64.

* This organization subsequently became Co. E, 11 Reg't U. S. Colored Infantry (New).

Book mark :

Lewis Copyist.

6 | 11 (New). | U.S.C.T.

George W. Carlisle
Capt., Co. E, 7 Reg't U. S. Col'd H. Art'y.*

Appears on

Company Muster Roll

for *May & June*, 186*4*.

Present or absent *Present*

Stoppage, \$ *100* for

Due Gov't, \$ *100* for

Remarks: *In command of the co. since its organization. Pay due for the same for May & June. Muster dated back as Capt. to Dec. 29/63 upon certificate of the Col. Comdg. that the Co. numbered the minimum prescribed by law at that date in accordance with Special Order No. 85 dated Natchez Miss. Oct. 24/63. By order of the Sec. of War. - Difference of (over)*

* This organization subsequently became Co. E, 11 Reg't U. S. Colored Infantry (New).

Book mark: _____

Crenshaw

JAN. 22

6329033

21891*

Pay between Captain and
1st Lieut. due from Dec. 29th
1863 to March 16th 1864. when
settled up with as 1st Lieut.
by Maj. Thurston Paymaster
U.S.A.

6 | 11 (New). | U.S.C.T.

George W. Carlisle
Capt., Co. E, 7 Reg't U. S. Col'd H. Art'y.*

Appears on

Company Muster Roll

for July & Aug., 1864

Present or absent Present

Stoppage, \$ 100 for

Due Gov't, \$ 100 for

Remarks: In command of the
Company. Muster dated back
as Captain to Dec. 29, 1863
upon the certificate of the Col.
Comdg. that the company numbered
the minimum prescribed by
law at that date in accordance
with Special order No. 85
dated Natchez Miss. Oct. 24/63
(over)

* This organization subsequently became Co. E, 11 Reg't U. S. Colored Infantry (New).

Book mark:

Crenshaw

JAN. 22

6329119

1891

By order of the Sec. of War.
Difference of pay between Capt.
and 1st Lieut. due from Dec. 29/63
to Mch. 16th 1864 when settled up
with as 1st Lieut. by Major
Thurston paymaster U.S.A.

10 | **11** (New). | **U.S.C.T.**

George W. Carlisle
Capt., Co. E, 7 Reg't U. S. Col'd H. Art'y.*

Appears on

Company Muster Roll
for *Sept. & Oct.*, 186*4*

Present or absent *Present*

Stoppage, \$ *100* for

Due Gov't, \$ *100* for

Remarks: *In command of
Company. Muster dated
back to Dec. 29, 1863.*

* This organization subsequently became Co. E, 11 Reg't U. S. Colored Infantry (New).

Book mark: _____

Ovenshaw

(358)

Co. Sgt.

Co | 11 (New). | U.S.C.T.

George W. Carlisle

Capt., Co. E, 7 Reg't U. S. Col'd H. Art'y.*

Appears on

Company Muster Roll

for Nov. & Dec., 1864.

Present or absent Present

Stoppage, \$ 100 for

Due Gov't, \$ 100 for

Remarks: In Command of the Company.

* This organization subsequently became Co. E, 11 Reg't U. S. Colored Infantry (New).

Book mark:

Crenshaw

C

11 (New).

U.S.C.T.

George W. Carlisle
Capt., Co. E, 11 Reg't U. S. Col'd Inf. (New).

Appears on

Company Muster Roll

for *Jan & Feb.*, 1865.

Present or absent *Present*

Stoppage, \$ *100* for

Due Gov't, \$ *100* for

Remarks: *In command of Company*

Book mark: *5145*

(858)

Lowry

Copyist.

6

11 (New). U.S.C.T.

Geo. M. Carlisle
Capt, Co. E, 11 Reg't U. S. Col'd Inf. (New).

Appears on

Company Muster Roll

for Mch & Apl , 1865

Present or absent Present

Stoppage, \$ 100 for

Due Gov't, \$ 100 for

Remarks: In command
 of Company

Book mark: 250323

 Lowry

6

11 (New).

U.S.C.T.

George H. Carlisle

Captain, Co. E, 11 Reg't U. S. Col'd Inf. (New).

Appears on

Company Muster Roll

for May & June, 1865.

Present or absent Present

Stoppage, \$ 100 for

Due Gov't, \$ 100 for

Remarks: In command of Co.

Book mark: 935721

(858)

Loring

Copyist.

C

11 (New).

U.S.C.T.

George H. Carlisle
Capt, Co. E, 11 Reg't U. S. Col'd Inf. (New).

Appears on

Company Muster Roll

for July & Aug, 1865

Present or absent present

Stoppage, \$ 100 for

Due Gov't, \$ 100 for

Remarks: In command
of Company.

Book mark:

(858)

Loring

Copist.

T

11 (New). U.S.C.T.

George W. Carlisle
Capt, Co. E, 11 Reg't U. S. Col'd Inf. (New).

Appears on

Company Muster Roll

for Sep & Oct, 1865.

Present or absent Present

Stoppage, \$ 100 for

Due Gov't, \$ 100 for

Remarks: Commanding Co.
Ten dollars per month
due for commanding
company from June 30
to Aug. 31/65.

Book mark:

Lowry

C | 11 (New). | U.S.C.T.

George W. Curristle
Capt, Co. E, 11 Reg't U. S. Col'd Inf. (New).

Appears on

Company Muster Roll

for Nov & Dec, 1865.

Present or absent Present

Stoppage, \$ 100 for

Due Gov't, \$ 100 for

Remarks:

On leave of absence
per special order # 141
dated Dept. Comm. Dec 4th
1865. Wounded Company
Jul. Aug. Sept. Oct. to Nov.

Book mark:

Valentine

C

11 (New).

U.S.C.T.

George M. Carlisle

Capt. Co. E, 11 Reg't U. S. Col'd Inf. (New).

Appears on Co. Muster-out Roll, dated

Memphis Tenn Jan 12, 1866.

Muster-out to date

Jan 12, 1866.

Last paid to

Oct 31, 1865.

Clothing account:

Last settled 186 ; drawn since \$ 100

Due soldier \$ 100 ; due U. S. \$ 100

Am't for cloth'g in kind or money adv'd \$ 100

Due U. S. for arms, equipments, &c., \$ 100

Bounty paid \$ 100 ; due \$ 100

Remarks: Enlisted at Chicago

Ill. Priv Co. "I" 9 Ill. Cavalry.

Promoted to 1st Lieut in Col'd Troops

Dec. 9/63 Promoted Captain May

8/64 Continued to serve from

enlistment to present time

(over)

Book mark: 1831 C. I. 84

Valentine

(361)

Copyist.

JAN. 22

6329779

1891

Commanding Company.
\$1000 per month due for
responsibility from Oct. 31st.
1865 to Jan 12th 1866

C. | 11. | U.S.C.P.

George W. Carlisle.
Capt. Co. C, 1 Reg't Tenn. H.A.
A.D. (11th U.S.C.P.)

NOTATION.

Book mark: R. and P. 423,363.

Record and Pension Office,

WAR DEPARTMENT.

Washington, July 17, 1895.

Under the provisions of the act of Congress, approved June 3, 1884, and the acts amendatory thereof, this officer is considered by this Department as commissioned to the grade of *captain*,

Co. C, 1 Reg't Tennessee
Heavy Artillery (A.D.)
to take effect from March 5, 1864
to fill an original
vacancy.

Estabrook.

Carlisle, George W.

Capt, Co.

11

Reg't. U. S. C. Inf.

13

Enclosures.

Bed Cards	Descriptive Lists
Burial Records	Final Statements
Certs. of Dis. for Discharge	Furloughs
C. M. Charges	Med. Des. Lists
Med. Certificates 2	Orders 3

Other papers relating to—

Admission to Hosp'l	Furlough 1
Casualty Sheet (Officer's)	Med. Examination
Confinement	Misc. Information 4
Contracts	Pay or Clothing
Death or Effects	Personal Reports
Desertions	Rank
Discharge from Hosp'l	Transfer to Hosp'l
Discharge from Service	Transfer to V. R. C.
Duty	Transportation

336.

346.

1864

Fort Pickering

April 5th 1864

Smith M. F. Lieut
Adj't 6th U.S. by acty

States in accordance with
instruction contained
in Spl. Order No. 78. 16th
of C. March 30th 1864.
Reports Capt George W.
Carlisle Co "C" absent
without leave last night
at Officers Roll call

Recd Hd Qrs Fort Pickering 5 April 1864

Head Quarters 6th U.S. Heavy Artillery
Fort Pickering Memphis Tenn. April 5th 1864.

Capt G. W. Dutton
A. S. G. Dist of Memphis

In accordance with instructions
contained in Special Order No 78. 16th A. G. March 20th 1864.
I have to report, absent without leave, last night
at Officers Roll call.

Capt George W. Barfield Co. E.

I have the honor to

Very Respectfully &c
W. F. Smith.

1st Lieut (Adj) Adjt 6th U.S. Heavy Artillery.

W. D. Jones
July 9th 1864

Inquiry from Col Turner
in regard to Capt Carlisle
not being in Batt in Dill

Head Quarters 7th U.S. C.A. (Hq.)
July 9 1864

Capt Carlisle

Plain account for ~~the~~ your not
being at Battalion Drill this morning
Any officer not on the Surgeons report
will be placed under arrest for diso-
bedience of orders. the 1st Office &
Court-martialed the second

Yrs respectfully

V. D. Turner

Col 7th U.S.C.A.

Captain
Officers reporting sick
are not allowed to visit
the city on account of their
health.

Good W. Baker
May ~~2nd~~
7:56 a.m.

Capt.

Carroll 500 24

Camp ^{my #} On of Col Artz (Hog)
Fort Pickens Term Oct-24 1864

L. M. Mearns Lieut
and A. A. A. Gen'l
Lieut

I have the honor
to request permission to go to Memphis on
private business to day

Very respectfully

Major Artz - Gen'l

Gen'l Carhile

Capt ^{my #} On of Col Artz (Hog)

George W. Carlisle

a captain of the U. S. Colored Artillery (Heavy), having applied for a certificate wherein to base an application for a leave of absence, I do hereby certify that I have carefully examined this officer, and find that he has been suffering from frequently repeated attacks of Bilious Intermittent Fever during the past seven (7) months; and that he has become debilitated thereby, rendering him thereby liable to future attacks and consequently unfit for duty much of the time. In my opinion, he and the service would be materially benefitted by a change of climate for him, immediately for twenty (20) days.

Dated at Memphis, Tenn.
this 30th day of October 1864.

Reese W. Kendall
Surgeon U. S. Colored Art. Heavy
Fort Pickens

Approved on personal examination

Wm. B. Steen,
Lieut. 72nd C.S.I.
Surgeon in Chief Dist. of Memphis

1072 H. S. Co. 105
Fort Pickering Tenn
Oct 30 1864

C-C-249-DW578
Leahle Geo. W. Captain
7th Reg Colored Artillery (Heavy)

Respectfully makes application
for a leave of absence for the
period of twenty days to go to
Chicago Ill. Surgeons certificate
enclosed

(One Enclosure)

127 G. S. Co.

Head Quarters 1st West Tenn
Memphis Tenn 2nd 1864
Approved
J. G. Hunter
Act. Med Director

J. 200 Co
See S. W. 185 III
Recd H. Q. D. M. Oct 31 1864
Recd H. Q. D. M. Oct 31 1864
Recd H. Q. D. M. Oct 31 1864

Head Quarters 7th W. S. Co
Fort Pickering Oct 30 1864
Respectfully forwarded
Approved

W. H. Turner
220 E. Col comd
E. M. B. 1864
Head Quarters Fort Pickering
Fort Pickering Oct 30 1864

Respectfully forwarded
and approved
J. Kappner
Col 3rd W. S. Co (Heavy)
Comd'g Fort

Head Quarters District Memphis
Memphis Tenn Oct 31 1864
Respectfully forwarded
Approved
W. H. French
Brig General
Comd'g

Camp ^{my #} N Y Colored Artz, Heavy,
Fort Pickering Memphis Tenn Oct-30th 1864

Major W H Morgan
A A Genl Dist of the Tenn

Major

I hereby have the
honor to make application for a leave of absence
for the period of twenty days to go to Chicago, Ill
for the reasons set forth in the enclosed Surgeons
Certificate

I have the honor to be

Very respectfully

Yours Obedt Servt

Geo W Canfield

Capt ^{my #} N Y Colored Artz (A Coy)

Board of
Examination
Memphis Tenn
Feb 13th 1863

Capt - G W Carhile
required to appear
before the Board for
Examination

Common Board of Examination
Memphis, Tenn. Feb. 13^d 1865

Capt. George W. Carlile
7th U. S. Colored Inf. Regt.

You are hereby summoned,
and required to appear before this
Board, forthwith at Fort Pickens,
Texas, for the purpose of examination
in compliance with the provisions
of Par. 5. Special Orders No. 50. C. S. from
Head-Quarters Dept. of Miss. Jan. 30th 1865.

By Order of the Board

Samuel S. Stevens

Adj. Gen. U. S. Col. Inf.

Recorder

W. A. L. Dept. of Miss
Feb 16th 1865 -

Capt. G. W. Parkis
Summoned, to appear
before Military Com
mission

Head Quarters Department of Mississippi,

JUDGE ADVOCATE'S OFFICE,

Memphis, Tenn., Feb. 16th 1865.

Capt. G. W. Carlisle
11th U. S. Cold. Inf (late 4th U. S. C. A. (H))
Captain,

You are hereby summoned and required to appear before the Military Commission of which Col. George B. Hoop, is President, at this office, to-morrow, Feb. 17th, at 9.30 A.M. to give evidence in the matter under investigation.

By Order of the Commission
James O. Pierce

Maj & Judge Advocate
Recorder

No. 207 11th Regt. Infy

July 20/1864

Special Orders

No 189

Capt. G. W. Carbido

Ordered to turn over
all surplus ~~ammunition~~
to Capt. Priest, Cornet
and report

Memphis Tenn
11th U.S. Co Infy
July 20th 1865.

Special Order
No 139

Captain, Geo M Carlisle
comdg company "C" 11th U.S. Co Infy; will turn over
to Capt. Rice, comdg Ordnance Dept; all surplus
ordnance and ordnance stores, that he may have
in his possession

By Order,
Saml Jackson
Lieut Col Comdg
Regt.

To
Capt Geo M Carlisle,

A. P. Martin
Adjt Capt

204. S.P. A 1765

Carlisle, Geo IV

Capt.

Order

Head-Quarters Department of Tennessee,
Memphis Tenn. Sept. 11th 1865.

SPECIAL ORDERS, }

NO. 17..... }

[EXTRACT.]

Leave of absence for *twenty (20)* days, on Surgeon's Certificate of Disability, is hereby granted to

Capt. Geo. W. Carlisle 11th U. S. C. Infantry

NOTE—The attention of the Officer receiving this leave is directed to the following extracts from General Orders No. 100, War Department, August 11th, 1862.

"So much of General Orders No. 61, Current Series, as relates to the extension of sick leaves of absence is hereby revoked and no applications for such extensions need hereafter be made. The Order of the President, dated July 31st, (General Orders No. 62.) fully explains what may be considered as good cause for absence. Surgeons' Certificates of Disability, required by existing orders and regulations, must be forwarded not only to the Adjutant General of the Army, but also to the Commander of the Regiment, or, in case of a Staff Officer, to his Commanding General." * * * "Officers absent from duty without leave, or beyond the time of their leaves, will not be allowed to draw pay until a court or commission, which will be ordered on their return to their post or command, shall determine whether there was sufficient cause for their absence. They will accordingly provide themselves with a full description of the nature and cause of their disability, certified by the proper medical authority, as required by existing orders and regulations."

BY COMMAND OF MAJOR GENERAL STONEMAN.

G. O. 11th U. S. C. Inf.

M. W. Cannon
Assistant Adjutant General

Gen. W. Carlisle

a captain of the 11th W. S. Col. Inf., at Memphis,
having applied for a certificate whereon to ground
an application for Leave of Absence, I do
hereby certify that I have examined this
officer and find him debilitated from a 3
weeks attack of Intermittent Fever.

He will not, in my opinion, be entirely fit
for duty in a less period than 3 months, unless
he should get a change of climate very soon.

Given at

Memphis, Tenn.

this

2nd September 1865

Reese P. Kendall

Surgeon

11th W. S. C. Inf.

5-548 + m B L K 231 P 90
1191 B 199 470 2865

Memphis Tenn
Sept 6 1865

G. E. Carlisle
U.S. Army
No 8 11 M. S. Col. Infy

Respectfully request a
leave of absence for twenty
days
Surgical Certificate enclosed

S. O. 18th Expt. I Dept. Tenn.

Recd. D. W. J. Sept 10/65
Recd. Hd Qrs 2nd Div. Sept 25th 1865
Recd. Hd Qrs 2nd Div. Sept 25th 1865

101 4th Regt Cav 1865

Head Quarters 11th U.S. C.
Sept 8th 1865 Memphis Tenn

Respectfully forwarded
Approved

I am satisfied that Capt
G. Carlisle will not recover
his health without change
of climate, I would respect-
fully ask for the enclosed
furlough, as the speediest
method of restoring him
to duty

W. H. Turner
Col Cong Regt.

[Faint signature]

Head Quarters Infantry Brig. D. W. J.
Pickens Tenn. Sept. 8 1865

Respectfully forwarded
Approved

J. H. Haffner

Col's U.S. Cav. (Regt)
Leadg Brigade

Head Quarters Post & Defenses
Memphis Tenn Sept 9 1865

Respectfully forwarded to
H. G. S. D. W. J. in the absence
of the S. U. C. Comd. by
Chas. W. Brown,
a. a. S.

Office Surg. in C. D. W. J.
Memphis Sept 10 65.

Approved.

R. F. Stratton
Surg. 11th Dec. 65

Surg. in C. D. W. J.

Camp 11" N.Y. Col Infy
Memphis Tenn Sept 6" 1865

Mr W Morgan Brw Brig Gen'l
& V. V. Gen'l Dist. W Tenn

General I have the
honor to request a leave of absence for the
period of twenty days for the reasons set forth
in the enclosed Surgeons Certificate
I have the honor to be

Very respectfully
Yours Obedt Serv't

Geo W Carlisle Capt
Co "E" 11" N.Y. Col Infy

8
E. G. W. B. Det. P. 46. 1865

Memphis Tenn
Nov 24 1865

Geo W Carlisle Capt
11th U.S. Col Infantry

Respectfully asks for a Leave
of Absence for thirty days for
the purpose of visiting his family
and attending to important business

L. C. S. J. W. Tom 1865

20 10/10

Head Quarters 11th U. S. Col.
Fort Pickens Nov 24 1865

Respectfully forwarded
Approved

W. D. Turner
Col 11th U.S. Col.

Lt Col. Gust. West
Memphis Tenn. Nov. 25. 1865.

Approved and Respectfully
forwarded.

Geo E Smith
Bvt. Maj. Genl.

Recd 762 One Det W. Tom 11th U.S. Col 1865

Camp 11th Regt. Infy
Fort Pickens Term Nov 23rd 1865

Wm W McCannan
Capt and A A Gen'l

Captain

I have the honor to request a leave of absence for the period of thirty days for the purpose of visiting my family and attending to business which demands my immediate attention.

I received a leave of absence on Surgeon's Certificate of Disability dated Sept 11th 1865, but owing to circumstances was unable to use it.

I am Captain

Very respectfully

Wm W McCannan
11th Regt. Infy

One officer absent with leave
Strength of officers. Present & absent 19.

W. D. Turner

C. 11th Regt. Infy

C. 513. N. J. 1865

Carlisle, Geo W

Capt

order

Recd Ad Geo W June 1865

HEAD-QUARTERS DEPARTMENT OF TENNESSEE,

Franklin Tenn Dec 4th 1865

SPECIAL ORDERS, }

No. 145 }

EXTRACT.

* * * * *
Leave of absence for _____ days, is hereby granted to the following named Officers, for the period of time set opposite their respective names.

Capt George M Carlisle 11th U S Co I

*For twenty (20) days with permission to apply to the
Head Quarters Mil Div Tenn for an extension
of ten days*

* * * * *
BY COMMAND OF MAJOR GENERAL STONEMAN:

Spencer Porter

Assistant Adjutant General.

*Approved by
11th U S Co I*

245

Barmitchie Abner

Co *A*, 11 U.S. Col'd Inf.

(New Organization.)

Private

Private

CARD NUMBERS.

1		26
2		27
3	<i>In Barmitchie Abner</i>	
4		29
5		30
6		31
7		32
8		33
9		34
10		35
11		36
12		37
13		38
14		39
15		40
16		41
17		42
18		43
19		44
20		45
21		46
22		47
23		48
24		49
25		50

Book Mark:

See also

246

Carpenter, Adam

Co A, 11 U.S. Col'd Inf.

(New Organization.)

Private

Private

CARD NUMBERS.

1	6327477	26
2	6327552	27
3	6327632	28
4	6327736	29
5	6327822	30
6	6327945	31
7	6328033	32
8	6328068	33
9	6328131	34
10	6328202	35
11	6328276	36
12	6328359	37
13	6328429	38
14	6328498	39
15	6328555	40
16	9071534	41
17	9071616	42
18	9071697	43
19		44
20		45
21		46
22		47
23		48
24		49
25		50

Book Mark:

See also

C | **11** (New). | **U.S.C.T.**

Adams Carpenter
Pvt, Co. *D*, 1 Reg't Ala. Art'y.*

Age *28* years.

Appears on

Company Muster-in Roll

of the organization named above. Roll dated

Perinth Miss, Oct 27, 186*3*.

Muster-in to date *Oct 27*, 186*3*

Joined for duty and enrolled:

When *Oct 21*, 186*3*.

Where *La Fayette Tenn*

Period *3* years.

Remarks:

* This organization subsequently became Co. *D*, 11 Reg't U. S. Colored Infantry (New).

Book mark:

(856)

Leger
Copyist.

C | **11 (New).** | **U.S.C.T.**

Adam Carpenter

Pvt, Co. D, 1 Reg't Ala. Siege Art'y.*

Appears on

Company Muster Roll

for *from Enlistment to Oct 31, 1863.*

Present or absent *Present*

Stoppage, \$ *100* for

Due Gov't, \$ *100* for

Remarks: *Has never drawn pay*

*This organization subsequently became Co. D, 11 Reg't U. S. Col'd Infantry (New).

Book mark:

Leyes

C.

11 (New).

U.S.C.T.

Adam Carpenter

Pvt, Co. D, 1 Reg't Ala. Siege Art'y.*

Appears on

Company Muster Roll

for

Nov + Dec

, 1863.

Present or absent

Present

Stoppage, \$

100 for

Due Gov't, \$

100 for

Remarks:

*In arrest & Con-
finement*

*This organization subsequently became Co. D, 11 Reg't U. S. Col'd Infantry (New).

Book mark:

Leger

C

11 (New). U.S.C.T.

Adam Carpenter

Pvt., Co. D, 4 Battalion, 1 Reg't Tenn. H. Art'y.*

Appears on

Company Muster Roll

for

Jan & Feb

, 1864.

Present or absent

Present

Stoppage, \$

100 for

Due Gov't, \$

100 for

Remarks:

* This organization subsequently became Co. D, 11 Reg't U. S. Colored Infantry (New).

Book mark:

Leger

C. | **11** (New) | **U.S.C.T.**

Adam Carpenter
Priv, Co. D, 7 Reg't U. S. Col'd H. Art'y.*

Appears on

Company Muster Roll

for *Mar. & Apr.*, 186*4*.

Present or absent *Absent*

Stoppage, \$ 100 for

Due Gov't, \$ 100 for

Remarks: *Making in action*
at Fort Pillow April
12, 1864.

*This organization subsequently became Co. D, 11 Reg't U. S. Col'd Infantry (New).

Book mark: _____

B. J. Cook
(358) Copyist.

C. | **11 (New)** | **U.S.C.T.**

Adam Carpenter
Ct, Co. D, 7 Reg't U. S. Col'd H. Art'y.*

Appears on

Company Muster Roll

for *May + June*, 186*4*.

Present or absent *Absent.*

Stoppage, \$ *100* for

Due Gov't, \$ *100* for

Remarks: *Miping in action*
at Fort Pillow since
April 12, 1864.

Name next appears on
roll for Sept - Oct - 64

*This organization subsequently became Co. D, 11 Reg't U. S. Col'd Infantry (New).

Book mark: _____

R J Cooke
(358) Copyist.

C. | 11 (New) | U.S.C.T.

Adam Carpenter
Pvt., Co. D, 7 Reg't U. S. Col'd H. Art'y.*

Appears on

Company Muster Roll
for Sept. & Oct., 1864.

Present or absent Present

Stoppage, \$ 100 for

Due Gov't, \$ 100 for

Remarks: Records of Co. lost
in action at Ft. Pillow
Apr. 12. 64.

*This organization subsequently became Co. D, 11 Reg't U. S. Col'd
Infantry (New).

Book mark:

(358) B J Cooke Copyist.

C. | 11 (New) | U.S.C.T.

Adam Carpenter
Pvt., Co. D, 7 Reg't U. S. Col'd H. Art'y.*

Appears on

Company Muster Roll

for Nov. & Dec., 1864.

Present or absent Present

Stoppage, \$ 100 for

Due Gov't, \$ 100 for

Remarks:

*This organization subsequently became Co. D, 11 Reg't U. S. Col'd Infantry (New).

Book mark:

(858)

B J Cooke

Copyist.

C | 11 (New). | U.S.C.T.

Adam Combs
Co. D, 11 Reg't U. S. Col'd Inf. (New).

Appears on

Company Muster Roll

for *Jan and Feb.*, 186*0*.

Present or absent *Present*

Stoppage, \$ *100* for

Due Gov't, \$ *100* for

Remarks:

Book mark: _____

(858) *J. B. Jones* Copyist

11 (New).

U.S.C.T.

Adam Carpenter

Co. D, 11 Reg't U. S. Col'd Inf. (New).

Appears on

Company Muster Roll

for *March and April*, 1865.

Present or absent *Present*

Stoppage, \$ *100* for

Due Gov't, \$ *100* for

Remarks:

Book mark:

(358)

J. B. Jones

Copyist

11 (New). U.S.C.T.

Adam Carpenter

Co. D, 11 Reg't U. S. Col'd Inf. (New).

Appears on

Company Muster Roll

for May and June, 1865.

Present or absent Present

Stoppage, \$ 100 for

Due Gov't, \$ 100 for

Remarks: Stoppage by High Court martial \$10.00.

Book mark:

(858)

J. B. Jones

Copyist

11 (New).

U.S.C.T.

A. J. Carpenter
Co. D, 11 Reg't U. S. Col'd Inf. (New).

Appears on

Company Muster Roll

for *July and August*, 186*5*.

Present or absent *present*

Stoppage, \$ *100* for

Due Gov't, \$ *100* for

Remarks: *Stoppage by A. J. C. M. \$100.00.
insurance each - see A. J. M. M. M.
w/ser, see A. J. P. C. M. 19.28.*

Book mark: *100*

(858)

A. J. Carpenter

Copyist

6 | 11 (New) | U.S.C.T.

Arnon Carpenter
ser, Co. D, 7 Reg't U. S. Col'd H. Art'y.*

Appears on

Company Muster Roll

for Sept + Oct, 186 J-

Present or absent present

Stoppage, \$ 100 for

Due Gov't, \$ 19 ⁶⁸ / 100 for ordnance

Remarks:

*This organization subsequently became Co. D, 11 Reg't U. S. Col'd Infantry (New).

Book mark:

(358)

E. McKeever
Camp. *Copyist.*

C | **11** (New). | **U.S.C.T.**

Adam Carpenter
Pr, Co. D, 11 Reg't U. S. Col'd Inf. (New).

Appears on

Company Muster Roll

for *Nov. & Dec.*, 186 *5*.

Present or absent *Present*

Stoppage, \$ *2* ^{*85*}/_{*100*} for *Camp &*

Gar. Equip.

Due Gov't, \$ *19* ^{*68*}/_{*100*} for *Ordinance*

Remarks: _____

Book mark: _____

(858)

Hodges

Copyist

C

11 (New).

U.S.C.T.

Adam Carpenter

Priv. S., 11 Reg't U. S. Col'd Inf. (New).

Appears on **Co. Muster-out Roll**, dated

Memphis Tenn. Jan. 12, 1866.

Muster-out to date

Jan. 12, 1866.

Last paid to

June 30, 1865.

Clothing account:

Last settled....., 186 ; drawn since \$..... 100

Due soldier \$.....100; due U. S. \$ *41*^{*34*}/₁₀₀

Am't for cloth'g in kind or money adv'd \$.....100

Due U. S. for arms, equipments, &c., \$ *22*^{*53*}/₁₀₀

Bounty paid \$.....100; due \$.....100

Remarks:.....

Book mark: *10445-1882*

(361)

Kadger
Copyist.

6

11 (New) U. S. C. T.

Adam Carpenter

, Co. *D*, 11 Reg't U. S. Col'd Inf. ^(New)

Appears on

Company Descriptive Book

of the organization named above.

DESCRIPTION.

Age *28* years height *5* feet *7* inches.

Complexion *Black*

Eyes; *Black* hair *Black*

Where born *Franklin Co., Tenn*

Occupation *Field Hand*

ENLISTMENT.

When *Oct 21*, 1863.

Where *in Fayette Tenn*

By whom *D. Carson*; term *3* y'rs.

Remarks: *Reported as missing
in action at Fort Pillow
Apr 12th 1864. Returned
to Company Sept 15th
1864.*

Leary

6

11 (New) U. S. C. T.

Adam Carpenter

(New)
Co. D, 11 Reg't U. S. Col'd Inf.

Appears on

Company Descriptive Book

of the organization named above.

DESCRIPTION.

Age 28 years height 5 feet 7 inches.

Complexion Black

Eyes; Black hair Black

Where born Franklin Co, Tenn

Occupation Field Hand

ENLISTMENT.

When Oct 21, 1863.

Where La Fayette Tenn

By whom D. Carson; term 3 y'rs.

Remarks: Missing in action at
Fort Pillow Apr 10th 1864.
Returned to his company
Sept. 15th 1864.

(338g)

Leary
Copyist.

C

11^(New) U.S.C.T.

Adam Carpenter

(New)
Co. *R*, 11 Reg't, U.S. Col'd Inf.

Appears on

Company Descriptive Book

of the organization named above.

DESCRIPTION. *No description*

Age years height... feet... inches.

Complexion

Eyes; hair

Where born

Occupation

ENLISTMENT.

When, 186 .

Where

By whom ; term y'rs.

Remarks:
.....
.....
.....
.....
.....
.....
.....
.....
.....

Army
Copyst.

Carpenter, Adam

P, Co. D, II Reg't U. S. C. Inf.

6 Enclosures.

Bed Cards	Descriptive Lists
Burial Records	Final Statements 2
Certs. of Dis. for Discharge	Furloughs
C. M. Charges /	Med. Des. Lists
Med. Certificates	Orders
	Prison Papers 1

Other papers relating to—

Admission to Hosp'l	Furlough
Casualty Sheet (Officer's)	Med. Examination
Confinement	Misc. Information /
Contracts	Pay or Clothing
Death or Effects /	Personal Reports
Desertions	Rank
Discharge from Hosp'l	Transfer to Hosp'l
Discharge from Service	Transfer to V. R. C.
Duty	Transportation

✓ *Co. D* *50*
FINAL STATEMENT

OF

Wm Carpenter

7th Reg't of *U.S. Col. Hey*

7th
VOLUNTEERS.
Disch. April 14 1864

NOTE 1.—Two of these certificates (or duplicates) are to be given to each volunteer soldier who may be discharged previously to the discharge of his company, that he may at once receive from the Paymaster the pay, &c., due him, and the captain or other officer commanding the company will certify to the act of the delivery of the duplicate certificates; on these certificates the soldier is "entitled to" his discharge, and should also present his discharge to the Paymaster to have the payment endorsed on it. The discharge is to be given back to the Soldier by the Paymaster; the latter only retaining as his voucher the duplicate certificates.

NOTE 2.—If the Soldier is entitled to pay for the use of his horse, the Company Commander will certify to that fact, and also to the time he has pay due for having been so mounted on his own horse.

NOTE 3.—Amounts due the Sutler and Laundress must be entered on the Muster Roll on which the death, desertion, &c., is reported, as well as on the final statement, otherwise the amount cannot be collected from the United States.

NOTE 4.—This blank will be used for deceased volunteers as well as others.

ADJUTANT GENERAL'S OFFICE
July 15th 1864
Duplicate with Inventory sent 2d Auditor.

Eubank & Co.

I certify, on honor, that Adam Carpenter a Private of
Captain D. Carson, Company (2^d) of the 7th Regiment of U.S. Col. Regt.
VOLUNTEERS, of the State of _____, born in _____, State
of _____, aged 28 years; _____ feet _____ inches high; Dark complexion,
Black eyes, Black hair, and by occupation a _____, having joined the company on
its original organization at La Fayette Tenn. and enrolled in it at the muster into
the service of the United States at Cornith Miss., on the 27th day
of October, 1863, (or was mustered in service as a recruit, by _____
at _____, on the _____ day of _____
186 , to serve in the Regiment.) for the term of Three years unless soon discharged
and having served **HONESTLY** and **FAITHFULLY** with his Company in The Field
to the present date, is now entitled to a **DISCHARGE** by reason of Missing in
action at Fort Pillow April 12 1864 supposed to be
Killed

The said Adam Carpenter was last paid by Paymaster
Mag. Palmer to include the last day of December, 1863, and has
pay due him from that time to the present date, he is entitled to pay and subsistence for
TRAVELING to place of enrollment and whatever other allowances are authorized to volunteer
soldiers, or militia, so discharged. He has received _____ dollars,
advanced by the United States on account of **CLOTHING**.

There is to be stopped from him, on account of the State of _____, or other
authorities for **CLOTHING**, &c., received on entering service, _____ dollars; also,
for expenses of **SUBSISTENCE** for **TRAVELING** from place of enrollment to the place of rendezvous,
amounting to _____ dollars: and on account of the United States for **EXTRA**
CLOTHING received in kind from _____ and for other
stoppages, viz: The Books & Papers of the U.S. Army for the
at Fort Pillow April 12 1864 amounting to small total _____ dollars;
and he has been **SUBSISTED** for **TRAVELING** to his place of enrollment, up to the _____
_____, 186 .

He is indebted to _____ **SUTLER**, _____ dollars.

He is indebted to _____ **LAUNDRESS**, _____ dollars.

Given in Duplicate, at Fort Pickens, this 2nd day of June, 1864.

D. B. Carson, Co. 2^d

7th U.S. Col. Regt.
Commanding Company.

1864 Sep 50
No. 11

FINAL STATEMENT

OF

Adam Carpenter

2nd Reg't of U.S. C.A. (G.)

VOLUNTEERS.

NOTE 1.—Two of these certificates (or duplicates) are to be given to each volunteer soldier who may be discharged previously to the discharge of his company, that he may at once receive from the Paymaster the pay, &c., due him, and the captain or other officer commanding the company will certify to the act of the delivery of the duplicate certificates; on these certificates the Soldier is "entitled to" his *discharge*, and should also present his discharge to the Paymaster to have the payment endorsed on it. The discharge is to be given back to the Soldier by the Paymaster; the latter only retaining as his voucher the duplicate certificates.

NOTE 2.—If the Soldier is entitled to pay for the use of his horse, the Company Commander will certify to that fact, and also to the time he has pay due for having been so mounted on his own horse.

NOTE 3.—Amounts due the Sutler and Laundress must be entered on the Muster Roll on which the death, desertion, &c., is reported, as well as on the final statement, otherwise the amount cannot be collected from the United States.

NOTE 4.—This blank will be used for deceased volunteers as well as others.

I certify, on honor, that *Adam Carpenter* a *Private* of Captain *J. Carson* Company (*D*) of the *7th* Regiment of *U.S. C.A. Reg.* VOLUNTEERS, of the State of _____, born in _____, State of _____, aged *28* years; _____ feet _____ inches high; *black* complexion, _____ eyes, *black* hair, and by occupation a _____, having joined the company on its original organization at _____ *La Fayette Tenn.* and enrolled in it at the muster into the service of the United States at _____ *Corinth Miss*, on the *Twenty Ninth* day of *October*, 186*3*, (or was mustered in service as a recruit, by _____, at _____, on the _____ day of _____, 186*3*, to serve in the Regiment.) for the term of *Three years unless sooner discharge* and having served HONESTLY and FAITHFULLY with his Company in _____ *The Field* to the present date, is now entitled to a **DISCHARGE** by reason of *Missing in action at Fort Pillow April 12th 1864 supposed to be killed*

The said *Adam Carpenter* was last paid by Paymaster *May Dalton* to include the *Thirtieth* day of *December*, 186*3*, and has pay due him from that time to ^{*April 12th 1864*} ~~the present date~~; he is entitled to pay and subsistence for TRAVELING to place of enrollment and whatever other allowances are authorized to volunteer soldiers, or militia, so discharged. He has received _____ dollars, advanced by the United States on account of **CLOTHING**.

There is to be stopped from him, on account of the State of _____, or other authorities for **CLOTHING**, &c., received on entering service, _____ dollars; also, for expenses of SUBSISTENCE for TRAVELING from place of enrollment to the place of rendezvous, amounting to _____ dollars: and on account of the United States for **EXTRA CLOTHING** received in kind from _____ and for other stoppages, viz: *The books & Papers of the Co were lost in action at Fort Pillow April 12th 1864* amounting to *unable to tell* _____ dollars; and he has been SUBSISTED for TRAVELING to his place of enrollment, up to the _____, 186*3*.

He is indebted to _____, SUTLER, _____ dollars.
He is indebted to _____, LAUNDRESS, _____ dollars.

Given in Duplicate, at *Fort Pickens*, this *2^d* day of *June*, 1864.

M. B. Adams
T. U. S. C. A. Reg.
Commanding Company.

ARTICLES OF WAR.

ART. 95. When any non-commissioned officer or soldier shall die, or be killed in the service of the United States, the then commanding officer of the troop or company shall, in the presence of two other commissioned officers, take an account of what effects he died possessed of, above his arms and accoutrements, and transmit the same to the office of the Department of War, which said effects are to be accounted for, and paid to the representatives of such deceased non-commissioned officer or soldier. And in case any of the officers, so authorized to take care of the effects of deceased officers and soldiers, should, before they have accounted to their representatives for the same, have occasion to leave the regiment or post by preferment or otherwise, they shall, before they be permitted to quit the same, deposit in the hands of the commanding officer, or of the assistant military agent, all the effects of such deceased non-commissioned officers and soldiers, in order that the same may be secured for, and paid to, their respective representatives.

ARMY REGULATIONS—EDITION OF 1863.

DECEASED SOLDIERS.

Par. 152. Inventories of the effects of deceased non-commissioned officers and soldiers, required by the 95th Article of War, will be forwarded to the Adjutant General, by the commander of the company to which the deceased belonged, and a duplicate of the same to the colonel of the regiment. Final statements of pay, clothing, &c., in duplicate, will be sent to the Adjutant General with one copy of the inventory. When a soldier dies at a post or station absent from his company, it will be the duty of his immediate commander to furnish the required inventory and final statements, and, at the same time, to forward to the commanding officer of the company to which the soldier belonged, a report of his death, specifying the date, place, and cause; to what time he was last paid, and the money or other effects in his possession at the time of his decease; which report will be noted on the next muster roll of the company to which the man belonged. Each inventory will be endorsed, "Inventory of the effects of _____, late of company (—), _____ regiment of _____, who died at _____, the _____ day of _____, 186-." If a legal representative receive the effects, it will be stated in the report. If the soldier leave no effects, the fact will be reported.

Par. 153. Should the effects of a deceased non-commissioned officer or soldier not be administered upon within a short period after his decease, they shall be disposed of by a Council of Administration, under the authority of the commanding officer of the post, and the proceeds deposited with the Paymaster, to the credit of the United States, until they shall be claimed by the legal representatives of the deceased.

Par. 154. In all such cases of sales by the Council of Administration, a statement in detail, or account of the proceeds, duly certified by the Council and commanding officer, accompanied by the Paymaster's receipt for the proceeds, will be forwarded by the commanding officer to the Adjutant General. The statement will be endorsed, "Report of the proceeds of the effects of _____, late of company (—), _____ regiment of _____, who died at _____, the _____ day of _____, 186-."

NOTE 1.—The effects in all cases, when called for, should be turned over to the legal representative, without further authority from the Adjutant General. When the effects are turned over to the relatives of the deceased before these inventories are sent to the Adjutant General, their receipts therefor should be attached to the inventories. In all other cases, one copy will be sent with a letter of transmittal direct to the Adjutant General, and a duplicate retained by the officer.

NOTE 2.—Particular care should be taken to take receipts in duplicate from the Paymaster for any funds turned over to him; one copy should be sent direct to the Adjutant General and one retained by the officer.

INVENTORY OF THE EFFECTS

OF

Adam Carpenter

Late of Company *D*

7th Reg't of *U.S. C.A. (Gy)*

Volunteers, who died at *Fort Pillow*

on the *12th* day of *April* 186*4*



Proceedings of a Field Officers Court
held at Hd Quarters 11th U.S. Co. Inf. Memphis
Tenn June 8th 1865 in pursuance of the following
Order

Head Quarters 1st Pickering
Memphis Tenn 13th May 1865

Special Order
No. 70

I Major Geo. L. Paddock
commanding 11th U.S. Co. Inf. being the only
field officer present with the command
is hereby announced as Field Officers Court
for said regiment in compliance with Part III
of the Act of Congress approved July 17th 1862
and will try such cases as come within his
jurisdiction

By order of

Lieut. A. G. Whipple

signed L. Paddock

Caplt & a. c. a. c.

No 21

In the case of Private Adam Carpenter
Co "D" 11th U.S. Co. Inf.
Present Major Geo. L. Paddock the court
also present the prisoners
George by St. Martin / Lying out of quarters
at night without leave at various times in the
month of June 1865 and on the 7th of June
in particular 2 Neglect of duty in laying

aside his accoutrements while on guard at
the pickets near Memphis Tenn. 7th June 1865
Plea guilty as to both charges
Finding of both charges guilty
Sentence that he forfeit ten dollars of his
monthly pay to be stopped on next roll

Geo. L. Paddock
Major 11th U.S. Inf.
T. O. South

474-8412-11-22-1865
1567
474-8412-11-22-1865
1567

APR 20 11 2000 Infy
Members from June 12/65

Approved - respectfully
forwarded.

Geo. L. Paddock
Major 11th U.S. Inf.
Tenn. Co.

Heard & Co. 11th U.S. Infy
Members from June 12/65

Major Geo L. Paddock
Field Officers Court

Respectfully forward proceeding
of Field O. Ct. in Case of Capt.
Adam Cooper vs Co D 11th U.S. Infy

20.

Adam Carpenter
Pot. Co. D. 11th U.S.C. & (new)

Ellerbrook

MEMORANDUM FROM PRISONER OF WAR RECORDS.

No. _____

(This blank to be used only in the arrangement of said records.)

NAME.	RANK.	ORGANIZATION.				INFORMATION OBTAINED FROM—				
		No. of Reg't.	State.	Arm of Service.	Co.	Records of—	Vol.	Page.	Vol.	Page.
<i>Carpenter Adam</i>	<i>♠</i>	<i>11</i>	<i>U.S.</i>	<i>C.T.</i>	<i>D</i>					

Captured at _____, 186 __, confined at Richmond, Va., _____, 186 __.

Admitted to Hospital at _____

where he died _____, 186 __, of _____

Paroled at _____, 186 __; reported at Camp Parole, Md., _____, 186 __.

*No Record. 2" and case
to Woodward May 2/82*

Copied by *J. J. H.*

²⁴⁷
Carr, William

Co ^{M.A.} 11 U.S. Col'd Inf.

(New Organization.)

Private Private

CARD NUMBERS.

1	6335676	26
2	6335769	27
3	6335844	28
4	6335911	29
5	6335971	30
6	6324533	31
7	6324611	32
8	6324682	33
9	6324747	34
10	6324815	35
11	9072988	36
12	9072911	37
13	9070867	38
14	9072402	39
15		40
16		41
17		42
18		43
19		44
20		45
21		46
22		47
23		48
24		49
25		50

Book Mark:

See also

C. | **11 (Crew) U.S.C.T.**

William Care,

(Crew)
Co. *M*, 11 Reg't U.S. Col'd Inf.

Appears on

Company Descriptive Book

of the organization named above.

DESCRIPTION.

Age *18* years height *6* feet *1 1/2* inches.

Complexion *lt*

Eyes; *blk* hair *brn*

Where born *Jalabasha, Miss.*

Occupation *farmer.*

ENLISTMENT.

When *15 Apr*, 186*4*

Where *Memphis.*

By whom *Capt Oyster*; term *3* y'rs.

Remarks: *Transfd to Co A.*

Dayton,

C. | 11 (Kew) U.S.C.T.

William Care

(Kew.)
Co. C, 11 Reg't U. S. Col'd Inf.

Appears on

Company Descriptive Book

of the organization named above.

DESCRIPTION

Age 18 years; height 6 feet 1 1/2 inches.

Complexion *lt*

Eyes *brn*; hair *blk*

Where born *Yellowbasha Co. Miss.*

Occupation *farmer*

ENLISTMENT

When *15 April*, 1864

Where *Memphis*

By whom *Capt Ripston*; term *3* y'rs.

Remarks:

Dayton,

C | 11 (New) U.S.C.T.

William Carr

(New)
....., Co., 11 Reg't U.S. Col'd Inf.

Appears on
Company Descriptive Book
of the organization named above.

DESCRIPTION.

Age 18 years height 5 feet 1 1/2 inches.

Complexion light

Eyes; Black hair Brown

Where born Yellow Busha Miss

Occupation farmer

ENLISTMENT.

When April 15, 1864.

Where Memphis Tenn

By whom Capt Eusta; term 3 y'rs.

Remarks: Transferred from
Co M special
order no 94, Adg. 11"
M. S. C. Inf. May
10th, 66

J E Park

C | 11 (new.) U. S. C. T.

William Carr

Co. A, 11 Reg't U. S. Col'd Inf. (new.)

Appears on

Company Descriptive Book

of the organization named above.

DESCRIPTION.

Age 18 years height 6 feet 2 inches.

Complexion Blk

Eyes; Blk hair Blk

Where born Yellowbush Miss.

Occupation Farmer.

ENLISTMENT.

When Apr 15, 1864.

Where Memphis.

By whom Capt. Eyster ; term 3 y'rs.

Remarks: Transferred from
Co. M per S.O. No. 119 dated
4th Dec. Dist West Tenn.
Memphis. Tenn. May 8-
65.

Hearst

C | **11** (New) | **U.S.C.T.**

William Case^{+bare}
Int, Co. M, 7 Reg't U. S. Col'd H. Art'y.*

Appears on

Company Muster Roll

for *July & Aug.*, 1864

Present or absent *Present*

Stoppage, \$ *100* for

Due Gov't, \$ *100* for

Remarks: *Assigned to Co. by
S. O. No. 116, Sec. War,
dated July 6, 1864.*

Connected by Worley

* This organization subsequently became Co. M, 11 Reg't U. S. Colored Infantry (New).

Book mark:

P. Pool

C

11 (New)

U.S.C.T.

William Care

Priv, Co. M, 7 Reg't U. S. Col'd H. Art'y.*

Appears on

Company Muster Roll

for *Sept & Oct*, 1864.

Present or absent *Present*

Stoppage, \$ *100* for

Due Gov't, \$ *100* for

Remarks:

* This organization subsequently became Co. M, 11 Reg't U. S. Colored Infantry (New).

Book mark:

J. Pool;

C | 11 (New) | U.S.C.T.

William ~~Care~~^{Care}
Pot, Co. M, 7 Reg't U. S. Col'd H. Art'y.*

Appears on

Company Muster Roll

for Nov + Dec, 1864.

Present or absent Present

Stoppage, \$ 100 for

Due Gov't, \$ 100 for

Remarks: Shot for one Gun
Sling 31.

+ borrowed by Worley 4/7

* This organization subsequently became Co. M, 11 Reg't U. S. Colored Infantry (New).

Book mark:

P. Pool,

C

11 (New).

U.S.C.T.

William Card

Co. M, 11 Reg't U.S. Col'd Inf. (New).

Appears on

Company Muster Roll

for July & July, 1865.

Present or absent Present

Stoppage, \$ 100 for

Due Gov't, \$ 100 for

Remarks: Stop for one
Gun Shy \$.31.

Book mark:

Washington

6 | 11 (New). U.S.C.T.

William Case

Pvt, Co. M, 11 Reg't U.S. Col'd Inf. (New).

Appears on

Company Muster Roll

for *March - April*, 186*5*.

Present or absent *Present*

Stoppage, \$ *100* for

Due Gov't, \$ *100* for

Remarks:

Book mark:

Washington

6 | 11 (New). | U.S.C.T.

William Cass

Pvt., Co. A, 11 Reg't U. S. Col'd Inf. (New).

Appears on

Company Muster Roll

for *May & June*, 1865.

Present or absent *Present*

Stoppage, \$ *100* for

Due Gov't, \$ *100* for

Remarks: *Transferred from
Co. M, S.C., No. 94 dated
Ad. Gens. Dist. West-Tenn.*

Book mark: _____

A. N. Reed

(858)

Copyist

C. | **11 (New).** | **U.S.C.T.**

William Carr.

Pvt., Co. A, 11 Reg't U. S. Col'd Inf. (New).

Appears on

Company Muster Roll

for *July & Aug.*, 1865.

Present or absent *Present.*

Stoppage, \$ *100* for

Due Gov't, \$ *100* for

Remarks:

Book mark:

H. W. Reed

(358)

Copyist

7 | **11** (New). | **U.S.C.T.**

William E. ...

10/10, Co. A, 11 Reg't U. S. Col'd Inf. (New).

Appears on

Company Muster Roll

for *Sept. & Oct.*, 1865.

Present or absent *- Present*

Stoppage, \$ *00* ^{*30*} *100* for *insurance*

is etc for ...

Due Gov't, \$ *100* for

Remarks:

Book mark:

Hoybarger

C | 11 (New). | U.S.C.T.

William Carr

Plt, Co. A, 11 Reg't U. S. Col'd Inf. (New).

Appears on

Company Muster Roll

for *Nov & Dec*, 1865.

Present or absent *Present*

Stoppage, \$ *100* for *allowance*
in-ct for U.S.C.

Due Gov't, \$ *100* for

Remarks:

Book mark:

Hayberger

C

11 (New).

U.S.C.T.

William Carr

Pt. A, 11 Reg't U. S. Col'd Inf. (New).

Appears on Co. Muster-out Roll, dated

Memphis Tenn, Jan'y 12 1866.

Muster-out to date

Jan'y 12 1866.

Last paid to

June 30 1865.

Clothing account:

Last settled 186 ; drawn since \$ 100

Due soldier \$ 100; due U. S. \$ *63* ⁸³/₁₀₀

Am't for cloth'g in kind or money adv'd \$ 100

Due U. S. for arms, equipments, &c., \$ 100

Bounty paid \$ 100; due \$ 100

Remarks: *Due U.S. for Ordnance*

90 cts Due U.S. for C. and G. S.

60 cts Transferred from

Co. M (late 7th U.S. C. A. S. G.)

per Special O. No 119 dated

16th Dec. Dept. West Tenn.

(over)

Book mark

Hoyberger

(361)

Copyist.

JAN. 22

6324815

018910

May 8/65 Spl order No 94
Hq. Gps. 11th U.S. C. P. 10th

May 65

(Age 18 yrs Enrolled
April 15, 64 and
moved in April 18, 64
at Memphis Tenn
for 2 yrs)

248

Cassington Samuel

Co H, 11 U.S. Col'd Inf.

(New Organization.)

Private

Private

CARD NUMBERS.

1	6328135	26
2	6328206	27
3	6328280	28
4	6328362	29
5	6328430	30
6	6328499	31
7	6328556	32
8	9071760	33
9	9072727	34
10		35
11		36
12		37
13		38
14		39
15		40
16		41
17		42
18		43
19		44
20		45
21		46
22		47
23		48
24		49
25		50

Book Mark:

See also

S-747 891 - P. O. m. + m. (Rtik)
S 2143854 P. O. Feb.
E. 2580210, and and

C | 11 (New) U.S.C.T.

Scimitar
Samuel Cunningham
....., Co. *A*, 11 Reg't U.S. Col'd Inf. *(New)*

Appears on

Company Descriptive Book

of the organization named above.

DESCRIPTION.

Age *21* years height *5* feet *7 1/2* inches.

Complexion *Black*

Eyes; *Black* hair *Black*

Where born *Virginia*

Occupation *Scimitar*

ENLISTMENT.

When *Dec 22*, 1863.

Where *Memphis*

By whom *H. Dickert*; term *3* y'rs.

Remarks: *Transferred to 7th U.S.C.A. Reg't*
July 14/64 L. Thomas
Adjt. Gen.

As it appears in Roll.

6

11 (new) U. S. C. T.

Simon Carington

, Co. L, 11 Reg't U. S. Col'd Inf.

Appears on

Company Descriptive Book

of the organization named above.

DESCRIPTION.

Age 21 years height 5 feet 9 1/2 inches.

Complexion *Blk*

Eyes; *Blk* hair *Blk*

Where born *Virginia*

Occupation *Teamster*

ENLISTMENT.

When *Dec. 22*, 186 *3*.

Where *Memphis*

By whom *A. Dickhut*; term *3* y'rs.

Remarks: *Present*

D. M. Kennedy

C

11 (New). U.S.C.T.

Samuel Cunningham
Priv., Co. D, 11 Reg't U. S. Col'd Inf. (New).

Appears on

Company Muster Roll

for June and July, 1864

Present or absent Present

Stoppage, \$ 100 for

Due Gov't, \$ 100 for

Remarks: assigned to 7th Reg't (N.Y.)
S. Co. 1st July 1864, L. Thomas
adj't. Gen.

Book mark:

(858)

J. P. Payne

Copyist

11 (New). U.S.C.T.

Samuel Harrington
Dunn, Co. D, 11 Reg't U. S. Col'd Inf. (New).

Appears on

Company Muster Roll

for *March and April*, 1865.

Present or absent *Present*.

Stoppage, \$ *100* for

Due Gov't, \$ *100* for

Remarks: *Enrolled Dec
22, 63 and mustid
in Apl 18, 64 at
Memphis Tenn
for 3 yrs*

Book mark:

(858)

J. B. James
Copyist

11 (New). U.S.C.T.

Samuel Carrington
Co. D; 11 Reg't U. S. Col'd Inf. (New).

Appears on

Company Muster Roll

for *May and June*, 186*5*.

Present or absent *Present*

Stoppage, \$ *100* for

Due Gov't, \$ *100* for

Remarks:

Book mark:

(358)

J. B. Jones

Copyist

W

11 (New).

U.S.C.T.

Samuel Harrington

Co. D, 11 Reg't U. S. Col'd Inf. (New).

Appears on

Company Muster Roll

for July and August, 1865.

Present or absent Present

Stoppage, \$ 100 for

Due Gov't, \$ 100 for

Remarks:

Book mark:

(858)

J. B. Jones

Copyist

6 | 11 (New). | U.S.C.T.

Samuel Carrington
Co. D, 11 Reg't U. S. Col'd Inf. (New).

Appears on

Company Muster Roll

for *Sept. and Oct.*, 186*4*.

Present or absent *Present*

Stoppage, \$ *100* for

Due Gov't, \$ *100* for

Remarks:

Book mark: *100*

(858)

J. B. Jones

Copyist

C | **11** (New). | **U.S.C.T.**

Samuel Harrington
Pr.; Co. D, 11 Reg't U. S. Col'd Inf. (New).

Appears on

Company Muster Roll

for *Nov & Dec*, 186*5*.

Present or absent *Present*

Stoppage, \$ *100* for

Due Gov't, \$ *100* for

Remarks:

Book mark:

(858)

Hodges

Copyist

C | **11 (New).** | **U.S.C.T.**

Samuel Carrington
Bridg, 11 Reg't U. S. Col'd Inf. (New).

Appears on **Co. Muster-out Roll**, dated
Memphis Tenn Jan 12, 1866.

Muster-out to date *Jan. 12*, 1866.

Last paid to *June 30*, 1865.

Clothing account:

Last settled 186 ; drawn since \$ 100

Due soldier \$ *29²⁵* ₁₀₀; due U. S. \$ 100

Am't for cloth'g in kind or money adv'd \$ 100

Due U. S. for arms, equipments, &c., \$ 100

Bounty paid \$ 100; due \$ 100

Remarks:

Joined by transfer
from Pioneer Corps
per S.O. 124 July
14. 64 L. Thomas A.S.
(Age 21 yrs)

Book mark:

(361)

Hodges

Copyist.

249

Garson Albert

Co A, 11 U.S. Col'd Inf.

(New Organization.)

Private

Private

CARD NUMBERS.

1	26
2	27
3	28
4	29
5	30
6	31
7	32
8	33
9	34
10	35
11	36
12	37
13	38
14	39
15	40
16	41
17	42
18	43
19	44
20	45
21	46
22	47
23	48
24	49
25	50

Book Mark:

See also

250

Carson, Rebo

Co A, 11 U.S. Col'd Inf.

(New Organization.)

Captain | Captain

CARD NUMBERS.

1	6327522	26
2	6327603	27
3	6327707	28
4	6327808	29
5	6328614	30
6	9428942	31
7	Reg-49-67	32
8		33
9		34
10		35
11		36
12		37
13		38
14		39
15		40
16		41
17		42
18		43
19		44
20		45
21		46
22		47
23		48
24		49
25		50

Book Mark: Reg-49-67

See also

6 | 11 (New) | U.S.C.T.

Lebos Carson
Capt, Co. D, 1 Reg't Ala. Siege Art'y.*

Age 36 years.

Appears on

Company Muster-in Roll

of the organization named above. Roll dated
Cornish Miss Nov 27, 1863.

Muster-in to date Nov 27, 1863.

Joined for duty and enrolled:

When Oct 7, 1862

Where Warrington Ills

Period 3 years.

Remarks: Promoted to Capt.
Nov 20th 1863 from Private
Co D 3rd Ills Cav.

*This organization subsequently became Co. D, 11 Reg't U. S Colored Infantry (New).

Book mark: Qaz-49-67.

Leyes

C | 11 (New). | U.S.C.T.

Delos Carson
capt, Co. D, 1 Reg't Ala. Siege Art'y.*

Appears on

Company Muster Roll

for Nov & Dec, 1863.

Present or absent present

Stoppage, \$ 100 for

Due Gov't, \$ 100 for

Remarks:

promoted from
private Co. I 3 Ill
heavy Vols. and assumed
command of Co by
Special Order No 2/4
Ud. Res. left Army 16
A.G. Nov. 25, '63.

*This organization subsequently became Co. D, 11 Reg't U. S. Col'd Infantry (New).

Book mark:

(358)

Est. Medicus
Comp. Copied.

11 (New). U.S.C.T.

Charles Carson
Capt, Co. D, 4 Battalion, 1 Reg't Tenn. H. Art'y.*

Appears on

Company Muster Roll

for *Jan 1864*, 1864.

Present or absent *Present*

Stoppage, \$ *100* for

Due Gov't, \$ *100* for

Remarks: *Commanding
Co - Promoted from Pvt
Co. "I" 3rd Ill. Cav. Vol. By
Special Orders No. 24. Dated
Hd. Qrs. Left Wing, 16 Army
Corps Nov. 25, 1863*

* This organization subsequently became Co. D, 11 Reg't U. S. Colored Infantry (New).

Book mark :

Legget

D. | **11 (New) U.S.C.T.**
Delos Carson

Capt., Co. D, 7 Reg't U. S. Col'd H. Art'y.*

Appears on

Company Muster Roll

for *Mar. & Apr.*, 186*4*.

Present or absent.....

Stoppage, \$ *100* for.....

Due Gov't, \$ *100* for.....

Remarks: *Killed in action*
at Fort Pillow April 12,
1864. Due Sutter Thirty
Two Dollars $\frac{65}{100}$.

*This organization subsequently became Co. D, 11 Reg't U. S. Col'd Infantry (New).

Book mark: *No. 56, 975, Dec. 22, 1864.*

B. J. Cooke
(358) Copyist.

C | 11 (New). | U.S.C.T.

Delos Carson

Captal, 11 Reg't U. S. Col'd Inf. (New).

Appears on **Co. Muster-out Roll**, dated

Memphis Tenn Jan. 12, 1866.

Muster-out to date _____, 186 .

Last paid to *Dec. 31*, 1865.

Clothing account:

Last settled _____, 186 ; drawn since \$ _____ 100

Due soldier \$ _____ 100; due U. S. \$ _____ 100

Am't for cloth'g in kind or money adv'd \$ _____ 100

Due U. S. for arms, equipments, &c., \$ _____ 100

Bounty paid \$ _____ 100; due \$ _____ 100

Remarks:

*Killed at Ft. Pillow
April 12.64 after he
had been captured.*

Book mark: *56.975*

(361)

Hodges

Copyist.

C 11 (New) W.S.C.A.

Delos Carson

, Co. D, 7 Reg't W.S.C.A.

NOTATION.

Book mark: Qaz-79-1867 with
Qaz-49-1867.

War Department,

Adjutant General's Office,

Washington. *Nov* 15, 1867.

*Name from list of interments at
Fort Pillow, Tenn., and on
list of names of Union dead,
collected from head-boards at
Fort Pillow, Tenn.*

H. E. Capshaw
Copyist.

251

Carter, Robert

Co L, 11 U.S. Col'd Inf.

(New Organization.)

Private Private

CARD NUMBERS.

1	6335038	26
2	6335198	27
3	2072791	28
4		29
5		30
6		31
7		32
8		33
9		34
10		35
11		36
12		37
13		38
14		39
15		40
16		41
17		42
18		43
19		44
20		45
21		46
22		47
23		48
24		49
25		50

Book Mark:

See also

6

11 (new) U. S. C. T.

Robert Carter

, Co. L, 11 Reg't U. S. Col'd Inf. (new)

Appears on

Company Descriptive Book

of the organization named above.

DESCRIPTION.

Age 35 years height 5 feet 5 inches.

Complexion Brown

Eyes; Blk hair Blk

Where born Giles Co. Va.

Occupation Farmer

ENLISTMENT.

When March 1st, 1864

Where Memphis Tenn.

By whom Serg. E. Crockett term 3 y'rs.

Remarks: Died in Regtl Hoopth at Fort Pickens Memphis Tenn. April 21st 1864 by reason of disease.

D. M. Kennedy

(338g)

Copyist.

C

11 (New). U.S.C.T.

Robert Carter

Private, Co. L, 6 Reg't U. S. Col'd H. Art'y.†

Appears on

Company Muster-in and Descriptive Roll of the organization named above. Roll dated

Fort Pickens
Memphis, Tenn., April 2, 1864.

Where born Giles Co., Virginia.

Age 35 yrs; occupation Farmer.

When enlisted March 1, 1864.*

Where enlisted Memphis, Tenn.,

For what period enlisted 3 years.

Eyes Black; hair Black

Complexion Brown; height 5 ft. 5 in.

When mustered in April 2, 1864.

Where mustered in Ft. Pickens, Memphis, Tenn.,

Bounty paid \$ 100; due \$ 100

Where credited

Company to which assigned

Remarks:

† This organization subsequently became Co. L, 11 Reg't U. S. Colored Infantry (New).

* Muster-in roll shows enrollment of all men of this company as of same date. See enrollment on subsequent card or cards.

Book mark:

[Signature]

C

11 (New). U.S.C.T.

Robert Carter

Private, Co. L, 6 Reg't U. S. Col'd H. Art'y.†

Appears on

Company Muster Roll

for March-April, 1864

Joined for duty and enrolled:

When March, 1864.*

Where Memphis, Tenn.*

Period 3 years.*

Present or absent

Stoppage, \$ 100 for

Due Gov't \$ 100 for

Remarks: Died of Disease in Reg't Hospital, April 21, 1864

No Co. M.O.R.

† This organization subsequently became Co. L, 11 Reg't U. S. Colored Infantry (New).

* See enrollment on card from muster-in roll.

Book mark: P. 30, 75, 68
V. 59, P. 122, 69

(358c)

Copyist.

Carter, Robert

Co. **L**, **11** Reg. **U. S. C. Inf.**

Enclosures.

Bed Cards	Descriptive Lists
Burial Records	Final Statements
Certs. of Dis. for Discharge	Furloughs
C. M. Charges	Med. Des. Lists
Med. Certificates	Orders

Other papers relating to—

Admission to Hosp'l	Furlough
Casualty Sheet (Officer's)	Med. Examination
Confinement	Misc. Information
Contracts	Pay or Clothing
Death or Effects	Personal Reports
Desertions	Rank
Discharge from Hosp'l	Transfer to Hosp'l
Discharge from Service	Transfer to V. R. C.
Duty	Transportation

✓

Co. - I -

51.

FINAL STATEMENT

OF

Robert [unclear]

7th Reg't of U.S. Colored Inf. (Heavy)

7 11 Co. B. new
VOLUNTEERS.

NOTE 1.—Two of these certificates (or duplicates) are to be given to each volunteer soldier who may be discharged previously to the discharge of his company, that he may at once receive from the Paymaster the pay, &c., due him, and the captain or other officer commanding the company will certify to the act of the delivery of the duplicate certificates; on these certificates the Soldier is "entitled to" his discharge, and should also present his discharge to the Paymaster to have the payment endorsed on it. The discharge is to be given back to the Soldier by the Paymaster; the latter only retaining as his voucher the duplicate certificates.

NOTE 2.—If the Soldier is entitled to pay for the use of his horse, the Company Commander will certify to that fact, and also to the time he has pay due for having been so mounted on his own horse.

NOTE 3.—Amounts due the Sutler and Laundress must be entered on the Muster Roll on which the death, desertion, &c., is reported, as well as on the final statement, otherwise the amount cannot be collected from the United States.

NOTE 4.—This blank will be used for deceased volunteers as well as others.

[Signature]

ADJUTANT GENERAL'S OFFICE
June 7th 1864
Dup [unclear] Inventory sent 2d Auditor.

Emerson R. of Co.

I certify, on honor, that Robert Carter a Member of
Captain Lieut. Mates Company (D) of the 4th Regiment of W.S. Colored Militia (Hoy)
VOLUNTEERS, of the State of _____, born in Fish County State
of Virginia, aged 33 years; 5 feet 5 inches high; Brown complexion,
Blue eyes, Black hair, and by occupation a Farmer, having joined the company on
its original organization at Hampton, and enrolled in it at the muster into
the service of the United States at Fort Pickens on the _____ day
of April, 1864, (or was mustered in service as a recruit, by _____
at _____, on the _____ day of _____,
186 , to serve in the Regiment,) for the term of 3 years
and having served **HONESTLY** and **FAITHFULLY** with his Company in Lieut. Mates
to the present date, is now entitled to a **DISCHARGE** by reason of dis. of service
in the U.S. Army at Fort Pickens on the 21st day
of April 1864

The said Robert Carter was last paid by Paymaster
Wm. H. ... to include the _____ day of _____, 186 , and has
pay due him from that time to the present date; he is entitled to pay and subsistence for
TRAVELING to place of enrollment and whatever other allowances are authorized to volunteer
soldiers, or militia, so discharged. He has received 21 ⁹⁶/₁₀₀ dollars,
advanced by the United States on account of **CLOTHING**.

There is to be stopped from him, on account of the State of _____, or other
authorities for **CLOTHING, &c.**, received on entering service, _____ ¹⁰⁰/₁₀₀ dollars; also,
for expenses of **SUBSISTENCE** for **TRAVELING** from place of enrollment to the place of rendezvous,
amounting to _____ ¹⁰⁰/₁₀₀ dollars: and on account of the United States for **EXTRA**
CLOTHING received in kind from _____ and for other
stoppages, viz: The said ...
amounting to _____ ¹⁰⁰/₁₀₀ dollars;
and he has been **SUBSISTED** for **TRAVELING** to his place of enrollment, up to the _____
_____, 186 .

He is indebted to C. A. Greys, **SUTLER**, _____ ¹⁰⁰/₁₀₀ dollars.
He is indebted to _____, **LAUNDRESS**, _____ ¹⁰⁰/₁₀₀ dollars.

Given in Duplicate, at Fort Pickens, this 13th day of May, 1864.

Richard B. Mates Lieut. Col. &
Jas S. Colvard (Hoy)
Commanding Company.

252

Barritchie Abner

Co G, 11 U.S. Col'd Inf.

(New Organization.)

Private Private

CARD NUMBERS.

1	6 3 2 2 6 0 8	26
2	6 3 3 0 9 5 2	27
3	6 3 3 1 0 4 1	28
4	6 3 3 1 2 0 8	29
5	6 3 3 1 2 1 3	30
6	6 3 3 1 2 9 4	31
7	6 3 3 1 3 7 7	32
8	6 3 3 1 4 6 0	33
9	6 3 3 1 5 4 4	34
10	6 3 3 1 6 2 6	35
11	6 3 3 1 7 0 9	36
12	6 3 3 1 7 8 1	37
13	6 3 3 1 8 5 4	38
14	6 3 3 1 9 2 3	39
15	9 0 7 2 2 1 9	40
16		41
17		42
18		43
19		44
20		45
21		46
22		47
23		48
24		49
25		50

Book Mark:

See also

A. 769682 - P.O. Recd.

1574774 P.O. Recd.

To misc no 497771 3/10/14 JMS

6 | 11 (New) U. S. C. T.

New Bernethie
(New)
Co. G, 11 Reg't U. S. Col'd Inf.

Appears on
Company Descriptive Book
of the organization named above.

DESCRIPTION.

Age 32 years height 5 feet 1/2 inches.

Complexion Black

Eyes; Blue hair Blue

Where born Virginia

Occupation Laborer

ENLISTMENT.

When Jan 12, 1864.

Where Fort Pickens

By whom Col. Kappner; term 3 y'rs.

Remarks:

.....
.....
.....
.....
.....
.....
.....
.....
.....
.....

A. J. Anderson
(338g) Copyist.

6 | 11 (New). | U.S.C.T.

Abner Barnitchie
Plt, Co. E, 1 Battalion, 1 Reg't Tenn. H. Art'y.†

Age years.

Appears on

Company Muster Roll*

for Feb 4 to 29, 1864.

Joined for duty and enrolled:

When Jan 12, 1864.

Where Fort Pickering.

Period 3 years.

Mustered in:

When Feb 4, 1864.

Where Fort Pickering.

Present or absent Present

Stoppage, \$ 100 for

Due Gov't \$ 100 for

Remarks:

† This organization subsequently became Co. G, 11 Reg't U. S. Colored Infantry (New).

* First current roll. No muster-in roll of this company on file. This roll shows enrollment of all men of this company as of same date. See enrollment on subsequent card or cards.

Book mark:

Sallade

b | **11 (New).** | **U.S.C.T.**

Abner Barnitchie
Pvt, Co. G, 6 Reg't U. S. Col'd H. Art'y.†

Appears on

Company Muster Roll

for *March & April*, 1864.

Joined for duty and enrolled:

When *Jan 12*, 1864.*

Where *Ft. Pickens* *

Period *3* years.*

Present or absent *Present*

Stoppage, \$ *100* for

Due Gov't \$ *100* for

Remarks :

* This organization subsequently became Co. G, 11 Reg't U. S. Colored Infantry (New).

* ~~See~~ See enrollment on card from first current roll.

Book mark :

Sallade

6 | 11 (New). | U.S.C.T.

Abner Carnitchie
Sgt., Co. G, 7 Reg't U. S. Col'd H. Art'y.†

Appears on

Company Muster Roll

for May & June, 1864.

Joined for duty and enrolled:

When Jan 12, 1864.

Where Ft Pickens *

Period 3 years.*

Present or absent Present

Stoppage, \$ 100 for

Due Gov't, \$ 100 for

Remarks:

† This organization subsequently became Co. G, 11 Reg't U. S. Colored Infantry (New).
* See enrollment on card from first current roll.

Book mark:-----

(358c)

Ballade

Copyist.

11 (New). U.S.C.T.

Henry Carnitchee

Pat, Co. G, 7 Reg't U. S. Col'd H. Art'y.†

Appears on

Company Muster Roll

for *July & Aug*, 186*4*.

Joined for duty and enrolled:

When *Jan 12*, 186*4*.*

Where *Ft Pickens* *

Period *3* years.*

Present or absent *Present*

Stoppage, \$ *100* for

Due Gov't, \$ *100* for

Remarks:

† This organization subsequently became Co. G, 11 Reg't U. S. Colored Infantry (New).
* See enrollment on card from first current roll.

Book mark:

Jacobi

6 | 11 (New). | U.S.C.T.

Rowe Carnitein
1st, Co. G, 7 Reg't U. S. Col'd H. Art'y.†

Appears on

Company Muster Roll

for Sept + Oct, 1864.

Joined for duty and enrolled:

When Jan 12, 1864.*

Where Ft. Pickens *

Period 3 years.*

Present or absent Present

Stoppage, \$ 100 for

Due Gov't, \$ 100 for

Remarks:

† This organization subsequently became Co. G, 11 Reg't U. S. Colored Infantry (New).

* See enrollment on card from first current roll.

Book mark:

Dallan
Coyist.

11 (New). U.S.C.T.

Abner Garnett

1st, Co. G, 7 Reg't U. S. Col'd H. Art'y.†

Appears on

Company Muster Roll

for *Nov + Dec*, 1864.

Joined for duty and enrolled:

When *Jan 12*, 1864.*

Where *Fort Pickens* *

Period *3* years.*

Present or absent *Present*

Stoppage, \$ *100* for

Due Gov't, \$ *100* for

Remarks:

† This organization subsequently became Co. G, 11 Reg't U. S. Colored Infantry (New).

* See enrollment on card from first current roll.

Book mark:

Saccade

C. | **11** (New). | **U.S.C.T.**

Abner Barnitchie
Priv, Co. G, 11 Reg't U. S. Col'd Inf. (New).

Appears on

Company Muster Roll
for *Jan & Feb*, 1865.

Joined for duty and enrolled:

When *Jan 12*, 1864.*

Where *F. H. Pickering*. *

Period *3* years.*

Present or absent *Present*.

Stoppage, \$ *100* for

Due Gov't \$ *100* for

Remarks:

Filed with Abner Barnitchie

* ~~See~~ See enrollment on card from first current roll.

Book mark:

(358c)

Ramsey
Coyust.

C | 11 (New). | U.S.C.T.

Abner Cornitchie
Pot, Co. G, 11 Reg't U. S. Col'd Inf. (New).

Appears on

Company Muster Roll
for Mar & Apr, 1865.

Joined for duty and enrolled:

When Jan 12, 1864.*

Where Ft. Pickering.*

Period 3 years.*

Present or absent Present.

Stoppage, \$ 100 for

Due Gov't \$ 160/100 for

Remarks:

Filed with abner cornitchie

* See enrollment on card from first current roll.

Book mark:

(358c)

Ramsey
Cpyist.

6 | **11 (New).** | **U.S.C.T.**

Abner Carnitchie
Pvt, Co. G, 11 Reg't U. S. Col'd Inf. (New).

Appears on

Company Muster Roll

for *May & June*, 186 *5*.

Joined for duty and enrolled:

When *Jan 12*, 186 *4*.*

Where *Fort Pickering*.*

Period *3* years.*

Present or absent *Present*.

Stoppage, \$ *100* for

Due Gov't \$ *100* for

Remarks:

Filed with Abner Carnitchie

* See enrollment on card from first current roll.

Book mark:

(358c)

Ramsay
Cpyist.

C | **11** (New). | **U.S.C.T.**

Abner Canitchie
Priv, Co. G, 11 Reg't U. S. Col'd Inf. (New).

Appears on

Company Muster Roll

for *July & Aug.*, 1865.

Joined for duty and enrolled:

When *Jan 12*, 1864.*

Where *Ft Pickering*.*

Period *3* years.*

Present or absent *Present*.

Stoppage, \$ *100* for

Due Gov't \$ *100* for

Remarks:

Fried with Abner Canitchie

* See enrollment on card from first current roll.

Book mark:

Ramsey
Cpyist.

C. | **11** (New). | **U.S.C.T.**

Abner Canatchie

Pvt., Co. G, 11 Reg't U. S. Col'd Inf. (New).

Appears on

Company Muster Roll

for *Sept & Oct*, 186*5*.

Joined for duty and enrolled:

When *Jan 12*, 186*4*.*

Where *Ft Pickering*, *

Period *3* years.*

Present or absent *Present*.

Stoppage, \$ *100* for

Due Gov't \$ *100* for

Remarks :

* See enrollment on card from first current roll.

Book mark :

(358c)

Ramsay
Cpyist.

C. | 11 (New). | U.S.C.T.

Abner Canitchie

Pri, Co. G, 11 Reg't U. S. Col'd Inf. (New).

Appears on

Company Muster Roll

for *Nov. + Dec.*, 1865.

Joined for duty and enrolled:

When *Jan. 12.*, 1864.*

Where *Fort Pickens* *

Period *3* years.*

Present or absent *Present*

Stoppage, \$ *100* for

Due Gov't \$ *100* for

Remarks :

* See enrollment on card from first current roll.

Book mark : *3*

(358c)

Copyst.

C. 11 (New). U.S.C.T.

Abner Cantrill
Pvt. G., 11 Reg't U. S. Col'd Inf. (New).

Appears on Co. Muster-out Roll, dated
Memphis T. Jan. 12, 1866.

Muster-out to date *Jan. 12*, 1866.

Last paid to *June 20*, 1865.

Clothing account:

Last settled 186 ; drawn since \$ 100

Due soldier \$ *7.72* ¹⁰⁰; due U. S. \$ 100

Am't for cloth'g in kind or money adv'd \$ 100

Due U. S. for arms, equipments, &c., \$ 100

Bounty paid \$ 100; due \$ 100

Remarks:

Book mark: *424. P. 140 68*

(361)

[Signature]
Copyist.

Barutchie, Abner

Co. *G*, *11* Reg't *US Col Ry*
(*CIVIL WAR*)
(Philippine Insurrection.)

1 Inclosures.

Bed Cards	Ex. Preliminary to M. O.
Burial Records	Final Statements
Certs. of Dis. for Discharge	Fines
C. M. Charges	Furloughs or L. of A.
Descriptive Lists	Med. Certificates
Descriptive and Assign- ment Cards }	Med. Des. Lists
Discharge Certificates	Orders
Enlistment Papers	Resignations

Other papers relating to—

Admission to Hosp'l	Furlough or L. of A.
Confinement	Med. Examination
Contracts	Misc. Information
Death or Effects	Pay or Clothing
Desertion	Personal Reports
Discharge from Hosp'l	Rank
Discharge from Service	Transfer to Hosp'l
Duty	Transportation

Sgt S Ry 1

6

11 (New). U.S.C.T.

Abner Barentchie

Appears with rank of *Pri* on

Muster and Descriptive Rolls of Detachments of U. S. Vols. forwarded

for the *11* Reg't U. S. Col'd *Inf*. Roll dated *Memphis Tenn, Feb 2*, 1864.

Where born *Virginia*

Age *30* y'rs; occupation

When enlisted *Jan 12*, 1864.

Where enlisted *Fort-Pickering*

For what period enlisted *3* years.

Eyes *black*; hair *black*

Complexion *black*; height *5* ft. *1/2* in.

When mustered in *Feb 4*, 1864.

Where mustered in *Fort-Pickering*

Bounty paid \$ *100*; due \$ *100*

Where credited

Company to which assigned

Remarks:

Filed with Abner Barentchie

Book mark:

Ashley

253

Canuthers, Abraham

Co G, 11 U.S. Col'd Inf.

(New Organization.)

Private

Private

CARD NUMBERS.

1	6322612	26
2	6330958	27
3	6331098	28
4	6331988	29
5	9072216	30
6		31
7		32
8		33
9		34
10		35
11		36
12		37
13		38
14		39
15		40
16		41
17		42
18		43
19		44
20		45
21		46
22		47
23		48
24		49
25		50

Book Mark:

See also

C | **11 (New) U.S.C.T.**

Niraham Carnthers
....., Co. G, 11 Reg't U.S. Col'd Inf. ^(New)

Appears on
Company Descriptive Book
of the organization named above.

DESCRIPTION.

Age 37 years height 5 feet 4 1/2 inches.

Complexion Black

Eyes; BRN hair BRN

Where born Richmond, Va

Occupation Laborer

ENLISTMENT.

When Jan 12, 1864.

Where Fort Pickens

By whom Co. Kappner; term 3 y'rs.

Remarks: Dis at Memphis Apr
15" 64 Final statements given

.....
.....
.....
.....
.....

A. J. Anderson Copyist.

6

11 (New). U.S.C.T.

Abraham Caruthers

Appears with rank of *Pri* on

Muster and Descriptive Rolls of Detachments of U. S. Vols. forwarded

for the *11* Reg't U. S. Col'd *Inf* Roll dated

Memphis Tenn, Feb 2, 1864.

Where born *Richmond Va*

Age *30* y'rs; occupation

When enlisted *Jan 12*, 1864.

Where enlisted *Fort-Pickering*

For what period enlisted *3* years.

Eyes *black*; hair *black*

Complexion *black*; height *5 ft. 4 1/2 in.*

When mustered in *Feb 4*, 1864.

Where mustered in *Fort-Pickering*

Bounty paid \$ *100*; due \$ *100*

Where credited

Company to which assigned

Remarks:

Book mark:

Ashley

6 | 11 (New). | U.S.C.T.

Abraham Caruthers
Pvt., Co. E, 1 Battalion, 1 Reg't Tenn. H. Art'y.†

Age years.

Appears on

Company Muster Roll*

for Feb 4 to 29, 1864.

Joined for duty and enrolled:

When Jan 12, 1864.

Where Fort Pickering

Period 3 years.

Mustered in:

When Feb 4, 1864.

Where Fort Pickering

Present or absent Present

Stoppage, \$ 100 for

Due Gov't \$ 100 for

Remarks: On daily duty as teamster since Jan 12, 1864.

† This organization subsequently became Co. G, 11 Reg't U. S. Colored Infantry (New).

* First current roll. No muster-in roll of this company on file. This roll shows enrollment of all men of this company as of same date. See enrollment on subsequent card or cards.

Book mark:

Sallade

(3586)

Copyist.

b | 11 (New). | U.S.C.T.

Abraham Baruthers
Pvt., Co. G, 6 Reg't U. S. Col'd H. Art'y.†

Appears on

Company Muster Roll

for March & April, 1864.

Joined for duty and enrolled:

When Jan 12, 1864.*

Where Ft Pickens *

Period 3 years.*

Present or absent

Stoppage, \$ 100 for

Due Gov't \$ 100 for

Remarks: Died in Small Pox
Hospital at Memphis, Tenn.
April 15, 1864

* This organization subsequently became Co. G, 11 Reg't U. S. Colored Infantry (New).

* See enrollment on card from first current roll.

Book mark: 11.278.2³ - and July 30, 64

(358c)

Ballade

Copyist.

Co. | 11 (New). U.S.C.T.

Abraham Caruthers,

Pvt., G., 11 Reg't U. S. Col'd Inf. (New).

Appears on **Co. Muster-out Roll**, dated

Memphis T. Jan. 12, 1866.

Muster-out to date _____, 186 .

Last paid to *Rec'd no pay*, 186 .

Clothing account:

Last settled _____, 186 ; drawn since \$ _____ 100

Due soldier \$ _____ 100; due U. S. \$ _____ 100

Am't for cloth'g in kind or money adv'd \$ _____ 100

Due U. S. for arms, equipments, &c., \$ _____ 100

Bounty paid \$ _____ 100; due \$ _____ 100

Remarks: *See'd at Memphis's*

Tenn. Apl. 15. /64

Final statement

permitted.

Book mark: *11. 278. 26 and July 30 /64*

100517

(361)

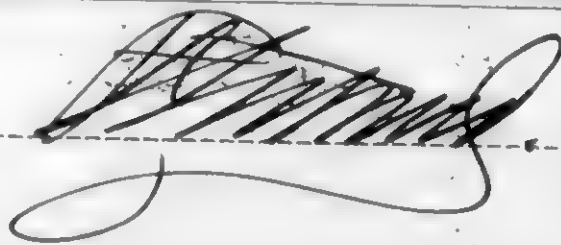

Copyist.

JAN. 23

6331988

01891*

✓ 228 826. 96

Caruthers, Abraham

P. Co. G, **11** U. S. C. Inf.
Reg't

6 Enclosures.

Bed Cards	Descriptive Lists
Burial Records	Final Statements 3
Certs. of Dis. for Discharge	Furloughs
C. M. Charges	Med. Des. Lists
Med. Certificates	Orders

Other papers relating to—

Admission to Hosp'l	Furlough
Casualty Sheet (Officer's)	Med. Examination
Confinement	Misc. Information
Contracts	Pay or Clothing
Death or Effects 3	Personal Reports
Desertions	Rank
Discharge from Hosp'l	Transfer to Hosp'l
Discharge from Service	Transfer to V. R. C.
Duty	Transportation

✓ Co - G 52

FINAL STATEMENT

OF

Abraham Caruthers

Co. G, Reg't of U.S. Art

11th E.D. Mass

VOLUNTEERS.

Disch April 15 1864

NOTE 1.—Two of these certificates (or duplicates) are to be given to each volunteer soldier who may be discharged previously to the discharge of his company, that he may at once receive from the Paymaster the pay, &c., due him, and the captain or other officer commanding the company will certify to the act of the delivery of the duplicate certificates; on these certificates the Soldier is "entitled to" his discharge, and should also present his discharge to the Paymaster to have the payment endorsed on it. The discharge is to be given back to the Soldier by the Paymaster; the latter only retaining as his voucher the duplicate certificates.

NOTE 2.—If the Soldier is entitled to pay for the use of his horse, the Company Commander will certify to that fact, and also to the time he has pay due for having been so mounted on his own horse.

NOTE 3.—Amounts due the Sutler and Laundress must be entered on the Muster Roll on which the death, desertion, &c., is reported, as well as on the final statement, otherwise the amount cannot be collected from the United States.

NOTE 4.—This blank will be used for deceased volunteers as well as others.

ADJUTANT GENERAL'S OFFICE.

May 11th 1864

Compare with Inventory sent 2d Auditor.

Emerson R. Wolfe

I certify, on honor, that Abraham Caruthers a Private of
Captain _____ Company (4) of the 6th Regiment of U.S.C. Hy. Art
VOLUNTEERS, of the State of _____, born in Richmond, State
of Virginia, aged 30 years; 5 feet 4 1/2 inches high; Black complexion,
Black eyes, Black hair, and by occupation a Laborer, having joined the company on
its original organization at Fort Pickens, and enrolled in it at the muster into
the service of the United States at Fort Pickens, on the 4th day
of February, 1864, (or was mustered in service as a recruit, by _____
at _____, on the _____ day of _____,
186 , to serve in the Regiment,) for the term of three years
and having served **HONESTLY** and **FAITHFULLY** with his Company in Fort Pickens
to the ^{15th April} present date, is now entitled to a **DISCHARGE** by reason of Death

Died April 15th 1864; see inventory
The said Abraham Caruthers has received no pay was last paid by Paymaster
_____ to include the _____ day of _____, 186 , and has
pay due him from that time to the present date; he is entitled to pay and subsistence for
TRAVELING to place of enrollment and whatever other allowances are authorized to volunteer
soldiers, or militia, so discharged. He has received _____ dollars,
advanced by the United States on account of **CLOTHING**.

There is to be stopped from him, on account of the State of U.S., or other
authorities for **CLOTHING**, &c., received on entering service, Forten _____ dollars; also,
for expenses of **SUBSISTENCE** for **TRAVELING** from place of enrollment to the place of rendezvous,
amounting to _____ dollars: and on account of the United States for **EXTRA**
CLOTHING received in kind from _____ and for other
stoppages, viz:

_____ amounting to _____ dollars;
and he has been **SUBSISTED** for **TRAVELING** to his place of enrollment, up to the _____
_____, 186 .

He is indebted to _____, **SUTLER**, _____ dollars.

He is indebted to _____, **LAUNDRESS**, _____ dollars.

Given in Duplicate, at Fort Pickens, this 28th day of April, 1864.

Nathaniel Reed Lt Lieut

6th U.S.C. Hy. Art
Commanding Company.

1864 Sep. 5-2
No. 11

FINAL STATEMENT

OF

Abraham Caruthers

Co. 26th Reg't of U.S. C. by Act
11th 9th 1865
VOLUNTEERS.

NOTE 1.—Two of these certificates (or duplicates) are to be given to each volunteer soldier who may be discharged previously to the discharge of his company, that he may at once receive from the Paymaster the pay, &c., due him, and the captain or other officer commanding the company will certify to the act of the delivery of the duplicate certificates; on these certificates the Soldier is "entitled to" his *discharge*, and should also present his discharge to the Paymaster to have the payment endorsed on it. The discharge is to be given back to the Soldier by the Paymaster; the latter only retaining as his voucher the duplicate certificates.

NOTE 2.—If the Soldier is entitled to pay for the use of his horse, the Company Commander will certify to that fact, and also to the time he has pay due for having been so mounted on his own horse.

NOTE 3.—Amounts due the Sutler and Laundress must be entered on the Muster Roll on which the death, desertion, &c., is reported, as well as on the final statement, otherwise the amount cannot be collected from the United States.

NOTE 4.—This blank will be used for deceased volunteers as well as others.



I certify, on honor, that Abraham Caruthers a Private of
Captain _____ Company (2) of the 6th Regiment of U.S. Art
VOLUNTEERS, of the State of _____, born in Richmond, State
of Virginia, aged 30 years; 5 feet 4 1/2 inches high; Black complexion,
Black eyes, Dark hair, and by occupation a Laborer, having joined the company on
its original organization at Fort Pickens, and enrolled in it at the muster into
the service of the United States at Fort Pickens, on the 4th day
of February, 1864, (or was mustered in service as a recruit, by _____
at _____, on the _____ day of _____,
186 , to serve in the Regiment,) for the term of Three Years;
and having served **HONESTLY** and **FAITHFULLY** with his Company in Fort Pickens
to the ^{15th April} ~~present date~~, is now entitled to a **DISCHARGE** by reason of Death

The said Abraham Caruthers has received no pay was last paid by Paymaster
_____ to include the _____ day of _____, 186 , and has
pay due him from that time to the present date; he is entitled to pay and subsistence for
TRAVELING to place of enrollment and whatever other allowances are authorized to volunteer
soldiers, or militia, so discharged. He has received _____ dollars,
advanced by the United States on account of **CLOTHING**.

There is to be stopped from him, on account of the State of U.S., or other
authorities for **CLOTHING**, &c., received on entering service, Fourteen 68 dollars; also,
for expenses of **SUBSISTENCE** for **TRAVELING** from place of enrollment to the place of rendezvous,
amounting to _____ dollars: and on account of the United States for **EXTRA**
CLOTHING received in kind from _____ and for other
stoppages, viz:

_____ amounting to _____ dollars;
and he has been **SUBSISTED** for **TRAVELING** to his place of enrollment, up to the _____
_____, 186 .

He is indebted to _____, **SUTLER**, _____ dollars.

He is indebted to _____, **LAUNDRESS**, _____ dollars.

Given in Duplicate, at Fort Pickens, this 28th day of April, 1864.

Nathaniel Reed 1st Lieut

6th U.S. Art
Commanding Company.

FINAL STATEMENT

OF

Abraham Caruthers

Co. G 6th Reg't of U.S.C. Hy Art

VOLUNTEERS.

NOTE 1.—Two of these certificates (or duplicates) are to be given to each volunteer soldier who may be discharged previously to the discharge of his company, that he may at once receive from the Paymaster the pay, &c., due him, and the captain or other officer commanding the company will certify to the act of the delivery of the duplicate certificates; on these certificates the Soldier is "entitled to" his *discharge*, and should also present his discharge to the Paymaster to have the payment endorsed on it. The discharge is to be given back to the Soldier by the Paymaster; the latter only retaining as his voucher the duplicate certificates.

NOTE 2.—If the Soldier is entitled to pay for the use of his horse, the Company Commander will certify to that fact, and also to the time he has pay due for having been so mounted on his own horse.

NOTE 3.—Amounts due the Sutler and Laundress must be entered on the Muster Roll on which the death, desertion, &c., is reported, as well as on the final statement, otherwise the amount cannot be collected from the United States.

NOTE 4.—This blank will be used for deceased volunteers as well as others.

dup



I certify, on honor, that Abraham Caruthers a Private of
Captain _____ Company (2) of the 6th Regiment of U.S. Col. Inf.
VOLUNTEERS, of the State of _____, born in Richmond, State
of Virginia, aged 30 years; 5 feet 4 1/2 inches high; Black complexion,
Black eyes, Black hair, and by occupation a Laborer, having joined the company on
its original organization at Fort Pickens Tenn., and enrolled in it at the muster into
the service of the United States at Fort Pickens, on the 15th day
of February, 1864, (or was mustered in service as a recruit, by _____
at _____, on the _____ day of _____,
186 , to serve in the Regiment,) for the term of three years
and having served **HONESTLY** and **FAITHFULLY** with his Company in Fort Pickens
to the ~~present date~~ ^{15th April}, is now entitled to a **DISCHARGE** by reason of Death

The said Abraham Caruthers ~~has drawn no pay~~ was last paid by Paymaster
_____ to include the _____ day of _____, 186 , and has
pay due him from that time to the present date; he is entitled to pay and subsistence for
TRAVELING to place of enrollment and whatever other allowances are authorized to volunteer
soldiers, or militia, so discharged. He has received _____ dollars,
advanced by the United States on account of **CLOTHING**.

There is to be stopped from him, on account of the State of U.S., or other
~~authorities~~ for **CLOTHING**, &c., received on entering service, Fourteen ⁶⁸/₁₀₀ dollars; also,
for expenses of **SUBSISTENCE** for **TRAVELING** from place of enrollment to the place of rendezvous,
amounting to _____ dollars: and on account of the United States for **EXTRA**
CLOTHING received in kind from _____ and for other
stoppages, viz:

_____ amounting to _____ dollars;
and he has been **SUBSISTED** for **TRAVELING** to his place of enrollment, up to the _____
_____, 186 .

He is indebted to _____, **SUTLER**, _____ dollars.

He is indebted to _____, **LAUNDRESS**, _____ dollars.

Given in Duplicate, at Fort Pickens, this 28th day of April, 1864.

Nathanial Reed 1st Lieut

6th U.S. Col. Inf.
Commanding Company.

ARTICLES OF WAR.

ART. 95. When any non-commissioned officer or soldier shall die, or be killed in the service of the United States, the then commanding officer of the troop or company shall, in the presence of two other commissioned officers, take an account of what effects he died possessed of, above his arms and accoutrements, and transmit the same to the office of the Department of War, which said effects are to be accounted for, and paid to the representatives of such deceased non-commissioned officer or soldier. And in case any of the officers, so authorized to take care of the effects of deceased officers and soldiers, should, before they have accounted to their representatives for the same, have occasion to leave the regiment or post, by preferment or otherwise, they shall, before they be permitted to quit the same, deposit in the hands of the commanding officer, or of the assistant military agent, all the effects of such deceased non-commissioned officers and soldiers, in order that the same may be secured for, and paid to, their respective representatives.

ARMY REGULATIONS—EDITION OF 1861.

DECEASED SOLDIERS.

Par. 152. Inventories of the effects of deceased non-commissioned officers and soldiers, required by the 95th Article of War, will be forwarded to the Adjutant General, by the commander of the company to which the deceased belonged, and a duplicate of the same to the colonel of the regiment. Final statements of pay, clothing, &c., will be sent with the inventories. When a soldier dies at a post or station absent from his company, it will be the duty of his immediate commander to furnish the required inventory, and, at the same time, to forward to the commanding officer of the company to which the soldier belonged, a report of his death, specifying the date, place, and cause; to what time he was last paid, and the money or other effects in his possession at the time of his decease; which report will be noted on the next muster-roll of the company to which the man belonged. Each inventory will be endorsed, "Inventory of the effects of _____, late of company (—) _____ regiment of _____, who died at _____, the _____ day of _____, 186—." If a legal representative receive the effects, it will be stated in the report. If the soldier leave no effects, the fact will be reported.

Par. 153. Should the effects of a deceased non-commissioned officer or soldier not be administered upon within a short period after his decease, they shall be disposed of by a Council of Administration, under the authority of the commanding officer of the post, and the proceeds deposited with the Paymaster, to the credit of the United States, until they shall be claimed by the legal representatives of the deceased.

Par. 154. In all such cases of sales by the Council of Administration, a statement in detail, or account of the proceeds, duly certified by the Council and commanding officer, accompanied by the Paymaster's receipt for the proceeds, will be forwarded by the commanding officer to the Adjutant General. The statement will be endorsed, "Report of the proceeds of the effects of _____, late of company (—) _____ regiment of _____, who died at _____, the _____ day of _____, 186—."

NOTE 1.—The effects in all cases, when called for, should be turned over to the legal representative, without further authority from the Adjutant General. When the effects are turned over to the relatives of the deceased before these inventories are sent to the Adjutant General, their receipts therefor should be attached to the inventories. In all other cases, one copy will be sent with a letter of transmittal direct to the Adjutant General, and a duplicate retained by the officer.

NOTE 2.—Particular care should be taken to take receipts in duplicate from the Paymaster for any funds turned over to him; one copy should be sent direct to the Adjutant General and one retained by the officer.

INVENTORY OF THE EFFECTS

OF

Private Abraham Caruthers

Late of Company *G*

6th Reg't of *U.S. Art*

Volunteers, who died at *Memphis Tenn*

on the *15th* day of *April* 186*4*.

dup



Inventory of the effects of Abraham Caruthers late
 a Private of Captain _____ Company G of
 the 6th Regiment of U.S. Art Volunteers, who was enrolled as
 a Private at Memphis in the State of Tennessee on
 the 12th day of January 1864, and mustered into the service of the United
 States as a Private on the 1st day of February 1864, at Fort Pickering
 in Company G, 6th Regiment of U.S. Art Volunteers, to serve three
 years or during the war; he was born in Richmond in the State
 of Virginia; he was 30 years of age, 5 feet 4 1/2 inches
 high, Black complexion, Blue eyes, Black hair, and by occupation, when enrolled,
 a Laborer; he died in Small Pox Hospital, at
Memphis Tenn on the 15th day of April 1864, by
 reason of Small Pox

INVENTORY.					
ARTICLES.	No.	ARTICLES.	No.	ARTICLES.	No.
Hats		Pairs trousers		Knapsacks	
Caps		Pairs flannel drawers			
Forage caps		Pairs cotton drawers	1		
Great coats	1	Flannel shirts			
Uniform coats		Cotton shirts			
Uniform jackets		Pairs boots			
Flannel sack coats		Pairs shoes	1		
Blouses	1	Pairs socks	1		
Stable frocks		Blankets			
Fatigue overalls		Haversacks			
				MONEY.	
					Specie
				Notes	\$

I CERTIFY, ON HONOR, that the above inventory comprises all the effects of Abraham Caruthers, deceased, and that the effects are in the hands of his legal representatives at Memphis Tenn to be disposed of by a Council of Administration.

(DUPLICATES.)

STATION: Fort Pickering Tenn
 DATE: April 28th 1864

William Reed 1st Lieut
Co. U.S. Art
 Commanding the Company.

[A. G. O. No. 104.]

I certify that the above inventory comprises all the effects of Abraham Caruthers deceased and that the effects are in the hands of his legal representatives at Memphis Tenn to be disposed of by a Council of Administration.

One pair shoes. One Blouse. One Great coat.

Witness Sergt W. H. Seymour

Susan Caruthers

ARTICLES OF WAR.

ART. 95. When any non-commissioned officer or soldier shall die, or be killed in the service of the United States, the then commanding officer of the troop or company shall, in the presence of two other commissioned officers, take an account of what effects he died possessed of, above his arms and accoutrements, and transmit the same to the office of the Department of War, which said effects are to be accounted for, and paid to the representatives of such deceased non-commissioned officer or soldier. And in case any of the officers, so authorized to take care of the effects of deceased officers and soldiers, should, before they have accounted to their representatives for the same, have occasion to leave the regiment or post, by preferment or otherwise, they shall, before they be permitted to quit the same, deposit in the hands of the commanding officer, or of the assistant military agent, all the effects of such deceased non-commissioned officers and soldiers, in order that the same may be secured for, and paid to, their respective representatives.

ARMY REGULATIONS—EDITION OF 1861.

DECEASED SOLDIERS.

Par. 152. Inventories of the effects of deceased non-commissioned officers and soldiers, required by the 95th Article of War, will be forwarded to the Adjutant General, by the commander of the company to which the deceased belonged, and a duplicate of the same to the colonel of the regiment. Final statements of pay, clothing, &c., will be sent with the inventories. When a soldier dies at a post or station absent from his company, it will be the duty of his immediate commander to furnish the required inventory, and, at the same time, to forward to the commanding officer of the company to which the soldier belonged, a report of his death, specifying the date, place, and cause; to what time he was last paid, and the money or other effects in his possession at the time of his decease; which report will be noted on the next muster-roll of the company to which the man belonged. Each inventory will be endorsed, "Inventory of the effects of _____, late of company (—) _____ regiment of _____, who died at _____, the _____ day of _____, 186—." If a legal representative receive the effects, it will be stated in the report. If the soldier leave no effects, the fact will be reported.

Par. 153. Should the effects of a deceased non-commissioned officer or soldier not be administered upon within a short period after his decease, they shall be disposed of by a Council of Administration, under the authority of the commanding officer of the post, and the proceeds deposited with the Paymaster, to the credit of the United States, until they shall be claimed by the legal representatives of the deceased.

Par. 154. In all such cases of sales by the Council of Administration, a statement in detail, or account of the proceeds, duly certified by the Council and commanding officer, accompanied by the Paymaster's receipt for the proceeds, will be forwarded by the commanding officer to the Adjutant General. The statement will be endorsed, "Report of the proceeds of the effects of _____, late of company (—) _____ regiment of _____, who died at _____, the _____ day of _____, 186—."

NOTE 1.—The effects in all cases, when called for, should be turned over to the legal representative, without further authority from the Adjutant General. When the effects are turned over to the relatives of the deceased before these inventories are sent to the Adjutant General, their receipts therefor should be attached to the inventories. In all other cases, one copy will be sent with a letter of transmittal direct to the Adjutant General, and a duplicate retained by the officer.

NOTE 2.—Particular care should be taken to take receipts in duplicate from the Paymaster for any funds turned over to him; one copy should be sent direct to the Adjutant General and one retained by the officer.

INVENTORY OF THE EFFECTS

OF

Private Abraham Baruthers

Late of Company *G*

6th Reg't of *U.S.C. Regt Art*

Volunteers, who died at *Memphis Tenn*

on the *15th* day of *April* 1864.

Inventory of the effects of Abraham Caruthers late
 a Private of Captain _____ Company G of
 the 6th Regiment of U.S.C. Hy Art Volunteers, who was enrolled as
 a Private at Memphis in the State of Tennessee on
 the 12th day of January 1864, and mustered into the service of the United
 States as a Private on the 4th day of February 1864, at Fort Pickering
 in Company G, 6th Regiment of U.S.C. Hy Art Volunteers, to serve three
 years or during the war; he was born in Richmond in the State
 of Virginia; he was 30 years of age, 5 feet 4 1/2 inches
 high, Black complexion, Black eyes, Black hair, and by occupation, when enrolled,
 a Farmer; he died in Small Pox Hospital, at
Memphis Tenn on the 15th day of April 1864, by
 reason of Small Pox

INVENTORY.					
ARTICLES.	No.	ARTICLES.	No.	ARTICLES.	No.
Hats		Pairs trousers		Knapsacks	
Caps		Pairs flannel drawers			
Forage caps		Pairs cotton drawers	1		
Great coats	1	Flannel shirts			
Uniform coats		Cotton shirts			
Uniform jackets		Pairs boots			
Flannel sack coats		Pairs shoes	1		
Blouses	1	Pairs socks	1		
Stable frocks		Blankets			
Fatigue overalls		Haversacks			
				MONEY.	
					Specie
				Notes	\$

I CERTIFY, ON HONOR, that the above inventory comprises all the effects of Abraham Caruthers, deceased, and that the effects are in the hands of his Legal Representative at Memphis Tenn to be disposed of by a Council of Administration.

(DUPLICATES.)

STATION: Fort Pickering Tenn

DATE: April 28th 1864

[A. G. O. No. 104.]

Nathaniel Reed 1st Lieut
6th U.S. Hy Art Colored
 Commanding the Company.

*Inventory of the effects of Abraham Caruthers deceased as per list of 1864
 of the 6th U.S. Hy Art Colored Co. at Fort Pickering Tenn
 which are as follows: one pair trousers, one pair flannel drawers, one pair
 cotton drawers, one pair boots, one pair shoes, one pair socks, one pair
 flannel shirts, one pair cotton shirts, one pair flannel sack coats, one pair
 great coats, one pair blouses, one pair fatigue overalls, one pair
 caps, one pair forage caps, one pair hats, one pair haversacks, one pair
 blankets, one pair haversacks, one pair haversacks, one pair haversacks*

Witness Supt S. H. Seymour

*Susan ^{her} Caruthers
 mark*

ARTICLES OF WAR.

ART. 95. When any non-commissioned officer or soldier shall die, or be killed in the service of the United States, the then commanding officer of the troop or company shall, in the presence of two other commissioned officers, take an account of what effects he died possessed of, above his arms and accoutrements, and transmit the same to the office of the Department of War, which said effects are to be accounted for, and paid to the representatives of such deceased non-commissioned officer or soldier. And in case any of the officers, so authorized to take care of the effects of deceased officers and soldiers, should, before they have accounted to their representatives for the same, have occasion to leave the regiment or post, by preferment or otherwise, they shall, before they be permitted to quit the same, deposit in the hands of the commanding officer, or of the assistant military agent, all the effects of such deceased non-commissioned officers and soldiers, in order that the same may be secured for, and paid to, their respective representatives.

ARMY REGULATIONS—EDITION OF 1861.

DECEASED SOLDIERS.

Par. 152. Inventories of the effects of deceased non-commissioned officers and soldiers, required by the 95th Article of War, will be forwarded to the Adjutant General, by the commander of the company to which the deceased belonged, and a duplicate of the same to the colonel of the regiment. Final statements of pay, clothing, &c., will be sent with the inventories. When a soldier dies at a post or station absent from his company, it will be the duty of his immediate commander to furnish the required inventory, and, at the same time, to forward to the commanding officer of the company to which the soldier belonged, a report of his death, specifying the date, place, and cause; to what time he was last paid, and the money or other effects in his possession at the time of his decease; which report will be noted on the next muster-roll of the company to which the man belonged. Each inventory will be endorsed, "Inventory of the effects of _____, late of company (—) _____ regiment of _____, who died at _____, the _____ day of _____, 186—." If a legal representative receive the effects, it will be stated in the report. If the soldier leave no effects, the fact will be reported.

Par. 153. Should the effects of a deceased non-commissioned officer or soldier not be administered upon within a short period after his decease, they shall be disposed of by a Council of Administration, under the authority of the commanding officer of the post, and the proceeds deposited with the Paymaster, to the credit of the United States, until they shall be claimed by the legal representatives of the deceased.

Par. 154. In all such cases of sales by the Council of Administration, a statement in detail, or account of the proceeds, duly certified by the Council and commanding officer, accompanied by the Paymaster's receipt for the proceeds, will be forwarded by the commanding officer to the Adjutant General. The statement will be endorsed, "Report of the proceeds of the effects of _____, late of company (—) _____ regiment of _____, who died at _____, the _____ day of _____, 186—."

NOTE 1.—The effects in all cases, when called for, should be turned over to the legal representative, without further authority from the Adjutant General. When the effects are turned over to the relatives of the deceased before these inventories are sent to the Adjutant General, their receipts therefor should be attached to the inventories. In all other cases, one copy will be sent with a letter of transmittal direct to the Adjutant General, and a duplicate retained by the officer.

NOTE 2.—Particular care should be taken to take receipts in duplicate from the Paymaster for any funds turned over to him; one copy should be sent direct to the Adjutant General and one retained by the officer.

INVENTORY OF THE EFFECTS

OF

Private Abraham CaruthersLate of Company B6th Reg't of U.S.C. Hy ArtVolunteers, who died at Memphis Tennon the 12th day of April 1864.

Inventory of the effects of Abraham Scaruthers late
a Private of Captain _____ Company G of
the 6th Regiment of U.S.C. Hy Art Volunteers, who was enrolled as
a Private at Memphis in the State of Tennessee on
the 12th day of January 1864, and mustered into the service of the United
States as a Private on the 4th day of February 1864, at Fort Pickering
in Company G, 6th Regiment of U.S.C. Hy Art Volunteers, to serve three
years or during the war; he was born in Richmond in the State
of Virginia; he was 30 years of age, 5 feet 4 1/2 inches
high, Black complexion, Black eyes, Black hair, and by occupation, when enrolled,
a Laborer; he died in Small Pox Hospital, at
Memphis Tenn on the 15th day of April 1864, by
reason of Small Pox

INVENTORY.					
ARTICLES.	No.	ARTICLES.	No.	ARTICLES.	No.
Hats		Pairs trousers		Knapsacks	
Caps		Pairs flannel drawers			
Forage caps		Pairs cotton drawers	/		
Great coats	/	Flannel shirts			
Uniform coats		Cotton shirts			
Uniform jackets		Pairs boots			
Flannel sack coats		Pairs shoes	/		
Blouses	/	Pairs socks	/		
Stable frocks		Blankets			
Fatigue overalls		Haversacks			
				MONEY.	
				Specie	\$
				Notes	\$

I CERTIFY, ON HONOR, that the above inventory comprises all the effects of Abraham Scaruthers, deceased, and that the effects are in the hands of his Legal Representatives at _____
~~to be disposed of by a Council of Administration.~~

(DUPLICATES.)

STATION: Fort Pickering Tenn

DATE: April 28th 1864

[A. G. O. No. 104.]

Nathaniel Reed 1st Lieut
6th U.S.C. Hy Art
Commanding the Company.

254

Caruthers, Adam

Co F, **11 U.S. Col'd Inf.**

(New Organization.)

Private

Private

CARD NUMBERS.

1	6322711	26
2	6329942	27
3	6330021	28
4	6330112	29
5	6330194	30
6	6330269	31
7	6330341	32
8	6330412	33
9	6330478	34
10	6330556	35
11	6330632	36
12	6330703	37
13	6330774	38
14	6330839	39
15	9072076	40
16		41
17		42
18		43
19		44
20		45
21		46
22		47
23		48
24		49
25		50

Book Mark:

See also

S. 1083175. P. m. m.

P. 1245277 M. P. d.

P. 1407896 P. O. P. d.

P. 2577434 a. m.

88 - 2mg / mullen) 11-18-41 c. d.

6

11 (new) U.S.C.T.

Adam Caruthers

(new)
Co. F., 11 Reg't U.S. Col'd Inf.

Appears on

Company Descriptive Book

of the organization named above.

DESCRIPTION.

Age 18 years height 5 feet 3 1/2 inches.

Complexion Bk

Eyes; Bk hair Bk

Where born Rankin-Miss.

Occupation

ENLISTMENT.

When Jan. 15, 1864.

Where Ft. Pickens

By whom J. G. Kappner; term 3 yrs.

Remarks:

J. A. Wright

6

11 (New). U.S.C.T.

Adam Caruthers

Appears with rank of *Pr* on

Muster and Descriptive Rolls of Detachments of U. S. Vols. forwarded

for the *11* Reg't U. S. Col'd *Inf.* Roll dated

Memphis Tenn *Mar 1*, 1864.

Where born *Rankin Co Miss*

Age *24* y'rs; occupation

When enlisted *Jan 15*, 1864.

Where enlisted *Ft Pickering*

For what period enlisted *3* years.

Eyes *black*; hair *black*

Complexion *black*; height *5* ft. *3 1/2* in.

When mustered in *Feb 24*, 1864.

Where mustered in *Ft Pickering*

Bounty paid \$ *100*; due \$ *100*

Where credited

Company to which assigned *F*

Remarks:

Book mark:

Ashley

C | 11 (New). | U.S.C.T.

Adam Caruthers
Pvt, Co. F, 1 Battalion, 1 Reg't Tenn. H. Art'y.†

Age years.

Appears on

Company Muster Roll*

for Jan 1 to Mch 1, 1864.

Joined for duty and enrolled:

When Jan 15, 1864.

Where J. H. Pickering

Period 3 years

Mustered in:

When Feb 24, 1864.

Where Memphis

Present or absent Present

Stoppage, \$ 100 for

Due Gov't, \$ 100 for

Remarks:

† This organization subsequently became Co. F, 11 Reg't U. S. Colored Infantry (New).

* First current roll. No muster-in roll of this company on file.

Book mark:

Rose

C

11 (New).

U.S.C.T.

Adam Caruthers

Musc, Co. F, 6 Reg't U. S. Col'd H. Art'y.*

Appears on

Company Muster Roll

for *Mch 4*, 1864

Present or absent *Present*

Stoppage, \$ 100 for

Due Gov't, \$ 100 for

Remarks:

* This organization subsequently became Co. F, 11 Reg't U. S. Colored Infantry (New).

Book mark:

Rose

C

11 (New).

U.S.C.T.

Adam Caruthers

Misc, Co. F, 7 Reg't U. S. Col'd H. Art'y.*

Appears on

Company Muster Roll

for *May to June*, 186*4*

Present or absent *Present*

Stoppage, \$ *100* for

Due Gov't, \$ *100* for

Remarks:

* This organization subsequently became Co. F. 11 Reg't U. S. Colored Infantry (New).

Book mark:

C

11 (New).

U.S.C.T.

Adam Caruthers
Musc, Co. F, 7 Reg't U. S. Col'd H. Art'y.*

Appears on

Company Muster Roll

for July and Aug, 1861

Present or absent Present

Stoppage, \$ 100 for

Due Gov't, \$ 100 for

Remarks: Taken from the
records

* This organization subsequently became Co. F, 11 Reg't U. S. Colored Infantry (New).

Book mark:

Tracy

C

11 (New).

U.S.C.T.

Adam Caruthers

Muse, Co. F, 7 Reg't U. S. Col'd H. Art'y.*

Appears on

Company Muster Roll

for *Sept and Oct*, 186*4*

Present or absent *Present*

Stoppage, \$ *100* for

Due Gov't, \$ *100* for

Remarks:

* This organization subsequently became Co. F, 11 Reg't U. S. Colored Infantry (New).

Book mark:

Present

C | 11 (New). | U.S.C.T.

Adam Caruthers

Musc, Co. F, 7 Reg't U. S. Col'd H. Art'y.*

Appears on

Company Muster Roll

for *Nov and Dec*, 186*4*

Present or absent *Present*

Stoppage, \$ *100* for

Due Gov't, \$ *100* for

Remarks:

* This organization subsequently became Co. F, 11 Reg't U. S. Colored Infantry (New).

Book mark:

Rose

C

11 (New)

U.S.C.T.

Adam Caruthers

Mus, Co. F, 11 Reg't U. S. Col'd Inf. (New).

Appears on

Company Muster Roll

for *Jan & Feb.*, 186*5*.

Present or absent *Present*

Stoppage, \$ *100* for

Due Gov't, \$ *100* for

Remarks:

Book mark:

Spuehu

① | 11 (New) | U.S.C.T.

William Caruthers
Sgt., Co. F, 11 Reg't U. S. Col'd Inf. (New).

Appears on

Company Muster Roll

for *March & Apr*, 1865.

Present or absent *Present*

Stoppage, \$ 100 for

Due Gov't, \$ 100 for

Remarks: *On duty duties*
Musician in Regt. Band.

Book mark: _____

(358)

Spencer

Copyist.

C

11 (New)

U.S.C.T.

Adam Caruthers

Pot, Co. F, 11 Reg't U. S. Col'd Inf. (New).

Appears on

Company Muster Roll

for *May & June*, 1865.

Present or absent *Present*

Stoppage, \$ *100* for

Due Gov't, \$ *100* for

Remarks: *On duty as Medicinal*

Book mark:

(358)

Specimen

Copyist.

© 11 (New) U.S.C.T.

Adam Caruthers

Priv., Co. F, 11 Reg't U. S. Col'd Inf. (New).

Appears on

Company Muster Roll

for *July & Aug*, 1865.

Present or absent *Present*

Stoppage, \$ 100 for

Due Gov't, \$ 100 for

Remarks:

Book mark:

Spencer

11 (New) U.S.C.T.

Adams Cursther
Pot., Co. F, 11 Reg't U. S. Col'd Inf. (New).

Appears on

Company Muster Roll

for *Sept & Oct*, 186*5*.

Present or absent *Present*

Stoppage, \$ *100* for

Due Gov't, \$ *100* for

Remarks:

Book mark:

(358)

Spencer

Copyist.

C 11 (New) U.S.C.T.

Adam Caruthers
Pl, Co. F, 11 Reg't U. S. Col'd Inf. (New).

Appears on

Company Muster Roll

for *Nov & Dec*, 1865.

Present or absent *Present*

Stoppage, \$ 100 for

Due Gov't, \$ 100 for

Remarks:

Book mark:

C

11 (New).

U.S.C.T.

Adam Caruthers

Plt, F, 11 Reg't U. S. Col'd Inf. (New).

Appears on Co. Muster-out Roll, dated

Memphis Tenn, Jan 12 1866.

Muster-out to date Jan 12, 1866.

Last paid to June 30, 1865.

Clothing account:

Last settled....., 186 ; drawn since \$..... 100

Due soldier \$..... 100; due U. S. \$ 27 ³⁴ 100

Am't for cloth'g in kind or money adv'd \$..... 100

Due U. S. for arms, equipments, &c., \$..... 100

Bounty paid \$..... 100; due \$..... 100

Remarks:.....

Book mark:.....

Deers

255

Caruthers Calvin

Co G, 11 U.S. Col'd Inf.
(New Organization.)

Private Private

CARD NUMBERS.

1	6322611	26
2	6333957	27
3	63311094	28
4	6331984	29
5	9072215	30
6	.	31
7	.	32
8	.	33
9	.	34
10	.	35
11	.	36
12	.	37
13	.	38
14	.	39
15	.	40
16	.	41
17	.	42
18	.	43
19	.	44
20	.	45
21	.	46
22	.	47
23	.	48
24	.	49
25	.	50

Book Mark: _____

See also _____

6

11 (New) U.S.C.T.

Calvin Caruthers

, Co. *G*, 11 Reg't U.S. Col'd Inf. ^(New)

Appears on

Company Descriptive Book

of the organization named above.

DESCRIPTION.

Age *25* years height *5* feet *10* inches.

Complexion *Black*

Eyes; *Blue* hair *Black*

Where born *Cenway Geo. Georgia*

Occupation *Labourer*

ENLISTMENT.

When *Jan 12*, 1864.

Where *Fort Pickens*

By whom *Cal Caruthers*; term *3* y'rs.

Remarks: *Died in small pox at Wash*
at Memphis Tenn March 10
1864. Final statement given

A. J. Anderson

6

11 (New). U.S.C.T.

Calvin Caruthers

Appears with rank of *Pri* on

Muster and Descriptive Rolls of Detachments of U. S. Vols. forwarded

for the *11* Reg't U. S. Col'd *Inf* Roll dated *Memphis Tenn Feb 2, 1864*

Where born *Cass Co Georgia*

Age *25* y'rs; occupation

When enlisted *Jan 12*, 1864

Where enlisted *Fort-Pickering*

For what period enlisted *3* years.

Eyes *black*; hair *black*

Complexion *black*; height *5 ft. 10 in.*

When mustered in *Feb 4*, 1864.

Where mustered in *Fort-Pickering*

Bounty paid \$ *100*; due \$ *100*

Where credited

Company to which assigned

Remarks:

Book mark:

Ashley

6 | 11 (New). U.S.C.T.

Calvin Caruthers
Pvt, Co. E, 1 Battalion, 1 Reg't Tenn. H. Art'y.

Age _____ years.

Appears on

Company Muster Roll*

for Feb 4 to 29, 1864.

Joined for duty and enrolled:

When Jan 12, 1864.

Where Fort Pickering

Period 3 years.

Mustered in:

When Feb 4, 1864.

Where Fort Pickering

Present or absent Present

Stoppage, \$ 100 for

Due Gov't \$ 100 for

Remarks: Sick in Hospital

Name appears in Column of present record with line drawn through it.

† This organization subsequently became Co. G, 11 Reg't U. S. Colored Infantry (New).

* First current roll. No muster-in roll of this company on file. This roll shows enrollment of all men of this company as of same date. See enrollment on subsequent card or cards.

Book mark: _____

Sallade

6 | 11 (New). | U.S.C.T.

Calvin Caruthers
Mtl, Co. G, 6 Reg't U. S. Col'd H. Art'y.†

Appears on

Company Muster Roll

for March & April, 1864.

Joined for duty and enrolled:

When Jan 12, 1864.*

Where St. Pickering *

Period 3 years.*

Present or absent

Stoppage, \$ 100 for

Due Gov't \$ 100 for

Remarks: Died in Small Pox Hospital March 10, 1864 at Memphis, Tenn.

* This organization subsequently became Co. G, 11 Reg't U. S. Colored Infantry (New).

* ~~See~~ See enrollment on card from first current roll.

Book mark:

Gallade
(358c) Copyist.

Co. | **11 (New).** | **U.S.C.T.**

Calvin Caruthers,
Priv G, 11 Reg't U. S. Col'd Inf. (New).

Appears on **Co. Muster-out Roll,** dated
Memphis T., Jan 12, 1866.

Muster-out to date _____, 186 .

Last paid to *Rec'd no pay,* 186 .

Clothing account:

Last settled _____, 186 ; drawn since \$ _____ 100

Due soldier \$ _____ 100 ; due U. S. \$ _____ 100

Am't for cloth'g in kind or money adv'd \$ _____ 100

Due U. S. for arms, equipments, &c., \$ _____ 100

Bounty paid \$ _____ 100 ; due \$ _____ 100

Remarks: *See'd at Memphis*
T. March 18/64,
Final Statement pending,

Book mark : _____

(361)

Copyist.

Caruthers, Calvin

P. Co. G

11

Reg't U. S. C. Inf.

5 Enclosures.

Bed Cards	Descriptive Lists
Burial Records	Final Statements 2
Certs. of Dis. for Discharge	Furloughs
C. M. Charges	Med. Des. Lists
Med. Certificates	Orders

Other papers relating to—

Admission to Hosp'l	Furlough
Casualty Sheet (Officer's)	Med. Examination
Confinement	Misc. Information
Contracts	Pay or Clothing
Death or Effects 3	Personal Reports
Desertions	Rank
Discharge from Hosp'l	Transfer to Hosp'l
Discharge from Service	Transfer to V. R. C.
Duty	Transportation

MICROFILM PUBLICATION M 1853

COMPILED MILITARY SERVICE RECORDS
OF VOLUNTEER UNION SOLDIERS WHO SERVED WITH
THE UNITED STATES COLORED TROOPS (USCT)
11TH REGIMENT OF INFANTRY-NEW ORGANIZATION

PERSONAL PAPERS' TARGET SHEET

PLEASE NOTE THE CHECKED INFORMATION ABOUT THE PERSONAL PAPERS IN
THIS FILE:

- NO PERSONAL PAPERS WERE FOUND IN THIS FILE WHEN THE
RECORDS WERE ARRANGED FOR MICROFILMING.
- 6 PERSONAL PAPER(S) FOUND IN THIS FILE WHEN THE RECORDS
WERE ARRANGED FOR MICROFILMING.

✓ Co - 2 53

FINAL STATEMENT

L. D. P. [unclear]
OF
Lewis [unclear] Caruthers

1st Reg't of *Ala. Siege Art*
7th U.S.,
VOLUNTEERS.

Died March 11, 1864

NOTE 1.—Two of these certificates (or duplicates) are to be given to each volunteer soldier who may be discharged previously to the discharge of his company, that he may at once receive from the Paymaster the pay, &c., due him, and the captain or other officer commanding the company will certify to the act of the delivery of the duplicate certificates; on these certificates the Soldier is "entitled to" his discharge, and should also present his discharge to the Paymaster to have the payment endorsed on it. The discharge is to be given back to the Soldier by the Paymaster; the latter only retaining as his voucher the duplicate certificates.

NOTE 2.—If the Soldier is entitled to pay for the use of his horse, the Company Commander will certify to that fact, and also to the time he has pay due for having been so mounted on his own horse.

NOTE 3.—Amounts due the Sutler and Laundress must be entered on the Muster Roll on which the death, desertion, &c., is reported, as well as on the final statement, otherwise the amount cannot be collected from the United States.

NOTE 4.—This blank will be used for deceased volunteers as well as others.

ADJUTANT GENERAL'S OFFICE.

June 22^d 1864

Duplicate with Inventory sent 2d Auditor.



Enthous [unclear] of [unclear]

I certify, on honor, that Melvin Paruthers a Private of
 Captain John B. Mullins Company (B) of the 1st Regiment of Ala. Sig. Art
VOLUNTEERS, of the State of _____, born in Way County, State
 of Georgia, aged 25 years; 5 feet 10 inches high; Black complexion,
Black eyes, Black hair, and by occupation a Laborer, having joined the company on
 its original organization at Fort Pickens Tenn., and enrolled in it at the muster into
 the service of the United States at Fort Pickens Tenn., on the 17th day
 of February, 1864, (or was mustered in service as a recruit, by _____
 _____, at _____, on the _____ day of _____,
 186 , to serve in the Regiment,) for the term of Three Years
 and having served **HONESTLY** and **FAITHFULLY** with his Company in Fort Pickens
 to the ~~present date~~ ^(10th of March 1864) is now entitled to a **DISCHARGE** by reason of Death in
Hospital

The said Melvin Paruthers has drawn no pay was last paid by Paymaster
 _____ to include the _____ day of _____, 186 , and has
 pay due him from that time to the present date; he is entitled to pay and subsistence for
TRAVELING to place of enrollment and whatever other allowances are authorized to volunteer
 soldiers, or militia, so discharged. He has received _____ 100 dollars,
 advanced by the United States on account of **CLOTHING**.

There is to be stopped from him, on account of the State of _____, or other
 authorities for **CLOTHING**, &c., received on entering service, _____ 100 dollars; also,
 for expenses of **SUBSISTENCE** for **TRAVELING** from place of enrollment to the place of rendezvous,
 amounting to _____ 100 dollars: and on account of the United States for **EXTRA**
CLOTHING received in kind from _____ and for other
 stoppages, viz: for loss of Haversack 4 2/100 dollars
 _____ Since enlistment amounting to twenty three 28 100 dollars;
 and he has been **SUBSISTED** for **TRAVELING** to his place of enrollment, up to the _____
 _____, 186 .

He is indebted to _____, **SUTLER**, _____ 100 dollars.
 He is indebted to _____, **LAUNDRESS**, _____ 100 dollars.

Given in Duplicate, at Fort Pickens, this 18th day of March, 1864.

Wm. Reed 1st Lieut
1st Ala. Sig. Art
 Commanding Company.

Died March 10, 1864

1864 Sup. 53
Hall.

FINAL STATEMENT

OF

Calvin Caruthers

C. G. Reg't of 7th U.S. A. (Hq.)

VOLUNTEERS.

NOTE 1.—Two of these certificates (or duplicates) are to be given to each volunteer soldier who may be discharged previously to the discharge of his company, that he may at once receive from the Paymaster the pay, &c., due him, and the captain or other officer commanding the company will certify to the act of the delivery of the duplicate certificates; on these certificates the Soldier is "entitled to" his *discharge*, and should also present his discharge to the Paymaster to have the payment endorsed on it. The discharge is to be given back to the Soldier by the Paymaster; the latter only retaining as his voucher the duplicate certificates.

NOTE 2.—If the Soldier is entitled to pay for the use of his horse, the Company Commander will certify to that fact, and also to the time he has pay due for having been so mounted on his own horse.

NOTE 3.—Amounts due the Sutler and Laundress must be entered on the Muster Roll on which the death, desertion, &c., is reported, as well as on the final statement, otherwise the amount cannot be collected from the United States.

NOTE 4.—This blank will be used for deceased volunteers as well as others.

I certify, on honor, that Calvin Caruthers a Private of
Captain John B. Muller Company (A) of the 14th Regiment of Ill. Colored Art. Bty
VOLUNTEERS, of the State of _____, born in Osage Co, State
of Georgia, aged 25 years; 5 feet 11 inches high; Black complexion,
Black eyes, Black hair, and by occupation a Laborer, having joined the company on
its original organization at Fort Pickens Tenn., and enrolled in it at the muster into
the service of the United States at Fort Pickens Tenn., on the 11th day
of February, 1864, (or was mustered in service as a recruit, by _____
at _____, on the _____ day of _____,
186 , to serve in the Regiment,) for the term of Three years
and having served **HONESTLY** and **FAITHFULLY** with his Company in the Field
to the ^{10th March} present date, is now entitled to a **DISCHARGE** by reason of Late by order
of General Fox

The said Calvin Caruthers has drawn no pay was last paid by Paymaster
_____ to include the _____ day of _____, 186 , and has
pay due him from that time to the present date; he is entitled to pay and subsistence for
TRAVELING to place of enrollment and whatever other allowances are authorized to volunteer
soldiers, or militia, so discharged. He has received _____ dollars,
advanced by the United States on account of **CLOTHING**.

There is to be stopped from him, on account of the State of _____, or other
authorities for **CLOTHING**, &c., received on entering service, _____ dollars; also,
for expenses of **SUBSISTENCE** for **TRAVELING** from place of enrollment to the place of rendezvous,
amounting to _____ dollars: and on account of the United States for **EXTRA**
CLOTHING received in kind from _____ and for other
stoppages, viz: loss of one staversack 48/100 dollars
since enlistment amounting to twenty three 8/100 dollars;
and he has been **SUBSISTED** for **TRAVELING** to his place of enrollment, up to the _____
_____, 186 .

He is indebted to _____, **SUTLER**, _____ dollars.
He is indebted to _____, **LAUNDRESS**, _____ dollars.

Given in Duplicate, at Fort Pickens, this 13th day of March, 1864.

Nath Reed 1st Lieut
14th Ill. Colored Art. Bty
Commanding Company.

Co. G,

FINAL STATEMENT

OF

Private James Casuthers

Co. G 1st Reg't of Ala Siege Art

VOLUNTEERS.

NOTE 1.—Two of these certificates (or duplicates) are to be given to each volunteer soldier who may be discharged previously to the discharge of his company, that he may at once receive from the Paymaster the pay, &c., due him, and the captain or other officer commanding the company will certify to the act of the delivery of the duplicate certificates; on these certificates the Soldier is "entitled to" his *discharge*, and should also present his discharge to the Paymaster to have the payment endorsed on it. The discharge is to be given back to the Soldier by the Paymaster; the latter only retaining as his voucher the duplicate certificates.

NOTE 2.—If the Soldier is entitled to pay for the use of his horse, the Company Commander will certify to that fact, and also to the time he has pay due for having been so mounted on his own horse.

NOTE 3.—Amounts due the Sutler and Laundress must be entered on the Muster Roll on which the death, desertion, &c., is reported, as well as on the final statement, otherwise the amount cannot be collected from the United States.

NOTE 4.—This blank will be used for deceased volunteers as well as others.

I certify, on honor, that Calvin Caruthers a Private of
 Captain Wm B Muller Company (D) of the 1st Regiment of Ala Siege Art
VOLUNTEERS, of the State of _____, born in Way, Geo, State
 of Georgia, aged 25 years; 5 feet 10 inches high; t complexion,
Black eyes, Black hair, and by occupation a Laborer, having joined the company on
 its original organization at Memphis Tenn, and enrolled in it at the muster into
 the service of the United States at Ford Pickens, on the 4th day
 of February, 1864, (or was mustered in service as a recruit, by _____
 _____, at _____, on the _____ day of _____,
 186 , to serve in the Regiment,) for the term of three years
 and having served **HONESTLY** and **FAITHFULLY** with his Company in Ford Pickens
 to the ~~present date~~, ^{March 10th 1864} is now entitled to a **DISCHARGE** by reason of Death in
Hospital March 10th 1864

The said Calvin Caruthers has drawn no pay was last paid by Paymaster
 _____ to include the _____ day of _____, 186 , and has
 pay due him from that time to the present date; he is entitled to pay and subsistence for
TRAVELING to place of enrollment and whatever other allowances are authorized to volunteer
 soldiers, or militia, so discharged. He has received _____ dollars,
 advanced by the United States on account of **CLOTHING**.

There is to be stopped from him, on account of the State of _____, or other
 authorities for **CLOTHING, &c.**, received on entering service, _____ dollars; also,
 for expenses of **SUBSISTENCE** for **TRAVELING** from place of enrollment to the place of rendezvous,
 amounting to _____ dollars: and on account of the United States for **EXTRA**
CLOTHING received in kind from _____ and for other
 stoppages, viz: _____
He has drawn clothing
since enlistment amounting to twenty three ⁹⁸ dollars;
 and he has been **SUBSISTED** for **TRAVELING** to his place of enrollment, up to the _____
 _____, 186 .

He is indebted to _____, **SUTLER**, _____ dollars.

He is indebted to _____, **LAUNDRESS**, _____ dollars.

Given in Duplicate, at Ford Pickens, this 23rd day of March, 1864.

Wm B Muller
Wm B Muller
 Commanding Company.

Receipt for the effects
of Calvin Wright deceased

Received at Memphis Tenn
on the 28th day of March 1864 of 1st Lieut
Sathaniel Wood Commandy Co I 1st Va. Siege
Art. the following articles of clothing, the
property of Calvin Caruthers, deceased. Viz

Emaley ^{for} Caruthers
_{mark}

ARTICLES OF WAR.

ART. 95. When any non-commissioned officer or soldier shall die, or be killed in the service of the United States, the then commanding officer of the troop or company shall, in the presence of two other commissioned officers, take an account of what effects he died possessed of, above his arms and accoutrements, and transmit the same to the office of the Department of War, which said effects are to be accounted for, and paid to the representatives of such deceased non-commissioned officer or soldier. And in case any of the officers, so authorized to take care of the effects of deceased officers and soldiers, should, before they have accounted to their representatives for the same, have occasion to leave the regiment or post, by preferment or otherwise, they shall, before they be permitted to quit the same, deposit in the hands of the commanding officer, or of the assistant military agent, all the effects of such deceased non-commissioned officers and soldiers, in order that the same may be secured for, and paid to, their respective representatives.

ARMY REGULATIONS—EDITION OF 1861.

DECEASED SOLDIERS.

Par. 152. Inventories of the effects of deceased non-commissioned officers and soldiers, required by the 95th Article of War, will be forwarded to the Adjutant General, by the commander of the company to which the deceased belonged, and a duplicate of the same to the colonel of the regiment. Final statements of pay, clothing, &c., will be sent with the inventories. When a soldier dies at a post or station absent from his company, it will be the duty of his immediate commander to furnish the required inventory, and, at the same time, to forward to the commanding officer of the company to which the soldier belonged, a report of his death, specifying the date, place, and cause; to what time he was last paid, and the money or other effects in his possession at the time of his decease; which report will be noted on the next muster-roll of the company to which the man belonged. Each inventory will be endorsed, "Inventory of the effects of _____, late of company (—) _____ regiment of _____, who died at _____, the _____ day of _____, 186—." If a legal representative receive the effects, it will be stated in the report. If the soldier leave no effects, the fact will be reported.

Par. 153. Should the effects of a deceased non-commissioned officer or soldier not be administered upon within a short period after his decease, they shall be disposed of by a Council of Administration, under the authority of the commanding officer of the post, and the proceeds deposited with the Paymaster, to the credit of the United States, until they shall be claimed by the legal representatives of the deceased.

Par. 154. In all such cases of sales by the Council of Administration, a statement in detail, or account of the proceeds, duly certified by the Council and commanding officer, accompanied by the Paymaster's receipt for the proceeds, will be forwarded by the commanding officer to the Adjutant General. The statement will be endorsed, "Report of the proceeds of the effects of _____, late of company (—) _____ regiment of _____, who died at _____, the _____ day of _____, 186—."

NOTE 1.—The effects in all cases, when called for, should be turned over to the legal representative, without further authority from the Adjutant General. When the effects are turned over to the relatives of the deceased before these inventories are sent to the Adjutant General, their receipts therefor should be attached to the inventories. In all other cases, one copy will be sent with a letter of transmittal direct to the Adjutant General, and a duplicate retained by the officer.

NOTE 2.—Particular care should be taken to take receipts in duplicate from the Paymaster for any funds turned over to him; one copy should be sent direct to the Adjutant General and one retained by the officer.

INVENTORY OF THE EFFECTS

OF

Private Calvin Caruthers

Late of Company *G*

1st Reg't of *Ala Siege Art*

Volunteers, who died at *Memphis Tenn*

on the *10th* day of *March* 1864.



Co. 1st Batt 14th Tenn Heavy Art of A.D. was transferred to Co. 1st Batt
 Siege Art of A.D. by S.O. 1192 Head Quarters U.S. Colored Troops Dec. - Memphis
 Tenn March 4th 1864

Inventory of the effects of Calvin Caruthers late
Private of Captain John B. Mullers Company G of
 the 1st Regiment of Ala Siege Art Volunteers, who was enrolled as
 a Private at Memphis in the State of Tennessee on
 the 12th day of January 1864, and mustered into the service of the United
 States as a Private on the 4th day of February 1864, at Franklin Tenn
 in Company E 1st Batt 14th Regt of Tenn Heavy Art Volunteers, to serve 3
 years or during the war; he was born in Cass County in the State
 of Georgia; he was 25 years of age, 5 feet 10 inches
 high, Black complexion, Black eyes, Black hair, and by occupation, when enrolled,
 a Farmer; he died in Franklin Tenn Hospital at
Franklin Tenn on the 10th day of March 1864, by
 reason of Disease

INVENTORY.					
ARTICLES.	No.	ARTICLES.	No.	ARTICLES.	No.
Hats		Pairs trousers		Knapsacks	
Caps		Pairs flannel drawers			
Forage caps		Pairs cotton drawers			
Great coats		Flannel shirts	1		
Uniform coats		Cotton shirts			
Uniform jackets		Pairs boots			
Flannel sack coats		Pairs shoes			
Blouses		Pairs socks			
Stable frocks		Blankets			
Fatigue overalls		Haversacks			
				MONEY.	
				Specie	\$
				Notes	\$

I CERTIFY, ON HONOR, that the above inventory comprises all the effects of
Calvin Caruthers, deceased, and that the effects are in the hands
 of his heirs at Memphis Tenn
 to be disposed of by a Council of Administration.

(DUPLICATES.)

STATION: Franklin Tenn

DATE: March 13th 1864

Franklin P. Russell
 G. J. 1st Al Siege Art
 Commanding the Company.

ARTICLES OF WAR.

ART. 95. Any non-commissioned officer or soldier shall die, or be of the United States, the then commanding officer of any shall, in the presence of two other commissioned account of what effects he died possessed of, above his treatments, and transmit the same to the office of the Department War, which said effects are to be accounted for, and paid to the representatives of such deceased non-commissioned officer or soldier. And in case any of the officers, so authorized to take care of the effects of deceased officers and soldiers, should, before they have accounted to their representatives for the same, have occasion to leave the regiment or post, by preferment or otherwise, they shall, before they be permitted to quit the same, deposit in the hands of the commanding officer, or of the assistant military agent, all the effects of such deceased non-commissioned officers and soldiers, in order that the same may be secured for, and paid to, their respective representatives.

ARMY REGULATIONS—EDITION OF 1861.

DECEASED SOLDIERS.

Par. 152. Inventories of the effects of deceased non-commissioned officers and soldiers, required by the 95th Article of War, will be forwarded to the Adjutant General, by the commander of the company to which the deceased belonged, and a duplicate of the same to the colonel of the regiment. Final statements of pay, clothing, &c., will be sent with the inventories. When a soldier dies at a post or station absent from his company, it will be the duty of his immediate commander to furnish the required inventory, and, at the same time, to forward to the commanding officer of the company to which the soldier belonged, a report of his death, specifying the date, place, and cause; to what time he was last paid, and the money or other effects in his possession at the time of his decease; which report will be noted on the next muster-roll of the company to which the man belonged. Each inventory will be endorsed, "Inventory of the effects of _____, late of company (—) _____ regiment of _____, who died at _____, the _____ day of _____, 186—." If a legal representative receive the effects, it will be stated in the report. If the soldier leave no effects, the fact will be reported.

Par. 153. Should the effects of a deceased non-commissioned officer or soldier not be administered upon within a short period after his decease, they shall be disposed of by a Council of Administration, under the authority of the commanding officer of the post, and the proceeds deposited with the Paymaster, to the credit of the United States, until they shall be claimed by the legal representatives of the deceased.

Par. 154. In all such cases of sales by the Council of Administration, a statement in detail, or account of the proceeds, duly certified by the Council and commanding officer, accompanied by the Paymaster's receipt for the proceeds, will be forwarded by the commanding officer to the Adjutant General. The statement will be endorsed, "Report of the proceeds of the effects of _____, late of company (—) _____ regiment of _____, who died at _____, the _____ day of _____, 186—."

NOTE 1.—The effects in all cases, when called for, should be turned over to the legal representative, without further authority from the Adjutant General. When the effects are turned over to the relatives of the deceased before these inventories are sent to the Adjutant General, their receipts therefor should be attached to the inventories. In all other cases, one copy will be sent with a letter of transmittal direct to the Adjutant General, and a duplicate retained by the officer.

NOTE 2.—Particular care should be taken to take receipts in duplicate from the Paymaster for any funds turned over to him; one copy should be sent direct to the Adjutant General and one retained by the officer.

Recd. from Div. of discontinued
Commands;

INVENTORY OF THE EFFECTS

Filed Sept. 21/1875

OF

Private Calvin Caruthers

Late of Company G

1st Reg't of Ala. Siege Art

Volunteers, who died at Memphis

on the 10th day of March 1864.



Inventory of the effects of Calvin Caruthers late
Private of Captain John B. Mullers Company G of
the 1st Regiment of Artillery Volunteers, who was enrolled as
a Private at Memphis in the State of Tennessee on
the 12th day of January 1864, and mustered into the service of the United
States as a Private on the 4th day of February 1864, at Fort Dickering
in Company C, 1st Regiment of Tenn. Art. Vol. Volunteers, to serve three
years or during the war; he was born in Way County in the State
of Georgia; he was 25 years of age, 5 feet 10 inches
high, Black complexion, Black eyes, Black hair, and by occupation, when enrolled,
a Laborer; he died in Small Pox Hospital, at
Memphis Tenn on the 10th day of March 1864, by
reason of Small Pox

INVENTORY.					
ARTICLES.	No.	ARTICLES.	No.	ARTICLES.	No.
Hats		Pairs trousers		Knapsacks	
Caps		Pairs flannel drawers			
Forage caps		Pairs cotton drawers			
Great coats		Flannel shirts	1		
Uniform coats		Cotton shirts			
Uniform jackets		Pairs boots			
Flannel sack coats		Pairs shoes			
Blouses		Pairs socks			
Stable frocks		Blankets			
Fatigue overalls		Haversacks			
				MONEY.	
					Specie
				Notes	\$

I CERTIFY, ON HONOR, that the above inventory comprises all the effects of Private
Calvin Caruthers, deceased, and that the effects are in the hands
of his heirs at Memphis Tenn
to be disposed of by a Council of Administration.

(DUPLICATES.)

Wath Reed 1st Lieut

STATION: Fort Dickering Tenn

Commanding the Company.

DATE: March 13th 1864

256

Caruthers & Daniel

Co *G*, 11 U.S. Col'd Inf.

(New Organization.)

Sergeant Sergeant

CARD NUMBERS.

1	6322584	26
2	6330930	27
3	6331017	28
4	6331106	29
5	6331191	30
6	6331273	31
7	6331356	32
8	6331440	33
9	6331523	34
10	6331606	35
11	6331689	36
12	6331761	37
13	6331833	38
14	6331904	39
15	0072213	40
16		41
17		42
18		43
19		44
20		45
21		46
22		47
23		48
24		49
25		50

Book Mark:

See also

Rep 362648.

J. W. G. P. O. M. M.
A 2309938 P. O. M.
ss. var. Bm. 11/9/25 2h.

6 | 11 (New) U.S.C.T.

Daniel Caruthers
Co. G, 11 Reg't U.S. Col'd Inf.

Appears on
Company Descriptive Book
of the organization named above.

DESCRIPTION.

Age 19 years height 5 feet 5 1/2 inches.

Complexion Black

Eyes; Blue hair Black

Where born Maryland

Occupation Laborer

ENLISTMENT.

When Jan. 12, 1864.

Where Fort Pickens

By whom Col. Kappner; term 3 y'rs.

Remarks: Appoint'd 4th Sgt. Jan. 12/64

A. J. Anderson

6

11 (New). U.S.C.T.

Daniel Caruthers

Appears with rank of 5th Sergt on

Muster and Descriptive Rolls of Detachments of U. S. Vols. forwarded

for the 11 Reg't U. S. Col'd Inf Roll dated

Memphis Tenn, Feb 2, 1864.

Where born Marcy Co Tenn

Age 19 y'rs; occupation

When enlisted Jan 12, 1864.

Where enlisted Fort-Pickering

For what period enlisted 3 years.

Eyes Black; hair Black

Complexion Light; height 5 ft. 5 1/2 in.

When mustered in Feb 4, 1864.

Where mustered in Fort-Pickering

Bounty paid \$ 100; due \$ 100

Where credited

Company to which assigned

Remarks:

Book mark:

Ashley

6 11 (New) U.S.C.T.

Daniel Baruthers
5 Seryt Co. E. 1 Battalion, 1 Reg't Tenn. H. Art'y.

Age years.

Appears on

Company Muster Roll

for Feb 4 to 29 , 1864

Joined for duty and enrolled:

When Jan 12 , 1864

Where Fort Pickering

Period 3 years.

Mustered in:

When Feb 4 , 1864

Where Fort Pickering

Present or absent Present

Stoppage, \$ 100 for

Due Gov't \$ 100 for

Remarks:

This organization subsequently became Co. G, 11 Reg't U. S. Colored Infantry (New).
* First current roll. No muster-in roll of this company on file. This roll shows enrollment of all men of this company as of same date. See enrollment on subsequent card or cards.

Book mark:

Ballade

b

11 (New).

U.S.C.T.

Daniel Caruthers

Sgt., Co. G, 6 Reg't U. S. Col'd H. Art'y.†

Appears on

Company Muster Roll

for *Feb + Apr*, 1864.

Joined for duty and enrolled:

When *Jan 12*, 1864.*

Where *Ft. Pickering* *

Period *3* years.*

Present or absent *Present*

Stoppage, \$ *100* for

Due Gov't \$ *100* for

Remarks:

* This organization subsequently became Co. G, 11 Reg't U. S. Colored Infantry (New).

* See enrollment on card from first current roll.

Book mark:

Ballade

6 | 11 (New). | U.S.C.T.

Daniel Lurthers
5th Reg't, Co. G, 7 Reg't U. S. Col'd H. Art'y.†

Appears on

Company Muster Roll

for May & June, 1864.

Joined for duty and enrolled:

When Jan 12, 1864.*

Where Ft Pickering *

Period 3 years.*

Present or absent Present

Stoppage, \$ 100 for

Due Gov't, \$ 100 for

Remarks:

† This organization subsequently became Co. G, 11 Reg't U. S. Colored Infantry (New).
* See enrollment on card from first current roll.

Book mark:

Mallade

6 | 11 (New). | U.S.C.T.
David Caruthers
Co. G, 7 Reg't U. S. Col'd H. Art'y.†

Appears on

Company Muster Roll

for July 1864, 1864

Joined for duty and enrolled:

When Jan 12, 1864.*

Where Ft Pickens *

Period 3 years.*

Present or absent Present

Stoppage, \$ 100 for

Due Gov't, \$ 100 for

Remarks: _____

† This organization subsequently became Co. G, 11 Reg't U. S. Colored Infantry (New).
* See enrollment on card from first current roll.

Book mark: _____

(358c)

Ballade

Copyist.

5 | 11 (New). | U.S.C.T.

Daniel Caruthers

Sgt., Co. G, 7 Reg't U. S. Col'd H. Art'y.†

Appears on

Company Muster Roll

for Sgt & Det, 1864

Joined for duty and enrolled:

When Jan 2, 1864*

Where Ft. Pickens *

Period 3 years.*

Present or absent Present

Stoppage, \$ 100 for

Due Gov't, \$ 100 for

Remarks: In duty duty in Engineers Det since Sept. 13, 1864

† This organization subsequently became Co. G, 11 Reg't U. S. Colored Infantry (New).

* See enrollment on card from first current roll.

Book mark:

Quillade

11 (New). U.S.C.T.

Daniel Caruthers

Co. G, 7 Reg't U. S. Col'd H. Art'y.†

Appears on

Company Muster Roll

for Two & Dec, 1864.

Joined for duty and enrolled:

When Jan 12, 1864.*

Where Fort Pickens *

Period 2 years.*

Present or absent Present

Stoppage, \$ 100 for

Due Gov't, \$ 100 for

Remarks:

† This organization subsequently became Co. G, 11 Reg't U. S. Colored Infantry (New).

* See enrollment on card from first current roll.

Book mark:

McCade

C. | 11 (New). | U.S.C.T.

Daniel Caruthers
5th Sgt, Co. G, 11 Reg't U. S. Col'd Inf. (New).

Appears on

Company Muster Roll
for Jan & Feb, 1865.

Joined for duty and enrolled:

When Jan 12, 1864.*

Where Ft. Pickering.*

Period 3 years.*

Present or absent Present.

Stoppage, \$ 100 for

Due Gov't \$ 100 for

Remarks:

* See enrollment on card from first current roll.

Book mark:

(358c)

Ramsey

Copyist.

6. | 11 (New). | U.S.C.T.

Daniel Caruthers
5th Sqr, Co. G, 11 Reg't U. S. Col'd Inf. (New).

Appears on

Company Muster Roll

for *Mar & Apr*, 1865.

Joined for duty and enrolled:

When *Jan 12*, 1864.*

Where *Ft. Pickering*, *

Period *3* years.*

Present or absent *Present*.

Stoppage, \$ *100* for

Due Gov't \$ *100* for

Remarks:

* See enrollment on card from first current roll.

Book mark:

Ramsey
Cpyist.

C. | 11 (New). | U.S.C.T.

Daniel Caruthers

5th Sgt., Co. G, 11 Reg't U. S. Col'd Inf. (New).

Appears on

Company Muster Roll

for May & June, 1865.

Joined for duty and enrolled:

When Jan 12, 1864.*

Where Ft Pickering.*

Period 3 years.*

Present or absent Present.

Stoppage, \$ 100 for

Due Gov't \$ 2 ⁷⁰/₁₀₀ for

Remarks:

* See enrollment on card from first current roll.

Book mark:

Ramsey

C. | 11 (New). | U.S.C.T.

Daniel Caruthers
5th Serj't Co. G, 11 Reg't U. S. Col'd Inf. (New).

Appears on

Company Muster Roll

for July & Aug., 1865.

Joined for duty and enrolled:

When Jan 12, 1864.*

Where Ft Pickering.*

Period 3 years.*

Present or absent Present.

Stoppage, \$ 100 for

Due Gov't \$ 100 for

Remarks:

* See enrollment on card from first current roll.

Book mark:

(358c)

Ramsey
Cpyist.

C. | 11 (New). | U.S.C.T.

Daniel Caruthers
3^d Sergt, Co. G, 11 Reg't U. S. Col'd Inf. (New).

Appears on

Company Muster Roll
for Sept & Oct., 1865.

Joined for duty and enrolled:

When Jan 12, 1864.*

Where Ft Pickering, *

Period 3 years.*

Present or absent Present.

Stoppage, \$ 100 for

Due Gov't \$ 100 for

Remarks:

* See enrollment on card from first current roll.

Book mark:

(358c)

Ramsey
Cpyist.

C. | 11 (New). | U.S.C.T.

Daniel Caruthers.

Sgt., Co. G, 11 Reg't U. S. Col'd Inf. (New).

Appears on

Company Muster Roll

for *Nov. & Dec., 1865.*

Joined for duty and enrolled:

When *Jan. 12*, 186*4*.*

Where *Fort Pickens* *

Period *3* years.*

Present or absent *present*

Stoppage, \$ *100* for

Due Gov't \$ *100* for

Remarks: _____

* See enrollment on card from first current roll.

Book mark: _____

[Signature]

C.

11 (New).

U.S.C.T.

Daniel Caruthers

Sgt., G., 11 Reg't U. S. Col'd Inf. (New).

Appears on Co. Muster-out Roll, dated

Memphis T. Jan 12, 1866.

Muster-out to date

Jan 12, 1866.

Last paid to

June 20, 1865.

Clothing account:

Last settled 186 ; drawn since \$ 100

Due soldier \$ ³² / 100 ; due U. S. \$ 100

Am't for cloth'g in kind or money adv'd \$ 100

Due U. S. for arms, equipments, &c., \$ 100

Bounty paid \$ 100 ; due \$ 100

Remarks:

Book mark: 157. 1882

(361)

[Signature]

Copyist.

Baruth, Paul

Sgt, Co G, 11th Reg't U.S. Army

1 Enclosures.

Bed Cards	Final Statements
Burial Records	Furloughs or L. of A.
Certs. of Dis. for Discharge	Med. Certificates
C. M. Charges	Med. Des. Lists
Descriptive Lists	Orders
Discharge Certificates	Pris. of War Record
Enlistment Papers	Resignations

Other papers relating to—

Admission to Hosp'l	Furlough or L. of A.
Casualty Sheet	Med. Examination
Confinement	Misc. Information
Contracts	Pay or Clothing
Death or Effects	Personal Reports
Desertion	Rank
Discharge from Hosp'l	Transfer to Hosp'l
Discharge from Service	Transfer to V. R. C.
Duty	Transportation

Fort. Pickens, Tenn.
July 18th 1864

Recd. Nathaniel
1st Lt. Co. G. 7th U.S.C. Art Hoy

state that Sergt. Daniel
Cuthers having been
sent under guard to
his Company Commander
and not knowing how to
dispose of his case sends
him with accompanying
papers to the Commandg.
Officer J. P. Pickens, for
orders

Recd. Ad. Off. Fort Pickens
Tenn. July 18th 1864

Fort Pickens July 18th 1864

Lieut Copeland
A. A. Fox says

Sergt James Cloutier
an entire man of Co. G. 1st Regt
has been sent under guard to
Sgt Co. Commander - not knowing
how to dispose of his case - he
having while with the Co. -
changed his duties faithfully
I send him under guard for further
The accompanying papers
together with the testimony of
Sergt Albert M. Conley and
Private F. H. Taylor are,
to the officers, to release of
~~the~~ ^{the} same

Matthew Reed
Lieut Comdg Co. G.
7th U.S. (Col'd) A. A.

257

Caruthers, James

Co G, 11 U.S. Col'd Inf.

(New Organization.)

Private

Private

CARD NUMBERS.

1	6 3 2 2 6 1 3	26
2	6 3 3 0 9 5 7	27
3	6 3 3 1 0 4 3	28
4	6 3 3 1 1 3 1	29
5	6 3 3 1 2 1 6	30
6	6 3 3 1 2 9 7	31
7	6 3 3 1 3 8 0	32
8	6 3 3 1 4 6 4	33
9	6 3 3 1 5 4 7	34
10	6 3 3 1 6 2 9	35
11	6 3 3 1 7 1 1	36
12	6 3 3 1 7 8 3	37
13	6 3 3 1 8 5 5	38
14	6 3 3 1 9 2 6	39
15	9 0 7 2 2 1 7	40
16		41
17		42
18		43
19		44
20		45
21		46
22		47
23		48
24		49
25		50

Book Mark:

See also

S 1304060 And. w. D.
S 1321886 And (W. D.)
D. 1420411 P.O. aff.
D 1524773 Poulton
S 1631977 P.O. aff.
A 2142483 P.O. aff.

C

11 (New) U. S. C. T.

Hans Caruthers

Co. *G*, 11 Reg't U. S. Col'd Inf. ^(New)

Appears on

Company Descriptive Book

of the organization named above.

DESCRIPTION.

Age *27* years height *5* feet *1* inches.

Complexion *Black*

Eyes; *Black* hair *Black*

Where born *Marshall Co. Miss*

Occupation *Laborer*

ENLISTMENT.

When *Jan 2*, 1864.

Where *Fort Pickens*

By whom *Col. Kappan*; term _____ y'rs.

Remarks:

A. J. Anderson

6

11 (New). U.S.C.T.

Hans Caruthers

Appears with rank of *Pri* on

Muster and Descriptive Rolls of Detachments of U. S. Vols. forwarded

for the *11* Reg't U. S. Col'd *Inf.* Roll dated *Memphis Tenn, Feb 2, 1864.*

Where born *Marshall Co Miss*

Age *27* y'rs; occupation

When enlisted *Jan 12*, 1864.

Where enlisted *Fort-Pickering*

For what period enlisted *3* years.

Eyes *black*; hair *black*

Complexion *black*; height *5* ft. *1* in.

When mustered in *Feb 4*, 1864.

Where mustered in *Fort-Pickering*

Bounty paid \$ *100*; due \$ *100*

Where credited

Company to which assigned

Remarks:

Book mark:

Ashley

B | **11** (New). | **U.S.C.T.**

Hans Caruthers

Priv, Co. E, 1 Battalion, 1 Reg't Tenn. H. Art'y.†

Age years.

Appears on

Company Muster Roll*

for *Feb 4 to 29* ..., 1864

Joined for duty and enrolled:

When *Jan 12* ..., 1864

Where *Fort Pickering*

Period *3* years.

Mustered in:

When *Feb 4* ..., 1864

Where *Fort Pickering*

Present or absent *Present*

Stoppage, \$ 100 for

Due Gov't \$ 100 for

Remarks: *On daily duty as teamster since Jan 12, 1864*

† This organization subsequently became Co. G, 11 Reg't U. S. Colored Infantry (New).

* First current roll. No muster-in roll of this company on file. This roll shows enrollment of all men of this company as of same date. See enrollment on subsequent card or cards.

Book mark:

Dallade

6 | 11 (New). | U.S.C.T.

Hans Caruthers

Plt., Co. G, 6 Reg't U. S. Col'd H. Art'y.†

Appears on

Company Muster Roll

for Feb + Apr, 1864.

Joined for duty and enrolled:

When Jan 12, 1864.*

Where Ft Pickens *

Period 3 years.*

Present or absent Present

Stoppage, \$ 100 for

Due Gov't \$ 100 for

Remarks:

* This organization subsequently became Co. G, 11 Reg't U. S. Colored Infantry (New).

* See enrollment on card from first current roll.

Book mark: 100

(358c)

Pallade

Copyist.

6 | 11 (New). | U.S.C.T.

Hans Caruthers
1st, Co. G, 7 Reg't U. S. Col'd H. Art'y.†

Appears on

Company Muster Roll

for May & June, 1864.

Joined for duty and enrolled:

When Jan 12, 1864.*

Where H. Preberius *

Period 3 years.*

Present or absent Present

Stoppage, \$ 100 for

Due Gov't, \$ 100 for

Remarks:

† This organization subsequently became Co. G, 11 Reg't U. S. Colored Infantry (New).
* See enrollment on card from first current roll.

Book mark:-----

(358c) Ballade Copyist.

6 | 11 (New). | U.S.C.T.

Hance Caruthers
Pat, Co. G, 7 Reg't U. S. Col'd H. Art'y.†

Appears on

Company Muster Roll

for *June & Aug*, 186 *4*

Joined for duty and enrolled:

When *Jan 12*, 186 *4**

Where *St. Petersburg* *

Period *2* years.*

Present or absent *Present*

Stoppage, \$ *100* for

Due Gov't, \$ *100* for

Remarks:

.....
.....
.....
.....

† This organization subsequently became Co. G, 11 Reg't U. S. Colored Infantry (New).
* See enrollment on card from first current roll.

Book mark:

374500
J. Allard

6 | 11 (New). | U.S.C.T.

Hans Carothers
Sgt., Co. G, 7 Reg't U. S. Col'd H. Art'y.†

Appears on

Company Muster Roll

for Sgt. Carothers, 1864.

Joined for duty and enrolled:

When Jan 12, 1864.*

Where Ft. Pickens *

Period 3 years.*

Present or absent Present

Stoppage, \$ 100 for

Due Gov't, \$ 100 for

Remarks: On daily duty in
Engineer Dept since
Sept 13, 1864

† This organization subsequently became Co. G, 11 Reg't U. S. Colored Infantry (New).

* See enrollment on card from first current roll.

Book mark: _____

(358c)

Ballade

Copyist.

6 | **11** (New). | **U.S.C.T.**

Hans Carstairs
1st, Co. G, 7 Reg't U. S. Col'd H. Art'y.†

Appears on

Company Muster Roll

for *Nov & Dec*, 186*4*.

Joined for duty and enrolled:

When *Jan 12*, 186*4*

Where *Fort Pickens**

Period *2* years.*

Present or absent *Present*

Stoppage, \$ *100* for

Due Gov't, \$ *100* for

Remarks:

† This organization subsequently became Co. G, 11 Reg't U. S. Colored Infantry (New).
* See enrollment on card from first current roll.

Book mark:

Sallade

C.

11 (New).

U.S.C.T.

Hans Caruthers

Priv., Co. G, 11 Reg't U. S. Col'd Inf. (New).

Appears on

Company Muster Roll

for *Jan & Feb*, 186*5*.

Joined for duty and enrolled:

When *Jan 12*, 186*4*.*

Where *Ft. Pickering*.*

Period *3* years.*

Present or absent. *Present.*

Stoppage, \$ *100* for

Due Gov't \$ *100* for

Remarks:

* See enrollment on card from first current roll.

Book mark:

(358c)

Ramsey

Copyist.

C. | **11** (New). | **U.S.C.T.**

Hans Caruthers
Pvt., Co. G, 11 Reg't U. S. Col'd Inf. (New).

Appears on

Company Muster Roll

for *Mar & Apr*, 186*5*.

Joined for duty and enrolled:

When *Jan 12*, 186*4*.*

Where *Ft. Pickering*.*

Period *3* years.*

Present or absent *Present*.

Stoppage, \$ *100* for

Due Gov't \$ *65* / *100* for

Remarks: _____

* ~~See~~ See enrollment on card from first current roll.

Book mark: _____

(358c)

Ramsey
Cpyist.

C. | 11 (New). | U.S.C.T.

Hans Caruthers

Priv, Co. G, 11 Reg't U. S. Col'd Inf. (New).

Appears on

Company Muster Roll

for *May & June*, 186 *5*.

Joined for duty and enrolled:

When *Jan 12*, 186 *4*.*

Where *Ft Pickering*.*

Period *3* years.*

Present or absent *Present*.

Stoppage, \$ $\frac{100}{100}$ for

Due Gov't \$ $\frac{65}{100}$ for

Remarks:

* See enrollment on card from first current roll.

Book mark:

Ramsey

B. | **11** (New). | **U.S.C.T.**

Hans Caruthers

Pvt., Co. G, 11 Reg't U. S. Col'd Inf. (New).

Appears on

Company Muster Roll

for *July & Aug.*, 186*5*.

Joined for duty and enrolled:

When *Jan 12*, 186*4*.*

Where *F. Pickering*.*

Period *3* years.*

Present or absent *Present*

Stoppage, \$ *100* for

Due Gov't \$ *100* for

Remarks:

* See enrollment on card from first current roll.

Book mark:

Ramsey

C. | 11 (New). | U.S.C.T.

Hans Caruthers

Priv., Co. G, 11 Reg't U. S. Col'd Inf. (New).

Appears on

Company Muster Roll

for Sept & Oct, 1865.

Joined for duty and enrolled:

When Jan 12, 1864.*

Where Ft Pickering.*

Period 3 years.*

Present or absent Present.

Stoppage, \$ 100 for

Due Gov't \$ 100 for

Remarks:

* See enrollment on card from first current roll.

Book mark:

Ramsey
Copyist.

C. | 11 (New). | U.S.C.T.

Hans Caruthers.

Pvt., Co. G, 11 Reg't U. S. Col'd Inf. (New).

Appears on

Company Muster Roll

for *Nov. & Dec.*, 1865.

Joined for duty and enrolled:

When *Jan. 12*, 1864.*

Where *Fort Pickens* *

Period *3* years.*

Present or absent *present.*

Stoppage, \$ *100* for

Due Gov't \$ *100* for

Remarks:

* ~~See~~ See enrollment on card from first current roll.

Book mark: -----

(358c)

[Signature]

Copyist.

C. | 11 (New). | U.S.C.T.

Hans Caruthers.

Prvt G., 11 Reg't U. S. Col'd Inf. (New).

Appears on **Co. Muster-out Roll**, dated
Memphis T. Jan. 12, 1866.

Muster-out to date *Jan. 12,* 1866.

Last paid to *June 20,* 1865.

Clothing account:

Last settled _____, 186 ; drawn since \$ _____ 100

Due soldier \$ ⁶⁸ 100; due U. S. \$ _____ 100

Am't for cloth'g in kind or money adv'd \$ _____ 100

Due U. S. for arms, equipments, &c., \$ _____ 100

Bounty paid \$ _____ 100; due \$ _____ 100

Remarks: _____

Book mark : *11 Reg't U.S. Col'd Inf.*

(361)

W. Wood
Copyist.

258

Caruthers, Henry

Co *C*, 11 U.S. Col'd Inf.

(New Organization.)

Private

Private

CARD NUMBERS.

1	6322710	26
2	6329941	27
3	6330030	28
4	6330121	29
5	6330203	30
6	6330277	31
7	6330349	32
8	6330420	33
9	6330484	34
10	6330553	35
11	6330629	36
12	6330744	37
13	6330883	38
14	9072107	39
15		40
16		41
17		42
18		43
19		44
20		45
21		46
22		47
23		48
24		49
25		50

Book Mark:

See also

6

11 (new) U. S. C. T.

Henry Caruthers

(new)
Co. F., 11 Reg't U. S. Col'd Inf.

Appears on

Company Descriptive Book

of the organization named above.

DESCRIPTION.

Age 18 years height 5 feet 3 1/2 inches.

Complexion Bk

Eyes; Bk hair Bk

Where born Desota-Miss.

Occupation

ENLISTMENT.

When Jun - 2 - , 1864.

Where Ft. Pickering.

By whom J. G. Kappner; term 3 y'rs.

Remarks: Discharged by
command of Maj. Genl.
Stoneman, July, 31,
1865.

F. A. Wright

6

11 (New). U.S.C.T.

Henry Caruthers

Appears with rank of *Pri* on

Muster and Descriptive Rolls of Detachments of U. S. Vols. forwarded

for the *11* Reg't U. S. Col'd *Inf* Roll dated
Memphis Tenn Mar 1, 1864.

Where born *De Soto Co Miss*

Age *18* y'rs; occupation

When enlisted *Jan 12*, 1864.

Where enlisted *Ft Pickering*

For what period enlisted *3* years.

Eyes *black*; hair *black*

Complexion *black*; height *5 ft. 3 1/2* in.

When mustered in *Feb 24*, 1864.

Where mustered in *Ft Pickering*

Bounty paid \$ *100*; due \$ *100*

Where credited

Company to which assigned *F*

Remarks:

Book mark:

Ashley

C

11 (New).

U.S.C.T.

Henry Caruthers
Capt., Co. F, 1 Battalion, 1 Reg't Tenn. H. Art'y.†

Age _____ years.

Appears on

Company Muster Roll*

for Jan 11 to Feb 11, 1864.

Joined for duty and enrolled:

When Jan 2, 1864.

Where Ft Pickering

Period 3 years

Mustered in:

When Feb 24, 1864.

Where Memphis

Present or absent Present

Stoppage, \$ 100 for

Due Gov't, \$ 100 for

Remarks:

† This organization subsequently became Co. F, 11 Reg't U. S. Colored Infantry (New).

* First current roll. No muster-in roll of this company on file.

Book mark:

Rose

C

11 (New).

U.S.C.T.

Henry Canthers

Priv, Co. F, 6 Reg't U. S. Col'd H. Art'y.*

Appears on

Company Muster Roll

for *March* *April*, 1864.

Present or absent *Present*

Stoppage, \$ *100* for

Due Gov't, \$ *100* for

Remarks:

* This organization subsequently became Co. F, 11 Reg't U. S. Colored Infantry (New).

Book mark:

Rose

C

11 (New).

U.S.C.T.

Henry Carnot

Sgt., Co. F, 7 Reg't U. S. Col'd H. Art'y.*

Appears on

Company Muster Roll

for *May and June*, 186*4*

Present or absent *Present*

Stoppage, \$ *100* for

Due Gov't, \$ *100* for

Remarks:

* This organization subsequently became Co. F, 11 Reg't U. S. Colored Infantry (New).

Book mark:

J. H. [unclear]

C

11 (New).

U.S.C.T.

Henry Caruthers

Private, Co. F, 7 Reg't U. S. Col'd H. Art'y.*

Appears on

Company Muster Roll

for July to Aug, 1864.

Present or absent Present

Stoppage, \$ 100 for

Due Gov't, \$ 100 for

Remarks:

* This organization subsequently became Co. F, 11 Reg't U. S. Colored Infantry (New).

Book mark:

Roll

C | 11 (New). | U.S.C.T.

Henry Caruthers

Priv, Co. F, 7 Reg't U. S. Col'd H. Art'y.*

Appears on

Company Muster Roll

for *Sept & Oct*, 1864.

Present or absent *Present*

Stoppage, \$ *100* for

Due Gov't, \$ *100* for

Remarks:

* This organization subsequently became Co. F, 11 Reg't U. S. Colored Infantry (New).

Book mark:

C | 11 (New). | U.S.C.T.

Henry Caruthers
Sgt., Co. F, 7 Reg't U. S. Col'd H. Art'y.*

Appears on

Company Muster Roll

for Nov and Dec, 1864.

Present or absent Present

Stoppage, \$ 100 for

Due Gov't, \$ 100 for

Remarks:

* This organization subsequently became Co. F, 11 Reg't U. S. Colored Infantry (New).

Book mark:

Rose

C

11 (New)

U.S.C.T.

Henry Caruthers

Priv, Co. F, 11 Reg't U. S. Col'd Inf. (New).

Appears on

Company Muster Roll

for *Jan & Feb*, 1865.

Present or absent *Present*

Stoppage, \$ 100 for

Due Gov't, \$ 100 for

Remarks:

Book mark:

Spucher

C | 11 (New) | U.S.C.T.

Henry Caruthers
Pat, Co. F, 11 Reg't U. S. Col'd Inf. (New).

Appears on

Company Muster Roll

for *March & Apr*, 1865.

Present or absent *Absent*

Stoppage, \$ *100* for

Due Gov't, \$ *100* for

Remarks: *Absent sick in*
Wobster Genl. Hospital

Book mark:

(358)

Spicher

Copyist.

C | 11 (New) | U.S.C.T.

Henry Caruthers
Pot., Co. F, 11 Reg't U. S. Col'd Inf. (New).

Appears on

Company Muster Roll

for *May & June*, 1865.

Present or absent *Absent*

Stoppage, \$ *100* for

Due Gov't, \$ *100* for

Remarks: *Absent sick in Genl.
Hospital Memphis Tenn.*

Book mark:

C

11 (New) U.S.C.T.

Henry Caruthers
Pot., Co. F, 11 Reg't U. S. Col'd Inf. (New).

Appears on

Company Muster Roll

for *July & Aug*, 1865.

Present or absent *Absent*

Stoppage, \$ 100 for

Due Gov't, \$ 100 for

Remarks: *Absent sick in Genl. Hospital Memphis, Tenn.*

Book mark:

Spencer

C 11 (New) U.S.C.T.

Henry Caruthers
Pvt, Co. F, 11 Reg't U. S. Col'd Inf. (New).

Appears on

Company Muster Roll

for *Sept & Oct*, 186*5*.

Present or absent

Stoppage, \$ 100 for

Due Gov't, \$ 100 for

Remarks: *Discharged for disability by order of Genl. Sherman. Final Statement given at Hospt.*

Book mark: *Discharged Aug. 3/165 ER 12/309*

(358)

Sprecher

Copist.

C

11 (New).

U.S.C.T.

Henry Caruthers

Plt F, 11 Reg't U. S. Col'd Inf. (New).

Appears on Co, Muster-out Roll, dated

Memphis Tenn. Jan 12, 1866.

Muster-out to date _____, 186 .

Last paid to *Aug 51*, 1864.

Clothing account:

Last settled _____, 186 ; drawn since \$ _____ 100

Due soldier \$ _____ 100; due U. S. \$ _____ 100

Am't for cloth'g in kind or money adv'd \$ _____ 100

Due U. S. for arms, equipments, &c., \$ _____ 100

Bounty paid \$ _____ 100; due \$ _____ 100

Remarks: *Discharged for disability at Memphis Tenn Aug 31/65 by order of Genl. Stoneham*

Book mark: *Des. list on file in Misc. Box - 734, 1878*

Caruthers, Henry -
 P, Co. I, 11 Reg't U. S. C. Inf.

Enclosures.

Bed Cards	Descriptive Lists
Burial Records	Final Statements
Certs. of Dis. for Discharge	Furloughs
C. M. Charges	Med. Des. Lists
Med. Certificates	Orders

Other papers relating to—

Admission to Hosp'l	Furlough
Casualty Sheet (Officer's)	Med. Examination
Confinement	Misc. Information
Contracts	Pay or Clothing
Death or Effects	Personal Reports
Desertions	Rank
Discharge from Hosp'l	Transfer to Hosp'l
Discharge from Service	Transfer to V. R. C.
Duty	Transportation

[OFFICE ENDORSEMENT.]

War Department,

ADJUTANT GENERAL'S OFFICE,

May 3, 18*67*

The discharge of *Priv. Henry Canther*,
Company G, *11th* Reg't U. S.
Colored *Inf.*, is reported as follows:

On Company Muster Roll.
For *September & October, 1865*, *no data*, 18*65*

Company Muster-out Roll.
August 31, 18*65*

Company Descriptive Book. 18*65*

Company Morning Reports. 18*65*

Soldier's Final Statement. 18*65*

Soldier's Record of Death and Interment. 18*65*

Soldier's Inventory of Effects. 18*65*

Soldier's Certificate of Disability for Discharge.
August 31, 18*65*

Soldier's Individual Muster-out Roll. 18*65*

Regimental Return.
For *September, 1865*, *August 31*, 18*65*

Regimental Quarterly Returns. 18*65*

Regimental Descriptive Book. 18*65*

By Surgeon General. 18*65*

(August 31, 1865, is held to be the correct date, and the Company Muster Roll will be amended accordingly.)

Thomas M. Sweet

C/3 Assistant Adjutant General.
Noted g.d.m.

C. B. 32. A. W. F. 1865.

No. 71. Roll of Discharges

CERTIFICATE OF DISABILITY FOR DISCHARGE

IN THE CASE OF

Henry Canther
a *Private* Co. *F*

11th Reg't of *W.C. Inf*
Office left *St. Louis*
when *sent* *Memphis Tenn.*
Aug - 30 1865.
Approved.

H. D. Wright
Bvt. Major & Comdr. of *Co.*
Inf. reg

HEAD-QUARTERS DEPT. OF TENNESSEE.

MEMPHIS, TENN. *Aug. 31*, 1865.

TO BE DISCHARGED.

BY COMMAND OF MAJ. GENERAL GEORGE STONEMAN

Wm. W. Cannon
CAPT. & A. G.

Received (A. G. Office) _____, 186*5*

En: on O. R. Roll

ARMY OF THE UNITED STATES.

CERTIFICATE

OF DISABILITY FOR DISCHARGE.



Private Henry Caruthers, of Captain Joseph L. Gates Company, (G) of the Essex Regiment of United States Colored Infantry was enlisted by Levi Kappner of the 9th Regiment of Ill at Fort Pickens on the 5th day of January, 1864, to serve 3 years; he was born in Desoto Co in the State of Mississippi, is Eighteen years of age, 5 feet 3 1/2 inches high, Black complexion, Black eyes, Black hair, and by occupation when enlisted a Laborer. During the last two months said soldier has been unfit for duty because of disease of the heart. Disease existed prior to enlistment. days.

STATION: Webster Quarters Memphis Tenn
 DATE: August 30 1865.

Chas. D. Jessop.
Asst Surg U.S.A.
Commanding Company.

I CERTIFY, that I have carefully examined the said Henry Caruthers of G Captain Gates Company, and find him incapable of performing the duties of a soldier because off Cardiac Hypertrophy. Disease existed prior to enlistment. Is not fit for transfer to Veteran Reserve Corps.

Chas. D. Jessop.
Asst Surgeon U.S.A.
in charge Webster's Regt Hoop.

DISCHARGED this 31 day of August, 1865, at Memphis
Tenn

Wm. H. Wright
Bvt Maj & Anty of U.S.A.
Commanding the Regt
Webster's Regt Hoop.

The Soldier desires to be addressed at
 Town County State

* See Note 1 on the back of this. † See Note 2 on the back of this.
 [A. G. O. No. 100 & 101—First.] [DUPLICATES.]

259
Paruthess, Lee

Co *Y*, 11 U.S. Col'd Inf.
(New Organization.)

Corporal Corporal

CARD NUMBERS.

1	6 3 2 2 5 9 0	26
2	6 3 3 0 9 3 6	27
3	6 3 3 1 0 2 4	28
4	6 3 3 1 1 2	29
5	6 3 3 1 1 9 7	30
6	6 3 3 1 2 7 9	31
7	6 3 3 1 3 6 2	32
8	6 3 3 1 4 4 4	33
9	6 3 3 1 5 2 7	34
10	6 3 3 1 6 1 0	35
11	6 3 3 1 6 9 3	36
12	6 3 3 1 7 6 7	37
13	6 3 3 1 8 3 9	38
14	6 3 3 1 9 1 1	39
15	9 0 7 2 5 1 4	40
16		41
17		42
18		43
19		44
20		45
21		46
22		47
23		48
24		49
25		50

Book Mark:

See also

6

11 ^(New) U.S.C.T.

Lee Caruthers

Co. *G*, 11 Reg't U.S. Col'd Inf. ^(New)

Appears on

Company Descriptive Book

of the organization named above.

DESCRIPTION.

Age *27* years height *5* feet *6* ¹/₄ inches.

Complexion *Black*

Eyes; *blue* hair *black*

Where born *De Soto Co. Miss.*

Occupation *laborer*

ENLISTMENT.

When *Jan 12*, 1864.

Where *Fort Pickens*

By whom *Lee Kappner*; term *3* y'rs.

Remarks: *Re-enlisted 6 Corporal*
Jan. 20 64

A. J. Anderson

6

11 (New). U.S.C.T.

Lee Caruthers

Appears with rank of 6th Corp'l on

Muster and Descriptive Rolls of Detachments of U. S. Vols. forwarded

for the 11 Reg't U. S. Col'd Inf. Roll dated
Memphis Tenn, Feb 2, 1864.

Where born De Soto Co Miss.

Age 27 y'rs; occupation

When enlisted Jan 12, 1864.

Where enlisted Fort Pickering

For what period enlisted 3 years.

Eyes Black; hair Black

Complexion Black; height 5 ft. 6 1/4 in.

When mustered in Feb 4, 1864.

Where mustered in Fort Pickering

Bounty paid \$ 100; due \$ 100

Where credited

Company to which assigned

Remarks:

Book mark:

Ashley

6 | 11 (New). | U.S.C.T.

Lee Baruthers
6" Corp. Co. E, 1 Battalion, 1 Reg't Tenn. H. Art'y.†

Age _____ years.

Appears on

Company Muster Roll*

for Feb 4 to 29, 1864.

Joined for duty and enrolled:

When Jan 12, 1864.

Where Fort Pickering

Period 3 years.

Mustered in:

When Feb 4, 1864.

Where Fort Pickering

Present or absent Present

Stoppage, \$ 100 for

Due Gov't \$ 100 for

Remarks: Detailed in charge of teams since Jan. 12. 1864

† This organization subsequently became Co. G, 11 Reg't U. S. Colored Infantry (New).

* First current roll. No muster-in roll of this company on file. This roll shows enrollment of all men of this company as of same date. See enrollment on subsequent card or cards.

Book mark:

(3586)

Sallade

Copyist.

6 | 11 (New). | U.S.C.T.

Lee Caruthers
Co. G, 7 Reg't U. S. Col'd H. Art'y.†

Appears on

Company Muster Roll

for May & June, 1864.

Joined for duty and enrolled:

When Jan 12, 1864.*

Where Ft Pickens *

Period 3 years.*

Present or absent Present

Stoppage, \$ 100 for

Due Gov't, \$ 100 for

Remarks: On daily duty as teamster since Jan. 12, 1864

† This organization subsequently became Co. G, 11 Reg't U. S. Colored Infantry (New).

* See enrollment on card from first current roll.

Book mark:

(858c)

Ballade
Copyist.

11 (New). U.S.C.T.

See Certificate

Ward, Co. G, 7 Reg't U. S. Col'd H. Art'y.†

Appears on

Company Muster Roll

for *July & Aug*, 1864.

Joined for duty and enrolled:

When *Jan 12*, 1864.*

Where *Ft. Pickens* *

Period *3* years.*

Present or absent *Present*

Stoppage, \$ *100* for

Due Gov't, \$ *100* for

Remarks: *In daily duty as
muster since Jan 12, 1864.*

† This organization subsequently became Co. G, 11 Reg't U. S. Colored Infantry (New).

* See enrollment on card from first current roll.

Book mark:

Sallade

11 (New). U.S.C.T.

Wm. Caruthers
Co. G, 7 Reg't U. S. Col'd H. Art'y.†

Appears on

Company Muster Roll

for *Sept 1864*, 1864.

Joined for duty and enrolled:

When *Jan 12*, 1864.*

Where *Ft. Pickens* *

Period *3* years.*

Present or absent *Present*

Stoppage, \$ *100* for

Due Gov't, \$ *100* for

Remarks: *On daily duty in
Engineers Department since
Jan 12, 1864*

† This organization subsequently became Co. G, 11 Reg't U. S. Colored Infantry (New).

* See enrollment on card from first current roll.

Book mark:

Sullivan

11 (New). U.S.C.T.

See Barathens
Corp, Co. G, 7 Reg't U. S. Col'd H. Art'y.†

Appears on

Company Muster Roll

for *Nov & Dec*, 1864.

Joined for duty and enrolled:

When *Jan 12*, 1864.*

Where *Fort Pickens* *

Period *3* years.*

Present or absent *Present*

Stoppage, \$ *100* for

Due Gov't, \$ *100* for

Remarks:

† This organization subsequently became Co. G, 11 Reg't U. S. Colored Infantry (New).
* See enrollment on card from first current roll.

Book mark:

Sacade
Copyist.

C. | 11 (New). | U.S.C.T.

Lee Caruthers

5th Corp., Co. G, 11 Reg't U. S. Col'd Inf. (New).

Appears on

Company Muster Roll

for Jan & Feb, 1865.

Joined for duty and enrolled:

When Jan 12, 1864.*

Where Ft Pickering. *

Period 3 years.*

Present or absent Present.

Stoppage, \$ 100 for

Due Gov't \$ 100 for

Remarks:

* See enrollment on card from first current roll.

Book mark:

(358c)

Ramsey
Coyist.

C. | **11** (New). | **U.S.C.T.**

Lee Caruthers

4th Corp, Co. G, 11 Reg't U. S. Col'd Inf. (New).

Appears on

Company Muster Roll

for *Mar & Apr*, 186 **5**

Joined for duty and enrolled:

When *Jan 12*, 186 **4**.*

Where *Ft Pickering*.*

Period *3* years.*

Present or absent *Present*

Stoppage, \$ *100* for

Due Gov't \$ *100* for

Remarks:

* ~~10~~ See enrollment on card from first current roll.

Book mark:

Ramsey
Cpyist.

(358c)

6 | 11 (New). | U.S.C.T.

Lee Caruthers

^{4th} Corp'l, Co. G, 11 Reg't U. S. Col'd Inf. (New).

Appears on

Company Muster Roll

for *May & June*, 1865.

Joined for duty and enrolled:

When *Jan 12*, 1864.*

Where *Ft Pickering*. *

Period *3* years.*

Present or absent *Present*.

Stoppage, \$ $\frac{100}{100}$ for

Due Gov't \$ $\frac{31}{100}$ for

Remarks:

* See enrollment on card from first current roll.

Book mark:

(358c)

Ramsey Copyist.

C. | 11 (New). | U.S.C.T.

Lee Caruthers

4th Corp, Co. G, 11 Reg't U. S. Col'd Inf. (New).

Appears on

Company Muster Roll

for July & Aug., 1865.

Joined for duty and enrolled:

When Jan 12, 1864.*

Where Ft Pickering.*

Period 3 years.*

Present or absent Present.

Stoppage, \$ 100 for

Due Gov't \$ 100 for

Remarks:

* See enrollment on card from first current roll.

Book mark:

Ramsey
Copyist.

C. | **11** (New). | **U.S.C.T.**

Liee Caruthers
4th Corp., Co. G, 11 Reg't U. S. Col'd Inf. (New).

Appears on

Company Muster Roll
for *Sept & Oct*, 1865.

Joined for duty and enrolled:

When *Jan 12*, 1864.*

Where *Ft Pickering.* *

Period *3* years.*

Present or absent *Present.*

Stoppage, \$ *100* for

Due Gov't \$ *100* for

Remarks:

* See enrollment on card from first current roll.

Book mark:

(358c)

Ramsay
Cpyist.

C. | 11 (New). | U.S.C.T.

Lee Caruthers

Corpl, Co. G, 11 Reg't U. S. Col'd Inf. (New).

Appears on

Company Muster Roll

for Nov. & Dec., 1865.

Joined for duty and enrolled:

When Jan. 12., 1864.*

Where Fort Pickens *

Period 3 years.*

Present or absent present

Stoppage, \$ 100 for

Due Gov't \$ 100 for

Remarks:

* See enrollment on card from first current roll.

Book mark:

(358c)

[Signature]
Copyist.

C | 11 (New). | U.S.C.T.

Lee Caruthers

Capt G, 11 Reg't U. S. Col'd Inf. (New).

Appears on **Co. Muster-out Roll**, dated
Memphis T., Jan. 12, 1866.

Muster-out to date *Jan. 12,* 1866.

Last paid to *June 30,* 1865.

Clothing account:

Last settled 186 ; drawn since \$ 100

Due soldier \$ 100; due U. S. \$ *1148* / 100

Am't for cloth'g in kind or money adv'd \$ 100

Due U. S. for arms, equipments, &c., \$ 100

Bounty paid \$ 100; due \$ 100

Remarks:

Book mark: *V24 P. 139: 68*

(861)

[Signature]
Copyist.

260

Caruthers, Louis

Co *A*, 11 U.S. Col'd Inf.

(New Organization.)

Musician | *Private*

CARD NUMBERS.

1	6322699	26
2	6329930	27
3	6330022	28
4	6330111	29
5	6330193	30
6	6330268	31
7	6330340	32
8	6330411	33
9	6330486	34
10	6330555	35
11	6330631	36
12	6330701	37
13	6330773	38
14	6330838	39
15	9072095	40
16		41
17		42
18		43
19		44
20		45
21		46
22		47
23		48
24		49
25		50

Book Mark:

See also

6

11 (new) U. S. C. T.

Louis Baruthers

(new)

Co. F, 11 Reg't U. S. Col'd Inf.

Appears on

Company Descriptive Book

of the organization named above.

DESCRIPTION.

Age 19 years height 5 feet 7 1/2 inches.

Complexion Bk

Eyes; Bk hair Bk

Where born Shelby - Tenn.

Occupation

ENLISTMENT.

When Jan - 13, 1864.

Where Ft. Pickens

By whom G. Kappner term 3 y'rs.

Remarks:

F. A. Knight

6

11 (New). U.S.C.T.

Louis Caruthers

Appears with rank of *Musician* on

Muster and Descriptive Rolls of Detachments of U. S. Vols. forwarded

for the *11* Reg't U. S. Col'd *Inf.* Roll dated
Memphis Tenn, *Mar 1*, 1864.

Where born *Shelby Co Tenn*

Age *19* y'rs; occupation

When enlisted *Jan 13*, 1864.

Where enlisted *Ft Pickering*

For what period enlisted *3* years.

Eyes *black*; hair *black*

Complexion *black*; height *5* ft. *7 1/2* in.

When mustered in *Feb 24*, 1864.

Where mustered in *Ft Pickering*

Bounty paid \$ *100*; due \$ *100*

Where credited

Company to which assigned *F*

Remarks:

Book mark:

Ashley

C

11 (New).

U.S.C.T.

Louis Caruthers

Misc, Co. F, 1 Battalion, 1 Reg't Tenn. H. Art'y.†

Age years.

Appears on

Company Muster Roll*

for Jan 11 to Mch 11, 1864.

Joined for duty and enrolled:

When Jan 13, 1864.

Where J. H. Pickering

Period 3 years

Mustered in:

When Feb 24, 1864.

Where Memphis

Present or absent Present

Stoppage, \$ 100 for

Due Gov't, \$ 100 for

Remarks:

† This organization subsequently became Co. F, 11 Reg't U. S. Colored Infantry (New).

* First current roll. No muster-in roll of this company on file.

Book mark:

Rose

C

11 (New).

U.S.C.T.

Louis Caruthers

Muse, Co. F, 6 Reg't U. S. Col'd H. Art'y.*

Appears on

Company Muster Roll

for *Michl Cpl*, 1864.

Present or absent *Present*

Stoppage, \$ 100 for

Due Gov't, \$ 100 for

Remarks:

* This organization subsequently became Co. F, 11 Reg't U. S. Colored Infantry (New).

Book mark: -----

Rose

C

11 (New).

U.S.C.T.

James Caruthers

Muse, Co. F, 7 Reg't U. S. Col'd H. Art'y.*

Appears on

Company Muster Roll

for *May 1st June*, 1861.

Present or absent *Present*

Stoppage, \$ *100* for

Due Gov't, \$ *100* for

Remarks:

* This organization subsequently became Co. F, 11 Reg't U. S. Colored Infantry (New).

Book mark:

W. H. ...

C

11 (New).

U.S.C.T.

Louis Caruthers
Musc, Co. F, 7 Reg't U. S. Col'd H. Art'y.*

Appears on

Company Muster Roll

for *July and Aug*, 186*4*

Present or absent *Present*

Stoppage, \$ *100* for

Due Gov't, \$ *100* for

Remarks: *Taken from the ranks.*

* This organization subsequently became Co. F, 11 Reg't U. S. Colored Infantry (New).

Book mark

(1)

11 (New). U.S.C.T.

James C. Gubbers
I use, Co. F, 7 Reg't U. S. Col'd H. Art'y.*

Appears on

Company Muster Roll

for *Sept & Oct*, 1864.

Present or absent *✓*

Stoppage, \$ *100* for

Due Gov't, \$ *100* for

Remarks: *Incongruent*

*& Name appears in present column
canceled by line.*

* This organization subsequently became Co. F, 11 Reg't U. S. Colored Infantry (New).

Book mark:

James C. Gubbers

C

11 (New).

U.S.C.T.

Lewis Caruthers

Misc, Co. F, 7 Reg't U. S. Col'd H. Art'y.*

Appears on

Company Muster Roll

for *Nov and Dec*, 186*4*

Present or absent *Present*

Stoppage, \$ *100* for

Due Gov't, \$ *100* for

Remarks:

* This organization subsequently became Co. F, 11 Reg't U. S. Colored Infantry (New).

Book mark:

Pass

C | 11 (New) | U.S.C.T.

Lewis Caruthers

Mus., Co. F, 11 Reg't U. S. Col'd Inf. (New).

Appears on

Company Muster Roll

for *Jan & Feb.*, 186 *3.*

Present or absent *Present*

Stoppage, \$ *100* for

Due Gov't, \$ *100* for

Remarks:

Book mark:

Spucher

C | 11 (New) | U.S.C.T.

Lewis Caruthers
Pot, Co. F, 11 Reg't U. S. Col'd Inf. (New).

Appears on

Company Muster Roll

for *March & Apr*, 1865.

Present or absent *Present*

Stoppage, \$ 100 for

Due Gov't, \$ 100 for

Remarks: *On daily duty as
Musician in Reg't Band*

Book mark:

Spencer

②

11 (New)

U.S.C.T.

Lewis Cummings

Priv, Co. F, 11 Reg't U. S. Col'd Inf. (New).

Appears on

Company Muster Roll

for *May & June*, 1865.

Present or absent *Present*

Stoppage, \$ *100* for

Due Gov't, \$ *100* for

Remarks: *Duties as Musician*

Book mark:

Spicher

C 11 (New) U.S.C.T.

Levin Caruthers

Priv, Co. F, 11 Reg't U. S. Col'd Inf. (New).

Appears on

Company Muster Roll

for *July & Aug*, 186*5*.

Present or absent *Present*

Stoppage, \$ *100* for

Due Gov't, \$ *100* for

Remarks:

Book mark:

Spencer

C 11 (New) U.S.C.T.

Low Caruthers

Priv, Co. F, 11 Reg't U. S. Col'd Inf. (New).

Appears on

Company Muster Roll

for *Sept & Oct*, 186*5*.

Present or absent *Present*

Stoppage, \$ *100* for

Due Gov't, \$ *3* ^{*65*}/_{*100*} for *C & G E*

Remarks :
.....
.....
.....
.....
.....
.....
.....
.....

Book mark :

(358) *Spuehr* Copyist.

C 11 (New) U.S.C.T.

Louis Caruthers

Plt., Co. F, 11 Reg't U. S. Col'd Inf. (New).

Appears on

Company Muster Roll

for *Nov - Dec*, 186*5*

Present or absent *Present*

Stoppage, \$ 100 for

Due Gov't, \$ *3 65* for *Equip*

Remarks:

Book mark:

Alford

C

11 (New). U.S.C.T.

Louis Caruthers

1st Lt, F, 11 Reg't U. S. Col'd Inf. (New).

Appears on Co. Muster-out Roll, dated

Memphis Tenn Jan 12 1866.

Muster-out to date

Jan 12 1866.

Last paid to

June 20 1865.

Clothing account:

Last settled 186 ; drawn since \$ 100

Due soldier \$ 100; due U. S. \$ 49 ²⁹/₁₀₀

Am't for cloth'g in kind or money adv'd \$ 100

Due U. S. for arms, equipments, &c., \$ 100

Bounty paid \$ 100; due \$ 100

Remarks Due M. for C. & G. E. & J. 65

Book mark :

Deus

Caruthers, Lewis

Co. **F**, **11** Reg't **U. S. C. Inf.**

2 Enclosures.

Bed Cards	Descriptive Lists
Burial Records	Final Statements
Certs. of Dis. for Discharge	Furloughs
C. M. Charges	Med. Des. Lists
Med. Certificates	Orders

Other papers relating to—

Admission to Hosp'l	Furlough
Casualty Sheet (Officer's)	Med. Examination
Confinement /	Misc. Information /
Contracts	Pay or Clothing
Death or Effects	Personal Reports
Desertions	Rank
Discharge from Hosp'l	Transfer to Hosp'l
Discharge from Service	Transfer to V. R. C.
Duty	Transportation

Fort Pickens Tenn
November 21, 1864

Col W. D. Turner
Comdr. 7th W. Va. Artillery

Requests that Lewis
Garrett's Co. of his
Regiment, be released
from Military Service

I have the honor to acknowledge the receipt of your letter of the 19th inst.

Head Quarter 7th U.S.C.A. Heavy
Fort Pickering Memphis. Nov. 20th 1864

Lieut L. M. Church

A. A. Gens

Fort Pickering.

Lieut

I would hereby respectfully
request that Lewis Caruthers, Co. G. and Musician of
this Regiment, be released from the Military Prison,
~~who~~ who was confined for stealing, no charges will be
preferred.

I am Lieut

Very Respectfully &c
W. H. Farver

Col Candy 7th U.S.C.A. Heavy

Caruthers, Lewis

Co. F.

Comp. Co.

Office Provost Marshal

Fort Pickens November 22. 1867

Commanding
Officer 4th U.S. Art

Sir

I send you under guard
Lewis Caruthers Co. F. 4th. Art confined
Oct 31 for until further order and
released Nov 20. By order of the Col. Comdr
but by request of my clerk he was not
released until this morning
Please receipt for the same by name Compy
and Bag and

Obliged Your most Obedt Servt

H. A. Houston

Capt and Provost Marshal
Fort Pickens

Chas. H. S.

. 261

Caruthers, Nelson

Co *A*, 11 U.S. Col'd Inf.

(New Organization.)

Private

Private

CARD NUMBERS.

1	6322755	26
2	6330122	27
3	6330204	28
4	6330278	29
5	6330350	30
6	6330421	31
7	6330485	32
8	6330554	33
9	6330630	34
10	6330707	35
11	6330772	36
12	6330837	37
13	9072108	38
14		39
15		40
16		41
17		42
18		43
19		44
20		45
21		46
22		47
23		48
24		49
25		50

Book Mark:

See also

261

Caruthers, Nelson

Co A, 11 U.S. Col'd Inf.

(New Organization.)

Private

Private

CARD NUMBERS.

1	6322755	26
2	6330122	27
3	6330204	28
4	6330278	29
5	6330350	30
6	6330421	31
7	6330485	32
8	6330554	33
9	6330630	34
10	6330707	35
11	6330772	36
12	6330837	37
13	9072108	38
14		39
15		40
16		41
17		42
18		43
19		44
20		45
21		46
22		47
23		48
24		49
25		50

Book Mark:

See also

S. 994232 P. 111111
D. 2470081 And wd.

6 | 11 (new) U.S.C.T.

Nelson Caruthers

Co. F, 11 Reg't U.S. Col'd Inf. (new)

Appears on

Company Descriptive Book

of the organization named above.

DESCRIPTION.

Age 29 years height 5 feet 7 inches.

Complexion black

Eyes; black hair black

Where born Richmond-Va-

Occupation

ENLISTMENT.

When April 8, 1864.

Where Fort Pickering

By whom ~~Thos J Jackson~~ term 3 y'rs.

Remarks:

* Entered not recorded in book

F. A. Wrigler.

6

11 (New). U.S.C.T.

Nelson Caruthers

Appears with rank of *Pvt* on

Muster and Descriptive Rolls of Detachments of U. S. Vols. forwarded

7th U S Hy. Art. (Colored)
for the *11* Reg't U. S. Col'd *Inf.* Roll dated

Fort Pickering, *May 24* 1864.

Where born *Richmond Virginia*

Age *29* y'rs; occupation *Farmer*

When enlisted *April 8*, 1864.

Where enlisted *Fort Pickering*

For what period enlisted *3* years.

Eyes *black*; hair *black*

Complexion *black*; height *5* ft. *7* in.

When mustered in *May 26*, 1864.

Where mustered in *Memphis*

Bounty paid \$ *100*; due \$ *100*

Where credited

Company to which assigned

Remarks: *joined as recruits*

Book mark:

Ashley

C

11 (New).

U.S.C.T.

Milson Capentier

Sgt., Co. F, 7 Reg't U. S. Col'd H. Art'y.*

Appears on

Company Muster Roll

for

May and June, 1864

Present or absent

Present

Stoppage, \$ 100 for

Due Gov't, \$ 100 for

Remarks:

* This organization subsequently became Co. F, 11 Reg't U. S. Colored Infantry (New).

Book mark:

Milson

C | 11 (New). | U.S.C.T.

Nelson Caruthers
Sgt, Co. F, 7 Reg't U. S. Col'd H. Art'y.*

Appears on

Company Muster Roll

for July 1st 1864

Present or absent Present

Stoppage, \$ 100 for

Due Gov't, \$ 100 for

Remarks:

* This organization subsequently became Co. F, 11 Reg't U. S. Colored Infantry (New).

Book mark:

C | 11 (New). | U.S.C.T.

Nelson Caruthers
Priv., Co. F, 7 Reg't U. S. Col'd H. Art'y.*

Appears on

Company Muster Roll

for Sep 1st 1864

Present or absent Present

Stoppage, \$ 100 for

Due Gov't, \$ 100 for

Remarks:

* This organization subsequently became Co. F, 11 Reg't U. S. Colored Infantry (New).

Book mark:

Rose

C | 11 (New). | U.S.C.T.

Nelson Caruthers

Put, Co. F, 7 Reg't U. S. Col'd H. Art'y.*

Appears on

Company Muster Roll

for Nov and Dec, 1864

Present or absent Present

Stoppage, \$ 100 for

Due Gov't, \$ 100 for

Remarks:

* This organization subsequently became Co. F, 11 Reg't U. S. Colored Infantry (New).

Book mark:

Rose

C | **11** (New) | **U.S.C.T.**

Wilson Caruthers

Priv, Co. F, 11 Reg't U. S. Col'd Inf. (New).

Appears on

Company Muster Roll

for *Jan & Feb*, 1865.

Present or absent *Present*

Stoppage, \$ *100* for

Due Gov't, \$ *100* for

Remarks:

Book mark:

Spucher

C | 11 (New) | U.S.C.T.

Nelson Caruthers
Priv, Co. F, 11 Reg't U. S. Col'd Inf. (New).

Appears on

Company Muster Roll

for *March & April*, 1865.

Present or absent *Present*

Stoppage, \$ 100 for

Due Gov't, \$ 100 for

Remarks:

Book mark:

Jircher

C. | 11 (New) | U.S.C.T.

Nelson Canthens
Priv, Co. F, 11 Reg't U. S. Col'd Inf. (New).

Appears on

Company Muster Roll

for *May & June*, 1865.

Present or absent *Present*

Stoppage, \$ $\frac{38}{100}$ for *Ordinance*

Due Gov't, \$ $\frac{100}{100}$ for

Remarks: *Ten dollars stopped
per sentence Field Officers
Court.*

Book mark:

Spueher

C | 11 (New) U.S.C.T.

Nelson Caruthers
Priv., Co. F, 11 Reg't U. S. Col'd Inf. (New).

Appears on

Company Muster Roll

for *July & Aug*, 186*5*.

Present or absent *Present*

Stoppage, \$ $\frac{38}{100}$ for *Ordinance*

Due Gov't, \$ $\frac{100}{100}$ for

Remarks: *Stop \$10. per sentence*
of Field Officers Court.

Book mark:

Spucher
(358) Copyist.

A 11 (New) U.S.C.T.

Nelson Caruthers
Pat, Co. F, 11 Reg't U. S. Col'd Inf. (New).

Appears on

Company Muster Roll

for *Sept & Oct*, 186*5*.

Present or absent *Present*

Stoppage, \$ *100* for

Due Gov't, \$ *100* for

Remarks:

Book mark:

Spurcku

C 11 (New) U.S.C.T.

Nelson Caruthers
Sgt, Co. F, 11 Reg't U. S. Col'd Inf. (New).

Appears on

Company Muster Roll

for *Nov & Dec*, 1865.

Present or absent *Present*

Stoppage, \$ 100 for

Due Gov't, \$ 100 for

Remarks:

Book mark:

W. W. W.
Copyist.

C

11 (New). U.S.C.T.

Nelson Caruthers

Pvt. F., 11 Reg't U. S. Col'd Inf. (New).

Appears on Co. Muster-out Roll, dated

Memphis Tenn July 12, 1866.

Muster-out to date

July 12, 1866.

Last paid to

June 30, 1865.

Clothing account:

Last settled, 186 ; drawn since \$ 100

Due soldier \$ *562* 100; due U. S. \$ 100

Am't for cloth'g in kind or money adv'd \$ 100

Due U. S. for arms, equipments, &c., \$ 100

Bounty paid \$ 100; due \$ 100

Remarks:

Book mark: *Y21 P. 160-68*

Deno

(861)

Copyist.

Caruthers, Nelson

P, Co. F. **11** U. S. C. Inf.
Reg't

2 Enclosures.

Bed Cards	Descriptive Lists
Burial Records	Final Statements
Certs. of Dis. for Discharge	Furloughs
C. M. Charges	Med. Des. Lists
Med. Certificates	Orders

Other papers relating to—

Admission to Hosp'l	Furlough
Casualty Sheet (Officer's)	Med. Examination
Confinement	Misc. Information
Contracts	Pay or Clothing
Death or Effects	Personal Reports
Desertions	Rank
Discharge from Hosp'l	Transfer to Hosp'l
Discharge from Service	Transfer to V. R. C.
Duty	Transportation

Proceedings of a Field Officers Court held, at
Head Quarters 11th U.S. Inf. Memphis Tenn
June 10th 1865

Head Quarters Fort Pickens
Memphis Tenn 13th May 1863

Special Order
No 70

|| Major Geo. S. Paddock
Commanding 11th U.S. Inf. being the only
Field Officer present with the command
is hereby announced as Field Officers Court
for said regiment in compliance with Par
VII of the Act of Congress approved July 17th
1862 and will try such cases as come within
his jurisdiction.

By order of

Col. J. S. Pappas

signed T. M. Hudgins

Capt & aqals

No 23

In the case of Private Welson Canthine Co F
11th U.S. Inf

Present Maj Geo. S. Paddock the court; also
present the Prisoner.

Charge by Capt Gales Violation of 50th Art
of War by leaving his company without
permission - this at Memphis Tenn
June 5. 1865

Plen Guilty

481 = 68, 11 = B = 1, 2, 157

Adj. Quarter M. U. S. Army

June 12th 1865

Major Gen. L. P. Brock
Field Officer, Genl.

Respectfully for records, procuring
in the case of the Nelson Cavalry
Co. 7th U. S. Army

23

Adj. Quarter M. U. S. Army
Approved - respectfully
forwarded
Geo. L. Saddock
Maj. U. S. Army
Bond

Traveling Guilty
Sentence that he forfeit \$10⁰⁰ of his
monthly pay to be stoped, on the next roll

Geo. L. Saddock
Maj. U. S. Army
F. O. Court

Nelson Caruthers

Pvt. Co. 4th 11th U.S. C. (new)

Ellersbrook

Adjutant General's Office,

COLORED TROOPS BRANCH,

Mr Ellertson

April 27, 1877

Vol. C. T., 187

Wanted in the case of *Nelson Caruthers* Private, Co. "F",
11th Reg't U. S. C. Troops (new) Record of Trial
Ten dollars stopped per sentence of F. O. C. - 2200
May & June 1865.

H. J. C.

Respectfully,

L. A. Woodward

J. J. Larson Chief Clerk.

Adjutant General's Office,

Record Room

May 3, 1877

Vol. C. T., 187

Reply in case of *Nelson Caruthers*, Co. "F",
11th Reg't U. S. C. T.

*Tried by F. O. Court June 10 1865 - Charge - Violation
of the 50th article of War. Guilty - To forfeit \$10-*

G. B.

262

Caruthers, Samuel

Co. G, 11 U.S. Col'd Inf.

(New Organization.)

Sergeant Corporal

CARD NUMBERS.

1	6322581	26
2	6330927	27
3	6331014	28
4	6331103	29
5	6331188	30
6	6331270	31
7	6331359	32
8	6331436	33
9	6331520	34
10	6331609	35
11	6331691	36
12	6331766	37
13	6331837	38
14	6331909	39
15	9072212	40
16		41
17		42
18		43
19		44
20		45
21		46
22		47
23		48
24		49
25		50

Book Mark:

See also

8130 7394 P.O. m. m.

11 (New) U.S.C.T.

Jammie Caruthers
(New)
Co. G, 11 Reg't U.S. Col'd Inf.

Appears on
Company Descriptive Book
of the organization named above.

DESCRIPTION.

Age 25 years height 5 feet 6 inches.

Complexion Black

Eyes; Blue hair Black

Where born Rockbridge Co., Va.

Occupation Laborer

ENLISTMENT.

When Jan 12, 1864.

Where Fort Pickens

By whom Capt. Rappin; term 3 y'rs.

Remarks: Appointed 2^d Sgt Jan 12/64. Promoted to Corp Jan 12/65 S.C. 114.

A. J. Anderson

6

11 (New). U.S.C.T.

Samuel Caruthers

Appears with rank of 2nd Sergt on

Muster and Descriptive Rolls of Detachments of U. S. Vols. forwarded

for the 11 Reg't U. S. Col'd Inf Roll dated

Memphis Tenn Feb 2, 1864.

Where born Rockbridge Co. Va,

Age 25 y'rs; occupation

When enlisted Jan 12, 1864.

Where enlisted Fort-Pickering

For what period enlisted 3 years.

Eyes Black; hair Black

Complexion Black; height 5 ft. 6 in.

When mustered in Feb 4, 1864.

Where mustered in Fort-Pickering

Bounty paid \$ 100; due \$ 100

Where credited

Company to which assigned

Remarks:

Book mark:

Ashley

6 11 (New). U.S.C.T.

Samuel Barthers
2nd Regt Co. E, 1 Battalion, 1 Reg't Tenn. H. Art'y.†

Age years.

Appears on

Company Muster Roll*

for Feb 4 to 29 , 1864.

Joined for duty and enrolled:

When Jan 12 , 1864.

Where Fort Pickering

Period 3 years.

Mustered in:

When Feb 4 , 1864.

Where Fort Pickering

Present or absent Present

Stoppage, \$ 100 for

Due Gov't \$ 100 for

Remarks:

† This organization subsequently became Co. G, 11 Reg't U. S. Colored Infantry (New).

* First current roll. No muster-in roll of this company on file. This roll shows enrollment of all men of this company as of same date. See enrollment on subsequent card or cards.

Book mark:

Ballade

(358b)

Copyist.

6 | 11 (New). | U.S.C.T.

Samuel Baruthers
2^d Seryt Co. G, 6 Reg't U. S. Col'd H. Art'y.†

Appears on

Company Muster Roll

for March + April, 1864.

Joined for duty and enrolled:

When Jan 12, 1864.*

Where Ft. Pickering *

Period 3 years.*

Present or absent Present

Stoppage, \$ 100 for

Due Gov't \$ 100 for

Remarks: On daily duty in
Engineer Dept since March
23^d 1864.

* This organization subsequently became Co. G, 11 Reg't U. S. Colored Infantry (New).

* See enrollment on card from first current roll.

Book mark:

Ballade

11 (New). U.S.C.T.

Samuel Baruthers
Seryt, Co. G, 7 Reg't U. S. Col'd H. Art'y.†

Appears on

Company Muster Roll

for May & June, 1864.

Joined for duty and enrolled:

When Jan 12, 1864.*

Where Ft Pickering *

Period 3 years.*

Present or absent Present

Stoppage, \$ 100 for

Due Gov't, \$ 100 for

Remarks: He did duty in
Engineer Dept since
March 23, 1864

† This organization subsequently became Co. G, 11 Reg't U. S. Colored Infantry (New).

* See enrollment on card from first current roll.

Book mark:

Ollade

6 | 11 (New). | U.S.C.T.

Samuel Baruthers

2^d Sgt, Co. G, 7 Reg't U. S. Col'd H. Art'y.†

Appears on

Company Muster Roll

for July & Aug, 1864.

Joined for duty and enrolled:

When Jan 12, 1864.*

Where Ft Pickens *

Period 3 years.*

Present or absent Present

Stoppage, \$ 100 for

Due Gov't, \$ 100 for

Remarks: On duty in Engineer Dept since March 23, 1864

† This organization subsequently became Co. G, 11 Reg't U. S. Colored Infantry (New).

* See enrollment on card from first current roll.

Book mark:

Jallade
Copyist.

6 | 11 (New). | U.S.C.T.

Samuel Carothers
2^d Sgt., Co. G, 7 Reg't U. S. Col'd H. Art'y.†

Appears on

Company Muster Roll

for Sept & Oct, 1864.

Joined for duty and enrolled:

When Jan 12, 1864.*

Where Ft. Pickens *

Period 3 years.*

Present or absent Present

Stoppage, \$ 100 for

Due Gov't, \$ 100 for

Remarks: On daily duty in
Engineers Dept since
March 23, 1864

† This organization subsequently became Co. G, 11 Reg't U. S. Colored Infantry (New).

* See enrollment on card from first current roll.

Book mark:

Ballade

11 (New). U.S.C.T.

William & arthers
Burt, Co. G, 7 Reg't U. S. Col'd H. Art'y.†

Appears on

Company Muster Roll

for Two Dec, 1864

Joined for duty and enrolled:

When Jan 12, 1864*

Where Fort Pickens*

Period 3 years.*

Present or absent Present

Stoppage, \$ 100 for

Due Gov't, \$ 100 for

Remarks:

† This organization subsequently became Co. G, 11 Reg't U. S. Colored Infantry (New).

* See enrollment on card from first current roll.

Book mark:

W. Burt

C, | 11 (New). | U.S.C.T.

Samuel Baruthers

2^d Sert, Co. G, 11 Reg't U. S. Col'd Inf. (New).

Appears on

Company Muster Roll

for Jan & Feb., 1865.

Joined for duty and enrolled:

When Jan. 12, 1864.*

Where Ft Pickering, *

Period 3 years.*

Present or absent Present.

Stoppage, \$ 100 for

Due Gov't \$ 100 for

Remarks:

* See enrollment on card from first current roll.

Book mark:

(358c)

Ramsey
Cpyist.

C. | **11** (New). | **U.S.C.T.**

Samuel Caruthers

2^d Sgt., Co. G, 11 Reg't U. S. Col'd Inf. (New).

Appears on

Company Muster Roll

for *Mar & Apr*, 186*5*.

Joined for duty and enrolled:

When *Jan 12*, 186*4*.*

Where *Ft. Pickering*. *

Period *3* years.*

Present or absent *Present*.

Stoppage, \$ *100* for

Due Gov't \$ *60* / *100* for

Remarks :

* ~~13~~ See enrollment on card from first current roll.

Book mark : -----

Ramsey
Cpyist.

C. | 11 (New). | U.S.C.T.

Samuel Caruthers
3^d Corp'l., Co. G, 11 Reg't U. S. Col'd Inf. (New).

Appears on

Company Muster Roll

for *May & June*, 1865.

Joined for duty and enrolled:

When *Jan 12*, 1864.*

Where *Ft Pickering*. *

Period *3* years.*

Present or absent *Present*.

Stoppage, \$ *100* for

Due Gov't \$ *1/10* for

Remarks: *Sergt Samuel Caruthers. Reduced to Corp'l. June 12/65, S.O. No. 114.*

* See enrollment on card from first current roll.

Book mark:

(358c)

Ramsey
Copyist.

C.

11 (New).

U.S.C.T.

Samuel Caruthers
3^d Corp'l, Co. G, 11 Reg't U. S. Col'd Inf. (New).

Appears on

Company Muster Roll

for July & Aug., 1865.

Joined for duty and enrolled:

When Jan 12, 1864.*

Where Ft Pickering, *

Period 3 years.*

Present or absent Present.

Stoppage, \$ 100 for

Due Gov't \$ 100 for

Remarks: Sergt Samuel Ca-
ruthers, reduced to Corp'l.
Jun 12/65, S.O. no. 114.

* ~~See~~ See enrollment on card from first current roll.

Book mark: _____

(358c)

Ramsey
Cpyist.

6. | 11 (New). | U.S.C.T.

Samuel Caruthers
3^d Corp'l, Co. G, 11 Reg't U. S. Col'd Inf. (New).

Appears on

Company Muster Roll

for Sept & Oct, 1865.

Joined for duty and enrolled:

When Jan 12, 1864.*

Where Ft Pickering *

Period 3 years.*

Present or absent Present.

Stoppage, \$ 100 for

Due Gov't \$ 100 for

Remarks:

* See enrollment on card from first current roll.

Book mark:

Ramsay
Cpyist.

C. | 11 (New). | U.S.C.T.

Sam. Caruthers.

Capt., Co. G, 11 Reg't. U. S. Col'd Inf. (New).

Appears on

Company Muster Roll

for *Nov. & Dec.*, 1865.

Joined for duty and enrolled:

When *Jan. 12*, 1864.*

Where *Fort Pickens*.*

Period *3* years.*

Present or absent *present*,

Stoppage, \$ *100* for

Due Gov't \$ *100* for

Remarks:

* ~~See~~ See enrollment on card from first current roll.

Book mark:

[Signature]

C. 11 (New). U.S.C.T.

Samuel Caruthers,
Capt G., 11 Reg't U. S. Col'd Inf. (New).

Appears on Co. Muster-out Roll, dated
Memphis T. Jan. 12, 1866.

Muster-out to date Jan. 12, 1866.

Last paid to June 30, 1865.

Clothing account:

Last settled 186 ; drawn since \$ 100

Due soldier \$ 5⁸⁰ 100; due U. S. \$ 100

Am't for cloth'g in kind or money adv'd \$ 100

Due U. S. for arms, equipments, &c., \$ 100

Bounty paid \$ 100; due \$ 100

Remarks:

Book mark: Des List on file

(361)

Copyist.

Caruthers Samuel

Corp, Co. G, 11 Reg't U. S. C. I

Enclosures.

Bed Cards	Final Statements
Burial Records	Furloughs or L. of A
Certs. of Dis. for Discharge	Med. Certificates
C. M. Charges	Med. Des. Lists
Descriptive Lists	Orders
Discharge Certificates	Pris. of War Record
Enlistment Papers	Resignations

Other papers relating to—

Admission to Hosp'l	Furlough or L. of A
Casualty Sheet	Med. Examination
Confinement	Misc. Information
Contracts	Pay or Clothing
Death or Effects	Personal Reports
Desertion	Rank
Discharge from Hosp'l	Transfer to Hosp'l
Discharge from Service	Transfer to V. R. C.
Duty	Transportation

Samuel Cantham

Capt. G. Co. 11th W. I. Regt.

Ellerswood

Adjutant General's Office,

COLORED TROOPS BRANCH,

Mr Ellertson

May 15th, 1877

Vol. C. T., 187

Wanted in the case of Samuel Caruthers Corp'l, Co. "D",
11th Reg't U. S. C. Troops (new) - Cause of reduction -
"Reduced to Corp'l - (from Sergt) June 12th 1865 S. O. 114."
M.R. May & June 1865.

Handwritten initials

Respectfully,

L. A. Woodward,
Chief Clerk
Per J. Halson

Adjutant General's Office,

Div. Records & discontinued Comd's &c

May 24th, 1877

Vol. C. T., 187

Reply in case of Samuel Caruthers Corp'l, Co. "G",
11th Reg't U. S. C. T.

Co. Descriptive book, Morning Rep. books and Order book,
show: Reduced from Sergt. to Corp'l. June 12th 1865
S. O. 114 Reg't. 14th Co. of same date. - Cause not stated.

Handwritten initials

263

Casson, Gardin

Co D, 11 U.S. Col'd Inf.

(New Organization.)

Private

Private

CARD NUMBERS.

1	6 3 2 3 5 2 5	26
2	6 3 2 3 6 1 6	27
3	6 3 2 3 7 9 7	28
4	6 3 2 3 8 1 0	29
5	6 3 2 3 9 1 4	30
6	6 3 2 4 0 2 0	31
7	6 3 2 4 1 1 1	32
8	6 3 2 2 9 6 1	33
9	6 3 2 4 2 1 2 5	34
10	6 3 2 4 2 8 5	35
11	6 3 2 4 3 2 7	36
12	6 3 2 4 3 9 3	37
13	6 3 2 4 4 6 0	38
14	6 3 2 4 5 7 6	39
15	6 3 2 4 9 1 5	40
16	9 0 7 0 5 7 4	41
17	9 0 7 0 6 1 2	42
18	9 0 7 0 7 9 8	43
19		44
20		45
21		46
22		47
23		48
24		49
25		50

Book Mark: 6-105-V-10-65-74

See also

P 1619496 P. O. m m

A 1912520 P O 7/2 A 9m

D. 2375-17, And. W. 29.

D. 2395378 And. W. 29.

C

11 (new) U. S. C. T.

Harder Carison

(new)
Co. A, 11 Reg't U. S. Col'd Inf.

Appears on

Company Descriptive Book

of the organization named above.

DESCRIPTION.

Age 27 years height . . . feet . . . inches.

Complexion Blk

Eyes; Blk hair Blk

Where born

Occupation

ENLISTMENT.

When June 16, 1863.

Where Corinth, Miss.

By whom A. Bischoff ; term 3 y'rs.

Remarks:

Heard

C | 11 | U.S.C.T.

Harden Carison

Co. A, 11 Reg't U.S. Col'd Inf.

Appears on

Company Descriptive Book

of the organization named above.

DESCRIPTION.

Age 27 years height feet inches.

Complexion Blk

Eyes; Blk hair Blk

Where born Tennessee

Occupation Farmer

ENLISTMENT.

When June 16, 1863.

Where Corinth, Miss.

By whom Lt. Bischoff; term 3 y'rs.

Remarks: Wounded at Fort Pillow, Tenn. Apr 12 64, in Mound City Hospital (Ills.). Discharged from Mound City Hospital May 28 1865 by Maj Gen. Hooker on Surgeon's Certificate of disability, caused by wounds rec'd in action at Fort Pillow Tenn. Apr 12 64.

Hearst

C

11 (New).

U.S.C.T.

Hardin Cason

Pvt, Co. A, 1 Reg't Ala. Siege Art'y.*

Age 27 years.

Appears on

Company Muster-in Roll

of the organization named above. Roll dated

Cornith Miss, June 20, 186 3

Muster-in to date June 20, 186 3

Joined for duty and enrolled:

When June 10, 186 3

Where Cornith Miss

Period 3 years.

Remarks:

* This organization subsequently became Co. , 11 Reg't U. S. Colored Infantry (New).

Book mark:

House

C | 11 (New). | U.S.C.T.

Hardin Cason

Co. A, 1 Reg't Ala. Siege Art'y.*

Appears on

Company Muster Roll

for June 20 to 30, 1863

Present or absent Present

Stoppage, \$ 1.00 for

Due Gov't, \$ 1.00 for

Remarks:

*This organization subsequently became Co. A, 11 Reg't U. S. Colored Infantry (New).

Book mark:

House

C | 11 (New). | U.S.C.T.

Hardin Cason
Pvt, Co. A, 1 Reg't Ala. Siege Art'y.*

Appears on

Company Muster Roll

for July and Aug., 1863.

Present or absent Present

Stoppage, \$ 100 for

Due Gov't, \$ 100 for

Remarks:

*This organization subsequently became Co. A, 11 Reg't U. S. Colored Infantry (New).

Book mark:

_____ House _____

(858)

Copyist.

C

11 (New).

U.S.C.T.

Hardin Cason

Pvt., Co. A, 1 Reg't Ala. Siege Art'y.*

Appears on

Company Muster Roll

for Sept. and Oct., 1863

Present or absent Present

Stoppage, \$ 100 for

Due Gov't, \$ 100 for

Remarks:

Due the U. S. for one
Haversack 48 cts

*This organization subsequently became Co. A, 11 Reg't U. S. Colored Infantry (New).

Book mark:

House

C | 11 (New). | U.S.C.T.

Hardin Cason

Cat, Co. A, 1 Reg't Ala. Siege Art'y.*

Appears on

Company Muster Roll

for Nov. and Dec., 1862

Present or absent Present

Stoppage, \$ 100 for

Due Gov't, \$ 100 for

Remarks:

*This organization subsequently became Co. A, 11 Reg't U. S. Colored Infantry (New).

Book mark:

(858)

House
Copyist.

C | 11 (New). | U.S.C.T.

Hardou Gaison
Pot., Co. A, 4 Batt'n, 1 Reg't Tenn. H. Art'y.*

Appears on

Company Muster Roll

for *Jany & Feby*, 1864.

Present or absent *Present*

Stoppage, \$ *100* for

Due Gov't, \$ *100* for

Remarks:

Filed with Hardin Gason

* This organization subsequently became Co. A, 11 Reg't U. S. Colored Infantry (New).

Book mark:

Rosenbaum

C 11 (New). U.S.C.T.

Garden Coison

Pvt, Co. A, 6 Reg't U. S. Col'd H. Art'y.*

Appears on

Company Muster Roll

for *March & April*, 1864.

Present or absent *Absent*

Stoppage, \$ *100* for

Due Gov't, \$ *100* for

Remarks: *Wounded at Fort
Pillow April 12-1864 in
Mound City Hospital*

* This organization subsequently became Co. A, 11 Reg't U. S. Colored Infantry (New).

Book mark :.....

Rosenbaum

C. M (new) U.S.C.T.

Harden Caision
Prv., Co. (11th Regt. Mo. S. C. Infy.)
6 Reg't U. S. Col'd Hy. Art.

Appears on a

Detachment Muster Roll

of the organization named above

for Mch. + Apl. 1864.

Station Fort Pickering, Tenn.

Present or absent Absent.

Stoppage, \$ 100 for

Due Gov't, \$ 100 for

Remarks: Wounded at Fort
Piller April 12/64. In
hospital, Mound City.

Book mark:

Philipson

6

11 (New).

U.S.C.T.

Harden Caison

Pvt., Co. A, 7 Reg't U. S. Col'd H. Art'y.*

Appears on

Company Muster Roll

for *May & June*, 1864.

Present or absent

Stoppage, \$ 100 for

Due Gov't, \$ 100 for

Remarks: *Wounded at Fort Pillow Tenn April 12" 1864 in wound city Hospital*

*This organization subsequently became Co. A, 11 Reg't U. S. Colored Infantry (New).

Book mark :

Rosenbaum
Copyst.

6 | 11 (New). | U.S.C.T.

Harden liaison

Privt., Co. A, 7 Reg't U.S. Col'd H. Art'y.*

Appears on

Company Muster Roll

for

to Aug 31, 1864.

Present or absent

Stoppage, \$ 100 for

Due Gov't, \$ 100 for

Remarks: *Wounded at Fort Pillow Tenn April 12-1864. In Wound City Hospital*

*This organization subsequently became Co. A, 11 Reg't U. S. Colored Infantry (New).

Book mark :

(358)

Rosenbaum
Copist.

6 | 11 (New). | U.S.C.T.

Harden Gaison

Priv-, Co. A, 7 Reg't U. S. Col'd H. Art'y.*

Appears on

Company Muster Roll

for *Sept & Oct*, 1864.

Present or absent

Stoppage, \$ 100 for

Due Gov't, \$ 100 for

Remarks: *Wounded at Fort
Pillow Tenn April 12-1864
In Mound City Hospital*

* This organization subsequently became Co. A, 11 Reg't U. S. Colored Infantry (New).

Book mark :

(358)

Rosenbaum
Copist.

6 | 11 (New). | U.S.C.T.

Harden Laison
Plt, Co. A, 7 Reg't U. S. Col'd H. Art'y.*

Appears on

Company Muster Roll

for *Nov & Dec*, 1864.

Present or absent *Absent*

Stoppage, \$ *100* for

Due Gov't, \$ *100* for

Remarks: *Wounded at Fort
Pillow Tenn April 12-64
In Mound City Hospital*

*This organization subsequently became Co. A, 11 Reg't U. S. Colored Infantry (New).

Book mark :

(358)

Rosenbaum
Copyst.

C. | **11 (New).** | **U.S.C.T.**

Harden Caison
Priv., Co. A, 11 Reg't U. S. Col'd Inf. (New).

Appears on

Company Muster Roll

for *Jan, & Febr*, 186*5*.

Present or absent *Absent.*

Stoppage, \$ *100* for

Due Gov't, \$ *100* for

Remarks:

*Wounded at Fort
Pillow, Tenn. April 12
/64. In Mound City
Hospital Ill.*

Book mark:

A. H. Reid

(858)

Copyist

6

11 (New).

U.S.C.T.

Harden Caison
Priv., Co. A, 11 Reg't U. S. Col'd Inf. (New).

Appears on

Company Muster Roll

for Mar. & Apr., 1865.

Present or absent Absent.

Stoppage, \$ 100 for

Due Gov't, \$ 100 for

Remarks: Wounded at Fort
Pillow Tenn. April 12
1864. In Mound City
Hospital, Ill.

Book mark:

A. N. Reed

(358)

Copyist

C. | 11 (New). | U.S.C.T.

Harden Caison

Pvt.; Co. A, 11 Reg't U. S. Col'd Inf. (New).

Appears on

Company Muster Roll

for *May & June*, 186*5?*

Present or absent

Stoppage, \$ *100* for

Due Gov't, \$ *100* for

Remarks:

Discharged on descriptive roll, May 28/55. Mound City Hospital, Ill.

Book mark:

A. M. Reed

C | 11 (New). | U.S.C.T.

Harold Caison

Co. A, 11 Reg't U. S. Col'd Inf. (New).

Appears on Co. Muster-out Roll, dated

Memphis Tenn Jan'y 12, 1866.

Muster-out to date _____, 186 .

Last paid to *Feb 28*, 1865.

Clothing account:

Last settled _____, 186 ; drawn since \$ _____ 100

Due soldier \$ _____ 100; due U. S. \$ _____ 100

Am't for cloth'g in kind or money adv'd \$ _____ 100

Due U. S. for arms, equipments, &c., \$ _____ 100

Bounty paid \$ _____ 100; due \$ _____ 100

Remarks: *Discharged May 28/65*
by order Maj. Genl Hooker
from Mound City Hospl.
Ills.

Book mark: *V51. P. 212. 67. C 105. U.S.C.T.*

C.D. *74*

(861)

Hoyberger

Copyist.

(or Horton)
Lasion Harmon

P, Co. A, 11 Reg't U.S. I

2 Enclosures.

Bed Cards	Final Statements
Burial Records	Furloughs or L. of A
Certs. of Dis. for Discharge /	Med. Certificates
C. M. Charges	Med. Des. Lists
Descriptive Lists	Orders
Discharge Certificates	Pris. of War Record /
Enlistment Papers	Resignations

Other papers relating to—

Admission to Hosp'l	Furlough or L. of A
Casualty Sheet	Med. Examination
Confinement	Misc. Information
Contracts	Pay or Clothing
Death or Effects	Personal Reports
Desertion	Rank
Discharge from Hosp'l	Transfer to Hosp'l
Discharge from Service	Transfer to V. R. C.
Duty	Transportation

MEMORANDUM FROM PRISONER OF WAR RECORDS.

No. _____

(This blank to be used only in the arrangement of said records.)

NAME.	RANK.	ORGANIZATION.				INFORMATION OBTAINED FROM—				
		No. of Reg't.	State.	Arm of Service.	Co.	Records of—	Vol.	Page.	Vol.	Page.
<i>Casen Horton</i>		<i>11</i>	<i>US</i>	<i>6th In</i>	<i>a</i>					

Captured at _____, 186 _____, confined at Richmond, Va., _____, 186 _____.

Admitted to Hospital at _____

where he died _____, 186 _____, of _____

Paroled at _____, 186 _____; reported at Camp Parole, Md., _____, 186 _____.

See 1 Ala

Copied by _____

Medical Director's Office

Northern Department.

Cincinnati, May 9 1865

Approved,

[Handwritten Signature]

Col J. S. A. Medical Director

Certificate of Disability for Discharge

In the case of

*O. W. B. of the
Harmon Cavalry*

a Private Co. "A"

7th Reg't of (Colored) U.S. Art.

[Handwritten Name]

Medical Director.

Headquarters, Department of the Mississippi,

St. Louis, 1865

TO BE DISCHARGED.

By order of Major General Hullock.

Assistant Adjutant General.

Received (A. G. Office,) 186



[Handwritten Signature]

En on order of [unclear]

*W. L. De Northen Dept,
Cincinnati, May 9 1865
is discharged*

*By command of
Maj. Gen. Hooker*

*P. von Schmidt
or as agent*

ADJUTANT GENERAL'S OFFICE

July 1 1865
Duplicates sent the Pension Office.

ARMY OF THE UNITED STATES.



CERTIFICATE OF DISABILITY FOR DISCHARGE.

(To be used, in duplicate, in all cases of discharge on account of disability.)

Private Hermon Casion
Ebanes's Company, [A], of the *7th* *colored* Regiment of United States
artillery, was enlisted by *Lt. Beseheff*, of
the Regiment of _____ at *Corinth Miss.*
on the *9th* day of *June* 1863, to serve *3* years; he was born
in _____ in the State of *Tennessee*, is *27*
years of age, _____ feet _____ inches high, *Black* complexion, *Black* eyes,
Black hair, and by occupation when enlisted a _____ . During the last two

months said soldier has been unfit for duty *sixty* days. (Here consult directions on Form 13, p. 325, par. 1340, p. 344, Rev. Army Reg.)

See day that while doing his duty as a soldier
at Fort Pillow Tenn. April 14th 1864 he received two gun
shot wounds, one in his right side and one in his
right leg and that in consequence he has not been
able to do any military duty since
STATION: *Maumee City Illinois*

DATE: *May 13th 1865*

Commanding Company.

I CERTIFY, that I have carefully examined the said *Hermon Casion* of
Captain *Ebanes's* Company, and find him incapable of performing the duties of a soldier
because of (Here consult par. 1269, p. 284; also, par. 1634, p. 445, and directions on Form 13, p. 325, Revised Army Regulations)

Two Gun Shot wounds, one through
the right side the other through the right
thigh both flesh wounds. There is considerable
lameness. wounds were received in battle
Disability one half
J. K. Foy Surgeon *USA*

DISCHARGED this *28th* day of *May* 1865, at *U.S. Gen. Hosp. Maumee City Ill.*

W. Wardman *Squire*
Commanding the *Regt.*

NOTE 1.—When a probable case for pension, special care must be taken to state the degree of disability.
NOTE 2.—The place where the soldier desires to be addressed may be here added.

Town— County— State—

[DUPLICATES.]

Approved
W. F. Underwood
Agent

264

Wason, Samuel

Co A 11 U.S. Col'd Inf.

(New Organization.)

Private | *Private*

CARD NUMBERS.

1	6323526	26
2	6323617	27
3	6323708	28
4	6323811	29
5	6323915	30
6	6324096	31
7	6324927	32
8	9070613	33
9	9070799	34
10		35
11		36
12		37
13		38
14		39
15		40
16		41
17		42
18		43
19		44
20		45
21		46
22		47
23		48
24		49
25		50

Book Mark: _____

See also _____

C | 11 (new) U. S. C. T.

Samuel Garrison

Co. A, 11 Reg't U. S. Col'd Inf.

Appears on

Company Descriptive Book

of the organization named above.

DESCRIPTION.

Age 21 years height feet inches.

Complexion Blk

Eyes; Blk hair Blk

Where born

Occupation

ENLISTMENT.

When June 16, 1863.

Where Corinth Miss

By whom Lt. Bischoff; term 3 y'rs.

Remarks: Died.

Hearst

C | 11 | U. S. C. T.

Samuel Carison

A, 11 Reg't U. S. Col'd Inf.

Appears on

Company Descriptive Book

of the organization named above.

DESCRIPTION.

Age 21 years height feet inches.

Complexion Blk

Eyes; Blk hair Blk

Where born

Occupation Farmer.

ENLISTMENT.

When June 16, 1863.

Where Cornith Miss.

By whom Lt. Bischoff; term 3 y'rs.

Remarks: Died at Memphis
Tenn. March 1864. day of
month and disease not
known. Company descrip-
tive book lost at Fort
Pillow, Tenn. Apl 12-64.
Final statements forwarded.

Hearst

C

11 (New).

U.S.C.T.

Samuel Carson

Private, Co *A*, 1 Reg't Ala. Siege Art'y.*

Age *21* years.

Appears on

Company Muster-in Roll

of the organization named above. Roll dated

Corinth Miss June 20, 186 *3*

Muster-in to date *June 20*, 186 *3*

Joined for duty and enrolled:

When *June 10*, 186 *3*

Where *Corinth Miss*

Period *3* years.

Remarks:

* This organization subsequently became Co. , 11 Reg't U. S. Colored Infantry (New).

Book mark:

House

C

11 (New).

U.S.C.T.

Samuel Carson

Sgt., Co. A, 1 Reg't Ala. Siege Art'y.*

Appears on

Company Muster Roll

for June 20 to 30, 1863

Present or absent present

Stoppage, \$ 100 for

Due Gov't, \$ 100 for

Remarks:

* This organization subsequently became Co. A, 11 Reg't U. S. Colored Infantry (New).

Book mark:

Home

C

11 (New).

U.S.C.T.

Samuel Cason

Out, Co. A, 1 Reg't Ala. Siege Art'y.*

Appears on

Company Muster Roll

for July and Aug., 1863.

Present or absent Present

Stoppage, \$ 100 for

Due Gov't, \$ 100 for

Remarks:

*This organization subsequently became Co. A, 11 Reg't U. S. Colored Infantry (New).

Book mark:

House

C

11 (New).

U.S.C.T.

Samuel Cason

Pvt., Co. A, 1 Reg't Ala. Siege Art'y.*

Appears on

Company Muster Roll

for Sept. and Oct., 1863

Present or absent Present

Stoppage, \$ 100 for

Due Gov't, \$ 100 for

Remarks:

*This organization subsequently became Co. A, 11 Reg't U. S. Colored Infantry (New).

Book mark:

House

C

11 (New).

U.S.C.T.

Samuel Cason

Priv., Co. A, 1 Reg't Ala. Siege Art'y.*

Appears on

Company Muster Roll

for Nov. and Dec., 1862

Present or absent Present

Stoppage, \$ 100 for

Due Gov't, \$ 100 for

Remarks:

*This organization subsequently became Co. A, 11 Reg't U. S. Colored Infantry (New).

Book mark:

House

(858)

Copyist.

C

11 (New).

U.S.C.T.

Samuel Mason

Pvt., Co. A, 4 Batt'n, 1 Reg't Tenn. H. Art'y.*

Appears on

Company Muster Roll

for *Jany & Feby*, 1864.

Present or absent

Stoppage, \$ 100 for

Due Gov't, \$ 100 for

Remarks: *died in Hospital
at Fort Pickens Feby 21/64*

Filed with Samuel Mason

* This organization subsequently became Co. A, 11 Reg't U. S. Colored Infantry (New).

Book mark: *PV 2 P 213: 68*

(358)

Rosenbaum

Copist.

11 (New). U.S.C.T.

Samuel Raison

Co. A, 11 Reg't U. S. Col'd Inf. (New).

Appears on Co. Muster-out Roll, dated
Memphis Tenn. Jan'y 12 1866.

Muster-out to date _____, 186 .

Last paid to Dec 31, 1863 .

Clothing account:

Last settled _____, 186 ; drawn since \$ _____ 100

Due soldier \$ _____ 100 ; due U. S. \$ _____ 100

Am't for cloth'g in kind or money adv'd \$ _____ 100

Due U. S. for arms, equipments, &c., \$ _____ 100

Bounty paid \$ _____ 100 ; due \$ _____ 100

Remarks: Died 21st Feb. '64 at
Memphis Tenn: disease not
known Descriptive Book
lost at Fort Lillie 12th Apr
'64

Book mark: U.S. R. 2, P. 215, '68 V. 148
P. 244: '72

(361)

Hoyberger

Copyist.

Caison Samuel

P, Co. A

11

U.S. Int.
Reg't

2 Enclosures.

Bed Cards	Descriptive Lists
Burial Records	Final Statements
Certs. of Dis. for Discharge	Furloughs
C. M. Charges	Med. Des. Lists
Med. Certificates	Orders

Other papers relating to—

Admission to Hosp'l	Furlough
Casualty Sheet (Officers) /	Med. Examination
Confinement	Misc. Information
Contracts	Pay or Clothing
Death or Effects /	Personal Reports
Desertions	Rank
Discharge from Hosp'l	Transfer to Hosp'l
Discharge from Service	Transfer to V. R. C.
Duty	Transportation

MICROFILM PUBLICATION M 1853

COMPILED MILITARY SERVICE RECORDS
OF VOLUNTEER UNION SOLDIERS WHO SERVED WITH
THE UNITED STATES COLORED TROOPS (USCT)
11TH REGIMENT OF INFANTRY-NEW ORGANIZATION

PERSONAL PAPERS' TARGET SHEET

PLEASE NOTE THE CHECKED INFORMATION ABOUT THE PERSONAL PAPERS IN
THIS FILE:

- NO PERSONAL PAPERS WERE FOUND IN THIS FILE WHEN THE
RECORDS WERE ARRANGED FOR MICROFILMING.
- 3 PERSONAL PAPER(S) FOUND IN THIS FILE WHEN THE RECORDS
WERE ARRANGED FOR MICROFILMING.

2nd & 3rd sent for to SGO. July 24th 1861,
Co. A

Complete
CASUALTY SHEET

No. _____

Daniel Carson

Priv. of Company *"A"*

11th Regiment of *W. C. Inf. Co.*

State Volunteers.

NATURE OF CASUALTY.

Died; Feby. 21st 1864

Emerson R. Co.

CASUALTY SHEET.

Name: Samuel Cousins

Rank: Private Company: "A" Regiment: 11th

Arm: U.S. Inf. State:

Nature of Casualty: Death

CAUSE OF CASUALTY—(NAME OF DISEASE, &c.)

Supposed not known
Pneumonia

DEGREE OF DISABILITY.

BY WHOM CERTIFIED.

Walter A. Field
Capt. Comd. Co.

DATE OF DISCHARGE, DEATH, &c.

Feb. 21st 1864.

PLACE OF DISCHARGE, DEATH, &c.

Memphis Tenn.

BY WHOM DISCHARGED.

FROM WHAT SOURCE THIS INFORMATION WAS
OBTAINED.

Musters - Cont. Roll.

REMARKS.

J. E. S.
Clerk.

Record and Pension Department,

Surgeon General's Office,

11 - March 15th 1867.

Respectfully returned, in answer to
Inquiry of Asst Adjt Genl Wm
Stephen of the 1st Regt of
Cavalry that Private
Samuel Case Co A 1st Tenn
Artillery "Hall" supposed to
be the soldier reported to
have died at Sherman's 1st 1864
at the same time at Regimental
Hospital located at Fort
Pickens and the records
of which were not in
file in this Office

BY ORDER OF THE SURGEON GENERAL:

 J. C. Woodward
Assistant Surgeon, U. S. A.

U. S. A.
C. S. M.

WAR DEPARTMENT,

ADJUTANT GENERAL'S OFFICE,

WASHINGTON, *Feb. 7th*, 186*4*.

SIR:

Final Statements in the cases of deceased soldiers are required to be sent to the Adjutant General's Office in duplicate, with one copy of the Inventory of Effects. The Descriptive List should also be sent to this Office in cases where the soldier was absent from his Company at the time of his death. Where there were no effects, it should be so stated on a blank Inventory, properly signed.

Certificates of Disability should be sent in duplicate. Special care should be taken that the date of discharge and signature of the discharging officer should be affixed.

No. of the Final Statements: *No.* Inventory, has been received in the case of *Samuel Caison, in Private* of Co. *A* *11th* Regiment of *U. S. Inf. V.* Volunteers, whose papers were forwarded to this Office. You will please forward the missing papers without delay.

I have the honor to be, sir,

Very respectfully,

Your obedient servant,

J. S. Hazard

Assistant Adjutant General.

(110)

~~COMMANDING OFFICER~~

Asst. Surg. J. J. Woodward.

S. G. Ouel

Died; Feb. 21st 1864. in at Memphis. Tenn

B.S. Samuel Caison Co. 1st Reg. Ala. Inf. B. Feb. 21st 1864. Cause of Death: Pneumonia. Dit Preserving Genl.

265

Lothel Eli

Co B, 11 U.S. Col'd Inf.

(New Organization.)

Private Corporal

CARD NUMBERS.

1	26
2	27
3	28
4	29
5	30
6	31
7	32
8	33
9	34
10	35
11	36
12	37
13	38
14	39
15	40
16	41
17	42
18	43
19	44
20	45
21	46
22	47
23	48
24	49
25	50

Lothel Eli

Book Mark:

See also

266

Patron Adam

Co *H*, 11 U.S. Col'd Inf.

(New Organization.)

Private

Private

CARD NUMBERS.

1	6332014	26
2	6332110	27
3	6332242	28
4	6323173	29
5	6323195	30
6	6332934	31
7	9072302	32
8		33
9		34
10		35
11		36
12		37
13		38
14		39
15		40
16		41
17		42
18		43
19		44
20		45
21		46
22		47
23		48
24		49
25		50

Book Mark:

See also

6 | 11 (New) U.S.C.T.

Alon Capron
(New)
Co. H, 11 Reg't U.S. Col'd Inf.

Appears on
Company Descriptive Book
of the organization named above.

DESCRIPTION.

Age 20 years height 5 feet 7 inches.

Complexion Black

Eyes; Black hair Black

Where born Mississippi

Occupation Farmer

ENLISTMENT.

When Mar 12, 1864

Where Memphis Tenn

By whom J. M. Ramey; term 3 y'rs.

Remarks: Described from
Fort Pickens, Mem
phis Tenn June 1st
1864

J. E. Ramey

6

11 (New).

U.S.C.T.

Adam Patrow

Priv., Co. H, 6 Reg't U. S. Col'd H. Art'y.*

Appears on

Battery Muster-in and Descriptive Roll

of the organization named above. Roll dated

March 12, 1864.
Memphis, Tenn.

Where born Desoto, Miss.

Age 30 y'rs; occupation Farmer

When enlisted Mar. 12, 1864.

Where enlisted Memphis, Tenn.

For what period enlisted 3 years.

Eyes Blk; hair Blk

Complexion Blk; height 5 ft. 9 in.

When mustered in Mar. 12, 1864.

Where mustered in Memphis, Tenn.

Bounty paid \$ 100; due \$ 100

Where credited

Battery to which assigned

Remarks:

* This organization subsequently became Co. H, 11 Reg't U. S. Colored Infantry (New).

Book mark :

(356g)

Wagner

Copyist.

6

11 (New).

U.S.C.T.

Adam Catrow

Pvt., Co. H, 6 Reg't U. S. Col'd H. Art'y.*

Appears on

Company Muster Roll

for 2d to 30th the April, 1864.

Present or absent Present.

Stoppage, \$ 100 for

Due Gov't, \$ 100 for

Remarks:

*This organization subsequently became Co. H, 11 Reg't U. S. Col'd Infantry (New).

Book mark:

Maginn

6

11 (New).

U.S.C.T.

Adam Catron

Priv., Co. H, 7 Reg't U. S. Col'd H. Art'y.*

Appears on

Company Muster Roll

for *May & June*, 1864.

Present or absent

Stoppage, \$ 100 for

Due Gov't, \$ 100 for

Remarks: *Deserted June 1st from Ft. Pickering, Tenn.*

*This organization subsequently became Co. H, 11 Reg't U. S. Col'd Infantry (New).

Book mark:

J. H. Wagner

6 | 11/11/60 U.S.C.T.

Adam Cotton

Pvt, Co. H, 11 (7 U.S.C.H.A.) (new)
Reg't U. S. Col'd Infantry

Appears on

Descriptive List of Deserters

dated Ft. Pickering Tenn June 29, 1864.

Deserted:

When

June 1, 1864

Where

Ft. Pickering Tenn.

Arrested:

When

186 .

Where

Remarks:

Book mark:

W.H. Bogan

(851)

Copist.

6 | 11 New | U.S.C.T.

Adam Catron
Pt, Co. H, 11 (7 U.S.C.H.A.) (New)
Reg't U. S. Col'd Infantry,

Appears on

Descriptive List of Deserters
Ft. Pickering
dated *Memphis Tenn June 30, 1864.*

Deserted :

When *June 1*, 1864
Where *Ft. Pickering*

Arrested :

When, 186 .
Where

Remarks :

Book mark :

(351)

W. H. Bogan

Copyist.

6

11 (New).

U.S.C.T.

Adam Catron
Capt, 11 Reg't U. S. Col'd Inf. (New).

Appears on Co. Muster-out Roll, dated
Memphis Tenn June 12, 1866.

Muster-out to date _____, 186 .

Last paid to _____, 186 .

Pay due from Enrollment

Clothing account:

Last settled _____, 186 ; drawn since \$ _____ 100

Due soldier \$ _____ 100 ; due U. S. \$ _____ 100

Am't for cloth'g in kind or money adv'd \$ _____ 100

Due U. S. for arms, equipments, &c., \$ _____ 100

Bounty paid \$ _____ 100 ; due \$ _____ 100

Remarks:

Discharged from M Pickering
June 1/64

Book mark :

(361)

M Eneary
Copyist.

267

Watson, Hudson

Co H, 11 U.S. Col'd Inf.

(New Organization)

Private Private

CARD NUMBERS.

1	6 3 3 2 0 1 2	26
2	6 3 3 2 1 0 9	27
3	6 3 3 2 1 9 0	28
4	6 3 3 2 3 6 8	29
5	6 3 3 2 3 2 9	30
6	6 3 3 2 3 9 2	31
7	6 3 3 2 4 5 0	32
8	6 3 3 2 5 4 2	33
9	6 3 3 2 9 2 2	34
10	9 0 7 2 3 0 1	35
11		36
12		37
13		38
14		39
15		40
16		41
17		42
18		43
19		44
20		45
21		46
22		47
23		48
24		49
25		50

Book Mark:

See also

6 | 11 (New) U. S. C. T.

Hydson Patton
Co. H, 11 Reg't U. S. Col'd Inf. (New)

Appears on

Company Descriptive Book

of the organization named above.

DESCRIPTION.

Age 27 years height 5 feet 7 inches.

Complexion yellow

Eyes; Black hair Black

Where born Fayette Co Tenn

Occupation farmer

ENLISTMENT.

When March 17, 1864.

Where Memphis Tenn

By whom J. J. McQueen; term 3 y'rs.

Remarks: Died at
Webster Genl
Hospital 7 Mar.
1865

A. E. Hanks

6 | 11 (New). | U.S.C.T.

Henderson Batson

Pvt., Co. H, 6 Reg't U. S. Col'd H. Art'y.*

Appears on

Battery Muster-in and Descriptive Roll

of the organization named above. Roll dated

Memphis Tenn. Apr. 2, 1864.

Where born Fayette Co. Tenn.

Age 27 y'rs; occupation Farmer

When enlisted Mar. 12, 1864.

Where enlisted Memphis, Tenn.

For what period enlisted 3 years.

Eyes Blk; hair Blk.

Complexion yellow; height 5 ft. 7 in.

When mustered in Mar 12, 1864.

Where mustered in Memphis, Tenn.

Bounty paid \$ 100; due \$ 100

Where credited

Battery to which assigned

Remarks:

* This organization subsequently became Co. H, 11 Reg't U. S. Colored Infantry (New).

Book mark ;

Wagner

B | **11 (New).** | **U.S.C.T.**

Hudson Patrow
Priv., Co. H, 6 Reg't U. S. Col'd H. Art'y.*

Appears on

Company Muster Roll

for *2^d to 30th Apr*, 1864.

Present or absent *Present.*

Stoppage, \$ *100* for

Due Gov't, \$ *100* for

Remarks:

*This organization subsequently became Co. H, 11 Reg't U. S. Col'd Infantry (New).

Book mark:

Wagner
Copist.

b | **11** (New). | **U.S.C.T.**

Hudson Patrow
Priv., Co. H, 7 Reg't U. S. Col'd H. Art'y.*

Appears on

Company Muster Roll

for *(May & June)*, 1864.

Present or absent *Present.*

Stoppage, \$ *100* for

Due Gov't, \$ *100* for

Remarks:

*This organization subsequently became Co. H, 11 Reg't U. S. Col'd Infantry (New).

Book mark:

J. H. Wagner
Copyist

6 | 11 (New). | U.S.C.T.

Henderson Watson
Pvt., Co. H, 7 Reg't U. S. Col'd H. Art'y.*

Appears on

Company Muster Roll

for *July & Aug.*, 1864.

Present or absent *Present.*

Stoppage, \$ *100* for

Due Gov't, \$ *100* for

Remarks:

*This organization subsequently became Co. H, 11 Reg't U. S. Col'd Infantry (New).

Book mark:

Wagner

6 | 11 (New). | U.S.C.T.

Ludlow Patman

Pvt, Co. H, 7 Reg't U. S. Col'd H. Art'y.*

Appears on

Company Muster Roll

for *Sept 7 Oct*, 1864.

Present or absent *Present*.

Stoppage, \$ *100* for

Due Gov't, \$ *100* for

Remarks:

*This organization subsequently became Co. H, 11 Reg't U. S. Col'd Infantry (New).

Book mark:

J. H. Wagner

C | **11** (New). | **U.S.C.T.**

Hudson Catron
Cm, Co. H, 7 Reg't U. S. Col'd H. Art'y.*

Appears on

Company Muster Roll

for *Nov & Dec*, 1864.

Present or absent *Present*

Stoppage, \$ *100* for

Due Gov't, \$ *100* for

Remarks:

*This organization subsequently became Co. H, 11 Reg't U. S. Col'd Infantry (New).

Book mark:

J. H. Wagner

C. | 11 (New). | U.S.C.T.

Hudson Catran

Pr., H, 11 Reg't U. S. Col'd Inf. (New).

Appears on

Company Muster Roll

for *Jan. & Feb.*, 1865.

Present or absent *Present.*

Stoppage, \$ *100* for

Due Gov't, \$ *100* for

Remarks:

Book mark:

(858)

Hewesling

Copyist.

C. | 11 (New). | U.S.C.T.

Henderson Cutron

Co., H, 11 Reg't U. S. Col'd Inf. (New).

Appears on

Company Muster Roll

for *Mar. & Apr.*, 186 *5*.

Present or absent _____

Stoppage, \$ _____ 100 for _____

Due Gov't, \$ _____ 100 for _____

Remarks: *Died at Webster*
Genl. Hospital Memphis
Tenn. 7th March. 1865.

Book mark: _____

(858)

Hausling

Copyist.

6

11 (New).

U.S.C.T.

Rudson Catron
Priv, *A*, 11 Reg't U. S. Col'd Inf. (New).

Appears on **Co. Muster-out Roll**, dated

Memphis Tenn Jan 12 1866.

Muster-out to date _____, 186 .

Last paid to *Aug 31*, 1864 .

Clothing account:

Last settled _____, 186 ; drawn since \$ _____ 100

Due soldier \$ _____ 100; due U. S. \$ _____ 100

Am't for cloth'g in kind or money adv'd \$ _____ 100

Due U. S. for arms, equipments, &c., \$ _____ 100

Bounty paid \$ _____ 100; due \$ _____ 100

Remarks:

died in Webster Gen Hosp
Mo 7/65

Book mark: *V. 233. P. 63. 68*

(361)

Mearns
Copyist.

Catron, Henderson
P. Co. **H** U.S.C. Inf.
Regt

Enclosures.

Bed Cards	Descriptive Lists
Burial Records	Final Statements
Certs. of Dis. for Discharge	Furloughs
C. M. Charges	Med. Des. Lists
Med. Certificates	Orders

Other papers relating to—

Admission to Hosp'l	Furlough
Casualty Sheet (Officer's)	Med. Examination
Confinement	Misc. Information
Contracts	Pay or Clothing
Death or Effects	Personal Reports
Desertions	Rank
Discharge from Hosp'l	Transfer to Hosp'l
Discharge from Service	Transfer to V. R. C.
Duty	Transportation

502
A.G.O. June 19, 1865
Gm. acct. for expenses. Value
\$3.00 sent 2d Auditor
13.

W.C.
Acct sent 2d Auditor
77K

Information of the Funds 13.
FINAL STATEMENT
G. R.

OF
Hudson Station
11th Reg't of NY Cold Lys

VOLUNTEERS.
Paid March 21st 1865

NOTE 1.—Two of these certificates (or duplicates) are to be given to each Volunteer Soldier or drafted man who may be discharged previously to the discharge of his company, that he may at once receive from the Paymaster the pay, &c., due him, and the captain or other COMMISSIONED officer commanding the company will certify to the act of the delivery of the duplicate certificates; on these certificates the Soldier is "entitled to," his discharge, and should also present his discharge to the Paymaster to have the payment endorsed on it. The discharge is to be given back to the Soldier by the Paymaster; the latter only retaining as his voucher the duplicate certificates.

NOTE 2.—If the Soldier is entitled to pay for the use of his horse, the Company Commander will certify to that fact on the back of both these final statements, and also to the time he has pay due for having been so mounted on his own horse.

NOTE 3.—When a Soldier is furnished with final statements, his descriptive list, if he has one, should be taken up by the officer who gives the Soldier these statements, and endorsed with a statement to this effect by the officer. This endorsement should exhibit a full statement of the time for which the Soldier was allowed pay on his final statements, the clothing account, and all other charges against him or in his favor, so as to comprise a complete exhibit of his account. It will then be transmitted to the company commander of the Soldier, who will enter all the data necessary to a full understanding of the Soldier's account on the muster roll upon which the Soldier's discharge is reported. The descriptive list will then be destroyed. The object of this is, that the remaining portion of the Soldier's account may be settled upon the receipt of these muster rolls, and the Soldier receive any pay or allowances that may be due him at the time of his discharge, and which may not appear on his final statements from the fact that his descriptive list is incomplete. These accounts for back pay, &c., are settled by the 2d Auditor of the Treasury Department.

NOTE 4.—Charges for loss or injury to ordnance, horse equipments, and other miscellaneous charges, should appear under the heading of "Other Stoppages."

NOTE 5.—Bounty paid by State authorities, and not by the United States, will not be entered on this statement.

NOTE 6.—Amounts due the Sutler and Laundress must be entered on the muster roll on which the discharge, death, desertion, &c., is reported, as well as on the final statement, otherwise the amount cannot be collected from the United States.

NOTE 7.—This blank will be used for deceased volunteers and drafted men, as well as for others.

NOTE 8.—Where a Soldier dies in Hospital or on detached service, his descriptive list, if he has one, should be sent with his final statements, in duplicate, to the Adjutant General, Washington, D. C.

ADJUTANT GENERAL'S OFFICE.
March 22nd 1865
Duplicate with Inventory sent 2d Auditor.

Emb...
1865

I certify, on honor, that Hudson Catron a private of
 Captain W. H. McRae Company (A) of the 11th Regiment of Missouri Inf
VOLUNTEERS, of the State of Mo, born in Wayne Co, State
 of Mo, aged 27 years; 5 feet 4 inches high; yellow complexion,
blk eyes, blk hair, and by occupation a farmer, having joined the company on
 its original organization at Mo, and enrolled in it at the muster into
 the service of the United States at Mo, on the Mo day
 of Mo, 1864, (or was mustered in service as a recruit, by Capt J. G.
McRae, at Memphis Tenn, on the 12th day of March,
 1864; or was drafted and mustered into the service of the United States from the
 Enrollment District of the State of Mo, at Mo,
 on the Mo day of Mo, 1864;) to serve in the Regiment, for
 the term of Mo: and having served **HONESTLY** and
FAITHFULLY with his Company in Mo to the present date, is now
 entitled to a **DISCHARGE** by reason of Went in White Mtn with Capt
Memphis Tenn March 4th 1865

The said Hudson Catron was last paid by Paymaster
Ray Smith to include the 31st day of August, 1864, and has
 pay due him from that time to the present date; he is entitled to pay and subsistence for
TRAVELING to place of enrollment, and whatever other allowances are authorized to volunteer
 soldiers, drafted men, or militia, so discharged. He has received from the United States **CLOTHING**
 amounting to sixty three (\$ 63 ⁸⁸ 100 dollars, since the Mo day of enlistment,
 1864, when his clothing account was last settled. He has received from the United States
100 dollars advanced **BOUNTY**.

There is to be stopped from him, on account of the State of Mo, or other
 authorities, for **CLOTHING**, &c., received on entering service, 100 dollars; and
 for other stoppages, viz: Mo

100 dollars.
 He has been furnished with **TRANSPORTATION** in kind from the place of his discharge to
Mo; and he has been **SUBSISTED** for **TRAVELING** to his
 place of enrollment, up to the Mo, 1864.

He is indebted to Mo, **SUTLER**, 100 dollars.

He is indebted to Mo, **LAUNDRESS**, 100 dollars.

Given in Duplicate, at White Mtn with Capt Memphis Tenn, this 4th day
 of March, 1865.

Saml S. Jessop
Adjutant
 Commanding Company.

268

Clayton Edward

Co F, 11 U.S. Col'd Inf.

(New Organization.)

Private Private

CARD NUMBERS.

1	26
2	27
3	28
4	29
5	30
6	31
7	32
8	33
9	34
10	35
11	36
12	37
13	38
14	39
15	40
16	41
17	42
18	43
19	44
20	45
21	46
22	47
23	48
24	49
25	50

Book Mark:

See also

269

Chairs Peter

Co E, 11 U.S. Col'd Inf.

(New Organization.)

Private Private

CARD NUMBERS.

1	6328720	26
2	6328781	27
3	6328862	28
4	6328962	29
5	6329065	30
6	6329151	31
7	6329237	32
8	6329313	33
9	6329389	34
10	6329459	35
11	6329524	36
12	6329600	37
13	6329680	38
14	6329743	39
15	6329803	40
16	7071772	41
17	7041951	42
18		43
19		44
20		45
21		46
22		47
23		48
24		49
25		50

Book Mark:

See also

A. 1274783 and. W.S.

A130245-2 Pomona

p. 162843 P. C. ~~copy~~

A13548835 - 00

C | 11 (new) U.S.C.T.

Peter Lehain

, Co. E, 11 Reg't U.S. Col'd Inf.

Appears on

Company Descriptive Book

of the organization named above.

DESCRIPTION.

Age 19 years height 6 feet — inches.

Complexion Brown

Eyes; Black hair Black

Where born Miss

Occupation

ENLISTMENT.

When Nov 19, 1863

Where La Grange Tenn

By whom Capt Craig; term 3 y'rs.

Remarks:

Houston

Co. | 11 (new) U.S.C.T.

Peter Chaires
(new)
Co. E, 11 Reg't U.S. Col'd Inf.

Appears on
Company Descriptive Book
of the organization named above.

DESCRIPTION.

Age 19 years height 6 feet " inches.

Complexion Brown

Eyes; Black hair Black

Where born Mississippi

Occupation

ENLISTMENT.

When Nov 19, 1863

Where Sagrarauga Tenn.

By whom J.H. Craig term 3 y'rs.

Remarks:

Harrison

6 | 11 (New) | U.S.C.T.

Peter Chavis
Pri, Co. C, 1 Reg't Ala. Siege Art'y.*

Age 19 years.

Appears on

Company Muster-in Roll

of the organization named above. Roll dated

Corinth Miss, Dec 9, 1863.

Muster-in to date Dec 9, 1863.

Joined for duty and enrolled:

When Nov 17, 1863

Where La Grange

Period 3 years.

Remarks:

*This organization subsequently became Co. C, 11 Reg't U. S Colored Infantry (New).

Book mark:

Chavis

6

11 (New).

U.S.C.T.

Peter Chairs

Pvt., Co. E, 1 Reg't Ala. Siege Art'y.*

Appears on

Company Muster Roll

for *Enrollment to Dec. 31, 1863.*

Present or absent *Present.*

Stoppage, \$ *100* for

Due Gov't, \$ *100* for

Remarks:

*This organization subsequently became Co. E, 11 Reg't U. S. Col'd Infantry (New).

Book mark :

Lewis

Copyist.

C

11 (New).

U.S.C.T.

Peter Chairs

Pvt., Co. E, 4 Battalion, 1 Reg't Tenn. H. Art'y.*

Appears on

Company Muster Roll

for Jan & Feb, 1864.

Present or absent Present.

Stoppage, \$ 100 for

Due Gov't, \$ 100 for

Remarks: Sick in Regtl Hospl.

* This organization subsequently became Co. E, 11 Reg't U. S. Colored Infantry (New).

Book mark:

Lewis

Copyst.

6

11 (New). U.S.C.T.

Peter Chairs

Pvt, Co. E, 6 Reg't U. S. Col'd H. Art'y.*

Appears on

Company Muster Roll

for..... *Mch & Apl* , 1864.

Present or absent *Present.*

Stoppage, \$..... 100 for

Due Gov't, \$..... 100 for.....

Remarks:

*This organization subsequently became Co. E, 11 Reg't U. S. Colored Infantry (New).

Book mark:

Lewis
Copyist.

C

11 (New).

U.S.C.T.

Peter Chairs

Priv, Co. E, 7 Reg't U. S. Col'd H. Art'y.*

Appears on

Company Muster Roll

for *May & June*, 1864.

Present or absent *Present*

Stoppage, \$ *100* for

Due Gov't, \$ *100* for

Remarks:

* This organization subsequently became Co. E, 11 Reg't U. S. Colored Infantry (New).

Book mark:

Crenshaw

Co | **11** (New). | **U.S.C.T.**

Peter C Hairs

Priv, Co. E, 7 Reg't U. S. Col'd H. Art'y.*

Appears on

Company Muster Roll

for *July & Aug.*, 186 *4*

Present or absent *Present*

Stoppage, \$ *100* for

Due Gov't, \$ *100* for

Remarks:

* This organization subsequently became Co. E, 11 Reg't U. S. Colored Infantry (New).

Book mark:

Cumshaw

60 | 11 (New). | U.S.C.T.

Peter Chairs

Priv., Co. E, 7 Reg't U. S. Col'd H. Art'y.*

Appears on

Company Muster Roll

for Sept. & Oct., 1864

Present or absent Present

Stoppage, \$ 100 for

Due Gov't, \$ 100 for

Remarks: On daily duty in Eng. Corps since Sept. 29, 1864. Stop for one canteen & haversack \$1.12.

* This organization subsequently became Co. E, 11 Reg't U. S. Colored Infantry (New).

Book mark:

Creshaw

Co | 11 (New). | U.S.C.T.

Peter Chairs

Priv, Co. E, 7 Reg't U. S. Col'd H. Art'y.*

Appears on

Company Muster Roll

for Nov. & Dec., 1864.

Present or absent Present

Stoppage, \$ 100 for

Due Gov't, \$ 100 for

Remarks: On daily duty in
Eng. Corps since Sept. 29,
1864. Stop for one canteen
& one haversack.

* This organization subsequently became Co. E, 11 Reg't U. S. Colored Infantry (New).

Book mark: _____

Crenshaw

To | 11 (New). | U.S.C.T.

Peter Chaires
Pvt, Co. E, 11 Reg't U. S. Col'd Inf. (New).

Appears on

Company Muster Roll

for *Jan & Feb*, 1865

Present or absent *Present*

Stoppage, \$ *100* for

Due Gov't, \$ *100* for

Remarks: *Stop for 1 Caritem*
& 1 Haversack,
in daily duty in
eng. Corps since Sep 29/64.

Book mark: *100000*

Lowry

C | 11 (New). | U.S.C.T.

Peter Chavis

Pvt, Co. E, 11 Reg't U. S. Col'd Inf. (New).

Appears on

Company Muster Roll

for *March & April*, 1865.

Present or absent *Present*

Stoppage, \$ *100* for

Due Gov't, \$ *100* for

Remarks: *On daily duty in
Eng. Corps since Sep.
29/64.*

Book mark:

(858)

Louvy

Copyist.

C

11 (New).

U.S.C.T.

Peter Charvis

Capt, Co. E, 11 Reg't U. S. Col'd Inf. (New).

Appears on

Company Muster Roll

for May & June, 1865

Present or absent Present

Stoppage, \$ 100 for

Due Gov't, \$ 100 for

Remarks: On daily duty in Eng Corps

Book mark:

Lowry

(858)

Copyist.

76

11 (New).

U.S.C.T.

Peter Chairs

Plt, Co. E, 11 Reg't U. S. Col'd Inf. (New).

Appears on

Company Muster Roll

for *July & Aug.*, 1865.

Present or absent *present*

Stoppage, \$ 100 for

Due Gov't, \$ 100 for

Remarks: *Detached in
Eng. Corps.*

Filed with Peter Chairs

Book mark:

Loring

(858)

Copyist.

76 | 11 (New). | U.S.C.T.

Peter Cross

Plt, Co. E, 11 Reg't U. S. Col'd Inf. (New).

Appears on

Company Muster Roll

for *July & Aug.*, 1865

Present or absent *present*

Stoppage, \$ 100 for

Due Gov't, \$ 100 for

Remarks: *Detached in
Eng. Corps.*

Filed with Peter Chairs

Book mark:

Loring

(358)

Copyist.

Co. | 11 (New). | U.S.C.T.

Peter Charis

Co., Co. E, 11 Reg't U. S. Col'd Inf. (New).

Appears on

Company Muster Roll

for *Sep. & Oct.*, 1865.

Present or absent *Present*

Stoppage, \$ *100* for

Due Gov't, \$ *100* for

Remarks:

Book mark:

Lowry

C | **11 (New).** | **U.S.C.T.**

Peter Chairs
Priv, Co. E, 11 Reg't U. S. Col'd Inf. (New).

Appears on

Company Muster Roll

for *c Nov. & Dec*, 1865.

Present or absent *Present*,

Stoppage, \$ *100* for

Due Gov't, \$ *22*
100 for *ordnance*

Remarks:

Book mark:

(858)

Valentine

Copyist.

Q | 11 (New). U.S.C.T.

Peter Chairs

Priv Co. C, 11 Reg't U. S. Col'd Inf. (New).

Appears on **Co. Muster-out Roll**, dated

Memphis Tenn. Jan 12, 1866 .

Muster-out to date Jan 12, 1866 .

Last paid to Feb 28, 1865 .

Clothing account:

Last settled , 186 ; drawn since \$ 100

Due soldier \$ 100 ; due U. S. \$ 2 79 100

Am't for cloth'g in kind or money adv'd \$ 100

Due U. S. for arms, equipments, &c., \$ 22 100

Bounty paid \$ 100 ; due \$ 100

Remarks:
.....
.....
.....
.....

Book mark :

Valentine

Chairs, Peter

P. E. II U.S.C. Inf.
Co. Reg't

Enclosures.

Bed Cards	Descriptive Lists
Burial Records	Final Statements
Certs. of Dis. for Discharge	Furloughs
C. M. Charges	Med. Des. Lists
Med. Certificates	Orders

Other papers relating to—

Admission to Hosp'l	Furlough
Casualty Sheet (Officer's)	Med. Examination
Confinement	Misc. Information
Contracts	Pay or Clothing
Death or Effects	Personal Reports
Desertions	Rank
Discharge from Hosp'l	Transfer to Hosp'l
Discharge from Service	Transfer to V. R. C.
Duty	Transportation

No. 2nd Dist W. Tenn
Oct 1st 1865

Special Orders
No 247

Private Peter Cham
relieved from duty
in Eng Dept

SPECIAL ORDERS, }
No. 247.

HEAD-QUARTERS,
DISTRICT OF WEST TENNESSEE,
Memphis, Tenn., October 1st, 1865

EXTRACT.

1 The following named enlisted men of the 11th U. S. colored Infantry are hereby relieved from duty in Engineer Department, and will report forthwith to their Company Commanders for duty:—

* * * * *
Private Peter Chairs, company 'E,'
* * * * *

BY ORDER OF BREVET MAJOR GENERAL J. E. SMITH

W. H. MORGAN,

Brevet Brigadier General and Assistant Adjutant General.

OFFICIAL:

W. M. Cannon
Captain & A. A. G.

*Private Peter Chairs
Co "E" 11th U.S. Col'd Inf'ty*

270

Chalmers John

Co G, 11 U.S. Col'd Inf.

(New Organization.)

Corporal Sergeant

CARD NUMBERS.

1	6322589	26
2	6330993	27
3	6331019	28
4	6331109	29
5	6331194	30
6	6331272	31
7	6331355	32
8	6331438	33
9	6331522	34
10	6331604	35
11	6331688	36
12	6331762	37
13	6331834	38
14	6331905	39
15	9072223	40
16		41
17		42
18		43
19		44
20		45
21		46
22		47
23		48
24		49
25		50

Book Mark:

See also

C | **11 (New) | U. S. C. T.**

John Chalmers
(New)
Co. *G*, 11 Reg't U. S. Col'd Inf.

Appears on
Company Descriptive Book
of the organization named above.

DESCRIPTION.

Age *33* years height *5* feet *8 1/2* inches.

Complexion *Black*

Eyes; *BRN* hair *BRN*

Where born *Scandinavia*

Occupation *Laborer*

ENLISTMENT.

When *Jan 12, 1864.*

Where *Fort Pickering*

By whom *Carl Kappeler*; term *3* y'rs.

Remarks: *appointed a 3rd Corp. Jan 12/64*
appointed a 4th Sgt. by S. Co. to 55
17 Sept 1864.

A. J. Anderson

6

11 (New).

U.S.C.T.

John Chalmers

Appears with rank of 3 Corp'l on

Muster and Descriptive Rolls of Detachments of U. S. Vols. forwarded

for the 11 Reg't U. S. Col'd Inf Roll dated

Memphis Tenn, Feb 2, 1864.

Where born South Carolina

Age 33 y'rs; occupation

When enlisted Jan 12, 1864.

Where enlisted Fort-Pickering

For what period enlisted 3 years.

Eyes Black; hair Black

Complexion Black; height 5 ft. 8 1/2 in.

When mustered in Feb 4, 1864.

Where mustered in Fort-Pickering

Bounty paid \$ 100; due \$ 100

Where credited

Company to which assigned

Remarks:

[Faint, illegible handwriting]

Book mark:

Ashley

6

11 (New). U.S.C.T.

John Shalmers
Pvt, Co. E, 1 Battalion, 1 Reg't Tenn. H. Art'y.†

Age years.

Appears on

Company Muster Roll*

for Feb 4 to 29, 1864.

Joined for duty and enrolled:

When Jan 12, 1864.

Where Fort Pickering

Period 3 years.

Mustered in:

When Feb. 4, 1864

Where Fort Pickering

Present or absent Present

Stoppage, \$ 100 for

Due Gov't \$ 100 for

Remarks:

† This organization subsequently became Co. G, 11 Reg't U. S. Colored Infantry (New).

* First current roll. No muster-in roll of this company on file. This roll shows enrollment of all men of this company as of same date. See enrollment on subsequent card or cards.

Book mark:

(3586)

Ballade

Copyist.

6 | **11** (New). | **U.S.C.T.**

John Chalmer's
3rd Corp, Co. G, 6 Reg't U. S. Col'd H. Art'y.†

Appears on

Company Muster Roll

for *Web & apl*, 1864

Joined for duty and enrolled:

When *Jan 12*, 1864.*

Where *Ft Pickering* *

Period *3* years.*

Present or absent *Present*

Stoppage, \$ *100* for

Due Gov't \$ *100* for

Remarks :

* This organization subsequently became Co. G, 11 Reg't U. S. Colored Infantry (New).
* See enrollment on card from first current roll.

Book mark :

Sallade
(358c) Copyist.

6 | 11 (New). | U.S.C.T.

Alpha Shaimers
Corp., Co. G, 7 Reg't U. S. Col'd H. Art'y.†

Appears on

Company Muster Roll

for *May & June*, 1864

Joined for duty and enrolled:

When *Jan 12*, 1864.*

Where *H. Pickering* *

Period *3* years.*

Present or absent *Present*

Stoppage, \$ *100* for

Due Gov't, \$ *100* for

Remarks:

† This organization subsequently became Co. G, 11 Reg't U. S. Colored Infantry (New).
* See enrollment on card from first current roll.

Book mark:

Dallade

6 | 11 (New). | U.S.C.T.

John Guainer
Supt., Co. G, 7 Reg't U. S. Col'd H. Art'y. †

Appears on

Company Muster Roll

for *July & Aug*, 1864

Joined for duty and enrolled:

When *Jan 12*, 1864*

Where *St. Petersburg**

Period *3* years.*

Present or absent *Present*

Stoppage, \$ *100* for

Due Gov't, \$ *100* for

Remarks:

† This organization subsequently became Co. G, 11 Reg't U. S. Colored Infantry (New).

* See enrollment on card from first current roll.

Book mark:

Saccade

6 | 11 (New). | U.S.C.T.

John Chainers

† Sgt., Co. G, 7 Reg't U. S. Col'd H. Art'y. †

Appears on

Company Muster Roll

for Sept 1864, 1864.

Joined for duty and enrolled:

When Jan 12, 1864.*

Where Fort Pickens *

Period 3 years.*

Present or absent Present

Stoppage, \$ 100 for

Due Gov't, \$ 100 for

Remarks: Appointed Sgt by S.O. No. 55 head quarters 7th U.S.C.A.H. Sept. 7. 1864

† This organization subsequently became Co. G, 11 Reg't U. S. Colored Infantry (New).

* See enrollment on card from first current roll.

Book mark:

Callade

4 | 11 (New). | U.S.C.T.

John Chalmers
4th Reg't Co. G, 7 Reg't U. S. Col'd H. Art'y.†

Appears on

Company Muster Roll

for *Nov & Dec*, 186*4*.

Joined for duty and enrolled:

When *Jan 12*, 186*4*.*

Where *Fort Pickens*.*

Period *3* years.*

Present or absent *Present*

Stoppage, \$ *100* for

Due Gov't, \$ *100* for

Remarks: *Appointed 1st sergeant
Sept 17, 1864*

† This organization subsequently became Co. G, 11 Reg't U. S. Colored Infantry (New).

* See enrollment on card from first current roll.

Book mark: _____

Ballade

6 | 11 (New). | U.S.C.T.

John Chalmers

4th Sgt., Co. G, 11 Reg't U. S. Col'd Inf. (New).

Appears on

Company Muster Roll

for Jan & Feb, 1865.

Joined for duty and enrolled:

When Jan 12, 1864.*

Where Ft. Pickering, *

Period 3 years.*

Present or absent Present.

Stoppage, \$ 100 for

Due Gov't \$ 100 for

Remarks: App'd Sgt. from Corp'l.
Sept. 17/64.

* See enrollment on card from first current roll.

Book mark:

(358c)

Ramsey

Copyist.

b. | **11** (New). | **U.S.C.T.**

John Chalmers
4th Seryt, Co. G, 11 Reg't U. S. Col'd Inf. (New).

Appears on

Company Muster Roll

for *Mar & Apr*, 1865.

Joined for duty and enrolled:

When *Jan 12*, 1864.*

Where *Ft. Pickering*. *

Period *3* years.*

Present or absent *Present*.

Stoppage, \$ *100* for

Due Gov't \$ *100* for

Remarks:

* ~~45~~ See enrollment on card from first current roll.

Book mark:

(358c)

Ramsey
C. Sgt.

C, | 11 (New). | U.S.C.T.

John C. Chalmers
4th Serg't, Co. G, 11 Reg't U. S. Col'd Inf. (New).

Appears on

Company Muster Roll

for *May & June*, 1865.

Joined for duty and enrolled:

When *Jan 12*, 1864.*

Where *Ft Pickering* *

Period *3* years.*

Present or absent *Present*.

Stoppage, \$ *100* for

Due Gov't \$ *100* for

Remarks :

* See enrollment on card from first current roll.

Book mark : -----

(358c)

Ramsey
C. Sgt.

C. | 11 (New). | U.S.C.T.

John Chalmers
4th Supt, Co. G, 11 Reg't U. S. Col'd Inf. (New).

Appears on

Company Muster Roll

for July & Aug., 1865.

Joined for duty and enrolled:

When Jan 12, 1864.*

Where Ft Pickering. *

Period 3 years.*

Present or absent Present.

Stoppage, \$ 100 for

Due Gov't \$ 100 for

Remarks:

* See enrollment on card from first current roll.

Book mark:

(358c)

Ramsey
Cpyist.

C. | **11** (New). | **U.S.C.T.**

John Chalmers
4th Sergt., Co. G, 11 Reg't U. S. Col'd Inf. (New).

Appears on

Company Muster Roll
for *Sept & Oct*, 186*5*.

Joined for duty and enrolled:

When *Jan 12*, 186*4*.*

Where *Ft Pickering*. *

Period *3* years.*

Present or absent *Present*.

Stoppage, \$ *100* for

Due Gov't \$ *100* for

Remarks:

* ~~43~~ See enrollment on card from first current roll.

Book mark:

(358c)

Carney
Cpyist.

C. | 11 (New). | U.S.C.T.

John Chalmers,
Sgt., Co. G, 11 Reg't U. S. Col'd Inf. (New).

Appears on

Company Muster Roll

for *Nov. & Dec.*, 186*4*.

Joined for duty and enrolled:

When *Jan. 12.*, 186*4*.*

Where *Ft. Pickens* *

Period *3* years.*

Present or absent

Stoppage, \$ 100 for

Due Gov't \$ 100 for

Remarks:

* See enrollment on card from first current roll.

Book mark:

(358c)

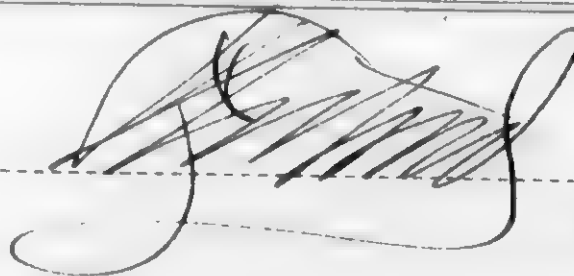

Copyist.

C. | 11 (New). | U.S.C.T.

John Chalmers.
Sgt. G., 11 Reg't U. S. Col'd Inf. (New).

Appears on Co. Muster-out Roll, dated
Memphis T. Jan. 12, 1866.

Muster-out to date *Jan. 12*, 1866.

Last paid to *June 30*, 1865.

Clothing account:

Last settled _____, 186 ; drawn since \$ _____ 100

Due soldier \$ *29³⁴* / 100; due U. S. \$ _____ 100

Am't for cloth'g in kind or money adv'd \$ _____ 100

Due U. S. for arms, equipments, &c., \$ _____ 100

Bounty paid \$ _____ 100; due \$ _____ 100

Remarks: _____

Book mark: *434.577*

(361)

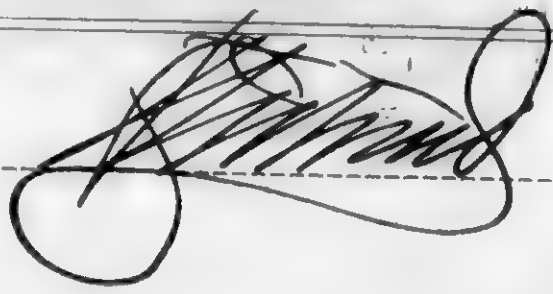

Copyist.

271

Chanley, Jefferson

Co *Co*, 11 U.S. Col'd Inf.

(New Organization)

Private

Private

CARD NUMBERS.

1	6322712	26
2	6329943	27
3	6330031	28
4	6330123	29
5	6330205	30
6	6330279	31
7	6330390	32
8	6330882	33
9	7072109	34
10		35
11		36
12		37
13		38
14		39
15		40
16		41
17		42
18		43
19		44
20		45
21		46
22		47
23		48
24		49
25		50

Book Mark: EB.V. 11. P. 444

See also

6 |

11 (new) U. S. C. T.

Jefferson Chanley

, Co. *F*, 11 Reg't U. S. Col'd Inf.

Appears on

Company Descriptive Book

of the organization named above.

DESCRIPTION.

Age *24* years height *5* feet *5½* inches.

Complexion *black*

Eyes; *black* hair *black*

Where born *N. Carolina*

Occupation

ENLISTMENT.

When *Jan 15*, 1864.

Where *Fort Pickering*

By whom *Col. Keppner*; term y'rs.

Remarks: *Discharged for disability Oct. 31, 1864.*

F. A. Wright

6

11 (New). U.S.C.T.

Jefferson Chanley

Appears with rank of *Pri* on

Muster and Descriptive Rolls of Detachments of U. S. Vols. forwarded

for the *11* Reg't U. S. Col'd *Inf* Roll dated *Memphis Tenn*, *Mar 1*, 1864.

Where born *N. Carolina*

Age *24* y'rs; occupation

When enlisted *Jan 15*, 1864.

Where enlisted *Ft Pickering*

For what period enlisted *3* years.

Eyes *black*; hair *black*

Complexion *black*; height *5* ft. *5 1/2* in.

When mustered in *Feb 24*, 1864.

Where mustered in *Ft Pickering*

Bounty paid \$ *100*; due \$ *100*

Where credited

Company to which assigned *F*

Remarks:

Book mark:

Ashley

C | 11 (New). | U.S.C.T.

Jefferson Chanley
Pvt, Co. F, 1 Battalion, 1 Reg't Tenn. H. Art'y.†

Age _____ years.

Appears on

Company Muster Roll*

for *Jan 11 to Mch 1*, 186*4*.

Joined for duty and enrolled:

When *Jan 15*, 186*4*.

Where *JH Pickering*

Period *3* years

Mustered in:

When *Feb 24*, 186*4*.

Where *Memphis*

Present or absent *Present*

Stoppage, \$ *100* for _____

Due Gov't, \$ *100* for _____

Remarks: _____

† This organization subsequently became Co. F, 11 Reg't U. S. Colored Infantry (New).

* First current roll. No muster-in roll of this company on file.

Book mark: _____

Rose

11

11 (New).

U.S.C.T.

Jefferson Chanley
Co. F, 6 Reg't U. S. Col'd H. Art'y.*

Appears on

Company Muster Roll

for *Meat & Appl*, 186 *4*

Present or absent *Present*

Stoppage, \$ *100* for

Due Gov't, \$ *100* for

Remarks: *Present sick*

in Quarters since
Apr 14/64

* This organization subsequently became Co. F, 11 Reg't U. S. Colored Infantry (New).

Book mark:

Rose

(11)

11 (New).

U.S.C.T.

Jefferson Chaulley
Sgt, Co. F, 7 Reg't U. S. Col'd H. Art'y.*

Appears on

Company Muster Roll

for *May 1st*, 186*4*

Present or absent *Present*

Stoppage, \$ *100* for

Due Gov't, \$ *100* for

Remarks: ** Absent not in*
small for Hospital
since

** As it appears on roll*

* This organization subsequently became Co. F, 11 Reg't U. S. Colored Infantry (New).

Book mark: _____

R. F. E.

(1)

11 (New).

U.S.C.T.

Jesse C. Chanley
Sgt., Co. F, 7 Reg't U. S. Col'd H. Art'y.*

Appears on

Company Muster Roll

for *July to Aug*, 186*4*

Present or absent *Present*

Stoppage, \$ *100* for

Due Gov't, \$ *100* for

Remarks:

* This organization subsequently became Co. F, 11 Reg't U. S. Colored Infantry (New).

Book mark:

100
1006

C

11 (New).

U.S.C.T.

Jepperson Bentley
Sgt, Co. F, 7 Reg't U. S. Col'd H. Art'y.*

Appears on

Company Muster Roll

for *Sept and Oct*, 1864.

Present or absent *Present*

Stoppage, \$ *100* for

Due Gov't, \$ *100* for

Remarks:

* This organization subsequently became Co. F, 11 Reg't U. S. Colored Infantry (New).

Book mark:

J. P. ...

(| **11** (New). | **U.S.C.T.**

Jefferson Chanley
Sgt., Co. F, 7 Reg't U. S. Col'd H. Art'y.*

Appears on

Company Muster Roll'

for *Nov and Dec*, 186*4*.

Present or absent

Stoppage, \$ *100* for

Due Gov't, \$ *100* for

Remarks: *Discharged & Final Statements given.*

* This organization subsequently became Co. F, 11 Reg't U. S. Colored Infantry (New).

Book mark: *Discharged Nov & Dec 64*
V. 11. P. 444.

J. P. Rose

(358)

Coy. Sgt.

C 11 (New). U.S.C.T.

Jefferson Chanley
Pt F, 11 Reg't U. S. Col'd Inf. (New).

Appears on Co. Muster-out Roll, dated
Memphis Tenn July 12, 1866 .

Muster-out to date _____, 186 .

Last paid to Aug 31, 1864 .

Clothing account:

Last settled _____, 186 ; drawn since \$ 100

Due soldier \$ 100 ; due U. S. \$ 100

Am't for cloth'g in kind or money adv'd \$ 100

Due U. S. for arms, equipments, &c., \$ 100

Bounty paid \$ 100 ; due \$ 100

Remarks: Discharged for disability
at Memphis Tenn Oct 31/64
by order of Genl M.L. Smith

Book mark: Discharged Oct 4/64

230891
Done
Revised

JAN. 23

6330882

018910

E.B.V. 11 P. 444.6376, 2nd and.
Jany 8/68
V. 218 P. 294-75-

Chanley, Jefferson

P. F. **11** U. S. C. Inf.
Co. Reg't

Enclosures.

Bed Cards	Descriptive Lists
Burial Records	Final Statements
Certs. of Dis. for Discharge	Furloughs
C. M. Charges	Med. Des. Lists
Med. Certificates	Orders

Other papers relating to—

Admission to Hosp'l	Furlough
Casualty Sheet (Officer's)	Med. Examination
Confinement	Misc. Information
Contracts	Pay or Clothing
Death or Effects	Personal Reports
Desertions	Rank
Discharge from Hosp'l	Transfer to Hosp'l
Discharge from Service	Transfer to V. R. C.
Duty	Transportation

[OFFICE ENDORSEMENT.]

War Department,

ADJUTANT GENERAL'S OFFICE,

Aug 23, 1875.

The discharge of Jefferson
Charles Public Co. 11th Reg't U. S.
Colored Troops, is reported as follows:

On Company Muster Roll.
For Nov 1864, date of place, & stated

Company Muster-out Roll
Oct 31, 1864

Company Descriptive Book. 186

Company Morning Reports. 186

Soldier's Final Statement. 186

Soldier's Record of Death and Interment. 186

Soldier's Inventory of Effects. 186

Soldier's Certificate of Disability for Discharge. 186

Soldier's Individual Muster-out Roll. 186

Regimental Return. 186

For 186, 186

Regimental Quarterly Returns. 186

Regimental Descriptive Book. 186

By Surgeon General. 186

() Nov 1864 is held to be

the correct date, and the Company Muster-out
Rolls will be amended accordingly.

Thomas M. Fuent

EB 11
444. Assistant Adjutant General.
Dec letter Dept 3 to
dated 7th. 2nd.

Duplicates sent the Pension Office.

CERTIFICATE OF DISABILITY FOR DISCHARGE

IN THE CASE OF

Jefferson Charles
a Private Co. 11th

Reg't of U.S. Army

Head-Quarters District of West Tennessee
Memphis Tenn Oct 31st 1864
Approved J. S. Hunt
Adj. Gen. Director

Evon O. P. of Cas

Received (A. G. Office) 186



Oct 31 - 1864

Head-Quarters District of West Tennessee,
Memphis, Tenn Oct 31st 1864

To be Discharged.

By order of Brig. Gen. M. L. SMITH.

W. H. Meyer
MAJ. & ASST. ADJ. GENL.

ARMY OF THE UNITED STATES
 CERTIFICATE
 OF DISABILITY FOR DISCHARGE.

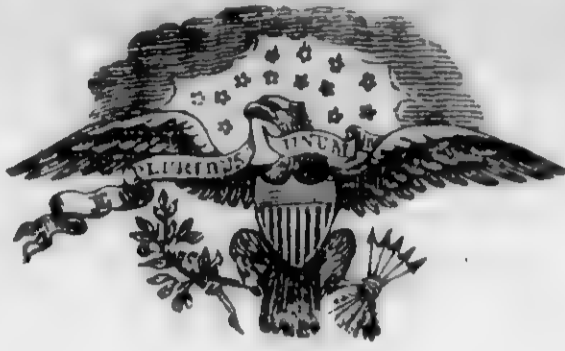

*Put in Lt. Surgeon Corps
 approved on personal examination
 M. O. B. Rice
 1864*

Jefferson Chanley (private) of Captain Joseph C. Gates Company, (7) of the 7th Separate Regiment of United States Colored Infantry was enlisted by Capt Joseph C. Gates of the 20th Regiment of Col. C. A. H. at Fort Pickering on the 15th day of January, 1864, to serve three years; he was born in _____ in the State of North Carolina twenty-four years of age, 5 feet 5 1/2 inches high, Black complexion, Black eyes Black hair, and by occupation when enlisted a farmer. During the last two months said soldier has been unfit for duty 60 days* by reason of a complication of diseases enumerated below partly contracted before entering the service and partly since.

STATION: Fort Pickering, Tenn
 DATE: Sept 27 1864

J. C. Gates
 Captain
 Commanding Company.

I CERTIFY, that I have carefully examined the said Jefferson Chanley of Captain Joseph C. Gates Company, and find him incapable of performing the duties of a soldier because of a Gun Shot Wound and Chronic Rheumatism to which is added a Scrophulous Discharge, before entering the service he was shot through the thigh which causes the hip joint to be stiffened and thus disqualifies him from hard marching. He has been under treatment for the rheumatism for months past and gets no better. Daniel W. Tindall, A. A. Surgeon, U. S. A. says few weeks indications of Scrophula make their appearance. and Surgeon in charge 7th U. S. Col. Inf. He is fit for Artillery Corps.

DISCHARGED, this 4th day of November, 1864, at Fort Pickering
 Memphis Tenn

D. W. Tindall
 Col
 Commanding the Reg't

The Soldier desires to be addressed at
 Town _____ County _____ State _____

* See Note 1 on the back of this. † See Note 2 on the back of this.
 [A. G. O. No. 100 & 101—First.] [DUPLICATES.]

272
Chauvian, Charles F.

Co A, 11 U.S. Col'd Inf.

(New Organization)

Private 1st Sergeant

CARD NUMBERS.

1	6322888	26
2	6328072	27
3	6328117	28
4	6328189	29
5	6328255	30
6	6328337	31
7	6328411	32
8	6328531	33
9	6328591	34
10	6323111	35
11	907.635	36
12	584-07-1877	37
13	42156692	38
14		39
15		40
16		41
17		42
18		43
19		44
20		45
21		46
22		47
23		48
24		49
25		50

Book Mark: EVB $\frac{12}{278}$ 584-07-1877

See also

A3186450 Acad 118

6 | 11 (new) U.S.C.T.

Charles Chaunice

, Co. D, 11 Reg't U.S. Col'd Inf. (new)

Appears on

Company Descriptive Book

of the organization named above.

DESCRIPTION.

Age 27 years height 5 feet 6 inches.

Complexion Yellow

Eyes; Black hair Black

Where born Miss

Occupation Laborer

ENLISTMENT.

When , 186 .

Where

By whom (Drafted) ; term 1 yr.

Remarks: (Drafted first Dist. assigned to 7th U.S.C.A. Hy. S. Co. No. 108 Brig. G. A.L. Chittain, Comdg. Colored Troops in Tenn. 21st November 1864
Discharged Nov. 11/65

Sony

C | 11 Sep | U.S.C.T.

Charles F. Chauvin

Appears with rank of *Priv* on

Muster and Descriptive Roll of a Detachment of Drafted Men and Substitutes forwarded

for the *11* Reg't U. S. Col'd Inf. Roll dated

St Louis Mo, *Nov 10*, 1864

Where born *Missouri*

Age *27* years; occupation *Labourer*

Drafted and mustered in:

When *Nov 10*, 1864

Where *St Louis Mo*

Period *1* years.

Eyes *Blk*; hair *Blk*

Complexion *Yellow*; height *5* ft. *6* in.

Paid bounty and advance pay, \$ *100*

Bounty due \$ *100*

Where credited *''*

Company to which assigned

Remarks:

Book mark: *584-CJ-1877*

R. Richardson

C

U.S.

Chas T Chauvin

Appears with rank of Pop on

Muster and Descriptive Roll

of Detachment of U.S.
Forwarded

Roll dated Nov 14, 1864
Gwld. Traff. Rndz ^{for no} Miss

Where born Miss

Age 27 years; occupation Laborer

When enlisted Nov 3, 1864

Where enlisted St Louis Mo

For what period enlisted 1 years.

Eyes Blk; hair Blk

Complexion Yellow; height 5 ft. 6 in.

When mustered in Nov 10, 1864

Where mustered in St Louis Mo

Bounty paid \$ 100; due \$ 100

Clothing account:

Last settled 186; drawn since \$ 33 69
100

Date of first muster Nov 10, 1864

Company to which assigned _____

Remarks: _____

Book mark: _____

J. W. Wilkinson

(356m)

Copyist.

C. | 11 (New) | U.S.C.T.

Charles F. Chauvin
Pvt., Co. D, 7 Reg't U. S. Col'd H. Art'y.*

Appears on

Company Muster Roll

for *Nov. & Dec.*, 1864.

Present or absent *Present*

Stoppage, \$ *100* for

Due Gov't, \$ *100* for

Remarks: *Assigned to U.S.C.A. (Hys)*
by S.O. No. 108 (Mig. Genl. A.L.)
Chattain Comdg U.S.C. 7. in June

*This organization subsequently became Co. D, 11 Reg't U. S. Col'd Infantry (New).

Book mark:

(358)

B. J. Cooke

Copyist.

C

11 (New).

U.S.C.T.

Charles H. Chauvin

Capt., Co. D, 11 Reg't U. S. Col'd Inf. (New).

Appears on

Company Muster Roll

for *Jan and Feb*, 186*3*.

Present or absent *Present*

Stoppage, \$ *100* for

Due Gov't, \$ *100* for

Remarks: *Transferred Capt to 31st
Mass Reg't (Col'd Inf) Feb. 10/63,
W. D. Turner Cal. Canada.*

Book mark: _____

(858)

J. B. Turner

) Copyist

6

11 (New).

U.S.C.T.

Charles F. Chauvin
Capl., Co. D, 11 Reg't U. S. Col'd Inf. (New).

Appears on

Company Muster Roll

for *March and April*, 186*5*.

Present or absent *Present.*

Stoppage, \$ *100* for

Due Gov't, \$ *100* for

Remarks:

Book mark:

(858)

J. B. Jones

Copyist

11 (New). U.S.C.T.

C. D. Chaviano

1st Sgt., Co. D, 11 Reg't U. S. Col'd Inf. (New).

Appears on

Company Muster Roll

for *May and June*, 1865.

Present or absent *Present*

Stoppage, \$ *100* for

Due Gov't, \$ *100* for

Remarks: *Promoted to 1st Sgt. from Corp
1st date May 1865, S.C. No. 107, Mess
of his, June. Maj. Reddock.*

Book mark:

(858)

J. B. James

Copyist

C

11 (New).

U.S.C.T.

Charles F. Chauvian

Lt., Co. D, 11 Reg't U. S. Col'd Inf. (New).

Appears on

Company Muster Roll

for July and August, 1868.

Present or absent Present

Stoppage, \$ 100 for

Due Gov't, \$ 100 for

Remarks: Promoted to 1st Lt. from Corp'l
at date May 4th, 1868, S. C. Co. 107.

Book mark:

(858)

J. B. James

Copyist

10

11 (New).

U.S.C.T.

Charles P. Chauvin

1st Lt; Co. D, 11 Reg't U. S. Col'd Inf. (New).

Appears on

Company Muster Roll

for *Sept. and Oct.*, 186*0*.

Present or absent *Present*

Stoppage, \$ *100* for

Due Gov't, \$ *100* for

Remarks: *removed 1st Lt. from Co. D
May 11 60. Stop for transportation
4.15.*

Book mark: _____

(858)

J. B. James

Copyist

U.S.C.T.

Charlie J. Hamilton

1391, Co. *A*, *11* Reg't U. S. Col'd Infantry.

Appears on a

Detachment Muster-out Roll

of the organization named above. Roll dated

New York, *Dec 11*, 186*5*.

Muster-out to date *Dec 9*, 186*5*.

Last paid to *Jan 30*, 186*5*.

Clothing account:

Last settled ... , 186 ; drawn since \$ 100

Due soldier \$ *5⁰⁰ 321* 100; due U. S. \$ 100

Am't for cloth'g in kind or money adv'd \$ 100

Due U. S. for arms, equipments, &c., \$ 100

Bounty paid \$ 100 due \$ 100

Remarks: *Map for his spec*

Letter of 11/15

Mustered out by reason

of expiration of enlist-

ment

discharged

Book mark:

John Hamilton

C | 11 (New). | U.S.C.T.

Charles J. Chauveau

1st Sgt, Co. D, 11 Reg't U. S. Col'd Inf. (New).

Appears on

Company Muster Roll

for *Nov. & Dec*, 1865.

Present or absent.....

Stoppage, \$.....100 for.....

Due Gov't, \$.....100 for.....

Remarks:

*Mustered out
Nov. 11/65 by reason
of expiration of en-
listment.*

Book mark: *Discharged Nov. 9
(over)*

Houlges

6 | 11 (New). U.S.C.T.

Charles J. Chauvoan

1st Supt. A., 11 Reg't U. S. Col'd Inf. (New).

Appears on **Co. Muster-out Roll**, dated

Memphis, Tenn. Jan. 12 1866.

Muster-out to date _____, 186 .

Last paid to *Nov. 11.*, 1865.

Clothing account:

Last settled _____, 186 ; drawn since \$ _____ 100

Due soldier \$ _____ 100; due U. S. \$ _____ 100

Am't for cloth'g in kind or money adv'd \$ _____ 100

Due U. S. for arms, equipments, &c., \$ _____ 100

Bounty paid \$ _____ 100; due \$ _____ 100

Remarks:

*Mustered out on rolls
dated Nov. 11. 65 - by
reason of expiration
of enlistment.*

Book mark: *Disch'd Nov. 9. 65 - C.B.*

12
278, - *M.O. on file.*

(361)

Huelgas
Copyist.

Co. 1 11th (new) U.S. C. I.
Charles F. Chauvin
Co. D 11th Reg't U.S. C. I. (new)

NOTATION.

Book mark: 584. C. I. 1877.

War Department,
Adjutant General's Office,

Washington, Mar. 20th, 1877.

Discharged November 9th 1865.

²⁷³
Lheirs Peter

Co E, 11 U.S. Col'd Inf.

(New Organization.)

Private Private

CARD NUMBERS.

1	26
2	27
3	28
4	29
5	30
6	31
7	32
8	33
9	34
10	35
11	36
12	37
13	38
14	39
15	40
16	41
17	42
18	43
19	44
20	45
21	46
22	47
23	48
24	49
25	50

Book Mark:

See also

274

Christian, Henry
Co B, 11 U.S. Col'd Inf.

(New Organization.)

Private | Private

CARD NUMBERS.

1	6322391	26
2	6325121	27
3	6325246	28
4	6325349	29
5	6325450	30
6	6325539	31
7	6325623	32
8	6325658	33
9	6325734	34
10	6326244	35
11	9071068	36
12	40969	37
13		38
14		39
15		40
16		41
17		42
18		43
19		44
20		45
21		46
22		47
23		48
24		49
25		50

Book Mark:

See also

6 | 114 (40) | U.S.C.T.

Henry Christian

Co. B, 11 Reg't U.S. Col'd Inf. ^{L. Fow}

Appears on

Company Descriptive Book

of the organization named above.

DESCRIPTION.

Age 24 years height 5 feet 8 1/2 inches.

Complexion yellow

Eyes; Black hair Black

Where born Saulsbury Tennessee

Occupation Laborer

ENLISTMENT.

When Sept 1, 1863.

Where Corinth Miss

By whom G. Story; term 3 y'rs.

Remarks: Discharged by order of Maj
Genl G. Washburn on Surgeon's
Certificate of Disability Nov 3 1864.

Tuesday

6

11 (tw) | U. S. C. T.

Mary Christian

, Co. (tw), 11 Reg't U. S. Col'd Inf.

Appears on

Company Descriptive Book

of the organization named above.

DESCRIPTION.

Age 24 years height 5 feet 8 1/2 inches.

Complexion Yellow

Eyes; Black hair Black

Where born Smithburg Tennessee

Occupation Laborer

ENLISTMENT.

When Sept 1, 1863.

Where Corinth, Miss

By whom Station; term 5 y'rs.

Remarks: Discharged by order of
Surgeon's Certificate of disability
Nov 2, 1864

T. T. Tindley
Copyist.

C | 11 (New) | U.S.C.T.

Henry Christian
Pri., Co B, 11. ^{1 Ala. S. Art. Vols.} Reg't U. S. Col'd Infantry.

Age 24 years.

Appears on a

Detachment Muster-in Roll

of the organization named above. Roll dated

Corinth Miss, Oct. 5, 1863.

Muster-in to date Oct. 5, 1863.

Joined for duty and enrolled:

When Sept 8, 1863.

Where Corinth Miss.

Period 3 years.

Remarks:

Book mark:

Avery Copyist.

6 | 11 (New) | U.S.C.T.

Henry Christian

Co. B, 1 Reg't Ala. Siege Art'y.*

Appears on

Company Muster Roll

for Sept 10th, 1863.

Present or absent Present

Stoppage, \$ 100 for

Due Gov't, \$ 100 for

Remarks: Promoted to private
Private Sept 13/63

* This organization subsequently became Co. B, 11 Reg't U.S. Col'd Infantry (New).

Book mark :

(358)

A. T. Leonard

Copyist.

6 | 11 (New). | U.S.C.T.

Henry Christian

Prvt, Co. B, 1 Reg't Ala. Siege Art'y.*

Appears on

Company Muster Roll

for Nov, 1 - Dec, 1863.

Present or absent Present

Stoppage, \$ 100 for

Due Gov't, \$ 100 for

Remarks:

* This organization subsequently became Co. B, 11 Reg't U.S. Col'd Infantry (New).

Book mark:

Handwritten marks

Handwritten signature

1 | **11 (New).** | **U.S.C.T.**

Henry Christian
Pr., Co. B, 4 Battalion, 1 Reg't Tenn. H. Art'y.*

Appears on

Company Muster Roll

for *Jan. and Feb.*, 1864.

Present or absent *Present.*

Stoppage, \$ *100* for

Due Gov't, \$ *100* for

Remarks:

*This organization subsequently became Co. B, 11 Reg't U. S. Col'd Infantry (New).

Book mark: _____

A. C. Gillbank

C

11 (New).

U.S.C.T.

Henry Christian

Pvt., Co. B, 6 Reg't U. S. Col'd H. Art'y.*

Appears on

Company Muster Roll

for *March and April*, 1864.

Present or absent *Absent.*

Stoppage, \$ *100* for

Due Gov't, \$ *100* for

Remarks: *Absent. Wounded in Mound City Hospital since Apr. 12, '64.*

*This organization subsequently became Co. B, 11 Reg't U. S. Col'd Infantry (New).

Book mark:

M. O. Gillis

10

11 (New)

U.S.C.T.

Henry Christian

Pr., Co. B, 7 Reg't U. S. Col'd H. Art'y.*

Appears on

Company Muster Roll

for

July and Aug., 1864.

Present or absent

Present

Stoppage, \$

100 for

Due Gov't, \$

100 for

Remarks:

*This organization subsequently became Co. B, 11 Reg't U. S. Col'd Infantry (New).

Book mark:

H. O. Gilbert

C | **11 (New) U.S.C.T.**

Henry Christian
Prv., Co. B, 7 Reg't U. S. Col'd H. Art'y.*

Appears on

Company Muster Roll

for *May and June*, 1864.

Present or absent *Absent.*

Stoppage, \$ *100* for

Due Gov't, \$ *100* for

Remarks: *Absent wounded
at Mound City Hosp.,
Ill. since Apr. 12, '64.*

*This organization subsequently became Co. B, 11 Reg't U. S. Col'd Infantry (New).

Book mark:

H. O. Gilber

10 | 11 (New) | U.S.C.T.

Henry Christian
Pr., Co. B, 7 Reg't U. S. Col'd H. Art'y.*

Appears on

Company Muster Roll

for July and Aug., 1864.

Present or absent Present

Stoppage, \$ 100 for

Due Gov't, \$ 100 for

Remarks:

*This organization subsequently became Co. B, 11 Reg't U. S. Col'd Infantry (New).

Book mark:

H. O. Gilbert

6

11 (New)

U.S.C.T.

Henry Christian
Priv. Co. B, 7 Reg't U. S. Col'd H. Art'y.*

Appears on

Company Muster Roll

for Sept. and Oct. , 1864.

Present or absent Present.

Stoppage, \$ 100 for

Due Gov't, \$ 100 for

Remarks:

Present sick.
Stopp a gun for lost
at Warfield, Spring
field Rifled Musket \$19.25
1 Cap Pouch and Pick 32 ch. 1
Waist Belt and Plate 32 ch.

*This organization subsequently became Co. B, 11 Reg't U. S. Col'd Infantry (New).

Book mark:

H. Gillies

C | **11 (New) U.S.C.T.**

Henry Christian
Pr., Co. B, 7 Reg't U. S. Col'd H. Art'y.*

Appears on

Company Muster Roll

for *Nov. and Dec.*, 186*4*.

Present or absent

Stoppage, \$ 100 for

Due Gov't, \$ 100 for

Remarks: *Discharged and*
final statements
given Nov. 3, '64 by
order of Maj. Gen. C. H.
Nashburn.

*This organization subsequently became Co. B, 11 Reg't U. S. Col'd Infantry (New).

Book mark:

A. Gilbert

C

11 (New).

U.S.C.T.

Henry Christian

Pr Q, 11 Reg't U. S. Col'd Inf. (New).

Appears on Co. Muster-out Roll, dated

Memphis Tenn, Jan 12, 1866.

Muster-out to date _____, 186 .

Last paid to Aug 31, 1863 .

Clothing account:

Last settled _____, 186 ; drawn since \$ _____ 100

Due soldier \$ _____ 100; due U. S. \$ _____ 100

Am't for cloth'g in kind or money adv'd \$ _____ 100

Due U. S. for arms, equipments, &c., \$ _____ 100

Bounty paid \$ _____ 100; due \$ _____ 100

Remarks: Discharged Nov. 3, 1864

Book mark: C.D.

Murphy

(361)

Copyist.

Christian, Henry.

P, Co. B, 11 U. S. C. Inf.
Reg't

6 Enclosures.

Bed Cards	Descriptive Lists
Burial Records	Final Statements /
Certs. of Dis. for Discharge /	Furloughs
C. M. Charges	Med. Des. Lists
Med. Certificates	Orders

Pris-of-war 1

Other papers relating to—

Admission to Hosp'l	Furlough
Casualty Sheet (Officer's)	Med. Examination
Confinement	Misc. Information 3
Contracts	Pay or Clothing
Death or Effects	Personal Reports
Desertions	Rank
Discharge from Hosp'l	Transfer to Hosp'l
Discharge from Service	Transfer to V. R. C.
Duty	Transportation

Cairo, Ill., July 25th 1864.

Order No. 6153

Requisition of Henry Christian
Priv. Co. B. 1st Ala. Arty.
cold for self & 4 men

From Cairo, Ill.,

To Memphis, Tenn.

Nature of Service dischgd. from Gen.
Heesp. Harard City, Ill. to join
Regt. by order of W. Ward-
ner Surgeon in charge

July 25th, 1864

NOTE 1.

The company commander will here add a statement of all the facts known to him concerning the disease or wound, or cause of disability of the soldier: the time, place, manner, and all the circumstances under which the injury occurred, or disease originated or appeared: the duty, or service, or situation of the soldier at the time the injury was received or disease contracted, stating particularly whether the injury was received or the disease contracted in the line of his duty; and whatever other facts may aid a judgment as to the cause, immediate or remote, of the disability, and the circumstances attending it.

When the facts are not known to the company commander, the certificate of any officer, or affidavit of other person having such knowledge, will be appended—as the surgeon in charge of a hospital, the officer commanding a detachment of recruits, &c., &c.

NOTE 2.

When a probable case for pension, special care must be taken to state the degree of disability—as 1/2, 3/4, &c., &c.; to describe particularly the disability, wound, or disease; the extent to which it deprives him of the use of any limb or faculty, or affects his health, strength, activity, constitution, or capacity to labor or earn his subsistence. The surgeon will add, from his knowledge of the facts and circumstances, and from the evidence in the case, his professional opinion of the cause or origin of the disability. In the case of discharges by Medical Inspectors, the last paragraph will state that the "discharge was given by consent of the soldier, after a personal examination, and for disability, the nature, degree, and origin of which are correctly described in the within certificate."

Par. 1260 Regulations, Edit. 1861.

Medical officers, in giving certificates of disability, are to take particular care in all cases that have not been under their charge; and especially in epilepsy, convulsions, chronic rheumatism, derangement of the urinary organs, ophthalmia, ulcers, or any obscure disease liable to be feigned or purposely produced; and in no case shall such certificate be given until after sufficient time and examination to detect any attempt at deception.

DIRECTIONS.

This certificate will be made out in duplicate by the soldier's company commander, or other officer commanding the separate detachment to which he belongs, and sent by him to the surgeon who has charge of the hospital where the soldier is sick. The surgeon will then fill out and sign the surgeon's certificate, and forward these papers to the regimental, detachment, or post commander, who will forward them, with his action endorsed thereon, through the proper channel, to his division commander; or, if the troops are not attached to a division, to his corps, department, or other commander or officer to whom the authority to discharge enlisted men may be specially delegated.

These certificates, after having received the action of the highest authority to which they are required to be sent, will be returned through the same channel to the regimental, post, or detachment commander, who will, if the discharge is authorized by the endorsement of the proper authority, sign the soldier's discharge, and the last certificate on this paper; see that the soldier is furnished with the proper final statements in duplicate, and forward BOTH of these certificates direct to the Adjutant General United States Army, at Washington, D. C.; they will not, under any circumstances, be given into the hands of the soldier.

ADJUTANT GENERAL'S OFFICE.

Nov 23rd 1864

Duplicate sent the Pension Office.

CERTIFICATE OF DISABILITY FOR DISCHARGE

IN THE CASE OF

Horsey Christian
a Private of Co. B

7th Reg't of U. S. Col. Infy

Head-Quarters West Tenn.

Memphis Oct 30th 1864

Approved

W. H. ...

Act Med Director

Received (A. G. Office), 186

Ev on P. of Cas



Head-Quarters District of West Tennessee,
Memphis, Tenn., 31st Oct 1864.

To be Discharged.

By order of Brig. Gen. M. L. SMITH.

W. H. ...
MAJ. & ASST. ADJT. GENL.

ARMY OF THE UNITED STATES

CERTIFICATE

OF DISABILITY FOR DISCHARGE.

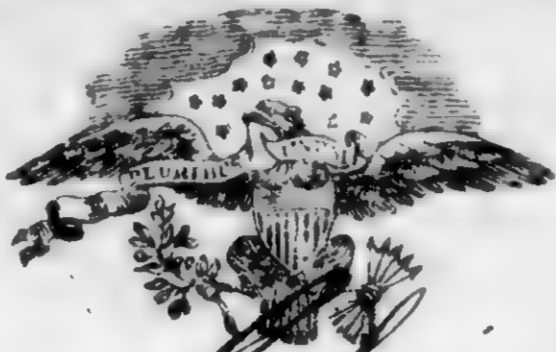

Private Henry Christian of Captain John H. Baker's Company, (B) of the Seventh Regiment of United States C. Art'y (Hq.) was enlisted by Lieut. W. R. Story of the 1st Regiment of Ala. Inf. Art'y at Corinth Miss on the 8th day of September 1863, to serve 3 years; he was born in Shelby in the State of Tennessee is 24 years of age, 5 feet 8 1/2 inches high, Yellow complexion, Black eyes, Black hair, and by occupation when enlisted a Sawyer

During the last two months said soldier has been unfit for duty 69 days.* On account of a gunshot wound received in the action of Fort Pillow April 12th 1864 he has been unable to perform any duty since receiving said wound and is in my opinion totally unfit to perform the duties of a soldier

STATION: Fort Pickering Tenn
 DATE: Sept-17th 1864

John R. McDougall
1st Lt 7th U.S. C. Art'y Hq
 Commanding Company. B

I CERTIFY, that I have carefully examined the said Henry Christian of Captain J. H. Baker's Company, and find him incapable of performing the duties of a soldier because of a "Gun Shot-Wound". The wound was received at Fort Pillow, April 12th 1864, while in the discharge of his duties as a soldier. The ball entered the abdominal cavity passing through the superior part of the posterior portion of the diaphragm and struck his liver, he is fit for "Reserve Corps" Disability 1/4 Reserve Corps

Daniel W. Randall, M.D., Surg. U.S.A.
and Surgeon in charge 7th U.S. C. Art'y Hq

DISCHARGED, this 9th day of November 1864, at Fort Pickering Tennessee

J. M. Furness
Col
 Commanding the Reg't.

The soldier desires to be addressed at
 Town Memphis County _____ State Tennessee

* See Note 1 on the back of this. † See Note 2 on the back of this.
 [A. G. O. No. 100 & 101—First.] (DUPLICATES.)

1864

FINAL STATEMENT

Discharged for his

OF

Private Henry Christian
Co B 7 Reg't of W.C. Army

VOLUNTEERS.

NOTE 1.—Two of these certificates (or duplicates) are to be given to each Volunteer Soldier or drafted man who may be discharged previously to the discharge of his company, that he may at once receive from the Paymaster the pay, &c., due him, and the captain or other COMMISSIONED officer commanding the company will certify to the act of the delivery of the duplicate certificates; on these certificates the Soldier is "entitled to" his discharge, and should also present his discharge to the Paymaster to have the payment endorsed on it. The discharge is to be given back to the Soldier by the Paymaster; the latter only retaining as his voucher the duplicate certificates.

NOTE 2.—If the Soldier is entitled to pay for the use of his horse, the Company Commander will certify to that fact on the back of both these final statements, and also to the time he has pay due for having been so mounted on his own horse.

NOTE 3.—When a Soldier is furnished with final statements, his descriptive list, if he has one, should be taken up by the officer who gives the Soldier these statements, and endorsed with a statement to this effect by the officer. This endorsement should exhibit a full statement of the time for which the Soldier was allowed pay on his final statements, the clothing account, and all other charges against him or in his favor, so as to comprise a complete exhibit of his account. It will then be transmitted to the Company Commander of the Soldier, who will enter all the data necessary to a full understanding of the Soldier's account on the muster roll upon which the Soldier's discharge is reported. The descriptive list will then be destroyed. The object of this is, that the remaining portion of the Soldier's account may be settled upon the receipt of these muster rolls, and the Soldier receive any pay or allowances that may be due him at the time of his discharge, and which may not appear on his final statements from the fact that his descriptive list is incomplete. These accounts for back pay, &c., are settled by the 2d Auditor of the Treasury Department.

NOTE 4.—Charges for loss or injury to ordnance, horse equipments, and other miscellaneous charges, should appear under the heading of "Other Stoppages."

NOTE 5.—Bounty paid by State authorities, and not by the United States, will not be entered on this statement.

NOTE 6.—Amounts due the Butler and Laundress must be entered on the muster roll on which the discharge, death, desertion, &c., is reported, as well as on the final statement, otherwise the amount cannot be collected from the United States.

NOTE 7.—This blank will be used for deceased volunteers and drafted men, as well as for others.

NOTE 8.—Where a Soldier dies in Hospital or on detached service, his descriptive list, if he has one, should be sent with his final statements, in duplicate, to the Adjutant General, Washington, D.C.



I certify, on honor, that Henry Christian a Sergeant of
 Captain J. S. Baines Company (D) of the 4th Regiment of W. L. H. H. H.
VOLUNTEERS, of the State of Massachusetts, born in Saundersbury, State
 of Massachusetts, aged 21 years; 5 feet 1 1/2 inches high; Fair complexion,
Black eyes, Black hair, and by occupation a Soldier, having joined the company on
 its original organization at Concord Mass, and enrolled in it at the muster into
 the service of the United States at Concord Mass, on the 8th day
 of September, 1863, (or was mustered in service as a recruit, by John Hoffman
1st Lieut, at Concord Mass on the 5th day of October,
 1863, or was drafted and mustered into the service of the United States from the
 Enrollment District of the State of _____, at _____,
 on the _____ day of _____, 186) to serve in the Regiment, for
 the term of Three Years: and having served **HONESTLY** and
FAITHFULLY with his Company in the field to the present date, is now

entitled to a **DISCHARGE** by reason of Disability by accident by a
gun shot wound recd at Fort Pillow Tenn 13th April 1864

The said Private Henry Christian was last paid by Paymaster
Wm Smith to include the 31st day of August, 1864, and has
 pay due him from that time to the present date; he is entitled to pay and subsistence for
TRAVELING to place of enrollment, and whatever other allowances are authorized to volunteer
 soldiers, drafted men, or militia, so discharged. He has received from the United States **CLOTHING**
 amounting to \$19 ²/₁₀₀ dollars, since the 12 day of April,
 1864, when his clothing account was last settled. He has received from the United States
 _____ ¹⁰⁰/₁₀₀ dollars advanced **BOUNTY**.

There is to be stopped from him, on account of the State of _____, or other
 authorities, for **CLOTHING**, &c., received on entering service, _____ ¹⁰⁰/₁₀₀ dollars; and
 for other stoppages, viz: 1 Springfield Rifle Musket lid 58 x 19 25 cts
1 Cap Buck & Pick 56 cts 1 Hair & Belt and Plate 52 cts
amounting in all to the sum of _____ ¹⁰⁰/₁₀₀ dollars.

He has been furnished with **TRANSPORTATION** in kind from the place of his discharge to
 _____; and he has been **SUBSISTED** for **TRAVELING** to his
 place of enrollment, up to the _____, 186 .

He is indebted to _____, **SUTLER**, _____ ¹⁰⁰/₁₀₀ dollars.
 He is indebted to _____, **LAUNDRESS**, _____ ¹⁰⁰/₁₀₀ dollars.

Given in Duplicate, at _____, this 3rd day
 of November, 1864

Walter H. [Signature]
[Signature]

 Commanding Company.

U. S. A. General Hospital.
Mound City Mo. May 23rd 1863
Respectfully returned with the
information that Private Henry Christian
was wounded by a musket ball
Entering on right side of vertebral
column two and a half (2 1/2) inches
above posterior superior angle
of Ilium and passing across
vertebral column to left
side emerged (10) ten inches
from point of entrance
immediately above left Ilium
Flesh wound
was Returned to Duty
July 22nd 1864.

M. C. Wardner
Surgeon U. S. A.
in charge of Hospital.

Forman

Quinn

Henry

Christian

Co B (ala City Co)

257-112

Surgeon General's Office,

Washington City, D. C.

May 20th 1865

In the case of Priv. Henry Christian ad. Co. "B" 1st
Regiment, Ala. Arty. Age 30. admitted April 14. 65. a patient in
the "Monnd City" Monnd City Ill. U. S. A. General Hospital, represented by
the hospital number 12318 having 4. S. W. right of spine 2 1/2
above the ilium, emerged 10 inches to left of point of entrance, at
H Pillow Massacre, you will please supply, if possible, from the records of the hospital, or
any other reliable source, the following facts for the use of this Office, viz.:

A more explicit diagnosis
Cause of death

I remain, Sir, Very respectfully,

Your obedient servant,

By Order of the Surgeon General:

C. H. CRANE,
Surgeon, U. S. Army

Medical Officer in charge of "Monnd City"
U. S. A. General Hospital

Monnd City Ill.

Henry Christian Post

Co B. 11th USCT

Ellettsville

Adjutant General's Office,

COLORED TROOPS BRANCH,

Mr Ellertson

Jan'y 11th, 1877

Vol. C. T., 187

Wanted in the case of Henry Christian Privt, Co. "D",
11th Reg't U.S.C. Troops (new) Cause of reduction -
"Promoted to Corp'l Sept 15th 1863" - in R Sept & Oct 1863
Born on subsequent in Rolls as Private - date of
reduction not given -

AJL

Respectfully,

W A Woodward
Chief Clerk.
J. H. Dalton

Adjutant General's Office,

, 187

Vol. C. T., 187

Reply in case of _____, Co. _____,
Reg't _____

Battery Williams, Corinth Miss,
Dec 2/63.
Co Order No 4.

For conduct unbecoming a non-com
Officer & soldier. I hereby reduce Corp'l Henry Christian
to the ranks -

Mr. Dalton
a report stating that there
was no order in this case was
made a few days ago.

By order

John H Baker capt comdr
Dec 20 1877 ✓

Adjutant General's Office,

COLORED TROOPS BRANCH,

Mr Ellertson

Jan'y 11th, 1877

Vol. _____ C. T., 187
Wanted in the case of Nemy Christian Privt, Co. "D",
11th Reg't U.S.C Troops (New) Cause of reduction -
"Promoted to Corp'l Sept 15th 1863" - M.R. Sept & Oct 1863
Born on subsequent M.Rolls as Private - date of
reduction not given -

AJL

Respectfully,

W. A. Woodward
Chief Clerk.
J. H. Hutton

Adjutant General's Office,

_____, 1877

Vol. _____ C. T., 187
Reply in case of _____, Co. _____,
Reg't _____

Co Des Book,
"Promoted to Corp'l Sept 12/63 & reduced
to the ranks Dec 8/63"

~~etc. [scribble]~~

W.A. Jan'y 17/77

MEMORANDUM FROM PRISONER OF WAR RECORDS.

No. _____

(This blank to be used only in the arrangement of said records.)

NAME.	RANK.	ORGANIZATION.				INFORMATION OBTAINED FROM—				
		No. of Reg't.	State.	Arm of Service.	Co.	Records of—	Vol.	Page.	Vol.	Page.
<i>Christian Henry</i>		<i>11</i>	<i>U.S.C.T.</i>		<i>B</i>					

Captured at _____, 186____, confined at Richmond, Va., _____, 186____.

Admitted to Hospital at _____ where he died _____, 186____, of _____

Paroled at _____, 186____; reported at Camp Parole, Md., _____, 186____.

See 1 Ala

Copied by _____

274-a

Christopher William

Co. F, 11 U. S. Col'd Inf.
(New Organization.)

CARD NUMBERS.

1	4072114	28
2		27
3		28
4		29
5		30
6		31
7		32
8		33
9		34
10		35
11		36
12		37
13		38
14		39
15		40
16		41
17		42
18		43
19		44
20		45
21		46
22		47
23		48
24		49
25		50

Number of personal papers herein.....

Book Mark :

See also

6

11 (new) U. S. C. T.

William Christopher

Co. F, 11 Reg't U. S. Col'd Inf. (new)

Appears on

Company Descriptive Book

of the organization named above.

DESCRIPTION.

Age 18 years height 5 feet $\frac{1}{2}$ inches.

Complexion black

Eyes; black hair black

Where born Decoto Co. Miss.

Occupation laborer

ENLISTMENT.

When Jan. 8 - , 1864

Where Fort Pickering

By whom F. E. Thompson; term 3 y'rs.

Remarks: Jan. 8th is the date of his coming to the company.

F. A. Wright

275

Chusson, Solomon

Co A, 11 U.S. Col'd Inf.

(New Organization.)

~~Private~~ Private

CARD NUMBERS.

1	6327478	26
2	6327553	27
3	6327633	28
4	6327737	29
5	6327823	30
6	6327946	31
7	6328678	32
8	9076535	33
9	9071695	34
10		35
11		36
12		37
13		38
14		39
15		40
16		41
17		42
18		43
19		44
20		45
21		46
22		47
23		48
24		49
25		50

Book Mark:

See also

C | 11 (New) U.S.C.T.

Samuel Chusex

....., Co. *D*, 11 Reg't U.S. Col'd Inf. ^(New)

Appears on

Company Descriptive Book

of the organization named above.

DESCRIPTION.

Age *18* years height feet inches.

Complexion *Black*

Eyes; *Black* hair *Black*

Where born

Occupation

ENLISTMENT.

When *Oct 18*, 186*3*.

Where *in Fayette Tenn.*

By whom *L. Carson*; term *3* y'rs.

Remarks: *Missing in action at
Fort Pillow April 12th 1864.*

L. Carson
Copyist.

C 11 (New). U.S.C.T.

Solomon Chusen
Pvt, Co. D, 1 Reg't Ala. Siege Art'y.*

Appears on

Company Muster Roll

for *Nov + Dec*, 1863.

Present or absent *Present*

Stoppage, \$ 100 for

Due Gov't, \$ 100 for

Remarks:

*This organization subsequently became Co. D, 11 Reg't U. S. Col'd Infantry (New).

Book mark:

Leves

6

11 (New). U.S.C.T.

Samuel Chuseen

PT, Co. D, 4 Battalion, 1 Reg't Tenn. H. Art'y.*

Appears on

Company Muster Roll

for *Jan & Feb*, 1864.

Present or absent *Present*

Stoppage, \$ *100* for

Due Gov't, \$ *100* for

Remarks :

* This organization subsequently became Co. D, 11 Reg't U. S. Colored Infantry (New).

Book mark :

Leger

Cy | **11** (New) | **U.S.C.T.**

Solomon Museu
Priv, Co. D, 7 Reg't U. S. Col'd H. Art'y.*

Appears on

Company Muster Roll

for *Mar. & Apr.*, 186*4*

Present or absent *Absent*

Stoppage, \$ *100* for

Due Gov't, \$ *100* for

Remarks: *Miping in action*
at Fort Pillow April
12, 1864.

*This organization subsequently became Co. D, 11 Reg't U. S. Col'd Infantry (New).

Book mark: _____

(358)

B J Cook

Copyist.

C. J. | **11** (New) | **U.S.C.T.**

Solomon Chusee

Priv, Co. D, 7 Reg't U. S. Col'd H. Art'y.*

Appears on

Company Muster Roll

for *May & June*, 1864

Present or absent *Absent*

Stoppage, \$ *100* for

Due Gov't, \$ *100* for

Remarks: *Wiping after battle
of Fort Pillow from
April 12, 1864.*

*This organization subsequently became Co. D, 11 Reg't U. S. Col'd Infantry (New).

Book mark:

(358)

B. J. Cook

Copyist.

C | 11 (New). | U.S.C.T.

Salomon Chusen
Privat, 11 Reg't U. S. Col'd Inf. (New).

Appears on **Co. Muster-out Roll**, dated
Memphis Tenn. Jan. 12, 1866.

Muster-out to date _____, 186 .

Last paid to *Oct. 31*, 1865.

Clothing account:

Last settled _____, 186 ; drawn since \$ _____ 100

Due soldier \$ _____ 100; due U. S. \$ _____ 100

Am't for cloth'g in kind or money adv'd \$ _____ 100

Due U. S. for arms, equipments, &c., \$ _____ 100

Bounty paid \$ _____ 100; due \$ _____ 100

Remarks: *Missing in action*

*& all records destroyed
at Ft. Pillow Apr. 12. 64
All that were not killed
were carried into sla-
very by their captors.*

Book mark: _____

(861)

Hedgus
Copyist.

6

11 (New) U. S. C. T.

Simon Hansen

Co. *D*, 11 Reg't U. S. Col'd Inf. ^(New)

Appears on

Company Descriptive Book

of the organization named above.

DESCRIPTION. *No description*

Age years height feet inches.

Complexion

Eyes; hair

Where born

Occupation

ENLISTMENT.

When , 186

Where

By whom ; term y'rs.

Remarks:

.

.

.

.

.

.

.

.

Leary Copyist.

Chusen, Solomon -

P, Co. D, 11 Reg't U.S.C. Inf.

3 Enclosures.

Bed Cards	Descriptive Lists
Burial Records	Final Statements 2
Certs. of Dis. for Discharge	Furloughs
C. M. Charges	Med. Des. Lists
Med. Certificates	Orders

Other papers relating to—

Admission to Hosp'l	Furlough
Casualty Sheet (Officer's)	Med. Examination
Confinement	Misc. Information
Contracts	Pay or Clothing
Death or Effects /	Personal Reports
Desertions	Rank
Discharge from Hosp'l	Transfer to Hosp'l
Discharge from Service	Transfer to V. R. C.
Duty	Transportation

ARTICLES OF WAR.

ART. 95. When any non-commissioned officer or soldier shall die, or be killed in the service of the United States, the then commanding officer of the troop or company shall, in the presence of two other commissioned officers, take an account of what effects he died possessed of, above his arms and accoutrements, and transmit the same to the office of the Department of War, which said effects are to be accounted for, and paid to the representatives of such deceased non-commissioned officer or soldier. And in case any of the officers, so authorized to take care of the effects of deceased officers and soldiers, should, before they have accounted to their representatives for the same, have occasion to leave the regiment or post, by preferment or otherwise, they shall, before they be permitted to quit the same, deposit in the hands of the commanding officer, or of the assistant military agent, all the effects of such deceased non-commissioned officers and soldiers, in order that the same may be secured for, and paid to, their respective representatives.

ARMY REGULATIONS—EDITION OF 1863.

DECEASED SOLDIERS.

Par. 152. Inventories of the effects of deceased non-commissioned officers and soldiers, required by the 95th Article of War, will be forwarded to the Adjutant General, by the commander of the company to which the deceased belonged, and a duplicate of the same to the colonel of the regiment. Final statements of pay, clothing, &c., in duplicate, will be sent to the Adjutant General with one copy of the inventory. When a soldier dies at a post or station absent from his company, it will be the duty of his immediate commander to furnish the required inventory and final statements, and, at the same time, to forward to the commanding officer of the company to which the soldier belonged, a report of his death, specifying the date, place, and cause; to what time he was last paid, and the money or other effects in his possession at the time of his decease; which report will be noted on the next muster roll of the company to which the man belonged. Each inventory will be endorsed, "Inventory of the effects of _____, late of company (—) _____ regiment of _____, who died at _____, the _____ day of _____, 186—." If a legal representative receive the effects, it will be stated in the report. If the soldier leave no effects, the fact will be reported.

Par. 153. Should the effects of a deceased non-commissioned officer or soldier not be administered upon within a short period after his decease, they shall be disposed of by a Council of Administration, under the authority of the commanding officer of the post, and the proceeds deposited with the Paymaster, to the credit of the United States, until they shall be claimed by the legal representatives of the deceased.

Par. 154. In all such cases of sales by the Council of Administration, a statement in detail, or account of the proceeds, duly certified by the Council and commanding officer, accompanied by the Paymaster's receipt for the proceeds, will be forwarded by the commanding officer to the Adjutant General. The statement will be endorsed, "Report of the proceeds of the effects of _____, late of company (—) _____ regiment of _____, who died at _____, the _____ day of _____, 186—."

NOTE 1.—The effects in all cases, when called for, should be turned over to the legal representative, without further authority from the Adjutant General. When the effects are turned over to the relatives of the deceased before these inventories are sent to the Adjutant General, their receipts therefor should be attached to the inventories. In all other cases, one copy will be sent with a letter of transmittal direct to the Adjutant General, and a duplicate retained by the officer.

NOTE 2.—Particular care should be taken to take receipts in duplicate from the Paymaster for any funds turned over to him; one copy should be sent direct to the Adjutant General and one retained by the officer.

INVENTORY OF THE EFFECTS

OF

Solomon Chasin

Late of Company *D*

7th Reg't of *U.S. C.A. (I)*

Volunteers, who died at *Fort Pillow*

on the *12* day of *April* 186*4*.



Inventory of the effects of Samson Chusen late
 a Private of Captain Delos Carson Company D of
 the 7th Regiment of U.S. C. A. Fly Volunteers, who was enrolled as
 a Private at La Fayette Tenn in the State of Tenn on
 the 18th day of October 1863, and mustered into the service of the United
 States as a Private on the 27th day of October 1863, at Carristown
 in Company D, 7th Regiment of U.S. C. A. Fly Volunteers, to serve Three
 years or during the war; he was born in _____ in the State
 of _____; he was 18 years of age, _____ feet _____ inches
 high, Black complexion, Black eyes, Black hair, and by occupation, when enrolled,
 a _____; he died in Missing in action at, at
Fort Pillow on the 15th day of April 1864, by
 reason of supposed to be killed

INVENTORY.					
ARTICLES.	No.	ARTICLES.	No.	ARTICLES.	No.
Hats.....		Pairs trousers.....		Knapsacks.....	
Caps.....		Pairs flannel drawers.....			
Forage caps.....		Pairs cotton drawers.....			
Great coats.....		Flannel shirts.....			
Uniform coats.....		Cotton shirts.....			
Uniform jackets.....		Pairs boots.....			
Flannel sack coats.....		Pairs shoes.....			
Blouses.....		Pairs socks.....			
Stable frocks.....		Blankets.....		MONEY.	
Fatigue overalls.....		Haversacks.....		Specie.....	\$
				Notes.....	\$

I CERTIFY, ON HONOR, that the above inventory comprises all the effects of _____
 _____, deceased, and that the effects are in the hands
 of Missing in action at Fort Pillow Tenn April 15th
1864 to be disposed of by a Council of Administration.

(DUPLICATES.)

STATION: Fort Pickens
 DATE: June 21st 1864

W. B. Edson
7th U.S. C. A. Fly
 Commanding the Company.

1864 Sup. H.M. 54

FINAL STATEMENT

OF

Solomon C. Fisher

1st Reg't of Ms. C. A. G.

VOLUNTEERS.

NOTE 1.—Two of these certificates (or duplicates) are to be given to each volunteer soldier who may be discharged previously to the discharge of his company, that he may at once receive from the Paymaster the pay, &c., due him, and the captain or other officer commanding the company will certify to the act of the delivery of the duplicate certificates; on these certificates the Soldier is "entitled to" his *discharge*, and should also present his discharge to the Paymaster to have the payment endorsed on it. The discharge is to be given back to the Soldier by the Paymaster; the latter only retaining as his voucher the duplicate certificates.

NOTE 2.—If the Soldier is entitled to pay for the use of his horse, the Company Commander will certify to that fact, and also to the time he has pay due for having been so mounted on his own horse.

NOTE 3.—Amounts due the Sutler and Laundress must be entered on the Muster Roll on which the death, desertion, &c., is reported, as well as on the final statement, otherwise the amount cannot be collected from the United States.

NOTE 4.—This blank will be used for deceased volunteers as well as others.

I certify, on honor, that Solomon Chuson a Private of
Captain D. Carson Company (3^d) of the 7th Regiment of U.S. C.A. Reg
VOLUNTEERS, of the State of _____, born in _____, State
of _____, aged 18 years; _____ feet _____ inches high; Black complexion,
Black eyes, Black hair, and by occupation a _____, having joined the company on
its original organization at La Fayette Tenn, and enrolled in it at the muster into
the service of the United States at Corinth Miss, on the Twenty Seventh day
of October, 1863, (or was mustered in service as a recruit, by _____
at _____, on the _____ day of _____
186 , to serve in the Regiment.) for the term of Three Years unless sooner discharged
and having served **HONESTLY** and **FAITHFULLY** with his Company in The Siege
to the present date, is now entitled to a **DISCHARGE** by reason of Missing in action
at Fort Pillow April 12th 1864 supposed to be
Killed

The said Solomon Chuson was last paid by Paymaster
Wm. J. Adams to include the thirty first day of December, 1863, and has
pay due him from that time to the present date; he is entitled to pay and subsistence for
TRAVELING to place of enrollment and whatever other allowances are authorized to volunteer
soldiers, or militia, so discharged. He has received _____ dollars,
advanced by the United States on account of **CLOTHING**.

There is to be stopped from him, on account of the State of _____, or other
authorities for **CLOTHING**, &c., received on entering service, _____ dollars; also,
for expenses of **SUBSISTENCE** for **TRAVELING** from place of enrollment to the place of rendezvous,
amounting to _____ dollars: and on account of the United States for **EXTRA**
CLOTHING received in kind from _____ and for other
stoppages, viz: The Books & Papers of the Co were lost in action
at Fort Pillow April 12th 1864 amounting to unable to tell _____ dollars;
and he has been **SUBSISTED** for **TRAVELING** to his place of enrollment, up to the _____
_____, 186 .

He is indebted to _____ **SUTLER**, _____ dollars.
He is indebted to _____ **LAUNDRESS**, _____ dollars.

Given in Duplicate, at Fort Pickens, this 21st day of June, 1864.

W. B. Adams
7th U.S. C.A. Reg
Commanding Company.

J Co D 54.

FINAL STATEMENT

OF
Abner Chasen

7th Reg't of U.S. Cavalry

7th Cav. Regt.
VOLUNTEERS.

Discharged 12/1/18

NOTE 1.—Two of these certificates (or duplicates) are to be given to each volunteer soldier who may be discharged previously to the discharge of his company, that he may at once receive from the Paymaster the pay, &c., due him, and the captain or other officer commanding the company will certify to the act of the delivery of the duplicate certificates; on these certificates the Soldier is "entitled to" his discharge, and should also present his discharge to the Paymaster to have the payment endorsed on it. The discharge is to be given back to the Soldier by the Paymaster; the latter only retaining as his voucher the duplicate certificates.

NOTE 2.—If the Soldier is entitled to pay for the use of his horse, the Company Commander will certify to that fact, and also to the time he has pay due for having been so mounted on his own horse.

NOTE 3.—Amounts due the Sutler and Laundress must be entered on the Muster Roll on which the death, desertion, &c., is reported, as well as on the final statement, otherwise the amount cannot be collected from the United States.

NOTE 4.—This blank will be used for deceased volunteers as well as others.

ADJUTANT GENERAL'S OFFICE.
July 18th 1861
Duplicate with Inventory sent 2d Auditor.

Ent an OR of Co

I certify, on honor, that Solomon Chusem a Private of
Captain G. Carson Company (D) of the 7th Regiment of U.S.C.A. (V)
VOLUNTEERS, of the State of _____, born in _____ State
of _____, aged 18 years; _____ feet _____ inches high; Black complexion,
Black eyes, Black hair, and by occupation a _____, having joined the company on
its original organization at La Fayette Tenn and enrolled in it at the muster into
the service of the United States at Corinth Miss, on the Twenty Seventh day
of October, 1863, (or was mustered in service as a recruit, by _____
at _____, on the _____ day of _____
186 , to serve in the Regiment.) for the term of Three years unless sooner discharged
and having served **HONESTLY** and **FAITHFULLY** with his Company in The Field
to the present date, is now entitled to a **DISCHARGE** by reason of Wounding in action
at Fort Pillow April 12th 1864 supposed to be killed

The said Solomon Chusem was last paid by Paymaster
W. J. Tolman to include the Thirty first day of December 1863, and has
pay due him from that time to the present date; he is entitled to pay and subsistence for
TRAVELING to place of enrollment and whatever other allowances are authorized to volunteer
soldiers, or militia, so discharged. He has received _____ dollars,
advanced by the United States on account of **CLOTHING**.

There is to be stopped from him, on account of the State of _____, or other
authorities for **CLOTHING**, &c., received on entering service, _____ dollars; also,
for expenses of **SUBSISTENCE** for **TRAVELING** from place of enrollment to the place of rendezvous,
amounting to _____ dollars; and on account of the United States for **EXTRA**
CLOTHING received in kind from _____ and for other
stoppages, viz:

The sick & Papers of the Co were lost in action
at Fort Pillow April 12th 1864 amounting to unable to tell _____ dollars;
and he has been **SUBSISTED** for **TRAVELING** to his place of enrollment, up to the _____
_____, 186 .

He is indebted to _____ **SUTLER**, _____ dollars.
He is indebted to _____ **LAUNDRESS**, _____ dollars.

Given in Duplicate, at Fort Pickens this 21st day of June, 1864.
W. B. Olson, Adj. (V)
7th U.S.C.A. (V)
Commanding Company.

276

Glafton Andrew

Co L & B 11 U.S. Col'd Inf.

(New Organization.)

Private

Private

CARD NUMBERS.

1	26
2	27
3	<i>In Glafton Andrew</i>
4	29
5	30
6	31
7	32
8	33
9	34
10	35
11	36
12	37
13	38
14	39
15	40
16	41
17	42
18	43
19	44
20	45
21	46
22	47
23	48
24	49
25	50

Book Mark.

See also

277

Clifton Braxton

Co. I B, 11 U.S. Col'd Inf.

(New Organization.)

Private

Private

CARD NUMBERS.

1	26
2	27
3	28
4	29
5	30
6	31
7	32
8	33
9	34
10	35
11	36
12	37
13	38
14	39
15	40
16	41
17	42
18	43
19	44
20	45
21	46
22	47
23	48
24	49
25	50

In Clifton Braxton

Book Mark:

See also

278
Lopton Joseph
Co L & B, 11 U.S. Col'd Inf.

(New Organization.)

Private | Private

CARD NUMBERS.

1		26
2		27
3	See Lopton Joseph	
4		29
5		30
6		31
7		32
8		33
9		34
10		35
11		36
12		37
13		38
14		39
15		40
16		41
17		42
18		43
19		44
20		45
21		46
22		47
23		48
24		49
25		50

Book Mark: _____

See also _____

279

Chanton Pompey

Co. A, 11 U.S. Col'd Inf.

(New Organization.)

Private

Private

CARD NUMBERS.

1	6328134	26
2	6328205	27
3	6328279	28
4	6328405	29
5	6328601	30
6	7071748	31
7	7072726	32
8		33
9		34
10		35
11		36
12		37
13		38
14		39
15		40
16		41
17		42
18		43
19		44
20		45
21		46
22		47
23		48
24		49
25		50

Book Mark:

See also

S.980098 - Land.

S-1027238 - Land.

S 1129373 On Mm Ret

6

11 (new) U.S.C.T.

Pompy Clanton (new)
Co. L, 11 Reg't U.S. Col'd Inf.

Appears on

Company Descriptive Book

of the organization named above.

DESCRIPTION.

Age 23 years height 5 feet 4 inches.

Complexion Blk.

Eyes; Blk. hair Blk.

Where born Tanola Miss.

Occupation Farmer

ENLISTMENT.

When July 16", 1863.

Where Memphis

By whom Lt Dickhut; term 3 yrs.

Remarks: Present

D. M. Kennedy Copyist.

11 (New) U. S. C. T.

Henry Clanton

(New)
Co. K, 11 Reg't U. S. Col'd Inf.

Appears on

Company Descriptive Book

of the organization named above.

DESCRIPTION.

Age 23 years height 5 feet 7 inches.

Complexion Black

Eyes; Black hair Black

Where born Andover, Miss.

Occupation Farmer

ENLISTMENT.

When July 16, 1863

Where Memphis, Tenn.

By whom Lieut. Washburn, term 3 y'rs.

Remarks: Transferred to 9th U. S. C. A.

By S. O. No 124 July 14/64, Lt.
Thomas Adj't 4th. Discharged
from the 1st Service for
Disability July 31st 1865

C | 11 (New). | U.S.C.T.

Company Clanton
Prin, Co. D, 11 Reg't U. S. Col'd Inf. (New).

Appears on

Company Muster Roll

for *Jan and Feb*, 1865.

Present or absent *Present*

Stoppage, \$ *100* for

Due Gov't, \$ *100* for

Remarks: *Assigned to 7th Me. C. Artillery*
So. to July 14/64, L. Thomas
Adj. Gen.

Book mark:

(858)

J. B. Green

Copyist

6

11 (New).

U.S.C.T.

Samuel Colclough
Co. D, 11 Reg't U. S. Col'd Inf. (New).

Appears on

Company Muster Roll

for *March and April*, 1865.

Present or absent *Present*

Stoppage, \$ *100* for

Due Gov't, \$ *100* for

Remarks:

Book mark:

(858)

J. B. Jones

Copyist

11 (New). U.S.C.T.

Samuel Claiborne
Co. D, 11 Reg't U. S. Col'd Inf. (New).

Appears on

Company Muster Roll

for *May and June*, 186*4*.

Present or absent *Present*

Stoppage, \$ *100* for

Due Gov't, \$ *100* for

Remarks:

Book mark:

(358)

S. B. Jones

Copyist

11 (New). U.S.C.T.

James C. ...
Co. D, 11 Reg't U. S. Col'd Inf. (New).

Appears on

Company Muster Roll

for *July and August*, 186*5*.

Present or absent

Stoppage, \$ *100* for

Due Gov't, \$ *100* for

Remarks: *Discharged for disability*
July 20 1865

Book mark:

(858)

W. B. James) Copyist

C 11 (New). U.S.C.T.

Pompey Clanton
Pri. A, 11 Reg't U. S. Col'd Inf. (New).

Appears on Co. Muster-out Roll, dated
Memphis Tenn. Jan. 12, 1866.

Muster-out to date _____, 186 .

Last paid to Feb. 28, 1865.

Clothing account:

Last settled _____, 186 ; drawn since \$ 100

Due soldier \$ 100; due U. S. \$ 100

Am't for cloth'g in kind or money adv'd \$ 100

Due U. S. for arms, equipments, &c., \$ 100

Bounty paid \$ 100; due \$ 100

Remarks:

July 30/65
Surgeons Certificate
of Disability.
(Age 23 yrs enrolled July
16, 63 + mustered in Nov. 27, 63
at Memphis Tenn. for 3 yrs)

Book mark: _____

(361)

Henderson
Copyist.

Clanton, Pompey -

P, Co. D, **II** Reg. **U. S. C. Inf.**

Enclosures.

Bed Cards	Descriptive Lists
Burial Records	Final Statements
Certs. of Dis. for Discharge	Furloughs
C. M. Charges	Med. Des. Lists
Med. Certificates	Orders

Other papers relating to—

Admission to Hosp'l	Furlough
Casualty Sheet (Officer's)	Med. Examination
Confinement	Misc. Information
Contracts	Pay or Clothing
Death or Effects	Personal Reports
Desertions	Rank
Discharge from Hosp'l	Transfer to Hosp'l
Discharge from Service	Transfer to V. R. C.
Duty	Transportation

NOTE 1.

The company commander will here add a statement of all the facts known to him concerning the disease or wound, or cause of disability of the soldier; the time, place, manner, and all the circumstances under which the injury occurred, or disease originated or appeared; the duty, or service, or situation of the soldier at the time the injury was received or disease contracted, stating particularly whether the injury was received or the disease contracted in the line of his duty; and whatever other facts may aid a judgment as to the cause, immediate or remote, of the disability, and the circumstances attending it.

When the facts are not known to the company commander, the certificate of any officer, or affidavit of other person having such knowledge, will be appended—as the surgeon in charge of a hospital, the officer commanding a detachment of recruits, &c., &c.

NOTE 2.

When a probable case for pension, special care must be taken to state the degree of disability—as *t, t*, &c., &c.; to describe particularly the disability, wound, or disease; the extent to which it deprives him of the use of any limb or faculty, or affects his health, strength, activity, constitution, or capacity to labor or earn his subsistence. The surgeon will add, from his knowledge of the facts and circumstances, and from the evidence in the case, his professional opinion of the cause or origin of the disability. In the case of discharges by Medical Inspectors, the last paragraph will state that the "discharge was given by consent of the soldier, after a personal examination, and for disability, the nature, degree, and origin of which are correctly described in the within certificate."

Par. 1260 Regulations, Edit. 1861.

Medical officers, in giving certificates of disability, are to take particular care in all cases that have not been under their charge; and especially in epilepsy, convulsions, chronic rheumatism, derangement of the urinary organs, ophthalmia, ulcers, or any obscure disease liable to be feigned or purposely produced; and in no case shall such certificate be given until after sufficient time and examination to detect any attempt at deception.

DIRECTIONS.

This certificate will be made out in duplicate by the soldier's company commander, or other officer commanding the separate detachment to which he belongs, and sent by him to the surgeon who has charge of the hospital where the soldier is sick. The surgeon will then fill out and sign the surgeon's certificate, and forward these papers to the regimental, detachment, or post commander, who will forward them, with his action endorsed thereon, through the proper channel, to his division commander; or, if the troops are not attached to a division, to his corps, department, or other commander or officer to whom the authority to discharge enlisted men may be specially delegated.

These certificates, after having received the action of the highest authority to which they are required to be sent, will be returned through the same channel to the regimental, post, or detachment commander, who will, if the discharge is authorized by the endorsement of the proper authority, sign the soldier's discharge, and the last certificate on this paper; see that the soldier is furnished with the proper final statements in duplicate, and forward BOTH of these certificates direct to the Adjutant General United States Army, at Washington, D. C.; they will not, under any circumstances, be given into the hands of the soldier.

ADJUTANT GENERAL'S OFFICE

Aug 19 1865

Duplicate sent to Pension Office.

CERTIFICATE OF DISABILITY FOR DISCHARGE

IN THE CASE OF

6-8-27 - D.W.T. - 1865
10
W. J. D. of Dis.
Private Co. D
Eleventh Reg't of U.S. Col.

HEAD-QUARTERS DIST. WEST TENNESSEE.

MEMPHIS, TENN. July 27 1865

TO BE DISCHARGED.

BY COMMAND OF MAJ. GENERAL GEORGE STONEMAN.

John C. Simpson
CAPT. & A. A. A. G.

Received (A. G. Office) _____, 1865

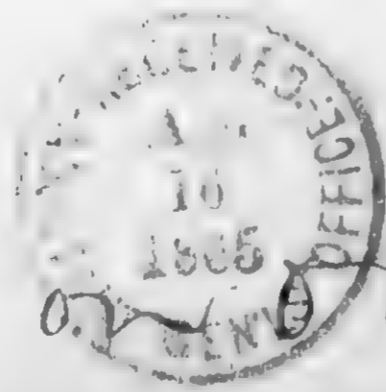

Ev Rofler

Approved
U.S. G. Inf -
Memphis Tenn
July 25 1865

Approved,
Wm. J. D.

O. S. G. - D. W. T. - 1865

OFFICE SURGEON IN CHIEF,
DIST. WEST TENN.

Memphis, Tenn., July 27 1865.

Approved.

R. J. Stratton

SURGEON...
Surgeon in Chief D. W. T.

ARMY OF THE UNITED STATES
CERTIFICATE
OF DISABILITY FOR DISCHARGE.

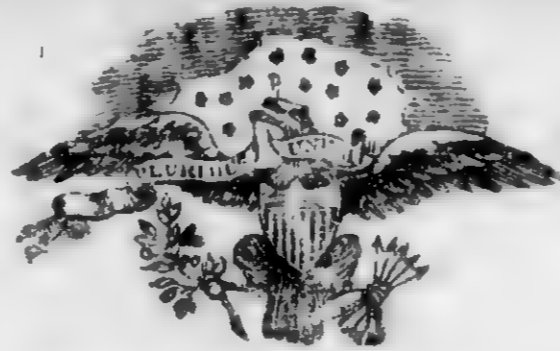

Private Pompey Clanton of Captain W.B. Edson Company, (D) of the Eleventh Regiment of United States Col. Infty was enlisted by Lieut. Washburn of the Pioneers Regiment of Memphis Tenn at Memphis Tenn on the sixteenth day of July 1865, to serve Three years; he was born in Panola in the State of Mississippi is Twenty three years of age, 5 feet 7 inches high, Black complexion, Black eyes, Black hair, and by occupation when enlisted a Farmer. During the last two months said soldier has been unfit for duty 60 days.* The said Pompey Clanton was injured in the legs while in line of duty since last enlistment, near Ripley, Miss. in the month of June 1864

STATION: Memphis Tenn
 DATE: July 17th 1865

W.B. Edson Cap & Co. D.
11th U.S. C. Infty
 Commanding Company.

I CERTIFY, that I have carefully examined the said Pompey Clanton of Captain W.B. Edson's Company, and find him incapable of performing the duties of a soldier because of Deformity of both legs from crushing by heavy wagon wheel passing over them since last enlistment and in line of duty. Unfit for duty since accident. Until six weeks Reserve Corps. Degree of Disability: Three Fourths

Heer P. Kendall
11th U.S. Col. Infy. Surgeon.
in charge

DISCHARGED, this Thirtieth day of July 1865, at Memphis Tenn

W. D. Turner
Col
 Commanding the Reg't.

The soldier desires to be addressed at
 Town Memphis County _____ State Tennessee.

* See Note 1 on the back of this. † See Note 2 on the back of this.

Vertical handwritten note on the left margin, partially illegible.

61 11 Reg't U.S.C.T.

Henry Clarke
Co. E, 11 Reg't U.S. Col'd Inf.

Appears on
Company Descriptive Book
of the organization named above.

DESCRIPTION.

Age 39 years height 5 feet 7/2 inches.

Complexion Dark

Eyes; Blue hair Black

Where born Alabama

Occupation

ENLISTMENT.

When Jan 1, 1864.

Where Pennsylvania

By whom Capt Craig; term 3 y'rs.

Remarks:

Houster

279-a

Clarke Henry

Co. E, 11 U. S. Col'd Inf.
(New Organization.)

CARD NUMBERS.

1	4071910	26
2		27
3		28
4		29
5		30
6		31
7		32
8		33
9		34
10		35
11		36
12		37
13		38
14		39
15		40
16		41
17		42
18		43
19		44
20		45
21		46
22		47
23		48
24		49
25		50

Number of personal papers herein.....

Book Mark :

See also

280

Clapton, Charles

Co K, 11 U.S. Col'd Inf.

(New Organization.)

Private

Private

CARD NUMBERS.

1	6334028	26
2	6334119	27
3	6334219	28
4	6334356	29
5	6335012	30
6	7072537	31
7		32
8		33
9		34
10		35
11		36
12		37
13		38
14		39
15		40
16		41
17		42
18		43
19		44
20		45
21		46
22		47
23		48
24		49
25		50

Book Mark:

See also

11 (New) U. S. C. T.

Charles Clayton
(New)
Co. *K*, 11 Reg't U. S. Col'd Inf.

Appears on

Company Descriptive Book

of the organization named above.

DESCRIPTION.

Age *19* years height *5* feet *8* inches.

Complexion *Blk*

Eyes; *Blk* hair *Blk*

Where born *Alabama*

Occupation *Waiter*

ENLISTMENT.

When *March*, 186*4*

Where *Memphis*

By whom *L. Woodham*; term *3* y'rs.

Remarks: *Absent sick in Walter*
Hospital since July 5/64
Died July 11, 64 of chronic
Scarfever.

Bryer

C

11 (New).

U.S.C.T.

Charles Clapton
Pvt, Co. K, 6 Reg't U. S. Col'd H. Art'y.†

Appears on

Company Muster-in and Descriptive Roll

of the organization named above. Roll dated

Fort Pickens
Memphis, Tenn, April 2, 1864.

Where born Alabama

Age 19 y'rs; occupation Writer

When enlisted March 1, 1864.*

Where enlisted Memphis, Tenn.

For what period enlisted 3 years.

Eyes Black; hair Black

Complexion Dark; height 5 ft. 8 in.

When mustered in March 1, 1864.*

Where mustered in

Bounty paid \$ 100; due \$ 100

Where credited Aberdeen, Monro Co. Miss

Company to which assigned

Remarks:

† This organization subsequently became Co. K, 11 Reg't U. S. Colored Infantry (New).

* Muster-in roll shows enrollment and muster-in of this company as of same date. See enrollment on subsequent card or cards.

Book mark:

Rochester

6 | 11 (New). | U.S.C.T.

Charles Clapton
Pt. Co. K, 6 Reg't U. S. Col'd H. Art'y.†

Appears on

Company Muster Roll

for Apr 2 to Apr 30, 1864.

Joined for duty and enrolled:

When March 1, 1864.*

Where Memphis, Tenn.*

Period 3 years.*

Present or absent Present

Stoppage, \$ 100 for

Due Gov't \$ 100 for

Remarks Sick in Quarters
(Must be in at Mem-
phis Tenn)

† This organization subsequently became Co. K, 11 Reg't U. S. Colored Infantry (New).
* See enrollment on card from muster-in roll.

Book mark:

Recherter

C | 11 (New). | U.S.C.T.

Charles Crapton
Pvt., Co. K, 7 Reg't U. S. Col'd H. Art'y.†

Appears on

Company Muster Roll

for May & June, 1864

Joined for duty and enrolled:

When March 1, 1864*

Where Memphis, Tenn.*

Period 3 years.*

Present or absent Present

Stoppage, \$ 100 for

Due Gov't \$ 100 for

Remarks:

†This organization subsequently became Co. K, 11 Reg't U. S. Col'd Infantry (New).
* See enrollment on card from muster-in roll.

Book mark:

Bochner

C | 11 (New). | U.S.C.T.

Charles Capton

Pvt., Co. K, 7 Reg't U. S. Col'd H. Art'y.†

Appears on

Company Muster Roll

for July & Aug, 1864.

Joined for duty and enrolled:

When March 1, 1864.*

Where Memphis, Tenn. *

Period 3 years.*

Present or absent

Stoppage, \$ 100 for

Due Gov't \$ 100 for

Remarks: Died Webster Gen's Hosp. July 11, 1864 of disease

†This organization subsequently became Co. K, 11 Reg't U. S. Col'd Infantry (New).

* See enrollment on card from muster-in roll.

Book mark: V. 230 P 31. 76

Proctor

6 | 11 (New). U.S.C.T.

Charles Clapton
Prvt., K 11 Reg't U. S. Col'd Inf. (New).

Appears on Co. Muster-out Roll, dated
Memphis, Tenn., Jan 12, 1866.

Muster-out to date _____, 1866.

Last paid to Apr. 30, 1864.

Clothing account:

Last settled _____, 1866; drawn since \$ 100

Due soldier \$ 100; due U. S. \$ 100

Am't for cloth'g in kind or money adv'd \$ 100

Due U. S. for arms, equipments, &c., \$ 100

Bounty paid \$ 100; due \$ 100

Remarks: Died July 11/64 in
Webster Genl Hospital

Filed with Charles Clapton

Book mark: S. S. P. V. 3. P. 105:68. V. 230
P. 31. 76

(861) Hammer Copyist.

Clupton, Charles -

P, Co. R, 11 U.S.C. Inf.
Reg't

2 Enclosures.

Bed Cards	Descriptive Lists
Burial Records	Final Statements /
Certs. of Dis. for Discharge	Furloughs
C. M. Charges	Med. Des. Lists
Med. Certificates	Orders

Other papers relating to—

Admission to Hosp'l	Furlough
Casualty Sheet (Officer's)	Med. Examination
Confinement	Misc. Information /
Contracts	Pay or Clothing
Death or Effects /	Personal Reports
Desertions	Rank
Discharge from Hosp'l	Transfer to Hosp'l
Discharge from Service	Transfer to V. R. C.
Duty	Transportation

Fort Pickering Tenn
June 9th 1864

Washington L. J. Capt
Comdy. Co. K. 7th U.S. C. A. Heavy

States that Charles Clopton
is a member of his Co.
and has been absent
since June 7th

Recd Ad Genl. Pickering June 11/64

Dues Co R 7th usca 24

Fort Pickens Tex June 9th 1864

J. A. Capeland }
Lieut & ADC }

Dear Sir Charles Clopton
is a member of my company and has
been absent since June 7th I gave him
a pass good until Retreat to visit
his friends in the city he has been
unfit for duty for several days I sent
for him this morning and the sergt
brought back word that he had started
for the Fort in a wagon and was sick
since that time I have not heard
from him

L. J. Washburn

Capt Comd'g Co R 7th usca 24

Webster U. S. Army General Hospital,
Memphis Tenn July 11 1864

Commanding Officer "K" Company,
7th Regt. U. S. Art. (Colored)

I have to inform you
that Priest Charles Clapton of your Company, died
in this hospital on the 11th day of July 1864
of Chronic Diarrhoea

~~I inclose his descriptive list, with pay and clothing account,
and inventory of his effects. He had no effects.~~

Very respectfully yours, &c.,

A. J. Shivers
Surgeon U. S. Army
In charge of General Hospital.

Inventory of the effects of *Private Charles Clapton*
 Company "K" 24th Regiment of Inf. (Colored)
 who died in the *Webster Inf. General Hospital Memphis*
Tenn July 11th 1864.

CAPS.....	BLANKETS.....
DRESS COATS.....	KNAPSACKS.....
OVERCOATS.....	CANTEENS.....
JACKETS.....	HAVERSACKS.....
TROUSERS.....	MUSKETS.....
SHIRTS.....	BAYONETS.....
DRAWERS.....	CARTRIDGE BOX.....
BOOTS, prs.....	BELT.....
SHOES, prs.....	MONEY.....
STOCKINGS.....	

1864 Dup. 76M 56

Inventory
 of the effects of *Private*
Charles Clapton
 late of Co. K. 24th Regiment
U.S. Army (Colored), who died
at Webster Inf. General
Hospital Memphis Tenn July 11th
 1864

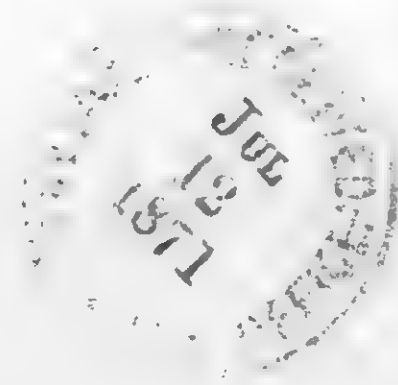

Final Statement of *56.*

Charles Cluption
11th C. Newy
7th U. S. Arb. (Col'd)

7th U. S.

And July 11th 1864

11th U. S. Newy

10th U. S.

ADJUTANT GENERAL'S OFFICE

July 23rd 1864

Duplicate with Inventory sent 2d Auditor.

Ent on R of 1863

281

Clapton, Harry

Co. B, 11 U.S. Col'd Inf.

(New Organization.)

Private

Private

CARD NUMBERS.

1	6332011	26
2	6332108	27
3	6332189	28
4	6332267	29
5	6332328	30
6	6332391	31
7	6332449	32
8	6332506	33
9	6332569	34
10	6332644	35
11	6332715	36
12	6332785	37
13	6332851	38
14	9072300	39
15		40
16		41
17		42
18		43
19		44
20		45
21		46
22		47
23		48
24		49
25		50

Book Mark:

See also

A1100811 P.O. m. m.

6 | 11 (New) U.S.C.T.

Harry Clapton (New)
Co. H, 11 Reg't U.S. Col'd Inf.

Appears on

Company Descriptive Book

of the organization named above.

DESCRIPTION.

Age 28 years height 5 feet 6 inches.

Complexion Black

Eyes; Black hair Black

Where born Monroe Co Miss

Occupation Farmer

ENLISTMENT.

When Mar 11, 1864.

Where Memphis Tenn

By whom J. J. McQueen, term 3 y'rs.

Remarks:

J. E. Karp

6 | 11 (New). | U.S.C.T.

Harry Clapton.

Priv., Co. H, 6 Reg't U. S. Col'd H. Art'y.*

Appears on

Battery Muster-in and Descriptive Roll

of the organization named above. Roll dated

Memphis Tenn. Feb 2, 1864.

Where born *Morse Co. Miss*

Age *28* y'rs; occupation *Farmer*

When enlisted *Mar. 12*, 1864.

Where enlisted *Memphis, Tenn.*

For what period enlisted *3* years.

Eyes *Bk* hair *Bk*

Complexion *Bk*; height *5* ft. *6* in.

When mustered in *Mar. 12*, 1864.

Where mustered in *Memphis, Tenn.*

Bounty paid \$ *100*; due \$ *100*

Where credited _____

Battery to which assigned _____

Remarks: _____

* This organization subsequently became Co. H, 11 Reg't U. S. Colored Infantry (New).

Book mark: _____

(356g)

Maguire

Copyist.

6 | 11 (New). | U.S.C.T.

Harry Clapton
Pvt. Co. H, 6 Reg't U. S. Col'd H. Art'y.*

Appears on

Company Muster Roll

for 2^d to 30th Apr., 1864.

Present or absent Present.

Stoppage, \$ 100 for

Due Gov't, \$ 100 for

Remarks:

*This organization subsequently became Co. H, 11 Reg't U. S. Col'd Infantry (New).

Book mark:

Wagner

B | 11 (New). | U.S.C.T.

Henry Clapton
Pvt., Co. H, 7 Reg't U. S. Col'd H. Art'y.*

Appears on

Company Muster Roll

for May & June, 1864.

Present or absent Present.

Stoppage, \$ 100 for _____

Due Gov't, \$ 100 for _____

Remarks: _____

*This organization subsequently became Co. H, 11 Reg't U. S. Col'd Infantry (New).

Book mark: _____

(358) J. H. Wagner Copyist

b | 11 (New). | U.S.C.T.

Henry Clapton

Pvt., Co. H, 7 Reg't U. S. Col'd H. Art'y.*

Appears on

Company Muster Roll

for *July & Aug.*, 186*4*.

Present or absent *Present.*

Stoppage, \$ *100* for

Due Gov't, \$ *100* for

Remarks:

*This organization subsequently became Co. H, 11 Reg't U. S. Col'd Infantry (New).

Book mark:

Wayner

C | 11 (New). | U.S.C.T.

Harry Clapton

Private, Co. H, 7 Reg't U. S. Col'd H. Art'y.*

Appears on

Company Muster Roll

for Sept & Oct., 186 4.

Present or absent Present.

Stoppage, \$ 100 for

Due Gov't, \$ 100 for

Remarks:

*This organization subsequently became Co. H, 11 Reg't U. S. Col'd Infantry (New).

Book mark:

F. M. Wagner

6 | 11 (New) | U.S.C.T.

Harry Clapton
Pvt., Co. H, 7 Reg't U. S. Col'd H. Art'y.*

Appears on

Company Muster Roll

for *Nov. & Dec.*, 1864.

Present or absent *Present.*

Stoppage, \$ *23³⁵* $\bar{100}$ for *Prodnawie*

Due Gov't, \$ $\bar{100}$ for

Remarks:

*This organization subsequently became Co. H, 11 Reg't U. S. Col'd Infantry (New).

Book mark:

(358)

H. W. Wagner
Copyist

C. | 11 (New). | U.S.C.T.

Henry Clapton

Co., H, 11 Reg't U. S. Col'd Inf. (New).

Appears on

Company Muster Roll

for *Jan. & Feb.*, 186*5*.

Present or absent *Present*

Stoppage, \$ *100* for

Due Gov't, \$ *100* for

Remarks: *Stop Ordinance
from Roll Nov. & Dec.
64 \$23.35.*

Book mark:

Hewsting

(858)

Copyist.

6. | 11 (New). | U.S.C.T.

Harry Clapton

Cor., H, 11 Reg't U. S. Col'd Inf. (New).

Appears on

Company Muster Roll

for Mar. & Apr., 1865.

Present or absent Present

Stoppage, \$ 100 for

Due Gov't, \$ 100 for

Remarks:

Book mark:

Hawling

Co.

11 (New).

U.S.C.T.

Harry Clapton

Priv., H, 11 Reg't U. S. Col'd Inf. (New).

Appears on

Company Muster Roll

for May & June, 1865.

Present or absent Present

Stoppage, \$ - 100 for Ards. &

Ards. Stones lost.

Due Gov't, \$ 100 for.

Remarks:

Filed with Harry Clapton

Book mark:

Accounting

C. | 11 (New). | U.S.C.T.

Harry Clapton
Prs., H, 11 Reg't U. S. Col'd Inf. (New).

Appears on

Company Muster Roll

for July & Aug, 1865.

Present or absent Present

Stoppage, \$ 43/100 for Ord. &

Ord. Stones lost

Due Gov't, \$ 100 for

Remarks:

Book mark:

Hawley
Copyist.

C. | 11 (New). | U.S.C.T.

Harry Clapton
Pl., H, 11 Reg't U. S. Col'd Inf. (New).

Appears on

Company Muster Roll

for Sept. & Oct., 1865.

Present or absent Present

Stoppage, \$ 43/100 for Ord. &

ord. stores lost

Due Gov't, \$ 100 for

Remarks:

Book mark:

Heasley

B

11 (New).

U.S.C.T.

Mary Clafeton

Pr, H, 11 Reg't U. S. Col'd Inf. (New).

Appears on

Company Muster Roll

for *Nov 7 Dec*, 1865.

Present or absent *Present*

Stoppage, \$ *43* / *100* for *Ordinance*

Due Gov't, \$ *100* for

Remarks:

Book mark:

McNeary
Copt. 1st.

6

11 (New).

U.S.C.T.

Harry Clapton

Priv, *14*, 11 Reg't U. S. Col'd Inf. (New).

Appears on Co. Muster-out Roll, dated

Memphis Tenn, Jan 12, 1866.

Muster-out to date

Jan 12, 1866.

Last paid to

June 30, 1865.

Clothing account:

Last settled....., 186 ; drawn since \$..... 100

Due soldier \$..... 100; due U. S. \$ *24* ^{*79*} 100

Am't for cloth'g in kind or money adv'd \$..... 100

Due U. S. for arms, equipments, &c., \$ ^{*43*} 100

Bounty paid \$..... 100; due \$..... 100

Remarks:

Book mark:

(361)

W. E. Meany
Copyist.

282

Clark, Benjamin

Co E, 11 U.S. Col'd Inf.

(New Organization.)

Private

Private

CARD NUMBERS.

1	6322484	26
2	6328927	27
3	6328964	28
4	6329030	29
5	6329147	30
6	6329606	31
7	6329646	32
8	6329856	33
9	9072484	34
10	9071916	35
11	9071493	36
12		37
13		38
14		39
15		40
16		41
17		42
18		43
19		44
20		45
21		46
22		47
23		48
24		49
25		50

Book Mark:

See also

C | **11 (New) U.S.C.T.**

Jim Clark
J. P., Co. *P*, 11 Reg't U.S. Col'd Inf. *(New)*

Appears on
Company Descriptive Book
of the organization named above.

DESCRIPTION.

Age *35* years height *5* feet *8 1/2* inches.
Complexion *Black*
Eyes; *Black* hair *Black*
Where born *Athens, Miss*
Occupation *Farmer*

ENLISTMENT.

When *March 1*, 186*4*
Where *Memphis Tenn*
By whom *P Slaughter*, term *13* y'rs.

Remarks:

Forrest
Copyist.

6

1 (new) U.S.C.T.

Benjamin Clarke
(new)
Co. E, 11 Reg't U.S. Col'd Inf.

Appears on

Company Descriptive Book

of the organization named above.

DESCRIPTION.

Age 26 years height 5 feet 7 inches.

Complexion Dark

Eyes; Brown hair Black

Where born Hardeman Co. Tenn.

Occupation

ENLISTMENT.

When Jan 6", 1864.

Where Corinth

By whom S.H. Craig, term 3 y'rs.

Remarks: Deserted at
Memphis Tenn
Feb 19/1864. Retaken
from desertion
March 10" 1864 and
confined in guard
house. Released
from confinement
March 28" 1864 and
over

Houston

MAY. 11

9071793

* 1891 *

reassigned to duty
Deserted at Memphis
Tenn. April 11" 1864
Took taken from deser-
tion July 23" 1865
Confined in Irving
Prison - Dishonor-
ably discharged
Aug 2" 1865 per Sentence
of Genl Court Martial
Genl Order No 84. Hd.
for West Tenn.
with loss of all pay
and allowances
Memphis Tenn.

61 11 (new) U.S.C.T.

Benjamin Clarke
(new)
Co. E, 11 Reg't U.S. Col'd Inf.

Appears on

Company Descriptive Book

of the organization named above.

DESCRIPTION.

Age 26 years height 5 feet 7 inches.

Complexion Dark

Eyes; Brown hair Black

Where born Hudsonian Tenn.

Occupation

ENLISTMENT.

When Jan 6, 1864

Where Corinth

By whom Capt Craig; term 3 y'rs.

Remarks:

.....
.....
.....
.....
.....
.....

Harrison

C | 11 (New) | U.S.C.T.

Benjamin Clarke
Pri, Co. E, 11th Ala-S. Art. V, A.S.
Reg't U. S. Col'd Infantry.

Age 26 years.

Appears on a

Detachment Muster-in Roll

of the organization named above. Roll dated

Memphis Tenn. Jan. 22, 1864.

Muster-in to date

Jan. 6, 1864.

Joined for duty and enrolled:

When Jan 6, 1864.

Where Corinth Miss.

Period 3 years.

Remarks:

Book mark:

(337)

Avery
Copyist.

C

11 (New).

U.S.C.T.

Benjamin Clarke

Priv., Co. E, 4 Battalion, 1 Reg't Tenn. H. Art'y.*

Appears on

Company Muster Roll

for *Jan. & Feb.*, 1864.

Present or absent

Stoppage, \$ 100 for

Due Gov't, \$ 100 for

Remarks *joined a recruit Jan. 6. 64.*
Deserted at Memphis Tenn.
Feb. 19. 64.

* This organization subsequently became Co. E, 11 Reg't U. S. Colored Infantry (New).

Book mark:

Lewis

6

11 (New). U.S.C.T.

Benjamin Clarke

Pvt, Co. E, 6 Reg't U. S. Col'd H. Art'y.*

Appears on

Company Muster Roll

for *Mch & Apl*, 1864.

Present or absent *Absent.*

Stoppage, \$ *100* for

Due Gov't, \$ *100* for

Remarks *Retaken from desertion*
Mch. 10. 64. deserted again
Apl 11. 64.

* This organization subsequently became Co. E, 11 Reg't U. S. Colored Infantry (New).

Book mark : *8335*

Lewis

Copyist.

6

11 (New).

U.S.C.T.

Benjamin Clarke

Pvt., Co. E, 6 Reg't U. S. Col'd H. Art'y.*

Appears on

Company Muster Roll

for *Mich & Apl*, 1864.

Present or absent

Stoppage, \$ 100 for

Due Gov't, \$ 100 for

Remarks: *Deserted Apl 11. 64.*

* This organization subsequently became Co. E, 11 Reg't U. S. Colored Infantry (New).

Book mark : *5736*

Lewis

Copyist.

6 11 Nov U.S.C.T.

Benjamin Clark
Pat, Co. E, 11 (6 U.S.C.H.A.) (new)
Reg't U. S. Col'd Infantry

Appears on

Descriptive List of Deserters
Fort Pickering
dated *Memphis Tenn. Apr. 30, 1864.*

Deserted:

When *April 11, 1864.*

Where *Memphis Tenn.*

Arrested:

When _____, 186 .

Where _____

Remarks: *Second deserter*

Book mark: _____

(851)

W. H. Bogart

Copyist.

C

11 (New).

U.S.C.T.

Bergman Clark

Co., Co. E, 11 Reg't U. S. Col'd Inf. (New).

Appears on

Company Muster Roll

for *July & Aug.*, 1865

Present or absent *both stated.*

Stoppage, \$ *100* for

Due Gov't, \$ *100* for

Remarks: *Retaken from
desertion July 23/65.*

Book mark:

Lowry

(858)

Copyist.

C

11 (New).

U.S.C.T.

Benjamin Clark
Priv., Co. E, 11 Reg't U. S. Col'd Inf. (New).

Appears on

Company Muster Roll

for *July & Aug.*, 1865.

Present or absent

Stoppage, \$ 100 for

Due Gov't, \$ 100 for

Remarks: *Dishonorably dis-*
charged by sentence of
G.C.M. Aug. 2/65, with
loss of all pay.

Book mark:

Lowry

(358)

Copyist.

C

11 (New). U.S.C.T.

Benjamin Clark

Priv. Co. E, 11 Reg't U. S. Col'd Inf. (New).

Appears on Co. Muster-out Roll, dated

Memphis Tenn. Jan 12, 1866

Muster-out to date _____, 186

Last paid to _____, 186

Pay due from enrollment

Clothing account:

Last settled _____, 186 ; drawn since \$ _____ 100

Due soldier \$ _____ 100; due U. S. \$ _____ 100

Am't for cloth'g in kind or money adv'd \$ _____ 100

Due U. S. for arms, equipments, &c., \$ _____ 100

Bounty paid \$ _____ 100; due \$ _____ 100

Remarks:

Dishonorably discharged Aug 2/65 per sentence of Genl Court Martial, Genl orders No 84 Hd Qrs. Dist. W. Tenn.

Book mark: 9084 Dist West Tenn. Aug 2/65

Valentine

(361)

Copyist.

Clark, Benjamin

Co. E, 11 U.S.C. Inf.

Enclosures.

Bed Cards	Descriptive Lists
Burial Records	Final Statements
Certs. of Dis. for Discharge	Furloughs
C. M. Charges	Med. Des. Lists
Med. Certificates	Orders

Other papers relating to—

Admission to Hosp'l	Furlough
Casualty Sheet (Officer's)	Med. Examination
Confinement	Misc. Information
Contracts	Pay or Clothing
Death or Effects	Personal Reports
Desertions	Rank
Discharge from Hosp'l	Transfer to Hosp'l
Discharge from Service	Transfer to V. R. C.
Duty	Transportation

275. 24.57. 1864

Head Quarters Co H 1st Tenn Inf
Memphis Tenn March 14 1864

Strong George W. Commanding
Co H 1st Tenn Inf A.D.

Respectfully requests that the
Commanding Officer of Co E
1st Alabama Sigs Artillery be
ordered to receipt for the several
articles of clothing worn away by
Benjamin Clark when arrested
as a deserter from that Regt

E - J. W. - M. C.

Head Quarters Co. H. 1st Tenn Inf
Memphis March 22 1864

Commanding Officer Co
E will receipt to Geo W
Strong Commanding Co H 1st Tenn
Inf A.D. for the several
articles of clothing mentioned
herein and charge them
to the Soldier who will be enrolled
as a member of Co H 1st Tenn Artillery

A. L. Chittum
The Major

Head Quarters 1st Tenn Inf of A.D.
Memphis Tenn March 16 1864

Respectfully forwarded
approved

Robt Cowden
Maj. Comdg. Regt.

37. SRB Co. 1864
127. Co. H.

Capt Cowden, commanding
Co. H. 1st Tenn Artillery
is to issue the outfit for
the soldier mentioned in
the foregoing order

Capt -
You will very soon
order you had better
cut on Capt Strong
for his services and receipt
from your own

Robt H. G. Taylor
Head Quarters 1st Tenn Inf

Head Quarters Co "A" 1st West Tenn Inf't A. S.
Memphis Tenn March 14th 1864

Sicut George Mason
A. S. A. Genl U. S. Colored Troops

Sir

I would respectfully
request that the Commanding Officer of Company "E"
7th Alabama Siege Artillery A. S. be ordered to Receipt
to me for the following articles of clothing (viz) one Hat -
one Flannel Sack Coat - one Pair Pants - one Flannel
Shirt - one Pair Drawers - one Pair Boots - Two Pair
Stockings - the above named ^{articles} having been issued to one
Benjamin Clark by me - the said Benjamin Clark
having since been arrested as a deserter from that Regt
and when taken wore the articles of clothing herein mentioned
away with him -

I have the Honor to be
Your Obedient Servant

Geo. W. Strong

Capt Co "A" 1st West Tenn Inf't A. S.

283

Clank, Gerry

Co *el*, 11 U.S. Col'd Inf.

(New Organization.)

Private

Corporal

CARD NUMBERS.

1	6332951	26
2	6333055	27
3	6333144	28
4	6333237	29
5	6333320	30
6	6333397	31
7	6333473	32
8	6333553	33
9	6333616	34
10	6333689	35
11	6333760	36
12	6333831	37
13	6333848	38
14		39
15		40
16		41
17		42
18		43
19		44
20		45
21		46
22		47
23		48
24		49
25		50

Book Mark:

See also

a H 201 (Cole, Samuel)
4-1-38

6

11 (New).

U.S.C.T.

Gerry, Clark

Pvt., Co. I, 6 Reg't U. S. Col'd II. Art'y.†

Appears on

Company Muster-in and Descriptive Roll
of the organization named above. Roll dated

Fort Pickens, Memphis Tenn. April 2, 1864.

Where born Athens Miss.

Age 35 y'rs; occupation Farmer

When enlisted March 1, 1864.*

Where enlisted Memphis Tenn.

For what period enlisted 3 years.

Eyes black; hair black

Complexion black; height 5 ft. 3 1/2 in.

When mustered in March 1, 1864.*

Where mustered in

Bounty paid \$ 100; due \$ 100

Where credited Chalona, Chickasaw Co. Miss.

Company to which assigned

Remarks:

† The organization subsequently became Co. A, 11 Reg't U. S. Colored Infantry (New).

* Muster period shows enrollment and muster-in of this company as of same date. See enrollment on subsequent card or cards.

Book mark:

Milliken

6

11 (New).

U.S.C.T.

Perry Clark
Priv, Co. I, 6 Reg't U. S. Col'd H. Art'y.†

Appears on

Company Muster Roll

for Mar. & Apr., 1864.

Joined for duty and enrolled:

When Mar. 1st, 1864.*

Where Memphis Tenn.*

Period 3 years.*

Present or absent present

Stoppage, \$ 100 for

Due Gov't \$ 100 for

Remarks: musted in at
Memphis Tenn

† This organization subsequently became Co. I, 11 Reg't U. S. Colored Infantry (New).

* See enrollment on card from muster-in roll.

Book mark:

Milliken

6 | 11 (New). | U.S.C.T.

Berry Clark
Priv., Co. I, 7 Reg't U. S. Col'd H. Art'y.†

Appears on

Company Muster Roll

for May & June, 1864.

Joined for duty and enrolled:

When 1st Mar., 1864.*

Where Memphis Tenn.†*

Period 3 years.*

Present or absent present

Stoppage, \$ 100 for

Due Gov't, \$ 100 for

Remarks: _____

†This organization subsequently became Co. I, 11 Reg't U. S. Col'd Infantry (New).
* See enrollment on card from muster-in roll.

Book mark: _____

(358c) Milliken Copyist.

6

11 (New). U.S.C.T.

Perry Clark
Co. I, 7 Reg't U. S. Col'd H. Art'y.†

Appears on

Company Muster Roll

for July & Aug't, 1864.

Joined for duty and enrolled:

When 1st Mar., 1864.*

Where Memphis Tenn. *

Period 3 years.*

Present or absent Not stated

Stoppage, \$ 100 for

Due Gov't, \$ 100 for

Remarks:

†This organization subsequently became Co. I, 11 Reg't U. S. Col'd Infantry (New).

* See enrollment on card from muster-in roll.

Book mark:

Milliken

le | 11 (New). | U.S.C.T.

Gerry Clark
Private, Co. I, 7 Reg't U. S. Col'd H. Art'y.†

Appears on

Company Muster Roll

for Sept + Oct, 1864.

Joined for duty and enrolled:

When 1st Mar, 1864.*

Where Memphis Tenn. *

Period 3 years.*

Present or absent present

Stoppage, \$ 100 for

Due Gov't, \$ 100 for

Remarks:

†This organization subsequently became Co. I, 11 Reg't U. S. Col'd Infantry (New).

* See enrollment on card from muster-in roll.

Book mark:

(358c)

Williken

Copyist.

6 | 11 (New). | U.S.C.T.

Berry Clark
Priv., Co. I, 7 Reg't U. S. Col'd H. Art'y.†

Appears on

Company Muster Roll

for Nov. & Dec., 1864.

Joined for duty and enrolled:

When 1st Mar., 1864.*

Where Memphis Tenn.*

Period 3 years.*

Present or absent present

Stoppage, \$ 100 for

Due Gov't, \$ 100 for

Remarks: Sick in Quarters.

†This organization subsequently became Co. I, 11 Reg't U. S. Col'd Infantry (New).

* See enrollment on card from muster-in roll.

Book mark:

(358c)

Milliken

Copyist.

C | **11** (New) | **U.S.C.T.**

Berry Clark

Private, Co. I, 11 Reg't U. S. Col'd Inf. (New.)
Appears on

Company Muster Roll

for *Jan & Febr*, 186*6*.

Joined for duty and enrolled:

When *March 1*, 186*4*.*

Where *Memphis Tenn.* *

Period *3* years.*

Present or absent *Present*

Stoppage, \$ *100* for

Due Gov't \$ *100* for

Remarks:

* See enrollment on card from muster-in roll.

Book mark:

M. A. Michaels

(358c)

Copyist.

B | 11 (New) | U.S.C.T.

Berry Clark

Private, Co. I, 11 Reg't U. S. Col'd Inf. (New.)
Appears on

Company Muster Roll

for *March & Apr.*, 1865.

Joined for duty and enrolled:

When *March*, 1864.*

Where *Memphis Tenn.**

Period *3* years.*

Present or absent *Present*.

Stoppage, \$ *100* for

Due Gov't \$ *100* for

Remarks:

* See enrollment on card from muster-in roll.

Book mark:

(358c)

M. A. Michaels

Copyist.

C | 11 (New) | U.S.C.T.

Berry Clark

Capt, Co. I, 11 Reg't U. S. Col'd Inf. (New.)
Appears on

Company Muster Roll

for *May & June*, 186*5*.

Joined for duty and enrolled:

When *March 1*, 186*4*.*

Where *Memphis Tenn.* *

Period *3* years.*

Present or absent *Present*

Stoppage, \$ *100* for

Due Gov't \$ *100* for

Remarks: *Promoted to Capt. from*

10 May 65 by Lt. No 103. Ad. Co.

all S. C. Profy

* See enrollment on card from muster-in roll.

Book mark: *358c*

(358c)

M. A. Michaels

Copyist.

C | 11 (New) | U.S.C.T.

Berry Clark

Corpl., Co. I, 11 Reg't U. S. Col'd Inf. (New.)
Appears on

Company Muster Roll

for *July & Aug.*, 1865.

Joined for duty and enrolled:

When *March 1*, 1864.*

Where *Memphis Tenn.* *

Period *3* years.*

Present or absent *Present*

Stoppage, \$ *100* for

Due Gov't \$ *100* for

Remarks: *Promoted to Corp from private per A.O. No 103 Hd. Qrs 11th S.I. 10 May 1865*

* See enrollment on card from muster-in roll.

Book mark:

M. A. Michaels

(358c)

Copyist.

C | 11 (New) | U.S.C.T.

Berry Clark

Corp., Co. I, 11 Reg't U. S. Col'd Inf. (New.)
Appears on.

Company Muster Roll

for Sept & Oct, 1864.

Joined for duty and enrolled:

When March, 1864.*

Where Memphis Tenn.*

Period 3 years.*

Present or absent Present

Stoppage, \$ 100 for

Due Gov't \$ 100 for

Remarks: Stop! ~~Bill~~ Screw 13⁹

* See enrollment on card from muster-in roll.

Book mark:

M. A. Michaels

(358c)

Copyist.

B | **11** (New) | **U.S.C.T.**

Berry Charles

Capt., Co. I, 11 Reg't U. S. Col'd Inf. (New.)
Appears on

Company Muster Roll

for *Nov. and Dec.*, 186*5*.

Joined for duty and enrolled:

When *1 March*, 186*4*.*

Where *Memphis Tenn.* *

Period *3* years.*

Present or absent *Present*

Stoppage, \$ *100* for

Due Gov't \$ *100* for

Remarks:

* See enrollment on card from muster-in roll.

Book mark:

J. M. Weber

B

11 (New). U.S.C.T.

Berry Bart

Capt. Ed, 11 Reg't U. S. Col'd Inf. (New).

Appears on **Co. Muster-out Roll**, dated

Memphis Tenn, Jan 12, 1866.

Muster-out to date

Jan 12, 1866.

Last paid to

June 30, 1865.

Clothing account:

Last settled, 186 ; drawn since \$ 100

Due soldier \$ *99* 100; due U. S. \$ 100

Am't for cloth'g in kind or money adv'd \$ 100

Due U. S. for arms, equipments, &c., \$ *13* 100

Bounty paid \$ 100; due \$ 100

Remarks:

Book mark: *58, 1882*

D.P. White

284

Clark, John

Co C, 11 U.S. Col'd Inf.

(New Organization.)

Private Sergeant

CARD NUMBERS.

1	6322797	26
2	6326817	27
3	6326847	28
4	6326890	29
5	6326952	30
6	6327009	31
7	6327087	32
8	6327159	33
9	6327229	34
10	6327293	35
11	7071424	36
12		37
13		38
14		39
15		40
16		41
17		42
18		43
19		44
20		45
21		46
22		47
23		48
24		49
25		50

Book Mark:

See also

03186451 Acclwd

• Ah. 2016^x 4/21/28^x

Alfred Clark

B |

11 (new) U.S.C.T.

John Clark

Co. C, 11 Reg't U.S. Col'd Inf. (new)

Appears on

Company Descriptive Book

of the organization named above.

DESCRIPTION.

Age 21 years height 5 feet 3 inches.

Complexion Yellow

Eyes; Gray hair Black

Where born Merri^{er} ^{or} ^m ^{des} ^{va}

Occupation Laborer

ENLISTMENT.

When Aug 21, 1864

Where Memphis Tenn

By whom M. J. Smith; term 3 y'rs.

Remarks: Appointed corporal

per special Jan 16 1865

per special order no. 9.

appointed sergeant to date from

March 10 1865 - by special order no. 57.

Shaebrook

6. 11 (New). U.S.C.T.

John Clark

Appears with rank of *Private* on

Muster and Descriptive Rolls of Detachments of U. S. Vols. forwarded

for the *7th* Reg't U. S. Col'd *Art'y. (N)* Roll dated

Memphis Tenn., *Sept. 8*, 1864.

Where born *Prince William Co. Va.*

Age *21* y'rs; occupation *Labourer*

When enlisted *Aug. 21st*, 1864.

Where enlisted *Memphis Tenn.*

For what period enlisted *3* years.

Eyes *Gray*; hair *Black*

Complexion *Yellow*; height *5* ft. *3* in.

When mustered in *Sept. 8th*, 1864.

Where mustered in *Memphis Tenn.*

Bounty paid \$ *100*; due \$ *100*

Where credited *Lora, Wabash Co. Ind.*

Company to which assigned *6.*

Remarks: *joined as Recruit*

Became 11th U. S. Col'd Inf't. (New)

Book mark: _____

Rhett

C

11 (New).

U.S.C.T.

John Clark
Co. C, 7 Reg't U. S. Col'd H. Art'y.*

Appears on

Company Muster Roll

for Sept & Oct, 1864

Present or absent Present

Stoppage, \$ 100 for

Due Gov't, \$ 100 for

Remarks :

* This organization subsequently became Co. C, 11 Reg't U. S. Col'd Infantry (New).

Book mark :

Actual

C | 11 (New). | U.S.C.T.

John Clark
Co. C, 7 Reg't U. S. Col'd H. Art'y.*

Appears on

Company Muster Roll
for *Nov 5 Dec*, 1864.

Present or absent *Present*

Stoppage, \$ 100 for

Due Gov't, \$ 100 for

Remarks:

* This organization subsequently became Co. C, 11 Reg't U.S. Col'd Infantry (New).

Book mark:

(358) *A. Neal* Copyist.

C 11 (New). U.S.C.T.

James Clark
Co. C, 11 Reg't U. S. Col'd Inf. (New).

Appears on

Company Muster Roll

for *Jan & Feb*, 186*4*.

Present or absent *Present*

Stoppage, \$ *100* for

Due Gov't, \$ *100* for

Remarks: *Appointed Corp.*
Wife killed deceased by
J. C. May Jan 16 64

Book mark:

J. S. Johnson
Cognist.

C 11 (New). U.S.C.T.

John Clark
Regt, Co. C, 11 Reg't U. S. Col'd Inf. (New).

Appears on

Company Muster Roll

for *Mar + Apr*, 186 ~~5~~

Present or absent *Present*

Stoppage, \$ 100 for

Due Gov't, \$ 100 for

Remarks: *Appointed from
Co. pl. Mar 10/65*

Book mark:

J. V. Johnson

11 (New). U.S.C.T.

John Clark

Co. C, 11 Reg't U. S. Col'd Inf. (New).

Appears on

Company Muster Roll

for *May & June*, 186*s.*

Present or absent *Present*

Stoppage, \$ *100* for

Due Gov't, \$ *100* for

Remarks: *Lost papers*

Book mark:

J. A. Johnson
Copist.

C

11 (New).

U.S.C.T.

John Clark

Serg, Co. C, 11 Reg't U. S. Col'd Inf. (New).

Appears on

Company Muster Roll

for *July & Aug*, 186*5*.

Present or absent *Absent*

Stoppage, \$ *100* for

Due Gov't, \$ *100* for

Remarks: *Lost 1 week
sick in Webster Hosp.
Memphis Tenn*

Book mark:

E. Johnson

C 11 (New). U.S.C.T.

John Clark

Serg, Co. C, 11 Reg't U. S. Col'd Inf. (New).

Appears on

Company Muster Roll

for *Sep & Oct*, 1865.

Present or absent *Present*

Stoppage, \$ 100 for

Due Gov't, \$ 100 for

Remarks: *Lost swiper*

Book mark:

T. A. Johnson
Copyist.

C

11 (New).

U.S.C.T.

John Clark

Sergeant, Co. C, 11 Reg't U. S. Col'd Inf. (New).

Appears on

Company Muster Roll

for *Nov. & Dec.*, 1865.

Present or absent *Present*

Stoppage, \$ *100* for

Due Gov't, \$ *26* 100 for *Ordnance*

Remarks:

Book mark:

S. W. Melhous

le | 11 (New). U.S.C.T.

John Clark
Sergt. Co. C, 11 Reg't U. S. Col'd Inf. (New).

Appears on Co. Muster-out Roll, dated
Memphis, Tenn. Jan. 12, 1866.

Muster-out to date Jan. 12, 1866.

Last paid to Feb. 28, 1865.

Clothing account:

Last settled 186 ; drawn since \$ 100

Due soldier \$ 2 / 28 / 100; due U. S. \$ 100

Am't for cloth'g in kind or money adv'd \$ 100

Due U. S. for arms, equipments, &c., \$ 100

Bounty paid \$ 100; due \$ 100

Remarks: Appointed Corporal
Jan. 16"/65: Promoted to
Sergt March 10"/65 per S.O.
No. 9. First installment
of Bounty due \$100.00

Book mark:

S. W. Williams

(861)

Copyist.

285

Clark, Parless

Co I, 11 U.S. Col'd Inf.

(New Organization.)

Private

Private

CARD NUMBERS.

1	6332952	26
2	6333056	27
3	6333150	28
4	6333238	29
5	6333321	30
6	6333398	31
7	6333474	32
8	6333554	33
9	6333625	34
10	6333698	35
11	6333772	36
12	6333841	37
13	6333909	38
14	7072485	39
15		40
16		41
17		42
18		43
19		44
20		45
21		46
22		47
23		48
24		49
25		50

Book Mark:

See also

A. 8185-11 P.O. aff

X

6 | 11 (new) U.S.C.T.

Parley Clark

, Co. A, 11 Reg't U.S. Col'd Inf. (new)

Appears on

Company Descriptive Book

of the organization named above.

DESCRIPTION.

Age 20 years height 5 feet 6 inches.

Complexion Black

Eyes; Black hair Black

Where born Aberdeen Miss

Occupation Farmer

ENLISTMENT.

When March 1862

Where Memphis Tenn

By whom P. Slaughter term 3 yrs.

Remarks:

.....
.....
.....
.....
.....
.....
.....

P. Jones
Copist.

6 | 11 (New). | U.S.C.T.

Jarless Clark
Priv., Co., 6 Reg't U. S. Col'd H. Art'y.†

Appears on

Company Muster-in and Descriptive Roll
of the organization named above. Roll dated

Fort Pickens Memphis Tenn, Apr. 2, 1864.

Where born Aberdeen Miss.

Age 20 y'rs; occupation Farmer

When enlisted March 1, 1864.*

Where enlisted Memphis Tenn.

For what period enlisted 3 years.

Eyes black; hair black

Complexion yellow; height 5 ft. 6 in.

When mustered in March 1, 1864.*

Where mustered in

Bounty paid \$ 100; due \$ 100

Where credited Pikeville Chickasaw Co. Miss.

Company to which assigned

Remarks:

† This organization subsequently became Co. I, 11 Reg't U. S. Colored Infantry (New).

* Muster in roll shows enrollment and muster-in of this company as of same date. See enrollment on subsequent card or cards.

Book mark:

Milliken

6 | 11 (New). | U.S.C.T.

Parless Clark
Priv., Co. I, 6 Reg't U. S. Col'd H. Art'y.†

Appears on

Company Muster Roll

for Mar. & Apr., 1864.

Joined for duty and enrolled:

When Mar. 1, 1864.*

Where Memphis Tenn.*

Period 3 years.*

Present or absent present

Stoppage, \$ 100 for

Due Gov't \$ 100 for

Remarks: Present sick.
(Mustered in at
Memphis Tenn.)

† This organization subsequently became Co. I, 11 Reg't U. S. Colored Infantry (New).

* See enrollment on card from muster-in roll.

Book mark: _____

(358c)

Milliken

Copyist.

le

11 (New).

U.S.C.T.

Charles Clark

Priv., Co. I, 7 Reg't U. S. Col'd H. Art'y.†

Appears on

Company Muster Roll

for May + June, 1864.

Joined for duty and enrolled:

When 1st Mar., 1864.*

Where Memphis Tenn. *

Period 3 years.*

Present or absent present

Stoppage, \$ 100 for

Due Gov't, \$ 100 for

Remarks:

†This organization subsequently became Co. I, 11 Reg't U. S. Col'd Infantry (New).

* See enrollment on card from muster-in roll.

Book mark:

Williken

6 | 11 (New). | U.S.C.T.

Parless Clark

Priv., Co. I, 7 Reg't U. S. Col'd H. Art'y.†

Appears on

Company Muster Roll

for July & Aug't, 1864.

Joined for duty and enrolled:

When 1st March, 1864.*

Where Memphis Tenn. *

Period 3 years.*

Present or absent Not stated

Stoppage, \$ 100 for

Due Gov't, \$ 100 for

Remarks:

†This organization subsequently became Co. I, 11 Reg't U. S. Col'd Infantry (New).

* See enrollment on card from muster-in roll.

Book mark:

Milliken

69

11 (New). U.S.C.T.

Parless Clark

Private, Co. I, 7 Reg't U. S. Col'd H. Art'y.†

Appears on

Company Muster Roll

for Sept. & Oct., 1864.

Joined for duty and enrolled:

When 1st Mar., 1864.*

Where Memphis Tenn. *

Period 3 years.*

Present or absent present

Stoppage, \$ 100 for

Due Gov't, \$ 100 for

Remarks:

†This organization subsequently became Co. I, 11 Reg't U. S. Col'd Infantry (New).
* See enrollment on card from muster-in roll.

Book mark:

Milliken

10 | 11 (New). | U.S.C.T.

Parless Clark

Priv., Co. I, 7 Reg't U. S. Col'd H. Art'y.†

Appears on

Company Muster Roll

for Nov. & Dec., 1864.

Joined for duty and enrolled:

When 1st Mar., 1864.*

Where Memphis Tenn. *

Period 3 years.*

Present or absent present

Stoppage, \$ 100 for

Due Gov't, \$ 100 for

Remarks:

†This organization subsequently became Co. I, 11 Reg't U. S. Col'd Infantry (New).

* See enrollment on card from muster-in roll.

Book mark:

Milliken

C | 11 (New) | U.S.C.T.

Parless Clark

Private, Co. I, 11 Reg't U. S. Col'd Inf. (New.)

Appears on

Company Muster Roll

for *Jan & Feb*, 186*5*.

Joined for duty and enrolled:

When *March 1*, 186*4*.*

Where *Memphis Tenn.* *

Period *3* years.*

Present or absent *Present*

Stoppage, \$ *100* for

Due Gov't \$ *100* for

Remarks:

* ~~See~~ See enrollment on card from muster-in roll.

Book mark:

M. A. Michaels

(358c)

Copyist.

C | 11 (New) | U.S.C.T.

Parless Clark

Private, Co. I, 11 Reg't U. S. Col'd Inf. (New.)
Appears on

Company Muster Roll

for March & Apr., 1865.

Joined for duty and enrolled:

When March 1, 1864.*

Where Memphis Tenn.*

Period 2 years.*

Present or absent Present

Stoppage, \$ 100 for

Due Gov't \$ 100 for

Remarks:

* See enrollment on card from muster-in roll.

Book mark:

M. A. Michaels
(358c) Copyist.

C | 11 (New) | U.S.C.T.

Parless Clark

Private Co. I, 11 Reg't U. S. Col'd Inf. (New.)
Appears on

Company Muster Roll

for *May + June*, 1865.

Joined for duty and enrolled:

When *March 1*, 186*4*.*

Where *Memphis Tenn* *

Period *3* years.*

Present or absent *Present*

Stoppage, \$ *100* for

Due Gov't \$ *100* for

Remarks:

* See enrollment on card from muster-in roll.

Book mark:

M. A. Michaels

(358c)

Copyist.

C | 11 (New) | U.S.C.T.

Charles Clark

Private, Co. I, 11 Reg't U. S. Col'd Inf. (New.)
Appears on

Company Muster Roll

for July & Aug., 1865.

Joined for duty and enrolled:

When March 1, 1864.*

Where Memphis Tenn. *

Period 3 years.*

Present or absent Present

Stoppage, \$ 100 for _____

Due Gov't \$ 100 for _____

Remarks: _____

* See enrollment on card from muster-in roll.

Book mark: _____

M. A. Michaels

(358c)

Copyist.

C | 11 (New) | U.S.C.T.

Parless Clark

Private Co. I, 11 Reg't U. S. Col'd Inf. (New.)
Appears on

Company Muster Roll

for Sept & Oct, 1865.

Joined for duty and enrolled:

When March 1, 1864.*

Where Memphis Tenn *

Period 3 years.*

Present or absent Present

Stoppage, \$ 100 for

Due Gov't \$ 100 for

Remarks: Stop for 1 Screw Dr CW
1 Tompaish & Wiper #5

* See enrollment on card from muster-in roll.

Book mark:

M. A. Michaels

B | **11** (New) | **U.S.C.T.**

Charles Clark

Priv., Co. I, 11 Reg't U. S. Col'd Inf. (New.)
Appears on

Company Muster Roll

for *Nov. and Dec.*, 186*5*.

Joined for duty and enrolled:

When *1 March*, 186*4*.*

Where *Memphis Tenn* *

Period *3* years.*

Present or absent *Present*

Stoppage, \$ *100* for

Due Gov't \$ *100* for

Remarks:

* See enrollment on card from muster-in roll.

Book mark: -----

D. Weber

S

11 (New). U.S.C.T.

Purless Clark

Priv. col.; 11 Reg't U. S. Col'd Inf. (New).

Appears on Co. Muster-out Roll, dated

Memphis Tenn Jan 12, 1866.

Muster-out to date *Jan 12*, 1866.

Last paid to *June 30*, 1865.

Clothing account:

Last settled....., 186 ; drawn since \$..... 100

Due soldier \$..... 100; due U. S. \$ *14* ^{*31*} ₁₀₀

Am't for cloth'g in kind or money adv'd \$..... 100

Due U. S. for arms, equipments, &c., \$ *45* ₁₀₀

Bounty paid \$..... 100; due \$..... 100

Remarks:.....

Book mark: *V 24 P 79 68*

D P Webster

(361)

Copyist.

286

Clark, Thomas

Co E, 11 U.S. Col'd Inf.

(New Organization.)

Private

Private

CARD NUMBERS.

1	6322625	26
2	6328963	27
3	6329066	28
4	6329152	29
5	6329238	30
6	6329314	31
7	6329390	32
8	6329460	33
9	6329525	34
10	6329601	35
11	6329681	36
12	6329744	37
13	6329804	38
14	9071872	39
15		40
16		41
17		42
18		43
19		44
20		45
21		46
22		47
23		48
24		49
25		50

Book Mark:

See also

02904992-111111

11 (new) U.S.C.T.

Clarke Thomas
(new)
Co. E, 11 Reg't U.S. Col'd Inf.

Appears on
Company Descriptive Book
of the organization named above.

DESCRIPTION.

Age 25 years height 3 feet 3 1/2 inches.

Complexion *Black*

Eyes; *Black* hair *Black*

Where born *Alabama*

Occupation

ENLISTMENT.

When *March 8*, 1864.

Where *Memphis Tenn*

By whom *Sergt Meales*; term *3* y'rs.

Remarks:
.....
.....
.....
.....
.....
.....
.....
.....

Harrison

6

11 (New). U.S.C.T.

Thomas Clarke

Appears with rank of *Pri...* on

Muster and Descriptive Rolls of Detachments of U. S. Vols. forwarded

for the *11* Reg't U. S. Col'd *Inf.* Roll dated
Memphis Tenn, *Mar 11*, 1864.

Where born *Alabama*

Age *25* y'rs; occupation *Farmer*

When enlisted *March 8*, 1864.

Where enlisted *Memphis Tenn*

For what period enlisted *3* years.

Eyes *Black*; hair *black*

Complexion *dark*; height *5* ft. *5 1/2* in.

When mustered in *Mar 11*, 1864.

Where mustered in *Memphis Tenn*

Bounty paid \$ *100*; due \$ *100*

Where credited

Company to which assigned *E*

Remarks: *Joined as Recruit*
Mar 11. 1864

Book mark:

Ashley

6

11 (New). U.S.C.T.

Thomas Clarke

Pvt., Co. E, 6 Reg't U. S. Col'd H. Art'y.*

Appears on

Company Muster Roll

for Mich & Apl, 1864.

Present or absent Present.

Stoppage, \$ 100 for

Due Gov't, \$ 100 for

Remarks joined a recruit Mich 8. 64.

*This organization subsequently became Co. E, 11 Reg't U. S. Colored Infantry (New).

Book mark :

Lewis

Copyist.

6 | **11** (New). | **U.S.C.T.**

Thomas Clarke

Priv, Co. E, 7 Reg't U. S. Col'd H. Art'y.*

Appears on

Company Muster Roll

for *May & June*, 186*4*.

Present or absent *Present*

Stoppage, \$ *100* for

Due Gov't, \$ *100* for

Remarks:

* This organization subsequently became Co. E, 11 Reg't U. S. Colored Infantry (New).

Book mark:

Overshaw

C | **11** (New). | **U.S.C.T.**

Thomas Clark

Priv, Co. E, 7 Reg't U. S. Col'd H. Art'y.*

Appears on

Company Muster Roll

for *July & Aug.*, 186 *4*

Present or absent *Present*

Stoppage, \$ *100* for

Due Gov't, \$ *100* for

Remarks:

* This organization subsequently became Co. E, 11 Reg't U. S. Colored Infantry (New).

Book mark:

Crenshaw

B | **11 (New).** | **U.S.C.T.**

Thomas Clark

Pvt, Co. E, 7 Reg't U. S. Col'd H. Art'y.*

Appears on

Company Muster Roll

for *Sept. & Oct.*, 186*4*

Present or absent *Present*

Stoppage, \$ *100* for

Due Gov't, \$ *100* for

Remarks: *Stop for one canteen & haversack \$1.12.*

* This organization subsequently became Co. E, 11 Reg't U. S. Colored Infantry (New).

Book mark: _____

Crenshaw

(358)

Co. *1st.*

6 | 11 (New). | U.S.C.T.

Thomas Clark

Priv., Co. E, 7 Reg't U. S. Col'd H. Art'y.*

Appears on

Company Muster Roll

for Nov. & Dec., 1864

Present or absent Present

Stoppage, \$ 100 for

Due Gov't, \$ 100 for

Remarks: On daily duty in
Q. M. Dept. since
Nov. 15/64. Stop for one
canteen & one haversack.

* This organization subsequently became Co. E, 11 Reg't U. S. Colored Infantry (New).

Book mark: 3305

Creshaw

6

11 (New).

U.S.C.T.

Thomas Clark

Pvt., Co. E, 11 Reg't U. S. Col'd Inf. (New).

Appears on

Company Muster Roll

for Jan. & Feb., 1865.

Present or absent Present

Stoppage, \$ 100 for

Due Gov't, \$ 100 for

Remarks: top for Carter

& Haverstick.

at daily duty in

2. M. Dep't since Nov. 1864.

Book mark:

Loring

6 | 11 (New). | **U.S.C.T.**

Thomas Clark

Park, Co. E, 11 Reg't U. S. Col'd Inf. (New).

Appears on

Company Muster Roll
for *March & April*, 1865.

Present or absent *Present*

Stoppage, \$ *100* for _____

Due Gov't, \$ *100* for _____

Remarks: *On daily duty
in 2nd Dept since
Nov. 1864.*

Book mark: _____

(858)

Loung

Copyist.

C

11 (New).

U.S.C.T.

Thomas Clark
1st Lt., Co. E, 11 Reg't U. S. Col'd Inf. (New).

Appears on

Company Muster Roll

for May & June, 1865

Present or absent Present

Stoppage, \$ 100 for

Due Gov't, \$ 100 for

Remarks: On daily duty
in L. M. Dep't

Book mark:

(358)

Lowry

Copyist.

C

11 (New).

U.S.C.T.

Thomas Clark

Prvt., Co. E, 11 Reg't U. S. Col'd Inf. (New).

Appears on

Company Muster Roll

for *July & Aug.*, 186*5*.

Present or absent *Present*

Stoppage, \$ *100* for

Due Gov't, \$ *100* for

Remarks:

Book mark:

Louise

C | 11 (New). | U.S.C.T.

Thomas Clark
Co. E, 11 Reg't U. S. Col'd Inf. (New).

Appears on

Company Muster Roll

for *Sep. & Oct.*, 1865.

Present or absent *Present*

Stoppage, \$ *100* for

Due Gov't, \$ *100* for

Remarks:

Book mark:

(858)

Lowry
Copyist.

Q | 11 (New). | U.S.C.T.

Thomas Clark,
Priv., Co. E, 11 Reg't U. S. Col'd Inf. (New).

Appears on

Company Muster Roll

for *e Nov & Dec*, 1865.

Present or absent *Present*

Stoppage, \$ *100* for

Due Gov't, \$ *100* for

Remarks:

Book mark:

Valentine

C | 11 (New). | U.S.C.T.

Thomas Clark

Pvt. Co. E, 11 Reg't U. S. Col'd Inf. (New).

Appears on Co. Muster-out Roll, dated
Memphis Tenn, Jan 12, 1866.

Muster-out to date Jan 12, 1866.

Last paid to June 30, 1865.

Clothing account:

Last settled _____, 186 ; drawn since \$ _____ 100

Due soldier \$ 9 ⁵⁸ / 100; due U. S. \$ _____ 100

Am't for cloth'g in kind or money adv'd \$ _____ 100

Due U. S. for arms, equipments, &c., \$ _____ 100

Bounty paid \$ _____ 100; due \$ _____ 100

Remarks: _____

Book mark: _____

Valentine
(361) Copyist.

Clark, Thomas -

, Co. **E**, **11** Reg't **U. S. C. Inf.**

2 Enclosures.

Bed Cards	Descriptive Lists
Burial Records	Final Statements
Certs. of Dis. for Discharge	Furloughs
C. M. Charges	Med. Des. Lists
Med. Certificates	Orders 2

Other papers relating to—

Admission to Hosp'l	Furlough
Casualty Sheet (Officer's)	Med. Examination
Confinement	Misc. Information
Contracts	Pay or Clothing
Death or Effects	Personal Reports
Desertions	Rank
Discharge from Hosp'l	Transfer to Hosp'l
Discharge from Service	Transfer to V. R. C.
Duty	Transportation

Vol 2nd 11th Regt Infy
Aug 14th 1863
Special Orders
No 144

Private Thomas Clark
relieved from daily duty
in Co. A. Dept.

2

Head Quarters 11th U.S.C.
Memphis Aug 14th 65

Special Orders }
No 15-4 }

The following named
enlisted man of this Regt now on duty
in R.G.M Dept, is hereby relieved
and will report to his Co commander
with out delay for duty.

Thomas Clark Co. E, 11th U.S.C.
By order of

Col. W. D. Turner
S. P. Denton,
Adj. Gen.

To Comdg. Officer
I. S.

H. L. 22 3/4" W. of lat. Anty 10"
Cor 16" / 8 top

Special Order
No 34

Private Thus blank
detailed in L. M. Dept.

Head Quarters 7th U. S. C. A. Heavy
Fort Pickering Memphis Nov 16th 1864

Special Order

No "74") Extract 1

Private Thomas Clarke Co "E" 7th U. S.
C. Heavy, is hereby detailed for special duty in 2^d M
Dept. 7th U. S. C. A. Heavy, and will report at once for duty
to Lieut J. W. Davis A. S. M

W. H. Turner
Col 7th U. S. C. A.

W. A. Smith, 1st Lt.
and Adjutant Genl

Commanding Officer
Co. E. 7th U. S. C. A. Heavy

28

Clay, Henry

Co *C*, 11 U.S. Col'd Inf.

(New Organization)

Private | *Private*

CARD NUMBERS.

1	6322770	26
2	6329155	27
3	6329241	28
4	6329317	29
5	6329393	30
6	6329463	31
7	6329528	32
8	6329604	33
9	6329684	34
10	6329747	35
11	6329807	36
12	907188	37
13	1	38
14		39
15		40
16		41
17		42
18		43
19		44
20		45
21		46
22		47
23		48
24		49
25		50

Book Mark:

See also

p. 1823893 N. Green

O. 2447778 And. N. 10,

D. 2468592 Paper.

D. 2550283 And. W. D.

D. 2861505 And. W. D.

61 | 11 (new) U.S.C.T.

Henry Clay
, Co. E, 11 Reg't (new) U. S. Col'd Inf.

Appears on

Company Descriptive Book

of the organization named above.

DESCRIPTION.

Age 18 years; height 5 feet 7 inches.

Complexion Dark

Eyes Black; hair Black

Where born Mississippi

Occupation

ENLISTMENT.

When July 26, 1864

Where Memphis Tenn

By whom Capt. [unclear]; term 3 y'rs.

Remarks:

Howson

6

11 (New). U.S.C.T.

Henry Clay

Appears with rank of *Pri* on

Muster and Descriptive Rolls of Detachments of U. S. Vols. forwarded

for the *11* ^{*7 U.S.C.A.A.*} Reg't U. S. Col'd *Inf.* Roll dated

Memphis Tenn July 28, 1864.

Where born *Mississippi*

Age *18* y'rs; occupation

When enlisted *July 26*, 1864.

Where enlisted *Memphis*

For what period enlisted *3* years.

Eyes *Black*; hair *Black*

Complexion *Dark*; height *5* ft. *7* in.

When mustered in *July 28*, 1864.

Where mustered in *Memphis Tenn*

Bounty paid \$ *100*; due \$ *100*

Where credited

Company to which assigned *E*

Remarks:

Book mark:

Ashley

6

11 (New).

U.S.C.T.

Henry Clay

Priv., Co. E, 7 Reg't U. S. Col'd H. Art'y.*

Appears on

Company Muster Roll

for July & Aug., 1864.

Present or absent Present

Stoppage, \$ 100 for

Due Gov't, \$ 100 for

Remarks: Joined a recruit
July 26. 1864.

* This organization subsequently became Co. E, 11 Reg't U. S. Colored Infantry (New).

Book mark:

Crenshaw

Co | 11 (New). | U.S.C.T.

Henry Clay

Priv., Co. E, 7 Reg't U. S. Col'd H. Art'y.*

Appears on

Company Muster Roll

for Sept. & Oct., 1864

Present or absent Present

Stoppage, \$ 100 for

Due Gov't, \$ 100 for

Remarks: Stop for one canteen & haversack \$1.17

* This organization subsequently became Co. E, 11 Reg't U. S. Colored Infantry (New).

Book mark:

Crewshaw

6

11 (New).

U.S.C.T.

Henry Clay

Pat, Co. E, 7 Reg't U. S. Col'd H. Art'y.*

Appears on

Company Muster Roll

for Nov. 1st Dec., 1864.

Present or absent Present

Stoppage, \$ 100 for

Due Gov't, \$ 100 for

Remarks: Stop for one canteen & one haversack.

* This organization subsequently became Co. E, 11 Reg't U. S. Colored Infantry (New).

Book mark:

Crenshaw

C | 11 (New). | U.S.C.T.

Henry Clay
Co. E, 11 Reg't U. S. Col'd Inf. (New).

Appears on

Company Muster Roll

for Jan 1st, 1865

Present or absent Present

Stoppage, \$ 100 for

Due Gov't, \$ 100 for

Remarks: Stop for 1 year
& 1 horseback

Book mark:

C | 11 (New). | U.S.C.T.

Henry Clay
Co. E, 11 Reg't U. S. Col'd Inf. (New).

Appears on

Company Muster Roll

for March & April, 1865.

Present or absent Present

Stoppage, \$ 100 for

Due Gov't, \$ 100 for

Remarks:

Book mark:

Lowry

C | 11 (New). | U.S.C.T.

Henry Clay
Co. E, 11 Reg't U. S. Col'd Inf. (New).

Appears on

Company Muster Roll

for *May & June*, 1865

Present or absent *Present*

Stoppage, \$ *100* for

Due Gov't, \$ *100* for

Remarks:

Book mark:

Lowry

C | **11 (New).** | **U.S.C.T.**

Henry Clay

1st, Co. E, 11 Reg't U. S. Col'd Inf. (New).

Appears on

Company Muster Roll

for *July & Aug.*, 1865

Present or absent *Present*

Stoppage, \$ *100* for

Due Gov't, \$ *100* for

Remarks:

Book mark:

(858)

Lowry

Copyist.

C | 11 (New). | U.S.C.T.

Henry Clay
Pvt., Co. E, 11 Reg't U. S. Col'd Inf. (New).

Appears on

Company Muster Roll

for Sept. & Oct., 1865.

Present or absent Present

Stoppage, \$ 100 for

Due Gov't, \$ 100 for

Remarks: Stop for ord

nance 13%

First installment of
100.00 bounty due in
accordance with Genl
Order No. 224, dated
War Dept A.G.O. July 6/64.

Book mark: _____

Lowry

(858)

Copyist.

6 | 11 (New). | U.S.C.T.

Henry Clay
Priv., Co. E, 11 Reg't U. S. Col'd Inf. (New).

Appears on

Company Muster Roll

for Nov. & Dec., 1865.

Present or absent Present

Stoppage, \$ 100 for

Due Gov't, \$ 1 ⁵⁷/₁₀₀ for ordnance

Remarks:

First instalment of \$100⁰⁰
found due in accordance
with Gen'l Ord. #224 dat^d
War Dept. & Adj't Gen'l Office
July 6th 1864

Book mark:

Valentine

C

11 (New).

U.S.C.T.

Henry Clay

Priv. Co. C, 11 Reg't U. S. Col'd Inf. (New).

Appears on Co. Muster-out Roll, dated

Memphis Tenn Jan 12 1866.

Muster-out to date Jan 12, 1866.

Last paid to June 30 1865.

Clothing account:

Last settled 186 ; drawn since \$ 100

Due soldier \$ 100; due U. S. \$ 54 ⁵⁴/₁₀₀

Am't for cloth'g in kind or money adv'd \$ 100

Due U. S. for arms, equipments, &c., \$ / ⁵⁷/₁₀₀

Bounty paid \$ 100; due \$ 100

Remarks:

Bounty due in accordance with Gen'l Order No 224 War Dept. July 6th 1864.

Book mark: 121. 1879

Valentine

288

Clay Henry

Co K, 11 U.S. Col'd Inf.

(New Organization.)

Private

Private

CARD NUMBERS.

1	6334029	26
2	6334120	27
3	6334220	28
4	6334353	29
5	6335009	30
6	9072538	31
7		32
8		33
9		34
10		35
11		36
12		37
13		38
14		39
15		40
16		41
17		42
18		43
19	1	44
20		45
21		46
22		47
23		48
24		49
25		50

Book Mark:

See also

C | 11 (New) | **U. S. C. T.**

Henry Clay
(New)
....., Co A, 11 Reg't U. S. Col'd Inf.

Appears on
Company Descriptive Book
of the organization named above.

DESCRIPTION.

Age 18 years height 5 feet 4 inches.

Complexion Blk

Eyes; Blk hair Blk

Where born Columbus Miss.

Occupation Farmer

ENLISTMENT.

When March, 1864

Where Memphis

By whom L. S. Washburn; term 3 y'rs.

Remarks: Henry Clay absent & sick in Webster Hosp since May 2/64. Restored to duty July 7, 1864. Died in Regimental Hosp June 3/64

Bryer

C 11 (New). U.S.C.T.

Henry Clay

Art., Co. K, 6 Reg't U. S. Col'd H. Art'y.†

Appears on

Company Muster-in and Descriptive Roll

of the organization named above. Roll dated

Fort Pickens
Memphis, Tenn. April 2, 1864.

Where born Mississippi

Age 18 y'rs; occupation Farmer

When enlisted March 1, 1864*

Where enlisted Memphis, Tenn.

For what period enlisted 3 years.

Eyes Black; hair Black

Complexion Black, height 5 ft. 4 in.

When mustered in March 1, 1864*

Where mustered in

Bounty paid \$ 100; due \$ 100

Where credited Colone, Miss.

Company to which assigned

Remarks:

† This organization subsequently became Co. K, 11 Reg't U. S. Colored Infantry (New).
* Muster-in roll shows enrollment and muster-in of this company as of same date. See enrollment on subsequent card or cards.

Book mark:

Proctor

C | 11 (New). | U.S.C.T.

Henry Clay
Sgt, Co. K, 6 Reg't U. S. Col'd H. Art'y.†

Appears on

Company Muster Roll

for April to August, 1867

Joined for duty and enrolled:

When March 1, 1867.*

Where Memphis, Tenn. *

Period 3 years.*

Present or absent Present

Stoppage, \$ 100 for

Due Gov't \$ 100 for

Remarks: Sick in Quarters
(mused in at Mem-
phis Tenn)

† This organization subsequently became Co. K, 11 Reg't U. S. Colored Infantry (New).

* See enrollment on card from muster-in roll.

Book mark: _____

Recher

S | 11 (New). | U.S.C.T.

Henry Clay
Co. K, 7 Reg't U. S. Col'd H. Art'y.†

Appears on

Company Muster Roll

for May & June, 1864

Joined for duty and enrolled:

When March 1, 1864*

Where Memphis, Tenn. *

Period 3 years.*

Present or absent Present

Stoppage, \$ 100 for

Due Gov't \$ 100 for

Remarks:

†This organization subsequently became Co. K, 11 Reg't U. S. Col'd Infantry (New).

* See enrollment on card from muster-in roll.

Book mark:

Reister

C 11 (New). U.S.C.T.

Henry Clay
Pot, Co. K, 7 Reg't U. S. Col'd H. Art'y.†

Appears on

Company Muster Roll

for July & Aug, 1864.

Joined for duty and enrolled:

When March 1, 1864.*

Where Memphis, Tenn.*

Period 3 years.*

Present or absent

Stoppage, \$ 100 for

Due Gov't \$ 100 for

Remarks: Died Reg't. Hosp'ts.
June 30. 1864 of
Disease - Charges for
Ordnance lost, Bayonet
Scabbard, Cartridge Box,
Belt & Plate, Cap Box, Waist
-over-

†This organization subsequently became Co. K, 11 Reg't U. S. Col'd Infantry (New).

* See enrollment on card from muster-in roll.

Book mark:

Rochester

JAN. 23

6334353

018910

*Belt & Plate Screw
Bolt Screw, Spring
Vise & Wiper*

60 | 11 (New) | U.S.C.T.

Henry Clay

Priv., Co, 11 Reg't U. S. Col'd Inf. (New).

Appears on Co. Muster-out Roll, dated
Memphis, Tenn., Jan. 12, 1866.

Muster-out to date _____, 186 .

Last paid to _____, 186 .

Pay due from enlistment

Clothing account:

Last settled _____, 186 ; drawn since \$ _____ 100

Due soldier \$ _____ 100; due U. S. \$ _____ 100

Am't for cloth'g in kind or money adv'd \$ _____ 100

Due U. S. for arms, equipments, &c., \$ _____ 100

Bounty paid \$ _____ 100; due \$ _____ 100

Remarks: Died June 19/66 in
Regt Hospital

Book mark: F.S. 301.347.121.1879

(361)

Hammer

Copyist.

Clay, Henry -

P, Co. *Rt*

11

Reg't **U. S. C. Inf.**

4

Enclosures.

Bed Cards	Descriptive Lists
Burial Records	Final Statements <i>2</i>
Certs. of Dis. for Discharge	Furloughs
C. M. Charges	Med. Des. Lists
Med. Certificates	Orders

Other papers relating to—

Admission to Hosp'l	Furlough
Casualty Sheet (Officer's)	Med. Examination
Confinement	Misc. Information
Contracts	Pay or Clothing
Death ^{<i>of</i>} or Effects <i>2</i>	Personal Reports
Desertions	Rank
Discharge from Hosp'l	Transfer to Hosp'l
Discharge from Service	Transfer to V. R. C.
Duty	Transportation

1864

sub roll 55

FINAL STATEMENT

OF

Henry Clay
7th Reg't of U.S. Army

VOLUNTEERS.

NOTE 1.—Two of these certificates (or duplicates) are to be given to each Volunteer Soldier or drafted man who may be discharged previously to the discharge of his company, that he may at once receive from the Paymaster the pay, &c., due him, and the captain or other COMMISSIONED officer commanding the company will certify to the act of the delivery of the duplicate certificates; on these certificates the Soldier is "entitled to" his discharge, and should also present his discharge to the Paymaster to have the payment endorsed on it. The discharge is to be given back to the Soldier by the Paymaster; the latter only retaining as his voucher the duplicate certificates.

NOTE 2.—If the Soldier is entitled to pay for the use of his horse, the Company Commander will certify to that fact on the back of both these final statements, and also to the time he has pay due for having been so mounted on his own horse.

NOTE 3.—When a Soldier is furnished with final statements, his descriptive list, if he has one, should be taken up by the officer who gives the Soldier these statements, and endorsed with a statement to this effect by the officer. This endorsement should exhibit a full statement of the time for which the Soldier was allowed pay on his final statements, the clothing account, and all other charges against him or in his favor, so as to comprise a complete exhibit of his account. It will then be transmitted to the company commander of the Soldier, who will enter all the data necessary to a full understanding of the Soldier's account on the muster roll upon which the Soldier's discharge is reported. The descriptive list will then be destroyed. The object of this is, that the remaining portion of the Soldier's account may be settled upon the receipt of these muster rolls, and the Soldier receive any pay or allowances that may be due him at the time of his discharge, and which may not appear on his final statements from the fact that his descriptive list is incomplete. These accounts for back pay, &c., are settled by the 2d Auditor of the Treasury Department.

NOTE 4.—Charges for loss or injury to ordnance, horse equipments, and other miscellaneous charges, should appear under the heading of "Other Stoppages."

NOTE 5.—Bounty paid by State authorities, and not by the United States, will not be entered on this statement.

NOTE 6.—Amounts due the Sutler and Laundress must be entered on the muster roll on which the discharge, death, desertion, &c., is reported, as well as on the final statement, otherwise the amount cannot be collected from the United States.

NOTE 7.—This blank will be used for deceased volunteers and drafted men, as well as for others.

NOTE 8.—Where a Soldier dies in Hospital or on detached service, his descriptive list, if he has one, should be sent with his final statements, in duplicate, to the Adjutant General, Washington, D. C.

I certify, on honor, that Henry Clay a Private of
 Captain L. J. Washburn Company (K) of the 7th Regiment of USCA (G)
VOLUNTEERS, of the State of _____, born in _____, State
 of _____, aged 18 years; 5 feet 4 inches high; Black complexion,
Black eyes, Black hair, and by occupation a Farmer, having joined the company on
 its original organization at Memphis March 1st, and enrolled in it at the muster into
 the service of the United States at Memphis Tenn, on the second day
 of April, 1864, (or was mustered in service as a recruit, by _____
 _____, at _____, on the _____ day of _____,
 186 , or was drafted and mustered into the service of the United States from the _____
 Enrollment District of the State of _____, at _____,
 on the _____ day of _____, 186) to serve in the Regiment, for
 the term of Three years: and having served **HONESTLY** and
FAITHFULLY with his Company in the 7th Regt. Co. K to the present date, is now
 entitled to a **DISCHARGE** by reason of Death died in Regiment at
Hospital June 30th 1864

The said Henry Clay was last paid by Paymaster
J. C. Smith to include the 30th day of April, 1864, and has
 pay due him from that time to the present date; he is entitled to pay and subsistence for
TRAVELING to place of enrollment, and whatever other allowances are authorized to volunteer
 soldiers, drafted men, or militia, so discharged. He has received from the United States **CLOTHING**
 amounting to Twenty five $\frac{15}{100}$ dollars, since the _____ day of _____,
 186 , when his clothing account was last settled. He has received from the United States
 _____ $\frac{100}{100}$ dollars advanced **BOUNTY**.

There is to be stopped from him, on account of the State of _____, or other
 authorities, for **CLOTHING, &c.**, received on entering service, _____ $\frac{100}{100}$ dollars; and
 for other stoppages, viz: one Regiment 4 Cent. one Cent. one Cent. one Cent. one Cent. one Cent.
Waist Belt & Plate 1 Ball Screen Spring steel Press Drive Wiper
 _____ $\frac{4}{100}$ dollars.

He has been furnished with **TRANSPORTATION** in kind from the place of his discharge to
 _____; and he has been **SUBSISTED** for **TRAVELING** to his
 place of enrollment, up to the _____, 1864.

He is indebted to Grigg & Sample, **SUTLER**, three $\frac{100}{100}$ dollars.
 He is indebted to _____, **LAUNDRESS**, _____ $\frac{100}{100}$ dollars.

Given in Duplicate, at _____, this 7th day
 of July, 1864.

L. J. Washburn Capt
7th USCA (G)
 Commanding Company.

A.G.O. July 25, 1861
to his acct. for reports
2nd Auditor.
(B.)

✓ *Carroll* 53
FINAL STATEMENT

OF

Henry Clay

7th Regt of usca regt

117 Co
VOLUNTEERS.

Disd June 30, 1861

NOTE 1.—Two of these certificates (or duplicates) are to be given to each Volunteer Soldier or drafted man who may be discharged previously to the discharge of his company, that he may at once receive from the Paymaster the pay, &c., due him, and the captain or other COMMISSIONED officer commanding the company will certify to the act of the delivery of the duplicate certificates; on these certificates the Soldier is "entitled to" his discharge, and should also present his discharge to the Paymaster to have the payment endorsed on it. The discharge is to be given back to the Soldier by the Paymaster; the latter only retaining as his voucher the duplicate certificates.

NOTE 2.—If the Soldier is entitled to pay for the use of his horse, the Company Commander will certify to that fact on the back of both these final statements, and also to the time he has pay due for having been so mounted on his own horse.

NOTE 3.—When a Soldier is furnished with final statements, his descriptive list, if he has one, should be taken up by the officer who gives the Soldier these statements, and endorsed with a statement to this effect by the officer. This endorsement should exhibit a full statement of the time for which the Soldier was allowed pay on his final statements, the clothing account, and all other charges against him or in his favor, so as to comprise a complete exhibit of his account. It will then be transmitted to the company commander of the Soldier, who will enter all the data necessary to a full understanding of the Soldier's account on the muster roll upon which the Soldier's discharge is reported. The descriptive list will then be destroyed. The object of this is, that the remaining portion of the Soldier's account may be settled upon the receipt of these muster rolls, and the Soldier receive any pay or allowances that may be due him at the time of his discharge, and which may not appear on his final statements from the fact that his descriptive list is incomplete. These accounts for back pay, &c., are settled by the 2d Auditor of the Treasury Department.

NOTE 4.—Charges for loss or injury to ordnance, horse equipments, and other miscellaneous charges, should appear under the heading of "Other Stoppages."

NOTE 5.—Bounty paid by State authorities, and not by the United States, will not be entered on this statement.

NOTE 6.—Amounts due the Sutler and Laundress must be entered on the muster roll on which the discharge, death, desertion, &c., is reported, as well as on the final statement, otherwise the amount cannot be collected from the United States.

NOTE 7.—This blank will be used for deceased volunteers and drafted men, as well as for others.

NOTE 8.—Where a Soldier dies in Hospital or on detached service; his descriptive list, if he has one, should be sent with his final statements, in duplicate, to the Adjutant General, Washington, D. C.

ADJUTANT GENERAL'S OFFICE

July 28, 1861

Duplicate with Inventory sent 2d Auditor.

Anthony R. ...

I certify, on honor, that Henry Clay a Private of
 Captain S. J. Washburn Company (55) of the 1st Regiment of Mississippi
VOLUNTEERS, of the State of _____, born in _____, State
 of _____, aged 28 years; 5 feet 7 inches high; Black complexion,
Black eyes, Black hair, and by occupation a farmer, having joined the company on
 its original organization at Memphis March 1st, and enrolled in it at the muster into
 the service of the United States at Memphis, on the second day
 of April, 1864 (or was mustered in service as a recruit, by _____
 _____, at _____, on the _____ day of _____,
 186 , or was drafted and mustered into the service of the United States from the _____
 Enrollment District of the State of _____, at _____,
 on the _____ day of _____, 186 ,) to serve in the Regiment, for
 the term of Three years: and having served **HONESTLY** and
FAITHFULLY with his Company in the 7th Mississippi to the present date, is now
 entitled to a **DISCHARGE** by reason of Death Died in Regiment at
Hospital June 30th 1864

The said Henry Clay was last paid by Paymaster
S. C. Smith to include the 30th day of April, 1864, and has
 pay due him from that time to the present date; he is entitled to pay and subsistence for
TRAVELING to place of enrollment, and whatever other allowances are authorized to volunteer
 soldiers, drafted men, or militia, so discharged. He has received from the United States **CLOTHING**
 amounting to twenty five $\frac{15}{100}$ dollars, since the _____ day of _____,
 186 , when his clothing account was last settled. He has received from the United States
 _____ $\frac{100}{100}$ dollars advanced **BOUNTY**.

There is to be stopped from him, on account of the State of _____, or other
 authorities, for **CLOTHING**, &c., received on entering service, _____ $\frac{100}{100}$ dollars; and
 for other stoppages, viz: one Boyon & Scoburn one Carney one Bell & Plate one Cap one
Waist one Belt & Plate one Spoon Spring rice & one Dinner one paper
 _____ $\frac{50}{100}$ dollars.

He has been furnished with **TRANSPORTATION** in kind from the place of his discharge to
 _____; and he has been **SUBSISTED** for **TRAVELING** to his
 place of enrollment, up to the _____, 186 .

He is indebted to Grigg & Smith, **SUTLER**, three $\frac{100}{100}$ dollars.
 He is indebted to _____, **LAUNDRESS**, _____ $\frac{100}{100}$ dollars.

Given in Duplicate, at Fort Pickens, Fla., this 7th day
 of July, 1864.

S. J. Washburn
7th Mississippi
 Commanding Company.

ARTICLES OF WAR.

ART. 95. When any non-commissioned officer or soldier shall die, or be killed in the service of the United States, the then commanding officer of the troop or company shall, in the presence of two other commissioned officers, take an account of what effects he died possessed of, above his arms and accoutrements, and transmit the same to the office of the Department of War, which said effects are to be accounted for, and paid to the representatives of such deceased non-commissioned officer or soldier. And in case any of the officers, so authorized to take care of the effects of deceased officers and soldiers, should, before they have accounted to their representatives for the same, have occasion to leave the regiment or post, by preferment or otherwise, they shall, before they be permitted to quit the same, deposit in the hands of the commanding officer, or of the assistant military agent, all the effects of such deceased non-commissioned officers and soldiers, in order that the same may be secured for, and paid to, their respective representatives.

ARMY REGULATIONS—EDITION OF 1861.

DECEASED SOLDIERS.

Par. 152. Inventories of the effects of deceased non-commissioned officers and soldiers, required by the 95th Article of War, will be forwarded to the Adjutant General, by the commander of the company to which the deceased belonged, and a duplicate of the same to the colonel of the regiment. Final statements of pay, clothing, &c., will be sent with the inventories. When a soldier dies at a post or station absent from his company, it will be the duty of his immediate commander to furnish the required inventory, and, at the same time, to forward to the commanding officer of the company to which the soldier belonged, a report of his death, specifying the date, place, and cause; to what time he was last paid, and the money or other effects in his possession at the time of his decease; which report will be noted on the next muster-roll of the company to which the man belonged. Each inventory will be endorsed, "Inventory of the effects of _____, late of company (—) _____ regiment of _____, who died at _____, the _____ day of _____, 186—." If a legal representative receive the effects, it will be stated in the report. If the soldier leave no effects, the fact will be reported.

Par. 153. Should the effects of a deceased non-commissioned officer or soldier not be administered upon within a short period after his decease, they shall be disposed of by a Council of Administration, under the authority of the commanding officer of the post, and the proceeds deposited with the Paymaster, to the credit of the United States, until they shall be claimed by the legal representatives of the deceased.

Par. 154. In all such cases of sales by the Council of Administration, a statement in detail, or account of the proceeds, duly certified by the Council and commanding officer, accompanied by the Paymaster's receipt for the proceeds, will be forwarded by the commanding officer to the Adjutant General. The statement will be endorsed, "Report of the proceeds of the effects of _____, late of company (—) _____ regiment of _____, who died at _____, the _____ day of _____, 186—."

NOTE 1.—The effects in all cases, when called for, should be turned over to the legal representative, without further authority from the Adjutant General. When the effects are turned over to the relatives of the deceased before these inventories are sent to the Adjutant General, their receipts therefor should be attached to the inventories. In all other cases, one copy will be sent with a letter of transmittal direct to the Adjutant General, and a duplicate retained by the officer.

NOTE 2.—Particular care should be taken to take receipts in duplicate from the Paymaster for any funds turned over to him; one copy should be sent direct to the Adjutant General and one retained by the officer.

*Recd from Div of Discontinued
Commands;*

INVENTORY OF THE EFFECTS

Filed Sept. 21, /75-

Henry Clay

Late of Company 92

7th Reg't of M S C A 46

Volunteers, who died at Fort Pickens

on the 30th day of June 1864.



Inventory of the effects of Henry Clay late
a Private of Captain L J Washburn Company R of
the seventh Regiment of Mississippi Volunteers, who was enrolled as
a Private at Memphis in the State of Tennessee on
the 1st day of March 1864, and mustered into the service of the United
States as a Private on the second day of April 1864, at Memphis
in Company R, 7th Regiment of Mississippi Volunteers, to serve
years or during the war; he was born in Columbia Miss in the State
of Miss; he was 18 years of age, 5 feet 4 inches
high, Black complexion, Black eyes, Black hair, and by occupation, when enrolled,
a Farmer; he died in Regimental Hospital, at
Fort Pickens on the 3rd day of June 1864, by
reason of disease

INVENTORY.					
ARTICLES.	No.	ARTICLES.	No.	ARTICLES.	No.
Hats		Pairs trousers		Knapsacks	
Caps		Pairs flannel drawers			
Forage caps		Pairs cotton drawers			
Great coats		Flannel shirts			
Uniform coats		Cotton shirts			
Uniform jackets		Pairs boots			
Flannel sack coats		Pairs shoes			
Blouses		Pairs socks			
Stable frocks		Blankets			
Fatigue overalls		Haversacks			
				MONEY.	
				Specie	\$
				Notes	\$ 14

I CERTIFY, ON HONOR, that the above inventory comprises all the effects of Henry Clay, deceased, and that the effects are in the hands of the Captain at Fort Pickens to be disposed of by a Council of Administration.

(DUPLICATES.)

STATION: Fort Pickens

DATE: July 7th 1864

[A. G. O. No. 104.]

L J Washburn capt
7th Miss
Commanding the Company.

(OFFICE INDORSEMENT.)

War Department,

ADJUTANT GENERAL'S OFFICE,

Mr. Anderson says - let the case go to the Pension Office as reported from "Book Records" which includes statement from Co. return for July 1864 that the soldier died July 1, 1864.

*Dec. 13/86 JMB
Increase of 6-14-17 Pension Register.*

....., 18 ..

The death of *Henry* ..
Company, Co. *K*, 11th Reg't U. S.
 Colored *troops*, is reported as follows:

On Company Muster Roll.
 For *May*, 1864, *June 30*, 1864.
 Company Muster-out Roll.
June 30, 1864.
 Company Descriptive Book.

....., 186 ..

Company Morning Reports.

June 30, 1864.
 Soldier's Final Statement.

June 30, 1864.
 Soldier's Record of Death and Interment.

....., 186 ..

Soldier's Inventory of Effects.

June 30, 1864.
 Soldier's Certificate of Disability for Discharge.

....., 186 ..

~~Soldier's Individual Muster-out Roll.~~

Ret. for July, *July 1*, 1864.
 Regimental Return,

For *May*, 1864, *May 17*, 1864.
 Regimental Quarterly Returns.

....., 186 ..

Regimental Descriptive Book.

....., 186 ..

By Surgeon General.

(.....) .., 186 ..

....., 186 .., is held to be
 the correct date, and the Company Muster
 Roll will be amended accordingly.

Assistant Adjutant General.

289
Clay, Henry 1st

Co M, 11 U.S. Col'd Inf.

(New Organization.)

Private

Private

CARD NUMBERS.

1	6335677	26
2	6335820	27
3	6323269	28
4	907240	29
5	9072885	30
6	9072989	31
7		32
8		33
9		34
10		35
11		36
12		37
13		38
14		39
15		40
16		41
17		42
18		43
19		44
20		45
21		46
22		47
23		48
24		49
25		50

Book Mark: _____

See also _____

C.

11 (A E W) U. S. C. T.

Henry Clay 1st

Co. 11 Reg't U. S. Col'd Inf.,
(A E W)

Appears on

Company Descriptive Book

of the organization named above.

DESCRIPTION.

Age 28 years height 5 feet 7 1/2 inches.

Complexion *blk*

Eyes; *blk* hair *blk*

Where born *Lawrence D. C.*

Occupation *farmer.*

ENLISTMENT.

When *1 Apr*, 1864.

Where *Memphis*

By whom *Capt Eyster*; term *3* y'rs.

Remarks:

Dayton

C. | 11 (A.S.) U.S.C.T.

Henry Clay
(A.S.)
, Co. 11, 11 Reg't U.S. Col'd Inf.

Appears on

Company Descriptive Book

of the organization named above.

DESCRIPTION.

Age 28 years height 5 feet 7 1/2 inches.

Complexion blk

Eyes; blk hair blk

Where born Lawrence Dist A.S.

Occupation farmer

ENLISTMENT.

When 10 April, 1864

Where Memphis

By whom A. P. ...; term 2 y'rs.

Remarks: Rejected from Fed
Army, June 1864
and returned with all
his clothing C. & G. E. as
follows, 11th Mass. act.
11 Canteen & Strap

Dayton

Copyright.

C | 11 (New) U.S.C.T.

Henry Clay (New)
Co., 11 Reg't U.S. Col'd Inf.

Appears on
Company Descriptive Book
of the organization named above.

DESCRIPTION.

Age 28 years height 5 feet 7 1/2 inches.

Complexion Black

Eyes; Black hair Black

Where born Lawrence S.C.

Occupation Farmer

ENLISTMENT.

When April 1, 1864

Where Memphis Tenn

By whom Capt Lystra, term 3 y'rs.

Remarks: Transferred
from Co M Spe
order No 94, Adgns.
11" U.S.C. Inf. May
10 - 1865

J E Park e

C | 11 (New) | U.S.C.T.

Henry Clay, 1st
Pot, Co. M, 7 Reg't U. S. Col'd H. Art'y.*

Appears on

Company Muster Roll

for *July & Aug.*, 1864.

Present or absent *Present*

Stoppage, \$ *100* for

Due Gov't, \$ *100* for

Remarks: *Assigned to Co. by*
S.O. No. 116, Sec. War,
dated July 6, 1864,
Sick in R. Hospital,
(Enrolled April 15, 64
& mustered in April
1864 at Memphis
Tenn for 3 yrs)

* This organization subsequently became Co. M, 11 Reg't U. S. Colored Infantry (New).

Book mark : _____

P. Pool,

(358)

Copyist.

Q

11 (New)

U.S.C.T.

Henry Clay, 1st
Pot, Co. M, 7 Reg't U. S. Col'd H. Art'y.*

Appears on

Company Muster Roll

for

Sept + Oct, 1864.

Present or absent

Stoppage, \$ 100 for

Due Gov't, \$ 100 for

Remarks: Deserted. Stop for
one Haversack, 67, + Canteen
+ Straps. 45, one Bayonet
45 + Bayonet Scabbard 56.
one Cap Pouch + Cove Pick, 56,
+ Tompion, 02, Due Charles
R. Griggs, Regtl. Suttler,
Six Dollars.

no co. m. o R

* This organization subsequently became Co. M, 11 Reg't U. S. Colored Infantry (New).

Book mark: 121, 1879.

P. Pool

(358)

Copyist.

6 | 11 New U.S.C.T.

Henry Clay
Pat, Co. M. 11 Reg't U. S. Col'd Infantry (7 U.S.C.H.A. (new))

Appears on

Descriptive List of Deserters

dated Ft. Pickering Memphis Nov. 1, 1864.

Deserted:

When Oct. 26, 1864

Where Ft. Pickering

Arrested:

When _____, 186 .

Where _____

Remarks: Stop for one haversack, one canteen & straps, one Bayonet and Bayonet scabbard. Cap pouch, cone & pick & Tamplin

Book mark: _____

290

Clay, Henry 2d

Co *Mr H*, 11 U.S. Col'd Inf.

(New Organization.)

Private

Private

CARD NUMBERS.

1	6335678	26
2	6335770	27
3	6335845	28
4	6335912	29
5	6335973	30
6	6332571	31
7	6332645	32
8	6332716	33
9	6332786	34
10	6332852	35
11	907296	36
12	9073944	37
13		38
14		39
15		40
16		41
17		42
18		43
19		44
20		45
21		46
22		47
23		48
24		49
25		50

Book Mark:

See also

C. | 116150 | U.S.C.T.

Henry Colay 2^d,
Co. *116150*, 41 Reg't U.S. Col'd Inf.

Appears on
Company Descriptive Book
of the organization named above.

DESCRIPTION.

Age *18* years height *5* feet *5* inches.
Complexion *blk*
Eyes; *blk* hair *blk*
Where born *Massachusetts*
Occupation *farmer*

ENLISTMENT.

When *25 May*, 186*4*
Where *Memphis*
By whom *Capt Cystra*, term *3* y'rs.
Remarks: *Transferred.*

Dayton
Copist.

C. | **11th Reg't U.S.C.T.**

Henry Clay 2^d
Co. ^(Kess) 11 Reg't U.S. Col'd Inf,

Appears on
Company Descriptive Book
of the organization named above.

DESCRIPTION.

Age *18* years height *5* feet *5* inches.
Complexion *blk*
Eyes; *blk* hair *blk*
Where born *Marshall's Miss*
Occupation *farmer*

ENLISTMENT.

When *25 May*, 186*4*.
Where *Memphis*,
By whom *Capt Eyster*; term *3* y'rs.

Remarks:
.....
.....
.....
.....
.....
.....
.....

Dayton,

C

11 (New)

U.S.C.T.

Henry Clay, 2^d
Sgt, Co. M, 7 Reg't U. S. Col'd H. Art'y.*

Appears on

Company Muster Roll

for July + Aug., 1864.

Present or absent Present

Stoppage, \$ 100 for

Due Gov't, \$ 100 for

Remarks: Assigned to Co. by
S. O. No. 146, Sec. War,
dated July 6, 1864.

* This organization subsequently became Co. M, 11 Reg't U. S. Colored Infantry (New).

Book mark :

P. Pool,

C

11 (New)

U.S.C.T.

Henry Clay, 2^d
Priv., Co. M, 7 Reg't U. S. Col'd H. Art'y.*

Appears on

Company Muster Roll

for Sept & Oct, 1864.

Present or absent Present

Stoppage, \$ 100 for

Due Gov't, \$ 100 for

Remarks:

* This organization subsequently became Co. M, 11 Reg't U. S. Colored Infantry (New).

Book mark:

J. Pool,

C | **11** (New) | **U.S.C.T.**

Henry Clay, 2^d
Priv, Co. M, 7 Reg't U. S. Col'd H. Art'y.*

Appears on

Company Muster Roll

for *Nov & Dec*, 1864.

Present or absent *Present*

Stoppage, \$ *100* for

Due Gov't, \$ *100* for

Remarks: *Stop two months*
pay proper sentence
S.C.M. G. O. No. 2, Hd.
Gr. Co. D. M., Dec. 22, 1864.

* This organization subsequently became Co. M, 11 Reg't U. S. Colored Infantry (New).

Book mark:

P. Pool,

H

11 (New).

U.S.C.T.

Henry Clay 2nd

Pvt, Co. M, 11 Reg't U. S. Col'd Inf. (New).

Appears on

Company Muster Roll

for Jan'y + Feb'y, 1865.

Present or absent Present

Stoppage, \$ 100 for

Due Gov't, \$ 100 for

Remarks: Plat two months
pay proper G. C. M.
G. O. No 2 145 Dr
P + D. Mo. Dec'r 22/64.

Book mark:

Washington

B

11 (New).

U.S.C.T.

Henry Clay, 2nd

Pat, Co. M, 11 Reg't U. S. Col'd Inf. (New).

Appears on

Company Muster Roll

for *March - April*, 1865.

Present or absent *Present*

Stoppage, \$ *100* for

Due Gov't, \$ *100* for

Remarks:

Book mark:

Washington

C. | 11 (New). | U.S.C.T.

Henry Clay
Pr. H, 11 Reg't U. S. Col'd Inf. (New).

Appears on

Company Muster Roll

for *May & June, 1865*

Present or absent *Present*

Stoppage, \$ *1.27* for *Ord. & Ord.*
stones lost.

Due Gov't, \$ *1.00* for

Remarks: *Transferred from*

Co. M. 1st U.S. Col'd Inf. Head.
Det. 11th U.S. Col'd Inf. May 10/65

Book mark:

Henry Clay

C. | 11 (New). | U.S.C.T.

Henry Clay
Co., H, 11 Reg't U. S. Col'd Inf. (New).

Appears on

Company Muster Roll

for *July & Aug*, 1865.

Present or absent *Present*

Stoppage, \$ *95* for *C. C. & G.*

Equipage lost.

Due Gov't, \$ *100* for

Remarks:

Book mark:

C. | 11 (New). | U.S.C.T.

Henry Clay

Pvt., H, 11 Reg't U. S. Col'd Inf. (New).

Appears on

Company Muster Roll

for *Sept. & Oct., 1865.*

Present or absent *Present*

Stoppage, \$ *43* for *ord. & ord.*
stones lost

Due Gov't, \$ *100* for

Remarks:-----

Book mark:-----

Hawling

B

11 (New).

U.S.C.T.

Henry Clay

Opt

H, 11 Reg't U. S. Col'd Inf. (New).

Appears on

Company Muster Roll

for *Nov & Dec*, 1865.

Present or absent *Present*

Stoppage, \$ *13* for *Ordnance*

Due Gov't, \$ *100* for

Remarks: *for br. G. 95 cts*

Book mark:

M. M. M. M. M.
Copyist.

6

11 (New).

U.S.C.T.

Henry Clay

Co. H, 11 Reg't U. S. Col'd Inf. (New).

Appears on Co. Muster-out Roll, dated

Memphis Tenn, June 12, 1866.

Muster-out to date

June 12, 1866.

Last paid to

June 30, 1865.

Clothing account:

Last settled 186 ; drawn since \$ 100

Due soldier \$ 100; due U. S. \$ 7 ¹⁵/₁₀₀

Am't for cloth'g in kind or money adv'd \$ 100

Due U. S. for arms, equipments, &c., \$ ¹³/₁₀₀

Bounty paid \$ 100; due \$ 100

Remarks: for b & h. & 95 cts

(Age 28 yrs Enrolled May 5, 64 and must'd in June 15, 65 at Memphis Tenn for 3 yrs)

Book mark: V. 570. 194. 69. 121. 1879

(361)

M. E. Meany
Corrlist.

Clay Henry 2d

P, Co. M, 11 Reg't U. S. C. I

Enclosures.

Bed Cards	Final Statements
Burial Records	Furloughs or L. of A
Certs. of Dis. for Discharge	Med. Certificates
C. M. Charges	Med. Des. Lists
Descriptive Lists	Orders
Discharge Certificates	Pris. of War Record
Enlistment Papers	Resignations

Other papers relating to—

Admission to Hosp'l	Furlough or L. of A
Casualty Sheet	Med. Examination
Confinement	Misc. Information
Contracts	Pay or Clothing
Death or Effects	Personal Reports
Desertion	Rank
Discharge from Hosp'l	Transfer to Hosp'l
Discharge from Service	Transfer to V. R. C.
Duty	Transportation

Henry Clay, 2nd,

Adjutant General's Office,

COLORED TROOPS BRANCH,

Dec 5, 1877

Wanted in the case of Henry Clay, Vol. C. T., 187, 2nd, Co. M,
11th Reg't U.S.C.A.

M. R. Mac & Dec 4 Stop two months pay

Sentence 90 No 2 Ad Gen's P. R. M., Dec 22, 61

Respectfully,

J. A. Woodward, Chief Clerk

J. J. Jackson

Adjutant General's Office,

Record Room

Dec. 10, 1877

Reply in case of Henry Clay, Vol. C. T., 187, Co. 'M',
7th Reg't U.S.C.A. (Sgt)

G.O. No. 2 H.Q. Post + Defences Memphis, Dec. 22, 1864.
Charge 1 - Conduct prej. to good order &c. Charge 2 -
Neglect of duty. Charge 3. Disobedience of Orders.
Finding - Of 1st & 2nd Charges - Guilty. Of 3rd Charge Not Guilty.
Sentence - To be placed at hard labor on the fortifications
of Fort Pickering for two mos. with loss of pay, proper
during that time. Finding and Sentence confirmed.
So much of sentence as imposes two mos. hard labor
is remitted.

By Order of
Brig. Gen. R. C. Buckland

G.B.

291

Clayton, Edward

Co. *A*, 11 U.S. Col'd Inf.

(New Organization.)

Private

Private

CARD NUMBERS.

1	6322776	26
2	6329946	27
3	6330088	28
4	6323152	29
5	6330907	30
6	9072113	31
7		32
8		33
9		34
10		35
11		36
12		37
13		38
14		39
15		40
16		41
17		42
18		43
19		44
20		45
21		46
22		47
23		48
24		49
25		50

Book Mark:

See also

0 | 11 (new) | U. S. C. T.

Edward Stanton
(new)
Co. A, 11 Reg't U. S. Col'd Inf.

Appears on

Company Descriptive Book

of the organization named above.

DESCRIPTION.

Age 30 years height 5 feet 6 inches.

Complexion yellow

Eyes; black hair black

Where born Richmond-Va-

Occupation

ENLISTMENT.

When Feb. 22, 1864.

Where Fort Pickering

By whom Col. Ripper; term 3 yrs.

Remarks: Deserted March 9, 1864 from Fort Pickering.

F. A. Wright

6

11 (New). U.S.C.T.

Edward Clayton

Appears with rank of *Priv* on

Muster and Descriptive Rolls of Detachments of U. S. Vols. forwarded

for the *11* Reg't U. S. Col'd *Inf* Roll dated

Memphis Tenn Mar 1, 1864.

Where born *Richmond Virginia*

Age *30* y'rs; occupation

When enlisted *Feb 22*, 1864.

Where enlisted *F1-Pickering*

For what period enlisted *3* years.

Eyes *black*; hair *black*

Complexion *black*; height *5* ft. *6* in.

When mustered in *Feb 24*, 1864.

Where mustered in *F1-Pickering*

Bounty paid \$ *100*; due \$ *100*

Where credited

Company to which assigned *F*

Remarks:

Filed with Edward Clayton

Book mark:

Ashley

C

11 (New).

U.S.C.T.

Edward Clayton
Pvt, Co. F, 1 Battalion, 1 Reg't Tenn. H. Art'y.†

Age years.

Appears on

Company Muster Roll*

for

Jan 11 to Mch 1, 1864.

Joined for duty and enrolled:

When

Feb 22, 1864.

Where

J. Pickering

Period

3 years

Mustered in:

When

Feb 24, 1864.

Where

Memphis

Present or absent.....

Stoppage, \$ 100 for

Due Gov't, \$ 100 for

Remarks:

† This organization subsequently became Co. F, 11 Reg't U. S. Colored Infantry (New).

* First current roll. No muster-in roll of this company on file.

Book mark:

Rose

C

11 (New).

U.S.C.T.

Edward Clayton

Priv., Co. F, 6 Reg't U. S. Col'd H. Art'y.*

Appears on

Company Muster Roll

for Mch & Apl, 1864.

Present or absent

Stoppage, \$ 100 for

Due Gov't, \$ 100 for

Remarks: Deserted from
J. Pickering
Mch 9, 1864

* This organization subsequently became Co. F, 11 Reg't U. S. Colored Infantry (New).

Book mark:

Rose

6 | 11 New U.S.C.T.

Edward Clayton

Pvt, Co. F 11 (6 U.S. B.H.A.) (new) Reg't U. S. Col'd Infantry

Appears on

Descriptive List of Deserters

Fort Pickering

dated *Memphis Tenn. Apr. 30*, 1864.

Deserted :

When *April 23*, 1864.

Where *Ft. Pickering*

Arrested :

When _____, 186 .

Where _____

Remarks :

Book mark :

W. H. Bogan

(351)

Copyist.

6

11 (New).

U.S.C.T.

Edward Clayton

Pr. F., 11 Reg't U. S. Col'd Inf. (New).

Appears on Co. Muster-out Roll, dated

Memphis Tenn, Aug 12 1866.

Muster-out to date 186 .

Last paid to Rec^d - no pay 186 .

Clothing account:

Last settled 186 ; drawn since \$ 100

Due soldier \$ 100 ; due U. S. \$ 100

Am't for cloth'g in kind or money adv'd \$ 100

Due U. S. for arms, equipments, &c., \$ 100

Bounty paid \$ 100 ; due \$ 100

Remarks Deserted at Fort Pickens Jan Mar 9/64

Book mark :

Edward

(361)

Copyist.

292

~~Clifford, Isaac~~

Co E, 11 U.S. Col'd Inf.

(New Organization.)

Private | Private

CARD NUMBERS.

1	26
2	27
3	28
4	29
5	30
6	31
7	32
8	33
9	34
10	35
11	36
12	37
13	38
14	39
15	40
16	41
17	42
18	43
19	44
20	45
21	46
22	47
23	48
24	49
25	50

In Clifford Isaac

Canceled.

Erroneously carded as Clifford.

Card corrected to read Clifford

J.W.S.

May 26, 1903.

Book Mark:

See also

293

Whipple & Isaac

Co E, 11 U.S. Col'd Inf.

(New Organization.)

Private

Private

CARD NUMBERS.

1	6322783	26
2	6328965	27
3	6327067	28
4	6329153	29
5	6329239	30
6	6329315	31
7	6329391	32
8	6329461	33
9	6329526	34
10	6329602	35
11	6329682	36
12	6329745	37
13	6329805	38
14	9071883	39
15		40
16		41
17		42
18		43
19		44
20		45
21		46
22		47
23		48
24		49
25		50

Book Mark:

See also

R4P719924

~~AD~~ 2701269 Pomtun

S- G.O. office 5/3007^w

6/5725 ✓.

6 | 11 (new) U.S.C.T.

Isaac Clippard
(new)
Co. E, 11 Reg't U. S. Col'd Inf.

Appears on

Company Descriptive Book
of the organization named above.

DESCRIPTION.

Age 18 years; height 5 feet 3/4 inches.

Complexion Dark

Eyes Black; hair Black

Where born Missouri

Occupation

ENLISTMENT.

When April 6, 1864

Where Memphis Tenn

By whom Capt Currier, term 3 y'rs.

Remarks:

Thompson

6

11 (New). U.S.C.T.

Isaac ~~Clifford~~ ^{Clifford} #

Appears with rank of Pri on

Muster and Descriptive Rolls of Detachments of U. S. Vols. forwarded

for the 7 U.S.C.H.A. Reg't U. S. Col'd Inf Roll dated

Memphis Tenn, July 1, 1864.

Where born Shelby Co. Tenn

Age 18 y'rs; occupation Farmer

When enlisted April 6, 1864.

Where enlisted Memphis Tenn

For what period enlisted 3 years.

Eyes Black; hair Black

Complexion Black ^{# dark}; height 5 ft. 3 in.

When mustered in July 1, 1864.

Where mustered in Memphis

Bounty paid \$ 100; due \$ 100

Where credited

Company to which assigned E

Remarks: Joined as Recruit

Filed with Isaac Clifford
Corrected by J.H.T. May 21, 1903.

Book mark:

Ashley

C | **11 (New). U.S.C.T.**

Isaac Clippard

Pvt ..., Co. E, 6 Reg't U. S. Col'd H. Art'y.*

Appears on

Company Muster Roll

for... *Mich & Apl* ..., 1864.

Present or absent *Present.*

Stoppage, \$ *100* for

Due Gov't, \$ *100* for

Remarks: *Joined a recruit Apl 6. 64.*

* This organization subsequently became Co. E, 11 Reg't U. S. Colored Infantry (New).

Book mark : *100*

C | **11** (New). | **U.S.C.T.**

Isaac Clippard

Priv, Co. E, 7 Reg't U. S. Col'd H. Art'y.*

Appears on

Company Muster Roll

for *May & June*, 186*4*

Present or absent

Present

Stoppage, \$ *100* for

Due Gov't, \$ *100* for

Remarks:

* This organization subsequently became Co. E, 11 Reg't U. S. Colored Infantry (New).

Book mark:

Overshaw

(858)

Co. 171st.

C

11 (New).

U.S.C.T.

Isaac Clippard

Priv, Co. E, 7 Reg't U. S. Col'd H. Art'y.*

Appears on

Company Muster Roll

for *July & Aug.*, 186*4*

Present or absent *Present*

Stoppage, \$ *100* for

Due Gov't, \$ *100* for

Remarks:

* This organization subsequently became Co. E, 11 Reg't U. S. Colored Infantry (New).

Book mark:

Crenshaw

(358)

Co. yist.

60 | 11 (New). | U.S.C.T.

Isaac Clippard

Pvt, Co. E, 7 Reg't U. S. Col'd H. Art'y.*

Appears on

Company Muster Roll
for Sept. & Oct., 1864.

Present or absent Present

Stoppage, \$ 100 for

Due Gov't, \$ 100 for

Remarks: Stop for one canteen
& haversack \$1.12.

* This organization subsequently became Co. E, 11 Reg't U. S. Colored Infantry (New).

Book mark:

Crenshaw

(358)

Co. 1961.

C | **11** (New). | **U.S.C.T.**

Isaac Clippard
Priv, Co. E, 7 Reg't U. S. Col'd H. Art'y.*

Appears on

Company Muster Roll

for *Nov. & Dec.*, 186*4*.

Present or absent *Present*

Stoppage, \$ *100* for

Due Gov't, \$ *100* for

Remarks: *Stop for one*
Canteen & one Laver
Sack.

* This organization subsequently became Co. E, 11 Reg't U. S. Colored Infantry (New).

Book mark: _____

Crenshaw

C | 11 (New). | U.S.C.T.

Waac Clippard
Pot, Co. E, 11 Reg't U. S. Col'd Inf. (New).

Appears on

Company Muster Roll

for Jan. & Feb., 1865

Present or absent Present

Stoppage, \$ 100 for

Due Gov't, \$ 100 for

Remarks: Stop for 1 Canteen
& 1 Haversack.

Book mark:

Lowry

C

11 (New).

U.S.C.T.

Wm Clippard
Pvt., Co. E, 11 Reg't U. S. Col'd Inf. (New).

Appears on

Company Muster Roll

for *Mar & Apl*, 1865.

Present or absent *Present*

Stoppage, \$ *100* for

Due Gov't, \$ *100* for

Remarks:

Book mark: _____

Loring

C | 11 (New). | U.S.C.T.

Isaac Clippard
Prvt., Co. E, 11 Reg't U. S. Col'd Inf. (New).

Appears on

Company Muster Roll

for *May & June*, 1865.

Present or absent *Present*

Stoppage, \$ *100* for

Due Gov't, \$ *100* for

Remarks:

Book mark:

Lowry

C | 11 (New). | U.S.C.T.

Isaac Clippard

Co. E, 11 Reg't U. S. Col'd Inf. (New).

Appears on

Company Muster Roll

for July & Aug., 1865.

Present or absent Present

Stoppage, \$ 100 for

Due Gov't, \$ 100 for

Remarks:

Book mark:

C | 11 (New). | U.S.C.T.

Isaac Clifford
Pvt., Co. E, 11 Reg't U. S. Col'd Inf. (New).

Appears on

Company Muster Roll

for Sept. & Oct., 1865.

Present or absent Present

Stoppage, \$ 100 for

Due Gov't, \$ 100 for

Remarks:

Book mark:

(858)

Lowry
Copyist.

6 | 11 (New). | U.S.C.T.

Isaac Clippard
Priv, Co. E, 11 Reg't U. S. Col'd Inf. (New).

Appears on

Company Muster Roll

for *Nov. & Dec.*, 186*5*.

Present or absent *Present*.

Stoppage, \$ *100* for

Due Gov't, \$ *20*/*100* for *ordnance*.

Remarks:

Book mark:

Valentine

C | 11 (New). | U.S.C.T.

Isaac Clissard

Priv. Co. E, 11 Reg't U. S. Col'd Inf. (New).

Appears on Co. Muster-out Roll, dated

Memphis Tenn. Jan 12, 1866 .

Muster-out to date Jan 12, 1866 .

Last paid to June 30, 1865 .

Clothing account:

Last settled, 186 ; drawn since \$ 100

Due soldier \$ 100; due U. S. \$ 75 ⁵¹/₁₀₀

Am't for cloth'g in kind or money adv'd \$ 100

Due U. S. for arms, equipments, &c., \$ ²⁰/₁₀₀

Bounty paid \$ 100; due \$ 100

Remarks:

Book mark: 1.22 P. 50. 68

Valentine

294

Clopton, Andrew

Co. *L. B.* 11 U.S. Col'd Inf.

(New Organization.)

Private | *Private*

CARD NUMBERS.

1	6335042	26
2	6335128	27
3	6335214	28
4	6335312	29
5	6335383	30
6	6335456	31
7	6335526	32
8	6335591	33
9	6325885	34
10	6325965	35
11	6326036	36
12	6326105	37
13	6326162	38
14	9073794	39
15	0041034	40
16		41
17		42
18		43
19		44
20		45
21		46
22		47
23		48
24		49
25		50

Book Mark: _____

See also _____

J. 641146. P. O. aff.
RCP 341765. aff.

S 858437 JS aff
A. 105-4710 P. O. M. M.
J. 141045 8 aut. W. L.

6

11 (new) U.S.C.T.

Andrew Clopton

(new)
Co. L, 11 Reg't U.S. Col'd Inf.

Appears on

Company Descriptive Book

of the organization named above.

DESCRIPTION.

Age 20 years height 5 feet 4 inches.

Complexion *Blk*

Eyes; *Blk* hair *Blk*

Where born *unknown Ala*

Occupation *Farmer*

ENLISTMENT.

When *March 1*, 186*4*.

Where *Memphis Tenn.*

By whom *Serg. E. Croukleton*; term *3* y'rs.

Remarks:

A. M. Kennedy

(338g)

Copyist.

12

11 (New) U.S.C.T.

William H. Johnson

(New)
Co. 11, 11 Reg't U.S. Col'd Inf.

Appears on

Company Descriptive Book

of the organization named above.

DESCRIPTION.

Age 20 years height 5 feet 4 inches.

Complexion Fair

Eyes; Blue hair Black

Where born unknown Alabama

Occupation Laborer

ENLISTMENT.

When March 1, 1864.

Where Memphis Tenn

By whom S. S. Johnson ; term 3 y'rs.

Remarks: transferred to Co 15 from
Co 11 11 Reg't U.S. Col'd Inf.

H. H. H. H. H.

Copist.

C 11 (New). U.S.C.T.

Andrew Clifton

Private, Co. L, 6 Reg't U. S. Col'd H. Art'y.†

Appears on

Company Muster-in and Descriptive Roll
of the organization named above. Roll dated

Fort Pickens, Memphis, Tenn. April 2, 1864.

Where born *Unknown, Havana.*

Age *20* y'rs; occupation *Farmer.*

When enlisted *March 1, 1864.*

Where enlisted *Memphis, Tenn.*

For what period enlisted *3* years.

Eyes *black*; hair *black*

Complexion *black*; height *5* ft. *4* in.

When mustered in *June 2, 1864.*

Where mustered in *Fort Pickens, Memphis, Tenn.*

Bounty paid \$ *100*; due \$ *100*

Where credited

Company to which assigned

Remarks:

† This organization subsequently became Co. L, 11 Reg't U. S. Colored Infantry (New).

* Muster-in roll shows enrollment of all men of this company as of same date. See enrollment on subsequent card or cards.

Book mark:

(3561)

[Signature]
Copyist.

C | **11** (New). | **U.S.C.T.**

Andrew Chapton

Priv, Co. *L*, 6 Reg't U. S. Col'd H. Art'y.†

Appears on

Company Muster Roll

for *Nichols*, 1864.

Joined for duty and enrolled:

When *March*, 1864.*

Where *Memphis, Tenn.**

Period *3* years.*

Present or absent *Absent*

Stoppage, \$ *100* for

Due Gov't \$ *100* for

Remarks:

† This organization subsequently became Co. *L*, 11 Reg't U. S. Colored Infantry (New).

* See enrollment on card from muster-in roll.

Book mark:

C

11 (New). U.S.C.T.

Andrew Capton

Privat, Co. L, 7 Reg't U. S. Col'd H. Art'y.†

Appears on

Company Muster Roll

for *May & June*, 186*4*

Joined for duty and enrolled:

When *March*, 186*4**

Where *Memphis, Tenn.**

Period *3* years.*

Present or absent *Present*

Stoppage, \$ *100* for

Due Gov't, \$ *100* for

Remarks:

†This organization subsequently became Co. L, 11 Reg't U. S. Col'd Infantry (New).

* See enrollment on card from muster-in roll.

Book mark:

[Signature]

C

11 (New).

U.S.C.T.

Andrew Clifton

Priv, Co. L, 7 Reg't U. S. Col'd H. Art'y.†

Appears on

Company Muster Roll

for *July 2 Aug*, 186*4*.

Joined for duty and enrolled:

When *March 1*, 186*4*.*

Where *Memphis, Tenn* *

Period *3* years.*

Present or absent *Present*

Stoppage, \$ *100* for

Due Gov't, \$ *100* for

Remarks:

†This organization subsequently became Co. L, 11 Reg't U. S. Col'd Infantry (New).

* ~~See~~ See enrollment on card from muster-in roll.

Book mark:

W. H. ...

C | 11 (New). | U.S.C.T.

Andrew Copton

Privat, Co. L, 7 Reg't U. S. Col'd H. Art'y.†

Appears on

Company Muster Roll

for *Sept - Oct*, 186*2*

Joined for duty and enrolled:

When *March 1*, 186*2**
Where *Memphis, Tenn.* *

Period *3* years.*

Present or absent *Present*

Stoppage, \$ *100* for

Due Gov't, \$ *112* for *Camp*

Garrison Equipage,

Remarks:

†This organization subsequently became Co. L, 11 Reg't U. S. Col'd Infantry (New).

* See enrollment on card from muster-in roll.

Book mark:

None

C | **11** (New). | **U.S.C.T.**

Andrew Lopton

Privt, Co. L, 7 Reg't U. S. Col'd H. Art'y.†

Appears on

Company Muster Roll

for *Nov + Dec*, 186*4*.*

Joined for duty and enrolled:

When *March*, 186*4*.*

Where *Memphis, Tenn.**

Period *3* years.*

Present or absent *Present*

Stoppage, \$ *100* for

Due Gov't, \$ *112* for *Camp*

Gas, Equipage

Remarks:

†This organization subsequently became Co. L, 11 Reg't U. S. Col'd Infantry (New).
* See enrollment on card from muster-in roll.

Book mark:

W...

C | **11** (New) | **U.S.C.T.**

Andrew Clapton

Priv, Co. L, 11 Reg't U. S. Col'd Infantry.

Appears on

Company Muster Roll

for *Jan & Feb*, 1865.

Joined for duty and enrolled:

When *March 1*, 1864.*

Where *Memphis Tenn* *

Period *3* years.*

Present or absent *Present*

Stoppage, \$ *100* for

Due Gov't \$ *79* / *100* for *C. & G. E.*

Remarks:

* See enrollment on card from muster-in roll.

Book mark:

S. M. Williams

Co | **11 (New)** | **U.S.C.T.**

Andrew Clopton
Plt, Co. L, 11 Reg't U. S. Col'd Infantry.

Appears on

Company Muster Roll
for *Dated April 30*, 186*5*.

Joined for duty and enrolled:

When *March 1*, 186*4*.*

Where *Memphis, Tenn**

Period *3* years.*

Present or absent *Present*

Stoppage, \$ *100* for

Due Gov't \$ *100* for

Remarks:

* See enrollment on card from muster-in roll.

Book mark:

S. W. Williams

C

11 (New). U.S.C.T.

Andrew Clopton

Pvt, Co. B, 11 Reg't U. S. Col'd Inf. (New).

Appears on

Company Muster Roll

for *May of June*, 186*5*.

Present or absent *Present*

Stoppage, \$ *100* for

Due Gov't, \$ *100* for

Remarks: *Transferred from Co "L"*

Book mark:

C | 11 (New). | U.S.C.T.

Andrew Copton
Pvt, Co. B, 11 Reg't U. S. Col'd Inf. (New).

Appears on

Company Muster Roll

for July & Aug, 1865.

Present or absent Present

Stoppage, \$ 100 for

Due Gov't, \$ 100 for

Remarks: Present sick in
flu

Book mark:

W. Mayne
(359) Copyist.

C | 11 (New). | U.S.C.T.

Andrew Clapton
Priv., Co. B, 11 Reg't U. S. Col'd Inf. (New).

Appears on

Company Muster Roll

for Sept & Oct, 1865.

Present or absent Present

Stoppage, \$ 1⁵⁰ 100 for Ordnance.

Due Gov't, \$ 1⁶⁰ 100 for C + B Equipage.

Remarks:

Book mark:

Murphy

(C)

11 (New).

U.S.C.T.

Andrew Clifton

Regt., Co. B, 11 Reg't U. S. Col'd Inf. (New).

Appears on

Company Muster Roll

for Nov & Dec, 1865.

Present or absent Present

Stoppage, \$ 1 50 for Bedroom

Due Gov't, \$ 1 00 for Co's Equipage

Remarks:

Filed with Andrew Clifton

Book mark:

Murphy

C

11 (New). U.S.C.T.

Andrew Clopton

Priv, B, 11 Reg't U. S. Col'd Inf. (New).

Appears on Co. Muster-out Roll, dated

Memphis Ten, Jan 12, 1865.

Muster-out to date

Jan 12, 1866.

Last paid to

June 30, 1865.

Clothing account:

Last settled _____, 186 ; drawn since \$ _____ 100

Due soldier \$ _____ 100; due U. S. \$ 44 ⁵⁰/₁₀₀

Am't for cloth'g in kind or money adv'd \$ _____ 100

Due U. S. for arms, equipments, &c., \$ _____ 100

Bounty paid \$ _____ 100; due \$ _____ 100

Remarks: due U. S. for Co. & G.

Equipage \$1.60.

due U. S. for ordnance \$1.52

Book mark :

Murphy

(361)

Copyist.

295

Clopton, Prayton

Co. L. B. 11 U.S. Col'd Inf.

(New Organization.)

Private | *Private*

CARD NUMBERS.

1	6335040	26
2	6322756	27
3	6335215	28
4	6335310	29
5	6335381	30
6	6335454	31
7	6335524	32
8	6335589	33
9	6325883	34
10	6325963	35
11	6326035	36
12	6326103	37
13	6326160	38
14	0071035	39
15		40
16		41
17		42
18		43
19		44
20		45
21		46
22		47
23		48
24		49
25		50

Book Mark: _____

See also _____

6

11 (New) U.S.C.T.

Maxon Clepton
(New)
Co. B, 11 Reg't U.S. Col'd Inf.

Appears on

Company Descriptive Book

of the organization named above.

DESCRIPTION.

Age 26 years height 5 feet 7 inches.

Complexion *SW*

Eyes; *Blk* hair *Blk*

Where born *Monroe, Mississippi*

Occupation *Laborer*

ENLISTMENT.

When *March 1*, 1864.

Where *Memphis Tenn.*

By whom *C. G. Hamilton*; term *3* y'rs.

Remarks: *Transferred to Co. B. from Co. L
11 U.S.C. Inf. late 7 U.S.C. L. Coy.*

Fairley

C

11 (New). U.S.C.T.

Drafton Clopton

Priv, Co. L, 6 Reg't U. S. Col'd H. Art'y.†

Appears on

Company Muster-in and Descriptive Roll
of the organization named above. Roll dated

*Fort Pickens, Memphis, Tenn, April 2, 1864.**

Where born *Unknown Habana*

Age *9* y'rs; occupation *Farmer*

When enlisted *March 1, 1864.**

Where enlisted *Memphis, Tenn*

For what period enlisted *3* years.

Eyes *Black*; hair *Black*

Complexion *Black*, height *5* ft. *5* in.

When mustered in *April 2, 1864.*

Where mustered in *Fort Pickens, Memphis, Tenn*

Bounty paid \$ *100*; due \$ *100*

Where credited

Company to which assigned

Remarks:

† This organization subsequently became Co. L, 11 Reg't U. S. Colored Infantry (New).
* Muster in roll shows enrollment of all men of this company as of same date. See enrollment on subsequent card or cards.

Book mark:

[Signature]
Copyist.

6

11 (New).

U.S.C.T.

Braxton Clopton

Appears with rank of *Pri* on

Muster and Descriptive Rolls of Detachments of U. S. Vols. forwarded

y to 56 d (Heavy)
for the *11* Reg't U. S. Col'd *Inf*. Roll dated

F-Pickering Memphis Tenn, May 18, 1864.

Where born *Aberdeen Miss*

Age *19* y'rs; occupation *Farmer*

When enlisted *March 1*, 1864.

Where enlisted *Memphis Tenn*

For what period enlisted *3* years.

Eyes *Black*; hair *Black*

Complexion *Black*; height *5* ft. *5* in.

When mustered in *May 20*, 1864.

Where mustered in *Memphis Tenn*

Bounty paid \$ *100*; due \$ *100*

Where credited

Company to which assigned *L*

Remarks: *Absent sick at the original muster of the Company*

Book mark:

Ashley

C | 11 (New). | U.S.C.T.

Granton Clopton

Priv, Co. L, 7 Reg't U. S. Col'd H. Art'y.†

Appears on

Company Muster Roll

for *May & June*, 1864.

Joined for duty and enrolled:

When *March*, 1864.*

Where *Memphis, Tenn.**

Period *3* years.*

Present or absent *Present*

Stoppage, \$ *100* for

Due Gov't, \$ *100* for

Remarks:

†This organization subsequently became Co. L, 11 Reg't U. S. Col'd Infantry (New).

*See enrollment on card from muster-in roll.

Book mark:

Stone
Copied

C

11 (New). U.S.C.T.

Brayton Clifton

Private, Co. L, 7 Reg't U. S. Col'd H. Art'y.†

Appears on

Company Muster Roll

for July & Aug, 1864.

Joined for duty and enrolled:

When March, 1864.*

Where Memphis, Tenn.*

Period 3 years.*

Present or absent Present

Stoppage, \$ 100 for

Due Gov't, \$ 100 for

Remarks:

Due shell for Ordnance 12

†This organization subsequently became Co. L, 11 Reg't U. S. Col'd Infantry (New).

* See enrollment on card from muster-in roll.

Book mark:

Norman

6 11 (New). | U.S.C.T.

Brayton Clopton

Priv, Co. L, 7 Reg't U. S. Col'd H. Art'y. †

Appears on

Company Muster Roll

for Sept & Oct, 1864.

Joined for duty and enrolled:

When March, 1864.*

Where Memphis, Tenn.*

Period 3 years.*

Present or absent Present

Stoppage, \$ 100 for

Due Gov't, \$ 100 for Camp &

Garrison's Equipage

Remarks:

†This organization subsequently became Co. L, 11 Reg't U. S. Col'd Infantry (New).

* See enrollment on card from muster-in roll.

Book mark:

C 11 (New). U.S.C.T.

Brayton Clopton

Priv, Co. L, 7 Reg't U. S. Col'd H. Art'y. †

Appears on

Company Muster Roll

for Sept & Oct, 1864.

Joined for duty and enrolled:

When March, 1864.*

Where Memphis, Tenn.*

Period 3 years.*

Present or absent Present

Stoppage, \$ 100 for

Due Gov't, \$ 67 for Camp &

Guaranty Equipage

Remarks:

†This organization subsequently became Co. L, 11 Reg't U. S. Col'd Infantry (New).

* See enrollment on card from muster-in roll.

Book mark:

Handwritten signature

C

11 (New).

U.S.C.T.

Brayton Copton

Privt, Co. L, 7 Reg't U. S. Col'd H. Art'y. †

Appears on

Company Muster Roll

for *Nov & Dec*, 186*4*.*

Joined for duty and enrolled:

When *March*, 186*4*.*

Where *Memphis, Tenn* *

Period *3* years.*

Present or absent *Present*

Stoppage, \$ *100* for

Due Gov't, \$ *67* for *Camp*

for Equipage

Remarks:

†This organization subsequently became Co. L, 11 Reg't U. S. Col'd Infantry (New).

* ~~40~~ See enrollment on card from muster-in roll.

Book mark:

Nov

6 | 11 (New) | U.S.C.T.

Braxton Clapton

Pat, Co. L, 11 Reg't U. S. Col'd Infantry.

Appears on

Company Muster Roll

for *Jan & Feb*, 1865.

joined for duty and enrolled:

When *March 1*, 1864.*

Where *Memphis, Tenn**

Period *3* years.*

Present or absent *Present*

Stoppage, \$ *100* for

Due Gov't \$ *67* / *100* for *C. & G. Co.*

Remarks:

* See enrollment on card from muster-in roll.

Book mark:

S. V. Williams

(358c)

Copyist.

C

11 (New)

U.S.C.T.

Braxton Clopton

Pat

Co. L, 11 Reg't U. S. Col'd Infantry.

Appears on

Company Muster Roll

for Dated April 30, 1865.

Joined for duty and enrolled:

When March 1, 1864.*

Where Memphis Tenn. *

Period 3 years.*

Present or absent.

Present

Stoppage, \$ 100 for

Due Gov't \$ 100 for

Remarks:

* See enrollment on card from muster-in roll.

Book mark:

S. W. Williams

(358c)

Copyist.

C

11 (New). U.S.C.T.

Braxton Copton
Pvt

, Co. B, 11 Reg't U. S. Col'd Inf. (New).

Appears on

Company Muster Roll

for *Mayo June*, 1865.

Present or absent *Present*

Stoppage, \$ 100 for

Due Gov't, \$ 100 for

Remarks: *Transferred from
Co "L"*

Book mark :

W. Wayne

(353)

Copyist.

C | 11 (New). | U.S.C.T.

Branton Copton

Pvt, Co. B, 11 Reg't U. S. Col'd Inf. (New).

Appears on

Company Muster Roll

for *July & Aug*, 1865.

Present or absent *Present*

Stoppage, \$ _____ 100 for _____

Due Gov't, \$ $\frac{416}{100}$ for *Ord*

Remarks : _____

Book mark : _____

W. H. [unclear]

C

11 (New). U.S.C.T.

Braxton Clifton
Priv., Co. B, 11 Reg't U. S. Col'd Inf. (New).

Appears on

Company Muster Roll
for Sept & Oct, 1865.

Present or absent Present

Stoppage, \$ 4 ^{1x}/₁₀₀ for *Medicine*.

Due Gov't, \$ 1 ⁶⁰/₁₀₀ for *C & Equipage*.

Remarks:

Filed with Braxton Clifton

Book mark:

SS. MAL

235037

Murphy

018810

(358)

Copyist.

11 (New). U.S.C.T.

Braxton Clifton
Pvt., Co. B, 11 Reg't U. S. Col'd Inf. (New).

Appears on

Company Muster Roll

for Nov. 1st Dec. 1865.

Present or absent Present

Stoppage, \$ 4¹⁸ 100 for Ordnance

Due Gov't, \$ 1⁰⁰ 100 for Co. Equipage

Remarks:

Book mark:

Murphy

C

11 (New). U.S.C.T.

Braxton Clapton

Priv, B, 11 Reg't U. S. Col'd Inf. (New).

Appears on Co. Muster-out Roll, dated

Memphis Tenn, Jan 12, 1866.

Muster-out to date

Jan 12, 1866.

Last paid to

June 30, 1865.

Clothing account:

Last settled _____, 186 ; drawn since \$ _____ 100

Due soldier \$ _____ 100; due U. S. \$ 81 ²⁹/₁₀₀

Am't for cloth'g in kind or money adv'd \$ _____ 100

Due U. S. for arms, equipments, &c., \$ _____ 100

Bounty paid \$ _____ 100; due \$ _____ 100

Remarks: Due U. S. for C & G

Equipage \$1.60

Due U. S. for Ordnance \$4.18

Book mark :

(361)

Murphy

Copyist.

Clapton Grayton

P, Co. L, 11 Reg't U.S. C. I

Enclosures.

Bed Cards	Final Statements
Burial Records	Furloughs or L. of A
Certs. of Dis. for Discharge	Med. Certificates
C. M. Charges	Med. Des. Lists
Descriptive Lists	Orders
Discharge Certificates	Pris. of War Record
Enlistment Papers	Resignations

Other papers relating to—

Admission to Hosp'l	Furlough or L. of A
Casualty Sheet	Med. Examination
Confinement	Misc. Information
Contracts	Pay or Clothing
Death or Effects	Personal Reports
Desertion	Rank
Discharge from Hosp'l	Transfer to Hosp'l
Discharge from Service	Transfer to V. R. C.
Duty	Transportation

Brown A. 100

Adjutant General's Office,

COLORED TROOPS BRANCH,

Nov 21st, 1877

Vol. C. T., 187

Wanted in the case of *Drayton Clifton*, Co. *L*,

11th Reg't *Colored Troops*

*Must be in with a certificate from the ...
an ... in ... to ...
May 3rd ...*

Respectfully,

Le A. Woodward
Chief Clerk

J. J. Jackson

Adjutant General's Office,

Record Room

Nov 30th, 1877

Vol. C. T., 187
Reply in case of *Braxton Clifton*, Co. *L*,
11th Reg't *U.S.C.T.*

*Co. M. R. Bk. May 21st 64 shows "Braxton Clifton and
Robert Randal mustered in the service."*

G.B.

296

Clapton Harry

Co H, 11 U.S. Col'd Inf.

(New Organization.)

Private Private

CARD NUMBERS.

1	26
2	27
3	28
4	29
5	30
6	31
7	32
8	33
9	34
10	35
11	36
12	37
13	38
14	39
15	40
16	41
17	42
18	43
19	44
20	45
21	46
22	47
23	48
24	49
25	50

Book Mark:

See also

297

Clopton, Joseph

Co L B 11 U.S. Col'd Inf.

(New Organization.)

Private Private

CARD NUMBERS.

1	6 3 3 5 0 4 1	26
2	6 3 3 5 1 2 7	27
3	6 3 3 5 2 1 3	28
4	6 3 3 5 3 1 1	29
5	6 3 3 5 3 8 2	30
6	6 3 3 5 4 5 5	31
7	6 3 3 5 5 2 5	32
8	6 3 3 5 5 9 0	33
9	6 3 2 5 8 8 4	34
10	6 3 2 5 9 6 4	35
11	6 3 2 6 0 3 4	36
12	6 3 2 6 1 0 4	37
13	6 3 2 6 1 6 1	38
14	0 0 4 1 0 3 5	39
15	9 0 7 2 7 0 3	40
16		41
17		42
18		43
19		44
20		45
21		46
22		47
23		48
24		49
25		50

Book Mark:

See also

Q. 1085928. P. O. M. M.

P. 2284453. P. O. app.

P. 2285926 P. O. app.

P. 3002887 a. M. W.

6

11 (New) U.S.C.T.

George W. ...

(New)

, Co. ..., 11 Reg't U. S. Col'd Inf.

Appears on

Company Descriptive Book

of the organization named above.

DESCRIPTION.

Age *21* years; height *5* feet *5* inches.

Complexion *ML*

Eyes *blue*; hair *black*

Where born *unknown* *Katonia*

Occupation *laborer*

ENLISTMENT.

When *March 1*, 1864.

Where *Company ...*

By whom *to ...*; term *3* y'rs.

Remarks: *Transferred to Co 'B' from Co 'D' 11 ... late 7 ...*

Friday

6 | 11 (new) | U.S.C.T.

Joseph Clopton (new)
Co. L, 11 Reg't U.S. Col'd Inf.

Appears on

Company Descriptive Book

of the organization named above.

DESCRIPTION.

Age 20 years height 5 feet 5 inches.

Complexion

Blk

Eyes;

Blk

hair

Blk

Where born

unknown ald.

Occupation

Farmer

ENLISTMENT.

When

March 1, 1864.

Where

Memphis Tenn.

By whom

Serg. E. Crockett, term 3 y'rs.

Remarks:

D. M. Kennedy
Copist.

C 11 (New). U.S.C.T.

Joseph Clopton

Private, Co. L, 6 Reg't U. S. Col'd H. Art'y.†

Appears on

Company Muster-in and Descriptive Roll
of the organization named above. Roll dated

Fort Pickering, Memphis, Tenn. April 2, 1864.

Where born *Unknown, Alabama*

Age *20* y'rs; occupation *Fanner*

When enlisted *March 1, 1864.**

Where enlisted *Memphis, Tenn.*

For what period enlisted *3* years.

Eyes *black*; hair *black*

Complexion *black*; height *5 ft. 5 in.*

When mustered in *April 2, 1864.*

Where mustered in *Pickering, Memphis, Tenn.*

Bounty paid \$ *100*; due \$ *100*

Where credited

Company to which assigned

Remarks:

† This organization subsequently became Co. L, 11 Reg't U. S. Colored Infantry (New).

* Muster-in roll shows enrollment of all men of this company as of same date. See enrollment on subsequent card or cards.

Book mark:

[Signature]
Copyist.

C | **11 (New).** | **U.S.C.T.**

Joseph Clapton
Priv, Co. *L*, 6 Reg't U. S. Col'd H. Art'y.†

Appears on

Company Muster Roll

for *Memphis*, 1864.

Joined for duty and enrolled:

When *March 1*, 1864.*

Where *Memphis, Tenn.* *

Period *3* years.*

Present or absent *Present*

Stoppage, \$ *100* for

Due Gov't \$ *100* for

Remarks:

† This organization subsequently became Co. *L*, 11 Reg't U. S. Colored Infantry (New).

* See enrollment on card from muster-in roll.

Book mark:

C | 11 (New). | U.S.C.T.

Joseph Clapton
Private, Co. L, 7 Reg't U. S. Col'd H. Art'y.†

Appears on

Company Muster Roll

for May & June, 1864

Joined for duty and enrolled:

When March 1, 1864*

Where Memphis, Tenn.*

Period 3 years.*

Present or absent Present

Stoppage, \$ 100 for

Due Gov't, \$ 100 for

Remarks:

†This organization subsequently became Co. L, 11 Reg't U. S. Col'd Infantry (New).

* See enrollment on card from muster-in roll.

Book mark:

C

11 (New). U.S.C.T.

Joseph Copton

Priv, Co. L, 7 Reg't U. S. Col'd H. Art'y.†

Appears on

Company Muster Roll

for July & Aug, 1864.

Joined for duty and enrolled:

When March, 1864.*

Where Memphis, Tenn. *

Period 3 years.*

Present or absent Present

Stoppage, \$ 100 for

Due Gov't, \$ 100 for

Remarks:

Due the U.S. for Ordnance \$ 270

†This organization subsequently became Co. L, 11 Reg't U. S. Col'd Infantry (New).

* See enrollment on card from muster-in roll.

Book mark:

Norman

C | 11 (New). | U.S.C.T.

Joseph Copton

Priv, Co. L, 7 Reg't U. S. Col'd H. Art'y.†

Appears on

Company Muster Roll

for Sept & Oct, 1864.

Joined for duty and enrolled:

When March 7, 1864.*

Where Memphis, Tenn. *

Period 3 years.*

Present or absent Present

Stoppage, \$ 100 for

Due Gov't, \$ 67 100 for Camp &

Garrison Equipages

Remarks:

†This organization subsequently became Co. L, 11 Reg't U. S. Col'd Infantry (New).

* See enrollment on card from muster-in roll.

Book mark:

[Signature]

C | 11 (New). | U.S.C.T.

Joseph Dopton
Sgt., Co. L, 7 Reg't U. S. Col'd H. Art'y.†

Appears on

Company Muster Roll

for *Nov & Dec*, 186*4*

Joined for duty and enrolled:

When *March*, 186*4**

Where *Memphis, Tenn.**

Period *3* years.*

Present or absent *Present*

Stoppage, \$ *100* for

Due Gov't, \$ *67* for *Camp*

for Equipage

Remarks:

†This organization subsequently became Co. L, 11 Reg't U. S. Col'd Infantry (New).

* See enrollment on card from muster-in roll.

Book mark:

[Signature]

6 | 11 (New) | U.S.C.T.

Joseph Clapton
Priv

, Co. L, 11 Reg't U. S. Col'd Infantry.

Appears on

Company Muster Roll

for Jan & Feb, 1865.

Joined for duty and enrolled:

When March 1, 1864.*

Where Memphis, Tenn *

Period 3 years.*

Present or absent Present

Stoppage, \$ 100 for

Due Gov't \$ $\frac{67}{100}$ for C. & G. E.

Remarks:

* See enrollment on card from muster-in roll.

Book mark:

S. W. Williams

(358c)

Copyist.

C | 11 (New) | U.S.C.T.

Joseph Clapton
Pvt, Co. L, 11 Reg't U. S. Col'd Infantry.

Appears on

Company Muster Roll
for Dated April 30, 1865.

Joined for duty and enrolled:

When March 1, 1864.*

Where Memphis, Tenn.*

Period 3 years.*

Present or absent Present

Stoppage, \$ 100 for

Due Gov't \$ 100 for

Remarks:

* See enrollment on card from muster-in roll.

Book mark: _____

S. W. Williams

(358c)

Copyist.

C

11 (New). U.S.C.T.

Joseph Clopton
Pvt., Co. B, 11 Reg't U. S. Col'd Inf. (New).

Appears on

Company Muster Roll

for *May & June*, 1865.

Present or absent *Present*

Stoppage, \$ 100 for

Due Gov't, \$ *100* for *Cr. G. L.*

Remarks: *Transferred from
Co "L"*

Book mark:

(358)

W. W. Sayre

Copyist.

C

11 (New).

U.S.C.T.

Joseph Clopton

Private, Co. B, 11 Reg't U. S. Col'd Inf. (New).

Appears on

Company Muster Roll

for July & Aug, 1865.

Present or absent Present

Stoppage, \$ 100 for

Due Gov't, \$ 160 for C. & G. E.

Remarks:

Book mark:

W. A. Daye

C

11 (New). U.S.C.T.

Joseph Clifton

Priv, Co. B, 11 Reg't U. S. Col'd Inf. (New).

Appears on

Company Muster Roll

for Sept & Oct, 1863.

Present or absent Present

Stoppage, \$ 100 for

Due Gov't, \$ 100 for

Remarks:

Filed with Joseph Clifton

Book mark:

Murphy

1

11 (New). U.S.C.T.

Joseph Clifton
Private, Co. B, 11 Reg't U. S. Col'd Inf. (New).

Appears on

Company Muster Roll

for Nov. 7 1864, 1864.

Present or absent Present

Stoppage, \$ 100 for

Due Gov't, \$ 100 for

Remarks:

Book mark:

Murphy
Coryist.

C

11 (New). U.S.C.T.

Joseph Copton
Pvt B, 11 Reg't U. S. Col'd Inf. (New).

Appears on Co. Muster-out Roll, dated
Memphis Ten. Jan 12, 1866.

Muster-out to date Jan 12, 1866.

Last paid to June 30, 1865.

Clothing account:

Last settled _____, 186 ; drawn since \$ _____ 100

Due soldier \$ _____ 100; due U. S. \$ 42 ³¹/₁₀₀

Am't for cloth'g in kind or money adv'd \$ _____ 100

Due U. S. for arms, equipments, &c., \$ _____ 100

Bounty paid \$ _____ 100; due \$ _____ 100

Remarks: _____

Book mark: _____

(361)

Murphy
Copyist.

Clopton, Joseph -
P., Co. L, II Reg't U.S.C. Inf.

Enclosures.

Bed Cards	Descriptive Lists
Burial Records	Final Statements
Certs. of Dis. for Discharge	Furloughs
C. M. Charges	Med. Des. Lists
Med. Certificates	Orders

Other papers relating to—

Admission to Hosp'l	Furlough
Casualty Sheet (Officer's)	Med. Examination
Confinement	Misc. Information
Contracts	Pay or Clothing
Death or Effects	Personal Reports
Desertions	Rank
Discharge from Hosp'l	Transfer to Hosp'l
Discharge from Service	Transfer to V. R. C.
Duty	Transportation

Wood Garters! ^WBatter Fuseassy!
Fort Pickens Tex Jan 11th 1865.

John H. Butler
Major & Field Officer Court-Martial

Proceedings of Field Officer Court-Martial
wherin Joseph Clapton
Private Co. S. Fuseassy was
arraigned and tried.

Head Quarters 1st Batt. 15th Regt.
Fort Pickens Jan. 11. 1865

Proceedings of a Field Officers Court-Martial
convened at Fort Pickens Memphis Tenn
By Virtue of following order.

Head Quarters 1st U.S.C.A. (Regt.)
Fort Pickens Memphis Jan 11 1864

Special Order
No 11

Major John H. Baker
1st U.S.C.A. (Regt.) is hereby detailed as Regimental
Court-Martial to try all cases that may
come before him and report the proceedings
in each case to these Head Quarters for
approval

By Order of
W. D. Turner Col.
Comd'g Regiment

M. A. Smith
Adj't

The following were assigned and tried

Jan. 11. 1865

Joseph Clepton Private

Co. L.

Disobedience of Orders

Charged on Sentence. - To hard labor for Twenty days

pay roll.

and to forfeit 1/2 of his monthly pay.

J. H. Baker
Major and Field Officers Court-
Martial 1st U.S.C.A. (Regt.)

Head Quarters 1st Batt - 10th Regt
Fort Pickens Tenn Jan 11 1865

Proceedings of a Field Officers Court-Martial
commenced at Fort Pickens Memphis Tennessee
By Virtue of the following order

Head Quarters 1st Batt - 10th Regt
Fort Pickens Memphis Jan 11 1864

Special Order
No 11

Major John V. Butler 1st US
C.A. Regt is hereby detailed as Regimental
Court-Martial to try all cases that may
come before him and report the proceedings
in each case to these Head Quarters for
approval

By order of
W. D. Turner Col
Commanding - Regiment

Wm. Smith
Adj't

The following were arraigned and tried

Jan. 11, 1865 Joseph Colapton Private Ch. L.
Disobedience of Orders
Charged on Sentence - To hard labor for twenty days
pay roll and to forfeit all of his monthly pay.

John V. Butler Major
1st Field Officers Court-Martial 1st Batt 10th Regt

Proceedings of a Court-Martial
held at Fort Pickens Memphis Tennessee
on the 11th day of January 1865

John V. Butler
Major and adj't of the 1st Regt
10th US Cavalry

298

Blupston Charles
Co H, 11 U.S. Col'd Inf.

(New Organization.)

Private + Private

CARD NUMBERS.

1		26
2		27
3	Blupston Charles	28
4		29
5		30
6		31
7		32
8		33
9		34
10		35
11		36
12		37
13		38
14		39
15		40
16		41
17		42
18		43
19		44
20		45
21		46
22		47
23		48
24		49
25		50

Book Mark:

See also

299

Coleman Birdie

Co *C*, 11 U.S. Col'd Inf.

(New Organization.)

Private | *Private*

CARD NUMBERS.

1	26
2	27
3	<i>In Coleman Birdie</i>
4	29
5	30
6	31
7	32
8	33
9	34
10	35
11	36
12	37
13	38
14	39
15	40
16	41
17	42
18	43
19	44
20	45
21	46
22	47
23	48
24	49
25	50

Book Mark:

See also

300

Locke Hill Israel

Co *A*, **11** U.S. Col'd Inf.

(New Organization.)

Private *Private*

CARD NUMBERS.

1	6322736	26
2	6335635	27
3	6335644	28
4	6335679	29
5	6335771	30
6	6335846	31
7	6335913	32
8	6335972	33
9	6336007	34
10	6324578	35
11	6324944	36
12	9070866	37
13	9072846	38
14	9072991	39
15		40
16		41
17		42
18		43
19		44
20		45
21		46
22		47
23		48
24		49
25		50

Book Mark: *ENB V. 12. P. 185-*

See also

C | **11 (New) U. S. C. T.**

Israel Cochrel

....., Co. A, 11 Reg't U. S. Col'd Inf. ^(New)

Appears on

Company Descriptive Book

of the organization named above.

DESCRIPTION.

Age 18 years height 5 feet 4 inches.

Complexion Blk

Eyes; Blk hair Blk

Where born West Point Miss

Occupation Farmer

ENLISTMENT.

When March 22, 1864.

Where Memphis

By whom John Holly; term 3 y'rs.

Remarks: Transferred from
Co. M. per SO No. 119. dated
11th Div. Dist. West. Term. Memphis
Term. May 8. 65. Final
Statements forwarded.
No. Description on Co. M. Book,

to on roll.

Hearn

3

11^(New) U.S.C.T.

Sergeal Cockerill

Co. ^(New) 11 Reg't U.S. Col'd Inf.

Appears on

Company Descriptive Book

of the organization named above.

DESCRIPTION.

Age 18 years height 5 feet 4 inches.

Complexion *bl'h*

Eyes; *bl'h* hair *bl'h*

Where born *West Point, Miss*

Occupation *farmer*

ENLISTMENT.

When *22 Oct*, 1864.

Where *Memphis, Tenn*

By whom *Jno Malloy*; term *3* y'rs.

Remarks:

Wayton

Copyist.

C.

11 (1861) U.S.C.T.

Sergeant Bokerell,

(1861)
Co. *B*, 11 Reg't U.S. Col'd Inf.

Appears on

Company Descriptive Book

of the organization named above.

DESCRIPTION.

Age years height feet inches.

Complexion

Eyes; hair

Where born

Occupation

ENLISTMENT.

When , 186

Where

By whom ; term y'rs.

Remarks:

Transfd to Co A.

Dayton,

Copyist.

6

11 (New). U.S.C.T.

Israel Cockerill

Appears with rank of *Pri* on

Muster and Descriptive Rolls of Detachments of U. S. Vols. forwarded

6 U.S. H & A (Colored)
for the *11* Reg't U. S. Col'd *Inf* Roll dated

Memphis Tenn April 28, 1864

Where born *West-Point Miss*

Age *18* y'rs; occupation *Farmer*

When enlisted *March 22*, 1864.

Where enlisted *Memphis Tenn*

For what period enlisted *3* years.

Eyes *Black*; hair *Black*

Complexion *Black*; height *5 ft. 4 in.*

When mustered in _____, 186 .

Where mustered in _____

Bounty paid \$ *100*; due \$ *100*

Where credited _____

Company to which assigned _____

Remarks: _____

Book mark: _____

Ashley

(339) _____ Cuygist.

C | 11 | U.S.C.T.

Israel Cokerill,
Priv., Co. M., 6 Reg't U.S. Col'd H. Art'y

Age.....years.

Appears on

Company Muster Roll*

for Apr. 28 to Apr. 30....., 1864.

Joined for duty and enrolled:

When Mar. 22, 1864.

Where Memphis, Tenn.

Period 3 years.

Mustered in:

When Apr. 28, 1864.

Where Memphis, Tenn.

Present or absent Present

Stoppage, \$ 100 for.....

Due Gov't, \$ 100 for.....

Valuation of horse, \$ 100

Valuation of horse equipments, \$ 100

Remarks :

* First current roll. No muster-in roll of this company on file.

Book mark :

I. Pool

O

11 (New)

U.S.C.T.

Israel Cockerill,
Priv, Co. M, 7 Reg't U. S. Col'd H. Art'y.*

Appears on

Company Muster Roll

for *May & June*, 1864.

Present or absent *Present*

Stoppage, \$ *100* for

Due Gov't, \$ *100* for

Remarks:

* This organization subsequently became Co. M, 11 Reg't U. S. Colored Infantry (New).

Book mark:

P. Pool

C

11 (New)

U.S.C.T.

Israel Cokerill

Co. M, 7 Reg't U. S. Col'd H. Art'y.*

Appears on

Company Muster Roll

for July & Aug., 1864.

Present or absent Present

Stoppage, \$ 100 for

Due Gov't, \$ 100 for

Remarks: Sick in Co. Quarters.

* This organization subsequently became Co. M, 11 Reg't U. S. Colored Infantry (New).

Book mark:

O'Neal

C

11 (New)

U.S.C.T.

Israel Cochrill

Priv., Co. M, 7 Reg't U. S. Col'd H. Art'y.*

Appears on

Company Muster Roll

for Sept & Oct., 1864.

Present or absent Present

Stoppage, \$ 100 for

Due Gov't, \$ 100 for

Remarks:

* This organization subsequently became Co. M, 11 Reg't U. S. Colored Infantry (New).

Book mark:

P. Pool,

C | 11 (New) | U.S.C.T.

Israel Cokerill
Pot, Co. M, 7 Reg't U. S. Col'd H. Art'y.*

Appears on

Company Muster Roll

for Nov + Dec, 1864

Present or absent Present

Stoppage, \$ 100 for

Due Gov't, \$ 100 for

Remarks: Stop for one Gun
Sling, 31.

* This organization subsequently became Co. M, 11 Reg't U. S. Colored Infantry (New).

Book mark :

(358)

O'Cool,

Copyist.

Q

11 (New).

U.S.C.T.

Israel Cockerill

Pat, Co. M, 11 Reg't U. S. Col'd Inf. (New).

Appears on

Company Muster Roll

for Jan'y & Feb'y, 1865.

Present or absent Present

Stoppage, \$ 100 for

Due Gov't, \$ 100 for

Remarks: Sick in Gro. Stop
one Gun String & .31.

Book mark:

Washington

C

11 (New).

U.S.C.T.

Israel Cokerill

Pat, Co. M, 11 Reg't U. S. Col'd Inf. (New).

Appears on

Company Muster Roll

for March - April, 1865.

Present or absent absent

Stoppage, \$ 100 for

Due Gov't, \$ 100 for

Remarks: Sick in Webster
Gen'l Hospital since
April 27 1865.

Book mark:

Washington

C

11 (New).

U.S.C.T.

Israel Cockerill

....., Co. M, 11 Reg't U. S. Col'd Inf. (New).

Appears on

Company Muster Roll

for *March - April*, 186*5*.

Present or absent.....

Stoppage, \$.....*100* for.....

Due Gov't, \$.....*100* for.....

Remarks: *Dies*

Book mark:.....

Washington

C. | 11 (New). | U.S.C.T.

Issal Cockerill

Priv., Co. A, 11 Reg't U. S. Col'd Inf. (New).

Appears on

Company Muster Roll

for *May & June*, 1865.

Present or absent

Stoppage, \$ 100 for

Due Gov't, \$ 100 for

Remarks:

Died in Reg'tl. Hospt. May 13/65, Final statements forwarded to A.G.O.

Book mark:

Died May 12/65, C.B. V. 12, p. 185

N. N. Reed

C 11 (New). U.S.C.T.

Israel Cockrel

P. A, 11 Reg't U. S. Col'd Inf. (New).

Appears on Co. Muster-out Roll, dated

Memphis Tenn, Jan'y 12, 1866.

Muster-out to date _____, 186 .

Last paid to Feb 28, 1865.

Clothing account:

Last settled _____, 186 ; drawn since \$ 100

Due soldier \$ 100; due U. S. \$ 100

Am't for cloth'g in kind or money adv'd \$ 100

Due U. S. for arms, equipments, &c., \$ 100

Bounty paid \$ 100; due \$ 100

Remarks: Died at Memphis Tenn. May 13th 65 disease not known joined Co as Recruit

Book mark: F. S. Died May 12 / 65
E. B. V. 12. P. 183

Hubberger

Cockerill, Israel -

P, Co. A 11,

U. S. C. Inf.
Reg't

Enclosures.

Bed Cards	Descriptive Lists
Burial Records	Final Statements
Certs. of Dis. for Discharge	Furloughs
C. M. Charges	Med. Des. Lists
Med. Certificates	Orders

Other papers relating to—

Admission to Hosp'l	Furlough
Casualty Sheet (Officer's)	Med. Examination
Confinement	Misc. Information
Contracts	Pay or Clothing
Death or Effects	Personal Reports
Desertions	Rank
Discharge from Hosp'l	Transfer to Hosp'l
Discharge from Service	Transfer to V. R. C.
Duty	Transportation

A. J. O. Des. list sent
2 Auditor

Co - A 16.

FINAL STATEMENT

OF

Private Israel Coxe

11th Reg't of U. S. C. Infantry

VOLUNTEERS.

Rec'd May 12th 1865

NOTE 1.—Two of these certificates (or duplicates) are to be given to each Volunteer Soldier or drafted man who may be discharged previously to the discharge of his company, that he may at once receive from the Paymaster the pay, &c., due him, and the captain or other COMMISSIONED officer commanding the company will certify to the act of the delivery of the duplicate certificates; on these certificates the Soldier is "entitled to" his discharge, and should also present his discharge to the Paymaster to have the payment endorsed on it. The discharge is to be given back to the Soldier by the Paymaster; the latter only retaining as his voucher the duplicate certificates.

NOTE 2.—If the Soldier is entitled to pay for the use of his horse, the Company Commander will certify to that fact on the back of both these final statements, and also to the time he has pay due for having been so mounted on his own horse.

NOTE 3.—When a Soldier is furnished with final statements, his descriptive list, if he has one, should be taken up by the officer who gives the Soldier these statements, and endorsed with a statement to this effect by the officer. This endorsement should exhibit a full statement of the time for which the Soldier was allowed pay on his final statements, the clothing account, and all other charges against him or in his favor, so as to comprise a complete exhibit of his account. It will then be transmitted to the Company Commander of the Soldier, who will enter all the data necessary to a full understanding of the Soldier's account on the muster roll upon which the Soldier's discharge is reported. The descriptive list will then be destroyed. The object of this is, that the remaining portion of the Soldier's account may be settled upon the receipt of these muster rolls, and the Soldier receive any pay or allowances that may be due him at the time of his discharge, and which may not appear on his final statements from the fact that his descriptive list is incomplete. These accounts for back pay, &c., are settled by the 2d Auditor of the Treasury Department.

NOTE 4.—Charges for loss or injury to ordnance, horse equipments, and other miscellaneous charges, should appear under the heading of "Other Stoppages."

NOTE 5.—Bounty paid by State authorities, and not by the United States, will not be entered on this statement.

NOTE 6.—Amounts due the Sutler and Laundress must be entered on the muster roll on which the discharge, death, desertion, &c., is reported, as well as on the final statement, otherwise the amount cannot be collected from the United States.

NOTE 7.—This blank will be used for deceased volunteers and drafted men, as well as for others.

NOTE 8.—Where a Soldier dies in Hospital or on detached service, his descriptive list, if he has one, should be sent with his final statements, in duplicate, to the Adjutant General, Washington, D. C.

Ent on O.R. of file

[OFFICE ENDORSEMENT.]

War Department,

ADJUTANT GENERAL'S OFFICE,

Number 11, 1876

The death of Pvt. Israel Coxe, Co. A, 11th Reg't U. S. Colored Inf., is reported as follows:

- On Company Muster Roll, For May 1st 1865, May 13th 1865, in Reg't Hosp. Must. his term Company Muster-out Roll, May 13th 1865, Company Descriptive Book, 186
- Company Morning Reports, 186
- Soldier's Final Statement, May 12th 1865, 1865
- Soldier's Record of Death and Interment, 186
- Soldier's Inventory of Effects, 186
- Soldier's Certificate of Disability for Discharge, 186
- Soldier's Individual Muster-out Roll, 186

- Regimental Return, For May 14, 1865, May 14, 1865
- Regimental Quarterly Returns, Dec 4th 1865, 2nd 2nd 1865, May 12th 1865, 1865
- Regimental Descriptive Book, 186

By Surgeon General, (May 12, 1865, is held to be the correct date and the Company Muster Roll will be amended accordingly.)

Y. M. Stewart
See letter to 2d Auditor
Assistant Adjutant General.
E. B. Hill

ADJUTANT GENERAL'S OFFICE
May 31st 1865
Duplicate with Inventory for 2d Auditor.

I certify, on honor, that Israel Cockrell a Private of
 Captain J. S. Brookham Company (2nd) of the 11th Regiment of U. S. Col. Inf
VOLUNTEERS, of the State of _____, born in West Point, State
 of Mississippi, aged 18 years; 5 feet 4 inches high; Blk complexion,
Blk eyes, Blk hair, and by occupation a Furmer, having joined the company on
 its original organization at _____, and enrolled in it at the muster into
 the service of the United States at _____, on the _____ day
 of _____, 1864, (or was mustered in service as a recruit, by Capt
Williams, at Memphis Tenn on the 28th day of April,
 1864, or was drafted and mustered into the service of the United States from the _____
 Enrollment District of the State of _____, at _____,
 on the _____ day of _____, 1864, to serve in the Regiment, for
 the term of Three Yrs: and having served **HONESTLY** and
FAITHFULLY with his Company in service to the present date, is now
 entitled to a **DISCHARGE** by reason of Death, caused by
Consumption on the 12th May 1865

The said Private Israel Cockrell was last paid by Paymaster
Wm. Whiting to include the 28th day of February, 1865, and has
 pay due him from that time to the present date; he is entitled to pay and subsistence for
TRAVELING to place of enrollment, and whatever other allowances are authorized to volunteer
 soldiers, drafted men, or militia, so discharged. He has received from the United States **CLOTHING**
 amounting to Sixty Three (63.75) 96 dollars, since the _____ day of Enrollment
 1864, when his clothing account was last settled. He has received from the United States
 _____ dollars advanced **BOUNTY**.

There is to be stopped from him, on account of the State of _____, or other
 authorities, for **CLOTHING**, &c., received on entering service, _____ dollars; and
 for other stoppages, viz: _____
 _____ dollars.

He has been furnished with **TRANSPORTATION** in kind from the place of his discharge to
 _____; and he has been **SUBSISTED** for **TRAVELING** to his
 place of enrollment, up to the _____, 1865.

He is indebted to _____, **SUTLER**, _____ dollars.
 He is indebted to _____, **LAUNDRESS**, _____ dollars.

Given in Duplicate, at Master Genl Hoopll Memphis Tenn this 12th day
 of May, 1865.

Wm. V. Cassop.
Asst Surg Regt
 Commanding Company
 in charge

301 Martin
Coffee Morton

Co B, 11 U.S. Col'd Inf.

(New Organization.)

Private

Private

CARD NUMBERS.

1	26
2	27
3	28
4	29
5	30
6	31
7	32
8	33
9	34
10	35
11	36
12	37
13	38
14	39
15	40
16	41
17	42
18	43
19	44
20	45
21	46
22	47
23	48
24	49
25	50

Book Mark:

See also

301-a

Coffin Cornelius
Co. L, // U. S. Col'd Inf.
(New organization.)

CARD NUMBERS.

1	26
2	27
3	Reference envelope
4	29
5	30
6	31
7	32
8	33
9	34
10	35
11	36
12	37
13	38
14	39
15	40
16	41
17	42
18	43
19	44
20	45
21	46
22	47
23	48
24	49
25	50

Number of personal papers herein.....

Book Mark :

See also Pioneer Corps, Col'd,
Cav. Div. 16 A.C.

302

Coffin, York
 Co I, 11 U.S. Col'd Inf.

(New Organization.)

Private | *Private*

CARD NUMBERS.

1	6332950	26
2	6333054	27
3	6333148	28
4	6333223	29
5	6333306	30
6	6333384	31
7	6333459	32
8	6333538	33
9	6333618	34
10	6333696	35
11	6333773	36
12	6333887	37
13	6333363	38
14	6334002	39
15	9072483	40
16	2684-65-1884	41
17		42
18		43
19		44
20		45
21		46
22		47
23		48
24		49
25		50

Book Mark: 2684-65-1884
 713 ¹⁶
 764

See also

P. 699172 P. 70

N. 818511 P. a. aff

(7603) P. a. aff

5112735 P. a. aff

C *(New)*
11 U.S.C.T.
York Coffin
(New)
Co. *A*, 11 Reg't U. S. Col'd Inf.

Appears on

Company Descriptive Book

of the organization named above.

DESCRIPTION.

Age *24* years; height, *6* feet *2* inches.

Complexion *Black*

Eyes *Black*; hair *Black*

Where born *Statesville N.C.*

Occupation *Farmer*

ENLISTMENT.

When *March*, 186 *4*.

Where *Memphis Tenn.*

By whom *Pllaughter*; term *3* y'rs.

Remarks: *Deserted from*
York Pickering Mem-
phis Tenn Nov 22/65

Forrest

le 11 (New). U.S.C.T.

York Coffin
Priv., Co. I, 6 Reg't U. S. Col'd H. Art'y.†

Appears on

Company Muster-in and Descriptive Roll
of the organization named above. Roll dated

Fort Pickens Memphis, Tenn. Apr. 2, 1864.

Where born Statesville North Carolina

Age 24 y'rs; occupation Farmer

When enlisted March 1, 1864.*

Where enlisted Memphis Tenn.

For what period enlisted 3 years.

Eyes black; hair black

Complexion black; height 6 ft. 2 in.

When mustered in March 1, 1864.*

Where mustered in Memphis Tenn.

Bounty paid \$ 100; due \$ 100

Where credited Pontitoc Pontitoc Co. Miss.

Company to which assigned

Remarks:

† This organization subsequently became Co. A, 11 Reg't U. S. Colored Infantry (New).

* Muster-in roll shows enrollment and muster-in of this company as of same date. See enrollment on subsequent card or cards.

Book mark:

Milliken

6

11 (New).

U.S.C.T.

York Coffin

Priv., Co. I, 6 Reg't U. S. Col'd H. Art'y.†

Appears on

Company Muster Roll

for *Mar. & Apr.*, 1864.

Joined for duty and enrolled:

When *Mar. 1st*, 1864.*

Where *Memphis Tenn.**

Period *3* years.*

Present or absent *present*

Stoppage, \$ *100* for

Due Gov't \$ *100* for

Remarks :

† This organization subsequently became Co. *I*, 11 Reg't U. S. Colored Infantry (New).

* See enrollment on card from muster-in roll.

Book mark :

Williken

(358c)

Copyist.

Co | **11** (New). | **U.S.C.T.**

York Coffin
Priv., Co. I, 7 Reg't U. S. Col'd H. Art'y.†

Appears on

Company Muster Roll

for *May & June*, 1864.

Joined for duty and enrolled:

When *1st Mar.*, 1864.*

Where *Memphis Tenn.* *

Period *3* years.*

Present or absent *present*

Stoppage, \$ *100* for

Due Gov't, \$ *100* for

Remarks:

†This organization subsequently became Co. I, 11 Reg't U. S. Col'd Infantry (New).

* See enrollment on card from muster-in roll.

Book mark:

Williken

6 | 11 (New). | U.S.C.T.

York Coffin
Serg't, Co. I, 7 Reg't U. S. Col'd H. Art'y.†

Appears on

Company Muster Roll

for July & Aug't, 1864.

Joined for duty and enrolled:

When 1st Mar., 1864.*

Where Memphis Tenn.*

Period 3 years.*

Present or absent Not stated.

Stoppage, \$ 100 for

Due Gov't, \$ 100 for

Remarks: Promoted to Serg't
per Sp. Ord. No. 22 Hd Qrs.
7th U.S. 5 July 1864.

†This organization subsequently became Co. I, 11 Reg't U. S. Col'd Infantry (New).

* See enrollment on card from muster-in roll.

Book mark: _____

Milliken

6

11 (New). U.S.C.T.

York Coffin
Sergeant, Co. I, 7 Reg't U. S. Col'd H. Art'y.†

Appears on

Company Muster Roll

for Sept. & Oct., 1864.

Joined for duty and enrolled:

When 1st Mar., 1864.*

Where Memphis Tenn. *

Period 3 years.*

Present or absent present

Stoppage, \$ 100 for

Due Gov't, \$ 100 for

Remarks:

†This organization subsequently became Co. I, 11 Reg't U. S. Col'd Infantry (New).

* See enrollment on card from muster-in roll.

Book mark:

Williken

le | 11 (New). | U.S.C.T.

York Coffin

Serjt., Co. I, 7 Reg't U. S. Col'd H. Art'y.†

Appears on

Company Muster Roll

for Nov. & Dec., 1864.

Joined for duty and enrolled:

When 1st Mar., 1864.*

Where Memphis Tenn. *

Period 3 years.*

Present or absent present

Stoppage, \$ 100 for

Due Gov't, \$ 100 for

Remarks:

†This organization subsequently became Co. I, 11 Reg't U. S. Col'd Infantry (New).

* See enrollment on card from muster-in roll.

Book mark:

Williken

C | 11 (New) | U.S.C.T.

York Coffin

Sergt., Co. I, 11 Reg't U. S. Col'd Inf. (New.)
Appears on

Company Muster Roll

for *Jan & Febr.*, 186*5*.

Joined for duty and enrolled:

When *Mar*, 186*4*.*

Where *Memphis Tenn.* *

Period *3* years.*

Present or absent *Present*

Stoppage, \$ *100* for

Due Gov't \$ *100* for

Remarks: *1*

* See enrollment on card from muster-in roll.

Book mark:

M. A. Michaels

(358c)

Copyist.

C | **11** (New) | **U.S.C.T.**

York Coffin

Serjt, Co. I, 11 Reg't U. S. Col'd Inf. (New.)
Appears on

Company Muster Roll

for *March + Apr.*, 1865.

Joined for duty and enrolled:

When *March 1*, 1864.*

Where *Memphis Tenn.* *

Period *3* years.*

Present or absent *Present*

Stoppage, \$ *1*^{*12*}/₁₀₀ for *C & G. Co.*

Due Gov't \$ *100* for

Remarks: *Due U.S. for one
Canteen & Haversack*

* See enrollment on card from muster-in roll.

Book mark:

M. A. Michaels

(358c)

Copyist.

C | 11 (New) | U.S.C.T.

York Coffin

Corpl., Co. I, 11 Reg't U. S. Col'd Inf. (New.)
Appears on

Company Muster Roll

for May & June, 1865.

Joined for duty and enrolled:

When March 1, 1864.*

Where Memphis Tenn. *

Period 3 years.*

Present or absent Present

Stoppage, \$ 100 for

Due Gov't \$ 100 for

Remarks: Pay due as Sergt from
1 March to 10 May 1865 reduced
to ranks by S.O. No 103 Hd Qrs
11 U.S. Infy. Promoted to Corpl
for S.O. No 118 Hd Qrs 11 U.S. Infy
May 23-1865.

* See enrollment on card from muster-in roll.

Book mark:

M. A. Michaels

C | 11 (New) | U.S.C.T.

York Coffin

Private Co. I, 11 Reg't U. S. Col'd Inf. (New.)
Appears on

Company Muster Roll

for July & Aug., 1865.

Joined for duty and enrolled:

When March 1, 1864.*

Where Memphis Tenn *

Period 3 years.*

Present or absent Present

Stoppage, \$ 100 for

Due Gov't \$ 100 for

Remarks: Promoted to Corp.
per St 98. Hed Cor 11 U S Col'd Infy
23 May 65 Pay due as Serjt
from Mar 65 to 11 May 65
Pay due as Corp from 23 May
to 17 Aug 1865.

* See enrollment on card from muster-in roll.

Book mark:

M. A. Michaels

(358c)

Copyist.

C | 11 (New) | U.S.C.T.

York Coffin

Private, Co. I, 11 Reg't U. S. Col'd Inf. (New.)
Appears on

Company Muster Roll

for *Sept & Oct.*, 1865.

Joined for duty and enrolled:

When *March 1*, 1864.*

Where *Memphis Tenn**

Period *3* years.*

Present or absent *Present*

Stoppage, \$ *100* for

Due Gov't \$ *100* for

Remarks: *Pay due as Corp from
1 July to 17 Aug 65. Stop
for 1 Screw D + C W, Tompion
& 1 Wiper 45⁴*

* See enrollment on card from muster-in roll.

Book mark:

M. A. Michaels

(358c)

Copyist.

6 | 11 Nov U.S.C.T.

York Caffin
Priv., Co. I, 11 Reg't U. S. Col'd Infantry (new)

Appears on

Descriptive List of Deserters

dated Memphis Tenn. Nov. 30, 1865.

Deserted :

When Nov. 22, 1865.

Where Memphis Tenn.

Arrested :

When _____, 186 .

Where _____

Remarks : Due U.S. for
ordnance 45c

Book mark : _____

(851)

W. H. Bogar

Copyist.

6 | 11 (New) | U.S.C.T.

Coffin, York

Priv, Co. I, 11 Reg't U. S. Col'd Inf. (New.)
Appears on

Company Muster Roll

for *Nov. and Dec.*, 1865.

Joined for duty and enrolled:

When *1 March*, 1864.*

Where *Memphis Tenn.* *

Period *3* years.*

Present or absent.....

Stoppage, \$ *100* for.....

Due Gov't \$ *100* for.....

Remarks:.....

*Deported from Regt. while
at Memphis Tenn 23rd Nov. 1865
Stop for Ord. 45 cts.*

* ~~See~~ See enrollment on card from muster-in roll.

Book mark:.....

D. J. Webster

L

11 (New). U.S.C.T.

Yorn Caffin

Priv. co d, 11 Reg't U. S. Col'd Inf. (New).

Appears on Co. Muster-out Roll, dated

Memphis Tenn. Jan 12, 1866.

Muster-out to date _____, 186

Last paid to *June 30*, 1865.

Clothing account:

Last settled _____, 186 ; drawn since \$ _____ 100

Due soldier \$ _____ 100; due U. S. \$ _____ 100

Am't for cloth'g in kind or money adv'd \$ _____ 100

Due U. S. for arms, equipments, &c., \$ _____ 100

Bounty paid \$ _____ 100; due \$ _____ 100

Remarks:

Deceased 22 Nov, 1865,

Book mark: *V. 115, P. 320, 70*
(over)

D P Webster

(361)

Copyist.

JAN. 23

6334002

★1891★

2684 Q.S. 1884 Dis-
Charged Nov. 22, 1865
L. B. 16/
/1764

C 11 7905
York Coffin
, Co. J, 11. Reg. 7905

NOTATION.

Book mark: *S. B. 17, 764 with*
2684. C. S. 1884

War Department,

Adjutant General's Office,

Washington, *October 11*, 1884.

The charge *of desertion of No. 22*
1865,

against this man removed and he is discharged
to date *Nov. 22*, 1865, under the pro-
visions of the act of Congress, approved July 5, 1884.

Discharge certificate furnished by Adjutant General's
Office *Oct. 14*, 1884.

(413b)

J. L. Robinson Copyist.

Loffin York

P, Co. *J*, *11* Reg't *U. S. C. I*

Enclosures.

Bed Cards	Final Statements
Burial Records	Furloughs or L. of A
Certs. of Dis. for Discharge	Med. Certificates
C. M. Charges	Med. Des. Lists
Descriptive Lists	Orders
Discharge Certificates	Pris. of War Record
Enlistment Papers	Resignations

Other papers relating to—

Admission to Hosp'l	Furlough or L. of A
Casualty Sheet	Med. Examination
Confinement	Misc. Information
Contracts	Pay or Clothing
Death or Effects	Personal Reports
Desertion	Rank
Discharge from Hosp'l	Transfer to Hosp'l
Discharge from Service	Transfer to V. R. C.
Duty	Transportation

York Coffee Pot

Co. D. 11th U.S.C.T. (reg)

Ellertson

Adjutant General's Office,

COLORED TROOPS BRANCH,

Mr. Ellertson

June 18th, 1877

Vol. C. T., 187

Wanted in the case of *York Coffin* *Prov. Co. I,*
11th Reg't U.S.C. Tro (new) Date & cause of reductions
 "Reduced to ranks (from Sgt) S.O. 103. Ad 2 to 11th U.S.C. Inf (no date)
 promoted to Corp'l May 23. 65" - M.R. May & June 1865.
 Born on subsequent M.Rolls as Private - (date of
 reduction not given.)

AJC

Respectfully,

R. A. Woodward,
 Chief Clerk.

P. J. Haerton

Adjutant General's Office,

Div. Records discontinued. Quids. &c
June 23rd, 1877

Vol. C. T., 187

Reply in case of *York Coffin*, Co. *I,*
11th Reg't U.S.C.T.

Reg'l. Order Book. Reduced to the ranks from Sgt.,
Cause: Excess in organization, to date May 10th 1865,
per S.O. no. 103 Reg'l. M.O. of May 22nd 1865.
Appointed a Corp'l. to date June 17th 65 per
S.O. No. 116 Reg'l. M.O. June 17th 1865.
Reduced to the ranks from Corp'l, for disob. of orders,
being out of Camp without leave, per S.O. 155 Reg'l.
M.O. of Aug. 17th 1865, to date Aug. 16th 1865.

W.F.

6 3 3 3 3 6 5
6 3 3 3 3 6
6 3 3 3 3 9
6 3 3 3 3 9 6
6 3 3 3 4 7 2
6 3 3 3 5 5 2
6 3 3 3 6 2 4
6 3 3 3 6 9 7
6 3 3 3 7 7 1
6 3 3 3 8 4 2
6 3 3 3 9 0 8
9 0 7 2 4 8 2

31
32
33
34
35
36
37
38
39
40
41
42
43
44
45
46
47
48
49
50

Book Mark:

See also

C. J. | **11 (New) U.S.C.T.**
Green Cole
Co. *A*, 11 Reg't U.S. Col'd Inf. ^(New)

Appears on
Company Descriptive Book

of the organization named above.

DESCRIPTION.

Age *35* years height *5* feet *6* inches.

Complexion *Black*

Eyes; *Black* hair *Black*

Where born *Chatham Co. C.*

Occupation *Farmer*

ENLISTMENT.

When *March*, 186*4*

Where *Memphis Tenn*

By whom *Slaughter*; term *3* y'rs.

Remarks:

Rover
Copist.

le | 11 (New). | U.S.C.T.

Green Cole
Priv., Co. I, 6 Reg't U. S. Col'd H. Art'y.†

Appears on

Company Muster-in and Descriptive Roll
of the organization named above. Roll dated

Fort Pickens Memphis Tenn. Apr. 2, 1864.

Where born Chatham Co. N.C.

Age 35 y'rs; occupation Farmer

When enlisted March 1, 1864.*

Where enlisted Memphis Tenn.

For what period enlisted 3 years.

Eyes black; hair black

Complexion black; height 5 ft. 6 in.

When mustered in March 1, 1864.*

Where mustered in

Bounty paid \$ 100; due \$ 100

Where credited Oakalona Chickasaw Co.

Mississippi
Company to which assigned

Remarks:

† This organization subsequently became Co. I, 11 Reg't U. S. Col'd H. Art'y. New.

*M. shows enrollment and muster-in of this company as of March 1, 1864. See enrollment on subsequent card or cards.

Boo' mark:

Milliken

6

11 (New).

U.S.C.T.

Green, Cole

Priv., Co. I, 6 Reg't U. S. Col'd H. Art'y.†

Appears on

Company Muster Roll

for Mar, + Apr., 1864.

Joined for duty and enrolled:

When Mar, 1st, 1864.*

Where Memphis Tenn.*

Period 3 years.*

Present or absent present

Stoppage, \$ 100 for

Due Gov't \$ 100 for

Remarks: Must in at Memphis Tenn

† This organization subsequently became Co. I, 11 Reg't U. S. Colored Infantry (New).

* See enrollment on card from muster-in roll.

Book mark:

Miliken

le | 11 (New). | U.S.C.T.

Green Cole

Private, Co. I, 7 Reg't U. S. Col'd H. Art'y.†

Appears on

Company Muster Roll

for May + June, 1864.

Joined for duty and enrolled:

When 1st Mar., 1864.*

Where Memphis Tenn.*

Period 3 years.*

Present or absent present

Stoppage, \$ 100 for

Due Gov't, \$ 100 for

Remarks: Daily duty as
Co. Clerk

†This organization subsequently became Co. I, 11 Reg't U. S. Col'd Infantry (New).

* See enrollment on card from muster-in roll.

Book mark:

Milliken

6 | 11 (New). | U.S.C.T.

Green Cole

Private, Co. I, 7 Reg't U. S. Col'd H. Art'y.†

Appears on

Company Muster Roll

for July & Aug., 1864.

Joined for duty and enrolled:

When 1st Mar., 1864.*

Where Memphis Tenn. *

Period 3 years.*

Present or absent

Stoppage, \$ 100 for

Due Gov't, \$ 100 for

Remarks: Daily duty as book

†This organization subsequently became Co. I, 11 Reg't U. S. Col'd Infantry (New).

* See enrollment on card from muster-in roll.

Book mark:

Milliken

6 | 11 (New). | U.S.C.T.

Green Cole

Private, Co. I, 7 Reg't U. S. Col'd H. Art'y.†

Appears on

Company Muster Roll

for Sept. + Oct., 1864.

Joined for duty and enrolled:

When 1st March, 1864.*

Where Memphis Tenn. *

Period 3 years.*

Present or absent present

Stoppage, \$ 100 for

Due Gov't, \$ 100 for

Remarks: Daily duty as Co. book.

†This organization subsequently became Co. I, 11 Reg't U. S. Col'd Infantry (New).

* See enrollment on card from muster-in roll.

Book mark:

Milliken

11 (New). U.S.C.T.

Green Cole

Priv., Co. I, 7 Reg't U. S. Col'd H. Art'y.†

Appears on

Company Muster Roll

for Nov. & Dec., 1864.

Joined for duty and enrolled:

When 1st Mar., 1864.*

Where Memphis Tenn. *

Period 3 years.*

Present or absent present

Stoppage, \$ 100 for

Due Gov't, \$ 100 for

Remarks: On daily duty as
Co. book.

†This organization subsequently became Co. I, 11 Reg't U. S. Col'd Infantry (New).

* See enrollment on card from muster-in roll.

Book mark:

Milliken

C | 11 (New) | U.S.C.T.

Green Cole

Private, Co. I, 11 Reg't U. S. Col'd Inf. (New.)
Appears on

Company Muster Roll

for *Jan & Febr*, 186*6*.

Joined for duty and enrolled:

When *March 1*, 186*4*.*

Where *Memphis Tenn.* *

Period *3* years.*

Present or absent *Present*

Stoppage, \$ *100* for

Due Gov't \$ *100* for

Remarks:

* See enrollment on card from muster-in roll.

Book mark:

M. A. Michaels

(358c)

Copyist.

C | 11 (New) | U.S.C.T.

Green Cole

Private, Co. I, 11 Reg't U. S. Col'd Inf. (New.)
Appears on

Company Muster Roll

for March & Apr., 1865.

Joined for duty and enrolled:

When March 1, 1865.*

Where Memphis Tenn.*

Period 3 years.*

Present or absent Present

Stoppage, \$ 100 for

Due Gov't \$ 100 for

Remarks:

* See enrollment on card from muster-in roll.

Book mark:

(358c)

M. A. Michaels
Copyist.

C | 11 (New) | U.S.C.T.

Green Cole

Private, Co. I, 11 Reg't U. S. Col'd Inf. (New.)
Appears on

Company Muster Roll

for May & June, 1865.

Joined for duty and enrolled:

When March 1, 1864.*

Where Memphis Tenn. *

Period 3 years.*

Present or absent Present

Stoppage, \$ 100 for

Due Gov't \$ 100 for

Remarks:

* See enrollment on card from muster-in roll.

Book mark: -----

M. A. Michaels

C | 11 (New) | U.S.C.T.

Green Cole

Private, Co. I, 11 Reg't U. S. Col'd Inf. (New.)
Appears on

Company Muster Roll

for *July & Aug.*, 1865.

Joined for duty and enrolled:

When *March 1*, 1864.*

Where *Memphis Tenn* *

Period *3* years.*

Present or absent *Present*

Stoppage, \$ *100* for

Due Gov't \$ *100* for

Remarks:

* See enrollment on card from muster-in roll.

Book mark:

M. A. Michaels

(358c)

Copyist.

C | 11 (New) | U.S.C.T.

Green Cole

Private, Co. I, 11 Reg't U. S. Col'd Inf. (New.)
Appears on

Company Muster Roll

for *Sept + Oct*, 186*5*.

Joined for duty and enrolled:

When *March 1*, 186*4*.*

Where *Memphis Tenn* *

Period *3* years.*

Present or absent *present*

Stoppage, \$ *100* for

Due Gov't \$ *100* for

Remarks: *Daily duty as Co Cook*

* ~~See~~ See enrollment on card from muster-in roll.

Book mark:

M. A. Michaels

(358c)

Copyist.

B | **11** (New) | **U.S.C.T.**

Green Lake

Priv., Co. I, 11 Reg't U. S. Col'd Inf. (New.)
Appears on

Company Muster Roll

for *Nov. and Dec.*, 1865.

Joined for duty and enrolled:

When *March*, 1864.*

Where *Memphis Tenn.**

Period *3* years.*

Present or absent *Present*

Stoppage, \$ *100* for

Due Gov't \$ *100* for

Remarks:

* See enrollment on card from muster-in roll.

Book mark:

J. J. Mebler

(358c)

Copyist.

B | **11** (New). **U.S.C.T.**

Green Lake

Co. I, 11 Reg't U. S. Col'd Inf. (New).

Appears on **Co. Muster-out Roll**, dated

Memphis Tenn Jan 12, 1866.

Muster-out to date *Jan 12*, 1866.

Last paid to *June 30*, 1865.

Clothing account:

Last settled....., 186 ; drawn since \$..... 100

Due soldier \$ *5 01* / 100; due U. S. \$..... 100

Am't for cloth'g in kind or money adv'd \$..... 100

Due U. S. for arms, equipments, &c., \$..... 100

Bounty paid \$..... 100; due \$..... 100

Remarks:.....
.....
.....
.....
.....

Book mark:.....

D. P. Webster

304

Cole, John
Co *E* 11 U.S. Col'd Inf.

(New Organization.)

Private | *Private*

CARD NUMBERS.

1	6322769	26
2	6329154	27
3	6329240	28
4	6329316	29
5	6329392	30
6	6329462	31
7	6329527	32
8	6329603	33
9	6329683	34
10	6329746	35
11	6329806	36
12	9071886	37
13		38
14		39
15		40
16		41
17		42
18		43
19		44
20		45
21		46
22		47
23		48
24		49
25		50

Book Mark: _____

See also _____

61 11 (new) U.S.C.T.

John Cole

, Co. B, 11 Reg't U. S. Col'd Inf. (new)

Appears on

Company Descriptive Book

of the organization named above.

DESCRIPTION.

Age 18 years; height 5 feet 9 inches.

Complexion Dark

Eyes Black; hair Black

Where born Tennessee

Occupation

ENLISTMENT.

When July 26, 1864.

Where Memphis Tenn

By whom Capt Carlisle, term 3 y'rs.

Remarks:

[Signature]

C

11 (New). U.S.C.T.

John Cole

Appears with rank of Pr on

Muster and Descriptive Rolls of Detachments of U. S. Vols. forwarded

for the 11th U.S. C. H. A. Reg't U. S. Col'd. Chy Roll dated

Memphis Tenn, July 28, 1864.

Where born Tennessee

Age 18 y'rs; occupation

When enlisted July 26, 1864.

Where enlisted Memphis Tenn

For what period enlisted 3 years.

Eyes Black; hair Black

Complexion Dark; height 5 ft. 9 in.

When mustered in July 28, 1864.

Where mustered in Memphis Tenn

Bounty paid \$ 100; due \$ 100

Where credited

Company to which assigned E

Remarks:

Book mark:

Ashley

C | **11** (New). | **U.S.C.T.**

John Cole
Priv, Co. E, 7 Reg't U. S. Col'd H. Art'y.*

Appears on

Company Muster Roll
for *July & Aug.*, 186*4*
Present or absent *Present*

Stoppage, \$ *100* for

Due Gov't, \$ *100* for

Remarks: *Joined a recruit*
July 26, 1864.

* This organization subsequently became Co. E, 11 Reg't U. S. Colored Infantry (New).

Book mark: _____

Crenshaw

C | 11 (New). | U.S.C.T.

John Cole
Priv., Co. E, 7 Reg't U. S. Col'd H. Art'y.*

Appears on

Company Muster Roll
for Sept. & Oct., 1864.
Present or absent Present

Stoppage, \$ _____ 100 for _____

Due Gov't, \$ _____ 100 for _____

Remarks: Stop for one canteen
& haversack \$1.12.

* This organization subsequently became Co. E, 11 Reg't U. S. Colored Infantry (New).

Book mark: _____

Co | **11 (New).** | **U.S.C.T.**

John Cole

Priv, Co. E, 7 Reg't U. S. Col'd H. Art'y.*

Appears on

Company Muster Roll

for *Nov. & Dec.*, 186*4*

Present or absent *Present*

Stoppage, \$ *100* for

Due Gov't, \$ *100* for

Remarks: *Stop for one canteen
& one hand saw K.*

* This organization subsequently became Co. E, 11 Reg't U. S. Colored Infantry (New).

Book mark:

Crenshaw

C | 11 (New). | U.S.C.T.

John Cole

P. Co., Co. E, 11 Reg't U. S. Col'd Inf. (New).

Appears on

Company Muster Roll

for *Jan. & Feb.*, 1865

Present or absent *Present*

Stoppage, \$ *100* for

Due Gov't, \$ *100* for

Remarks: *top one Canton*
41 Haversack.

Book mark:

Louren

C

11 (New). U.S.C.T.

John Cole

Prvt, Co. E, 11 Reg't U. S. Col'd Inf. (New).

Appears on

Company Muster Roll

for *Mch & Apr*, 1865

Present or absent *Present*

Stoppage, \$ *100* for

Due Gov't, \$ *100* for

Remarks:

Book mark: _____

Loring

(858)

Copyist.

C | 11 (New). | U.S.C.T.

John Cole
Co. E, 11 Reg't U. S. Col'd Inf. (New).

Appears on

Company Muster Roll

for *May & June*, 1865.

Present or absent *Present*

Stoppage, \$ *100* for

Due Gov't, \$ *100* for

Remarks: *Stop for ord-*
nance 1.28

Book mark:

(858)

Lowry
Copyist.

C | 11 (New). | U.S.C.T.

John Cole

Co. E, 11 Reg't U. S. Col'd Inf. (New).

Appears on

Company Muster Roll

for July & Aug., 1865.

Present or absent Present

Stoppage, \$ 100 for

Due Gov't, \$ 100 for

Remarks: Stop for ordinance 1.28

Book mark:

(858)

Lowny

Copyst.

6

11 (New).

U.S.C.T.

John Cole
Co. E, 11 Reg't U. S. Col'd Inf. (New).

Appears on

Company Muster Roll

for Sep. & Oct., 1865

Present or absent Present

Stoppage, \$ 100 for

Due Gov't, \$ 100 for

Remarks: First instalment
of 100.00 bounty due
in accordance with
Gen'l Order, No. 224,
dated War Dept. A.G.O.
July 6/64

Book mark:

Lowry

6 | 11 (New). | U.S.C.T.

John Cole

Priv, Co. E, 11 Reg't U. S. Col'd Inf. (New).

Appears on

Company Muster Roll

for Nov. & Dec., 1865.

Present or absent Present

Stoppage, \$ 100 for

Due Gov't, \$ $\frac{20}{100}$ for ordnance

Remarks:

First instalment of \$100.00
found due, in accordance
with Gen. Ord. no 224, dated
Mar Dept. Adjt Gen'l Office
July 6th 1864

Book mark:

Valentine

6

11 (New). U.S.C.T.

John Cole

Priv. Co. E, 11 Reg't U. S. Col'd Inf. (New).

Appears on Co. Muster-out Roll, dated

Memphis Tenn Jan 12, 1866.

Muster-out to date Jan 12, 1866.

Last paid to June 30, 1865.

Clothing account:

Last settled , 186 ; drawn since \$ 100

Due soldier \$ 100 ; due U. S. \$ 39 ¹⁸/₁₀₀

Am't for cloth'g in kind or money adv'd \$ 100

Due U. S. for arms, equipments, &c., \$ ²⁰/₁₀₀

Bounty paid \$ 100 ; due \$ 100

Remarks:

Bounty due in accordance
with Genl Order No 224, War
Dept. July 6th 1864

Book mark:

53349

Valentine

(361)

Copyist.

305

Cole, Sandy

Co *A*, 11 U.S. Col'd Inf.

(New Organization.)

Private

Private

CARD NUMBERS.

1	6327479	26
2	6327554	27
3	6327634	28
4	6327738	29
5	6327824	30
6	6323019	31
7	6327917	32
8	6327999	33
9	6328032	34
10	6328069	35
11	6328130	36
12	6328257	37
13	6328623	38
14	9071688	39
15	9071596	40
16	9071536	41
17		42
18		43
19		44
20		45
21		46
22		47
23		48
24		49
25		50

Book Mark:

See also

C | 11 (New) U. S. C. T.

Sandy Cole

(New)
Co. *D*, 11 Reg't U. S. Col'd Inf.

Appears on

Company Descriptive Book

of the organization named above.

DESCRIPTION.

Age *20* years height *5* feet *6* inches.

Complexion *Black*

Eyes; *Blue* hair *Black*

Where born *Fayette Co., Tenn.*

Occupation *Field Hon.*

ENLISTMENT.

When *Oct. 6*, 1863.

Where *La Fayette Tenn*

By whom *(D. Carson)*; term *3* y'rs.

Remarks: *Was wounded at Fort
Pillar Apr 12th 1864*

C

11 (New) U. S. C. T.

Sandy Cole

(New)
Co. 20, 11 Reg't U. S. Col'd Inf.

Appears on

Company Descriptive Book

of the organization named above.

DESCRIPTION.

Age 20 years height 5 feet 6 inches.

Complexion Black

Eyes; Black hair Black

Where born Fayette Co, Tenn

Occupation Field Hand

ENLISTMENT.

When Oct 6, 1863.

Where Fayette Tenn

By whom D. Carson; term 3 y'rs.

Remarks: Died Mar. 14/65 at

Small Pox Hospital
Memphis, Tenn.

Sandy
Copyist.

C

11 (New) U.S.C.T.

Judy Cole

(New)
Co. A, 11 Reg't U.S. Col'd Inf.

Appears on

Company Descriptive Book

of the organization named above.

DESCRIPTION.

Age years height feet inches.

Complexion

Eyes; hair

Where born

Occupation

ENLISTMENT.

When , 186

Where

By whom ; term y'rs.

Remarks:
.....
.....
.....
.....
.....
.....
.....
.....

Scay Copyst.

W

11 (New). U.S.C.T.

Samuel Cole
Co. D, 1 Reg't Ala. Art'y.*

Age *20* years.

Appears on

Company Muster-in Roll

of the organization named above. Roll dated

Month *Miss*, *Oct 27*, 186*3*.

Muster-in to date

Oct 27, 186*3*

Joined for duty and enrolled:

When *Oct 6*, 186*3*.

Where *at Fayette Tenn*

Period *3* years.

Remarks:

* This organization subsequently became Co. *N*, 11 Reg't U. S. Colored Infantry (New).

Book mark:

Legis

C

11 (New). U.S.C.T.

Squady Cole
Pvt

Co. D, 1 Reg't Ala. Siege Art'y.*

Appears on

Company Muster Roll

for *from Enlistment to Oct 31, 1863.*

Present or absent *Present*

Stoppage, \$ *100* for

Due Gov't, \$ *100* for

Remarks: *Has never
drawn pay.*

*This organization subsequently became Co. D, 11 Reg't U. S. Col'd Infantry (New).

Book mark :

Leger

Cy

11 (New). U.S.C.T.

Sandy Cole

Pvt, Co. D, 1 Reg't Ala. Siege Art'y.*

Appears on

Company Muster Roll

for *Nov, Dec*, 186*3*.

Present or absent *Present*

Stoppage, \$ *100* for

Due Gov't, \$ *100* for

Remarks :
.....
.....
.....
.....
.....
.....
.....
.....
.....
.....
.....

*This organization subsequently became Co. D, 11 Reg't U. S. Col'd Infantry (New).

Book mark :

Leger

C | **11 (New).** | **U.S.C.T.**

Sandy Cole
Pvt, Co. D, 4 Battalion, 1 Reg't Tenn. H. Art'y.*

Appears on

Company Muster Roll

for *Jan & Feb*, 1864.

Present or absent *Present*

Stoppage, \$ *100* for

Due Gov't, \$ *100* for

Remarks :

* This organization subsequently became Co. D, 11 Reg't U. S. Colored Infantry (New).

Book mark :

Leggs
Copyist.

Cy 11 (New) U.S.C.T.

Sandy Cole
Prvt, Co. D, 7 Reg't U. S. Col'd H. Art'y.*

Appears on

Company Muster Roll
for *Mar. & Apr.*, 186*4*

Present or absent *Absent*

Stoppage, \$ *100* for

Due Gov't, \$ *100* for

Remarks: *In Wound City Hospital. Wounded at Fort Pillow April 12/86. Due cutter one dollar.*

*This organization subsequently became Co. D, 11 Reg't U. S. Col'd Infantry (New).

Book mark:

E J Cooke

6111 (new) **U.S.C.T.**

Sandy Cole

Prv., Co., (11th Regt. U.S. Col'd Infy.)
6 Reg't U. S. Col'd Hy. Art.

Appears on a

Detachment Muster Roll

of the organization named above

for *March & April*, 1864.

Station *Fort Pickering, Tenn.*

Present or absent *Absent*

Stoppage, \$ *100* for ..

Due Gov't, \$ *100* for ..

Remarks: *In Mound City
Hospital. Wounded at
Fort Piller, April 12th, 1864.*

Book mark: ..

Philipson

Q 11 (New) U.S.C.T.

Gandy Cole
Pvt., Co. D, 7 Reg't U. S. Col'd H. Art'y.*

Appears on

Company Muster Roll

for *May & June*, 186*4*.

Present or absent *Present*.

Stoppage, \$ *100* for

Due Gov't, \$ *100* for

Remarks :

*This organization subsequently became Co. D, 11 Reg't U. S. Col'd Infantry (New).

Book mark :

(858)

B J Cooke

Copyist.

Cy | **11 (New)** | **U.S.C.T.**

Sandy Cole
Cvt, Co. D, 7 Reg't U. S. Col'd H. Art'y.*

Appears on

Company Muster Roll

for *Apr. 30 to Aug. 31*, 1864.

Present or absent. *Present*

Stoppage, \$ *100* for

Due Gov't, \$ *100* for

Remarks :

*This organization subsequently became Co. D, 11 Reg't U. S. Col'd Infantry (New).

Book mark :

B. J. Cooke

C. J. | **11** (New) | **U.S.C.T.**

Sandy Cole
Priv, Co. D, 7 Reg't U. S. Col'd H. Art'y.*

Appears on

Company Muster Roll
for *Sept. & Oct.*, 1864.
Present or absent *Present*

Stoppage, \$ *100* for

Due Gov't, \$ *100* for

Remarks: *Records of Co. lost
in action at Ft. Pillow
Apr. 12. 64.*

*This organization subsequently became Co. D, 11 Reg't U. S. Col'd
Infantry (New).

Book mark:

(858)

B. J. Cooke

Copyist.

C. | **11** (New) | **U.S.C.T.**

Sandy Cole
Pvt, Co. D, 7 Reg't U. S. Col'd H. Art'y.*

Appears on

Company Muster Roll

for *Nov. & Dec.*, 1864.

Present or absent *Present.*

Stoppage, \$ *100* for

Due Gov't, \$ *100* for

Remarks :

*This organization subsequently became Co. D, 11 Reg't U. S. Col'd Infantry (New).

Book mark :

B. J. Cooke

C 11 (New). U.S.C.T.

Sandy Cole
Co. D, 11 Reg't U. S. Col'd Inf. (New).

Appears on

Company Muster Roll

for June and July, 1865.

Present or absent Present

Stoppage, \$ 100 for

Due Gov't, \$ 100 for

Remarks:

Book mark:

(858)

J. D. James

Copyist

6

11 (New). U.S.C.T.

Frederick Cole

Tenn., Co. D, 11 Reg't U. S. Col'd Inf. (New).

Appears on

Company Muster Roll

for *March and April*, 1865.

Present or absent

Stoppage, \$ 100 for

Due Gov't, \$ 100 for

Remarks: *Rec'd at small Post House
March 11/15, Memphis, Tenn.*

Book mark:

(858)

J. H. Jones

Copyist

C | 11 (New). | U.S.C.T.

Sandy Cole
Pr. A, 11 Reg't U. S. Col'd Inf. (New).

Appears on **Co. Muster-out Roll**, dated
Memphis Tenn, Jan. 12, 1866.

Muster-out to date _____, 186 .

Last paid to *Aug 31*, 1864.

Clothing account:

Last settled _____, 186 ; drawn since \$ _____ 100

Due soldier \$ _____ 100; due U. S. \$ _____ 100

Am't for cloth'g in kind or money adv'd \$ _____ 100

Due U. S. for arms, equipments, &c., \$ _____ 100

Bounty paid \$ _____ 100; due \$ _____ 100

Remarks:

died at Small Box
G. H. Memphis Tenn.
March 14/65,

Book mark: ~~*P. 214.68 - 2230*~~

P. 49. 76.

(361)

Hodges
Copyist.

Colt, Sandy

P, Co. **D**, **11** **Reg't** **U.S.C. Inf.**

4 Enclosures.

Bed Cards.....	Descriptive Lists.....
Burial Records.....	Final Statements 3
Certs. of Dis. for Discharge.....	Furloughs.....
C. M. Charges.....	Med. Des. Lists.....
Med. Certificates.....	Orders.....

Other papers relating to—

Admission to Hosp'l.....	Furlough.....
Casualty Sheet (Officer's).....	Med. Examination.....
Confinement.....	Misc. Information.....
Contracts.....	Pay or Clothing.....
Death or Effects..... /	Personal Reports.....
Desertions.....	Rank.....
Discharge from Hosp'l.....	Transfer to Hosp'l.....
Discharge from Service.....	Transfer to V. R. C.....
Duty.....	Transportation.....

V Co-D 5/

FINAL STATEMENT

OF
Sandy Cole
7th Reg't of U.S.C.A. (N.Y.)
7th U.S. Cavalry
VOLUNTEERS.
discharged 12/18/64

NOTE 1.—Two of these certificates (or duplicates) are to be given to each volunteer soldier who may be discharged previously to the discharge of his company, that he may at once receive from the Paymaster the pay, &c., due him, and the captain or other officer commanding the company will certify to the act of the delivery of the duplicate certificates; on these certificates the Soldier is "entitled" to his discharge, and should also present his discharge to the Paymaster to have the payment endorsed on it. The discharge is to be given back to the Soldier by the Paymaster; the latter only retaining as his voucher the duplicate certificates.

NOTE 2.—If the Soldier is entitled to pay for the use of his horse, the Company Commander will certify to that fact, and also to the time he has pay due for having been mounted on his own horse.

NOTE 3.—Amount due the Suttler and Laundress must be entered on the Muster Roll on which the death, desertion, &c., is reported, as well as on the final statement, otherwise the amount cannot be collected from the United States.

NOTE 4.—This blank will be used for deceased volunteers as well as others.

Returned to Company and
due March 14, 1865
See F.S. of that date.

ADJUTANT GENERAL'S OFFICE.
July 18th 1864
Duplicate with Inventory sent 2^d Auditor.

Emerson R. Appleton

I certify, on honor, that *Simey Cole* a *Private* of
 Captain *J. Curran* Company *A* of the *7th* Regiment of *U.S.C.A. (Ily)*
VOLUNTEERS, of the State of _____, born in _____, State
 of _____, aged *20* years; _____ feet _____ inches high; *Black* complexion,
Black eyes, *Black* hair, and by occupation a _____, having joined the company on
 its original organization at *St. Haytham Tenn.* and enrolled in it at the muster into
 the service of the United States at *Corinth Miss.*, on the *Twenty Fourth* day
 of *October*, 1863, (or was mustered in service as a recruit, by _____
 _____ at _____, on the _____ day of _____
 186____, to serve in the Regiment.) for the term of *Three years unless sooner discharged*
 and having served **HONESTLY** and **FAITHFULLY** with his Company in *The Field*
 to the present date, is now entitled to a **DISCHARGE** by reason of *Wounding in action*
at Fort Pillow Tenn April 4th 1864 Sup. paid to be
Willed

The said *Simey Cole* was last paid by Paymaster
Wm. Sullivan to include the *Third* day of *December* 1863, and has
 pay due him from that time to the present date; he is entitled to pay and subsistence for
TRAVELING to place of enrollment and whatever other allowances are authorized to volunteer
 soldiers, or militia, so discharged. He has received _____ dollars,
 advanced by the United States on account of **CLOTHING**.

There is to be stopped from him, on account of the State of _____, or other
 authorities for **CLOTHING**, &c., received on entering service, _____ dollars; also,
 for expenses of **SUBSISTENCE** for **TRAVELING** from place of enrollment to the place of rendezvous,
 amounting to _____ dollars: and on account of the United States for **EXTRA**
CLOTHING received in kind from _____ and for other
 stoppages, viz:

The Books & Papers of the Co were all lost at
Fort Pillow in action April 4th 1864 amounting to *unable to tell* dollars;
 and he has been **SUBSISTED** for **TRAVELING** to his place of enrollment, up to the _____
 _____, 186_____.

He is indebted to *Cross* _____ **SUTLER**, *one* _____ dollars.

He is indebted to _____ **LAUNDRESS**, _____ dollars.

Given in Duplicate, at *Fort Ripley*, this *21st* day of *June*, 1864

W. B. Benson
U.S.C.A. (Ily)

 Commanding Company.

1864 Sep Roll, 57

FINAL STATEMENT

OF

Sandy Cole

7th Reg't of U.S. C. (A. H.)

VOLUNTEERS.

NOTE 1.—Two of these certificates (or duplicates) are to be given to each volunteer soldier who may be discharged previously to the discharge of his company, that he may at once receive from the Paymaster the pay, &c., due him, and the captain or other officer commanding the company will certify to the act of the delivery of the duplicate certificates; on these certificates the Soldier is "entitled to" his *discharge*, and should also present his discharge to the Paymaster to have the payment endorsed on it. The discharge is to be given back to the Soldier by the Paymaster; the latter only retaining as his voucher the duplicate certificates.

NOTE 2.—If the Soldier is entitled to pay for the use of his horse, the Company Commander will certify to that fact, and also to the time he has pay due for having been so mounted on his own horse.

NOTE 3.—Amounts due the Sutler and Laundress must be entered on the Muster Roll on which the death, desertion, &c., is reported, as well as on the final statement, otherwise the amount cannot be collected from the United States.

NOTE 4.—This blank will be used for deceased volunteers as well as others.



I certify, on honor, that Sandy Cole a Private of
 Captain L. Brown Company (D) of the 7th Regiment of U.S. C. A. Fly
VOLUNTEERS, of the State of _____, born in _____, State
 of _____, aged 20 years; _____ feet _____ inches high; Black complexion,
Black eyes, Black hair, and by occupation a _____, having joined the company on
 its original organization at La Hayell Ga, and enrolled in it at the muster into
 the service of the United States at Corinth Miss, on the Twenty seventh day
 of October, 1863, (or was mustered in service as a recruit, by _____

at _____, on the _____ day of _____
 186____, to serve in the Regiment.) for the term of Three years unless soon discharged
 and having served **HONESTLY** and **FAITHFULLY** with his Company in The Field
 to the present date, is now entitled to a **DISCHARGE** by reason of Missing in action
at Fort Pillow Tenn April 12th 1864 supposed to have
killed

The said Sandy Cole was last paid by Paymaster
Wm. J. Brown to include the Thirty first day of December, 1863, and has
 pay due him from that time to the present date; he is entitled to pay and subsistence for
TRAVELING to place of enrollment and whatever other allowances are authorized to volunteer
 soldiers, or militia, so discharged. He has received _____ dollars,
 advanced by the United States on account of **CLOTHING**.

There is to be stopped from him, on account of the State of _____, or other
 authorities for **CLOTHING**, &c., received on entering service, _____ dollars; also,
 for expenses of **SUBSISTENCE** for **TRAVELING** from place of enrollment to the place of rendezvous,
 amounting to _____ dollars: and on account of the United States for **EXTRA**
CLOTHING received in kind from _____ and for other
 stoppages, viz:

The books & paper of the Personal Post instruction
at Fort Pillow April 1864 amounting to unable to tell dollars;
 and he has been **SUBSISTED** for **TRAVELING** to his place of enrollment, up to the _____

_____ 186____
 He is indebted to Cruggs **SUTLER**, one _____ dollars.
 He is indebted to _____ **LAUNDRESS**, _____ dollars.

Given in Duplicate, at Fort Pickens, this 21st day of June, 1864
W. B. Edson
U.S. C. A. Fly
 Commanding Company.

lev-D. 18.
FINAL STATEMENT

OF

Sandy Cole

11th Regt of U. S. C. I.
Died March 14th 1865.
VOLUNTEERS.

"Died at Memphis Tennessee"

NOTE 1.—Two of these certificates (or duplicates) are to be given to each Volunteer Soldier or drafted man who may be discharged previously to the discharge of his company, that he may at once receive from the Paymaster the pay, &c., due him, and the captain or other COMMISSIONED officer commanding the company will certify to the act of the delivery of the duplicate certificates; on these certificates the Soldier is "entitled to" his discharge, and should also present his discharge to the Paymaster to have the payment endorsed on it. The discharge is to be given back to the Soldier by the Paymaster; the latter only retaining as his voucher the duplicate certificates.

NOTE 2.—If the Soldier is entitled to pay for the use of his horse, the Company Commander will certify to that fact on the back of both these final statements, and also to the time he has pay due for having been so mounted on his own horse.

NOTE 3.—When a Soldier is furnished with final statements, his descriptive list, if he has one, should be taken up by the officer who gives the Soldier these statements, and endorsed with a statement to this effect by the officer. This endorsement should exhibit a full statement of the time for which the Soldier was allowed pay on his final statements, the clothing account, and all other charges against him or in his favor, so as to comprise a complete exhibit of his account. It will then be transmitted to the company commander of the Soldier, who will enter all the data necessary to a full understanding of the Soldier's account on the muster roll upon which the Soldier's discharge is reported. The descriptive list will then be destroyed. The object of this is, that the remaining portion of the Soldier's account may be settled upon the receipt of these muster rolls, and the Soldier receive any pay or allowances that may be due him at the time of his discharge, and which may not appear on his final statements from the fact that his descriptive list is incomplete. These accounts for back pay, &c., are settled by the 2d Auditor of the Treasury Department.

NOTE 4.—Charges for loss or injury to ordnance, horse equipments, and other miscellaneous charges, should appear under the heading of "Other Stoppages."

NOTE 5.—Bounty paid by State authorities, and not by the United States, will not be entered on this statement.

NOTE 6.—Amounts due the Sutler and Laundress must be entered on the muster roll on which the discharge, death, desertion, &c., is reported, as well as on the final statement, otherwise the amount cannot be collected from the United States.

NOTE 7.—This blank will be used for deceased volunteers and drafted men, as well as for others.

NOTE 8.—Where a Soldier dies in Hospital or on detached service, his descriptive list, if he has one, should be sent with his final statements, in duplicate, to the Second Auditor, Washington, D. C.

Capt on Co of Co

A. G. O.
Recd from 2d Auditor
7/19

ADJUTANT GENERAL'S OFFICE.

March 29th 1865.

Duplicate with Inventory sent 2d Auditor.

I certify, on honor, that Sandy Cole a Private of
 Captain W. Bladron's Company (D.) of the 11th Regiment of U. S. C. I.
VOLUNTEERS, of the State of _____, born in Fayette County, State
 of Tennessee, aged 20 years; 5 feet 6 inches high; Black complexion,
Black eyes, Black hair, and by occupation a Field Hand, having joined the company on
 its original organization at La Fayette Tennessee, and enrolled in it at the muster into
 the service of the United States at Corinth Miss, on the 27th day
 of October, 1863, (or was mustered in service as a recruit, by _____
 _____, at _____, on the _____ day of _____,
 186 , or was drafted and mustered into the service of the United States from the _____
 Enrollment District of the State of _____, at _____,
 on the _____ day of _____, 186), to serve in the Regiment, for
 the term of Three Years; and having served HONESTLY and
 FAITHFULLY with his Company in the Field to the present date, is now
 entitled to a **DISCHARGE** by reason of death Died at Small Pox Hospital
Memphis Tenn March 14th 1865 of Small Pox

The said Sandy Cole was last paid by Paymaster
Maj. Smith to include the 31st day of August, 1864, and has
 pay due him from that time to the present date; he is entitled to pay and subsistence for
 TRAVELING to place of enrollment, and whatever other allowances are authorized to volunteer
 soldiers, drafted men, or militia, so discharged. He has received from the United States **CLOTHING**
 amounting to 44 ²³/₁₀₀ dollars, since the 12th day of April,
 1864, when his clothing account was last settled. He has received from the United States
 dollars advanced **BOUNTY**.

There is to be stopped from him, on account of the State of _____, or other
 authorities, for **CLOTHING**, &c., received on entering service, _____ dollars; and
 for other stoppages, viz: _____
 _____ dollars.

He has been furnished with **TRANSPORTATION** in kind from the place of his discharge to
 _____; and he has been **SUBSISTED** for **TRAVELING** to his
 place of enrollment, up to the _____, 186 .

He is indebted to _____, **SUTLER**, _____ dollars.

He is indebted to _____, **LAUNDRESS**, _____ dollars.

Given in Duplicate, at Memphis Tennessee, this 18th day
 of March, 1865.

G. B. Montgomery

Chief Surgeon U.S. Army in chg Hosp
 Commanding Company.

Small Post Genl Hospital
Memphis Tennessee
March 19th 1865

Remington G. F.
A.A. Surgeon U.S.A.
Incharge Hospital

Notification of the Death
of Private Sandy Cole
Late of "D" Co., 11th U.S.C.I.

Small Pox

U. S. Army General Hospital,

Memphis Tenn March 19th 1865

I have to report that Private Sandy Cole
of Company "D" 11th Regiment U. S. C. S. Died in this General
Hospital on the 14th day of March 1865
Cause of Death "Small Pox"

Very respectfully,

Your obedient servant,

G. H. W. W. W. W. W.

A. A. Surgeon U. S. A. in chg Hosp't.

Comd'g Officer I. Co.
11th Regt U. S. C. S. Memphis
Tenn

Cole, William

Co *G*, 11 U.S. Col'd Inf.

(New Organization.)

Private | *Private*

CARD NUMBERS.

1	6322614	26
2	6330960	27
3	6331044	28
4	6331132	29
5	6331217	30
6	6331298	31
7	6331381	32
8	6331463	33
9	6331548	34
10	6331630	35
11	6331712	36
12	6331784	37
13	6331858	38
14	6331927	39
15	9072222	40
16		41
17		42
18		43
19		44
20		45
21		46
22		47
23		48
24		49
25		50

Book Mark:

See also

8654419 - Page
S-1137937 - Corn + m
A. 1477668. Po. red
D. 2234480 and 121.

6 | **11** *(New)* | **U. S. C. T.**

William Leale
(New)
Co. *G*, 11 Reg't U. S. Col'd Inf.

Appears on
Company Descriptive Book
of the organization named above.

DESCRIPTION.

Age *40* years height *5* feet *6 1/2* inches.
Complexion *Black*
Eyes; *BRN* hair *BRN*
Where born *Alabama*
Occupation *Laborer*

ENLISTMENT.

When *Jan 12*, 1864.
Where *Fort Pickens*
By whom *Col. Hopper*; term *3* y'rs.
Remarks:

A. J. Anderson

6

11 (New). U.S.C.T.

William Cole

Appears with rank of *Pri* on

Muster and Descriptive Rolls of Detachments of U. S. Vols. forwarded

for the 11 Reg't U. S. Col'd *Inf*. Roll dated *Memphis Tenn, Feb 2*, 1864.

Where born *Alabama*

Age *40* y'rs; occupation

When enlisted *Jan 12*, 1864.

Where enlisted *Fort-Pickering*

For what period enlisted *3* years.

Eyes *black*; hair *black*

Complexion *black*; height *5* ft. *6 1/2* in.

When mustered in *Feb 4*, 1864.

Where mustered in *Fort-Pickering*

Bounty paid \$ *100*; due \$ *100*

Where credited

Company to which assigned

Remarks:

Book mark: *3088*

6 | 11 (New). | U.S.C.T.

William Cole
Sgt., Co. E, 1 Battalion, 1 Reg't Tenn. H. Art'y.†

Age years.

Appears on

Company Muster Roll*

for *Feb 4 to 12*, 186*4*.

Joined for duty and enrolled:

When *Jan 12*, 186*4*.

Where *Fort Pickering*

Period *3* years.

Mustered in:

When *Feb 4*, 186*4*.

Where *Fort Pickering*

Present or absent *Present*

Stoppage, \$ 100 for

Due Gov't \$ 100 for

Remarks:

† This organization subsequently became Co. G, 11 Reg't U. S. Colored Infantry (New).

* First current roll. No muster-in roll of this company on file. This roll shows enrollment of all men of this company as of same date. See enrollment on subsequent card or cards.

Book mark:

Salleads

6

11 (New).

U.S.C.T.

William Cole

Pvt., Co. G, 6 Reg't U. S. Col'd H. Art'y.†

Appears on

Company Muster Roll

for Feb + Apr, 1864.

Joined for duty and enrolled:

When Jan 12, 1864*

Where Ht Pickering*

Period 3 years.*

Present or absent Present

Stoppage, \$ 100 for

Due Gov't \$ 100 for

Remarks:

* This organization subsequently became Co. G. 11 Reg't U. S. Colored Infantry (New).

* See enrollment on card from first current roll.

Book mark:

Ballade

6 | 11 (New). | U.S.C.T.

William Cole
Pvt., Co. G, 7 Reg't U. S. Col'd H. Art'y.†

Appears on

Company Muster Roll

for May & June, 1864.

Joined for duty and enrolled:

When Jan 12, 1864.*

Where Ft Pickering *

Period 3 years.*

Present or absent Present

Stoppage, \$ 100 for _____

Due Gov't, \$ 100 for _____

Remarks: _____

† This organization subsequently became Co. G, 11 Reg't U. S. Colored Infantry (New).
* ~~See~~ See enrollment on card from first current roll.

Book mark: _____

(358c)

Dallade
Copyist.

11 (New), U.S.C.T.
William Coie
Sgt., Co. G, 7 Reg't U. S. Col'd H. Art'y. †

Appears on

Company Muster Roll

for Nov 7 1864, 1864

Joined for duty and enrolled:

When Jan 12, 1864.*

Where Ft Pickens *

Period 3 years.*

Present or absent Present

Stoppage, \$ 100 for

Due Gov't, \$ 100 for

Remarks: _____

† This organization subsequently became Co. G, 11 Reg't U. S. Colored Infantry (New).
* See enrollment on card from first current roll.

Book mark: _____

(358c) Callade Copyist.

6 | **11** (New). | **U.S.C.T.**

William Cole
Sgt, Co. G, 7 Reg't U. S. Col'd H. Art'y.†

Appears on

Company Muster Roll

for *Sept & Oct*, 186*4*

Joined for duty and enrolled:

When *Jan 12*, 186*4*.*

Where *Ft. Pickering**

Period *3* years.*

Present or absent *Present*

Stoppage, \$ *100* for

Due Gov't, \$ *100* for

Remarks: *On daily duty in Engineer Dept. since Sept. 15, 1864.*

Stoppage for loss of Haversack & Canteen #1. $\frac{12}{100}$

† This organization subsequently became Co. G, 11 Reg't U. S. Colored Infantry (New).

* See enrollment on card from first current roll.

Book mark: _____

Sallade

10 | **11 (New).** | **U.S.C.T.**

William Cole
Co. G, 7 Reg't U. S. Col'd H. Art'y.†

Appears on

Company Muster Roll

for *Nov - Dec*, 1864.

Joined for duty and enrolled:

When *Jan 12*, 1864.*

Where *Fort Pickens* *

Period *2* years.*

Present or absent *Present*

Stoppage, \$ *100* for

Due Gov't, \$ *100* for

Remarks: *Stoppage for Bus
Canteen + Sawmill 4, 12*

† This organization subsequently became Co. G, 11 Reg't U. S. Colored Infantry (New).
* See enrollment on card from first current roll.

Book mark: _____

Dallade

6. | 11 (New). | U.S.C.T.

William Cole

Privt, Co. G, 11 Reg't U. S. Col'd Inf. (New).

Appears on

Company Muster Roll
for *Jan & Feb*, 186*5*.

Joined for duty and enrolled:

When *Jan 12*, 186*4*.*

Where *Ft. Pickering*, *

Period *3* years.*

Present or absent. *Present*.

Stoppage, \$ *100* for

Due Gov't \$ *100* for

Remarks: *Stoppage \$1.12 for C. & G. Equip. brot forward from Rolls of Nov. & Dec. '64.*

* ~~See~~ See enrollment on card from first current roll.

Book mark: _____

Ramsey

(358c)

Copyist.

C. | 11 (New). | U.S.C.T.

William Cole

Pvt., Co. G, 11 Reg't U. S. Col'd Inf. (New).

Appears on

Company Muster Roll

for Mar & Apr, 1865.

Joined for duty and enrolled:

When Jan 12, 1864.*

Where Ft Pickering.*

Period 3 years.*

Present or absent Present.

Stoppage, \$ 100 for

Due Gov't \$ 100 for

Remarks:

* See enrollment on card from first current roll.

Book mark:

Ramsey
Capt.

(358c)

Co. | **11** (New). | **U.S.C.T.**

William Cole

Priv., Co. G, 11 Reg't U. S. Col'd Inf. (New).

Appears on

Company Muster Roll

for *May & June*, 186*5*.

Joined for duty and enrolled:

When *Jan 12*, 186*4*.*

Where *Ft Pickering*. *

Period *3* years.*

Present or absent *Present.*

Stoppage, \$ *100* for

Due Gov't \$ *100* for

Remarks:

* ~~See~~ See enrollment on card from first current roll.

Book mark:

Rumsey
C. pyist.

C. | **11** (New). | **U.S.C.T.**

William Cole

Priv, Co. G, 11 Reg't U. S. Col'd Inf. (New).

Appears on

Company Muster Roll

for *July & Aug.*, 1865.

Joined for duty and enrolled:

When *Jan 12*, 1864.*

Where *7th Pickering*.*

Period *3* years.*

Present or absent *Present.*

Stoppage, \$ *100* for

Due Gov't \$ *100* for

Remarks: _____

* ~~See~~ See enrollment on card from first current roll.

Book mark: _____

(358c)

Ramsey C. Sgt.

C. | 11 (New). | U.S.C.T.

William Cole

Priv., Co. G, 11 Reg't U. S. Col'd Inf. (New).

Appears on :

Company Muster Roll
for Sept & Oct, 1865.

Joined for duty and enrolled:

When Jan 12, 1864.*

Where Ft Pickering *

Period 3 years.*

Present or absent Present.

Stoppage, \$ 100 for

Due Gov't \$ 100 for

Remarks :

* See enrollment on card from first current roll.

Book mark :

(358c)

Ramsey
Capt.

C

11 (New). U.S.C.T.

William Cole

Pvt, Co. G, 11 Reg't U. S. Col'd Inf. (New).

Appears on

Company Muster Roll

for *Nov, & Dec.*, 1865.

Joined for duty and enrolled:

When *Jan. 12.*, 1864.*

Where *Fort Pickens* *

Period *3* years.*

Present or absent. *Present*

Stoppage, \$ *100* for

Due Gov't \$ *100* for

Remarks :

* See enrollment on card from first current roll.

Book mark :

(358c)

Copyst.

C

11 (New).

U.S.C.T.

William Cole,

Pvt G, 11 Reg't U. S. Col'd Inf. (New).

Appears on Co. Muster-out Roll, dated

Murphy's T., *Jan. 12*, 1866.

Muster-out to date

Jan. 12, 1866.

Last paid to

June 20, 1865.

Clothing account:

Last settled 186 ; drawn since \$ 100

Due soldier \$ *13 50* 100; due U. S. \$ 100

Am't for cloth'g in kind or money adv'd \$ 100

Due U. S. for arms, equipments, &c., \$ 100

Bounty paid \$ 100; due \$ 100

Remarks:

Book mark: *V 24 P. 38 68*

(381)

[Signature]

Copyist.

Coleman, Alfred

Co B, 11 U.S. Col'd Inf.

(New Organization.)

Private

Private

CARD NUMBERS.

1	6322380	26
2	6325060	27
3	6325-137	28
4	6325-234	29
5	6325-338	30
6	6325440	31
7	63255-34	32
8	6325-618	33
9	6325-653	34
10	6325-685	35
11	6325753	36
12	6325-819	37
13	6325-887	38
14	6325-967	39
15	6326085	40
16	6323332	41
17	6323337	42
18	6326316	43
19	1071065	44
20	9070959	45
21	Q-125-QJ-1875	46
22		47
23		48
24		49
25		50

Book Mark: 1888-65-1885
+ 213-18/13 Q-125-QJ-1875

See also

S-1889362 - P.M.M.

A290502 - and

6

11 (tw) U. S. C. T.

Alfred Coleman

Co. K, 11 Reg't U. S. Col'd Inf. (tw)

Appears on

Company Descriptive Book

of the organization named above.

DESCRIPTION.

Age 30 years height 5 feet $7\frac{1}{2}$ inches.

Complexion yellow.

Eyes; Black hair brown

Where born ~~Louis, La.~~ Virginia

Occupation Carpenter

ENLISTMENT.

When Aug 27, 1863.

Where ~~South~~ West

By whom capt. Fisher; term 3 y'rs.

Remarks: Deserted Sept 11 1865 at Memphis, Tenn.

Handwritten signature

C

11 (us) | U. S. C. T.

Alfred Solomon

, Co. B, 11 Reg't U. S. Col'd Inf. ^(us)

Appears on

Company Descriptive Book

of the organization named above.

DESCRIPTION.

Age 30 years height 5 feet 7 1/2 inches.

Complexion Yellow

Eyes; Black hair Black

Where born Sussex Co. Virginia

Occupation Carpenter

ENLISTMENT.

When Aug 27, 1863.

Where Corinth Miss.

By whom Capt Baker; term 3 y'rs.

Remarks: Deserted Sept 11 1865 at Memphis, Tenn.

Fairley

C | 11 (New) | U.S.C.T.

Alfred Coleman
Pri, Co B, 11 Reg't U. S. Col'd Infantry.
^{1-Ala. S. arty Vols}

Age 30 years.

Appears on a

Detachment Muster-in Roll

of the organization named above. Roll dated

Corinth Miss, Aug 29, 1863.

Muster-in to date

Aug 29, 1863.

Joined for duty and enrolled:

When Aug 27, 1863.

Where Corinth Miss.

Period 3 years.

Remarks:

Book mark: C-125-CJ-1875

(237)

Army

Copyist.

6 | 11 (New). | U.S.C.T.

Alfred Solomon
Pvt., Co. B, 1 Reg't Ala. Siege Art'y.*

Appears on

Company Muster Roll

for June 21st to August 1st, 1861.

Present or absent Present

Stoppage, \$ 100 for

Due Gov't, \$ 100 for

Remarks :

* This organization subsequently became Co. B, 11 Reg't U.S. Col'd Infantry (New).

Book mark :

Alfred Solomon
Copyist.

60 | 11 (New). | U.S.C.T.

Alfred Wolterman

Co. B, 1 Reg't Ala. Siege Art'y.*

Appears on

Company Muster Roll

for *Sept 17, 1863*, 1863.

Present or absent *Present*

Stoppage, \$ *100* for

Due Gov't, \$ *100* for

Remarks :

* This organization subsequently became Co. B, 11 Reg't U. S. Col'd Infantry (New).

Book mark : _____

Alfred Wolterman
Copyist.

4 : | 11 (New). | U.S.C.T.

Alfred Coleman
Alfred, Co. B, 1 Reg't Ala. Siege Art'y.*

Appears on

Company Muster Roll

for *Nov & Dec*, 1863.

Present or absent *Present*

Stoppage, \$ 100 for

Due Gov't, \$ 100 for

Remarks :

* This organization subsequently became Co. B, 11 Reg't U. S. Col'd Infantry (New).

Book mark :

(358)

Alfred Coleman

Copyist.

6

11 (New).

U.S.C.T.

Alfred Coleman

Artificer, Co. B, 4 Battalion, 1 Reg't Tenn. H. Art'y.*

Appears on

Company Muster Roll

for *Jan. and Feb.*, 1864.

Present or absent *Present.*

Stoppage, \$ *100* for

Due Gov't, \$ *100* for

Remarks:

*This organization subsequently became Co. B, 11 Reg't U. S. Col'd Infantry (New).

Book mark:

H. C. Gilbert

C

11 (New).

U.S.C.T.

Alfred Coleman
Artificer, Co. B, 6 Reg't U. S. Col'd H. Art'y.*

Appears on

Company Muster Roll

for *Mich. and Apr.*, 1864.

Present or absent *Present.*

Stoppage, \$ *100* for

Due Gov't, \$ *100* for

Remarks: *Was captured at Ft. Pillow, but escaped.*

*This organization subsequently became Co. B, 11 Reg't U. S. Col'd Infantry (New).

Book mark: _____

M. O. Gilbert

6 | 11 (New) | U.S.C.T.

Alfred Coleman
Artificer, Co. B, 7 Reg't U. S. Col'd H. Art'y.*

Appears on

Company Muster Roll

for *May and June*, 1864.

Present or absent *Present*

Stoppage, \$ *100* for

Due Gov't, \$ *100* for

Remarks:

*This organization subsequently became Co. B, 11 Reg't U. S. Col'd Infantry (New).

Book mark:

N. O. Gilbert

11 (New) U.S.C.T.

Alfred Coleman
artificer, Co. B, 7 Reg't U. S. Col'd H. Art'y.*

Appears on

Company Muster Roll

for July and Aug, 1864.

Present or absent Present.

Stoppage, \$ 1.00 for

Due Gov't, \$ 1.00 for

Remarks: On daily duty as
Magazine Master.

*This organization subsequently became Co. B, 11 Reg't U. S. Col'd
Infantry (New).

Book mark:

H. O. Gilbert

(358)

Copyist.

6 | **11** (New) | **U.S.C.T.**

Alfred Coleman
Artificer, Co. B, 7 Reg't U. S. Col'd H. Art'y.*

Appears on

Company Muster Roll
for *Sept. and Oct.*, 186*4*.

Present or absent *Present.*

Stoppage, \$ *100* for

Due Gov't, \$ *100* for

Remarks: *On daily duty as
Wagon Master.*

*This organization subsequently became Co. B, 11 Reg't U. S. Col'd
Infantry (New).

Book mark:

A. O. Gilbert
(358) Copyist.

6

11 (New)

U.S.C.T.

Alfred Coleman

Artificer, Co. B, 7 Reg't U. S. Col'd H. Art'y.*

Appears on

Company Muster Roll

for *Nov. and Dec.*, 1864.

Present or absent *Present*

Stoppage, \$ *100* for

Due Gov't, \$ *100* for

Remarks: *On daily duty as
Regt. Wagon Master.*

*This organization subsequently became Co. B, 11 Reg't U. S. Col'd Infantry (New).

Book mark:

H. O. Gilbert

C | **11 (New).** | **U.S.C.T.**

Alfred Coleman
Pvt, Co. B, 11 Reg't U. S. Col'd Inf. (New).

Appears on

Company Muster Roll

for *Jan & Feb*, 186*5*.

Present or absent *Present*

Stoppage, \$ *100* for

Due Gov't, \$ *100* for

Remarks: *On daily duty
at Reg't Hd Qrs.*

Book mark :

W. W. Sayre
Copyist.

C

11 (New).

U.S.C.T.

Alfred Coleman
Prvt, Co. B, 11 Reg't U. S. Col'd Inf. (New).

Appears on

Company Muster Roll

for *March & April*, 1865.

Present or absent *Present*

Stoppage, \$ 100 for

Due Gov't, \$ 100 for

Remarks: *On daily duty
at Regt's Hqrs.*

Book mark:

W. Sayre

C

11 (New).

U.S.C.T.

Alfred Coleman
Present

, Co. B, 11 Reg't U. S. Col'd Inf. (New).

Appears on

Company Muster Roll

for

May & June, 1865.

Present or absent

Present

Stoppage, \$ 100 for

Due Gov't, \$ 100 for

Remarks:

*Present on
daily duty.*

Book mark:

(358)

W. Wray

Copyist.

C

11 (New).

U.S.C.T.

Alfred Coleman

Pvt

, Co. B, 11 Reg't U. S. Col'd Inf. (New).

Appears on

Company Muster Roll

for

July & Aug, 1865.

Present or absent

Present

Stoppage, \$

100 for

Due Gov't, \$

100 for

Remarks:

Book mark:

M. Wayne

(353)

Copyist.

C

11 (New). U.S.C.T.

Alfred Colman

Pvt, Co. B, 11 Reg't U. S. Col'd Inf. (New).

Appears on

Company Muster Roll

for *Sept & Oct*, 1865.

Present or absent

Stoppage, \$ *1*^{*60*} *100* for *C. & Equipage*

Due Gov't, \$ *100* for

Remarks: *Deserted Sept. 11, 1865*
at Memphis Tenn.

Book mark:

Murphy

6 | 11 New U.S.C.T.

Alfred Coleman
Priv., Co. B, 11 Reg't U. S. Col'd Infantry (new)

Appears on

Descriptive List of Deserters

dated *Memphis Tenn. Sept. 30, 1865.*

Deserted :

When *Sept. 11, 1865.*

Where *Memphis Tenn.*

Arrested :

When, 186 .

Where

Remarks :

Book mark :

(351)

W. H. Bogan

Copist.

6 | 11 New | U.S.C.T.

Alfred Colman

Priv., Co. B, 11 Reg't U. S. Col'd Infantry^(new)_A

Appears on

Descriptive List of Deserters

dated *Memphis Tenn. Sept 30*, 1865.

Deserted:

When *Sept. 11*, 1865.

Where *Memphis Tenn.*

Arrested:

When _____, 186 .

Where _____

Remarks:

Book mark:

(351)

W.H. Bogar

Copyist.

O

11 (New). U.S.C.T.

Alfred Coleman

Priv B, 11 Reg't U. S. Col'd Inf. (New).

Appears on Co. Muster-out Roll, dated

Memphis Tenn Jan 12, 1866 .

Muster-out to date _____, 186 .

Last paid to June 30, 1865 .

Clothing account:

Last settled _____, 186 ; drawn since \$ _____ 100

Due soldier \$ _____ 100; due U. S. \$ _____ 100

Am't for cloth'g in kind or money adv'd \$ _____ 100

Due U. S. for arms, equipments, &c., \$ _____ 100

Bounty paid \$ _____ 100; due \$ _____ 100

Remarks: Deserted at Memphis
Tenn. Sept 11, 1865

Book mark: V 216, P. 137, 75, 1888, 29, 1885, 80 1/3

(861)

Murphy

Copyist.

Co. 11 (new) 1 U.S. I.

Alfred Coleman.

, Co. "B", 11th Reg't U.S. I. (new)

NOTATION.

LB 18/13
Book mark:

1888. I. I. 1885 with.

Co. 125. I. I. 1875.

War Department,

Adjutant General's Office,

Washington, July 11th, 1885.

The charge of desertion of Sept. 11th, 1865,

against this man is removed and he is discharged to date Sept. 11th, 1865, under the provisions of the act of Congress, approved July 5, 1884.

Discharge certificate furnished by Adjutant General's Office July 13th, 1885

E. P. Sawyer

308

Coleman Birdie

Co *F*, **11** U.S. Col'd Inf.

(New Organization.)

Private | *Private*

CARD NUMBERS.

1	6 3 2 2 7 1 4	26
2	6 3 2 9 9 4 5	27
3	6 3 3 0 0 3 4	28
4	6 3 3 0 1 2 5	29
5	6 3 3 0 2 0 7	30
6	6 3 3 0 2 8 1	31
7	6 3 3 0 3 5 2	32
8	6 3 3 0 4 2 3	33
9	6 3 3 0 4 8 8	34
10	6 3 3 0 5 5 7	35
11	6 3 3 0 6 3 3	36
12	6 3 3 0 7 0 2	37
13	6 3 3 0 7 7 5	38
14	6 3 3 0 8 4 0	39
15	9 0 7 2 1 1 1	40
16		41
17		42
18		43
19		44
20		45
21		46
22		47
23		48
24		49
25		50

Book Mark:

See also

S-1116376-P.O. m m m

6 | 11 (new) U. S. C. T.

Bridie Coleman
....., Co. *F*, 11 Reg't U. S. Col'd Inf. (new)

Appears on

Company Descriptive Book

of the organization named above.

DESCRIPTION.

Age *24* years height *5* feet *7 $\frac{3}{4}$* inches.

Complexion *black*

Eyes; *black* hair *black*

Where born *Tipton - Tenn.*

Occupation

ENLISTMENT.

When *Jan. 11*, 186*4*.

Where *Fort Pickering*

By whom *Col. Kappner*; term *3* y'rs.

Remarks:

F. A. Wright

6

11 (New). U.S.C.T.

Birdie Coalman

Appears with rank of *Priv* on

Muster and Descriptive Rolls of Detachments of U. S. Vols. forwarded

for the *11* Reg't U. S. Col'd *Inf* Roll dated *Memphis Tenn Mar 1*, 1864.

Where born *Tipton Co Tenn*

Age *24* y'rs; occupation

When enlisted *Jan 11*, 1864.

Where enlisted *F1 Pickering*

For what period enlisted *3* years.

Eyes *black*; hair *black*

Complexion *black*; height *5 ft. 7 3/4 in.*

When mustered in *Feb 24*, 1864.

Where mustered in *F1 Pickering*

Bounty paid \$ *100*; due \$ *100*

Where credited

Company to which assigned *F*

Remarks:

Book mark:

Ashley

C

11 (New).

U.S.C.T.

Burdie Coleman
Pat, Co. F, 1 Battalion, 1 Reg't Tenn. H. Art'y.†

Age years.

Appears on

Company Muster Roll*

for Jan 11 to Mch 1, 1864.

Joined for duty and enrolled:

When Jan 11, 1864.

Where JM Pickering

Period 9 years

Mustered in:

When Feb 24, 1864.

Where Memphis

Present or absent Present

Stoppage, \$ 100 for

Due Gov't, \$ 100 for

Remarks:

† This organization subsequently became Co. F, 11 Reg't U. S. Colored Infantry (New).

* First current roll. No muster-in roll of this company on file.

Book mark:

Rose

C

11 (New).

U.S.C.T.

Birdie Coleman
Priv., Co. F, 6 Reg't U. S. Col'd H. Art'y.*

Appears on

Company Muster Roll

for *March & April*, 186*4*.

Present or absent *Present*

Stoppage, \$ *100* for

Due Gov't, \$ *100* for

Remarks: *On special duty since April 2/64 A.D. No 59 HQ 3rd Picketing.*

* This organization subsequently became Co. F, 11 Reg't U. S. Colored Infantry (New).

Book mark: _____

Rose

C

11 (New).

U.S.C.T.

Winnie Coleman

Sgt, Co. F, 7 Reg't U. S. Col'd H. Art'y.*

Appears on

Company Muster Roll

for May and June, 1864

Present or absent Present

Stoppage, \$ 100 for

Due Gov't, \$ 100 for

Remarks: An extra duty since
Apr. 26th J. B. Hoberg
H. L. H. Pickering

* This organization subsequently became Co. F, 11 Reg't U. S. Colored Infantry (New).

Book mark:

Hase

(11) | **11 (New).** | **U.S.C.T.**

Birdie Coleman

*Co. F, 7 Reg't U. S. Col'd H. Art'y.**

Appears on

Company Muster Roll

for *Jan. 1864*, 186 *4*

Present or absent *Present*

Stoppage, \$ *100* for

Due Gov't, \$ *100* for

Remarks: *Completed duty in
April 1864 J.C. No 59
H.P. H. Pickering*

* This organization subsequently became Co. F, 11 Reg't U. S. Colored Infantry (New).

Book mark: _____

Present

C

11 (New).

U.S.C.T.

Bindie Calman
Priv., Co. F, 7 Reg't U. S. Col'd H. Art'y.*

Appears on

Company Muster Roll

for Sep 2nd Oct, 1864

Present or absent Present

Stoppage, \$ 100 for

Due Gov't, \$ 100 for

Remarks: On daily duty since
Apr 27 1864.

* This organization subsequently became Co. F, 11 Reg't U. S. Colored Infantry (New).

Book mark:

Rose

() | 11 (New). | U.S.C.T.

Birdie Coleman

Priv, Co. F, 7 Reg't U. S. Col'd H. Art'y.*

Appears on

Company Muster Roll

for *Nov and Dec*, 1864.

Present or absent *Present*

Stoppage, \$ 100 for

Due Gov't, \$ 100 for

Remarks: *On daily duty in
Engineer Dept since
April 26th.*

* This organization subsequently became Co. F, 11 Reg't U. S. Colored Infantry (New).

Book mark : _____

Rose

C

11 (New)

U.S.C.T.

Birdie Coleman

Bot, Co. F, 11 Reg't U. S. Col'd Inf. (New).

Appears on

Company Muster Roll

for *Jan & Feb*, 1865.

Present or absent *Present*

Stoppage, \$ *100* for

Due Gov't, \$ *100* for

Remarks: *On duty duty in En-
gineer Dept. since Apr. 12,
1864.*

Book mark:

(358)

Spencer

Copyist.

C | 11 (New) | U.S.C.T.

Birdie Coleman
Pvt, Co. F, 11 Reg't U. S. Col'd Inf. (New).

Appears on

Company Muster Roll

for *March & Apr*, 186*5*.

Present or absent *Present*

Stoppage, \$ *100* for

Due Gov't, \$ *100* for

Remarks: *On daily duty in En-
gineer Dept. per O.O. #36, 1865.*

Book mark:

Spicher

C | **11** (New) | **U.S.C.T.**

Quinn Coleman

Pat., Co. F, 11 Reg't U. S. Col'd Inf. (New).

Appears on

Company Muster Roll

for *May & June*, 186*5*.

Present or absent *Present*

Stoppage, \$ *100* for

Due Gov't, \$ *100* for

Remarks: *Admitted in Engineer Dept.*

Book mark :

11 (New) U.S.C.T.

Birdie Coleman

Priv, Co. F, 11 Reg't U. S. Col'd Inf. (New).

Appears on

Company Muster Roll

for *July & Aug*, 1865.

Present or absent *Present*

Stoppage, \$ *100* for

Due Gov't, \$ *100* for

Remarks: *On daily duty in En-
gineer Dept.*

Book mark:

Grecher

C 11 (New) U.S.C.T.

Siddie Coleman
Priv, Co. F, 11 Reg't U. S. Col'd Inf. (New).

Appears on

Company Muster Roll

for *Sept & Oct*, 1865.

Present or absent *Present*

Stoppage, \$ *100* for

Due Gov't, \$ *100* for

Remarks:

Book mark:

(358)

Spencer

Copyist.

C 11 (New) U.S.C.T.

Birdie Coleman
Pt, Co. F, 11 Reg't U. S. Col'd Inf. (New).

Appears on

Company Muster Roll

for *Nov + Dec*, 1865.

Present or absent *Present*

Stoppage, \$ 100 for

Due Gov't, \$ 100 for

Remarks:

Filed with Birdie Coleman

Book mark:

(358)

Deer

Copyist.

C

11 (New).

U.S.C.T.

Prider Collman

Pt F

, 11 Reg't U. S. Col'd Inf. (New).

Appears on **Co. Muster-out Roll**, dated

Memphis Tenn Jan 12, 1866.

Muster-out to date

Jan 12, 1866.

Last paid to

June 30, 1865.

Clothing account:

Last settled _____, 186 ; drawn since \$ _____ 100

Due soldier \$ *16 54* 100; due U. S. \$ _____ 100

Am't for cloth'g in kind or money adv'd \$ _____ 100

Due U. S. for arms, equipments, &c., \$ _____ 100

Bounty paid \$ _____ 100; due \$ _____ 100

Remarks: _____

Book mark: _____

Deus

(861)

Copyist.

309

Coleman, Jeremiah

Co G, 11 U.S. Col'd Inf.

(New Organization.)

Private

Private

CARD NUMBERS.

1	6322610	26
2	63130956	27
3	63310421	28
4	6331129	29
5	6331214	30
6	6331295	31
7	6331378	32
8	6331461	33
9	6331546	34
10	6331628	35
11	6331710	36
12	6331782	37
13	6331856	38
14	6331925	39
15	9072221	40
16		41
17		42
18		43
19		44
20		45
21		46
22		47
23		48
24		49
25		50

Book Mark:

See also

1

6

11 (New) U. S. C. T.

Amelius Coleman

(New)

Co. G, 11 Reg't U. S. Col'd Inf.

Appears on

Company Descriptive Book

of the organization named above.

DESCRIPTION.

Age *43* years height *5* feet *3 1/4* inches.

Complexion *Black*

Eyes; *BRN* hair *BRN*

Where born *Charleston S.C.*

Occupation *Laborer*

ENLISTMENT.

When *Jan 12, 1864.*

Where *Fort Pickens*

By whom *Col. Kappan*; term *3* y'rs.

Remarks:

A. J. Anderson

6

11 (New). U.S.C.T.

Cornelius Coleman

Appears with rank of *Pri* on

Muster and Descriptive Rolls of Detachments of U. S. Vols. forwarded

for the *11* Reg't U. S. Col'd *Inf* Roll dated

Memphis Tenn, Feb 2, 1864.

Where born *Charleston S.C.*

Age *43* y'rs; occupation

When enlisted *Jan 12*, 1864.

Where enlisted *Fort Pickering*

For what period enlisted *3* years.

Eyes *black*; hair *black*

Complexion *black*; height *5 ft. 3 1/4 in.*

When mustered in *Feb 4*, 1864.

Where mustered in *Fort Pickering*

Bounty paid \$ *100*; due \$ *100*

Where credited

Company to which assigned

Remarks:

Book mark: *3350*

Ashley

6 | 11 (New). U.S.C.T.

Cornelius Coleman

Plt, Co. E, 1 Battalion, 1 Reg't Tenn. H. Art'y.†

Age years.

Appears on

Company Muster Roll*

for Feb 4 to 29, 1864.

Joined for duty and enrolled:

When Jan 12, 1864

Where Fort Pickering

Period 3 years.

Mustered in:

When Feb 4, 1864

Where Fort Pickering

Present or absent Present

Stoppage, \$ 100 for

Due Gov't \$ 100 for

Remarks:

† This organization subsequently became Co. G, 11 Reg't U. S. Colored Infantry (New).

* First current roll. No muster-in roll of this company on file. This roll shows enrollment of all men of this company as of same date. See enrollment on subsequent card or cards.

Book mark:

(3586)

Sallack

Copyist.

6 | 11 (New). | U.S.C.T.

Cornelius Coleman
Pvt, Co. G, 6 Reg't U. S. Col'd H. Art'y.†

Appears on

Company Muster Roll

for *March* *April*, 1864.

Joined for duty and enrolled:

When *Jan 12*, 1864.*

Where *Ft Pickens* *

Period *3* years.*

Present or absent *Present*

Stoppage, \$ *100* for

Due Gov't \$ *100* for

Remarks: *On daily duty as*
company cook

* This organization subsequently became Co. G, 11 Reg't U. S. Colored Infantry (New).

* See enrollment on card from first current roll.

Book mark:

Ballade

(858c)

Copyist.

p | **11** (New). | **U.S.C.T.**

Cornelius Coleman
1st, Co. G, 7 Reg't U. S. Col'd H. Art'y.†

Appears on

Company Muster Roll

for *May & June*, 1867.

Joined for duty and enrolled:

When *Jan 12*, 1864.*

Where *Fort Pickering* *

Period *3* years.*

Present or absent *Present*

Stoppage, \$ *100* for

Due Gov't, \$ *100* for

Remarks: *On daily duty as
Company Cook*

† This organization subsequently became Co. G, 11 Reg't U. S. Colored Infantry (New).

* See enrollment on card from first current roll.

Book mark:

Dallade

6 | 11 (New). | U.S.C.T.

James Coleman
1st, Co. G, 7 Reg't U. S. Col'd H. Art'y.†

Appears on

Company Muster Roll

for *July & Aug*, 1864.

Joined for duty and enrolled:

When *Jan 12*, 1864.*

Where *Ft. Pickens* *

Period *7* years.*

Present or absent *Present*

Stoppage, \$ *100* for

Due Gov't, \$ *100* for

Remarks: *In daily duty as
Canteen Cook.*

† This organization subsequently became Co. G, 11 Reg't U. S. Colored Infantry (New).
* See enrollment on card from first current roll.

Book mark: *1000*

11 (New). U.S.C.T.

Concius Coleman
Pvt, Co. G, 7 Reg't U. S. Col'd H. Art'y.†

Appears on

Company Muster Roll

for Sept - Oct, 1864

Joined for duty and enrolled:

When Jan 12, 1864*

Where Ft. Pickens *

Period 3 years.*

Present or absent Present

Stoppage, \$ 100 for

Due Gov't, \$ 100 for

Remarks:

† This organization subsequently became Co. G, 11 Reg't U. S. Colored Infantry (New):
* See enrollment on card from first current roll.

Book mark:

Ballard

6 | 11 (New). | U.S.C.T.

Cornelius Solomon
Pat, Co. G, 7 Reg't U. S. Col'd H. Art'y.†

Appears on

Company Muster Roll

for *Nov & Dec*, 1864.

Joined for duty and enrolled:

When *Jan 12*, 1864.*

Where *Fort Pickens* *

Period *3* years.*

Present or absent *Present*

Stoppage, \$ *100* for

Due Gov't, \$ *100* for

Remarks: _____

† This organization subsequently became Co. G, 11 Reg't U. S. Colored Infantry (New).
* See enrollment on card from first current roll.

Book mark: _____

(358c) *Sallade* Copyist.

C. | **11** (New). | **U.S.C.T.**

Cornelius Coleman

Priv, Co. G, 11 Reg't U. S. Col'd Inf. (New).

Appears on

Company Muster Roll
for *Jan & Feb*, 1865.

Joined for duty and enrolled:

When *Jan 12*, 1864.*

Where *Ft. Pickering*, *

Period *3* years.*

Present or absent. *Present*

Stoppage, \$ *100* for

Due Gov't \$ *100* for

Remarks:

* See enrollment on card from first current roll.

Book mark:

(358c)

Ramsey
Coyt.

6. | 11 (New). | U.S.C.T.

Cornelius Coleman
Priv., Co. G, 11 Reg't U. S. Col'd Inf. (New).

Appears on

Company Muster Roll

for Mar & Apr, 1865.

Joined for duty and enrolled:

When Jan 12, 1864.*

Where Ft Pickering.*

Period 3 years.*

Present or absent Present.

Stoppage, \$ 100 for

Due Gov't \$ 95/100 for

Remarks :

* See enrollment on card from first current roll.

Book mark :

(358c)

Ramsey
Cpywt.

C. | 11 (New). | U.S.C.T.

Cornelius Coleman
Svt, Co. G, 11 Reg't U. S. Col'd Inf. (New).

Appears on

Company Muster Roll

for *May & June*, 1865.

Joined for duty and enrolled:

When *Jan 12*, 1864.*

Where *FT Pickering*, *

Period *3* years.*

Present or absent *Present.*

Stoppage, \$ $\frac{100}{100}$ for

Due Gov't \$ $\frac{95}{100}$ for

Remarks :

* See enrollment on card from first current roll.

Book mark : -----

Ramsay
Cpyist.

C. | 11 (New). | U.S.C.T.

Cornelius Coleman

Priv., Co. G, 11 Reg't U. S. Col'd Inf. (New).

Appears on

Company Muster Roll

for July & Aug., 1865.

Joined for duty and enrolled:

When Jan 12, 1864.*

Where Ft Pickering, *

Period 3 years.*

Present or absent Present

Stoppage, \$ 100 for

Due Gov't \$ 100 for

Remarks:

* See enrollment on card from first current roll.

Book mark:

(358c)

Ramsey
Cpyist.

C. | 11 (New). | U.S.C.T.

Cornelius Coleman
Pvt, Co. G, 11 Reg't U. S. Col'd Inf. (New).

Appears on

Company Muster Roll
for Sept & Oct, 1865.

Joined for duty and enrolled:

When Jan 12, 1864.*

Where Ft Pickering.*

Period 3 years.*

Present or absent Present.

Stoppage, \$ 100 for

Due Gov't \$ 100 for

Remarks:

* See enrollment on card from first current roll.

Book mark:

(358c)

Russell
C. pyist.

C. | 11 (New). | U.S.C.T.

Cornelius Coleman

Priv., Co. G, 11 Reg't U. S. Col'd Inf. (New).

Appears on

Company Muster Roll

for Nov. & Dec., 1865.

Joined for duty and enrolled:

When Jan. 12, 1864.*

Where Fort Pickens *

Period 3 years.*

Present or absent present

Stoppage, \$ 100 for

Due Gov't \$ 100 for

Remarks:

* See enrollment on card from first current roll.

Book mark:

(358c)

[Handwritten signature]

Copyist.

C₂

11 (New).

U.S.C.T.

Cornelius Coleman.

Pvt. G., 11 Reg't U. S. Col'd Inf. (New).

Appears on Co. Muster-out Roll, dated

Memphis, Jan. 12, 1866.

Muster-out to date

Jan. 12, 1866.

Last paid to

June 30, 1865.

Clothing account:

Last settled 186 ; drawn since \$ 100

Due soldier \$ 9⁹⁵ 100; due U. S. \$ 100

Am't for cloth'g in kind or money adv'd \$ 100

Due U. S. for arms, equipments, &c., \$ 100

Bounty paid \$ 100; due \$ 100

Remarks:

Book mark:

(361)

W. W. ...

Copyist.

310
Coleman Edward

Co *G*, 11 U.S. Col'd Inf.

(New Organization.)

Private Musician

CARD NUMBERS.

1	6322609	26
2	6330955	27
3	6331026	28
4	6331130	29
5	6331215	30
6	6331296	31
7	6331379	32
8	6331462	33
9	6331545	34
10	6331627	35
11	6331699	36
12	6331774	37
13	6331845	38
14	6331916	39
15	9072220	40
16		41
17		42
18		43
19		44
20		45
21		46
22		47
23		48
24		49
25		50

Book Mark:

See also

A. 2506130 Poutum
S 2407099 P or Retd
AY 2104561

6

11 (New) U.S.C.T.

Edward Coleman
(New)

Co. G, 11 Reg't U.S. Col'd Inf.

Appears on

Company Descriptive Book

of the organization named above.

DESCRIPTION.

Age 18 years height 5 feet 6 inches.

Complexion Black

Eyes; Blue hair Blue

Where born Charleston S.C.

Occupation Laborer

ENLISTMENT.

When Jan 12, 1864.

Where Fort Pickens

By whom Gen. Kautner; term 3 y'rs.

Remarks:

A. J. Anderson

6

11 (New). U.S.C.T.

Edward Coleman

Appears with rank of *Pvt* on

Muster and Descriptive Rolls of Detachments of U. S. Vols. forwarded

for the *11* Reg't U. S. Col'd. *Inf* Roll dated

Memphis Tenn, *Feb 2*, 1864.

Where born *Charleston So Car.*

Age *18* y'rs; occupation

When enlisted *Jan 12*, 1864.

Where enlisted *Fort-Pickering*

For what period enlisted *3* years.

Eyes *black*; hair *black*

Complexion *black*; height *5 ft. 6 in.*

When mustered in *Feb 4*, 1864.

Where mustered in *Fort-Pickering*

Bounty paid \$ *100*; due \$ *100*

Where credited

Company to which assigned

Remarks:

Book mark

Ashley

6 | 11 (New). | U.S.C.T.

Edward Coleman
Sgt., Co. E, 1 Battalion, 1 Reg't Tenn. H. Art'y.†

Age years.

Appears on

Company Muster Roll*

for Feb 4 to 29, 1864.

Joined for duty and enrolled:

When . . . Jan 12, 1864.

Where . . . Fort Pickering

Period 3 years.

Mustered in:

When . . . Feb 4, 1864.

Where . . . Fort Pickering

Present or absent Present

Stoppage, \$. . . 100 for

Due Gov't \$. . . 100 for

Remarks:

† This organization subsequently became Co. G, 11 Reg't U. S. Colored Infantry (New).

* First current roll. No muster-in roll of this company on file. This roll shows enrollment of all men of this company as of same date. See enrollment on subsequent card or cards.

Book mark:

(358b)

W. Allade

Copyist.

b | 11 (New). | U.S.C.T.

Edward Coleman

Musicians Co. G, 6 Reg't U. S. Col'd H. Art'y.†

Appears on

Company Muster Roll

for March + April, 186 4

Joined for duty and enrolled:

When Jan 12, 186 4*

Where Ft Pickering *

Period 3 years.*

Present or absent Present

Stoppage, \$ 100 for

Due Gov't \$ 100 for

Remarks :

* This organization subsequently became Co. G, 11 Reg't U. S. Colored Infantry (New).

* See enrollment on card from first current roll.

Book mark :

Ballade

6 | 11 (New). | U.S.C.T.

Edward Coleman
1st, Co. G, 7 Reg't U. S. Col'd H. Art'y.†

Appears on

Company Muster Roll

for May & June, 1864.

Joined for duty and enrolled:

When Jan 12, 1864.*

Where Ft Pickens *

Period 3 years.*

Present or absent Present

Stoppage, \$ 100 for

Due Gov't, \$ 100 for

Remarks: Detained as
musician

† This organization subsequently became Co. G, 11 Reg't U. S. Colored Infantry (New).

* ~~40~~ See enrollment on card from first current roll.

Book mark: _____

(358c)

Sallade
Copyist.

6 | 11 (New). | U.S.C.T.

Edmond Coleman
Co. G, 7 Reg't U. S. Col'd H. Art'y.†

Appears on

Company Muster Roll

for July & Aug, 1864

Joined for duty and enrolled:

When Jan 2, 1864*

Where Ft Pickens*

Period 3 years.*

Present or absent Present

Stoppage, \$ 100 for

Due Gov't, \$ 100 for

Remarks: Detained as Musician

† This organization subsequently became Co. G, 11 Reg't U. S. Colored Infantry (New).

* See enrollment on card from first current roll.

Book mark:

(358c) Baker Copyist.

6 | 11 (New). | U.S.C.T.

Edward Coleman
Pvt., Co. G, 7 Reg't U. S. Col'd H. Art'y.†

Appears on

Company Muster Roll

for Sept 1864, 1864.

Joined for duty and enrolled:

When Jan 12, 1864.*

Where Ft Pickens *

Period 3 years.*

Present or absent Present

Stoppage, \$ 100 for

Due Gov't, \$ 100 for

Remarks: Detained as Musician
Stoppage for loss of harness
67 cts.

† This organization subsequently became Co. G, 11 Reg't U. S. Colored Infantry (New).

* See enrollment on card from first current roll.

Book mark:

Salmon Copyist.

6 | 11 (New). | U.S.C.T.

Edward Coleman
Sgt, Co. G, 7 Reg't U. S. Col'd H. Art'y.†

Appears on

Company Muster Roll

for Nov & Dec, 1864.

Joined for duty and enrolled:

When Jan 12, 1864.*

Where Fort Pickens*

Period 2 years.*

Present or absent Present

Stoppage, \$ 100 for

Due Gov't, \$ 100 for

Remarks: Discharge and
honored etc.

† This organization subsequently became Co. G, 11 Reg't U. S. Colored Infantry (New).

* See enrollment on card from first current roll.

Book mark:

Sallade

C. | **11** (New). | **U.S.C.T.**

Edward Coleman

Priv, Co. G, 11 Reg't U. S. Col'd Inf. (New).

Appears on

Company Muster Roll

for *Jan & Feb*, 186*5*.

Joined for duty and enrolled:

When *Jan 12*, 186*4*.*

Where *Ft. Pickering*, *

Period *3* years.*

Present or absent *Present*.

Stoppage, \$ *100* for

Due Gov't \$ *100* for

Remarks: *Stop by sentence of Regtl Court Martial \$2.00. Stoppage 67¢ for C. & G. Equip. brot forward from Roll for Nov. & Dec. '64.*

* See enrollment on card from first current roll.

Book mark:

Ramsey

(358c)

Copyist.

C | 11 (New). | U.S.C.T.

Edward Coleman
Pvt., Co. G, 11 Reg't U. S. Col'd Inf. (New).

Appears on

Company Muster Roll

for *Mar & Apr*, 1865.

Joined for duty and enrolled:

When *Jan. 12*, 1864.*

Where *Ft Pickering*.*

Period *3* years.*

Present or absent *Present*.

Stoppage, \$ *100* for

Due Gov't \$ *160* / *100* for

Remarks:

* See enrollment on card from first current roll.

Book mark:

(358c)

Ramsey
Cpyist.

C. | 11 (New). | U.S.C.T.

Edward Coleman

Pvt., Co. G, 11 Reg't U. S. Col'd Inf. (New).

Appears on

Company Muster Roll

for *May & June*, 1865.

Joined for duty and enrolled:

When *Jan 12*, 1864.*

Where *Ft Pickering*. *

Period *3* years.*

Present or absent *Present*.

Stoppage, \$ *100* for

Due Gov't \$ *296* / *100* for

Remarks :

* See enrollment on card from first current roll.

Book mark : -----

(358c)

Ramsey
Cpyist.

C. | 11 (New). | U.S.C.T.

Edward Coleman

Musician, Co. G, 11 Reg't U. S. Col'd Inf. (New).

Appears on

Company Muster Roll

for July & Aug., 1865.

Joined for duty and enrolled:

When Jan 12, 1864.*

Where Ft Pickering.*

Period 3 years.*

Present or absent Present.

Stoppage, \$ 100 for

Due Gov't \$ 100 for

Remarks: Stoppage by sentence of Court Martial \$16.00/100.

* See enrollment on card from first current roll.

Book mark:

Ramsey Copyist.

(358c)

C. | 11 (New). | U.S.C.T.

Edward Coleman

Musician, Co. G, 11 Reg't U. S. Col'd Inf. (New).

Appears on

Company Muster Roll

for Sept & Oct, 1865.

Joined for duty and enrolled:

When Jan 12, 1864.*

Where Ft Pickering.*

Period 3 years.*

Present or absent Present.

Stoppage, \$ 1.00 for

Due Gov't \$ 16.00/100 for

Remarks: Stoppage by sentence of Court Martial \$16.00

* See enrollment on card from first current roll.

Book mark:

(358c)

Ramsey
Cpyist.

C. | 11 (New). | U.S.C.T.

Edward Coleman

Muse, Co. G, 11 Reg't U. S. Col'd Inf. (New).

Appears on

Company Muster Roll

for Nov. & Dec., 1865.

Joined for duty and enrolled:

When Jan. 12., 1866.*

Where Fort Pickens *

Period 3 years.*

Present or absent Present

Stoppage, \$ 100 for

Due Gov't \$ 100 for

Remarks: Stop 11/12/65
Sentence Court Martial

* See enrollment on card from first current roll.

Book mark:

(358c)

[Signature]

Copyist.

C. | 11 (New). | U.S.C.T.

Edward Coleman,
Mus. G., 11 Reg't U. S. Col'd Inf. (New).

Appears on Co. Muster-out Roll, dated
Memphis T., Jan. 12, 1866.

Muster-out to date Jan. 12, 1866.

Last paid to June 20, 1865.

Clothing account:

Last settled _____, 186 ; drawn since \$ 100

Due soldier \$ 100; due U. S. \$ 23/100

Am't for cloth'g in kind or money adv'd \$ 100

Due U. S. for arms, equipments, &c., \$ 100

Bounty paid \$ 100; due \$ 100

Remarks: Stop \$16 per
Sentence Court Martial

Book mark: V 89 P 117 69

(361)

[Signature]

Copyist.

Coleman Edward

Mus. Co. G, 11 Reg't U.S. I

Enclosures.

Bed Cards	Final Statements
Burial Records	Furloughs or L. of A
Certs. of Dis. for Discharge	Med. Certificates
C. M. Charges	Med. Des. Lists
Descriptive Lists	Orders
Discharge Certificates	Pris. of War Record
Enlistment Papers	Resignations

Other papers relating to—

Admission to Hosp'l	Furlough or L. of A
Casualty Sheet	Med. Examination
Confinement	Misc. Information
Contracts	Pay or Clothing
Death or Effects	Personal Reports
Desertion	Rank
Discharge from Hosp'l	Transfer to Hosp'l
Discharge from Service	Transfer to V. R. C.
Duty	Transportation

Edward Coleman
Musician
Co. G. 11th U.S.C. I m

Ellenbrook

Adjutant General's Office,

Mr. Ellersbrook

COLORED TROOPS BRANCH,

May 15th, 1877

Vol.

C. T., 187

Wanted in the case of Edward Coleman Musician, Co. "G",
11th Reg't U.S.C. Troops (new) Record of Trials -
"Stop by sentence of Res. Court martial 2,00 - M.R. Jan'y & Feb'y 1865 -
"Stoppage by sentence of Court martial 1,600 - M.R. July & Aug 1865 -

ASe

Respectfully,

R. A. Woodward
Chief Clerk.

In J. Falcon

Adjutant General's Office,

Dir., Records discontinued Comd's. &c
May 23rd, 1877.

Vol.

C. T., 187

Reply in case of

Edward Coleman Mus., Co. "G",

11th Reg't U.S.C. i.

Tried before a F.O. Court July 15 1865.

Charges - Stealing Peaches in Picket line
Finding - Guilty - Sentence - To forfeit \$16.⁰⁰
& to 10 days hard labor.

App'd July 21 1865 by Col. Turner Comd'g 2nd Inf. Brig. Det. U.S. Army.
Sentence promulgated in G.O. 20 H. Q. of Regt. July 27 1865.

Rec'd Co. records do not furnish any evidence relative to
Charges, trial &c &c in Jan'y & Feb. 1865.

W.F.

311

Coleman, Robert

Co B, 11 U.S. Col'd Inf.

(New Organization.)

Private

Private

CARD NUMBERS.

1	6325694	26
2	6325754	27
3	6325820	28
4	6325888	29
5	6325968	30
6	6326035	31
7	5326106	32
8	6326163	33
9	7071031	34
10	7071182	35
11	43156626	36
12	43156547	37
13		38
14		39
15		40
16		41
17		42
18		43
19		44
20		45
21		46
22		47
23		48
24		49
25		50

Book Mark:

See also

6

11 (tw) U.S.C.T.

Robert Coleman

Co. B, 11 Reg't U.S. Col'd Inf. (tw)

Appears on

Company Descriptive Book

of the organization named above.

DESCRIPTION.

Age 43 years height 5 feet 4 inches.

Complexion Black

Eyes; Black hair Black

Where born Mississippi

Occupation Laborer

ENLISTMENT.

When Nov 2, 1864.

Where St Louis, Mo

By whom Capt Coleman; term 3 y'rs.

Remarks:

[Empty lined area for remarks]

K. Ridley

Copyist.

6

11 (New) U. S. C. T.

Sgt. Coleman
Co. *F*, 11 Reg't U. S. Col'd Inf. *(New)*

Appears on
Company Descriptive Book
of the organization named above.

DESCRIPTION.

Age *43* years; height *5* feet *6* inches.

Complexion *Swath*

Eyes *Swath*; hair *Swath*

Where born *St. Louis, Missouri*

Occupation *Laborer*

ENLISTMENT.

When *June 2*, 1864.

Where *St. Louis, Mo.*

By whom *Sgt. Coleman*; term *3* y'rs.

Remarks: *Substitute for Henry
Simpson, discharged Mo.*

W. J. ...

C | 11 En. U.S.A.

Robert Coleman

Appears with rank of *Private* on

Muster and Descriptive Roll

of *Detachment of U.S. Substitute forwarded Memphis Tenn.*

Roll dated *St Louis Mo., Nov 2, 1864.*

Where born *Mississippi*

Age *43* years; occupation *Laborer*

When enlisted *Nov 2, 1864*

Where enlisted *St Louis Mo*

For what period enlisted *3* years.

Eyes *black*; hair *black*

Complexion *black*; height *5 ft. 6 in.*

When mustered in *Nov*, 1864.

Where mustered in *St Louis Mo*

Bounty paid \$ *100*; due \$ *100*

Clothing account:

Last settled *Nov*, 1864; drawn since \$ *35⁸⁹* *100*

Date of first muster *Nov*, 1864.

Company to which assigned

Remarks: *Substitute for Henry Stupinski. Enrolled and drafted in 9th Ward. 1 Dec Mo. Not entitled to bounty*

Book mark:

J. N. Wilkinson
(356m) Copyist.

C

U.S. 65.

Robert Coleman

Appears with rank of Pvt on

Muster and Descriptive Roll

of Detachment of U.S. Substitute forwarded

Roll dated Nov 14, 1864
Gen. Draft Rendezvous for mo

Where born Miss

Age 43 years; occupation Laborer

When enlisted Nov 2, 1864

Where enlisted St Louis Mo

For what period enlisted 3 years.

Eyes Blk; hair Blk

Complexion Blk; height 5 ft. 6 in.

When mustered in Nov 2, 1864

Where mustered in St Louis Mo.

Bounty paid \$ 100; due \$ 100

Clothing account:

Last settled 186; drawn since \$ 35-85 100

Date of first muster Nov 2, 1864

Company to which assigned

Remarks: Credited to 1 Cong Dist
9 Ward. Mo. Sub for
Henry Stupurski. D.

Book mark:

J. N. Wilkinson
(356m) Copyist.

6 | 11 (New) | U.S.C.T.

Robert Coleman
Pr., Co. B, 7 Reg't U. S. Col'd H. Art'y.*

Appears on

Company Muster Roll

for Nov. and Dec., 1864.

Present or absent Present.

Stoppage, \$ 100 for

Due Gov't, \$ 100 for

Remarks:

*This organization subsequently became Co. B, 11 Reg't U. S. Col'd Infantry (New).

Book mark:

H. C. Gilbert

C

11 (New).

U.S.C.T.

Robert Coleman

Pvt., Co. B, 11 Reg't U. S. Col'd Inf. (New).

Appears on

Company Muster Roll

for Jan & Feb, 1865.

Present or absent Present

Stoppage, \$ 100 for

Due Gov't, \$ 100 for

Remarks: Substitute

Book mark :

W W Sayre

(358)

Copyist.

C

11 (New).

U.S.C.T.

Robert Coleman

Pvt, Co. B, 11 Reg't U. S. Col'd Inf. (New).

Appears on

Company Muster Roll

for *Mich Gape*, 1865

Present or absent *Present*

Stoppage, \$ 100 for

Due Gov't, \$ 100 for

Remarks: *Stop for 1 gun
wiper 20 cts
Substitute*

Book mark:

W. Sayre

(359)

Copyist.

C

11 (New).

U.S.C.T.

Robert Coleman

Pvt, Co. B, 11 Reg't U. S. Col'd Inf. (New).

Appears on

Company Muster Roll

for *May & June*, 1865

Present or absent *Present*

Stoppage, \$ 100 for

Due Gov't, \$ ²⁰ 100 for *Ord*

Remarks: *Substitute*

Book mark:

W. M. Sayre

C | 11 (New). | U.S.C.T.

Robert Coleman

Pvt, Co. B, 11 Reg't U. S. Col'd Inf. (New).

Appears on

Company Muster Roll

for July-Aug, 1865

Present or absent Present

Stoppage, \$ 100 for

Due Gov't, \$ 100 for

Remarks: Stop. by order of field officer's court \$2.00 substitute

Book mark :

W. M. Sayre

(358)

Copyist.

0

11 (New). U.S.C.T.

Robert Colman

Private, Co. B, 11 Reg't U. S. Col'd Inf. (New).

Appears on

Company Muster Roll

for Sept & Oct, 1864.

Present or absent Present

Stoppage, \$ 100 for

Due Gov't, \$ 100 for

Remarks: Stoppage by order of Field Officers Court \$2.00

Book mark :

Murphy

C | 11 (New). | U.S.C.T.

Robert Colman

Prv, Co. B, 11 Reg't U. S. Col'd Inf. (New).

Appears on

Company Muster Roll

for March 1864.

Present or absent Present

Stoppage, \$ 100 for

Due Gov't, \$ 100 for

Remarks: Stop. by Order of G. C. Court \$100

Book mark :

Murphy

C

11 (New). U.S.C.T.

Robert Coleman
Pot, B, 11 Reg't U. S. Col'd Inf. (New).

Appears on Co. Muster-out Roll, dated
Memphis Ten. Jan 12, 1866.

Muster-out to date Jan 12, 1866.

Last paid to June 30, 1865.

Clothing account:

Last settled _____, 186 ; drawn since \$ 100

Due soldier \$ 100; due U. S. \$ 46⁶⁵/₁₀₀

Am't for cloth'g in kind or money adv'd \$ 100

Due U. S. for arms, equipments, &c., \$ 100

Bounty paid \$ 100; due \$ 100

Remarks: Stop by Order of Field
Officers Court \$ 2.00
(Age 43 yrs Substi-
tute must'd in Nov. 2,
64 at St Louis mo. for
3 yrs. Enrollment not given)

Book mark : _____

(361)

Murphy

Copyist.

Coleman Robert

P, Co. B, 11 Reg't 1st S

Enclosures.

Bed Cards	Final Statements
Burial Records	Furloughs or L. of A
Certs. of Dis. for Discharge	Med. Certificates
C. M. Charges	Med. Des. Lists
Descriptive Lists	Orders
Discharge Certificates	Pris. of War Record
Enlistment Papers	Resignations

Other papers relating to—

Admission to Hosp'l	Furlough or L. of A
Casualty Sheet	Med. Examination
Confinement	Misc. Information
Contracts	Pay or Clothing
Death or Effects	Personal Reports
Desertion	Rank
Discharge from Hosp'l	Transfer to Hosp'l
Discharge from Service	Transfer to V. R. C.
Duty	Transportation

Robert Coleman
Out Co B. 11th Regt

Ellerbrook

Adjutant General's Office,

COLORED TROOPS BRANCH,

Mr Ellerton

Jan 6th, 1877

Vol. C. T., 187

Wanted in the case of *Robert Coleman* *Por., Co. "F",*
11th Reg't U.S.C.T.s (new) Record of Trial -
"Stoppage by order of Field Officers Court #202" -
MR July or August 1865

AJG

Respectfully,

L. A. Woodward
Chief Clerk.
J. A. Halson

Adjutant General's Office,

, 187

Vol. C. T., 187

~~Reply in case of~~
~~Reg't~~ *Reg't. Genl Order #23 / Aug 13/65*, Co. *-*
~~Proceedings of a Field Officers Court held at camp~~
~~of 11 U.S.C.T.s. July 25/65.~~

Robert Coleman, por co 'F'
Charge - Unlawfully in person,
Finding - Guilty.
Sentence xxx "two dollars of his monthly pay
pay to be stopped on the next roll."

AJG

L.A. Jan 13/77

312

Coleman Washington

Co H, 11 U.S. Col'd Inf.

(New Organization.)

Private | Private

CARD NUMBERS.

1	6332015	26
2	6332098	27
3	6332239	28
4	6323176	29
5	6323198	30
6	6332935	31
7	9072304	32
8		33
9		34
10		35
11		36
12		37
13		38
14		39
15		40
16		41
17		42
18		43
19		44
20		45
21		46
22		47
23		48
24		49
25		50

Book Mark:

See also

61 | **11** (New) **U.S.C.T.**

Washington Colman
(New)
....., Coc 7 11 Reg't U.S. Col'd Inf.

Appears on
Company Descriptive Book
of the organization named above.

DESCRIPTION.

Age 37 years height 5 feet 5 inches.
Complexion Black
Eyes; Black hair Black
Where born Wedgeville Ga
Occupation Farmer

ENLISTMENT.

When Feb 24 , 1864.
Where Memphis Tenn
By whom Gunn ; term 3 y'rs.
Remarks: Rescribed from
Fort Pickens
Memphis Tenn June
2nd '864

F. E. Pucke

6

11 (New).

U.S.C.T.

Washington Coleman

Pvt., Co. H, 6 Reg't U. S. Col'd H. Art'y.*

Appears on

Battery Muster-in and Descriptive Roll

of the organization named above. Roll dated

Memphis, Tenn. (Apr. 2), 1864.

Where born Millidgeville, Ga.

Age 27 y'rs; occupation Farmer

When enlisted Feb. 24, 1864.

Where enlisted Memphis, Tenn.

For what period enlisted 3 years.

Eyes Blk; hair Blk

Complexion Blk; height 5 ft. 5 in.

When mustered in Feb. 24, 1864.

Where mustered in Memphis, Tenn.

Bounty paid \$ 100; due \$ 100

Where credited _____

Battery to which assigned _____

Remarks: _____

* This organization subsequently became Co. H, 11 Reg't U. S. Colored Infantry (New).

Book mark; _____

(356g)

W. J. ...

Copyist.

6

11 (New).

U.S.C.T.

Washington Coleman

Pvt., Co. H, 6 Reg't, U. S. Col'd H. Art'y.*

Appears on

Battery Muster-in and Descriptive Roll

of the organization named above. Roll dated

Memphis Tenn April 2, 1864.

Where born Millersville, Ga.

Age 27 y'rs; occupation Farmer

When enlisted Feb. 24, 1864.

Where enlisted Memphis, Tenn.

For what period enlisted 3 years.

Eyes Blk; hair Blk

Complexion Blk; height 5 ft. 5 in.

When mustered in Feb. 24, 1864.

Where mustered in Memphis, Tenn.

Bounty paid \$ 100; due \$ 100

Where credited

Battery to which assigned

Remarks:

* This organization subsequently became Co. H, 11 Reg't U. S. Colored Infantry (New).

Book mark ;

(356g)

Original

Copyist.

6

11 (New). U.S.C.T.

Washington Coleman
Corpl, Co. H, 6 Reg't U. S. Col'd H. Art'y.*

Appears on

Company Muster Roll

for 2^d to 30th Apl. 1864.

Present or absent Present.

Stoppage, \$ 100 for

Due Gov't, \$ 100 for

Remarks: Appointed Corpl from
Ord. per S.O. No. dated Feb,
20. 6th U.S. Army, Apl. 29,
'64.

*This organization subsequently became Co. H, 11 Reg't U. S. Col'd Infantry (New).

Book mark :

5-0000

Wagner

60

11 (New).

U.S.C.T.

Washington Coleman
Corpl, Co. H, 7 Reg't U. S. Col'd H. Art'y.*

Appears on

Company Muster Roll

for May & June, 1864.

Present or absent _____

Stoppage, \$ 100 for _____

Due Gov't, \$ 100 for _____

Remarks: Deserted June 2/64 from 1st
Pickering Tenn. carrying away
with him one Springfield Rifle
Cal. 38. Complete Carb Box & plate
waist belt & plate C Box belt & plate
rep pouch, complete screw
driver & cone wrench

*This organization subsequently became Co. H, 11 Reg't U. S. Col'd
Infantry (New).

Book mark: _____

J. H. Wagner

Lo | 11 Neo U.S.C.T.

Washington Coleman
Corp, Co. H, 11 (7 U.S.C.H.A.) (New)
Reg't U. S. Col'd Infantry

Appears on

Descriptive List of Deserters

dated Ft. Pickering Tenn. June 29, 1864.

Deserted:

When June 2, 1864

Where Ft. Pickering Tenn.

Arrested:

When _____, 186 .

Where _____

Remarks: _____

Book mark: _____

(851)

W. H. Bogan

Copyright.

6 | 11 New | U.S.C.T.

Washington Coleman
Co. H (7 U.S.C.H.A.) (new)
Reg't U. S. Col'd Infantry

Appears on

Descriptive List of Deserters

dated Ft. Pickering
Memphis Tenn. June 30, 1864.

Deserted:

When June 2, 1864.

Where Ft. Pickering

Arrested:

When _____, 186 .

Where _____

Remarks: _____

Book mark: _____

(351)

W. H. Bogan

Copyist.

B

11 (New).

U.S.C.T.

Washington Coleman

Priv. H., 11 Reg't U. S. Col'd Inf. (New).

Appears on **Co. Muster-out Roll**, dated

Memphis Tenn, Jan 12, 1866.

Muster-out to date _____, 186 .

Last paid to _____, 186 .

Pay due from Enrollment

Clothing account:

Last settled _____, 186 ; drawn since \$ _____ 100

Due soldier \$ _____ 100; due U. S. \$ _____ 100

Am't for cloth'g in kind or money adv'd \$ _____ 100

Due U. S. for arms, equipments, &c., \$ _____ 100

Bounty paid \$ _____ 100; due \$ _____ 100

Remarks: _____

*Deserted from A. Pickering
June 7/64*

Book mark: _____

(361)

M. E. any
Copyist.

313

Coleman, Xavier

Co A, 11 U.S. Col'd Inf.

(New Organization.)

Private

Private

CARD NUMBERS.

1	6328070	26
2	6328133	27
3	6328204	28
4	6328278	29
5	6328361	30
6	6328469	31
7	6328603	32
8	6323103	33
9	9071629	34
10	577-07-1877	35
11	43156534	36
12	43156688	37
13		38
14		39
15		40
16		41
17		42
18		43
19		44
20		45
21		46
22		47
23		48
24		49
25		50

Book Mark: EPB $\frac{17}{276}$ + 577-a-12
65-77

See also

S. 1336034 P.O. Mtn

S. 1930835 P.O. Mtn

P.O. Mtn box 410 12/3/18
Hog

6

11 (New) U. S. C. T.

Xavier Calman

(New)
Co. N, 11 Reg't U. S. Col'd Inf.

Appears on

Company Descriptive Book

of the organization named above.

DESCRIPTION.

Age 22 years height 5 feet 7 inches.

Complexion Black

Eyes; Black hair Black

Where born Miss

Occupation Laborer

ENLISTMENT.

When Oct 25, 1864.

Where St. Louis, Mo.

By whom Capt Calman; term 1 yr.

Remarks: Received as substitute for
R. W. Finkenburgh (Citizen) of
St. Louis, Mo. assigned to 7th
U. S. C. A. (Hy) pr. S. O. 108 Brig 4th A.
L. Chatland Comdg. Colored Troops
in Tenn 21st November
1864. Discharged Oct.
24/64.

C

U.S.A.

Xavier Colman

Appears with rank of Pvt on

Muster and Descriptive Roll

of Detachment of U. S.
forwarded

Roll dated
Genl. Draft Rendezvous, Nov 14, 1864

Where born Miss

Age 22 years; occupation Laborer

When enlisted Oct 25, 1864

Where enlisted St Louis Mo

For what period enlisted 1 years.

Eyes Blue; hair Black

Complexion Black; height 5 ft. 7 in.

When mustered in Oct 25, 1864

Where mustered in St Louis Mo

Bounty paid \$ 100; due \$ 100

Clothing account:

Last settled , 186 ; drawn since \$ 32 80
100

Date of first muster Oct 25, 1864

Company to which assigned

Remarks: Credited 1 Cong Dist.
6 Ward, Mo. Sub for
R. W. Tinkelnburg. dr

Book mark:

J. W. McKuson
(356m) **Copyist.**

C | 11 Inf. | US 65

Xavier Coleman

Appears with rank of Priv on

Muster and Descriptive Roll

of Detachment of U.S. Sub-stitute forwarded

Memphis Tenn. Roll dated St Louis Mo, Oct 25, 1864

Where born Mississippi

Age 22 years; occupation Laborer

When enlisted Oct 25, 1864

Where enlisted St Louis Mo

For what period enlisted 1 years.

Eyes Blu; hair Blk

Complexion Blk; height 5 ft. 9 in.

When mustered in Oct 25, 1864

Where mustered in St Louis Mo

Bounty paid \$ 100; due \$ 100

Clothing account:
Last settled _____, 1864; drawn since \$ 32.80 / 100

Date of first muster Oct 25, 1864

Company to which assigned _____

Remarks: Substitute for Rudolph W Finkelburg. Enrolled and drafted in the 6th Ward. Credited to Dist. Mo (our)

Book mark: _____

J. N. Wilkinson
(356m) Copyist.

OCT 12

43156534

1906.

Not entitled to Bounty

C. | 11 (New) | U.S.C.T.

Havia Colman

Priv, Co. D, 7 Reg't U. S. Col'd H. Art'y.*

Appears on

Company Muster Roll

for *Nov. 7 Dec.*, 1864.

Present or absent *Present.*

Stoppage, \$ *100* for

Due Gov't, \$ *100* for

Remarks *Assigned to 7 U.S.C.A. (44)*
by S.O. No. 108 Brig Genl. A. F.
Chetlain Comdg U.S.C. 7. in
turn.
(Substitute musted in
Oct-25, 64 at St Louis
mo for 1 yr)

*This organization subsequently became Co. D, 11 Reg't U. S. Col'd Infantry (New).

Book mark:

(858)

R. J. Cook

Copyist.

11 (New). U.S.C.T.

Lucia Colman

Co. D, 11 Reg't U. S. Col'd Inf. (New).

Appears on

Company Muster Roll

for *Jan and Feb.*, 186*6*.

Present or absent *Present*

Stoppage, \$ *100* for

Due Gov't, \$ *100* for

Remarks: *(Assigned to Co. 115 (Agt.)*
Subs. 108 Brig. Gen. L. Chellain
and W. C. D. Lane.

Book mark:

(858)

J. S. James

Copyist

Q

11 (New).

U.S.C.T.

Xarvia Holman

Prin., Co. D, 11 Reg't U. S. Col'd Inf. (New).

Appears on

Company Muster Roll

for *March and April*, 1865.

Present or absent *Present*.

Stoppage, \$ 100 for

Due Gov't, \$ 100 for

Remarks:

Book mark:-----

(858)

J. B. Jones

Copyist

(11 (New). U.S.C.T.

James Coleman
Co. D, 11 Reg't U. S. Col'd Inf. (New).

Appears on

Company Muster Roll

for *May 1st June*, 186*7*.

Present or absent *Present*

Stoppage, \$ *100* for

Due Gov't, \$ *100* for

Remarks:

Book mark:

(858)

James Coleman

Copyist

C | 11 (New). | U.S.C.T.

Xenia Coleman

Prin, Co. D, 11 Reg't U. S. Col'd Inf. (New).

Appears on

Company Muster Roll

for *July and August*, 186*5*.

Present or absent *Present*

Stoppage, \$ *100* for

Due Gov't, \$ *100* for

Remarks:

Book mark:

(858)

J. D. [Signature]

Copyist

6

11 (New).

U.S.C.T.

Senior Sergeant

Pri., Co. D, 11 Reg't U. S. Col'd Inf. (New).

Appears on

Company Muster Roll

for *Sept. and Oct.*, 1865.

Present or absent

Stoppage, \$ 100 for

Due Gov't, \$ 100 for

Remarks: *Mustered out Oct 30/65
by reason of expiration of
enlistment.*

Book mark: *Discharged Oct. 25/65 - S. B. 1276*

(858)

J. D. James

Copyist

L, | *11 Nov*, **U.S.C.T.**

David Solomon
P, Co., *11* Reg't U. S. Col'd Infantry.

Appears on a

Detachment Muster-out Roll

of the organization named above. Roll dated
Memphis Tenn, *Nov 1*, 186⁵.

Muster-out to date *Oct 21*, 186⁵.

Last paid to *June 30*, 186⁵.

Clothing account:

Last settled, 186 . . . ; drawn since \$ 100

Due soldier \$ *31*^{*48*}/₁₀₀; due U. S. \$ 100

Am't for cloth'g in kind or money adv'd \$ 100

Due U. S. for arms, equipments, &c., \$ 100

Bounty paid \$ 100 due \$ 100

Remarks: *Mustered out by*
reason of expiration
of enlistment to date
Oct. 21, 1865, substitute

Book mark:

Wm. H. [unclear]

C | 11 (New). U.S.C.T.

Xavier Coleman

Chi. Ill., 11 Reg't U. S. Col'd Inf. (New).

Appears on **Co. Muster-out Roll**, dated

Memphis Tenn. Jan. 12, 1866.

Muster-out to date _____, 186 .

Last paid to *Nov. 1*, 1865.

Clothing account:

Last settled _____, 186 ; drawn since \$ _____ 100

Due soldier \$ _____ 100 ; due U. S. \$ _____ 100

Am't for cloth'g in kind or money adv'd \$ _____ 100

Due U. S. for arms, equipments, &c., \$ _____ 100

Bounty paid \$ _____ 100 ; due \$ _____ 100

Remarks:

*Mustered on roll
dated Nov. 1st/65 -
by reason of expi-
ration of enlistment.
(Age 22 yrs)*

Book mark: *Dischg'd Oct. 24/65
E.B. 276 M. O. on file.*

(861)

Hodges
Copyist.

JAN. 22

6328603

01891*

~~+ 577-12-65-77~~

+ 577-a-12-65-77

+ corrected by Worley 4r.

Co. 11th (new) U.S. I.

Xavier Lohman

Co. 29th, 11 Reg't U.S. I. (new)

NOTATION.

EB 17/276

Book mark:

577.6.2.1877

War Department,

Adjutant General's Office,

Washington, Mch. 20th, 1877.

"Discharged October 24th, 1865."

E. P. Conroy

Coleman, Xavier

Co.

Reg't

4

Enclosures.

Bed Cards	Final Statements
Burial Records	Furloughs or L. of A.
Certs. of Dis. for Discharge	Med. Certificates
C. M. Charges	Med. Des. Lists
Descriptive Lists	Orders
Discharge Certificates	Pris. of War Record
Enlistment Papers	Resignations

Other papers relating to—

Admission to Hosp'l	Furlough or L. of A.
Casualty Sheet	Med. Examination
Confinement	Misc. Information /
Contracts	Pay or Clothing
Death or Effects	Personal Reports
Desertion	Rank
Discharge from Hosp'l	Transfer to Hosp'l
Discharge from Service	Transfer to V. R. C.
Duty	Transportation

DECLARATION OF SUBSTITUTE.

I, Harvey Coleman desiring to ENLIST in the Army of the United States; for ~~THREE YEARS~~ one, Do declare, That I am 22 years and one months of age; that I have never been discharged from the United States service on account of disability or by sentence of a court martial; and I know of no impediment to my serving honestly and faithfully as a soldier for ~~three years~~ one

GIVEN at St. Louis Mo the 25 day of Oct 1864

WITNESS:

Singer Harvey ^{his} Coleman

581

No. 1
Harvey Coleman

Enlisted at St. Louis Mo

As Substitute for

Quackler Minkelman

On the 25 day of Oct, 1864

By

Capt. A. S. Johnson

W. M. S. Powell

J. B. Bates

Board of Enrollment,

Dist. of Mo

1864

SUBSTITUTE VOLUNTEER ENLISTMENT.

STATE OF



TOWN OF

Missouri

St. Louis

I, *Havier Coleman* (*color*) born in the State of *Mississippi*, aged *22* years, and by occupation a *laborer*

Do HEREBY ACKNOWLEDGE to have agreed with *Rudolph W. Dunkelburg* Esq., of *St. Louis Mo*

to become his **SUBSTITUTE** in the Military Service, for a sufficient consideration paid and delivered to me, on the *23* day of *Oct*, 186*4*

and having thus agreed with said *Rudolph W. Dunkelburg*, I DO HEREBY ACKNOWLEDGE to have enlisted this *23* day of *Oct*

186*4*, to serve as a **Soldier** in the **Army of the United States of America**, for the period of ~~THREE YEARS~~ *one*, unless sooner discharged by proper authority: I do also agree to accept such bounty, pay, rations, and clothing, as are, or may be, established by law for soldiers. And I do solemnly swear that I will bear true and faithful allegiance to the **United States of America**; that I will serve them honestly and faithfully against all their enemies or opposers whomsoever; and that I will observe and obey the orders of the President of the United States, and the orders of the Officers appointed over me, according to the Rules and Articles of War.

SWORN and subscribed to, at *St. Louis Mo* this *25* day of *Oct* 186*4* *Havier Coleman*

BEFORE *C. Healeman* *Capt & Propost Marshal* *18th Dist Mo*

We certify, on honor, That we have carefully examined the above-named Volunteer Substitute agreeably to the Regulations, and that, in our opinion, he is free from all bodily defects and mental infirmity which would in any way disqualify him from performing the duties of a soldier; that he was entirely sober when enlisted; that he is of lawful age, (not under 18 years;) and that, in accepting him as duly qualified to perform the duties of an able-bodied soldier, and as a Substitute in lieu of *R. W. Dunkelburg* enrolled and drafted in *St. Louis Mo* under act of *Mar 3*, 186*3*, we have strictly observed the Regulations which govern in such cases. This soldier has *Blk* eyes, *Blk* hair, *Blk* complexion; is *5* feet *7* inches high.

C. Healeman
Capt & Propost Marshal
18th Dist Mo

N. McDonald
Commissioner of Board

Julian Bates
Surgeon of Board

Board of Enrollment of *18th* Dist of *Mo*

*Mustered into the service of the United States
this 25 day of Oct 1864 at St. Louis Mo*

C. Healeman
Capt & Propost Marshal
18th Dist Mo

DECLARATION OF SUBSTITUTE.

x, Harrier Coleman desiring to ENLIST in the Army of the United States, for ~~THREE YEARS~~ one **Do declare**, That I am 22 years and one months of age; that I have never been discharged from the United States service on account of disability or by sentence of a court martial; and I know of no impediment to my serving honestly and faithfully as a soldier for one three years.

GIVEN at St. Louis Mo
the 25 day of Oct 1864

WITNESS:

S. Singer Harrier ^{wif} Coleman
mark

No. 229

Harrier Coleman
Enlisted at St. Louis Mo

As Substitute for

Joseph W. Sinterbury

On the 25 day of Oct, 1864

By

Joseph W. Sinterbury

N. M. G. Towell

Jubain Bates

Board of Enrollment,
1st Dist. of Mo

64

SUBSTITUTE VOLUNTEER ENLISTMENT.

STATE OF

TOWN OF

Missouri

St. Louis



Joavies Coleman (col) born in the State of Mississippi, aged 22 years, and by occupation a Laborer

DO HEREBY ACKNOWLEDGE to have agreed with Rudolph W. Dunkelburg Esq., of the Ward 11 Dist St. Louis Mo

to become his **SUBSTITUTE** in the Military Service, for a sufficient consideration paid and delivered to me, on the 23 day of Oct, 1864

and having thus agreed with said Rudolph W. Dunkelburg I DO HEREBY ACKNOWLEDGE to have enlisted this 23 day of Oct

1864, to serve as a **Soldier** in the Army of the United States of America, for the period of ~~THREE YEARS~~ one unless sooner discharged by proper authority: I do also agree to accept such bounty, pay, rations, and clothing, as are, or may be, established by law for soldiers. And I do solemnly swear that I will bear true and faithful allegiance to the **United States of America**; that I will serve them honestly and faithfully against all their enemies or opposers whomsoever; and that I will observe and obey the orders of the President of the United States, and the orders of the Officers appointed over me, according to the Rules and Articles of War.

SWORN and subscribed to, at St. Louis Mo this 23 day of Oct 1864

BEFORE C. Coleman Capt + Prov Marshal / 11th Dist Mo

Joavies Coleman mat

Mustered into the service of the United States this 23 day of Oct 1864 at St. Louis Mo

We certify, on honor, That we have carefully examined the above-named Volunteer Substitute agreeably to the Regulations, and that, in our opinion, he is free from all bodily defects and mental infirmity, which would in any way disqualify him from performing the duties of a soldier; that he was entirely sober when enlisted; that he is of lawful age, (not under 18 years;) and that, in accepting him as duly qualified to perform the duties of an able-bodied soldier, and as a Substitute in lieu of R. W. Dunkelburg enlisted and drafted in the Ward 11 Dist St. Louis under Capt. Wm. M. G., 1863, we have strictly observed the Regulations which govern in such cases. This soldier has Blk eyes, Blk hair, Blk complexion; is 5 feet 7 inches high.

C. Coleman Capt. Provost Marshal / 11th Dist Mo

N. McDonald Commissioner of Board

Julian Bates Surgeon of Board

Board of Enrollment of 11th Dist of Mo

C. Coleman
Capt + Prov Marshal / 11th Dist Mo

DECLARATION OF SUBSTITUTE.

x, Harrier Coleman desiring to ENLIST in the Army of the United States, for ~~THREE YEARS~~ ^{one} **Do declare**, That I am 22 years and nm months of age; that I have never been discharged from the United States service on account of disability or by sentence of a court martial; and I know of no impediment to my serving honestly and faithfully as a soldier for three years.

GIVEN at St. Louis Mo
the 23 day of Oct 1864

WITNESS:

S Singer

Harrier Coleman
mark

934

No. 229

Harrier Coleman
Enlisted at St. Louis Mo

As Substitute for

Rudolph W. Winkler

On the 25 day of Oct, 1864

By

Capt. J. A. Johnson

W. M. B. B. B.

J. B. B.

Board of Enrolment,
Dist. of Mo
1864

SUBSTITUTE VOLUNTEER ENLISTMENT.

STATE OF



TOWN OF

Missouri

St Louis

I, Harvey Coleman (col) born in the State of Mississippi, aged 22 years, and by occupation a laborer

Do HEREBY ACKNOWLEDGE to have agreed with Rudolph W. Dinkelsburg Esq., of St Louis Mo

to become his **SUBSTITUTE** in the Military Service, for a sufficient consideration paid and delivered to me, on the 25 day of Oct, 1864

and having thus agreed with said Rudolph W. Dinkelsburg I DO HEREBY ACKNOWLEDGE to have enlisted the 25 day of Oct

1864, to serve as a **Soldier** in the **Army of the United States of America**, for the period of THREE YEARS unless sooner discharged by proper authority: I do also agree to accept such bounty, pay, rations, and clothing, as are, or may be, established by law for soldiers. And I do solemnly swear that I will bear true and faithful allegiance to the **United States of America**; that I will serve them honestly and faithfully against all their enemies or opposers whomsoever; and that I will observe and obey the orders of the President of the United States, and the orders of the Officers appointed over me, according to the Rules and Articles of War.

SWORN and subscribed to, at St Louis Mo this 23 day of Oct 1864

BEFORE C. Coleman Harvey Coleman
Capt + Prov. Marshal 1st Dist Mo mark

Mustered into the service of the United States the 25 day of Oct 1864 at St Louis Mo

We certify, on honor, That we have carefully examined the above-named Volunteer Substitute agreeably to the Regulations, and that, in our opinion, he is free from all bodily defects and mental infirmity which would in any way disqualify him from performing the duties of a soldier; that he was entirely sober when enlisted; that he is of lawful age, (not under 18 years;) and that, in accepting him as duly qualified to perform the duties of an able-bodied soldier, and as a Substitute in lieu of R. W. Dinkelsburg enrolled and drafted in St Louis Mo manapt Oct 1864, we have strictly observed the Regulations which govern in such cases. This soldier has Blk eyes, Blk hair, Blk complexion; is 3 feet 7 inches high.

C. Coleman
Capt + Provost Marshal
1st Dist Mo
A. McDonald
Commissioner of Board

Julian Bates
Surgeon of Board

Board of Enrollment of 1st Dist. of Mo

*C. Coleman
Capt + Prov. Marshal 1st Dist Mo*

468-7
C. C. C. 25-26 May

Coleman, James
Substitute

R. W. Finkbeiner

6/27/26

11/1/26

534

C. C. C. 25-26 May

Personally appeared before Me, Xavier Coleman
who being duly sworn, upon his oath says, that he is ~~an~~ a native
of Jackson Mississippi and a subject of
the rebellious States That he came to the
State of Missouri in or about the year month of Oct 1864
since that time he has resided in the State City of St Louis but
still claims to be a citizen of Mississippi
forming a Slave of Ben Dalton who
came into the Rebel Army

that he never declared his intention to become a Citizen of the United States
and has never exercised the right of suffrage by voting at any election in any
State. That he claims to be exempted from Military Service on the ground
that he is a Subject of a Foreign Government, and has not declared his inten-
tion to become a Citizen of the United States, and has never voted at any elec-
tion in any State.

Xavier Coleman
his
Mark

We, the subscribers, and
citizens of County and State aforesaid, hereby certify
that the above statement of is correct and
true to the best of our knowledge and belief.

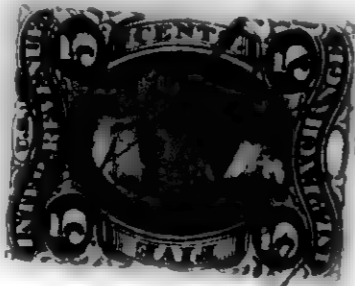

STATE OF MISSOURI, }
County of St. Louis, } SS.

Before the undersigned a Justice of the Peace within and for the County aforesaid, per-
sonally came Xavier Coleman

who being severally duly sworn accord-
ing to law, depose and say that the facts set forth in the above certificate by them respectively sub-
scribed are correct and true.

In Witness Whereof, I have hereunto set my hand, this 25th
day of Oct A. D. 1864
John W. Cunningham
Justice of the Peace.

314

Collier, James

Co *A*, **11** U.S. Col'd Inf.

(New Organization.)

Private | *Private*

CARD NUMBERS.

1	6322367	26
2	6323709	27
3	6323812	28
4	6323916	29
5	6324021	30
6	6324151	31
7	6324862	32
8	9070829	33
9	9070615	34
10		35
11		36
12		37
13		38
14		39
15		40
16		41
17		42
18		43
19		44
20		45
21		46
22		47
23		48
24		49
25		50

Book Mark: _____

See also _____

C | 11 (New) U.S.C.T.

James Collier (New)
Co. A, 11 Reg't U.S. Col'd Inf.

Appears on

Company Descriptive Book

of the organization named above.

DESCRIPTION.

Age 18 years height . . . feet . . . inches.

Complexion *Blk*

Eyes; *Blk* hair *Blk*

Where born

Occupation

ENLISTMENT.

When *July 1*, 1863.

Where *Corinth Miss.*

By whom *Capt. Booth*; term *3* y'rs.

Remarks: *Wiping after battle
at Fort Pillow, Tenn.
Apr 12 1864.*

Heart

C | 11 | U.S.C.T.

James Collier

Co. A., 11 Reg't U.S. Col'd Inf.

Appears on

Company Descriptive Book

of the organization named above.

DESCRIPTION.

Age 18 years height feet inches.

Complexion Blk

Eyes; Blk hair Blk

Where born

Occupation Laborer.

ENLISTMENT.

When July 1, 1863.

Where Corinth Miss.

By whom Capt. Booth; term 3 y'rs.

Remarks: Missing after battle
at Fort Pillow, Tenn.
Apr 12-64.

Hearst

le | 11 (New) | U.S.C.T.

James Collier
Pri. Co. Ala. S. Arty Vols
11. Reg't U. S. Col'd Infantry.

Age 18 years.

Appears on a

Detachment Muster-in Roll

of the organization named above. Roll dated

Corinth Miss., July 28, 1863.

Muster-in to date July 10, 1863.

Joined for duty and enrolled:

When July 1, 1863.

Where Corinth Miss.

Period 3 years.

Remarks:

Book mark:

Avoy

C | 11 (New). | U.S.C.T.

James Collins

Pvt, Co. A, 1 Reg't Ala. Siege Art'y.*

Appears on

Company Muster Roll

for July and Aug., 1863.

Present or absent Present

Stoppage, \$ 100 for

Due Gov't, \$ 100 for

Remarks:

*This organization subsequently became Co. A, 11 Reg't U. S. Colored Infantry (New).

Book mark:

House

C | 11 (New). | U.S.C.T.

James Collins

Prvt, Co. A, 1 Reg't Ala. Siege Art'y.*

Appears on

Company Muster Roll

for *Sept. and Oct.*, 186*3*

Present or absent *Present*

Stoppage, \$ 100 for

Due Gov't, \$ 100 for

Remarks:

*This organization subsequently became Co. A, 11 Reg't U. S. Colored Infantry (New).

Book mark:

Howe

C

11 (New).

U.S.C.T.

James Collins

Prst, Co. A, 1 Reg't Ala. Siege Art'y.*

Appears on

Company Muster Roll

for *New and Old*, 186 *3*

Present or absent *Present*

Stoppage, \$ *100* for

Due Gov't, \$ *100* for

Remarks:

*This organization subsequently became Co. A, 11 Reg't U. S. Colored Infantry (New).

Book mark:

House

6 | 11 (New). | U.S.C.T.

James Collier
.....
Pvt., Co. A, 4 Batt'n, 1 Reg't Tenn. H. Art'y.*

Appears on

Company Muster Roll

for *Jany & Feby*, 1864.

Present or absent *Present*

Stoppage, \$ 100 for

Due Gov't, \$ 100 for

Remarks :

* This organization subsequently became Co. A, 11 Reg't U. S. Colored Infantry (New).

Book mark :

Rosenbaum
.....
Coptist.

C 11 (New). U.S.C.T.

James Collier
Privt., Co. A, 6 Reg't U. S. Col'd H. Art'y.*

Appears on

Company Muster Roll

for *March & April*, 1864.

Present or absent *absent*

Stoppage, \$ *100* for

Due Gov't, \$ *100* for

Remarks: *Missing after Battle
at Fort Pillow from April
12-1864*

* This organization subsequently became Co. A, 11 Reg't U. S. Colored Infantry (New).

Book mark :

Rosenbaum
Coptist.

Q

11 (New). U.S.C.T.

James Collier

Pl. A, 11 Reg't U. S. Col'd Inf. (New).

Appears on Co. Muster-out Roll, dated

Memphis Tenn, Jan'y 12, 1866.

Muster-out to date _____, 186 .

Last paid to Dec 31, 1863 .

Clothing account:

Last settled _____, 186 ; drawn since \$ _____ 100

Due soldier \$ _____ 100; due U. S. \$ _____ 100

Am't for cloth'g in kind or money adv'd \$ _____ 100

Due U. S. for arms, equipments, &c., \$ _____ 100

Bounty paid \$ _____ 100; due \$ _____ 100

Remarks: Missing in action at
F. Pillow Tenn. 12th Apr 64
Joined as a Recruit

Book mark: Feb.

Hoyberger

Collier, James

P, Co. A, **11** U.S.C. Inf.
Reg't

Enclosures.

Bed Cards	Descriptive Lists
Burial Records	Final Statements /
Certs. of Dis. for Discharge	Furloughs
C. M. Charges	Med. Des. Lists
Med. Certificates	Orders

Other papers relating to—

Admission to Hosp'l	Furlough
Casualty Sheet (Officer's)	Med. Examination
Confinement	Misc. Information
Contracts	Pay or Clothing
Death or Effects	Personal Reports
Desertions	Rank
Discharge from Hosp'l	Transfer to Hosp'l
Discharge from Service	Transfer to V. R. C.
Duty	Transportation

Co-A ✓ 58.

✓ FINAL STATEMENT

OF
James
Private James Collins

7 Reg't of *U.S. Col. 47*

711 *U.S. Col. 47*
VOLUNTEERS.

Disch. April 12 1864

NOTE 1.—Two of these certificates (or duplicates) are to be given to each Volunteer Soldier or drafted man who may be discharged previously to the discharge of his company, that he may at once receive from the Paymaster the pay, &c., due him, and the captain or other COMMISSIONED officer commanding the company will certify to the act of the delivery of the duplicate certificates; on these certificates the Soldier is "entitled to" his discharge, and should also present his discharge to the Paymaster to have the payment endorsed on it. The discharge is to be given back to the Soldier by the Paymaster; the latter only retaining as his voucher the duplicate certificates.

NOTE 2.—If the Soldier is entitled to pay for the use of his horse, the Company Commander will certify to that fact on the back of both these final statements, and also to the time he has pay due for having been so mounted on his own horse.

NOTE 3.—When a Soldier is furnished with final statements, his descriptive list, if he has one, should be taken up by the officer who gives the Soldier these statements, and endorsed with a statement to this effect by the officer. This endorsement should exhibit a full statement of the time for which the Soldier was allowed pay on his final statements, the clothing account, and all other charges against him or in his favor, so as to comprise a complete exhibit of his account. It will then be transmitted to the company commander of the Soldier, who will enter all the data necessary to a full understanding of the Soldier's account on the muster roll upon which the Soldier's discharge is reported. The descriptive list will then be destroyed. The object of this is, that the remaining portion of the Soldier's account may be settled upon the receipt of these muster rolls, and the Soldier receive any pay or allowances that may be due him at the time of his discharge, and which may not appear on his final statements from the fact that his descriptive list is incomplete. These accounts for back pay, &c., are settled by the 2d Auditor of the Treasury Department.

NOTE 4.—Charges for loss or injury to ordnance, horse equipments, and other miscellaneous charges, should appear under the heading of "Other Stoppages."

NOTE 5.—Bounty paid by State authorities, and not by the United States, will not be entered on this statement.

NOTE 6.—Amounts due the Sutler and Laundress must be entered on the muster roll on which the discharge, death, desertion, &c., is reported, as well as on the final statement, otherwise the amount cannot be collected from the United States.

NOTE 7.—This blank will be used for deceased volunteers and drafted men, as well as for others.

NOTE 8.—Where a Soldier dies in Hospital or on detached service, his descriptive list, if he has one, should be sent with his final statements, in duplicate, to the Adjutant General, Washington, D. C.

ADJUTANT GENERAL'S OFFICE.

July 18th 1864

Duplicate with Inventory sent 2d Auditor.

Ent on OR of 1864

I certify, on honor, that James Collier a Private of
 Captain Joseph Penner Company (C) of the 7th Regiment of U.S. Heavy Arty Reg
VOLUNTEERS, of the State of _____, born in _____, State
 of _____, aged 18 years; _____ feet _____ inches high; Dark complexion,
Blue eyes, Black hair, and by occupation a _____, having joined the company on
 its original organization at South Miss, and enrolled in it at the muster into
 the service of the United States at South Miss, on the First day
 of July, 1863, (or was mustered in service as a recruit, by _____
 _____, at _____, on the _____ day of _____,
 186 , or was drafted and mustered into the service of the United States from the _____
 Enrollment District of the State of _____, at _____,
 on the _____ day of _____, 186), to serve in the Regiment, for
 the term of Three years unless sooner discharged and having served **HONESTLY** and
FAITHFULLY with his Company in the field to the present date, is now
 entitled to a **DISCHARGE** by reason of Missing after Battle of Fort
Pollen Tenn April 12 1864 Supper to be Collier

The said Private James Collier was last paid by Paymaster
Mr. Salmon to include the 31st day of December, 1863, and has
 pay due him from that time to the present date; he is entitled to pay and subsistence for
TRAVELING to place of enrollment, and whatever other allowances are authorized to volunteer
 soldiers, drafted men, or militia, so discharged. He has received from the United States **CLOTHING**
 amounting to _____ 100 dollars, since the _____ day of _____,
 186 , when his clothing account was last settled. He has received from the United States
 _____ 100 dollars advanced **BOUNTY**.

There is to be stopped from him, on account of the State of _____, or other
 authorities, for **CLOTHING**, &c., received on entering service, _____ 100 dollars; and
 for other stoppages, viz: Company Books were all destroyed at Fort
Pollen Tenn April 12 1864. Reasoning it impossible for
me to give the amount of Clothing _____ 100 dollars.
 He has been furnished with **TRANSPORTATION** in kind from the place of his discharge to
 _____; and he has been **SUBSISTED** for **TRAVELING** to his
 place of enrollment, up to the _____, 186 .

He is indebted to A. B. Gugg, **SUTLER**, _____ 2. 00 dollars.
 He is indebted to _____, **LAUNDRESS**, _____ 100 dollars.

Given in Duplicate, at Fort Pickens Tenn, this 22 day
 of June, 1864.

H. B. Martin
2nd Lieut.

 Commanding Company.

315

Collins Lewis

Co A, 11 U.S. Col'd Inf.

(New Organization.)

Private

Private

CARD NUMBERS.

1	6327526	26
2	6327635	27
3	6327739	28
4	6327887	29
5	6328624	30
6	7071738	31
7	7071579	32
8		33
9		34
10		35
11		36
12		37
13		38
14		39
15		40
16		41
17		42
18		43
19		44
20		45
21		46
22		47
23		48
24		49
25		50

Book Mark: *EB. 12*
335

See also

6 | 11^(new) U.S.C.T.

Lewis Collier

Co. *L*, 11 Reg't U.S. Col'd Inf. ^(new)

Appears on

Company Descriptive Book

of the organization named above.

DESCRIPTION. *No Description*

Age years height feet inches.

Complexion

Eyes; hair

Where born

Occupation

ENLISTMENT.

When , 186

Where

By whom ; term y'rs.

Remarks:

.
.
.
.
.
.
.
.
.
.

Leary
Coryist.

C | 11 (New) | U.S.C.T.

Louis Collier
Co. *D*, 11 Reg't U.S. Col'd Inf. ^(New)

Appears on
Company Descriptive Book
of the organization named above.

DESCRIPTION.

Age *17* years height . . . feet . . . inches.

Complexion *Black*

Eyes; *Black* hair *Black*

Where born

Occupation

ENLISTMENT.

When *Nov 23*, 1863.

Where *Corinth, Miss.*

By whom *D. Carson*; term *3* y'rs.

Remarks: *Died in Hospital Memphis, Tenn. of Disease. Records of Co. lost in action at Fort Pillow April 12th 1864. (Died Feb*

Learny
Copyst.

Cy | **11** (New) | **U.S.C.T.**

Lewis Collins
PT, Co. *D*, 1 Reg't Ala. Siege Art'y.*

Age *17* years.

Appears on

Company Muster-in Roll

of the organization named above. Roll dated
Corinth Miss, *Nov 27*, 186*3*.

Muster-in to date *Nov 23*, 186*3*.

Joined for duty and enrolled:

When *Nov 23*, 186*3*

Where *Corinth Miss*

Period *3* years.

Remarks:
.....
.....
.....
.....
.....

*This organization subsequently became Co. *D*, 11 Reg't U. S Colored Infantry (New).

Book mark:

Leger

Cy | **11 (New). U.S.C.T.**

Lewis Collier

Pvt, Co. D, 1 Reg't Ala. Siege Art'y.*

Appears on

Company Muster Roll

for *Nov & Dec*, 1863.

Present or absent *Present*

Stoppage, \$ *100* for

Due Gov't, \$ *100* for

Remarks: *Sick in quarters. Has never drawn pay.*

*This organization subsequently became Co. D, 11 Reg't U. S. Col'd Infantry (New).

Book mark:

Leger

11 | **11 (New).** | **U.S.C.T.**

James M. ...
... Co. D, 4 Battalion, 1 Reg't Tenn. H. Art'y.*

Appears on

Company Muster Roll

for *May 1864*, 1864.

Present or absent *Absent*

Stoppage, \$ *100* for

Due Gov't, \$ *100* for

Remarks: *Admitted to Hospital Memphis Tenn.*

* This organization subsequently became Co. D, 11 Reg't U. S. Colored Infantry (New).

Book mark :

James M. ...

D. | **11** (New) | **U.S.C.T.**
Lewis Collier
Priv., Co. D, 7 Reg't U. S. Col'd H. Art'y.*

Appears on

Company Muster Roll
for *Mar. & Apr.*, 1864.

Present or absent

Stoppage, \$ 100 for

Due Gov't, \$ 100 for

Remarks: *Died in Hosp. at
Memphis, Tenn*

*This organization subsequently became Co. D, 11 Reg't U. S. Col'd
Infantry (New).

Book marks *Died Apr. 26/64 EP. 12
336*

(358)

B. J. Cooke

Copyist.

B | 11 (New). U.S.C.T.

Lewis Collier

Co. A, 11 Reg't U. S. Col'd Inf. (New).

Appears on **Co. Muster-out Roll**, dated
Memphis Tenn. Jan. 12, 1866.

Muster-out to date _____, 186 .

Last paid to *Never paid*, 186 .

Clothing account:

Last settled _____, 186 ; drawn since \$ _____ 100

Due soldier \$ _____ 100 ; due U. S. \$ _____ 100

Am't for cloth'g in kind or money adv'd \$ _____ 100

Due U. S. for arms, equipments, &c., \$ _____ 100

Bounty paid \$ _____ 100 ; due \$ _____ 100

Remarks:

*Died at Webster
G.H. Memphis Mar.
16. 64 Pneumonia.*

Book mark: *P. 77. P. 10. 69-789
P. 93. 69. (over)*

Hadgus
Copyist.

JAN. 22

6328624

018910

Died Apr. 26/64 E.B. ¹²/₃₃₅

Collier, Lewis

P, Co. D, **11**, **U. S. C. Inf.**

2 Enclosures.

Bed Cards	Descriptive Lists
Burial Records	Final Statements
Certs. of Dis. for Discharge	Furloughs
C. M. Charges	Med. Des. Lists
Med. Certificates	Orders

Other papers relating to—

Admission to Hosp'l	Furlough
Casualty Sheet (Officer's) ^{Priv} /	Med. Examination
Confinement	Misc. Information /
Contracts	Pay or Clothing
Death or Effects	Personal Reports
Desertions	Rank
Discharge from Hosp'l	Transfer to Hosp'l
Discharge from Service	Transfer to V. R. C.
Duty	Transportation

Spec. I. sent for to Sgo July 15/9

CASUALTY SHEET

No.

Lewis Collier
Private of Company "C"
11th Regiment of U. S. C. I.

State Volunteers.

NATURE OF CASUALTY.

Dead; April 26 1864.

*Sum of effects sent to
Grand. a pl. 9486 of
10.
Ent on R of Co.*

[OFFICE ENDORSEMENT.]

War Department,

ADJUTANT GENERAL'S OFFICE,

June 11, 187*7*

The death of *Priv Lewis*
Collier, Co "C", 11th Reg't U.S.

Colored Inf. (regt), is reported as follows:

- On Company Muster Roll. For *March*, 1864, *No date*, 1864
- Company Muster-out Roll. *March 16*, 1864
- Company Descriptive Book. *March 16th*, 1864
- Company Morning Report. *does not cover date*, 1864
- Soldier's Final Statement. _____, 1864
- Soldier's Record of Death and Interment. _____, 1864
- Soldier's Inventory of Effects. _____, 1864
- Soldier's Certificate of Disability for Discharge. _____, 1864
- Soldier's Individual Muster-out Roll. _____, 1864
- Regimental Return. For *Nov*, 1864, *Records*, 1864
- Regimental Quarterly Returns. *Dec 1863*, *No Records*, 1864
- Regimental Descriptive Book. _____, 1864

The name of Lewis Collier is not borne on any Rolls of Co B 11th U.S.C. (regt)

See the name of Lewis Collier in the roll of Co B 11th U.S.C. (regt) dated April 26 1864

By Surgeon General. *(May 16 77) (Lewis Collier Co B) April 26*, 1864

April 26, 1864, is held to be the correct date, and the Company Muster Roll will be amended accordingly.

THOMAS M. LAURENT

Assistant Adjutant General.

Noted H.M.

*813 14
335*

CASUALTY SHEET.

Name: Lewis Collins

Rank: Priv. Company: "G" Regiment: 11th

Arm: U.S. Inf. State:

Nature of Casualty: Death.

CAUSE OF CASUALTY—(NAME OF DISEASE, &c.)

Pneumonia

BY WHOM DISCHARGED.

FROM WHAT SOURCE THIS INFORMATION WAS OBTAINED.

Musters - Cert. Roll

DEGREE OF DISABILITY.

BY WHOM CERTIFIED.

Bethel M. Custer
1st St. Cav. Co.

REMARKS.

DATE OF DISCHARGE, DEATH, &c.

April 26
1864

PLACE OF DISCHARGE, DEATH, &c.

Webster - Gen. Hosp.
Memphis, Tenn.

B. C. S.
Clerk.

Surgeon General's Office,

Record and Pension Division,

March 14th, 1867.

Respectfully returned to Assistant Adjutant General *J. W. Saggard*

A. G. O., with an Inventory of Effects enclosed, in case of *Jadis Collier*
Prvt Co B 1st Tenn A D.

(supposed to be the soldier referred to within).

No evidence on file from which Final Statements can be prepared.



By Order of the Surgeon General:

J. Woodward

Brevet Major and Assistant Surgeon, U. S. Army.

R. of A., Vol. *7* No. *213* *W. M. B.*
4.9.67

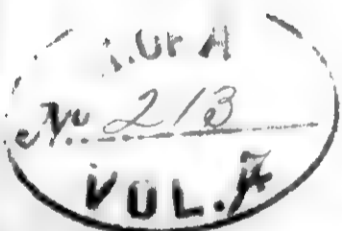

WAR DEPARTMENT,

ADJUTANT GENERAL'S OFFICE,

WASHINGTON, *Feb. 7th*, 186*4*.

SIR:

Final Statements in the cases of deceased soldiers are required to be sent to the Adjutant General's Office in duplicate, with one copy of the Inventory of Effects. The Descriptive List should also be sent to this Office in cases where the soldier was absent from his Company at the time of his death. Where there were no effects, it should be so stated on a blank Inventory, properly signed.

Certificates of Disability should be sent in duplicate. Special care should be taken that the date of discharge and signature of the discharging officer should be affixed.

No of the Final Statements *on* Inventory, has been received in the case of *Lewis Collier* Private, of Co. *"D"*, *11th* Regiment of *U. S. C. Inf.* Volunteers, whose papers were forwarded to this Office. You will please forward the missing papers without delay.

I have the honor to be, sir,

Very respectfully,

Your obedient servant,

T. C. Hazard

Assistant Adjutant General.

(110)

~~COMMANDING OFFICER~~

Asst. Surg. J. J. Woodward.

S. G. O. W.

Died; March. 16th 1864. in Memphis. Tenn

Bledwell

Died in 1st Regt. Ind. Co. 13. Pneumonia April 25th 1864 Memphis Tenn

MODEL FOR SET OF PAPERS FOR A DECEASED SOLDIER.

FORM 1.—FINAL STATEMENT.

I CERTIFY, ON HONOR, that *John Smith*, a Private of Captain J. Brown's Company, (A.) of the 1st Regiment of Pennsylvania Volunteers, of the State of Pennsylvania, born in Pittsburg, State of Pennsylvania, aged 21 years, 5 feet 10 inches high, light complexion, blue eyes, dark hair, and by occupation a Farmer, having joined the Company on its original organization at Pittsburg, and enrolled in it at the muster into the service of the United States at Pittsburg, on the 1st day of July, 1861, (or was mustered in service as a recruit, by —, at —, on the — day of —, 186—, or was drafted and mustered into the service of the United States from the — Enrollment District of the State of —, at —, on the — day of —, 186—,) to serve in the Regiment for the term of Three Years, and having served *honestly and faithfully* with his Company in the field to the present date, is now entitled to a DISCHARGE by reason of death. Died in Regimental Hospital, Fort Brown, Texas, December 31, 1863, of typhoid fever.

The said John Smith was last paid by Paymaster Major Morse, to include the 31st day of October, 1863, and has pay due him from that time to the present date. He is entitled to pay and subsistence for *traveling* to place of enrollment, and whatever other allowances are authorized to volunteer soldiers, drafted men, or militia, so discharged. He has received from the United States *clothing* amounting to 20.00 dollars, since the 31st day of December, 1862, when his clothing account was last settled. He has received from the United States 25.00 dollars advanced *bounty*.

There is to be stopped from him on account of the State of —, or other authorities, for *clothing, &c.*, received on entering service, nothing, .00 dollars; and for other stoppages, viz: nothing, .00 dollars. He has been furnished with no *transportation* in kind from the place of his discharge to —; and he has not been *subsisted* for *traveling* to his place of enrollment up to the —, 186—.

He is indebted to —, Sutler, —.00 dollars.

He is indebted to —, Laundress, —.00 dollars.

GIVEN, IN DUPLICATE, at Fort Brown, Texas, this 31st day of December, 1863.

JAMES BROWN,
Captain Co. A, 1st Penn. Vols.,
Commanding Company.

FORM 2.

INVENTORY of the effects of John Smith, late a Private of Captain J. Brown's Company, (A.) of the 1st Regiment of Pennsylvania Volunteers, who was enrolled as a Private at Pittsburg, in the State of Pennsylvania, on the 1st day of July, 1861, and mustered into the service of the United States as a Private on the 1st day of July, 1861, at Pittsburg, in Company A, 1st Regiment of Pennsylvania Volunteers, to serve three years or during the war. He was born in Pittsburg, in the State of Pennsylvania; he was 21 years of age, 5 feet 10 inches high, light complexion, blue eyes, dark hair, and by occupation, when enrolled, a Farmer. He died in Regimental Hospital, at Fort Brown, Texas, on the 31st day of December, 1863, of typhoid fever.

INVENTORY.					
ARTICLES.	No.	ARTICLES.	No.	ARTICLES.	No.
Hats.....		Pairs trousers.....		Knapsacks.....	
Caps.....		Pairs flannel drawers.....			
Forage caps.....		Pairs cotton drawers.....			
Great coats.....	1	Flannel shirts.....	1	Watch, silver.....	1
Uniform coats.....		Cotton shirts.....			
Uniform jackets.....		Pairs boots.....			
Flannel sack coats.....		Pairs shoes.....			
Blouses.....		Pairs socks.....			
Stable frocks.....		Blankets.....			
Fatigue overalls.....		Haversacks.....			
				MOONEY	
				Specie.....	\$2 00
				Notes.....	\$50 00

I CERTIFY, ON HONOR, that the above inventory comprises all the effects of Private John Smith, deceased, and that the effects are in the hands of Captain J. Brown, at Fort Brown, Texas, to be disposed of by a Council of Administration, except the money, which has been turned over to Major Wm. C. Morse, Paymaster, U. S. Army, whose receipt is hereto annexed.*

STATION: Fort Brown, Texas.

DATE: December 31, 1863.

(Duplicates.)

JAMES BROWN,
Captain Co. A, 1st Penn. Vols.,
Commanding the Company.

*NOTE.—If the effects have been turned over to relatives of deceased, so state on certificate, instead of "in the hands of Captain," &c., and give the names of the persons, and their relation to the deceased person.

FORM 3.—HEIR'S RECEIPT FOR EFFECTS.

RECEIVED of Captain John Brown, Company A, 1st Regiment of Pennsylvania Volunteers, the following effects of Private John Smith, late of Company A, 1st Regiment of Pennsylvania Volunteers, now deceased, which I claim as his wife:

1 great coat, 1 flannel shirt, 1 silver watch, fifty dollars in notes, and two dollars in specie.

MARY SMITH.

FORM 4.—PAYMASTER'S RECEIPT FOR MONEY.

RECEIVED, this 31st day of December, 1863, at Fort Brown, Texas, of Captain James Brown, of Company A, 1st Pennsylvania Volunteers, fifty dollars in Treasury notes and two dollars in specie, the property of the late Private John Smith, of Company A, 1st Pennsylvania Volunteers, who died at Fort Brown, Texas, on the 31st day of December, 1863.

WM. C. MORSE, Paymaster, U. S. A.

FORM 5.—PROCEEDINGS OF A COUNCIL OF ADMINISTRATION,

Convened at Fort Brown, Texas, pursuant to Orders, No. 1, dated Post Headquarters, Fort Brown, Texas, January 2, 1864—consisting of Captain James Keith, Company C, 1st Pennsylvania Volunteers; Captain John Brown, Company D, 1st Pennsylvania Volunteers; and Lieutenant William Roe, Company E, 1st Pennsylvania Volunteers—for the purpose of disposing of the effects of the late John Smith, of Company A, 1st Pennsylvania Volunteers:

The Council found that the effects consisted of the following articles. They were ordered to be sold at auction, which was accordingly done, and the amount set opposite the articles respectively obtained, for which the receipt of the Paymaster is annexed:

AT AUCTION.		
1 shirt brought.....		\$1 00
1 great coat ".....		2 50
1 silver watch ".....		25 00
		<u>\$28 50</u>

JAMES KEITH,
Capt. Co. C, 1st Penn. Vols., President.
WILLIAM ROE,
Lieut. Co. E, 1st Penn. Vols., Recorder.

APPROVED:
JOHN SANDERS,
Colonel 1st Penn. Vols.,
Commanding Post.

FORM 6.—PAYMASTER'S RECEIPT.

RECEIVED from Captain John Brown, Company A, 1st Pennsylvania Volunteers, at Fort Brown, Texas, January 10, 1864, twenty-eight dollars and fifty cents, the result of the sale of the effects of the late Private John Smith, of Company A, 1st Pennsylvania Volunteers.

WM. C. MORSE, Paymaster U. S. Army.

ARTICLES OF WAR.

ART. 95. When any non-commissioned officer or soldier shall die, or be killed in the service of the United States, the then commanding officer of the troop or company shall, in the presence of two other commissioned officers, take an account of what effects he died possessed of, above his arms and accoutrements, and transmit the same to the office of the Department of War, which said effects are to be accounted for, and paid to the representatives of such deceased non-commissioned officer or soldier. And in case any of the officers, so authorized to take care of the effects of deceased officers and soldiers, should, before they have accounted to their representatives for the same, have occasion to leave the regiment or post, by preferment or otherwise, they shall, before they be permitted to quit the same, deposit in the hands of the commanding officer, or of the assistant military agent, all the effects of such deceased non-commissioned officers and soldiers, in order that the same may be secured for, and paid to, their respective representatives.

DIRECTIONS.

NOTE 1.—One copy of the inventories of the effects of deceased non-commissioned officers and soldiers, required by the 95th Article of War, will be forwarded to the Adjutant General, by the commander of the company to which the deceased belonged, and a duplicate of the same to the colonel of the regiment. Final statements of pay, clothing, &c., in duplicate, will be sent to the Adjutant General with one copy of the inventory. Both inventory and final statements should be forwarded, as a general rule, through Regimental Headquarters. When a soldier dies at a post or station absent from his company, it will be the duty of his immediate commander to furnish, direct to the Adjutant General, the required inventory and final statements, and, at the same time, to forward to the commanding officer of the company to which the soldier belonged, a report of his death, specifying the date, place, and cause; to what time he was last paid, and the money or other effects in his possession at the time of his decease; which report will be noted on the next muster roll of the company to which the man belonged. Each inventory will be endorsed "Inventory of the effects of —, late of company (—) — regiment of —, who died at — the — day of —, 186—." If a legal representative receive the effects, it will be stated in the report. If the soldier leave no effects, the fact will be reported on the blank for inventory.

NOTE 2.—Should the effects of a deceased non-commissioned officer or soldier not be administered upon within a short period after his decease, they shall be disposed of by a Council of Administration under the authority of the commanding officer of the post, and the proceeds deposited with the Paymaster, to the credit of the United States, until they shall be claimed by the legal representatives of the deceased. This should be done according to Forms 5 and 6, and one copy of each sent to the Adjutant General. No copy of the order convening the board is required, the approval of the commanding officer being sufficient.

NOTE 3.—In all such cases of sales by the Council of Administration, a statement in detail, or account of the proceeds duly certified by the Council and commanding officer (Form 5), accompanied by the Paymaster's receipt of the proceeds, will be forwarded by the commanding officer to the Adjutant General. The statement will be endorsed "Report of the proceeds of the effects of —, late of company (—) — regiment of —, who died at — the — day of —, 186—."

NOTE 4.—The effects in all cases, when called for, should be turned over to the legal representative, without further authority from the Adjutant General. When the effects are turned over to the relatives of the deceased before these inventories are sent to the Adjutant General, their receipts therefor should be attached to the inventories. In all other cases, one copy will be sent with a letter of transmittal direct to the Adjutant General, and a duplicate retained by the officer.

NOTE 5.—Particular care should be taken to take receipts in duplicate from the Paymaster for any funds turned over to him; one copy should be sent direct to the Adjutant General, and one retained by the officer.

NOTE 6.—Where a soldier dies in hospital or on detached service, his descriptive list, if he has one, should be sent with his final statements, in duplicate, to the Adjutant General, Washington, D. C.

NOTE 7.—Form 1 will be forwarded in duplicate to the Adjutant General, through Regimental Headquarters, as soon as possible after the death of the soldier, accompanied by one copy of Forms 2 and 3, or 4, as the case may require. A duplicate of the inventory (Form 2) should be retained until the articles are finally disposed of.

NOTE 8.—The papers for each man should be made SEPARATELY for each man, and, when possible, fastened together. This is especially necessary, and must be done in all cases. The papers cannot be properly disposed of at the Adjutant General's Office unless this is done, and must be returned for correction.

NOTE 9.—Where there are no line officers, as for instance, a general hospital without a line officer to command the guard, the Council of Administration may be made up from other commissioned officers, in the same way as prescribed for line officers.

NOTE 10.—Where a soldier dies away from his company or regiment, and the officer having charge of him cannot furnish Final Statements by reason of not being able to obtain a Descriptive List, he should notify the regimental or company commander, giving him full particulars as to history and description of the man, as far as possible, whose duty it will then be, in such case, to furnish the necessary papers from the best data he can obtain.

MICROCOPY

ROLL

M

1821

ROLL

62

END

IMAGE EVALUATION TEST TARGET (QA-3)

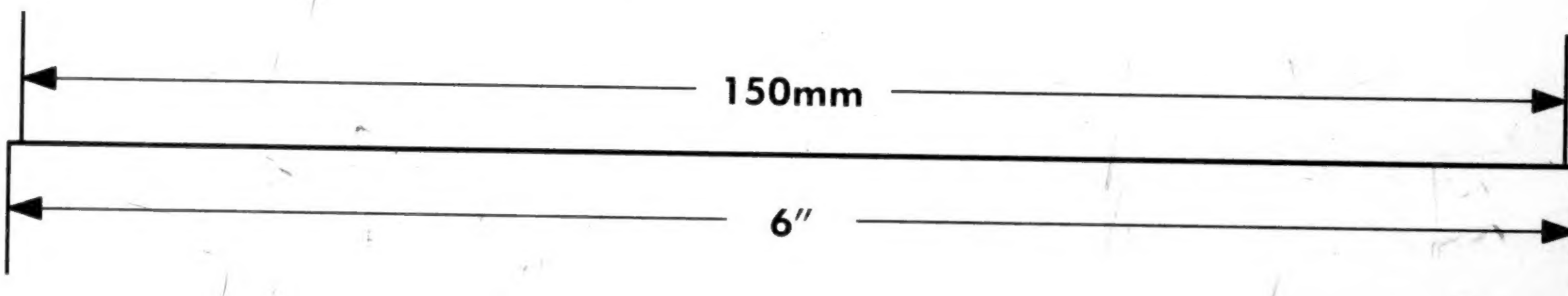
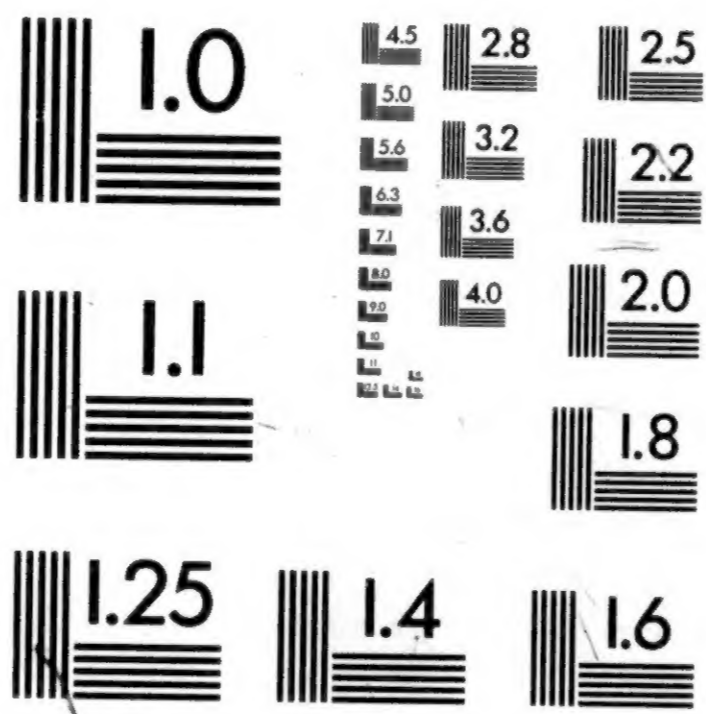
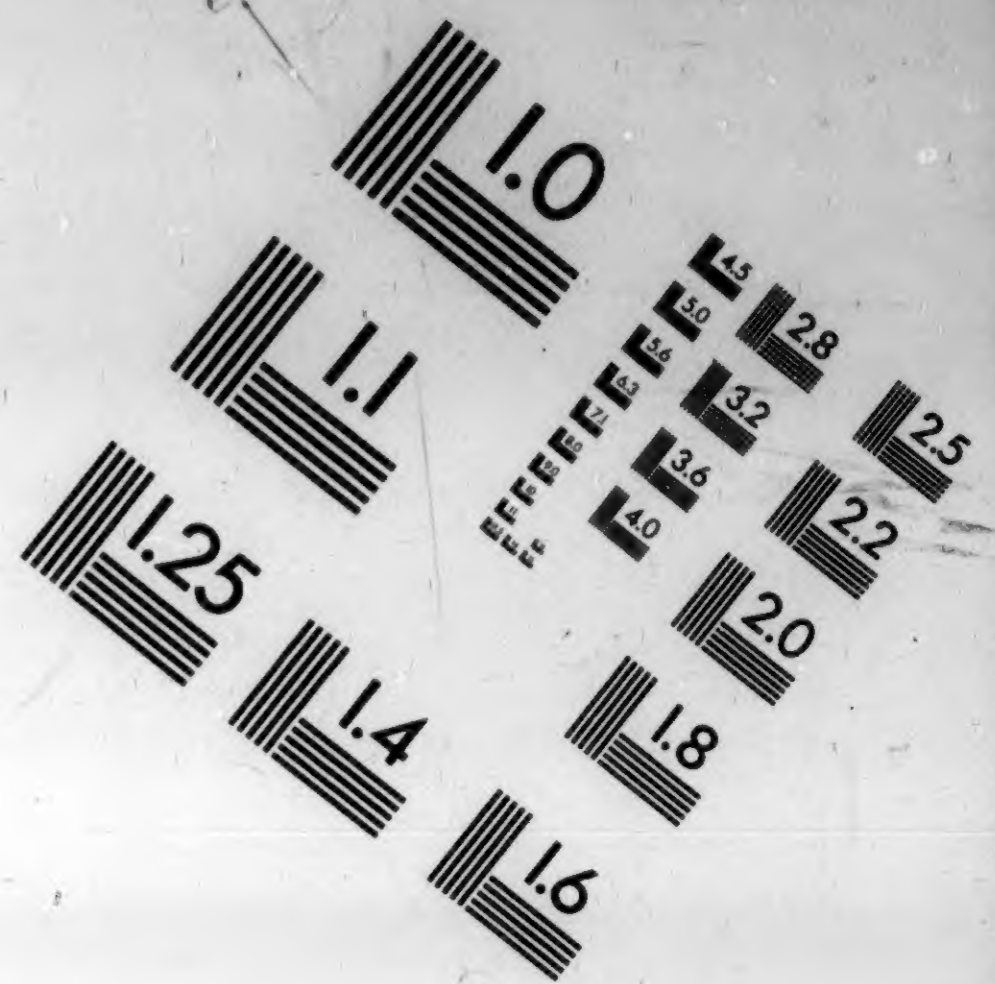
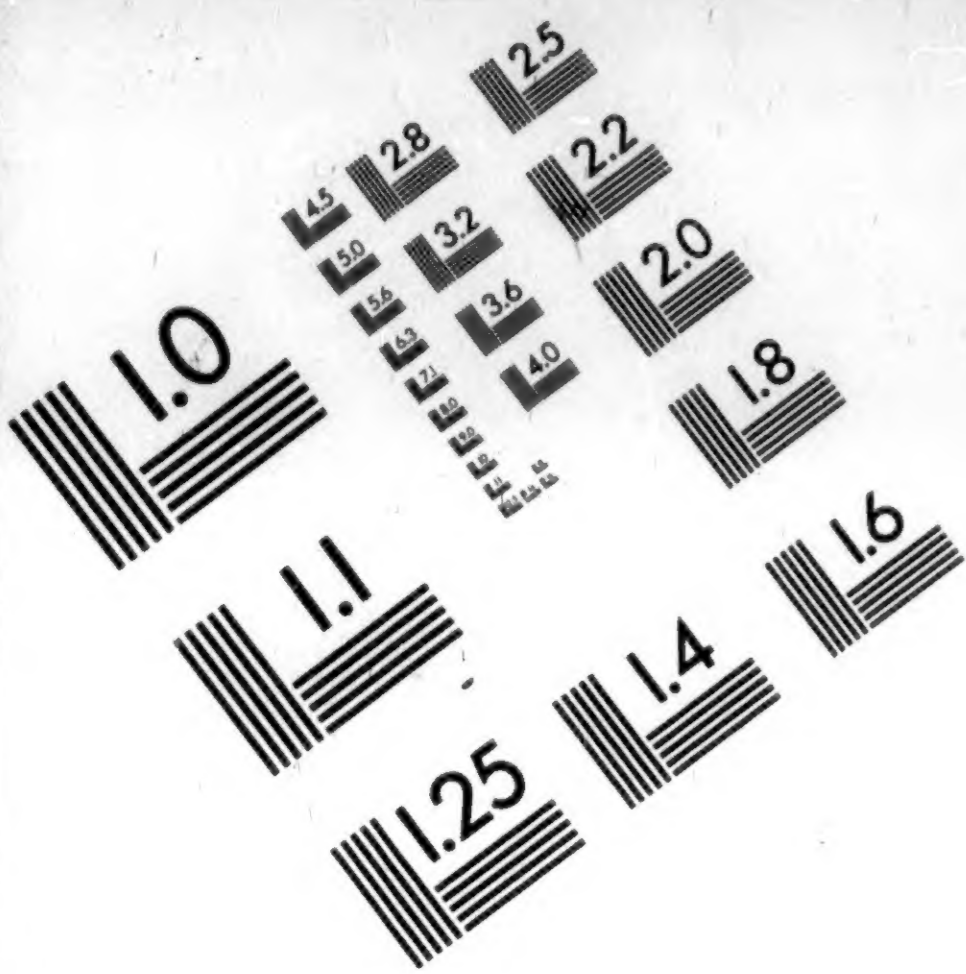

APPLIED IMAGE, Inc
1653 East Main Street
Rochester, NY 14609 USA
Phone: 716/482-0300
Fax: 716/288-5989

© 1993, Applied Image, Inc., All Rights Reserved

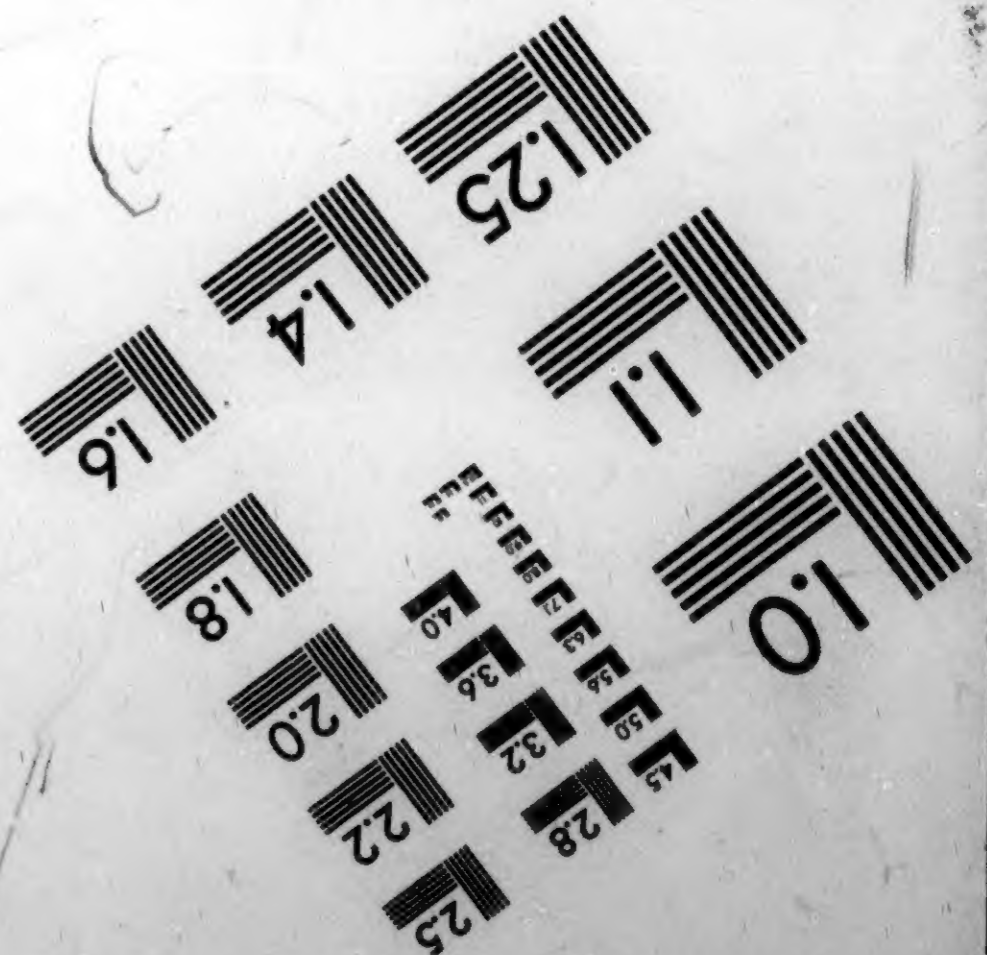
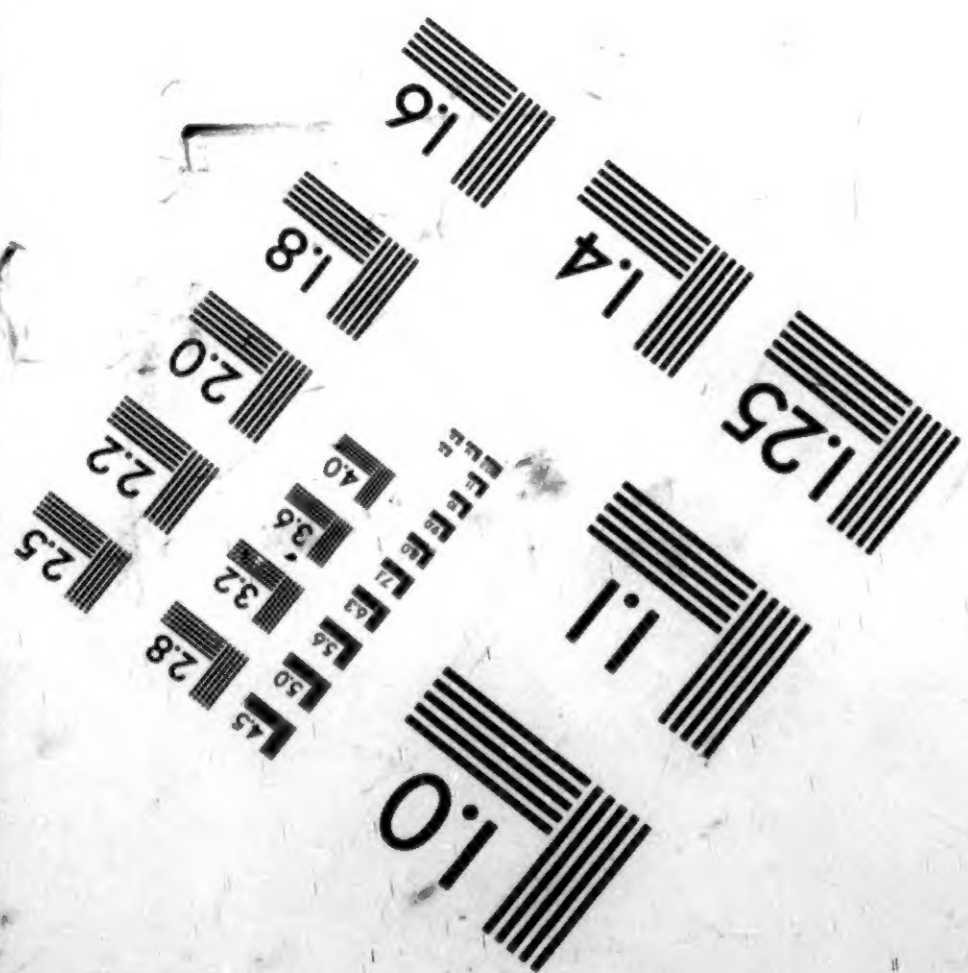

THE END

PLEASE

REWIND