

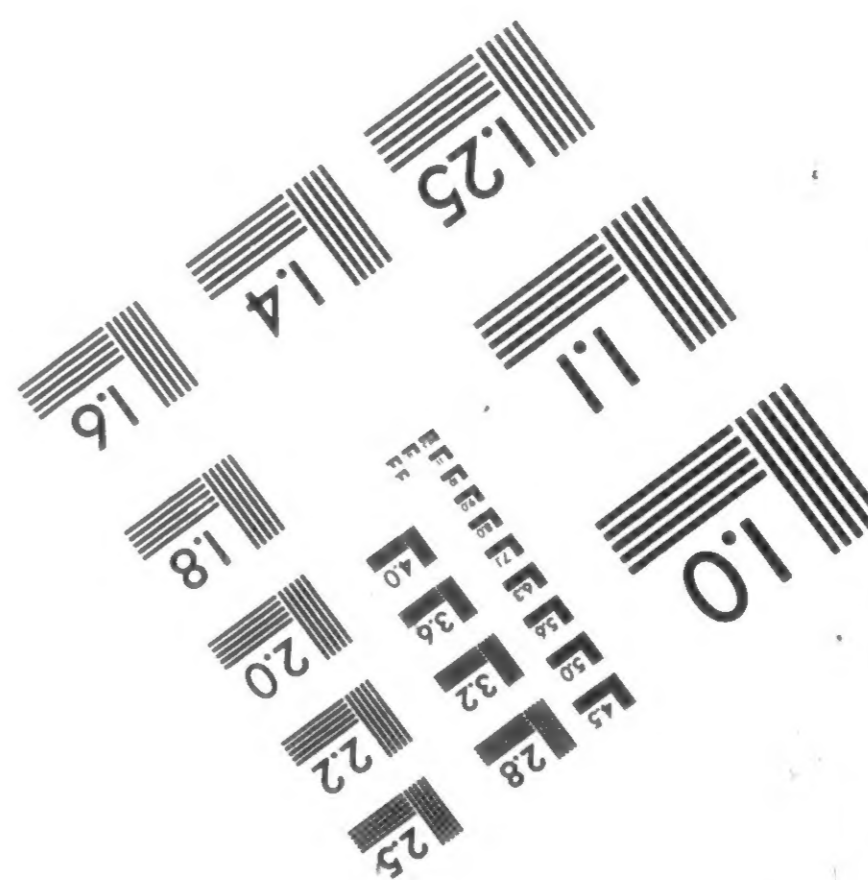

NATIONAL  
ARCHIVES  
MICROFILM  
PUBLICATIONS

IMAGE EVALUATION  
TEST TARGET (QA-3)

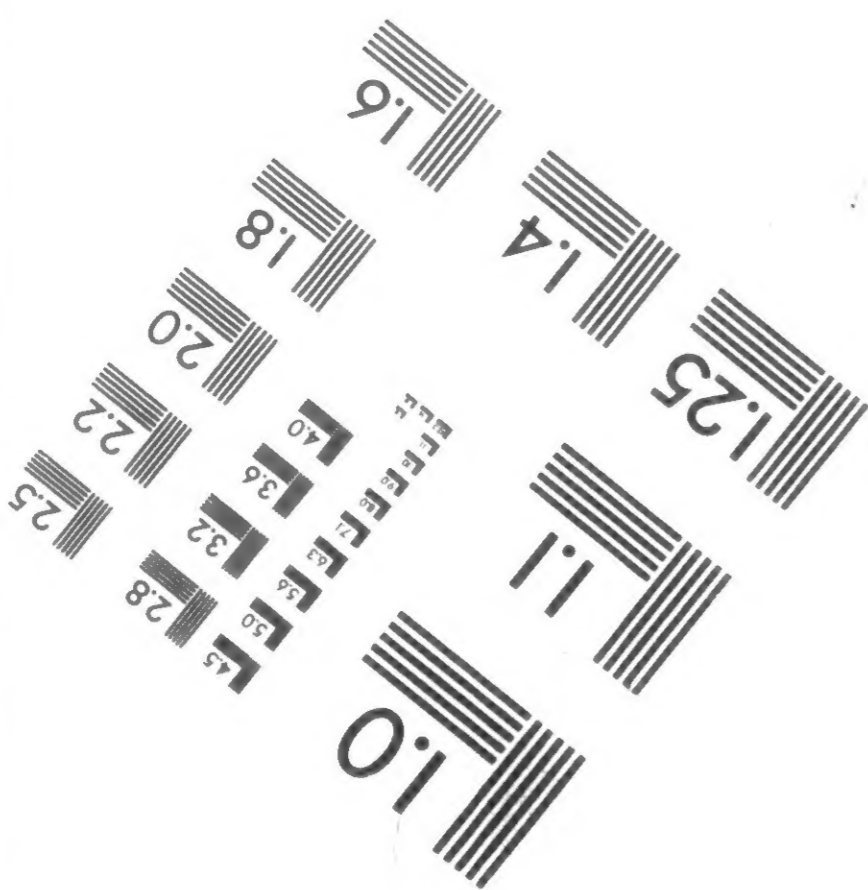
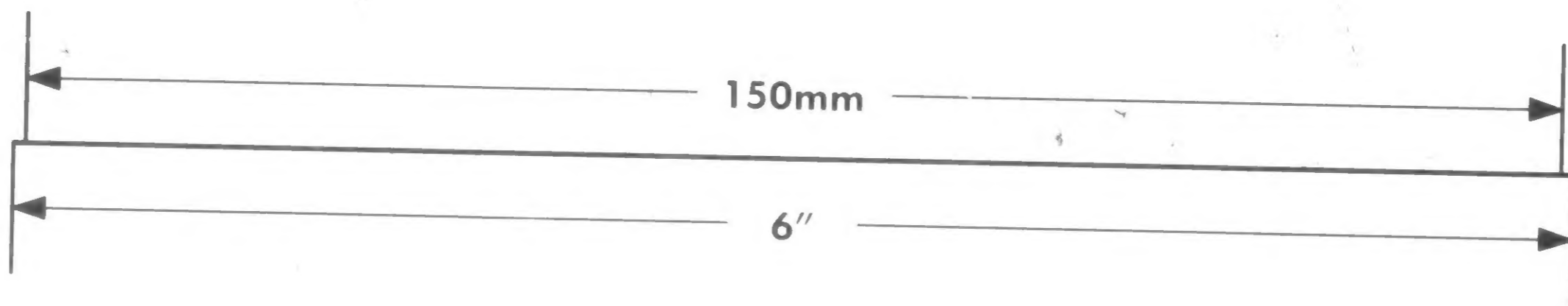
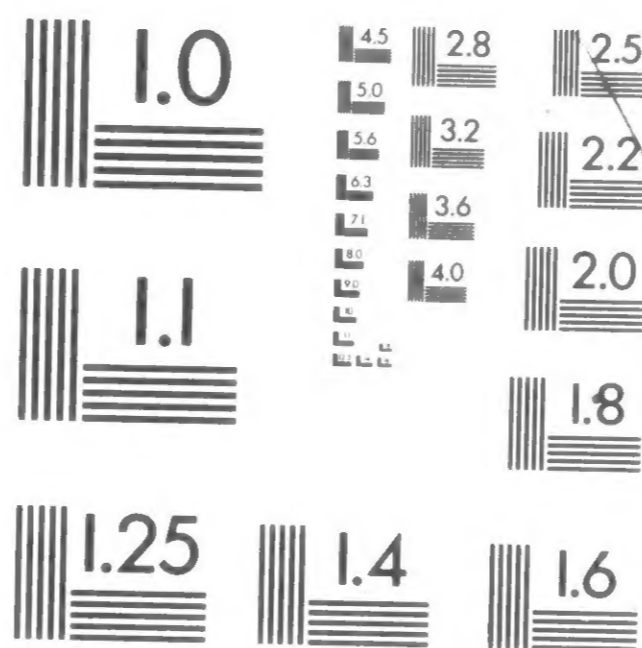
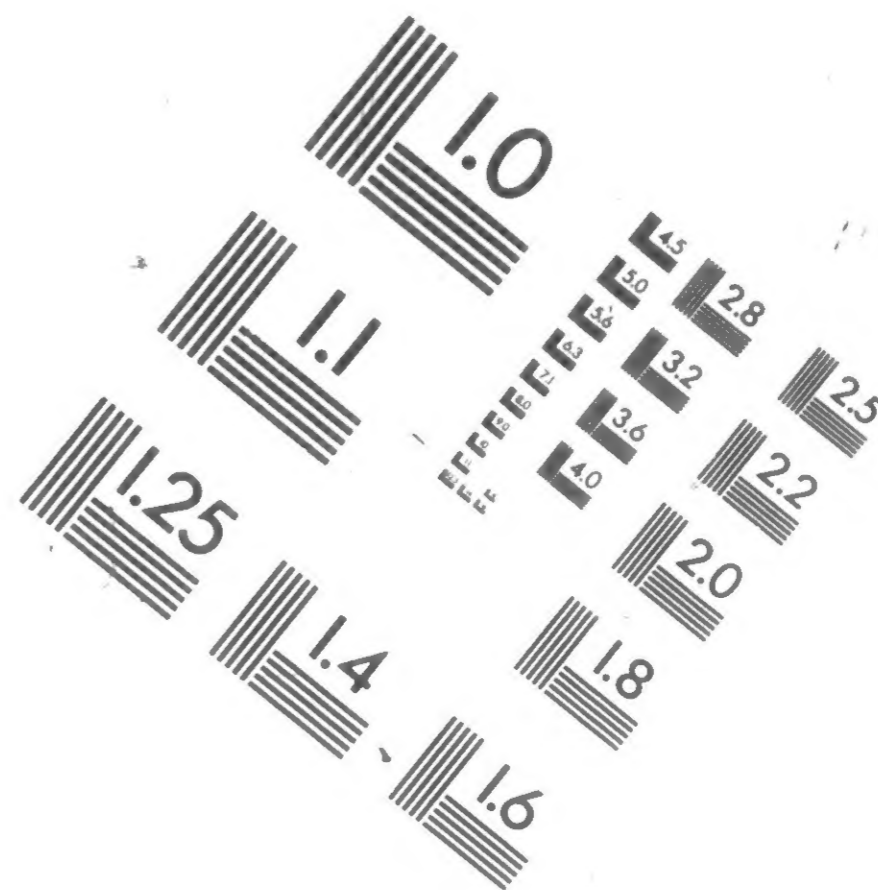
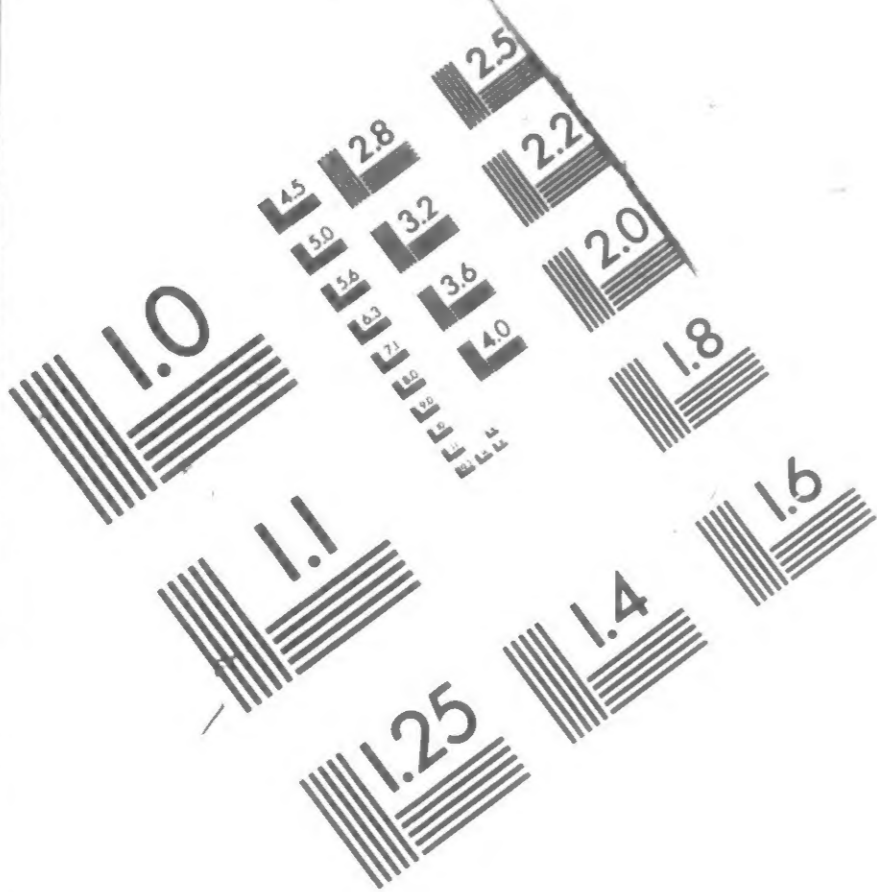

APPLIED IMAGE, Inc  
1653 East Main Street  
Rochester, NY 14609 USA  
Phone: 716/482-0300  
Fax: 716/288-5989

© 1993, Applied Image, Inc., All Rights Reserved

VW

National Archives at College Park

8601 Adelphi Road College Park MD 20740-6001



V. WARE

OPERATOR

CAMERA

7-9-98

Z-4

DATE FILMED

REDUCTION RATIO

1461-0552-018-04

10X

FILM EMULSION NUMBER

M.1818

118

PROJECT NUMBER

ROLL NUMBER

**MICROCOPY**

**18 18**

**ROLL**

**118**

M1818

COMPILED MILITARY SERVICE RECORDS OF  
VOLUNTEER UNION SOLDIERS WHO SERVED WITH THE  
UNITED STATES COLORED TROOPS:  
Artillery Organizations

Introduction by Budge Weidman, Project Manager

Records prepared for microfilming by members of  
the Civil War Conservation Corps

Pat Alfredson	Sue Goward*	Mary Poggioli
Phyllis Altrogge	Bert Greenstein	Peggy Pratt
Kenneth Ashton	Anne Greenwood	Ray Puzio
Sue Barnard*	Jim Harris	Sylvia Scott
Dee Benson	Walter Hayden	Lynn Shearouse
Ann N. Brown	Mary Hayden	Mary Stack-Dunne
Robert Budway	Pat Ikonen	Ben Stearns
Randy Caldwell	Dick Ives	Bill Stormer*
MaryAnn Castellana*	Sarah Jaffe	Pat Sullivan
Mary Lou Cole	Barbara Kemp	Gorman Tidball*
Giovanni Croce	Bev Manypenny	Cathy Tinston
B.H. Custer	Frank Masterson	John Toole
Bob Denney	Joe Mazur	Maryellen Toole
Richard Dow	Kathleen McCarthy	Milt Weatherhead
Earl Dunn	Sarah McDougall	Russ Weidman
Yvette Fallin	Catherine McManus	C. Lois Young
Maria Flesher	Ben Miles	Robert Young
Naomi Glass	Dave Murray	

Team leaders are indicated by the asterisk.

National Archives and Records Administration  
Washington, DC  
1998

## INTRODUCTION

On the 299 rolls of this microfilm publication, M1818, are reproduced the compiled military service records of volunteer Union soldiers belonging to the artillery units organized for service with the United States Colored Troops (USCT). The USCT included 7 numbered cavalry regiments; 13 numbered artillery regiments plus one independent battery; 144 numbered infantry regiments; plus Brigade Bands Nos. 1 & 2 (Corps d'Afrique and US Colored Troops); Powell's Regiment Colored Infantry; Southard's Company Colored Infantry; Quartermaster Detachment; Pioneer Corps, 1st Division, 16th Army Corps; Unassigned Company A Colored Infantry; and Unassigned USCT. There are also miscellaneous service cards arranged alphabetically by surname at the end of the unit records. The records reproduced are part of the Records of the Adjutant General's Office, 1780's-1917, Record Group (RG) 94.

## Background

## United States Colored Troops

Since the time of the American Revolution, African Americans have volunteered to serve their country in time of war. The Civil War was no exception. Official sanction was the difficulty. In the fall of 1862 there were four Union regiments of African Americans raised in New Orleans, LA: the 1st, 2d, and 3d Louisiana Native Guard, and the 1st Louisiana Heavy Artillery (African Descent). The 1st South Carolina Infantry (African Descent) was not officially organized until January 1863; however, three companies of the regiment were on coastal expeditions as early as November 1862. Similarly, the 1st Kansas Colored Infantry was not mustered into Federal service until January 1863, even though the regiment had already participated in the action at Island Mound, MO, on October 27, 1862. These early unofficial regiments received little Federal support, but they showed the strength of the African American soldier's desire to fight for freedom.

The first official authorization to employ African Americans in Federal service was the Second Confiscation and Militia Act of July 17, 1862. This act allowed President Abraham Lincoln to receive into the military or naval service persons of African descent and gave him permission to use them for any purpose "he may judge best for the public welfare." However, the President did not authorize use of African Americans in combat until issuance of the Emancipation Proclamation on January 1, 1863.

In late January 1863, Governor John Andrew of Massachusetts received permission to raise a regiment of African American soldiers. The pace of organizing additional regiments was very slow. In March Secretary of War Edwin M. Stanton sent Gen. Lorenzo Thomas to the lower Mississippi Valley to recruit free and contraband African Americans. Thomas was given broad authority. He was to explain the administration's policy regarding African American soldiers and recruit



volunteers to raise and command them. Stanton wanted all officers of such units to be white, but that policy was softened to allow African American surgeons and chaplains. By the end of the war, in addition to the chaplains and surgeons, there were some 87 African American officers. Thomas's endeavor was very successful, and on May 22, 1863, the Bureau of Colored Troops was established to coordinate and organize regiments from all parts of the country. Created under War Department General Order No. 143, the bureau was responsible for handling "all matters relating to the organization of Colored Troops." The bureau was directly under the Adjutant General's Office and its procedures and rules were specific and strict. All African American regiments were now to be designated United States Colored Troops (USCT). At this time there were some African American regiments with state names and a few regiments in the Department of the Gulf designated as Corps d'Afrique. All these were ultimately assimilated into the USCT, even though some of the regiments, such as the 5th Massachusetts, retained their state designations.

To facilitate recruiting in the states of Maryland, Missouri, Tennessee, and eventually Kentucky, the War Department issued General Order No. 329 on October 3, 1863. Section 6 of the order stated that if any citizen should offer his or her slave for enlistment into the military service, that person would, "if such slave be accepted, receive from the recruiting officer a certificate thereof, and become entitled to compensation for the service or labor of said slave, not exceeding the sum of three hundred dollars, upon filing a valid deed of manumission and of release, and making satisfactory proof of title." For this reason, some records of manumission are contained in the compiled service records reproduced in this publication.

The USCT fought in 39 major engagements and over 400 lesser ones. Sixteen African American soldiers received Medals of Honor. As it was in other units, the death toll from disease was very high in the USCT. Deaths from disease and battle totaled 37,000. The last regiment of the USCT was mustered out of Federal service in December 1867.

Important sources for information about African American units in the Civil War are the War Department's *The War of the Rebellion: A Compilation of the Official Records of the Union and Confederate Armies* (Washington, DC: 1880-1901; reprinted Harrisburg, 1971 and 1985) and the Navy Department's *The War of the Rebellion: A Compilation of the Official Records of the Union and Confederate Navies* (Washington, DC: 1874-1922; reprinted Harrisburg, 1971 and 1985). These multivolume works contain reports of operations and other official correspondence.

#### U. S. Colored Heavy Artillery

**1st Heavy Artillery:** This regiment was organized at Knoxville, TN, between February and November 1864. It served in Knoxville, eastern Tennessee, western Virginia, northern Alabama, and western North Carolina. It was mustered out on March 31, 1866.

**2d Heavy Artillery:** This regiment was changed from the 2d Heavy Artillery to the 3d Heavy Artillery on April 26, 1864, and the compiled military service records appear there.

**3d Heavy Artillery:** Organized as the 1st Tennessee Heavy Artillery (African descent) at Memphis and Fort Pickering, TN, from June 5 to December 22, 1863, this regiment's designation was changed to the 3d United States Colored Heavy Artillery in April 1864. It served garrison duty at Fort Pickering and in defense of Memphis, TN. The unit mustered out on April 30, 1866.

**4th Heavy Artillery:** This unit was organized as the 2d Regiment Tennessee Heavy Artillery (African descent) from June 1863 until April 1864. It became the 4th United States Colored Heavy Artillery in April 1864. It served at Fort Halleck; Columbus, KY; and Union City, TN. The regiment had duty near Fort Donelson, TN, and moved to Pine Bluff, AR, where it was mustered out on February 25, 1866.

**5th Heavy Artillery:** This regiment was organized at Vicksburg, MS, between August 1863 and January 1864, as the 9th Louisiana Volunteers (African descent). Its designation was changed to the 5th Heavy Artillery in April 1864. The unit served garrison duty at Vicksburg, MS, and was mustered out on May 20, 1866.

**6th Heavy Artillery:** This regiment was organized as the 2d Mississippi Heavy Artillery (African descent) at Natchez, MS, from September 1863 to January 1864. It was changed to the 6th United States Colored Heavy Artillery on April 26, 1864. The unit served at Natchez, Mississippi, and Vidalia, LA. It was mustered out on May 18, 1866.

**7th Heavy Artillery:** The 7th Heavy Artillery was designated the 11th United States Colored Infantry (New) on January 23, 1865, and the compiled military service records appear there.

**8th Heavy Artillery:** This regiment was organized at Paducah, KY, from April to October 1864. It served garrison duty at Paducah and was mustered out on February 10, 1866.

**9th Heavy Artillery:** This regiment consisted of four companies and was organized at Clarksville and Nashville, TN, during October 1864. It was mustered out on May 5, 1865.

**10th Heavy Artillery:** Organization of this regiment at New Orleans, LA, began in November 1862. First designated the 1st Louisiana Heavy Artillery (African descent) in November 1863, it became the 1st Regiment Corps d'Afrique. In May 1864 the unit became the 10th United States Colored Heavy Artillery. The regiment was on garrison duty at New Orleans during its entire service. It served longer than any other USCT regiment, mustering out on February 22, 1867.

**11th Heavy Artillery:** This regiment was organized at Providence, RI, from August 1863 through January 1864, as the 14th Rhode Island Colored Heavy Artillery. In May 1864 it became the 11th United States Colored Heavy Artillery. The unit served garrison duty at New Orleans, LA, and was mustered out on October 2, 1865.

**12th Heavy Artillery:** This regiment was organized at Camp Nelson, KY, from July 1864 through July 1865. It served garrison duty at Camp Nelson, Bowling Green, and other points in the District of Kentucky. It was mustered out on April 24, 1866.

**13th Heavy Artillery:** This regiment was organized at Camp Nelson, KY, in June 1865, where it served garrison duty. It also served at Smithland and Lexington, KY. It was mustered out on November 18, 1865.

**14th Heavy Artillery:** This regiment was organized at New Bern and Morehead City, NC, from March 1864 to April 1865, as the 1st North Carolina Colored Heavy Artillery. It became the 14th United States Colored Heavy Artillery in March 1865. The unit served garrison duty at New Bern, NC, and was mustered out on December 11, 1865.

#### U. S. Colored Light Artillery

The 1st Regiment Light Artillery was recruited and organized under Maj. Gen. Benjamin F. Butler in December 1863. In February 1864 it was changed to Battery B of the 2d Light Artillery.

The 2d Regiment Light Artillery consisted of nine batteries, A through I, that were independently organized and deployed.

Battery A was organized at Nashville, TN, in April 1864. The battery served garrison duty at Nashville and participated in the Battle of Nashville December 15-16, 1864. It was mustered out January 13, 1866.

Battery B was organized at Fort Monroe, VA, in January and February 1864. It operated in Virginia and participated in the siege against Petersburg and Richmond. The battery was ordered to Texas in May 1865, and mustered out March 17, 1866.

Battery C was organized at Hebron's Plantation, MS, in November 1863, as the 1st Battery Louisiana Light Artillery (African descent). It was designated Battery C in April 1864. The battery had garrison duty at Goodrich Landing, Vicksburg, and Milliken's Bend. It was mustered out December 28, 1865.

Battery D was organized at Black River Bridge, MS, in December 1863, as the 2d Battery Louisiana Light Artillery (African descent). It was designated Battery D in April 1864. The battery had garrison duty at Goodrich Landing and Vicksburg, MS, and was mustered out on December 28, 1865.

Battery E was organized at Helena, AR, in December 1863, as the 3d Battery Louisiana Light Artillery (African descent). It was designated Battery E in April 1864. The battery had garrison duty at Helena, AR, and was mustered out on September 26, 1865.

Battery F was organized at Memphis, TN, in November 1863, as the Memphis Light Battery. It was designated Battery F in April 1864. The battery had garrison duty at Memphis, TN, until April 1865, when it moved to Bridgeport, AL. It was mustered out on December 28, 1865.

Battery G was organized at Hilton Head, SC, in May 1864 and had garrison duty at Hilton Head for its entire term. The battery was mustered out on August 12, 1865.

Battery H was organized at Pine Bluff, AR, in June 1864, as the 1st Arkansas Colored Battery. It was designated as Battery H in December 1864. The battery had garrison duty at Pine Bluff the entire term and was mustered out on September 14, 1865.

Battery I was organized at Memphis, TN, in April 1864. The battery had garrison duty at Memphis, TN, and operations in Mississippi. It was mustered out on January 10, 1866.

Independent Battery was organized at Leavenworth, KS, in December 1864. It had duty at Fort Leavenworth until it was mustered out on July 22, 1865.

#### Records Description

Compiled service records consist of a jacket-envelope for each soldier, labeled with his name, rank, unit, and card numbers. The compilation of service records of Union soldiers began in 1890 under the direction of Col. Fred C. Ainsworth, head of the Record and Pension Office of the Adjutant General's Office, Department of War. Information from muster rolls, regimental returns, descriptive books, and other records was copied verbatim onto cards. A separate card was prepared each time an individual name appeared on a document. These cards were numbered on the back, and these numbers were entered onto the outside jacket containing the cards. The carded information was verified by a separated operation of comparison; great care was taken to ensure that the cards were accurate.

A typical jacket contains card abstracts of entries found in original records relating to the soldier and original documents relating solely to that soldier. Examples of the latter include enlistment papers, substitute certificates, casualty sheets, death reports, prisoner-of-war memorandums, and correspondence. Unique to the records of the USCT are deeds of manumission, oaths of allegiance, proof of ownership, certificates of monetary award, and bills of sale. These items appear most frequently in units recruited in the border states of Kentucky, Missouri, and Maryland. These states remained in the Union but were slave states. Jackets and

cards include a section labeled "bookmark" which was reserved for cross-references to other records relating to the individual or his unit. The service records are arranged by arm of service, thereunder numerically by regiment or independent battalion or company, and thereunder alphabetically by name of the soldier. Records for officers are interfiled alphabetically by name with the records of enlisted men. If an individual served in more than one unit, which was typical for USCT officers, there will be a separate service record for each unit in which he served.

The unjacketed miscellaneous cards were accumulated by the War Department with the expectation that they would be incorporated in individual compiled service records. However, the expectation was never fulfilled, because either insufficient or contradictory information made it impossible to associate the cards or papers with a particular soldier's service records.

#### Related Records

Among the records of the Adjutant General's Office in the National Archives are many of the original records that were abstracted or "carded" by the Record and Pension Office. These include the individual unit's muster rolls, returns and descriptive books. Other series in RG 94 that contain information relating to volunteer Union soldiers who served with the USCT include carded records relating to Union staff officers, carded medical records of volunteer Union soldiers, unbound and bound regimental records and "record of events" cards. The regimental records of the 54th Massachusetts Infantry (Colored) have been reproduced as Microfilm Publication M1659, *Records of the Fifty-fourth Massachusetts Infantry Regiment (Colored), 1863-1865*.

The "record of events" cards include information copied from the unit's muster rolls and returns. They show the stations of the field and staff and those of the various companies of the regiment at the time the muster roll or return was prepared and sometimes mention battles, skirmishes, or other activities in which the regiment participated. The cards have been reproduced as Microfilm Publication M594, *Compiled Records Showing Service of Military Units in Volunteer Union Organizations*.

Record Group 94 also includes a card index for the USCT, reproduced as Microfilm Publication M589, *Index to Compiled Military Service Records of Volunteer Union Soldiers Who Served with U.S. Colored Troops*, which may be used to locate the regiment of USCT personnel. An index card gives the name of the soldier and his rank, as well as the unit in which he served; sometimes there is a cross-reference to his service in other units or organizations. The National Archives is continually producing microfilm publications of volunteer Union compiled military service records. A complete listing of finished publications can be found in the National Archives *Microfilm Resources for Research: A Comprehensive Catalog* which is available online at <http://www.nara.gov>.

The Records of the Colored Troops Division, within RG 94, include division correspondence and records relating to recruiting, the appointment of officers, and the slave or free status of individuals; and a compilation of historical extracts and official papers concerning the military service of African Americans from the colonial period through the Civil War entitled *The Negro in the Military Service of the United States 1639-1886*. This compilation is reproduced as Microfilm Publication M858. The Records of the Bounty and Claims Division, also in RG 94, include correspondence of the division and records relating to bounties and claims paid to loyal owners of slaves by the Slave Claims Commissions of Delaware, Kentucky, Maryland, Missouri, Tennessee, and West Virginia.

If an application for a pension was made, the pension application case file may be among the Records of the Veterans Administration (RG 15). Indexes to the pension applications have been reproduced as Microfilm Publication T288, *General Index to Pension Files, 1861-1934*, and T289, *Organizational Index to Pension Files of Veterans Who Served Between 1861 and 1900*.

If a soldier or officer was tried before a general court-martial or if an individual or his unit was the subject of a court of inquiry or military commission, transcripts of the proceedings may be among the Records of the Office of the Judge Advocate General (Army) (RG 153). The registers to the proceedings have been reproduced as Microfilm Publication M1105, *Registers of the Records of the Proceedings of the U.S. Army General Courts-Martial, 1809-1890*.

Other record groups having information pertaining to the USCT include Records of the Bureau of Refugees, Freedmen, and Abandoned Lands (RG 105); Records of the Provost Marshal General's Bureau (Civil War) (RG 110); Records of the Accounting Officers of the Department of the Treasury (RG 217); and Records of U.S. Army Continental Commands, 1821-1920 (RG 393).

NATIONAL ARCHIVES MICROFILM PUBLICATIONS

Roll list

Roll Description

1st United States Colored Heavy Artillery

- 1 Ackerson, David - Baker, Barney
- 2 Baker, George - Bogle, Harry
- 3 Bolden, Joseph - Brown, Edwin G.
- 4 Brown, George - Carmack, Bachus
- 5 Carmack, Gilbert - Cleveland, Loudon
- 6 Clevenger, Charles - Cune, John C.
- 7 Curd, George - Eblin, Richard
- 8 Eckles, Silas - Furbush, Lewis
- 9 Gaines, George - Greenleaf, Andrew
- 10 Greenleaf, Julius - Hart, Benjamin
- 11 Hartman, Henry - Hoff, David
- 12 Holland, John - Jackson, Thomas J.
- 13 Jackson, Washington - Jones, James
- 14 Jones, John - Ledgewood, Clayborne
- 15 Lee, Elhanon - Martin, Robert
- 16 Mason, Henry - McKenney, Elijah
- 17 McKinney, Lewis - Montcastle, Stewart
- 18 Montgomery, Alfred - Owens, Benjamin
- 19 Owens, Granville - Ragan, Nelson
- 20 Ragan, Rome - Russell, Orlando A.
- 21 Russell, Perry - Smith, Archie
- 22 Smith, Bart - Suddles, Robert
- 23 Summers, Joseph D. - Turner, Charles
- 24 Turner, Henry - Weir, Richard
- 25 Weir, Robert - Willis, Albert
- 26 Willis, Beverly S. - Zimmerman, William

3d United States Colored Heavy Artillery

- 27 Abel, William - Armour, Lewis
- 28 Armstaed, William - Beaufort, Thomas
- 29 Beaumont, Henry - Bowler, Lafayette P.
- 30 Bowman, Fleming - Brummer, John E.
- 31 Bryan, Solon - Carter, William
- 32 Cartman, John - Cook, Isham
- 33 Cook, John - Davis, Doctor
- 34 Davis, George - Easen, Samuel
- 35 Easley, Wesley - Flinn, Clay
- 36 Flint, James - Gilbreth, Eli

NATIONAL ARCHIVES MICROFILM PUBLICATIONS

Roll	Description
37	Gilbreth, Guy - Griffin, Samuel
38	Griffin, William - Harrison, James
39	Harrison, James C. - Hicks, Smith
40	Higginbottom, Nimrod - Hunt, Rubin
41	Hunt, William - Johnson, Charles
42	Johnson, Crawford - Jones, Isaac
43	Jones, Isam - Knight, Warren
44	Knox, Overton - Mabin, Baker
45	Mabin, James - McDonald, Manuel
46	McDonald, Ruben - Mills, Robert
47	Milroy, John - Nealy, Henry
48	Ned, Lewis - Patterson, Pembroke J. (Perin J.)
49	Patton, Richmond - Powers, William
50	Prewitt, Greene - Roberts, Lewis
51	Robinette, Henry - Scott, Edmond
52	Scott, Elijah - Smith, Peter
53	Smith, Randall - Tapscott, Julius
54	Tarwater, Jesse - Todd, William
55	Todd, Willis - Wallace, Robert
56	Wallace, Sandford - Wells, Duncan
57	Wells, Joseph - Williams, Guyo
58	Williams, George - Wolbrecht, Adolf
59	Wood, Charles - Young, William H.

4th United States Colored Heavy Artillery

60	Abbott, John - Barnes, Samuel
61	Barnes, Thomas - Britt, Jackson
62	Britten, Charles - Clark, Mitchell
63	Clay, Henry - Daniel, Richard
64	Daniels, William - Dyson, Jack
65	Dyson, Paul - Gardner, Riley
66	Gardner, Washington - Hall, Henry
67	Hall, Jack - Horton, Mack
68	Horton, William - Jones, Levi
69	Jones, Louis - Lewis, Stephen
70	Lewis, Thomas - McMurray, Anderson (John)
71	McMurray, George - Need, Benjamin
72	Nelson, John - Prior, Alfred
73	Prior, Gabriel - Rutland, Isaac
74	Ruttkey, Albert - Smith, Louis
75	Smith, Samuel - Turner, Frank
76	Turner, James - White, Henry
77	White, Raven - Youngs, William



NATIONAL ARCHIVES MICROFILM PUBLICATIONS

Roll Description

5th United States Colored Heavy Artillery

78 Abbott, Richard - Armstrong, William  
 79 Arrindale, John B. - Bentley, Francis A.  
 80 Bentley, Isam - Brooks, Lawyer  
 81 Brooks, Robert - Cabin, Henry  
 82 Cabin, Shadrick - Coleman, Nathan  
 83 Coleman, William - Davidson, Ellis  
 84 Davis, Alfred - Dodd, Taylor  
 85 Dodds, Peter - Feltis, Jackson  
 86 Felton, Martin - Gilford, Charles  
 87 Gillespie, Gilbert - Hagan, Alex  
 88 Hagans, Joseph - Hayes, John S.  
 89 Haythorn, Henry - Hood, John  
 90 Hooker, William - James, Warren  
 91 January, Nathan - Johnson, Wiley  
 92 Johnson, William - Kindley, Edward  
 93 King, Elijah - Lewis, Ely J.  
 94 Lewis, George W. - Manitoe, Samuel  
 95 Manly, Elisha - McNeil, William  
 96 McQuilley, Clayton - Mosley, Jacob  
 97 Moss, Alfred - Parker, James  
 98 Parker, John H. - Powell, Monroe  
 99 Power, Henry - Roach, Watt  
 100 Robb, Benjamin - Shaw, Barrow  
 101 Shaw, James - Smith, Robert  
 102 Smith, Samuel - Tate, John  
 103 Taylor, Anderson - Trueman, Henry  
 104 Truman, Nelson - Ward, George  
 105 Ward, Jacob - West, Moses  
 106 Westbrook, Ellick - Williams, John B.  
 107 Williams, Jordan - Wood, Theodore  
 108 Woodam, Henry - Young, William  
 Miscellaneous Service Cards  
 Allen, Geo. - Young, L.

6th United States Colored Heavy Artillery

109 Aaron, William - Barton, Granderson  
 110 Baseman, Jerry - Bracton, John  
 111 Bradford, Henry - Bush, Wilson  
 112 Bustis, Mondey - Clay, Henry  
 113 Clay, William - Davenport, William  
 114 Davenport, Wilson - Dunbar, Newton

NATIONAL ARCHIVES MICROFILM PUBLICATIONS

Roll	Description
115	Dunbow, Hannibal - Fox, William
116	Francis, James - Green, George
117	Green, James - Harris, Hiram
118	Harris, John - Hopper, Anthony
119	Hopper, Handy - James, Joseph
120	Jasper, Samuel - Jones, John
121	Jones, Jonas - Leavitt, Charles B.
122	Lee, David - McBride, Samuel
123	McCabe, Alexander H. - Moore, Joseph
124	Moore, Manual - Owens, Willis
125	Page, Benjamin - Reece, Edward
126	Reese, William - Samuel, William
127	Sanders, Archibald - Smart, Robert
128	Smith, Aaron - Suzette, Armstead
129	Swanson, Jack - Trotter, George
130	Troyman, George - Waters, Robert
131	Waters, Wesley - Williams, Bedney
132	Williams, Benjamin - Wilson, George
133	Wilson, Guy - Young, Wesley
	Miscellaneous Service Cards
	Adams, Winder - Williams, John
<b>8th United States Colored Heavy Artillery</b>	
134	Abanather, Paten - Beasley, George W.
135	Beasley, Washington - Boyd, Isaac
136	Boyd, Paine - Burrill, George
137	Burriss, Abram - Cofield, Henry
138	Cofield, Isaac - Davis, George
139	Davis, Jerry - Edwards, Frank
140	Edwards, Gus - Ginigan, Thomas
141	Givens, George - Hampton, Phillip
142	Hancock, James - Hodge, Cotney
143	Hodge, Gaines - Johnson, Charles
144	Johnson, Clinton - Lee, Wash
145	Leeper, Thomas - Maxwell, Henry
146	Maxwell, Samuel - Moore, Amos
147	Moore, David - Pearson, Alexander
148	Pearson, Charley - Rice, Pleasant
149	Rice, Taylor - Sherrer, Elick
150	Shirles, James - Talbot, Henry
151	Talley, William - Turner, Robert
152	Tyler, Jerry - Williams, John
153	Williams, Sam - Young, William

NATIONAL ARCHIVES MICROFILM PUBLICATIONS

Roll	Description
<b>9th United States Colored Heavy Artillery</b>	
154	Ailer, John - Coleman, Miles
155	Collins, Moses A. - Grosskopff, Edward
156	Grubb, Andrew - Landon, Harry
157	Lanier, Jesse - Payne, George
158	Payne, James - Tory, Madison
159	Toryand, Emanuel - Young, George
<b>10th United States Colored Heavy Artillery</b>	
160	Aaron, Benjamin - Auguste, Daniel
161	Augustus, Edward - Benson, George
162	Bentley, William H. - Brooks, Walker
163	Brooks, Washington - Camel, Paul
164	Cameron, Henry - Coleman, James
165	Coleman, John - Deale, Joseph
166	Deale, Thomas - Ellis, Robert
167	Ellis, Silas - Frederick, Joseph
168	Freeland, Martin A. - Grandison, Alfred
169	Grant, Moses - Harrison, Logan
170	Harrison, Thomas - Hoyt, Joseph
171	Hubbard, Henry - Jenkins, Solomon
172	Jennings, Caleb - Jozen, Jules
173	Julia, Nora - Libscomb, George
174	Lightfoot, Columbus - Maryday, John
175	Masdael, Noel - Misker, Robert
176	Mitchel, Alexander - Oldham, George B.
177	Oliver, Emile - Purnell, John
178	Putnam, Winthrop D. - Robinson, Henry
179	Robinson, Isaac - Simmons, Owen
180	Simms, Amos - Spencer, John
181	Spriggs, Thomas - Thornton, John
182	Thurston, Charles - Warner, Dudley
183	Warner, George E. - Wesley, John
184	West, Alexander - Willis, Stephen
185	Willson, George - Zozey, Jules
	Miscellaneous Service Cards
	Cann, Mercer - Grayson, John W.
186	Miscellaneous Service Cards
	Green, Andrew P. - Rygaard, Soren
187	Miscellaneous Service Cards
	Sabatier, Peter - Zevenette, Paul

NATIONAL ARCHIVES MICROFILM PUBLICATIONS

Roll	Description
<b>11th United States Colored Heavy Artillery</b>	
188	Abbott, George M. - Bailey, James A.
189	Baird, Sylvester - Boardley, James
190	Boardley, John W. - Brown, Nathan
191	Brown, Samuel - Carter, William H.
192	Cartright, George W. - Comings, Hugh S.
193	Comstock, Joseph J. - Davis, Lyman
194	Davis, Stephen - Dubois, James
195	Duesenbury, Lewis - Fletcher, Roderick S.
196	Fletcher, Samuel - Garrison, John
197	Gaskell, George L. - Groff, Joseph
198	Guard, Andrew - Hector, William H.
199	Heelms, Harkness - Howard, Richard
200	Howard, Thomas - Jackson, Lewis
201	Jackson, Norton - Johnson, Joseph W.
202	Johnson, Nathan - King, Cornelius
203	King, George - Loucks, John A.
204	Low, Charles H. - Miller, Benjamin
205	Miller, Floyd N. - Nicholas, Samuel
206	Nichols, Alfred - Pierce, George W.
207	Pierce, John B. - Reed, Washington
208	Reese, Edward - Sampson, William H.
209	Sanders, Edward - Skanks, James S.
210	Skanks, Thomas C. - Sommerset, Levi
211	Southwick, Henry K. - Taylor, Alfred M.
212	Taylor, Charles - Townsend, John
213	Tracy, John - Warren, John
214	Washington, George - Whiting, Joseph C., Jr.
215	Wigden, Cyrus B. - Wilson, Samuel
216	Wilson, William - Young, Francis
	Miscellaneous Service Cards
	Abbot, George W. - Dyer, William S.
217	Miscellaneous Service Cards
	Earl, Peter - Young, William H.
<b>12th United States Colored Heavy Artillery</b>	
218	Abbott, John - Barbee, Squire
219	Barber, Sherwood - Boller, Jerry
220	Bolor, Collins - Bryant, Frederick
221	Bryant, Henry - Bush, Reason
222	Butler, Aaron - Clark, Richard
223	Clark, Samuel - Criffield, Lewis

NATIONAL ARCHIVES MICROFILM PUBLICATIONS

Roll	Description
224	Christopher, James - Dock, Calvin E.
225	Dodge, Henry - Farnesley, Jack
226	Farrus, Ephraim - Gaves, David
227	Gentry, George - Haggin, George
228	Haggin, Samuel - Hawkins, Robert
229	Hawkins, Thomas - Hode, Adam
230	Hodge, Charles - Jackson, Andrew
231	Jackson, Augustus - Jopee, Joseph
232	Juda, Enoch - Lewis, Windsor
233	Lidick, Randall - Maton, Levi
234	Matthews, Charles W. - Mitchell, John
235	Mitchell, Monroe - Nelson, Joseph
236	Nesbin, William - Porter, Daniel
237	Porter, William R. - Richason, Shelly
238	Richie, George - Scott, Smith
239	Scott, Stephen - Smith, Leroy
240	Smith, Lyman - Taylor, Charles
241	Taylor, Cornelius - Turner, David
242	Turner, George - Warren, James
243	Washington, Anthony - Williams, Berry
244	Williams, Charles - Woodson, David
245	Woodson, Egbert - Young, Thomas
	Miscellaneous Service Cards
	Baughman, John - Heel, Rubin
246	Miscellaneous Service Cards
	Helm, Harry - Young, Stephen
	 13th United States Colored Heavy Artillery
247	Abbott, Josiah - Bell, Augustine
248	Bell, Charles - Brown, Jesse
249	Brown, Lindsay - Connor, Cyrus
250	Connor, Isaac - Dyre, George
251	Early, Edward - Ginn, Samuel
252	Ginnis, Sidney Clay - Heath, Henry
253	Heath, Lewis - Jarrett, Charles
254	Jay, Johnson - Lee, William
255	Lender, Richard - McKinney, Cass
256	McKinney, Henry Clay - Owens, Robert
257	Owens, Smith - Randolph, Loyd
258	Rankins, Archibald - Scott, Jerry
259	Scott, John - Sugg, Edmond
260	Suiter, Jacob A. - Waddie, Harry
261	Waddy, Peter - Willett, Price

NATIONAL ARCHIVES MICROFILM PUBLICATIONS

Roll	Description
262	Willett, Robert - Young, William
263	Miscellaneous Service Cards Abbott, Josiah - Yumber, Anthony
<b>14th United States Colored Heavy Artillery</b>	

264	Acot, Isaac - Becton, Henry
265	Becton, Moses - Burke, George W.
266	Burke, William A. - Davis, Toney
267	Dean, Thomas - Fullford, William
268	Fulton, James - Hardy, William
269	Harget, Israel - Hovey, William
270	Howard, Calvin - Kensley, Silas
271	Kent, Henry - McKeever, Simon
272	McMichael, Joseph - Noble, William
273	Nobles, Charles - Randall, Evans
274	Randall, Willey - Shark, Bryant
275	Sheckelford, Daniel - Smith, Samuel
276	Smith, Sterling - Thompson, John Henry
277	Thompson, Mark - Weeks, Ezekiel
278	Weidman, Albert - Wilson, Payton
279	Wilson, Richard - Young, William
	Miscellaneous Service Cards Acott, Isaac - Young, William

**2d Regiment United States Colored Light Artillery**

280	Able, John - Bernard, Albert
281	Berry, Henry - Brown, Sang
282	Brown, Thomas - Clark, William
283	Clay, Henry - Disen, Henry
284	Disen, Watkins - Francis, Henry
285	Franklin, Albert - Haines, Roe
286	Haines, Thomas - Hunt, Thomas
287	Hunter, Alexander M. - Kennedy, Abram
288	Kennel, George - March, George
289	Marcy, Anthony - Mobbs, Daniel
290	Moffet, John - Pattiller, Alfred
291	Pattiller, Patrick - Richardson, Jacob
292	Ridgeway, Anthony - Smith, Louis B.
293	Smith, Minus - Tucker, Alfred

NATIONAL ARCHIVES MICROFILM PUBLICATIONS

Roll	Description
294	Tucker, Sandy - Williams, Calvin
295	Williams, Charles - Zinum, John
296	Miscellaneous Service Cards Abraham, Francis - Young, Ruben
Independent Battery, United States Colored Light Artillery	
297	Alexander, John - Hancock, George W.
298	Hanson, Noah C. - Scott, Andrew
299	Scott, Reynolds - Yeager, John Miscellaneous Service Cards Douglass, H. Ford - Minor, P.M.

**NATIONAL ARCHIVES MICROFILM PUBLICATIONS**

Microfilm Publication M1818

**COMPILED MILITARY SERVICE RECORDS OF VOLUNTEER UNION  
SOLDIERS WHO SERVED WITH THE UNITED STATES COLORED  
TROOPS: Artillery Organizations**

Roll 118

6th United States Colored Heavy Artillery

Harris, John - Hopper, Anthony

**NATIONAL ARCHIVES AND RECORDS ADMINISTRATION**



Harris John

Co A, 6 U.S. Col'd H. Art'y.

Private Private

CARD NUMBERS.

1	6154687	26
2	6156785	27
3	6156918	28
4	6157050	29
5	6157177	30
6	6157304	31
7	6157430	32
8	6157552	33
9	6157672	34
10	9118975	35
11	40742416	36
12		37
13		38
14		39
15		40
16		41
17		42
18		43
19		44
20		45
21		46
22		47
23		48
24		49
25		50

Book Mark:

See also

*A* | 6 H. Art'y. | U.S.C.T.

*John Harris*  
....., Co. *A*, 6 Reg't U. S. Col'd H. Art'y.

Appears on  
**Company Descriptive Book**  
of the organization named above.

**DESCRIPTION.**

Age *40* years; height *5* feet *11/2* inches.  
Complexion *Black*  
Eyes *Black*; hair *Black*  
Where born *Cumberland Ky*  
Occupation *Laborer*

**ENLISTMENT.**

When *Mar 10*....., 186 *5*.  
Where *Wetzelburg W. Va*  
By whom *Co. K. K. K.*; term *3* y'rs.

Remarks: .....

.....

.....

.....

.....

.....

.....

.....

*H. H. H.*  
(383g) Coppist.

*H* | 6 H. Art'y. | U.S.C.T.

*John Harris.*  
Appears with rank of *Put* on

**Muster and Descriptive Roll of a Detachment of U. S. Vols. forwarded**

for the 6 Reg't U. S. Col'd H. Art'y. Roll dated

*Vicksburg Miss, Oct 11, 1863.*

Where born *Chamberland Co, Ky*

Age *40* y'rs; occupation *Farming*

When enlisted *Oct 10*, 1863.

Where enlisted *Vicksburg Miss*

For what period enlisted *3* years.

Eyes *Black*; hair *Black*

Complexion *Colored*, height *5* ft. *11 1/2* in.

When mustered in *Oct 11*, 1863.

Where mustered in *Vicksburg Miss*

Bounty paid \$ *100*; due \$ *300* *100*

Where credited

Company to which assigned

Remarks: *To be credited to  
Stoneman Middlesex  
Co, 6<sup>th</sup> Congl Dist Mass.*

Book mark:

*Montague*  
Copyist.

3  
H | 6 H. Art'y. | U.S.C.T.

John Harris

Pri., Co. A, 6 Reg't U. S. Col'd H. Art'y.

Appears on

Company Muster Roll  
for Mar. & Apr., 1865.

Joined for duty and enrolled:

When Mar. 10, 1865.\*

Where Vicksburg, Miss. \*

Period 3 years.\*

Present or absent Present

Stoppage, \$ 100 for

Due Gov't \$ 100 for

Remarks: 1st Installment  
Bounty \$100 due

\* See enrollment on card from muster-in roll.

Book mark:

(358c) J. H. Henderson Copyist.

3  
H

6 H. Art'y.

U.S.C.T.

John Harris  
Pri.

, Co. A, 6 Reg't U. S. Col'd H. Art'y.

Appears on

Company Muster Roll

for Feb. 28 to June 30, 1865.

Joined for duty and enrolled:

When Mar. 10, 1865.\*

Where Vicksburg, Miss. \*

Period 3 years.\*

Present or absent

Present

Stoppage, \$ 100 for

Due Gov't \$ 100 for

Remarks:

\* See enrollment on card from muster-in roll.

Book mark:

J. H. Henderson  
(358c) Copyist.

76

6 H. Art'y.

U.S.C.T.

*John Harris*

*priv*, Co. A, 6 Reg't U. S. Col'd H. Art'y.

Appears on

**Company Muster Roll**

for *July & August*, 1865.

Joined for duty and enrolled:

When *Mch 10*, 1865.\*

Where *Vicksburg Miss*\*

Period *3* years.\*

Present or absent *Present*

Stoppage, \$ *100* for

Due Gov't \$ *100* for

Remarks:

-----  
-----  
-----  
-----  
-----  
-----

\* See enrollment on card from muster-in roll.

Book mark:

(358c)

*D. J. Gippich*

Copyist.

*John Harris*

....., Co. A, 6 Reg't U. S. Col'd H. Art'y.

Appears on

**Company Muster Roll**

for *Sept & Oct*....., 186*5*.

Joined for duty and enrolled:

When *March 10*....., 186*5*.\*

Where *Vicksburg Miss*.....\*

Period *3*..... years.\*

Present or absent *Present*.....

Stoppage, \$..... *100* for.....

Due Gov't \$..... *100* for.....

Remarks: *Sick in Post  
Hospital Natchez Miss  
Since Oct 3, 1865*

*Remark cancelled by line  
drawn through it*

\* See enrollment on card from muster-in roll.

Book mark:.....

(358c) *D. J. Griffen*..... Copyist.

John Harris  
Pri., Co. A, 6 Reg't U. S. Col'd H. Art'y.

Appears on

Company Muster Roll

for Nov + Dec, 1865.

Joined for duty and enrolled:

When Aug 30, 1863.\*

Where Vicksburg Miss \*

Period 3 years.\*

Present or absent Present

Stoppage, \$ 100 for

Due Gov't \$ 100 for

Remarks: Daily duty at 2 M.  
Dept Natchez Miss A.O.  
No 103 Post of Natchez  
Miss Nov 30, 1865

\* See enrollment on card from muster-in roll.

Book mark:

(358c)

D. J. Griffith Copyist.



*John Harris*  
....., Co. A, 6 Reg't U. S. Col'd H. Art'y.

Appears on

**Company Muster Roll**

for *Jan + Feb*....., 1866.

Joined for duty and enrolled:

When *March 10*....., 1865.\*

Where *Natchez Miss*.....\*

Period *3* years.\*

Present or absent *Present*.....

Stoppage, \$ *100* for.....

Due Gov't \$ *100* for.....

Remarks: *Daily duty in L.M.  
Sept per A.O. No 103 dated  
Feb 2nd Post and Forces of  
Natchez Nov 30, 1865*

\* See enrollment on card from muster-in roll.

Book mark:.....

(358c)

*D. J. Giffith* Copyist.

26

6 H. Art'y.

U.S.C.T.

*John Harris*  
for, Co. A, 6 Reg't U. S. Col'd H. Art'y.

Appears on

**Company Muster Roll**

for *March & April*, 1866.

Joined for duty and enrolled:

When *March 10*, 1865.\*

Where *Vicksburg Miss* \*

Period *3* years.\*

Present or absent *Present*

Stoppage, \$ *100* for

Due Gov't \$ *100* for

Remarks:

-----  
-----  
-----  
-----  
-----

\* See enrollment on card from muster-in roll.

Book mark:

*A. J. Gifford*  
(358c) Copyist.

26

6 H. Art'y.

U.S.C.T.

*John Harris*

*ser.*, Co. A, 6 Reg't U. S. Col'd H. Art'y.

Appears on

**Company Muster Roll**

for *March & April*, 1866.

Joined for duty and enrolled:

When *March 10*, 1865.\*

Where *Vicksburg Miss*\*

Period *3* years.\*

Present or absent *Present*

Stoppage, \$ *100* for

Due Gov't \$ *100* for

Remarks:

-----  
-----  
-----  
-----  
-----  
-----

\* See enrollment on card from muster-in roll.

Book mark:

(358c)

*D. J. Gifford*

Copyist.

A

6 H. Art'y.

U.S.C.T.

John Harris  
Post, Co. A, 6 Reg't U. S. Col'd H. Art'y.

Appears on Returns as follows:

April 1865 - Gain April  
2, 65 - Katchez  
Embarked at Vicks-  
burg

June & July 1865 - On  
duty at Post Black-  
smith since  
June 25, 65 -

Nov 1865 - On duty  
Post Blacksmith

Book mark:

(546)

A. G. Ingles

Copyist.

A

6 H. Art'y.

U.S.C.T.

John Harris

Priv., Co. A, 6 Reg't U. S. Col'd H. Art'y.

Appears on Co. Muster-out Roll, dated

Watches Miss May 13, 1866.

Muster-out to date May 13, 1866.

Last paid to Dec. 31, 1865.

Clothing account:

Last settled, 186 ; drawn since \$ 100

Due soldier \$ 76 <sup>61</sup>/<sub>100</sub>; due U. S. \$ 100

Am't for cloth'g in kind or money adv'd \$ 100

Due U. S. for arms, equipments, &c., \$ 100

Bounty paid \$ 100 <sup>00</sup>/<sub>100</sub>; due \$ 100 <sup>00</sup>/<sub>100</sub>

Remarks: Joined as a recruit

\* As it appears on roll.

Book mark: V239 P89. 76

A. L. Ames

Copyist.

(361)

Harris John

P, Co.

6 Reg't U.S.C.A.

Enclosures.

Bed Cards	Final Statements
Burial Records	Furloughs or L. of A.
Certs. of Dis. for Discharge	Med. Certificates
C. M. Charges	Med. Des. Lists
Descriptive Lists	Orders
Discharge Certificates	Pris. of War Record
Enlistment Papers	Resignations

Other papers relating to—

Admission to Hosp'l	Furlough or L. of A.
Casualty Sheet	Med. Examination
Confinement	Misc. Information
Contracts	Pay or Clothing
Death or Effects	Personal Reports
Desertion	Rank
Discharge from Hosp'l	Transfer to Hosp'l
Discharge from Service	Transfer to V. R. C.
Duty	Transportation

VOLUNTEER ENLISTMENT.

STATE OF

TOWN OF

Mississippi

Vicksburg

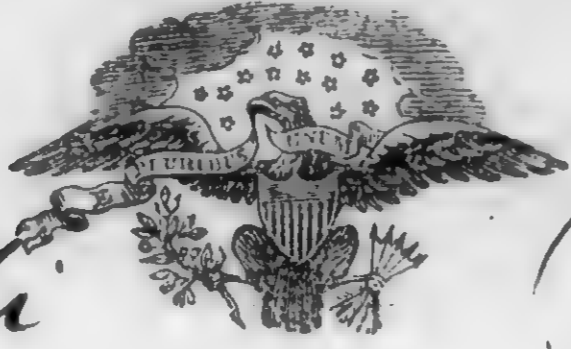

I, John Harris, born in Cumberland Co. in the State of Kentucky, aged forty years, and by occupation a Farmer, Do HEREBY ACKNOWLEDGE to have volunteered this tenth day of March, 1865, to serve as a Soldier in the Army of the United States of America, for the period of THREE YEARS, unless sooner discharged by proper authority: Do also agree to accept such bounty, pay, rations, and clothing, as are, or may be, established by law for volunteers. And I, John Harris, do solemnly swear, that I will bear true faith and allegiance to the United States of America, and that I will serve them honestly and faithfully against all their enemies or opposers whomsoever; and that I will observe and obey the orders of the President of the United States; and the orders of the officers appointed over me, according to the Rules and Articles of War.

U. S. Bounty,
Local Bounty, \$325

Mustered into the service of the United States, for three years or during the war, from date of enlistment, in Co. ... Regiment of ... and credited to ... 11 day of March, 1865, at ... Ward, (or Sub-district,) in the Town of ... in the County of ...

Certificate for the Signature of the Mustering Officer, Commissary, or Assistant Commissary of Musters, as the case may be.

Sworn and subscribed to, at Vicksburg his March 10th day of 1865, John Harris

BEFORE St. Col. Asst. Dir. Marshal Fred. Douglas Jr

I CERTIFY, ON HONOR, That I have carefully examined the above-named Volunteer agreeably to the General Regulations of the Army, and that, in my opinion, he is free from all bodily defects and mental infirmity, which would in any way disqualify him from performing the duties of a soldier.

Examining Surgeon signature

I CERTIFY, ON HONOR, That I have minutely inspected the Volunteer J. Harris previously to his enlistment, and that he was entirely sober when enlisted; that, to the best of my judgment and belief, he is of lawful age; and that, in accepting him as duly qualified to perform the duties of an able-bodied soldier, I have strictly observed the Regulations which govern the recruiting service. This soldier has ... eyes, ... hair, ... complexion, is ... feet ... inches high.

Recruiting Officer signature: Asst. Dir. Marshal of Mass

(A. G. O. No. 74 & 76.)

DECLARATION OF RECRUIT.

I, John Harris, desiring  
 VOLUNTEER as a Soldier in the Army of the United States, for the term of THREE YEARS,  
 Do Declare, That I am Forty years and \_\_\_\_\_ months  
 of age; that I have never been discharged from the United States service on account of disability or by  
 sentence of a court martial, or by order before the expiration of a term of enlistment; and I know of no  
 impediment to my serving honestly and faithfully as a soldier for three years.

GIVEN at Pickensville Miss.  
 the 10<sup>th</sup> day of March 1865

Witness: Lud. Douglass John Harris  
 mark

NOTE 1.—This blank will be used for both enlistments and re-enlistments—enlistment of veterans, &c., &c., in the volunteer service. They will be made out in duplicate in all cases—one to accompany the recruiting return of the superintendent (not the recruiting officer) to the Adjutant General, and one to accompany the accounts of the officer who pays bounty, &c. The Regiment and Company in which the soldier last served should be given on the back.

NOTE 2.—An enlistment holds to service. A muster-in must, in all cases, precede payment of pay, bounty, pension, &c. A muster-in roll must, in all cases, be filed in the Adjutant General's Office as evidence of muster. The mustering officer, commissary, or assistant commissary of musters, as the case may be, will countersign both enlistments as having mustered the soldier into the service of the United States before either of them is given to the disbursing officer

enlistment; last served in Company ( )  
1<sup>st</sup> Regt of Miss. Inf.  
 Discharged \_\_\_\_\_, 18 \_\_\_\_\_

No. \_\_\_\_\_  
John Harris  
 Volunteered at Pickensville Miss.  
10<sup>th</sup> March 1865  
 By E. C. Smith Capt.  
2nd Regt. Miss. Inf.  
Meas.  
 Regiment of \_\_\_\_\_

CONSENT IN CASE OF MINOR.

I, \_\_\_\_\_, Do CERTIFY, That I am  
 the \_\_\_\_\_ of \_\_\_\_\_; that the  
 said \_\_\_\_\_ is \_\_\_\_\_ years of age; and I  
 do hereby freely give my CONSENT to his volunteering as a SOLDIER in the ARMY OF THE UNITED STATES  
 for the period of THREE YEARS.

GIVEN at \_\_\_\_\_  
 the \_\_\_\_\_ day of \_\_\_\_\_

Witness: \_\_\_\_\_



*Private*  
A, 6 U.S. Col'd H. Art'y.

*Private* | *Private*

CARD NUMBERS.

1	6175661	26
2	6175763	27
3	6175897	28
4	6176034	29
5	6176154	30
6	6176267	31
7	6176380	32
8	6176495	33
9	6176616	34
10	6176737	35
11	6176860	36
12	6176974	37
13	6177087	38
14	6177195	39
15	6177303	40
16	6177411	41
17	9120716	42
18		43
19		44
20		45
21		46
22		47
23		48
24		49
25		50

Book Mark: *H44 811 C576*

See also

*Joseph Harris*  
Co. *K*, 6 Reg't U. S. Col'd H. Art'y.

Appears on

**Company Descriptive Book**  
of the organization named above.

**DESCRIPTION.**

Age *26* years; height *5* feet *11* inches.

Complexion *Dark*

Eyes *Black*; hair *Black*

Where born *Richmond Va*

Occupation *Salver*

**ENLISTMENT.**

When *Jan 1*, 1864.

Where *Spotsylvania Va*

By whom *Capt. Humpers*; term *3* y'rs.

Remarks:

-----  
-----  
-----  
-----  
-----  
-----  
-----  
-----

*Hittner*

*Joseph Harris*  
*Co. K*, Co. *K*, 2 Reg't Miss. Art'y. †

Age *26* years.

Appears on

**Company Muster-in Roll**

of the organization named above. Roll dated

*Natchez Miss*, *Jan 8*, 1864.

Muster-in to date

*Jan 1*, 1864.

Joined for duty and enrolled:

When *Jan 1*, 1864.\*

Where *Natchez Miss* \*

Period *3* years.\*

Valuation of horse, \$ *100*

Valuation of horse equipments, \$ *100*

Remarks:

† This organization subsequently became Co. *K*, 6 Reg't U. S. Colored Heavy Artillery.

\* Muster-in roll shows enrollment of all men of this company as of same date and place. See enrollment on subsequent card or cards.

Book mark:

*Harris*

*Joseph Harris*  
*Priv.*, Co. K, 2 Reg't Miss. Artillery.†

Appears on

**Company Muster Roll**

for *Jan 8*" to *July 29*, 186*4*\*

Joined for duty and enrolled:

When *Jan 1*" , 186*4*\*

Where *Natchez Miss* \*

Period *3* years.\*

Present or absent *Present*

Stoppage, \$ *100* for

Due Gov't \$ *100* for

Valuation of horse, \$ *100*

Valuation of horse equipments, *100*

Remarks:  
.....  
.....

† This organization subsequently became Co. K, 6 Reg't U. S. Colored H. Art'y.  
\* See enrollment on card from muster-in roll.

Book mark: .....

(358c)

*J. Hillis*

Copyist.

v

Joseph Harris  
Pot, Co. K, 5 Reg't U. S. Col'd H. Art'y.\*

Appears on

Company Muster Roll

for Mar + Apr, 1864.

Joined for duty and enrolled :

When Jan 1", 1864.\*

Where Natchez Miss \*

Period 3 years.\*

Present or absent Present

Stoppage, \$ 100 for

Due Gov't, \$ 100 for

Valuation of horse, \$ 100

Valuation of horse equipments, \$ 100

Remarks :

\* This organization subsequently became Co. , 6 Reg't U. S. Col'd Heavy Artillery.

\* See enrollment on card from muster-in roll.

Book mark :

Spiller

*A*

6 H. Art'y.

U.S.C.T.

*Joseph Harris*  
*Priv*

Co. K, 6 Reg't U. S. Col'd H. Art'y.

Appears on

**Company Muster Roll**

for *May & June*, 1864.

Joined for duty and enrolled:

When *Jan 1*, 1864.\*

Where *Nash Mills*\*

Period *3* years.\*

Present or absent *present*

Stoppage, \$ *100* for

Due Gov't \$ *100* for

Remarks:

-----  
-----  
-----  
-----  
-----  
-----

\* See enrollment on card from muster-in roll.

Book mark: -----

-----  
*J. Hill*  
-----

(358c)

Copyist.

36

6 H. Art'y.

U.S.C.T.

Joseph Harris

6 Reg't U. S. Col'd H. Art'y.  
Pri: Co. K, 2 Reg't Miss Artillery. † x

Appears on

Company Muster Roll

for July & Aug. 1864.

Joined for duty and enrolled:

When Jan. 1864.\*

Where Hatchez, Miss. \*

Period 3 years.\*

Present or absent Present.

Stoppage, \$ 100 for

Due Gov't \$ 100 for

Valuation of horse, \$ 100

Valuation of horse equipments, 100

Remarks: Stoppage for one  
Massachusetts (\$100.48)

† This organization subsequently became Co. K, 6 Reg't U. S. Colored H. Art'y. x

\* See enrollment on card from muster-in roll.

x Corrected Oct. 29, 1894. B.S.D.

Book mark:

(358c)

J. G. Smith  
Copyist.

*A*

6 H. Art'y.

U.S.C.T.

*Joseph Harris*

*Pvt*, Co. K, 6 Reg't U. S. Col'd H. Art'y.

Appears on

**Company Muster Roll**

for *Sept & Oct*, 1864.

Joined for duty and enrolled:

When *Jan*, 1864.\*

Where *Natchez, Miss.*\*

Period *3* years.\*

Present or absent *Present*

Stoppage, \$ *100* for

Due Gov't \$ *100* for

Remarks: *Stoppage for C. & G. E.*  
*(\$0.65)*

\* See enrollment on card from muster-in roll.

Book mark:

(358c)

*J. B. Gage*

Copyist.



H

6 H. Art'y.

U.S.C.T.

Joseph Harris  
Private Co. K, 6 Reg't U. S. Col'd H. Art'y.

Appears on

Company Muster Roll

for Nov and Dec, 1864.

Joined for duty and enrolled:

When Jan. 1, 1864.\*

Where Natchez Miss.\*

Period 3 years.\*

Present or absent Present

Stoppage, \$ 100 for

Due Gov't \$ 100 for

Remarks:

\* See enrollment on card from muster-in roll.

Book mark:

C. J. Powell

(358c)

Copyist.

H

6 H. Art'y.

U.S.C.T.

*Joseph Harris*  
Private, Co. K, 6 Reg't U. S. Col'd H. Art'y.

Appears on

**Company Muster Roll**

for *Jan. and Feb.*, 186*5*.

Joined for duty and enrolled:

When *Jan. 1*, 186*4*.\*

Where *Natchez, Miss.* \*

Period *3* years.\*

Present or absent.....

Stoppage, \$ *100* for.....

Due Gov't \$ *100* for.....

Remarks:.....

.....  
.....  
.....  
.....  
.....

\* See enrollment on card from muster-in roll.

Book mark:.....

*C. J. Powell*

(358c)

Copyist.

H

6 H. Art'y.

U.S.C.T.

Joseph Harris

Private, Co. K, 6 Reg't U. S. Col'd H. Art'y.

Appears on

Company Muster Roll

for March and April, 1865.

Joined for duty and enrolled:

When Jan. 1, 1864.\*

Where Hatcher, Miss \*

Period 3 years.\*

Present or absent Present -

Stoppage, \$ 100 for

Due Gov't \$ 100 for

Remarks:

-----  
-----  
-----  
-----  
-----

\* See enrollment on card from muster-in roll.

Book mark: -----

C. J. Powell

(358c)

Copyist.

H

6 H. Art'y.

U.S.C.T.

Joseph Harris  
Private, Co. K, 6 Reg't U. S. Col'd H. Art'y.

Appears on

**Company Muster Roll**

for May and June, 1865.

Joined for duty and enrolled:

When Jan. 11, 1864.\*

Where Natchez, Miss. \*

Period 3 years.\*

Present or absent Present

Stoppage, \$ 100 for

Due Gov't \$ 100 for

Remarks:

-----  
-----  
-----  
-----  
-----  
-----

\* See enrollment on card from muster-in roll.

Book mark: -----

C. G. Powell

(358c)

Copyist.

14

6 H. Art'y.

U.S.C.T.

*Joseph Harris*  
Private, Co. K, 6 Reg't U. S. Col'd H. Art'y.

Appears on

**Company Muster Roll**

for *July and Aug.*, 186*0*.\*

Joined for duty and enrolled:

When *Jan. 11*, 186*4*.\*

Where *Natchez, Miss.* \*

Period *3* years.\*

Present or absent *Present*

Stoppage, \$ *100* for

Due Gov't \$ *100* for

Remarks:  
-----  
-----  
-----  
-----  
-----

\* See enrollment on card from muster-in roll.

Book mark: -----

*C. J. Powell*

(358c)

Copyist.

07

6 H. Art'y.

U.S.C.T.

*Joseph Ovarrie*  
Co. K, 6 Reg't U. S. Col'd H. Art'y.

Appears on

**Company Muster Roll**

for *Sept & Oct*, 186*5*.

Joined for duty and enrolled:

When *Jan'y 1<sup>st</sup>*, 186*4*.\*

Where *Natchez Miss*.\*

Period *3* years.\*

Present or absent *Present*

Stoppage, \$ *100* for

Due Gov't \$ *100* for

Remarks:  
-----  
-----  
-----  
-----  
-----

\* See enrollment on card from muster-in roll.

Book mark: -----

*W. Houston*

(358c)

Copyist.

76

6 H. Art'y.

U.S.C.T.

Joseph Harris  
Paris, Co. K, 6 Reg't U. S. Col'd H. Art'y.

Appears on

Company Muster Roll

for Nov Dec, 1865.

Joined for duty and enrolled:

When Jan 1, 1864.\*

Where Natchez Miss.\*

Period 3 years.\*

Present or absent Present

Stoppage, \$ 100 for

Due Gov't \$ 100 for

Remarks:

\* See enrollment on card from muster-in roll.

Book mark:

(358c)

W.D. Houston

Copyist.

Joseph Harris  
Sgt., Co. K, 6 Reg't U. S. Col'd H. Art'y.

Appears on

**Company Muster Roll**

for Jan'y & Feb'y, 1866.

Joined for duty and enrolled:

When Jan'y 1, 1864.\*

Where Natchez Miss\*

Period 3 years.\*

Present or absent Present

Stoppage, \$ 100 for \_\_\_\_\_

Due Gov't \$ 100 for \_\_\_\_\_

Remarks: \_\_\_\_\_  
\_\_\_\_\_  
\_\_\_\_\_  
\_\_\_\_\_  
\_\_\_\_\_

\* See enrollment on card from muster-in roll.

Book mark: \_\_\_\_\_

(358c)

J. S. Houston

Copyist.



N

6 H. Art'y.

U.S.C.T.

Joseph Harris  
Priv., Co. K, 6 Reg't U. S. Col'd H. Art'y.

Appears on

Company Muster Roll

for March + April, 1860.

Joined for duty and enrolled:

When Jan 1, 1864.\*

Where Natchez Miss.\*

Period 3 years.\*

Present or absent Present

Stoppage, \$ 100 for

Due Gov't \$ 100 for

Remarks:

\* See enrollment on card from muster-in roll.

Book mark:

(358c)

W. L. Houston  
Copyist.

H

6 H. Art'y.

U.S.C.T.

Joseph Harris  
Priv., Co. K, 6 Reg't U. S. Col'd H. Art'y.

Appears on Co. Muster-out Roll, dated  
Natchez, Miss, May 13, 1866.

Muster-out to date May 13, 1866.  
Last paid to Dec 31, 1865.

Clothing account:

Last settled....., 186 ; drawn since \$..... 100

Due soldier \$..... 100; due U. S. \$ 4 <sup>85</sup>/<sub>100</sub>

Am't for cloth'g in kind or money adv'd \$..... 100

Due U. S. for arms, equipments, &c., \$..... 100

Bounty paid \$..... 100; due \$..... 100

Remarks:

Joined original organization.

Book mark: H 44, Vol. 11, p. 76

G. W. Chase

Copyist.

(361)

*James, James*

Co *M*, 6 U.S. Col'd H. Art'y.

*Private*

*Private*

CARD NUMBERS.

1	6179204	26
2	6179296	27
3	6179420	28
4	6179532	29
5	6179616	30
6	6179708	31
7	6179804	32
8	6179920	33
9	6180037	34
10	6180145	35
11	6180252	36
12	6180349	37
13	6180445	38
14	6180535	39
15	6180624	40
16	6180713	41
17	9121048	42
18		43
19		44
20		45
21		46
22		47
23		48
24		49
25		50

Book Mark: \_\_\_\_\_

See also \_\_\_\_\_

*N*

6 H. Art'y. U.S.C.T.

*Manuel Harris*

*Co. D*, 6 Reg't U. S. Col'd H. Art'y.

Appears on

**Company Descriptive Book**

of the organization named above.

**DESCRIPTION.**

Age *20* years; height *3* feet *6 1/2* inches.

Complexion *Bo*

Eyes *blk*; hair *blk*

Where born *Adams Co Miss*

Occupation *farmer*

**ENLISTMENT.**

When *Jan 21*, 1864.

Where *Natchez Miss*

By whom *Capt Cade*; term *3* y'rs.

Remarks:

-----  
-----  
-----  
-----  
-----  
-----  
-----  
-----  
-----  
-----  
-----  
-----

*Hillman*

26.

6 H. Art'y.

U.S.C.T.

Manuel Harris

Priv., Co. M, 2 Reg't Miss. Art'y.†

Age 20 years.

Appears on

Company Muster-in Roll

of the organization named above. Roll dated

Natchez, Miss., Jan. 21, 1864.

Muster-in to date Jan. 21, 1864.

Joined for duty and enrolled:

When Jan. 21, 1864.\*

Where Natchez, Miss.\*

Period 3 years.\*

Valuation of horse, \$ 100

Valuation of horse equipments, \$ 100

Remarks:

† This organization subsequently became Co. M, 6 Reg't U. S. Colored Heavy Artillery.

\* Muster-in roll shows enrollment and muster-in of this company as of same date and place. See enrollment on subsequent card or cards.

Book mark:

(356c)

J. J. Kearney

Copyist.

No.

6 H. Art'y.

U.S.C.T.

*Mannuel Harris*

*Priv.*, Co. M, 2 Reg't Miss. Art'y.†

Appears on

**Company Muster Roll**

for *Jan. 21 to Feb. 29*, 1864.

Joined for duty and enrolled:

When *Jan. 21*, 1864.\*

Where *Natchez, Miss.*\*

Period *3* years.\*

Present or absent *Present*

Stoppage, \$ *100* for

Due Gov't, \$ *100* for

Valuation of horse, \$ *100*

Valuation of horse equipments, \$ *100*

Remarks:

† This organization subsequently became Co. M, 6 Reg't U.S. Col'd Heavy Artillery.

\* See enrollment on card from muster-in roll.

Book mark:

(358c)

*J. J. Henry*

Copyright.

Manuel Harris

Priv., Co. M, 5 Reg't U. S. Col'd H. Art'y.\*

Appears on

Company Muster Roll

for Mch & Apl, 1864.

Joined for duty and enrolled:

When Jan. 21, 1864.\*

Where Natchez, Miss. \*

Period 3 years.\*

Present or absent Present

Stoppage, \$ 100 for

Due Gov't, \$ 100 for

Valuation of horse, \$ 100

Valuation of horse equipments, \$ 100

Remarks:

\* This organization subsequently became Co. M, 6 Reg't U. S. Col'd Heavy Artillery.

\* See enrollment on card from muster-in roll.

Book mark:

(358c)

J. J. Kearney  
Copist.

No.

6 H. Art'y.

U.S.C.T.

Manuel Harris

Priv., Co. M, 6 Reg't U. S. Col'd H. Art'y.

Appears on

Company Muster Roll

for May & June, 1864.

Joined for duty and enrolled:

When Jan. 21, 1864.\*

Where Natchez, Miss \*

Period 3 years.\*

Present or absent Present

Stoppage, \$ 100 for

Due Gov't, \$ 100 for

Valuation of horse, \$ 100

Valuation of horse equipments, \$ 100

Remarks:

\* See enrollment on card from muster-in roll.

Book mark:

(358c)

J. J. Kearney  
Copyist.



No.

6 H. Art'y.

U.S.C.T.

*Manuel Harris*

*Priv.*, Co. M, 6 Reg't U. S. Col'd H. Art'y.

Appears on

**Company Muster Roll**

for *July + Aug*, 1864.

Joined for duty and enrolled:

When *Jan. 21*, 1864.\*

Where *Natchez, Miss* \*

Period *3* years.\*

Present or absent *Present*

Stoppage, \$ *100* for

Due Gov't, \$ *100* for

Valuation of horse, \$ *100*

Valuation of horse equipments, \$ *100*

Remarks:

\* See enrollment on card from muster-in roll.

Book mark:

(358c)

*J. J. Kearney*  
Copyist.

26.

6 H. Art'y.

U.S.C.T.

Mannuel Harris

Prk, Co. M, 6 Reg't U. S. Col'd H. Art'y.

Appears on

Company Muster Roll

for Sept. & Oct., 1864.

Joined for duty and enrolled:

When Jan. 21, 1864.\*

Where Natchez, Miss.\*

Period 3 years.\*

Present or absent Present

Stoppage, \$ 100 for

Due Gov't, \$ 100 for

Valuation of horse, \$ 100

Valuation of horse equipments, \$ 100

Remarks:

\* See enrollment on card from muster-in roll.

Book mark:

(358c)

J. J. Kearney Copyist.

H

6 H. Art'y.

U.S.C.T.

*Mamel Harris*

*Priv.*, Co. M, 6 Reg't U. S. Col'd H. Art'y.

Appears on

**Company Muster Roll**

for *Nov & Dec*, 1864.

Joined for duty and enrolled:

When *Jan. 21*, 1864.\*

Where *Gatchez, Miss.* \*

Period *3* years.\*

Present or absent *Present*

Stoppage, \$ *100* for

Due Gov't, \$ *100* for

Valuation of horse, \$ *100*

Valuation of horse equipments, \$ *100*

Remarks: *Stoppage for one Cartridge Box Plate \$1.08.*

\* See enrollment on card from muster-in roll.

Book mark:

(358c)

*Beck*  
Copyist.

Manuel Harris

Priv., Co. M, 6 Reg't U. S. Col'd H. Art'y.

Appears on

Company Muster Roll

for Jan. & Feb., 1865.

Joined for duty and enrolled:

When Jan. 21, 1865.\*

Where Watchey Miss \*

Period 3 years.\*

Present or absent Present

Stoppage, \$ 100 for

Due Gov't, \$ 100 for

Valuation of horse, \$ 100

Valuation of horse equipments, \$ 100

Remarks: Stoppage for one waist Belt, one Bayonet Scabbard & one Cartridge Box Plate \$ 1.02

\* See enrollment on card from muster-in roll.

Book mark:

Beck Copyist.

H

6 H. Art'y.

U.S.C.T.

Mammel Harris

Priv., Co. M, 6 Reg't U. S. Col'd H. Art'y.

Appears on

Company Muster Roll

for Mar & Apr, 1865.

Joined for duty and enrolled:

When Jan. 21, 1864.\*

Where Natchez, Miss.\*

Period 3 years.\*

Present or absent Present

Stoppage, \$ 100 for

Due Gov't, \$ 100 for

Valuation of horse, \$ 100

Valuation of horse equipments, \$ 100

Remarks: Stoppage for one  
Waist Belt, 1 Bayonet  
Scabbard, 1 Cartg, Box Plate,  
\$ 1.02

\* See enrollment on card from muster-in roll.

Book mark:

Beck

Copyist.

(358c)

A

6 H. Art'y.

U.S.C.T.

*Mammel Harris*

*Priv.*, Co. M, 6 Reg't U. S. Col'd H. Art'y.

Appears on

**Company Muster Roll**

for *May & June*, 1865.

Joined for duty and enrolled:

When *Jan. 21*, 1864.\*

Where *Natchez, Miss.* \*

Period *3* years.\*

Present or absent *Present*

Stoppage, \$ *100* for

Due Gov't, \$ *100* for

Valuation of horse, \$ *100*

Valuation of horse equipments, \$ *100*

Remarks: *Stoppage for  
Ordnance Stores 3'2 cts.*

\* See enrollment on card from muster-in roll.

Book mark:

*Beck*

(358c)

Copyist.

A

6 H. Art'y.

U.S.C.T.

*Mannel Harris*

*Priv*, Co. M, 6 Reg't U. S. Col'd H. Art'y.

Appears on

**Company Muster Roll**

for *July & Aug*, 1865.

Joined for duty and enrolled:

When *Jan. 21*, 1864.\*

Where *Natchez, Miss.*\*

Period *3* years.\*

Present or absent *Present*

Stoppage, \$ *100* for

Due Gov't, \$ *100* for

Valuation of horse, \$ *100*

Valuation of horse equipments, \$ *100*

Remarks: *Stoppage for  
Ordnance Stores, 32 cts.*

\* See enrollment on card from muster-in roll.

Book mark:

*Beck*

(858c)

Copyist.

*M*

6 H. Art'y.

U.S.C.T.

*Manuel Harris*

*Pt A*, Co. M, 6 Reg't U. S. Col'd H. Art'y.

Appears on

**Company Muster Roll**

for *Sept. & Oct*, 1865.

Joined for duty and enrolled:

When *Jan. 21*, 186*4*.\*

Where *Sanchez, Miss*\*

Period *3* years.\*

Present or absent *Present*.

Stoppage, \$ *100* for

Due Gov't, \$ *100* for

Valuation of horse, \$ *100*

Valuation of horse equipments, \$ *100*

Remarks:

\* See enrollment on card from muster-in roll.

Book mark:

(358c)

*Jno J Bell Jr*

Copyist.



26

6 H. Art'y.

U.S.C.T.

Mmanuel Harris  
Pvt., Co. M, 6 Reg't U. S. Col'd H. Art'y.

Appears on

Company Muster Roll

for Nov. & Dec, 1865.

Joined for duty and enrolled:

When Jan. 21, 1864.\*

Where Maury, Miss.\*

Period 3 years.\*

Present or absent Present

Stoppage, \$ 100 for

Due Gov't, \$ 100 for

Valuation of horse, \$ 100

Valuation of horse equipments, \$ 100

Remarks: Stoppage for Ordnance  
Stores 20 cts - for Camp  
& Equipage 95 cts.

\* See enrollment on card from muster-in roll.

Book mark:

(358c) J. W. Bell Copyist.

No

6 H. Art'y.

U.S.C.T.

*Manuel Harris*

*Pr't*, Co. M, 6 Reg't U. S. Col'd H. Art'y.

Appears on

**Company Muster Roll**

for *Jan. \* Feb*, 1866.

Joined for duty and enrolled:

When *Jan. 21*, 186*4*.\*

Where *Wabehay, Miss* \*

Period *3* years.\*

Present or absent *Present*

Stoppage, \$ *100* for

Due Gov't, \$ *100* for

Valuation of horse, \$ *100*

Valuation of horse equipments, \$ *100*

Remarks: *Stoppage for food stores & Eq. Exp. #115*

\* See enrollment on card from muster-in roll.

Book mark:

*Geo. J. Bell, Jr.*  
(358c) Copyist.

26

6 H. Art'y.

U.S.C.T.

Manuel Harris

Pvt., Co. M, 6 Reg't U. S. Col'd H. Art'y.

Appears on

Company Muster Roll

for March & April, 1866.

Joined for duty and enrolled:

When Jan. 21, 1864.\*

Where Marches, Miss \*

Period 0 years.\*

Present or absent Present

Stoppage, \$ 100 for

Due Gov't, \$ 100 for

Valuation of horse, \$ 100

Valuation of horse equipments, \$ 100

Remarks: \_\_\_\_\_  
\_\_\_\_\_  
\_\_\_\_\_  
\_\_\_\_\_

\* See enrollment on card from muster-in roll.

Book mark: \_\_\_\_\_

(358c) J. G. Bell Copyist.

*Manuel Fortie*

*Priv*, Co. *M*, 6 Reg't U. S. Col'd H. Art'y.

Appears on **Co. Muster-out Roll**, dated

*Natches Miss May 13*, 1866.

Muster-out to date

*May 13*, 1866.

Last paid to

*Dec 31*, 1865.

Clothing account:

Last settled....., 186 ; drawn since \$.....<sup>100</sup>

Due soldier \$.....<sup>100</sup>; due U. S. \$ *77*<sup>3</sup>/<sub>100</sub>

Am't for cloth'g in kind or money adv'd \$.....<sup>100</sup>

Due U. S. for arms, equipments, &c., \$.....<sup>100</sup>

Bounty paid \$.....<sup>100</sup>; due \$.....<sup>100</sup>

Remarks:

*Joined at original organization*

Book mark:

(361)

*J. Nelson*

Copyist.

Harris, Nelson

Co B, 6 U.S. Col'd H. Art'y.

Private

Private

CARD NUMBERS.

1	6154125	26
2	6180856	27
3	6160993	28
4	6161118	29
5	6161257	30
6	6161393	31
7	6161533	32
8	6161673	33
9	6161883	34
10	6162677	35
11	6154729	36
12	9119440	37
12	40742452	38
14		39
15		40
16		41
17		42
18		43
19		44
20		45
21		46
22		47
23		48
24		49
25		50

Book Mark: *Sp. Co. P. 257*

See also

*Nelson Harris*

Co. *C*, 6 Reg't U. S. Col'd H. Art'y.

Appears on

**Company Descriptive Book**

of the organization named above.

**DESCRIPTION.**

Age *23* years; height *5* feet *6 1/2* inches.

Complexion *copper*

Eyes *Black*; hair *Black*

Where born *Darwin Co Iowa*

Occupation *Laborer*

**ENLISTMENT.**

When *Jan 25*, 186*4*.

Where *Nashua Miss*

By whom *L F Birnworth* term *3* y'rs.

Remarks: *Discharged at Nashua Miss June 24/65*

-----  
-----  
-----  
-----  
-----

*J. H. [Signature]*

*Nelson Harris*  
-----  
Pvt., Co. *6*, *2<sup>d</sup>* Reg't *Miss.* # *117* U.S. Corp'd *Art'y.*

Age *23* years.

Appears on a

**Detachment Muster-in Roll**

of the organization named above. Roll dated  
*Natchez Miss*, *Mar 7*, 1864.

Muster-in to date *Jan. 25*, 1864.

Joined for duty and enrolled:

When *Jan. 25*, 1864.

Where *Natchez Miss*

Period *3* years.

Valuation of horse, \$ *100*

Valuation of horse equipments, \$ *100*

Remarks: -----  
-----  
-----

*# Corrected May 27, 96, G. R. N.*  
*\* Became the 6<sup>th</sup> U.S. C. H. Art'y.*

Book mark: -----

(337)

*Daggett*

Copyist.

H

6 H. Art'y.

U.S.C.T.

Nelson Harris

Plt, Co. C, 5 Reg't U. S. Col'd H. Art'y.†

Appears on

Company Muster Roll

for Mar & Apr, 1864.

Joined for duty and enrolled:

When Jan 25, 1864.\*

Where Natchez Miss.\*

Period 3 years.\*

Present or absent Present

Stoppage, \$ 100 for

Due Gov't \$ 100 for

Valuation of horse, \$ 100

Valuation of horse equipments, 100

Remarks:

†This organization subsequently became Co. C, 6 Reg't U. S. Colored Heavy Artillery.

\* See enrollment on card from muster-in roll.

Book mark:

mochame

(358c)

Copyist.



H

6 H. Art'y.

U.S.C.T.

Nelson Harris

5  
no, Co. C, 6 Reg't U. S. Col'd H. Art'y.

Appears on

**Company Muster Roll**

for May & June, 1864.

Joined for duty and enrolled:

When Jan 25, 1864.\*

Where Natchez, Miss\*

Period 3 years.\*

Present or absent Present

Stoppage, \$ 100 for

Due Gov't, \$ 100 for

Valuation of horse, \$ 100

Valuation of horse equipments, \$ 100

Remarks:

\* See enrollment on card from muster-in roll.

Book mark:

mochance

(358c)

Copyist.

*H*

6 H. Art'y.

U.S.C.T.

*Nelson Harris*

*Priv*, Co. C, 6 Reg't U. S. Col'd H. Art'y.

Appears on

Company Muster Roll

for *July & Aug*, 1864.

Joined for duty and enrolled:

When *Jan 25*, 1864.\*

Where *Natchez, Miss*

Period *8* years.\*

Present or absent *Present*

Stoppage, \$ *100* for

Due Gov't, \$ *100* for

Valuation of horse, \$ *100*

Valuation of horse equipments, \$ *100*

Remarks:

\* See enrollment on card from muster-in roll.

Book mark:

*M. Smith*

(358c)

Copyist.

*H*

6 H. Art'y.

U.S.C.T.

*Nelson Harris*

*Pvt*, Co. C, 6 Reg't U. S. Col'd H. Art'y.

Appears on

**Company Muster Roll**

for *Sept & Oct*, 186*4*

Joined for duty and enrolled:

When *Jan 25*, 186*4*\*

Where *Natchez, Miss\**

Period *3* years.\*

Present or absent *Present*

Stoppage, \$ *100* for

Due Gov't, \$ *100* for

Valuation of horse, \$ *100*

Valuation of horse equipments, \$ *100*

Remarks:

\* ~~See~~ See enrollment on card from muster-in roll.

Book mark:

*H. A. Smith*

H

6 H. Art'y.

U.S.C.T.

Nelson Harris

Pvt., Co. C, 6 Reg't U. S. Col'd H. Art'y.

Appears on

Company Muster Roll

for Nov & Dec, 1864

Joined for duty and enrolled:

When Jan 25, 1864\*

Where Natchez, Miss

Period 3 years.\*

Present or absent Present

Stoppage, \$ 100 for

Due Gov't, \$ 100 for

Valuation of horse, \$ 100

Valuation of horse equipments, \$ 100

Remarks:

\* See enrollment on card from muster-in roll.

Book mark

H. A. Smith

(368c)

Copyist.

*H*

6 H. Art'y.

U.S.C.T.

*Nelson Harris*  
*Pr*, Co. C, 6 Reg't U. S. Col'd H. Art'y.

Appears on

Company Muster Roll

for *Jan & Feb*, 1865.

Joined for duty and enrolled:

When *Jan 23* 1864.\*

Where *Natchez, Miss*\*

Period *3* years.\*

Present or absent *Present*

Stoppage, \$ *100* for

Due Gov't, \$ *100* for

Valuation of horse, \$ *100*

Valuation of horse equipments, \$ *100*

Remarks:

\* See enrollment on card from muster-in roll.

Book mark:

*H. A. Smith*

(358c)

Copyist.

*Nelson Harris*  
Priv., Co. C, 6 Reg't U. S. Col'd H. Art'y.

Appears on

Company Muster Roll  
for *Mar & Apr*, 1865.

Joined for duty and enrolled:

When *Jan 25*, 1864

Where *Natchez, Miss*

Period *3* years.\*

Present or absent *Absent*

Stoppage, \$ *100* for

Due Gov't, \$ *100* for

Valuation of horse, \$ *100*

Valuation of horse equipments, \$ *100*

Remarks: *Sick in Post Hosp Natchez, Miss since April 7, 1865*

\* See enrollment on card from muster-in roll.

Book mark:

*H. Smith*

H

6 H. Art'y.

U.S.C.T.

Nelson Harris

Priv., Co. C, 6 Reg't U. S. Col'd H. Art'y.

Appears on

Company Muster Roll

for May & June, 1865.

Joined for duty and enrolled:

When Jan 25, 1864\*

Where Natchez, Miss \*

Period 3 years.\*

Present or absent

Stoppage, \$ 100 for

Due Gov't, \$ 100 for

Remarks: Discharged per G.O. 44, Hd Qrs Dept. of Miss. Vicksburg June 20, 1865

\* See enrollment on card from muster-in roll.

Book mark: see E. B. U. 11, P. 259

Discharged June 27, 1865

W. Smith

(358c)

Copyright

A

6 H. Art'y.

U.S.C.T.

Nelson Harris  
Pot., Co. C, 6 Reg't U. S. Col'd H. Art'y.

Appears on Returns as follows:

April & May 1865  
Absent Sick in  
Post Hosp since  
April 7, 65  
June 1865 to June  
20, 65 at Vicksburg Miss  
Disch'd for \$  
0.44 dated Hd Qrs  
Dept Miss Vicks-  
burg Miss May  
8, 65

Book mark:

(546) A. J. Gouglas Copyist.



26

6 H. Art'y.

U.S.C.T.

*Nelson Harris*

*Part*, Co. *C*, 6 Reg't U. S. Col'd H. Art'y.

Appears on **Co. Muster-out Roll**, dated

*Katchez Miss May 13*, 186*6*

Muster-out to date \_\_\_\_\_, 186

Last paid to \_\_\_\_\_, 186

**Clothing account:**

Last settled \_\_\_\_\_, 186 ; drawn since \$ \_\_\_\_\_ 100

Due soldier \$ \_\_\_\_\_ 100 ; due U. S. \$ \_\_\_\_\_ 100

Am't for cloth'g in kind or money adv'd \$ \_\_\_\_\_ 100

Due U. S. for arms, equipments, &c., \$ \_\_\_\_\_ 100

Bounty paid \$ \_\_\_\_\_ 100 ; due \$ \_\_\_\_\_ 100

Remarks: *Joined as recruit  
Discharged June 20, 1865 at  
Katchez Miss per G.O. No 44  
Hed Drs Dept of Miss  
Final statement furnished*

Book mark *Dischd June 22, 1865 G.O. No 44 P 259*

*W McAlhorn*

(361)

Copyist.

*Nelson Harris*  
*Pow, Co. C., 6 Reg't U. S. Col'd. Arty.*

Appears on a

**Detachment Muster-out Roll**

of the organization named above. Roll dated

*Natchez, Miss., June 27, 1865.*

Muster-out to date *June 27, 1865.*

Last paid to *Feby 28, 1865.*

**Clothing account:**

Last settled ..... 186 ; drawn since \$ ..... 100

Due soldier \$ ..... 100; due U. S. \$ ..... 100

Am't for cloth'g in kind or money adv'd \$ ..... 100

Due U. S. for arms, equipments, &c., \$ ..... 100

Bounty paid \$ ..... 100 due \$ ..... 100

**Remarks:**

*Clothing acct. settled to include ~~to~~*  
*March 28, '64. Amt. since drawn \$75.84.*  
*Bounty all due*

Book mark:

*D. Mahor*

(349)

Copyist.

*Harris, Peter*  
Co B, 6 U.S. Col'd H. Art'y

*Private*

*Private*

CARD NUMBERS.

1	6160325	26
2	6160474	27
3	6160617	28
4	6160741	29
5	6160857	30
6	6160994	31
7	6161119	32
8	6161258	33
9	6161392	34
10	6161534	35
11	6161674	36
12	6161884	37
12	6162618	38
14	6184730	39
15	9119351	40
16	40982454	41
17		42
18		43
19		44
20		45
21		46
22		47
23		48
24		49
25		50

Book Mark *2B. D. 11. P. 259*

See also

Peter Harris

, Co. C, 6 Reg't U. S. Col'd H. Art'y.

Appears on

Company Descriptive Book

of the organization named above.

DESCRIPTION.

Age 26 years; height 5 feet 6 inches.

Complexion Black

Eyes Black; hair Black

Where born Lake St John La.

Occupation Buckmoulder

ENLISTMENT.

When Sept 1, 1863.

Where Natchez Miss

By whom W. J. Lee; term 3 y'rs.

Remarks: Discharged at Natchez Miss June 20 1865

J. P. [Signature]

Peter Harris

Priv., Co. C, 2 Reg't Miss. Art'y. †

Age 26 years.

Appears on

**Company Muster-in Roll**

of the organization named above. Roll dated

Natchez, Miss, Sept 12, 1863.

Muster-in to date Sept 12, 1863.

Joined for duty and enrolled:

When Sept 1, 1863.\*

Where Natchez, Miss. \*

Period 3 years.\*

Valuation of horse, \$ 100

Valuation of horse equipments, \$ 100

Remarks:

† This organization subsequently became Co. C, 6 Reg't U. S. Colored Heavy Artillery.

\* Muster-in roll shows enrollment of all men of this company as of same date and place. See enrollment on subsequent card or cards.

Book mark:

M. Chauce

K<sup>o</sup>

6 H. Art'y.

U.S.C.T.

Peter Harris

Inw, Co. C, 2 Reg't Miss. Artillery.†

Appears on

Company Muster Roll

for Sept 12 to Oct 31, 1863.

Joined for duty and enrolled:

When Sept 1, 1863.\*

Where Natchez, Miss.\*

Period 3 years.\*

Present or absent Present,

Stoppage, \$ 100 for

Due Gov't \$ 100 for

Valuation of horse, \$ 100

Valuation of horse equipments, \$ 100

Remarks:

† This organization subsequently became Co. C, 6 Reg't U. S. Colored Heavy Artillery.  
\* See enrollment on card from muster-in roll.

Book mark:

Moochance

K

6 H. Art'y.

U.S.C.T.

Peter Harris

Private, Co. C, 2 Reg't Miss. Artillery.†

Appears on

Company Muster Roll

for Nov + Dec, 1863.

Joined for duty and enrolled:

When Sept 1, 1863.\*

Where Natchez, Miss.\*

Period 3 years.\*

Present or absent Present

Stoppage, \$ 100 for

Due Gov't \$ 100 for

Valuation of horse, \$ 100

Valuation of horse equipments, \$ 100

Remarks:

† This organization subsequently became Co. C, 6 Reg't U. S. Colored Heavy Artillery.

\* See enrollment on card from muster-in roll.

Book mark:

Moochance

7

6 H. Art'y.

U.S.C.T.

Peter Harris

Lot, Co. C, 2 Reg't Miss. Artillery.†

Appears on

Company Muster Roll

for Jan + Feb, 1864.

Joined for duty and enrolled:

When Sept 1, 1863.\*

Where Natchez, Miss \*

Period 3 years.\*

Present or absent Present

Stoppage, \$ 100 for

Due Gov't \$ 100 for

Valuation of horse, \$ 100

Valuation of horse equipments, \$ 100

Remarks:

† This organization subsequently became Co. C, 6 Reg't U. S. Colored Heavy Artillery.  
\* See enrollment on card from muster-in roll.

Book mark:

Wochance

(358c)

Copyist.



H

6 H. Art'y.

U.S.C.T.

Peter Harris

Priv., Co. C, 5 Reg't U. S. Col'd H. Art'y. †

Appears on

Company Muster Roll

for Mar & Apr., 1864.

Joined for duty and enrolled:

When Sept 1, 1863.\*

Where Natchez, Miss.\*

Period 3 years.\*

Present or absent Present

Stoppage, \$ 100 for

Due Gov't \$ 100 for

Valuation of horse, \$ 100

Valuation of horse equipments, 100

Remarks:

†This organization subsequently became Co. C, 6 Reg't U. S. Colored Heavy Artillery.

\* See enrollment on card from muster-in roll.

Book mark:

MoChance

(358c)

Copyist.

H

6 H. Art'y.

U.S.C.T.

Peter Harris

Priv., Co. C, 6 Reg't U. S. Col'd H. Art'y.

Appears on

Company Muster Roll

for May & June, 1864.

Joined for duty and enrolled:

When Sept 1, 1863.\*

Where Natchez, Miss.\*

Period 3 years.\*

Present or absent Present

Stoppage, \$ 100 for

Due Gov't, \$ 100 for

Valuation of horse, \$ 100

Valuation of horse equipments, \$ 100

Remarks:

\* See enrollment on card from muster-in roll.

Book mark:

no chance

(358c)

Copyst.

*Peter Harris*  
Co. C, 6 Reg't U. S. Col'd H. Art'y.

Appears on

**Company Muster Roll**

for *July & Aug*, 186*4*.

Joined for duty and enrolled:

When *Sept 1*, 186*3*\*

Where *Natchez, Miss*\*

Period *3* years.\*

Present or absent *Present*

Stoppage, \$ *100* for

Due Gov't, \$ *100* for

Valuation of horse, \$ *100*

Valuation of horse equipments, \$ *100*

Remarks:

\* See enrollment on card from muster-in roll.

Book mark:

*H. Smith*

Peter Harris  
Pvt., Co. C, 6 Reg't U. S. Col'd H. Art'y.

Appears on

Company Muster Roll

for Sept & Oct, 1864.

Joined for duty and enrolled:

When September 1, 1863.\*

Where Natchez, Miss.\*

Period 3 years.\*

Present or absent Present

Stoppage, \$ 100 for

Due Gov't, \$ 100 for

Valuation of horse, \$ 100

Valuation of horse equipments, \$ 100

Remarks:

-----  
-----  
-----

\* See enrollment on card from muster-in roll.

Book mark:

J. H. Smith

H

6 H. Art'y.

U.S.C.T.

Peter Harris

Prv, Co. C, 6 Reg't U. S. Col'd H. Art'y.

Appears on

Company Muster Roll

for Nov & Dec, 1864

Joined for duty and enrolled:

When Sept 1, 1863\*

Where Natchez, Miss.\*

Period 3 years.\*

Present or absent Present

Stoppage, \$ 100 for

Due Gov't, \$ 100 for

Valuation of horse, \$ 100

Valuation of horse equipments, \$ 100

Remarks:

\* See enrollment on card from muster-in roll.

Book mark:

H. A. Smith

(358c)

Copyist.

Peter Harris  
Co. C, 6 Reg't U. S. Col'd H. Art'y.

Appears on

Company Muster Roll  
for Jan & Feb, 1865.

Joined for duty and enrolled:

When Sept 1, 1863.\*

Where Natchez, Miss.\*

Period 3 years.\*

Present or absent Present

Stoppage, \$ 100 for

Due Gov't, \$ 100 for

Valuation of horse, \$ 100

Valuation of horse equipments, \$ 100

Remarks:

\* See enrollment on card from muster-in roll.

Book mark:

M. Smith

H

6 H. Art'y.

U.S.C.T.

Peter Harris

Pr, Co. C, 6 Reg't U. S. Col'd H. Art'y.

Appears on

Company Muster Roll

for Mar & Apr, 1865.

Joined for duty and enrolled:

When Sept 1, 1863.\*

Where Natchez. Miss.\*

Period 3 years.\*

Present or absent Present

Stoppage, \$ 100 for

Due Gov't, \$ 20 100 for Ordnance

Valuation of horse, \$ 100

Valuation of horse equipments, \$ 100

Remarks:

\* See enrollment on card from muster-in roll.

Book mark:

M.A. Smith

(358c)

Copyist.

H

6 H. Art'y.

U.S.C.T.

Peter Harris

B Co., 6 Reg't U. S. Col'd H. Art'y.

Appears on

Company Muster Roll

for May & June, 1865.

Joined for duty and enrolled:

When Sept 1, 1863\*

Where Natchez, Miss \*

Period 3 years.\*

Present or absent

Stoppage, \$ 100 for

Due Gov't, \$ 100 for

Remarks:

Discharged per G.O. 44. Ad. 20 dep't of Miss. Vicksburg, June 20/65

\* See enrollment on card from muster-in roll.

Book mark:

see E. B. V. 11, P. 259  
Discharged June 27, 1865.

M. A. Smith

(358c)

Copyright.



*Peter Harris*

*Co. C*, 6 Reg't U. S. Col'd H. Art'y.

Appears on **Co. Muster-out Roll**, dated

*Statches Miss May 13*, 1866

Muster-out to date \_\_\_\_\_, 186

Last paid to \_\_\_\_\_, 186

**Clothing account:**

Last settled \_\_\_\_\_, 186 ; drawn since \$ \_\_\_\_\_ 100

Due soldier \$ \_\_\_\_\_ 100 ; due U. S. \$ \_\_\_\_\_ 100

Am't for cloth'g in kind or money adv'd \$ \_\_\_\_\_ 100

Due U. S. for arms, equipments, &c., \$ \_\_\_\_\_ 100

Bounty paid \$ \_\_\_\_\_ 100 ; due \$ \_\_\_\_\_ 100

Remarks: *Joined at original organization Discharged June 20 1865 at Statches Miss per G.O. #4 Hd Qrs Dept of Miss. Final Statement furnished*

Book mark: *Dischd June 22 65 E B V 11 P 259*

*W. M. Calhoun*

Peter Harris

Private, Co. \_\_\_\_\_, 6 Reg't U. S. Col'd H. Art'y.

Appears on Returns as follows:

April 1864 (Co E 5th U.S. Col'd H.A.), Died of disease Feb 8th March

Book mark: \_\_\_\_\_

(546) *A. Gougeon* Copyist.

Peter Harris

Porri, Co. C, 6 Reg't U. S. Col'de Arty

Appears on a

**Detachment Muster-out Roll**

of the organization named above. Roll dated

Natchez, Miss. June 27, 1865.

Muster-out to date June 27, 1865.

Last paid to Feby 28, 1865.

**Clothing account:**

Last settled ..... 186 ; drawn since \$ ..... 100

Due soldier \$ ..... 100 ; due U. S. \$ ..... 100

Am't for cloth'g in kind or money adv'd \$ ..... 100

Due U. S. for arms, equipments, &c., \$ ..... 100

Bounty paid \$ ..... 100 due \$ ..... 100

**Remarks:**

Clothing acct. settled to include  
Oct. 31. 64. amt. since drawn \$ 24.40  
Bounty all due.

Book mark:

D. Maher

Copyist.

*Howes, Peter*

Co E, 6 U.S. Col'd H. Art'y.

*Private*

*Private*

CARD NUMBERS.

1	6165202	26
2	6165341	27
3	6165484	28
4	6165608	29
5	6165786	30
6	6167154	31
7	9119747	32
8	40742453	33
9		34
10		35
11		36
12		37
12		38
14		39
15		40
16		41
17		42
18		43
19		44
20		45
21		46
22		47
23		48
24		49
25		50

Book Mark: \_\_\_\_\_

See also \_\_\_\_\_

*Peter Harris*

....., Co. *E*, 6 Reg't U. S. Col'd H. Art'y.

Appears on

**Company Descriptive Book**

of the organization named above.

**DESCRIPTION.**

Age *24* years; height *5* feet *4* inches.

Complexion *Blk*

Eyes *Brk*; hair *Blk*

Where born *Adams Co Miss.*

Occupation *Farmer*

**ENLISTMENT.**

When *Sept. 1*, 186*3*.

Where *Natchez, Miss.*

By whom *J. N. Dickerson*, term *3* y'rs.

Remarks: *Died Feb. 8/64 in Regt Hospital at Natchez Miss. of Flux*

*Warren*

Peter Harris  
Pot., Co. E, 2 Reg't Miss. Art'y.†

Age 24 years.

Appears on

Company Muster-in Roll

of the organization named above. Roll dated  
Hatchez Miss sept 12, 1863.

Muster-in to date sept 12, 1863.

Joined for duty and enrolled:

When Sep 1, 1863.\*

Where Hatchez Miss \*

Period 3 years.\*

Valuation of horse, \$ 100

Valuation of horse equipments, \$ 100

Remarks:

† This organization subsequently became Co. E, 6 Reg't U. S. Colored Heavy Artillery.

\*#-Muster-in roll shows enrollment of all men of this company as of same date and place. See enrollment on subsequent card or cards.

Book mark:

Hadfield

(356c)

Copyist.

*H*

6 H. Art'y. U.S.C.T.

*Peter Harris*

*Pvt*, Co. E, 2 Reg't Miss. Art'y.†

Appears on

**Company Muster Roll**

for *sept & oct*, 1863.

Joined for duty and enrolled:

When *sept 1*, 1863.\*

Where *Natches Miss* \*

Period *3* years.\*

Present or absent *Present*

Stoppage, \$ *100* for

Due Gov't, \$ *100* for

Remarks:

† This organization subsequently became Co. E, 6 Reg't U. S. Colored Heavy Artillery.

\* See enrollment on card from muster-in roll.

Book mark:

*Hadfield*  
Copyist.

(358c)

*H* 6 H. Art'y. U.S.C.T.

*Peter Harris*

*Pvt*, Co. E, 2 Reg't Miss. Art'y.†

Appears on

**Company Muster Roll**

for *Nov + Dec*, 1863.

Joined for duty and enrolled:

When *Sept 1*, 1863.\*

Where *Natchez Miss* \*

Period *3* years.\*

Present or absent *Present*

Stoppage, \$ *100* for

Due Gov't, \$ *100* for

Remarks:  
-----  
-----  
-----  
-----  
-----

† This organization subsequently became Co. E, 6 Reg't U. S. Colored Heavy Artillery.  
\* See enrollment on card from muster-in roll.

Book mark: -----

*Hadfield*

(358c)

Copyist.



*Peter Harris*

*Pvt*, Co. E, 2 Reg't Miss. Art'y.†

Appears on

**Company Muster Roll**

for *Jan & Feb*, 1864.

Joined for duty and enrolled:

When *Sept 1*, 1863.\*

Where *Katchez Miss* \*

Period *3* years.\*

Present or absent *Present*

Stoppage, \$ *100* for

Due Gov't, \$ *100* for

Remarks: *sick in Regt Hosp since Feb 4 1864*

† This organization subsequently became Co. E, 6 Reg't U. S. Colored Heavy Artillery.  
\* See enrollment on card from muster-in roll.

Book mark:

*Hadfield*

(358c)

Copyist.

*H*

6 H. Art'y.

U.S.C.T.

*Peter Harris*

*Pot*, Co. *E*, 5 Reg't U. S. Col'd H. Art'y.†

Appears on

**Company Muster Roll**

for *Mar & Apr*, 1864.

Joined for duty and enrolled:

When *Sept 1*, 1863.\*

Where *Natchez miss*\*

Period *3* years.\*

Present or absent

Stoppage, \$ *100* for

Due Gov't \$ *100* for

Valuation of horse, \$ *100*

Valuation of horse equipments, *100*

Remarks: *died in Regt Hapt  
Feb 8 1864 Natchez miss  
of flux*

†This organization subsequently became Co. *E*, 6 Reg't U. S. Colored Heavy Artillery.

\* See enrollment on card from muster-in roll.

Book mark:

(358c)

*Hadfield*

Copyist.

A

6 H. Art'y.

U.S.C.T.

Peter Harris

Priv., Co. C, 6 Reg't U. S. Col'd H. Art'y.

Appears on Returns as follows:

May 1865 Present  
Sick in Post  
Hosp since May  
23, 65

June 1865 Left June  
20, 65 Matched Miss  
Disch'd per G.O.  
4-4 dated Hd Qrs  
Rept Miss Vicks-  
burg Miss May  
8, 65

Book mark:

(546)

A. Gouglard

Copyist.

*Peter Harris*

Private, Co. E, 6 Reg't U. S. Col'd H. Art'y.

Appears on **Co. Muster-out Roll**, dated

*Natchez, Miss. May 13, 1866*

Muster-out to date \_\_\_\_\_, 186 .

Last paid to \_\_\_\_\_, 186 .

**Clothing account:**

Last settled \_\_\_\_\_, 186 ; drawn since \$ \_\_\_\_\_ 100

Due soldier \$ \_\_\_\_\_ 100 ; due U. S. \$ \_\_\_\_\_ 100

Am't for cloth'g in kind or money adv'd \$ \_\_\_\_\_ 100

Due U. S. for arms, equipments, &c., \$ \_\_\_\_\_ 100

Bounty paid \$ \_\_\_\_\_ 100 ; due \$ \_\_\_\_\_ 100

Remarks: *Joined at original  
organization. Died Feb. 8,  
1864 Natchez, Miss. of Diarrhea.  
Final statements forwarded,  
June 8, 1864.*

Book mark: \_\_\_\_\_

(361)

*O. J. Markle,*

Copyist.

Harris, Peter

P, Co. E, 6 U.S.C.H.A.

2 Enclosures,

Bed Cards	Descriptive Lists
Burial Records	Final Statements
Certs. of Dis. for Discharge	Furloughs
C. M. Charges	Med. Des. Lists
Med. Certificates	Orders

Other papers relating to—

Admission to Hosp'l	Furlough
Casualty Sheet (Officer's)	Med. Examination
Confinement	Misc. Information
Contracts	Pay or Clothing
Death or Effects	Personal Reports
Desertions	Rank
Discharge from Hosp'l	Transfer to Hosp'l
Discharge from Service	Transfer to V. R. C.
Duty	Transportation

Inventories of the Effects  
of

Peter Harris

late of Company E

6th Regt U.S. Artillery

who died at Watch Mt

on the 8th day of February 1864



Inventory of the effects of *Peter Harris* late  
 a *Private* of Captain *J. M. Wickman's* Company *C* of  
 the *Sixth* Regiment of *U.S. Col. Art. (H)* Volunteers, who was enrolled as  
 a *Private* at *Natchez* in the State of *Mississippi* on  
 the *12th* day of *September* 1863, and mustered into the service of the United  
 States as a *Private* on the *12th* day of *September* 1863, at *Natchez Miss*  
 in Company *C*, *6th* Regiment of *U.S. Col. Art. (H)* to serve *Three*  
 years or during the war; he was born in *Adams County* in the State  
 of *Mississippi*; he was *24* years of age, *5* feet *4* inches  
 high, *Black* complexion, *Dark* eyes, *Black* hair, and by occupation, when enrolled,  
 a *Farmer*; he died in *Regt. Hospital* at  
*Natchez Miss* on the *8th* day of *February* 1864, by  
 reason of *Heat*.

INVENTORY.					
ARTICLES.	NO.	ARTICLES	NO.	ARTICLES.	NO.
Hats.....		Pairs Trowsers.....		Knapsacks.....	
Caps.....		Pairs flannel Drawers.....			
Forage Caps.....		Pairs cotton Drawers.....			
Great Coats.....		Flannel Shirts.....			
Uniform Coats.....		Cotton Shirts.....			
Uniform Jackets.....		Pairs boots.....			
Flannel Sack Coats.....		Pairs shoes.....			
Blouses.....		Pairs socks.....			
Stable Frocks.....		Blankets.....			
Fatigue Overalls.....		Haversacks.....			
				MONEY.	
				Specie.....	\$
				Notes.....	\$

I CERTIFY ON HONOR, that the above inventory comprises all the effects of *Private*  
*Peter Harris*, deceased, and that the effects are in the hands  
 of ..... at .....  
 ..... to be disposed of by a Council of Administration.

(DUPLICATES.)

*Daniel Dillon*  
*1st Lieutenant*  
 Commanding the Company.

STATION: *Natchez Miss*  
 DATE: *September 9th 1864*

V  
B. E.  
FINAL STATEMENT

OF

*Peter Harris*  
C<sup>th</sup> Reg't of *U. S. Light Arty*

**VOLUNTEERS.**

*Rec'd Feb 8<sup>th</sup> 1864*

NOTE 1.—Two of these certificates (or duplicates) are to be given to each Volunteer Soldier or drafted man who may be discharged previously to the discharge of his company, that he may at once receive from the Paymaster the pay, &c., due him, and the captain or other COMMISSIONED officer commanding the company will certify to the act of the delivery of the duplicate certificates; on these certificates the Soldier is "entitled to" his discharge, and should also present his discharge to the Paymaster to have the payment endorsed on it. The discharge is to be given back to the Soldier by the Paymaster; the latter only retaining as his voucher the duplicate certificates.

NOTE 2.—If the Soldier is entitled to pay for the use of his horse, the Company Commander will certify to that fact on the back of both these final statements, and also to the time he has pay due for having been so mounted on his own horse.

NOTE 3.—When a Soldier is furnished with final statements, his descriptive list, if he has one, should be taken up by the officer who gives the Soldier these statements, and endorsed with a statement to this effect by the officer. This endorsement should exhibit a full statement of the time for which the Soldier was allowed pay on his final statements, the clothing account, and all other charges against him or in his favor, so as to comprise a complete exhibit of his account. It will then be transmitted to the company commander of the Soldier, who will enter all the data necessary to a full understanding of the Soldier's account on the muster roll upon which the Soldier's discharge is reported. The descriptive list will then be destroyed. The object of this is, that the remaining portion of the Soldier's account may be settled upon the receipt of these muster rolls, and the Soldier receive any pay or allowances that may be due him at the time of his discharge, and which may not appear on his final statements from the fact that his descriptive list is incomplete. These accounts for back pay, &c., are settled by the 2d Auditor of the Treasury Department.

NOTE 4.—Charges for loss or injury to ordnance, horse equipments, and other miscellaneous charges, should appear under the heading of "Other Stoppages."

NOTE 5.—Bounty paid by State authorities, and not by the United States, will not be entered on this statement.

NOTE 6.—Amounts due the Sutler and Laundress must be entered on the muster roll on which the discharge, death, desertion, &c., is reported, as well as on the final statement, otherwise the amount cannot be collected from the United States.

NOTE 7.—This blank will be used for deceased volunteers and drafted men, as well as for others.

NOTE 8.—Where a Soldier dies in Hospital or on detached service, his descriptive list, if he has one, should be sent with his final statements, in duplicate, to the Adjutant General, Washington, D. C.

ADJUTANT GENERAL'S OFFICE

*Dec 1<sup>st</sup> 1864*

Duplicate with Inventory sent 2d Auditor.





I certify, on honor, that Peter Harris a Private of  
Captain A. N. Wickman's Company (E) of the 6<sup>th</sup> Regiment of U. S. Co. Artillery  
**VOLUNTEERS**, of the State of \_\_\_\_\_, born in Adams Co., State  
of Mississippi, aged 24 years; 5 feet 4 inches high; Black complexion,  
Dark eyes, Black hair, and by occupation a Farmer having joined the company on  
its original organization at Natchez Miss, and enrolled in it at the muster into  
the service of the United States at Natchez Miss, on the first day  
of September, 1863, (or was mustered in service as a recruit, by \_\_\_\_\_  
at \_\_\_\_\_, on the \_\_\_\_\_ day of \_\_\_\_\_,  
186 \_\_\_\_\_, or was drafted and mustered into the service of the United States from the \_\_\_\_\_  
Enrollment District of the State of \_\_\_\_\_, at \_\_\_\_\_,  
on the \_\_\_\_\_ day of \_\_\_\_\_, 186 \_\_\_\_\_) to serve in the Regiment, for  
the term of Three Years: and having served **HONESTLY** and  
**FAITHFULLY** with his Company in the field to the present date, is now  
entitled to a **DISCHARGE** by reason of death died in Regt.  
Co. Capt. Natchez Miss Feb 8<sup>th</sup> 1864 of Illness

The said Peter Harris was last paid by Paymaster  
Maj. Clark to include the 31<sup>st</sup> day of December, 1863, and has  
pay due him from that time to the present date; he is entitled to pay and subsistence for  
**TRAVELING** to place of enrollment, and whatever other allowances are authorized to volunteer  
soldiers, drafted men, or militia, so discharged. He has received from the United States **CLOTHING**  
amounting to 57<sup>41</sup>/<sub>100</sub> dollars, since the 1<sup>st</sup> day of September,  
1863, when his clothing account was last settled. He has received from the United States  
100 dollars advanced **BOUNTY**.

There is to be stopped from him, on account of the State of \_\_\_\_\_, or other  
authorities, for **CLOTHING**, &c., received on entering service, \_\_\_\_\_ dollars; and  
for other stoppages, viz: \_\_\_\_\_

\_\_\_\_\_ dollars.  
He has been furnished with **TRANSPORTATION** in kind from the place of his discharge to  
\_\_\_\_\_; and he has been **SUBSISTED** for **TRAVELING** to his  
place of enrollment, up to the \_\_\_\_\_, 186 \_\_\_\_\_.

He is indebted to \_\_\_\_\_, **SUTLER**, \_\_\_\_\_ dollars.

He is indebted to \_\_\_\_\_, **LAUNDRESS**, \_\_\_\_\_ dollars.

Given in Duplicate, at Natchez Miss, this 9<sup>th</sup> day  
of September, 1864.

Daniel Dillon  
1<sup>st</sup> Lieutenant  
Commanding Company.

Harris, Washington  
Co B, 6 U.S. Col'd H. Art'y.

Private | Private

CARD NUMBERS.

1	6160327	26
2	6160476	27
3	6160619	28
4	6160743	29
5	6160859	30
6	6160996	31
7	6161121	32
8	6161260	33
9	6161395	34
10	6161536	35
11	6161674	36
12	6161810	37
13	6161948	38
14	6162071	39
15	6162194	40
16	6162311	41
17	6162427	42
18	6162541	43
19	9119354	44
20		45
21		46
22		47
23		48
24		49
25		50

Book Mark:

See also

26

6 H. Art'y.

U.S.C.T.

Washington Harris

, Co. C, 6 Reg't U. S. Col'd H. Art'y.

Appears on

**Company Descriptive Book**

of the organization named above.

**DESCRIPTION.**

Age 22 years; height 5 feet 6 inches.

Complexion *Black*

Eyes *Black*; hair *Black*

Where born *Adam & Miss*

Occupation *Laborer*

**ENLISTMENT.**

When *Sept 1<sup>st</sup>*, 1863.

Where *Natchez Miss*

By whom *W D Fuller*; term 3 y'rs.

Remarks:

-----  
-----  
-----  
-----  
-----  
-----  
-----  
-----

*J. P. ...*

(3830)

Copist.

H

Washington Harris

Tot, Co. C, 2 Reg't Miss. Art'y.†

Age 22 years.

Appears on

Company Muster-in Roll

of the organization named above. Roll dated

Natchez, Miss, Sept 12, 1863.

Muster-in to date Sept 12, 1863.

Joined for duty and enrolled:

When Sept 1, 1863.\*

Where Natchez, Miss. \*

Period 3 years.\*

Valuation of horse, \$ 100

Valuation of horse equipments, \$ 100

Remarks:

† This organization subsequently became Co. C, 6 Reg't U. S. Colored Heavy Artillery.

\* Muster-in roll shows enrollment of all men of this company as of same date and place. See enrollment on subsequent card or cards.

Book mark:

no chance

K

6 H. Art'y.

U.S.C.T.

Washington Harris

D. C. Co. C, 2 Reg't Miss. Artillery.†

Appears on

Company Muster Roll

for Sept 12 to Oct 31, 1863.

Joined for duty and enrolled:

When Sept 1, 1863.\*

Where Natchez, Miss \*

Period 3 years.\*

Present or absent Present

Stoppage, \$ 100 for

Due Gov't \$ 100 for

Valuation of horse, \$ 100

Valuation of horse equipments, \$ 100

Remarks:

† This organization subsequently became Co. C, 6 Reg't U. S. Colored Heavy Artillery.

\* See enrollment on card from muster-in roll.

Book mark:

W. O. Chance

(358c)

Copyist.

7

6 H. Art'y.

U.S.C.T.

Washington Harris

Priv., Co. C, 2 Reg't Miss. Artillery.†

Appears on

Company Muster Roll

for Nov & Dec, 1863.

Joined for duty and enrolled:

When Sept 1, 1863.\*

Where Natchez, Miss.\*

Period 3 years.\*

Present or absent Present

Stoppage, \$ 100 for

Due Gov't \$ 100 for

Valuation of horse, \$ 100

Valuation of horse equipments, \$ 100

Remarks:

† This organization subsequently became Co. C, 6 Reg't U. S. Colored Heavy Artillery.

\* See enrollment card from muster-in roll.

Book mark:

no chance

H

6 H. Art'y.

U.S.C.T.

Washington Harris

Pvt., Co. C, 2 Reg't Miss. Artillery.†

Appears on

Company Muster Roll

for Jan + Feb, 1864

Joined for duty and enrolled:

When Sept 1, 1863.\*

Where Natchez, Miss.\*

Period 3 years.\*

Present or absent Present

Stoppage, \$ 100 for

Due Gov't \$ 100 for

Valuation of horse, \$ 100

Valuation of horse equipments, \$ 100

Remarks:

† This organization subsequently became Co. C, 6 Reg't U. S. Colored Heavy Artillery.  
\* See enrollment on card from muster-in roll.

Book mark:

W. M. Chance

2

6 H. Art'y.

U.S.C.T.

Washington Harris

Priv., Co. C, 5 Reg't U. S. Col'd H. Art'y.†

Appears on

Company Muster Roll

for Mar & Apr, 1864.

Joined for duty and enrolled:

When Sept 1, 1863.\*

Where Natchez, Miss.\*

Period 3 years.\*

Present or absent Present

Stoppage, \$ 100 for

Due Gov't \$ 100 for

Valuation of horse, \$ 100

Valuation of horse equipments, 100

Remarks:

†This organization subsequently became Co. C, 6 Reg't U. S. Colored Heavy Artillery.

\* See enrollment on card from muster-in roll.

Book mark:

No Change

(358c)

Copyist.



H

6 H. Art'y.

U.S.C.T.

Washington Harris

D.  
srw

, Co. C, 6 Reg't U. S. Col'd H. Art'y.

Appears on

**Company Muster Roll**

for May & June, 1864.

Joined for duty and enrolled:

When Sept 1, 1863.\*

Where Natchez, Miss.\*

Period 3 years.\*

Present or absent Present

Stoppage, \$ 100 for

Due Gov't, \$ 100 for

Valuation of horse, \$ 100

Valuation of horse equipments, \$ 100

Remarks:

\* See enrollment on card from muster-in roll.

Book mark:

no chance

(358c)

Copyist.

*Washington Harris*  
*Par*, Co. C, 6 Reg't U. S. Col'd H. Art'y.

Appears on

Company Muster Roll  
for *July & Aug*, 1864.

Joined for duty and enrolled:

When *Sept 1*, 1863.\*

Where *Natchez, Miss*\*

Period *3* years.\*

Present or absent *Present*

Stoppage, \$ *100* for

Due Gov't, \$ *100* for

Valuation of horse, \$ *100*

Valuation of horse equipments, \$ *100*

Remarks:  
.....  
.....  
.....

\* See enrollment on card from muster-in roll.

Book mark: .....

*W. Smith*

(358c)

Copyist.

7

6 H. Art'y.

U.S.C.T.

Washington Harris

Pr, Co. C, 6 Reg't U. S. Col'd H. Art'y.

Appears on

Company Muster Roll

for Sept & Oct, 1864.

Joined for duty and enrolled:

When Sept 1, 1863.\*

Where Natchez, Miss.\*

Period 3 years.\*

Present or absent Present

Stoppage, \$ 100 for

Due Gov't, \$ 100 for

Valuation of horse, \$ 100

Valuation of horse equipments, \$ 100

Remarks:

\* See enrollment on card from muster-in roll.

Book mark:

H. A. Smith

(358c)

Copyist.

*H*

6 H. Art'y.

U.S.C.T.

*Washington Harris*  
*Priv*, Co. C, 6 Reg't U. S. Col'd H. Art'y.

Appears on

Company Muster Roll

for *Nov & Dec*, 186 *4*

Joined for duty and enrolled:

When *Sept 1*, 186 *3*\*

Where *Natchez, Miss\**

Period *3* years.\*

Present or absent *Present*

Stoppage, \$ *100* for

Due Gov't, \$ *100* for

Valuation of horse, \$ *100*

Valuation of horse equipments, \$ *100*

Remarks: \_\_\_\_\_

\* See enrollment on card from muster-in roll.

Book mark: \_\_\_\_\_

*J. H. Smith*

(358c)

Copyist.

*H*

6 H. Art'y.

U.S.C.T.

*Washington Harris*  
*Pr*, Co. C, 6 Reg't U. S. Co'd H. Art'y.

Appears on

Company Muster Roll

for *Jan & Feb*, 186*5*.

Joined for duty and enrolled:

When *Sept 1*, 186*3*.\*

Where *Natchez, Miss*\*

Period *3* years.\*

Present or absent *Present*

Stoppage, \$ *100* for

Due Gov't, \$ *100* for

Valuation of horse, \$ *100*

Valuation of horse equipments, \$ *100*

Remarks: \_\_\_\_\_  
\_\_\_\_\_  
\_\_\_\_\_

\* See enrollment on card from muster-in roll.

Book mark: \_\_\_\_\_

*H. A. Smith*

(358c)

Copyist.

*H*

6 H. Art'y.

U.S.C.T.

*Washington Harris*  
*Par*, Co. C, 6 Reg't U. S. Col'd H. Art'y.

Appears on

Company Muster Roll  
for *Mar & Apr*, 186*5*.

Joined for duty and enrolled:

When *Sept 1*, 186*3*.\*

Where *Natchez. Miss* \*

Period *3* years.\*

Present or absent *Present*

Stoppage, \$ *100* for

Due Gov't, \$ *100* for

Valuation of horse, \$ *100*

Valuation of horse equipments, \$ *100*

Remarks:

\* See enrollment on card from muster-in roll.

Book mark:

*H.A. Smith*

(358c)

Copyist.

Washington Harris  
Pr, Co. C, 6 Reg't U. S. Col'd H. Art'y.

Appears on

Company Muster Roll

for May & June, 1865.

Joined for duty and enrolled:

When Sept 1, 1863.\*

Where Natchez, Miss \*

Period 3 years.\*

Present or absent Present

Stoppage, \$ 100 for

Due Gov't, \$ 100 for

Valuation of horse, \$ 100

Valuation of horse equipments, \$ 100

Remarks:

-----  
-----  
-----

\* See enrollment on card from muster-in roll.

Book mark:

W. A. Smith

*GH*

6 H. Art'y.

U.S.C.T.

*Washington Harris*

*Plt*, Co. C, 6 Reg't U. S. Col'd H. Art'y.

Appears on

**Company Muster Roll**

for *July & Aug*, 1865.

Joined for duty and enrolled:

When *1 Sep*, 1863.\*

Where *Natchez, Miss.*\*

Period *3* years.\*

Present or absent *present*

Stoppage, \$ *100* for

Due Gov't, \$ *100* for

Valuation of horse, \$ *100*

Valuation of horse equipments, \$ *100*

Remarks:

\* See enrollment on card from muster-in roll.

Book mark:

*G. E. Dayton*



Washington Harris  
Pat., Co. C, 6 Reg't U. S. Col'd H. Art'y.

Appears on

Company Muster Roll  
for Sep roct, 1865.

Joined for duty and enrolled:

When 1 Sep, 1865.\*

Where Atchez Miss \*

Period 3 years.\*

Present or absent present.

Stoppage, \$ 100 for

Due Gov't, \$ 02 for ordnance

Valuation of horse, \$ 100

Valuation of horse equipments, \$ 100

Remarks:

\* See enrollment on card from muster-in roll.

Book mark:

G. E. Dayton

*YH*

6 H. Art'y.

U.S.C.T.

*Washington Harris*

*Pvt*

, Co. C, 6 Reg't U. S. Col'd H. Art'y.

Appears on

**Company Muster Roll**

for *Nov + Dec*, 1865.

Joined for duty and enrolled:

When *1 Sep*, 1863.\*

Where *Catchez, Miss.* \*

Period *3* years.\*

Present or absent *present*.

Stoppage, \$ *100* for

Due Gov't, \$ *02* for *ordnance*.

Valuation of horse, \$ *100*

Valuation of horse equipments, \$ *100*

Remarks:

\* See enrollment on card from muster-in roll.

Book mark: *21310*

*F. E. Dayton*

(358c)

Copyst.

*H.*

6 H. Art'y.

U.S.C.T.

*Washington Harris*

*Priv*, Co. C, 6 Reg't U. S. Col'd H. Art'y.

Appears on

**Company Muster Roll**

for *Jan & Feb*, 186*6*

Joined for duty and enrolled:

When *1 Sep*, 186*3*.\*

Where *Natchez, Miss.* \*

Period *3* years.\*

Present or absent *present*.

Stoppage, \$ *100* for

Due Gov't, \$ *100* for

Valuation of horse, \$ *100*

Valuation of horse equipments, \$ *100*

Remarks:

\* See enrollment on card from muster-in roll.

Book mark:

*G. E. Dayton*

(358c)

Copyright.

H.

6 H. Art'y.

U.S.C.T.

Washington Harris

Priv., Co. C, 6 Reg't U. S. Col'd H. Art'y.

Appears on

Company Muster Roll

for *Alch Seppel*, 1866

Joined for duty and enrolled:

When *1 Sep*, 1863.\*

Where *Atchez Miss.* \*

Period *3* years.\*

Present or absent *present.*

Stoppage, \$ *100* for

Due Gov't, \$ *100* for

Valuation of horse, \$ *100*

Valuation of horse equipments, \$ *100*

Remarks:

\* See enrollment on card from muster-in roll.

Book mark:

*G. E. Dayton*

(358c)

Copyist.

*26*

6 H. Art'y.

U.S.C.T.

*Washington Harris*  
Pot., Co. C, 6 Reg't U. S. Col'd H. Art'y.

Appears on **Co. Muster-out Roll**, dated

*Natchez Miss, May 13, 1866*

Muster-out to date

*May 13, 1866*

Last paid to

*Dec 31, 1865*

**Clothing account:**

Last settled....., 186 ; drawn since \$..... 100

Due soldier \$ *38 62* / 100; due U. S. \$..... 100

Am't for cloth'g in kind or money adv'd \$..... 100

Due U. S. for arms, equipments, &c., \$..... 100

Bounty paid \$..... 100; due \$..... 100

Remarks: *Joined at original  
Organization*

Book mark:

*2, 5, 7, 217, 68*

*W. M. Calhoun*

(361)

Copyist.

*W. M. W. W.*  
Co A, 6 U.S. Co'd H. Art'y

*Private* | *Private*

CARD NUMBERS.

1	6171517	26
2	6171604	27
3	6171750	28
4	6171893	29
5	6172033	30
6	6172158	31
7	6172287	32
8	6172406	33
9	6172585	34
10	6172701	35
11	6172820	36
12	6172935	37
12	6173043	38
14	6173157	39
15	6173263	40
16	6173365	41
17	6173468	42
18	9120358	43
19	40742415	44
20		45
21		46
22		47
23		48
24		49
25		50

Book Mark: \_\_\_\_\_

See also \_\_\_\_\_

*Wiley Harris*

Co. *H*, 6 Reg't U. S. Col'd H. Art'y.

Appears on

**Company Descriptive Book**  
of the organization named above.

**DESCRIPTION.**

Age *39* years; height *5* feet *9* inches.

Complexion *Btk*

Eyes *Btk*; hair *Btk*

Where born *Burk Co., N.C.*

Occupation *Carpenter*

**ENLISTMENT.**

When *Nov. 1*, 186 *3*

Where *Natchez, Miss.*

By whom *J.P. Crane*; term *3* y'rs.

Remarks:  
.....  
.....  
.....  
.....  
.....  
.....  
.....  
.....

*Warren*

*H.* | **6 H. Art'y.** | **U. S. C. T.**

*Wiley Harris*

*Co. H., 2 Reg't Miss. Art'y. †*

Age *39* years.

Appears on

**Company Muster-in Roll**

of the organization named above. Roll dated

*Natchez Miss. Nov. 23, 1863*

Muster-in to date *Nov. 1, 1863*

Joined for duty and enrolled:

When *Nov 1* 186*3*.\*

Where *Natchez Miss* \*

Period *3* years.\*

Valuation of horse, \$ *100*

Valuation of horse equipments, \$ *100*

Remarks:

† This organization subsequently became Co. *H.* 6 Reg't U. S. Colored Heavy Artillery.

\* Muster-in roll shows enrollment of all men of this company as of same date and place. See enrollment on subsequent card or cards.

Book mark:

*W. Harris*



*W.C.*

6 H. Art'y.

U.S.C.T.

*Wiley Harris*  
*Col.*, Co. H, 2 Reg't Miss. Art'y.†

Appears on

**Company Muster Roll**

for *Nov. 25 to Dec. 31*, 186<sup>3</sup>\*

Joined for duty and enrolled:

When *Nov 1*, 186<sup>3</sup>\*

Where *Natchez Miss.*\*

Period *3* years.\*

Present or absent *Present.*

Stoppage, \$ *100* for

Due Gov't, \$ *100* for

Valuation of horse, \$ *100*

Valuation of horse equipments, \$ *100*

Remarks:

† This organization subsequently became Co. H, 6 Reg't U. S. Co'd Heavy Artillery.

\* See enrollment on card from muster-in roll.

Book mark:

*J. Stearns*

(358c)

Copyist

110

6 H. Art'y.

U.S.C.T.

Wiley Harris  
Col., Co. H, 2 Reg't Miss. Art'y.†

Appears on

**Company Muster Roll**

for Jan. & Feb., 1864.

Joined for duty and enrolled:

When Nov., 1863.\*

Where Mobile Ala.\*

Period 3 years.\*

Present or absent Present

Stoppage, \$ 100 for

Due Gov't, \$ 100 for

Valuation of horse, \$ 100

Valuation of horse equipments, \$ 100

Remarks:

† This organization subsequently became Co. H, 6 Reg't U. S. Co'd Heavy Artillery.

\* See enrollment on card from muster-in roll.

Book mark:

*Y.C.*

6 H. Art'y.

U.S.C.T.

*Wiley Harris*

*Co. H., 5 Reg't U. S. Col'd H. Art'y.\**

Appears on

**Company Muster Roll**

for *Mar + Apr.*, 1864.

Joined for duty and enrolled :

When *Nov. 1*, 1863.\*

Where *Natchez Miss.\**

Period *3* years.\*

Present or absent *Present.*

Stoppage, \$ *100* for

Due Gov't, \$ *100* for

Valuation of horse, \$ *100*

Valuation of horse equipments, \$ *100*

Remarks: \_\_\_\_\_

\_\_\_\_\_

\_\_\_\_\_

\* This organization subsequently became Co. *Y.C.*, 6 Reg't U. S. Col'd Heavy Artillery.

\* See enrollment on card from muster-in roll.

Book mark: \_\_\_\_\_

(358c)

*W. Harris*

Copyist.

*H.C.*

6 H. Art'y.

U.S.C.T.

*Wiley Harris*

*Col.*, Co. H, 6 Reg't U. S. Col'd H. Art'y.

Appears on

**Company Muster Roll**

for *May & June*, 186*4*.

Joined for duty and enrolled:

When *Nov. 1*, 186*3*\*

Where *Victoria Mis'*

Period *3* years.\*

Present or absent *Present*

Stoppage, \$ *100* for

Due Gov't \$ *100* for

Remarks:

-----  
-----  
-----  
-----  
-----

\* See enrollment on card from muster-in roll.

Book mark:

-----  
*W. Harris*

(358c)

Copyist.

*Wylie Harris*  
*ser.*, Co. H, 6 Reg't U. S. Col'd H. Art'y.

Appears on

**Company Muster Roll**

for *July & August*, 186*4*.

Joined for duty and enrolled:

When *Nov 1*, 186*3*.\*

Where *Natchez Miss*\*

Period *3* years.\*

Present or absent *Present*.

Stoppage, \$ *100* for

Due Gov't \$ *100* for

Remarks: *Stoppage for*  
*5 mo. canton*  
*4/ etc*

-----  
-----  
-----

\* ~~See~~ See enrollment on card from muster-in roll.

Book mark: -----

*A. B. Stearns*  
(358c) Copyist.

H

6 H. Art'y.

U.S.C.T.

*Wiley Harris*  
Corp, Co. H, 6 Reg't U. S. Col'd H. Art'y.

Appears on

Company Muster Roll  
for *Sept and Oct.*, 1864.

Joined for duty and enrolled:

When *Nov 1*, 1863.\*

Where *Natchez, Miss*\*

Period *3* years.\*

Present or absent *present*

Stoppage, \$ *100* for

Due Gov't \$ *100* for

Remarks: *Due U.S. for one  
canteen lost 41 cts.*

\* See enrollment on card from muster-in roll.

Book mark:

*O'Leary*

(358c)

Copyist.

Niley Harris  
Corp, Co. H, 6 Reg't U. S. Col'd H. Art'y.

Appears on

Company Muster Roll  
for Nov and Dec, 1864.

Joined for duty and enrolled:

When Nov 1, 1863.\*

Where Natchez Miss \*

Period 3 years.\*

Present or absent Present

Stoppage, \$ 100 for

Due Gov't \$ 100 for

Remarks:

\* See enrollment on card from muster-in roll.

Book mark:

O'Leary  
(358c) Copyist.

H

6 H. Art'y.

U.S.C.T.

Wiley Harris  
Pvt., Co. H, 6 Reg't U. S. Col'd H. Art'y.

Appears on

Company Muster Roll

for Jan & Feb., 1865

Joined for duty and enrolled:

When Nov 1, 1863

Where Ketchy Mills

Period 3 years.\*

Present or absent present

Stoppage, \$ 100 for

Due Gov't \$ 100 for

Remarks: Reduced from  
Corp. by special  
order No 1. Reg't  
Hdg's to date from  
Jan. 1 '65.

\* See enrollment on card from muster-in roll.

Book mark:

O. Henry

(358c)

Copyist.



H

6 H. Art'y.

U.S.C.T.

*Niley Harris*  
Pvt., Co. H, 6 Reg't U. S. Col'd H. Art'y.

Appears on

Company Muster Roll  
for *May and April*, 1865.

Joined for duty and enrolled:

When *Nov 1*, 1863.\*

Where *Natchez Miss*\*

Period *3* years.\*

Present or absent *Present*

Stoppage, \$ *100* for

Due Gov't \$ *100* for

Remarks: *Reduced from  
corp by S.O Nov 1  
Reg't H'd Qrs. to date  
Jan 1 '65*

\* See enrollment on card from muster in roll.

Book mark:

(358c)

*O'Leary*

Copyist.

*A*

6 H. Art'y.

U.S.C.T.

*Wiley Harris*

*1st Lt.*, Co. H, 6 Reg't U. S. Col'd H. Art'y.

Appears on

**Company Muster Roll**

for *May & June*, 186*5*.

Joined for duty and enrolled:

When *Nov. 1*, 186*5*.

Where *Natchez Miss.*

Period *2* years.\*

Present or absent *Present*

Stoppage, \$ *100* for

Due Gov't \$ *100* for

Remarks:

-----  
-----  
-----  
-----  
-----

\* See enrollment on card from muster-in roll.

Book mark:

-----

*Paul*

(358c)

Copyist.

A. V. H. Artz | **U.S.C.T.**

Wiley Harris  
Pvt., Co. H, 6 Reg't U. S. Col'd H. Artz,

Appears on

**Company Muster Roll**

for July & Aug., 1865.

Joined for duty and enrolled:

When Nov. 1, 1865.\*

Where Natchez Miss. \*

Period 3 years.\*

Present or absent Present

Stoppage, \$ 100 for

Due Gov't, \$ 100 for

Remarks: \_\_\_\_\_  
\_\_\_\_\_  
\_\_\_\_\_  
\_\_\_\_\_  
\_\_\_\_\_

\* See enrollment on card from muster-in roll.

Book mark: \_\_\_\_\_  
\_\_\_\_\_

Paull

*N*

6 H. Art'y.

U.S.C.T.

*Wiley Harris*

*Plt*, Co *H*, 6 Reg't U. S. Col'd H. Art'y.

Appears on

**Company Muster Roll**

for *Sept & Oct*, 1865.

Joined for duty and enrolled:

When *Nov*, 1863.\*

Where *Natchez Miss.*

Period *3* years.\*

Present or absent *present*

Stoppage, \$ *100* for

Due Gov't \$ *100* for

Remarks:  
-----  
-----  
-----  
-----  
-----  
-----

\* See enrollment on card from muster-in roll.

Book mark: -----

*Harpes*  
Copyist.

(358c)

H. D.

6 H. Art'y.

U.S.C.T.

Wiley Harris

Priv., Co. H, 6 Reg't U. S. Col'd H. Art'y.

Appears on

Company Muster Roll

for Nov & Dec, 1865.

Joined for duty and enrolled:

When Nov 1, 1863.

Where Natchez, Miss.

Period 3 years.\*

Present or absent present

Stoppage, \$ 100 for

Due Gov't \$ 100 for

Remarks:

[Empty lines for remarks]

\* See enrollment on card from muster-in roll.

Book mark:

B. C. Harper Copyist.

(358c)

*Wiley Harris*  
Bt., Co. H, 6 Reg't U. S. Col'd H. Art'y.

Appears on

**Company Muster Roll**  
for *Jan Feb*, 1866.

Joined for duty and enrolled:

When *Nov 1*, 1863.\*

Where *State Reg, Miss*\*

Period *3* years.\*

Present or absent *present*

Stoppage, \$ *100* for

Due Gov't \$ *100* for

Remarks:  
.....  
.....  
.....  
.....  
.....

\* See enrollment on card from muster-in roll.

Book mark: .....

*W. C. Harper*  
(358c) Copyist

Wiley Harris  
Priv., Co. H, 6 Reg't U. S. Col'd H. Art'y.

Appears on

Company Muster Roll  
for Mar & Apr, 1866.

Joined for duty and enrolled:

When Nov 1, 1863.\*

Where Kaschez, Miss.\*

Period 3 years.\*

Present or absent present

Stoppage, \$ 100 for

Due Gov't \$ 100 for

Remarks:  
\_\_\_\_\_  
\_\_\_\_\_  
\_\_\_\_\_  
\_\_\_\_\_

\* See enrollment on card from muster-in roll.

Book mark:

B. C. Harper  
Copyist.

A

6 H. Art'y.

U.S.C.T.

Wiley Harris  
Cpl, Co H, 6 Reg't U. S. Col'd H. Art'y.  
Pot

Appears on Returns as follows:

July 1864 Absent with  
sick leave since  
July 25, 64  
Mar 1865 - On duty  
at Ordnance  
Dept by instruc-  
tions from Regt  
Hd 2<sup>nd</sup> Mar<sup>29</sup> (Pot)  
Nov 1865 On daily  
duty

Book mark:

(546)

W. J. Angles  
Copyist.



H

6 H. Art'y.

U.S.C.T.

*Wiley Harris*

*Private*, Co. *H*, 6 Reg't U. S. Col'd H. Art'y.

Appears on **Co. Muster-out Roll**, dated

*Natchez, Miss May 13*, 1866.

Muster-out to date

*May 13*, 1866.

Last paid to

*Dec 31*, 1865.

**Clothing account:**

Last settled....., 186 ; drawn since \$..... 100

Due soldier \$ *62*, <sup>*55*</sup>100; due U. S. \$..... 100

Am't for cloth'g in kind or money adv'd \$..... 100

Due U. S. for arms, equipments, &c., \$..... 100

Bounty paid \$..... 100; due \$..... 100

**Remarks:**

*Joined original organization*

Book mark: *143 P 62.69-465, 268, 263, 117*

*C. J. Powell*

(361)

Copyist.

Harris Wiley

Corp., Co. *H*, *6* Reg't *16. S.H.A.*

/ Enclosures.

Bed Cards .....	Final Statements .....
Burial Records .....	Furloughs or L. of A. ....
Certs. of Dis. for Discharge .....	Med. Certificates .....
C. M. Charges .....	Med. Des. Lists .....
Descriptive Lists .....	Orders .....
Discharge Certificates .....	Pris. of War Record .....
Enlistment Papers .....	Resignations .....

Other papers relating to—

Admission to Hosp'l .....	Furlough or L. of A. ....
Casualty Sheet .....	Med. Examination .....
Confinement .....	Misc. Information .....
Contracts .....	Pay or Clothing .....
Death or Effects .....	Personal Reports .....
Desertion .....	Rank .....
Discharge from Hosp'l .....	Transfer to Hosp'l .....
Discharge from Service .....	Transfer to V. R. C. ....
Duty .....	Transportation .....

Wiley Harris ✓  
Corpl. Co. B 6<sup>th</sup> Artillery

---

Report of Div of W. Co.

---

Adjutant General's Office,

COLORED TROOPS BRANCH,

Mr. Ellertson

April 29<sup>th</sup>, 1875

Vol. C. T., 187

Wanted in the case of Wiley Harris Capt., Co. A,  
Sixth Reg't U.S.C. Artillery

Period Absent & whether tried.  
"Absent without leave since July 25<sup>th</sup> 1864" - RR for July 1864  
Present for duty - RR for July & August 1864

H.S.

Respectfully,

W. A. Woodward  
Chief Clerk.  
J. H. Harkon

Adjutant General's Office,

Division of Discontinued Commands.

May 11<sup>th</sup>, 1875

Vol. C. T., 187

Reply in case of Wiley Harris Capt., Co. H,  
6<sup>th</sup> Reg't U.S.C.A. (Heavy)

Reg't and Co. Des Rts furnish no information - Co.  
Moig Repts July 25<sup>th</sup> 64 - "Absent without leave" Aug<sup>th</sup>  
6<sup>th</sup> 64 - "Returned from absent without leave" - No  
record of trial

P.P.K.

File date of return - no record of trial

*Wm. W. W.*  
Co A, 6 U.S. Col'd H. Art'y

*Private Private*

CARD NUMBERS.

1	6154535	26	
2	6156660	27	
3	6156784	28	
4	6156917	29	
5	6157048	30	
6	6157176	31	
7	6157306	32	
8	6157428	33	
9	6157551	34	
10	6157671	35	
11	9118974	36	
12	40742455	37	
13		38	
14		39	
15		40	
16		41	
17		42	
18		43	
19		44	
20		45	
21		46	
22		47	
23		48	
24		49	
25		50	

Book Mark: \_\_\_\_\_

See also \_\_\_\_\_

28

6 H. Art'y.

U.S.C.T.

William Harris

Appears with rank of *Priv* on

**Muster and Descriptive Roll of a Detachment of U. S. Vols. forwarded**

for the 6 Reg't U. S. Col'd H. Art'y. Roll dated *Vicksburg, Miss, Dec, 24, 1864.*

Where born *Adams Co, Miss*

Age *20* y'rs; occupation *Farmer*

When enlisted *Dec. 12*, 1864.

Where enlisted *Vicksburg, Miss*

For what period enlisted *3* years.

Eyes *Black*; hair *Black*

Complexion *Redd*; height *5* ft. *4* in.

When mustered in \_\_\_\_\_, 186

Where mustered in \_\_\_\_\_

Bounty paid \$ *100* <sup>100</sup>; due \$ *200* <sup>100</sup>

Where credited *quota of the State of Miss*

Company to which assigned \_\_\_\_\_

Remarks: \_\_\_\_\_

\_\_\_\_\_

\_\_\_\_\_

Book mark: \_\_\_\_\_

*Montague*

(339)

Copyist.

26

6 H. Art'y.

U.S.C.T.

William Harris

Pri., Co. A, 6 Reg't U. S. Col'd H. Art'y.

Appears on

Company Muster Roll

for Jan. & Feb., 1865.

Joined for duty and enrolled:

When Dec. 12, 1864\*

Where Vicksburg, Miss.\*

Period 3 years.\*

Present or absent Present

Stoppage, \$ 100 for

Due Gov't \$ 100 for

Remarks:

Mut'd Dec'r 24/64, Vicksburg Miss.

\* See enrollment on card from muster-in roll.

Book mark:

J. H. Henderson Copyist.

(358c)

*H*

6 H. Art'y.

U.S.C.T.

*William Harris*

*Pri.*, Co. A, 6 Reg't U. S. Col'd H. Art'y.

Appears on

Company Muster Roll

for *Mar. 3 Apr.*, 1865.

Joined for duty and enrolled:

When *Dec. 12*, 1864\*

Where *Vicksburg, Miss.*\*

Period *3* years.\*

Present or absent *Present*

Stoppage, \$ *100* for

Due Gov't \$ *100* for

Remarks:  
-----  
-----  
-----  
-----  
-----

\* See enrollment on card from muster-in roll.

Book mark: -----

*J. H. Henderson*  
(358c) Copyist.



Ho

6 H. Art'y.

U.S.C.T.

William Harris

Priv., Co. A, 6 Reg't U. S. Col'd H. Art'y.

Appears on

Company Muster Roll  
for Feb. 28 to June 30, 1865.

Joined for duty and enrolled:

When Dec. 12, 1864.\*

Where Vicksburg, Miss \*

Period 3 years.\*

Present or absent Present

Stoppage, \$ 100 for

Due Gov't \$ 100 for

Remarks:

\* See enrollment on card from muster-in roll.

Book mark:

J. H. Henderson  
(358c) Copyist.

26

6 H. Art'y.

U.S.C.T.

*William Harris*

*3rd*, Co. A, 6 Reg't U. S. Col'd H. Art'y.

Appears on

**Company Muster Roll**

for *July & August*, 186*5*.

Joined for duty and enrolled:

When *Dec 12*, 186*4*.\*

Where *Vicksburg Miss* \*

Period *3* years.\*

Present or absent. *Present*

Stoppage, \$ *100* for

Due Gov't \$ *100* for

Remarks:

-----  
-----  
-----  
-----  
-----

\* See enrollment on card from muster-in roll.

Book mark: -----

(358c)

*D. J. Gifford*

Copyist.

76

6 H. Art'y.

U.S.C.T.

*William Harris*

*76*, Co. A, 6 Reg't U. S. Col'd H. Art'y.

Appears on

**Company Muster Roll**

for *Sept + Oct*, 186*5*.

Joined for duty and enrolled:

When *Dec 12*, 186*4*.\*

Where *Vicksburg Miss* \*

Period *3* years.\*

Present or absent *Present*

Stoppage, \$ *100* for

Due Gov't \$ *100* for

Remarks: *Sick in Post  
Hospital Natchez Miss  
Since Oct 3, 65*

\* See enrollment on card from muster-in roll.

Book mark:

(358c)

*T. J. Griffith*

Copyist.

26

6 H. Art'y.

U.S.C.T.

William Harris

3rd, Co. A, 6 Reg't U. S. Col'd H. Art'y.

Appears on

Company Muster Roll

for Nov & Dec, 1865.

Joined for duty and enrolled:

When Mch 10, 1865.\*

Where Vicksburg Miss \*

Period 3 years.\*

Present or absent Present

Stoppage, \$ 100 for

Due Gov't \$ 100 for

Remarks:

\* See enrollment on card from muster-in roll.

Book mark:

(358c)

J. Griffith

Copyist.

26

6 H. Art'y.

U.S.C.T.

William Harris

Co. A, 6 Reg't U. S. Col'd H. Art'y.

Appears on

Company Muster Roll

for Jan & Feb, 1866.

Joined for duty and enrolled:

When March 10, 1865.\*

Where Vicksburg Miss \*

Period 3 years.\*

Present or absent Present

Stoppage, \$ 100 for

Due Gov't \$ 100 for

Remarks:

\* See enrollment on card from muster-in roll.

Book mark:

(358c)

D. J. Gifford

Copyist.

26

6 H. Art'y.

U.S.C.T.

William Harris

Jan', Co. A, 6 Reg't U. S. Col'd H. Art'y.

Appears on

Company Muster Roll

for March & April, 1866.

Joined for duty and enrolled:

When Dec 12, 1864.\*

Where Vicksburg Miss \*

Period 3 years.\*

Present or absent Present

Stoppage, \$ 100 for

Due Gov't \$ 100 for

Remarks:

\* See enrollment on card from muster-in roll.

Book mark:

(358c)

D. J. Giffish

Copyist.

*W*

6 H. Art'y.

U.S.C.T.

*William Harris*  
Priv., Co. A, 6 Reg't U. S. Col'd H. Art'y.

Appears on **Co. Muster-out Roll**, dated  
*Natchez Miss. May 13, 1866*.

Muster-out to date *May 13, 1866*.

Last paid to *Dec. 31, 1865*.

Clothing account:

Last settled....., 186 ; drawn since \$.....<sup>100</sup>

Due soldier \$ *66*<sup>*17*</sup>/<sub>100</sub>; due U. S. \$.....<sup>100</sup>

Am't for cloth'g in kind or money adv'd \$.....<sup>100</sup>

Due U. S. for arms, equipments, &c., \$.....<sup>100</sup>

Bounty paid \$ *100*<sup>*50*</sup>/<sub>100</sub>; due \$ ~~*150*~~<sup>*x*</sup>/<sub>100</sub>

Remarks: *Joined as a recruit*

*As it appears on roll.*

Book mark: .....

*A. L. Ames*

(361)

Copyist.

William Harris

Co. A, 6 Reg't U. S. Col'd H. Art'y.

Appears on Returns as follows:

Jan 1865 Gain Jan  
2, 65 Natchez  
Rec'd from Depot  
joined for service  
at Vicksburg Dec  
12, 64

Oct 1865 Absent sick  
in Post Hosp  
Natchez since  
Oct 30

Book mark:

(646) *Agarola* Copyist.



*William Harris*

....., Co. *A*, 6 Reg't U. S. Col'd H. Art'y.

Appears on

**Company Descriptive Book**  
of the organization named above.

**DESCRIPTION.**

Age *20* years; height *5* feet *4* inches.

Complexion *colored*

Eyes *Black*; hair *Black*

Where born *Adams Co Miss*

Occupation *Farmer*

**ENLISTMENT.**

When *Dec 12*, 186 *4*

Where *Vicksburg Miss*

By whom *Lt Col Knudly*; term *3* y'rs.

Remarks: .....

.....  
.....  
.....  
.....  
.....  
.....  
.....  
.....  
.....  
.....

*Spiller*

Harris, William

P. Co. A, 6 U.S.C.H.A.

~~4~~ Enclosures.

Bed Cards	Descriptive Lists
Burial Records	Final Statements
Certs. of Dis. for Discharge	Furloughs
C. M. Charges 7	Med. Des. Lists
Med. Certificates	Orders
Enlistments 2	

Other papers relating to—

Admission to Hosp'l	Furlough
Casualty Sheet (Officer's)	Med. Examination
Confinement	Misc. Information
Contracts	Pay or Clothing
Death or Effects	Personal Reports
Desertions 1	Rank
Discharge from Hosp'l	Transfer to Hosp'l
Discharge from Service	Transfer to V. R. C.
Duty	Transportation

NOTE 1.—This blank will be used for both enlistments and re-enlistments—enlistment of veterans, &c., &c., in the volunteer service. They will be made out in duplicate in all cases—one to accompany the recruiting return of the superintendent (not the recruiting officer) to the Adjutant General, and one to accompany the accounts of the officer who pays bounty, &c. The Regiment and Company in which the soldier last served should be given on the back.

NOTE 2.—An enlistment holds to service. A muster-in must, in all cases, precede payment of pay, bounty, pension, &c. A muster-in roll must, in all cases, be filed in the Adjutant General's Office as evidence of muster-in. The mustering officer, commissary, or assistant commissary of musters, as the case may be, will countersign both enlistments as having mustered the soldier into the service of the United States before either of them is given to the disbursing officer.

DECLARATION OF RECRUIT.

I, William Harris, desiring to VOLUNTEER as a Soldier in the Army of the United States, for the term of THREE YEARS. Do Declare, That I am Twenty years and 1 months of age; that I have never been discharged from the United States service on account of disability or by sentence of a court martial, or by order before the expiration of a term of enlistment; and I know of no impediment to my serving honestly and faithfully as a soldier for three years.

GIVEN at Wickburg Miss. the 24 day of December 1864

Witness: B. F. Stevens William Harris  
Major

Discharged \_\_\_\_\_, 18\_\_

Enlistment; last served in Company ( )  
 Reg't of 100th

Major

By E. C. Kinney Major  
 1st Reg't of 100th

Volunteered at Wickburg Miss. 24 December, 1864

No. \_\_\_\_\_  
William Harris

CONSENT IN CASE OF MINOR.

I, \_\_\_\_\_, Do CERTIFY, That I am the \_\_\_\_\_ of \_\_\_\_\_; that the said \_\_\_\_\_ is \_\_\_\_\_ years of age; and I do hereby freely give my CONSENT to his volunteering as a SOLDIER in the ARMY OF THE UNITED STATES for the period of THREE YEARS.

GIVEN at \_\_\_\_\_ the \_\_\_\_\_ day of \_\_\_\_\_

Witness: \_\_\_\_\_

(A. G. O. No. 74 & 76.)

VOLUNTEER ENLISTMENT.

STATE OF

TOWN OF

*Mississippi*

*Vicksburg*

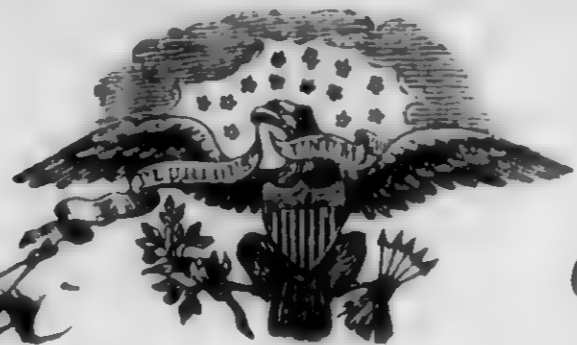

I, *William Harris*, born in *Adams Co.*, in the State of *Mississippi*, aged *Twenty* years, and by occupation a *Farmer*, Do HEREBY ACKNOWLEDGE to have volunteered this *Twelfth* day of *December*, 186*4*, to serve as a **Soldier** in the **Army of the United States of America**, for the period of **THREE YEARS**, unless sooner discharged by proper authority: Do also agree to accept such bounty, pay, rations and clothing, as are, or may be, established by law for volunteers. And I, *William Harris*, do solemnly swear, that I will bear true faith and allegiance to the **United States of America**, and that I will serve them honestly and faithfully against all their enemies or opposers whomsoever; and that I will observe and obey the orders of the President of the United States, and the orders of the officers appointed over me, according to the Rules and Articles of War.

*Marked*

Sworn and subscribed to, at *Vicksburg* this *12* day of *December*, 186*4*.

BEFORE *Edw C Knudsen* *St. Col. Pro. Marshal* *Wm Harris*

I CERTIFY, ON HONOR, That I have carefully examined the above-named Volunteer, agreeably to the General Regulations of the Army, and that, in my opinion, he is free from all bodily defects and mental infirmity, which would in any way disqualify him from performing the duties of a soldier.

*H. G. Huntsman*  
*Surgeon*  
EXAMINING SURGEON.

I CERTIFY, ON HONOR, That I have minutely inspected the Volunteer *Wm Harris* previously to his enlistment, and that he was entirely sober when enlisted; that, to the best of my judgment and belief, he is of lawful age; and that, in accepting him as duly qualified to perform the duties of an able-bodied soldier, I have strictly observed the Regulations which govern the recruiting service. This soldier has *Blue* eyes, *Blue* hair, *Light* complexion, is *Five* feet *Four* inches high.

*Edw C Knudsen*  
*St. Col. Pro. Marshal of Mass.*  
Regiment of *Miss. and* Volunteers,  
RECRUITING OFFICER.

(A. G. O. No. 74 & 76.)

Mustered into the service of the United States, for three years or during the war from date of enlistment, in Company *1st* Regiment of *Miss. and* Volunteers, on the *22* day of *December*, 186*4*, at *Vicksburg*

*Entitled to Bounty*

NOTE 1.—This blank will be used for both enlistments and re-enlistments—enlistment of veterans, &c., &c., in the volunteer service. They will be made out in duplicate in all cases—one to accompany the recruiting return of the superintendent (not the recruiting officer) to the Adjutant General, and one to accompany the accounts of the officer who pays bounty, &c. The Regiment and Company in which the soldier last served should be given on the back.

NOTE 2.—An enlistment holds to service. A muster-in must, in all cases, precede payment of pay, bounty, pension, &c. A muster-in roll must, in all cases, be filed in the Adjutant General's Office as evidence of muster-in. The mustering officer, commissary, or assistant commissary of masters, as the case may be, will countersign both enlistments as having mustered the soldier into the service of the United States before either of them is given to the disbursing officer.

DECLARATION OF RECRUIT.

I, William Harris, desiring to VOLUNTEER as a Soldier in the Army of the United States, for the term of THREE YEARS, Do Declare, That I am twenty years and \_\_\_\_\_ months of age; that I have never been discharged from the United States service on account of disability or by sentence of a court martial, or by order before the expiration of a term of enlistment; and I know of no impediment to my serving honestly and faithfully as a soldier for three years.

GIVEN at Richburg Miss the 12th day of December 1864  
 Witness: B. Stevens William Harris  
 his mark

L. H. A.  
 No. 172  
William Harris  
 Volunteered at Richburg Miss  
12th December 1864  
 By Wm. C. Hindle  
Regiment of  
Mass

enlistment, last served in Company ( )  
 Regt of \_\_\_\_\_  
 Discharged \_\_\_\_\_, 18 \_\_\_\_\_

Rec'd from 2nd. Aud. May 13th 1865

CONSENT IN CASE OF MINOR.

I, \_\_\_\_\_, Do CERTIFY, That I am the \_\_\_\_\_ of \_\_\_\_\_; that the said \_\_\_\_\_ is \_\_\_\_\_ years of age; and I do hereby freely give my CONSENT to his volunteering as a SOLDIER in the ARMY OF THE UNITED STATES for the period of THREE YEARS.

GIVEN at \_\_\_\_\_ the \_\_\_\_\_ day of \_\_\_\_\_

Witness: \_\_\_\_\_

VOLUNTEER ENLISTMENT.

STATE OF

TOWN OF

Mississippi

Vicksburg

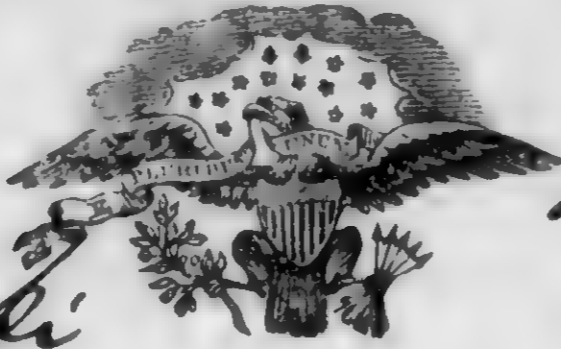

I, William Harris, born in Adams Co in the State of Mississippi, aged twenty years, and by occupation a Farmer, Do HEREBY ACKNOWLEDGE to have volunteered this twelfth day of December, 1864, to serve as a **Soldier** in the Army of the United States of America, for the period of **THREE YEARS**, unless sooner discharged by proper authority: Do also agree to accept such bounty, pay, rations, and clothing, as are, or may be, established by law for volunteers. And I, William Harris, do solemnly swear, that I will bear true faith and allegiance to the **United States of America**, and that I will serve them honestly and faithfully against all their enemies or opposers whomsoever; and that I will observe and obey the orders of the President of the United States, and the orders of the officers appointed over me, according to the Rules and Articles of War.

*Marrried*

Mustered into the service of the United States, for three years or during the war, from date of enlistment, in Company        Regiment of        Volunteers, on the 24 day of December, 1864, at Vicksburg, Miss

*Entitled to Bounty*

Sworn and subscribed to, at Vicksburg this 12th day of Decem, 1864.  
BEFORE Eli C. Kinsley witness Mark  
Joseph B. Marshall R. F. Stevens

I CERTIFY, ON HONOR, That I have carefully examined the above-named Volunteer, agreeably to the General Regulations of the Army, and that, in my opinion, he is free from all bodily defects and mental infirmity, which would in any way disqualify him from performing the duties of a soldier.

Hobbs  
King St. U.S. Army  
EXAMINING SURGEON.

I CERTIFY, ON HONOR, That I have minutely inspected the Volunteer W. Harris previously to his enlistment, and that he was entirely sober when enlisted; that, to the best of my judgment and belief, he is of lawful age; and that, in accepting him as duly qualified to perform the duties of an able-bodied soldier, I have strictly observed the Regulations which govern the recruiting service. This soldier has blue eyes, black hair, fair complexion, is five feet four inches high.

Col Eli C Kinsley  
1st Regt of Missand  
REGIMENT OF VOLUNTEERS,  
DISTRICT OF MISSISSIPPI  
RECRUITING OFFICER.

(A. G. O. No. 74 & 76.)

*Handwritten signatures and notes on the right side of the document, including names like 'Capt. J. B. ...' and 'Major ...'.*

Charges and Specifications preferred  
-rd against Private William  
Morris, Co. A. 6<sup>th</sup> S. I. Art. 169.

---

CME

Charges and Specifications preferred against  
Private-William Harris Co. A. Co. 6<sup>th</sup> U. S. C. Art. Heavy,

Charge 1<sup>st</sup> Absence without Leave.

Specification - In this that the said Private-William

Harris, Co. A. Co. 6<sup>th</sup> U. S. C. Art. Heavy, did  
absent himself from his company Quarters  
on Saturday the 27<sup>th</sup> day of January, 1866,  
without proper authority. <sup>He</sup> did proceed to  
the Bayou Plaquemine in Louisiana.

<sup>and</sup> then remain until on Monday the 29<sup>th</sup>  
day of January 1866

Charge 2<sup>d</sup> Larceny.

Specification - In this that the said Private-William

Harris Co. A. Co. 6<sup>th</sup> U. S. C. Art. Heavy, did take  
from the house of one William Beaumont, Co. D.  
without his the said William Beaumont's permis-  
sion, a sum of money to the amount of  
Twenty nine Dollars, \$29.00, more or less.

This at or near Tratchee, Miss.  
between the 26<sup>th</sup> <sup>and</sup> 30<sup>th</sup> day of January  
1866.

2110813



George W. Porter 1<sup>st</sup> Lieut  
Co. H. S. C. Art. Heavy,  
Candy Co. Va.

Witnesses

Wilson Wood 1<sup>st</sup> Sgt Co. A. S. C. Art. Heavy

Richard O. Conwell " " " " " "

William Beaman Capt. City of Syracuse, Pa. }  
} Loc

Susan Beaman " " " " " " }

Harris, William  
P. a. C. 25 Jan

am. 25

Natchez Miss

February 16<sup>th</sup> 1866

Lieut. James Dickson  
Adjutant 6<sup>th</sup> U.S. Artillery

Lieut.

I have the honor to report that Private William Harris Co. "A", having been regularly posted on Guard at 6 O'clock P.M. yesterday, did desert the same, and did remain absent from his guard all night

Very Respectfully

Your obedient Servant

Edward O'Neill

Capt and Officer of the Day

*Waris Hill*

0000 **6 U.S. Col'd H. Art'y.**

*Private Private*

**CARD NUMBERS.**

1	6162754	26
2	6162900	27
3	6163049	28
4	6163090	29
5	6163317	30
6	6163522	31
7	6154915	32
8	6155027	33
9	9119555	34
10	407+2456	35
11		36
12		37
13		38
14		39
15		40
16		41
17		42
18		43
19		44
20		45
21		46
22		47
23		48
24		49
25		50

Book Mark:

See also

Pop 375352

S922147 - 2 and

7/7/1947

*Willis Harris*

....., Co. *D*, 6 Reg't U.S. Col'd H. Art'y.

Appears on

**Company Descriptive Book**

of the organization named above.

**DESCRIPTION.**

Age *19* years; height *5* feet *8* inches.

Complexion *Black*

Eyes *Black*; hair *Black*

Where born *Haskell Mo*

Occupation *Farmer*

**ENLISTMENT.**

When *Aug 31.*....., 186*3*.

Where *Hackney Miss*

By whom *Capt A. Beard*; term *3* y'rs.

Remarks: *Resentful May 1<sup>st</sup>*  
*1864*

.....  
.....  
.....  
.....  
.....  
.....  
.....  
.....

*J. Miller*

Willis Harris  
Pr, Co. D, 2 Reg't Miss. Art'y.†

Age 19 years.

Appears on

Company Muster-in Roll

of the organization named above. Roll dated

Natchez Miss Sep 12, 1863.

Muster-in to date Sep 12, 1863.

Joined for duty and enrolled:

When Aug 31, 1863.\*

Where Natchez Miss \*

Period 3 years.\*

Valuation of horse, \$ 100

Valuation of horse equipments, \$ 100

Remarks:

† This organization subsequently became Co. D, 6 Reg't U. S. Colored Heavy Artillery.

\* Muster-in roll shows enrollment of all men of this company as of same date and place. See enrollment on subsequent card or cards.

Book mark:

L. B. Sawyer

(356c)

Copyist.

24

6 H. Art'y.

U.S.C.T.

*Willis Harris*

*Sgt*, Co. D, 2 Reg't Miss. Art'y.†

Appears on

**Company Muster Roll**

for *Sept. 12. to Oct. 31*, 1863.

Joined for duty and enrolled:

When *Aug. 31*, 186 .\*

Where *Natchez, Miss* \*

Period *2* years.\*

Present or absent *Present*

Stoppage, \$ *100* for

Due Gov't, \$ *100* for

Remarks: *Sick in Reg't Hospital.*

† This organization subsequently became Co. D, 6 Reg't U. S. Colored Heavy Artillery.

\* See enrollment on card from muster-in roll.

Book mark:

*Kugler*



Willis Harris  
Pvt., Co. D, 2 Reg't Miss. Artillery.†

Appears on

Company Muster Roll  
for Nov & Dec, 1863.

Joined for duty and enrolled:

When Aug 31, 1863.\*

Where Hatchery Miss \*

Period 3 years.\*

Present or absent Absent

Stoppage, \$ 100 for

Due Gov't \$ 100 for

Valuation of horse, \$ 100

Valuation of horse equipments 100

Remarks: Sick in Reg mental  
Hospital

† This organization subsequently became Co. D, 6 Reg't U. S. Col'd Heavy Artillery.

\* See enrollment on card from muster-in roll.

Book mark:

L B Sayer  
Copyist.

*L*

6 H. Art'y. U.S.C.T.

*Willis Harris*

*Prm*, Co. D, 2 Reg't Miss. Art'y.†

Appears on

Company Muster Roll

for *Jan 8 Feb*, 1864.

Joined for duty and enrolled:

When *Aug 31*, 1863.\*

Where *Matchey Miss* \*

Period *3* years.\*

Present or absent *Absent*

Stoppage, \$ *100* for

Due Gov't, \$ *100* for

Remarks: *sick in Regimental Hospital*

† This organization subsequently became Co. D, 6 Reg't U. S. Colored Heavy Artillery.  
\* See enrollment on card from muster-in roll.

Book mark:

(358c)

*L B Sawyer*  
Copyist.

H

6 H. Art'y.

U.S.C.T.

Willis Harris  
Am., Co. D, 5 Reg't U. S. Col'd H. Art'y.†

Appears on

Company Muster Roll

for Feb & Apr, 1864

Joined for duty and enrolled:

When Aug 31, 1863.\*

Where Natchez Miss \*

Period 8 years.\*

Present or absent Absent

Stoppage, \$ 100 for

Due Gov't \$ 100 for

Valuation of horse, \$ 100

Valuation of horse equipments, 100

Remarks: Absent without leave since April 27, 1864

†This organization subsequently became Co. D, 6 Reg't U. S. Colored Heavy Artillery.

\* See enrollment on card from muster-in roll.

Book mark:

(358c)

L. B. Sayer

Copyist.

H

6 H. Art'y.

U. S. C. T.

Willis Harris

Pvt., Co. D, 6 Reg't U. S. Col'd H. Art'y.

Appears on

Company Muster Roll

for May & June, 1864.

Joined for duty and enrolled.

When Aug 31, 1863.\*

Where Natchez Miss.\*

Period 3 years.\*

Present or absent

Stoppage, \$ 100 for

Due Gov't, \$ 100 for

Valuation of horse, \$ 100

Valuation of horse equipments, \$ 100

Remarks: Disinited May 1-1864

\* See enrollment on card from muster-in roll.

Book mark :

(258c)

L. B. Sawyer  
Copist.

A- | *C. H. Arz* | U.S.C.T.

*Willis Harris*

*Pvt.*, Co *D*, Co Reg't U. S. Col'd *Arz*.

Appears on \_\_\_\_\_

**Descriptive List of Deserters**

dated *Natchez Miss May 31*, 186 *4*.

**Deserted:**

When *May 1*, 186 *4*.

Where *Vidalia La*.

**Arrested:**

When \_\_\_\_\_, 186 .

Where \_\_\_\_\_

**Remarks:**

\_\_\_\_\_  
\_\_\_\_\_  
\_\_\_\_\_  
\_\_\_\_\_

**Book mark:**

*W. H. Garrison*

(851)

Copyright.

\* *Willis Harris*

*Priv*, Co. *D*, *6* Reg't U. S. Col'd *N. Arty.*

Appears on

**Descriptive List of Deserters**

dated *Feb 20*, 186*5*.

Deserted:

When *May 7*, 186*4*.

Where *Waldalia La*

Arrested:

When \_\_\_\_\_, 186 .

Where \_\_\_\_\_

Remarks:

\* *Name canceled by line*

Book mark:

*R. S. Shelton*

A

6 H. Art'y.

U.S.C.T.

Willis Harris

Pvt., Co. Q, 6 Reg't U. S. Col'd H. Art'y.

Appears on Returns as follows:

April 1864 (5th US Col'd  
H Art) Absent  
without leave  
since April 27, 64

May 1864 (6th US Col'd  
H A), Deserted  
May 1, 64 Vidalia  
La

Book mark:

(546)

A. G. Gault

Copyist.

26

6 H. Art'y.

U.S.C.T.

Willis Harris

Art, Co. D, 6 Reg't U. S. Col'd H. Art'y.

Appears on Co. Muster-out Roll, dated Natchez Miss May 13, 1864.

Muster-out to date \_\_\_\_\_, 186 .

Last paid to Oct 31, 1863.

Clothing account:

Last settled never, 186 ; drawn since \$ 48 <sup>4</sup>/<sub>100</sub>

Due soldier \$ 100; due U. S. \$ 100

Am't for cloth'g in kind or money adv'd \$ 100

Due U. S. for arms, equipments, &c., \$ 100

Bounty paid \$ None 100; due \$ None 100

Remarks: Deserted at Natchez Miss May 1/64

Book mark:

S. W. Tucker

Copyist.



*Harris, Willis*  
Col, 6 U.S. Col'd H. Art'y.

*Private* | *Sergeant*

CARD NUMBERS.

1	6169375	26
2	6169527	27
3	6169669	28
4	6169813	29
5	6169898	30
6	6170025	31
7	6170132	32
8	6170236	33
9	6170338	34
10	6170439	35
11	6170548	36
12	6170669	37
13	6170786	38
14	6170893	39
15	6171001	40
16	6171098	41
17	6171194	42
18	6171289	43
19	9120073	44
20	9120246	45
21	40942414	46
22		47
23		48
24		49
25		50

Book Mark: \_\_\_\_\_

See also \_\_\_\_\_

*H* | 6 H. Art'y. | U.S.C.T.

*Willie Harris*

....., Co. *G*, 6 Reg't U. S. Col'd H. Art'y.

Appears on

**Company Descriptive Book**

of the organization named above.

**DESCRIPTION.**

Age *28* years; height *5* feet *6 1/2* inches.

Complexion *Yellow*

Eyes *Hazel*; hair *Brown*

Where born *Lamar Co., Miss.*

Occupation *Farmer*

**ENLISTMENT.**

When *Sept. 20*, 1863.

Where *Natchez, Miss.*

By whom *C. W. Smith*, term *3* y'rs.

Remarks: *Appointed Corp'l.  
Mch 25/64 App'd  
Serg't Oct 11/65*

*Warren*

*A*

6 H. Art'y.

U.S.C.T.

*Wills Harris*

Co. *G*, 6 Reg't U. S. Col'd H. Art'y.

Appears on

**Company Descriptive Book**

of the organization named above.

**DESCRIPTION.**

Age *28* years; height *5* feet *6 1/2* inches.

Complexion *Yellow*

Eyes *hazel*; hair *brown*

Where born *Lanitt Co Miss.*

Occupation *Farmer*

**ENLISTMENT.**

When *Sept 20*, 186*3*.

Where *Natchez Miss.*

By whom *C. W. Smith*, term *3* y'rs.

Remarks:

.....  
.....  
.....  
.....  
.....  
.....

*Warron*

7

6 H. Art'y.

U.S.C.T.

*Willis Harris*

*Pat* Co. G, 2 Reg't Miss. Art'y.\*

Age *28* years.

Appears on

**. Company Muster-in Roll**

of the organization named above. Roll dated

*Natcher, Miss, Oct 20*, 1863.

Muster-in to date *Oct 20*, 1863.

Joined for duty and enrolled:

When *Sept 20*, 1863.

Where *Natcher, Miss.*

Period *3* years.

Valuation of horse, \$ 100

Valuation of horse equipments, \$ 100

Remarks: \_\_\_\_\_

\* This organization subsequently became Co. G, 6 Reg't U. S. Colored Heavy Artillery.

Book mark: \_\_\_\_\_

*O. A. Ward*

(356)

Copyist.

A

6 H. Art'y.

U.S.C.T.

Willis Harris

Put, Co. G, 2 Reg't Miss. Art'y.\*

Appears on

Company Muster Roll

for Oct 20 to 31, 1863.

Present or absent Present

Stoppage, \$ 100 for

Due Gov't, \$ 100 for

Valuation of horse, \$ 100

Valuation of horse equipments, \$ 100

Remarks:

\* This organization subsequently became Co. G, 6 Reg't U. S. Colored Heavy Artillery.

Book mark:

(358)

P. A. Ward

Copyist.

*Willis Harris*

*Pat*, Co. G, 2 Reg't Miss. Art'y.\*

Appears on

**Company Muster Roll**

for *Nov & Dec*, 1863.

Present or absent *Present*

Stoppage, \$ 100 for

Due Gov't, \$ 100 for

Valuation of horse, \$ 100

Valuation of horse equipments, \$ 100

Remarks:  
-----  
-----  
-----  
-----  
-----  
-----  
-----

\* This organization subsequently became Co. G, 6 Reg't U. S. Colored Heavy Artillery.

Book mark: -----

(358) *P. A. Ward* Copyist.

*A*

6 H. Art'y.

U.S.C.T.

*Willis Harris*

*Port*, Co. G, 2 Reg't Miss. Art'y.\*

Appears on

**Company Muster Roll**

for *Jan & Feb*, 1864

Present or absent. *Present*

Stoppage, \$ 100 for

Due Gov't, \$ 100 for

Valuation of horse, \$ 100

Valuation of horse equipments, \$ 100

Remarks:

\* This organization subsequently became Co. G, 6 Reg't U. S. Colored Heavy Artillery.

Book mark:

*L. J. Spann*

(358)

Copyist.

Willis Harris

4<sup>th</sup> Cap, Co. G, 5 Reg't U. S. Col'd H. Art'y.\*

Appears on

Company Muster Roll

for *March & Apr*, 186*4*

Present or absent *Absent*

Stoppage, \$ *100* for

Due Gov't, \$ *100* for

Valuation of horse, \$ *100*

Valuation of horse equipments, \$ *100*

Remarks: *Appointed Corporal March 25/64 detailed as nurse in Variole Hosp. April 21/64 Per Order of Brig. Genl. J. M. Tuttle*

\* This organization subsequently became Co. G, 6 Reg't U. S. Col'd Heavy Artillery.

Book mark:

*L. Y. Sparr*  
(358) Copyist.



*A* | **6 H. Art'y.** | **U.S.C.T.**

*Willis Harris*

*4<sup>th</sup> Capt*, Co. G, 6 Reg't U. S. Col'd H. Art'y.

Appears on

**Company Muster Roll**

for *May & June*, 186*4*.

Present or absent *Present*

Stoppage, \$.....100 for .....

Due Gov't, \$.....100 for .....

Valuation of horse, \$.....100

Valuation of horse equipments, \$.....100

Remarks: .....

Book mark: .....

*L. Y. Spann*

(358)

Copyist.

96

6 H. Art'y.

U.S.C.T.

*Willis Harris*

*Capt.*, Co. G, 6 Reg't U. S. Col'd H. Art'y.

Appears on

**Company Muster Roll**

for *July & Aug.*, 1864.

Present or absent *Present*.

Stoppage, \$ 100 for

Due Gov't, \$ 100 for

Valuation of horse, \$ 100

Valuation of horse equipments, \$ 100

Remarks:

Book mark:

(358)

*J. L. Smith*

Copyist.

*John H. ...*  
\_\_\_\_\_, Co. G, 6 Reg't U. S. Col'd H. Art'y.

Appears on

**Company Muster Roll**

for *Sept 1st*, 186*4*.

Present or absent *present*

Stoppage, \$ *100* for \_\_\_\_\_

Due Gov't, \$ *100* for \_\_\_\_\_

Valuation of horse, \$ *100*

Valuation of horse equipments, \$ *100*

Remarks: \_\_\_\_\_

Book mark: \_\_\_\_\_

96

6 H. Art'y. U.S.C.T.

Willis Harris

4 Corp'l., Co. G, 6 Reg't U. S. Col'd H. Art'y.

Appears on

Company Muster Roll

for Nov. & Dec., 1864.

Present or absent Present.

Stoppage, \$ 100 for

Due Gov't, \$ 100 for

Valuation of horse, \$ 100

Valuation of horse equipments, \$ 100

Remarks:

Book mark:

J. J. Smith

(358)

Copyist.

*A*

*Willis Harris*

*4<sup>th</sup> Corp.*, Co. G, 6 Reg't U. S. Col'd H. Art'y.

Appears on

**Company Muster Roll**

for *Jan'y & Feb.*, 186*5*.

Present or absent *Present*

Stoppage, \$ *100* for

Due Gov't, \$ *100* for

Valuation of horse, \$ *100*

Valuation of horse equipments, \$ *100*

Remarks:

-----  
-----  
-----  
-----  
-----  
-----  
-----  
-----  
-----

Book mark:

-----  
-----

(358)

*F. J. McCall*

Copyist.

*W*

6 H. Art'y.

U.S.C.T.

*Willis Harris*

*4<sup>th</sup> Co. G,* Co. G, 6 Reg't U. S. Col'd H. Art'y.

Appears on

**Company Muster Roll**

for *McK & apl*, 186*5*.

Present or absent *Present*

Stoppage, \$ *100* for

Due Gov't, \$ *100* for

Valuation of horse, \$ *100*

Valuation of horse equipments, \$ *100*

Remarks:

Book mark:

*J. D. Neale*

(358)

Copyist.

*A*

6 H. Art'y.

U.S.C.T.

*Willis Harris*

*Corpl*, Co. G, 6 Reg't U. S. Col'd H. Art'y.

Appears on

**Company Muster Roll**

for *May & June*, 186*3*.

Present or absent *Present*

Stoppage, \$ *100* for

Due Gov't, \$ *100* for

Valuation of horse, \$ *100*

Valuation of horse equipments, \$ *100*

Remarks:

Book mark:

*E. M. Meale*

(358)

Copyist.

*A*

6 H. Art'y.

U.S.C.T.

*Willis Harris*

*Capt*, Co. G, 6 Reg't U. S. Col'd H. Art'y.

Appears on

**Company Muster Roll**

for *July 4<sup>th</sup> Aug*, 1865.

Present or absent *present*

Stoppage, \$ *100* for

Due Gov't, \$ *100* for

Valuation of horse, \$ *100*

Valuation of horse equipments, \$ *100*

Remarks:

Book mark:

*E. Weston*

(358)

Copyist.



H

6 H. Art'y.

U.S.C.T.

Willis Harris

Sergt., Co. G, 6 Reg't U. S. Col'd H. Art'y.

Appears on

Company Muster Roll

for Sept<sup>r</sup> & Oct<sup>r</sup>, 1865.

Present or absent present

Stoppage, \$ 100 for

Due Gov't, \$ 100 for

Valuation of horse, \$ 100

Valuation of horse equipments, \$ 100

Remarks: Promoted from Corp'l to  
Sergt. Oct 25 1865 per S.O. No  
40. H. 2rs 6. U. S. C. Art'y (H.)

Book mark:

E. Arsten

(358)

Copyist.

H

6 H. Art'y.

U.S.C.T.

Willis Harris

Serj't, Co. G, 6 Reg't U. S. Col'd H. Art'y.

Appears on

Company Muster Roll

for Nov & Dec, 1865-

Present or absent present

Stoppage, \$ 100 for

Due Gov't, \$ 100 for

Valuation of horse, \$ 100

Valuation of horse equipments, \$ 100

Remarks: Promoted from Corp  
Oct. 11, 1865, per S.O. No. 40  
dated 11<sup>th</sup> 2<sup>nd</sup> Div U. S. C. Art'y.  
(Navy) Oct. 15, 1865.

Book mark:

E. O. Proster

70

Willis Harris

Sgt, Co. G, 6 Reg't U. S. Col'd H. Art'y.

Appears on

Company Muster Roll

for Jan + Feb, 1866.

Present or absent Present

Stoppage, \$ 100 for

Due Gov't, \$ 100 for

Valuation of horse, \$ 100

Valuation of horse equipments, \$ 100

Remarks:

Book mark:

no chance

H

6 H. Art'y.

U.S.C.T.

Willis Harris

Serq't, Co. G, 6 Reg't U. S. Col'd H. Art'y.

Appears on

Company Muster Roll

for Mar + Apr, 1866.

Present or absent Present,

Stoppage, \$ 100 for

Due Gov't, \$ 100 for

Valuation of horse, \$ 100

Valuation of horse equipments, \$ 100

Remarks:

Book mark:

no charge

(358)

Copyist.

H<sup>o</sup>

6 H. Art'y.

U.S.C.T.

Willis Harris

Serjt, Co. G, 6 Reg't U. S. Col'd H. Art'y.

Appears on

Company Muster Roll

for Mar & Apr, 1866.

Present or absent Present,

Stoppage, \$ 100 for

Due Gov't, \$ 100 for

Valuation of horse, \$ 100

Valuation of horse equipments, \$ 100

Remarks:

[Empty lines for remarks]

Book mark:

no chance

(358)

Copyist.

A

6 H. Art'y.

U.S.C.T.

Willis Harris

Cpl, Co. G, 6 Reg't U. S. Col'd H. Art'y.

Sgt

Appears on Returns as follows:

April 1864 (15 US Col'd H. Art'y) Absent  
Nursing in Variola Hospital

May 1864 (6 US Col'd H. Art'y) Absent  
on det serv since April 21, 64

Sept 1865 Absent  
sick in Post Hosp Natchez Miss  
since Sept 20/65

Mar 1866 (Sgt) Absent  
with leave since  
Mar 26, 66

Book mark:

(546)

A. J. Garglas

Copyist.

A

G H. Art'y.

U.S.C.T.

Willis Harris

Serjt, Co. G, 6 Reg't U. S. Col'd H. Art'y.

Appears on Co. Muster-out Roll, dated Natchez, Miss May 13, 1866.

Muster-out to date May 13, 1866.

Last paid to Dec 31, 1865.

Clothing account:

Last settled, 186 ; drawn since \$ 100

Due soldier \$ 20 <sup>77</sup>/<sub>100</sub>; due U. S. \$ 100

Am't for cloth'g in kind or money adv'd \$ 100

Due U. S. for arms, equipments, &c., \$ 100

Bounty paid \$ 100; due \$ 100

Remarks: Joined at original organization. Was priv. to March 25/64 then Corporal to Dec 11/65 then Serjt.

Book mark: V86 P 12 69

W. Chance

*Co. A, 6 U.S. Col'd H. Art'y*

*Private Private*

CARD NUMBERS.

1	6155529	26
2	6155591	27
3	6155742	28
4	6155887	29
5	6156030	30
6	6156162	31
7	6156291	32
8	6156411	33
9	6156531	34
10	6156655	35
11	6156786	36
12	6156919	37
12	6157049	38
14	6157178	39
15	6157308	40
16	6157431	41
17	6157553	42
18	6157673	43
19	9118967	44
20		45
21		46
22		47
23		48
24		49
25		50

Book Mark:

See also



*Wilson Harris*

Co. *A*, 6 Reg't U.S. Col'd H. Art'y.

Appears on

**Company Descriptive Book**

of the organization named above.

**DESCRIPTION.**

Age *40* years; height *5* feet *7* inches.

Complexion *Dark*

Eyes *Dark*; hair *Dark*

Where born *Adams Co. Miss*

Occupation *Farmer*

**ENLISTMENT.**

When *Aug 24*, 186*9*

Where *Adams Miss*

By whom *Capt. Ryan*; term *9* y'rs.

Remarks:

-----  
-----  
-----  
-----  
-----  
-----  
-----  
-----  
-----  
-----

(383g)

*John A. Allen*  
Supt.

76

6 H. Art'y. | U.S.C.T.

Wilson Harris  
Pri., Co. A, 2 Reg't Miss. Art'y.†

Age 20 years.

Appears on

Company Muster-in Roll

of the organization named above. Roll dated

Natchez Miss Sept 12, 1863.

Muster-in to date Sept 7 2, 1863.

Joined for duty and enrolled:

When Aug 30, 1863.\*

Where Natchez Miss \*

Period 3 years.\*

Valuation of horse, \$ 100

Valuation of horse equipments, \$ 100

Remarks:

† This organization subsequently became Co. A, 6 Reg't U. S. Colored Heavy Artillery.

\* Muster-in roll shows enrollment of all men of this company as of same date and place. See enrollment on subsequent card or cards.

Book mark:

O. G. Smith

(356c)

Copyist.

Wilson Harris  
Pri, Co. A, 2 Reg't Miss. Art'y.†

Appears on

Company Muster Roll

for Aug 30 to Oct 31, 1863.

Joined for duty and enrolled:

When Aug 30, 1863.\*

Where Natchez, Miss.\*

Period 3 years.\*

Present or absent Present

Stoppage, \$ 100 for

Due Gov't \$ 100 for

Valuation of horse, \$ 100

Valuation of horse equipments, 100

Remarks:

† This organization subsequently became Co. A, 6 Reg't U. S. Colored Heavy Artillery.

\* See enrollment on card from muster-in roll.

Book mark:

W. Smith

(358c)

Copyist.

*Wilson Harris*

*Co*, Co. A, 2 Reg't Miss. Art'y.†

Appears on

**Company Muster Roll**

for *Nov & Dec*, 186*3*.

Joined for duty and enrolled:

When *Aug 30*, 186*3*.\*

Where *Matched Miss* \*

Period *3* years.\*

Present or absent *Present*

Stoppage, \$ *100* for

Due Gov't \$ *100* for

Valuation of horse, \$ *100*

Valuation of horse equipments, *100*

Remarks:

† This organization subsequently became Co. A, 6 Reg't U. S. Colored Heavy Artillery.  
\* See enrollment on card from muster-in roll.

Book mark:

*C. Smith*

70

6 H. Art'y.

U.S.C.T.

*Wilson Harris*

*Pr*..., Co. A, 2 Reg't Miss. Art'y.†

Appears on

**Company Muster Roll**

for *Jan & Feb*, 186*7*.

Joined for duty and enrolled:

When *Aug 30*, 186*3*.\*

Where *Natchez Miss* \*

Period *3* years.\*

Present or absent *Present*

Stoppage, \$ *100* for

Due Gov't \$ *100* for

Valuation of horse, \$ *100*

Valuation of horse equipments, *100*

Remarks:

† This organization subsequently became Co. A, 6 Reg't U. S. Colored Heavy Artillery.

\* See enrollment on card from muster-in roll.

Book mark:

*O G Smith*

(358c)

Copyist.

76

6 H. Art'y.

U.S.C.T.

Wilson Harris

Co. A, 5 Reg't U. S. Col'd H. Art'y.†

Appears on

Company Muster Roll

for March & April, 1867.

Joined for duty and enrolled:

When Aug 30, 1867.\*

Where Natchez Miss \*

Period 3 years.\*

Present or absent Present

Stoppage, \$ 100 for

Due Gov't \$ 100 for

Valuation of horse, \$ 100

Valuation of horse equipments, 100

Remarks:

†This organization subsequently became Co. A, 6 Reg't U. S. Colored Heavy Artillery.

\* See enrollment on card from muster-in roll.

Book mark:

O G Smith

(358c)

Copyist.

26

6 H. Art'y.

U.S.C.T.

Wilson Harris

Pri, Co. A, 6 Reg't U. S. Col'd H. Art'y.

Appears on

Company Muster Roll

for May & June, 1864

Joined for duty and enrolled:

When Aug 30, 1863.\*

Where Natchez Miss \*

Period 3 years.\*

Present or absent Present

Stoppage, \$ 100 for

Due Gov't \$ 100 for

Remarks:

[Empty lines for remarks]

\* See enrollment on card from muster-in roll.

Book mark:

C. G. Smith

(358c)

Copyist.

26

6 H. Art'y.

U.S.C.T.

*Wilson Harris*

*Pri.*, Co. A, 6 Reg't U. S. Col'd H. Art'y.

Appears on

Company Muster Roll

for *July & Aug*, 1864.

Joined for duty and enrolled:

When *Aug. 30*, 186*8*.\*

Where *Watches*.\*

Period *3* years.\*

Present or absent *Present*

Stoppage, \$ *100* for

Due Gov't \$ *100* for

Remarks:

-----  
-----  
-----  
-----  
-----

\* See enrollment on card from muster-in roll.

Book mark: -----

*J. H. Henderson*

(358c)

Copyist.



26

6 H. Art'y.

U.S.C.T.

Wilson Harris

Pri., Co. A, 6 Reg't U. S. Col'd H. Art'y.

Appears on

Company Muster Roll  
for Sept. & Oct., 1864.

Joined for duty and enrolled:

When Aug. 30, 1863.\*

Where Katchez, Miss.\*

Period 3 years.\*

Present or absent Present

Stoppage, \$ 100 for

Due Gov't \$ 100 for

Remarks:

\* See enrollment on card from muster-in roll.

Book mark:

J. H. Henderson  
(358c) Copyist.

16

6 H. Art'y.

U.S.C.T.

Wilson Harris

Pri., Co. A, 6 Reg't U. S. Col'd H. Art'y.

Appears on

Company Muster Roll

for Nov. 8 Dec., 1864

Joined for duty and enrolled:

When Aug. 30, 1863.\*

Where Natchez, Miss.\*

Period 3 years.\*

Present or absent Present

Stoppage, \$ 100 for

Due Gov't \$ 100 for

Remarks:

\* See enrollment on card from muster-in roll.

Book mark:

J. H. Henderson  
(358c) Copyist.

*H*

6 H. Art'y.

U.S.C.T.

*Wilson Harris*

*Pri.*, Co. A, 6 Reg't U. S. Col'd H. Art'y.

Appears on

**Company Muster Roll**

for *Jan. & Feb.*, 186*5*.

Joined for duty and enrolled:

When *Aug. 30*, 186*3*.\*

Where *Natchez, Miss.*\*

Period *3* years.\*

Present or absent *Present*

Stoppage, \$ *100* for

Due Gov't \$ *100* for

Remarks:

-----  
-----  
-----  
-----  
-----

\* See enrollment on card from muster-in roll.

Book mark:

*J. H. Henderson*  
(358c) Copyist.

H

6 H. Art'y.

U.S.C.T.

Wilson Harris

Pr., Co. A, 6 Reg't U. S. Col'd H. Art'y.

Appears on

Company Muster Roll

for Mar. 8 Apr., 1865.

Joined for duty and enrolled:

When Aug. 30, 1863.\*

Where Natchez, Miss.\*

Period 3 years.\*

Present or absent

Present

Stoppage, \$ 100 for

Due Gov't \$ 100 for

Remarks:

\* See enrollment on card from muster-in roll.

Book mark:

J. H. Henderson

(358c)

Copyist.

*H*

6 H. Art'y.

U.S.C.T.

*Wilson Harris*

*Pr*, Co. A, 6 Reg't U. S. Col'd H. Art'y.

Appears on

Company Muster Roll

for *Feb. 28 to June 30*, 1865.

Joined for duty and enrolled:

When *Aug. 30*, 1863.\*

Where *Katchez, Miss*\*

Period *3* years.\*

Present or absent *Present*

Stoppage, \$ *100* for

Due Gov't \$ *100* for

Remarks:

-----  
-----  
-----  
-----  
-----

\* See enrollment on card from muster-in roll.

Book mark: -----

*J. H. Henderson*  
(358c) Copyist.

26

6 H. Art'y.

U.S.C.T.

*Wilson Harris*

*ser*, Co. A, 6 Reg't U. S. Col'd H. Art'y.

Appears on

**Company Muster Roll**

for *July + August*, 186*5*.

Joined for duty and enrolled:

When *Aug 30*, 186*3*.\*

Where *Natchez Miss* \*

Period *3* years.\*

Present or absent *Present*

Stoppage, \$ *100* for

Due Gov't \$ *100* for

Remarks:

-----  
-----  
-----  
-----  
-----

\* See enrollment on card from muster-in roll.

Book mark:

*P. J. Griffith*  
(358c) Copyist.

26

6 H. Art'y.

U.S.C.T.

*Wilson Harris*

*for* Co. A, 6 Reg't U. S. Col'd H. Art'y.

Appears on

**Company Muster Roll**

for *Sept + Oct*, 186*5*.

Joined for duty and enrolled:

When *Aug 30*, 186*3*.\*

Where *Natchez Miss* \*

Period *3* years.\*

Present or absent *Present*

Stoppage, \$ *100* for

Due Gov't \$ *100* for

Remarks:

-----  
-----  
-----  
-----  
-----

\* See enrollment on card from muster-in roll.

Book mark:

(358c)

*A. J. Griffith*

Copyist.

96

6 H. Art'y.

U.S.C.T.

*Wilson Harris*

*Jan*, Co. A, 6 Reg't U. S. Col'd H. Art'y.

Appears on

**Company Muster Roll**

for *Nov & Dec*, 186*5*.

Joined for duty and enrolled:

When *Aug 30*, 186*3*.\*

Where *Natchez Miss*\*

Period *3* years.\*

Present or absent *Present*

Stoppage, \$ *100* for *1*

Due Gov't \$ *100* for

Remarks:  
\_\_\_\_\_  
\_\_\_\_\_  
\_\_\_\_\_  
\_\_\_\_\_  
\_\_\_\_\_

\* See enrollment on card from muster-in roll.

Book mark: \_\_\_\_\_

(358c) *D. J. Griffith* Copyist.



26

6 H. Art'y.

U.S.C.T.

*Wilson Harris*

*Jan*, Co. A, 6 Reg't U. S. Col'd H. Art'y.

Appears on

**Company Muster Roll**

for *Jan + Feb*, 1866.

Joined for duty and enrolled:

When *Aug 30*, 186*3*.\*

Where *Natchez Miss* \*

Period *3* years.\*

Present or absent *Present*

Stoppage, \$ *100* for

Due Gov't \$ *100* for

Remarks:

-----  
-----  
-----  
-----  
-----

\* See enrollment on card from muster-in roll.

Book mark:

(358c)

*D. J. Griffith*  
Copyist.

*W*

6 H. Art'y.

U.S.C.T.

*Wilson Harris*

*Pr*, Co. A, 6 Reg't U. S. Col'd H. Art'y.

Appears on

**Company Muster Roll**

for *March & April*, 186*6*

Joined for duty and enrolled:

When *Aug 30*, 186*3*.\*

Where *Natchez Miss* \*

Period *3* years.\*

Present or absent *Present*

Stoppage, \$ *100* for

Due Gov't \$ *100* for

Remarks:

-----  
-----  
-----  
-----  
-----

\* See enrollment on card from muster-in roll.

Book mark:

*T. J. Gifford*  
(358c) Copyist.

*Wilson Harris*  
Priv., Co. *A*, 6 Reg't U. S. Col'd H. Art'y.

Appears on Co. Muster-out Roll, dated  
*Natchez Miss, May 13*, 1866.

Muster-out to date *May 13*, 1866.

Last paid to *Dec. 31*, 1865.

Clothing account:

Last settled....., 186 ; drawn since \$..... 100

Due soldier \$ *34*<sup>*64*</sup>/<sub>100</sub>; due U. S. \$..... 100

Am't for cloth'g in kind or money adv'd \$..... 100

Due U. S. for arms, equipments, &c., \$..... 100

Bounty paid \$..... 100; due \$..... 100

Remarks: *Joined at original organization*

Book mark:

*A. L. Ames*

(361)

Copyist.

*W. M. ...*  
L, 6 U.S. Col'd H. Art'y

*Private*

*Private*

CARD NUMBERS.

6154430	26
6178054	27
6178147	28
6178311	29
6155013	30
6179149	31
9120994	32
40742457	33
	34
	35
	36
	37
	38
	39
	40
	41
	42
	43
	44
	45
	46
	47
	48
	49
	50

Book Mark: \_\_\_\_\_

See also \_\_\_\_\_

*N* | 6 H. Art'y. | U.S.C.T.

*Briston Harrison*

Co. *L*, 6 Reg't U. S. Col'd H. Art'y.

Appears on

**Company Descriptive Book**

of the organization named above.

**DESCRIPTION.**

Age *23* years; height *5* feet *8 3/4* inches.

Complexion *Black*

Eyes *Black*; hair *Black*

Where born *Petersburg Va*

Occupation *farmer*

**ENLISTMENT.**

When *Sept 30*, 186*4*.

Where *Nicholsburg*

By whom *Eli Kinsley*; term *3* y'rs.

Remarks: *Deserted Feb 5 1865*

*Hilton*

26

6 H. Art'y.

U.S.C.T.

Bractor Harrison

Appears with rank of Pvt on

**Muster and Descriptive Roll of a Detachment of U. S. Vols. forwarded**

for the 6 Reg't U. S. Col'd H. Art'y. Roll dated Vicksburg, Miss, Oct 1, 1864

Where born Petersburg, Va.

Age 35 y'rs; occupation Farmer

When enlisted Sept 30, 1864

Where enlisted V Bury, Miss

For what period enlisted 3 years.

Eyes Black; hair Black

Complexion Gold; height 5 ft. 8 3/4 in.

When mustered in Sept 30, 1864

Where mustered in Vicksburg

Bounty paid \$none <sup>100</sup>; due \$300 <sup>100</sup>

Where credited Quota of Men

Company to which assigned

Remarks:

Book mark:

W. S. Log

A

6 H. Art'y.

U.S.C.T.

*Bristor Harrison*

*Private*, Co. L, 6 Reg't U. S. Col'd H. Art'y.

Appears on

**Company Muster Roll**

for *Sept. & Oct.*, 1864.

Joined for duty and enrolled :

When *Sept 31*, 1864.\*

Where *Nicksburg Miss.* \*

Period *3* years.\*

Present or absent *Present*

Stoppage, \$ *100* for

Due Gov't \$ *100* for

Valuation of horse, \$ *100*

Valuation of horse equipments, \$ *100*

Remarks:

\* See enrollment on card from muster-in roll.

Book mark:

(358c)

*E. D. Meals*

Copyst.

*A*

6 H. Art'y.

U.S.C.T.

*District Harrison*

*Pat*, Co. L, 6 Reg't U. S. Col'd H. Art'y.

Appears on

**Company Muster Roll**

for *Nov + Dec*, 1864.

Joined for duty and enrolled:

When *Sept 30*, 1864.\*

Where *Vicksburg Miss* \*

Period *3* years.\*

Present or absent *Present*

Stoppage, \$ *100* for

Due Gov't \$ *100* for

Valuation of horse, \$ *100*

Valuation of horse equipments, \$ *100*

Remarks:

\* See enrollment on card from muster-in roll.

Book mark:

*R S Shelton*

(358c)

Copyist.



*N*

6 H. Art'y.

U.S.C.T.

*Gristor Harrison*

*Pol*

Co. L, 6 Reg't U. S. Col'd H. Art'y.

Appears on

**Company Muster Roll**

for

*Jan'y & Feby*, 1865.

Joined for duty and enrolled :

When

*Sept 30*, 1864.\*

Where

*Vicksburg Miss* \*

Period

*3* years.\*

Present or absent

Stoppage, \$ 100 for

Due Gov't \$ 100 for

Valuation of horse, \$ 100

Valuation of horse equipments, \$ 100

Remarks:

*Charged for Out-  
rance lost \$32.90.  
Deserted Feby 5" 1865.*

\* See enrollment on card from muster-in roll.

Book mark:

*9-1865*

*R B Sheltin*

(158c)

Copy 8.

*A. C. Hart* | U.S.C.T.

*Bristor Harrison*

*Art*, Co. *L*, *6* Reg't U. S. Col'd *Hart*

Appears on

**Descriptive List of Deserters**

dated *Atchey Miss Feb 28*, 186 *5*.

Deserted:

When *Feb 17*, 186 *5*.

Where *Atchey Miss*.

Arrested:

When ....., 186 .

Where .....

Remarks : .....

Book mark : .....

*B. Harrison*

A

6 H. Art'y.

U.S.C.T.

*Priscot Harrison*

*Priv., Co. I, 6 Reg't U. S. Col'd H. Art'y.*

Appears on Returns as follows:

*Oct 1864 Gain Oct*  
*3,64 Matches*  
*Miss, Rec'd from*  
*Defeat*  
*Feb 1865 Deserted*  
*Feb 6, 65 Matches*  
*Miss*

Book mark:

*A. J. Gould*  
 (446) Copyist.

H | W. H. Artz U.S.C.T.

Bristor Harrison

Private Co. G, 6 Reg't U. S. Col'd W. Artz

Appears on **Co. Muster-out Roll**, dated

Natchez, Miss. May 13, 1866

Muster-out to date \_\_\_\_\_, 1866

Last paid to Oct 31, 1864

Clothing account:

Last settled Sept 30, 1864; drawn since \$ 43 <sup>28</sup>/<sub>100</sub>

Due soldier \$ \_\_\_\_\_ <sup>100</sup>/<sub>100</sub>; due U. S. \$ \_\_\_\_\_ <sup>100</sup>/<sub>100</sub>

Am't for cloth'g in kind or money adv'd \$ \_\_\_\_\_ <sup>100</sup>/<sub>100</sub>

Due U. S. for arms, equipments, &c., \$ \_\_\_\_\_ <sup>100</sup>/<sub>100</sub>

Bounty paid \$ \_\_\_\_\_ <sup>100</sup>/<sub>100</sub>; due \$ \_\_\_\_\_ <sup>100</sup>/<sub>100</sub>

Remarks: Joined as a Recruit  
Deserted Feby 5<sup>th</sup> 65 at  
Natchez, Miss.

Book mark: \_\_\_\_\_

(361)

Keefe  
Copyist.

*Harrison, Clifton*  
Co *F*, 6 U.S. Col'd H. Art'y

*Private* | *Private*

CARD NUMBERS.

1	6167252	26
2	6167474	27
3	6169301	28
4	9119916	29
5	40742458	30
6		31
7		32
8		33
9		34
10		35
11		36
12		37
13		38
14		39
15		40
16		41
17		42
18		43
19		44
20		45
21		46
22		47
23		48
24		49
25		50

Book Mark: \_\_\_\_\_

See also \_\_\_\_\_

Clipton Harris

Co. F, 6 Reg't U. S. Col'd H. Art'y.

Appears on

Company Descriptive Book

of the organization named above.

DESCRIPTION.

Age 35 years; height 5 feet 10 inches.

Complexion Blk

Eyes Blk; hair Blk

Where born Adams Co Miss.

Occupation Farmer

ENLISTMENT.

When Aug, 29, 1863.

Where Natchez

By whom Lt Schuck; term 3 y'rs.

Remarks: Deserted at Natchez Miss. Oct 22/63

Warren

*J. B.* | **6 H. Art'y.** | **U. S. C. T.**

*Colifton Barrie*  
*Priv., Co. F., 2 Reg't Miss. Art'y.†*

Age *35* years.

Appears on

**Company Muster-in Roll**

of the organization named above. Roll dated

*Natchez, Miss. Sept. 12, 1863.*

Muster-in to date *Sept. 12, 1863.*

Joined for duty and enrolled:

When *Aug. 29*, 1863.\*

Where *Natchez, Miss.* \*

Period *3* years.\*

Valuation of horse, \$ *100*

Valuation of horse equipments, \$ *100*

Remarks:

† This organization subsequently became Co. *F.*, 6 Reg't U. S. Colored Heavy Artillery.

\* *MS* - Muster-in roll shows enrollment of all men of this company as of same date and place. See enrollment on subsequent card or cards.

Book mark:

*Brooks.*

(356c)

Copyist.

26

6 H. Art'y.

U.S.C.T.

Whiston Harrison

C.A., Co. F, 2 Reg't Miss. Artillery.†

Appears on

Company Muster Roll

for Sept. 12 to Oct. 31, 1863.

Joined for duty and enrolled:

When Aug. 29, 1863.\*

Where Natchez, Miss.\*

Period 3 years.\*

Present or absent

Stoppage, \$ 100 for

Due Gov't \$ 100 for

Valuation of horse, \$ 100

Valuation of horse equipments, \$ 100

Remarks: Deserted at Natchez, Miss. October 22, 1863.

† This organization subsequently became Co. F, 6 Reg't U. S. Colored Heavy Artillery.

\* See enrollment on card from muster-in roll.

Book mark:

Brooke



Clifton Harrison  
Pt., Co. ...., 6 Reg't U. S. Col'd H. Art'y.

Appears on Returns as follows:

Oct 1863 (Co F 2 Miss  
H. Art A. R. Iss  
Oct 22, 63 Katchez  
Miss Deserted)

Book mark: .....

(546)

A. G. Gould

Copyist.

*H*

6 H. Art'y.

U.S.C.T.

*Stephen D. Garrison*  
Sgt., Co. *F*, 6 Reg't U.S. Col'd H. Art'y.

Appears on **Co. Muster-out Roll**, dated

*Hatchez Nev. May 13*, 186*6*.

Muster-out to date \_\_\_\_\_, 186 .

Last paid to *Pay due from recruitment*, 186 .

Clothing account:

*No settlement*  
Last settled \_\_\_\_\_, 186 ; drawn since \$ *36*/*100*

Due soldier \$ \_\_\_\_\_*100*; due U. S. \$ \_\_\_\_\_*100*

Am't for cloth'g in kind or money adv'd \$ \_\_\_\_\_*100*

Due U. S. for arms, equipments, &c., \$ \_\_\_\_\_*100*

Bounty paid \$ \_\_\_\_\_*100*; due \$ \_\_\_\_\_*100*

Remarks: *joined at original*  
*organization, Deserted Oct.*  
*22, 63 at Hatchez Nev.*

Book mark: \_\_\_\_\_

(361)

*[Signature]*

Copyist.

Harrison, George

Co A, 6 U.S. Col'd H. Art'y.

Private

Artificer

CARD NUMBERS.

1	6167253	26
2	6167396	27
3	6167542	28
4	6167668	29
5	6167787	30
6	6167907	31
7	6168018	32
8	6168126	33
9	6168237	34
10	6168344	35
11	6168455	36
12	6168536	37
13	6168648	38
14	6168759	39
15	6168864	40
16	6168962	41
17	6169059	42
18	6169156	43
19	9119917	44
20	40742413	45
21		46
22		47
23		48
24		49
25		50

Book Mark:

See also

J. 636297 P. G. aff.

R. P. 349365.

D. 1602307 P. G. aff.

D. 1616913 P. G. aff.

*F. N. Chandler*

George Harrison

Co. F, 6 Reg't U. S. Col'd H. Art'y.

Appears on

Company Descriptive Book

of the organization named above.

DESCRIPTION.

Age 45 years; height 5 feet 11 inches.

Complexion Blk

Eyes Blk; hair Blk

Where born Charles City, Va.

Occupation Carpenter

ENLISTMENT.

When Aug. 29, 1863.

Where Hatchery

By whom Lt Schreck; term 3 y'rs.

Remarks:

[Empty lines for remarks]

Warren

Copist.

George Harrison  
Pvt., Co. D, 2 Reg't Miss. Art'y.†

Age 45- years.

Appears on

**Company Muster-in Roll**

of the organization named above. Roll dated  
Natchez Miss. Sept. 12, 1863.

Muster-in to date Sept. 12, 1863.

Joined for duty and enrolled:

When Aug. 29, 1863.\*

Where Natchez, Miss. \*

Period 3 years.\*

Valuation of horse, \$ 100,

Valuation of horse equipments, \$ 100

Remarks:

† This organization subsequently became Co. D, 6 Reg't U. S. Colored Heavy Artillery.

\* Muster-in roll shows enrollment of all men of this company as of same date and place. See enrollment on subsequent card or cards.

Book mark:

Brooks.

*L.H.*

6 H. Art'y.

U.S.C.T.

*George Harrison*

*Det.*, Co. F, 2 Reg't Miss. Artillery.†

Appears on

**Company Muster Roll**

for *Sept. 17 to Oct. 31*, 1863.

Joined for duty and enrolled:

When *Aug. 29*, 1863.\*

Where *Watches, Miss.*\*

Period *3* years.\*

Present or absent *Present*

Stoppage, \$ *100* for

Due Gov't \$ *100* for

Valuation of horse, \$ *100*

Valuation of horse equipments, \$ *100*

Remarks:

† This organization subsequently became Co. F, 6 Reg't U. S. Colored Heavy Artillery.

\* See enrollment on card from muster-in roll.

Book mark:

*Brooks*

(358c)

Copyist.

H. 6.

6 H. Art'y.

U.S.C.T.

George Harrison

Pvt., Co. F, 2 Reg't Miss. Artillery.†

Appears on

Company Muster Roll

for Nov. 1 to Dec. 31, 1863.

Joined for duty and enrolled:

When Aug. 29, 1863.\*

Where Matchez.\*

Period 3 years.\*

Present or absent Present.

Stoppage, \$ 100 for

Due Gov't \$ 100 for

Valuation of horse, \$ 100

Valuation of horse equipments, \$ 100

Remarks:

† This organization subsequently became Co. F, 6 Reg't U. S. Colored Heavy Artillery.

\* See enrollment on card from muster-in roll.

Book mark:

Brooks.



George Harrison  
Priv., Co. F, 2 Reg't Miss. Artillery.†

Appears on

**Company Muster Roll**

for Jan. to Feb. 29, 1864

Joined for duty and enrolled:

When Aug. 29, 1863.\*

Where Natchez, Miss.\*

Period 3 years.\*

Present or absent Present

Stoppage, \$ 100 for

Due Gov't \$ 100 for

Valuation of horse, \$ 100

Valuation of horse equipments, \$ 100

Remarks:

† This organization subsequently became Co. F, 6 Reg't U. S. Colored Heavy Artillery.  
\* See enrollment on card from muster-in roll.

Book mark:

Crooke  
(358c) Copyist.

*George J. Harrison*  
*Priv. Co. I., 5 Reg't U. S. Col'd H. Art'y.\**

Appears on

**Company Muster Roll**

for *Mar. 1 to Apr. 30, 1864.*

Joined for duty and enrolled:

When *Aug. 29*, 1863.\*

Where *Natchez, Miss.\**

Period *3* years.\*

Present or absent *Present.*

Stoppage, \$ *100* for

Due Gov't, \$ *100* for

Valuation of horse, \$ *100*

Valuation of horse equipments, \$ *100*

Remarks: \_\_\_\_\_  
\_\_\_\_\_  
\_\_\_\_\_

\* This organization subsequently became Co. *I.*, 6 Reg't U. S. Col'd Heavy Artillery.  
\* See enrollment on card from muster-in roll.

Book mark: \_\_\_\_\_

*B. Root*

*George Harrison*  
Pvt., Co. F, 6 Reg't U. S. Col'd H. Art'y.

Appears on

**Company Muster Roll**

for *May to June 30, 1864*.

Joined for duty and enrolled:

When *Aug. 29*, 1863.\*

Where *Natchez Miss.*\*

Period *3* years.\*

Present or absent *Present.*

Stoppage, \$ *100* for \_\_\_\_\_

Due Gov't \$ *100* for \_\_\_\_\_

Remarks: \_\_\_\_\_  
\_\_\_\_\_  
\_\_\_\_\_  
\_\_\_\_\_  
\_\_\_\_\_  
\_\_\_\_\_

\* See enrollment on card from muster-in roll.

Book mark: \_\_\_\_\_

(358c)

*Brooks,*

Copyist.

*George Harrison*  
*Pol*, Co. F, 6 Reg't U. S. Col'd H. Art'y.

Appears on

**Company Muster Roll**

for *July & Aug*, 186*4*.

Joined for duty and enrolled:

When *Aug 29*, 186*3*.\*

Where *Natchez Miss*\*

Period *3* years.\*

Present or absent *Present*

Stoppage, \$ *100* for

Due Gov't \$ *100* for

Remarks:  
\_\_\_\_\_  
\_\_\_\_\_  
\_\_\_\_\_  
\_\_\_\_\_  
\_\_\_\_\_

\* See enrollment on card from muster-in roll.

Book mark: \_\_\_\_\_

*S. Duncan*  
(358c) Copyist.

*A*

6 H. Art'y. U.S.C.T.

*George Harrison*

*Priv*, Co. F, 6 Reg't U. S. Col'd H. Art'y.

Appears on

**Company Muster Roll**

for *Sept & Oct*, 186*4*

Joined for duty and enrolled:

When *Aug 29*, 186*3*.\*

Where *Natchez Miss* \*

Period *3* years.\*

Present or absent *Present*

Stoppage, \$ *100* for \_\_\_\_\_

Due Gov't \$ *100* for \_\_\_\_\_

Remarks: \_\_\_\_\_

\_\_\_\_\_

\_\_\_\_\_

\_\_\_\_\_

\_\_\_\_\_

\_\_\_\_\_

\* See enrollment on card from muster-in roll.

Book mark: \_\_\_\_\_

\_\_\_\_\_

*S. Duncan*

(358c)

Copyist.

*A*

6 H. Art'y. U.S.C.T.

*George Harrison*  
*Col*, Co. F, 6 Reg't U. S. Col'd H. Art'y.

Appears on

**Company Muster Roll**

for *Nov & Dec*, 1864

Joined for duty and enrolled:

When *Aug 29*, 1863.\*

Where *Natchez Miss*\*

Period *3* years.\*

Present or absent *Present*

Stoppage, \$ *100* for

Due Gov't \$ *100* for

Remarks:

-----  
-----  
-----  
-----  
-----

\* See enrollment on card from muster-in roll.

Book mark: -----

(358c)

*S. Linnear*

Copyist.

A

6 H. Art'y. U.S.C.T.

George Harrison

Plt, Co. F, 6 Reg't U. S. Col'd H. Art'y.

Appears on

Company Muster Roll

for Jan & Feb, 1865.

Joined for duty and enrolled:

When Aug 29, 1863.\*

Where Natchez Miss \*

Period 3 years.\*

Present or absent Present

Stoppage, \$ 100 for

Due Gov't \$ 100 for

Remarks:

\* See enrollment on card from muster-in roll.

Book mark:

(358c)

S. Duncan

Copyist.

A

6 H. Art'y.

U.S.C.T.

George Harrison

Plt, Co. F, 6 Reg't U. S. Col'd H. Art'y.

Appears on

Company Muster Roll

for Feb & Apl, 1865.

Joined for duty and enrolled:

When Aug 29, 1863.\*

Where Katchez Miss. \*

Period 3 years.\*

Present or absent Present

Stoppage, \$ 100 for

Due Gov't \$ 100 for

Remarks:

\* See enrollment on card from muster-in roll.

Book mark:

(358c)

J. Duncan

Copyist.



*A*

6 H. Art'y.

U.S.C.T.

*George Harrison*  
Artificer Co. F, 6 Reg't U. S. Col'd H. Art'y.

Appears on

**Company Muster Roll**

for *May & June*, 186*5*.

Joined for duty and enrolled:

When *Aug 29*, 186*3*.\*

Where *Natchez Miss*\*

Period *3* years.\*

Present or absent *Present*

Stoppage, \$ *100* for

Due Gov't, \$ *100* for

Valuation of horse, \$ *100*

Valuation of horse equipments, \$ *100*

Remarks: \_\_\_\_\_

\_\_\_\_\_

\_\_\_\_\_

\_\_\_\_\_

\* See enrollment on card from muster-in roll.

Book mark: \_\_\_\_\_

\_\_\_\_\_

*S. Duncan*

(358c)

Copyist.

*H*

6 H. Art'y.

U.S.C.T.

*George Harrison*

*Artificer*, Co. F, 6 Reg't U. S. Col'd H. Art'y.

Appears on

**Company Muster Roll**

for *July + Aug.*, 186*5*.

Joined for duty and enrolled:

When *Aug. 29*, 186*5*.\*

Where *Catchez Miss.*\*

Period *3* years.\*

Present or absent *Present*

Stoppage, \$ *100* for

Due Gov't \$ *100* for

Remarks:

-----  
-----  
-----  
-----  
-----

\* See enrollment on card from muster-in roll.

Book mark: -----

(358c)

*J. W. Ames*

Copyist.

H

6 H. Art'y.

U.S.C.T.

George Harrison

Artificer, Co. F, 6 Reg't U. S. Col'd H. Art'y.

Appears on

Company Muster Roll

for Sept. + Oct., 1863.

Joined for duty and enrolled:

When Aug. 29<sup>th</sup>, 1863.\*

Where Natchez Miss. \*

Period 3 years.\*

Present or absent Present

Stoppage, \$ 100 for

Due Gov't \$ 100 for

Remarks:

Due U. S. for advances  
45  
100.

\* See enrollment on card from muster-in roll.

Book mark:

J. W. Chiles

(358c)

Copyist.

26

6 H. Art'y.

U.S.C.T.

George Harrison

Art'y, Co. 7, 6 Reg't U. S. Col'd H. Art'y.

Appears on

Company Muster Roll

for Jan & Dec, 1865.

Joined for duty and enrolled:

When Aug 29, 1863.\*

Where Katchez Miss. \*

Period 3 years.\*

Present or absent Present

Stoppage, \$ 100 for

Due Gov't \$ 100 for

Remarks:

Due U. S. for advances 75 cts.

\* See enrollment on card from muster-in roll.

Book mark:

(358c)

J. W. Chaves

Copyist.

H

6 H. Art'y.

U.S.C.T.

George Harrison  
Art'y., Co. F, 6 Reg't U. S. Col'd H. Art'y.

Appears on

Company Muster Roll

for Jan'y + Feby, 1866.

Joined for duty and enrolled:

When Aug. 29<sup>th</sup>, 1863.\*

Where Natchez Miss.\*

Period 3 years.\*

Present or absent Present

Stoppage, \$ 100 for \_\_\_\_\_

Due Gov't \$ 100 for \_\_\_\_\_

Remarks: \_\_\_\_\_

Due U.S. for advances  
75cts.

\* See enrollment on card from muster-in roll.

Book mark: \_\_\_\_\_

(358c)

J. W. Ames  
Copyist.

28

George Harrison

Co. F, 6 Reg't U. S. Col'd H. Art'y.

Appears on

Company Muster Roll

for March & April, 1866.

Joined for duty and enrolled:

When Aug 29<sup>th</sup>, 1863.\*

Where Ketcherz Miss. \*

Period 3 years.\*

Present or absent Present

Stoppage, \$ 100 for \_\_\_\_\_

Due Gov't \$ 100 for \_\_\_\_\_

Remarks: \_\_\_\_\_

\_\_\_\_\_

\_\_\_\_\_

\_\_\_\_\_

\_\_\_\_\_

\_\_\_\_\_

\* See enrollment on card from muster-in roll.

Book mark: \_\_\_\_\_

\_\_\_\_\_

J. W. Jones

(358c)

Copyist.

H

6 H. Art'y.

U.S.C.T.

George Harrison  
Pot, Co. F, 6 Reg't U. S. Col'd H. Art'y.

Appears on Returns as follows:

May 1864 On daily  
duty Co Cook

Book mark :

(546)

A. Ganga  
Copyist.

*10*

6 H. Art'y.

U.S.C.T.

*George Harrison*  
Art'y., Co. *F*, 6 Reg't U. S. Col'd H. Art'y.

Appears on Co. Muster-out Roll, dated

*Natchez Miss*, *May 13*, 186*6*.

Muster-out to date

*May 13*, 186*6*.

Last paid to

*Dec 31*, 186*5*.

Clothing account:

Last settled....., 186 ; drawn since \$.....<sup>100</sup>

Due soldier \$ *34*<sup>*21*</sup>/<sub>100</sub>; due U. S. \$.....<sup>100</sup>

Am't for cloth'g in kind or money adv'd \$.....<sup>100</sup>

Due U. S. for arms, equipments, &c., \$.....<sup>100</sup>

Bounty paid \$.....<sup>100</sup>; due \$.....<sup>100</sup>

Remarks: *Joined at original*

*organization was private to*

*June 30, 65. Sien Artificer*

Book mark:

*7. 243. P. 191*

(361)

*[Signature]*

Copyist.



Harrison, Henry

Co M, 6 U.S. Col'd H. Art'y.

Private

Private

CARD NUMBERS.

1	6179206	26
2	6179299	27
3	6179422	28
4	6179534	29
5	6179617	30
6	6179709	31
7	6179805	32
8	6179921	33
9	6180038	34
10	6180146	35
11	6180253	36
12	6180350	37
13	6180446	38
14	6180536	39
15	6180625	40
16	6180714	41
17	9121049	42
18	40742459	43
19		44
20		45
21		46
22		47
23		48
24		49
25		50

Book Mark: \_\_\_\_\_

See also \_\_\_\_\_

D. 2253376 *Prunin*

D. 2439128 *copy*

MS Va 9/7/32 *CTP*

*F. F. Jones*

Henry Garrison

Co. *C*, 6 Reg't U. S. Col'd H. Art'y.

Appears on  
**Company Descriptive Book**  
of the organization named above.

**DESCRIPTION.**

Age *20* years; height *5* feet *1* inches.

Complexion *Bo*

Eyes *blk*; hair *blk*

Where born *Adams Co Miss*

Occupation *fr*

**ENLISTMENT.**

When *Jan 21*, 186*5*.

Where *Waltham Miss*

By whom *Capt Cade*; term *3* y'rs.

Remarks:  
.....  
.....  
.....  
.....  
.....  
.....  
.....  
.....  
.....  
.....

*Hilton*

26

6 H. Art'y.

U.S.C.T.

Henry Harrison

Priv., Co. M, 2 Reg't Miss. Art'y.†

Age 18 years.

Appears on

Company Muster-in Roll

of the organization named above. Roll dated

Natchez, Miss Jan. 21, 1864.

Muster-in to date Jan. 21, 1864.

Joined for duty and enrolled:

When Jan. 21, 1864.\*

Where Natchez, Miss \*

Period 3 years.\*

Valuation of horse, \$ 100

Valuation of horse equipments, \$ 100

Remarks:

† This organization subsequently became Co. M, 6 Reg't U. S. Colored Heavy Artillery.

\* Muster-in roll shows enrollment and muster-in of this company as of same date and place. See enrollment on subsequent card or cards.

Book mark:

J. J. Kearney

(356c)

Copyst.

No. | 6 H. Art'y. | U.S.C.T.

Henry Harrison

Prvt., Co. M, 2 Reg't Miss. Art'y.†

Appears on

**Company Muster Roll**

for Jan. 21 to Feb. 29, 1864.

Joined for duty and enrolled:

When Jan. 21, 1864.\*

Where Hatchery, Miss.\*

Period 3 years.\*

Present or absent Present

Stoppage, \$ 100 for

Due Gov't, \$ 100 for

Valuation of horse, \$ 100

Valuation of horse equipments, \$ 100

Remarks:

† This organization subsequently became Co. M, 6 Reg't U.S. Col'd Heavy Artillery.

\* See enrollment on card from muster-in roll.

Book mark:

(358c)

J. J. Kearney

Copyist.

26

6 H. Art'y.

U.S.C.T.

Henry Harrison

Pvt., Co. M., 5 Reg't U. S. Col'd H. Art'y.†

Appears on

Company Muster Roll

for Feb & Apl, 1864.

Joined for duty and enrolled:

When Jan. 21, 1864.\*

Where Natchez, Miss\*

Period 3 years.\*

Present or absent Present

Stoppage, \$ 100 for

Due Gov't \$ 100 for

Valuation of horse, \$ 100

Valuation of horse equipments, 100

Remarks:

†This organization subsequently became Co. M, 6 Reg't U. S. Colored Heavy Artillery.  
\* See enrollment on card from muster-in roll.

Book mark:

(358c)

J. J. Kearney  
Copyist.

26

6 H. Art'y.

U.S.C.T.

Henry Harrison

Pvt., Co. M, 6 Reg't U. S. Col'd H. Art'y.

Appears on

Company Muster Roll

for May & June, 1864.

Joined for duty and enrolled:

When Jan. 21, 1864.\*

Where Natchez, Miss.\*

Period 3 years.\*

Present or absent Present

Stoppage, \$ 100 for

Due Gov't, \$ 100 for

Valuation of horse, \$ 100

Valuation of horse equipments, \$ 100

Remarks:

-----  
-----  
-----  
-----

\* See enrollment on card from muster-in roll.

Book mark:

-----

(358c)

J. J. Kearney  
Copyist.

26

6 H. Art'y.

U.S.C.T.

Henry Harrison

Prvt, Co. M, 6 Reg't U. S. Col'd H. Art'y.

Appears on

Company Muster Roll

for June & Aug, 1864.

Joined for duty and enrolled:

When Jan. 21, 1864.\*

Where Ketchikan, Alaska.\*

Period 3 years.\*

Present or absent Present

Stoppage, \$ 100 for

Due Gov't, \$ 100 for

Valuation of horse, \$ 100

Valuation of horse equipments, \$ 100

Remarks: Stoppage for 1 Haversack

\* See enrollment on card from muster-in roll.

Book mark:

(358c)

J. J. Kearney Copyist.



26.

6 H. Art'y.

U.S.C.T.

Henry Harrison

Priv., Co. M, 6 Reg't U. S. Col'd H. Art'y.

Appears on

Company Muster Roll

for Sept. & Oct., 1864.

Joined for duty and enrolled:

When Jan. 21, 1864.\*

Where Hatchery, Miss.\*

Period 1 years.\*

Present or absent Present

Stoppage, \$ 100 for

Due Gov't, \$ 100 for

Valuation of horse, \$ 100

Valuation of horse equipments, \$ 100

Remarks: Stop for 1 Haversack. 6/7/64

\* See enrollment on card from muster-in roll.

Book mark:

(358c)

J. J. Kearney Copyist.

H

6 H. Art'y.

U.S.C.T.

Henry Harrison  
Priv., Co. M, 6 Reg't U. S. Col'd H. Art'y.

Appears on

**Company Muster Roll**

for Nov & Dec, 1864.

Joined for duty and enrolled:

When Jan. 21, 1864.\*

Where Natchez, Miss.\*

Period 3 years.\*

Present or absent Present

Stoppage, \$ 100 for

Due Gov't, \$ 100 for

Valuation of horse, \$ 100

Valuation of horse equipments, \$ 100

Remarks:

-----  
-----  
-----  
-----

\* See enrollment on card from muster-in roll.

Book mark:-----

-----

(358c)

Beck  
Copyist.

*Henry Harrison*  
*Priv*, Co. M, 6 Reg't U. S. Col'd H. Art'y.

Appears on  
**Company Muster Roll**  
for *Jan. & Feb.*, 186*5*.

Joined for duty and enrolled:  
When *Jan. 21*, 186*4*.  
Where *Natchez, Miss.*  
Period *3* years.\*

Present or absent *Present*

Stoppage, \$ *100* for

Due Gov't, \$ *100* for

Valuation of horse, \$ *100*

Valuation of horse equipments, \$ *100*

Remarks: \_\_\_\_\_  
\_\_\_\_\_  
\_\_\_\_\_  
\_\_\_\_\_

\* See enrollment on card from muster-in roll.

Book mark: \_\_\_\_\_

(358c)

*Weck*  
Copyist.

Henry Harrison  
Priv., Co. M, 6 Reg't U. S. Col'd H. Art'y.

Appears on

**Company Muster Roll**

for Mar & Apr, 1865:

Joined for duty and enrolled:

When Jan. 21, 1864.\*

Where Natchez Miss.\*

Period 3 years.\*

Present or absent Present

Stoppage, \$ 100 for

Due Gov't, \$ 100 for

Valuation of horse, \$ 100

Valuation of horse equipments, \$ 100

Remarks: \_\_\_\_\_

\_\_\_\_\_

\_\_\_\_\_

\_\_\_\_\_

\* See enrollment on card from muster-in roll.

Book mark: \_\_\_\_\_

\_\_\_\_\_

W. Beck  
Copyist.

Henry Harrison

Priv., Co. M, 6 Reg't U. S. Col'd H. Art'y.

Appears on

Company Muster Roll

for May & June, 1865.

Joined for duty and enrolled:

When Jan. 21, 1864.\*

Where Natchez, Miss.\*

Period 3 years.\*

Present or absent Present

Stoppage, \$ 100 for

Due Gov't, \$ 100 for

Valuation of horse, \$ 100

Valuation of horse equipments, \$ 100

Remarks:

[Empty lines for remarks]

\* See enrollment on card from muster-in roll.

Book mark:

[Empty line for book mark]

(358c)

Beck Copyist.

H

6 H. Art'y.

U.S.C.T.

Henry Harrison

Priv., Co. M, 6 Reg't U. S. Col'd H. Art'y.

Appears on

Company Muster Roll

for July & Aug., 1865.

Joined for duty and enrolled:

When Jan. 21, 1864.\*

Where Natchez, Miss. \*

Period 3 years.\*

Present or absent Absent

Stoppage, \$ 100 for

Due Gov't, \$ 100 for

Valuation of horse, \$ 100

Valuation of horse equipments, \$ 100

Remarks: Sick in Post Hospital, Natchez, Miss. since Aug 27 '65

\* See enrollment on card from muster-in roll.

Book mark:

(358c)

Beck Copyist.

*N*

6 H. Art'y.

U.S.C.T.

*Henry Harrison*

*Prst*, Co. M, 6 Reg't U. S. Col'd H. Art'y.

Appears on

**Company Muster Roll**

for *Sept & Oct*, 186*4*.

Joined for duty and enrolled:

When *Jan. 21*, 186*4*.\*

Where *Watches, Miss* \*

Period *3* years.\*

Present or absent *Present*

Stoppage, \$ *100* for

Due Gov't, \$ *100* for

Valuation of horse, \$ *100*

Valuation of horse equipments, \$ *100*

Remarks:

-----  
-----  
-----  
-----

\* See enrollment on card from muster-in roll.

Book mark:-----

*Jno Bell Jr*  
(358c) Copyist.

*Henry Harrison*

*1st*, Co *M*, 6 Reg't U. S. Col'd H. Art'y.

Appears on

**Company Muster Roll**

for *Nov. & Dec*, 186*5*.

Joined for duty and enrolled:

When *Jan*, 21, 186*4*.\*

Where *Katchez Miss* \*

Period *3* years.\*

Present or absent *Present*

Stoppage, \$ *100* for

Due Gov't, \$ *100* for

Valuation of horse, \$ *100*

Valuation of horse equipments, \$ *100*

Remarks: \_\_\_\_\_

\_\_\_\_\_

\_\_\_\_\_

\_\_\_\_\_

\* See enrollment on card from muster-in roll.

Book mark: \_\_\_\_\_

(358c)

*Geo J. Bell Jr*  
Copyist.



26

6 H. Art'y.

U.S.C.T.

Henry Harrison  
Prk., Co. M, 6 Reg't U. S. Col'd H. Art'y.

Appears on

**Company Muster Roll**

for Jan. & Feb., 1866.

Joined for duty and enrolled:

When Jan 21, 1866.\*

Where Natchez, Miss \*

Period 3 years.\*

Present or absent Present.

Stoppage, \$ 100 for

Due Gov't, \$ 100 for

Valuation of horse, \$ 100

Valuation of horse equipments, \$ 100

Remarks:

\* See enrollment on card from muster-in roll.

Book mark:

(358c) *Geo H Bell Jr* Copyist.

26

6 H. Art'y.

U.S.C.T.

Henry Harrison  
Pvt., Co. M, 6 Reg't U. S. Col'd H. Art'y.

Appears on

**Company Muster Roll**

for Mich & April, 1866.

Joined for duty and enrolled:

When Jan. 21, 1864.\*

Where Wardens, Miss \*

Period 3 years.\*

Present or absent Present

Stoppage, \$ 100 for

Due Gov't, \$ 100 for

Valuation of horse, \$ 100

Valuation of horse equipments, \$ 100

Remarks: \_\_\_\_\_

\_\_\_\_\_

\_\_\_\_\_

\_\_\_\_\_

\_\_\_\_\_

\* See enrollment on card from muster-in roll.

Book mark: \_\_\_\_\_

(358d) Jno J Bell Jr. Copyist.

A

6 H. Art'y.

U.S.C.T.

Henry Harrison  
Pat., Co. M, 6 Reg't U. S. Col'd H. Art'y.

Appears on Returns as follows:

Aug 1865 Absent  
Sick in Post  
Hosp. Natchez  
Miss since Aug  
27, 65

Book mark:

(545)

A. J. Gouglas

Copyist.

*Henry Fabian*

*Bvt. Co. M., 6 Reg't U. S. Col'd H. Art'y.*

Appears on **Co. Muster-out Roll**, dated

*Natchez Miss, May 13, 1866.*

Muster-out to date *May 13, 1866.*

Last paid to *Dec 31, 1865.*

Clothing account:

Last settled....., 186 ; drawn since \$..... 100

Due soldier \$ *7<sup>20</sup>*/<sub>100</sub>; due U. S. \$..... 100

Am't for cloth'g in kind or money adv'd \$..... 100

Due U. S. for arms, equipments, &c., \$..... 100

Bounty paid \$..... 100; due \$..... 100

Remarks: *Found at original organization*

Book mark: *1101-202-69*

*J. Nelson*

*William, O. ...*  
I, **6 U.S. Col'd H. Art'y**

*Private* | *Private*

CARD NUMBERS.

1	6173623	26
2	6173765	27
3	6173910	28
4	6174039	29
5	6174172	30
6	6174289	31
7	6174400	32
8	6174511	33
9	6174624	34
10	6174724	35
11	6174860	36
12	6174976	37
12	6175082	38
14	6175191	39
15	6175297	40
16	6175396	41
17	6175492	42
18	9120554	43
19	40742494	44
20		45
21		46
22		47
23		48
24		49
25		50

Book Mark: \_\_\_\_\_

See also \_\_\_\_\_

*Julius Harrison*

....., Co. *I*, 6 Reg't U. S. Col'd H. Art'y.

Appears on

**Company Descriptive Book**  
of the organization named above.

**DESCRIPTION.**

Age *25* years; height *5* feet *3* inches.

Complexion *Blk*

Eyes *Dark Brown*, hair *Blk*

Where born *Davis, Co., Tenn.*

Occupation *Labourer*

**ENLISTMENT.**

When *Dec. 8*....., 186*3*.

Where *Natchez, Miss.*

By whom *Capt. H. Hubert*; term *3* y'rs.

Remarks: .....

.....  
.....  
.....  
.....  
.....  
.....  
.....

*Warren*

A

6 H. Art'y.

U.S.C.T.

*Arbit Harrison*  
Pvt., Co. *I*, 2 Reg't Miss. Art'y.†

Age *25* years.

Appears on

**Company Muster-in Roll**

of the organization named above. Roll dated

*Natchez, Miss. Dec. 17*, 186*3*.

Muster-in to date *Dec. 8*, 186*3*.

Joined for duty and enrolled:

When *Dec. 8*, 186*3*\*

Where *Natchez, Miss.* \*

Period *3* years.\*

Valuation of horse, \$ 100

Valuation of horse equipments, \$ 100

Remarks: .....

† This organization subsequently became Co. *I* 6 Reg't U. S. Colored Heavy Artillery.

\* Muster-in roll shows enrollment of all men of this company as of same date and place. See enrollment on subsequent card or cards.

Book mark: .....

*J. C. Taylor*

(356c)

Copyist.

AH

6 H. Art'y.

U.S.C.T.

*Milit Harrison*  
*Priv.*, Co. I, 2 Reg't Miss. Artillery.†

Appears on

**Company Muster Roll**

for *Dec. 17 to Dec. 31*, 186 *3*.

Joined for duty and enrolled:

When *Dec. 8*, 186 *3*.\*

Where *Natchez* \*

Period *3* years.\*

Present or absent *Present*

Stoppage, \$ *100* for

Due Gov't, \$ *100* for

Valuation of horse, \$ *100*

Valuation of horse equipments, \$ *100*

Remarks: \_\_\_\_\_  
\_\_\_\_\_  
\_\_\_\_\_  
\_\_\_\_\_

† This organization subsequently became Co. I, 6 Reg't U. S. Colored Heavy Artillery.  
\* See enrollment on card from muster-in roll.

Book mark: *358c*

(358c)

*D. C. Taylor*

Copyist.



*Walter Harrison*  
Pvt., Co. I, 2 Reg't Miss. Artillery.†

Appears on

**Company Muster Roll**

for *Jan. and Feb.*, 1864.

Joined for duty and enrolled:

When *Dec. 8*, 1863.\*

Where *Natchez*\*

Period *3* years.\*

Present or absent *Present*

Stoppage, \$ *100* for

Due Gov't \$ *100* for

Valuation of horse, \$ *100*

Valuation of horse equipments, *100*

Remarks:

† This organization subsequently became Co. I, 6 Reg't U. S. Colored Heavy Artillery.  
\* See enrollment on card from muster-in roll.

Book mark:

*J. C. Taylor*  
(358c) Copyist.

*Hulit Harrison*  
Pvt., Co. I, 5 Reg't U. S. Col'd H. Art'y.\*

Appears on

**Company Muster Roll**

for *Mar. and Apr., 1864.*

Joined for duty and enrolled :

When *December 8,* 186*3*.\*

Where *Katchez* \*

Period *3* years.\*

Present or absent *Present*

Stoppage, \$ *100* for

Due Gov't, \$ *100* for

Valuation of horse, \$ *100*

Valuation of horse equipments, \$ *100*

Remarks: \_\_\_\_\_  
\_\_\_\_\_  
\_\_\_\_\_

\* This organization subsequently became Co. *I*, 6 Reg't U. S. Col'd Heavy Artillery.  
\* See enrollment on card from muster-in roll.

Book mark : \_\_\_\_\_

(358c) *D. C. Taylor* Copyist.

*Hulit Harrison*  
*Out.*, Co. I, 6 Reg't U. S. Col'd H. Art'y.

Appears on

**Company Muster Roll**

for *May and June*, 186*4*.

Joined for duty and enrolled:

When *Dec. 8*, 186*3*\*

Where *Natchez*\*

Period *3* years.\*

Present or absent *Present*

Stoppage, \$ *100* for

Due Gov't \$ *100* for

Remarks:  
-----  
-----  
-----  
-----  
-----  
-----

\* See enrollment on card from muster-in roll.

Book mark:-----

(358c)

*J. C. Taylor*

Copyist.

A

6 H. Art'y.

U.S.C.T.

*Habit Harrison*

*Privt*, Co. I, 6 Reg't U. S. Col'd H. Art'y.

Appears on

**Company Muster Roll**

for *July and Aug*, 186*4*.

Joined for duty and enrolled:

When *Dec. 8*, 186*3*.\*

Where *Natchez* \*

Period *3* years.\*

Present or absent *Present*

Stoppage, \$ *100* for

Due Gov't \$ *100* for

Remarks:

\* See enrollment on card from muster-in roll.

Book mark:

(358c)

*A. C. Taylor*

Copyist.

*H* 6 H. Art'y. | U.S.C.T.

*Hidit Harrison*

*H*, Co. I, 6 Reg't U. S. Col'd H. Art'y.

Appears on

Company Muster Roll  
for *Sept. & Oct.* 1864.

Joined for duty and enrolled:

When *Dec. 8*, 1863.\*

Where *Natchez* \*

Period *3* years.\*

Present or absent *Present*

Stoppage, \$ *100* for

Due Gov't, \$ *100* for

Valuation of horse, \$ *100*.

Valuation of horse equipments, \$ *100*

Remarks: \_\_\_\_\_

\_\_\_\_\_

\_\_\_\_\_

\_\_\_\_\_

\_\_\_\_\_

\* See enrollment on card from muster-in roll.

Book-mark: \_\_\_\_\_

\_\_\_\_\_

(358c)

*Steele*  
Copyist.

*Hunter Harrison*

*Pt.*, Co. I, 6 Reg't U. S. Col'd H. Art'y.

Appears on

Company Muster Roll  
for *Wm. & Doe*, 1864.

Joined for duty and enrolled:

When *Dec. 8*, 1863.\*

Where *Matchez.*\*

Period *3* years.\*

Present or absent *Present.*

Stoppage, \$ *100* for

Due Gov't \$ *100* for

Remarks:  
-----  
-----  
-----  
-----  
-----

\* See enrollment on card from muster-in roll.

Book mark: *100*

*Stuk*  
-----  
Copyist.

*H.*

6 H. Art'y.

U.S.C.T.

*Wesley Garrison,*

*(Pl.)*, Co. I, 6 Reg't U. S. Col'd H. Art'y.

Appears on

**Company Muster Roll**

for *Jan. & Feb.*, 1865.

Joined for duty and enrolled:

When *Dec. 8*, 1864.\*

Where *Wachusetts*, \*

Period *3* years.\*

Present or absent *Present*

Stoppage, \$ *100* for

Due Gov't \$ *100* for

Remarks:

\* See enrollment on card from muster-in roll.

Book mark:

*Atta*

(358c)

Copyist.

46

6 H. Art'y.

U.S.C.T.

*Abel Harrison*

*Pt.*, Co. I, 6 Reg't U. S. Col'd H. Art'y.

Appears on

**Company Muster Roll**

for *Mch. 7<sup>th</sup>*, 1865.

Joined for duty and enrolled:

When *Dec 8*, 1863.\*

Where *Natchez Miss*\*

Period *3* years.\*

Present or absent *Present*

Stoppage, \$ *100* for

Due Gov't \$ *100* for

Remarks:

\* See enrollment on card from muster-in roll.

Book mark:

*Steel*

(358c)

Copyist.



H. C. + 1/2 City | **U.S.C.T.**

Harcit Harrison  
Pl. Co. 2, 6 Reg't U. S. Col'd city

Appears on

**Company Muster Roll**

for May & June, 1865.

Joined for duty and enrolled:

When Dec. 8, 1863\*

Where Watches\*

Period 3 years.\*

Present or absent Present

Stoppage, \$ 100 for

Due Gov't, \$ 100 for

Valuation of horse, \$ 100

Valuation of horse equipments, \$ 100

Remarks: \_\_\_\_\_  
\_\_\_\_\_  
\_\_\_\_\_

\* See enrollment on card from muster-in roll.

Book mark: \_\_\_\_\_

Steele

(358c)

Copyist.

*H*

6 H. Art'y.

U.S.C.T.

*Walter Harrison*  
Pvt., Co. I, 6 Reg't U. S. Col'd H. Art'y.

Appears on

**Company Muster Roll**

for *July & Aug*, 1865.

Joined for duty and enrolled:

When *Dec. 8*, 1863.\*

Where *Natchez Miss\**

Period *3* years.\*

Present or absent *Present*

Stoppage, \$ *100* for

Due Gov't \$ *100* for

Remarks:

-----  
-----  
-----  
-----  
-----

\* ~~See~~ See enrollment on card from muster-in roll.

Book mark: -----

-----

*Steile*

(358c)

Copyist.

H

6 H. Art'y.

U.S.C.T.

*Hulit Harrison*

*Pvt.*, Co. I, 6 Reg't U. S. Col'd H. Art'y.

Appears on

**Company Muster Roll**

for *Sept. & Oct.*, 186*5*.

Joined for duty and enrolled:

When *Dec. 8*, 186*5*.\*

Where *Natchez Miss.* \*

Period *1* years.\*

Present or absent *Present.*

Stoppage, \$ *1* <sup>*30*</sup>/<sub>*100*</sub> for *Camp & G. E.*

Due Gov't \$ *0* <sup>*00*</sup>/<sub>*100*</sub> for

Remarks:  
-----  
-----  
-----  
-----  
-----  
-----

\* See enrollment on card from muster-in roll.

Book mark: -----

*E. P. Rankin*

(358c)

Copyist.

A

6 H. Art'y.

U.S.C.T.

*Healit Harrison*  
Pvt., Co. I, 6 Reg't U. S. Col'd H. Art'y.

Appears on

Company Muster Roll

for *Nov. & Dec.*, 1865.

Joined for duty and enrolled:

When *Dec. 8*, 1863.\*

Where *Skatchez Miss\**

Period *3* years.\*

Present or absent *Present*

Stoppage, \$ *1 <sup>30</sup>/<sub>100</sub>* for *C. & G. trans*  
*from Roll dated Oct. 31, 1865.*  
Due Gov't \$ *100* for

Remarks:

\* See enrollment on card from muster-in roll.

Book mark:

(358c)

*C. E. Rankin*  
Copyist.

A

6 H. Art'y.

U.S.C.T.

*Hulit Harrison*  
Pvt, Co. I, 6 Reg't U. S. Col'd H. Art'y.

Appears on

**Company Muster Roll**

for *Jan. & Feb.*, 186*6*.

Joined for duty and enrolled:

When *Dec. 8,* 186*3*.\*

Where *Natchez Miss.* \*

Period *3* years.\*

Present or absent *Present*

Stoppage, \$ *100* for

Due Gov't \$ *100* for

Remarks:  
-----  
-----  
-----  
-----  
-----

\* See enrollment on card from muster-in roll.

Book mark: -----

*E. P. Rankin*

(358c)

Copyist.

A

6 H. Art'y.

U.S.C.T.

*Hulit Harrison*

*Pvt.*, Co. I, 6 Reg't U. S. Col'd H. Art'y.

Appears on

**Company Muster Roll**

for *Mar. & Apr.*, 186*6*.

Joined for duty and enrolled:

When *Dec. 8*, 186*3*.\*

Where *Katchez* \*

Period *3* years.\*

Present or absent *Present*

Stoppage, \$ *100* for

Due Gov't \$ *100* for

Remarks:  
-----  
-----  
-----  
-----  
-----  
-----

\* See enrollment on card from muster-in roll.

Book mark: -----

*E. E. Rankin*

(358c)

Copyist.

H

6 H. Art'y.

U.S.C.T.

<sup>x</sup>  
Auelit Harrison

Cot., Co. I, 6 Reg't U. S. Col'd H. Art'y.

Appears on Returns as follows:

Jan & Feb 1864 (2 Mos  
H Art A.D.) On

duty Co Cook

Mar 1864 (5 US Col'd

H Art) On duty  
Co Cook

Sept 1865 (6 US Col'd

H Art) Absent  
without leave

since Sept 26/65

<sup>x</sup>  
Entry Cancelled

Book mark:

(546) A. G. Langley  
Copyist.

*H*

6 H. Art'y.

U.S.C.T.

*Hulit Harrison*

*Priv., Co. A., 6 Reg't U. S. Col'd H. Art'y.*

Appears on **Co. Muster-out Roll**, dated

*Natchez, Miss., May 13, 1866.*

Muster-out to date

*May 13, 1866.*

Last paid to

*Dec. 31, 1865.*

Clothing account:

Last settled....., 186 ; drawn since \$..... 100

Due soldier \$ *33 <sup>52</sup>* / 100; due U. S. \$..... 100

Am't for cloth'g in kind or money adv'd \$..... 100

Due U. S. for arms, equipments, &c., \$..... 100

Bounty paid \$..... 100; due \$..... 100

Remarks: *Joined at original organization. - Due Soldier on Account of Clothing \$ 33 <sup>52</sup> / 100*

Book mark :

*C. E. M. Laughlin*

(361)

Copyist.



*Private*  
No. 2, 6 U.S. Col'd H. Art'y.

*Private* | *Private*

CARD NUMBERS.

6173613	26
6173755	27
6173902	28
6174031	29
6174164	30
6174281	31
6174390	32
6174501	33
6174614	34
6174732	35
6174850	36
6174966	37
6175072	38
6175182	39
6175287	40
6175386	41
6175482	42
9120544	43
	44
	45
	46
	47
	48
	49
	50

Book Mark: \_\_\_\_\_

See also \_\_\_\_\_

*John Harrison*

....., Co. *C*, 6 Reg't U. S. Col'd H. Art'y.

Appears on

**Company Descriptive Book**

of the organization named above.

**DESCRIPTION.**

Age *28* years; height *5* feet *6 3/4* inches.

Complexion *Blk*

Eyes *Blk*; hair *Blk*

Where born *Wilkeson, Miss.*

Occupation *Labourer*

**ENLISTMENT.**

When *Dec. 8*, 186*3*.

Where *Natchez Miss.*

By whom *Capt. H. Harbert*, term *3* y'rs.

Remarks: .....

.....  
.....  
.....  
.....  
.....  
.....  
.....  
.....  
.....  
.....

*Barren*

John Harrison  
Pvt., Co. I, 2 Reg't Miss. Art'y.†

Age 28 years.

Appears on

Company Muster-in Roll

of the organization named above. Roll dated

Natchez, Miss., Dec 17, 1863.

Muster-in to date Dec. 8, 1863.

Joined for duty and enrolled:

When Dec. 8, 1863.\*

Where Natchez, Miss. \*

Period 3 years.\*

Valuation of horse, \$ 100

Valuation of horse equipments, \$ 100

Remarks:

† This organization subsequently became Co. I, 6 Reg't U. S. Colored Heavy Artillery.

\* Muster-in roll shows enrollment of all men of this company as of same date and place. See enrollment on subsequent card or cards.

Book mark:

(356c)

T. C. Taylor

Copyist.

*A*

6 H. Art'y.

U.S.C.T.

*John Harrison*

*Ph.t.*, Co. I, 2 Reg't Miss. Artillery.†

Appears on

**Company Muster Roll**

for *Dec. 17 to Dec. 31*, 186*3*.

Joined for duty and enrolled:

When *Dec. 8*, 186*3*.\*

Where *Natchez* \*

Period *3* years.\*

Present or absent *Present*

Stoppage, \$ *100* for

Due Gov't, \$ *100* for

Valuation of horse, \$ *100*

Valuation of horse equipments, \$ *100*

Remarks:

† This organization subsequently became Co. I, 6 Reg't U. S. Colored Heavy Artillery.

\* See enrollment on card from muster-in roll.

Book mark:

*J. C. Taylor*

(358c)

Copyist.

*John Harrison*  
Pvt., Co. I, 2 Reg't Miss. Artillery.†

Appears on

**Company Muster Roll**

for *Jan. and Feb.*, 186*4*.

Joined for duty and enrolled:

When *Dec. 8*, 186*3*.\*

Where *Natchez* \*

Period *3* years.\*

Present or absent *Present*

Stoppage, \$ *100* for

Due Gov't \$ *100* for

Valuation of horse, \$ *100*

Valuation of horse equipments, *100*

Remarks:  
-----  
-----

† This organization subsequently became Co. I, 6 Reg't U. S. Colored Heavy Artillery.  
\* See enrollment on card from muster-in roll.

Book mark:-----  
-----

(358c) *J. C. Taylor* Copyist.

John Harrison  
Plt., Co. I, 5 Reg't U. S. Col'd H. Art'y.\*

Appears on

**Company Muster Roll**

for Mar. and Apr., 1864.

Joined for duty and enrolled:

When December 8, 1863.\*

Where Natchez.\*

Period 3 years.\*

Present or absent Present

Stoppage, \$ 100 for

Due Gov't, \$ 100 for

Valuation of horse, \$ 100

Valuation of horse equipments, \$ 100

Remarks: \_\_\_\_\_  
\_\_\_\_\_  
\_\_\_\_\_

\* This organization subsequently became Co. I, 6 Reg't U. S. Col'd Heavy Artillery.  
\* See enrollment on card from muster-in roll.

Book mark: \_\_\_\_\_

J. C. Taylor  
Copyist.

A

6 H. Art'y.

U.S.C.T.

*John Harrison*  
Pvt., Co. I, 6 Reg't U. S. Col'd H. Art'y.

Appears on

**Company Muster Roll**

for *May and June*, 1864.

Joined for duty and enrolled:

When *Dec. 8*, 186*3*.\*

Where *Natchez* \*

Period *3* years.\*

Present or absent *Present*

Stoppage, \$ *100* for

Due Gov't \$ *100* for

Remarks:  
-----  
-----  
-----  
-----  
-----

\* See enrollment on card from muster-in roll.

Book mark: -----

(358c)

*P. C. Taylor*

Copyist.

A

6 H. Art'y.

U.S.C.T.

John Harrison  
Pvt., Co. I, 6 Reg't U. S. Col'd H. Art'y.

Appears on

**Company Muster Roll**

for July and Aug., 1864.

Joined for duty and enrolled:

When Dec. 8, 1863.\*

Where Katchez \*

Period 3 years.\*

Present or absent Present

Stoppage, \$ 100 for

Due Gov't \$ 100 for

Remarks:

-----  
-----  
-----  
-----  
-----

\* See enrollment on card from muster-in roll.

Book mark:

-----

(358c)

P. C. Taylor

Copyist.



86

6 H. Art'y.

U.S.C.T.

John Harrison  
Pt., Co. I, 6 Reg't U. S. Col'd H. Art'y.

Appears on

Company Muster Roll

for Sep. 10 Oct. 1864.

Joined for duty and enrolled:

When Dec. 8, 1863.\*

Where Matchez.\*

Period 3 years.\*

Present or absent Present

Stoppage, \$ 100 for

Due Gov't, \$ 100 for

Valuation of horse, \$ 100

Valuation of horse equipments, \$ 100

Remarks: Bank equip  
page lost 838

\*See enrollment on card from muster-in roll.

Book-mark :

Steel

(358c)

Copyist.

76

6 H. Art'y.

U.S.C.T.

John Harrison,  
Co. I, 6 Reg't U. S. Col'd H. Art'y.

Appears on

Company Muster Roll

for *Nov. & Dec*, 1864.

Joined for duty and enrolled:

When *Dec. 8*, 1863.\*

Where *Matchez*\*

Period *3* years.\*

Present or absent *Present*

Stoppage, \$ *100* for

Due Gov't \$ *100* for

Remarks:

-----  
-----  
-----  
-----  
-----

\* See enrollment on card from muster-in roll.

Book mark: *17*

*Steel*  
(358c) Copyist.

26

6 H. Art'y.

U.S.C.T.

John Harrison  
Co. I, 6 Reg't U. S. Col'd H. Art'y.

Appears on

Company Muster Roll

for Jan. & Feb., 1865.

Joined for duty and enrolled:

When Dec. 8, 1864.\*

Where Matetoy \*

Period 3 years.\*

Present or absent Present.

Stoppage, \$ 100 for

Due Gov't \$ 100 for

Remarks:

\* See enrollment on card from muster-in roll.

Book mark:

Hub Copyist.

(358c)

*H*

6 H. Art'y.

U.S.C.T.

*John Harrison,*  
*Pl.*

Co. I, 6 Reg't U. S. Col'd H. Art'y.

Appears on

**Company Muster Roll**

for *Mch. & Apr.* 1865.

Joined for duty and enrolled:

When *Dec. 8*, 1863.\*

Where *Natchez, Miss.*\*

Period *3* years.\*

Present or absent *Present.*

Stoppage, \$ *100* for

Due Gov't, \$ *100* for

Valuation of horse, \$ *100*

Valuation of horse equipments, \$ *100*

Remarks:

.....  
.....  
.....

\* See enrollment on card from muster-in roll.

Book-mark:

.....

*Steel*

(358c)

Copyist.

*H. Harty* U.S.C.T.

*John Harrison*  
*Pt. Co. 2, 6 Reg't U. S. Col'd Arty.*

Appears on

**Company Muster Roll**

for *May & June*, 1865.

Joined for duty and enrolled:

When *Dec. 8*, 1863\*

Where *Matchez*\*

Period *3* years.\*

Present or absent *Present*

Stoppage, \$ *100* for

Due Gov't, \$ *100* for

Valuation of horse, \$ *100*

Valuation of horse equipments, \$ *100*

Remarks:

\* See enrollment on card from muster-in roll.

Book mark:

*Stiller*

(358c)

Copyist.

26

John Harrison,  
Co. I, 6 Reg't U. S. Col'd H. Art'y.

Appears on

Company Muster Roll

for July & Aug., 1865.

Joined for duty and enrolled.

When Dec. 8, 1863.\*

Where Hatchiz, Miss.\*

Period 3 years.\*

Present or absent Present.

Stoppage, \$ 100 for

Due Gov't \$ 100 for

Remarks:

\* See enrollment on card from muster-in roll.

Book mark:

Stewart

*John Harrison,*  
*Priv.,* Co. I, 6 Reg't U. S. Col'd H. Art'y.

Appears on

**Company Muster Roll**

for *Sept & Oct*, 186*3*.

Joined for duty and enrolled:

When *Dec. 8*, 186*3*\*

Where *Watches Miss\**

Period *2* years.\*

Present or absent *Present*

Stoppage, \$ *1* <sup>*30*</sup>/<sub>*100*</sub> for *Camp. + G. E.*

Due Gov't \$ *100* for

Remarks:

-----  
-----  
-----  
-----  
-----

\* See enrollment on card from muster-in roll.

Book mark:

*E. E. Rauter*  
Copyist.

A

6 H. Art'y.

U.S.C.T.

*John Harrison*  
Pvt., Co. I, 6 Reg't U. S. Col'd H. Art'y.

Appears on

**Company Muster Roll**

for *Nov. & Dec.*, 1865.

Joined for duty and enrolled:

When *Dec. 8*, 1865.\*

Where *Natchez Miss.*\*

Period *3* years.\*

Present or absent *Present.*

Stoppage, \$ *1* <sup>*30*</sup>/<sub>*100*</sub> for *C. & G. C. trans.*  
*from Roll dated Oct. 31, 1865.*  
Due Gov't \$ <sup>*100*</sup>/<sub>*100*</sub> for

Remarks: \_\_\_\_\_  
\_\_\_\_\_  
\_\_\_\_\_  
\_\_\_\_\_  
\_\_\_\_\_

\* See enrollment on card from muster-in roll.

Book mark: \_\_\_\_\_

*J. J. Rankin*

(358c)

Copyist.



*John Harrison*  
*Priv.*, Co. I, 6 Reg't U. S. Col'd H. Art'y.

Appears on

**Company Muster Roll**  
for *Jan. & Feb.*, 186*6*.

Joined for duty and enrolled:

When *Dec. 8*, 186*3*.\*

Where *Natchez Miss* \*

Period *3* years.\*

Present or absent *Present*.

Stoppage, \$ *100* for

Due Gov't \$ *100* for

Remarks:

-----  
-----  
-----  
-----  
-----

\* See enrollment on card from muster-in roll.

Book mark:

*A. A. Rankin*

*John Harrison*  
Pvt., Co. I, 6 Reg't U. S. Col'd H. Art'y.

Appears on

**Company Muster Roll**

for *Mar. & Apr.*, 186*6*.

Joined for duty and enrolled:

When *Dec. 8*, 186*3*\*

Where *Matchez.*\*

Period *3* years.\*

Present or absent *Present.*

Stoppage, \$ *100* for

Due Gov't \$ *100* for

Remarks:  
-----  
-----  
-----  
-----  
-----  
-----  
-----  
-----

\* ~~See~~ See enrollment on card from muster-in roll.

Book mark: -----

*E. L. Rankin*  
(358c) Copyist.

*John Harrison*  
*Priv, Co. I, 6 Reg't U. S. Col'd H. Art'y.*

Appears on **Co. Muster-out Roll**, dated  
*Watches Miss May 13, 1866*

Muster-out to date *May 13, 1866*

Last paid to *Dec. 31, 1865*

Clothing account:

Last settled....., 186 ; drawn since \$..... 100

Due soldier \$ *32*<sup>*37*</sup>/<sub>*100*</sub>; due U. S. \$..... 100

Am't for cloth'g in kind or money adv'd \$..... 100

Due U. S. for arms, equipments, &c., \$..... 100

Bounty paid \$..... 100; due \$..... 100

Remarks: *Joined at original organization. Due Soldier on Account of clothing \$ 32*<sup>*37*</sup>/<sub>*100*</sub>

Book mark: *V. 133. P. 46. 71*  
*V. 240. P. 85. 77*

(361)

*C. E. M. Laughlin*  
Copyist.

*William, Mearns*  
Sgt., 6 U.S. Col'd H. Arty.

*Private* | *Private*

CARD NUMBERS.

1	6169371	26
2	6169523	27
3	6169665	28
4	6169809	29
5	6169932	30
6	6170059	31
7	6170164	32
8	6170267	33
9	6170373	34
10	6170477	35
11	6170591	36
12	6170710	37
13	6170825	38
14	6170936	39
15	6171044	40
16	6171142	41
17	6171236	42
18	6171331	43
19	9120069	44
20	9120242	45
21		46
22		47
23		48
24		49
25		50

Book Mark: \_\_\_\_\_

See also \_\_\_\_\_

*Martin Harrison*

....., Co. *G*, 6 Reg't U. S. Col'd H. Art'y.

Appears on

**Company Descriptive Book**

of the organization named above.

**DESCRIPTION.**

Age *23* years; height *5* feet *7 1/2* inches.

Complexion *Blk*

Eyes *Blk*; hair *Blk*

Where born *Memphis, Tenn.*

Occupation *Farmer*

**ENLISTMENT.**

When *Sept. 20*, 186*3*.

Where *Natchez Miss.*

By whom *C. N. Smith*; term *3* y'rs.

Remarks:  
.....  
.....  
.....  
.....  
.....  
.....  
.....  
.....  
.....  
.....

*Warren*

*Martin Harrison*

....., Co. *G*, 6 Reg't U. S. Col'd H. Art'y.

Appears on

**Company Descriptive Book**

of the organization named above.

**DESCRIPTION.**

Age *23* years; height *5* feet *7 1/2* inches.

Complexion *Blk*

Eyes *Blk*; hair *Blk*

Where born *Memphis, Tenn.*

Occupation *Farmer*

**ENLISTMENT.**

When *Sept. 20*, 186*3*.

Where *Natchez Miss.*

By whom *C. H. Smith*, term *3* y'rs.

Remarks:

.....  
.....  
.....  
.....  
.....  
.....  
.....  
.....

*Warren*

7

6 H. Art'y.

U.S.C.T.

*Martin Harrison*

*Put*, Co. G, 2 Reg't Miss. Art'y.\*

Age *23* years.

Appears on

**Company Muster-in Roll**

of the organization named above. Roll dated

*Katcher, Miss*, *Oct 20*, 1863.

Muster-in to date *Oct 20*, 1863.

Joined for duty and enrolled:

When *Sept 20*, 1863.

Where *Katcher, Miss*

Period *3* years.

Valuation of horse, \$ *100*

Valuation of horse equipments, \$ *100*

Remarks:

\*This organization subsequently became Co. G, 6 Reg't U. S. Colored Heavy Artillery.

Book mark:

*J. A. Ward*

(356)

Copyist.

4

6 H. Art'y.

U.S.C.T.

*Martin Harrison*

*Put*....., Co. G, 2 Reg't Miss. Art'y.\*

Appears on

**Company Muster Roll**

for *Oct 20 to 31*....., 1863.

Present or absent *Present*.....

Stoppage, \$..... *100* for.....

Due Gov't, \$..... *100* for.....

Valuation of horse, \$..... *100*

Valuation of horse equipments, \$..... *100*

Remarks:.....  
.....  
.....  
.....  
.....  
.....  
.....

\* This organization subsequently became Co. G, 6 Reg't U. S. Colored Heavy Artillery.

Book mark:.....

(358)

*J. A. Ward*

Copyist.



74

6 H. Art'y.

U.S.C.T.

Martin Harrison

Put, Co. G, 2 Reg't Miss. Art'y.\*

Appears on

Company Muster Roll

for Nov & Dec, 1863.

Present or absent Present

Stoppage, \$ 100 for

Due Gov't, \$ 100 for

Valuation of horse, \$ 100

Valuation of horse equipments, \$ 100

Remarks:

\* This organization subsequently became Co. G, 6 Reg't U. S. Colored Heavy Artillery.

Book mark:

J. A. Ward

*A*

6 H. Art'y.

U.S.C.T.

*Martin Harrison*

*Port*, Co. G, 2 Reg't Miss. Art'y.\*

Appears on

**Company Muster Roll**

for *Jan & Feb*, 186*4*.

Present or absent. *Present*

Stoppage, \$.....*100* for.....

Due Gov't, \$.....*100* for.....

Valuation of horse, \$.....*100*

Valuation of horse equipments, \$.....*100*

Remarks:.....

\* This organization subsequently became Co. G, 6 Reg't U. S. Colored Heavy Artillery.

Book mark:.....

*L. Y. Spann*

(358)

Copyist.

A

6 H. Art'y.

U.S.C.T.

Martin Harrison

Ort, Co. G, 5 Reg't U. S. Col'd H. Art'y.\*

Appears on

Company Muster Roll

for *March & April*, 1864

Present or absent *Present*

Stoppage, \$ *100* for

Due Gov't, \$ *100* for

Valuation of horse, \$ *100*

Valuation of horse equipments, \$ *100*

Remarks:

\* This organization subsequently became Co. G, 6 Reg't U. S. Col'd Heavy Artillery.

Book mark:

*L. J. Spann*

(358)

Copyist.

Martin Harrison

Prvt, Co. G, 6 Reg't U. S. Col'd H. Art'y.

Appears on

Company Muster Roll

for May & June, 1864

Present or absent Present

Stoppage, \$ 100 for

Due Gov't, \$ 100 for

Valuation of horse, \$ 100

Valuation of horse equipments, \$ 100

Remarks:

Book mark:

(358)

L. J. Spamer

Copyist.

*H*

6 H. Art'y.

U.S.C.T.

*Martin Garrison*

*Pvt.*, Co. G, 6 Reg't U. S. Col'd H. Art'y.

Appears on

**Company Muster Roll**

for *July & Aug.*, 1864.

Present or absent *Present.*

Stoppage, \$ *100* for

Due Gov't, \$ *100* for

Valuation of horse, \$ *100*

Valuation of horse equipments, \$ *100*

Remarks: *Due the United States  
for the loss of one harness  
\$0.44.  
100*

Book mark:

*H. Smith*

(358)

Copyist.

26

6 H. Art'y.

U.S.C.T.

*Madison Harrison*

*Pl*, Co. G, 6 Reg't U. S. Col'd H. Art'y.

Appears on

**Company Muster Roll**

for *Sept / Oct*, 1864.

Present or absent *Present*

Stoppage, \$ *100* for

Due Gov't, \$ *100* for

Valuation of horse, \$ *100*

Valuation of horse equipments, \$ *100*

Remarks: *Due the United States*

*for loss of one harness*

*40/100*

Book mark:

*[Signature]*

Copyist.

26

Martin Harrison

Pri., Co. G, 6 Reg't U. S. Col'd H. Art'y.

Appears on

Company Muster Roll

for Nov. & Dec., 1864.

Present or absent Present.

Stoppage, \$ 100 for

Due Gov't, \$ 100 for

Valuation of horse, \$ 100

Valuation of horse equipments, \$ 100

Remarks:

Book mark:

(358)

J. Smith

Copyist.

*Martin Harrison*

*Private*, Co. G, 6 Reg't U. S. Col'd H. Art'y.

Appears on

**Company Muster Roll**

for *Jany 1. Feb.*, 1865.

Present or absent. *Present*

Stoppage, \$ *100* for

Due Gov't, \$ *100* for

Valuation of horse, \$ *100*

Valuation of horse equipments, \$ *100*

Remarks:

Book mark:

*F. D. Neale*



*A*

6 H. Art'y.

U.S.C.T.

*Martin Harrison*

*Private*, Co. G, 6 Reg't U. S. Col'd H. Art'y.

Appears on

**Company Muster Roll**

for *March & April*....., 186*5*.

Present or absent *Present*.....

Stoppage, \$.....100 for.....

Due Gov't, \$.....100 for.....

Valuation of horse, \$.....100

Valuation of horse equipments, \$.....100

Remarks:.....

.....

.....

.....

.....

.....

.....

.....

Book mark:.....

.....

.....

*J. D. Neal*

Copyist.

*A*

6 H. Art'y.

U.S.C.T.

*Martin Harrison*

*Private*, Co. G, 6 Reg't U. S. Col'd H. Art'y.

Appears on

**Company Muster Roll**

for *May & June*, 186*5*.

Present or absent *Present*

Stoppage, \$ 100 for

Due Gov't, \$ 100 for

Valuation of horse, \$ 100

Valuation of horse equipments, \$ 100

Remarks:

Book mark:

*J. D. Neale*

(358)

Copyist.

H

6 H. Art'y.

U.S.C.T.

Martin Harrison

Plt, Co. G, 6 Reg't U. S. Col'd H. Art'y.

Appears on

Company Muster Roll

for July & Aug, 1865.

Present or absent present.

Stoppage, \$ 100 for

Due Gov't, \$ 100 for

Valuation of horse, \$ 100

Valuation of horse equipments, \$ 100

Remarks:

[Empty lines for remarks]

Book mark:

E Arsten Copyist.

Martin Harrison

Priv., Co. G, 6 Reg't U. S. Col'd H. Art'y.

Appears on

Company Muster Roll

for Sept<sup>-4</sup> Oct, 1865

Present or absent present

Stoppage, \$ 100 for

Due Gov't, \$ 100 for

Valuation of horse, \$ 100

Valuation of horse equipments, \$ 100

Remarks:

Book mark:

E. Grstein

H

6 H. Art'y.

U.S.C.T.

Martin Harrison

Plt., Co. G, 6 Reg't U. S. Col'd H. Art'y.

Appears on

Company Muster Roll

for Nov. 24 Dec, 1865:

Present or absent present

Stoppage, \$ 100 for

Due Gov't, \$ 100 for

Valuation of horse, \$ 100

Valuation of horse equipments, \$ 100

Remarks:

Book mark:

E. A. Arsten

Copyist.

H

Martin Harrison

Private, Co. G, 6 Reg't U. S. Col'd H. Art'y.

Appears on

Company Muster Roll

for Jan + Feb, 1866.

Present or absent Present

Stoppage, \$ 100 for

Due Gov't, \$ 100 for

Valuation of horse, \$ 100

Valuation of horse equipments, \$ 100

Remarks:

Book mark:

M. Chance

Copyist.

*H*

6 H. Art'y.

U.S.C.T.

*Martin Harrison*

*Priv*, Co. G, 6 Reg't U. S. Col'd H. Art'y.

Appears on

**Company Muster Roll**

for *Mar & Apr*, 1866 .

Present or absent *Present*

Stoppage, \$ *100* for

Due Gov't, \$ *100* for

Valuation of horse, \$ *100*

Valuation of horse equipments, \$ *100*

Remarks:  
\_\_\_\_\_  
\_\_\_\_\_  
\_\_\_\_\_  
\_\_\_\_\_  
\_\_\_\_\_  
\_\_\_\_\_  
\_\_\_\_\_  
\_\_\_\_\_

Book mark: \_\_\_\_\_

*W. O. Chance*

H

6 H. Art'y.

U.S.C.T.

Martin Harrison

Pvt, Co. G, 6 Reg't U. S. Col'd H. Art'y.

Appears on Co. Muster-out Roll, dated

Natchez, Miss, May 13, 1866.

Muster-out to date May 13, 1866.

Last paid to Dec 31, 1866.

Clothing account:

Last settled, 186 ; drawn since \$ 100

Due soldier \$ 100; due U. S. \$ 11 88/100

Am't for cloth'g in kind or money adv'd \$ 100

Due U. S. for arms, equipments, &c., \$ 100

Bounty paid \$ 100; due \$ 100

Remarks: Joined at original organization.

Book mark: 468891

no chance

(361)

Copyist.



Harrison, John  
Co B, 6 U.S. Col'd H. Art'y

Private

Private

CARD NUMBERS.

1	6157859	26
2	6158004	27
3	6158146	28
4	6158267	29
5	6158393	30
6	6158533	31
7	6158663	32
8	6158785	33
9	6158907	34
10	6159038	35
11	6159181	36
12	6159325	37
13	6159466	38
14	6159604	39
15	6159733	40
16	6159856	41
17	6159977	42
18	6160098	43
19	9119122	44
20		45
21		46
22		47
23		48
24		49
25		50

Book Mark:

See also

Peter Hanson

Co. B, 6 Reg't U. S. Col'd H. Art'y.

Appears on

Company Descriptive Book of the organization named above.

DESCRIPTION.

Age 19 years; height 5 feet 6 inches.

Complexion Black

Eyes Black; hair Black

Where born Ansonia Pa La

Occupation Farmer

ENLISTMENT.

When Sept 1, 1863.

Where Tachon Mass

By whom Capt. Hopkins; term 3 y'rs.

Remarks:

J. P. [Signature]

Peter Harrison  
Sgt., Co. B, 2 Reg't Miss. Art'y.†

Age 19 years.

Appears on

**Company Muster-in Roll**

of the organization named above. Roll dated

Natchez, Miss. Sept 12, 1863.

Muster-in to date Sept. 12, 1863.

Joined for duty and enrolled:

When Sept. 1st, 1863.\*

Where Natchez, Miss. \*

Period 3 years.\*

Valuation of horse, \$ 100

Valuation of horse equipments, \$ 100

Remarks:

† This organization subsequently became Co. B, 6 Reg't U. S. Colored Heavy Artillery.

\* Muster-in roll shows enrollment of all men of this company as of same date and place. See enrollment on subsequent card or cards.

Book mark:

M. W. Harrison

A.

6 H. Art'y.

U.S.C.T.

Peter Harrison

Private, Co. B, 2 Reg't Miss. Art'y.†

Appears on

Company Muster Roll

for Sept. 12 to Oct. 31, 1863.

Joined for duty and enrolled:

When Sept. 1st, 1863.\*

Where Hatchers Miss.\*

Period 3 years.\*

Present or absent Present

Stoppage, \$ 100 for

Due Gov't, \$ 100 for

Valuation of horse, \$ 100

Valuation of horse equipments, \$ 100

Remarks:

† This organization subsequently became Co. B, 6 Reg't U. S. Co'd Heavy Artillery.

\* See enrollment on card from muster-in roll.

Book mark:

W. M. Warren

(358c)

Copyist

Peter Harrison  
Private, Co. B, 2 Reg't Miss. Art'y.†

Appears on

**Company Muster Roll**

for Nov. & Dec., 1863.

Joined for duty and enrolled:

When Sept. 1st, 1863.\*

Where Shatchez, Miss. \*

Period 3 years.\*

Present or absent Present

Stoppage, \$ 100 for

Due Gov't, \$ 100 for

Valuation of horse, \$ 100

Valuation of horse equipments, \$ 100

Remarks: \_\_\_\_\_  
\_\_\_\_\_  
\_\_\_\_\_

† This organization subsequently became Co. B, 6 Reg't U. S. Co'd Heavy Artillery.  
\* See enrollment on card from muster-in roll.

Book mark: \_\_\_\_\_

M. M. Sharpe

*N.*

6 H. Art'y.

U.S.C.T.

*Peter Harrison*

*Private*, Co. B, ~~6~~ <sup>2</sup> Reg't U. S. ~~Col'd~~ <sup>Miss.</sup> Art'y. \*

Appears on

**Company Muster Roll**

for *Jan'y & Feb'y* 1864.

Joined for duty and enrolled:

When *Sept. 1st*, 1863.\*

Where *Shatchiz, Miss.* \*

Period *3* years.\*

Present or absent *Present*

Stoppage, \$ *100* for

Due Gov't, \$ *100* for

Remarks: \_\_\_\_\_  
\_\_\_\_\_  
\_\_\_\_\_

\* This organization subsequently be-  
came Co. B, 6<sup>th</sup> Regt. U. S. Col'd H. A.

\* See enrollment on card from muster-in roll.

\* *Connected War. 19/95: Drum.*  
Book-mark: \_\_\_\_\_

*M. M. Hasse*

(358c)

Copyist.

Peter Harrison

Private, Co. B, 5 Reg't U. S. Col'd H. Art'y.\*

Appears on

Company Muster Roll

for Mar. & April, 1864.

Joined for duty and enrolled:

When Sept. 1st, 1863.\*

Where Hatchery, Miss.\*

Period 3 years.\*

Present or absent Present

Stoppage, \$ 100 for

Due Gov't, \$ 100 for

Valuation of horse, \$ 100

Valuation of horse equipments, \$ 100

Remarks:

\* This organization subsequently became Co. B, 6 Reg't U. S. Col'd Heavy Artillery.  
\* See enrollment on card from muster-in roll.

Book mark:

M. M. Warren

*A.*

6 H. Art'y.

U.S.C.T.

*Peter Harrison*

*Private*, Co. B, 6 Reg't U. S. Col'd H. Art'y.

Appears on

**Company Muster Roll**

for *May & June* 1864.

Joined for duty and enrolled:

When *Sept. 1st*, 1863.\*

Where *Hatchez, Miss.*\*

Period *3* years.\*

Present or absent *Present*

Stoppage, \$ *100* for

Due Gov't, \$ *100* for

Remarks:

.....  
.....  
.....  
.....  
.....  
.....

\*See enrollment on card from muster-in roll.

Book-mark :

*M. M. Harrow*

(358c)

Copyist.



H.

6 H. Art'y.

U.S.C.T.

*Peter Harrison*

*Privt.*, Co. B, 6 Reg't U. S. Col'd H. Art'y.

Appears on

**Company Muster Roll**

for *July & Aug.* 1864.

Joined for duty and enrolled:

When *Sept. 1<sup>st</sup>*, 1863.\*

Where *Natchez Miss.*\*

Period *3* years.\*

Present or absent *Present.*

Stoppage, \$ *100* for

Due Gov't, \$ *100* for

Remarks:

\*See enrollment on card from muster-in roll.

Book-mark:

*H. C. Thomas*

(358c)

Copyist.

H.

6 H. Art'y.

U.S.C.T.

*Peter Harrison*

*Sgt*, Co. B, 6 Reg't U. S. Col'd H. Art'y.

Appears on

**Company Muster Roll**

for *Sept. & Oct.* 1864.

Joined for duty and enrolled:

When *Sept. 1<sup>st</sup>*, 1863.\*

Where *Natchez Miss.* \*

Period *3* years.\*

Present or absent *Present.*

Stoppage, \$ *100* for

Due Gov't, \$ *100* for

Remarks:

-----  
-----  
-----  
-----  
-----  
-----  
-----  
-----

\* See enrollment on card from muster-in roll.

Book-mark:

-----  
-----

(358c)

*H. C. Thomas*

Copyist.

H.

6 H. Art'y.

U.S.C.T.

*Peter Harrison*

*Privt.*, Co. B, 6 Reg't U. S. Col'd H. Art'y.

Appears on

**Company Muster Roll**

for *Nov. & Dec.* 1864.

Joined for duty and enrolled:

When *Sept. 1<sup>st</sup>*, 1863.\*

Where *Natchez Miss.* \*

Period *3* years.\*

Present or absent *Present*.

Stoppage, \$ *100* for

Due Gov't, \$ *100* for

Remarks:

.....  
.....  
.....  
.....  
.....  
.....

\* See enrollment on card from muster-in roll.

Book-mark:

.....

*H. C. Thomas*

Copyist.

(358c)

H.

6 H. Art'y.

U.S.C.T.

*Peter Harrison.*

*Smt.*, Co. B, 6 Reg't U. S. Col'd H. Art'y.

Appears on

**Company Muster Roll**

for *Jan'y. & Feby.* 1865.

Joined for duty and enrolled:

When *Sept. 1<sup>st</sup>*, 1863.\*

Where *Natchez Miss.* \*

Period *3* years.\*

Present or absent *Present.*

Stoppage, \$ *100* for

Due Gov't, \$ *100* for

Remarks:

.....  
.....  
.....  
.....  
.....  
.....  
.....

\*~~See~~ See enrollment on card from muster-in roll.

Book-mark:

.....

(358c)

*H. C. Thomas.*

Copyist.

H.

6 H. Art'y.

U.S.C.T.

*Peter Harrison.*

*Privt.*, Co. B, 6 Reg't U. S. Col'd H. Art'y.

Appears on

**Company Muster Roll**

for *March April* 1865.

Joined for duty and enrolled:

When *Sept. 1<sup>st</sup>*, 1863.\*

Where *Natchez Miss.*\*

Period *3* years.\*

Present or absent *Present.*

Stoppage, \$ *100* for

Due Gov't, \$ *100* for

Remarks:

\*~~See~~ See enrollment on card from muster-in roll.

Book-mark :

*H. C. Thomas.*

(358c)

Copyist.

H.

6 H. Art'y.

U.S.C.T.

*Peter Harrison.*

*Privt.*, Co. B, 6 Reg't U. S. Col'd H. Art'y.

Appears on

**Company Muster Roll**

for *May & June* 1865.

Joined for duty and enrolled:

When *Sept. 1<sup>st</sup>*, 1863.\*

Where *Natchez Miss.*\*

Period *3* years.\*

Present or absent *Present.*

Stoppage, \$ *100* for

Due Gov't, \$ *100* for

Remarks:

\* See enrollment on card from muster-in roll.

Book-mark :

(358c)

Copyist.

5

*Peter Harrison*  
Pvt, Co. B, 6 Reg't U. S. Col'd H. Art'y.

Appears on

**Company Muster Roll**

for *July & Aug* 1865.

Joined for duty and enrolled:

When *Sep. 1*, 1865.\*

Where *Tatchez, Miss.* \*

Period *2* years.\*

Present or absent *Present*,

Stoppage, \$ *100* for

Due Gov't, \$ *100* for

Remarks:  
.....  
.....  
.....  
.....  
.....  
.....  
.....

\* See enrollment on card from muster-in roll.

Book-mark : .....

(358c)

*Cabine*  
Copyist.

76

6 H. Art'y.

U.S.C.T.

*Peter Harrison*

*Pvt.*, Co. B, 6 Reg't U. S. Col'd H. Art'y.

Appears on

**Company Muster Roll**

for *Sep<sup>r</sup> Oct* 1865.

Joined for duty and enrolled:

When *Sep. 1*, 1865.\*

Where *Natchez, Miss.*\*

Period *3* years.\*

Present or absent *Absent.*

Stoppage, \$ *100* for

Due Gov't, \$ *100* for

Remarks *Detached at*

*Rodney, Miss. since*  
*Sept. 1, '65.*

\*See enrollment on card from muster-in roll.

Book-mark :

*Sabine*

(358c)

Copyist.



*H*

6 H. Art'y.

U.S.C.T.

*Peter Harrison*

*Art*, Co. B, 6 Reg't U. S. Col'd H. Art'y.

Appears on

**Company Muster Roll**

for *Nov Dec* 1865.

Joined for duty and enrolled:

When *Sep. 1*, 1865.\*

Where *Natchez, Miss.*\*

Period *2* years.\*

Present or absent *Present.*

Stoppage, \$ *100* for

Due Gov't, \$ *100* for

Remarks:

-----  
-----  
-----  
-----  
-----  
-----

\* See enrollment on card from muster-in roll.

Book-mark:

-----  
-----

*Sabine*

Copyist.

(358c)

*H*

6 H. Art'y.

U.S.C.T.

*Peter Harrison*

*Cpt.*, Co. B, 6 Reg't U. S. Col'd H. Art'y.

Appears on

**Company Muster Roll**

for *Jan Feb* 186*6*.

Joined for duty and enrolled:

When *Sep*, 186*3*.\*

Where *Natchez, Miss.*\*

Period *3* years.\*

Present or absent *Present*.

Stoppage, \$ *100* for

Due Gov't, \$ *100* for

Remarks:

-----  
-----  
-----  
-----  
-----  
-----  
-----

\* See enrollment on card from muster-in roll.

Book-mark:

-----

*Savine*

(358c)

Copyist.

*Peter Harrison*

*Pvt*, Co. B, 6 Reg't U. S. Col'd H. Art'y.

Appears on

**Company Muster Roll**

for *Mar & Apr* 1866.

Joined for duty and enrolled:

When *Sept 1<sup>st</sup>*, 1863.\*

Where *Madison Miss* \*

Period *3* years.\*

Present or absent *present*

Stoppage, \$ *100* for

Due Gov't, \$ *100* for

Remarks:

\*~~See~~ See enrollment on card from muster-in roll.

Book-mark:

*W. H. Miller*

Copyist.

*Peter Harrison*

*Pvt.*, Co. *B.*, 6 Reg't U. S. Col'd H. Art'y.

Appears on **Co. Muster-out Roll**, dated

*Natchez Miss May 13, 1866.*

Muster-out to date *May 13, 1866.*

Last paid to *Dec. 31, 1865.*

**Clothing account:**

Last settled....., 186 ; drawn since \$..... 100

Due soldier \$ *78* <sup>*60*</sup> 100; due U. S. \$..... 100

Am't for cloth'g in kind or money adv'd \$..... 100

Due U. S. for arms, equipments, &c., \$..... 100

Bounty paid \$..... 100; due \$..... 100

Remarks: *Joined at Original Organization*

Book mark: .....

(361)

*J. E. Nichol*

Copyist.

Harrison, Rand

Co M, 6 U.S. Col'd H. Art'y.

Private

Private

CARD NUMBERS.

1	6179207	26
2	6179300	27
3	6179475	28
4	6180792	29
5	9121051	30
6	40712460	31
7		32
8		33
9		34
10		35
11		36
12		37
13		38
14		39
15		40
16		41
17		42
18		43
19		44
20		45
21		46
22		47
23		48
24		49
25		50

Book Mark:

See also

Rep 350360  
S-1013279-P.O. aff  
S.1240207 and 2nd.

F. H. Hardy

Randall Harrison  
Col. (M), 6 Reg't U. S. Col'd H. Art'y.

Appears on  
Company Descriptive Book  
of the organization named above.

DESCRIPTION.

Age 18 years; height 5 feet 3 inches.  
Complexion Brown  
Eyes black; hair black  
Where born Adams Co Miss  
Occupation farmer

ENLISTMENT.

When Jan 21, 1864.  
Where Natchez Miss  
By whom Capt Padu; term 3 y'rs.  
Remarks: Died

-----  
-----  
-----  
-----  
-----  
-----  
-----  
-----  
-----  
-----

Hilton

No.

6 H. Art'y.

U.S.C.T.

Randall Harrison

Priv., Co. M, 2 Reg't Miss. Art'y.†

Age 18 years.

Appears on

**Company Muster-in Roll**

of the organization named above. Roll dated

Natchez, Miss., Jan. 21, 1864.

Muster-in to date Jan. 21, 1864.

Joined for duty and enrolled:

When Jan. 21, 1864.\*

Where Natchez, Miss.\*

Period 3 years.\*

Valuation of horse, \$ 100

Valuation of horse equipments, \$ 100

Remarks:

† This organization subsequently became Co. M, 6 Reg't U. S. Colored Heavy Artillery.

\* Muster-in roll shows enrollment and muster-in of this company as of same date and place. See enrollment on subsequent card or cards.

Book mark:

(356c)

J. J. Kearney

Copyist.



26

6 H. Art'y.

U.S.C.T.

Randall Harrison

Priv., Co. M, 2 Reg't Miss. Art'y.†

Appears on

Company Muster Roll

for Jan. 21 to Feb. 29, 1864.

Joined for duty and enrolled:

When Jan. 21, 1864.\*

Where Natchez, Miss.\*

Period 3 years.\*

Present or absent Present

Stoppage, \$ 100 for

Due Gov't, \$ 100 for

Valuation of horse, \$ 100

Valuation of horse equipments, \$ 100

Remarks:

† This organization subsequently became Co. M, 6 Reg't U. S. Col'd Heavy Artillery.

\* See enrollment on card from muster-in roll.

Book mark:

(358c)

J. J. Kearney

Copyist.

Randall Harrison

Priv., Co. M, 5 Reg't U. S. Col'd H. Art'y.\*

Appears on

Company Muster Roll

for Feb & Apl, 1864.

Joined for duty and enrolled :

When Jan 21, 1864.\*

Where Natchez, Miss.\*

Period 3 years.\*

Present or absent

Stoppage, \$ 100 for

Due Gov't, \$ 100 for

Valuation of horse, \$ 100

Valuation of horse equipments, \$ 100

Remarks: Died in Reg't Hospital of Disease Apl 8. '64

\* This organization subsequently became Co. M, 6 Reg't U. S. Col'd Heavy Artillery.

\* See enrollment on card from muster-in roll.

Book mark :

(358c)

J. J. Kearney Copyist.

A

6 H. Art'y.

U.S.C.T.

Randall Harrison

Private, Co. ...., 6 Reg't U. S. Col'd H. Art'y.

Appears on Returns as follows:

April 1864 (Co M 5th  
Col'd H. Art'y) Died  
in Reg't Hospital  
of disease April  
8, 64 Natchez Miss

Book mark:

(546)

A. Gouglad

Copyist.

Randall Harrison

Com, Co. M, 6 Reg't U. S. Col'd H. Art'y.

Appears on Co. Muster-out Roll, dated Natchez Miss May 13, 1866.

Muster-out to date \_\_\_\_\_, 1866 .

Last paid to \_\_\_\_\_, 1866 .

Clothing account:

Last settled \_\_\_\_\_, 1866 ; drawn since \$ \_\_\_\_\_ 100

Due soldier \$ \_\_\_\_\_ 100 ; due U. S. \$ \_\_\_\_\_ 100

Am't for cloth'g in kind or money adv'd \$ \_\_\_\_\_ 100

Due U. S. for arms, equipments, &c., \$ \_\_\_\_\_ 100

Bounty paid \$ \_\_\_\_\_ 100 ; due \$ \_\_\_\_\_ 100

Remarks: Joined at original organization. Died April 8 1864 of pneumonia at Natchez Miss. Final statements furnished April 1864

Book mark: 606, 1882 V. 71.P. 46.69

J. Nelson Copyist.

(361)

Harrison, Randall

O, Co. M, 6 U.S.C.H.A.

2 Enclosures.

Bed Cards	Descriptive Lists
Burial Records	Final Statements /
Certs. of Dis. for Discharge	Furloughs
C. M. Charges	Med. Des. Lists
Med. Certificates	Orders

Other papers relating to—

Admission to Hosp'l	Furlough
Casualty Sheet (Officer's)	Med. Examination
Confinement	Misc. Information
Contracts	Pay or Clothing
Death or Effects /	Personal Reports
Desertions	Rank
Discharge from Hosp'l	Transfer to Hosp'l
Discharge from Service	Transfer to V. R. C.
Duty	Transportation

*C. M.*  
**FINAL STATEMENT**

OF

*Frank Randall Harrison*  
*C. M.*

*5<sup>th</sup>* Reg't of *U. S. Art (C)*  
*6<sup>th</sup> U. S.*

**VOLUNTEERS.**

*Rec'd - Paid 5/18/64*

NOTE 1.—Two of these certificates (or duplicates) are to be given to each Volunteer Soldier or drafted man who may be discharged previously to the discharge of his company, that he may at once receive from the Paymaster the pay, &c., due him, and the captain or other COMMISSIONED officer commanding the company will certify to the act of the delivery of the duplicate certificates; these certificates the Soldier is "entitled to" his discharge, and should also present his discharge to the Paymaster to have the payment endorsed on it. The discharge is to be given back to the Soldier by the Paymaster; the latter only retaining as his voucher the duplicate certificates.

NOTE 2.—If the Soldier is entitled to pay for the use of his horse, the Company Commander will certify to that fact on the back of both these final statements, and also to the time he has pay due for having been mounted on his own horse.

NOTE 3.—When a Soldier is furnished with final statements, his descriptive list, if he has one, should be taken up by the officer who gives the Soldier these statements, and endorsed with a statement to this effect by the officer. This endorsement should exhibit a full statement of the time for which the Soldier was allowed pay on his final statements, the clothing account, and all other charges against him or in his favor, so as to comprise a complete exhibit of his account. It will then be transmitted to the company commander of the Soldier, who will enter all the data necessary to a full understanding of the Soldier's account on the muster roll upon which the Soldier's discharge is reported. The descriptive list will then be destroyed. The object of this is, that the remaining portion of the Soldier's account may be settled upon the receipt of these muster rolls, and the Soldier receive any pay or allowances that may be due him at the time of his discharge, and which may not appear on his final statements from the fact that his descriptive list is incomplete. These accounts for back pay, &c., are settled by the 2d Auditor of the Treasury Department.

NOTE 4.—Charges for loss or injury to ordnance, horse equipments, and other miscellaneous charges, should appear under the heading of "Other Stoppages."

NOTE 5.—Bounty paid by State authorities, and not by the United States, will not be entered on this statement.

NOTE 6.—Amounts due the Sutler and Laundress must be entered on the muster roll on which the discharge, death, desertion, &c., is reported, as well as on the final statement, otherwise the amount cannot be collected from the United States.

NOTE 7.—This blank will be used for deceased volunteers and drafted men, as well as for others.

NOTE 8.—Where a Soldier dies in Hospital or on detached service, his descriptive list, if he has one, should be sent with his final statements, in duplicate, to the Second Auditor, Washington, D. C.

**ADJUTANT GENERAL'S OFFICE.**

*Aug 24<sup>th</sup> 1864*

Duplicate with Inventory sent 2d Auditor.



*[Handwritten signature]*

I certify, on honor, that Randall Garrison a Private of  
Captain Leadle's Company (M) of the 5<sup>th</sup> Regiment of U.S. Regt Art (C)  
~~VOLUNTEERS~~, of the State of \_\_\_\_\_, born in Dumas Co., State  
of Miss, aged 18 years; 5 feet 3 inches high; Brown complexion,  
Black eyes, Black hair, and by occupation a Farmer having joined the company on  
its original organization at Natchez Miss, and enrolled in it at the muster into  
the service of the United States at Natchez Miss, on the Twenty first day  
of January, 1864, (or was mustered in service as a recruit, by \_\_\_\_\_  
at \_\_\_\_\_, on the \_\_\_\_\_ day of \_\_\_\_\_,  
1864, or was drafted and mustered into the service of the United States from the \_\_\_\_\_  
Enrollment District of the State of \_\_\_\_\_, at \_\_\_\_\_,  
on the \_\_\_\_\_ day of \_\_\_\_\_, 1864,) to serve in the Regiment, for  
the term of Three Years: and having served HONESTLY and  
FAITHFULLY with his Company in the Regiment to the present date, is now  
entitled to a **DISCHARGE** by reason of Death

The said Randall Garrison has pay due  
from Enrollment to include the \_\_\_\_\_ day of \_\_\_\_\_, 1864, and has  
pay due him from that time to the present date; he is entitled to pay and subsistence for  
TRAVELING to place of enrollment, and whatever other allowances are authorized to volunteer  
soldiers, drafted men, or militia, so discharged. He has received from the United States **CLOTHING**  
amounting to Forty four  $\frac{47}{100}$  dollars, since the 21<sup>st</sup> day of January,  
1864, when his clothing account was last settled. He has received from the United States  
100 dollars advanced **BOUNTY**.

There is to be stopped from him, on account of the State of \_\_\_\_\_, or other  
authorities, for **CLOTHING**, &c, received on entering service, \_\_\_\_\_  $\frac{100}{100}$  dollars; and  
for other stoppages, viz:  
\_\_\_\_\_  
\_\_\_\_\_  $\frac{100}{100}$  dollars.  
He has been furnished with **TRANSPORTATION** in kind from the place of his discharge to  
\_\_\_\_\_; and he has been **SUBSISTED** for **TRAVELING** to his  
place of enrollment, up to the \_\_\_\_\_, 1864.  
He is indebted to \_\_\_\_\_, **SUTLER**, \_\_\_\_\_  $\frac{100}{100}$  dollars.  
He is indebted to \_\_\_\_\_, **LAUNDRESS**, \_\_\_\_\_  $\frac{100}{100}$  dollars.

Given in Duplicate, at Natchez Mississippi, this 8<sup>th</sup> day  
of April, 1864.

William S. Leadle  
Capt 5<sup>th</sup> U.S. Regt Art (C)  
Commanding Company M

Inventory of Effects.

Randall Harrison

2 Miss vols — city

(Key)



Inventory of the effects of *Randall Harrison* late  
 a *Private* of Captain *John L. Cadles* Company *M* of  
 the *5th* Regiment of *Ms. Heavy Artillery* Volunteers, who was enrolled as  
 a *Private* at *Natchez Miss* in the State of *Mississippi* on  
 the *21st* day of *January* 1864 and mustered into the service of the United  
 States as a *Private* on the *21st* day of *January* 1864 at *Natchez Miss*  
 in Company *M*, *5th* Regiment of *Ms. Heavy Artillery* to serve *3*  
 years or during the war; he was born in *Adams Co* in the State  
 of *Mississippi*; he was *18* years of age, *5* feet *7* inches  
 high, *Brown* complexion; *Black* eyes, *Black* hair, and by occupation, when enrolled,  
 a *Hammer*; he died in *Hospital* at  
*Natchez Miss* on the *8th* day of *April* 1864 by  
 reason of *Disease*

INVENTORY.					
ARTICLES.	NO.	ARTICLES	NO.	ARTICLES.	NO.
Hats.....		Pairs Trowsers.....		Knapsacks.....	
Caps.....		Pairs flannel Drawers.....			
Forage Caps.....		Pairs cotton Drawers.....			
Great Coats.....		Flannel Shirts.....			
Uniform Coats.....		Cotton Shirts.....			
Uniform Jackets.....		Pairs boots.....			
Flannel Sack Coats.....		Pairs shoes.....			
Blouses.....		Pairs socks.....			
Stable Frocks.....		Blankets.....			
Fatigue Overalls.....		Haversacks.....			
				MONEY.	
				Specie.....	\$
				Notes.....	\$

I CERTIFY ON HONOR, that the above inventory comprises all the effects of *Private*  
*Randall Harrison*, deceased, and that the effects are in the hands  
 of ..... at .....  
 to be disposed of by a Council of Administration.

(DUPLICATES.)

STATION *Natchez Miss*  
 DATE: *April 8, 1864*

*William L. Cadles*  
*Capt 5th Ms. Heavy Artillery*  
 Commanding the Company.

*Harrison, Thomas*

Co I, 6 U.S. Col'd H. Art'y.

*Private*

*Private*

CARD NUMBERS.

1	6173619	26
2	6173761	27
3	6173907	28
4	6174036	29
5	6174169	30
6	6174286	31
7	6174395	32
8	6174506	33
9	6174619	34
10	6174737	35
11	6174855	36
12	6174971	37
13	6175077	38
14	6175187	39
15	6175292	40
16	6175391	41
17	6175487	42
18	9120550	43
19		44
20		45
21		46
22		47
23		48
24		49
25		50

Book Mark: \_\_\_\_\_

See also \_\_\_\_\_

Thomas Harrison

Co. I, 6 Reg't U. S. Col'd H. Art'y.

Appears on

Company Descriptive Book

of the organization named above.

DESCRIPTION.

Age 23 years; height 5 feet 2 1/2 inches.

Complexion Light Brown

Eyes Brown; hair Blk

Where born Adams Co., Miss.

Occupation Laborer

ENLISTMENT.

When Dec 8, 1863.

Where Natchez, Miss.

By whom Capt. H. Harburt, term 3 y'rs.

Remarks:

[Empty lines for remarks]

Warren

Thomas Harrison  
Capt., Co. I, 2 Reg't Miss. Art'y.†

Age 23 years.

Appears on

**Company Muster-in Roll**

of the organization named above. Roll dated

Natchez, Miss., Dec. 17, 1863.

Muster-in to date Dec. 8, 1863.

Joined for duty and enrolled:

When Dec. 8, 1863.\*

Where Natchez, Miss. \*

Period 3 years.\*

Valuation of horse, \$ 100

Valuation of horse equipments, \$ 100

Remarks:

† This organization subsequently became Co. I, 6 Reg't U. S. Colored Heavy Artillery.

\* Muster-in roll shows enrollment of all men of this company of same date and place. See enrollment on subsequent card or cards.

Book mark:

(356c) T. C. Taylor Copyist.

Thomas Harrison  
Pvt., Co. I, 2 Reg't Miss. Artillery.†

Appears on

**Company Muster Roll**

for Dec. 17 to Dec. 31, 1863.

Joined for duty and enrolled:

When Dec. 8, 1863.\*

Where Natchez \*

Period 3 years.\*

Present or absent Present

Stoppage, \$ 100 for

Due Gov't, \$ 100 for

Valuation of horse, \$ 100

Valuation of horse equipments, \$ 100

Remarks:

† This organization subsequently became Co. I, 6 Reg't U. S. Colored Heavy Artillery.  
\* See enrollment on card from muster-in roll.

Book mark:

J. C. Taylor

A

6 H. Art'y.

U.S.C.T.

Thomas Harrison

Pvt., Co. I, 2 Reg't Miss. Artillery.†

Appears on

Company Muster Roll

for Jan. and Feb., 1864.

Joined for duty and enrolled:

When Dec. 8, 1863.\*

Where Natchez \*

Period 3 years.\*

Present or absent Present

Stoppage, \$ 100 for

Due Gov't \$ 100 for

Valuation of horse, \$ 100

Valuation of horse equipments, 100

Remarks:

† This organization subsequently became Co. I, 6 Reg't U. S. Colored Heavy Artillery.

\* See enrollment on card from muster-in roll.

Book mark:

(358c)

J. C. Taylor

Copyist.

Thomas Harrison  
Pvt, Co. I, 5 Reg't U. S. Col'd H. Art'y.\*

Appears on

**Company Muster Roll**

for *Mar. and Apr.*, 1864.

Joined for duty and enrolled :

When *December 8*, 1863.\*

Where *Natchez* \*

Period *3* years.\*

Present or absent *Present*

Stoppage, \$ *100* for

Due Gov't, \$ *100* for

Valuation of horse, \$ *100*

Valuation of horse equipments, \$ *100*

Remarks: \_\_\_\_\_  
\_\_\_\_\_  
\_\_\_\_\_

\* This organization subsequently became Co. I, 6 Reg't U. S. Col'd Heavy Artillery.  
\* See enrollment on card from muster-in roll.

Book mark: \_\_\_\_\_

(358c)

*T. C. Taylor*

Copyist.

A

6 H. Art'y.

U.S.C.T.

Thomas Harrison  
Pvt., Co. I, 6 Reg't U. S. Col'd H. Art'y.

Appears on

**Company Muster Roll**

for *May and June*, 1864.

Joined for duty and enrolled:

When *Dec. 8*, 186*3*.\*

Where *Natchez* \*

Period *3* years.\*

Present or absent *Present*

Stoppage, \$ *100* for

Due Gov't \$ *100* for

Remarks:

-----  
-----  
-----  
-----  
-----

\* See enrollment on card from muster-in roll.

Book mark:

*J. C. Taylor*  
(358c) Copyist.



A

6 H. Art'y.

U.S.C.T.

Thomas Harrison  
Capt., Co. I, 6 Reg't U. S. Col'd H. Art'y.

Appears on

**Company Muster Roll**

for July and Aug., 1864.

Joined for duty and enrolled:

When Dec. 8, 1863\*

Where Natchez \*

Period 3 years.\*

Present or absent Present

Stoppage, \$ 100 for

Due Gov't \$ 100 for

Remarks:

\* See enrollment on card from muster-in roll.

Book mark:

(358c)

D. C. Taylor

Copyist.

*M. J.* 6 H. Art'y. | U.S.C.T.

*Thomas Harrison,*

*Sgt.*, Co. I, 6 Reg't U. S. Col'd H. Art'y.

Appears on

Company Muster Roll

for *Sep. & Oct.* 186*4*.

Joined for duty and enrolled:

When *Dec. 8*, 186*3*.\*

Where *Marchez* \*

Period *3* years.\*

Present or absent *Present.*

Stoppage, \$ *100* for

Due Gov't, \$ *100* for

Valuation of horse, \$ *100*

Valuation of horse equipments, \$ *100*

Remarks: *Account Equi*  
*Page lost 40¢.*

\* See enrollment on card from muster-in roll.

Book-mark :

*Steele*

(358c)

Copyist.

*H*

6 H. Art'y.

U.S.C.T.

*Thomas Harrison*

*A.*, Co. I, 6 Reg't U. S. Col'd H. Art'y.

Appears on

**Company Muster Roll**

for *Nov & Dec*, 1864.

Joined for duty and enrolled:

When *Dec 8*, 1863.\*

Where *Katchy*\*

Period *3* years.\*

Present or absent *Present*

Stoppage, \$ *100* for

Due Gov't \$ *100* for

Remarks:

-----  
-----  
-----  
-----  
-----

\* See enrollment on card from muster-in roll.

Book mark:

-----  
*Auto*

50

6 H. Art'y.

U.S.C.T.

Thomas Harrison

St., Co. I, 6 Reg't U. S. Col'd H. Art'y.

Appears on

Company Muster Roll

for Jan & Feb, 1865.

Joined for duty and enrolled:

When Dec. 8, 1864.\*

Where Natchez\*

Period 3 years.\*

Present or absent Present

Stoppage, \$ 100 for

Due Gov't \$ 100 for

Remarks:

\* See enrollment on card from muster-in roll.

Book mark:

Steele

(358c)

Copyist.

*N* | 6 H. Art'y. | U.S.C.T.

*Thomas Harrison*

*Pl.*, Co. I, 6 Reg't U. S. Col'd H. Art'y.

Appears on

**Company Muster Roll**

for *mch. & upc.* 186*9*.

Joined for duty and enrolled:

When *Dec. 8*, 186*8*.\*

Where *Watches, Miss.*\*

Period *3* years.\*

Present or absent *Present.*

Stoppage, \$ *100* for

Due Gov't, \$ *100* for

Valuation of horse, \$ *100*

Valuation of horse equipments, \$ *100*

Remarks:

\*See enrollment on card from muster-in roll.

Book-mark:

*Stale*  
(358c) Copyist.

H. G. Hart. U.S.C.T.

Thomas Harrison,  
Pt. Co. I, 6 Reg't U. S. Col'd. arty.

Appears on

**Company Muster Roll**

for May & June, 1865.

Joined for duty and enrolled:

When Dec. 8, 1863\*

Where Matchez\*

Period 3 years.\*

Present or absent Present

Stoppage, \$ 100 for

Due Gov't, \$ 100 for

Valuation of horse, \$ 100

Valuation of horse equipments, \$ 100

Remarks:

\* See enrollment on card from muster-in roll.

Book mark:

Steele

*TH*

6 H. Art'y. | U.S.C.T.

*Thomas Harrison*

*D.*, Co. I, 6 Reg't U. S. Col'd H. Art'y.

Appears on

**Company Muster Roll**

for *July & Aug*, 186*5*.

Joined for duty and enrolled:

When *Dec. 8*, 186*5*.\*

Where *Natchez, Miss* \*

Period *3* years.\*

Present or absent *Present*

Stoppage, \$ *100* for

Due Gov't \$ *100* for

Remarks:  
-----  
-----  
-----  
-----  
-----  
-----

\* See enrollment on card from muster-in roll.

Book mark:-----

*Steele*

(358c)

Copyist.

A.

6 H. Art'y.

U.S.C.T.

Thomas Harrison

Priv., Co. I, 6 Reg't U. S. Col'd H. Art'y.

Appears on

Company Muster Roll

for Sept & Oct., 1865.

Joined for duty and enrolled:

When Dec. 8, 1863.\*

Where Natchez Miss. \*

Period 3 years.\*

Present or absent Present.

Stoppage, \$ 1 <sup>30</sup>/<sub>100</sub> for Camp & G. E.

Due Gov't \$ <sup>100</sup>/<sub>100</sub> for

Remarks:

-----  
-----  
-----  
-----  
-----

\* See enrollment on card from muster-in roll.

Book mark:

P. E. Rankin

(358c)

Copyist.



Thomas Harrison  
Pvt., Co. I, 6 Reg't U. S. Col'd H. Art'y.

Appears on

Company Muster Roll

for Nov. & Dec., 1865.

Joined for duty and enrolled:

When Dec. 8, 1863.\*

Where Stachez Miss.\*

Period 2 years.\*

Present or absent Present

Stoppage, \$ 1 <sup>30</sup>/<sub>100</sub> for Co. & G. E. trans  
from Roll dated Oct. 31, 1865.  
Due Gov't \$ <sup>100</sup>/<sub>100</sub> for

Remarks:

\* See enrollment on card from muster-in roll.

Book mark:

(358c)

E. E. Rankin  
Copyist.

H

6 H. Art'y.

U.S.C.T.

Thomas Harrison  
Pvt., Co. I, 6 Reg't U. S. Col'd H. Art'y.

Appears on

Company Muster Roll

for Jan. & Feb., 1866.

Joined for duty and enrolled:

When Dec. 8, 1863.\*

Where Natchez Miss.\*

Period 2 years.\*

Present or absent Present.

Stoppage, \$ 100 for

Due Gov't \$ 100 for

Remarks:

\* See enrollment on card from muster-in roll.

Book mark:

J. E. Rankin

(358c)

Copyist.

*H* | **6 H. Art'y.** | **U.S.C.T.**

*Thomas Harrison*  
*Priv.*, Co. I, 6 Reg't U. S. Col'd H. Art'y.

Appears on

**Company Muster Roll**  
for *Mar. & Apr.*, 186*6*.

Joined for duty and enrolled:

When *Dec. 8*, 186*3*.\*

Where *Matchez*.\*

Period *3* years.\*

Present or absent *Present*.

Stoppage, \$ *100* for

Due Gov't \$ *100* for

Remarks:

\* See enrollment on card from muster-in roll.

Book mark:

*J. A. Rankin*  
(358c) Copyist.

*Thomas Harrison*  
*Priv., Co. I., 6 Reg't U. S. Col'd H. Art'y.*

Appears on **Co. Muster-out Roll**, dated  
*Natchez, Miss. May 13, 1866.*

Muster-out to date *May 13, 1866.*

Last paid to *Dec. 31, 1865.*

Clothing account:

Last settled....., 186 ; drawn since \$..... 100

Due soldier \$ *26<sup>20</sup>*/<sub>100</sub>; due U. S. \$..... 100

Am't for cloth'g in kind or money adv'd \$..... 100

Due U. S. for arms, equipments, &c., \$..... 100

Bounty paid \$..... 100; due \$..... 100

Remarks: *Joined at original organization. Due Soldier on Account of Clothing \$26<sup>20</sup>/<sub>100</sub>*

Book mark: *V. 79. P. 115. 69*

(361) *C. E. M. Laughlin*  
Coppist.

426  
Harrison, William

Co A, 6 U.S. Col'd H. Art.

Private

Corporal

CARD NUMBERS.

1	6154113	26
2	6175769	27
3	6175904	28
4	6176039	29
5	6176159	30
6	6176272	31
7	6176384	32
8	6176499	33
9	6176621	34
10	6176741	35
11	6176818	36
12	6176932	37
13	6177045	38
14	6177153	39
15	6177261	40
16	6177369	41
17	9120795	42
18	40742461	43
19		44
20		45
21		46
22		47
23		48
24		49
25		50

Book Mark:

See also

J 636298 P.6. 96.  
D 2437818 PONTM  
D. 3022800 PONTM  
D. 3024178 PONTM  
Hdt care UK 1516 5-5-42

H. H. G. G.

William Harwood

Co. K, 6 Reg't U. S. Col'd H. Art'y.

Appears on

Company Descriptive Book  
of the organization named above.

DESCRIPTION.

Age 25 years; height 5 feet 1 inches.

Complexion Copper

Eyes Black; hair black

Where born Calahoula, La.

Occupation Soldier

ENLISTMENT.

When Jan 29, 1864.

Where Natchez, Miss.

By whom Capt Kempes; term 3 y'rs.

Remarks: Appointed Corp Oct 25 1865

-----  
-----  
-----  
-----  
-----  
-----  
-----

W. H. Hittner

*William Harrison*  
Pvt., Co. *K*, *2<sup>d</sup>* Reg't *Miss. \** U.S. *Art.* *Art.*

Age *25* years.

Appears on a

**Detachment Muster-in Roll**

of the organization named above. Roll dated

*Natchez Miss.*, *Jan. 29*, 186*4*.

Muster-in to date *Jan. 29*, 186*4*.

Joined for duty and enrolled:

When *Jan. 29*, 186*4*.

Where *Natchez Miss.*

Period *3* years.

Valuation of horse, \$ *100*

Valuation of horse equipments, \$ *100*

Remarks: *Muster in to take effect from date of enrollment.*

*\* Corrected May 27, 96, Comd.*

*\* Became the 6<sup>th</sup> U.S. C. H. Art.*

Book mark: \_\_\_\_\_

*Waggett*



*L*

6 H. Art'y.

U.S.C.T.

*William Harrison*

*Co. K, 2 Reg't Miss. Artillery.†*

Appears on

**Company Muster Roll**

for *Jan 8<sup>th</sup> to July 29<sup>th</sup>*, 1864.

Joined for duty and enrolled:

When *Jan 29<sup>th</sup>*, 1864.\*

Where *Natchez Miss* \*

Period *3* years.\*

Present or absent *Present*

Stoppage, \$ *100* for

Due Gov't \$ *100* for

Valuation of horse, \$ *100*

Valuation of horse equipments, *100*

Remarks:

† This organization subsequently became Co. K, 6 Reg't U. S. Colored H. Art'y.

\* See enrollment on card from muster-in roll.

Book mark:

*J. P. Miller*

William Harrison

Bat Co. K, 5 Reg't U. S. Col'd H. Art'y.\*

Appears on

Company Muster Roll

for Mar & Apr, 1864

Joined for duty and enrolled:

When Jan 29, 1864\*

Where Washington Miss\*

Period 3 years.\*

Present or absent present

Stoppage, \$ 100 for

Due Gov't, \$ 100 for

Valuation of horse, \$ 100

Valuation of horse equipments, \$ 100

Remarks:

\* This organization subsequently became Co. , 6 Reg't U. S. Col'd Heavy Artillery.

\* See enrollment on card from muster-in roll.

Book mark:

(858c)

M. H. Harris

Copyist.

*A*

6 H. Art'y.

U.S.C.T.

*William Harrison*

*Art*, Co. K, 6 Reg't U. S. Col'd H. Art'y.

Appears on

**Company Muster Roll**

for *May & June*, 1864.

Joined for duty and enrolled:

When *Jan 29*, 1864.\*

Where *Nashy Mus* \*

Period *3* years.\*

Present or absent *present*

Stoppage, \$ *100* for

Due Gov't \$ *100* for

Remarks:

-----  
-----  
-----  
-----  
-----

\* See enrollment on card from muster-in roll.

Book mark:

-----

(358c)

*Spiller*

Copyist.

26

6 H. Art'y.

U.S.C.T.

William Harrison  
Pri., Co. K, ~~2 Reg't Miss. Artillery.~~ <sup>6 Reg't U. S. Col'd Art'y.</sup>

Appears on

Company Muster Roll

for July & Aug., 1864.

Joined for duty and enrolled:

When Jan. 29, 1864.\*

Where Natchez, Miss.\*

Period 3 years.\*

Present or absent Present.

Stoppage, \$ 100 for

Due Gov't \$ 100 for

Valuation of horse, \$ 100

Valuation of horse equipments, 100

Remarks:

~~†This organization subsequently became Co. K, 6 Reg't U. S. Colored H. Art'y. x~~

\* See enrollment on card from muster-in-roll.  
x Corrected Oct. 29, 1894. GBS

Book mark:

(358c)

J. Smith

Copyist.

*William Harrison*  
*Priv*, Co. K, 6 Reg't U. S. Col'd H. Art'y.

Appears on

Company Muster Roll  
for *Sept. & Oct.*, 186*4*

Joined for duty and enrolled:

When *Jan 29*, 186*4*\*

Where *Natchez, Miss*\*

Period *3* years.\*

Present or absent *Present*

Stoppage, \$ *100* for

Due Gov't \$ *100* for

Remarks:  
-----  
-----  
-----  
-----  
-----  
-----

\* See enrollment on card from muster-in roll.

Book mark: -----

(358c)

*J B Gage*  
Copyist.

H

6 H. Art'y.

U.S.C.T.

*William Harrison*  
Private, Co. K, 6 Reg't U. S. Col'd H. Art'y.

Appears on

**Company Muster Roll**

for *Nov. and Dec.*, 1864

Joined for duty and enrolled:

When *Jan. 29*, 1864\*

Where *Natchez, Miss*\*

Period *3* years.\*

Present or absent *Present*

Stoppage, \$ *100* for

Due Gov't \$ *100* for

Remarks:  
-----  
-----  
-----  
-----  
-----  
-----

\* See enrollment on card from muster-in roll.

Book mark:-----

*C. J. Powell*

(358c)

Copyist.

A

6 H. Art'y.

U.S.C.T.

William Harrison,  
Private, Co. K, 6 Reg't U. S. Col'd H. Art'y.

Appears on

**Company Muster Roll**

for Jan, and Feb., 1865.

Joined for duty and enrolled:

When Jan. 29, 1864.\*

Where Natchez, Miss. \*

Period 3 years.\*

Present or absent Present

Stoppage, \$ 100 for

Due Gov't \$ 100 for

Remarks:

\* See enrollment on card from muster-in roll.

Book mark:

C. J. Powell

(358c)

Copyist.

H

6 H. Art'y.

U.S.C.T.

William Harrison  
Private, Co. K, 6 Reg't U. S. Col'd H. Art'y.

Appears on

**Company Muster Roll**

for March and April, 1865.

Joined for duty and enrolled:

When Jan. 29, 1864.\*

Where Natchez, Miss \*

Period 3 years.\*

Present or absent Present

Stoppage, \$ 100 for

Due Gov't \$ 100 for

Remarks:

-----  
-----  
-----  
-----  
-----

\* ~~See~~ See enrollment on card from muster-in roll.

Book mark: 1

C. G. Powell

(358c)

Copyist.



N

6 H. Art'y.

U.S.C.T.

William Harrison,  
Private, Co. K, 6 Reg't U. S. Col'd H. Art'y.

Appears on

Company Muster Roll

for May and June, 1865.

Joined for duty and enrolled:

When Jan. 29, 1864.\*

Where Natchez, Miss. \*

Period 3 years.\*

Present or absent Present

Stoppage, \$ 100 for \_\_\_\_\_

Due Gov't \$ 100 for \_\_\_\_\_

Remarks: \_\_\_\_\_  
\_\_\_\_\_  
\_\_\_\_\_  
\_\_\_\_\_  
\_\_\_\_\_

\* See enrollment on card from muster-in roll.

Book mark: \_\_\_\_\_

O. J. Powell  
Copyist.

*H*

6 H. Art'y.

U.S.C.T.

*William Harrison*  
*Copple*, Co. K, 6 Reg't U. S. Col'd H. Art'y.

Appears on

**Company Muster Roll**

for *July and Aug.*, 186*5*.

Joined for duty and enrolled:

When *Jan. 23*, 186*4*\*

Where *Natchez, Miss.* \*

Period *3* years.\*

Present or absent *Present*

Stoppage, \$ *100* for

Due Gov't \$ *100* for

Remarks:

*Promoted to Corporal*  
*July 25/65. vice Ham-*  
*ilton Promoted*

\* ~~See~~ See enrollment on card from muster-in roll.

Book mark:

*C. G. Powell*

(358c)

Copyist.

William Harrison  
Corpl, Co. K, 6 Reg't U. S. Col'd H. Art'y.

Appears on

Company Muster Roll  
for Sept & Oct, 1865.

Joined for duty and enrolled:

When Jan 29<sup>th</sup>, 1864.\*

Where Natchez, Miss.\*

Period 3 years.\*

Present or absent Present

Stoppage, \$ 100 for

Due Gov't \$ 100 for

Remarks:  
-----  
-----  
-----  
-----  
-----

\* See enrollment on card from muster-in roll.

Book mark: -----

(858c) *W. Harrison* Copyist.

0.4

6 H. Art'y.

U.S.C.T.

*William Harrison*  
Co. K, 6 Reg't U. S. Col'd H. Art'y.

Appears on

**Company Muster Roll**

for *Nov & Dec*, 1865.

Joined for duty and enrolled:

When *Jan 29*, 1864\*

Where *Marchez Miss*\*

Period *3* years.\*

Present or absent *Present*

Stoppage, \$ *100* for

Due Gov't \$ *100* for

Remarks:

-----  
-----  
-----  
-----  
-----

\* See enrollment on card from muster-in roll.

Book mark:

(358c)

*W. H. Harrison*

Copyist.

QV

6 H. Art'y.

U.S.C.T.

William Harrison  
Lopez, Co. K, 6 Reg't U. S. Col'd H. Art'y.

Appears on

**Company Muster Roll**

for Jan & Feb, 1866.

Joined for duty and enrolled:

When Jan 29, 1864.\*

Where Natchez Miss.\*

Period 3 years.\*

Present or absent Present

Stoppage, \$ 100 for

Due Gov't \$ 100 for

Remarks:

\* See enrollment on card from muster-in roll.

Book mark:

W. L. Houston

(358c)

Copyist.

W

6 H. Art'y.

U.S.C.T.

William Harrison  
Copy, Co. K, 6 Reg't U. S. Col'd H. Art'y.

Appears on

Company Muster Roll

for March & April, 1866.

Joined for duty and enrolled:

When Jan 29", 1864.\*

Where Natchez Miss \*

Period 3 years.\*

Present or absent Present

Stoppage, \$ 100 for

Due Gov't \$ 100 for

Remarks:

\* See enrollment on card from muster-in roll.

Book mark:

W. L. Davidson

(358c)

Copyist.

A

6 H. Art'y.

U.S.C.T.

William Harrison

Co. \_\_\_\_\_, 6 Reg't U. S. Col'd H. Art'y.

Appears on Returns as follows:

Jan 1864 (Co K 2<sup>nd</sup> Miss  
H Art A.D.) Gain  
Jan 29, 64 Katchez  
Miss. Recruited

Book mark: \_\_\_\_\_

(545)

*R. Gouglab*

Copyist.

HC

6 H. Art'y.

U.S.C.T.

William Harrison  
Corp., Co. K, 6 Reg't U. S. Col'd H. Art'y.

Appears on Co. Muster-out Roll, dated  
Natchez, Miss May 13 1866.

Muster-out to date May 13, 1866.

Last paid to Dec. 31, 1865.

Clothing account:

Last settled, 186 ; drawn since \$ 100

Due soldier \$ 21 <sup>18</sup>/<sub>100</sub>; due U. S. \$ 100

Am't for cloth'g in kind or money adv'd \$ 100

Due U. S. for arms, equipments, &c., \$ 100

Bounty paid \$ 100; due \$ 100

Remarks: Joined as recruit.  
Promoted Corp. July 25, 1865.

Book mark: V. 248, P. 33, 77

G. W. Chase



*Harry Henry*  
Co *A*, 6 U.S. Col'd H. Art'y

*Private*

CARD NUMBERS.

1	26
2	27
3 <i>Henry, Harry</i>	28
4	29
5	30
6	31
7	32
8	33
9	34
10	35
11	36
12	37
13	38
14	39
15	40
16	41
17	42
18	43
19	44
20	45
21	46
22	47
23	48
24	49
25	50

Book Mark:

See also

*Harvey, William*

Co I, 6 U.S. Col'd H. Art'y.

*Private*

*Private*

CARD NUMBERS.

1	6173620	26
2	6155667	27
3	6173762	28
4	6173979	29
5	6175578	30
6	9120551	31
7	40742463	32
8		33
9		34
10		35
11		36
12		37
12		38
14		39
15		40
16		41
17		42
18		43
19		44
20		45
21		46
22		47
23		48
24		49
25		50

Book Mark:

See also

*A*

*James William Harvey*

....., Co. *D*, 6 Reg't U. S. Col'd H. Art'y.

Appears on

**Company Descriptive Book**

of the organization named above.

**DESCRIPTION.**

Age *26* years; height *5* feet *8* inches.

Complexion *Blk*

Eyes *Blk*; hair *Blk*

Where born *Concordia La*

Occupation *Laborer*

**ENLISTMENT.**

When *Dec 8*, 186*3*.

Where *Natchez, Miss.*

By whom *Capt. G. Herbert*; term *3* y'rs.

Remarks: *Died Jan. 23/64 of Typhoid Fever*

*\* as appears on Roll*

*W. J. Wassen*

A

6 H. Art'y. | U.S.C.T.

William Harvey  
Pvt., Co. I, 2 Reg't Miss. Art'y.†

Age 36 years.

Appears on

**Company Muster-in Roll**

of the organization named above. Roll dated

Natchez, Miss., Dec. 17, 1863.

Muster-in to date Dec. 8, 1863.

Joined for duty and enrolled:

When Dec. 8, 1863.\*

Where Natchez, Miss. \*

Period 3 years.\*

Valuation of horse, \$ 100

Valuation of horse equipments, \$ 100

Remarks:

† This organization subsequently became Co. I, 6 Reg't U. S. Colored Heavy Artillery.

\* Muster-in roll shows enrollment of all men of this company as of same date and place. See enrollment on subsequent card or cards.

Book mark:

D. C. Taylor

(356c)

Copyist.

76

6 H. Art'y.

U.S.C.T.

William Harvey  
Pri., Co. A, 2 Reg't Miss. Art'y.†

Appears on

**Company Muster Roll**

for Aug 30 to Oct 31, 1863.

Joined for duty and enrolled:

When Oct 12, 1863.\*

Where Natchez Miss.\*

Period 3 years.\*

Present or absent Present

Stoppage, \$ 100 for

Due Gov't \$ 100 for

Valuation of horse, \$ 100

Valuation of horse equipments, 100

Remarks Joined by enlistment  
in Company

† This organization subsequently became Co. A, 6 Reg't U. S. Colored Heavy Artillery.

\* See enrollment on card from muster-in roll.

Book mark:

W. Smith

(358c)

Copyist.

A

6 H. Art'y.

U.S.C.T.

*William Harvey*  
Pvt., Co. I, 2 Reg't Miss. Artillery.†

Appears on

**Company Muster Roll**

for *Dec. 17 to Dec. 31, 1863*

Joined for duty and enrolled:

When *Dec. 8*, 186*3*.\*

Where *Natchez* \*

Period *3* years.\*

Present or absent *Present*

Stoppage, \$ *100* for

Due Gov't, \$ *100* for

Valuation of horse, \$ *100*

Valuation of horse equipments, \$ *100*

Remarks: \_\_\_\_\_

† This organization subsequently became Co. I, 6 Reg't U. S. Colored Heavy Artillery.  
\* See enrollment on card from muster-in roll.

Book mark: \_\_\_\_\_

(358c)

*J. C. Taylor*

Copyist.

A

6 H. Art'y.

U.S.C.T.

*William Harvey*  
Pvt., Co. I, 2 Reg't Miss. Artillery.†

Appears on

**Company Muster Roll**

for *Jan. and Feb.*, 1864.

Joined for duty and enrolled:

When *Dec. 8*, 186*B*.\*

Where *Natchez* \*

Period *3* years.\*

Present or absent.....

Stoppage, \$..... 100 for.....

Due Gov't \$..... 100 for.....

Valuation of horse, \$..... 100

Valuation of horse equipments, ..... 100

Remarks: *Died in Reg't Hospital Jan. 23, 1864.*

† This organization subsequently became Co. I, 6 Reg't U. S. Colored Heavy Artillery.

\* See enrollment on card from muster-in roll.

Book mark:.....

*D. C. Taylor*

(358c)

Copyist.

A

H. Art'y.

U.S.C.T.

William Harvey  
Pot, Co. ...., 6 Reg't U. S. Col'd H. Art'y.

Appears on Returns as follows:

Dec 1863 (Co I 2<sup>nd</sup> Miss  
H Art. P. H.) On  
duty in Reg'l  
Hosp  
Jan 1864 Died  
of disease Jan  
2/3, 64 Reg'l Hosp

Book mark:

(546) A. Gouglan Copyist.



*H*

6 H. Art'y.

U.S.C.T.

*William Harvey*

*Priv., Co.*, 6 Reg't U. S. Col'd H. Art'y.

Appears on **Co. Muster-out Roll**, dated

*Natchez Miss., May 13, 1866*

Muster-out to date \_\_\_\_\_, 186

*Pay due from Enrollment*

Last paid to \_\_\_\_\_, 186

**Clothing account:**

Last settled \_\_\_\_\_, 186 ; drawn since \$ 100

Due soldier \$ 100; due U. S. \$ 100

Am't for cloth'g in kind or money adv'd \$ 100

Due U. S. for arms, equipments, &c., \$ 100

Bounty paid \$ 100; due \$ 100

Remarks: *Joined at original organization. Died of Typhoid Fever January 23, 1864 at Natchez Miss. Final Statements furnished.*

Book mark: *93.289*

*C. E. M. Laughlin*

(361)

*Copist.*

Harvey, William

P, Co. *D*, 6 U.S.C.H.A.

*3* Enclosures.

Bed Cards	Descriptive Lists
Burial Records	Final Statements <i>/</i>
Certs. of Dis. for Discharge	Furloughs
C. M. Charges	Med. Des. Lists
Med. Certificates	Orders

Other papers relating to—

Admission to Hosp'l	Furlough
Casualty Sheet (Officer's)	Med. Examination
Confinement	Misc. Information
Contracts	Pay or Clothing
Death or Effects <i>2</i>	Personal Reports
Desertions	Rank
Discharge from Hosp'l	Transfer to Hosp'l
Discharge from Service	Transfer to V. R. C.
Duty	Transportation

INVENTORY OF THE EFFECTS

OF

William Harvey

Late of Company I

5<sup>th</sup> Reg't of 1<sup>st</sup> Arty Heavy

Volunteers, who died at Putney

on the 23<sup>rd</sup> day of January 1864.

JUL  
17  
1864

Inventory of the effects of William Harvey late  
 a Private of Captain H. Herbert Company of  
 the 2<sup>nd</sup> Regiment of Miss Art Volunteers, who was enrolled as  
 a Private at Hatchers in the State of Mississippi  
 the 8<sup>th</sup> day of December 1863, and mustered into the service of the United  
 States as a Private on the 17<sup>th</sup> day of December 1863, at Hatchers  
 in Company I, 2<sup>nd</sup> Regiment of Miss Art Volunteers, to serve Three  
 years or during the war; he was born in Concordia in the State  
 of Louisiana; he was 26 years of age, 5 feet 11 inches  
 high Yellow complexion Brown eyes, Black hair, and by occupation, when enrolled,  
 a Laborer; he died in Hospital at  
Hatchers Miss on the 23<sup>rd</sup> day of January 1864, by  
 reason of Intermittent Fever.

INVENTORY.					
ARTICLES.	No.	ARTICLES.	No.	ARTICLES.	No.
Hats .....		Pairs trousers .....		Knapsacks .....	
Caps .....		Pairs flannel drawers .....			
Forage caps .....		Pairs cotton drawers .....			
Great coats .....		Flannel shirts .....			
Uniform coats .....		Cotton shirts .....			
Uniform jackets .....		Pairs boots .....			
Flannel sack coats .....		Pairs shoes .....			
Blouses .....		Pairs socks .....			
Stable frocks .....		Blankets .....			
Fatigue overalls .....		Haversacks .....			
				MONEY.	
				Specie .....	\$
				Notes .....	\$

I CERTIFY, ON HONOR, that the above inventory comprises all the effects of .....,  
 deceased, and that the effects are in the hands  
 of ..... at .....  
 to be disposed of by a Council of Administration.

( DUPLICATES. )

STATION: Hatchers Miss

DATE: January 24<sup>th</sup> 1864

[ A. G. O. No. 104. ]

H. Herbert  
Capt 2<sup>d</sup> Miss Art. A. V.  
 Commanding the Company.

INVENTORY OF THE EFFECTS

OF

Private ~~William~~ Harvey

Late of Company *I*

*6<sup>th</sup>* Reg't of *U. S. Artillery*

Volunteers, who died at *Hatchers Mill*

on the *23* day of *January* 1864.

JUL  
17  
1871

Inventory of the effects of William Harvey late  
 a Private of Captain H. Harburt Company D of  
 the Sixth Regiment of U.S. Artillery Volunteers, who was enrolled as  
 a Private at Natchez in the State of Mississippi on  
 the 8<sup>th</sup> day of December 1863, and mustered into the service of the United  
 States as a Private on the 17<sup>th</sup> day of December 1863, at Natchez  
 in Company D, 6<sup>th</sup> Regiment of U.S. Artillery Volunteers, to serve three  
 years or during the war; he was born in Carrollton in the State  
 of Louisiana; he was 26 years of age, 5 feet 8 inches  
 high, Black complexion, Black eyes, Black hair, and by occupation, when enrolled,  
 a Laborer; he died in Hospital, at  
Natchez Miss on the 23<sup>rd</sup> day of January 1864, by  
 reason of Dysphoria Fever

INVENTORY.					
ARTICLES.	No.	ARTICLES.	No.	ARTICLES.	No.
Hats.....		Pairs trousers.....		Knapsacks.....	
Caps.....		Pairs flannel drawers.....			
Forage caps.....		Pairs cotton drawers.....			
Great coats.....		Flannel shirts.....			
Uniform coats.....		Cotton shirts.....			
Uniform jackets.....		Pairs boots.....			
Flannel sack coats.....		Pairs shoes.....			
Blouses.....		Pairs socks.....			
Stable frocks.....		Blankets.....			
Fatigue overalls.....		Haversacks.....			
				MONEY.	
				Specie.....	\$
				Notes.....	\$

I CERTIFY, ON HONOR, that the above inventory comprises all the effects of .....  
 ....., deceased, and that the effects are in the hands  
 of ..... at .....  
 ..... to be disposed of by a Council of Administration.

(DUPLICATES.)

STATION: Natchez Miss

DATE: January 25<sup>th</sup> 1865

[A. G. O. No. 404.]

H. Harburt  
Capt 6<sup>th</sup> U.S. Artillery  
 Commanding the Company.

SEC. 12. And be it further enacted, That the fees of agents and attorneys for making out and causing to be executed the papers necessary to establish a claim for a pension, bounty, and other allowance before the Pension Office, under this act, shall not exceed the following rates: For making out and causing to be duly executed a declaration by the applicant, with the necessary affidavits, and forwarding the same to the Pension Office, with the requisite correspondence, ten dollars; which sum shall be received by such agent or attorney in full for all services in obtaining such pension, and shall not be demanded or received, in whole or in part, until such pension shall be obtained; and the sixth and seventh sections of an act entitled "An act to grant pensions," approved July [fourteenth,] eighteen hundred and sixty-two, are hereby repealed.

SEC. 13. And be it further enacted, That any agent or attorney who shall, directly or indirectly, demand or receive any greater compensation for his services under this act than is prescribed in the preceding section of this act, or who shall contract or agree to prosecute any claim for a pension, bounty, or other allowance under this act, on the condition that he shall receive a per centum upon any portion of the amount of such claim, or who shall wrongfully withhold from a pensioner or other claimant the whole or any part of the pension or claim allowed and due to such pensioner or claimant, shall be deemed guilty of a high misdemeanor, and, upon conviction thereof, shall, for every such offense, be fined not exceeding three hundred dollars, or imprisoned at hard labor not exceeding two years, or both, according to the circumstances and aggravations of the offense.

Approved July 4, 1864.

NOTE. 10.—If any soldier is charged a higher fee than that allowed by the above act, he should report the fact and the name of the agent to the Adjutant General, in order that steps may be taken to have the same refunded.

OF  
Private William Carvey  
Co. C. Reg't of U. S. C. Artillery

VOLUNTEERS.  
Died Jan'y 23<sup>rd</sup> 1864

NOTE 1.—Two of these certificates (or duplicates) are to be given to each Volunteer Soldier or drafted man who may be discharged without being mustered out (Final Statements are never given to men mustered out of service) that he may at once receive from the Paymaster the pay, &c., due to him, and the captain or other COMMISSIONED officer commanding the company will certify to the act of the delivery of the duplicate certificates; with these certifies the Soldier is "entitled to" his discharge, and should also present his discharge to the Paymaster to have the payment endorsed on it. The discharge is to be given back to the Soldier by the Paymaster; the latter only retaining as his vouchers the duplicate certificates.

NOTE 2.—If the Soldier is entitled to pay for the use of his horse, the Company Commander will certify to that fact on the back of both these final statements, and also to the time he has pay due for having been so mounted on his own horse.

NOTE 3.—When a Soldier is furnished with final statements, his descriptive list, if he has one, should be taken up by the officer who gives the Soldier these statements, and endorsed with a statement to this effect by the officer. The endorsement should exhibit a full statement of the time for which the Soldier was allowed pay on his final statements, the clothing account, and all other charges against him or in his favor, so as to comprise a complete exhibit of his account. It will then be transmitted to the Company Commander of the Soldier, who will enter all the data necessary to a full understanding of the Soldier's account on the muster roll upon which the Soldier's discharge is reported. The descriptive list will then be destroyed. The object of this is, that the remaining portion of the Soldier's account may be settled upon the receipt of these muster rolls, and the Soldier receive any pay or allowances that may be due him at the time of his discharge, and which may not appear on his last final statements from the fact that his descriptive list is incomplete. These accounts for back pay, &c., are settled by the 2d Auditor of the Treasury Department.

NOTE 4.—Charges for loss or injury to ordnance, horse equipments, and other miscellaneous charges, should appear under the heading of "Other Stoppages."

NOTE 5.—Bounty paid by State authorities, and not by the United States, will not be entered on this statement.

NOTE 6.—Amounts due the Sutler and Laundress must be entered on the muster roll on which the discharge, death, desertion, &c., is reported, as well as on the final statement, otherwise the amount cannot be collected from the United States.

NOTE 7.—This blank will be used for deceased volunteers and drafted men, as well as for others.

NOTE 8.—Where a Soldier dies in Hospital or on detached service, his descriptive list, if he has one, should be sent with his final statements, in duplicate, to the Adjutant General, Washington, D. C.

NOTE 9.—If the soldier is a drafted man or substitute, the space for time of enrolled, should contain only the word *drafted* or *substitute*, as the case may be. If the Soldier is a "VETERAN," (or RECRUIT,) the words *as a veteran*, (or *recruit*,) as the case may be, should be interlined after the word *entered into the service of the U. S.* A statement of all the instalments of Veteran or Recruit Bounty RECEIVED by the Soldier must be made on the back of each final statement.

ADJUTANT GENERAL'S OFFICE  
May 19<sup>th</sup> 1864  
Duplicate with file in [unclear]

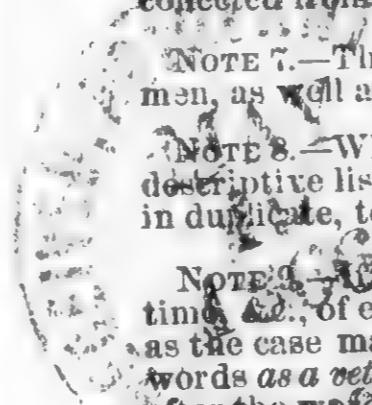

[Handwritten signature]

I certify on honor, that William Harvey, a Private of  
Captain Roberts Company of the 6<sup>th</sup> Regiment of U.S. Col. Infy.  
Volunteers, of the State of \_\_\_\_\_, born in Concordia State  
of Louisiana, aged 26 years; 5 feet 8 inches high; Black complexion,  
Black eyes, Black hair, and by occupation a Laborer, who joined for service  
and was enrolled (see Note 9) on the 8<sup>th</sup> day of December, 1863, at Natchez Miss  
by Capt. Roberts, for the period of Three years, and mustered into  
the service of the United States on the 17<sup>th</sup> day of December, 1863, at  
Natchez Miss, by Capt. C. E. Gaustman; and ~~having~~ <sup>has</sup> served  
**HONESTLY** and **FAITHFULLY** with his Company to the present date, is now entitled to a  
**DISCHARGE** by reason of Victory of January 1864. when he died.  
at Natchez Miss. Cause Typhoid fever.

The said William Harvey was last paid by Paymaster  
pay due him from to include the 8<sup>th</sup> day of Dec 1863, date of Enlistment and  
has pay due him from that time to the present date; he is entitled to pay and subsistence for  
**TRAVELING** to place of enrollment, and whatever other allowances are authorized to volunteer  
soldiers, drafted men, or militia, so discharged. He has received from the United States **CLOTHING**  
amounting since Enlistment \_\_\_\_\_ dollars since the \_\_\_\_\_ day of \_\_\_\_\_,  
1863, when his clothing account was last settled. He has received from the United States  
\_\_\_\_\_ dollars advanced **BOUNTY**.

There is to be stopped from him, on account of the State of \_\_\_\_\_, or other  
authorities, for **CLOTHING**, &c., received on entering service, \_\_\_\_\_ dollars; and  
for other stoppages, viz: \_\_\_\_\_  
\_\_\_\_\_ dollars.  
He has been furnished with **TRANSPORTATION** in kind from the place of his discharge to  
\_\_\_\_\_; and he has been **Subsisted** for **Traveling** to his  
place of enrollment, up to the \_\_\_\_\_, 1863.

He is indebted to \_\_\_\_\_, **Sutler**, \_\_\_\_\_ dollars.

He is indebted to \_\_\_\_\_, **Laundress**, \_\_\_\_\_ dollars.

Given in Duplicate, at Natchez Miss, this 6<sup>th</sup> day  
of May, 1866.

Roberts  
Capt. 6<sup>th</sup> U.S. Col. Infy.  
Commanding Company.



*1861*  
G., 6 U.S. Col'd H. Art'y

*Private*

CARD NUMBERS.

1	26
2	27
3	28
4	29
5	30
6	31
7	32
8	33
9	34
10	35
11	36
12	37
13	38
14	39
15	40
16	41
17	42
18	43
19	44
20	45
21	46
22	47
23	48
24	49
25	50

Book Mark:

See also

Hatkins Robert

Co G, 6 U.S. Col'd H. Art'y.

Private

CARD NUMBERS.

1	26
2	27
3	28
4	29
5	30
6	31
7	32
8	33
9	34
10	35
11	36
12	37
13	38
14	39
15	40
16	41
17	42
18	43
19	44
20	45
21	46
22	47
23	48
24	49
25	50

Book Mark:

See also

*Havel Isaac*

Co *F*, 6 U.S. Col'd H. Art'y.

*Private* | *Private*

CARD NUMBERS.

1	6167257	26
2	6167475	27
3	6169302	28
4	9119921	29
5	76-39-05-1875	30
6		31
7		32
8		33
9		34
10		35
11		36
12		37
12		38
14		39
15		40
16		41
17		42
18		43
19		44
20		45
21		46
22		47
23		48
24		49
25		50

Book Mark: *2/B. 1/331.*      *739 D. 11 C. 575*

See also

14 | 6 H. Art'y. | U.S.C.T.

*Joads*  
*Jack A. Javel*

Co. *A*, 6 Reg't U. S. Col'd H. Art'y.

Appears on

**Company Descriptive Book**  
of the organization named above.

**DESCRIPTION.**

Age *31* years; height *5* feet *9* inches.

Complexion *Blk*

Eyes *Blk*; hair *Blk*

Where born *Adams Co, Miss*

Occupation *Farmer*

**ENLISTMENT.**

When *Aug. 29*, 186*3*.

Where *Natchez*

By whom *Lt. Scheek*; term *3* y'rs.

Remarks: *Resisted at Natchez*  
*Miss. Sept. 23/63*

-----  
-----  
-----  
-----  
-----  
-----  
-----  
-----

*Warren*

(383g)

Copist.

28.

| 6 H. Art'y. | U.S.C.T.

Isaac Havel

Pvt., Co. <sup>F.</sup>, 2 Reg't Miss. Art'y.†

Age 31 years.

Appears on

**Company Muster-in Roll**

of the organization named above. Roll dated

Natchez, Miss., Sept. 12, 1863.

Muster-in to date Sept. 12, 1863.

Joined for duty and enrolled:

When Aug. 29, 1863.\*

Where Natchez, Miss. \*

Period 3 years.\*

Valuation of horse, \$ 100

Valuation of horse equipments, \$ 100

Remarks:

† This organization subsequently became Co. <sup>F.</sup>, 6 Reg't U. S. Colored Heavy Artillery.

\* Muster-in roll shows enrollment of all men of this company as of same date and place. See enrollment on subsequent card or cards.

Book mark:

Crooks

*Isack Havel*

*Pvt.*, Co. F, 2 Reg't Miss. Artillery.†

Appears on

**Company Muster Roll**

for *Sept. 12 to Oct. 31*, 1863.

Joined for duty and enrolled:

When *Aug. 27*, 1863.\*

Where *Matchez, Miss.*\*

Period *3* years.\*

Present or absent.....

Stoppage, \$ *100* for.....

Due Gov't \$ *100* for.....

Valuation of horse, \$ *100*

Valuation of horse equipments, \$ *100*

Remarks: *Deserted at  
Matchez, Miss.  
September 23, 1863.*

† This organization subsequently became Co. F, 6 Reg't U. S. Colored Heavy Artillery.  
\* See enrollment on card from muster-in roll.

Book mark: .....

*Brooke*

*W*

*Isaac Havel*  
Sgt., Co. *T*, 6 Reg't U. S. Col'd H. Art'y.

Appears on **Co. Muster-out Roll**, dated  
*Hatchers Run, May 13*, 186*6*.  
Muster-out to date \_\_\_\_\_, 186*6*.  
Last paid to *Pay due from enrollment*, 186*6*.

Clothing account:  
*No settlement*  
Last settled \_\_\_\_\_, 186*6*; drawn since \$ *41*<sup>*93*</sup>/<sub>*100*</sub>  
Due soldier \$ \_\_\_\_\_<sup>*100*</sup>; due U. S. \$ \_\_\_\_\_<sup>*100*</sup>  
Am't for cloth'g in kind or money adv'd \$ \_\_\_\_\_<sup>*100*</sup>

Due U. S. for arms, equipments, &c., \$ \_\_\_\_\_<sup>*100*</sup>  
Bounty paid \$ \_\_\_\_\_<sup>*100*</sup>; due \$ \_\_\_\_\_<sup>*100*</sup>

Remarks: *Found at original*  
*organization, Deserted Oct-*  
*22. 63. at Hatchers Run*

Book mark: *Deserted Sept. 23. 63*  
*C.B. 331 Co. 39 411 CS 75*

*P J Moore*

No. | Co. | Reg't | U.S.

Isaac Havel.

, Co. F, 6<sup>th</sup> Reg't U.S. Army

**NOTATION.**

Book mark: *613.11.331. No. 39. C. D. 1875.*

**War Department,**

Adjutant General's Office,

Washington, *March 29.*, 1875.

*Accepted September 23. 1863.*

*A. M. Muzzey*  
Copyist.



Hawkins Augustus  
Co D, 6 U.S. Col'd H. Art'y.

Private

CARD NUMBERS.

1	6162751	26
2	6162897	27
3	6163046	28
4	6163187	29
5	6163386	30
6	6165105	31
7	9119552	32
8	S-98-0J-1875	33
9	407x2465	34
10		35
11		36
12		37
13		38
14		39
15		40
16		41
17		42
18		43
19		44
20		45
21		46
22		47
23		48
24		49
25		50

Book Mark: G.B. 211 P 375  
S-98-0J-1875

See also

A

Augustus Hawkins

, Co. D, 6 Reg't U.S. Col'd H. Art'y.

Appears on

Company Descriptive Book

of the organization named above.

DESCRIPTION.

Age 24 years; height 5 feet 10 inches.

Complexion Black

Eyes Black; hair Black

Where born Newbern NC

Occupation Servant

ENLISTMENT.

When Aug 31, 1863.

Where Newbern N.C.

By whom Capt A Beard; term 3 y'rs.

Remarks: Served in Hoop  
Medal La Oct 12  
1863.

Final statements  
forwarded Jan 15/65

Company

J. P. Jones

Augustus Hawkins  
Co. D, 2 Reg't Miss. Art'y.†

Age 24 years.

Appears on

Company Muster-in Roll

of the organization named above. Roll dated

Natchez Miss, Sept 12, 1863.

Muster-in to date Sept 12, 1863.

Joined for duty and enrolled:

When Aug 31, 1863.\*

Where Natchez Miss \*

Period 3 years.\*

Valuation of horse, \$ 100

Valuation of horse equipments, \$ 100

Remarks:

† This organization subsequently became Co. D, 6 Reg't U. S. Colored Heavy Artillery.

\* Muster-in roll shows enrollment of all men of this company as of same date and place. See enrollment on subsequent card or cards.

Book mark: 2-98-05-1875

L. B. Sawyer

*A.*

6 H. Art'y.

U.S.C.T.

*Augustus Hawkins*

*Sgt.*, Co. D, 2 Reg't Miss. Art'y.†

Appears on

**Company Muster Roll**

for *Sept. 12, to Oct. 31*, 1863.

Joined for duty and enrolled:

When *Aug. 31*, 186 .\*

Where *Natchez, Miss.* \*

Period *3* years.\*

Present or absent *Present*

Stoppage, \$ *100* for

Due Gov't, \$ *100* for

Remarks: *Sick in Reg't Hospital.*

† This organization subsequently became Co. D, 6 Reg't U. S. Colored Heavy Artillery.

\* See enrollment on card from muster-in roll.

Book mark:

*King*

*L* | **6 H. Art'y.** | **U.S.C.T.**  
*Augustus Hawkins*  
*Co. D, 2 Reg't Miss. Artillery.†*

Appears on

**Company Muster Roll**  
for *Nov & Dec*, 1863.

Joined for duty and enrolled:

When *Aug 31, 1863.\**  
Where *Natchez Miss* \*  
Period *3* years.†

Present or absent *Present*

Stoppage, \$ *100* for

Due Gov't \$ *100* for

Valuation of horse, \$ *100*

Valuation of horse equipments, *100*

Remarks:

† This organization subsequently became Co. *D*, 6 Reg't U. S. Col'd Heavy Artillery.  
\* See enrollment on card from muster-in roll.

Book mark:

*L. B. Sayer*  
(358c) Copyist.

*Augustus Hawkins*  
*Prue*, Co. D, 2 Reg't Miss. Art'y.†

Appears on

**Company Muster Roll**

for *Jan & Feb*, 1864.

Joined for duty and enrolled:

When *Aug 31, 1863.\**

Where *Hatchery Miss.\**

Period *3* years.\*

Present or absent *Absent-*

Stoppage, \$ *100* for

Due Gov't, \$ *100* for

Remarks: *sick in Regimental Hospital*

† This organization subsequently became Co. D, 6 Reg't U. S. Colored Heavy Artillery.

\* See enrollment on card from muster-in roll.

Book mark:

(358c)

*L. B. Sayer*  
Copyist.

August Hakin  
Co. D, 5 Reg't U. S. Col'd H. Art'y.†

Appears on

Company Muster Roll  
for Feb 9 April, 1864.

Joined for duty and enrolled:

When Aug 31, 1863.\*

Where Natchez Miss\*

Period 3 years.\*

Present or absent

Stoppage, \$ 100 for

Due Gov't \$ 100 for

Valuation of horse, \$ 100

Valuation of horse equipments, 100

Remarks: Died of disease March 24-1864

†This organization subsequently became Co. D, 6 Reg't U. S. Colored Heavy Artillery.  
\* See enrollment on card from muster-in roll.

Book mark Ordn. Act 72-63-2B-2118  
375

(358c)

L B Sayre

Copyist.

A

6 H. Art'y.

U.S.C.T.

Augustus Hawkins  
Capt., Co. \_\_\_\_\_, 6 Reg't U. S. Col'd H. Art'y.

Appears on Returns as follows:

Mar 1864 Died  
in Reg't Mass  
Oct 12 Ketching  
Miss (Co H F  
U.S. Col'd H A)

Book mark:

(546) *A. Gougeon* Copyist.



26

Augustus Hardin  
Priv, Co. D, 6 Reg't U. S. Col'd H. Art'y.

Appears on Co. Muster-out Roll, dated  
Natchez, Miss, May 13, 1866.

Muster-out to date \_\_\_\_\_, 1866 .

Last paid to \_\_\_\_\_, 1866 .

Clothing account:

Last settled \_\_\_\_\_, 1866 ; drawn since \$ \_\_\_\_\_ 100

Due soldier \$ \_\_\_\_\_ 100; due U. S. \$ \_\_\_\_\_ 100

Am't for cloth'g in kind or money adv'd \$ \_\_\_\_\_ 100

Due U. S. for arms, equipments, &c., \$ \_\_\_\_\_ 100

Bounty paid \$ \_\_\_\_\_ 100; due \$ \_\_\_\_\_ 100

Remarks: *Joined at Organization  
Died, Disease not known  
Oct 12/63. Final Statements  
forwarded Jan'y 65, 65*

Book mark: *PV. 7. P. 81-89 over*

*E. W. Tucker*

Copyist.

JAN. 14

6165105

1891

*Y 98. VII. Cont. 1875.*

*A* | *6th Army U.S. Army*  
*Augustus Hawkins*  
*, Co. 6. Regt. U.S. Army.*

**NOTATION.**

Book mark *L-98. 25. 1875.*

**Record and Pension Office,**

WAR DEPARTMENT.

This book mark refers only to a report from the medical records, made by the Surgeon General to the Adjutant General, relative to the above-named man. As the medical records have since been carded, no transcript of this report is made hereon.

(491)

*J. L. Robinson*

Copyist.

Hawkins, Augustus

P, Co. D., 6 Regt S. C. H. A.

2 Enclosures.

Bed Cards	Descriptive Lists
Burial Records	Final Statements /
Certs. of Dis. for Discharge	Furloughs
C. M. Charges	Med. Des. Lists
Med. Certificates	Orders

Other papers relating to—

Admission to Hosp'l	Furlough
Casualty Sheet (Officer's)	Med. Examination
Confinement	Misc. Information
Contracts	Pay or Clothing
Death or Effects /	Personal Reports
Desertions	Rank
Discharge from Hosp'l	Transfer to Hosp'l
Discharge from Service	Transfer to V. R. C.
Duty	Transportation

# War Department.

ADJUTANT GENERAL'S OFFICE,

May 24, 1875.

The death of Augustus Hawkins  
Private, Co. D, 6<sup>th</sup> Reg't U. S.  
Colored Art'y (Wgt), is reported as follows:

On Company Muster Roll.  
For Mar & Apr, 1864, Mar 24<sup>th</sup>, 1864  
Company Muster-out Roll.  
Oct 12<sup>th</sup>, 1863  
✓ Company Descriptive Book.  
Oct 12<sup>th</sup>, 1863  
✓ Company Morning Reports.

Soldier's Final Statement.  
Oct 12<sup>th</sup>, 1863

~~Soldier's Record of Death and Interment~~  
M.R. for Sept & Oct '63 "Absent sick", 1863

~~Soldier's Inventory of Effects~~  
M.R. for Nov & Dec '63 "Absent for duty", 1863

~~Soldier's Certificate of Disability for Discharge~~  
M.R. for Jan & Feb '64 "Absent sick", 1863

Soldier's Individual Muster-out Roll.  
1863

Regimental Return.  
For March, 1864, Oct 12<sup>th</sup>, 1863.

Regimental Quarterly Returns. ~~dec~~ Soldiers  
Oct 12<sup>th</sup>, 1863

✓ Regimental Descriptive Book.  
Oct 12<sup>th</sup>, 1863

By Surgeon General.  
Noted  
Oct 12<sup>th</sup>, 1863

is held to be  
the correct date, and the Company Muster  
Roll will be amended accordingly.

Thomas M. Sweeney  
C.B.  
Assistant Adjutant General.  
Noted 375. See letter to 2<sup>d</sup> Auditor  
Hd. June 19, 1875.

# FINAL STATEMENT

disease

Augustus Hawkins (Print)

2<sup>d</sup> Reg't of Miss. Art'y

6 VOLUNTEERS.  
Died Oct 12<sup>th</sup> 1863.

NOTE 1.—Two of these certificates (or duplicates) are to be given to each Volunteer Soldier or drafted man who may be discharged previously to the discharge of his company, that he may at once receive from the Paymaster the pay, &c., due him, and the captain or other COMMISSIONED officer commanding the company will certify to the act of the delivery of the duplicate certificates; on these certificates the Soldier is "entitled to" his discharge, and should also present his discharge to the Paymaster to have the payment endorsed on it. The discharge is to be given back to the Soldier by the Paymaster; the latter only retaining as his voucher the duplicate certificates.

NOTE 2.—If the Soldier is entitled to pay for the use of his horse, the Company Commander will certify to that fact on the back of both these final statements, and also to the time he has pay due for having been so mounted on his own horse.

NOTE 3.—When a Soldier is furnished with final statements, his descriptive list, if he has one, should be taken up by the officer who gives the Soldier these statements, and endorsed with a statement to this effect by the officer. This endorsement should exhibit a full statement of the time for which the Soldier was allowed pay on his final statements, the clothing account, and all other charges against him or in his favor, so as to comprise a complete exhibit of his account. It will then be transmitted to the company commander of the Soldier, who will enter all the data necessary to a full understanding of the Soldier's account on the muster roll upon which the Soldier's discharge is reported. The descriptive list will then be destroyed. The object of this is, that the remaining portion of the Soldier's account may be settled upon the receipt of these muster rolls, and the Soldier receive any pay or allowances that may be due him at the time of his discharge, and which may not appear on his final statements from the fact that his descriptive list is incomplete. These accounts for back pay, &c., are settled by the 2d Auditor of the Treasury Department.

NOTE 4.—Charges for loss or injury to ordnance, horse equipments, and other miscellaneous charges, should appear under the heading of "Other Stoppages."

NOTE 5.—Bounty paid by State authorities, and not by the United States, will not be entered on this statement.

NOTE 6.—Amounts due the Sutler and Laundress must be entered on the muster roll on which the discharge, death, desertion, &c., is reported, as well as on the final statement, otherwise the amount cannot be collected from the United States.

NOTE 7.—This blank will be used for deceased volunteers and drafted men, as well as for others.

NOTE 8.—Where a Soldier dies in Hospital or on detached service, his descriptive list, if he has one, should be sent with his final statements, in duplicate, to the Second Auditor, Washington, D. C.

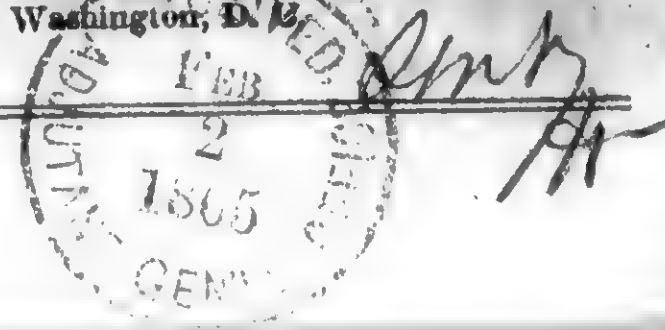

I certify, on honor, that Augustus Hawkins a Private of  
Captain Harry Beard Company (D) of the 2 Regiment of Miss. Vol. Inf. A. C.  
**VOLUNTEERS**, of the State of Mississippi, born in New-bourn, State  
of North Carolina, aged 21 years; 5 feet 10 inches high; Black complexion,  
Black eyes, Black hair, and by occupation a Servant, having joined the company on  
its original organization at Natchez Miss, and enrolled in it at the muster into  
the service of the United States at Natchez Miss, on the 12<sup>th</sup> day  
of September, 1863, (or was mustered in service as a recruit, by  
....., at ....., on the ..... day of .....,  
186 , or was drafted and mustered into the service of the United States from the .....  
Enrollment District of the State of ....., at .....,  
on the ..... day of ....., 186 ) to serve in the Regiment, for  
the term of .....: and having served **HONESTLY** and  
**FAITHFULLY** with his Company in Garrison to the present date, is now  
entitled to a **DISCHARGE** by reason of Sick of Disease Oct 12<sup>th</sup> 1863  
Nature of Disease Unknown

The said Private Augustus Hawkins was last paid by Paymaster  
has pay due from date of enlistment to include the ..... day of ....., 186 , and has  
pay due him from that time to the present date; he is entitled to pay and subsistence for  
**TRAVELING** to place of enrollment, and whatever other allowances are authorized to volunteer  
soldiers, drafted men, or militia, so discharged. He has received from the United States **CLOTHING**  
amounting to 12.5 42/100 dollars, since the 31<sup>st</sup> day of August,  
1863, when his clothing account was last settled. He has received from the United States  
..... 100 dollars advanced **BOUNTY**.

There is to be stopped from him, on account of the State of ....., or other  
authorities, for **CLOTHING**, &c., received on entering service, ..... 100 dollars; and  
for other stoppages, viz: .....  
..... 100 dollars.  
He has been furnished with **TRANSPORTATION** in kind from the place of his discharge to  
.....; and he has been **SUBSISTED** for **TRAVELING** to his  
place of enrollment, up to the ....., 186 .

He is indebted to ....., **SUTLER**, ..... 100 dollars.  
He is indebted to ....., **LAUNDRESS**, ..... 100 dollars.

Given in Duplicate, at Natchez Mississippi, this 21<sup>st</sup> day  
of January, 1865 .

Jesse B. Shadle Lt. Supt  
Wm. S. Art. Wm.  
Commanding Company D

Inventory of Effects  
of  
Private Augustus Hawkins  
Co 2<sup>d</sup> Regt Miss Hy Art



Inventory of the effects of *Augustus Hawkins* late  
 a *Private* of Captain *Harry Beards* Company *D* of  
 the *2<sup>d</sup>* Regiment of *Miss. Vol. Art. A. S.* Volunteers, who was enrolled as  
 a *Private* at *Natchez* in the State of *Mississippi* on  
 the *31<sup>st</sup>* day of *August* 1863, and mustered into the service of the United  
 States as a *Private* on the *12<sup>th</sup>* day of *September* 1863, at *Natchez*  
 in Company *D*, *2<sup>d</sup>* Regiment of *Miss. Vol. Art. A. S.* to serve *3*  
 years or during the war; he was born in *New-bourn* in the State  
 of *North Carolina*; he was *21* years of age, *5* feet *10* inches  
 high, *Black* complexion, *Black* eyes, *Black* hair, and by occupation, when enrolled,  
 a *Sergeant*; he died in *Regimental Hospital* at  
*Pidalia* on the *12<sup>th</sup>* day of *October* 1863, by  
 reason of *Disease* (Nature of Disease Unknown)

INVENTORY.					
ARTICLES.	NO.	ARTICLES	NO.	ARTICLES.	NO.
Hats.....		Pairs Trowsers.....		Knapsacks.....	
Caps.....		Pairs flannel Drawers.....			
Forage Caps.....		Pairs cotton Drawers.....			
Great Coats.....		Flannel Shirts.....			
Uniform Coats.....		Cotton Shirts.....			
Uniform Jackets.....		Pairs boots.....			
Flannel Sack Coats.....		Pairs shoes.....			
Blouses.....		Pairs socks.....			
Stable Frocks.....		Blankets.....			
Fatigue Overalls.....		Haversacks.....			
				MONEY.	
				Specie.....	\$
				Notes.....	\$

I CERTIFY ON HONOR, that the above inventory comprises all the effects of *Private*  
*Augustus Hawkins*, deceased, and that the effects are in the hands  
 of ..... at .....  
 ..... to be disposed of by a Council of Administration.

(DUPLICATES.)

STATION: *Natchez Miss.*

DATE: *January 22<sup>nd</sup> 1865*

*Jesse B. Shadle* Lt. Col.  
*P. M. S. C. Art. Vol.*  
 Commanding the Company *D*



Hawkins Charles

Co H, 6 U.S. Col'd H. Art'y.

Private Private

CARD NUMBERS.

1	6171514	26
2	6171664	27
3	6171804	28
4	6171946	29
5	6172084	30
6	6172211	31
7	6172340	32
8	6172460	33
9	6172578	34
10	6172694	35
11	6172813	36
12	6172928	37
13	6173037	38
14	6173151	39
15	6173257	40
16	6173359	41
17	6173462	42
18	9120418	43
19	40722466	44
20		45
21		46
22		47
23		48
24		49
25		50

Book Mark:

See also

*Charles Hawkins*

....., Co. *A*, 6 Reg't U. S. Col'd H. Art'y.

Appears on

**Company Descriptive Book**

of the organization named above.

**DESCRIPTION.**

Age *40* years; height *5* feet *9* inches.

Complexion *Blk*

Eyes *Blk*; hair *Gray*

Where born *Natchez Miss.*

Occupation *Farmer*

**ENLISTMENT.**

When *Apr. 1*, 186*3*.

Where *Natchez Miss.*

By whom *J. P. Grove*; term *3* y'rs.

Remarks: .....

.....  
.....  
.....  
.....  
.....  
.....  
.....  
.....  
.....  
.....

*Hawkins*

*M.*

**6 H. Art'y. | U.S.C.T.**

*Charles Hawkins*

*Co. H., 2 Reg't Miss. Art'y.†*

Age *40* years.

Appears on

**Company Muster-in Roll**

of the organization named above. Roll dated

*March 25, 1863.*

Muster-in to date *Nov 1, 1863.*

Joined for duty and enrolled:

When *Nov 1, 1863.\**

Where *March 25 Miss.\**

Period *8* years.\*

Valuation of horse, \$ *100*

Valuation of horse equipments, \$ *100*

Remarks:

† This organization subsequently became Co. *H.* 6 Reg't U. S. Colored Heavy Artillery.

\* Muster-in roll shows enrollment of all men of this company as of same date and place. See enrollment on subsequent card or cards.

Book mark:

*W. S. ...*

*Charles Hawkins*

*Pr.*, Co. H, 2 Reg't Miss. Art'y.†

Appears on

**Company Muster Roll**

for *Nov. 25 to Dec. 31*, 1863.

Joined for duty and enrolled:

When *Nov. 1*, 1863.\*

Where *Madison Miss.* \*

Period *3* years.\*

Present or absent *Present*

Stoppage, \$ *100* for

Due Gov't, \$ *100* for

Valuation of horse, \$ *100*

Valuation of horse equipments, \$ *100*

Remarks:  
.....  
.....  
.....

† This organization subsequently became Co. H, 6 Reg't U. S. Co'ld Heavy Artillery.

\* See enrollment on card from muster-in roll.

Book mark: .....

*No.*

6 H. Art'y.

U.S.C.T.

*Charles Hawkins*

*Co.*, Co. H, 2 Reg't Miss. Art'y.†

Appears on

**Company Muster Roll**

for *Jan. & Feb.*, 186*4*.

Joined for duty and enrolled:

When *Apr. 1*, 186*3*.\*

Where *Fort Mifflin Pa.*\*

Period *3* years.\*

Present or absent *Present*

Stoppage, \$ *100* for

Due Gov't, \$ *100* for

Valuation of horse, \$ *100*

Valuation of horse equipments, \$ *100*

Remarks:

† This organization subsequently became Co. H, 6 Reg't U. S. Co'd Heavy Artillery.

\* See enrollment on card from muster-in roll.

Book mark:

*Application*

*Charles Hawkins*  
*Pvt.*, Co. *A*, 5 Reg't U. S. Col'd H. Art'y.\*

Appears on

**Company Muster Roll**

for *Mar. + Apr.*, 186*4*.

Joined for duty and enrolled:

When *Nov. 1*, 186*3*.\*

Where *Vatley Miss* \*

Period *3* years.\*

Present or absent *Absent*.\*

Stoppage, \$ *100* for

Due Gov't, \$ *100* for

Valuation of horse, \$ *100*

Valuation of horse equipments, \$ *100*

Remarks: *Absent without leave since April 29<sup>th</sup> 1864.*

*\* Name in present column cancelled by lines drawn through it.*

\* This organization subsequently became Co. *A*, 6 Reg't U. S. Col'd Heavy Artillery.

\* See enrollment on card from muster-in roll.

Book mark: \_\_\_\_\_

*W. H. ...*

(358c)

Copyist.

10.

6 H. Art'y.

U.S.C.T.

Charles Hawkins

Pvt., Co. H, 6 Reg't U. S. Col'd H. Art'y.

Appears on

Company Muster Roll

for May & June, 1864.

Joined for duty and enrolled:

When Nov. 1, 1863.\*

Where Natchez Miss.\*

Period 3 years.\*

Present or absent Present.

Stoppage, \$ 100 for

Due Gov't \$ 100 for

Remarks:

\* See enrollment on card from muster-in roll.

Book mark:

(358c)

J. J. Hearns

Copyist.

*H.*

6 H. Art'y.

U.S.C.T.

*Charles Hawkins*  
Priv., Co. H, 6 Reg't U. S. Col'd H. Art'y.

Appears on

**Company Muster Roll**

for *July + August*, 1864.

Joined for duty and enrolled:

When *Nov. 1*, 1863.\*

Where *Natchez Miss.\**

Period *3* years.\*

Present or absent *Present.*

Stoppage, \$ *100* for

Due Gov't \$ *100* for

Remarks:  
-----  
-----  
-----  
-----  
-----

\* See enrollment on card from muster-in roll.

Book mark: -----

(358c)

*A. Stearns*

Copyist.



H

6 H. Art'y.

U.S.C.T.

Charles Hawkins

Private, Co. H, 6 Reg't U. S. Col'd H. Art'y.

Appears on

Company Muster Roll  
for Sept and Oct., 1864.

Joined for duty and enrolled:

When Nov 1, 1863.

Where Natchez Miss.

Period 3 years.\*

Present or absent present.

Stoppage, \$ 100 for

Due Gov't \$ 100 for

Remarks:

\* See enrollment on card from muster-in roll.

Book mark:

O. Leary

(358c)

Copyist.

H

6 H. Art'y.

U.S.C.T.

Charles Hawkins

Pvt., Co. H, 6 Reg't U. S. Col'd H. Art'y.

Appears on

Company Muster Roll

for Nov and Dec, 1864.

Joined for duty and enrolled:

When Nov 1, 1863.\*

Where Katchez Miss \*

Period 3 years.\*

Present or absent present

Stoppage, \$ 100 for

Due Gov't \$ 100 for

Remarks: Due U.S. for  
ordnance lost \$2.33

\* See enrollment on card from muster-in roll.

Book mark:

O'Leary

(358c)

Copyist.

76

6 H. Art'y.

U.S.C.T.

Charles Hawkins  
Pvt, Co. H, 6 Reg't U. S. Col'd H. Art'y.

Appears on

Company Muster Roll  
for Jan and Feb, 1865.

Joined for duty and enrolled:

When Nov 1, 1863.

Where Natchez Miss.

Period 3 years.\*

Present or absent present

Stoppage, \$ 100 for

Due Gov't \$ 100 for

Remarks: Due U. S. for ord-  
nance lost \$2.30.

\* See enrollment on card from muster-in roll.

Book mark:

O'Leary

(358c)

Copyist.

H

6 H. Art'y.

U.S.C.T.

Charles Hawkins  
PM, Co. H, 6 Reg't U. S. Col'd H. Art'y.

Appears on

Company Muster Roll  
for Mch and Apr, 1865.

Joined for duty and enrolled:

When Nov 1, 1863.\*

Where Natchez, Miss.\*

Period 3 years.\*

Present or absent present

Stoppage, \$ 100 for

Due Gov't \$ 100 for

Remarks: Due U.S. for ord  
nance lost \$ 2.10

\* See enrollment on card from muster-in roll.

Book mark:

O'Leary

(358c)

Copyist.

A

6 H. Art'y.

U.S.C.T.

Charles Hawkins

Co. H, 6 Reg't U. S. Col'd H. Art'y.

Appears on

Company Muster Roll

for May & June, 1863.

Joined for duty and enrolled:

When April, 1863.\*

Where Hatchery Mills.\*

Period 3 years.\*

Present or absent Present

Stoppage, \$ 100 for

Due Gov't \$ 100 for

Remarks:

[Empty lines for remarks]

\* See enrollment on card from muster-in roll.

Book mark:

[Signature]

(358c)

Copyist.

*A* | *C. H. Artz* | **U.S.C.T.**

*Charles Hawkins*  
Prs., Co. *H.*, 6 Reg't U. S. Col'd *H. Artz*

Appears on

**Company Muster Roll**

for *July & Aug.*, 186*5*.

Joined for duty and enrolled:

When *Nov. 1*, 186*5*.\*

Where *Natchez Miss.* \*

Period *3* years.\*

Present or absent *Present*

Stoppage, \$ *100* for

Due Gov't, \$ *100* for

Remarks: \_\_\_\_\_  
\_\_\_\_\_  
\_\_\_\_\_  
\_\_\_\_\_  
\_\_\_\_\_

\* See enrollment on card from muster-in roll.

Book mark: \_\_\_\_\_

(858c)

*Paul*

Copyist.

*G.H.*

6 H. Art'y.

U.S.C.T.

*Charles Hawkins*

*Co. H*, 6 Reg't U. S. Col'd H. Art'y.

Appears on

**Company Muster Roll**

for *Sept & Oct*, 1865.

Joined for duty and enrolled:

When *Nov 1*, 1863.\*

Where *Statches, Miss*\*

Period *3* years.\*

Present or absent *present*

Stoppage, \$ *100* for

Due Gov't \$ *100* for

Remarks:  
-----  
-----  
-----  
-----  
-----

\* See enrollment on card from muster-in roll.

Book mark: -----

*Harpes* Copyist.

(358c)

*Charles Hawkins*

*Priv.*, Co. H, 6 Reg't U. S. Col'd H. Art'y.

Appears on

**Company Muster Roll**

for *Nov & Dec*, 186*5*.

Joined for duty and enrolled:

When *Nov 1*, 186*3*.\*

Where *Watches, Miss.*

Period *3* years.\*

Present or absent *present.*

Stoppage, \$ *100* for

Due Gov't \$ *100* for

Remarks:  
-----  
-----  
-----  
-----  
-----

\* See enrollment on card from muster-in roll.

Book mark: \_\_\_\_\_

(358c)

*J. B. Harper*  
Copyist.



H. | **6 H. Art'y.** | **U.S.C.T.**

*Charles Hawkins*  
Pvt., Co. H, 6 Reg't U. S. Col'd H. Art'y.

Appears on

**Company Muster Roll**  
for *Jan & Feb*, 1866.

Joined for duty and enrolled:

When *Nov 1*, 186*3*

Where *Katchez, Miss*

Period *3* years.\*

Present or absent *present*

Stoppage, \$ *100* for

Due Gov't \$ *100* for

Remarks:  
-----  
-----  
-----  
-----  
-----

\* See enrollment on card from muster-in roll.

Book mark: -----

(358c)

*D. A. Harper*  
Copyist.

*Charles Hawkins*  
-----  
*Priv.*, Co. H, 6 Reg't U. S. Col'd H. Art'y.

Appears on

**Company Muster Roll**  
for *Mar & Apr*, 1866.

Joined for duty and enrolled:

When *Nov 1*, 1863.\*

Where *Natchez, Miss.*\*

Period *3* years.\*

Present or absent *present*

Stoppage, \$ *100* for

Due Gov't \$ *100* for

Remarks: -----  
-----  
-----  
-----  
-----

\* See enrollment on card from muster-in roll.

Book mark: -----

*J. C. Harper*  
-----  
(358c) Copyist.

A

6 H. Art'y.

U.S.C.T.

Charles Hawkins  
Pat., Co. A, 6 Reg't U. S. Col'd H. Art'y.

Appears on Returns as follows:

Nov 1863 (2<sup>d</sup> Miss A  
Art (20) Absent  
without leave  
since Nov 26, 63  
May 1864 (6 U.S. Col'd  
H Art) Absent  
without leave  
since May 1, 64

Book mark:

(646)

A. J. Gould

Copyist.

H

6 H. Art'y.

U.S.C.T.

Charles Hawkins

Private, Co. H, 6 Reg't U. S. Col'd H. Art'y.

Appears on Co. Muster-out Roll, dated

Watches, Miss May 13, 1866.

Muster-out to date May 13, 1866.

Last paid to Dec. 31, 1865.

Clothing account:

Last settled, 186 ; drawn since \$ 100

Due soldier \$ 37.75; due U. S. \$ 100

Am't for cloth'g in kind or money adv'd \$ 100

Due U. S. for arms, equipments, &c., \$ 100

Bounty paid \$ 100; due \$ 100

Remarks:

Joined original organization

Book mark: V43 P60, 69, P13 P244, 69.

C. Powell

(361)

Copyist.

Hawkins Charles

P., Co. H, 6 Reg't U.S.A.

Enclosures.

Bed Cards .....	Final Statements .....
Burial Records .....	Furloughs or L. of A. ....
Certs. of Dis. for Discharge .....	Med. Certificates .....
C. M. Charges .....	Med. Des. Lists .....
Descriptive Lists .....	Orders .....
Discharge Certificates .....	Pris. of War Record .....
Enlistment Papers .....	Resignations .....

Other papers relating to—

Admission to Hosp'l .....	Furlough or L. of A. ....
Casualty Sheet .....	Med. Examination .....
Confinement .....	Misc. Information .....
Contracts .....	Pay or Clothing .....
Death or Effects .....	Personal Reports .....
Desertion .....	Rank .....
Discharge from Hosp'l .....	Transfer to Hosp'l .....
Discharge from Service .....	Transfer to V. R. C. ....
Duty .....	Transportation .....

Charles Hawkins ✓  
Pot Co "N" 6<sup>th</sup> Arty Coy

Report of Div of D. C.

---

Adjutant General's Office,

COLORED TROOPS BRANCH,

Wm Ellersbrook

April 28<sup>th</sup>, 1875

Vol. C. T., 187

Wanted in the case of Charles Hawkins Private, Co. A,  
Sixth Reg't U.S.C.A. (Hoy)

1<sup>st</sup> Period absent or whether tried -

"Absent without leave since Nov 26/63" RR for Nov 1863

Present for duty - MSB for Nov 1863

2<sup>nd</sup> Period absent or whether tried -

"Absent without leave since

Apr 29 '64" MR for March & Apr 1864 Present for duty -

MR for May 1864

Respectfully,

WJE

W. A. Woodward

Chief Clerk  
In H. Harkon

Adjutant General's Office,

Division of Discontinued Commands.

May 11<sup>th</sup>, 1875

Vol. C. T., 187

Reply in case of Charles Hawkins, Co. B,  
6<sup>th</sup> Reg't U.S.C.A. (Hoy)

1<sup>st</sup> - Reg't and Co's R's and Com'g R's furnish no evidence of absence without leave, return to duty, charges arrest or trial in Nov or Dec 1863 -

2<sup>nd</sup> - No record of absence without leave in March, April or May 1864 - Com'g R's June 13 '64 - "Absent without leave" June 30 '64 - "Returned from absence without leave" - No record of arrest, charges or trial -

D.P.K.

Note 1<sup>st</sup> No record of absence without leave in which - I now record 3 in the Com'g R's of 1863  
(give what is at hand)

*Hawkins. James*  
 Co A, 6 U.S. Col'd H. Art'y.  
*Private Private*

CARD NUMBERS.

1	6155446	26
2	6155592	27
3	6155743	28
4	6155888	29
5	6156031	30
6	6156163	31
7	6156292	32
8	6156412	33
9	6156532	34
10	6156656	35
11	6156788	36
12	6156921	37
13	6157057	38
14	6157179	39
15	6157309	40
16	6157432	41
17	6157554	42
18	6157674	43
19	9118968	44
20	40742467	45
21		46
22		47
23		48
24		49
25		50

Book Mark: \_\_\_\_\_

See also \_\_\_\_\_



*X*

6 H. Art'y.

U.S.C.T.

*James Hawkins*

, Co. *A*, 6 Reg't U. S. Col'd H. Art'y.

Appears on

**Company Descriptive Book**

of the organization named above.

**DESCRIPTION.**

Age *27* years; height *6* feet *1/2* inches.

Complexion *Black*

Eyes *Black*; hair *Black*

Where born *Queridia La*

Occupation *Farmer*

**ENLISTMENT.**

When *Aug 30*, 1863.

Where *Natchez Miss*

By whom *Capt Ogden*; term *3* y'rs.

Remarks:

.....  
.....  
.....  
.....  
.....  
.....  
.....  
.....  
.....

*J. Willis*

(383g)

Copist.

76

Jacob Hawkins  
Pri., Co. A, 2 Reg't Miss. Art'y.†

Age 44 years.

Appears on

Company Muster-in Roll

of the organization named above. Roll dated

Natchez Miss Sept 12, 1863.

Muster-in to date Sept 7 2, 1863.

Joined for duty and enrolled:

When Aug 30, 1863.\*

Where Natchez Miss \*

Period 3 years.\*

Valuation of horse, \$ 100

Valuation of horse equipments, \$ 100

Remarks:

† This organization subsequently became Co. A, 6 Reg't U. S. Colored Heavy Artillery.

\* Muster-in roll shows enrollment of all men of this company as of same date and place. See enrollment on subsequent card or cards.

Book mark:

C. G. Smith

76

6 H. Art'y.

U.S.C.T.

Jacob Hawkins  
Pi..., Co. A, 2 Reg't Miss. Art'y.†

Appears on

Company Muster Roll

for Aug 30 to Oct 31, 1863.

Joined for duty and enrolled:

When Aug 30, 1863.\*

Where Natchez Miss \*

Period 3 years.\*

Present or absent Absent

Stoppage, \$ 100 for

Due Gov't \$ 100 for

Valuation of horse, \$ 100

Valuation of horse equipments, 100

Remarks: Absent without  
Leave

† This organization subsequently became Co. A, 6 Reg't U. S. Colored Heavy Artillery.

\* See enrollment on card from muster-in roll.

Book mark:

O. G. Smith

(358c)

Copyist.

76

6 H. Art'y.

U.S.C.T.

Jacob Hawkins  
Pri, Co. A, 2 Reg't Miss. Art'y.†

Appears on

Company Muster Roll

for Nov & Dec, 1863.

Joined for duty and enrolled:

When Aug 30, 1863.\*

Where Watchers Miss.\*

Period 3 years.\*

Present or absent Present

Stoppage, \$ 100 for

Due Gov't \$ 100 for

Valuation of horse, \$ 100

Valuation of horse equipments, 100

Remarks:

† This organization subsequently became Co. A, 6 Reg't U. S. Colored Heavy Artillery.

\* See enrollment on card from muster-in roll.

Book mark:

O. W. Smith

(358c)

Copyist.

76

6 H. Art'y.

U.S.C.T.

Jacob Hawkins  
Pri., Co. A, 2 Reg't Miss. Art'y.†

Appears on

Company Muster Roll

for Jan & Feb, 1864.

Joined for duty and enrolled:

When Aug. 30, 1863\*

Where Watch of Miss \*

Period 3 years.\*

Present or absent Present

Stoppage, \$ 100 for

Due Gov't \$ 100 for

Valuation of horse, \$ 100

Valuation of horse equipments, 100

Remarks:

† This organization subsequently became Co. A, 6 Reg't U. S. Colored Heavy Artillery.  
\* See enrollment on card from muster-in roll.

Book mark:

O. G. Smith

(358c)

Copyist.

76

6 H. Art'y.

U.S.C.T.

Jacob Hawkins

Pri., Co. A, 5 Reg't U. S. Col'd H. Art'y.†

Appears on

Company Muster Roll

for March & April, 1864.

Joined for duty and enrolled:

When Aug 30, 1863.\*

Where Watches Miss \*

Period 3 years.\*

Present or absent Present

Stoppage, \$ 100 for

Due Gov't \$ 100 for

Valuation of horse, \$ 100

Valuation of horse equipments, 100

Remarks:

†This organization subsequently became Co. A, 6 Reg't U. S. Colored Heavy Artillery.

\* See enrollment on card from muster-in roll.

Book mark:

O. G. Smith

(358c)

Copyist.

76

6 H. Art'y.

U.S.C.T.

*Jack Hawkins*

*Pri*, Co. A, 6 Reg't U. S. Col'd H. Art'y.

Appears on

**Company Muster Roll**

for *May & June*, 186*4*.

Joined for duty and enrolled:

When *Aug 30*, 1863.\*

Where *Natchez Miss* \*

Period *3* years.\*

Present or absent *Present*

Stoppage, \$ *100* for

Due Gov't \$ *100* for

Remarks:  
\_\_\_\_\_  
\_\_\_\_\_  
\_\_\_\_\_  
\_\_\_\_\_  
\_\_\_\_\_

\* See enrollment on card from muster-in roll.

Book mark: \_\_\_\_\_

*C. G. Smith*

(858c)

Copyist.

76

6 H. Art'y.

U.S.C.T.

Jacob Hawkins  
Pri., Co. A, 6 Reg't U. S. Col'd H. Art'y.

Appears on

Company Muster Roll

for July 8 Aug., 1864.

Joined for duty and enrolled:

When Aug. 30, 1863.\*

Where Hatchez \*

Period 3 years.\*

Present or absent Present

Stoppage, \$ 100 for

Due Gov't \$ 100 for

Remarks:

\* See enrollment on card from muster-in roll.

Book mark:

J. H. Henderson  
(358c) Copyist.



*Jacob Hawkins*  
*Pri.*, Co. A, 6 Reg't U. S. Col'd H. Art'y.

Appears on

Company Muster Roll  
for *Sept. & Oct.*, 186*4*.

Joined for duty and enrolled:

When *Aug. 30*, 186*3*.\*

Where *Natchez, Miss.* \*

Period *3* years.\*

Present or absent *Present*

Stoppage, \$ *100* for

Due Gov't \$ *100* for

Remarks:  
-----  
-----  
-----  
-----  
-----

\* See enrollment on card from muster-in roll.

Book mark: -----

*J. H. Henderson*  
(358c) Copyist.

76

6 H. Art'y.

U.S.C.T.

Jacob Hawkins  
Pri., Co. A, 6 Reg't U. S. Col'd H. Art'y.

Appears on

Company Muster Roll

for Nov. & Dec., 1864

Joined for duty and enrolled:

When Aug. 30, 1863.\*

Where Hatchey, Miss. \*

Period 3 years.\*

Present or absent Present

Stoppage, \$ 100 for

Due Gov't \$ 100 for

Remarks:

-----  
-----  
-----  
-----  
-----

\* See enrollment on card from muster-in roll.

Book mark:

J. H. Benderson  
(358c) Copyist.

*H*

6 H. Art'y.

U.S.C.T.

*Jacob Hawkins*  
*Pr.*

Co. A, 6 Reg't U. S. Col'd H. Art'y.

Appears on

Company Muster Roll

for *Jan. & Feb.*, 1865.

Joined for duty and enrolled:

When *Aug. 30*, 1863.\*

Where *Katchez, Miss.*\*

Period *3* years.\*

Present or absent *Present*

Stoppage, \$ *100* for

Due Gov't \$ *100* for

Remarks:

-----  
-----  
-----  
-----  
-----

\* See enrollment on card from muster-in roll.

Book mark:

*J. H. Henderson*  
(358c) Copyist.

26

6 H. Art'y.

U.S.C.T.

Jacob Hawkins  
Pri., Co. A, 6 Reg't U. S. Col'd H. Art'y.

Appears on

Company Muster Roll  
for Mar. 7 Apr., 1865.

Joined for duty and enrolled:

When Aug. 30, 1863.\*

Where Hatchez, Miss.\*

Period 3 years.\*

Present or absent Present

Stoppage, \$ 100 for

Due Gov't \$ 100 for

Remarks:

-----  
-----  
-----  
-----  
-----

\* See enrollment on card from muster-in roll.

Book mark:

J. H. Henderson  
(358c) Copyist.

26

6 H. Art'y.

U.S.C.T.

*Jacob Hawkins*  
*Pri.*, Co. A, 6 Reg't U. S. Col'd H. Art'y.

Appears on

**Company Muster Roll**  
for *Feb. 28 to June 30*, 1865.

Joined for duty and enrolled:

When *Aug. 30*, 1863.\*

Where *Hatchez, Miss.*\*

Period *3* years.\*

Present or absent *Present*

Stoppage, \$ *100* for

Due Gov't \$ *100* for

Remarks:

-----  
-----  
-----  
-----  
-----

\* See enrollment on card from muster-in roll.

Book mark:

*J. H. Henderson*  
(358c) Copyist.

26

6 H. Art'y.

U.S.C.T.

Jacob Hawkins  
pru, Co. A, 6 Reg't U. S. Col'd H. Art'y.

Appears on

**Company Muster Roll**

for July & August, 1865.

Joined for duty and enrolled:

When Aug 30, 1863.\*

Where Natchez Miss \*

Period 3 years.\*

Present or absent Present

Stoppage, \$ 100 for

Due Gov't \$ 100 for

Remarks:

-----  
-----  
-----  
-----  
-----

\* See enrollment on card from muster-in roll.

Book mark:

(358c)

D. J. Gippish

Copyist.

76

6 H. Art'y.

U.S.C.T.

Jacob Hawkins  
Co. A, 6 Reg't U. S. Col'd H. Art'y.

Appears on

Company Muster Roll

for Sept & Oct, 1865.

Joined for duty and enrolled:

When Aug 30, 1863.\*

Where Watauga Miss\*

Period 3 years.\*

Present or absent Present

Stoppage, \$ 100 for

Due Gov't \$ 100 for

Remarks:

\* See enrollment on card from muster-in roll.

Book mark:

(358c)

D. J. Griffith Copyist.

Jacob Hawkins  
priv., Co. A, 6 Reg't U. S. Col'd H. Art'y.

Appears on

Company Muster Roll

for Nov + Dec, 1865.

Joined for duty and enrolled:

When Aug 30, 1863.\*

Where Natchez Miss \*

Period 3 years.\*

Present or absent Present

Stoppage, \$ 100 for

Due Gov't \$ 100 for

Remarks:

\* See enrollment on card from muster-in roll.

Book mark:

(358c)

D. J. Griffith Copyist.



76

G H. Art'y.

U.S.C.T.

*Jacob Hawkins*

*Private*, Co. A, 6 Reg't U. S. Col'd H. Art'y.

Appears on

**Company Muster Roll**

for *Jan & Feb*, 186*6*.

Joined for duty and enrolled:

When *Aug 30*, 186*3*.\*

Where *Natchez Miss* \*

Period *3* years.\*

Present or absent *Present*

Stoppage, \$ *100* for

Due Gov't \$ *100* for

Remarks:

-----  
-----  
-----  
-----  
-----

\* See enrollment on card from muster-in roll.

Book mark:

*D. J. Giffith*  
(358c) Copyist.

26

6 H. Art'y.

U.S.C.T.

Jacob Hawkins  
Co. A, 6 Reg't U. S. Col'd H. Art'y.

Appears on

Company Muster Roll

for *March & April*, 1866.

Joined for duty and enrolled:

When *Aug 30*, 186*3*.\*

Where *Natchez Miss* \*

Period *3* years.\*

Present or absent *Present*

Stoppage, \$ *100* for

Due Gov't \$ *100* for

Remarks:

-----  
-----  
-----  
-----  
-----

\* See enrollment on card from muster-in roll.

Book mark:

*D. J. Gifford*  
(358c) Copyist.

A

6 H. Art'y.

U.S.C.T.

Jacob Hawkins  
Co. V, 6 Reg't U. S. Col'd H. Art'y.

Appears on Returns as follows:

Sept 1863 (Co. A. 2  
Miss. H. Art. A. R.)  
Absent sick in  
Katchez since Sept  
27, 63.

Oct 1863 Absent  
without leave

\*  
Entry cancelled

Book mark:

(546) A. J. Gargala  
Copyist.

*H*

6 H. Art'y.

U.S.C.T.

*Jacob Hawkins*  
Priv., Co. *A*, 6 Reg't U. S. Col'd H. Art'y.

Appears on **Co. Muster-out Roll**, dated  
*Matches Miss. May 13*, 1866.

Muster-out to date *May 13*, 1866.

Last paid to *Dec. 31*, 1865.

**Clothing account:**

Last settled....., 186 ; drawn since \$..... 100

Due soldier \$ *59*<sup>*33*</sup> / 100; due U. S. \$..... 100

Am't for cloth'g in kind or money adv'd \$..... 100

Due U. S. for arms, equipments, &c., \$..... 100

Bounty paid \$..... 100; due \$..... 100

Remarks: *Joined at original organization*

Book mark:

*A. L. Ames*

(361)

Copyist.

Haworth John

Co L, 6 U.S. Col'd H. Art'y.

Private 1st Sergeant

CARD NUMBERS

1	6 1 7 7 5 7 5	26
2	6 1 7 7 6 2 1	27
3	6 1 7 7 7 4 3	28
4	6 1 7 7 8 4 7	29
5	6 1 7 7 9 3 9	30
6	6 1 7 8 0 1 6	31
7	6 1 7 8 0 9 9	32
8	6 1 7 8 2 0 5	33
9	6 1 7 8 3 1 6	34
10	6 1 7 8 4 2 4	35
11	6 1 7 8 5 2 6	36
12	6 1 7 8 7 1 8	37
12	6 1 7 9 0 8 9	38
14	9 1 2 0 8 8 7	39
15	4 0 7 4 2 4 6 8	40
16		41
17		42
18		43
19		44
20		45
21		46
22		47
23		48
24		49
25		50

Book Mark: 400-C.Y-65.

See also

*M* | 6 H. Art'y. | U.S.C.T.

*John Hawth*

, Co. *L*, 6 Reg't U. S. Col'd H. Art'y.

Appears on

**Company Descriptive Book**

of the organization named above.

**DESCRIPTION.**

Age *22* years; height *5* feet *5* inches.

Complexion *Slight*

Eyes *Blue*; hair *Slight*

Where born *Hamilton Co. Ind.*

Occupation *Farmer*

**ENLISTMENT.**

When *Jan 15*, 186 .

Where *Watches, Miss*

By whom *J. H. Yamall*; term *3* y'rs.

Remarks *Discharged Oct 9 1865.*  
*Special Order*

*J. Hillier*

(383a)

Copist.

*John Haworth*  
Private Co. *L*, 2 Reg't Miss. Art'y. †

Age *22* years.

Appears on

**Company Muster-in Roll**

of the organization named above. Roll dated

*Watches Miss. Jan'y 15, 1864.*

Muster-in to date *Jan'y 15, 1864.*

Joined for duty and enrolled:

When *Jan'y 15*, 186*4*\*

Where *Watches Miss*\*

Period *3* years.\*

Valuation of horse, \$.....*100*

Valuation of horse equipments, \$.....*100*

Remarks:.....  
.....  
.....

† This organization subsequently became Co. *L*, 6 Reg't U. S. Colored Heavy Artillery.

\* Muster-in roll shows enrollment and muster-in of this company as of same date and place. See enrollment on subsequent card or cards.

Book mark:.....

*E. M. Neal*

A

6 H. Art'y.

U.S.C.T.

*John Haworth*  
*1st Sgt, Co. L, 2 Reg't Miss. Art'y.†*

Appears on

**Company Muster Roll**

for *Jan'y 15 to Feb. 29, 1864.*

Joined for duty and enrolled:

When *Jan'y 15*, 186 .\*

Where *Hatchers Miss.* \*

Period *3* years.\*

Present or absent *Present*

Stoppage, \$ *100* for

Due Gov't, \$ *100* for

Valuation of horse, \$ *100*

Valuation of horse equipments, \$ *100*

Remarks: *Appointed from*  
*Private Co. "K" 4th Reg't Ill. Vols.*  
*Car. to be 1st Sgt's Co. "L" 2nd Reg't*  
*Miss. Art'y. D. Vols. by order*  
*over*

† This organization subsequently became Co. L, 6 Reg't U.S. Col'd Heavy Artillery.

\* See enrollment on card from muster-in roll.

Book mark:

*J. H. Neal*

Copyist.



JAN. 14

6177621

☆1891☆

*Major Genl. Wilkerson.  
Master in to date Jan'y  
15<sup>th</sup> 1864*

*John Haworth*  
1st Sgt, Co. L, 5 Reg't U. S. Col'd H. Art'y.\*

Appears on

**Company Muster Roll**

for *Mich & Apl*, 1864.

Joined for duty and enrolled:

When *Jan'y 15*, 1864.\*

Where *Hatchez Miss* \*

Period *3* years.\*

Present or absent *Present*

Stoppage, \$ *100* for

Due Gov't, \$ *100* for

Valuation of horse, \$ *100*

Valuation of horse equipments, \$ *100*

Remarks: *Appointed from Private K Co. 4th Regt. Ills Pol. Cav. to be 1st Sgt of Co. L. 5th Regt. U. S. over*

\* This organization subsequently became Co. L, 6 Reg't U. S. Col'd Heavy Artillery.  
\* See enrollment on card from muster-in roll.

Book mark :

*E. D. Neal*

JAN. 14

6177743

☆1891☆

Heavy arty (cold) by  
order Maj. Gen. Miller=  
son Muster-in to date

Jan'y 15 - 1864

Stoppages for  
Transportation nine dol-  
lars and seventy seven  
cents (\$9.77)

A

6 H. Art'y.

U.S.C.T.

*John Haworth*  
Sergeant, Co. L, 6 Reg't U. S. Col'd H. Art'y.

Appears on

**Company Muster Roll**

for *May & June*, 186*4*

Joined for duty and enrolled :

When *Jan'y 15*, 186*4*.\*

Where *Atchez Miss.* \*

Period *3* years.\*

Present or absent *Present*

Stoppage, \$ *100* for

Due Gov't \$ *100* for

Valuation of horse, \$ *100*

Valuation of horse equipments, \$ *100*

Remarks:  
.....  
.....  
.....

\* See enrollment on card from muster-in roll.

Book mark: .....

*E. D. Neale*

(358c)

Copyst.

A

6 H. Art'y.

U.S.C.T.

*John Haworth*

*Serg't*, Co. L, 6 Reg't U. S. Col'd H. Art'y.

Appears on

**Company Muster Roll**

for *July & Aug*, 186*4*.

Joined for duty and enrolled :

When *July 15*, 186*4*.\*

Where *Natchez Miss* \*

Period *3* years.\*

Present or absent *Present*

Stoppage, \$ *100* for

Due Gov't \$ *100* for

Valuation of horse, \$ *100*

Valuation of horse equipments, \$ *100*

Remarks:

\* See enrollment on card from muster-in roll.

Book mark:

*F. D. Neale*

(358c)

Copist.

*A*

6 H. Art'y.

U.S.C.T.

*John Haworth*

*1st Sgt*, Co. L, 6 Reg't U. S. Col'd H. Art'y.

Appears on

**Company Muster Roll**

for *Sept. & Oct.*, 186*4*

Joined for duty and enrolled :

When *Jan'y 15*, 186*4*\*

Where *Patchez Miss.* \*

Period *3* years.\*

Present or absent *Present*

Stoppage, \$ *100* for

Due Gov't \$ *100* for

Valuation of horse, \$ *100*

Valuation of horse equipments, \$ *100*

Remarks:

-----  
-----  
-----

\* ~~See~~ See enrollment on card from muster-in roll.

Book mark: -----

(358c)

*A. D. Neal*

Copyst.

A

6 H. Art'y.

U.S.C.T.

*John Hawthorth*  
Sergeant, Co. L, 6 Reg't U. S. Col'd H. Art'y.

Appears on

**Company Muster Roll**

for *Nov & Dec*, 186*4*.

Joined for duty and enrolled :

When *Jan. 15*, 186*4*.\*

Where *Natchez Miss.* \*

Period *3* years.\*

Present or absent *Present*

Stoppage, \$ *100* for

Due Gov't \$ *100* for

Valuation of horse, \$ *100*

Valuation of horse equipments, \$ *100*

Remarks: .....

\* See enrollment on card from muster-in roll.

Book mark: .....

*R. B. Shelton*

(358c)

Copyst.

*John Haworth*  
Sgt, Co. L, 6 Reg't U. S. Col'd H. Art'y.

Appears on

**Company Muster Roll**

for *Jan'y & Feb*, 1865.

Joined for duty and enrolled:

When *Jan 15*, 1864.\*

Where *Watches Mis* \*

Period *3* years.\*

Present or absent *Present*

Stoppage, \$ *100* for

Due Gov't \$ *100* for

Valuation of horse, \$ *100*

Valuation of horse equipments, \$ *100*

Remarks: *Charged for Ordnance lost 59¢*

\* See enrollment on card from muster-in roll.

Book mark:

*R. S. Shelton*  
Copyist.



A

6 H. Art'y.

U.S.C.T.

*John Harvorth*  
1 *Sgt*, Co. L, 6 Reg't U. S. Col'd H. Art'y.

Appears on

**Company Muster Roll**

for *Micho Apl*, 1865.

Joined for duty and enrolled:

When *Jan 15*, 1864.\*

Where *Natchez Miss* \*

Period *3* years.\*

Present or absent *Present*

Stoppage, \$ *100* for

Due Gov't \$ *100* for

Valuation of horse, \$ *100*

Valuation of horse equipments, \$ *100*

Remarks: *Charged with Out-  
rance lost 59¢.*

\* See enrollment on card from muster-in roll.

Book mark:

*R S Shelton*

(358c)

Copyst.

*John Haworth*

*Sgt*, Co. L, 6 Reg't U. S. Col'd H. Art'y.

Appears on

**Company Muster Roll**

for *May & June*, 1865.

Joined for duty and enrolled :

When *Jan 15*, 1864.\*

Where *Natchez Miss* \*

Period *3* years.\*

Present or absent *Present*

Stoppage, \$ *100* for

Due Gov't \$ *100* for

Valuation of horse, \$ *100*

Valuation of horse equipments, \$ *100*

Remarks: *Advance Bounty  
and 1<sup>st</sup>, 2<sup>nd</sup>, & 3<sup>rd</sup> instalments  
Commutation Bounty  
Now due.*

\* See enrollment on card from muster-in roll.

Book mark: \_\_\_\_\_

*R. S. Shelton*  
Copyist.

*John Harvorth*  
Pvt. Co. L, 6 Reg't U. S. Col'd H. Art'y.

Appears on

**Company Muster Roll**  
for *July & Aug*, 1865.

Joined for duty and enrolled :

When *Jan'y 15*, 1864.\*

Where *Natchez Miss* \*

Period *3* years.\*

Present or absent *Present*

Stoppage, \$ *100* for

Due Gov't \$ *100* for

Valuation of horse, \$ *100*

Valuation of horse equipments, \$ *100*

Remarks: *Advance Bounty and  
1<sup>st</sup>, 2<sup>nd</sup>, & 3<sup>rd</sup> instalments  
Commutation Bounty  
now due.*

\* See enrollment on card from muster-in roll.

Book mark:

*R. S. Dutton*

(358c)

Copyist.

26

6 H. Art'y.

U.S.C.T.

*John Haworth*

*Serjt.*, Co. L, 6 Reg't U. S. Col'd H. Art'y.

Appears on

**Company Muster Roll**

for *dated Oct. 31*, 1865.

Joined for duty and enrolled :

When *Jan. 15*, 1864.\*

Where *Hatchez Miss* \*

Period *3* years.\*

Present or absent.....

Stoppage, \$.....100 for.....

Due Gov't \$.....100 for.....

Valuation of horse, \$.....100

Valuation of horse equipments, \$.....100

Remarks: *Discharged per S. O. No. 512 Par. 10 W. D. A. G. O. Sept. 25 1865 Discharge & Final Statement given.*

\* See enrollment on card from muster-in roll.

Book mark:.....

*Daggett*

(358c)

Copyist.

A

6 H. Art'y.

U.S.C.T.

John Haworth

Sgt, Co. 2, 6 Reg't U. S. Col'd H. Art'y.

1/5gt

Appears on Returns as follows:

Mar 1864 (5th U.S. Col'd H. Art'y) Absent with leave since Mar 19, 64

Oct 1864 (1/5gt 6th U.S. Col'd H. Art'y) Present signs Return as Comdg' Co

Mar 1865 (Sgt) On duty acting Sgt May since Mar 3, 65

Oct 1865 (Sgt) 1st Lt Oct 9, 65 Matched Miss Discharge per O. No 512 Par 10 H. W. A. G. O Sept 25, 65

Book mark:

(546) A. Gougeon Copyist.

*John Haworth*

*Sergt.* Co. *L.*, 6 Reg't U. S. Col'd H. Art'y.

Appears on **Co. Muster-out Roll**, dated

*Natchez, Miss* *May 13*, 1866 .

Muster-out to date ..... , 186 .

Last paid to ..... , 186 .

**Clothing account:**

Last settled ..... , 186 ; drawn since \$ ..... 100

Due soldier \$ ..... 100 ; due U. S. \$ ..... 100

Am't for cloth'g in kind or money adv'd \$ ..... 100

Due U. S. for arms, equipments, &c., \$ ..... 100

Bounty paid \$ ..... 100 ; due \$ ..... 100

Remarks: *Joined at original organization Discharged Oct 10 '65 at Natchez Miss. par. 10. S. O. 512 dated War Dept. Washington Sept. 25, 1865. final statements furnished.*

Book mark: *U.S.O. War Dept. U.S.O. (over)*

*Keefe*

JAN. 14

6179089

★ 168

Sept. 5, 65 S. O. No. 572  
(on file). 12327- V. 4. P. 50  
68.

Haworth, John

Co. L

6

Reg't

250th

Enclosures.

Bed Cards .....	Final Statements .....
Burial Records .....	Furloughs or L. of A. ....
Certs. of Dis. for Discharge .....	Med. Certificates .....
C. M. Charges .....	Med. Des. Lists .....
Descriptive Lists .....	Orders .....
Discharge Certificates .....	Pris. of War Record .....
Enlistment Papers .....	Resignations .....

Other papers relating to—

Admission to Hosp'l .....	Furlough or L. of A. ....
Casualty Sheet .....	Med. Examination .....
Confinement .....	Misc. Information .....
Contracts .....	Pay or Clothing .....
Death or Effects .....	Personal Reports .....
Desertion .....	Rank .....
Discharge from Hosp'l .....	Transfer to Hosp'l .....
Discharge from Service / .....	Transfer to V. R. C. ....
Duty .....	Transportation .....



# War Department,

ADJUTANT GENERAL'S OFFICE,

Washington, September 25, 1865.

Special Orders,  
No. 512.

Extract.

x x x x  
10. The following named enlisted men (white) of  
the 6<sup>th</sup> U.S. Colored Artillery, (Heavy) will be discharged  
the service of the United States, on the receipt of this  
Order at the places where they may be serving:—

x x x x  
1<sup>st</sup> Sergeant, John Haworth, Company "D,"

By order of the Secretary of War:

War Department,  
ADJUTANT GENERAL'S OFFICE,

Aug 8, 1862.

A true copy.

(Sgd) E. W. Townsend  
Asst. Adjutant General.

For office use only  
J. W. P.

Assistant Adjutant General.

R. P. Div.

Wages Charles

Co B, 6 U.S. Col'd H. Art'y.

Private Private

CARD NUMBERS.

1	6154124	26
2	6160928	27
3	6162646	28
4	9119441	29
5	40742469	30
6		31
7		32
8		33
9		34
10		35
11		36
12		37
13		38
14		39
15		40
16		41
17		42
18		43
19		44
20		45
21		46
22		47
23		48
24		49
25		50

Book Mark:

See also

Charles Hays

Co. B, 6 Reg't U. S. Col'd H. Art'y.

Appears on

Company Descriptive Book  
of the organization named above.

DESCRIPTION.

Age 24 years; height 5 feet 10 inches.

Complexion Black

Eyes Blue; hair Blue

Where born Adams Co Miss

Occupation Laborer

ENLISTMENT.

When Feb 14, 1864.

Where Natchez Miss

By whom L. F. Burwick; term 3 y'rs.

Remarks: Died in Hoop at  
Natchez Miss Apr 12/64

Apier

Charles Hays

Pl., Co. C, 2<sup>d</sup> Reg't U. S. Cold ~~Artz~~ <sup>Miss</sup>

Age 24 years.

Appears on a

**Detachment Muster-in Roll**

of the organization named above. Roll dated

Natchez Miss, Mar. 7, 1864.

Muster-in to date Feb. 14, 1864.

Joined for duty and enrolled:

When Feb. 14, 1864.

Where Natchez Miss.

Period 3 years.

Valuation of horse, \$ 100

Valuation of horse equipments, \$ 100

Remarks:

# Corrected May 27/96 to ma

\* Became the 6<sup>th</sup> U. S. C. H. Artz.

Book mark:

Gaggett

H

6 H. Art'y.

U.S.C.T.

Charles Hays

Priv., Co. C, 5 Reg't U. S. Col'd H. Art'y.†

Appears on

Company Muster Roll

for Mar & Apr, 1864.

Joined for duty and enrolled:

When Feb 14, 1864.\*

Where Natchez, Miss.\*

Period 3 years.\*

Present or absent

Stoppage, \$ 100 for

Due Gov't \$ 100 for

Valuation of horse, \$ 100

Valuation of horse equipments, 100

Remarks: Died in Regimental Hosp. Natchez, April 12<sup>th</sup> 1864,

†This organization subsequently became Co. C, 6 Reg't U. S. Colored Heavy Artillery.

\* See enrollment on card from muster-in roll.

Book mark:

no chance

(358c)

Copyist.

A

6 H. Art'y.

U.S.C.T.

Charles Hays  
Pot., Co. ...., 6 Reg't U. S. Col'd H. Art'y.

Appears on Returns as follows:

April 1864 (Co C. 5  
U. S. Col'd H. Art'y)  
Died of disease  
in Reg't Wash  
April 22, 64 Natchez  
Miss

Book mark:

(546)

A. J. Gougeon  
Copyist.

96

6 H. Art'y.

U.S.C.T.

*Charles Hayes*  
Cpt., Co. C, 6 Reg't U. S. Col'd H. Art'y.

Appears on **Co. Muster-out Roll**, dated  
*Natchez Miss May 13*, 1866 .

Muster-out to date \_\_\_\_\_, 186 .

Last paid to \_\_\_\_\_, 186 .

**Clothing account:**

Last settled \_\_\_\_\_, 186 ; drawn since \$ \_\_\_\_\_ 100

Due soldier \$ \_\_\_\_\_ 100 ; due U. S. \$ \_\_\_\_\_ 100

Am't for cloth'g in kind or money adv'd \$ \_\_\_\_\_ 100

Due U. S. for arms, equipments, &c., \$ \_\_\_\_\_ 100

Bounty paid \$ \_\_\_\_\_ 100 ; due \$ \_\_\_\_\_ 100

Remarks: *Joined as recruit  
Died April 12 1864  
at Natchez Miss  
of Pneumonia. Final  
Statement forwarded.*

Book mark: *95, P 27, 68*

*J. M. Calloway*

(361)

Copyist.

Hays, Charles

P. Co. C., 6 U.S.C.H.A.

2 Enclosures.

Bed Cards	Descriptive Lists
Burial Records	Final Statements /
Certs. of Dis. for Discharge	Furloughs
C. M. Charges	Med. Des. Lists
Med. Certificates	Orders

Other papers relating to—

Admission to Hosp'l	Furlough
Casualty Sheet (Officer's)	Med. Examination
Confinement	Misc. Information
Contracts	Pay or Clothing
Death or Effects /	Personal Reports
Desertions	Rank
Discharge from Hosp'l	Transfer to Hosp'l
Discharge from Service	Transfer to V. R. C.
Duty	Transportation



FINAL STATEMENT

OF

*60 30*  
Pat Charles Hayes Cole  
6th Reg't of U.S. A. V.

**VOLUNTEERS.**

Dead April 12 1864

NOTE 1.—Two of these certificates (or duplicates) are to be given to each Volunteer Soldier or drafted man who may be discharged previously to the discharge of his company, that he may at once receive from the Paymaster the pay, &c., due him, and the captain or other COMMISSIONED officer commanding the company will certify to the act of the delivery of the duplicate certificates; on these certificates the Soldier is "entitled to" his discharge, and should also present his discharge to the Paymaster to have the payment endorsed on it. The discharge is to be given back to the Soldier by the Paymaster; the latter only retaining as his voucher the duplicate certificates.

NOTE 2.—If the Soldier is entitled to pay for the use of his horse, the Company Commander will certify to that fact on the back of both these final statements, and also to the time he has pay due for having been so mounted on his own horse.

NOTE 3.—When a Soldier is furnished with final statements, his descriptive list, if he has one, should be taken up by the officer who gives the Soldier these statements, and endorsed with a statement to this effect by the officer. This endorsement should exhibit a full statement of the time for which the Soldier was allowed pay on his final statements, the clothing account, and all other charges against him or in his favor, so as to comprise a complete exhibit of his account. It will then be transmitted to the company commander of the Soldier, who will enter all the data necessary to a full understanding of the Soldier's account on the muster roll upon which the Soldier's discharge is reported. The descriptive list will then be destroyed. The object of this is, that the remaining portion of the Soldier's account may be settled upon the receipt of these muster rolls, and the Soldier receive any pay or allowances that may be due him at the time of his discharge, and which may not appear on his final statements from the fact that his descriptive list is incomplete. These accounts for back pay, &c., are settled by the 2d Auditor of the Treasury Department.

NOTE 4.—Charges for loss or injury to ordnance, horse equipments, and other miscellaneous charges, should appear under the heading of "Other Stoppages."

NOTE 5.—Bounty paid by State authorities, and not by the United States, will not be entered on this statement.

NOTE 6.—Amounts due the Sutler and Laundress must be entered on the muster roll on which the discharge, death, desertion, &c., is reported, as well as on the final statement, otherwise the amount cannot be collected from the United States.

NOTE 7.—This blank will be used for deceased volunteers and drafted men, as well as for others.

NOTE 8.—Where a Soldier dies in Hospital or on detached service, his descriptive list, if he has one, should be sent with his final statements, in duplicate, to the Adjutant General, Washington, D. C.

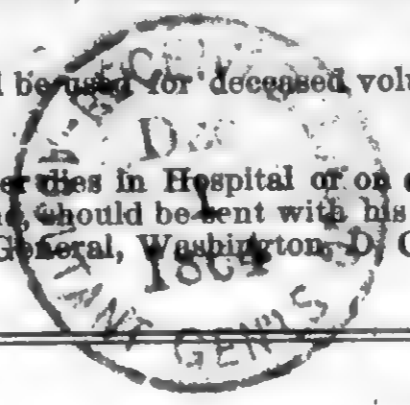

ADJUTANT GENERAL'S OFFICE.

*Dec 1 1864*

Duplicate with Inventory sent 2d Auditor.

I certify, on honor, that Charles Hays a private of  
Captain L. F. Bismuth Company (C) of the 6<sup>th</sup> Regiment of Ill. S. A.  
**VOLUNTEERS**, of the State of \_\_\_\_\_, born in Adams County, State  
of Miss., aged 24 years; 5 feet 10 inches high; Black complexion,  
Black eyes, Black hair, and by occupation a Labourer, having joined the company on  
its original organization at \_\_\_\_\_, and enrolled in it at the muster into  
the service of the United States at \_\_\_\_\_, on the \_\_\_\_\_ day  
of \_\_\_\_\_, 186 \_\_\_\_\_, (or was mustered in service as a recruit, by Captain  
L. F. Bismuth, at Wahatchy Miss. on the 5<sup>th</sup> day of March,  
186 4, or was drafted and mustered into the service of the United States from the \_\_\_\_\_  
Enrollment District of the State of \_\_\_\_\_, at \_\_\_\_\_,  
on the \_\_\_\_\_ day of \_\_\_\_\_, 186 \_\_\_\_\_,) to serve in the Regiment, for  
the term of Three years: and having served HONESTLY and  
FAITHFULLY with his Company in The field to the present date, is now  
entitled to a **DISCHARGE** by reason of Death, died in Regimental  
Hospital at Wahatchy Miss. April 12<sup>th</sup> 1864 of Pneumonia

The said Charles Hays was last paid by Paymaster  
Pay to include the due day of from enlistment 186 \_\_\_\_\_, and has  
pay due him from that time to the present date; he is entitled to pay and subsistence for  
TRAVELING to place of enrollment, and whatever other allowances are authorized to volunteer  
soldiers, drafted men, or militia, so discharged. He has received from the United States **CLOTHING**  
amounting to 44 47 dollars, since the 5<sup>th</sup> day of March,  
186 4, when his clothing account was last settled. He has received from the United States  
\_\_\_\_\_ dollars advanced **BOUNTY**.

There is to be stopped from him, on account of the State of \_\_\_\_\_, or other  
authorities, for **CLOTHING**, &c., received on entering service, \_\_\_\_\_ dollars; and  
for other stoppages, viz: \_\_\_\_\_  
\_\_\_\_\_ dollars.

He has been furnished with **TRANSPORTATION** in kind from the place of his discharge to  
\_\_\_\_\_ ; and he has been **SUBSISTED** for **TRAVELING** to his  
place of enrollment, up to the \_\_\_\_\_, 186 \_\_\_\_\_.

He is indebted to \_\_\_\_\_, **SUTLER**, \_\_\_\_\_ dollars.  
He is indebted to \_\_\_\_\_, **LAUNDRESS**, \_\_\_\_\_ dollars.

Given in Duplicate, at Wahatchy Miss., this 17 day  
of Nov., 186 4.

Louis F. Bismuth  
Capt. Command Co C  
6<sup>th</sup> Ill. S. A. Commanding Company

INVENTORY OF THE EFFECTS

OF

*Col Charles Heap*

Late of Company

*C'*

*6<sup>th</sup>*  
Reg't of

*U. S. C. A. (Heap)*

Volunteers, who died at

*Watches Ship*

on the

*12*

day of

*April*

1864,



Inventory of the effects of Charles Hays late  
 a private of Captain 1<sup>st</sup> Lt M. J. Nelson Company C of  
 the 6<sup>th</sup> Regiment of 2<sup>nd</sup> S. C. V. Volunteers, who was enrolled as  
 a Soldier at Laurens S.C. in the State of Miss on  
 the 14 day of Feb. 1864 and mustered into the service of the United  
 States as a private on the 3 day of March 1864, at Natchez  
 in Company C, 6<sup>th</sup> Regiment of 2<sup>nd</sup> S. C. V. Volunteers, to serve 3  
 years or during the war; he was born in Georgetown S.C. in the State  
 of Miss; he was 24 years of age, 5 feet 10 inches  
 high, black complexion, black eyes, black hair, and by occupation, when enrolled,  
 a laborer; he died in Hospital, at  
Laurens Miss on the 12 day of April 1864 by  
 reason of menstrua

INVENTORY.					
ARTICLES.	No.	ARTICLES.	No.	ARTICLES.	No.
Hats.....		Pairs trousers.....		Knapsacks.....	
Caps.....		Pairs flannel drawers.....			
Forage caps.....		Pairs cotton drawers.....			
Great coats.....		Flannel shirts.....			
Uniform coats.....		Cotton shirts.....			
Uniform jackets.....		Pairs boots.....			
Flannel sack coats.....		Pairs shoes.....			
Blouses.....		Pairs socks.....		MONEY.	
Stable frocks.....		Blankets.....		Specie.....	\$
Fatigue overalls.....		Haversacks.....		Notes.....	\$

I CERTIFY, ON HONOR, that the above inventory comprises all the effects of  
Charles Hays, deceased, and that the effects are in the hands  
 of \_\_\_\_\_ at \_\_\_\_\_  
 \_\_\_\_\_ to be disposed of by a Council of Administration.

(DUPLICATES.)

STATION: U. S. Cavalry

DATE: Apr 3<sup>rd</sup> 1864.

[A. G. O. No. 104.]

Amos J. Burroughs  
J. Burroughs  
 Commanding the Company.

*Hayes, Toby*

**Co 8, 6 U.S. Col'd H. Art'y.**

*Private*

**CARD NUMBERS.**

1	26
2	27
3 <i>see Hayes, Toby</i>	28
4	29
5	30
6	31
7	32
8	33
9	34
10	35
11	36
12	37
13	38
14	39
15	40
16	41
17	42
18	43
19	44
20	45
21	46
22	47
23	48
24	49
25	50

**Book Mark:**

**See also**

*Hayley Henry*

Co A, 6 U.S. Col'd H. Art'y.

*Private*

CARD NUMBERS.

1	26
2	27
3 <i>in Haley, Henry</i>	28
4	29
5	30
6	31
7	32
8	33
9	34
10	35
11	36
12	37
13	38
14	39
15	40
16	41
17	42
18	43
19	44
20	45
21	46
22	47
23	48
24	49
25	50

Book Mark:

See also

*Hays Benjamin*

Co *K*, 6 U.S. Col'd H. Art'y.

*Private* | *Private*

CARD NUMBERS.

1	6175658	26
2	6175760	27
3	6175896	28
4	6176033	29
5	6176153	30
6	6176266	31
7	6176379	32
8	6176494	33
9	6176615	34
10	6176736	35
11	6176859	36
12	6176973	37
13	6177086	38
14	6177194	39
15	6177302	40
16	6177410	41
17	9120713	42
18	40742472	43
19		44
20		45
21		46
22		47
23		48
24		49
25		50

Book Mark: \_\_\_\_\_

See also \_\_\_\_\_

*Benjamin Nays*

*N*, Co. *N*, 6 Reg't U. S. Col'd H. Art'y.

Appears on

**Company Descriptive Book**

of the organization named above.

**DESCRIPTION.**

Age *22* years; height *5* feet *8* inches.

Complexion *Dark*

Eyes *black*; hair *black*

Where born *Texas, Parish La.*

Occupation *Solider*

**ENLISTMENT**

When *Jan 1*, 186*4*.

Where *Wachey Miss*

By whom *Capt. Rempus*; term *3* y'rs.

Remarks:

-----  
-----  
-----  
-----  
-----  
-----  
-----  
-----

*D. S. Pittman*



*Benjamin Hays*  
*Co. K, 2 Reg't Miss. Art'y.†*

Age *22* years.

Appears on

**Company Muster-in Roll**

of the organization named above. Roll dated

*Natchez Miss, Jan 8, 1864*

Muster-in to date

*Jan 1, 1864*

Joined for duty and enrolled:

When

*Jan 1, 1864\**

Where

*Natchez Miss \**

Period

*3* years.\*

Valuation of horse, \$ *100*

Valuation of horse equipments, \$ *100*

Remarks:

† This organization subsequently became Co. *K*, 6 Reg't U. S. Colored Heavy Artillery.

\*~~42~~ Muster-in roll shows enrollment of all men of this company as of same date and place. See enrollment on subsequent card or cards.

Book mark:

*Spillo*

*H*

*Benjamin Hays*  
*Co. K*, Co. K, 2 Reg't Miss. Artillery.†

Appears on

**Company Muster Roll**

for *Jan 8<sup>th</sup> to Feb 29*, 1864.

Joined for duty and enrolled:

When *Jan 1<sup>st</sup>*, 1864.\*

Where *Nashville Miss* \*

Period *3* years.\*

Present or absent *present*

Stoppage, \$ *100* for

Due Gov't \$ *100* for

Valuation of horse, \$ *100*

Valuation of horse equipments, *100*

Remarks:

† This organization subsequently became Co. K, 6 Reg't U. S. Colored H. Art'y.

\* See enrollment on card from muster-in roll.

Book mark:

*Spills*

*Benjamin Hays*

*Co. A*, Co. *A*, 5 Reg't U. S. Col'd H. Art'y.\*

Appears on

**Company Muster Roll**

for *Mar & Apr*, 1864.

Joined for duty and enrolled:

When *Jan 1<sup>st</sup>*, 1864.\*

Where *Natchez Miss* \*

Period *3* years.\*

Present or absent *present*

Stoppage, \$ *100* for

Due Gov't, \$ *100* for

Valuation of horse, \$ *100*

Valuation of horse equipments, \$ *100*

Remarks: \_\_\_\_\_  
\_\_\_\_\_  
\_\_\_\_\_

\* This organization subsequently became Co. *6* Reg't U. S. Col'd Heavy Artillery.

\* ~~See~~ See enrollment on card from muster-in roll.

Book mark: \_\_\_\_\_

*J. P. Jones*

(358c)

Copyist.

*A*

6 H. Art'y.

U.S.C.T.

*Benjamin Hays*

*Art*, Co. K, 6 Reg't U. S. Col'd H. Art'y.

Appears on

**Company Muster Roll**

for *May & June*, 186*4*.

Joined for duty and enrolled:

When *Jan 1<sup>st</sup>*, 186*4*.\*

Where *Nashy Miss*.\*

Period *3* years.\*

Present or absent *present*

Stoppage, \$ *100* for

Due Gov't \$ *100* for

Remarks:  
\_\_\_\_\_  
\_\_\_\_\_  
\_\_\_\_\_  
\_\_\_\_\_  
\_\_\_\_\_

\* See enrollment on card from muster-in roll.

Book mark: \_\_\_\_\_

(358c)

*J. J. J. J.*

Copyist.

26

6 H. Art'y.

U.S.C.T.

*Benjamin Hays*  
6 Reg't U. S. Col'd Art'y.  
Pr: Co. K, 2 Reg't Miss. Artillery.†

Appears on

**Company Muster Roll**

for *July & Aug.*, 1864.

Joined for duty and enrolled:

When *June.*, 1864.\*

Where *Natchez, Miss.* \*

Period *3* years.\*

Present or absent *Present.*

Stoppage, \$ *100* for

Due Gov't \$ *100* for

Valuation of horse, \$ *100*

Valuation of horse equipments, *100*

Remarks:

† This organization subsequently became Co. K, 6 Reg't U. S. Colored H. Art'y. x

\* See enrollment on card from muster-in roll.  
x Corrected Oct. 29, 1894. JES.

Book mark:

*J. Smith*

*H*

6 H. Art'y.

U.S.C.T.

*Benjamin Hoays*  
*Pvt*, Co. K, 6 Reg't U. S. Col'd H. Art'y.

Appears on

**Company Muster Roll**

for *Sept to Oct*, 186*4*.

Joined for duty and enrolled:

When *Jan 1*, 186*4*.\*

Where *Natchez, Miss.*\*

Period *3* years.\*

Present or absent *Present*

Stoppage, \$ *100* for

Due Gov't \$ *100* for

Remarks:  
-----  
-----  
-----  
-----  
-----  
-----

\* See enrollment on card from muster-in roll.

Book mark: -----

(358c)

*J B Gage*  
Copyist.

H

6 H. Art'y.

U.S.C.T.

*Benjamin Hays*  
Private, Co. K, 6 Reg't U. S. Corp'd H. Art'y.

Appears on

**Company Muster Roll**

for *Nov. and Dec.*, 1864.

Joined for duty and enrolled:

When *Jan. 1.*, 1864.\*

Where *Natches, Miss.* \*

Period *3* years.\*

Present or absent *Present*

Stoppage, \$ *100* for

Due Gov't \$ *100* for

Remarks:

-----  
-----  
-----  
-----  
-----  
-----

\* See enrollment on card from muster-in roll.

Book mark: -----

(358c)

*C. J. Powell*

Copyist.

H

6 H. Art'y.

U.S.C.T.

*Benjamin Hayes*  
*Hiram*, Co. K, 6 Reg't U. S. Col'd H. Art'y.

Appears on

**Company Muster Roll**

for *Jan. and Feb*, 186*5*.

Joined for duty and enrolled:

When *Jan. 1*, 186*4*.\*

Where *Natchez, Miss.* \*

Period *3* years.\*

Present or absent *Present*

Stoppage, \$ *100* for

Due Gov't \$ *100* for

Remarks:

\* See enrollment on card from muster-in roll.

Book mark:

*C. J. Powell*

(358c)

Copyist.



N

6 H. Art'y.

U.S.C.T.

*Benjamin Hays*  
*Pirate*, Co. K, 6 Reg't U. S. Col'd H. Art'y.

Appears on

**Company Muster Roll**

for *March and April*, 1865.

Joined for duty and enrolled:

When *Jun. 1.*, 1864.\*

Where *Natchez, Miss.* \*

Period *3* years.\*

Present or absent *Present*

Stoppage, \$ *100* for

Due Gov't \$ *100* for

Remarks:

-----  
-----  
-----  
-----  
-----  
-----

\* See enrollment on card from muster-in roll.

Book mark:

*C. J. Powell*

(358c)

Copyist.

H

6 H. Art'y.

U.S.C.T.

Benjamin Hayes  
Private, Co. K, 6 Reg't U. S. Col'd H. Art'y.

Appears on

**Company Muster Roll**

for May and June, 1865.

Joined for duty and enrolled:

When Jan. 1, 1864.\*

Where Natchez, Miss \*

Period 3 years.\*

Present or absent Present

Stoppage, \$ 100 for

Due Gov't \$ 100 for

Remarks:

\* See enrollment on card from muster-in roll.

Book mark:

C. G. Powell

(358c)

Copyist.

A

6 H. Art'y.

U.S.C.T.

*Benjamin Hays*  
*Private*, Co. K, 6 Reg't U. S. Col'd H. Art'y.

Appears on

**Company Muster Roll**

for *July and Aug.*, 1865.

Joined for duty and enrolled:

When *Jan. 1.*, 1864.\*

Where *Natchez, Miss.*\*

Period *3* years.\*

Present or absent *Present*

Stoppage, \$ *100* for

Due Gov't \$ *100* for

Remarks:  
-----  
-----  
-----  
-----  
-----  
-----

\* See enrollment on card from muster-in roll.

Book mark: -----

*C. J. Powell*

(358c)

Copyist.

W

6 H. Art'y.

U.S.C.T.

Benjamin D. Hays  
Priv., Co. K, 6 Reg't U. S. Col'd H. Art'y.

Appears on

Company Muster Roll

for Sept & Oct, 1867.

Joined for duty and enrolled:

When Jan'y 1864.\*

Where Natchez Miss.\*

Period 3 years.\*

Present or absent Present

Stoppage, \$ 100 for

Due Gov't \$ 100 for

Remarks: \* Absent sick  
in Post Hospital

\* As it appears on roll.

\* See enrollment on card from muster-in roll.

Book mark:

W. S. Houston

(358c)

Copyist.

H

6 H. Art'y.

U.S.C.T.

*Benjamin Hayes*  
Capt., Co. K, 6 Reg't U. S. Col'd H. Art'y.

Appears on

**Company Muster Roll**

for *Nov & Dec*, 1865.

Joined for duty and enrolled:

When *Jan 1*, 1864.\*

Where *Natchez Miss\**

Period *3* years.\* -

Present or absent *Present*

Stoppage, \$ *100* for

Due Gov't \$ *100* for

Remarks:

\* See enrollment on card from muster-in roll.

Book mark:

*W. D. Hoisington*

(358c)

Copyist.

QV

6 H. Art'y.

U.S.C.T.

*Benjamin Hayes*  
Co. K, 6 Reg't U. S. Col'd H. Art'y.

Appears on

**Company Muster Roll**

for *Jan'y & Feb'y*, 1866.

Joined for duty and enrolled:

When *Jan'y 1*, 1864.\*

Where *Natchez Miss\**

Period *3* years.\*

Present or absent *Present*

Stoppage, \$ *100* for

Due Gov't \$ *100* for

Remarks:  
-----  
-----  
-----  
-----  
-----

\* See enrollment on card from muster-in roll.

Book mark: -----

*W. L. Houston*

(358c)

Copyist.

04

6 H. Art'y.

U.S.C.T.

*Benjamin Hays*  
Co. K, 6 Reg't U. S. Col'd H. Art'y.

Appears on

**Company Muster Roll**

for *March & April*, 186*6*

Joined for duty and enrolled:

When *January 1*, 186*4*.\*

Where *Natchez Miss*.\*

Period *3* years.\*

Present or absent *Present*

Stoppage, \$ *100* for

Due Gov't \$ *100* for

Remarks:

-----  
-----  
-----  
-----  
-----

\* See enrollment on card from muster-in roll.

Book mark:

-----

(358c)

*W. R. Houston*

Copyist.

A

6th H. Art'y.

U.S.C.T.

Benjamin Hays

Pvt., Co. K, 6 Reg't U. S. Col'd H. Art'y.

Appears on Returns as follows:

Jan 1864 (2 Miss Hart  
A.W.) Absent sick

Jan 23, 64 indefinite  
Natchez Miss

May 1865 Absent  
sick in Post

Hosp (6 US Col'd HA)

Oct 1865 Absent sick  
in Post Hosp

Oct 9, 65

Book mark:

(545)

A. Goulds

Copyist.



H

6 H. Art'y.

U.S.C.T.

*Benjamin Hays*

*Out*, Co. *K*, 6 Reg't U. S. Col'd H. Art'y.

Appears on **Co. Muster-out Roll**, dated

*Natchez, Miss May 13, 1866*.

Muster-out to date

*May 13, 1866*.

Last paid to

*Dec. 31, 1865*.

Clothing account:

Last settled....., 186 ; drawn since \$..... 100

Due soldier \$ *8* <sup>*60*</sup>/<sub>100</sub>; due U. S. \$..... 100

Am't for cloth'g in kind or money adv'd \$..... 100

Due U. S. for arms, equipments, &c., \$..... 100

Bounty paid \$..... 100; due \$..... 100

Remarks:

*Joined original organization.*

Book mark:

*G. W. Chase*

(361)

Copyist.

*Ways Jan*  
Co B, 6 U.S. Col'd H. Art'y.

*Private Private*

CARD NUMBERS.

1	6154423	26
2	6161256	27
3	6161391	28
4	6161532	29
5	6161672	30
6	6161882	31
7	6162616	32
8	6154731	33
9	9119476	34
10	40742471	35
11		36
12		37
13		38
14		39
15		40
16		41
17		42
18		43
19		44
20		45
21		46
22		47
23		48
24		49
25		50

Book Mark: *21. On P 259*

See also

*James Hays*

....., Co. *C*, 6 Reg't U.S. Col'd H. Art'y.

Appears on

**Company Descriptive Book**

of the organization named above.

**DESCRIPTION.**

Age *28* years; height *5* feet *8* inches.

Complexion *Black*

Eyes *Black*; hair *Black*

Where born *William Mass*

Occupation .....

**ENLISTMENT.**

When *Sept 22*, 186*4*.

Where *Nashua Mass*

By whom *L. Bennett*; term *3* y'rs.

Remarks: *Discharged at Nashua  
Mass June 20<sup>th</sup> 1865*

.....  
.....  
.....  
.....  
.....  
.....  
.....  
.....  
.....

*H. Jones*

James Hayes

Appears with rank of *Pvt* on

**Muster and Descriptive Roll of a Detachment of U. S. Vols. forwarded**

for the 6 Reg't U. S. Col'd H. Art'y. Roll dated *Natchez, Miss, Sept 24, 1864.*

Where born *Wilkinson, Miss.*

Age *28* y'rs; occupation *Farmer*

When enlisted *Sept 22, 1864.*

Where enlisted *Natchez, Miss.*

For what period enlisted *3* years.

Eyes *Black*; hair *Black*

Complexion *Black*; height *5 ft. 8 in.*

When mustered in *Sept 22, 1864.*

Where mustered in *Natchez, Miss.*

Bounty paid \$ *none* *100*; due \$ *all* *100*

Where credited *Natchez, Adams Co, Miss.*

Company to which assigned *C*

Remarks:

Book mark:

*W. D. G.*

*James Hays*  
Pvt., Co. C, 6 Reg't U. S. Col'd H. Art'y.

Appears on  
**Company Muster Roll**  
for *Sept & Oct*, 1864.

Joined for duty and enrolled:  
When *Sept 22*, 1864\*  
Where *Natchez Miss\**  
Period *3* years.\*

Present or absent *Present*

Stoppage, \$ *100* for

Due Gov't, \$ *100* for

Valuation of horse, \$ *100*

Valuation of horse equipments, \$ *100*

Remarks:  
.....  
.....  
.....

\* See enrollment on card from muster-in roll.

Book mark: .....

*M. Smith*

*J*

6 H. Art'y.

U.S.C.T.

*James Hays*

*Or*, Co. C, 6 Reg't U. S. Col'd H. Art'y.

Appears on

Company Muster Roll

for *Nov & Dec*, 1864.

Joined for duty and enrolled:

When *Sept 22*, 1864.\*

Where *Natchez, Miss\**

Period *3* years.\*

Present or absent *Present*

Stoppage, \$ *100* for

Due Gov't, \$ *100* for

Valuation of horse, \$ *100*

Valuation of horse equipments, \$ *100*

Remarks:

\* See enrollment on card from muster-in roll.

Book mark:

*J. H. Smith*

(358c)

Copyist.

*James Hays*

*Pr*, Co. C, 6 Reg't U. S. Col'd H. Art'y.

Appears on

**Company Muster Roll**

for *Jan & Feb*, 186*5*.

Joined for duty and enrolled:

When *Sept 22*, 186*4*.\*

Where *Natchez, Miss*\*

Period *3* years.\*

Present or absent *Present*

Stoppage, \$ *100* for

Due Gov't, \$ *100* for

Valuation of horse, \$ *100*

Valuation of horse equipments, \$ *100*

Remarks: *Sick in Post Hosp<sup>e</sup>*

\* See enrollment on card from muster-in roll.

Book mark:

*A. Smith*

H

6 H. Art'y.

U.S.C.T.

James Hays  
Pr

, Co. C, 6 Reg't U. S. Col'd H. Art'y.

Appears on

Company Muster Roll

for Mar & Apr, 1865.

Joined for duty and enrolled:

When Sept 22, 1864.\*

Where Katchez, Miss.\*

Period 3 years.\*

Present or absent Absent

Stoppage, \$ 100 for

Due Gov't, \$ 100 for

Valuation of horse, \$ 100

Valuation of horse equipments, \$ 100

Remarks: Sick in Post  
Hosp. Katchez, Miss.  
since Jan. 19, 1865

\* See enrollment on card from muster-in roll.

Book mark:

H. A. Smith

(358c)

Copyist.



*James Hayes*

*Co. C*, 6 Reg't U. S. Col'd H. Art'y.

Appears on

**Company Muster Roll**

for *May & June*, 1865.

Joined for duty and enrolled:

When *Sept 22*, 1864.\*

Where *Natchez, Miss\**

Period *3* years.\*

Present or absent

Stoppage, \$ *100* for

Due Gov't, \$ *100* for

Remarks:

*Discharged per  
G.O. 44 Hd Qrs. Dept of  
Miss. Vicksburg, June 20, 1865*

\* See enrollment on card from muster-in roll.

Book mark:

*see E. B. V. 11. P. 259  
Discharged June 27, 1865*

*H. A. Smith*

A

6 H. Art'y.

U.S.C.T.

James Hays

Pat., Co. C, 36 Reg't U. S. Col'd H. Art'y.

Appears on Returns as follows:

Sept 1864 Gain Sept  
24 Natchez Miss  
By Enlistment

Nov 1864 Absent with-  
out leave since  
Nov 7 64

Jan to May 1865 Ab-  
sent sick in  
Post Hosp since  
Jan 19, 65

June 1865 20, 65 Natchez Miss  
Disch'd per G.O.  
44 Adsted Ad 2rs  
Wefst Miss Vicks-  
burg Miss May  
8, 65

Book mark:

(546)

A. J. Douglas

Copyist.

*H*

6 H. Art'y.

U.S.C.T.

*James Hayes*

*Co. C*, 6 Reg't U.S. Col'd H. Art'y.

Appears on **Co. Muster-out Roll**, dated *Natchez Miss May 3*, 1866 .

Muster-out to date \_\_\_\_\_, 186 .

Last paid to \_\_\_\_\_, 186 .

**Clothing account:**

Last settled \_\_\_\_\_, 186 ; drawn since \$ \_\_\_\_\_ 100

Due soldier \$ \_\_\_\_\_ 100 ; due U. S. \$ \_\_\_\_\_ 100

Am't for cloth'g in kind or money adv'd \$ \_\_\_\_\_ 100

Due U. S. for arms, equipments, &c., \$ \_\_\_\_\_ 100

Bounty paid \$ \_\_\_\_\_ 100 ; due \$ \_\_\_\_\_ 100

Remarks: *Joined as recruit  
Discharged June 20 65  
at Natchez Miss per  
G.O. No 44 Fed Ins Dept  
of Miss. Final Statement  
furnished*

Book mark: *Dischd June 23 65 63 11 P 259*

*J. M. Calhoun*

(361)

Copyist.

*James Hays*  
*Priv, Co. C, 6* Reg't U. S. Col'de *Arty.*

Appears on a

**Detachment Muster-out Roll**

of the organization named above. Roll dated

*Natchez, Miss. June 27, 1865.*

Muster-out to date *June 27, 1865.*

Last paid to *Feb'y 28, 1865.*

**Clothing account:**

Last settled \_\_\_\_\_, 186 ; drawn since \$ \_\_\_\_\_ 100

Due soldier \$ \_\_\_\_\_ 100; due U. S. \$ \_\_\_\_\_ 100

Am't for cloth'g in kind or money adv'd \$ \_\_\_\_\_ 100

Due U. S. for arms, equipments, &c., \$ \_\_\_\_\_ 100

Bounty paid \$ \_\_\_\_\_ 100 due \$ \_\_\_\_\_ 100

**Remarks:**

*Clothing acct settled to include  
Sept. 22 '64 amt since drawn \$39.75.  
Bounty all due.*

Book mark: \_\_\_\_\_

*D. Mahon*

*Ways Jerry*

Co *N*, 6 U.S. Col'd H. Art'y.

*Private* | *Private*

CARD NUMBERS.

1	6171579	26
2	6171668	27
3	6171808	28
4	6171949	29
5	6172087	30
6	6172214	31
7	6172343	32
8	6172463	33
9	6172581	34
10	6172697	35
11	6172816	36
12	6172931	37
12	6173092	38
14	6173523	39
15	9120423	40
16	6701-a-1889	41
17	40782470	42
18		43
19		44
20		45
21		46
22		47
23		48
24		49
25		50

Book Mark: 6701-a-1889

See also

S-947814 - P.O. m + m  
Emel Hoston 6/6/33

F. H. Gooden

*Jerry Hays*  
....., Co. *H*, 6 Reg't U. S. Col'd H. Art'y.

Appears on

**Company Descriptive Book**  
of the organization named above.

**DESCRIPTION.**

Age *45* years; height *5* feet, *7 1/4* inches.  
Complexion *Blk*  
Eyes *Blk*; hair *Gray*  
Where born *Richmond, Va.*  
Occupation *farmer*

**ENLISTMENT.**

When *Apr. 1*, 186*5*.  
Where *Natchez Miss.*  
By whom *Jas P. Snow*, term *3* y'rs.  
Remarks: *Discharged for*  
*Disability*

*Warren*

*Serry Gray*  
*Chie., Co. H., 2 Reg't Miss. Art'y.†*

Age *4*<sup>\*</sup> years.

Appears on

**Company Muster-in Roll**

of the organization named above. Roll dated  
*Natchez Miss. Nov 23, 1863*  
Muster-in to date *Nov 1, 1863*

Joined for duty and enrolled:

When *Nov 1*, 186*3*<sup>\*</sup>  
Where *Natchez Miss.*<sup>\*</sup>  
Period *3* years.\*

Valuation of horse, \$ *100*

Valuation of horse equipments, \$ *100*

Remarks:

*\*Unit figure gone from roll.*

† This organization subsequently became Co. *H.*, 6 Reg't U. S. Colored Heavy Artillery.

\*~~ed~~ Muster-in roll shows enrollment of all men of this company as of same date and place. See enrollment on subsequent card or cards.

Book mark: *6701-a-1889*

*A. S. ...*



*H.C.*

6 H. Art'y.

U.S.C.T.

*Berry Blays*  
*Chieft.*, Co. H, 2 Reg't Miss. Art'y.†

Appears on

**Company Muster Roll**

for *Jan 23 to Dec. 31*, 186*3*.

Joined for duty and enrolled:

When *Jan 1*, 186*3*.\*

Where *St. Louis, Mo.* \*

Period *1* years.\*

Present or absent *Present*

Stoppage, \$ *100* for

Due Gov't, \$ *100* for

Valuation of horse, \$ *100*

Valuation of horse equipments, \$ *100*

Remarks:  
.....  
.....  
.....

† This organization subsequently became Co. H, 6 Reg't U. S. Co'ld Heavy Artillery.  
\* See enrollment on card from muster-in roll.

Book mark: .....

*B. Blays*

(358c)

Copyist

*140*

**6 H. Art'y.**

**U.S.C.T.**

*Jerry Hayes*  
Co. H, 2 Reg't Miss. Art'y.†

Appears on

**Company Muster Roll**

for *Jan. & Feb.*, 186*4*.

Joined for duty and enrolled:

When *Nov. 1*, 186*3*.\*

Where *Natchez Miss.*\*

Period *3* years.\*

Present or absent *Present*

Stoppage, \$ *100* for

Due Gov't, \$ *100* for

Valuation of horse, \$ *100*

Valuation of horse equipments, \$ *100*

Remarks:

† This organization subsequently became Co. H, 6 Reg't U. S. Co'd. Heavy Artillery.  
\* See enrollment on card from muster-in roll.

Book mark:

*Hayes*

*Gerry Hays*  
*Co. A*, 5 Reg't U. S. Col'd H. Art'y.\*

Appears on

**Company Muster Roll**

for *Mar. & Apr.*, 1864.

Joined for duty and enrolled:

When *Nov. 1*, 1863.\*

Where *Valley Forge Pa.*\*

Period *3* years.\*

Present or absent *Present*

Stoppage, \$ *100* for

Due Gov't, \$ *100* for

Valuation of horse, \$ *100*

Valuation of horse equipments, \$ *100*

Remarks: \_\_\_\_\_  
\_\_\_\_\_  
\_\_\_\_\_

\* This organization subsequently became Co. *A*, 6 Reg't U. S. Col'd Heavy Artillery.  
\* See enrollment on card from muster-in roll.

Book mark: \_\_\_\_\_  
\_\_\_\_\_

*G. H. Hays*

*H.*

6 H. Art'y.

U.S.C.T.

*Berry Bays*  
Priv. Co. H, 6 Reg't U. S. Col'd H. Art'y.

Appears on

**Company Muster Roll**

for *May & June*, 186*4*.

Joined for duty and enrolled:

When *Nov.*, 186*3*.\*

Where *Natchez Miss.*\*

Period *3* years.\*

Present or absent *Present*.

Stoppage, \$ *100* for

Due Gov't \$ *100* for

Remarks:  
-----  
-----  
-----  
-----  
-----

\* See enrollment on card from muster-in roll.

Book mark: -----

(358c) *J. H. Adams* Copyist.

*H.*

6 H. Art'y.

U.S.C.T.

*Berry Hayes*  
Pri., Co. H, 6 Reg't U. S. Col'd H. Art'y.

Appears on

**Company Muster Roll**

for *July & August*, 186*4*.

Joined for duty and enrolled:

When *Nov. 1*, 186*3*.

Where *Natchez Miss.*

Period *3* years.\*

Present or absent *Present*.

Stoppage, \$ *100* for

Due Gov't \$ *100* for

Remarks:  
-----  
-----  
-----  
-----  
-----

\* See enrollment on card from muster-in roll.

Book mark: -----

(358c)

*J. B. Stearns*

Copyist.

H

6 H. Art'y.

U.S.C.T.

Jerry Hayes

PM, Co. H, 6 Reg't U. S. Col'd H. Art'y.

Appears on

Company Muster Roll

for Sept and Oct., 1864.

Joined for duty and enrolled:

When Nov 1, 1863.\*

Where Katchez Miss.\*

Period 3 years.\*

Present or absent present

Stoppage, \$ 100 for

Due Gov't \$ 100 for

Remarks:

\* See enrollment on card from muster-in roll.

Book mark:

O'Leary

(358c)

Copyist.

H

6 H. Art'y.

U.S.C.T.

Jerry Hayes

Private, Co. H, 6 Reg't U. S. Col'd H. Art'y.

Appears on

Company Muster Roll

for Nov and Dec, 1864.

Joined for duty and enrolled:

When Nov 1, 1863.

Where Hatchez Miss

Period 3 years.\*

Present or absent present

Stoppage, \$ 100 for

Due Gov't \$ 100 for

Remarks:

-----  
-----  
-----  
-----  
-----

\* See enrollment on card from muster-in roll.

Book mark:

O'Leary

(353c)

Copyist.

H

6 H. Art'y.

U.S.C.T.

Jerry Hayes

Priv, Co. H, 6 Reg't U. S. Col'd H. Art'y.

Appears on

Company Muster Roll

for Jan and Feb, 1865

Joined for duty and enrolled:

When Nov 1, 1863.\*

Where Ketchum Miss.\*

Period 3 years.\*

Present or absent present

Stoppage, \$ 100 for

Due Gov't \$ 100 for

Remarks:

\* See enrollment on card from muster-in roll.

Book mark:

O'Leary

(358c)

Copyist.



H

6 H. Art'y.

U.S.C.T.

Jerry Hayes

PM

Co. H, 6 Reg't U. S. Col'd H. Art'y.

Appears on

Company Muster Roll

for Mch and Apr, 1865

Joined for duty and enrolled:

When Nov 1, 1863

Where Natchez, Miss\*

Period 3 years.\*

Present or absent Present

Stoppage, \$ 100 for

Due Gov't \$ 100 for

Remarks:

\* See enrollment on card from muster-in roll.

Book mark:

O'Leary

(358c)

Copyist.

*Jerry Hayes*  
.....  
*Pat. T.*, Co. H, 6 Reg't U. S. Col'd H, Art'y.

Appears on

**Company Muster Roll**

for *May & June*, 186 *3*.

Joined for duty and enrolled:

When *Nov. 1*, 186 *3*.\*

Where *Watches Miss.* \*

Period *3* years.\*

Present or absent *Present*

Stoppage, \$ *100* for .....

Due Gov't \$ *100* for .....

Remarks: .....

\* See enrollment on card from muster-in roll.

Book mark: .....

(358c) *Paul* Copyist.

A | C. H. Arty | U.S.C.T.

Jerry Hays  
Pvt, Co A, 6 Reg't U. S. Col'd H. Arty

Appears on

**Company Muster Roll**

for July & Aug., 1865.

Joined for duty and enrolled:

When Nov. 1, 1863.\*

Where Natchez Miss.\*

Period 3 years.\*

Present or absent Absent

Stoppage, \$ 100 for

Due Gov't, \$ 100 for

Remarks: Absent sick in  
Post Hospital Natchez  
Miss. since July 8/65

\* See enrollment on card from muster-in roll.

Book mark:

(358c) Paul Copyist.

*H*

6 H. Art'y.

U.S.C.T.

*Jerry Hayes*

*Priv.*, Co. H, 6 Reg't U. S. Col'd H. Art'y.

Appears on

**Company Muster Roll**

for *Sept & Oct*, 1865.

Joined for duty and enrolled:

When *Jan 1*, 1865.

Where *Catchez Miss.*

Period *3* years.\*

Present or absent.....

Stoppage, \$ *100* for.....

Due Gov't \$ *100* for.....

Remarks: *Discharged for disability Sept 28 1865 Final statement given*

\* ~~45~~ See enrollment on card from muster-in roll.

Book mark:.....

*B. A. Harper*

(358c)

Copyist.

Jerry Hays  
Pvt., Co. A, 6 Reg't U. S. Col'd H. Art'y.

Appears on Returns as follows:

July 1865 Absent  
Sick Post Hosp  
Natchez July 4, 65  
Aug 1865 Absent  
Sick in City Hosp  
since July 4, 65  
Oct 1865 Disch'd  
for disability Sept  
28, 65 Natchez Miss

Book mark ::

(546)

A. Gouglas  
Copyist.

*Jerry Hays*  
Private, Co. H, 6 Reg't U. S. Col'd H. Art'y.

Appears on Co. Muster-out Roll, dated  
*Natchez, Miss. May 13*, 186*6*.

Muster-out to date \_\_\_\_\_, 186 .

Last paid to \_\_\_\_\_, 186 .

Clothing account:

Last settled \_\_\_\_\_, 186 ; drawn since \$ \_\_\_\_\_ 100

Due soldier \$ \_\_\_\_\_ 100; due U. S. \$ \_\_\_\_\_ 100

Am't for cloth'g in kind or money adv'd \$ \_\_\_\_\_ 100

Due U. S. for arms, equipments, &c., \$ \_\_\_\_\_ 100

Bounty paid \$ \_\_\_\_\_ 100; due \$ \_\_\_\_\_ 100

Remarks: *Discharged*  
*Joined original organization, dis-*  
*charged on certificate of*  
*Disability, Sept. 28/65, at Natchez*  
*Miss. Final statement given.*

Book mark: *V 244, V 230, 77 - G. D. 6701,*  
*over*

*C. J. Powell*

JAN 14

6173523

☆T68T☆

a.89.

H. | 6 H.A. | W.C.

Jerry Hays

Co. H, 6<sup>th</sup> Reg't W.C. Harty

NOTATION.

Book mark: 6701. A. 1889.

War Department  
Adjutant General's Office,

Washington, August 23, 1889.

Application for certificate in lieu of lost discharge.

One Certificate — furnished.

Muzzey  
Copvist.

(476)



Hays, Jerry

P. Co. H

6 U.S.C.H.A.

Enclosures.

Bed Cards	Descriptive Lists
Burial Records	Final Statements
Certs. of Dis. for Discharge	Furloughs
C. M. Charges	Med. Des. Lists
Med. Certificates	Orders

Other papers relating to—

Admission to Hosp'l	Furlough
Casualty Sheet (Officer's)	Med. Examination
Confinement	Misc. Information
Contracts	Pay or Clothing
Death or Effects	Personal Reports
Desertions	Rank
Discharge from Hosp'l	Transfer to Hosp'l
Discharge from Service	Transfer to V. R. C.
Duty	Transportation

NOTE 1.

The company commander will here add a statement of all the facts known to him concerning the disease or wound, or cause of disability of the soldier: the time, place, manner, and all the circumstances under which the injury occurred, or disease originated or appeared: the duty, or service, or situation of the soldier at the time the injury was received or disease contracted, stating particularly whether the injury was received or the disease contracted in the line of his duty; and whatever other facts may aid a judgment as to the cause, immediate or remote, of the disability, and the circumstances attending it.

When the facts are not known to the company commander, the certificate of any officer, or affidavit of other person having such knowledge, will be appended—as the surgeon in charge of a hospital, the officer commanding a detachment of recruits, &c., &c.

NOTE 2.

When a probable case for pension, special care must be taken to state the degree of disability—as  $\frac{1}{2}$ , &c., &c.; to describe particularly the disability, wound, or disease; the extent to which it deprives him of the use of any limb or faculty, or affects his health, strength, activity, constitution, or capacity to labor or earn his subsistence. The surgeon will add, from his knowledge of the facts and circumstances, and from the evidence in the case, his professional opinion of the cause or origin of the disability. In the case of discharges by Medical Inspectors, the last paragraph will state that the "discharge was given by consent of the soldier, after a personal examination, and for disability, the nature, degree, and origin of which are correctly described in the within certificate."

Par. 1260 Regulations, Edit. 1861.

Medical officers, in giving certificates of disability, are to take particular care in all cases that have not been under their charge; and especially in epilepsy, convulsions, chronic rheumatism, derangement of the urinary organs, ophthalmia, ulcers, or any obscure disease liable to be feigned or purposely produced; and in no case shall such certificate be given until after sufficient time and examination to detect any attempt at deception.

DIRECTIONS.

This certificate will be made out in duplicate by the soldier's company commander, or other officer commanding the separate detachment to which he belongs, and sent by him to the surgeon who has charge of the hospital where the soldier is sick. The surgeon will then fill out and sign the surgeon's certificate, and forward these papers to the regimental, detachment, or post commander, who will forward them, with his endorsement thereon, through the proper channel, to his division commander; or, if the troops are not attached to a division, to his corps, department, or other commander or officer to whom the authority to discharge enlisted men may be specially delegated.

These certificates, after having received the action of the highest authority to which they are required to be sent, will be returned through the same channel to the regimental, post, or detachment commander, who will, if the discharge is authorized by the endorsement of the proper authority, sign the soldier's discharge, and the last certificate on this paper; see that the soldier is furnished with the proper final statements in duplicate, and forward BOTH of these certificates direct to the Adjutant General United States Army, at Washington, D. C.; they will not, under any circumstances, be given into the hands of the soldier.

ADJUTANT GENERAL'S OFFICE

Oct 6 1865

Duplicate sent to Pension Office.

CERTIFICATE OF DISABILITY FOR DISCHARGE

IN THE CASE OF

Henry Hayes  
Private Co. 46

6th Reg't of U.S. Artillery

Headquarters Department of Mississippi,

Vicksburg, Sept 22<sup>nd</sup> 1865.

To be Discharged,

By order of MAJOR GENERAL

O. P. Marshall

St. Asst. Adjutant General

Extract furnished 2<sup>d</sup>

Andover May 23<sup>rd</sup> 708

Received (A. G. Office) ..... 186



Emb on drafters

ARMY OF THE UNITED STATES  
 CERTIFICATE OF DISABILITY FOR DISCHARGE.

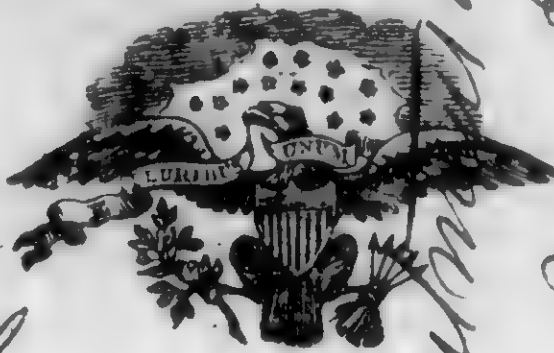

*Gerry Hoays* of Captain *Oscar A*  
*Kelso* Company, (No) of the *Light* Regiment of United States  
*Artillery* was enlisted by *James P. Grove* of  
 the *1st* Regiment of *Artillery* at *Natchez Miss*  
 on the *first* day of *November* 1863, to serve *Three* years; he was born  
 in *Richmond* in the State of *Virginia* is *forty five*  
 years of age, *five* feet *seven* inches high, *Black* complexion, *Black* eyes,  
*Gray* hair, and by occupation when enlisted a *Lanner*. During the last two  
 months said soldier has been unfit for duty *60* days.\* *He was admitted into*  
*hospital July 8<sup>th</sup> 1865. Since which time he has*  
*not been able to perform any duty what ever.*  
*He appears to be over sixty years of age.*

STATION: *Natchez Miss*  
 DATE: *August 23<sup>rd</sup> 1868*

*A. L. Davis*  
*a. a. Surg. U.S.A.*  
*in charge of Post Hospital*

I CERTIFY, that I have carefully examined the said *Gerry Hoays* of  
 Captain *O. A. Kelso* Company, and find him incapable of performing the duties of a soldier  
 because of *old age and Phthisis. Not fit for the*  
*U.S.A.*

*A. L. Davis*  
*act. Asst. Surgeon, U.S.A.*  
*in charge of Post Hospital*

DISCHARGED, this *28<sup>th</sup>* day of *Sept* 186*5*, at *Natchez Miss*

*A. J. Thompson*  
*Sargt. "N. H. U.S.A."*  
*in charge Post Hospital Natchez Miss.*

The soldier desires to be addressed at  
 Town \_\_\_\_\_ County \_\_\_\_\_ State \_\_\_\_\_

\* See Note 1 on the back of this. † See Note 2 on the back of this.

*A. J. Thompson*  
*Sept 28<sup>th</sup> 1865*  
*Natchez Miss*

*Approved*  
*James P. Grove*  
*of Captain*  
*Oscar A*  
*Company*  
*Light*  
*Regiment of United States*  
*Artillery*

Haywood ~~Smith~~

Co *A*, 6 U.S. Col'd H. Art'y.

Private | Private

CARD NUMBERS.

1	6167254	26
2	6167597	27
3	6167607	28
4	6169303	29
5	4119918	30
6	40722412	31
7		32
8		33
9		34
10		35
11		36
12		37
13		38
14		39
15		40
16		41
17		42
18		43
19		44
20		45
21		46
22		47
23		48
24		49
25		50

Book Mark:

See also

*George Hayward*

Co. *A*, 6 Reg't U. S. Col'd H. Art'y.

Appears on  
**Company Descriptive Book**  
of the organization named above.

DESCRIPTION.

Age *27* years; height *5* feet *8* inches.

Complexion *Blk*

Eyes *Blk*; hair *Blk*

Where born *Adams Co Miss*

Occupation *Farmer*

ENLISTMENT.

When *Aug, 29*, 186*3*.

Where *hatcheg*

By whom *L. Schuck*; term *3* y'rs.

Remarks: *Diserted at hatcheg  
Miss Nov. 11/63*

*Warren*

George Hayward  
Co. D, 2 Reg't Miss. Art'y.†

Age 29 years.

Appears on

**Company Muster-in Roll**

of the organization named above. Roll dated  
Natchez Miss., Sept. 12, 1863.

Muster-in to date Sept. 12, 1863.

Joined for duty and enrolled:

When Aug. 29, 1863.\*

Where Natchez Miss. \*

Period 3 years.\*

Valuation of horse, \$ 100

Valuation of horse equipments, \$ 100

Remarks:

† This organization subsequently became Co. D, 6 Reg't U. S. Colored Heavy Artillery.

\* Muster-in-roll shows enrollment of all men of this company as of same date and place. See enrollment on subsequent card or cards.

Book mark:

Brooks

86

6 H. Art'y.

U.S.C.T.

George Hayward

1st., Co. F, 2 Reg't Miss. Artillery.†

Appears on

Company Muster Roll

for Sept. 12 to Oct. 31, 1863.

Joined for duty and enrolled:

When Aug. 29, 1863.\*

Where Natchez, Miss.\*

Period 3 years.\*

Present or absent Absent.

Stoppage, \$ 100 for

Due Gov't \$ 100 for

Valuation of horse, \$ 100

Valuation of horse equipments, \$ 100

Remarks: Absent without leave since Oct. 27/63.

† This organization subsequently became Co. F, 6 Reg't U. S. Colored Heavy Artillery.

\* See enrollment on card from muster-in roll.

Book mark:

Brooks.

George Hayward  
Cvt., Co. F, 2 Reg't Miss. Artillery.†

Appears on

Company Muster Roll

for Nov. 1 to Dec. 31, 1863.

Joined for duty and enrolled:

When Aug. 29, 1863.\*

Where Matchez.\*

Period 3 years.\*

Present or absent

Stoppage, \$ 100 for

Due Gov't \$ 100 for

Valuation of horse, \$ 100

Valuation of horse equipments, \$ 100

Remarks: deserted at  
Camp Parrar, Nov.  
11th, 1863.

† This organization subsequently became Co. F, 6 Reg't U. S. Colored Heavy Artillery.  
\* See enrollment on card from muster-in roll.

Book mark:

Brooks  
Copyist.

(358c)



H

6 H. Art'y.

U.S.C.T.

George Hayward

Capt., Co. ...., 6 Reg't U. S. Col'd H. Art'y.

Appears on Returns as follows:

Oct 1863 (Co F 2 Miss  
 H Art A. 10) Detl<sup>d</sup>  
 in Regl Pioneer  
 Corps Oct 7, 63  
 Nov 1863 Deserted  
 Nov 11, 63 Natchez  
 Miss

Book mark : .....

(546)

A. Douglas

Copyist.

*K*

6 H. Art'y.

U.S.C.T.

*George Caswood*  
*Co. F*, 6 Reg't U.S. Col'd H. Art'y.

Appears on **Co. Muster-out Roll**, dated

*Katchus New*, *May 13*, 1866.

Muster-out to date \_\_\_\_\_, 1866.

Last paid to *by due from enrollment*, 1866.

**Clothing account:**

*No settlement*  
Last settled \_\_\_\_\_, 1866 ; drawn since \$ *3898* <sup>100</sup>

Due soldier \$ <sup>100</sup> ; due U. S. \$ <sup>100</sup>

Am't for cloth'g in kind or money adv'd \$ <sup>100</sup>

Due U. S. for arms, equipments, &c., \$ <sup>100</sup>

Bounty paid \$ <sup>100</sup> ; due \$ <sup>100</sup>

Remarks: *found at original*  
*organization. Deserted Nov*  
*11, 63 at Katchus New*

Book mark: \_\_\_\_\_

*A. Brown*

Haywood Stephen

Co *A*, 6 U.S. Col'd H. Art'y.

Private Private

CARD NUMBERS.

1	6147250	26
2	6167394	27
3	6167540	28
4	6167667	29
5	6167786	30
6	6167906	31
7	6168017	32
8	6168125	33
9	6168236	34
10	6168343	35
11	6168454	36
12	6168570	37
13	6168679	38
14	6168790	39
15	6168895	40
16	6168993	41
17	6169089	42
18	6169186	43
19	9119914	44
20	40942473	45
21		46
22		47
23		48
24		49
25		50

Book Mark:

See also

*Stephen Hayward*

....., Co. *F*, 6 Reg't U. S. Col'd H. Art'y.

Appears on

**Company Descriptive Book**

of the organization named above.

**DESCRIPTION.**

Age *33* years; height *5* feet *6* inches.

Complexion *Blk*

Eyes *Blk*; hair *Blk*

Where born *Wake Co., N. C.*

Occupation *Blacksm.*

**ENLISTMENT.**

When *Aug. 29*, 186*3*.

Where *Batchers*

By whom *Lt. Schuck*, term *3* y'rs.

Remarks:

.....  
.....  
.....  
.....  
.....  
.....  
.....  
.....

*Warren*

Stephen Hayward

Co. F, 2 Reg't Miss. Art'y.†

Age 33 years.

Appears on

Company Muster-in Roll

of the organization named above. Roll dated

Natchez, Miss. Sept. 12, 1863.

Muster-in to date Sept. 12, 1863.

Joined for duty and enrolled:

When Aug. 29, 1863.\*

Where Natchez, Miss. \*

Period 3 years.\*

Valuation of horse, \$ 100

Valuation of horse equipments, \$ 100

Remarks:

† This organization subsequently became Co. F, 6 Reg't U. S. Colored Heavy Artillery.

\* Muster-in roll shows enrollment of all men of this company as of same date and place. See enrollment on subsequent card or cards.

Book mark:

Brooks

96

6 H. Art'y.

U.S.C.T.

Stephan Hayward

Priv., Co. F, 2 Reg't Miss. Artillery.†

Appears on

Company Muster Roll

for Sept. 12 to Oct. 31, 1863.

Joined for duty and enrolled:

When Aug. 29, 1863.\*

Where Natchez, Miss.\*

Period 3 years.\*

Present or absent Present

Stoppage, \$ 100 for

Due Gov't \$ 100 for

Valuation of horse, \$ 100

Valuation of horse equipments, \$ 100

Remarks:

† This organization subsequently became Co. F, 6 Reg't U. S. Colored Heavy Artillery.

\* See enrollment on card from muster-in roll.

Book mark:

Brooker

Stephen Hayward  
Private, Co. F, 2 Reg't Miss. Artillery.†

Appears on

**Company Muster Roll**

for Nov. 1 to Dec. 31, 1863.

Joined for duty and enrolled:

When Aug. 29, 1863.\*

Where Watauga.\*

Period 3 years.\*

Present or absent Present.

Stoppage, \$ 100 for

Due Gov't \$ 100 for

Valuation of horse, \$ 100

Valuation of horse equipments, \$ 100

Remarks:

† This organization subsequently became Co. F, 6 Reg't U. S. Colored Heavy Artillery.

\* See enrollment on card from muster-in roll.

Book mark:

Brooks  
(358c) Copyist.

*J.C.* | **6 H. Art'y.** | **U.S.C.T.**

*Stephan Howard*

*Priv.*, Co. F, 2 Reg't Miss. Artillery.†

Appears on

**Company Muster Roll**

for *Jan. 1 to Feb. 29*, 1864.

Joined for duty and enrolled:

When *Aug. 29*, 1863.\*

Where *Natchez, Miss.*\*

Period *3* years.\*

Present or absent *Present.*

Stoppage, \$ *100* for

Due Gov't \$ *100* for

Valuation of horse, \$ *100*

Valuation of horse equipments, \$ *100*

Remarks: \_\_\_\_\_

\_\_\_\_\_

\_\_\_\_\_

\_\_\_\_\_

\_\_\_\_\_

\_\_\_\_\_

\_\_\_\_\_

† This organization subsequently became Co. F, 6 Reg't U. S. Colored Heavy Artillery.

\* See enrollment on card from muster-in roll.

Book mark: \_\_\_\_\_

*Brooker*

(358c)

Copyist.



Stephen Harwood  
Pvt., Co. F, 5 Reg't U. S. Col'd H. Art'y.\*

Appears on

**Company Muster Roll**

for Mar. 1 to Apr. 30, 1864.

Joined for duty and enrolled :

When Aug. 29, 1863.\*

Where Natchez Miss.\*

Period 3 years.\*

Present or absent Present

Stoppage, \$ 100 for

Due Gov't, \$ 100 for

Valuation of horse, \$ 100

Valuation of horse equipments, \$ 100

Remarks :

\* This organization subsequently became Co. F, 6 Reg't U. S. Col'd Heavy Artillery.

\* See enrollment on card from muster-in roll.

Book mark :

Brooks

(358c)

Copyist.

Stephen L. Hawood  
Pvt.; Co. F, 6 Reg't U. S. Col'd H. Art'y.

Appears on

**Company Muster Roll**

for May 1 to June 30, 1864.

Joined for duty and enrolled:

When Aug. 29, 1863.\*

Where Natchez, Miss \*

Period 3 years.\*

Present or absent Present.

Stoppage, \$ 100 for \_\_\_\_\_

Due Gov't \$ 100 for \_\_\_\_\_

Remarks: \_\_\_\_\_  
\_\_\_\_\_  
\_\_\_\_\_  
\_\_\_\_\_  
\_\_\_\_\_

\* See enrollment on card from muster-in roll.

Book mark: \_\_\_\_\_

(358c) Brooks Copyist.

*A*

6 H. Art'y.

U.S.C.T.

*Stephan Hayward*

*Cor*, Co. F, 6 Reg't U. S. Col'd H. Art'y.

Appears on

**Company Muster Roll**

for *July & Aug*, 186*4*

Joined for duty and enrolled:

When *Aug 29*, 186*3*.\*

Where *Natchez Miss*\*

Period *3* years.\*

Present or absent *Present*

Stoppage, \$ *100* for

Due Gov't \$ *100* for

Remarks:

-----  
-----  
-----  
-----  
-----

\* See enrollment on card from muster-in roll.

Book mark:

-----  
*S. Linnear*  
-----

(358c)

Copyist.

*A*

6 H. Art'y.

U.S.C.T.

*Stephan Haywood*  
*Cor*, Co. F, 6 Reg't U. S. Col'd H. Art'y.

Appears on

**Company Muster Roll**

for *Sept & Oct*, 1864

Joined for duty and enrolled:

When *Aug 29*, 1863.\*

Where *Katchez Miss*\*

Period *3* years.\*

Present or absent *Present*

Stoppage, \$ *100* for

Due Gov't \$ *100* for

Remarks:

\* See enrollment on card from muster-in roll.

Book mark:

*S. Linnear*

(358c)

Copyist.

7

Stephan Hayward  
Pvt., Co. F, 6 Reg't U. S. Col'd H. Art'y.

Appears on

Company Muster Roll

for Nov & Dec, 1864

Joined for duty and enrolled:

When Aug. 29, 1863.\*

Where Katchez, Miss.\*

Period 3 years.\*

Present or absent Present

Stoppage, \$ 100 for

Due Gov't \$ 100 for

Remarks:

-----  
-----  
-----  
-----  
-----

\* See enrollment on card from muster-in roll.

Book mark:

S. Duncan  
Copyist.

*A*

6 H. Art'y. U.S.C.T.

*Stephan Hayward*

*Out*, Co. F, 6 Reg't U. S. Col'd H. Art'y.

Appears on

**Company Muster Roll**

for *Jany & Feby*, 1865.

Joined for duty and enrolled:

When *Aug 29*, 1863.\*

Where *Katchez Miss* \*

Period *3* years.\*

Present or absent *Present*

Stoppage, \$ *100* for

Due Gov't \$ *100* for

Remarks:

\* See enrollment on card from muster-in roll.

Book mark:

(358c)

*S. Duncan*

Copyist.

7A

6 H. Art'y.

U.S.C.T.

Stephen Haywood

Out, Co. F, 6 Reg't U. S. Col'd H. Art'y.

Appears on

Company Muster Roll

for           , 1865.

Joined for duty and enrolled:

When           , 1863.\*

Where            \*

Period       years.\*

Present or absent           

Stoppage, \$            for     

Due Gov't \$            for     

Remarks:       
      
      
      
      
      
      
    

\* See enrollment on card from muster-in roll.

Book mark:     

(358c)

*S. Duncan*

Copyist.

A | 6 H. Arty **U.S.C.T.**

Stephan Hayward  
Priv., Co. F, 6 Reg't U. S. Col'd H. Arty

Appears on

**Company Muster Roll**

for May & June, 1865.

Joined for duty and enrolled:

When Aug 29, 1863.\*

Where Katchez Miss\*

Period 3 years.\*

Present or absent Present

Stoppage, \$ 100 for

Due Gov't, \$ 100 for

Valuation of horse, \$ 100

Valuation of horse equipments, \$ 100

Remarks: \_\_\_\_\_  
\_\_\_\_\_  
\_\_\_\_\_  
\_\_\_\_\_

\* See enrollment on card from muster-in roll.

Book mark: \_\_\_\_\_

(358c)

S. Duncan

Copyist.



*H*

6 H. Art'y.

U.S.C.T.

*Stephen Haywood*

*Pr.*, Co. F, 6 Reg't U. S. Col'd H. Art'y.

Appears on

**Company Muster Roll**

for *July + Aug.*, 186 *3*<sup>1</sup>.

Joined for duty and enrolled:

When *Aug. 29<sup>th</sup>*, 186 *3*<sup>\*</sup>.

Where *Natchez Miss.* \*

Period *3* years.\*

Present or absent *Absent*

Stoppage, \$ *100* for \_\_\_\_\_

Due Gov't \$ *100* for \_\_\_\_\_

Remarks: \_\_\_\_\_

*On daily duty as  
Blacksmith at Post  
Blacksmith Shop  
Natchez Miss.*

\* ~~See~~ See enrollment on card from muster-in roll.

Book mark: \_\_\_\_\_

(358c)

*J. W. Ames*

Copyist.

*H*

6 H. Art'y. U.S.C.T.

*Stephen Hayward*  
*Pvt.*, Co. F, 6 Reg't U. S. Col'd H. Art'y.

Appears on

**Company Muster Roll**

for *Sept + Oct*, 186*5*.

Joined for duty and enrolled:

When *Aug. 29<sup>th</sup>*, 186*3*.\*

Where *Natchez Miss.* \*

Period *3* years.\*

Present or absent *Absent*

Stoppage, \$ *100* for

Due Gov't \$ *100* for

Remarks:

*On daily duty as  
Blacksmith at Post  
I. M. Natchez Miss.*

\* See enrollment on card from muster-in roll.

Book mark:

(358c)

*J. W. Ames*

Copyist.

*H*

6 H. Art'y.

U.S.C.T.

*Stephen Haywood*

*Plt.*, Co. *H*, 6 Reg't U. S. Col'd H. Art'y.

Appears on

**Company Muster Roll**

for *Nov. + Dec.*, 186 *5*

Joined for duty and enrolled:

When *Aug. 29*, 186 *3*\*

Where *Hatchez Miss.* \*

Period *3* years.\*

Present or absent *Absent*

Stoppage, \$ *100* for

Due Gov't \$ *100* for

Remarks: *on duty at Blksmith Shop Post 2d U. Hatchez Miss.*

\* See enrollment on card from muster-in roll.

Book mark:

(358c)

*J. W. Jones*

Copyist.

*H*

6 H. Art'y.

U.S.C.T.

*Stephen Hayward*  
*Private*, Co. F, 6 Reg't U. S. Col'd H. Art'y.

Appears on

**Company Muster Roll**

for *Jan'y + Feby*, 1866.

Joined for duty and enrolled:

When *Aug 29<sup>th</sup>*, 186*3*\*

Where *Natchez Miss.*\*

Period *3* years.\*

Present or absent *Present*

Stoppage, \$ *100* for

Due Gov't, \$ *100* for

Valuation of horse, \$ *100*

Valuation of horse equipments, \$ *100*

Remarks:

\* See enrollment on card from muster-in roll.

Book mark:

(358c)

*J. W. Ames*

Copyist.

*H*

**6 H. Art'y. | U.S.C.T.**

*Stephen Hayward*  
*Prst*, Co. F, 6 Reg't U. S. Col'd H. Art'y.

Appears on

**Company Muster Roll**

for *March + April*, 1866.

Joined for duty and enrolled:

When *Aug. 29<sup>th</sup>*, 186*3*.\*

Where *Satchez Miss.*\*

Period *3* years.\*

Present or absent *Present*

Stoppage, \$ *100* for

Due Gov't \$ *100* for

Remarks:

-----  
-----  
-----  
-----  
-----

\* See enrollment on card from muster-in roll.

Book mark: -----

*J. W. Jones*  
(358c) Copyist.

A

6 H. Art'y.

U.S.C.T.

Stephen Haywood  
Co. F, 6 Reg't U. S. Col'd H. Art'y.

Appears on Returns as follows:

June to Sept 1865  
On daily duty  
as Blksmith  
at the Post of  
Natchez Miss since  
June 25, 65

Oct 1865 On daily  
duty as Black-  
smith at Depot  
2 M.

Nov 1865 On duty  
Post Blksmith

Dec 1865 On daily  
duty at Depot  
2 M since Nov  
30, 65

Book mark :

(546) A. J. Gouglas Copyist.

*Ko*

6 H. Art'y.

U.S.C.T.

*Stephen Kaywood*  
Co. *F*, 6 Reg't U. S. Col'd H. Art'y.

Appears on **Co. Muster-out Roll**, dated  
*Natchez Miss, May 13*, 186*6*  
Muster-out to date *May 13*, 186*6*  
Last paid to *Dec 31*, 186*5*.

Clothing account:

Last settled....., 186 ; drawn since \$.....100  
Due soldier \$ *78* <sup>*25*</sup> 100; due U. S. \$.....100  
Am't for cloth'g in kind or money adv'd \$.....100

Due U. S. for arms, equipments, &c., \$.....100

Bounty paid \$.....100; due \$.....100

Remarks: *found at original*  
*organization*

Book mark: *11688 71 P. 169 68*

*J. M. ...*

*Haze Copy*

Co *E*, 6 U.S. Col'd H. Art'y.

*Private Private*

CARD NUMBERS.

1	6165205	26
2	6165342	27
3	6165485	28
4	6165609	29
5	6165727	30
6	6165839	31
7	6165950	32
8	6166057	33
9	6166169	34
10	6166279	35
11	6166389	36
12	6166497	37
13	6166600	38
14	6166701	39
15	6166797	40
16	6166888	41
17	6166978	42
18	6167068	43
19	9119748	44
20	40742474	45
21		46
22		47
23		48
24		49
25		50

Book Mark:

See also



*Fabry Hayes*

Co. *E*, 6 Reg't U. S. Col'd H. Art'y.

Appears on

**Company Descriptive Book**

of the organization named above.

**DESCRIPTION.**

Age *23* years; height *5* feet *8* inches.

Complexion *Blk*

Eyes *Ork*; hair *Blk*

Where born *Adams Co, Miss.*

Occupation *Farmer*

**ENLISTMENT.**

When *Aug. 15*, 186*3*.

Where *patching Miss*

By whom *A. M. Hookman*; term *3* y'rs.

Remarks: \_\_\_\_\_

\_\_\_\_\_  
\_\_\_\_\_  
\_\_\_\_\_  
\_\_\_\_\_  
\_\_\_\_\_  
\_\_\_\_\_  
\_\_\_\_\_

*Wasson*

*H*

6 H. Art'y.

U.S.C.T.

*Toby Hazr*

*Pot*, Co. *E*, 2 Reg't Miss. Art'y.†

Age *23* years.

Appears on

**Company Muster-in Roll**

of the organization named above. Roll dated

*Hatchez Miss Sep 12, 1863.*

Muster-in to date *Sep 12, 1863.*

Joined for duty and enrolled:

When *Aug 18, 1863.\**

Where *Hatchez Miss \**

Period *3* years.\*

Valuation of horse, \$ *100*

Valuation of horse equipments, \$ *100*

Remarks:

† This organization subsequently became Co. *E*, 6 Reg't U. S. Colored Heavy Artillery.

\* \* \* Muster-in roll shows enrollment of all men of this company as of same date and place. See enrollment on subsequent card or cards.

Book mark:

*Hudfield*

*H*

6 H. Art'y. U.S.C.T.

*Toby Hayes*

*Prst*, Co. E, 2 Reg't Miss. Art'y.†

Appears on

**Company Muster Roll**

for *Sept & Oct*, 1863.

Joined for duty and enrolled:

When *Aug 18*, 1863.\*

Where *Natchez miss* \*

Period *3* years.\*

Present or absent *Present*

Stoppage, \$ *100* for

Due Gov't, \$ *100* for

Remarks:

† This organization subsequently became Co. E, 6 Reg't U. S. Colored Heavy Artillery.

\* See enrollment on card from muster-in roll.

Book mark:

(358c)

*Hadfield*

Copyist.

*Goby Hayes*  
Cot, Co. E, 2 Reg't Miss. Art'y.†

Appears on

Company Muster Roll

for *Nov Dec*, 1863.

Joined for duty and enrolled:

When *Aug 18*, 1863.\*

Where *Katchez miss* \*

Period *3* years.\*

Present or absent *Present*

Stoppage, \$ *100* for

Due Gov't, \$ *100* for

Remarks:  
.....  
.....  
.....  
.....

† This organization subsequently became Co. E, 6 Reg't U. S. Colored Heavy Artillery.  
\* See enrollment on card from muster-in roll.

Book mark: .....

*Hadfield*  
(358c) Copyist.

*Goby Hayes*

*Pat*, Co. E, 2 Reg't Miss. Art'y.†

Appears on

**Company Muster Roll**

for *Jan Feb*, 1864

Joined for duty and enrolled:

When *Aug 18*, 1863.\*

Where *Hatchery Miss*\*

Period *3* years.\*

Present or absent *Present*

Stoppage, \$ *100* for

Due Gov't, \$ *100* for

Remarks:

† This organization subsequently became Co. E, 6 Reg't U. S. Colored Heavy Artillery.  
\* See enrollment on card from muster-in roll.

Book mark:

*Madfield*

(358c)

Copyist.

16

6 H. Art'y.

U.S.C.T.

Goby Hayes

Pot, Co. E, 5 Reg't U. S. Col'd H. Art'y.†

Appears on

Company Muster Roll

for Mar & Apr, 1864.

Joined for duty and enrolled:

When Aug 18, 1863.\*

Where Natchez Miss \*

Period 3 years.\*

Present or absent Present

Stoppage, \$ 100 for

Due Gov't \$ 100 for

Valuation of horse, \$ 100

Valuation of horse equipments, 100

Remarks:

†This organization subsequently became Co. E, 6 Reg't U. S. Colored Heavy Artillery.

\* See enrollment on card from muster-in roll.

Book mark:

Hadfield

(358c)

Copyist.

*John Hayes*  
Cot, Co. E, 6 Reg't U. S. Col'd H. Art'y.

Appears on

**Company Muster Roll**

for *May - June* 1864.

Joined for duty and enrolled:

When *Aug 18*, 186*3*.\*

Where *Natchez Miss* \*

Period *3* years.\*

Present or absent *Present*

Stoppage, \$ *100* for

Due Gov't, \$ *100* for

Remarks: \_\_\_\_\_  
\_\_\_\_\_  
\_\_\_\_\_  
\_\_\_\_\_  
\_\_\_\_\_

\* See enrollment on card from muster-in roll.

Book-mark: \_\_\_\_\_

*Hudfield*  
Coryist.

*A*

6 H. Art'y.

U.S.C.T.

*Joby Harge*

*Privt.*, Co. E, 6 Reg't U. S. Col'd H. Art'y.

Appears on

**Company Muster Roll**

for *July & Aug.* 186*4*.

Joined for duty and enrolled:

When *Aug. 18'*, 186*3*.\*

Where *Natchez Miss.*\*

Period *3* years.\*

Present or absent *present*,

Stoppage, \$ *100* for

Due Gov't, \$ *100* for

Remarks:

.....  
.....  
.....  
.....  
.....  
.....  
.....

\* See enrollment on card from muster-in roll.

Book-mark : .....

*J. M. Row*

(358c)

Copyist.



*N* | 6 H. Art'y. | U.S.C.T.

*Toby Naze*  
Priv., Co. E, 6 Reg't U. S. Col'd H. Art'y.

Appears on

**Company Muster Roll**

for *Sept + Oct,* 186*4*.

Joined for duty and enrolled:

When *Aug. 18'*, 186*3*.\*

Where *Witcher Min*\*

Period *3* years.\*

Present or absent *present*

Stoppage, \$ *100* for

Due Gov't, \$ *100* for

Remarks: \_\_\_\_\_

\*See enrollment on card from muster-in roll.

Book-mark : \_\_\_\_\_

*E. M. Rowe*

A

6 H. Art'y.

U.S.C.T.

Toby Haze

Priv., Co. E, 6 Reg't U. S. Col'd H. Art'y.

Appears on

Company Muster Roll

for Nov & Dec, 1864.

Joined for duty and enrolled:

When Aug 18", 1863.\*

Where Natchez Miss.\*

Period 1 years.\*

Present or absent Present

Stoppage, \$ 100 for

Due Gov't, \$ 100 for

Remarks: Due U.S. for Ordnance 65 cents,

\*See enrollment on card from muster-in roll.

Book-mark :

J. Moore

(358c)

Copyist.

A

6 H. Art'y.

U.S.C.T.

*Soby Naze*

*Priv.*, Co. E, 6 Reg't U. S. Col'd H. Art'y.

Appears on

**Company Muster Roll**

for *Jan & Feb.* 1863.

Joined for duty and enrolled:

When *Aug 18<sup>th</sup>*, 1863.\*

Where *Natchez Miss* \*

Period *3* years.\*

Present or absent *present*

Stoppage, \$ *100* for

Due Gov't, \$ *100* for

Remarks: *Due U.S. for Oud. 63 cents,*

\*See enrollment on card from muster-in-roll.

Book-mark :

*C. M. Howe*

(358c)

Copyist.

*H*

6 H. Art'y.

U.S.C.T.

*Toby Haze*

*Pratt*, Co. E, 6 Reg't U. S. Col'd H. Art'y.

Appears on

**Company Muster Roll**

for *March & April* 1863.

Joined for duty and enrolled:

When *Aug 18*, 1863.\*

Where *Natchez Miss*\*

Period *3* years.\*

Present or absent *present*,

Stoppage, \$ *100* for

Due Gov't, \$ *100* for

Remarks: *due U.S. for Ord  
65 cents,*

\* See enrollment on card from muster-in roll.

Book-mark :

(358c)

*G. M. Rowe*

Copyist.

Toby Hayes  
Privt, Co. E, 6 Reg't U. S. Col'd H. Art'y.

Appears on

Company Muster Roll

for May & June 1865.

Joined for duty and enrolled:

When Aug. 18<sup>th</sup>, 1863.\*

Where Witcher Mills \*

Period 3 years.\*

Present or absent Present

Stoppage, \$ 100 for

Due Gov't, \$ 100 for

Remarks:  
-----  
-----  
-----  
-----  
-----  
-----  
-----  
-----

\* See enrollment on card from muster-in roll.

Book-mark :  
-----  
-----

(358c)

E. M. Rowe  
Copyist.

H.

6 H. Art'y.

U.S.C.T.

Toby Haze,

Sgt., Co. E, 6 Reg't U. S. Col'd H. Art'y.

Appears on

Company Muster Roll

for July and Aug. 1865.

Joined for duty and enrolled:

When Aug. 10, 1863.\*

Where Natchez, Miss.\*

Period 3 years.\*

Present or absent present.

Stoppage, \$ 100 for

Due Gov't, \$ 100 for

Remarks:

\* See enrollment on card from muster-in roll.

Book-mark:

Dwight Webb

(358e)

Copyist.

Toby Haze,  
Capt., Co. E, 6 Reg't U. S. Col'd H. Art'y.

Appears on

Company Muster Roll  
for Sept. and Oct. 1865.

Joined for duty and enrolled:

When Aug. 18 1863.\*

Where Natchez, Miss \*

Period 3 years.\*

Present or absent present

Stoppage, \$ 100 for

Due Gov't, \$ 100 for

Remarks: Sick in post  
Hospital

\* See enrollment on card from muster-in roll.

Book-mark :

Dwight Webb

H

6 H. Art'y.

U.S.C.T.

Joby Hage

Pvt., Co. E, 6 Reg't U. S. Col'd H. Art'y.

Appears on

Company Muster Roll

for Nov + Dec 1865

Joined for duty and enrolled:

When Aug 18 1863\*

Where Hatchey, Miss\*

Period 3 years.\*

Present or absent Present

Stoppage, \$ 100 for

Due Gov't, \$ 1<sup>10</sup>/<sub>100</sub> for ord; 1<sup>30</sup>/<sub>100</sub> for case

Remarks:

\* See enrollment on card from muster-in roll.

Book-mark:

(358c)

W. H. Hage

Copyist.



26

6 H. Art'y.

U.S.C.T.

Joby Haze

Pvt, Co. E, 6 Reg't U. S. Col'd H. Art'y.

Appears on

Company Muster Roll

for Jan 0 Feb 1866

Joined for duty and enrolled:

When Aug 15, 1863.\*

Where Natchez, Miss

Period 3 years.\*

Present or absent Present

Stoppage, \$ 100 for

Due Gov't, \$ 100 for

Remarks:

\*See enrollment on card from muster-in roll.

Book-mark :

Wooler

(358c)

Copyist.

H

6 H. Art'y.

U.S.C.T.

Joby Haze

Art., Co. E, 6 Reg't U. S. Col'd H. Art'y.

Appears on

Company Muster Roll

for March & April 1866.

Joined for duty and enrolled:

When Aug 18, 1863.\*

Where Katchez, Miss \*

Period 3 years.\*

Present or absent Present

Stoppage, \$ 100 for

Due Gov't, \$ 100 for

Remarks:

\*See enrollment on card from muster-in roll.

Book-mark:

W. H. H. H.

(358c)

Copyist.

Toby Haze  
Post, Co. E, 6 Reg't U. S. Col'd H. Art'y.

Appears on Returns as follows:

Oct 1865 Absent sick  
in Post Hosp.  
Katchez Miss. since  
Oct 17, 65

Book mark:

(546) *A. Gouglas* Copyist.

*H*

6 H. Art'y.

U.S.C.T.

*Toby Haze*

*Private E*, 6 Reg't U. S. Col'd H. Art'y.

Appears on **Co. Muster-out Roll**, dated

*Vatchez, Miss., May 13, 1866*

Muster-out to date *May 13, 1866*

Last paid to *Dec. 31, 1865*

Clothing account:

Last settled....., 186 ; drawn since \$.....<sup>100</sup>

Due soldier \$ *23*<sup>*53*</sup>.....<sup>100</sup>; due U. S. \$.....<sup>100</sup>

Am't for cloth'g in kind or money adv'd \$.....<sup>100</sup>

Due U. S. for arms, equipments, &c., \$.....<sup>100</sup>

Bounty paid \$.....<sup>100</sup>; due \$.....<sup>100</sup>

Remarks: *joined at original organization.*

Book mark:

*O. J. Markle,*

(361)

Copyist.

*Keenan, John B.*

*Co D*, 6 U.S. Col'd H. Art'y.

*Private*      *Corporal*

CARD NUMBERS.

1	6157856	26
2	6157975	27
3	6158118	28
4	6158242	29
5	6158474	30
6	6160192	31
7	9119419	32
8	40742476	33
9		34
10		35
11		36
12		37
13		38
14		39
15		40
16		41
17		42
18		43
19		44
20		45
21		46
22		47
23		48
24		49
25		50

Book Mark:

See also

*N* | **6 H. Art'y. | U.S.C.T.**

*John C. Fenon*  
....., Co. *B*, 6 Reg't U. S. Col'd H. Art'y.

Appears on  
**Company Descriptive Book**  
of the organization named above.

**DESCRIPTION.**

Age *25* years; height *5* feet *3 1/2* inches.

Complexion *Brown*

Eyes *Black*; hair *Black*

Where born *Warrenton Co. Miss*

Occupation *Farmer*

**ENLISTMENT.**

When *Sept 1*, 1863.

Where *Warrenton Miss*

By whom *Capt J. P. ...* term *3* y'rs.

Remarks: *Died April 27/04*  
*Van delin for of Disease*

.....  
.....  
.....  
.....  
.....

*J. P. ...*

*John C. Seamon*  
Private, Co. *B.*, 2 Reg't Miss. Art'y. †

Age *29* years.

Appears on

**Company Muster-in Roll**

of the organization named above. Roll dated

*Natchez, Miss, Sept 12, 1863.*

Muster-in to date *Sept 12, 1863.*

Joined for duty and enrolled:

When *Sept 1st*, 186*3*.\*

Where *Natchez, Miss.* \*

Period *3* years.\*

Valuation of horse, \$ ..... 100

Valuation of horse equipments, \$ ..... 100

Remarks: .....

† This organization subsequently became Co. *B.*, 6 Reg't U. S. Colored Heavy Artillery.

\* Muster-in roll shows enrollment of all men of this company as of same date and place. See enrollment on subsequent card or cards.

Book mark: .....

*M. J. Harrison*

John C. Heinson  
7<sup>th</sup> Corp<sup>t</sup>, Co. B, 2 Reg't Miss. Art'y.†

Appears on

Company Muster Roll  
for Sept. 12 to Oct. 31, 1863.

Joined for duty and enrolled:

When Sept. 1st, 1863.\*

Where Watchdog Miss. \*

Period 3 years.\*

Present or absent Present

Stoppage, \$ 100 for

Due Gov't, \$ 100 for

Valuation of horse, \$ 100

Valuation of horse equipments, \$ 100

Remarks:

† This organization subsequently became Co. B, 6 Reg't U. S. Co'd Heavy Artillery.

\* See enrollment on card from muster-in roll.

Book mark:

M. M. Warren



John C. Steenon  
Corpl, Co. B, 2 Reg't Miss. Art'y.†

Appears on

**Company Muster Roll**

for *Nov. & Dec.*, 1863.

Joined for duty and enrolled:

When *Sept. 1st*, 1863.\*

Where *Shatchez, Miss.*\*

Period *3* years.\*

Present or absent *Present*

Stoppage, \$ *100* for

Due Gov't, \$ *100* for

Valuation of horse, \$ *100*

Valuation of horse equipments, \$ *100*

Remarks:  
-----  
-----  
-----

† This organization subsequently became Co. B, 6 Reg't U. S. Co'd Heavy Artillery.  
\* See enrollment on card from muster-in roll.

Book mark: -----

*W. M. Warren*

*M*

6 H. Art'y.

U.S.C.T.

*John C. Hunan*

*4<sup>th</sup> Corp'd* Co. B, ~~6 Reg't U. S. Col'd H. Art'y.~~  
2 Reg't Miss. Art'y \*

Appears on

Company Muster Roll

for *Jan. & Feb.* 1864.

Joined for duty and enrolled:

When *Sept. 1st*, 1863.\*

Where *Batchy Miss.* \*

Period *3* years.\*

Present or absent *Present*

Stoppage, \$ *100* for

Due Gov't, \$ *100* for

Remarks:

.....  
.....  
.....  
.....

\* This organization subsequently became Co. B, 6 Reg't U.S. Col'd H. Art.

\* See enrollment on card from muster-in roll.

\* *Corrected Mar. 19/95. Oum.*  
Book-mark:

*M. M. Warren*

(358c)

Copyist.

*John C. Keener*  
Corp., Co. B, 5 Reg't U. S. Col'd H. Art'y.\*

Appears on

**Company Muster Roll**

for *Mar. & April*, 186*4*.

Joined for duty and enrolled:

When *Sept. 1st*, 186*3*.\*

Where *Statchy, Miss.* \*

Period *3* years.\*

Present or absent.....

Stoppage, \$.....*100* for.....

Due Gov't, \$.....*100* for.....

Valuation of horse, \$.....*100*

Valuation of horse equipments, \$.....*100*

Remarks: *Died at Vidalia*  
*La.*

\* This organization subsequently became Co. *B*, 6 Reg't U. S. Col'd Heavy Artillery.  
\* ~~See~~ See enrollment on card from muster-in roll.

Book mark :.....

*M. M. Warren*

A

6 H. Art'y.

U.S.C.T.

John C Heemen

....., Co. ...., 6 Reg't U. S. Col'd H. Art'y.

Appears on Returns as follows:

Apr 1864 (Corp. Co B  
5 US Col'd H A,  
Died of disease  
Apr 27, 64 Typhoid)

Book mark : .....

(548)

A. G. Gouglas

Copyist.

H

G H. Art'y.

U.S.C.T.

John C. Heenan  
Corpl, Co. B., 6 Reg't U. S. Col'd H. Art'y.

Appears on **Co. Muster-out Roll**, dated  
Natchez Miss May 13, 1866.

Muster-out to date ..... 186 .

Last paid to ..... 186 .

**Clothing account:**

Last settled ..... 186 ; drawn since \$ ..... 100

Due soldier \$ ..... 100 ; due U. S. \$ ..... 100

Am't for cloth'g in kind or money adv'd \$ ..... 100

Due U. S. for arms, equipments, &c., \$ ..... 100

Bounty paid \$ ..... 100 ; due \$ ..... 100

Remarks: *Joined at Original  
Organization.*

*Died at Natchez, Miss.  
Apr. 2 7/64 of Pneumonia  
Final Statements  
furnished Apr. 30/64*

Book mark: *See 92, 252*

(361)

*J. E. Nichol*  
Copyist.

Heenan, John C.

Comp. Co. B., 6 U.S.C.H.A.

Enclosures.

Bed Cards	Descriptive Lists
Burial Records	Final Statements /
Certs. of Dis. for Discharge	Furloughs
C. M. Charges	Med. Des. Lists
Med. Certificates	Orders

Other papers relating to—

Admission to Hosp'l	Furlough
Casualty Sheet (Officer's)	Med. Examination
Confinement	Misc. Information
Contracts	Pay or Clothing
Death or Effects /	Personal Reports
Desertions	Rank
Discharge from Hosp'l	Transfer to Hosp'l
Discharge from Service	Transfer to V. R. C.
Duty	Transportation

INVENTORY OF THE EFFECTS

OF

Capt John L. Heenon

Late of Company "B"

9<sup>th</sup> Reg't of U.S. Col Art Secy

Volunteers, who died at Vera Cruz

on the 27<sup>th</sup> day of April 1864

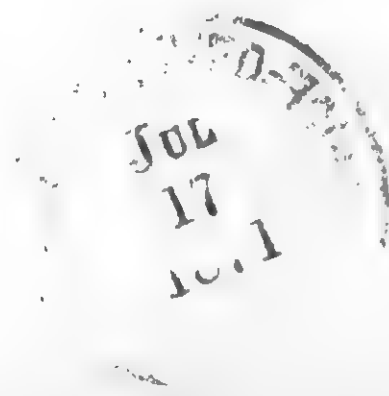

be  
of  
ed  
his  
e-  
to  
er.  
ts  
to  
or  
to  
he  
ed  
id

ers  
to  
he  
gi-  
he  
his  
he  
ng  
h.  
nd  
e;  
to  
ry  
of  
al  
he

or  
e,  
he  
o-  
y

a  
he  
pt  
he  
ie

er  
nt  
le-  
air  
es,  
nt

te  
ld

Inventory of the effects of John C. Heenan late  
 a Private of Captain W. C. True's Company "B" of  
 the 1st Regiment of Miss Artillery, Volunteers, who was enrolled as  
 a Private at Natchez in the State of Miss on  
 the 1st day of Sept 1869, and mustered into the service of the United  
 States as a Private on the 12th day of Sept 1869, at Natchez Miss's  
 in Company "B", 2nd Regiment of Miss Artillery Volunteers, to serve Three  
 years or during the war; he was born in Warrenton Ore in the State  
 of Miss; he was 25 years of age, 5 feet 9 1/2 inches  
 high, Rose complexion, Black eyes, Black hair, and by occupation, when enrolled,  
 a Farmer; he died in Hospital, at  
Vidalia La on the 27th day of April 1864, by  
 reason of Sid of disease

INVENTORY.					
ARTICLES.	No.	ARTICLES.	No.	ARTICLES.	No.
Hats.....		Pairs trousers.....		Knapsacks.....	
Caps.....		Pairs flannel drawers.....			
Forage caps.....		Pairs cotton drawers.....			
Great coats.....		Flannel shirts.....			
Uniform coats.....		Cotton shirts.....			
Uniform jackets.....		Pairs boots.....			
Flannel sack coats.....		Pairs shoes.....			
Blouses.....		Pairs socks.....			
Stable frocks.....		Blankets.....			
Fatigue overalls.....		Haversacks.....			
				MONEY.	
				Specie.....	\$
				Notes.....	\$

I CERTIFY, ON HONOR, that the above inventory comprises all the effects of Carporal  
John C. Heenan, deceased, and that the effects are in the hands  
 of \_\_\_\_\_ at \_\_\_\_\_  
 to be disposed of by a Council of Administration.

( DUPLICATES. )

STATION: Natchez Miss  
 DATE: Nov 10th 1864

W. C. True  
1st Lt. Miss Artillery  
 Commanding the Company.



V 40. B  
FINAL STATEMENT

OF

Capt. John C. Steenow Capt. B.  
Co. Reg't of U. S. C. Artillery

VOLUNTEERS.

Recd. April 27 1864

NOTE 1.—Two of these certificates (or duplicates) are to be given to each Volunteer Soldier or drafted man who may be discharged previously to the discharge of his company, that he may at once receive from the Paymaster the pay, &c., due him, and the captain or other COMMISSIONED officer commanding the company will certify to the act of the delivery of the duplicate certificates; on these certificates the Soldier is "entitled to" his discharge, and should also present his discharge to the Paymaster to have the payment endorsed on it. The discharge is to be given back to the Soldier by the Paymaster; the latter only retaining as his voucher the duplicate certificates.

NOTE 2.—If the Soldier is entitled to pay for the use of his horse, the Company Commander will certify to that fact on the back of both these final statements, and also to the time he has pay due for having been so mounted on his own horse.

NOTE 3.—When a Soldier is furnished with final statements, his descriptive list, if he has one, should be taken up by the officer who gives the Soldier these statements, and endorsed with a statement to this effect by the officer. This endorsement should exhibit a full statement of the time for which the Soldier was allowed pay on his final statements, the clothing account, and all other charges against him or in his favor, so as to comprise a complete exhibit of his account. It will then be transmitted to the company commander of the Soldier, who will enter all the data necessary to a full understanding of the Soldier's account on the muster roll upon which the Soldier's discharge is reported. The descriptive list will then be destroyed. The object of this is, that the remaining portion of the Soldier's account may be settled upon the receipt of these muster rolls, and the Soldier receive any pay or allowances that may be due him at the time of his discharge, and which may not appear on his final statements from the fact that his descriptive list is incomplete. These accounts for back pay, &c., are settled by the 2d Auditor of the Treasury Department.

NOTE 4.—Charges for loss or injury to ordnance, horse equipments, and other miscellaneous charges, should appear under the heading of "Other Stoppages."

NOTE 5.—Bounty paid by State authorities, and not by the United States, will not be entered on this statement.

NOTE 6.—Amounts due the Sutler and Laundress must be entered on the muster roll on which the discharge, death, desertion, &c., is reported, as well as on the final statement, otherwise the amount cannot be collected from the United States.

NOTE 7.—This blank will be used for deceased volunteers and drafted men, as well as for others.

NOTE 8.—Where a Soldier dies in Hospital or on detached service, his descriptive list, if he has one, should be sent with his final statements, in duplicate, to the Adjutant General, Washington, D. C.

ADJUTANT GENERAL'S OFFICE

Dec 7 1864

Duplicate with Inventory sent 2d Auditor.

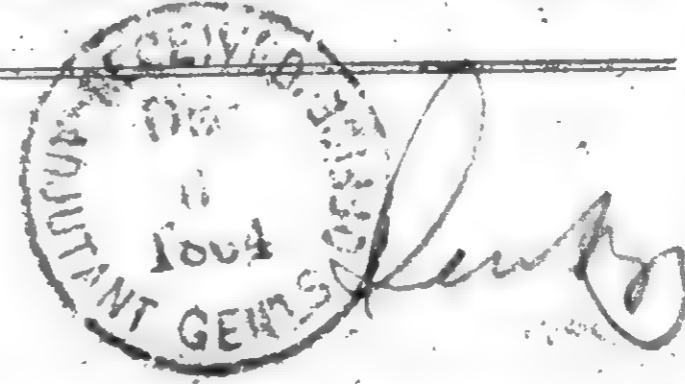

I certify, on honor, that John L. Keenan a Corporal of  
Captain T. E. Lane Company (B) of the 2d Regiment of U.S.C. Artillery  
**VOLUNTEERS**, of the State of Massachusetts, born in Wassentown Co, State  
of Mass, aged 25 years, 5 feet 3/4 inches high, Brown complexion,  
Black eyes, Black hair, and by occupation a Ferrier, having joined the company on  
its original organization at Hatchus Miss, and enrolled in it at the muster into  
the service of the United States at Hatchus Miss, on the 12<sup>th</sup> day  
of Sept, 1863, (or was mustered in service as a recruit, by  
....., at ....., on the ..... day of .....,  
1863, or was drafted and mustered into the service of the United States from the  
Enrollment District of the State of ....., at .....,  
on the ..... day of ....., 1863 ) to serve in the Regiment, for

the term of Three Years; and having served **HONESTLY** and  
**FAITHFULLY** with his Company in Service to the present date, is ~~now~~  
entitled to a **DISCHARGE** by reason of Sick of Disease in Hoop  
at Vidalia La April 27<sup>th</sup> 1864

The said Capt John L. Keenan was last paid by Paymaster  
Maj. Clark to include the 31<sup>st</sup> day of Dec, 1863, and has  
pay due him from that time to the present date; ~~he is entitled to pay and subsistence for~~  
**TRAVELING** to place of enrollment, and whatever other allowances are authorized to volunteer  
soldiers, drafted men, or militia, so discharged. He has received from the United States **CLOTHING**  
amounting to \$ 5-1 <sup>58</sup>/<sub>100</sub> dollars, since the 12<sup>th</sup> day of Sept,  
1863, when his clothing account was last settled. He has received from the United States  
100 dollars advanced **BOUNTY**.

There is to be stopped from him, on account of the State of ....., or other  
authorities, for **CLOTHING, &c.**, received on entering service, ..... dollars; and  
for other stoppages, viz:  
..... dollars.

He has been furnished with **TRANSPORTATION** in kind from the place of his discharge to  
.....; and he has been **SUBSISTED** for **TRAVELING** to his  
place of enrollment, up to the ..... 1863.

He is indebted to ....., **SUTLER**, ..... dollars.  
He is indebted to ....., **LAUNDRESS**, ..... dollars.

Given in Duplicate, at Hatchus Miss, this 18<sup>th</sup> day  
of November, 1864.

S. S. D. Taylor  
2d U.S.C. Artillery  
Commanding Company.

*Nehmes Nathan*  
Co F, 6 U.S. Col'd H. Art'y.

*Private Private*

CARD NUMBERS.

1	6167248	26
2	6167592	27
3	6167507	28
4	6167665	29
5	6167784	30
6	6167964	31
7	6169266	32
8	9119912	33
9	40742478	34
10		35
11		36
12		37
12		38
14		39
15		40
16		41
17		42
18		43
19		44
20		45
21		46
22		47
23		48
24		49
25		50

Book Mark:

See also

*Nathan Helmes*

....., Co. *F*, 6 Reg't U. S. Col'd H. Art'y.

Appears on

**Company Descriptive Book**  
of the organization named above.

**DESCRIPTION.**

Age *25* years; height *5* feet *5* inches.

Complexion *Copper*

Eyes *Brown*; hair *Blk*

Where born *Lincoln Co Ky*

Occupation *Farmer*

**ENLISTMENT.**

When *Aug. 29*, 186*3*.

Where *hatchiz*

By whom *St. Schrock*; term *3* y'rs.

Remarks: *Wid of disease*  
*in Camp Sherman*  
*Miss. June 15/64*

.....  
.....  
.....  
.....  
.....

*Warren*

*H.*

6 H. Art'y.

U.S.C.T.

*Nathan Helmes*  
Pvt., Co. *P*, 2 Reg't Miss. Art'y.†

Age *25* years.

Appears on

**Company Muster-in Roll**

of the organization named above. Roll dated

*Natchez, Miss, Sep. 12, 1863.*

Muster-in to date *Sep. 12, 1863.*

Joined for duty and enrolled:

When *Aug. 29*, 1863.\*

Where *Natchez, Miss.*\*

Period *3* years.\*

Valuation of horse, \$ *100*

Valuation of horse equipments, \$ *100*

Remarks:

† This organization subsequently became Co. *P*, 6 Reg't U. S. Colored Heavy Artillery.

\* Muster-in roll shows enrollment of all men of this company as of same date and place. See enrollment on subsequent card or cards.

Book mark:

*Brooker*

(356c)

Copyist.

SB

6 H. Art'y.

U.S.C.T.

Nathan Helmes

Pvt., Co. F, 2 Reg't Miss. Artillery.†

Appears on

Company Muster Roll

for Sept. 12 to Oct. 31, 1863.

Joined for duty and enrolled:

When Aug. 29, 1863.\*

Where Natchez, Miss.\*

Period 3 years.\*

Present or absent Present.

Stoppage, \$ 100 for

Due Gov't \$ 100 for

Valuation of horse, \$ 100

Valuation of horse equipments, \$ 100

Remarks:

† This organization subsequently became Co. F, 6 Reg't U. S. Colored Heavy Artillery.  
\* See enrollment on card from muster-in roll.

Book mark:

Brooks

(358c)

Copyist.

Nathan Holmes

Pvt., Co. F, 2 Reg't Miss. Artillery.†

Appears on

Company Muster Roll

for Nov. 1 to Dec. 31, 1863.

Joined for duty and enrolled:

When Aug. 29, 1863.\*

Where Natchez.\*

Period 3 years.\*

Present or absent Present.

Stoppage, \$ 100 for

Due Gov't \$ 100 for

Valuation of horse, \$ 100

Valuation of horse equipments, \$ 100

Remarks:

† This organization subsequently became Co. F, 6 Reg't U. S. Colored Heavy Artillery.  
\* See enrollment on card from muster-in roll.

Book mark:

Brooker

g. b.

6 H. Art'y.

U.S.C.T.

Nathan Helmes

Private, Co. F, 2 Reg't Miss. Artillery.†

Appears on

Company Muster Roll

for Jan. 1 to Feb. 29, 1864.

Joined for duty and enrolled:

When Aug. 29, 1863.\*

Where Natchez, Miss.\*

Period 3 years.\*

Present or absent Present

Stoppage, \$ 100 for

Due Gov't \$ 100 for

Valuation of horse, \$ 100

Valuation of horse equipments, \$ 100

Remarks:

† This organization subsequently became Co. F, 6 Reg't U. S. Colored Heavy Artillery.

\* See enrollment on card from muster-in roll.

Book mark:

Brooks

(358c)

Copyist.



Nathan Selmer

Co. D, 5 Reg't U. S. Col'd H. Art'y.\*

Appears on

Company Muster Roll

for Mar. to Apr. 30, 1864.

Joined for duty and enrolled:

When Aug. 29, 1863.\*

Where Natchez Miss. \*

Period 3 years.\*

Present or absent Present.

Stoppage, \$ 100 for

Due Gov't, \$ 100 for

Valuation of horse, \$ 100

Valuation of horse equipments, \$ 100

Remarks:

\* This organization subsequently became Co. D, 6 Reg't U. S. Col'd Heavy Artillery.

\* See enrollment on card from muster-in roll.

Book mark:

Brooks.

(358c)

Copyist.

Nathan Helmer

Priv., Co. F, 6 Reg't U. S. Col'd H. Art'y.

Appears on

Company Muster Roll

for May 1 to June 30, 1864.

Joined for duty and enrolled:

When Aug. 29, 1863.\*

Where Natches Miss.\*

Period 3 years.\*

Present or absent

Stoppage, \$ 100 for

Due Gov't \$ 100 for

Remarks: Died in quarters  
June 15th, 1864

\* See enrollment on card from muster-in roll.

Book mark:

Brooks

(358c)

Copyist.

H

6 H. Art'y.

U.S.C.T.

Nathan Holmer  
Priv., Co. F, 6 Reg't U. S. Col'd H. Art'y.

Appears on Returns as follows:

May 1864 Absent  
Sick in Post  
Hosp since May  
24

June 1864 Died  
June 15 in Quar-  
ters

Book mark:

(546)

A. Gouglal  
Copyist.

*Nathan Helmes*  
.....  
*Art.*, Co. *F.*, 6 Reg't U. S. Col'd H. Art'y.

Appears on **Co. Muster-out Roll**, dated  
*Katchez, Miss May 13*, 186*6*.

Muster-out to date ..... 186 .

Last paid to ..... 186 .

**C. othing account:**

Last settled....., 186 ; drawn since \$..... 100

Due soldier \$..... 100; due U. S. \$..... 100

Am't for cloth'g in kind or money adv'd \$..... 100

Due U. S. for arms, equipments, &c., \$..... 100

Bounty paid \$..... 100; due \$..... 100

Remarks: *Joined at original organization. Died of disease (Typhoid) at Katchez, Miss June 15. Official statements forwarded Aug 5, 64*

Book mark: .....

.....  
*[Signature]*  
.....  
(361) Copyist.

Delmes, Nathan

P, Co. F, 6 U<sup>Reg</sup>S. C. H. A.

2 Enclosures.

Bed Cards	Descriptive Lists
Burial Records	Final Statements
Certs. of Dis. for Discharge	Furloughs
C. M. Charges	Med. Des. Lists
Med. Certificates	Orders

Other papers relating to—

Admission to Hosp'l	Furlough
Casualty Sheet (Officer's)	Med. Examination
Confinement	Misc. Information
Contracts	Pay or Clothing
Death or Effects	Personal Reports
Desertions	Rank
Discharge from Hosp'l	Transfer to Hosp'l
Discharge from Service	Transfer to V. R. C.
Duty	Transportation

✓ Co. J.  
FINAL STATEMENT

OF

Nathan Helmes

Co. J. 6<sup>th</sup> Regiment U. S. Heavy Artillery, (O.)

Recd June 15<sup>th</sup> 1864

ADJUTANT GENERAL'S OFFICE.  
*Aug 24<sup>th</sup> 1864*  
Duplicate with Inventory sent 2d Auditor.



*Dwight*

I Certify, on honor, that Nathan Helmes a private of  
Captain S. U. Schreck Company (I.) of the 6<sup>th</sup> Regiment of United States Heavy Artillery, (Colored.)  
born in Lincoln County State of Kentucky, aged 25 years; 5 feet 7 inches high;  
Black complexion. Black eyes, Black hair and by occupation a Farmer, having joined the company on  
its original organization at Natchez Miss, and enrolled ~~in at the muster~~ into the service of the  
United States at Natchez Miss on the 29<sup>th</sup> day  
of August, 1863, (or was mustered in service ~~as a recruit~~, by Captain  
W. A. at Natchez Miss on the 12 day of September  
1863, or was drafted and mustered into the service of the United States from the \_\_\_\_\_ Enrollment District of the State  
of \_\_\_\_\_, at \_\_\_\_\_ on the \_\_\_\_\_  
day of \_\_\_\_\_ 1863,) to serve in the Regiment for the term of Three Years; and having served

HONESTLY and FAITHFULLY with his Company in the 6<sup>th</sup> U.S. Art. Col. to the present date, is now en-  
titled to a **DISCHARGE** by reason of Died of Disease at Camp M<sup>o</sup>  
Pherson, Natchez Miss June 15<sup>th</sup> 1864

The said Nathan Helmes was last paid by Paymaster  
Farrish to include the 30 day of April, 1864, and has  
pay due him from that time to the present date; he is entitled to pay and subsistence for TRAVELING to place of enrollment, and what-  
ever other allowances are authorized to volunteer soldiers, or drafted men, or militia, so discharged. He received from the United States

**CLOTHING** amounting to fifty seven 82 dollars, since the 29 day of August  
1863 when his clothing account was last settled. He received from the United States \_\_\_\_\_ 100 dollars, advanced

**BOUNTY.**

There is to be stopped from him, on account of the State of \_\_\_\_\_ or other authorities, for  
**CLOTHING, &c.**, received on entering service, \_\_\_\_\_, 100 dollars; and for other stoppages, viz: \_\_\_\_\_  
\_\_\_\_\_ 100 dollars.

He has been furnished TRANSPORTATION in kind from the place of his discharge to \_\_\_\_\_  
and he has been SUBSISTED for TRAVELING to his place of enrollment, up to the \_\_\_\_\_ 186

He is indebted to \_\_\_\_\_, **SUTLER**, \_\_\_\_\_ 100 dollars.  
He is indebted to \_\_\_\_\_, **LAUNDRESS**, \_\_\_\_\_ 100 dollars.

**GIVEN IN DUPLICATE**, at Natchez Miss, this 5 day  
of August, 1864.

Inventary of the Effects  
of  
David Nathan Helmes

J. Comp. & W. D. C. Art. Hr.

3

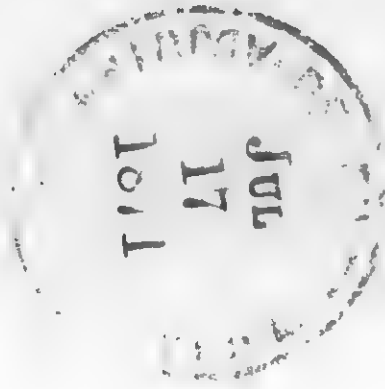



Inventory of the effects of *Nathan Helmes* late  
 a *Private* of Captain *S. A. Schreck* Company *F* of  
 the *6<sup>th</sup>* Regiment of *U. S. "C" Art. Hy.* Volunteers, who was enrolled as  
 a ..... at *Natchez* in the State of *Miss.* on  
 the *29<sup>th</sup>* day of *August* 1863, and mustered into the service of the United  
 States as a *Private* on the *12<sup>th</sup>* day of *September* 1863, at *Natchez, Miss.*  
 in Company *F*, *6<sup>th</sup>* Regiment of *U. S. "C" Art. Hy.* to serve *three*  
 years or during the war; he was born in *Lincoln County* in the State  
 of *Kentucky*; he was *25* years of age, *5* feet *7* inches  
 high, *black* complexion, *black* eyes, *black* hair, and by occupation, when enrolled,  
 a *Farmer*; he died in *Camp McPherson* at  
*Natchez, Miss.* on the *15<sup>th</sup>* day of *June* 1864, by  
 reason of *Disease*.

INVENTORY.					
ARTICLES.	NO.	ARTICLES	NO.	ARTICLES.	NO.
Hats.....		Pairs Trowsers.....		Knapsacks.....	
Caps.....		Pairs flannel Drawers.....			
Forage Caps.....		Pairs cotton Drawers.....			
Great Coats.....		Flannel Shirts.....			
Uniform Coats.....	<i>No Effects</i>	Cotton Shirts.....			
Uniform Jackets.....		Pairs boots.....			
Flannel Sack Coats.....		Pairs shoes.....			
Blouses.....		Pairs socks.....			
Stable Frocks.....		Blankets.....			
Fatigue Overalls.....		Haversacks.....			
				MONEY.	
				Specie.....	\$
				Notes.....	\$

I CERTIFY ON HONOR, that the above inventory comprises all the effects of  
*Nathan Helmes*, deceased, and that the effects are in the hands  
 of ..... at .....  
 ..... to be disposed of by a Council of Administration.

(DUPLICATES.)

STATION: *Natchez, Miss.*

DATE: *August 5<sup>th</sup> 1864.*

*Andrew Greenwald*  
*1<sup>st</sup> Lieut.*  
 Commanding the Company.

*Venderson*

Co *G*, 6 U.S. Col'd H. Art'y

*Private Private*

CARD NUMBERS.

1	6169364	26
2	6169516	27
3	6169743	28
4	6171398	29
5	9120062	30
6	9120235	31
7	40742479	32
8		33
9		34
10		35
11		36
12		37
13		38
14		39
15		40
16		41
17		42
18		43
19		44
20		45
21		46
22		47
23		48
24		49
25		50

Book Mark: *EB. 211 P. 339*

See also

Burk in Henderson

....., Co. G, 6 Reg't U. S. Col'd H. Art'y.

Appears on

**Company Descriptive Book**

of the organization named above.

**DESCRIPTION.**

Age 20 years; height 5 feet 5 inches.

Complexion *Rbk*

Eyes *Rbk*; hair *Rbk*

Where born *Wilson Miss.*

Occupation *Farmer*

**ENLISTMENT.**

When *Oct 10*, 1863.

Where *Watches Miss.*

By whom *C. W. Smith*; term *3* y'rs.

Remarks: *Died in Reg'tl Hosp  
at Vidalia La. opposite  
Watches Miss. Nov. 23/63*

*Warren*

Burkton Henderson

Co. G, 6 Reg't U. S. Col'd H. Art'y.

Appears on  
Company Descriptive Book

of the organization named above.

DESCRIPTION.

Age 20 years; height 5 feet 5 inches.

Complexion *Ork*

Eyes *Blk*; hair *Blk*

Where born *Wilson Co., Miss.*

Occupation *Farmer*

ENLISTMENT.

When *Oct. 10*, 1863.

Where *Atchey, Miss.*

By whom *Ch. Smith*, term *3* y'rs.

Remarks: *Died Nov. 23/63  
at Reg'tl Hosp. Vidalia  
La. of Parryhoea  
Final Statement forward  
ed Apr. 28/64*

*Warren*

Copist.

71

G H. Art'y.

U.S.C.T.

Burkoy Henderson

Pat, Co. G, 2 Reg't Miss. Art'y.\*

Age 20 years.

Appears on

Company Muster-in Roll

of the organization named above. Roll dated

Hatcher, Miss, Oct 20, 1863.

Muster-in to date Oct 20, 1863.

Joined for duty and enrolled:

When Oct 10, 1863.

Where Hatcher, Miss.

Period 3 years.

Valuation of horse, \$ 100

Valuation of horse equipments, \$ 100

Remarks:

\* This organization subsequently became Co. G, 6 Reg't U. S. Colored Heavy Artillery.

Book mark:

D. A. Ward

(356)

Copyist.

*Baykon Henderson*

*Put*, Co. G, 2 Reg't Miss. Art'y.\*

Appears on

**Company Muster Roll**

for *Oct 20 to 31*, 1863.

Present or absent *Present*

Stoppage, \$ *100* for

Due Gov't, \$ *100* for

Valuation of horse, \$ *100*

Valuation of horse equipments, \$ *100*

Remarks:

\* This organization subsequently became Co. G, 6 Reg't U. S. Colored Heavy Artillery.

Book mark:

*A. D. Ward*

*Henderson, Purdon*

*Put*, Co. G, 2 Reg't Miss. Art'y.\*

Appears on

**Company Muster Roll**

for *Nov & Dec*, 1863.

Present or absent.....

Stoppage, \$.....100 for .....

Due Gov't, \$.....100 for .....

Valuation of horse, \$.....100

Valuation of horse equipments, \$.....100

Remarks: *Died Nov 23/63.  
in Regt. Hospital.*

\* This organization subsequently became Co. G, 6 Reg't U. S. Colored Heavy Artillery.

Book mark: .....

*P. A. Ward*  
(358) Copyist.

A

6 H. Art'y.

U.S.C.T.

Pearlson Henderson

Co., Co. ...., 6 Reg't U. S. Col'd H. Art'y.

Appears on Returns as follows:

Nov 1863 (Co G 2 Miss  
K Art A.W.) Died  
Nov 23 Hospital

Book mark : .....

(546)

A. Gouglas

Copyist.



Burxon Henderson

Priv., Co. G, 6 Reg't U. S. Col'd H. Art'y.

Appears on Co. Muster-out Roll, dated Natchez, Miss, May 13, 1866.

Muster-out to date, 1866.

Last paid to, 1866.

Clothing account:

Last settled, 1866; drawn since \$100

Due soldier \$100; due U. S. \$100

Am't for cloth'g in kind or money adv'd \$100

Due U. S. for arms, equipments, &c., \$100

Bounty paid \$100; due \$100

Remarks: Joined at original organization. Died Nov 20/63 at Vidalia, La. of Diarrhea. Final statements forwarded April 28/64

Book mark: Died November 23, 1863. E.B.V II P 339.

W. Chance

Burton Henderson

P, Co. G, 6 Reg't U.S. 6 A.A.

5 Enclosures.

Bed Cards .....	Final Statements .....
Burial Records .....	Furloughs or L. of A .....
Certs. of Dis. for Discharge .....	Med. Certificates .....
C. M. Charges .....	Med. Des. Lists .....
Descriptive Lists .....	Orders .....
Discharge Certificates .....	Pris. of War Record .....
Enlistment Papers .....	Resignations .....

Other papers relating to—

Admission to Hosp'l .....	Furlough or L. of A .....
Casualty Sheet .....	Med. Examination .....
Confinement .....	Misc. Information .....
Contracts .....	Pay or Clothing .....
Death or Effects .....	Personal Reports .....
Desertion .....	Rank .....
Discharge from Hosp'l .....	Transfer to Hosp'l .....
Discharge from Service .....	Transfer to V. R. C. .....
Duty .....	Transportation .....

COMPILED MILITARY SERVICE RECORDS  
OF VOLUNTEER UNION SOLDIERS WHO SERVED WITH  
THE UNITED STATES COLORED TROOPS (USCT)  
6TH REGIMENT OF HEAVY ARTILLY

PERSONAL PAPERS' TARGET SHEET

PLEASE NOTE THE CHECKED INFORMATION ABOUT THE PERSONAL PAPERS IN  
THIS FILE:

NO PERSONAL PAPERS WERE FOUND IN THIS FILE WHEN THE  
RECORDS WERE ARRANGED FOR MICROFILMING.

4 PERSONAL PAPER(S) FOUND IN THIS FILE WHEN THE RECORDS  
WERE ARRANGED FOR MICROFILMING.

INVENTORY OF THE EFFECTS

OF

*Private Burton Henderson*

Late of Company "G"

*6<sup>th</sup>* Reg't of U.S. Col'd Artz (Heavy)

Volunteers, who died at *Vidalia La.*

on the *23<sup>d</sup>* day of *November* 1863.



Inventory of the effects of Buckton Henderson late  
a Private of Captain John Louis Company "G" of  
the 6<sup>th</sup> Regiment of U.S. Colored Artillery (Heavy) Volunteers, who was enrolled as  
a Private at Natchez Miss in the State of Mississippi on  
the 10<sup>th</sup> day of October 1863, and mustered into the service of the United  
States as a Private on the 20<sup>th</sup> day of October 1863, at Natchez Miss  
in Company "G", 6<sup>th</sup> Regiment of U.S. Colored Artillery (Heavy) Volunteers, to serve Three  
years or during the war; he was born in Wilson County in the State  
of Mississippi; he was 20 years of age, 5 feet 5 inches  
high, dark complexion, Black eyes, Black hair, and by occupation, when enrolled,  
a Farmer; he died in Regimental Hospital, at  
Udellia Louisiana on the 23<sup>rd</sup> day of November 1863, by  
reason of Chronic Diarrhea

INVENTORY.						
ARTICLES.	No.	ARTICLES.	No.	ARTICLES.	No.	
Hats.....		Pairs trousers.....		Knapsacks.....		
Caps.....		Pairs flannel drawers.....				
Forage Caps.....		Pairs cotton drawers.....				
Great coats.....		Flannel shirts.....				
Uniform coats.....		Cotton shirts.....		MONEY.	Specie.....	\$
Uniform jackets.....		Pairs boots.....			Notes.....	\$
Flannel sack coats.....		Pairs shoes.....				
Blouses.....		Pairs socks.....				
Stable frocks.....		Blankets.....				
Fatigue overalls.....		Haversacks.....				

I CERTIFY, ON HONOR, that the above inventory comprises all the effects of \_\_\_\_\_  
\_\_\_\_\_, deceased, and that the effects are in the hands  
of \_\_\_\_\_ at \_\_\_\_\_  
\_\_\_\_\_ to be disposed of by a Council of Administration.

(DUPLICATES.)

STATION: Natchez Miss

DATE: March 18 1865

Edward O. Bell  
Captain 6<sup>th</sup> Regt U.S. Colored Artillery (Heavy)  
Commanding the Company "G"

Inventary of Effects  
Henry Buckrow  
Co. 4. 6. U.S. Cavalry

Inventory of the effects of Wenderson Burkton late  
 a Private of Captain John Louis Company G of  
 the Sixth Regiment of U.S. Col'd Art. Heavy ~~Volunteers~~, who was enrolled as  
 a Private at Natchez in the State of Mississippi on  
 the 10<sup>th</sup> day of October 1863, and mustered into the service of the United  
 States as a Private on the 20<sup>th</sup> day of October 1863, at Natchez Miss.  
 in Company G, Sixth Regiment of U.S. Col'd Art. Heavy to serve three  
 years ~~or during the war~~, he was born in Wilson County in the State  
 of Mississippi; he was 20 years of age, 5 feet 5 inches  
 high, Dark complexion, Black eyes, Black hair, and by occupation, when enrolled,  
 a Farmer; he died in Regimental Hospital at  
Viola La on the 23<sup>rd</sup> day of November 1863, by  
 reason of chronic Diarrhea

INVENTORY.					
ARTICLES.	NO.	ARTICLES	NO.	ARTICLES.	NO.
Hats.....		Pairs Trowsers.....		Knapsacks.....	
Caps.....		Pairs flannel Drawers.....			
Forage Caps.....		Pairs cotton Drawers.....			
Great Coats.....		Flannel Shirts.....			
Uniform Coats.....		Cotton Shirts.....			
Uniform Jackets.....		Pairs boots.....			
Flannel Sack Coats.....		Pairs shoes.....			
Blouses.....		Pairs socks.....			
Stable Frocks.....		Blankets.....			
Fatigue Overalls.....		Haversacks.....			
				MONEY.	
				Specie.....	\$
				Notes.....	\$

I CERTIFY ON HONOR, that the above inventory comprises all the effects of \_\_\_\_\_  
 \_\_\_\_\_, deceased, and that the effects are in the hands  
 of \_\_\_\_\_ at \_\_\_\_\_  
 \_\_\_\_\_ to be disposed of by a Council of Administration.

(DUPLICATES.)

STATION: Natchez Miss.

DATE: July 6<sup>th</sup> 1864

John Louis  
Captain  
 Commanding the Company.

FINAL STATEMENT

OF

*B. G.*  
*Burton Henderson, Private*  
*6<sup>th</sup> Reg't of U. S. Col. Heavy Arty*

**VOLUNTEERS.**

NOTE 1.—Two of these certificates (or duplicates) are to be given to each Volunteer Soldier or drafted man who may be discharged without being mustered out, (Final Statements are never given to men mustered out of service) that he may at once receive from the Paymaster the pay, &c., due him, and the captain or other COMMISSIONED officer commanding the company will certify to the act of the delivery of the duplicate certificates; with these certificates the Soldier is "entitled to" his discharge, and should also present his discharge to the Paymaster to have the payment endorsed on it. The discharge is to be given back to the Soldier by the Paymaster; the latter only retaining as his vouchers the duplicate certificates.

NOTE 2.—If the Soldier is entitled to pay for the use of his horse, the Company Commander will certify to that fact on the back of both these final statements, and also to the time he has pay due for having been so mounted on his own horse.

NOTE 3.—When a Soldier is furnished with final statements, his descriptive list, if he has one, should be taken up by the officer who gives the Soldier these statements, and endorsed with a statement to this effect by the officer. The endorsement should exhibit a full statement of the time for which the Soldier was allowed pay on his final statements, the clothing account, and all other charges against him or in his favor, so as to comprise a complete exhibit of his account. It will then be transmitted to the Company Commander of the Soldier, who will enter all the data necessary to a full understanding of the Soldier's account on the muster roll upon which the Soldier's discharge is reported. The descriptive list will then be destroyed. The object of this is, that the remaining portion of the Soldier's account may be settled upon the receipt of these muster rolls, and the Soldier receive any pay or allowances that may be due him at the time of his discharge, and which may not appear on his last final statements from the fact that his descriptive list is incomplete. These accounts for back pay, &c., are settled by the 2d Auditor of the Treasury Department.

NOTE 4.—Charges for loss or injury to ordnance, horse equipments, and other miscellaneous charges, should appear under the heading of "Other Stoppages."

NOTE 5.—Bounty paid by State authorities, and not by the United States, will not be entered on this statement.

NOTE 6.—Amounts due the Sutler and Laundress must be entered on the muster roll on which the discharge, death, desertion, &c., is reported, as well as on the final statement, otherwise the amount cannot be collected from the United States.

NOTE 7.—This blank will be used for deceased volunteers and drafted men, as well as for others.

NOTE 8.—Where a Soldier dies in Hospital or on detached service, his descriptive list, if he has one, should be sent with his final statement, in duplicate, to the Adjutant General, Washington, D. C.

NOTE 9.—If the soldier is a drafted man or substitute, the space for time, &c., of enrolled, should contain only the word *drafted* or *substitute*, as the case may be. If the Soldier is a "VETERAN," (OR RECRUIT,) the words as a *veteran*, (or *recruit*,) as the case may be, should be interlined after the words *mustered into the service of the U. S.* A statement of all the installments of *Veteran* or *Recruit* **BOUNTY RECEIVED** by the Soldier must be made on the back of each final statement.

[OFFICE ENDORSEMENT.]

War Department,

ADJUTANT GENERAL'S OFFICE,

*April 14*, 1875  
 The death of *Burton Henderson*  
*Henderson* of *Co. G*, *6<sup>th</sup> Reg't U. S. Colored Arty* is reported as follows:  
 On Company Muster Roll.  
 For *Nov Dec*, 1863, *Nov 23<sup>rd</sup>*, 1863  
 Company Muster-out Roll.  
*Nov 20<sup>th</sup>*, 1863  
 Company Descriptive Book.  
 Company Morning Reports.  
 Soldier's Final Statement.  
*Nov 23<sup>rd</sup>*, 1863  
 Soldier's Record of Death and Interment.  
 Soldier's Inventory of Effects.  
 Soldier's Certificate of Disability for Discharge.  
 Soldier's Individual Muster-out Roll.  
 Regimental Return.  
 For *Nov*, 1863, *Nov 23<sup>rd</sup>*, 1863  
 Regimental Quarterly Returns.  
*Nov 23<sup>rd</sup>*, 1863  
 Regimental Descriptive Book.  
 By Surgeon General.  
*(Nov 23)*, 1863, is held to be  
 the correct date, and the Company Muster-out Roll will be amended accordingly.

*Roman*  
*EB*  
 Voted *Nov 23<sup>rd</sup>*  
 M. 339.  
 Assistant Adjutant General.

ADJUTANT GENERAL'S OFFICE.

*April 6<sup>th</sup> 1875*

Duplicate with Inventory sent 2d Auditor.

*See letter of May 4<sup>th</sup> 1875 to 2d Auditor*



*Burton Henderson*  
I Certify, on honor, that *Henderson Burkton* *Private* of  
Captain *John Louis* Company (*G*) of the *Sixth* Regiment of United States Heavy Artillery, (Colored.)  
born in *Wilson County*, State of *Mississippi*, aged *20* years; *5* feet *6* inches high;  
*Dark* complexion, *Dark* eyes, *Black* hair and by occupation a *Farmer*, having joined the company on  
its original organization at *Natchez Miss*, and enrolled in at the muster into the service of the  
United States at *Natchez Miss* on the *20<sup>th</sup>* day  
of *October*, 1863, (or was mustered in service as a recruit, by

at \_\_\_\_\_ on the \_\_\_\_\_ day of \_\_\_\_\_  
1863, or was drafted and mustered into the service of the United States from the \_\_\_\_\_ Enrollment District of the State

of \_\_\_\_\_ at \_\_\_\_\_ on the \_\_\_\_\_ day of \_\_\_\_\_ 1863) to serve in the Regiment, for the term of *three years*; and having served

HONESTLY and FAITHFULLY with his Company in \_\_\_\_\_ to the present date, is now en-  
titled to a ~~DISCHARGE~~ by reason of *Died in Regimental Hospital at*  
*Vidalia Louisiana November 23<sup>rd</sup> 1863*

The said *Henderson Burkton* was last paid by Paymaster  
*was never paid* to include the \_\_\_\_\_ day of \_\_\_\_\_, 1863, and has  
*Date of discharge*  
pay due him from ~~that time~~ to the present date; he is entitled to pay and subsistence for TRAVELING to place of enrollment, and what-  
ever other allowances are authorized to volunteer soldiers, or drafted men, or militia, so discharged. He received from the United States

**CLOTHING** amounting to *32 58* dollars, since the \_\_\_\_\_ day of *Enlistment*  
1863, when his clothing account was last settled. He received from the United States \_\_\_\_\_ dollars, advanced

**BOUNTY.**

There is to be stopped from him, on account of the State of \_\_\_\_\_ or other authorities, for  
**CLOTHING, &c.**, received on entering service, \_\_\_\_\_, 100 dollars; and for other stoppages, viz: \_\_\_\_\_  
\_\_\_\_\_ 100 dollars.

He has been furnished TRANSPORTATION in kind from the place of his discharge to \_\_\_\_\_  
and he has been SUBSISTED for TRAVELING to his place of enrollment, up to the \_\_\_\_\_ 1863.

He is indebted to \_\_\_\_\_, **SUTLER**, \_\_\_\_\_ 100 dollars.

He is indebted to \_\_\_\_\_, **LAUNDRESS**, \_\_\_\_\_ 100 dollars.

**GIVEN IN DUPLICATE**, at *Natchez Miss*, this *21<sup>st</sup>* day  
of *July*, 1864;

*John Louis*  
*Captain*  
Commanding Company.



FINAL STATEMENT

*Richard Henderson*  
OF  
*Henderson Burkton, Pmari*

*Sixth* Regiment U. S. Heavy Artillery, (O.)

*to Aid Nov 23. 1863*



*Jan 11*

I certify, on honor, that Burton Henderson, a Private of  
Captain John Louis Company (G) of the 6<sup>th</sup> Regiment of U.S. Artillery (Heavy)  
~~of the State of~~ born in Wilson County, State  
of Mississippi, aged 20 years; 5 feet 5 inches high; dark complexion,  
black eyes, black hair, and by occupation a Farmer, who joined for service  
and was enrolled (see Note 9) on the 10<sup>th</sup> day of October, 1863, at Natchez Miss  
by Le. W. Smith, for the period of three years, and mustered into  
the service of the United States on the 20<sup>th</sup> day of October, 1863, at  
Natchez Miss., by Capt. C. C. Lanstrum, and having served  
~~HONESTLY and FAITHFULLY~~ with his Company to the present date, is now entitled to a  
~~DISCHARGE~~ by reason of Died in Regimental Hospital at  
Vidalia Louisiana on the 23<sup>rd</sup> day of November 1863

The said Burton Henderson has never been paid ~~was last paid by Paymaster~~  
~~to include the~~ day of ~~186~~, and  
has pay due him from <sup>date of Enlistment</sup> ~~that time to the present date~~; he is entitled to pay and subsistence for  
**TRAVELING** to place of enrollment, and whatever other allowances are authorized to volunteer  
soldiers, drafted men, or militia, so discharged. He has received from the United States **CLOTHING**  
amounting to Twenty two  $\frac{38}{100}$  dollars, since the ~~the~~ day of Enlistment  
~~1863~~, when his clothing account was last settled. He has received from the United States  
 $\frac{100}{100}$  dollars advanced **BOUNTY**.

There is to be stopped from him, on account of the State of \_\_\_\_\_, or other  
authorities, for **CLOTHING**, &c., received on entering service, \_\_\_\_\_  $\frac{100}{100}$  dollars; and  
for other stoppages, viz: \_\_\_\_\_

\_\_\_\_\_  $\frac{100}{100}$  dollars.  
He has been furnished with **TRANSPORTATION** in kind from the place of his discharge to  
\_\_\_\_\_; and he has been **SUBSISTED** for **TRAVELING** to his  
place of enrollment, up to the \_\_\_\_\_, 186 .

He is indebted to \_\_\_\_\_, **SUTLER**, \_\_\_\_\_  $\frac{100}{100}$  dollars.

He is indebted to \_\_\_\_\_, **LAUNDRESS**, \_\_\_\_\_  $\frac{100}{100}$  dollars.

Given in Duplicate, at Natchez Mississippi, this 18<sup>th</sup> day  
of March, 1865.

Edward O. Neill  
Captain 6<sup>th</sup> Regt U.S. Artillery (Heavy)  
Commanding Company "G"

Anderson Harrison

Co B, 6 U.S. Col'd H. Art'y.

Private Private

CARD NUMBERS.

1	6157857	26
2	6158003	27
3	6158145	28
4	6158266	29
5	6158392	30
6	6158532	31
7	6158662	32
8	6158784	33
9	6158906	34
10	6159037	35
11	6159180	36
12	6159324	37
13	6159465	38
14	6159603	39
15	6159732	40
16	6159855	41
17	6159976	42
18	6160097	43
19	9119120	44
20	40742480	45
21		46
22		47
23		48
24		49
25		50

Book Mark:

See also

*Harrison Henderson*

Co. *B*, 6 Reg't U. S. Col'd H. Art'y.

Appears on

**Company Descriptive Book**  
of the organization named above.

**DESCRIPTION.**

Age *47* years; height *5* feet *7 1/2* inches.

Complexion *Brown*

Eyes *Black*; hair *Black*

Where born *Woodford Co. Ky*

Occupation *Farmer*

**ENLISTMENT.**

When *Sept 1*, 186*3*.

Where *Nashville*

By whom *Capt Hopkins*; term *3* y'rs.

Remarks:  
.....  
.....  
.....  
.....  
.....  
.....  
.....  
.....

*J. J. J. J.*

*Marrison Hudsonson*

*Private*, Co. *B*, 2 Reg't Miss. Art'y.†

Age *47* years.

Appears on

**Company Muster-in Roll**

of the organization named above. Roll dated

*Natchez, Miss. Sept. 12, 1863.*

Muster-in to date *Sept. 12, 1863.*

Joined for duty and enrolled:

When *Sept. 1st*, 186*3*.\*

Where *Natchez, Miss.* \*

Period *3* years.\*

Valuation of horse, \$ ..... *100*

Valuation of horse equipments, \$ ..... *100*

Remarks: .....

† This organization subsequently became Co. *B*, 6 Reg't U. S. Colored Heavy Artillery.

\* \* \* Muster-in roll shows enrollment of all men of this company as of same date and place. See enrollment on subsequent card or cards.

Book mark: .....

*M. M. [Signature]*

Harrison Henderson

Private, Co. B, 2 Reg't Miss. Art'y.†

Appears on

Company Muster Roll

for Sept. 12 to Oct 31, 1863.

Joined for duty and enrolled:

When Sept. 1st, 1863.\*

Where Spatchez Miss. \*

Period 3 years.\*

Present or absent Present

Stoppage, \$ 100 for

Due Gov't, \$ 100 for

Valuation of horse, \$ 100

Valuation of horse equipments, \$ 100

Remarks: Sick in Regimental Hospital

† This organization subsequently became Co. B, 6 Reg't U. S. Co'd Heavy Artillery.

\* See enrollment on card from muster-in roll.

Book mark:

W. W. Warren

Copyist

Harrison Anderson  
Private, Co. B, 2 Reg't Miss. Art'y.†

Appears on

**Company Muster Roll**

for *Nov. & Dec.*, 186*3*.

Joined for duty and enrolled:

When *Sept. 1st*, 186*3*.\*

Where *Shatchey, Miss.* \*

Period *3* years.\*

Present or absent *Present*

Stoppage, \$ *100* for

Due Gov't, \$ *100* for

Valuation of horse, \$ *100*

Valuation of horse equipments, \$ *100*

Remarks:

† This organization subsequently became Co. B, 6 Reg't U. S. Co'd Heavy Artillery.

\* See enrollment on card from muster-in roll.

Book mark:

*M. M. Warren*



A.

6 H. Art'y.

U.S.C.T.

Harrison Henderson

Private, Co. B, 2 Reg't Miss. Art'y \*  
~~6 Reg't U. S. Col'd H. Art'y.~~

Appears on

Company Muster Roll

for Jan'y & Feb'y 1864.

Joined for duty and enrolled:

When Sept. 1st, 1863.\*

Where Shatchez, Miss. \*

Period 3 years.\*

Present or absent Present

Stoppage, \$ 100 for

Due Gov't, \$ 100 for

Remarks: Detained on Re-  
cruiting service

\* This organization subsequently be-  
came Co. B, 6 Reg't U. S. Col'd H. Art'y.

\* See enrollment on card from muster-in roll.

\* Corrected Mar. 19/95: over.

Book-mark :

W. M. Warren

(358c)

Copyist.

Harrison Henderson  
Private, Co. B, 5 Reg't U. S. Col'd H. Art'y.\*

Appears on

Company Muster Roll

for Mar. & April, 1864.

Joined for duty and enrolled:

When Sept. 1st, 1863.\*

Where Hatcheg, Miss.\*

Period 3 years.\*

Present or absent Present

Stoppage, \$ 100 for

Due Gov't, \$ 100 for

Valuation of horse, \$ 100

Valuation of horse equipments, \$ 100

Remarks:

\* This organization subsequently became Co. B, 6 Reg't U. S. Col'd Heavy Artillery.  
\* See enrollment on card from muster-in roll.

Book mark:

M. W. Harrison

Copyist.

*Harrison Henderson*

*Private*, Co. B, 6 Reg't U. S. Col'd H. Art'y.

Appears on

**Company Muster Roll**

for *May & June* 186*4*.

Joined for duty and enrolled:

When *Sept. 1st*, 186*2*.\*

Where *Hatchez, Miss.* \*

Period *3* years.\*

Present or absent *Present*

Stoppage, \$ *100* for

Due Gov't, \$ *100* for

Remarks: \_\_\_\_\_  
\_\_\_\_\_  
\_\_\_\_\_  
\_\_\_\_\_  
\_\_\_\_\_

\* See enrollment on card from muster-in roll.

Book-mark: \_\_\_\_\_

*M. M. Shasen*

H.

6 H. Art'y.

U.S.C.T.

*Harrison Henderson.*

*Privt.*, Co. B, 6 Reg't U. S. Col'd H. Art'y.

Appears on

**Company Muster Roll**

for *July & Aug.* 1864.

Joined for duty and enrolled:

When *Sept. 1<sup>st</sup>*, 1863.\*

Where *Natchez Miss.* \*

Period *3* years.\*

Present or absent *Present.*

Stoppage, \$ *100* for

Due Gov't, \$ *100* for

Remarks:

-----  
-----  
-----  
-----  
-----  
-----  
-----  
-----

\* See enrollment on card from muster-in roll.

Book-mark :  
-----  
-----

*H. C. Thomas.*

(358c)

Copyist.

H.

6 H. Art'y.

U.S.C.T.

*Henderson Harrison*

*Privt.*, Co. B, 6 Reg't U. S. Col'd H. Art'y.

Appears on

**Company Muster Roll**

for *Sept. & Oct.* 1864.

Joined for duty and enrolled:

When *Sept. 1<sup>st</sup>*, 1863.\*

Where *Natchez Miss.* \*

Period *3* years.\*

Present or absent *Present.*

Stoppage, \$ *100* for

Due Gov't, \$ *100* for

Remarks:

\* See enrollment on card from muster-in roll.

Book-mark:

*H. C. Thomas*

(358c)

Copyist.

H.

6 H. Art'y.

U.S.C.T.

Harrison Henderson.

Priv., Co. B, 6 Reg't U. S. Col'd H. Art'y.

Appears on

Company Muster Roll

for Nov. & Dec. 1864.

Joined for duty and enrolled:

When Sept. 1<sup>st</sup>, 1863.\*

Where Natchez Miss.\*

Period 3 years.\*

Present or absent Present.

Stoppage, \$ 100 for

Due Gov't, \$ 100 for

Remarks:

\* See enrollment on card from muster-in roll.

Book-mark:

H. C. Thomas

(358c)

Copyist.

H.

6 H. Art'y.

U.S.C.T.

*Harrison Henderson*

*Privt*, Co. B, 6 Reg't U. S. Col'd H. Art'y.

Appears on

**Company Muster Roll**

for *Jan'y. & Feby.* 1865.

Joined for duty and enrolled:

When *Sept. 1<sup>st</sup>*, 1863.\*

Where *Natchez Miss.*\*

Period *3* years.\*

Present or absent *Present*

Stoppage, \$ *100* for

Due Gov't, \$ *100* for

Remarks:

\*~~See~~ See enrollment on card from muster-in roll.

Book-mark :

*H. C. Thomas*

Copyist.

(358c)

H.

6 H. Art'y.

U.S.C.T.

*Harrison Henderson.*

*Privt.*, Co. B, 6 Reg't U. S. Col'd H. Art'y.

Appears on

**Company Muster Roll**

for *March & April* 1865.

Joined for duty and enrolled:

When *Sept. 1"*, 1863.\*

Where *Natchez Miss.*\*

Period *3* years.\*

Present or absent *Present.*

Stoppage, \$ *100* for

Due Gov't, \$ *100* for

Remarks:

\* See enrollment on card from muster-in roll.

Book-mark:

*H. C. Thomas*

(358c)

Copyist.



H.

6 H. Art'y.

U.S.C.T.

*Harrison Henderson*

*Pvt.*, Co. B, 6 Reg't U. S. Col'd H. Art'y.

Appears on

**Company Muster Roll**

for *May & June* 1865.

Joined for duty and enrolled:

When *Sept. 1<sup>st</sup>*, 1863.\*

Where *Natchez Miss.*\*

Period *3* years.\*

Present or absent *Present*

Stoppage, \$ *100* for

Due Gov't, \$ *100* for

Remarks:

\*~~See~~ See enrollment on card from muster-in roll.

Book-mark:

(358c)

*H. C. Thomas*

Copyist.

*Harrison Anderson*

*Pr.*, Co. B, 6 Reg't U. S. Col'd H. Art'y.

Appears on

**Company Muster Roll**

for *July Aug* 1865.

Joined for duty and enrolled:

When *Sept.*, 1865.\*

Where *Archaz, Miss.*\*

Period *3* years.\*

Present or absent *Present.*

Stoppage, \$ *100* for

Due Gov't, \$ *100* for

Remarks: \_\_\_\_\_  
\_\_\_\_\_  
\_\_\_\_\_  
\_\_\_\_\_  
\_\_\_\_\_

\* See enrollment on card from muster-in roll.

Book-mark: \_\_\_\_\_

(358c)

*Satine*  
Copyist.

*H*

6 H. Art'y.

U.S.C.T.

*Harrison Henderson*

*Cpt*, Co. B, 6 Reg't U. S. Col'd H. Art'y.

Appears on

**Company Muster Roll**

for *Sept + Oct* 1865.

Joined for duty and enrolled:

When *Sept 1*, 1865.\*

Where *Natchez, Miss.*\*

Period *8* years.\*

Present or absent *Present*

Stoppage, \$ *100* for

Due Gov't, \$ *100* for

Remarks: \_\_\_\_\_  
\_\_\_\_\_  
\_\_\_\_\_  
\_\_\_\_\_  
\_\_\_\_\_

\* See enrollment on card from muster-in roll.

Book-mark: \_\_\_\_\_

(358c)

*Sabine*

Copyist.

*H*

6 H. Art'y.

U.S.C.T.

*Harrison Anderson*

*Co.*, Co. B, 6 Reg't U. S. Col'd H. Art'y.

Appears on

**Company Muster Roll**

for *Nov Dec* 1865.

Joined for duty and enrolled:

When *Sep. 1*, 1865.\*

Where *Natchez Miss.*\*

Period *2* years.\*

Present or absent *Present.*

Stoppage, \$ *100* for

Due Gov't, \$ *100* for

Remarks *In daily duty  
in the gun depart-  
ment, Natchez Miss.,  
by S.O. No. 103.*

\* See enrollment on card from muster-in roll.

Book-mark :

*Sabine*

(358c)

Copyist.

*75*

6 H. Art'y.

U.S.C.T.

*Harrison Henderson*

*Private*, Co. B, 6 Reg't U. S. Col'd H. Art'y.

Appears on

**Company Muster Roll**

for *Jan Feb* 186*6*.

Joined for duty and enrolled:

When *Feb*, 186*6*.\*

Where *March 4, Miss* \*

Period *2* years.\*

Present or absent *Present*.

Stoppage, \$ *100* for

Due Gov't, \$ *100* for

Remarks: \_\_\_\_\_  
\_\_\_\_\_  
\_\_\_\_\_  
\_\_\_\_\_  
\_\_\_\_\_  
\_\_\_\_\_

\* See enrollment on card from muster-in roll.

Book-mark: \_\_\_\_\_

(358c)

*Carroll*  
Copyist.

A

6 H. Art'y.

U.S.C.T.

*Harrison Henderson*

*Co.*, Co. B, 6 Reg't U. S. Col'd H. Art'y.

Appears on

**Company Muster Roll**

for *Mar & Apr* 186*6*.

Joined for duty and enrolled:

When *Sept 1\**, 186*3*.\*

Where *Nashville Miss* \*

Period *3* years.\*

Present or absent *present*

Stoppage, \$ *100* for

Due Gov't, \$ *100* for

Remarks: \_\_\_\_\_  
\_\_\_\_\_  
\_\_\_\_\_  
\_\_\_\_\_  
\_\_\_\_\_  
\_\_\_\_\_

\* See enrollment on card from muster-in roll.

Book-mark: \_\_\_\_\_

*H. P. Jones*

Copyist.

(358c)

A

6 H. Art'y.

U.S.C.T.

Harrison Henderson

Pol, Co. B, 6 Reg't U. S. Col'd H. Art'y.

Appears on Returns as follows:

Jan & Feb 1864 2 Mns  
H. Art. A. I. Det'd  
on Recruiting  
service

Mar 1864 15 US Col'd  
H. Art. On duty  
Recruiting service

Dec 1865 6 US Col'd H  
Art On duty  
in Dr. Mns Dept

Book mark:

(546)

A. Gouglas

Copyist.

H

6 H. Art'y.

U.S.C.T.

*Harrison Henderson*

*Pvt.*, Co. *B*, 6 Reg't U. S. Col'd H. Art'y.

Appears on **Co. Muster-out Roll**, dated

*Natchez Miss*, *May 13*, 1866.

Muster-out to date *May 13*, 1866.

Last paid to *Dec. 31*, 1865.

Clothing account:

Last settled....., 186 ; drawn since \$..... 100

Due soldier \$ *46* <sup>*45*</sup>/<sub>100</sub>; due U. S. \$..... 100

Am't for cloth'g in kind or money adv'd \$..... 100

Due U. S. for arms, equipments, &c., \$..... 100

Bounty paid \$..... 100; due \$..... 100

Remarks: *Joined at Original Organization*

.....  
.....  
.....  
.....

Book mark: .....

(361) *J. E. Nichol* Copyist.



Henderson, Harrison

P. Co. B, 6 U.S.C.H.A.

Enclosures.

Bed Cards	Descriptive Lists
Burial Records	Final Statements
Certs. of Dis. for Discharge	Furloughs
C. M. Charges	Med. Des. Lists
Med. Certificates	Orders

Other papers relating to—

Admission to Hosp'l	Furlough
Casualty Sheet (Officer's)	Med. Examination
Confinement	Misc. Information
Contracts	Pay or Clothing
Death or Effects	Personal Reports
Desertions	Rank
Discharge from Hosp'l	Transfer to Hosp'l
Discharge from Service	Transfer to V. R. C.
Duty	Transportation

Harrison Henderson

8736 USCA

SPECIAL ORDERS,  
No. 9.

HEAD-QUARTERS,  
SOUTHERN DISTRICT OF MISSISSIPPI,  
Natchez, Miss., Jan. 11, 1866.

I. Private HARRISON HENDERSON, Company "B," 6th U. S. C.  
Artillery, (Heavy), is hereby detailed for duty at these Head-Quarters,  
and will report accordingly.

\* \* \* \* \*

By order of

Brevet Major Gen'l J. W. DAVIDSON,

D. L. KINNINMENT,

Capt., A. D. C., & A. A. A. Gen'l.

OFFICIAL.

*D. L. Kinniment*  
*Capt. A. D. C. & A. A. A. Gen'l.*

*Henderson Henry*

Co *M*, 6 U.S. Col'd H. Art'y

*Private* | *Private*

CARD NUMBERS.

1	6154157	26
2	6179301	27
3	6179423	28
4	6179505	29
5	6179618	30
6	6179710	31
7	6179806	32
8	6179922	33
9	6180039	34
10	6180147	35
11	6180254	36
12	6180351	37
13	6180447	38
14	6180537	39
15	6180626	40
16	6180715	41
17	9121109	42
18	40442481	43
19		44
20		45
21		46
22		47
23		48
24		49
25		50

Book Mark:

See also

Henderson, Henry

P. Co. M., 6 Reg. S. C. H. A.

Enclosures.

Bed Cards .....	Descriptive Lists .....
Burial Records .....	Final Statements .....
Certs. of Dis. for Discharge .....	Furloughs .....
C. M. Charges .....	Med. Des. Lists .....
Med. Certificates .....	Orders .....

Other papers relating to—

Admission to Hosp'l .....	Furlough .....
Casualty Sheet (Officer's) .....	Med. Examination .....
Confinement .....	Misc. Information .....
Contracts .....	Pay or Clothing .....
Death or Effects .....	Personal Reports .....
Desertions .....	Rank .....
Discharge from Hosp'l .....	Transfer to Hosp'l .....
Discharge from Service .....	Transfer to V. R. C. .....
Duty .....	Transportation .....

Henderson, Henry  
P.M. 6 22, 1872

Daily

Head Quarters Detachment Light Artillery  
Fort M. P. Herson Natchez Miss July 21 1874

Lieut. Dickson  
Act. Capt 6<sup>th</sup> U.S. Col. Arty Hears

Sir

I most respectfully  
request that Henry Henderson of Company M 6<sup>th</sup> U.S. Col. Arty.  
be detailed for a few days on Special Duty as Right Blacksmith  
to help shoe my Horses

Most Respectfully Yours  
W. D. Bennett  
Lt. Command Detachment

3

*Henry Anderson*

Co. *M*, 6 Reg't U. S. Col'd H. Art'y.

Appears on

**Company Descriptive Book**

of the organization named above.

**DESCRIPTION.**

Age *36* years; height *6* feet *0* inches.

Complexion *Blk*

Eyes *blue*; hair *Blk*

Where born *Laurance Ala*

Occupation *Blk Mh*

**ENLISTMENT.**

When *Feb 16*, 1864.

Where *Spatehaz Miss*

By whom *Capt Cadde*; term *3* y'rs.

Remarks:

-----  
-----  
-----  
-----  
-----  
-----  
-----  
-----  
-----  
-----

*Hillman*



N

G H. Art'y.

U.S.C.T.

*Henry Anderson*

Appears with rank of *1<sup>st</sup> Lt.* on

**Muster and Descriptive Roll of a Detachment of U. S. Vols. forwarded**

★ **2 Regt. Miss. Art'y.**

for the ~~6 Reg't U. S. Col'd H. Art'y.~~ Roll dated

*Natchez, Miss., July 23, 1864*

Where born *Lanark, Ala.*

Age *36* y'rs; occupation *Bl. Smith*

When enlisted *July 16*, 1864.

Where enlisted *Natchez, Miss.*

For what period enlisted *3* years.

Eyes *Blue*; hair *Blk.*

Complexion *Blk.*; height *6* ft. *5* in.

When mustered in *July 23*, 1864.

Where mustered in *Natchez, Miss.*

Bounty paid \$ *100*; due \$ *100*

Where credited

Company to which assigned *W*

Remarks:

★ **This organization subsequently became**  
**6 Regt. U. S. Col'd H. Artillery.**

★ **Corrected June 2 1896.** *e.n.a.*

Book mark:

*R. Clark*

26

6 H. Art'y.

U.S.C.T.

Henry Henderson

Priv., Co. M, 2 Reg't Miss. Art'y.†

Appears on

Company Muster Roll

for Jan. 21 to Feb. 29, 1864.

Joined for duty and enrolled:

When Feb. 16, 1864.\*

Where Satchez, Miss.\*

Period 3 years.\*

Present or absent Present

Stoppage, \$ 100 for

Due Gov't, \$ 100 for

Valuation of horse, \$ 100

Valuation of horse equipments, \$ 100

Remarks:

† This organization subsequently became Co. M, 6 Reg't U.S. Col'd Heavy Artillery.

\* See enrollment on card from muster-in roll.

Book mark:

(358c)

J. J. Kearney

Copyist.

Henry Henderson

Priv., Co. M., 5 Reg't U. S. Col'd H. Art'y.\*

Appears on

Company Muster Roll

for March & April, 1864.

Joined for duty and enrolled:

When Feb. 16, 1864.\*

Where Natchez, Miss \*

Period 3 years.\*

Present or absent Present

Stoppage, \$ 100 for

Due Gov't, \$ 100 for

Valuation of horse, \$ 100

Valuation of horse equipments, \$ 100

Remarks: \_\_\_\_\_  
\_\_\_\_\_  
\_\_\_\_\_

\* This organization subsequently became Co. M, 6 Reg't U. S. Col'd Heavy Artillery.  
\* See enrollment on card from muster-in roll.

Book mark: \_\_\_\_\_

(358c)

J. J. Kearney  
Copyist.

No.

6 H. Art'y.

U.S.C.T.

Henry Henderson

Prvt., Co. M, 6 Reg't U. S. Col'd H. Art'y.

Appears on

Company Muster Roll

for May & June, 1864.

Joined for duty and enrolled:

When Feb. 16, 1864.\*

Where Natchez, Miss.\*

Period 3 years.\*

Present or absent Present

Stoppage, \$ 100 for

Due Gov't, \$ 100 for

Valuation of horse, \$ 100

Valuation of horse equipments, \$ 100

Remarks:

\* See enrollment on card from muster-in roll.

Book mark:

(358c)

J. J. Kearney Copyist.

No.

6 H. Art'y.

U.S.C.T.

Henry Henderson

Prvt., Co. M, 6 Reg't U. S. Col'd H. Art'y.

Appears on

Company Muster Roll

for July & Aug, 1864.

Joined for duty and enrolled:

When Feb. 16, 1864.\*

Where Katchez, Miss.\*

Period 3 years.\*

Present or absent Present

Stoppage, \$ 100 for

Due Gov't, \$ 100 for

Valuation of horse, \$ 100

Valuation of horse equipments, \$ 100

Remarks: On daily duty 2. M. Sept. Blacksmith since July 10. '64.

\* See enrollment on card from muster-in roll.

Book mark:

(358c)

J. J. Kearney Copyist.

26

6 H. Art'y.

U.S.C.T.

Henry Henderson

Cpt, Co. M, 6 Reg't U. S. Col'd H. Art'y.

Appears on

Company Muster Roll

for Sept. & Oct, 1864.

Joined for duty and enrolled:

When Feb. 16, 1864.\*

Where Natchez, Miss.\*

Period 3 years.\*

Present or absent Present

Stoppage, \$ 100 for

Due Gov't, \$ 100 for

Valuation of horse, \$ 100

Valuation of horse equipments, \$ 100

Remarks: Stop for 1 Haversack - 67 cts

\* See enrollment on card from muster-in roll.

Book mark:

(358c)

J. J. Kearney

Copyist.

Henry Henderson  
Priv., Co. M, 6 Reg't U. S. Col'd H. Art'y.

Appears on

Company Muster Roll

for Nov 7 Dec, 1864.

Joined for duty and enrolled:

When Feb 10, 1864.\*

Where Natchez, Miss, \*

Period 3 years.\*

Present or absent Present

Stoppage, \$ 100 for

Due Gov't, \$ 100 for

Valuation of horse, \$ 100

Valuation of horse equipments, \$ 100

Remarks: Stoppage for one  
Cartridge Box & Plate and  
one Cartdg Box Belt &  
Plate \$2,13

\* See enrollment on card from muster-in roll.

Book mark:

(358c)

Beck  
Copyist.

4

6 H. Art'y.

U.S.C.T.

*Henry Henderson*

*Priv*, Co. M, 6 Reg't U. S. Col'd H. Art'y.

Appears on

**Company Muster Roll**

for *Jan. & Feb*, 1865.

Joined for duty and enrolled:

When *Feb. 16*, 1864.\*

Where *Natchez, Miss.*\*

Period *3* years.\*

Present or absent *Present*

Stoppage, \$ *100* for

Due Gov't, \$ *100* for

Valuation of horse, \$ *100*

Valuation of horse equipments, \$ *100*

Remarks: *On daily duty R. Q. M. Dept. Bismuth since Feb 5 '65. Stoppage for one Cartridge Box & plate & one Cartridge Box Belt Plate 2, 13*

\* See enrollment on card from muster-in roll.

Book mark:

*Weck*  
Copyist.

(358c)



H

6 H. Art'y.

U.S.C.T.

Henry Henderson

Priv., Co. M, 6 Reg't U. S. Col'd H. Art'y.

Appears on

Company Muster Roll

for Mar & Apr, 1865.

Joined for duty and enrolled:

When Feb. 16, 1864.\*

Where Hatchey, Miss. \*

Period 3 years.\*

Present or absent Present

Stoppage, \$ 100 for

Due Gov't, \$ 100 for

Valuation of horse, \$ 100

Valuation of horse equipments, \$ 100

Remarks: Co. H. O. R. & M. Dept. B. K. Smith since Feb. 5 '65. Stoppage for one Cartridge Box & Plate & one Cartg Box Belt & Plate 2.13

\* See enrollment on card from muster-in roll.

Book mark:

Beck Copyist.

H

6 H. Art'y.

U.S.C.T.

Henry Henderson

Priv., Co. M, 6 Reg't U. S. Col'd H. Art'y.

Appears on

Company Muster Roll

for May & June, 1865.

Joined for duty and enrolled:

When Feb. 16, 1864.\*

Where Natchez, Miss.\*

Period 3 years.\*

Present or absent Present

Stoppage, \$ 100 for

Due Gov't, \$ 100 for

Valuation of horse, \$ 100

Valuation of horse equipments, \$ 100

Remarks: On daily duty at the Q.M. Dept. Natchez Miss. Blacksmith since June 4 '65

\* See enrollment on card from muster-in roll.

Book mark:

Beck Copyist.

(358c)

Henry Henderson  
Priv., Co. M, 6 Reg't U. S. Col'd H. Art'y.

Appears on

**Company Muster Roll**

for July & Aug, 1865:

Joined for duty and enrolled:

When Feb. 16, 1864.\*

Where Natchez, Miss. \*

Period 3 years.\*

Present or absent Present

Stoppage, \$ 100 for

Due Gov't, \$ 100 for

Valuation of horse, \$ 100

Valuation of horse equipments, \$ 100

Remarks: On daily duty  
at the I. M. Dept.  
Natchez, Miss. since  
June 4 '65

\* See enrollment on card from muster-in roll.

Book mark:

W Beck  
Copyist.

*N*

6 H. Art'y.

U.S.C.T.

*Henry Henderson*

*Pr.*, Co. M, 6 Reg't U. S. Col'd H. Art'y.

Appears on

**Company Muster Roll**

for *Sept & Oct*, 1865.

Joined for duty and enrolled:

When *Feb. 16*, 1864.\*

Where *Natchez, Miss.*\*

Period *3* years.\*

Present or absent *Absent*.

Stoppage, \$ *100* for

Due Gov't, \$ *100* for

Valuation of horse, \$ *100*

Valuation of horse equipments, \$ *100*

Remarks: *On Detached Service at the I. M. Dept Natchez Miss per S.O. No. 149 dated Ad. Gens. District of Miss, June 9/65*

\* ~~See~~ See enrollment on card from muster-in roll.

Book mark:

*Jno W Bell*  
(358c) Copyist.

Henry Henderson

Prt, Co. M, 6 Reg't U. S. Col'd H. Art'y.

Appears on

Company Muster Roll

for Nov & Dec, 1865.

Joined for duty and enrolled:

When Jan, 21, 1864\*

Where Natchez, Miss \*

Period 3 years.\*

Present or absent Present.

Stoppage, \$ 100 for

Due Gov't, \$ 100 for

Valuation of horse, \$ 100

Valuation of horse equipments, \$ 100

Remarks: On daily duty at the Q.M. Dept, Natchez, Miss, as Blacksmith per S.O. No. 103 dated H.Q. Post of Natchez, Miss Nov. 30/65

\* See enrollment on card from muster-in roll.

Book mark:

(358c) Jno J Bell Copyist.

26

6 H. Art'y.

U.S.C.T.

Henry Henderson  
Pvt., Co. M, 6 Reg't U. S. Col'd H. Art'y.

Appears on

**Company Muster Roll**

for Jan. & Feb, 1866.

Joined for duty and enrolled:

When Feb. 16, 1864.\*

Where Natchez, Miss \*

Period 3 years.\*

Present or absent

Stoppage, \$ 100 for

Due Gov't, \$ 100 for

Valuation of horse, \$ 100

Valuation of horse equipments, \$ 100

Remarks: On daily duty  
L. M. Dept. Natchez,  
Miss - Brumitt  
since Nov. 3, 1865

\* ~~45~~ See enrollment on card from muster-in roll.

Book mark:

(358c)

J. J. Bell  
Copyist.

26

6 H. Art'y.

U.S.C.T.

Henry Henderson  
Pr., Co. M, 6 Reg't U. S. Col'd H. Art'y.

Appears on

Company Muster Roll

for March & April, 1866

Joined for duty and enrolled:

When Feb. 16, 1864.\*

Where Natchez, Miss \*

Period 3 years.\*

Present or absent Present

Stoppage, \$ 100 for

Due Gov't, \$ 100 for

Valuation of horse, \$ 100

Valuation of horse equipments, \$ 100

Remarks: \_\_\_\_\_  
\_\_\_\_\_  
\_\_\_\_\_  
\_\_\_\_\_

\* See enrollment on card from muster-in roll.

Book mark: \_\_\_\_\_

(358c) Geo J Bell Jr Copyist.

A

6 H. Art'y.

U.S.C.T.

Avery Henderson

Priv., Co. M, 6 Reg't U. S. Col'd H. Art'y.

Appears on Returns as follows:

Feb 1864 (2 Miss H Art  
A. d. ) Gain Feb  
16, 64 Natchez Miss  
joined by enlist-  
ment

Aug & Sept 1864 (6 U.S.  
Col'd H. Art.) On duty  
2 M Dept  
Blk Smith since  
July 10, 64

Feb to May 1865 On  
daily duty R 2  
M Dept Blk Smith  
since Feb 6, 65

June to Oct 1865 On  
daily duty as  
Blk Smith at  
2 M Dept Natchez  
Miss since June  
4, 65

Nov 1865 Absent  
on

Book mark:

(546) *A. J. Gouglas* Copyist.



JAN. 19.

40742481

5681  
1899.

det serv at the  
2<sup>d</sup> M Dept Natchez  
Miss as Blksmith  
per S.O. 149 dated at  
2<sup>d</sup> Dist of Natchez  
June 9, 65  
Dec 1865 On daily  
duty as Blksmith  
at 2<sup>d</sup> M Dept since  
Nov 30, 65  
Mar 1866 On daily  
duty Post 2<sup>d</sup> M  
Dept Blksmith  
since Nov 30, 65

*Henry Anderson*  
Co. M, 6 Reg't U. S. Col'd H. Art'y.

Appears on Co. Muster-out Roll, dated  
*March 13, 1866*

Muster-out to date *May 3, 1866*

Last paid to *Dec 31, 1865*

Clothing account:

Last settled....., 186 ; drawn since \$..... 100

Due soldier \$ <sup>x</sup> *44* <sup>07</sup> / 100; due U. S. \$..... 100

Am't for cloth'g in kind or money adv'd \$..... 100

Due U. S. for arms, equipments, &c., \$..... 100

Bounty paid \$..... 100; due \$..... 100

Remarks: *Joined as a recruit*

\* *Inserted by compour*

Book mark: .....

*J. Nelson*

*Wenderson*  
Co. I, 6 U.S. Col'd H. Art'y.

*Private* *Capron*

CARD NUMBERS.

1	6173115	26
2	6173757	27
3	6173817	28
4	6173999	29
5	6174155	30
6	6174294	31
7	6174405	32
8	6174514	33
9	6174627	34
10	6174745	35
11	6174863	36
12	6174978	37
13	6175084	38
14	6175157	39
15	6175259	40
16	6175362	41
17	6175458	42
18	9120545	43
19	40742482	44
20		45
21		46
22		47
23		48
24		49
25		50

Book Mark: \_\_\_\_\_

See also \_\_\_\_\_

*H*

6 H. Art'y.

U.S.C.T.

*John Henderson*

Co. *C*, 6 Reg't U. S. Col'd H. Art'y.

Appears on

**Company Descriptive Book**

of the organization named above.

**DESCRIPTION.**

Age *34* years; height *5* feet *6 1/2* inches.

Complexion *Yellow*

Eyes *Btk*; hair *Btk*

Where born *Cummul Co., Ga.*

Occupation *Labourer*

**ENLISTMENT.**

When *Dec 8*, 186*3*.

Where *Natchez Miss.*

By whom *Capt. H. Herbert*, term *3* y'rs.

Remarks: *Promoted Capt  
Jan 14/64 reduced  
May 20/64 Appointed  
Capt Dec. 20/65 - by order  
of Maj Smith*

*W. W. W.*

A

6 H. Art'y.

U.S.C.T.

John Henderson  
Pvt., Co. I, 2 Reg't Miss. Art'y.†

Age 34 years.

Appears on

**Company Muster-in Roll**

of the organization named above. Roll dated

Natchez, Miss., Dec. 17, 1863.

Master-in to date Dec. 8, 1863.

Joined for duty and enrolled:

When Dec. 8, 1863.\*

Where Natchez, Miss. \*

Period 3 years.\*

Valuation of horse, \$ 100

Valuation of horse equipments, \$ 100

Remarks:

† This organization subsequently became Co. I, 6 Reg't U. S. Colored Heavy Artillery.

\* Muster-in roll shows enrollment of all men of this company as of same date and place. See enrollment on subsequent card or cards.

Book mark:

T. C. Taylor

(856c)

Copyist.

*John Henderson*  
Pvt., Co. I, 2 Reg't Miss. Artillery.†

Appears on

**Company Muster Roll**

for *Dec. 17 to Dec. 31*, 1863.\*

Joined for duty and enrolled:

When *Dec. 8*, 1863.\*

Where *Natchez* \*

Period *3* years.\*

Present or absent *Present*

Stoppage, \$ *100* for

Due Gov't, \$ *100* for

Valuation of horse, \$ *100*

Valuation of horse equipments, \$ *100*

Remarks: \_\_\_\_\_

\_\_\_\_\_

\_\_\_\_\_

\_\_\_\_\_

\_\_\_\_\_

† This organization subsequently became Co. I, 6 Reg't U. S. Colored Heavy Artillery.

\* See enrollment on card from muster-in roll.

Book mark: \_\_\_\_\_

\_\_\_\_\_

(358c)

*J. C. Taylor*

Copyist.

*John Henderson*  
3 Corp., Co. I, 2 Reg't Miss. Artillery.†

Appears on

**Company Muster Roll**

for *Jan. and Feb.*, 186*4*.

Joined for duty and enrolled:

When *Dec. 8*, 186*3*\*

Where *Natchez* \*

Period *3* years.\*

Present or absent *Present*

Stoppage, \$ *100* for

Due Gov't, \$ *100* for

Valuation of horse, \$ *100*

Valuation of horse equipments, \$ *100*

Remarks: *Appointed 3 Corp.,  
by order of H. A. McCaleb,  
Lt. Col. Comdg 2 Miss. Art'y.*

† This organization subsequently became Co. I, 6 Reg't U. S. Colored Heavy Artillery.  
\* See enrollment on card from muster-in roll.

Book mark: \_\_\_\_\_

(358c)

*J. C. Taylor*

Copyist.

John Henderson  
Corp., Co. I, 5 Reg't U. S. Col'd H. Art'y.\*

Appears on

**Company Muster Roll**

for Mar. and Apr., 1864.

Joined for duty and enrolled :

When December 8, 1863.\*

Where Natchez \*

Period 3 years.\*

Present or absent Present

Stoppage, \$ 100 for

Due Gov't, \$ 100 for

Valuation of horse, \$ 100

Valuation of horse equipments, \$ 100

Remarks :

\* This organization subsequently became Co. I, 6 Reg't U. S. Col'd Heavy Artillery.  
\* See enrollment on card from muster-in roll.

Book mark :

(358c)

D. C. Taylor

Copyist.



*John Henderson*  
Corps., Co. I, 6 Reg't U. S. Col'd H. Art'y.

Appears on

**Company Muster Roll**  
for *May and June*, 1864.

Joined for duty and enrolled:

When *Dec. 8*, 1863.\*

Where *Natchez* \*

Period *3* years.\*

Present or absent *Present*

Stoppage, \$ *100* for

Due Gov't \$ *100* for

Remarks:  
.....  
.....  
.....  
.....  
.....

\* See enrollment on card from muster-in roll.

Book mark: .....

(358c) *J. C. Taylor* Copyist.

John Henderson  
Pvt., Co. I, 6 Reg't U. S. Col'd H. Art'y.

Appears on

Company Muster Roll

for July and Aug., 1864.

Joined for duty and enrolled:

When Dec. 8, 1863.\*

Where Natchez \*

Period 3 years.\*

Present or absent Present

Stoppage, \$ 100 for

Due Gov't \$ 100 for

Remarks: Reduced to ranks  
July 16, 1864.

\* See enrollment on card from muster-in roll.

Book mark:

(358c) J. C. Taylor Copyist.

*John Henderson*  
*St.*, Co. I, 6 Reg't U. S. Col'd H. Art'y.

Appears on

**Company Muster Roll**  
for *Sep. & Oct.*, 1864.

Joined for duty and enrolled:

When *Dec. 8*, 1863.\*

Where *Matchez* \*

Period *3* years.\*

Present or absent *Present.*

Stoppage, \$ *100* for

Due Gov't \$ *100* for

Remarks: *Lauch equi  
page lost 85¢*

\* See enrollment on card from muster-in roll.

Book mark:

*Stew*  
(358c) Copyist.

26

6 H. Art'y.

U.S.C.T.

*John Henderson*  
St., Co. I, 6 Reg't U. S. Col'd H. Art'y.

Appears on

**Company Muster Roll**  
for *Nov, & Dec.*, 1864.

Joined for duty and enrolled:

When *Dec. 8*, 1863\*

Where *Watchey*\*

Period *3* years.\*

Present or absent *Present*

Stoppage, \$ *100* for

Due Gov't \$ *100* for

Remarks:  
\_\_\_\_\_  
\_\_\_\_\_  
\_\_\_\_\_  
\_\_\_\_\_  
\_\_\_\_\_

\* See enrollment on card from muster-in roll.

Book mark: \_\_\_\_\_

*Stick*

(358c)

Copyist.

*John Henderson*  
Co. I, 6 Reg't U. S. Col'd H. Art'y.

Appears on

**Company Muster Roll**

for *Jan. Feb.*, 186*3*.

Joined for duty and enrolled:

When *Dec. 8*, 186*3*\*

Where *Matchez*\*

Period *3* years.\*

Present or absent *Presub.*

Stoppage, \$ *100* for

Due Gov't \$ *100* for

Remarks:  
-----  
-----  
-----  
-----  
-----

\* See enrollment on card from muster-in roll.

Book mark: -----

*Stub*

26

6 H. Art'y.

U.S.C.T.

John Henderson,  
Pl., Co. I, 6 Reg't U. S. Col'd H. Art'y.

Appears on

Company Muster Roll

for March & April, 1865.

Joined for duty and enrolled:

When Dec. 8, 1863.\*

Where Watches, Miss.\*

Period 3 years.\*

Present or absent Present.

Stoppage, \$ 100 for

Due Gov't \$ 100 for

Remarks:

\* See enrollment on card from muster-in roll.

Book mark:

Stull

(358c)

Copyist.

*H. Harty* | **U.S.C.T.**

*John Henderson*  
Co. *2*, *6* Reg't U. S. Col'd *Arty.*

Appears on

**Company Muster Roll**

for *May + June*, 186 *5*.

Joined for duty and enrolled:

When *Dec. 8*, 186 *3*\*

Where *Matchez*\*

Period *3* years.\*

Present or absent *Present*

Stoppage, \$ *100* for

Due Gov't, \$ *100* for

Valuation of horse, \$ *100*

Valuation of horse equipments, \$ *100*

Remarks:

\* ~~See~~ See enrollment on card from muster-in roll.

Book mark:

*Stuck*

26

6 H. Art'y.

U.S.C.T.

John Henderson,  
Co. I, 6 Reg't U. S. Col'd H. Art'y.

Appears on

Company Muster Roll

for July & Aug, 1865.

Joined for duty and enrolled:

When Dec. 8, 1863.\*

Where Katchem, Mo. \*

Period 3 years.\*

Present or absent Absent

Stoppage, \$ 100 for

Due Gov't \$ 100 for

Remarks: Absent without leave

\* See enrollment on card from muster-in roll.

Book mark:

Seale

(358c)

Copyist.



A

6 H. Art'y.

U.S.C.T.

*John Henderson*

*Private*, Co. I, 6 Reg't U. S. Col'd H. Art'y.

Appears on

**Company Muster Roll**

for *Sept & Oct*, 1865.

Joined for duty and enrolled:

When *Dec. 8*, 1863.\*

Where *Statches Miss* \*

Period *3* years.\*

Present or absent *Present*

Stoppage, \$ *100* for

Due Gov't \$ *100* for

Remarks:

\* See enrollment on card from muster-in roll.

Book mark:

*E. C. Rankin*  
Copyist.

(358c)

John Henderson  
Corp., Co. I, 6 Reg't U. S. Col'd H. Art'y.

Appears on

Company Muster Roll

for Nov. & Dec, 1865.

Joined for duty and enrolled:

When Dec. 8, 1863.\*

Where Patehez Miss \*

Period 3 years.\*

Present or absent Present

Stoppage, \$ 100 for

Due Gov't \$ 100 for

Remarks: Appointed Corp.  
December 20" 1863.

\* See enrollment on card from muster-in roll.

Book mark:

J. E. Rankin  
(358c) Copyist.

*John Henderson*  
Corp., Co. I, 6 Reg't U. S. Col'd H. Art'y.

Appears on

**Company Muster Roll**

for *Jan & Feb.*, 186*6*.

Joined for duty and enrolled:

When *Dec. 8*, 186*3*.\*

Where *Katchez Miss\**

Period *3* years.\*

Present or absent *Present*

Stoppage, \$ *100* for

Due Gov't \$ *100* for

Remarks:

-----  
-----  
-----  
-----  
-----

\* See enrollment on card from muster-in roll.

Book mark:

*J. E. Rankin*

(358c)

Copyist.

John Henderson  
Corp., Co. I, 6 Reg't U. S. Col'd H. Art'y.

Appears on

Company Muster Roll

for Mar. & Apr., 1866.

Joined for duty and enrolled:

When Dec. 8, 1863.\*

Where Natchez.\*

Period 3 years.\*

Present or absent Present.

Stoppage, \$ 100 for

Due Gov't \$ 100 for

Remarks:

\* See enrollment on card from muster-in roll.

Book mark:

(358c)

J. P. Rankin  
Copyist.

A

6 H. Art'y.

U.S.C.T.

John Henderson  
Pvt, Co. I, 6 Reg't U. S. Col'd H. Art'y.

Appears on Returns as follows:

Aug 1865 Absent  
Without leave  
since Aug 28/65

Book mark:

(546)

A. J. Garland  
Copist.

*H*

6 H. Art'y.

U.S.C.T.

*John Henderson*  
Corp., Co. I., 6 Reg't U. S. Col'd H. Art'y.

Appears on **Co. Muster-out Roll**, dated  
*Stachez, Miss. May 13, 1866*.

Muster-out to date *May 13, 1866*.

Last paid to *Dec. 25, 1866*.

Clothing account:

Last settled....., 186 ; drawn since \$..... 100

Due soldier \$ *39<sup>20</sup>*/<sub>100</sub>; due U. S. \$..... 100

Am't for cloth'g in kind or money adv'd \$..... 100

Due U. S. for arms, equipments, &c., \$..... 100

Bounty paid \$..... 100; due \$..... 100

Remarks: *Joined at original organization Promoted to Corporal January 14, 1864. Reduced May 20, 1864. Promoted to Corporal Dec. 20, 1865. Due Soldier on account of Clothing \$ 39<sup>20</sup>/<sub>100</sub>*

Book mark: *v. 78. P. 171. 69*

*C. C. McLaughlin*  
Copyist.

(361)

Henderson John

P, Co. I, 6 Reg't 168th

Enclosures.

Bed Cards .....	Final Statements .....
Burial Records .....	Furloughs or L. of A. ....
Certs. of Dis. for Discharge .....	Med. Certificates .....
C. M. Charges .....	Med. Des. Lists .....
Descriptive Lists .....	Orders .....
Discharge Certificates .....	Pris. of War Record .....
Enlistment Papers .....	Resignations .....

Other papers relating to—

Admission to Hosp'l .....	Furlough or L. of A. ....
Casualty Sheet .....	Med. Examination .....
Confinement .....	Misc. Information .....
Contracts .....	Pay or Clothing .....
Death or Effects .....	Personal Reports .....
Desertion .....	Rank .....
Discharge from Hosp'l .....	Transfer to Hosp'l .....
Discharge from Service .....	Transfer to V. R. C. ....
Duty .....	Transportation .....

John Henderson ✓

Oct 25<sup>th</sup> 6<sup>th</sup> City Coy

---

Report of Div of D.C.

---

---



Adjutant General's Office,

COLORED TROOPS BRANCH,

Mr Ellertson

May 15<sup>th</sup>, 1875

Vol. C. T., 187

Wanted in the case of John Henderson Private, Co. I,  
Sixth Reg't U.S.C.A. (Hoy)

Period absent & whether tried -

"Absent without leave" - M.R. for July & August 1865  
Present for duty - M.R. for Sept & Oct 1865

AG

Respectfully,

L. A. Woodward  
Chief Clerk

Adjutant General's Office,

Division of discontinued Commands,

May 18<sup>th</sup>, 1875

Vol. C. T., 187

Reply in case of John Henderson, Co. I,  
Sixth Reg't U.S.C.A. (Hoy)

Right Col. 1865 furnish no information -  
Maj. Repts for July & August 1865 furnish no  
evidence of absence without leave - Sept 10<sup>th</sup> 65 -  
"Returned from absence without leave" - No record  
of arrest, charges or trial

W. K.

like return - no record of trial

*Anderson Mary*

Co D, 6 U.S. Col'd H. Art'y

*Private Private*

CARD NUMBERS.

1	6173625	26
2	6173767	27
3	6173912	28
4	6174041	29
5	6174174	30
6	6174291	31
7	6174398	32
8	6174509	33
9	6174622	34
10	6174740	35
11	6174858	36
12	6174974	37
13	6175080	38
14	6175190	39
15	6175295	40
16	6175394	41
17	6175490	42
18	9120556	43
19	40742483	44
20		45
21		46
22		47
23		48
24		49
25		50

Book Mark:

See also

A108491900000000

A1133640000000000

H. H. Arnold

*Martin Henderson*

....., Co. *D*, 6 Reg't U. S. Col'd H. Art'y.

Appears on

**Company Descriptive Book**  
of the organization named above.

**DESCRIPTION.**

Age *22* years; height *5* feet *4* inches.

Complexion *Blk*

Eyes *Dark Brown*; hair *Blk*

Where born *Natchez Miss.*

Occupation *Laborer*

**ENLISTMENT.**

When *Dec, 8*, 186 *3*.

Where *Natchez, Miss.*

By whom *Opt. H. Harbert*; term *3* y'rs.

Remarks: .....

.....  
.....  
.....  
.....  
.....  
.....  
.....  
.....  
.....  
.....

*Harbert*

A

6 H. Art'y.

U. S. C. T.

Martin Henderson  
Pvt., Co. I, 2 Reg't Miss. Art'y.†

Age 22 years.

Appears on

**Company Muster-in Roll**

of the organization named above. Roll dated

Natchez, Miss., Dec. 17, 1863.

Muster-in to date Dec. 8, 1863.

Joined for duty and enrolled:

When Dec. 8, 1863.\*

Where Natchez, Miss. \*

Period 3 years.\*

Valuation of horse, \$ 100

Valuation of horse equipments, \$ 100

Remarks:

† This organization subsequently became Co. I, 6 Reg't U. S. Colored Heavy Artillery.

\* Muster-in roll shows enrollment of all men of this company as of same date and place. See enrollment on subsequent card or cards.

Book mark:

D. C. Taylor

(356c)

Copyist.

*Martin Henderson*  
*Pvt.*, Co. I, 2 Reg't Miss. Artillery.†

Appears on

**Company Muster Roll**

for *Dec. 17 to Dec. 31*, 186*3*.

Joined for duty and enrolled:

When *Dec. 8*, 186*3*.\*

Where *Natchez* \*

Period *3* years.\*

Present or absent *Present*

Stoppage, \$ *100* for

Due Gov't, \$ *100* for

Valuation of horse, \$ *100*

Valuation of horse equipments, \$ *100*

Remarks: \_\_\_\_\_  
\_\_\_\_\_  
\_\_\_\_\_  
\_\_\_\_\_

† This organization subsequently became Co. I, 6 Reg't U. S. Colored Heavy Artillery.  
\* See enrollment on card from muster-in roll.

Book mark: \_\_\_\_\_  
\_\_\_\_\_

(358c) *D. C. Taylor* Copyist.

A

6 H. Art'y.

U.S.C.T.

Martin Henderson  
Pvt., Co. I, 2 Reg't Miss. Artillery.†

Appears on

**Company Muster Roll**

for Jan. and Feb., 1864.

Joined for duty and enrolled:

When Dec. 8, 1863.\*

Where Natchez \*

Period 3 years.\*

Present or absent Present

Stoppage, \$ 100 for

Due Gov't \$ 100 for

Valuation of horse, \$ 100

Valuation of horse equipments, 100

Remarks:

† This organization subsequently became Co. I, 6 Reg't U. S. Colored Heavy Artillery.

\* See enrollment on card from muster-in roll.

Book mark:

(358c)

J. C. Taylor

Copyist.

Martin Henderson  
Pvt., Co. I, 5 Reg't U. S. Col'd H. Art'y.\*

Appears on

**Company Muster Roll**

for Mar. and Apr., 1864.

Joined for duty and enrolled:

When December 8, 1863.\*

Where Natchez.\*

Period 3 years.\*

Present or absent Present

Stoppage, \$ 100 for

Due Gov't, \$ 100 for

Valuation of horse, \$ 100

Valuation of horse equipments, \$ 100

Remarks: \_\_\_\_\_  
\_\_\_\_\_  
\_\_\_\_\_

\* This organization subsequently became Co. I, 6 Reg't U. S. Col'd Heavy Artillery.  
\* See enrollment on card from muster-in roll.

Book mark: \_\_\_\_\_

(358c) J. C. Taylor Copyist.



A

6 H. Art'y.

U.S.C.T.

Martin Henderson  
Capt., Co. I, 6 Reg't U. S. Col'd H. Art'y.

Appears on

**Company Muster Roll**

for May and June, 1864.

Joined for duty and enrolled:

When Dec. 8, 1863.\*

Where Natchez \*

Period 3 years.\*

Present or absent Present

Stoppage, \$ 100 for

Due Gov't \$ 100 for

Remarks:  
-----  
-----  
-----  
-----  
-----

\* ~~See~~ See enrollment on card from muster-in roll.

Book mark: -----

(358c)

D. C. Taylor

Copyist.

A

6 H. Art'y.

U.S.C.T.

*Martin Henderson*  
Pvt., Co. I, 6 Reg't U. S. Col'd H. Art'y.

Appears on

**Company Muster Roll**

for *July and Aug.*, 1864.

Joined for duty and enrolled:

When *Dec. 8*, 186 *3*.\*

Where *Natchez* \*

Period *3* years.\*

Present or absent *Present*

Stoppage, \$ *100* for

Due Gov't \$ *100* for

Remarks: *Detained as ambulance driver by order of Maj. Coleman.*

\* See enrollment on card from muster-in roll.

Book mark:

(358c)

*J. C. Taylor*

Copyist.

*M*

6 H. Art'y.

U.S.C.T.

*Martin Henderson*

*M*, Co. I, 6 Reg't U. S. Col'd H. Art'y.

Appears on

**Company Muster Roll**

for *Sept. & Oct.* 186*4*.

Joined for duty and enrolled:

When *Dec. 8*, 186*3*.\*

Where *Matchez*, \*

Period *3* years.\*

Present or absent *Present*

Stoppage, \$ *100* for

Due Gov't, \$ *100* for

Valuation of horse, \$ *100*

Valuation of horse equipments, \$ *100*

Remarks:

\* See enrollment on card from muster-in roll.

Book-mark:

*H. C.*

(358c)

Copyist.

*M.*

6 H. Art'y.

U.S.C.T.

*Matth. Hudson*

*A.*, Co. I, 6 Reg't U. S. Col'd H. Art'y.

Appears on

Company Muster Roll

for *Mar. & Dec*, 1864.

Joined for duty and enrolled:

When *Dec. 8*, 1865.\*

Where *Matchey* \*

Period *3* years.\*

Present or absent *Present*

Stoppage, \$ *100* for

Due Gov't \$ *100* for

Remarks:

\* See enrollment on card from muster-in roll.

Book mark:

*Steck*

(358c)

Copyist.

*M*

6 H. Art'y.

U.S.C.T.

*Martin Anderson,*

*Pt.*, Co. I, 6 Reg't U. S. Col'd H. Art'y.

Appears on

**Company Muster Roll**

for *Jan. & Feb.*, 1865.

Joined for duty and enrolled:

When *Dec. 8*, 1864.\*

Where *Watebury*\*

Period *3* years.\*

Present or absent *Present*

Stoppage, \$ *100* for

Due Gov't \$ *100* for

Remarks:  
-----  
-----  
-----  
-----  
-----

\* ~~See~~ See enrollment on card from muster-in roll.

Book mark: -----

*Heck*

76

6 H. Art'y.

U.S.C.T.

Martin Anderson

Pr., Co. I, 6 Reg't U. S. Col'd H. Art'y.

Appears on

Company Muster Roll

for Meh. Cape. 1865.

Joined for duty and enrolled:

When Dec. 8, 1863.\*

Where Watchez, Miss.\*

Period.....years.\*

Present or absent Present.

Stoppage, \$ 100 for

Due Gov't, \$ 100 for

Valuation of horse, \$ 100

Valuation of horse equipments, \$ 100

Remarks:

\* See enrollment on card from muster-in roll.

Book-mark :

Stewart

(858c)

Copyist.

*W. C. + 1. City* U.S.C.T.

*Martin Henderson*  
*St. Co. 2, 6* Reg't U. S. Col'd *city.*

Appears on

**Company Muster Roll**

for *May & June*, 1865.

Joined for duty and enrolled:

When *Dec 8*, 1863.\*

Where *Watchesy*.\*

Period *3* years.\*

Present or absent *Present*

Stoppage, \$ *100* for

Due Gov't, \$ *100* for

Valuation of horse, \$ *100*

Valuation of horse equipments, \$ *100*

Remarks:

-----  
-----  
-----

\* See enrollment on card from muster-in roll.

Book mark:

-----

*Steele*

(358c)

Copyist.

*H.*

6 H. Art'y.

U.S.C.T.

*Martin Huberson*

*A.*, Co. I, 6 Reg't U. S. Col'd H. Art'y.

Appears on

**Company Muster Roll**

for *July & Aug.*, 186*5*.

Joined for duty and enrolled:

When *Dec. 8*, 186*3*.\*

Where *Natchez Miss.*\*

Period *3* years.\*

Present or absent *Present.*

Stoppage, \$ *100* for

Due Gov't \$ *100* for

Remarks:  
-----  
-----  
-----  
-----  
-----

\* ~~See~~ See enrollment on card from muster-in roll.

Book mark:-----

(358c)

*Steele*

Copyist.



*A*

6 H. Art'y.

U.S.C.T.

*Martin Henderson*  
Pvt., Co. I, 6 Reg't U. S. Col'd H. Art'y.

Appears on

**Company Muster Roll**

for *Spt & Oct.*, 1865

Joined for duty and enrolled:

When *Dec 8*, 1865.\*

Where *Statches Miss* \*

Period *3* years.\*

Present or absent *Present.*

Stoppage, \$ *1* <sup>*30*</sup>/<sub>*100*</sub> for *Camp G. C.*

Due Gov't \$ *100* for

Remarks:

-----  
-----  
-----  
-----  
-----

\* See enrollment on card from muster-in roll.

Book mark:

*E. C. Rantain*

(358c)

Copyist.

A

6 H. Art'y.

U.S.C.T.

Martin Henderson

Pvt., Co. I, 6 Reg't U. S. Col'd H. Art'y.

Appears on

Company Muster Roll

for Nov & Dec., 1863.

Joined for duty and enrolled:

When Dec. 8, 1863.\*

Where Natchez Miss.\*

Period 3 years.\*

Present or absent Present.

Stoppage, \$ 1 <sup>30</sup>/<sub>100</sub> for Co. & G. C. trans. from Roll dated Oct. 31, 1863.  
Due Gov't \$ <sup>100</sup>/<sub>100</sub> for

Remarks:

\* See enrollment on card from muster-in roll.

Book mark:

E. C. Rankin

(358c)

Copyist.

A

6 H. Art'y.

U.S.C.T.

*Martin Henderson*  
Pvt., Co. I, 6 Reg't U. S. Col'd H. Art'y.

Appears on

**Company Muster Roll**

for *Jan. & Feb.*, 186*6*.

Joined for duty and enrolled:

When *Dec. 8,* 186*3*.\*

Where *Matchez Miss.*\*

Period *3* years.\*

Present or absent *Present*

Stoppage, \$ *100* for

Due Gov't \$ *100* for

Remarks:  
-----  
-----  
-----  
-----  
-----  
-----

\* See enrollment on card from muster-in roll.

Book mark: -----

*A. L. Rankin*  
(358c) Copyist.

Martin Henderson  
Pvt., Co. I, 6 Reg't U. S. Col'd H. Art'y.

Appears on

Company Muster Roll

for Mar. & Apr., 1866.

Joined for duty and enrolled:

When Dec. 8, 1863.\*

Where Hatchez.\*

Period 3 years.\*

Present or absent Present.

Stoppage, \$ 100 for

Due Gov't \$ 100 for

Remarks:

\* See enrollment on card from muster-in roll.

Book mark:

(358c) J. B. Rankin Copyist.

A

6 H. Art'y.

U.S.C.T.

Martin Anderson

Priv., Co. I, 6 Reg't U. S. Col'd H. Art'y.

Appears on Returns as follows:

Aug 1864 On duty  
Ambul driver  
for Regt Hospital

Book mark:

(546) *A. J. Gould* Copyist.

H

6 H. Art'y.

U.S.C.T.

Martin Henderson  
Priv., Co. A., 6 Reg't U. S. Col'd H. Art'y.

Appears on Co. Muster-out Roll, dated  
Statches, Miss., May 13, 1866.

Muster-out to date May 13, 1866.

Last paid to Dec. 31, 1865.

Clothing account:

Last settled....., 186 ; drawn since \$ 100

Due soldier \$ 21 <sup>61</sup>/<sub>100</sub>; due U. S. \$ 100

Am't for cloth'g in kind or money adv'd \$ 100

Due U. S. for arms, equipments, &c., \$ 100

Bounty paid \$ 100; due \$ 100

Remarks: Joined at original  
organization. Due  
Soldier on Account of  
Clothing \$ 21 <sup>61</sup>/<sub>100</sub>

Book mark:

C. E. M. Laughlin  
Coryist.

(361)

Henderson Rufus

Co. 6, 6 U.S. Col'd H. Art'y.

Private Private

CARD NUMBERS.

1	6160557	26
2	6160485	27
3	6160674	28
4	6162648	29
5	9119363	30
6	40442484	31
7		32
8		33
9		34
10		35
11		36
12		37
13		38
14		39
15		40
16		41
17		42
18		43
19		44
20		45
21		46
22		47
23		48
24		49
25		50

Book Mark:

See also

*Rufus Henderson*

....., Co. *B*, 6 Reg't U. S. Col'd H. Art'y.

Appears on

**Company Descriptive Book**

of the organization named above.

**DESCRIPTION.**

Age *19* years; height *5* feet *5* inches.

Complexion *white*

Eyes *Blue*; hair *Blue*

Where born *Wickham Co. Miss*

Occupation *Labourer*

**ENLISTMENT.**

When *Sept 1<sup>st</sup>*, 1863.

Where *Natchez Miss*

By whom *W. J. Lusk*; term *3* y'rs.

Remarks: *Died in camp. Fannin*  
*Natchez Miss Dec 4. 63*

*J. P. Lusk*



H

Rufus Henderson

Fort Co. C., 2 Reg't Miss. Art'y. †

Age 19 years.

Appears on

Company Muster-in Roll

of the organization named above. Roll dated

Natchez, Miss, Sept 12, 1863.

Muster-in to date Sept 12, 1863.

Joined for duty and enrolled:

When Sept 1, 1863\*

Where Natchez, Miss \*

Period 3 years.\*

Valuation of horse, \$ 100

Valuation of horse equipments, \$ 100

Remarks:

† This organization subsequently became Co. C, 6 Reg't U. S. Colored Heavy Artillery.

\* Muster-in roll shows enrollment of all men of this company as of same date and place. See enrollment on subsequent card or cards.

Book mark:

Wochance

74

6 H. Art'y.

U.S.C.T.

Rufus Henderson

Priv., Co. C, 2 Reg't Miss. Artillery.†

Appears on

Company Muster Roll

for Sept 12 to Oct 31, 1863.

Joined for duty and enrolled:

When Sept 1, 1863.\*

Where Natchez, Miss.\*

Period 3 years.\*

Present or absent Present

Stoppage, \$ 100 for

Due Gov't \$ 100 for

Valuation of horse, \$ 100

Valuation of horse equipments, \$ 100

Remarks:

† This organization subsequently became Co. C, 6 Reg't U. S. Colored Heavy Artillery.

\* See enrollment on card from muster-in roll.

Book mark:

mocha

H

6 H. Art'y.

U.S.C.T.

Rufus Henderson

1st Lt., Co. C, 2 Reg't Miss. Artillery.†

Appears on

Company Muster Roll

for Nov + Dec, 1863.

Joined for duty and enrolled:

When Sept 1, 1863.\*

Where Natchez, Miss.\*

Period 3 years.\*

Present or absent

Stoppage, \$ 100 for

Due Gov't \$ 100 for

Valuation of horse, \$ 100

Valuation of horse equipments, \$ 100

Remarks: Died in Camp  
McPherson Dec 4, 1863.

† This organization subsequently became Co. C, 6 Reg't U. S. Colored Heavy Artillery.

\* See enrollment on card from muster-in roll.

Book mark:

no chance

(358c)

Copyist.



*H*

6 H. Art'y.

U.S.C.T.

*Rufus Henderson*  
Pvt., Co. *H*, 6 Reg't U. S. Col'd H. Art'y.

Appears on **Co. Muster-out Roll**, dated  
*Natchez Miss May 3*, 1866 .

Muster-out to date ....., 186 .

Last paid to ....., 186 .

**Clothing account:**

Last settled ....., 186 ; drawn since \$ ..... 100

Due soldier \$ ..... 100; due U. S. \$ ..... 100

Am't for cloth'g in kind or money adv'd \$ ..... 100

Due U. S. for arms, equipments, &c., \$ ..... 100

Bounty paid \$ ..... 100; due \$ ..... 100

Remarks: *Joined at original*  
*Det'd Dec 4 1863 at*  
*Natchez Miss of*  
*Pneumonia. Final*  
*Statement furnished*

Book mark: *501/84*

*A. M. Calhoun*

*Henderson, Rufus*

*P*, Co. *C*, **6** Reg't **U.S.C.H.A.**

*2* Enclosures.

Bed Cards	Descriptive Lists
Burial Records	Final Statements /
Certs. of Dis. for Discharge	Furloughs
C. M. Charges	Med. Des. Lists
Med. Certificates	Orders

Other papers relating to—

Admission to Hosp'l	Furlough
Casualty Sheet (Officer's)	Med. Examination
Confinement	Misc. Information
Contracts	Pay or Clothing
Death or Effects /	Personal Reports
Desertions	Rank
Discharge from Hosp'l	Transfer to Hosp'l
Discharge from Service	Transfer to V. R. C.
Duty	Transportation

INVENTORY OF THE EFFECTS

OF

*Private Rufus Anderson*

Late of Company *B*

*2* Reg't of *Art Mps 4th*

Volunteers, who died at *Antietam Mps*

on the *4* day of *December* 186*3*.



Inventory of the effects of Ruffus Henderson late  
 a Private of Captain Wm J Lusk Company C of  
 the 2 Regiment of Art Miss Vol Volunteers, who was enrolled as  
 a Soldier at Natchez in the State of Miss on  
 the 1 day of September 1863; and mustered into the service of the United  
 States as a Private on the 12 day of September 1863, at Natchez Miss  
 in Company C, 2 Regiment of Art Miss Vol Volunteers, to serve 3  
 years or during the war; he was born in Millersburg in the State  
 of Miss; he was 19 years of age, 5 feet 5 inches  
 high, Light complexion, Black eyes, Black hair, and by occupation, when enrolled,  
 a Laborer; he died in Camp M'Disson at  
Natchez Miss on the 4 day of December 1863, by  
 reason of Pneumonia

INVENTORY.					
ARTICLES.	No.	ARTICLES.	No.	ARTICLES.	No.
Hats .....		Pairs trousers .....		Knapsacks .....	
Caps .....		Pairs flannel drawers .....			
Forage caps .....		Pairs cotton drawers .....			
Great coats .....		Flannel shirts .....			
Uniform coats .....		Cotton shirts .....			
Uniform jackets .....		Pairs boots .....			
Flannel sack coats .....		Pairs shoes .....			
Blouses .....		Pairs socks .....			
Stable frocks .....		Blankets .....			
Fatigue overalls .....		Haversacks .....			
				MONEY.	
				Specie .....	\$
				Notes .....	\$

I CERTIFY, ON HONOR, that the above inventory comprises all the effects of \_\_\_\_\_  
 \_\_\_\_\_, deceased, and that the effects are in the hands  
 of \_\_\_\_\_ at \_\_\_\_\_  
 \_\_\_\_\_ to be disposed of by a Council of Administration.

( DUPLICATES. )

STATION: Natchez Miss

DATE: December 31<sup>st</sup> 1863

[ A. G. O. No. 104. ]

A. M. Mahala  
Lt and  
 Commanding the Company.



✓ FINAL STATEMENT

OF

*Co. C*  
*Co. C*  
Reg't of *U. S. Cavalry*

VOLUNTEERS.

*Quoted Dec 4 1863*

NOTE 1.—Two of these certificates (or duplicates) are to be given to each Volunteer Soldier or drafted man who may be discharged previously to the discharge of his company, that he may at once receive from the Paymaster the pay, &c., due him, and the captain or other COMMISSIONED officer commanding the company will certify to the act of the delivery of the duplicate certificates; on these certificates the Soldier is "entitled to" his discharge, and should also present his discharge to the Paymaster to have the payment endorsed on it. The discharge is to be given back to the Soldier by the Paymaster; the latter only retaining as his voucher the duplicate certificates.

NOTE 2.—If the Soldier is entitled to pay for the use of his horse, the Company Commander will certify to that fact on the back of both these final statements, and also to the time he has pay due for having been so mounted on his own horse.

NOTE 3.—When a Soldier is furnished with final statements, his descriptive list, if he has one, should be taken up by the officer who gives the Soldier these statements, and endorsed with a statement to this effect by the officer. This endorsement should exhibit a full statement of the time for which the Soldier was allowed pay on his final statements, the clothing account, and all other charges against him or in his favor, so as to comprise a complete exhibit of his account. It will then be transmitted to the company commander of the Soldier, who will enter all the data necessary to a full understanding of the Soldier's account on the muster roll upon which the Soldier's discharge is reported. The descriptive list will then be destroyed. The object of this is, that the remaining portion of the Soldier's account may be settled upon the receipt of these muster rolls, and the Soldier receive any pay or allowances that may be due him at the time of his discharge, and which may not appear on his final statements from the fact that his descriptive list is incomplete. These accounts for back pay, &c., are settled by the 2d Auditor of the Treasury Department.

NOTE 4.—Charges for loss or injury to ordnance, horse equipments, and other miscellaneous charges, should appear under the heading of "Other Stoppages."

NOTE 5.—Bounty paid by State authorities, and not by the United States, will not be entered on this statement.

NOTE 6.—Amounts due the Sutler and Laundress must be entered on the muster roll on which the discharge, death, desertion, &c., is reported, as well as on the final statement, otherwise the amount cannot be collected from the United States.

NOTE 7.—This blank will be used for deceased volunteers and drafted men, as well as for others.

NOTE 8.—Where a Soldier dies in Hospital or on detached service, his descriptive list, if he has one, should be sent with his final statements, in duplicate, to the Adjutant General, Washington, D. C.



*Dinty*  
*AA*

ADJUTANT GENERAL'S OFFICE  
*July 1 1865*  
Duplicate with Inventory and receipt.

I certify, on honor, that Rufus Henderson a private of  
Captain L. F. Bierwith Company (B) of the 6<sup>th</sup> Regiment of U. S. Colored Troop  
**VOLUNTEERS**, of the State of \_\_\_\_\_, born in Milkinson Co., State  
of Mississippi, aged 19 years; 5 feet 5 inches high; Black complexion,  
Black eyes, Black hair, and by occupation a laborer, having joined the company on  
its original organization at Watches Inn, and enrolled in it at the muster into  
the service of the United States at Watches Inn, on the 12<sup>th</sup> day  
of September, 1863, (or was mustered in service as a recruit, by \_\_\_\_\_  
\_\_\_\_\_, at \_\_\_\_\_, on the \_\_\_\_\_ day of \_\_\_\_\_,  
186  , or was drafted and mustered into the service of the United States from the \_\_\_\_\_

Enrollment District of the State of \_\_\_\_\_, at \_\_\_\_\_,  
on the \_\_\_\_\_ day of \_\_\_\_\_, 186  ), to serve in the Regiment, for  
the term of Three Years; and having served **HONESTLY** and  
**FAITHFULLY** with his Company in The 6<sup>th</sup> to the present date, is now  
entitled to a **DISCHARGE** by reason of Death, died at Hospital  
at Watches Inn December 4<sup>th</sup> 1863 of Pneumonia.

The said Rufus Henderson was last paid by Paymaster  
pay due to include the from day of Enlistment, 1863, and has  
pay due him from that time to the present date; he is entitled to pay and subsistence for  
**TRAVELING** to place of enrollment, and whatever other allowances are authorized to volunteer  
soldiers, drafted men, or militia, so discharged. He has received from the United States **CLOTHING**  
amounting to 48 44 dollars, since the 12<sup>th</sup> day of September,  
1863, when his clothing account was last settled. He has received from the United States  
   dollars advanced **BOUNTY**.

There is to be stopped from him, on account of the State of \_\_\_\_\_, or other  
authorities, for **CLOTHING**, &c., received on entering service, \_\_\_\_\_ dollars; and  
for other stoppages, viz: \_\_\_\_\_  
\_\_\_\_\_ dollars.

He has been furnished with **TRANSPORTATION** in kind from the place of his discharge to \_\_\_\_\_;  
and he has been **SUBSISTED** for **TRAVELING** to his  
place of enrollment, up to the \_\_\_\_\_, 186  .

He is indebted to \_\_\_\_\_, **SUTLER**, \_\_\_\_\_ dollars.

He is indebted to \_\_\_\_\_, **LAUNDRESS**, \_\_\_\_\_ dollars.

Given in Duplicate, at Watches Inn, this 22<sup>d</sup> day  
of January, 1865.

Louis F. Bierwith  
Capt. U. S. Colored Troop  
Commanding Company "B"

Henderson William

Co B, 6 U.S. Col'd H. Art'y.

Private Private

CARD NUMBERS.

1	6157861	26
2	6158096	27
3	6160209	28
4	9119122	29
5	40747486	30
6		31
7		32
8		33
9		34
10		35
11		36
12		37
13		38
14		39
15		40
16		41
17		42
18		43
19		44
20		45
21		46
22		47
23		48
24		49
25		50

Book Mark:

See also

William Anderson

Co. B, 6 Reg't U. S. Col'd H. Art'y.

Appears on

Company Descriptive Book

of the organization named above.

DESCRIPTION.

Age 34 years; height 5 feet 7 inches.

Complexion Black

Eyes Black; hair Black

Where born Emerald Pa La

Occupation Farmer

ENLISTMENT.

When Sept 1, 1863.

Where Natchez Miss

By whom Capt. Holmes, term 3 y'rs.

Remarks: Died in Hospital Vidalia La Oct 15, 1863

J. Piles

William Henderson

Privt., Co. B, 2 Reg't Miss. Art'y.†

Age 34 years.

Appears on

Company Muster-in Roll

of the organization named above. Roll dated

Natchez, Miss., Sept. 12, 1863.

Muster-in to date Sept. 12, 1863.

Joined for duty and enrolled:

When Sept. 1st, 1863.\*

Where Natchez, Miss. \*

Period 3 years.\*

Valuation of horse, \$ 100

Valuation of horse equipments, \$ 100

Remarks:

† This organization subsequently became Co. B, 6 Reg't U. S. Colored Heavy Artillery.

\* Muster-in roll shows enrollment of all men of this company as of same date and place. See enrollment on subsequent card or cards.

Book mark:

M. M. Warren

*A*

6 H. Art'y.

U.S.C.T.

*William Henderson*  
*Private*, Co. B, 2 Reg't Miss. Art'y.†

Appears on

**Company Muster Roll**

for *Sept. 12 to Oct. 31*, 186*3*.

Joined for duty and enrolled:

When *Sept. 1st*, 186*3*.\*

Where *Natchez, Miss.* \*

Period *3* years.\*

Present or absent

Stoppage, \$ *100* for

Due Gov't, \$ *100* for

Valuation of horse, \$ *100*

Valuation of horse equipments, \$ *100*

Remarks: *Died in Hospital*  
*Vidalia, La. Oct. 13\**  
*\* Roll turn*

† This organization subsequently became Co. B, 6 Reg't U. S. Co'd Heavy Artillery.

\* See enrollment on card from muster-in roll.

Book mark:

*W. W. Warren*

(358c)

Copyist

William Henderson  
Co., 6 Reg't U. S. Col'd H. Art'y.

Appears on Returns as follows:

Oct 1863 Co B 2  
Miss Art A. D.,  
Died in Reg'l Hosp  
Oct 1863 Vidalia  
La

Book mark:

(546) *A. Gougeon* Copyist.

H

6 H. Art'y.

U.S.C.T.

William Henderson

Pvt, Co. B, 6 Reg't U. S. Col'd H. Art'y.

Appears on Co. Muster-out Roll, dated

Natches Miss May 13, 1866 .

Muster-out to date . . . . ., 186 .

Last paid to . . . . ., 186 .

Clothing account:

Last settled . . . . ., 186 ; drawn since \$ . . . . . 100

Due soldier \$ . . . . . 100; due U. S. \$ . . . . . 100

Am't for cloth'g in kind or money adv'd \$ . . . . . 100

Due U. S. for arms, equipments, &c., \$ . . . . . 100

Bounty paid \$ . . . . . 100; due \$ . . . . . 100

Remarks: *Joined at Original Organization.*

*Died at Vidalia, La.*

*Oct. 15/63 of Pneumonia.*

*Final Statements*

*furnished Oct. 20/63*

Book mark: *See 93, 237*

*(over)*

(361)

*J. E. Nichol*

Copyist.



Henderson, William

P, Co. B, 6 U.S.C.H.A.

2 Enclosures.

Bed Cards	Descriptive Lists
Burial Records	Final Statements
Certs. of Dis. for Discharge	Furloughs
C. M. Charges	Med. Des. Lists
Med. Certificates	Orders

Other papers relating to—

Admission to Hosp'l	Furlough
Casualty Sheet (Officer's)	Med. Examination
Confinement	Misc. Information
Contracts	Pay or Clothing
Death or Effects	Personal Reports
Desertions	Rank
Discharge from Hosp'l	Transfer to Hosp'l
Discharge from Service	Transfer to V. R. C.
Duty	Transportation

INVENTORY OF THE EFFECTS

OF

Private William Henderson

Late of Company "B"

2<sup>d</sup> Reg't of Miss Art A. C.

Volunteers, who died at Vicksburg La

on the 19<sup>th</sup> day of October 1863.



Inventory of the effects of William Henderson late  
 a Private of Captain R. B. Keightley's Company B of  
 the 2<sup>nd</sup> Regiment of Miss Art A. S. Volunteers, who was enrolled as  
 a Private at Natchez in the State of Miss on  
 the 1<sup>st</sup> day of Sept 1863, and mustered into the service of the United  
 States as a Private on the 12<sup>th</sup> day of Sept 1863, at Natchez Miss  
 in Company B, 2<sup>nd</sup> Regiment of Miss Art A. S. Volunteers, to serve Three  
 years or during the war; he was born in Concordia Parish in the State  
 of Louisiana; he was 34 years of age, 5 feet 7 inches  
 high, Black complexion, Black eyes, Black hair, and by occupation, when enrolled,  
 a Farmers; he died in Regt Keight, at  
Vidalia La on the 19<sup>th</sup> day of October 1863, by  
 reason of Sick of Scurvy

INVENTORY.					
ARTICLES.	No.	ARTICLES.	No.	ARTICLES.	No.
Hats.....		Pairs trousers.....		Knapsacks.....	
Caps.....		Pairs flannel drawers.....			
Forage caps.....		Pairs cotton drawers.....			
Great coats.....		Flannel shirts.....			
Uniform coats.....		Cotton shirts.....			
Uniform jackets.....		Pairs boots.....			
Flannel sack coats.....		Pairs shoes.....			
Blouses.....		Pairs socks.....			
Stable frocks.....		Blankets.....		MONEY.	
Fatigue overalls.....		Haversacks.....		Specie.....	\$
				Notes.....	\$

I CERTIFY, ON HONOR, that the above inventory comprises all the effects of Private  
William Henderson, deceased, and that the effects are in the hands  
 of \_\_\_\_\_ at \_\_\_\_\_  
 \_\_\_\_\_ to be disposed of by a Council of Administration.

( DUPLICATES. )

STATION: Natchez Miss

DATE: Oct 10<sup>th</sup> 1864

Frank Furse  
2<sup>nd</sup> Lt. U.S. Col. Art Regt  
 Commanding the Company.

FINAL STATEMENT

OF

*Private William Anderson Co B*

*2<sup>d</sup> Reg't of Miss Art A.D.  
6<sup>th</sup> [unclear]*

**VOLUNTEERS.**

*Disch Oct 15<sup>th</sup> / 63.*

NOTE 1.—Two of these certificates (or duplicates) are to be given to each Volunteer Soldier or drafted man who may be discharged previously to the discharge of his company, that he may at once receive from the Paymaster the pay, &c., due him, and the captain or other COMMISSIONED officer commanding the company will certify to the act of the delivery of the duplicate certificates; on these certificates the Soldier is "entitled to" his discharge, and should also present his discharge to the Paymaster to have the payment endorsed on it. The discharge is to be given back to the Soldier by the Paymaster; the latter only retaining as his voucher the duplicate certificates.

NOTE 2.—If the Soldier is entitled to pay for the use of his horse, the Company Commander will certify to that fact on the back of both these final statements, and also to the time he has pay due for having been so mounted on his own horse.

NOTE 3.—When a Soldier is furnished with final statements, his descriptive list, if he has one, should be taken up by the officer who gives the Soldier these statements, and endorsed with a statement to this effect by the officer. This endorsement should exhibit a full statement of the time for which the Soldier was allowed pay on his final statements, the clothing account, and all other charges against him or in his favor, so as to comprise a complete exhibit of his account. It will then be transmitted to the company commander of the Soldier, who will enter all the data necessary to a full understanding of the Soldier's account on the muster roll upon which the Soldier's discharge is reported. The descriptive list will then be destroyed. The object of this is, that the remaining portion of the Soldier's account may be settled upon the receipt of these muster rolls, and the Soldier receive any pay or allowances that may be due him at the time of his discharge, and which may not appear on his final statements from the fact that his descriptive list is incomplete. These accounts for back pay, &c., are settled by the 2d Auditor of the Treasury Department.

NOTE 4.—Charges for loss or injury to ordnance, horse equipments, and other miscellaneous charges, should appear under the heading of "Other Stoppages."

NOTE 5.—Bounty paid by State authorities, and not by the United States, will not be entered on this statement.

NOTE 6.—Amounts due the Sutler and Laundress must be entered on the muster roll on which the discharge, death, desertion, &c., is reported, as well as on the final statement, otherwise the amount cannot be collected from the United States.

NOTE 7.—This blank will be used for deceased volunteers and drafted men, as well as for others.

NOTE 8.—Where a Soldier dies in Hospital or on detached service, his descriptive list, if he has one, should be sent with his final statements, in duplicate, to the Adjutant General, Washington, D. C.

**ADJUTANT GENERAL'S OFFICE.**  
*Rec 24<sup>th</sup> 1864*  
Duplicate with Inventory sent 2d Auditor

*H. W. H.*  
RECEIVED  
NOV 21  
ADJUTANT GENERAL'S OFFICE  
WASHINGTON D. C.

# War Department.

ADJUTANT GENERAL'S OFFICE,

....., 187

The death..... of *William Henderson*  
*Private*....., Co. *B*....., *6<sup>th</sup>* Reg't U. S.

Colored *Army* (.....) is reported as follows:

On Company Muster Roll.

For *Sept & Oct*, 1863, *Oct 15<sup>th</sup>*, 1863

Company Muster-out Roll.

*October 15<sup>th</sup>*....., 1863

Company Descriptive Book.

....., 186

Company Morning Reports.

....., 186

Soldier's Final Statement.

*October 18<sup>th</sup>*....., 1863

Soldier's Record of Death and Interment.

....., 186

Soldier's Inventory of Effects.

....., 186

Soldier's Certificate of Disability for Discharge.

....., 186

Soldier's Individual Muster-out Roll.

....., 186

Regimental Return.

For *October*, 1863, *Oct 15<sup>th</sup>*, 1863

Regimental Quarterly Returns of *decd* soldiers

*Oct 15<sup>th</sup>*....., 1863

Regimental Descriptive Book.

....., 186

By Surgeon General.

(.....), 186

*Oct 15<sup>th</sup>*....., 1863 is held to be  
the correct date, and the Company Muster.....  
Roll will be amended accordingly.

Assistant Adjutant General.

THE RETURN OF

THE RETURN OF

THE RETURN OF

He has been furnished with TRANSPORTATION in kind from the place of his discharge to

I certify, on honor, that William Henderson a Private of  
 Captain R. B. Kepple Company (B<sup>3</sup>) of the 22 Regiment of Miss Art Ad  
**VOLUNTEERS**, of the State of \_\_\_\_\_, born in Concordia Pa, State  
 of Louisiana, aged 24 years; 5 feet 7 inches high; Black complexion,  
Black eyes, Black hair, and by occupation a Farmer, having joined the company on  
 its original organization at Natchez Miss, and enrolled in it at the muster into  
 the service of the United States at Natchez Miss, on the 12<sup>th</sup> day  
 of Sept, 1863, (or was mustered in service as a recruit, by \_\_\_\_\_  
 \_\_\_\_\_, at \_\_\_\_\_, on the \_\_\_\_\_ day of \_\_\_\_\_,  
 1863, or was drafted and mustered into the service of the United States from the \_\_\_\_\_  
 Enrollment District of the State of \_\_\_\_\_, at \_\_\_\_\_,  
 on the \_\_\_\_\_ day of \_\_\_\_\_, 1863;) to serve in the Regiment, for  
 the term of Three Years: and having served **HONESTLY** and  
**FAITHFULLY** with his Company in Service to the present date, is now  
 entitled to a **DISCHARGE** by reason of Sick of Disease in Regt  
Atpt at Vidalia La Oct 18<sup>th</sup> 1863 Chas D. Darrhman

The said Private William Henderson was last paid by Paymaster  
~~never been paid~~ to include the \_\_\_\_\_ day of \_\_\_\_\_, 1863, and has  
 pay due him from that time to the present date; he is entitled to pay and subsistence for  
~~TRAVELING~~ to place of enrollment, and whatever other allowances are authorized to volunteer  
 soldiers, drafted men, or militia, so discharged. He has received from the United States **CLOTHING**  
 amounting to \$ 21 <sup>24</sup>/<sub>100</sub> dollars, since the 12<sup>th</sup> day of Sept,  
 1863, when his clothing account was last settled. He has received from the United States  
100 dollars advanced **BOUNTY**. Clothing or amt never been settled

There is to be stopped from him, on account of the State of \_\_\_\_\_, or other  
 authorities, for **CLOTHING**, &c., received on entering service, \_\_\_\_\_ dollars, and  
 for other stoppages, viz: \_\_\_\_\_

\_\_\_\_\_ dollars.  
 He has been furnished with **TRANSPORTATION** in kind from the place of his discharge to  
 \_\_\_\_\_; and he has been **SUBSISTED** for **TRAVELING** to his  
 place of enrollment, up to the \_\_\_\_\_, 1863.

He is indebted to \_\_\_\_\_, **SUTLER**, \_\_\_\_\_ dollars.

He is indebted to \_\_\_\_\_, **LAUNDRESS**, \_\_\_\_\_ dollars.

Given in Duplicate, at Natchez Miss, this 10<sup>th</sup> day  
 of October, 1864

Franki Friese  
2d Lt Co. H 8th Cal Art Regt  
 Commanding Company.

*A. Anderson*

Co. *B*, 6 U.S. Col'd H. Art'y.

*Private* | *Private*

CARD NUMBERS.

1	6154523	26
2	6161390	27
3	6161531	28
4	6161671	29
5	6161881	30
6	6162615	31
7	6154732	32
8	9119482	33
9	40742487	34
10		35
11		36
12		37
13		38
14		39
15		40
16		41
17		42
18		43
19		44
20		45
21		46
22		47
23		48
24		49
25		50

Book Mark: *213. 211 P 259*

See also

*William Newman*

, Co. *C*, 6 Reg't U.S. Col'd H. Art'y.

Appears on

**Company Descriptive Book**

of the organization named above.

**DESCRIPTION.**

Age *20* years; height *5* feet *7* inches.

Complexion *Brown*

Eyes *Black*; hair *Black*

Where born *Concordia La*

Occupation *Farmer*

**ENLISTMENT.**

When *Dec 15*, 186*4*

Where *Natchez Miss*

By whom *Lt Burnett*; term *3* y'rs.

Remarks: *Discharged at Natchez Miss June 20/65*

*Spilus*



H

6 H. Art'y.

U.S.C.T.

William Henderson

Appears with rank of Priv on

**Muster and Descriptive Roll of a Detachment of U. S. Vols. forwarded**

for the 6 Reg't U. S. Col'd H. Art'y. Roll dated

Natchez Miss, Dec. 20, 1864.

Where born Concordia, La.

Age 20 yrs; occupation Farmer

When enlisted Dec. 12, 1864.

Where enlisted Natchez Miss

For what period enlisted 3 years.

Eyes Black; hair Black

Complexion Brown, height 5 ft. 7 in.

When mustered in Dec. 12, 1864.

Where mustered in Natchez Miss

Bounty paid \$ None 100; due \$ all 100

Where credited Natchez Adams & Co

Company to which assigned C

Remarks:

Book mark:

Montague

*H*

6 H. Art'y.

U.S.C.T.

*William Henderson*  
*Pvt*, Co. C, 6 Reg't U. S. Col'd H. Art'y.

Appears on

Company Muster Roll

for *Nov & Dec*, 1864.

Joined for duty and enrolled:

When *Dec 12*, 1864\*

Where *Katchez Miss.*\*

Period *3* years.\*

Present or absent *Present*

Stoppage, \$ *100* for

Due Gov't, \$ *100* for

Valuation of horse, \$ *100*

Valuation of horse equipments, \$ *100*

Remarks:

\* See enrollment on card from muster-in roll.

Book mark:

*J. H. Smith*

(358c)

Copyist.

11

6 H. Art'y.

U.S.C.T.

William Henderson

Private, Co. C, 6 Reg't U. S. Col'd H. Art'y.

Appears on

Company Muster Roll

for Jan & Feb, 1865.

Joined for duty and enrolled:

When Dec 12, 1864.\*

Where Natchez, Miss.\*

Period 3 years.\*

Present or absent Present

Stoppage, \$ 100 for

Due Gov't, \$ 100 for

Valuation of horse, \$ 100

Valuation of horse equipments, \$ 100

Remarks:

-----  
-----  
-----

\* See enrollment on card from muster-in roll.

Book mark:

-----

W. Smith

(358c)

Copyist.

7/

6 H. Art'y.

U.S.C.T.

William Henderson

Priv., Co. C, 6 Reg't U. S. Col'd H. Art'y.

Appears on

Company Muster Roll

for Mar & Apr, 1865.

Joined for duty and enrolled:

When Dec 12, 1864\*

Where Natchez, Miss\*

Period 3 years.\*

Present or absent Present

Stoppage, \$ 100 for

Due Gov't, \$ 100 for

Valuation of horse, \$ 100

Valuation of horse equipments, \$ 100

Remarks:

\* See enrollment on card from muster-in roll.

Book mark:

H. A. Smith

(358c)

Copyist.

*William Henderson*

*Co. C*, 6 Reg't U. S. Col'd H. Art'y.

Appears on

**Company Muster Roll**

for *May & June*, 1865.

Joined for duty and enrolled:

When *Dec 12*, 1864.\*

Where *Natchez, Miss\**

Period *3* years.\*

Present or absent

Stoppage, \$ *100* for

Due Gov't, \$ *100* for

Remarks:

*Discharged  
per Gen O. 44, Hdqrs  
Dept. of Miss. Vicksburg  
June 20 1865*

\* See enrollment on card from muster-in roll.

Book mark:

*see E. B. V. 11. P. 259  
Discharged June 27. 1865*

*W. A. Smith*

26

6 H. Art'y.

U.S.C.T.

William Henderson  
Pvt., Co. C, 6 Reg't U. S. Col'd H. Art'y.

Appears on **Co. Muster-out Roll**, dated  
*Natchez Miss May 13, 1866*

Muster-out to date \_\_\_\_\_, 186

Last paid to \_\_\_\_\_, 186

**Clothing account:**

Last settled \_\_\_\_\_, 186 ; drawn since \$ \_\_\_\_\_ 100

Due soldier \$ \_\_\_\_\_ 100; due U. S. \$ \_\_\_\_\_ 100

Am't for cloth'g in kind or money adv'd \$ \_\_\_\_\_ 100

Due U. S. for arms, equipments, &c., \$ \_\_\_\_\_ 100

Bounty paid \$ \_\_\_\_\_ 100; due \$ \_\_\_\_\_ 100

Remarks: *Joined as a recruit  
Discharged June 29, 1865  
at Natchez Miss for G. O.  
44 Hd Qrs Dept of Miss  
Final statements furnished*

Book mark: *Dischd June 27 65 CB, VII P 259*  
*over*

*A. W. Mallum*

(361)

Copyist.

JAN. 13

6162615

☆1891☆

*Book Mark 1, 246, P175, 71*

A

6 H. Art'y.

U.S.C.T.

William Henderson  
Pvt., Co. C, 6 Reg't U. S. Col'd H. Art'y.

Appears on Returns as follows:

Dec 1864 Gain Dec  
 12, 64 Matched Miss  
 Enlisted in Regt  
 May 1865 Absent sick  
 in Post, Hoop  
 since May 23, 65  
 June 1865 Loss June  
 20, 65 Matched Miss  
 Disch'd for G.O.  
 44 dated Hd Qrs  
 Dept Miss Vicks-  
 burg Miss Mary  
 8, 65

Book mark:

(546) *A Douglas* Copyist.



*William Henderson*  
*Priv*, Co. *C*, *6* Reg't U. S. Col'd *Arty.*

Appears on a

**Detachment Muster-out Roll**

of the organization named above. Roll dated

*Katchez, Miss June 27*, 1865.

Muster-out to date *June 27*, 1865.

Last paid to *Feby 28*, 1865.

**Clothing account:**

Last settled ..... 186 ; drawn since \$ ..... 100

Due soldier \$ ..... 100; due U. S. \$ ..... 100

Am't for cloth'g in kind or money adv'd \$ ..... 100

Due U. S. for arms, equipments, &c., \$ ..... 100

Bounty paid \$ ..... 100 due \$ ..... 100

**Remarks:**

*Clothing acct, settled to include*  
*Decr. 12, '64. Amt. since drawn \$53.53.*  
*Bounty all due*

Book mark:

*D. Mahan*

(349)

Copyist.

*40*  
Arendson & Williams

Co D, 6 U.S. Col'd H. Art'y.

Private Sergeant

CARD NUMBERS.

1	6162756	26
2	6162842	27
3	6162990	28
4	6163152	29
5	6163267	30
6	6163404	31
7	6163531	32
8	6163653	33
9	6163859	34
10	6163974	35
11	6154998	36
12	6155017	37
13	6164113	38
14	6164187	39
15	6164330	40
16	6164585	41
17	6165070	42
18	9119498	43
19	40442488	44
20		45
21		46
22		47
23		48
24		49
25		50

Book Mark:

See also

*H*

**6 H. Art'y. | U.S.C.T.**

*William Anderson*

, Co. *D*, 6 Reg't U.S. Col'd H. Art'y.

Appears on

**Company Descriptive Book**

of the organization named above.

**DESCRIPTION.**

Age *21* years; height *5* feet *6* inches.

Complexion *Fair*

Eyes *Blue*; hair *Dark*

Where born *St Louis Mo*

Occupation *Pilot*

**ENLISTMENT.**

When *Aug 31*, 1863.

Where *Richy Miss*

By whom *Sam Beard*; term *3* y'rs.

Remarks: *Discharged Oct 5/63*  
*SO 112 MO Sept 25/65*

*W. A. [Signature]*

William Henderson  
Priv., Co. D., 2 Reg't Miss. Art'y. †

Age 24 years.

Appears on

**Company Muster-in Roll**

of the organization named above. Roll dated

Natchez Miss. Sep 12, 1863.

Muster-in to date Sep 12, 1863.

Joined for duty and enrolled:

When Aug 31, 1863.\*

Where Natchez Miss. \*

Period years.\*

Valuation of horse, \$ 100

Valuation of horse equipments, \$ 100

Remarks:

† This organization subsequently became Co. D., 6 Reg't U. S. Colored Heavy Artillery.

\*45-Muster-in roll shows enrollment of all men of this company as of same date and place. See enrollment on subsequent card or cards.

Book mark:

L. B. Sayer

(356c)

Copyist.

21

*William S. Henderson*

*5 Sgt*, Co. D, 2 Reg't Miss. Art'y.†

Appears on

**Company Muster Roll**

for *Sept. 2 to Oct. 31, 1863.*

Joined for duty and enrolled:

When *Aug. 31*, 186 .\*

Where *Natchez, Miss* \*

Period *3* years.\*

Present or absent *Present*

Stoppage, \$ *100* for

Due Gov't, \$ *100* for

Remarks:

† This organization subsequently became Co. D, 6 Reg't U. S. Colored Heavy Artillery.  
\* See enrollment on card from muster-in roll.

Book mark:

*Chapler*

*William H. Henderson*  
5 Seryt, Co. D, 2 Reg't Miss. Art'y.†

Appears on

**Company Muster Roll**

for *Nov & Dec*, 1863.

Joined for duty and enrolled:

When *Aug 31*, 1863.\*

Where *Natchez Miss* \*

Period *2* years.\*

Present or absent *Present*

Stoppage, \$ *100* for

Due Gov't, \$ *100* for

Remarks:  
-----  
-----  
-----  
-----  
-----

† This organization subsequently became Co. D, 6 Reg't U. S. Colored Heavy Artillery.  
\* See enrollment on card from muster-in roll.

Book mark: -----

*L B Sawyer*  
(358c) Copyist.

*William Henderson*  
Serg't, Co. D, 2 Reg't Miss. Art'y.†

Appears on  
**Company Muster Roll**

for *Jan & July*, 1864.

Joined for duty and enrolled:

When *Aug 31, 1863*.\*

Where *Natchez Miss* \*

Period *3* years.\*

Present or absent *Present*

Stoppage, \$ *100* for

Due Gov't, \$ *100* for

Remarks:  
-----  
-----  
-----  
-----  
-----

† This organization subsequently became Co. D, 6 Reg't U. S. Colored Heavy Artillery.  
\* See enrollment on card from muster-in roll.

Book mark: \_\_\_\_\_

(358c)

*L. B. Sayer*  
Copyist.

William H Henderson  
Seryt, Co. D, 5 Reg't U. S. Col'd H. Art'y.†

Appears on

Company Muster Roll

for March & April, 1864.

Joined for duty and enrolled:

When Aug 31, 1863.\*

Where Natchez Miss \*

Period 3 years.\*

Present or absent Present

Stoppage, \$ 100 for

Due Gov't \$ 100 for

Valuation of horse, \$ 100

Valuation of horse equipments, 100

Remarks:

†This organization subsequently became Co. D, 6 Reg't U. S. Colored Heavy Artillery.

\* See enrollment on card from muster-in roll.

Book mark:

L B Sayer  
Copyist.



H

6 H. Art'y. | U. S. C. T.

William H Henderson  
Sergt, Co. D, 6 Reg't U. S. Col'd H. Art'y.

Appears on

Company Muster Roll

for May & June, 1864

Joined for duty and enrolled:

When Aug 31, 1863.\*

Where Palcha Mus \*

Period 3 years.\*

Present or absent Present

Stoppage, \$ 100 for

Due Gov't, \$ 100 for

Valuation of horse, \$ 100

Valuation of horse equipments, \$ 100

Remarks :

\* See enrollment on card from muster-in roll.

Book mark :

(358c)

L B Sayer  
Copist.

*William H. Henderson*  
Serg't., Co. D, 6 Reg't U. S. Col'd H. Art'y.

Appears on

**Company Muster Roll**

for *July & Aug.*, 186*4*.

Joined for duty and enrolled:

When *Aug 31*, 186*3*.\*

Where *Natchez Miss.*\*

Period *3* years.\*

Present or absent *Present*

Stoppage, \$ *100* for

Due Gov't, \$ *100* for

Valuation of horse, \$ *100*

Valuation of horse equipments, \$ *100*

Remarks: *Charged for trans-  
portation from Memphis  
to Vicksburg \$2 <sup>35</sup>/<sub>100</sub>*

\* See enrollment on card from muster-in roll.

Book mark :

*Jenkins* Copyist.

A

6 H. Art'y.

U. S. C. T.

William H. Henderson,  
Supt., Co. D, 6 Reg't U. S. Col'd H. Art'y.

Appears on

Company Muster Roll

for Sept, & Oct, 1864.

Joined for duty and enrolled:

When Aug. 31, 1863.\*

Where Natchez Miss.\*

Period 3 years.\*

Present or absent Present

Stoppage, \$ 100 for

Due Gov't, \$ 100 for

Valuation of horse, \$ 100

Valuation of horse equipments, \$ 100

Remarks: Charged for  
transportation from  
Memphis to Cairo  
\$2 35  
100

\* See enrollment on card from muster-in roll.

Book mark :

(358c)

Jenkins

Copyist.

William H. Henderson,  
Priv., Co. D, 6 Reg't U. S. Col'd H. Art'y.

Appears on

Company Muster Roll

for Nov. & Dec., 1864.

Joined for duty and enrolled:

When Aug. 31, 1863\*

Where Matchez Miss.\*

Period 3 years.\*

Present or absent Present

Stoppage, \$ 100 for

Due Gov't, \$ 100 for

Valuation of horse, \$ 100

Valuation of horse equipments, \$ 100

Remarks Reduced to the ranks  
S. O. No 156 Hd. Qrs Co  
U. S. C. Art'y Hd. Qrs. 8. 1864.  
Detailed teamster in ord Depot  
S. O. No 141 Hd Qrs. U. S. forces  
(over)

\* See enrollment on card from muster-in roll.

Book mark :

Jenkins  
Coprinst.

ST  
13

6163839

891\*

Hatchey Miss.

Dec. 12. 1864.

A

6 H. Art'y.

U. S. C. T.

William A. Henderson,  
Co. D, 6 Reg't U. S. Col'd H. Art'y.

Appears on

Company Muster Roll

for *Jany & Feby*, 186*3*.

Joined for duty and enrolled:

When *Aug 31*, 186*3*.\*

Where *Matchez Miss* \*

Period *3* years.\*

Present or absent *Present*

Stoppage, \$ *100* for

Due Gov't, \$ *100* for

Valuation of horse, \$ *100*

Valuation of horse equipments, \$ *100*

Remarks *Reduced to the  
Rankes S. O. No 156  
Ad. Ins. 6" U.S. Col'rt'y  
Dec. 8" 1864.*

\* See enrollment on card from muster-in roll.

Book mark :

(358c)

*Jenkins*

Copist.

A 16 Gary | U.S.C.T.

William A. Anderson

Opt, Co. 25, 6 Reg't U. S. Col'd Gary

Appears on

**Descriptive List of Deserters**

dated *Natchez Miss Jan 31*, 1865.

Deserted:

When *Jan 11*, 1865.

Where *Natchez Miss*

Arrested:

When ....., 186 .

Where .....

Remarks:

.....  
.....  
.....  
.....  
.....

Book mark:

*J. M. Harmon*

*H. C. Hart* | U.S.C.T.

*William A. Henderson*

*Pvt, Co D, C* Reg't U. S. Col'd *Hart*

Appears on

**Descriptive List of Deserters**

dated *Watches, Miss Feb 28, 1865*

Deserted:

When *Jan 11*, 1865.

Where *Watches, Miss,*

Arrested:

When \_\_\_\_\_, 186 .

Where \_\_\_\_\_

Remarks: *Returned from  
desertion Feb  
14/65*

Book mark:

*J. M. Harmon*

(851)

Copyist.



H

6 H. Art'y.

U. S. C. T.

William H. Henderson

Co. D, 6 Reg't U. S. Col'd H. Art'y.

Appears on

Company Muster Roll

for March 4th April, 1865.

Joined for duty and enrolled:

When Aug 31, 1863.\*

Where Watcher Mess.\*

Period 3 years.\*

Present or absent Present.

Stoppage, \$ 100 for

Due Gov't, \$ 100 for

Valuation of horse, \$ 100

Valuation of horse equipments, \$ 100

Remarks: Reduced to the ranks S.O. No 156 2nd Div 6th U.S. Cavalry. Dec 8/64. Relieved from charge of Desertion with forfeiture of acc pay & allowances

\* See enrollment on card from muster-in roll.

Book mark:

Over.

Henderson  
Compt. (Approved)

JAN. 13

6164113

★1891★

Due previous to  
July 11/65. S. O. No. 86.  
Had 2nd Dist. Notice  
Miss. April 3, 1865. By  
President's Proclamation

A/

William H. Henderson,  
Serg't Co. D, 6 Reg't U. S. Col'd H. Art'y.

Appears on

Company Muster Roll

for *May & June*, 186*3*.

Joined for duty and enrolled:

When *Aug. 31*, 186*3*\*

Where *Matchez Miss.*

Period *3* years.\*

Present or absent *Present*

Stoppage, \$ *100* for

Due Gov't, \$ *100* for

Valuation of horse, \$ *100*

Valuation of horse equipments, \$ *100*

Remarks: *Promoted to Serg't,  
May 2/65 also re-  
lieved from charge  
of Desertion with loss  
of all pay & allowances.*

\* See enrollment on card from muster-in roll.

Book mark : .....

(358c)

*Jenkins*  
Copyist.

*William H. Henderson*  
Sergt, Co. D, 6 Reg't U. S. Col'd H. Art'y.

Appears on

**Company Muster Roll**

for *July - Aug*, 186 *5*

Joined for duty and enrolled:

When *Aug 31*, 186 *5*\*

Where *Natchez Miss* \*

Period *3* years.\*

Present or absent *Not Stated.*

Stoppage, \$ *100* for

Due Gov't, \$ *100* for

Valuation of horse, \$ *100*

Valuation of horse equipments, \$ *100*

Remarks: *Promoted from private to Sergt. May 2/65. Relieved from charges of desertion with the loss of all pay and allowances*

\*~~See~~ See enrollment on card from muster-in roll.

Book mark :

(358c) *Lopez* Copyist.  
*(over)*

JAN. 13

6164330

☆1891☆

due previous to Sep. 11, '65 S. O. No 954d.  
Qrs Dist Natchez Apr. 31/65.

William H. Henderson  
Sergeant, Co. D, 6 Reg't U. S. Col'd H. Art'y.

Appears on

Company Muster Roll

for Sept & Oct, 1865.

Joined for duty and enrolled:

When Aug. 31, 1863\*

Where Natchez Miss\*

Period 3 years.\*

Present or absent

Stoppage, \$ 100 for

Due Gov't, \$ 100 for

Valuation of horse, \$ 100

Valuation of horse equipments, \$ 100

Remarks: Discharged the service of the United States by order of the Secretary War per G.O. No 5120 War Dept.

\* See enrollment on card from muster-in roll.

Book mark:

(358c)

Laper Copyist.  
(over)

JAN. 13

6164585

1891

*dated Sept. 25, 1865.  
Final statements  
given Oct. 5, 1865.*

William A Henderson

Sgt, Co Q, 6 Reg't U. S. Col'd H. Art'y.  
For

Appears on Returns as follows:

Nov 1863 (2 Miss A  
Art A, B) Absent  
with leave on  
furlough from  
Nov 24 63

May 1864 (6 U.S. Col'd  
H. Art) On duty  
Foot Detachment

July 1864 Absent  
with leave since  
July 18

Dec 1864 (Pot) On duty  
teamster at Ordnance  
Depot

Jan 1865 Deserted Jan  
11 65 Katchup Miss

Feb 6 1865 Garrison Feb  
8 65 Katchup Miss  
Ret'd from desertion  
Absent in confine-  
ment in Military  
order

Book mark:

(546)

A. J. Gould  
Copyist.



JAN. 19.

40742488

1899.

Prison Natchez Miss  
Mar 1865 Absent in  
Arrest in Military  
Prison at Natchez  
Miss Feb 15, 65  
Oct 1865 Sgt, 1st  
Oct 5, 65 Natchez  
Deschd S. O. 517  
At W. H. D. C. Sept  
25, 65

*William H. Henderson*

*Sgt*, Co. *D*, 6 Reg't U. S. Col'd H. Art'y.

Appears on **Co. Muster-out Roll**, dated

*Natchez Miss*, *May 13*, 1866.

Muster-out to date \_\_\_\_\_, 186 .

Last paid to *June 30*, 1865 .

Clothing account:

Last settled \_\_\_\_\_, 186 ; drawn since \$ \_\_\_\_\_ 100

Due soldier \$ \_\_\_\_\_ 100; due U. S. \$ \_\_\_\_\_ 100

Am't for cloth'g in kind or money adv'd \$ \_\_\_\_\_ 100

Due U. S. for arms, equipments, &c., \$ \_\_\_\_\_ 100

Bounty paid \$ \_\_\_\_\_ 100; due \$ \_\_\_\_\_ 100

Remarks: *Joined at Organization*  
*Was Sgt from Enlistment,*  
*Discharged. per S. O.*  
*572, Ex 10 W. 20. Dated Sept 25,*  
*Final Statement furnished*

Book mark *U. S. O. War Dept.* over

*S. M. Tucker*

JAN. 14

6165070

★1891★

U. G. O. Sept 25/65 No. 512  
S. O. on file,  
v. 84 P. 77 69.

Henderson Gust

Sgt D, Co.

6

Reg't 251st A

Enclosures.

Bed Cards	Final Statements
Burial Records	Furloughs or L. of A.
Certs. of Dis. for Discharge	Med. Certificates
C. M. Charges	Med. Des. Lists
Descriptive Lists	Orders
Discharge Certificates	Pris. of War Record
Enlistment Papers	Resignations

Other papers relating to—

Admission to Hosp'l	Furlough or L. of A.
Casualty Sheet	Med. Examination
Confinement	Misc. Information /
Contracts	Pay or Clothing
Death or Effects	Personal Reports
Desertion	Rank
Discharge from Hosp'l	Transfer to Hosp'l
Discharge from Service	Transfer to V. R. C.
Duty	Transportation

William H. Henderson

Sgt Co "D" 6<sup>th</sup> Artillery

Report of Div of D (C)  
in case of

---

Adjutant General's Office,

COLORED TROOPS BRANCH,

W. Ellersbrook

February 17<sup>th</sup>, 1875

Vol. C. T., 187

Wanted in case of William H Henderson Sglt, Co. "D",

Sixth Reg't U. S. C. Art. (Hoy)

1<sup>st</sup> Copy of order Relieving him from charge of desertion.

Relieve from charge of desertion oc 90 St. Hd 2<sup>nd</sup> Dist Hatchery April 3/15"

MR for March April 1875.

2<sup>nd</sup> Cause of absence oc -

Absent Cause not stated - MR for July & Aug 1875

Respectfully,

WJG

W. A. Woodward

Chief Clerk.

In Halton

Adjutant General's Office,

Division of Discontinued Commands,

Feb 24<sup>th</sup>, 1875.

Vol. C. T., 187

Reply in case of Wm H Henderson, Co. "D",

6<sup>th</sup> Reg't U. S. C. A. (Hoy)

Hatchery Dist of Hatchery.

April 3, 1865.

Special Orders }  
No 86 }

(Extract)

1. Private Wm H Henderson Co "D" 6<sup>th</sup> U. S. C. A. (Hoy) is hereby relieved from the charge of desertion, and restored to duty without trial, forfeiting all pay and allowances which may have been due him at the time of his voluntary return to his regiment, and on condition that he makes good the time lost by desertion -

By order of Brig Genl J. M. Davidson -  
Signed

Capt & anal.

over

2nd. Regt & Co Des Bks furnish no information -

Co M. L. Bk July 2. 1865 - "In military Prison in arrest at Natchez, Miss."  
July 14. 65. "Released from arrest" July 18. 65. "In arrest in mil Pris at Natchez, Miss."  
July 19. 65. "Relieved from arrest" - July 27. 65. "In Quarters in arrest and  
confinement" - Aug. 18. 65. "Relieved from arrest" - Aug. 26. 65. "Placed  
in arrest in military Prison - Natchez, Miss." - Sept 5. 1865. "In arrest at  
mil Prison in Natchez, Miss, since Sept 2. 1865" - Sept 16. 65. "Relieved from  
arrest" - Sept 17. 65. "Put in arrest & confinement" - Oct 25. 65. "Discharged"  
Co Des Bk reports him discharged "Oct 5. 65" by "S.O. 572 Mandell"  
No record of trial in any of the above cases - No Records of Prisoners Con-  
fined at Natchez Miss on file in this office -

H. R. K.

*Henderson*

Co *A*, 6 U.S. Col'd H. Art'y.

*Private* *Private*

CARD NUMBERS.

1	6157235	26
2	6167783	27
3	6167971	28
4	6155034	29
5	6169304	30
6	6154921	31
7	9120002	32
8	40742491	33
9	40742485	34
10		35
11		36
12		37
13		38
14		39
15		40
16		41
17		42
18		43
19		44
20		45
21		46
22		47
23		48
24		49
25		50

Book Mark:

See also



*S. F.* | 6 H. Art'y. | U.S.C.T.

*William Sanderson*

....., Co. *F*, 6 Reg't U. S. Col'd H. Art'y.

Appears on

**Company Descriptive Book**  
of the organization named above.

**DESCRIPTION.**

Age *20* years; height *5* feet ..... inches.

Complexion *Blk*

Eyes *Blk*; hair *Blk*

Where born *Concordia Co. La.*

Occupation *Farmer*

**ENLISTMENT.**

When *Feb. 29* ....., 186*4*.

Where *Natchez*

By whom *Capt Schreck*, term *3* y'rs.

Remarks: *Deserted at Natchez*  
*Miss. Apr. 10/64*

.....  
.....  
.....  
.....  
.....

*Warren*

*N*

6 H. Art'y.

U.S.C.T.

*William Henry*

Appears with rank of *Private* on

**Muster and Descriptive Roll of a Detachment of U. S. Vols. forwarded**

★ **2 Regt. Miss. Art'y.**

for the ~~6 Reg't U. S. Col'd H. Art'y.~~ Roll dated

*Natchez, Miss., March 4, 1864.*

Where born *Covington La. La.*

Age *22* y'rs; occupation *Farmer*

When enlisted *July 1, 1864.*

Where enlisted *Natchez, Miss.*

For what period enlisted *3* years.

Eyes *Dark*; hair *Blk.*

Complexion *Dark*; height *5* ft. *7* in.

When mustered in *March 4, 1864.*

Where mustered in *Natchez, Miss.*

Bounty paid \$ *100*; due \$ *100*

Where credited

Company to which assigned *C*

Remarks: *Muster in to take effect from*

*date of enrollment.*

★ This organization subsequently became

6 Regt. U. S. Col'd H. Artillery.

★ Corrected June 3 1896. *C. F. A.*

Book mark: *accounted for on rolls of C. F.*

*as William Henderson.*

*Belmont*

*William Henderson*

*Co. D*, 5 Reg't U. S. Col'd H. Art'y.\*

Appears on

**Company Muster Roll**

for *Mar. 1 to Apr. 30*, 186*2*.

Joined for duty and enrolled:

When *Feb. 1st*, 186*3*.\*

Where *Natchez, Miss.*\*

Period *3* years.\*

Present or absent *Absent.*

Stoppage, \$ *100* for

Due Gov't, \$ *100* for

Valuation of horse, \$ *100*

Valuation of horse equipments, \$ *100*

Remarks: *Absent without leave since April 10<sup>th</sup> 1864.*

\* This organization subsequently became Co. *D*, 6 Reg't U. S. Col'd Heavy Artillery.

\* See enrollment on card from muster-in roll.

Book mark:

*Brooks*

*J.C.*

6 H. Art'y.

U.S.C.T.

*William Henderson*

*Priv.*, Co. F, 6 Reg't U. S. Col'd H. Art'y.

Appears on

**Company Muster Roll**

for *March to June 30*, 1864.

Joined for duty and enrolled:

When *Feb. 1st*, 1864.\*

Where *Natchez, Miss.*\*

Period *3* years.\*

Present or absent

Stoppage, \$ *100* for

Due Gov't \$ *100* for

Remarks: *Deserted at Natchez Miss, May 1st 1864.*

\* See enrollment on card from muster-in roll.

Book mark:

*Brooks*

(358c)

Copyist.

~~77~~ | C. H. Harg | U.S.C.T.

Anderson, Williams

Cpt, Co. A, 6 Reg't U. S. Col'd Harg

Appears on

**Descriptive List of Deserters**

dated Vatchez Miss May 31, 1864.

Deserted:

When May 1st, 1864.

Where Vatchez Miss.

Arrested:

When \_\_\_\_\_, 186 .

Where \_\_\_\_\_

Remarks:

Book mark:

J. M. Harmon

(851)

Copyright.

\* William Henderson  
Priv., Co. F, 6 Reg't U. S. Col'd A. Atty.

Appears on

**Descriptive List of Deserters**

dated February 20, 1865.

Deserted:

When April 10, 1864.

Where Natchez Miss.

Arrested:

When \_\_\_\_\_, 186 .

Where \_\_\_\_\_

Remarks:

\* Name cancelled by line.

Book mark:

R S Shelton

A

6 H. Art'y.

U.S.C.T.

William Henry

Pat, Co. ...., 6 Reg't U. S. Col'd H. Art'y.

Appears on Returns as follows:

Mar 1864 (Co E 5th  
 Cal'd H Art) Garrison  
 Feb 10, 64 Natchez  
 Miss Enlisted  
 by Capt J W Hick-  
 man  
 Loss Mar 4, 64  
 Natchez Miss  
 Transfd from Co  
 E to Co F

Book mark:

(546)

A. J. Gould

Copyist.

A

6 H. Art'y.

U.S.C.T.

William Henderson

Por, Co F, 6 Reg't U. S. Col'd H. Art'y.

Appears on Returns as follows:

May 864 Deserted  
Apr 10 Natchez  
Miss

Book mark:

(546)

A. Gould  
Copyist.



*H*

6 H. Art'y.

U.S.C.T.

*William Henderson*  
Co. *F*, 6 Reg't U. S. Col'd H. Art'y.

Appears on **Co. Muster-out Roll**, dated  
*March 13*, 186*6*.

Muster-out to date \_\_\_\_\_, 186 .

Last paid to *June 30*, 186*5*.

Clothing account:

*No settlement*  
Last settled \_\_\_\_\_, 186 ; drawn since \$ *32*<sup>*19*</sup>/<sub>*100*</sub>

Due soldier \$ \_\_\_\_\_<sup>*100*</sup>; due U. S. \$ \_\_\_\_\_<sup>*100*</sup>

Am't for cloth'g in kind or money adv'd \$ \_\_\_\_\_<sup>*100*</sup>

Due U. S. for arms, equipments, &c., \$ \_\_\_\_\_<sup>*100*</sup>

Bounty paid \$ \_\_\_\_\_<sup>*100*</sup>; due \$ \_\_\_\_\_<sup>*100*</sup>

Remarks: *Joined as a recruit*

*Deserted Apr 10. 64 at*

*March, Miss*

Book mark: \_\_\_\_\_

(361)

*W. Henderson*  
Copyist.

*Kennesey Charles*  
Co *K*, 6 U.S. Col'd H. Art'y.

*Private Sergeant.*  
CARD NUMBERS.

1	6175665	26
2	6175767	27
3	6175902	28
4	6176038	29
5	6176158	30
6	6176271	31
7	6176339	32
8	6176453	33
9	6176572	34
10	6176695	35
11	6176813	36
12	6176925	37
13	6177038	38
14	6177146	39
15	6177257	40
16	6177361	41
17	9120720	42
18		43
19		44
20		45
21		46
22		47
23		48
24		49
25		50

Book Mark: /

See also

81874906 P.O. in m

S. 2611287 2. in. W.D.

P.O. in m out 588431-11-23-18  
W.D.

*F. F. C. C.*

1

Charles Ramsey

Co. K, 6 Reg't U. S. Col'd H. Art'y.

Appears on

Company Descriptive Book  
of the organization named above.

DESCRIPTION.

Age: 23 years; height 5 feet 8 inches.

Complexion Dark

Eyes Black; hair Black

Where born Natchez Miss

Occupation Sailor

ENLISTMENT.

When Jan 1, 1864.

Where Natchez Miss

By whom Capt Kempfer; term 3 y'rs.

Remarks: Appointed Capt  
Nov 20, 64, vice  
Wilson reduced.  
App'd Capt. from  
Capt. Oct. 12/65

\* Companion

Wittner

*Charles Kemmersey*

*Co. K*, 2 Reg't Miss. Art'y. †

Age *23* years.

Appears on

**Company Muster-in Roll**

of the organization named above. Roll dated

*Natchez Miss Jan 5*, 1864.

Muster-in to date *Jan 1*, 1864.

Joined for duty and enrolled:

When *Jan 1*, 1864.\*

Where *Natchez Miss\**

Period *3* years.\*

Valuation of horse, \$ *100*

Valuation of horse equipments, \$ *100*

Remarks: .....

† This organization subsequently became Co. *K*, 6 Reg't U. S. Colored Heavy Artillery.

\* Muster-in roll shows enrollment of all men of this company as of same date and place. See enrollment on subsequent card or cards.

Book mark: .....

*J. H. Hillis*

*Charles Hemmery*  
*Bob*, Co. K, 2 Reg't Miss. Artillery.†

Appears on

**Company Muster Roll**  
for *Jan 8<sup>th</sup> to July 29*, 1864.

Joined for duty and enrolled:

When *Jan 1<sup>st</sup>*, 1864.\*

Where *Natchez Miss* \*

Period *3* years.\*

Present or absent *present*

Stoppage, \$ *100* for

Due Gov't \$ *100* for

Valuation of horse, \$ *100*

Valuation of horse equipments, *100*

Remarks:  
.....  
.....  
.....

† This organization subsequently became Co. K, 6 Reg't U. S. Colored H. Art'y.

\* See enrollment on card from muster-in roll.

Book mark: .....

*Spillo*  
.....  
(358c) Copyist.

*Charles Hennessey*

*B*, Co. *A*, 5 Reg't U. S. Col'd H. Art'y.\*

Appears on

**Company Muster Roll**

for *Mar & Apr*, 186*4*.

Joined for duty and enrolled :

When *Jan 1<sup>st</sup>*, 186*4*.\*

Where *Nashy Miss* \*

Period *3* years.\*

Present or absent *Present*

Stoppage, \$ *100* for

Due Gov't, \$ *100* for

Valuation of horse, \$ *100*

Valuation of horse equipments, \$ *100*

Remarks: \_\_\_\_\_  
\_\_\_\_\_  
\_\_\_\_\_

\* This organization subsequently became Co. *A*, 6 Reg't U. S. Col'd Heavy Artillery.  
\* ~~See~~ See enrollment on card from muster-in roll.

Book mark: \_\_\_\_\_

*J. J. [Signature]*

A

6 H. Art'y.

U.S.C.T.

*Charles Hennessey*

*Co. K*, Co. K, 6 Reg't U. S. Col'd H. Art'y.

Appears on

**Company Muster Roll**

for *May - June*, 1864.

Joined for duty and enrolled:

When *Jan 1<sup>st</sup>*, 1864.\*

Where *Nashville Miss* \*

Period *3* years.\*

Present or absent *Present*

Stoppage, \$ *100* for

Due Gov't \$ *100* for

Remarks:  
\_\_\_\_\_  
\_\_\_\_\_  
\_\_\_\_\_  
\_\_\_\_\_  
\_\_\_\_\_

\* See enrollment on card from muster-in roll.

Book mark: \_\_\_\_\_

(358c)

*J. J. [Signature]*  
Copyist.



*36*

6 H. Art'y.

U.S.C.T.

*Charles Hennessey*  
*Pvt.*, Co. K, ~~2 Reg't Miss. Artillery.~~ <sup>6 Reg't U. S. Col'd. Art'y.</sup>

Appears on

**Company Muster Roll**

for *July & Aug.*, 1864.

Joined for duty and enrolled:

When *Jan. 1*, 1864.\*

Where *Natchez, Miss* \*

Period *3* years.\*

Present or absent *Present.*

Stoppage, \$ *100* for

Due Gov't \$ *100* for

Valuation of horse, \$ *100*

Valuation of horse equipments, *100*

Remarks:

~~† This organization subsequently became Co. K, 6 Reg't U. S. Colored H. Art'y. X~~

\* See enrollment on card from muster-in roll.

x *Corrected Oct. 29, 1894. D&S*

Book mark:

(358c)

*J. J. Smith*

Copyist.

27

6 H. Art'y.

U.S.C.T.

Charles Hennessey

Priv, Co. K, 6 Reg't U. S. Col'd H. Art'y.

Appears on

Company Muster Roll

for Sept & Oct, 1864.

Joined for duty and enrolled:

When Jan 1, 1864.\*

Where Natchez, Miss.\*

Period 3 years.\*

Present or absent Present

Stoppage, \$ 100 for

Due Gov't \$ 100 for

Remarks:

-----  
-----  
-----  
-----  
-----

\* See enrollment on card from muster-in roll.

Book mark:

J.B. Gage Copyist.

(358c)

H

6 H. Art'y.

U.S.C.T.

Charles Hennessy  
Corpl, Co. K, 6 Reg't U. S. Col'd H. Art'y.

Appears on

**Company Muster Roll**

for Nov. and Dec., 1864.

Joined for duty and enrolled:

When Jan. 1, 1864.\*

Where Natchez, Miss. \*

Period 3 years.\*

Present or absent Present

Stoppage, \$ 100 for

Due Gov't \$ 100 for

Remarks:  
Promotion to Corp'l Nov. 22, 1864, vice Wilson reduced by order of Maj. Reynolds.

\* See enrollment on card from muster-in roll.

Book mark:

(358c) C. J. Powell Copyist.

14

6 H. Art'y.

U.S.C.T.

*Charles Hennessy*  
Coptl, Co. K, 6 Reg't U. S. Col'd H. Art'y.

Appears on

**Company Muster Roll**

for *Jan, and Feb.*, 1865.

Joined for duty and enrolled:

When *Jan. 1.*, 1864.\*

Where *Hatchez, Miss.*\*

Period *3* years.\*

Present or absent *Present*

Stoppage, \$ *100* for

Due Gov't \$ *100* for

Remarks:

*Promoted Coptl Nov. 30,  
64. via Millson reduced.*

\* See enrollment on card from muster-in roll.

Book mark:

*Ch. Powell*

(358c)

Copyist.

H

6 H. Art'y.

U.S.C.T.

*Charles Hennessey*  
Copl, Co. K, 6 Reg't U. S. Col'd H. Art'y.

Appears on

**Company Muster Roll**

for *March and April*, 1865.

Joined for duty and enrolled:

When *Jan. 1*, 1864.\*

Where *Natchez, Miss.*\*

Period *3* years.\*

Present or absent *Present*

Stoppage, \$ *100* for

Due Gov't \$ *100* for

Remarks:  
*Promoted to Corporal Nov. 20/64, vice Wills reduced*

\* See enrollment on card from muster-in roll.

Book mark:

*C. J. Powell*

(358c)

Copyist.

*N*

6 H. Art'y.

U.S.C.T.

*Charles Hennessy*

*Corpl*, Co. K, 6 Reg't U. S. Col'd H. Art'y.

Appears on

**Company Muster Roll**

for *May and June*, 1865.

Joined for duty and enrolled:

When *Jan. 1*, 1864.\*

Where *Natchez Miss.* \*

Period *3* years.\*

Present or absent *Present*

Stoppage, \$ *100* for

Due Gov't \$ *100* for

Remarks:

\* See enrollment on card from muster-in roll.

Book mark:

*C. Powell*

(358c)

Copyist.

11

6 H. Art'y.

U.S.C.T.

*Charles Hennessey*

*Co. K*, Co. K, 6 Reg't U. S. Col'd H. Art'y.

Appears on

**Company Muster Roll**

for *July and Aug.*, 186*5*.

Joined for duty and enrolled:

When *Jan. 1.*, 186*4*.\*

Where *Matchez, Miss.* \*

Period *3* years.\*

Present or absent *Present*

Stoppage, \$ *100* for

Due Gov't \$ *100* for

Remarks:

\* ~~See~~ See enrollment on card from muster-in roll.

Book mark:

*C. J. Powell*

(358c)

Copyist.

*Charles Henry*  
Serg't, Co. K, 6 Reg't U. S. Col'd H. Art'y.

Appears on

**Company Muster Roll**

for *Sept & Oct*, 186*5*.

Joined for duty and enrolled:

When *Jan 1st*, 186*4*.\*

Where *Natchez Miss\**

Period *3* years.\*

Present or absent *Present*

Stoppage, \$ *100* for

Due Gov't \$ *100* for

Remarks: *Promoted to Serg't  
October 12" 1865 vice  
Bennett discharged.*

\* See enrollment on card from muster-in roll.

Book mark:

*W. L. Houston*



27

6 H. Art'y.

U.S.C.T.

Charles Hennessey  
Serg't, Co. K, 6 Reg't U. S. Col'd H. Art'y.

Appears on

**Company Muster Roll**

for Nov & Dec, 1865.

Joined for duty and enrolled:

When Jan'y 1<sup>st</sup>, 1864\*

Where Natchez Miss\*

Period 3 years.\*

Present or absent Present

Stoppage, \$ 100 for

Due Gov't \$ 100 for

Remarks: Promoted from  
Corpl. to Serg't Oct 12<sup>th</sup> 1865  
vice Bennett discharged.

\* See enrollment on card from muster-in roll.

Book mark:

W L Houston

(358c)

Copyist.

Charles Hennessy  
Serg't, Co. K, 6 Reg't U. S. Col'd H. Art'y.

Appears on

**Company Muster Roll**

for January & February, 1866.

Joined for duty and enrolled:

When Jan 1, 1864\*

Where Natchez Miss\*

Period 3 years.\*

Present or absent Present

Stoppage, \$ 100 for

Due Gov't \$ 100 for

Remarks:

\* See enrollment on card from muster-in-roll.

Book mark:

W. L. Houston

(358c)

Copyist.

07

6 H. Art'y.

U.S.C.T.

Charles Hennessy  
Sergt, Co. K, 6 Reg't U. S. Col'd H. Art'y.

Appears on

Company Muster Roll

for March & April, 1866

Joined for duty and enrolled:

When Jan 1, 1864.\*

Where Natchez Miss \*

Period 3 years.\*

Present or absent Present

Stoppage, \$ 100 for

Due Gov't \$ 100 for

Remarks:

\* See enrollment on card from muster-in roll.

Book mark:

(358c)

W. L. Houston

Copyist.

*H*

6 H. Art'y.

U.S.C.T.

*Charles Hennessy*

*Sgt.*, Co. *K*, 6 Reg't U. S. Col'd H. Art'y.

Appears on **Co. Muster-out Roll**, dated

*Natchez, Miss May 13, 1866.*

Muster-out to date *May 13, 1866.*

Last paid to *Dec. 31, 1865.*

Clothing account:

Last settled....., 186 ; drawn since \$..... 100

Due soldier \$ *5* <sup>*23*</sup>/<sub>100</sub>; due U. S. \$..... 100

Am't for cloth'g in kind or money adv'd \$..... 100

Due U. S. for arms, equipments, &c., \$..... 100

Bounty paid \$..... 100; due \$..... 100

Remarks: *Joined original organization,*

*Promoted Corp. Nov. 22, 1864.*

*Promoted Sgt. Oct. 12, 1865.*

Book mark:

*G. W. Chase*

(361)

Copyist.

*Private*

Co *S*, 6 U.S. Col'd H. Art'y.

*Private Private*

CARD NUMBERS.

1	6169362	26
2	6169514	27
3	6169658	28
4	6169802	29
5	6169928	30
6	6170055	31
7	6170160	32
8	6170263	33
9	6170369	34
10	6170473	35
11	6170587	36
12	6170706	37
13	6170822	38
14	6170933	39
15	6171041	40
16	6171139	41
17	6171233	42
18	6171328	43
19	9120233	44
20	9120060	45
21	40742490	46
22		47
23		48
24		49
25		50

Book Mark:

See also

A | 6 H. Art'y. | U.S.C.T.

Captain Henry

, Co. G, 6 Reg't U. S. Col'd H. Art'y.

Appears on

**Company Descriptive Book**

of the organization named above.

**DESCRIPTION.**

Age 25 years; height 5 feet 7 inches.

Complexion Dark

Eyes Dark; hair Dark

Where born Benton Co., Mo.

Occupation Farmer

**ENLISTMENT.**

When Sept. 20, 1863.

Where Hatchery, Miss.

By whom C. H. Smith; term 3 y'rs.

Remarks:

-----  
-----  
-----  
-----  
-----  
-----  
-----  
-----  
-----  
-----

James

Captain Henry

....., Co. G, 6 Reg't U. S. Col'd H. Art'y.

Appears on

**Company Descriptive Book**

of the organization named above.

**DESCRIPTION.**

Age 23 years; height 5 feet 7 inches.

Complexion Dark

Eyes Dark; hair Dark

Where born Benton Co. Mo.

Occupation Farmer

**ENLISTMENT.**

When Sept 20, 1863.

Where Hatchey Miss.

By whom C. W. Smith, term 3 y'rs.

Remarks:

.....  
.....  
.....  
.....  
.....  
.....  
.....  
.....  
.....

W. W. W. W.

77

Captain Henry Put, Co. G, 2 Reg't Miss. Art'y.\*

Age 25 years.

Appears on

Company Muster-in Roll

of the organization named above. Roll dated

Katchez Miss, Oct 20, 1863.

Muster-in to date Oct 20, 1863.

Joined for duty and enrolled:

When Sept 20, 1863.

Where Katchez Miss.

Period 3 years.

Valuation of horse, \$ 100

Valuation of horse equipments, \$ 100

Remarks:

\* This organization subsequently became Co. G, 6 Reg't U. S. Colored Heavy Artillery.

Book mark:

P. A. Stan Copyist.



Captain Henry  
Put, Co. G, 2 Reg't Miss. Art'y.\*

Appears on

Company Muster Roll

for Oct 20 to 31, 1863

Present or absent Present

Stoppage, \$ 100 for

Due Gov't, \$ 100 for

Valuation of horse, \$ 100

Valuation of horse equipments, \$ 100

Remarks:

\* This organization subsequently became Co. G, 6 Reg't U. S. Colored Heavy Artillery.

Book mark:

(358) J. A. Ward Copyist.

*Captain Henry*

*Put*, Co. G, 2 Reg't Miss Art'y.\*

Appears on

**Company Muster Roll**

for *Nov & Dec*, 1863.

Present or absent *Present*

Stoppage, \$ 100 for

Due Gov't, \$ 100 for

Valuation of horse, \$ 100

Valuation of horse equipments, \$ 100

Remarks:  
-----  
-----  
-----  
-----  
-----  
-----  
-----

\* This organization subsequently became Co. G, 6 Reg't U. S. Colored Heavy Artillery.

Book mark: -----

*O. A. Ward*

Captain Henry  
Ort, Co. G, 2 Reg't Miss. Art'y.\*

Appears on

Company Muster Roll

for Jan & Feb, 1864

Present or absent Present

Stoppage, \$ 100 for

Due Gov't, \$ 100 for

Valuation of horse, \$ 100

Valuation of horse equipments, \$ 100

Remarks:

\* This organization subsequently became Co. G, 6 Reg't U. S. Colored Heavy Artillery.

Book mark:

L. Y. Sparr

Captain Henry  
Port, Co. G, 5 Reg't U. S. Col'd H. Art'y.\*

Appears on

Company Muster Roll

for *March & April*, 186*4*

Present or absent *Absent*

Stoppage, \$ *100* for

Due Gov't, \$ *100* for

Valuation of horse, \$ *100*

Valuation of horse equipments, \$ *100*

Remarks: *Absent without  
leave since April  
28th/64*

\* This organization subsequently became Co. G, 6 Reg't U. S. Col'd Heavy Artillery.

Book mark:

*L. Y. Spann*

(358)

Copyist.

Captain Henry

Ort, Co. G, 6 Reg't U. S. Col'd H. Art'y.

Appears on

Company Muster Roll

for May & June, 1864

Present or absent Present

Stoppage, \$ 100 for

Due Gov't, \$ 100 for

Valuation of horse, \$ 100

Valuation of horse equipments, \$ 100

Remarks:

[Empty lines for remarks]

Book mark:

L. J. Sparrow

(358)

Copyist.

*A*

6 H. Art'y.

U.S.C.T.

*Captain Henry*

*Pri.*....., Co. G, 6 Reg't U. S. Col'd H. Art'y.

Appears on

**Company Muster Roll**

for *July & Aug.*....., 186*4*.

Present or absent *Present.*.....

Stoppage, \$.....100 for .....

Due Gov't, \$.....100 for .....

Valuation of horse, \$.....100

Valuation of horse equipments, \$.....100

Remarks:.....

Book mark:.....

*J. Smith*

(358)

Copyist.

*76*  
*James King*

*76*, Co. G, 6 Reg't U. S. Col'd H. Art'y.

Appears on

**Company Muster Roll**

for *Sept. 1 Oct*, 186*4*.

Present or absent *Present*

Stoppage, \$ *100* for

Due Gov't, \$ *100* for

Valuation of horse, \$ *100*

Valuation of horse equipments, \$ *100*

Remarks:  
\_\_\_\_\_  
\_\_\_\_\_  
\_\_\_\_\_  
\_\_\_\_\_  
\_\_\_\_\_  
\_\_\_\_\_  
\_\_\_\_\_  
\_\_\_\_\_

Book mark: \_\_\_\_\_

(358)

*[Signature]*  
\_\_\_\_\_  
Copyist.

*A*

*Captain Henry*  
*Pri.*, Co. G, 6 Reg't U. S. Col'd H. Art'y.

Appears on

**Company Muster Roll**

for *Nov. & Dec.*, 186*4*.

Present or absent *Present.*

Stoppage, \$ *100* for

Due Gov't, \$ *100* for

Valuation of horse, \$ *100*

Valuation of horse equipments, \$ *100*

Remarks:  
\_\_\_\_\_  
\_\_\_\_\_  
\_\_\_\_\_  
\_\_\_\_\_  
\_\_\_\_\_  
\_\_\_\_\_  
\_\_\_\_\_  
\_\_\_\_\_

Book mark: \_\_\_\_\_

(358)

*J. Smith*

Copyist.



*Captain Henry*

*Private*, Co. G, 6 Reg't U. S. Col'd H. Art'y.

Appears on

**Company Muster Roll**

for *Jan'y & Feb.*, 186*5*.

Present or absent *Present*

Stoppage, \$.....100 for .....

Due Gov't, \$.....100 for .....

Valuation of horse, \$.....100

Valuation of horse equipments, \$.....100

Remarks: *Due U. S. for Ordnance 79 cents*

Book mark: .....

(358)

*J. W. Neal*

Copyist.

*Captain Henry*

*Private*, Co. G, 6 Reg't U. S. Col'd H. Art'y.

Appears on

**Company Muster Roll**

for *March & April*....., 186*5*.

Present or absent *Present*.....

Stoppage, \$.....*100* for.....

Due Gov't, \$.....*100* for.....

Valuation of horse, \$.....*100*

Valuation of horse equipments, \$.....*100*

Remarks:.....  
.....  
.....  
.....  
.....  
.....  
.....  
.....

Book mark:.....

*A. D. Neal*  
Copyist.

*Captain Henry*

*Private*, Co. G, 6 Reg't U. S. Col'd H. Art'y.

Appears on

**Company Muster Roll**

for *May & June*, 1865.

Present or absent *Private*

Stoppage, \$ 100 for

Due Gov't, \$ 100 for

Valuation of horse, \$ 100

Valuation of horse equipments, \$ 100

Remarks:

Book mark:

*F. M. Neal*

*H*

**6 H. Art'y.**

**U.S.C.T.**

*Captain Henry.*

*Pt-*, Co. G, 6 Reg't U. S. Col'd H. Art'y.

Appears on

**Company Muster Roll**

for *July to Aug*, 186*5*.

Present or absent *present*.

Stoppage, \$ *100* for

Due Gov't, \$ *100* for

Valuation of horse, \$ *100*

Valuation of horse equipments, \$ *100*

Remarks:

Book mark:

*E. M. Stearns*

(358)

Copyist.

*H*

6 H. Art'y.

U.S.C.T.

*Captain Henry*

*Pr*, Co. G, 6 Reg't U. S. Col'd H. Art'y.

Appears on

**Company Muster Roll**

for *Sept: 2<sup>d</sup> Oct*, 1865.

Present or absent *present*

Stoppage, \$ *100* for

Due Gov't, \$ *100* for

Valuation of horse, \$ *100*

Valuation of horse equipments, \$ *100*

Remarks:

Book mark:

*E. W. Foster*

(358)

Copyist.

Captain Henry

Pl- Co. G, 6 Reg't U. S. Col'd H. Art'y.

Appears on

Company Muster Roll

for Nov. & Dec, 1865:

Present or absent present

Stoppage, \$ 100 for

Due Gov't, \$ 100 for

Valuation of horse, \$ 100

Valuation of horse equipments, \$ 100

Remarks:

Book mark:

E. Weston

7

Captain Henry

P. H. W., Co. G, 6 Reg't U. S. Col'd H. Art'y.

Appears on

Company Muster Roll

for Jan + Feb, 1866.

Present or absent Present.

Stoppage, \$ 100 for

Due Gov't, \$ 100 for

Valuation of horse, \$ 100

Valuation of horse equipments, \$ 100

Remarks:

Book mark:

no chance

H<sup>o</sup>

6 H. Art'y.

U.S.C.T.

Captain Henry

Priv

, Co. G, 6 Reg't U. S. Col'd H. Art'y.

Appears on

Company Muster Roll

for Mar & Apr, 1866.

Present or absent Present,

Stoppage, \$ 100 for

Due Gov't, \$ 100 for

Valuation of horse, \$ 100

Valuation of horse equipments, \$ 100

Remarks: Stop for Ordnance  
lost \$ 18 <sup>34</sup>/<sub>100</sub>

Book mark:

No Change

(358)

Copyist.



A

6 H. Art'y.

U.S.C.T.

Captain Henry

....., Co. ...., 6 Reg't U. S. Col'd H. Art'y.

Appears on Returns as follows:

April 1864 (Co. G. S. U.S. Col'd H. Art.) Absent without leave April 28

Book mark : .....

(546)

A. Gougeon

Copyist.

Captain Henry  
Pot, Co. G., 6 Reg't U. S. Col'd H. Art'y.

Appears on Co. Muster-out Roll, dated  
Natchez, Miss, May 13, 1866.

Muster-out to date May 13, 1866.

Last paid to Dec 31, 1865.

Clothing account:

Last settled, 186 ; drawn since \$ 100

Due soldier \$ 43 <sup>47</sup>/<sub>100</sub>; due U. S. \$ 100

Am't for cloth'g in kind or money adv'd \$ 100

Due U. S. for arms, equipments, &c., \$ 16 <sup>04</sup>/<sub>100</sub>

Bounty paid \$ 100; due \$ 100

Remarks: Joined at original  
organization. Shop for Ord-  
nance lost \$ 16 <sup>4</sup>/<sub>100</sub>.

Book mark:

no chance

Henry Captain

P, Co. G, 6 Reg't U.S.A.

1 Enclosures.

Bed Cards .....	Final Statements .....
Burial Records .....	Furloughs or L. of A .....
Certs. of Dis. for Discharge .....	Med. Certificates .....
C. M. Charges .....	Med. Des. Lists .....
Descriptive Lists .....	Orders .....
Discharge Certificates .....	Pris. of War Record .....
Enlistment Papers .....	Resignations .....

Other papers relating to—

Admission to Hosp'l .....	Furlough or L. of A .....
Casualty Sheet .....	Med. Examination .....
Confinement .....	Misc. Information .....
Contracts .....	Pay or Clothing .....
Death or Effects .....	Personal Reports .....
Desertion .....	Rank .....
Discharge from Hosp'l .....	Transfer to Hosp'l .....
Discharge from Service .....	Transfer to V. R. C. .....
Duty .....	Transportation .....

Captain Berby  
Pot Co. G<sup>th</sup> 6<sup>th</sup> Art'y Hvy

Report of Div of D. C.

Adjutant General's Office,

COLORED TROOPS BRANCH,

Mr Ellertson

April 10<sup>th</sup>, 1875

Vol. C. T., 187

Wanted in case of Captain Henry Private, Co. "G",  
Reg't U. S. C. (Key)

Period absent without leave & whether tried

MR for March & April 1864 reports - "Absent without leave since April 28<sup>th</sup> 1864"

MR for May & June 1864 - reports - Present for duty

WJG

Respectfully,

W. A. Woodward  
In J. H. Chief Clerk

Adjutant General's Office,

Division of Discontinued Commands.

April 28<sup>th</sup> 1875

Vol. C. T., 187

Reply in case of Captain Henry, Co. "G",  
Reg't U. S. C. (Key)

Reg't "G" Co. Des Rts furnish no information

Co. M. G. Rpts. Apr 29. 64 - "Absent without leave"

May 1. 64 - "Returned to Co. from absence without leave"

No record of trial

D.B.K.

Henry Harry  
Co F, 6 U.S. Col'd H. Art'y.

Private Private

CARD NUMBERS.

1	6167259	26
2	6167401	27
3	6167608	28
4	6167672	29
5	6167782	30
6	6167904	31
7	6168016	32
8	6168124	33
9	6168235	34
10	6168342	35
11	6168453	36
12	6168569	37
13	6168678	38
14	6168789	39
15	6168894	40
16	6168992	41
17	6169088	42
18	6169185	43
19	9119923	44
20	40742462	45
21		46
22		47
23		48
24		49
25		50

Book Mark:

See also

24

6 H. Art'y.

U.S.C.T.

Harry Henry

Co. F, 6 Reg't U. S. Col'd H. Art'y.

Appears on

Company Descriptive Book

of the organization named above.

DESCRIPTION.

Age 28 years; height 5 feet 9 inches.

Complexion Copper

Eyes Blk; hair Blk

Where born Richmond, Va.

Occupation Laborer

ENLISTMENT.

When Aug. 29, 1863.

Where Fatches

By whom St. Schreck, term 3 y'rs.

Remarks:

Warren

(383g)

Coppist.

*J. H.*

| 6 H. Art'y. | U.S.C.T.

*Harry Henry*

*Out.*, Co. *F.*, 2 Reg't Miss. Art'y.†

Age *28* years.

Appears on

**Company Muster-in Roll**

of the organization named above. Roll dated

*Natchez Miss, Sept. 12*, 1863.

Muster-in to date *Sept. 12*, 1863.

Joined for duty and enrolled:

When *Aug. 29*, 1863.\*

Where *Natchez, Miss.* \*

Period *3* years.\*

Valuation of horse, \$ *100*

Valuation of horse equipments, \$ *100*

Remarks: \_\_\_\_\_

† This organization subsequently became Co. *F.*, 6 Reg't U. S. Colored Heavy Artillery.

\*† Muster-in roll shows enrollment of all men of this company as of same date and place. See enrollment on subsequent card or cards.

Book mark: \_\_\_\_\_

*Brooks*

(356c)

Copyist.



Harry Henry  
Det., Co. F, 2 Reg't Miss. Artillery.†

Appears on

**Company Muster Roll**

for Sept. 12 to Oct. 31, 1863.

Joined for duty and enrolled:

When Aug. 29, 1863.\*

Where Natchez, Miss.\*

Period 3 years.\*

Present or absent Absent

Stoppage, \$ 100 for

Due Gov't \$ 100 for

Valuation of horse, \$ 100

Valuation of horse equipments, \$ 100

Remarks: Absent

without leave  
since Oct. 27/63

† This organization subsequently became Co. F, 6 Reg't U. S. Colored Heavy Artillery.

\* See enrollment on card from muster-in roll.

Book mark:

Brooks

Harry Henry  
Cvt., Co. F, 2 Reg't Miss. Artillery.†

Appears on

Company Muster Roll

for Nov. 1 to Dec. 31, 1863.

Joined for duty and enrolled:

When Aug. 29, 1863.\*

Where Matchez.\*

Period 3 years.\*

Present or absent

Stoppage, \$ 100 for

Due Gov't \$ 100 for

Valuation of horse, \$ 100

Valuation of horse equipments, \$ 100

Remarks: Deserted at  
Camp Farrar,  
Nov. 11<sup>th</sup>, 1863.

† This organization subsequently became Co. F, 6 Reg't U. S. Colored Heavy Artillery.  
\* See enrollment on card from muster-in roll.

Book mark:

Brooker  
(358c) Copyist.

H.

6 H. Art'y.

U.S.C.T.

Henry, Harry  
Co. F, 2 Reg't Miss. Artillery.†

Appears on

Company Muster Roll

for Jan. 1 to Feb. 29, 1864.

Joined for duty and enrolled:

When Aug. 29, 1863.\*

Where Natchez, Miss.\*

Period 3 years.\*

Present or absent Present.

Stoppage, \$ 100 for

Due Gov't \$ 100 for

Valuation of horse, \$ 100

Valuation of horse equipments, \$ 100

Remarks:

† This organization subsequently became Co. F, 6 Reg't U. S. Colored Heavy Artillery.  
\* See enrollment on card from muster-in roll.

Book mark:

Brooks

(358c)

Copyist.

*J. Henry J. Harry*

*Art.*, Co. *P*, 5 Reg't U. S. Col'd H. Art'y.\*

Appears on

**Company Muster Roll**

for *Mar 1 to Apr. 30*, 1864.

Joined for duty and enrolled :

When *Aug. 29*, 1863.\*

Where *Natchez, Miss.* \*

Period *3* years.\*

Present or absent *Present.*

Stoppage, \$ *100* for

Due Gov't, \$ *100* for

Valuation of horse, \$ *100*

Valuation of horse equipments, \$ *100*

Remarks :

\* This organization subsequently became Co. *P*, 6 Reg't U. S. Col'd Heavy Artillery.

\* See enrollment on card from muster-in roll.

Book mark :

*Brooks,*

*Henry, Harry*  
*Priv.*, Co. F, 6 Reg't U. S. Col'd H. Art'y.

Appears on

**Company Muster Roll**  
for *May 1 to June 30*, 186*4*.

Joined for duty and enrolled:

When *Aug. 29*, 1863.\*

Where *Natchez Miss.*\*

Period *3* years.\*

Present or absent *Present*

Stoppage, \$ *100* for

Due Gov't \$ *100* for

Remarks:  
-----  
-----  
-----  
-----  
-----

\* See enrollment on card from muster-in roll.

Book mark: -----

*Brooks,*  
(358c) Copyist.

*H*

6 H. Art'y.

U.S.C.T.

*Harry Henry*

*Plt*, Co. F, 6 Reg't U. S. Col'd H. Art'y.

Appears on

**Company Muster Roll**

for *July & Aug*, 1864.

Joined for duty and enrolled:

When *Aug 29*, 1863.\*

Where *Natchez Miss*\*

Period *3* years.\*

Present or absent *Present*

Stoppage, \$ *100* for

Due Gov't \$ *100* for

Remarks:

-----  
-----  
-----  
-----  
-----

\* See enrollment on card from muster-in roll.

Book mark: -----

-----  
*S. Curran*  
-----

(358c)

Copyist.

*A*

6 H. Art'y. U.S.C.T.

*Harry Henry*  
*Priv* Co. F, 6 Reg't U. S. Cav'd H. Art'y.

Appears on

Company Muster Roll

for *Sept & Oct*, 186*4*.

Joined for duty and enrolled:

When *Aug 29*, 186*3*.\*

Where *Katchez Miss*.\*

Period *3* years.\*

Present or absent *Present*

Stoppage, \$ *100* for

Due Gov't \$ *100* for

Remarks:

-----  
-----  
-----  
-----  
-----

\* See enrollment on card from muster-in roll.

Book mark: -----

(358c)

*S. Duncan*

Copyist.

*A*

6 H. Art'y.

U.S.C.T.

*Harry Henry*  
*Plt*, Co. F, 6 Reg't U. S. Col'd H. Art'y.

Appears on

**Company Muster Roll**

for *Nov & Dec*, 1864.

Joined for duty and enrolled:

When *Aug 29*, 1863.\*

Where *Katchez Miss*\*

Period *3* years.\*

Present or absent *Present*

Stoppage, \$ *100* for

Due Gov't \$ *100* for

Remarks:  
\_\_\_\_\_  
\_\_\_\_\_  
\_\_\_\_\_  
\_\_\_\_\_  
\_\_\_\_\_

\* See enrollment on card from muster-in roll.

Book mark: \_\_\_\_\_

(358c)

*S. Duncan*  
Copyist.



*A*

*Harry Henry*

*Col*, Co. F, 6 Reg't U. S. Col'd H. Art'y.

Appears on

**Company Muster Roll**

for *Company & Feby*, 1865.

Joined for duty and enrolled:

When *Aug 29*, 1863.\*

Where *Katchez Miss* \*

Period *3* years.\*

Present or absent *Present*

Stoppage, \$ *100* for

Due Gov't \$ *100* for

Remarks:  
-----  
-----  
-----  
-----  
-----

\* See enrollment on card from muster-in roll.

Book mark: -----

(358c)

*S. Linnear*

Copyist.

*A*

6 H. Art'y.

U.S.C.T.

*Harry Henry*

*Priv*, Co. F, 6 Reg't U. S. Col'd H. Art'y.

Appears on

**Company Muster Roll**

for *Mich & apl*, 186*5*.

Joined for duty and enrolled:

When *Aug 29*, 186*3*.\*

Where *Katchez Miss* \*

Period *3* years.\*

Present or absent *Present*

Stoppage, \$ *100* for \_\_\_\_\_

Due Gov't \$ *100* for \_\_\_\_\_

Remarks: \_\_\_\_\_  
\_\_\_\_\_  
\_\_\_\_\_  
\_\_\_\_\_  
\_\_\_\_\_  
\_\_\_\_\_

\* See enrollment on card from muster-in roll.

Book mark: \_\_\_\_\_

(358c)

*S. Curran*

Copyist.

*A* | *6 H. Arty* **U.S.C.T.**

*Harry Henry*  
*Priv, Co. B, 6 Reg't U. S. Col'd H. Arty*

Appears on

**Company Muster Roll**

for *May & June*, 1865.

Joined for duty and enrolled:

When *Aug 29*, 1863.\*

Where *Natchez Miss*\*

Period *3* years.\*

Present or absent *Present*

Stoppage, \$ *100* for

Due Gov't, \$ *100* for

Valuation of horse, \$ *100*

Valuation of horse equipments, \$ *100*

Remarks: \_\_\_\_\_

\_\_\_\_\_

\_\_\_\_\_

\* See enrollment on card from muster-in roll.

Book mark: \_\_\_\_\_

\_\_\_\_\_

*S. Curran*  
Copyist.

Harry Henry  
Co. F, 6 Reg't U. S. Col'd H. Art'y.

Appears on

Company Muster Roll

for July & Aug., 1865.

Joined for duty and enrolled:

When Aug. 29<sup>th</sup>, 1863.\*

Where Natchez Miss. \*

Period 3 years.\*

Present or absent Present

Stoppage, \$ 100 for

Due Gov't \$ 100 for

Remarks:

\* See enrollment on card from muster-in roll.

Book mark:

J. W. Thomas  
(358c) Copyist.

*H*

*Harry Henry*

*Co. F*, Co. F, 6 Reg't U. S. Col'd H. Art'y.

Appears on

Company Muster Roll

for *Sept + Oct*, 186 *3*.

Joined for duty and enrolled:

When *Aug 29<sup>th</sup>*, 186 *3*.\*

Where *Natchez Miss*, \*

Period *3* years.\*

Present or absent *Present*

Stoppage, \$ *100* for

Due Gov't \$ *100* for

Remarks:

-----  
-----  
-----  
-----  
-----

\* See enrollment on card from muster-in roll.

Book mark:

*J. W. Jones*

(358c)

Copyist.

H

6 H. Art'y.

U.S.C.T.

Harry Henry

Pvt., Co. F, 6 Reg't U. S. Col'd H. Art'y.

Appears on

Company Muster Roll

for Nov. & Dec., 1863

Joined for duty and enrolled:

When Aug. 29, 1863\*

Where Hatchez Mill's \*

Period 3 years.\*

Present or absent Present

Stoppage, \$ 100 for

Due Gov't \$ 100 for

Remarks:

\* See enrollment on card from muster-in roll.

Book mark:

(358c)

J. J. Jones

Copyist.

*Harry Henry*  
Pvt., Co. F, 6 Reg't U. S. Col'd H. Art'y.

Appears on

**Company Muster Roll**

for *January + February*, 186*8*.

Joined for duty and enrolled:

When *Aug. 29*, 186*8*\*

Where *Natchez Miss.*\*

Period *3* years.\*

Present or absent *Present*

Stoppage, \$ *100* for

Due Gov't, \$ *100* for

Valuation of horse, \$ *100*

Valuation of horse equipments, \$ *100*

Remarks: \_\_\_\_\_

\_\_\_\_\_

\_\_\_\_\_

\_\_\_\_\_

\* See enrollment on card from muster-in roll.

Book mark: \_\_\_\_\_

\_\_\_\_\_

*J. W. Ames*  
(358c) Copyist.

*Harry Henry*  
*Pr*, Co. F, 6 Reg't U. S. Col'd H. Art'y.

Appears on

**Company Muster Roll**  
for *March + April*, 186*6*.

Joined for duty and enrolled:

When *Aug. 29<sup>th</sup>*, 186*3*.\*

Where *Hatchez Miss.* \*

Period *3* years.\*

Present or absent *Present*

Stoppage, \$ *100* for \_\_\_\_\_

Due Gov't \$ *100* for \_\_\_\_\_

Remarks: \_\_\_\_\_  
\_\_\_\_\_  
\_\_\_\_\_  
\_\_\_\_\_  
\_\_\_\_\_

\* See enrollment on card from muster-in roll.

Book mark: \_\_\_\_\_

(358c) *J. S. Jones* Copyist.



<sup>x</sup>  
Henry Harry  
Pot., Co. F, 6 Reg't U. S. Col'd H. Art'y.

Appears on Returns as follows:

No 1863 (2 Miss H  
Art A D), Deserted  
No 11, 63 Natchez  
Miss  
Jan 1864 Gain Jan  
5, Natchez Ret'd  
from desertion  
Sept 1865, 6 US Col'd  
H Art), Absent  
sick in Post  
Hosp since  
Sept 20, 65

<sup>x</sup>  
Name appears also as  
Harry Henry

Book mark:

(546) *A. Gouglal* Copyist.

*Henry Kenney*  
.....  
*Pvt. Co. F*, 6 Reg't U. S. Col'd H. Art'y.

Appears on **Co. Muster-out Roll**, dated  
*Natchez Miss, May 13*, 1866.

Muster-out to date *May 13*, 1866.

Last paid to *Dec 31*, 1865.

**Clothing account:**

Last settled....., 186 ; drawn since \$..... 100

Due soldier \$ *38 97* 100; due U. S. \$..... 100

Am't for cloth'g in kind or money adv'd \$..... 100

Due U. S. for arms, equipments, &c., \$..... 100

Bounty paid \$..... 100; due \$..... 100

Remarks: *Joined at original*  
*organization*

Book mark: .....

*J. J. Brown*  
.....  
Copyist.

Henry John  
Co D, 6 U.S. Col'd H. Art'y.

Private Private

CARD NUMBERS.

1	6157864	26
2	6158008	27
3	6158150	28
4	6158271	29
5	6158397	30
6	6158537	31
7	6158667	32
8	6158789	33
9	6158911	34
10	6159042	35
11	6159185	36
12	6159329	37
13	6159470	38
14	6159607	39
15	6159736	40
16	6159859	41
17	6159980	42
18	6160101	43
19	9119127	44
20	40742492	45
21		46
22		47
23		48
24		49
25		50

Book Mark:

See also



193

Henry John

Co D, 6 U.S. Col'd H. Art'y.

Private Private

CARD NUMBERS.

1	6157864	26
2	6158008	27
3	6158150	28
4	6158271	29
5	6158397	30
6	6158537	31
7	6158667	32
8	6158789	33
9	6158911	34
10	6159042	35
11	6159185	36
12	6159329	37
13	6159470	38
14	6159607	39
15	6159736	40
16	6159859	41
17	6159980	42
18	6160101	43
19	9119127	44
20	40742492	45
21		46
22		47
23		48
24		49
25		50

Book Mark:

See also

Rep 427084.

Rep 433692

S. 1378502 P.O. return

S. 1382700. P.O. return

*H. H. Gandy*

*John Henry*  
....., Co. *B*, 6 Reg't U. S. Col'd H. Art'y.

Appears on

**Company Descriptive Book**  
of the organization named above.

**DESCRIPTION.**

Age *20* years; height *5* feet *5 1/2* inches.

Complexion *Black*

Eyes *Black*; hair *Black*

Where born *Baltimore Md*

Occupation *Farmer*

**ENLISTMENT.**

When *Sept 1*....., 1863.

Where *Nashon Mass*

By whom *Capt Hopkins*; term *3* y'rs.

Remarks: .....

.....  
*J. J. Hill*  
Coppist.

*A*

6 H. Art'y. U.S.C.T.

*John Henry*  
Private, Co. B, 2 Reg't Miss. Art'y. †

Age *25* years.

Appears on

**Company Muster-in Roll**

of the organization named above. Roll dated

*Natchez, Miss. Sept. 12, 1863.*

Muster-in to date

*Sept. 12, 1863.*

Joined for duty and enrolled:

When *Sept. 1st*, 1863.\*

Where *Natchez, Miss.* \*

Period *3* years.\*

Valuation of horse, \$ ..... 100

Valuation of horse equipments, \$ ..... 100

Remarks:

† This organization subsequently became Co. *B*, 6 Reg't U. S. Colored Heavy Artillery.

\* Muster-in roll shows enrollment of all men of this company as of same date and place. See enrollment on subsequent card or cards.

Book mark:

*W. M. Johnson*

(356c)

Copyist.



*John Henry*  
*Private*, Co. B, 2 Reg't Miss. Art'y.†

Appears on

**Company Muster Roll**  
for *Sept. 12 to Oct. 31*, 186*3*.

Joined for duty and enrolled:

When *Sept. 1st*, 186*3*.\*

Where *Hatchez, Miss.* \*

Period *3* years.\*

Present or absent *Present*

Stoppage, \$ *100* for

Due Gov't, \$ *100* for

Valuation of horse, \$ *100*

Valuation of horse equipments, \$ *100*

Remarks: .....

† This organization subsequently became Co. B, 6 Reg't U. S. Co'd Heavy Artillery.  
\* See enrollment on card from muster-in roll.

Book mark: .....

*W. W. Warren*

*John Henry*  
Private, Co. B, 2 Reg't Miss. Art'y.†

Appears on

**Company Muster Roll**

for *Nov. & Dec.*, 1863.

Joined for duty and enrolled:

When *Sept. 1st*, 1863.\*

Where *Hatchez, Miss.* \*

Period *3* years.\*

Present or absent *Present*

Stoppage, \$ *100* for

Due Gov't, \$ *100* for

Valuation of horse, \$ *100*

Valuation of horse equipments, \$ *100*

Remarks:

† This organization subsequently became Co. B, 6 Reg't U. S. Co'd Heavy Artillery.  
\* See enrollment on card from muster-in roll.

Book mark:

*M. M. Shallen*

*Sh.*

6 H. Art'y.

U.S.C.T.

*John Henry*

*Private*, Co. B, ~~6 Reg't U. S. Col'd H. Art'y.~~ **2 Reg't Miss. Art'y** \*

Appears on

**Company Muster Roll**

for *Jam'y V. Kelly* 1864.

Joined for duty and enrolled:

When *Sept. 1st*, 1863.\*

Where *Shatchez, Miss.*\*

Period *3* years.\*

Present or absent *Present*

Stoppage, \$ *100* for

Due Gov't, \$ *100* for

Remarks:

\* This organization subsequently became Co. B, 6 Reg't U. S. Col'd H. Art'y.

\* See enrollment on card from muster-in roll.

\* corrected. Mar. 19/95. Summ.

Book-mark :

*M. M. Hasse*

*John Hurry*  
Private, Co. B, 5 Reg't U. S. Col'd H. Art'y.\*

Appears on

**Company Muster Roll**

for *Mar. & April*, 1864.

Joined for duty and enrolled:

When *Sept 1st*, 1863.\*

Where *Shatchez, Miss.*\*

Period *3* years.\*

Present or absent *Present*

Stoppage, \$ *100* for

Due Gov't, \$ *100* for

Valuation of horse, \$ *100*

Valuation of horse equipments, \$ *100*

Remarks: \_\_\_\_\_

\_\_\_\_\_

\_\_\_\_\_

\_\_\_\_\_

\* This organization subsequently became Co. B, 6 Reg't U. S. Col'd Heavy Artillery.

\* See enrollment on card from muster-in roll.

Book mark: \_\_\_\_\_

*M. M. Harnum*

*A*

6 H. Art'y.

U.S.C.T.

*John Henry*

*Private*, Co. B, 6 Reg't U. S. Col'd H. Art'y.

Appears on

**Company Muster Roll**

for *May & June* 1864.

Joined for duty and enrolled:

When *Sept. 1st*, 1863.\*

Where *Statches, Miss.* \*

Period *3* years.\*

Present or absent *Present*

Stoppage, \$ *100* for

Due Gov't, \$ *100* for

Remarks:

-----  
-----  
-----  
-----  
-----  
-----  
-----  
-----

\* See enrollment on card from muster-in roll.

Book-mark:

-----

*M. M. Harmon*

(358c)

Copyist.

H.

6 H. Art'y.

U.S.C.T.

*John Henry*

*Priv.*, Co. B, 6 Reg't U. S. Col'd H. Art'y.

Appears on

**Company Muster Roll**

for *July & Aug.* 1864.

Joined for duty and enrolled:

When *Sept. 1<sup>st</sup>*, 1863.\*

Where *Natchez Miss.* \*

Period *3* years.\*

Present or absent

Stoppage, \$ *100* for

Due Gov't, \$ *100* for

Remarks:

.....  
.....  
.....  
.....  
.....  
.....

\* See enrollment on card from muster-in roll.

Book-mark : .....

(358c)

*H. C. Thomas*

Copyist.

H.

6 H. Art'y.

U.S.C.T.

*John Henry*

*Priv.*, Co. B, 6 Reg't U. S. Col'd H. Art'y.

Appears on

**Company Muster Roll**

for *Sept. & Oct.* 1864.

Joined for duty and enrolled:

When *Sept. 1<sup>st</sup>*, 1863.\*

Where *Natchez Miss.* \*

Period *3* years.\*

Present or absent *Present.*

Stoppage, \$ *100* for

Due Gov't, \$ *100* for

Remarks:

-----  
-----  
-----  
-----  
-----  
-----  
-----  
-----

\* See enrollment on card from muster-in roll.

Book-mark:

-----

*H. C. Thomas*

(358c)

Copyist.

H.

6 H. Art'y.

U.S.C.T.

*John Henry*

*Ser't*, Co. B, 6 Reg't U. S. Col'd H. Art'y.

Appears on

**Company Muster Roll**

for *Nov. & Dec.* 1864.

Joined for duty and enrolled:

When *Sept. 1<sup>st</sup>*, 1863.\*

Where *Natchez Miss.* \*

Period *3* years.\*

Present or absent *Present.*

Stoppage, \$ *100* for

Due Gov't, \$ *100* for

Remarks:

\*~~See~~ See enrollment on card from muster-in roll.

Book-mark:

*H. C. Thomas*

(358c)

Copyist.



H.

6 H. Art'y.

U.S.C.T.

*John Henry.*

*Privt.*, Co. B, 6 Reg't U. S. Col'd H. Art'y.

Appears on

**Company Muster Roll**

for *Jan'y, & Feby.* 1865.

Joined for duty and enrolled:

When *Sept. 1<sup>st</sup>*, 1863.\*

Where *Natchez Miss.*\*

Period *3* years.\*

Present or absent *Present.*

Stoppage, \$ *100* for

Due Gov't, \$ *100* for

Remarks:

\*~~See~~ See enrollment on card from muster-in roll.

Book-mark :

(358c)

*H. C. Thomas.*

Copyist.

H.

6 H. Art'y.

U.S.C.T.

*John Henry*

*Serv.*, Co. B, 6 Reg't U. S. Col'd H. Art'y.

Appears on

**Company Muster Roll**

for *Mar. & April* 1865.

Joined for duty and enrolled:

When *Sept. 1*, 1863.\*

Where *Natchez Miss.*\*

Period *3* years.\*

Present or absent *Present*.

Stoppage, \$ *100* for

Due Gov't, \$ *100* for

Remarks:

-----  
-----  
-----  
-----  
-----  
-----  
-----  
-----

\* See enrollment on card from muster-in roll.

Book-mark:

*H. C. Thomas*

(358c)

Copyist.

*John Henry.*  
*Privt., Co. B., 6<sup>th</sup> Reg't U. S. Col'd Ho. Arty.*

Appears on

**Company Muster Roll**

for *May & June*, 1865.

Joined for duty and enrolled:

When *Sept. 1<sup>st</sup>*, 1863.\*

Where *Natchez Miss.*\*

Period *3* years.\*

Present or absent *Present.*

Stoppage, \$ *100* for

Due Gov't, \$ *100* for

Remarks:

\* See enrollment on card from muster-in roll.

Book mark:

*H. C. Thomas.*

*H*

6 H. Art'y.

U.S.C.T.

*John Henry*

*Priv.*, Co. B, 6 Reg't U. S. Col'd H. Art'y.

Appears on

**Company Muster Roll**

for *July & Aug* 1865.

Joined for duty and enrolled:

When *Sept 1*, 1865.\*

Where *Atchafalaya, Miss.*\*

Period *3* years.\*

Present or absent *Present*

Stoppage, \$ *100* for

Due Gov't, \$ *100* for

Remarks:

-----  
-----  
-----  
-----  
-----  
-----  
-----

\* See enrollment on card from muster-in roll.

Book-mark:

-----

(358c)

*Sabine*  
Copyist.

*H*

6 H. Art'y.

U.S.C.T.

*John Henry*

*Cpt.*, Co. B, 6 Reg't U. S. Col'd H. Art'y.

Appears on

**Company Muster Roll**

for *Sep\* Oct* 1865.

Joined for duty and enrolled:

When *Sep*, 1865.\*

Where *Natchez Miss.* \*

Period *3* years.\*

Present or absent *Present.*

Stoppage, \$ *100* for

Due Gov't, \$ *100* for

Remarks:

\* See enrollment on card from muster-in roll.

Book-mark :

(358c)

*Sabine*  
Copyist.

*H*

6 H. Art'y.

U.S.C.T.

*John Henry*

*Co.*, Co. B, 6 Reg't U. S. Col'd H. Art'y.

Appears on

**Company Muster Roll**

for *Nov Dec* 1865.

Joined for duty and enrolled:

When *Sep. 1*, 1865.\*

Where *Natchez, Miss.*\*

Period *3* years.\*

Present or absent *Present*

Stoppage, \$ *100* for

Due Gov't, \$ *100* for

Remarks:

-----  
-----  
-----  
-----  
-----  
-----  
-----

\* See enrollment on card from muster-in roll.

Book-mark: -----

(358c)

*Chasine*  
Copyist.

*3*

6 H. Art'y.

U.S.C.T.

*John Henry*

*Cpt.*, Co. B, 6 Reg't U. S. Col'd H. Art'y.

Appears on

**Company Muster Roll**

for *Jan & Feb* 1866.

Joined for duty and enrolled:

When *Sep. 1*, 1865.\*

Where *Natchez, Miss.*\*

Period *3* years.\*

Present or absent *Present.*

Stoppage, \$ *100* for

Due Gov't, \$ *100* for

Remarks:

.....  
.....  
.....  
.....  
.....  
.....  
.....

\*See enrollment on card from muster-in roll.

Book-mark :

(358c)

*Sabine*  
Copyist.

*H*

6 H. Art'y,

U.S.C.T.

*John Henry*

*Prk*, Co. B, 6 Reg't U. S. Col'd H. Art'y.

Appears on

**Company Muster Roll**

for *Mar & Apr* 1866.

Joined for duty and enrolled:

When *Sept* " , 1863.\*

Where *Natchez Miss* \*

Period *3* years.\*

Present or absent *present*

Stoppage, \$ *100* for

Due Gov't, \$ *100* for

Remarks: \_\_\_\_\_  
\_\_\_\_\_  
\_\_\_\_\_  
\_\_\_\_\_  
\_\_\_\_\_  
\_\_\_\_\_

\* See enrollment on card from muster-in roll.

Book-mark : \_\_\_\_\_

*J. H. Hill*



A

6 H. Art'y.

U.S.C.T.

John Henry  
Pvt, Co. ...., 6 Reg't U. S. Col'd H. Art'y.

Appears on Returns as follows:

Mar 1864 Co G 5 U S  
Col'd H A  
Deserted from  
Camp Watauga  
Miss. Mar 20/64

Book mark :

(546)

A. Gouglad

Copyist.

H

6 H. Art'y.

U.S.C.T.

*John Henry*  
Pvt., Co. B., 6 Reg't U. S. Col'd H. Art'y.

Appears on **Co. Muster-out Roll**, dated  
*Natchez Miss, May 13, 1866.*

Muster-out to date *May 13, 1866.*

Last paid to *Dec. 31, 1865.*

**Clothing account:**

Last settled....., 186 ; drawn since \$..... 100

Due soldier \$..... 100; due U. S. \$..... 3 67

Am't for cloth'g in kind or money adv'd \$..... 100

Due U. S. for arms, equipments, &c., \$..... 100

Bounty paid \$..... 100; due \$..... 100

Remarks: *Joined at Original  
Organization.*

Book mark: .....

(361)

*J. E. Nichol* Copyist.

Henry John

Co G, 6 U.S. Col'd H. Art'y.

Private Private

CARD NUMBERS.

1	6169368	26
2	6169520	27
3	6169663	28
4	6169807	29
5	6170010	30
6	6154846	31
7	6171437	32
8	9120066	33
9	9120239	34
10		35
11		36
12		37
13		38
14		39
15		40
16		41
17		42
18		43
19		44
20		45
21		46
22		47
23		48
24		49
25		50

Book Mark:

See also

*John Henry*

....., Co. *D*, 6 Reg't U. S. Col'd H. Art'y.

Appears on

**Company Descriptive Book**

of the organization named above.

**DESCRIPTION.**

Age *33* years; height *5* feet *6* inches.

Complexion *Blk*

Eyes *Blk*; hair *Blk*

Where born *Salifax Co., Va.*

Occupation *Farmer*

**ENLISTMENT.**

When *Sept 20*, 186*3*.

Where *Natchez Miss.*

By whom *W. Smith*; term *3* y'rs.

Remarks: *Resested from Natchez Miss. Mar 20/64*

*Warren*

*H* | **6 H. Art'y.** | **U.S.C.T.**

*John Henry*

....., Co. *G*, 6 Reg't U. S. Col'd H. Art'y.

Appears on

**Company Descriptive Book**

of the organization named above.

**DESCRIPTION.**

Age *33* years; height *5* feet *6* inches.

Complexion *Blk*

Eyes *Blk*; hair *Blk*

Where born *Halifax Co Va.*

Occupation *Farmer*

**ENLISTMENT.**

When *Sept 20*, 186*3*.

Where *Natchez Miss.*

By whom *W Smith*; term *3* y'rs.

Remarks: *Deserted Mch 20/64  
at Natchez Miss.*

*Harmon*

7

6 II. Art'y.

U.S.C.T.

*John Henry*

*Out*, Co. G, 2 Reg't Miss. Art'y.\*

Age *33* years.

Appears on

**Company Muster-in Roll**

of the organization named above. Roll dated

*Katcher, Miss Oct 20*, 1863.

Muster-in to date

*Oct 20*, 1863.

Joined for duty and enrolled:

When *Sept 20*, 1863.

Where *Katcher, Miss*.

Period *3* years.

Valuation of horse, \$ *100*

Valuation of horse equipments, \$ *100*

Remarks:

\* This organization subsequently became Co. G, 6 Reg't U. S. Colored Heavy Artillery.

Book mark:

*J. A. Ward*

(356)

Copyist.

*John Henry*

*Privat*, Co. G, 2 Reg't Miss. Art'y.\*

Appears on

**Company Muster Roll**

for *Oct 20 to 31*, 1863.

Present or absent *Present*

Stoppage, \$ *100* for

Due Gov't, \$ *100* for

Valuation of horse, \$ *100*

Valuation of horse equipments, \$ *100*

Remarks:

\* This organization subsequently became Co. G, 6 Reg't U. S. Colored Heavy Artillery.

Book mark:

*O. A. Ward*

*John Henry*  
*1st*, Co. G, 2 Reg't Miss. Art'y.\*

Appears on

**Company Muster Roll**

for *Nov & Dec*, 1863.

Present or absent *Present*

Stoppage, \$ *100* for

Due Gov't, \$ *100* for

Valuation of horse, \$ *100*

Valuation of horse equipments, \$ *100*

Remarks:

-----  
-----  
-----  
-----  
-----  
-----

\* This organization subsequently became Co. G, 6 Reg't U. S. Colored Heavy Artillery.

Book mark: -----

*O. A. Ward*



A

6 H. Art'y.

U.S.C.T.

John Henry  
Port

Co. G, 2 Reg't Miss. Art'y.\*

Appears on

Company Muster Roll

for Jan & Feb, 1864.

Present or absent Present

Stoppage, \$ 100 for

Due Gov't, \$ 100 for

Valuation of horse, \$ 100

Valuation of horse equipments, \$ 100

Remarks:

\* This organization subsequently became Co. G, 6 Reg't U. S. Colored Heavy Artillery.

Book mark:

L. J. Spann

(358)

Copyist.

A

6 H. Art'y.

U.S.C.T.

John Henry  
Port, Co. G, 5 Reg't U. S. Col'd H. Art'y.\*

Appears on

**Company Muster Roll**

for March & Apr, 186 4

Present or absent.....

Stoppage, \$.....100 for .....

Due Gov't, \$.....100 for .....

Valuation of horse, \$.....100

Valuation of horse equipments, \$.....100

Remarks: Deserted from  
March Miss  
March 20"/64

\* This organization subsequently became Co. G, 6 Reg't U. S. Col'd Heavy Artillery.

Book mark: .....

L. Y. Sparr

(358)

Copyist.

*John Henry*  
*Pvt*, Co. *G*, *5* Reg't U. S. Col'd *Arty*

Appears on

**Descriptive List of Deserters**

dated *April 6*, 1864.

Deserted:

When *March 20*, 1864.

Where *Natchez Miss*

Arrested:

When \_\_\_\_\_, 186 .

Where \_\_\_\_\_

Remarks: \_\_\_\_\_

\_\_\_\_\_

\_\_\_\_\_

\_\_\_\_\_

\* *Became le.*

Book mark: \_\_\_\_\_

*R. S. Shelton*

*John Henry*  
Pvt, Co. G, 6 Reg't U. S. Col'd H. Art'y.

Appears on **Co. Muster-out Roll**, dated  
*Natchez, Miss, May 13, 1866*.

Muster-out to date \_\_\_\_\_, 186 .

Last paid to *Dec 31*, 1863 .

**Clothing account:**

Last settled *Sep 20, 1863*; drawn since \$ *51* <sup>*45*</sup>/<sub>*100*</sub>

Due soldier \$ 100; due U. S. \$ 100

Am't for cloth'g in kind or money adv'd \$ 100

Due U. S. for arms, equipments, &c., \$ 100

Bounty paid \$ 100; due \$ 100

Remarks: *Joined at original organization. Deserted Mch 20/64 at Natchez, Miss.*

Book mark:

*W. O. Chance*

995

Henry, William

Co., 6 U.S. Col'd H. Art'y.

Private

CARD NUMBERS.

1	26
2	27
3	28
4	29
5	30
6	31
7	32
8	33
9	34
10	35
11	36
12	37
13	38
14	39
15	40
16	41
17	42
18	43
19	44
20	45
21	46
22	47
23	48
24	49
25	50

see Henderson, William

Book Mark:

See also

196  
Nensy, George

Co E, 6 U.S. Col'd H. Art'y.

Private Private

CARD NUMBERS.

1	6165210	26
2	6165346	27
3	6165488	28
4	6165612	29
5	6165728	30
6	6165841	31
7	6165952	32
8	6166059	33
9	6166171	34
10	6166281	35
11	6166391	36
12	6166499	37
12	6166602	38
14	6166704	39
15	6166799	40
16	6166891	41
17	6166980	42
18	6167070	43
19	9119754	44
20		45
21		46
22		47
23		48
24		49
25		50

Book Mark:

See also

*e 4*

6 H. Art'y.

U.S.C.T.

*George Hancy*

Co. *E*, 6 Reg't U. S. Col'd H. Art'y.

Appears on

**Company Descriptive Book**

of the organization named above.

**DESCRIPTION.**

Age *18* years; height *5* feet *1* inches.

Complexion *Blk*

Eyes *blk*; hair *Blk*

Where born *Jefferson Co, Miss.*

Occupation *Farmer*

**ENLISTMENT.**

When *Sept 1*, 186*3*.

Where *Natchez Miss*

By whom *W. Wickman*; term *3* y'rs.

Remarks:

.....  
.....  
.....  
.....  
.....  
.....  
.....  
.....

*W. Wickman*

*H* | 6 H. Art'y. | U.S.C.T.

*George Henry*  
Pot, Co. *E*, 2 Reg't Miss. Art'y.†

Age \* years.

Appears on

**Company Muster-in Roll**

of the organization named above. Roll dated

*Natchez Miss Sep 12, 1863.*

Muster-in to date *Sep 12, 1863.*

Joined for duty and enrolled:

When *Sept 1, 1863.\**

Where *Natchez Miss \**

Period *3* years.\*

Valuation of horse, \$ 100

Valuation of horse equipments, \$ 100

Remarks:

*\* Roll torn*

† This organization subsequently became Co. *E* 6 Reg't U. S. Colored Heavy Artillery.

\*† Muster-in roll shows enrollment of all men of this company as of same date and place. See enrollment on subsequent card or cards.

Book mark:

*Hadfield*

(356c)

Copyist.



*H*

6 H. Art'y.

U.S.C.T.

*George Henry*

*Port*, Co. E, 2 Reg't Miss. Art'y.†

Appears on

**Company Muster Roll**

for *Sept Oct*, 1863.

Joined for duty and enrolled:

When *Sept 1*, 1863.\*

Where *Natchez Miss* \*

Period *3* years.\*

Present or absent *Present*

Stoppage, \$ *100* for

Due Gov't, \$ *100* for

Remarks:

† This organization subsequently became Co. E, 6 Reg't U. S. Colored Heavy Artillery.

\* See enrollment on card from muster-in roll.

Book mark:

*Hadfield*

(358c)

Copyist.

*H*

6 H. Art'y. U.S.C.T.

*George Henry*  
Pvt, Co E, 2 Reg't Miss. Art'y.†

Appears on

**Company Muster Roll**

for *Nov & Dec*, 1863.

Joined for duty and enrolled:

When *Sept 1*, 1863.\*

Where *Watches Miss*\*

Period *3* years.\*

Present or absent *Present*

Stoppage, \$ *100* for

Due Gov't, \$ *100* for

Remarks:

† This organization subsequently became Co. E, 6 Reg't U. S. Colored Heavy Artillery.

\* See enrollment on card from muster-in roll.

Book mark:

*Hadfield*

(358c)

Copyist.

*H*

6 H. Art'y.

U.S.C.T.

*George Henry*

*Pvt*

Co. E, 2 Reg't Miss. Art'y.†

Appears on

**Company Muster Roll**

for

*Jan & Feb*

, 1864

Joined for duty and enrolled:

When

*Sept 1*

, 1863.\*

Where

*Watches Miss*

\*

Period

*3*

years.\*

Present or absent

*Present*

Stoppage, \$

100 for

Due Gov't, \$

100 for

Remarks:

† This organization subsequently became Co. E, 6 Reg't U. S. Colored Heavy Artillery.

\* See enrollment on card from muster-in roll.

Book mark:

*Hadfield*

(358c)

Copyst.

*H.* | **6 H. Art'y.** | **U.S.C.T.**

*George Henry*  
*Priv.*, Co. *E*, 5 Reg't U. S. Col'd H. Art'y.†

Appears on

**Company Muster Roll**

for *Mar & Apr*, 1864.

Joined for duty and enrolled:

When *Sept 1*, 1863.\*

Where *Katchez miss* \*

Period *3* years.\*

Present or absent *Present*

Stoppage, \$ *100* for

Due Gov't \$ *100* for

Valuation of horse, \$ *100*

Valuation of horse equipments, *100*

Remarks:

†This organization subsequently became Co. *E*, 6 Reg't U. S. Colored Heavy Artillery.

\* See enrollment on card from muster-in roll.

Book mark:

(358c)

*Hadfield*

Copyist.

H

6 H. Art'y.

U.S.C.T.

George Honey

Pvt., Co. E, 6 Reg't U. S. Col'd H. Art'y.

Appears on

Company Muster Roll

for May & June 1864.

Joined for duty and enrolled:

When Sept 1, 1863.\*

Where Hatchers Mills \*

Period 3 years.\*

Present or absent Present

Stoppage, \$ 100 for

Due Gov't, \$ 100 for

Remarks:

[Empty lines for remarks]

\* See enrollment on card from muster-in roll.

Book-mark:

[Empty line for book-mark]

(358c)

Hadfield Copyist.

A

6 H. Art'y.

U.S.C.T.

George Henry

Privat., Co. E, 6 Reg't U. S. Col'd H. Art'y.

Appears on

Company Muster Roll

for July Aug, 1864.

Joined for duty and enrolled:

When Sept 1", 1863.\*

Where Natchez Miss.\*

Period 3 years.\*

Present or absent present.

Stoppage, \$ 100 for

Due Gov't, \$ 100 for

Remarks:

[Empty lines for remarks]

\* See enrollment on card from muster-in roll.

Book-mark :

(358c)

C. M. Lowe

Copist.

N

6 H. Art'y.

U.S.C.T.

George Henry

Privat, Co. E, 6 Reg't U. S. Col'd H. Art'y.

Appears on

Company Muster Roll

for Sept & Oct, 1864.

Joined for duty and enrolled:

When Sept. 1, 1863.\*

Where Watchez Mills \*

Period 3 years.\*

Present or absent present,

Stoppage, \$ 100 for

Due Gov't, \$ 100 for

Remarks:

\* See enrollment on card from muster-in roll.

Book-mark:

Copyist

(358c)

Copyist.

*H*

6 H. Art'y.

U.S.C.T.

*George Henry*

*Must*, Co. E, 6 Reg't U. S. Col'd H. Art'y.

Appears on

**Company Muster Roll**

for *Nov & Dec* 186*4*.

Joined for duty and enrolled:

When *Sept 1'*, 186*3*.\*

Where *Watches Hill* \*

Period *3* years.\*

Present or absent *present*

Stoppage, \$ *100* for

Due Gov't, \$ *100* for

Remarks:

\*See enrollment on card from muster-in roll.

Book-mark :

(358c)

*C. M. Howe*

Copyist.



A

6 H. Art'y.

U.S.C.T.

*George Henry*  
Must, Co. E, 6 Reg't U. S. Col'd H. Art'y.

Appears on

**Company Muster Roll**

for *June & Feb,* 186*5*.

Joined for duty and enrolled:

When *Sept 1<sup>st</sup>*, 186*3*.\*

Where *Natchez Miss* \*

Period *3* years.\*

Present or absent *Present*.

Stoppage, \$ *100* for

Due Gov't, \$ *100* for

Remarks: *Due U.S. for Card 20 cents,*

\*See enrollment on card from muster-in roll.

Book-mark :

*C. M. Howard*

(358c)

Copyist.

A

6 H. Art'y.

U.S.C.T.

*George Henry*

*Pvt.*, Co. E, 6 Reg't U. S. Col'd H. Art'y.

Appears on

**Company Muster Roll**

for *March & April* 1865.

Joined for duty and enrolled:

When *Sept. 1'*, 1865.\*

Where *Natchez Miss* \*

Period *3* years.\*

Present or absent *present.*

Stoppage, \$ *100* for

Due Gov't, \$ *100* for

Remarks:

-----  
-----  
-----  
-----  
-----  
-----  
-----  
-----

\* See enrollment on card from muster-in roll.

Book-mark :

-----

(358c)

*M. R. C.*

Copyist.

A

6 H. Art'y.

U.S.C.T.

George Henry

Privt., Co. E, 6 Reg't U. S. Col'd H. Art'y.

Appears on

Company Muster Roll

for May & June 1865.

Joined for duty and enrolled:

When Sept. 1<sup>st</sup>, 1863.\*

Where Drutcher Mills \*

Period 3 years.\*

Present or absent private

Stoppage, \$ 100 for

Due Gov't, \$ 100 for

Remarks:

\* See enrollment on card from muster-in roll.

Book-mark:

*G. M. Moore*

(358c)

Copyist.

H.

6 H. Art'y.

U.S.C.T.

George Henry

Pvt., Co. E, 6 Reg't U. S. Col'd H. Art'y.

Appears on

Company Muster Roll

for July and Aug. 1865.

Joined for duty and enrolled:

When Sept 1, 1863.\*

Where Hatchery, Miss.\*

Period 3 years.\*

Present or absent present.

Stoppage, \$ 100 for

Due Gov't, \$ 100 for

Remarks:

\*Corrected by H. H. Gardner

\*See enrollment on card from muster-in roll.

Book-mark:

Amey Webb

(358c)

Copyist.

H. | 6 H. Art'y. | U.S.C.T.

George Henry,  
Det, Co. E, 6 Reg't U. S. Col'd H. Art'y.

Appears on

Company Muster Roll  
for Sept. and Oct. 1865.

Joined for duty and enrolled:

When Sept. 1, 1863.\*

Where Hatchez, Miss.\*

Period 3 years.\*

Present or absent present.

Stoppage, \$ 100 for

Due Gov't, \$ 100 for

Remarks:

\* Corrected by H. H. Cordes

\* See enrollment on card from muster-in roll.

Book-mark :

D. W. Webb.  
Copyist.

(358c)

H

6 H. Art'y.

U.S.C.T.

George Henry

Prst, Co. E, 6 Reg't U. S. Col'd H. Art'y.

Appears on

Company Muster Roll

for Nov + Dec 1865.

Joined for duty and enrolled:

When Sept 1, 1863.\*

Where Hatcheg, Miss\*

Period 3 years.\*

Present or absent Present

Stoppage, \$ 100 for

Due Gov't, \$ 100 for

Remarks:

\* See enrollment on card from muster-in roll.

Book-mark

Wobler

H

6 H. Art'y.

U.S.C.T.

George Henry

Pvt

, Co. E, 6 Reg't U. S. Col'd H. Art'y.

Appears on

Company Muster Roll

for Jan & Feb 1866.

Joined for duty and enrolled:

When Sept 1, 1863.\*

Where Ketches. Mass. \*

Period 3 years.\*

Present or absent Present

Stoppage, \$ 100 for

Due Gov't, \$ 100 for

Remarks:

\* See enrollment on card from muster-in roll.

Book-mark:

Wobbe

H

6 H. Art'y.

U.S.C.T.

George Hensy

Pvt., Co. E, 6 Reg't U. S. Col'd H. Art'y.

Appears on

Company Muster Roll

for Mehsapi 1866.

Joined for duty and enrolled:

When Sept 1, 1863.\*

Where Statches, Miss

Period 3 years.\*

Present or absent Absent

Stoppage, \$ 100 for

Due Gov't, \$ 100 for

Remarks:

\*See enrollment on card from muster-in roll.

Book-mark:

W. J. Doe

(358c)

Copyist.



*H*

6 H. Art'y.

U.S.C.T.

*George Hensy*

*Private*, Co. *E*, 6 Reg't U. S. Col'd H. Art'y.

Appears on **Co. Muster-out Roll**, dated

*Watches, Miss.*, *May 13*, 186*6*.

Muster-out to date

*May 13*, 186*6*.

Last paid to

*Dec. 31*, 186*5*.

**Clothing account:**

Last settled....., 186 ; drawn since \$..... 100

Due soldier \$ *11* <sup>*83*</sup>/<sub>100</sub>; due U. S. \$..... 100

Am't for cloth'g in kind or money adv'd \$..... 100

Due U. S. for arms, equipments, &c., \$..... 100

Bounty paid \$..... 100; due \$..... 100

Remarks: *joined at original organization.*

Book mark: *V. 4 P. 125-68. 35-73/83.*

*O. J. Markle*

(361)

Copyist.

*Hershey, John*

*Co M, 6 U.S. Col'd H. Art'y.*

*Private Private*

CARD NUMBERS.

1	6154158	26
2	6179302	27
3	6179424	28
4	6179536	29
5	6179619	30
6	6179711	31
7	6179807	32
8	6179923	33
9	6180040	34
10	6180148	35
11	6180255	36
12	6180352	37
13	6180448	38
14	6180538	39
15	6180627	40
16	6180716	41
17	9121110	42
18	40742493	43
19		44
20		45
21		46
22		47
23		48
24		49
25		50

Book Mark: \_\_\_\_\_

See also \_\_\_\_\_

997  
Hershey, John

Co M, 6 U.S. Col'd H. Art'y.

Private Private

CARD NUMBERS.

1	6154158	26
2	6179302	27
3	6179424	28
4	6179536	29
5	6179619	30
6	6179711	31
7	6179807	32
8	6179923	33
9	6180040	34
10	6180148	35
11	6180255	36
12	6180352	37
13	6180448	38
14	6180538	39
15	6180627	40
16	6180716	41
17	9121110	42
18	40742493	43
19		44
20		45
21		46
22		47
23		48
24		49
25		50

Book Mark:

See also

S 744609 2d Arch

D. 769656 - P.O. Off

657412

D. 147328 A.S. 2d

D. 2200000 P.O. Off

D. 2223496 P.O. Off

D. 2249539 P.O. Off

D. 2258301 P.O. Off

D. 2259112 " "

D. 2260076 " "

M. A. 1000906

S. 1720610 00 Arch

S. 1151710 00 Arch

D. 147328 A.S. 2d

D. 147328 A.S. 2d

*F. F. Chandler*

*John Newley*  
Co. *M*, 6 Reg't U. S. Col'd H. Art'y.

Appears on  
**Company Descriptive Book**

of the organization named above.

**DESCRIPTION.**

Age *23* years; height *5* feet *6* inches.

Complexion *Bro*

Eyes *gray*; hair *blk*

Where born *Milkinson Miss*

Occupation *farmer*

**ENLISTMENT.**

When *Feb 16*, 186*4*.

Where *Watahey Miss*

By whom *Capt Cudde*; term *3* y'rs.

Remarks:  
.....  
.....  
.....  
.....  
.....  
.....  
.....  
.....  
.....  
.....

*Hilton*

28

*John Newhey*

Appears with rank of *Pat.* on

**Muster and Descriptive Roll of a Detachment of U. S. Vols. forwarded  
★ 2 Regt. Miss. Art'y.**

for the ~~6 Reg't U. S. Col'd H. Art'y.~~ Roll dated

*Natchez, Miss., July 29, 1864.*

Where born *Wickwood, Miss.*

Age *23* y'rs; occupation *Farmer*

When enlisted *July 16,* 186*4.*

Where enlisted *Natchez, Miss.*

For what period enlisted *3* years.

Eyes *Grey*; hair *Blk.*

Complexion *Blk.*; height *5* ft. *1* in.

When mustered in *July 29,* 186*4.*

Where mustered in *Natchez, Miss.*

Bounty paid \$ *100*; due \$ *100*

Where credited

Company to which assigned *M*

Remarks:

*\* This organization subsequently became U. S. Col'd H. Artillery.*

*\* Corrected June 2 1896. W.N.A.*

Book mark:

*E. Clarke*

*John Hoershey*

*Priv.*, Co. M, 2 Reg't Miss. Art'y.†

Appears on

**Company Muster Roll**

for *Jan. 21 to Feb. 29*, 1864.

Joined for duty and enrolled:

When *Feb. 16*, 1864.\*

Where *Atalaphy, Miss* \*

Period *3* years.\*

Present or absent *Present*

Stoppage, \$ *100* for

Due Gov't, \$ *100* for

Valuation of horse, \$ *100*

Valuation of horse equipments, \$ *100*

Remarks: \_\_\_\_\_  
\_\_\_\_\_  
\_\_\_\_\_

† This organization subsequently became Co. M, 6 Reg't U.S. Col'd Heavy Artillery.  
\* See enrollment on card from muster-in roll.

Book mark: \_\_\_\_\_  
\_\_\_\_\_

(358c)

*J. J. Kearney* Copyist.

No.

6 H. Art'y.

U.S.C.T.

John Hershey

Priv., Co. M, 5 Reg't U. S. Col'd H. Art'y.†

Appears on

Company Muster Roll

for March & April, 1864.

Joined for duty and enrolled:

When Feb. 16, 1864.\*

Where Natchez, Miss \*

Period 3 years.\*

Present or absent Present

Stoppage, \$ 100 for

Due Gov't \$ 100 for

Valuation of horse, \$ 100

Valuation of horse equipments, 100

Remarks:

†This organization subsequently became Co. M, 6 Reg't U. S. Colored Heavy Artillery.

\* See enrollment on card from muster-in roll.

Book mark:

(358c)

J. J. Kearney

Copyist.



No.

6 H. Art'y.

U.S.C.T.

*John Harsby*

*Priv.*, Co. M, 6 Reg't U. S. Col'd H. Art'y.

Appears on

**Company Muster Roll**

for *May + June*, 1864.

Joined for duty and enrolled:

When *Feb. 16*, 1864.\*

Where *Atchey, Miss* \*

Period *3* years.\*

Present or absent *Present*

Stoppage, \$ *100* for

Due Gov't, \$ *100* for

Valuation of horse, \$ *100*

Valuation of horse equipments, \$ *100*

Remarks:

-----  
-----  
-----  
-----

\* See enrollment on card from muster-in roll.

Book mark:-----

(358c)

*J. J. Kearney*  
Copyist.

26

6 H. Art'y.

U.S.C.T.

John H. Crosby

Prk, Co. M, 6 Reg't U. S. Col'd H. Art'y.

Appears on

Company Muster Roll

for July & Aug, 1864.

Joined for duty and enrolled:

When Dec 16, 1864.\*

Where Hatchez, Miss.\*

Period 3 years.\*

Present or absent Present

Stoppage, \$ 100 for

Due Gov't, \$ 100 for

Valuation of horse, \$ 100

Valuation of horse equipments, \$ 100

Remarks:

\* See enrollment on card from muster-in roll.

Book mark:

(358c)

J. J. Kearney Copyist.

26.

6 H. Art'y.

U.S.C.T.

*John Hensley*

*Priv.*, Co. M, 6 Reg't U. S. Col'd H. Art'y.

Appears on

**Company Muster Roll**

for *Sept. & Oct.*, 1864.

Joined for duty and enrolled:

When *Feb. 16*, 1864.\*

Where *Catchez, Miss* \*

Period *3* years.\*

Present or absent *Present*

Stoppage, \$ *100* for

Due Gov't, \$ *100* for

Valuation of horse, \$ *100*

Valuation of horse equipments, \$ *100*

Remarks: *Stop for 1 Haversack, 1/2 of etc*

\* See enrollment on card from muster-in roll.

Book mark:

(358c)

*J. J. Heaney*  
Copyist.

A

6 H. Art'y.

U.S.C.T.

*John Hershey*

*Priv.*, Co. M, 6 Reg't U. S. Col'd H. Art'y.

Appears on

**Company Muster Roll**

for *Nov & Dec*, 1864.

Joined for duty and enrolled:

When *Feb. 10*, 1864.\*

Where *Natchez Miss.* \*

Period *3* years.\*

Present or absent *Present*

Stoppage, \$ *100* for

Due Gov't, \$ *100* for

Valuation of horse, \$ *100*

Valuation of horse equipments, \$ *100*

Remarks: *Stoppage for one  
Gun Sling 31 cts.*

\* See enrollment on card from muster-in roll.

Book mark:

(358c)

*W Beck*  
Copyist.

A

6 H. Art'y.

U.S.C.T.

*John Hershey*

*Priv*, Co. M, 6 Reg't U. S. Col'd H. Art'y.

Appears on

**Company Muster Roll**

for *Jan. & Feb.*, 186*3*.

Joined for duty and enrolled:

When *Feb. 16*, 186*4*.\*

Where *Matchey, Miss.*\*

Period *3* years.\*

Present or absent *Present*

Stoppage, \$ *100* for

Due Gov't, \$ *100* for

Valuation of horse, \$ *100*

Valuation of horse equipments, \$ *100*

Remarks: *Stoppage for*  
*one Gun Sling 31cts,*

\* See enrollment on card from muster-in roll.

Book mark:

(358c)

*Beck*  
Copyist.

H

6 H. Art'y.

U.S.C.T.

*John Hershey*  
Priv., Co. M, 6 Reg't U. S. Col'd H. Art'y.

Appears on

**Company Muster Roll**

for *Mar & Apr*, 1865.

Joined for duty and enrolled:

When *Feb. 16*, 1864.\*

Where *Natchez Miss.*\*

Period *3* years.\*

Present or absent *Present*

Stoppage, \$ *100* for

Due Gov't, \$ *100* for

Valuation of horse, \$ *100*

Valuation of horse equipments, \$ *100*

Remarks: *Stoppage for one  
Gun Sling .31 etc.*

\* See enrollment on card from muster-in roll.

Book mark:

(358c)

*WBeck*  
Copyist.

A

6 H. Art'y.

U.S.C.T.

*John Hershey*

*Priv*, Co. M, 6 Reg't U. S. Col'd H. Art'y.

Appears on

**Company Muster Roll**

for *May & June*, 186*3*.

Joined for duty and enrolled:

When *Feb. 16*, 186*4*.\*

Where *Hatchey Mrs*, \*

Period *3* years.\*

Present or absent *Present*

Stoppage, \$ *100* for

Due Gov't, \$ *100* for

Valuation of horse, \$ *100*

Valuation of horse equipments, \$ *100*

Remarks: *Stoppage for  
Ordnance Stores @ 4 g  
Equipage \$ 1.80*

\* See enrollment on card from muster-in roll.

Book mark:

(358c)

*Beck*  
Copyist.

*John Hershey*  
Priv, Co. M, 6 Reg't U. S. Col'd H. Art'y.

Appears on

**Company Muster Roll**

for *July & Aug*, 1865.

Joined for duty and enrolled:

When *Feb. 16*, 1865.\*

Where *Natchez, Miss.*\*

Period *3* years.\*

Present or absent *Present*

Stoppage, \$ *100* for

Due Gov't, \$ *100* for

Valuation of horse, \$ *100*

Valuation of horse equipments, \$ *100*

Remarks: *Stoppage for  
Ordnance Stores and  
C & G Equipage \$ 1.80*

\* See enrollment on card from muster-in roll.

Book mark:

(358c)

*W Beck*  
Copyist.



*VX*

6 H. Art'y.

U.S.C.T.

*John Hershey*  
Co. M, 6 Reg't U. S. Col'd H. Art'y.

Appears on

**Company Muster Roll**

for *Sept & Oct*, 186*5*.

Joined for duty and enrolled:

When *Feb. 16*, 186*4*.\*

Where *Notchez, Miss.*\*

Period *3* years.\*

Present or absent *Present*

Stoppage, \$ *100* for

Due Gov't, \$ *100* for

Valuation of horse, \$ *100*

Valuation of horse equipments, \$ *100*

Remarks: *Stoppage for  
Ordnance Horse 2.3ct.*

\* See enrollment on card from muster-in roll.

Book mark:

*John Bell Jr*  
(358c) Copyist.

26

6 H. Art'y.

U.S.C.T.

*John Hershey*  
Co. M, 6 Reg't U. S. Col'd H. Art'y.

Appears on

**Company Muster Roll**

for *Nov. & Dec*, 1865.

Joined for duty and enrolled:

When *Feb 16*, 1864.\*

Where *Natchez, Miss* \*

Period *3* years.\*

Present or absent *Present*.

Stoppage, \$ *100* for

Due Gov't, \$ *100* for

Valuation of horse, \$ *100*

Valuation of horse equipments, \$ *100*

Remarks: *Stoppage for Ordnance  
Stores as per previous  
Muster Roll 23cts  
Additional Stoppage for  
Camp & G. Equipage \$160  
+ also borne as Murphy*

\* See enrollment on card from muster-in roll.

Book mark:

(358c) *John Bell* Copyist.

A

6 H. Art'y.

U.S.C.T.

*John Hershey*

*1st Lt*, Co. M, 6 Reg't U. S. Col'd H. Art'y.

Appears on

**Company Muster Roll**

for *January July*, 1866.

Joined for duty and enrolled:

When *July 16*, 1864.\*

Where *Natchez Miss* \*

Period *3* years.\*

Present or absent *Present*

Stoppage, \$ *100* for

Due Gov't, \$ *100* for

Valuation of horse, \$ *100*

Valuation of horse equipments, \$ *100*

Remarks: *Stoppage for  
ord stores *Wm E. Coffey*  
*\$ 4.53.**

\* See enrollment on card from muster-in roll.

Book mark:

(358c)

*Estillman's  
Comp. ~~Company~~*

26

6 H. Art'y.

U.S.C.T.

*John Hershey*  
Co. M, 6 Reg't U. S. Col'd H. Art'y.

Appears on

**Company Muster Roll**

for *Mch & Apr*, 186*6*.

Joined for duty and enrolled:

When *Feb. 16*, 186*4*\*

Where *Natchez, Miss*\*

Period *3* years.\*

Present or absent *Present*

Stoppage, \$ *100* for

Due Gov't, \$ *100* for

Valuation of horse, \$ *100*

Valuation of horse equipments, \$ *100*

Remarks: \_\_\_\_\_  
\_\_\_\_\_  
\_\_\_\_\_  
\_\_\_\_\_

\* See enrollment on card from muster-in roll.

Book mark: \_\_\_\_\_

*John J. Bell*  
(358c) Copied.

A

6 H. Art'y.

U.S.C.T.

John Hershey  
Pot., Co., 6 Reg't U. S. Col'd H. Art'y.

Appears on Returns as follows:

Feb 1864 (Com 2 Miss  
H. Art. A. O.) Gain  
Feb 16 64 (Ketching  
Miss Journal by  
Enlistment)

Book mark:

(546)

A. G. England

Copyist.

*John Hershby*  
*priv*, Co. *M*, 6 Reg't U. S. Col'd H. Art'y.

Appears on **Co. Muster-out Roll**, dated  
*Natchez Miss*, *March*, 186*6*.  
Muster-out to date *May*, 186*6*.  
Last paid to *Dec 31*, 186*5*.

Clothing account:

Last settled....., 186 ; drawn since \$..... 100  
Due soldier \$..... 100; due U. S. \$ *35* 100  
Am't for cloth'g in kind or money adv'd \$..... 100  
Due U. S. for arms, equipments, &c., \$..... 100  
Bounty paid \$..... 100; due \$..... 100

Remarks: *Joined as a*  
*recruit*

Book mark: .....

(361)

*J. Nelson*  
Copyist.

COMPILED MILITARY SERVICE RECORDS  
OF VOLUNTEER UNION SOLDIERS WHO SERVED WITH  
THE UNITED STATES COLORED TROOPS (USCT)  
6TH REGIMENT OF HEAVY ARTILLY

PERSONAL PAPERS' TARGET SHEET

PLEASE NOTE THE CHECKED INFORMATION ABOUT THE PERSONAL PAPERS IN  
THIS FILE:

- NO PERSONAL PAPERS WERE FOUND IN THIS FILE WHEN THE  
RECORDS WERE ARRANGED FOR MICROFILMING.
- 1 ~~PERSONAL~~ PAPER(S) FOUND IN THIS FILE WHEN THE RECORDS  
WERE ARRANGED FOR MICROFILMING.

Old Files Recd - 528 - S.W. & N. Bldg.  
Executive Div. 6-12-25

Please loan M. S. 1000906. and all other record  
cards & apps. relating to John Hershey Co. M.  
6" Rpt. U.S.C. Hy. Div.

10<sup>00</sup>

Darragh  
JH

John Hershey

6" Rpt. U.S.C. Hy. Div.

U.S.C. Hy. Div.

U.S.C. Hy. Div.

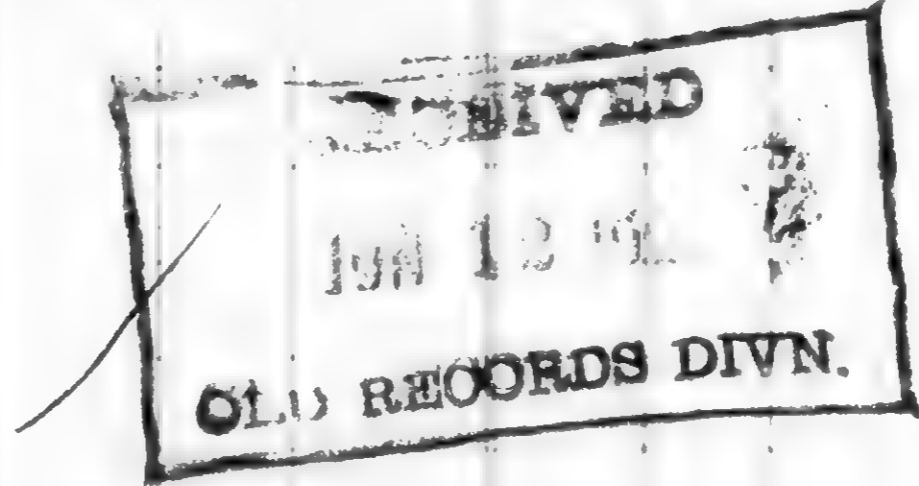

Rec'd back 3<sup>00</sup>, JH

Corp Records Recd - (Two B books) 6-12-25  
For name of former owner of John Hershey Co. M. 6" Rpt  
U.S.C. Hy. Div. Darragh  
JH

Vol. Recd  
no record of owner found  
6/13/25 Darragh

St. Louis furnished  
6/13/25 JH



*Wester, Paul*

Co B, 6 U.S. Col'd H. Art'y.

*Private Corporal*

CARD NUMBERS.

1	6155448	26
2	6155594	27
3	6155745	28
4	6155890	29
5	6156033	30
6	6156165	31
7	6156260	32
8	6156381	33
9	6156490	34
10	6156613	35
11	6156740	36
12	6156869	37
13	6157001	38
14	6157131	39
15	6157260	40
16	6157383	41
17	6157505	42
18	6157625	43
19	9118894	44
20	40742549	45
21		46
22		47
23		48
24		49
25		50

Book Mark:

See also

Paul Hester

Co. A, 6 Reg't U. S. Col'd H. Art'y.

Appears on

Company Descriptive Book  
of the organization named above.

DESCRIPTION.

Age 20 years; height 5 feet 9 inches.

Complexion *Black*

Eyes *Black*; hair *Black*

Where born *Wright Co Ky*

Occupation *Teamster*

ENLISTMENT.

When *Aug 30*, 1863.

Where *Natchez Miss*

By whom *Capt Bryan*; term *3* y'rs.

Remarks:  
\_\_\_\_\_  
\_\_\_\_\_  
\_\_\_\_\_  
\_\_\_\_\_  
\_\_\_\_\_  
\_\_\_\_\_  
\_\_\_\_\_

*J. Hillis*

75

6 H. Art'y. | U. S. C. T.

Paul Hester  
Pri, Co. A, 2 Reg't Miss. Art'y.†

Age 19 years.

Appears on

Company Muster-in Roll

of the organization named above. Roll dated  
Natchez, Miss Sept. 12, 1863.

Muster-in to date Sept 12, 1863.

Joined for duty and enrolled:

When Aug 30, 1863.\*

Where Natchez, Miss \*

Period 3 years.\*

Valuation of horse, \$ 100

Valuation of horse equipments, \$ 100

Remarks:

† This organization subsequently became Co. A, 6 Reg't U. S. Colored Heavy Artillery.

\* \* \* Muster-in roll shows enrollment of all men of this company as of same date and place. See enrollment on subsequent card or cards.

Book mark:

C. G. Smith

(356a)

Copyist.

76

6 H. Art'y.

U.S.C.T.

Paul Hester

Pri, Co. A, 2 Reg't Miss. Art'y.†

Appears on

Company Muster Roll

for Aug 30 to Oct 31, 1863.

Joined for duty and enrolled:

When Aug 30, 1863.\*

Where Natchez Miss \*

Period 3 years.\*

Present or absent Present

Stoppage, \$ 100 for

Due Gov't \$ 100 for

Valuation of horse, \$ 100

Valuation of horse equipments, 100

Remarks:

† This organization subsequently became Co: A, 6 Reg't U. S. Colored Heavy Artillery.

\* See enrollment on card from muster-in roll.

Book mark:

C. G. Smith

(358c)

Copyist.

76

6 H. Art'y.

U.S.C.T.

Paul Hester

Ori., Co. A, 2 Reg't Miss. Art'y.†

Appears on

Company Muster Roll

for Nov & Dec, 1863.

Joined for duty and enrolled:

When Aug 30, 1863.\*

Where Catcher Miss \*

Period 3 years.\*

Present or absent Present

Stoppage, \$ 100 for

Due Gov't \$ 100 for

Valuation of horse, \$ 100

Valuation of horse equipments, 100

Remarks:

† This organization subsequently became Co. A, 6 Reg't U. S. Colored Heavy Artillery.

\* See enrollment on card from muster-in roll.

Book mark:

O. G. Smith

(358c)

Copyist.

Paul Hester

Pri, Co. A, 2 Reg't Miss. Art'y.†

Appears on

Company Muster Roll

for Jan & Feb, 1864.

Joined for duty and enrolled:

When Aug. 30, 1863.\*

Where Natchez Miss. \*

Period 3 years.\*

Present or absent Present

Stoppage, \$ 100 for

Due Gov't \$ 100 for

Valuation of horse, \$ 100

Valuation of horse equipments, 100

Remarks: Sick in hospital.

† This organization subsequently became Co. A, 6 Reg't U. S. Colored Heavy Artillery.  
\* See enrollment on card from muster-in roll.

Book mark:

O. G. Smith

Paul Hester  
Pri., Co. A, 5 Reg't U. S. Col'd H. Art'y.†

Appears on

Company Muster Roll  
for March & April, 1864.

Joined for duty and enrolled:

When Aug 3, 1863.\*

Where Natchez Miss\*

Period 3 years.\*

Present or absent Absent

Stoppage, \$ 100 for

Due Gov't \$ 100 for

Valuation of horse, \$ 100

Valuation of horse equipments, 100

Remarks: Died in Reg't  
Hospital.

†This organization subsequently became Co. A, 6 Reg't U. S. Colored Heavy Artillery.  
\* See enrollment on card from muster-in roll.

Book mark:

O G Smith  
Copyist.

26

6 H. Art'y.

U.S.C.T.

Paul Hester

Ori, Co. A, 6 Reg't U. S. Col'd H. Art'y.

Appears on

Company Muster Roll

for May & June, 1864.

Joined for duty and enrolled:

When Aug 30, 1863.\*

Where Hatchers Mill \*

Period 3 years.\*

Present or absent Present

Stoppage, \$ 100 for

Due Gov't \$ 100 for

Remarks:

-----  
-----  
-----  
-----  
-----

\* See enrollment on card from muster-in roll.

Book mark:

C G Smith

(358c)

Copyist.



*H*

6 H. Art'y.

U.S.C.T.

*Paul Heester*

*Capt.*, Co. A, 6 Reg't U. S. Col'd H. Art'y.

Appears on

**Company Muster Roll**

for *July 8 Aug.*, 1864.

Joined for duty and enrolled:

When *Aug 30*, 1863.\*

Where *Natchez* \*

Period *3* years.\*

Present or absent *Present*

Stoppage, \$ *100* for

Due Gov't \$ *100* for

Remarks:

-----  
-----  
-----  
-----  
-----

\* See enrollment on card from muster-in roll.

Book mark:

*J. H. Henderson*  
(358c) Copyist.

70

6 H. Art'y.

U.S.C.T.

Paul Heester

Capt.

Co. A, 6 Reg't U. S. Col'd H. Art'y.

Appears on

Company Muster Roll

for Sept. 8 Oct., 1864.

Joined for duty and enrolled:

When Aug. 20, 1863.\*

Where Hatchez, Miss. \*

Period 3 years.\*

Present or absent Present

Stoppage, \$ 100 for

Due Gov't \$ 100 for

Remarks:

\* See enrollment on card from muster-in roll.

Book mark:

J. H. Henderson Copyist.

(358c)

26

6 H. Art'y.

U.S.C.T.

Paul Hester

Corpl, Co. A, 6 Reg't U. S. Col'd H. Art'y.

Appears on

Company Muster Roll

for Nov. 8 Dec., 1864

Joined for duty and enrolled:

When Aug. 30, 1863.\*

Where Hatchez, Miss. \*

Period 3 years.\*

Present or absent Present

Stoppage, \$ 100 for

Due Gov't \$ 100 for

Remarks:

-----  
-----  
-----  
-----  
-----

\* See enrollment on card from muster-in roll.

Book mark:

J. C. Henderson  
(358) Copyist.

76

6 H. Art'y.

U.S.C.T.

Paul Hester

Capt., Co. A, 6 Reg't U. S. Col'd H. Art'y.

Appears on

Company Muster Roll

for Jan. & Feb., 1865.

Joined for duty and enrolled:

When Aug. 30, 1863.\*

Where Natchez, Miss.\*

Period 3 years.\*

Present or absent Present

Stoppage, \$ 100 for

Due Gov't \$ 100 for

Remarks:

\* See enrollment on card from muster-in roll.

Book mark:

J. H. Henderson Copyist.

(358c)

H

6 H. Art'y.

U.S.C.T.

Paul Heeter

Capt

, Co. A, 6 Reg't U. S. Col'd H. Art'y.

Appears on

Company Muster Roll

for Mar. 8 Apr., 1865-

Joined for duty and enrolled:

When Aug. 30, 1863.\*

Where Hatchez, Miss.\*

Period 3 years.\*

Present or absent Present

Stoppage, \$ 100 for

Due Gov't \$ 100 for

Remarks:

-----  
-----  
-----  
-----  
-----

\* See enrollment on card from muster-in roll.

Book mark:

(358c) J. H. Henderson Copyist.

86

6 H. Art'y.

U.S.C.T.

Paul Hester

Capt

, Co. A, 6 Reg't U. S. Col'd H. Art'y.

Appears on

Company Muster Roll

for Feb. 28 to June 30, 1865.

Joined for duty and enrolled:

When Aug. 30, 1863.\*

Where Hatchez, Miss.\*

Period 3 years.\*

Present or absent Present

Stoppage, \$ 100 for

Due Gov't \$ 100 for

Remarks:

\* See enrollment on card from muster-in roll.

Book mark:

(358c) J. H. Henderson Copyist.

26

6 H. Art'y.

U.S.C.T.

Paul Hester

Capt., Co. A, 6 Reg't U. S. Col'd H. Art'y.

Appears on

Company Muster Roll

for July & August, 1863.

Joined for duty and enrolled:

When Aug 30, 1863.\*

Where Natchez Miss \*

Period 3 years.\*

Present or absent Present

Stoppage, \$ 100 for

Due Gov't \$ 100 for

Remarks:

\* See enrollment on card from muster-in roll.

Book mark:

(358c)

D. J. Giffith Copyist.

26

6 H. Art'y.

U.S.C.T.

Paul Hester

Corpl., Co. A, 6 Reg't U. S. Col'd H. Art'y.

Appears on

Company Muster Roll

for Sept + Oct, 1865

Joined for duty and enrolled:

When Aug 30, 1863.\*

Where Natchez Miss.\*

Period 3 years.\*

Present or absent Present

Stoppage, \$ 100 for

Due Gov't \$ 100 for

Remarks:

[Empty lines for remarks]

\* See enrollment on card from muster-in roll.

Book mark:

(358c) T. J. Giffith Copyist.



26

6 H. Art'y.

U.S.C.T.

Paul Hester

Capt., Co. A, 6 Reg't U. S. Col'd H. Art'y.

Appears on

Company Muster Roll

for Nov & Dec, 1865.

Joined for duty and enrolled:

When Aug 30, 1863.\*

Where Natchez Miss \*

Period 3 years.\*

Present or absent Present

Stoppage, \$ 100 for

Due Gov't \$ 100 for

Remarks:

-----  
-----  
-----  
-----  
-----

\* See enrollment on card from muster-in roll.

Book mark:

(358c)

D. J. Griffith

Copyist.

76

6 H. Art'y.

U.S.C.T.

Paul Hester

Capt., Co. A, 6 Reg't U. S. Col'd E. Art'y.

Appears on

Company Muster Roll

for Jan & Feb, 1866

Joined for duty and enrolled:

When Aug 30, 1863.\*

Where Natchez Miss \*

Period 3 years.\*

Present or absent Present

Stoppage, \$ 100 for

Due Gov't \$ 100 for

Remarks:

-----  
-----  
-----  
-----  
-----

\* See enrollment on card from muster-in roll.

Book mark:

(358c)

D. J. Griffith

Copyist.

26

6 H. Art'y.

U.S.C.T.

Paul Hester

Corpl, Co. A, 6 Reg't U. S. Col'd H. Art'y.

Appears on

Company Muster Roll

for March + Apr, 1866.

Joined for duty and enrolled:

When Aug 30, 1863\*

Where Natchez Miss\*

Period 3 years.\*

Present or absent Present

Stoppage, \$ 100 for

Due Gov't \$ 100 for

Remarks:

-----  
-----  
-----  
-----  
-----

\* See enrollment on card from muster-in roll.

Book mark:

(358c)

D. J. Griffith  
Copyist.

A

6 H. Art'y.

U.S.C.T.

Paul Hester

Por., Co. A, 6 Reg't U. S. Col'd H. Art'y.

Appears on Returns as follows:

x<sup>c</sup> Mar 1864 (5 US Col'd  
H Art, Absent  
Sick in Hosp  
or Absent - week  
leave

Apr 1864 Absent sick

May 1864 (6 US Col'd  
H Art) Absent  
Sick in Reg't  
Hosp

x  
Entry cancelled on Reg't  
Return

Book mark:

(546)

A. G. G. G. G.

Copyist.

*H*

6 H. Art'y.

U.S.C.T.

*Paul Hester*

*Capt*, Co. *A*, 6 Reg't U. S. Col'd H. Art'y.

Appears on **Co. Muster-out Roll**, dated

*Watches Miss, May 13*, 1866.

Muster-out to date

*May 13*, 1866.

Last paid to

*Dec. 31*, 1865.

Clothing account:

Last settled....., 186 ; drawn since \$..... 100

Due soldier \$ *33<sup>20</sup>*<sub>100</sub>; due U. S. \$..... 100

Am't for cloth'g in kind or money adv'd \$..... 100

Due U. S. for arms, equipments, &c., \$..... 100

Bounty paid \$..... 100; due \$..... 100

Remarks: *Joined at original organization.*

*App'd Capt Aug. 1, 64*

Book mark: *345, 750*

*A. L. Ames*

(361)

Copyist.

*Nickenbottom*

*Co K, 6 U.S. Col'd H. Art'y.*

*Private Private*

CARD NUMBERS.

1	6175659	26
2	6175761	27
3	6175962	28
4	6177487	29
5	9120774	30
6	40742495	31
7		32
8		33
9		34
10		35
11		36
12		37
12		38
14		39
15		40
16		41
17		42
18		43
19		44
20		45
21		46
22		47
23		48
24		49
25		50

Book Mark:

See also

*Samuel Hicknutten*

Co. *K*, 6 Reg't U. S. Col'd H. Art'y.

Appears on

**Company Descriptive Book**

of the organization named above.

**DESCRIPTION.**

Age *20* years; height *5* feet *7* inches.

Complexion *Dark*

Eyes *Black*; hair *Black*

Where born *Nashville Co Tenn*

Occupation *Soldier*

**ENLISTMENT.**

When *Jan 1*, 1864.

Where *Natchez Miss*

By whom *Capt Kemper*; term *3* y'rs.

Remarks: *Guid of Quian in Regt  
Hospital Natchez Miss April 27  
1865*

*Hicknutten*

*A*

*Daniel Hookerbottom*  
Co. *K*, 2 Reg't Miss. Art'y. †

Age *20* years.

Appears on

**Company Muster-in Roll**

of the organization named above Roll dated

*Natchez Miss. Jan 8, 1864.*

Muster-in to date *Jan, 1864*

Joined for duty and enrolled:

When *Jan 1, 1864\**

Where *Natchez Miss* \*

Period *3* years.\*

Valuation of horse, \$ 100

Valuation of horse equipments, \$ 100

Remarks:

† This organization subsequently became Co. *K*, 6 Reg't U. S. Colored Heavy Artillery.

\* Muster-in roll shows enrollment of all men of this company as of same date and place. See enrollment on subsequent card or cards.

Book mark:

*Spiller*



A

6 H. Art'y.

U.S.C.T.

Daniel Hickentottom

Prk, Co. K, 2 Reg't Miss. Artillery.†

Appears on

Company Muster Roll

for Jan 5<sup>th</sup> to July 29, 1864.

Joined for duty and enrolled:

When Jan 1<sup>st</sup>, 1864\*

Where Natchez Miss \*

Period 3 years.\*

Present or absent present

Stoppage, \$ 100 for

Due Gov't \$ 100 for

Valuation of horse, \$ 100

Valuation of horse equipments, 100

Remarks:

†This organization subsequently became Co. K, 6 Reg't U. S. Colored H. Art'y.  
\* See enrollment on card from muster-in roll.

Book mark:

Spills

(358c)

Copyist.

A

6 H. Art'y.

U.S.C.T.

Daniel Hebertson

Book, Co. C, 6 Reg't U. S. Col'd H. Art'y.

Appears on

Company Muster Roll

for Mar & Apr, 1864.

Joined for duty and enrolled:

When Jan 1, 1864\*

Where Natchez Miss \*

Period 3 years.\*

Present or absent

Stoppage, \$ 100 for

Due Gov't, \$ 100 for

Valuation of horse, \$ 100

Valuation of horse equipments, \$ 100

Remarks: Died in Regt Hosp.  
Apr 27/64

\* See enrollment on card from muster-in roll.

Book mark:

Spiller

(358c)

Copyist.

A

6 H. Art'y.

U.S.C.T.

Daniel Nickerbottom

Co. F, Co. ...., 6 Reg't U. S. Col'd H. Art'y.

Appears on Returns as follows:

Apr 1864 (Co K S U S  
Col'd H Art) died  
of disease in  
Hosp Apr 27, 64  
Watches Miss

Book mark:

(546) *A. Googel* Copyist.

H

6 H. Art'y.

U.S.C.T.

Daniel Hickinbottom

Priv, Co. K, 6 Reg't U. S. Col'd H. Art'y.

Appears on Co. Muster-out Roll, dated

Natchez Miss, May 13, 1864.

Muster-out to date \_\_\_\_\_, 186 .

Last paid to \_\_\_\_\_, 186 .

Clothing account:

Last settled \_\_\_\_\_, 186 ; drawn since \$ \_\_\_\_\_ 100

Due soldier \$ \_\_\_\_\_ 100; due U. S. \$ \_\_\_\_\_ 100

Am't for cloth'g in kind or money adv'd \$ \_\_\_\_\_ 100

Due U. S. for arms, equipments, &c., \$ \_\_\_\_\_ 100

Bounty paid \$ \_\_\_\_\_ 100; due \$ \_\_\_\_\_ 100

Remarks: Joined original org-  
anization.

Died in Regimental Hospital,  
Apr. 27, 1864 of Chronic Diarrhea.  
Final Statement forwarded  
May 12, 1864.

Book mark: 477, 1879

G. W. Chase

Copyist.

*Wickenbottom, Daniel*

*P*, Co. *K*, **6** *Reg't* **U. S. C. H. A.**

**2** Enclosures.

Bed Cards .....	Descriptive Lists .....
Burial Records .....	Final Statements .....
Certs. of Dis. for Discharge .....	Furloughs .....
C. M. Charges .....	Med. Des. Lists .....
Med. Certificates .....	Orders .....

Other papers relating to—

Admission to Hosp'l .....	Furlough .....
Casualty Sheet (Officer's) .....	Med. Examination .....
Confinement .....	Misc. Information .....
Contracts .....	Pay or Clothing .....
Death or Effects .....	Personal Reports .....
Desertions .....	Rank .....
Discharge from Hosp'l .....	Transfer to Hosp'l .....
Discharge from Service .....	Transfer to V. R. C. .....
Duty .....	Transportation .....

Inventary of the Effects  
of  
Daniel Hickbottom  
Late of Co R.  
6<sup>th</sup> Regt. U.S. Col<sup>d</sup> Art<sup>y</sup> Heavy  
who died at Natchez Miss  
On the 27<sup>th</sup> day of April 1864

JUN 17 1864

Inventory of the effects of *Daniel Hickeshottom* late  
 a *Private* of Captain *Adams Kemper* Company *16* of  
 the *6th* Regiment of *Miss. Vol. Artillery Heavy* Volunteers, who was enrolled as  
 a *Private* at *Natchez* in the State of *Mississippi* on  
 the *1* day of *January* 1862, and mustered into the service of the United  
 States as a *Private* on the *8* day of *January* 1862, at *Natchez Miss*  
 in Company *16*, *6* Regiment of *Miss. Vol. Artillery Heavy* to serve *Three*  
 years or during the war; he was born in *Westville County* in the State  
 of *Tennessee*; he was *20* years of age, *5* feet *7* inches  
 high, *Dark* complexion, *Black* eyes, *Black* hair, and by occupation, when enrolled,  
 a *Laborer*; he died in *Regimental Hospital* at  
*Natchez Miss* on the *27* day of *April* 1862, by  
 reason of.....

INVENTORY.

ARTICLES.	NO.	ARTICLES	NO.	ARTICLES.	NO.
Hats.....	—	Pairs Trowsers.....	—	Knapsacks.....	
Caps.....	—	Pairs flannel Drawers.....	—		
Forage Caps.....	—	Pairs cotton Drawers.....	—		
Great Coats.....	—	Flannel Shirts.....	—		
Uniform Coats.....	—	Cotton Shirts.....	—		
Uniform Jackets.....	—	Pairs boots.....	—		
Flannel Sack Coats.....	—	Pairs shoes.....	—		
Blouses.....	—	Pairs socks.....	—		
Stable Frocks.....	—	Blankets.....	—		
Fatigue Overalls.....	—	Haversacks.....	—		
				MONEY.	
				Specie.....	\$ 0
				Notes.....	\$ 0

I CERTIFY ON HONOR, that the above inventory comprises all the effects of *Daniel Hickeshottom*  
*Private of Co. 16, Miss. Vol. Artillery Heavy*, deceased, and that the effects are in the hands  
 of *The deceased left no effects*  
 to be disposed of by a Council of Administration.

(DUPLICATES.)

STATION: *Natchez Miss*

DATE: *July 13<sup>th</sup> 1864*

*Adam Kemper*  
 Captain  
 Commanding the Company.

✓ *C. 30*  
FINAL STATEMENT

OF

*Samuel Richardson*

*6<sup>th</sup>*  
Regiment U. S. Heavy Artillery, (C.)

*Discharged April 27<sup>th</sup> 1864*

ADJUTANT GENERAL'S OFFICE.

*July 28<sup>th</sup> 1864*  
Duplicate with Inventory sent 2d Auditor.



*[Handwritten signature]*  
*DeWitt*



I Certify, on honor, that David Hickenbattana a Private of  
Captain Kempfer Company (Ka) of the 6 Regiment of United States Heavy Artillery, (Colored.)  
born in Verchville Mo, State of Missouri, aged 29 years; 5 feet 7 inches high;  
dark complexion, Black eyes, Black hair and by occupation a Labourer, having joined the company on  
its original organization at Vatchez Miss, and enrolled in at the muster into the service of the  
United States at Vatchez Miss on the 8<sup>th</sup> day  
of January, 1864 (or was mustered in service as a recruit, by \_\_\_\_\_  
\_\_\_\_\_ at \_\_\_\_\_ on the \_\_\_\_\_ day of \_\_\_\_\_  
1864, or was drafted and mustered into the service of the United States from the \_\_\_\_\_ Enrollment District of the State  
of \_\_\_\_\_, at \_\_\_\_\_ on the \_\_\_\_\_ day of \_\_\_\_\_ 1864) to serve in the Regiment for the term of Three Years; and having served

HONESTLY and FAITHFULLY with his Company in Garrison to the present date, is now en-  
titled to a **DISCHARGE** by reason of David Hickenbattana Private Co. K 10<sup>th</sup> U.S. Col.  
is killed May, 1864 Missouri Regiment Hospital April 27<sup>th</sup> 1864

The said David Hickenbattana was last paid by Paymaster  
\_\_\_\_\_ to include the \_\_\_\_\_ day of \_\_\_\_\_, 1864, and has  
pay due him from ~~that time~~ enrollment to the present date; he is entitled to pay and subsistence for TRAVELING to place of enrollment, and what-  
ever other allowances are authorized to volunteer soldiers, or drafted men, or militia, so discharged. He received from the United States

**CLOTHING** amounting to 44 <sup>5</sup> dollars, since the 5<sup>th</sup> day of January  
1864, when his clothing account was last settled. He received from the United States \_\_\_\_\_ 100 dollars, advanced

**BOUNTY.**  
There is to be stopped from him, on account of the State of \_\_\_\_\_, or other authorities, for  
**CLOTHING, &c.**, received on entering service, \_\_\_\_\_, 100 dollars; and for other stoppages, viz: \_\_\_\_\_  
\_\_\_\_\_ 100 dollars.

He has been furnished TRANSPORTATION in kind from the place of his discharge to \_\_\_\_\_  
and he has been SUBSISTED for TRAVELING to his place of enrollment, up to the \_\_\_\_\_, 1864.

He is indebted to \_\_\_\_\_, **SUTLER**, \_\_\_\_\_, 100 dollars.  
He is indebted to \_\_\_\_\_, **LAUNDRESS**, \_\_\_\_\_, 100 dollars.

**GIVEN IN DUPLICATE**, at Vatchez Miss, this 12<sup>th</sup> day  
of July, 1864.

Adam Kempfer  
Captain  
Commanding Company.

Nickensbottom Madison

Co I, 6 U.S. Col'd H. Art'y.

Private Private

CARD NUMBERS.

1	6173618	26
2	6173760	27
3	6173906	28
4	6174035	29
5	6174168	30
6	6174285	31
7	6174394	32
8	6174505	33
9	6174618	34
10	6174736	35
11	6174854	36
12	6174970	37
13	6175076	38
14	6175186	39
15	6175291	40
16	6175390	41
17	6175486	42
18	9120549	43
19		44
20		45
21		46
22		47
23		48
24		49
25		50

Book Mark:

See also

Madison Hickenbottom

Co. C, 6 Reg't U. S. Col'd H. Art'y.

Appears on

Company Descriptive Book of the organization named above.

DESCRIPTION.

Age 21 years; height 5 feet 6 inches.

Complexion Blk

Eyes Blk; hair Blk

Where born Nashville, Tenn.

Occupation Laborer

ENLISTMENT.

When Dec 8, 1863

Where Natchez, Miss.

By whom Capt. H. Harber, term 3 y'rs.

Remarks:

[Empty lines for remarks]

Thompson

A

Madison Hickenbottom  
Pnt., Co. I, 2 Reg't Miss. Art'y. †

Age 21 years.

Appears on

Company Muster-in Roll

of the organization named above. Roll dated

Natchez, Miss., Dec. 17, 1863.

Muster-in to date Dec. 8, 1863.

Joined for duty and enrolled:

When Dec. 8, 1863.\*

Where Natchez, Miss. \*

Period 3 years.\*

Valuation of horse, \$ 100

Valuation of horse equipments, \$ 100

Remarks:

† This organization subsequently became Co. I, 6 Reg't U. S. Colored Heavy Artillery.

\* Muster-in roll shows enrollment of all men of this company as of same date and place. See enrollment on subsequent card or cards.

Book mark:

T. C. Taylor

(356c)

Copyist.

*A*

6 H. Art'y.

U.S.C.T.

*Madison Hickenbottom*

*Pvt.*, Co. I, 2 Reg't Miss. Artillery.†

Appears on

**Company Muster Roll**

for *Dec. 17 to Dec. 31*, 1863.

Joined for duty and enrolled:

When *Dec. 8*, 1863.\*

Where *Natchez* \*

Period *3* years.\*

Present or absent *Present*

Stoppage, \$ *100* for

Due Gov't, \$ *100* for

Valuation of horse, \$ *100*

Valuation of horse equipments, \$ *100*

Remarks: \_\_\_\_\_

\_\_\_\_\_

\_\_\_\_\_

\_\_\_\_\_

\_\_\_\_\_

† This organization subsequently became Co. I, 6 Reg't U. S. Colored Heavy Artillery.

\* See enrollment on card from muster-in roll.

Book mark: \_\_\_\_\_

(358c)

*D. C. Taylor*

Copyist.

A

6 H. Art'y.

U.S.C.T.

Madison Hickenbottom

Pat., Co. I, 2 Reg't Miss. Artillery.†

Appears on

Company Muster Roll

for Jan. and Feb., 1864.

Joined for duty and enrolled:

When Dec. 8, 1863.\*

Where Natchez \*

Period 3 years.\*

Present or absent Present

Stoppage, \$ 100 for

Due Gov't \$ 100 for

Valuation of horse, \$ 100

Valuation of horse equipments, 100

Remarks:

† This organization subsequently became Co. I, 6 Reg't U. S. Colored Heavy Artillery.

\* See enrollment on card from muster-in roll.

Book mark:

P. C. Taylor

(358c)

Copyist.

Madison Hickenbottom  
Capt., Co. I, 5 Reg't U. S. Col'd H. Art'y.\*

Appears on

**Company Muster Roll**

for Mar. and Apr., 1864.

Joined for duty and enrolled :

When December 8, 1863.\*

Where Katchez \*

Period 3 years.\*

Present or absent Present

Stoppage, \$ 100 for

Due Gov't, \$ 100 for

Valuation of horse, \$ 100

Valuation of horse equipments, \$ 100

Remarks :

\* This organization subsequently became Co. I, 6 Reg't U. S. Col'd Heavy Artillery.

\* See enrollment on card from muster-in roll.

Book mark :

P. C. Taylor

A

6 H. Art'y.

U.S.C.T.

Madison Hickenbottom  
Priv., Co. I, 6 Reg't U. S. Col'd H. Art'y.

Appears on

**Company Muster Roll**

for May and June, 1864.

Joined for duty and enrolled:

When Dec. 8, 1863\*

Where Natchez\*

Period 3 years.\*

Present or absent Present

Stoppage, \$ 100 for

Due Gov't \$ 100 for

Remarks:

-----  
-----  
-----  
-----  
-----

\* See enrollment on card from muster-in roll.

Book mark:-----

(358c)

D. C. Taylor

Copyist.



A

6 H. Art'y.

U.S.C.T.

*Madison Hickenbottom*

*Privt.*, Co. I, 6 Reg't U. S. Col'd H. Art'y.

Appears on

**Company Muster Roll**

for *July and Aug.*, 186*4*.

Joined for duty and enrolled:

When *Dec. 8*, 186*3*\*

Where *Natchez*\*

Period *3* years.\*

Present or absent *Present*

Stoppage, \$ *100* for

Due Gov't \$ *100* for

Remarks:

\* See enrollment on card from muster-in roll.

Book mark:

(358c)

*J. C. Taylor*

Copyist.

*H.* | **6 H. Art'y.** | **U.S.C.T.**

*Madison Hickbottom*  
*Co. I, 6 Reg't U. S. Col'd H. Art'y.*

Appears on

**Company Muster Roll**

for *Sept. & Oct.* 186*4*.

Joined for duty and enrolled:

When *Dec. 8*, 186*3*.\*

Where *Natchez* \*

Period *3* years.\*

Present or absent *Present*

Stoppage, \$ *100* for

Due Gov't, \$ *100* for

Valuation of horse, \$ *100*

Valuation of horse equipments, \$ *100*

Remarks: *Camp  
& equipage lost & etc.*

\*~~See~~ See enrollment on card from muster-in roll.

Book-mark :

*Steele*  
Copyist.

26

6 H. Art'y.

U.S.C.T.

Madison Hickenbottom

Pl., Co. I, 6 Reg't U. S. Col'd H. Art'y.

Appears on

Company Muster Roll

for Nov. & Dec., 1864.

Joined for duty and enrolled:

When Dec. 8, 1863.\*

Where Matchez,\*

Period 3 years.\*

Present or absent Present.

Stoppage, \$ 100 for

Due Gov't \$ 100 for

Remarks:

\* See enrollment on card from muster-in roll.

Book mark:

Stuck

*H.*

6 H. Art'y.

U.S.C.T.

*Madison Street Station*

*Pt.*, Co. I, 6 Reg't U. S. Col'd H. Art'y.

Appears on

**Company Muster Roll**

for *Jan & Feb.*, 1865.

Joined for duty and enrolled:

When *Dec. 8*, 1864.\*

Where *Wachuz*\*

Period *3* years.\*

Present or absent *Present.*

Stoppage, \$ *100* for

Due Gov't \$ *100* for

Remarks:

\* See enrollment on card from muster-in roll.

Book mark:

*Steel*

*H*

6 H. Art'y.

U.S.C.T.

*Madison, H. K. Embattom*

*Co. I, 6 Reg't U. S. Col'd H. Art'y.*

Appears on

**Company Muster Roll**

for *Mch. & Apr. 1865.*

Joined for duty and enrolled:

When *Dec. 8*, 1863.\*

Where *Natchez, Miss. \**

Period *3* years.\*

Present or absent *Present.*

Stoppage, \$ *100* for

Due Gov't, \$ *100* for

Valuation of horse, \$ *100*

Valuation of horse equipments, \$ *100*

Remarks:

.....  
.....  
.....

\* See enrollment on card from muster-in roll.

Book-mark:

.....

*Steele,*

(358c)

Copyist.

H. Hart U.S.C.T.

Madison Wisconsin bottom  
Pt. Co. 2, 6 Reg't U. S. Col'd Art'y

Appears on

**Company Muster Roll**

for May & June, 1865.

Joined for duty and enrolled:

When Dec. 8, 1863.\*

Where Watechez.\*

Period 3 years.\*

Present or absent Present

Stoppage, \$ 100 for

Due Gov't, \$ 100 for

Valuation of horse, \$ 100

Valuation of horse equipments, \$ 100

Remarks:

.....  
.....  
.....

\* See enrollment on card from muster-in roll.

Book mark:

.....

Hart

A.

6 H. Art'y.

U.S.C.T.

Madison Hickentbottom

Pt., Co. I, 6 Reg't U. S. Col'd H. Art'y.

Appears on

Company Muster Roll

for July & Aug., 1865.

Joined for duty and enrolled:

When Dec. 8, 1863.\*

Where Wachez Miss \*

Period 3 years.\*

Present or absent Present.

Stoppage, \$ 100 for

Due Gov't \$ 100 for

Remarks:

\* See enrollment on card from muster-in roll.

Book mark:

Steele

(358c)

Copyist.

Madison Hickenbottom  
Pvt., Co. I, 6 Reg't U. S. Col'd H. Art'y.

Appears on

Company Muster Roll

for Sept & Oct, 1865.

Joined for duty and enrolled:

When Dec. 8, 1863.\*

Where Hatchez Miss.\*

Period 3 years.\*

Present or absent Present

Stoppage, \$ 100 for

Due Gov't \$ 100 for

Remarks:

-----  
-----  
-----  
-----  
-----

\* See enrollment on card from muster-in roll.

Book mark:

-----  
E. E. Rankin  
-----

(358c)

Copyist.



A

6 H. Art'y.

U.S.C.T.

Madison Hickenbottom  
Pvt., Co. I, 6 Reg't U. S. Col'd H. Art'y.

Appears on

Company Muster Roll

for Nov. & Dec., 1863.

Joined for duty and enrolled:

When Dec. 8, 1863.\*

Where Hatchers Mills \*

Period 3 years.\*

Present or absent Present

Stoppage, \$ 100 for

Due Gov't \$ 100 for

Remarks:

\* See enrollment on card from muster-in roll.

Book mark:

J. A. Rankin

(358c)

Copyist.

*H*

6 H. Art'y.

U.S.C.T.

*Madison Hickenbottom*

*Pvt*, Co. I, 6 Reg't U. S. Col'd H. Art'y.

Appears on

**Company Muster Roll**

for *Jan. & Feb.*, 186*6*.

Joined for duty and enrolled:

When *Dec. 8*, 186*3*.\*

Where *Natchez Miss.* \*

Period *3* years.\*

Present or absent *Present.*

Stoppage, \$ *100* for

Due Gov't \$ *100* for

Remarks:

-----  
-----  
-----  
-----  
-----

\* See enrollment on card from muster-in roll.

Book mark:

*J. P. Rankin*  
Copyist.

(358c)

Madison Hickbottom  
Pvt., Co. I, 6 Reg't U. S. Col'd H. Art'y.

Appears on

Company Muster Roll

for Mar. & Apr., 1866

Joined for duty and enrolled:

When Dec. 8, 1863\*

Where Natchez.\*

Period 3 years.\*

Present or absent Present.

Stoppage, \$ 100 for

Due Gov't \$ 100 for

Remarks:

\* See enrollment on card from muster-in roll.

Book mark:

E. E. Rankin

(358c)

Copyist.

H

6 H. Art'y.

U.S.C.T.

Madison Hickenbottom

Priv., Co. I, 6 Reg't U. S. Col'd H. Art'y.

Appears on Co. Muster-out Roll, dated

Statches, Miss. May 13, 1866 .

Muster-out to date May 13, 1866 .

Last paid to Dec. 31, 1865 .

Clothing account:

Last settled....., 186 ; drawn since \$..... 100

Due soldier \$ <sup>3-90</sup> 100; due U. S. \$..... 100

Am't for cloth'g in kind or money adv'd \$..... 100

Due U. S. for arms, equipments, &c., \$..... 100

Bounty paid \$..... 100; due \$..... 100

Remarks: Joined at original organization. - Due Soldier on Account of Clothing \$ <sup>3-90</sup> 100

Book mark:

C. C. M. Laughlin

(861)

Copyist.

Nickenbottom Scott

Co I, 6 U.S. Col'd H. Art'y.

Private Private

CARD NUMBERS.

1	6173616	26
2	6173758	27
3	6173904	28
4	6174033	29
5	6174166	30
6	6174283	31
7	6174392	32
8	6174503	33
9	6174616	34
10	6174734	35
11	6174852	36
12	6174968	37
12	6175074	38
14	6175184	39
15	6175289	40
16	6175388	41
17	6175484	42
18	9120547	43
19	40742496	44
20		45
21		46
22		47
23		48
24		49
25		50

Book Mark:

See also

*Scott Dickenson*

....., Co. *A*, 6 Reg't U. S. Col'd H. Art'y.

Appears on

**Company Descriptive Book**  
of the organization named above.

**DESCRIPTION.**

Age *28* years; height *5* feet *11 1/2* inches.

Complexion *Dark brown*

Eyes *Brown*; hair *Blk*

Where born *Jackson Co., Mo.*

Occupation *Blacksmith*

**ENLISTMENT.**

When *Dec. 8*....., 186*3*.

Where *Natchez Miss*

By whom *Capt. H. Herbert*, term *3* y'rs.

Remarks: .....

.....  
.....  
.....  
.....  
.....  
.....  
.....  
.....

*Harson*

A

6 H. Art'y. U.S.C.T.

Scott Hickelbottom  
Cpt., Co. I, 2 Reg't Miss. Art'y. †

Age 28 years.

Appears on

Company Muster-in Roll

of the organization named above. Roll dated

Natchez, Miss. Dec. 17, 1863.

Muster-in to date Dec. 8, 1863.

Joined for duty and enrolled:

When Dec. 8, 1863.\*

Where Natchez, Miss. \*

Period 3 years.\*

Valuation of horse, \$ 100

Valuation of horse equipments, \$ 100

Remarks:

† This organization subsequently became Co. I, 6 Reg't U. S. Colored Heavy Artillery.

\* Muster-in roll shows enrollment of all men of this company as of same date and place. See enrollment on subsequent card or cards.

Book mark:

D. C. Taylor

(356c)

Copyst.

Scott Hickensbottom  
Pvt., Co. I, 2 Reg't Miss. Artillery.†

Appears on

**Company Muster Roll**

for Dec. 17 to Dec. 31, 1863.

Joined for duty and enrolled:

When Dec. 8, 1863\*

Where Natchez\*

Period 3 years.\*

Present or absent Present

Stoppage, \$ 100 for

Due Gov't, \$ 100 for

Valuation of horse, \$ 100

Valuation of horse equipments, \$ 100

Remarks:

† This organization subsequently became Co. I, 6 Reg't U. S. Colored Heavy Artillery.  
\* See enrollment on card from muster-in roll.

Book mark:

(358c) P. C. Taylor Copyist.



A

6 H. Art'y.

U.S.C.T.

Scott Hickman Bottom

Priv., Co. I, 2 Reg't Miss. Artillery.†

Appears on

Company Muster Roll

for Jan. and Feb., 1864.

Joined for duty and enrolled:

When Dec. 8, 1863\*

Where Natchez \*

Period 3 years.\*

Present or absent Present

Stoppage, \$ 100 for

Due Gov't \$ 100 for

Valuation of horse, \$ 100

Valuation of horse equipments, 100

Remarks:

† This organization subsequently became Co. I, 6 Reg't U. S. Colored Heavy Artillery.

\* See enrollment on card from muster-in roll.

Book mark:

D. C. Taylor

(358c)

Copyist.

Scott Hickenbottom  
Pvt., Co. I, 5 Reg't U. S. Col'd H. Art'y.\*

Appears on

**Company Muster Roll**

for Mar. and Apr., 1864.

Joined for duty and enrolled:

When December 8, 1863\*

Where Natchez \*

Period 3 years.\*

Present or absent Present

Stoppage, \$ 100 for

Due Gov't, \$ 100 for

Valuation of horse, \$ 100

Valuation of horse equipments, \$ 100

Remarks: \_\_\_\_\_

\* This organization subsequently became Co. I, 6 Reg't U. S. Col'd Heavy Artillery.

\* See enrollment on card from muster-in roll.

Book mark: \_\_\_\_\_

(358c)

A. C. Taylor

Copyist.

A | 6 H. Art'y. | U.S.C.T.

Scott Hickenbottom

Private, Co. I, 6 Reg't U. S. Col'd H. Art'y.

Appears on

Company Muster Roll

for May and June, 1864.

Joined for duty and enrolled:

When Dec. 8, 1863.\*

Where Natchez \*

Period 3 years.\*

Present or absent Present

Stoppage, \$ 100 for

Due Gov't \$ 100 for

Remarks:

-----  
-----  
-----  
-----  
-----

\* See enrollment on card from muster-in roll.

Book mark: -----

(358c)

A. C. Taylor

Copyist.

Scott Hickenbottom  
Out., Co. I, 6 Reg't U. S. Col'd H. Art'y.

Appears on

**Company Muster Roll**

for July and Aug., 1864.

Joined for duty and enrolled:

When Dec. 8, 1863\*

Where Natchez\*

Period 3 years.\*

Present or absent Present

Stoppage, \$ 100 for

Due Gov't \$ 100 for

Remarks:  
-----  
-----  
-----  
-----  
-----

\* See enrollment on card from muster-in roll.

Book mark: -----

(358c) J. C. Taylor Copyist.

*H*

6 H. Art'y. U.S.C.T.

*Scott Hickenbottom*

*Pl.*, Co. I, 6 Reg't U. S. Col'd H. Art'y.

Appears on

Company Muster Roll

for *Sep. root.* 186*4*.

Joined for duty and enrolled:

When *Dec. 8*, 186*3*\*

Where *Matchez*\*

Period *3* years.\*

Present or absent *Present*

Stoppage, \$ *100* for

Due Gov't, \$ *100* for

Valuation of horse, \$ *100*

Valuation of horse equipments, \$ *100*

Remarks: *Camp equi  
bag lost 85 @*

\* See enrollment on card from muster-in roll.

Book-mark :

*Scott*

(358c)

Copyist.

76

6 H. Art'y.

U.S.C.T.

Scott Hickman

Co. I, 6 Reg't U. S. Col'd H. Art'y.

Appears on

Company Muster Roll

for Nov. & Dec, 1864.

Joined for duty and enrolled:

When Dec. 8, 1863.\*

Where Matchezy \*

Period 3 years.\*

Present or absent Present

Stoppage, \$ 100 for

Due Gov't \$ 100 for

Remarks:

\* See enrollment on card from muster-in roll.

Book mark:

Steel

(358c)

Copyist.

76

6 H. Art'y.

U.S.C.T.

Scott Hickenbottom,  
Pl., Co. I, 6 Reg't U. S. Col'd H. Art'y.

Appears on

Company Muster Roll

for Jan. Feb., 1865.

Joined for duty and enrolled:

When Dec. 8, 1864.\*

Where Matchez\*

Period 3 years.\*

Present or absent Present.

Stoppage, \$ 100 for

Due Gov't \$ 100 for

Remarks:

\* See enrollment on card from muster-in roll.

Book mark:

Steele,  
Copyist.

*76*

6 H. Art'y.

U.S.C.T.

*Scott H. Robertson*

*Pt.*, Co. I, 6 Reg't U. S. Col'd H. Art'y.

Appears on

Company Muster Roll

for *Feb. & Apr.* 1863.

Joined for duty and enrolled:

When *Dec. 8*, 1863.\*

Where *Watachez, Miss.*\*

Period *3* years.\*

Present or absent *Present.*

Stoppage, \$ *100* for

Due Gov't, \$ *100* for

Valuation of horse, \$ *100*

Valuation of horse equipments, \$ *100*

Remarks:

.....  
.....  
.....

\* See enrollment on card from muster-in roll.

Book-mark : .....

*Steele*

(358c)

Copyist.



*H. 164. A. 100* U.S.C.T.

*Deatt y. H. K. Leubottom*  
*Pl. Co. 2, 6* Reg't U. S. Col'd *100*

Appears on

**Company Muster Roll**

for *May & June*, 186*5*.

Joined for duty and enrolled:

When *Dec. 8*, 186*3*\*

Where *Matchez*\*

Period *3* years.\*

Present or absent *Present*

Stoppage, \$ *100* for

Due Gov't, \$ *100* for

Valuation of horse, \$ *100*

Valuation of horse equipments, \$ *100*

Remarks:

.....  
.....  
.....

\* ~~See~~ See enrollment on card from muster-in roll.

Book mark:

.....

*Stule*

*H.*

6 H. Art'y.

U.S.C.T.

*Scute Hickentott*

*H.*, Co. I, 6 Reg't U. S. Col'd H. Art'y.

Appears on

**Company Muster Roll**

for *July & Aug.*, 186*5*.

Joined for duty and enrolled:

When *Dec. 8*, 186*3*\*

Where *Watehery, Miss.*\*

Period *3* years.\*

Present or absent *Present*

Stoppage, \$ *100* for

Due Gov't \$ *100* for

Remarks:  
-----  
-----  
-----  
-----  
-----  
-----

\* See enrollment on card from muster-in roll.

Book mark:-----

*Steele*

(358c)

Copyist.

A

6 H. Art'y.

U.S.C.T.

Scott Hickenbottom

Priv., Co. I, 6 Reg't U. S. Col'd H. Art'y.

Appears on

Company Muster Roll

for Sept + Oct., 1865.

Joined for duty and enrolled:

When Dec. 8, 1863.\*

Where Hatchez Miss.\*

Period 3 years.\*

Present or absent Present

Stoppage, \$ 100 for

Due Gov't \$ 100 for

Remarks:

[Empty lines for remarks]

\* See enrollment on card from muster-in roll.

Book mark:

E. E. Hankin Copyist.

A

6 H. Art'y.

U.S.C.T.

Scott Hickbottom

Pvt., Co. I, 6 Reg't U. S. Col'd H. Art'y.

Appears on

Company Muster Roll

for Nov. & Dec., 1865.

Joined for duty and enrolled:

When Dec. 8, 1863.\*

Where March Miss \*

Period 3 years.\*

Present or absent Present.

Stoppage, \$ 100 for

Due Gov't \$ 100 for

Remarks:

[Empty lines for remarks]

\* See enrollment on card from muster-in roll.

Book mark:

E. P. Rankin

(358c)

Copyist.

A

6 H. Art'y.

U.S.C.T.

Scott Hickenbottom  
Pvt., Co. I, 6 Reg't U. S. Col'd H. Art'y.

Appears on

Company Muster Roll

for Jan. & Feb., 1866.

Joined for duty and enrolled:

When Dec. 8, 1863.\*

Where Natchez Miss. \*

Period 3 years.\*

Present or absent Present.

Stoppage, \$ 100 for

Due Gov't \$ 100 for

Remarks:

\* See enrollment on card from muster-in roll.

Book mark:

A. P. Rankin

(358c)

Copyist.

A

6 H. Art'y.

U.S.C.T.

Scott Hickenbottom

Pvt., Co. I, 6 Reg't U. S. Col'd H. Art'y.

Appears on

Company Muster Roll

for Mar & Apr., 1866.

Joined for duty and enrolled:

When Dec. 8, 1863.\*

Where Patehez \*

Period 3 years.\*

Present or absent Present.

Stoppage, \$ 100 for

Due Gov't \$ 100 for

Remarks:

-----  
-----  
-----  
-----  
-----

\* See enrollment on card from muster-in roll.

Book mark:

-----  
-----  
-----

(358c)

J. P. Rankin  
Copyist.

A

6 H. Art'y.

U.S.C.T.

Scott Hickenbottom

Post, Co. I, 6 Reg't U. S. Col'd H. Art'y.

Appears on Returns as follows:

June 1865 Det'd as  
Blksmith by  
order Genl Davidson  
July to Nov 1865 On  
duty Post Blk-  
smith since June  
22, 65 - S.O. 6,

Dec 1865 On daily  
duty as Blksmith  
by S.O. 103 Ad 2nd  
Post of Natches

Book mark:

(546)

A. G. England

Copyist.

Scott Hickenbottom  
Priv., Co. D, 6 Reg't U. S. Col'd H. Art'y.

Appears on Co. Muster-out Roll, dated  
Statches Miss, May 13, 1866.

Muster-out to date May 13, 1866.

Last paid to Dec. 31, 1865.

Clothing account:

Last settled....., 186 ; drawn since \$ 100

Due soldier \$ 37<sup>06</sup>/<sub>100</sub>; due U. S. \$ 100

Am't for cloth'g in kind or money adv'd \$ 100

Due U. S. for arms, equipments, &c., \$ 100

Bounty paid \$ 100; due \$ 100

Remarks: Joined at original organization.  
Due Soldier on account of clothing \$ 37<sup>06</sup>/<sub>100</sub>

Book mark:

C. E. M. Laughlin  
Coryist.



7000  
Nickman, Harvey

Co C, 6 U.S. Col'd H. Art'y.

Private Private

CARD NUMBERS.

1	6160336	26
2	6160484	27
3	6160627	28
4	6160750	29
5	6160934	30
6	6154870	31
7	6162684	32
8	9119362	33
9	40782497	34
10		35
11		36
12		37
12		38
14		39
15		40
16		41
17		42
18		43
19		44
20		45
21		46
22		47
23		48
24		49
25		50

Book Mark: \_\_\_\_\_

See also \_\_\_\_\_

Harry Hickman

Co. C, 6 Reg't U. S. Col'd H. Art'y.

Appears on

Company Descriptive Book

of the organization named above.

DESCRIPTION.

Age 20 years; height 5 feet 6 inches.

Complexion Black

Eyes Blue; hair Black

Where born Natchez Miss

Occupation Laborer

ENLISTMENT.

When Sept 1, 1863.

Where Natchez Miss

By whom W. J. Lusk; term 3 y'rs.

Remarks: Drilled at Camp  
Methuon Natchez Miss  
Apr 2/64

J. P. Miller

Harvey Hickman  
Sot, Co. C, 2 Reg't Miss. Art'y.†

Age 20 years.

Appears on

Company Muster-in Roll

of the organization named above. Roll dated

Natchez, Miss, Sept 12, 1863.

Muster-in to date Sept 12, 1863.

Joined for duty and enrolled:

When Sept 1, 1863.\*

Where Natchez, Miss \*

Period 3 years.\*

Valuation of horse, \$ 100

Valuation of horse equipments, \$ 100

Remarks:

† This organization subsequently became Co. C, 6 Reg't U. S. Colored Heavy Artillery.

\* Muster-in roll shows enrollment of all men of this company as of same date and place. See enrollment on subsequent card or cards.

Book mark:

no chance

H

6 H. Art'y.

U.S.C.T.

Harvey Hickman

D. No., Co. C, 2 Reg't Miss. Artillery.†

Appears on

Company Muster Roll

for Sept 12 to Oct 31, 1863.

Joined for duty and enrolled:

When Sept 1, 1863.\*

Where Natchez, Miss.\*

Period 3 years.\*

Present or absent Present.

Stoppage, \$ 100 for

Due Gov't \$ 100 for

Valuation of horse, \$ 100

Valuation of horse equipments, \$ 100

Remarks: Sick in Regimental Hospital.

† This organization subsequently became Co. C, 6 Reg't U. S. Colored Heavy Artillery.

\* See enrollment on card from muster-in roll.

Book mark:

no chance

H

6 H. Art'y.

U.S.C.T.

Farvey Hickman

Pvt., Co. C, 2 Reg't Miss. Artillery.†

Appears on

Company Muster Roll

for Nov + Dec, 1863.

Joined for duty and enrolled:

When Sept 1, 1863.\*

Where Natchez, Miss.\*

Period 3 years.\*

Present or absent Present.

Stoppage, \$ 100 for

Due Gov't \$ 100 for

Valuation of horse, \$ 100

Valuation of horse equipments, \$ 100

Remarks: Sick in Regimental Hospital Sept 26, 1863.

† This organization subsequently became Co. C, 6 Reg't U. S. Colored Heavy Artillery.

\* See enrollment on card from muster-in roll.

Book mark:

MoChance

(358c)

Copyist.

70

6 H. Art'y.

U.S.C.T.

Harvey Hickman

Priv., Co. C, 2 Reg't Miss. Artillery.†

Appears on

Company Muster Roll

for Jan & Feb, 1864.

Joined for duty and enrolled:

When Sept 1, 1863.\*

Where Natchez, Miss.\*

Period 3 years.\*

Present or absent Present

Stoppage, \$ 100 for

Due Gov't \$ 100 for

Valuation of horse, \$ 100

Valuation of horse equipments, \$ 100

Remarks: Sick in Regimental Hosp since Sept 26<sup>th</sup> 1863

† This organization subsequently became Co. C, 6 Reg't U. S. Colored Heavy Artillery.

\* See enrollment on card from muster-in roll.

Book mark:

Wochance

(358c)

Copyist.

H

6 H. Art'y.

U.S.C.T.

Harvey Fickman

Pvt., Co. C, 5 Reg't U. S. Col'd H. Art'y.\*

Appears on

Company Muster Roll

for Mar & Apr, 1864.

Joined for duty and enrolled:

When Sept 1, 1863.\*

Where Natchez, Miss.\*

Period 3 years.\*

Present or absent

Stoppage, \$ 100 for

Due Gov't, \$ 100 for

Valuation of horse, \$ 100

Valuation of horse equipments, \$ 100

Remarks: Deserted at Camp  
McPherson, Natchez, Miss.,  
April 2, 1864.

\* This organization subsequently became Co. C, 6 Reg't U. S. Col'd Heavy Artillery.

\* See enrollment on card from muster-in roll.

Book mark:

mochance

(358c)

Copyist.

*Harvey Hickman*  
*Pvt*, Co. *C*, *5*<sup>\*</sup> Reg't U. S. Col'd *H. Arty*

Appears on

**Descriptive List of Deserters**

dated *May 3*, 1864.

Deserted:

When *April 2*, 1864.

Where *Natchez Miss.*

Arrested:

When ....., 186 .

Where .....

Remarks : .....

\* *Became a boy*

Book mark : .....

*R. S. Shelton*



A

6 H. Art'y.

U.S.C.T.

Harvey Hickman  
Prvt, Co. ...., 6 Reg't U. S. Col'd H. Art'y.

Appears on Returns as follows:

April 1864 (Co C 5 US  
Col'd H Art) De  
scribed from Wash  
April 2, 64 Natchez  
Miss

Book mark :

(46) *A. Gouglas* Copyist.

96

6 H. Art'y.

U.S.C.T.

Harry Hickman  
Co. C, 6 Reg't U. S. Col'd H. Art'y.

Appears on Co. Muster-out Roll, dated

Natchez Miss, May 13, 1866.

Muster-out to date \_\_\_\_\_, 1866

Last paid to \_\_\_\_\_, 1866

Clothing account:

Last settled Sept 1, 1863; drawn since \$ 19 <sup>82</sup>/<sub>100</sub>

Due soldier \$ 100; due U. S. \$ 100

Am't for cloth'g in kind or money adv'd \$ 100

Due U. S. for arms, equipments, &c., \$ 100

Bounty paid \$ 100; due \$ 100

Remarks: Found at original  
organization. Deserted  
April 2 64 at  
Natchez Miss.

Book mark:

H. M. Calhoun  
Copyist.

(361)

Nickman, Isaac D.

Co E, 6 U.S. Col'd H. Art'y.

Captain Captain

CARD NUMBERS.

1	6165144	26
2	6165288	27
3	6165432	28
4	6165556	29
5	6165673	30
6	6165789	31
7	6166005	32
8	6167111	33
9	<del>6167111</del> 4236773	34
10	42716120	35
11	42716457	36
12	42716694	37
13	40742498	38
14		39
15		40
16		41
17		42
18		43
19		44
20		45
21		46
22		47
23		48
24		49
25		50

Book Mark:

See also:

S-1260604 And. W.D.

REP 435079

REP. 473450

REP. 435079

REP. 475-688

*Z. Z. Cordley*

*A. V. Artz* U.S.C.T.

*Isaac N. Hickman*

*Capt'n E. C.* Reg't U. S. Col'd *A. Artz*

Appears on

**Regimental Descriptive Book**

(List of Commissioned Officers)

of the regiment named above.

Rank *Capt'n*

Date of appointment *Oct. 28* 186*3*

Remarks: *App'd from 1<sup>st</sup> Lt.  
30<sup>th</sup> Mo. Infy. Mustered  
in to date Sept-12  
1863*

*F. M. Neal*

H

6 H. Art'y. U.S.C.T.

Isaac N Hickman  
Capt, Co. E, 2 Reg't Miss. Art'y.†

Age 22 years.

Appears on

Company Muster-in Roll

of the organization named above. Roll dated

Matchez Miss Sept 12, 1863.

Muster-in to date Sep 12, 1863.

Joined for duty and enrolled:

When \_\_\_\_\_, 186 .\*

Where \_\_\_\_\_ \*

Period 3 years.\*

Valuation of horse, \$ 100

Valuation of horse equipments, \$ 100

Remarks: appointed from 1<sup>st</sup>  
Sergeant in 30<sup>th</sup> Reg Mod Art  
Vols to be Capt 2<sup>nd</sup> Miss  
E

† This organization subsequently became Co. .... 6 Reg't U. S. Colored Heavy Artillery.

\* Muster-in roll shows enrollment of all men of this company as of same date and place. See enrollment on subsequent card or cards.

Book mark:

Hadfield

(356c)

Copyist.

*H*

6 H. Art'y. | U.S.C.T.

*Isaac N. Hickman*

*Captain* Co. E, 2 Reg't Miss. Art'y.†

Appears on

**Company Muster Roll**

for *Sept & Oct*, 1863.

Joined for duty and enrolled:

When *Sept 12*, 1863.\*

Where *Katchez Miss* \*

Period *3* years.\*

Present or absent *Absent*

Stoppage, \$ *100* for

Due Gov't, \$ *100* for

Remarks: *Absent with leave since Sept 28 1863*

† This organization subsequently became Co. E, 6 Reg't U. S. Colored Heavy Artillery.

\* See enrollment on card from muster-in roll.

Book mark: ~~*2" Feb 1849, Nov 13 1860*~~

(358c)

*Hadfield*

Copyist.

H

6 H. Art'y. U.S.C.T.

Isaac O Hickman

Captain, Co. E, 2 Reg't Miss. Art'y.†

Appears on

Company Muster Roll

for Nov & Dec, 1863.

Joined for duty and enrolled:

When Sept 12, 1863.\*

Where Natchez Miss \*

Period 3 years.\*

Present or absent Present

Stoppage, \$ 100 for

Due Gov't, \$ 100 for

Remarks:

† This organization subsequently became Co. E, 6 Reg't U. S. Colored Heavy Artillery.

\* See enrollment on card from muster-in roll.

Book mark:

(358c)

Hadfield

Copyist.



H | 6 H.A. | U.S.C.T.

James M. Hickman  
Capt. Co. E. 2. Miss. Art. A. D.

**Return**

of the Post of Natchez, Miss.,

for the month of Dec, 1863,

dated Dec 31, 1863,

shows the following with regard to the person  
named above :

Post or station \_\_\_\_\_

Remarks Present for duty

Book mark: \_\_\_\_\_

A. E. Black

*85*

**6 H. Art'y. U.S.C.T.**

*Isaac N. Heitman*

*Captain*, Co. E, 2 Reg't Miss. Art'y.†

Appears on

**Company Muster Roll**

for *Jan & Feb*, 1864.

Joined for duty and enrolled:

When *Sept 12*, 1863.\*

Where *Katches Miss* \*

Period *3* years.\*

Present or absent *Present*

Stoppage, \$ *100* for

Due Gov't, \$ *100* for

Remarks:

† This organization subsequently became Co. E, 6 Reg't U. S. Colored Heavy Artillery.

\* See enrollment on card from muster-in roll.

Book mark:

(358c)

*Hadfield*

Copyist.

*H*

6 H. Art'y.

U.S.C.T.

*Isaac N. Hickman*  
Capt., Co. *E*, 5 Reg't U. S. Col'd H. Art'y.†

Appears on

**Company Muster Roll**

for *Mar & Apr*, 186 *4*

Joined for duty and enrolled:

When *Sept 12*, 186 *3*.\*

Where *Natchez Miss* \*

Period *3* years.\*

Present or absent *Present*

Stoppage, \$ *100* for

Due Gov't \$ *100* for

Valuation of horse, \$ *100*

Valuation of horse equipments, *100*

Remarks:

†This organization subsequently became Co. *E*, 6 Reg't U. S. Colored Heavy Artillery.

\* See enrollment on card from muster-in roll.

Book mark:

(358c)

*Madzies*

Copyist.

H | G.H.A. U.S.C.T.

Isaac N. Hickman  
Cap. Co. E. 5 U.S. Ar (Gen)

**Return**

of the Post of Natchez, Miss.,

for the month of Apr, 1867,

dated not dated, 186  ,

shows the following with regard to the person  
named above:

Post or station \_\_\_\_\_

Remarks: Present for duty

Book mark: \_\_\_\_\_

Al Black

(546)

Copyist.

16

6 H. Art'y.

U.S.C.T.

Isaac N. Heiman

Capt, Co. E, 6 Reg't U. S. Col'd H. Art'y.

Appears on

Company Muster Roll

for May - June 1864.

Joined for duty and enrolled:

When Sept 12, 1863.\*

Where Natchez Miss.\*

Period 3 years.\*

Present or absent Present

Stoppage, \$ 100 for

Due Gov't, \$ 100 for

Remarks: On special duty  
Landq Regiment

\* See enrollment on card from muster-in roll.

Book-mark :

Hadzield

(358c)

Copyist.

A

6 H. Art'y.

U.S.C.T.

Isaac N. Hickman

Capt., Co. E, 6 Reg't U. S. Col'd H. Art'y.

Appears on

Company Muster Roll

for July & Aug., 1864.

Joined for duty and enrolled:

When Sept. 12, 1863.\*

Where Natchez, Miss.\*

Period 3 years.\*

Present or absent

Stoppage, \$ 100 for

Due Gov't, \$ 100 for

Remarks: Resignation accepted by Special order No. 146, from Sec. of war, dated Natchez Aug. 9<sup>th</sup> 1864, received Aug 15<sup>th</sup> 1864.

\*See enrollment on card from muster-in roll.

Book-mark :

M. Rowe

(358c)

Copyist.

H | 6 H.A. U.S.C.T.

J. A. Hickman  
Cap-6. U.S.C.A. (Hy)

Return

of the Post and Defences of Natchez, Miss.,

for the month of Aug, 1867,

dated Aug 31, 1867,

shows the following with regard to the person  
named above:

Post or station

Remarks:

Loss - Resignation  
accepted per SO 139  
War Dep. A.G.O.

From Remarks on Return

Book mark:

A C Black

(046)

Copyist.

A

6 H. Art'y.

U.S.C.T.

Isaac N. Nickman

Capt; Co. E, 6 Reg't U. S. Col'd H. Art'y.

Appears on Returns as follows:

Sept & Oct 1863 (2 Miss  
H Art A, W) Absent  
with leave since  
Sept 28, 63

Nov 1863 to Feb 1864  
Present

Mar 1864 (5 US Col'd  
H Art) Present

Apr 1864 Present  
Comdg 2 Battln

May 1864 Present

June 1864 Present

Comdg Regt

Signs return

July 1864 Present

Aug 1864 Resigned

Excepted S.O. 146

from Secy of War  
dated Natchez Miss

Aug 9, 64 Rec'd Aug  
15, 64

Book mark:

A. Gouglan

(546)

Copyst.



*N*

6 H. Art'y.

U.S.C.T.

*Isaac N. Hickman*

*Capt.*, Co. *E*, 6 Reg't U. S. Col'd H. Art'y.

Appears on **Co. Muster-out Roll**, dated

*Natchez, Miss., May 13, 1866*

Muster-out to date \_\_\_\_\_, 186 .

Last paid to \_\_\_\_\_, 186 .

**Clothing account:**

Last settled \_\_\_\_\_, 186 ; drawn since \$ \_\_\_\_\_ 100

Due soldier \$ \_\_\_\_\_ 100 ; due U. S. \$ \_\_\_\_\_ 100

Am't for cloth'g in kind or money adv'd \$ \_\_\_\_\_ 100

Due U. S. for arms, equipments, &c., \$ \_\_\_\_\_ 100

Bounty paid \$ \_\_\_\_\_ 100 ; due \$ \_\_\_\_\_ 100

Remarks: *Discharged. Joined at original organization, resigned, resignation accepted, ser J. O. 146 Sec of War, Dated Natchez, Miss., Aug. 9, 1864.*

Book mark: \_\_\_\_\_

*O. J. Markle*

(361)

Copyist.

*Nickman Isaac N.*

*Capt. Co. E, 5<sup>th</sup> Reg't U.S. C.A.*

**Enclosures.**

Bed Cards .....	Final Statements .....
Burial Records .....	Furloughs or L. of A. ....
Certs. of Dis. for Discharge .....	Med. Certificates .....
C. M. Charges .....	Med. Des. Lists .....
Descriptive Lists .....	Orders .....
Discharge Certificates .....	Pris. of War Record .....
Enlistment Papers .....	Resignations .....

**Other papers relating to—**

Admission to Hosp'l .....	Furlough or L. of A. ....
Casualty Sheet .....	Med. Examination .....
Confinement .....	Misc. Information .....
Contracts .....	Pay or Clothing .....
Death or Effects .....	Personal Reports .....
Desertion .....	Rank .....
Discharge from Hosp'l .....	Transfer to Hosp'l .....
Discharge from Service .....	Transfer to V. R. C. ....
Duty .....	Transportation .....

Francis W. Wickman  
Capt Co E 6th US Cavalry (Reg)

2654 D.V. 1864  
Asks leave of absence  
for twenty (20) days  
to proceed to St Louis Mo

Granted see O 131 June 8/1864

Hd. Qrs. Dist. Vicksburg  
Vicksburg Miss.  
June 8<sup>th</sup> 1864

Respectfully forwarded  
Approved

W. H. Scurra

EB66 Maj. Gen. Comdg.

Approved

June 11 1864

Head Qrs 6th US Cavalry (Reg)  
Fort M. P. June 3<sup>rd</sup> 1864

Approved and respectfully  
forwarded  
W. H. Smith  
Maj Comdg Regt

Hd. Qrs. Fort M. P. June 5<sup>th</sup> 1864  
Natchez Miss

Approved and respect-  
fully forwarded  
Mr R. W. Wallace  
Col. Comdg

Headqrs. U. S. Forces  
Natchez. June 6. 1864

Respectfully forwarded  
approved  
J. L. Scurra  
Col. Comdg

June 11 1864

Fort M'Pherson.  
Watches Trip June 3<sup>rd</sup> 1864.

Sir,

I have the honor to request a leave of absence for Twenty (20) days, to proceed to St Louis Mo.

I have not had a leave of absence since the Organization of the Regt. Nor have I been absent from my Command without proper authority.

Sr C M Higby is present for duty with the Company and my services can readily be spared for the Period mentioned.

Very respectfully

Your Obedient Servant.

Isaac W. Hickman,

Capt Co "E"

6<sup>th</sup> W.S. Co'd Arty (Heavy.)

W. L. Nelson,

1<sup>st</sup> Lt & Capt

6<sup>th</sup> W.S. Co'd Arty (Heavy.)

Head Quarters Dept of Army of the Tennessee.  
Chattanooga Tenn. June 18<sup>th</sup> 1864

---

Special Order  
No 131.

---

Leave of absence granted  
to Capt Hickman Co. "E"

---

Headquarters, Department and Army of the Tennessee,

*Chattanooga Tenn June 15<sup>th</sup> 1864.*

SPECIAL ORDERS, }  
No. 131 } II

Leave of Absence, for twenty days, is hereby granted

*Capt Isaac S. Hickman 1<sup>st</sup> Lt. U.S. Army*

with Permission to proceed beyond the limits of the Department.

This Leave of Absence is subject to the provisions of Section 31, of "An. Act for Enrolling and calling out the National Forces, and for other purposes," published in General Orders No. 73, War Department, March 24, 1863, and will be so noted on the proper Muster and Pay Rolls.

By order of Major General JAS. B. McPHERSON.

*C. O.  
1<sup>st</sup> Lt. U. S. Arty Col.*

*J. A. Munro*

Assistant Adjutant General.

*J. B.*

Extracts from General Orders, A. G. O., War Department.

In time of War, Leaves of Absence will only be granted by the Secretary of War, except when the certificate of a Medical Officer shall show beyond doubt that a change of location "is necessary to save life or prevent permanent disability."—*Gen. Orders No. 61, series 1862.*

So much of General Orders, No. 61, current series, as relates to the extension of sick leaves of absence is hereby revoked, and no applications for extensions need hereafter be made. The order of the President, dated July 31, (General Orders No. 92,) fully explains what may be considered a good cause for absence. Surgeon's Certificate of disability, required by existing orders and regulations, must be forwarded not only to the Adjutant General of the Army, but also to the Commander of the Regiment, or in case of a staff officer, to his Commanding General.

Officers absent from duty without leave or beyond the time of their leaves, will not be allowed to draw pay until a court or commission, which will be ordered on their return to their post or command, shall determine whether there was sufficient cause for their absence. They will accordingly provide themselves with a full description of the nature and cause of their disability, certified by proper medical authority, as required by existing orders and regulations.

When an officer returns to his command after having overstaid his leave of absence, he may be tried by a court-martial for this as a military offense, or a commission may be appointed by the commanding officer of his division, army corps, or army, as the case may be, to investigate his case, and to determine whether or not, he was absent from proper cause; and if there should be found to be such proper cause, he will be entitled to pay during such absence. The proceedings of such commission will be sent to the Adjutant General of the Army for the approval of the Secretary of War, which commissions will consist of not less than three nor over five commissioned officers.—*Gen. Orders No. 100, series 1862.*

H. 36. 1864

Forb. M. P. 1864

No. 40. C. P. 1864

Hickman Capt. U.S. Army  
No. 10. 6. 6. Heavy  
Sends his resignation  
unconditional and  
immediate

One Enclosure

Head Quarters U.S. Artillery  
Fort M. P. Stationary 23<sup>rd</sup> 1864

Approved and respectfully  
forwarded

John P. Coleman  
Maj. Comd'g Regt.

Sp. Qu. Fort M. P. Station

Aug 7<sup>th</sup> 1864

Approved, and respectfully  
forwarded

B. L. Fessenden  
Col Comd'g

2 Enc.

Recd. Hd. Qu. 1864. Aug. 9. 64

Recd. A. G. O. August 23<sup>rd</sup> 1864

Copy furnished and for W.D., April 12, 1897, Ed.

Fort M. Person Hatchery Miss  
August 2<sup>nd</sup> 1864

James N. Dickson  
Lieut & Adjt 6<sup>th</sup> U.S. Cav. Arty Regt

I hereby most respectfully  
tender my resignation to be unconditional and  
immediate for the following reason viz business of  
immediate importance at home requiring my  
personal attention

I hereby certify on honor that I have no govt  
property in my possession except what I am prepared  
to turn over to the proper authority on the acceptance  
of my resignation That I am not indebted to the  
United States Govt on any account That I have  
been absent with leave twenty days since last  
paid That I was last paid by May Brown  
to include the 30<sup>th</sup> day of June 1864

Very Respectfully,  
Your Obedt Servt

James N. Hickman  
Capt Co E, 6<sup>th</sup> U.S. Cav. Arty Regt



S.O. 146

Par  
patches. Miss  
and 9. '64

L. M. Officer 6<sup>th</sup> U.S.C. Art (Heavy)  
N. Steves Mif August 8<sup>th</sup> 1864.

I hereby certify that  
J. N. Hickman Capt Co. E, 6<sup>th</sup> U.S. Col  
Art (Heavy) is not indebted to  
Regimentals L. M. Officer in any  
respect whatever

M. L. Nelson  
Lieut Col H. R. G. M. 6<sup>th</sup> U.S.C. Art (Heavy)

Natchez, Miss.,

Aug. 9, 1864.

Special Orders  
No. 146.

[Extract.]

II. . . . The resignations of the following named officers are accepted, and they are hereby discharged the service of the U. S., with the condition that they shall receive no final payment until they have satisfied the Pay Department that they are not indebted to the Government:

\* Captain D. N. Hickman, 6th U. S. Colored Artillery (Heavy).

\* By order of the Secretary of War.  
L. Thomas  
Adjutant General.

Adjutant General's Office.

*Licks, Swerson*

*Co L*, 6 U.S. Col'd H. Art'y.

*Private Private*

CARD NUMBERS.

1	61574191	26
2	6177665	27
3	6177785	28
4	6177883	29
5	6177973	30
6	6178053	31
7	6178151	32
8	6178255	33
9	6178363	34
10	6178521	35
11	6179093	36
12	91209451	37
13	40742499	38
14		39
15		40
16		41
17		42
18		43
19		44
20		45
21		46
22		47
23		48
24		49
25		50

Book Mark: *213. 09 P 428*

See also

QIP 5178H  
D 1560669 POUTUM

A166 7984 And West  
D-1670287 - And West

7/7/1947

*James Hicks*

Co. *L*, 6 Reg't U. S. Col'd H. Art'y.

Appears on

**Company Descriptive Book**

of the organization named above.

**DESCRIPTION.**

Age *44* years; height *5* feet *7* inches.

Complexion *Brown*

Eyes *Black*; hair *Black*

Where born *William C. Miss*

Occupation *farmer*

**ENLISTMENT.**

When *Feb 16*, 186 .

Where *Matchez*

By whom *J. H. Yarnall*; term *3* y'rs.

Remarks: *From Opelousas Louisiana  
Discharged in Surgeons Certificate  
by order of Major Genl. C. S. Harris  
Comdg Dist of Miss June 7  
1865*

*Hillman*



N

6 H. Art'y.

U.S.C.T.

*Irron Nickle*

Appears with rank of *Pl.*

**Muster and Descriptive Roll of a Detachment of U. S. Vols. forwarded**

★ **2 Regt. Miss. Art'y.**  
for the ~~6 Reg't U. S. Col'd H. Art'y.~~ Roll dated

*Natchez, Miss., July 24, 1864.*

Where born *Wilson, Miss.*

Age *44* y'rs; occupation *Farmer*

When enlisted *July 16, 1864.*

Where enlisted *Natchez, Miss.*

For what period enlisted *9* years.

Eyes *Blk.*; hair *Blk.*

Complexion *Brown*; height *5 ft. 7 in.*

When mustered in *July 24, 1864.*

Where mustered in *Natchez, Miss.*

Bounty paid \$ *100*; due \$ *100*

Where credited

Company to which assigned *L*

Remarks:

★ This organization subsequently became  
6 Regt. U. S. Col'd H. Artillery.

★ Corrected June 2 1896. *A. N. A.*

Book mark:

*Blank*

A

6 H. Art'y.

U.S.C.T.

*Iverson Hicks*

*Private*, Co. L, 2 Reg't Miss. Art'y.†

Appears on

**Company Muster Roll**

for *Jan'y 15 to Feb 29*, 1864

Joined for duty and enrolled:

When *Feb 16*, 186 .\*

Where *Notchez Quis* \*

Period *3* years.\*

Present or absent *Present*

Stoppage, \$ *100* for

Due Gov't, \$ *100* for

Valuation of horse, \$ *100*

Valuation of horse equipments, \$ *100*

Remarks:

† This organization subsequently became Co. L, 6 Reg't U.S. Col'd Heavy Artillery.

\* See enrollment on card from muster-in roll.

Book mark:

(358c)

*J. Jones*  
*Company* Company

4



Iverson Hicks  
Private, Co. L, 5 Reg't U. S. Col'd H. Art'y.\*

Appears on

Company Muster Roll

for *March & April*, 1864.

Joined for duty and enrolled :

When *Feb. 16*, 1864.\*

Where *Catchez Miss.* \*

Period *3* years.\*

Present or absent *Present*

Stoppage, \$ *100* for

Due Gov't, \$ *100* for

Valuation of horse, \$ *100*

Valuation of horse equipments, \$ *100*

Remarks: \_\_\_\_\_  
\_\_\_\_\_  
\_\_\_\_\_

\* This organization subsequently became Co. L, 6 Reg't U. S. Col'd Heavy Artillery.  
\* See enrollment on card from muster-in roll.

Book mark: \_\_\_\_\_

*J. W. Neal*

*A*

6 H. Art'y.

U.S.C.T.

*Iverson Hicks*

*Private*, Co. L, 6 Reg't U. S. Col'd H. Art'y.

Appears on

**Company Muster Roll**

for *May & June*, 186*4*\*

Joined for duty and enrolled :

When *Feb. 16*, 186*4*\*

Where *Catchez Miss* \*

Period *3* years.\*

Present or absent *Present*

Stoppage, \$ *100* for

Due Gov't \$ *100* for

Valuation of horse, \$ *100*

Valuation of horse equipments, \$ *100*

Remarks:

.....  
.....  
.....

\* See enrollment on card from muster-in roll.

Book mark: .....

.....

*J. H. Neal*

(358c)

Copyist.

A

6 H. Art'y.

U.S.C.T.

*Iverson Hicks*

*Private*, Co. L, 6 Reg't U. S. Col'd H. Art'y.

Appears on

**Company Muster Roll**

for *July & Aug.*, 186*4*.

Joined for duty and enrolled :

When *Feb. 16*, 186*4*.\*

Where *Watches Miss.* \*

Period *3* years.\*

Present or absent *Present*

Stoppage, \$.....*100* for.....

Due Gov't \$.....*100* for.....

Valuation of horse, \$.....*100*

Valuation of horse equipments, \$.....*100*

Remarks: .....

.....

.....

.....

\* ~~See~~ See enrollment on card from muster-in roll.

Book mark: .....

.....

*J. D. Neale*

Copist.

(358c)

A

6 H. Art'y.

U.S.C.T.

*Iverson Hicks*

*Private*, Co. L, 6 Reg't U. S. Col'd H. Art'y.

Appears on

**Company Muster Roll**

for *Sept. & Oct.*, 1864

Joined for duty and enrolled:

When *Feb. 16*, 1864\*

Where *Hatchers Mills* \*

Period *3* years.\*

Present or absent *Present*

Stoppage, \$ *100* for

Due Gov't \$ *100* for

Valuation of horse, \$ *100*

Valuation of horse equipments, \$ *100*

Remarks:

\* See enrollment on card from muster-in roll.

Book mark:

*J. H. Neal*

(358c)

Copist.

*Amperson Nichols*

*Pat*, Co. L, 6 Reg't U. S. Col'd H. Art'y.

Appears on

**Company Muster Roll**

for *Nov + Dec*, 1864.

Joined for duty and enrolled :

When *Feb 16*, 1864.\*

Where *Natchez Miss* \*

Period *3* years.\*

Present or absent *Present*

Stoppage, \$ *100* for

Due Gov't \$ *100* for

Valuation of horse, \$ *100*

Valuation of horse equipments, \$ *100*

Remarks:

\* See enrollment on card from muster-in roll.

Book mark:

*R. S. Shelton*

*H*

6 H. Art'y.

U.S.C.T.

*Inerson Hicke*

*Pat*, Co. L, 6 Reg't U. S. Col'd H. Art'y.

Appears on

**Company Muster Roll**

for *Jan & Feb*, 1865.

Joined for duty and enrolled:

When *Feb 16*, 1864.\*

Where *Natchez Miss*\*

Period *3* years.\*

Present or absent *Present*

Stoppage, \$ *100* for

Due Gov't \$ *100* for

Valuation of horse, \$ *100*

Valuation of horse equipments, \$ *100*

Remarks:

.....  
.....  
.....

\* See enrollment on card from muster-in roll.

Book mark: .....

*R S Sheltm*

(358c)

Copyist.

A

6 H. Art'y.

U.S.C.T.

*Svenson Hicks*

*Pat*, Co. L, 6 Reg't U. S. Col'd H. Art'y.

Appears on

**Company Muster Roll**

for *March & April*, 1865.

Joined for duty and enrolled:

When *Feb. 16*, 1864.\*

Where *Natchez Miss* \*

Period *3* years.\*

Present or absent *Present*.

Stoppage, \$ *100* for.....

Due Gov't \$ *100* for.....

Valuation of horse, \$.....100

Valuation of horse equipments, \$.....100

Remarks: .....

.....

.....

.....

\* See enrollment on card from muster-in roll.

Book mark: .....

*R. S. Shelton*

(378c)

Capt.

N

6 H. Art'y.

U.S.C.T.

*Johnson Hicks*

*Priv*, Co. L, 6 Reg't U. S. Col'd H. Art'y.

Appears on

**Company Muster Roll**

for *May & June*, 1865.

Joined for duty and enrolled:

When *Feb 16*, 1864.\*

Where *Natchez Miss* \*

Period *3* years.\*

Present or absent

Stoppage, \$ *100* for

Due Gov't \$ *100* for

Valuation of horse, \$ *100*

Valuation of horse equipments, \$ *100*

Remarks: *Discharged for Disability  
by order of Maj Gen. Osterhaus  
Comdg. Dist. of Miss. June 7<sup>th</sup> 1865.  
Discharge & final Statement fur-*  
*(over)*

\* See enrollment on card from muster-in roll.

Book mark:

*R. B. Shelton*

(358c)

Copyist.



JAN. 14

6178521

☆1891☆

*missed.*

*Dwerson Hicks*

*Prvt.*, Co. *L*, 6 Reg't U. S. Col'd H. Art'y.

Appears on Returns as follows:

*June 1865 Disch'd  
for disability June  
27, 65 Ketching Miss*

Book mark:

(546) *A. Googla* Copyist.

*Iverson Hicks*

*Private* Co. *L.*, 6 Reg't U. S. Col'd H. Art'y.

Appears on **Co. Muster-out Roll**, dated

*Natchez, Miss.* ..... *May 13*, 186*6* .

Muster-out to date ..... , 186 .

Last paid to ..... , 186 .

Clothing account:

Last settled ..... , 186 ; drawn since \$ ..... 100

Due soldier \$ ..... 100 ; due U. S. \$ ..... 100

Am't for cloth'g in kind or money adv'd \$ ..... 100

Due U. S. for arms, equipments, &c., \$ ..... 100

Bounty paid \$ ..... 100 ; due \$ ..... 100

Remarks: *Joined as a Recruit.*  
*Disch'd June 27 '65 at*  
*Natchez, Miss. Surgeons*  
*certificate of disability.*  
*final statements furnished.*

Book mark: *12.328.2.4 P. 57. 68 (over)*

(361)

*Keefer*

Copyist.

JUN. 14

6179093

8914

V. 11. P. 450. 68. P. 2. 24 P. 89.

70. C.D. Discharged June

7. 65. E. B. V. 9. P. 428.

Hicks, Overton

P, Co. L, 6 U.S.C.H.A.

Enclosures.

Bed Cards	Descriptive Lists
Burial Records	Final Statements
Certs. of Dis. for Discharge	Furloughs
C. M. Charges	Med. Des. Lists
Med. Certificates	Orders

Other papers relating to—

Admission to Hosp'l	Furlough
Casualty Sheet (Officer's)	Med. Examination
Confinement	Misc. Information
Contracts	Pay or Clothing
Death or Effects	Personal Reports
Desertions	Rank
Discharge from Hosp'l	Transfer to Hosp'l
Discharge from Service	Transfer to V. R. C.
Duty	Transportation

CERTIFICATE OF DISABILITY FOR DISCHARGE

IN THE CASE OF

718  
Person Vicks  
Private of Co. "G"  
Sixth Reg't of U.S.  
Colored Artillery Heavy

Head Quarters 6th Col Artillery Heavy  
Fort W. Sherman Natchez Miss April 24/65

Approved and respectfully  
forwarded  
John P. Coleman  
Major Commanding

Adjutant General's Office  
Act 4<sup>th</sup> 1871.  
On Muster-out Roll of Company  
"L" 6<sup>th</sup> U.S.C. Artillery (Hvy.) Private  
Person Vicks is reported as  
discharged June 24<sup>th</sup> 1865.

Muster Roll of Company for May  
& June, 1865 and a Surgeons Certificate  
of disability for discharge of the  
soldier give date of discharge as  
June 7<sup>th</sup> 1865.

The latter date (June seventh,  
1865) is held to be correct and the  
Company Muster-out Roll will  
be amended accordingly.

Thomas M. Vincent  
Asst. Adj. Genl.  
Per Order of  
6.71 to 2<sup>nd</sup> Genl  
Hall

Headquarters Department of Mississippi,

Vicksburg June 7<sup>th</sup> 1865.

To be Discharged,  
Osterhaus

By Command of Major General W. H. T. WALKER:

Assistant Adjutant General.

Head Quarters,  
District of Natchez,  
Natchez Miss, Apr 20/65

Approved and  
respectfully forwarded to  
Head Quarters, Department  
of Mississippi

Brigadier General  
Commanding

pers to the regimental, detachment, or post commander, who will forward them, with his action endorsed thereon, through the proper channel, to his division commander; or, if the troops are not attached to a division, to his corps, department, or other commander or officer to whom the authority to discharge enlisted men may be specially delegated.

These certificates, after having received the action of the highest authority to which they are required to be sent, will be returned through the same channel to the regimental, post, or detachment commander, who will, if the discharge is authorized by the endorsement of the proper authority, sign the soldier's discharge, and the last certificate on this paper; see that the soldier is furnished with the proper final statements in duplicate, and forward BOTH of these certificates direct to the Adjutant General United States Army, at Washington, D.C., and will not, under any circumstances be given into the hands of the soldier.

ADJUTANT GENERAL'S OFFICE

July 22. 1865.

Duplicate sent the Pension Office.

Received (A. G. Office) 1865

Enthorn & Profless

Approved  
George S. Schumler  
Surgeon U.S. Medical Director

ARMY OF THE UNITED STATES  
 CERTIFICATE  
 OF DISABILITY FOR DISCHARGE.



Private Everson Hicks of Captain David J. Kimmment Company, (2<sup>d</sup>) of the Sixth Regiment of United States Artillery was enlisted by Captain Thomas G. Yarnall of the Sixth Regiment of U.S. Artillery at Natchez Miss on the thirtieth day of February 1864, to serve 3 years; he was born in Wilton Co in the State of Mississippi is forty four years of age, 5 feet 7 inches high, Black complexion, Black eyes, Black hair, and by occupation when enlisted a Farmer. During the last two months said soldier has been unfit for duty 59 days.\* His disease is Rheumatism and General Debility caused by exposure since Enlistment

STATION: Natchez Miss  
 DATE: \_\_\_\_\_

Jesse W. Morehouse  
2<sup>d</sup> Lt. U.S. Artillery  
 Commanding Company.

*Approved  
 J. P. Baylyn  
 Surg. 23 U.S. Cavalry  
 Surg. in Charge Dist. of*

I CERTIFY, that I have carefully examined the said Private Everson Hicks of Captain Kimmment's Company, and find him incapable of performing the duties of a soldier because of Chronic Rheumatism and general physical debility arising chiefly from exposure since enlistment of age (33) fifty three years Disability one half (1/2) unfit for Vet Res. Corps

DISCHARGED, this 7<sup>th</sup> day of June 1865, at Natchez Mississippi By order of Major Emil Osterhaus  
George M. Peal  
 Assistant Surgeon in Charge  
 U.S. Col. Artillery (Regt.)

\_\_\_\_\_  
 Commanding the Reg't.

The soldier desires to be addressed at  
 Town \_\_\_\_\_ County \_\_\_\_\_ State \_\_\_\_\_

\* See Note 1 on the back of this. † See Note 2 on the back of this.

*Highby, Cornelius*

Co *B*, 6 U.S. Col'd H. Art'y.

*2 Lieutenant & Lieutenant*

CARD NUMBERS.

1	6165146	26
2	6165290	27
3	6165434	28
4	6165558	29
5	6165675	30
6	6165791	31
7	6166006	32
8	6166119	33
9	6166230	34
10	6166341	35
11	6166449	36
12	6166557	37
12	6166658	38
14	6166754	39
15	6165330	40
16	6166845	41
17	6166935	42
18	6167025	43
19	9436777	44
20	42716122	45
21	42716479	46
22	42716806	47
23	40742411	48
24		49
25		50

Book Mark: *H87 U10 C573*

See also *30 No. 10.*



2406432 DOMM  
S. CO. Highby Erie Pa 4/24/26  
Cor Sec.

7/7/26

Cornelius Higby

2<sup>nd</sup> Lt, Co. E, 6<sup>th</sup> Reg't U. S. Col'd Art'y

Appears on

**Regimental Descriptive Book**

(List of Commissioned Officers)

of the regiment named above.

Rank 2<sup>nd</sup> Lieut.

Date of appointment Oct. 28 1863

Remarks: App<sup>d</sup> from Sgt.  
30<sup>th</sup> Mo. Infy.

Muster in to date Sept.  
12- 63

E. D. Neal

H

Cornelius M Higby  
2 Sicut Co. E, 2 Reg't Miss. Art'y.†

Age 47 years.

Appears on

Company Muster-in Roll

of the organization named above. Roll dated

atches Miss Sep 12, 1863.

Muster-in to date Sep 12, 1863.

Joined for duty and enrolled:

When \_\_\_\_\_, 186 .\*

Where \_\_\_\_\_ \*

Period 3 years.\*

Valuation of horse, \$ 100

Valuation of horse equipments, \$ 100

Remarks: appointed from  
Commissary sergt in  
30 Reg Mo Inf Vols  
E

† This organization subsequently became Co. .... 6 Reg't U. S. Colored Heavy Artillery.

\* Muster-in roll shows enrollment of all men of this company as of same date and place. See enrollment on subsequent card or cards.

Book mark: \_\_\_\_\_

Hadfield

JAN. 14

6165146

1891

*to 2<sup>nd</sup> Lieut in 2<sup>nd</sup>  
Miss Art Reg A + O*

*H*

6 H. Art'y.

U.S.C.T.

*Cornelius M Higby*

*2 Lieut*, Co. E, 2 Reg't Miss. Art'y.†

Appears on

**Company Muster Roll**

for *Sept - Oct*, 1863.

Joined for duty and enrolled:

When *Sept 12*, 1863.\*

Where *Hatchez Miss* \*

Period *3* years.\*

Present or absent *Present*

Stoppage, \$ *100* for

Due Gov't, \$ *100* for

Remarks:

† This organization subsequently became Co. E, 6 Reg't U. S. Colored Heavy Artillery.

\* See enrollment on card from muster-in roll.

Book mark:

*Hadfield*

(358c)

Copyist.

H

Cornelius M. Highby

2 Sicut, Co. E, 2 Reg't Miss. Art'y.†

Appears on

Company Muster Roll

for Nov Dec, 1863.

Joined for duty and enrolled:

When Sept 12, 1863.\*

Where Hatchers miss \*

Period 3 years.\*

Present or absent Present

Stoppage, \$ 100 for

Due Gov't, \$ 100 for

Remarks:

† This organization subsequently became Co. E, 6 Reg't U. S. Colored Heavy Artillery.  
\* See enrollment on card from muster-in roll.

Book mark:

Hadfield

H | 6 H.A. USCT  
Cornelius Higby  
2-L-G, E. 2. Miss. M. A. D.

**Return**

of the Post of Natchez, Miss.,  
for the month of Dec, 1863,  
dated Dec 31, 1863,

shows the following with regard to the person  
named above:

Post or station \_\_\_\_\_

Remarks: Present for duty

Book mark: \_\_\_\_\_

AC Black

H

6 H. Art'y. U.S.C.T.

Cornelius M Higby  
2 Sicut, Co. E, 2 Reg't Miss. Art'y.†

Appears on

Company Muster Roll

for Jan & Feb, 1864.

Joined for duty and enrolled:

When Sept 12, 1863.\*

Where Vatches Miss \*

Period 3 years.\*

Present or absent Present

Stoppage, \$ 100 for

Due Gov't, \$ 100 for

Remarks:

† This organization subsequently became Co. E, 6 Reg't U. S. Colored Heavy Artillery.

\* See enrollment on card from muster-in roll.

Book mark:

Hadfield

(358c)

Copyist.



14

6 H. Art'y.

U.S.C.T.

Cornelius M. Higby  
2 Lt., Co. E, 5 Reg't U. S. Col'd H. Art'y.†

Appears on

Company Muster Roll

for Mar & Apr, 1864.

Joined for duty and enrolled:

When Sept 12, 1863.\*

Where Ketches Mrs \*

Period 3 years.\*

Present or absent Present

Stoppage, \$ 100 for

Due Gov't \$ 100 for

Valuation of horse, \$ 100

Valuation of horse equipments, 100

Remarks: \*U. A. L. M. for  
Fortifications

\* In pencil

†This organization subsequently became Co. E, 6 Reg't U. S. Colored Heavy Artillery.

\* See enrollment on card from muster-in roll.

Book mark:

Hadfield

(358c)

Copyist.

7H | 6 H.A. | U.S.C.T.

Cornelius Higby  
2<sup>d</sup> Lt.-Co. E. 5<sup>th</sup> U.S. Heavy Art. (C.)

Return

of the Post of Natchez, Miss.,

for the month of Apr, 1864,

dated not dated, 186 ,

shows the following with regard to the person  
named above :

Post or station

Remarks: absent A.A. Q.M.  
for fortifications

Book mark:

A C Black

H

6 H. Art'y.

U.S.C.T.

Cornelius M Higby

2 Lieut, Co. E, 6 Reg't U. S. Col'd H. Art'y.

Appears on

Company Muster Roll

for May - June 1864.

Joined for duty and enrolled:

When Sept 12, 1863.\*

Where Hatchers Mills.\*

Period 3 years.\*

Present or absent Present

Stoppage, \$ 100 for

Due Gov't, \$ 100 for

Remarks:

\*See enrollment on card from muster-in roll.

Book-mark:

Hadfield

(358c)

Copyist.

A

6 H. Art'y.

U.S.C.T.

Cornelius M. Higby

2<sup>d</sup> Lieut Co. E, 6 Reg't U. S. Col'd H. Art'y.

Appears on

Company Muster Roll

for July Aug, 1864.

Joined for duty and enrolled:

When Sept 12', 1863.\*

Where Natchez Miss, \*

Period 3 years.\*

Present or absent

Stoppage, \$ 100 for

Due Gov't, \$ 100 for

Remarks: A prisoner of war captured in action at Cross Bayou La on the 6<sup>th</sup> of August 1864.

\* See enrollment on card from muster-in roll.

Book-mark :

C. M. Rowe

H | C H. A. USCY

C. M. Highby  
2-Lt-C. U. S. C. (H. G.)

Return

of the Post and Defences of Natchez, Miss.,

for the month of *Nov*, 1864,

dated *Nov 30*, 1864,

shows the following with regard to the person  
named above:

Post or station

Remarks:

*2 Lt C. M. Highby  
gain from missing w  
action*

*From Remains on Return*

Book mark:

*A. C. Black*

Cornelius M. Higley

2 Lieut, Co. E, 6 Reg't U. S. Col'd H. Art'y.

Appears on

Company Muster Roll

for Nov & Dec 1864.

Joined for duty and enrolled:

When Sept 12, 1863.\*

Where Natchez, Miss.\*

Period 3 years.\*

Present or absent Absent,

Stoppage, \$ 100 for

Due Gov't, \$ 100 for

Remarks: Prisoner of war in the hands of the enemy since August 6<sup>th</sup> 1864. Gained by error in report he having been dropped from rolls of Company as lost in action.

\* See enrollment on card from muster-in roll.

Book-mark :

(358c)

C. M. Rowland Copyist.

A

6 H. Art'y.

U.S.C.T.

Cornelius M. Higby

2 Lieut, Co. E, 6 Reg't U. S. Col'd H. Art'y.

Appears on

Company Muster Roll

for Jan & Feb, 1863.

Joined for duty and enrolled:

When Sept 12', 1863.\*

Where Watcher Min \*

Period 3 years.\*

Present or absent Absent,

Stoppage, \$ 100 for

Due Gov't, \$ 100 for

Remarks: Prisoner of war in the hands of the enemy since Aug. 6/64.

\* See enrollment on card from muster-in roll.

Book-mark :

C. M. Rowe

(358c)

Copyist.

*N*

6 H. Art'y.

U.S.C.T.

*Cornelius M Higby*

*2 Lieut*, Co. E, 6 Reg't U. S. Col'd H. Art'y.

Appears on

**Company Muster Roll**

for *March & April* 186*5*.

Joined for duty and enrolled:

When *Sept 12*" , 186*5*.\*

Where *Natchez Miss* \*

Period *3* years.\*

Present or absent *Absent*.

Stoppage, \$ *100* for

Due Gov't, \$ *100* for

Remarks: *Prisoner of war in the hands of the enemy since Aug. 6, 1864,*

\* See enrollment on card from muster-in roll.

Book-mark :

*J M Moore*



*Cornelius M Higley*

*2<sup>nd</sup> Lieut*, Co. E, 6 Reg't U. S. Col'd H. Art'y.

Appears on  
**Company Muster Roll**

for *May & June* 1865

Joined for duty and enrolled:

When *Sept 12*, 1865.\*

Where *Natchez Miss*\*

Period *3* years.\*

Present or absent *present*,

Stoppage, \$ *100* for

Due Gov't, \$ *100* for

Remarks: \_\_\_\_\_  
\_\_\_\_\_  
\_\_\_\_\_  
\_\_\_\_\_  
\_\_\_\_\_

\* See enrollment on card from muster-in roll.

Book-mark: \_\_\_\_\_

*J. M. [Signature]*  
Copyist.

H.

6 H. Art'y.

U.S.C.T.

Cornelius M. Higby  
2<sup>d</sup> Lieut., Co. E, 6 Reg't U. S. Col'd H. Art'y.

Appears on

**Company Muster Roll**

for July and Aug. 1865.

Joined for duty and enrolled:

When Sept. 12, 1863.\*

Where Natchez, Miss.\*

Period 3 years.\*

Present or absent present.

Stoppage, \$ 100 for

Due Gov't, \$ 100 for

Remarks:

Act. Batt. 2<sup>d</sup> M.

\*~~See~~ See enrollment on card from muster-in roll.

Book-mark :

D. M. Webb

(358c)

Copyist.

26

6 H. Art'y.

U.S.C.T.

Cornelius W. Higby

2d Lieut., Co. E, 6 Reg't U. S. Col'd H. Art'y.

Appears on

Company Muster Roll

for Sept. and Oct. 1865.

Joined for duty and enrolled:

When Sept. 12, 1863.\*

Where Natchez, Miss.\*

Period 3 years.\*

Present or absent Present

Stoppage, \$ 100 for

Due Gov't, \$ 100 for

Remarks:

\* See enrollment on card from muster-in roll.

Book-mark:

Drury Webb

(358c)

Copyist.

26

6 H. Art'y.

U.S.C.T.

Cornelius M. Higby

2nd Lt., Co. E, 6 Reg't U. S. Col'd H. Art'y.

Appears on

Company Muster Roll

for *Nov & Dec* 1865.

Joined for duty and enrolled:

When *Sept 12*, 186*3*\*

Where *Katchez, Miss*\*

Period *3* years.\*

Present or absent *Present*

Stoppage, \$ *100* for

Due Gov't, \$ *100* for

Remarks: *act. R. 2 M.*

\*See enrollment on card from muster-in roll.

Book-mark :

*W. H. L.*

*Cornelius M. Higby*  
Rank *2d Lt*, *6* Reg't U. S. Col'd *H. Hart*

Appears on

**Field and Staff Muster Roll**

for *Nov & Dec*, 1865.

Present or absent *Present*

Stoppage, \$ *100* for

Due Gov't, \$ *100* for

Valuation of horse, \$ *100*

Valuation of horse equipments, \$ *100*

Remarks: *Appointed R. Sgt.*  
*by G.O. No. 48. Ed. 3. Regt.*  
*Hd qrs Nov. 1, 1865.*

Book mark:

*C. Hart*  
Copyist.

26

6 H. Art'y.

U.S.C.T.

Cornelius M. Higby

2nd Lt, Co. E, 6 Reg't U. S. Col'd H. Art'y.

Appears on

Company Muster Roll

for Jan & Feb 1866.

Joined for duty and enrolled:

When Sept 12, 1863.\*

Where Hatchez, Miss\*

Period 3 years.\*

Present or absent Present

Stoppage, \$ 100 for

Due Gov't, \$ 100 for

Remarks:

\*See enrollment on card from muster-in roll.

Book-mark:

(358c)

W. H. [Signature]

Copyist.

26

6 H. Art'y.

U.S.C.T.

Cornelius M. Higby

2nd Lt, Co. E, 6 Reg't U. S. Col'd H. Art'y.

Appears on

Company Muster Roll

for March 1866.

Joined for duty and enrolled:

When Sept 12, 1863\*

Where Hatchez, Miss\*

Period 3 years.\*

Present or absent Present

Stoppage, \$ 100 for

Due Gov't, \$ 100 for

Remarks:

\* See enrollment on card from muster-in roll.

Book-mark:

W. D. D. G.

(358c)

Copyist.

A

6 H. Art'y.

U.S.C.T.

Corporal M. Higby  
25th, Co. C, 6 Reg't U. S. Col'd H. Art'y.

Appears on Returns as follows:

Sept 1863 to Feb 1864 (2 Mns  
H Art A.D.) Present

Mar 1864 (5 U.S. Col'd H.A.)  
Present

Apr 1864 Present A.A. 2 M  
for Fortifications

May 1864 6 U.S. Col'd H.A.)  
Present A.A. 2 M Engi-  
neer Dept Fort  
McPherson

June 1864 Present signs  
Return Comdg the Co

July 1864 Present on Spec'l  
duty in Reg'l Commissary

Aug 1864 Absent missing in  
action at Cross Bayou  
La Aug 6, 64

Nov 1864 to Apr 1865 Ab-  
sent Prisoner of  
war in hands of ene-  
my since Aug 6, 64

Book mark:

(546)

A. J. Gougeon  
Copyist.



JAN. 19.

40742411

1899.

May 1865 Absent Missing  
(in action Aug 5, 64)  
June 1865 Present  
July 1865 Present sick in Camp  
Aug & Sept 1865 Present on  
Special duty as Actg  
Batt 2<sup>nd</sup>  
Oct 1865 Present  
Nov 1865 to Jan 1866  
Present on Special duty  
as A. R. & M.  
Nov 1865 to Jan 1866 (2 Lt  
& A. R. & M.) Present  
Detach<sup>d</sup> from Co E  
Feb 1866 (2 Lt Co E) Pres-  
ent  
Mar 1866 Present in  
Arrest  
Apr 1866 Present

77

6 H. Art'y.

U.S.C.T.

*Cornelius M. Hily*

2<sup>d</sup> Lieut, Co. *E*, 6 Reg't U. S. Col'd H. Art'y.

Appears on **Co. Muster-out Roll**, dated

*Hatcher, Miss.*, *Mar 13*, 1866.

Muster-out to date *Mar 13*, 1866.

Last paid to *Dec. 31*, 1865.

**Clothing account:**

Last settled....., 186 ; drawn since \$..... 100

Due soldier \$..... 100; due U. S. \$..... 100

Am't for cloth'g in kind or money adv'd \$..... 100

Due U. S. for arms, equipments, &c., \$..... 100

Bounty paid \$..... 100; due \$..... 100

Remarks: *is not original organization*  
*Enlisted July 30, 1862 at St. Louis,*  
*Mo., as private in Co. "C" 30 Mo. Inf.*  
*Vol. Was discharged from*  
*this organization Feb 12, 63 to*  
*enable him to receive promotion*  
*\* (As it is on the Roll.)*

Book mark: *H 87 V 10 C.T. 73*

*[Over]*

*Q. J. Markle,*

(361)

Copyist.

JAN. 14

6167025

☆1891☆

as 2<sup>nd</sup> Lt. in Co. E. 6<sup>th</sup> U. S. C.  
Art. Hy. (then 2<sup>nd</sup> Miss. Art.  
A. D.) Mustered in as 2<sup>nd</sup> Lt. in  
Co. E. 6 U. S. C. Art. Hy. at its  
original organization - Has Com-  
plied with par. 71 musterings  
Regulations. Entitled to three  
months pay proper per Act  
of Congress. Service Continuous  
from 30<sup>th</sup> Mo. Vol. Inf. to 6<sup>th</sup> U. S.  
C. Art. Hy.

*Higby Cornelius M.*

*2nd Lt., Co. E*

*6*

*Reg't No. 1-6th A*

*2* Enclosures.

Bed Cards .....	Final Statements .....
Burial Records .....	Furloughs or L. of A. ....
Certs. of Dis. for Discharge .....	Med. Certificates .....
C. M. Charges .....	Med. Des. Lists .....
Descriptive Lists .....	Orders .....
Discharge Certificates .....	Pris. of War Record .....
Enlistment Papers .....	Resignations .....

Other papers relating to—

Admission to Hosp'l .....	Furlough or L. of A. .... /
Casualty Sheet .....	Med. Examination .....
Confinement .....	Misc. Information .....
Contracts .....	Pay or Clothing .....
Death or Effects .....	Personal Reports .....
Desertion .....	Rank .....
Discharge from Hosp'l .....	Transfer to Hosp'l .....
Discharge from Service .....	Transfer to V. R. C. ....
Duty .....	Transportation .....

COMPILED MILITARY SERVICE RECORDS  
OF VOLUNTEER UNION SOLDIERS WHO SERVED WITH  
THE UNITED STATES COLORED TROOPS (USCT)  
6TH REGIMENT OF HEAVY ARTILLY

PERSONAL PAPERS' TARGET SHEET

PLEASE NOTE THE CHECKED INFORMATION ABOUT THE PERSONAL PAPERS IN  
THIS FILE:

- NO PERSONAL PAPERS WERE FOUND IN THIS FILE WHEN THE  
RECORDS WERE ARRANGED FOR MICROFILMING.
- 4 PERSONAL PAPER(S) FOUND IN THIS FILE WHEN THE RECORDS  
WERE ARRANGED FOR MICROFILMING.

No 5-334 Dept Miss 1865

A 9 (2) 10 m 1865

Natchez Mississippi  
August 11<sup>th</sup> 1865

Hon. Cornelius M.  
2<sup>nd</sup> Sigs Comp "E" 6<sup>th</sup> U.S. Cav<sup>ry</sup>

Respectfully asks for a leave  
of absence for twenty days  
with the privilege of applying  
for an Extension to visit his  
home at Albany New York

S. D. O. # 24 - Par. 6 - 1865

and receipt sent Aug 18<sup>th</sup> 1865

Rec'd S. D. O. Aug 14<sup>th</sup> 1865

Head Qu 6<sup>th</sup> U.S. Cav<sup>ry</sup>

For M. P. P. Natchez Miss  
August 11, 1865

Respectfully forwarded  
Approved

John P. Coleman  
Maj Comdg

Ex No (22) 2. B. (128)

HEAD-QUARTERS,

POST OF NATCHEZ,

Natchez, Miss., August 13, 1865.

Respectfully forwarded

Approved  
Joseph M. H. J.

Colonel 2d N. J. Cavalry,  
Commanding Post.

HEADQUARTERS,

Southern District of Mississippi,

Natchez, Miss., Aug. 14<sup>th</sup> 1865

RESPECTFULLY forwarded to  
Headquarters Dept of  
Miss Approved  
E. M. B. P. 60

W. S. S. C. S.

Brevet Maj. Gen'l Com'd'g.

Head -  
make it

211

with

Fort McPherson Natchez Miss Aug 17/865

Sir

I have the honor to request a leave of absence for Thirty days with permission to apply for Ten days Extension for the purpose of visiting the city of Albany N.Y. also permission to apply to the Secretary of War for an Extension of Thirty days. I have been a prisoner of war for ten months was Exchanged at the mouth of Red River on the 27<sup>th</sup> day of May have been over three years in the Service and have never had a leave of absence, a leave of a shorter period would not be of much Service to me

Captain Daniel Dillon and Simeon Forman J. White are both serving with the Company to which I am attached, and my Services can be readily spared for the period desired

Very Respectfully Your Obedient Servt

J. W. Rodgers

Simeon & Adjt 6<sup>th</sup> U.S. Colored  
Artillery (Heavy)

C. M. Hight 2<sup>nd</sup> Simeon

Company 6<sup>th</sup> U.S. Colored Artillery (Heavy)

Wm. H. H. S. M. S. 1865

Washington Miss.

August 23<sup>rd</sup> 1865

Highly Cornelius M. 2<sup>nd</sup> Lieut.

Co. E. 6<sup>th</sup> U.S. Colored Art. Regt.

Respectfully asks that  
a ten days extension  
of his leave of absence  
be granted him, and that  
it be directed to him in  
Albany New York



Washington Mississippi  
August 25<sup>th</sup> 1865

Asst Adjt Genl,  
Military Division of the Gulf.  
Sir.

By permission  
given me in the accompanying Leave of Absence  
I have the honor to most respectfully ask  
that you will grant me a ten days extension  
of my Leave of absence, and direct it  
to me in Albany New York

Very Respectfully  
Your Obedient Servant  
Cornelius W. Higby  
2<sup>nd</sup> Lieut Co E 6<sup>th</sup> U.S. Cold Art. 147

Cornelius M. Highby  
2<sup>nd</sup> Lieut & R. Q. M.  
6<sup>th</sup> U. S. Artillery  
Copy of order appointing  
&  
Copy of order relieving  
C. M. Highby

Adjutant General's Office,

COLORED TROOPS BRANCH,

Oct 27, 1874

Mr. Ellsworth, Vol. C.T., 187  
Wanted in case of  
Reg't of Col. M. H. High, 1st Col.,  
and relieved him from duty last Reg't  
Appointed in November 1865 and relieved in  
January or July, 1866

Respectfully,

A. Woodward  
Chief Clerk.

Sr. J. H.

Adjutant General's Office,

, 187

Vol. C. T., 187

Reply in case of \_\_\_\_\_, Co. \_\_\_\_\_,

Reg't

Hd. Qrs. 6th U.S. Col. Art. Hy. Fort McPherson March 7th 1865.  
Nov. 1st 1865, Special Order No. 48. 2d Lieut. Cor-  
nelius M. High by Cos. "E" is hereby appointed Regimental  
Quarter Master and will at once report to Lieut. M. S. Nelson  
for the books, papers, and property pertaining to that office.  
He will report to these Headquarters for instructions.

By order Maj. John P. Lealman Comd'g.

Hd. Qrs. 6th U.S. Col. Art. Hy. Fort McPherson Feb. 23rd 1866, Special Order No

19. 2d Lieut. C. M. High is hereby relieved from duty as  
Acting Regimental Quartermaster, and will at once turn over all public  
property in his possession pertaining to the Quartermaster's Department, to  
Lieut. J. B. Shadle, who will receive and receipt for the same, report  
compliance he will without delay report to his Company Commander  
for duty. By order Maj. C. W. Smith Comd'g.

11-4-74  
B.

Cornelius W. Higby U

2<sup>nd</sup> Lieut Co "E" 6<sup>th</sup> Army Reg

---

Report of Div of DC

Adjutant General's Office,

COLORED TROOPS BRANCH,

Mr Ellertrook

March 6<sup>th</sup>, 1875

Vol. C. T., 187

Wanted in case of Cornelius M Higby 2<sup>nd</sup> Lt., Co. "E",  
6<sup>th</sup> Reg't U. S. C. Art. (Hvy)

1<sup>st</sup> Date of Return from Prisoner War - "Prisoner of War Captured  
at Cross Bayou La Ang 6 "1864" - M Roll from June 30/64 to  
April 30/65 - Present for duty - M R for 17 days June 1865.  
2<sup>nd</sup> Cause of Arrest whether trial - "Present in Arrest" Regt Rbk  
for March 1866.

Respectfully,

A. G.

W. A. Woodward  
Chief Clerk.  
J. W. H.

Adjutant General's Office,

Division of Discontinued Commands.

March 9<sup>th</sup>, 1875.

Vol. C. T., 187

Reply in case of C. M. Higby 2<sup>nd</sup> Lt., Co. "E",  
6<sup>th</sup> Reg't U. S. C. A. (Hvy)

1<sup>st</sup> - Co Morig Repts June 6, 1860 - "Returned to Co from Pris of  
War"

2<sup>nd</sup> - Regt & Co Recs furnish no information - Co Morig  
Reports (no remarks) March 1 to 17 "66 - One 2<sup>nd</sup> Lt present  
sick - March 16<sup>th</sup> to 21<sup>st</sup> - One Com<sup>d</sup> Officer absent without  
leave - March 22<sup>nd</sup> to 31<sup>st</sup> - One 2<sup>nd</sup> Lt present in arrest - April  
1<sup>st</sup> to 18 One 2<sup>nd</sup> Lt present in arrest - April 19<sup>th</sup> and subsequently  
present for duty - Regt & Co Records and G<sup>o</sup> S. O.,  
Dept Mis 1866 furnish no evidence of trial or release  
from, or cause of arrest -  
A. G.

*Niggs Benjamin*  
Co C, 6 U.S. Col'd H. Art'y.

*Private*      *Private*

CARD NUMBERS.

1	6165209	26
2	6165411	27
3	6167123	28
4	9119753	29
5	76103-CJ-1875	30
6	40742501	31
7		32
8		33
9		34
10		35
11		36
12		37
13		38
14		39
15		40
16		41
17		42
18		43
19		44
20		45
21		46
22		47
23		48
24		49
25		50

Book Mark: 3710 C 88 76103-CJ-1875

See also

27

6 H. Art'y.

U.S.C.T.

Benjamin Higgs

, Co. E, 6 Reg't U. S. Col'd H. Art'y.

Appears on

**Company Descriptive Book**

of the organization named above.

**DESCRIPTION.**

Age 20 years; height 5 feet 3 inches.

Complexion Dark

Eyes Dark; hair Blk

Where born Moro Plant, La.

Occupation Farmer

**ENLISTMENT.**

When Sept 1, 1863.

Where Hatchez Miss

By whom J. N. Hickman, term 3 y'rs.

Remarks: Discharged Oct 24 63 at Hatchez Miss by order of Sec. of War S.O. 87 dated Hatchez Miss, Oct 22/63

Warren

*JL* | 6 H. Art'y. U.S.C.T.

*Benjamin Hillis.*  
*Pot*, Co. *E*, 2 Reg't Miss. Art'y.†

Age *20* years.

Appears on

**Company Muster-in Roll**

of the organization named above. Roll dated  
*Katchez Miss Sep 12, 1863.*

Muster-in to date *Sep 12, 1863.*

Joined for duty and enrolled:

When *Sep 1*, 1863.\*

Where *Katchez Miss* \*

Period *3* years.\*

Valuation of horse, \$ 100

Valuation of horse equipments, \$ 100

Remarks:

† This organization subsequently became Co. *E*, 6 Reg't U. S. Colored Heavy Artillery.

\* \* \* Muster-in roll shows enrollment of all men of this company as of same date and place. See enrollment on subsequent card or cards.

Book mark: *see 3710-6-1888*  
*26103-05-1875*

*Hadfield*



H

6 H. Art'y. U.S.C.T.

Benjamin Higgs

Pvt, Co. E, 2 Reg't Miss. Art'y.†

Appears on

Company Muster Roll

for Sept & Oct, 1863.

Joined for duty and enrolled:

When Sept 1, 1863.\*

Where Natchez Miss \*

Period 3 years.\*

Present or absent

Stoppage, \$ 100 for

Due Gov't, \$ 100 for

Remarks: Discharged Oct 24 1863 at Natchez Miss by order of the Secretary of War

\* Borne as Benjamin Hills on Muster-in roll of company.

† This organization subsequently became Co. E, 6 Reg't U. S. Colored Heavy Artillery.

\* See enrollment on card from muster-in roll.

Book mark: p 3710.6 1888

Hadfield

A

6 H. Art'y.

U.S.C.T.

Benjamin Higgs

Pvt., Co. ...., 6 Reg't U. S. Col'd H. Art'y.

Appears on Returns as follows:

Oct 1863, Co E 2 Miss  
H. Art'y (1)  
Disch'd Oct 24  
Watches Miss by  
order Sec of War

Book mark:

(546)

A. J. G. L. A.

Copyist.

H

6 H. Art'y.

U.S.C.T.

*Benjamin Higgs*

Private Co. E, 6 Reg't U. S. Col'd H. Art'y.

Appears on **Co. Muster-out Roll**, dated  
*Natchez, Miss. May 13, 1866*.

Muster-out to date \_\_\_\_\_, 186 .

Last paid to \_\_\_\_\_, 186 .

**Clothing account:**

Last settled \_\_\_\_\_, 186 ; drawn since \$ \_\_\_\_\_ 100

Due soldier \$ \_\_\_\_\_ 100; due U. S. \$ \_\_\_\_\_ 100

Am't for cloth'g in kind or money adv'd \$ \_\_\_\_\_ 100

Due U. S. for arms, equipments, &c., \$ \_\_\_\_\_ 100

Bounty paid \$ \_\_\_\_\_ 100; due \$ \_\_\_\_\_ 100

Remarks: *Discharged. joined at original organization, discharged Nov. 1, 1863 by S.O. 89 Sec. 57 War dated Natchez, Miss, Oct. 29, 1863. Final statements furnished.*

Book mark: *3710 C. 1888*

*O. J. Markle*

(361)

Copyist.

H. | Co. E. 6. Reg't | 1st

Benjamin Higgin.

, Co. E., 6. Reg't 1st

**NOTATION.**

Book mark: 3710 C. 1888. with  
H. 103 C. D. 1875.

**War Department,**

Adjutant General's Office,

Washington, August 8", 1888.

"Discharged Oct. 24 1863. by  
order of the Secretary of War.  
per D.O. No 82, 1863. Matchuz  
Miss. Cause of discharge not  
stated"

A. M. Muzzey  
Copyist.

*Gilbert, Peter*

Co *G*, 6 U.S. Col'd H. Art'y.

*Private Private*

CARD NUMBERS.

1	6169363	26
2	6169515	27
3	6169659	28
4	6169803	29
5	6170000	30
6	6171401	31
7	9120061	32
8	9120234	33
9	40742500	34
10		35
11		36
12		37
13		38
14		39
15		40
16		41
17		42
18		43
19		44
20		45
21		46
22		47
23		48
24		49
25		50

Book Mark *E.B. G. 11 P. 344*

See also

*Peter Hilbert*

....., Co. *I*, 6 Reg't U. S. Col'd H. Art'y.

Appears on

**Company Descriptive Book**

of the organization named above.

**DESCRIPTION.**

Age *25* years; height *5* feet *7* inches.

Complexion *Yellow*

Eyes *Dark*; hair *Dark*

Where born *Montgomery, Ala.*

Occupation *Carriage Driver*

**ENLISTMENT.**

When *Sept. 20*, 1863.

Where *Natchez, Miss.*

By whom *C. H. Smith*; term *3* y'rs.

Remarks: *Died Mar. 22/64*  
*in Reg't. Hospital*

*Warren*

Peter Gilbert

Co. G, 6 Reg't U. S. Col'd H. Art'y.

Appears on

Company Descriptive Book

of the organization named above.

DESCRIPTION.

Age 25 years; height 5 feet 7 inches.

Complexion yellow

Eyes Dark; hair Dark

Where born Montgomery, Ala.

Occupation Laborer

ENLISTMENT.

When Sept. 20, 1863.

Where Natchez, Miss.

By whom O. W. Smith; term 3 y'rs.

Remarks: Died Mch. 22/64 at Post Hospital, Natchez Miss. of Dyspepsy. Final Statement forwarded May 11/64

[Signature]

71

6 H. Art'y.

U.S.C.T.

Peter Hillbert

Put, Co. G, 2 Reg't Miss. Art'y.\*

Age 25 years.

Appears on

Company Muster-in Roll

of the organization named above. Roll dated

Katchez, Miss, Oct 20, 1863.

Muster-in to date Oct 20, 1863.

Joined for duty and enrolled:

When Sept 29, 1863.

Where Katchez, Miss.

Period 3 years.

Valuation of horse, \$ 100

Valuation of horse equipments, \$ 100

Remarks:

\* This organization subsequently became Co. G, 6 Reg't U. S. Colored Heavy Artillery.

Book mark:

J. A. Ward

(356)

Copyist.



*Peter Hilbert*

*Privat*, Co. G, 2 Reg't Miss. Art'y.\*

Appears on

**Company Muster Roll**

for *Oct 20 to 31*, 186*3*.

Present or absent *Present*

Stoppage, \$ *100* for

Due Gov't, \$ *100* for

Valuation of horse, \$ *100*

Valuation of horse equipments, \$ *100*

Remarks:

\* This organization subsequently became Co. G, 6 Reg't U. S. Colored Heavy Artillery.

Book mark:

(358)

*D. A. Ward*

Copyist.

*A*

6 H. Art'y.

U.S.C.T.

*Peter Hilbert*

*Pat*

Co. G, 2 Reg't Miss. Art'y.\*

Appears on

**Company Muster Roll**

for *Nov & Dec*, 1863.

Present or absent *Present*

Stoppage, \$ *100* for

Due Gov't, \$ *100* for

Valuation of horse, \$ *100*

Valuation of horse equipments, \$ *100*

Remarks:

\* This organization subsequently became Co. G, 6 Reg't U. S. Colored Heavy Artillery.

Book mark:

*O. A. [Signature]*

*Peter Hilbert*

*Prvt*, Co. G, 2 Reg't Miss. Art'y.\*

Appears on

**Company Muster Roll**

for *Jan & Feb*, 186*4*

Present or absent *Present*

Stoppage, \$ *100* for

Due Gov't, \$ *100* for

Valuation of horse, \$ *100*

Valuation of horse equipments, \$ *100*

Remarks:  
-----  
-----  
-----  
-----  
-----  
-----  
-----

\* This organization subsequently became Co. G, 6 Reg't U. S. Colored Heavy Artillery.

Book mark: -----

*L. Y. Spann*

(358)

Copyist.

*W*

*Peter A Gilbert*

*Prvt*, Co. G, 5 Reg't U. S. Col'd H. Art'y.\*

Appears on

**Company Muster Roll**

for *March & Apr*, 1864

Present or absent.....

Stoppage, \$.....100 for .....

Due Gov't, \$.....100 for .....

Valuation of horse, \$.....100

Valuation of horse equipments, \$.....100

Remarks: *Died in Regtl. Hosp. March 23/64*

\* This organization subsequently became Co. G, 6 Reg't U. S. Col'd Heavy Artillery.

Book mark: .....

*L. Y. Sparr*

A

6 H. Art'y.

U.S.C.T.

Peter Hilbert

Pat., Co. ...., 6 Reg't U. S. Col'd H. Art'y.

Appears on Returns as follows:

Mar 1864 Co I S. U. S.  
Co E H. Art., N. D. C.  
in Reg't H. Art.  
Mar 23, 64  
Natchez Miss

Book mark:

(546) *A. J. G. Gled* Copyist.

Peter Hilbert

Pvt., Co. G, 6 Reg't U. S. Col'd H. Art'y.

Appears on Co. Muster-out Roll, dated

Natchez, Miss, May 13, 1866 .

Muster-out to date . . . . ., 186 .

Last paid to . . . . ., 186 .

Clothing account:

Last settled . . . . ., 186 ; drawn since \$ . . . . . 100

Due soldier \$ . . . . . 100 ; due U. S. \$ . . . . . 100

Am't for cloth'g in kind or money adv'd \$ . . . . . 100

Due U. S. for arms, equipments, &c., \$ . . . . . 100

Bounty paid \$ . . . . . 100 ; due \$ . . . . . 100

Remarks: Joined at original organization. Died March 28/64 at Natchez, Miss of Dropsy. Final statement forwarded May 11/64.

Book mark: Died March 23, 1864 E.B.V. 11 P 344.

W. C. Chance

Hilbert, Peter

P. Co. G., 6 U.S.C.H.A.

2 Enclosures.

Bed Cards	Descriptive Lists
Burial Records	Final Statements
Certs. of Dis. for Discharge	Furloughs
C. M. Charges	Med. Des. Lists
Med. Certificates	Orders

Other papers relating to—

Admission to Hosp'l	Furlough
Casualty Sheet (Officer's)	Med. Examination
Confinement	Misc. Information
Contracts	Pay or Clothing
Death or Effects	Personal Reports
Desertions	Rank
Discharge from Hosp'l	Transfer to Hosp'l
Discharge from Service	Transfer to V. R. C.
Duty	Transportation

FINAL STATEMENT

OF

*Peter Wilbert, Private*

*Sixth* Regiment U. S. Heavy Artillery, (O.)

*Died March 22<sup>nd</sup> 1864*

ADJUTANT GENERAL'S OFFICE.

*July 26<sup>th</sup> 1864*

Duplicate with inventory sent Ad. Gen.



*21143*

[OFFICE ENDORSEMENT.]

War Department,

ADJUTANT GENERAL'S OFFICE,

*April 17*, 1875

The death of *Peter Wilbert*, Co. *G*, *6<sup>th</sup>* Reg't U. S. Colored *Artillery*, is reported as follows:

- On Company Muster Roll. For *March*, 1864, *March 23<sup>rd</sup>*, 1864
- Company Muster-out Roll. *March 28<sup>th</sup>*, 1864
- Company Descriptive Book. *March 22<sup>nd</sup>*, 1864
- Company Morning Reports. *March 23<sup>rd</sup>*, 1864
- Soldier's Final Statement. *March 22<sup>nd</sup>*, 1864
- Soldier's Record of Death and Interment. , 1864
- Soldier's Inventory of Effects. , 1864
- Soldier's Certificate of Disability for Discharge. , 1864
- Soldier's Individual Muster-out Roll. , 1864
- Regimental Return. For *March*, 1864, *March 23<sup>rd</sup>*, 1864
- Regimental Quarterly Returns. *March 22<sup>nd</sup>*, 1864
- Regimental Descriptive Book. *In evidence*, 1864
- By Surgeon General. ( *March 23* ), 1864

*March 23*, 1864, is held to be the correct date, and the Company Muster-out Roll will be amended accordingly.

*Thomas M. Sargent*

*C.B.* <sup>11</sup>/<sub>344</sub> Assistant Adjutant General.  
*Noted*  
*H.M.*

*Letter of May 14 1875 to Ad. Gen.*



I Certify, on honor, that Peter Hillert a Private of  
Captain John Louis Company (G) of the 1<sup>st</sup> Regiment of United States Heavy Artillery, (Colored.)  
born in Montgomery Co., State of Alabama aged 25 years; 5 feet 7 inches high;  
yellow complexion dark eyes, dark hair and by occupation a barriage driver, having joined the company on  
its original organization at Natchez Miss., and enrolled in at the muster into the service of the  
United States at Natchez Miss. on the twentieth day  
of October, 1863, (or was mustered in service as a recruit, by Capt. Lehas W.  
Smith, at Natchez Miss. on the twentieth day of September  
1868, or was drafted and mustered into the service of the United States from the \_\_\_\_\_ Enrollment District of the State

of \_\_\_\_\_ at \_\_\_\_\_ on the \_\_\_\_\_ day of \_\_\_\_\_ 186.) to serve in the Regiment, for the term of three years; and having served  
HONESTLY and FAITHFULLY with his Company in \_\_\_\_\_ to the present date, is now en-  
titled to a DISCHARGE by reason of died in Regimental Hospital at  
Natchez Miss. on the 22<sup>nd</sup> day of March 1864

The said Peter Hillert was last paid by Paymaster  
Major Clark to include the 31<sup>st</sup> day of December, 1868, and has  
pay due him from that time to the present date; he is entitled to pay and subsistence for TRAVELING to place of enrollment, and what-  
ever other allowances are authorized to volunteer soldiers, or drafted men, or militia, so discharged. He received from the United States  
**CLOTHING** amounting to Forty-two 84 dollars, since the \_\_\_\_\_ day of Enlistment  
186, when his clothing account was last settled. He received from the United States \_\_\_\_\_ 100 dollars, advanced  
**BOUNTY.**

There is to be stopped from him, on account of the State of \_\_\_\_\_, or other authorities, for  
**CLOTHING, &c.**, received on entering service, \_\_\_\_\_, 100 dollars; and for other stoppages, viz: \_\_\_\_\_  
\_\_\_\_\_ 100 dollars.

He has been furnished TRANSPORTATION in kind from the place of his discharge to \_\_\_\_\_  
and he has been SUBSISTED for TRAVELING to his place of enrollment, up to the \_\_\_\_\_ 186.

He is indebted to \_\_\_\_\_, **SUTLER**, \_\_\_\_\_ 100 dollars.  
He is indebted to \_\_\_\_\_, **LAUNDRESS**, \_\_\_\_\_ 100 dollars.

**GIVEN IN DUPLICATE**, at Natchez Miss., this \_\_\_\_\_ day  
of July 10<sup>th</sup>, 1864.

John Louis  
Captain  
Commanding Company. J

Peter Hilbert.  
G. L. A. S. C. A. (Key)

REC'D  
JUL 17  
1911

Inventory of the effects of Peter Hilbert late  
 a Private of Captain John Lewis Company G of  
 the Sixth Regiment of U. S. Col. d. Art. Heavy ~~Volunteers~~, who was enrolled as  
 a Private at Natchez in the State of Mississippi on  
 the 20<sup>th</sup> day of September 1863, and mustered into the service of the United  
 States as a Private on the 20<sup>th</sup> day of October 1863, at Natchez, Miss.  
 in Company G, 6<sup>th</sup> Regiment of U. S. Col. d. Art. Heavy, to serve three  
 years ~~or during the war~~, he was born in Montgomery County in the State  
 of Alabama; he was 25 years of age, 5 feet 7 inches  
 high, yellow complexion, dark eyes, dark hair, and by occupation, when enrolled,  
 a Carriage driver; he died in Regimental Hospital at  
Natchez, Miss. on the 22<sup>nd</sup> day of March 1864, by  
 reason of Dropsy.

INVENTORY.

ARTICLES.	NO.	ARTICLES.	NO.	ARTICLES.	NO.
Hats.....		Pairs Trousers.....		Knapsacks.....	
Caps.....		Pairs flannel Drawers.....			
Forage Caps.....		Pairs cotton Drawers.....			
Great Coats.....		Flannel Shirts.....			
Uniform Coats.....		Cotton Shirts.....			
Uniform Jackets.....		Pairs boots.....			
Flannel Sack Coats.....		Pairs shoes.....			
Blouses.....		Pairs socks.....			
Stable Frocks.....		Blankets.....			
Fatigue Overalls.....		Haversacks.....			
				MONEY.	
				Specie.....	\$
				Notes.....	\$

I CERTIFY ON HONOR, that the above inventory comprises all the effects of \_\_\_\_\_  
 \_\_\_\_\_, deceased, and that the effects are in the hands  
 of \_\_\_\_\_ at \_\_\_\_\_  
 \_\_\_\_\_ to be disposed of by a Council of Administration.

(DUPLICATES.)

STATION: Natchez Miss.

DATE: July 10<sup>th</sup> 1864

John Lewis  
Lewis  
 Commanding the Company G

*Alldrich, Alfred*

*Co D*, 6 U.S. Col'd H. Art'y.

*Private Private*

CARD NUMBERS.

1	6154534	26
2	6159044	27
3	6159187	28
4	6159331	29
5	6159472	30
6	6159609	31
7	6159739	32
8	6159862	33
9	6159983	34
10	6160104	35
11	9119281	36
12	40742502	37
13		38
14		39
15		40
16		41
17		42
18		43
19		44
20		45
21		46
22		47
23		48
24		49
25		50

Book Mark: \_\_\_\_\_

See also \_\_\_\_\_

A

6 H. Art'y. | U.S.C.T.

Alfred Hedreth

, Co. B., 6 Reg't U. S. Col'd H. Art'y.

Appears on

**Company Descriptive Book**

of the organization named above.

**DESCRIPTION.**

Age 20 years; height 5 feet 4 inches.

Complexion *color*

Eyes *Black*; hair *Blk*

Where born *Bayou Bay La*

Occupation *Farmer*

**ENLISTMENT.**

When *Dec 12*, 186*4*.

Where *V Burg.*

By whom *E. Kinsley*; term *3* y'rs.

Remarks:  
-----  
-----  
-----  
-----  
-----  
-----  
-----  
-----  
-----

*Spicer*

*20*

6 II. Art'y.

U.S.C.T.

*Alfred Heildritte*

Appears with rank of *Priv* on

**Muster and Descriptive Roll of a Detachment of U. S. Vols. forwarded**

for the 6 Reg't U. S. Col'd H. Art'y. Roll dated

*Vicksburg Miss, Dec. 21, 1864.*

Where born *Bayou Lafourche*

Age *20* yrs; Occupation *Farmer*

When enlisted *Dec. 12*, 1864.

Where enlisted *Vicksburg Miss*

For what period enlisted *3* years.

Eyes *Black*; hair *Black*

Complexion *Colored*; height *5* ft. *4* in.

When mustered in \_\_\_\_\_, 1864.

Where mustered in \_\_\_\_\_

Bounty paid \$ *100* 100; due \$ *200* 100

Where credited *quota of the State of Miss*

Company to which assigned \_\_\_\_\_

Remarks: \_\_\_\_\_

Book mark: \_\_\_\_\_

*Montague*

Copyist.

*H.*

6 H. Art'y.

U.S.C.T.

*Alfred Heildrich.*

*Privat*, Co. B, 6 Reg't U. S. Col'd H. Art'y.

Appears on

**Company Muster Roll**

for *Jan'y & Feb'y* 1865.

Joined for duty and enrolled:

When *Dec 12*", 1864.\*

Where *Vicksburg*.\*

Period *3* years.\*

Present or absent *Present*.

Stoppage, \$ *100* for

Due Gov't, \$ *100* for

Remarks:

*Musk'd Dec'r 24/64, Vicksburg Miss.*

\*~~See~~ See enrollment on card from muster-in roll.

Book-mark:

*H. C. Thomas.*

(358c)

Copyist.

H.

6 H. Art'y.

U.S.C.T.

*Alfred Hildrich*

*Co. B, 6 Reg't U. S. Col'd H. Art'y.*

Appears on

**Company Muster Roll**

for *March, April* 1865.

Joined for duty and enrolled:

When *Dec. 12<sup>th</sup>*, 1864.\*

Where *Vicksburg Miss.* \*

Period *3* years.\*

Present or absent *Present.*

Stoppage, \$ *100* for

Due Gov't, \$ *100* for

Remarks:

\*See enrollment on card from muster-in roll.

Book-mark:

*H. C. Thomas*

(358c)

Copyist.



*Alfred Hildreth.*

*Privt, Co. B, 6" Reg't U. S. Col'd H. Arty.*

Appears on

**Company Muster Roll**

for *May & June*, 1865.

Joined for duty and enrolled :

When *Dec. 12*, 1864.\*

Where *Vicksburg Miss.*\*

Period *3* years.\*

Present or absent *Present.*

Stoppage, \$ *100* for

Due Gov't, \$ *100* for

Remarks:

\* See enrollment on card from muster-in roll.

Book mark :

*H. C. Thomas.*

*JG*

6 H. Art'y.

U.S.C.T.

*Alfred Hildrich*

*Co.*, Co. B, 6 Reg't U. S. Col'd H. Art'y.

Appears on

**Company Muster Roll**

for *July Aug* 1865.

Joined for duty and enrolled:

When *Dec. 12*, 1864.\*

Where *V Burg, Miss.* \*

Period *3* years.\*

Present or absent *Present.*

Stoppage, \$ *100* for

Due Gov't, \$ *100* for

Remarks:

\* See enrollment on card from muster-in roll.

Book-mark:

(358c)

*Sabine*

Copyist.

76

6 H. Art'y.

U.S.C.T.

*Alfred Hilarius*

*Co.*, Co. B, 6 Reg't U. S. Col'd H. Art'y.

Appears on

**Company Muster Roll**

for *Sept Oct* 1865.

Joined for duty and enrolled:

When *Dec 12*, 1864\*

Where *Tburg Miss.*\*

Period *3* years.\*

Present or absent *Absent.*

Stoppage, \$ *100* for

Due Gov't, \$ *100* for

Remarks: *Absent without leave.*

\*See enrollment on card from muster-in roll.

Book-mark:

(358c)

*Sabine*  
Copyist.

76

6 H. Art'y.

U.S.C.T.

*Alfred Hildrich*

*Cpt.*, Co. B, 6 Reg't U. S. Col'd H. Art'y.

Appears on

**Company Muster Roll**

for *Nov Dec* 1865.

Joined for duty and enrolled:

When *Dec. 12*, 1864.\*

Where *T. B. Miss.* \*

Period *3* years.\*

Present or absent *Present.*

Stoppage, \$ *100* for

Due Gov't, \$ *100* for

Remarks:

-----  
-----  
-----  
-----  
-----  
-----  
-----

\* See enrollment on card from muster-in roll.

Book-mark:

-----

(358c)

*Sabine*

Copyist.

76

6 H. Art'y.

U.S.C.T.

*Alfred Hildrich*

*Co.*, Co. B, 6 Reg't U. S. Col'd H. Art'y.

Appears on

**Company Muster Roll**

for *Jan & Feb* 1866.

Joined for duty and enrolled:

When *Dec. 12*, 1864.\*

Where *1 Burg, Miss.*\*

Period *9* years.\*

Present or absent *Present*.

Stoppage, \$ *100* for

Due Gov't, \$ *100* for

Remarks: \_\_\_\_\_

\_\_\_\_\_

\_\_\_\_\_

\_\_\_\_\_

\_\_\_\_\_

\_\_\_\_\_

\*See enrollment on card from muster-in roll.

Book-mark : \_\_\_\_\_

\_\_\_\_\_

*Sabine*

A

6 H. Art'y.

U.S.C.T.

Alfred Hildrich

Co. B, 6 Reg't U. S. Col'd H. Art'y.

Appears on

Company Muster Roll

for Mar & Apr, 1866.

Joined for duty and enrolled:

When Dec 17, 1864.\*

Where V. Burg Miss \*

Period 3 years.\*

Present or absent present

Stoppage, \$ 100 for

Due Gov't \$ 100 for

Remarks:

[Empty lines for remarks]

\* See enrollment on card from muster-in roll.

Book mark:

[Signature]

(358c)

Copyist.

Alfred Hildrith\*

Prvt., Co. B, 6 Reg't U. S. Col'd H. Art'y.

Appears on Returns as follows:

Jan'y 1865. Gaen Jan'y 2/65  
V. Burg Miss. Recruit  
from Depot

July to Oct. 1865 Absent sick  
in Post Hosp. Natchez,  
since July 11/65

\*Name appears also as  
Alfred Hildry

Book mark:

Storrell

*H*

6 H. Art'y.

U.S.C.T.

*Alfred Hildreth*

*Pvt*, Co. *B*, 6 Reg't U. S. Col'd H. Art'y.

Appears on **Co. Muster-out Roll**, dated

*Natchez Miss*, *May 13*, 1866 .

Muster-out to date *May 13*, 1866 .

Last paid to *Dec. 31*, 1865 .

**Clothing account:**

Last settled....., 186 ; drawn since \$..... 100

Due soldier \$ *20* <sup>*73*</sup> <sub>100</sub>; due U. S. \$..... 100

Am't for cloth'g in kind or money adv'd \$..... 100

Due U. S. for arms, equipments, &c., \$..... 100

Bounty paid \$ *100* 100; due \$..... 100

Remarks: *Joined as a*  
*Recruit.*

Book mark: .....

(361) *J. E. Nichol* Copyist.



Hildrith Alfred

, Co. ,

6

Reg't

1st Reg't

2

Enclosures.

Bed Cards .....	Final Statements .....
Burial Records .....	Furloughs or L. of A. ....
Certs. of Dis. for Discharge .....	Med. Certificates .....
C. M. Charges .....	Med. Des. Lists .....
Descriptive Lists .....	Orders .....
Discharge Certificates .....	Pris. of War Record .....
Enlistment Papers <i>2</i> .....	Resignations .....

Other papers relating to—

Admission to Hosp'l .....	Furlough or L. of A. ....
Casualty Sheet .....	Med. Examination .....
Confinement .....	Misc. Information .....
Contracts .....	Pay or Clothing .....
Death or Effects .....	Personal Reports .....
Desertion .....	Rank .....
Discharge from Hosp'l .....	Transfer to Hosp'l .....
Discharge from Service .....	Transfer to V. R. C. ....
Duty .....	Transportation .....

Note 1.—This blank will be used for both enlistments and re-enlistments—enlistment of veterans, &c., &c., in the volunteer service. They will be made out in duplicate in all cases—one to accompany the accounts of the Adjutant General, and one to accompany the accounts of the officer who pays bounty, &c. The Regiment and Company in which the soldier was served should be given in the back.

Note 2.—An enlistment holds to service. A recruit must be in an exact period of time, say, bounty period, &c. A master-in-roll must, in all cases, be filed in the Adjutant General's Office as evidence of muster-in. The mustering officer, commissary, or assistant commissary of musters, as the case may be, will countersign both enlistments as having mustered the soldier into the service of the United States before either of them is given to the disbursing officer.

JUL  
17  
1864

DECLARATION OF RECRUIT.

I, Alfred Hildrith, desiring to VOLUNTEER as a Soldier in the Army of the United States, for the term of THREE YEARS, Do Declare, That I am Twenty years and \_\_\_\_\_ months of age; that I have never been discharged from the United States service on account of disability or by sentence of a court martial, or by order before the expiration of a term of enlistment; and I know of no impediment to my serving honestly and faithfully as a soldier for three years.

GIVEN at Wickshury Miss. the 19th day of December 1864

Witness: B. H. Stevens Alfred Hildrith  
mark

No. \_\_\_\_\_  
Alfred Hildrith  
Volunteered at Wickshury Miss.  
19th December, 1864,  
By E. C. Kinney Major  
Special Pro. Marshal  
Regiment of \_\_\_\_\_  
\_\_\_\_\_  
enlistment; last served in Company ( )  
Reg't of \_\_\_\_\_  
Discharged \_\_\_\_\_, 1864.

CONSENT IN CASE OF MINOR.

I, \_\_\_\_\_, Do CERTIFY, That I am the \_\_\_\_\_ of \_\_\_\_\_; that the said \_\_\_\_\_ is \_\_\_\_\_ years of age; and I do hereby freely give my CONSENT to his volunteering as a SOLDIER in the ARMY OF THE UNITED STATES for the period of THREE YEARS.

GIVEN at \_\_\_\_\_ the \_\_\_\_\_ day of \_\_\_\_\_

Witness: \_\_\_\_\_

VOLUNTEER ENLISTMENT.

STATE OF

TOWN OF

Mississippi

Vicksburg

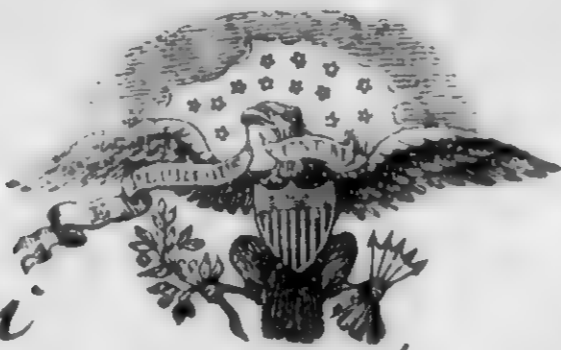

I, Alfred Hildrith, born in Big Bay in the State of Louisiana, aged twenty years, and by occupation a Farmer, Do HEREBY ACKNOWLEDGE to have volunteered this twelfth day of December, 1864, to serve as a **Soldier** in the Army of the United States of America, for the period of **THREE YEARS**, unless sooner discharged by proper authority: Do also agree to accept such bounty, pay, rations, and clothing, as are, or may be, established by law for volunteers. And I, Alfred Hildrith, do solemnly swear, that I will bear true faith and allegiance to the **United States of America**, and that I will serve them honestly and faithfully against all their enemies or opposers whomsoever; and that I will observe and obey the orders of the President of the United States, and the orders of the officers appointed over me, according to the Rules and Articles of War.

Sworn and subscribed to, at Vicksburg this 12 day of December, 1864, before Alfred Hildrith his mark, St. Col. Asst. Pm. Marshal witness J. Stevens

I CERTIFY, ON HONOR, That I have carefully examined the above-named volunteer, agreeably to the General Regulations of the Army, and that, in my opinion, he is free from all bodily defects and mental infirmity, which would in any way disqualify him from performing the duties of a soldier.

H. G. [Signature]  
Sur 32 U.S.A.  
EXAMINING SURGEON.

I CERTIFY, ON HONOR, That I have minutely inspected the Volunteer A. Hildrith previously to his enlistment, and that he was entirely sober when enlisted; that, to the best of my judgment and belief, he is of lawful age; and that, in accepting him as duly qualified to perform the duties of an able-bodied soldier, I have strictly observed the Regulations which govern the recruiting service. This soldier has blue eyes, black hair, cold complexion, is five feet four inches high.

St. Col. E. C. Kusby  
asst. pm. marshal of mass.  
Regiment of Dist. of Miss. and Volunteers,  
RECRUITING OFFICER.

(A. G. O. No. 74 & 76.)

Mustered into the service of the United States, for three years or during the war, from date of enlistment, in Company 1st Regiment of Volunteers, on the 24 day of December, 1864, at Vicksburg, Miss.

Entitled to Bounty

Ample

[Signature]  
[Signature]  
[Signature]

Note 1.—This blank will be used for the enlistment of veterans, &c., &c., in the volunteer service. They will be made out in duplicate in all cases to accompany the accounts of the officer who pays bounty, &c. The Regiment and Company in which the soldier served should be given on the back.

Note 2.—An enlistment holds to service. A muster-roll must, in all cases, precede payment of pay, bounty, pension, &c. A muster-roll must, in all cases, be made in the Adjutant General's Office as evidence of muster-in. The mustering officer, commissary, or assistant commissary of masters, as the case may be, will countersign both enlistments as having mustered the soldier into the service of the United States before either of them is given to the disbursing officer.

DECLARATION OF RECRUIT.

I, Alfred Hildrith, desiring to VOLUNTEER as a Soldier in the Army of the United States, for the term of THREE YEARS, Do Declare, That I am twenty years and \_\_\_\_\_ months of age; that I have never been discharged from the United States service on account of disability or by sentence of a court martial, or by order before the expiration of a term of enlistment; and I know of no impediment to my serving honestly and faithfully as a soldier for three years.

GIVEN at Wicksburg Miss. the 12<sup>th</sup> day of December 1864

Witness: B. F. Adams Alfred Hildrith  
his mark

Rec'd from 2nd. Aud. May 13th 1893

Volunteered at Wicksburg Miss.  
12<sup>th</sup> December 1864  
By Ol. B. Knicker 1st. Lieut.  
1st. Regt. 1st. Mass. Cavalry  
Regiment of Mass.  
enlistment; last served in Company ( )  
Reg't of \_\_\_\_\_  
Discharged \_\_\_\_\_, 18\_\_\_\_

CONSENT IN CASE OF MINOR.

I, \_\_\_\_\_, Do CERTIFY, That I am the \_\_\_\_\_ of \_\_\_\_\_; that the said \_\_\_\_\_ is \_\_\_\_\_ years of age; and I do hereby freely give my CONSENT to his volunteering as a SOLDIER in the ARMY OF THE UNITED STATES for the period of THREE YEARS.

GIVEN at \_\_\_\_\_ the \_\_\_\_\_ day of \_\_\_\_\_

Witness: \_\_\_\_\_

(A. G. O. No. 74 & 76.)

VOLUNTEER ENLISTMENT.

STATE OF

TOWN OF

Mississippi

Vicksburg

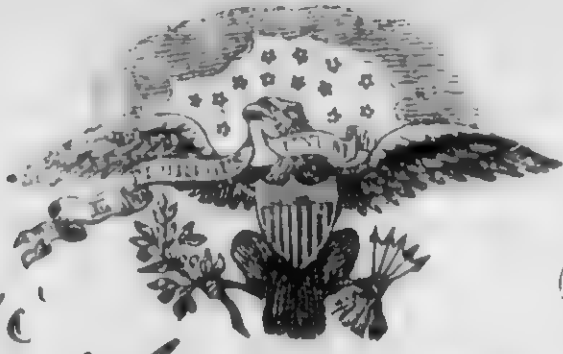

I, Alfred Hildrith, born in Bayou Poff in the State of Louisiana, aged twenty years, and by occupation a Farmer, Do HEREBY ACKNOWLEDGE to have volunteered this twelfth day of December, 1864, to serve as a Soldier in the Army of the United States of America, for the period of THREE YEARS, unless sooner discharged by proper authority: Do also agree to accept such bounty, pay, rations, and clothing, as are, or may be, established by law for volunteers. And I, Alfred Hildrith, do solemnly swear, that I will bear true faith and allegiance to the United States of America, and that I will serve them honestly and faithfully against all their enemies or opposers whomsoever; and that I will observe and obey the orders of the President of the United States, and the orders of the officers appointed over me, according to the Rules and Articles of War.

Simple

Sworn and subscribed to, at Vicksburg this 12th day of December, 1864, BEFORE Eli C. Hussey, witness, Lt. Col. Asst. Pro. Marshal

I CERTIFY, ON HONOR, That I have carefully examined the above-named Volunteer, agreeably to the General Regulations of the Army, and that, in my opinion, he is free from all bodily defects and mental infirmity, which would in any way disqualify him from performing the duties of a soldier.

W. H. Montgomery, EXAMINING SURGEON.

I CERTIFY, ON HONOR, That I have minutely inspected the Volunteer Alfred Hildrith previously to his enlistment, and that he was entirely sober when enlisted; that, to the best of my judgment and belief, he is of lawful age; and that, in accepting him as duly qualified to perform the duties of an able-bodied soldier, I have strictly observed the Regulations which govern the recruiting service. This soldier has blue eyes, blue hair, cold complexion, is five feet four inches high.

Eli C. Hussey, Rec. Officer, Regiment of Volunteers, Dist. of Miss and

(A. G. O. No. 74 & 76.)

Mustered into the service of the United States, for three years or during the war, from date of enlistment, in Company 1st Regiment of Volunteers, on the 24th day of December, 1864, at Vicksburg, Miss.

Alfred Hildrith, Private, 1st Regt. Vol.

Enlisted to Bounty

Will Caesar

Co K, 6 U.S. Col'd H. Art'y.

Private Private

CARD NUMBERS.

1	6171522	26
2	6171671	27
3	6171811	28
4	6171952	29
5	6172090	30
6	6172217	31
7	6172346	32
8	6172466	33
9	6172584	34
10	6172700	35
11	6172819	36
12	6172934	37
13	6173042	38
14	6173156	39
15	6173262	40
16	6173364	41
17	6173467	42
18	9120425	43
19		44
20		45
21		46
22		47
23		48
24		49
25		50

Book Mark:

See also

S 767766 P.O. m + m  
S-776370 - P.O. - aff  
R. + P. 522890

*H. H. Cordes*

*A* | 6 H. Art'y. | U.S.C.T.

*Cassan Lill*

....., Co. *A*, 6 Reg't U. S. Col'd H. Art'y.

Appears on

**Company Descriptive Book**  
of the organization named above.

**DESCRIPTION.**

Age *25* years; height *5* feet *7* inches.

Complexion *Blk*

Eyes *Blk*; hair *Blk*

Where born *Hatchers Miss.*

Occupation *Farmer*

**ENLISTMENT.**

When *Mar. 1*, 186*3*

Where *Hatchers Miss.*

By whom *Jas P. Green*; term *3* y'rs.

Remarks:  
.....  
.....  
.....  
.....  
.....  
.....  
.....

*Harmon*



*J.C.*

6 H. Art'y.

U.S.C.T.

*Calvin Hill*

*Mi*, Co. *2*, 2 Reg't Miss. Art'y. †

Age *23* years.

Appears on

**Company Muster-in Roll**

of the organization named above. Roll dated

*October 1st*, 1863.

Muster-in to date *Nov 1st*, 1863.

Joined for duty and enrolled:

When *Nov 1st*, 1863.\*

Where *Meridian Miss*\*

Period *3* years.\*

Valuation of horse, \$ *100*

Valuation of horse equipments, \$ *100*

Remarks:

† This organization subsequently became Co. *6* Reg't U. S. Colored Heavy Artillery.

\* \* \* Muster-in roll shows enrollment of all men of this company as of same date and place. See enrollment on subsequent card or cards.

Book mark:

*W. S. Hill*

(356c)

Copyist.

*M. C.*

6 H. Art'y.

U.S.C.T.

*Richard Hill*

*Mich.*, Co. H, 2 Reg't Miss. Art'y.†

Appears on

**Company Muster Roll**

for *April 23 to Dec. 31*, 186*2*.

Joined for duty and enrolled:

When *April 1*, 186*2*.\*

Where *Michigan* \*

Period *2* years.\*

Present or absent *Present*

Stoppage, \$ *100* for

Due Gov't, \$ *100* for

Valuation of horse, \$ *100*

Valuation of horse equipments, \$ *100*

Remarks:

† This organization subsequently became Co. H, 6 Reg't U. S. Co'd Heavy Artillery.

\* See enrollment on card from muster-in roll.

Book mark:

*Y.C.*

6 H. Art'y.

U.S.C.T.

*Beasari Hill*

*Pr*, Co. H, 2 Reg't Miss. Art'y.†

Appears on

**Company Muster Roll**

for *Jan + Feb.*, 1864.

Joined for duty and enrolled:

When *Nov. 1*, 1863.\*

Where *Natchez Miss*\*

Period *3* years.\*

Present or absent *Present*

Stoppage, \$ *100* for

Due Gov't, \$ *100* for

Valuation of horse, \$ *100*

Valuation of horse equipments, \$ *100*

Remarks:

† This organization subsequently became Co. H, 6 Reg't U. S. Co'ld Heavy Artillery.  
\* See enrollment on card from muster-in roll.

Book mark:

*ME*

6 H. Art'y.

U.S.C.T.

*Beasler* *Bill*

*Co. H*, 5 Reg't U. S. Col'd H. Art'y.\*

Appears on

**Company Muster Roll**

for *Mar. & Apr.*, 1864.

Joined for duty and enrolled :

When *Nov. 1*, 1863.\*

Where *Natchez Miss.*\*

Period *3* years.\*

Present or absent *Present*

Stoppage, \$ *100* for

Due Gov't, \$ *100* for

Valuation of horse, \$ *100*

Valuation of horse equipments, \$ *100*

Remarks: \_\_\_\_\_  
\_\_\_\_\_  
\_\_\_\_\_

\* This organization subsequently became Co. *H*, 6 Reg't U. S. Col'd Heavy Artillery.  
\* ~~See~~ See enrollment on card from muster-in roll.

Book mark: \_\_\_\_\_  
\_\_\_\_\_

*Bill Beasler*  
\_\_\_\_\_  
(358c) Copyist.

*Cesar Hill*

*Pri.*, Co. H, 6 Reg't U. S. Col'd H. Art'y.

Appears on

**Company Muster Roll**

for *May + June*, 186*4*.

Joined for duty and enrolled:

When *Nov. 1*, 186*3*.\*

Where *Natchez, Miss*\*

Period *3* years.\*

Present or absent *Present*.

Stoppage, \$ *100* for

Due Gov't \$ *100* for

Remarks:

-----  
-----  
-----  
-----  
-----  
-----

\* See enrollment on card from muster-in roll.

Book mark:

(358c)

*H. A. Stearns*

Copyist.

*W. H.*

6 H. Art'y.

U.S.C.T.

*Cassan Hill*

*Pr.*, Co. H, 6 Reg't U. S. Col'd H. Art'y.

Appears on

**Company Muster Roll**

for *July & August*, 1864:

Joined for duty and enrolled:

When *Nov. 1*, 1863.\*

Where *Vatchez Miss.*\*

Period *3* years.\*

Present or absent *Present*.

Stoppage, \$ *100* for

Due Gov't \$ *100* for

Remarks:

-----  
-----  
-----  
-----  
-----

\* See enrollment on card from muster-in roll.

Book mark: -----

*C. A. Stearns*  
-----  
(358c) Copyist.

H

6 H. Art'y.

U.S.C.T.

Caesar Hill

Private, Co. H, 6 Reg't U. S. Col'd H. Art'y.

Appears on

Company Muster Roll

for Sept and Oct., 1864.

Joined for duty and enrolled:

When Nov 1, 1863.

Where Natchez Miss.

Period 3 years.\*

Present or absent present.

Stoppage, \$ 100 for

Due Gov't \$ 100 for

Remarks:

[Empty lines for remarks]

\* See enrollment on card from muster-in roll.

Book mark:

O Leary

(358c)

Copyist.

H

6 H. Art'y.

U.S.C.T.

Caesar Hill  
Pvt., Co. H, 6 Reg't U. S. Col'd H. Art'y.

Appears on

Company Muster Roll  
for Nov and Dec., 1864.

Joined for duty and enrolled:

When Nov, 1863.\*

Where Natchez Miss \*

Period 3 years.\*

Present or absent present

Stoppage, \$ 100 for

Due Gov't \$ 100 for

Remarks:

\* See enrollment on card from muster-in roll.

Book mark:

O'Leary Copyist.

(358c)



H

6 H. Art'y.

U.S.C.T.

Caesar Hill  
Pitt, Co. H, 6 Reg't U. S. Col'd H. Art'y.

Appears on

Company Muster Roll  
for Jan and Feb., 1865.

Joined for duty and enrolled:

When Nov 1, 1863.\*

Where Natchez Miss.\*

Period 3 years.\*

Present or absent present

Stoppage, \$ 100 for

Due Gov't \$ 100 for

Remarks:

-----  
-----  
-----  
-----  
-----

\* See enrollment on card from muster-in roll.

Book mark:

O'Leary  
Copyist.

(358c)

H

6 H. Art'y.

U.S.C.T.

Caesar Hill

PM

, Co. H, 6 Reg't U. S. Col'd H. Art'y.

Appears on

Company Muster Roll

for

Mich and Apl

, 1865.

Joined for duty and enrolled:

When

Nov 1

, 1863\*

Where

Natchez Miss

Period

3

years.\*

Present or absent

present

Stoppage, \$

100

for

Due Gov't \$

100

for

Remarks:

\* See enrollment on card from muster-in roll.

Book mark:

O'Leary

(358c)

Copyist.

Caesar Hill

1st., Co. H, 6 Reg't U. S. Col'd H. Art'y.

Appears on

Company Muster Roll

for May & June, 1863.

Joined for duty and enrolled:

When Nov. 1, 1863.\*

Where Natchez Miss.\*

Period 3 years.\*

Present or absent Present

Stoppage, \$ 100 for

Due Gov't \$ 100 for

Remarks:

\* See enrollment on card from muster-in roll.

Book mark:

(358c) *Paul* Copyist.

A. G. Artz U.S.C.T.

Caesar's Hill

Pvt., Co. H, 6 Reg't U. S. Col'd A. Artz

Appears on

**Company Muster Roll**

for July & Aug., 1865.

Joined for duty and enrolled:

When Nov. 1, 1865.\*

Where Natchez Miss. \*

Period 3 years.\*

Present or absent Present

Stoppage, \$ 100 for

Due Gov't, \$ 100 for

Remarks: \_\_\_\_\_  
\_\_\_\_\_  
\_\_\_\_\_  
\_\_\_\_\_

\* See enrollment on card from muster-in roll.

Book mark: \_\_\_\_\_

Paul

*N*

6 H. Art'y.

U.S.C.T.

*Caesar Hill*

*Pvt*, Co *H*, 6 Reg't U. S. Col'd H. Art'y.

Appears on

**Company Muster Roll**

for *Sept & Oct*, 186*5*.

Joined for duty and enrolled:

When *Nov*, 186*3*.\*

Where *Starches Miss\**

Period *3* years.\*

Present or absent *present*

Stoppage, \$ *100* for

Due Gov't \$ *100* for

Remarks:

-----  
-----  
-----  
-----  
-----

\* See enrollment on card from muster-in roll.

Book mark: -----

(358c)

*Harpies*

Copyist.

*H.* | **6 H. Art'y.** | **U.S.C.T.**

*Caesar Kille*  
Pvt., Co. H, 6 Reg't U. S. Col'd H. Art'y.

Appears on

**Company Muster Roll**  
for *Nov & Dec*, 1865.

Joined for duty and enrolled:

When *Nov 1*, 1863.\*

Where *Natchez Miss*\*

Period *3* years.\*

Present or absent *present*

Stoppage, \$ *100* for

Due Gov't \$ *100* for

Remarks:  
\_\_\_\_\_  
\_\_\_\_\_  
\_\_\_\_\_  
\_\_\_\_\_

\* See enrollment on card from muster-in roll.

Book mark: \_\_\_\_\_

(358c)

*D. C. Harker*  
Copyist.

*A.*

6 H. Art'y.

U.S.C.T.

*Caesar Hill*

*Plt.*, Co. H, 6 Reg't U. S. Col'd H. Art'y.

Appears on

**Company Muster Roll**

for *Jan & Feb*, 186*6*.

Joined for duty and enrolled:

When *Nov*, 186*3*.

Where *Natchez, Miss.*

Period *3* years.\*

Present or absent *present*

Stoppage, \$ *100* for

Due Gov't \$ *100* for

Remarks:

\* See enrollment on card from muster-in roll.

Book mark:

*B. C. Harper*

(358c)

Copyist.

*Caesar Hill.*

*Priv.*, Co. H, 6 Reg't U. S. Col'd H. Art'y.

Appears on

**Company Muster Roll**

for *Mar 24/66*, 1866.

Joined for duty and enrolled:

When *Nov. 1*, 1863.\*

Where *Watachez, Miss.*\*

Period *3* years.\*

Present or absent *present.*

Stoppage, \$ *100* for

Due Gov't \$ *100* for

Remarks:  
-----  
-----  
-----  
-----  
-----

\* ~~See~~ See enrollment on card from muster-in roll.

Book mark: -----

*B. C. Harber*  
Copyist.



H

6 H. Art'y.

U.S.C.T.

Caesar Will

Private, Co. H., 6 Reg't U. S. Col'd H. Art'y.

Appears on **Co. Muster-out Roll**, dated

*Matchez, Miss May 13*, 1866.

Muster-out to date *May 13*, 1866.

Last paid to *Dec. 31*, 1865.

**Clothing account:**

Last settled....., 186 ; drawn since \$..... 100

Due soldier \$..... 100; due U. S. \$ *2* <sup>85</sup>/<sub>100</sub>

Am't for cloth'g in kind or money adv'd \$..... 100

Due U. S. for arms, equipments, &c., \$..... 100

Bounty paid \$..... 100; due \$..... 100

**Remarks:**

*Joined original organization*

Book mark: *V143 P166.72*

*C. G. Powell*

(361)

Copyist.

Mill Frank

Co G, 6 U.S. Col'd H. Art'y.

Private Private

CARD NUMBERS.

1	6169373	26
2	6169525	27
3	6169667	28
4	6169811	29
5	6169934	30
6	6170061	31
7	6170166	32
8	6170269	33
9	6170375	34
10	6170479	35
11	6170593	36
12	6170712	37
13	6170827	38
14	6170938	39
15	6171045	40
16	6171143	41
17	6171237	42
18	6171332	43
19	9120244	44
20	9120071	45
21		46
22		47
23		48
24		49
25		50

Book Mark:

See also

*A* | 6 H. Art'y. | U.S.C.T.

*Frank Hill*

....., Co. *G*, 6 Reg't U. S. Col'd H. Art'y.

Appears on

**Company Descriptive Book**

of the organization named above.

**DESCRIPTION.**

Age *26* years; height *5* feet *7* inches.

Complexion *Dark*

Eyes *Dark*; hair *Dark*

Where born *Richmond, Va.*

Occupation *Farmer*

**ENLISTMENT.**

When *Sept. 20*, 186*3*.

Where *Hatchery Miss.*

By whom *C. M. Smith*, term *3* y'rs.

Remarks:

.....  
.....  
.....  
.....  
.....  
.....  
.....  
.....

*Wasson*

*A* | **6 H. Art'y.** | **U.S.C.T.**

*Frank Still*

....., Co. *I*, 6 Reg't U. S. Col'd H. Art'y.

Appears on

**Company Descriptive Book**

of the organization named above.

**DESCRIPTION.**

Age *26* years; height *5* feet *7* inches.

Complexion *Dark*

Eyes *Dark*; hair *Dark*

Where born *Richmond, Va*

Occupation *Farmer*

**ENLISTMENT.**

When *Sept. 20*, 186*3*.

Where *Matchless - Miss.*

By whom *C. H. Smith*, term *3* y'rs.

Remarks: .....

.....

.....

.....

.....

.....

.....

.....

.....

*Warren*  
Coppist.

(383a)

*H*

6 H. Art'y.

U.S.C.T.

*Frank Hill*

*Pat*, Co. G, 2 Reg't Miss. Art'y.\*

Age *26* years.

Appears on

**Company Muster-in Roll**

of the organization named above. Roll dated

*Hatcher, Miss, Oct 20*, 186*3*.

Muster-in to date

*Oct 20*, 186*3*.

Joined for duty and enrolled:

When *Sept 20*, 186*3*.

Where *Hatcher, Miss.*

Period *3* years.

Valuation of horse, \$ 100

Valuation of horse equipments, \$ 100

Remarks: \_\_\_\_\_

\_\_\_\_\_

\_\_\_\_\_

\_\_\_\_\_

\* This organization subsequently became Co. G, 6 Reg't U. S. Colored Heavy Artillery.

Book mark: \_\_\_\_\_

\_\_\_\_\_

*J-A Ward*

(356)

Copyist.

4

6 H. Art'y.

U.S.C.T.

Frank Hill

Put, Co. G, 2 Reg't Miss. Art'y.\*

Appears on

Company Muster Roll

for Oct 20 to 31, 1863.

Present or absent Present

Stoppage, \$ 100 for

Due Gov't, \$ 100 for

Valuation of horse, \$ 100

Valuation of horse equipments, \$ 100

Remarks:

\* This organization subsequently became Co. G, 6 Reg't U. S. Colored Heavy Artillery.

Book mark:

D.A. Ward

(358)

Copyist.

71

6 H. Art'y.

U.S.C.T.

Frank Hill

Put, Co. G, 2 Reg't Miss. Art'y.\*

Appears on

Company Muster Roll

for Nov & Dec, 1863.

Present or absent Present

Stoppage, \$ 100 for

Due Gov't, \$ 100 for

Valuation of horse, \$ 100

Valuation of horse equipments, \$ 100

Remarks:

\* This organization subsequently became Co. G, 6 Reg't U. S. Colored Heavy Artillery.

Book mark:

J. A. Marshall

(358)

Copyist.

*A*

6 H. Art'y.

U.S.C.T.

*Frank Hill*

*Prt*, Co. G, 2 Reg't Miss. Art'y.\*

Appears on

**Company Muster Roll**

for *Jan & Feb*, 186*4*

Present or absent *Present*

Stoppage, \$ *100* for

Due Gov't, \$ *100* for

Valuation of horse, \$ *100*

Valuation of horse equipments, \$ *100*

Remarks:

\* This organization subsequently became Co. G, 6 Reg't U. S. Colored Heavy Artillery.

Book mark:

*L. J. Sparr*

(358)

Copyist.



*A*

6 H. Art'y.

U.S.C.T.

*Frank Hill*

*Pvt*, Co. G, 5 Reg't U. S. Col'd H. Art'y.\*

Appears on

**Company Muster Roll**

for *March & Apr*, 1864

Present or absent *Present*

Stoppage, \$ 100 for

Due Gov't, \$ 100 for

Valuation of horse, \$ 100

Valuation of horse equipments, \$ 100

Remarks:

\* This organization subsequently became Co. G, 6 Reg't U. S. Col'd Heavy Artillery.

Book mark:

*L. Y. Spann*

(358)

Copyist.

Frank Hill

Prvt, Co. G, 6 Reg't U. S. Col'd H. Art'y.

Appears on

Company Muster Roll

for May & June, 1864

Present or absent Present

Stoppage, \$ 100 for

Due Gov't, \$ 100 for

Valuation of horse, \$ 100

Valuation of horse equipments, \$ 100

Remarks:

Book mark:

L. Y. Sparr

(358)

Copyist.

26

6 H. Art'y.

U.S.C.T.

Frank Hill

Pri., Co. G, 6 Reg't U. S. Col'd H. Art'y.

Appears on

Company Muster Roll

for July & Aug., 1864.

Present or absent Present.

Stoppage, \$ 100 for

Due Gov't, \$ 100 for

Valuation of horse, \$ 100

Valuation of horse equipments, \$ 100

Remarks:

Book mark:

J. T. Smith

(358)

Copyist.

*Frank ...*

..., Co. G, 6 Reg't U. S. Col'd H. Art'y.

Appears on

**Company Muster Roll**

for *Sept 1st*, 186 .

Present or absent *Present*

Stoppage, \$ *100* for

Due Gov't, \$ *100* for

Valuation of horse, \$ *100*

Valuation of horse equipments, \$ *100*

Remarks:

Book mark:

26

6 H. Art'y. U.S.C.T.

Frank Hill

Pri., Co. G, 6 Reg't U. S. Col'd H. Art'y.

Appears on

Company Muster Roll

for Nov. & Dec., 1864.

Present or absent Present.

Stoppage, \$ 100 for

Due Gov't, \$ 100 for

Valuation of horse, \$ 100

Valuation of horse equipments, \$ 100

Remarks:

Book mark:

(358)

J. Y. Smith

Copyist.

*Frank Hill*

*Private*, Co. G, 6 Reg't U. S. Col'd H. Art'y.

Appears on

**Company Muster Roll**

for *Jamieson*, 1865.

Present or absent *Present*

Stoppage, \$ 100 for

Due Gov't, \$ 100 for

Valuation of horse, \$ 100

Valuation of horse equipments, \$ 100

Remarks:  
\_\_\_\_\_  
\_\_\_\_\_  
\_\_\_\_\_  
\_\_\_\_\_  
\_\_\_\_\_  
\_\_\_\_\_  
\_\_\_\_\_

Book mark: \_\_\_\_\_

*J. A. Neale*  
Copyist.

A

*Frank Hill*

*Private*, Co. G, 6 Reg't U. S. Col'd H. Art'y.

Appears on

**Company Muster Roll**

for *March & April*, 1865.

Present or absent *Present*

Stoppage, \$ *100* for

Due Gov't, \$ *100* for

Valuation of horse, \$ *100*

Valuation of horse equipments, \$ *100*

Remarks:

-----  
-----  
-----  
-----  
-----  
-----  
-----  
-----

Book mark: -----

-----

*F. D. Neale*

A

6 H. Art'y. U.S.C.T.

Frank Hill

Private, Co. G, 6 Reg't U. S. Col'd H. Art'y.

Appears on

Company Muster Roll

for May & June, 1865.

Present or absent Present

Stoppage, \$ 100 for

Due Gov't, \$ 100 for

Valuation of horse, \$ 100

Valuation of horse equipments, \$ 100

Remarks:

-----  
-----  
-----  
-----  
-----  
-----  
-----  
-----

Book mark: -----

-----

J. W. Neale

Copyist.



Frank Hill,

Pop, Co. G, 6 Reg't U. S. Col'd H. Art'y.

Appears on

Company Muster Roll

for July to Aug, 1865.

Present or absent present.

Stoppage, \$ 100 for

Due Gov't, \$ 100 for

Valuation of horse, \$ 100

Valuation of horse equipments, \$ 100

Remarks:

Book mark:

E. W. Stein

A

6 H. Art'y.

U.S.C.T.

Frank Hill.

Priv., Co. G, 6 Reg't U. S. Col'd H. Art'y.

Appears on

Company Muster Roll

for Sept-<sup>23</sup> Oct- , 1865

Present or absent present

Stoppage, \$ 100 for

Due Gov't, \$ 100 for

Valuation of horse, \$ 100

Valuation of horse equipments, \$ 100

Remarks:

[Empty lines for remarks]

Book mark:

E. Weston

(358)

Copyist.

H

6 H. Art'y.

U.S.C.T.

Frank Hill.

Pvt., Co. G, 6 Reg't U. S. Col'd H. Art'y.

Appears on

Company Muster Roll

for Nov. & Dec, 1865.

Present or absent present

Stoppage, \$ 100 for

Due Gov't, \$ 100 for

Valuation of horse, \$ 100

Valuation of horse equipments, \$ 100

Remarks:

Book mark:

E. Auster

(358)

Copyist.

70

6 H. Art'y. U.S.C.T.

Frank Hill

Private, Co. G, 6 Reg't U. S. Col'd H. Art'y.

Appears on

Company Muster Roll

for Jan & Feb, 1866.

Present or absent Present.

Stoppage, \$ 100 for

Due Gov't, \$ 100 for

Valuation of horse, \$ 100

Valuation of horse equipments, \$ 100

Remarks:

Book mark:

W. O. Chance

7

6 H. Art'y.

U.S.C.T.

<sup>of</sup>  
Frank Hill

Fris, Co. G, 6 Reg't U. S. Col'd H. Art'y.

Appears on

**Company Muster Roll**

for Mar & Apr, 1866.

Present or absent Present

Stoppage, \$ 100 for

Due Gov't, \$ 100 for

Valuation of horse, \$ 100

Valuation of horse equipments, \$ 100

Remarks:

Book mark:

W. O. Chance

(358)

Copyist.

Frank Hill

Plt, Co. G, 6 Reg't U. S. Col'd H. Art'y.

Appears on Co. Muster-out Roll, dated

Natchez, Miss, May 13, 1866 .

Muster-out to date May 13, 1866 .

Last paid to Dec 31, 1865 .

Clothing account:

Last settled, 186 ; drawn since \$ 100

Due soldier \$ 29 <sup>95</sup>/<sub>100</sub>; due U. S. \$ 100

Am't for cloth'g in kind or money adv'd \$ 100

Due U. S. for arms, equipments, &c., \$ 100

Bounty paid \$ 100; due \$ 100

Remarks: Joined at original organization.

Book mark: V 230 P 97 76

Mochance

1011  
Mills Benjamin

Co E, 6 U.S. Col'd H. Art'y.

Private

CARD NUMBERS.

1	26
2	27
3	28
4	29
5	30
6	31
7	32
8	33
9	34
10	35
11	36
12	37
13	38
14	39
15	40
16	41
17	42
18	43
19	44
20	45
21	46
22	47
23	48
24	49
25	50

Book Mark:

See also

*see Higgs, Benjamin*

1015  
Winson, Perry

Co L, 6 U.S. Col'd H. Art'y.

Private Private

CARD NUMBERS.

1	6154467	26
2	6178149	27
3	6178253	28
4	6178361	29
5	6178473	30
6	6178575	31
7	6178674	32
8	6178772	33
9	6178868	34
10	6178959	35
11	6179050	36
12	9120978	37
13	40742503	38
14		39
15		40
16		41
17		42
18		43
19		44
20		45
21		46
22		47
23		48
24		49
25		50

Book Mark:

See also



*N* | 6 H. Art'y. | U.S.C.T.

*Perry Wilson*

Co. *L*, 6 Reg't U. S. Col'd H. Art'y.

Appears on

**Company Descriptive Book**

of the organization named above.

**DESCRIPTION.**

Age *34* years; height *5* feet *7* inches.

Complexion *Black*

Eyes *Black*; hair *black*

Where born *Jensen, Parik La*

Occupation *farmer*

**ENLISTMENT.**

When *Nov 20*, 1864.

Where *S. Huleberg, Pruss*

By whom *C. B. Lovitt*; term *3* y'rs.

Remarks:

-----  
-----  
-----  
-----  
-----  
-----  
-----  
-----  
-----  
-----

*Wilson*

Perry Hinson

Appears with rank of Put on

**Muster and Descriptive Roll of a Detachment of U. S. Vols. forwarded**

for the 6 Reg't U. S. Col'd H. Art'y. Roll dated

Natchez, Miss North, 1864.

Where born Massachusetts

Age 34 y'rs; occupation Farmer

When enlisted Nov 20, 1864.

Where enlisted Natchez, Miss

For what period enlisted 3 years.

Eyes Black; hair Black

Complexion Black; height 5 ft. 7 in.

When mustered in Nov 20, 1864.

Where mustered in Natchez, Miss

Bounty paid \$ None 100; due \$ All 100

Where credited Natchez, Adams Co. Miss

Company to which assigned L

Remarks:

.....  
.....  
.....

Book mark:

W. B. Long

A

6 H. Art'y.

U.S.C.T.

*Perry Simard*

*Priv*, Co. L, 6 Reg't U. S. Col'd H. Art'y.

Appears on

**Company Muster Roll**

for *Nov + Dec*, 1864.

Joined for duty and enrolled :

When *Nov 20*, 1864.\*

Where *Natchez Miss* \*

Period *3* years.\*

Present or absent *Present*

Stoppage, \$ *100* for

Due Gov't \$ *100* for

Valuation of horse, \$ *100*

Valuation of horse equipments, \$ *100*

Remarks:

\* See enrollment on card from muster-in roll.

Book mark:

*R. S. Shelton*

(358c)

Copyist.

*Perry Winsor*  
-----  
*Priv*, Co. L, 6 Reg't U. S. Col'd H. Art'y.

Appears on

**Company Muster Roll**  
for *Jan & Feb*, 1865.

Joined for duty and enrolled :

When *Nov 20*, 1864.\*

Where *Natchez Miss*\*

Period *3* years.\*

Present or absent *Present*

Stoppage, \$.....100 for.....

Due Gov't \$.....100 for.....

Valuation of horse, \$.....100

Valuation of horse equipments, \$.....100

Remarks:

-----  
-----  
-----

\* See enrollment on card from muster-in roll.

Book mark:-----

-----  
*R. S. Shetton*  
-----  
(358c) Copyist.

*A*

6 H. Art'y.

U.S.C.T.

*Perry Hinson*

*Priv*, Co. L, 6 Reg't U. S. Col'd H. Art'y.

Appears on

**Company Muster Roll**

for *March* *Apr*, 1865.

Joined for duty and enrolled :

When *Nov 20*, 1864.\*

Where *Natchez Miss* \*

Period *3* years.\*

Present or absent *Present*

Stoppage, \$ *100* for

Due Gov't \$ *100* for

Valuation of horse, \$ *100*

Valuation of horse equipments, \$ *100*

Remarks:

\* See enrollment on card from muster-in roll.

Book mark:

*R. S. Shelton*

(58c)

Copist.

*Perry Simpson*  
-----  
*Col*, Co. L, 6 Reg't U. S. Col'd H. Art'y.

Appears on

**Company Muster Roll**

for *May & June*, 1865.

Joined for duty and enrolled:

When *Apr 20*, 1864.\*

Where *Natches Miss* \*

Period *3* years.\*

Present or absent *Present*

Stoppage, \$ *100* for

Due Gov't \$ *100* for

Valuation of horse, \$ *100*

Valuation of horse equipments, \$ *100*

Remarks: -----  
-----  
-----

\* See enrollment on card from muster-in roll.

Book mark: -----

*R S Shelton*  
-----  
Copyist.

*Perry Hinsons*  
*Col*, Co. L, 6 Reg't U. S. Col'd H. Art'y.

Appears on

**Company Muster Roll**

for *July & Aug*, 186*5*.

Joined for duty and enrolled :

When *Nov 20*, 186*4*\*

Where *Natchez Miss* \*

Period *3* years.\*

Present or absent *Present*

Stoppage, \$ *100* for

Due Gov't \$ *100* for

Valuation of horse, \$ *100*

Valuation of horse equipments, \$ *100*

Remarks:

\* ~~42~~ See enrollment on card from muster-in roll.

Book mark:

*R S Shelton*

(358c)

Copist.

*Perry Hinson*

*Pvt.*, Co. L, 6 Reg't U. S. Col'd H. Art'y.

Appears on

**Company Muster Roll**

for *dated Oct. 31*, 1865.

Joined for duty and enrolled :

When *Nov. 20*, 1864.\*

Where *Watches Miss* \*

Period *3* years.\*

Present or absent *Present.*

Stoppage, \$ *100* for

Due Gov't \$ *100* for

Valuation of horse, \$ *100*

Valuation of horse equipments, \$ *100*

Remarks:

\* See enrollment on card from muster-in roll.

Book mark:

*Daggett*



*H*

6 H. Art'y.

U.S.C.T.

*Perry Hinson*

*Pvt.*, Co. L, 6 Reg't U. S. Col'd H. Art'y.

Appears on

**Company Muster Roll**

for *Nov. & Dec.*, 1865.

Joined for duty and enrolled:

When *Nov. 20*, 1864.\*

Where *Natchez Miss.* \*

Period *3* years.\*

Present or absent *Present.*

Stoppage, \$ *100* for

Due Gov't \$ *100* for

Valuation of horse, \$ *100*

Valuation of horse equipments, \$ *100*

Remarks:

-----  
-----  
-----

\* See enrollment on card from muster-in roll.

Book mark:-----

(358c)

*Daggett*

Copyist.

No.

6 H. Art'y.

U.S.C.T.

*Perry Hinson*

*Pvt.*, Co. L, 6 Reg't U. S. Col'd H. Art'y.

Appears on

**Company Muster Roll**

for *Jan. & Feb.*, 186*6*.

Joined for duty and enrolled :

When *Nov. 20*, 186*4*.\*

Where *Natchez Miss.*\*

Period *3* years.\*

Present or absent *Present.*

Stoppage, \$ *100* for

Due Gov't \$ *100* for

Valuation of horse, \$ *100*

Valuation of horse equipments, \$ *100*

Remarks:

\* See enrollment on card from muster-in roll.

Book mark:

(358c)

*Taggart*

Copyist.

*H*

6 H. Art'y.

U.S.C.T.

*Perry Hinson*

*Pvt.*, Co. L, 6 Reg't U. S. Col'd H. Art'y.

Appears on

**Company Muster Roll**

for *Mar. & Apr.*, 1866 .

Joined for duty and enrolled :

When *Nov. 20*, 1864.\*

Where *Natchez Miss.* \*

Period *3* years.\*

Present or absent *Present.*

Stoppage, \$ *100* for

Due Gov't \$ *100* for

Valuation of horse, \$ *100*

Valuation of horse equipments, \$ *100*

Remarks:

\* See enrollment on card from muster-in roll.

Book mark: *24 1/2 1/2 1/2*

(358c)

*Daggett*

Copyist.

A

6 H. Art'y.

U.S.C.T.

Perry Hinson

Pat. Co. I, 6 Reg't U. S. Col'd H. Art'y.

Appears on Returns as follows:

Nov 1864  
Nov 20, 64  
Miss enlisted  
in Reg't

Book mark:

(546) *A. Googla* Copyist.

*Perry Hinson*

*Private Co. L., 6 Reg't U. S. Col'd H. Art'y.*

Appears on **Co. Muster-out Roll**, dated  
*Natchez, Miss., May 13, 1866.*

Muster-out to date *May 13, 1866.*

Last paid to *Dec 31, 1865.*

Clothing account:

Last settled....., 186 ; drawn since \$..... 100

Due soldier \$..... 100; due U. S. \$ *9* <sup>52</sup>/<sub>100</sub>

Am't for cloth'g in kind or money adv'd \$..... 100

Due U. S. for arms, equipments, &c., \$..... 100

Bounty paid \$..... 100; due \$ *100* 100

Remarks: *Joined as a Recruit.  
First installment Recruit  
Bounty due.*

Book mark: .....

*Keefe*

104  
Hippes, John

Co F, 6 U.S. Col'd H. Art'y.

Private Private

CARD NUMBERS.

1	6167256	26
2	6167399	27
3	6167544	28
4	6167670	29
5	6167789	30
6	6167909	31
7	6168020	32
8	6168128	33
9	6168239	34
10	6168347	35
11	6168457	36
12	6168572	37
13	6168681	38
14	6168792	39
15	6168897	40
16	6168995	41
17	6169081	42
18	6169188	43
19	9119920	44
20	40742504	45
21		46
22		47
23		48
24		49
25		50

Book Mark:

See also

*A* | 6 H. Art'y. | U.S.C.T.

*John Shipps*  
....., Co. *F*, 6 Reg't U. S. Col'd H. Art'y.

Appears on

**Company Descriptive Book**  
of the organization named above.

**DESCRIPTION.**

Age *33* years; height *5* feet *8* inches.

Complexion *Blk*

Eyes *Blk*; hair *Blk*

Where born *Nelson Co. Ky*

Occupation *Farmer*

**ENLISTMENT.**

When *Aug 29*....., 186*3*.

Where *batching*

By whom *St Schrick*, term *3* y'rs.

Remarks:.....  
.....  
.....  
.....  
.....  
.....  
.....  
.....

*Warren*

H. | 6 II. Art'y. | U.S.C.T.

John Hipps

Co. F, 2 Reg't Miss. Art'y.†

Age 33 years.

Appears on

Company Muster-in Roll

of the organization named above. Roll dated

Natchez, Miss. Sept. 12, 1863.

Muster-in to date Sept. 12, 1863.

Joined for duty and enrolled:

When August 29, 1863.\*

Where Natchez, Miss.\*

Period 3 years.\*

Valuation of horse, \$ 100

Valuation of horse equipments, \$ 100

Remarks:

† This organization subsequently became Co. F, 6 Reg't U. S. Colored Heavy Artillery.

\* Muster-in roll shows enrollment of all men of this company as of same date and place. See enrollment on subsequent card or cards.

Book mark:

Brooks

(356c)

Corvial.



26

6 H. Art'y.

U.S.C.T.

John H. Hefner

Pvt., Co. F, 2 Reg't Miss. Artillery.†

Appears on

Company Muster Roll

for Sept. 17 to Oct. 31, 1863.

Joined for duty and enrolled:

When Aug. 29, 1863.\*

Where Natchez, Miss.\*

Period 3 years.\*

Present or absent Present.

Stoppage, \$ 100 for

Due Gov't \$ 100 for

Valuation of horse, \$ 100

Valuation of horse equipments, \$ 100

Remarks:

† This organization subsequently became Co. F, 6 Reg't U. S. Colored Heavy Artillery.  
\* See enrollment on card from muster-in roll.

Book mark:

Brooks

76

6 H. Art'y.

U.S.C.T.

John Hiffes

Priv., Co. F, 2 Reg't Miss. Artillery.†

Appears on

Company Muster Roll

for Nov 31, 1863.

Joined for duty and enrolled:

When Aug 29, 1863.\*

Where Natchez.\*

Period 3 years.\*

Present or absent Present.

Stoppage, \$ 100 for

Due Gov't \$ 100 for

Valuation of horse, \$ 100

Valuation of horse equipments, \$ 100

Remarks:

† This organization subsequently became Co. F, 6 Reg't U. S. Colored Heavy Artillery.

\* See enrollment on card from muster-in roll.

Book mark:

Brooker

(358c)

Copyist.

H. | 6 H. Art'y. | U.S.C.T.

John Lips.

Co. F, 2 Reg't Miss. Artillery.†

Appears on

Company Muster Roll

for Jan. 1 to Feb. 29, 1864.

Joined for duty and enrolled:

When Aug. 29, 1863.\*

Where Natchez, Miss.\*

Period 3 years.\*

Present or absent Present.

Stoppage, \$ 100 for

Due Gov't \$ 100 for

Valuation of horse, \$ 100

Valuation of horse equipments, \$ 100

Remarks:

† This organization subsequently became Co. F, 6 Reg't U. S. Colored Heavy Artillery.

\* See enrollment on card from muster-in roll.

Book mark:

Brooks.

G.I. | 6 H. Art'y. | U.S.C.T.

John L. Wilcox  
Capt., Co. I, 5 Reg't U. S. Col'd H. Art'y.\*

Appears on

**Company Muster Roll**

for Mar. 1st to Apr. 30, 1864.

Joined for duty and enrolled :

When Aug. 29, 1863.\*

Where Natchez, Miss. \*

Period 3 years.\*

Present or absent Present.

Stoppage, \$ 100 for

Due Gov't, \$ 100 for

Valuation of horse, \$ 100

Valuation of horse equipments, \$ 100

Remarks :

\* This organization subsequently became Co. I, 6 Reg't U. S. Col'd Heavy Artillery.

\* See enrollment on card from muster-in roll.

Book mark :

Brooker

(358c)

Copyist.

John Hipps  
Priv., Co. F, 6 Reg't U. S. Col'd H. Art'y.

Appears on

Company Muster Roll

for May, to June 30, 1864

Joined for duty and enrolled:

When Aug. 29, 1863.\*

Where Natchez, Miss. \*

Period 3 years.\*

Present or absent Present

Stoppage, \$ 100 for

Due Gov't \$ 100 for

Remarks:

\* See enrollment on card from muster-in roll.

Book mark:

(358c)

Brooks  
Copyist.

*A*

6 H. Art'y.

U.S.C.T.

*John Hipps*  
*Priv*

, Co. F, 6 Reg't U. S. Col'd H. Art'y.

Appears on

**Company Muster Roll**

for *July & Aug*, 186*4*.

Joined for duty and enrolled:

When *Aug 29*, 186*3*.\*

Where *Natchez Miss.* \*

Period *3* years.\*

Present or absent *Present*

Stoppage, \$ *100* for

Due Gov't \$ *100* for

Remarks:

-----  
-----  
-----  
-----  
-----

\* See enrollment on card from muster-in roll.

Book mark:

*S. Duncan*  
Copyist.

(358c)

*A*

6 H. Art'y.

U.S.C.T.

*John Higgs*  
*Priv*

, Co. F, 6 Reg't U. S. Col'd H. Art'y.

Appears on

**Company Muster Roll**

for *Sept & Oct*, 186*4*

Joined for duty and enrolled:

When *Aug 29*, 186*3*.\*

Where *Katchez Miss.* \*

Period *3* years.\*

Present or absent *Present*

Stoppage, \$ *100* for \_\_\_\_\_

Due Gov't \$ *100* for \_\_\_\_\_

Remarks: \_\_\_\_\_  
\_\_\_\_\_  
\_\_\_\_\_  
\_\_\_\_\_  
\_\_\_\_\_  
\_\_\_\_\_

\* See enrollment on card from muster-in roll.

Book mark: \_\_\_\_\_

(358c)

*S. Duncan*

Copyist.

74

6 H. Art'y. U.S.C.T.

John Hipps

Priv., Co. F, 6 Reg't U. S. Col'd H. Art'y.

Appears on

Company Muster Roll

for Nov & Dec, 1864

Joined for duty and enrolled:

When Aug 29, 1863.\*

Where Natchez Miss.\*

Period 3 years.\*

Present or absent Present

Stoppage, \$ 100 for

Due Gov't \$ 100 for

Remarks:

\* See enrollment on card from muster-in roll.

Book mark:

S. L. Luman

(358c)

Copyist.



*A*

6 H. Art'y. U.S.C.T.

*John Hipps*

*Col.*, Co. F, 6 Reg't U. S. Col'd H. Art'y.

Appears on

**Company Muster Roll**

for *gang & Levy*, 1865.

Joined for duty and enrolled:

When *Aug 29*, 1863.\*

Where *Natchez Miss* \*

Period *3* years.\*

Present or absent *Present*

Stoppage, \$ *100* for

Due Gov't \$ *100* for

Remarks:

\* See enrollment on card from muster-in roll.

Book mark:

(358c)

*S. Linnear*  
Copyist.

*A*

*John Hepps*

*Priv*, Co. F, 6 Reg't U. S. Col'd H. Art'y.

Appears on

Company Muster Roll

for *Mea & Apl*, 1863.

Joined for duty and enrolled:

When *Aug 29*, 1863.\*

Where *Katchez Miss.* \*

Period *3* years.\*

Present or absent *Present*

Stoppage, \$ *100* for

Due Gov't \$ *100* for

Remarks:

-----  
-----  
-----  
-----  
-----

\* See enrollment on card from muster-in roll.

Book mark:

-----

(358c)

*S. Bureau*

Copyist.

*A* | *6 H. Arty* | **U.S.C.T.**

*John Hipps*  
*Plt*, Co. *F*, *6* Reg't U. S. Col'd *H. Arty*

Appears on

**Company Muster Roll**

for *May & June*, 186*5*.

Joined for duty and enrolled:

When *Aug 29*, 186*3*.\*

Where *Katchez Miss* \*

Period *3* years.\*

Present or absent *Present*

Stoppage, \$ *100* for

Due Gov't, \$ *100* for

Valuation of horse, \$ *100*

Valuation of horse equipments, \$ *100*

Remarks: \_\_\_\_\_

\_\_\_\_\_

\_\_\_\_\_

\* ~~See~~ See enrollment on card from muster-in roll.

Book mark: \_\_\_\_\_

*J. Duncan*

(358c)

Copyist.

*H*

6 H. Art'y.

U.S.C.T.

*John Ripps*

*Pvt.*, Co. F, 6 Reg't U. S. Col'd H. Art'y.

Appears on

**Company Muster Roll**

for *July + Aug.*, 186*5*.

Joined for duty and enrolled:

When *Aug. 29<sup>th</sup>*, 186*5*.\*

Where *Natchez Miss.* \*

Period *3* years.\*

Present or absent *Present*

Stoppage, \$ *100* for

Due Gov't \$ *100* for

Remarks:

-----  
-----  
-----  
-----  
-----

\* See enrollment on card from muster-in roll.

Book mark:

-----

(358c)

*J. W. Ames*

Copyist.

*H*

6 H. Art'y. U.S.C.T.

*John Higgs*

*Pvt.*, Co. F, 6 Reg't U. S. Col'd H. Art'y.

Appears on

**Company Muster Roll**

for *Sept. + Oct.*, 186*5*.

Joined for duty and enrolled:

When *Aug. 29<sup>th</sup>*, 186*3*.\*

Where *Katchez Miss.*, \*

Period *3* years.\*

Present or absent *Present*

Stoppage, \$ *100* for

Due Gov't \$ *100* for

Remarks:

\* See enrollment on card from muster-in roll.

Book mark:

(358c)

*J. W. Thomas*

Copyist.

*A* | *G. A. Army* | U.S.C.T.

*John H. Higgs*

*Co. F, 6* Reg't U. S. Col'd *A. Army*

Appears on

Company Muster Roll

for *Nov 10*, 186*5*

Joined for duty and enrolled :

When *Aug 29*, 186*3*\*

Where *Wichita, Miss* \*

Period *3* years.\*

Present or absent *Present*

Stoppage, \$ *100* for

Due Gov't, \$ *100* for

Remarks:

\* See enrollment on card from muster-in roll.

Book mark:

*E. H. Mason*

(358c)

*Compr*

*H*

6 H. Art'y.

U.S.C.T.

*John Hipps*

*Co. F*, Co. F, 6 Reg't U. S. Col'd H. Art'y.

Appears on

**Company Muster Roll**

for *Jan'y + Feby*, 186 *6*

Joined for duty and enrolled:

When *Aug. 29*, 186 *3*\*

Where *Natchez Miss.*\*

Period *3* years.\*

Present or absent *Present*

Stoppage, \$ *100* for

Due Gov't, \$ *100* for

Valuation of horse, \$ *100*

Valuation of horse equipments, \$ *100*

Remarks:

\* ~~See~~ See enrollment on card from muster-in roll.

Book mark:

(358c)

*J. W. Jones*

Copyist.

*H*

6 H. Art'y. U.S.C.T.

*John Higgs*

*Pl.*, Co. F, 6 Reg't U. S. Col'd H. Art'y.

Appears on

**Company Muster Roll**

for *March & April*, 186*6*.

Joined for duty and enrolled:

When *Aug 29<sup>th</sup>*, 186*3*\*

Where *Natchez Miss,*\*

Period *3* years.\*

Present or absent *Present*

Stoppage, \$ *100* for

Due Gov't \$ *100* for

Remarks:  
-----  
-----  
-----  
-----  
-----

\* See enrollment on card from muster-in roll.

Book mark: -----

*J. M. Cross*  
(358c) Copyist.



A

6 H. Art'y.

U.S.C.T.

John H. Fisher

Pat, Co. F, 6 Reg't U. S. Col'd H. Art'y.

Appears on Returns as follows:

Sept 1864 Absent  
without leave  
since Sept 29  
Jan 1866 Absent  
in " " " " " "  
Washington Miss

x

Entry cancelled

Book mark :

(546)

A. J. Douglas

Copyist.

*John H. Higgs*  
Co. *F*, 6 Reg't U. S. Col'd H. Art'y.

Appears on **Co. Muster-out Roll**, dated  
*Natchez Miss*, *Nov 13*, 186 *6*.

Muster-out to date *Nov 13*, 186 *6*.

Last paid to *Dec 31*, 186 *5*.

**C. othing account:**

Last settled....., 186 ; drawn since \$..... 100

Due soldier \$ *26* 100; due U. S. \$..... 100

Am't for cloth'g in kind or money adv'd \$..... 100

Due U. S. for arms, equipments, &c., \$..... 100

Bounty paid \$..... 100; due \$..... 100

Remarks: *Forried at original*  
*organization*

Book mark: *200*

*J. H. Higgs*  
Copyist.

*Asket*

Co H., 6 U.S. Col'd H. Art'y.

*Private* | *Private*

CARD NUMBERS.

1	6171521	26
2	6171670	27
3	6171810	28
4	6171951	29
5	6172089	30
6	6172216	31
7	6172345	32
8	6172465	33
9	6172583	34
10	6172699	35
11	6172818	36
12	6172933	37
13	6173041	38
14	6173155	39
15	6173261	40
16	6173369	41
17	6173466	42
18	9120424	43
19		44
20		45
21		46
22		47
23		48
24		49
25		50

Book Mark:

See also

S-1337820 PO Union

A 1729578 P.O. Box

USVA 6/24/32 etc

H H Corder

Nicholas Hackett

Co. H, 6 Reg't U. S. Col'd H. Art'y.

Appears on

Company Descriptive Book  
of the organization named above.

DESCRIPTION.

Age 25 years; height 5 feet 6 1/2 inches.

Complexion Bk

Eyes Bk; hair Bk

Where born Adams Co, Miss.

Occupation Farmer

ENLISTMENT.

When Apr. 1st, 1863.

Where Patching Miss.

By whom Jas P. Brown, term 3 y'rs.

Remarks:

Warren

*No.*

**6 H. Art'y. U.S.C.T.**

*Nicholas Hockett*

*Pri*, Co. *H*, 2 Reg't Miss. Art'y. †

Age *23* years.

Appears on

**Company Muster-in Roll**

of the organization named above. Roll dated

*Voluntary (Miss), Nov 23, 1863*

Muster-in to date *Nov 1, 1863*

Joined for duty and enrolled:

When *Nov 1*, 186 *3*.\*

Where *Voluntary, Miss*.\*

Period *3* years.\*

Valuation of horse, \$ *100*

Valuation of horse equipments, \$ *100*

Remarks: .....

† This organization subsequently became Co. *H*, 6 Reg't U. S. Colored Heavy Artillery.

\* *4th* Muster-in roll shows enrollment of all men of this company as of same date and place. See enrollment on subsequent card or cards.

Book mark: .....

*Nicholas Hockett*

No.

G H. Art'y.

U.S.C.T.

Nicholas Boquet

Chie., Co. H, 2 Reg't Miss. Art'y.†

Appears on

Company Muster Roll

for Nov 23 to Dec 31, 1863.

Joined for duty and enrolled:

When Nov 1, 1863.\*

Where Natchez Miss.\*

Period 1 years.\*

Present or absent Present.

Stoppage, \$ 100 for

Due Gov't, \$ 100 for

Valuation of horse, \$ 100

Valuation of horse equipments, \$ 100

Remarks:

† This organization subsequently became Co. H, 6 Reg't U. S. Co'd Heavy Artillery.

\* See enrollment on card from muster-in roll.

Book mark:

*No.*

6 H. Art'y.

U.S.C.T.

*Nicholas Rocket*

*Prv.*, Co. H, 2 Reg't Miss. Art'y.†

Appears on

**Company Muster Roll**

for *Jan. & Feb.*, 186*4*.

Joined for duty and enrolled:

When *Nov. 1*, 186*3*.\*

Where *Natchez Miss.*\*

Period *3* years.\*

Present or absent *Present*.

Stoppage, \$ *100* for

Due Gov't, \$ *100* for

Valuation of horse, \$ *100*

Valuation of horse equipments, \$ *100*

Remarks:

† This organization subsequently became Co. H, 6 Reg't U. S. Co'd Heavy Artillery.

\* See enrollment on card from muster-in roll.

Book mark:

*[Signature]*



*110*

6 H. Art'y.

U.S.C.T.

*William*

*Co. A*, 5 Reg't U. S. Col'd H. Art'y.\*

Appears on

**Company Muster Roll**

for *Mar & Apr*, 1864.

Joined for duty and enrolled:

When *Nov 1*, 1863.\*

Where *Salisbury Mass*\*

Period *3* years.\*

Present or absent *Present*

Stoppage, \$ *100* for

Due Gov't, \$ *100* for

Valuation of horse, \$ *100*

Valuation of horse equipments, \$ *100*

Remarks:

\* This organization subsequently became Co. *A*, 6 Reg't U. S. Col'd Heavy Artillery.

\* ~~See~~ See enrollment on card from muster-in roll.

Book mark:

*William*

*Y.C.*

6 H. Art'y.

U.S.C.T.

*Nicholas Hockett*

*Pr.*, Co. H, 6 Reg't U. S. Col'd H. Art'y.

Appears on

**Company Muster Roll**

for *May & June*, 1864:

Joined for duty and enrolled:

When *Nov. 1*, 1863.\*

Where *Natchez Miss.*

Period *3* years.\*

Present or absent *Present*

Stoppage, \$ *100* for

Due Gov't \$ *100* for

Remarks:  
-----  
-----  
-----  
-----  
-----

\* See enrollment on card from muster-in roll.

Book mark: -----

*H. Stearns*  
-----  
(358c) Copyist.

*110*

6 H. Art'y.

U.S.C.T.

*Nicholas Rocket*

*Plt.*, Co. H, 6 Reg't U. S. Col'd H. Art'y.

Appears on

**Company Muster Roll**

for *July + August*, 186*4*.

Joined for duty and enrolled:

When *Nov.*, 186*3*.\*

Where *Natchez Miss.*\*

Period *3* years.\*

Present or absent *Present*.

Stoppage, \$ *100* for

Due Gov't \$ *100* for

Remarks:

-----  
-----  
-----  
-----  
-----

\* See enrollment on card from muster-in roll.

Book mark:

-----

(358c)

*J. A. Stearns*

Copyist.

H

6 H. Art'y.

U.S.C.T.

Nicholas Hocket

Pr, Co. H, 6 Reg't U. S. Col'd H. Art'y.

Appears on

Company Muster Roll

for Sept and Oct, 1864.

Joined for duty and enrolled:

When Nov 1, 1863.\*

Where Statches Miss \*

Period 3 years.\*

Present or absent present

Stoppage, \$ 100 for

Due Gov't \$ 100 for

Remarks:

\* See enrollment on card from muster-in roll.

Book mark:

O Leary

(358c)

Copyist.

H

6 H. Art'y.

U.S.C.T.

Nicholas Hockett

Private, Co. H, 6 Reg't U. S. Col'd H. Art'y.

Appears on

Company Muster Roll

for Nov and Dec, 1864.

Joined for duty and enrolled:

When Nov 1, 1863.\*

Where Hatchery Mass \*

Period 3 years.\*

Present or absent Present

Stoppage, \$ 100 for

Due Gov't \$ 100 for

Remarks:

\* See enrollment on card from muster-in roll.

Book mark:

O'Leary

(358c)

Copyist.

H

6 H. Art'y.

U.S.C.T.

Nicholas Hockett

Private

, Co. H, 6 Reg't U. S. Col'd H. Art'y.

Appears on

Company Muster Roll

for Jan and Feb, 1865

Joined for duty and enrolled:

When Nov 1, 1863

Where Natchez Miss

Period 3 years.\*

Present or absent present

Stoppage, \$ 100 for

Due Gov't \$ 100 for

Remarks: Due U. S. for ord-  
nance lost \$2.10.

\* See enrollment on card from muster-in roll.

Book mark:

O'Leary

(358c)

Copyist.

H

6 H. Art'y.

U.S.C.T.

Nicholas Hockett

Private, Co. H, 6 Reg't U. S. Col'd H. Art'y.

Appears on

Company Muster Roll

for Mch and Apr, 1865.

Joined for duty and enrolled:

When Nov 1, 1863.\*

Where Natchez Miss \*

Period 3 years.\*

Present or absent present

Stoppage, \$ 100 for

Due Gov't \$ 100 for

Remarks: Due U.S. for ord-  
nance cost. \$ 2.41

\* See enrollment on card from muster-in roll.

Book mark:

Odum

(358c)

Copyist.

5

6 H. Art'y.

U.S.C.T.

Nicholas, Robert

Private, Co. H, 6 Reg't U. S. Col'd H. Art'y.

Appears on

Company Muster Roll

for May & June, 1863.

Joined for duty and enrolled:

When Nov. 1, 1863.\*

Where Mutchey Miss.\*

Period 2 years.\*

Present or absent Present

Stoppage, \$ 100 for

Due Gov't \$ 100 for

Remarks:

-----  
-----  
-----  
-----  
-----

\* See enrollment on card from muster-in roll.

Book mark:

-----

Paul

(358c)

Copyist.



*H* | *6 H. Arty* | **U.S.C.T.**

*Nicholas Hockett*  
*Priv.*, Co. *H*, *6* Reg't U. S. Col'd *H. Arty.*

Appears on

**Company Muster Roll**

for *July and Aug.*, 186*3*.

Joined for duty and enrolled:

When *Nov. 1*, 186*3*.\*

Where *Natchez Miss.* \*

Period *3* years.\*

Present or absent *Present*

Stoppage, \$ *100* for

Due Gov't, \$ *100* for

Remarks:

\* See enrollment on card from muster-in roll.

Book mark:

(358c)

*Paul*

Copyist.

H. B. Hartig | U.S.C.T.

Nicholas Rockett  
Pt, Co H, E Reg't U. S. Col'd Hartig

Appears on

**Company Muster Roll**

for Sept & Oct, 1865.

Joined for duty and enrolled:

When Nov 1, 1863\*

Where Natchez, Miss\*

Period 3 years.\*

Present or absent present

Stoppage, \$ 100 for

Due Gov't, \$ 100 for

Remarks: \_\_\_\_\_  
\_\_\_\_\_  
\_\_\_\_\_  
\_\_\_\_\_

\* See enrollment on card from muster-in roll.

Book mark: \_\_\_\_\_

Hartig  
Copyist.

*Nicholas Rockett*  
Pvt., Co. H, 6 Reg't U. S. Col'd H. Art'y.

Appears on

**Company Muster Roll**  
for *Nov & Dec*, 1865.

Joined for duty and enrolled:

When *Nov 1*, 1863.\*

Where *Natchez, Miss.*\*

Period *3* years.\*

Present or absent *present.*

Stoppage, \$ *100* for

Due Gov't \$ *100* for

Remarks:  
-----  
-----  
-----  
-----  
-----

\* See enrollment on card from muster-in roll.

Book mark: -----

*B. A. Harper*  
(358c) Copyist.

*H.*

6 H. Art'y.

U.S.C.T.

*Nicholas Hockett*

*Private*, Co. H, 6 Reg't U. S. Col'd H. Art'y.

Appears on

**Company Muster Roll**

for *Jan & Feb*, 186*6*.

Joined for duty and enrolled:

When *Nov 1*, 186*3*.\*

Where *Matchez Miss*.\*

Period *3* years.\*

Present or absent *present*

Stoppage, \$ *100* for

Due Gov't \$ *100* for

Remarks:  
-----  
-----  
-----  
-----  
-----  
-----

\* See enrollment on card from muster-in roll.

Book mark: -----

*B. A. Harper*

(358c)

Copyist.

*H.*

6 H. Art'y.

U.S.C.T.

*Nicholas Hockett*

*Pvt.*, Co. H, 6 Reg't U. S. Col'd H. Art'y.

Appears on

**Company Muster Roll**

for *Mar 25*, 186*6*.

Joined for duty and enrolled:

When *Nov 1*, 186*3*.\*

Where *Natchez Miss.*\*

Period *3* years.\*

Present or absent *present.*

Stoppage, \$ *100* for

Due Gov't \$ *100* for

Remarks:

-----  
-----  
-----  
-----  
-----

\* See enrollment on card from muster-in roll.

Book mark:

*S. C. Harper*  
Copyist.

(358c)

Nicholas Hockett

Private, Co. H, 6 Reg't U. S. Col'd H. Art'y.

Appears on Co. Muster-out Roll, dated Natchez, Miss. May 13, 1866.

Muster-out to date May 13, 1866.

Last paid to Dec 31, 1865.

Clothing account:

Last settled, 186 ; drawn since \$ 100

Due soldier \$ 39.15; due U. S. \$ 100

Am't for cloth'g in kind or money adv'd \$ 100

Due U. S. for arms, equipments, &c., \$ 100

Bounty paid \$ 100; due \$ 100

Remarks: joined original organization.

Book mark: V43 P6 3.69

C. J. Powell

*Wicket Snapper*

Co *D*, 6 U.S. Col'd H. Art'y

*Private* | *Private*

CARD NUMBERS.

1	6169377	26
2	6169529	27
3	6169671	28
4	6169815	29
5	6169936	30
6	6170063	31
7	6170168	32
8	6170271	33
9	6170377	34
10	6170481	35
11	6170595	36
12	6170714	37
13	6170829	38
14	6170940	39
15	6171047	40
16	6171145	41
17	6171282	42
18	6155146	43
19	6171483	44
20	9120076	45
21	9120248	46
22	40742505	47
23		48
24		49
25		50

Book Mark:

See also

*Senapher Hockett*

*Put*, Co. G, 2 Reg't Miss. Art'y.\*

Age *20* years.

Appears on

**Company Muster-in Roll**

of the organization named above. Roll dated

*Katcher, Miss, Oct 20*, 1863.

Muster-in to date *Oct 20*, 1863.

Joined for duty and enrolled:

When *Sept 20*, 1863.

Where *Katcher, Miss.*

Period *3* years.

Valuation of horse, \$ 100

Valuation of horse equipments, \$ 100

Remarks: \_\_\_\_\_

\_\_\_\_\_

\_\_\_\_\_

\*This organization subsequently became Co. G, 6 Reg't U. S. Colored Heavy Artillery.

Book mark: \_\_\_\_\_

*P. A. Ward*



74

6 H. Art'y.

U.S.C.T.

*Amos Hockett*

*Private*, Co. G, 2 Reg't Miss. Art'y.\*

Appears on

**Company Muster Roll**

for *Oct 20 to 31*, 1863.

Present or absent *Present*

Stoppage, \$ *100* for

Due Gov't, \$ *100* for

Valuation of horse, \$ *100*

Valuation of horse equipments, \$ *100*

Remarks:

\* This organization subsequently became Co. G, 6 Reg't U. S. Colored Heavy Artillery.

Book mark:

*D. A. [Signature]*

7

6 H. Art'y.

U.S.C.T.

*Leapher Horkel*  
*Put*, Co. G, 2 Reg't Miss. Art'y.\*

Appears on

**Company Muster Roll**

for *Nov & Dec*, 1863.

Present or absent *Present*

Stoppage, \$ *100* for

Due Gov't, \$ *100* for

Valuation of horse, \$ *100*

Valuation of horse equipments, \$ *100*

Remarks:  
-----  
-----  
-----  
-----  
-----  
-----  
-----

\* This organization subsequently became Co. G, 6 Reg't U. S. Colored Heavy Artillery.

Book mark: -----

*D. A. Ward*

(358)

Copyist.

*D*

6 H. Art'y.

U.S.C.T.

*Senapher Hocratt*

*Ort*, Co. G, 2 Reg't Miss. Art'y.\*

Appears on

**Company Muster Roll**

for *Jan & Feb*, 186*4*

Present or absent *Present*

Stoppage, \$ *100* for

Due Gov't, \$ *100* for

Valuation of horse, \$ *100*

Valuation of horse equipments, \$ *100*

Remarks:

\* This organization subsequently became Co. G, 6 Reg't U. S. Colored Heavy Artillery.

Book mark:

*L. Y. Spann*

(358)

Copyist.

*A*

6 H. Art'y.

U.S.C.T.

*Senapher Hockett*

*Ort*, Co. G, 5 Reg't U. S. Col'd H. Art'y.\*

Appears on

**Company Muster Roll**

for *mch & apr*, 186*4*

Present or absent *Present*

Stoppage, \$ *100* for

Due Gov't, \$ *100* for

Valuation of horse, \$ *100*

Valuation of horse equipments, \$ *100*

Remarks:

\* This organization subsequently became Co. G, 6 Reg't U. S. Col'd Heavy Artillery.

Book mark:

*L. Y. Spann*

(358)

Copyist.

*A*

6 H. Art'y.

U.S.C.T.

*Senapher Hockett*

*Ort*, Co. G, 6 Reg't U. S. Col'd H. Art'y.

Appears on

**Company Muster Roll**

for *May & June*, 1864.

Present or absent *Present*

Stoppage, \$.....100 for .....

Due Gov't, \$.....100 for .....

Valuation of horse, \$.....100

Valuation of horse equipments, \$.....100

Remarks: .....

.....

.....

.....

.....

.....

Book mark: .....

.....

*L. Y. Spamm*

(358)

Copyist.

*H*

6 H. Art'y.

U.S.C.T.

*Samuel Hockett*

*Pri.*, Co. G, 6 Reg't U. S. Col'd H. Art'y.

Appears on

**Company Muster Roll**

for *July & Aug.*, 1864.

Present or absent *Present.*

Stoppage, \$ 100 for

Due Gov't, \$ 100 for

Valuation of horse, \$ 100

Valuation of horse equipments, \$ 100

Remarks:

Book mark:

(358)

*J. Smith*

Copyist.

*Amphib. B. Co.*  
*H*

Co. G, 6 Reg't U. S. Col'd H. Art'y.

Appears on

**Company Muster Roll**

for *Sept 1st*, 186*4*.

Present or absent *Present*

Stoppage, \$ *100* for

Due Gov't, \$ *100* for

Valuation of horse, \$ *100*

Valuation of horse equipments, \$ *100*

Remarks:

Book mark:

26

6 H. Art'y.

U.S.C.T.

*Senapher Hockett*

*Pri.*, Co. G, 6 Reg't U. S. Col'd H. Art'y.

Appears on

**Company Muster Roll**

for *Nov. & Dec.*, 1864.

Present or absent. *Present.*

Stoppage, \$ 100 for

Due Gov't, \$ 100 for

Valuation of horse, \$ 100

Valuation of horse equipments, \$ 100

Remarks:

-----  
-----  
-----  
-----  
-----  
-----  
-----  
-----

Book mark: -----

-----  
*J. Y. Smith*  
-----

(358)

Copyist.



*A*

6 H. Art'y.

U.S.C.T.

*Senapher Hockett*

*Private*, Co. G, 6 Reg't U. S. Col'd H. Art'y.

Appears on

**Company Muster Roll**

for *Jan & Feb.*, 186*5*.

Present or absent *Present*

Stoppage, \$ 100 for

Due Gov't, \$ 100 for

Valuation of horse, \$ 100

Valuation of horse equipments, \$ 100

Remarks:

Book mark:

*F. M. Neal*

(358)

Copyist.

*Samuel Hockett*  
Private, Co. G, 6 Reg't U. S. Col'd H. Art'y.

Appears on

**Company Muster Roll**

for *Mich & Apl*, 1865.

Present or absent *Present*

Stoppage, \$ 100 for

Due Gov't, \$ 100 for

Valuation of horse, \$ 100

Valuation of horse equipments, \$ 100

Remarks:

-----  
-----  
-----  
-----  
-----  
-----  
-----  
-----

Book mark:

-----  
-----

(358) *E. D. Neale* Copyist.

*A*

*Senaphor Hockett*

*Private*, Co. G, 6 Reg't U. S. Col'd H. Art'y.

Appears on

**Company Muster Roll**

for *May & June*, 186*5*.

Present or absent *Present*

Stoppage, \$ *100* for

Due Gov't, \$ *100* for

Valuation of horse, \$ *100*

Valuation of horse equipments, \$ *100*

Remarks: *Due the U. S. for Ordinance 75 cents.*

Book mark: *211011-2*

*J. D. Neal*

H

6 H. Art'y.

U.S.C.T.

Senopher Hockell:

Priv., Co. G, 6 Reg't U. S. Col'd H. Art'y.

Appears on

Company Muster Roll

for July 4<sup>th</sup> Aug., 1865.

Present or absent present

Stoppage, \$ 100 for

Due Gov't, \$ 100 for

Valuation of horse, \$ 100

Valuation of horse equipments, \$ 100

Remarks: Due the United States for  
ordnance lost - 75 etc.

Book mark:

E. W. M. Stearns

Copyist.

*Menophor Hackett.*

*Priv.*, Co. G, 6 Reg't U. S. Col'd H. Art'y.

Appears on

**Company Muster Roll**

for *Sept - 1* *Oct*, 1865.

Present or absent *present*

Stoppage, \$ *100* for

Due Gov't, \$ *100* for

Valuation of horse, \$ *100*

Valuation of horse equipments, \$ *100*

Remarks: \_\_\_\_\_  
\_\_\_\_\_  
\_\_\_\_\_  
\_\_\_\_\_  
\_\_\_\_\_  
\_\_\_\_\_  
\_\_\_\_\_  
\_\_\_\_\_

Book mark: \_\_\_\_\_

*E. Weston*

H

6 H. Art'y.

U.S.C.T.

*Senapher Hackett*

*Pr.*, Co. G, 6 Reg't U. S. Col'd H. Art'y.

Appears on

**Company Muster Roll**

for *Nov. & Dec.*, 186*5*.

Present or absent *present*

Stoppage, \$ *100* for

Due Gov't, \$ *100* for

Valuation of horse, \$ *100*

Valuation of horse equipments, \$ *100*

Remarks:

Book mark:

*E. West.*

*A* | **6 H. Art'y.** | **U.S.C.T.**

*Senapher Hocket*

....., Co. *9*, 6 Reg't U. S. Col'd H. Art'y.

Appears on

**Company Descriptive Book**

of the organization named above.

**DESCRIPTION.**

Age *20* years; height *5* feet *2 1/2* inches.

Complexion *Dark*

Eyes *black*; hair *Dark*

Where born *Williamson Pa., La.*

Occupation *Farmer*

**ENLISTMENT.**

When *Sept. 20*, 186*3*.

Where *Ketchum Miss.*

By whom *Capt. Smith*, term *3* y'rs.

Remarks:

.....  
.....  
.....  
.....  
.....  
.....  
.....  
.....  
.....  
.....

*Warren*

*A* | 6 H. Art'y. | U.S.C.T.

*Joseph Sackett*

Co. *G*, 6 Reg't U. S. Col'd H. Art'y.

Appears on

**Company Descriptive Book**

of the organization named above.

**DESCRIPTION.**

Age *20* years; height *5* feet *2 1/2* inches.

Complexion *Drk*

Eyes *Blk*; hair *Blk*

Where born *Wilson, Pa. La.*

Occupation *Farmer*

**ENLISTMENT.**

When *Sept. 20*, 1863.

Where *Natchez Miss.*

By whom *C. M. Smith*, term *3* y'rs.

Remarks: *Deserted Mich 13/66  
from Depot Q. M. Dept.  
at Natchez Miss.*

*Wassen*

Copist.



H

6 H. Art'y. U.S.C.T.

Senapher Hockett

Priv, Co. G, 6 Reg't U. S. Col'd H. Art'y.

Appears on

Company Muster Roll

for Jan + Feb, 1866.

Present or absent Absent

Stoppage, \$ 100 for

Due Gov't, \$ 100 for

Valuation of horse, \$ 100

Valuation of horse equipments, \$ 100

Remarks: Absent without leave,

Book mark:

M. Chance

H

6 H. Art'y.

U.S.C.T.

Senapher Hockett

Priv, Co. G, 6 Reg't U. S. Col'd H. Art'y.

Appears on

Company Muster Roll

for Mar & Apr, 1866.

Present or absent

Stoppage, \$ 100 for

Due Gov't, \$ 100 for

Valuation of horse, \$ 100

Valuation of horse equipments, \$ 100

Remarks: Deserted Mch 13 '66 at Natchez, Miss. Stop for Ordnance lost \$1<sup>09</sup>/<sub>100</sub> for C & E. 12 cents,

Book mark:

M. Chance

(358)

Copyist.

A | C. Hart | U.S.C.T.

Senapher Hackett

Priv., Co. G, 6 Reg't U. S. Col'd Hart

Appears on

**Descriptive List of Deserters**

dated *Natchez Miss Mar 31, 1866.*

**Deserted :**

When *Mar 13*, 1866

Where *Natchez Miss*

**Arrested :**

When ....., 186 .

Where .....

**Remarks :** .....

**Book mark :** .....

(851)

*B. Harmon*

Copyright.

A

6 H. Art'y.

U.S.C.T.

Leopold Hockett  
Pat. Co. G, 6 Reg't U. S. Col'd H. Art'y.

Appears on Returns as follows:

Mar 1866 Deserted  
from Depot 2  
M Depot Natchez  
Miss Mar 13, 66

Book mark:

(546)

A. J. Gougeon  
Copyist.

Senapher Hockett

Pvt., Co. G., 6 Reg't U. S. Col'd H. Art'y.

Appears on **Co. Muster-out Roll**, dated  
Natchez, Miss., May 13, 1866.

Muster-out to date \_\_\_\_\_, 1866.

Last paid to June 30, 1865.

**Clothing account:**

Last settled Mar 2, 1865; drawn since \$ 63 <sup>49</sup>/<sub>100</sub>

Due soldier \$ 100; due U. S. \$ 100

Am't for cloth'g in kind or money adv'd \$ 100

Due U. S. for arms, equipments, &c., \$ 1 <sup>21</sup>/<sub>100</sub>

Bounty paid \$ 100; due \$ 100

Remarks: Joined at original organization, Deserted Mch 13, '66 at Natchez, Miss. Stop for ordnance lost \$ 1 <sup>09</sup>/<sub>100</sub> for Camp & Garrison Equipage .12 cents

Book mark: Y 135 P 60, 72

Mochance

Hodge, William  
Co A, 6 U.S. Col'd H. Art'y.

1st Lieutenant

CARD NUMBERS.

1	6155287	26
2	40742410	27
3		28
4		29
5		30
6		31
7		32
8		33
9		34
10		35
11		36
12		37
13		38
14		39
15		40
16		41
17		42
18		43
19		44
20		45
21		46
22		47
23		48
24		49
25		50

Book Mark:

See also 31 No. 100.

William Hodge  
1st Lt., Co. A, 2 Reg't Miss. Art'y.†

Age 36 ... years.

Appears on

**Company Muster-in Roll**

of the organization named above. Roll dated  
Natchez Miss Sept. 12, 1863.

Muster-in to date Sept 12, 1863.

Joined for duty and enrolled:

When \_\_\_\_\_, 186 .\*

Where \_\_\_\_\_ \*

Period 3 .. years.\*

Valuation of horse, \$ ..... 100

Valuation of horse equipments, \$ ..... 100

Remarks: Appointed from 2nd  
Lt. of the 30th Mo. Inftry. Vols.  
to be 1st Lt. in the 2nd (over)

† This organization subsequently became Co. A, 6 Reg't U. S. Colored Heavy Artillery.

\* \* \* Muster-in roll shows enrollment of all men of this company as of same date and place. See enrollment on subsequent card or cards.

Name not borne on sub. rolls.

Book mark : .....

*C. G. Smith*

JAN. 13

6155387

☆1891☆

Regt. Miss. arty.  
Musters in to date  
Sept. 12 - 1863.



*H*

6 H. Art'y.

U.S.C.T.

*William Hodge*

....., Co. ...., 6 Reg't U. S. Col'd H. Art'y.

Appears on Returns as follows:

*Sept 1863 (1st Co A  
2 Miss H Art  
A. Q.) Present  
(Signed Ret' Comdg  
Co.)*

Book mark : .....

(546)

*H. J. Gungl*  
Copist.

Hodge William  
2nd Co., 6 Reg't U.S. A.A.

2 Enclosures.

Bed Cards .....	Final Statements .....
Burial Records .....	Furloughs or L. of A .....
Certs. of Dis. for Discharge .....	Med. Certificates .....
C. M. Charges .....	Med. Des. Lists .....
Descriptive Lists .....	Orders .....
Discharge Certificates .....	Pris. of War Record .....
Enlistment Papers .....	Resignations .....

Other papers relating to—

Admission to Hosp'l .....	Furlough or L. of A .....
Casualty Sheet .....	Med. Examination .....
Confinement .....	Misc. Information .....
Contracts .....	Pay or Clothing .....
Death or Effects .....	Personal Reports .....
Desertion .....	Rank .....
Discharge from Hosp'l .....	Transfer to Hosp'l .....
Discharge from Service .....	Transfer to V. R. C. .....
Duty .....	Transportation .....

Hd. Qrs. Dept of Vidalia  
S. 1 October 28-1863

Gen. B. G.  
Col. Comdg

Communicates facts in  
reference to the conduct of <sup>1st</sup>  
Lieutenant W<sup>m</sup> Hodge Co. C.  
~~2<sup>d</sup> Regt. Miss. Arty of A. D.~~

Recommends that he may  
be dismissed thro service of the  
United States

~~527 S. C. I.~~

~~6 U. S. C. N. A.~~

S. O. n<sup>o</sup> 89

Par 2.

Recd. U. S. C. 200, 29

Fort Quartermaster Post of Beadwell  
Oct 28<sup>th</sup> 1868

Genl

I have the honor to communicate  
the following facts respecting the conduct of  
1<sup>st</sup> Lt Wm Dodge Co A 2<sup>d</sup> Miss A.D. This officer  
since his muster out of the 30<sup>th</sup> Me<sup>o</sup> Vols as 2<sup>d</sup> Sgt Co E,  
and his muster in, as 1<sup>st</sup> Lt of Co A 2<sup>d</sup> Miss Army A.D.,  
has on several occasions allowed himself  
while on duty to become badly drunk, and in  
that condition to expose himself to the ridicule  
of his men - much to the discredit of the service.  
Such conduct is unbecoming an officer  
Therefore respectfully recommended that he  
be dismissed the service of the United States.

I have the honor to be

Very respectfully,  
Your obedient servant  
B. G. Harwood  
Col Com'y

Brig Genl C. Thomas  
Asst Genl U.S.

Special Order  
No. 89 ~

---

Appointment of 1<sup>st</sup> Lt  
William Hough "Revoked"  
and is Discharged the  
Service of the US Service  
Date Oct. 28. 1863 ~

---

EWS&A

Natchez Miss

October 29<sup>th</sup> 1863

Special Orders }  
No 89 }

[Extract]

III The appointment of First  
Lieutenant William Hodge, 2<sup>d</sup> Regiment Mississippi  
Volunteer Artillery of African Descent is revoked,  
to date from the 28<sup>th</sup> instant; and Lieutenant Hodge  
is hereby discharged from the service of the United  
States.

x

x

x

x

By order of the Secretary of War  
J. Thomas  
Adjutant General

Wm. Hodge  
2<sup>d</sup> Miss. Art. (A. G.)

*W. J. Williams*

*Co. D,* 6 U.S. Col'd H. Art'y

*Private Corporal*

CARD NUMBERS.

1	6157858	26
2	6157971	27
3	6158115	28
4	6158335	29
5	6160191	30
6	9119121	31
7	40742506	32
8		33
9		34
10		35
11		36
12		37
13		38
14		39
15		40
16		41
17		42
18		43
19		44
20		45
21		46
22		47
23		48
24		49
25		50

Book Mark:

See also

William Hodges

....., Co. B, 6 Reg't U. S. Col'd H. Art'y.

Appears on

**Company Descriptive Book**  
of the organization named above.

**DESCRIPTION.**

Age 26 years; height 5 feet 7 inches.

Complexion Black

Eyes Black; hair Black

Where born Jefferson Co. Mo.

Occupation Farmer

**ENLISTMENT.**

When Sept 1, 1863.

Where Neshy Mo.

By whom Capt. [unclear]; term 3 y'rs.

Remarks: Discharged  
Neshy Mo. 8/10/64

[Signature]



William Hayes  
Privt, Co. B, 2 Reg't Miss. Art'y.†

Age 26 years.

Appears on

Company Muster-in Roll (

of the organization named above. Roll dated

Natchez, Miss. Sept. 12, 1863.

Muster-in to date Sept. 12, 1863.

Joined for duty and enrolled:

When Sept. 1st, 1863.\*

Where Natchez, Miss. \*

Period 3 years.\*

Valuation of horse, \$ 100

Valuation of horse equipments, \$ 100

Remarks:

† This organization subsequently became Co. B, 6 Reg't U. S. Colored Heavy Artillery.

\* Muster-in roll shows enrollment of all men of this company as of same date and place. See enrollment on subsequent card or cards.

Book mark:

M. W. Warren

(356c)

Copyist.

William Hodges

3rd Corp., Co. B, 2 Reg't Miss. Art'y.†

Appears on

Company Muster Roll

for Sept. 12 to Oct 31, 1863.

Joined for duty and enrolled:

When Sept 1, 1863.\*

Where Natchez Miss. \*

Period 3 years.\*

Present or absent Present

Stoppage, \$ 100 for

Due Gov't, \$ 100 for

Valuation of horse, \$ 100

Valuation of horse equipments, \$ 100

Remarks:

† This organization subsequently became Co. B, 6 Reg't U. S. Co'd Heavy Artillery.  
\* See enrollment on card from muster-in roll.

Book mark:

W. W. Warren

A

6 H. Art'y.

U.S.C.T.

William Hodges

Capt., Co. B, 2 Reg't Miss. Art'y.†

Appears on

Company Muster Roll

for Nov. & Dec., 1863.

Joined for duty and enrolled:

When Sept 1st, 1863.\*

Where Hatchey, Miss. \*

Period 3 years.\*

Present or absent Present

Stoppage, \$ 100 for

Due Gov't, \$ 100 for

Valuation of horse, \$ 100

Valuation of horse equipments, \$ 100

Remarks:

† This organization subsequently became Co. B, 6 Reg't U. S. Co'd Heavy Artillery.

\* See enrollment on card from muster-in roll.

Book mark:

W. M. Tharrell

*A.* | 6 H. Art'y. | U.S.C.T.

*William Hodges*

*Coop'd*, ~~2 Reg't Miss. Art'y \*~~  
Co. B, ~~6 Reg't U. S. Col'd H. Art'y.~~

Appears on

**Company Muster Roll**

for *Jan'y & Feby* 1864.

Joined for duty and enrolled:

When *Sept. 1st*, 1863.\*

Where *Statches, Miss.* \*

Period *3* years.\*

Present or absent

Stoppage, \$ *100* for

Due Gov't, \$ *100* for

Remarks: *Died at Statches, Miss. Feby 8 1864*

\* This organization subsequently became Co. B. 6 Reg't U. S. Col'd H. Art.

\* See enrollment on card from muster-in roll.

\* *Corrected reg. 19195 - Omm.*

Book-mark: *8555 2nd A - apt 3/68*

*M. M. Harner*

(358c)

Copyist.

A

6 H. Art'y.

U.S.C.T.

William Hodges

....., Co. ...., 6 Reg't U. S. Col'd H. Art'y.

Appears on Returns as follows:

Feb 1864 (Corp. Co B  
2 Miss. H. Art  
A. H. Hodges died of  
disease Feb 8, 64  
Walchey

Book mark:

(546)

A. Gouglal

Copyist.

H

6 H. Art'y.

U.S.C.T.

William Hodges

Capt, Co. B, 6 Reg't U. S. Col'd H. Art'y.

Appears on Co. Muster-out Roll, dated

Natchez Miss May 13, 1866.

Muster-out to date ..... 186 .

Last paid to ..... 186 .

Clothing account:

Last settled....., 186 ; drawn since \$..... 100

Due soldier \$..... 100; due U. S. \$..... 100

Am't for cloth'g in kind or money adv'd \$..... 100

Due U. S. for arms, equipments, &c., \$..... 100

Bounty paid \$..... 100; due \$..... 100

Remarks: Joined at Original Organization.

Died at Natchez Miss Feb. 8/64 of Small Pox.

Final Statements furnished Feb. 12/64

Book mark: P. V. 37, P. 105 - 1876

(over)

(361)

J. E. Nichol Copyist.

JAN. 13

6160191

☆1891☆

U. S. O. P. 84 '69

Hodges, Wm

Cmp, Co. B., 6 <sup>Begt</sup> U.S.C.H.A.

2 Enclosures.

Bed Cards	Descriptive Lists
Burial Records	Final Statements /
Certs. of Dis. for Discharge	Furloughs
C. M. Charges	Med. Des. Lists
Med. Certificates	Orders

Other papers relating to—

Admission to Hosp'l	Furlough
Casualty Sheet (Officer's)	Med. Examination
Confinement	Misc. Information
Contracts	Pay or Clothing
Death or Effects /	Personal Reports
Desertions	Rank
Discharge from Hosp'l	Transfer to Hosp'l
Discharge from Service	Transfer to V. R. C.
Duty	Transportation



OF

*George Wm. Hedges*  
*6 Reg't of 1st Col. 1st Heavy*  
*Volunteers.*  
*New Jersey 8<sup>th</sup> 1864*

SEC. 12. *And be it further enacted,* That the fees of agents and attorneys for making out and causing to be executed the papers necessary to establish a claim for a pension, bounty, and other allowance before the Pension Office, under this act, shall not exceed the following rates: For making out and causing to be duly executed a declaration by the applicant, with the necessary affidavits, and forwarding the same to the Pension Office, with the requisite correspondence, ten dollars; which sum shall be received by such agent or attorney in full for all services in obtaining such pension, and shall not be demanded or received, in whole or in part, until such pension shall be obtained; and the sixth and seventh sections of an act entitled "An act to grant pensions," approved July [fourteenth,] eighteen hundred and sixty-two, are hereby repealed.

SEC. 13. *And be it further enacted,* That any agent or attorney who shall, directly or indirectly, demand or receive any greater compensation for his services under this act than is prescribed in the preceding section of this act, or who shall contract or agree to prosecute any claim for a pension, bounty, or other allowance under this act, on the condition that he shall receive a per centum upon any portion of the amount of such claim, or who shall wrongfully withhold from a pensioner or other claimant the whole or any part of the pension or claim allowed and due to such pensioner or claimant, shall be deemed guilty of a high misdemeanor, and, upon conviction thereof, shall, for every such offense, be fined not exceeding three hundred dollars, or imprisoned at hard labor not exceeding two years, or both, according to the circumstances and aggravations of the offense.

Approved July 4, 1864.

NOTE. 10.—If any soldier is charged a higher fee than that allowed by the above act, he should report the fact and the name of the agent to the Adjutant General, in order that steps may be taken to have the same refunded.

NOTE 1.—Two of these certificates (or duplicates) are to be given to each Volunteer Soldier or drafted man who may be discharged without being mustered out (Final Statements are never given to men mustered out of service,) that he may at once receive from the Paymaster the pay, &c., due to him, and the captain or other commissioned officer commanding the company will certify to the act of the delivery of the duplicate certificates; with these certificates the Soldier is "entitled to" his discharge, and should also present his discharge to the Paymaster to have the payment endorsed on it. The discharge is to be given back to the Soldier by the Paymaster; the latter only retaining as his vouchers the duplicate certificates.

NOTE 2.—If the Soldier is entitled to pay for the use of his horse, the Company Commander will certify to that fact on the back of both these final statements, and also to the time he has pay due for having been so mounted on his own horse.

NOTE 3.—When a Soldier is furnished with final statements, his descriptive list, if he has one, should be taken up by the officer who gives the Soldier these statements, and endorsed with a statement to this effect by the officer. The endorsement should exhibit a full statement of the time for which the Soldier was allowed pay on his final statements, the clothing account, and all other charges against him or in his favor, so as to comprise a complete exhibit of his account. It will then be transmitted to the Company Commander of the Soldier, who will enter all the data necessary to a full understanding of the Soldier's account on the muster roll upon which the Soldier's discharge is reported. The descriptive list will then be destroyed. The object of this is, that the remaining portion of the Soldier's account may be settled upon the receipt of these muster rolls, and the Soldier receive any pay or allowances that may be due him at the time of his discharge, and which may not appear on his last final statements from the fact that his descriptive list is incomplete. These accounts for back pay, &c., are settled by the 2d Auditor of the Treasury Department.

NOTE 4.—Charges for loss or injury to ordnance, horse equipments, and other miscellaneous charges, should appear under the heading of "Other Stoppages."

NOTE 5.—Bounty paid by State authorities, and not by the United States, will not be entered on this statement.

NOTE 6.—Amounts due the Sutler and Laundress must be entered on the muster roll on which the discharge, death, desertion, &c., is reported, as well as on the final statement, otherwise the amount cannot be collected from the United States.

NOTE 7.—This blank will be used for deceased volunteers and drafted men, as well as for others.

NOTE 8.—Where a Soldier dies in Hospital or on detached service, his descriptive list, if he has one, should be sent with his final statements, in duplicate, to the Adjutant General, Washington, D. C.

NOTE 9.—If the soldier is a drafted man or substitute, the space for time, &c., of enrolled, should contain only the word *drafted* or *substitute*, as the case may be. If the Soldier is a "VETERAN," (or RECRUIT,) the words *as a veteran*, (or *recruit*,) as the case may be, should be interlined after the words *mustered into the service of the U.S.* A statement of all the installments of *Veteran or Recruit Bounty RECEIVED* by the Soldier must be made on the back of each final statement.

ADJUTANT GENERAL'S OFFICE  
*March 8<sup>th</sup> 1866*  
Duplicates with inventory sent 2<sup>d</sup> Auditor.

MAR 7 1866

*[Signature]*

I certify, on honor, that William Hodges, a Corporal of  
Captain H. Q. Stover Company B of the 6<sup>th</sup> Regiment of Infantry Art Heavy  
Volunteers, of the State of \_\_\_\_\_, born in Jefferson County State  
of Mississippi, aged 26 years; 5 feet 7<sup>1</sup>/<sub>2</sub> inches high; Black complexion,  
Black eyes, Black hair, and by occupation a Farmer, who joined for service,  
and was enrolled (see Note 9) on the 1<sup>st</sup> day of September, 1863, at Natch, Mississippi  
by Capt. R. R. Hopkins, for the period of Three years, and mustered into  
the service of the United States on the 12<sup>th</sup> day of September, 1863, at  
Natch, Mississippi, by Capt. Cole; and having served  
**HONESTLY** and **FAITHFULLY** with his Company to the present date, is now entitled to a  
**DISCHARGE** by reason of Die in Hospital at Natch, Mississippi  
February 8<sup>th</sup> 1864 Disease not known

The said Corporal, William Hodges was last paid by Paymaster  
Maj. Atkinson, to include the 31<sup>st</sup> day of October, 1863, and  
has pay due him from that time to the present date; he is entitled to pay and subsistence for  
**TRAVELING** to place of enrollment, and whatever other allowances are authorized to volunteer  
soldiers, drafted men, or militia, so discharged. He has received from the United States **CLOTHING**  
amounting to \$ 43 <sup>44</sup>/<sub>100</sub> dollars, since the 1<sup>st</sup> day of September,  
1863, when his clothing account was last settled. He has received from the United States  
None None <sup>—</sup>/<sub>100</sub> dollars advanced **BOUNTY**.

There is to be stopped from him, on account of the State of \_\_\_\_\_, or other  
authorities, for **CLOTHING**, &c., received on entering service, \_\_\_\_\_ <sup>—</sup>/<sub>100</sub> dollars; and  
for other stoppages, viz: \_\_\_\_\_

\_\_\_\_\_ <sup>—</sup>/<sub>100</sub> dollars.  
He has been furnished with **TRANSPORTATION** in kind from the place of his discharge to  
\_\_\_\_\_; and he has been **Subsisted** for **Traveling** to his  
place of enrollment, up to the \_\_\_\_\_, 186 .

He is indebted to \_\_\_\_\_, **Sutler**, \_\_\_\_\_ <sup>—</sup>/<sub>100</sub> dollars.

He is indebted to \_\_\_\_\_, **Laundress**, \_\_\_\_\_ <sup>—</sup>/<sub>100</sub> dollars.

Given in Duplicate, at Natch, Mississippi, this 24 day  
of February, 1866.

H. Q. Stover

Capt 6<sup>th</sup> Inf Art Heavy  
Commanding Company.

INVENTORY OF THE EFFECTS

OF

*Samuel Wm Hodge's*

Late of Company

*6<sup>th</sup> Reg't of U.S. Col. Artillery*

Volunteers, who died at *North Miss*

on the *8* day of *February* 186*4*

JUL  
17  
1871

be  
of  
ned  
his  
le-  
to  
er.  
ects  
to  
or  
to  
the  
on-  
and

non-  
War,  
the  
to  
in  
the  
d, as  
dies  
of his  
e re-  
ward  
ged,  
time  
at the  
roll  
ll be  
pany  
ed in  
d on

er or  
ease,  
the  
s de-  
they

on, a  
the  
ymas-  
nding  
Re-  
y (-)  
86-  
urned  
e Ad-  
of the  
their  
other  
to the

uplicate  
ould  
fficer

Inventory of the effects of William Hodge late  
 a Corporal of Captain Hugh B. Stover Company B of  
 the 6th Regiment of Miss. Art Heavy Volunteers, who was enrolled as  
 a \_\_\_\_\_ at Natchez in the State of Mississippi on  
 the 1<sup>st</sup> day of September 1863, and mustered into the service of the United  
 States as a 12<sup>th</sup> on the 12 day of September 1863, at Natchez, Mississippi  
 in Company B, 6 Regiment of Miss. Art Heavy Volunteers, to serve Three  
 years or during the war; he was born in Jefferson County in the State  
 of Mississippi; he was 26 years of age, 5 feet 7<sup>1</sup>/<sub>2</sub> inches  
 high, Black complexion, Black eyes, Black hair, and by occupation, when enrolled,  
 a Farmer; he died in Hospital, at  
Natchez, Mississippi on the 8<sup>th</sup> day of February 1864, by  
 reason of Disease not known

INVENTORY.

ARTICLES.	No.	ARTICLES.	No.	ARTICLES.	No.
Hats.....		Pairs trousers.....		Knapsacks.....	
Caps.....		Pairs flannel drawers.....			
Forage caps.....		Pairs cotton drawers.....			
Great coats.....		Flannel shirts.....			
Uniform coats.....		Cotton shirts.....			
Uniform jackets.....		Pairs boots.....			
Flannel sack coats.....		Pairs shoes.....			
Blouses.....		Pairs socks.....		MONEY.	
Stable frocks.....		Blankets.....		Specie.....	\$
Fatigue overalls.....		Haversacks.....		Notes.....	\$

I CERTIFY, ON HONOR, that the above inventory comprises all the effects of Corporal  
William Hodge, deceased, and that the effects are in the hands  
 of \_\_\_\_\_ at \_\_\_\_\_  
 \_\_\_\_\_ to be disposed of by a Council of Administration.

(DUPLICATES.)

STATION: Natchez, Mississippi

DATE: February 24<sup>th</sup> 1864

A. G. O., No. 104.]

H. D. Stover  
Capt 6<sup>th</sup> Miss. Art Heavy  
 Commanding the Company.

*Hodding Jerry*

Co D, 6 U.S. Col'd H. Art'y

*Private Private*

CARD NUMBERS.

1	6173624	26
2	6173766	27
3	6173911	28
4	6174040	29
5	6174173	30
6	6174290	31
7	6174397	32
8	6174508	33
9	6174621	34
10	6174739	35
11	6174857	36
12	6174973	37
13	6175079	38
14	6175189	39
15	6175294	40
16	6175393	41
17	6175489	42
18	9120555	43
19		44
20		45
21		46
22		47
23		48
24		49
25		50

Book Mark:

See also

*Jerry Hadwin*

....., Co. *C*, 6 Reg't U. S. Col'd H. Art'y.

Appears on

**Company Descriptive Book**

of the organization named above.

**DESCRIPTION.**

Age *38* years; height *5* feet *10 1/2* inches.

Complexion *Blk*

Eyes *Blk*; hair *Blk*

Where born *Nelson Va.*

Occupation *Labourer*

**ENLISTMENT.**

When *Dec. 8*, 186*3*.

Where *Natchez Miss*

By whom *Capt. H. Hart*; term *3* y'rs.

Remarks: .....

.....  
.....  
.....  
.....  
.....  
.....  
.....  
.....

*Warren*

A

*Jerry Hodlin*  
Pvt., Co. *D*, 2 Reg't Miss. Art'y.†

Age *38* years.

Appears on

**Company Muster-in Roll**

of the organization named above. Roll dated

*Natchez, Miss., Dec. 17, 1863.*

Muster-in to date *Dec. 8, 1863.*

Joined for duty and enrolled:

When *Dec. 8*, 186*3*.\*

Where *Natchez, Miss.* \*

Period *3* years.\*

Valuation of horse, \$ *100*

Valuation of horse equipments, \$ *100*

Remarks: \_\_\_\_\_

† This organization subsequently became Co. *D*, 6 Reg't U. S. Colored Heavy Artillery.

\* Muster-in roll shows enrollment of all men of this company as of same date and place. See enrollment on subsequent card or cards.

Book mark: \_\_\_\_\_

*R. C. Taylor*

(356c)

Copyist.

Jerry Hodlin  
Pvt., Co. I, 2 Reg't Miss. Artillery.†

Appears on

**Company Muster Roll**

for Dec. 17 to Dec. 31, 1863.

Joined for duty and enrolled:

When Dec. 8, 1863.\*

Where Natchez \*

Period 3 years.\*

Present or absent Present

Stoppage, \$ 100 for

Due Gov't, \$ 100 for

Valuation of horse, \$ 100

Valuation of horse equipments, \$ 100

Remarks: \_\_\_\_\_

† This organization subsequently became Co. I, 6 Reg't U. S. Colored Heavy Artillery.

\* See enrollment on card from muster-in roll.

Book mark: \_\_\_\_\_

(358c)

P. C. Taylor

Copyist.



A

*Jessie Hodlin*  
Plt., Co. I, 2 Reg't Miss. Artillery.†

Appears on

**Company Muster Roll**

for *Jan. and Feb.*, 1864.

Joined for duty and enrolled:

When *Dec. 8*, 1863.\*

Where *Natchez*\*

Period *3* years.\*

Present or absent *Present*

Stoppage, \$ *100* for

Due Gov't \$ *100* for

Valuation of horse, \$ *100*

Valuation of horse equipments, *100*

Remarks:

† This organization subsequently became Co. I, 6 Reg't U. S. Colored Heavy Artillery.  
\* See enrollment on card from muster-in roll.

Book mark:

*P. C. Taylor*

(358c)

Copyist.

*Jerry Hodlin*  
Pvt., Co. *D*, 5 Reg't U. S. Col'd H. Art'y.\*

Appears on

**Company Muster Roll**

for *Mar. and Apr.*, 1864.

Joined for duty and enrolled :

When *December 8*, 186*3*.\*

Where *Natchez* \*

Period *3* years.\*

Present or absent *Present*

Stoppage, \$ *100* for

Due Gov't, \$ *100* for

Valuation of horse, \$ *100*

Valuation of horse equipments, \$ *100*

Remarks :

\* This organization subsequently became Co. *D*, 6 Reg't U. S. Col'd Heavy Artillery.

\* See enrollment on card from muster-in roll.

Book mark :

(358c)

*J. C. Taylor*

Copyist.

*Jerry Hodlin*  
Pvt., Co. I, 6 Reg't U. S. Col'd H. Art'y.

Appears on

**Company Muster Roll**

for *May and June*, 186*4*.

Joined for duty and enrolled :

When *Dec. 8*, 186*3*.\*

Where *Natchez* \*

Period *3* years.\*

Present or absent *Present*

Stoppage, \$ *100* for

Due Gov't \$ *100* for

Remarks:  
-----  
-----  
-----  
-----  
-----  
-----

\* See enrollment on card from muster-in roll.

Book mark:-----

(358c) *D. C. Taylor* Copyist.

A

6 H. Art'y.

U.S.C.T.

*Jerry Hodlin*  
*Capt*

Co. I, 6 Reg't U. S. Col'd H. Art'y.

Appears on

**Company Muster Roll**

for *July and Aug*, 1864.

Joined for duty and enrolled:

When *Dec. 8*, 186*3*.\*

Where *Natchez* \*

Period *3* years.\*

Present or absent *Present*

Stoppage, \$ *100* for

Due Gov't \$ *100* for

Remarks:

-----  
-----  
-----  
-----  
-----  
-----

\* See enrollment on card from muster-in roll.

Book mark:

-----

(358c)

*J. C. Taylor*

Copyist.

*H.*

6 H. Art'y.

U.S.C.T.

*Jerry Hodson*

*Co. I, 6 Reg't U. S. Col'd H. Art'y.*

Appears on

**Company Muster Roll**

for *Sept. 1864* 186<sup>4</sup>.

Joined for duty and enrolled:

When *Dec. 8*, 186<sup>3</sup>.\*

Where *Matchez*.\*

Period *3* years.\*

Present or absent *Present*.

Stoppage, \$ *100* for

Due Gov't, \$ *100* for

Valuation of horse, \$ *100*

Valuation of horse equipments, \$ *100*

Remarks: *Charged for  
ordnance \$3.30  
saddle & equipment*

\*See enrollment on card from muster-in roll.

Book-mark :

*Stall*

(358c)

Copyist.

*H. D.*

6 H. Art'y.

U.S.C.T.

*Jerry Hopkins*  
Co., Co. I, 6 Reg't U. S. Col'd H. Art'y.

Appears on

Company Muster Roll  
for *Wm. & Nee*, 1864.

Joined for duty and enrolled:

When *Dec. 8*, 1863.\*

Where *Matchburg* \*

Period *3* years.\*

Present or absent *Present*

Stoppage, \$ *100* for

Due Gov't \$ *100* for

Remarks:

-----  
-----  
-----  
-----  
-----

\* See enrollment on card from muster-in roll.

Book mark:

*Heck*

(358c)

Copyist.

*H*

6 H. Art'y.

U.S.C.T.

*Jerry Hoslin*

Co. I, 6 Reg't U. S. Col'd H. Art'y.

Appears on

**Company Muster Roll**

for *Jan. & Feb.*, 1865.

Joined for duty and enrolled:

When *Dec. 8*, 1864.\*

Where *Watebury* \*

Period *3* years.\*

Present or absent *Present*

Stoppage, \$ *100* for

Due Gov't \$ *100* for

Remarks:

\* ~~See~~ See enrollment on card from muster-in roll.

Book mark:

*Heck*

(358c)

Copyist.

*H*

6 H. Art'y.

U.S.C.T.

*Jerry Hodium*

Co. I, 6 Reg't U. S. Col'd H. Art'y.

Appears on

Company Muster Roll

for *Meck. & Aple* 1865.

Joined for duty and enrolled:

When *Dec. 8*, 1863.\*

Where *Natchez, Miss.*\*

Period *3* years.\*

Present or absent *Present*

Stoppage, \$ *100* for

Due Gov't, \$ *100* for

Valuation of horse, \$ *100*

Valuation of horse equipments, \$ *100*

Remarks:

\* See enrollment on card from muster-in roll.

Book-mark:

(358c)

*Stuck*

Copyist.



H. C. Harty U.S.C.T.

Jerry Hobbs  
Co. 2, 6 Reg't U. S. Col'd arty.

Appears on

**Company Muster Roll**

for May & June, 1865.

Joined for duty and enrolled.

When Dec. 8, 1863.\*

Where Natchez.\*

Period 3 years.\*

Present or absent Present

Stoppage, \$ 100 for

Due Gov't, \$ 100 for

Valuation of horse, \$ 100

Valuation of horse equipments, \$ 100

Remarks: \_\_\_\_\_  
\_\_\_\_\_  
\_\_\_\_\_

\* See enrollment on card from muster-in roll.

Book mark: \_\_\_\_\_  
\_\_\_\_\_

H. C. Harty  
Copyist.

26

6 H. Art'y.

U.S.C.T.

Jerry Hosline  
Co. I, 6 Reg't U. S. Col'd H. Art'y.

Appears on

Company Muster Roll

for July & Aug., 1865.

Joined for duty and enrolled:

When Dec. 8, 1863.\*

Where Natchez, Miss.\*

Period 3 years.\*

Present or absent Present

Stoppage, \$ 100 for

Due Gov't \$ 100 for

Remarks:

-----  
-----  
-----  
-----  
-----

\* See enrollment on card from muster-in roll.

Book mark:

-----  
-----  
-----  
-----  
-----

Steel

Copyist.

(358c)

*Jerry Hodlin*  
-----  
*Private*, Co. I, 6 Reg't U. S. Col'd H. Art'y.

Appears on

**Company Muster Roll**  
for *Sept & Oct*, 186 *5*

Joined for duty and enrolled:

When *Dec 8*, 186 *3*.\*

Where *Shatchez Miss.* \*

Period *8* years.\*

Present or absent *Present*

Stoppage, \$ *1* <sup>*30*</sup>/<sub>*100*</sub> for *Camp G. E.*

Due Gov't \$ *100* for

Remarks:-----  
-----  
-----  
-----  
-----  
-----

\* ~~See~~ See enrollment on card from muster-in roll.

Book mark:-----

*E. E. Rankin*  
-----  
(358c) Copyist.

A

6 H. Art'y.

U.S.C.T.

*Jerry Hodline*  
Pvt., Co. I, 6 Reg't U. S. Col'd H. Art'y.

Appears on

**Company Muster Roll**

for *Nov. & Dec.*, 1865.

Joined for duty and enrolled:

When *Dec. 8*, 1863.\*

Where *Natchez Miss.*\*

Period *3* years.\*

Present or absent *Present*

Stoppage, \$ *1*<sup>*30*</sup>/<sub>*100*</sub> for *C. & G. C. trans.*  
*from Roll dated Oct. 31, 1865.*  
Due Gov't \$ *1*<sup>*30*</sup>/<sub>*100*</sub> for

Remarks:  
-----  
-----  
-----  
-----  
-----  
-----  
-----

\* See enrollment on card from muster-in roll.

Book mark: -----

(358c)

*E. J. Rankin*  
Copyist.

*Jerry Hodlin*  
Pvt., Co. I, 6 Reg't U. S. Col'd H. Art'y.

Appears on

**Company Muster Roll**

for *Jan. & Feb.*, 186*6*.

Joined for duty and enrolled:

When *Dec. 8*, 186*3*.\*

Where *Statchey Miss* \*

Period *3* years.\*

Present or absent *Present*.

Stoppage, \$ *100* for

Due Gov't \$ *100* for

Remarks:

-----  
-----  
-----  
-----  
-----  
-----

\* See enrollment on card from muster-in roll.

Book mark: -----

(358c)

*E. E. Kantein*  
Copyist.

A

6 H. Art'y.

U.S.C.T.

*Jerry Hodlin*

*Prk*, Co. I, 6 Reg't U. S. Col'd H. Art'y.

Appears on

**Company Muster Roll**

for *Mar. & Apr.*, 186*6*.

Joined for duty and enrolled:

When *Dec. 8*, 186*3*.\*

Where *Watches*.\*

Period *3* years.\*

Present or absent *Present*.

Stoppage, \$ *100* for

Due Gov't \$ *100* for

Remarks:

-----  
-----  
-----  
-----  
-----

\* See enrollment on card from muster-in roll.

Book mark: -----

(358c)

*J. E. Rankin*  
Copyist.

*Jerry Hodlin*  
Priv., Co. I, 6 Reg't U. S. Col'd H. Art'y.

Appears on **Co. Muster-out Roll**, dated  
*Statches, Miss. May 13*, 1866 .

Muster-out to date *May 13*, 1866 .

Last paid to \_\_\_\_\_, 186 .

Clothing account:

Last settled \_\_\_\_\_, 186 ; drawn since \$ 100

Due soldier \$ *27*<sup>*10*</sup>/<sub>100</sub>; due U. S. \$ 100

Am't for cloth'g in kind or money adv'd \$ 100

Due U. S. for arms, equipments, &c., \$ 100

Bounty paid \$ 100 ; due \$ 100

Remarks: *Joined at original organization. Due Soldier on Account of Clothing \$27<sup>10</sup>/<sub>100</sub>*

Book mark: *2148.83*

(361) *C. E. M. Laughlin* Copyist.

Hoffman, Joseph  
Co F, 6 U.S. Col'd H. Art'y

Private Sergeant

CARD NUMBERS.

1	6167260	26
2	6167338	27
3	6167484	28
4	6167617	29
5	6167740	30
6	6167865	31
7	6167976	32
8	6168083	33
9	6168191	34
10	6168298	35
11	6168408	36
12	6168521	37
13	6168633	38
14	6168840	39
15	6169241	40
16	9119849	41
17	40742508	42
18		43
19		44
20		45
21		46
22		47
23		48
24		49
25		50

Book Mark:

See also



*A*

6 H. Art'y.

U.S.C.T.

*Joseph Hoffman*

Co. *F*, 6 Reg't U. S. Col'd H. Art'y.

Appears on

**Company Descriptive Book**

of the organization named above.

**DESCRIPTION.**

Age *23* years; height *5* feet *8* inches.

Complexion *fair*

Eyes *Blue*; hair *Sandy*

Where born *Schlesien Prussia*

Occupation *Labour*

**ENLISTMENT.**

When *Sept 13*, 186 *2*.

Where *St Louis*

By whom *La Rassiens*, term *3* y'rs.

Remarks: *Discharged by  
virtue of S.O. No 5712  
Was kept. dated Sept.  
25 65 on Oct. 10 / 65 at  
Washington Miss.*

*Warren*

JH.

6 II. Art'y.

U. S. C. T.

Joseph Hoffman  
P. A., Co. J., 2 Reg't Miss. Art'y. †

Age 23 years.

Appears on

**Company Muster-in Roll**

of the organization named above. Roll dated

Natchez, Miss., Sept. 12, 1863.

Muster-in to date

Sept. 12, 1863.

Joined for duty and enrolled:

When Aug. 29, 1863.\*

Where Natchez, Miss. \*

Period 3 years.\*

Valuation of horse, \$ 100

Valuation of horse equipments, \$ 100

Remarks:

† This organization subsequently became Co. J., 6 Reg't U. S. Colored Heavy Artillery.

\* Muster-in roll shows enrollment of all men of this company as of same date and place. See enrollment on subsequent card or cards.

Book mark:

Brooks

26

6 H. Art'y.

U.S.C.T.

Joseph J Hoffman

2 Sqn., Co. F, 2 Reg't Miss. Artillery.†

Appears on

Company Muster Roll

for Sept 12 to Oct 31, 1863

Joined for duty and enrolled:

When Sept. 12, 1863.\*

Where Natchez, Miss.\*

Period 3 years.\*

Present or absent Present.

Stoppage, \$ 100 for

Due Gov't \$ 100 for

Valuation of horse, \$ 100

Valuation of horse equipments, \$ 100

Remarks :

† This organization subsequently became Co. F, 6 Reg't U. S. Colored Heavy Artillery.  
\* See enrollment on card from muster-in roll.

Book mark :

Brooks

(358c)

Copyist.

*J. H.*

**6 H. Art'y.**

**U.S.C.T.**

*Joseph Hoffman*  
*2d Sgt.*, Co. F, 2 Reg't Miss. Artillery.†

Appears on

**Company Muster Roll**

for *Nov. 1 to Dec. 31*, 1863.

Joined for duty and enrolled:

When *Sept. 12*, 1863.\*

Where *Natchez, Miss.\**

Period *3* years.\*

Present or absent: *Absent.*

Stoppage, \$ *100* for

Due Gov't \$ *100* for

Valuation of horse, \$ *100*

Valuation of horse equipments, \$ *100*

Remarks: *Absent sick with leave since Dec. 24th, 1863.*

† This organization subsequently became Co. F, 6 Reg't U. S. Colored Heavy Artillery.

\* See enrollment on card from muster-in roll.

Book mark: \_\_\_\_\_

*Brooks*

(358c)

Copyist.

H.

6 H. Art'y.

U.S.C.T.

Joseph Hoffman  
2d Sgt., Co. F, 2 Reg't Miss. Artillery.†

Appears on

**Company Muster Roll**

for Jan. 1 to Feb. 29, 1864.

Joined for duty and enrolled:

When Sept. 12, 1863.\*

Where Natchez, Miss.\*

Period 3 years.\*

Present or absent Present

Stoppage, \$ 100 for

Due Gov't \$ 100 for

Valuation of horse, \$ 100

Valuation of horse equipments, \$ 100

Remarks:

† This organization subsequently became Co. F, 6 Reg't U. S. Colored Heavy Artillery.  
\* See enrollment on card from muster-in roll.

Book mark:

Brooks

(358c)

Copyist.

Joseph T Loffman  
2<sup>d</sup> Sgt, Co. F, 5 Reg't U. S. Col'd H. Art'y.\*

Appears on

**Company Muster Roll**

for Mar. 1 to Apr. 30, 1864

Joined for duty and enrolled :

When Sept. 12, 1863.\*

Where Natchez Miss.\*

Period 3 years.\*

Present or absent Present.

Stoppage, \$ 100 for

Due Gov't, \$ 100 for

Valuation of horse, \$ 100

Valuation of horse equipments, \$ 100

Remarks :  
-----  
-----  
-----

\* This organization subsequently became Co. F, 6 Reg't U. S. Col'd Heavy Artillery.  
\* See enrollment on card from muster-in roll.

Book mark :  
-----

Brooks

Joseph L. Hoffman  
2d Sgt., Co. F, 6 Reg't U. S. Col'd H. Art'y.

Appears on

**Company Muster Roll**

for May to June 30, 1864.

Joined for duty and enrolled:

When Sept. 2, 1863.\*

Where Watches, Miss\*

Period 3 years.\*

Present or absent Present

Stoppage, \$ 100 for

Due Gov't \$ 100 for

Remarks:

-----  
-----  
-----  
-----  
-----

\* See enrollment on card from muster-in roll.

Book mark:

-----  
Brooks  
-----

A

6 H. Art'y.

U.S.C.T.

Joseph Hoffmann

2<sup>d</sup> Sgt., Co. F, 6 Reg't U. S. Col'd H. Art'y.

Appears on

Company Muster Roll

for July & Aug, 1864.

Joined for duty and enrolled:

When Sept 12, 1863.\*

Where Natchez Miss.\*

Period 3 years.\*

Present or absent Present

Stoppage, \$ 100 for

Due Gov't \$ 100 for

Remarks:

-----  
-----  
-----  
-----  
-----

\* See enrollment on card from muster-in roll.

Book mark: -----

(358c)

S. Duncan

Copyist.



*H*

6 H. Art'y. U.S.C.T.

*Joseph Hoffmann*  
*2nd Sgt*, Co. F, 6 Reg't U. S. Col'd H. Art'y.

Appears on

**Company Muster Roll**

for *Sept & Oct*, 186*4*

Joined for duty and enrolled:

When *Sept 12*, 186*3*.\*

Where *Natchez Miss* \*

Period *3* years.\*

Present or absent *Present*

Stoppage, \$ *100* for \_\_\_\_\_

Due Gov't \$ *100* for \_\_\_\_\_

Remarks: \_\_\_\_\_

\_\_\_\_\_  
\_\_\_\_\_  
\_\_\_\_\_  
\_\_\_\_\_

\* ~~See~~ See enrollment on card from muster-in roll.

Book mark: \_\_\_\_\_

\_\_\_\_\_  
*S. Duneau*  
(358c) Copyist.

*H*

*Joseph Hoffmann*  
*208*, Co. F, 6 Reg't U. S. Col'd H. Art'y.

Appears on

Company Muster Roll

for *Nov & Dec*, 1864

Joined for duty and enrolled:

When *Sept 12*, 1863.\*

Where *Natchez Miss*\*

Period *3* years.\*

Present or absent *Present*

Stoppage, \$ *100* for

Due Gov't \$ *100* for

Remarks:  
-----  
-----  
-----  
-----  
-----  
-----

\* See enrollment on card from muster-in roll.

Book mark: -----

(358c)

*S. Bureau*

Copyist.

74

Joseph Hoffman  
2<sup>d</sup> Lt, Co. F, 6 Reg't U. S. Col'd H. Art'y.

Appears on

Company Muster Roll

for Jan'y & Feby, 1865.

Joined for duty and enrolled:

When Sept 12, 1863.\*

Where Natchez Miss\*

Period 3 years.\*

Present or absent Present

Stoppage, \$ 100 for

Due Gov't \$ 100 for

Remarks:

\* See enrollment on card from muster-in roll.

Book mark:

(358c)

S. Duncan

Copyist.

*A*

*Joseph Hoffmann*  
*2<sup>d</sup> Sgt*, Co. F, 6 Reg't U. S. Col'd H. Art'y..

Appears on

**Company Muster Roll**

for *March & April*, 186*3*.

Joined for duty and enrolled:

When *Sept 12*, 186*3*.\*

Where *Katchez Miss* \*

Period *3* years.\*

Present or absent *Present*

Stoppage, \$ *100* for

Due Gov't \$ *100* for

Remarks:

\* See enrollment on card from muster-in roll.

Book mark:

*S. Duncan*

*Joseph Hoffmann*  
Pvt., Co. F, 6 Reg't U. S. Col'd H. Art'y.

Appears on

**Company Muster Roll**

for *May & June*, 186*5*.

Joined for duty and enrolled:

When *Sept 12*, 186*3*.\*

Where *Katchez Miss* \*

Period *3* years.\*

Present or absent *Present*

Stoppage, \$ *100* for

Due Gov't, \$ *100* for

Valuation of horse, \$ *100*

Valuation of horse equipments, \$ *100*

Remarks: \_\_\_\_\_

\_\_\_\_\_

\_\_\_\_\_

\* See enrollment on card from muster-in roll.

Book mark: \_\_\_\_\_

*J. Duncan*

*H*

6 H. Art'y.

U.S.C.T.

*Joseph Hoffmann*  
*Sgt.*, Co. F, 6 Reg't U. S. Col'd H. Art'y.

Appears on

**Company Muster Roll**

for *July + Aug.*, 1865.

Joined for duty and enrolled:

When *Sept. 12*, 186*5*.\*

Where *Father Miss* \*

Period *3* years.\*

Present or absent *Present*

Stoppage, \$ *100* for

Due Gov't \$ *100* for

Remarks:  
-----  
-----  
-----  
-----  
-----

\* See enrollment on card from muster-in roll.

Book mark: -----

*J. W. Ames*  
(358c) Copyist.

H

Joseph Hoffman  
2 Sgt, Co. F, 6 Reg't U. S. Col'd H. Art'y.

Appears on

Company Muster Roll

for Sept, & Oct, 1863.

Joined for duty and enrolled:

When Sept 12<sup>th</sup>, 1863.\*

Where Natchez Miss, \*

Period 3 years.\*

Present or absent

Stoppage, \$ 100 for

Due Gov't \$ 100 for

Remarks: Disch'd the 10<sup>th</sup> day of Oct,  
1865 per S.O. 512 dated  
War Dept, Sept 25<sup>th</sup> 65 discharge  
and final statement  
given.

\* See enrollment on card from muster-in roll.

Book mark:

(358c) J. W. Thores Copyist.

A

6 H. Art'y.

U.S.C.T.

Joseph Hoggman  
Sgt, Co. F, 6 Reg't U. S. Col'd H. Art'y.

Appears on Returns as follows:

Dec 1863 Jan 1864  
2<sup>d</sup> mess H. Art'y,  
A count on for  
rough since Dec  
24, 63

Sept 1865 U.S. Col'd  
H. A. 1<sup>st</sup> Or daily  
duty at Post Hdq  
2<sup>d</sup> for S.O. 2  
dated Aug 19, 65

Oct 1865 S.O. Oct  
10, 65 Washington  
Miss Desch'd  
for S.O. 12 dated  
Mar West Sept  
25, 65

Book mark:

(546) *A. G. G. G.* Copyist.



*H*

6 H. Art'y.

U.S.C.T.

*Joseph Hoffman*  
Sgt., Co. *F*, 6 Reg't U. S. Col'd H. Art'y.

Appears on **Co. Muster-out Roll**, dated  
*Natchez Miss. May 13, 1866*.

Muster-out to date ..... 186 .

Last paid to ..... 186 .

**C.othing account:**

Last settled....., 186 ; drawn since \$..... 100

Due soldier \$..... 100; due U. S. \$..... 100

Am't for cloth'g in kind or money adv'd \$..... 100

Due U. S. for arms, equipments, &c., \$..... 100

Bounty paid \$..... 100; due \$..... 100

Remarks: *Joined at original  
organization. Discharged at  
Washington. Miss Oct 10, 55  
by G. O. 512. Was Capt. dated  
Sept. 25 65 final statements  
furnished*

Book mark: *A. S. C. War Dept. A. G. O.  
Sept. 25. 1865. G. O. No 512 on file*

*J. M. Brown*

1020

Hodges, William

Co I, 6 U.S. Col'd H. Art'y.

Private Private

CARD NUMBERS.

1	26
2	27
3	<i>see Hodges, William</i>
4	29
5	30
6	31
7	32
8	33
9	34
10	35
11	36
12	37
13	38
14	39
15	40
16	41
17	42
18	43
19	44
20	45
21	46
22	47
23	48
24	49
25	50

Book Mark:

See also

Holden, Alfred

Co K, 6 U.S. Col'd H. Art'y.

Private Corporal

CARD NUMBERS.

1	6154290	26
2	6175905	27
3	6176040	28
4	6176160	29
5	6176273	30
6	6176385	31
7	6176500	32
8	6176620	33
9	6176699	34
10	6176816	35
11	6176926	36
12	6177042	37
13	6177150	38
14	6177258	39
15	6177366	40
16	7120814	41
17	40742509	42
18		43
19		44
20		45
21		46
22		47
23		48
24		49
25		50

Book Mark:

See also

*Alfred Golden*

Co. *H*, 6 Reg't U. S. Col'd H. Art'y.

Appears on

**Company Descriptive Book**  
of the organization named above.

**DESCRIPTION.**

Age *26* years; height *5* feet *3* inches.

Complexion *Dark*

Eyes *Black*; hair *Black*

Where born *Harden Co Ky*

Occupation *Salver*

**ENLISTMENT.**

When *March 1*, 186*4*.

Where *Stalches Miss*

By whom *Capt Kemper*; term *3* y'rs.

Remarks: *Appointed Capt May 1*  
*1865*

-----  
-----  
-----  
-----  
-----  
-----

*Wilton*

*A*

6 II. Art'y.

U.S.C.T.

*Alfred Holden*

Appears with rank of *Private* on

**Muster and Descriptive Roll of a Detachment of U. S. Vols. forwarded**

★ 2 Regt. Miss. Art'y.

for the ~~6 Reg't U. S. Col'd H. Art'y.~~ Roll dated

*Natchez, Miss., March 8, 1864.*

Where born *Nardin Co. Ky.*

Age *26* y'rs; occupation *Labourer*

When enlisted *March 1, 1864.*

Where enlisted *Natchez, Miss.*

For what period enlisted *3* years.

Eyes *Blk.*; hair *Red.*

Complexion *Dark*; height *5* ft. *5* in.

When mustered in *March 8, 1864.*

Where mustered in *Natchez, Miss.*

Bounty paid \$ *100*; due \$ *100*

Where credited

Company to which assigned *K*

Remarks: *Muster-in to take effect*

*from date of enrollment*

★ This organization subsequently became Regt. U. S. Col'd H. Artillery.

★ Corrected June 3 1896. *A.M.V.*

Book mark:

*Blank*

Alfred Holden  
Co. 4, 5 Reg't U. S. Col'd H. Art'y.\*

Appears on

Company Muster Roll

for Mar & Apr, 1864

Joined for duty and enrolled:

When Mar 1, 1864\*

Where Kachee Miss\*

Period 3 years.\*

Present or absent Present

Stoppage, \$ 100 for

Due Gov't, \$ 100 for

Valuation of horse, \$ 100

Valuation of horse equipments, \$ 100

Remarks:

\* This organization subsequently became Co. , 6 Reg't U. S. Col'd Heavy Artillery.  
\* See enrollment on card from muster-in roll.

Book mark:

*[Signature]*

*A*

6 H. Art'y.

U.S.C.T.

*Alfred Holden*

*Co. K*, Co. K, 6 Reg't U. S. Col'd H. Art'y.

Appears on

**Company Muster Roll**

for *May & June*, 186*4*\*

Joined for duty and enrolled:

When *Mar 1<sup>st</sup>*, 186*4*\*

Where *Nachez Miss*\*

Period *3* years.\*

Present or absent *present*

Stoppage, \$ *100* for

Due Gov't \$ *100* for

Remarks:

-----  
-----  
-----  
-----  
-----

\* See enrollment on card from muster-in roll.

Book mark:

-----

(358c)

*J. P. ...*  
Copyist.

26

6 H. Art'y.

U.S.C.T.

Alfred Golden  
Pri., Co. K, ~~2 Reg't Miss. Artillery~~ <sup>6 Reg't U.S. Col'd H. Art'y.</sup> †x

Appears on

Company Muster Roll

for July & Aug., 1864

Joined for duty and enrolled:

When Mar. 1, 1864\*

Where Natchez, Miss. \*

Period 3 years.\*

Present or absent Present.

Stoppage, \$ 100 for

Due Gov't \$ 100 for

Valuation of horse, \$ 100

Valuation of horse equipments, 100

Remarks:

† This organization subsequently became Co. K, 6 Reg't U. S. Colored H. Art'y. x

\* See enrollment on card from muster-in roll.  
x corrected Oct. 29, 1894. D.E.J.

Book mark:

(358c)

J. J. Smith

Copyist.



*H*

6 H. Art'y.

U.S.C.T.

*Alfred Holden*

*Private*, Co. K, 6 Reg't U. S. Col'd H. Art'y.

Appears on

**Company Muster Roll**

for *Sept & Oct*, 186*4*

Joined for duty and enrolled:

When *Mar 1*, 186*4*.\*

Where *Natchez, Miss* \*

Period *3* years.\*

Present or absent *Present*

Stoppage, \$ *100* for

Due Gov't \$ *100* for

Remarks:

-----  
-----  
-----  
-----  
-----

\* See enrollment on card from muster-in roll.

Book mark: -----

(358c)

*J.B. Gage*

Copyist.

H

6 H. Art'y.

U.S.C.T.

*Alfred Halden*  
Private, Co. K, 6 Reg't U. S. Col'd H. Art'y.

Appears on

**Company Muster Roll**

for *Nov. and Dec.*, 1864.

Joined for duty and enrolled:

When *March 1.*, 1864.\*

Where *Natchez, Miss.* \*

Period *3* years.\*

Present or absent *Present*

Stoppage, \$ *100* for

Due Gov't \$ *100* for

Remarks:  
-----  
-----  
-----  
-----  
-----

\* See enrollment on card from muster-in roll.

Book mark: -----

*C. G. Powell*  
-----  
(358c) Copyist.

N

6 H. Art'y.

U.S.C.T.

*Alfred Holden*  
*Pirater*, Co. K, 6 Reg't U. S. Col'd H. Art'y.

Appears on

**Company Muster Roll**

for *Jan. and Feb.*, 186*5*.

Joined for duty and enrolled:

When *March 1,* 186*4*\*

Where *Natches, Miss.*\*

Period *3* years.\*

Present or absent *Present*

Stoppage, \$ *100* for

Due Gov't \$ *100* for

Remarks:  
-----  
-----  
-----  
-----  
-----  
-----

\* See enrollment on card from muster-in roll.

Book mark: -----

*O. J. Powell*  
(358c) Copyist.

A

6 H. Art'y.

U.S.C.T.

*Alfred Holden*

*Private*, Co. K, 6 Reg't U. S. Col'd H. Art'y.

Appears on

**Company Muster Roll**

for *March and April*, 186*5*.

Joined for duty and enrolled:

When *March 1*, 186*4*\*

Where *Natchez*\*

Period *3* years.\*

Present or absent *Present*

Stoppage, \$ *100* for

Due Gov't \$ *100* for

Remarks:  
-----  
-----  
-----  
-----  
-----

\* See enrollment on card from muster-in roll.

Book mark: -----

*C. F. Powell*

(358c)

Copyist.

*Alfred Halden*  
Copt, Co. K, 6 Reg't U. S. Col'd H. Art'y.

Appears on

**Company Muster Roll**

for *May and June*, 1865.

Joined for duty and enrolled:

When *March 1*, 1864.\*

Where *Natchez, Miss.*\*

Period *2* years.\*

Present or absent *Present*

Stoppage, \$ *100* for

Due Gov't \$ *100* for

Remarks:

*Promoted to Copt May 1, 1865 by order of Maj. Smith via letter addressed*

\* See enrollment on card from muster-in roll.

Book mark:

*C. J. Powell*

A

6 H. Art'y.

U.S.C.T.

*Alfred Holden*  
*Leopold*, Co. K, 6 Reg't U. S. Col'd H. Art'y.

Appears on

**Company Muster Roll**

for *July and Aug.*, 186*5*.

Joined for duty and enrolled:

When *March 1.*, 186*4*.\*

Where *Natchez, Miss.* \*

Period *3* years.\*

Present or absent *Present*

Stoppage, \$ *100* for

Due Gov't \$ *100* for

Remarks:

\* See enrollment on card from muster-in roll.

Book mark:

*Ch Powell*

(358c)

Copyist.

OV

6 H. Art'y.

U.S.C.T.

*Alfred Wildman*  
Capt, Co. K, 6 Reg't U. S. Col'd H. Art'y.

Appears on

**Company Muster Roll**

for *Sept & Oct*, 186*5*.

Joined for duty and enrolled:

When *March 1<sup>st</sup>*, 186*4*.\*

Where *Marches Mass*\*

Period *3* years.\*

Present or absent *Present*

Stoppage, \$ *100* for

Due Gov't \$ *100* for

Remarks:  
-----  
-----  
-----  
-----  
-----

\* See enrollment on card from muster-in roll.

Book mark: -----

(358c)

*W. J. Houston*

Copyist.

*H*

6 H. Art'y.

U.S.C.T.

*Alfred Holdeen*  
Cofel, Co. K, 6 Reg't U. S. Col'd H. Art'y.

Appears on

**Company Muster Roll**

for *Nov & Dec*, 186*5*.

Joined for duty and enrolled:

When *Mar 1*, 186*4*.\*

Where *Mariney Miss\**

Period *3* years.\*

Present or absent *Present*

Stoppage, \$ *100* for

Due Gov't \$ *100* for

Remarks:  
-----  
-----  
-----  
-----  
-----

\* See enrollment on card from muster-in roll.

Book mark: -----

*W. L. Brown*  
(358c) Copyist.



D

6 H. Art'y.

U.S.C.T.

Alfred Holdeman  
Cpl., Co. K, 6 Reg't U. S. Col'd H. Art'y.

Appears on

Company Muster Roll

for Jan'y + Feb'y, 1866.

Joined for duty and enrolled:

When Mar 1, 1864.\*

Where Hatchery Miss\*

Period 3 years.\*

Present or absent Present

Stoppage, \$ 100 for

Due Gov't \$ 100 for

Remarks:

\* See enrollment on card from muster-in roll.

Book mark:

(358c)

J. D. Houston  
Copyist.

07

6 H. Art'y.

U.S.C.T.

*Alfred Holden*

*Co. K, 6 Reg't U. S. Col'd H. Art'y.*

Appears on

**Company Muster Roll**

for *March & April, 1866*

Joined for duty and enrolled:

When *Mar 1*, 186*4*\*

Where *Natchez Miss*\*

Period *3* years.\*

Present or absent *Present*

Stoppage, \$ *100* for

Due Gov't \$ *100* for

Remarks:

-----  
-----  
-----  
-----  
-----

\* See enrollment on card from muster-in roll.

Book mark: -----

(358c)

*W. L. Garrison*

Copyist.

A

Alfred Holden  
Co. K, 6 Reg't U. S. Col'd H. Art'y.

Appears on Returns as follows:

Mar 1864 (S. M. Col'd  
H. Art'y) Jan-Mar  
8, 64 Malakoff Miss  
Enlisted in Co  
as a recruit  
Sept 1865 (Coop' 6<sup>th</sup> U.S.  
Col'd H. A.) absent  
sick in Post  
Hosp. since Sept 22<sup>nd</sup> 65

Book mark :

(546) A. J. Douglas Copyist.

H

6 H. Art'y.

U.S.C.T.

Alfred Holden

Corp, Co. K, 6 Reg't U. S. Col'd H. Art'y.

Appears on Co. Muster-out Roll, dated

Natchez, Miss May 13, 1866.

Muster-out to date May 13, 1866.

Last paid to Dec. 31, 1865.

Clothing account:

Last settled, 186 ; drawn since \$ 100

Due soldier \$ 24 <sup>03</sup>/<sub>100</sub>; due U. S. \$ 100

Am't for cloth'g in kind or money adv'd \$ 100

Due U. S. for arms, equipments, &c., \$ 100

Bounty paid \$ 100; due \$ 100

Remarks: Joined as a recruit.  
Promoted Corp. May 1, 1865.

Book mark:

G. W. Chase

(361)

Copyist.

Holden, Isaac

Co K, 6 U.S. Col'd H. Art.

Private Private

CARD NUMBERS.

1	6154289	26
2	6175900	27
3	6176037	28
4	6176157	29
5	6176270	30
6	6176383	31
7	6176498	32
8	6176619	33
9	6176740	34
10	6176863	35
11	6176975	36
12	6177088	37
13	6177196	38
14	6177304	39
15	6177412	40
16	9120813	41
17	40742510	42
18		43
19		44
20		45
21		46
22		47
23		48
24		49
25		50

Book Mark:

See also

2179 601. And W.D.  
SS R.S. Pyroning, 1535 Main St.,  
La Crosse, Wis 1/6/32 CXP  
2 Mrs. Hester 575733

F. H. Gandy

*N* | 6 H. Art'y. | U.S.C.T.

*James Holden*

Co. *K*, 6 Reg't U. S. Col'd H. Art'y.

Appears on

**Company Descriptive Book**  
of the organization named above.

**DESCRIPTION.**

Age *32* years; height *5* feet *3* inches.

Complexion *Dark*

Eyes *Black*; hair *Black*

Where born *Franklin Co Miss*

Occupation *Soldier*

**ENLISTMENT.**

When *March 1*, 1864.

Where *Natchez Miss*

By whom *Capt Rempfer*; term *3* y'rs.

Remarks:  
\_\_\_\_\_  
\_\_\_\_\_  
\_\_\_\_\_  
\_\_\_\_\_  
\_\_\_\_\_  
\_\_\_\_\_

*Holden*

*Juan Golden*

Appears with rank of *Pvt.* on

**Muster and Descriptive Roll of a Detachment of U. S. Vols. forwarded**

★ 2 Regt. Miss. Art'y.  
for the ~~6 Reg't U. S. Col'd H. Art'y.~~ Roll dated

*Natchez, Miss., March 8, 1864.*

Where born *Franklin Co., Miss.*

Age *3* y'rs; occupation *Labourer*

When enlisted *March 1, 1864*

Where enlisted *Natchez, Miss.*

For what period enlisted *3* years.

Eyes *Blk.*; hair *Blk.*

Complexion *Dark*; height *5* ft. *9* in.

When mustered in *March 8, 1864.*

Where mustered in *Natchez, Miss.*

Bounty paid \$ *100*; due \$ *100*

Where credited

Company to which assigned *K*

Remarks: *Muster-in to take effect*

*from date of Enrollment*

★ This organization subsequently became  
6 Regt. U. S. Col'd H. Artillery.

★ Corrected June 3 1896. *C.N.A*

Book mark:

*J. W. Clark*



*Lease Halden*

*B*, Co. *A*, 5 Reg't U. S. Col'd H. Art'y.\*

Appears on

**Company Muster Roll**

for *Mar + Apr*, 186*4*.

Joined for duty and enrolled:

When *Mar 1'*, 186*4*.\*

Where *Natchez Miss* \*

Period *3* years.\*

Present or absent *present*

Stoppage, \$ *100* for

Due Gov't, \$ *100* for

Valuation of horse, \$ *100*

Valuation of horse equipments, \$ *100*

Remarks: \_\_\_\_\_  
\_\_\_\_\_  
\_\_\_\_\_

\* This organization subsequently became Co. *A*, 6 Reg't U. S. Col'd Heavy Artillery.  
\* ~~See~~ See enrollment on card from muster-in roll.

Book mark: \_\_\_\_\_

*Spills*

A

6 H. Art'y.

U.S.C.T.

*Isaac Holden*

*Co. K*, Co. K, 6 Reg't U. S. Col'd H. Art'y.

Appears on

**Company Muster Roll**

for *May - June*, 186*4*.

Joined for duty and enrolled:

When *Mar 1*, 186*4*.\*

Where *Nachy Miss* \*

Period *3* years.\*

Present or absent *present*

Stoppage, \$ *100* for

Due Gov't \$ *100* for

Remarks:

\* See enrollment on card from muster-in roll.

Book mark:

*J. Miles*

(358c)

Copyist.

26

6 H. Art'y.

U.S.C.T.

Isaac Holden  
Pri., Co. K, ~~2 Reg't Miss Artillery~~ <sup>6 Reg't U.S. Col'd Art'y.</sup>

Appears on

Company Muster Roll

for July & Aug., 1864.

Joined for duty and enrolled:

When Mar. 1, 1864.\*

Where Hatchez, Miss.\*

Period 3 years.\*

Present or absent Present.

Stoppage, \$ 100 for

Due Gov't \$ 100 for

Valuation of horse, \$ 100

Valuation of horse equipments, 100

Remarks: Stoppage for one  
Haversack \$10.48.

† This organization subsequently became Co. K, 6 Reg't U. S. Colored H. Art'y. x

\* See enrollment on card from muster-in roll.

x Corrected Oct. 29, 1894. GED

Book mark:

J. Smith  
Copyist.

*A*

6 H. Art'y.

U.S.C.T.

*Isaac Holden*

*Pr*, Co. K, 6 Reg't U. S. Col'd H. Art'y.

Appears on

**Company Muster Roll**

for *Sept & Oct*, 186*4*.

Joined for duty and enrolled:

When *Mar 1*, 186*4*.\*

Where *Natchez, Miss.* \*

Period *3* years.\*

Present or absent *Present*

Stoppage, \$ *100* for

Due Gov't \$ *100* for

Remarks: *Stoppage for C. & G.C.  
(\$0.65)*

\* See enrollment on card from muster-in roll.

Book mark:

(358c)

*J.B. Gage*

Copyist.

H

6 H. Art'y.

U.S.C.T.

Isaac Holden

Private, Co. K, 6 Reg't U. S. Col'd H. Art'y.

Appears on

Company Muster Roll

for Nov, and Dec, 1864.

Joined for duty and enrolled:

When March 1, 1864.

Where Natchez, Miss. \*

Period 3 years.\*

Present or absent Present

Stoppage, \$ 100 for

Due Gov't \$ 100 for

Remarks:

\* See enrollment on card from muster-in roll.

Book mark:

C. J. Powell

(358c)

Copyist.

A

6 H. Art'y.

U.S.C.T.

*Isaac Holden*

*Priv*, Co. K, 6 Reg't U. S. Col'd H. Art'y.

Appears on

**Company Muster Roll**

for *Jan'y & Feb'y*, 1865.

Joined for duty and enrolled:

When *March 1*, 1864.\*

Where *Natchez Miss*\*

Period *3* years.\*

Present or absent *Present*

Stoppage, \$ *100* for

Due Gov't \$ *100* for

Remarks:  
-----  
-----  
-----  
-----  
-----  
-----

\* See enrollment, on card from muster-in roll.

Book mark: -----

(358c)

*Medwig*  
*Company* *Company*

A

6 H. Art'y.

U.S.C.T.

*Isaac Holden*

*Private*, Co. K, 6 Reg't U. S. Col'd H. Art'y.

Appears on

**Company Muster Roll**

for *March and April*, 1865.

Joined for duty and enrolled:

When *March 1*, 1864.\*

Where *Natchez, Miss.* \*

Period *3* years.\*

Present or absent *Present*

Stoppage, \$ *100* for

Due Gov't \$ *100* for

Remarks:

-----  
-----  
-----  
-----  
-----

\* See enrollment on card from muster-in roll.

Book mark:

*A. Powell*

(358c)

Copyist.

A

6 H. Art'y.

U.S.C.T.

Isaac Alder

Private, Co. K, 6 Reg't U. S. Col'd H. Art'y.

Appears on

Company Muster Roll

for May and June, 1864.

Joined for duty and enrolled:

When March 1, 1864.\*

Where Natchez, Miss. \*

Period 3 years.\*

Present or absent Present

Stoppage, \$ 100 for

Due Gov't \$ 100 for

Remarks:

\* See enrollment on card from muster-in roll.

Book mark:

C. G. Powell

(358c)

Copyist.



14

6 H. Art'y.

U.S.C.T.

*Isaac Holden*

*Private*, Co. K, 6 Reg't U. S. Col'd H. Art'y.

Appears on

**Company Muster Roll**

for *July and Aug*, 186*5*.

Joined for duty and enrolled:

When *Jan. 1*, 186*4*\*

Where *Wichita, Miss.*\*

Period *3* years.\*

Present or absent *Present*

Stoppage, \$ *100* for

Due Gov't \$ *100* for

Remarks:  
-----  
-----  
-----  
-----  
-----

\* ~~See~~ See enrollment on card from muster-in roll.

Book mark: -----

*C. J. Powell*

(358c)

Copyist.

*George Holden*

*1st*, Co. K, 6 Reg't U. S. Col'd H. Art'y.

Appears on

**Company Muster Roll**

for *Sept & Oct*, 186 *6*?

Joined for duty and enrolled:

When *March 1st*, 186 *4*\*

Where *Natchez Miss.*\*

Period *3* years.\*

Present or absent *Present*

Stoppage, \$ *100* for

Due Gov't \$ *100* for

Remarks:  
-----  
-----  
-----  
-----  
-----

\* See enrollment on card from muster-in roll.

Book mark:-----

*J. R. Anderson*

(358c)

Copyist.

07

6 H. Art'y.

U.S.C.T.

*James Holden*

*Co. K, 6 Reg't U. S. Col'd H. Art'y.*

Appears on

**Company Muster Roll**

for *May 1<sup>st</sup> Dec*, 186*5*.

Joined for duty and enrolled:

When *No 1*, 186*4*.\*

Where *Natchez Miss*.\*

Period *3* years.\*

Present or absent *Present*

Stoppage, \$ *100* for

Due Gov't \$ *100* for

Remarks:

-----  
-----  
-----  
-----  
-----

\* ~~See~~ See enrollment on card from muster-in roll.

Book mark: -----

*J. L. Harrison*

(358c)

Copyist.

Isaac Holden  
Co. K, 6 Reg't U. S. Col'd H. Art'y.

Appears on

**Company Muster Roll**

for Jan'y & Feb'y, 1866.

Joined for duty and enrolled:

When Mar 1, 1864\*

Where Watches Miss\*

Period 3 years.\*

Present or absent Present

Stoppage, \$ 100 for \_\_\_\_\_

Due Gov't \$ 100 for \_\_\_\_\_

Remarks: \_\_\_\_\_  
\_\_\_\_\_  
\_\_\_\_\_  
\_\_\_\_\_  
\_\_\_\_\_

\* See enrollment on card from muster-in roll.

Book mark: \_\_\_\_\_

J. S. Houston

(358c)

Copyist.

74

6 H. Art'y.

U.S.C.T.

Isaac Golden

Tris, Co. K, 6 Reg't U. S. Col'd H. Art'y.

Appears on

Company Muster Roll

for March + April, 1866.

Joined for duty and enrolled:

When Mar 1, 1864\*

Where Natchez Miss\*

Period 3 years.\*

Present or absent Present

Stoppage, \$ 100 for

Due Gov't \$ 100 for

Remarks:

\* See enrollment on card from muster-in roll.

Book mark:

W. L. Houston

(358c)

Copyist.

Isaac Holden

Pvt, Co. ...., 6 Reg't U. S. Col'd H. Art'y.

Appears on Returns as follows:

Mar 1864, Co K S  
U.S. Col'd H. Art'y  
Jan-Mar 1864  
Natchez Miss  
Enlisted in Co  
as a recruit

Book mark:

(546) *A. J. Gould* Copyist.

*76*

6 H. Art'y.

U.S.C.T.

*Isaac Holden*

*Prvt*, Co. *K*, 6 Reg't U. S. Col'd H. Art'y.

Appears on **Co. Muster-out Roll**, dated  
*Natchez, Miss May 13, 1864.*

Muster-out to date *May 13, 1864.*

Last paid to *Dec 31, 1865.*

Clothing account:

Last settled....., 186 ; drawn since \$..... 100

Due soldier \$..... 100; due U. S. \$ *4* <sup>05</sup>/<sub>100</sub>

Am't for cloth'g in kind or money adv'd \$..... 100

Due U. S. for arms, equipments, &c., \$..... 100

Bounty paid \$..... 100; due \$..... 100

Remarks: *Joined as a recruit*

Book mark:

*G. W. Chase*

Copyist.

Male Female

CARD NUMBERS.

6165 207	26
6165 345	27
6165 487	28
6165 611	29
6165 727	30
6165 840	31
6165 951	32
616 6058	33
616 6170	34
616 6280	35
616 6390	36
616 6498	37
616 6601	38
616 6702	39
616 6798	40
616 6889	41
616 6979	42
616 7069	43
4119 751	44
40742 511	45
	46
	47
	48
	49
	50

Book Mark:

also



14

6 H. Art'y.

U.S.C.T.

*George Solinger*

Co. *C*, 6 Reg't U. S. Col'd H. Art'y.

Appears on

**Company Descriptive Book**

of the organization named above.

**DESCRIPTION.**

Age *29* years; height *5* feet *2* inches.

Complexion *Yellow*

Eyes *Hazel*; hair *Blk*

Where born *Franklin Miss.*

Occupation *Farmer*

**ENLISTMENT.**

When *Sept 1*, 186*3*.

Where *Natchez Miss.*

By whom *A. Wickman*; term *3* y'rs.

Remarks:

.....  
.....  
.....  
.....  
.....  
.....  
.....  
.....

*J. Barner*

*H* | 6 H. Art'y. U.S.C.T.

*George Hollinger*  
Pot, Co. *E*, 2 Reg't Miss. Art'y.†

Age *28* years.

Appears on

**Company Muster-in Roll**

of the organization named above. Roll dated  
*Hatchers miss Sep 12, 1863.*

Muster-in to date *Sep 12, 1863.*

Joined for duty and enrolled:

When *Sep 1, 1863.\**

Where *Hatchers miss*

Period *3* years.\*

Valuation of horse, \$ 100

Valuation of horse equipments, \$ 100

Remarks:

† This organization subsequently became Co. *E* 6 Reg't U. S. Colored Heavy Artillery.

\* Muster-in roll shows enrollment of all men of this company as of same date and place. See enrollment on subsequent card or cards.

Book mark:

*Hadfield*

(356c)

Copyist.

H.

6 H. Art'y.

U.S.C.T.

George Holinger

Pvt., Co. E, 2 Reg't Miss. Art'y.†

Appears on

Company Muster Roll

for Sept & Oct, 1863.

Joined for duty and enrolled:

When Sept 1, 1863\*

Where Vatches Miss \*

Period 3 years.\*

Present or absent Present

Stoppage, \$ 100 for

Due Gov't, \$ 100 for

Remarks:

† This organization subsequently became Co. E, 6 Reg't U. S. Colored Heavy Artillery.

\* See enrollment on card from muster-in roll.

Book mark:

Hudfield

*J* 6 H. Art'y. U.S.C.T.

*George Holinger*  
Pvt, Co. E, 2 Reg't Miss. Art'y.†

Appears on

**Company Muster Roll**

for *Nov + Dec*, 1863.

Joined for duty and enrolled:

When *Sept 1*, 1863.\*

Where *Natches miss* \*

Period *3* years.\*

Present or absent *Present*

Stoppage, \$ *100* for

Due Gov't, \$ *100* for

Remarks:  
-----  
-----  
-----  
-----  
-----

† This organization subsequently became Co. E, 6 Reg't U. S. Colored Heavy Artillery.  
\* See enrollment on card from muster-in roll.

Book mark: *Handfield*

(358c)

Copyist.

*George Kolinger*  
Pvt., Co. E, 2 Reg't Miss. Art'y.†

Appears on

**Company Muster Roll**

for *Jan & Feb*, 1864.

Joined for duty and enrolled:

When *Sept 1*, 1863.\*

Where *Katches Miss* \*

Period *3* years.\*

Present or absent *Present*

Stoppage, \$ *100* for

Due Gov't, \$ *100* for

Remarks:

† This organization subsequently became Co. E, 6 Reg't U. S. Colored Heavy Artillery.  
\* See enrollment on card from muster-in roll.

Book mark:

(358c) *Hadfield* Copyist.

*George Klinger*  
Co. *E*, 5 Reg't U. S. Col'd H. Art'y.†

Appears on

**Company Muster Roll**

for *March Apr*, 186 *4*.

Joined for duty and enrolled:

When *Sept 1*, 186 *3*.\*

Where *Watches miss* \*

Period *3* years.\*

Present or absent *Present*

Stoppage, \$ *100* for

Due Gov't \$ *100* for

Valuation of horse, \$ *100*

Valuation of horse equipments, *100*

Remarks:

†This organization subsequently became Co. *E*, 6 Reg't U. S. Colored Heavy Artillery.

\* See enrollment on card from muster-in roll.

Book mark:

*Hadfield*

*George Kolinger*  
*Cot*, Co. E, 6 Reg't U. S. Col'd H. Art'y.

Appears on

**Company Muster Roll**

for *May - June* 186*4*.

Joined for duty and enrolled:

When *Sept 1*, 186*3*.\*

Where *Katchiz Miss* \*

Period *3* years.\*

Present or absent *Absent*

Stoppage, \$ *100* for

Due Gov't, \$ *100* for

Remarks: *sick in Best Hospital*

\* See enrollment on card from muster-in roll.

Book-mark :

*Hadfield*  
Copyst.

A

6 H. Art'y.

U.S.C.T.

*George Hollinger*  
Priv., Co. E, 6 Reg't U. S. Col'd H. Art'y.

Appears on

**Company Muster Roll**

for *July Aug.* 186*4*.

Joined for duty and enrolled:

When *Sept 1<sup>st</sup>*, 186*3*.\*

Where *Natchez Miss* \*

Period *3* years.\*

Present or absent *present*.

Stoppage, \$ *100* for

Due Gov't, \$ *100* for

Remarks:

-----  
-----  
-----  
-----  
-----  
-----

\*See enrollment on card from muster-in roll.

Book-mark:

*C. M. Lowe*

(358c)

Copyist.



*A*

6 H. Art'y.

U.S.C.T.

*George Hollinger*

*Privat*, Co. E, 6 Reg't U. S. Col'd H. Art'y.

Appears on

**Company Muster Roll**

for *Sept & Oct,* 1864.

Joined for duty and enrolled:

When *Sept 1<sup>st</sup>*, 1863.\*

Where *Natchez Miss* \*

Period *9* years.\*

Present or absent *Present*

Stoppage, \$ *100* for

Due Gov't, \$ *100* for

Remarks:

-----  
-----  
-----  
-----  
-----  
-----  
-----

\* See enrollment on card from muster-in roll.

Book-mark : *100*

*C. M. Howe*

(358c)

Copyst.

A

6 H. Art'y.

U.S.C.T.

George Hollinger  
Privat, Co. E, 6 Reg't U. S. Col'd H. Art'y.

Appears on

Company Muster Roll

for Nov, + Dec, 1864.

Joined for duty and enrolled:

When Sept. 1, 1863.\*

Where Natchez Miss.\*

Period 3 years.\*

Present or absent present.

Stoppage, \$ 100 for

Due Gov't, \$ 100 for

Remarks: Due U.S. for Ordnance  
25 cents.

\* See enrollment on card from muster-in roll.

Book-mark :

M. Moore

(358c)

Copyist.

*A*

6 H. Art'y.

U.S.C.T.

*George Hollinger*

*Privat*, Co. E, 6 Reg't U. S. Col'd H. Art'y.

Appears on

**Company Muster Roll**

for *Jan & Feb.* 186*8*.

Joined for duty and enrolled:

When *Sept 1'*, 186*7*.\*

Where *Wentworth, Miss*.\*

Period *3* years.\*

Present or absent *present*.

Stoppage, \$ *100* for

Due Gov't, \$ *100* for

Remarks: *Due US for Qud 35 cents,*  
*for Camp & G. E. 40 cents,*

\*~~See~~ See enrollment on card from muster-in roll.

Book-mark :

*M. Rowe*

(358c)

Copyist.

A

6 H. Art'y.

U.S.C.T.

*George Hollinger*  
Privat., Co. E, 6 Reg't U. S. Col'd H. Art'y.

Appears on

**Company Muster Roll**

for *March & April* 1865.

Joined for duty and enrolled:

When *Sept. 1<sup>st</sup>*, 1865.\*

Where *Natchez Miss.*\*

Period *3* years.\*

Present or absent *present*

Stoppage, \$ *100* for

Due Gov't, \$ *100* for

Remarks: *Due pay for Qd. 55 cents*  
*for C & G. E. 40 cents.*

\* See enrollment on card from muster-in roll.

Book-mark :

*G. M. Row*

(358c)

Copyist.

*N*

6 H. Art'y.

U.S.C.T.

*George Hollinger*

*Privt*, Co. E, 6 Reg't U. S. Col'd H. Art'y.

Appears on

**Company Muster Roll**

for *May & June* 1865.

Joined for duty and enrolled:

When *Sept 1<sup>st</sup>*, 1863.\*

Where *Watauga Miss* \*

Period *3* years.\*

Present or absent *present*

Stoppage, \$ *100* for

Due Gov't, \$ *100* for

Remarks:

-----  
-----  
-----  
-----  
-----  
-----

\*See enrollment on card from muster-in roll.

Book-mark:

-----

*C. M. Rowe*

(358c)

Copyist.

George Hollinger,  
Priv., Co. E, 6 Reg't U. S. Col'd H. Art'y.

Appears on

**Company Muster Roll**

for July and Aug 1865.

Joined for duty and enrolled:

When Sept. 1, 1863\*

Where Katchez, Miss\*

Period 3 years.\*

Present or absent present

Stoppage, \$ 100 for

Due Gov't, \$ 100 for

Remarks:  
.....  
.....  
.....  
.....  
.....  
.....

\* See enrollment on card from muster-in roll.

Book-mark : .....

Dwight Webb

George Hollinger,  
Pvt., Co. E, 6 Reg't U. S. Col'd H. Art'y.

Appears on

**Company Muster Roll**

for Sept. and Oct. 1865.

Joined for duty and enrolled:

When Sept. 1, 1863.\*

Where Watches, Miss\*

Period 3 years.\*

Present or absent present

Stoppage, \$ 100 for

Due Gov't, \$ 100 for

Remarks: \_\_\_\_\_  
\_\_\_\_\_  
\_\_\_\_\_  
\_\_\_\_\_  
\_\_\_\_\_

\* See enrollment on card from muster-in roll.

Book-mark: \_\_\_\_\_

Henry Webb  
Coptist.

H

6 H. Art'y.

U.S.C.T.

George Hallinger,

Pvt., Co. E, 6 Reg't U. S. Col'd H. Art'y.

Appears on

Company Muster Roll

for Nov & Dec 1865.

Joined for duty and enrolled:

When Sept 1, 1863.\*

Where Watauga, Me.\*

Period 3 years.\*

Present or absent Present

Stoppage, \$ 100 for 82

Due Gov't, \$ 100 for order.

Remarks: \_\_\_\_\_

\_\_\_\_\_

\_\_\_\_\_

\_\_\_\_\_

\_\_\_\_\_

\_\_\_\_\_

\* See enrollment on card from muster-in roll.

Book-mark: \_\_\_\_\_

\_\_\_\_\_

W. H. Hallinger

(358c)

Copyist.



H

6 H. Art'y.

U.S.C.T.

George Hallinger

Pvt

, Co. E, 6 Reg't U. S. Col'd H. Art'y.

Appears on

Company Muster Roll

for Jan or Feb 1866.

Joined for duty and enrolled:

When Sept, 1863.\*

Where Natchez, Miss.\*

Period 3 years.\*

Present or absent Present

Stoppage, \$ 100 for

Due Gov't, \$ 100 for

Remarks:

\*See enrollment on card from muster-in roll.

Book-mark:

(358c)

W. B. Logg

Copyist.

H

6 H. Art'y.

U.S.C.T.

George Hollinger

Pvt., Co. E, 6 Reg't U. S. Col'd H. Art'y.

Appears on

Company Muster Roll

for March & April 1866.

Joined for duty and enrolled:

When Sept 1, 1863.\*

Where Natchez, Miss.

Period 3 years.\*

Present or absent Present

Stoppage, \$ 100 for

Due Gov't, \$ 100 for

Remarks:

\*See enrollment on card from muster-in roll.

Book-mark:

W. B. [Signature]

(358c)

Copyist.

George Hallinger  
Capt., Co. E, 6 Reg't U. S. Col'd H. Art'y.

Appears on Returns as follows:

June 1864 Absent  
Sick in Post  
Hosp. Natchez  
Miss

Book mark:

(545) A. Gouglat Copyist.

H

6 H. Art'y.

U.S.C.T.

*George Hollinger*

Private, Co. *C*, 6 Reg't U. S. Col'd H. Art'y.

Appears on **Co. Muster-out Roll**, dated *Vicksburg, Miss. May 13, 1866*.

Muster-out to date *May 13, 1866*.

Last paid to *Dec. 31, 1865*.

**Clothing account:**

Last settled....., 186 ; drawn since \$..... 100

Due soldier \$ *30* 100; due U. S. \$..... 100

Am't for cloth'g in kind or money adv'd \$..... 100

Due U. S. for arms, equipments, &c., \$..... 100

Bounty paid \$..... 100; due \$..... 100

Remarks: *joined at original organization.*

Book mark : .....

*O. J. Markle,*  
Copyist.

(361)

Hollinger, Wm

Co C, 6 U.S. Col'd H. Art'y

Private Private

CARD NUMBERS.

1	6165208	26
2	6165419	27
3	6167153	28
4	9119752	29
5	40742512	30
6		31
7		32
8		33
9		34
10		35
11		36
12		37
12		38
14		39
15		40
16		41
17		42
18		43
19		44
20		45
21		46
22		47
23		48
24		49
25		50

Book Mark:

See also

William Hollinger

Co. E, 6 Reg't U. S. Col'd H. Art'y.

Appears on

Company Descriptive Book

of the organization named above.

DESCRIPTION.

Age 20 years; height 5 feet 6 1/2 inches.

Complexion Yellow

Eyes Brk; hair Blk

Where born Franklin, Miss.

Occupation Farmer

ENLISTMENT.

When Sept 1, 1863.

Where Atchafalaya, Miss.

By whom J. M. Wickman; term 3 y'rs.

Remarks: Died Oct, 5/63 at  
at Vidalia La of  
Masses

Farren

*W* | **6 H. Art'y. U.S.C.T.**

*William Hollinger*  
*Pvt*, Co. *E*, 2 Reg't Miss. Art'y.†

Age *20* years.

Appears on

**Company Muster-in Roll**

of the organization named above. Roll dated

*Natchez Miss Sep 12, 1863.*

Muster-in to date *sep 12, 1863.*

Joined for duty and enrolled:

When *sept 1, 1863.\**

Where *Natchez Miss \**

Period *3* years.\*

Valuation of horse, \$ . . . . . 100

Valuation of horse equipments, \$ . . . . . 100

Remarks:

† This organization subsequently became Co. *E* 6 Reg't U. S. Colored Heavy Artillery.

\* Muster-in roll shows enrollment of all men of this company as of same date and place. See enrollment on subsequent card or cards.

Book mark:

*Hadfield*

*H*

6 H. Art'y.

U.S.C.T.

*William Holmiger*

*Pvt*, Co. E, 2 Reg't Miss. Art'y.†

Appears on

**Company Muster Roll**

for *Sept & Oct*, 1863.

Joined for duty and enrolled:

When *Sept 1*, 1863.\*

Where *Hatchez Miss* \*

Period *3* years.\*

Present or absent

Stoppage, \$ *100* for

Due Gov't, \$ *100* for

Remarks: *Died Oct 15 1863  
at Vida Lia La of*

† This organization subsequently became Co. E, 6 Reg't U. S. Colored Heavy Artillery.

\* See enrollment on card from muster-in roll.

Book mark:

*Hadfield*

(358c)

Copyist.



A

6 H. Art'y.

U.S.C.T.

William Holinger

Pat, Co. ...., 6 Reg't U. S. Col'd H. Art'y.

Appears on Returns as follows:

Oct 1863 (Co E 2 Miss  
H Art A.D.) Died  
Oct 15 in Hosp  
Vidalia La of  
Measles

Book mark:

(546) A. G. Angled Copyist.

H

6 H. Art'y.

U.S.C.T.

*William Hollinger*

*Private*, Co. *E*, 6 Reg't U. S. Col'd H. Art'y.

Appears on **Co. Muster-out Roll**, dated

*Natchez, Miss.*, *May 13*, 186*6*.

Muster-out to date \_\_\_\_\_, 186 .

Last paid to \_\_\_\_\_, 186 .

**Clothing account:**

Last settled \_\_\_\_\_, 186 ; drawn since \$ \_\_\_\_\_ <sup>100</sup>

Due soldier \$ \_\_\_\_\_ <sup>100</sup>; due U. S. \$ \_\_\_\_\_ <sup>100</sup>

Am't for cloth'g in kind or money adv'd \$ \_\_\_\_\_ <sup>100</sup>

Due U. S. for arms, equipments, &c., \$ \_\_\_\_\_ <sup>100</sup>

Bounty paid \$ \_\_\_\_\_ <sup>100</sup>; due \$ \_\_\_\_\_ <sup>100</sup>

Remarks: *Joined at original  
Organization. Died Oct. 15,  
1863 Vidalia, La. of measles.  
Final statement forwarded,  
June 8, 1864.*

Book mark: *V. 2.35 - P. 17 76*

*O. J. Markle*

(361)

Copyist.

Hollinger, William

....., Co. ....,

Reg't .....

..... / **Enclosures.**

Bed Cards .....	Final Statements .....
Burial Records .....	Furloughs or L. of A. ....
Certs. of Dis. for Discharge .....	Med. Certificates .....
C. M. Charges .....	Med. Des. Lists .....
Descriptive Lists .....	Orders .....
Discharge Certificates .....	Pris. of War Record .....
Enlistment Papers .....	Resignations .....

Other papers relating to—

Admission to Hosp'l .....	Furlough or L. of A. ....
Casualty Sheet .....	Med. Examination .....
Confinement .....	Misc. Information .....
Contracts .....	Pay or Clothing .....
Death or Effects ..... /	Personal Reports .....
Desertion .....	Rank .....
Discharge from Hosp'l .....	Transfer to Hosp'l .....
Discharge from Service .....	Transfer to V. R. C. ....
Duty .....	Transportation .....

Dear Mother  
I received your letter  
of the 14th and was  
glad to hear from  
you and all the family  
I am well and hope  
these few lines will  
find you all the same

1000  
JUL 11 1891

Inventory of the effects of *William H. Wilson* late  
 a *Sergeant* of Captain *John C. Williams* Company of  
 the *1st* Regiment of *Volunteers*, who was enrolled as  
 a *Sergeant* at *...* in the State of *...* on  
 the *...* day of *...* 1863, and mustered into the service of the United  
 States as a *Sergeant* on the *...* day of *...* 1863, at *...*  
 in Company *...* Regiment of *...* to serve *...*  
 years or during the war; he was born in *...* in the State  
 of *...*; he was *...* years of age, *...* feet *...* inches  
 high, *...* complexion, *...* eyes, *...* hair, and by occupation, when enrolled,  
 a *...*; he died in *...* at  
*...* on the *...* day of *...* 183?, by  
 reason of *...*

INVENTORY.

ARTICLES.	NO.	ARTICLES	NO.	ARTICLES.	NO.
Hats.....	✓	Pairs Trowsers.....	✓	Knapsacks.....	✓
Caps.....	✓	Pairs flannel Drawers.....	✓		
Forage Caps.....	✓	Pairs cotton Drawers.....	✓		
Great Coats.....	✓	Flannel Shirts.....	✓		
Uniform Coats.....	✓	Cotton Shirts.....	✓		
Uniform Jackets.....	✓	Pairs boots.....	✓		
Flannel Sack Coats.....	✓	Pairs shoes.....	✓		
Blouses.....	✓	Pairs socks.....	✓		
Stable Frocks.....	✓	Blankets.....	✓		
Fatigue Overalls.....	✓	Haversacks.....	✓		
				MONEY.	
				Specie.....	✓
				Notes.....	✓

I CERTIFY ON HONOR, that the above inventory comprises all the effects of *William H. Wilson*  
*...*, deceased, and that the effects are in the hands  
 of *...* at *...*  
*...* to be disposed of by a Council of Administration.

(DUPLICATES.)

STATION: *...*

*...*  
 Commanding the Company.

DATE: *...*

*Thomas Alfred*  
Co. G, 6 U.S. Col'd H. Art'y.

*Private Private*

CARD NUMBERS.

1	6169376	26
2	6169528	27
3	6169670	28
4	6169814	29
5	6169935	30
6	6170062	31
7	6170167	32
8	6170270	33
9	6170376	34
10	6170480	35
11	6170594	36
12	6170713	37
13	6170828	38
14	6170939	39
15	6171046	40
16	6171144	41
17	6171238	42
18	6171333	43
19	9120074	44
20	9120247	45
21	40742513	46
22		47
23		48
24		49
25		50

Book Mark:

See also

*Alfred Holmes*

....., Co. *A*, 6 Reg't U. S. Col'd H. Art'y.

Appears on

**Company Descriptive Book**

of the organization named above.

**DESCRIPTION.**

Age *20* years; height *5* feet *6* inches.

Complexion *Dark*

Eyes *Dark*; hair *Brown*

Where born *Jefferson Co, Miss.*

Occupation *Farmer*

**ENLISTMENT.**

When *Sept 20*, 186*3*.

Where *Patux Miss.*

By whom *C. W. Smith*; term *3* y'rs.

Remarks:  
.....  
.....  
.....  
.....  
.....  
.....  
.....  
.....  
.....  
.....

*Warner*

*Alfred Holmes*

Co. *G*, 6 Reg't U. S. Col'd H. Art'y.

Appears on

**Company Descriptive Book**

of the organization named above.

**DESCRIPTION.**

Age *20* years; height *5* feet *6* inches.

Complexion *dark*

Eyes *dark*; hair *brown*

Where born *Jefferson Co, Miss.*

Occupation *farmer*

**ENLISTMENT.**

When *Sept. 20*, 186*3*.

Where *Natchez Miss.*

By whom *C. Smith*; term *3* y'rs.

Remarks:

*Warren*



*Alfred Holmes*  
*Put*, Co. G, 2 Reg't Miss. Art'y.\*

Age *20* years.

Appears on

**Company Muster-in Roll**

of the organization named above. Roll dated  
*Katcher, Miss, Oct 20*, 1863.  
Muster-in to date *Oct 20*, 1863.

Joined for duty and enrolled:

When *Sept 20*, 1863.

Where *Katcher, Miss.*

Period *3* years.

Valuation of horse, \$ 100

Valuation of horse equipments, \$ 100

Remarks: \_\_\_\_\_  
\_\_\_\_\_  
\_\_\_\_\_

\*This organization subsequently became Co. G, 6 Reg't U. S. Colored Heavy Artillery.

Book mark: \_\_\_\_\_

*J. A. Ward*  
(356) Copyist.

*K*

6 H. Art'y.

U.S.C.T.

*Alfred Holmes*

*Put*, Co. G, 2 Reg't Miss. Art'y.\*

Appears on

**Company Muster Roll**

for *Oct 20 to 31*, 1863.

Present or absent *Present*

Stoppage, \$ *100* for

Due Gov't, \$ *100* for

Valuation of horse, \$ *100*

Valuation of horse equipments, \$ *100*

Remarks:  
-----  
-----  
-----  
-----  
-----  
-----  
-----

\* This organization subsequently became Co. G, 6 Reg't U. S. Colored Heavy Artillery.

Book mark: -----

(358)

*A. A. Ward*

Copyist.

Alfred Holmes  
Sgt., Co. G, 2 Reg't Miss. Art'y.\*

Appears on

Company Muster Roll

for Nov & Dec, 1863.

Present or absent Present

Stoppage, \$ 100 for

Due Gov't, \$ 100 for

Valuation of horse, \$ 100

Valuation of horse equipments, \$ 100

Remarks:

\* This organization subsequently became Co. G, 6 Reg't U. S. Colored Heavy Artillery.

Book mark:

J. A. Ward

*Alfred Holmes*

*Art*, Co. G, 2 Reg't Miss. Art'y.\*

Appears on

**Company Muster Roll**

for *Jan & Feb*, 186*4*

Present or absent *Present*

Stoppage, \$ *100* for

Due Gov't, \$ *100* for

Valuation of horse, \$ *100*

Valuation of horse equipments, \$ *100*

Remarks: \_\_\_\_\_  
\_\_\_\_\_  
\_\_\_\_\_  
\_\_\_\_\_  
\_\_\_\_\_

\* This organization subsequently became Co. G, 6 Reg't U. S. Colored Heavy Artillery.

Book mark: \_\_\_\_\_

*L. Y. Sparr*

(358)

Copyist.

*A*

6 H. Art'y.

U.S.C.T.

*Alfred Holmes*

*Pr't*, Co. G, 5 Reg't U. S. Col'd H. Art'y.\*

Appears on

**Company Muster Roll**

for *mch & apr*, 1864

Present or absent *Present*

Stoppage, \$ *100* for

Due Gov't, \$ *100* for

Valuation of horse, \$ *100*

Valuation of horse equipments, \$ *100*

Remarks:

\* This organization subsequently became Co. G, 6 Reg't U. S. Col'd Heavy Artillery.

Book mark:

*L. Y. Sparr*

(358)

Copyist.

Alfred Holmes  
Ort, Co. G, 6 Reg't U. S. Col'd H. Art'y.

Appears on

Company Muster Roll

for May & June, 1864

Present or absent Present

Stoppage, \$ 100 for

Due Gov't, \$ 100 for

Valuation of horse, \$ 100

Valuation of horse equipments, \$ 100

Remarks:

Book mark:

L. Y. Sparr

26

6 H. Art'y.

U.S.C.T.

*Alfred Holmes*

*Pvt.*, Co. G, 6 Reg't U. S. Col'd H. Art'y.

Appears on

**Company Muster Roll**

for *July & Aug.*, 186*4*.

Present or absent *Present.*

Stoppage, \$ 100 for

Due Gov't, \$ 100 for

Valuation of horse, \$ 100

Valuation of horse equipments, \$ 100

Remarks:

Book mark:

(358)

*J. Smith*

Copyist.

*Alfred Holmes*

Co. G, 6 Reg't U. S. Col'd H. Art'y.

Appears on

**Company Muster Roll**

for *Sept 10*, 186*4*.

Present or absent *Present*

Stoppage, \$ *100* for

Due Gov't, \$ *100* for

Valuation of horse, \$ *100*

Valuation of horse equipments, \$ *100*

Remarks:

Book mark:



*H*

6 H. Art'y.

U.S.C.T.

*Alfred Hoernes*

*Pri.*, Co. G, 6 Reg't U. S. Col'd H. Art'y.

Appears on

**Company Muster Roll**

for *Nov. & Dec.*, 1864.

Present or absent *Present.*

Stoppage, \$ *100* for

Due Gov't, \$ *100* for

Valuation of horse, \$ *100*

Valuation of horse equipments, \$ *100*

Remarks:

-----  
-----  
-----  
-----  
-----  
-----  
-----  
-----  
-----

Book mark: -----

(358)

*J. Y. Smith*

Copyist.

A

6 H. Art'y.

U.S.C.T.

*Alfred Holmes*

*Private*, Co. G, 6 Reg't U. S. Col'd H. Art'y.

Appears on

**Company Muster Roll**

for *Jan'y Feb.*, 186*5*.

Present or absent *Present*

Stoppage, \$ *100* for

Due Gov't, \$ *100* for

Valuation of horse, \$ *100*

Valuation of horse equipments, \$ *100*

Remarks:

Book mark:

*J. M. Neale*

(358)

Copyist.

*Alfred Holmes*  
*Private*, Co. G, 6 Reg't U. S. Col'd H. Art'y.

Appears on

**Company Muster Roll**

for *March & April*, 1865.

Present or absent *Present*

Stoppage, \$ *100* for

Due Gov't, \$ *100* for

Valuation of horse, \$ *100*

Valuation of horse equipments, \$ *100*

Remarks: \_\_\_\_\_  
\_\_\_\_\_  
\_\_\_\_\_  
\_\_\_\_\_  
\_\_\_\_\_  
\_\_\_\_\_  
\_\_\_\_\_  
\_\_\_\_\_

Book mark: \_\_\_\_\_

*F. D. Neal*

A

Alfred Holmes

Private, Co. G, 6 Reg't U. S. Col'd H. Art'y.

Appears on

Company Muster Roll

for May & June, 1865

Present or absent Present

Stoppage, \$ 100 for

Due Gov't, \$ 100 for

Valuation of horse, \$ 100

Valuation of horse equipments, \$ 100

Remarks:

Book mark: A 10

ET 10 17 19

F. D. Neale

H

6 H. Art'y.

U.S.C.T.

Alpha Holmes

Pvt., Co. G, 6 Reg't U. S. Col'd H. Art'y.

Appears on

Company Muster Roll

for July and Aug, 1865

Present or absent present

Stoppage, \$ 100 for

Due Gov't, \$ 100 for

Valuation of horse, \$ 100

Valuation of horse equipments, \$ 100

Remarks:

[Empty lines for remarks]

Book mark:

E. Weston

*Alfred Holmes*  
*Pvt.*, Co. G, 6 Reg't U. S. Col'd H. Art'y.

Appears on

**Company Muster Roll**

for *Sept - Oct*, 1865.

Present or absent *present*

Stoppage, \$ *100* for

Due Gov't, \$ *100* for

Valuation of horse, \$ *100*

Valuation of horse equipments, \$ *100*

Remarks:

-----  
-----  
-----  
-----  
-----  
-----  
-----  
-----  
-----

Book mark: -----

-----  
*E. Weston*

A/

6 H. Art'y.

U.S.C.T.

Alfred Holmes

Pvt., Co. G, 6 Reg't U. S. Col'd H. Art'y.

Appears on

Company Muster Roll

for Nov, & Dec, 1865 :

Present or absent present,

Stoppage, \$ 100 for

Due Gov't, \$ 100 for

Valuation of horse, \$ 100

Valuation of horse equipments, \$ 100

Remarks:

Book mark:

E. Arsten

(358)

Copyist.

7

*Alfred Holmes*

*Priv*, Co. G, 6 Reg't U. S. Col'd H. Art'y.

Appears on

**Company Muster Roll**

for *Jan & Feb*, 1866.

Present or absent *Present*

Stoppage, \$ *100* for

Due Gov't, \$ *100* for

Valuation of horse, \$ *100*

Valuation of horse equipments, \$ *100*

Remarks:

Book mark:

*no chance*



70

6 H. Art'y.

U.S.C.T.

Alfred Holmes

Priv., Co. G, 6 Reg't U. S. Col'd H. Art'y.

Appears on

Company Muster Roll

for Mar + Apr, 1866.

Present or absent Present

Stoppage, \$ 100 for

Due Gov't, \$ 100 for

Valuation of horse, \$ 100

Valuation of horse equipments, \$ 100

Remarks: Stop for Ordnance  
lost 34 cuts.

Book mark:

W. O. Chance

(358)

Copyist.

*N* | 6 H. Art'y. | U.S.C.T.

*Benjamin Holmes*  
*Pop*, Co. ✓, 6 Reg't U. S. Col'd H. Art'y.

Appears on Returns as follows:

*Feb 4 1864 (Col 2*  
*Miss of Art Adl)*  
*Died in Hosp*  
*Feb 5, 64*

Book mark : \_\_\_\_\_

(546) *A. J. Gangle* Copyist.

H

6 H. Art'y.

U.S.C.T.

Alfred Holmes

Pvt, Co. G, 6 Reg't U. S. Col'd H. Art'y.

Appears on Co. Muster-out Roll, dated

Natchez, Miss, May 13, 1866 .

Muster-out to date May 13, 1866 .

Last paid to Dec 31, 1865 .

Clothing account:

Last settled....., 186 ; drawn since \$..... 100

Due soldier \$..... 100; due U. S. \$..... 30 <sup>32</sup> 100

Am't for cloth'g in kind or money adv'd \$..... 100

Due U. S. for arms, equipments, &c., \$..... <sup>34</sup> 100

Bounty paid \$..... 100; due \$..... 100

Remarks: Joined at original organization. Stop for ordnance lost, 34 cents.

Book mark:

No chance

(361)

Copyist.

Holmes, Benjamin

Co B, 6 U.S. Col'd H. Art'y.

Private Private

CARD NUMBERS.

1	6155449	26
2	6155595	27
3	6155746	28
4	6155965	29
5	6157778	30
6	9118969	31
7		32
8		33
9		34
10		35
11		36
12		37
13		38
14		39
15		40
16		41
17		42
18		43
19		44
20		45
21		46
22		47
23		48
24		49
25		50

Book Mark: .....

See also .....

*Benjamin Holmes*  
Co. *A*, 6 Reg't U. S. Col'd H. Art'y.

Appears on

**Company Descriptive Book**  
of the organization named above.

**DESCRIPTION.**

Age *25* years; height *5* feet *4 3/4* inches.

Complexion *Black*

Eyes *Black*; hair *Black*

Where born *Richmond Va*

Occupation *farmer*

**ENLISTMENT.**

When *Aug 30*, 186*3*.

Where *Natchez Miss*

By whom *Capt Ogden*; term *3* y'rs.

Remarks: *Died in Hospital*  
*at Natchez Miss Feb*  
*5. 64.*

*\*Companion*

*J. P. [Signature]*

76

6 H. Art'y. | U.S.C.T.

Benjamin Holmes  
Pri<sup>o</sup>, Co. A, 2 Reg't Miss. Art'y.†

Age 25 years.

Appears on

Company Muster-in Roll

of the organization named above. Roll dated

Natchez Miss. Sept 12, 1863.

Muster-in to date Sept 12, 1863.

Joined for duty and enrolled:

When Aug 30, 1863.\*

Where Natchez Miss. \*

Period 3 years.\*

Valuation of horse, \$ 100

Valuation of horse equipments, \$ 100

Remarks:

† This organization subsequently became Co. A, 6 Reg't U. S. Colored Heavy Artillery.

\* Muster-in roll shows enrollment of all men of this company as of same date and place. See enrollment on subsequent card or cards.

Book mark:

C. J. Smith

(356c)

Copyist.

76

6 H. Art'y.

U.S.C.T.

Benjamin Holmes  
Pi Co. A, 2 Reg't Miss. Art'y.†

Appears on

**Company Muster Roll**

for Aug 30 to Oct 31, 1863.

Joined for duty and enrolled:

When Aug 30, 1863.\*

Where Natchez Miss \*

Period 3 years.\*

Present or absent Absent

Stoppage, \$ 100 for

Due Gov't \$ 100 for

Valuation of horse, \$ 100

Valuation of horse equipments, 100

Remarks: Sick in Hospital

† This organization subsequently became Co. A, 6 Reg't U. S. Colored Heavy Artillery.

\* See enrollment on card from muster-in roll.

Book mark:

O. G. Smith

(358c)

Copyist.

76

6 H. Art'y.

U.S.C.T.

Benjamin Holmes  
Priv., Co. A, 2 Reg't Miss. Art'y.†

Appears on

Company Muster Roll

for Nov & Dec, 1863.

Joined for duty and enrolled:

When Aug 30, 1863.\*

Where State of Miss.\*

Period 3 years.\*

Present or absent Present

Stoppage, \$ 100 for

Due Gov't \$ 100 for

Valuation of horse, \$ 100

Valuation of horse equipments, 100

Remarks:

† This organization subsequently became Co. A, 6 Reg't U. S. Colored Heavy Artillery.

\* See enrollment on card from muster-in roll.

Book mark:

O. W. Smith

(358c)

Copyist.



*Benjamin Holmes*  
Pri. Co. A, 2 Reg't Miss. Art'y.†

Appears on

**Company Muster Roll**

for *Jan & Feb*, 1864.

Joined for duty and enrolled:

When *Aug 30*, 1863.\*

Where *Natchez Miss*.\*

Period *3* years.\*

Present or absent.....

Stoppage, \$ *100* for.....

Due Gov't \$ *100* for.....

Valuation of horse, \$ *100*

Valuation of horse equipments, *100*

Remarks: *Died in Hospital*  
*Feb. 5-1864.*

† This organization subsequently became Co. A, 6 Reg't U. S. Colored Heavy Artillery.

\* See enrollment on card from muster-in roll.

Book mark:.....

*O G Smith*

*Benjamin Holmes*  
Co. A, 2 Reg't Miss. Art'y.†

Appears on

**Company Muster Roll**

for *Jan & Feb*, 1864.

Joined for duty and enrolled:

When *Aug 30*, 1863.\*

Where *Natchez Miss* \*

Period *3* years.\*

Present or absent.....

Stoppage, \$..... 100 for.....

Due Gov't \$..... 100 for.....

Valuation of horse, \$..... 100

Valuation of horse equipments, ..... 100

Remarks: *Died in Hospital*  
*Feb. 5-1864.*

† This organization subsequently became Co. A, 6 Reg't U. S. Colored Heavy Artillery.

\* See enrollment on card from muster-in roll.

Book mark: .....

*O. G. Smith*

(358c)

Copyist.

*H*

6 H. Art'y.

U.S.C.T.

*Benjamin Holmes*

*Priv., Co. A., 6 Reg't U. S. Col'd H. Art'y.*

Appears on **Co. Muster-out Roll**, dated

*Natchez Miss. May 13, 1866*

Muster-out to date ..... 186 .

Last paid to ..... 186 .

**Clothing account:**

Last settled....., 186 ; drawn since \$..... 100

Due soldier \$..... 100; due U. S. \$..... 100

Am't for cloth'g in kind or money adv'd \$..... 100

Due U. S. for arms, equipments, &c., \$..... 100

Bounty paid \$..... 100; due \$..... 100

Remarks: *Joined at original*

*organization. Died in*

*Hosp'l Natchez Miss.*

*Feb. 5, 64. Final state-*

*ments for'd April 1, 65*

Book mark : .....

*A. L. Ames*

(361)

Copyist.

*Hombs, Benjamin*

*P, Co. a*, **6** Reg't **U.S.C.H.A.**

**2** Enclosures.

Bed Cards	Descriptive Lists
Burial Records	Final Statements /
Certs. of Dis. for Discharge	Furloughs
C. M. Charges	Med. Des. Lists
Med. Certificates	Orders

Other papers relating to—

Admission to Hosp'l	Furlough
Casualty Sheet (Officer's)	Med. Examination
Confinement	Misc. Information
Contracts	Pay or Clothing
Death or Effects /	Personal Reports
Desertions	Rank
Discharge from Hosp'l	Transfer to Hosp'l
Discharge from Service	Transfer to V. R. C.
Duty	Transportation

INVENTORY OF THE EFFECTS

OF

*Private Benjamin Combs*

Late of Company *A*

*Supt* Reg't of *A. S. G. Artillery*

Volunteers, who died at *Watches Mt.*

on the *5* day of *February* 186*4*.



Inventory of the effects of Benjamin Bonds late  
 a Private of Captain James T. Ocean's Company A. of  
 the 6<sup>th</sup> Regiment of U.S. Colored Regt Volunteers, who was enrolled as  
 a Private at Natchez in the State of Mississippi on  
 the 30 day of August 1863, and mustered into the service of the United  
 States as a Private on the 12 day of September 1863, at Natchez Miss.  
 in Company A., 6<sup>th</sup> Regiment of U.S. Colored Regt Volunteers, to serve 3  
 years or during the war; he was born in Richmond in the State  
 of Virginia; he was 25 years of age, 5 feet 4 3/4 inches  
 high, Black complexion, Black eyes, Black hair, and by occupation, when enrolled,  
 a Servant; he died in Regimental Hospital, at  
Natchez Miss. on the 5 day of February 1864, by  
 reason of Nature of Disease not known

INVENTORY.					
ARTICLES.	No.	ARTICLES.	No.	ARTICLES.	No.
Hats.....		Pairs trousers.....		Knapsacks.....	
Caps.....		Pairs flannel drawers.....			
Forage caps.....		Pairs cotton drawers.....			
Great coats.....		Flannel shirts.....			
Uniform coats.....		Cotton shirts.....			
Uniform jackets.....		Pairs boots.....			
Flannel sack coats.....		Pairs shoes.....			
Blouses.....		Pairs socks.....			
Stable frocks.....		Blankets.....			
Fatigue overalls.....		Haversacks.....			
				MONEY.	
				Specie.....	\$
				Notes.....	\$

I CERTIFY, ON HONOR, that the above inventory comprises all the effects of \_\_\_\_\_  
 \_\_\_\_\_, deceased, and that the effects are in the hands  
 of \_\_\_\_\_ at \_\_\_\_\_  
 \_\_\_\_\_ to be disposed of by a Council of Administration.

(DUPLICATES.)

STATION: Natchez Miss.

DATE: April 7 1865

[A. G. O. No. 104.]

Orrin W. Moon  
1st Lt. U.S. Colored Regt  
 Commanding the Company.

FINAL STATEMENT

OF

*Private Benjamin Bond*

*5th Reg't of U.S. Cavalry*

VOLUNTEERS.

NOTE 1.—Two of these certificates (or duplicates) are to be given to each Volunteer Soldier or drafted man who may be discharged previously to the discharge of his company, that he may at once receive from the Paymaster the pay, &c., due him, and the captain or other COMMISSIONED officer commanding the company will certify to the act of the delivery of the duplicate certificates; on these certificates the Soldier is "entitled to" his discharge, and should also present his discharge to the Paymaster to have the payment endorsed on it. The discharge is to be given back to the Soldier by the Paymaster; the latter only retaining as his voucher the duplicate certificates.

NOTE 2.—If the Soldier is entitled to pay for the use of his horse, the Company Commander will certify to that fact on the back of both these final statements, and also to the time he has pay due for having been so mounted on his own horse.

NOTE 3.—When a Soldier is furnished with final statements, his descriptive list, if he has one, should be taken up by the officer who gives the Soldier these statements, and endorsed with a statement to this effect by the officer. This endorsement should exhibit a full statement of the time for which the Soldier was allowed pay on his final statements, the clothing account, and all other charges against him or in his favor, so as to comprise a complete exhibit of his account. It will then be transmitted to the company commander of the Soldier, who will enter all the data necessary to a full understanding of the Soldier's account on the muster roll upon which the Soldier's discharge is reported. The descriptive list will then be destroyed. The object of this is, that the remaining portion of the Soldier's account may be settled upon the receipt of these muster rolls, and the Soldier receive any pay or allowances that may be due him at the time of his discharge, and which may not appear on his final statements from the fact that his descriptive list is incomplete. These accounts for back pay, &c., are settled by the 2d Auditor of the Treasury Department.

NOTE 4.—Charges for loss or injury to ordnance, horse equipments, and other miscellaneous charges, should appear under the heading of "Other Stoppages."

NOTE 5.—Bounty paid by State authorities, and not by the United States, will not be entered on this statement.

NOTE 6.—Amounts due the Sutler and Laundress must be entered on the muster roll on which the discharge, death, desertion, &c., is reported, as well as on the final statement, otherwise the amount cannot be collected from the United States.

NOTE 7.—This blank will be used for deceased volunteers and drafted men, as well as for others.

NOTE 8.—Where a Soldier dies in Hospital or on detached service, his descriptive list, if he has one, should be sent with his final statements, in duplicate, to the Second Auditor, Washington, D. C.

ADJUTANT GENERAL'S OFFICE.

*May 8<sup>th</sup> 1860.*

Duplicate with Inventory sent 2d Auditor.

I certify, on honor, that Benjamin Howls a Private of  
Captain J. J. Ogan Company (A.) of the Sixth Regiment of U.S.C. & A.  
**VOLUNTEERS**, of the State of \_\_\_\_\_, born in Richmond, State  
of Virginia, aged 25 years; 5 feet 4 3/4 inches high; Black complexion,  
Black eyes, Black hair, and by occupation a Servant, having joined the company on  
its original organization at Natchez Miss, and enrolled in it at the muster into  
the service of the United States at Natchez Miss, on the 12<sup>th</sup> day  
of September, 1863, (or was mustered in service as a recruit, by \_\_\_\_\_  
at \_\_\_\_\_, on the \_\_\_\_\_ day of \_\_\_\_\_,  
186 , or was drafted and mustered into the service of the United States from the \_\_\_\_\_  
Enrollment District of the State of \_\_\_\_\_, at \_\_\_\_\_,  
on the \_\_\_\_\_ day of \_\_\_\_\_, 186 ), to serve in the Regiment, for

the term of Three Years: and having served **HONESTLY** and  
**FAITHFULLY** with his Company in The Field, to the present date, is now  
entitled to a **DISCHARGE** by reason of Died of disease in Regimental  
Hospital Feb. 5<sup>th</sup> 1864

The said Benjamin Howls was last paid by Paymaster  
Enrollment to include the \_\_\_\_\_ day of \_\_\_\_\_, 186 , and has  
pay due him from that time to the present date; he is entitled to pay and subsistence for  
**TRAVELING** to place of enrollment, and whatever other allowances are authorized to volunteer  
soldiers, drafted men, or militia, so discharged. He has received from the United States **CLOTHING**  
amounting to \$43 76 dollars, since the 12<sup>th</sup> day of September,  
1863, when his clothing account was last settled. He has received from the United States  
\_\_\_\_\_ dollars advanced **BOUNTY**.

There is to be stopped from him, on account of the State of \_\_\_\_\_, or other  
authorities, for **CLOTHING**, &c., received on entering service, \_\_\_\_\_ dollars; and  
for other stoppages, viz: \_\_\_\_\_  
\_\_\_\_\_ dollars.

He has been furnished with **TRANSPORTATION** in kind from the place of his discharge to  
\_\_\_\_\_ ; and he has been **SUBSISTED** for **TRAVELING** to his  
place of enrollment, up to the \_\_\_\_\_, 186 .

He is indebted to \_\_\_\_\_, **SUTLER**, \_\_\_\_\_ dollars.  
He is indebted to \_\_\_\_\_, **LAUNDRESS**, \_\_\_\_\_ dollars.

Given in Duplicate, at Natchez Mississippi, this 17<sup>th</sup> day  
of April, 1863.

Orrin W. Moore  
1<sup>st</sup> Lt. & Adj. (U.S.C. & A.)  
Commanding Company.



*James, Joshua*  
Co *E*, 6 U.S. Col'd H. Art'y.

*Private Private*

CARD NUMBERS.

1	6169361	26
2	6169513	27
3	6169657	28
4	6169801	29
5	6170009	30
6	6154842	31
7	6155085	32
8	6190598	33
9	6190717	34
10	6170832	35
11	6155123	36
12	6170994	37
12	6171438	38
14	9120059	39
15	9120232	40
16	1268-C.F.-1887	41
17	40742515	42
18		43
19		44
20		45
21		46
22		47
23		48
24		49
25		50

Book Mark: *1268 C.F. 87*

See also

*Elisha Holmes*

....., Co. *G*, 6 Reg't U. S. Col'd H. Art'y.

Appears on  
**Company Descriptive Book**

of the organization named above.

**DESCRIPTION.**

Age *44* years; height *5* feet *7* inches.  
Complexion *dark*  
Eyes *dark*; hair *dark*  
Where born *Richmond Va*  
Occupation *Farmer*

**ENLISTMENT.**

When *Sept. 20*, 186*3*.  
Where *Natchez Miss*  
By whom *Ch Smith*; term *3* y'rs.

Remarks: *Deserted from*  
*Natchez Miss. Mar. 20/64*  
*Recovered from*  
*desertion Mar. 17/65-*

*Warren*

Elisha Holmes

Co. G, 6 Reg't U. S. Col'd H. Art'y.

Appears on

Company Descriptive Book

of the organization named above.

DESCRIPTION.

Age 44 years; height 5 feet 7 inches.

Complexion Dark

Eyes Dark; hair Dark

Where born Richmond, Va.

Occupation Farmer

ENLISTMENT.

When Sept 20, 1863.

Where Natchez, Miss.

By whom C. W. Smith, term 3 y'rs.

Remarks: Deserted Mar. 20/64 at Natchez Recaptured

from desertion Mar. 17/65 Deserted second time

July 7/1865 from Military Prison Natchez Miss.

W. H. Miller

7

6 H. Art'y.

U.S.C.T.

*Elisha Holmes*

*Put*, Co. G, 2 Reg't Miss. Art'y.\*

Age *44* years.

Appears on

**Company Muster-in Roll**

of the organization named above. Roll dated

*Katchez Miss Oct 20*, 186*3*.

Muster-in to date

*Oct 20*, 186*3*.

Joined for duty and enrolled:

When *Sept 20*, 186*3*.

Where *Katchez, Miss.*

Period *3* years.

Valuation of horse, \$.....100

Valuation of horse equipments, \$.....100

Remarks:.....

\*This organization subsequently became Co. G, 6 Reg't U. S. Colored Heavy Artillery.

Book mark: *1268-27-1887*

*O. A. Ward*

(356)

Copyist.

4

6 H. Art'y.

U.S.C.T.

Elisha Holmes

Put, Co. G, 2 Reg't Miss. Art'y.\*

Appears on

Company Muster Roll

for Oct 20 to 31, 1863.

Present or absent Present

Stoppage, \$ 100 for

Due Gov't, \$ 100 for

Valuation of horse, \$ 100

Valuation of horse equipments, \$ 100

Remarks:

\* This organization subsequently became Co. G, 6 Reg't U. S. Colored Heavy Artillery.

Book mark:

D. A. Ward

(358)

Copyist.

*Elisha Holmes*

*Put*, Co. G, 2 Reg't Miss. Art'y.\*

Appears on

**Company Muster Roll**

for *Nov & Dec*, 1863.

Present or absent *Present*

Stoppage, \$ *100* for

Due Gov't, \$ *100* for

Valuation of horse, \$ *100*

Valuation of horse equipments, \$ *100*

Remarks:  
-----  
-----  
-----  
-----  
-----  
-----  
-----

\* This organization subsequently became Co. G, 6 Reg't U. S. Colored Heavy Artillery.

Book mark: -----

*D. A. [Signature]*

(358)

Copyist,

*Olisha Holmes*

*Pvt*, Co. G, 2 Reg't Miss. Art'y.\*

Appears on

**Company Muster Roll**

for *Jan & Feb*, 1864

Present or absent *Present*

Stoppage, \$ *100* for

Due Gov't, \$ *100* for

Valuation of horse, \$ *100*

Valuation of horse equipments, \$ *100*

Remarks:  
-----  
-----  
-----  
-----  
-----  
-----  
-----

\* This organization subsequently became Co. G, 6 Reg't U. S. Colored Heavy Artillery.

Book mark: -----

*L. J. Spann*

A

6 H. Art'y.

U.S.C.T.

*Olisha Holmes*

*Art*, Co. G, 5 Reg't U. S. Col'd H. Art'y.\*

Appears on

**Company Muster Roll**

for *March & Apr*, 1864

Present or absent.....

Stoppage, \$.....<sup>100</sup> for .....

Due Gov't, \$.....<sup>100</sup> for .....

Valuation of horse, \$.....<sup>100</sup>

Valuation of horse equipments, \$.....<sup>100</sup>

Remarks: *Deserted from  
Mather's Mias  
March 20"/64*

\* This organization subsequently became Co. G, 6 Reg't U. S. Col'd Heavy Artillery.

Book mark: .....

*L. Y. Spann*

(358)

Copyist.



*Elisha Holmes*

*Priv*, Co. *G*, \**5* Reg't U. S. Col'd *N. Arty.*

Appears on

**Descriptive List of Deserters**

dated *April 6*, 1864.

Deserted:

When *March 20*, 1864.

Where *Natchez Miss.*

Arrested:

When \_\_\_\_\_, 186 .

Where \_\_\_\_\_

Remarks : \_\_\_\_\_

\* *Became b.*

Book mark : \_\_\_\_\_

*R. S. Shelton*

A 16 A. art | U.S.C.T.

Elisha Holmes

Pvt., Co. G, 6 Reg't U. S. Col'd A. art

Appears on

**Descriptive List of Deserters**

dated Katchez Miss Mar 31, 1865.

Deserted:

When Mar 20, 1864.

Where Katchez Miss

Arrested:

When \_\_\_\_\_, 186 .

Where \_\_\_\_\_

Remarks: Returned Mar 16/65

Book mark: \_\_\_\_\_

G. M. Harmon

*H*

*Elisha Holmes*

*Private*, Co, G, 6 Reg't U. S. Col'd H. Art'y.

Appears on

**Company Muster Roll**

for *March & April*, 186*5*.

Present or absent *absent*

Stoppage, \$ *100* for

Due Gov't, \$ *100* for

Valuation of horse, \$ *100*

Valuation of horse equipments, \$ *100*

Remarks: *Returned from de-  
sertion March 17 - 65 -  
Confined in the mili-  
tary Prison in Hatchers Run  
since March 18 - 65*

Book mark:

*F. D. Neale*

A

6 H. Art'y.

U.S.C.T.

Elisha Holmes

Private, Co. G, 6 Reg't U. S. Col'd H. Art'y.

Appears on

Company Muster Roll

for May & June, 1865.

Present or absent absent

Stoppage, \$ 100 for

Due Gov't, \$ 100 for

Valuation of horse, \$ 100

Valuation of horse equipments, \$ 100

Remarks: Confined in  
Military Prison in  
Chatchez Miss. after  
being tried for deser-  
tion by general court  
marshal and sentenced  
to the loss of all pay  
and allowances now  
over

Book mark:

F. D. Neal

JAN. 14

6170717

★1891★

*due or that may become  
due for the period of (6)  
six months after trial.*

A.

6 H. Art'y.

U.S.C.T.

*Elisha Holmes*

*Pr-*, Co. G, 6 Reg't U. S. Col'd H. Art'y.

Appears on

**Company Muster Roll**

for *July 4<sup>th</sup> Aug*, 1865.

Present or absent *absent*

Stoppage, \$ *100* for

Due Gov't, \$ *100* for

Valuation of horse, \$ *100*

Valuation of horse equipments, \$ *100*

Remarks: *Confined in Military  
Prison Notches Miss by Services  
of G. C. M. for Desertion.*

Book mark:

*E. W. Foster*

*Elisha Holmes*

*Plt*, Co. *G*, *6* Reg't U. S. Col'd *A. art*

Appears on

**Descriptive List of Deserters**

dated *Natchez Miss* *Nov 3*, 1865.

Deserted:

When *July 9*, 1865.

Where *Natchez Miss*

Arrested:

When \_\_\_\_\_, 186 .

Where \_\_\_\_\_

Remarks: *Arrested from*  
*Military Prison*

Book mark: \_\_\_\_\_

*J. M. Harmon*

H

6 H. Art'y.

U.S.C.T.

Elisha Holmes

Priv., Co. G, 6 Reg't U. S. Col'd H. Art'y.

Appears on

Company Muster Roll

for Sept & Oct, 1865.

Present or absent

Stoppage, \$ 100 for

Due Gov't, \$ 100 for

Valuation of horse, \$ 100

Valuation of horse equipments, \$ 100

Remarks: Deserted from Military Prison for - McPherson Natches Miss July 9, 1865.

Book mark:

E. Weston



H

6 H. Art'y.

U.S.C.T.

<sup>60</sup>  
Elisha Holmes  
Capt., Co. G, 6 Reg't U. S. Col'd H. Art'y.

Appears on Returns as follows:

Mar 1864 (5<sup>th</sup> US Col'd  
H Art) Deserted  
Mar 20, 64 from  
Camp at Natchez  
Miss

Mar to July 1865 Gain  
Mar 17, 65 Natchez  
Miss from desertion  
at Natchez confined  
in Military Prison  
Natchez Miss since  
Mar 17, 65

(6<sup>th</sup> US Col'd H Art)  
Aug & Sept 1865 Ab-  
sent in Mil Pris-  
on at Natchez Miss  
since May 1865 by  
sentence of G. C. M.

Co F 1865 Deserted  
July 9, 65 from Mil-  
itary Prison Natchez Miss

Book mark:

(546)

A. G. England

Copyist.

20

6 H. Art'y.

U.S.C.T.

Elisha Holmes

Priv., Co. G, 6 Reg't U. S. Col'd H. Art'y.

Appears on Co. Muster-out Roll, dated

Natchez, Miss, May 13, 1866.

Muster-out to date \_\_\_\_\_, 1866.

Last paid to Dec 31, 1863.

Clothing account:

Last settled Sep 20, 1863; drawn since \$ 48 <sup>44</sup>/<sub>100</sub>

Due soldier \$ 100; due U. S. \$ 100

Am't for cloth'g in kind or money adv'd \$ 100

Due U. S. for arms, equipments, &c., \$ 100

Bounty paid \$ 100; due \$ 100

Remarks: Joined at original organization, Deserted Mch 20/64 at Natchez, Miss. Recovered from desertion Mch 23/65. Deserted second time July 9/65 at Natchez, Miss.

Book mark: 1268-CT/87.

M. O'Chance

No. 6 Reg. Arty | U.S. Art

Elisha Holmes

, Co. G, 6 Reg't U.S. Art.

**NOTATION.**

Book mark: 1268 - G. J. - 1887

**War Department,**

Adjutant General's Office,

Washington, Oct. 20, 1887.

Application for removal of the charge of desertion and  
for an honorable discharge has been denied.

E. P. Connerly

(437b)

Copyist.

Holmes <sup>Sha</sup> ~~Clifford~~

6, Co. G, 6 Reg't U.S.C.A.

Enclosures.

Bed Cards .....	Final Statements .....
Burial Records .....	Furloughs or L. of A. ....
Certs. of Dis. for Discharge .....	Med. Certificates .....
C. M. Charges .....	Med. Des. Lists .....
Descriptive Lists .....	Orders .....
Discharge Certificates .....	Pris. of War Record .....
Enlistment Papers .....	Resignations .....

Other papers relating to—

Admission to Hosp'l .....	Furlough or L. of A. ....
Casualty Sheet .....	Med. Examination .....
Confinement .....	Misc. Information .....
Contracts .....	Pay or Clothing .....
Death or Effects .....	Personal Reports .....
Desertion .....	Rank .....
Discharge from Hosp'l .....	Transfer to Hosp'l .....
Discharge from Service .....	Transfer to V. R. C. ....
Duty .....	Transportation .....

Elisha Holmes ✓

Pol. Co. "G" 6<sup>th</sup> Artillery

Report of Div of D. C.

Adjutant General's Office,

COLORED TROOPS BRANCH

Mr Ellinbrook

April 13<sup>th</sup>, 1875

Vol. C. T., 187

Wanted in case of Elisha Holmes

Private, Co. "G",

6<sup>th</sup> Reg't U. S. Colored Troops

Record of trial &c

Admt. "Confined in Military Prison Maches Miss by sentence of C. M. for desertion" - M. P. for May & June 1865

A. J. G.

Respectfully,

L. A. Woodward

Per J. Patton Chief Clerk

Adjutant General's Office,

Division of Discontinued Commands.

April 27<sup>th</sup>, 1875.

Vol. C. T., 187

Reply in case of Elisha Holmes

Co. "G";

6<sup>th</sup> Reg't U. S. C. T. (Reg't)

G.O. No 27 Rogers Dist of Maches May 18. 1865 -

Charge - Desertion - Findings - Guilty - Sentence -

"That he forfeit all pay and allowances now due or may become due for the period of six months, and that he be confined at hard labor at Fort M. Person Maches Miss, with a ball and chain on his leg for the period of six months, and make good the time lost by desertion, by serving a sufficient length of time after the expiration of his present term of service" - Approved

A. J. G.

Co. B, 6 U.S. Col'd H. Art'y

Private Private

CARD NUMBERS.

1	6154450	26
2	6163830	27
3	6163965	28
4	6164104	29
5	6164247	30
6	6164390	31
7	6164523	32
8	6164650	33
9	6164773	34
10	6164891	35
11	6165010	36
12	9119660	37
13	40742516	38
14		39
15		40
16		41
17		42
18		43
19		44
20		45
21		46
22		47
23		48
24		49
25		50

Book Mark: 2/13<sup>14</sup>/670

See also

*James Holmes*

....., Co. *D*, 6 Reg't U.S. Col'd H. Art'y.

Appears on

**Company Descriptive Book**

of the organization named above.

**DESCRIPTION.**

Age *19* years; height *5* feet *5 1/2* inches.

Complexion *Black*

Eyes *Black*; hair *Black*

Where born *Louisiana*

Occupation *Farmer*

**ENLISTMENT.**

When *Oct 26*, 186*4*.

Where *V.burg Miss*

By whom *Lt Col Knely*; term *3* y'rs.

Remarks: .....

.....  
.....  
.....  
.....  
.....  
.....  
.....  
.....  
.....  
.....

*J. Miles*



H

6 H. Art'y.

U.S.C.T.

James Holmea

Appears with rank of Put on

**Muster and Descriptive Roll of a Detachment of U. S. Vols. forwarded**

for the 6 Reg't U. S. Col'd H. Art'y. Roll dated Vicksburg, Miss, Oct 26, 1864

Where born La

Age 19 y'rs; occupation Farmer

When enlisted Oct 26, 1864

Where enlisted Vicksburg, Miss

For what period enlisted 3 years.

Eyes Blue; hair Black

Complexion Colored; height 5 3/4 ft. 2 in.

When mustered in Oct 26, 1864

Where mustered in

Bounty paid \$ 100 <sup>100</sup>; due \$ 200 <sup>100</sup>

Where credited Quota of 200

Company to which assigned

Remarks:

Book mark:

W. D. ...

(339)

Copyist.

*A*

6 H. Art'y. | U. S. C. T.

*James Holmes,*  
*Prvt.*, Co. D, 6 Reg't U. S. Col'd H. Art'y.

Appears on

**Company Muster Roll**

for *Nov. 7 Dec.*, 1864.

Joined for duty and enrolled:

When *Nov. 26*, 1864.\*

Where *Vicksburg Miss\**

Period *3* years.\*

Present or absent *Present*

Stoppage, \$ *100* for

Due Gov't, \$ *100* for

Valuation of horse, \$ *100*

Valuation of horse equipments, \$ *100*

Remarks :

\* See enrollment on card from muster-in roll.

Book mark :

(358c)

*Jenkins* Copist.

*James Holmes,*  
*Co. D, 6 Reg't U. S. Col'd H. Art'y.*

Appears on

**Company Muster Roll**

for *James V. Seby*, 186*5*.

Joined for duty and enrolled:

When *Nov. 26*, 186*4*.\*

Where *V. Burg Miss.* \*

Period *3* years.\*

Present or absent *Present*

Stoppage, \$ *100* for

Due Gov't, \$ *100* for

Valuation of horse, \$ *100*

Valuation of horse equipments, \$ *100*

Remarks :

.....  
.....  
.....  
.....

\* See enrollment on card from muster-in roll.

Book mark :

.....

(358c)

*Jenkins* Copist.

*James Holmes,*  
Co. D, 6 Reg't U. S. Col'd H. Art'y.

Appears on

Company Muster Roll  
for *Mech & Apl*, 186 *5*

Joined for duty and enrolled:

When *Nov. 26*, 186 *4*\*

Where *V<sup>n</sup> Burg Miss.*\*

Period *3* years.\*

Present or absent *Present*

Stoppage, \$ *100* for

Due Gov't, \$ *100* for

Valuation of horse, \$ *100*

Valuation of horse equipments, \$ *100*

Remarks :

\* See enrollment on card from muster-in roll.

Book mark :

(358c)

*Jenkins* Copist.

A

6 H. Art'y.

U. S. C. T.

James Holmes,  
Co. D, 6 Reg't U. S. Col'd H. Art'y.

Appears on

Company Muster Roll

for *May & June*, 186*5*.

Joined for duty and enrolled:

When *Nov 26*, 186*4*.\*

Where *Warburg Miss* \*

Period *3* years.\*

Present or absent *Present*

Stoppage, \$ *100* for

Due Gov't, \$ *100* for

Valuation of horse, \$ *100*

Valuation of horse equipments, \$ *100*

Remarks :

\* See enrollment on card from muster-in roll.

Book mark :

(358c)

*Jenkins*  
Copist.

James Holmes

Co. D, 6 Reg't U. S. Col'd H. Art'y.

Appears on

Company Muster Roll

for July & Aug, 1865

Joined for duty and enrolled:

When Nov. 26, 1864\*

Where Vicksburg Miss

Period 3 years.\*

Present or absent Present

Stoppage, \$ 100 for

Due Gov't, \$ 100 for

Valuation of horse, \$ 100

Valuation of horse equipments, \$ 100

Remarks :

-----  
-----  
-----  
-----

\* See enrollment on card from muster-in roll.

Book mark :

Superz.

H. | 6 H. Art'y. | U. S. C. T.

James Holmes  
Pr., Co. D, 6 Reg't U. S. Col'd H. Art'y.

Appears on

Company Muster Roll

for Sept - Oct, 186 2

Joined for duty and enrolled:

When Nov. 26, 186 4\*

Where Vicksburg Miss

Period 3 years.\*

Present or absent Present

Stoppage, \$ 100 for

Due Gov't, \$ 100 for

Valuation of horse, \$ 100

Valuation of horse equipments, \$ 100

Remarks :

\* See enrollment on card from muster-in roll.

Book mark :

Soper

(358c)

Copyst.

James Holms  
Prs, Co. D, 6 Reg't U. S. Col'd H. Art'y.

Appears on

Company Muster Roll

for Nov & Dec, 186 5

Joined for duty and enrolled:

When Nov. 26, 186 4\*

Where Vicksburg Miss\*

Period 3 years.\*

Present or absent Present.

Stoppage, \$ 100 for

Due Gov't, \$ 100 for

Valuation of horse, \$ 100

Valuation of horse equipments, \$ 100

Remarks :

\* See enrollment on card from muster-in roll.

Book mark :

(358c)

Soper

Copyist.



*James Holms*  
Prvt., Co. D, 6 Reg't U. S. Col'd H. Art'y.

Appears on

**Company Muster Roll**  
for *Jan & Feb*, 1866

Joined for duty and enrolled:

When *Nov. 26*, 1864\*  
Where *Dicksburg Miss*  
Period *3* years.\*

Present or absent *Present*

Stoppage, \$ *100* for

Due Gov't, \$ *100* for

Valuation of horse, \$ *100*

Valuation of horse equipments, \$ *100*

Remarks :  
-----  
-----  
-----  
-----  
-----

\* See enrollment on card from muster-in roll.

Book mark :  
-----

*Lopez.*

*H.*

6 H. Art'y. | U. S. C. T.

*James Hobbs*  
Co. D, 6 Reg't U. S. Col'd H. Art'y.

Appears on

**Company Muster Roll**

for *March & April*, 186*6*

Joined for duty and enrolled:

When *Nov. 26*, 186*6* \*

Where *Vicksburg Miss\**

Period *3* years.\*

Present or absent *Present*

Stoppage, \$ *100* for

Due Gov't, \$ *100* for

Valuation of horse, \$ *100*

Valuation of horse equipments, \$ *100*

Remarks :

-----  
-----  
-----  
-----

\* See enrollment on card from muster-in roll.

Book mark : *Page 10*

*Saper*

A

6 H. Art'y.

U.S.C.T.

James Holmes  
Pvt, Co H, 6 Reg't U. S. Col'd H. Art'y.

Appears on Returns as follows:

Nov 1864 Garrison by  
Enlistment Roll  
3,64 Katchez Miss

Book mark:

(546) *A. Gould* Copyist.

James Holmes

Co. 20, 6 Reg't U. S. Col'd H. Art'y.

Appears on Co. Muster-out Roll, dated  
Katchez Miss, May 13, 1866.

Muster-out to date May 13, 1866.

Last paid to Dec 31, 1866.

Clothing account:

Last settled....., 186 ; drawn since \$..... 100

Due soldier \$ 14 <sup>92</sup>/<sub>100</sub>; due U. S. \$..... 100

Am't for cloth'g in kind or money adv'd \$..... 100

Due U. S. for arms, equipments, &c., \$..... 100

Bounty paid \$ 100 <sup>100</sup>/<sub>100</sub>; due \$..... 100

Remarks: Joined as Recruit

Book mark: B 14  
670

J. W. Tucker  
Copyist.

Holmes, James

, Co. ; 6 Reg't N.C.H.A.

2 Enclosures.

Bed Cards .....	Final Statements .....
Burial Records .....	Furloughs or L. of A. ....
Certs. of Dis. for Discharge .....	Med. Certificates .....
C. M. Charges .....	Med. Des. Lists .....
Descriptive Lists .....	Orders .....
Discharge Certificates .....	Pris. of War Record .....
Enlistment Papers .....	Resignations .....

Other papers relating to—

Admission to Hosp'l .....	Furlough or L. of A. ....
Casualty Sheet .....	Med. Examination .....
Confinement .....	Misc. Information .....
Contracts .....	Pay or Clothing .....
Death or Effects .....	Personal Reports .....
Desertion .....	Rank .....
Discharge from Hosp'l .....	Transfer to Hosp'l .....
Discharge from Service .....	Transfer to V. R. C. ....
Duty .....	Transportation .....

NOTE 1.—This blank will be used for both enlistments and re-enlistments—enlistment of veterans, &c., &c., in the volunteer service. They will be made out in duplicate in all cases—one to accompany the recruiting return of the superintendent (not the recruiting officer) to the Adjutant General, and one to accompany the accounts of the officer who pays bounty, &c. The Regiment and Company in which the soldier last served should be given on the back.

NOTE 2.—An enlistment holds to service. A muster-in must, in all cases, precede payment of pay, bounty, pension, &c. A muster-in roll must, in all cases, be filed in the Adjutant General's Office as evidence of muster-in. The mustering officer, commissary, or assistant commissary of musters, as the case may be, will countersign both enlistments as having mustered the soldier into the service of the United States before either of them is given to the disbursing officer.

DECLARATION OF RECRUIT.

I, James Holmes, desiring to VOLUNTEER as a Soldier in the Army of the United States, for the term of THREE YEARS, Do Declare, That I am nineteen years and X months of age; that I have never been discharged from the United States service on account of disability or by sentence of a court martial, or by order before the expiration of a term of enlistment; and I know of no impediment to my serving honestly and faithfully as a soldier for three years.

GIVEN at Vicksburg, Miss the 26 day of October 1864

Witness: A. O. Dyson James Holmes  
Master

No. \_\_\_\_\_  
James Holmes  
 Volunteered at Vicksburg, Miss  
26<sup>th</sup> October, 1864  
 By Wm. C. Brimley  
 Capt. 1st Regiment of  
Miss  
 \_\_\_\_\_  
 enlistment; last served in Company ( )  
 Reg't of \_\_\_\_\_  
 Discharged \_\_\_\_\_, 18 \_\_\_\_\_

CONSENT IN CASE OF MINOR.

I, \_\_\_\_\_, Do CERTIFY, That I am \_\_\_\_\_ the \_\_\_\_\_ of \_\_\_\_\_; that the said \_\_\_\_\_ is \_\_\_\_\_ years of age; and I do hereby freely give my CONSENT to his volunteering as a SOLDIER in the ARMY OF THE UNITED STATES for the period of THREE YEARS.

GIVEN at \_\_\_\_\_ the \_\_\_\_\_ day of \_\_\_\_\_

Witness: \_\_\_\_\_

VOLUNTEER ENLISTMENT.

STATE OF

Mississippi



TOWN OF

Vicksburg

I, James Holmes, born in \_\_\_\_\_

in the State of Louisiana, aged nineteen years,

and by occupation a Farmer, Do HEREBY ACKNOWLEDGE to have

volunteered this Twenty sixth day of October, 1864,

to serve as a **Soldier** in the **Army of the United States of America**, for the period of **THREE YEARS**, unless sooner discharged by proper authority:

Do also agree to accept such bounty, pay, rations, and clothing, as are, or may be, established by law for volunteers. And I, James Holmes, do

solemnly swear, that I will bear true faith and allegiance to the **United States of America**, and that I will serve them honestly and faithfully against all

their enemies or opposers whomsoever; and that I will observe and obey the orders of the President of the United States, and the orders of the officers

appointed over me, according to the Rules and Articles of War.

Sworn and subscribed to, at Vicksburg this 26 day of October, 1864

BEFORE

Eli C Kinch  
St Col Capt & Marshal

James Holmes  
Witness N. O. Synson

I CERTIFY, ON HONOR, that I have carefully examined the above-named Volunteer, agreeably to the General Regulations of the Army, and that, in my opinion, he is free from all bodily defects and mental infirmity, which would in any way disqualify him from performing the duties of a soldier.

H. C. Huntman  
Surg 30<sup>th</sup> U.S. Regt  
EXAMINING SURGEON.

I CERTIFY, ON HONOR, That I have minutely inspected the Volunteer James Holmes previously to his enlistment, and that he was entirely sober when enlisted; that, to the best of my judgment and belief, he is of lawful age; and that, in accepting him as duly qualified to perform the duties of an able-bodied soldier, I have strictly observed the Regulations which govern the recruiting service. This soldier has Blue eyes, Black hair, Colored complexion, is five feet five  $\frac{1}{2}$  inches high.

St Col Eli C Kinch  
apt & Marshal of Mass  
Regiment of Mississippi Volunteers,  
Dist of Mississippi RECRUITING OFFICER.

(A. G. O. No. 74 & 76.)

*Entitled to Bounty*

*Sample*

Mustered into the service of the United States, for three years or during the war from date of enlistment, in Company \_\_\_\_\_  
Regiment of 4th Mississippi Volunteers, on the 26 day of Oct, 1864, at Wallingburg  
Wallingburg  
Mississippi

NOTE 1.—This blank will be used for both enlistments and re-enlistments—enlistment of veterans, &c., &c., in the volunteer service. They will be made out in duplicate in all cases—one to accompany the recruiting return of the superintendent (not the recruiting officer) to the Adjutant General, and one to accompany the accounts of the officer who pays bounty, &c. The Regiment and Company in which the soldier last served should be given on the back.

NOTE 2.—An enlistment holds to service. A muster-in must, in all cases, precede payment of pay, bounty, pension, &c. A muster-in roll must, in all cases, be filed in the Adjutant General's Office as evidence of muster-in. The mustering officer, commissary, or assistant commissary of musters, as the case may be, will countersign both enlistments as having mustered the soldier into the service of the United States before either of them is given to the disbursing officer.

DECLARATION OF RECRUIT.

I, James Holmes, desiring to VOLUNTEER as a Soldier in the Army of the United States, for the term of THREE YEARS, Do Declare, That I am Nineteen years and X months of age; that I have never been discharged from the United States service on account of disability or by sentence of a court martial, or by order before the expiration of a term of enlistment; and I know of no impediment to my serving honestly and faithfully as a soldier for three years.

GIVEN at Vicksburg Miss the 29 day of October 1864

Witness: A. C. Johnson James Holmes *mark*

Rec'd from 2nd. Aud. May 13th 1893

enlistment; last served in Company ( )  
Reg't of \_\_\_\_\_  
Discharged \_\_\_\_\_, 18\_\_

No. 224  
James Holmes  
Volunteered at Vicksburg Miss  
29 October, 1864  
By Wm. C. ...  
Regiment of Miss

CONSENT IN CASE OF MINOR.

I, \_\_\_\_\_, Do CERTIFY, That I am the \_\_\_\_\_ of \_\_\_\_\_; that the said \_\_\_\_\_ is \_\_\_\_\_ years of age; and I do hereby freely give my CONSENT to his volunteering as a SOLDIER in the ARMY OF THE UNITED STATES for the period of THREE YEARS.

GIVEN at \_\_\_\_\_ the \_\_\_\_\_ day of \_\_\_\_\_

Witness: \_\_\_\_\_

( A. G. O. No. 74 & 76. )



VOLUNTEER ENLISTMENT.

STATE OF

Mississippi

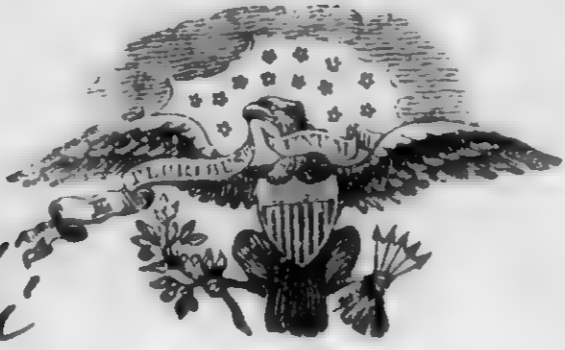

TOWN OF

Vicksburg

I, James Holmes, born in \_\_\_\_\_, in the State of Louisiana, aged Nineteen years, and by occupation a Farmer, Do HEREBY ACKNOWLEDGE to have volunteered this Twenty Sixth day of October, 1864, to serve as a Soldier in the Army of the United States of America, for the period of THREE YEARS, unless sooner discharged by proper authority: Do also agree to accept such bounty, pay, rations, and clothing, as are, or may be, established by law for volunteers. And I, James Holmes, do solemnly swear, that I will bear true faith and allegiance to the United States of America, and that I will serve them honestly and faithfully against all their enemies or opposers whomsoever; and that I will observe and obey the orders of the President of the United States, and the orders of the officers appointed over me, according to the Rules and Articles of War.

Entitled to Bounty

Sworn and subscribed to, at Vicksburg, Mississippi, this 26 day of October, 1864, before Eli C. Kinsley, Notary Public, and Stobart P. Marshall, Clerk of the Court.

I CERTIFY, ON HONOR, That I have carefully examined the above-named Volunteer, agreeably to the General Regulations of the Army, and that, in my opinion, he is free from all bodily defects and mental infirmity, which would in any way disqualify him from performing the duties of a soldier.

H. C. Huntman, Surg 50th U.S. Inf., Examining Surgeon.

I CERTIFY, ON HONOR, That I have minutely inspected the Volunteer James Holmes previously to his enlistment, and that he was entirely sober when enlisted; that, to the best of my judgment and belief, he is of lawful age; and that, in accepting him as duly qualified to perform the duties of an able-bodied soldier, I have strictly observed the Regulations which govern the recruiting service. This soldier has Blue eyes, Blue hair, Colored complexion, is five feet five 1/2 inches high.

Lt Col Eli C. Kinsley, APT of Stobart P. Marshall of Miss, Regiment of Volunteers, Dist of Miss and RECRUITING OFFICER.

(A. G. O. No. 74 & 76.)

Mustered into the service of the United States, for three years or during the war, from date of enlistment, in Company \_\_\_\_\_, Regiment of \_\_\_\_\_ Volunteers, on the 26 day of October, 1864 at Vicksburg, Miss.

Single

Stobart P. Marshall, Clerk of the Court, Vicksburg, Miss.

*W. J. Jones*

# 6 U.S. Col'd H. Art'y.

*Private Corporal*

## CARD NUMBERS.

1	6175660	26
2	6175762	27
3	6175863	28
4	6175996	29
5	6176113	30
6	6176229	31
7	6176342	32
8	6176501	33
9	6176622	34
10	6176742	35
11	6176820	36
12	6176955	37
13	6177046	38
14	6177154	39
15	6177262	40
16	6177370	41
17	9120715-	42
18	40942517	43
19		44
20		45
21		46
22		47
23		48
24		49
25		50

Book Mark:

See also:

*James Holmes*  
Co. *K*, 6 Reg't U. S. Col'd H. Art'y.

Appears on

**Company Descriptive Book**  
of the organization named above.

**DESCRIPTION.**

Age *20* years; height *5* feet *2* inches.

Complexion *Dark*

Eyes *Black*; hair *Black*

Where born *Jefferson Co Miss*

Occupation *Soldier*

**ENLISTMENT.**

When *Jan 1*, 1864.

Where *Statcher Miss*

By whom *Capt Kemper*; term *3* y'rs.

Remarks: *Appointed Capt March 11<sup>th</sup>*  
*1864. Reduced Jan 1<sup>st</sup> 1865*  
*Appointed Capt Aug 19<sup>th</sup> 1865*

*J. Hillier*  
(383g) Coppist.

H | 6 H. Art'y. U.S.C.T.

John Holmes

Co. A, 2 Reg't Miss. Art'y.†

Age 20 years.

Appears on

Company Muster-in Roll

of the organization named above. Roll dated

Natchez Miss Jan 8, 1864.

Muster-in to date

Jan 1, 1864.

Joined for duty and enrolled:

When

Jan 1, 1864.

Where

Natchez Miss \*

Period 3 years.\*

Valuation of horse, \$ 100

Valuation of horse equipments, \$ 100

Remarks:

† This organization subsequently became Co. A, 6 Reg't U. S. Colored Heavy Artillery.

\* \* \* Muster-in roll shows enrollment of all men of this company as of same date and place. See enrollment on subsequent card or cards.

Book mark:

Handwritten signature

*John Holmes*  
-----  
*Priv* Co. K, 2 Reg't Miss. Artillery.†

Appears on

**Company Muster Roll**  
for *Jan 8<sup>th</sup> to July 29<sup>th</sup>*, 1864.

Joined for duty and enrolled:

When *Jan 1<sup>st</sup>*, 1864.\*

Where *Natchez Miss* \*

Period *3* years.\*

Present or absent *present*

Stoppage, \$ *100* for

Due Gov't \$ *100* for

Valuation of horse, \$ *100*

Valuation of horse equipments, *100*

Remarks:-----  
-----  
-----

†This organization subsequently became Co. K, 6 Reg't U. S. Colored H. Art'y.  
\* See enrollment on card from muster-in roll.

Book mark:-----  
-----

*J. J. [Signature]*  
-----  
(358c) Copyist.

*John Holmes*  
C<sup>o</sup>pl, Co. *K* 5 Reg't U. S. Col'd H. Art'y.\*  
Appears on

**Company Muster Roll**

for *Mar - Apr*, 186*4*\*

Joined for duty and enrolled:

When *Jan 1<sup>st</sup>*, 186*4*\*

Where *Natchez Miss*\*

Period *3* years.\*

Present or absent *Present*

Stoppage, \$ *100* for

Due Gov't, \$ *100* for

Valuation of horse, \$ *100*

Valuation of horse equipments, \$ *100*

Remarks: *Promoted to Corp'l  
May 4/64 by order of Maj  
Chas W. Smith Comdr  
Regt*

\* This organization subsequently became Co. *6* Reg't U. S. Col'd Heavy Artillery.  
\* ~~See~~ See enrollment on card from muster-in roll.

Book mark : .....

*[Signature]*

*A*

6 H. Art'y.

U.S.C.T.

*John Holmes*

*Capt.*, Co. K, 6 Reg't U. S. Col'd H. Art'y.

Appears on

**Company Muster Roll**

for *May - June*, 186*4*.

Joined for duty and enrolled:

When *Jan 1\**, 186*4*.\*

Where *Natchez Miss* \*

Period *3* years.\*

Present or absent *present*

Stoppage, \$ *100* for

Due Gov't \$ *100* for

Remarks:

\* ~~See~~ See enrollment on card from muster-in roll.

Book mark:

(358c)

*Spiles*

Copyist.

26

6 H. Art'y.

U.S.C.T.

*John Holmes*

*Capt*, Co. K, 6 Reg't U. S. Col'd H. Art'y.

Appears on

**Company Muster Roll**

for *July & Aug*, 186*7*.

Joined for duty and enrolled:

When *Jan 1*, 186*7*.\*

Where *Trachen Miss* \*

Period *3* years.\*

Present or absent *present*

Stoppage, \$ *100* for

Due Gov't \$ *100* for

Remarks: *Stoppage for one cent*  
*(# 00 34)*

\* See enrollment on card from muster-in roll.

Book mark: *300 100*

*J. H. [Signature]*

(358c)

Copyist.



*JH*

6 H. Art'y.

U.S.C.T.

*John Holmes*  
*Corp*, Co. K, 6 Reg't U. S. Col'd H. Art'y.

Appears on

**Company Muster Roll**

for *Sept & Oct*, 1864.

Joined for duty and enrolled:

When *Jan 1*, 1864.\*

Where *Natchez, Miss.*\*

Period *3* years.\*

Present or absent *Present*

Stoppage, \$ *100* for

Due Gov't \$ *100* for

Remarks: *Stoppage for C. & G. E. (\$0.65)*

\* See enrollment on card from muster-in roll.

Book mark:

(358c)

*J B Gage*

Copyist.

A

6 H. Art'y.

U.S.C.T.

*John Holmes*  
Coptl, Co. K, 6 Reg't U. S. Col'd H. Art'y.

Appears on

**Company Muster Roll**

for *Nov. and Dec.*, 1864.

Joined for duty and enrolled:

When *Jan. 1*, 1864.\*

Where *Natchez, Miss.* \*

Period *3* years.\*

Present or absent *Present*

Stoppage, \$ *100* for

Due Gov't \$ *100* for

Remarks:

-----  
-----  
-----  
-----  
-----  
-----

\* See enrollment on card from muster-in roll.

Book mark:

*C. G. Powell*

(358c)

Copyist.

H

6 H. Art'y.

U.S.C.T.

*John Holmes*  
Private, Co. K, 6 Reg't U. S. Col'd H. Art'y.

Appears on

**Company Muster Roll**  
for *Jan. and Feb*, 186*5*.

Joined for duty and enrolled:

When *Jan. 1*, 186*4*.\*

Where *Natchez, Miss.* \*

Period *3* years.\*

Present or absent *Present*

Stoppage, \$ *100* for

Due Gov't \$ *100* for

Remarks:

-----  
-----  
-----  
-----  
-----

\* See enrollment on card from muster-in roll.

Book mark: -----

*C. G. Powell*  
Copyist.

(358c)

14

6 H. Art'y.

U.S.C.T.

*John Holmes*  
*Private*, Co. K, 6 Reg't U. S. Col'd H. Art'y.

Appears on

**Company Muster Roll**

for *March and April*, 1865.

Joined for duty and enrolled:

When *Jan. 1*, 1864.\*

Where *Natchez, Miss.*\*

Period *3* years.\*

Present or absent *Present*

Stoppage, \$ *100* for

Due Gov't \$ *100* for

Remarks:  
\_\_\_\_\_  
\_\_\_\_\_  
\_\_\_\_\_  
\_\_\_\_\_  
\_\_\_\_\_

\* See enrollment on card from muster-in roll.

Book mark: \_\_\_\_\_

*C. G. Powell*

(358c)

Copyist.

*John Holmes*  
Private, Co. K, 6 Reg't U. S. Col'd H. Art'y.

Appears on

**Company Muster Roll**

for *May and June*, 186*5*.

Joined for duty and enrolled:

When *Jan. 1*, 186*4*.\*

Where *Natchez, Miss.* \*

Period *3* years.\*

Present or absent *Present*

Stoppage, \$ *100* for

Due Gov't \$ *100* for

Remarks:

-----  
-----  
-----  
-----  
-----

\* See enrollment on card from muster-in roll.

Book mark: -----

*C. G. Powell*

(358c)

Copyist.

H

6 H. Art'y.

U.S.C.T.

*John Holmes*  
Cpl, Co. K, 6 Reg't U. S. Col'd H. Art'y.

Appears on

**Company Muster Roll**

for *July and Aug.*, 186*5*.

Joined for duty and enrolled:

When *Jan. 1.*, 186*4*.\*

Where *Natchez, Miss* \*

Period *3* years.\*

Present or absent *Present*

Stoppage, \$ *100* for

Due Gov't \$ *100* for

Remarks:

*Promoted to Cpl Aug. 19/65  
Miss Baker u-  
duced stoppage for food  
lost 60c*

*Added may 2/65*

\* See enrollment on card from muster-in roll.

Book mark:

*C. Powell*

(358c)

Copyist.

17

6 H. Art'y.

U.S.C.T.

*John W. Holmes*  
Co. K, 6 Reg't U. S. Col'd H. Art'y.

Appears on

**Company Muster Roll**

for *Sept & Oct*, 1865.

Joined for duty and enrolled:

When *Jan 1st*, 1864.\*

Where *Walden, Miss.*\*

Period *3* years.\*

Present or absent *Present*

Stoppage, \$ *100* for

Due Gov't \$ *100* for

Remarks:

-----  
-----  
-----  
-----  
-----  
-----

\* See enrollment on card from muster-in roll.

Book mark:

-----

*J. W. Holmes*

(358c)

Copyist.

*John M. Colman*  
Co. K, 6 Reg't U. S. Col'd H. Art'y.

Appears on

**Company Muster Roll**

for *Nov & Dec*, 1865.

Joined for duty and enrolled:

When *Jan 1st*, 1864\*

Where *Natchez Miss\**

Period *3* years.\*

Present or absent *Present*

Stoppage, \$ *100* for

Due Gov't \$ *100* for

Remarks:  
\_\_\_\_\_  
\_\_\_\_\_  
\_\_\_\_\_  
\_\_\_\_\_

\* See enrollment on card from muster-in roll.

Book mark: \_\_\_\_\_

*[Signature]*  
(358c) Copyist.



24

6 H. Art'y.

U.S.C.T.

*John Tolson*  
Capt, Co. K, 6 Reg't U. S. Col'd H. Art'y.

Appears on

**Company Muster Roll**

for *Jan & Feby*, 1866.

Joined for duty and enrolled:

When *Jan 1*, 1864.\*

Where *Wutchez Miss\**

Period *3* years.\*

Present or absent *Present*

Stoppage, \$ *100* for

Due Gov't \$ *100* for

Remarks:  
\_\_\_\_\_  
\_\_\_\_\_  
\_\_\_\_\_  
\_\_\_\_\_  
\_\_\_\_\_

\* See enrollment on card from muster-in roll.

Book mark: \_\_\_\_\_

*W. L. Houston*

(358c)

Copyist.

04

6 H. Art'y.

U.S.C.T.

*John Holmes*  
Sgt., Co. K, 6 Reg't U. S. Col'd H. Art'y.

Appears on

**Company Muster Roll**

for *March & April*, 1866.

Joined for duty and enrolled:

When *Jan 1*, 1864.\*

Where *Natchez Miss\**

Period *3* years.\*

Present or absent *Present*

Stoppage, \$ *100* for

Due Gov't \$ *100* for

Remarks: *Stoppage for  
Ordinance No. 17105*

\* See enrollment on card from muster-in roll.

Book mark:

*J. P. Harrison*

(358c)

Copyist.

John <sup>x</sup> Holmes  
Capt, Co. K, 6 Reg't U. S. Col'd H. Art'y.

Appears on Returns as follows:

Oct 1865 - On daily  
duty at Post  
Company Oct 25, 65

Nov 1865 - On duty at  
C.S. Dept. order of  
M. H. Smith Nov  
7, 65

Dec 1865 - Absent on  
det. serv. at C.S.  
Dept. S.O. 77 dated  
Oct 24, 65

Salary received

Book mark:

(546)

A. Douglas

Copyist.

H

6 H. Art'y.

U.S.C.T.

*John Holmes*  
Corp, Co. K, 6 Reg't U. S. Col'd H. Art'y.

Appears on **Co. Muster-out Roll**, dated  
*Natchez, Miss, May 13, 1866.*  
Muster-out to date *May 13, 1866.*  
Last paid to *Dec. 31, 1865.*

Clothing account:

Last settled....., 186 ; drawn since \$..... 100

Due soldier \$ *37* <sup>*76*</sup>/<sub>100</sub>; due U. S. \$..... 100

Am't for cloth'g in kind or money adv'd \$..... 100

Due U. S. for arms, equipments, &c., \$ *1* <sup>*05*</sup>/<sub>100</sub>

Bounty paid \$..... 100; due \$..... 100

Remarks: *Joined original org-  
anization.  
Promoted Corp. Aug. 20, 1865*

Book mark:

*G. W. Chase*

(361)

Copyist.

Holmes, John

P, Co. K, 6 U.S.C.H.A.

1 Enclosures.

Bed Cards	Descriptive Lists
Burial Records	Final Statements
Certs. of Dis. for Discharge	Furloughs
C. M. Charges	Med. Des. Lists
Med. Certificates	Orders

Other papers relating to—

Admission to Hosp'l	Furlough
Casualty Sheet (Officer's)	Med. Examination
Confinement	Misc. Information
Contracts	Pay or Clothing
Death or Effects	Personal Reports
Desertions	Rank
Discharge from Hosp'l	Transfer to Hosp'l
Discharge from Service	Transfer to V. R. C.
Duty	Transportation

Hd. Qrs. Post Hatching  
Oct. 24, 1865-

Special Orders  
No 77, Ex IIIIII

~~Deputy~~ ~~for~~ ~~of~~  
Holmes to be on  
daily duty

7  
Lieut. Gen. Post <sup>as</sup> Surgeon of Surgery  
Boston Mass Oct 24/63.

Special Order }  
to 77 } Contract

THE Private House of the  
"Hon. G. Post, Surgeon" is hereby notified to make  
arrangements in due order as ordered and  
will report to Post at the office of the  
Surgeon of Surgery without unnecessary delay

is a Contract of the U.S. with the Contract  
of the Contract of the Contract

Contract of the  
Contract of the

C. O. 6" U.S. Col. Art. Heavy.

*Johnes Rufus*  
Co D, 6 U.S. Col'd H. Art'y

*Private Private*

CARD NUMBERS.

1	61627591	28
2	6162903	27
3	6163052	28
4	6163193	29
5	6163322	30
6	6163459	31
7	6163585	32
8	6163707	33
9	6163834	34
10	6163969	35
11	6164108	36
12	6164249	37
12	6164385	38
14	6164519	39
15	6164646	40
16	6164769	41
17	6164887	42
18	6165006	43
19	9119559	44
20		45
21		46
22		47
23		48
24		49
25		50

Book Mark: \_\_\_\_\_

See also \_\_\_\_\_



*Rufus Holmes*  
....., Co. *D*, 6 Reg't U. S. Col'd H. Art'y.

Appears on  
**Company Descriptive Book**  
of the organization named above.

**DESCRIPTION.**

Age *18* years; height *5* feet *4* inches.

Complexion *Black*

Eyes *Black*; hair *Black*

Where born *Woodbury Miss*

Occupation *F*

**ENLISTMENT.**

When *Aug 31*....., 186*3*.

Where *Washen Miss*

By whom *Capt. A. B. ...*; term *3* y'rs.

Remarks:.....  
.....  
.....  
.....  
.....  
.....  
.....  
.....  
.....  
.....

*[Signature]*

*Rufus Holmes*  
No. *2*, Co. *D*, 2 Reg't Miss. Art'y. †

Age *18* years.

Appears on

**Company Muster-in Roll**

of the organization named above. Roll dated

*Natchez Miss. Sept 12, 1863.*

Muster-in to date

*Sept 12, 1863.*

Joined for duty and enrolled:

When

*Aug 31, 1863.\**

Where

*Natchez Miss.\**

Period

*3* years.\*

Valuation of horse, \$ *100*

Valuation of horse equipments, \$ *100*

Remarks:

† This organization subsequently became Co. *D*, 6 Reg't U. S. Colored Heavy Artillery.

\* \* \* Muster-in roll shows enrollment of all men of this company as of same date and place. See enrollment on subsequent card or cards.

Book mark:

*L. B. Sayre*  
Copyist.

*N.*

6 H. Art'y.

U.S.C.T.

*Rufus Holmes*

*Cpt.*, Co. D, 2 Reg't Miss. Art'y.†

Appears on

**Company Muster Roll**

for *Sept. 12, to Oct. 31*, 1863.

Joined for duty and enrolled:

When *Aug. 31*, 186 .\*

Where *Natchez, Miss.* \*

Period *3* years.\*

Present or absent *Present*

Stoppage, \$ *100* for

Due Gov't, \$ *100* for

Remarks:

† This organization subsequently became Co. D, 6 Reg't U. S. Colored Heavy Artillery.

\* See enrollment on card from muster-in roll.

Book mark:

*Kuyler*

*Rufus Holmes*  
Co. *D*, 2 Reg't Miss. Artillery.†

Appears on

Company Muster Roll  
for *Nov & Dec*, 186*3*.

Joined for duty and enrolled:

When *Aug 31*, 186*3*.\*

Where *Hatchers Mill* \*

Period *3* years.\*

Present or absent *Present*

Stoppage, \$ *100* for

Due Gov't \$ *100* for

Valuation of horse, \$ *100*

Valuation of horse equipments, *100*

Remarks:

† This organization subsequently became Co. *D*, 6 Reg't U. S. Col'd Heavy Artillery.

\* See enrollment on card from muster-in roll.

Book mark:

(358c)

*L. B. Sawyer*  
Copyist.

*L*

6 H. Art'y. U.S.C.T.

*Rufus Holmes*

*Pvt.*, Co. D, 2 Reg't Miss. Art'y.†

Appears on

Company Muster Roll

for *Jan'y & Feb.*, 186*4*.

Joined for duty and enrolled:

When *Aug 31*, 186*3*.\*

Where *Walden Mass* \*

Period *3* years.\*

Present or absent *Present*

Stoppage, \$ *100* for

Due Gov't, \$ *100* for

Remarks:

.....  
.....  
.....  
.....

† This organization subsequently became Co. D, 6 Reg't U. S. Colored Heavy Artillery.  
\* See enrollment on card from muster-in roll.

Book mark:

*L B Singer*  
Copyist.

(358c)

*H*

6 H. Art'y.

U.S.C.T.

*Rufus Holmes*

*Co. D*, 5 Reg't U. S. Col'd H. Art'y.†

Appears on

**Company Muster Roll**

for *Meck & aff*, 1864

Joined for duty and enrolled:

When *Aug 31*, 1863.\*

Where *Watches Mass* \*

Period *3* years.\*

Present or absent *Present*

Stoppage, \$ *100* for

Due Gov't \$ *100* for

Valuation of horse, \$ *100*

Valuation of horse equipments, *100*

Remarks:

-----  
-----

†This organization subsequently became Co. *D*, 6 Reg't U. S. Colored Heavy Artillery.

\* ~~See~~ See enrollment on card from muster-in roll.

Book mark:

*A. B. Sayer*  
Copyist.

(358c)

*Rufus Holmes*  
Comd, Co. D, 6 Reg't U. S. Col'd H. Art'y.

Appears on

**Company Muster Roll**

for *May & June*, 186*4*.

Joined for duty and enrolled:

When *August*, 186*3*.\*

Where *Natchez Miss* \*

Period *3* years.\*

Present or absent *Present*

Stoppage, \$ *100* for

Due Gov't, \$ *100* for

Valuation of horse, \$ *100*

Valuation of horse equipments, \$ *100*

Remarks :

-----  
-----  
-----  
-----  
-----

\* See enrollment on card from muster-in roll.

Book mark :

*L. B. Sawyer*  
Copyst.

*Rufus Holmes*  
 *Pvt.* , Co. D, 6 Reg't U. S. Col'd H. Art'y.

Appears on

**Company Muster Roll**

for  *July & Aug.* , 186*4*.  
Joined for duty and enrolled:

When  *Aug. 31* , 186*3*.\*

Where  *Matchez Miss.* \*

Period  *3*  years.\*

Present or absent  *Present*

Stoppage, \$  *100*  for

Due Gov't, \$  *100*  for

Valuation of horse, \$  *100*

Valuation of horse equipments, \$  *100*

Remarks  *Stoppage of pay  
23 cts. losing and  
screw driver.*

\*~~See~~ See enrollment on card from muster-in roll.

Book mark :

*Jackson*  Copyist.



A

6 H. Art'y.

U. S. C. T.

*Rufus Holmes,*   
 *Pvt.,*  Co. D, 6 Reg't U. S. Col'd H. Art'y.

Appears on

**Company Muster Roll**

for  *Sept & Oct,*  186*4.*

Joined for duty and enrolled:

When  *Aug. 31* , 186*3.\**

Where  *Watauga Miss.,* \*

Period  *3*  years.\*

Present or absent  *Present,*

Stoppage, \$  *100*  for

Due Gov't, \$  *100*  for

Valuation of horse, \$  *100*

Valuation of horse equipments, \$  *100*

Remarks  *Stoppage of pay*   
 *23 cts. living served*   
 *driver.*

\* See enrollment on card from muster-in roll.

Book mark :

(258c)

*Jenkins*

Copyist.

*A*

6 H. Art'y.

U. S. C. T.

*Rufus Holmes,*

, Co. D, 6 Reg't U. S. Col'd H. Art'y.

Appears on

Company Muster Roll

for *Nov. & Dec.*, 1864.

Joined for duty and enrolled:

When *Aug. 31*, 1863.\*

Where *Matchez Miss.*

Period *3* years.\*

Present or absent *Present*

Stoppage, \$ *100* for

Due Gov't, \$ *100* for

Valuation of horse, \$ *100*

Valuation of horse equipments, \$ *100*

Remarks:

\* See enrollment on card from muster-in roll.

Book mark:

(358c)

*Jenkins*  
Copist.

A

6 H. Art'y.

U. S. C. T.

Rufus Holmes,  
Co. D, 6 Reg't U. S. Col'd H. Art'y.

Appears on

Company Muster Roll

for *Jan'y & Feby*, 1865.

Joined for duty and enrolled:

When *Aug. 31*, 1863.\*

Where *Matchez Miss.\**

Period *3* years.\*

Present or absent *Present*

Stoppage, \$ *100* for

Due Gov't, \$ *100* for

Valuation of horse, \$ *100*

Valuation of horse equipments, \$ *100*

Remarks :

\* See enrollment on card from muster-in roll.

Book mark :

(358c)

*Jenkins*

Copist.

*Rufus Holmes,*   
Co. D, 6 Reg't U. S. Col'd H. Art'y.

Appears on

Company Muster Roll  
for  *Mch & Apt* , 1865.

Joined for duty and enrolled:

When  *Aug. 31* , 1863\*

Where  *Natchez Miss.*

Period  *3*  years.\*

Present or absent  *Present*

Stoppage, \$  *100*  for

Due Gov't, \$  *100*  for

Valuation of horse, \$  *100*

Valuation of horse equipments, \$  *100*

Remarks :  
-----  
-----  
-----  
-----

\* See enrollment on card from muster-in roll.

Book mark :  
-----

*Jenkins*   
Copist.

A | 6 H. Art'y. | U. S. C. T.

Rufus Holmes,  
Co. D, 6 Reg't U. S. Col'd H. Art'y.

Appears on

Company Muster Roll

for May & June, 1865.

Joined for duty and enrolled:

When Aug. 31, 1865.\*

Where Matchey Miss.

Period 3 years.\*

Present or absent Present

Stoppage, \$ 100 for

Due Gov't, \$ 100 for

Valuation of horse, \$ 100

Valuation of horse equipments, \$ 100

Remarks :

\* See enrollment on card from muster-in roll.

Book mark :

(358c)

Jenkins  
Copist.

*H*

6 H. Art'y.

U. S. C. T.

*Rufus Holmes*  
Co. D, 6 Reg't U. S. Col'd H. Art'y.

Appears on

**Company Muster Roll**

for *July & Aug*, 186*5*.

Joined for duty and enrolled:

When *Aug. 3<sup>d</sup>*, 186*3*\*

Where *Natchez Miss*\*

Period *3* years.\*

Present or absent *Present*

Stoppage, \$ *100* for

Due Gov't, \$ *100* for

Valuation of horse, \$ *100*

Valuation of horse equipments, \$ *100*

Remarks : *\**

\* See enrollment on card from muster-in roll.

Book mark :

(358c)

*Lopez*

Copyist.

*H.* | 6 H. Art'y. | U. S. C. T.

*Jufus Holmes*  
Pt., Co. D, 6 Reg't U. S. Col'd H. Art'y.

Appears on

Company Muster Roll  
for *Sept - Oct*, 186 *5*

Joined for duty and enrolled:

When *Aug 31*, 186 *3*\*

Where *Natchez Miss\**

Period *3* years.\*

Present or absent *Present.*

Stoppage, \$ *100* for

Due Gov't, \$ *100* for

Valuation of horse, \$ *100*

Valuation of horse equipments, \$ *100*

Remarks : \_\_\_\_\_

\_\_\_\_\_

\_\_\_\_\_

\_\_\_\_\_

\_\_\_\_\_

\*~~45~~ See enrollment on card from muster-in roll.

Book mark : \_\_\_\_\_

\_\_\_\_\_

(358c)

*Lopez* Copyist.

*H.* | 6 H. Art'y. | U. S. C. T.

*Rufus Holmes*  
Co. D, 6 Reg't U. S. Col'd H. Art'y.

Appears on

**Company Muster Roll**

for *Nov & Dec*, 186*5*.

Joined for duty and enrolled:

When *Aug 31*, 186*3*

Where *Natchez Miss\**

Period *3* years.\*

Present or absent *Present*

Stoppage, \$ *100* for

Due Gov't, \$ *100* for

Valuation of horse, \$ *100*

Valuation of horse equipments, \$ *100*

Remarks :

\* See enrollment on card from muster-in roll.

Book mark :

*Lopez*  
(358e) Copyst.



H. | 6 H. Art'y. | U. S. C. T.

Rufus Holms  
Prt, Co. D, 6 Reg't U. S. Col'd H. Art'y.

Appears on

**Company Muster Roll**

for Jan & Feb, 1866

Joined for duty and enrolled:

When Aug 31, 1863

Where Nat & Herz Miss\*

Period 3 years.\*

Present or absent Present.

Stoppage, \$ 100 for

Due Gov't, \$ 100 for

Valuation of horse, \$ 100

Valuation of horse equipments, \$ 100

Remarks :

\* See enrollment on card from muster-in roll.

Book mark :

Soperz.

H | 6 H. Art'y. | U. S. C. T.

Rufus Holms  
Prk, Co. D, 6 Reg't U. S. Col'd H. Art'y.

Appears on

Company Muster Roll

for Mch + Apl, 186 6

Joined for duty and enrolled:

When Aug. 31, 186 3

Where Natchez Miss \*

Period 3 years.\*

Present or absent Present

Stoppage, \$ 100 for

Due Gov't, \$ 100 for

Valuation of horse, \$ 100

Valuation of horse equipments, \$ 100

Remarks:

\* See enrollment on card from muster-in roll.

Book mark:

(358c)

Lopez

Copist.

26

6 H. Art'y.

U.S.C.T.

*Rufus Holmes*

*Pvt., Co. D, 6 Reg't U. S. Col'd H. Art'y.*

Appears on **Co. Muster-out Roll**, dated  *Natchez, Miss, May 13, 1866.*

Muster-out to date  *May 13, 1866.*

Last paid to  *Dec 31, 1865.*

**Clothing account:**

Last settled....., 186 ; drawn since \$.....100

Due soldier \$  *18<sup>66</sup>*  100; due U. S. \$.....100

Am't for cloth'g in kind or money adv'd \$.....100

Due U. S. for arms, equipments, &c., \$.....100

Bounty paid \$.....100; due \$.....100

Remarks:  *Joined at Original Organization*

Book mark:  *[faint handwritten text]*

*S. W. Tucker*   
Copyist.

Holmes, Cyrus  
Co G, 6 U.S. Col'd H. Art'y

Private Private

CARD NUMBERS.

1	6169367	26
2	6169519	27
3	6169662	28
4	6169806	29
5	6169998	30
6	6171400	31
7	9120065-	32
8	9120238	33
9	40742514	34
10		35
11		36
12		37
13		38
14		39
15		40
16		41
17		42
18		43
19		44
20		45
21		46
22		47
23		48
24		49
25		50

Book Mark:

See also

*A* | 6 H. Art'y. | U.S.C.T.

*Syrus E. Johnson*

....., Co. *E*, 6 Reg't U. S. Col'd H. Art'y.

Appears on

**Company Descriptive Book**

of the organization named above.

**DESCRIPTION.**

Age *49* years; height *5* feet *7 1/2* inches.

Complexion *Dark*

Eyes *Dark*; hair *Dark*

Where born *Essex Co., Va.*

Occupation *Farmer*

**ENLISTMENT.**

When *Sept. 20*, 1863.

Where *Natchez, Miss.*

By whom *C. H. Smith*; term *3* y'rs.

Remarks: *Died in Pest. Hoopst.*

*Mar 18/64*

*Wasser*

Cyrus Holmes

, Co. G, 6 Reg't U. S. Col'd H. Art'y.

Appears on

**Company Descriptive Book**

of the organization named above.

**DESCRIPTION.**

Age 40 years; height 5 feet 7 1/2 inches.

Complexion Dark

Eyes Dark; hair Dark

Where born Essex Co., Va.

Occupation Farmer

**ENLISTMENT.**

When Sept 20, 1863.

Where Natchez, Miss.

By whom C. W. Smith; term 3 y'rs.

Remarks: Died Mch 18/64 at  
West Hospital Natchez  
Miss. of Small Pox.  
Final Statements for-  
warded May 11/64

Warrior

*H* | .6 II. Art'y. | U.S.C.T.

*Lyons Holmes*

*Pvt*, Co. G, 2 Reg't Miss. Art'y.\*

Age *40* years.

Appears on

**Company Muster-in Roll**

of the organization named above. Roll dated

*Katcher, Miss, Oct 20, 1863.*

Muster-in to date *Oct 20, 1863.*

Joined for duty and enrolled:

When *Sept 20*, 1863.

Where *Katcher, Miss.*

Period *3* years.

Valuation of horse, \$.....*100*

Valuation of horse equipments, \$.....*100*

Remarks: .....

\* This organization subsequently became Co. G, 6 Reg't U. S. Colored Heavy Artillery.

Book mark: .....

*P. A. Ward*

(356)

Copyist.

*Syrus Holmes*  
*Sub*

Co. G, 2 Reg't Miss. Art'y.\*

Appears on

**Company Muster Roll**

for *Oct 20 to 21*, 1863.

Present or absent *Present*

Stoppage, \$ *100* for

Due Gov't, \$ *100* for

Valuation of horse, \$ *100*

Valuation of horse equipments, \$ *100*

Remarks:

\* This organization subsequently became Co. G, 6 Reg't U. S. Colored Heavy Artillery.

Book mark:

*O. A. Ward*



21

6 H. Art'y.

U.S.C.T.

*Cyrus Holmes*

*Int*, Co. G, 2 Reg't Miss. Art'y.\*

Appears on

**Company Muster Roll**

for *Nov & Dec*, 1863.

Present or absent *Present*

Stoppage, \$ 100 for

Due Gov't, \$ 100 for

Valuation of horse, \$ 100

Valuation of horse equipments, \$ 100

Remarks:  
-----  
-----  
-----  
-----  
-----  
-----  
-----  
-----

\* This organization subsequently became Co. G, 6 Reg't U. S. Colored Heavy Artillery.

Book mark: -----

(358) *P. A. Ward* Copyist.

*Cyrus Holmes*

*Pvt*, Co. G, 2 Reg't Miss. Art'y.\*

Appears on

**Company Muster Roll**

for *Jan & Feb*, 186*4*

Present or absent *Present*

Stoppage, \$ *100* for . . .

Due Gov't, \$ *100* for . . .

Valuation of horse, \$ *100*

Valuation of horse equipments, \$ *100*

Remarks: . . .

. . .  
. . .  
. . .  
. . .  
. . .  
. . .

\* This organization subsequently became Co. G, 6 Reg't U. S. Colored Heavy Artillery.

Book mark: . . .

*L. J. Sparr*  
Copyist.

*A*

6 H. Art'y.

U.S.C.T.

*Cyrus Holmes*  
*Prvt*, Co. G, 5 Reg't U. S. Col'd H. Art'y.\*

Appears on

**Company Muster Roll**

for *March & Apr*, 1864

Present or absent.....

Stoppage, \$.....100 for .....

Due Gov't, \$.....100 for .....

Valuation of horse, \$.....100

Valuation of horse equipments, \$.....100

Remarks: *Died in Pest*  
*Hosp. Matches*  
*Miss. March 18th/64.*

\* This organization subsequently became Co. G, 6 Reg't U. S. Col'd Heavy Artillery.

Book mark: .....

*L. J. Sparr*

(358)

Copyist.

A

6 H. Art'y.

U.S.C.T.

Cyrus Holmes

Pat., Co. ...., 6 Reg't U. S. Col'd H. Art'y.

Appears on Returns as follows:

Jan 1864 (Co G 2  
Miss H Art A.D.)  
Absent on det  
serv since Jan  
29 64

Feb 1864 Absent sick  
in Reg'l Hosp  
at Natchez

Mar 1864 (Co G 5  
US Col'd H Art)  
Died in Post  
Hosp Mar 18, 64  
Natchez Miss

Book mark :

(646) A Googled Copyist.

70

6 H. Art'y.

U.S.C.T.

Cyrus Holmes

Pvt., Co. G., 6 Reg't U. S. Col'd H. Art'y.

Appears on Co. Muster-out Roll, dated

Natchez, Miss., May 13, 1866 .

Muster-out to date ..... 186 .

Last paid to ..... 186 .

Clothing account:

Last settled....., 186 ; drawn since \$..... 100

Due soldier \$..... 100 ; due U. S. \$..... 100

Am't for cloth'g in kind or money adv'd \$..... 100

Due U. S. for arms, equipments, &c., \$..... 100

Bounty paid \$..... 100 ; due \$..... 100

Remarks: Joined at original organization. Died March 18/64 at Natchez, Miss. of Small Pox. Final statement forwarded May 11/64.

Book mark: 1530, 1880

Mochance

Holmes, Cyrus

P, Co. G, 6 U.S.C.H.A.

2 Enclosures.

Bed Cards	Descriptive Lists
Burial Records	Final Statements /
Certs. of Dis. for Discharge	Furloughs
C. M. Charges	Med. Des. Lists
Med. Certificates	Orders

Other papers relating to—

Admission to Hosp'l	Furlough
Casualty Sheet (Officer's)	Med. Examination
Confinement	Misc. Information
Contracts	Pay or Clothing
Death or Effects /	Personal Reports
Desertions	Rank
Discharge from Hosp'l	Transfer to Hosp'l
Discharge from Service	Transfer to V. R. C.
Duty	Transportation

Inventary Effects  
Cyrus, Holmes  
6. A S C A (Noy)



Inventory of the effects of Cyrus Holmes late  
 a Private of Captain John Louis Company G of  
 the Sixth Regiment of U.S. Col. Art. Heavy Volunteers, who was enrolled as  
 a Private at Natchez in the State of Mississippi on  
 the 20<sup>th</sup> day of September 1863, and mustered into the service of the United  
 States as a Private on the 20<sup>th</sup> day of October 1863, at Natchez Miss.  
 in Company G, 5<sup>th</sup> Regiment of U.S. Col. Art. Heavy to serve three  
 years or during the war, he was born in Essex County in the State  
 of Virginia; he was 40 years of age, 5 feet 7 1/2 inches  
 high, dark complexion, dark eyes, dark hair, and by occupation, when enrolled,  
 a Carpenter; he died in Small Pox Hospital at  
Natchez Miss. on the 18<sup>th</sup> day of March 1864, by  
 reason of Small Pox

INVENTORY.					
ARTICLES.	NO.	ARTICLES	NO.	ARTICLES.	NO.
Hats.....		Pairs Trowsers.....		Knapsacks.....	
Caps.....		Pairs flannel Drawers.....			
Forage Caps.....		Pairs cotton Drawers.....			
Great Coats.....		Flannel Shirts.....			
Uniform Coats.....		Cotton Shirts.....			
Uniform Jackets.....		Pairs boots.....			
Flannel Sack Coats.....		Pairs shoes.....			
Blouses.....		Pairs socks.....			
Stable Frocks.....		Blankets.....			
Fatigue Overalls.....		Haversacks.....			
				MONEY.	
				Specie.....	\$
				Notes.....	\$

I CERTIFY ON HONOR, that the above inventory comprises all the effects of \_\_\_\_\_  
 \_\_\_\_\_, deceased, and that the effects are in the hands  
 of \_\_\_\_\_ at \_\_\_\_\_  
 \_\_\_\_\_ to be disposed of by a Council of Administration.

(DUPLICATES.)

STATION: Natchez Miss.

DATE: July 11<sup>th</sup> 1864

John Louis  
 Captain  
 Commanding the Company.



S  
FINAL STATEMENT

OF

*Cyrus Holmes, Private*  
*Sixth* Regiment U. S. Heavy Artillery, (O.)  
*Died March 18<sup>th</sup> 1864*  
6

ADJUTANT GENERAL'S OFFICE.  
*July 23<sup>rd</sup> 1864*  
Duplicate with Inventory sent 2d Auditor.

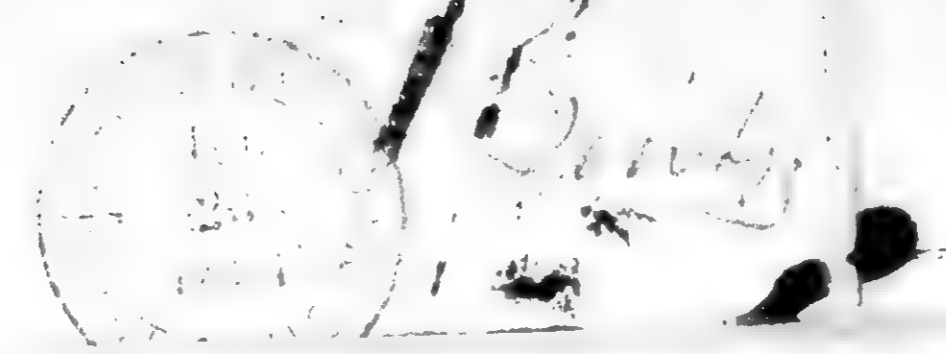

I Certify, on honor that Cyrus Holmes a Private of  
Captain John Louis Company (G.) of the 6<sup>th</sup> Regiment of United States Heavy Artillery, (Colored.)  
born in Essex County, State of Virginia, aged 40 years; 5- feet 7 1/2 inches high;  
dark complexion, dark eyes, dark hair and by occupation a Farmer, having joined the company on  
its original organization at Natchez Miss. and enrolled in at the muster into the service of the  
United States at Natchez Miss. on the twentieth day  
of October, 1863, (or was mustered in service as a recruit, by Capt. Chas. W.  
Smith, at Natchez Miss. on the twentieth day of September  
1863, or was drafted and mustered into the service of the United States from the \_\_\_\_\_ Enrollment District of the State

of \_\_\_\_\_, at \_\_\_\_\_, on the \_\_\_\_\_ day of \_\_\_\_\_, 1863, to serve in the Regiment, for the term of three years; and having served  
**HONESTLY and FAITHFULLY** with his Company in \_\_\_\_\_ to the present date, is now en-

~~rolled in~~ **DISCHARGED** Dead in Small Pox Hospital at  
Natchez Miss. on the 18<sup>th</sup> day of March 1864

The said Cyrus Holmes was last paid by Paymaster  
Major Clark to include the 31<sup>st</sup> day of December, 1863, and has  
pay due him from that time to the present date; he is entitled to pay and subsistence for TRAVELING to place of enrollment, and what-

ever other allowances are authorized to volunteer soldiers, or drafted men, or militia, so discharged. He received from the United States  
**CLOTHING** amounting to Fifty four <sup>54</sup> 100 dollars, since the \_\_\_\_\_ day of Enlistment  
1863, when his clothing account was last settled. He received from the United States \_\_\_\_\_ 100 dollars, advanced

**BOUNTY.**

There is to be stopped from him, on account of the State of \_\_\_\_\_, or other authorities, for  
**CLOTHING, &c.**, received on entering service, \_\_\_\_\_, 100 dollars; and for other stoppages, viz: \_\_\_\_\_  
\_\_\_\_\_ 100 dollars.

He has been furnished TRANSPORTATION in kind from the place of his discharge to \_\_\_\_\_  
and he has been SUBSISTED for TRAVELING to his place of enrollment, up to the \_\_\_\_\_ 1863.

He is indebted to \_\_\_\_\_, **SUTLER**, \_\_\_\_\_ 100 dollars.

He is indebted to \_\_\_\_\_, **LAUNDRESS**, \_\_\_\_\_ 100 dollars.

**GIVEN IN DUPLICATE**, at Natchez Miss. this 10<sup>th</sup> day  
of July 1864.

John Louis  
Captain  
Commanding Company.

Holmes, Washington

Co F, 6 U.S. Col'd H. Art'y

Private Private

CARD NUMBERS.

1	6167251	26
2	6167395	27
3	6167541	28
4	6167734	29
5	6169265	30
6	9119915	31
7	40742518	32
8		33
9		34
10		35
11		36
12		37
13		38
14		39
15		40
16		41
17		42
18		43
19		44
20		45
21		46
22		47
23		48
24		49
25		50

Book Mark: *S/B. 11/224*

See also

*N*

6 H. Art'y.

U.S.C.T.

*Washington Homes*

....., Co. *F*, 6 Reg't U. S. Col'd H. Art'y.

Appears on

**Company Descriptive Book**  
of the organization named above.

**DESCRIPTION.**

Age *20* years; height *5* feet .. inches.

Complexion *Blk*

Eyes *Hazel*; hair *Blk*

Where born *Jefferson Co., Ga.*

Occupation *Laborer*

**ENLISTMENT.**

When *Aug. 29*, 186*3*.

Where *Watches Miss*

By whom *Lt Schuck*, term *3* y'rs.

Remarks: *Died of mescal at  
Reg't Hospital Watches  
Miss. Feb. 22/64*

*Warren*

46

6 H. Art'y. | U.S.C.T.

Washington G Colmes  
Pot., Co. G, 2 Reg't Miss. Art'y.†

Age <sup>x</sup> years.

Appears on

**Company Muster-in Roll**

of the organization named above. Roll dated

Natchez, Miss. Sept. 12, 1863.

Muster-in to date Sept. 12, 1863.

Joined for duty and enrolled:

When Aug. 29, 1863.\*

Where Natchez Miss. \*

Period 3 years.\*

Valuation of horse, \$ 100

Valuation of horse equipments, \$ 100

Remarks:

x Taken from roll.

† This organization subsequently became Co. G, 6 Reg't U. S. Colored Heavy Artillery.

\* Muster-in roll shows enrollment of all men of this company as of same date and place. See enrollment on subsequent card or cards.

Book mark:

Brooks

H.

6 H. Art'y.

U.S.C.T.

Washington Jones

Cvt., Co. F, 2 Reg't Miss. Artillery.†

Appears on

**Company Muster Roll**

for Sept. 12 to Oct. 31, 1863.

Joined for duty and enrolled:

When Aug. 29, 1863.\*

Where Natchez, Miss.\*

Period 3 years.\*

Present or absent Present.

Stoppage, \$ 100 for

Due Gov't \$ 100 for

Valuation of horse, \$ 100

Valuation of horse equipments, \$ 100

Remarks:

† This organization subsequently became Co. F, 6 Reg't U. S. Colored Heavy Artillery.

\* See enrollment on card from muster-in roll.

Book mark:

Brooker

(358c)

Copyist.

H.

6 H. Art'y.

U.S.C.T.

Washington Homes

Pvt., Co. F, 2 Reg't Miss. Artillery.†

Appears on

Company Muster Roll

for Nov. 1 to Dec. 31, 1863.

Joined for duty and enrolled:

When Aug. 29, 1863.\*

Where Matchez.\*

Period 3 years.\*

Present or absent Present

Stoppage, \$ 100 for

Due Gov't \$ 100 for

Valuation of horse, \$ 100

Valuation of horse equipments, \$ 100

Remarks:

† This organization subsequently became Co. F, 6 Reg't U. S. Colored Heavy Artillery.

\* See enrollment on card from muster-in roll.

Book mark:

Brooker

96

6 H. Art'y.

U.S.C.T.

Washington Holmes

Co. F, 2 Reg't Miss. Artillery.†

Appears on

Company Muster Roll

for Jan 1 to Feb. 29, 1864.

Joined for duty and enrolled:

When Aug. 29, 1864.\*

Where Natchez, Miss.\*

Period 3 years.\*

Present or absent

Stoppage, \$ 100 for

Due Gov't \$ 100 for

Valuation of horse, \$ 100

Valuation of horse equipments, \$ 100

Remarks: died in the Reg't Hospital February 22<sup>nd</sup>, 1864.

† This organization subsequently became Co. F, 6 Reg't U. S. Colored Heavy Artillery.

\* See enrollment on card from muster-in roll.

Book mark: V. 30 P. 83, 69.

Brooker

(358c)

Copyist.



H

6 H. Art'y.

U.S.C.T.

Wash Holmes

Post, Co. ...., 6 Reg't U. S. Col'd H. Art'y.

Appears on Returns as follows:

Feb 1864 (Co F 2<sup>nd</sup> Miss  
H Art A. D.)

Died of disease  
Feb 22 March

Book mark :

(546)

A. J. Angles

Copyist.

*H*

6 H. Art'y.

U.S.C.T.

*Washington Jones*

*Co. F*, 6 Reg't U. S. Col'd H. Art'y.

Appears on **Co. Muster-out Roll**, dated

*Natchez Miss*, *May 13*, 186*5*.

Muster-out to date \_\_\_\_\_, 186 .

Last paid to \_\_\_\_\_, 186 .

**C.othing account:**

Last settled \_\_\_\_\_, 186 ; drawn since \$ \_\_\_\_\_ 100

Due soldier \$ \_\_\_\_\_ 100; due U. S. \$ \_\_\_\_\_ 100

Am't for cloth'g in kind or money adv'd \$ \_\_\_\_\_ 100

Due U. S. for arms, equipments, &c., \$ \_\_\_\_\_ 100

Bounty paid \$ \_\_\_\_\_ 100; due \$ \_\_\_\_\_ 100

Remarks: *Joined at original or-  
ganization. Died at Natchez  
at Natchez Miss Feb. 22, 63  
final statements forwarded  
Aug 5. 64*

Book mark: *311 P. 83, 69* *Died Feb 22, 1864* *6 P. 324*

(361)

*[Signature]*

Copyist.

Homes, Washington

P, Co. J, 6 U.S.C.H.A. Reg't

Enclosures.

Bed Cards	Descriptive Lists
Burial Records	Final Statements /
Certs. of Dis. for Discharge	Furloughs
C. M. Charges	Med. Des. Lists
Med. Certificates	Orders

Other papers relating to—

Admission to Hosp'l	Furlough
Casualty Sheet (Officer's)	Med. Examination
Confinement	Misc. Information
Contracts	Pay or Clothing
Death or Effects /	Personal Reports
Desertions	Rank
Discharge from Hosp'l	Transfer to Hosp'l
Discharge from Service	Transfer to V. R. C.
Duty	Transportation



Inventory of the effects of *Washington Homes* late  
 a *Private* of Captain *L. A. Schneck* Company *F* of  
 the *6<sup>th</sup>* Regiment of *U. S. "C" Art. Reg.* Volunteers, who was enrolled as  
 a *Private* at *Watches* in the State of *Miss.* on  
 the *29<sup>th</sup>* day of *August* 1863, and mustered into the service of the United  
 States as a *Private* on the *12<sup>th</sup>* day of *September* 1863, at *Watches Miss*  
 in Company *F* of *6<sup>th</sup>* Regiment of *U. S. "C" Art. Reg.* to serve *three*  
 years or during the war; he was born in *Jefferson County* in the State  
 of *Georgia*, he was *30* years of age, *5* feet *—* inches  
 high, *black* complexion, *black* eyes, *black* hair, and by occupation, when enrolled,  
 a *Laborer*; he died in *Hospital* at  
*Watches Miss* on the *22<sup>nd</sup>* day of *February* 1864, by  
 reason of *Malaria*.

INVENTORY.

ARTICLES.	NO.	ARTICLES	NO.	ARTICLES.	NO.
Hats.....		Pairs Trowsers.....		Knapsacks.....	
Caps.....		Pairs flannel Drawers.....			
Forage Caps.....		Pairs cotton Drawers.....			
Great Coats.....		Flannel Shirts.....			
Uniform Coats..... <i>No Effects</i>		Cotton Shirts.....			
Uniform Jackets.....		Pairs boots.....			
Flannel Sack Coats.....		Pairs shoes.....			
Blouses.....		Pairs socks.....			
Stable Frocks.....		Blankets.....			
Fatigue Overalls.....		Haversacks.....			
				MONEY.	
				Specie.....	\$
				Notes.....	\$

I CERTIFY ON HONOR, that the above inventory comprises all the effects of  
*Washington Homes*, deceased, and that the effects are in the hands  
 of *—* at *—*  
 to be disposed of by a Council of Administration.

(DUPLICATES.)

*Andrew G. ...*  
*1st Lieut.*  
 Commanding the Company.

STATION: *Watches Miss*

DATE: *August 5<sup>th</sup> 1864*

✓ *C. J.*  
**FINAL STATEMENT**

OF

*Washington Holmes*

*6<sup>th</sup>* Regiment U. S. Heavy Artillery, (

*Dead*

[OFFICE ENDORSEMENT.]

**War Department,**

ADJUTANT GENERAL'S OFFICE,

*March 29*, 1875.

The death of *Washington Holmes*, Pvt. Co. *F*, *6<sup>th</sup>* Reg't U. S. Colored *Art. Coy.*, is reported as follows:

On Company Muster Roll.	
For <i>Jan'y 5<sup>th</sup></i> 1864, <i>Feb'y 22<sup>nd</sup></i> , 1864	
<i>n</i> Company Muster-out Roll.	
<i>Feb'y 22<sup>nd</sup></i>	1864
Company Descriptive Book.	
	186
Company Morning Reports.	
	186
Soldier's Final Statement.	
<i>Feb'y 22<sup>nd</sup></i>	1864
Soldier's Record of Death and Interment.	
	186
Soldier's Inventory of Effects.	
	186
Soldier's Certificate of Disability for Discharge.	
	186
Soldier's Individual Muster-out Roll.	
	186
Regimental Returns	
For <i>Feb'y</i> , 1864, <i>Feb'y 22<sup>nd</sup></i> , 1864	
Regimental Quarterly Returns.	
<i>Feb'y 22<sup>nd</sup></i>	1864
Regimental Descriptive Book.	
	186

By Surgeon General.

(*Feb'y 22*), 1864, is held to be the correct date, and the Company Muster-out Roll will be amended accordingly.

*Thomas M. Seward*  
C.B. 11 See letter to 2<sup>d</sup> Auditor  
No. 324. Assistant Adjutant General.  
*16.4.* of April 9<sup>th</sup> 1875.

ADJUTANT GENERAL'S OFFICE.

*Aug. 24<sup>th</sup> 1864*

• Duplicates with inventory sent 2d and 3d.



*20045*

I Certify, on honor, that Washington Holmes a private of  
Captain L. A. Debreck Company (F.) of the 6<sup>th</sup> Regiment of United States Heavy Artillery, (Colored.)  
born in Jefferson County, State of Georgia, aged 30 years; 5 feet — inches high;  
black complexion, black eyes, black hair and by occupation a laborer, having joined the company on  
its original organization at Natchez, Miss., and enrolled ~~in at the muster~~ into the service of the  
United States at Natchez, Miss. on the 29<sup>th</sup> day  
of August, 1863, (or was mustered in service ~~as~~ — by Captain  
Tele, at Natchez, Miss. on the 12<sup>th</sup> day of September  
1863, or was drafted and mustered into the service of the United States from the — Enrollment District of the State  
of —, at — on the — day of — 186—) to serve in the Regiment, for the term of Three Years; and having served

HONESTLY and FAITHFULLY with his Company in The 6<sup>th</sup> U.S. C. Art. Regt. to the present date, is now en-  
titled to a **DISCHARGE** by reason of  Died of Measles at Natchez, Miss.  
on the 22<sup>nd</sup> day of February 1864

The said Washington Holmes was last paid by Paymaster  
Mr. Clark to include the 31<sup>st</sup> day of December, 1863, and has  
paid him from that time to the present date; he is entitled to pay and subsistence for TRAVELING to place of enrollment, and what-  
ever other allowances are authorized to volunteer soldiers, or drafted men, or militia, so discharged. He received from the United States

**CLOTHING** amounting to forty five <sup>23</sup> no dollars, since the 29<sup>th</sup> day of August  
1863, when his clothing account was ~~last~~ settled. He received from the United States — 100 dollars, advanced

**BOUNTY.**

There is to be stopped from him, on account of the State of —, or other authorities, for  
**CLOTHING**, &c., received on entering service, —, 100 dollars; and for other stoppages, viz: —  
— 100 dollars.

He has been furnished TRANSPORTATION in kind from the place of his discharge to —  
and he has been SUBSISTED for TRAVELING to his place of enrollment, up to the — 186—.

He is indebted to —, **SUTLER**, — 100 dollars.

He is indebted to —, **LAUNDRESS**, — 100 dollars.

**GIVEN IN DUPLICATE**, at Natchez, Miss., this 5<sup>th</sup> day  
of August 1863

Holmes, Willis

Co D, 6 U.S. Col'd H. Art'y.

Private Private

CARD NUMBERS.

1	6157862	26
2	6158006	27
3	6158148	28
4	6158269	29
5	6158395	30
6	6158535	31
7	6158665	32
8	6158787	33
9	6158909	34
10	6159040	35
11	6159183	36
12	6159327	37
13	6159468	38
14	6159606	39
15	6159735	40
16	6159858	41
17	6159979	42
18	6160100	43
19	9119125	44
20		45
21		46
22		47
23		48
24		49
25		50

Book Mark:

See also



28

*Willis Holmes*

, Co. *B*, 6 Reg't U. S. Col'd H. Art'y.

Appears on

**Company Descriptive Book**

of the organization named above.

**DESCRIPTION.**

Age *23* years; height *5* feet *7* inches.

Complexion *Black*

Eyes *Black*; hair *Black*

Where born *La Crosse La*

Occupation *Farmer*

**ENLISTMENT.**

When *Sept 1*, 18*63*.

Where *Wash D.C.*

By whom *Capt. H. H. ...*; term *3* y'rs.

Remarks:

-----  
-----  
-----  
-----  
-----  
-----  
-----  
-----

*W. Miller*

*A* | 6 H. Art'y. | U.S.C.T.

*Willis Holmes*  
Privt., Co. *B*, 2 Reg't Miss. Art'y.†

Age *23* years.

Appears on

**Company Muster-in Roll**

of the organization named above. Roll dated

*Natchez, Miss, Sept. 12, 1863.*

Muster-in to date *Sept. 12, 1863.*

Joined for duty and enrolled:

When *Sept. 1<sup>st</sup>*, 186*3*.\*

Where *Natchez, Miss.* \*

Period *3* years.\*

Valuation of horse, \$ ..... 100

Valuation of horse equipments, \$ ..... 100

Remarks:

† This organization subsequently became Co. *B*, 6 Reg't U. S. Colored Heavy Artillery.

\* \* \* Muster-in roll shows enrollment of all men of this company as of same date and place. See enrollment on subsequent card or cards.

Book mark:

*W. M. Barren*

(356c)

Copyist.

Willis Holmes

Private, Co. B, 2 Reg't Miss. Art'y.†

Appears on

Company Muster Roll  
for Sept. 12 to Oct 31, 1863.

Joined for duty and enrolled:

When Sept 1st, 1863.\*

Where Hatcheg, Miss.\*

Period 3 years.\*

Present or absent Present

Stoppage, \$ 100 for

Due Gov't, \$ 100 for

Valuation of horse, \$ 100

Valuation of horse equipments, \$ 100

Remarks:

† This organization subsequently became Co. B, 6 Reg't U. S. Co'd Heavy Artillery.

\* See enrollment on card from muster-in roll.

Book mark:

M. M. Charney

*N*

6 H. Art'y.

U.S.C.T.

*Willis Holmes*

*Private*, Co. B, 2 Reg't Miss. Art'y. †

Appears on

**Company Muster Roll**

for *Apr. & Dec.*, 186*3*.

Joined for duty and enrolled:

When *Sept 1st*, 186*3*.\*

Where *Natchez, Miss.* \*

Period *3* years.\*

Present or absent *Present*

Stoppage, \$ *100* for

Due Gov't, \$ *100* for

Valuation of horse, \$ *100*

Valuation of horse equipments, \$ *100*

Remarks: \_\_\_\_\_

† This organization subsequently became Co. B, 6 Reg't U. S. Co'd Heavy Artillery.

\* See enrollment on card from muster-in roll.

Book mark: \_\_\_\_\_

*W. M. Warren*

*W* | **6 H. Art'y.** | **U.S.C.T.**

*Willis Holmes*

*Private*, **2 Reg't Miss. Art'y \***  
~~Co. B, 6 Reg't U. S. Col'd H. Art'y.~~

Appears on

**Company Muster Roll**  
for *Jan'y & Feb.*, 186*4*.

Joined for duty and enrolled:

When *Sept. 1<sup>st</sup>*, 186*3*.\*

Where *Shatchez, Miss.* \*

Period *3* years.\*

Present or absent *Present*

Stoppage, \$ *100* for

Due Gov't, \$ *100* for

Remarks:

\* This organization subsequently be-  
came Co. B, 6 Reg't U.S. Col'd H. Art'y.

\* See enrollment on card from muster-in roll.

\* Corrected Mar. 19/95: Drum.  
Book-mark:

*M. M. Warren*

(358c)

Copyist.

*A* | **6 H. Art'y.** | **U.S.C.T.**

*Willis Holmes*  
Private, Co. *B*, 5 Reg't U. S. Col'd H. Art'y.\*

Appears on

**Company Muster Roll**  
for *Mar. & April*, 1864.

Joined for duty and enrolled:

When *Sept. 1st*, 1863.\*

Where *Shatchez, Miss.* \*

Period *3* years.\*

Present or absent *Present*

Stoppage, \$ *100* for

Due Gov't, \$ *100* for

Valuation of horse, \$ *100*

Valuation of horse equipments, \$ *100*

Remarks:

\* This organization subsequently became Co. *B*, 6 Reg't U. S. Col'd Heavy Artillery.

\* See enrollment on card from muster-in roll.

Book mark:

(358c)

*M. M. Warren*

Copyist.

*A*

6 H. Art'y.

U.S.C.T.

*William Holmes*

*Private* Co. B, 6 Reg't U. S. Col'd H. Art'y.

Appears on

Company Muster Roll

for *May & June* 1864.

Joined for duty and enrolled:

When *Sept. 1st*, 1863.\*

Where *Spatehaz, Miss* \*

Period *3* years.\*

Present or absent *Present*

Stoppage, \$ *100* for

Due Gov't, \$ *100* for

Remarks: *Detached as  
Teamster*

\* See enrollment on card from muster-in roll.

Book-mark :

*W. M. Barnes*

(358c)

Copyist.

H.

6 H. Art'y.

U.S.C.T.

*Willis Holmes*

*Privt.*, Co. B, 6 Reg't U. S. Col'd H. Art'y.

Appears on

**Company Muster Roll**

for *July & Aug.* 1864.

Joined for duty and enrolled:

When *Sept. 1<sup>st</sup>*, 1863.\*

Where *Natchez Miss.* \*

Period *3* years.\*

Present or absent *Present*

Stoppage, \$ *100* for

Due Gov't, \$ *100* for

Remarks:

\* See enrollment on card from muster-in roll.

Book-mark:

*H. C. Thomas*

(358c)

Copyist.



*H.*

6 H. Art'y.

U.S.C.T.

*Willis Holmes.*

*Privt.*, Co. B, 6 Reg't U. S. Col'd H. Art'y.

Appears on

**Company Muster Roll**

for *Sept. & Oct.* 1864.

Joined for duty and enrolled:

When *Sept. 1<sup>st</sup>*, 1863.\*

Where *Natchez Miss.* \*

Period *3* years.\*

Present or absent *Present.*

Stoppage, \$ *100* for

Due Gov't, \$ *100* for

Remarks:

-----  
-----  
-----  
-----  
-----  
-----  
-----

\*See enrollment on card from muster-in roll.

Book-mark:

-----  
-----

*H. C. Thomas*

(358c)

Copyist.

*H.*

6 H. Art'y.

U.S.C.T.

*Willis Holmes.*

*Sent.*, Co. B, 6 Reg't U. S. Col'd H. Art'y.

Appears on

**Company Muster Roll**

for *Nov. & Dec.* 186*4*.

Joined for duty and enrolled:

When *Sept. 1<sup>st</sup>*, 1863.\*

Where *Natchez Miss.* \*

Period *3* years.\*

Present or absent *Present.*

Stoppage, \$ *100* for

Due Gov't, \$ *100* for

Remarks:

\* See enrollment on card from muster-in roll.

Book-mark:

*H. C. Thomas.*

(358c)

Copyist.

H.

6 H. Art'y.

U.S.C.T.

*Willis Holmes.*

*Privt.*, Co. B, 6 Reg't U. S. Col'd H. Art'y.

Appears on

**Company Muster Roll**

for *Jan'y. & Feby.* 1865.

Joined for duty and enrolled:

When *Sept. 1<sup>st</sup>*, 1863.\*

Where *Natchez Miss.* \*

Period *3* years.\*

Present or absent *Present.*

Stoppage, \$ *100* for

Due Gov't, \$ *100* for

Remarks:

-----  
-----  
-----  
-----  
-----  
-----  
-----  
-----

\* See enrollment on card from muster-in roll.

Book-mark:

-----  
-----

*H. C. Thomas.*

(358c)

Copyist.

H.

6 H. Art'y.

U.S.C.T.

*Willis Holmes.*

*Private*, Co. B, 6 Reg't U. S. Col'd H. Art'y.

Appears on

**Company Muster Roll**

for *March & April* 1865.

Joined for duty and enrolled:

When *Sept. 1<sup>st</sup>*, 1863.\*

Where *Natchez Miss.* \*

Period *3* years.\*

Present or absent *Present*

Stoppage, \$ *100* for

Due Gov't, \$ *100* for

Remarks:

\* See enrollment on card from muster-in roll.

Book-mark:

*H. C. Thomas.*

(358c)

Copyist.

H. | 6<sup>th</sup> H. Art'y. | U.S.C.T.

*Willie Holmes.*

*Privt., Co. B., 6<sup>th</sup> Reg't U. S. Col'd H. Art'y.*

Appears on

**Company Muster Roll**

for *May & June*, 1865.

Joined for duty and enrolled :

When *Sept. 1<sup>st</sup>*, 1863.\*

Where *Natchez, Miss.* \*

Period *3* years.\*

Present or absent *Present.*

Stoppage, \$ *100* for

Due Gov't, \$ *100* for

Remarks :

\* See enrollment on card from muster-in roll.

Book mark :

*H. C. Thomas.*

(358c)

Copyist.

*76*

6 H. Art'y.

U.S.C.T.

*Mellie Holmes*

*Cpt.*, Co. B, 6 Reg't U. S. Col'd H. Art'y.

Appears on

**Company Muster Roll**

for *July & Aug* 1865.

Joined for duty and enrolled:

When *Sept. 1*, 1865.\*

Where *Sanchez, Miss.* \*

Period *3* years.\*

Present or absent *Present.*

Stoppage, \$ *100* for

Due Gov't, \$ *100* for

Remarks:

-----  
-----  
-----  
-----  
-----  
-----  
-----  
-----

\* See enrollment on card from muster-in roll.

Book-mark:

-----

*Sabine*  
Copyist.

(358c)

76

6 H. Art'y.

U.S.C.T.

*William Holmes*

*Co.*, Co. B, 6 Reg't U. S. Col'd H. Art'y.

Appears on

**Company Muster Roll**

for *Sept-Oct* 1865.

Joined for duty and enrolled:

When *Sept*, 1865.\*

Where *Hatchez, Miss.*\*

Period *3* years.\*

Present or absent *Present.*

Stoppage, \$ *100* for

Due Gov't, \$ *100* for

Remarks:

-----  
-----  
-----  
-----  
-----  
-----  
-----  
-----

\* See enrollment on card from muster-in roll.

Book-mark:

(358c)

*Satine*  
Copyist.

*H*

6 H. Art'y.

U.S.C.T.

*Willis Holmes*

*Co.* Co. B, 6 Reg't U. S. Col'd H. Art'y.

Appears on

**Company Muster Roll**

for *Nov Dec* 1865.

Joined for duty and enrolled:

When *Sep*, 1865.\*

Where *Natchez, Miss.*\*

Period *2* years.\*

Present or absent *Present.*

Stoppage, \$ *100* for

Due Gov't, \$ *100* for

Remarks *In daily duty in the gen. department, Natchez, Miss., by A. Q. No. 102.*

\* See enrollment on card from muster-in roll.

Book-mark :

(358c)

*Sabine*  
Copyist.



*H*

6 H. Art'y.

U.S.C.T.

*William Holmes*

*Cpt.*, Co. B, 6 Reg't U. S. Col'd H. Art'y.

Appears on

**Company Muster Roll**

for *Jan Feb* 1866.

Joined for duty and enrolled:

When *Sep 1*, 186*5*.\*

Where *Hatchery, Miss.*\*

Period *3* years.\*

Present or absent *Present.*

Stoppage, \$ *100* for

Due Gov't, \$ *100* for

Remarks:

-----  
-----  
-----  
-----  
-----  
-----  
-----

\*See enrollment on card from muster-in roll.

Book-mark:

-----

*Sabine*

(358c)

Copyist.

29

6 H. Art'y.

U.S.C.T.

*Willis James*

*Co.* Co. B, 6 Reg't U. S. Col'd H. Art'y.

Appears on

**Company Muster Roll**

for *Mar & Apr* 1866.

Joined for duty and enrolled:

When *Sept*, 1863.\*

Where *Kachey Miss*\*

Period *3* years.\*

Present or absent *present*

Stoppage, \$ *100* for

Due Gov't, \$ *100* for

Remarks:

\* See enrollment on card from muster-in roll.

Book-mark:

*Spicer*

Copyist.

(358c)

H

6 H. Art'y.

U.S.C.T.

*Willis Holmes*

*Pvt*, Co. *B*, 6 Reg't U. S. Col'd H. Art'y.

Appears on **Co. Muster-out Roll**, dated

*Natchez Miss*, *May 13*, 1866.

Muster-out to date *May 13*, 1866.

Last paid to *Dec. 31*, 1865.

Clothing account:

Last settled....., 186 ; drawn since \$..... 100

Due soldier \$ *33*<sup>*17*</sup>..... 100; due U. S. \$..... 100

Am't for cloth'g in kind or money adv'd \$..... 100

Due U. S. for arms, equipments, &c., \$..... 100

Bounty paid \$..... 100; due \$..... 100

Remarks: *Joined at Original  
Organization.*

Book mark: *400003*

(361)

*J. E. Nichol*

Copyist.

*Holt, Isaiah*

Co *M* 6 U.S. Col'd H. Art'y.

*Private Sergeant*

CARD NUMBERS.

1	<i>6154356</i>	26
2	<i>6179385</i>	27
3	<i>6179495</i>	28
4	<i>6179579</i>	29
5	<i>6179668</i>	30
6	<i>6179759</i>	31
7	<i>6179872</i>	32
8	<i>6179988</i>	33
9	<i>6180100</i>	34
10	<i>6180211</i>	35
11	<i>6180397</i>	36
12	<i>6180763</i>	37
13	<i>9121010</i>	38
14	<i>40742519</i>	39
15		40
16		41
17		42
18		43
19		44
20		45
21		46
22		47
23		48
24		49
25		50

Book Mark:

See also *29 - The Book*

896022. Ронин

04. 1965181

А. А. Ронин

*W*  
*Spah, Holt*  
Sgt, Co *M*, 6 Reg't U. S. Col'd H. Art'y.

Appears on  
**Company Descriptive Book**  
of the organization named above.

**DESCRIPTION.**

Age *21* years; height *5* feet *8* inches.

Complexion *Light*

Eyes *Blue*; hair *Light*

Where born *Carinthia, Miss*

Occupation *Farmer*

**ENLISTMENT.**

When *April 1*, 186*4*.

Where *Spatehaz, Miss*

By whom *Major Gen M. Sherman* term *3* y'rs.

Remarks: *Discharged June 10, No 512*  
*dated W. G. A. G. Sept 25, 1865*  
*to date Oct 10, 1865*

*W. H. Miller*

H

6 H. Art'y.

U.S.C.T.

Isiah Holt

Appears with rank of Priv on

**Muster and Descriptive Roll of a Detachment of U. S. Vols. forwarded**

for the <sup>5<sup>th</sup></sup> Reg't U. S. Col'd H. Art'y. Roll dated Natchez, Miss, Apr 2, 1864.

Where born Cornuth, Miss

Age 21 yrs; occupation Farmer

When enlisted Apr 1, 1864.

Where enlisted Natchez, Miss

For what period enlisted 3 years.

Eyes Blue; hair Light

Complexion Light; height 5 ft. 8 in.

When mustered in Apr 2, 1864.

Where mustered in Natchez, Miss

Bounty paid \$ 60<sup>00</sup>; due \$ 34<sup>00</sup>

Where credited Metropolis, Marack Co. Ill.

Company to which assigned M

Remarks: Detained by O. No. 85 from Maj. Gen McPherson's Head Quarters dated Vicksburg, Miss  
(over)

Book mark: .....

W. D. A. G.

JAN. 13

6154356

★1891★

Feb 25/64. From  
a private in "K"  
Comp. 29<sup>th</sup> Regt  
Ill. Vet. Vol. Infy  
to be a sergeant in  
"M" Comp. 5<sup>th</sup> Regt  
As Heavy Arty  
(Colored) Muster in  
to take effect  
from date of  
enrollment.

& subsequently became  
the 6<sup>th</sup> U.S. Colored Heavy  
Arty



No.

6 H. Art'y.

U.S.C.T.

Isiah Holt

Serg<sup>t</sup>, Co. M., 5 Reg't U. S. Col'd H. Art'y.\*

Appears on

Company Muster Roll

for   Mch   \*   Apr  , 1864.

Joined for duty and enrolled:

When   Apr     1  , 1864.\*

Where   Katchez, Miss   \*

Period   3   years.\*

Present or absent   Present  

Stoppage, \$   100   for

Due Gov't, \$   100   for

Valuation of horse, \$   100  

Valuation of horse equipments, \$   100  

Remarks: Promoted from Private Co. K.  
29 Reg<sup>t</sup> Ills. Vet. Vols. Duft. to be a  
Serg<sup>t</sup> in Co. M. 5 U.S.C. H. Art'y. by  
Maj. Genl. W. Sherman, S.O. No. 85 dated

\* This organization subsequently became Co. M., 6 Reg't U. S. Col'd Heavy Artillery.

\* See enrollment on card from muster-in roll.

Book mark: \_\_\_\_\_

(358c)

  J. J. Kearney    
Copyist.

JAN. 14

6179385

★1891★

March 25. '64 1<sup>st</sup> Installment  
of Veh. Bond by paid. 2<sup>d</sup> Install<sup>t</sup>  
now due

26

6 H. Art'y.

U.S.C.T.

Isiah Holt

Serg<sup>t</sup>, Co. M, 6 Reg't U. S. Col'd H. Art'y.

Appears on

Company Muster Roll

for May & June, 1864.

Joined for duty and enrolled:

When April 1, 1864.\*

Where Natchez, Miss \*

Period 3 years.\*

Present or absent Present

Stoppage, \$ 100 for

Due Gov't, \$ 100 for

Valuation of horse, \$ 100

Valuation of horse equipments, \$ 100

Remarks: Promoted from Private Co. K, 29 Ill. Vet. Vols. Injy to be a Serg<sup>t</sup> in Co. M, 6<sup>th</sup> U.S. C. H. Art'y by Major Genl. McPherson S.O. No 85 dated March 25. '64. 1<sup>st</sup> & 2<sup>d</sup> Installs ments Vet. bounty paid. Third now due

\* See enrollment on card from muster-in roll.

Book mark:

(358c)

J. J. Kearney Copyist.

No.

6 H. Art'y.

U.S.C.T.

*Enoch Holt*

*Serg't*, Co. M, 6 Reg't U. S. Col'd H. Art'y.

Appears on

**Company Muster Roll**

for *July & Aug*, 1864.

Joined for duty and enrolled:

When *Apr 1*, 1864.\*

Where *Natchez, Miss* \*

Period *3* years.\*

Present or absent *Present*

Stoppage, \$ *100* for

Due Gov't, \$ *100* for

Valuation of horse, \$ *100*

Valuation of horse equipments, \$ *100*

Remarks: *1<sup>st</sup> & 2<sup>d</sup> Installt of Veteran  
bounty paid - Third none due*

\* See enrollment on card from muster-in roll.

Book mark:

(358c)

*J. J. Kearney*

Copyist.

*Leiah Holt*

*Serg't*, Co. M, 6 Reg't U. S. Col'd H. Art'y.

Appears on

**Company Muster Roll**

for *Sept. & Oct.*, 1864.

Joined for duty and enrolled:

When *Apr 1*, 1864.\*

Where *Natchez Miss.*\*

Period *3* years.\*

Present or absent *Present*

Stoppage, \$ *100* for

Due Gov't, \$ *100* for

Valuation of horse, \$ *100*

Valuation of horse equipments, \$ *100*

Remarks: *1<sup>st</sup> & 2<sup>d</sup> Install<sup>5</sup> Veterans  
county paid 3<sup>d</sup> now due.*

\* See enrollment on card from muster-in roll.

Book mark:

(358c)

*J. J. Kearney* Copyist.

*Isiah Holt*

Sergrt., Co. M, 6 Reg't U. S. Col'd H. Art'y.

Appears on

**Company Muster Roll**

for *Nov & Dec*, 1864.

Joined for duty and enrolled:

When *Apr. 1*, 1864.\*

Where *Natchez, Miss.*\*

Period *3* years.\*

Present or absent *Present*

Stoppage, \$ *100* for

Due Gov't, \$ *100* for

Valuation of horse, \$ *100*

Valuation of horse equipments, \$ *100*

Remarks: \_\_\_\_\_  
\_\_\_\_\_  
\_\_\_\_\_  
\_\_\_\_\_

\* See enrollment on card from muster-in roll.

Book mark: \_\_\_\_\_

*Beck*  
Copyist.

*H*

6 H. Art'y.

U.S.C.T.

*Isaiah Holt*

Sergh., Co. M, 6 Reg't U. S. Col'd H. Art'y.

Appears on

**Company Muster Roll**

for *Jan. & Feb.*, 1865.

Joined for duty and enrolled:

When *Apr. 1*, 1864.\*

Where *Hatchez, Miss.*\*

Period *3* years.\*

Present or absent *Present*

Stoppage, \$ *100* for

Due Gov't, \$ *100* for

Valuation of horse, \$ *100*

Valuation of horse equipments, \$ *100*

Remarks: \_\_\_\_\_

\_\_\_\_\_

\_\_\_\_\_

\_\_\_\_\_

\* See enrollment on card from muster-in roll.

Book mark: \_\_\_\_\_

\_\_\_\_\_

*W Beck*  
Copyist.

(358c)

Isaiah Holt

Sergrt., Co. M, 6 Reg't U. S. Col'd H. Art'y.

Appears on

Company Muster Roll

for Mar & Apr., 1865.

Joined for duty and enrolled:

When Apr. 1, 1864.\*

Where Natchez, Miss.\*

Period 3 years.\*

Present or absent Present

Stoppage, \$ 100 for

Due Gov't, \$ 100 for

Valuation of horse, \$ 100

Valuation of horse equipments, \$ 100

Remarks: First, Second & Third installments of Veteran Bounty Paid; Fourth now due,

\* See enrollment on card from muster-in roll.

Book mark:



*H* | **6 H. Art'y.** | **U.S.C.T.**

*Isiah Holt*

*Sergt*, Co. M, 6 Reg't U. S. Col'd H. Art'y.

Appears on

**Company Muster Roll**

for *May & June*, 186*5*.

Joined for duty and enrolled:

When *Apr 1*, 186*4*.\*

Where *Natchez, Miss.*\*

Period *3* years.\*

Present or absent *Present*

Stoppage, \$ *100* for

Due Gov't, \$ *100* for

Valuation of horse, \$ *100*

Valuation of horse equipments, \$ *100*

Remarks: *Rein listed as a Vet.*  
*Jan. 1 '64. 1<sup>st</sup>, 2<sup>nd</sup>, & 3<sup>rd</sup>*  
*installments of G. Bounty Paid*  
*4<sup>th</sup> & 5<sup>th</sup>. Now due*

\* See enrollment on card from muster-in roll.

Book mark:

(358c)

*Beck*  
Copyist.

Isiah Holt

Serget, Co. M, 6 Reg't U. S. Col'd H. Art'y.

Appears on

Company Muster Roll

for July & Aug, 1866.

Joined for duty and enrolled:

When Apr. 1, 1864.\*

Where Natchez, Miss. \*

Period 3 years.\*

Present or absent Present

Stoppage, \$ 100 for

Due Gov't, \$ 100 for

Valuation of horse, \$ 100

Valuation of horse equipments, \$ 100

Remarks: Reinstated as a Vet.

Jan. 1 '64,  
1st, 2nd & 3rd installments of  
G. Bounty Paid 4th & 5th.  
Now due

\* See enrollment on card from muster-in roll.

Book mark:

W Beck  
Copyist.

26

6 H. Art'y.

U.S.C.T.

*Isiah Holt*

*Sgt*, Co. M, 6 Reg't U. S. Col'd H. Art'y.

Appears on

**Company Muster Roll**

for *Sept. & Oct*, 186*5*.

Joined for duty and enrolled:

When *April*, 186*4*.\*

Where *Natchez, Miss* \*

Period *3* years.\*

Present or absent

Stoppage, \$ *100* for

Due Gov't, \$ *100* for

Valuation of horse, \$ *100*

Valuation of horse equipments, \$ *100*

Remarks: *Discharged Oct. 10/65 by reason of S.O. No. 512 dated War Dept Adj. Genl. Office Sept. 25/65. Final statements given*

\* See enrollment on card from muster-in roll.

Book mark: *S Service 508ly Pm. usa 1863 March 14, 1866.*

(358c)

*Wm J Bell Jr*  
Copyist.

H

6 H. Art'y.

U.S.C.T.

Isiah Holt

Sgt, Co. M, 6 Reg't U. S. Col'd H. Art'y.  
Plat

Appears on Returns as follows:

April 1864 (5 US Col'd  
H Art) Gain April  
1, 64 Natchez Miss  
Det'd by S.O. 85  
from Maj Genl  
McPherson's Hd Qrs  
Mustered in by Capt  
Lanstram April 2/64  
May & June 1864 (6"  
US Col'd H A) On  
daily duty in  
Det Light Art  
Comd by Lt Nei-  
hardt Co 76rs.  
Col'd Art since May  
30, 64

Oct 1865 Loss Oct 10/65  
Natchez Miss  
Disch'd for S.O.  
512. Dated War  
Dept G.O. Sept 25, 65

Book mark:

(546) *A. J. England* Copyist.

*Isiah Holt*

*Serjt*, Co. *M*, 6 Reg't U. S. Col'd H. Art'y.

Appears on **Co. Muster-out Roll**, dated  
*Natchez Miss*, *May 13*, 1866 .

Muster-out to date ..... , 186 .

Last paid to ..... , 186 .

**Clothing account:**

Last settled....., 186 ; drawn since \$..... 100

Due soldier \$..... 100; due U. S. \$..... 100

Am't for cloth'g in kind or money adv'd \$..... 100

Due U. S. for arms, equipments, &c., \$..... 100

Bounty paid \$..... 100; due \$..... 100

Remarks: *Detached from priv Co*  
*to 29th Ills Infy to be a serjt*  
*in Co M 6th U.S. Col'd Art'y (41)*  
*by S.O. No 85 dated Vicksburg Miss*  
*Mar 25 64. Discharged Oct*  
*10 65 by S.O. No 572 dated War*  
*Dept A. G. Washington D.C. Sept*

Book mark: *17. P. 72. 70*

*S.O. No 572 (on file)*

*J. Nelson*  
(361) *over* Copyist.

JAN. 14

6180763

1891

25 1865. Final state-  
ments furnished.

Holt, Robert

Co. A, 6 U.S. Col'd H. Art'y

Private

CARD NUMBERS.

1	26
2	27
3	28
4	29
5	30
6	31
7	32
8	33
9	34
10	35
11	36
12	37
13	38
14	39
15	40
16	41
17	42
18	43
19	44
20	45
21	46
22	47
23	48
24	49
25	50

Book Mark:

See also

*Holter, Robert*

Co B, 6 U.S. Col'd H. Art'y.

*Private Private*

CARD NUMBERS.

1	6155450	26
2	6155596	27
3	6155747	28
4	6155891	29
5	6156034	30
6	6156166	31
7	6156294	32
8	6156414	33
9	6156534	34
10	6156658	35
11	6156790	36
12	6156923	37
12	6157053	38
14	6157181	39
15	6157311	40
16	6157434	41
17	6157613	42
18	6157742	43
19	9118970	44
20	40742550	45
21		46
22		47
23		48
24		49
25		50

Book Mark:

See also



Robert Holter

Co. A, 6 Reg't U. S. Col'd H. Art'y.

Appears on

**Company Descriptive Book**

of the organization named above.

**DESCRIPTION.**

Age ~~43~~ years; height 5 feet 9 1/2 inches.

Complexion *Brown*

Eyes *Black*; hair *Black*

Where born *Masson Co Ky*

Occupation *servant*

**ENLISTMENT.**

When *Aug 30*, 1863.

Where *Wachen Miss*

By whom *Capt Orquin*; term *3* y'rs.

Remarks: *Discharged by name of Surgeon certificate of disability at Wachen Miss March 25, 1866 by order of Maj Genl J F Wood Hqs Dept of Miss Washington, Miss*

*J. Miller*

Copist.

*Robert Holton*

*Pri*, Co. *A*, 2 Reg't Miss. Art'y.†

Age *35* years.

Appears on

**Company Muster-in Roll**

of the organization named above. Roll dated

*Natchez Miss, Sept 12, 1863.*

Muster-in to date *Sept 72, 1863.*

Joined for duty and enrolled:

When *Aug 30, 1863.\**

Where *Natchez Miss* \*

Period *3* years.\*

Valuation of horse, \$ 100

Valuation of horse equipments, \$ 100

Remarks: \_\_\_\_\_

† This organization subsequently became Co. *A*, 6 Reg't U. S. Colored Heavy Artillery.

\* Muster-in roll shows enrollment of all men of this company as of same date and place. See enrollment on subsequent card or cards.

Book mark: \_\_\_\_\_

*C. W. Smith*

Robert Holt

Qui, Co. A, 2 Reg't Miss. Art'y.†

Appears on

Company Muster Roll

for Aug 30 To Oct 31, 1863.

Joined for duty and enrolled:

When Aug 30, 1863.\*

Where Hatchers Miss \*

Period 3 years.\*

Present or absent Present

Stoppage, \$ 100 for

Due Gov't \$ 100 for

Valuation of horse, \$ 100

Valuation of horse equipments, 100

Remarks:

† This organization subsequently became Co. A, 6 Reg't U. S. Colored Heavy Artillery.  
\* See enrollment on card from muster-in roll.

Book mark:

C. G. Smith

*Robert Hoffer*  
Pri., Co. A, 2 Reg't Miss. Art'y.†

Appears on

**Company Muster Roll**

for *Nov Dec*, 186*3*.

Joined for duty and enrolled:

When *Aug 30*, 186*3*.\*

Where *Watchdog Miss* \*

Period *3* years.\*

Present or absent *Present*

Stoppage, \$ *100* for

Due Gov't \$ *100* for

Valuation of horse, \$ *100*

Valuation of horse equipments, *100*

Remarks:

† This organization subsequently became Co. A, 6 Reg't U. S. Colored Heavy Artillery.

\* See enrollment on card from muster-in roll.

Book mark:

*C. G. Smith*

Robert Holter  
Pri., Co. A, 2 Reg't Miss. Art'y.†

Appears on

Company Muster Roll  
for Jan & Feb, 1864.

Joined for duty and enrolled:

When Aug 30, 1863.\*

Where Watchdog Miss \*

Period 3 years.\*

Present or absent Present

Stoppage, \$ 100 for

Due Gov't \$ 100 for

Valuation of horse, \$ 100

Valuation of horse equipments, 100

Remarks:

† This organization subsequently became Co. A, 6 Reg't U. S. Colored Heavy Artillery.  
\* See enrollment on card from muster-in roll.

Book mark:

O G Smith  
Copyist.

76

6 H. Art'y.

U.S.C.T.

Robert Holter

Pri., Co. A, 5 Reg't U. S. Col'd H. Art'y.†

Appears on

Company Muster Roll

for March & April, 1864.

Joined for duty and enrolled:

When Aug 3, 1863.\*

Where Natchez Miss\*

Period 3 years.\*

Present or absent Present

Stoppage, \$ 100 for

Due Gov't \$ 100 for

Valuation of horse, \$ 100

Valuation of horse equipments, 100

Remarks:

†This organization subsequently became Co. A, 6 Reg't U. S. Colored Heavy Artillery.

\* See enrollment on card from muster-in roll.

Book mark:

O. G. Smith

(358c)

Copyist.

*H*

6 H. Art'y.

U.S.C.T.

*Robert Holter*

*Pri*, Co. A, 6 Reg't U. S. Col'd H. Art'y.

Appears on

**Company Muster Roll**

for *May - June*, 186*4*.

Joined for duty and enrolled:

When *Aug 30*, 186*3*.\*

Where *Natchez Miss*.\*

Period *3* years.\*

Present or absent *Present*

Stoppage, \$ *100* for

Due Gov't \$ *100* for

Remarks:

-----  
-----  
-----  
-----  
-----

\* See enrollment on card from muster-in roll.

Book mark: -----

*C. G. Smith*

(358c)

Copyist.

*No*

6 H. Art'y.

U.S.C.T.

*Robert Holter*

*Pr.*, Co. A, 6 Reg't U. S. Col'd H. Art'y.

Appears on

Company Muster Roll

for *July & Aug.*, 186*4*.

Joined for duty and enrolled:

When *Aug. 30*, 186*3*.\*

Where *Patchez* \*

Period *3* years.\*

Present or absent *Present*

Stoppage, \$ *100* for

Due Gov't \$ *100* for

Remarks:

-----  
-----  
-----  
-----  
-----

\* See enrollment on card from muster-in roll.

Book mark:

*J. H. Henderson*

(358c)

Copyist.



No

6 H. Art'y.

U.S.C.T.

Robert Holter

Pri., Co. A, 6 Reg't U. S. Col'd H. Art'y.

Appears on

Company Muster Roll

for Sept. & Oct., 1864.

Joined for duty and enrolled:

When Aug 30, 1863.\*

Where Hatchez, Miss. \*

Period 3 years.\*

Present or absent Present

Stoppage, \$ 100 for

Due Gov't \$ 100 for

Remarks:

-----  
-----  
-----  
-----  
-----

\* See enrollment on card from muster-in roll.

Book mark:

J. B. Henderson  
(358c) Copyist.

10

6 H. Art'y.

U.S.C.T.

Robert Holter

Pri., Co. A, 6 Reg't U. S. Col'd H. Art'y.

Appears on

Company Muster Roll

for *Nov. 3 Dec.*, 1864.

Joined for duty and enrolled:

When *Aug. 30*, 1863.\*

Where *Natchez, Miss.* \*

Period *3* years.\*

Present or absent *Present*

Stoppage, \$ *100* for

Due Gov't \$ *100* for

Remarks:  
-----  
-----  
-----  
-----  
-----

\* See enrollment on card from muster-in roll.

Book mark: -----

*J. H. Henderson*  
(358c) Copyist.

No

6 H. Art'y.

U.S.C.T.

Robert Walter

Pri., Co. A, 6 Reg't U. S. Col'd H. Art'y.

Appears on

Company Muster Roll

for Jan. & Feb., 1865.

Joined for duty and enrolled:

When Aug. 30, 1863.\*

Where Natchez, Miss.\*

Period 3 years.\*

Present or absent Present

Stoppage, \$ 100 for

Due Gov't \$ 100 for

Remarks:

\* See enrollment on card from muster-in roll.

Book mark:

J. W. Henderson

(358c)

Copyist.

10

6 H. Art'y.

U.S.C.T.

Robert Walter

Priv., Co. A, 6 Reg't U. S. Col'd H. Art'y.

Appears on

Company Muster Roll

for Mar. & Apr., 1865.

Joined for duty and enrolled:

When Aug. 30, 1863.\*

Where Natchez, Miss.\*

Period 3 years.\*

Present or absent Present

Stoppage, \$ 100 for

Due Gov't \$ 100 for

Remarks:

\* See enrollment on card from muster-in roll.

Book mark:

J. H. Henderson Copyist.

(358c)

*H*

6 H. Art'y.

U.S.C.T.

*Robert Walter*

*Pri.*, Co. A, 6 Reg't U. S. Col'd H. Art'y.

Appears on

Company Muster Roll  
for *Feb. 24 to June 30*, 1865.

Joined for duty and enrolled:

When *Aug. 30*, 1863.\*

Where *Natchez, Miss.* \*

Period *3* years.\*

Present or absent *Present*

Stoppage, \$ *100* for

Due Gov't \$ *100* for

Remarks:

\* See enrollment on card from muster-in roll.

Book mark:

*J. H. Henderson*

(358c)

Copyist.

76

6 H. Art'y.

U.S.C.T.

*Robert Haller*

*3rd*, Co. A, 6 Reg't U. S. Col'd H. Art'y.

Appears on

**Company Muster Roll**

for *July + August*, 186*3*.

Joined for duty and enrolled:

When *Aug 30*, 186*3*.\*

Where *Natchez Miss* \*

Period *3* years.\*

Present or absent *Present*

Stoppage, \$ *100* for

Due Gov't \$ *100* for

Remarks:

.....  
.....  
.....  
.....  
.....

\* See enrollment on card from muster-in roll.

Book mark: .....

(358c)

*D. J. Guipich*

Copyist.

76

6 H. Art'y.

U.S.C.T.

Robert Holler

76, Co. A, 6 Reg't U. S. Col'd H. Art'y.

Appears on

Company Muster Roll

for Sept & Oct, 1865.

Joined for duty and enrolled:

When Aug 30, 1863.\*

Where Natchez Miss \*

Period 3 years.\*

Present or absent Absent

Stoppage, \$ 100 for

Due Gov't \$ 100 for

Remarks: Detained in Post Hospl Natchez Miss, by A.O. No 64 Hd Qrs Post Natchez Oct 11, 65

\* See enrollment on card from muster-in roll.

Book mark:

(358c)

D. J. Griffith Copyist.

26

6 H. Art'y.

U.S.C.T.

Robert Colter

Co. A, 6 Reg't U. S. Col'd H. Art'y.

Appears on

Company Muster Roll

for Nov + Dec, 1865.

Joined for duty and enrolled:

When Aug 30, 1865.\*

Where Natchez Miss \*

Period 3 years.\*

Present or absent Present

Stoppage, \$ 100 for

Due Gov't \$ 100 for

Remarks: Daily duty in Post Hospital Natchez Miss, per A.O. No 64 Post of Natchez Miss Oct 11, 1865

\* See enrollment on card from muster-in roll.

Book mark:

D. J. Griffith

(358c)

Copyist.



26

6 H. Art'y.

U.S.C.T.

Robert Holter

Private, Co. A, 6 Reg't U. S. Col'd H. Art'y.

Appears on

Company Muster Roll

for Jan & Feb, 1866.

Joined for duty and enrolled:

When Aug 30, 1863.\*

Where Natchez Miss.\*

Period 3 years.\*

Present or absent Present

Stoppage, \$ 100 for

Due Gov't \$ 100 for

Remarks:

\* See enrollment on card from muster-in roll.

Book mark:

(358c)

J. J. Gifford

Copyist.

Robert Hollar

Inf., Co. A, 6 Reg't U. S. Col'd Harty

Appears on

Company Muster Roll

for March + April, 1866.

Joined for duty and enrolled:

When Aug 30, 1863\*

Where Natchez Miss\*

Period 3 years.\*

Present or absent.....

Stoppage, \$..... 100 for.....

Due Gov't, \$..... 100 for.....

Valuation of horse, \$..... 100

Valuation of horse equipments, \$..... 100

Remarks: Disch'd at Natchez Miss  
March 25, 1866, by reason Surgeons  
certificate of disability

\* See enrollment on card from muster-in roll.

Book mark :.....

D. J. Gifford  
Copyst.

A

6 H. Art'y.

U.S.C.T.

<sup>x</sup>  
Robert Walter

Priv., Co. A., 6 Reg't U. S. Col'd H. Art'y.

Appears on Returns as follows:

\*<sup>5</sup> Mar 1864 (5 U.S. Col'd  
H Art) Absent  
sick in Hosp or  
Absent with leave

Oct & Nov 1865 (6 U.S.  
Col'd H Art) Absent  
det as Nurse in  
Post Hosp Katchez  
since Oct 11, 65

Mar 1866 Disch'd  
for disab'y War  
R. S. 64 Katchez  
Miss

<sup>x</sup>  
Name appears also as  
<sup>x</sup> Walter in  
index of  
index of  
index of

Book mark:

(546) A. G. Gougeon Copyist.

2

Robert Holter

Priv., Co. A, 6 Reg't U. S. Col'd H. Art'y.

Appears on Co. Muster-out Roll, dated

Natchez Miss. May 13, 1866.

Muster-out to date \_\_\_\_\_, 186 .

Last paid to Dec 31, 1865.

Clothing account:

Last settled \_\_\_\_\_, 186 ; drawn since \$ 100

Due soldier \$ 100; due U. S. \$ 100

Am't for cloth'g in kind or money adv'd \$ 100

Due U. S. for arms, equipments, &c., \$ 100

Bounty paid \$ 100; due \$ 100

Remarks: joined at original organization. Disch'd at Natchez Miss. Mch. 25 66 on Surg. Certificate of Disability. Final statements given

Book mark: V19P 222, 68-460, 305

A. J. Jones

Holter, Robert

P, Co. A, 6 U.S.C.H.A.

Enclosures.

Bed Cards	Descriptive Lists
Burial Records	Final Statements
Certs. of Dis. for Discharge	Furloughs
C. M. Charges	Med. Des. Lists
Med. Certificates	Orders

Other papers relating to—

Admission to Hosp'l	Furlough
Casualty Sheet (Officer's)	Med. Examination
Confinement	Misc. Information
Contracts	Pay or Clothing
Death or Effects	Personal Reports
Desertions	Rank
Discharge from Hosp'l	Transfer to Hosp'l
Discharge from Service	Transfer to V. R. C.
Duty	Transportation

NOTE 1.

The company commander will here add a statement of all the facts known to him concerning the disease or wound, or cause of disability of the soldier; the time, place, manner, and all the circumstances under which the injury occurred, or disease originated or appeared; the duty, or service, or situation of the soldier at the time the injury was received or disease contracted, stating particularly whether the injury was received or the disease contracted in the line of his duty; and whatever other facts may aid a judgment as to the cause, immediate or remote, of the disability, and the circumstances attending it.

When the facts are not known to the company commander, the certificate of any officer, or affidavit of other person having such knowledge, will be appended—as the surgeon in charge of a hospital, the officer commanding a detachment of recruits, &c., &c.

NOTE 2.

When a probable case for pension, special care must be taken to state the degree of disability—as  $\frac{1}{2}$ ,  $\frac{3}{4}$ , &c., &c.; to describe particularly the disability, wound, or disease; the extent to which it deprives him of the use of any limb or faculty, or affects his health, strength, activity, constitution, or capacity to labor or earn his subsistence. The surgeon will add, from his knowledge of the facts and circumstances, and from the evidence in the case, his professional opinion of the cause or origin of the disability. In the case of discharges by Medical Inspectors, the last paragraph will state that the "discharge was given by consent of the soldier, after a personal examination, and for disability, the nature, degree, and origin of which are correctly described in the within certificate."

Par. 1260 Regulations, Edit. 1861.

Medical officers, in giving certificates of disability, are to take particular care in all cases that have not been under their charge; and especially in epilepsy, convulsions, chronic rheumatism, derangement of the urinary organs, ophthalmia, ulcers, or any obscure disease liable to be feigned or purposely produced; and in no case shall such certificate be given until after sufficient time and examination to detect any attempt at deception.

DIRECTIONS.

This certificate will be made out in duplicate by the soldier's company commander, or other officer commanding the separate detachment to which he belongs, and sent by him to the surgeon who has charge of the hospital where the soldier is sick. The surgeon will then fill out and sign the surgeon's certificate, and forward these papers to the regimental, detachment, or post commander, who will forward them, with his action endorsed thereon, through the proper channel, to his division commander; or, if the troops are not attached to a division, to his corps, department, or other commander or officer to whom the authority to discharge enlisted men may be specially delegated.

These certificates, after having received the action of the highest authority to which they are required to be sent, will be returned through the same channel to the regimental, post, or detachment commander, who will, if the discharge is authorized by the endorsement of the proper authority, sign the soldier's discharge, and the last certificate on this paper; see that the soldier is furnished with the proper final statements in duplicate, and forward BOTH of these certificates direct to the Adjutant General United States Army, at Washington, D. C.; they will not, under any circumstances, be given into the hands of the soldier.

ADJUTANT GENERAL'S OFFICE

Apr 16 1866

Duplicate sent the Pension Office.

1866  
CERTIFICATE OF DISABILITY FOR DISCHARGE  
IN THE CASE OF

Robert Allen +  
a Private Co. A  
Sick Reg't of U.S.C. Art. 4th

Approved,  
Jno. Moore  
Brevet Major and Surg. U.S.A.,  
Med Director Dept. Miss.  
M.D. 2  
Mar 20/66

Headquarters Department of Mississippi,

Vicksburg, March 20th 1866.

To be Discharged.

By order of Maj. Gen. TH. J. WOOD:

Munroe P. Weston  
Adj. Assistant Adjutant General.

Received

RECEIVED, ADJUTANT GENERAL  
APR 1866  
OFFICE, ST. LOUIS

Subj. file

# ARMY OF THE UNITED STATES

## CERTIFICATE

### OF DISABILITY FOR DISCHARGE.

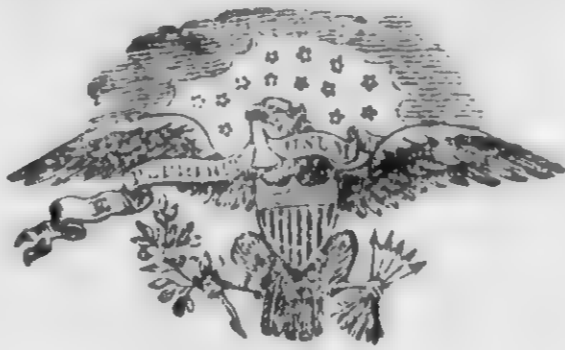

Privt. Robert Holler, of Captain James S. Organ's Company, (A) of the Sixth Regiment of United States Cavalry was enlisted by Capt James S. Organ of the Sixth Regiment of U.S. Cavalry at Natchez, Mississippi on the Thirtieth day of August, 1863, to serve three years; he was born in Mason County, in the State of Kentucky, is fifty-five years of age, five feet six inches high, Black complexion, Black eyes, Black hair, and by occupation when enlisted a Farmer. During the last two months said soldier has been unfit for duty 59 days. Said Private Robert Holler has been absent sick in Post-Hospital for the past six months he was sent to Hospital by reason of Phthisis and Lung disease contracted in the line of duty.

STATION: Natchez, Mississippi  
 DATE: February 28, 1866  
 George W. Porter 1<sup>st</sup> Lieut  
 Co. U.S. C. Cav. - Heavy  
 Commanding Company.

I CERTIFY, that I have carefully examined the said Private Robert Holler of Captain Organ's Company, and find him incapable of performing the duties of a soldier because of his physical condition. He was never well in his life and had several attacks of Hemoptysis accompanied by weak lungs before enlistment. He is now in a very weak condition.

DISCHARGED this twenty eighth day of February, 1866, at Natchez, Mississippi.  
 Surgeon  
 Lieut. Colonel  
 Commanding the Reg't

The Soldier desires to be addressed at  
 Town \_\_\_\_\_ County \_\_\_\_\_ State \_\_\_\_\_

\* See Note 1 on the back of this. \* See Note 2 on the back of this.  
 [A. G. O. No. 100 & 101--First.] [DUPLICATES.]

P. M. S. Organ

Head of no. 8000  
 Natchez Miss Mo 8/1863  
 Respectfully forwarded

2600

*Hopkins, Richard*

Co D, 6 U.S. Col'd H. Art'y

*Captain Captain*

CARD NUMBERS.

1	6157817	26
2	6157961	27
3	6160167	28
4	40742520	29
5		30
6		31
7		32
8		33
9		34
10		35
11		36
12		37
12		38
14		39
15		40
16		41
17		42
18		43
19		44
20		45
21		46
22		47
23		48
24		49
25		50

Book Mark:

See also *30 No Vols*



*Richard R Hopkins*  
Capt, Co. *B*, 2 Reg't Miss. Art'y. †

Age *39* years.

Appears on

**Company Muster-in Roll**

of the organization named above. Roll dated

*Shatchez, Miss*, *Sept 12*, 186*3*.

Muster-in to date *Sept 12*, 186*3*.

Joined for duty and enrolled:

When *Sept 1st*, 186*3*.\*

Where *Shatchez, Miss* \*

Period *3* years.\*

Valuation of horse, \$ 100

Valuation of horse equipments, \$ 100

Remarks: *Appointed from Captain in the 30<sup>th</sup> Reg't Mo. Inf'try Vols to be Capt in the 2<sup>nd</sup> Reg't Miss. Art'y by adjt. Gen Thomas muster into date.*

† This organization subsequently became Co. *B*, 6 Reg't U. S. Colored Heavy Artillery.

\* \* \* Muster-in roll shows enrollment of all men of this company as of same date and place. See enrollment on subsequent card or cards.

Book mark : .....

*W. M. Warren*

*R. R. Hopkins*

*Capt.*, Co. B, 2 Reg't Miss. Art'y.†

Appears on

**Company Muster Roll**  
for *Sept. 12 to Oct. 31*, 186*3*.

Joined for duty and enrolled:

When *Sept. 1st*, 186*3*.\*

Where *Atatchez, Miss* \*

Period *3* years.\*

Present or absent *Present*

Stoppage, \$ *100* for

Due Gov't, \$ *100* for

Valuation of horse, \$ *100*

Valuation of horse equipments, \$ *100*

Remarks: .....

*M. C. J. on which name appears.*

† This organization subsequently became Co. B, 6 Reg't U. S. Co'ld Heavy Artillery.  
\* See enrollment on card from muster-in roll.

Book mark: .....

*W. W. Warren*

A

6 H. Art'y.

U.S.C.T.

Richard C Hopkins

....., Co. ...., 6 Reg't U. S. Col'd H. Art'y.

Appears on Returns as follows:

Oct 1863, Capt Co B  
2 Miss H Art A & Q,  
Present

Nov 1863 Absent. De-  
clined to accept  
his appointment  
Nov 9, 63

Book mark : .....

(546)

A. Goigled

Copyist.

*Richard R. Hopkins*

*Capt.*, Co. *B.*, 6 Reg't U. S. Col'd H. Art'y.

Appears on **Co. Muster-out Roll**, dated

*Natchez Miss*, *May 13*, 1866 .

Muster-out to date ..... 186 .

Last paid to ..... 186 .

**Clothing account:**

Last settled....., 186 ; drawn since \$.....<sup>100</sup>

Due soldier \$.....<sup>100</sup>; due U. S. \$.....<sup>100</sup>

Am't for cloth'g in kind or money adv'd \$.....<sup>100</sup>

Due U. S. for arms, equipments, &c., \$.....<sup>100</sup>

Bounty paid \$.....<sup>100</sup>; due \$.....<sup>100</sup>

Remarks: *This officer is borne on the Muster in roll as having been Mustered in by Capt. Ide Sep. 12/63 The records of this company show that he declined his appointment.*

Book mark: .....

*(over)*

*J. E. Nichol*

JAN. 13

6160167

1891

He was formerly  
a Capt. in 30th Mo.  
Infy & signed the  
muster in rolls as Capt  
Comdg. Company.

*Wagner, Adam*

Co. C, 6 U.S. Col'd H. Art'y.

*Private Corporal*

CARD NUMBERS.

1	6160333	26
2	6160482	27
3	6160625	28
4	6160748	29
5	6160864	30
6	6161001	31
7	6161124	32
8	6161263	33
9	6161398	34
10	6161539	35
11	6161679	36
12	6161813	37
13	6161906	38
14	6162032	39
15	6162154	40
16	6162272	41
17	6162387	42
18	6162503	43
19	911935-9	44
20		45
21		46
22		47
23		48
24		49
25		50

Book Mark:

See also

*Adam Hopper*

....., Co. *C*, 6 Reg't U. S. Col'd H. Art'y.

Appears on

**Company Descriptive Book**

of the organization named above.

**DESCRIPTION.**

Age *18* years; height *5* feet *4* inches.

Complexion *Copper*

Eyes *Black*; hair *Black*

Where born *Jefferson Co Miss*

Occupation *Cowman*

**ENLISTMENT.**

When *Sept 11*, 1863.

Where *Nashville Miss*

By whom *W D Luck*; term *3* y'rs.

Remarks: *Promoted corp July 1/65*

*Spiller*

70

Adam Hopper

Priv., Co. C, 2 Reg't Miss. Art'y.†

Age 18 years.

Appears on

Company Muster-in Roll

of the organization named above. Roll dated

Natchez, Miss, Sept 12, 1863.

Muster-in to date Sept 12, 1863.

Joined for duty and enrolled:

When Sept 1, 1863.\*

Where Natchez, Miss. \*

Period 3 years.\*

Valuation of horse, \$ 100

Valuation of horse equipments, \$ 100

Remarks:

† This organization subsequently became Co. C, 6 Reg't U. S. Colored Heavy Artillery.

\* Muster-in roll shows enrollment of all men of this company as of same date and place. See enrollment on subsequent card or cards.

Book mark:

Mochance



70

6 H. Art'y.

U.S.C.T.

Adam Kopper

Priv., Co. C, 2 Reg't Miss. Artillery.†

Appears on

Company Muster Roll

for Sept 12 to Oct 31, 1863.

Joined for duty and enrolled:

When Sept 1, 1863.\*

Where Natchez, Miss.\*

Period 3 years.\*

Present or absent Present

Stoppage, \$ 100 for

Due Gov't \$ 100 for

Valuation of horse, \$ 100

Valuation of horse equipments, \$ 100

Remarks:

† This organization subsequently became Co. C, 6 Reg't U. S. Colored Heavy Artillery.

\* See enrollment on card from muster-in roll.

Book mark:

Mochance

7

6 H. Art'y.

U.S.C.T.

Adam Kopper

Lot, Co. C, 2 Reg't Miss. Artillery.†

Appears on

Company Muster Roll

for Nov + Dec, 1863.

Joined for duty and enrolled:

When Sept 1, 1863.\*

Where Natchez, Miss.\*

Period 3 years.\*

Present or absent Present

Stoppage, \$ 100 for

Due Gov't \$ 100 for

Valuation of horse, \$ 100

Valuation of horse equipments, \$ 100

Remarks:

† This organization subsequently became Co. C, 6 Reg't U. S. Colored Heavy Artillery.

\* See enrollment on card from muster-in roll.

Book mark:

no chance

(358c)

Copyist.

H

6 H. Art'y.

U.S.C.T.

Adam Hopper

Pvt., Co. C, 2 Reg't Miss. Artillery.†

Appears on

Company Muster Roll

for Jan + Feb, 1864.

Joined for duty and enrolled:

When Sept 1, 1863.\*

Where Natchez, Miss \*

Period 3 years.\*

Present or absent Present.

Stoppage, \$ 100 for

Due Gov't \$ 100 for

Valuation of horse, \$ 100

Valuation of horse equipments, \$ 100

Remarks:

† This organization subsequently became Co. C, 6 Reg't U. S. Colored Heavy Artillery.  
\* See enrollment on card from muster-in roll.

Book mark:

Mochance

(358c)

Copyist.

70

6 H. Art'y.

U.S.C.T.

Adam Hopper  
Pot, Co. C, 5 Reg't U. S. Col'd H. Art'y.†

Appears on

**Company Muster Roll**

for Mar & Apr, 1864.

Joined for duty and enrolled:

When Sept 1, 1863.\*

Where Natchez, Miss.\*

Period 3 years.\*

Present or absent Present

Stoppage, \$ 100 for

Due Gov't \$ 100 for

Valuation of horse, \$ 100

Valuation of horse equipments, 100

Remarks:

†This organization subsequently became Co. C, 6 Reg't U. S. Colored Heavy Artillery.

\* See enrollment on card from muster-in roll.

Book mark:

Wochance

(358c)

Copyist.

H

6 H. Art'y.

U.S.C.T.

Adam Harper

Priv., Co. C, 6 Reg't U. S. Col'd H. Art'y.

Appears on

Company Muster Roll

for May & June, 1864.

Joined for duty and enrolled:

When Sept 1, 1863.\*

Where Natchez, Miss. \*

Period 3 years.\*

Present or absent Present

Stoppage, \$ 100 for

Due Gov't, \$ 100 for

Valuation of horse, \$ 100

Valuation of horse equipments, \$ 100

Remarks:

\* See enrollment on card from muster-in roll.

Book mark:

Mochance

2

6 H. Art'y.

U.S.C.T.

Adam Hopper

Prv., Co. C, 6 Reg't U. S. Col'd H. Art'y.

Appears on

Company Muster Roll

for July + Aug, 1864

Joined for duty and enrolled:

When Sept 1, 1863.\*

Where Natchez Miss.\*

Period 3 years.\*

Present or absent Present

Stoppage, \$ 100 for

Due Gov't, \$ 100 for

Valuation of horse, \$ 100

Valuation of horse equipments, \$ 100

Remarks:

\* See enrollment on card from muster-in roll.

Book mark:

H. Smith

(358c)

Copyist.

*Adam Hopper*  
*Prv*, Co. C, 6 Reg't U. S. Col'd H. Art'y.

Appears on

**Company Muster Roll**

for *Sept & Oct*, 186*4*.

Joined for duty and enrolled:

When *Sept 1*, 186*3*.\*

Where *Natchez, Miss* \*

Period *3* years.\*

Present or absent *Present*

Stoppage, \$ *100* for

Due Gov't, \$ *100* for

Valuation of horse, \$ *100*

Valuation of horse equipments, \$ *100*

Remarks:

\* See enrollment on card from muster-in roll.

Book mark:

*H. Smith*  
Coryist.

*H*

6 H. Art'y.

U.S.C.T.

*Adam Hopfer*

*Pr*, Co. C, 6 Reg't U. S. Col'd H. Art'y.

Appears on

Company Muster Roll

for *Nov & Dec*, 1864.

Joined for duty and enrolled:

When *Sept 1*, 1863.\*

Where *Natchez, Miss*\*

Period *3* years.\*

Present or absent *Present*

Stoppage, \$ *100* for

Due Gov't, \$ *100* for

Valuation of horse, \$ *100*

Valuation of horse equipments, \$ *100*

Remarks:

\* See enrollment on card from muster-in roll.

Book mark:

*H. Schmitt*

(858c)

Copyist.



*H*

6 H. Art'y.

U.S.C.T.

*Adam Hopper*  
*Private*, Co. C, 6 Reg't U. S. Col'd H. Art'y.

Appears on

**Company Muster Roll**

for *Jan & Feb*, 1865.

Joined for duty and enrolled:

When *Sept 1*, 1863.\*

Where *Natchez, Miss\**

Period *9* years.\*

Present or absent *Present*

Stoppage, \$ *100* for

Due Gov't, \$ *100* for

Valuation of horse, \$ *100*

Valuation of horse equipments, \$ *100*

Remarks: \_\_\_\_\_  
\_\_\_\_\_  
\_\_\_\_\_

\* See enrollment on card from muster-in roll.

Book mark: \_\_\_\_\_

*W. A. Smith*

(358c)

Copyist.

*Adam Hopper*  
*Priv*, Co. C, 6 Reg't U. S. Col'd H. Art'y.

Appears on  
Company Muster Roll  
for *Mar & Apr*, 186*5*.

Joined for duty and enrolled:  
When *Sept 1*, 186*3*\*  
Where *Natchez, Miss\**  
Period *3* years.\*

Present or absent *Present*

Stoppage, \$ *100* for

Due Gov't, \$ *100* for

Valuation of horse, \$ *100*

Valuation of horse equipments, \$ *100*

Remarks: \_\_\_\_\_  
\_\_\_\_\_  
\_\_\_\_\_

\* ~~See~~ See enrollment on card from muster-in roll.

Book mark: \_\_\_\_\_

*J. W. Smith*

2

6 H. Art'y.

U.S.C.T.

Adam Hopper  
Pvt., Co. C, 6 Reg't U. S. Col'd H. Art'y.

Appears on

Company Muster Roll

for May & June, 1865.

Joined for duty and enrolled:

When Sept 1, 1863\*

Where Ketchikan Mts \*

Period 3 years.\*

Present or absent Present

Stoppage, \$ 100 for

Due Gov't, \$ 100 for

Valuation of horse, \$ 100

Valuation of horse equipments, \$ 100

Remarks:

\* See enrollment on card from muster-in roll.

Book mark:

W. A. Smith

(358c)

Copyist.

Adam Hopper  
Corp, Co. C, 6 Reg't U. S. Col'd H. Art'y.

Appears on

Company Muster Roll

for July & Aug, 1865.

Joined for duty and enrolled:

When 1 Sep, 1863.\*

Where Hatchez Miss \*

Period 3 years.\*

Present or absent present

Stoppage, \$ 100 for

Due Gov't, \$ 100 for

Valuation of horse, \$ 100

Valuation of horse equipments, \$ 100

Remarks: Promoted Corp to  
rank from July 1/65  
per S.O. No 90 H&S 2nd 6  
U.S.A. Art'y.

\* See enrollment on card from muster-in roll.

Book mark:

G. E. Dayton

Adam Hopper  
Corp., Co. C, 6 Reg't U. S. Col'd H. Art'y.

Appears on

Company Muster Roll

for Sep. + Oct, 1865.

Joined for duty and enrolled:

When 1 Sep., 1865.\*

Where Natchez, Miss \*

Period 3. years.\*

Present or absent present

Stoppage, \$ 100 for

Due Gov't, \$ 100 for

Valuation of horse, \$ 100

Valuation of horse equipments, \$ 100

Remarks: Promoted from Private  
to rank from July '65 per  
S.O. 90 H's 2nd 6 U.S.C.A. 24

\* See enrollment on card from muster-in roll.

Book mark:

G. E. Dayton

H

6 H. Art'y.

U.S.C.T.

Adam Hopper

Corp., Co. C, 6 Reg't U. S. Col'd H. Art'y.

Appears on

Company Muster Roll

for Nov & Dec, 1865.

Joined for duty and enrolled:

When 1 Sep, 1863.\*

Where Hatcher Miss \*

Period 3 years.

Present or absent present.

Stoppage, \$ 100 for

Due Gov't, \$ 100 for

Valuation of horse, \$ 100

Valuation of horse equipments, \$ 100

Remarks: Promoted Corp to rank from July 1/65 per S.O. 90 H&20  
C U.S.C.A. 14.

\* See enrollment on card from muster-in roll.

Book mark:

G. E. Dayton

H.

6 H. Art'y.

U.S.C.T.

Adam Hopper

Cop, Co. C, 6 Reg't U. S. Col'd H. Art'y.

Appears on

Company Muster Roll

for Jan & Feb, 1866

Joined for duty and enrolled:

When 1 Sep, 1863.\*

Where Natchez, Miss. \*

Period 3. years.\*

Present or absent present

Stoppage, \$ 100 for

Due Gov't, \$ 100 for

Valuation of horse, \$ 100

Valuation of horse equipments, \$ 100

Remarks:

\* See enrollment on card from muster-in roll.

Book mark:

G. E. Dayton

(358c)

Copist.

Y6

6 H. Art'y.

U.S.C.T.

Adam Hopper

Corp., Co. C, 6 Reg't U. S. Col'd H. Art'y.

Appears on

Company Muster Roll

for March, 1866, 1866

Joined for duty and enrolled:

When 1 Sep, 1863.\*

Where Natchez Miss.\*

Period 3 years.\*

Present or absent present.

Stoppage, \$ 100 for

Due Gov't, \$ 100 for

Valuation of horse, \$ 100

Valuation of horse equipments, \$ 100

Remarks:

\* See enrollment on card from muster-in roll.

Book mark:

G. E. Dayton



*Adam Hooper*  
Cof., Co. C, 6 Reg't U. S. Col'd H. Art'y.

Appears on **Co. Muster-out Roll**, dated  
*Kateh, Miss May 13, 1866*.

Muster-out to date *May 13, 1866*.

Last paid to *Dec 31, 1865*.

Clothing account:

Last settled....., 186 ; drawn since \$..... 100

Due soldier \$..... 100; due U. S. \$ *1850* 100

Am't for cloth'g in kind or money adv'd \$..... 100

Due U. S. for arms, equipments, &c., \$..... 100

Bounty paid \$..... 100; due \$..... 100

Remarks: *Promoted Corp*  
*July 1st 1865*  
*joined*  
*at original organization*

Book mark: *U 57 P 112 69*

*A. M. Callum*  
(361) Copyist.

Hopper, Anthony  
Co F, 6 U.S. Col'd H. Art'y.

Private Private

CARD NUMBERS.

1	6167255	26
2	6167398	27
3	6167543	28
4	6167669	29
5	6167784	30
6	6167908	31
7	6168019	32
8	6168127	33
9	6168238	34
10	6168345	35
11	6168456	36
12	6168571	37
13	6168680	38
14	6168791	39
15	6168896	40
16	6168994	41
17	6169090	42
18	6169187	43
19	9119919	44
20		45
21		46
22		47
23		48
24		49
25		50

Book Mark: \_\_\_\_\_

See also \_\_\_\_\_

*A*

*Anthony Stepper*

Co. *F*, 6 Reg't U. S. Col'd H. Art'y.

Appears on

**Company Descriptive Book**  
of the organization named above.

**DESCRIPTION.**

Age *45* years; height *5* feet *9* inches.

Complexion *Blk*

Eyes *Blk*; hair *Blk*

Where born *Jefferson Co. Miss.*

Occupation *Labourer*

**ENLISTMENT.**

When *Aug. 29*, 186*3*.

Where *Atatchin*

By whom *J. Schrick*; term *3* y'rs.

Remarks:  
\_\_\_\_\_  
\_\_\_\_\_  
\_\_\_\_\_  
\_\_\_\_\_  
\_\_\_\_\_  
\_\_\_\_\_  
\_\_\_\_\_

*Warren*

*Anthony Hopper.*  
Pvt., Co. *A*, 2 Reg't Miss. Art'y.†

Age *45* years.

Appears on

**Company Muster-in Roll**

of the organization named above. Roll dated

*Natchez Miss, Sept. 12, 1863.*

Muster-in to date *Sept. 12, 1863.*

Joined for duty and enrolled:

When *Aug. 29*, 1863.\*

Where *Natchez, Miss.* \*

Period *3* years.\*

Valuation of horse, \$ ..... 100

Valuation of horse equipments, \$ ..... 100

Remarks:

† This organization subsequently became Co. *F*, 6 Reg't U. S. Colored Heavy Artillery.

\*Muster-in roll shows enrollment of all men of this company as of same date and place. See enrollment on subsequent card or cards.

Book mark: .....

*Brooks.*

H. | 6 H. Art'y. | U.S.C.T.

Anthony Hopper  
Co. F, 2 Reg't Miss. Artillery.†

Appears on

**Company Muster Roll**

for Sept. 12 to Oct. 31, 1863

Joined for duty and enrolled:

When Aug. 29, 1863.\*

Where Watauga Miss.\*

Period 3 years.\*

Present or absent Present

Stoppage, \$ 100 for

Due Gov't \$ 100 for

Valuation of horse, \$ 100

Valuation of horse equipments, \$ 100

Remarks:

† This organization subsequently became Co. F, 6 Reg't U. S. Colored Heavy Artillery.

\* See enrollment on card from muster-in roll.

Book mark:

Brooker

(358c)

Copyist.

Anthony Hopper  
Co. F, 2 Reg't Miss. Artillery.†

Appears on

Company Muster Roll

for Nov. 1 to Dec. 31, 1863.

Joined for duty and enrolled:

When Aug. 29, 1863.\*

Where Matches.\*

Period 3 years.\*

Present or absent Present.

Stoppage, \$ 100 for

Due Gov't \$ 100 for

Valuation of horse, \$ 100

Valuation of horse equipments, \$ 100

Remarks:

† This organization subsequently became Co. F, 6 Reg't U. S. Colored Heavy Artillery.  
\* See enrollment on card from muster-in roll.

Book mark:

Brooks  
Copyist.

96.

6 H. Art'y.

U.S.C.T.

*Antony Hoopes*

*Prvt.*, Co. F, 2 Reg't Miss. Artillery.†

Appears on

**Company Muster Roll**

for *Jan. 1 to Feb. 29*, 1864.

Joined for duty and enrolled:

When *Aug. 29*, 1863.\*

Where *Natches, Miss.\**

Period *3* years.\*

Present or absent *Present*

Stoppage, \$ *100* for

Due Gov't \$ *100* for

Valuation of horse, \$ *100*

Valuation of horse equipments, \$ *100*

Remarks :

† This organization subsequently became Co. F, 6 Reg't U. S. Colored Heavy Artillery.

\* See enrollment on card from muster-in roll.

Book mark :

*Brooks*

(358c)

Copyist.

I.L. | 6 H. Art'y. | U.S.C.T.

Anthony Hooper  
Pvt., Co. *F*, 5 Reg't U. S. Col'd H. Art'y.\*

Appears on

**Company Muster Roll**

for *Mar. 1 to Apr. 30*, 186*4*.

Joined for duty and enrolled:

When *Aug. 29*, 186*3*.\*

Where *Natchez, Miss.* \*

Period *3* years.\*

Present or absent *Present*

Stoppage, \$ *100* for

Due Gov't, \$ *100* for

Valuation of horse, \$ *100*

Valuation of horse equipments, \$ *100*

Remarks: \_\_\_\_\_  
\_\_\_\_\_  
\_\_\_\_\_

\* This organization subsequently became Co. *F*, 6 Reg't U. S. Col'd Heavy Artillery.  
\* See enrollment on card from muster-in roll.

Book mark: \_\_\_\_\_

*Brooks*

(358c)

Copyist.



*Antony F. Lopper*  
*Capt.*, Co. F, 6 Reg't U. S. Col'd H. Art'y.

Appears on

**Company Muster Roll**

for *May 1 to June 30*, 1864.

Joined for duty and enrolled:

When *Aug. 29*, 1863\*

Where *Natchez, Miss.* \*

Period *3* years.\*

Present or absent *Present.*

Stoppage, \$ *100* for

Due Gov't \$ *100* for

Remarks:

-----  
-----  
-----  
-----  
-----  
-----

\* See enrollment on card from muster in roll.

Book mark: -----

*Brooks*  
Copyist.

*A*

6 H. Art'y. U.S.C.T.

*Anthony Hopper*  
*Pol*, Co. F, 6 Reg't U. S. Col'd H. Art'y.

Appears on

**Company Muster Roll**

for *July & Aug*, 1864.

Joined for duty and enrolled:

When *Aug 29*, 1863.\*

Where *Natchez Miss*\*

Period *3* years.\*

Present or absent *Present*

Stoppage, \$ *100* for

Due Gov't \$ *100* for

Remarks:

\* See enrollment on card from muster-in roll.

Book mark:

(358c)

*S. Duncan*

Copyist.

*A*

6 H. Art'y.

U.S.C.T.

*Anthony Hopper*  
*Priv*, Co. F, 6 Reg't U. S. Col'd H. Art'y.

Appears on

**Company Muster Roll**

for *Sept & Oct*, 186*4*

Joined for duty and enrolled:

When *Aug 29*, 186*3*.\*

Where *Natchez Miss* \*

Period *3* years.\*

Present or absent *Present*

Stoppage, \$ *100* for

Due Gov't \$ *100* for

Remarks:

-----  
-----  
-----  
-----  
-----  
-----

\* See enrollment on card from muster-in roll.

Book mark: *†*

(358c)

*S. Dunnean*

Copyist.

*A*

6 H. Art'y.

U.S.C.T.

*Anthony Hopper*  
Cvt., Co. F, 6 Reg't U. S. Col'd H. Art'y.

Appears on

**Company Muster Roll**

for *Nov & Dec*, 1864

Joined for duty and enrolled:

When *Aug 29*, 1863.\*

Where *Natchez Miss.*\*

Period *3* years.\*

Present or absent *Present*

Stoppage, \$ *100* for

Due Gov't \$ *100* for

Remarks:

-----  
-----  
-----  
-----  
-----

\* See enrollment on card from muster-in roll.

Book mark:

-----  
*S. Linnear*  
Copyist.

(358c)

*A*

6 H. Art'y. U.S.C.T.

*Anthony Hopper*  
*Pol*, Co. F, 6 Reg't U. S. Col'd H. Art'y.

Appears on

**Company Muster Roll**

for *Jan'y & Feb'y*, 1865.

Joined for duty and enrolled:

When *Aug 29*, 1863.\*

Where *Katchez Miss* \*

Period *3* years.\*

Present or absent *Present*

Stoppage, \$ *100* for

Due Gov't \$ *100* for

Remarks:

-----  
-----  
-----  
-----  
-----

\* See enrollment on card from muster-in roll.

Book mark:

*S. Curran*  
Copyist.

(358c)

*A*

6 H. Art'y. U.S.C.T.

*Anthony Harper*  
*Cpl*, Co. F, 6 Reg't U. S. Col'd H. Art'y.

Appears on

**Company Muster Roll**

for *Feb & Apl*, 1865.

Joined for duty and enrolled:

When *Aug 29*, 1863.\*

Where *Katchez Miss*\*

Period *3* years.\*

Present or absent *Present*

Stoppage, \$ *100* for

Due Gov't \$ *100* for

Remarks:

-----  
-----  
-----  
-----  
-----

\* See enrollment on card from muster-in roll.

Book mark:

*S. Bureau*  
Copyist.

(358c)

A 16 H. Artz U.S.C.T.

Anthony Hopper  
Priv., Co. F, 6 Reg't U. S. Col'd H. Artz

Appears on

**Company Muster Roll**

for May & June, 1865.

Joined for duty and enrolled:

When Aug 29, 1863.\*

Where Katchez Miss.\*

Period 3 years.\*

Present or absent Present

Stoppage, \$ 100 for

Due Gov't, \$ 100 for

Valuation of horse, \$ 100

Valuation of horse equipments, \$ 100

Remarks: \_\_\_\_\_

\_\_\_\_\_

\_\_\_\_\_

\* See enrollment on card from muster-in roll.

Book mark: \_\_\_\_\_

\_\_\_\_\_

(358c)

A. Duncan

Copyist.

*H*

6 H. Art'y.

U.S.C.T.

*Anthony Happer*

*Pvt.*, Co. F, 6 Reg't U. S. Col'd H. Art'y.

Appears on

**Company Muster Roll**

for *July & Aug.*, 186*5*!

Joined for duty and enrolled:

When *Aug 29<sup>th</sup>*, 186*3*\*

Where *Atchez Mills*\*

Period *3* years.\*

Present or absent *Present*

Stoppage, \$ *100* for

Due Gov't \$ *100* for

Remarks:  
-----  
-----  
-----  
-----  
-----  
-----

\* See enrollment on card from muster-in roll.

Book mark: -----

*J. W. Ames*  
(358c) Copyist.

*5*



H

6 H. Art'y. U.S.C.T.

Anthony Hopper

Pvt., Co. F, 6 Reg't U. S. Col'd H. Art'y.

Appears on

Company Muster Roll

for Sept & Oct, 1863.

Joined for duty and enrolled:

When Aug. 29<sup>th</sup>, 1863.\*

Where Hatchers Miss, \*

Period 3 years.\*

Present or absent Present

Stoppage, \$ 100 for

Due Gov't \$ 100 for

Remarks:

\* See enrollment on card from muster-in roll.

Book mark:

(358c) J. W. Jones Copyist.

H

6 H. Art'y.

U.S.C.T.

Anthony Gopper

Co. F, 6 Reg't U. S. Col'd H. Art'y.

Appears on

Company Muster Roll

for Nov. & Dec., 1860

Joined for duty and enrolled:

When Aug. 29, 1863\*

Where Hotchkiss, \*

Period 3 years.\*

Present or absent Present

Stoppage, \$ 100 for

Due Gov't \$ 100 for

Remarks:

\* See enrollment on card from muster-in roll.

Book mark:

(358c) J. W. Thomas Copyist.

*H*

6 H. Art'y.

U.S.C.T.

*Anthony Hopper*

*Pvt.*, Co. F, 6 Reg't U. S. Col'd H. Art'y.

Appears on

**Company Muster Roll**

for *Jan'y + Febr'y*, 186*6*.

Joined for duty and enrolled:

When *Aug. 29<sup>th</sup>*, 186*3*.\*

Where *Natchez Miss.*\*

Period *3* years.\*

Present or absent *Present*

Stoppage, \$ *100* for

Due Gov't, \$ *100* for

Valuation of horse, \$ *100*

Valuation of horse equipments, \$ *100*

Remarks:  
-----  
-----  
-----

\* See enrollment on card from muster-in roll.

Book mark:-----

(358c)

*J. W. Thomas*

Copyist.

*L*

6 H. Art'y. U.S.C.T.

*Anthony Hopper*

*Pvt.*, Co. F, 6 Reg't U. S. Col'd H. Art'y.

Appears on

**Company Muster Roll**

for *Men + Equip*, 1866.

Joined for duty and enrolled:

When *Aug. 29<sup>th</sup>*, 186*3*.\*

Where *Atchez Miss.* \*

Period *3* years.\*

Present or absent *Absent*

Stoppage, \$ *100* for

Due Gov't \$ *100* for

Remarks:  
-----  
-----  
-----  
-----  
-----

\* See enrollment on card from muster-in roll.

Book mark: -----

(358c)

*J. W. Ames*  
Copyist.

*H*

6 H. Art'y.

U.S.C.T.

*Anthony Kopper*

*Pvt.*, Co. *F*, 6 Reg't U. S. Col'd H. Art'y.

Appears on **Co. Muster-out Roll**, dated

*Natchez, Miss*, *May 13*, 186 *6*.

Muster-out to date

*May 13*, 186 *6*.

Last paid to

*Dec 31*, 186 *5*.

**Clothing account:**

Last settled....., 186 ; drawn since \$.....<sup>100</sup>

Due soldier \$ *52* <sup>*24*</sup>/<sub>100</sub>; due U. S. \$.....<sup>100</sup>

Am't for cloth'g in kind or money adv'd \$.....<sup>100</sup>

Due U. S. for arms, equipments, &c., \$.....<sup>100</sup>

Bounty paid \$.....<sup>100</sup>; due \$.....<sup>100</sup>

Remarks: *joined at original*

*organization*

Book mark:

(361)

*C. J. Moore*

Copyist.

**MICROCOPY**

**18 18**

**ROLL**

**18**



IMAGE EVALUATION  
TEST TARGET (QA-3)

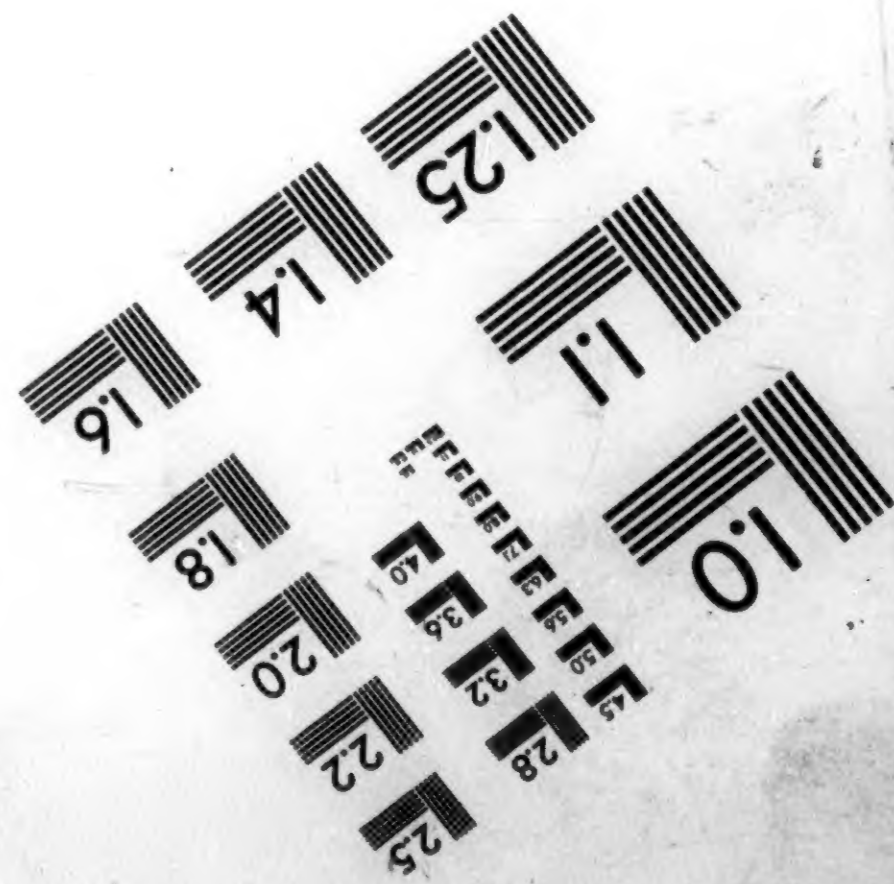
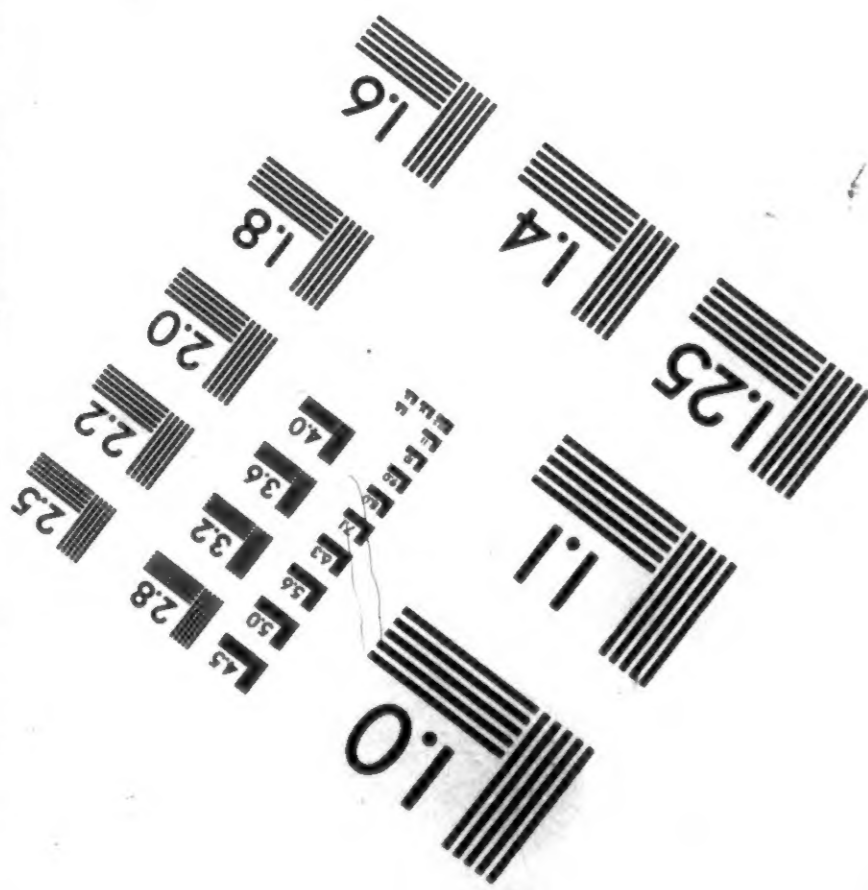
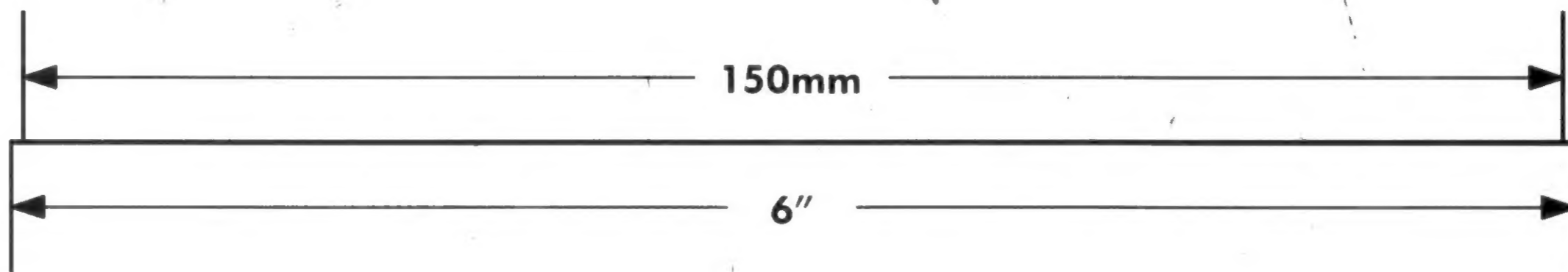
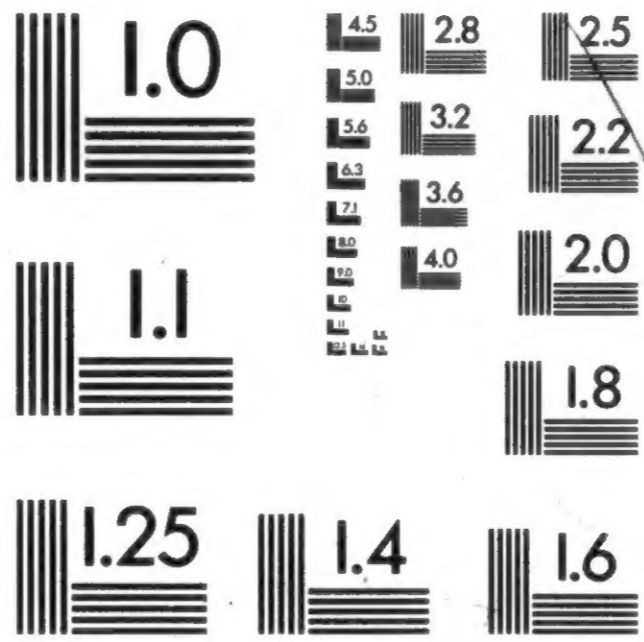
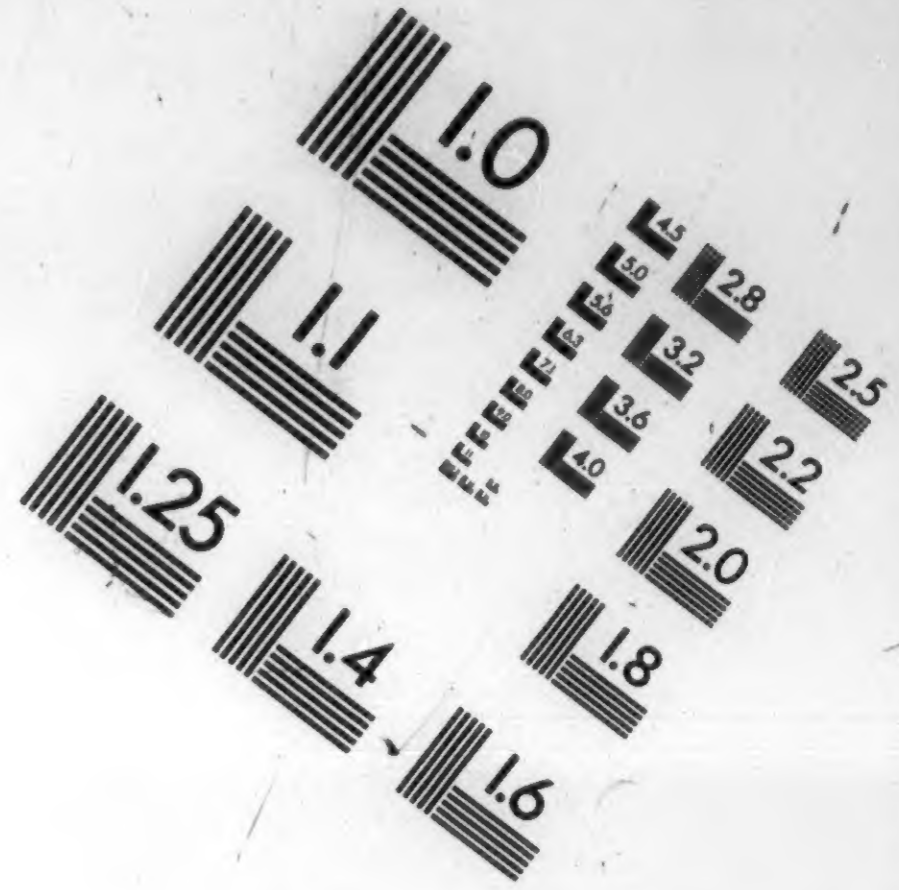
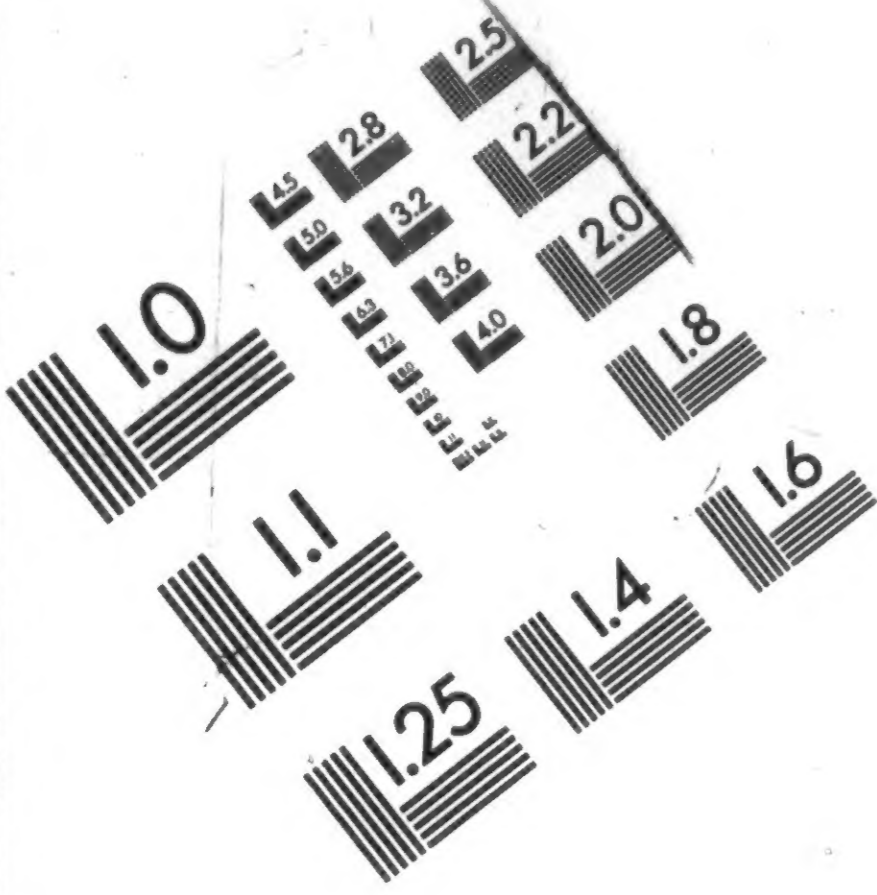

APPLIED IMAGE, Inc  
1653 East Main Street  
Rochester, NY 14609 USA  
Phone: 716/482-0300  
Fax: 716/288-5989

© 1993, Applied Image, Inc., All Rights Reserved

**THE END**

**PLEASE**

**REWIND**