

NATIONAL
ARCHIVES
MICROFILM
PUBLICATIONS

IMAGE EVALUATION TEST TARGET (QA-3)

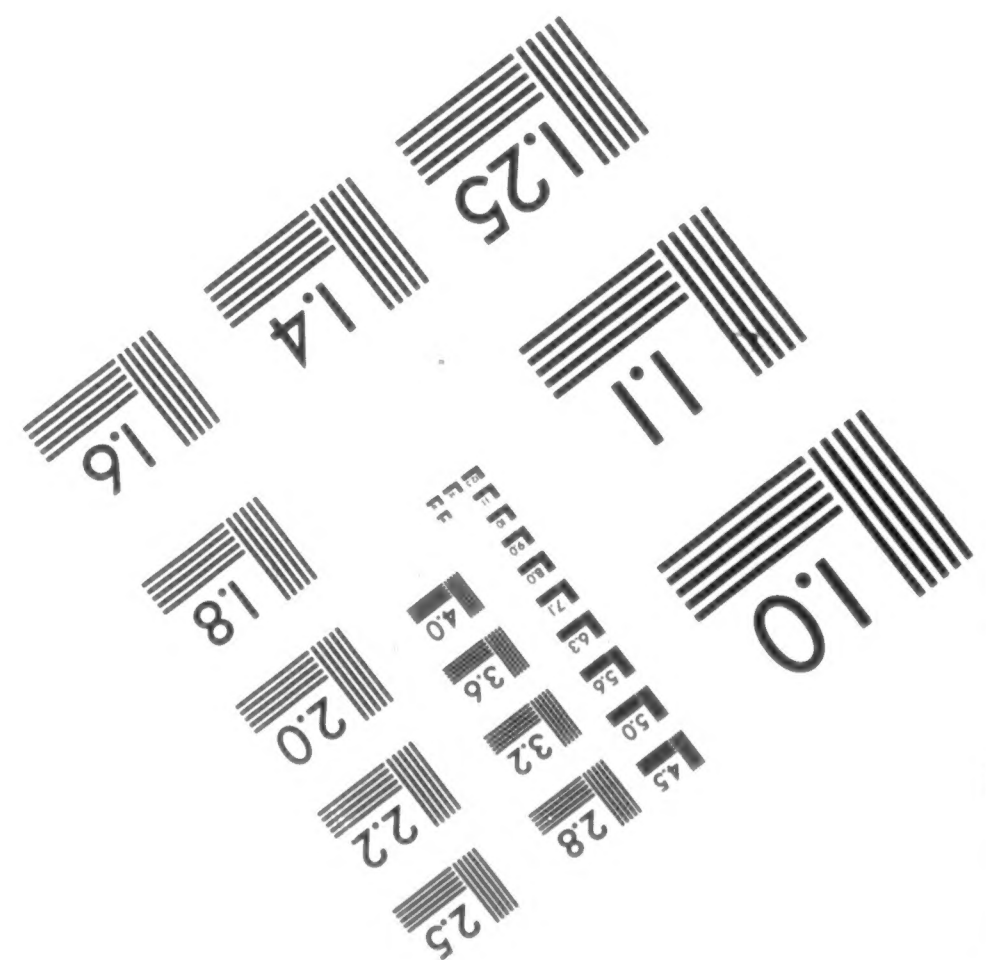
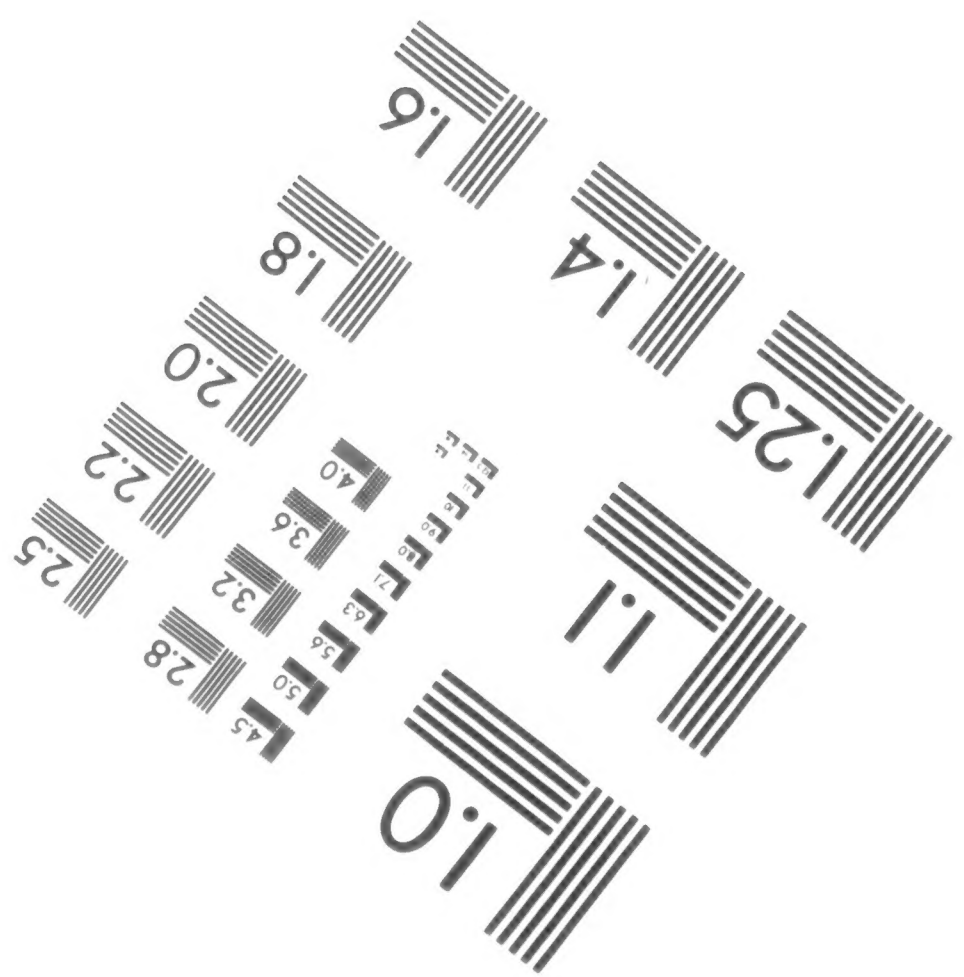
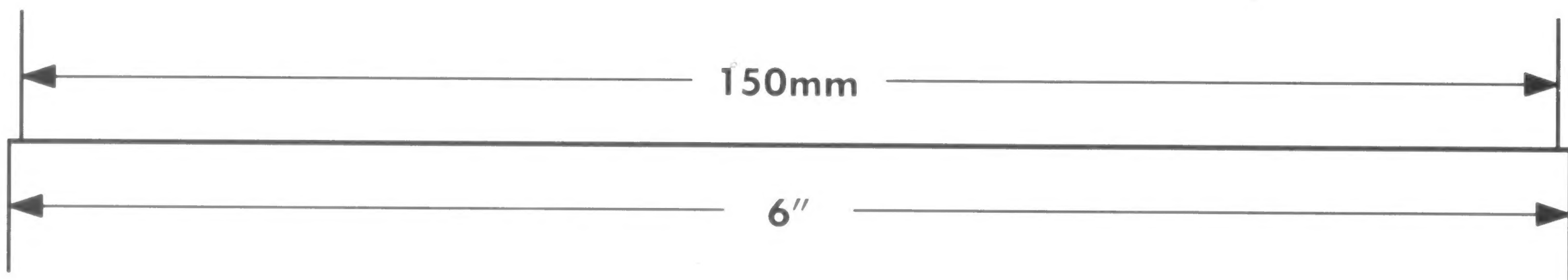
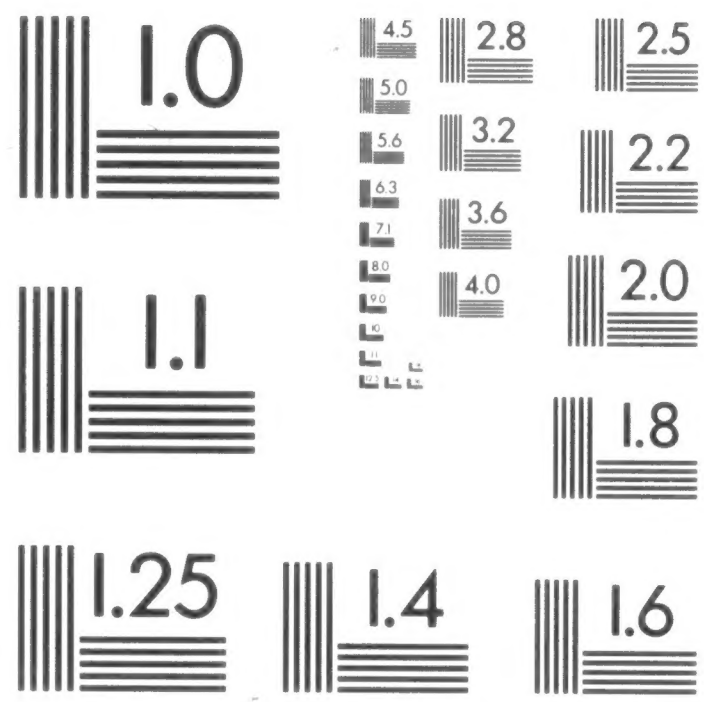
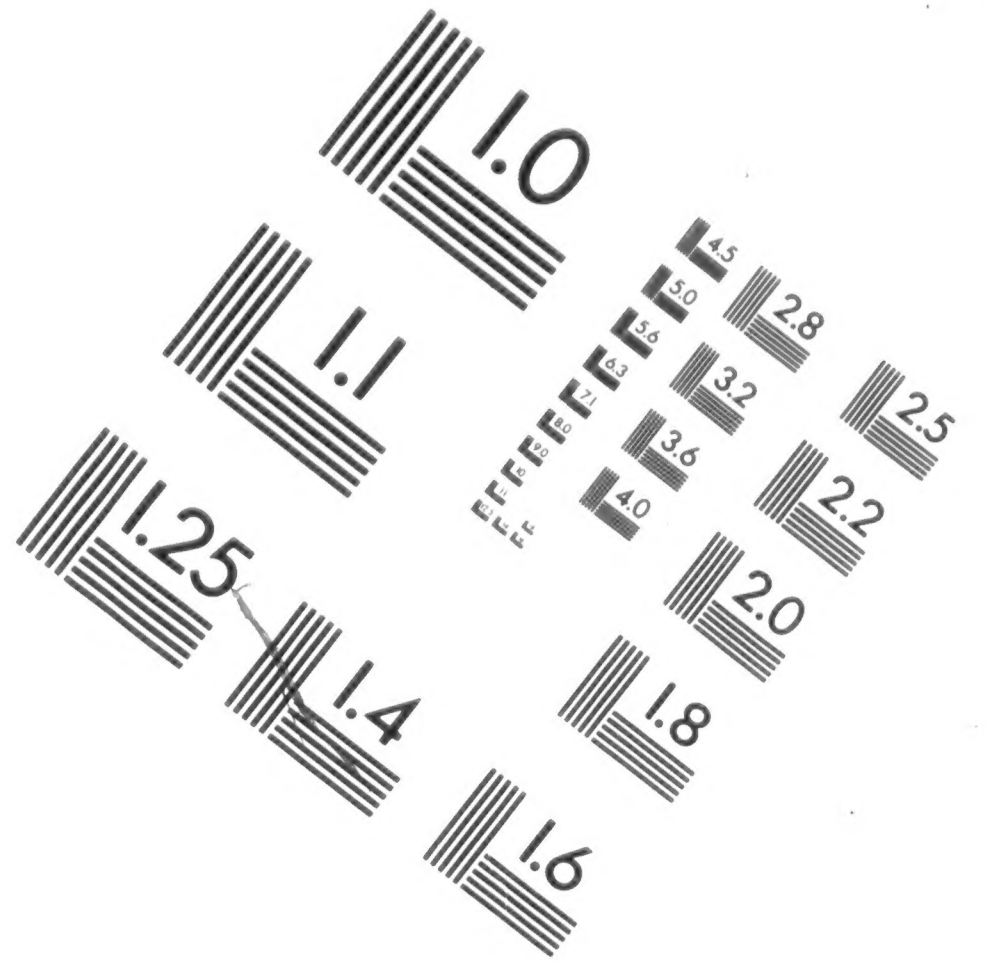
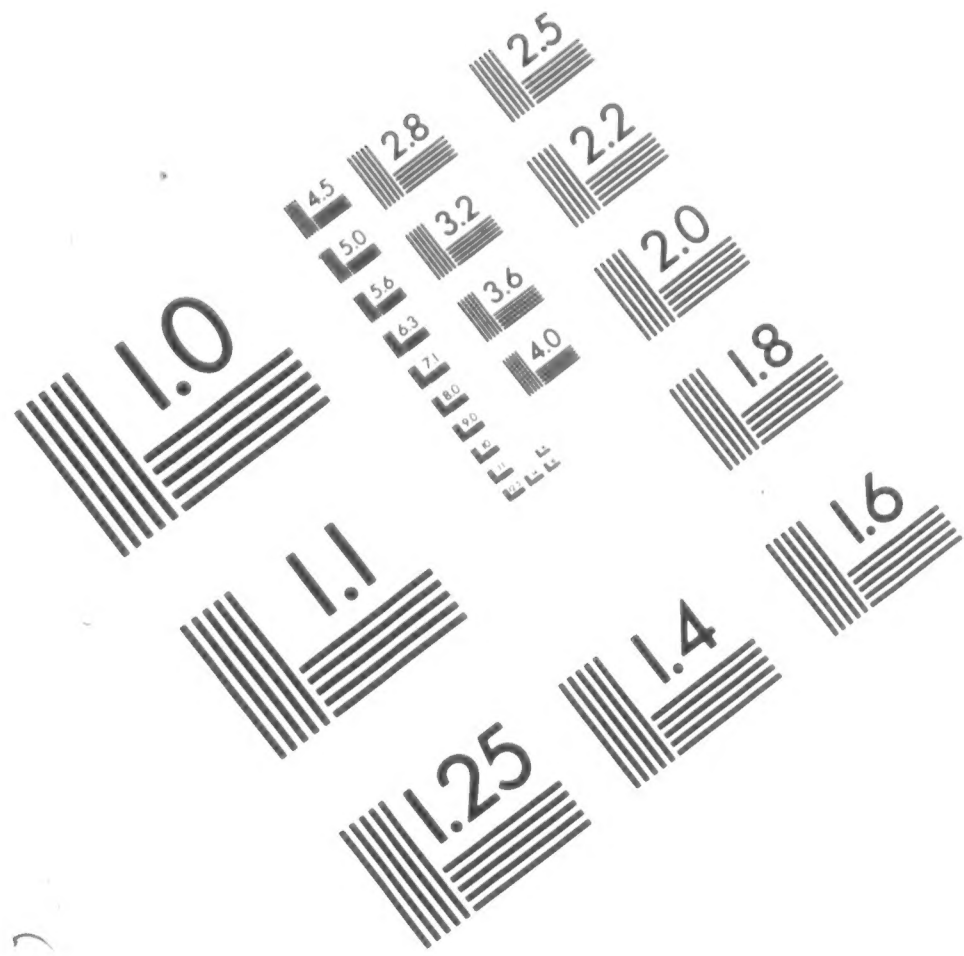

APPLIED IMAGE, Inc
 1653 East Main Street
 Rochester, NY 14609 USA
 Phone: 716/482-0300
 Fax: 716/288-5989

© 1993, Applied Image, Inc., All Rights Reserved

100

National Archives at College Park



8601 Adelphi Road College Park MD 20740-6001

C. Smith

Z-3

OPERATOR

7-24-98

CAMERA

10x

DATE FILMED

1961-0552-118-04

REDUCTION RATIO

FILM EMULSION NUMBER

M-1818

153

PROJECT NUMBER

ROLL NUMBER

MICROCOPY

18 18

ROLL

153

NATIONAL ARCHIVES MICROFILM PUBLICATIONS

M1818

**COMPILED MILITARY SERVICE RECORDS OF
VOLUNTEER UNION SOLDIERS WHO SERVED WITH THE
UNITED STATES COLORED TROOPS:
Artillery Organizations**

Introduction by Budge Weidman, Project Manager

Records prepared for microfilming by members of
the Civil War Conservation Corps

Pat Alfredson	Sue Goward*	Mary Poggioli
Phyllis Altrogge	Bert Greenstein	Peggy Pratt
Kenneth Ashton	Anne Greenwood	Ray Puzio
Sue Barnard*	Jim Harris	Sylvia Scott
Dee Benson	Walter Hayden	Lynn Shearouse
Ann N. Brown	Mary Hayden	Mary Stack-Dunne
Robert Budway	Pat Ikonen	Ben Stearns
Randy Caldwell	Dick Ives	Bill Stormer*
MaryAnn Castellana*	Sarah Jaffe	Pat Sullivan
Mary Lou Cole	Barbara Kemp	Gorman Tidball*
Giovanni Croce	Bev Manypenny	Cathy Tinston
B.H. Custer	Frank Masterson	John Toole
Bob Denney	Joe Mazur	Maryellen Toole
Richard Dow	Kathleen McCarthy	Milt Weatherhead
Earl Dunn	Sarah McDougall	Russ Weidman
Yvette Fallin	Catherine McManus	C. Lois Young
Maria Flesher	Ben Miles	Robert Young
Naomi Glass	Dave Murray	

Team leaders are indicated by the asterisk.

National Archives and Records Administration
Washington, DC
1998

NATIONAL ARCHIVES MICROFILM PUBLICATIONS

INTRODUCTION

On the 299 rolls of this microfilm publication, M1818, are reproduced the compiled military service records of volunteer Union soldiers belonging to the artillery units organized for service with the United States Colored Troops (USCT). The USCT included 7 numbered cavalry regiments; 13 numbered artillery regiments plus one independent battery; 144 numbered infantry regiments; plus Brigade Bands Nos. 1 & 2 (Corps d'Afrique and US Colored Troops); Powell's Regiment Colored Infantry; Southard's Company Colored Infantry; Quartermaster Detachment; Pioneer Corps, 1st Division, 16th Army Corps; Unassigned Company A Colored Infantry; and Unassigned USCT. There are also miscellaneous service cards arranged alphabetically by surname at the end of the unit records. The records reproduced are part of the Records of the Adjutant General's Office, 1780's-1917, Record Group (RG) 94.

Background

United States Colored Troops

Since the time of the American Revolution, African Americans have volunteered to serve their country in time of war. The Civil War was no exception. Official sanction was the difficulty. In the fall of 1862 there were four Union regiments of African Americans raised in New Orleans, LA: the 1st, 2d, and 3d Louisiana Native Guard, and the 1st Louisiana Heavy Artillery (African Descent). The 1st South Carolina Infantry (African Descent) was not officially organized until January 1863; however, three companies of the regiment were on coastal expeditions as early as November 1862. Similarly, the 1st Kansas Colored Infantry was not mustered into Federal service until January 1863, even though the regiment had already participated in the action at Island Mound, MO, on October 27, 1862. These early unofficial regiments received little Federal support, but they showed the strength of the African American soldier's desire to fight for freedom.

The first official authorization to employ African Americans in Federal service was the Second Confiscation and Militia Act of July 17, 1862. This act allowed President Abraham Lincoln to receive into the military or naval service persons of African descent and gave him permission to use them for any purpose "he may judge best for the public welfare." However, the President did not authorize use of African Americans in combat until issuance of the Emancipation Proclamation on January 1, 1863.

In late January 1863, Governor John Andrew of Massachusetts received permission to raise a regiment of African American soldiers. The pace of organizing additional regiments was very slow. In March Secretary of War Edwin M. Stanton sent Gen. Lorenzo Thomas to the lower Mississippi Valley to recruit free and contraband African Americans. Thomas was given broad authority. He was to explain the administration's policy regarding African American soldiers and recruit

volunteers to raise and command them. Stanton wanted all officers of such units to be white, but that policy was softened to allow African American surgeons and chaplains. By the end of the war, in addition to the chaplains and surgeons, there were some 87 African American officers. Thomas's endeavor was very successful, and on May 22, 1863, the Bureau of Colored Troops was established to coordinate and organize regiments from all parts of the country. Created under War Department General Order No. 143, the bureau was responsible for handling "all matters relating to the organization of Colored Troops." The bureau was directly under the Adjutant General's Office and its procedures and rules were specific and strict. All African American regiments were now to be designated United States Colored Troops (USCT). At this time there were some African American regiments with state names and a few regiments in the Department of the Gulf designated as Corps d'Afrique. All these were ultimately assimilated into the USCT, even though some of the regiments, such as the 5th Massachusetts, retained their state designations.

To facilitate recruiting in the states of Maryland, Missouri, Tennessee, and eventually Kentucky, the War Department issued General Order No. 329 on October 3, 1863. Section 6 of the order stated that if any citizen should offer his or her slave for enlistment into the military service, that person would, "if such slave be accepted, receive from the recruiting officer a certificate thereof, and become entitled to compensation for the service or labor of said slave, not exceeding the sum of three hundred dollars, upon filing a valid deed of manumission and of release, and making satisfactory proof of title." For this reason, some records of manumission are contained in the compiled service records reproduced in this publication.

The USCT fought in 39 major engagements and over 400 lesser ones. Sixteen African American soldiers received Medals of Honor. As it was in other units, the death toll from disease was very high in the USCT. Deaths from disease and battle totaled 37,000. The last regiment of the USCT was mustered out of Federal service in December 1867.

Important sources for information about African American units in the Civil War are the War Department's *The War of the Rebellion: A Compilation of the Official Records of the Union and Confederate Armies* (Washington, DC: 1880-1901; reprinted Harrisburg, 1971 and 1985) and the Navy Department's *The War of the Rebellion; A Compilation of the Official Records of the Union and Confederate Navies* (Washington, DC: 1874-1922; reprinted Harrisburg, 1971 and 1985). These multivolume works contain reports of operations and other official correspondence.

U. S. Colored Heavy Artillery

1st Heavy Artillery: This regiment was organized at Knoxville, TN, between February and November 1864. It served in Knoxville, eastern Tennessee, western Virginia, northern Alabama, and western North Carolina. It was mustered out on March 31, 1866.

2d Heavy Artillery: This regiment was changed from the 2d Heavy Artillery to the 3d Heavy Artillery on April 26, 1864, and the compiled military service records appear there.

3d Heavy Artillery: Organized as the 1st Tennessee Heavy Artillery (African descent) at Memphis and Fort Pickering, TN, from June 5 to December 22, 1863, this regiment's designation was changed to the 3d United States Colored Heavy Artillery in April 1864. It served garrison duty at Fort Pickering and in defense of Memphis, TN. The unit mustered out on April 30, 1866.

4th Heavy Artillery: This unit was organized as the 2d Regiment Tennessee Heavy Artillery (African descent) from June 1863 until April 1864. It became the 4th United States Colored Heavy Artillery in April 1864. It served at Fort Halleck; Columbus, KY; and Union City, TN. The regiment had duty near Fort Donelson, TN, and moved to Pine Bluff, AR, where it was mustered out on February 25, 1866.

5th Heavy Artillery: This regiment was organized at Vicksburg, MS, between August 1863 and January 1864, as the 9th Louisiana Volunteers (African descent). Its designation was changed to the 5th Heavy Artillery in April 1864. The unit served garrison duty at Vicksburg, MS, and was mustered out on May 20, 1866.

6th Heavy Artillery: This regiment was organized as the 2d Mississippi Heavy Artillery (African descent) at Natchez, MS, from September 1863 to January 1864. It was changed to the 6th United States Colored Heavy Artillery on April 26, 1864. The unit served at Natchez, Mississippi, and Vidalia, LA. It was mustered out on May 18, 1866.

7th Heavy Artillery: The 7th Heavy Artillery was designated the 11th United States Colored Infantry (New) on January 23, 1865, and the compiled military service records appear there.

8th Heavy Artillery: This regiment was organized at Paducah, KY, from April to October 1864. It served garrison duty at Paducah and was mustered out on February 10, 1866.

9th Heavy Artillery: This regiment consisted of four companies and was organized at Clarksville and Nashville, TN, during October 1864. It was mustered out on May 5, 1865.

10th Heavy Artillery: Organization of this regiment at New Orleans, LA, began in November 1862. First designated the 1st Louisiana Heavy Artillery (African descent) in November 1863, it became the 1st Regiment Corps d'Afrique. In May 1864 the unit became the 10th United States Colored Heavy Artillery. The regiment was on garrison duty at New Orleans during its entire service. It served longer than any other USCT regiment, mustering out on February 22, 1867.

11th Heavy Artillery: This regiment was organized at Providence, RI, from August 1863 through January 1864, as the 14th Rhode Island Colored Heavy Artillery. In May 1864 it became the 11th United States Colored Heavy Artillery. The unit served garrison duty at New Orleans, LA, and was mustered out on October 2, 1865.

12th Heavy Artillery: This regiment was organized at Camp Nelson, KY, from July 1864 through July 1865. It served garrison duty at Camp Nelson, Bowling Green, and other points in the District of Kentucky. It was mustered out on April 24, 1866.

13th Heavy Artillery: This regiment was organized at Camp Nelson, KY, in June 1865, where it served garrison duty. It also served at Smithland and Lexington, KY. It was mustered out on November 18, 1865.

14th Heavy Artillery: This regiment was organized at New Bern and Morehead City, NC, from March 1864 to April 1865, as the 1st North Carolina Colored Heavy Artillery. It became the 14th United States Colored Heavy Artillery in March 1865. The unit served garrison duty at New Bern, NC, and was mustered out on December 11, 1865.

U. S. Colored Light Artillery

The **1st Regiment Light Artillery** was recruited and organized under Maj. Gen. Benjamin F. Butler in December 1863. In February 1864 it was changed to Battery B of the 2d Light Artillery.

The **2d Regiment Light Artillery** consisted of nine batteries, A through I, that were independently organized and deployed.

Battery A was organized at Nashville, TN, in April 1864. The battery served garrison duty at Nashville and participated in the Battle of Nashville December 15-16, 1864. It was mustered out January 13, 1866.

Battery B was organized at Fort Monroe, VA, in January and February 1864. It operated in Virginia and participated in the siege against Petersburg and Richmond. The battery was ordered to Texas in May 1865, and mustered out March 17, 1866.

Battery C was organized at Hebron's Plantation, MS, in November 1863, as the 1st Battery Louisiana Light Artillery (African descent). It was designated Battery C in April 1864. The battery had garrison duty at Goodrich Landing, Vicksburg, and Milliken's Bend. It was mustered out December 28, 1865.

Battery D was organized at Black River Bridge, MS, in December 1863, as the 2d Battery Louisiana Light Artillery (African descent). It was designated Battery D in April 1864. The battery had garrison duty at Goodrich Landing and Vicksburg, MS, and was mustered out on December 28, 1865.

NATIONAL ARCHIVES MICROFILM PUBLICATIONS

Battery E was organized at Helena, AR, in December 1863, as the 3d Battery Louisiana Light Artillery (African descent). It was designated Battery E in April 1864. The battery had garrison duty at Helena, AR, and was mustered out on September 26, 1865.

Battery F was organized at Memphis, TN, in November 1863, as the Memphis Light Battery. It was designated Battery F in April 1864. The battery had garrison duty at Memphis, TN, until April 1865, when it moved to Bridgeport, AL. It was mustered out on December 28, 1865.

Battery G was organized at Hilton Head, SC, in May 1864 and had garrison duty at Hilton Head for its entire term. The battery was mustered out on August 12, 1865.

Battery H was organized at Pine Bluff, AR, in June 1864, as the 1st Arkansas Colored Battery. It was designated as Battery H in December 1864. The battery had garrison duty at Pine Bluff the entire term and was mustered out on September 14, 1865.

Battery I was organized at Memphis, TN, in April 1864. The battery had garrison duty at Memphis, TN, and operations in Mississippi. It was mustered out on January 10, 1866.

Independent Battery was organized at Leavenworth, KS, in December 1864. It had duty at Fort Leavenworth until it was mustered out on July 22, 1865.

Records Description

Compiled service records consist of a jacket-envelope for each soldier, labeled with his name, rank, unit, and card numbers. The compilation of service records of Union soldiers began in 1890 under the direction of Col. Fred C. Ainsworth, head of the Record and Pension Office of the Adjutant General's Office, Department of War. Information from muster rolls, regimental returns, descriptive books, and other records was copied verbatim onto cards. A separate card was prepared each time an individual name appeared on a document. These cards were numbered on the back, and these numbers were entered onto the outside jacket containing the cards. The carded information was verified by a separated operation of comparison; great care was taken to ensure that the cards were accurate.

A typical jacket contains card abstracts of entries found in original records relating to the soldier and original documents relating solely to that soldier. Examples of the latter include enlistment papers, substitute certificates, casualty sheets, death reports, prisoner-of-war memorandums, and correspondence. Unique to the records of the USCT are deeds of manumission, oaths of allegiance, proof of ownership, certificates of monetary award, and bills of sale. These items appear most frequently in units recruited in the border states of Kentucky, Missouri, and Maryland. These states remained in the Union but were slave states. Jackets and

NATIONAL ARCHIVES MICROFILM PUBLICATIONS

cards include a section labeled "bookmark" which was reserved for cross-references to other records relating to the individual or his unit. The service records are arranged by arm of service, thereunder numerically by regiment or independent battalion or company, and thereunder alphabetically by name of the soldier. Records for officers are interfiled alphabetically by name with the records of enlisted men. If an individual served in more than one unit, which was typical for USCT officers, there will be a separate service record for each unit in which he served.

The unjacketed miscellaneous cards were accumulated by the War Department with the expectation that they would be incorporated in individual compiled service records. However, the expectation was never fulfilled, because either insufficient or contradictory information made it impossible to associate the cards or papers with a particular soldier's service records.

Related Records

Among the records of the Adjutant General's Office in the National Archives are many of the original records that were abstracted or "carded" by the Record and Pension Office. These include the individual unit's muster rolls, returns and descriptive books. Other series in RG 94 that contain information relating to volunteer Union soldiers who served with the USCT include carded records relating to Union staff officers, carded medical records of volunteer Union soldiers, unbound and bound regimental records and "record of events" cards. The regimental records of the 54th Massachusetts Infantry (Colored) have been reproduced as Microfilm Publication M1659, *Records of the Fifty-fourth Massachusetts Infantry Regiment (Colored), 1863-1865*.

The "record of events" cards include information copied from the unit's muster rolls and returns. They show the stations of the field and staff and those of the various companies of the regiment at the time the muster roll or return was prepared and sometimes mention battles, skirmishes, or other activities in which the regiment participated. The cards have been reproduced as Microfilm Publication M594, *Compiled Records Showing Service of Military Units in Volunteer Union Organizations*.

Record Group 94 also includes a card index for the USCT, reproduced as Microfilm Publication M589, *Index to Compiled Military Service Records of Volunteer Union Soldiers Who Served with U.S. Colored Troops*, which may be used to locate the regiment of USCT personnel. An index card gives the name of the soldier and his rank, as well as the unit in which he served; sometimes there is a cross-reference to his service in other units or organizations. The National Archives is continually producing microfilm publications of volunteer Union compiled military service records. A complete listing of finished publications can be found in the National Archives *Microfilm Resources for Research: A Comprehensive Catalog* which is available online at <http://www.nara.gov>.

NATIONAL ARCHIVES MICROFILM PUBLICATIONS

The Records of the Colored Troops Division, within RG 94, include division correspondence and records relating to recruiting, the appointment of officers, and the slave or free status of individuals; and a compilation of historical extracts and official papers concerning the military service of African Americans from the colonial period through the Civil War entitled *The Negro in the Military Service of the United States 1639-1886*. This compilation is reproduced as Microfilm Publication M858. The Records of the Bounty and Claims Division, also in RG 94, include correspondence of the division and records relating to bounties and claims paid to loyal owners of slaves by the Slave Claims Commissions of Delaware, Kentucky, Maryland, Missouri, Tennessee, and West Virginia.

If an application for a pension was made, the pension application case file may be among the Records of the Veterans Administration (RG 15). Indexes to the pension applications have been reproduced as Microfilm Publication T288, *General Index to Pension Files, 1861-1934*, and T289, *Organizational Index to Pension Files of Veterans Who Served Between 1861 and 1900*.

If a soldier or officer was tried before a general court-martial or if an individual or his unit was the subject of a court of inquiry or military commission, transcripts of the proceedings may be among the Records of the Office of the Judge Advocate General (Army) (RG 153). The registers to the proceedings have been reproduced as Microfilm Publication M1105, *Registers of the Records of the Proceedings of the U.S. Army General Courts-Martial, 1809-1890*.

Other record groups having information pertaining to the USCT include Records of the Bureau of Refugees, Freedmen, and Abandoned Lands (RG 105); Records of the Provost Marshal General's Bureau (Civil War) (RG 110); Records of the Accounting Officers of the Department of the Treasury (RG 217); and Records of U.S. Army Continental Commands, 1821-1920 (RG 393).

NATIONAL ARCHIVES MICROFILM PUBLICATIONS

Roll list

Roll Description

1st United States Colored Heavy Artillery

1	Ackerson, David - Baker, Barney
2	Baker, George - Bogle, Harry
3	Bolden, Joseph - Brown, Edwin G.
4	Brown, George - Carmack, Bachus
5	Carmack, Gilbert - Cleveland, Loudon
6	Clevenger, Charles - Cune, John C.
7	Curd, George - Eblin, Richard
8	Eckles, Silas - Furbush, Lewis
9	Gaines, George - Greenleaf, Andrew
10	Greenleaf, Julius - Hart, Benjamin
11	Hartman, Henry - Hoff, David
12	Holland, John - Jackson, Thomas J.
13	Jackson, Washington - Jones, James
14	Jones, John - Ledgewood, Clayborne
15	Lee, Elhanon - Martin, Robert
16	Mason, Henry - McKenney, Elijah
17	McKinney, Lewis - Montcastle, Stewart
18	Montgomery, Alfred - Owens, Benjamin
19	Owens, Granville - Ragan, Nelson
20	Ragan, Rome - Russell, Orlando A.
21	Russell, Perry - Smith, Archie
22	Smith, Bart - Suddles, Robert
23	Summers, Joseph D. - Turner, Charles
24	Turner, Henry - Weir, Richard
25	Weir, Robert - Willis, Albert
26	Willis, Beverly S. - Zimmerman, William

3d United States Colored Heavy Artillery

27	Abel, William - Armour, Lewis
28	Armstaed, William - Beaufort, Thomas
29	Beaumont, Henry - Bowler, Lafayette P.
30	Bowman, Fleming - Brummer, John E.
31	Bryan, Solon - Carter, William
32	Cartman, John - Cook, Isham
33	Cook, John - Davis, Doctor
34	Davis, George - Easen, Samuel
35	Easley, Wesley - Flinn, Clay
36	Flint, James - Gilbreth, Eli

NATIONAL ARCHIVES MICROFILM PUBLICATIONS

Roll	Description
37	Gilbreth, Guy - Griffin, Samuel
38	Griffin, William - Harrison, James
39	Harrison, James C. - Hicks, Smith
40	Higginbottom, Nimrod - Hunt, Rubin
41	Hunt, William - Johnson, Charles
42	Johnson, Crawford - Jones, Isaac
43	Jones, Isam - Knight, Warren
44	Knox, Overton - Mabin, Baker
45	Mabin, James - McDonald, Manuel
46	McDonald, Ruben - Mills, Robert
47	Milroy, John - Nealy, Henry
48	Ned, Lewis - Patterson, Pembroke J. (Perin J.)
49	Patton, Richmond - Powers, William
50	Prewitt, Greene - Roberts, Lewis
51	Robinette, Henry - Scott, Edmond
52	Scott, Elijah - Smith, Peter
53	Smith, Randall - Tapscott, Julius
54	Tarwater, Jesse - Todd, William
55	Todd, Willis - Wallace, Robert
56	Wallace, Sandford - Wells, Duncan
57	Wells, Joseph - Williams, Guyo
58	Williams, George - Wolbrecht, Adolf
59	Wood, Charles - Young, William H.

4th United States Colored Heavy Artillery

60	Abbott, John - Barnes, Samuel
61	Barnes, Thomas - Britt, Jackson
62	Britten, Charles - Clark, Mitchell
63	Clay, Henry - Daniel, Richard
64	Daniels, William - Dyson, Jack
65	Dyson, Paul - Gardner, Riley
66	Gardner, Washington - Hall, Henry
67	Hall, Jack - Horton, Mack
68	Horton, William - Jones, Levi
69	Jones, Louis - Lewis, Stephen
70	Lewis, Thomas - McMurray, Anderson (John)
71	McMurray, George - Need, Benjamin
72	Nelson, John - Prior, Alfred
73	Prior, Gabriel - Rutland, Isaac
74	Ruttkey, Albert - Smith, Louis
75	Smith, Samuel - Turner, Frank
76	Turner, James - White, Henry
77	White, Raven - Youngs, William

NATIONAL ARCHIVES MICROFILM PUBLICATIONS

Roll	Description
5th United States Colored Heavy Artillery	
78	Abbott, Richard - Armstrong, William
79	Arrindale, John B. - Bentley, Francis A.
80	Bentley, Isam - Brooks, Lawyer
81	Brooks, Robert - Cabin, Henry
82	Cabin, Shadrick - Coleman, Nathan
83	Coleman, William - Davidson, Ellis
84	Davis, Alfred - Dodd, Taylor
85	Dodds, Peter - Feltis, Jackson
86	Felton, Martin - Gilford, Charles
87	Gillespie, Gilbert - Hagan, Alex
88	Hagans, Joseph - Hayes, John S.
89	Haythorn, Henry - Hood, John
90	Hooker, William - James, Warren
91	January, Nathan - Johnson, Wiley
92	Johnson, William - Kindley, Edward
93	King, Elijah - Lewis, Ely J.
94	Lewis, George W. - Manitoie, Samuel
95	Manly, Elisha - McNeil, William
96	McQuilley, Clayton - Mosley, Jacob
97	Moss, Alfred - Parker, James
98	Parker, John H. - Powell, Monroe
99	Power, Henry - Roach, Watt
100	Robb, Benjamin - Shaw, Barrow
101	Shaw, James - Smith, Robert
102	Smith, Samuel - Tate, John
103	Taylor, Anderson - Trueman, Henry
104	Truman, Nelson - Ward, George
105	Ward, Jacob - West, Moses
106	Westbrook, Ellick - Williams, John B.
107	Williams, Jordan - Wood, Theodore
108	Woodam, Henry - Young, William
	Miscellaneous Service Cards
	Allen, Geo. - Young, L.

6th United States Colored Heavy Artillery

109	Aaron, William - Barton, Granderson
110	Baseman, Jerry - Bracton, John
111	Bradford, Henry - Bush, Wilson
112	Bustis, Mondey - Clay, Henry
113	Clay, William - Davenport, William
114	Davenport, Wilson - Dunbar, Newton

NATIONAL ARCHIVES MICROFILM PUBLICATIONS

Roll	Description
115	Dunbow, Hannibal - Fox, William
116	Francis, James - Green, George
117	Green, James - Harris, Hiram
118	Harris, John - Hopper, Anthony
119	Hopper, Handy - James, Joseph
120	Jasper, Samuel - Jones, John
121	Jones, Jonas - Leavitt, Charles B.
122	Lee, David - McBride, Samuel
123	McCabe, Alexander H. - Moore, Joseph
124	Moore, Manual - Owens, Willis
125	Page, Benjamin - Reece, Edward
126	Reese, William - Samuel, William
127	Sanders, Archibald - Smart, Robert
128	Smith, Aaron - Suzette, Armstead
129	Swanson, Jack - Trotter, George
130	Troyman, George - Waters, Robert
131	Waters, Wesley - Williams, Bedney
132	Williams, Benjamin - Wilson, George
133	Wilson, Guy - Young, Wesley
	Miscellaneous Service Cards
	Adams, Winder - Williams, John

8th United States Colored Heavy Artillery

134	Abanather, Paten - Beasley, George W.
135	Beasley, Washington - Boyd, Isaac
136	Boyd, Paine - Burrill, George
137	Burris, Abram - Cofield, Henry
138	Cofield, Isaac - Davis, George
139	Davis, Jerry - Edwards, Frank
140	Edwards, Gus - Ginigan, Thomas
141	Givens, George - Hampton, Phillip
142	Hancock, James - Hodge, Cotney
143	Hodge, Gaines - Johnson, Charles
144	Johnson, Clinton - Lee, Wash
145	Leeper, Thomas - Maxwell, Henry
146	Maxwell, Samuel - Moore, Amos
147	Moore, David - Pearson, Alexander
148	Pearson, Charley - Rice, Pleasant
149	Rice, Taylor - Sherrer, Elick
150	Shirles, James - Talbot, Henry
151	Talley, William - Turner, Robert
152	Tyler, Jerry - Williams, John
153	Williams, Sam - Young, William

NATIONAL ARCHIVES MICROFILM PUBLICATIONS

Roll	Description
9th United States Colored Heavy Artillery	
154	Ailer, John - Coleman, Miles
155	Collins, Moses A. - Grosskopff, Edward
156	Grubb, Andrew - Landon, Harry
157	Lanier, Jesse - Payne, George
158	Payne, James - Tory, Madison
159	Toryand, Emanuel - Young, George
10th United States Colored Heavy Artillery	
160	Aaron, Benjamin - Auguste, Daniel
161	Augustus, Edward - Benson, George
162	Bentley, William H. - Brooks, Walker
163	Brooks, Washington - Camel, Paul
164	Cameron, Henry - Coleman, James
165	Coleman, John - Deale, Joseph
166	Deale, Thomas - Ellis, Robert
167	Ellis, Silas - Frederick, Joseph
168	Freeland, Martin A. - Grandison, Alfred
169	Grant, Moses - Harrison, Logan
170	Harrison, Thomas - Hoyt, Joseph
171	Hubbard, Henry - Jenkins, Solomon
172	Jennings, Caleb - Jozen, Jules
173	Julia, Nora - Libscomb, George
174	Lightfoot, Columbus - Maryday, John
175	Masdael, Noel - Misker, Robert
176	Mitchel, Alexander - Oldham, George B.
177	Oliver, Emile - Purnell, John
178	Putnam, Winthrop D. - Robinson, Henry
179	Robinson, Isaac - Simmons, Owen
180	Simms, Amos - Spencer, John
181	Spriggs, Thomas - Thornton, John
182	Thurston, Charles - Warner, Dudley
183	Warner, George E. - Wesley, John
184	West, Alexander - Willis, Stephen
185	Willson, George - Zozey, Jules
	Miscellaneous Service Cards
	Cann, Mercer - Grayson, John W.
186	Miscellaneous Service Cards
	Green, Andrew P. - Rygaard, Soren
187	Miscellaneous Service Cards
	Sabatier, Peter - Zevenette, Paul

NATIONAL ARCHIVES MICROFILM PUBLICATIONS

Roll	Description
11th United States Colored Heavy Artillery	
188	Abbott, George M. - Bailey, James A.
189	Baird, Sylvester - Boardley, James
190	Boardley, John W. - Brown, Nathan
191	Brown, Samuel - Carter, William H.
192	Cartright, George W. - Commings, Hugh S.
193	Comstock, Joseph J. - Davis, Lyman
194	Davis, Stephen - Dubois, James
195	Duesenbury, Lewis - Fletcher, Roderick S.
196	Fletcher, Samuel - Garrison, John
197	Gaskell, George L. - Groff, Joseph
198	Guard, Andrew - Hector, William H.
199	Heelms, Harkness - Howard, Richard
200	Howard, Thomas - Jackson, Lewis
201	Jackson, Norton - Johnson, Joseph W.
202	Johnson, Nathan - King, Cornelius
203	King, George - Loucks, John A.
204	Low, Charles H. - Miller, Benjamin
205	Miller, Floyd N. - Nicholas, Samuel
206	Nichols, Alfred - Pierce, George W.
207	Pierce, John B. - Reed, Washington
208	Reese, Edward - Sampson, William H.
209	Sanders, Edward - Skanks, James S.
210	Skanks, Thomas C. - Sommerset, Levi
211	Southwick, Henry K. - Taylor, Alfred M.
212	Taylor, Charles - Townsend, John
213	Tracy, John - Warren, John
214	Washington, George - Whiting, Joseph C., Jr.
215	Wigden, Cyrus B. - Wilson, Samuel
216	Wilson, William - Young, Francis
	Miscellaneous Service Cards
	Abbot, George W. - Dyer, William S.
217	Miscellaneous Service Cards
	Earl, Peter - Young, William H.
12th United States Colored Heavy Artillery	
218	Abbott, John - Barbee, Squire
219	Barber, Sherwood - Boller, Jerry
220	Bolor, Collins - Bryant, Frederick
221	Bryant, Henry - Bush, Reason
222	Butler, Aaron - Clark, Richard
223	Clark, Samuel - Criffield, Lewis

NATIONAL ARCHIVES MICROFILM PUBLICATIONS

Roll	Description
224	Christopher, James - Dock, Calvin E.
225	Dodge, Henry - Farnesley, Jack
226	Farrus, Ephraim - Gaves, David
227	Gentry, George - Haggin, George
228	Haggin, Samuel - Hawkins, Robert
229	Hawkins, Thomas - Hode, Adam
230	Hodge, Charles - Jackson, Andrew
231	Jackson, Augustus - Jopee, Joseph
232	Juda, Enoch - Lewis, Windsor
233	Lidick, Randall - Maton, Levi
234	Matthews, Charles W. - Mitchell, John
235	Mitchell, Monroe - Nelson, Joseph
236	Nesbin, William - Porter, Daniel
237	Porter, William R. - Richason, Shelly
238	Richie, George - Scott, Smith
239	Scott, Stephen - Smith, Leroy
240	Smith, Lyman - Taylor, Charles
241	Taylor, Cornelius - Turner, David
242	Turner, George - Warren, James
243	Washington, Anthony - Williams, Berry
244	Williams, Charles - Woodson, David
245	Woodson, Egbert - Young, Thomas
	Miscellaneous Service Cards
	Baughman, John - Heel, Rubin
246	Miscellaneous Service Cards
	Helm, Harry - Young, Stephen

13th United States Colored Heavy Artillery

247	Abbott, Josiah - Bell, Augustine
248	Bell, Charles - Brown, Jesse
249	Brown, Lindsay - Connor, Cyrus
250	Connor, Isaac - Dyre, George
251	Early, Edward - Ginn, Samuel
252	Ginnis, Sidney Clay - Heath, Henry
253	Heath, Lewis - Jarrett, Charles
254	Jay, Johnson - Lee, William
255	Lender, Richard - McKinney, Cass
256	McKinney, Henry Clay - Owens, Robert
257	Owens, Smith - Randolph, Loyd
258	Rankins, Archibald - Scott, Jerry
259	Scott, John - Sugg, Edmond
260	Suiter, Jacob A. - Waddie, Harry
261	Waddy, Peter - Willett, Price

NATIONAL ARCHIVES MICROFILM PUBLICATIONS

Roll	Description
262	Willett, Robert - Young, William
263	Miscellaneous Service Cards Abbott, Josiah - Yumber, Anthony
14th United States Colored Heavy Artillery	
264	Acot, Isaac - Becton, Henry
265	Becton, Moses - Burke, George W.
266	Burke, William A. - Davis, Toney
267	Dean, Thomas - Fullford, William
268	Fulton, James - Hardy, William
269	Harget, Israel - Hovey, William
270	Howard, Calvin - Kensley, Silas
271	Kent, Henry - McKeever, Simon
272	McMichael, Joseph - Noble, William
273	Nobles, Charles - Randall, Evans
274	Randall, Willey - Shark, Bryant
275	Sheckelford, Daniel - Smith, Samuel
276	Smith, Sterling - Thompson, John Henry
277	Thompson, Mark - Weeks, Ezekiel
278	Weidman, Albert - Wilson, Payton
279	Wilson, Richard - Young, William
	Miscellaneous Service Cards Acott, Isaac - Young, William
2d Regiment United States Colored Light Artillery	
280	Able, John - Bernard, Albert
281	Berry, Henry - Brown, Sang
282	Brown, Thomas - Clark, William
283	Clay, Henry - Disen, Henry
284	Disen, Watkins - Francis, Henry
285	Franklin, Albert - Haines, Roe
286	Haines, Thomas - Hunt, Thomas
287	Hunter, Alexander M. - Kennedy, Abram
288	Kennel, George - March, George
289	Marcy, Anthony - Mobbs, Daniel
290	Moffet, John - Pattiller, Alfred
291	Pattiller, Patrick - Richardson, Jacob
292	Ridgeway, Anthony - Smith, Louis B.
293	Smith, Minus - Tucker, Alfred

NATIONAL ARCHIVES MICROFILM PUBLICATIONS

Roll	Description
294	Tucker, Sandy - Williams, Calvin
295	Williams, Charles - Zinum, John
296	Miscellaneous Service Cards Abraham, Francis - Young, Ruben

Independent Battery, United States Colored Light Artillery

297	Alexander, John - Hancock, George W.
298	Hanson, Noah C. - Scott, Andrew
299	Scott, Reynolds - Yeager, John
	Miscellaneous Service Cards Douglass, H. Ford - Minor, P.M.

NARA 1

NATIONAL ARCHIVES MICROFILM PUBLICATIONS

Microfilm Publication M1818

COMPILED MILITARY SERVICE RECORDS OF VOLUNTEER UNION
SOLDIERS WHO SERVED WITH THE UNITED STATES COLORED
TROOPS: Artillery Organizations

Roll 153

8th United States Colored Heavy Artillery

Williams, Sam - Young, William

NATIONAL ARCHIVES AND RECORDS ADMINISTRATION

1893

Williams Sam

Co B, 8 U.S. Col'd H. Art'y.

Private

Corporal

CARD NUMBERS.

1	5467439	26
2	5467375	27
3	5482500	28
4	5482513	29
5	5482703	30
6	5480226	31
7	9122888	32
8	40744942	33
9		34
10		35
11		36
12		37
13		38
14		39
15		40
16		41
17		42
18		43
19		44
20		45
21		46
22		47
23		48
24		49
25		50

Book Mark:

See also

21 8 H. Art'y. U.S.C.T.

Sam Williams

, Co. L, 8 Reg't U.S. Col'd H. Art'y.

Appears on

Company Descriptive Book

of the organization named above.

DESCRIPTION.

Age 18 years; height 5 feet 8 inches.

Complexion Black

Eyes Black; hair Black

Where born Logan, Ky.

Occupation Farmer

ENLISTMENT.

When Oct. 13, 1864.

Where Paducah, Ky.

By whom Capt. Morgan; term 3 y'rs.

Remarks: Promoted to rank from Nov. 8th 1864. Died in Regt. Jan. 9th 1865 of Typhoid Malaria Fever.

Keeper

W

8 H. Art'y.

U.S.C.T.

Sam Williams

Appears with rank of *Private* on

Muster and Descriptive Roll of a Detachment of U. S. Vols. forwarded

for the 8 Reg't U. S. Col'd H. Art'y. Roll dated

Paducah Ky., N.Y. Oct. 31, 1864.

Where born *Logan Ky.*

Age *17* y'rs; occupation *Farmer*

When enlisted *Oct. 13,* 186 .

Where enlisted *Paducah Ky.*

For what period enlisted *3* years.

Eyes *Black*; hair *Black*

Complexion *Bright*; height *5 ft. 8 in.*

When mustered in *Oct. 13,* 186 .

Where mustered in *Paducah,*

Bounty paid \$ *100*; due \$ *100*

Where credited *1st Co. Dist of Ky.*

Company to which assigned *McCracken Co.*

Remarks :

Book mark :

Doyle

M | 8 H. Art'y. | U.S.C.T.

Am Williams

Appears with rank of *Pri* on

Muster and Descriptive Roll of a Detachment of U. S. Vols. forwarded

for the 8 Reg't U. S. Col'd H. Art'y. Roll dated *Paducah, Ky., ~~N.Y.~~ Oct 31, 1864*

Where born *Logan, Ky.*

Age *17* y'rs; occupation *farmer*

When enlisted *Oct 13*, 186 .

Where enlisted *Paducah, Ky.*

For what period enlisted *3* years.

Eyes *blk*; hair *blk*

Complexion *brn*; height *5* ft. *8* in.

When mustered in *Oct 13*, 186 .

Where mustered in *Paducah*

Bounty paid \$ *100*; due \$ *100*

Where credited *McCracken Co. 1st Long Dist. Ky.*

Company to which assigned

Remarks :

Book mark :

Morgan Jr.
Copyist.

W. | 8 II. Art'y. | U.S.C.T.

Sam Williams
Priv., Co. *L*, 8 Reg't U. S. Col'd H. Art'y.

Age years.

Appears on

Company Muster Roll*

for *No Oct. 31*, 186*4*.

Joined for duty and enrolled:

When *Oct. 13*, 186*4*.

Where *Paducah, Ky.*

Period *3* years.

Mustered in:

When *Oct. 13*, 186*4*.

Where *Paducah, Ky.*

Present or absent. *Present.*

Stoppage, \$ *100* for

Due Gov't \$ *100* for

Valuation of horse, \$ *100*

Valuation of horse equipments, \$ *100*

Remarks:

*First current roll. No muster-in roll of this company on file.

Book mark:

Brooks

(358d)

Copyist.

91.

8 H. Art'y.

U.S.C.T.

Sam Williams

Cpl., Co. L, 8 Reg't U. S. Col'd Heavy Art'y.

Appears on

Company Muster Roll

for *Nov. + Dec.*, 186 *4*.

Present or absent *Present*

Stoppage, \$ *100* for

Due Gov't, \$ *100* for

Valuation of horse, \$ *100*

Valuation of horse equipments, \$ *100*

Remarks:

Book mark:

Asrook

(358)

Copyist.

27.

8 H. Art'y.

U.S.C.T.

Sam Williams

Cpl., Co. L, 8 Reg't U. S. Col'd Heavy Art'y.

Appears on

Company Muster Roll

for *Oct. 31, 1864 to Feb. 28, 1865.*

Present or absent.....

Stoppage, \$.....100 for.....

Due Gov't, \$.....100 for.....

Valuation of horse, \$.....100

Valuation of horse equipments, \$.....100

Remarks: *lied in Regtl Hospital, Paducah, Ky, Jan. 7th, 1865.*

Book mark: *19011 June 22/66, 99011 +*

Brooke

W | 8 H. Art'y. | U.S.C.T.

Sam Williams
Cpl., Co. *L*, 8 Reg't U. S. Col'd H. Art'y.

Appears on Returns as follows:

Jan 18 63 *Jan 9/65*
Paducah Ky. Held
in Reg't Hospital

Book mark : _____

Paul J. [Signature]

(546)

Copyist.

W

S H. Art'y.

U.S.C.T.

Sam Williams

Corpl, Co. L, 8 Reg't U. S. Col'd H. Art'y.

Appears on **Co. Muster-out Roll**, dated *Victoria, Texas Feb'y 10, 1866.*

Muster-out to date _____, 186 .

Last paid to *Oct 31, 1864.*

Clothing account:

Last settled _____, 186 ; drawn since \$ _____ 100

Due soldier \$ _____ 100; due U. S. \$ _____ 100

Am't for cloth'g in kind or money adv'd \$ _____ 100

Due U. S. for arms, equipments, &c., \$ _____ 100

Bounty paid \$ _____ 100; due \$ _____ 100

Remarks *Entered service at organization as Private. Promoted Corpl, Nov 8/64 Died at Paducah, Ky, Jan 7/65 of Typho Malarial Fever.*

Inventory of Effects & Final Statements furnished Sept. 1st 1865

Book mark: *V. 59. P. 236, 69.*

E. B. O. 9. P. 451.

J. L. Storrie

Williams, Sam

Copl, Co. L, 8 U.S.C.H.A.
Reg't

4 Enclosures.

Bed Cards	Descriptive Lists
Burial Records	Final Statements 1
Certs. of Dis. for Discharge	Furloughs
C. M. Charges	Med. Des. Lists
Med. Certificates	Orders
<i>Enlistments</i>	2

Other papers relating to—

Admission to Hosp'l	Furlough
Casualty Sheet (Officer's)	Med. Examination
Confinement	Misc. Information
Contracts	Pay or Clothing
Death or Effects	Personal Reports
Desertions	Rank
Discharge from Hosp'l	Transfer to Hosp'l
Discharge from Service	Transfer to V. R. C.
Duty	Transportation

No. *Sixty two*

Sam Williams

Volunteered at *Paducah*

October 13th 18*64*

By *Capt. G. H. Morgan*
Prov. Mar, 1st Dist of Ky.

10
15
1864

Consent of Parent or Guardian in case of a Minor, if a Free Man, or in the case of a Slave, of the Person to whom he owes Service.

United States colored troops. They will be made out in duplicate in all cases. A general, and one to accompany the accounts of the officer who pays bounty, &c. &c. must in all cases, precede payment of pay, bounty, pension, &c. A general, commissary, or assistant commissary of musters, as the case may be, or of them is given to the disbursing officer.

UNITED STATES COLORED TROOPS ENLISTMENT.

STATE OF

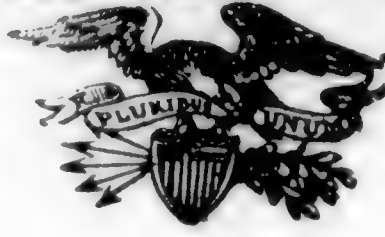

credited to
TOWN OF

Kentucky
I, *Sam Williams*

McCracken Co
Paducah
born in *Bogan*

in the State of *Kentucky* aged *Eighteen* years
and by occupation a *Farming* Do HEREBY ACKNOWLEDGE to have
volunteered this *thirteenth* day of *October* 186*4*,

to serve as a **Soldier** in the **Army of the United States of America**, for
the period of **THREE YEARS**, unless sooner discharged by proper authority:
Do also agree to accept such bounty, pay, rations, and clothing, as are, or may be,
established by law for the U. S. colored troops.

And I, *Sam Williams of McCracken Co*

do solemnly swear, that I will bear true faith and allegiance to the **United States of America**, and that I will serve them honestly and faithfully against all their enemies or opposers whomsoever; and that I will observe and obey the orders of the President of the United States, and the orders of the officers appointed over me, according to the Rules and Articles of War.

Sworn and subscribed to, at, *Paducah*
this *13* day of *October* 186*4*, } *Sam Williams*
mark

Before *Capt H. Morgan*
Capt H. Morgan, 1st Dist of Ky

I CERTIFY, ON HONOR, That I have carefully examined the above named Volunteer, agreeably to the General Regulations of the Army, and that, in my opinion, he is free from all bodily defects and mental infirmity, which would in any way disqualify him from performing the duties of a soldier.

M. H. Kidd

EXAMINING SURGEON.

I CERTIFY, ON HONOR, That I have minutely inspected the Volunteer, *Sam Williams* previously to his enlistment, and that he was entirely sober when enlisted; that, to the best of my judgment and belief, he is of lawful age; and that, in accepting him as duly qualified to perform the duties of an able-bodied soldier, I have strictly observed the regulations which govern the recruiting service. This soldier has *Black* eyes, *Black* hair, *Light-brown* complexion, is *5* feet *8* inches high.

RECRUITING OFFICER OR AGENT.

Mustered into the United States service *Thirteenth* day of *October* 186*4*

Capt H. Morgan
Capt H. Morgan, 1st Dist of Ky
Mustering Officer.

Mustered into the service of the United States, for three years or during the war, from date of enlistment, in Company *P* Regiment of *Madison Artillery* Volunteers, on the *13* day of *October*, 186*4*, at *Paducah*.

Capt H. Morgan
Capt H. Morgan, 1st Dist of Ky

NOTE 1.—This blank will be used for enlistments of United States colored troops. They will be made out in duplicate in all cases—one to accompany the recruiting return of the superintendent (not the recruiting officer) to the Adjutant General, and one to accompany the accounts of the officer who pays bounty, &c.

NOTE 2.—An enlistment holds to service. A muster-in, must in all cases, precede payment of pay, bounty, pension, &c. A muster-in roll, must in all cases, be filed in the Adjutant General's Office as evidence of muster-in. The mustering officer, commissary, or assistant commissary of musters, as the case may be, will countersign both enlistments as having mustered the soldier into the service of the United States before either of them is given to the disbursing officer.

DECLARATION OF RECRUIT.

I, Sam Williams of McCracken Co Ky desiring to volunteer as a soldier in the ARMY OF THE UNITED STATES, for the term of Three Years, DO DECLARE That I am Eighteen years and months of age; that I have never been discharged from the United States service on account of disability or by sentence of a court-martial, or by order before the expiration of a term of enlistment; and I know of no impediment to my serving honestly and faithfully as a soldier for three years.

GIVEN at Paducah Ky

the 13 day of October 1864

Witness: H T Lyon

Sam Williams
No. Eighteen
Volunteered at Paducah
October 13th 1864
By Leah & M. H. Morgan
Pres. War 1st Div. Ky



Consent of Parent or Guardian in case of a Minor, if a Free Man, or in the case of a Slave, of the Person to whom he owes Service:

I, Do CERTIFY, That I am the that the said is years of age; and I do freely give my CONSENT to his volunteering as a SOLDIER in the Army of the United States, for the period of THREE YEARS, under the conditions of the laws of the United States.

GIVEN at

the day of

Witness:

220

No. Sixty-two

Sam Williams

Volunteered at Canucahoy

October 13 1864

By Capt J N Morgan
Ordnary Wm R. H. H. H.

8165017-a

(Signature)

JUN 11 1864
RECORDED

Sam Williams

(Signature)

Consent of Parent or Guardian in case of a Minor, if a Free Man, or in the case of a Slave, of the Person to whom he owes Service.

United States colored troops. They will be made out in duplicate in all cases—one to the commanding officer, and one to accompany the accounts of the officer who pays bounty, &c. A muster-roll, must in all cases, precede payment of pay, bounty, pension, &c. A muster-roll of them is given to the disbursing officer.

UNITED STATES COLORED TROOPS ENLISTMENT.

STATE OF

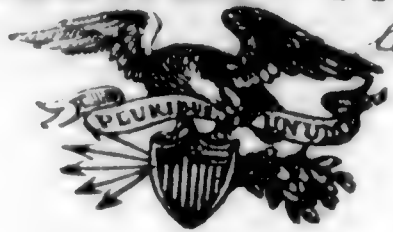

credited to

TOWN OF

Kentucky

McCracken

Fulton

I, *Sam Williams* born in *Lugan*

in the State of *Kentucky* aged *18* *Eighteen* years

and by occupation a *Farmer* Do HEREBY ACKNOWLEDGE to have

volunteered this *thirteenth* day of *October* 186*4*

to serve as a **Soldier** in the **Army of the United States of America**, for the period of **THREE YEARS**, unless sooner discharged by proper authority: Do also agree to accept such bounty, pay, rations, and clothing, as are, or may be, established by law for the U. S. colored troops.

And I, *Sam Williams of McCracken Co. Ky.* do solemnly swear, that I will bear true faith and allegiance to the **United States of America**, and that I will serve them honestly and faithfully against all their enemies or opposers whomsoever; and that I will observe and obey the orders of the President of the United States, and the orders of the officers appointed over me, according to the Rules and Articles of War.

Sworn and subscribed to, at *Puducunda*

this *13* day of *October* 186*4*,

Before *J. V. Morgan*
Major Co. 1st Regt. Col. 8th U.S.C.T.

his
Sam Williams
mark

I CERTIFY, ON HONOR, That I have carefully examined the above named Volunteer, agreeably to the General Regulations of the Army, and that, in my opinion, he is free from all bodily defects and mental infirmity, which would in any way disqualify him from performing the duties of a soldier.

W. H. Kidd

EXAMINING SURGEON.

I CERTIFY, ON HONOR, That I have minutely inspected the Volunteer, *Sam Williams* previously to his enlistment, and that he was entirely sober when enlisted; that, to the best of my judgment and belief, he is of lawful age; and that, in accepting him as duly qualified to perform the duties of an able-bodied soldier, I have strictly observed the regulations which govern the recruiting service. This soldier has *Black* eyes, *Black* hair, *Black* complexion, is *5* feet *8* inches high.

RECRUITING OFFICER OR AGENT.

Mustered into the United States service *Thirteenth* day of *October* 186*4*

J. V. Morgan
Major Co. 1st Regt. Col. 8th U.S.C.T. Mustering Officer.

P. B. Distafsky

Mustered into the service of the United States, for three years or during the war, from date of enlistment, in Company *B* of *1st* Regiment of *1st* *Col. 8th U.S.C.T.* Volunteers, on the *13* day of *October*, 1864, at *Puducunda*

J. V. Morgan
Major Co. 1st Regt. Col. 8th U.S.C.T.

P. B. Distafsky

NOTE 1.—This blank will be used for enlistments of United States colored troops. They will be made out in duplicate in all cases—one to accompany the recruiting return of the superintendent (not the recruiting officer) to the Adjutant General, and one to accompany the accounts of the officer who pays bounty, &c.

NOTE 2.—An enlistment holds to service. A muster-in, must in all cases, precede payment of pay, bounty, pension, &c. A muster-in roll, must in all cases, be filed in the Adjutant General's Office as evidence of muster-in. The mustering officer, commissary, or assistant commissary of musters, as the case may be, will countersign both enlistments as having mustered the soldier into the service of the United States before either of them is given to the disbursing officer.

DECLARATION OF RECRUIT.

I, Sam Williams of McCracken Co Ky, desiring to volunteer as a soldier in the ARMY OF THE UNITED STATES, for the term of Three Years, DO DECLARE That I am Eighteen years and months of age; that I have never been discharged from the United States service on account of disability or by sentence of a court-martial, or by order before the expiration of a term of enlistment; and I know of no impediment to my serving honestly and faithfully as a soldier for three years.

GIVEN at Paducah Ky the 13 day of October 1864

Witness:

H. Byron

his
Sam Williams

Volunteered at Paducah Ky
October 13 1864
By Quadr J. W. Morgan
Capt. Major 1st Army Corps

Sam Williams
No. 115014

RECORDED
OCT 11 1864

(Seal)

Consent of Parent or Guardian in case of a Minor, if a Free Man, or in the case of a Slave, of the Person to whom he owes Service:

I, Do CERTIFY, That I am the that the said is years of age; and I do freely give my CONSENT to his volunteering as a SOLDIER in the Army of the United States, for the period of **THREE YEARS**, under the conditions of the laws of the United States.

GIVEN at

the day of

Witness:

ARTICLES OF WAR.

ART. 95. When any non-commissioned officer or soldier shall die, or be killed in the service of the United States, the then commanding officer of the troop or company shall, in the presence of two other commissioned officers, take an account of what effects he died possessed of, above his arms and accoutrements, and transmit the same to the office of the Department of War, which said effects are to be accounted for, and paid to the representatives of such deceased non-commissioned officer or soldier. And in case any of the officers, so authorized to take care of the effects of deceased officers and soldiers, should, before they have accounted to their representatives for the same, have occasion to leave the regiment or post, by preferment or otherwise, they shall, before they be permitted to quit the same, deposit in the hands of the commanding officer, or of the assistant military agent, all the effects of such deceased non-commissioned officers and soldiers, in order that the same may be secured for, and paid to, their respective representatives.

ARMY REGULATIONS—EDITION OF 1861.

DECEASED SOLDIERS.

Par. 152. Inventories of the effects of deceased non-commissioned officers and soldiers, required by the 95th Article of War, will be forwarded to the Adjutant General, by the commander of the company to which the deceased belonged, and a duplicate of the same to the colonel of the regiment. Final statements of pay, clothing, &c., will be sent with the inventories. When a soldier dies at a post or station absent from his company, it will be the duty of his immediate commander to furnish the required inventory, and, at the same time, to forward to the commanding officer of the company to which the soldier belonged, a report of his death, specifying the date, place, and cause; to what time he was last paid, and the money or other effects in his possession at the time of his decease; which report will be noted on the next muster roll of the company to which the man belonged. Each inventory will be endorsed, "Inventory of the effects of _____, late of company (—) _____ regiment of _____, who died at _____, the _____ day of _____, 186—." If a legal representative receive the effects, it will be stated in the report. If the soldier leave no effects, the fact will be reported.

Par. 153. Should the effects of a deceased non-commissioned officer or soldier not be administered upon within a short period after his decease, they shall be disposed of by a Council of Administration, under the authority of the commanding officer of the post, and the proceeds deposited with the Paymaster, to the credit of the United States, until they shall be claimed by the legal representatives of the deceased.

Par. 154. In all such cases of sales by the Council of Administration, a statement in detail, or account of the proceeds, duly certified by the Council and commanding officer, accompanied by the Paymaster's receipt for the proceeds, will be forwarded by the commanding officer to the Adjutant General. The statement will be endorsed, "Report of the proceeds of the effects of _____, late of company (—) _____ regiment of _____, who died at _____, the _____ day of _____, 186—."

NOTE 1.—The effects in all cases, when called for, should be turned over to the legal representative, without further authority from the Adjutant General. When the effects are turned over to the relatives of the deceased before these inventories are sent to the Adjutant General, their receipts therefor should be attached to the inventories. In all other cases, one copy will be sent with a letter of transmittal direct to the Adjutant General, and a duplicate retained by the officer.

NOTE 2.—Particular care should be taken to take receipts in duplicate from the Paymaster for any funds turned over to him; one copy should be sent direct to the Adjutant General and one retained by the officer.

INVENTORY OF THE EFFECTS

OF
Capt Sam Williams
 Late of Company *L*
9th Reg't of *U.S.A.*
 Volunteers, who died at *Vicksburg*
 on the *1st* day of *January* 186*2*.

MAR 19

Inventory of the effects of Sam Williams late
 a Capt of James J. Randall's Company 2^d of
 the 8th Regiment of U.S.A. Volunteers, who was enrolled as
 a Sergeant at Paducah in the State of Kentucky on
 the 13th day of October 1864, and mustered into the service of the United
 States as a Private on the 13th day of October 1864, at Paducah Ky
 in Company F, 8th Regiment of U.S.A. Volunteers, to serve Three
 years or during the war; he was born in Logan Co in the State
 of Kentucky; he was 28 years of age, 5 feet 8 inches
 high, Blk complexion, Blk eyes, Blk hair, and by occupation, when enrolled,
 a Farmer; he died in Recytl Hosp, at
Paducah Ky on the 7th day of January 1865, by
 reason of Type Malaria Fever

INVENTORY.					
ARTICLES.	No.	ARTICLES.	No.	ARTICLES.	No.
Hats.....		Pairs trowsers.....	/	Knapsacks.....	/
Caps.....		Pairs flannel drawers.....	/		
Forage caps.....	/	Pairs cotton drawers.....			
Great coats.....	/	Flannel shirts.....			
Uniform coats.....		Cotton shirts.....			
Uniform jackets.....	/	Pairs boots.....	/		
Flannel sack coats.....	/	Pairs shoes.....			
Blouses.....		Pairs socks.....			
Stable frocks.....		Blankets.....	/		
Fatigue overalls.....		Haversacks.....			
				MONEY.	
				Specie.....	\$
				Notes.....	\$

I CERTIFY, ON HONOR, that the above inventory comprises all the effects of Capt
Sam Williams, deceased, and that the effects are in the hands
 of Sam J. DeWint at Paducah Ky
 to be disposed of by a Council of Administration.

(DUPLICATES.)

STATION: Paducah Ky

DATE: Jan 7th 1865

James J. Randall
Lieut 8th U.S.A.
 Commanding the Company.

FINAL STATEMENT

OF
Capt Sam Williams
1st Reg't of U.S.C.A. Hoop

VOLUNTEERS.

Soldier Reg't 11 Hoop 1st Reg't

NOTE 1.—Two of these certificates (or duplicates) are to be given to each Volunteer Soldier or drafted man who may be discharged previously to the discharge of his company, that he may at once receive from the Paymaster the pay, &c., due him, and the captain or other COMMISSIONED officer commanding the company will certify to the act of the delivery of the duplicate certificates; on these certificates the Soldier is "entitled to" his discharge, and should also present his discharge to the Paymaster to have the payment endorsed on it. The discharge is to be given back to the Soldier by the Paymaster; the latter only retaining as his voucher the duplicate certificates.

NOTE 2.—If the Soldier is entitled to pay for the use of his horse, the Company Commander will certify to that fact on the back of both these final statements, and also to the time he has pay due for having been so mounted on his own horse.

NOTE 3.—When a Soldier is furnished with final statements, his descriptive list, if he has one, should be taken up by the officer who gives the Soldier these statements, and endorsed with a statement to this effect by the officer. This endorsement should exhibit a full statement of the time for which the Soldier was allowed pay on his final statements, the clothing account, and all other charges against him or in his favor, so as to comprise a complete exhibit of his account. It will then be transmitted to the company commander of the Soldier, who will enter all the data necessary to a full understanding of the Soldier's account on the muster roll upon which the Soldier's discharge is reported. The descriptive list will then be destroyed. The object of this is, that the remaining portion of the Soldier's account may be settled upon the receipt of these muster rolls, and the Soldier receive any pay or allowances that may be due him at the time of his discharge, and which may not appear on his final statements from the fact that his descriptive list is incomplete. These accounts for back pay, &c., are settled by the 2d Auditor of the Treasury Department.

NOTE 4.—Charges for loss or injury to ordnance, horse equipments, and other miscellaneous charges, should appear under the heading of "Other Stoppages."

NOTE 5.—Bounty paid by State authorities, and not by the United States, will not be entered on this statement.

NOTE 6.—Amounts due the Sutler and Laundress must be entered on the muster roll on which the discharge, death, desertion, &c., is reported, as well as on the final statement, otherwise the amount cannot be collected from the United States.

NOTE 7.—This blank will be used for deceased volunteers and drafted men, as well as for others.

NOTE 8.—Where a Soldier dies in Hospital or on detached service, his descriptive list, if he has one, should be sent with his final statements, in duplicate, to the Adjutant General, Washington, D. C.

Williams

ADJUTANT GENERAL'S OFFICE
Dec 26 1860
Duplicate with Inventory sent 2d Auditor.

I certify, on honor, that Sam Williams a Capt of
 Captain Lieut J. Candall's Company (L) of the 8th Regiment of U.S.C. & Bray,
VOLUNTEERS, of the State of Kentucky, born in Logan Co, State
 of Kentucky, aged 19 years; 5 feet 8 inches high; Blk complexion,
Blk eyes, Blk hair, and by occupation a Farmer, having joined the company on
 its original organization at Paducah Ky, and enrolled in it at the muster into
 the service of the United States at Paducah Ky, on the 13th day
 of October, 1864, ~~or was mustered in service as a recruit, by~~ Capt John H.
Morgan, at Paducah Ky, on the 13th day of October,
 1864, ~~or was drafted and mustered into the service of the United States from the~~
 Enrollment District of the State of _____, at _____,
 on the _____ day of _____, 186) to serve in the Regiment, for
 the term of Three Years: and having served **HONESTLY** and
FAITHFULLY with his Company in 8th U.S.C. & Bray to the present date, is now
 entitled to a **DISCHARGE** by reason of Death in the Regt Hospital at
Paducah Ky on the 13th day of June 1865 - Cause of death - by the malaria

The said Sam Williams was last paid by Paymaster
Henns to include the 31st day of October, 1864, and has
 pay due him from that time to the present date; he is entitled to pay and subsistence for
TRAVELING to place of enrollment, and whatever other allowances are authorized to volunteer
 soldiers, drafted men, or militia, so discharged. He has received from the United States **CLOTHING**
 amounting to Twenty four \$44.95 dollars, since the 13th day of October,
 1864, ~~when his clothing account was last settled.~~ He has received from the United States
 _____ dollars advanced **BOUNTY**.

There is to be stopped from him, on account of the State of _____, or other
 authorities, for **CLOTHING**, &c., received on entering service, _____ dollars; and
 for other stoppages, viz: _____

_____ dollars.
 He has been furnished with **TRANSPORTATION** in kind from the place of his discharge to
 _____; and he has been **SUBSISTED** for **TRAVELING** to his
 place of enrollment, up to the _____, 186 .

He is indebted to _____, **SUTLER**, _____ dollars.
 He is indebted to _____, **LAUNDRESS**, _____ dollars.

Given in Duplicate, at Paducah Ky, this 1st day
 of October, 1865.

James J. Candall
Lieut 8th U.S.C. & Bray
 Commanding Company.

1894

Williams Strother

Co E, 8 U.S. Col'd H. Art'y.

Private

Private

CARD NUMBERS.

1	26
2	27
3	28
4	29
5	30
6	31
7	32
8	33
9	34
10	35
11	36
12	37
13	38
14	39
15	40
16	41
17	42
18	43
19	44
20	45
21	46
22	47
23	48
24	49
25	50

See Strother William

Book Mark:

See also

1895
Williams Thomas

Co G, 8 U.S. Col'd H. Art'y.

Private

Private

CARD NUMBERS.

1	5467486	26
2	5477503	27
3	5477638	28
4	5477907	29
5	5478018	30
6	5478120	31
7	5478225	32
8	5477736	33
9	9122122	34
10		35
11		36
12		37
13		38
14		39
15		40
16		41
17		42
18		43
19		44
20		45
21		46
22		47
23		48
24		49
25		50

Book Mark:

See also

W | 8 H. Art'y. | U.S.C.T.

Thomas Williams

Co. G, 8 Reg't U.S. Col'd H. Art'y.

Appears on

Company Descriptive Book
of the organization named above.

DESCRIPTION.

Age 8 years; height 5 feet 1/2 inches.

Complexion *Rdsk*

Eyes *Rdsk*; hair *Rdsk*

Where born *Vicksburg, Mississippi*

Occupation *Boatman*

ENLISTMENT.

When *Jan'y. 24*, 1865.

Where *Moain, Ill*

By whom *A. Col. Low*; term *3* y'rs.

Remarks:

E. A. Moreland

(3830)

Copist.

W | 8 H. Art'y. | U.S.C.T.

Thomas Williams

Appears with rank of *Private* on

Muster and Descriptive Roll of a Detachment of U. S. Vols. forwarded

for the 8 Reg't U. S. Col'd H. Art'y. Roll dated

Puduech Ky, N. Y. *Jan 25*, 1865.

Where born *Vicksburg Miss*

Age *18* y'rs; occupation *Dratman*

When enlisted *Jan 24*, 1865.

Where enlisted *Ohio Ill.*

For what period enlisted *3* years.

Eyes *Blk*; hair *Blk*

Complexion *Blk*; height *5 ft. 1/2 in.*

When mustered in *Jan 25*, 1865.

Where mustered in *Puduech Ky*

Bounty paid \$ *100*; due \$ *100*

Where credited

Company to which assigned

Remarks: *Residence 5 Inst Bureau
Co Ill*

Book mark:

Bryer

W | **8 H. Art'y.** | **U.S.C.T.**

Thomas Williams

H, Co. G, 8 Reg't U. S. Col'd H. Art'y.

Appears on

Company Muster Roll

for *May 1 1861*, 1861.

Present or absent *Present*

Stoppage, \$ *100* for

Due Gov't, \$ *100* for

Valuation of horse, \$ *100*

Valuation of horse equipments, \$ *100*

Remarks:

Book mark:

8 H. Art'y.

U.S.C.T.

Thomas William

Pl, Co. G, 8 Reg't U. S. Col'd H. Art'y.

Appears on

Company Muster Roll

for *Jan 1*, 186 *3*.

Present or absent *Present*

Stoppage, \$ *100* for

Due Gov't, \$ *100* for

Valuation of horse, \$ *100*

Valuation of horse equipments, \$ *100*

Remarks: *Stoppage for*

particulars according to G.O.

Book mark:

Thomas William

W

8 H. Art'y.

U.S.C.T.

Wm. Williams

, Co. G, 8 Reg't U. S. Col'd H. Art'y.

Appears on

Company Muster Roll

for *Nov 1st 1865*, 1865.

Present or absent *Present*

Stoppage, \$ 100 for

Due Gov't, \$ 100 for

Valuation of horse, \$ 100

Valuation of horse equipments, \$ 100

Remarks: *Wm. Williams, Co. G, 8th Regt, U.S. Col'd H. Art'y.*

not accounted to G.S. pt.

Book mark:

Wm. Williams

W | **8 H. Art'y.** | **U.S.C.T.**

Thomas William

Pk, Co. G, 8 Reg't U. S. Col'd H. Art'y.

Appears on

Company Muster Roll

for *July 1 Aug*, 186*1*.

Present or absent *Present*

Stoppage, \$ *100* for

Due Gov't, \$ *100* for

Valuation of horse, \$ *100*

Valuation of horse equipments, \$ *100*

Remarks: *Stoppage for one*

Quadrant lost amounting to

25 ct.

Book mark:

J. J. Moore

Thomas Williams

Sgt, Co. G, 8 Reg't U. S. Col'd H. Art'y.

Appears on

Company Muster Roll

for *Sept 18* *Oct*, 186*8*.

Present or absent *Present*

Stoppage, \$ *100* for

Due Gov't, \$ *100* for

Valuation of horse, \$ *100*

Valuation of horse equipments, \$ *100*

Remarks:

Book mark:

W. Williams

Thomas Williams

Co. G, 8 Reg't U. S. Col'd H. Art'y.

Appears on

Company Muster Roll

for *Avondale*, 186*7*.

Present or absent *Present*

Stoppage, \$ *100* for

Due Gov't, \$ *100* for

Valuation of horse, \$ *100*

Valuation of horse equipments, \$ *100*

Remarks:

Book mark:

Miller

Thomas Williams

Co. G., 8 Reg't U. S. Col'd H. Art'y.

Appears on Co. Muster-out Roll, dated
February 10, 1861

Muster-out to date February, 1861

Last paid to August, 1861

Clothing account:

Last settled....., 1861 ; drawn since \$..... 100

Due soldier \$..... 100; due U. S. \$..... 122 1/2 / 100

Am't for cloth'g in kind or money adv'd \$..... 100

Due U. S. for arms, equipments, &c., \$..... 100

Bounty paid \$..... 100; due \$..... 100

Remarks: Entered service a
private in Co. G., 8th Reg't
U.S. Col'd H. Art'y.
Feb 10, 1861

Book mark:

(861) W. J. Fisher Copyist.

1896

Williams William

Co., 8 U.S. Col'd H. Art'y.

Private Private

CARD NUMBERS.

1	5467020	26
2	5467521	27
3		28
4		29
5		30
6		31
7		32
8		33
9		34
10		35
11		36
12		37
13		38
14		39
15		40
16		41
17		42
18		43
19		44
20		45
21		46
22		47
23		48
24		49
25		50

Book Mark:

See also

W | 8 H. Art'y. | U.S.C.T.

Wm Williams

Appears with rank of on

Muster and Descriptive Roll of a Detachment of U. S. Vols. forwarded

for the 8 Reg't U. S. Col'd H. Art'y. Roll dated

Paducah Ky, N.Y. Aug 1, 1864.

Where born *Paducah Ky*

Age *35* y'rs; occupation *Farmer*

When enlisted *Aug 1*, 186 .

Where enlisted *Paducah Ky*

For what period enlisted *3* years.

Eyes *Blk*; hair *Blk*

Complexion *Blk*; height *5 ft. 10 in.*

When mustered in *Aug 1*, 186 .

Where mustered in *Paducah Ky*

Bounty paid \$ *100*; due \$ *100*

Where credited *100 Ky*

Company to which assigned *A*

Remarks: *Drafted Man*

Not taken upon Rolls co

a.

Book mark:

Burger

77 | 8 H. Arty. | U.S.C.T

William Williams

Appears with rank of Private on

Muster and Descriptive Roll of a Detachment of Drafted Men and Substitutes forwarded

for the 8 Reg't U.S. Col'd H. Arty. Roll dated Paducah Ky, July 31, 1864

Where born Union Co Ky

Age 35 years; occupation Farmer

Drafted and mustered in:

When July 31, 186 .

Where Paducah Ky

Period 3 years.

Eyes Black; hair Black

Complexion Black; height 5 ft 10 in.

Paid bounty and advance pay, \$ 100

Bounty due \$ 100

Where credited

Company to which assigned T & D

Remarks:

As appears in roll

Book mark:

(340)

C. S. Rozzell

Copyist.

1897

Williamson Henry
Co No , 8 U.S. Col'd H. Art'y.

Private | Private

CARD NUMBERS.

1	5478324	26
2	5478464	27
3	5478615	28
4	5478767	29
5	5478902	30
6	5479039	31
7	5479165	32
8	5479286	33
9	5479396	34
10	5479508	35
11	5479611	36
12	9123980	37
13		38
14		39
15		40
16		41
17		42
18		43
19		44
20		45
21		46
22		47
23		48
24		49
25		50

Book Mark

See also

Ch | *8 N. Arly* | **U. S. C. T.**

Henry Williamson

, Co. H, 8 Reg't U. S. Col'd N. Arly

Appears on

Company Descriptive Book

of the organization named above.

DESCRIPTION.

Age *23* years; height *5* feet *10 1/2* inches.

Complexion *Black*

Eyes *Black*; hair *Black*

Where born *New Orleans, Louisiana*

Occupation *laborer*

ENLISTMENT.

When *May 28*, 1864.

Where *Union, Ky*

By whom *A. J. Chase*; term *3* y'rs.

Remarks:

E. A. Norland

W | 8 II. Art'y. | U.S.C.T.

Henry Williamson
Pvt, Co. B, 8 Reg't U. S. Col'd H. Art'y.

Age _____ years.

Appears on

Company Muster Roll*

for *Enlistment to June 30*, 1864.

Joined for duty and enrolled:

When *May 28*, 1864.

Where *Union Co Ky*

Period *3* years.

Mustered in:

When *June 6*, 1864.

Where *Paducah Ky*

Present or absent *Present*

Stoppage, \$ *100* for _____

Due Gov't \$ *100* for _____

Valuation of horse, \$ *100*

Valuation of horse equipments, \$ *100*

Remarks: _____

*First current roll. No muster-in roll of this company on file.

Book mark: _____

S. W. T. ...
Copyist.

(358d)

W

S H. Art'y.

U.S.C.T.

Henry Williamson
Sgt., Co. H, 8 Reg't U. S. Col'd H. Art'y.

Appears on

Company Muster Roll

for *Dated Aug 31*, 1864.

Present or absent *Present*

Stoppage, \$ *100* for

Due Gov't, \$ *100* for

Valuation of horse, \$ *100*

Valuation of horse equipments, \$ *100*

Remarks:

Book mark:

L. W. Tucker

(358)

Copyist.

W | 8 H. Art'y. | U.S.C.T.

Henry Williamson

Priv, Co. H, 8 Reg't U. S. Col'd H. Art'y.

Appears on

Company Muster Roll

for *Sept & Oct*, 1864.

Present or absent. *Present*

Stoppage, \$ 100 for

Due Gov't, \$ 100 for

Valuation of horse, \$ 100

Valuation of horse equipments, \$ 100

Remarks: -----

Book mark: -----

J. M. ...

W | S H. Art'y. | U.S.C.T.

Henry Williamson
Priv, Co. H, 8 Reg't U. S. Col'd H. Art'y.

Appears on

Company Muster Roll

for Nov & Dec, 1864.

Present or absent Present

Stoppage, \$ 100 for

Due Gov't, \$ 100 for

Valuation of horse, \$ 100

Valuation of horse equipments, \$ 100

Remarks:

Book mark:

J. W. Tucker

(358)

Copyist.

M | S H. Art'y. | U.S.C.T.

Henry Williamson
Private, Co. H, 8 Reg't U. S. Col'd H. Art'y.

Appears on

Company Muster Roll

for *Jan. & Feb.*, 1865.

Present or absent *Present*

Stoppage, \$ *100* for

Due Gov't, \$ *100* for

Valuation of horse, \$ *100*

Valuation of horse equipments, \$ *100*

Remarks:

Book mark:

(358) *J. E. Nichol* Copyist.

W

S H. Art'y.

U.S.C.T.

Henry Williamson

Private, Co. H, 8 Reg't U. S. Col'd H. Art'y.

Appears on

Company Muster Roll

for Mch. & Apl., 1865.

Present or absent present

Stoppage, \$ 100 for

Due Gov't, \$ 100 for

Valuation of horse, \$ 100

Valuation of horse equipments, \$ 100

Remarks:

Book mark:

(358) J. E. Nichol Copyist.

W. S. H. Artz U.S.C.T.

Henry Williamson
Pvt, Co. H, 8 Reg't U. S. Col'd H. Artz.

Appears on

Company Muster Roll

for May & June, 1865.

Present or absent present

Stoppage, \$ 100 for

Due Gov't, \$ 100 for

Valuation of horse, \$ 100

Valuation of horse equipments, \$ 100

Remarks:

Book mark:

(358) J. E. Nichol Copyist.

W

S H. Art'y.

U.S.C.T.

Henry Williamson

Priv, Co. H, 8 Reg't U. S. Col'd H. Art'y.

Appears on

Company Muster Roll

for *July & Aug.*, 186*5*.

Present or absent *present*

Stoppage, \$ *100* for

Due Gov't, \$ *100* for

Valuation of horse, \$ *100*

Valuation of horse equipments, \$ *100*

Remarks:

.....
.....
.....
.....
.....
.....
.....
.....
.....

Book mark:

J. E. Nichol
Copyist.

(358)

W 8 H. Art'y. | U.S.C.T.

Henry Williamson
Priv., Co. H, 8 Reg't U. S. Col'd H. Art'y.

Appears on

Company Muster Roll
for Sept + Oct, 1863.

Present or absent Present

Stoppage, \$ 100 for

Due Gov't, \$ 100 for

Valuation of horse, \$ 100

Valuation of horse equipments, \$ 100

Remarks:

Book mark:

G W Deasrick

(358)

Copyist.

W | 8 H. Art'y. | U.S.C.T.

Henry Williamson

Trid, Co. H, 8 Reg't U. S. Col'd H. Art'y.

Appears on

Company Muster Roll

for Nov + Dec, 1865.

Present or absent Present

Stoppage, \$ 100 for

Due Gov't, \$ 100 for

Valuation of horse, \$ 100

Valuation of horse equipments, \$ 100

Remarks:

Book mark:

G. W. Nesbitt

(358)

Copyist.

W. S. Hart U. S. C. T.

Henry Williams
Sgt, Co. H., 8 Reg't U. S. Col'd Hart

Appears on Co. Muster-out Roll, dated
Victoria Texas, Feb 10, 1866

Muster-out to date Feb 10, 1866.

Last paid to Aug 31, 1865.

Clothing account:

Last settled _____, 1866 ; drawn since \$ _____ 100

Due soldier \$ $14 \frac{51}{100}$; due U. S. \$ _____ 100

Am't for cloth'g in kind or money adv'd \$ _____ 100

Due U. S. for arms, equipments, &c., \$ _____ $\frac{68}{100}$

Bounty paid \$ None 100 due \$ 100 100

Remarks: Entered service as Private
as herein shown. Staps for
One Cant Belt 59 ct + Plate
09 ct

Book mark: 0118 0159 70
Page 23

G. W. Deadrick

1898.

Willingham Jordan
Co E, 8 U.S. Col'd H. Art'y.

Private

Private

CARD NUMBERS.

1	5467317	26
2	5467197	27
3	5474757	28
4	5474883	29
5	5475003	30
6	5475124	31
7	5475239	32
8	5475349	33
9	5475452	34
10	5467677	35
11	5475648	36
12	9122313	37
13	Mr-69-05-1876	38
14	40744907	39
15		40
16		41
17		42
18		43
19		44
20		45
21		46
22		47
23		48
24		49
25		50

Book Mark: EB 212 - P23

Mr-69-05-1876

See also

W | 8 H. Art'y. | U.S.C.T.

Jordan Williamson

Co. *E*, 8 Reg't U.S. Col'd H. Art'y.

Appears on

Company Descriptive Book

of the organization named above.

DESCRIPTION.

Age *24* years; height *5* feet *7 1/2* inches.

Complexion *Tan*

Eyes *Tan*; hair *Tan*

Where born *Nickman Co. Ky.*

Occupation *Farmer*

ENLISTMENT.

When *Sept. 17*, 1864.

Where *Paducah, Ky.*

By whom *Capt. Hall*; term *3* y'rs.

Remarks: *Discharged June 24, 65
at Alexandria, Va.*

C. A. Moreland

W

8 H. Art'y.

U.S.C.T.

Jordan Willingham

Appears with rank of *Priv* on

Muster and Descriptive Roll of a Detachment of U. S. Vols. forwarded

for the 8 Reg't U. S. Col'd H. Art'y. Roll dated

Panama, Ky., ~~Nov 30~~ Sep 30, 1864.

Where born *Hickman, Ky.*

Age *35* y'rs; occupation *Farmer*

When enlisted *Sep 12*, 186 .

Where enlisted *Panama, Ky.*

For what period enlisted *3* years.

Eyes *Blk*; hair *Blk*

Complexion *Blk*; height *5* ft. *7 1/2* in.

When mustered in *Sep 12*, 186 .

Where mustered in *Panama*

Bounty paid \$ *100*; due \$ *100*

Where credited *Ballard Co. 1st Dist. Ky.*

Company to which assigned *E*

Remarks :

Book mark : *W-69-03-1846*

Murray J.

W

8 H. Art'y.

U.S.C.T.

Jordan Willingham.

Appears with rank of Private on

Muster and Descriptive Roll of a Detachment of U. S. Vols. forwarded

for the 8 Reg't U. S. Col'd H. Art'y. Roll dated

Paducah, Ky., N.Y., Sept. 30, 1864.

Where born Hickman, Ky.

Age 30 y'rs; occupation Farmer

When enlisted Sept. 12, 186 .

Where enlisted Paducah, Ky.

For what period enlisted 3 years.

Eyes Black; hair Black

Complexion Black; height 5 ft. 7 1/2 in.

When mustered in Sept. 12, 186 .

Where mustered in Paducah.

Bounty paid \$ 100; due \$ 100

Where credited Ballard, pet. D. Ky.

Company to which assigned E.

Remarks :

Book mark :

Calloway

(339)

Copyist.

W

S H. Art'y.

U.S.C.T.

Jordan Willingham

AK, Co. E, 8 Reg't U. S. Col'd H. Art'y.

Appears on

Company Muster Roll

for *Sept and Oct*, 186*4*.

Present or absent *Present*

Stoppage, \$ 100 for

Due Gov't, \$ 100 for

Valuation of horse, \$ 100

Valuation of horse equipments, \$ 100

Remarks:

Book mark:

Jas. V. Keamy
Copyist.

74

S. H. Art'y.

U.S.C.T.

Jordan Willingham
Priv., Co. E, 8 Reg't U. S. Col'd H. Art'y.

Appears on

Company Muster Roll

for Nov. + Dec., 1864.

Present or absent Present

Stoppage, \$ 100 for

Due Gov't, \$ 100 for

Valuation of horse, \$ 100

Valuation of horse equipments, \$ 100

Remarks:

Book mark:

C. E. M'Laughlin

(358)

Copyist.

W

8 H. Art'y.

U.S.C.T.

Jordon Kellingham

Piv., Co. E, 8 Reg't U. S. Col'd H. Art'y.

Appears on

Company Muster Roll

for Jan & Feb., 1865.

Present or absent Present

Stoppage, \$ 100 for

Due Gov't, \$ 100 for

Valuation of horse, \$ 100

Valuation of horse equipments, \$ 100

Remarks: Due the U.S. for
1 canteen 1 Haversack
\$1.60 Due U.S. for
ordnance \$0.26

Book mark:

(358)

C. E. M. Laughlin
Copyist.

IV

8 H. Art'y.

U.S.C.T.

Jordon Wellingham

Priv., Co. E, 8 Reg't U. S. Col'd H. Art'y.

Appears on

Company Muster Roll

for *Mar. & Apr.*, 1865.

Present or absent *Absent*

Stoppage, \$ *100* for

Due Gov't, \$ *100* for

Valuation of horse, \$ *100*

Valuation of horse equipments, \$ *100*

Remarks: *Sick in Hospital at Washington D.C. Since April 20th 65.*

Book mark:

C. E. M. Laughlin

(358)

Copist.

JW

8 H. Art'y. U.S.C.T.

Jordan Hellingham
Priv., Co. E, 8 Reg't U. S. Col'd H. Art'y.

Appears on

Company Muster Roll
for *May & June*, 186*9*.

Present or absent *Absent*

Stoppage, \$ *100* for

Due Gov't, \$ *100* for

Valuation of horse, \$ *100*

Valuation of horse equipments, \$ *100*

Remarks: *Absent Sick*

Book mark:

C. E. M. Laughlin
Copyist.

(358)

W

8 H. Art'y.

U.S.C.T.

Jordan Wellington
Private, Co. E, 8 Reg't U. S. Col'd H. Art'y.

Appears on

Company Muster Roll

for *July & Aug.*, 1865.

Present or absent *Absent*

Stoppage, \$ *100* for

Due Gov't, \$ *100* for

Valuation of horse, \$ *100*

Valuation of horse equipments, \$ *100*

Remarks: *Sick in Hosp'l. at Wash'n*
D.C. Since May 24, 1865.

Book mark:

E. Carroll

A

8 H. Art'y.

U.S.C.T.

Jordan Wellingham

Priv, Co. E, 8 Reg't U. S. Col'd H. Art'y.

Appears on

Company Muster Roll

for *Sept & Oct*, 1865.

Present or absent

Stoppage, \$ *100* for

Due Gov't, \$ *100* for

Valuation of horse, \$ *100*

Valuation of horse equipments, \$ *100*

Remarks: *Discharged by Order of the
Sec of War at Alexandria Va.
June 24th 1865.*

Book mark: *Discharged May 27th 65
(1004)*

E. B. Carroll

(358)

Copyist.

JAN. 14

5475452

☆ 1891 ☆

*E. B. V. 12 P. 237 N. 69. 25.
H. C. J. 76,*

W | 8 H arty. | U.S.C.T.

Jordan Wellingham
Print, Co., 8 Reg't U. S. Col'd H arty

Appears on a

Detachment Muster-out Roll

of the organization named above. Roll dated

Washington D.C., May 27, 1865.

Muster-out to date May 27, 1865.

Last paid to Oct 31, 1864.

Clothing account:

Last settled 186 ; drawn since \$ 100

Due soldier \$ 100; due U. S. \$ 100

Am't for cloth'g in kind or money adv'd \$ 77³⁰/100

Due U. S. for arms, equipments, &c., \$ 100

Bounty paid \$ 100 due \$ 100

Remarks: Money value of

clothing drawn since
enrollment - \$47³⁰

Mustered out - in
compliance with par
6 G. O. 77 A. G. O. April 28th 65.

Book mark:

C. S. Rozzell

(349)

Copyist.

W | 8 H. Art'y. | U.S.C.T.

C. Willingham

Prv, Co. E, 8 Reg't U. S. Col'd H. Art'y.

Appears on Returns as follows:

April⁴ & May 18 63. absent
sick at Washington
D.C. since April 20 63.

June 4. Sept 18 63 absent
sick at Alexandria Va
since April 20 63.

Oct 18 63. June 24 63.
Alexandria Va
Discharged

Name also appears as J. Willingham
and Gordon Willingham

Book mark:

Chas. Patton

Jourdan Willingham
Pvt., Co. E, 8 Reg't U. S. Col'd H. Art'y.

Appears on Co. Muster-out Roll, dated
Victoria Texas, Feb 10, 1866.

Muster-out to date _____, 1866 .
Last paid to Oct 31, 1864 .

Clothing account:

Last settled _____, 1866 ; drawn since \$ _____ 100

Due soldier \$ _____ 100 ; due U. S. \$ _____ 100

Am't for cloth'g in kind or money adv'd \$ _____ 100

Due U. S. for arms, equipments, &c., \$ _____ 100

Bounty paid \$ _____ 100 ; due \$ _____ 100

Remarks: Entered service as recruit
Joined Co for duty Sept 12, 64.
Discharged at Alex. Va. June
24, 1865, per G.O. No 77. Par 6(63)
War Dept; Des. list, furnished
May 24-1865.

Book mark Dischd May 27-1865. E.B.
(over)

E. B. Carroll

JAN. 14

5475648

★ 1891 ★

V12-P.23. W-69 V11. 6 J 96

- 802 - 1879 -

W | 8th Regt. Arty | U.S.C.S.

Jordan Wellingham

, Co. E, 8th Reg't U.S.C.H.A.

NOTATION.

EB 12/23

Book mark: W. 69. C. S. - 1876.

War Department,

Adjutant General's Office,

Washington, April 12, 1876.

Mustered out May 27, 1865.

W. Allen

Copyist.

Willinghause Jurdon
P. E., Co. 8 Reg't U.S.C.H.A.

2 Enclosures.

Bed Cards	1	Descriptive Lists
Burial Records		Final Statements
Certs. of Dis. for Discharge		Furloughs
C. N. Charges		Med. Des. Lists
Med. Certificates		Orders

Enlistments 1

Other papers relating to—

Admission to Hosp'l	Furlough
Casualty Sheet (Officer's)	Med. Examination
Confinement	Misc. Information
Contracts	Pay or Clothing
Death or Effects	Personal Reports
Desertions	Rank
Discharge from Hosp'l	Transfer to Hosp'l
Discharge from Service	Transfer to V. R. C.
Duty	Transportation

TREATMENT.

[HERE NOTE IMPORTANT COMPLICATIONS AND ALL OPERATIONS.]

Freely Stimulating
application - Cleanliness
and proper position -

RESULT AND DATE.

Discharged May 29/65
by reason of telegram from
R. G. O. May 3/65

L. H. Hunt
a. a. Surg. M. D.



Hospital Number 1453

Name Juroton Willingham

Age 36 Nativity Kentucky

Married or Single Married

Residence Lawlessville, Barren Co

Post Office address of wife Mrs Maria Willingham
or nearest relative. Paducah, McCracken Co Ky

Rank Priv Co "E" Regiment 8 U.S.C.T.

When admitted April 20, 1865

From what source The West Washington

Diagnosis: (in surgical cases state explicitly seat and character of wound or injury.)

Ulcer of the left leg

L'Ouverture G.H.

On what occasion wounded Alexandria, Va.

Date.....

Nature of missile or weapon.....

8th U.S.C. Art. 26

No. Eighty-eight

Jordan Willingham

Volunteered at Paducah Ky

September 12th 1864

By Capt R. H. Hall

Pro Mar 1st Dist of Ky

2183

Consent of Parent or Guardian in case of a Minor, if a Free Man, or in the case of a Slave, of the Person to whom he owes Service:

of United States colored troops. They will be made out in duplicate in all cases... General, and one to accompany the accounts of the officer who pays bounty, &c. A... mustering, must in all cases, precede payment of pay, bounty, pension, &c. A... rting officer, commissary, or assistant commissary of musters, as the case may be, either of them is given to the disbursing officer.

UNITED STATES COLORED TROOPS ENLISTMENT.

STATE OF

TOWN OF

Kentucky



Paducah

I, *Willingham Jordan* born in *Hickman Co*
in the State of *Kentucky* aged *thirty five* years
and by occupation a *Farmer* Do HEREBY ACKNOWLEDGE to have
volunteered this *Twelfth* day of *September* 1864,
to serve as a **Soldier** in the **Army of the United States of America**, for
the period of **THREE YEARS**, unless sooner discharged by proper authority:
Do also agree to accept such bounty, pay, rations, and clothing, as are, or may be,
established by law for the U. S. colored troops.

And I, *Jordan Willingham of Ballard Co*
do solemnly swear, that I will bear true faith and allegiance to the **United States
of America**, and that I will serve them honestly and faithfully against all their
enemies or opposers whomsoever; and that I will observe and obey the orders of
the President of the United States, and the orders of the officers appointed over
me, according to the Rules and Articles of War.

Sworn and subscribed to, at *Paducah Ky*
this *12th* day of *Sept* 1864, } *Jordan Willingham*
Before *Capt. P. H. Hull* } *mark*

I CERTIFY, ON HONOR, That I have carefully examined the above named Volunteer, agreeably to the
General Regulations of the Army, and that, in my opinion, he is free from all bodily defects and mental infirmity,
which would in any way disqualify him from performing the duties of a soldier.

EXAMINING SURGEON.

I CERTIFY, ON HONOR, That I have minutely inspected the Volunteer, *Jordan Willingham*
previously to his enlistment, and that he was entirely sober when enlisted; that, to the best of my judgment and
belief, he is of lawful age; and that, in accepting him as duly qualified to perform the duties of an able-bodied
soldier, I have strictly observed the regulations which govern the recruiting service. This soldier has *blue*
eyes, *blue* hair, *blue* complexion, is *five* feet *7 1/2* inches high.

RECRUITING OFFICER OR AGENT.

Mustered into the United States service *12th* day of *September* 1864.

N. M. Hall
Capt. Pro Mar. Mustering Officer.

Mustered into the service of the United States, for three years or during the war, from date of enlistment, in Company *B*
of *7th* Regiment of *1st Col. 11th Regt. Volunteers*, on the *12th* day of *September*, 1864, at *Paducah Ky*
By P. H. Hull
Capt. Pro Mar.
W. D. Smith

NOTE 1.—This blank will be used for enlistments of United States colored troops. They will be made out in duplicate in all cases—one to accompany the recruiting return of the superintendent (not the recruiting officer) to the Adjutant General, and one to accompany the accounts of the officer who pays bounty, &c.

NOTE 2.—An enlistment holds to service. A muster-in, must in all cases, precede payment of pay, bounty, pension, &c. A muster-in roll, must in all cases, be filed in the Adjutant General's Office as evidence of muster-in. The mustering officer, commissary, or assistant commissary of musters, as the case may be, will countersign both enlistments as having mustered the soldier into the service of the United States before either of them is given to the disbursing officer.

DECLARATION OF RECRUIT.

I, Jordan Willingham of Ballard Co desiring to volunteer as a soldier in the ARMY OF THE UNITED STATES, for the term of Three Years, DO DECLARE That I am Thirty years and months of age; that I have never been discharged from the United States service on account of disability or by sentence of a court-martial, or by order before the expiration of a term of enlistment; and I know of no impediment to my serving honestly and faithfully as a soldier for three years.

GIVEN at Paducah Ky
the 12th day of September 1864

Witness: A. J. Sykes

Jordan Willingham
wrote

By Robert B. Hill
Comdr. 1st Dist of Ky
Volunteer at Paducah Ky
September 12th 1864

No. Eighty-seventh

1111111111

Consent of Parent or Guardian in case of a Minor, if a Free Man, or in the case of a Slave, of the Person to whom he owes Service:

I, Do CERTIFY, That I am the that the said is years of age; and I do freely give my CONSENT to his volunteering as a SOLDIER in the Army of the United States, for the period of THREE YEARS, under the conditions of the laws of the United States.

GIVEN at

the day of

Witness:

1899
Willis Peter

Co K, 8 U.S. Col'd H. Art'y.

Private | Private

CARD NUMBERS.

1	548/215	26
2	548/356	27
3	548/496	28
4	548/630	29
5	548/762	30
6	548/883	31
7	548/991	32
8	5482094	33
9	5482190	34
10	5482282	35
11	5482368	36
12	4122764	37
13		38
14		39
15		40
16		41
17		42
18		43
19		44
20		45
21		46
22		47
23		48
24		49
25		50

Book Mark:

See also

W | 8 H. Art'y. | U.S.C.T.

Peter Miller

....., Co. *K*, 8 Reg't U.S. Col'd H. Art'y.

Appears on

Company Descriptive Book

of the organization named above.

DESCRIPTION.

Age *21* years; height *5* feet *4* inches.

Complexion *Black*

Eyes *Black*; hair *Black*

Where born *Virginia*

Occupation *Farmer*

ENLISTMENT.

When *June 4*, 186*4*.

Where *Fort Donelson*

By whom *John Cook*; term *3* y'rs.

Remarks:

.....
.....
.....
.....
.....
.....
.....
.....

Keefe

H.

8 H. Art'y.

U.S.C.T.

Peter Miller,

Prvt, Co. *K*, 8 Reg't U. S. Col'd H. Art'y.

Age _____ years.

Appears on

Company Muster Roll*
for *Enlistment to June 30th*, 1864.

Joined for duty and enrolled:

When *June 4th*, 1864

Where *Camp Donaldson, La.*

Period *3* years.

Mustered in:

When *June 20th*, 1864

Where *Paducah, Ky.*

Present or absent *Present*.

Stoppage, \$ *100* for _____

Due Gov't \$ *100* for _____

Valuation of horse, \$ *100*

Valuation of horse equipments, \$ *100*

Remarks: _____

*First current roll. No muster-in roll of this company on file.

Book mark: *H. 428. Ky.*

Harin

(358d)

Copyist.

W. | 8 H. Art'y. | U.S.C.T.

Peter Willis,
Cpt., Co. K, 8 Reg't U. S. Col'd H. Art'y.

Appears on

Company Muster Roll

for *July and August, 1864*

Present or absent *Present*

Stoppage, \$ 100 for

Due Gov't, \$ 100 for

Valuation of horse, \$ 100

Valuation of horse equipments, \$ 100

Remarks :
.....
.....
.....
.....
.....
.....
.....
.....
.....
.....
.....

Book mark :

Harri.

M. | 8 H. Art'y. | U.S.C.T.

Peter Miller,
Pvt., Co. K, 8 Reg't U. S. Col'd H. Art'y.

Appears on

Company Muster Roll
for *Sept and Oct*, 186*4*

Present or absent *Present*

Stoppage, \$ *100* for

Due Gov't, \$ *100* for

Valuation of horse, \$ *100*

Valuation of horse equipments, \$ *100*

Remarks:

Book mark:

Harin

H.

8 H. Art'y.

U.S.C.T.

Peter Hillis,

Pvt., Co. K, 8 Reg't U. S. Col'd H. Art'y.

Appears on

Company Muster Roll

for *Nov. and Dec.*, 186*4*.

Present or absent *Present.*

Stoppage, \$ *100* for

Due Gov't, \$ *100* for

Valuation of horse, \$ *100*

Valuation of horse equipments. \$ *100*

Remarks :

Book mark :

Harris

W

8 H. Art'y.

U.S.C.T.

Peter Willis

Priv, Co. K, 8 Reg't U. S. Col'd H. Art'y.

Appears on

Company Muster Roll

for *Jan'y. & Feby.*, 1865.

Present or absent *Present*

Stoppage, \$ 100 for

Due Gov't, \$ 100 for

Valuation of horse, \$ 100

Valuation of horse equipments, \$ 100

Remarks:

Book mark:

D. Maher
Copyist.

W

S H. Art'y.

U.S.C.T.

Peter Willis

Orvi, Co. K, 8 Reg't U. S. Col'd H. Art'y.

Appears on

Company Muster Roll

for *March & April*, 1865.

Present or absent *Present*

Stoppage, \$ 100 for

Due Gov't, \$ 100 for

Valuation of horse, \$ 100

Valuation of horse equipments, \$ 100

Remarks:

Book mark:

D. Maher

(358)

Copyist.

W

S H. Art'y.

U.S.C.T.

Peter Willis

Orin, Co. K, 8 Reg't U. S. Col'd H. Art'y.

Appears on

Company Muster Roll

for *May + June*, 1865.

Present or absent *Present*

Stoppage, \$ 100 for

Due Gov't, \$ 100 for

Valuation of horse, \$ 100

Valuation of horse equipments, \$ 100

Remarks:

Book mark: -----

D. Maher

W | 8 H. Art'y. | U.S.C.T.

Peter Willis

Pvt, Co. K, 8 Reg't U. S. Col'd H. Art'y.

Appears on

Company Muster Roll

for *July & August*, 1865.

Present or absent *Present*

Stoppage, \$ *100* for

Due Gov't, \$ *100* for

Valuation of horse, \$ *100*

Valuation of horse equipments, \$ *100*

Remarks:

One Cap Bouch + Pick 41¢
One Bayonet Scabbard + frog. 56¢

Book mark:

(358)

D. Mahser
Copyist.

W

S H. Art'y.

U.S.C.T.

Peter Willis

Priv., Co. K, 8 Reg't U. S. Col'd H. Art'y.

Appears on

Company Muster Roll

for Sept. + Oct., 1865.

Present or absent Present

Stoppage, \$ 100 for

Due Gov't, \$ 100 for

Valuation of horse, \$ 100

Valuation of horse equipments, \$ 100

Remarks:

Book mark:

(358)

D. P. York

Copyist.

W

8 H. Art'y.

U.S.C.T.

Peter Willis

Oris, Co. K, 8 Reg't U. S. Col'd H. Art'y.

Appears on

Company Muster Roll

for Nov & Dec, 1864

Present or absent Present

Stoppage, \$ 100 for

Due Gov't, \$ 100 for

Valuation of horse, \$ 100

Valuation of horse equipments, \$ 100

Remarks:

Book mark:

S. P. York

(358)

Copyist.

Peter Willis

Priv., Co. K, 8 Reg't U. S. Col'd H. Art'y.

Appears on Co. Muster-out Roll, dated
Victoria Texas, Feby 10, 1866.

Muster-out to date Feby 10, 1866.

Last paid to Aug 31, 1865.

Clothing account:

Last settled....., 186 ; drawn since \$..... 100

Due soldier \$ 8 ⁰⁵/₁₀₀; due U. S. \$..... 100

Am't for cloth'g in kind or money adv'd \$..... 100

Due U. S. for arms, equipments, &c., \$..... 100

Bounty paid \$..... 100; due \$ 100 100

Remarks Entered service at organization
of Co as private Enrolled & subject
to draft in 1st Enrollment Dist
State of Ky at time of enlistment

Book mark: H. 428 Ky
A 22 217

S O York

Willis, Peter

A. Co. H, 8 Reg't U.S. Cavalry

Enclosures.

Bed Cards	Descriptive Lists
Burial Records	Final Statements
Certs. of Dis. for Discharge	Furloughs
C. M. Charges	Med. Des. Lists
Med. Certificates	Orders

Other papers relating to—

Admission to Hosp'l	Furlough
Casualty Sheet (Officer's)	Med. Examination
Confinement	Misc. Information /
Contracts	Pay or Clothing
Death or Effects	Personal Reports
Desertions	Rank
Discharge from Hosp'l	Transfer to Hosp'l
Discharge from Service	Transfer to V. R. C.
Duty	Transportation

Headquarters Kentucky Volunteers,

Adjutant-General's Office,

Frankfort, 7th Dec. 1862

I hereby certify, that it appears from the U. S. ~~Register~~ ^{Registration} Polls on file in this Office, that Peter Willis was enrolled on the 4th day of June, 1864, at Ft. Donalson, by John Cook and mustered into the U. S. service on the 9th day of June, 1864, at Paducah Ky, by Lt Wm. Fox to serve three years. Said Peter Willis is described as follows: 24 yrs age, — eyes, — hair, — complexion, — height. It further appears from said Polls, that Peter Willis owed service to Daniel Bellman and is credited to Trigg County Kentucky and was assigned to Company "K" 8th Regt: W. S. C. Artly (Heavy)

In Testimony Whereof, I have hereunto set my hand, and affixed my Official Seal, this 7th day of December, 1862.

D. W. Lindsay
Adjutant General of Kentucky.

J. A. Long & Co: "K" 8th Regt W. S. C. Artly (Heavy)

War Department,

ADJUTANT GENERAL'S OFFICE,

Washington, *Aug 25* 1867.

Respectfully returned to the Commission for the State of Kentucky, with the information that Peter Willis was enlisted at St. Louis, Missouri, June 25, 1864, and was mustered in as Private Co. K, 8th U.S. Colored Troops June 25/64, *inducap Ky*

No. 428 Ky

J. J. [Signature]

Asst. Adj't General.

W.C.S.

No. _____

APPLICATION OF

Daniel Hillman

OF

Frigg County Ky

FOR COMPENSATION FOR SLAVE,

Named *Peter Willis*

Enlisted *June 25* 1864,

In *Co. K*, *8th* Regiment,

U. S. COLORED TROOPS *Heavy Arty*

Received *Dec 25*, 1866.

Compensation Awarded

_____, 1866.

Dollars.

President of Board of Claims.

Claimant's Attorney,

Claimant's Post-office Address,

Empire Iron Works

FRANKFORT COMMONWEALTH PRINT.

2

No.

CLAIM OF

FOR THE COMPENSATION OF SLAVE NAMED

I, *Daniel Hillman* a loyal citizen, and a resident of *Empire Iron Works*
County of *Franklin* State of Kentucky, hereby claim compensation, under
the provisions of Section 24, act approved February 24, 1864, and section 2, act approved July 28,
1866, for my slave *Peter Willis*, enlisted *June 25th*,
1864, at *Paducah Ky*, by *Lt. M. J. Swan*
in the *8th Heavy Artillery* regiment U. S. Colored Troops, Co. *K*; certificate of
which enlistment, and a descriptive list, as required, accompany this application. That I did not ac-
quire said slave subsequent to said enlistment, but had a valid title to him at the date of said enlist-
ment, and previous thereto: I having acquired my title to him and my ownership over him as fol-
lows, to-wit: *Purchase of Sheriff of Dallas Co. Ala. as*
subil of sale bearing date April 1856

In proof of my loyalty to the Constitution and Government of the United States, I present the ac-
companying oath, which I have taken, signed and acknowledged; to be filed with this application, in
accordance with requirement of General Orders, No. 329, 1863, War Department, Adjutant General's
Office.

Dec 21st, 1866.

OATH OF ALLEGIANCE.

I, *Daniel Hillman* the owner and Claimant, do solemnly swear that
the foregoing claim is a just and true claim due to me as master and owner of the said slave, and that
the facts alleged in said claim in respect to the draft or enlistment (as the case may be) of said slave
into the Military service of the United States are true. And I do further swear that I have never
joined, or been concerned in, any insurrection or rebellion; that I have never borne arms against the
United States; that I have never given any aid, countenance, counsel or encouragement to any person
or persons engaged, or whom I had reason to believe were about to engage, in insurrection, rebellion
or armed hostility against the United States; that I have neither sought, nor accepted, nor attempted
to exercise the functions of any office, civil or military, nor to perform any service whatever, under
any authority or pretended authority in hostility to the United States; that I have not yielded a vol-
untary support to any insurrection, rebellion or pretended government, authority, power or constitution
within the United States hostile thereto. And I do further swear that, to the best of my knowledge
and ability, I have supported and defended, and will continue to support and defend, the United
States against all enemies, foreign and domestic; and that I have supported, defended and obeyed, and
will continue to support, defend and obey, the Constitution and laws of the United States; that I will
bear true faith and allegiance to the same; and that I take this oath freely, without any mental reserva-
tion or purpose of evasion: So help me God.

Daniel Hillman

Sworn to and subscribed before me, at *Empire Iron Works, Ky*
this *21st* day of *December*, 1866.

G. B. Grady J. P. S. C.

PROOF OF OWNERSHIP.

STATE OF KENTUCKY,

COUNTY OF

Trigg

SS.

We

D. N. Pryor

and

J. Shop

each of lawful

age, and resident citizens of the State and County aforesaid, do certify that

Daniel

Hellman

of the State and County aforesaid, was on the

25th

day of

June

1864, the lawful owner of the slave named

Peter Willis

;

referred to and described in the foregoing claim for compensation.

D. N. Pryor
J. Shop

Sworn to and subscribed before me a

Magistrate

for the County of

Trigg

State of Kentucky, this the

21st

day of

Dec

1866.

C. B. Brady J. P. J. C.



PROOF OF LOYALTY.

STATE OF KENTUCKY,

COUNTY OF

Trigg

SS.

We

D. W. Standrod

and

J. H. Spriggs

loyal men and

each of lawful age, and resident citizens of the

of

Empire Iron Works

in the State and County aforesaid, upon our oaths declare that we have known

Daniel Hellman

a resident of the State and County aforesaid, since the 4th day of March, 1861, and know that he has

firmly and faithfully maintained his or her adherence and allegiance to the Government of the United

States, by defending its cause against the Government and forces of the so-called Confederate States

of America, in all suitable and practicable ways, and according to his or her ability and opportunity.

D. W. Standrod

J. H. Spriggs

Sworn to and subscribed before me a

Magistrate

for the county of

Trigg

State of Kentucky, this the

21st

day of

Dec

1866.

C. B. Brady J. P. J. C.

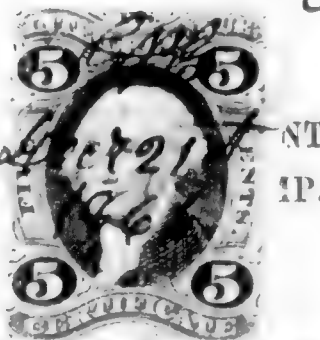

POWER OF ATTORNEY.

My Post-Office address is

County of

State of

Kentucky, and I hereby direct that all communications to me, touching this claim, be sent under cover

to

, who is hereby appointed and consti-

tuted my true and lawful attorney, to prosecute this claim for me, and who is hereby authorized and

empowered to receive and receipt for any award, order, draft, certificate, voucher, warrant, papers or

money that may be issued in the adjustment of this claim, or the payment thereof, the same as I

might or could do in person were I present and acting for myself, and to file any additional evidence

or papers that may be required in the prosecution of this claim.

[WITNESS.]

The owner signs here.

Two witnesses to owner's signature sign here.

50 CENT STAMP.

1900
Willis Hanson
Co E, 8 U.S. Col'd H. Art'y.

Private | Corporal

CARD NUMBERS.

1	26
2	27
3	28
4	29
5	30
6	31
7	32
8	33
9	34
10	35
11	36
12	37
13	38
14	39
15	40
16	41
17	42
18	43
19	44
20	45
21	46
22	47
23	48
24	49
25	50

See Hanson Willis

Book Mark:

See also

1901
Wilson Alexander

Co B, 8 U.S. Col'd H. Art'y.

Private Private

CARD NUMBERS.

1	5470033	26
2	5470176	27
3	5470317	28
4	5470445	29
5	5470574	30
6	5470704	31
7	5470826	32
8	5470948	33
9	5471060	34
10	5471176	35
11	5471256	36
12	9121503	37
13	40744943	38
14		39
15		40
16		41
17		42
18		43
19		44
20		45
21		46
22		47
23		48
24		49
25		50

Book Mark: G.B. 611 P 572

See also

7400-4-24-33 JG MC

W | 8 H. Art'y. | U.S.C.T.

Alexander Wilson

....., Co. *B*, 8 Reg't U.S. Col'd H. Art'y.

Appears on

Company Descriptive Book

of the organization named above.

DESCRIPTION.

Age *18* years; height *5* feet *4* inches.

Complexion *Dark*

Eyes *Dark*; hair *Dark*

Where born *Lynn Co., Ky*

Occupation *Farmer*

ENLISTMENT.

When *June 16*, 1864.

Where *Paducah, Ky.*

By whom *Wm. Brown*; term *3* y'rs.

Remarks: *Sent to Hospital at Paducah, Ky. Apr. 6/65 (sick) Descriptive list furnished*

Henderson

Alexandria Wilson

Privt., Co. B, 8 Reg't U. S. Col'd H. Art'y.

Appears on

Company Muster Roll

for May & June, 1864.

Present or absent Present

Stoppage, \$ 100 for

Due Gov't, \$ 100 for

Valuation of horse, \$ 100

Valuation of horse equipments, \$ 100

Remarks:

Committed to the
hospital by M. D. at
Paducah June 25 by
(for 34 days)

Book mark:

J. A. Boyd

21

8 H. Art'y.

U.S.C.T.

Alexander Wilson

Private, Co. B, 8 Reg't U. S. Col'd H. Art'y.

Appears on

Company Muster Roll

for July and Aug., 1864.

Present or absent Present

Stoppage, \$ 100 for

Due Gov't, \$ 100 for

Valuation of horse, \$ 100

Valuation of horse equipments, \$ 100

Remarks:

Book mark:

J. A. Boyd

(358)

Copyist.

W. H. Art U. S. C. T

Alexander Wilson

Priv. Co. B, 8 Reg't U. S. Col'd H. Art.

Appears on

Company Muster Roll

for *Sept. and Oct.*, 1864.

Present or absent *Present*

Stoppage, \$ *100* for

Due Gov't, \$ *100* for

Valuation of horse, \$ *100*

Valuation of horse equipments, \$ *100*

Remarks:

Book mark:

J. Boyd

71

S H. Art'y.

U.S.C.T.

Alexander Wilson

510, Co. B, 8 Reg't U. S. Col'd H. Art'y.

Appears on

Company Muster Roll

for November, 1861.

Present or absent Present

Stoppage, \$ 100 for

Due Gov't, \$ 100 for

Valuation of horse, \$ 100

Valuation of horse equipments, \$ 100

Remarks: with in Summ.

Book mark:

E. S. [Signature]

Copyist.

Alexander Wilson

Fri., Co. B, 8 Reg't U. S. Col'd H. Art'y.

Appears on

Company Muster Roll

for September, 1865.

Present or absent Present

Stoppage, \$ 100 for

Due Gov't, \$ 100 for

Valuation of horse, \$ 100

Valuation of horse equipments, \$ 100

Remarks:

Book mark:

J. C. [Signature]
Copyist.

Alexander Wilson

Spri, Co. B, 8 Reg't U. S. Col'd H. Art'y.

Appears on

Company Muster Roll

for March and April, 1865.

Present or absent absent

Stoppage, \$ 100 for

Due Gov't, \$ 100 for

Valuation of horse, \$ 100

Valuation of horse equipments, \$ 100

Remarks: Sick in Post Hospital Paducah Ky.

Book mark:

(358)

J. G. Reeves Copyist.

W 18 H Artz U.S.C.T.

Alexander Wilson
Private, Co B, 8 Reg't U. S. Col'd Artz

Appears on

Company Muster Roll

for May & June, 1865.

Present or absent Absent

Stoppage, \$ 100 for

Due Gov't, \$ 100 for

Valuation of horse, \$ 100

Valuation of horse equipments, \$ 100

Remarks: Sent to Hospital
Paducah, Ky Apr 6/65

Book mark:

(358)

Permes
Overly Copyist

M | 8 H. Art'y. | U.S.C.T.

Alexander Wilson

Co. B, Co. B, 8 Reg't U. S. Col'd H. Art'y.

Appears on

Company Muster Roll

for *July & Aug*, 186*5*.

Present or absent *Absent*

Stoppage, \$ *100* for

Due Gov't, \$ *100* for

Valuation of horse, \$ *100*

Valuation of horse equipments, \$ *100*

Remarks: *Left sick in Hos-
pital at Haducah, Ky.
Apr. 10", 1865*

Book mark: _____

Randall

Alexander Milner

Co. B, 8 Reg't U. S. Col'd H. Art'y.

Appears on

Company Muster Roll

for Sept & Oct, 1865.

Present or absent Absent

Stoppage, \$ 100 for

Due Gov't, \$ 100 for

Valuation of horse, \$ 100

Valuation of horse equipments, \$ 100

Remarks Sick in Hospital at Paducah, Ky. since Apr. 6th 1865

Book mark:

Paridac

11 | 8 H. Art'y. | U.S.C.T.

Alexander Wilson

Port., Co. B, 8 Reg't U. S. Col'd H. Art'y.

Appears on

Company Muster Roll

for Nov. & Dec., 1865.

Present or absent Absent

Stoppage, \$ 100 for

Due Gov't, \$ 100 for

Valuation of horse, \$ 100

Valuation of horse equipments, \$ 100

Remarks: Sick in Hospital at
Paducah, Ky. Since Apr. 6th
1865

Book mark:

Randall

(358)

Copyist.

W | 8 H. Art'y. | U.S.C.T.

Alex Wilson
Priv, Co. B, 8 Reg't U. S. Col'd H. Art'y.

Appears on Returns as follows:

April 1865. to June 1866.
at New York Paducah
Ky. since April 6/65.

Book mark: _____

Chas. J. ...

Alexander Wilson

Co. D, 8 Reg't U. S. Col'd H. Art'y.

Appears on **Co. Muster-out Roll**, dated

Victoria, Texas, Feb. 11, 1866.

Muster-out to date _____, 186 .

Last paid to *Oct. 31*, 1864 .

Clothing account:

Last settled _____, 186 ; drawn since \$ _____ 100

Due soldier \$ _____ 100; due U. S. \$ _____ 100

Am't for cloth'g in kind or money adv'd \$ _____ 100

Due U. S. for arms, equipments, &c., \$ _____ 100

Bounty paid \$ _____ 100; due \$ _____ 100

Remarks: *Entered service as recruit
joined Co. for duty June 16th 1864.
Enrolled and subject to Draft
in 1st Enrollment Dist. of Ky.
at time of enlistment. Sent
to hospital at Paducah, Ky.*

Book mark: *3983, 1880. See Vol. (over)
Siedman 1905. C. R. 110 5-72*

Randall

JAN. 14

5471286

* 1891 *

April 11, '80, Sick. De-
scriptive list furnished.
No discharge given.
Clothing drawn since
En. (with Co) \$96.77-
(aged)

Wilson, Alexander

B, Co. B, 8 Reg't U.S. C.H.A.

5 Enclosures.

Bed Cards	Descriptive Lists
Burial Records 2	Final Statements 1
Certs. of Dis. for Discharge	Furloughs
C. M. Charges	Med. Des. Lists
Med. Certificates	Orders

Other papers relating to—

Admission to Hosp'l	Furlough
Casualty Sheet (Officer's)	Med. Examination
Confinement	Misc. Information
Contracts	Pay or Clothing
Death or Effects 2	Personal Reports
Desertions	Rank
Discharge from Hosp'l	Transfer to Hosp'l
Discharge from Service	Transfer to V. R. C.
Duty	Transportation

Alexander Wilson,
8 U.S. C.T. Post B.
June 19/65.
Attending Louisville
Ky

HOSPITAL RECORD,

SUBJECT TO THE

ORDER OF THE SURGEON GENERAL

UNITED STATES ARMY.

No. 1.

RECORD OF DEATH AND INTERMENT.

Name and number of person interred. *Alexander Wilson*

Number and locality of the grave . *Grave #. Range 38*

Hospital number of the deceased . . *3044*

Regiment, rank, and company . . . *8th U.S.C. I. Inf. Co "B"*

Residence before enlistment . . . *Paducah Ky.*

Conjugal condition, (and if married, }
 the residence of the widow) . . } *Single; Stephen Wilson
 Paducah Ky.*

Cause of death } *Chronic Diarrhoea*

Age of the deceased *Sixteen, (16)*

Nativity *Ky.*

References and remarks }

Date of death and burial *died June 19th* , 1865.

Duplicates sent to the Adjutant General of the United States Army, and to the Sexton of the *Paul Hill* Cemetery.

Memoranda:

Attest, Dec. 15th 1865,
 Prov. Sec. of War Dept.
 for 50th and 20th Divs.
) B.

603
FINAL STATEMENT

OF
Alexander Wilson

8th Reg't of *W. Va. Inf.*

VOLUNTEERS.

At June 19, 1865

NOTE 1.—Two of these certificates (or duplicates) are to be given to each Volunteer Soldier or drafted man who may be discharged previously to the discharge of his company, that he may at once receive from the Paymaster the pay, &c., due him, and the captain or other COMMISSIONED officer commanding the company will certify to the act of the delivery of the duplicate certificates; on these certificates the Soldier is "entitled to" his discharge, and should also present his discharge to the Paymaster to have the payment endorsed on it. The discharge is to be given back to the Soldier by the Paymaster; the latter only retaining as his voucher the duplicate certificates.

NOTE 2.—If the Soldier is entitled to pay for the use of his horse, the Company Commander will certify to that fact on the back of both these final statements, and also to the time he has pay due for having been so mounted on his own horse.

NOTE 3.—When a Soldier is furnished with final statements, his descriptive list, if he has one, should be taken up by the officer who gives the Soldier these statements, and endorsed with a statement to this effect by the officer. This endorsement should exhibit a full statement of the time for which the Soldier was allowed pay on his final statements, the clothing account, and all other charges against him or in his favor, so as to comprise a complete exhibit of his account. It will then be transmitted to the Company Commander of the Soldier, who will enter all the data necessary to a full understanding of the Soldier's account on the muster roll upon which the Soldier's discharge is reported. The descriptive list will then be destroyed. The object of this is, that the remaining portion of the Soldier's account may be settled upon the receipt of these muster rolls, and the Soldier receive any pay or allowances that may be due him at the time of his discharge, and which may not appear on his final statements from the fact that his descriptive list is incomplete. These accounts for back pay, &c., are settled by the 2d Auditor of the Treasury Department.

NOTE 4.—Charges for loss or injury to ordnance, horse equipments, and other miscellaneous charges, should appear under the heading of "Other Steppages."

NOTE 5.—Bounty paid by State authorities, and not by the United States, will not be entered on this statement.

NOTE 6.—Amounts due the Sutler and Laundress must be entered on the muster roll on which the discharge, death, desertion, &c., is reported, as well as on the final statement, otherwise the amount cannot be collected from the United States.

NOTE 7.—This blank will be used for deceased volunteers and drafted men, as well as for others.

NOTE 8.—Where a Soldier dies in Hospital or on detached service, his descriptive list, if he has one, should be sent with his final statements, in duplicate, to the Adjutant General, Washington, D. C.

[OFFICE ENDORSEMENT.]

War Department,

ADJUTANT GENERAL'S OFFICE,

February 24 1876,

The Death of Alexander
 Wilson, Co. "B," 8th Reg't U. S.
 Colored Army, is reported as follows:

On Company Muster Roll.	
For	186 , 186
Company Muster-out Roll.	
Sent to Hospital at Taduscab. Ky.	186
Co. 7 th 1865 (Sick)	
Company Descriptive Book.	186
Company Morning Reports.	186
Soldier's Final Statement.	186 5
June 19 th	
Soldier's Record of Death and Interment.	186 5
June 19 th	
Soldier's Inventory of Effects.	186
Soldier's Certificate of Disability for Discharge.	186
Soldier's Individual Muster-out Roll.	186
Regimental Return.	186
Regimental Quarterly Returns.	186
Regimental Descriptive Book.	186
By Surgeon General.	186

Absent, sent to Hospital at Paducah, Ky.
 and 14th Reg't from 1865 to 1865
 R. Returns for 1865 and 1865

June 19th, 1865, is held to be
 the correct date, and the Company Muster-out
 Roll will be amended accordingly.

Thos. M. S. J. S. J.
 Assistant Adjutant General.
 March 10, 1876.

ADJUTANT GENERAL'S OFFICE.
 July 15. 1865.
 Duplicate with Inventory sent 2d Auditor.

I certify, on honor, that *Alexander Wilson* a *Private* of
 Captain *John Cook* Company (B) of the *8* Regiment of *Volunteers*
VOLUNTEERS, of the State of *Kentucky*, born in *Lyon Co.*, State
 of *Kentucky*, aged *18* years; *5* feet *4* inches high; *dark* complexion,
dark eyes, *dark* hair, and by occupation a *Farmer*, having joined the company on
 its original organization at *Lyon Co. June 16 1864*, and enrolled in it at the muster into
 the service of the United States at *Paducah*, on the *20* day
 of *June*, 1864, (or was mustered in service as a recruit, by
 , at , on the day of ,
 186 , or was drafted and mustered into the service of the United States from the
 Enrollment District of the State of , at ,
 on the day of , 186) to serve in the Regiment, for
 the term of *Three years*; and having served **HONESTLY** and
FAITHFULLY with his Company in to the present date, is now
 entitled to a **DISCHARGE** by reason of *Death*.

The said *Alexander Wilson* was last paid by Paymaster
Wm. F. ... to include the *31* day of *October*, 1864, and has
 pay due him from that time to the present date; he is entitled to pay and subsistence for
TRAVELING to place of enrollment, and whatever other allowances are authorized to volunteer
 soldiers, drafted men, or militia, so discharged. He has received from the United States **CLOTHING**
 amounting to *36* ^{*77*} _{*100*} dollars, since the *enlistment* day of *X X X*,
 186 , when his clothing account was last settled. He has received from the United States
X _{*100*} dollars advanced **BOUNTY**.

Paid June 1865

There is to be stopped from him, on account of the State of , or other
 authorities, for **CLOTHING**, &c. received on entering service, *100* dollars; and
 for other stoppages, viz: *Stop for Am. Knapsack*.

100 dollars.
 He has been furnished with **TRANSPORTATION** in kind from the place of his discharge to
 ; and he has been **SUBSISTED** for **TRAVELING** to his
 place of enrollment, up to the , 186 .

He is indebted to , **SUTLER**, *100* dollars.

He is indebted to , **LAUNDRESS**, *100* dollars.

Given in Duplicate, at *Fort Henderson, La. Camp, Louisiana* this *15* day
 of *June*, 1865.

R. R. Taylor
 Surgeon *Major*
 Commanding Company
 In charge of Hospital

ARTICLES OF WAR.

ART. 95. When any non-commissioned officer or soldier shall die, or be killed in the service of the United States, the then commanding officer of the troop or company shall, in the presence of two other commissioned officers, take an account of what effects he died possessed of, above his arms and accoutrements, and transmit the same to the office of the Department of War, which said effects are to be accounted for, and paid to the representatives of such deceased non-commissioned officer or soldier. And in case any of the officers, so authorized to take care of the effects of deceased officers and soldiers, should, before they have accounted to their representatives for the same, have occasion to leave the regiment or post, by preferment or otherwise, they shall, before they be permitted to quit the same, deposit in the hands of the commanding officer, or of the assistant military agent, all the effects of such deceased non-commissioned officers and soldiers, in order that the same may be secured for, and paid to, their respective representatives.

ARMY REGULATIONS—EDITION OF 1861.

DECEASED SOLDIERS.

Par. 152. Inventories of the effects of deceased non-commissioned officers and soldiers, required by the 95th Article of War, will be forwarded to the Adjutant General, by the commander of the company to which the deceased belonged, and a duplicate of the same to the colonel of the regiment. Final statements of pay, clothing, &c., will be sent with the inventories. When a soldier dies at a post or station absent from his company, it will be the duty of his immediate commander to furnish the required inventory, and, at the same time, to forward to the commanding officer of the company to which the soldier belonged, a report of his death, specifying the date, place, and cause; to what time he was last paid, and the money or other effects in his possession at the time of his decease; which report will be noted on the next muster roll of the company to which the man belonged. Each inventory will be endorsed, "Inventory of the effects of _____, late of company (—) _____ regiment of _____, who died at _____, the _____ day of _____, 186—." If a legal representative receive the effects, it will be stated in the report. If the soldier leave no effects, the fact will be reported.

Par. 153. Should the effects of a deceased non-commissioned officer or soldier not be administered upon within a short period after his decease, they shall be disposed of by a Council of Administration, under the authority of the commanding officer of the post, and the proceeds deposited with the Paymaster, to the credit of the United States, until they shall be claimed by the legal representatives of the deceased.

Par. 154. In all such cases of sales by the Council of Administration, a statement in detail, or account of the proceeds, duly certified by the Council and commanding officer, accompanied by the Paymaster's receipt for the proceeds, will be forwarded by the commanding officer to the Adjutant General. The statement will be endorsed, "Report of the proceeds of the effects of _____, late of company (—) _____ regiment of _____, who died at _____, the _____ day of _____, 186—."

NOTE 1.—The effects in all cases, when called for, should be turned over to the legal representative, without further authority from the Adjutant General. When the effects are turned over to the relatives of the deceased before these inventories are sent to the Adjutant General, their receipts therefor should be attached to the inventories. In all other cases, one copy will be sent with a letter of transmittal direct to the Adjutant General, and a duplicate retained by the officer.

NOTE 2.—Particular care should be taken to take receipts in duplicate from the Paymaster for any funds turned over to him; one copy should be sent direct to the Adjutant General and one retained by the officer.

INVENTORY OF THE EFFECTS

OF

Alexander Wilson

Late of Company B.

8th Reg't of V. C. H. Art'y.

Volunteers, who died at Louisville Ky.

on the 19th day of June 1865.

Inventory of the effects of Alexander Wilson late
 a Private of Captain John Cook Company B of
 the 8th Regiment of W. G. H. Artz Volunteers, who was enrolled as
 a Private at Lyon Co in the State of Kentucky on
 the 16th day of June 1864, and mustered into the service of the United
 States as a Private on the 25 day of June 1864, at Paducah
 in Company B, 8th Regiment of W. G. H. Artz Volunteers, to serve 3
 years or during the war; he was born in Lyon Co in the State
 of Kentucky; he was 18 years of age, 5 feet 4 inches
 high, dark complexion, dark eyes, dark hair, and by occupation, when enrolled,
 a Farmer; he died in Griffiths Gen Hospital at
Louisville Ky on the 19th day of June 1865, by
 reason of Chronic Diarrhoea.

INVENTORY					
ARTICLES.	No.	ARTICLES.	No.	ARTICLES.	No.
Hats.....		Pairs trousers.....		Knapsacks.....	
Caps.....		Pairs flannel drawers.....			
Forage caps.....		Pairs cotton drawers.....			
Great coats.....		Flannel shirts.....			
Uniform coats.....		Cotton shirts.....			
Uniform jackets.....		Pairs boots.....			
Flannel sack coats.....		Pairs shoes.....			
Blouses.....		Pairs socks.....			
Stable frocks.....		Blankets.....			
Fatigue overalls.....		Haversacks.....			
				MONEY.	
				Specie.....	\$
				Notes.....	\$

I CERTIFY, ON HONOR, that the above inventory comprises all the effects of Private
Alexander Wilson, deceased, and that the effects are in the hands
 of # at #
to be disposed of by a Council of Administration.

(DUPLICATES.)

STATION: Louisville Ky
 DATE: June 19 1865
 [A. G. O. No. 141.]

R. H. Zanger
Surgeon Major
Commanding the Company
in charge of Hospital

1800

1800

1800

1800

RECORD OF DEATH AND INTERMENT.

Name and number of person interred.	Alexander Wilson
Number and locality of the grave . . .	Range 38 Grave 4
Hospital number of the deceased . . .	3044
Regiment, rank, and company . . .	8th U.S. Cav. Regt. Co. "B"
Residence before enlistment . . .	Paducah Ky.
Conjugal condition, (and if married, } the residence of the widow) . . . }	Single; Stephen Wilson Paducah Ky.
Cause of death }	Chronic Diarrhoea
Age of the deceased	Sixteen (16)
Nativity	Ky.
References and remarks }	
Date of death and burial	died June 19 th

, 1865.

[A duplicate of this Record has been forwarded to the Sexton, and another remains at this Hospital.]

To

Capt. A. M. Tucker A. M. H.

SIR:

It becomes my duty to inform you that the person above described died at this Hospital as herein stated; and that it is desired his remains should be interred with the usual military honors.

Respectfully,

R. H. Taylor
Surgeon U. S. Army

Sanitation Louisville Ky June 24/65
MILITARY HOSPITAL

This copy of Record is to be transmitted to the Adjutant General at Washington immediately after the place of burial and the number of the grave have been ascertained and registered. The above notification is to remain attached.

REPORT
OF THE
PROCEEDS of the EFFECTS

OF
Hilson, Alexander

LATE OF
Co. *B*, *8 W. C. H. A.*

WHO DIED AT
Critterden Hospital,

LOUISVILLE, KY.,

the *19* day of *June 1865*

PROCEEDINGS OF A COUNCIL OF ADMINISTRATION.

Convened at Louisville, Kentucky, pursuant to Special Orders, No. 187, dated Post Headquarters, Louisville, Ky., Aug. 14, 1865, consisting of Capt F. Dame, 72nd U. S. C. Inf., 1st Lt. J. L. Irwin, 72nd U. S. C. Inf., and 1st Lt. Basil R. Hall, 135th U. S. C. Inf. for the purpose of disposing of the effects of late *Alexander Wilson* of Company *B* 8th Regiment *U.S.C.* Volunteer *K.A.*

The Council found the effects consisted of the following articles. They were ordered to be sold at auction, which was accordingly done, and the amount set opposite the articles respectively obtained, for which the receipt of the Paymaster is annexed.

AT AUCTION.

- Great coat, brought, \$
- Uniform coat, "
- Flannel sack coat, "
- Trousers, pairs, "
- Shirts, "
- Drawers, pairs "
- Socks, " "
- Shoes, " "
- Boots, " "
- Wool blanket, "
- Rubber, "
- Knapsack "
- Haversack, "
- Canteen, "

\$ - 50

Fred. Dame

Capt. 72nd Regt. U. S. C. Inf., President.

A. Kennedy, Capt 19 Regt.
vice (the 1st Lt. 135th Regt. U. S. C. Inf.) Recorder.

APPROVED *Louis D. Watkins*

Colonel, Commanding Post.

Brig Genl

PAYMASTERS RECEIPT.

RECEIVED from Capt. F. Dame, 72nd Regt. U. S. C. Inf., at Louisville, Ky., October 24, 1865, *50* Dollars and *50* cents, the result of the sale of the late *Alexander Wilson* of Company *B* 8th Regiment *U.S.C.* Volunteers.

J. M. Kussel
PAYMASTER, UNITED STATES ARMY.

1902
Wilson Alfred M

Co E, 8 U.S. Col'd H. Art'y.

Private Corporal

CARD NUMBERS.

1	5474491	26
2	5474554	27
3	5474658	28
4	5474782	29
5	5474906	30
6	5475028	31
7	5475146	32
8	5475262	33
9	5475373	34
10	5475477	35
11	5475565	36
12	9122321	37
13		38
14		39
15		40
16		41
17		42
18		43
19		44
20		45
21		46
22		47
23		48
24		49
25		50

Book Mark:

See also

W | 8 H. Art'y. | U.S.C.T.

Alfred M Wilson

Co. E, 8 Reg't U.S. Col'd H. Art'y.

Appears on

Company Descriptive Book
of the organization named above.

DESCRIPTION.

Age 23 years; height 5 feet 10 inches.

Complexion *Blk*

Eyes *Blk*; hair *Blk*

Where born *Waldwell Co., Ky*

Occupation *Farmer*

ENLISTMENT.

When *May 24*, 1867.

Where *Paducah, Ky*

By whom *Capt. Durr*; term *3* y'rs.

Remarks:

.....
.....
.....
.....
.....

E. A. Moreland

(3830)

Copyist.

W

S H. Art'y.

U.S.C.T.

Alford M. Wilson

Rk, Co. E, 8 Reg't U. S. Col'd H. Art'y.

Appears on

Company Muster Roll

for *May and June*, 1864.

Present or absent *Present*

Stoppage, \$ *100* for

Due Gov't, \$ *100* for

Valuation of horse, \$ *100*

Valuation of horse equipments, \$ *100*

Remarks:

*(Enrolled May 21st,
M. I. June 1st
at Paducah for
2 years)*

Book mark:

Jas. v. Kearny
Copyist.

(358)

W

8 H. Art'y.

U.S.C.T.

Alfred Wilson

Corpl., Co. E, 8 Reg't U. S. Col'd H. Art'y.

Appears on

Company Muster Roll

for *July and Aug*, 1864.

Present or absent *Present*

Stoppage, \$ *100* for

Due Gov't, \$ *100* for

Valuation of horse, \$ *100*

Valuation of horse equipments, \$ *100*

Remarks:

Appointed July 1. 1864.

Book mark:

(358)

A. V. Kearny
Copyist.

W

S H. Art'y.

U.S.C.T.

Alfred Wilson

Corpl., Co. E, 8 Reg't U. S. Col'd H. Art'y.

Appears on

Company Muster Roll

for *Sept and Oct*, 186*4*.

Present or absent *Present*

Stoppage, \$ *100* for

Due Gov't, \$ *100* for

Valuation of horse, \$ *100*

Valuation of horse equipments, \$ *100*

Remarks:

Book mark:

Jas. v. Kearny
Copyist.

W

8 H. Art'y.

U.S.C.T.

Alfred Wilson
Coptl., Co. E, 8 Reg't U. S. Col'd H. Art'y.

Appears on

Company Muster Roll

for *Nov. & Dec.*, 186*4*.

Present or absent *Present*

Stoppage, \$ *100* for

Due Gov't, \$ *100* for

Valuation of horse, \$ *100*

Valuation of horse equipments, \$ *100*

Remarks:

Book mark:

C. E. M. Langhlin

(358)

Copyist.

W

S H. Art'y.

U.S.C.T.

Alfred Wilson
Corp., Co. E, 8 Reg't U. S. Col'd H. Art'y.

Appears on

Company Muster Roll

for Jan. + Feb., 1865.

Present or absent Present

Stoppage, \$ 100 for

Due Gov't, \$ 100 for

Valuation of horse, \$ 100

Valuation of horse equipments, \$ 100

Remarks: Due the U.S. for one
canteen and one Havers-
sack \$1.60

Book mark:

C. E. M. Laughlin

(358)

Copyist.

W | 8 H. Art'y. | U.S.C.T.

Alfred Wilson
Corp., Co. E, 8 Reg't U. S. Col'd H. Art'y.

Appears on

Company Muster Roll
for Mar. & Apr., 1865.

Present or absent Present

Stoppage, \$ 100 for

Due Gov't, \$ 100 for

Valuation of horse, \$ 100

Valuation of horse equipments, \$ 100

Remarks: Due the U.S. for
one canteen and one
Haversack \$1⁶⁰/₁₀₀

Book mark:

(358) C. E. M. Laughlin Copyist.

It

S H. Art'y.

U.S.C.T.

Alfred Wilson
Corp., Co. E, 8 Reg't U. S. Col'd H. Art'y.

Appears on

Company Muster Roll

for *May & June*, 186*5*.

Present or absent *Present*

Stoppage, \$ *100* for

Due Gov't, \$ *100* for

Valuation of horse, \$ *100*

Valuation of horse equipments, \$ *100*

Remarks: *Due U. S. for C & G.*
\$1 80
100

Book mark:

C. E. M. Laughlin

(358)

Copyist.

Alfred Wilson
Compl., Co. E, 8 Reg't U. S. Col'd H. Art'y.

Appears on

Company Muster Roll

for *July + Aug.*, 1865.

Present or absent *Present*

Stoppage, \$ *100* for

Due Gov't, \$ *100* for

Valuation of horse, \$ *100*

Valuation of horse equipments, \$ *100*

Remarks: *Due the U.S. for 6798
#1 Co.*

Book mark:

E. B. Carroll

W

8 H. Art'y.

U.S.C.T.

Alfred Wilson

Compl., Co. E, 8 Reg't U. S. Col'd H. Art'y.

Appears on

Company Muster Roll

for *Sept & Oct*, 186*5*.

Present or absent *Present*

Stoppage, \$ *100* for

Due Gov't, \$ *100* for

Valuation of horse, \$ *100*

Valuation of horse equipments, \$ *100*

Remarks:

Book mark: *257*

E. B. Carroll

A

S H. Art'y.

U.S.C.T.

Alfred Wilson

Corpl., Co. E, 8 Reg't U. S. Col'd H. Art'y.

Appears on

Company Muster Roll

for *Nov & Dec*, 186*6*.

Present or absent *Present*

Stoppage, \$ *100* for

Due Gov't, \$ *100* for

Valuation of horse, \$ *100*

Valuation of horse equipments, \$ *100*

Remarks:

Book mark: *358*

E. C. Carroll

27

8 H. Art'y.

U.S.C.T.

Alfred M. Wilson
Co. E, 8 Reg't U. S. Col'd H. Art'y.

Appears on **Co. Muster-out Roll**, dated
Victoria Texas, Feb 10, 1866.

Muster-out to date *Feb 10, 1866.*

Last paid to *Aug 31, 1865.*

Clothing account:

Last settled....., 186 ; drawn since \$..... 100

Due soldier \$ *2 27* 100; due U. S. \$..... 100

Am't for cloth'g in kind or money adv'd \$..... 100

Due U. S. for arms, equipments, &c., \$..... 100

Bounty paid \$ *None* 100; due \$ *100* 100

Remarks: *Entered Service as recruit
joined Co for duty May 24, 1864
Enrolled & subject to draft 1st
in dist. of Ky at time of
Enlistment. Promoted to
Co. July 1st 1864.*

Book mark: *Page 23*

E. C. Carroll

1903 or amzi
Wilson Amazi

Co G B, 8 U.S. Col'd H. Art'y.

Private

Private

CARD NUMBERS.

1	5470031	26
2	5470174	27
3	5470315	28
4	5470451	29
5	5471338	30
6	9121501	31
7	49744944	32
8		33
9		34
10		35
11		36
12		37
13		38
14		39
15		40
16		41
17		42
18		43
19		44
20		45
21		46
22		47
23		48
24		49
25		50

Book Mark: EB 111 - P 575

See also

W

8 H. Art'y.

U.S.C.T.

Amiga Wilson

Co. *B*, 8 Reg't U.S. Col'd H. Art'y.

Appears on

Company Descriptive Book

of the organization named above.

DESCRIPTION.

Age *18* years; height *5* feet *4* inches.

Complexion *Dark*

Eyes *Dark*

hair *Dark*

Where born *Crittenden Co., Ky.*

Occupation *Farmer*

ENLISTMENT.

When *June 13*, 186*4*.

Where *Paducah, Ky.*

By whom *W.C. Brown*

term *3* y'rs.

Remarks: *Died at Paducah, Ky. Dec. 15/64. Cause of death, C. Diphtheria*

Henderson

71

S H. Art'y.

U.S.C.T.

Amzi Wilson
Print, Co. B, 8 Reg't U. S. Col'd H. Art'y.

Appears on

Company Muster Roll

for *May & June*, 1864.

Present or absent *Present*

Stoppage, \$ *100* for

Due Gov't, \$ *100* for

Valuation of horse, \$ *100*

Valuation of horse equipments, \$ *100*

Remarks:

*Enrolled in muster roll
at Paducah Ky. June 2,
1864. See page 11 of
book 1409.*

Book mark: *1409 '64*

J. A. Boyd

(358)

Copyist.

W

8 H. Art'y.

U.S.C.T.

Amzi Wilson

Privt., Co. B, 8 Reg't U. S. Col'd H. Art'y.

Appears on

Company Muster Roll

for *July & Aug.*, 1864.

Present or absent *Absent*

Stoppage, \$ *100* for

Due Gov't, \$ *100* for

Valuation of horse, \$ *100*

Valuation of horse equipments, \$ *100*

Remarks: *Absent sick at Paducah, Ky.*

Book mark:

J. A. Boyd

(358)

Copyist.

H *8 H. Arty* **U.S.C.T**

Anzi Wilson
Privt, Co. *B*, *8* Reg't U. S. Col'd *H. Arty*

Appears on

Company Muster Roll

for *Sept. and Oct.*, 186 *4*.

Present or absent *Present*

Stoppage, \$ *100* for

Due Gov't, \$ *100* for

Valuation of horse, \$ *100*

Valuation of horse equipments, \$ *100*

Remarks:

Book mark:

(355)

J. A. Boyd

Copyist.

George Wilson

Sp. Co. B, 8 Reg't U. S. Col'd H. Art'y.

Appears on

Company Muster Roll

for *Nov and Dec*, 1864.

Present or absent

Stoppage, \$ 100 for

Due Gov't, \$ 100 for

Valuation of horse, \$ 100

Valuation of horse equipments, \$ 100

Remarks: *Died in light hospital at Paducah Ky, Dec 15 1864*

Book mark:

(358)

J. B. [Signature]

Copyist.

W

8 H. Art'y.

U.S.C.T.

Amazi Wilson

Priv, Co. B, 8 Reg't U. S. Col'd H. Art'y.

Appears on Returns as follows:

July 18 64 absent sick
in Hosp. since July 6/64

Aug 18 64 absent sick in
Hosp. Paducah Ky since
Aug 26 1864

Dec 18 64 Dec 14 64
Paducah Ky died in
Reg't Hosp

Book mark:

Paul Brown

Amazi Wilson
Co. H, 8 Reg't U. S. Col'd H. Art'y.

Appears on Co. Muster-out Roll, dated
Victoria, Texas Feb. 10, 1866.

Muster-out to date _____, 186 .
Last paid to *Oct 31*, 1864.

Clothing account:

Last settled _____, 186 ; drawn since \$ _____ 100

Due soldier \$ _____ 100; due U. S. \$ _____ 100

Am't for cloth'g in kind or money adv'd \$ _____ 100

Due U. S. for arms, equipments, &c., \$ _____ 100

Bounty paid \$ _____ 100; due \$ _____ 100

Remarks: *Entered service as recruit,*
joined Co for duty June 13 1864.
Died at Paducah Ky Dec. 16 1864.
Cause of death Chronic Diarrhoea.
Final statement & Inventory
of effects forwarded to A.G.O.
(over)

Book mark: *W 1409 Ky.*
Died Dec. 1864. EB 11 P 75

Kandall

JAN. 14

5471338

1891

Dec 18th 1864

Wilson Amayi

Co. B, 8 U.S.C.H.A.
Reg't

3 Enclosures.

Bed Cards	Descriptive Lists
Burial Records	Final Statements /
Certs. of Dis. for Discharge	Furloughs
C. M. Charges	Med. Des. Lists
Med. Certificates	Orders

Other papers relating to—

Admission to Hosp'l	Furlough
Casualty Sheet (Officer's)	Med. Examination
Confinement	Misc. Information /
Contracts	Pay or Clothing
Death or Effects /	Personal Reports
Desertions	Rank
Discharge from Hosp'l	Transfer to Hosp'l
Discharge from Service	Transfer to V. R. C.
Duty	Transportation

✓ Co B

FINAL STATEMENT

OF

Amazi Wilson
8th Reg't of M. S. A. Heavy

VOLUNTEERS.

Enl Dec 15 1864

NOTE 1.—Two of these certificates (or duplicates) are to be given to each volunteer soldier who may be discharged previously to the discharge of his company, that he may at once receive from the Paymaster the pay, &c., due him, and the captain or other officer commanding the company will certify to the act of the delivery of the duplicate certificates; on these certificates the Soldier is "entitled to" his discharge, and should also present his discharge to the Paymaster to have the payment endorsed on it. The discharge is to be given back to the Soldier by the Paymaster; the latter only retaining as his voucher the duplicate certificates.

NOTE 2.—If the Soldier is entitled to pay for the use of his horse, the Company Commander will certify to that fact, and also to the time he has pay due for having been so mounted on his own horse.

NOTE 3.—Amounts due the Sutler and Laundress must be entered on the Muster Roll on which the death, desertion, &c., is reported, as well as on the final statement, otherwise the amount cannot be collected from the United States.

NOTE 4.—This blank will be used for deceased volunteers as well as others.

[OFFICE ENDORSEMENT.]

War Department,

ADJUTANT GENERAL'S OFFICE,

February 25, 1876,

The Death of *Amazi Wilson*
Private, Co. B, 8th Reg't U. S.
Colored Artillery, is reported as follows:

On Company Muster Roll.
For Muster Dec, 1864, Dec. 15th, 1864
Company Muster-out Boll.
Dec. 16th, 1864
Company Descriptive Book.

Company Morning Reports, 186

Soldier's Final Statement, 186

Soldier's Record of Death and Interment, 1864
Dec. 15th

Soldier's Inventory of Effects, 186

Soldier's Certificate of Disability for Discharge, 186

Soldier's Individual Muster-out Roll, 186

Regimental Return, 1864, Dec 16th, 1864

Regimental Quarterly Returns, 1864, Dec 15th, 1864

Regimental Descriptive Book, 186

By Surgeon General, 186

Dec 15, 1864 is held to be

the correct date, and the Company Muster-out

Roll will be amended accordingly.

Thomas M. Smith
Assistant Adjutant General

Noted 75 of March 10, 1876.

ADJUTANT GENERAL'S OFFICE.

Dec 28 1864

Duplicate with Inventory sent 2d Auditor.



I certify, on honor, that Amey Wilson a Private of
 Captain J. W. Coffin Company (B) of the 8th Regiment of W. S. A. Heavy
VOLUNTEERS, of the State of _____, born in Wirtland Co. State
 of Kentucky, aged 18 years; 5 feet 4 inches high; Dark complexion,
Dark eyes, Dark hair, and by occupation a Farmer, having joined the company on
 its original organization at Paducah Ky, and enrolled in it at the muster into
 the service of the United States at Paducah Ky, on the 13th day
 of June, 1864, (or was mustered in service as a recruit, by Lieut J. P.
Thayer, at Paducah Ky, on the 23rd day of June
 1864, to serve in the Regiment,) for the term of Three years
 and having served **HONESTLY** and **FAITHFULLY** with his Company in 8th Reg. W. S. A. Heavy

to the present date, is now entitled to a **DISCHARGE** by reason of Death the said
Amey Wilson died in Rees Hosp at Paducah Ky cause
of Death Diarrhea Died Dec 13th 1864

The said Amey Wilson was last paid by Paymaster
Mag. Fenner to include the 3rd day of October, 1864, and has
 pay due him from that time to the present date; he is entitled to pay and subsistence for
TRAVELING to place of enrollment and whatever other allowances are authorized to volunteer
 soldiers, or militia, so discharged. He has received \$ 5.00 22/100 dollars,
 advanced by the United States on account of **CLOTHING**. Clothing account settled

There is to be stopped from him, on account of the State of _____, or other
 authorities for **CLOTHING**, &c., received on entering service, _____ 100/100 dollars; also,
 for expenses of **SUBSISTENCE** for **TRAVELING** from place of enrollment to the place of rendezvous,
 amounting to _____ 100/100 dollars: and on account of the United States for **EXTRA**
CLOTHING received in kind from _____ and for other
 stoppages, viz:

_____ amounting to _____ 100/100 dollars;
 and he has been **SUBSISTED** for **TRAVELING** to his place of enrollment, up to the _____
 _____, 186 .

He is indebted to _____, **SUTLER**, _____ 100/100 dollars.

He is indebted to _____, **LAUNDRESS**, _____ 100/100 dollars.

Given in Duplicate, at Paducah Ky, this 18th day of December, 1864.

Wm. C. Brown
 1st Lieut 8th W. S. A. Heavy
 Commanding Company.

with date of discharge 13/12/64

ARTICLES OF WAR.

ART. 95. When any non-commissioned officer or soldier shall die, or be killed in the service of the United States, the then commanding officer of the troop or company shall, in the presence of two other commissioned officers, take an account of what effects he died possessed of, above his arms and accoutrements, and transmit the same to the office of the Department of War, which said effects are to be accounted for, and paid to the representatives of such deceased non-commissioned officer or soldier. And in case any of the officers, so authorized to take care of the effects of deceased officers and soldiers, should, before they have accounted to their representatives for the same, have occasion to leave the regiment or post, by preferment or otherwise, they shall, before they be permitted to quit the same, deposit in the hands of the commanding officer, or of the assistant military agent, all the effects of such deceased non-commissioned officers and soldiers, in order that the same may be secured for, and paid to, their respective representatives.

ARMY REGULATIONS—EDITION OF 1861.

DECEASED SOLDIERS.

Par. 152. Inventories of the effects of deceased non-commissioned officers and soldiers, required by the 95th Article of War, will be forwarded to the Adjutant General, by the commander of the company to which the deceased belonged, and a duplicate of the same to the colonel of the regiment. Final statements of pay, clothing, &c., will be sent with the inventories. When a soldier dies at a post or station absent from his company, it will be the duty of his immediate commander to furnish the required inventory, and, at the same time, to forward to the commanding officer of the company to which the soldier belonged, a report of his death, specifying the date, place, and cause; to what time he was last paid, and the money or other effects in his possession at the time of his decease; which report will be noted on the next muster-roll of the company to which the man belonged. Each inventory will be endorsed, "Inventory of the effects of _____, late of company (—) _____ regiment of _____, who died at _____, the _____ day of _____, 186—." If a legal representative receive the effects, it will be stated in the report. If the soldier leave no effects, the fact will be reported.

Par. 153. Should the effects of a deceased non-commissioned officer or soldier not be administered upon within a short period after his decease, they shall be disposed of by a Council of Administration, under the authority of the commanding officer of the post, and the proceeds deposited with the Paymaster, to the credit of the United States, until they shall be claimed by the legal representatives of the deceased.

Par. 154. In all such cases of sales by the Council of Administration, a statement in detail, or account of the proceeds, duly certified by the Council and commanding officer, accompanied by the Paymaster's receipt for the proceeds, will be forwarded by the commanding officer to the Adjutant General. The statement will be endorsed, "Report of the proceeds of the effects of _____, late of company (—) _____ regiment of _____, who died at _____, the _____ day of _____, 186—."

NOTE 1.—The effects in all cases, when called for, should be turned over to the legal representative, without further authority from the Adjutant General. When the effects are turned over to the relatives of the deceased before these inventories are sent to the Adjutant General, their receipts therefor should be attached to the inventories. In all other cases, one copy will be sent with a letter of transmittal direct to the Adjutant General, and a duplicate retained by the officer.

NOTE 2.—Particular care should be taken to take receipts in duplicate from the Paymaster for any funds turned over to him; one copy should be sent direct to the Adjutant General and one retained by the officer.

INVENTORY OF THE EFFECTS

OF

Amzi Wilson

Late of Company *B*

8th Reg't of *U.S.C. A. Henry*

Volunteers, who died at *Paducah Ky*

on the *15th* day of *December*, 186*4*.



Inventory of the effects of Emory Wilson late
 a Private of Captain John W. Coffin Company B of
 the 8th Regiment of W. C. A. Heavy Volunteers, who was enrolled as
 a Private at Paducah Ky in the State of Kentucky on
 the 13th day of June 1864, and mustered into the service of the United
 States as a Private on the 25 day of June 1864, at Paducah Ky
 in Company B, 8th Regiment of W. C. A. Heavy Volunteers, to serve three
 years or during the war; he was born in Crittenden County in the State
 of Kentucky; he was 18 years of age, 5 feet 4 inches
 high, Dark complexion, Dark eyes, Dark hair, and by occupation, when enrolled,
 a Farmer; he died in Dec. Wash, at
Paducah Ky on the 15th day of December 1864, by
 reason of Diarrhea

INVENTORY.					
ARTICLES.	No.	ARTICLES.	No.	ARTICLES.	No.
Hats		Pairs trousers		Knapsacks	
Caps		Pairs flannel drawers			
Forage caps	1	Pairs cotton drawers			
Great coats	1	Flannel shirts			
Uniform coats		Cotton shirts			
Uniform jackets	1	Pairs boots			
Flannel sack coats		Pairs shoes	1		
Blouses		Pairs socks			
Stable frocks		Blankets			
Fatigue overalls		Haversacks			
				MONEY.	
				Specie	\$
				Notes	\$

I CERTIFY, ON HONOR, that the above inventory comprises all the effects of Private
Emory Wilson, deceased, and that the effects are in the hands
 of Regimental Surgeon at Paducah
Kentucky to be disposed of by a Council of Administration.

(DUPLICATES.)

STATION: Paducah Ky

DATE: December 18th 1864

[A. G. O. No. 104.]

J. E. Brown
1st Lieut 8th W. C. A. Heavy
 Commanding the Company.

MAR 14 1867

War Department,

ADJUTANT GENERAL'S OFFICE,

Washington, March 6th 1867.

Respectfully returned to the Commission for the State of Kentucky, with the information that Anzi Wilson

was enlisted at Paducah Ky. June 13, 1864, and was mustered in as Pvt. in Co. "B." 8th U.S. Col. Art. Regt. June 25, 1864,

A. F. B. [Signature]

Asst. Adj't General.

W. H. [Signature]

No. _____

APPLICATION OF

W. H.

Wilson &c

OF

Crittenden Co

FOR COMPENSATION FOR SLAVE.

Named Anzi Wilson

Enlisted June 13th 1864,

In Com. B, 8th Art. Regiment,

U. S. COLORED TROOPS.

Received Jan'y 28, 1867.

Compensation Awarded

_____, 186__

Dollars.

President of Board of Claims.

Claimant's Attorney,

Robt. F. Boyers

Marion Ky

Claimant's Post-office Address,

Marion

Crittenden Co. Ky

FRANKFORT COMMONWEALTH PRINT.

No.

CLAIM OF

FOR THE COMPENSATION OF SLAVE NAMED

The W. F. Wilson, R. W. Wilson & Mary E. Armstrong, ^{loyal citizens and a residents of}

County of Crittenden, State of Kentucky, hereby claim compensation, under

the provisions of Section 21, act approved February 21, 1864, and section 2, act approved July, 28,

1866, for ~~my~~ ^{our} slave Angus Wilson, enlisted 13th June

1864, at Paducah Ky, by W. E. Brown

in the 8th (Heavy Arty) Regiment U. S. Colored Troops, Co. B; certificate of

which enlistment, and a descriptive list, as required, accompany this application. That ~~we~~ did not ac-

quire said slave subsequent to said enlistment, but had a valid title to him at the date of said enlist-

ment, and previous thereto ~~we~~ having acquired ~~our~~ ^{our} title to him and ~~my~~ ^{our} ownership over him as fol-

lows, to wit: By inheritance from our ~~deed~~ ^{father} James W. Wilson

who died April 23rd 1865 (see administration ~~had~~) and who was at

the time of said enlistment & long prior ~~to~~ ^{to} the ~~owner~~ ^{owner} of

said Angus Wilson and we the said W. F. Wilson, R. W. Wilson

and Mary E. Armstrong are the children and only heirs at

law of the said James W. Wilson ~~deed~~ ^{deed} who was actively loyal

to the United States up to his death.

In proof of ~~our~~ ^{our} loyalty to the Constitution and Government of the United States ~~we~~ present the ac-

companying oath, which ~~we~~ have taken, signed and acknowledged; to be filed with this application, in

accordance with requirements of General Orders, No. 329, 1863, War Department, Adjutant General's

Office.

W. F. Wilson
R. W. Wilson
M. E. Armstrong

January 16th 1867

OATH OF ALLEGIANCE.

~~we~~ W. F. Wilson, R. W. Wilson & Mary E. Armstrong, the owners and Claimants do solemnly swear that

the foregoing claim is a just and true claim due to ~~us~~ ^{us} as masters and owners of the said slave, and that

the facts alleged in said claim in respect to the draft or enlistment (as the case may be) of said slave

into the Military service of the United States are true. And ~~we~~ do further swear that ~~we~~ have never

joined, or been concerned in, any insurrection or rebellion; that ~~we~~ have never borne arms against the

United States; that ~~we~~ have never given any aid, countenance, counsel or encouragement to any person

or persons engaged, or whom ~~we~~ had reason to believe were about to engage, in insurrection, rebellion

or armed hostility against the United States; that ~~we~~ have neither sought, nor accepted, nor attempted

to exercise the functions of any office, civil or military, nor to perform any service whatever, under

any authority or pretended authority in hostility to the United States; that ~~we~~ have not yielded a vol-

untary support to any insurrection, rebellion or pretended government, authority, power or constitution

within the United States hostile thereto. And ~~we~~ do further swear that, to the best of ~~our~~ ^{our} knowledge

and ability ~~we~~ have supported and defended, and will continue to support and defend, the United

States against all enemies, foreign and domestic; and that ~~we~~ have supported, defended and obeyed, and

will continue to support, defend and obey, the Constitution and laws of the United States; that ~~we~~ will

bear true faith and allegiance to the same; and that ~~we~~ make this oath freely, without any mental reserva-

tion or purpose of evasion: So help ~~us~~ ^{us} God.

W. F. Wilson
R. W. Wilson
M. E. Armstrong

Sworn to and subscribed before me, at Marion Ky,

this 16th day of January, 1867.

J. H. [unclear] Notary Public
for Crittenden County Ky

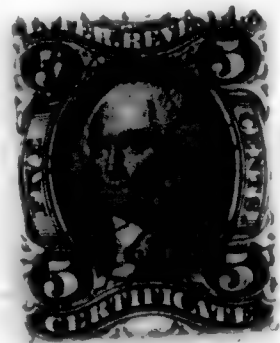

PROOF OF OWNERSHIP.

STATE OF KENTUCKY, } SS.
COUNTY OF _____

We _____ and _____ each of lawful age, and resident citizens of the State and County aforesaid, do certify that *James W Wilson*

died late of the State and County aforesaid, was on the *13th* day of *June* 186*4* ^{& for years before} the lawful owner of the slave named *Amzi Wilson*; referred to and described in the foregoing claim for compensation. *that J W Wilson is dead and W F Wilson is W Wilson & Mary E Armstrong are the children and only heirs at law of sd James W Wilson*

W. J. Wilson
J. K. Dean

Sworn to and subscribed before me a *Notary Public* for the County of *Crittenden* State of Kentucky, this the *16th* day of *January* 186*7*.

5 CENT STAMP



J. W. Blue Notary Public for Crittenden County Ky

PROOF OF LOYALTY.

STATE OF KENTUCKY, } SS.
COUNTY OF *Crittenden*

We _____ and _____ loyal men and each of lawful age, and resident citizens of the _____ of _____

in the State and County aforesaid, upon our oaths declare that we have known *James W Wilson died* *W F Wilson is W Wilson & Mary E Armstrong (widow)* *residents of the State and County aforesaid, since the 4th day of March, 1861, and know that he has they have* firmly and faithfully maintained *their* his or her adherence and allegiance to the Government of the United States, by defending its cause against the Government and forces of the so-called Confederate States of America, in all suitable and practicable ways, and according to *their* his or her ability and opportunity.

L. N. Stinson
J. W. Blue

Sworn to and subscribed before me a *Notary Public* for the county of *Crittenden* State of Kentucky, this the *16th* day of *January* 186*7*.

5 CENT STAMP



J. W. Blue Notary Public for Crittenden County Ky

POWER OF ATTORNEY.

604 My Post-Office address is *Morgan* County of *Crittenden* State of Kentucky, and I hereby direct that all communications to me, touching this claim, be sent under cover to *Claimants or either of them*, who is hereby appointed and constituted my true and lawful attorney, to prosecute this claim for me, and who is hereby authorized and empowered to receive and receipt for any award, order, draft, certificate, voucher, warrant, papers or money that may be issued in the adjustment of this claim, or the payment thereof, the same as I might or could do in person were I present and acting for myself, and to file any additional evidence or papers that may be required in the prosecution of this claim.

[WITNESS.]

The owner signs here. }

50 CENT STAMP

Two witnesses to owner's signature sign here.

Headquarters Kentucky Volunteers,

Adjutant-General's Office,

Frankfort, Dec 31, 1866.

I hereby certify, that it appears from the U. S. Muster-
Rolls on file in this Office, that Amzi Wilson
was enrolled on the 13 day of June, 1864, at
Paducah Ky, by W E Brown,
and mustered into the U. S. service on the 25 day of June,
1864, at Paducah Ky by S H Jover,
to serve Three years. Said Amzi Wilson
is described as follows: Age, 18 years; eyes, blue; hair, brn,
complexion, fair; height, 5 feet 6 inches. It further
appears from said Rolls, that Amzi Wilson owed service
to James Wilson, was credited to Crittenden
County, Ky., and was assigned to Co. B, 8 Regiment
U. S. C. A J Steary

In Testimony Whereof, I have hereunto set my
hand, and affixed my Official Seal, this
31 day of Dec, 1866.

J. W. Lindsay
Adjutant General of Kentucky.

B. C. G. S. R. B. S. Army



1904 or Pauidy
Wilson Andy

Co G, 8 U.S. Col'd H. Art'y.

Private Corporal

CARD NUMBERS.

1	5467496	26
2	5477410	27
3	5477545	28
4	5477820	29
5	5477936	30
6	5478043	31
7	5478148	32
8	5477659	33
9	9122119	34
10		35
11		36
12		37
13		38
14		39
15		40
16		41
17		42
18		43
19		44
20		45
21		46
22		47
23		48
24		49
25		50

Book Mark:

See also

A

8 H. Art'y. U.S.C.T.

Sandy Wilson

, Co. *G*, 8 Reg't U.S. Col'd H. Art'y.

Appears on

Company Descriptive Book

of the organization named above.

DESCRIPTION.

Age *30* years; height *5* feet *4* inches.

Complexion *Brown*

Eyes *Blk*; hair *Blk*

Where born *Souletts, Ky*

Occupation *Plumber*

ENLISTMENT.

When *Jan'y 26*, 186*0*.

Where *Paris, Ill*

By whom *H. Col. Low*; term *3* y'rs.

Remarks:

.....
.....
.....
.....
.....

S. A. McDaniel

(383a)

Coqvist.

4 | 8 H. Art'y. | U.S.C.T.

Andy Wilson

Appears with rank of *Private* on

Muster and Descriptive Roll of a Detachment of U. S. Vols. forwarded

for the 8 Reg't U. S. Col'd H. Art'y, Roll dated *Paducah Ky, N.Y. Jan 26, 1865.*

Where born *Bullett Co Ky*

Age *30* y'rs; occupation *Planter*

When enlisted *Jan 26*, 1865.

Where enlisted *Carroll Ill*

For what period enlisted *3* years.

Eyes *Blk*; hair *Blk*

Complexion *Blk*; height *5* ft. *4* in.

When mustered in *Jan 26*, 1865.

Where mustered in *Paducah*

Bounty paid \$ *100*; due \$ *100*

Where credited

Company to which assigned

Remarks: *Residence & Dist Woodford Co Ranker Tp Ill.*

Book mark:

Breger

7

8 H. Art'y.

U.S.C.T.

Fred Wilson

Co. G, 8 Reg't U. S. Col'd H. Art'y.

Appears on

Company Muster Roll

for *Jan 1st*, 186 *7*.

Present or absent *present*

Stoppage, \$ *100* for

Due Gov't, \$ *100* for

Valuation of horse, \$ *100*

Valuation of horse equipments, \$ *100*

Remarks: *Abandoned to the Gov't*

by the order of the Adjutant

on the 24th Feb 1867

Book mark:

Samuel Wilson

911, Co. G, 8 Reg't U. S. Col'd H. Art'y.

Appears on

Company Muster Roll

for *Mar 1941*, 186 *3*

Present or absent *Present*

Stoppage, \$ *100* for

Due Gov't, \$ *100* for

Valuation of horse, \$ *100*

Valuation of horse equipments, \$ *100*

Remarks:

Book mark:

Samuel Wilson

S H. Art'y.

U.S.C.T.

John S. Stone

1111, Co. G, 8 Reg't U. S. Col'd H. Art'y.

Appears on

Company Muster Roll

for *July / August*, 186*5*.

Present or absent *Present*

Stoppage, \$ *100* for

Due Gov't, \$ *100* for

Valuation of horse, \$ *100*

Valuation of horse equipments, \$ *100*

Remarks:

Book mark:

John S. Stone

(358)

Copyist.

Henry Brown

Capt., Co. G, 8 Reg't U. S. Col'd H. Art'y.

Appears on

Company Muster Roll

for *July 1* *Sept*, 186*5*.

Present or absent *Present*

Stoppage, \$ 100 for

Due Gov't, \$ 100 for

Valuation of horse, \$ 100

Valuation of horse equipments, \$ 100

Remarks:

Book mark: -----

D. M. ...

A

S H. Art'y.

U.S.C.T.

Sandy Wilson

Cnp, Co. G, 8 Reg't U. S. Col'd H. Art'y.

Appears on

Company Muster Roll

for *Sept & Oct*, 1865.

Present or absent *Present*

Stoppage, \$ *100* for

Due Gov't, \$ *100* for

Valuation of horse, \$ *100*

Valuation of horse equipments, \$ *100*

Remarks:

Book mark:

(358)

Miller

Copyist.

W

8 H. Art'y.

U.S.C.T.

Gandy Wilson

Inf, Co. G, 8 Reg't U. S. Col'd H. Art'y.

Appears on

Company Muster Roll

for *Nov & Dec*, 1863.

Present or absent *Present*

Stoppage, \$ 100 for

Due Gov't, \$ 100 for

Valuation of horse, \$ 100

Valuation of horse equipments, \$ 100

Remarks:

Book mark: -----

W. C. C.

(358)

Copyist.

Andy Nelson

Co. G, 8 Reg't U. S. Col'd H. Art'y.

Appears on **Co. Muster-out Roll**, dated *Feb 10*, 186*6*.

Muster-out to date *Feb 10*, 186*6*.

Last paid to *Aug 31*, 186*5*.

Clothing account:

Last settled....., 186 ; drawn since \$..... 100

Due soldier \$ *12 57*/₁₀₀; due U. S. \$..... 100

Am't for cloth'g in kind or money adv'd \$..... 100

Due U. S. for arms, equipments, &c., \$..... 100

Bounty paid \$..... 100; due \$ *100*/₁₀₀

Remarks: *Joined service as a recruit from Co. G. dated Jan 26 1865. Promoted to Co. Feb 24 1865*

Book mark: *1000 000*

M. Kelly
(361) Copyist.

1905
Wilson & Quek

Co A, 8 U.S. Col'd H. Art'y.

Private Private

CARD NUMBERS.

1	5475838	26
2	5475946	27
3	5476072	28
4	5476183	29
5	5476292	30
6	5476420	31
7	5476527	32
8	5476633	33
9	5476734	34
10	5476835	35
11	5476925	36
12	9122469	37
13	73744945	38
14		39
15		40
16		41
17		42
18		43
19		44
20		45
21		46
22		47
23		48
24		49
25		50

Book Mark:

See also

S. 1275555 P.O. 201. 4. 11.

REP 475555

S, 1935052 P.O. aff

A1946468 P.O. aff

S - 2087455 P.O. aff

S - 2088574 P.O. aff

W | 8 H. Art'y. | U.S.C.T.

Buck Wilson

....., Co. F, 8 Reg't U.S. Col'd H. Art'y.

Appears on

Company Descriptive Book
of the organization named above.

DESCRIPTION.

Age 19 years; height 5 feet 7 1/2 inches.

Complexion *Rbk*

Eyes *Rbk*; hair *Rbk*

Where born *Wentenden Co., Kentucky*

Occupation *Farm*

ENLISTMENT.

When *May 24*, 1864.

Where *Caducah, Ky*

By whom *C. A. Holmes*; term *3* y'rs.

Remarks:

.....
.....
.....
.....
.....

E. A. Moreland

W. S. Harris | U.S.C.T.

Quack, William
Quack, Co. T. C. Reg't U.S. Col'd. H. Art.

Age _____ years.

Appears on

Company Muster Roll*

for *from enlistment to June 30*, 1864.

Joined for duty and enrolled:

When *May 24*, 1864.

Where *Paducah Ky*

Period *3* years.

Mustered in:

When *June 6*, 1864.

Where *Paducah Ky*

Present or absent *Present*

Stoppage, \$ *100* for _____

Due Gov't, \$ *100* for _____

Valuation of horse, \$ *100*

Valuation of horse equipments, \$ *100*

Remarks : _____

* First current roll. No muster-in roll of this company on file.

Book mark : _____

J. Nelson

(3586)

Copyist.

W. | S H. Art'y. | U.S.C.T.

Frank Wilson

Co. F, 8 Reg't U. S. Col'd H. Art'y.

Appears on

Company Muster Roll

for *July & Aug*, 186*4*

Present or absent *+*

Stoppage, \$ *100* for

Due Gov't, \$ *100* for

Valuation of horse, \$ *100*

Valuation of horse equipments, \$ *100*

Remarks: *In cavalry scout
division New York*

*Some abrasions in columns
of train to cancel by line*

Book mark:

J. Wilson

126

S H. Art'y. U.S.C.T.

Buck Millers

Company, Co. F, 8 Reg't U. S. Col'd H. Art'y.

Appears on

Company Muster Roll

for *Sept - Oct*, 186*7*.

Present or absent *Present*

Stoppage, \$ *100* for

Due Gov't, \$ *100* for

Valuation of horse, \$ *100*

Valuation of horse equipments, \$ *100*

Remarks:

Book mark:

J. C. Millers
(358) Copyist.

W

8 H. Art'y.

U.S.C.T.

Buck Wilson

Priv, Co. F, 8 Reg't U. S. Col'd H. Art'y.

Appears on

Company Muster Roll

for *Nov Dec*, 1864.

Present or absent *Present*

Stoppage, \$ *100* for

Due Gov't, \$ *100* for

Valuation of horse, \$ *100*

Valuation of horse equipments, \$ *100*

Remarks:

Book mark:

(358)

J. Nelson

Copyist.

W | S H. Art'y. | U.S.C.T.

Buck Wilson

Pvt., Co. F, 8 Reg't U. S. Col'd H. Art'y.

Appears on

Company Muster Roll

for Jan & Feb, 1865.

Present or absent Present

Stoppage, \$ 100 for

Due Gov't, \$ 100 for

Valuation of horse, \$ 100

Valuation of horse equipments, \$ 100

Remarks:

Book mark:

G. W. Chace

W | S H. Art'y. | U.S.C.T.

Buck Wilson

Pvt, Co. F, 8 Reg't U. S. Col'd H. Art'y.

Appears on

Company Muster Roll

for *Me* & *Apr* , 1865.

Present or absent *Present*

Stoppage, \$ 100 for

Due Gov't, \$ 100 for

Valuation of horse, \$ 100

Valuation of horse equipments, \$ 100

Remarks:

Book mark:

G. W. Chase

W | S H. Art'y. | U.S.C.T.

Buek Wilson

Priv., Co. F, 8 Reg't U. S. Col'd H. Art'y.

Appears on

Company Muster Roll

for May & June, 1865.

Present or absent Present

Stoppage, \$ 100 for

Due Gov't, \$ 100 for

Valuation of horse, \$ 100

Valuation of horse equipments, \$ 100

Remarks:

Book mark:

G. W. Chase

W | S H. Art'y. | U.S.C.T.

Buck Wilson

Pr, Co. F, 8 Reg't U. S. Col'd H. Art'y.

Appears on

Company Muster Roll

for July & Aug, 1865.

Present or absent Present

Stoppage, \$ 100 for

Due Gov't, \$ 100 for

Valuation of horse, \$ 100

Valuation of horse equipments, \$ 100

Remarks:

Book mark:

G. W. Chase

(358)

Copyist.

W

S H. Art'y.

U.S.C.T.

Buck Wilson

Private, Co. F, 8 Reg't U. S. Col'd H. Art'y.

Appears on

Company Muster Roll

for *Sept. & Oct.*, 186*3*.

Present or absent *Present*

Stoppage, \$ *100* for

Due Gov't, \$ *100* for

Valuation of horse, \$ *100*

Valuation of horse equipments, \$ *100*

Remarks:

Book mark:

(358)

Keefe

Copyist.

4

8 H. Art'y.

U.S.C.T.

Buck Wilson

Private Co. F, 8 Reg't U. S. Col'd H. Art'y.

Appears on

Company Muster Roll

for *Nov. & Dec.*, 1865.

Present or absent *Absent*

Stoppage, \$ *100* for

Due Gov't, \$ *100* for

Valuation of horse, \$ *100*

Valuation of horse equipments, \$ *100*

Remarks: *Absent on detached service per A.O. No. 20 Dated Hd Qrs sub Dist Victoria, Victoria, Tex.*

Book mark:

(358)

Kiefer

Copyist.

W

8 H. Art'y.

U.S.C.T.

Frank Wilson

Pvt, Co. F, 8 Reg't U. S. Col'd H. Art'y.

Appears on Returns as follows:

Nov 1864 on duty
train guard

Nov & Dec 1865. absent
on detached service for S.O.#3
Ex-2 - Hqsrs Subdist.
Victoria Victoria Tex
Nov 18/65

Book mark:

Chas. Butler

(546)

Copyist.

N | S H. Art'y. | U.S.C.T.

Buck Wilson
Private, Co. *F*, 8 Reg't U. S. Col'd H. Art'y.

Appears on Co. Muster-out Roll, dated
Victoria, Texas Feb 10 186*6*.

Muster-out to date *Feb 10*, 186*6*.

Last paid to *Aug 31*, 186*5*.

Clothing account:

Last settled....., 186 ; drawn since \$..... 100

Due soldier \$ *10 62* / 100; due U. S. \$..... 100

Am't for cloth'g in kind or money adv'd \$..... 100

Due U. S. for arms, equipments, &c., \$..... 100

Bounty paid \$..... 100; due \$..... 100

Remarks *Entered the service*
at organization of Co. as
private.

Book mark: *V 212 P 774*
Uge 19

(861) *Keifer*
Copyist.

1906
Wilson Charles

Co. D, 8 U.S. Col'd H. Art'y.

Private Private

CARD NUMBERS.

1	5467004	26
2	5466877	27
3	5473155	28
4	5474287	29
5	9121833	30
6	M-134-CJ-1870	31
7	40744947	32
8		33
9		34
10		35
11		36
12		37
13		38
14		39
15		40
16		41
17		42
18		43
19		44
20		45
21		46
22		47
23		48
24		49
25		50

Book Mark: M-134-CJ-1870

See also

W | 8 H. Art'y | U. S. C. T.
Charles Wilson

Co. D, 8 Reg't U. S. Col'd H. Art'y

Appears on

Company Descriptive Book

of the organization named above.

DESCRIPTION.

Age 22 years; height 5 feet 6 3/4 inches.

Complexion Black

Eyes Black; hair Black

Where born Crittenden, Ky.

Occupation Farmer

ENLISTMENT.

When July 28, 186 .

Where Paducah,

By whom R. H. Hall; term 3 y'rs.

Remarks: Died at No 2, Hosp't
Paducah, Ky., Aug.
8/66 of Typhoid Fever

Rendell

Mr. 1 of 4a U.S. 67.

Charles Wilson
, Co. D, 8 Reg't 76/a

NOTATION.

Book mark:

A. 13416.7.1870

Record and Pension Office,

WAR DEPARTMENT.

This book mark refers only to a report from the medical records, made by the Surgeon General to the Adjutant General, relative to the above-named man. As the medical records have since been carded, no transcript of this report is made hereon.

(491)

C. C. Casey
Copyist.

Charles Wilson

Appears with rank of *Priv.* on

Muster and Descriptive Roll of a Detachment of U. S. Vols, forwarded

for the 8 Reg't U. S. Col'd H. Art'y. Roll dated

Paducah Ky., N.Y. July 31, 1864.

Where born *Crittenden Ky.*

Age *22* y'rs; occupation *Furrier*

When enlisted *July 28*, 186 .

Where enlisted *Paducah Ky.*

For what period enlisted *3* years.

Eyes *Black*; hair *Black*

Complexion *Black*; height *5* ft. *6 3/4* in.

When mustered in *July 28*, 186 .

Where mustered in

Bounty paid \$ *100*; due \$ *100*

Where credited *Crittenden Co. 1st Con. Dist. of Ky.*

Company to which assigned *D*

Remarks:

Book mark:

A. L. Ames

Charles Wilson

Appears with rank of _____ on

Muster and Descriptive Roll of a Detachment of U. S. Vols. forwarded

for the 8 Reg't U. S. Col'd H. Art'y. Roll dated

Paducah Ky, N.Y. Aug 1, 1864.

Where born *Crittenden Ky*

Age *22* y'rs; occupation *Farmer*

When enlisted *July 28*, 186 .

Where enlisted *Paducah Ky*

For what period enlisted *3* years.

Eyes *Blk*; hair *Blk*

Complexion *Blk*; height *5 ft. 6 3/4 in.*

When mustered in *July 28*, 186 .

Where mustered in *Paducah Ky*

Bounty paid \$ *100*; due \$ *100*

Where credited *1st Ky*

Company to which assigned *G.*

Remarks : _____

Book mark : *W-134-07-1870*

Breger

14

S H. Art'y.

U.S.C.T.

Charles Wilson

Private, Co. D, 8 Reg't U. S. Col'd H. Art'y.

Appears on

Company Muster Roll

for July & Aug., 1864.

Present or absent

Stoppage, \$ 100 for

Due Gov't, \$ 100 for

Remarks: Died in Hospital
No 2, Paducah, Ky, Aug.
8 1864

Book mark: Died Aug. 8/64 E B Vol 9 P 168
(over)

M. M. Warren

JAN. 14

5473155

1891

149.5-89 N. H. D.

W | 8 H. Art'y. | U.S.C.T.

Charles Wilson

Priv., Co. B, 8 Reg't U. S. Col'd H. Art'y.

Appears on Returns as follows:

Aug. 1864 Aug 18/64
Parruck Ky. Died
at Reg't Hoopl.

Book mark : _____

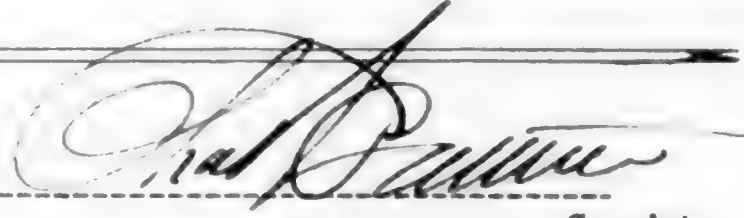

(546)

Copyist.

7

S H. Art'y.

U.S.C.T.

Charles Wilson

Co. 20, 8 Reg't U. S. Col'd H. Art'y.

Appears on **Co. Muster-out Roll**, dated
Victoria, Tex., Feb. 11, 1864.

Muster-out to date _____, 186 .

Last paid to *Never paid*, 186 .

Clothing account:

Last settled _____, 186 ; drawn since \$ _____ 100

Due soldier \$ _____ 100; due U. S. \$ _____ 100

Am't for cloth'g in kind or money adv'd \$ _____ 100

Due U. S. for arms, equipments, &c., \$ _____ 100

Bounty paid \$ _____ 100; due \$ _____ 100

Remarks: *Entered service as recruit
Joined Co for duty July 28 '64.
Died Aug 8 '64 in Rpt Camp
Caducah, Ky, of Typhoid
fever. Final statements
forward. Sept 30 '64.*

Book mark: *V. 117. P. 140. No. 1410. Ky.
= 129. 589. = W. 134. V. 8. C. 2. No.*

(861) *J. Brown* Copyist.

Wilson Charles

B Co. D

8

U.S.C.H.A.
Reg't

7 Enclosures.

Bed Cards	Descriptive Lists
Burial Records	Final Statements 2
Certs. of Dis. for Discharge	Furloughs
C. M. Charges	Med. Des. Lists
Med. Certificates	Orders
Enlistments 2	

Other papers relating to—

Admission to Hosp'l	Furlough
Casualty Sheet (Officer's)	Med. Examination
Confinement	Misc. Information 1
Contracts	Pay or Clothing
Death or Effects 2	Personal Reports
Desertions	Rank
Discharge from Hosp'l	Transfer to Hosp'l
Discharge from Service	Transfer to V. R. C.
Duty	Transportation

Co. Testy sine

~~XXXXXXXXXXXX~~

Charles Wilson

Volunteered at Paducah, Ky.

July 28th 1864.

By Capt. R. H. Hall,

Prov. Mar. for 1st Dist. of Ky.

Charles Wilson

Consent of Parent or Guardian in case of a Minor, if a Free Man, or in the case of a Slave, of the Person to whom he owes Service:

I, Do CERTIFY, That I am



nts of United States colored troops. They will be made out in duplicate in all cases--one
ant General, and one to accompany the accounts of the officer who pays bounty, &c.
muster-in, must in all cases, precede payment of pay, bounty, pension, &c. A must
ustering officer, commissary, or assistant commissary of musters, as the case may be, will
re either of them is given to the disbursing officer.

UNITED STATES COLORED TROOPS ENLISTMENT.

STATE OF



TOWN OF

Kentucky

Paducah

I, Charles Wilson, born in Crittenden Co. in the State of Kentucky, aged Twenty Two years and by occupation a Farmer, Do HEREBY ACKNOWLEDGE to have volunteered this Twenty-Eighth day of July, 1864, to serve as a Soldier in the Army of the United States of America, for the period of THREE YEARS, unless sooner discharged by proper authority: Do also agree to accept such bounty, pay, rations, and clothing, as are, or may be, established by law for the U. S. colored troops.

And I, Charles Wilson, of Crittenden Co. Ky. do solemnly swear, that I will bear true faith and allegiance to the United States of America, and that I will serve them honestly and faithfully against all their enemies or opposers whomsoever; and that I will observe and obey the orders of the President of the United States, and the orders of the officers appointed over me, according to the Rules and Articles of War.

Sworn and subscribed to, at Paducah, Ky. this 28th day of July, 1864, Before Capt. R. A. Hall Charles Wilson his mark

I CERTIFY, ON HONOR, That I have carefully examined the above named Volunteer, agreeably to the General Regulations of the Army, and that, in my opinion, he is free from all bodily defects and mental infirmity, which would in any way disqualify him from performing the duties of a soldier.

W. M. Adams

EXAMINING SURGEON.

I CERTIFY, ON HONOR, That I have minutely inspected the Volunteer, previously to his enlistment, and that he was entirely sober when enlisted; that, to the best of my judgment and belief, he is of lawful age; and that, in accepting him as duly qualified to perform the duties of an able-bodied soldier, I have strictly observed the regulations which govern the recruiting service. This soldier has eyes, hair, complexion, is feet, inches high.

RECRUITING OFFICER OR AGENT.

Mustered into the United States service 28th day of July, 1864.

Capt. M. W. Hall

Mustering Officer.

Mustered into the service of the United States, for three years or during the war, from date of enlistment, in Company "S" 28th Regiment of U.S. Colored Artillery, Volunteers, on the 28th day of July, 1864 at Paducah, Ky.

By R. A. Hall, Capt. & Rev. Marshal

1st Dist. of Ky.

NOTE 1.—This blank will be used for enlistments of United States colored troops. They will be made out in duplicate in all cases—one to accompany the recruiting return of the superintendent (not the recruiting officer) to the Adjutant General, and one to accompany the accounts of the officer who pays bounty, &c.

NOTE 2.—An enlistment holds to service. A muster-in, must in all cases, precede payment of pay, bounty, pension, &c. A muster-in roll, must in all cases, be filed in the Adjutant General's Office as evidence of muster-in. The mustering officer, commissary, or assistant commissary of musters, as the case may be, will countersign both enlistments as having mustered the soldier into the service of the United States before either of them is given to the disbursing officer.

DECLARATION OF RECRUIT.

I, Charles Wilson, of Crittenden Co. Ky. desiring to volunteer as a soldier in the ARMY OF THE UNITED STATES, for the term of Three Years, DO DECLARE That I am Twenty Two years and _____ months of age; that I have never been discharged from the United States service on account of disability or by sentence of a court-martial, or by order before the expiration of a term of enlistment; and I know of no impediment to my serving honestly and faithfully as a soldier for three years.

GIVEN at Paducah, McCracken Co. Ky.
 the 28th day of July, 1864

Witness:
Geo. P. Howard

his
Charles Wilson
 mark

Volunteered at Paducah, Ky.
July 28th
1864.
 By Capt. R. H. Hall,
Prov. Man. for 1st Dist. of Ky.

Charles Wilson

So. West Virginia



Consent of Parent or Guardian in case of a Minor, if a Free Man, or in the case of a Slave, of the Person to whom he owes Service:

I, _____ Do CERTIFY, That I am the _____ that the said _____ is _____ years of age; and I do freely give my CONSENT to his volunteering as a SOLDIER in the Army of the United States, for the period of THREE YEARS, under the conditions of the laws of the United States.

GIVEN at _____ the _____ day of _____

Witness: _____

No. 210

No. *Forty Nine*

Charles Wilson

Volunteered at *Paducah, Ky.*

July 28th 1864

By *Capt. R. H. Hall*

Prov. Mar. 1st. Dist. of Ky.

A. U. S. Art. Heavy

Consent of Parent or Guardian in case of a Minor, or in the case of a Slave, of the Person to whom he owes Service:

parts of United States colored troops. They will be made out in duplicate in all cases—
tant General, and one to accompany the accounts of the officer who pays bounty, &c.
muster-in, must in all cases, precede payment of pay, bounty, pension, &c. A m
muster-ing officer, commissary, or assistant commissary of musters, as the case may be,
re either of them is given to the disbursing officer.

UNITED STATES COLORED TROOPS ENLISTMENT.

STATE OF

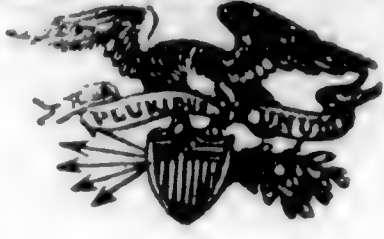

TOWN OF

Kentucky

Paducah

I, Charles Wilson, born in Brittenden Co
in the State of Kentucky, aged Twenty Two years
and by occupation a Farmer Do HEREBY ACKNOWLEDGE to have
volunteered this Twenty Eighth day of July, 1864,
to serve as a **Soldier** in the **Army of the United States of America**, for
the period of **THREE YEARS**, unless sooner discharged by proper authority:
Do also agree to accept such bounty, pay, rations, and clothing, as are, or may be,
established by law for the U. S. colored troops.

And I, Charles Wilson, of Brittenden Co. Ky.
do solemnly swear, that I will bear true faith and allegiance to the **United States
of America**, and that I will serve them honestly and faithfully against all their
enemies or opposers whomsoever; and that I will observe and obey the orders of
the President of the United States, and the orders of the officers appointed over
me, according to the Rules and Articles of War.

Sworn and subscribed to, at Paducah, Ky.
this 28th day of July, 1864,
Before Capt. R. H. Hall } Charles Wilson
his mark

I CERTIFY, ON HONOR, That I have carefully examined the above named Volunteer, agreeably to the
General Regulations of the Army, and that, in my opinion, he is free from all bodily defects and mental infirmity,
which would in any way disqualify him from performing the duties of a soldier.

W. P. Adams

EXAMINING SURGEON.

I CERTIFY, ON HONOR, That I have minutely inspected the Volunteer,.....
previously to his enlistment, and that he was entirely sober when enlisted; that, to the best of my judgment and
belief, he is of lawful age; and that, in accepting him as duly qualified to perform the duties of an able-bodied
soldier, I have strictly observed the regulations which govern the recruiting service. This soldier has Black
eyes, Black hair, Black complexion, is Free feet, 6 3/4 inches high.

RECRUITING OFFICER OR AGENT.

Mustered into the United States service 28th day of July, 1864.

Capt. R. H. Hall

Mustering Officer.

Mustered into the service of the United States, for three years or during the war, from date of enlistment, in Company S
28th Regiment of U.S. Army, Volunteers, on the 28th day of July, 1864, at Paducah, Ky.

Capt. R. H. Hall
1st. Dist. of Ky.

Note 1.—This blank will be used for enlistments of United States colored troops. They will be made out in duplicate in all cases—one to accompany the recruiting return of the superintendent (not the recruiting officer) to the Adjutant General, and one to accompany the accounts of the officer who pays bounty, &c.

Note 2.—An enlistment holds to service. A muster-in, must in all cases, precede payment of pay, bounty, pension, &c. A muster-in roll, must in all cases, be filed in the Adjutant General's Office as evidence of muster-in. The mustering officer, commissary, or assistant commissary of musters, as the case may be, will countersign both enlistments as having mustered the soldier into the service of the United States before either of them is given to the disbursing officer.

DECLARATION OF RECRUIT.

I, Charles Wilson, of Crittenden Co. Ky. desiring to volunteer as a soldier in the ARMY OF THE UNITED STATES, for the term of Three Years, do DECLARE That I am Twenty Two years and months of age; that I have never been discharged from the United States service on account of disability or by sentence of a court-martial, or by order before the expiration of a term of enlistment; and I know of no impediment to my serving honestly and faithfully as a soldier for three years.

GIVEN at Paducah, McCracken Co. Ky.

the 28th day of July, 1864

Witness:
Geo. P. Howard

Charles Wilson
his mark

No. Forty Nine
Charles Wilson
Volunteered at Paducah, Ky.
July 28th 1864
By Capt. R. S. Stahl
Prov. Mar. 1st. Dist. of Ky.

Geo. P. Howard

Consent of Parent or Guardian in case of a Minor, if a Free Man, or in the case of a Slave, of the Person to whom he owes Service:

I, Do CERTIFY, That I am the that the said is years of age; and I do freely give my CONSENT to his volunteering as a SOLDIER in the Army of the United States, for the period of THREE YEARS, under the conditions of the laws of the United States.

GIVEN at

the day of

Witness:

FINAL STATEMENT

OF

James H. [unclear]

Reg't of *[unclear]*
Co. D.

VOLUNTEERS.

NOTE 1.—Two of these certificates (or duplicates) are to be given to each Volunteer Soldier or drafted man who may be discharged previously to the discharge of his company, that he may at once receive from the Paymaster the pay, &c., due him, and the captain or other COMMISSIONED officer commanding the company will certify to the act of the delivery of the duplicate certificates; on these certificates the Soldier is "entitled to" his discharge, and should also present his discharge to the Paymaster to have the payment endorsed on it. The discharge is to be given back to the Soldier by the Paymaster; the latter only retaining as his voucher the duplicate certificates.

NOTE 2.—If the Soldier is entitled to pay for the use of his horse, the Company Commander will certify to that fact on the back of both these final statements, and also to the time he has pay due for having been so mounted on his own horse.

NOTE 3.—When a Soldier is furnished with final statements, his descriptive list, if he has one, should be taken up by the officer who gives the Soldier these statements, and endorsed with a statement to this effect by the officer. This endorsement should exhibit a full statement of the time for which the Soldier was allowed pay on his final statements, the clothing account, and all other charges against him or in his favor, so as to comprise a complete exhibit of his account. It will then be transmitted to the company commander of the Soldier, who will enter all the data necessary to a full understanding of the Soldier's account on the muster roll upon which the Soldier's discharge is reported. The descriptive list will then be destroyed. The object of this is, that the remaining portion of the Soldier's account may be settled upon the receipt of these muster rolls, and the Soldier receive any pay or allowances that may be due him at the time of his discharge, and which may not appear on his final statements from the fact that his descriptive list is incomplete. These accounts for back pay, &c., are settled by the 2d Auditor of the Treasury Department.

NOTE 4.—Charges for loss or injury to ordnance, horse equipments, and other miscellaneous charges, should appear under the heading of "Other Stoppages."

NOTE 5.—Bounty paid by State authorities, and not by the United States, will not be entered on this statement.

NOTE 6.—Amounts due the Sutler and Laundress must be entered on the muster roll on which the discharge, death, desertion, &c., is reported, as well as on the final statement, otherwise the amount cannot be collected from the United States.

NOTE 7.—This blank will be used for deceased volunteers and drafted men, as well as for others.

NOTE 8.—Where a Soldier dies in Hospital or on detached service, his descriptive list, if he has one, should be sent with his final statements, in duplicate, to the Adjutant General, Washington, D. C.

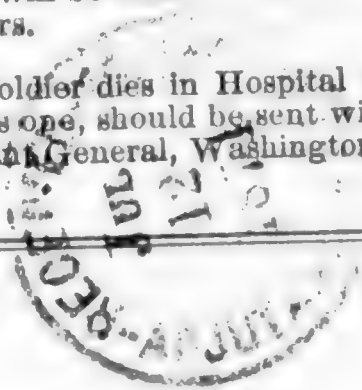

I certify, on honor, that Charles H. Gibson a Private of
 Captain Robert M. Smith Company (B) of the 8th Regiment of 24th
VOLUNTEERS, of the State of California, born in Scotts Valley, State
 of California, aged 22 years; 5 feet 8 inches high; fair complexion,
blue eyes, dark hair, and by occupation a farmer, having joined the company on
 its original organization at Scotts Valley, and enrolled in it at the muster into
 the service of the United States at Scotts Valley, on the 1st day
 of September, 1861, (or was mustered in service as a recruit, by
 _____, at _____, on the _____ day of _____,
 1861, or was drafted and mustered into the service of the United States from the _____
 Enrollment District of the State of _____, at _____,
 on the _____ day of _____, 1861) to serve in the Regiment, for
 the term of three months: and having served HONESTLY and
 FAITHFULLY with his Company in _____ to the present date, is now
 entitled to a **DISCHARGE** by reason of _____

The said Charles H. Gibson was last paid by Paymaster
 _____ to include the _____ day of _____, 1861, and has
 pay due him from that time to the present date; he is entitled to pay and subsistence for
 TRAVELING to place of enrollment, and whatever other allowances are authorized to volunteer
 soldiers, drafted men, or militia, so discharged. He has received from the United States **CLOTHING**
 amounting to 22 ³⁸/₁₀₀ dollars, since the _____ day of September,
 1861, when his clothing account was last settled. He has received from the United States
 _____ ¹⁰⁰/₁₀₀ dollars advanced **BOUNTY**.

There is to be stopped from him, on account of the State of U.S., or other
 authorities, for **CLOTHING**, &c., received on entering service, 22 ³⁸/₁₀₀ dollars; and
 for other stoppages, viz: _____
 _____ ¹⁰⁰/₁₀₀ dollars.

He has been furnished with TRANSPORTATION in kind from the place of his discharge to
 _____; and he has been SUBSISTED for TRAVELING to his
 place of enrollment, up to the _____, 1861.

He is indebted to _____, **SUTLER**, _____ ¹⁰⁰/₁₀₀ dollars.
 He is indebted to _____, **LAUNDRESS**, _____ ¹⁰⁰/₁₀₀ dollars.

Given in Duplicate, at _____, this _____ day
 of _____, 1861.

Robert M. Smith

 Commanding Company

Adjutant General's Office
Washington, D.C., Sept. 16, 1870.

The Muster Roll of Company "G" 9th
M. S. Colored Artillery (Regt) for July
and August 1864 reports the death of
Private Charles Wilson August 6, 1864.

The Muster Out Roll of the Company
and the Final Statement of the soldier
report date of death August 8, 1864.

The latter date (August eighth 1864)
is held to be correct and the Company
Muster Roll above cited will be
amended accordingly.

H. R. Rathbone

Major U.S.A.
In Charge Bureau Adj. Gen.

E. W. D.

*I certify that the
above is correct and true*

ADJUTANT GENERAL'S OFFICE

Oct 11 1870

Duplicate with Inventory sent 2d Auditor.

✓ FINAL STATEMENT

OF

Reg't of

VOLUNTEERS.

NOTE 1.—Two of these certificates (or duplicates) are to be given to each Volunteer Soldier or drafted man who may be discharged previously to the discharge of his company, that he may at once receive from the Paymaster the pay, &c., due him, and the captain or other COMMISSIONED officer commanding the company will certify to the act of the delivery of the duplicate certificates; on these certificates the Soldier is "entitled to" his discharge, and should also present his discharge to the Paymaster to have the payment endorsed on it. The discharge is to be given back to the Soldier by the Paymaster; the latter only retaining as his voucher the duplicate certificates.

NOTE 2.—If the Soldier is entitled to pay for the use of his horse, the Company Commander will certify to that fact on the back of both these final statements, and also to the time he has pay due for having been so mounted on his own horse.

NOTE 3.—When a Soldier is furnished with final statements, his descriptive list, if he has one, should be taken up by the officer who gives the Soldier these statements, and endorsed with a statement to this effect by the officer. This endorsement should exhibit a full statement of the time for which the Soldier was allowed pay on his final statements, the clothing account, and all other charges against him or in his favor, so as to comprise a complete exhibit of his account. It will then be transmitted to the company commander of the Soldier, who will enter all the data necessary to a full understanding of the Soldier's account on the muster roll upon which the Soldier's discharge is reported. The descriptive list will then be destroyed. The object of this is, that the remaining portion of the Soldier's account may be settled upon the receipt of these muster rolls, and the Soldier receive any pay or allowances that may be due him at the time of his discharge, and which may not appear on his final statements from the fact that his descriptive list is incomplete. These accounts for back-pay, &c., are settled by the 2d Auditor of the Treasury Department.

NOTE 4.—Charges for loss or injury to ordnance, horse equipments, and other miscellaneous charges, should appear under the heading of "Other Stoppages."

NOTE 5.—Bounty paid by State authorities, and not by the United States, will not be entered on this statement.

NOTE 6.—Amounts due the Sutler and Laundress must be entered on the muster roll on which the discharge, death, desertion, &c., is reported, as well as on the final statement, otherwise the amount cannot be collected from the United States.

NOTE 7.—This blank will be used for deceased volunteers and drafted men, as well as for others.

NOTE 8.—Where a Soldier dies in Hospital or on detached service, his descriptive list, if he has one, should be sent with his final statements, in duplicate, to the Adjutant General, Washington, D. C.

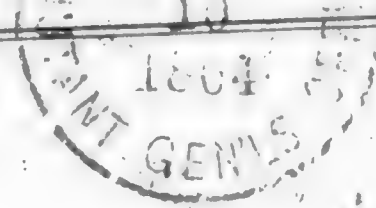

[The text in this section is extremely faint and illegible. It appears to be a list or a series of entries, possibly names and dates, but the characters are too light to transcribe accurately.]

[The text in this section is also extremely faint and illegible, appearing to be a continuation of the list or entries from the previous section.]

ARTICLES OF WAR.

ART. 95. When any non-commissioned officer or soldier shall die, or be killed in the service of the United States, the then commanding officer of the troop or company shall, in the presence of two other commissioned officers, take an account of what effects he died possessed of, above his arms and accoutrements, and transmit the same to the office of the Department of War, which said effects are to be accounted for, and paid to the representatives of such deceased non-commissioned officer or soldier. And in case any of the officers, so authorized to take care of the effects of deceased officers and soldiers, should, before they have accounted to their representatives for the same, have occasion to leave the regiment or post, by preferment or otherwise, they shall, before they be permitted to quit the same, deposit in the hands of the commanding officer, or of the assistant military agent, all the effects of such deceased non-commissioned officers and soldiers, in order that the same may be secured for, and paid to, their respective representatives.

ARMY REGULATIONS—EDITION OF 1863.

DECEASED SOLDIERS.

Par. 152. Inventories of the effects of deceased non-commissioned officers and soldiers, required by the 95th Article of War, will be forwarded to the Adjutant General, by the commander of the company to which the deceased belonged, and a duplicate of the same to the colonel of the regiment. Final statements of pay, clothing, &c., in duplicate, will be sent to the Adjutant General with one copy of the inventory. When a soldier dies at a post or station absent from his company, it will be the duty of his immediate commander to furnish the required inventory and final statements, and, at the same time, to forward to the commanding officer of the company to which the soldier belonged, a report of his death, specifying the date, place, and cause; to what time he was last paid, and the money or other effects in his possession at the time of his decease; which report will be noted on the next muster roll of the company to which the man belonged. Each inventory will be endorsed, "Inventory of the effects of _____, late of company (—) _____ regiment of _____, who died at _____, the _____ day of _____, 186—." If a legal representative receive the effects, it will be stated in the report. If the soldier leave no effects, the fact will be reported.

Par. 153. Should the effects of a deceased non-commissioned officer or soldier not be administered upon within a short period after his decease, they shall be disposed of by a Council of Administration, under the authority of the commanding officer of the post, and the proceeds deposited with the Paymaster, to the credit of the United States, until they shall be claimed by the legal representatives of the deceased.

Par. 154. In all such cases of sales by the Council of Administration, a statement in detail, or account of the proceeds, duly certified by the Council and commanding officer, accompanied by the Paymaster's receipt for the proceeds, will be forwarded by the commanding officer to the Adjutant General. The statement will be endorsed, "Report of the proceeds of the effects of _____, late of company (—) _____ regiment of _____, who died at _____, the _____ day of _____, 186—."

NOTE 1.—The effects in all cases, when called for, should be turned over to the legal representative, without further authority from the Adjutant General. When the effects are turned over to the relatives of the deceased before these inventories are sent to the Adjutant General, their receipts therefor should be attached to the inventories. In all other cases, one copy will be sent with a letter of transmittal direct to the Adjutant General, and a duplicate retained by the officer.

NOTE 2.—Particular care should be taken to take receipts in duplicate from the Paymaster for any funds turned over to him; one copy should be sent direct to the Adjutant General and one retained by the officer.

INVENTORY OF THE EFFECTS

OF

Charles L. ...

Late of Company _____

Reg't of _____

Volunteers, who died at _____

on the _____ day of _____ 1864.

1864
12
1871

Inventory of the effects of Alfred W. ... late
a Private of Captain ... Company "D" of
the 8th Regiment of ... Volunteers, who was enrolled as
a Private at ... in the State of ... on
the 28th day of ... 1864, and mustered into the service of the United
States as a Private on the 28th day of ... 1864, at ...
in Company "D", 8th Regiment of ... Volunteers, to serve three
years or during the war; he was born in ... in the State
of ...; he was 22 years of age, ... feet ... inches
high, ... complexion, ... eyes, ... hair, and by occupation, when enrolled,
a ...; he died in ... at
... on the ... day of ... 1864, by
reason of ...

INVENTORY.					
ARTICLES.	No.	ARTICLES.	No.	ARTICLES.	No.
Hats.....		Pairs trousers.....		Knapsacks.....	
Caps.....		Pairs flannel drawers.....			
Forage caps.....		Pairs cotton drawers.....			
Great coats.....		Flannel shirts.....			
Uniform coats.....		Cotton shirts.....			
Uniform jackets.....		Pairs boots.....			
Flannel sack coats.....		Pairs shoes.....			
Blouses.....		Pairs socks.....			
Stable frocks.....		Blankets.....			
Fatigue overalls.....		Haversacks.....			
				MONEY.	
				Specie.....	\$
				Notes.....	\$

I CERTIFY, ON HONOR, that the above inventory comprises all the effects of
....., deceased, and that the effects are in the hands
of at
..... to be disposed of by a Council of Administration.

(DUPLICATES.)

STATION: ...

DATE: ...

...
...
Commanding the Company.

ARTICLES OF WAR.

ART. 95. When any non-commissioned officer or soldier shall die, or be killed in the service of the United States, the then commanding officer of the troop or company shall, in the presence of two other commissioned officers, take an account of what effects he died possessed of, above his arms and accoutrements, and transmit the same to the office of the Department of War, which said effects are to be accounted for, and paid to the representatives of such deceased non-commissioned officer or soldier. And in case any of the officers, so authorized to take care of the effects of deceased officers and soldiers, should, before they have accounted to their representatives for the same, have occasion to leave the regiment or post, by preferment or otherwise, they shall, before they be permitted to quit the same, deposit in the hands of the commanding officer, or of the assistant military agent, all the effects of such deceased non-commissioned officers and soldiers, in order that the same may be secured for, and paid to, their respective representatives.

ARMY REGULATIONS—EDITION OF 1863.

DECEASED SOLDIERS.

Par. 152. Inventories of the effects of deceased non-commissioned officers and soldiers, required by the 95th Article of War, will be forwarded to the Adjutant General, by the commander of the company to which the deceased belonged, and a duplicate of the same to the colonel of the regiment. Final statements of pay, clothing, &c., in duplicate, will be sent to the Adjutant General with one copy of the inventory. When a soldier dies at a post or station absent from his company, it will be the duty of his immediate commander to furnish the required inventory and final statements, and, at the same time, to forward to the commanding officer of the company to which the soldier belonged, a report of his death, specifying the date, place, and cause; to what time he was last paid, and the money or other effects in his possession at the time of his decease; which report will be noted on the next muster roll of the company to which the man belonged. Each inventory will be endorsed, "Inventory of the effects of _____, late of company (—) _____ regiment of _____, who died at _____, the _____ day of _____, 186—." If a legal representative receive the effects, it will be stated in the report. If the soldier leave no effects, the fact will be reported.

Par. 153. Should the effects of a deceased non-commissioned officer or soldier not be administered upon within a short period after his decease, they shall be disposed of by a Council of Administration, under the authority of the commanding officer of the post, and the proceeds deposited with the Paymaster, to the credit of the United States, until they shall be claimed by the legal representatives of the deceased.

Par. 154. In all such cases of sales by the Council of Administration, a statement in detail, or account of the proceeds, duly certified by the Council and commanding officer, accompanied by the Paymaster's receipt for the proceeds, will be forwarded by the commanding officer to the Adjutant General. The statement will be endorsed, "Report of the proceeds of the effects of _____, late of company (—) _____ regiment of _____, who died at _____, the _____ day of _____, 186—."

NOTE 1.—The effects in all cases, when called for, should be turned over to the legal representative, without further authority from the Adjutant General. When the effects are turned over to the relatives of the deceased before these inventories are sent to the Adjutant General, their receipts therefor should be attached to the inventories. In all other cases, one copy will be sent with a letter of transmittal direct to the Adjutant General, and a duplicate retained by the officer.

NOTE 2.—Particular care should be taken to take receipts in duplicate from the Paymaster for any funds turned over to him; one copy should be sent direct to the Adjutant General and one retained by the officer.

INVENTORY OF THE EFFECTS

OF

Philip H. ...

Late of Company _____

Reg't of _____

Volunteers, who died at _____

on the _____ day of _____, 186—.



Inventory of the effects of James H. [unclear] late
 a Private of Captain [unclear] Company "D" of
 the 8th Regiment of Volunteers, who was enrolled as
 a Private at [unclear] in the State of Virginia on
 the 28th day of July 1864, and mustered into the service of the United
 States as a Private on the 28th day of July 1864, at [unclear]
 in Company "D", 8th Regiment of Volunteers, to serve Three
 years or during the war; he was born in [unclear] in the State
 of Virginia; he was 22 years of age, 5 feet 3 inches
 high, Dark complexion, Dark eyes, Dark hair, and by occupation, when enrolled,
 a [unclear]; he died in [unclear], at
[unclear] on the 8th day of August 1864, by
 reason of [unclear]

INVENTORY.					
ARTICLES.	No.	ARTICLES.	No.	ARTICLES.	No.
Hats.....		Pairs trousers.....		Knapsacks.....	
Caps.....		Pairs flannel drawers.....			
Forage caps.....		Pairs cotton drawers.....			
Great coats.....		Flannel shirts.....			
Uniform coats.....		Cotton shirts.....			
Uniform jackets.....		Pairs boots.....			
Flannel sack coats.....		Pairs shoes.....			
Blouses.....		Pairs socks.....			
Stable frocks.....		Blankets.....			
Fatigue overalls.....		Haversacks.....			
				MONEY.	
				Specie.....	\$
				Notes.....	\$

I CERTIFY, ON HONOR, that the above inventory comprises all the effects of _____
 _____, deceased, and that the effects are in the hands
 of _____ at _____
 _____ to be disposed of by a Council of Administration.

(DUPLICATES.)

STATION: [unclear]

DATE: [unclear]

[Signature]

Commanding the Company.

War Department,

ADJUTANT GENERAL'S OFFICE,

Washington, March 7 1867.

Respectfully returned to the Commission for the State of Kentucky, with the information that Charles Wilson was enlisted at Paducah Ky, July 28, 1864 and was mustered in as Pvt. in Co. "D" 8th U.S.C. Artillery July 31, 1864,

W. H. 1410. Ky.

[Signature]

W. H. 1410

Asst. Adj't General.

No. _____

APPLICATION OF

W. H. Wilson & Co

OF

Crittenden Co

FOR COMPENSATION FOR SLAVE,

Named Charles Wilson

Enlisted July 28th 1864,

In Com. 8th Artillery Regiment,

U. S. COLORED TROOPS.

Received Jan 4 28, 1867.

Compensation Awarded

_____, 1867.

Dollars.

President of Board of Claims.

Claimant's Attorney,

Robt H. Hargus
Marion Ky

Claimant's Post-office Address,

Marion
Crittenden Co Ky

No.

CLAIM OF

FOR THE COMPENSATION OF SLAVE NAMED

We *W. H. Wilson* *R. W. Wilson* and *Mary E. Armstrong* (widow)
 & loyal citizens and residents of the
 County of *Crittenden* State of Kentucky, hereby claim compensation, under
 the provisions of Section 24, act approved February 21, 1861, and section 2, act approved July, 28,
 1866, for ~~my~~ ^{our} slave *Charles Wilson*, enlisted *28th July*
 1864, at *Paducah Ky*, by *R. A. Hall*
 in the *8th (Heavy Art)* regiment U. S. Colored Troops, Co. *D*; certificate of
 which enlistment, and a descriptive list, as required, accompany this application. That *we* did not ac-
 quire said slave subsequent to said enlistment, but had a valid title to him at the date of said enlist-
 ment, and previous thereto: *we* having acquired ^{our} ~~my~~ title to him and ~~my~~ ownership over him as fol-
 lows, to-wit: *By inheritance from our dead father James W. Wilson*
who died April 23rd 1865 and who was at his ^{enlistment} death and long
previous thereto the owner of said Lewis Wilson and ~~we~~
the said W. H. Wilson R. W. Wilson and Mary E. Armstrong
are the children and only heirs at law of the said James
W. Wilson dead & that James W. Wilson was actually loyal to
the United States up to his death
 In proof of ^{our} ~~my~~ loyalty to the Constitution and Government of the United States, *we* present the ac-
 companying oath, which *we* have taken, signed and acknowledged; to be filed with this application, in
 accordance with requirement of General Orders, No. 329, 1863, War Department, Adjutant General's
 Office.

W. H. Wilson
R. W. Wilson
M. E. Armstrong

January 16th 1867

OATH OF ALLEGIANCE.
We *W. H. Wilson* *R. W. Wilson* & *Mary E. Armstrong* the owners and Claimants do solemnly swear that
 the foregoing claim is a just and true claim due to ~~me~~ ^{us} as masters and owners of the said slave, and that
 the facts alleged in said claim in respect to the draft or enlistment (as the case may be) of said slave
 into the Military service of the United States are true. And *we* do further swear that *we* have never
 joined, or been concerned in, any insurrection or rebellion; that *we* have never borne arms against the
 United States; that *we* have never given any aid, countenance, counsel or encouragement to any person
 or persons engaged, or whom *we* had reason to believe were about to engage, in insurrection, rebellion
 or armed hostility against the United States; that *we* have neither sought, nor accepted, nor attempted
 to exercise the functions of any office, civil or military, nor to perform any service whatever, under
 any authority or pretended authority in hostility to the United States; that *we* have not yielded a vol-
 untary support to any insurrection, rebellion or pretended government, authority, power or constitution
 within the United States hostile thereto. And *we* do further swear that, to the best of ^{our} ~~my~~ knowledge
 and ability, *we* have supported and defended, and will continue to support and defend, the United
 States against all enemies, foreign and domestic; and that *we* have supported, defended and obeyed, and
 will continue to support, defend and obey, the Constitution and laws of the United States; that *we* will
 bear true faith and allegiance to the same; and that *we* take this oath freely, without any mental reserva-
 tion or purpose of evasion: So help ~~us~~ God.

W. H. Wilson
R. W. Wilson
M. E. Armstrong

Sworn to and subscribed before me, at *Marion Ky*,
 this *16th* day of *January*, 1867.
J. W. Blue Notary Public
 for Crittenden County, Ky



PROOF OF OWNERSHIP.

STATE OF KENTUCKY,

COUNTY OF Crittenden

} SS.

We W. H. Wilson

and J. L. Dean

each of lawful

age, and resident citizens of the State and County aforesaid, do certify that

Wilson

of the State and County aforesaid, was on the 28th day of

July

1864

and long previously thereto the lawful owner of the slave named

Charles Wilson;

referred to and described in the foregoing claim for compensation. That James W. Wilson is dead and W. H. Wilson, B. W. Wilson & Mary E. Armstrong are the children and only heirs at law of said dead

W. H. Wilson
J. L. Dean

Sworn to and subscribed before me a Notary Public
Crittenden State of Kentucky, this the 16th

for the County of

day of January 1867.

5 CENT
STAMP



J. W. Blue Notary Public
for Crittenden County, Ky

PROOF OF LOYALTY.

STATE OF KENTUCKY,

COUNTY OF Crittenden

} SS.

We D. N. Stinson

and A. R. Black

loyal men and

each of lawful age, and resident citizens of the County of Crittenden

in the State and County aforesaid, upon our oaths declare that we have known James W. Wilson died
W. H. Wilson B. W. Wilson & Mary E. Armstrong (widow) residents of the State and County aforesaid, since the 4th day of March, 1861, and know that he has they all
firmly and faithfully maintained ^{their} ~~his or her~~ adherence and allegiance to the Government of the United States, by defending its cause against the Government and forces of the so-called Confederate States of America, in all suitable and practicable ways, and according to ^{their} ~~his or her~~ ability and opportunity.

D. N. Stinson
A. R. Black

Sworn to and subscribed before me a Notary Public
Crittenden State of Kentucky, this the 16th

for the county of

day of January 1867.

5 CENT
STAMP.



J. W. Blue Notary Public
for Crittenden County, Ky

POWER OF ATTORNEY.

My Post-Office address is Marion County of Crittenden State of Kentucky, and I hereby direct that all communications to me, touching this claim, be sent under cover to Claimants or either of them, who is hereby appointed and constituted my true and lawful attorney, to prosecute this claim for me, and who is hereby authorized and empowered to receive and receipt for any award, order, draft, certificate, voucher, warrant, papers or money that may be issued in the adjustment of this claim, or the payment thereof, the same as I might or could do in person were I present and acting for myself, and to file any additional evidence or papers that may be required in the prosecution of this claim.

[WITNESS.]

The owner signs here.

50 CENT
STAMP.

Two witnesses to owner's signature sign here.

Headquarters Kentucky Volunteers,

Adjutant-General's Office,

Frankfort, Dec 31, 1866.

I hereby certify, that it appears from the U. S. Muster-
Polls on file in this Office, that Chas Wilson
was enrolled on the 28 day of July, 1864, at
Paducah Ky, by R H Hall,
and mustered into the U. S. service on the 28 day of July,
1864, at Paducah Ky by R H Hall,
to serve Three years. Said Chas Wilson
is described as follows: Age, 22 years; eyes, Black, hair, Black,
complexion, Black; height, 5 feet 6 1/2 inches. It further
appears from said Polls, that Chas Wilson, owed service
to James Wilson, was credited to Crittenden
County, Ky., and was assigned to Co. D, 8 Regiment
U. S. C. Artillery

In Testimony Whereof, I have hereunto set my
hand, and affixed my Official Seal, this
31 day of Dec, 1866.

D. W. Lindsay
Adjutant General of Kentucky.



B. 10, R. 128

1901
Wilson Clark

Co B, 8 U.S. Col'd H. Art'y.

Private Private

CARD NUMBERS.

1	5474486	26
2	5474619	27
3	5474752	28
4	5474878	29
5	5474998	30
6	5475119	31
7	5475234	32
8	5475345	33
9	5475443	34
10	5475546	35
11	5475634	36
12	9122320	37
13		38
14		39
15		40
16		41
17		42
18		43
19		44
20		45
21		46
22		47
23		48
24		49
25		50

Book Mark:

See also

✓

8 H. Art'y.

U.S.C.T.

Blank Wilson

, Co. E, 8 Reg't U.S. Col'd H. Art'y.

Appears on

Company Descriptive Book

of the organization named above.

DESCRIPTION.

Age 22 years; height 5 feet 6 inches.

Complexion

Blk

Eyes

Blk

; hair

Blk

Where born

Baldwell Co., Ky.

Occupation

Farmer

ENLISTMENT.

When

May 24

, 1864.

Where

Paducah, Ky.

By whom

Capt. Dunn

; term

3

y'rs.

Remarks:

E. A. Moreland

(383g)

Copyist.

W

8 H. Art'y.

U.S.C.T.

Clark Wilson

Pvt, Co. E, 8 Reg't U. S. Col'd H. Art'y.

Appears on

Company Muster Roll

for *July and Aug.*, 186*4*.

Present or absent *Present*

Stoppage, \$ *100* for

Due Gov't, \$ *100* for

Valuation of horse, \$ *100*

Valuation of horse equipments, \$ *100*

Remarks:

Book mark:

Jas. v. Kearny

Copyist.

(358)

N

8 H. Art'y.

U.S.C.T.

Clark Wilson

Pl, Co. E, 8 Reg't U. S. Col'd H. Art'y.

Appears on

Company Muster Roll

for *Sept and Oct*, 1864.

Present or absent *Present*

Stoppage, \$ *100* for

Due Gov't, \$ *100* for

Valuation of horse, \$ *100*

Valuation of horse equipments, \$ *100*

Remarks:

Book mark:

Jas. R. Keamy
Copyist.

W | 8 H. Art'y. | U.S.C.T.

Clark Wilson
Priv., Co. E, 8 Reg't U. S. Col'd H. Art'y.

Appears on

Company Muster Roll

for *Nov. + Dec.*, 186*4*.

Present or absent *Present*

Stoppage, \$ *100* for

Due Gov't, \$ *100* for

Valuation of horse, \$ *100*

Valuation of horse equipments, \$ *100*

Remarks: _____

Book mark: _____

C. E. M. Laughlin
(358) Copyist.

W

8 H. Art'y.

U.S.C.T.

Clark Wilson

Priv., Co. E, 8 Reg't U. S. Col'd H. Art'y.

Appears on

Company Muster Roll

for Jan. & Feb., 1865.

Present or absent Present

Stoppage, \$ 100 for

Due Gov't, \$ 100 for

Valuation of horse, \$ 100

Valuation of horse equipments, \$ 100

Remarks: Due the U. S. for
ordnance \$ 0.10 Saw-
sack and canteen \$ 1.60

Book mark:

B. E. M. Laughlin

(358)

Copyist.

W | 8 H. Art'y. | U.S.C.T.

Clark Wilson
Priv., Co. E, 8 Reg't U. S. Col'd H. Art'y.

Appears on

Company Muster Roll

for Mar. & Apr., 1865.

Present or absent Present

Stoppage, \$ 100 for

Due Gov't, \$ 100 for

Valuation of horse, \$ 100

Valuation of horse equipments, \$ 100

Remarks: Due the U.S.
for Ord. \$0.10 C. & G.
G. E. \$1.00

Book mark:

(358) C. E. M. Laughlin Copyist.

W

8 H. Art'y.

U.S.C.T.

Clark Wilson

Priv., Co. E, 8 Reg't U. S. Col'd H. Art'y.

Appears on

Company Muster Roll

for May & June, 1865.

Present or absent Present

Stoppage, \$ 100 for

Due Gov't, \$ 100 for

Valuation of horse, \$ 100

Valuation of horse equipments, \$ 100

Remarks: Due U. S. for Co. + G. E. \$100

Book mark:

C. E. M. Laughlin

(358)

Copyist.

H

8 H. Art'y.

U.S.C.T.

Clark Wilson

Plt, Co. E, 8 Reg't U. S. Col'd H. Art'y.

Appears on

Company Muster Roll

for *July & Aug*, 1865.

Present or absent *Present*

Stoppage, \$ *100* for

Due Gov't, \$ *100* for

Valuation of horse, \$ *100*

Valuation of horse equipments, \$ *100*

Remarks: *Due the U.S. for C & G. E. \$160.*

Book mark:

E. B. Carroll

(358)

Copyist.

H

S H. Art'y.

U.S.C.T.

Clark Wilson

Plt, Co. E, 8 Reg't U. S. Col'd H. Art'y.

Appears on

Company Muster Roll

for *Sept & Oct*, 1865.

Present or absent *Present*

Stoppage, \$ *100* for

Due Gov't, \$ *100* for

Valuation of horse, \$ *100*

Valuation of horse equipments, \$ *100*

Remarks:

Book mark:

E. Carroll

(358)

Copist.

W

S H. Art'y.

U.S.C.T.

Clark Wilson

Pvt, Co. E, 8 Reg't U. S. Col'd H. Art'y.

Appears on

Company Muster Roll

for *Nov + Dec*, 1865.

Present or absent *Present*

Stoppage, \$ 100 for

Due Gov't, \$ 100 for

Valuation of horse, \$ 100

Valuation of horse equipments, \$ 100

Remarks:

Book mark:

E. Carroll

H

8 H. Art'y.

U.S.C.T.

Clank Wilson

Pot, Co. *E*, 8 Reg't U. S. Col'd H. Art'y.

Appears on **Co. Muster-out Roll**, dated
Victoria Texas, Feb. 10, 1866.

Muster-out to date *Feb 10, 1866.*

Last paid to *Aug 31, 1865.*

Clothing account:

Last settled....., 186 ; drawn since \$..... 100

Due soldier \$ *9* ^{*36*}/₁₀₀; due U. S. \$..... 100

Am't for cloth'g in kind or money adv'd \$..... 100

Due U. S. for arms, equipments, &c., \$..... 100

Bounty paid \$ *None* 100; due \$ *100* 100

Remarks: *Entered Service as recruit*
joined Co for duty May 21st 64
Enrolled & subject to draft
in 1st En. Dist. of Ky at time
of Enlistment.
(Age 22 years)

Book mark:

E. B. Carroll

(361)

Copyist.

1908-1909
Wilson David

Co I, 8 U.S. Col'd H. Art'y.

Corporal Corporal

CARD NUMBERS.

1	5479693	26
2	5479838	27
3	5479990	28
4	5480128	29
5	5480261	30
6	5480391	31
7	5480511	32
8	5480624	33
9	5480731	34
10	5480833	35
11	5480933	36
12	9122629	37
13	40743919½	38
14		39
15		40
16		41
17		42
18		43
19		44
20		45
21		46
22		47
23		48
24		49
25		50

Book Mark:

See also

W. H. Co. (City) U.S.C.T.

David Wilson
Co. C, 8 Reg't U.S. Col'd. City

Age.....years.

Appears on

Company Muster Roll*

for May & June, 1864.

Joined for duty and enrolled:

When May 29, 1864.

Where Caducah, Ken

Period 3 years.

Mustered in:

When June 25, 1864.

Where Caducah, Ken

Present or absent Present

Stoppage, \$ 100 for.....

Due Gov't, \$ 100 for.....

Valuation of horse, \$ 100

Valuation of horse equipments, \$ 100

Remarks :

* First current roll. No muster-in roll of this company on file.

Book mark :

(3586)

E. L. Thornton
Copyist.

44

S H. Art'y.

U.S.C.T.

David Wilson
Capt., Co. I, 8 Reg't U. S. Col'd H. Art'y.

Appears on

Company Muster Roll

for July & Aug., 1864.

Present or absent Present

Stoppage, \$ 100 for

Due Gov't, \$ 100 for

Valuation of horse, \$ 100

Valuation of horse equipments, \$ 100

Remarks:

Book mark:

E. L. Shannon

(358)

Copyist.

W

| 8 H. Art'y. |

U.S.C.T.

David Wilson,

Capt., Co. I, 8 Reg't U. S. Col'd H. Art'y.

Appears on

Company Muster Roll

for *Sept & Oct*, 1864.

Present or absent *Present*

Stoppage, \$ *100* for

Due Gov't, \$ *100* for

Valuation of horse, \$ *100*

Valuation of horse equipments, \$ *100*

Remarks: *Stop pay
for one canteen
lost 43¢.*

Book mark:

(358)

J. H. ...

Copyist.

David Nelson
Capt., Co. I, 8 Reg't U. S. Col'd H. Art'y.

Appears on

Company Muster Roll

for *Nov. & Dec.*, 186*4*.

Present or absent *Present*

Stoppage, \$ *100* for

Due Gov't, \$ *100* for

Valuation of horse, \$ *100*

Valuation of horse equipments, \$ *100*

Remarks:
.....
.....
.....
.....
.....
.....
.....
.....
.....
.....

Book mark:

E. L. Thornton
Copyist.

W

8 H. Art'y. | U.S.C.T.

David Wilson

Capt. Co. I, 8 Reg't U. S. Col'd H. Art'y.

Appears on

Company Muster Roll

for Jan'y & Feb'y, 1865.

Present or absent Present

Stoppage, \$ 100 for

Due Gov't, \$ 100 for

Valuation of horse, \$ 100

Valuation of horse equipments, \$ 100

Remarks:

Book mark:

L. B. Sayer

(358)

Copyist.

11 | 8 H. Art'y. | U.S.C.T.

David Wilson

Co. I, 8 Reg't U. S. Col'd H. Art'y.

Appears on

Company Muster Roll

for *Mar & Apr*, 1865.

Present or absent *Present*

Stoppage, \$ 100 for

Due Gov't, \$ 100 for

Valuation of horse, \$ 100

Valuation of horse equipments, \$ 100

Remarks:

Book mark:

(358)

L. B. Sayre
Copyist.

David Wilson

Serpl, Co. I, 8 Reg't U. S. Col'd H. Art'y.

Appears on

Company Muster Roll

for *May & June*, 186 *5*.

Present or absent *Present*

Stoppage, \$ 100 for

Due Gov't, \$ 100 for

Valuation of horse, \$ 100

Valuation of horse equipments, \$ 100

Remarks:

Book mark:

L. B. Sawyer

(358)

Copyist.

W

S H. Art'y. | U.S.C.T.

David Wilson

Capt; Co. I, 8 Reg't U. S. Col'd H. Art'y.

Appears on

Company Muster Roll

for *July & August*, 1865.

Present or absent *Present*

Stoppage, \$ *100* for

Due Gov't, \$ *100* for

Valuation of horse, \$ *100*

Valuation of horse equipments, \$ *100*

Remarks:

Book mark:

L B Sawyer

(358)

Copyist.

77

8 H. Art'y. | U.S.C.T.

David Wilson

Capt., Co. I, 8 Reg't U. S. Col'd H. Art'y.

Appears on

Company Muster Roll

for Sept & Oct, 1865.

Present or absent Present

Stoppage, \$ 100 for

Due Gov't, \$ 100 for

Valuation of horse, \$ 100

Valuation of horse equipments, \$ 100

Remarks:

Book mark:

J. A. [Signature]

70

8 H. Art'y. | U.S.C.T.

David Wilson

Capt., Co. I, 8 Reg't U. S. Col'd H. Art'y.

Appears on

Company Muster Roll

for Nov & Dec, 1865.

Present or absent Present

Stoppage, \$ 100 for

Due Gov't, \$ 100 for

Valuation of horse, \$ 100

Valuation of horse equipments, \$ 100

Remarks:

Book mark:

C. A. Ward

(358)

Copyist.

D

S H. Art'y.

U.S.C.T.

David Wilson

Corp, Co. *I*, 8 Reg't U. S. Col'd H. Art'y.

Appears on Returns as follows:

*Mich 1865 Absent at Lexington
Ky. since Mich 27 65
Witness on G. C. M.*

Book mark :

(546)

Stappell

Copyist.

W | S H. Art'y. | U.S.C.T.

David Wilson

Capt., Co. I, 8 Reg't U. S. Col'd H. Art'y.

Appears on Co. Muster-out Roll, dated Victoria Texas, Feby 10, 1866.

Muster-out to date Feby 10, 1866.

Last paid to Aug 31, 1865.

Clothing account:

Last settled....., 186 ; drawn since \$..... 100

Due soldier \$ 28 ⁶¹/₁₀₀; due U. S. \$..... 100

Am't for cloth'g in kind or money adv'd \$..... 100

Due U. S. for arms, equipments, &c., \$..... 100

Bounty paid \$ none 100; due \$ 100 100

Remarks: Entered service as Private as herein shown. Promoted to Capt June 6-1864. Enrolled and subject to Draft- 1st enrollment

Book mark: Aug 31

C. S. Roggele

(361)

Copyist.

JAN. 14

5480933

1891

*Dist of Ky at time of
enlistment-*

1908-a.

Wilson, Emily

Co.—, 8 U.S. C. Army Artillery

Laundress

CARD NUMBERS.

1 3200023

26

2 32946206

27

3

28

4

29

5

30

6

31

7

32

8

33

9

34

10

35

11

36

12

37

13

38

14

39

15

40

16

41

17

42

18

43

19

44

20

45

21

46

22

47

23

48

24

49

25

50

Number of personal papers herein.....

Book Mark:

See also

W I A

Emily Wilson

, Co. , Reg't

Appears on **Hospital Muster Roll**

of 8 Reg't U.S. Art. Heavy

for Sep & Oct, 1864.

When attached to Hosp. Oct 20, 1864.

How employed Laundress

Present or absent present

Remarks:

+ Emily in pres col.

Book mark:

Gustin

71 | |

Emily Wilson

....., Co., Reg't

Appears on **Hospital Muster Roll**

of 8 Reg't U.S.C. 26. Army

for Nov & Dec, 1864.

When attached to Hosp. Oct 20, 1864.

How employed Laundress

Present or absent Present

Remarks: Pay due from
Oct 31 to Nov 20
1864.

Book mark :

Thornston

(343)

Copyist.

PREVIOUS NUMBER

1908/a

1909

Wilson Frank

Co B, 8 U.S. Col'd H. Art'y.

Private

Private

CARD NUMBERS.

1	5470030	26
2	5470173	27
3	5470314	28
4	5470452	29
5	5471339	30
6	9121500	31
7	40744948	32
8		33
9		34
10		35
11		36
12		37
13		38
14		39
15		40
16		41
17		42
18		43
19		44
20		45
21		46
22		47
23		48
24		49
25		50

Book Mark:

See also

A | 8 H. Art'y. | U.S.C.T.

Frank Wilson

....., Co. *B*, 8 Reg't U.S. Col'd H. Art'y.

Appears on

Company Descriptive Book

of the organization named above.

DESCRIPTION.

Age *19* years; height *5* feet *6* inches.

Complexion *Dark*

Eyes *Dark*; hair *Dark*

Where born *Crittenden Co., Ky*

Occupation *Farm*

ENLISTMENT.

When *Jan. 13*, 186*4*

Where *Paducah, Ky.*

By whom *Wm. E. Brown*; term *3* y'rs.

Remarks: *Died at Paducah, Ky., Dec. 15/64. Cause of death, C. Diph.*

Henderson

24

8 H. Art'y.

U.S.C.T.

Frank Wilson

Privt., Co. B, 8 Reg't U. S. Col'd H. Art'y.

Appears on

Company Muster Roll

for May & June, 1864.

Present or absent Present

Stoppage, \$ 100 for

Due Gov't, \$ 100 for

Valuation of horse, \$ 100

Valuation of horse equipments, \$ 100

Remarks:

Enrolled June 13/64
Dis. June 25 by at
Paducah Ky for 3 years

Book mark: W 1428 Ky

J. A. Boyd

(358)

Copyist.

W

S H. Art'y.

U.S.C.T.

Frank R. Wilson

Privt, Co. B, 8 Reg't U. S. Col'd H. Art'y.

Appears on

Company Muster Roll

for July ²¹ Aug. 1864.

Present or absent Present

Stoppage, \$ 100 for

Due Gov't, \$ 100 for

Valuation of horse, \$ 100

Valuation of horse equipments, \$ 100

Remarks:

Book mark:

J. A. Boyd

(358)

Copyist.

A *S.H. arty* **U.S.C.T**

Frank Wilson

Port, Co. D, 8 Reg't U. S. Col'd N. arty.

Appears on

Company Muster Roll

for *Sept. and Oct., 1864.*

Present or absent *Present*

Stoppage, \$ *100* for

Due Gov't, \$ *100* for

Valuation of horse, \$ *100*

Valuation of horse equipments, \$ *100*

Remarks:

.....
.....
.....
.....
.....
.....
.....
.....
.....
.....

Book mark:

J. A. Boyd

W

8 H. Art'y.

U.S.C.T.

Frank Wilson

Paris, Co. B, 8 Reg't U. S. Col'd H. Art'y.

Appears on

Company Muster Roll

for *Nov & Dec*, 186*4*.

Present or absent

Stoppage, \$ *100* for

Due Gov't, \$ *100* for

Valuation of horse, \$ *100*

Valuation of horse equipments, \$ *100*

Remarks: *Died in Regt Hospital
at Paducah Ky Dec 15
1864*

Book mark:

(358)

J. G. Reeves

Copyist.

W

8 H. Art'y.

U.S.C.T.

Frank Wilson

Priv, Co. D, 8 Reg't U. S. Col'd H. Art'y.

Appears on Returns as follows:

Dec 18 64. Dec 16 64
Pardoned by Genl
in Reg't Hosp.

Book mark:

Chas J. Stone

(546)

Copyist.

W | 8 H. Art'y. | U.S.C.T.

Frank Wilson
Co. 19, 8 Reg't U. S. Col'd H. Art'y.

Appears on Co. Muster-out Roll, dated
Victoria, Texas, Feb. 10, 1866.

Muster-out to date _____, 186 .

Last paid to Oct 31, 1864.

Clothing account:

Last settled _____, 186 ; drawn since \$ _____ 100

Due soldier \$ _____ 100; due U. S. \$ _____ 100

Am't for cloth'g in kind or money adv'd \$ _____ 100

Due U. S. for arms, equipments, &c., \$ _____ 100

Bounty paid \$ _____ 100; due \$ _____ 100

Remarks Entered service as recruit
Joined to go for duty June 13th 1864.
Died at Paducah, Ky. Dec. 15th 1864.
Cause of death, Epidemic Diarrhoea.
Final statements & inventory of
effects forwarded to A. G. O. Dec. 18th 1864.

Book mark: 598154.69-267.054

5251P14.78-251408. Ky.

Randall

(861)

Copyist.

JAN. 14

5471339

1891 *

(age 19 years)

Wilson, Frank
B, Co. B, 8 U.S.C.H.A.
Reg't

3 Enclosures.

Bed Cards	Descriptive Lists
Burial Records	Final Statements <input checked="" type="checkbox"/>
Certs. of Dis. for Discharge	Furloughs
C. M. Charges	Med. Des. Lists
Med. Certificates	Orders

Other papers relating to—

Admission to Hosp'l	Furlough
Casualty Sheet (Officer's)	Med. Examination
Confinement	Misc. Information <input checked="" type="checkbox"/>
Contracts	Pay or Clothing
Death or Effects <input checked="" type="checkbox"/>	Personal Reports
Desertions	Rank
Discharge from Hosp'l	Transfer to Hosp'l
Discharge from Service	Transfer to V. R. C.
Duty	Transportation
.....

ARTICLES OF WAR.

ART. 95. When any non-commissioned officer or soldier shall die, or be killed in the service of the United States, the then commanding officer of the troop or company shall, in the presence of two other commissioned officers, take an account of what effects he died possessed of, above his arms and accoutrements, and transmit the same to the office of the Department of War, which said effects are to be accounted for, and paid to the representatives of such deceased non-commissioned officer or soldier. And in case any of the officers, so authorized to take care of the effects of deceased officers and soldiers, should, before they have accounted to their representatives for the same, have occasion to leave the regiment or post, by preferment or otherwise, they shall, before they be permitted to quit the same, deposit in the hands of the commanding officer, or of the assistant military agent, all the effects of such deceased non-commissioned officers and soldiers, in order that the same may be secured for, and paid to, their respective representatives.

ARMY REGULATIONS—EDITION OF 1861.

DECEASED SOLDIERS.

Par. 152. Inventories of the effects of deceased non-commissioned officers and soldiers, required by the 95th Article of War, will be forwarded to the Adjutant General, by the commander of the company to which the deceased belonged, and a duplicate of the same to the colonel of the regiment. Final statements of pay, clothing, &c., will be sent with the inventories. When a soldier dies at a post or station absent from his company, it will be the duty of his immediate commander to furnish the required inventory, and, at the same time, to forward to the commanding officer of the company to which the soldier belonged, a report of his death, specifying the date, place, and cause; to what time he was last paid, and the money or other effects in his possession at the time of his decease; which report will be noted on the next muster-roll of the company to which the man belonged. Each inventory will be endorsed, "Inventory of the effects of _____, late of company (—) _____ regiment of _____, who died at _____, the _____ day of _____, 186—." If a legal representative receive the effects, it will be stated in the report. If the soldier leave no effects, the fact will be reported.

Par. 153. Should the effects of a deceased non-commissioned officer or soldier not be administered upon within a short period after his decease, they shall be disposed of by a Council of Administration, under the authority of the commanding officer of the post, and the proceeds deposited with the Paymaster, to the credit of the United States, until they shall be claimed by the legal representatives of the deceased.

Par. 154. In all such cases of sales by the Council of Administration, a statement in detail, or account of the proceeds, duly certified by the Council and commanding officer, accompanied by the Paymaster's receipt for the proceeds, will be forwarded by the commanding officer to the Adjutant General. The statement will be endorsed, "Report of the proceeds of the effects of _____, late of company (—) _____ regiment of _____, who died at _____, the _____ day of _____, 186—."

NOTE 1.—The effects in all cases, when called for, should be turned over to the legal representative, without further authority from the Adjutant General. When the effects are turned over to the relatives of the deceased before these inventories are sent to the Adjutant General, their receipts therefor should be attached to the inventories. In all other cases, one copy will be sent with a letter of transmittal direct to the Adjutant General, and a duplicate retained by the officer.

NOTE 2.—Particular care should be taken to take receipts in duplicate from the Paymaster for any funds turned over to him; one copy should be sent direct to the Adjutant General and one retained by the officer.

INVENTORY OF THE EFFECTS

OF

Late of Company B

Reg't of U. S. A. Heary

Volunteers, who died at Cashport, Ky.

on the 15th day of December 1864.



Inventory of the effects of Frank Wilson late
 a Private of Captain John W. Coffin Company B of
 the 8th Regiment of W. C. A. Healy Volunteers, who was enrolled as
 a Private at Paducah in the State of Kentucky on
 the 13th day of June 1864, and mustered into the service of the United
 States as a Private on the 25th day of June 1864, at Paducah Ky
 in Company B, 8th Regiment of W. C. A. Healy Volunteers, to serve Three
 years or during the war; he was born in Orinda Co in the State
 of Kentucky; he was 9 years of age, 3 feet 6 inches
 high, Dark complexion, Dark eyes, Dark hair, and by occupation, when enrolled,
 a Lumber; he died in Gov 46, at
Paducah Ky on the 13th day of December 1864, by
 reason of Chronic Diarrhea

INVENTORY.					
ARTICLES.	No.	ARTICLES.	No.	ARTICLES.	No.
Hats		Pairs trousers		Knapsacks	
Caps		Pairs flannel drawers			
Forage caps	1	Pairs cotton drawers			
Great coats		Flannel shirts			
Uniform coats		Cotton shirts			
Uniform jackets	1	Pairs boots	1		
Flannel sack coats		Pairs shoes			
Blouses		Pairs socks			
Stable frocks		Blankets <u>Wool</u>	1		
Fatigue overalls		Haversacks			
				MONEY.	
				Specie	\$
				Notes	\$

I CERTIFY, ON HONOR, that the above inventory comprises all the effects of Private
Frank Wilson, deceased, and that the effects are in the hands
 of Surg in charge of Hosp at Paducah
Kentucky to be disposed of by a Council of Administration.

(DUPLICATES.)

STATION: Paducah Ky

DATE: December 18th 1864

[A. G. O. No. 104.]

John W. Coffin
Comd'g the Company.

V
103 B

FINAL STATEMENT

OF

Frank Wilson

8th Reg't of U.S.C.A. Heavy

VOLUNTEERS.

Dec 15 1864

NOTE 1.—Two of these certificates (or duplicates) are to be given to each volunteer soldier who may be discharged previously to the discharge of his company, that he may at once receive from the Paymaster the pay, &c., due him, and the captain or other officer commanding the company will certify to the act of the delivery of the duplicate certificates; on these certificates the Soldier is "entitled to" his discharge, and should also present his discharge to the Paymaster to have the payment endorsed on it. The discharge is to be given back to the Soldier by the Paymaster; the latter only retaining as his voucher the duplicate certificates.

NOTE 2.—If the Soldier is entitled to pay for the use of his horse, the Company Commander will certify to that fact, and also to the time he has pay due for having been so mounted on his own horse.

NOTE 3.—Amounts due the Sutler and Laundress must be entered on the Muster Roll on which the death, desertion, &c., is reported, as well as on the final statement, otherwise the amount cannot be collected from the United States.

NOTE 4.—This blank will be used for deceased volunteers as well as others.

ADJUTANT GENERAL'S OFFICE.

Dec 28th 1864

Duplicate with Inventory sent 2d Auditor.



I certify, on honor, that Frank Wilson a Private of
 Captain J. W. Coffin Company (B) of the 8th Regiment of W. G. A. Hayes
VOLUNTEERS, of the State of _____, born in Orithelen Co, State
 of Kentucky, aged 19 years; 5 feet 6 inches high; Dark complexion,
Dark eyes, Dark hair, and by occupation a Labourer, having joined the company on
 its original organization at Paducah Ky, and enrolled in it at the muster into
 the service of the United States at Paducah Ky, on the 13th day
 of June, 1864, (or was mustered in service as a recruit, by Lieut. J. D.
W. Luer, at Paducah Ky, on the 25 day of June
 1864, to serve in the Regiment.) for the term of Three years
 and having served **HONESTLY** and **FAITHFULLY** with his Company in 8th Reg. W. G. A. Hayes
 to the present date, is now entitled to a **DISCHARGE** by reason of Death cause of
Death Chronic Diarrhea died in Reg. Hospital

The said Frank Wilson was last paid by Paymaster
Mag. Jensen to include the 31st day of October, 1864, and has
 pay due him from that time to the present date; he is entitled to pay and subsistence for
TRAVELING to place of enrollment and whatever other allowances are authorized to volunteer
 soldiers, or militia, so discharged. He has received \$ 37 85 dollars,
 advanced by the United States on account of **CLOTHING**. clothing account never settled

There is to be stopped from him, on account of the State of _____, or other
 authorities for **CLOTHING**, &c., received on entering service, _____ dollars; also,
 for expenses of **SUBSISTENCE** for **TRAVELING** from place of enrollment to the place of rendezvous,
 amounting to _____ dollars: and on account of the United States for **EXTRA**
CLOTHING received in kind from _____ and for other
 stoppages, viz:

_____ amounting to _____ dollars;
 and he has been **SUBSISTED** for **TRAVELING** to his place of enrollment, up to the _____
 _____, 186 .

He is indebted to _____, **SUTLER**, _____ dollars.

He is indebted to _____, **LAUNDRESS**, _____ dollars.

Given in Duplicate, at Paducah Ky, this 18th day of December, 1864.

Wm O Brown
 per Lieut J. D. Hayes
 Commanding Company.

War Department,

ADJUTANT GENERAL'S OFFICE,

Washington, *March 6* 1867.

Respectfully returned to the Commission for the State of Kentucky, with the information that *Frank Wilson*

was enlisted at *Paducah Ky.* June 13, 1864, and was

mustered in as *Private Co. "B," 8th*

U.S. Colored Troops June 25, 1864,

S. F. Russell

W. H. R.

Asst. Adj't General.

No. _____

APPLICATION OF

W. H.

Wilson & Co.

OF

Leitchfield Ky.

FOR COMPENSATION FOR SLAVE,

Named *Frank Wilson*

Enlisted *June 13th* 1864,

In *Com. B,* 8th Regiment,

U. S. COLORED TROOPS.

Received *Jan'y 28th* 1867.

Compensation Awarded

_____, 186__

Dollars.

President of Board of Claims.

Claimant's Attorney,

Robt. H. Hughes

Marion Ky.

Claimant's Post-office Address,

Marion

Greentown Co. Ky.

No.

CLAIM OF

FOR THE COMPENSATION OF SLAVE NAMED

We W. F. Wilson R. W. Wilson and Mary E. Armstrong (widow)
loyal citizens and residents of

County of Crittenden State of Kentucky, hereby claim compensation, under
the provisions of Section 21, act approved February 21, 1861, and section 2, act approved July, 28,
1866, for ~~our~~ slave Frank Wilson, ^(sometimes called Frank Wilson) enlisted June 13th

1864, at Paducah Ky by W. E. Brown
in the 8th (Heavy Artillery) regiment U. S. Colored Troops, Co. B; certificate of
which enlistment, and a descriptive list, as required, accompany this application. That ~~we~~ did not ac-
quire said slave subsequent to said enlistment, but had a valid title to him at the date of said enlist-
ment, and previous thereto: ~~we~~ having acquired ~~our~~ title to him and ~~our~~ ownership over him as fol-
lows, to-wit: By inheritance from our ~~decd~~ father James W.

Wilson who died April 23rd 1865 and who was at the
time of the enlistment & long before the owner of said Frank
Wilson and we the sd W. F. Wilson R. W. Wilson and
Mary E. Armstrong are the children and only heirs at
law of the said James W. Wilson ~~decd~~ and that ~~decd~~ was
actively loyal to date of his death

In proof of ~~our~~ loyalty to the Constitution and Government of the United States, ~~we~~ present the ac-
companying oath, which ~~we~~ have taken, signed and acknowledged; to be filed with this application, in
accordance with requirement of General Orders, No. 329, 1863, War Department, Adjutant General's
Office.

W. F. Wilson
R. W. Wilson
M. E. Armstrong

January 16th 1867

OATH OF ALLEGIANCE.

We W. F. Wilson R. W. Wilson & Mary E. Armstrong the owners and Claimants do solemnly swear that
the foregoing claim is a just and true claim due to ~~us~~ as masters and owners of the said slave, and that
the facts alleged in said claim in respect to the draft or enlistment (as the case may be) of said slave
into the Military service of the United States are true. And ~~we~~ do further swear that ~~we~~ have never
joined, or been concerned in any insurrection or rebellion; that ~~we~~ have never borne arms against the
United States; that ~~we~~ have never given any aid, countenance, counsel or encouragement to any person
or persons engaged, or whom ~~we~~ had reason to believe were about to engage, in insurrection, rebellion
or armed hostility against the United States; that ~~we~~ have neither sought, nor accepted, nor attempted
to exercise the functions of any office, civil or military, nor to perform any service whatever, under
any authority or pretended authority in hostility to the United States; that ~~we~~ have not yielded a vol-
untary support to any insurrection, rebellion or pretended government, authority, power or constitution
within the United States hostile thereto. And ~~we~~ do further swear that, to the best of ~~our~~ knowledge
and ability ~~we~~ have supported and defended, and will continue to support and defend, the United
States against all enemies, foreign and domestic; and that ~~we~~ have supported, defended and obeyed, and
will continue to support, defend and obey, the Constitution and laws of the United States; that ~~we~~ will
bear true faith and allegiance to the same; and that ~~we~~ take this oath freely, without any mental reserva-
tion or purpose of evasion: So help ~~us~~ God.

W. F. Wilson
R. W. Wilson
M. E. Armstrong

Sworn to and subscribed before me, at Marion Ky }
this 16th day of January 1867 }
J. W. Blue Notary Public
for Crittenden County Ky



PROOF OF OWNERSHIP.

STATE OF KENTUCKY,

} SS.

COUNTY OF

We and each of lawful age, and resident citizens of the State and County aforesaid, do certify that

James W Wilson died *late June* of the State and County aforesaid, was on the *13th* day of *June* 186*4*, ^{*7 for years before*} the lawful owner of the slave named *Asaiah Wilson*; referred to and described in the foregoing claim for compensation. *that James W Wilson is dead & W F Wilson B W Wilson and Mary B Armstrong are the children and only heirs at law of sd dead*

*W. J. Wilson
T. L. Dean*

Sworn to and subscribed before me a *Notary Public* for the County of *Kentucky*, State of Kentucky, this the *16th* day of *January* 186*7*.

5 CENT STAMP

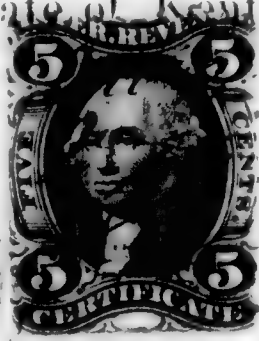

*J. W. Blue Notary Public
for Crittenden County Ky*

PROOF OF LOYALTY.

STATE OF KENTUCKY,

} SS.

COUNTY OF

We and loyal men and each of lawful age, and resident citizens of the of

in the State and County aforesaid, upon our oaths declare that we have known *James W Wilson dead and W F Wilson B W Wilson & Mary B Armstrong* a resident of the State and County aforesaid, since the 4th day of March, 1861, and know that he ~~has~~ ^{*they have*} firmly and faithfully maintained ~~his or her~~ ^{*their*} adherence and allegiance to the Government of the United States, by defending its cause against the Government and forces of the so-called Confederate States of America, in all suitable and practicable ways, and according to ~~his or her~~ ^{*their*} ability and opportunity.

*D. N. Stinson
J. W. Blue*

Sworn to and subscribed before me a *Notary Public* for the county of *Crittenden*, State of Kentucky, this the *16th* day of *January* 186*7*.

5 CENT STAMP



*J. W. Blue Notary Public
for Crittenden County Ky*

POWER OF ATTORNEY.

own My Post-Office address is *Meason* County of *Crittenden* State of Kentucky, and I hereby direct that all communications to me, touching this claim, be sent under cover to *Claimants or either of them*, who is hereby appointed and constituted my true and lawful attorney, to prosecute this claim for me, and who is hereby authorized and empowered to receive and receipt for any award, order, draft, certificate, voucher, warrant, papers or money that may be issued in the adjustment of this claim, or the payment thereof, the same as I might or could do in person were I present and acting for myself, and to file any additional evidence or papers that may be required in the prosecution of this claim.

[WITNESS.]

The owner signs here. }

Two witnesses to owner's signature sign here. }

50 CENT STAMP

Headquarters Kentucky Volunteers,

Adjutant-General's Office,

Frankfort, Dec 31, 1866.

I hereby certify, that it appears from the U. S. Muster-
Rolls on file in this Office, that Frank Wilson
was enrolled on the 13 day of June, 1864, at
Paducah Ky, by W. C. Brown
and mustered into the U. S. service on the 25 day of June,
1864, at Paducah Ky, by S. McIver
to serve three years. Said Frank Wilson
is described as follows: Age, 19 years; eyes, _____; hair, _____,
complexion, _____, height, _____ feet _____ inches. It further
appears from said Rolls, that Frank Wilson, owed service
to James Wilson, was credited to Crittenden
County, Ky., and was assigned to Co. B, 8 Regiment
U. S. C. Army Heavy

In Testimony Whereof, I have hereunto set my
hand, and affixed my Official Seal, this
31 day of Dec, 1866.

D. Lindsay
Adjutant General of Kentucky.



D. G. S. R. B. 8 Army

1910
Wilson George

Col., 8 U.S. Col'd H. Art'y.

Private Private

CARD NUMBERS.

1	5467090	26
2	5467059	27
3	5471706	28
4	5471855	29
5	5472006	30
6	5472142	31
7	5472274	32
8	5472399	33
9	5472511	34
10	5472616	35
11	5472720	36
12	5472816	37
13	9121682	38
14		39
15		40
16		41
17		42
18		43
19		44
20		45
21		46
22		47
23		48
24		49
25		50

Book Mark: _____

See also _____

W

8 H. Art'y. U.S.C.T.

George Wilson

b, Co. *b*, 8 Reg't U.S. Col'd H. Art'y.

Appears on

Company Descriptive Book

of the organization named above.

DESCRIPTION.

Age *18* years; height *5* feet *1/2* inches.

Complexion *Blk*

Eyes *Blk*; hair *Blk*

Where born *La.*

Occupation *Farmer*

ENLISTMENT.

When *Aug. 15*, 1864.

Where *Paducah, Ky.*

By whom *R. H. Hall*; term *3* y'rs.

Remarks:

Henderson

M | 8 H. Art'y. | U.S.C.T.

George Wilson

Appears with rank of *Priv* on

Muster and Descriptive Roll of a Detachment of U. S. Vols. forwarded

for the 8 Reg't U. S. Col'd H. Art'y. Roll dated

Paducah, Ky., N.Y. Aug. 31, 1864.

Where born *La*

Age *18* y'rs; occupation *Farmer*

When enlisted *Aug. 15, 1864*

Where enlisted *Paducah Ky*

For what period enlisted *3* years.

Eyes *Black*; hair *Black*

Complexion *Black*; height *5 ft. 1 1/2 in.*

When mustered in *Aug. 15, 1864*

Where mustered in *Paducah*

Bounty paid \$ *100*; due \$ *100*

Where credited *Graves Co., Dist. of Ky.*

Company to which assigned

Remarks :

Book mark :

Geo J Bell Jr
(339) Copyist.

W

8 H. Art'y.

U.S.C.T.

George Wilson

Appears with rank of Private on

Muster and Descriptive Roll of a Detachment of U. S. Vols. forwarded

for the 8 Reg't U. S. Col'd H. Art'y. Roll dated

Paducah, Ky., N. Y. Aug. 31, 1864

Where born Louisiana

Age 18 y'rs; occupation Farmer

When enlisted Aug 15, 186 .

Where enlisted Paducah, Ky.

For what period enlisted 3 years.

Eyes Black; hair Black

Complexion Black; height 5 ft. 1/2 in.

When mustered in Aug. 15, 186 .

Where mustered in Paducah, Ky.

Bounty paid \$ 100; due \$ 100

Where credited Lawrence, 1st D. Ky.

Company to which assigned B.

Remarks :

Book mark :

Calloway

(339)

Copyist.

W

8 H. Art'y.

U.S.C.T.

George Wilson

Private, Co. C, 8 Reg't U. S. Col'd H. Art'y.

Appears on

Company Muster Roll

for *July & Aug*, 1864.

Present or absent *Present*

Stoppage, \$ 100 for

Due Gov't, \$ 100 for

Valuation of horse, \$ 100

Valuation of horse equipments, \$ 100

Remarks:

Book mark:

E H Lipscomb
Copyist.

(358)

N

8 H. Art'y.

U.S.C.T.

George Wilson

Private, Co. C, 8 Reg't U. S. Col'd H. Art'y.

Appears on

Company Muster Roll

for *Nov. & Dec.*, 1864.

Present or absent *Present.*

Stoppage, \$ *100* for

Due Gov't, \$ *100* for

Valuation of horse, \$ *100*

Valuation of horse equipments, \$ *100*

Remarks:

Book mark:

O. J. Markle,
Copyist.

A

8 H. Art'y.

U.S.C.T.

George Wilson

Private, Co. C, 8 Reg't U. S. Col'd H. Art'y.

Appears on

Company Muster Roll

for *Jan. & Feb.*, 1865.

Present or absent *Present.*

Stoppage, \$ *100* for

Due Gov't, \$ *100* for

Valuation of horse, \$ *100*

Valuation of horse equipments, \$ *100*

Remarks:

Book mark:

C. J. Markle,

(358)

Copyist.

George Wilson

Private, Co. C, 8 Reg't U. S. Col'd H. Art'y.

Appears on

Company Muster Roll

for *March & April*, 186 *5*.

Present or absent *Present*.

Stoppage, \$ *100* for

Due Gov't, \$ *100* for

Valuation of horse, \$ *100*

Valuation of horse equipments, \$ *100*

Remarks:

Book mark : -----

O. S. Markle

H

8 H. Art'y.

U.S.C.T.

George Millson

Private, Co. C, 8 Reg't U. S. Col'd H. Art'y.

Appears on

Company Muster Roll

for *May + June*, 1865.

Present or absent *Present.*

Stoppage, \$ 100 for

Due Gov't, \$ 100 for

Valuation of horse, \$ 100

Valuation of horse equipments, \$ 100

Remarks:

Book mark:

O. J. Markle

(358)

Copyist.

W | **S H. Art'y.** | **U.S.C.T.**

George Willson
Cot, Co. C, 8 Reg't U. S. Col'd H. Art'y.

Appears on

Company Muster Roll

for *July and Aug*, 186*5*.

Present or absent *Present*

Stoppage, \$ *100* for

Due Gov't, \$ *100* for

Valuation of horse, \$ *100*

Valuation of horse equipments, \$ *100*

Remarks:

Book mark: -----

W. McAlister

(358)

Copyist.

W | 8 H. Art'y. | U.S.C.T.

George Wilson

Pat, Co. C, 8 Reg't U. S. Col'd H. Art'y.

Appears on

Company Muster Roll

for *Sept + Oct*, 1865.

Present or absent *Present*

Stoppage, \$ 100 for

Due Gov't, \$ 100 for

Valuation of horse, \$ 100

Valuation of horse equipments, \$ 100

Remarks:

Book mark:

G. M. Johnson

(358)

Copyist.

W

8 H. Art'y.

U.S.C.T.

George Wilson

Prk, Co. C, 8 Reg't U. S. Col'd H. Art'y.

Appears on

Company Muster Roll

for *27th Dec*, 186 5.

Present or absent *Present*

Stoppage, \$ *100* for

Due Gov't, \$ *100* for

Valuation of horse, \$ *100*

Valuation of horse equipments, \$ *100*

Remarks:

Book mark:

G. Wilson

W | 8 H. Art'y. | U.S.C.T.

George Wilson
Pot., Co. *C*, 8 Reg't U. S. Col'd H. Art'y.

Appears on Co. Muster-out Roll, dated
Victoria Texas Feb 10, 1866.

Muster-out to date *Feb 16*, 1866.

Last paid to *Aug 31*, 1865.

Clothing account:

Last settled....., 186 ; drawn since \$..... 100

Due soldier \$ *4 86* 100; due U. S. \$..... 100

Am't for cloth'g in kind or money adv'd \$..... 100

Due U. S. for arms, equipments, &c., \$..... 100

Bounty paid \$ *none* 100; due \$ *100* 100

Remarks: *Entered service as Re-
cruit joined Co for duty Aug
15, 1864. Enrolled & subject
to draft in 1st Cu Dist of
Ky at time of enlistment*

Book mark: *v 239 P 225 76*

W M Madson

Wilson, George

Co.

8

Reg't

A S C H A

Enclosures.

Bed Cards	Final Statements
Burial Records	Furloughs or L. of A.
Certs. of Dis. for Discharge	Med. Certificates
C. M. Charges	Med. Des. Lists
Descriptive Lists	Orders
Discharge Certificates	Pris. of War Record
Enlistment Papers	Resignations

Other papers relating to—

Admission to Hosp'l	Furlough or L. of A.
Casualty Sheet	Med. Examination
Confinement	Misc. Information
Contracts	Pay or Clothing
Death or Effects	Personal Reports
Desertion	Rank
Discharge from Hosp'l	Transfer to Hosp'l
Discharge from Service	Transfer to V. R. C.
Duty	Transportation

254

N. Hundred seventeen
Wilson George

Volunteered at Paducah Ky
Aug 15th 1864

By R. H. Hall
Capt & Prov. Marshal Dist of Ky

8th U. S. C. Art. Heavy

Consent of Parent or Guardian in case of a Minor, if a Free Man, or in the case of a Slave, of the Person to whom he owes Service:

of United States colored troops. They will be made out in duplicate in all cases—one
General, and one to accompany the accounts of the officer who pays bounty, &c.
ster-in, must in all cases, precede payment of pay, bounty, pension, &c. A muster
ing officer, commissary, or assistant commissary of musters, as the case may be, will
ther of them is given to the disbursing officer.

George Wilson

UNITED STATES COLORED TROOPS ENLISTMENT.

STATE OF

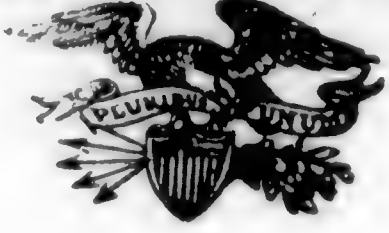

TOWN OF

Kentucky *Paducah*

I, *William George* born in
in the State of *La* aged *Eighteen* years
and by occupation a *Farmer* Do HEREBY ACKNOWLEDGE to have
volunteered this *Fifteenth* day of *August* 1864,
to serve as a **Soldier** in the **Army of the United States of America**, for
the period of **THREE YEARS**, unless sooner discharged by proper authority:
Do also agree to accept such bounty, pay, rations, and clothing, as are, or may be,
established by law for the U. S. colored troops.

And I, *George Wilson of Gravesled Ky*
do solemnly swear, that I will bear true faith and allegiance to the **United States
of America**, and that I will serve them honestly and faithfully against all their
enemies or opposers whomsoever; and that I will observe and obey the orders of
the President of the United States, and the orders of the officers appointed over
me, according to the Rules and Articles of War.

Sworn and subscribed to, at *Paducah Ky*
this *15th* day of *Aug* 1864, *George Wilson*

Before *R. H. Hall*
Capt & Pro Mar 1st Dist of Ky

I CERTIFY, ON HONOR, That I have carefully examined the above named Volunteer, agreeably to the
General Regulations of the Army, and that, in my opinion, he is free from all bodily defects and mental infirmity,
which would in any way disqualify him from performing the duties of a soldier.

M. H. Keida

EXAMINING SURGEON.

I CERTIFY, ON HONOR, That I have minutely inspected the Volunteer, *George Wilson*
previously to his enlistment, and that he was entirely sober when enlisted; that, to the best of my judgment and
belief, he is of lawful age; and that, in accepting him as duly qualified to perform the duties of an able-bodied
soldier, I have strictly observed the regulations which govern the recruiting service. This soldier has *dark*
eyes, *dark* hair, *dark* complexion, is *five* feet *four* inches high.

RECRUITING OFFICER OR AGENT.

Mustered into the United States service *15th* day of *Aug* 1864.

R. H. Hall
Capt & Pro Mar Mustering Officer.

Mustered into the service of the United States, for three years or during the war, from date of enlistment, in Company
1st Regiment of *Miss Ala* Volunteers, on the *15th* day of *Aug* 1864 at *Paducah Ky*
R. H. Hall
Capt & Pro Mar

NOTE 1.—This blank will be used for enlistments of United States colored troops. They will be made out in duplicate in all cases—one to accompany the recruiting return of the superintendent (not the recruiting officer) to the Adjutant General, and one to accompany the accounts of the officer who pays bounty, &c.

NOTE 2.—An enlistment holds to service. A muster-in, must in all cases, precede payment of pay, bounty, pension, &c. A muster-in roll, must in all cases, be filed in the Adjutant General's Office as evidence of muster-in. The mustering officer, commissary, or assistant commissary of musters, as the case may be, will counter-sign both enlistments as having mustered the soldier into the service of the United States before either of them is given to the disbursing officer.

DECLARATION OF RECRUIT.

I, George Wilson of Graves Co Ky desiring to volunteer as a soldier in the ARMY OF THE UNITED STATES, for the term of Three Years, DO DECLARE That I am Eighteen years and months of age; that I have never been discharged from the United States service on account of disability or by sentence of a court-martial, or by order before the expiration of a term of enlistment; and I know of no impediment to my serving honestly and faithfully as a soldier for three years.

GIVEN at Paducah Ky

the 15th day of August 1864

Witness: [Signature]

George Wilson

[Signature]

By [Signature]

Volunteered at Paducah Ky
Aug. 15th 1864

77-2-4

Consent of Parent or Guardian in case of a Minor, if a Free Man, or in the case of a Slave, of the Person to whom he owes Service:

I, Do CERTIFY, That I am the that the said is years of age; and I do freely give my CONSENT to his volunteering as a SOLDIER in the Army of the United States, for the period of THREE YEARS, under the conditions of the laws of the United States.

GIVEN at

the day of

Witness:

1911
Wilson George Thos.

Co A, 8 U.S. Col'd H. Art'y.

Private Sergeant

CARD NUMBERS.

1	5467441	26
2	5467377	27
3	5468640	28
4	5468655	29
5	5468811	30
6	5468961	31
7	5469105	32
8	5469242	33
9	5469376	34
10	5469502	35
11	5469618	36
12	9121346	37
13	9122887	38
14	33256895	39
15	40744349	40
16		41
17		42
18		43
19		44
20		45
21		46
22		47
23		48
24		49
25		50

Book Mark:

See also

W | 8 H. Art'y. U.S.C.T.

Gen. J. Wilson

....., Co. *A*, 8 Reg't U.S. Col'd H. Art'y.

Appears on

Company Descriptive Book
of the organization named above.

DESCRIPTION.

Age *20* years; height *5* feet *7* inches.

Complexion *Dark*

Eyes *Brown*; hair *Dark*

Where born *McCracken Co., Ky.*

Occupation *Boatman*

ENLISTMENT.

When *Oct. 13*, 1864

Where *Paducah, Ky.*

By whom *R. Schfield*; term *3* y'rs.

Remarks:

.....
.....
.....
.....
.....
.....

Henderson

21 | 8 H. Art'y. | U.S.C.T.

George F. Wilson
....., Co. *D*, 8 Reg't U.S. Col'd H. Art'y.

Appears on

Company Descriptive Book
of the organization named above.

DESCRIPTION.

Age *20* years; height *5* feet *7* inches.

Complexion *Black*

Eyes *Black*; hair *Black*

Where born *McCracken, Ky.*

Occupation *Boatman*

ENLISTMENT.

When *Oct. 13*, 1864.

Where *Paducah, Ky.*

By whom *Capt. Morgan*; term *3* y'rs.

Remarks:

* *Company "A"*

Corrected by Moyer

Keeper.

Geo. Thos. Wilson

Appears with rank of *Private* on

Muster and Descriptive Roll of a Detachment of U. S. Vols. forwarded

for the 8 Reg't U. S. Col'd H. Art'y. Roll dated *Paducah Ky.*, ~~Nov~~ *Oct. 31*, 1864.

Where born *McCracken Ky.*

Age *20* y'rs; occupation *Boatman*

When enlisted *Oct. 13*, 186 .

Where enlisted *Paducah, Ky.*

For what period enlisted *3* years.

Eyes *Black*; hair *Black*

Complexion *Black*; height *5* ft. *7* in.

When mustered in *Oct. 13*, 186 .

Where mustered in *Paducah,*

Bounty paid \$ *100*; due \$ *100*

Where credited *1st Co. Dist. 4 Ky.*
McCracken Co.

Company to which assigned

Remarks :

Book mark :

Daggett

M

8 H. Art'y.

U.S.C.T.

Geo. Tho. Wilson

Appears with rank of *Pr* on

Muster and Descriptive Roll of a Detachment of U. S. Vols. forwarded

for the 8 Reg't U. S. Col'd II. Art'y. Roll dated *Panama, Ky., N.Y. Oct 31, 1864.*

Where born *Marckens, Ky.*

Age *20* y'rs; occupation *Boatman*

When enlisted *Oct 13, 186*

Where enlisted *Panama, Ky.*

For what period enlisted *3* years.

Eyes *blk*; hair *blk*

Complexion *blk*; height *5* ft. *7* in.

When mustered in *Oct 13, 186*

Where mustered in *Panama*

Bounty paid \$ *100*; due \$ *100*

Where credited *Marckens, Long, Dist, Ky.*

Company to which assigned

Remarks:

Book mark:

Henry J. Copyist.

W

| 8 H. Art'y. | U.S.C.T.

George J. Wilson
Co. A, 8 Reg't U. S. Col'd H. Art'y.

Appears on

Company Muster Roll

for Sept. & Oct., 1864

Present or absent Present

Stoppage, \$ 100 for

Due Gov't, \$ 100 for

Valuation of horse, \$ 100

Valuation of horse equipments, \$ 100

Remarks:

Book mark:

C. B. Owen

W | 8 H. Art'y. | U.S.C.T.

George S. Wilson
Sergt, Co. A, 8 Reg't U. S. Col'd H. Art'y.

Appears on

Company Muster Roll

for Nov. & Dec., 1864.

Present or absent Present.

Stoppage, \$ 100 for

Due Gov't, \$ 100 for

Valuation of horse, \$ 100

Valuation of horse equipments, \$ 100

Remarks: Promoted to Sergt,
Nov. 21st / 64 per Co.
orders, No. 1, dated,
76th Irs. Co. "A" 8th U.S. C
A. H., Nov. 21st / 64.

Book mark:

C. R. Owen,

W | S H. Art'y. | U.S.C.T.

George J. Wilson
Serjt., Co. A, 8 Reg't U. S. Col'd H. Art'y.

Appears on

Company Muster Roll

for Jan. & Feb., 1865.

Present or absent Present

Stoppage, \$ 100 for

Due Gov't, \$ 100 for

Valuation of horse, \$ 100

Valuation of horse equipments, \$ 100

Remarks: Promoted from
Copli. to Serjt.
Nov. 21, 1864.

Book mark: _____

C. R. Allen

W | 8 H. Art'y. | U.S.C.T.

George I. Wilson
Sergt., Co. A, 8 Reg't U. S. Col'd H. Art'y.

Appears on

Company Muster Roll

for *March & Apr*, 1865.

Present or absent *Present*

Stoppage, \$ *100* for

Due Gov't, \$ *100* for

Valuation of horse, \$ *100*

Valuation of horse equipments, \$ *100*

Remarks: *Promoted from Corp to Sergt. Nov. 4, 1864,*

Book mark:

C. H. Owen

2

| S H. Art'y. | U.S.C.T.

George T. Wilson
Sergeant, Co. A, 8 Reg't U. S. Col'd H. Art'y.

Appears on

Company Muster Roll

for *May & June*, 1865.

Present or absent *Present*

Stoppage, \$ *100* for

Due Gov't, \$ *100* for

Valuation of horse, \$ *100*

Valuation of horse equipments, \$ *100*

Remarks: *Promoted
from Corp
Nov. 21, 1864.*

Book mark:

C. A. [Signature]

(358)

Copyist.

M 18 art W.C.T.
George T. Wilson
Sgt., Co. A, 8 Reg't W.C.A.

Appears on

Hospital Muster Roll

of U. S. A. Hospital, 1 Brig., 2 Div., 25 Army Corps,

for July & Aug, 1865.

Station Indianola Texas

Attached to hospital :

When....., 186 .

How employed.....

Last paid by Maj. Fenns
to Oct. 31, 1864.

Bounty paid \$ 100, due \$ 100

Present or absent Present

Remarks :

Book mark:

Dr. J. M. ...

(343)

Copyist.

21

| S H. Art'y. | U. S. C. T.

Geo. G. Wilson

Sept, Co. A, 8 Reg't U. S. Col'd H. Art'y.

Appears on

Company Muster Roll

for *July and Aug*, 1865.

Present or absent *present*

Stoppage, \$ *100* for

Due Gov't, \$ *100* for

Valuation of horse, \$ *100*

Valuation of horse equipments, \$ *100*

Remarks: *Promoted from Corp. No 21, 4th Dist. of Indiana, Tex. since July 5, 65*

Book mark:

W. S. Merrill

21

| 8 H. Art'y. | U.S.C.T.

Geo. J. Wilson

1st, Co. A, 8 Reg't U. S. Col'd H. Art'y.

Appears on

Company Muster Roll

for *Sept and Oct*, 186*6*.

Present or absent *Present*

Stoppage, \$ *100* for

Due Gov't, \$ *100* for

Valuation of horse, \$ *100*

Valuation of horse equipments, \$ *100*

Remarks:

Book mark: -----

W. H. Merrill

2/

| S H. Art'y. | U.S.C.T.

George S. Wilson

Supt, Co. A, 8 Reg't U. S. Col'd H. Art'y.

Appears on

Company Muster Roll

for *Nov and Dec*, 186*8*.

Present or absent *Present*

Stoppage, \$ *100* for

Due Gov't, \$ *100* for

Valuation of horse, \$ *100*

Valuation of horse equipments, \$ *100*

Remarks:

Book mark:

W. H. Merrill

W

8 H. Art'y.

U.S.C.T.

George G. Wilson

Supt, Co. A, 8 Reg't U. S. Col'd H. Art'y.

Appears on Returns as follows:

July & Aug 1865 absent
sick at Indianola & Co
since July 5. 1865.

Book mark:

W. B. Patterson

(546)

Copyist.

21

S H. Art'y.

U.S.C.T.

George H. ...

Sgt., Co. *...*, 8 Reg't U. S. Col'd H. Art'y.

Appears on **Co. Muster-out Roll**, dated

..., *...*, 186*6*.

Muster-out to date *...*, 186*6*.

Last paid to *...*, 186*6*.

Clothing account:

Last settled....., 186 ; drawn since \$..... 100

Due soldier \$..... ²⁵100; due U. S. \$..... 100

Am't for cloth'g in kind or money adv'd \$..... 100

Due U. S. for arms, equipments, &c., \$..... ¹⁰100

Bounty paid \$..... 100; due \$..... 100

Remarks: *...*
...
...
...

Book mark :

W. H. ...

Wilson, Geo. H.

....., Co., 8 Reg't U.S.C.A.

..... / **Enclosures.**

Bed Cards	Final Statements
Burial Records	Furloughs or L. of A.
Certs. of Dis. for Discharge	Med. Certificates
C. M. Charges	Med. Des. Lists
Descriptive Lists	Orders
Discharge Certificates	Pris. of War Record
Enlistment Papers	Resignations

Other papers relating to—

Admission to Hosp'l	Furlough or L. of A.
Casualty Sheet	Med. Examination
Confinement	Misc. Information
Contracts	Pay or Clothing
Death or Effects	Personal Reports
Desertion	Rank
Discharge from Hosp'l	Transfer to Hosp'l
Discharge from Service	Transfer to V. R. C.
Duty	Transportation

No. 239
of the 1st Artillery.

No. Sixty four

Wilson, George Thomas

Volunteered at Paducah, Ky.

October 13th. 1864

By Capt. John H. Morgan
Prov. Marshal 1st Dist. Ky.

Geo. Thomas Wilson
mark

Major C. F. ...
Clerk for Prov. Mar.

Consent of Parent or Guardian in case of a Minor, if a Free Man, or in the case of a
Slave, of the Person to whom he owes Service:

United States colored troops. They will be made out in duplicate in all cases—one to
general, and one to accompany the accounts of the officer who pays bounty, &c.
return; must in all cases, precede payment of pay, bounty, pension, &c. A muster-
roll officer, commissary, or assistant commissary of musters, as the case may be, will copy
of them is given to the disbursing officer.

UNITED STATES COLORED TROOPS ENLISTMENT.

STATE OF



Ascribed to

TOWN OF

Kentucky

*McCracken Co
Paducah*

I, *Wilson, George Thomas* born in *McCracken Co.*

in the State of *Kentucky* aged *Twenty* years

and by occupation a *Steamboat Hand* Do HEREBY ACKNOWLEDGE to have

volunteered this *Thirteenth* day of *October*, 1864,

to serve as a **Soldier** in the **Army of the United States of America**, for the period of **THREE YEARS**, unless sooner discharged by proper authority:

Do also agree to accept such bounty, pay, rations, and clothing, as are, or may be, established by law for the U. S. colored troops.

And I, *Wilson, George Thomas, of McCracken Co Ky.*

do solemnly swear, that I will bear true faith and allegiance to the **United States of America**, and that I will serve them honestly and faithfully against all their enemies or opposers whomsoever; and that I will observe and obey the orders of the President of the United States, and the orders of the officers appointed over me, according to the Rules and Articles of War.

Sworn and subscribed to, at *Paducah, Ky.*

this *13th* day of *October*, 1864,

Before *Capt. John H. Morgan*

Capt. Prov. Mar. Dist of Ky.

Geo. Thos. Wilson
his
mark

I CERTIFY, ON HONOR, That I have carefully examined the above named Volunteer, agreeably to the General Regulations of the Army, and that, in my opinion, he is free from all bodily defects and mental infirmity, which would in any way disqualify him from performing the duties of a soldier.

W. H. Kidd

EXAMINING SURGEON.

I CERTIFY, ON HONOR, That I have minutely inspected the Volunteer, *Geo. Thos. Wilson* previously to his enlistment, and that he was entirely sober when enlisted; that, to the best of my judgment and belief, he is of lawful age; and that, in accepting him as duly qualified to perform the duties of an able-bodied soldier, I have strictly observed the regulations which govern the recruiting service. This soldier has..... eyes, hair, complexion, is *Five* feet *seven* inches high.

RECRUITING OFFICER OR AGENT.

Mustered into the United States service *13th* day of *October*, 1864.

John H. Morgan
Capt. & Prov. Mar. Dist of Ky.
Mustering Officer.

1st Dist. of Ky.

Mustered into the service of the United States, for three years or during the war, from date of enlistment, in Company
5th Regiment of *US Colored Art.* Volunteers, on the *13th* day of *October*, 1864, at *Paducah, Ky.*

Capt. J. H. Morgan

Capt. & Prov. Marshal

1st Dist. of Ky.

NOTE 1.—This blank will be used for enlistments of United States colored troops. They will be made out in duplicate in all cases—one to accompany the recruiting return of the superintendent (not the recruiting officer) to the Adjutant General, and one to accompany the accounts of the officer who pays bounty, &c.

NOTE 2.—An enlistment holds to service. A muster-in, must in all cases, precede payment of pay, bounty, pension, &c. A muster-in roll, must in all cases, be filed in the Adjutant General's Office as evidence of muster-in. The mustering officer, commissary, or assistant commissary of musters, as the case may be, will counter-sign both enlistments as having mustered the soldier into the service of the United States before either of them is given to the disbursing officer.

DECLARATION OF RECRUIT.

I, Wilson, George Thomas, of MCracken Co. Ky., desiring to volunteer as a soldier in the ARMY OF THE UNITED STATES, for the term of Three Years, DO DECLARE That I am Twenty years and months of age; that I have never been discharged from the United States service on account of disability or by sentence of a court-martial, or by order before the expiration of a term of enlistment; and I know of no impediment to my serving honestly and faithfully as a soldier for three years.

GIVEN at Paducah, MCracken Co. Ky.
 the 19th day of October, 1864

Witness:
Geo. P. Howard,
 Clerk for Prov. Mar.

his
Geo. Thos. Wilson
 mark

Volunteered at Paducah, Ky.
October 19th 1864
 By Capt. John S. Morgan
 Prov. Marshal 1st Dist. Ky.

No. 514 year
Wilson, George Thomas
McCracken Co. Ky.
1864

Consent of Parent or Guardian in case of a Minor, if a Free Man, or in the case of a Slave, of the Person to whom he owes Service:

I, Do CERTIFY, That I am
 the
 that the said is years of age; and I
 do freely give my CONSENT to his volunteering as a SOLDIER in the Army of the United States, for the period of
 THREE YEARS, under the conditions of the laws of the United States.

GIVEN at
 the day of

Witness:

 (A. G. O. No. 74 & 76.)

1912

Wilson Jack

Co L, 8 U.S. Col'd H. Art'y.

Private - Private

CARD NUMBERS.

1	5467558	26
2	5482625	27
3	5482822	28
4	5482910	29
5	5482994	30
6	5483087	31
7	5483144	32
8	5467684	33
9	5483225	34
10	9122892	35
11	40744958	36
12		37
13		38
14		39
15		40
16		41
17		42
18		43
19		44
20		45
21		46
22		47
23		48
24		49
25		50

Book Mark: _____

See also _____

4 | 8 H. Art'y. | U.S.C.T.

Jack Wilson

Co. L, 8 Reg't U.S. Col'd H. Art'y.

Appears on

Company Descriptive Book
of the organization named above.

DESCRIPTION.

Age 18 years; height 5 feet $7\frac{1}{2}$ inches.

Complexion *Blk*

Eyes *Blk*; hair *Blk*

Where born *Mississippi*

Occupation *Laborer*

ENLISTMENT.

When *Jan'y 9*, 1865.

Where *Paducah, Ky.*

By whom *Capt. Morgan*; term *3* y'rs.

Remarks: *Reduced to the ranks
March 30th, 1865. Promoted
Sergt. to rank from Feb.
10th 1865. Discharged at
Victoria, B.C. Jan. 9th 1865 -
expiration of service.
Substitute for S.C. Wilkins
of 1st Dist. Ky.*

(383g)

Keefe

Copyist.

N. | S | U.S.C.T.

Jack Wilson

Appears with rank of Private on

Muster and Descriptive Roll of a Detachment of Substitutes forwarded

for the 8 Reg't U. S. Col'd Arty Roll dated

Paducah Ky, Jan. 9, 1865.

Where born Mississippi

Age 18 y'rs; occupation Laborer

When enlisted Jan 9, 1865.

Where enlisted Paducah Ky

For what period enlisted 1 years.

Eyes black; hair black

Complexion black; height 5 ft. 7 1/2 in.

When mustered in Jan. 9, 1865.

Where mustered in Paducah Ky.

Bounty paid \$ 100; due \$ 100

Where credited

Company to which assigned

Remarks: Substitute (sold) in
lieu of B. C. McKinnis, a drafted
man of Hickman Co. Dist. Ky.

Book mark:

Lopez.

21. | 8 H. Art'y. | U.S.C.T.

Jack Wilson
Sgt., Co. L, 8 Reg't U. S. Col'd Heavy Art'y.

Appears on

Company Muster Roll

for *Oct. 31, 1864 to Feb. 28, 1865.*

Present or absent *Present.*

Stoppage, \$ *100* for

Due Gov't, \$ *100* for

Valuation of horse, \$ *100*

Valuation of horse equipments, \$ *100*

Remarks: *Appointed Serg't
to rank as such
from the 1st of Feb'y
1865.*

Book mark: _____

Brooks.

H.

8 H. Art'y.

U.S.C.T.

Jack Wilson,
Private, Co. L, 8 Reg't U. S. Col'd Heavy Art'y.

Appears on

Company Muster Roll

for *Mar. & Apr.*, 1865.

Present or absent *Present.*

Stoppage, \$ 100 for

Due Gov't, \$ 100 for

Valuation of horse, \$ 100

Valuation of horse equipments, \$ 100

Remarks: *Pay due as Sergeant from 1, 1865 to Mar. 29, 1865.*

Book mark: _____

(358)

E. H. Woodford,
Copyist.

W.

8 H. Art'y.

U.S.C.T.

Jack Wilson,
Private, Co. L, 8 Reg't U. S. Col'd Heavy Art'y.

Appears on

Company Muster Roll

for May & June, 1865.

Present or absent Present.

Stoppage, \$ 100 for

Due Gov't, \$ 100 for

Valuation of horse, \$ 100

Valuation of horse equipments, \$ 100

Remarks:

Book mark: _____

(358)

E. H. Woodford,
Copyist.

W.

S H. Art'y.

U.S.C.T.

Jack Wilson,
Private, Co. L, 8 Reg't U. S. Col'd Heavy Art'y.

Appears on

Company Muster Roll

for *July & Aug.*, 1865.

Present or absent *Present*

Stoppage, \$ 100 for

Due Gov't, \$ 100 for

Valuation of horse, \$ 100

Valuation of horse equipments, \$ 100

Remarks: *Due pay as Sergeant
from Feby. 10 to Mar 30, 1865.*

Book mark: _____

E. H. Woodford
Copyist.

W

8 H. Art'y. U.S.C.T.

Jack Wilson

W, Co. L, 8 Reg't U. S. Col'd Heavy Art'y.

Appears on

Company Muster Roll

for *Sept & Oct*, 1865.

Present or absent *Present*

Stoppage, \$ *100* for

Due Gov't, \$ *100* for

Valuation of horse, \$ *100*

Valuation of horse equipments, \$ *100*

Remarks: *Due U.S. for over (1)
Knapsack & over (1) Cartrou \$3 75.*

Book mark:

J. L. Borris

(358)

Copyist.

W

S H. Art'y.

U.S.C.T.

Jack Wilson

Pvt., Co. L, 8 Reg't U. S. Col'd Heavy Art'y.

Appears on

Company Muster Roll

for Nov & Dec, 1865.

Present or absent Present

Stoppage, \$ 100 for

Due Gov't, \$ 100 for

Valuation of horse, \$ 100

Valuation of horse equipments, \$ 100

Remarks: Due U.S. one days pay on account of error in Muster & Pay Rolls of Aug 31. 1865.

Due U.S. for one Knapsack & one (1) Canteen \$ 3.75.

Book mark:

J. L. Norris

(358)

Copyist.

W | 8 A. Arty | U.S.C.T.

Jack Wilson
Priv., Co. L., 8 Reg't U. S. Col'd A. Arty.

Appears on an

Individual Muster-out Roll

of the organization named above. Roll dated

Victoria, Texas, Jan. 9., 1866.

Muster-out to date Jan. 9., 1866.

Last paid to Aug. 31., 1865.

Clothing account:

Last settled , 186 ; drawn since \$ 100

Due soldier \$ 6 ²⁷/₁₀₀; due U. S. \$ 100

Am't for cloth'g in kind or money adv'd \$ 100

Due U. S. for arms, equipments, &c., \$ 3 ⁷⁵/₁₀₀

Bounty paid \$ 100 due \$ 100

Remarks: Entered the service as set forth in this roll. Mustered out by reason of expiration of service, substitute for B. C. Wilkins 1 Dist. of Ky. Entitled to traveling, rations & subsistence.

Book mark:

W Beck
Copyist.

JAN. 14

5467664

1891

*to place of enlistment,
Due U.S. for one knapsack
and straps, and one canteen
and straps. carelessly lost,*

W | 8 H. Art'y. | U.S.C.T.

Jack Wilson
Pr, Co. *L*, 8 Reg't U. S. Col'd H. Art'y.

Appears on Returns as follows:

Army 1866. Jan'y 9/66.
Victoria Bx
Discharged by reason
of expiration of service

Book mark: _____

Wm. Dutton

(546)

Copyist.

W

S H. Art'y.

U.S.C.T.

Jack Wilson

Priv, Co. *L*, 8 Reg't U. S. Col'd H. Art'y.

Appears on **Co. Muster-out Roll**, dated *Victoria, Texas Feb 10*, 1866.

Muster-out to date _____, 186 .

Last paid to *Aug 31*, 1865.

Clothing account:

Last settled _____, 186 ; drawn since \$ _____ 100

Due soldier \$ _____ 100; due U. S. \$ _____ 100

Am't for cloth'g in kind or money adv'd \$ _____ 100

Due U. S. for arms, equipments, &c., \$ _____ 100

Bounty paid \$ _____ 100; due \$ _____ 100

Remarks *Entered service as herein shown,
joined for duty Jan 9/65. Mustered
Out at Victoria, Texas Jan 9/65
by reason of expiration of service.
All accounts settled.*

Book mark : _____

J. L. Borris

(361)

Copyist.

1913

Wilson James
Co *B*, 8 U.S. Col'd H. Art'y.

Private | *Private*

CARD NUMBERS.

1	5479817	26
2	5479956	27
3	5480100	28
4	5480232	29
5	5480363	30
6	5480483	31
7	5480598	32
8	5480706	33
9	5480811	34
10	5480913	35
11	5481013	36
12	9122620	37
13	40744946	38
14		39
15		40
16		41
17		42
18		43
19		44
20		45
21		46
22		47
23		48
24		49
25		50

Book Mark: _____

See also _____

M | 8 H. Art'y. | U.S.C.T.

James Wilson
....., Co. *A*, 8 Reg't U.S. Col'd H. Art'y.

Appears on

Company Descriptive Book
of the organization named above.

DESCRIPTION.

Age *37* years; height *6* feet *1/2* inches.

Complexion *black*

Eyes *black* ; hair *black*

Where born *Caldwell Co., Ky.*

Occupation *Farmer*

ENLISTMENT.

When *June 5*, 1864.

Where *Paducah, Ky.*

By whom *J. H. Johnson*; term *3* y'rs.

Remarks:

.....
.....
.....
.....
.....
.....
.....
.....
.....
.....

Keefe

W

8 H. Art'y.

U.S.C.T.

James Wilson
Priv., Co. I, 8 Reg't U. S. Col'd H. Art'y.

Age _____ years.

Appears on

Company Muster Roll*

for *May 5 June*, 1864.

Joined for duty and enrolled:

When *June 25*, 1864.

Where *Paducah, Ky*

Period *3* years.

Mustered in:

When *June 25*, 1864.

Where *Paducah, Ky*

Present or absent *Present*

Stoppage, \$ *100* for _____

Due Gov't \$ *100* for _____

Valuation of horse, \$ *100*

Valuation of horse equipments, \$ *100*

Remarks: _____

*First current roll. No muster-in roll of this company on file.

Book mark: _____

E. L. Thornton

(358d)

Copist.

James Wilson
Quin, Co. I, 8 Reg't U. S. Col'd H. Art'y.

Appears on

Company Muster Roll

for *July & Aug.*, 1864.

Present or absent *Present*

Stoppage, \$ 100 for

Due Gov't, \$ 100 for

Valuation of horse, \$ 100

Valuation of horse equipments, \$ 100

Remarks: _____

Book mark: _____

E. Thornton

W

8 H. Art'y.

U.S.C.T.

James Wilson
Co. I, Co. I, 8 Reg't U. S. Col'd H. Art'y.

Appears on

Company Muster Roll

for *Sept & Oct*, 1864.

Present or absent *Present*

Stoppage, \$ 100 for

Due Gov't, \$ 100 for

Valuation of horse, \$ 100

Valuation of horse equipments, \$ 100

Remarks:

Book mark:

J. H. [unclear]

11
11

James Wilson

Or, Co. I, 8 Reg't U. S. Col'd H. Art'y.

Appears on

Company Muster Roll

for *Jan 9 Feb*, 186 *5*

Present or absent *Present*

Stoppage, \$ *100* for

Due Gov't, \$ *100* for

Valuation of horse, \$ *100*

Valuation of horse equipments, \$ *100*

Remarks:

Book mark:

L. B. Sawyer
Copyist.

17

8 H. Art'y. | U.S.C.T.

James Wilson

Co. I, 8 Reg't U. S. Col'd H. Art'y.

Appears on

Company Muster Roll

for *Month of April*, 1865.

Present or absent *Present*

Stoppage, \$ *100* for

Due Gov't, \$ *100* for

Valuation of horse, \$ *100*

Valuation of horse equipments, \$ *100*

Remarks:

Book mark:

L. B. Sayre

(358)

Copyist.

James Wilson

Co. I, 8 Reg't U. S. Col'd H. Art'y.

Appears on

Company Muster Roll

for May & June, 1865.

Present or absent Present

Stoppage, \$ 100 for

Due Gov't, \$ 100 for

Valuation of horse, \$ 100

Valuation of horse equipments, \$ 100

Remarks:

Book mark:

H B Sawyer

James Wilson

Qu., Co. I, 8 Reg't U. S. Col'd H. Art'y.

Appears on

Company Muster Roll

for *July & August*, 186*5*.

Present or absent *Present*

Stoppage, \$ 100 for

Due Gov't, \$ 100 for

Valuation of horse, \$ 100

Valuation of horse equipments, \$ 100

Remarks:
.....
.....
.....
.....
.....
.....
.....
.....
.....
.....

Book mark:

L. B. Sayre
Copyist.

72

8 H. Art'y. | U.S.C.T.

James Wilson

Plt, Co. I, 8 Reg't U. S. Col'd H. Art'y.

Appears on

Company Muster Roll

for Sept & Oct, 1865.

Present or absent Present

Stoppage, \$ 100 for

Due Gov't, \$ 100 for

Valuation of horse, \$ 100

Valuation of horse equipments, \$ 100

Remarks:

Book mark:

C. A. Ward

(358)

Copyist.

W

S H. Art'y.

U.S.C.T.

Wilson

Pr, Co. *I*, 8 Reg't U. S. Col'd H. Art'y.

Appears on Returns as follows:

Sept 18 64
Trani Guard *on duty*

Book mark:

W. H. ...

(546)

Copyist.

W

S H. Art'y.

U.S.C.T.

James Wilson

Private, Co. I, 8 Reg't U. S. Col'd H. Art'y.

Appears on Co. Muster-out Roll, dated Victoria Texas, Feb 10, 1866.

Muster-out to date Feb 10, 1866.

Last paid to Aug 31, 1865.

Clothing account:

Last settled....., 186 ; drawn since \$..... 100

Due soldier \$ 71/100; due U. S. \$..... 100

Am't for cloth'g in kind or money adv'd \$..... 100

Due U. S. for arms, equipments, &c., \$..... 100

Bounty paid \$ none 100; due \$..... 100

Remarks: Entered service at original organization as herein shown.

Copy 29

Book mark:

C. S. Rozzell

(361)

Copyist.

1914
Wilson James

Co G, 8 U.S. Col'd H. Art'y.

Private Private

CARD NUMBERS.

1	5467484	26
2	5467485	27
3	5477504	28
4	5477646	29
5	5477785	30
6	9122123	31
7	9122123	32
8	1180-05-1877	33
9	40744937	34
10		35
11		36
12		37
13		38
14		39
15		40
16		41
17		42
18		43
19		44
20		45
21		46
22		47
23		48
24		49
25		50

* Erroneously noted 3-24-1903. Austin

Book Mark: EB 12/96 1180-05-1877
~~9122123~~

See also

2

8 H. Art'y. U.S.C.T.

James Wilson

Co. A, 8 Reg't U.S. Col'd H. Art'y.

Appears on

Company Descriptive Book

of the organization named above.

DESCRIPTION.

Age 5 years; height 5 feet 3 inches.

Complexion *Blk*

Eyes *Blk*; hair *Blk*

Where born *Cottinuit, Ohio*

Occupation *Boatman*

ENLISTMENT.

When *Jan'y 20*, 1860.

Where *Cairo, Ill.*

By whom *Lt. Col. Low*; term *3* y'rs.

Remarks: *Died in Dist Hospital, Pa. Lynch, Ky., 31st March, 67. Cause of death Pneumonia.*

S. A. Moreland

W | 8 H. Art'y. | U.S.C.T.

James Wilson

Appears with rank of *Private* on

Muster and Descriptive Roll of a Detachment of U. S. Vols. forwarded

for the 8 Reg't U. S. Col'd H. Art'y. Roll dated *Paducah Ky, N.Y. Jan 25, 1865.*

Where born *Portsmouth, Ohio*

Age *18* y'rs; occupation *Boatman*

When enlisted *Jan 25*, 1865.

Where enlisted *Camp Ill*

For what period enlisted *3* years.

Eyes *Blk*; hair *Blk*

Complexion *Blk*; height *5 ft. 3 in.*

When mustered in *Jan 25*, 1865.

Where mustered in *Paducah Ky*

Bounty paid \$ *100*; due \$ *100*

Where credited

Company to which assigned

Remarks: *Residence & Dist Woodford Co. Linn Township Ill.*

Book mark: *1120 05 1877*

Bryer

W | 8 H. Art'y. | U.S.C.T.

James Wilson

Appears with rank of *Priv* on

Muster and Descriptive Roll of a Detachment of U. S. Vols. forwarded

for the 8 Reg't U. S. Col'd H. Art'y. Roll dated *Paducah Ky., N.Y. Jan 25, 1865*:

Where born *Jackson Miss*

Age *18* y'rs; occupation *Boatman*

When enlisted *Jan 24*, 1865.

Where enlisted *Levin Ill.*

For what period enlisted *3* years.

Eyes *Blk*; hair *Blk*

Complexion *Blk*; height *5 ft. 3 1/2 in.*

When mustered in *Jan 25*, 1865.

Where mustered in *Paducah Ky.*

Bounty paid \$ *100*; due \$ *100*

Where credited

Company to which assigned

Remarks *Residence 5 Dist Bureau
lev Ill*

Book mark :

Breger

RECEIVED

H. J. | 8 H. Art'y. | U.S.C.T.

James Wilson

H. J., Co. G, 8 Reg't U. S. Col'd H. Art'y.

Appears on

Company Muster Roll

for *Jan 1st*, 186*1*.

Present or absent *Present*

Stoppage, \$ *100* for

Due Gov't, \$ *100* for

Valuation of horse, \$ *100*

Valuation of horse equipments, \$ *100*

Remarks:

Book mark: _____

H. J. Wilson

Copyist.

W. J. ... 8 H. Art'y. U.S.C.T.

W. J. ...

W. J. ..., Co. G, 8 Reg't U. S. Col'd H. Art'y.

Appears on

Company Muster Roll

for *...*, 186*...*

Present or absent *...*

Stoppage, \$ *...* 100 for *...*

Due Gov't, \$ *...* 100 for *...*

Valuation of horse, \$ *...* 100

Valuation of horse equipments, \$ *...* 100

Remarks: *...*

...

...

...

...

...

Book mark: *...*

...

W

8 H. Art'y.

U.S.C.T.

James Wilson

Priv, Co. 4; 8 Reg't U. S. Col'd H. Art'y.

Appears on Returns as follows:

April 1865. April 5/65.
Paid up by dies of
disease

Book mark :

Wm. J. Butler

(546)

Copyist.

11.

S H. Art'y.

U.S.C.T.

James Wilson

No 1, Co. *G*, 8 Reg't U. S. Col'd H. Art'y.

Appears on **Co. Muster-out Roll**, dated *Mustina Texas, May*, 186*6*.

Muster-out to date _____, 186 .

Last paid to *Never Paid*, 186 .

Clothing account:

Last settled _____, 186 ; drawn since \$ _____ 100

Due soldier \$ _____ 100; due U. S. \$ _____ 100

Am't for cloth'g in kind or money adv'd \$ _____ 100

Due U. S. for arms, equipments, &c., \$ _____ 100

Bounty paid \$ _____ 100; due \$ _____ 100

Remarks: *Entered service as a*
Private, joined Co. & duty,
Jan 23, 1863, at Ward,
Pa. Died at Post Hospital
at Fort Sumner, Texas, cause of
death Pneumonia

Book mark { *1180 04 47* *1000*
1180 04 47 *1000*

Weller

(361)

Copyist.

JAN 14

5477785

1891

Inventory of effects
and final state
accounts forwarded
April 6, 1865

W. S. Hoy, Art'y U. S. C. S.

James Wilson

, Co. G, 8th Reg't U. S. C. H. A.

NOTATION.

Book mark: 1180 - G - J - 1877.

Record and Pension Office,

WAR DEPARTMENT.

This book mark refers only to a report from the medical records, made by the Surgeon General to the Adjutant General, relative to the above-named man. As the medical records have since been carded, no transcript of this report is made hereon.

W. Allen

(491)

Copyist.

Wilson, James

B, Co. G, 8 Reg't U.S.C.A.

3

Enclosures.

Bed Cards	Descriptive Lists
Burial Records	Final Statements /
Certs. of Dis. for Discharge	Furloughs
C. M. Charges	Med. Des. Lists
Med. Certificates	Orders

Other papers relating to—

Admission to Hosp'l	Furlough
Casualty Sheet (Officer's)	Med. Examination
Confinement	Misc. Information /
Contracts	Pay or Clothing
Death or Effects /	Personal Reports
Desertions	Rank
Discharge from Hosp'l	Transfer to Hosp'l
Discharge from Service	Transfer to V. R. C.
Duty	Transportation

ARTICLES OF WAR.

ART. 95. When any non-commissioned officer or soldier shall die, or be killed in the service of the United States, the then commanding officer of the troop or company shall, in the presence of two other commissioned officers, take an account of what effects he died possessed of, above his arms and accoutrements, and transmit the same to the office of the Department of War, which said effects are to be accounted for, and paid to the representatives of such deceased non-commissioned officer or soldier. And in case any of the officers, so authorized to take care of the effects of deceased officers and soldiers, should, before they have accounted to their representatives for the same, have occasion to leave the regiment or post, by preferment or otherwise, they shall, before they be permitted to quit the same, deposit in the hands of the commanding officer, or of the assistant military agent, all the effects of such deceased non-commissioned officers and soldiers, in order that the same may be secured for, and paid to, their respective representatives.

ARMY REGULATIONS—EDITION OF 1861.

DECEASED SOLDIERS.

Par. 152. Inventories of the effects of deceased non-commissioned officers and soldiers, required by the 95th Article of War, will be forwarded to the Adjutant General, by the commander of the company to which the deceased belonged, and a duplicate of the same to the colonel of the regiment. Final statements of pay, clothing, &c., will be sent with the inventories. When a soldier dies at a post or station absent from his company, it will be the duty of his immediate commander to furnish the required inventory, and, at the same time, to forward to the commanding officer of the company to which the soldier belonged, a report of his death, specifying the date, place, and cause; to what time he was last paid, and the money or other effects in his possession at the time of his decease; which report will be noted on the next muster roll of the company to which the man belonged. Each inventory will be endorsed, "Inventory of the effects of _____, late of company (—) _____ regiment of _____, who died at _____, the _____ day of _____, 186—." If a legal representative receive the effects, it will be stated in the report. If the soldier leave no effects, the fact will be reported.

Par. 153. Should the effects of a deceased non-commissioned officer or soldier not be administered upon within a short period after his decease, they shall be disposed of by a Council of Administration, under the authority of the commanding officer of the post, and the proceeds deposited with the Paymaster, to the credit of the United States, until they shall be claimed by the legal representatives of the deceased.

Par. 154. In all such cases of sales by the Council of Administration, a statement in detail, or account of the proceeds, duly certified by the Council and commanding officer, accompanied by the Paymaster's receipt for the proceeds, will be forwarded by the commanding officer to the Adjutant General. The statement will be endorsed, "Report of the proceeds of the effects of _____, late of company (—) _____ regiment of _____, who died at _____, the _____ day of _____, 186—."

NOTE 1.—The effects in all cases, when called for, should be turned over to the legal representative, without further authority from the Adjutant General. When the effects are turned over to the relatives of the deceased before these inventories are sent to the Adjutant General, their receipts therefor should be attached to the inventories. In all other cases, one copy will be sent with a letter of transmittal direct to the Adjutant General, and a duplicate retained by the officer.

NOTE 2.—Particular care should be taken to take receipts in duplicate from the Paymaster for any funds turned over to him; one copy should be sent direct to the Adjutant General and one retained by the officer.

INVENTORY OF THE EFFECTS

OF

Private James Wilson

Late of Company "G"

of Reg't of W.S.C.A. Heavy

Volunteers, who died at Paducah Ky

on the 6th day of April 1865

Inventory of the effects of James Wilson late
 a Private of Captain Lieut Willis Spence's Company G of
 the 8 Regiment of U.S. Art. Heavy Volunteers, who was enrolled as
 a private at Cairo in the State of Illinois on
 the 25th day of January 1865, and mustered into the service of the United
 States as a private on the 25th day of January 1865, at Paducah Ky
 in Company G, 8 Regiment of U.S. Art. Heavy Volunteers, to serve 31
 years or during the war; he was born in Portsmouth in the State
 of Ohio; he was 18 years of age, 5 feet 3 inches
 high, black complexion, black eyes, black hair, and by occupation, when enrolled,
 a Boatman; he died in East Tennessee, at
Paducah Ky. on the 6th day of April 1865, by
 reason of Pneumonia

INVENTORY.					
ARTICLES.	No.	ARTICLES.	No.	ARTICLES.	No.
Hats.....		Pairs trousers.....		Knapsacks.....	
Caps.....		Pairs flannel drawers.....			
Forage caps.....		Pairs cotton drawers.....			
Great coats.....		Flannel shirts.....			
Uniform coats.....		Cotton shirts.....			
Uniform jackets.....		Pairs boots.....			
Flannel sack coats.....		Pairs shoes.....			
Blouses.....		Pairs socks.....			
Stable frocks.....		Blankets.....			
Fatigue overalls.....		Haversacks.....			
				MONEY.	
				Specie.....	\$
				Notes.....	\$147.75

I CERTIFY, ON HONOR, that the above inventory comprises all the effects of James Wilson
James Wilson, deceased, and that the effects are in the hands
 of Lieut Willis Spence at Camp Lincoln Va.
 to be disposed of by a Council of Administration.

the money to be turned over to the Quaraster

(DUPLICATES.)

STATION: Camp Lincoln Va.

DATE: May 2nd 1865

[A. G. O. No. 104.]

Willis Spence Lieut
8th U.S. Art. Heavy
 Commanding the Company.

The money effects contained in
 the above inventory were turned
 over to Major S. M. Crosby Pay
 master U.S. at Victoria B.C. on 21st 1865
 W. Spence Capt. Co. G

21-4-2nd-2015. 10th St
Springfield, Ill.

Aug. 11. 1865,

Grover Ayers, & Son,

Request certificate of enlistment of James Wilson, Col. of Maine, Ill. Jan. 25. 1865. in 8th. U. S. A. Artillery.

A. S.

Aug. 1908. This paper was formerly filed with the records of the Acting Assistant Provost Marshal General of Illinois, in the Enrollment Div. R. & P. O.

R (Acting P. M. G. Ill) Aug 11/65-

Springfield Illinois
August 11th 1845-

Brig Gen James Oakes
C. P. M. G. State of Illinois
General,

We have the honor to request
a certificate of credit of James Wilson Capt^d,
who was enlisted at Cairo Ills. January 25th 1845
and assigned to 8th U. S. Heavy Artillery A. C.

Respectfully Yours
Robert Ayers & Son

War Department,

ADJUTANT GENERAL'S OFFICE,

July 9, 1877

The death of James M. [Name] Private, Co. "G", 5th Reg't U.S. Colored (Infantry), is reported as follows:

- On Company Muster Roll. For [Date] 1865, [Date] 1865
- Company Muster-out Roll. [Date] 1865
- Company Descriptive Book. [Date] 1865
- Company Morning Reports. [Date] 1865
- Soldier's Final Statement. [Date] 1865
- Soldier's Record of Death and Interment. 1865
- Soldier's Inventory of Effects. 1865
- Soldier's Certificate of Disability for Discharge. 1865
- Soldier's Individual Muster-out Roll. 1865

Regimental Return. For [Date] 1865, [Date] 1865

Regimental Quarterly Returns. [Date] 1865

Regimental Descriptive Book. [Date] 1865

By Surgeon General. (1865) No record of death. [Date] 1865

[Date] 1865, is held to be the correct date, and the Company Muster-out Roll will be amended accordingly.

L. H. [Signature]

Assistant Adjutant General.

813 ¹²/₃₆₁

Notes noted on register held. - W. M.

A. G. C. Co. 4th 1865.
S. M. recd. for \$147.75
sent 2^d Auditor.

Rec'd
FINAL STATEMENT

OF
Private James Wilson
8th Reg't of W. S. C. A. Reg't

James Wilson
VOLUNTEERS.

NOTE 1.—Two of these certificates (or duplicates) are to be given to each Volunteer Soldier or drafted man who may be discharged previously to the discharge of his company, that he may at once receive from the Paymaster the pay, &c., due him, and the captain or other COMMISSIONED officer commanding the company will certify to the act of the delivery of the duplicate certificates; on these certificates the Soldier is "entitled to" his discharge, and should also present his discharge to the Paymaster to have the payment endorsed on it. The discharge is to be given back to the Soldier by the Paymaster; the latter only retaining as his voucher the duplicate certificates.

NOTE 2.—If the Soldier is entitled to pay for the use of his horse, the Company Commander will certify to that fact on the back of both these final statements, and also to the time he has pay due for having been so mounted on his own horse.

NOTE 3.—When a Soldier is furnished with final statements, his descriptive list, if he has one, should be taken up by the officer who gives the Soldier these statements, and endorsed with a statement to this effect by the officer. This endorsement should exhibit a full statement of the time for which the Soldier was allowed pay on his final statements, the clothing account, and all other charges against him or in his favor, so as to comprise a complete exhibit of his account. It will then be transmitted to the Company Commander of the Soldier, who will enter all the data necessary to a full understanding of the Soldier's account on the muster roll upon which the Soldier's discharge is reported. The descriptive list will then be destroyed. The object of this is, that the remaining portion of the Soldier's account may be settled upon the receipt of these muster rolls, and the Soldier receive any pay or allowances that may be due him at the time of his discharge, and which may not appear on his final statements from the fact that his descriptive list is incomplete. These accounts for back pay, &c., are settled by the 2d Auditor of the Treasury Department.

NOTE 4.—Charges for loss or injury to ordnance, horse equipments, and other miscellaneous charges, should appear under the heading of "Other Stoppages."

NOTE 5.—Bounty paid by State authorities, and not by the United States, will not be entered on this statement.

NOTE 6.—Amounts due the Sutler and Laundress must be entered on the muster roll on which the discharge, death, desertion, &c., is reported, as well as on the final statement, otherwise the amount cannot be collected from the United States.

NOTE 7.—This blank will be used for deceased volunteers and drafted men, as well as for others.

NOTE 8.—Where a Soldier dies in Hospital or on detached service, his descriptive list, if he has one, should be sent with his final statements, in duplicate, to the Adjutant General, Washington, D. C.

RECEIVED
Leahy
ADJUTANT GENERAL'S OFFICE.

May 26th 1865

Duplicate with Inventory sent 2d Auditor.

I certify, on honor, that James Nelson a Private of Captain Will's Pence's Company (4) of the 8 Regiment of West Art. Heavy **VOLUNTEERS**, of the State of Ohio, born in Portsmouth, State of Ohio, aged 18 years; 5 feet 3 inches high; Black complexion, Black eyes, Black hair, and by occupation a Boatman having joined the company on its original organization at _____, and enrolled in it at the muster into the service of the United States at _____, on the _____ day of _____, 1865, (~~or~~ was mustered in service as a recruit, by Genl. J. P. M. Coe, at Paducah Ky., on the 25th day of January, 1865, ~~or~~ was drafted and mustered into the service of the United States from the Enrollment District of the State of _____, at _____, on the _____ day of _____, 1865.) to serve in the Regiment, for the term of Three Years; and having served **HONESTLY** and **FAITHFULLY** with his Company in aid Regt. to the present date, is ~~now~~ entitled to a **DISCHARGE** by reason of being in a Hospital Paducah Ky. by reason of Pneumonia. 6th April 1865

The said James Nelson was ~~last~~ ^{never} paid by Paymaster _____ to include the _____ day of _____, 1865, and has pay due him from that time to the present date; he is entitled to pay and subsistence for **TRAVELING** to place of enrollment, and whatever other allowances are authorized to volunteer soldiers, drafted men, or militia, so discharged. He has received from the United States **CLOTHING** amounting to 36⁹⁹ ~~100~~ dollars, since the _____ day of January, 1865, when his clothing account was ~~last~~ ^{never} settled. He has received from the United States 100 dollars advanced **BOUNTY**.

There is to be stopped from him, on account of the State of _____, or other authorities, for **CLOTHING**, &c., received on entering service, _____ 100 dollars; and for other stoppages, viz: _____

_____ 100 dollars. He has been furnished with **TRANSPORTATION** in kind from the place of his discharge to _____; and he has been **SUBSISTED** for **TRAVELING** to his place of enrollment, up to the _____, 1865.

He is indebted to _____, **SUTLER**, _____ 100 dollars. He is indebted to _____, **LAUNDRESS**, _____ 100 dollars.

Given in Duplicate, at Camp Lincoln Ia., this 21st day of May, 1865

W. Simpson 1st Lt.
8th West. Artillery
Commanding Company.

1915
Wilson Jasper

Co C, 8 U.S. Col'd H. Art'y.

Private Private

CARD NUMBERS.

1	5467092	26
2	5467061	27
3	5471705	28
4	5471854	29
5	5472005	30
6	5472141	31
7	5472273	32
8	5472398	33
9	5472519	34
10	5472861	35
11	9121680	36
12	40744953	37
13	30851850	38
14	30853755	39
15		40
16		41
17		42
18		43
19		44
20		45
21		46
22		47
23		48
24		49
25		50

Book Mark:

See also

P.O. inf. N.O. 1179216 Jan. 3/22.

R

W

8 H. Art'y.

U.S.C.T.

Jasper Wilson

6, Co. *6*, 8 Reg't U.S. Col'd H. Art'y.

Appears on

Company Descriptive Book

of the organization named above.

DESCRIPTION.

Age *26* years; height *5* feet *9* inches.

Complexion *Blk*

Eyes *Blk*; hair *Blk*

Where born *Trigg Co., Ky.*

Occupation *Farmer*

ENLISTMENT.

When *Aug. 16*, 186*4*.

Where *Paducah, Ky.*

By whom *R. H. Hall*; term *3* y'rs.

Remarks: *Died in Gen'l Hospital
at New Orleans, July
4/65*

Henderson

W

8 H. Art'y.

U.S.C.T.

Jasper Wilson
Private, Co. C, 8 Reg't U. S. Col'd H. Art'y.

Appears on

Company Muster Roll

for *July & Aug*, 1864.

Present or absent *Present*

Stoppage, \$ 100 for

Due Gov't, \$ 100 for

Valuation of horse, \$ 100

Valuation of horse equipments, \$ 100

Remarks:

Book mark:

E H Lipscomb

(358)

Copyist.

Jasper Wilson
Appears with rank of *Priv* on

Muster and Descriptive Roll of a Detachment of U. S. Vols. forwarded

for the 8 Reg't U. S. Col'd H. Art'y. Roll dated

Paducah Ky N.Y. Aug. 3, 1867.

Where born *Trigg Ky*

Age *26* y'rs; occupation *Farmer*

When enlisted *Aug. 16, 1867*

Where enlisted *Paducah, Ky*

For what period enlisted *3* years.

Eyes *Black*; hair *Black*

Complexion *Black*; height *5 ft. 9 in.*

When mustered in *Aug. 16, 1867*

Where mustered in *Paducah*

Bounty paid \$ *100*; due \$ *100*

Where credited *Graves Co. Dist. of Ky*

Company to which assigned _____

Remarks: _____

Book mark: _____

Jno J Bell Jr
(339) Copyist.

W | 8 H. Art'y. | U.S.C.T.

Jasper Wilson.

Appears with rank of *Private* on

Muster and Descriptive Roll of a Detachment of U. S. Vols. forwarded

for the 8 Reg't U. S. Col'd H. Art'y. Roll dated

Paducah, Ky, N.Y. Aug 31, 1864.

Where born *Trigg, Ky,*

Age *26* y'rs; occupation *Farmer.*

When enlisted *Aug. 16*, 186 .

Where enlisted *Paducah, Ky,*

For what period enlisted *3* years.

Eyes *Black*; hair *Black*

Complexion *Black*; height *5' 9* in.

When mustered in *Aug. 16*, 186 .

Where mustered in *Paducah,*

Bounty paid \$ *100*; due \$ *100*

Where credited *Graves, 1st D. Ky,*

Company to which assigned *C,*

Remarks :

Book mark :

Callaway.

(339)

Copyist.

W

S H. Art'y.

U.S.C.T.

Jasper Wilson

Private, Co. C, 8 Reg't U. S. Col'd H. Art'y.

Appears on

Company Muster Roll

for Nov. - Dec., 1864.

Present or absent Present.

Stoppage, \$ 100 for

Due Gov't, \$ 100 for

Valuation of horse, \$ 100

Valuation of horse equipments, \$ 100

Remarks:

Book mark:

O. J. Markle

(358)

Copyist.

M

8 H. Art'y.

U.S.C.T.

Jasper Wilson

White, Co. C, 8 Reg't U. S. Col'd H. Art'y.

Appears on

Company Muster Roll

for *Jan. + Feb.*, 186*7*.

Present or absent *Present.*

Stoppage, \$ 100 for

Due Gov't, \$ 100 for

Valuation of horse, \$ 100

Valuation of horse equipments, \$ 100

Remarks:
.....
.....
.....
.....
.....
.....
.....
.....

Book mark:

O. J. Markle

(358)

Copyist.

1864

A | **S H. Art'y.** | **U.S.C.T.**

Jasper Wilson

Private, Co. C, 8 Reg't U. S. Col'd H. Art'y.

Appears on

Company Muster Roll

for *March & April*, 186*4*.

Present or absent *Present*

Stoppage, \$ *100* for

Due Gov't, \$ *100* for

Valuation of horse, \$ *100*

Valuation of horse equipments, \$ *100*

Remarks:

Book mark: -----

O. J. Markle

(358)

Copyist.

M

8 H. Art'y.

U.S.C.T.

Jasper Millson

Private, Co. C, 8 Reg't U. S. Col'd H. Art'y.

Appears on

Company Muster Roll

for *May & June*, 186*5*.

Present or absent *Absent.*

Stoppage, \$ *100* for

Due Gov't, \$ *100* for

Valuation of horse, \$ *100*

Valuation of horse equipments, \$ *100*

Remarks *Sent to Hospital at
New Orleans, June 20, 1865.*

Book mark:

O. J. Markle,

(358)

Copyist.

W | 8 HA | 11567

Jasper Wilson

Pl Co. C, 8 Reg't 1156 HA

Appears on

Hospital Muster Roll

of Corps d'Afrique U. S. A. General Hospital,

at New Orleans, La.,

for May & June, 1867.

Attached to hospital:

When, 186 .

How employed

Last paid by Maj.

to, 186 .

Bounty paid \$ 100; due \$ 100

Present or absent Present

Remarks:

.....
.....
.....
.....
.....
.....
.....
.....

Book mark:

.....

W. Brown

W | *S. Harty* | **U.S.C.T.**

Jasper Hillson
Priv, Co. *C*, *S* Reg't U. S. Col'd *Harty*

Appears on

Company Muster Roll

for *July & Aug.*, 186 *5*.

Present or absent

Stoppage, \$ *100* for

Due Gov't, \$ *100* for

Valuation of horse, \$ *100*

Valuation of horse equipments, \$ *100*

Remarks: *Died at Genl. Hoop,*
New Orleans, La. July 4,
1865, cause not known.

Book mark:

(358)

Fitz

Copyist.

Compr.

W | 8 H. Art'y. | U.S.C.T.

Jasper Wilson

Priv., Co. *C*, 8 Reg't U. S. Col'd H. Art'y.

Appears on Returns as follows:

June 4/July 18 63 absent
sick at N.O. La since
June 20 1863

Aug 18 63. July 4/63.
N.O. La. Died

Book mark : _____

Chas. Patton

(546)

Copyist.

W & Hart U.S.C.T.

Jasper Wilson
Co. C, 8 Reg't U. S. Col'd

Appears on Co. Muster-out Roll, dated
Victoria Texas, Feb 10, 1866.

Muster-out to date _____, 186 .

Last paid to Feb 31, 1867 .

Clothing account:

Last settled _____, 186 ; drawn since \$ _____ 100

Due soldier \$ _____ 100; due U. S. \$ _____ 100

Am't for cloth'g in kind or money adv'd \$ _____ 100

Due U. S. for arms, equipments, &c., \$ _____ 100

Bounty paid \$ none 100; due \$ _____ 100

Remarks: Entered service as
recruit joined Co for
duty Aug 16, 56 & Enrolled
& subject to draft in 1st
En Dist of Ky at time of
enlistment Died in

Book mark: PV 23 P139, 71-1140 P51 72

W M Calhoun
(over)

(361)

Copyist.

JAN. 14

5472861

1891

Corps of Artillery Gen
Hospital New Orleans
La. July, 4, 1865. Des.
List furnished June
20 1865

Bookmark 3-70, 225-72

Wilson, Gasper

P, Co. C, 8 Reg't USCHA.

2 Enclosures.

Bed Cards	Descriptive Lists
Burial Records /	Final Statements 2
Certs. of Dis. for Discharge	Furloughs
C. M. Charges	Med. Des. Lists
Med. Certificates	Orders

Enlistment /

Other papers relating to—

Admission to Hosp'l	Furlough
Casualty Sheet (Officer's)	Med. Examination
Confinement	Misc. Information
Contracts	Pay or Clothing
Death or Effects /	Personal Reports
Desertions	Rank
Discharge from Hosp'l	Transfer to Hosp'l
Discharge from Service	Transfer to V. R. C.
Duty	Transportation

MICROFILM PUBLICATION M 1829

COMPILED MILITARY SERVICE RECORDS
OF VOLUNTEER UNION SOLDIERS WHO SERVED WITH
THE UNITED STATES COLORED TROOPS (USCT)
8TH REGIMENT OF HEAVY ARTILLY

PERSONAL PAPERS' TARGET SHEET

PLEASE NOTE THE CHECKED INFORMATION ABOUT THE PERSONAL PAPERS IN
THIS FILE:

- NO PERSONAL PAPERS WERE FOUND IN THIS FILE WHEN THE
RECORDS WERE ARRANGED FOR MICROFILMING.

- 6 PERSONAL PAPER(S) FOUND IN THIS FILE WHEN THE RECORDS
WERE ARRANGED FOR MICROFILMING.

No 265

No. *Two hundred nineteen*

Willson Jasper

Volunteered at *Parducan Ky*

August 16th 1864

By *Capt R. H. Hall*

Pro Mar W. Dist of Ky

U. S. Army

Consent of Parent or Guardian in case of a Minor, if a Free Man, or in the case of a Slave, of the Person to whom he owes Service:

United States colored troops. They will be made out in duplicate in all cases. A general, and one to accompany the accounts of the officer who pays bounty, &c. &c. must in all cases, precede payment of pay, bounty, pension, &c. &c. by officer, commissary, or assistant commissary of musters, as the case may be. or of them is given to the disbursing officer.

UNITED STATES COLORED TROOPS ENLISTMENT.

STATE OF Kentucky TOWN OF Paducah

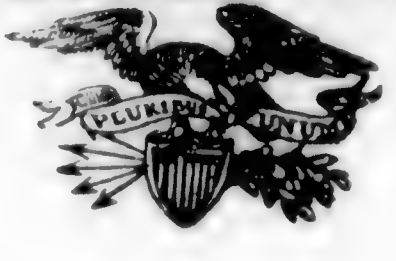

I, Wilson Gasper born in Trigg Co
in the State of Kentucky aged Twenty six years
and by occupation a Farmer Do HEREBY ACKNOWLEDGE to have
volunteered this Seventh day of August 1864,
to serve as a **Soldier** in the **Army of the United States of America**, for
the period of **THREE YEARS**, unless sooner discharged by proper authority:
Do also agree to accept such bounty, pay, rations, and clothing, as are, or may be,
established by law for the U. S. colored troops.

And I, Gasper Wilson of Graves Co
do solemnly swear, that I will bear true faith and allegiance to the **United States
of America**, and that I will serve them honestly and faithfully against all their
enemies or opposers whomsoever; and that I will observe and obey the orders of
the President of the United States, and the orders of the officers appointed over
me, according to the Rules and Articles of War.

Sworn and subscribed to, at Paducah Ky
this 16th day of Aug 1864, } Gasper Wilson
Before Capt R. H. Hall } mark
Prov Mar 1st Dist Ky

I CERTIFY, ON HONOR, That I have carefully examined the above named Volunteer, agreeably to the
General Regulations of the Army, and that, in my opinion, he is free from all bodily defects and mental infirmity,
which would in any way disqualify him from performing the duties of a soldier.

W. H. Kidd

EXAMINING SURGEON.

I CERTIFY, ON HONOR, That I have minutely inspected the Volunteer, Gasper Wilson
previously to his enlistment, and that he was entirely sober when enlisted; that, to the best of my judgment and
belief, he is of lawful age; and that, in accepting him as duly qualified to perform the duties of an able bodied
soldier, I have strictly observed the regulations which govern the recruiting service. This soldier has Black
eyes, Black hair, Black complexion, is five feet 9 inches high.

RECRUITING OFFICER OR AGENT.

Mustered into the United States service 16th day of August 1864

R. H. Hall
Capt & Prov Mar Mustering Officer.

Mustered into the service of the United States, for three years or during the war, from date of enlistment, in Company 1st
16th Regiment of Colored Volunteers, on the 16th day of August, 1864, at Paducah Ky

Capt R. H. Hall
Prov Mar 1st Dist Ky

NOTE 1.—This blank will be used for enlistments of United States colored troops. They will be made out in duplicate in all cases—one to accompany the recruiting return of the superintendent (not the recruiting officer) to the Adjutant General, and one to accompany the accounts of the officer who pays bounty, &c.

NOTE 2.—An enlistment holds to service. A muster-in, must in all cases, precede payment of pay, bounty, pension, &c. A muster-in roll, must in all cases, be filed in the Adjutant General's Office as evidence of muster-in. The mustering officer, commissary, or assistant commissary of musters, as the case may be, will countersign both enlistments as having mustered the soldier into the service of the United States before either of them is given to the disbursing officer.

DECLARATION OF RECRUIT.

I, *Jasper Wilson of Gravesend Ky.* desiring to volunteer as a soldier in the ARMY OF THE UNITED STATES, for the term of *Three Years*, DO DECLARE That I am *Twenty six* years and months of age; that I have never been discharged from the United States service on account of disability or by sentence of a court-martial, or by order before the expiration of a term of enlistment; and I know of no impediment to my serving honestly and faithfully as a soldier for three years.

GIVEN at *Paducah Ky.*

the *16th* day of *August 1864*

Witness: *[Signature]*

Jasper Wilson
his *Wilson*
mark
By *[Signature]*
Volunteered at *Paducah Ky.*
August 16th 1864
[Signature]
[Signature]

No. *Unnumbered*

92365

Consent of Parent or Guardian in case of a Minor, if a Free Man, or in the case of a Slave, of the Person to whom he owes Service:

I, Do CERTIFY, That I am the that the said is years of age; and I do freely give my CONSENT to his volunteering as a SOLDIER in the Army of the United States, for the period of THREE YEARS, under the conditions of the laws of the United States.

GIVEN at

the day of

Witness:

606
FINAL STATEMENT

OF

James Wilson Smith
8th Reg't of *Wis. Cal & Arty (H)*

VOLUNTEERS.

Smith James Wilson

NOTE 1.—Two of these certificates (or duplicates) are to be given to each Volunteer Soldier or drafted man who may be discharged previously to the discharge of his company, that he may at once receive from the Paymaster the pay, &c., due him, and the captain or other COMMISSIONED officer commanding the company will certify to the act of the delivery of the duplicate certificates; on these certificates the Soldier is "entitled to" his discharge, and should also present his discharge to the Paymaster to have the payment endorsed on it. The discharge is to be given back to the Soldier by the Paymaster; the latter only retaining as his voucher the duplicate certificates.

NOTE 2.—If the Soldier is entitled to pay for the use of his horse, the Company Commander will certify to that fact on the back of both these final statements, and also to the time he has pay due for having been so mounted on his own horse.

NOTE 3.—When a Soldier is furnished with final statements, his descriptive list, if he has one, should be taken up by the officer who gives the Soldier these statements, and endorsed with a statement to this effect by the officer. This endorsement should exhibit a full statement of the time for which the Soldier was allowed pay on his final statements, the clothing account, and all other charges against him or in his favor, so as to comprise a complete exhibit of his account. It will then be transmitted to the company commander of the Soldier, who will enter all the data necessary to a full understanding of the Soldier's account on the muster roll upon which the Soldier's discharge is reported. The descriptive list will then be destroyed. The object of this is, that the remaining portion of the Soldier's account may be settled upon the receipt of these muster rolls, and the Soldier receive any pay or allowances that may be due him at the time of his discharge, and which may not appear on his final statements from the fact that his descriptive list is incomplete. These accounts for back pay, &c., are settled by the 2d Auditor of the Treasury Department.

NOTE 4.—Charges for loss or injury to ordnance, horse equipments, and other miscellaneous charges, should appear under the heading of "Other Stoppages."

NOTE 5.—Bounty paid by State authorities, and not by the United States, will not be entered on this statement.

NOTE 6.—Amounts due the Sutler and Laundress must be entered on the muster roll on which the discharge, death, desertion, &c., is reported, as well as on the final statement, otherwise the amount cannot be collected from the United States.

NOTE 7.—This blank will be used for deceased volunteers and drafted men, as well as for others.

NOTE 8.—Where a Soldier dies in Hospital or on detached service, his descriptive list, if he has one, should be sent with his final statements, in duplicate, to the Adjutant General, Washington, D. C.

ADJUTANT GENERAL'S OFFICE

Aug 11 1864

Duplicate with Inventory sent 2d " " for.

I certify, on honor, that Gasper Wilson a Private of Capt. J. Jeffers Company (6) of the 8th Regiment of Vol. Inf. Regt (H) **VOLUNTEERS**, of the State of _____, born in Halifax, State of Virginia, aged 43 years; 5 feet 7 inches high; Blk complexion, Blk eyes, Blk hair, and by occupation a Farmer, having joined the company on its original organization at _____, and enrolled in it at the muster into the service of the United States at Paducah Ky, on the fifteenth day of August, 1864, (or was mustered in service as a recruit, by R. H. Hall, _____, at Paducah Ky, on the sixteenth day of August, 1864, or was drafted and mustered into the service of the United States from the _____ Enrollment District of the State of _____, at _____, on the _____ day of _____, 1864,) to serve in the Regiment, for the term of Three years: and having served **HONESTLY** and **FAITHFULLY** with his Company in No. Service to the present date, is now entitled to a **DISCHARGE** by reason of Death from Dysentery route at New Orleans La July 4th 1865.

The said Gasper Wilson was last paid by Paymaster May James to include the 31st day of October, 1864, and has pay due him from that time to the present date; he is entitled to pay and subsistence for **TRAVELING** to place of enrollment, and whatever other allowances are authorized to volunteer soldiers, drafted men, or militia, so discharged. He has received from the United States **CLOTHING** amounting to Seventeen 20 dollars, since the 1st day of March, 1864, when his clothing account was last settled. He has received from the United States _____ 100 dollars advanced **BOUNTY**.

There is to be stopped from him, on account of the State of _____, or other authorities, for **CLOTHING**, &c., received on entering service, _____ 100 dollars; and for other stoppages, viz: On account of U.S. for Extra Clothing, drawn previous to March 1st 1865. \$11.31 Also for loss of Camp & Garrison Equipage \$4.90 \$4.90 dollars. He has been furnished with **TRANSPORTATION** in kind from the place of his discharge to _____; and he has been **SUBSISTED** for **TRAVELING** to his place of enrollment, up to the _____, 1864.

He is indebted to _____, **SUTLER**, _____ 100 dollars.
 He is indebted to _____, **LAUNDRESS**, _____ 100 dollars.

Given in Duplicate, at New Orleans La, this 4th day of July, 1865.

F. E. Pinette
Surgeon in Charge
Commanding Company
Corps Desfrigue U.S. Gen Hosp

D. H. H. H.

FINAL STATEMENT

OF

Priv. Gasper Wilson
8th Reg't of U.S. Col^d W.A.H.

VOLUNTEERS.

C. H. H. H.

NOTE 1.—Two of these certificates (or duplicates) are to be given to each Volunteer Soldier or drafted man who may be discharged previously to the discharge of his company, that he may at once receive from the Paymaster the pay, &c., due him, and the captain or other COMMISSIONED officer commanding the company will certify to the act of the delivery of the duplicate certificates; on these certificates the Soldier is "entitled to" his discharge, and should also present his discharge to the Paymaster to have the payment endorsed on it. The discharge is to be given back to the Soldier by the Paymaster; the latter only retaining as his voucher the duplicate certificates.

NOTE 2.—If the Soldier is entitled to pay for the use of his horse, the Company Commander will certify to that fact on the back of both these final statements, and also to the time he has pay due for having been so mounted on his own horse.

NOTE 3.—When a Soldier is furnished with final statements, his descriptive list, if he has one, should be taken up by the officer who gives the Soldier these statements, and endorsed with a statement to this effect by the officer. This endorsement should exhibit a full statement of the time for which the Soldier was allowed pay on his final statements, the clothing account, and all other charges against him or in his favor, so as to comprise a complete exhibit of his account. It will then be transmitted to the company commander of the Soldier, who will enter all the data necessary to a full understanding of the Soldier's account on the muster roll upon which the Soldier's discharge is reported. The descriptive list will then be destroyed. The object of this is, that the remaining portion of the Soldier's account may be settled upon the receipt of these muster rolls, and the Soldier receive any pay or allowances that may be due him at the time of his discharge, and which may not appear on his final statements from the fact that his descriptive list is incomplete. These accounts for back pay, &c., are settled by the 2d Auditor of the Treasury Department.

NOTE 4.—Charges for loss or injury to ordnance, horse equipments, and other miscellaneous charges, should appear under the heading of "Other Stoppages."

NOTE 5.—Bounty paid by State authorities, and not by the United States, will not be entered on this statement.

NOTE 6.—Amounts due the Sutler and Laundress must be entered on the muster roll on which the discharge, death, desertion, &c., is reported, as well as on the final statement, otherwise the amount cannot be collected from the United States.

NOTE 7.—This blank will be used for deceased volunteers and drafted men, as well as for others.

NOTE 8.—Where a Soldier dies in Hospital or on detached service, his descriptive list, if he has one, should be sent with his final statements, in duplicate, to the Adjutant General, Washington, D. C.

ARTICLES OF WAR.

ART. 95. When any non-commissioned officer or soldier shall die, or be killed in the service of the United States, the then commanding officer of the troop or company shall, in the presence of two other commissioned officers, take an account of what effects he died possessed of, above his arms and accoutrements, and transmit the same to the office of the Department of War, which said effects are to be accounted for, and paid to the representatives of such deceased non-commissioned officer or soldier. And in case any of the officers, so authorized to take care of the effects of deceased officers and soldiers, should, before they have accounted to their representatives for the same, have occasion to leave the regiment or post, by preferment or otherwise, they shall, before they be permitted to quit the same, deposit in the hands of the commanding officer, or of the assistant military agent, all the effects of such deceased non-commissioned officers and soldiers, in order that the same may be secured for, and paid to, their respective representatives.

ARMY REGULATIONS—EDITION OF 1863.

DECEASED SOLDIERS.

Par. 152. Inventories of the effects of deceased non-commissioned officers and soldiers, required by the 95th Article of War, will be forwarded to the Adjutant General, by the commander of the company to which the deceased belonged, and a duplicate of the same to the colonel of the regiment. Final statements of pay, clothing, &c., in duplicate, will be sent to the Adjutant General with one copy of the inventory. When a soldier dies at a post or station absent from his company, it will be the duty of his immediate commander to furnish the required inventory and final statements, and, at the same time, to forward to the commanding officer of the company to which the soldier belonged, a report of his death, specifying the date, place, and cause; to what time he was last paid, and the money or other effects in his possession at the time of his decease; which report will be noted on the next muster roll of the company to which the man belonged. Each inventory will be endorsed, "Inventory of the effects of _____, late of company (—) _____ regiment of _____, who died at _____, the _____ day of _____, 186—." If a legal representative receive the effects, it will be stated in the report. If the soldier leave no effects, the fact will be reported.

Par. 153. Should the effects of a deceased non-commissioned officer or soldier not be administered upon within a short period after his decease, they shall be disposed of by a Council of Administration, under the authority of the commanding officer of the post, and the proceeds deposited with the Paymaster, to the credit of the United States, until they shall be claimed by the legal representatives of the deceased.

Par. 154. In all such cases of sales by the Council of Administration, a statement in detail, or account of the proceeds, duly certified by the Council and commanding officer, accompanied by the Paymaster's receipt for the proceeds, will be forwarded by the commanding officer to the Adjutant General. The statement will be endorsed, "Report of the proceeds of the effects of _____, late of company (—) _____ regiment of _____, who died at _____, the _____ day of _____, 186—."

NOTE 1.—The effects in all cases, when called for, should be turned over to the legal representative, without further authority from the Adjutant General. When the effects are turned over to the relatives of the deceased before these inventories are sent to the Adjutant General, their receipts therefor should be attached to the inventories. In all other cases, one copy will be sent with a letter of transmittal direct to the Adjutant General, and a duplicate retained by the officer.

NOTE 2.—Particular care should be taken to take receipts in duplicate from the Paymaster for any funds turned over to him; one copy should be sent direct to the Adjutant General and one retained by the officer.

~~He had no Descriptive Roll~~
INVENTORY OF THE EFFECTS

OF

Priv. Parker Wilson

Late of Company C

8th Reg't of U.S.C. Art. Heavy

Volunteers, who died at New Orleans La

on the 4th day of July 1865.

Inventory of the effects of Casper Wilson late
a Private of Captain W. Wilson Company C of
the 8th Regiment of U.S.C. Art'y Heavy Volunteers, who was enrolled as
a Private at Frankfort in the State of Kentucky on
the 15th day of August 1864, and mustered into the service of the United
States as a Private on the 16th day of August 1864, at Frankfort
in Company C, 8th Regiment of U.S.C. Art'y Heavy Volunteers, to serve 3
years or during the war; he was born in Frankfort in the State
of Kentucky; he was 23 years of age, 5 feet 7 inches
high, 12 complexion, blue eyes, black hair, and by occupation, when enrolled,
a farmer; he died in Corps De Afrique U.S. Gen Hosp at
New Orleans La on the 4th day of July 1865, by
reason of Dysentery Acute.

INVENTORY.					
ARTICLES.	No.	ARTICLES.	No.	ARTICLES.	No.
Hats.....		Pairs trousers.....		Knapsacks.....	1
Caps.....		Pairs flannel drawers.....		<u>Canteen</u>	
Forage caps.....		Pairs cotton drawers.....			
Great coats.....	1	Flannel shirts.....			
Uniform coats.....		Cotton shirts.....			
Uniform jackets.....		Pairs boots.....			
Flannel sack coats.....		Pairs shoes.....			
Blouses.....		Pairs socks.....			
Stable frocks.....		Blankets.....			
Fatigue overalls.....		Haversacks.....	1		
				MONEY.	
				Specie.....	\$
				Notes.....	\$

I CERTIFY, ON HONOR, that the above inventory comprises all the effects of Private
Casper Wilson, deceased, and that the effects are in the hands
of Surgeon in Charge at Corps De Afrique U.S. Gen Hosp.
New Orleans La to be disposed of by a Council of Administration.

(DUPLICATES.)

STATION: New Orleans La

DATE: July 4th 1865

[A. G. O. No. 104]

Surgeon in Charge
Commanding the Company.

REH 354



No. 2.

RECORD OF DEATH AND INTERMENT.

Name and number of person interred,

Casper Wilson

Number and locality of the grave, -

Hospital number of the deceased, -

6065

Regiment, Rank, and Company, - -

8 U.S.C. Artillery - Private - "C"

Residence before enlistment, - - -

Conjugal condition (and if married,)
the residence of the widow,)

Cause of death,)

Dysentery Acute

Age of the deceased, - - - - -

Nativity, - - - - -

References and Remarks, - - - }

Date of death and burial, - - -

July 4th 1865

186

[A duplicate of this Record has been forwarded to the Sexton, and the other remains at this Hospital.]

To *Adj. General U.S. Army*
SIR:

It becomes my duty to inform you that the person above described died at this Hospital as herein stated: and that it is desired his remains should be interred with the usual military honors.

Respectfully,

F. C. Piquette
Surgeon U. S. Army.
86 Col. Infantry
in charge

MILITARY HOSPITAL,

Corps d'Afrique N. Orleans La.

This copy of Record is to be transmitted to the Adjutant General at Washington immediately after the place of burial and the number of the grave have been ascertained and registered. The above notification is to remain attached.

FINAL STATEMENT

OF

Orvali Jasper Willson
8th Reg't of U.S.C.A. Coy. 1

VOLUNTEERS.

Paid July 21 1865

NOTE 1.—Two of these certificates (or duplicates) are to be given to each Volunteer Soldier or drafted man who may be discharged previously to the discharge of his company, that he may at once receive from the Paymaster the pay, &c., due him, and the captain or other COMMISSIONED officer commanding the company will certify to the act of the delivery of the duplicate certificates; on these certificates the Soldier is "entitled to" his discharge, and should also present his discharge to the Paymaster to have the payment endorsed on it. The discharge is to be given back to the Soldier by the Paymaster; the latter only retaining as his voucher the duplicate certificates.

NOTE 2.—If the Soldier is entitled to pay for the use of his horse, the Company Commander will certify to that fact on the back of both these final statements, and also to the time he has pay due for having been so mounted on his own horse.

NOTE 3.—When a Soldier is furnished with final statements, his descriptive list, if he has one, should be taken up by the officer who gives the Soldier these statements, and endorsed with a statement to this effect by the officer. This endorsement should exhibit a full statement of the time for which the Soldier was allowed pay on his final statements, the clothing account, and all other charges against him or in his favor, so as to comprise a complete exhibit of his account. It will then be transmitted to the company commander of the Soldier, who will enter all the data necessary to a full understanding of the Soldier's account on the muster roll upon which the Soldier's discharge is reported. The descriptive list will then be destroyed. The object of this is, that the remaining portion of the Soldier's account may be settled upon the receipt of these muster rolls, and the Soldier receive any pay or allowances that may be due him at the time of his discharge, and which may not appear on his final statements from the fact that his descriptive list is incomplete. These accounts for back pay, &c., are settled by the 2d Auditor of the Treasury Department.

NOTE 4.—Charges for loss or injury to ordnance, horse equipments, and other miscellaneous charges, should appear under the heading of "Other Stoppages."

NOTE 5.—Bounty paid by State authorities, and not by the United States, will not be entered on this statement.

NOTE 6.—Amounts due the Sutler and Laundress must be entered on the muster roll on which the discharge, death, desertion, &c., is reported, as well as on the final statement, otherwise the amount cannot be collected from the United States.

NOTE 7.—This blank will be used for deceased volunteers and drafted men, as well as for others.

NOTE 8.—Where a Soldier dies in Hospital or on detached service, his descriptive list, if he has one, should be sent with his final statements, in duplicate, to the Second Auditor, Washington, D. C.

ADJUTANT GENERAL'S OFFICE.

Dec 18 1865

Duplicate with inventory sent 2d Auditor.

I certify on honor, that Asper Willson a Private of
 Captain E. D. Chapman's Company (C) of the Eighth Regiment of U. S. Col. Art. Regt.
VOLUNTEERS, of the State of _____, born in Trigg Co., State
 of Kentucky, aged 26 years; 5 feet 9 inches high; Black complexion,
Black eyes, Black hair, and by occupation a Farmer, having joined the company on
 its original organization at _____, and enrolled in it at the muster into
 the service of the United States at _____, on the _____ day
 of _____, 1864. (He was mustered in service as a recruit, by Capt. R. H. Hall
 _____, at Paducah Ky., on the 16th day of August,
 1864; _____ as drafted and mustered into the service of the United States from the
 Enrollment District of the State of _____, at _____,
 on the _____ day of _____, 1864) to serve in the Regiment, for
 the term Three Years; and having served HONESTLY and
 FAITHFULLY with his Company in Said Regiment to the present date, is now
 entitled to **DISCHARGE** by reason of Death. Died in General Hospital
at New Orleans July 4th 1865

The Asper Willson was last paid by Paymaster
Major Fenno to include the 31st day of October, 1864, and has
 pay due _____ from that time to the present date; he is entitled to pay and subsistence for
 TRAVEL _____ to place of enrollment, and whatever other allowances are authorized to volunteer
 soldiers, drafted men, or militia, so discharged. He has received from the United States **CLOTHING**
 amounting to Sixty (60) ^{never} dollars, since the _____ day of Enlistment,
 1864, _____ his clothing account was _____ settled. He has received from the United States
 _____ dollars advanced **BOUNTY**.

There is to be stopped from him, on account of the State of _____, or other
 authorities for **CLOTHING**, &c. received on entering service, _____ dollars; and
 for other purposes, viz: _____

_____ dollars.
 He has _____ furnished with TRANSPORTATION in kind from the place of his discharge to
 _____; and he has been SUBSISTED for TRAVELING to his
 place of enrollment, up to the _____, 1864.

He is indebted to _____, SUTLER, _____ dollars.
 He is indebted to _____, LAUNDRESS, _____ dollars.

Given in Duplicate, at Victoria Texas, this 24th day
 of August, 1865.

E. D. Chapman
Capt. 8th U. S. Col. Art. Regt.
 Commanding Company.

1916
Wilson John

Co C, 8 U.S. Col'd H. Art'y.

Private Private

CARD NUMBERS.

1	5467091	26
2	5467060	27
3	5471707	28
4	5471856	29
5	5472007	30
6	5472143	31
7	5472286	32
8	5467876	33
9	5472871	34
10	9121683	35
11	4374495	36
12		37
13		38
14		39
15		40
16		41
17		42
18		43
19		44
20		45
21		46
22		47
23		48
24		49
25		50

Book Mark: Q 3489

See also

W

8 H. Art'y. U.S.C.T.

John Wilson

, Co. *C*, 8 Reg't U.S. Col'd H. Art'y.

Appears on

Company Descriptive Book

of the organization named above.

DESCRIPTION.

Age *43* years; height *5* feet *9* inches.

Complexion *Blk*

Eyes *Blk*; hair *Blk*

Where born *Halifax, Va.*

Occupation *Farmer*

ENLISTMENT.

When *Aug. 15* 1864.

Where *Paducah, Ky.*

By whom *B. H. Hall*; term *3* y'rs.

Remarks: *Deserted Apr. 6/65
at Paducah, Ky.*

Henderson

H

8 H. Art'y.

U.S.C.T.

John Wilson
Private

, Co. C, 8 Reg't U. S. Col'd H. Art'y.

Appears on

Company Muster Roll

for *July & Aug*, 1864.

Present or absent *Present*

Stoppage, \$ *100* for

Due Gov't, \$ *100* for

Valuation of horse, \$ *100*

Valuation of horse equipments, \$ *100*

Remarks:

Book mark:

E H Lipscombe

(358)

Copyist.

John Wilson

Appears with rank of *Priv* on

Muster and Descriptive Roll of a Detachment of U. S. Vols. forwarded

for the 8 Reg't U. S. Col'd H. Art'y. Roll dated *Paducah Ky, N. Y. Aug 31, 1864.*

Where born *Halifax, Va.*

Age *43* y'rs; occupation *Farmer*

When enlisted *Aug, 15, 1864*

Where enlisted *Paducah, Ky*

For what period enlisted *3* years.

Eyes *Black*, hair *Black*

Complexion *Black*, height *5* ft. *9* in.

When mustered in *Aug, 15, 1864*

Where mustered in *Paducah,*

Bounty paid \$ *100*; due \$ *100*

Where credited *Graves Co., Dist. of Ky*

Company to which assigned

Remarks:

Book mark:

Geo Bell Jr
(339) Copy.st.

W

8 H. Art'y.

U.S.C.T.

John Wilson.

Appears with rank of *Private* on

Muster and Descriptive Roll of a Detachment of U. S. Vols. forwarded

for the 8 Reg't U. S. Col'd H. Art'y. Roll dated

Paducah, Ky, NY Aug 31, 1864.

Where born *Halifax, Va.*

Age *43* y'rs; occupation *Farmer*

When enlisted *Aug, 15th*, 186 .

Where enlisted *Paducah, Ky.*

For what period enlisted *3* years.

Eyes *Black*; hair *Black.*

Complexion *Black*; height *5* ft. *9* in.

When mustered in *Aug, 15th*, 186 .

Where mustered in *Paducah*

Bounty paid \$ *100*; due \$ *100*

Where credited *Graves, 1st D. Ky.*

Company to which assigned *C.*

Remarks :

Book mark :

Calloway

(339)

Copyist.

H *8 Arty* **U.S.C.T**

John Wilson
Prot Co. C, 8 Reg't U. S. Col'd Arty

Appears on

Company Muster Roll

for *Sept & Oct*, 186*4*.

Present or absent. *Present*

Stoppage, \$.....*100* for

Due Gov't, \$.....*100* for

Valuation of horse, \$.....*100*

Valuation of horse equipments, \$.....*100*

Remarks:.....
.....
.....
.....
.....
.....
.....
.....
.....
.....

Book mark:.....

E H Sepocombe

(358)

Copyist.

W

8 H. Art'y.

U.S.C.T.

John Wilson

Comate Co. C, 8 Reg't U. S. Col'd H. Art'y.

Appears on

Company Muster Roll

for *Nov. & Dec.*, 1864.

Present or absent *Present*

Stoppage, \$ *100* for

Due Gov't, \$ *100* for

Valuation of horse, \$ *100*

Valuation of horse equipments, \$ *100*

Remarks:

Book mark:

C. J. Markle
Copyist.

(358)

W

8 H. Art'y.

U.S.C.T.

John Wilson

Wrate, Co. C, 8 Reg't U. S. Col'd H. Art'y.

Appears on

Company Muster Roll

for *Jan. + Feb.*, 186*5*.

Present or absent *Present.*

Stoppage, \$ 100 for

Due Gov't, \$ 100 for

Valuation of horse, \$ 100

Valuation of horse equipments, \$ 100

Remarks:

Book mark: -----

O. J. Markle

W

S H. Art'y.

U.S.C.T.

John Wilson

Private, Co. C, 8 Reg't U. S. Col'd H. Art'y.

Appears on

Company Muster Roll

for March + April, 1865.

Present or absent

Stoppage, \$ 100 for

Due Gov't, \$ 100 for

Valuation of horse, \$ 100

Valuation of horse equipments, \$ 100

Remarks: Deserted from Camp at Paducah, Ky, April 6, 1865.

Book mark:

O. J. Markle.

(358)

Copyist.

W. S. Hart U.S.C.T.

John Wilson
Priv., Co. C., 8. Reg't U. S. Col'd Hart

Appears on

Descriptive List of Deserters

dated *City Point Va. April 30*, 1865.

Deserted:

When *April 6*, 1865.

Where *Paducah Ky.*

Arrested:

When _____, 186 .

Where _____

Remarks: _____

Book mark: _____

C. S. Hart
Copied.

W

S H. Art'y.

U.S.C.T.

Ino Wilson

Inf, Co. C., 8 Reg't U. S. Col'd H. Art'y.

Appears on Returns as follows:

April 1865

April 4/65.

Paducah Ky. Deserted

Book mark:

Chas. Patton

(546)

Copyist.

W & Harty U.S.C.T.

John Wilson
Co. C, 8 Reg't U. S. Col'd Harty

Appears on Co. Muster-out Roll, dated
Victoria Texas, Feb 10, 1866.

Muster-out to date _____, 186 .

Last paid to Oct 3, 1867.

Clothing account:

Last settled _____, 186 ; drawn since \$ _____ 100

Due soldier \$ _____ 100 ; due U. S. \$ _____ 100

Am't for cloth'g in kind or money adv'd \$ _____ 100

Due U. S. for arms, equipments, &c., \$ _____ 100

Bounty paid \$ none 100 ; due \$ _____ 100

Remarks: Entered service as recruit
Joined Co for duty Aug, 15-1864. Enrolled
& subject to draft in Co. List of Co
at time of enlistment Deserted
at Paducah Apr 6 1865. Amt
of clothing drawn \$51.00

Book mark: B-34-89

(361)

W. M. Ashburn
Copyist.

Wilson, John

....., Co., 8 Reg't U. S. C. A.

..... / **Enclosures.**

Bed Cards	Final Statements
Burial Records	Furloughs or L. of A.
Certs. of Dis. for Discharge	Med. Certificates
C. M. Charges	Med. Des. Lists
Descriptive Lists	Orders
Discharge Certificates	Pris. of War Record
Enlistment Papers	Resignations

Other papers relating to—

Admission to Hosp'l	Furlough or L. of A.
Casualty Sheet	Med. Examination
Confinement	Misc. Information
Contracts	Pay or Clothing
Death or Effects	Personal Reports
Desertion	Rank
Discharge from Hosp'l	Transfer to Hosp'l
Discharge from Service	Transfer to V. R. C.
Duty	Transportation
.....

No 283

No. Hundred eighteen

Wilson John

Volunteered at Paducah Ky

August 15th 1864

R. H. Hall

Capt - & Pro Mar 1st Dist
Ky

J. U. G. Art. Heavy

John Wilson
Mar 1st Dist

Consent of Parent or Guardian in case of a Minor, if a Free Man, or in the case of a Slave of the Person to be

of them is given to the disbursing officer.
of pay, commissary, or assistant commissary of musters, as the case may be, will
in, must in all cases, precede payment of pay, bounty, pension, &c. A muster
eral, and one to accompany the accounts of the officer who pays bounty, &c.
United States colored troops. They will be made out in duplicate in all cases—one

UNITED STATES COLORED TROOPS ENLISTMENT.

STATE OF



TOWN OF

Kentucky *Paducah*

I, *William John* born in *Halifax*
in the State of *Va* aged *Forty three* years
and by occupation a *Farmer* Do HEREBY ACKNOWLEDGE to have
volunteered this *Fifteenth* day of *August* 1864,
to serve as a **Soldier** in the **Army of the United States of America**, for
the period of **THREE YEARS**, unless sooner discharged by proper authority:
Do also agree to accept such bounty, pay, rations, and clothing, as are, or may be,
established by law for the U. S. colored troops.

And I, *John Wilson of Graves Co*
do solemnly swear, that I will bear true faith and allegiance to the **United States
of America**, and that I will serve them honestly and faithfully against all their
enemies or opposers whomsoever; and that I will observe and obey the orders of
the President of the United States, and the orders of the officers appointed over
me, according to the Rules and Articles of War.

Sworn and subscribed to, at *Paducah Ky*
this *15th* day of *Aug* 1864, *John Wilson*
name

Before *R. H. Hall*
Capt & Pro Marshal Dist of Ky

I CERTIFY, ON HONOR, That I have carefully examined the above named Volunteer, agreeably to the
General Regulations of the Army, and that, in my opinion, he is free from all bodily defects and mental infirmity,
which would in any way disqualify him from performing the duties of a soldier.

M. H. Kidd

EXAMINING SURGEON.

I CERTIFY, ON HONOR, That I have minutely inspected the Volunteer, *John Wilson*
previously to his enlistment, and that he was entirely sober when enlisted; that, to the best of my judgment and
belief, he is of lawful age; and that, in accepting him as duly qualified to perform the duties of an able-bodied
soldier, I have strictly observed the regulations which govern the recruiting service. This soldier has *Dark*
eyes, *Dark* hair, *Dark* complexion, is *Five* feet *9* inches high.

RECRUITING OFFICER OR AGENT.

Mustered into the United States service *15th* day of *Aug* 1864.

R. H. Hall
Capt & Pro Marshal Mustering Officer.

Mustered into the service of the United States, for three years or during the war, from date of enlistment, in Company *2nd*
Regiment of *Mississippi* Volunteers, on the *15th* day of *August*, 1864, at *Paducah Ky*

By R. H. Hall
Capt & Pro Marshal
W. D. ...

NOTE 1.—This blank will be used for enlistments of United States colored troops. They will be made out in duplicate in all cases—one to accompany the recruiting return of the superintendent (not the recruiting officer) to the Adjutant General, and one to accompany the accounts of the officer who pays bounty, &c.

NOTE 2.—An enlistment holds to service. A muster-in, must in all cases, precede payment of pay, bounty, pension, &c. A muster-in roll, must in all cases, be filed in the Adjutant General's Office as evidence of muster-in. The mustering officer, commissary, or assistant commissary of musters, as the case may be, will countersign both enlistments as having mustered the soldier into the service of the United States before either of them is given to the disbursing officer.

DECLARATION OF RECRUIT.

I, John Wilson of Paducah Ky desiring to volunteer as a soldier in the ARMY OF THE UNITED STATES, for the term of Three Years, DO DECLARE That I am Forty three years and months of age; that I have never been discharged from the United States service on account of disability or by sentence of a court-martial, or by order before the expiration of a term of enlistment; and I know of no impediment to my serving honestly and faithfully as a soldier for three years.

GIVEN at Paducah Ky the 15th day of August-1864

Witness: A. T. [Signature]

John Wilson
Mar
 Volunteered at Paducah Ky
August 15th 1864
R. H. Hall
Capt & Co. 1st Cav. Ar.
St. W. G. L. [Signature]
 Notarially signed

Me 283

Consent of Parent or Guardian in case of a Minor, if a Free Man, or in the case of a Slave, of the Person to whom he owes Service:

I, Do CERTIFY, That I am the that the said is years of age; and I do freely give my CONSENT to his volunteering as a SOLDIER in the Army of the United States, for the period of THREE YEARS, under the conditions of the laws of the United States.

GIVEN at the day of

Witness:

1917
Wilson John

Co D, 8 U.S. Col'd H. Art'y.

Private

Private

CARD NUMBERS.

1	57479795	26
2	57479965	27
3	57480101	28
4	57480233	29
5	57480364	30
6	57480484	31
7	57480599	32
8	57480707	33
9	57480812	34
10	57480914	35
11	57481014	36
12	9122619	37
13		38
14		39
15		40
16		41
17		42
18		43
19		44
20		45
21		46
22		47
23		48
24		49
25		50

Book Mark:

See also

D. 3184808 POKET.

P.O. M. McC. 508967 2/29/16 B

P.O. Abbr. 6/27/23 - 2

As. Vet. Bur.

2-18-27. 2

24 | 8 H. Art'y. | U.S.C.T.

John Wilson
....., Co. *A*, 8 Reg't U.S. Col'd H. Art'y.

Appears on

Company Descriptive Book
of the organization named above.

DESCRIPTION.

Age *23* years; height *5* feet *4³/₄* inches.

Complexion *black*

Eyes *black*; hair *black*

Where born *Davidson Co., Tenn.*

Occupation *Farmer.*

ENLISTMENT.

When *May 29*, 186*4*.

Where *Paducah, Ky.*

By whom *J. H. Johnson*; term *3* y'rs.

Remarks:

.....
.....
.....
.....
.....
.....
.....
.....

Keefe

(3830)

Copyist.

John Wilson
Private, Co. I, 8 Reg't U. S. Col'd H. Art'y.

Appears on

Company Muster Roll

for July 10th Aug, 1861.

Present or absent Present

Stoppage, \$ 100 for

Due Gov't, \$ 100 for

Valuation of horse, \$ 100

Valuation of horse equipments, \$ 100

Remarks: Was mustered
on last roll by mistake
as Alexander Rice.

Book mark:

E. L. Chapman

W

8 H. Art'y.

U.S.C.T.

John Wilson,
Pvt., Co. I, 8 Reg't U. S. Col'd H. Art'y.

Appears on

Company Muster Roll

for *Sept 1 (cty)*, 1864.

Present or absent *Present*

Stoppage, \$ 100 for

Due Gov't, \$ 100 for

Valuation of horse, \$ 100

Valuation of horse equipments, \$ 100

Remarks:

Book mark: -----

J. A. Kinn

Com. Wilson
Co. I, 8 Reg't U. S. Col'd H. Art'y.

Appears on

Company Muster Roll

for *Nov. & Dec.*, 186*4*.

Present or absent *Present*

Stoppage, \$ *100* for

Due Gov't, \$ *100* for

Valuation of horse, \$ *100*

Valuation of horse equipments, \$ *100*

Remarks:
.....
.....
.....
.....
.....
.....
.....
.....
.....
.....
.....

Book mark:

E. L. Thayer
Copyist.

W | 8 H. Art'y. | U.S.C.T.

John Wilson

Dr, Co. I, 8 Reg't U. S. Col'd H. Art'y.

Appears on

Company Muster Roll

for *Jan & July*, 186 *5*.

Present or absent *Present*

Stoppage, \$ *100* for

Due Gov't, \$ *100* for

Valuation of horse, \$ *100*

Valuation of horse equipments, \$ *100*

Remarks:

.....
.....
.....
.....
.....
.....
.....
.....
.....
.....

Book mark:

L. B. Sayre
Copyist.

if | 8 H. Art'y. | U.S.C.T.

John Wilson

Pr, Co. I, 8 Reg't U. S. Col'd H. Art'y.

Appears on

Company Muster Roll

for *March & April*, 1865.

Present or absent *Present*

Stoppage, \$ *100* for

Due Gov't, \$ *100* for

Valuation of horse, \$ *100*

Valuation of horse equipments, \$ *100*

Remarks:
.....
.....
.....
.....
.....
.....
.....
.....
.....
.....
.....

Book mark:

L. B. Sawyer
Copyist.

Mr.

| 8 H. Art'y. | U.S.C.T.

John Wilson

Private, Co. I, 8 Reg't U. S. Col'd H. Art'y.

Appears on

Company Muster Roll

for *May & June*, 1865.

Present or absent *Present*

Stoppage, \$ *100* for

Due Gov't, \$ *100* for

Valuation of horse, \$ *100*

Valuation of horse equipments, \$ *100*

Remarks:

Book mark:

L. B. Sayre

(358)

Copyist.

W

| 8 H. Art'y. |

U.S.C.T.

John Wilson
But, Co. I, 8 Reg't U. S. Col'd H. Art'y.

Appears on

Company Muster Roll

for *Sept & Oct*, 1865.

Present or absent *Present*

Stoppage, \$ *100* for

Due Gov't, \$ *100* for

Valuation of horse, \$ *100*

Valuation of horse equipments, \$ *100*

Remarks:

Book mark: -----

J. A. [Signature]

W

S H. Art'y.

U.S.C.T.

John Wilson

Private, Co. *I*, 8 Reg't U. S. Col'd H. Art'y.

Appears on **Co. Muster-out Roll**, dated

Victoria Texas, Feb 10, 1866.

Muster-out to date *Feb 10, 1866*.

Last paid to *Aug 31, 1865*.

Clothing account:

Last settled....., 186 ; drawn since \$..... 100

Due soldier \$..... 100; due U. S. \$..... $5\frac{12}{100}$

Am't for cloth'g in kind or money adv'd \$..... 100

Due U. S. for arms, equipments, &c., \$..... 100

Bounty paid \$ *none* 100; due \$ *100* 100

Remarks: *Entered service*

at original organization as herein shown. Enrolled and subject to draft in 1st enrollment Dist of Ky at time of enlistment.

Book mark:

Ag' 23

C. S. Rozzell

(361)

Copyist.

W

820A

U.S.C.A.

Wilson, John

Co. I

8

Reg't U.S.C.A.

/ Inclosures.

Bed Cards	Final Statements
Burial Records	Furloughs or L. of A
Certs. of Dis. for Disch	Med. Certificates
C. M. Charges	Med. Des. Lists
Descriptive Lists	Orders
Discharge Certificates	Pris. of War Record
Enlistment Papers	Resignations

Other papers relating to—

Admission to Hosp'l	Furlough or L. of A
Casualty Sheet	Med. Examination
Confinement	Misc. Information
Contracts	Pay or Clothing
Death or Effects	Personal Reports
Desertion	Rank
Discharge from Hosp'l	Transfer to Hosp'l
Discharge from Service	Transfer to V. R. C.
Duty	Transportation
S. of S. Ref. Slips. /	

Statement of Service Reference Slip.

Office PO

Claim No. Qty. 508 967

John Wilson
(Name.)

, Co. I, 8 Reg't U.S.C. Art.,

To Med. Div. Feb 29, 1916

For report

No med. found

Johnson

RNB

Ja

No medical record found

Statement furnished MAR 2 1916, 191

Shu.

1918
Wilson John

Co G, 8 U.S. Col'd H. Art'y.

Private Private

CARD NUMBERS.

1	5477502	26
2	5477637	27
3	5477914	28
4	5407670	29
5	5477752	30
6	9122121	31
7	40744954	32
8		33
9		34
10		35
11		36
12		37
13		38
14		39
15		40
16		41
17		42
18		43
19		44
20		45
21		46
22		47
23		48
24		49
25		50

Book Mark:

See also

D. 1626411 P. 100000

D. 2699858 P. 100000

Ag. 1752161

S 3020247 C. 100000

SS Sol 1 + Dayton $\frac{12}{31}$ 3000

Fr. H. H. Stone - $\frac{8}{24/34}$ P. 100000

22

8 H. Art'y. U.S.C.T.

John Wilson

, Co. G, 8 Reg't U.S. Col'd H. Art'y.

Appears on

Company Descriptive Book

of the organization named above.

DESCRIPTION.

Age 23 years; height 5 feet 6 inches.

Complexion Brown

Eyes Gray; hair Black

Where born South A., Ky.

Occupation Farmer

ENLISTMENT.

When July 6, 1867

Where Cairo, Ill.

By whom Capt Cook; term 3 y'rs.

Remarks: Mustard Col. of service
Wagon of Co. at Baltimore, Md.

E. A. Moreland

(383g)

Copyist.

8 H. Art'y.

U.S.C.T.

John Wilson

Co. G, 8 Reg't U. S. Col'd H. Art'y.

Appears on

Company Muster Roll

for *Jan / July*, 186*5*.

Present or absent *Present*

Stoppage, \$ *100* for

Due Gov't, \$ *100* for

Valuation of horse, \$ *100*

Valuation of horse equipments, \$ *100*

Remarks:
*(Controlled at Cairo Ill
Feb 6/65 (M.) at
Paducah. Feb 12/65 for
3 years)*

Book mark:

John Wilson

M 8 H. Art'y. U.S.C.T.

John ...

..., Co. G, 8 Reg't U. S. Col'd H. Art'y.

Appears on

Company Muster Roll

for *...*, 186 *...*

Present or absent *...*

Stoppage, \$ *...* 100 for *...*

Due Gov't, \$ *...* 100 for *...*

Valuation of horse, \$ *...* 100

Valuation of horse equipments, \$ *...* 100

Remarks: *...*

...

...

...

...

Book mark: *...*

...

8 H. Art'y.

U.S.C.T.

[Signature]
....., Co. G, 8 Reg't U. S. Col'd H. Art'y.

Appears on

Company Muster Roll

for *May 1863*, 1863.

Present or absent.....

Stoppage, \$..... 100 for.....

Due Gov't, \$..... 100 for.....

Valuation of horse, \$..... 100

Valuation of horse equipments, \$..... 100

Remarks:.....

*Mustered out of service at
Baltimore Md May 24 63
per order of the Dept*

Book mark:.....

[Signature]

W

8 H. Art'y.

U.S.C.T.

St John Wilson

Priv, Co. G, 8 Reg't U. S. Col'd H. Art'y.

Appears on Returns as follows:

Apr 4th May 18 63 absent
sick at Baltimore Md
since Apr 15/63.

June 18 65 May 24/65
Multi Md discharged

Book mark:

Chas D. Bates

(546)

Copyist.

77 | 8 H. Arty. | U.S.C.T.

John Wilson
Priv, Co. G, 8 Reg't U. S. Col'd Arty

Appears on a

Detachment Muster-out Roll

of the organization named above. Roll dated

Baltimore Md, May, 1865.

Muster-out to date May 24, 1865.

Last paid to ~~None~~ paid, 186 .

Clothing account:

Last settled, 186 ; drawn since \$ 100

Due soldier \$ 100; due U. S. \$ 100

Am't for cloth'g in kind or money adv'd \$ 100

Due U. S. for arms, equipments, &c., \$ 100

Bounty paid \$ 100 due \$ 100

Remarks: Descriptive list -
silent as regards
Bounty due U.S. for
clothing overdrawn
\$23 ⁷⁵/₁₀₀ Has in his pos-
session U. S property
over

Book mark:

C. S. Rozzell

(349)

Copyist.

JAN. 14

5467670

1891

One Knapsack, one
Haversack on Canton
M.O. in accordance
with Telegram dated
A. G. O. Washington D.C.
May 4 - /65-

N.H.H. 447
N. | S H. Art'y. | U.S.C.T.

John Nilson
Reg't Co. J., 8 Reg't U. S. Col'd H. Art'y.

Appears on **Co. Muster-out Roll**, dated
Victoria Texas Feb 10, 186.

Muster-out to date _____, 186 .

Last paid to *None Paid*, 186 .

Clothing account:

Last settled _____, 186 ; drawn since \$ _____ 100

Due soldier \$ _____ 100 ; due U. S. \$ _____ 100

Am't for cloth'g in kind or money adv'd \$ _____ 100

Due U. S. for arms, equipments, &c., \$ _____ 100

Bounty paid \$ _____ 100 ; due \$ _____ 100

Remarks: *Discharged by order of the commanding officer of the 8th Regt U.S. Col'd H. Art'y. at Victoria Texas on Feb 10 1865. He was wounded at the Battle of Ball Bluffs on May 6 1865.*

Book mark: *Page 23*

(861) *W. Kelley* Copyist.

1919
Wilson Jordan

Co B, 8 U.S. Col'd H. Art'y.

Private Private

CARD NUMBERS.

1	5469904	26
2	5470029	27
3	5470172	28
4	5470313	29
5	5470443	30
6	5470572	31
7	5470702	32
8	5470824	33
9	5470946	34
10	5471058	35
11	5471174	36
12	5471284	37
13	9121499	38
14		39
15		40
16		41
17		42
18		43
19		44
20		45
21		46
22		47
23		48
24		49
25		50

Book Mark: _____

See also _____

M

8 H. Art'y. U.S.C.T.

Jordan Wilson

Co. *B*, 8 Reg't U.S. Col'd H. Art'y.

Appears on

Company Descriptive Book

of the organization named above.

DESCRIPTION.

Age *26* years; height *5* feet *7* inches.

Complexion *Dark*

Eyes *Dark*; hair *Dark*

Where born *Clarkeville, Tenn.*

Occupation *Farmer*

ENLISTMENT.

When *Feb. 28*, 186*4*.

Where *Paducah, Ky.*

By whom *W Coffin*; term *3* y'rs.

Remarks:

A. Anderson

N | 8 H. Art'y. | U.S.C.T.

Jordan Wilson
Print, Co. B, 1 Reg't Ky. H. Art'y.†

Age years.

Appears on

Company Muster Roll*

for Paducah, Ky. Apl 30, 1864.

Joined for duty and enrolled:

When Febry. 28, 1864.

Where Paducah, Ky.

Period 3 years.

Mustered in:

When April 26, 1864.

Where Paducah, Ky.

Present or absent Present

Stoppage, \$ 100 for

Due Gov't \$ 100 for

Valuation of horse, \$ 100

Valuation of horse equipments, \$ 100

Remarks:

†This organization subsequently became Co. D, 8 Reg't U. S. Colored Heavy Artillery.

*First current roll. No muster-in roll of this company on file.

Book mark:

(3586)

Jas Boyd

Copyist.

Jordan Wilson

Privt., Co. B, 8 Reg't U. S. Col'd H. Art'y.

Appears on

Company Muster Roll

for *May & June*, 186*4*.

Present or absent *Present*

Stoppage, \$ *100* for

Due Gov't, \$ *100* for

Valuation of horse, \$ *100*

Valuation of horse equipments, \$ *100*

Remarks:

Book mark: _____

J. A. Boyd

21

8 H. Art'y.

U.S.C.T.

Jordan Wilson

Private, Co. B, 8 Reg't U. S. Col'd H. Art'y.

Appears on

Company Muster Roll

for *July and Aug.*, 1864.

Present or absent *Present*

Stoppage, \$ *100* for

Due Gov't, \$ *100* for

Valuation of horse, \$ *100*

Valuation of horse equipments, \$ *100*

Remarks:

Book mark:

J. M. Boyd

(358)

Copyist.

N 8 *H. Arty* U.S.C.T

Jordan Wilson
Pvt., Co. *B*, 8 Reg't U. S. Col'd *H. Arty*

Appears on

Company Muster Roll

for *Sept and Oct*, 186*4*

Present or absent *Present*

Stoppage, \$ *100* for

Due Gov't, \$ *100* for

Valuation of horse, \$ *100*

Valuation of horse equipments, \$ *100*

Remarks:

Book mark:

(358)

J. A. Boyd

Copyist.

21 | 8 H. Art'y. | U.S.C.T.

London Wilson

Prin., Co. B, 8 Reg't U. S. Col'd H. Art'y.

Appears on

Company Muster Roll

for *December Dec*, 1864.

Present or absent *Present*

Stoppage, \$ *100* for

Due Gov't, \$ *100* for

Valuation of horse, \$ *100*

Valuation of horse equipments, \$ *100*

Remarks:

Book mark: -----

(358)

J. G. Hoover
Copyist.

W

8 H. Art'y.

U.S.C.T.

Jordan Wilson

Co. B, Co. B, 8 Reg't U. S. Col'd H. Art'y.

Appears on

Company Muster Roll

for *Annual Feb*, 186*7*.

Present or absent *Present*

Stoppage, \$ *100* for

Due Gov't, \$ *100* for

Valuation of horse, \$ *100*

Valuation of horse equipments, \$ *100*

Remarks:

Book mark:

(358)

J. Wilson
Copyist.

Jordan Wilson
Scrib, Co. B, 8 Reg't U. S. Col'd H. Art'y.

Appears on

Company Muster Roll

for March and April, 1865.

Present or absent Present

Stoppage, \$ 100 for

Due Gov't, \$ 100 for

Valuation of horse, \$ 100

Valuation of horse equipments, \$ 100

Remarks:

Book mark: -----

(358)

J. H. [Signature]
Copyist.

W 8 H. Artg. **U. S. C. T**

Jordan Wilson
His. Co. B., 8 Reg't U. S. Col'd H. Artg.

Appears on

Company Muster Roll

for May and June, 1865.

Present or absent Present

Stoppage, \$ 100 for

Due Gov't, \$ 100 for

Valuation of horse, \$ 100

Valuation of horse equipments, \$ 100

Remarks:
.....
.....
.....
.....
.....
.....
.....
.....
.....
.....

Book mark:

(358)

J. G. R. 112
Copyist.

Jordan Wilson
Capt., Co. B, 8 Reg't U. S. Col'd H. Art'y.

Appears on

Company Muster Roll

for June 21st, 1865

Present or absent Present

Stoppage, \$ 100 for

Due Gov't, \$ 100 for

Valuation of horse, \$ 100

Valuation of horse equipments, \$ 100

Remarks:

Book mark:

(358)

Handwritten Signature
Copyist.

Jordan Wilson

Priv., Co. B, 8 Reg't U. S. Col'd H. Art'y.

Appears on

Company Muster Roll

for *Sept. & Oct.*, 186*3*.

Present or absent *Absent*

Stoppage, \$ 100 for

Due Gov't, \$ 100 for

Valuation of horse, \$ 100

Valuation of horse equipments, \$ 100

Remarks:

Book mark: -----

J. Handley

Jordan Wilson
Sgt, Co. B, 8 Reg't U. S. Col'd H. Art'y.

Appears on

Company Muster Roll

for *Nov. & Dec.*, 186*5*.

Present or absent *Present*

Stoppage, \$ *100* for

Due Gov't, \$ *100* for

Valuation of horse, \$ *100*

Valuation of horse equipments, \$ *100*

Remarks:
.....
.....
.....
.....
.....
.....
.....
.....
.....
.....

Book mark:

(358) *Randall* Copyist.

Jordan Wilson
Co. A, 8 Reg't U. S. Col'd H. Art'y.

Appears on **Co. Muster-out Roll**, dated
Victoria, B.C., Feb. 10, 1866.

Muster-out to date *Feb. 10*, 1866.

Last paid to *Aug. 31*, 1865.

Clothing account:

Last settled....., 186 ; drawn since \$..... 100

Due soldier \$ *12 39* / 100; due U. S. \$..... 100

Am't for cloth'g in kind or money adv'd \$..... 100

Due U. S. for arms, equipments, &c., \$..... 100

Bounty paid \$..... 100; due \$..... 100

Remarks *Entered service as here-*
in shown. Enrolled and
subject to draft in 1st En-
rollment Dist. of Ky. at
time of enlistment.

Book mark:

Wye 26

Randall
Coryist.

1920
Wilson Lewis

Co B, 8 U.S. Col'd H. Art'y.

Private | Private

CARD NUMBERS.

1 5470032	26
2 5470175	27
3 5470316	28
4 5470444	29
5 5470573	30
6 5470703	31
7 5470825	32
8 5470947	33
9 5471059	34
10 5471175	35
11 5471285	36
12 9121502	37
13 40744955	38
14	39
15	40
16	41
17	42
18	43
19	44
20	45
21	46
22	47
23	48
24	49
25	50

Book Mark: _____

See also _____

D. 620836 P.O. aff
S 724425, P.O. aff

D-1670565 P.O. aff

A.S.O. 1234283

J-2689198 A.S.O. 10. 10.
D 2788645 P.O. aff

W | 8 H. Art'y. | U.S.C.T.

Lewis Wilson

Co. *B*, 8 Reg't U.S. Col'd H. Art'y.

Appears on

Company Descriptive Book

of the organization named above.

DESCRIPTION.

Age *26* years; height *5* feet *8* inches.

Complexion *Dark*

Eyes *Dark*; hair *Dark*

Where born *Brittenden Co., Ky.*

Occupation *Farmed*

ENLISTMENT.

When *June 10*, 186*4*

Where *Paducah, Ky.*

By whom *Wm. Brown*; term *3* y'rs.

Remarks: _____

Henderson

Lewis Wilson

Privt, Co. B, 8 Reg't U. S. Col'd H. Art'y.

Appears on

Company Muster Roll

for May & June, 1864.

Present or absent Present

Stoppage, \$ 100 for

Due Gov't, \$ 100 for

Valuation of horse, \$ 100

Valuation of horse equipments, \$ 100

Remarks:

(Continued at Serial
7 June 11 1864
present for 25/04
for 5 years)

Book mark: W140714

J. A. Boyd

91

8 H. Art'y.

U.S.C.T.

Louis Wilson

Privt., Co. B, 8 Reg't U. S. Col'd H. Art'y.

Appears on

Company Muster Roll

for July and Aug., 1864.

Present or absent Present

Stoppage, \$ 100 for

Due Gov't, \$ 100 for

Valuation of horse, \$ 100

Valuation of horse equipments, \$ 100

Remarks:

Book mark:

J. A. Boyd

(358)

Copyist.

11 8th. arty U.S.C.T

Louis Wilson

Art., Co. B, 8 Reg't U. S. Col'd 8th. arty

Appears on

Company Muster Roll

for Sept. and Oct., 1864.

Present or absent Present

Stoppage, \$ 100 for

Due Gov't, \$ 100 for

Valuation of horse, \$ 100

Valuation of horse equipments, \$ 100

Remarks:

Book mark:

J. Boyd

(358)

Copyist.

W

8 H. Art'y.

U.S.C.T.

Lewis Wilson

Plt, Co. B, 8 Reg't U. S. Col'd H. Art'y.

Appears on

Company Muster Roll

for *Nov and Dec*, 1864.

Present or absent *Present*

Stoppage, \$ *100* for

Due Gov't, \$ *100* for

Valuation of horse, \$ *100*

Valuation of horse equipments, \$ *100*

Remarks: *Sick in Regt Hospital.*

Book mark:

(358)

G. P. ...
Copyist.

M | 8 H. Art'y. | U.S.C.T.

Lewis Wilson

M, Co. B, 8 Reg't U. S. Col'd H. Art'y.

Appears on

Company Muster Roll

for *January 1863*, 1863:

Present or absent *Present*

Stoppage, \$ *100* for

Due Gov't, \$ *100* for

Valuation of horse, \$ *100*

Valuation of horse equipments, \$ *100*

Remarks:

Book mark:

(358)

S. C. [Signature]
Copyist.

24 | S H. Art'y. | U.S.C.T.

Lewis Wilson

3rd, Co. B, 8 Reg't U. S. Col'd H. Art'y.

Appears on

Company Muster Roll

for March and April, 1865.

Present or absent Present

Stoppage, \$ 100 for

Due Gov't, \$ 100 for

Valuation of horse, \$ 100

Valuation of horse equipments, \$ 100

Remarks:

Book mark:

(358)

J. G. Reeves Copyist.

W. S. H. Inty U.S.C.T

Lewis Wilson

Chi. Co. B, 8 Reg't U. S. Col'd

Appears on

Company Muster Roll

for May and June, 1863.

Present or absent Present

Stoppage, \$ 100 for

Due Gov't, \$ 100 for

Valuation of horse, \$ 100

Valuation of horse equipments, \$ 100

Remarks: Sent to New Orleans La U.S.A. June 20 1863

Book mark:

(358)

J. G. Reeves Copyist.

11 | 8 H. Art'y. | U.S.C.T.

Lewis Wilson

Co. B, 8 Reg't U. S. Col'd H. Art'y.

Appears on

Company Muster Roll

for July & Aug., 1865

Present or absent Absent

Stoppage, \$ 100 for

Due Gov't, \$ 100 for

Valuation of horse, \$ 100

Valuation of horse equipments, \$ 100

Remarks Sent to Hospital at New Orleans La June 20 1865

Book mark:

(358) Randall Copyist.

M | 8 H. Art'y. | U.S.C.T.

Lewis Wilson

Priv., Co. B, 8 Reg't U. S. Col'd H. Art'y.

Appears on

Company Muster Roll

for *Sept. & Oct.*, 186*5*.

Present or absent *Present*

Stoppage, \$ 100 for

Due Gov't, \$ 100 for

Valuation of horse, \$ 100

Valuation of horse equipments, \$ 100

Remarks: _____

Book mark: _____

Handall

W- | 8 H. Art'y. | U.S.C.T.

Louis Wilson

Art., Co. B, 8 Reg't U. S. Col'd H. Art'y.

Appears on

Company Muster Roll

for Dec 2 Dec, 1860

Present or absent Present

Stoppage, \$ 100 for

Due Gov't, \$ 100 for

Valuation of horse, \$ 100

Valuation of horse equipments, \$ 100

Remarks:

Book mark:

Randall

(358)

Copyist.

W | 8 H. Art'y. | U.S.C.T.

L. Wilson

Priv, Co B, 8 Reg't U. S. Col'd H. Art'y.

Appears on Returns as follows:

June to Aug 1865 absent
sick at N.O. La since
June 20/65.

Book mark :

Paul Patton

(546)

Copyist.

James Wilson
Co. B, 8 Reg't U. S. Col'd H. Art'y.

Appears on **Co. Muster-out Roll**, dated
Montreal, Sept 10, 1866.
Muster-out to date *Feb 10*, 1866.
Last paid to *Jan 31*, 1865.

Clothing account:

Last settled....., 186 ; drawn since \$..... 100
Due soldier \$..... 100; due U. S. \$ *11* ⁸⁷/₁₀₀
Am't for cloth'g in kind or money adv'd \$..... 100

Due U. S. for arms, equipments, &c., \$..... 100
Bounty paid \$..... 100; due \$ *100* 100

Remarks: *Entered service as re-*
cruit. joined Co. for duty
June 10, 1864. Enrolled and
subject to draft in "Enroll-
ment list of Ky. at time
of enlistment."

Book mark: *N 1407 Hef*
(Age 20 years)

Randall
Copied.

Wilson, Lewis

B, Co. B, 8 Reg't U.S.C. Hy. Arty.

----- / Enclosures.

Bed Cards	Descriptive Lists
Burial Records	Final Statements
Certs. of Dis. for Discharge	Furloughs
C. M. Charges	Med. Des. Lists
Med. Certificates	Orders

Other papers relating to—

Admission to Hosp'l	Furlough
Casualty Sheet (Officer's)	Med. Examination
Confinement	Misc. Information
Contracts	Pay or Clothing
Death or Effects	Personal Reports
Desertions	Rank
Discharge from Hosp'l	Transfer to Hosp'l
Discharge from Service	Transfer to V. R. C.
Duty	Transportation

War Department,

ADJUTANT GENERAL'S OFFICE,

Washington, *June 6, 1867.*

Respectfully returned to the Commission for the State of Kentucky, with the information that

Lewis Wilson was enlisted at Paducah Ky June 10, 1864, and was mustered in as Pvt. in Co "B" 8th U.S. Colored Regt June 25, 1864.

H. R. ...

Asst. Adj't General.

W.C.S.

No. *...*

APPLICATION OF

W.H. Wilson & Co

OF

Crittenden Co

FOR COMPENSATION FOR SLAVE,

Named *Lewis Wilson*

Enlisted *10th June* 1864,

In Com. *B*, *8th* Regiment,

U. S. COLORED TROOPS.

Received *Jan 28*, 1867.

Compensation Awarded

....., 186...

..... Dollars.

President of Board of Claims.

Claimant's Attorney,

Robert H. Rogers

Marion Ky

Claimant's Post-office Address,

Marion

Crittenden Co Ky

FRANKFORT COMMONWEALTH PRINT.

No.

CLAIM OF

FOR THE COMPENSATION OF SLAVE NAMED

We *W. F. Wilson, R. W. Wilson & Mary E. Armstrong*
 a loyal citizens and residents of *the*
 County of *Crittenden* State of Kentucky, hereby claim compensation, under
 the provisions of Section 21, act approved February 21, 1864, and section 2, act approved July, 28,
 1866, for ~~my~~ ^{our} slave *Lewis Wilson*, enlisted *10th June 18*
 1864, at *Padrucak Ky*, by *W. E. Brown*
 in the *8th (Heavy Art)* Regiment U. S. Colored Troops, Co. *B*; certificate of
 which enlistment, and a descriptive list, as required, accompany this application. That ~~we~~ did not ac-
 quire said slave subsequent to said enlistment, but had a valid title to him at the date of said enlist-
 ment, and previous thereto: ~~we~~ having acquired ~~my~~ ^{our} title to him and ~~my~~ ^{our} ownership over him as fol-
 lows, to-wit: *By inheritance from our deceased*
father James W. Wilson, who died, April 23rd
1865 & who was at that ^{time of enlistment} the owner of said
Lewis Wilson & we the said W. F. Wilson R. W. Wilson and
Mary E. Armstrong (widow) are the children & only heirs at law
of the said James W. Wilson died who was actively loyal rep.
 In proof of ~~our~~ ^{our} loyalty to the Constitution and Government of the United States ~~we~~ present the ac-
 companying oath, which ~~we~~ have taken, signed and acknowledged; to be filed with this application, in
 accordance with requirement of General Orders, No. 329, 1863, War Department, Adjutant General's
 Office.

*W. F. Wilson
 R. W. Wilson
 M. E. Armstrong*

January 16th 1867

For the Term of this certificate No. 16

We W. F. Wilson R. W. Wilson
and Mary E. Armstrong
 OATH OF ALLEGIANCE.
 the owners and Claimants do solemnly swear that
 the foregoing claim is a just and true claim due to ~~me~~ ^{us} as masters and owners of the said slave, and that
 the facts alleged in said claim in respect to the draft or enlistment (as the case may be) of said slave
 into the Military service of the United States are true. And ~~we~~ do further swear that ~~we~~ have never
 joined, or been concerned in, any insurrection or rebellion; that ~~we~~ have never borne arms against the
 United States; that ~~we~~ have never given any aid, countenance, counsel or encouragement to any person
 or persons engaged, or whom ~~we~~ had reason to believe were about to engage, in insurrection, rebellion
 or armed hostility against the United States; that ~~we~~ have neither sought, nor accepted, nor attempted
 to exercise the functions of any office, civil or military, nor to perform any service whatever, under
 any authority or pretended authority in hostility to the United States; that ~~we~~ have not yielded a vol-
 untary support to any insurrection, rebellion or pretended government, authority, power or constitution
 within the United States hostile thereto. And ~~we~~ do further swear that, to the best of ~~my~~ ^{our} knowledge
 and ability ~~we~~ have supported and defended, and will continue to support and defend, the United
 States against all enemies, foreign and domestic; and that ~~we~~ have supported, defended and obeyed, and
 will continue to support, defend and obey, the Constitution and laws of the United States; that ~~we~~ will
 bear true faith and allegiance to the same; and that ~~we~~ make this oath freely, without any mental reserva-
 tion or purpose of evasion: So help ~~me~~ ^{us} God.

*W. F. Wilson
 R. W. Wilson
 M. E. Armstrong*

Sworn to and subscribed before me, at *Marion Ky*
 this *16th* day of *January*, 1867
J. W. Blue Notary Public
for Crittenden County Ky



PROOF OF OWNERSHIP.

STATE OF KENTUCKY, }
COUNTY OF Crittenden } SS.

We _____ and _____ each of lawful age, and resident citizens of the State and County aforesaid, do certify that *James W Wilson deed* of the State and County aforesaid, was on the *25th* day of *June* 186*4*, ^{long previous thereto} the lawful owner of the slave named *Speris Wilson*; referred to and described in the foregoing claim for compensation. *That said James W Wilson is dead & J W Wilson & W Wilson & Mary E Armstrong are the children & only heirs at law of sd deed*

J. W. Wilson
L. A. Dean

Sworn to and subscribed before me a *Notary Public* for the County of *Crittenden* State of Kentucky, this the *16th* day of *January* 186*7*.

J. W. Blue Notary Public
for Crittenden County Ky

5 CENT
STAMP.



PROOF OF LOYALTY.

STATE OF KENTUCKY, }
COUNTY OF _____ } SS.

We _____ and _____ loyal men and each of lawful age, and resident citizens of the _____ of _____

in the State and County aforesaid, upon our oaths declare that we have known *James W Wilson deed* and *W A Wilson & W Wilson & Mary E Armstrong* ^{him} of sd *J W Wilson* a resident of the State and County aforesaid, since the 4th day of March, 1861, and know that ~~he has~~ ^{they have} ~~he has~~ ^{they have} firmly and faithfully maintained ^{their} ~~his~~ adherence and allegiance to the Government of the United States, by defending its cause against the Government and forces of the so-called Confederate States of America, in all suitable and practicable ways, and according to ^{their} ~~his~~ or her ability and opportunity. *That both Father & Children were truly loyal*

J. P. Stinson
N. R. [unclear]

Sworn to and subscribed before me a *Notary Public* for the county of *Crittenden* State of Kentucky, this the *16th* day of *January* 186*7*.

J. W. Blue Notary Public
for Crittenden County, Ky

5 CENT
STAMP.



POWER OF ATTORNEY.

My Post-Office address is *Warion* County of *Crittenden* State of Kentucky, and I hereby direct that all communications to me, touching this claim, be sent under cover to *Claimant, or either of them*, who is hereby appointed and constituted my true and lawful attorney, to prosecute this claim for me, and who is hereby authorized and empowered to receive and receipt for any award, order, draft, certificate, voucher, warrant, papers or money that may be issued in the adjustment of this claim, or the payment thereof, the same as I might or could do in person were I present and acting for myself, and to file any additional evidence or papers that may be required in the prosecution of this claim.

[WITNESS.]

The owner signs here. }

50 CENT
STAMP.

Two witnesses to owner's signature sign here.

Headquarters Kentucky Volunteers,

Adjutant-General's Office,

Frankfort, Dec 31, 1866.

I hereby certify, that it appears from the U. S. Muster-
Rolls on file in this Office, that Lewis Wilson
was enrolled on the 10 day of June, 1864, at
Paducah Ky, by W. E. Brown,
and mustered into the U. S. service on the 25 day of June,
1864, at Paducah Ky, by S. H. Iver,
to serve three years. Said Lewis Wilson
is described as follows: Age, 26 years; eyes, _____, hair, _____,
complexion, _____; height, _____ feet _____ inches. It further
appears from said Rolls, that Lewis Wilson, owed service
to James Wilson, was credited to Crestedon
County, Ky., and was assigned to Co. B, 8 Regiment
U. S. C. A. J. Heary

In Testimony Whereof, I have hereunto set my
hand, and affixed my Official Seal, this
31 day of Dec 1866.

D. W. Lindsey
Adjutant General of Kentucky.

B. Org, R. B 8 Army

1921
Wilson Samuel

Co B, 8 U.S. Col'd H. Art'y.

Private Private

CARD NUMBERS.

1	5470034	26
2	5470184	27
3	5471337	28
4	9121505	29
5	49744956	30
6		31
7		32
8		33
9		34
10		35
11		36
12		37
13		38
14		39
15		40
16		41
17		42
18		43
19		44
20		45
21		46
22		47
23		48
24		49
25		50

Book Mark:

See also

W

8 H. Art'y. U.S.C.T.

Samuel Wilson

Co. *B*, 8 Reg't U.S. Col'd H. Art'y.

Appears on

Company Descriptive Book

of the organization named above.

DESCRIPTION.

Age *18* years; height *5* feet *7* inches.

Complexion *Dark*

Eyes *Dark*; hair *Dark*

Where born *Crittenden Co., Ky.*

Occupation *Teamster*

ENLISTMENT.

When *June 13*, 1864

Where *Paducah, Ky.*

By whom *Wm. Brown*; term *3* y'rs.

Remarks: *Died at Paducah, Ky. Aug. 22/64, Dysentery*

Henderson

W

S H. Art'y.

U.S.C.T.

Samuel Wilson

Privt., Co. B, 8 Reg't U. S. Col'd H. Art'y.

Appears on

Company Muster Roll

for May & June, 1864.

Present or absent Present

Stoppage, \$ 100 for

Due Gov't, \$ 100 for

Valuation of horse, \$ 100

Valuation of horse equipments, \$ 100

Remarks:

(Committed June 13/64
for 3 years at
Baltimore by per
3 years.)

Book mark: W 1412 Kj

J. A. Boyd

(358)

Copyist.

21

8 H. Art'y.

U.S.C.T.

Samuel Wilson

Privt., Co. B, 8 Reg't U. S. Col'd H. Art'y.

Appears on

Company Muster Roll

for July^{3rd} Aug., 1864.

Present or absent

Stoppage, \$ 100 for

Due Gov't, \$ 100 for

Valuation of horse, \$ 100

Valuation of horse equipments, \$ 100

Remarks: Died in Regimental Hospital August 20th 1864.

Book mark:

J. M. Boyd

(358)

Copyist.

W

8 H. Art'y.

U.S.C.T.

Samuel Wilson

Pvt, Co. B, 8 Reg't U. S. Col'd H. Art'y.

Appears on Returns as follows:

Aug 18 64 Aug 22 1864
Paducah Ky died
in Regt Hosp.

Book mark :

Chas. Patton

(546)

Copyist.

Samuel Wilson
Co. B, 8 Reg't U. S. Col'd H. Art'y.

Appears on Co. Muster-out Roll, dated
Victoria, Texas, Feb 15, 1864.

Muster-out to date _____, 186 .

Last paid to June 30, 1864.

Clothing account:

Last settled _____, 186 ; drawn since \$ _____ 100

Due soldier \$ _____ 100; due U. S. \$ _____ 100

Am't for cloth'g in kind or money adv'd \$ _____ 100

Due U. S. for arms, equipments, &c., \$ _____ 100

Bounty paid \$ _____ 100; due \$ _____ 100

Remarks Entered service as recruit.

Joined Co. for duty June 13, 1864.

Died at Caducah, Ky, Aug 20, 1864.

Cause of death not reported.

Final statements & Inventory
of effects forwarded to A.G.C.
(over)

Book mark: Died Aug. 22, 1864

E.B. 911 P. 5-73. W. 1412 Ky.

W. 1412 Ky.
P. 5-73
P. 5-73

JAN. 14

5471337

1891 ☆

Aug. 20" 1864.

N 11 4 4 4
Nelson, Samuel

B., Co. B, 8 Reg't U.S.C.H.A.

3 Enclosures.

Bed Cards	Descriptive Lists
Burial Records	Final Statements 1
Certs. of Dis. for Discharge	Furloughs
C. M. Charges	Med. Des. Lists
Med. Certificates	Orders

Other papers relating to—

Admission to Hosp'l	Furlough
Casualty Sheet (Officer's)	Med. Examination
Confinement	Misc. Information 1
Contracts	Pay or Clothing
Death or Effects 1	Personal Reports
Desertions	Rank
Discharge from Hosp'l	Transfer to Hosp'l
Discharge from Service	Transfer to V. R. C.
Duty	Transportation

War Department,

ADJUTANT GENERAL'S OFFICE,

February 25, 1876,

The Death of Samuel
Wilson Bk. Co. "D", 8th Reg't U.S.

Colored Arty Hvy, is reported as follows:

On Company Muster Roll.
For July + Aug, 1864, Aug. 20th, 1864

Company Muster-out Roll.
Aug. 20th, 1864

Company Descriptive Book.
....., 186

Company Morning Reports.
....., 186

Soldier's Final Statement.
Aug. 22nd, 1864

Soldier's Record of Death and Interment.
....., 186

Soldier's Inventory of Effects.
....., 186

Soldier's Certificate of Disability for Discharge.
....., 186

Soldier's Individual Muster-out Roll.
....., 186

Regimental Return.
For August, 1864, Aug. 22nd, 1864

Regimental Quarterly Returns.
Aug. 20th, 1864

Regimental Descriptive Book.
....., 186

By Surgeon General.
(.....), 186

Aug 22, 1864 is held to be
the correct date, and the Company Muster
Roll will be amended accordingly.

Thomas M. Swenick
C/3 see letter to Adjutant
Assistant Adjutant General.
dated 573 of March 10, 1876.
H.M.

V FINAL STATEMENT

OF

Co B
Priv Samuel Wilson

Co B 8th Reg't of U S A (Heavy)

~~...~~
VOLUNTEERS.

Rec'd Mar 22 1864

NOTE 1.—Two of these certificates (or duplicates) are to be given to each Volunteer Soldier or drafted man who may be discharged previously to the discharge of his company, that he may at once receive from the Paymaster the pay, &c., due him, and the captain or other COMMISSIONED officer commanding the company will certify to the act of the delivery of the duplicate certificates; on these certificates the Soldier is "entitled to" his discharge, and should also present his discharge to the Paymaster to have the payment endorsed on it. The discharge is to be given back to the Soldier by the Paymaster; the latter only retaining as his voucher the duplicate certificates.

NOTE 2.—If the Soldier is entitled to pay for the use of his horse, the Company Commander will certify to that fact on the back of both these final statements, and also to the time he has pay due for having been so mounted on his own horse.

NOTE 3.—When a Soldier is furnished with final statements, his descriptive list, if he has one, should be taken up by the officer who gives the Soldier these statements, and endorsed with a statement to this effect by the officer. This endorsement should exhibit a full statement of the time for which the Soldier was allowed pay on his final statements, the clothing account, and all other charges against him or in his favor, so as to comprise a complete exhibit of his account. It will then be transmitted to the company commander of the Soldier, who will enter all the data necessary to a full understanding of the Soldier's account on the muster roll upon which the Soldier's discharge is reported. The descriptive list will then be destroyed. The object of this is, that the remaining portion of the Soldier's account may be settled upon the receipt of these muster rolls, and the Soldier receive any pay or allowances that may be due him at the time of his discharge, and which may not appear on his final statements from the fact that his descriptive list is incomplete. These accounts for back pay, &c., are settled by the 2d Auditor of the Treasury Department.

NOTE 4.—Charges for loss or injury to ordnance, horse equipments, and other miscellaneous charges, should appear under the heading of "Other Stoppages."

NOTE 5.—Bounty paid by State authorities, and not by the United States, will not be entered on this statement.

NOTE 6.—Amounts due the Sutler and Laundress must be entered on the muster roll on which the discharge, death, desertion, &c., is reported, as well as on the final statement, otherwise the amount cannot be collected from the United States.

NOTE 7.—This blank will be used for deceased volunteers and drafted men, as well as for others.

NOTE 8.—Where a Soldier dies in Hospital or on detached service, his descriptive list, if he has one, should be sent with his final statements, in duplicate, to the Adjutant General, Washington, D. C.

Sept 14th
Duplicate with [unclear] Auditor.

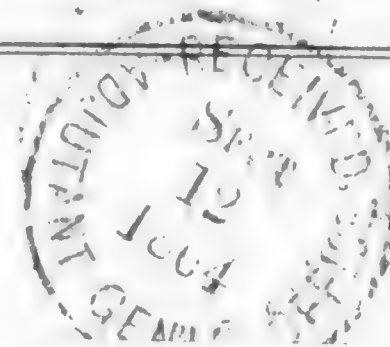

I certify, on honor, that Samuel Gibson a Private of
 Captain J. H. Coffin Company (D) of the 8th Regiment of P. S. Kentucky
VOLUNTEERS, of the State of Kentucky, born in Warttenden Co., State
 of Kentucky, aged 18 years, 5 feet 7 inches high; Dark complexion,
Dark eyes, Dark hair, and by occupation a Teamster, having joined the company on
 its original organization at Paducah Ky, and enrolled in it at the muster into
 the service of the United States at as a recruit, on the 13th day
 of June, 1864, (or was mustered in service as a recruit, by W. M. Jones
 at Paducah Ky, on the 22nd day of June,
 1864, or was drafted and mustered into the service of the United States from the
 Enrollment District of the State of _____, at _____,
 on the _____ day of _____, 186-), to serve in the Regiment, for
 the term of Three years: and having served HONESTLY and
 FAITHFULLY with his Company in 8th P. S. Kentucky to the present date, is now
 entitled to a **DISCHARGE** by reason of Death

Died in Regimental Hospital at Paducah Ky August 22nd 1864

The said Private Samuel Gibson was last paid by Paymaster
Major F. Jones to include the 30th day of June, 1864, and has
 pay due him from that time to the present date; he is entitled to pay and subsistence for
 TRAVELING to place of enrollment, and whatever other allowances are authorized to volunteer
 soldiers, drafted men, or militia, so discharged. He has received from the United States **CLOTHING**
 amounting to 18.16 dollars, since the 13th day of June,
 1864, when his clothing account was last settled. He has received from the United States
100 dollars advanced **BOUNTY**.

There is to be stopped from him, on account of the State of _____, or other
 authorities, for **CLOTHING**, &c., received on entering service, _____ dollars; and
 for other stoppages, viz: _____

_____ dollars.

He has been furnished with **TRANSPORTATION** in kind from the place of his discharge to
 _____; and he has been **SUBSISTED** for **TRAVELING** to his
 place of enrollment, up to the _____, 186- .

He is indebted to _____, **SUTLER**, _____ dollars.

He is indebted to _____, **LAUNDRESS**, _____ dollars.

Given in Duplicate, at Paducah Kentucky, this 22nd day
 of August, 1864.

J. H. Coffin
Capt. U. S. A. C. A. Hoy
 Commanding Company

ARTICLES OF WAR.

ART. 95. When any non-commissioned officer or soldier shall die, or be killed in the service of the United States, the then commanding officer of the troop or company shall, in the presence of two other commissioned officers, take an account of what effects he died possessed of, above his arms and accoutrements, and transmit the same to the office of the Department of War, which said effects are to be accounted for, and paid to the representatives of such deceased non-commissioned officer or soldier. And in case any of the officers, so authorized to take care of the effects of deceased officers and soldiers, should, before they have accounted to their representatives for the same, have occasion to leave the regiment or post, by preferment or otherwise, they shall, before they be permitted to quit the same, deposit in the hands of the commanding officer, or of the assistant military agent, all the effects of such deceased non-commissioned officers and soldiers, in order that the same may be secured for, and paid to, their respective representatives.

ARMY REGULATIONS—EDITION OF 1861.

DECEASED SOLDIERS.

Par. 152. Inventories of the effects of deceased non-commissioned officers and soldiers, required by the 95th Article of War, will be forwarded to the Adjutant General, by the commander of the company to which the deceased belonged, and a duplicate of the same to the colonel of the regiment. Final statements of pay, clothing, &c., will be sent with the inventories. When a soldier dies at a post or station absent from his company, it will be the duty of his immediate commander to furnish the required inventory, and, at the same time, to forward to the commanding officer of the company to which the soldier belonged, a report of his death, specifying the date, place, and cause; to what time he was last paid, and the money or other effects in his possession at the time of his decease; which report will be noted on the next muster-roll of the company to which the man belonged. Each inventory will be endorsed, "Inventory of the effects of _____, late of company (—) _____ regiment of _____, who died at _____, the _____ day of _____, 186—." If a legal representative receive the effects, it will be stated in the report. If the soldier leave no effects, the fact will be reported.

Par. 153. Should the effects of a deceased non-commissioned officer or soldier not be administered upon within a short period after his decease, they shall be disposed of by a Council of Administration, under the authority of the commanding officer of the post, and the proceeds deposited with the Paymaster, to the credit of the United States, until they shall be claimed by the legal representatives of the deceased.

Par. 154. In all such cases of sales by the Council of Administration, a statement in detail, or account of the proceeds, duly certified by the Council and commanding officer, accompanied by the Paymaster's receipt for the proceeds, will be forwarded by the commanding officer to the Adjutant General. The statement will be endorsed, "Report of the proceeds of the effects of _____, late of company (—) _____ regiment of _____, who died at _____, the _____ day of _____, 186—."

NOTE 1.—The effects in all cases, when called for, should be turned over to the legal representative, without further authority from the Adjutant General. When the effects are turned over to the relatives of the deceased before these inventories are sent to the Adjutant General, their receipts therefor should be attached to the inventories. In all other cases, one copy will be sent with a letter of transmittal direct to the Adjutant General, and a duplicate retained by the officer.

NOTE 2.—Particular care should be taken to take receipts in duplicate from the Paymaster for any funds turned over to him; one copy should be sent direct to the Adjutant General and one retained by the officer.

INVENTORY OF THE EFFECTS

OF

James M. ...

Late of Company

Reg't of

Volunteers, who died at

on the _____ day of _____ 1867.



Inventory of the effects of 30 late
a 11 of Captain 11 Company 11 of
the 11 Regiment of 11 Volunteers, who was enrolled as
a 11 at 11 in the State of 11 on
the 11 day of 11 1864, and mustered into the service of the United
States as a 11 on the 11 day of 11 1864, at 11
in Company 11, Regiment of 11 Volunteers, to serve 11
years or during the war; he was born in 11 in the State
of 11; he was 11 years of age, 11 feet 11 inches
high, 11 complexion, 11 eyes, 11 hair, and by occupation, when enrolled,
a 11; he died in 11, at
11 on the 11 day of 11 1864, by
reason of 11

INVENTORY.					
ARTICLES.	No.	ARTICLES.	No.	ARTICLES.	No.
Hats		Pairs trousers	1	Knapsacks	
Caps		Pairs flannel drawers			
Forage caps		Pairs cotton drawers			
Great coats		Flannel shirts			
Uniform coats		Cotton shirts			
Uniform jackets	/	Pairs boots			
Flannel sack coats		Pairs shoes			
Blouses	/	Pairs socks			
Stable frocks		Blankets			
Fatigue overalls		Haversacks			
				MONEY.	
				Specie	\$
				Notes	\$

I CERTIFY, ON HONOR, that the above inventory comprises all the effects of 11
11, deceased, and that the effects are in the hands
of 11 / at 11
11 to be disposed of by a Council of Administration.

(DUPLICATES.)

STATION : 11

11
Commanding the Company.

DATE : 11

War Department,

ADJUTANT GENERAL'S OFFICE,

Washington, *March 6* 1867.

Respectfully returned to the Commission for the State of Kentucky, with the information that *Samuel Wilson* was enlisted at *Paducah Ky.* June 13, 1864, and was mustered in as *Sgt. in Co. "B."* 5th U. S. C. T. June 25, 1864.

W. H. D. Ry.

A. R. R. R. R. R.

W. H. D.

Asst. Adj't General.

No. _____

APPLICATION OF

OF *W. H. Wilson & Co.*

FOR COMPENSATION FOR SLAVE,
Named *Samuel Wilson*
Enlisted *June 13th* 1864,
In Com. *B.*, *8th* Regiment,
U. S. COLORED TROOPS.

Received *28 Jan'y*, 1867.

Compensation Awarded

_____, 186____

Dollars.

President of Board of Claims.

Claimant's Attorney,

Robt F. Hayes,
Merion Ky.

Claimant's Post-office Address,

Merion
Crittenden Co Ky.

FRANKFORT COMMONWEALTH PRINT.

No.

CLAIM OF

FOR THE COMPENSATION OF SLAVE NAMED

We *W. H. Wilson, W. Wilson and Mary E. Armstrong (Widow)*
 † *loyal citizens and residents of* *the*
 County of *Crittenden*, State of Kentucky, hereby claim compensation, under
 the provisions of Section 24, act approved February 24, 1864, and section 2, act approved July, 28,
 1866, for ~~my~~ ^{our} slave *Samuel Wilson*, enlisted *June 13th*
 1864, at *Paducah Ky*, by *W. E. Brown*
 in the *9th (Heavy Arty.)* regiment U. S. Colored Troops, Co. *B*; certificate of

which enlistment, and a descriptive list, as required, accompany this application. That *we* did not ac-
 quire said slave subsequent to said enlistment, but had a valid title to him at the date of said enlist-
 ment, and previous thereto; *we* having acquired ~~my~~ ^{our} title to him and ~~my~~ ^{our} ownership over him as fol-
 lows, to-wit: *By inheritance from our dead father James W. Wilson*
who died Apr 29th 1865 - (No administration had) and who was at
at time of enlistment & long previously the owner of the said
Samuel Wilson and the W. H. Wilson, W. Wilson and Mary E.
Armstrong are the children and only heirs at law of the said
James W. Wilson who was actually loyal to the United
States up to his death

In proof of ~~my~~ ^{our} loyalty to the Constitution and Government of the United States, *we* present the ac-
 companying oath, which *we* have taken, signed and acknowledged; to be filed with this application, in
 accordance with requirement of General Orders, No. 329, 1863, War Department, Adjutant General's
 Office.

W. H. Wilson
R. W. Wilson
M. E. Armstrong

January 16th 1867.

OATH OF ALLEGIANCE.

We *W. H. Wilson, W. Wilson & Mary E. Armstrong* the owners and Claimants do solemnly swear that
 the foregoing claim is a just and true claim due to *us* as masters and owners of the said slave, and that
 the facts alleged in said claim in respect to the draft or enlistment (as the case may be) of said slave
 into the Military service of the United States are true. And *we* do further swear that *we* have never
 joined, or been concerned in, any insurrection or rebellion; that *we* have never borne arms against the
 United States; that *we* have never given any aid, countenance, counsel or encouragement to any person
 or persons engaged, or whom *we* had reason to believe were about to engage, in insurrection, rebellion
 or armed hostility against the United States; that *we* have neither sought, nor accepted, nor attempted
 to exercise the functions of any office, civil or military, nor to perform any service whatever, under
 any authority or pretended authority in hostility to the United States; that *we* have not yielded a vol-
 untary support to any insurrection, rebellion or pretended government, authority, power or constitution
 within the United States hostile thereto. And *we* do further swear that, to the best of ~~my~~ ^{our} knowledge
 and ability *we* have supported and defended, and will continue to support and defend, the United
 States against all enemies, foreign and domestic; and that *we* have supported, defended and obeyed, and
 will continue to support, defend and obey, the Constitution and laws of the United States; that *we* will
 bear true faith and allegiance to the same; and that *we* take this oath freely, without any mental reserva-
 tion or purpose of evasion: So help *us* God.

W. H. Wilson
R. W. Wilson
M. E. Armstrong

Sworn to and subscribed before me, at *Manion Ky*,
 this *16th* day of *January*, 1867.

J. W. Blue Notary Public
 for Crittenden County Ky



PROOF OF OWNERSHIP.

STATE OF KENTUCKY,

COUNTY OF

} SS.

We and each of lawful age, and resident citizens of the State and County aforesaid, do certify that James W Wilson died late of the State and County aforesaid, was on the 13th day of June 1864 and for years before the lawful owner of the slave named Samuel Wilson;

referred to and described in the foregoing claim for compensation. And that James W Wilson is dead that W F Wilson & W Wilson and Mary E Armstrong are the children and only heirs at law of dead

W. F. Wilson
T. L. Dean

Sworn to and subscribed before me a Notary Public for the County of Crittenden State of Kentucky, this the 16th day of January 1867.

5 CENT STAMP.

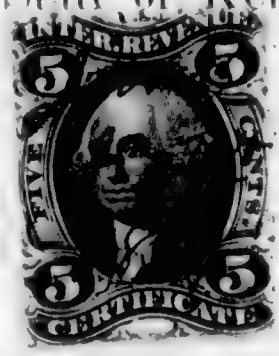

J. W. Blue Notary Public for Crittenden County Ky

PROOF OF LOYALTY.

STATE OF KENTUCKY,

COUNTY OF

} SS.

We and loyal men and each of lawful age, and resident citizens of the County of Crittenden

in the State and County aforesaid, upon our oaths declare that we have known James W Wilson died by W Wilson W F Wilson & Mary E Armstrong (Widow) residents of the State and County aforesaid, since the 4th day of March, 1861, and know that he has they firmly and faithfully maintained their adherence and allegiance to the Government of the United States, by defending its cause against the Government and forces of the so-called Confederate States of America, in all suitable and practicable ways, and according to their ability and opportunity.

S. H. Stinson
W. W. Black

Sworn to and subscribed before me a Notary Public for the county of Crittenden State of Kentucky, this the 16th day of January 1867.

5 CENT STAMP.



J. W. Blue Notary Public for Crittenden County Ky

POWER OF ATTORNEY.

My Post Office address is County of State of Kentucky, and I hereby direct that all communications to me, touching this claim, be sent under cover to , who is hereby appointed and constituted my true and lawful attorney, to prosecute this claim for me, and who is hereby authorized and empowered to receive and receipt for any award, order, draft, certificate, voucher, warrant, papers or money that may be issued in the adjustment of this claim, or the payment thereof, the same as I might or could do in person were I present and acting for myself, and to file any additional evidence or papers that may be required in the prosecution of this claim.

[WITNESS.]

The owner signs here.

50 CENT STAMP.

Two witnesses to owner's signature sign here.

Headquarters Kentucky Volunteers,

Adjutant-General's Office,

Frankfort, Dec 31, 1866.

I hereby certify, that it appears from the U. S. Muster-
Rolls on file in this Office, that Samuel Wilson
was enrolled on the 13 day of June, 1864, at
Paducah Ky., by W. E. Brown,
and mustered into the U. S. service on the 25 day of June,
1864, at Paducah Ky., by S. H. Over,
to serve three years. Said Samuel Wilson
is described as follows: Age, 18 years; eyes, _____, hair, _____,
complexion, _____; height, _____ feet _____ inches. It further
appears from said Rolls, that Samuel Wilson owed service
to James Wilson, was credited to Crittenden
County, Ky., and was assigned to Co. B, 8 Regiment
U. S. C. Artillery Heavy

In Testimony Whereof, I have hereunto set my
hand, and affixed my Official Seal, this
31 day of Dec 1866.

D. W. Lindsay
Adjutant General of Kentucky.

B. O. G. S. B. Gary

1922
Wilson Simon

Co H, 8 U.S. Col'd H. Art'y.

Private Private

CARD NUMBERS.

1	57467093	26
2	57467062	27
3	57478472	28
4	57478629	29
5	57467776	30
6	57479681	31
7	9121989	32
8	40744958	33
9		34
10		35
11		36
12		37
13		38
14		39
15		40
16		41
17		42
18		43
19		44
20		45
21		46
22		47
23		48
24		49
25		50

Book Mark:

See also

W | *S. N. Artz* | **U. S. C. T.**

Simon Wilson

, Co. H, 8 Reg't U. S. Col'd N. Artz.

Appears on

Company Descriptive Book

of the organization named above.

DESCRIPTION.

Age *38* years; height *5* feet *4 1/2* inches.

Complexion *Black*

Eyes *Black*; hair *Black*

Where born *Maryland*

Occupation *Farmer*

ENLISTMENT.

When *August 25*, 186*4*.

Where *Paducah, Ky.*

By whom *R. S. Hall*; term *3* y'rs.

Remarks: *Deserted August 31, 64.*

G. J. Moreland

Simon Wilson

Appears with rank of *Priv* on

Muster and Descriptive Roll of a Detachment of U. S. Vols. forwarded

for the 8 Reg't U. S. Col'd H. Art'y. Roll dated

Paducah Ky N. Y. Aug 3, 1864.

Where born *Md.*

Age *38* y'rs; occupation *Farmer.*

When enlisted *Aug 25*, 186 .

Where enlisted *Paducah Ky*

For what period enlisted *3* years.

Eyes *Black*; hair *Black*

Complexion *Black*; height *5 ft. 4 1/2* in.

When mustered in *Aug 25*, 186 .

Where mustered in *Paducah*

Bounty paid \$ *100*; due \$ *100*

Where credited *M Cracker Co. Dist of Ky*

Company to which assigned

Remarks :

Book mark :-----

Geo Bull Jr
(339) Copyist.

W

8 H. Art'y.

U.S.C.T.

Simon Wilson.

Appears with rank of *Private* on

Muster and Descriptive Roll of a Detachment of U. S. Vols. forwarded

for the 8 Reg't U. S. Col'd H. Art'y. Roll dated

Paducah, Ky., N.Y. Aug 31, 1864

Where born *W.Va.*

Age *38* y'rs; occupation *Farmer*

When enlisted *May 25th*, 186 .

Where enlisted *Paducah, Ky.*

For what period enlisted *3* years.

Eyes *Black*; hair *Black*

Complexion *Black*; height *5' 4 1/2 in.*

When mustered in *Aug. 25th*, 186 .

Where mustered in *Paducah,*

Bounty paid \$ *100*; due \$ *100*

Where credited *McCracken Co. Ky.*

Company to which assigned

Remarks :

Book mark :

Calloway

(339)

Copyist.

94 | 8 H. Art'y. | U.S.C.T.

Simon Wilson

Pr, Co. H, 8 Reg't U. S. Col'd H. Art'y.

Appears on

Company Muster Roll

for *Dated Aug 31*, 1864.

Present or absent *Present*

Stoppage, \$ *100* for

Due Gov't, \$ *100* for

Valuation of horse, \$ *100*

Valuation of horse equipments, \$ *100*

Remarks:

.....
.....
.....
.....
.....
.....
.....
.....
.....
.....

Book mark:

S. W. Taylor

H. S. Hart U.S.C.T.

Simon Wilson

1st, Co. A, 8. Reg't U. S. Col'd Hart

Appears on

Descriptive List of Deserters

dated *Paducah Ky Sept 3, 1864*

Deserted :

When *Augt 31*, 1864

Where *Paducah Ky*

Arrested :

When _____, 186 .

Where _____

Remarks : _____

Book mark : _____

(351)

J. S. Hart
Coryist.

215 | 8 H. Art'y. | U.S.C.T.

Samuel Wilson

Art, Co. H, 8 Reg't U. S. Col'd H. Art'y.

Appears on

Company Muster Roll

for *Sept + Oct*, 1864.

Present or absent.....

Stoppage, \$.....100 for.....

Due Gov't, \$.....100 for.....

Valuation of horse, \$.....100

Valuation of horse equipments, \$.....100

Remarks: *Deserted Aug 21/64
immediately after muster
no payme. &*

Book mark:.....

J. W. Tucker

W | S H. Art'y. | U.S.C.T.

Ammon Wilson

Pvt, Co. N., 8 Reg't U. S. Col'd H. Art'y.

Appears on Returns as follows:

Sept 18 64. Sept 22
Paducah Deserted

Book mark :

Wm. L. Patton

(546)

Copyist.

W 8 H. Art'y. U.S.C.T.

Simon Wilson
Sgt., Co. K, 8 Reg't U. S. Col'd H. Art'y.

Appears on Co. Muster-out Roll, dated
Victoria Texas Feb 10, 1866.

Muster-out to date _____, 186 .
Last paid to Never Paid _____, 186 .

Clothing account:

Last settled _____, 186 ; drawn since \$ _____ 100

Due soldier \$ _____ 100; due U. S. \$ _____ 100

Am't for cloth'g in kind or money adv'd \$ _____ 100

Due U. S. for arms, equipments, &c., \$ _____ 100

Bounty paid \$ _____ 100; due \$ _____ 100

Remarks: Entered service as Recruit
as herein shown. Joined Co for duty Aug
25 1864 Deserted Aug 31 1864 Pa
due at Ky Never clothed.

Book mark: _____

G. W. Deadrick
(361) Copyist.

Wilson, Simon

B Co. A, 8 Reg't U S A

Enclosures.

Bed Cards	Final Statements
Burial Records	Furloughs or L. of A.
Certs. of Dis. for Discharge	Med. Certificates
C. M. Charges	Med. Des. Lists
Descriptive Lists	Orders
Discharge Certificates	Pris. of War Record
Enlistment Papers	Resignations

Other papers relating to—

Admission to Hosp'l	Furlough or L. of A.
Casualty Sheet	Med. Examination
Confinement	Misc. Information
Contracts	Pay or Clothing
Death or Effects	Personal Reports
Desertion	Rank
Discharge from Hosp'l	Transfer to Hosp'l
Discharge from Service	Transfer to V. R. C.
Duty	Transportation

1864

25 525

N. Hundred twenty

Wilson Simon

Volunteered at Paducah Ky

August 25th 1864

By Capt R. A. Hall

Pro Marshal Dist of Ky.

The U. S. Art. Heavy

Consent of Parent or Guardian in case of a Minor, if a Free Man, or in the case of a

United States colored troops. They will be made out in duplicate in all cases—
eral, and one to accompany the accounts of the officer who pays bounty, &c.
in, must in all cases, precede payment of pay, bounty, pension, &c. A m
officer, commissary, or assistant commissary of musters, as the case may be, w
of them is given to the disbursing officer.

UNITED STATES COLORED TROOPS ENLISTMENT.

STATE OF



TOWN OF

Kentucky *Paducah*

I, *Wilson Simon* born in

in the State of *Maryland* aged *Thirty Eight* years

and by occupation a *Farmer* Do HEREBY ACKNOWLEDGE to have

volunteered this *Twenty fifth* day of *August* 1864,

to serve as a **Soldier** in the **Army of the United States of America**, for

the period of **THREE YEARS**, unless sooner discharged by proper authority:

Do also agree to accept such bounty, pay, rations, and clothing, as are, or may be, established by law for the U. S. colored troops.

And I, *Simon Wilson of McCracken Co Ky*

do solemnly swear, that I will bear true faith and allegiance to the **United States**

of America, and that I will serve them honestly and faithfully against all their

enemies or opposers whomsoever; and that I will observe and obey the orders of

the President of the United States, and the orders of the officers appointed over

me, according to the Rules and Articles of War.

Sworn and subscribed to, at *Paducah Ky*

this *25th* day of *Aug* 1864, *Simon Wilson*

Before *Capt R. H. Hall* *Major*

Pro Marshal Dist of Ky

I CERTIFY, ON HONOR, That I have carefully examined the above named Volunteer, agreeably to the General Regulations of the Army, and that, in my opinion, he is free from all bodily defects and mental infirmity, which would in any way disqualify him from performing the duties of a soldier.

W. H. Kidd

EXAMINING SURGEON.

I CERTIFY, ON HONOR, That I have minutely inspected the Volunteer, *Simon Wilson* previously to his enlistment, and that he was entirely sober when enlisted; that, to the best of my judgment, and belief, he is of lawful age; and that, in accepting him as duly qualified to perform the duties of an able bodied soldier, I have strictly observed the regulations which govern the recruiting service. This soldier has *Dark* eyes, *Dark* hair, *Dark* complexion, is *five* feet *4 1/2* inches high.

RECRUITING OFFICER OR AGENT.

Mustered into the United States service *25th* day of *August* 1864.

R. H. Hall
Capt. Pro Marshal Mustering Officer.

Mustered into the service of the United States, for three years or during the war, from date of enlistment, in Company *D*,
25th Regiment of *Vol Artillery* Volunteers, on the *25th* day of *August*, 1864, at *Paducah Ky*.

Capt R. H. Hall
Capt Pro Marshal
Pro Marshal Dist of Ky

NOTE 1.—This blank will be used for enlistments of United States colored troops. They will be made out in duplicate in all cases—one to accompany the recruiting return of the superintendent (not the recruiting officer) to the Adjutant General, and one to accompany the accounts of the officer who pays bounty, &c.

NOTE 2.—An enlistment holds to service. A muster-in, must in all cases, precede payment of pay, bounty, pension, &c. A muster-in roll, must in all cases, be filed in the Adjutant General's Office as evidence of muster-in. The mustering officer, commissary, or assistant commissary of musters, as the case may be, will countersign both enlistments as having mustered the soldier into the service of the United States before either of them is given to the disbursing officer.

DECLARATION OF RECRUIT.

I, *Simon Wilson of Paducah Ky* desiring to volunteer as a soldier in the ARMY OF THE UNITED STATES, for the term of *Three Years*, DO DECLARE That I am *Thirty eight* years and months of age; that I have never been discharged from the United States service on account of disability or by sentence of a court-martial, or by order before the expiration of a term of enlistment; and I know of no impediment to my serving honestly and faithfully as a soldier for three years.

GIVEN at *Paducah Ky* the *25th* day of *August* 186*4*

Witness: *[Signature]*

Simon Wilson

St. W. G. L. St. Henry

By *Paducah Ky*
Volunteered at Paducah Ky
August 25th 1864
By *Mar W. G. St. Henry*

N. M. ...

505

Consent of Parent or Guardian in case of a Minor, if a Free Man, or in the case of a Slave, of the Person to whom he owes Service:

I, Do CERTIFY, That I am the that the said is years of age; and I do freely give my CONSENT to his volunteering as a SOLDIER in the Army of the United States, for the period of THREE YEARS, under the conditions of the laws of the United States.

GIVEN at

the day of

Witness:

1923
Wilson Simon

Co 76, 8 U.S. Col'd H. Art'y.

Private

CARD NUMBERS.

1	57481505	26
2	57481639	27
3	57481764	28
4	57481885	29
5	57481993	30
6	57482096	31
7	57482192	32
8	57482284	33
9	57482370	34
10	9122759	35
11	240744957	36
12		37
13		38
14		39
15		40
16		41
17		42
18		43
19		44
20		45
21		46
22		47
23		48
24		49
25		50

Book Mark:

See also

NH 47
A. 620836 P.O. aff

Rep 437413

D 1295484 - Aud WKS

D 1346656 - P.O. M. 9 M

S. 2161396 P. O. M. 9 M

S. 2163574 P.O. M. 9 M

M | 8 H. Art'y. | U.S.C.T.

Simon Wilson

....., Co. *K*, 8 Reg't U.S. Col'd H. Art'y.

Appears on

Company Descriptive Book
of the organization named above.

DESCRIPTION.

Age *38* years; height *5* feet *7* inches.

Complexion *Black*

Eyes *Black*; hair *Black*

Where born *Georgia*

Occupation *Farmer*

ENLISTMENT.

When *Aug. 19*, 186 *4*

Where *Paducah, Ky.*

By whom *John Cook*; term *3* y'rs.

Remarks:
.....
.....
.....
.....
.....
.....
.....

Keefe

W. | 8 H. Art'y. | U.S.C.T.

Simon Wilson,
Pvt., Co. K, 8 Reg't U. S. Col'd H. Art'y.

Appears on

Company Muster Roll
for *Sept and Oct*, 186 *4*
Present or absent *Present*

Stoppage, \$.....100 for.....

Due Gov't, \$.....100 for.....

Valuation of horse, \$.....100

Valuation of horse equipments, \$.....100

Remarks:.....

*(Commissioned M. S.
Aug 17 1864 (Padeau's
for 3 years)*

Book mark:.....

Shaw

W. S. H. Art'y. U.S.C.T.

Simon Wilson,
Capt., Co. K, 8 Reg't U. S. Col'd H. Art'y.

Appears on

~~Company Muster Roll~~

for Nov. and Dec., 1864

Present or absent Present

Stoppage, \$ 100 for

Due Gov't, \$ 100 for

Valuation of horse, \$ 100

Valuation of horse equipments. \$ 100

Remarks :

Book mark :

Tharvin

(358)

Copyist.

W | 8 H. Art'y. | U.S.C.T.

Simon Wilson

Priv, Co. K, 8 Reg't U. S. Col'd H. Art'y.

Appears on

Company Muster Roll

for *Jany. + Feby.*, 1865.

Present or absent *Present*

Stoppage, \$ 100 for

Due Gov't, \$ 100 for

Valuation of horse, \$ 100

Valuation of horse equipments, \$ 100

Remarks:

Book mark:

D. Maher
Copyist.

M

8 H. Art'y.

U.S.C.T.

Simon Wilson.

Priv., Co. K, 8 Reg't U. S. Col'd H. Art'y.

Appears on

Company Muster Roll

for *March & April*, 1865.

Present or absent *Present*

Stoppage, \$ 100 for

Due Gov't, \$ 100 for

Valuation of horse, \$ 100

Valuation of horse equipments, \$ 100

Remarks:

Book mark:

D. Maher

Copyist.

W

S H. Art'y.

U.S.C.T.

Simon Wilson

Priv, Co. K, 8 Reg't U. S. Col'd H. Art'y.

Appears on

Company Muster Roll

for *May + June*, 1865.

Present or absent *Present*

Stoppage, \$ *100* for

Due Gov't, \$ *100* for

Valuation of horse, \$ *100*

Valuation of horse equipments, \$ *100*

Remarks:

Book mark: -----

D. Maher

(358)

Copyist.

W

8 H. Art'y.

U.S.C.T.

Simon Wilson

Priv, Co. K, 8 Reg't U. S. Col'd H. Art'y.

Appears on

Company Muster Roll

for *July & August*, 1865.

Present or absent *Present*

Stoppage, \$ *100* for

Due Gov't, \$ *100* for

Valuation of horse, \$ *100*

Valuation of horse equipments, \$ *100*

Remarks:

*One Canteen 41¢,
One Haversack 49¢.*

Book mark:

D. Maher

(358)

Copyist.

W

8 H. Art'y.

U.S.C.T.

Simon Wilson

Priv., Co. K, 8 Reg't U. S. Col'd H. Art'y.

Appears on

Company Muster Roll

for Sept + Oct, 1867

Present or absent Present

Stoppage, \$ 100 for

Due Gov't, \$ 100 for

Valuation of horse, \$ 100

Valuation of horse equipments, \$ 100

Remarks:

Book mark:

D. P. York

(358)

Copyist.

W

8 H. Art'y.

U.S.C.T.

Simon Wilson

Pris, Co. K, 8 Reg't U. S. Col'd H. Art'y.

Appears on

Company Muster Roll

for Nov & Dec, 1865.

Present or absent Present

Stoppage, \$ 100 for

Due Gov't, \$ 100 for

Valuation of horse, \$ 100

Valuation of horse equipments, \$ 100

Remarks:

Book mark:

(358)

S. P. York

Copyist.

W

8 H. Art'y.

U.S.C.T.

Acmore Wilson

Pr., Co. K, 8 Reg't U. S. Col'd H. Art'y.

Appears on Returns as follows:

Sept 18 64

absent

in Hoopl at Paducah Ky

Book mark :

Chas. D. Patton

(546)

Copyist.

W

S H. Art'y.

U.S.C.T.

Simon Wilson

Priv., Co. K, 8 Reg't U. S. Col'd H. Art'y.

Appears on Co. Muster-out Roll, dated
Victoria Texas, Feby 10, 1866.

Muster-out to date Feby 10, 1866.

Last paid to Aug 31, 1866.

Clothing account:

Last settled....., 186 ; drawn since \$..... 100

Due soldier \$ 2 ⁵⁸/₁₀₀; due U. S. \$..... 100

Am't for cloth'g in kind or money adv'd \$..... 100

Due U. S. for arms, equipments, &c., \$..... ¹⁸/₁₀₀

Bounty paid \$..... 100; due \$ 100 ¹⁰⁰

Remarks: Entered service as Recruit
Joined Co for duty Aug 19th 1864
Stopped for (2) Cartridge Box
Bell Plates (18¢)

Book mark: W. 1413 Ky
Page 38

(261)

D. O. York

Copyist.

Nelson, Simon

B, Co. K, 8 Reg't US Cavalry

Enclosures.

Bed Cards.....	Descriptive Lists.....
Burial Records.....	Final Statements.....
Certs. of Dis. for Discharge.....	Furloughs.....
C. M. Charges.....	Med. Des. Lists.....
Med. Certificates.....	Orders.....

Other papers relating to—

Admission to Hosp'l.....	Furlough.....
Casualty Sheet (Officer's).....	Med. Examination.....
Confinement.....	Misc. Information /.....
Contracts.....	Pay or Clothing.....
Death or Effects.....	Personal Reports.....
Desertions.....	Rank.....
Discharge from Hosp'l.....	Transfer to Hosp'l.....
Discharge from Service.....	Transfer to V. R. C.....
Duty.....	Transportation.....

Simon Wilson

Lo

Affidavit

State of Kentucky }
County of Crittenden } set

The Affiant Simon Wilson states that he is the identical Simon Wilson who was enrolled into the United States service at Paducah Kentucky by Capt B. H. Hall on the 25th day of August 1864 and mustered into said service on the same day into Company 1E of the 8th Regiment of United States Colored Artillery Heavy. He further states that he does not know why it was that he was placed to the credit of McCracken County, or to whom he owed service was left blank. He states that he was from Crittenden County Kentucky that he had belonged ever since he was a small boy to James W. Wilson (now dead) & late of Crittenden County Kentucky. He further states that James W. Wilson and all his children were Unionists, and always opposed the rebellion & threw all their influence in favor of putting down the

rebellion, and in helping
the Union Party and Soldiers
in this County

Simon ^{his} Wilson
must

H. J. Wilson

G. S. Hammond

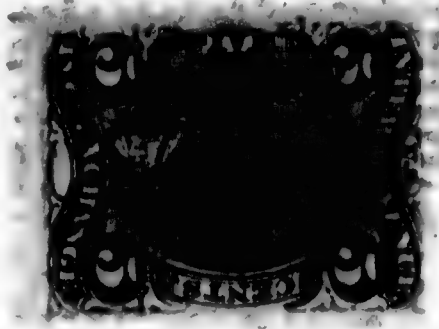

I John W. Blue Notary Public
in and for the County and State
of Iowa do certify that the fore-
going Affidavit of Simon Wilson
(a Man of Color) was read to and
explained to him so that he fully
understood the same and that he
then made oath that the facts
therein contained were true

Given under my hand and seal
of office this 18th day January 1867

J. W. Blue Notary Public
for Callender County, Ia

War Department,

ADJUTANT GENERAL'S OFFICE,

Washington, *March 1st 1867.*

Respectfully returned to the
Commission for the State of
Kentucky, with the informa-

tion that *Simon Wilson*
was enlisted at *Franklin Ky.*
Capt. W. D. ... and was
mustered in, as *Pvt. in Co. "K" 5th*
U.S. Col. (Inf.) Aug. 17, 1864,

W. H. 1413. Ky

[Signature]

Asst. Adj't General.

No. -----

APPLICATION OF

W. H. Wilson & Co.

OF

Crittenden Co.

FOR COMPENSATION FOR SLAVE,

Named *Simon Wilson*

Enlisted *Aug 25th 1864,*

In Com. *18,* *5th* Regiment,

U. S. COLORED TROOPS.

Received *28th Jan'y 1867.*

Compensation Awarded

-----, 186-----
----- Dollars.

President of Board of Claims.

Claimant's Attorney,

Robt H. Hayes

Marion Ky.

Claimant's Post-office Address,

Marion

Crittenden Co Ky

FRANKFORT COMMONWEALTH PRINT.

No.

CLAIM OF

FOR THE COMPENSATION OF SLAVE NAMED

We W. H. Wilson, R. W. Wilson and Mary E. Armstrong (widow)
loyal citizens and residents of

County of Crittenden State of Kentucky, hereby claim compensation, under

the provisions of Section 21, act approved February 24, 1864, and section 2, act approved July, 28,

1866, for our slave - Simon Wilson, enlisted August 25th

1864, at Paducah Ky, by Capt R. H. Hall

in the 9th (Heavy Artillery) regiment U. S. Colored Troops, Co. W; certificate of

which enlistment, and a descriptive list, as required, accompany this application. That we did not ac-

quire said slave subsequent to said enlistment, but had a valid title to him at the date of said enlist-

ment, and previous thereto we having acquired our title to him and our ownership over him as fol-

lows, to-wit: By inheritance from our deceased father James W.

Wilson who died April 23rd 1865 and who was at the time

of the enlistment & long previously the owner of the said Simon

Wilson & we the said W. H. Wilson, R. W. Wilson and Mary E.

Armstrong are the children and only heirs at law of said

James W. Wilson died and that he the said James W. Wilson

was actually loyal to the United States up to his death

In proof of my loyalty to the Constitution and Government of the United States, we present the ac-

companying oath, which we have taken, signed and acknowledged; to be filed with this application, in

accordance with requirement of General Orders, No. 329, 1863, War Department, Adjutant General's

Office.

W. H. Wilson
R. W. Wilson
M. E. Armstrong

January 16th 1867

OATH OF ALLEGIANCE.

We W. H. Wilson, R. W. Wilson and Mary E. Armstrong the owners and Claimants do solemnly swear that

the foregoing claim is a just and true claim due to us as masters and owners of the said slave, and that

the facts alleged in said claim in respect to the draft or enlistment (as the case may be) of said slave

into the Military service of the United States are true. And we do further swear that we have never

joined, or been concerned in, any insurrection or rebellion; that we have never borne arms against the

United States; that we have never given any aid, countenance, counsel or encouragement to any person

or persons engaged, or whom we had reason to believe were about to engage, in insurrection, rebellion

or armed hostility against the United States; that we have neither sought, nor accepted, nor attempted

to exercise the functions of any office, civil or military, nor to perform any service whatever, under

any authority or pretended authority in hostility to the United States; that we have not yielded a vol-

untary support to any insurrection, rebellion or pretended government, authority, power or constitution

within the United States hostile thereto. And we do further swear that, to the best of our knowledge

and ability we have supported and defended, and will continue to support and defend, the United

States against all enemies, foreign and domestic; and that we have supported, defended and obeyed, and

will continue to support, defend and obey, the Constitution and laws of the United States; that we will

bear true faith and allegiance to the same; and that we make this oath freely, without any mental reserva-

tion or purpose of evasion: So help us God.

W. H. Wilson
R. W. Wilson
M. E. Armstrong

Sworn to and subscribed before me, at Marion Ky

this 16th day of January, 1867.

J. H. Blue Notary Public
for Crittenden County Ky



PROOF OF OWNERSHIP.

STATE OF KENTUCKY,

COUNTY OF

} SS.

We and each of lawful age, and resident citizens of the State and County aforesaid, do certify that

James W Wilson died late of the State and County aforesaid, was on the *25th* day of *August* 186*4* the lawful owner of the slave named *Simon Wilson*; referred to and described in the foregoing claim for compensation. *That James W Wilson is dead & W H Wilson & W Wilson & Mary E Armstrong are the children & only heirs at law of sd dead*

*W. J. Wilson
J. C. Dean*

Sworn to and subscribed before me a *Notary Public* for the County of *Crittenden* State of Kentucky, this the *16th* day of *January* 186*7*.

5 CENT STAMP.



*J. W. Blue Notary Public
for Crittenden County Ky*

PROOF OF LOYALTY.

STATE OF KENTUCKY,

COUNTY OF

} SS.

We and loyal men and each of lawful age, and resident citizens of the of

in the State and County aforesaid, upon our oaths declare that we have known *James W Wilson died* and *W H Wilson & W Wilson & Mary E Armstrong* a residents of the State and County aforesaid, since the 4th day of March, 1861, and know that *he has* *they* *firmly* and faithfully maintained *their* *his or her* adherence and allegiance to the Government of the United States, by defending its cause against the Government and forces of the so-called Confederate States of America, in all suitable and practicable ways, and according to *their* *his or her* ability and opportunity.

*D. V. Stinson
J. W. Blue*

Sworn to and subscribed before me a *Notary Public* for the county of *Crittenden* S. ricky, this the *16th* day of *January* 186*7*.

5 CENT STAMP.



*J. W. Blue Notary Public
for Crittenden County Ky*

POWER OF ATTORNEY.

My Post-Office address is *Warren* County of *Crittenden* State of Kentucky, and I hereby direct that all communications to me, touching this claim, be sent under cover to *Claimants or either of them*, who is hereby appointed and constituted my true and lawful attorney, to prosecute this claim for me, and who is hereby authorized and empowered to receive and receipt for any award, order, draft, certificate, voucher, warrant, papers or money that may be issued in the adjustment of this claim, or the payment thereof, the same as I might or could do in person were I present and acting for myself, and to file any additional evidence or papers that may be required in the prosecution of this claim.

[WITNESS.]

The owner signs here.

50 CENT STAMP.

Two witnesses to owner's signature sign here.

HEADQUARTERS KENTUCKY VOLUNTEERS,

Adjutant-General's Office,

Frankfort, Dec 31, 1866.

I hereby certify, that it appears from the U. S. Muster-Inspection Rolls on file in this Office, that Simon Wilson was enrolled on the 25 day of Augt, 1864, at Paducah Ky, by Capt R. H. Hall, and mustered into the U. S. service on the 25 day of Augt, 1864, at Paducah Ky, by Capt R. H. Hall, to serve Three years. Said Simon Wilson is described as follows: Age, 38 years; eyes, Black; hair, Black; complexion, Black; height, 5 feet 4 1/2 inches. It further appears from said Rolls, that Simon Wilson owed service to McCracken County, Ky., and was assigned to Co. K, 8 Regiment U. S. C. Army Heavy

In Testimony Whereof, I have hereunto set my hand, and affixed my Official Seal, this 31 day of Dec, 1866.

W. Lindsay
Adjutant-General of Kentucky.



H. SR. 289

1924
Wilson Wesley

Co K, 8 U.S. Col'd H. Art'y.

Private | Private

CARD NUMBERS.

1	548/217	26
2	548/358	27
3	548/498	28
4	548/631	29
5	548/763	30
6	548/884	31
7	548/992	32
8	548/2095	33
9	548/2191	34
10	548/2283	35
11	548/2369	36
12	9122766	37
13	40544959	38
14		39
15		40
16		41
17		42
18		43
19		44
20		45
21		46
22		47
23		48
24		49
25		50

Book Mark:

See also

M | 8 H. Art'y. | U.S.C.T.

Wesley Wilson

....., Co. *B*, 8 Reg't U.S. Col'd H. Art'y.

Appears on

Company Descriptive Book

of the organization named above.

DESCRIPTION.

Age *25* years; height *5* feet *7* inches.

Complexion *Black*

Eyes *Black*; hair *Black*

Where born *Gadswell, Ky.*

Occupation *Farmer*

ENLISTMENT.

When *June 24*, 186 *4*.

Where *Puducan*

By whom *W. H. Beggart*, term *3* y'rs.

Remarks:

.....
.....
.....
.....
.....
.....
.....

Keeler

N. H. Art'y. U.S.C.T.

Wesley Wilson,
Co. K 8 Reg't U. S. Col'd H. Art'y.

Age years.

Appears on

Company Muster Roll*
for Enlistment to June 30th, 1864

Joined for duty and enrolled:

When June 24th, 1864

Where Paducah, Ky.

Period 3 years.

Mustered in:

When June 25th, 1864

Where Paducah, Ky.

Present or absent Present

Stoppage, \$ 100 for

Due Gov't \$ 100 for

Valuation of horse, \$ 100

Valuation of horse equipments, \$ 100

Remarks:

*First current roll. No muster-in roll of this company on file.

Book mark: N. 1411, 164.

Harin

(358d)

Copyist.

W.

8 H. Art'y.

U.S.C.T.

Wesley Wilson
Pvt., Co. K, 8 Reg't U. S. Col'd H. Art'y.

Appears on

Company Muster Roll

for *July and August, 1864*

Present or absent *Present*

Stoppage, \$ 100 for

Due Gov't, \$ 100 for

Valuation of horse, \$ 100

Valuation of horse equipments. \$ 100

Remarks :

Book mark :

Harri

W.

8 H. Art'y.

U.S.C.T.

Wesley Wilson,

Co. K, 8 Reg't U. S. Col'd H. Art'y.

Appears on

Company Muster Roll

for

Sept and Oct, 1864

Present or absent

Present

Stoppage, \$

100 for

Due Gov't, \$

100 for

Valuation of horse, \$

100

Valuation of horse equipments, \$

100

Remarks:

Book mark:

Harin

(358)

Copyist.

444 444
N. | 8 H. Art'y. | U.S.C.T.

Wesley Wilson,
Pvt., Co. K, 8 Reg't U. S. Col'd H. Art'y.

Appears on

Company Muster Roll

for Nov. and Dec., 1864.

Present or absent Present

Stoppage, \$ 100 for

Due Gov't, \$ 100 for

Valuation of horse, \$ 100

Valuation of horse equipments. \$ 100

Remarks:

Book mark:

Harris

W

8 H. Art'y.

U.S.C.T.

Wesley Wilson

Priv., Co. K, 8 Reg't U. S. Col'd H. Art'y.

Appears on

Company Muster Roll

for *Jan'y. & Feby.*, 1865.

Present or absent *Present*

Stoppage, \$ *100* for

Due Gov't, \$ *100* for

Valuation of horse, \$ *100*

Valuation of horse equipments, \$ *100*

Remarks:

Carpenter for Regt. Q. M.

Book mark:

(358)

A. Maher
Copyist.

W

S H. Art'y.

U.S.C.T.

Westly Wilson

Priv, Co. K, 8 Reg't U. S. Col'd H. Art'y.

Appears on

Company Muster Roll

for *March & April*, 1865.

Present or absent *Present*

Stoppage, \$ 100 for

Due Gov't, \$ 100 for

Valuation of horse, \$ 100

Valuation of horse equipments, \$ 100

Remarks:

Book mark:

(358)

D. Maher
Copyist.

W

8 H. Art'y.

U.S.C.T.

Westly Wilson
Priv., Co. K, 8 Reg't U. S. Col'd H. Art'y.

Appears on

Company Muster Roll

for *May + June*, 1865.

Present or absent *Present*

Stoppage, \$ 100 for

Due Gov't, \$ 100 for

Valuation of horse, \$ 100

Valuation of horse equipments, \$ 100

Remarks:

Book mark:

D. Maher
Copyist.

W

S H. Art'y.

U.S.C.T.

Westly Wilson

Priv, Co. K, 8 Reg't U. S. Col'd H. Art'y.

Appears on

Company Muster Roll

for July & August, 1865.

Present or absent Present

Stoppage, \$ 100 for

Due Gov't, \$ 100 for

Valuation of horse, \$ 100

Valuation of horse equipments, \$ 100

Remarks:

Book mark:

D. Maher

(358)

Copyist.

W

8 H. Art'y.

U.S.C.T.

Wesley Wilson

Priv, Co. K, 8 Reg't U. S. Col'd H. Art'y.

Appears on

Company Muster Roll

for *Sept & Oct*, 186*7*.

Present or absent *Present*

Stoppage, \$ *100* for

Due Gov't, \$ *100* for

Valuation of horse, \$ *100*

Valuation of horse equipments, \$ *100*

Remarks:

Book mark:

S O York

(358)

Copyist.

W

8 H. Art'y.

U.S.C.T.

Wesley Wilson

Priv., Co. K, 8 Reg't U. S. Col'd H. Art'y.

Appears on

Company Muster Roll

for Nov + Dec, 1865

Present or absent absent

Stoppage, \$ 100 for

Due Gov't, \$ 100 for

Valuation of horse, \$ 100

Valuation of horse equipments, \$ 100

Remarks: Detached per D.O. No 38 dated Ad. Ins. Sub Dist Victoria Texas Nov 26/65

Book mark:

D. P. York

(358)

Copyist.

W

8 H. Art'y.

U.S.C.T.

Wesley Wilson

Pvt, Co. K, 8 Reg't U. S. Col'd H. Art'y.

Appears on Returns as follows:

Sept 18 64 on duty
Carpenter

Jan'y to Mch 1865: Reg't
Carpenter

July 1865. absent sick
at Powderhorn Texas

Dec 1865 & Jan'y 1866. absent
Det Serv U S M R R
Victoria Tex. since
Nov 18/65

Book mark :

Chas. Patton

(546)

Copyist.

W

S H. Art'y.

U.S.C.T.

Wesley Wilson

Priv., Co. K, 8 Reg't U. S. Col'd H. Art'y.

Appears on Co. Muster-out Roll, dated

Victoria Texas, Feb'y 10, 1866.

Muster-out to date Feb'y 10, 1866.

Last paid to Aug 31, 1865.

Clothing account:

Last settled....., 186 ; drawn since \$..... 100

Due soldier \$ 7 77/100; due U. S. \$..... 100

Am't for cloth'g in kind or money adv'd \$..... 100

Due U. S. for arms, equipments, &c., \$..... 100

Bounty paid \$..... 100; due \$ 100 100

Remarks Entire service organization of Co as private. Enrolled & subject to draft in 1st Enrollment Dist State of Ky at time of enlistment

Book mark: W. 1411 Ky
Ocey & St

J. P. York

Milton Wesley

P. Co. 76, 8 Reg't 110th A.

24 Enclosures.

Bed Cards	Final Statements
Burial Records	Furloughs or L. of A.
Certs. of Dis. for Discharge	Med. Certificates
C. M. Charges	Med. Des. Lists
Descriptive Lists	Orders
Discharge Certificates	Pris. of War Record
Enlistment Papers	Resignations

Other papers relating to—

Admission to Hosp'l	Furlough or L. of A.
Casualty Sheet	Med. Examination
Confinement	Misc. Information
Contracts	Pay or Clothing
Death or Effects	Personal Reports
Desertion	Rank
Discharge from Hosp'l	Transfer to Hosp'l
Discharge from Service	Transfer to V. R. C.
Duty	Transportation
	Slave claim

March 9th 1865
Paducah Ky

Respectfully returned
Danson

2nd Lt George W.
Comdg Co, 1st 8th U.S. Col.

Requests that a furlough
for five days be granted
to Wesley Wilson Private Co. 1st
8th U.S. Col., to go to
Carr-in-rock Ills.

Very truly
yours

Hdqtrs 8th U.S. Col. (Reg) 11th Infantry Dist West Ky
Paducah Ky Mar 9/65 Paducah Ky Mar 9, 1865

Respectfully forwarded

Approved,
J. D. McBride,

Hdqtrs Post of Paducah
Paducah Ky Mar 9, 1865

Respectfully forwarded
disapproved for
the reason that all
our men are needed.
When there is less duty
to do, I will approve
such an application
A. J. Guffey
Col. comdg

Respectfully returned
disapproved

By order of
Brig Genl. Meredith
A. P. Taylor
Adj. Genl.

Hdqrs 11th Infantry
Paducah Ky March 9, 1865

Respectfully returned
and attention called
to the foregoing order
by order of
J. D. McBride
Col. comdg

Head Qu Co "K" 8th U S Art, Ky
Paducah Ky

March 9th 1863

A. J. Saylor
1st Lt and A. A. H. Co.

Sir

I have the honor to request that a furlough
of five days be granted to Wesley Wilson
a private of my Co. to go to Lawrence
Ks. for the purpose of getting some money
that is due him and also some money
that is due Simon Wilson Private of my Co.

Very Respectfully Your Obedient Servant

George W. Sanson
2nd Lieut Comd'g Co "K"
8th U. S. Art, Ky

Jan 17 1865
Saturday

Dansom

George W
2d Lieut 1st Regt 11th

Recd that a person, a few
days ago, was granted to
Wm. Wilson (alias) Co. & 8th Regt
to go to Cave in State
Illinois

John Smith

L.B. 253. P. 124

Wm. O. Adams, U.S. Atty.
P.O. No. 17, Springfield, Mo.

Approved
J. M. Smith

S.R. 253 of P. 124

Wm. O. Adams, U.S. Atty.
P.O. No. 17, Springfield, Mo.

Respectfully returned
disapproved

J. M. Smith

~~S.R. 33 of P. 124~~

Wm. O. Adams, U.S. Atty.
Cadm. No. April 1, 1865

Respectfully returned
disapproved

By order of the
Wm. O. Adams
J. M. Smith
14th Regt

Head Quarters U.S. Army,

Laducan Ky

April 1st 1862

A. A. Taylor
1st Lieut and M.A.S.

Sir

I have the honor to request that a furlough of five days be granted Wesley Wilson a private of my Co. to go to Cave in Rock Illinois for the purpose of getting some money that is due him and also some money that is due Simon Wilson of my Co. Said Wesley Wilson is detailed in Regt of the 2nd Div and his services can be easily spared for that time.

Very Respectfully Your Obedient Servant

George W. Dawson

2nd Lieut 8th U.S. Cavalry (10)

Commanding Co. K.

War Department,

ADJUTANT GENERAL'S OFFICE,

Washington, *March 1* 186*7*.

Respectfully returned to the
Commission for the State of
Delaware, with the informa-
tion that *Wesley Wilson*
was enlisted at *Butternut Ky*
Jan 24 1864 and was
mustered in as *Co. "K" 8th*
U.S. Colored Troops *Jan 25 1864*.

W. H. H. H. H.

A. J. Rowland

Asst. Adj't General.

W. H. H.

No. *11*

APPLICATION OF

OF

W. H. Wilson & others

FOR COMPENSATION FOR SLAVE,

Named *Wesley Wilson*

Enlisted *Jan 24 1864*

In Com. *1st*, *8th* Regiment,

U. S. COLORED TROOPS.

Received *Jan 28*, 186*7*.

Compensation Awarded

180 Dollars.

180 Dollars.

President of Board of Claims.

Claimant's Attorney,

Robert F. Hayes,

Marion Ky

Claimant's Post-office Address,

Marion

Crittenden Co Ky

FRANKFORT COMMONWEALTH PRINT.

No.

CLAIM OF

FOR THE COMPENSATION OF SLAVE NAMED

We W. H. Wilson R. W. Wilson and Mary E. Armstrong (widow)
loyal citizens and residents of

County of Crittenden State of Kentucky, hereby claim compensation, under

the provisions of Section 21, act approved February 21, 1861, and section 2, act approved July, 28,

1866, for ~~our~~ slave Wesley Wilson enlisted June 24th

1864, at Paducah Ky by W. W. Biggest

in the 8th (Heavy Artillery) regiment U. S. Colored Troops, Co. 10; certificate of

which enlistment, and a descriptive list, as required, accompany this application. That we did not acquire said slave subsequent to said enlistment, but had a valid title to him at the date of said enlistment, and previous thereto we having acquired ~~our~~ title to him and ~~our~~ ownership over him as follows, to-wit: By inheritance from our deceased father James W. Wilson who died April 23rd 1865 and who was at time of said enlistment & long previously the owner of said Wesley Wilson and we W. H. Wilson R. W. Wilson and Mary E. Armstrong are the children and only heirs at law of the said James W. Wilson died who was actively loyal to the United States up to his death.

In proof of ~~our~~ loyalty to the Constitution and Government of the United States, we present the accompanying oath, which we have taken signed and acknowledged: to be filed with this application, in accordance with requirement of General Orders, No. 329, 1863. War Department, Adjutant General's Office.

Jan'y 16th 1867

W. H. Wilson
R. W. Wilson
M. E. Armstrong

OATH OF ALLEGIANCE.

We W. H. Wilson R. W. Wilson & Mary E. Armstrong the owners and Claimants do solemnly swear that

the foregoing claim is a just and true claim due to ~~us~~ as masters and owners of the said slave, and that the facts alleged in said claim in respect to the draft or enlistment (as the case may be) of said slave into the Military service of the United States are true. And we do further swear that we have never joined, or been concerned in, any insurrection or rebellion; that we have never borne arms against the United States; that we have never given any aid, countenance, counsel or encouragement to any person or persons engaged, or whom we had reason to believe were about to engage, in insurrection, rebellion or armed hostility against the United States; that we have neither sought, nor accepted, nor attempted to exercise the functions of any office, civil or military, nor to perform any service whatever, under any authority or pretended authority in hostility to the United States; that we have not yielded a voluntary support to any insurrection, rebellion or pretended government, authority, power or constitution within the United States hostile thereto. And we do further swear that, to the best of ~~our~~ knowledge and ability, we have supported and defended, and will continue to support and defend, the United States against all enemies, foreign and domestic; and that we have supported, defended and obeyed, and will continue to support, defend and obey, the Constitution and laws of the United States; that we will bear true faith and allegiance to the same; and that we take this oath freely, without any mental reservation or purpose of evasion: So help ~~us~~ God.

W. H. Wilson
R. W. Wilson
M. E. Armstrong

Sworn to and subscribed before me, at Marion Ky,
this 16th day of January 1867.

J. W. Blue Notary Public
for Crittenden County Ky

NARR 514

PROOF OF OWNERSHIP.

STATE OF KENTUCKY, }
 COUNTY OF *Crittenden* } SS.
 We *H. J. Wilson* and *J. S. Dean* each of lawful
 age, and resident citizens of the State and County aforesaid, do certify that *James W. Wilson*
deed late of the State and County aforesaid, was on the *24th* day of
June 1864, ^{for years previous thereto} the lawful owner of the slave named *Wesley Wilson*;
 referred to and described in the foregoing claim for compensation, *that James W. Wilson is dead*
W. H. Wilson, R. W. Wilson & Mary E. Armstrong, are the children & only heirs
at law of said James W. Wilson deed

H. J. Wilson
J. S. Dean

Sworn to and subscribed before me a *Notary Public* for the County of
Crittenden State of Kentucky, this the *16th* day of *January* 1867.
J. W. Blue N. P. & Co.



PROOF OF LOYALTY.

STATE OF KENTUCKY, }
 COUNTY OF *Crittenden* } SS.
 We *D. N. Stinson* and *A. R. Black* loyal men and
 each of lawful age, and resident citizens of the County of *Crittenden*
 in the State and County aforesaid, upon our oaths declare that we have known *James W. Wilson deed*
and W. H. Wilson, R. W. Wilson & Mary E. Armstrong (widow)
 A resident of the State and County aforesaid, since the 4th day of March, 1861, and know that ~~he has~~ *they were*
 firmly and faithfully maintained ^{their} ~~his or her~~ adherence and allegiance to the Government of the United
 States, by defending its cause against the Government and forces of the so-called Confederate States
 of America, in all suitable and practicable ways, and according to ^{their} ~~his or her~~ ability and opportunity.

D. N. Stinson
A. R. Black

Sworn to and subscribed before me a *Notary Public* for the county of
Crittenden State of Kentucky, this the *16th* day of *January* 1867.

J. W. Blue Notary Public
for Crittenden County Ky



POWER OF ATTORNEY.

our Post-Office address is *Marion* County of *Crittenden* State of
 Kentucky, and I hereby direct that all communications to me, touching this claim, be sent under cover
 to *Claimants or either of them*, who is hereby appointed and consti-
 tuted my true and lawful attorney, to prosecute this claim for me, and who is hereby authorized and
 empowered to receive and receipt for any award, order, draft, certificate, voucher, warrant, papers or
 money that may be issued in the adjustment of this claim, or the payment thereof, the same as I
 might or could do in person were I present and acting for myself, and to file any additional evidence
 or papers that may be required in the prosecution of this claim.

[WITNESS.]

The owner
 signs here. }

Two witnesses to
 owner's signature
 sign here. }

50 CENT
STAMP.

Headquarters Kentucky Volunteers,

Adjutant-General's Office,

Frankfort, Dec 31, 1866.

I hereby certify, that it appears, from the U. S. Muster-
Rolls on file in this Office, that Wesley Wilson
was enrolled on the 24 day of June, 1864, at
Paducah Ky, by Mr Biggert
and mustered into the U. S. service on the 25 day of June,
1864, at Paducah Ky by S. McJover
to serve Three years. Said Wesley Wilson
is described as follows: Age, 25 years; eyes, _____; hair, _____,
complexion, _____; height, _____ feet _____ inches. It further
appears from said Rolls, that Wesley Wilson owed service
to James Wilson, was credited to Crittenden
County, Ky., and was assigned to Co. B, 8th Regiment
U. S. C. Army Henry _____

In Testimony Whereof, I have hereunto set my
hand, and affixed my Official Seal, this
31 day of Dec, 1866.

D. W. Lindsay
Adjutant General of Kentucky.

B. Org. SR. K 8 Army

1925
Wilson Thomas

Co E, 8 U.S. Col'd H. Art'y.

Private Private

CARD NUMBERS.

1	5274492	26
2	5274620	27
3	5274753	28
4	5274879	29
5	5274999	30
6	5275120	31
7	5275235	32
8	5275346	33
9	5275444	34
10	5275547	35
11	5275635	36
12	9122322	37
13	4074496	38
14		39
15		40
16		41
17		42
18		43
19		44
20		45
21		46
22		47
23		48
24		49
25		50

Book Mark:

See also

W | 8 H. Art'y. | U.S.C.T.

William F Wilson

....., Co. E, 8 Reg't U.S. Col'd H. Art'y.

Appears on

Company Descriptive Book
of the organization named above.

DESCRIPTION.

Age 21 years; height 5 feet 10 inches.

Complexion *Blk*

Eyes *Blk*; hair *Blk*

Where born *Wardwell Co., Ky*

Occupation *Fanner*

ENLISTMENT.

When *May 24*, 1864.

Where *Paducah, Ky*

By whom *Capt Dunn*; term *3* y'rs.

Remarks:

.....
.....
.....
.....
.....
.....
.....
.....

E. A. Moreland

W

S H. Art'y.

U.S.C.T.

William J. Wilson

Prk, Co. E, 8 Reg't U. S. Col'd H. Art'y.

Appears on

Company Muster Roll

for *May and June*, 186*4*.

Present or absent *Present*

Stoppage, \$ *100* for

Due Gov't, \$ *100* for

Valuation of horse, \$ *100*

Valuation of horse equipments, \$ *100*

Remarks:

*(Committed to prison by
Muster roll in August 1864,
at Newmarket for 3
years)*

Book mark:

J. V. Kearney
Copyist.

W

8 H. Art'y.

U.S.C.T.

William Wilson

Pl, Co. E, 8 Reg't U. S. Col'd H. Art'y.

Appears on

Company Muster Roll

for *July and Aug*, 1864.

Present or absent *Present*

Stoppage, \$ *100* for

Due Gov't, \$ *100* for

Valuation of horse, \$ *100*

Valuation of horse equipments, \$ *100*

Remarks:

On daily duty as mounted infantry.

Book mark:

J. V. Kearney

Copyist.

(358)

W

S II. Art'y.

U.S.C.T.

William Wilson

Wk, Co. E, 8 Reg't U. S. Col'd H. Art'y.

Appears on

Company Muster Roll

for *Sept and Oct*, 186*4*.

Present or absent *Present*

Stoppage, \$ *100* for

Due Gov't, \$ *100* for

Valuation of horse, \$ *100*

Valuation of horse equipments, \$ *100*

Remarks:

Book mark:

(358)

Jas. V. Kearny
Copist.

W

8 H. Art'y.

U.S.C.T.

William Wilson

Priv., Co. E, 8 Reg't U. S. Col'd H. Art'y.

Appears on

Company Muster Roll

for *Nov. & Dec.*, 186*4*.

Present or absent *Present*

Stoppage, \$ *100* for

Due Gov't, \$ *100* for

Valuation of horse, \$ *100*

Valuation of horse equipments, \$ *100*

Remarks:

Book mark:

C. E. M. Laughlin
Copyist.

W | S H. Art'y. | U.S.C.T.

William Wilson
Priv., Co. E, 8 Reg't U. S. Col'd H. Art'y.

Appears on

Company Muster Roll

for *Jan. & Feb.*, 186*5*.

Present or absent *Present*

Stoppage, \$ *100* for

Due Gov't, \$ *100* for

Valuation of horse, \$ *100*

Valuation of horse equipments, \$ *100*

Remarks: *Due the U.S. for
one Haversack and
canteen \$1.00*

Book mark:

C. E. M. Lang *Illin.*
(358) Copyist.

W | 8 H. Art'y. | U.S.C.T.

William Wilson
Priv., Co. E, 8 Reg't U. S. Col'd H. Art'y.

Appears on

Company Muster Roll
for *Mar. + Apr.*, 186*3*.
Present or absent *Present*

Stoppage, \$ *100* for

Due Gov't, \$ *100* for

Valuation of horse, \$ *100*

Valuation of horse equipments, \$ *100*

Remarks: *Due the U.S.*
for 6. and G.E. \$160
100

Book mark: _____

(358)

C. E. M. Laughlin
Copyist.

74

8 H. Art'y.

U.S.C.T.

William Wilson

Priv., Co. E, 8 Reg't U. S. Col'd H. Art'y.

Appears on

Company Muster Roll

for May & June, 1863.

Present or absent Present

Stoppage, \$ 100 for

Due Gov't, \$ 100 for

Valuation of horse, \$ 100

Valuation of horse equipments, \$ 100

Remarks: Due U.S. for Co. & G. E. \$160 / 100

Book mark:

C. E. M. Laughlin

(358)

Copist.

W

S H. Art'y.

U.S.C.T.

William Wilson

Plt, Co. E, 8 Reg't U. S. Col'd H. Art'y.

Appears on

Company Muster Roll

for *July & Aug.*, 1865.

Present or absent *Present*

Stoppage, \$ *100* for

Due Gov't, \$ *100* for

Valuation of horse, \$ *100*

Valuation of horse equipments, \$ *100*

Remarks: *Due the W.S. for C & G. E. \$160.*

Book mark: *W. S. 160*

E. C. Carroll

24 | S' H. Art'y. | U.S.C.T.

William Wilson

Sgt., Co. E, 8 Reg't U. S. Col'd H. Art'y.

Appears on

Company Muster Roll

for *Sept & Oct*, 1865.

Present or absent *Present*

Stoppage, \$ *100* for

Due Gov't, \$ *100* for

Valuation of horse, \$ *100*

Valuation of horse equipments, \$ *100*

Remarks:

Book mark:

E. B. Carroll

H

8 H. Art'y.

U.S.C.T.

Am Wilson

Pat, Co. E, 8 Reg't U. S. Col'd H. Art'y.

Appears on

Company Muster Roll

for *Nov & Dec*, 1865.

Present or absent *Present*

Stoppage, \$ *100* for

Due Gov't, \$ *100* for

Valuation of horse, \$ *100*

Valuation of horse equipments, \$ *100*

Remarks:

Book mark:

E. B. Carroll

W

8 H. Art'y.

U.S.C.T.

Will Willson

Pvt, Co. E, 8 Reg't U. S. Col'd H. Art'y.

Appears on Returns as follows:

Aug 18 62 on daily duty
as mounted Infantry
by order of Col. Barry

Book mark :

Chas. D. ...

(546)

Copyist.

W

H. Art'y.

U.S.C.T.

Wm Thomas Wilson

Pvt, Co. C, 8 Reg't U. S. Col'd H. Art'y.

Appears on Co. Muster-out Roll, dated

Victoria Texas Feb 10, 1866.

Muster-out to date Feb 10, 1866.

Last paid to Aug 31, 1865.

Clothing account:

Last settled....., 186 ; drawn since \$..... 100

Due soldier \$ 3 ⁴⁹/₁₀₀; due U. S. \$..... 100

Am't for cloth'g in kind or money adv'd \$..... 100

Due U. S. for arms, equipments, &c., \$..... 100

Bounty paid \$ None 100; due \$ 100 100

Remarks: Entered service as recruit. Joined Co for duty May 24 64. Enrolled & Subject to draft in 1st En Dist. of Ky at time of Enlistment.

Book mark:

Age 21

E. B. Barroll

1926

Kimberly James
Co E, 8 U.S. Col'd H. Art'y.

Private | Private

CARD NUMBERS.

1	5471445	26
2	5471546	27
3	5471697	28
4	5471846	29
5	5471999	30
6	5472135	31
7	5472267	32
8	5472393	33
9	5472507	34
10	5472613	35
11	5472717	36
12	5472813	37
13	9121670	38
14		39
15		40
16		41
17		42
18		43
19		44
20		45
21		46
22		47
23		48
24		49
25		50

Book Mark: _____

See also _____

W | 8 H. Art'y. U.S.C.T.

James Chamberly

Co. 6, 8 Reg't U.S. Col'd H. Art'y.

Appears on

Company Descriptive Book

of the organization named above.

DESCRIPTION.

Age 22 years; height 5 feet 11 1/2 inches.

Complexion Blk

Eyes Blk; hair Blk

Where born Graves Co., Ky.

Occupation Laborer

ENLISTMENT.

When Mar. 1, 1864.

Where Mayfield, Ky.

By whom E.S. Chapman; term 3 y'rs.

Remarks: Was in the battle of Paducah, Ky., Mar. 25/64. Was in a skirmish on Cumberland River, June 18/64

Henderson

W | 8 H. Art'y. | U.S.C.T.

James Kimberly
Private, Co. B, 1 Reg't Ky. H. Art'y.†

Age years.

Appears on

Company Muster Roll*

for Enlistment to Apr 30, 1864.

Joined for duty and enrolled:

When Mar 1, 1864.

Where Mayfield Ky

Period 3 years.

Mustered in:

When Apr 20, 1864.

Where Paducah Ky

Present or absent Present

Stoppage, \$ 100 for

Due Gov't \$ 100 for

Valuation of horse, \$ 100

Valuation of horse equipments, \$ 100

Remarks: Taken from Roll May June '64

†This organization subsequently became Co. B, 8 Reg't U. S. Colored Heavy Artillery.

*First current roll. No muster-in roll of this company on file.

Book mark:

(3586) E H Lepocomb Copyist.

W

S H. Art'y.

U.S.C.T.

James Kimberly
Private, Co. C, 8 Reg't U. S. Col'd H. Art'y.

Appears on

Company Muster Roll

for *May & June*, 186*4*.

Present or absent *Present*

Stoppage, \$.....100 for

Due Gov't, \$.....100 for

Valuation of horse, \$.....100

Valuation of horse equipments, \$.....100

Remarks:.....

.....

.....

.....

.....

.....

.....

Book mark:.....

.....

(358)

E H Lipscomb
Copyist.

W

S H. Art'y.

U.S.C.T.

James Kimberly
Private, Co. C, 8 Reg't U. S. Col'd H. Art'y.

Appears on

Company Muster Roll

for *July 7 Aug*, 1864.

Present or absent *Present*

Stoppage, \$.....100 for

Due Gov't, \$.....100 for

Valuation of horse, \$.....100

Valuation of horse equipments, \$.....100

Remarks:.....
.....
.....
.....
.....
.....
.....
.....

Book mark:.....

E H Lipscomb

(358)

Copyist.

H

8th Arty

U.S.C.T

James Kimberly
Proto Co. *6*, *8* Reg't U. S. Col'd *8th Arty*

Appears on

Company Muster Roll

for *Sept & Oct*, 1864.

Present or absent *Present*

Stoppage, \$ *100* for

Due Gov't, \$ *100* for

Valuation of horse, \$ *100*

Valuation of horse equipments, \$ *100*

Remarks:

Book mark:

E H Sipocombe

(358)

Copyist.

W

8 H. Art'y.

U.S.C.T.

James Kimberly

Private, Co. C, 8 Reg't U. S. Col'd H. Art'y.

Appears on

Company Muster Roll

for 1st Dec., 1864.

Present or absent Present.

Stoppage, \$ 100 for

Due Gov't, \$ 100 for

Valuation of horse, \$ 100

Valuation of horse equipments, \$ 100

Remarks:

Book mark:

O. J. Markle

(358)

Copyist.

H

8 H. Art'y.

U.S.C.T.

James Wimberly

Private, Co. C, 8 Reg't U. S. Col'd H. Art'y.

Appears on

Company Muster Roll

for *Jan. & Feb.*, 186*5*.

Present or absent *present.*

Stoppage, \$ *100* for

Due Gov't, \$ *100* for

Valuation of horse, \$ *100*

Valuation of horse equipments, \$ *100*

Remarks:

Book mark:

O. S. Markle

(358)

Copyist.

H

S H. Art'y.

U.S.C.T.

James Kimberley
Private, Co. C, 8 Reg't U. S. Col'd H. Art'y.

Appears on

Company Muster Roll

for *March & April*, 186*5*.

Present or absent *Present*

Stoppage, \$ 100 for

Due Gov't, \$ 100 for

Valuation of horse, \$ 100

Valuation of horse equipments, \$ 100

Remarks:
.....
.....
.....
.....
.....
.....
.....
.....
.....
.....

Book mark:

(358)

O. J. Munkle

Copyist.

W

8 II. Art'y.

U.S.C.T.

James Kimberley
Private, Co. C, 8 Reg't U. S. Col'd H. Art'y.

Appears on

Company Muster Roll

for *May & June*, 186*5*.

Present or absent *Present.*

Stoppage, \$ *100* for

Due Gov't, \$ *100* for

Valuation of horse, \$ *100*

Valuation of horse equipments, \$ *100*

Remarks: *Went to Hospital at
Wichita, Texas, June 27, 1865.*

** Entire mark cancelled by line
drawn through it.*

Book mark:

O. J. Markle

W

S H. Art'y.

U.S.C.T.

James Kimberly
Pat, Co. C, 8 Reg't U. S. Col'd H. Art'y.

Appears on

Company Muster Roll

for *July and Aug*, 1865.

Present or absent *Present*

Stoppage, \$ 100 for

Due Gov't, \$ 100 for

Valuation of horse, \$ 100

Valuation of horse equipments, \$ 100

Remarks:

Book mark:

W. M. Calhoun

(358)

Copyist.

9

8 H. Art'y.

U.S.C.T.

James Kimberly
Pvt, Co. C, 8 Reg't U. S. Col'd H. Art'y.

Appears on

Company Muster Roll

for Sept and Oct, 1865.

Present or absent Present

Stoppage, \$ 100 for

Due Gov't, \$ 100 for

Valuation of horse, \$ 100

Valuation of horse equipments, \$ 100

Remarks:

Book mark:

M. Ballou

(358)

Copyist.

W | 8 H. Art'y. | U.S.C.T.

James Kimberly

Co. C, Co. C, 8 Reg't U. S. Col'd H. Art'y.

Appears on

Company Muster Roll

for *Chas. D. C.*, 1865.

Present or absent *Present*

Stoppage, \$ 100 for

Due Gov't, \$ 100 for

Valuation of horse, \$ 100

Valuation of horse equipments, \$ 100

Remarks:

Book mark:

W. M. Gibson

(358)

Copyist.

W

8 H. Art'y.

U.S.C.T.

James Finney
Pvt., Co. *C*, 8 Reg't U. S. Cold H. Art'y.

Appears on Co. Muster-out Roll, dated
Victoria Texas, Feb 11, 1866.

Muster-out to date *Feb 11, 1866.*

Last paid to *Aug 31, 1865.*

Clothing account:

Last settled....., 186 ; drawn since \$..... 100

Due soldier \$..... 100; due U. S. \$..... ¹⁵ 100

Am't for cloth'g in kind or money adv'd \$..... 100

Due U. S. for arms, equipments, &c., \$..... 100

Bounty paid \$ *None* 100; due \$ *300* 100

Remarks: *Joined at organization as Pvt. Enrolled and subject to draft in 1st Co Dist of Ky at time of enlistment (Aug 2)*

Book mark:

W M Calhoun

1927
Kimberly Jerry
Co E, 8 U.S. Col'd H. Art'y.

Private | Sergeant

CARD NUMBERS.

1	5471449	26
2	5471455	27
3	5471565	28
4	5471718	29
5	5471873	30
6	5472019	31
7	5472163	32
8	5472292	33
9	5472411	34
10	5472525	35
11	5472632	36
12	5472874	37
13	9121674	38
14	20853756	39
15	20851851	40
16	40744987	41
17		42
18		43
19		44
20		45
21		46
22		47
23		48
24		49
25		50

Book Mark:

See also

Jerry Mumberly

....., Co., 8 Reg't U.S. Col'd H. Art'y.

Appears on

Company Descriptive Book

of the organization named above.

DESCRIPTION.

Age *35* years; height *5* feet *11 3/4* inches.

Complexion *Yellow*

Eyes *Black*; hair *Black*

Where born *Grace Co., Ky.*

Occupation *Laborer*

ENLISTMENT.

When *Feb. 28*, 1864.

Where *Maryfield, Ky.*

By whom *E. Chapman*; term *3* y'rs.

Remarks: *Was in the battle of Paducah, Ky., Mar. 25/64. Was in a skirmish on Cumberland River June 18/64. Promoted to Serjeant May 1/64. Died July 24/65 at Camp D'Arigue, U.S.A. Genl Hospitl, New Orleans, La. Cause of death, Dysentery*

Henderson

W | 8 H. Art'y. | U.S.C.T.

Jerry Kimberly
Private *B*, 1 Reg't Ky. H. Art'y.†

Age years.

Appears on

Company Muster Roll*

for *Enlistment to Apl 30*, 1864.

Joined for duty and enrolled:

When *Feb 28*, 1864.

Where *Mayfield Ky*

Period *3* years.

Mustered in:

When *Apl 26*, 1864.

Where *Paducah Ky*

Present or absent *Present*

Stoppage, \$ *100* for

Due Gov't \$ *100* for

Valuation of horse, \$ *100*

Valuation of horse equipments, \$ *100*

Remarks: *X Taken from Roll May + June '64*

†This organization subsequently became Co. *B*, 8 Reg't U. S. Colored Heavy Artillery.

*First current roll. No muster-in roll of this company on file.

Book mark:

E H Lipscomb
(3586) Copyist.

W

S H. Art'y.

U.S.C.T.

Jerry Kimberly
3rd Sergt Co. C, 8 Reg't U. S. Col'd H. Art'y.

Appears on

Company Muster Roll

for *May & June*, 1864.

Present or absent *Present*

Stoppage, \$ *100* for

Due Gov't, \$ *100* for

Valuation of horse, \$ *100*

Valuation of horse equipments, \$ *100*

Remarks: *Promoted to 3rd
Sergt May 1st 1864*

Book mark :

(358)

E H Lipscombe
Copyist.

W

8 H. Art'y.

U.S.C.T.

Jerry Kimberly
Sergt, Co. C, 8 Reg't U. S. Col'd H. Art'y.

Appears on

Company Muster Roll

for *July & Aug.*, 1864.

Present or absent *Present*

Stoppage, \$ *100* for

Due Gov't, \$ *100* for

Valuation of horse, \$ *100*

Valuation of horse equipments, \$ *100*

Remarks:

Book mark:

E H Sepcomb

(358)

Copyist.

W

8 H. Art'y.

U.S.C.T.

Jerry Kimberly
Srgt, Co. C, 8 Reg't U. S. Col'd H. Art'y.

Appears on

Company Muster Roll

for *Sept & Oct*, 1864.

Present or absent *Present*

Stoppage, \$.....100 for

Due Gov't, \$.....100 for

Valuation of horse, \$.....100

Valuation of horse equipments, \$.....100

Remarks:.....

.....

.....

.....

.....

.....

.....

.....

.....

.....

.....

.....

.....

.....

.....

.....

.....

.....

.....

.....

.....

.....

.....

.....

.....

.....

.....

.....

.....

.....

.....

(358)

E H Lipscomb

Copyist.

W

S H. Art'y.

U.S.C.T.

Jerry Winberly

1st Lt., Co. C, 8 Reg't U. S. Col'd H. Art'y.

Appears on

Company Muster Roll

for *10th Dec.*, 1864.

Present or absent *present*

Stoppage, \$ 100 for

Due Gov't, \$ 100 for

Valuation of horse, \$ 100

Valuation of horse equipments, \$ 100

Remarks:

Book mark:

A. J. Markle

(358)

Copyist.

H

8 H. Art'y.

U.S.C.T.

Jerry Kimberly
Co. C, 8 Reg't U. S. Col'd H. Art'y.

Appears on

Company Muster Roll

for *Jan. & Feb.*, 186*7*.

Present or absent *Present*

Stoppage, \$ *100* for

Due Gov't, \$ *100* for

Valuation of horse, \$ *100*

Valuation of horse equipments, \$ *100*

Remarks:

Book mark:

(358)

O. J. Murkle
Copyist.

Jerry Kinney

Co. C, 8 Reg't U. S. Col'd H. Art'y.

Appears on

Company Muster Roll

for *1861*, 186*1*.

Present or absent *Present*

Stoppage, \$ *100* for

Due Gov't, \$ *100* for

Valuation of horse, \$ *100*

Valuation of horse equipments, \$ *100*

Remarks:

Book mark:

C. J. Markle

H

8 H. Art'y.

U.S.C.T.

Jerry Kimberley

Regt., Co. C, 8 Reg't U. S. Col'd H. Art'y.

Appears on

Company Muster Roll

for *May & June*, 186*5*

Present or absent *Absent*

Stoppage, \$ *100* for

Due Gov't, \$ *100* for

Valuation of horse, \$ *100*

Valuation of horse equipments, \$ *100*

Remarks: *Admitted to hospital at New Orleans, La., June 20, 1865.*

Book mark: *7-2-65*

O. J. Murkle

(358)

Copyist.

W. 1 826.a U.S. 65

Jerry Kimberty
Sgt- (Co. 1st), 8 Reg't U.S. 626

Appears on

Hospital Muster Roll

of **Corps d'Afrique U. S. A. General Hospital,**

at **New Orleans, La.,**

for July & Aug, 1865.

Attached to hospital:

When, 186 .

How employed

Last paid by Maj.

to, 186 .

Bounty paid \$ 100; due \$ 100

Present or absent

Remarks: Dead July 24/65-

Book mark:

(343)

J. J. Kimberty

Copyist.

W

8 H. Art'y.

U.S.C.T.

Jerry Kimbaley
Serjt, Co. C, 8 Reg't U. S. Col'd H. Art'y.

Appears on

Company Muster Roll

for *July and August*, 1865.

Present or absent *Present*

Stoppage, \$ 100 for

Due Gov't, \$ 100 for

Valuation of horse, \$ 100

Valuation of horse equipments, \$ 100

Remarks: *Sent to General*
Hesselt at New Orleans
La June 29, 65 (Sick)

Book mark:

W M Calhoun

(358)

Copyist.

W

8 H. Art'y.

U.S.C.T.

Jerry Kimberly
Sgt, Co. C, 8 Reg't U. S. Col'd H. Art'y.

Appears on

Company Muster Roll

for *Sept and Oct*, 1865.

Present or absent *Absent*

Stoppage, \$ *100* for

Due Gov't, \$ *100* for

Valuation of horse, \$ *100*

Valuation of horse equipments, \$ *100*

Remarks: *Sent to General Hospital at New Orleans June 20/865 (Sick)*

Book mark:

W M Calhoun

(358)

Copyist.

M

8 H. Art'y.

U.S.C.T.

Jerry Kimberly
Sgt, Co. C, 8 Reg't U. S. Col'd H. Art'y.

Appears on

Company Muster Roll

for *Novem & Dec*, 1865.

Present or absent *Absent*

Stoppage, \$ *100* for

Due Gov't, \$ *100* for

Valuation of horse, \$ *100*

Valuation of horse equipments, \$ *100*

Remarks: *Sent to Genl*
Wright at N.C. Lu
June 20, 1865

Book mark: *107091 Feb. 15/66*

J. M. Walker

(358)

Copyist.

W

8 H. Art'y.

U.S.C.T.

Cerry Wimberly

Plat
Surgeon, Co. C, 8 Reg't U. S. Col'd H. Art'y.

Appears on Returns as follows:

June 1865 absent sick
at Indianola Texas
since June 27/65

July to Dec 1865 absent sick
N O La since June 11 1865

July 1866. July 24/65
N O La. died

Book mark :

Chas. W. Carter

(546)

Copyist.

W

8 H. Art'y.

U.S.C.T.

Simon P. ...
Sgt., Co. *B*, 8 Reg't U. S. Col'd H. Art'y.

Appears on Co. Muster-out Roll, dated
March 1st, 1866, 186*6*.

Muster-out to date _____, 186 .

Last paid to *Oct 31*, 186*7*.

Clothing account:

Last settled _____, 186 ; drawn since \$ _____ *100*

Due soldier \$ _____ *100*; due U. S. \$ _____ *100*

Am't for cloth'g in kind or money adv'd \$ _____ *100*

Due U. S. for arms, equipments, &c., \$ _____ *100*

Bounty paid \$ *none* *100*; due \$ _____ *100*

Remarks: *Enlisted at age 21 as private*
Promoted to Sgt. May 1, 1864
Enrolled subject to draft
in 12th Cu Dist of Ky at time of
enlistment. Died in Corps
De Afrique New York

Book mark: *107091-959 P238-69*
Age 35 *241*

W. Calhoun

JAN. 14

5472874

1891

*© New Orleans La July 24
1865. Cause of Death
Acute Dysentery. Final
Statement forwarded by
Surgeon in Charge
Aug 2nd 1865*

Wimberly, Jerry -
Sgt, Co. C, Reg't USCHA.

4 Enclosures.

Bed Cards	Descriptive Lists
Burial Records /	Final Statements /
Certs. of Dis. for Discharge	Furloughs
C. M. Charges	Med. Des. Lists
Med. Certificates	Orders

Other papers relating to—

Admission to Hosp'l	Furlough
Casualty Sheet (Officer's)	Med. Examination
Confinement	Misc. Information
Contracts	Pay or Clothing
Death or Effects /	Personal Reports
Desertions	Rank
Discharge from Hosp'l	Transfer to Hosp'l
Discharge from Service	Transfer to V. R. C.
Duty	Transportation

Extract from Act of Congress.

SEC. 12. *And be it further enacted,* That the fees of agents and attorneys for making out and causing to be executed the papers necessary to establish a claim for a pension, bounty, and other allowance before the Pension Office, under this act, shall not exceed the following rates: For making out and causing to be duly executed a declaration by the applicant, with the necessary affidavits, and forwarding the same to the Pension Office, with the requisite correspondence, ten dollars: which sum shall be received by such agent or attorney in full for all services in obtaining such pension, and shall not be demanded or received, in whole or in part, until such pension shall be obtained; and the sixth and seventh sections of an act entitled "An act to grant pensions," approved July [fourteenth,] eighteen hundred and sixty-two, are hereby repealed.

SEC. 13. *And be it further enacted,* That any agent or attorney who shall, directly or indirectly, demand or receive any greater compensation for his services under this act than is prescribed in the preceding section of this act, or who shall contract or agree to prosecute any claim for a pension, bounty, or other allowance under this act, on the condition that he shall receive a per centum upon any portion of the amount of such claim, or who shall wrongfully withhold from a pensioner or other claimant the whole or any part of the pension or claim allowed and due to such pensioner or claimant, shall be deemed guilty of a high misdemeanor, and, upon conviction thereof, shall, for every such offense, be fined not exceeding three hundred dollars, or imprisoned at hard labor not exceeding two years, or both, according to the circumstances and aggravations of the offense.

Approved July 4, 1864.

NOTE. 10.—If any soldier is charged a higher fee than that allowed by the above act, he should report the fact and the name of the agent to the Adjutant General, in order that steps may be taken to have the same refunded.

FINAL STATEMENT.

OF

George J. H. ...
Reg't of ... (A)

By d'A ...
VOLUNTEERS.

NOTE 1.—Two of these certificates (or duplicates) are to be given to each Volunteer Soldier or drafted man who may be discharged without being mustered out (Final Statements are never given to men mustered out of service,) that he may at once receive from the Paymaster the pay, &c., due to him, and the captain or other COMMISSIONED officer commanding the company will certify to the act of the delivery of the duplicate certificates; with these certificates the Soldier is "entitled to" his discharge, and should also present his discharge to the Paymaster to have the payment endorsed on it. The discharge is to be given back to the Soldier by the Paymaster; the latter only retaining as his vouchers the duplicate certificates.

NOTE 2.—If the Soldier is entitled to pay for the use of his horse, the Company Commander will certify to that fact on the back of both these final statements, and also to the time he has pay due for having been so mounted on his own horse.

NOTE 3.—When a Soldier is furnished with final statements, his descriptive list, if he has one, should be taken up by the officer who gives the Soldier these statements, and endorsed with a statement to this effect by the officer. The endorsement should exhibit a full statement of the time for which the Soldier was allowed pay on his final statements, the clothing account, and all other charges against him or in his favor, so as to comprise a complete exhibit of his account. It will then be transmitted to the Company Commander of the Soldier, who will enter all the data necessary to a full understanding of the Soldier's account on the muster roll upon which the Soldier's discharge is reported. The descriptive list will then be destroyed. The object of this is, that the remaining portion of the Soldier's account may be settled upon the receipt of these muster rolls, and the Soldier receive any pay or allowances that may be due him at the time of his discharge, and which may not appear on his last final statements from the fact that his descriptive list is incomplete. These accounts for back pay, &c., are settled by the 2d Auditor of the Treasury Department.

NOTE 4.—Charges for loss or injury to ordnance, horse equipments, and other miscellaneous charges, should appear under the heading of "Other Stoppages."

NOTE 5.—Bounty paid by State authorities, and not by the United States, will not be entered on this statement.

NOTE 6.—Amounts due the Sutler and Laundress must be entered on the muster roll on which the discharge, death, desertion, &c., is reported, as well as on the final statement, otherwise the amount cannot be collected from the United States.

NOTE 7.—This blank will be used for deceased volunteers and drafted men, as well as for others.

NOTE 8.—Where a Soldier dies in Hospital or on detached service, his descriptive list, if he has one, should be sent with his final statements, in duplicate, to the Adjutant General, Washington, D. C.

NOTE 9.—If the soldier is a drafted man or substitute, the space for time, &c., of enrolled, should contain only the word *drafted* or *substitute*, as the case may be. If the Soldier is a "VETERAN," (or RECRUIT,) the words *as a veteran*, (or *recruit*,) as the case may be, should be interlined after the words *mustered into the service of the U. S.* A statement of all the installments of *Veteran* or *Recruit Bounty* RECEIVED by the Soldier must be made on the back of each final statement.

I certify, on honor, that Jerry Kimberly, a 40 year old of Company (B) of the 5th Regiment of Volunteers, of the State of Illinois, born in Illinois State of Illinois, aged 35 years; 5 feet 11 3/4 inches high; fair complexion, blue eyes, black hair, and by occupation a farmer, who joined for service and was enrolled (see Note 9) on the 25th day of February, 1864, at Springfield, Ill. by E. S. Chapman, for the period of three years, and mustered into the service of the United States on the 26th day of April, 1864, at Saducan, Ill., by St. Paul; and having served

HONESTLY and **FAITHFULLY** with his Company to the present date, is now entitled to a **DISCHARGE** by reason of Death from Dysentery while at Camp No. 2, Aprigue U.S. Gen. Hospital New Orleans on July 24th 1865

The said Jerry Kimberly was last paid by Paymaster Mag. James, to include the 31st day of October, 1864, and has pay due him from that time to the present date; he is entitled to pay and subsistence for **TRAVELING** to place of enrollment, and whatever other allowances are authorized to volunteer soldiers, drafted men, or militia, so discharged. He has received from the United States **CLOTHING** amounting to Ten 10/₁₀₀ dollars, since the first day of March, 1865, when his clothing account was last settled. He has received from the United States 100/₁₀₀ dollars advanced **BOUNTY**.

There is to be stopped from him, on account of the State of _____, or other authorities, for **CLOTHING**, &c., received on entering service, _____ dollars; and for other stoppages, viz: Indebted to U.S. for clothing overdrawn previous to March 1st 1865 \$ 24.35 due for Camp & Garrison 657 _____ dollars.

He has been furnished with **TRANSPORTATION** in kind from the place of his discharge to _____; and he has been **Subsisted** for **Traveling** to his place of enrollment, up to the _____, 186 .

He is indebted to _____, **Sutler**, _____ dollars.
He is indebted to _____, **Laundress**, _____ dollars.

Given in Duplicate, at New Orleans La, this 24th day of July, 1865.

F. E. Piquette
Surgeon in Charge
Commanding Company.

Extract from Act of Congress.

SEC. 12. And be it further enacted, That the fees of agents and attorneys for making out and causing to be executed the papers necessary to establish a claim for a pension, bounty, and other allowance before the Pension Office, under this act, shall not exceed the following rates: For making out and causing to be duly executed a declaration by the applicant, with the necessary affidavits, and forwarding the same to the Pension Office, with the requisite correspondence, ten dollars: which sum shall be received by such agent or attorney in full for all services in obtaining such pension, and shall not be demanded or received, in whole or in part, until such pension shall be obtained; and the sixth and seventh sections of an act entitled "An act to grant pensions," approved July [fourteenth,] eighteen hundred and sixty-two, are hereby repealed.

SEC. 13. And be it further enacted, That any agent or attorney who shall, directly or indirectly, demand or receive any greater compensation for his services under this act than is prescribed in the preceding section of this act, or who shall contract or agree to prosecute any claim for a pension, bounty, or other allowance under this act, on the condition that he shall receive a per centum upon any portion of the amount of such claim, or who shall wrongfully withhold from a pensioner or other claimant the whole or any part of the pension or claim allowed and due to such pensioner or claimant, shall be deemed guilty of a high misdemeanor, and, upon conviction thereof, shall, for every such offense, be fined not exceeding three hundred dollars, or imprisoned at hard labor not exceeding two years, or both, according to the circumstances and aggravations of the offense.

Approved July 4, 1864.

NOTE. 10.—If any soldier is charged a higher fee than that allowed by the above act, he should report the fact and the name of the agent to the Adjutant General, in order that steps may be taken to have the same refunded.

White
Dear Sir
2nd Regt
Aug 11 1864
Duplicate with inventory sent 2d [unclear]

FINAL STATEMENT.

600 '6
OF

2d Regt of [unclear]
Reg't of [unclear]

VOLUNTEERS.

NOTE 1.—Two of these certificates (or duplicates) are to be given to each Volunteer Soldier or drafted man who may be discharged without being mustered out (Final Statements are never given to men mustered out of service,) that he may at once receive from the Paymaster the pay, &c., due to him, and the captain or other COMMISSIONED officer commanding the company will certify to the act of the delivery of the duplicate certificates; with these certificates the Soldier is "entitled to" his discharge, and should also present his discharge to the Paymaster to have the payment endorsed on it. The discharge is to be given back to the Soldier by the Paymaster; the latter only retaining as his vouchers the duplicate certificates.

NOTE 2.—If the Soldier is entitled to pay for the use of his horse, the Company Commander will certify to that fact on the back of both these final statements, and also to the time he has pay due for having been so mounted on his own horse.

NOTE 3.—When a Soldier is furnished with final statements, his descriptive list, if he has one, should be taken up by the officer who gives the Soldier these statements, and endorsed with a statement to this effect by the officer. The endorsement should exhibit a full statement of the time for which the Soldier was allowed pay on his final statements, the clothing account, and all other charges against him or in his favor, so as to comprise a complete exhibit of his account. It will then be transmitted to the Company Commander of the Soldier, who will enter all the data necessary to a full understanding of the Soldier's account on the muster roll upon which the Soldier's discharge is reported. The descriptive list will then be destroyed. The object of this is, that the remaining portion of the Soldier's account may be settled upon the receipt of these muster rolls, and the Soldier receive any pay or allowances that may be due him at the time of his discharge, and which may not appear on his last final statements from the fact that his descriptive list is incomplete. These accounts for back pay, &c., are settled by the 2d Auditor of the Treasury Department.

NOTE 4.—Charges for loss or injury to ordnance, horse equipments, and other miscellaneous charges, should appear under the heading of "Other Stoppages."

NOTE 5.—Bounty paid by State authorities, and not by the United States, will not be entered on this statement.

NOTE 6.—Amounts due the Sutler and Laundress must be entered on the muster roll on which the discharge, death, desertion, &c., is reported, as well as on the final statement, otherwise the amount cannot be collected from the United States.

NOTE 7.—This blank will be used for deceased volunteers and drafted men, as well as for others.

NOTE 8.—Where a Soldier dies in Hospital or on detached service, his descriptive list, if he has one, should be sent with his final statements, in duplicate, to the Adjutant General, Washington, D. C.

NOTE 9.—If the soldier is a drafted man or substitute, the space for time, &c., of enrolled, should contain only the word *drafted* or *substitute*, as the case may be. If the Soldier is a "VETERAN," (or RECRUIT,) the words *as a veteran*, (or *recruit*,) as the case may be, should be interlined after the words *mustered into the service of the U. S.* A statement of all the installments of *Veteran* or *Recruit Bounty* RECEIVED by the Soldier must be made on the back of each final statement.



RECORD OF DEATH AND INTERMENT.

Name and number of person interred, *Sgt Kimberly*
 Number and locality of the grave, -
 Hospital number of the deceased, - *6066*
 Regiment, Rank, and Company, - - *8th U.S. Cavalry Sergeant in C*
 Residence before enlistment, - - -
 Conjugal condition (and if married,)
 the residence of the widow,)
 Cause of death,) *Dysentery Acute*
 Age of the deceased, - - - - -
 Nativity, - - - - -
 References and Remarks, - - }
 Date of death and burial, - - - *Sept 21/66*

[A duplicate of this Record has been forwarded to the Sexton, and the other remains at this Hospital.]

To *Adj. Genl. W. S. Clark*
SIR:

It becomes my duty to inform you that the person above described died at this Hospital as herein stated: and that it is desired his remains should be interred with the usual military honors.

Respectfully,

F. E. Piquette
Surgeon U. S. Army.
1st U. S. Cavalry
in Charge.

MILITARY HOSPITAL, *Camp Ufiqua New Orleans*
Laf.

This copy of Record is to be transmitted to the Adjutant General at Washington immediately after the place of burial and the number of the grave have been ascertained and registered. The above notification is to remain attached.

ARTICLES OF WAR.

ART. 95. When any non-commissioned officer or soldier shall die, or be killed in the service of the United States, the then commanding officer of the troop or company shall, in the presence of two other commissioned officers, take an account of what effects he died possessed of, above his arms and accoutrements, and transmit the same to the office of the Department of War, which said effects are to be accounted for, and paid to the representatives of such deceased non-commissioned officer or soldier. And in case any of the officers, so authorized to take care of the effects of deceased officers and soldiers, should, before they have accounted to their representatives for the same, have occasion to leave the regiment or post, by preferment or otherwise, they shall, before they be permitted to quit the same, deposit in the hands of the commanding officer, or of the assistant military agent, all the effects of such deceased non-commissioned officers and soldiers, in order that the same may be secured for, and paid to, their respective representatives.

ARMY REGULATIONS—EDITION OF 1861.

DECEASED SOLDIERS.

Par. 152. Inventories of the effects of deceased non-commissioned officers and soldiers, required by the 95th Article of War, will be forwarded to the Adjutant General, by the commander of the company to which the deceased belonged, and a duplicate of the same to the colonel of the regiment. Final statements of pay, clothing, &c., will be sent with the inventories. When a soldier dies at a post or station absent from his company, it will be the duty of his immediate commander to furnish the required inventory, and, at the same time, to forward to the commanding officer of the company to which the soldier belonged, a report of his death, specifying the date, place, and cause; to what time he was last paid, and the money or other effects in his possession at the time of his decease; which report will be noted on the next muster roll of the company to which the man belonged. Each inventory will be endorsed, "Inventory of the effects of _____, late of company (—) _____ regiment of _____, who died at _____, the _____ day of _____, 186—." If a legal representative receive the effects, it will be stated in the report. If the soldier leave no effects, the fact will be reported.

Par. 153. Should the effects of a deceased non-commissioned officer or soldier not be administered upon within a short period after his decease, they shall be disposed of by a Council of Administration, under the authority of the commanding officer of the post, and the proceeds deposited with the Paymaster, to the credit of the United States, until they shall be claimed by the legal representatives of the deceased.

Par. 154. In all such cases of sales by the Council of Administration, a statement in detail, or account of the proceeds, duly certified by the Council and commanding officer, accompanied by the Paymaster's receipt for the proceeds, will be forwarded by the commanding officer to the Adjutant General. The statement will be endorsed, "Report of the proceeds of the effects of _____, late of company (—) _____ regiment of _____, who died at _____, the _____ day of _____, 186—."

NOTE 1.—The effects in all cases, when called for, should be turned over to the legal representative, without further authority from the Adjutant General. When the effects are turned over to the relatives of the deceased before these inventories are sent to the Adjutant General, their receipts therefor should be attached to the inventories. In all other cases, one copy will be sent with a letter of transmittal direct to the Adjutant General, and a duplicate retained by the officer.

NOTE 2.—Particular care should be taken to take receipts in duplicate from the Paymaster for any funds turned over to him; one copy should be sent direct to the Adjutant General and one retained by the officer.

INVENTORY OF THE EFFECTS

OF

Sergt. Gerry Winterberry

Late of Company *C*

8th Reg't of *U.S. Col'd Arty. (H)*

Volunteers, who died at *New Orleans La*

on the *2^d* day of *July* 186*5*.

Inventory of the effects of Jerry Kimberley late
a Sergeant of ~~Captain~~ St. Jell's Company C of
the 8th Regiment of U.S. Col'd Arty. Volunteers, who was enrolled as
a at Mayfield in the State of Kentucky on
the 28th day of February 1864, and mustered into the service of the United
States as a on the 26th day of April 1864, at Paducah Ky.
in Company C, 8th Regiment of U.S. Col'd Arty. Volunteers, to serve Three
years or during the war; he was born in Greene Co in the State
of Kentucky; he was 35 years of age, 5 feet 11³/₄ inches
high, Yellow complexion, Blk. eyes, Blk. hair, and by occupation, when enrolled,
a Laborer; he died in Camps De Afrique, U.S. Gen. Hosp at
New Orleans La on the 24th day of July 1864, by
reason of Dysentery Acute

INVENTORY.					
ARTICLES.	No.	ARTICLES.	No.	ARTICLES.	No.
Hats.....		Pairs trousers.....	1	Knapsacks.....	1
Caps.....		Pairs flannel drawers.....		<u>Canteen</u>	1
Forage caps.....		Pairs cotton drawers.....			
Great coats.....		Flannel shirts.....			
Uniform coats.....		Cotton shirts.....			
Uniform jackets.....		Pairs boots.....			
Flannel sack coats.....		Pairs shoes.....			
Blouses.....	1	Pairs socks.....			
Stable frocks.....		Blankets.....			
Fatigue overalls.....		Haversacks.....	1		
				MONEY.	
				Specie.....	\$
				Notes.....	\$

I CERTIFY, ON HONOR, that the above inventory comprises all the effects of Ser. Jt
Jerry Kimberley, deceased, and that the effects are in the hands
of Surgeon in Charge at Camps De Afrique, U.S. Gen. Hosp,
New Orleans La to be disposed of by a Council of Administration.

(DUPLICATES.)

STATION: New Orleans La

DATE: July 24th 1865

[A. G. O. No. 104]

Surgeon in Charge
Commanding the Company

1928

Wimble Beryle

Coet, 8 U.S. Col'd H. Art'y.

Private

Private

CARD NUMBERS.

1	5468099	26
2	5468212	27
3	5468330	28
4	5468480	29
5	5468634	30
6	5468784	31
7	5468933	32
8	5469078	33
9	5469220	34
10	5469350	35
11	5469478	36
12	5469598	37
12	5469709	38
14	9121271	39
15	40741961	40
16		41
17		42
18		43
19		44
20		45
21		46
22		47
23		48
24		49
25		50

Book Mark:

See also

1475576 P.O. Mon
2307621 P.O. Mon
M. A. 1067265

N | 8 H. Art'y. | U.S.C.T.

Bery Nimble

, Co. *A*, 8 Reg't U.S. Col'd H. Art'y.

Appears on

Company Descriptive Book

of the organization named above.

DESCRIPTION.

Age *20* years; height *5* feet *5 1/2* inches.

Complexion *Dark*

Eyes *Dark*; hair *Dark*

Where born *Greaves, Ky.*

Occupation *Farmer*

ENLISTMENT.

When *Feb. 2*, 1864.

Where *Paducah, Ky.*

By whom *J. Dobson*; term *3* y'rs.

Remarks:

Kenderson

N. | S H. Art'y. | U.S.C.T.

Beryle Wamble
Co. A, 1 Reg't Ky. H. Art'y.*

Appears on
Company Muster-in and Descriptive Roll
of the organization named above. Roll dated
Paducah Ky, Apr 26, 1864
Where born Graves Ky
Age 20 y'rs; occupation Farmer
When enlisted Feb 2, 1864.
Where enlisted Paducah Ky
For what period enlisted 3 years.
Eyes Dk; hair Dk
Complexion Dk; height 5 ft. 2 in.
When mustered in Apr 26, 1864.
Where mustered in Paducah Ky
Bounty paid \$ 100; due \$ 100
Where credited 1st Dist Ky
Company to which assigned

Remarks:

* This organization subsequently became Co. A, 8 Reg't U. S. Colored Heavy Artillery.

Book mark:

Paducah

W | 8 II. Art'y. | U.S.C.T.

Beryl Kimbly
Priv, Co. A, 1 Reg't Ky. H. Art'y.*

Appears on

Company Muster Roll

for *Enlistment to Apr 30*, 1864.

Present or absent *Present*

Stoppage, \$ *100* for

Due Gov't, \$ *100* for

Valuation of horse, \$ *100*

Valuation of horse equipments, \$ *100*

Remarks:

*This organization subsequently became Co. A, 8 Reg't U. S. Col'd Heavy Artillery.

Book mark:

(358)

Wauwington

Copyist.

Of

| S H. Art'y. |

U.S.C.T.

Barly Kimble
Priv, Co. A, 8 Reg't U. S. Col'd H. Art'y.

Appears on

Company Muster Roll

for *May & June*, 1864.

Present or absent *Present*

Stoppage, \$ *100* for

Due Gov't, \$ *100* for

Valuation of horse, \$ *100*

Valuation of horse equipments, \$ *100*

Remarks:

Book mark:

Waddington

M | 8 H. Art'y. | U.S.C.T.

Berle Kimberly

Priv, Co. A, 8 Reg't U. S. Col'd H. Art'y.

Appears on

Company Muster Roll

for *July & Aug*, 186*4*.

Present or absent *+*

Stoppage, \$ *100* for

Due Gov't, \$ *100* for

Valuation of horse, \$ *100*

Valuation of horse equipments, \$ *100*

Remarks: *On detached service at Mayfield Ky*

Name appears on roll in column of present with line drawn through it.

Book mark:

Waddington

25

8 H. Art'y. | U.S.C.T.

Berle Wimbley

Priv., Co. A, 8 Reg't U. S. Col'd H. Art'y.

Appears on

Company Muster Roll

for Sept. & Oct., 1864.

Present or absent Present

Stoppage, \$ 100 for

Due Gov't, \$ 100 for

Valuation of horse, \$ 100

Valuation of horse equipments, \$ 100

Remarks:

Book mark:

C. R. Owen

W | 8 H. Art'y. | U.S.C.T.

Berle Wimbler

Priv., Co. A, 8 Reg't U. S. Col'd H. Art'y.

Appears on

Company Muster Roll

for *Nov. 12*, 186*4*

Present or absent *Present*

Stoppage, \$ *100* for

Due Gov't, \$ *100* for

Valuation of horse, \$ *100*

Valuation of horse equipments, \$ *100*

Remarks: *On daily duty
with section
of H. Art'y.*

Book mark:

Chilman

W | 8 H. Art'y. | U.S.C.T.

Berl Wimbley

Priv., Co. A, 8 Reg't U. S. Col'd H. Art'y.

Appears on

Company Muster Roll

for Jan. & Feb., 1865.

Present or absent Present.

Stoppage, \$ 100 for

Due Gov't, \$ 45-
100 for Ordnance

Valuation of horse, \$ 100

Valuation of horse equipments, \$ 100

Remarks: On daily duty
with Dep't light-
Arty.

Book mark:

C. R. Allen,

W. | **S H. Art'y.** | **U. S. C. T.**

Carl Wimbley

Priv., Co. A, 8 Reg't U. S. Col'd H. Art'y.

Appears on

Company Muster Roll

for *March & Apr.*, 1865.

Present or absent *Present,*

Stoppage, \$ 100 for

Due Gov't, \$ ⁴⁵/₁₀₀ for *Ordinance*

Valuation of horse, \$ 100

Valuation of horse equipments, \$ 100

Remarks: _____

Book mark: _____

C. H. Owen,

W.

| S H. Art'y. | U.S.C.T.

Bill O'Connell

Paite, Co. A, 8 Reg't U. S. Col'd H. Art'y.

Appears on

Company Muster Roll

for *May 7 June*, 1865.

Present or absent *Present*

Stoppage, \$ *100* for

Due Gov't, \$ *45* for *Ordnance*

Valuation of horse, \$ *100*

Valuation of horse equipments, \$ *100*

Remarks:

Book mark:

C. R. Owen

24

| S H. Art'y. | U. S. C. T. |

Wm. H. H. H. H.

....., Co. A, 8 Reg't U. S. Col'd H. Art'y.

Appears on

Company Muster Roll

for *July and Aug*....., 1865 .

Present or absent *Present*.....

Stoppage, \$.....100 for.....

Due Gov't, \$.....⁴⁵/100 for *Contract*.....

Valuation of horse, \$.....100

Valuation of horse equipments, \$.....100

Remarks:.....

Book mark:.....

W. H. H. H.

W | S H. Art'y. | U. S. C. T.

Beal Wainbley

Par, Co. A, 8 Reg't U. S. Col'd H. Art'y.

Appears on

Company Muster Roll

for *Sept and Oct*, 186*3*.

Present or absent *Present*

Stoppage, \$ *100* for

Due Gov't, \$ *100* for

Valuation of horse, \$ *100*

Valuation of horse equipments, \$ *100*

Remarks:

Book mark:

N. H. Wainbley

4444 555

7 | **S H. Art'y.** | **U.S.C.T.**

100

-----, Co. A, 8 Reg't U. S. Col'd H. Art'y.

Appears on

Company Muster Roll

for ----- *100* -----, 186*6*.

Present or absent ----- *Present* -----

Stoppage, \$ ----- *100* for -----

Due Gov't, \$ ----- *100* for -----

Valuation of horse, \$ ----- *100*

Valuation of horse equipments, \$ ----- *100*

Remarks: -----

Book mark: -----

----- *W. H. Smith* -----
(358) Copyist.

W

8 H. Art'y.

U.S.C.T.

Berle Wimbley

Priv, Co. A, 8 Reg't U. S. Col'd H. Art'y.

Appears on Returns as follows:

Nov 1864 absent on
det serv. (with in this regt)
at Paducah Ky as [?]

Book mark :

Geo. Patton

(546)

Copyist.

21

H. Art'y.

U.S.C.T.

George W. White

Co. *C*, 8 Reg't U. S. Col'd H. Art'y.

Appears on Co. Muster-out Roll, dated

Feb 10, 1866 .

Muster-out to date *Feb 10*, 1866 .

Last paid to *Aug 1*, 1865 .

Clothing account:

Last settled....., 186 ; drawn since \$..... 100

Due soldier \$ *4* ^{*21*} 100; due U. S. \$..... 100

Am't for cloth'g in kind or money adv'd \$..... 100

Due U. S. for arms, equipments, &c., \$..... 100

Bounty paid \$ *200* 100; due \$ *500* 100

Remarks: *He is at present a private*
and is now in the 1st
reg't of the 8th
reg't of the 1st

Book mark:

1929 or child's
Wimbley Giles

Co of, 8 U.S. Col'd H. Art'y.

Private

Private

CARD NUMBERS.

1	5467302	26
2	5467190	27
3	5468642	28
4	5468791	29
5	5468940	30
6	5469085	31
7	5469227	32
8	5469357	33
9	5469479	34
10	5469599	35
11	5469710	36
12	9121340	37
13	40744962	38
14		39
15		40
16		41
17		42
18		43
19		44
20		45
21		46
22		47
23		48
24		49
25		50

Book Mark:

See also

A | 8 H. Art'y. | U.S.C.T.

Giles Mumbly

....., Co. *A*....., 8 Reg't U.S. Col'd H. Art'y.

Appears on

Company Descriptive Book

of the organization named above.

DESCRIPTION.

Age *22* years; height *5* feet *9* inches.

Complexion *Dark*

Eyes *Dark*; hair *Dark*

Where born *Memphis, Tenn.*

Occupation *Farmer*

ENLISTMENT.

When *Sept. 5*....., 186*4*.

Where *Paducah, Ky.*

By whom *R. Schofield*.....; term *3* y'rs.

Remarks:

.....
.....
.....
.....
.....

Henderson

W

8 H. Art'y.

U.S.C.T.

Chas Wmley

Appears with rank of *Prvt* on

Muster and Descriptive Roll of a Detachment of U. S. Vols. forwarded

for the 8 Reg't U. S. Col'd H. Art'y. Roll dated

Panmash Ky, ~~Sept~~ Sep 30, 1864

Where born *Miss*

Age *25* y'rs; occupation *Farmer*

When enlisted *Sep 5*, 186 .

Where enlisted *Panmash Ky.*

For what period enlisted *3* years.

Eyes *Blk*; hair *Blk*

Complexion *Yellow*; height *5 ft. 9 1/2 in.*

When mustered in *Sep 5*, 186 .

Where mustered in *Panmash*

Bounty paid \$ *100*; due \$ *100*

Where credited *McEachen Co. 1st Dist. Ky.*

Company to which assigned

Remarks:

Book mark:

Provy, Jr

(339)

Copyist.

W

8 H. Art'y.

U.S.C.T.

Whiles Himley

Appears with rank of *Private* on

Muster and Descriptive Roll of a Detachment of U. S. Vols. forwarded

for the 8 Reg't U. S. Col'd H. Art'y. Roll dated

Paducah, Ky. N.Y. Sept. 30, 1864.

Where born *Miss.*

Age *25* y'rs; occupation *Farmer*

When enlisted *Sept. 5*, 186 .

Where enlisted *Paducah, Ky.*

For what period enlisted *3* years.

Eyes *Black*; hair *Black*

Complexion *Black*; height *5' 9 1/2* in.

When mustered in *Sept. 5*, 186 .

Where mustered in *Paducah.*

Bounty paid \$ *100*; due \$ *100*

Where credited *Ballard, pt D. Ky.*

Company to which assigned *E.*

Remarks:

Book mark:

Calloway

(339)

Copyist.

W | **S H. Art'y.** | **U. S. C. T.**

Giles Wimbley
Priv., Co. A, 8 Reg't U. S. Col'd H. Art'y.

Appears on

Company Muster Roll

for *Sept. Oct.*, 186*6*

Present or absent *Present*

Stoppage, \$ *100* for

Due Gov't, \$ *100* for

Valuation of horse, \$ *100*

Valuation of horse equipments, \$ *100*

Remarks:

Book mark: -----

C. R. Owen

(358)

Copyist.

W | 8 H. Art'y. | U.S.C.T.

Giles Winibley

P, Co. A, 8 Reg't U. S. Col'd H. Art'y.

Appears on

Company Muster Roll

for *Nov. Dec.*, 1864.

Present or absent *Present*

Stoppage, \$ *100* for

Due Gov't, \$ *100* for

Valuation of horse, \$ *100*

Valuation of horse equipments, \$ *100*

Remarks:

Book mark:

C. R. Owen

W | 8 H. Art'y. | U.S.C.T.

Giles Wimbley
Priv., Co. A, 8 Reg't U. S. Col'd H. Art'y.

Appears on

Company Muster Roll

for Jan. & Feb., 1865.

Present or absent Present-

Stoppage, \$ 100 for

Due Gov't, \$ 23/100 for Ordnance

Valuation of horse, \$ 100

Valuation of horse equipments, \$ 100

Remarks:

Book mark:

C. R. Allen

W | 8 H. Art'y. | U.S.C.T.

Giles Wimbley

Priv., Co. A, 8 Reg't U. S. Col'd H. Art'y.

Appears on

Company Muster Roll

for *March & Apr.*, 186*5*.

Present or absent *Present*,

Stoppage, \$ *100* for

Due Gov't, \$ *100* for

Valuation of horse, \$ *100*

Valuation of horse equipments, \$ *100*

Remarks:

Book mark: _____

(358)

C. R. Owen
Copyist.

W

| 8 H. Art'y. | U.S.C.T.

Giles Wimbley

Paris, Co. A, 8 Reg't U. S. Col'd H. Art'y.

Appears on

Company Muster Roll

for May & June, 1863.

Present or absent Present

Stoppage, \$ 100 for

Due Gov't, \$ 23/100 for Ordnance

Valuation of horse, \$ 100

Valuation of horse equipments, \$ 100

Remarks:

Book mark:

C. R. Owen

21

| S H. Art'y. | U.S.C.T.

Geo. Trimbley

215, Co. A, 8 Reg't U. S. Col'd H. Art'y.

Appears on

Company Muster Roll

for *July and Aug*, 186*4*.

Present or absent *Present*

Stoppage, \$ *100* for

Due Gov't, \$ *100* for *cont'd pay*

Valuation of horse, \$ *100*

Valuation of horse equipments, \$ *100*

Remarks: *Ship for 7 months term
1 year back & 1 year term*

Book mark:

W. S. Smith

21

| S H. Art'y. | U. S. C. T.

Giles Wimbley

100, Co. A, 8 Reg't U. S. Col'd H. Art'y.

Appears on

Company Muster Roll

for *Sept and Oct*, 1865.

Present or absent *Present*

Stoppage, \$ *100* for

Due Gov't, \$ *100* for

Valuation of horse, \$ *100*

Valuation of horse equipments, \$ *100*

Remarks:

Book mark:

W. H. Smith

27

Giles Hinchey

....., Co. A, 8 Reg't U. S. Col'd H. Art'y.

Appears on

Company Muster Roll

for *Nov and Dec*, 1865 .

Present or absent *Present*

Stoppage, \$ *100* for

Due Gov't, \$ *100* for

Valuation of horse, \$ *100*

Valuation of horse equipments, \$ *100*

Remarks: *Co. A, 8th Regt. U.S. Col'd H. Art'y.
since Dec 20, 1865*

Book mark:

W. G. ...

W

8 H. Art'y.

U.S.C.T.

Giles Wimbley

Priv, Co. A, 8 Reg't U. S. Col'd H. Art'y.

Appears on Returns as follows:

Dec 1863 - ⁴⁴ Jan 1866. absent
Construction Corps. USMAA,
since Dec 27/63.

Book mark:

Chas. Patton

(546)

Copyist.

4

8 H. Art'y.

U.S.C.T.

Wm. H. ...

Co. *...*, 8 Reg't U. S. Col'd H. Art'y.

Appears on Co. Muster-out Roll, dated *Michigan ... Feb 10*, 186*6*.

Muster-out to date *Feb 10*, 186*6*.

Last paid to *...*, 186*5*.

Clothing account:

Last settled....., 186 ; drawn since \$..... 100

Due soldier \$..... 100; due U. S. \$..... $\frac{30}{100}$

Am't for cloth'g in kind or money adv'd \$..... 100

Due U. S. for arms, equipments, &c., \$..... $\frac{60}{100}$

Bounty paid \$..... 100; due \$..... 100

Remarks: *...*
...
...
...

Book mark: *...* 1891.

(861)

Copyist.

Stimley, Chiles

....., Co.

8 Reg't U S A H A

2 Enclosures.

Bed Cards	Final Statements
Burial Records	Furloughs or L. of A.
Certs. of Dis. for Discharge	Med. Certificates
C. M. Charges	Med. Des. Lists
Descriptive Lists	Orders
Discharge Certificates	Pris. of War Record
Enlistment Papers 2	Resignations

Other papers relating to—

Admission to Hosp'l	Furlough or L. of A.
Casualty Sheet	Med. Examination
Confinement	Misc. Information
Contracts	Pay or Clothing
Death or Effects	Personal Reports
Desertion	Rank
Discharge from Hosp'l	Transfer to Hosp'l
Discharge from Service	Transfer to V. R. C.
Duty	Transportation
.....

847011 1011 11

No. Eighty one

Wimley, Charles

Volunteered at Paducah Ky

September 5th 1864

By Capt R. H. Wall

Pro Mar 1st Dist of Ky

OK 122

Charles Wimley

Consent of Parent or Guardian in case of a Minor, if a Free Man, or in the case of a Slave, of the Person to whom he owes Service:

United States colored troops. They will be made out in duplicate in all cases--one
general, and one to accompany the accounts of the officer who pays bounty, &c.
tr-in, must in all cases, precede payment of pay, bounty, pension, &c. A must
g officer, commissary, or assistant commissary of musters, as the case may be, will
er of them is given to the disbursing officer.

Wimley, Charles

UNITED STATES COLORED TROOPS ENLISTMENT.

STATE OF

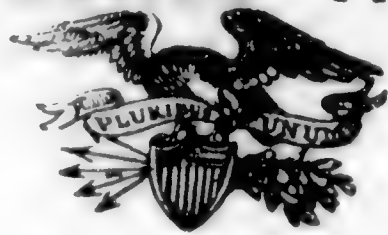

TOWN OF

Kentucky *Paducah*

I, *Wimley, Charles* born in
 in the State of *Miss* aged *Twenty five* years
 and by occupation a *Farmer* Do HEREBY ACKNOWLEDGE to have
 volunteered this *Fifth* day of *September* 1864,

to serve as a **Soldier** in the **Army of the United States of America**, for
 the period of **THREE YEARS**, unless sooner discharged by proper authority:
 Do also agree to accept such bounty, pay, rations, and clothing, as are, or may be,
 established by law for the U. S. colored troops.

And I, *Charles Wimley of McCracken Co*
 do solemnly swear, that I will bear true faith and allegiance to the **United States
 of America**, and that I will serve them honestly and faithfully against all their
 enemies or opposers whomsoever; and that I will observe and obey the orders of
 the President of the United States, and the orders of the officers appointed over
 me, according to the Rules and Articles of War.

Sworn and subscribed to, at *Paducah Ky*
 this *5th* day of *Sept* 1864, } *Charles Wimley*
 Before *Capt. Pro Mars* } *Mar*

I CERTIFY, ON HONOR, That I have carefully examined the above named Volunteer, agreeably to the
 General Regulations of the Army, and that, in my opinion, he is free from all bodily defects and mental infirmity,
 which would in any way disqualify him from performing the duties of a soldier.

W. H. Kidd

EXAMINING SURGEON.

I CERTIFY, ON HONOR, That I have minutely inspected the Volunteer, *Charles Wimley*
 previously to his enlistment, and that he was entirely sober when enlisted; that, to the best of my judgment and
 belief, he is of lawful age; and that, in accepting him as duly qualified to perform the duties of an able bodied
 soldier, I have strictly observed the regulations which govern the recruiting service. This soldier has *dark*
 eyes, *dark* hair, *dark* complexion, is *five* feet *9 1/2* inches high.

RECRUITING OFFICER OR AGENT.

Mustered into the United States service *Fifth* day of *September* 1864
W. H. Kidd
Capt. Pro Mars Mustering Officer.

Mustered into the service of the United States, for three years or during the war, from date of enlistment, in Company
S Co
 Regiment of *1st Regt Colored Cavalry*, on the *5th* day of *September*, 1864, at *Paducah Ky*

Capt. Pro Mars
W. H. Kidd
W. H. Kidd

NOTE 1.—This blank will be used for enlistments of United States colored troops. They will be made out in duplicate in all cases—one to accompany the recruiting return of the superintendent (not the recruiting officer) to the Adjutant General, and one to accompany the accounts of the officer who pays bounty, &c.

NOTE 2.—An enlistment holds to service. A muster-in, must in all cases, precede payment of pay, bounty, pension, &c. A muster-in roll, must in all cases, be filed in the Adjutant General's Office as evidence of muster-in. The mustering officer, commissary, or assistant commissary of musters, as the case may be, will countersign both enlistments as having mustered the soldier into the service of the United States before either of them is given to the disbursing officer.

DECLARATION OF RECRUIT.

I, *Charles Winley of McCracken Co* desiring to volunteer as a soldier in the ARMY OF THE UNITED STATES, for the term of *Three Years*, do DECLARE That I am *Twenty-four* years and months of age; that I have never been discharged from the United States service on account of disability or by sentence of a court-martial, or by order before the expiration of a term of enlistment; and I know of no impediment to my serving honestly and faithfully as a soldier for three years.

GIVEN at *Pudmough Ky* the *5th* day of *September* 1861

Witness: *[Signature]*

Charles Winley
mark

to my skin by

OK 122

By *Robert O. Adams*
Provr. of McCracken Co

Volunteered at *Pudmough Ky*
September 5th 1861

Charles Winley

No. *Eighty one*

5111111111

Consent of Parent or Guardian in case of a Minor, if a Free Man, or in the case of a Slave, of the Person to whom he owes Service:

I, Do CERTIFY, That I am the that the said is years of age; and I do freely give my CONSENT to his volunteering as a SOLDIER in the Army of the United States, for the period of THREE YEARS, under the conditions of the laws of the United States.

GIVEN at the day of

Witness:

No. *Eighty-one*

Wm. Charles

Volunteered at *Paducah Ky*

September 5th 1864

By *Capt. R. H. Hall*

Pro Marshal District

Consent of Parent or Guardian in case of a Minor, if a Free Man, or in the case of a Slave, of the Person to whom he owes Service:

JUL
15
1871

of United States colored troops. They will be made out in duplicate in all cases of General, and one to accompany the accounts of the officer who pays bounty, muster-in, must in all cases, precede payment of pay, bounty, pension, &c. either of them is given to the disbursing officer.

UNITED STATES COLORED TROOPS ENLISTMENT.

STATE OF

TOWN OF

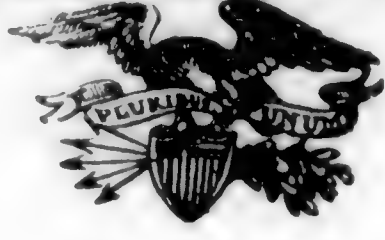

Kentucky *Paducah*

I, *Chiles Wimley* born in *Miss* in the State of *Miss* aged *Twenty-five* years and by occupation a *Farmer* Do HEREBY ACKNOWLEDGE to have volunteered this *Fifth* day of *September* 1864,

to serve as a **Soldier** in the **Army of the United States of America**, for the period of **THREE YEARS**, unless sooner discharged by proper authority: Do also agree to accept such bounty, pay, rations, and clothing, as are, or may be, established by law for the U. S. colored troops.

And I, *Chiles Wimley of Mcbracken* do solemnly swear, that I will bear true faith and allegiance to the **United States of America**, and that I will serve them honestly and faithfully against all their enemies or opposers whomsoever; and that I will observe and obey the orders of the President of the United States, and the orders of the officers appointed over me, according to the Rules and Articles of War.

Sworn and subscribed to, at *Paducah* this *5th* day of *Sept* 1864; Before *Capt. R. S. Hall* *Chiles Wimley*

I CERTIFY, ON HONOR, That I have carefully examined the above named Volunteer, agreeably to the General Regulations of the Army, and that, in my opinion, he is free from all bodily defects and mental infirmity, which would in any way disqualify him from performing the duties of a soldier.

Dr. H. Kidd

EXAMINING SURGEON.

I CERTIFY, ON HONOR, That I have minutely inspected the Volunteer, *Chiles Wimley* previously to his enlistment, and that he was entirely sober when enlisted; that, to the best of my judgment and belief, he is of lawful age; and that, in accepting him as duly qualified to perform the duties of an able bodied soldier. I have strictly observed the regulations which govern the recruiting service. This soldier has *Blue* eyes, *Black* hair, *Black* complexion, is *5 1/2* feet *9 1/2* inches high.

RECRUITING OFFICER OR AGENT.

Mustered into the United States service *Fifth* day of *September* 1864.

R. S. Hall
Capt. Pro. Mar. Mustering Officer.

Mustered into the service of the United States, for three years or during the war, from date of enlistment, in Company *8th* Regiment of *Mcbracken* Volunteers, on the *5th* day of *September*, 1864 at *Paducah Ky.*

Capt. R. S. Hall
1st Dist. 1st Regt.

NOTE 1.—This blank will be used for enlistments of United States colored troops. They will be made out in duplicate in all cases—one to accompany the recruiting return of the superintendent (not the recruiting officer) to the Adjutant General, and one to accompany the accounts of the officer who pays bounty, &c.

NOTE 2.—An enlistment holds to service. A muster-in, must in all cases, precede payment of pay, bounty, pension, &c. A muster-in roll, must in all cases, be filed in the Adjutant General's Office as evidence of muster-in. The mustering officer, commissary, or assistant commissary of musters, as the case may be, will countersign both enlistments as having mustered the soldier into the service of the United States before either of them is given to the disbursing officer.

DECLARATION OF RECRUIT.

I, Charles Wimley of Paducah Ky desiring to volunteer as a soldier in the ARMY OF THE UNITED STATES, for the term of Three Years, do DECLARE That I am Twenty five years and months of age; that I have never been discharged from the United States service on account of disability or by sentence of a court-martial, or by order before the expiration of a term of enlistment; and I know of no impediment to my serving honestly and faithfully as a soldier for three years.

GIVEN at Paducah Ky the 5th day of September 1864

Witness: A. J. [Signature]

Charles Wimley
By James [Signature]
Volunteered at Paducah Ky
September 5th 1864
By James [Signature]
No. Eighty-one

JUL 15 1871

Consent of Parent or Guardian in case of a Minor, if a Free Man, or in the case of a Slave, of the Person to whom he owes Service:

I, Do CERTIFY, That I am the that the said is years of age; and I do freely give my CONSENT to his volunteering as a SOLDIER in the Army of the United States, for the period of THREE YEARS, under the conditions of the laws of the United States.

GIVEN at the day of

Witness: (A. G. O. No. 74 & 76.)

NARA 689

1930

Winbush Bob

Co —, 8 U.S. Col'd H. Art'y.

Private

Private

CARD NUMBERS.

1	5467057	26
2	5467089	27
3		28
4		29
5		30
6		31
7		32
8		33
9		34
10		35
11		36
12		37
13		38
14		39
15		40
16		41
17		42
18		43
19		44
20		45
21		46
22		47
23		48
24		49
25		50

Book Mark: _____

See also _____

W | 8 H. Art'y. | U.S.C.T.

Bob Winbush

Appears with rank of *Private* on

Muster and Descriptive Roll of a Detachment of U. S. Vols. forwarded

for the 8 Reg't U. S. Col'd H. Art'y. Roll dated *Paduosh, Ky, N.Y. Aug 31, 1864.*

Where born *McCracken, Ky.*

Age *18* y'rs; occupation *Farmer*

When enlisted *Aug. 11*, 186 .

Where enlisted *Paduosh, Ky.*

For what period enlisted *3* years.

Eyes *Black*; hair *Black*

Complexion *Black*; height *5* ft. *4* in.

When mustered in *Aug. 11*, 186 .

Where mustered in *Paduosh.*

Bounty paid \$ *100*; due \$ *100*

Where credited *McCracken, P.D. Ky.*

Company to which assigned

Remarks:

Name not taken upon rolls

Book mark:

Callaway

W | 8 H. Art'y. | U.S.C.T.

Bob Winbush

Appears with rank of Prvt on

Muster and Descriptive Roll of a Detachment of U. S. Vols. forwarded

for the 8 Reg't U. S. Col'd H. Art'y. Roll dated

Paducah Ky, N.Y. Aug 3/1864.

Where born McCracken, Ky

Age 18 y'rs; occupation Farmer

When enlisted Aug. 11, 186

Where enlisted Paducah, Ky

For what period enlisted 3 years.

Eyes Black; hair Black

Complexion Black; height 5 ft. 4 in.

When mustered in Aug. 11, 186

Where mustered in Paducah

Bounty paid \$ 100; due \$ 100

Where credited McCracken Co. 1st Dist. of Ky.

Company to which assigned _____

Remarks : _____

Book mark : _____

Geo J Bell

(339)

Copyist.

Stambush, Bob

....., Co., 8 Reg't U.S.C. HA.

Enclosures.

Bed Cards	Final Statements
Burial Records	Furloughs or L. of A.
Certs. of Dis. for Discharge	Med. Certificates
C. M. Charges	Med. Des. Lists
Descriptive Lists	Orders
Discharge Certificates	Pris. of War Record
Enlistment Papers /	Resignations

Other papers relating to—

Admission to Hosp'l	Furlough or L. of A.
Casualty Sheet	Med. Examination
Confinement	Misc. Information
Contracts	Pay or Clothing
Death or Effects	Personal Reports
Desertion	Rank
Discharge from Hosp'l	Transfer to Hosp'l
Discharge from Service	Transfer to V. R. C.
Duty	Transportation
.....

Oh 124

No. *Four hundred sixteenth*

Bob Winbush

Volunteered at *Paducah Ky*

Aug 11th 1864

By *R. H. Hall*

Capt & Co Mar 1st Dist Ky

J. H. L. A. Henry

Consent of Parent or Guardian in case of a Minor, if a Free Man, or in the case of
Slave, of the Person to whom he owes Service:

I, Do CERTIFY, That I am

ents of United States colored troops. They will be made out in duplicate in all cas
tant General, and one to accompany the accounts of the officer who pays bounty, &
muster-in, must in all cases, precede payment of pay, bounty, pension, &c. A
muster-ing officer, commissary, or assistant commissary of musters, as the case may b
re either of them is given to the disbursing officer.

UNITED STATES COLORED TROOPS ENLISTMENT.

STATE OF

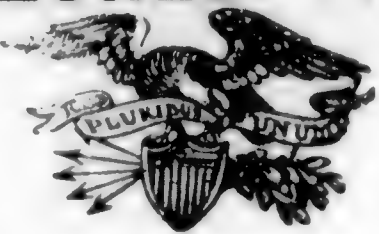

TOWN OF

Kentucky

Paducah

I, *Bob Winbush* born in
in the State of *Virginia* aged *Eighteen* years
and by occupation a *Farmer* Do HEREBY ACKNOWLEDGE to have
volunteered this *Eleventh* day of *August* 1864,
to serve as a **Soldier** in the **Army of the United States of America**, for
the period of **THREE YEARS**, unless sooner discharged by proper authority:
Do also agree to accept such bounty, pay, rations, and clothing, as are, or may be,
established by law for the U. S. colored troops.

And I, *Bob Winbush of McCracken Co Ky*
do solemnly swear, that I will bear true faith and allegiance to the **United States
of America**, and that I will serve them honestly and faithfully against all their
enemies or opposers whomsoever; and that I will observe and obey the orders of
the President of the United States, and the orders of the officers appointed over
me, according to the Rules and Articles of War.

Sworn and subscribed to, at *Paducah Ky*
this *11th* day of *Aug* 1864, *Bob Winbush*
mark

Before *R. H. Hall*
Capt & Pro Mar 1st Dist of Ky

I CERTIFY, ON HONOR, That I have carefully examined the above named Volunteer, agreeably to the
General Regulations of the Army, and that, in my opinion, he is free from all bodily defects and mental infirmity,
which would in any way disqualify him from performing the duties of a soldier.

W. H. Kidd

EXAMINING SURGEON.

I CERTIFY, ON HONOR, That I have minutely inspected the Volunteer, *Bob Winbush*
previously to his enlistment, and that he was entirely sober when enlisted; that, to the best of my judgment and
belief, he is of lawful age; and that, in accepting him as duly qualified to perform the duties of an able bodied
soldier, I have strictly observed the regulations which govern the recruiting service. This soldier has *dark*
eyes, *dark* hair, *dark* complexion, is *5 ft 2 in* high.

RECRUITING OFFICER OR AGENT.

Mustered into the United States service *Eleventh* day of *Aug* 1864

R. H. Hall
Capt & Pro Marshall Mustering Officer.

Mustered into the service of the United States, for three years or during the war, from date of enlistment, in Company
2nd Regiment of *Old Maryland* Volunteers, on the *11th* day of *Aug* 1864 at *Paducah Ky*

R. H. Hall

Capt & Pro Mar

1st Dist of Ky

NOTE 1.—This blank will be used for enlistments of United States colored troops. They will be made out in duplicate in all cases—one to accompany the recruiting return of the superintendent (not the recruiting officer) to the Adjutant General, and one to accompany the accounts of the officer who pays bounty, &c.

NOTE 2.—An enlistment holds to service. A muster-in, must in all cases, precede payment of pay, bounty, pension, &c. A muster-in roll, must in all cases, be filed in the Adjutant General's Office as evidence of muster-in. The mustering officer, commissary, or assistant commissary of musters, as the case may be, will countersign both enlistments as having mustered the soldier into the service of the United States before either of them is given to the disbursing officer.

DECLARATION OF RECRUIT.

I, Bob Winbush of McCracken Co desiring to volunteer as a soldier in the ARMY OF THE UNITED STATES, for the term of Three Years, do DECLARE That I am Eighteen years and months of age; that I have never been discharged from the United States service on account of disability or by sentence of a court-martial, or by order before the expiration of a term of enlistment; and I know of no impediment to my serving honestly and faithfully as a soldier for three years.

GIVEN at Paducah Ky the 11th day of August 1864

Witness: [Signature]

Bob Winbush

By [Signature]
Volunteered at Paducah Ky
Aug 11th 1864
By [Signature]
No. Seventy

20 1864

Consent of Parent or Guardian in case of a Minor, if a Free Man, or in the case of Slave, of the Person to whom he owes Service:

I, Do CERTIFY, That I am the that the said is years of age; and I do freely give my CONSENT to his volunteering as a SOLDIER in the Army of the United States, for the period of THREE YEARS, under the conditions of the laws of the United States.

GIVEN at the day of

Witness:

1931
Winn Benjamin
Co D, 8 U.S. Col'd H. Art'y.

Private | Corporal

CARD NUMBERS.

1	5466875	26
2	5466998	27
3	5473146	28
4	5473291	29
5	5473425	30
6	5473555	31
7	5473681	32
8	5473801	33
9	5473916	34
10	5474023	35
11	5474128	36
12	5474148	37
13	9121832	38
14	40752963	39
15		40
16		41
17		42
18		43
19		44
20		45
21		46
22		47
23		48
24		49
25		50

Book Mark:

See also

W | S.H. Artz | U.S.C.T.

Benjamin W. Wain

, Co. D, 8 Reg't U.S. Col'd S.H. Artz

Appears on

Company Descriptive Book

of the organization named above.

DESCRIPTION.

Age 28 years; height 5 feet 8 inches.

Complexion *blk*

Eyes *blk*; hair *blk*

Where born *N. C.*

Occupation *A farmer*

ENLISTMENT.

When *July 28*, 1864.

Where *Paducah, Ky.*

By whom *R. H. Hall*; term *3* y'rs.

Remarks: *Promoted to Corp
Jan. 1/66*

Henderson

Benjamin Wynn

Appears with rank of *Priv.* on

Muster and Descriptive Roll of a Detachment of U. S. Vols. forwarded

for the 8 Reg't U. S. Col'd H. Art'y. Roll dated

Paducah Ky., N.Y. July 31, 1864.

Where born *N.C.*

Age *28* y'rs; occupation *Farmer*

When enlisted *July 25*, 186 .

Where enlisted *Paducah Ky.*

For what period enlisted *3* years.

Eyes *Black*; hair *Black*

Complexion *Black*; height *5 ft. 8 in.*

When mustered in *July 28*, 186 .

Where mustered in

Bounty paid \$ *100*; due \$ *100*

Where credited *Union Co. 1st Con. Dist. of Ky.*

Company to which assigned *D*

Remarks :

Book mark :

H. L. Amel

Benj. Mann

Appears with rank of _____ on _____

Muster and Descriptive Roll of a Detachment of U. S. Vols. forwarded

for the 8 Reg't U. S. Col'd H. Art'y. Roll dated

Paducah Ky, N. Y. Aug 1, 1864.

Where born *S. C.*

Age *28* y'rs; occupation *Farmer*

When enlisted *July 28*, 186 .

Where enlisted *Paducah Ky*

For what period enlisted *3* years.

Eyes *Blk*; hair *Blk*

Complexion *Blk*; height *5 ft. 8 in.*

When mustered in *July 28*, 186 .

Where mustered in *Paducah Ky*

Bounty paid \$ *100*; due \$ *100*

Where credited *1 Dist Ky*

Company to which assigned *I*

Remarks : _____

Book mark : _____

Breyer

N

S H. Art'y.

U.S.C.T.

Benjamin Winsor

Proste, Co. D, 8 Reg't U. S. Col'd H. Art'y.

Appears on

Company Muster Roll

for *July & Aug.*, 1864.

Present or absent *

Stoppage, \$ *100* for

Due Gov't, \$ *100* for

Remarks: *Absent sick at Paducah Ky. since the 26 of Aug.*

Book mark:

M. M. Sharsen

W. | '8 H. Art'y. | **U.S.C.T.**

Benz Minn

Co. D, 8 Reg't U. S. Col'd H. Art'y.

Appears on

Company Muster Roll

for *Sep. & Oct.*, 186*4*.

Present or absent *Present.*

Stoppage, \$ *100* for

Due Gov't, \$ *100* for

Valuation of horse, \$ *100*

Valuation of horse equipments, \$ *100*

Remarks: _____

Book mark: _____

J. G. White.

4

8 H. Art'y.

U.S.C.T.

Benjamin Wimer

Pr., Co. D, 8 Reg't U. S. Col'd H. Art'y.

Appears on

Company Muster Roll

for *Nov. & Dec.*, 186*4*.

Present or absent *Present.*

Stoppage, \$ *100* for

Due Gov't, \$ *100* for

Valuation of horse, \$ *100*

Valuation of horse equipments, \$ *100*

Remarks:

Book mark:

J. Smith

(358)

Copyist.

97

S H. Art'y.

U.S.C.T.

Benjamin Wimer
Priv., Co. D, 8 Reg't U. S. Col'd H. Art'y.

Appears on

Company Muster Roll

for *Jan. 7 Feb.*, 1865.

Present or absent *Present*

Stoppage, \$ *100* for

Due Gov't, \$ *100* for

Remarks:

Book mark:

(358)

[Signature]

Copyist.

W

S H. Art'y.

U.S.C.T.

Benjamin Wier

Pvt., Co. D, 8 Reg't U. S. Col'd H. Art'y.

Appears on

Company Muster Roll

for *May & June*, 186*5*.

Present or absent *Present.*

Stoppage, \$ *100* for

Due Gov't, \$ *100* for

Remarks:

Book mark:

(358)

J. G. Mutton

Copyist.

94

S H. Art'y.

U.S.C.T.

Benjamin Nye

Pi, Co. D, 8 Reg't U. S. Col'd H. Art'y.

Appears on

Company Muster Roll

for *July & Aug*, 1865.

Present or absent *present*

Stoppage, \$ *100* for

Due Gov't, \$ *100* for

Remarks:

Benjamin Nye

Book mark:

J. J. Brown
(358) Copyist.

31

8 H. Art'y. | U.S.C.T.

Benjamin Minn

Priv, Co. D, 8 Reg't U. S. Col'd H. Art'y.

Appears on

Company Muster Roll

for *Nov + Dec*, 1865.

Present or absent *present*

Stoppage, \$ 100 for

Due Gov't, \$ 100 for

Valuation of horse, \$ 100

Valuation of horse equipments, \$ 100

Remarks:

Book mark:

(358)

J. Brown

Copyist.

W

8 H. Art'y.

U.S.C.T.

Benjamin Wain

Priv, Co. *dB*, 8 Reg't U. S. Col'd H. Art'y.

Appears on Returns as follows:

Aug 18 64 *labour sick*
in Hosp

Book mark : _____

Chas. J. Gutter

(546)

Copyist.

91

S H. Art'y.

U.S.C.T.

Benjamin Hiram

Co. 20, 8 Reg't U. S. Col'd H. Art'y.

Appears on Co. Muster-out Roll, dated
Victoria, Mex., Feb 10, 1866.

Muster-out to date *Feb 10,* 1866.

Last paid to *Aug 31,* 1865.

Clothing account:

Last settled....., 186 ; drawn since \$..... 100

Due soldier \$ *10 28* 100; due U. S. \$..... 100

Am't for cloth'g in kind or money adv'd \$..... 100

Due U. S. for arms, equipments, &c., \$..... 100

Bounty paid \$..... 100; due \$ *200* 100

Remarks: *Ent'd service as a recruit*

Joined Comp'y for duty July
28/64. Appt'd Corp'l Jan 1
1866.

Book mark:

(861)

J. Brown

Copyist.

Wm. B. ...

Co.

8 Reg't

U.S.A.

3

Enclosures.

Bed Cards	Final Statements
Burial Records	Furloughs or L. of A.
Certs. of Dis. for Discharge	Med. Certificates
C. M. Charges	Med. Des. Lists
Descriptive Lists	Orders
Discharge Certificates	Pris. of War Record
Enlistment Papers 3	Resignations

Other papers relating to—

Admission to Hosp'l	Furlough or L. of A.
Casualty Sheet	Med. Examination
Confinement	Misc. Information
Contracts	Pay or Clothing
Death or Effects	Personal Reports
Desertion	Rank
Discharge from Hosp'l	Transfer to Hosp'l
Discharge from Service	Transfer to V. R. C.
Duty	Transportation

No. *Fifty*

Benj. Turner

Volunteered at *Paducah Ky*

July 20th 1864

By *Capt R. A. Hall*

Pro Mar 1st Dist Ky

8th U. S. Col. Art. Heavy

Consent of Parent or Guardian in case of a Minor, or in the case of a Slave of the Person to whom he owes Services.

United States colored troops. They will be made out in duplicate in all cases -
neral, and one to accompany the accounts of the officer who pays bounty, &c.
-in, must in all cases, precede payment of pay, bounty, pension, &c. A m
g officer, commissary, or assistant commissary of musters, as the case may be,
r of them is given to the disbursing officer.

UNITED STATES COLORED TROOPS ENLISTMENT.

STATE OF

TOWN OF

Kentucky



Paducah

I, *Benj. Wilson* born in
in the State of *Kentucky* aged *Twenty eight* years
and by occupation a *Farmer* Do HEREBY ACKNOWLEDGE to have
volunteered this *Twenty eighth* day of *July* 186*4*
to serve as a **Soldier** in the **Army of the United States of America**, for
the period of **THREE YEARS**, unless sooner discharged by proper authority:
Do also agree to accept such bounty, pay, rations, and clothing, as are, or may be,
established by law for the U. S. colored troops.

And I, *Benj. Wilson of Union Co. Ky.*
do solemnly swear, that I will bear true faith and allegiance to the **United States
of America**, and that I will serve them honestly and faithfully against all their
enemies or opposers whomsoever; and that I will observe and obey the orders of
the President of the United States, and the orders of the officers appointed over
me, according to the Rules and Articles of War.

Sworn and subscribed to, at *Paducah Ky.*
this *28th* day of *July* 186*4*, } *Benj. Wilson*
Before *Capt. R. H. Hall* } *mark*
Pro Marshal 1st Dist Ky.

I CERTIFY, ON HONOR, That I have carefully examined the above named Volunteer, agreeably to the
General Regulations of the Army, and that, in my opinion, he is free from all bodily defects and mental infirmity,
which would in any way disqualify him from performing the duties of a soldier.

W. H. Adams
EXAMINING SURGEON.

I CERTIFY, ON HONOR, That I have minutely inspected the Volunteer, *Benj. Wilson*
previously to his enlistment, and that he was entirely sober when enlisted; that, to the best of my judgment and
belief, he is of lawful age; and that, in accepting him as duly qualified to perform the duties of an able-bodied
soldier, I have strictly observed the regulations which govern the recruiting service. This soldier has *blue*
eyes, *blue* hair, *blue* complexion, is *5 ft 2 in* feet, *4 1/2* inches high.

RECRUITING OFFICER OR AGENT.
Mustered into the United States service *28th* day of *July* 186*4*
Capt. R. H. Hall
Mustering Officer.

Mustered into the service of the United States, for three years or during the war, from date of enlistment, in Company *D*
7th Regiment of *Old Guard Colored Volunteers*, on the *28th* day of *July* 186*4* at *Paducah Ky.*

Capt. R. H. Hall
1st Dist Ky.

NOTE 1.—This blank will be used for enlistments of United States colored troops. They will be made out in duplicate in all cases—one to accompany the recruiting return of the superintendent (not the recruiting officer) to the Adjutant General, and one to accompany the accounts of the officer who pays bounty, &c.

NOTE 2.—An enlistment holds to service. A muster-in, must in all cases, precede payment of pay, bounty, pension, &c. A muster-in roll, must in all cases, be filed in the Adjutant General's Office as evidence of muster-in. The mustering officer, commissary, or assistant commissary of musters, as the case may be, will countersign both enlistments as having mustered the soldier into the service of the United States before either of them is given to the disbursing officer.

DECLARATION OF RECRUIT.

I, Benj. Wiann of Union Co. Ky desiring to volunteer as a soldier in the ARMY OF THE UNITED STATES, for the term of Three Years, DO DECLARE That I am Twenty eight years and months of age; that I have never been discharged from the United States service on account of disability or by sentence of a court-martial, or by order before the expiration of a term of enlistment; and I know of no impediment to my serving honestly and faithfully as a soldier for three years.

GIVEN at Paducah McCracken Co. Ky the 29th day of July 1864

Witness: H. Dixon

Benj. Wiann
Volunteer of Paducah Ky
July 27th 1864
By Wm. R. D. State
Adjutant Genl. U.S.A.
No. 5178

Wm. R. D. State

Consent of Parent or Guardian in case of a Minor, if a Free Man, or in the case of a Slave, of the Person to whom he owes Service:

I, Do CERTIFY, That I am the that the said is years of age; and I do freely give my CONSENT to his volunteering as a SOLDIER in the Army of the United States, for the period of THREE YEARS, under the conditions of the laws of the United States.

GIVEN at the day of

Witness:

No. Fifty

~~Free Man~~

Benjamin Mann

Volunteered at Paducah Ky

July 29th

1864

By

Capt R. H. Hall

Co. Mar. 1st Dist. Ky

No 142



Consent of Parent or Guardian in case of a Minor, if a Free Man, or in the case of a Slave, of the Person to whom he owes Service:

of United States colored troops. They will be made out in duplicate in all cases
and General, and one to accompany the accounts of the officer who pays bounty, &c.
muster-in, must in all cases, precede payment of pay, bounty, pension, &c. A
stering officer, commissary, or assistant commissary of musters, as the case may be
either of them is given to the disbursing officer.

UNITED STATES COLORED TROOPS ENLISTMENT.

STATE OF

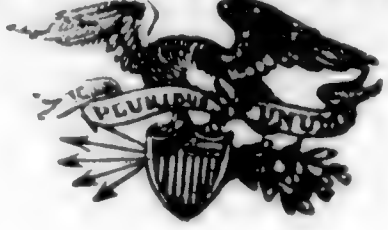

TOWN OF

Kentucky

Paducah

I, *Benjamin Winn* born in *Twenty eight*
in the State of *North C* aged *Twenty eight* years
and by occupation a *Farmer* Do HEREBY ACKNOWLEDGE to have
volunteered this *Twenty eighth* day of *July* 186*4*,
to serve as a **Soldier** in the **Army of the United States of America**, for
the period of **THREE YEARS**, unless sooner discharged by proper authority:
Do also agree to accept such bounty, pay, rations, and clothing, as are, or may be,
established by law for the U. S. colored troops.

And I, *Benj Winn of Union Co Ky*
do solemnly swear, that I will bear true faith and allegiance to the **United States
of America**, and that I will serve them honestly and faithfully against all their
enemies or opposers whomsoever; and that I will observe and obey the orders of
the President of the United States, and the orders of the officers appointed over
me, according to the Rules and Articles of War.

Sworn and subscribed to, at *Paducah Ky*
this *28th* day of *July* 186*4*,
Before *Capt R. H. Hall*
Paducah 1st Dist Ky

I CERTIFY, ON HONOR, That I have carefully examined the above named Volunteer, agreeably to the
General Regulations of the Army, and that, in my opinion, he is free from all bodily defects and mental infirmity,
which would in any way disqualify him from performing the duties of a soldier.

W. R. Adair

EXAMINING SURGEON.

I CERTIFY, ON HONOR, That I have minutely inspected the Volunteer, *Benj Winn*
previously to his enlistment, and that he was entirely sober when enlisted; that, to the best of my judgment and
belief, he is of lawful age; and that, in accepting him as duly qualified to perform the duties of an able bodied
soldier, I have strictly observed the regulations which govern the recruiting service. This soldier has *blue*
eyes, *blue* hair, *fair* complexion, is *five* feet *seven* inches high.

RECRUITING OFFICER OR AGENT.

Mustered into the United States service *28th* day of *July* 186*4*
Capt. W. R. Hall
Mustering Officer.

Mustered into the service of the United States, for three years or during the war, from date of enlistment, in Company *D*
71st Regiment of *Missouri* Volunteers, on the *28th* day of *July* 186*4* at *Paducah Ky*

Capt R. H. Hall
1st Dist Ky
Capt W. R. Hall
1st Dist Ky

NOTE 1.—This blank will be used for enlistments of United States colored troops. They will be made out in duplicate in all cases—one to accompany the recruiting return of the superintendent (not the recruiting officer) to the Adjutant General, and one to accompany the accounts of the officer who pays bounty, &c.

NOTE 2.—An enlistment holds to service. A muster-in, must in all cases, precede payment of pay, bounty, pension, &c. A muster-in roll, must in all cases, be filed in the Adjutant General's Office as evidence of muster-in. The mustering officer, commissary, or assistant commissary of musters, as the case may be, will countersign both enlistments as having mustered the soldier into the service of the United States before either of them is given to the disbursing officer.

DECLARATION OF RECRUIT.

I, Benjamin Thim of Union Co. S.C. desiring to volunteer as a soldier in the ARMY OF THE UNITED STATES, for the term of Three Years, DO DECLARE That I am Twenty eight years and months of age; that I have never been discharged from the United States service on account of disability or by sentence of a court-martial, or by order before the expiration of a term of enlistment; and I know of no impediment to my serving honestly and faithfully as a soldier for three years.

GIVEN at Adrian, Marlinton Co. S.C. the 29th day of July 1861

Witness: H. D. [Signature]

Benj. S. Wilson

By [Signature]
 Volunteered at Adrian S.C.
July 29th 1861

Benjamin Thim
~~Benjamin Thim~~
20. 14. 2
20. 14. 2



Consent of Parent or Guardian in case of a Minor, if a Free Man, or in the case of a Slave, of the Person to whom he owes Service:

I, Do CERTIFY, That I am the that the said is years of age; and I do freely give my CONSENT to his volunteering as a SOLDIER in the Army of the United States, for the period of THREE YEARS, under the conditions of the laws of the United States.

GIVEN at the day of

Witness:

UNITED STATES COLORED TROOPS ENLISTMENT.

STATE OF



TOWN OF

Kentucky

Parruck

I, *Benj Winn* born in _____
 in the State of *North Carolina* aged *Twenty Eight* years
 and by occupation a *Farmer* Do HEREBY ACKNOWLEDGE to
 have volunteered *Twenty Eightth* day of *July* 186*4*
 to serve as a **Soldier** in the **Army of the United States of America**, for the
 period of **THREE YEARS**, unless sooner discharged by proper authority: Do
 also agree to accept such bounty, pay, rations, and clothing, as are, or may be,
 established by law for the U. S. colored troops.

And I, *Benj Winn*
 do solemnly swear that I will bear true faith and allegiance to the **United States
 of America**, and that I will serve them honestly and faithfully against all their
 enemies or opposers whomsoever; and that I will observe and obey the orders
 of the President of the United States, and the orders of the officers appointed
 over me, according to the Rules and Articles of War.

Sworn and subscribed to, at *Parruck Ky*
 this *28th* day of *July* 186*4* *Benj Winn*
 Before *Capt & Quost Morgan* *his mark*

I CERTIFY, ON HONOR, That I have carefully examined the above named Volunteer agree-
 ably to the General Regulations of the Army, and that, in my opinion, he is free from all bodily
 defects and mental infirmity, which would in any way disqualify him from performing the
 duties of a soldier.

EXAMINING SURGEON.

I CERTIFY, ON HONOR, That I have minutely inspected the Volunteer, *Benj Winn*
 previously to his enlistment, and that he was entirely sober when enlisted; that, to the best of
 my judgment and belief, he is of lawful age; and that, in accepting him as duly qualified to per-
 form the duties of an able-bodied soldier, I have strictly observed the regulations which govern
 the recruiting service. This soldier has *Blk* eyes, *Blk* hair, *Blk* complexion, is *5* feet *6* inches high.

RECRUITING OFFICER OR AGENT.

Mustered into the United States Service *28th* day of *July* 186*4*

Quost Morgan
 Capt & Quost Morgan
 Mustering Officer.
R. S. Bishop

..... Mustered into the service of the United States, for three years or during the war, from date of enlistment, in Company
 Regiment of Volunteers, on the day of 186, at

*Benj Winn does not appear on our Rollo
 since the name of Benj Winn being near as like it*

1950
Winn Charles H

Co L, 8 U.S. Col'd H. Art'y.

Private | Private

CARD NUMBERS.

1	5467309	26
2	5467199	27
3	5482502	28
4	5482809	29
5	5482701	30
6	5482821	31
7	5482909	32
8	5482993	33
9	5483066	34
10	5483143	35
11	5483213	36
12	9122890	37
13		38
14		39
15		40
16		41
17		42
18		43
19		44
20		45
21		46
22		47
23		48
24		49
25		50

Book Mark:

See also

S-1707876-P. O. M. M.
a. g. 201/5.4.26.1

4 | 8 H. Art'y. | U.S.C.T.

Charles H. Winn

....., Co. *L*, 8 Reg't U.S. Col'd H. Art'y.

Appears on

Company Descriptive Book

of the organization named above.

DESCRIPTION.

Age *20* years; height *5* feet *11* inches.

Complexion *Black*

Eyes *Black* ; hair *Black*

Where born *Webster, Ky.*

Occupation *Farmer*

ENLISTMENT.

When *Sept. 15*, 1864.

Where *Paducah, Ky.*

By whom *Capt. Hall* ; term *3* y'rs.

Remarks:

Keefe

N | 8 H. Art'y. | U.S.C.T.

Henry Winn

Appears with rank of *Pri* on

Muster and Descriptive Roll of a Detachment of U. S. Vols. forwarded

for the 8 Reg't U. S. Col'd H. Art'y. Roll dated

Panucah, Ky, ~~N.Y.~~ Sep 30, 1864

Where born *Webster, Ky.*

Age *20* y'rs; occupation *Farmer*

When enlisted *Sep 15*, 186 .

Where enlisted *Panucah, Ky.*

For what period enlisted *3* years.

Eyes *blk*; hair *blk*

Complexion *Yellow*, height *5* ft. *11* in.

When mustered in *Sep 15*, 186 .

Where mustered in *Panucah*

Bounty paid \$ *100*; due \$ *100*

Where credited *Webster Co. Ind. Ky.*

Company to which assigned

Remarks:

Book mark:

Murray J.
Copyist.

Henry Wynn

Appears with rank of Private on

Muster and Descriptive Roll of a Detachment of U. S. Vols. forwarded

for the 8 Reg't U. S. Col'd H. Art'y. Roll dated

Paducah, Ky, N. Y. Sept. 30, 1864.

Where born Webster, Ky

Age 20 y'rs; occupation Farmer

When enlisted Sept. 15, 186 .

Where enlisted Paducah, Ky.

For what period enlisted 3 years.

Eyes Black; hair Black

Complexion Black; height 5 ft. 11 in.

When mustered in Sept. 15, 186 .

Where mustered in Paducah,

Bounty paid \$ 100; due \$ 100

Where credited Webster, W. Va., Ky

Company to which assigned

Remarks:

Book mark: C. L. & art'y.

Callaway

(339)

Copyist.

28 | 8 H. Art'y. | U.S.C.T.

Charles H. Quinn
Pt. L, Co. L, 8 Reg't U. S. Col'd H. Art'y.

Age ----- years.

Appears on

Company Muster Roll*

for 30 Oct. 31, 1864.

Joined for duty and enrolled:

When Sept. 15, 1864.

Where Paducah, Ky.

Period 3 years.

Mustered in:

When Sept. 15, 1864.

Where Paducah, Ky.

Present or absent Present.

Stoppage, \$ 100 for -----

Due Gov't \$ 100 for -----

Valuation of horse, \$ 100

Valuation of horse equipments, \$ 100

Remarks: -----

*First current roll. No muster-in roll of this company on file.

Book mark: -----

Brooke

(358d)

Copyist.

V. | 8 H. Art'y. | U.S.C.T.

Charles G. Kimm
Pvt., Co. L, 8 Reg't U. S. Col'd Heavy Art'y.

Appears on

Company Muster Roll

for Nov & Dec, 1864.

Present or absent Present

Stoppage, \$ 100 for

Due Gov't, \$ 100 for

Valuation of horse, \$ 100

Valuation of horse equipments, \$ 100

Remarks:

Book mark:

Brooks

H.

S H. Art'y.

U.S.C.T.

Charles A. Wynn,

Private, Co. L, 8 Reg't U. S. Col'd Heavy Art'y.

Appears on

Company Muster Roll

for *Mar. & Apr.*, 1865.

Present or absent *Present*

Stoppage, \$ 100 for

Due Gov't, \$ 100 for

Valuation of horse, \$ 100

Valuation of horse equipments, \$ 100

Remarks:

Book mark:

E. A. Woodford,
Copyist.

N. | 8 H. Art'y. | U.S.C.T.

Charles A. Wynn,

Private, Co. L, 8 Reg't U. S. Col'd Heavy Art'y.

Appears on

Company Muster Roll

for *May & June*, 1865.

Present or absent *Present.*

Stoppage, \$ *100* for

Due Gov't, \$ *100* for

Valuation of horse, \$ *100*

Valuation of horse equipments, \$ *100*

Remarks: *due U. S. for one set of accoutrements complete Spring rifle, one screw driver, one ball screw, one spring vice, one knapsack, one haversack, and one canteen.*

Book mark: _____

E. H. Woodford,
Copyist.

W.

S H. Art'y.

U.S.C.T.

Charles H. Winn,

Private, Co. L, 8 Reg't U. S. Col'd Heavy Art'y.

Appears on

Company Muster Roll

for *July & Aug.*, 1865.

Present or absent *Present.*

Stoppage, \$ *100* for

Due Gov't, \$ *100* for

Valuation of horse, \$ *100*

Valuation of horse equipments, \$ *100*

Remarks: *Due U.S. for Ord. & Ord. Stores four dollars and seventy cents (\$4.70). Due U.S. for one knapsack, one haversack, and one canteen.*

Book mark:

E. H. Woodford,

(358)

Copyist.

W

8 H. Art'y.

U.S.C.T.

Charles H. Miner
Pvt, Co. L, 8 Reg't U. S. Col'd Heavy Art'y.

Appears on

Company Muster Roll

for Sept & Oct, 1865.

Present or absent Present

Stoppage, \$ 100 for

Due Gov't, \$ 100 for

Valuation of horse, \$ 100

Valuation of horse equipments, \$ 100

Remarks: Due U.S. for one (1) Haversack & one (1) Canteen \$1.60

Book mark:

J. L. Morris

(358)

Copyist.

W

S H. Art'y.

U.S.C.T.

Charles W. Minn
Pvt, Co. L, 8 Reg't U. S. Col'd Heavy Art'y.

Appears on

Company Muster Roll

for Nov & Dec, 1865.

Present or absent Present

Stoppage, \$ 100 for

Due Gov't, \$ 100 for

Valuation of horse, \$ 100

Valuation of horse equipments, \$ 100

Remarks: Due U.S. for one (1)
Haversack & one (1) Cartrm
\$ 1 60.

Book mark:

J. L. Morris

(358)

Copyist.

21. | 8 H. Art'y. | U.S.C.T.

Charles H. Quinn
Pvt., Co. L, 8 Reg't U. S. Col'd Heavy Art'y.

Appears on

Company Muster Roll

for *Oct. 31, 1864 to Feb. 28, 1865.*

Present or absent *Present*

Stoppage, \$ *100* for

Due Gov't, \$ *100* for

Valuation of horse, \$ *100*

Valuation of horse equipments, \$ *100*

Remarks:

Book mark: -----

(358)

Brooks

Copyist.

W

S H. Art'y.

U.S.C.T.

Charles W. Minn

Priv., Co. L, 8 Reg't U. S. Col'd H. Art'y.

Appears on Co. Muster-out Roll, dated Victoria, Texas July 10, 1866.

Muster-out to date July 10, 1866.

Last paid to Aug 31, 1865.

Clothing account:

Last settled....., 186 ; drawn since \$..... 100

Due soldier \$..... 5 ³³/₁₀₀; due U. S. \$..... 100

Am't for cloth'g in kind or money adv'd \$..... 100

Due U. S. for arms, equipments, &c., \$..... 3 ¹⁰/₁₀₀

Bounty paid \$..... 100; due \$..... 100

Remarks Entered service at organization as herein shown. Due U.S. for one Haversack 95, one canteen 65, one k. P & C. Pick 60, one k. B. B. Plate 9, one gun sling 34, one Enfield appendage 46 cts

Book mark: 1313, 1882
4473.92. (192 20 years)

J. L. Morris

(861)

Copyist.

Starr, Henry

....., Co.

8 Reg't *U.S.A.*

Enclosures.

Bed Cards	Final Statements
Burial Records	Furloughs or L. of A.
Certs. of Dis. for Discharge	Med. Certificates
C. M. Charges	Med. Des. Lists
Descriptive Lists	Orders
Discharge Certificates	Pris. of War Record
Enlistment Papers	Resignations

Other papers relating to—

Admission to Hosp'l	Furlough or L. of A.
Casualty Sheet	Med. Examination
Confinement	Misc. Information
Contracts	Pay or Clothing
Death or Effects	Personal Reports
Desertion	Rank
Discharge from Hosp'l	Transfer to Hosp'l
Discharge from Service	Transfer to V. R. C.
Duty	Transportation

1096, 4, 16

No. Eighty nine

Wm. Henry

Volunteered at Paducah Ky

September 18th 1864

By Capt R. H. Hall

Pro Mar 1st Dist of Ky

1096

Consent of Parent or Guardian in case of a Minor, if a Free Man, or in the case of a Slave, of the Person to whom he owes Service:

of United States colored troops. They will be made out in duplicate in all cases— General, and one to accompany the accounts of the officer who pays bounty, &c. &c. A muster-in, must in all cases, precede payment of pay, bounty, pension, &c. A mustering officer, commissary, or assistant commissary of musters, as the case may be, whether of them is given to the disbursing officer.

UNITED STATES COLORED TROOPS ENLISTMENT.

STATE OF

TOWN OF

Kentucky

Paducah

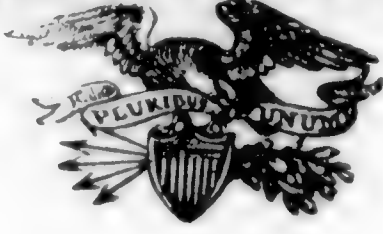

I, *Winn Henry* born in *Webster Co*

in the State of *Kentucky* aged *Twenty* years

and by occupation a *Farmer* Do HEREBY ACKNOWLEDGE to have volunteered this *Fifteenth* day of *September* 186*4*

to serve as a **Soldier** in the **Army of the United States of America**, for the period of **THREE YEARS**, unless sooner discharged by proper authority:

Do also agree to accept such bounty, pay, rations, and clothing, as are, or may be, established by law for the U. S. colored troops.

And I, *Henry Winn of Webster Co*

do solemnly swear, that I will bear true faith and allegiance to the **United States of America**, and that I will serve them honestly and faithfully against all their enemies or opposers whomsoever; and that I will observe and obey the orders of the President of the United States, and the orders of the officers appointed over me, according to the Rules and Articles of War.

Sworn and subscribed to, at *Paducah Ky*
this *15th* day of *Sept* 186*4*, } *Henry Winn*
Before *Capt. Proctor* } *Marshall*

I CERTIFY, ON HONOR, That I have carefully examined the above named Volunteer, agreeably to the General Regulations of the Army, and that, in my opinion, he is free from all bodily defects and mental infirmity, which would in any way disqualify him from performing the duties of a soldier.

M. H. Kidd

EXAMINING SURGEON.

I CERTIFY, ON HONOR, That I have minutely inspected the Volunteer, *Henry Winn* previously to his enlistment, and that he was entirely sober when enlisted; that, to the best of my judgment and belief, he is of lawful age; and that, in accepting him as duly qualified to perform the duties of an able-bodied soldier, I have strictly observed the regulations which govern the recruiting service. This soldier has *dark* eyes, *dark* hair, *dark* complexion, is *five* feet *11* inches high.

RECRUITING OFFICER OR AGENT.

Mustered into the United States service *15th* day of *September* 186*4*.

M. H. Hall
Capt. Proctor Mustering Officer.

Mustered into the service of the United States, for three years or during the war, from date of enlistment, in Company *8th* Regiment of *Missouri* Volunteers, on the *15th* day of *September* 186*4* at *Paducah Ky*

Capt. Proctor

Capt. Proctor

1st Div. of 1st

NOTE 1.—This blank will be used for enlistments of United States colored troops. They will be made out in duplicate in all cases—one to accompany the recruiting return of the superintendent (not the recruiting officer) to the Adjutant General, and one to accompany the accounts of the officer who pays bounty, &c.

NOTE 2.—An enlistment holds to service. A muster-in, must in all cases, precede payment of pay, bounty, pension, &c. A muster-in roll, must in all cases, be filed in the Adjutant General's Office as evidence of muster-in. The mustering officer, commissary, or assistant commissary of musters, as the case may be, will countersign both enlistments as having mustered the soldier into the service of the United States before either of them is given to the disbursing officer.

DECLARATION OF RECRUIT.

I, Henry Winn of Paducah Ky desiring to volunteer as a soldier in the ARMY OF THE UNITED STATES, for the term of Three Years, DO DECLARE That I am Twenty years and months of age; that I have never been discharged from the United States service on account of disability or by sentence of a court-martial, or by order before the expiration of a term of enlistment; and I know of no impediment to my serving honestly and faithfully as a soldier for three years.

GIVEN at Paducah Ky the 15th day of September 1864

Witness: A. D. [Signature]

Henry Winn his Winn

Volunteer at Paducah Ky
September 15 1864
By Capt. A. H. [Signature]
Co. 1st [Signature]

No. Sept 15 1864

Sept 15 1864

Consent of Parent or Guardian in case of a Minor, if a Free Man, or in the case of a Slave, of the Person to whom he owes Service:

I, Do CERTIFY, That I am the that the said is years of age; and I do freely give my CONSENT to his volunteering as a SOLDIER in the Army of the United States, for the period of THREE YEARS, under the conditions of the laws of the United States.

GIVEN at the day of

Witness:

No. Eighty nine

Winn Henry

Volunteered at Paducah Ky

September 15th 1864

By Capt R. H. Hall

Pro Mar 1st Dist of Ky

Consent of Parent or Guardian in case of a Minor, if a Free Man, or in the case of a Slave, of the Person to whom he owes Service:

1864
SEP 15

of United States colored troops. They will be made out in duplicate in all cases
General, and one to accompany the accounts of the officer who pays bounty, &c.
muster-in, must in all cases, precede payment of pay, bounty, pension, &c. A
returning officer, commissary, or assistant commissary of musters, as the case may be,
either of them is given to the disbursing officer.

UNITED STATES COLORED TROOPS ENLISTMENT.

STATE OF



TOWN OF

Kentucky Paducah

I, *Henry Henry* born in *Missouri*
in the State of *Kentucky* aged *Twenty* years
and by occupation a *Farmer* Do HEREBY ACKNOWLEDGE to have
volunteered this *Fifteenth* day of *September* 1864,
to serve as a **Soldier** in the **Army of the United States of America**, for
the period of **THREE YEARS**, unless sooner discharged by proper authority:
Do also agree to accept such bounty, pay, rations, and clothing, as are, or may be,
established by law for the U. S. colored troops.

And I, *Henry Henry of Missouri*
do solemnly swear, that I will bear true faith and allegiance to the **United States
of America**, and that I will serve them honestly and faithfully against all their
enemies or opposers whomsoever; and that I will observe and obey the orders of
the President of the United States, and the orders of the officers appointed over
me, according to the Rules and Articles of War.

Sworn and subscribed to, at *Paducah Ky*
this *15th* day of *Sept* 1864,
Before *Capt R. A. Hall*

Henry Henry
his
mark

I CERTIFY, ON HONOR, That I have carefully examined the above named Volunteer, agreeably to the
General Regulations of the Army, and that, in my opinion, he is free from all bodily defects and mental infirmity,
which would in any way disqualify him from performing the duties of a soldier.

W. H. K. Add

EXAMINING SURGEON.

I CERTIFY, ON HONOR, That I have minutely inspected the Volunteer, *Henry Henry*
previously to his enlistment, and that he was entirely sober when enlisted: that, to the best of my judgment and
belief, he is of lawful age; and that, in accepting him as duly qualified to perform the duties of an able-bodied
soldier, I have strictly observed the regulations which govern the recruiting service. This soldier has *Blue*
eyes, *Blue* hair, *Light* complexion, is *5-7* feet *11* inches high.

RECRUITING OFFICER OR AGENT.

Mustered into the United States service *15th* day of *September* 1864

W. H. Hall
Capt. R. A. Hall
Mustering Officer.

Mustered into the service of the United States, for three years or during the war, from date of enlistment, in Company *B*
Regiment of *Missouri* Volunteers, on the *15th* day of *September*, 1864, at *Paducah Ky*

Capt R. A. Hall
W. H. K. Add
Mr. O. H. Hall

NOTE 1.—This blank will be used for enlistments of United States colored troops. They will be made out in duplicate in all cases—one to accompany the recruiting return of the superintendent (not the recruiting officer) to the Adjutant General, and one to accompany the accounts of the officer who pays bounty, &c.

NOTE 2.—An enlistment holds to service. A muster-in, must in all cases, precede payment of pay, bounty, pension, &c. A muster-in roll, must in all cases, be filed in the Adjutant General's Office as evidence of muster-in. The mustering officer, commissary, or assistant commissary of musters, as the case may be, will countersign both enlistments as having mustered the soldier into the service of the United States before either of them is given to the disbursing officer.

DECLARATION OF RECRUIT.

I, Henry Winward of Webster Co desiring to volunteer as a soldier in the ARMY OF THE UNITED STATES, for the term of Three Years, do DECLARE That I am Twenty years and months of age; that I have never been discharged from the United States service on account of disability or by sentence of a court-martial, or by order before the expiration of a term of enlistment; and I know of no impediment to my serving honestly and faithfully as a soldier for three years.

GIVEN at Paducah Ky

the 18th day of September 1864

Witness: A. S. [Signature]

Henry Winward
Volunteered at Paducah Ky
September 18th 1864
By Robert [Signature]
Pro Marshal 1st Dist of Ky

No. Eighty nine



Consent of Parent or Guardian in case of a Minor, if a Free Man, or in the case of a Slave, of the Person to whom he owes Service:

I, Do CERTIFY, That I am the that the said is years of age; and I do freely give my CONSENT to his volunteering as a SOLDIER in the Army of the United States, for the period of THREE YEARS, under the conditions of the laws of the United States.

GIVEN at

the day of

Witness:

1933
Mimi Peter
Co F, 8 U.S. Col'd H. Art'y.

Private - Private

CARD NUMBERS.

1	5475839	26
2	5475948	27
3	5476074	28
4	5476185	29
5	5476294	30
6	5476422	31
7	5476529	32
8	5476635	33
9	5476736	34
10	5476837	35
11	5476927	36
12	9122470	37
13		38
14		39
15		40
16		41
17		42
18		43
19		44
20		45
21		46
22		47
23		48
24		49
25		50

Book Mark: _____

See also _____

7/1

8 H. Art'y.

U.S.C.T.

Peter Grimm

....., Co. E, 8 Reg't U.S. Col'd H. Art'y.

Appears on

Company Descriptive Book

of the organization named above.

DESCRIPTION.

Age 20 years; height 5 feet 7 inches.

Complexion Light

Eyes Black; hair Black

Where born Indiana Co., Ky

Occupation Farmer

ENLISTMENT.

When May 24, 1864.

Where Paducah, Ky

By whom C. A. Holmes; term 3 y'rs.

Remarks:

.....
.....
.....
.....
.....
.....

C. A. Moreland

(383g)

Copyist.

N. Nelson | U.S.C.T.

Peter Wilson
Reg't U.S. Col'd - *1st*

Age _____ years.

Appears on

Company Muster Roll*

for *Assignment to Service*, 1864.

Joined for duty and enrolled:

When *May 24*, 1864.

Where *Paducah Ky*

Period *3* years.

Mustered in:

When *June 6*, 1864.

Where *Paducah Ky*

Present or absent *Present*

Stoppage, \$ *100* for _____

Due Gov't, \$ *100* for _____

Valuation of horse, \$ *100*

Valuation of horse equipments, \$ *100*

Remarks : _____

* First current roll. No muster-in roll of this company on file.

Book mark : _____

J. Nelson

(3586)

Copyist.

N | S H. Art'y. | U.S.C.T.

Peter Nelson

Driver, Co. F, 8 Reg't U. S. Col'd H. Art'y.

Appears on

Company Muster Roll
for *July & Aug*, 186*4*

Present or absent *Present*

Stoppage, \$ *100* for

Due Gov't, \$ *100* for

Valuation of horse, \$ *100*

Valuation of horse equipments, \$ *100*

Remarks:

Book mark: _____

P. Nelson
(358) Copyist.

77

S H. Art'y. U.S.C.T.

John W. ...

Co. F, 8 Reg't U. S. Col'd H. Art'y.

Appears on

Company Muster Roll

for Sept & Oct, 1864

Present or absent Present

Stoppage, \$ 100 for

Due Gov't, \$ 100 for

Valuation of horse, \$ 100

Valuation of horse equipments, \$ 100

Remarks:

Book mark:

J. Nelson

(358)

Copyist.

27

S H. Art'y.

U.S.C.T.

Peter Wilson

Co. F, 8 Reg't U. S. Col'd H. Art'y.

Appears on

Company Muster Roll

for Nov + Dec, 1864

Present or absent Present

Stoppage, \$ 100 for

Due Gov't, \$ 100 for

Valuation of horse, \$ 100

Valuation of horse equipments, \$ 100

Remarks:

Book mark:

(358)

J. Nelson

Copyist.

W | **S H. Art'y.** | **U.S.C.T.**

Peter Winn

Priv, Co. F, 8 Reg't U. S. Col'd H. Art'y.

Appears on

Company Muster Roll

for *Jan & Feb*, 1865.

Present or absent *Present*

Stoppage, \$ *100* for

Due Gov't, \$ *100* for

Valuation of horse, \$ *100*

Valuation of horse equipments, \$ *100*

Remarks: _____

Book mark: _____

G. W. Chase

W | S H. Art'y. | U.S.C.T.

Peter Winn

Priv, Co. F, 8 Reg't U. S. Col'd H. Art'y.

Appears on

Company Muster Roll

for *Feb & Apr*, 1865.

Present or absent *Present*

Stoppage, \$ *100* for

Due Gov't, \$ *100* for

Valuation of horse, \$ *100*

Valuation of horse equipments, \$ *100*

Remarks: _____

Book mark: _____

G. W. Chase
(358) Copyist.

N

S H. Art'y.

U.S.C.T.

Peter Winn

Priv, Co. F, 8 Reg't U. S. Col'd H. Art'y.

Appears on

Company Muster Roll

for *May & June*, 1865.

Present or absent *Present*

Stoppage, \$ *100* for

Due Gov't, \$ *100* for

Valuation of horse, \$ *100*

Valuation of horse equipments, \$ *100*

Remarks:

Book mark:

G. W. Chase

W

S H. Art'y.

U.S.C.T.

Peter Winn

Priv, Co. F, 8 Reg't U. S. Col'd H. Art'y.

Appears on

Company Muster Roll

for July & Aug, 1865.

Present or absent Present

Stoppage, \$ 100 for

Due Gov't, \$ 100 for

Valuation of horse, \$ 100

Valuation of horse equipments, \$ 100

Remarks:

Book mark:

G. W. Chase

(358)

Copyist.

Peter Wimmer

Private, Co. F, 8 Reg't U. S. Col'd H. Art'y.

Appears on

Company Muster Roll

for *Sept & Oct*, 186*5*.

Present or absent *Present*

Stoppage, \$ *100* for

Due Gov't, \$ *100* for

Valuation of horse, \$ *100*

Valuation of horse equipments, \$ *100*

Remarks: _____

Book mark: _____

Kiefer

M | S H. Art'y. | U.S.C.T.

Peter Skinn

Private Co. F, 8 Reg't U. S. Col'd H. Art'y.

Appears on

Company Muster Roll

for *Nov. & Dec.*, 1865.

Present or absent *Present*

Stoppage, \$ *100* for

Due Gov't, \$ *100* for

Valuation of horse, \$ *100*

Valuation of horse equipments, \$ *100*

Remarks: _____

Book mark: _____

Keeper

W | S H. Art'y. | U.S.C.T.

Peter Winn

Private, Co. *F*, 8 Reg't U. S. Col'd H. Art'y.

Appears on Co. Muster-out Roll, dated
Victoria, Texas Feb. 10, 1866.

Muster-out to date *Feb. 10*, 1866.

Last paid to *Aug 31*, 1865.

Clothing account:

Last settled....., 186 ; drawn since \$..... 100

Due soldier \$..... 100; due U. S. \$..... $\frac{41}{100}$

Am't for cloth'g in kind or money adv'd \$..... 100

Due U. S. for arms, equipments, &c., \$ *3* $\frac{28}{100}$

Bounty paid \$..... 100; due \$..... 100

Remarks: *Entered the service at organization of Co as private. Stop for 1 Cap Ponch 60, 1 Cartridge Box 1.15, 1 C. B. Belt Plate 13, 1 C. B. Plate. 09, 1 C. B. (over)*

Book mark: *age 20*

(861)

Keefe

Copyist.

JAN. 14

5476927

1891 *

Belt. 59, 1 Waist Belt
.36, 1 W. B Plate. 06,
1 Bayonet scabbard. 60.

1934

Winson Willis

Co B, 8 U.S. Col'd H. Art'y.

Private | Corporal

CARD NUMBERS.

1	57479821	26
2	57479842	27
3	57479992	28
4	57480130	29
5	57480266	30
6	57480393	31
7	57480609	32
8	57481034	33
9	9122628	34
10		35
11		36
12		37
13		38
14		39
15		40
16		41
17		42
18		43
19		44
20		45
21		46
22		47
23		48
24		49
25		50

Book Mark: _____

See also _____

M

8 H. Art'y.

U.S.C.T.

Willie Winsom

....., Co. *A*, 8 Reg't U.S. Col'd H. Art'y.

Appears on

Company Descriptive Book

of the organization named above.

DESCRIPTION.

Age *28* years; height *5* feet *11 1/2* inches.

Complexion *black*

Eyes *black*; hair *black*

Where born *Shelby Co., Ky.*

Occupation *Farmer*

ENLISTMENT.

When *June 5*, 1864.

Where *Paducah, Ky.*

By whom *J. Johnson*; term *3* y'rs.

Remarks: *Promoted to Corporal Aug. 18th 1864. Died at Sea on Board Steamer Daniel Webster June 4th 1865, his final statements was forward to Adj't General's Office from Ft. St. Phillips, La. June 22 1865.*

Keeper.

(383g)

Copyist.

W

S H. Art'y.

U.S.C.T.

Willis Winean

Priv., Co. I, 8 Reg't U. S. Col'd H. Art'y.

Age _____ years.

Appears on

Company Muster Roll*

for *May & June, 1864.*

Joined for duty and enrolled:

When *June 25*, 1864.

Where *Paducah, Ky.*

Period *3* years.

Mustered in:

When *June 25*, 1864.

Where *Paducah, Ky.*

Present or absent *Present*

Stoppage, \$ *100* for _____

Due Gov't \$ *100* for _____

Valuation of horse, \$ *100*

Valuation of horse equipments, \$ *100*

Remarks: _____

*First current roll. No muster-in roll of this company on file.

Book mark: _____

E. L. Thornton

(358d)

Copyist.

Willie Minnion
Corp., Co. I, 8 Reg't U. S. Col'd H. Art'y.

Appears on

Company Muster Roll

for July & Aug., 1864.

Present or absent Present

Stoppage, \$ 100 for

Due Gov't, \$ 100 for

Valuation of horse, \$ 100

Valuation of horse equipments, \$ 100

Remarks: Promoted
August 1864

Book mark:

(358) E. L. Haunton Copyist.

W | 8 H. Art'y. | U.S.C.T.

Willis Winson
Capt., Co. I, 8 Reg't U. S. Col'd H. Art'y.

Appears on

Company Muster Roll

for *Sept & Oct*, 1864

Present or absent *Present*

Stoppage, \$ *100* for

Due Gov't, \$ *100* for

Valuation of horse, \$ *100*

Valuation of horse equipments, \$ *100*

Remarks: *Stoppage pay
for one centen 434*

Book mark:

(358)

Jen. Winson
Copyist.

11

8 H. Art'y. | U.S.C.T.

Willis Winsor

Capt. Co. I, 8 Reg't U. S. Col'd H. Art'y.

Appears on

Company Muster Roll

for Jan'y & Feb'y, 1865.

Present or absent Present

Stoppage, \$ 100 for

Due Gov't, \$ 100 for

Valuation of horse, \$ 100

Valuation of horse equipments, \$ 100

Remarks:

Book mark:

C. B. Sayer

H.

8 H. Art'y. | U.S.C.T.

Willis Wason
Co. I, 8 Reg't U. S. Col'd H. Art'y.

Appears on

Company Muster Roll

for *March & April*, 186 *5*.

Present or absent *Present*

Stoppage, \$ *100* for

Due Gov't, \$ *100* for

Valuation of horse, \$ *100*

Valuation of horse equipments, \$ *100*

Remarks:

Book mark:

L. B. Sawyer
Copyist.

W

8 H. Art'y.

U.S.C.T.

Willis Winsor

Corpl., Co. I, 8 Reg't U. S. Col'd H. Art'y.

Appears on

Company Muster Roll

for *May & June*, 186*5*.

Present or absent.....

Stoppage, \$.....100 for.....

Due Gov't, \$.....100 for.....

Valuation of horse, \$.....100

Valuation of horse equipments, \$.....100

Remarks: *Died June 4, '65 on
Board Sr. Daniel Webster
while at sea.*

Book mark:.....

(358)

Fitz

Copyist.

Compr.

W

S H. Art'y.

U.S.C.T.

Winson Willis

Corpl, Co. I, 8 Reg't U. S. Col'd H. Art'y.

Appears on Co. Muster-out Roll, dated
Victoria Texas Feb 10, 1866.

Muster-out to date _____, 186 .

Last paid to _____, 186 .

Clothing account:

Last settled _____, 186 ; drawn since \$ _____ 100

Due soldier \$ _____ 100; due U. S. \$ _____ 100

Am't for cloth'g in kind or money adv'd \$ _____ 100

Due U. S. for arms, equipments, &c., \$ _____ 100

Bounty paid \$ _____ 100; due \$ _____ 100

Remarks: Entered service
at original organization
as herein shown. Pro-
moted to Corpl Aug 18-1864.
Died June 4-1865- on
board steamer Daniel

Book mark: V130 P104-71-463

C. S. Rozzell

(361)

Copyist.

JAN. 14

5481034

1891

Webster at sea. Inflin-
mation of Bowell. In-
ventory and Final
Statements forwarded
June 22. 1865.

1879-A. N. 23-077-71-
(page 28)

1
Kinson Hillis

Copl, Co. 1, 8 Reg't U.S.C.H.A.

2 Enclosures.

Bed Cards	Descriptive Lists
Burial Records	Final Statements .. /
Certs. of Dis. for Discharge	Furloughs
C. M. Charges	Med. Des. Lists
Med. Certificates	Orders

Other papers relating to—

Admission to Hosp'l	Furlough
Casualty Sheet (Officer's)	Med. Examination
Confinement	Misc. Information
Contracts	Pay or Clothing
Death or Effects .. /	Personal Reports
Desertions	Rank
Discharge from Hosp'l	Transfer to Hosp'l
Discharge from Service	Transfer to V. R. C.
Duty	Transportation

I certify, on honor, that Capt Willis Winsor, a Member of
 Captain 1st Lieut J. B. Rebsbach Company (1) of the Eighth Regiment of U. S. C. A. Heavy
VOLUNTEERS, of the State of Kentucky, born in Shelby County, State
 of Kentucky, aged 28 years; 5 feet 11 1/2 inches high; Dark complexion,
Black eyes, Black hair, and by occupation a Farmer, who joined for service
 and was enrolled (see Note 9) on the 5 day of June, 1865, at Paducah Ky
 by J. W. Johnson, for the period of three years, and mustered into
 the service of the United States on the 5th day of June, 1865, at
Paducah Ky, by J. W. Johnson; and having served
 HONESTLY and FAITHFULLY with his Company to the present date, is now entitled to a
DISCHARGE by reason of Weather

The said Capt Willis Winsor was last paid by Paymaster
Major H. H. H. H., to include the 31st day of Oct, 1864; and
 has pay due him from that time to the present date; he is entitled to pay and subsistence for
TRAVELING to place of enrollment, and whatever other allowances are authorized to volunteer
 soldiers, drafted men, or militia, so discharged. He has received from the United States **CLOTHING**
 amounting to 56 33/₁₀₀ dollars, since the 5th day of June,
 1864, when his clothing account was last settled. He has received from the United States
 /₁₀₀ dollars advanced **BOUNTY**.

There is to be stopped from him, on account of the State of _____, or other
 authorities, for **CLOTHING, &c.**, received on entering service, _____/100 dollars; and
 for other stoppages, viz: _____
 _____/100 dollars.

He has been furnished with **TRANSPORTATION** in kind from the place of his discharge to
 _____; and he has been **SUBSISTED** for **TRAVELING** to his
 place of enrollment, up to the _____, 186 .

He is indebted to J. W. Robinson, **SUTLER**, 2 00/₁₀₀ dollars.
 He is indebted to _____, **LAUNDRESS**, _____/100 dollars.

Given in Duplicate, at Fort St. Phillip, this 22 day
 of June, 1865.

James Rebsbach
1st Lieutenant
 Commanding Company.

ARTICLES OF WAR.

ART. 95. When any non-commissioned officer or soldier shall die, or be killed in the service of the United States, the then commanding officer of the troop or company shall, in the presence of two other commissioned officers, take an account of what effects he died possessed of, above his arms and accoutrements, and transmit the same to the office of the Department of War, which said effects are to be accounted for, and paid to the representatives of such deceased non-commissioned officer or soldier. And in case any of the officers, so authorized to take care of the effects of deceased officers and soldiers, should, before they have accounted to their representatives for the same, have occasion to leave the regiment or post, by preferment or otherwise, they shall, before they be permitted to quit the same, deposit in the hands of the commanding officer, or of the assistant military agent, all the effects of such deceased non-commissioned officers and soldiers, in order that the same may be secured for, and paid to, their respective representatives.

ARMY REGULATIONS—EDITION OF 1861.

DECEASED SOLDIERS.

Par. 152. Inventories of the effects of deceased non-commissioned officers and soldiers, required by the 95th Article of War, will be forwarded to the Adjutant General, by the commander of the company to which the deceased belonged, and a duplicate of the same to the colonel of the regiment. Final statements of pay, clothing, &c., will be sent with the inventories. When a soldier dies at a post or station absent from his company, it will be the duty of his immediate commander to furnish the required inventory, and, at the same time, to forward to the commanding officer of the company to which the soldier belonged, a report of his death, specifying the date, place, and cause; to what time he was last paid, and the money or other effects in his possession at the time of his decease; which report will be noted on the next muster roll of the company to which the man belonged. Each inventory will be endorsed, "Inventory of the effects of _____, late of company (—) _____, regiment of _____, who died at _____, the _____ day of _____, 186—." If a legal representative receive the effects, it will be stated in the report. If the soldier leave no effects, the fact will be reported.

Par. 153. Should the effects of a deceased non-commissioned officer or soldier not be administered upon within a short period after his decease, they shall be disposed of by a Council of Administration, under the authority of the commanding officer of the post, and the proceeds deposited with the Paymaster, to the credit of the United States, until they shall be claimed by the legal representatives of the deceased.

Par. 154. In all such cases of sales by the Council of Administration, a statement in detail, or account of the proceeds, duly certified by the Council and commanding officer, accompanied by the Paymaster's receipt for the proceeds, will be forwarded by the commanding officer to the Adjutant General. The statement will be endorsed, "Report of the proceeds of the effects of _____, late of company (—) _____, regiment of _____, who died at _____, the _____ day of _____, 186—."

NOTE 1.—The effects in all cases, when called for, should be turned over to the legal representative, without further authority from the Adjutant General. When the effects are turned over to the relatives of the deceased before these inventories are sent to the Adjutant General, their receipts therefor should be attached to the inventories. In all other cases, one copy will be sent with a letter of transmittal direct to the Adjutant General, and a duplicate retained by the officer.

NOTE 2.—Particular care should be taken to take receipts in duplicate from the Paymaster for any funds turned over to him; one copy should be sent direct to the Adjutant General and one retained by the officer.

INVENTORY OF THE EFFECTS

OF

Cop. Willie Winson

Late of Company *A*

Capt. R. C. (Henry)

Volunteers, who died at *Sea*

on the *11th* day of *June* 186*5*



Inventory of the effects of Capt. Willis Winson late
a Member of Captain Ensign Jas. Rebstock Company I of
the Eighth Regiment of U.S. G. A. (Heavy) Volunteers, who was enrolled as
a Private at Paducah in the State of Kentucky on
the 5 day of June 1865, and mustered into the service of the United
States as a Private on the 5 day of June 1865, at Paducah Ky
in Company I, 8 Regiment of U.S. G. A. (Heavy) Volunteers, to serve 3
years or during the war; he was born in Shelby County in the State
of Kentucky; he was 23 years of age, 5 feet 11 inches
high, Dark complexion, Black eyes, Black hair, and by occupation, when enrolled,
a Farmer; he died on board Daniel Webster, at
Sea June 24th on the 11th day of June 1865, by
reason of Inflammation of bowels

INVENTORY.								
ARTICLES.	No.	ARTICLES.	No.	ARTICLES.	No.			
Hats.....	=	Pairs trousers.....	=	Kuapsacks.....				
Caps.....	=	Pairs flannel drawers.....	=					
Forage caps.....	=	Pairs cotton drawers.....	=					
Great coats.....	=	Flannel shirts.....	=					
Uniform coats.....	=	Cotton shirts.....	=					
Uniform jackets.....	=	Pairs boots.....	=					
Flannel sack coats.....	=	Pairs shoes.....	=					
Blouses.....	=	Pairs socks.....	=					
Stable frocks.....	=	Blankets.....	=					
Fatigue overalls.....	=	Haversacks.....	=					
						MONEY.	Specie.....	\$ 5 = "
							Notes.....	\$ 1 = "

I CERTIFY, ON HONOR, that the above inventory comprises all the effects of Capt. Willis Winson, deceased, and that the effects are in the hands of James Rebstock at St. Phillip La to be disposed of by a Council of Administration.

(DUPLICATES.)

STATION: St. Phillip La

DATE: June 22 1865

[A. G. O. No. 104.]

James Rebstock
1st Lieutenant
Commanding the Company.

1935
Winston Beverly
Coct. C., 8 U.S. Col'd H. Art'y.

Private - Private

CARD NUMBERS.

1	5468104	26
2	5468217	27
3	5468350	28
4	5471551	29
5	5471702	30
6	5471851	31
7	5471886	32
8	5472144	33
9	5472275	34
10	5472400	35
11	5472512	36
12	5472617	37
13	5472721	38
14	54729752	39
15	5472817	40
16	9121678	41
17	9121276	42
18		43
19		44
20		45
21		46
22		47
23		48
24		49
25		50

Book Mark:

See also

W | 8 H. Art'y. | U.S.C.T.

Beverly Winston

Co. A, 8 Reg't U.S. Col'd H. Art'y.

Appears on

Company Descriptive Book

of the organization named above.

DESCRIPTION.

Age 17 years; height 5 feet 5/2 inches.

Complexion Dark

Eyes Dark; hair Dark

Where born Paducah, Ky

Occupation Farmer

ENLISTMENT.

When Apr. 6, 1864

Where Paducah, Ky.

By whom S. Dobson; term 3 y'rs.

Remarks: Transferred to Co. C, May 20/64

Henderson

A

8 H. Art'y.

U.S.C.T.

Beverly Winston

B, Co. , 8 Reg't U.S. Col'd H. Art'y.

Appears on

Company Descriptive Book

of the organization named above.

DESCRIPTION.

Age *19* years; height *5* feet *5 1/2* inches.

Complexion *Brown*

Eyes *Black*; hair *Black*

Where born *Union Co., Ky.*

Occupation *Labourer*

ENLISTMENT.

When *Apr. 6*, 1864.

Where *Paducah, Ky.*

By whom *E. Chapman*; term *3* y'rs.

Remarks: *Was in a skirmish on Cumberland River June 18/64. Transferred from Co. A, May 26/64 per S.O. No 7 dated May 26/64. Signed Col. A.M. Barry. Paducah, Ky.*

Henderson

N. | S H. Art'y. | U.S.C.T.

Beverly Winston
Pm, Co. A, 1 Reg't Ky. H. Art'y.*

Appears on

Company Muster-in and Descriptive Roll

of the organization named above. Roll dated

Paducah Ky, Apr 26, 1864.

Where born Paducah Ky

Age 27^r y'rs; occupation Farmer

When enlisted Apr 6, 1864.

Where enlisted Paducah Ky

For what period enlisted 3 years.

Eyes dk; hair dk

Complexion dk; height 5 ft. 5 1/2 in.

When mustered in Apr 26, 1864.

Where mustered in Paducah Ky

Bounty paid \$ 100; due \$ 100

Where credited 18th Dist Ky

Company to which assigned

Remarks:

As appears in roll

* This organization subsequently became Co. A, 8 Reg't U. S. Colored Heavy Artillery.

Book mark:

Randolph

W

8 H. Art'y.

U.S.C.T.

Beverly Winston
Priv, Co. A, 1 Reg't Ky. II. Art'y.*

Appears on

Company Muster Roll

for *Enlistment to Apr 30*, 186 *4*

Present or absent *Present*

Stoppage, \$ *100* for

Due Gov't, \$ *100* for

Valuation of horse, \$ *100*

Valuation of horse equipments, \$ *100*

Remarks:

*This organization subsequently became Co. A, 8 Reg't U. S. Col'd Heavy Artillery.

Book mark:

(358)

Waddington

Copyist.

Beverly Kinston
Priv, Co. A, 8 Reg't U. S. Col'd H. Art'y.

Appears on

Company Muster Roll

for *May & June*, 1864.

Present or absent.....

Stoppage, \$.....100 for.....

Due Gov't, \$.....100 for.....

Valuation of horse, \$.....100

Valuation of horse equipments, \$.....100

Remarks: *Transferred to Co. C. 8th*
U.S.C.A. Henry per special order
No. 7 dated May 20th 64. by
order of Col Barr

Book mark:.....

Washington

A

S H. Art'y.

U.S.C.T.

Beverly Winston

Private, Co. C, 8 Reg't U. S. Col'd H. Art'y.

Appears on

Company Muster Roll

for *May & June*, 1864.

Present or absent *Present*

Stoppage, \$ *100* for

Due Gov't, \$ *100* for

Valuation of horse, \$ *100*

Valuation of horse equipments, \$ *100*

Remarks: *Transferred from Co. A per special order No. 7 dated May 20th 1864 H. W. Barry*

Book mark:

E. N. Lipscombe

(358)

Copyist.

W

8 H. Art'y.

U.S.C.T.

Beverly Winston
Private, Co. C, 8 Reg't U. S. Col'd H. Art'y.

Appears on

Company Muster Roll

for July & Aug., 1864.

Present or absent Present

Stoppage, \$ 100 for

Due Gov't, \$ 100 for

Valuation of horse, \$ 100

Valuation of horse equipments, \$ 100

Remarks:

Book mark:

E H Lipscomb

(358)

Copyist.

NHRA 644

N | 8 H. Art'y. | U.S.C.T.

Beverly Winston

Copson, Co. C, 8 Reg't U. S. Col'd H. Art'y.

Appears on

Company Muster Roll

for *17th Dec.*, 1864.

Present or absent *Present*

Stoppage, \$ *100* for

Due Gov't, \$ *100* for

Valuation of horse, \$ *100*

Valuation of horse equipments, \$ *100*

Remarks: *Committed from Court
Dec. 6, 1864 and has Corporals
pay due him from that date.*

Book mark:

C. J. Markle,

(358)

Copyist.

8 H. Art'y. U.S.C.T.

Beverly Winston

Private, Co. C, 8 Reg't U. S. Col'd H. Art'y.

Appears on

Company Muster Roll

for Jun. + Feb., 1865.

Present or absent Present.

Stoppage, \$ 100 for

Due Gov't, \$ 100 for

Valuation of horse, \$ 100

Valuation of horse equipments, \$ 100

Remarks: Promoted to Corp'l. Dec. 6, 1864 and reduced to Private Feb. 14, 1865.

Book mark:

(358)

C. J. Markle, Copyist.

RECEIVED

N

S II. Art'y.

U.S.C.T.

Berney Hineston

Private, Co. C, 8 Reg't U. S. Col'd H. Art'y.

Appears on

Company Muster Roll

for *March - April*, 186 *5*.

Present or absent *Present*.

Stoppage, \$ 100 for

Due Gov't, \$ 100 for

Valuation of horse, \$ 100

Valuation of horse equipments, \$ 100

Remarks:

Book mark:

O. J. Markle

(358)

Copyist.

H

S H. Art'y.

U.S.C.T.

Beverly Winston

Private, Co. C, 8 Reg't U. S. Col'd H. Art'y.

Appears on

Company Muster Roll

for *May & June*, 186*5*.

Present or absent *Present.*

Stoppage, \$ *100* for

Due Gov't, \$ *100* for

Valuation of horse, \$ *100*

Valuation of horse equipments, \$ *100*

Remarks:

Book mark:

O. J. Markle,
Copyist.

W

8 H. Art'y.

U.S.C.T.

Beverly Winston

Priv, Co. C, 8 Reg't U. S. Col'd H. Art'y.

Appears on

Company Muster Roll

for *July and Aug*, 1865.

Present or absent *Present*

Stoppage, \$ *100* for

Due Gov't, \$ *100* for

Valuation of horse, \$ *100*

Valuation of horse equipments, \$ *100*

Remarks:

Book mark:

W McArthur

(358)

Copyist.

W

8 H. Art'y.

U.S.C.T.

Beverly Winston

Pat, Co. C, 8 Reg't U. S. Col'd H. Art'y.

Appears on

Company Muster Roll

for *Sept & Oct*, 1865.

Present or absent *Present*

Stoppage, \$ *100* for

Due Gov't, \$ *100* for

Valuation of horse, \$ *100*

Valuation of horse equipments, \$ *100*

Remarks:

Book mark:

W. G. Calhoun

(358)

Copyist.

W | 8 H. Art'y. | U.S.C.T.

Beverly Hamilton

Priv., Co. C, 8 Reg't U. S. Col'd H. Art'y.

Appears on

Company Muster Roll

for *27th Dec*, 1865.

Present or absent *Present*

Stoppage, \$ 100 for

Due Gov't, \$ 100 for

Valuation of horse, \$ 100

Valuation of horse equipments, \$ 100

Remarks:

Book mark:

W. Hamilton
Copyist.

W

8 H. Art'y.

U.S.C.T.

Beverly Winston
Pvt., Co. *C*, 8 Reg't U. S. Col'd H. Art'y.

Appears on Co. Muster-out Roll, dated

Victoria Texas Feb 10, 1866.

Muster-out to date *Feb 10*, 1866.

Last paid to *Aug 31*, 1865.

Clothing account:

Last settled....., 186 ; drawn since \$..... 100

Due soldier \$..... 100; due U. S. \$ *321* 100

Am't for cloth'g in kind or money adv'd \$..... 100

Due U. S. for arms, equipments, &c., \$..... 100

Bounty paid \$ *none* 100; due \$, *50* 100

Remarks: *Transferred to Co*

from Co A 8th S.C. Art'y

Gen May 26, 1864 per SB,

No 7 Hd Qrs 8th S.C. Art'y

Gen May 26/64 Promoted

to Capt Dec, 6, 1864

Book mark: *110 P 5470*

W. M. Colburn

JAN. 14

5472817

1891

Reduced to Post June
27 1865 No Order on record
Enrolled and subject
to draft in 1st Cu. Dist
of Ky. at time of Enlist-
ment.

21

8 H. Art'y.

U.S.C.T.

Henry Winston

Co. C., 8 Reg't U. S. Col'd H. Art'y.

Appears on **Co. Muster-out Roll**, dated

Feb 10, 186*1*.

Muster-out to date _____, 186 .

Last paid to *Apr 30*, 186*1* .

Clothing account:

Last settled _____, 186 ; drawn since \$ _____ 100

Due soldier \$ _____ 100; due U. S. \$ _____ 100

Am't for cloth'g in kind or money adv'd \$ _____ 100

Due U. S. for arms, equipments, &c., \$ _____ 100

Bounty paid \$ _____ 100; due \$ _____ 100

Remarks: *Discharged*

*He is not at camp as per. He was sent to
detachment of 1st Reg't of Cavalry of
Smith's Troop Co. C. 8th U.S. Art'y
for 10 days at Fort H. G. 1861
May 20, 61*

Book mark: _____

H. H. Winston

(361)

Copyist.

1936
Wesley Fred

Co G, 8 U.S. Col'd H. Art'y.

Private Private

CARD NUMBERS.

1	54 773 13	26
2	54 777 83	27
3	9122126	28
4	40744964	29
5		30
6		31
7		32
8		33
9		34
10		35
11		36
12		37
13		38
14		39
15		40
16		41
17		42
18		43
19		44
20		45
21		46
22		47
23		48
24		49
25		50

Book Mark:

See also

7.

S H. Art'y.

U.S.C.T.

Ned Weir

, Co. G, 8 Reg't U.S. Col'd H. Art'y.

Appears on

Company Descriptive Book

of the organization named above.

DESCRIPTION.

Age 27 years; height 5 feet 7 inches.

Complexion *fair*

Eyes *gray*; hair *black*

Where born *Georgia*

Occupation *farmer*

ENLISTMENT.

When *Jan'y, 26*, 1865.

Where *Cairo, Ill.*

By whom *Lt. Col. Low*; term *3* y'rs.

Remarks: *Died at Reg't. Hosp. Cadu-*
sch, N.Y., Feby. 19, 65.

S. A. Morland

(383g)

Copyist.

8 H. Art'y.

U.S.C.T.

J. J. Miller

, Co. G, 8 Reg't U. S. Col'd H. Art'y.

Appears on

Company Muster Roll

for *Jan 1 July*, 186*3*.

Present or absent

Stoppage, \$ 100 for

Due Gov't, \$ 100 for

Valuation of horse, \$ 100

Valuation of horse equipments, \$ 100

Remarks: *Died at Dept Camp*

Paducah Ky. July 21 1863

*Enrolled & Jan 20 1863
M. J. Van Dine at
Paducah Ky for
3 years*

Book mark:

J. J. Miller

N | 8 H. Art'y. | U.S.C.T.

Med. Note

Pr., Co. *4*, 8 Reg't U. S. Col'd H. Art'y.

Appears on Returns as follows:

July 18/65. *July 21/65.*
Paduechky *Kind of*
miscell.

Book mark:

W. D. Patton

(546)

Copyist.

W.

S H. Art'y.

U.S.C.T.

Med Wein

Co. J., 8 Reg't U. S. Col'd H. Art'y.

Appears on Co. Muster-out Roll, dated
at *St. Louis, Mo.*, 186

Muster-out to date _____, 186

Last paid to *Never Paid* 186

Clothing account:

Last settled _____, 186 ; drawn since \$ _____ 100

Due soldier \$ _____ 100; due U. S. \$ _____ 100

Am't for cloth'g in kind or money adv'd \$ _____ 100

Due U. S. for arms, equipments, &c., \$ _____ 100

Bounty paid \$ _____ 100; due \$ _____ 100

Remarks: *Enlisted in service
1862, joined Reg't
at St. Louis, Mo. Dis-
charged by General
order from
1863*

Book mark: *Page 27*

W. L. L.

JAN. 14

5477783

1891

Inventory of Effects and
Annual Statements for
recorded April 6, 1865

Wine, Ned

B, Co. G, 8 Reg't U.S.C.H.A.

2 Enclosures.

Bed Cards	Descriptive Lists
Burial Records	Final Statements /
Certs. of Dis. for Discharge	Furloughs
C. M. Charges	Med. Des. Lists
Med. Certificates	Orders

Other papers relating to—

Admission to Hosp'l	Furlough
Casualty Sheet (Officer's)	Med. Examination
Confinement	Misc. Information
Contracts	Pay or Clothing
Death or Effects /	Personal Reports
Desertions	Rank
Discharge from Hosp'l	Transfer to Hosp'l
Discharge from Service	Transfer to V. R. C.
Duty	Transportation

I certify, on honor, that Ned Ware a Private of
 Captain Wm. H. Sp... Company (G) of the 8th Regiment of U. S. Col. Regt. Heavy
VOLUNTEERS, of the State of _____, born in Co. Unknown, State
 of Georgia, aged 27 years; 5 feet 7 inches high; Black complexion,
Gray eyes, Black hair, and by occupation a Business, having joined the company on
 its original organization at _____, and enrolled in it at the muster into
 the service of the United States at _____, on the _____ day
 of _____, 1865, (or was mustered in service as a recruit, by St. J. M. Green
 _____, at Pacheco Reg., on the Twenty eighth day of January,
 1865, or was drafted and mustered into the service of the United States from the
 Enrollment District of the State of _____, at _____,
 on the _____ day of _____, 1865.) to serve in the Regiment, for
 the term of Three years : and having served HONESTLY and
 FAITHFULLY with his Company in Said Regt to the present date, is now

~~entitled to a DISCHARGE~~ by reason of Died in Regt. Hospital at Pacheco
Reg. 19th day of February 1865 by reason of Pneumonia

The said Ned Ware was ~~last~~ paid by Paymaster
 _____ to include the _____ day of _____, 1865, and has
 pay due him from ^{date of Enrollment} ~~that time~~ to the present date; he is entitled to pay and subsistence for
 TRAVELING to place of enrollment, and whatever other allowances are authorized to volunteer
 soldiers, drafted men, or militia so discharged. He has received from the United States **CLOTHING**
 amounting to \$36.99 dollars, since the _____ day of _____,
 1865, when his clothing account was ~~last~~ ^{never} settled. He has received from the United States
 _____ dollars advanced **BOUNTY**.

There is to be stopped from him, on account of the State of _____, or other
 authorities, for **CLOTHING, &c.**, received on entering service, _____ dollars; and
 for other stoppages, viz: _____
 _____ dollars.

He has been furnished with TRANSPORTATION in kind from the place of his discharge to
 _____; and he has been SUBSISTED for TRAVELING to his
 place of enrollment, up to the _____, 1865.

He is indebted to _____, **SUTLER**, _____ dollars.
 He is indebted to _____, **LAUNDRESS**, _____ dollars.

Given in Duplicate, at Pacheco Reg., this 16th day
 of March, 1865

Wm. H. Spence 1st Lieut
U. S. Col. Regt. Heavy
 Commanding Company.

ARTICLES OF WAR.

ART. 95. When any non-commissioned officer or soldier shall die, or be killed in the service of the United States, the then commanding officer of the troop or company shall, in the presence of two other commissioned officers, take an account of what effects he died possessed of, above his arms and accoutrements, and transmit the same to the office of the Department of War, which said effects are to be accounted for, and paid to the representatives of such deceased non-commissioned officer or soldier. And in case any of the officers, so authorized to take care of the effects of deceased officers and soldiers, should, before they have accounted to their representatives for the same, have occasion to leave the regiment or post, by promotion or otherwise, they shall, before they be permitted to quit the same, deposit in the hands of the commanding officer, or of the assistant military agent, all the effects of such deceased non-commissioned officers and soldiers, in order that the same may be secured for, and paid to, their respective representatives.

ARMY REGULATIONS—EDITION OF 1863.

DECEASED SOLDIERS.

Par. 152. Inventories of the effects of deceased non-commissioned officers and soldiers, required by the 95th Article of War, will be forwarded to the Adjutant General, by the commander of the company to which the deceased belonged, and a duplicate of the same to the colonel of the regiment. Final statements of pay, clothing, &c., in duplicate, will be sent to the Adjutant General with one copy of the inventory. When a soldier dies at a post or station absent from his company, it will be the duty of his immediate commander to furnish the required inventory and final statements, and, at the same time, to forward to the commanding officer of the company to which the soldier belonged, a report of his death, specifying the date, place, and cause; to what time he was last paid, and the money or other effects in his possession at the time of his decease; which report will be noted on the next muster roll of the company to which the man belonged. Each inventory will be endorsed, "Inventory of the effects of _____, late of company (—) _____ regiment of _____, who died at _____, the _____ day of _____, 186—." If a legal representative receive the effects, it will be stated in the report. If the soldier leave no effects, the fact will be reported.

Par. 153. Should the effects of a deceased non-commissioned officer or soldier not be administered upon within a short period after his decease, they shall be disposed of by a Council of Administration, under the authority of the commanding officer of the post, and the proceeds deposited with the Paymaster, to the credit of the United States, until they shall be claimed by the legal representatives of the deceased.

Par. 154. In all such cases of sales by the Council of Administration, a statement in detail, or account of the proceeds, duly certified by the Council and commanding officer, accompanied by the Paymaster's receipt for the proceeds, will be forwarded by the commanding officer to the Adjutant General. The statement will be endorsed, "Report of the proceeds of the effects of _____, late of company (—) _____ regiment of _____, who died at _____, the _____ day of _____, 186—."

NOTE 1.—The effects in all cases, when called for, should be turned over to the legal representative, without further authority from the Adjutant General. When the effects are turned over to the relatives of the deceased before these inventories are sent to the Adjutant General, their receipts therefor should be attached to the inventories. In all other cases, one copy will be sent with a letter of transmittal direct to the Adjutant General, and a duplicate retained by the officer.

NOTE 2.—Particular care should be taken to take receipts in duplicate from the Paymaster for any funds turned over to him; one copy should be sent direct to the Adjutant General and one retained by the officer.

INVENTORY OF THE EFFECTS

OF

John C. Miller
 Late of Company *C*
 Reg't of *11th (W.Va.)*
 Volunteers, who died at *Durham*
 on the _____ day of *February* 186*2*.



INVENTORY

Inventory of the effects of Neil Gray late
 a Private of Captain First Miles Spence Company G of
 the 1st Regiment of W. Va. Artillery Volunteers, who was enrolled as
 a Private at Greenville in the State of Illinois on
 the 25 day of January 1862, and mustered into the service of the United
 States as a Private on the 25 day of January 1862, at Greenville
 in Company G, 1st Regiment of W. Va. Artillery Volunteers, to serve three
 years or during the war; he was born in Illinois in the State
 of Illinois: he was 25 years of age, 5 feet 7 inches
 high, Light complexion, Blue eyes, Dark hair, and by occupation, when enrolled,
 a Farmer; he died in Greenville Hospital, at
Greenville on the 17 day of February 1865, by
 reason of Smallpox.

INVENTORY.					
ARTICLES.	No.	ARTICLES.	No.	ARTICLES.	No.
Hats.....		Pairs trousers.....		Knapsacks.....	
Caps.....		Pairs flannel drawers.....			
Forage Caps.....		Pairs cotton drawers.....			
Great coats.....	/	Flannel shirts.....			
Uniform coats.....		Cotton shirts.....			
Uniform jackets.....		Pairs boots.....			
Flannel sack coats.....		Pairs shoes.....			
Blouses.....	/	Pairs socks.....			
Sable frocks.....		Blankets <u>Woolen</u>	/		
Fatigue overalls.....		Haversacks <u>Woolen</u>	/		
				MONEY.	
					Specie.....
				Notes.....	\$

I CERTIFY, ON HONOR, that the above inventory comprises all the effects of Neil Gray
Neil Gray, deceased, and that the effects are in the hands
 of First Miles Spence at Greenville
 to be disposed of by a Council of Administration.

(DUPLICATES.)

STATION: Redwood

DATE: 10th March 1865

First Miles Spence
1st Regt W. Va. Artillery,
 Commanding the Company.

1937

Wise Benjamin
Co L, 8 U.S. Col'd H. Art'y.

Private | Sergeant

CARD NUMBERS.

1 5467218	26
2 5482501	27
3 5482514	28
4 5482628	29
5 5482743	30
6 5482834	31
7 5482922	32
8 5483001	33
9 5483081	34
10 5483151	35
11 9122889	36
12	37
13	38
14	39
15	40
16	41
17	42
18	43
19	44
20	45
21	46
22	47
23	48
24	49
25	50

Book Mark: _____

See also _____

A | 8 H. Art'y. | U.S.C.T.

Benjamin Wise
....., Co. *L*, 8 Reg't U.S. Col'd H. Art'y.

Appears on

Company Descriptive Book
of the organization named above.

DESCRIPTION.

Age *24* years; height *5* feet *7* inches.

Complexion *Black*

Eyes *Black*; hair *Black*

Where born *Virginia*

Occupation *Farmer*

ENLISTMENT.

When *Sept. 15*, 186*4*:

Where *Paducah, Ky.*

By whom *Capt. Hall*; term *3* y'rs.

Remarks: *Appointed Corporal rank*
from Nov. 8th 1864. Promoted
Serj't. to rank from May
1st 1865. Promoted 1st Serj't.
to rank from Sept. 1st
1865. Substitute for John
H. Miller 1st Dist. Ky.

Keefe.

W | S H. Art'y. | U.S.C.T.

Benjamin Wise.

Appears with rank of *Private* on

Muster and Descriptive Roll of a Detachment of U. S. Vols. forwarded

for the 8 Reg't U. S. Col'd H. Art'y. Roll dated

Paducoh, Ky, N.Y. Sept. 30, 1864.

Where born *Virginia*

Age *24* rs; occupation *Farmer*

When enlisted *Sept. 15*, 186 .

Where enlisted *Paducoh, Ky.*

For what period enlisted *3* years.

Eyes *Black*; hair *Black*

Complexion *Black*; height *5* ft. *7* in.

When mustered in *Sept. 15*, 186 .

Where mustered in *Paducoh,*

Bounty paid \$ *100*; due \$ *100*

Where credited

Company to which assigned

Remarks: *Credited to M. Bracken Co, 1st D. Ky. & is a substitute in lieu of A. A. Miller an enrolled man of said county.*

Book mark:

(339)

Callesway

Copyist.

27. | 8 II. Art'y. | U.S.C.T.

Benjamin Wise
Det., Co. L, 8 Reg't U. S. Col'd H. Art'y.

Age years.

Appears on

Company Muster Roll*

for Sept. 31, 1864.

Joined for duty and enrolled:

When Sept. 15, 1864.

Where Paducah, Ky.

Period 3 years.

Mustered in:

When Sept. 15, 1864.

Where Paducah, Ky.

Present or absent Present.

Stoppage, \$ 100 for

Due Gov't \$ 100 for

Valuation of horse, \$ 100

Valuation of horse equipments, \$ 100

Remarks:

*First current roll. No muster-in roll of this company on file.

Book mark:

Brooks

(358d)

Copyist.

9/6

8 H. Art'y.

U.S.C.T.

Benjamin Wise
Cpl., Co. L, 8 Reg't U. S. Col'd Heavy Art'y.

Appears on

Company Muster Roll

for *Nov. + Dec.*, 1864.

Present or absent *Present*

Stoppage, \$ *100* for

Due Gov't, \$ *100* for

Valuation of horse, \$ *100*

Valuation of horse equipments, \$ *100*

Remarks:

Book mark:

Brooks

W. | 8 H. Art'y. | U.S.C.T.

Benjamin Wise

Cpl., Co. L, 8 Reg't U. S. Col'd Heavy Art'y.

Appears on

Company Muster Roll

for *Oct. 31, 1864 to Feb. 28, 1865*

Present or absent *Present*

Stoppage, \$ *100* for

Due Gov't, \$ *100* for

Valuation of horse, \$ *100*

Valuation of horse equipments, \$ *100*

Remarks:

Book mark:

Brooks

(358)

Copyist.

W.

S H. Art'y.

U.S.C.T.

Benjamin Wise,
Capt., Co. L, 8 Reg't U. S. Col'd Heavy Art'y.

Appears on

Company Muster Roll

for *Mar. & Apr.*, 1865.

Present or absent *Present.*

Stoppage, \$ *100* for

Due Gov't, \$ *100* for

Valuation of horse, \$ *100*

Valuation of horse equipments, \$ *100*

Remarks:

Book mark:

E. H. Woodford

(358)

Copyist.

N. | 8 H. Art'y. | U.S.C.T.

Benjamin Kise,
Sergeant, Co. L, 8 Reg't U. S. Col'd Heavy Art'y.

Appears on

Company Muster Roll

for *May & June*, 1865.

Present or absent *Present*

Stoppage, \$ *100* for

Due Gov't, \$ *100* for

Valuation of horse, \$ *100*

Valuation of horse equipments, \$ *100*

Remarks: *Promoted Sergeant
to rank as such from
May 1, 1865.*

Book mark: *100*

E. A. Woodford,
Copyist.

W.

8 H. Art'y.

U.S.C.T.

Benjamin Wise,
Serg't, Co. L, 8 Reg't U. S. Col'd Heavy Art'y.

Appears on

Company Muster Roll

for *July & Aug.*, 1865.

Present or absent *Present.*

Stoppage, \$ *100* for

Due Gov't, \$ *100* for

Valuation of horse, \$ *100*

Valuation of horse equipments, \$ *100*

Remarks: *Appointed Corp'l. to rank as such from Nov. 8, 1865. Promoted to Serg't. to rank as such from May 1, 1865.*

Book mark: _____

E. H. Woodford
Copyist.

W

8 H. Art'y.

U.S.C.T.

Benjamin Wise

1st Supt, Co. L, 8 Reg't U. S. Col'd Heavy Art'y.

Appears on

Company Muster Roll

for *Sept & Oct*, 1865.

Present or absent *Present*

Stoppage, \$ *100* for

Due Gov't, \$ *100* for

Valuation of horse, \$ *100*

Valuation of horse equipments, \$ *100*

Remarks:

Book mark:

J. L. Morris

(358)

Copyist.

W

S H. Art'y.

U.S.C.T.

Benj. Wise

1st Supt. Co. L, 8 Reg't U. S. Col'd Heavy Art'y.

Appears on

Company Muster Roll

for *Nov & Dec*, 1865.

Present or absent *Present*

Stoppage, \$ *100* for

Due Gov't, \$ *100* for

Valuation of horse, \$ *100*

Valuation of horse equipments, \$ *100*

Remarks:

Book mark:

J. L. Morris

(358)

Copyist.

W

S H. Art'y. | U.S.C.T.

Benjamin Wise
1st Supt, Co. R, 8 Reg't U. S. Col'd H. Art'y.

Appears on Co. Muster-out Roll, dated
Victoria, Texas, July 10, 1866.

Muster-out to date *July 10,* 1866.

Last paid to *Aug 31,* 1865.

Clothing account:

Last settled....., 186 ; drawn since \$..... 100

Due soldier \$ *3* ²³/₁₀₀; due U. S. \$..... 100

Am't for cloth'g in kind or money adv'd \$..... 100

Due U. S. for arms, equipments, &c., \$..... 100

Bounty paid \$..... 100; due \$..... 100

Remarks: *Entered service as Substitute
for John A. Miller, 1st Dist. Regt.
promoted Corporal Nov 8, 1864;
promoted Sergeant May 1, 1865.
promoted 1st Supt Sept. 1, 1865.*

Book mark: *See 5543-B 89.*

(361)

J. L. Harris

Copyist.

1938

Woolfolk Scott

Co A, 8 U.S. Col'd H. Art'y.

Private | Private

CARD NUMBERS.

1	26
2	27
3	28
4	29
5	30
6	31
7	32
8	33
9	34
10	35
11	36
12	37
13	38
14	39
15	40
16	41
17	42
18	43
19	44
20	45
21	46
22	47
23	48
24	49
25	50

See Woolfolk Scott

Book Mark: _____

See also _____

1939
Woods Bart

Co E, 8 U.S. Col'd H. Art'y.

Private | Sergeant

CARD NUMBERS.

1	5474384	26
2	5474481	27
3	5474614	28
4	5474648	29
5	5474775	30
6	5474899	31
7	5475021	32
8	5475139	33
9	5475255	34
10	5475367	35
11	5475471	36
12	5475559	37
13	9122303	38
14	40744965	39
15		40
16		41
17		42
18		43
19		44
20		45
21		46
22		47
23		48
24		49
25		50

Book Mark:

See also

7/

S H. Art'y.

U.S.C.T.

Paul Woods

....., Co. *E* .., 8 Reg't U.S. Col'd H. Art'y.

Appears on

Company Descriptive Book
of the organization named above.

DESCRIPTION.

Age *24* years; height *5* feet *7* inches.

Complexion *Yellow*

Eyes *Blk* ; hair *Blk*

Where born *Decatur Co., Tennessee*

Occupation *Farmer*

ENLISTMENT.

When *Mar 20* .., 186*4*.

Where *Effron, Tenn*

By whom *R. Dunn* ; term *3* y'rs.

Remarks:

.....
.....
.....
.....
.....
.....
.....
.....

E. A. Moreland

(383g)

Copist.

W

S H. Art'y.

U.S.C.T.

Dark Woods

W, Co. *E*, 1 Reg't Ky. H. Art'y.†

Age years.

Appears on

Company Muster Roll*

for *Enlistment to April 30*, 1864.

Joined for duty and enrolled:

When *March 20*, 1864.

Where *Clepton, Tenn.*

Period *3* years.

Mustered in:

When *April 26*, 1864.

Where *Paducah, Ky.*

Present or absent *Present*

Stoppage, \$ *100* for

Due Gov't \$ *100* for

Valuation of horse, \$ *100*

Valuation of horse equipments, \$ *100*

Remarks:

†This organization subsequently became Co. "E", 8 Reg't U. S. Colored Heavy Artillery.

*First current roll. No muster-in roll of this company on file.

Book mark:

(3586)

J. R. Keamy
Copyist.

W

S H. Art'y.

U.S.C.T.

Barthus Woods

Pl, Co. E, 8 Reg't U. S. Col'd H. Art'y.

Appears on

Company Muster Roll

for *May and June*, 1864.

Present or absent *Present*

Stoppage, \$ *100* for

Due Gov't, \$ *100* for

Valuation of horse, \$ *100*

Valuation of horse equipments, \$ *100*

Remarks:

Book mark:

(358)

Jas. v. Kearny
Copyist.

W

8 H. Art'y.

U.S.C.T.

Barlow Woods

PK, Co. E, 8 Reg't U. S. Col'd H. Art'y.

Appears on

Company Muster Roll

for *July and Aug*, 186*4*.

Present or absent *Present*

Stoppage, \$ *100* for

Due Gov't, \$ *100* for

Valuation of horse, \$ *100*

Valuation of horse equipments, \$ *100*

Remarks:

On daily duty as mounted infantry.

Book mark:

(358)

Jas. R. Kearny
Copyist.

W

8 H. Art'y.

U.S.C.T.

Bark. Woods

Sgt, Co. E, 8 Reg't U. S. Col'd H. Art'y.

Appears on

Company Muster Roll

for *Sept and Oct*, 1864.

Present or absent *Present*

Stoppage, \$ *100* for

Due Gov't, \$ *100* for

Valuation of horse, \$ *100*

Valuation of horse equipments, \$ *100*

Remarks:

Promoted to be Sargt, Sept. 19, 1864.

Book mark:

Jas. V. Kearny
Copyist.

(358)

W

8 H. Art'y.

U.S.C.T.

Bart Woods

Sgt., Co. E, 8 Reg't U. S. Col'd H. Art'y.

Appears on

Company Muster Roll

for Nov. & Dec., 1864.

Present or absent Present

Stoppage, \$ 100 for

Due Gov't, \$ 100 for

Valuation of horse, \$ 100

Valuation of horse equipments, \$ 100

Remarks:

Book mark:

C. E. M. Laughlin
Copyist.

W | 8 H. Art'y. | U.S.C.T.

Bart Woods

Sgt, Co. E, 8 Reg't U. S. Col'd H. Art'y.

Appears on

Company Muster Roll

for *Jan + Feb.*, 1865.

Present or absent *Present*

Stoppage, \$ *100* for

Due Gov't, \$ *100* for

Valuation of horse, \$ *100*

Valuation of horse equipments, \$ *100*

Remarks: *Due the U. S. for
one Canter and one
Haversack \$1.60.*

Book mark: *22752*

C. E. M. Laughlin
Copyist.

W

8 H. Art'y.

U.S.C.T.

Bart Woods

Sgt., Co. E, 8 Reg't U. S. Col'd H. Art'y.

Appears on

Company Muster Roll

for *Mar & Apr.*, 1865.

Present or absent *Present*

Stoppage, \$ *100* for

Due Gov't, \$ *100* for

Valuation of horse, \$ *100*

Valuation of horse equipments, \$ *100*

Remarks: *Due the U. S. for one canteen and one Haversack \$1.60*

Book mark:

C. E. M. Langhlin
Copyist.

(358)

W

8 H. Art'y.

U.S.C.T.

Bart Woods

Sgt., Co. E, 8 Reg't U. S. Col'd H. Art'y.

Appears on

Company Muster Roll

for May & June, 1865.

Present or absent Present

Stoppage, \$ 100 for

Due Gov't, \$ 100 for

Valuation of horse, \$ 100

Valuation of horse equipments, \$ 100

Remarks: Due U.S. for

@ 4 H. E. \$160 / 100

Promoted from Corp. to date Dec. 25, 1864.

Book mark:

B. E. M. Laughlin

(358)

Copypist.

Bart Woods

3^d Supt, Co. E, 8 Reg't U. S. Col'd H. Art'y.

Appears on

Company Muster Roll

for *July & Aug*, 1865.

Present or absent *Present*

Stoppage, \$ *100* for

Due Gov't, \$ *100* for

Valuation of horse, \$ *100*

Valuation of horse equipments, \$ *100*

Remarks: *Promoted from Capt.
Dec 25. 64. Due the U.S.
for C & G. E. \$160.*

Book mark: *[Faint stamp]*

E. C. Carroll

W | 8 H. Art'y. | U.S.C.T.

Bart Woods

Sgt, Co. E, 8 Reg't U. S. Col'd H. Art'y.

Appears on

Company Muster Roll

for *Sept & Oct*, 1865.

Present or absent *Present*

Stoppage, \$ 100 for

Due Gov't, \$ 100 for

Valuation of horse, \$ 100

Valuation of horse equipments, \$ 100

Remarks:

Book mark: *Sept 1865*

E. C. Carroll

N | 8 H. Art'y. | U.S.C.T.

Barton Woods

Sergt, Co. E, 8 Reg't U. S. Col'd H. Art'y.

Appears on

Company Muster Roll

for *Nov & Dec*, 1865.

Present or absent *Present*

Stoppage, \$ *100* for

Due Gov't, \$ *100* for

Valuation of horse, \$ *100*

Valuation of horse equipments, \$ *100*

Remarks:
.....
.....
.....
.....
.....
.....
.....
.....
.....
.....

Book mark:

E. B. Carroll

W

8 H. Art'y.

U.S.C.T.

Barton Woods

Priv. Co. E; 8 Reg't U. S. Col'd H. Art'y.

Appears on Returns as follows:

Aug 1864 on duty duty
as mounted Infantry by
order of Col Tracy

Book mark:

Chas Barton

(546)

Copyist.

Barl Woods

Sgtl., Co. *C*, 8 Reg't U. S. Col'd H. Art'y.

Appears on **Co. Muster-out Roll**, dated *Victoria Texas*, *Feb 10*, 1866 .

Muster-out to date *Feb 10*, 1866 .

Last paid to *Aug 31*, 1865 .

Clothing account:

Last settled....., 186 ; drawn since \$..... 100

Due soldier \$..... 100; due U. S. \$..... ²⁷100

Am't for cloth'g in kind or money adv'd \$..... 100

Due U. S. for arms, equipments, &c., \$..... 100

Bounty paid \$ *None* 100; due \$ *300* 100

Remarks: *Joined at Original organi-*
-zation as Private. Promoted to Capt
Sep 19, 1864. to Sgt Dec 25. 64.
Free on or before April 19, 1864
Has filed affidavit to that effect
with the Asst. Com. Quarters Gen
Dist Texas.

Book mark: *Age 214*

E. Carroll

1940

Woods David

Co et, 8 U.S. Col'd H. Art'y.

Private

Sergeant

CARD NUMBERS.

1	5468107	26
2	5468220	27
3	5468221	28
4	5468229	29
5	5468370	30
6	5468494	31
7	5468652	32
8	5468808	33
9	5468958	34
10	5469102	35
11	5469239	36
12	5469374	37
13	5469607	38
14	5469720.	39
15	9121279	40
16	32156784	41
17	22099059	42
18	40744968	43
19		44
20		45
21		46
22		47
23		48
24		49
25		50

Book Mark: E. B. 811-P 552

See also

W | 8 H. Art'y. | U.S.C.T.

David Noble

, Co. A, 8 Reg't U.S. Col'd H. Art'y.

Appears on

Company Descriptive Book

of the organization named above.

DESCRIPTION.

Age 27 years; height 5 feet 8 1/2 inches.

Complexion Dark

Eyes Dark; hair Dark

Where born Bedford, Tenn.

Occupation Farmer

ENLISTMENT.

When Jan. 25, 1864.

Where Paducah, Ky.

By whom J. G. Olson; term 3 y'rs.

Remarks: Discharged at U.S.A. Gen. Hosp., Jeffersonville, Ind., Nov. 7/65, on Surgeon's Cert. of Disability. It is not fully decided whether his disease was contracted prior or subsequent to enlistment

Henderson

David Woods

Private, Co. A, 1 Reg't Ky. H. Art'y.*

Appears on

Company Muster-in and Descriptive Roll

of the organization named above. Roll dated

Paducah Ky, Apr 26, 1864

Where born Redford Tenn

Age 27 y'rs; occupation Farmer

When enlisted Jan 25, 1864

Where enlisted Paducah Ky

For what period enlisted 3 years.

Eyes dk; hair dk

Complexion dk; height 5 ft. 8 1/2 in.

When mustered in Apr 26, 1864.

Where mustered in Paducah Ky

Bounty paid \$ 100; due \$ 100

Where credited 1st Dist. Ky

Company to which assigned

Remarks:

* This organization subsequently became Co. A, 8 Reg't U. S. Colored Heavy Artillery.

Book mark:

Randolph

Off | 8 H. Art'y. | U.S.C.T.

David Hood

Priv, Co. A, 1 Reg't Ky. H. Art'y.*

Appears on

Company Muster Roll

for *Enlistment to Apr 30*, 1864.

Present or absent *Present*

Stoppage, \$ *100* for

Due Gov't, \$ *100* for

Valuation of horse, \$ *100*

Valuation of horse equipments, \$ *100*

Remarks:

*This organization subsequently became Co. A, 8 Reg't U. S. Col'd Heavy Artillery.

Book mark:

Waddington

D | 8 H. Art'y. | U.S.C.T.

Daniel Woods
Priv, Co. A, 1 Reg't Ky. H. Art'y.*

Appears on

Company Muster Roll

for *Enlistment to Apr 30*, 1864.

Present or absent *Present*

Stoppage, \$.....100 for

Due Gov't, \$.....100 for

Valuation of horse, \$.....100

Valuation of horse equipments, \$.....100

Remarks:

*This organization subsequently became Co. A, 8 Reg't U. S. Col'd Heavy Artillery.

Book mark:

(358)

Waddington

Copyist.

W | 8 H. Art'y. | U.S.C.T.

David Woods

Corp, Co. A, 8 Reg't U. S. Col'd H. Art'y.

Appears on

Company Muster Roll

for *May & June*, 1864.

Present or absent *Present*

Stoppage, \$ *100* for

Due Gov't, \$ *100* for

Valuation of horse, \$ *100*

Valuation of horse equipments, \$ *100*

Remarks:

Book mark: -----

Wauwington

M

| S H. Art'y. | U.S.C.T.

David Woods

Corp, Co. A, 8 Reg't U. S. Col'd H. Art'y.

Appears on

Company Muster Roll

for *July & Aug*, 1864.

Present or absent *Present*

Stoppage, \$ *100* for

Due Gov't, \$ *100* for

Valuation of horse, \$ *100*

Valuation of horse equipments, \$ *100*

Remarks:

Book mark:

Waddington

(358)

Copyist.

W | 8 H. Art'y. | U.S.C.T.

David Woods

Sergt, Co. A, 8 Reg't U. S. Col'd H. Art'y.

Appears on

Company Muster Roll

for *Sept. 7 Oct.*, 1864.

Present or absent *Present*

Stoppage, \$ *100* for

Due Gov't, \$ *100* for

Valuation of horse, \$ *100*

Valuation of horse equipments, \$ *100*

Remarks:

Book mark:

C. Owen

W | 8 H. Art'y. | U.S.C.T.

David Woods

Serg't, Co. A, 8 Reg't U. S. Col'd H. Art'y.

Appears on

Company Muster Roll

for *Nov, & Dec.*, 1864.

Present or absent *Present*

Stoppage, \$ *100* for

Due Gov't, \$ *100* for

Valuation of horse, \$ *100*

Valuation of horse equipments, \$ *100*

Remarks:

Book mark: -----

C. R. Allen

W

| 8 H. Art'y. |

U.S.C.T.

David Woods

Serg't, Co. A, 8 Reg't U. S. Col'd H. Art'y.

Appears on

Company Muster Roll

for Jan. & Feb., 1865.

Present or absent Present.

Stoppage, \$ 100 for

Due Gov't, \$ 75- / 100 for Ordnance

Valuation of horse, \$ 100

Valuation of horse equipments, \$ 100

Remarks:

Book mark:

C. R. Liner

W | P.H.A. | U.S.C.T.

David Wood
Sergt., Co. A, 8 Reg't U.S. C.H. Art.

Appears on

Hospital Muster Roll

of **U. S. A. Post Hospital,**

at **Paducah, Ky.,**

for Mar & Apr, 1865.

Attached to hospital:

When Apr 6, 1865.

How employed patient

Last paid by Maj. Ferris

to Oct 31, 1864.

Bounty paid \$ 100; due \$ 100

Present or absent present

Remarks : _____

Book mark : _____

W Spencer

W

| 8 H. Art'y. | U.S.C.T.

David Wood

Sgt., Co. A, 8 Reg't U. S. Col'd H. Art'y.

Appears on

Company Muster Roll

for *March 9th*, 1865-

Present or absent *Absent*

Stoppage, \$ *100* for

Due Gov't, \$ *75* for *Ind name*

Valuation of horse, \$ *100*

Valuation of horse equipments, \$ *100*

Remarks: *Left sick at Paducah, Ky, Apr. 6, 1865*

Book mark: ..

Chilmen

W | 8 H. Art'y. | U.S.C.T.

David Woods

Serg't, Co. A, 8 Reg't U. S. Col'd H. Art'y.

Appears on

Company Muster Roll

for *May & June*, 1865-

Present or absent *Absent*

Stoppage, \$ *100* for

Due Gov't, \$ *5* ⁵/₁₀₀ for *Ordinance*

Valuation of horse, \$ *100*

Valuation of horse equipments, \$ *100*

Remarks: *Lick at Paducah
Ky. since Apr. 6,
1865.*

Book mark:

C.R. Owen

24

| 8 H. Art'y. | U.S.C.T.

David Woods

Supt, Co. A, 8 Reg't U. S. Col'd H. Art'y.

Appears on

Company Muster Roll

for *July and Aug*, 1865.

Present or absent *Absent*

Stoppage, \$ *100* for

Due Gov't, \$ *75* for *uniform*

Valuation of horse, \$ *100*

Valuation of horse equipments, \$ *100*

Remarks: *Sick at railroad Ky. since*
Apr. 6 1865

Book mark:

H. H. Merrill

Mr 1874 a 1866

David Woods
Sgt, Co A, 8. Reg't US 67 a

Appears on

Hospital Muster Roll

of Jefferson U. S. A. General Hospital,

at Jeffersonville, Ind.,

for July - Aug, 1865

Attached to hospital:

When....., 186 .

How employed.....

Last paid by Maj.....

to....., 186 .

Bounty paid \$ 100; due \$ 100

Present or absent Present

Remarks :

.....

.....

.....

.....

.....

Ward 19

.....

Book mark :

.....

P. H. Allen

21

| S H. Art'y. | U. S. C. T.

David Woods

Sergeant, Co. A, 8 Reg't U. S. Col'd H. Art'y.

Appears on

Company Muster Roll

for *Sept and Oct*, 1865.

Present or absent *absent*

Stoppage, \$ *100* for

Due Gov't, \$ *100* for

Valuation of horse, \$ *100*

Valuation of horse equipments, \$ *100*

Remarks: *Sick at Paducah Ky since
Apr. 6 '65*

Book mark:

W. H. Merrill

David Woods
Supt., Co. A, 8 Reg't U. S. Col'd H. Art'y.

Appears on Returns as follows:

April to Oct 1863 absent
sick at Paducah Ky
since April 6/63.

Nov 1863. Nov 7/63.
Jeff-ville Ind. Discharged
on Surgeons certificate of
disability.

Book mark: _____

Chas. Patton

21

S H. Art'y.

U.S.C.T.

David Woods

Sgt., Co. *U*, 8 Reg't U. S. Col'd H. Art'y.

Appears on **Co. Muster-out Roll**, dated

March 10 *Nov.*, *Feb. 10*, 186*6*.

Muster-out to date _____, 186 .

Last paid to *Oct 21*, 186*6*.

Clothing account:

Last settled _____, 186 ; drawn since \$ _____ 100

Due soldier \$ _____ 100; due U. S. \$ _____ 100

Am't for cloth'g in kind or money adv'd \$ _____ 100

Due U. S. for arms, equipments, &c., \$ _____ 100

Bounty paid \$ _____ 100; due \$ _____ 100

Remarks: *Joined at age 15 yrs Enrolled
and served until 1861 at age 19
at Fort Sumter. Promoted to Sgt. at age 21
and served until 1864. Discharged at
age 24. He has a wife and 3
children and is now residing at
No. 700 E. 1st St. St. Louis Mo.*

Book mark: _____

(361)

W. L. ...
Copyist.

JAN. 14

5469720

☆ 1891 ☆

Handwritten text, likely bleed-through from the reverse side of the page.

Woods, David -
 Sgt, Co. A, 8 Reg't USCHA

4 Enclosures.

Bed Cards	1	Descriptive Lists
Burial Records		Final Statements
Certs. of Dis. for Discharge		Furloughs
C. M. Charges		Med. Des. Lists
Med. Certificates		Orders

Other papers relating to—

Admission to Hosp'l	Furlough
Casualty Sheet (Officer's)	Med. Examination
Confinement	Misc. Information
Contracts	Pay or Clothing
Death or Effects	Personal Reports
Desertions	Rank
Discharge from Hosp'l	Transfer to Hosp'l
Discharge from Service	Transfer to V. R. C.
Duty	Transportation

TREATMENT.

[HERE NOTE IMPORTANT COMPLICATIONS AND ALL OPERATIONS.]

RESULT AND DATE.

Discharge on
Anglowm Allprato
Nov 7

Hospital Number 15555

Name David Woods
Age 28 Nativity Tenn.
Married or Single Married
Residence Paducah Mo Cracraft Ky
Post Office address of
wife or nearest relative. wife Matilda woods
Rank Sargt Co. A Regiment 8 Ind 70
When admitted August 20th
From what source Joe Holt

Diagnosis: (in surgical cases, state explicitly seat and
character of wound or injury.
Ser. fracture

On what occasion wounded Jefferson G. B.
Date Jeffersonville, Ind.
Nature of missile or weapon

Jefferson U. S. A. Gen'l Hospital,

JEFFERSONVILLE, IND.,

Nov. 9th 1865.

GOLDSMITH, M.,

Surgeon U. S. Vols, in charge.

Advises as to Discharge from Service of
Sergt David Woods
A Co., Eighth Reg't Wis.,
upon Surgeon's Certificate of Disability.

Received *Nov. 28th* 1865.

JEFFERSON U. S. A. GENERAL HOSPITAL,
Jeffersonville, Ind., November 9th, 1865.

Sir:

I have to inform you that Sergeant David Woods, 1865,
of your Company, was discharged the service at this Hospital, on the seventh (?) Nov.,
by Surgeon's Certificate of Disability, made by reason of "scrophulous abscess of the
left groin, of eight months duration."

See stoppage for transportation, and endorsement
relative to bounty - the question of his fitness for
service when enlistment not fully decided.

His Descriptive List, endorsed with a statement of his account with the Government, as appeared from
his Final Statements, is herewith enclosed. Your attention is respectfully invited to the following "note," the
provisions of which are required to be complied with by existing orders:

"8.—When a soldier is furnished with Final Statements, his Descriptive List (if he has one), should be taken up by the officer who gives the soldier
these Statements, and endorsed with a statement to this effect by the officer. This endorsement should exhibit a full statement of the time for which the
soldier was allowed pay on his Final Statements, the Clothing Account, and all other charges against him or in his favor, so as to comprise a complete
exhibit of his account. It will then be transmitted to the Company Commander of the soldier, who will enter all the data necessary to a full under-
standing of the soldier's account on the Muster Roll upon which the soldier's discharge is reported. The Descriptive List will then be destroyed. The
object of this is, that the remaining portion of the soldier's account may be settled upon receipt of these Muster Rolls, and the soldier receive any pay
or allowances that may be due him at the time of his discharge, and which may not appear upon his Final Statements from the fact that his Descriptive
List is incomplete. These accounts for back pay, &c., are settled by the Second Auditor of the Treasury Department."

You are requested to acknowledge receipt of this notice.

Very respectfully,

Your obedient servant,

M. W. Smith

Surgeon U. S. V., in charge.
(31)

Commanding Officer

A Co., 8th Regt.

Regt.

N.S. Col.

Hann. Art.

Victoria Detach.

U. S. A. Gen. Hospital
Jeffersonville Ind. Aug 20 65

Surg. in Charge

Notifies me to stop transportation
against Sgt. David Woods

Sent Disb List with stoppage entered to
Surg in Charge Sept 29" 1865

Jefferson U. S. A. General Hospital,

Jeffersonville, Ind. Aug 20th 1865.

Sir:

I am directed to inform you that *Serg. t David Wood* of your Company, has been furnished by the Quartermaster's Department with transportation, while on furlough from ^{the Holt Genl} this Hospital, by authority of Maj. General Palmer Commanding Department of Kentucky as follows

By Capt. J. R. DeVecke, from Louisville Ky. to Paducah Ky. - 339 miles. - cost \$1.99 - July 20th 1865.

By Capt. J. H. Wilson, from Paducah Ky. to Louisville Ky. cost \$2.00. - Aug 16th 1865.

I have to request that you will cause the same to be charged to him on your Company books, for stoppage against his pay, as his Descriptive Roll has not been received at this Hospital.

Please acknowledge receipt of this notice.

Very respectfully,
Your obedient servant,

By order of Surgeon M. Goldsmith, U. S. V., in charge:

S. A. Seymour
Acty. Asst. Surgeon U. S. A., Executive Officer.

Comdg. Off. Co. "A."
8th U. S. Col'd. Heavy Arty.

} Jefferson U. S. Gen. Hosp.

War Department,

ADJUTANT GENERAL'S OFFICE,

February 5, 1876,

The Discharge of *Sgt. David*
Needs, Co. "A", 8th Reg't U. S.

Colored Art. "H" is reported as follows:

On Company Muster Roll.	
For <i>Nov 1st</i> , 1865, <i>Nov 9th</i> , 1865.	
Company Muster-out Roll.	
<i>November 7th</i> , 1865.	
Company Descriptive Book.	186
Company Morning Reports.	186
Soldier's Final Statement.	186
Soldier's Record of Death and Interment.	186
Soldier's Inventory of Effects.	186
Soldier's Certificate of Disability for Discharge.	
<i>November 7th</i> , 1865.	186
Soldier's Individual Muster-out Roll.	186
Regimental Return.	
For <i>Nov 1st</i> , 1865, <i>Nov 7th</i> , 1865.	186
Regimental Quarterly Returns.	186
Regimental Descriptive Book.	186
By Surgeon General.	186

(*Nov 7*) *Nov 7*, 1865, is held to be the correct date, and the Company Muster Roll will be amended accordingly.

Thomas M. Sweney
C.B. 11 *per letter to Auditor*
Assistant Adjutant General.
552. Adm. H.H. of March 10/1876

✓ 1865
 Co. A
 43
 1893 12 7 1865

NOTE 1.

The company commander will here add a statement of all the facts known to him concerning the disease or wound, or cause of disability of the soldier; the time, place, manner, and all the circumstances under which the injury occurred, or disease originated or appeared; the duty, or service, or situation of the soldier at the time the injury was received or disease contracted, stating particularly whether the injury was received or the disease contracted in the line of his duty; and whatever other facts may aid a judgment as to the cause, immediate or remote, of the disability, and the circumstances attending it.

When the facts are not known to the company commander, the certificate of any officer, or affidavit of other person having such knowledge, will be appended—as the surgeon in charge of a hospital, the officer commanding a detachment of recruits, &c., &c.

CERTIFICATE OF DISABILITY FOR DISCHARGE
 IN THE CASE OF

David Woods
 a Sergeant. 5th
 8th Cal. Reg't of A. Art.

NOTE 2.

When a probable case for pension, special care must be taken to state the degree of disability—as $\frac{1}{2}$, $\frac{3}{4}$, &c., &c.; to describe particularly the disability, wound, or disease; the extent to which it deprives him of the use of any limb or faculty, or affects his health, strength, activity, constitution, or capacity to labor or earn his subsistence. The surgeon will add, from his knowledge of the facts and circumstances, and from the evidence in the case, his professional opinion of the cause or origin of the disability. In the case of discharges by Medical Inspectors, the last paragraph will state that the "discharge was given by consent of the soldier, after a personal examination, and for disability, the nature, degree, and origin of which are correctly described in the within certificate."

Par. 1260 Regulations, Edit. 1861.

Medical officers, in giving certificates of disability, are to take particular care in all cases that have not been under their charge; and especially in epilepsy, convulsions, chronic rheumatism, derangement of the urinary organs, ophthalmia, ulcers, or any obscure disease liable to be feigned or purposely produced; and in no case shall such certificate be given until after sufficient time and examination to detect any attempt at deception.

DIRECTIONS.

This certificate will be made out in duplicate by the soldier's company commander, or other officer commanding the separate detachment to which he belongs, and sent by him to the surgeon who has charge of the hospital where the soldier is sick. The surgeon will then fill out and sign the surgeon's certificate, and forward these papers to the regimental, detachment, or post commander, who will forward them, with his action endorsed thereon, through the proper channel, to his division commander; or, if the troops are not attached to a division, to his corps, department, or other commander or officer to whom the authority to discharge enlisted men may be specially delegated.

These certificates, after having received the action of the highest authority to which they are required to be sent, will be returned through the same channel to the regimental, post, or detachment commander, who will, if the discharge is authorized by the endorsement of the proper authority, sign the soldier's discharge, and the last certificate on this paper; see that the soldier is furnished with the proper final statements in duplicate, and forward BOTH of these certificates direct to the Adjutant General United States Army, at Washington, D. C.; they will not, under any circumstances, be given into the hands of the soldier.

Received (A. G. Office) _____, 186 .

ADJUTANT GENERAL'S OFFICE

7. 1865

Duplicate sent the Pension Office.

Entwistle & Rogers

OF THE UNITED
CERTIFICATE

STATES.

DISABILITY

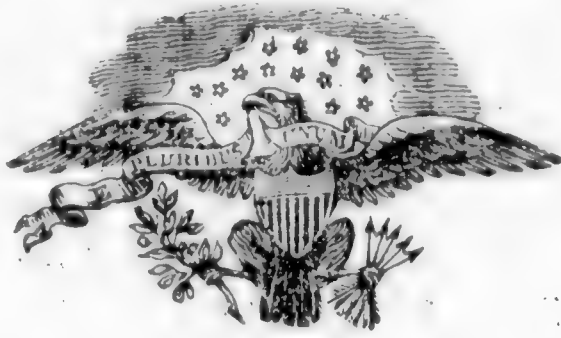

FOR DISCHARGE.

Approved A. M. Stearns
Sergeant David Woods, of Captain *Chas. Robinson's* Company, (*A*) of the *8th* *Co.* *8th* Regiment of United States Heavy Art. was enlisted by *Capt. Robson* of the *8th* Regiment of *Pa.* at *Pasneah, Ky.* on the *25th* day of *January*, 186*4*, to serve *3* years; he was born in *Relaford* in the State of *ennessee*, is *twenty-seven* years of age, *five* feet *8 1/2* inches high; *dark* complexion, *dark* eyes *dark* hair, and by occupation when enlisted a *farmer*. During the last two months said soldier has been unfit for duty *60* days.*

STATION: *Jefferson M. S. A. Genl. Hospital, Jeffersonville, Ind.*
DATE: *Oct. 30th 1865.*

M. W. Smith
Surgeon U. S. Army, in chg.
Commanding ~~Company~~

I CERTIFY, that I have carefully examined the said *David Woods* of Captain *Robson* Company, and find him incapable of performing the duties of a soldier because of *Scrophulous abscess of the left arm - of 3 months duration*.

M. W. Smith

Surgeon U. S. Army,
in chg. *Hospital*.

DISCHARGED, this *seventh* day of *November* 186*5*, at *Jefferson M. S. A. General Hospital, Jeffersonville, Ind.*

M. W. Smith
Surgeon U. S. Army, in chg.
Commanding the *Regt.*

The Soldier desires to be addressed at

Town *Pasneah* County *McCracken* State *Ky.*

* See Note 1 on the back of this.

† See Note 2 on the back of this.

1941
Woods Link

Co *F*, 8 U.S. Col'd H. Art'y.

Private | Private

CARD NUMBERS.

1	5475840	26
2	5475947	27
3	5476073	28
4	5476184	29
5	5476293	30
6	5476421	31
7	5476528	32
8	5476634	33
9	5476735	34
10	5476836	35
11	5476926	36
12	9122468	37
13	49744969	38
14		39
15		40
16		41
17		42
18		43
19		44
20		45
21		46
22		47
23		48
24		49
25		50

Book Mark:

See also

26

S H. Art'y.

U.S.C.T.

James Wood

, Co. *E*, 8 Reg't U.S. Col'd H. Art'y.

Appears on

Company Descriptive Book

of the organization named above.

DESCRIPTION.

Age *24* years; height *5* feet *7* inches.

Complexion *Light*

Eyes *Blk*; hair *Blk*

Where born *Dyon Co., Ky*

Occupation *Farmer*

ENLISTMENT.

When *May 24*, 186*4*.

Where *Paducah, Ky*

By whom *C.A. Holmes*; term *3* y'rs.

Remarks:

J. A. Moreland

W. S. H. [unclear] U.S.C.T.

Frank Wood
Cm. Co. F, 8 Reg't U.S. Col'd. 4. Arty.

Age _____ years.

Appears on

Company Muster Roll*

for from enlistment to June 30, 1864.

Joined for duty and enrolled:

When May 24, 1864.

Where Paducah Ky

Period 3 years.

Mustered in:

When June 6, 1864.

Where Paducah Ky

Present or absent present

Stoppage, \$ 100 for _____

Due Gov't, \$ 100 for _____

Valuation of horse, \$ 100

Valuation of horse equipments, \$ 100

Remarks : _____

* First current roll. No muster-in roll of this company on file.

Book mark : _____

J. Nelson

(358b)

Copyist.

27 | 8 H. Art'y. | U.S.C.T.

Dunk Wood

Co. F, 8 Reg't U. S. Col'd H. Art'y.

Appears on

Company Muster Roll

for *July & Aug*, 186 —

Present or absent *Present*

Stoppage, \$ 100 for

Due Gov't, \$ 100 for

Valuation of horse, \$ 100

Valuation of horse equipments, \$ 100

Remarks:

Book mark:

J. Nelson
Copyist.

91

S H. Art'y.

U.S.C.T.

Quint Wood

Co. F, 8 Reg't U. S. Col'd H. Art'y.

Appears on

Company Muster Roll

for *Sept & Oct*, 186*4*.

Present or absent *present*

Stoppage, \$ *100* for

Due Gov't, \$ *100* for

Valuation of horse, \$ *100*

Valuation of horse equipments, \$ *100*

Remarks:

Book mark:

(358)

J. Wilson

Copyist.

W

8 H. Art'y. U.S.C.T.

Dunk Wood

Co., Co. F, 8 Reg't U. S. Col'd H. Art'y.

Appears on

Company Muster Roll

for *Nov + Dec*, 186*4*

Present or absent *Present*

Stoppage, \$ *100* for

Due Gov't, \$ *100* for

Valuation of horse, \$ *100*

Valuation of horse equipments, \$ *100*

Remarks:

Book mark: -----

J. Nelson
(358) Copyist.

W

S H. Art'y.

U.S.C.T.

Dunk Wood

Pvt., Co. F, 8 Reg't U. S. Col'd H. Art'y.

Appears on

Company Muster Roll

for Jan & Feb, 1865.

Present or absent Present

Stoppage, \$ 100 for

Due Gov't, \$ 100 for

Valuation of horse, \$ 100

Valuation of horse equipments, \$ 100

Remarks:

Book mark:

G. W. Chase

(358)

Copyist.

W | S H. Art'y. | U.S.C.T.

Dunk Wood

Priv, Co. F, 8 Reg't U. S. Col'd H. Art'y.

Appears on

Company Muster Roll

for *Feb & Apr*, 1865.

Present or absent *Present*

Stoppage, \$ *100* for

Due Gov't, \$ *100* for

Valuation of horse, \$ *100*

Valuation of horse equipments, \$ *100*

Remarks:

Book mark:

G. W. Chase

(358)

Copyist.

W | S H. Art'y. | U.S.C.T.

Dunk Wood

Priv, Co. F, 8 Reg't U. S. Col'd H. Art'y.

Appears on

Company Muster Roll

for *May & June*, 1865.

Present or absent *Present*

Stoppage, \$ *100* for

Due Gov't, \$ *100* for

Valuation of horse, \$ *100*

Valuation of horse equipments, \$ *100*

Remarks:

Book mark:

G. W. Chase

W | S H. Art'y. | U.S.C.T.

Dunk Wood

Priv, Co. F, 8 Reg't U. S. Col'd H. Art'y.

Appears on

Company Muster Roll

for *July & Aug*, 1865.

Present or absent *Present*.

Stoppage, \$ *100* for

Due Gov't, \$ *100* for

Valuation of horse, \$ *100*

Valuation of horse equipments, \$ *100*

Remarks:

Book mark:

G. W. Chase

W

S H. Art'y.

U.S.C.T.

Dunk Woods

Private, Co. F, 8 Reg't U. S. Col'd H. Art'y.

Appears on

Company Muster Roll

for *Sept. & Oct.*, 1865.

Present or absent *Present*

Stoppage, \$ *100* for

Due Gov't, \$ *100* for

Valuation of horse, \$ *100*

Valuation of horse equipments, \$ *100*

Remarks:

Book mark:

Keefe

(358)

Copyist.

W | S H. Art'y. | U.S.C.T.

Dunk Woods

Private, Co. F, 8 Reg't U. S. Col'd H. Art'y.

Appears on

Company Muster Roll

for *Nov. & Dec.*, 186*5*.

Present or absent *Absent*

Stoppage, \$ *100* for

Due Gov't, \$ *100* for

Valuation of horse, \$ *100*

Valuation of horse equipments, \$ *100*

Remarks: *Absent on detached service per S.O. No. 20 Dated Hd. Qrs. Sub-Dist Victoria, Victoria, Tex.*

Book mark: _____

(358)

Keeper

Copyist.

W

S H. Art'y.

U.S.C.T.

Amos Wood

Priv, Co. *F*, 8 Reg't U. S. Col'd H. Art'y.

Appears on Returns as follows:

Nov 4/Dec 1865 absent
On detached service per
A.O. No. 25 Hdqrs Sub
List Victoria Victoria
Feb. Nov. 2/65.

Book mark:

A. D. Patton

(546)

Copyist.

M | S H. Art'y. | U.S.C.T.

Dink Woods

Private, 8 Reg't U. S. Col'd H. Art'y.

Appears on **Co. Muster-out Roll**, dated

Victoria, Texas, Feb. 10, 1866.

Muster-out to date *Feb. 10*, 1866.

Last paid to *Aug 31*, 1865.

Clothing account:

Last settled....., 186 ; drawn since \$..... 100

Due soldier \$..... 100; due U. S. \$ *3* ⁷⁵/₁₀₀

Am't for cloth'g in kind or money adv'd \$..... 100

Due U. S. for arms, equipments, &c., \$..... 100

Bounty paid \$..... 100; due \$..... 100

Remarks *Entered service at organization of Co. as private.*

Book mark *280 P. 245.69*

Age 24

(361)

Kiefer

Copyist.

1942

Woods Horace

Co E, 8 U.S. Col'd H. Art'y.

Private

Private

CARD NUMBERS.

1	5474494	26
2	5474622	27
3	5474755	28
4	5474881	29
5	5475001	30
6	5475122	31
7	5475237	32
8	5475347	33
9	5475445	34
10	5475548	35
11	5475636	36
12	9122324	37
13	40944970	38
14		39
15		40
16		41
17		42
18		43
19		44
20		45
21		46
22		47
23		48
24		49
25		50

Book Mark:

See also

W | 8 H. Art'y. | U.S.C.T.

Horace Woods

Co. E., 8 Reg't U.S. Col'd H. Art'y.

Appears on

Company Descriptive Book
of the organization named above.

DESCRIPTION.

Age 20 years; height 5 feet 4 inches.

Complexion Brown

Eyes Blue; hair Blue

Where born Virginia

Occupation Farmer

ENLISTMENT.

When May 27, 1864

Where Paducah, Ky

By whom Capt. Dunn; term 3 y'rs.

Remarks:

E. A. Moreland

(383g)

Copyist.

W

8 H. Art'y.

U.S.C.T.

Horace Woods

Plk, Co. E, 8 Reg't U. S. Col'd H. Art'y.

Appears on

Company Muster Roll

for *May and June*, 186*4*.

Present or absent *Present*

Stoppage, \$ *100* for

Due Gov't, \$ *100* for

Valuation of horse, \$ *100*

Valuation of horse equipments, \$ *100*

Remarks:

*(Enrolled March 27/64
Mustered at Paducah
Sept 15 for 3 years)*

Book mark:

Jas. r. Kearny

Copyist.

(358)

W

8 H. Art'y.

U.S.C.T.

Horace Wood

W, Co. E, 8 Reg't U. S. Col'd H. Art'y.

Appears on

Company Muster Roll

for *July and Aug*, 1864.

Present or absent *Present*

Stoppage, \$ *100* for

Due Gov't, \$ *100* for

Valuation of horse, \$ *100*

Valuation of horse equipments, \$ *100*

Remarks:

Book mark: -----

Wm. V. Keamy
Copyist.

W

S H. Art'y.

U.S.C.T.

Horace Woods

PK, Co. E, 8 Reg't U. S. Col'd H. Art'y.

Appears on

Company Muster Roll

for *Sept and Oct*, 186*4*.

Present or absent *Present*

Stoppage, \$ 100 for

Due Gov't, \$ 100 for

Valuation of horse, \$ 100

Valuation of horse equipments, \$ 100

Remarks:

Book mark:

(358)

J. V. Keamy
Copyist.

H | 8 H. Art'y. | U.S.C.T.

Horace Woods
Priv., Co. E, 8 Reg't U. S. Col'd H. Art'y.

Appears on

Company Muster Roll
for *Nov. & Dec.*, 186*4*.

Present or absent *Present*

Stoppage, \$..... *100* for

Due Gov't, \$..... *100* for

Valuation of horse, \$..... *100*

Valuation of horse equipments, \$..... *100*

Remarks:
.....
.....
.....
.....
.....
.....
.....

Book mark:

C. E. M. Laughlin
(358) Copyist.

M | 8 H. Art'y. | U.S.C.T.

Horace Woods

Priv., Co. E, 8 Reg't U. S. Col'd H. Art'y.

Appears on

Company Muster Roll

for *Jan. + Feb.*, 186*5*.

Present or absent *Present*

Stoppage, \$ *100* for

Due Gov't, \$ *100* for

Valuation of horse, \$ *100*

Valuation of horse equipments, \$ *100*

Remarks: *Due the U. S.
for one canteen and
Haversack \$1.60*

Book mark: _____

(358)

C. E. M. Laughlin
Copyist.

W

8 H. Art'y.

U.S.C.T.

Horace Woods

Priv., Co. E, 8 Reg't U. S. Col'd H. Art'y.

Appears on

Company Muster Roll

for *Mar. & Apr.*, 1865.

Present or absent *Present*

Stoppage, \$ 100 for

Due Gov't, \$ 100 for

Valuation of horse, \$ 100

Valuation of horse equipments, \$ 100

Remarks: *Due the U.S. for
C. and G.E. \$1 ⁶⁰/₁₀₀*

Book mark: _____

(358)

C. E. M. Laughlin
Copyist.

W

S H. Art'y.

U.S.C.T.

Horace Woods

Priv., Co. E, 8 Reg't U. S. Col'd H. Art'y.

Appears on

Company Muster Roll

for May & June, 1865.

Present or absent Present

Stoppage, \$ 100 for

Due Gov't, \$ 100 for

Valuation of horse, \$ 100

Valuation of horse equipments, \$ 100

Remarks: Due U.S. for
C. & G. E. \$100

Book mark:

C. E. M. Laughlin

(358)

Copist.

Horace Woods

Pvt, Co. E, 8 Reg't U. S. Col'd H. Art'y.

Appears on

Company Muster Roll

for *July & Aug.*, 1865.

Present or absent *Present*

Stoppage, \$ *100* for

Due Gov't, \$ *100* for

Valuation of horse, \$ *100*

Valuation of horse equipments, \$ *100*

Remarks: *Due the U.S. for C & G. \$160.*

Book mark:

E. C. Cannoll

Honore Woods

Plt, Co. E, 8 Reg't U. S. Col'd H. Art'y.

Appears on

Company Muster Roll

for *Sept & Oct*, 1865.

Present or absent *Present*

Stoppage, \$ *100* for

Due Gov't, \$ *100* for

Valuation of horse, \$ *100*

Valuation of horse equipments, \$ *100*

Remarks:

Book mark: *100*

E. Carroll

H

S H. Art'y.

U.S.C.T.

Horace Woods

Plt, Co. E, 8 Reg't U. S. Col'd H. Art'y.

Appears on

Company Muster Roll

for *Nov & Dec*, 1865.

Present or absent *Present*

Stoppage, \$ *100* for

Due Gov't, \$ *100* for

Valuation of horse, \$ *100*

Valuation of horse equipments, \$ *100*

Remarks:

Book mark:

E. B. Carroll

W

8 H. Art'y.

U.S.C.T.

Horace Woods

Priv, Co. *E*, 8 Reg't U. S. Col'd H. Art'y.

Appears on Returns as follows:

June 1864 Transfd from
7 Minn. Infly for
Wm L. Thomas

Sept to Nov 1864 Co Cook

Jan'y to Mch 1863 Co Cook

Book mark :

Chas Patton

(546)

Copyist.

H

S H. Art'y.

U.S.C.T.

*of Horace
Thomas Woods*

Pot, Co. *C*, 8 Reg't U. S. Col'd H. Art'y.

Appears on **Co. Muster-out Roll**, dated

Victoria Texas, *Feb 10*, 1866.

Muster-out to date

Feb 10, 1866.

Last paid to

Aug 31, 1865.

Clothing account:

Last settled....., 186 ; drawn since \$..... 100

Due soldier \$ *33*^{*74*}/₁₀₀; due U. S. \$..... 100

Am't for cloth'g in kind or money adv'd \$..... 100

Due U. S. for arms, equipments, &c., \$..... 100

Bounty paid \$ *None* 100; due \$ *100* 100

Remarks: *Entered Service as recruit*

Joined Co. for duty May 24-64

Enrolled & subject to draft

in 1st Enl. Dist. of Ky. at

time of Enlistment.

Book mark: *1499-1881-*

Age 30

E. Carroll

(861)

Copyist.

1943

Woods Jack

Co B, 8 U.S. Col'd H. Art'y.

Private

Private

CARD NUMBERS.

1	5470035	26
2	5470177	27
3	5470318	28
4	5470446	29
5	5470575	30
6	5470705	31
7	5470827	32
8	5470949	33
9	5471081	34
10	5471177	35
11	5471287	36
12	9121504	37
13	30851849	38
14	30853679	39
15	40544971	40
16		41
17		42
18		43
19		44
20		45
21		46
22		47
23		48
24		49
25		50

Book Mark:

See also

B 637035 P. M. + wa
P. 1974340 P. O. aff
S. 205-1664 P. O. aff

R.P. 752363

S. 2905706 And. N. A

S. 2965359 " "

P.O. misc. N.O. 1117357-5/9/18 - T.H.L.

W

8 H. Art'y.

U.S.C.T.

Jack Woods

Co. *B*, 8 Reg't U.S. Col'd H. Art'y.

Appears on

Company Descriptive Book

of the organization named above.

DESCRIPTION.

Age *20* years; height *5* feet *6* inches.

Complexion *Dark*

Eyes *Dark*; hair *Dark*

Where born *Livingstone, Ky.*

Occupation *Farmer*

ENLISTMENT.

When *June 10*, 186*4*.

Where *Paducah, Ky.*

By whom *W. Brown*; term *3* y'rs.

Remarks:

.....
.....
.....
.....
.....

A. Henderson

W

S H. Art'y.

U.S.C.T.

Jackson Woods
Privt, Co. B, 8 Reg't U. S. Col'd H. Art'y.

Appears on

Company Muster Roll

for *May & June*, 1864.

Present or absent *Present*

Stoppage, \$ *100* for

Due Gov't, \$ *100* for

Valuation of horse, \$ *100*

Valuation of horse equipments, \$ *100*

Remarks:

Compl'd by
at Paducah by
M. J. at Paducah by
James for 3/10/64

Book mark:

J. A. Boyd

(358)

Copyist.

Jackson Woods
Privt., Co. B, 8 Reg't U. S. Col'd H. Art'y.

Appears on

Company Muster Roll

for *July 3rd Aug.*, 1864.

Present or absent

Stoppage, \$ 100 for

Due Gov't, \$ 100 for

Valuation of horse, \$ 100

Valuation of horse equipments, \$ 100

Remarks: *Detached in mtd. service.*

X Name appears in "Present" column concealed by red line.

Book mark:

J. Boyd
Copyist.

N | S. H. Arty **U. S. C. T**

Jackson Woods
Privt, Co. B, 8 Reg't U. S. Col'd H. Arty

Appears on

Company Muster Roll

for Sept and Oct, 1864.

Present or absent Present

Stoppage, \$ 100 for

Due Gov't, \$ 100 for

Valuation of horse, \$ 100

Valuation of horse equipments, \$ 100

Remarks:

Book mark:

(358)

J. A. Boyd

Copyist.

71

S H. Art'y.

U.S.C.T.

Jackson Hiale

Co. B, 8 Reg't U. S. Col'd H. Art'y.

Appears on

Company Muster Roll

for Jan 1st Dec, 1864.

Present or absent Present

Stoppage, \$ 100 for

Due Gov't, \$ 100 for

Valuation of horse, \$ 100

Valuation of horse equipments, \$ 100

Remarks:

Book mark:

(358)

J. Hiale
Copyist.

25

8 H. Art'y.

U.S.C.T.

Jackson Woods

Co. B, 8 Reg't U. S. Col'd H. Art'y.

Appears on

Company Muster Roll

for January 1867, 1867.

Present or absent Present

Stoppage, \$ 100 for

Due Gov't, \$ 100 for

Valuation of horse, \$ 100

Valuation of horse equipments, \$ 100

Remarks:

Book mark:

(358)

J. C. Wood
Copyist.

Jackson Woods

Quir, Co. B, 8 Reg't U. S. Col'd H. Art'y.

Appears on

Company Muster Roll

for *March and April*, 186*5*.

Present or absent *Present*

Stoppage, \$ *100* for

Due Gov't, \$ *100* for

Valuation of horse, \$ *100*

Valuation of horse equipments, \$ *100*

Remarks:

Book mark:

(358)

J. G. Reeves
Copyist.

A 1865 U.S.C.T

Jackson Woods
1st Co. 13, 8 Reg't U. S. Col'd 7th Army

Appears on

Company Muster Roll

for May and June, 1865.

Present or absent absent

Stoppage, \$ 100 for

Due Gov't, \$ 100 for

Valuation of horse, \$ 100

Valuation of horse equipments, \$ 100

Remarks: Sent to U.S. Hospital
New Orleans La June 20
1865

Book mark: _____

(358)

J. G. Brewer
Copyist.

W | 8 Ha | us67

Jack Wood

A, Co. B, 8 Reg't us67 Ha

Appears on

Hospital Muster Roll

of Corps d'Afrique U. S. A. General Hospital,

at New Orleans, La.,

for May & June, 1865.

Attached to hospital:

When, 186 .

How employed

Last paid by Maj.

to, 186 .

Bounty paid \$ 100; due \$ 100

Present or absent Present

Remarks:

Book mark:

M

8 H. Art'y.

U.S.C.T.

Jack Woods

Wt., Co. B, 8 Reg't U. S. Col'd H. Art'y.

Appears on

Company Muster Roll

for *July & Aug.*, 186*5*.

Present or absent *Present*

Stoppage, \$ *100* for

Due Gov't, \$ *100* for

Valuation of horse, \$ *100*

Valuation of horse equipments, \$ *100*

Remarks *sent to hospital at
New Orleans, June 20th 1865*

Book mark:

Paridal

(358)

Copyist.

W. | 826.a. | U.S.A.

Jack Wood
Priv. (Co. B), 8 Reg't U.S.A.

Appears on

Hospital Muster Roll

of **Corps d'Afrique U. S. A. General Hospital,**

at **New Orleans, La.,**

for July & Aug, 1865.

Attached to hospital:

When....., 186 .

How employed.....

Last paid by Maj.

to, 186 .

Bounty paid \$ 100; due \$ 100

Present or absent

Remarks: Returned to duty Aug 7/65.

Book mark:

W | 8 H. Art'y. | U.S.C.T.

Jack Woods

1st Lt., Co. B, 8 Reg't U. S. Col'd H. Art'y.

Appears on

Company Muster Roll

for Sept. & Oct., 1865.

Present or absent Present

Stoppage, \$ 100 for

Due Gov't, \$ 100 for

Valuation of horse, \$ 100

Valuation of horse equipments, \$ 100

Remarks:

Book mark:

(358)

Carroll Copyist.

W | 8 H. Art'y. | U.S.C.T.

Jack Woods

Art., Co. B, 8 Reg't U. S. Col'd H. Art'y.

Appears on

Company Muster Roll

for *Jan. & Dec.*, 1865.

Present or absent *Present*

Stoppage, \$ *100* for

Due Gov't, \$ *100* for

Valuation of horse, \$ *100*

Valuation of horse equipments, \$ *100*

Remarks:

Book mark:

(358)

Randall
Copyist.

W

S H. Art'y.

U.S.C.T.

Woods

Chas, Co. *B*, 8 Reg't U. S. Col'd H. Art'y.

Appears on Returns as follows:

June 1. Aug 1865. absent
sent at No. 10. 2nd
June 20 1865.

Book mark:

Chas Woods

(546)

Copyist.

W | 8 H. Art'y. | U.S.C.T.

Jack Woods
Wgt, Co. B, 8 Reg't U. S. Col'd H. Art'y.

Appears on Co. Muster-out Roll, dated
Victoria, Texas, Feb 10, 1866.
Muster-out to date Feb 10, 1866.
Last paid to Aug 31, 1865.

Clothing account:

Last settled....., 186 ; drawn since \$..... 100

Due soldier \$..... 100; due U. S. \$ 10 ⁵⁰/₁₀₀

Am't for cloth'g in kind or money adv'd \$..... 100

Due U. S. for arms, equipments, &c., \$..... 100

Bounty paid \$..... 100; due \$..... 100

Remarks Entered service as re-
cruit joined Co. for duty
June 10, 1864. Enrolled
and subject to draft in
Enrollment Dist. of Ky. at
time of enlistment.

Book mark:
(Age 20 years)

Randall

Woods Jerry
Co G, 8 U.S. Col'd H. Art'y.

Private Private

CARD NUMBERS.

1	5477099	26
2	547795	27
3	5477290	28
4	5477383	29
5	5477499	30
6	5477633	31
7	5477904	32
8	5478030	33
9	5477787	34
10	9122114	35
11	32156781	36
12	40744972	37
13		38
14		39
15		40
16		41
17		42
18		43
19		44
20		45
21		46
22		47
23		48
24		49
25		50

Book Mark:

See also

Q. | 8 H. Art'y. | U.S.C.T.

Jerry Woods

Co. *G*, 8 Reg't U.S. Col'd H. Art'y.

Appears on

Company Descriptive Book

of the organization named above.

DESCRIPTION.

Age *26* years; height *5* feet *7* inches.

Complexion *Black*

Eyes *Black*; hair *Black*

Where born *Livingston Co., Ky.*

Occupation *Farmer*

ENLISTMENT.

When *May 28*, 1864.

Where *Smithland, Ky.*

By whom *A. N. Shenee*; term *3* y'rs.

Remarks: *Died at Crittenden Genl
Hosp., Louisville, Ky June 60*

E. A. Moreland

(383g)

Copist.

W

S H. Art'y.

U.S.C.T.

Jerry Woods.
Pr, Co. *G*, 8 Reg't U. S. Col'd H. Art'y.

Age _____ years.

Appears on

Company Muster Roll*

for *Enlistment to June 30, 1864.*

Joined for duty and enrolled:

When *May 28*, 1864.

Where *Smithland, Ky*

Period *3* years.

Mustered in:

When *June 6*, 1864.

Where *Paducah, Ky*

Present or absent *present.*

Stoppage, \$ *100* for _____

Due Gov't \$ *100* for _____

Valuation of horse, \$ *100*

Valuation of horse equipments, \$ *100*

Remarks: _____

*First current roll. No muster-in roll of this company on file.

Book mark: _____

E. W. W. W.

(358d)

Copyist.

44

8 H. Art'y.

U.S.C.T.

Jerry Woods

F. W., Co. G, 8 Reg't U. S. Col'd H. Art'y.

Appears on

Company Muster Roll

for July & Aug, 1864.

Present or absent Present.

Stoppage, \$ 100 for

Due Gov't, \$ 100 for

Valuation of horse, \$ 100

Valuation of horse equipments, \$ 100

Remarks:

Book mark:

m. o. chance

Jerry Woods
Co. G, 8 Reg't U. S. Col'd H. Art'y.

Appears on

Company Muster Roll

for Sept & Oct, 1864.

Present or absent Present

Stoppage, \$ 100 for

Due Gov't, \$ 100 for

Valuation of horse, \$ 100

Valuation of horse equipments, \$ 100

Remarks:

Book mark:

C. J. M. Laughlin

24

8 H. Art'y.

U.S.C.T.

Jerry Woods

Pr, Co. G, 8 Reg't U. S. Col'd H. Art'y.

Appears on

Company Muster Roll

for *Nov & Dec*, 186*4*.

Present or absent *Present*

Stoppage, \$ *100* for

Due Gov't, \$ *100* for

Valuation of horse, \$ *100*

Valuation of horse equipments, \$ *100*

Remarks:

Book mark:

A. M. Laughlin

(358)

Copyist.

W | 8 H. Art'y. | U.S.C.T.

Jerry Wood,
Co. G, 8 Reg't U. S. Col'd H. Art'y.

Appears on

Company Muster Roll

for *Jan 1 Feb*, 186*5*.

Present or absent *Present*

Stoppage, \$ 100 for

Due Gov't, \$ 100 for

Valuation of horse, \$ 100

Valuation of horse equipments, \$ 100

Remarks:

Book mark: -----

J. M. Brown

James Books

A, Co. G, 8 Reg't U. S. Col'd H. Art'y.

Appears on

Company Muster Roll

for *James Books*, 186*5*.

Present or absent *Present*

Stoppage, \$ *100* for

Due Gov't, \$ *100* for

Valuation of horse, \$ *100*

Valuation of horse equipments, \$ *100*

Remarks: *Admitted to service*

Admitted to service

Book mark:

W | I.H.A. | U.S.C.A.

Jerry Woods
Pvt, Co. G, 8 Reg't U.S.C.A.

Appears on

Hospital Muster Roll

of U. S. A. Post Hospital,

at Paducah, Ky.,

for Mar + apr, 1865.

Attached to hospital:

When Mch 31, 1865.

How employed patient

Last paid by Maj. Ferris

to Oct 31, 1864.

Bounty paid \$ 100; due \$ 100

Present or absent present

Remarks:

Book mark:

W. Ferris
(343) Copyist.

8 H. Art'y.

U.S.C.T.

James H. ...

W. ..., Co. G, 8 Reg't U. S. Col'd H. Art'y.

Appears on

Company Muster Roll

for *May 1st June*, 186 *5*.

Present or absent *Absent*

Stoppage, \$ *100* for

Due Gov't, \$ *100* for

Valuation of horse, \$ *100*

Valuation of horse equipments, \$ *100*

Remarks:

Book in ...

Padre's ...

1865

Book mark:

...

W

8 H. Art'y.

U.S.C.T.

Jerry Wood

Pl, Co. G, 8 Reg't U. S. Col'd H. Art'y.

Appears on

Company Muster Roll

for *July & Aug*, 186*3*.

Present or absent

Stoppage, \$ *100* for

Due Gov't, \$ *100* for

Valuation of horse, \$ *100*

Valuation of horse equipments, \$ *100*

Remarks: *Wied in Crullender*

Gen Hosp. Louisville Ky

June 21 / 65

Book mark:

[Signature]

W

8 H. Art'y.

U.S.C.T.

Jerry Woods

Priv. Co. G., 8 Reg't U. S. Col'd H. Art'y.

Appears on Returns as follows:

April 1865 to July 1865 absent
sick since April 1865
at Paducah Ky.

Aug 1865. Louisville Ky.
Died

Book mark :

[Signature]

(546)

Copyist.

James Woods
B Co., 8 Reg't U. S. Col'd H. Art'y.

Appears on **Co. Muster-out Roll**, dated
1st Decr, 1861, 1861.

Muster-out to date _____, 1861.

Last paid to *(Oct 31)*, 1861.

Clothing account:

Last settled _____, 1861 ; drawn since \$ _____ 100

Due soldier \$ _____ 100; due U. S. \$ _____ 100

Am't for cloth'g in kind or money adv'd \$ _____ 100

Due U. S. for arms, equipments, &c., \$ _____ 100

Bounty paid \$ _____ 100; due \$ _____ 100

Remarks: *Out of service a*
few days in winter
generally in camp
21, 1861, in Fort Mifflin
Terre Haute Ky. (arrived)
about Jan 1st, 1862

Book mark: *V 1118 P 109 12*
V 1110 P 204 12

(861) _____ Copyist.

Hood, Jerry

Co.

9 8

Reg't

U.S.C.H.A.

3

Enclosures.

Bed Cards	Descriptive Lists
Burial Records... /	Final Statements
Certs. of Dis. for Discharge	Furloughs
C. M. Charges	Med. Des. Lists
Med. Certificates	Orders

Other papers relating to—

Admission to Hosp'l	Furlough
Casualty Sheet (Officer's)	Med. Examination
Confinement	Misc. Information
Contracts	Pay or Clothing
Death or Effects	Personal Reports
Desertions	Rank
Discharge from Hosp'l	Transfer to Hosp'l
Discharge from Service	Transfer to V. R. C.
Duty	Transportation

ARTICLES OF WAR.

ART. 95. When any non-commissioned officer or soldier shall die, or be killed in the service of the United States, the then commanding officer of the troop or company shall, in the presence of two other commissioned officers, take an account of what effects he died possessed of, above his arms and accoutrements, and transmit the same to the office of the Department of War, which said effects are to be accounted for, and paid to the representatives of such deceased non-commissioned officer or soldier. And in case any of the officers, so authorized to take care of the effects of deceased officers and soldiers, should, before they have accounted to their representatives for the same, have occasion to leave the regiment or post, by preferment or otherwise, they shall, before they be permitted to quit the same, deposit in the hands of the commanding officer, or of the assistant military agent, all the effects of such deceased non-commissioned officers and soldiers, in order that the same may be secured for, and paid to, their respective representatives.

ARMY REGULATIONS—EDITION OF 1861.

DECEASED SOLDIERS.

Par. 152. Inventories of the effects of deceased non-commissioned officers and soldiers, required by the 95th Article of War, will be forwarded to the Adjutant General, by the commander of the company to which the deceased belonged, and a duplicate of the same to the colonel of the regiment. Final statements of pay, clothing, &c., will be sent with the inventories. When a soldier dies at a post or station absent from his company, it will be the duty of his immediate commander to furnish the required inventory, and, at the same time, to forward to the commanding officer of the company to which the soldier belonged, a report of his death, specifying the date, place, and cause; to what time he was last paid, and the money and other effects in his possession at the time of his decease; which report will be noted on the next muster roll of the company to which the man belonged. Each inventory will be endorsed, "Inventory of the effects of _____, late of company (—) _____ regiment of _____, who died at _____, the _____ day of _____, 186—." If a legal representative receive the effects, it will be stated in the report. If the soldier leave no effects, the fact will be reported.

Par. 153. Should the effects of a deceased non-commissioned officer or soldier not be administered upon within a short period after his decease, they shall be disposed of by a Council of Administration, under the authority of the commanding officer of the post, and the proceeds deposited with the Paymaster, to the credit of the United States, until they shall be claimed by the legal representatives of the deceased.

Par. 154. In all such cases of sales by the Council of Administration, a statement in detail, or account of the proceeds, duly certified by the Council and commanding officer, accompanied by the Paymaster's receipt for the proceeds, will be forwarded by the commanding officer to the Adjutant General. The statement will be endorsed, "Report of the proceeds of the effects of _____, late of company (—) _____ regiment of _____, who died at _____, the _____ day of _____, 186—."

NOTE 1.—The effects in all cases, when called for, should be turned over to the legal representative, without further authority from the Adjutant General. When the effects are turned over to the relatives of the deceased before these inventories are sent to the Adjutant General, their receipts therefor should be attached to the inventories. In all other cases, one copy will be sent with a letter of transmittal direct to the Adjutant General, and a duplicate retained by the officer.

NOTE 2.—Particular care should be taken to take receipts in duplicate from the Paymaster for any funds turned over to him; one copy should be sent direct to the Adjutant General and one retained by the officer.

INVENTORY OF THE EFFECTS

OF

Jerry Wood

Late of Company *F*

8 Reg't of *Reg'tal Artillery*

Volunteers, who died at *Louisville*

on the *21* day of *March* 186*5*.

Inventory of the effects of *Serry Wood* late
 a *Private* of Captain *X* Company *S* of
 the *8* Regiment of *U.S. Artillery* Volunteers, who was enrolled as
 a *X* at *X* in the State of *X* on
 the *X* day of *X* 186*X*, and mustered into the service of the United
 States as a *X* on the *X* day of *X* 186*X*, at *X*
 in Company *X*, *X* Regiment of *X* Volunteers, to serve *X*
 years or during the war; he was born in *X* in the State
 of *X*; he was *X* years of age, *X* feet *X* inches
 high, *X* complexion, *X* eyes, *X* hair, and by occupation, when enrolled,
 a *X*; he died in *Leitchfield U.S. Genl Hospital* at
Louisville Ky on the *21* day of *June* 186*5*, by
 reason of *Dysentery*

INVENTORY					
ARTICLES.	No.	ARTICLES.	No.	ARTICLES.	No.
Hats.....		Pairs trousers.....		Knapsacks.....	1
Caps.....		Pairs flannel drawers.....			
Forage caps.....		Pairs cotton drawers.....			
Great coats.....	1	Flannel shirts.....	2		
Uniform coats.....		Cotton shirts.....			
Uniform jackets.....		Pairs boots.....			
Flannel sack coats.....		Pairs shoes.....			
Blouses.....		Pairs socks.....			
Stable frocks.....		Blankets.....			
Fatigue overalls.....		Haversacks.....			
				MONEY.	
				Specie.....	\$
				Notes.....	\$

I CERTIFY, ON HONOR, that the above inventory comprises all the effects of *Private*
Serry Wood, deceased, and that the effects are in the hands
 of *Surgeon R. H. Taylor* at *Leitchfield U.S. Genl Hospital*
Louisville Ky to be disposed of by a Council of Administration.

(DUPLICATES.)

R. H. Taylor

STATION: *Louisville Ky*

Commanding the Company.

DATE: *June 21, 1865*

I Complete
Ledger
Jerry Wood
L.S. 8th 21. S. C. A. (X)
Lead June 21st 1865

As per
...
...
...
...
... 2, 1, 1865

Acq. Dec. 15th 1865,
Pro. of A. of an & P. M. act
for \$1.25 and 20 Acridors,
23.

No. 2.

RECORD OF DEATH AND INTERMENT.

Name and number of person interred.	<i>Qury Ward</i>
Number and locality of the grave . . .	<i>Range 38 Grave 6</i>
Hospital number of the deceased . . .	<i>3040</i>
Regiment, rank, and company . . .	<i>8" Ind. Cal. Co. G.</i>
Residence before enlistment . . .	<i>Smithland Ky.</i>
Conjugal condition, (and if married, } the residence of the widow) . . . }	<i>Single Anna Ward Smithland Ky.</i>
Cause of death }	<i>Verofula</i>
Age of the deceased	<i>Seventeen (17)</i>
Nativity	<i>Kentucky</i>
References and remarks }	
Date of death and burial	<i>June 21 " , 1865.</i>

[A duplicate of this Record has been forwarded to the Sexton, and another remains at this Hospital.]

To *Capt. W. M. Tucker A. M.*

SIR:

It becomes my duty to inform you that the person above described died at this Hospital as herein stated; and that it is desired his remains should be interred with the usual military honors.

Respectfully,

R. R. Taylor *Col*
Surgeon U. S. Army.

Dr. Wm. L. ...
MILITARY HOSPITAL, *Louisville Ky. June 21/65*

This copy of Record is to be transmitted to the Adjutant General at Washington immediately after the place of burial and the number of the grave have been ascertained and registered. The above notification is to remain attached.

REPORT
OF THE
PROCEEDS of the EFFECTS

OF
Wood Perry
LATE OF
Co. G, 8 W.S.C.A.

WHO DIED AT

Crittenden Hospital.

LOUISVILLE, KY.,

the *21* day of *June* 1865

PROCEEDINGS OF A COUNCIL OF ADMINISTRATION.

Convened at Louisville, Kentucky, pursuant to Special Orders, No. 187, dated Post Headquarters, Louisville, Ky., ^{Sept 16} Aug. 14, 1865, consisting of Capt F. Dame, 72nd U. S. C. Inf., 1st Lt. J. L. Erwin, 72nd U. S. C. Inf., and 1st Lt. Basil R. Ball, 135th U. S. C. Inf., for the purpose of disposing of the effects of late... of Company G... Regiment... U. S. C. H. A. Volunteer...

The Council found the effects consisted of the following articles. They were ordered to be sold at auction, which was accordingly done, and the amount set opposite the articles respectively obtained, for which the receipt of the Paymaster is annexed.

AT AUCTION.

- 1 Great coat, brought, \$
- Uniform coat, ,, 125-
- Flannel sack coat, ,,
- Trousers, pairs, ,,
- 2 Shirts, ,,
- Drawers, pairs ,,
- Socks, ,, ,,
- Shoes, ,, ,,
- Boots, ,, ,,
- Wool blanket, ,,
- Rubber ,, ,,
- 1 Knapsack ,,
- Haversack, ,,
- Canteen, ,,

All sold in one lot

\$ 1.25

Capt. 72nd Regt. U. S. C. Inf., President.

J. D. Kennedy
vice (Pres)

Capt W. J. Wood
1st Lt. 135th Regt. U. S. C. Inf., Recorder.

APPROVED
Raymond
Colonel, Commanding Post.

PAYMASTERS RECEIPT.

RECEIVED from Capt. F. Dame, 72nd Regt. U. S. C. Inf., at Louisville, Ky., October 24, 1865... One Dollar and twenty five cents the result of the sale of the late... of Company G... Regiment... Volunteers...

Jerry Wood
W. M. Knapp
PAYMASTER, UNITED STATES ARMY.

1943
Woods Kinchen

Co L, 8 U.S. Col'd H. Art'y.

Private | Private

CARD NUMBERS.

1	5467438	26
2	5467374	27
3	5482498	28
4	5482606	29
5	5482712	30
6	5483251	31
7	9122886	32
8		33
9		34
10		35
11		36
12		37
13		38
14		39
15		40
16		41
17		42
18		43
19		44
20		45
21		46
22		47
23		48
24		49
25		50

Book Mark: _____

See also _____

24 | 8 H. Art'y. | U.S.C.T.

Hinchen Woods

....., Co. *L*, 8 Reg't U.S. Col'd H. Art'y.

Appears on

Company Descriptive Book

of the organization named above.

DESCRIPTION.

Age *46* years; height *5* feet *5 1/2* inches.

Complexion *Black*

Eyes *Black*; hair *Black*

Where born *Livingston, Ky.*

Occupation *Farmer*

ENLISTMENT.

When *Oct. 13*, 186*4*.

Where *Paducah, Ky.*

By whom *Capt. Morgan*; term *3* y'rs.

Remarks: *Died at Reg'tl Hos-
pital at Paducah, Ky.
Feb'y 15th 1865.*

(383a)

Keifer

Copyist.

Hinchen Woods

Appears with rank of *Private* on

Muster and Descriptive Roll of a Detachment of U. S. Vols. forwarded

for the 8 Reg't U. S. Col'd H. Art'y. Roll dated *Paducah Ky., N.Y. (Oct. 31), 1864.*

Where born *Ky.*

Age *46* y'rs; occupation *Farmer*

When enlisted *Oct. 13*, 186 .

Where enlisted *Paducah Ky.*

For what period enlisted *3* years.

Eyes *Black*; hair *Black*

Complexion *Black*; height *5* ft. *4 1/2* in.

When mustered in *Oct. 13*, 186 .

Where mustered in *Paducah.*

Bounty paid \$ *100*; due \$ *100*

Where credited *1st Co. Dist. of Ky.*

Company to which assigned *Livingston Co*

Remarks :

Book mark :

Waggett

M | 8 H. Art'y. | U.S.C.T.

Kircher Woods

Appears with rank of *Pri* on

Muster and Descriptive Roll of a Detachment of U. S. Vols. forwarded

for the 8 Reg't U. S. Col'd H. Art'y. Roll dated

Pamunah N.Y. Oct 31, 1864

Where born *N.Y.*

Age *46* y'rs; occupation *Farmer*

When enlisted *Oct 13, 1864*

Where enlisted *Pamunah N.Y.*

For what period enlisted *3* years.

Eyes *blk*; hair *blk*

Complexion *blk*; height *5 ft. 5 in.*

When mustered in *Oct 13, 1864*

Where mustered in *Pamunah*

Bounty paid \$ *100*; due \$ *100*

Where credited *Livingston Co. 1st Long Dis. N.Y.*

Company to which assigned

Remarks:

Book mark:

Murray, Jr.
Copyist.

21 | 8 H. Art'y. | U.S.C.T.

Winchell Woods
Co. L, 8 Reg't U. S. Col'd H. Art'y.

Age _____ years.

Appears on

Company Muster Roll*

for *To Oct. 31*, 186*4*.

Joined for duty and enrolled:

When *Oct. 13*, 186*4*.

Where *Paducah, Ky.*

Period *3* years.

Mustered in:

When *Oct. 13*, 186*4*.

Where *Paducah, Ky.*

Present or absent *Present*

Stoppage, \$ *100* for _____

Due Gov't \$ *100* for _____

Valuation of horse, \$ *100*

Valuation of horse equipments, \$ *100*

Remarks: _____

*First current roll. No muster-in roll of this company on file.

Book mark: _____

Brooks
Coptist.

(558d)

94

8 H. Art'y.

U.S.C.T.

Kincher Wood
Pvt., Co. L, 8 Reg't U. S. Col'd Heavy Art'y.

Appears on

Company Muster Roll

for *Nov & Dec*, 1864

Present or absent *Present*

Stoppage, \$ *100* for

Due Gov't, \$ *100* for

Valuation of horse, \$ *100*

Valuation of horse equipments, \$ *100*

Remarks:

Book mark:

Brooks

(358)

Copyist.

W

S H. Art'y.

U.S.C.T.

Kirchner Woods

Art., Co. L, 8 Reg't U. S. Col'd Heavy Art'y.

Appears on

Company Muster Roll

for *Oct. 31, 1864 to Feb. 28, 1865*.

Present or absent.....

Stoppage, \$..... 100 for.....

Due Gov't, \$..... 100 for.....

Valuation of horse, \$..... 100

Valuation of horse equipments. \$..... 100

Remarks: *Die d in Regimental Hospital at Paducah Ky. Feb. 15th, 1865.*

Book mark: *2d. Ind. 10836 June 9, 68.*

Brooks

(358)

Copyist.

W

S H. Art'y.

U.S.C.T.

Fincham Woods

Pat., Co. *L*, 8 Reg't U. S. Col'd H. Art'y.

Appears on **Co. Muster-out Roll**, dated *Victoria, Texas, July 10,* 1866.

Muster-out to date _____, 186 .

Last paid to *Oct 31*, 1864 .

Clothing account:

Last settled _____, 186 ; drawn since \$ _____ 100

Due soldier \$ _____ 100; due U. S. \$ _____ 100

Am't for cloth'g in kind or money adv'd \$ _____ 100

Due U. S. for arms, equipments, &c., \$ _____ 100

Bounty paid \$ _____ 100; due \$ _____ 100

Remarks *Entered service at organization as herein shown. Died at Paducah Ky. July 15/65 of Pneumonia. Inventories of Effects & Final Statements forwarded July 15/65.*

Book mark: *2 Aud 10836 June 9/68. P. 121. P. 94. 71. U. 232. P. 191. 76.*

(361)

J. L. Norris

Copyist.

Hoods, Kinchen

B, Co. L, 8

Reg't U.S.C.H.A.

5 Enclosures.

Bed Cards	Descriptive Lists
Burial Records	Final Statements 2
Certs. of Dis. for Discharge	Furloughs
C. M. Charges	Med. Des. Lists
Med. Certificates	Orders

Enlistments

2

Other papers relating to—

Admission to Hosp'l	Furlough
Casualty Sheet (Officer's)	Med. Examination
Confinement	Misc. Information
Contracts	Pay or Clothing
Death or Effects 1	Personal Reports
Desertions	Rank
Discharge from Hosp'l	Transfer to Hosp'l
Discharge from Service	Transfer to V. R. C.
Duty	Transportation

~~X #~~

No. *Sixty one*

Kincen Woods

Volunteered at *Paducah Ky*

October 13 18 *64*

By *George A Morgan*

Prov Mar 1st

James

[Signature]

JUL 15 1871

Consent of Parent or Guardian in case of a Minor, or in the case of a Slave, of the Person to whom he owes Service:

I, Do CERTIFY, That I am

ments of United States colored troops. They will be made out in duplicate in all cases
utant General, and one to accompany the accounts of the officer who pays bounty, &c.
A muster-in, must in all cases, precede payment of pay, bounty, pension, &c. A
muster-in, must in all cases, precede payment of pay, bounty, pension, &c. A
mustering officer, commissary, or assistant commissary of musters, as the case may be
before either of them is given to the disbursing officer.

UNITED STATES COLORED TROOPS ENLISTMENT.

STATE OF

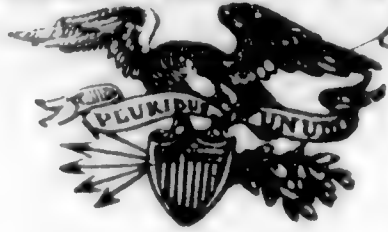

credited to

TOWN OF

Kentucky

*Livingston Co
Paducah*

I, *Kimchen Woods* born in

in the State of *Kentucky* aged *Forty Six* years

and by occupation a *Farmer* Do HEREBY ACKNOWLEDGE to have
volunteered this *Thirtieth* day of *October* 186*4*

to serve as a **Soldier** in the **Army of the United States of America**, for
the period of **THREE YEARS**, unless sooner discharged by proper authority:

Do also agree to accept such bounty, pay, rations, and clothing, as are, or may be,
established by law for the U. S. colored troops.

And I, *Kimchen Woods of Livingston Co*
do solemnly swear, that I will bear true faith and allegiance to the **United States
of America**, and that I will serve them honestly and faithfully against all their
enemies or opposers whomsoever; and that I will observe and obey the orders of
the President of the United States, and the orders of the officers appointed over
me, according to the Rules and Articles of War.

Sworn and subscribed to, at *Paducah Ky*
this *13* day of *October* 186*4* *Kimchen Woods*
mark

Before *J. H. Morgan*
Capt & Comm. 1st Dist. Ky

I CERTIFY, ON HONOR, That I have carefully examined the above named Volunteer, agreeably to the
General Regulations of the Army, and that, in my opinion, he is free from all bodily defects and mental infirmity,
which would in any way disqualify him from performing the duties of a soldier.

W. H. Seidel

EXAMINING SURGEON.

I CERTIFY, ON HONOR, That I have minutely inspected the Volunteer, *Kimchen Woods*
previously to his enlistment, and that he was entirely sober when enlisted; that, to the best of my judgment and
belief, he is of lawful age; and that, in accepting him as duly qualified to perform the duties of an able-bodied
soldier, I have strictly observed the regulations which govern the recruiting service. This soldier has *Black*
eyes, *Blue* hair, *Dark* complexion, is *2* feet *5 1/2* inches high.

RECRUITING OFFICER OR AGENT.

Mustered into the United States service *Thirtieth* day of *October* 186*4*

J. H. Morgan
Capt & Comm. 1st Dist. Ky
Mustering Officer.
per Dist. of Ky

Mustered into the service of the United States, for three years or during the war, from date of enlistment, in Company *B*
Regiment of *1st Colored Regt. Volunteers*, on the *13* day of *October*, 186*4*, at *Paducah*

J. H. Morgan
Capt & Comm. 1st Dist. Ky
per Dist. of Ky

NOTE 1.—This blank will be used for enlistments of United States colored troops. They will be made out in duplicate in all cases—one to accompany the recruiting return of the superintendent (not the recruiting officer) to the Adjutant General, and one to accompany the accounts of the officer who pays bounty. &c.

NOTE 2.—An enlistment holds to service. A muster-in, must in all cases, precede payment of pay, bounty, pension, &c. A muster-in roll, must in all cases, be filed in the Adjutant General's Office as evidence of muster-in. The mustering officer, commissary, or assistant commissary of musters, as the case may be, will countersign both enlistments as having mustered the soldier into the service of the United States before either of them is given to the disbursing officer.

DECLARATION OF RECRUIT.

I, *Kinchen Woods of Swinerton Co. Ky.* desiring to volunteer as a soldier in the ARMY OF THE UNITED STATES, for the term of *Three Years*, DO DECLARE That I am *Forty Six* years and *—* months of age; that I have never been discharged from the United States service on account of disability or by sentence of a court-martial, or by order before the expiration of a term of enlistment; and I know of no impediment to my serving honestly and faithfully as a soldier for three years.

GIVEN at *Caducah Ky.* the *13* day of *October 1864*

Witness: *H. J. Brown*

Kinchen Woods
his mark
Kinchen Woods
Volunteered at *Caducah Ky.*
October 13 1864
By *Cooper A. Morgan*
Capt. Major 1st Mass Col.

1864
OCT
13

X #4

Consent of Parent or Guardian in case of a Minor, if a Free Man, or in the case of a Slave, of the Person to whom he owes Service :

I, Do CERTIFY, That I am the that the said is years of age; and I do freely give my CONSENT to his volunteering as a SOLDIER in the Army of the United States, for the period of THREE YEARS, under the conditions of the laws of the United States.

GIVEN at the day of

Witness:

44

No. *Sixty one*

Richard Woods

Volunteered at *Paducah Ky*

October 13 18 *64*

By *L. H. Morgan*
Capt & Prov. Marshal Dist. of Ky

Woods

Consent of Parent or Guardian in case of a Minor, if a Free Man, or in the case of a Slave of the Person to whom...

United States colored troops. They will be made out in duplicate in all cases... and one to accompany the accounts of the officer who pays bounty, &c. A... in, must in all cases, precede payment of pay, bounty, pension, &c. A... officer, commissary, or assistant commissary of musters, as the case may be, of them is given to the disbursing officer.

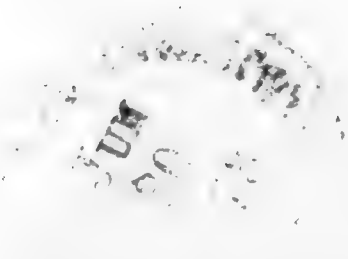

UNITED STATES COLORED TROOPS ENLISTMENT.

STATE OF

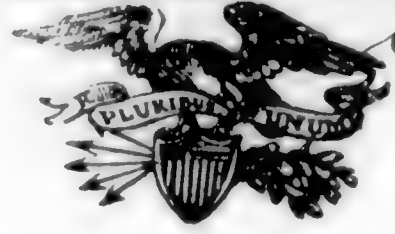

TOWN OF

Kentucky

Credited to
Wm G Livingston
Indiana

I, *Kinchen Woods* born in

in the State of *Kentucky* aged *Forty six* years

and by occupation a *Farmer* Do HEREBY ACKNOWLEDGE to have
volunteered this *Thirtieth* day of *October* 186*4*

to serve as a **Soldier** in the **Army of the United States of America**, for
the period of **THREE YEARS**, unless sooner discharged by proper authority:
Do also agree to accept such bounty, pay, rations, and clothing, as are, or may be,
established by law for the U. S. colored troops.

And I, *Kinchen Woods of Livingston Co*

do solemnly swear, that I will bear true faith and allegiance to the **United States
of America**, and that I will serve them honestly and faithfully against all their
enemies or opposers whomsoever; and that I will observe and obey the orders of
the President of the United States, and the orders of the officers appointed over
me, according to the Rules and Articles of War.

Sworn and subscribed to, at *Buducott Ky*

this *13* day of *October* 186*4* of *Kinchen Woods* ^{his} mark

Before *J. H. Morgan*
Capt & Prov. Mar. 1st Dist of Ky

I CERTIFY, ON HONOR, That I have carefully examined the above named Volunteer, agreeably to the
General Regulations of the Army, and that, in my opinion, he is free from all bodily defects and mental infirmity,
which would in any way disqualify him from performing the duties of a soldier.

M. H. Kidd

EXAMINING SURGEON.

I CERTIFY, ON HONOR, That I have minutely inspected the Volunteer, *Kinchen Woods*
previously to his enlistment, and that he was entirely sober when enlisted; that, to the best of my judgment and
belief, he is of lawful age; and that, in accepting him as duly qualified to perform the duties of an able-bodied
soldier, I have strictly observed the regulations which govern the recruiting service. This soldier has *Black*
eyes, *Black* hair, *Black* complexion, is *5* feet *5 1/2* inches high.

RECRUITING OFFICER OR AGENT.

Mustered into the United States service *Thirtieth* day of *October* 186*4*

J. H. Morgan
Capt & Prov. Mar. 1st Dist of Ky
Mustering Officer.

1st Dist of Ky

Mustered into the service of the United States, for three years or during the war, from date of enlistment, in Company *A* of *24th* Regiment of *Volunteer* on the *13* day of *October* 186*4* at *Buducott Ky*

J. H. Morgan
Capt & Prov. Mar. 1st Dist of Ky

NOTE 1.—This blank will be used for enlistments of United States colored troops. They will be made out in duplicate in all cases—one to accompany the recruiting return of the superintendent (not the recruiting officer) to the Adjutant General, and one to accompany the accounts of the officer who pays bounty, &c.

NOTE 2.—An enlistment holds to service. A muster-in, must in all cases, precede payment of pay, bounty, pension, &c. A muster-in roll, must in all cases, be filed in the Adjutant General's Office as evidence of muster-in. The mustering officer, commissary, or assistant commissary of musters, as the case may be, will countersign both enlistments as having mustered the soldier into the service of the United States before either of them is given to the disbursing officer.

DECLARATION OF RECRUIT.

I, Kinchen Woods of Livingston Co. N.Y. desiring to volunteer as a soldier in the ARMY OF THE UNITED STATES, for the term of Three Years, DO DECLARE That I am Forty Six years and months of age; that I have never been discharged from the United States service on account of disability or by sentence of a court-martial, or by order before the expiration of a term of enlistment; and I know of no impediment to my serving honestly and faithfully as a soldier for three years.

GIVEN at Pardons, N.Y.

the 13 day of October 1864

Witness: A. J. Lynn

Kinchen Woods
No. Sixty one
Kinchen Woods
Volunteer of St. Lawrence
October 13 1864
By: W. H. Morgan
Adj. Gen. New York

Consent of Parent or Guardian in case of a Minor, if a Free Man, or in the case of a Slave, of the Person to whom he owes Service:

I, Do CERTIFY, That I am the that the said is years of age; and I do freely give my CONSENT to his volunteering as a SOLDIER in the Army of the United States, for the period of THREE YEARS, under the conditions of the laws of the United States.

GIVEN at

the day of

Witness:

1

v

C. D.

FINAL STATEMENT

OF

Private Kinchen Woods

8th Reg't of U.S. Col. (Heavy)

~~VOLUNTEERS~~
Company

NOTE 1.—Two of these certificates (or duplicates) are to be given to each Volunteer Soldier or drafted man who may be discharged previously to the discharge of his company, that he may at once receive from the Paymaster the pay, &c., due him, and the captain or other COMMISSIONED officer commanding the company will certify to the act of the delivery of the duplicate certificates; on these certificates the Soldier is "entitled to" his *discharge*, and should also present his discharge to the Paymaster to have the payment endorsed on it. The discharge is to be given back to the Soldier by the Paymaster; the latter only retaining as his voucher the duplicate certificates.

NOTE 2.—If the Soldier is entitled to pay for the use of his horse, the Company Commander will certify to that fact on the back of both these final statements, and also to the time he has pay due for having been so mounted on his own horse.

NOTE 3.—When a Soldier is furnished with final statements, his descriptive list, if he has one, should be taken up by the officer who gives the Soldier these statements, and endorsed with a statement to this effect by the officer. This endorsement should exhibit a full statement of the time for which the Soldier was allowed pay on his final statements, the clothing account, and all other charges against him or in his favor, so as to comprise a complete exhibit of his account. It will then be transmitted to the Company Commander of the Soldier, who will enter all the data necessary to a full understanding of the Soldier's account on the muster roll upon which the Soldier's discharge is reported. The descriptive list will then be destroyed. The object of this is, that the remaining portion of the Soldier's account may be settled upon the receipt of these muster rolls, and the Soldier receive any pay or allowances that may be due him at the time of his discharge, and which may not appear on his final statements from the fact that his descriptive list is incomplete. These accounts for back pay, &c., are settled by the 2d Auditor of the Treasury Department.

NOTE 4.—Charges for loss or injury to ordnance, horse equipments, and other miscellaneous charges, should appear under the heading of "Other Stoppages."

NOTE 5.—Bounty paid by State authorities, and not by the United States, will not be entered on this statement.

NOTE 6.—Amounts due the Sutler and Laundress must be entered on the muster roll on which the discharge, death, desertion, &c., is reported, as well as on the final statement, otherwise the amount cannot be collected from the United States.

NOTE 7.—This blank will be used for deceased volunteers and drafted men, as well as for others.

NOTE 8.—Where a Soldier dies in Hospital or on detached service, his descriptive list, if he has one, should be sent with his final statements, in duplicate, to the Adjutant General, Washington, D. C.

ADJUTANT GENERAL'S OFFICE

Nov 16th 1865.

Duplicate with Inventory sent 2d Auditor.

I certify, on honor, that Private Kitchen Woods a member of Captain M. W. Kennedy's Company (Co.) of the 8th Regiment of U.S. Army (Heavy) **VOLUNTEERS**, of the State of Kentucky, born in Sarlington Co., State of Kentucky, aged 46 years; 5 feet 5 1/2 inches high; Black complexion, Black eyes, Black hair, and by occupation a Farmer, having joined the company on its original organization at Paducah Kentucky, and enrolled in it at the muster into the service of the United States at Paducah Ky., on the Thirteenth day of October, 1864, (or was mustered in service as a recruit, by Capt. John H. Morgan, at Paducah, on the 19th day of October, 1864, or was drafted and mustered into the service of the United States from the

~~Enrollment District of the State of~~ at ~~on the~~ day of ~~186~~ 186,) to serve in the Regiment, for

the term of Three Years: and having served **HONESTLY** and **FAITHFULLY** with his Company in 8th Reg't U.S.A. to the present date, is now

entitled to a **DISCHARGE** by reason of Death at Regimental Hospital Paducah Ky on the 15th day of Feb'y 1865 of

Pneumonia. The said Kitchen Woods was last paid by Paymaster Hemo to include the 31st day of October 1864, to include the day of 186, and has

pay due him from that time to the present date; he is entitled to pay and subsistence for **TRAVELING** to place of enrollment, and whatever other allowances are authorized to volunteer soldiers, drafted men, or militia, so discharged. He has received from the United States **CLOTHING** amounting to \$42.29 100 dollars, since the date of his enlistment, 186, when his clothing account was last settled. He has received from the United States 100 dollars advanced **BOUNTY**.

There is to be stopped from him, on account of the State of _____, or other authorities, for **CLOTHING**, &c., received on entering service, _____ dollars; and for other stoppages, viz: _____

_____ dollars.

He has been furnished with **TRANSPORTATION** in kind from the place of his discharge to _____; and he has been **SUBSISTED** for **TRAVELING** to his place of enrollment, up to the _____, 186.

He is indebted to _____, **SUTLER**, _____ dollars.

He is indebted to _____, **LAUNDRESS**, _____ dollars.

Given in Duplicate, at Paducah - Kentucky, this 5th day of February, 1865.

M. W. Kennedy

1st Lieutenant

Commanding Company.

FINAL STATEMENT

OF

Private Kirchen Woods

8th Reg't of U.S. Col'd Art'y (Heavy)

VOLUNTEERS.

NOTE 1.—Two of these certificates (or duplicates) are to be given to each Volunteer Soldier or drafted man who may be discharged previously to the discharge of his company, that he may at once receive from the Paymaster the pay, &c., due him, and the captain or other COMMISSIONED officer commanding the company will certify to the act of the delivery of the duplicate certificates; on these certificates the Soldier is "entitled to" his discharge, and should also present his discharge to the Paymaster to have the payment endorsed on it. The discharge is to be given back to the Soldier by the Paymaster; the latter only retaining as his voucher the duplicate certificates.

NOTE 2.—If the Soldier is entitled to pay for the use of his horse, the Company Commander will certify to that fact on the back of both these final statements, and also to the time he has pay due for having been so mounted on his own horse.

NOTE 3.—When a Soldier is furnished with final statements, his descriptive list, if he has one, should be taken up by the officer who gives the Soldier these statements, and endorsed with a statement to this effect by the officer. This endorsement should exhibit a full statement of the time for which the Soldier was allowed pay on his final statements, the clothing account, and all other charges against him or in his favor, so as to comprise a complete exhibit of his account. It will then be transmitted to the Company Commander of the Soldier, who will enter all the data necessary to a full understanding of the Soldier's account on the muster roll upon which the Soldier's discharge is reported. The descriptive list will then be destroyed. The object of this is, that the remaining portion of the Soldier's account may be settled upon the receipt of these muster rolls, and the Soldier receive any pay or allowances that may be due him at the time of his discharge, and which may not appear on his final statements from the fact that his descriptive list is incomplete. These accounts for back pay, &c., are settled by the 2d Auditor of the Treasury Department.

NOTE 4.—Charges for loss or injury to ordnance, horse equipments, and other miscellaneous charges, should appear under the heading of "Other Stoppages."

NOTE 5.—Bounty paid by State authorities, and not by the United States, will not be entered on this statement.

NOTE 6.—Amounts due the Sutler and Laundress must be entered on the muster roll on which the discharge, death, desertion, &c., is reported, as well as on the final statement, otherwise the amount cannot be collected from the United States.

NOTE 7.—This blank will be used for deceased volunteers and drafted men, as well as for others.

NOTE 8.—Where a Soldier dies in Hospital or on detached service, his descriptive list, if he has one, should be sent with his final statements, in duplicate, to the Adjutant General, Washington, D. C.

RECEIVED
1861
JULY

I certify, on honor, that Private Kinchen Woods a member of
 Lieut. M. W. Kennedy's Company (2nd) of the 8th Regiment of U.S. Artillery
~~VOLUNTEERS~~, of the State of Kentucky, born in Springton Co., State
 of Kentucky, aged 46 years; 5 feet 5 inches high; Black complexion,
Black eyes, Black hair, and by occupation a Farmer, having joined the company on
 its original organization at Paducah Kentucky, and enrolled in it at the muster into
 the service of the United States at Paducah Kentucky on the Thirteenth day
 of October, 1864, (or was mustered in service as a recruit, by Capt. John H.
Morgan, at Paducah, on the Thirteenth day of October,
 1864, ~~or was drafted and mustered into the service of the United States from the~~
~~Enrollment District of the State of~~ at
~~on the~~ day of 186) to serve in the Regiment, for
 the term of Three Years: and having served HONESTLY and
 FAITHFULLY with his Company in 8th Regt. U.S. Artillery to the present date, is now
 entitled to a **DISCHARGE** by reason of Death at Regimental
Hospital Paducah Ky on the 15th day of February 1865 of
Pneumonia Kinchen Woods was last paid by Major
 The said Kinchen Woods was last paid by Paymaster
Henry W. [unclear] to include the 31st day of October 1864,
~~never paid~~ to include the day of 186, and has
 pay due him from that time to the present date; he is entitled to pay and subsistence for
 TRAVELING to place of enrollment, and whatever other allowances are authorized to volunteer
 soldiers, drafted men, or militia, so discharged. He has received from the United States **CLOTHING**
 amounting to \$42.29 100 dollars, since the date of his enlistment
~~186~~, ~~when his clothing account was last settled.~~ He has received from the United States
100 dollars advanced **BOUNTY**.

There is to be stopped from him, on account of the State of _____, or other
 authorities, for **CLOTHING**, &c., received on entering service, _____ 100 dollars; and
 for other stoppages, viz: _____

_____ 100 dollars.
 He has been furnished with **TRANSPORTATION** in kind from the place of his discharge to
 _____; and he has been **SUBSISTED** for **TRAVELING** to his
 place of enrollment, up to the _____, 186 .

He is indebted to _____, **SUTLER**, _____ 100 dollars.
 He is indebted to _____, **LAUNDRESS**, _____ 100 dollars.

Given in Duplicate, at Paducah Kentucky, this 15th day
 of February, 1865.

M. W. Kennedy
1st Lieutenant
 Commanding Company.

ARTICLES OF WAR.

ART. 95. When any non-commissioned officer or soldier shall die, or be killed in the service of the United States, the then commanding officer of the troop or company shall, in the presence of two other commissioned officers, take an account of what effects he died possessed of, above his arms and accoutrements, and transmit the same to the office of the Department of War, which said effects are to be accounted for, and paid to the representatives of such deceased non-commissioned officer or soldier. And in case any of the officers, so authorized to take care of the effects of deceased officers and soldiers, should, before they have accounted to their representatives for the same, have occasion to leave the regiment or post, by preferment or otherwise, they shall, before they be permitted to quit the same, deposit in the hands of the commanding officer, or of the assistant military agent, all the effects of such deceased non-commissioned officers and soldiers, in order that the same may be secured for, and paid to, their respective representatives.

ARMY REGULATIONS—EDITION OF 1861.

DECEASED SOLDIERS.

Par. 152. Inventories of the effects of deceased non-commissioned officers and soldiers, required by the 95th Article of War, will be forwarded to the Adjutant General, by the commander of the company to which the deceased belonged, and a duplicate of the same to the colonel of the regiment. Final statements of pay, clothing, &c., will be sent with the inventories. When a soldier dies at a post or station absent from his company, it will be the duty of his immediate commander to furnish the required inventory, and, at the same time, to forward to the commanding officer of the company to which the soldier belonged, a report of his death, specifying the date, place, and cause; to what time he was last paid, and the money or other effects in his possession at the time of his decease; which report will be noted on the next muster roll of the company to which the man belonged. Each inventory will be endorsed, "Inventory of the effects of _____, late of company (—) _____ regiment of _____, who died at _____, the _____ day of _____, 186—." If a legal representative receive the effects, it will be stated in the report. If the soldier leave no effects, the fact will be reported.

Par. 153. Should the effects of a deceased non-commissioned officer or soldier not be administered upon within a short period after his decease, they shall be disposed of by a Council of Administration, under the authority of the commanding officer of the post, and the proceeds deposited with the Paymaster, to the credit of the United States, until they shall be claimed by the legal representatives of the deceased.

Par. 154. In all such cases of sales by the Council of Administration, a statement in detail, or account of the proceeds, duly certified by the Council and commanding officer, accompanied by the Paymaster's receipt for the proceeds, will be forwarded by the commanding officer to the Adjutant General. The statement will be endorsed, "Report of the proceeds of the effects of _____, late of company (—) _____ regiment of _____, who died at _____, the _____ day of _____, 186—."

NOTE 1.—The effects in all cases, when called for, should be turned over to the legal representative, without further authority from the Adjutant General. When the effects are turned over to the relatives of the deceased before these inventories are sent to the Adjutant General, their receipts therefor should be attached to the inventories. In all other cases, one copy will be sent with a letter of transmittal direct to the Adjutant General, and a duplicate retained by the officer.

NOTE 2.—Particular care should be taken to take receipts in duplicate from the Paymaster for any funds turned over to him; one copy should be sent direct to the Adjutant General and one retained by the officer.

INVENTORY OF THE EFFECTS

OF

Private Kinchen WoodsLate of Company L8th Reg't of U. S. Cold Army (Heavy)~~Volunteers~~, who died at Padrucan Kyon the 15th day of February 1865.

1865
FEB
15

Inventory of the effects of Winchen Woods late
 a Private of Captain Lieut. M. B. Kennedy's Company L of
 the 8th Regiment of U.S. Col. of Art. (Heavy) Volunteers, who was enrolled as
 a Private at Paducah in the State of Kentucky on
 the 13th day of October 1864, and mustered into the service of the United
 States as a Volunteer on the 13th day of October 1864, at Paducah Ky
 in Company L, 8th Regiment of U.S. Col. of Art. (Heavy) Volunteers, to serve Three
 years or during the war; he was born in Swingston Co in the State
 of Kentucky; he was 45 years of age, 5 feet 5 1/2 inches
 high, Black complexion, Black eyes, Black hair, and by occupation, when enrolled,
 a Farmer; he died in the Regiment at Paducah, at
Paducah Ky on the 15th day of February 1865, by
 reason of Pneumonia.

INVENTORY.					
ARTICLES.	No.	ARTICLES.	No.	ARTICLES.	No.
Hats.....		Pairs trousers.....	1	Knapsacks.....	
Caps.....	1	Pairs flannel drawers.....			
Forage caps.....		Pairs cotton drawers.....			
Great coats.....	1	Flannel shirts.....			
Uniform coats.....		Cotton shirts.....			
Uniform jackets.....	1	Pairs boots.....			
Flannel sack coats.....		Pairs shoes.....			
Blouses.....		Pairs socks.....			
Stable frocks.....		Blankets.....			
Fatigue overalls.....		Haversacks.....			
				MONEY.	
				Specie.....	\$
				Notes.....	\$

I CERTIFY, ON HONOR, that the above inventory comprises all the effects of Private
Winchen Woods, deceased, and that the effects are in the hands
 of Map F. DeWent at Paducah Ky
 to be disposed of by a Council of Administration.

(DUPLICATES.)

M. B. Kennedy
1st Lieut.

Commanding the Company.

STATION: Paducah Ky

DATE: Feb'y 15th 1865

Woods ^{f Levi}
~~Levi~~

Co F, 8 U.S. Col'd H. Art'y.

Corporal | Corporal

CARD NUMBERS.

1	5475756	26
2	5475860	27
3	5475979	28
4	5476094	29
5	5476204	30
6	5476327	31
7	5476437	32
8	5476548	33
9	5476655	34
10	5476759	35
11	5476855	36
12	9122466	37
12	40744973	38
14		39
15		40
16		41
17		42
18		43
19		44
20		45
21		46
22		47
23		48
24		49
25		50

X corrected by H. A. J. Dec. 1, 1900

Book Mark:

See also

2

8 H. Art'y.

U.S.C.T.

Levi Wood

Co. E, 8 Reg't U.S. Col'd H. Art'y.

Appears on

Company Descriptive Book

of the organization named above.

DESCRIPTION.

Age 29 years; height 5 feet 5 1/2 inches.

Complexion Black

Eyes Black; hair Black

Where born Lyon Co., Ky

Occupation Farmer

ENLISTMENT.

When May 24, 1864

Where Paducah, Ky

By whom C. A. Holmes; term 3 y'rs.

Remarks:

[Empty lines for remarks]

C. A. Moreland

(383g)

Copyist.

M

8 H. Art'y. U.S.C.T.

Levi Wood

Capt, Co. F, 8 Reg't U. S. Col'd H. Art'y.

Age ... years.

Appears on

Company Muster Roll*

From enlistment to June 30, 1864.

Joined for duty and enrolled:

When May 24, 1864

Where Caducah Ky

Period 3 years.

Mustered in:

When June 6, 1864

Where Caducah Ky

Present or absent Present

Stoppage, \$ 100 for

Due Gov't \$ 100 for

Valuation of horse, \$ 100

Valuation of horse equipments, \$ 100

Remarks:

*First current roll. No muster-in roll of this company on file.

Book mark:

(358d)

J. H. ...

Copyist.

77

S H. Art'y. | U.S.C.T.

Mini Wood

Co. F, 8 Reg't U. S. Col'd H. Art'y.

Appears on

Company Muster Roll

for *July & Aug*, 186*4*.

Present or absent *+*

Stoppage, \$ *100* for

Due Gov't, \$ *100* for

Valuation of horse, \$ *100*

Valuation of horse equipments, \$ *100*

Remarks: *in hospital
Caudan Key*

*+ Name appears in column
of present canceled by pencil
line*

Book mark:

(358)

J. Nelson

Copyist.

27 | S H. Art'y. | U.S.C.T.

Wm. Wood

Capt., Co. F, 8 Reg't U. S. Col'd H. Art'y.

Appears on

Company Muster Roll

for *Sept & Oct*, 186*4*

Present or absent *Present*

Stoppage, \$.....100 for

Due Gov't, \$.....100 for

Valuation of horse, \$.....100

Valuation of horse equipments, \$.....100

Remarks:

Book mark:

J. Allen
(358) Copyist.

No. | S H. Art'y. | U.S.C.T.

Levi Wood

Capt. Co. F, 8 Reg't U. S. Col'd H. Art'y.

Appears on

Company Muster Roll

for *Nov Dec*, 186 *4*

Present or absent *Present*

Stoppage, \$ *100* for

Due Gov't, \$ *100* for

Valuation of horse, \$ *100*

Valuation of horse equipments, \$ *100*

Remarks:

Book mark:

J. Wilson
(358) Copyist.

W | 8 H. Art'y. | U.S.C.T.

Levi Wood

Corp., Co. F, 8 Reg't U. S. Col'd H. Art'y.

Appears on

Company Muster Roll

for Jan & Feb, 1865.

Present or absent Present

Stoppage, \$ 100 for

Due Gov't, \$ 100 for

Valuation of horse, \$ 100

Valuation of horse equipments, \$ 100

Remarks:

Book mark:

G. W. Chase

W

8 H. Art'y.

U.S.C.T.

Levi Wood

Capt, Co. F, 8 Reg't U. S. Col'd H. Art'y.

Appears on

Company Muster Roll

for *Me* & *Apr*, 1865.

Present or absent *Present*

Stoppage, \$ *100* for

Due Gov't, \$ *100* for

Valuation of horse, \$ *100*

Valuation of horse equipments, \$ *100*

Remarks:

Book mark:

G. W. Chase

W | S H. Art'y. | U.S.C.T.

Levi Wood

Co. F, 8 Reg't U. S. Col'd H. Art'y.

Appears on

Company Muster Roll

for May & June, 1865.

Present or absent Present

Stoppage, \$ 100 for

Due Gov't, \$ 100 for

Valuation of horse, \$ 100

Valuation of horse equipments, \$ 100

Remarks:

Book mark:

G. W. Chase

W | **S** H. Art'y. | **U.S.C.T.**

Levi Woods

Corp, Co. F, 8 Reg't U. S. Col'd H. Art'y.

Appears on

Company Muster Roll

for *July & Aug*, 1865.

Present or absent *Present*

Stoppage, \$ *100* for

Due Gov't, \$ *100* for

Valuation of horse, \$ *100*

Valuation of horse equipments, \$ *100*

Remarks:

Book mark:

G. W. Chase

N

S H. Art'y.

U.S.C.T.

Levi Woods

Corpl, Co. F, 8 Reg't U. S. Col'd H. Art'y.

Appears on

Company Muster Roll

for *Sept & Oct.*, 1865.

Present or absent *Present*

Stoppage, \$ *100* for

Due Gov't, \$ *100* for

Valuation of horse, \$ *100*

Valuation of horse equipments, \$ *100*

Remarks:

Book mark:

(358)

Keifer

Copyist.

Lewis Woods

Drum, Co. F, 8 Reg't U. S. Col'd H. Art'y.

Appears on

Company Muster Roll

for *Nov. & Dec.*, 1865.

Present or absent *Present*

Stoppage, \$ 100 for

Due Gov't, \$ 100 for

Valuation of horse, \$ 100

Valuation of horse equipments, \$ 100

Remarks: _____

Book mark: _____

Keeper

W

8 H. Art'y.

U.S.C.T.

Levi Wood

Ans, Co. G, 8 Reg't U. S. Col'd H. Art'y.

Appears on Returns as follows:

July 18 64 absent sick
in Hosp. at Paudon
Ky.

Aug 18 64 absent sick in
Regt. Hosp. Paudon Ky
since Aug 26 64

Book mark:

Levi Wood

(546)

Copyist.

W | S H. Art'y. | **U.S.C.T.**

Levi
Levi Woods

Coppl., Co. *F*, 8 Reg't U. S. Col'd H. Art'y.

Appears on **Co. Muster-out Roll**, dated

Victoria, Texas, Feb. 10, 186*4*.

Muster-out to date *Feb. 10*, 186*4*.

Last paid to *Aug. 31*, 186*5*.

Clothing account:

Last settled....., 186 ; drawn since \$..... 100

Due soldier \$ *7*^{*68*}/₁₀₀; due U. S. \$..... 100

Am't for cloth'g in kind or money adv'd \$..... 100

Due U. S. for arms, equipments, &c., \$ ^{*50*}/₁₀₀

Bounty paid \$..... 100; due \$ *100* 100

Remarks: *Entered the service*

as private in organization
of Co. Promoted to coppl June
6'64. Enrolled & subject to draft
in 1st Enrollment Dist. of Ky
at time of enlistment (over)

Book mark: *FV 33 P. 9 75*

0.9120
x corrected by G. J. G. re. 1. 1900

Keefe

JAN. 14

5476855

1891 *

Stopp for Spring vise 30.

1947

Woods Martin

Co Det, 8 U.S. Col'd H. Art'y.

Private

Private

CARD NUMBERS.

1	5474392	26
2	5474529	27
3	5473104	28
4	5473142	29
5	5473287	30
6	5473424	31
7	5473554	32
8	5473680	33
9	5473807	34
10	5467819	35
11	5467883	36
12	5474293	37
13	5475683	38
14	9122315	39
15	9121830	40
16	140744974	41
17		42
18		43
19		44
20		45
21		46
22		47
23		48
24		49
25		50

Book Mark:

See also

26 | 8 H. Art'y. | U.S.C.T.

Martin Woods

....., Co. E, 8 Reg't U.S. Col'd H. Art'y.

Appears on

Company Descriptive Book
of the organization named above.

DESCRIPTION.

Age 26 years; height 5 feet 6 1/2 inches.

Complexion Brown

Eyes Blue; hair Blue

Where born Caldwell Co., Kentucky

Occupation Farmer

ENLISTMENT.

When March 2, 1864.

Where E. Donaldson

By whom R. Dunn; term 3 y'rs.

Remarks: Transferred to Co. D

Remarks written with lead pencil

E. A. Moreland

(383g)

Copist.

W | *8 H. Artz* | U.S.C.T.

Martin Woods

, Co. *D 8*, Reg't U. S. Col'd. *H. Artz*

Appears on

Company Descriptive Book

of the organization named above.

DESCRIPTION.

Age *36* years; height *5* feet *5 1/2* inches.

Complexion *Brown*

Eyes *Blk* hair *Blk*

Where born *Cobwell Co. Ky.*

Occupation *Farmer*

ENLISTMENT.

When *Mar. 12*, 1864.

Where *Fort Donaldson, Tenn.*

By whom *Robert Dunn*; term *3* y'rs.

Remarks: *Deserted from*
Paducah, Ky., Apr. 7/64
Charged on rolls with
\$22.01 for ordnance

Henderson

W

8 H. Art'y.

U.S.C.T.

Martin Woods

Rk, Co. *E*, 1 Reg't Ky. H. Art'y.†

Age _____ years.

Appears on

Company Muster Roll*

for *Enlistment to April 30*, 1864.

Joined for duty and enrolled:

When *March 12*, 1864.

Where *H. Donelson, Tenn.*

Period *3* years.

Mustered in:

When *April 26*, 1864.

Where *Paducah, Ky.*

Present or absent *Present*

Stoppage, \$ *100* for _____

Due Gov't \$ *100* for _____

Valuation of horse, \$ *100*

Valuation of horse equipments, \$ *100*

Remarks: _____

†This organization subsequently became Co. "E", 8 Reg't U. S. Colored Heavy Artillery.

*First current roll. No muster-in roll of this company on file.

Book mark: _____

Jas. v. Kearny
Copyist.

(3586)

N

8 H. Art'y.

U.S.C.T.

Martin's Woods

Prk ..., Co. E, 8 Reg't U. S. Col'd H. Art'y.

Appears on

Company Muster Roll

for *May and June* ..., 1864.

Present or absent

Stoppage, \$ 100 for

Due Gov't, \$ 100 for

Valuation of horse, \$ 100

Valuation of horse equipments, \$ 100

Remarks:

*Transferred to Co. D, 8 U.S., by order of
Col. H. W. Barry, dated Ft. Anderson, Padu-
cah, Ky, May 20, 1864; Special order No. 7.*

Book mark:

Jas. v. Keamy

Copyist.

(358)

11 | 8 H. Art'y. | U.S.C.T.

Martin Hood

A, Co. *D*, 8 Reg't U. S. Col'd H. Art'y.

Age _____ years.

Appears on

Company Muster Roll*

for *May 6*, 1864.

Joined for duty and enrolled:

When *Mar 12*, 1864.

Where *W. Danielson Tenn*

Period *3* years.

Mustered in:

When *Apr 20*, 1864.

Where *Paducah Ky*

Present or absent *Present*

Stoppage, \$ *100* for _____

Due Gov't \$ *100* for _____

Valuation of horse, \$ *100*

Valuation of horse equipments, \$ *100*

Remarks: *Transferred from Co. "E" per O.C. No 7.*

*First current roll. No muster-in roll of this company on file.

Book mark: _____

(358d) *Joseph Stewart* Copyist

JAN. 14

5473004

1891

Remarks:

Hd. Lrs. 8th U.S. C. A. N.

by order H W Barry
Col.

A. S. Harty U.S.C.T.

Martin Hood

1st, Co. D, 8. Reg't U. S. Col'd Harty

Appears on

Descriptive List of Deserters

dated *Indianapolis, Ind. June 30, 1865*

Deserted:

When *April 7*, 1865.

Where *Paducah Ky*

Arrested:

When _____, 186 .

Where _____

Remarks: *Has been reported absent "without leave" until June 30/65 - Due H. S. for Ord # 22.01. Taken with him at time of desertion, Chid on muster Roll June 30/65.*

Book mark: _____

(351)

J. H. Miller
Coryist.

H. S. Hart U.S.C.T.

Martin Wood

Co. D, 8th Reg't U. S. Col'd Hart

Appears on

Descriptive List of Deserters

dated *Indianapolis Ind. July 3, 1865*

Deserted :

When *April 4*, 1865

Where *Paducah Ky.*

Arrested :

When, 186 .

Where

Remarks : *Due to foot
ord taken with him
at time of desertion
22.01. Charged on muster
Roll of June/65*

Book mark :

J. S. Hart
Coptist.

A | 8 H. Art'y. | U.S.C.T.

Martin Wood

Private, Co. D, 8 Reg't U. S. Col'd H. Art'y.

Appears on

Company Muster Roll

for *July & Aug.*, 1864.

Present or absent *

Stoppage, \$ 100 for

Due Gov't, \$ 100 for

Remarks: *Absent sick at Paducah, Ky. since the 26 of Aug. 1864*

* *As cancelled in Presence of*

Book mark:

W. W. Warren

1864
No. | 8 H. Art'y. | U.S.C.T.

Martin Woods,
Sgt., Co. D, 8 Reg't U. S. Col'd H. Art'y.

Appears on

Company Muster Roll

for Sept. & Oct., 1864.

Present or absent Present.

Stoppage, \$ 100 for

Due Gov't, \$ 100 for

Valuation of horse, \$ 100

Valuation of horse equipments, \$ 100

Remarks:

Book mark:

J. G. White

(358)

Copyist.

37

S H. Art'y.

U.S.C.T.

Martin Havel

Pi., Co. D, 8 Reg't U. S. Col'd H. Art'y.

Appears on

Company Muster Roll

for *Nov. & Dec.*, 186*4*.

Present or absent *Present.*

Stoppage, \$ *100* for

Due Gov't, \$ *100* for

Valuation of horse, \$ *100*

Valuation of horse equipments, \$ *100*

Remarks:

Book mark:

J. Smith

(358)

Copyist.

W

S H. Art'y.

U.S.C.T.

Martin Woods

3rd, Co. D, 8 Reg't U. S. Col'd H. Art'y.

Appears on

Company Muster Roll

for June & Sep., 1865.

Present or absent Present.

Stoppage, \$ 100 for

Due Gov't, \$ 100 for

Remarks:

Book mark:

[Signature]

(358)

Copyist.

W^r | 8 H. Art'y. | U.S.C.T.

Martin Woods

Co. D, 8 Reg't U. S. Col'd H. Art'y.

Appears on

Company Muster Roll

for Mar. & April, 1865.

Present or absent absent.

Stoppage, \$ 100 for

Due Gov't, \$ 100 for

Remarks: Left at Paducah, Ky., Apr. 7, 65. Cannot be found.

Book mark:

(358)

J. L. Smith Copyist.

W

8 H. Art'y.

U.S.C.T.

Martin Woods

Pri., Co. D, 8 Reg't U. S. Col'd H. Art'y.

Appears on

Company Muster Roll

for *May & June*, 186*5*.

Present or absent

Stoppage, \$ *100* for

Due Gov't, \$ *100* for

Remarks: *Deserted at Paducah Ky., April 7, 65. Reported absent without leave until 23rd June. Due the U. S. for advances \$22.01 taken with him at time of desertion.*

Book mark:

(358)

J. Smith

Copyist.

W

S H. Art'y.

U. S. C. T.

Martin Woods

Co A, 8 Reg't U. S. Col'd H. Art'y.

Appears on Returns as follows:

May 1864 May 27/64.
Paducah Ky. Transf'd
from Co E 4th Cal.

Aug 1864 absent sick in
Hosp.

Sept 1864 on duty Train
Guard

Apr 4th May 1865. absent
without leave at
Paducah April 7/65

June 1865. April 7, 1865
Paducah Ky. Deserted.
Has been reported as
absent without leave
until 23 inst.

Book mark:

Chas. Patten

(546)

Copyist.

27

8 H. Art'y.

U.S.C.T.

Wm. B. Cook

Co. D, 8 Reg't U. S. Col'd H. Art'y.

Appears on **Co. Muster-out Roll**, dated *Victoria, B.C., 24th*, 1866.

Muster-out to date _____, 186 . . .

Last paid to *ditto*, 1864.

Clothing account:

Last settled _____, 186 ; drawn since \$ _____ 100

Due soldier \$ _____ 100; due U. S. \$ _____ 100

Am't for cloth'g in kind or money adv'd \$ _____ 100

Due U. S. for arms, equipments, &c., \$ _____ 100

Bounty paid \$ _____ 100; due \$ _____ 100

Remarks: *Trans from Co E as per S. O. No. 1491 H. O. No. May 20 1864. Deserted April 1865 at Paducah. Ky. Amount of clothing drawn from enlistment to time of desertion*

Book mark : _____

W. B. Cook (over.)
(261) _____ Copyright.

JAN. 14

5474293

1891

\$62.88. Charged on muster
roll with \$22.01 for ord.
taken with time at time
of desertion.

Mountain Woods

Priv., Co. *E*, 8 Reg't U. S. Col'd H. Art'y.

Appears on **Co. Muster-out Roll**, dated

Victoria Texas, *Feb 10*, 1866 .

Muster-out to date _____, 186 .

Last paid to *April 30* 1864 .

Clothing account:

Last settled _____, 186 ; drawn since \$ _____ 100

Due soldier \$ _____ 100; due U. S. \$ _____ 100

Am't for cloth'g in kind or money adv'd \$ _____ 100

Due U. S. for arms, equipments, &c., \$ _____ 100

Bounty paid \$ _____ 100; due \$ _____ 100

Remarks: *Joined Co at Original Organization as Private Transfd. from Co. E. to Co. D. by Ad. Neg. Hd. Qrs. 8 W.S. Co. Regularly May 20. 1864.*

(See page 12)

Book mark : _____

E. C. Barrall

1940
Woods Seldon

Co H, 8 U.S. Col'd H. Art'y.

Private | Private

CARD NUMBERS.

1	5478322	26
2	5478463	27
3	5478614	28
4	5478766	29
5	5478901	30
6	5479038	31
7	5479164	32
8	5479285	33
9	5479395	34
10	5479507	35
11	5479610	36
12	9121979	37
13		38
14		39
15		40
16		41
17		42
18		43
19		44
20		45
21		46
22		47
23		48
24		49
25		50

Book Mark:

See also

P.O. Mil. S. S. 18492-5/16/22 all

Or | S. H. Ardy | U. S. C. T.

Soldon Woods

, Co. H, 8 Reg't U. S. Col'd H. Ardy

Appears on

Company Descriptive Book

of the organization named above.

DESCRIPTION.

Age 18 years; height 5 feet 5 inches.

Complexion Black

Eyes Black; hair Black

Where born New Haven, Kentucky

Occupation Laborer

ENLISTMENT.

When May 25, 1864.

Where Union, Ky

By whom H. J. Chase; term 3 y'rs.

Remarks:

S. A. McFarland

W | 8 H. Art'y. | U.S.C.T.

Seldon Woods
Art, Co. H, 8 Reg't U. S. Col'd H. Art'y.

Age _____ years.

Appears on

Company Muster Roll*

for *Enlistment to June 30, 1864.*

Joined for duty and enrolled:

When *May 28*, 1864.

Where *Union Co Ky*

Period *3* years.

Mustered in:

When *June 6*, 1864

Where *Paducah Ky*

Present or absent *Present*

Stoppage, \$ *100* for _____

Due Gov't \$ *100* for _____

Valuation of horse, \$ *100*

Valuation of horse equipments, \$ *100*

Remarks: _____

*First current roll. No muster-in roll of this company on file.

Book mark: _____

S. W. Smith

(358d)

Copyist.

W | 8 H. Art'y. | **U.S.C.T.**

Soldier Woods

Plt, Co. H, 8 Reg't U. S. Col'd H. Art'y.

Appears on

Company Muster Roll

for *dated Aug 31*, 1864

Present or absent *Present*

Stoppage, \$ *100* for

Due Gov't, \$ *100* for

Valuation of horse, \$ *100*

Valuation of horse equipments, \$ *100*

Remarks:

Book mark:

E. W. J. Baker

W | 8 H. Art'y. | U.S.C.T.

Saiden Woods

Pr, Co. H, 8 Reg't U. S. Col'd H. Art'y.

Appears on

Company Muster Roll

for *Sept & Oct*, 1864.

Present or absent *Present*

Stoppage, \$ *100* for

Due Gov't, \$ *100* for

Valuation of horse, \$ *100*

Valuation of horse equipments, \$ *100*

Remarks:

Book mark:

E. W. ...

W | **S H. Art'y.** | **U.S.C.T.**

Seldon Woods

Priv, Co. H, 8 Reg't U. S. Col'd H. Art'y.

Appears on

Company Muster Roll

for *Nov & Dec*, 1864.

Present or absent *Present*

Stoppage, \$ *100* for

Due Gov't, \$ *100* for

Valuation of horse, \$ *100*

Valuation of horse equipments, \$ *100*

Remarks:

Book mark:

S. W. Tucker

(358)

Copyist.

W | **S H. Art'y.** | **U.S.C.T.**

Soldier Wood
PA, Co. H, 8 Reg't U. S. Col'd H. Art'y.

Appears on

Company Muster Roll

for *Jan. & Feb.*, 1865.

Present or absent *present*

Stoppage, \$ *100* for

Due Gov't, \$ *100* for

Valuation of horse, \$ *100*

Valuation of horse equipments, \$ *100*

Remarks:
.....
.....
.....
.....
.....
.....
.....
.....

Book mark:

(358) *J. E. Nichol* Copyist.

W | 8 H. Art'y. | **U.S.C.T.**

Solden Woods
Pr, Co. H, 8 Reg't U. S. Col'd H. Art'y.

Appears on

Company Muster Roll

for *Mch. & Apr.*, 1865.

Present or absent *present*

Stoppage, \$ *100* for

Due Gov't, \$ *100* for

Valuation of horse, \$ *100*

Valuation of horse equipments, \$ *100*

Remarks:

Book mark:

(358) *J. E. Nichol* Copyist.

W. E. Hardy U.S.C.T.

Soldier Woods

Pvt, Co. *H*, *8* Reg't U. S. Col'd *H. Arty*

Appears on

Company Muster Roll

for *May & June*, 186*5*.

Present or absent *present*

Stoppage, \$ *100* for

Due Gov't, \$ *100* for

Valuation of horse, \$ *100*

Valuation of horse equipments, \$ *100*

Remarks:

Book mark:

(358) *J. E. Nichol* Copyist.

M | S H. Art'y. | U.S.C.T.

Soldier Woods

PR, Co. H, 8 Reg't U. S. Col'd H. Art'y.

Appears on

Company Muster Roll

for *July & Aug.*, 1865.

Present or absent *present*

Stoppage, \$.....100 for.....

Due Gov't, \$.....100 for.....

Valuation of horse, \$.....100

Valuation of horse equipments, \$.....100

Remarks:.....

Book mark:.....

(358) *J. E. Nichol* Copyist.

7 | S H. Art'y. | U.S.C.T.

Soldier Woods
Co. H, 8 Reg't U. S. Col'd H. Art'y.

Appears on

Company Muster Roll
for *Sept & Oct*, 1865.

Present or absent *Present*

Stoppage, \$ *100* for

Due Gov't, \$ *100* for

Valuation of horse, \$ *100*

Valuation of horse equipments, \$ *100*

Remarks:
.....
.....
.....
.....
.....
.....
.....
.....
.....
.....

Book mark:

G. W. Deabrick

W | 8 H. Art'y. | U.S.C.T.

Judson Ward
Co. H, 8 Reg't U. S. Col'd H. Art'y.

Appears on

Company Muster Roll

for *Nov + Dec*, 186*5*.

Present or absent *Present*

Stoppage, \$ *100* for

Due Gov't, \$ *100* for

Valuation of horse, \$ *100*

Valuation of horse equipments, \$ *100*

Remarks:
.....
.....
.....
.....
.....
.....
.....
.....
.....
.....

Book mark:

G W Deadrick
Copyst.

W | S H. Art'y. | U.S.C.T.

Soldon Woods

Priv., Co. K, 8 Reg't U. S. Col'd H. Art'y.

Appears on Co. Muster-out Roll, dated
Victoria Texas, Feb 10, 1866.

Muster-out to date Feb 10, 1866.

Last paid to Aug 31, 1865.

Clothing account:

Last settled....., 186 ; drawn since \$..... 100

Due soldier \$..... 100; due U. S. \$ 13 ⁸⁸/₁₀₀

Am't for cloth'g in kind or money adv'd \$..... 100

Due U. S. for arms, equipments, &c., \$..... ⁵²/₁₀₀

Bounty paid \$ None 100; due \$ 100 100

Remarks: Entered service as Private
as herein shown Stop for One
G Shing 34 ct One S Dr re m 1865

Aug 18 1

Book mark :

G W Deasrick

(261)

Copyist.

1949

Woods Smith

Co G, 8 U.S. Col'd H. Art'y.

Private Private

CARD NUMBERS.

1	5477100	26
2	5477196	27
3	5477292	28
4	5477383	29
5	5477500	30
6	5477634	31
7	5477905	32
8	5478016	33
9	5478118	34
10	5478221	35
11	5477732	36
12	9122115	37
13		38
14		39
15		40
16		41
17		42
18		43
19		44
20		45
21		46
22		47
23		48
24		49
25		50

Book Mark:

See also

Q. | 8 H. Art'y. | U.S.C.T.

Smith Lewis

....., Co. *A*....., 8 Reg't U.S. Col'd H. Art'y.

Appears on

Company Descriptive Book

of the organization named above.

DESCRIPTION.

Age *23* years; height *5* feet *9 1/2* inches.

Complexion *Black*

Eyes *Black*; hair *Black*

Where born *Nelson Co., Kentucky*

Occupation *Farmer*

ENLISTMENT.

When *May 28*....., 186*4*.

Where *Union Co., Ky*

By whom *A. H. Spence*; term *3* y'rs.

Remarks:

.....
.....
.....
.....
.....
.....
.....
.....
.....
.....

E. A. McDaniel

W | 8 H. Art'y. | U.S.C.T.

Smith Woods.

Pvt., Co. G, 8 Reg't U. S. Col'd H. Art'y.

Age years.

Appears on

Company Muster Roll*

for Enlistment to June 30, 1864.

Joined for duty and enrolled:

When May 28, 1864.

Where Union Co. Ky

Period 3 years.

Mustered in:

When June 6, 1864.

Where Paducah, Ky

Present or absent present

Stoppage, \$ 100 for

Due Gov't \$ 100 for

Valuation of horse, \$ 100

Valuation of horse equipments, \$ 100

Remarks:

*First current roll. No muster-in roll of this company on file.

Book mark:

E Weston

(358d)

Copist.

W. | 8 H. Art'y. | U.S.C.T.

Smith Woods

Priv., Co. G, 8 Reg't U. S. Col'd H. Art'y.

Appears on

Company Muster Roll

for July & Aug, 1864.

Present or absent Present.

Stoppage, \$ 100 for

Due Gov't, \$ 100 for

Valuation of horse, \$ 100

Valuation of horse equipments, \$ 100

Remarks:

Book mark:

no chance

NUMBER 915

W | 8 H. Art'y. | U.S.C.T.

Smith Woods

Pr, Co. G, 8 Reg't U. S. Col'd H. Art'y.

Appears on

Company Muster Roll

for *Sept & Oct*, 1864.

Present or absent *Present*

Stoppage, \$ *100* for

Due Gov't, \$ *100* for

Valuation of horse, \$ *100*

Valuation of horse equipments, \$ *100*

Remarks:

Book mark:

C. M. Laughlin

(358)

Copyist.

W 1840 12.2.07

Smith Woods

Pvt, Co. G, 8 Reg't Ill Cav

Appears on

Company Muster Roll

for Nov. 1864

Present or absent Present

Stoppage, \$ 100 for

Due Gov't, \$ 100 for

Remarks:

Book mark:

M. J. Smith

(358)

Copyist.

MAR 4 1861

M | 8 H. Art'y. | U.S.C.T.

Smith Wood,

Pvt, Co. G, 8 Reg't U. S. Col'd H. Art'y.

Appears on

Company Muster Roll

for *May 1 July*, 1861.

Present or absent *Present*

Stoppage, \$ *100* for

Due Gov't, \$ *100* for

Valuation of horse, \$ *100*

Valuation of horse equipments, \$ *100*

Remarks:

Book mark :

112012

H

8 H. Art'y.

U.S.C.T.

Smith's Horse

Sgt, Co. G, 8 Reg't U. S. Col'd H. Art'y.

Appears on

Company Muster Roll

for *March 1865*, 1865

Present or absent *Present*

Stoppage, \$ *100* for

Due Gov't, \$ *100* for

Valuation of horse, \$ *100*

Valuation of horse equipments, \$ *100*

Remarks: *Subscribed*

See list according to Act

Book mark:

Smith

8 H. Art'y.

U.S.C.T.

Joseph Ford

J. Ford, Co. G, 8 Reg't U. S. Col'd H. Art'y.

Appears on

Company Muster Roll

for *May 1st*, 186*1*.

Present or absent *Present*

Stoppage, \$ *100* for

Due Gov't, \$ *100* for

Valuation of horse, \$ *100*

Valuation of horse equipments, \$ *100*

Remarks: *Stoppage for one month*

lost amount to B's

Book mark:

J. M. Moore

Smith Woods

Pl, Co. G, 8 Reg't U. S. Col'd H. Art'y.

Appears on

Company Muster Roll

for *July to Aug*, 186 ³.

Present or absent *Present*

Stoppage, \$ 100 for

Due Gov't, \$ 100 for

Valuation of horse, \$ 100

Valuation of horse equipments, \$ 100

Remarks: *Stoppage for me*

Carlsen lost amounting

to 65¢

Book mark:

W. J. Brown

M

8 H. Art'y.

U.S.C.T.

Smith Hood

Dr., Co. G, 8 Reg't U. S. Col'd H. Art'y.

Appears on

Company Muster Roll

for *Sept 1st Oct 1*, 186 *5*.

Present or absent *Present*

Stoppage, \$ *100* for

Due Gov't, \$ *100* for

Valuation of horse, \$ *100*

Valuation of horse equipments, \$ *100*

Remarks:

Book mark:

N

8 H. Art'y.

U.S.C.T.

Amiah Woods

Capt, Co. G, 8 Reg't U. S. Col'd H. Art'y.

Appears on

Company Muster Roll

for *Foot Roll*, 1865.

Present or absent *Present*.

Stoppage, \$ *100* for

Due Gov't, \$ *100* for

Valuation of horse, \$ *100*

Valuation of horse equipments, \$ *100*

Remarks:

Book mark:

Wiley

James H. Moore
Co. *A*, 8 Reg't U. S. Col'd H. Art'y.

Appears on **Co. Muster-out Roll**, dated
1st, Adams, July, 186*1*.
Muster-out to date *July*, 186*1*.
Last paid to *1000*, 186*1*.

Clothing account:

Last settled....., 186 ; drawn since \$.....100
Due soldier \$.....100; due U. S. \$.....¹⁰100
Am't for cloth'g in kind or money adv'd \$.....100

Due U. S. for arms, equipments, &c., \$.....100
Bounty paid \$.....100; due \$.....¹⁰⁰100

Remarks: *Entered service as*
private in Co. A, 8th Regt U.S. Col'd H. Art'y.
and served in the same until
July 1st, 1861.

Book mark: *Page 23*

1958

Woodson Henry
Co E, 8 U.S. Col'd H. Art'y.

Private | Private

CARD NUMBERS.

1	5474391	26
2	5474488	27
3	5474628	28
4	5475728	29
5	9122312	30
6	40744975	31
7		32
8		33
9		34
10		35
11		36
12		37
13		38
14		39
15		40
16		41
17		42
18		43
19		44
20		45
21		46
22		47
23		48
24		49
25		50

Book Mark: _____

See also _____

W | 8 H. Art'y. | U.S.C.T.

Henry Woodson

Co. G, 8 Reg't U.S. Col'd H. Art'y.

Appears on

Company Descriptive Book
of the organization named above.

DESCRIPTION.

Age 27 years; height 5 feet 5 inches.

Complexion *Blk*

Eyes *Blk*; hair *Blk*

Where born *Christian, Ky*

Occupation *Farmer*

ENLISTMENT.

When *March 6*, 1864.

Where *Paducah, Ky*

By whom *R. Dunn*; term *3* y'rs.

Remarks: *Died August 25, 64.*

(3837)

E. A. Moreland

Copyist.

N

S H. Art'y.

U.S.C.T.

Henry Woodson

Rk, Co. *E*, 1 Reg't Ky. H. Art'y.†

Age years.

Appears on

Company Muster Roll*

for *Enlistment to April 30*, 186*4*.

Joined for duty and enrolled:

When *March 6*, 186*4*.

Where *Clyton, Tenn.*

Period *3* years.

Mustered in:

When *April 26*, 186*4*.

Where *Paducah, Ky.*

Present or absent *Present*

Stoppage, \$ *100* for

Due Gov't \$ *100* for

Valuation of horse, \$ *100*

Valuation of horse equipments, \$ *100*

Remarks:

†This organization subsequently became Co. "E", 8 Reg't U. S. Colored Heavy Artillery.

*First current roll. No muster-in roll of this company on file.

Book mark:

Jas. v. Keamy
Copyist.

(3586)

W

S H. Art'y.

U.S.C.T.

Henry Woodson

Plk, Co. E, 8 Reg't U. S. Col'd H. Art'y.

Appears on

Company Muster Roll

for *May and June*, 186*4*.

Present or absent *Present*

Stoppage, \$ *100* for

Due Gov't, \$ *100* for

Valuation of horse, \$ *100*

Valuation of horse equipments, \$ *100*

Remarks:

Book mark:

Jas. V. Kearney
Copyist.

W

8 H. Art'y.

U.S.C.T.

Henry Woodson

Prk, Co. E, 8 Reg't U. S. Col'd H. Art'y.

Appears on

Company Muster Roll

for *July and Aug*, 186*4*.

Present or absent.....

Stoppage, \$.....100 for

Due Gov't, \$.....100 for

Valuation of horse, \$.....100

Valuation of horse equipments, \$.....100

Remarks:.....

Died of disease, in Regt. Hospital, Paducah, Ky., Aug. 25, 1864.

Book mark:.....

Jas. v. Kearny

Copyist.

W

8 H. Art'y.

U. S. C. T.

Henry Woodson

Priv, Co. *E*, 8 Reg't U. S. Col'd H. Art'y.

Appears on Returns as follows:

July 1864 *absent well*
in Hosp at Paducah
Ky

Aug 1864 *aug 25/64*
Paducah Ky *Disch*
in Right Hosp.

Book mark:

Chas. J. ...

(546)

Copyist.

Henry Woodson
Private, Co. *E*, 8 Reg't U. S. Col'd H. Art'y.

Appears on **Co. Muster-out Roll**, dated
Victoria Texas Feb 10, 1866.

Muster-out to date _____, 186 .

Last paid to *June 30*, 1864 .

Clothing account:

Last settled _____, 186 ; drawn since \$ _____ 100

Due soldier \$ _____ 100; due U. S. \$ _____ 100

Am't for cloth'g in kind or money adv'd \$ _____ 100

Due U. S. for arms, equipments, &c., \$ _____ 100

Bounty paid \$ _____ 100; due \$ _____ 100

Remarks: *Joined at Original organiza-*
-tion as Private, Died of Diarrhoea
at Regt. Hospital. Paducah Ky
Aug. 25, 1864. Inventory & final
Statements forwarded. Sept. 6, 1864

Book mark: *Age 22*

E. Carroll

Hoodson, Henry

B, Co. *8*, **8** **U.S.C.H.A.**
Reg't

2 Enclosures.

Bed Cards	Descriptive Lists
Burial Records	Final Statements
Certs. of Dis. for Discharge	Furloughs
C. M. Charges	Med. Des. Lists
Med. Certificates	Orders

Other papers relating to—

Admission to Hosp'l	Furlough
Casualty Sheet (Officer's)	Med. Examination
Confinement	Misc. Information
Contracts	Pay or Clothing
Death or Effects	Personal Reports
Desertions	Rank
Discharge from Hosp'l	Transfer to Hosp'l
Discharge from Service	Transfer to V. R. C.
Duty	Transportation
.....

ARTICLES OF WAR.

ART. 95. When any non-commissioned officer or soldier shall die, or be killed in the service of the United States, the then commanding officer of the troop or company shall, in the presence of two other commissioned officers, take an account of what effects he died possessed of, above his arms and accoutrements, and transmit the same to the office of the Department of War, which said effects are to be accounted for, and paid to the representatives of such deceased non-commissioned officer or soldier. And in case any of the officers, so authorized to take care of the effects of deceased officers and soldiers, should, before they have accounted to their representatives for the same, have occasion to leave the regiment or post, by preferment or otherwise, they shall, before they be permitted to quit the same, deposit in the hands of the commanding officer, or of the assistant military agent, all the effects of such deceased non-commissioned officers and soldiers, in order that the same may be secured for, and paid to, their respective representatives.

ARMY REGULATIONS—EDITION OF 1863.

DECEASED SOLDIERS.

Par. 152. Inventories of the effects of deceased non-commissioned officers and soldiers, required by the 95th Article of War, will be forwarded to the Adjutant General, by the commander of the company to which the deceased belonged, and a duplicate of the same to the colonel of the regiment. Final statements of pay, clothing, &c., in duplicate, will be sent to the Adjutant General with one copy of the inventory. When a soldier dies at a post or station absent from his company, it will be the duty of his immediate commander to furnish the required inventory and final statements, and, at the same time, to forward to the commanding officer of the company to which the soldier belonged, a report of his death, specifying the date, place, and cause; to what time he was last paid, and the money or other effects in his possession at the time of his decease; which report will be noted on the next muster roll of the company to which the man belonged. Each inventory will be endorsed, "Inventory of the effects of _____, late of company (—) _____ regiment of _____, who died at _____, the _____ day of _____, 186—." If a legal representative receive the effects, it will be stated in the report. If the soldier leave no effects, the fact will be reported.

Par. 153. Should the effects of a deceased non-commissioned officer or soldier not be administered upon within a short period after his decease, they shall be disposed of by a Council of Administration, under the authority of the commanding officer of the post, and the proceeds deposited with the Paymaster, to the credit of the United States, until they shall be claimed by the legal representatives of the deceased.

Par. 154. In all such cases of sales by the Council of Administration, a statement in detail, or account of the proceeds, duly certified by the Council and commanding officer, accompanied by the Paymaster's receipts for the proceeds, will be forwarded by the commanding officer to the Adjutant General. The statement will be endorsed, "Report of the proceeds of the effects of _____, late of company (—) _____ regiment of _____, who died at _____, the _____ day of _____, 186—."

NOTE 1.—The effects in all cases, when called for, should be turned over to the legal representative, without further authority from the Adjutant General. When the effects are turned over to the relatives of the deceased before these inventories are sent to the Adjutant General, their receipts therefor should be attached to the inventories. In all other cases, one copy will be sent with a letter of transmittal direct to the Adjutant General, and a duplicate retained by the officer.

NOTE 2.—Particular care should be taken to take receipts in duplicate from the Paymaster for any funds turned over to him; one copy should be sent direct to the Adjutant General and one retained by the officer.

INVENTORY OF THE EFFECTS

OF

Henry Woodson

Late of Company "E"

Eight Reg't of W. S. Col. Art'y Heavy

Volunteers, who died at Paducah Ky

on the 25th day of August 1864.

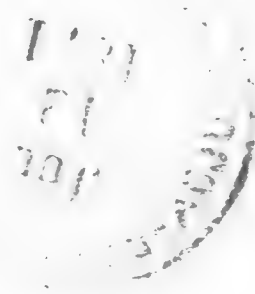

Inventory of the effects of Henry Woodson late
a Private of Captain Robert Dunn Company E of
the Eighth Regiment of U.S. Army Heavy Volunteers, who was enrolled as
a Private at Paducah Ky. in the State of Kentucky on
the 6th day of March 1864, and mustered into the service of the United
States as a Private on the 26th day of April 1864, at Paducah Ky.
in Company E, Eighth Regiment of U.S. Army Heavy Volunteers, to serve 3
years or during the war; he was born in Christian County in the State
of Kentucky; he was 22 years of age, 5 feet 8 inches
high, Black complexion, black eyes, black hair, and by occupation, when enrolled,
a Farmer; he died in Regimental Hospital at
Paducah Ky. on the 25th day of August 1864, by
reason of Diarhoea.

INVENTORY.					
ARTICLES.	No.	ARTICLES.	No.	ARTICLES.	No.
Hats.....		Pairs trousers.....		Knapsacks.....	
Caps.....		Pairs flannel drawers.....			
Forage caps.....		Pairs cotton drawers.....			
Great coats.....		Flannel shirts.....			
Uniform coats.....		Cotton shirts.....			
Uniform jackets.....		Pairs boots.....			
Flannel sack coats.....		Pairs shoes.....			
Blouses.....		Pairs socks.....			
Stable frocks.....		Blankets.....			
Fatigue overalls.....		Haversacks.....			
				MONEY.	
					Specie.....
				Notes.....	\$

I CERTIFY, ON HONOR, ^{that} ~~that~~ the above inventory comprises all the effects of Henry Woodson, deceased, and that the effects are in the hands
of Trade no Effects at the time
of his Death to be disposed of by a Council of Administration.

(DUPLICATES.)

STATION: Paducah Ky

DATE: Sept 6th 1864

[A. G. O. No. 104.]

Robert Dunn

Capt & 8th U.S. Col. Arty Heavy

Commanding the Company.

✓ 68
FINAL STATEMENT

OF

Henry Woodson
Eight Reg't of *U.S. Col. Art. Regt.*

VOLUNTEERS.

NOTE 1.—Two of these certificates (or duplicates) are to be given to each Volunteer Soldier or drafted man who may be discharged previously to the discharge of his company, that he may at once receive from the Paymaster the pay, &c., due him, and the captain or other COMMISSIONED officer commanding the company will certify to the act of the delivery of the duplicate certificates; on these certificates the Soldier is "entitled to" his discharge, and should also present his discharge to the Paymaster to have the payment endorsed on it. The discharge is to be given back to the Soldier by the Paymaster; the latter only retaining as his voucher the duplicate certificates.

NOTE 2.—If the Soldier is entitled to pay for the use of his horse, the Company Commander will certify to that fact on the back of both these final statements, and also to the time he has pay due for having been so mounted on his own horse.

NOTE 3.—When a Soldier is furnished with final statements, his descriptive list, if he has one, should be taken up by the officer who gives the Soldier these statements, and endorsed with a statement to this effect by the officer. This endorsement should exhibit a full statement of the time for which the Soldier was allowed pay on his final statements, the clothing account, and all other charges against him or in his favor, so as to comprise a complete exhibit of his account. It will then be transmitted to the company commander of the Soldier, who will enter all the data necessary to a full understanding of the Soldier's account on the muster roll upon which the Soldier's discharge is reported. The descriptive list will then be destroyed. The object of this is, that the remaining portion of the Soldier's account may be settled upon the receipt of these muster rolls, and the Soldier receive any pay or allowances that may be due him at the time of his discharge, and which may not appear on his final statements from the fact that his descriptive list is incomplete. These accounts for back pay, &c., are settled by the 2d Auditor of the Treasury Department.

NOTE 4.—Charges for loss or injury to ordnance, horse equipments, and other miscellaneous charges, should appear under the heading of "Other Stoppages."

NOTE 5.—Bounty paid by State authorities, and not by the United States, will not be entered on this statement.

NOTE 6.—Amounts due the Sutler and Laundress must be entered on the muster roll on which the discharge, death, desertion, &c., is reported, as well as on the final statement, otherwise the amount cannot be collected from the United States.

NOTE 7.—This blank will be used for deceased volunteers and drafted men, as well as for others.

NOTE 8.—Where a Soldier dies in Hospital or on detached service, his descriptive list, if he has one, should be sent with his final statements, in duplicate, to the Adjutant General, Washington, D. C.

ADJUTANT GENERAL'S OFFICE.
Sept 24 1861
Duplicate with Inventory sent 2d Auditor.

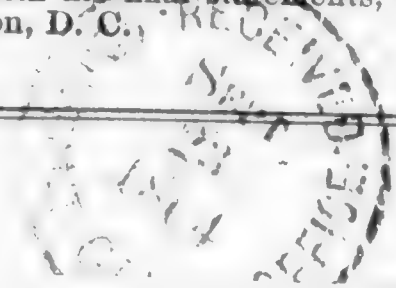

MAR 23 1864

I certify, on honor, that Henry Woodson a Private of
 Captain R. Dunn Company (B) of the Eighth Regiment of U.S. Col. Art. Heavy
VOLUNTEERS, of the State of _____, born in Bristain County, State
 of Kentucky, aged 22 years; 5 feet 5 inches high; Black complexion,
Black eyes, Black hair, and by occupation a Farmer, having joined the company on
 its original organization at Paducah Ky, and enrolled in it at the muster into
 the service of the United States at Paducah Ky, on the 26th day
 of April, 1864, (or was mustered in service as a recruit, by Deut. D. C. M. Scher
 _____, at _____, on the _____ day of _____,
 1864, or was drafted and mustered into the service of the United States from the _____
 Enrollment District of the State of _____, at _____,
 on the _____ day of _____, 1864,) to serve in the Regiment, for
 the term of Three Years; and having served HONESTLY and
 FAITHFULLY with his Company in the present Rebellion to the present date, is now
 entitled to a **DISCHARGE** by reason of Death said Henry Woodson
died in Regimental Hospital at Paducah Ky on the 25th day of August 1864

The said Henry Woodson was last paid by Paymaster
Major Fennell to include the 30th day of June, 1864, and has
 pay due him from that time to the present date; he is entitled to pay and subsistence for
TRAVELING to place of enrollment, and whatever other allowances are authorized to volunteer
 soldiers, drafted men, or militia, so discharged. He has received from the United States **CLOTHING**
 amounting to Twenty Six & 3/4 dollars, since the 6th day of May,
 1864 when his clothing account was last settled. He has received from the United States
 _____ dollars advanced **BOUNTY**.

There is to be stopped from him, on account of the State of _____, or other
 authorities, for **CLOTHING**, &c., received on entering service, _____ dollars; and
 for other stoppages, viz: Henry Woodson has one month
Twenty five days Pay due him
Amount Twenty Eight & 94 dollars.
 He has been furnished with **TRANSPORTATION** in kind from the place of his discharge to
 _____; and he has been **SUBSISTED** for **TRAVELING** to his
 place of enrollment, up to the _____, 1864.

He is indebted to _____, **SUTLER**, _____ dollars.
 He is indebted to _____, **LAUNDRESS**, _____ dollars.

Given in Duplicate, at Paducah Ky, this 6th day
 of September, 1864.

Robert Dunn
Capt. 8th Reg. Col. Art. Heavy
 Commanding Company

MARK 547

1951

Woolfolk Scott
Co et, 8 U.S. Col'd H. Art'y.

Private | Private

CARD NUMBERS.

1	5468100	26
2	5468213	27
3	5468331	28
4	5468481	29
5	5468635	30
6	5468785	31
7	5468934	32
8	5469079	33
9	5469221	34
10	5469351	35
11	5469480	36
12	5469600	37
12	5469711	38
14	9121272	39
15		40
16		41
17		42
18		43
19		44
20		45
21		46
22		47
23		48
24		49
25		50

Book Mark:

See also

P. 75-6964 P. aff
P. 1603899 P. aff
USDA 4/9/31 OR P

A | 8 H. Art'y. U.S.C.T.

Scott Woolfolk

....., Co. *A*, 8 Reg't U.S. Col'd H. Art'y.

Appears on

Company Descriptive Book

of the organization named above.

DESCRIPTION.

Age *18* years; height *5* feet *7* inches.

Complexion *Dark*

Eyes *Dark*; hair *Dark*

Where born *Paducah, Ky.*

Occupation *Writer*

ENLISTMENT.

When *Jan. 21*, 1864.

Where *Paducah, Ky.*

By whom *J. Dobson*; term *3* y'rs.

Remarks:

.....
.....
.....
.....
.....

Henderson

77. | 8 H. Art'y. | U.S.C.T.

Scott Woolfolk
Sri, Co. A, 1 Reg't Ky. H. Art'y.*

Appears on

Company Muster-in and Descriptive Roll

of the organization named above. Roll dated

Paducah Ky., Apr 26, 1864.

Where born Paducah Ky

Age 18 y'rs; occupation Waiter

When enlisted Jan 21, 1864.

Where enlisted Paducah Ky

For what period enlisted 3 years.

Eyes dk; hair dk

Complexion dk; height 5 ft. 7 in.

When mustered in Apr 26, 1864.

Where mustered in Paducah Ky

Bounty paid \$ 100; due \$ 100

Where credited 1st Dist Ky

Company to which assigned

Remarks:

* This organization subsequently became Co. A, 8 Reg't U. S. Colored Heavy Artillery.

Book mark:

Paulough

Off

8 H. Art'y.

U.S.C.T.

Scott Norfolk
Priv, Co. A, 1 Reg't Ky. H. Art'y.*

Appears on

Company Muster Roll

for *Enlistment to Apr 30*, 1864.

Present or absent *Present*

Stoppage, \$ *100* for

Due Gov't, \$ *100* for

Valuation of horse, \$ *100*

Valuation of horse equipments, \$ *100*

Remarks:

*This organization subsequently became Co. A, 8 Reg't U. S. Col'd Heavy Artillery.

Book mark:

(358)

Wauington

Copyist.

M | **S H. Art'y.** | **U.S.C.T.**

Scott Norfolk
Priv., Co. A, 8 Reg't U. S. Col'd H. Art'y.

Appears on

Company Muster Roll

for *May & June*, 1864

Present or absent *Present*

Stoppage, \$ *100* for

Due Gov't, \$ *100* for

Valuation of horse, \$ *100*

Valuation of horse equipments, \$ *100*

Remarks:

Book mark:

(358)

Wauwington

Copyist.

W

| S H. Art'y. | U. S. C. T.

Scott Norfolk
Priv, Co. A, 8 Reg't U. S. Col'd H. Art'y.

Appears on

Company Muster Roll

for *July & Aug*, 1864.

Present or absent *+*

Stoppage, \$ *100* for

Due Gov't, \$ *100* for

Valuation of horse, \$ *100*

Valuation of horse equipments, \$ *100*

Remarks: *in detached service at Mayfield Ky went on detached service on day of muster before muster*

+ Name appears on roll in column of present with line drawn through

Book mark:

Wauwington

W | 8 H. Art'y. | U.S.C.T.

Scott Woolfolk
Priv., Co. A, 8 Reg't U. S. Col'd H. Art'y.

Appears on

Company Muster Roll

for Sept. & Oct., 1864

Present or absent Present

Stoppage, \$ 100 for

Due Gov't, \$ 100 for

Valuation of horse, \$ 100

Valuation of horse equipments, \$ 100

Remarks:

Book mark:

C. R. Owen

W | S H. Art'y. | U.S.C.T.

Scott Woolfolk
Priv., Co. A, 8 Reg't U. S. Col'd H. Art'y.

Appears on

Company Muster Roll

for *Nov. & Dec.*, 1864.

Present or absent *Present.*

Stoppage, \$ *100* for

Due Gov't, \$ *100* for

Valuation of horse, \$ *100*

Valuation of horse equipments, \$ *100*

Remarks:

Book mark:

Glavin

W | 8 H. Art'y. | U.S.C.T.

Scott Woodfolk
Priv., Co. A, 8 Reg't U. S. Col'd H. Art'y.

Appears on

Company Muster Roll
for *Jan. & Feb.*, 1863.
Present or absent *Present.*

Stoppage, \$ *100* for

Due Gov't, \$ *100* for

Valuation of horse, \$ *100*

Valuation of horse equipments, \$ *100*

Remarks: *Due U.S. for*
one year, 39

Book mark:

C. R. Owen

W

| S H. Art'y. | U.S.C.T.

Scott Woolfolk

Pvt., Co. A, 8 Reg't U. S. Col'd H. Art'y.

Appears on

Company Muster Roll

for March & Apr., 1863.

Present or absent Present,

Stoppage, \$ 100 for

Due Gov't, \$ 100 for

Valuation of horse, \$ 100

Valuation of horse equipments, \$ 100

Remarks: Due U.S. for one
year, 39 cents,

Book mark:

C. R. Owen,

W | S H. Art'y. | U.S.C.T.

Scott Woolfolk

Priv., Co. A, 8 Reg't U. S. Col'd H. Art'y.

Appears on

Company Muster Roll

for *May 1 June*, 1865.

Present or absent *Present*

Stoppage, \$ *100* for

Due Gov't, \$ *100* for

Valuation of horse, \$ *100*

Valuation of horse equipments, \$ *100*

Remarks:

Book mark: -----

C. B. Owen

(358)

/ Copyist.

71

| 8 H. Art'y. | U. S. C. T.

Isaiah Woodfath

2nd, Co. A, 8 Reg't U. S. Col'd H. Art'y.

Appears on

Company Muster Roll

for *July and Aug*, 186*0*.

Present or absent *Present*

Stoppage, \$ *100* for

Due Gov't, \$ *100* for

Valuation of horse, \$ *100*

Valuation of horse equipments, \$ *100*

Remarks: *Keep you on file*

Book mark:

H. W. Woodfath

21

| S H. Art'y. | U. S. C. T. |

Scott Woolfolk

Priv, Co. A, 8 Reg't U. S. Col'd H. Art'y.

Appears on

Company Muster Roll

for *Sept and Oct*, 1863 .

Present or absent *Present*

Stoppage, \$ *100* for

Due Gov't, \$ *100* for

Valuation of horse, \$ *100*

Valuation of horse equipments, \$ *100*

Remarks:

Book mark:

N. H. Merrill

(358)

Copyist.

11

| S H. Art'y. | U. S. C. T. |

South Woolfolk

220, Co. A, 8 Reg't U. S. Col'd H. Art'y.

Appears on

Company Muster Roll

for *Nov and Dec*, 186*3*.

Present or absent *Present*

Stoppage, \$ *100* for

Due Gov't, \$ *100* for

Valuation of horse, \$ *100*

Valuation of horse equipments, \$ *100*

Remarks: _____

Book mark: _____

W. W. Smith

21

8 H. Art'y.

U.S.C.T.

Asst. Muster-roll

Co. C, 8 Reg't U. S. Col'd H. Art'y.

Appears on **Co. Muster-out Roll**, dated

1861, *Feb 10*, 1861 .

Muster-out to date *Feb 10*, 1861 .

Last paid to *1861*, 1861 .

Clothing account:

Last settled....., 1861 ; drawn since \$.....¹⁰⁰

Due soldier \$.....¹⁹/₁₀₀; due U. S. \$.....¹⁰⁰

Am't for cloth'g in kind or money adv'd \$.....¹⁰⁰

Due U. S. for arms, equipments, &c., \$.....¹⁸/₁₀₀

Bounty paid \$.....¹⁰⁰; due \$.....²⁷⁷/₁₀₀

Remarks: *joined at age 18*
in the 1st Reg't
of Artillery, Enlist paper
not signed for 1861

Book mark:

1952

Wright Henry
Co et, 8 U.S. Col'd H. Art'y.

Private | Private

CARD NUMBERS.

1	5467217	26
2	5468641	27
3	5468790	28
4	5468939	29
5	5469084	30
6	5469226	31
7	5469356	32
8	5469481	33
9	5469601	34
10	5469712	35
11	9121342	36
12	40744988	37
13		38
14		39
15		40
16		41
17		42
18		43
19		44
20		45
21		46
22		47
23		48
24		49
25		50

Book Mark:

See also

W | 8 H. Art'y. | U.S.C.T.

Henry Wright

....., Co. A, 8 Reg't U.S. Col'd H. Art'y.

Appears on

Company Descriptive Book

of the organization named above.

DESCRIPTION.

Age 28 years; height 5 feet 6 inches.

Complexion Dark

Eyes Dark; hair Dark

Where born Sintonia, Miss.

Occupation Farmer

ENLISTMENT.

When Sept. 13, 1864.

Where Paducah, Ky.

By whom R. Schofield; term 3 y'rs.

Remarks:

.....
.....
.....
.....
.....

Anderson

W

8 H. Art'y.

U.S.C.T.

Henry Knight

Appears with rank of *Private* on

Muster and Descriptive Roll of a Detachment of U. S. Vols. forwarded

for the 8 Reg't U. S. Col'd H. Art'y. Roll dated

Paducah, Ky., N.Y. Sept. 30, 1864.

Where born *Mississippi*

Age *28* y'rs; occupation *Farmer*

When enlisted *Sept. 13, 1864*

Where enlisted *Paducah, Ky.*

For what period enlisted *3* years.

Eyes *Black*; hair *Black*

Complexion *Black*; height *5* ft. *0* in.

When mustered in *Sept. 13, 1864*

Where mustered in *Paducah*

Bounty paid \$ *100*; due \$ *100*

Where credited

Company to which assigned

Remarks: *Credited to Mcbracken Co. 12th D. Ky. is a substitute in lieu of John R. Thompson an enrolled man of said county.*

Book mark:

Callaway

(339)

Copyist.

W

| 8 H. Art'y. | U.S.C.T.

Henry Wright

Priv., Co. A, 8 Reg't U. S. Col'd H. Art'y.

Appears on

Company Muster Roll

for *Sept. 9 Oct. 1*, 186*4*

Present or absent *Present*

Stoppage, \$ *100* for

Due Gov't, \$ *100* for

Valuation of horse, \$ *100*

Valuation of horse equipments, \$ *100*

Remarks:

Book mark:

C. R. Owen

W | 8 H. Art'y. | U.S.C.T.

Henry Wright-
Priv., Co. A, 8 Reg't U. S. Col'd H. Art'y.

Appears on

Company Muster Roll

for *Nov. & Dec.*, 186 *4*.

Present or absent *Present.*

Stoppage, \$ *100* for

Due Gov't, \$ *100* for

Valuation of horse, \$ *100*

Valuation of horse equipments, \$ *100*

Remarks:

Book mark:

C.R. Owen,

(358)

Copyist.

W | **S H. Art'y.** | **U.S.C.T.**

Henry Wright -
Priv, Co. A, 8 Reg't U. S. Col'd H. Art'y.

Appears on

Company Muster Roll

for *Jan 9 Feb*, 1865.

Present or absent *Present*

Stoppage, \$ *100* for

Due Gov't, \$ *100* for

Valuation of horse, \$ *100*

Valuation of horse equipments, \$ *100*

Remarks:

Book mark: -----

C. B. Owen

W

| 8 H. Art'y. |

U.S.C.T.

Henry Wright

Priv., Co. A, 8 Reg't U. S. Col'd H. Art'y.

Appears on

Company Muster Roll

for *March & Apr.*, 186*5*.

Present or absent *Present,*

Stoppage, \$.....100 for

Due Gov't, \$.....100 for

Valuation of horse, \$.....100

Valuation of horse equipments, \$.....100

Remarks:.....

.....
.....
.....
.....
.....
.....
.....
.....
.....

Book mark:.....

C. R. Allen

W | 8 H. Art'y. | U.S.C.T.

Henry Wright
Pvt., Co. A, 8 Reg't U. S. Col'd H. Art'y.

Appears on

Company Muster Roll

for *Mary V. Jones*, 1865.

Present or absent *Present*

Stoppage, \$.....100 for

Due Gov't, \$.....100 for

Valuation of horse, \$.....100

Valuation of horse equipments, \$.....100

Remarks:.....
.....
.....
.....
.....
.....
.....
.....

Book mark:.....

C. B. Owen,
Copyist.

21

| S H. Art'y. | U. S. C. T.

Henry Wright

219, Co. A, 8 Reg't U. S. Col'd H. Art'y.

Appears on

Company Muster Roll

for *July and Aug*, 186*9*.

Present or absent *Present*

Stoppage, \$ *100* for

Due Gov't, \$ *100* for

Valuation of horse, \$ *100*

Valuation of horse equipments, \$ *100*

Remarks: *Stop for 1 Haversack & 1 Quilt*

Book mark:

H. T. ...

21

| 8 H. Art'y. | U.S.C.T.

Henry Wright

Priv, Co. A, 8 Reg't U. S. Col'd H. Art'y.

Appears on

Company Muster Roll

for *Sept and Oct*, 1865.

Present or absent *Present*

Stoppage, \$ *100* for

Due Gov't, \$ *100* for

Valuation of horse, \$ *100*

Valuation of horse equipments, \$ *100*

Remarks:

Book mark:

N. H. Merrill

21

| S H. Art'y. | U. S. C. T. |

Henry Wright

2nd, Co. A, 8 Reg't U. S. Col'd H. Art'y.

Appears on

Company Muster Roll

for *Nov. 1st 1862*, 1862 .

Present or absent *absent*

Stoppage, \$ *1.00* for

Due Gov't, \$ *1.00* for

Valuation of horse, \$ *1.00*

Valuation of horse equipments, \$ *1.00*

Remarks: *In quarantine at Victoria B.C. since Dec. 8th 1862*

Book mark:

Henry Wright

W

8 H. Art'y.

U.S.C.T.

Henry Wright

Prvt, Co. A, 8 Reg't U. S. Col'd H. Art'y.

Appears on Returns as follows:

Sept 1864 Aug 30/64
Paducah Ky. - Recruit
from depot since last
Return

Dec 1863 Camp 1864
about in confinement
at Victoria Tex since
Dec 8/63.

Book mark :

Chas. J. Allen

(546)

Copyist.

21

S. H. Art'y.

U.S.C.T.

Henry Wright

C, Co. *A*, 8 Reg't U. S. Col'd H. Art'y.

Appears on **Co. Muster-out Roll**, dated

Victoria Tex, *Feb. 10*, 1866 .

Muster-out to date *Feb. 10*, 1866 .

Last paid to *Aug 31*, 1866 .

Clothing account:

Last settled....., 186 ; drawn since \$..... 100

Due soldier \$..... *80* 100; due U. S. \$..... 100

Am't for cloth'g in kind or money adv'd \$..... 100

Due U. S. for arms, equipments, &c., \$..... 100

Bounty paid \$ *none* 100; due \$ *none* 100

Remarks: *Entered service as a Sub. for*

John B. Thompson 1st Enroll Dist. of Tex.

Book mark:

Night & Berry
P, Co. A, 8 Reg't 125th A.

Enclosures.

Bed Cards	Final Statements
Burial Records	Furloughs or L. of A.
Certs. of Dis. for Discharge	Med. Certificates
C. M. Charges	Med. Des. Lists
Descriptive Lists	Orders
Discharge Certificates	Pris. of War Record
Enlistment Papers	Resignations

Other papers relating to—

Admission to Hosp'l	Furlough or L. of A.
Casualty Sheet	Med. Examination
Confinement	Misc. Information
Contracts	Pay or Clothing
Death or Effects	Personal Reports
Desertion	Rank
Discharge from Hosp'l	Transfer to Hosp'l
Discharge from Service	Transfer to V. R. C.
Duty	Transportation

Henry Wright. Art
Co. "A". 8th U.S.C. & Hy

Mr Ellbrook.

Entered

Adjutant General's Office,

COLORED TROOPS BRANCH,

W. H. Ellenbrook

February 3rd, 1876

Vol. C.T., 187

Wanted in the case of Newry Wright, Pvt., Co. A,
8th Reg't U.S.C.T. "Hooey"
Cause of Confinement, Copy of trial, if tried -
Absent. in Confinement at Victoria Texas
since Dec. 8/65 vide M.R. for Nov 11 Dec 65.

Respectfully,

W. H. Ellenbrook
I. J. Paxton
Chief Clerk

Adjutant General's Office,

, 187

Vol. C. T., 187

Reply in case of _____, Co. _____,
Reg't _____

No charges on file - no record of
trial.
Company Moon Repr dated Dec 8/65 -
Private Henry Wright arrested by my order
and delivered to the P.M. for trial by C.M. "

Extra, Feb 18/76

See of Mr. Dept for Co. Moon Reports dated Dec 8/65 "Arrested
by order and delivered to P.M. for trial in C.M. - no record
of trial, or charges -

1955

Wright Peter

Co K, 8 U.S. Col'd H. Art'y.

Private

Private

CARD NUMBERS.

1	57481221	26
2	57481361	27
3	57481501	28
4	57481634	29
5	57481765	30
6	57481887	31
7	57481995	32
8	57482097	33
9	57482196	34
10	57482437	35
11	9122769	36
12	49744976	37
13		38
14		39
15		40
16		41
17		42
18		43
19		44
20		45
21		46
22		47
23		48
24		49
25		50

Book Mark:

See also

M | 8 H. Art'y. U.S.C.T.

Peter Wright

Co. *K*, 8 Reg't U. S. Col'd H. Art'y.

Appears on

Company Descriptive Book
of the organization named above.

DESCRIPTION.

Age *17* years; height *5* feet *5* inches.

Complexion *Black*

Eyes *Black*; hair *Black*

Where born *Calumet, Ky.*

Occupation *Farmer*

ENLISTMENT.

When *June 24*, 186*4*

Where *Paducah*

By whom *M. H. Beggart*; term *3* y'rs.

Remarks: *Died June 22nd 1865 -
at Fort Louisa, U. S. A. Genl
Hosp. Ohio at New
Albany, Ind of Typhoid
Fever.*

Keefe

(383g)

Copist.

N

S II. Art'y.

U.S.C.T.

Peter Wright,
Prt. Co. *K* 8 Reg't U. S. Col'd H. Art'y.

Age _____ years.

Appears on

Company Muster Roll*

for *Enlistment to June 30th*, 186*4*.

Joined for duty and enrolled:

When *June 24th*, 186*4*.

Where *Paducah, Ky.*

Period *3* years.

Mustered in:

When *June 25th*, 186*4*.

Where *Paducah, Ky.*

Present or absent *Present.*

Stoppage, \$ 100 for _____

Due Gov't \$ 100 for _____

Valuation of horse, \$ 100

Valuation of horse equipments, \$ 100

Remarks: _____

*First current roll. No muster-in roll of this company on file.

Book mark: _____

Harin

(358d)

Copyist.

Jr.

8 H. Art'y.

U.S.C.T.

Peter Wright,
Pvt., Co. K, 8 Reg't U. S. Col'd H. Art'y.

Appears on

Company Muster Roll

for *July and August, 1864.*

Present or absent *Present.*

Stoppage, \$ 100 for

Due Gov't, \$ 100 for

Valuation of horse, \$ 100

Valuation of horse equipments. \$ 100

Remarks :

Book mark :

Harvi

(358)

Copyist.

W 8 H. Art'y. U.S.C.T.

Peter Wright

Pr, Co. K, 8 Reg't U. S. Col'd H. Art'y.

Appears on

Company Muster Roll

for Sept - Mar Oct, 1864

Present or absent Present

Stoppage, \$ 100 for

Due Gov't, \$ 100 for

Valuation of horse, \$ 100

Valuation of horse equipments, \$ 100

Remarks: Sick in Regimental Hospital

Book mark:

(358)

Lewey
Compr Copyist.

Jk. | 8 H. Art'y. | U.S.C.T.

Peter Knight,
Pvt., Co. K, 8 Reg't U. S. Col'd H. Art'y.

Appears on

Company Muster Roll

for *Nov. and Dec.*, 1864.

Present or absent *Present.*

Stoppage, \$ 100 for

Due Gov't, \$ 100 for

Valuation of horse, \$ 100

Valuation of horse equipments, \$ 100

Remarks: *Sick in quarters.*

Book mark:

Sharin

W

8 H. Art'y.

U.S.C.T.

Peter Wright

Priv, Co. K, 8 Reg't U. S. Col'd H. Art'y.

Appears on

Company Muster Roll

for *Jan'y. + Feby.*, 1865.

Present or absent *Present*

Stoppage, \$ 100 for

Due Gov't, \$ 100 for

Valuation of horse, \$ 100

Valuation of horse equipments, \$ 100

Remarks:

Book mark:

D. Mahser
Copyist.

Peter Weight

Priv, Co. K, 8 Reg't U. S. Col'd H. Art'y.

Appears on

Company Muster Roll

for *March & April*, 1865.

Present or absent *absent*

Stoppage, \$ *100* for

Due Gov't, \$ *100* for

Valuation of horse, \$ *100*

Valuation of horse equipments, \$ *100*

Remarks:

Sick in Hospl. at Paducah, Ky.

Book mark:

D. Mahrr

Peter Wright

Priv, Co. K, 8 Reg't U. S. Col'd H. Art'y.

Appears on

Company Muster Roll

for *May & June*, 1865.

Present or absent *absent*.

Stoppage, \$ 100 for

Due Gov't, \$ 100 for

Valuation of horse, \$ 100

Valuation of horse equipments, \$ 100

Remarks:

Sick in Hospl. Paducah, Ky.

Book mark:

D. Mahser
Copyist.

W. | 8 H. Art'y. | U.S.C.T.

Peter Wright

Priv, Co. K, 8 Reg't U. S. Col'd H. Art'y.

Appears on

Company Muster Roll

for *July & August*, 1865.

Present or absent *Absent*

Stoppage, \$ *100* for

Due Gov't, \$ *100* for

Valuation of horse, \$ *100*

Valuation of horse equipments, \$ *100*

Remarks:

Sick in Hospl. Paducah, Ky.

Book mark:

D. Maher

(358)

Copyist.

M

8 H. Art'y.

U.S.C.T.

Peter Wright

Priv, Co. K, 8 Reg't U. S. Col'd H. Art'y.

Appears on

Company Muster Roll

for *Sept & Oct*, 1865.

Present or absent

Stoppage, \$ *100* for

Due Gov't, \$ *100* for

Valuation of horse, \$ *100*

Valuation of horse equipments, \$ *100*

Remarks: *Died June 22/65 on Floating
Hesper, New Albany Ind.
L. M. Stone (909)*

Book mark:

J. O. York

(358)

Copyist.

W | 8 H. Art'y. | U.S.C.T.

Peter Wright

Priv., Co. K, 8 Reg't U. S. Col'd H. Art'y.

Appears on Returns as follows:

Sept 18 64 absent sick
in Hosp at Paucaok Ky.

April 1. Sept 18 65 absent sick
in hosp. at Paucaok Ky.
since April 7 / 65.

Oct 8 65. June 22 / 65.
New Albany Ind - Disch

Book mark:

Chas. J. Sutton

(546)

Copyist.

W

S H. Art'y.

U.S.C.T.

Peter Wright

Tris, Co. K, 8 Reg't U. S. Col'd H. Art'y.

Appears on Co. Muster-out Roll, dated

Victoria Texas, Feby 10, 1866.

Muster-out to date _____, 186 .

Last paid to Oct-31, 1864.

Clothing account:

Last settled _____, 186 ; drawn since \$ _____ 100

Due soldier \$ _____ 100; due U. S. \$ _____ 100

Am't for cloth'g in kind or money adv'd \$ _____ 100

Due U. S. for arms, equipments, &c., \$ _____ 100

Bounty paid \$ _____ 100; due \$ _____ 100

Remarks: Entered service at organization of Co as private. Died at New Albany Ind June 22nd 1865 of Typhoid Fever. Final Statements and Inventory of effects forwarded Oct 25th 1865.

Book mark 2691.1861-132052-159 P 25-69
over

J. P. York

(361)

Copyist.

JAN. 14

5482437

1891 *

71. 1882

Knight, Peter

P. Co. K 8 Reg't 26th A.

2

Enclosures.

Bed Cards	Final Statements /
Burial Records	Furloughs or L. of A.
Certs. of Dis. for Discharge	Med. Certificates
C. M. Charges	Med. Des. Lists
Descriptive Lists	Orders
Discharge Certificates	Pris. of War Record
Enlistment Papers	Resignations

Other papers relating to—

Admission to Hosp'l	Furlough or L. of A.
Casualty Sheet	Med. Examination
Confinement	Misc. Information
Contracts	Pay or Clothing
Death or Effects	Personal Reports
Desertion	Rank
Discharge from Hosp'l	Transfer to Hosp'l
Discharge from Service	Transfer to V. R. C.
Duty	Transportation

REPORT

OF THE PROCEEDS OF THE EFFECTS OF

Peter Knight

late of Co. *A 8* Regt.

of *W. S. C. A. C.* Vols., who

died at *Ohio float U.S.A. Ohio River*

General Hospital, ~~Louisville~~ Ky.,

the *22* day of *June*

186 *5*

PROCEEDINGS OF A COUNCIL OF ADMINISTRATION

Convened at Louisville, Kentucky, pursuant to Special Orders, No. 187, dated Post Headquarters, Louisville, Ky., Aug. 14, 1865, consisting of Capt. L. O. Marshall, Company D, 30th Regt. Wisconsin Vol. Inf., Capt. E. B. Strong, Company K, 30th Regt. Wisconsin Vol. Inf., and Lieut. B. F. Cowen, Company I, 30th Regt. Wisconsin Vol. Inf., for the purpose

of disposing of the effects of the late *Peter Wright* of Company *K* Regiment *W S I* Volunteer

The Council found the effects consisted of the following articles. They were ordered to be sold at auction, which was accordingly done, and the amount set opposite the articles respectively obtained, for which the receipt of the Paymaster is annexed.

AT AUCTION.

/	Great coat,	brought,	\$ 1.00
	Uniform coat,	"	
	Flannel sack coat,	"	
2	Trousers, pairs.,	"	1.25
5	Shirts,	"	1.00
2	Drawers, pairs.	"	.50
			10
/	Socks,	" "	
	Shoes,	" "	
	Boots,	" "	
/	Wool blanket,	"	1.50
	Rubber "	"	5.35
/	Knapsack,	<i>Nothing</i>	
	Haversack,	"	
	Canteen,	"	

L O Marshall
Capt. Co. D, 30th Regt. Wisconsin Vols., President.

B F Cowen
2d Lieut. Co. I, 30th Regt. Wisconsin Vols., Recorder.

APPROVED:

Daniel Dill
Colonel, Commanding Post.

FORM 6.

PAYMASTER'S RECEIPT.

RECEIVED, from Capt L. O. Marshall, Company D, 30th Regt. Wisconsin Vols., at Louisville, Ky., August 1865, *Five* Dollars and *thirty*

five cents, the result of the sale of the effects of the late *Peter Wright* of Company, *K* Regiment *W S I* Volunteers

W. Williams
Paymaster, United States Army.

✓

FINAL STATEMENT

OF

NOTE 1. When a soldier transfers his certificates the transfer must be made on them, witnessed by a commissioned officer when practicable, or by some other reputable person known to the Paymaster.

NOTE 2. The amount of additional pay per month, if any, for former services under the act of August 4, 1854, must be carefully noted in the exact words used on the Muster Roll.

NOTE 3. Likewise, the amount due the soldier for a certificate of merit; or in lieu of a commission, under sec. 4, act of August 4, 1854.

NOTE 4. So, also, of any other extra pay, for which he may be mustered; ex. gr. as acting Hospital Steward, as Saddler, &c., and which may be still due him.

NOTE 5. Stoppages for loss or damage done to arms, or other public property, must be noted, and the articles, and particular damage to each, specified.

NOTE 6. Stoppages due, under the sentence of a Court-martial, must be carefully stated, with No. and date of order.

NOTE 7. In cases of desertion, the date, and that of delivery or apprehension, must be given, together with a correct transcript of the order of sentence or pardon, whenever the final settlement of the man's accounts may be affected by either.

[Handwritten signature]

a in Company *[Handwritten]*

Regt. of *[Handwritten]*

[Handwritten signature]

[Faint handwritten notes]
Oct 2nd 1865
135
2nd Regt
14

[Handwritten signature]

ADJUTANT GENERAL'S OFFICE
[Handwritten signature]
Duplicate with Inventory sent 2d Auditor.



I certify, That John Adams,
of Captain Company [5] of the Regiment
of born in, in the State of aged 17 years, feet inches high, complexion,
eyes, hair, and by profession a was enlisted
by at on the day
eighteen hundred and to serve for years,
and is now entitled to a discharge by reason of

The said was last paid by
Paymaster to include the day
of eighteen hundred and, and has pay due from that
time to this present date.

He has been drawing \$ per month for re-enlistment, under sec. 2, act of Aug. 4, 1854.
There is due to him dollars retained pay.
There is due to him dollars retained bounty.
There is due to him dollars on account of clothing not drawn in kind.
He is indebted to the United States dollars on account of extra clothing.
He is indebted to the United States
He is indebted to laundress
at dollars.
The cost of the ration at this post is cents.

GIVEN in duplicate at this day
of 18.

W. D. Beggart
1st Lieut. 5th U.S.C.A. Heavy
Commanding Company.

1953(a)

Murtz, Peter

Co _____, U.S. Col'd H. Arty.

Private

Private

REFERENCE ENVELOPE.

This man was temporarily attached to the organization named above. His cards are filed with the

46 Ills. Inf,

to which organization he belonged.

MAR 4 1954
Wyatt George
Co A, 8 U.S. Col'd H. Art'y.

Private | Private

CARD NUMBERS.

1	5468103	26
2	5468216	27
3	5468360	28
4	5469791	29
5	9121275	30
6		31
7		32
8		33
9		34
10		35
11		36
12		37
13		38
14		39
15		40
16		41
17		42
18		43
19		44
20		45
21		46
22		47
23		48
24		49
25		50

Book Mark: _____

See also _____

W | 8 H. Art'y. U.S.C.T.

George Wyatt

, Co. A, 8 Reg't U.S. Col'd H. Art'y.

Appears on

Company Descriptive Book

of the organization named above.

DESCRIPTION.

Age 18 years; height 5 feet 6 inches.

Complexion Dark

Eyes Dark; hair Dark

Where born Belvidere, Tenn

Occupation Farmer

ENLISTMENT.

When Nov. 27, 1864.

Where Paducah, Ky.

By whom S. D. Olson; term 3 y'rs.

Remarks: Died at Hospital
No 2, Paducah, Ky.
May 14/64. Cause of
death, Bubola

Henderson

77. | S H. Art'y. | U.S.C.T.

George Wyatt
Private, Co. A, 1 Reg't Ky. H. Art'y.*

Appears on

Company Muster-in and Descriptive Roll

of the organization named above. Roll dated

Paducah Ky, Apr 26, 1864.

Where born Beloford Tenn

Age ¹⁸~~27~~ y'rs; occupation Farmer

When enlisted Mar 27, 1864.

Where enlisted Paducah Ky

For what period enlisted 3 years.

Eyes dk; hair dk

Complexion dk; height 5 ft. 6 in.

When mustered in Apr 26, 1864.

Where mustered in Paducah Ky

Bounty paid \$ 100; due \$ 100

Where credited 1st Dist Ky

Company to which assigned

Remarks:

* As it appears on roll

* This organization subsequently became Co. A, 8 Reg't U. S. Colored Heavy Artillery.

Book mark:

Randolph

G

8 H. Art'y.

U.S.C.T.

George Wyatt
Priv, Co. A, 1 Reg't Ky. H. Art'y.*

Appears on

Company Muster Roll

for *Enlistment to Apr 30*, 1864.

Present or absent *Present*

Stoppage, \$ *100* for

Due Gov't, \$ *100* for

Valuation of horse, \$ *100*

Valuation of horse equipments, \$ *100*

Remarks:

*This organization subsequently became Co. A, 8 Reg't U. S. Col'd Heavy Artillery.

Book mark:

Waddington

(358)

Copyist.

N | 8 H. Art'y. | U.S.C.T.

George Nyath
Priv, Co. A, 8 Reg't U. S. Col'd H. Art'y.

Appears on

Company Muster Roll

for *May & June*, 186*4*.

Present or absent.....

Stoppage, \$.....*100* for.....

Due Gov't, \$.....*100* for.....

Valuation of horse, \$.....*100*

Valuation of horse equipments, \$.....*100*

Remarks: *Died at Hosp. No. 2*
Paducah Ky. May 14th 64.

Book mark:.....

Waddington

George Myall

Co. G., 8 Reg't U. S. Col'd H. Art'y.

Appears on **Co. Muster-out Roll**, dated *Victoria Bv*, *Feb. 10*, 1866 .

Muster-out to date _____, 186 .

Last paid to *Apr 30*, 186*6* .

Clothing account:

Last settled _____, 186 ; drawn since \$ _____ 100

Due soldier \$ _____ 100; due U. S. \$ _____ 100

Am't for cloth'g in kind or money adv'd \$ _____ 100

Due U. S. for arms, equipments, &c., \$ _____ 100

Bounty paid \$ *none* 100; due \$ _____ 100

Remarks: *Rec'd*

*joined at orga us firm. Enroll'd & sub. h. servt
in 1st Cav. regt of Ky. at time of enrole
Rec'd at US Hqs for G. T. at Paducah Ky May 14, 64
of Bureau Sns. & final stats for May 31, 64*

Book mark: *292750*

Hyatt, George

B, Co. A

8

U.S.C.H.A.

Enclosures.

Bed Cards	Descriptive Lists
Burial Records	Final Statements
Certs. of Dis. for Discharge	Furloughs
C. M. Charges	Med. Des. Lists
Med. Certificates	Orders

Other papers relating to—

Admission to Hosp'l	Furlough
Casualty Sheet (Officer's)	Med. Examination
Confinement	Misc. Information
Contracts	Pay or Clothing
Death or Effects	Personal Reports
Desertions	Rank
Discharge from Hosp'l	Transfer to Hosp'l
Discharge from Service	Transfer to V. R. C.
Duty	Transportation

Adj. Gen.
2d Auditor
P.

FINAL STATEMENT

V
1000
OF

Private George Wyatt
8th Reg't of U.S.C.A. Heavy

VOLUNTEERS.

See Muster Roll

NOTE 1.—Two of these certificates (or duplicates) are to be given to each Volunteer Soldier or drafted man who may be discharged previously to the discharge of his company, that he may at once receive from the Paymaster the pay, &c., due him, and the captain or other COMMISSIONED officer commanding the company will certify to the act of the delivery of the duplicate certificates; on these certificates the Soldier is "entitled to" his discharge, and should also present his discharge to the Paymaster to have the payment endorsed on it. The discharge is to be given back to the Soldier by the Paymaster; the latter only retaining as his voucher the duplicate certificates.

NOTE 2.—If the Soldier is entitled to pay for the use of his horse, the Company Commander will certify to that fact on the back of both these final statements, and also to the time he has pay due for having been so mounted on his own horse.

NOTE 3.—When a Soldier is furnished with final statements, his descriptive list, if he has one, should be taken up by the officer who gives the Soldier these statements, and endorsed with a statement to this effect by the officer. This endorsement should exhibit a full statement of the time for which the Soldier was allowed pay on his final statements, the clothing account, and all other charges against him or in his favor, so as to comprise a complete exhibit of his account. It will then be transmitted to the company commander of the Soldier, who will enter all the data necessary to a full understanding of the Soldier's account on the muster roll upon which the Soldier's discharge is reported. The descriptive list will then be destroyed. The object of this is, that the remaining portion of the Soldier's account may be settled upon the receipt of these muster rolls, and the Soldier receive any pay or allowances that may be due him at the time of his discharge, and which may not appear on his final statements from the fact that his descriptive list is incomplete. These accounts for back pay, &c., are settled by the 2d Auditor of the Treasury Department.

NOTE 4.—Charges for loss or injury to ordnance, horse equipments, and other miscellaneous charges, should appear under the heading of "Other Stoppages."

NOTE 5.—Bounty paid by State authorities, and not by the United States, will not be entered on this statement.

NOTE 6.—Amounts due the Sutler and Laundress must be entered on the muster roll on which the discharge, death, desertion, &c., is reported, as well as on the final statement, otherwise the amount cannot be collected from the United States.

NOTE 7.—This blank will be used for deceased volunteers and drafted men, as well as for others.

NOTE 8.—Where a Soldier dies in Hospital or on detached service, his descriptive list, if he has one, should be sent with his final statements, in duplicate, to the Adjutant General, Washington, D. C.

ADJUTANT GENERAL'S OFFICE.
Copy 2711864
Duplicate with Inventory sent 2d Auditor.

P.

I certify, on honor, that George Wyatt a Private of
 Captain Stephen Johnson Company (A) of the 8th Regiment of U.S.C.A. Heavy
~~VOLUNTEERS~~, of the State of _____, born in Reloford, State
 of Tennessee, aged 18 years; 5 feet 6 inches high; Dark complexion,
Dark eyes, Dark hair, and by occupation a Farmer, having joined the company on
 its original organization at Paducah Kentucky, and enrolled in it at the muster into
 the service of the United States at Paducah Kentucky, on the 27th day
 of March, 1864, (or was mustered in service as a recruit, by Lieut. W. L. M. Over
 _____, at Paducah Ky., on the 26th day of April,
 1864, or was drafted and mustered into the service of the United States from the _____
 Enrollment District of the State of _____, at _____,
 on the _____ day of _____, 186) to serve in the Regiment, for
 the term of Three Years or War: and having served HONESTLY and
 FAITHFULLY with his Company in U.S.C.A. Heavy to the present date, is now
 entitled to a **DISCHARGE** by reason of Death in Paducah Kentucky
on the 14th day of May 1864, Cause of death Rubella.

The said George Wyatt was last paid by Paymaster
May Linn to include the 31st day of April, 1864 and has
 pay due him from that time to the present date; he is entitled to pay and subsistence for
 TRAVELING to place of enrollment, and whatever other allowances are authorized to volunteer
 soldiers, drafted men, or militia, so discharged. He has received from the United States **CLOTHING**
 amounting to Twenty-Two $\frac{82}{100}$ dollars, since the _____ day of _____,
 1864, when his clothing account was last settled. He has received from the United States
 _____ $\frac{100}{100}$ dollars advanced **AGUNTY**.

There is to be stopped from him, on account of the State of _____, or other
 authorities, for **CLOTHING**, &c., received on entering service, _____ $\frac{100}{100}$ dollars; and
 for other stoppages, viz: _____

_____ $\frac{100}{100}$ dollars.
 He has been furnished with TRANSPORTATION in kind from the place of his discharge to
 _____; and he has been SUBSISTED for TRAVELING to his
 place of enrollment, up to the _____, 1864.

He is indebted to _____, **BUTLER**, _____ $\frac{100}{100}$ dollars.

He is indebted to _____, **LAUNDRESS**, _____ $\frac{100}{100}$ dollars.

Given in Duplicate, at Paducah Kentucky, this 10th day
 of July, 1864.

Stephen Johnson
Capt 8th U.S.C.A. Heavy
 Commanding Company

1955
Wyatt Gideon

Co & D, 8 U.S. Col'd H. Art'y.

Private | Private

CARD NUMBERS.

1	5474394	26
2	5474530	27
3	5472914	28
4	5473026	29
5	5473292	30
6	5473419	31
7	5473550	32
8	5473676	33
9	5473797	34
10	5473912	35
11	5474019	36
12	5474124	37
13	5475684	38
14	5474226	39
15	9122317	40
16	9121831	41
17	40744477	42
18		43
19		44
20		45
21		46
22		47
23		48
24		49
25		50

Book Mark:

See also

W. H. Artz U.S.C.T.

Gideon Wyatt

, Co. D, 8 Reg't U.S. Col'd H. Artz

Appears on

Company Descriptive Book

of the organization named above.

DESCRIPTION.

Age 23 years; height 5 feet 8 inches.

Complexion blk

Eyes blk; hair blk

Where born Clarksville, Tenn.

Occupation Farmer

ENLISTMENT.

When Mar. 14 1865

Where Ft. Donelson, Tenn.

By whom Robt. Dunn; term 3 y'rs.

Remarks: Appointed Corp'l
& reduced to private
at his own request

Henderson

W | 8 H. Art'y. | U.S.C.T.

Isidon Wyatt

Co. E, 8 Reg't U.S. Col'd H. Art'y.

Appears on

Company Descriptive Book
of the organization named above.

DESCRIPTION.

Age 28 years; height 5 feet 8 inches.

Complexion *Blk*

Eyes *Blk*; hair *Blk*

Where born *Blacksville, Tenn*

Occupation *Farmer*

ENLISTMENT.

When *March 14*, 1864.

Where *E. Donaldson*

By whom *R. D. ...*; term *3* y'rs.

Remarks: *Transferred to Co. D*

Remainder written with lead pencil

S. A. Moreland

N

8 H. Art'y.

U.S.C.T.

Isidore Nyath

Rk, Co. *E*, 1 Reg't Ky. H. Art'y.†

Age _____ years.

Appears on

Company Muster Roll*

for *Enlistment to April 30*, 1864.

Joined for duty and enrolled:

When *March 11*, 1864.

Where *H. Doublson, Tenn.*

Period *3* years.

Mustered in:

When *April 26*, 1864.

Where *Paducah, Ky.*

Present or absent *Present*

Stoppage, \$ *100* for _____

Due Gov't \$ *100* for _____

Valuation of horse, \$ *100*

Valuation of horse equipments, \$ *100*

Remarks: _____

†This organization subsequently became Co. "E", 8 Reg't U. S. Colored Heavy Artillery.

*First current roll. No muster-in roll of this company on file.

Book mark: _____

(3586)

Jas. V. Kearny
Copyist.

W

S H. Art'y.

U.S.C.T.

Gedion Wick

Wick, Co. E, 8 Reg't U. S. Col'd H. Art'y.

Appears on

Company Muster Roll

for *May and June*, 1864.

Present or absent

Stoppage, \$ 100 for

Due Gov't, \$ 100 for

Valuation of horse, \$ 100

Valuation of horse equipments, \$ 100

Remarks:

*Transferred to Co. D, 8 U.S., by order of
Col. H. W. Barry, dated Ft. Anderson, Pa-
ducate, Ky., May 20, 1864, Special orders.*

Book mark:

Fair. Kearny
Copyist.

William Wyatt
Co. A, Co. *A*, 8 Reg't U. S. Col'd H. Art'y.

Age _____ years.

Appears on

Company Muster Roll*

for *May 7 June*, 186*1*.

Joined for duty and enrolled:

When *Mar. 14*, 186*1*.

Where *Madison Tenn*

Period *3* years.

Mustered in:

When *Apr. 26*, 186*1*.

Where *Pudroak Ky*

Present or absent *Present*

Stoppage, \$ *100* for _____

Due Gov't \$ *100* for _____

Valuation of horse, \$ *100*

Valuation of horse equipments, \$ *100*

Remarks: *Transferred from Co. "B" per D.O. No. 7 Hd Qrs.*

*First current roll. No muster-in roll of this company on file.

Book mark: _____

Joseph Stewart
(358d) Copyist.

JAN. 14

5472914

1891

Remarks:
1st ... C. A. Hy. pr.
order May 20. H. W.
Barry Col.

Gideon Nyath

7 Coop, Co. D, 8 Reg't U. S. Col'd H. Art'y.

Appears on

Company Muster Roll

for *July & Aug.*, 186*4*.

Present or absent ***

Stoppage, \$ *100* for

Due Gov't, \$ *100* for

Remarks: *Absent sick in Paducah since the 20 of Aug. 1864.*

** Name cancelled in presence of*

Book mark:

M. M. Warren

Mr. | 8 H. Art'y. | U.S.C.T.

Gideon Wyatt.

Plt., Co. D, 8 Reg't U. S. Col'd H. Art'y.

Appears on

Company Muster Roll

for Sept. & Oct., 1864.

Present or absent Present.

Stoppage, \$ 100 for

Due Gov't, \$ 100 for

Valuation of horse, \$ 100

Valuation of horse equipments, \$ 100

Remarks: Resigned Corporal
Sept. 1, 1864.

Book mark:

J. G. White.

W

8 H. Art'y.

U.S.C.T.

Gideon Wyatt

Pi., Co. D, 8 Reg't U. S. Col'd H. Art'y.

Appears on

Company Muster Roll

for *Nov. & Dec.*, 186*4*

Present or absent *Present.*

Stoppage, \$ *100* for

Due Gov't, \$ *100* for

Valuation of horse, \$ *100*

Valuation of horse equipments, \$ *100*

Remarks: *On detached duty
as teamster in Post
G.M. Department.*

Book mark:

(358)

J. J. Smith

Copyist.

71

8 H. Art'y.

U.S.C.T.

Gideon Wyatt

Pr., Co. D, 8 Reg't U. S. Col'd H. Art'y.

Appears on

Company Muster Roll

for *Jan. & Feb.*, 1863.

Present or absent *Present.*

Stoppage, \$ *100* for

Due Gov't, \$ *100* for

Remarks: *On daily duty
as tender in Post
Q. M. Dept.*

Book mark:

[Signature]

Sp

8 H. Art'y.

U.S.C.T.

Gideon Hyatt

Pvt., Co. D, 8 Reg't U. S. Col'd H. Art'y.

Appears on

Company Muster Roll

for *Mar. & Apr.*, 1863.

Present or absent *Present.*

Stoppage, \$ *100* for

Due Gov't, \$ *100* for

Remarks:

Book mark:

(358)

[Signature]

Copyist.

W

S H. Art'y.

U.S.C.T.

Gideon Myatt

Pvt., Co. D, 8 Reg't U. S. Col'd H. Art'y.

Appears on

Company Muster Roll

for *May & June*, 186 *5*.

Present or absent *Absent.*

Stoppage, \$ *100* for

Due Gov't, \$ *100* for

Remarks: *Absent in detached*
Service as Dir. Quartermaster.

Book mark: _____

(358)

J. Smith

Copyist.

Op

S H. Art'y.

U.S.C.T.

Gideon Pratt

Pr, Co. D, 8 Reg't U. S. Col'd H. Art'y.

Appears on

Company Muster Roll

for *July & Aug*, 1865.

Present or absent *present*

Stoppage, \$ *100* for

Due Gov't, \$ *100* for

Remarks: *Due U.S. for Drk
10. Due U.S. for 1/2 Shelter
tent \$4.90; 1 Traverser
.95; 1 Great Coat Strap; 2.*

Book mark:

J. Brown
(358) Copyist.

M

S H. Art'y.

U.S.C.T.

Gideon W. Gatt

Pr, Co. D, 8 Reg't U. S. Col'd H. Art'y.

Appears on

Company Muster Roll

for *Sept & Oct*, 1865.

Present or absent *present*

Stoppage, \$ *100* for

Due Gov't, \$ *100* for

Remarks:

Book mark:

(358)

J. Brown

Copyist.

G.

8 H. Art'y. | U.S.C.T.

Gideon W. Gatt

Tri, Co. D, 8 Reg't U. S. Col'd H. Art'y.

Appears on

Company Muster Roll

for *Jan & Dec*, 1865.

Present or absent *present*

Stoppage, \$ *100* for

Due Gov't, \$ *100* for

Valuation of horse, \$ *100*

Valuation of horse equipments, \$ *100*

Remarks:

Book mark:

J. Brown

(358)

Copyist.

W

8 H. Art'y.

U.S.C.T.

Gidron Wyatt

^{1st} Capt., Co. K, 8 Reg't U. S. Col'd H. Art'y.

Appears on Returns as follows:

May 1864 May 20 1864
Paucely transferred from
Co. E 4. Co. K

July & Aug 1864 absent
sick in Hoopl.

Dec 1864 to Feb 1865
on duty Franster in
Post 2. M. Dept

May 1865 absent detached
as Franster with Div
train

June 1865 absent
Div train

Book mark:

Chas. G. Patten

(546)

Copyist.

9/1

8 H. Art'y.

U.S.C.T.

Lideon W. Hart

Co. D, 8 Reg't U. S. Col'd H. Art'y.

Appears on **Co. Muster-out Roll**, dated

Victoria, Tex., *Feb 10*, 186*0*.

Muster-out to date *Feb 10*, 186*0*.

Last paid to *Aug 31*, 186*5*.

Clothing account:

Last settled....., 186 ; drawn since \$..... 100

Due soldier \$..... 100; due U. S. \$..... *8* ¹⁰/₁₀₀

Am't for cloth'g in kind or money adv'd \$..... 100

Due U. S. for arms, equipments, &c., \$..... 100

Bounty paid \$..... 100; due \$ *300* 100

Remarks: *Transferred from Co E*

as per S. O. No 9 H. Q. Regt

May 20 1864. Appointed Boyl

May 20 1864. Reduced to the

rank at his own request

Sept 1 1864. Enrolled in (over)

Book mark: *245. P. 167. 7.*

(U.S.C.T.)

J. J. Brown

(361)

Copyist.

JAN. 14

5474226

1891

Dist. No. and subject to draft
at time of enlistment.

Gideon Wyatt
Pvt., Co. *E*, 8 Reg't U. S. Col'd H. Art'y.

Appears on **Co. Muster-out Roll**, dated
Victoria Texas, Feb 10, 186*6*.

Muster-out to date _____, 186 .

Last paid to *April 30,* 1864 .

Clothing account:

Last settled _____, 186 ; drawn since \$ _____ 100

Due soldier \$ _____ 100; due U. S. \$ _____ 100

Am't for cloth'g in kind or money adv'd \$ _____ 100

Due U. S. for arms, equipments, &c., \$ _____ 100

Bounty paid \$ _____ 100; due \$ _____ 100

Remarks: *Joined Co at Original
Organization as Private, Transfd
from Co. E to Co. D, by S.O. No. 7
Ad. Gas. & WSC Hy Arty May
20-1864.*

Book mark : _____

(361) *E. B. Cannoll* Copyist.

1956

Wyatt Gus

Co D, 8 U.S. Col'd H. Art'y.

Private - Private

CARD NUMBERS.

1	5466823	26
2	5473005	27
3	5473143	28
4	5473288	29
5	5473420	30
6	5473551	31
7	5473677	32
8	5473798	33
9	5473913	34
10	5474020	35
11	5474125	36
12	5474227	37
12	9121826	38
14		39
15		40
16		41
17		42
18		43
19		44
20		45
21		46
22		47
23		48
24		49
25		50

Book Mark:

See also

W. H. Artz | **U. S. C. T.**

Geo Wyatt

Co. *D*, 8 Reg't U. S. Col'd *H. Artz*

Appears on

Company Descriptive Book

of the organization named above.

DESCRIPTION.

Age *29* years; height *5* feet *6* inches.

Complexion *Dark*

Eyes *Dark*; hair *Dark*

Where born *Colwell Co., Ky.*

Occupation *Farmer*

ENLISTMENT.

When *May 24*, 1864.

Where *Madison, Ky.*

By whom *S. Lambert*; term *3* y'rs.

Remarks:

.....
.....
.....
.....
.....
.....
.....
.....
.....
.....

Henderson

M

8 H. Art'y.

U.S.C.T.

Wm Hyatt
Priv., Co. *D*, 8 Reg't U. S. Col'd H. Art'y.

Age _____ years.

Appears on

Company Muster Roll*

for *May to June*, 1864.

Joined for duty and enrolled:

When *May 24*, 1864.

Where *Panama Ky*

Period *3* years.

Mustered in:

When *June 6*, 1864.

Where *Panama Ky*

Present or absent *Present*

Stoppage, \$ *100* for _____

Due Gov't \$ *100* for _____

Valuation of horse, \$ *100*

Valuation of horse equipments, \$ *100*

Remarks: _____

*First current roll. No muster-in roll of this company on file.

Book mark: _____

(358d)

Joseph Stewart
Capt.

Of | 8 H. Art'y. | U.S.C.T.

Gus Wyatt

Appears with rank of *Priv.* on

Muster and Descriptive Roll of a Detachment of U. S. Vols. forwarded

for the 8 Reg't U. S. Col'd H. Art'y. Roll dated

Paducah Ky., N.Y. June 6, 1864.

Where born *Colwell Co. Ky.*

Age *29* y'rs; occupation *Farmer*

When enlisted *May 24*, 1864.

Where enlisted *Paducah Ky.*

For what period enlisted *3* years.

Eyes *dark*; hair *dark*

Complexion *dark*; height *5* ft. *6* in.

When mustered in *June 6*, 1864.

Where mustered in *Paducah Ky.*

Bounty paid \$ *100*; due \$ *100*

Where credited *McCracken Co. Ky. 1st Dist.*

Company to which assigned *D*

Remarks :
.....
.....

Book mark :
.....

J. A. Jones

A

8 H. Art'y.

U.S.C.T.

Gus Nyath
Private, Co. D, 8 Reg't U. S. Col'd H. Art'y.

Appears on

Company Muster Roll

for *July & Aug.*, 1864.

Present or absent *Present*

Stoppage, \$ *100* for

Due Gov't, \$ *100* for

Remarks:

Book mark:

M. M. Warren

(358)

Copyist.

No. | 8 H. Art'y. | U.S.C.T.

Guy Bryant

Plt., Co. D, 8 Reg't U. S. Col'd H. Art'y.

Appears on

Company Muster Roll

for Sept. & Oct., 1864.

Present or absent Present.

Stoppage, \$ 100 for

Due Gov't, \$ 100 for

Valuation of horse, \$ 100

Valuation of horse equipments, \$ 100

Remarks:

Book mark:

J. G. White.

W

8 H. Art'y.

U.S.C.T.

Chas Wyatt

Pri., Co. D, 8 Reg't U. S. Col'd H. Art'y.

Appears on

Company Muster Roll

for *Nov. & Dec.*, 186*4*.

Present or absent *Present.*

Stoppage, \$ *100* for

Due Gov't, \$ *100* for

Valuation of horse, \$ *100*

Valuation of horse equipments, \$ *100*

Remarks:

Book mark:

(358)

J. J. Smith

Copyist.

W

S H. Art'y.

U.S.C.T.

Geo Wyatt

Pvt., Co. D, 8 Reg't U. S. Col'd H. Art'y.

Appears on

Company Muster Roll

for *Jan. 7 Feb.*, 1865.

Present or absent *Present.*

Stoppage, \$ *100* for

Due Gov't, \$ *100* for

Remarks:

Book mark:

J. Smith

71

8 H. Art'y.

U.S.C.T.

Gus Wyatt

Pvt., Co. D, 8 Reg't U. S. Col'd H. Art'y.

Appears on

Company Muster Roll

for *Mar. & Apr.*, 1865.

Present or absent *Present.*

Stoppage, \$ *100* for

Due Gov't, \$ *100* for

Remarks:

Book mark:

(358)

R. Smith

Copyist.

97

S H. Art'y.

U.S.C.T.

Gus Hyatt

Pvt., Co. D, 8 Reg't U. S. Col'd H. Art'y.

Appears on

Company Muster Roll

for *May & June*, 186*5*.

Present or absent *Present.*

Stoppage, \$ *100* for

Due Gov't, \$ *100* for

Remarks:

Book mark:

(358)

J. L. Smith

Copyist.

31

8 H. Art'y.

U.S.C.T.

Emmett

Pr, Co. D, 8 Reg't U. S. Col'd H. Art'y.

Appears on

Company Muster Roll

for *July + Aug*, 1867.

Present or absent *present*

Stoppage, \$ *100* for

Due Gov't, \$ *100* for

Remarks:

Book mark:

J. Brown

(358)

Copyist.

91

S H. Art'y.

U.S.C.T.

Gus Wyatt

Pri, Co. D, 8 Reg't U. S. Col'd H. Art'y.

Appears on

Company Muster Roll

for *Sept + Oct*, 1865.

Present or absent *present*

Stoppage, \$ *100* for

Due Gov't, \$ *100* for

Remarks:

Book mark:

(358)

J. J. Brown

Copyist.

Gf | **8** H. Art'y. | **U.S.C.T.**

Gus Wyatt

Pri, Co. D, 8 Reg't U. S. Col'd H. Art'y.

Appears on

Company Muster Roll

for *Nov & Dec*, 186*5*.

Present or absent *present*

Stoppage, \$ *100* for

Due Gov't, \$ *100* for

Valuation of horse, \$ *100*

Valuation of horse equipments, \$ *100*

Remarks:
.....
.....
.....
.....
.....
.....
.....
.....

Book mark:

(358) *J. Brown* Copyist.

W

S H. Art'y.

U.S.C.T.

Geo Matt

Co. D, 8 Reg't U. S. Col'd H. Art'y.

Appears on **Co. Muster-out Roll**, dated
Victoria, Tex, *Feb 10*, 1866.

Muster-out to date *Feb 10*, 1866.

Last paid to *Aug 31*, 1865.

Clothing account:

Last settled....., 186 ; drawn since \$..... 100

Due soldier \$ *22* ^{*55*}/₁₀₀; due U. S. \$..... 100

Am't for cloth'g in kind or money adv'd \$..... 100

Due U. S. for arms, equipments, &c., \$..... 100

Bounty paid \$..... 100; due \$ *100* 100

Remarks: *Entered service as a private at Terrell shown. Enrolled in 1st Dist Tex and subject to draft at time of enlistment.*

Book mark:

J. J. Brown
(361) *C* Copyist.

1957

Wyatt Isaac
Co. ~~AW~~ 8 U.S. Col'd H. Art'y.

Private

Private

CARD NUMBERS.

1	5468102	26
2	5468215	27
3	5468348	28
4	5473006	29
5	5473144	30
6	5473289	31
7	5473421	32
8	5473552	33
9	5473678	34
10	5473799	35
11	5473914	36
12	5474021	37
13	5474126	38
14	5469753	39
15	5474228	40
16	9121274	41
17	9121827	42
18	40744966	43
19		44
20		45
21		46
22		47
23		48
24		49
25		50

Book Mark:

See also

W | S. H. Artz | U. S. C. T.

Isaac Wyatt

, Co. G, 8 Reg't U. S. Col'd S. H. Artz

Appears on

Company Descriptive Book

of the organization named above.

DESCRIPTION.

Age 21 years; height 5 feet 7 1/2 inches.

Complexion Dark

Eyes Dark; hair Dark

Where born Crittenden Co., Ky.

Occupation Farmer

ENLISTMENT.

When Nov. 26, 1864.

Where Paducah, Ky.

By whom J. D. Dobson; term 3 y'rs.

Remarks:

Henderson

M

8 H. Art'y. U.S.C.T.

Lease Wyatt

Co. *A*, 8 Reg't U.S. Col'd H. Art'y.

Appears on

Company Descriptive Book

of the organization named above.

DESCRIPTION.

Age *21* years; height *5* feet *7/2* inches.

Complexion *Dark*

Eyes *Dark*; hair *Dark*

Where born *Crittenden, Ky.*

Occupation *Farmer*

ENLISTMENT.

When *Mar. 26*, 186*4*.

Where *Paducah, Ky.*

By whom *S. Dobson*; term *3* y'rs.

Remarks: *Transferred to
Co. D, May 20/64*

Lease Wyatt

NARA 1935
N. | S H. Art'y. | U.S.C.T.

Isaac Wyatt

Private, Co. A, 1 Reg't Ky. H. Art'y.*

Appears on

Company Muster-in and Descriptive Roll

of the organization named above. Roll dated

Paducah Ky, Apr 26, 1864.

Where born Crittenden Ky

Age 21 y'rs; occupation Farmer

When enlisted Mar 26, 1864

Where enlisted Paducah Ky

For what period enlisted 3 years.

Eyes dk; hair dk

Complexion dk; height 5 ft. 7 1/2 in.

When mustered in Apr 26, 1864.

Where mustered in Paducah Ky

Bounty paid \$ 100; due \$ 100

Where credited 1st Dist Ky

Company to which assigned

Remarks:

*This organization subsequently became Co. A, 8 Reg't U. S. Colored Heavy Artillery.

Book mark:

Ward

Of | 8 H. Art'y. | U.S.C.T.

Isaac Hyatt
Priv., Co. A, 1 Reg't Ky. H. Art'y.*

Appears on

Company Muster Roll

for *Enlistment to Apr 30, 1864.*

Present or absent. *Present*

Stoppage, \$.....100 for.....

Due Gov't, \$.....100 for.....

Valuation of horse, \$.....100

Valuation of horse equipments, \$.....100

Remarks:.....

*This organization subsequently became Co. A, 8 Reg't U. S. Col'd Heavy Artillery.

Book mark:.....

(358)

Waudin

Copyist.

It | S H. Art'y. | U.S.C.T.

Isaac Nyath
Priv, Co. A, 8 Reg't U. S. Col'd H. Art'y.

Appears on

Company Muster Roll

for *May & June*, 1864.

Present or absent.....

Stoppage, \$.....100 for.....

Due Gov't, \$.....100 for.....

Valuation of horse, \$.....100

Valuation of horse equipments, \$.....100

Remarks: *Transferred to Co. D. 8th*
U.S. C.A. Heavy. per special order
No. 7 dated Head Quarters 8th U.S.
C.A. Heavy May 20th 64. by order
of Col. H. N. Barry

Book mark:.....

Waudington

H | 8 H. Art'y. | U.S.C.T.

Isaac Hyatt
Co. D, 8 Reg't U. S. Col'd H. Art'y.

Age _____ years.

Appears on

Company Muster Roll*

for *May 10 June*, 186*4*.

Joined for duty and enrolled:

When *Mar 20*, 186*4*.

Where *Paducah Ky*

Period *3* years.

Mustered in:

When *Apr 20*, 186*4*.

Where *Paducah Ky*

Present or absent *Present*

Stoppage, \$ *100* for _____

Due Gov't \$ *100* for _____

Valuation of horse, \$ *100*

Valuation of horse equipments, \$ *100*

Remarks: *Transferred from*
Co. "A" per J. O. No. 7.

*First current roll. No muster-in roll of this company on file.

Book mark: _____

Joseph Stewart
(358*d*) Coryist.

JAN. 14

5473006

1891

Remarks:
H. S. 1st U.S. C.A. N.
by order H. C. Barry
Col.

W

S H. Art'y.

U.S.C.T.

Isaac Hyatt
Private, Co. D, 8 Reg't U. S. Col'd H. Art'y.

Appears on

Company Muster Roll

for *July & Aug.*, 1864.

Present or absent *Present*

Stoppage, \$ *100* for

Due Gov't, \$ *100* for

Remarks:

Book mark:

M. W. Warren

W. | 8 H. Art'y. | U.S.C.T.

Isaac Wyatt

Plt., Co. D, 8 Reg't U. S. Col'd H. Art'y.

Appears on

Company Muster Roll

for Sept. & Oct., 1864.

Present or absent Present.

Stoppage, \$ 100 for

Due Gov't, \$ 100 for

Valuation of horse, \$ 100

Valuation of horse equipments, \$ 100

Remarks:

Book mark:

J. G. White

W

8 H. Art'y.

U.S.C.T.

Isaac Wyatt

Pi., Co. D, 8 Reg't U. S. Col'd H. Art'y.

Appears on

Company Muster Roll

for *Nov. & Dec.*, 186 *4*.

Present or absent *Present.*

Stoppage, \$ 100 for

Due Gov't, \$ 100 for

Valuation of horse, \$ 100

Valuation of horse equipments, \$ 100

Remarks:

Book mark:

J. J. Smith
Copyist.

9

S H. Art'y.

U.S.C.T.

Isaac Wyatt

Pvt., Co. D, 8 Reg't U. S. Col'd H. Art'y.

Appears on

Company Muster Roll

for *Jan. 7 Feb.*, 1863.

Present or absent *Present.*

Stoppage, \$ *100* for

Due Gov't, \$ *100* for

Remarks:

Book mark:

(358)

J. Smith

Copyist.

W

8 H. Art'y.

U.S.C.T.

Isaac Hyatt

Pvt., Co. D, 8 Reg't U. S. Col'd H. Art'y.

Appears on

Company Muster Roll

for *Mar. & Apr.*, 1863.

Present or absent *Present.*

Stoppage, \$ *100* for

Due Gov't, \$ *100* for

Remarks:

Book mark:

(358)

R. Smith

Copyist.

Isaac Wyatt

Co., Co. D, 8 Reg't U. S. Col'd H. Art'y.

Appears on

Company Muster Roll

for *July & Aug*, 1865.

Present or absent *present*

Stoppage, \$ *100* for

Due Gov't, \$ *100* for

Remarks: *Aue U. S. for 100.23*

Book mark:

J. Brown
(358) Copyist.

Op

8 H. Art'y.

U.S.C.T.

Isaac Nyatt

Pr, Co. D, 8 Reg't U. S. Col'd H. Art'y.

Appears on

Company Muster Roll

for *Sept & Oct*, 1865.

Present or absent *present*

Stoppage, \$ *100* for

Due Gov't, \$ *100* for

Remarks: -----

Book mark: -----

J. Brown

(358)

Copyist.

3/

8 H. Art'y. | U.S.C.T.

Isaac Noyatt

Pr, Co. D, 8 Reg't U. S. Col'd H. Art'y.

Appears on

Company Muster Roll

for *Nov 1, Dec*, 1865.

Present or absent *present*

Stoppage, \$ *100* for

Due Gov't, \$ *100* for

Valuation of horse, \$ *100*

Valuation of horse equipments, \$ *100*

Remarks:

Book mark:

J. B. Brown
(358) Copyist.

W

8 H. Art'y.

U.S.C.T.

Isaac Wyatt

Priv, Co. B, 8 Reg't U. S. Col'd H. Art'y.

Appears on Returns as follows:

May 18 64. May 20 64.
Paused by Transfer
from Co. A to Co. B

Book mark :

Isaac Wyatt

(546)

Copyist.

21

H. Art'y.

U.S.C.T.

Isaac Myatt

Co. A, 8 Reg't U. S. Col'd H. Art'y.

Appears on **Co. Muster-out Roll**, dated *Victoria Tex*, *Feb. 10*, 1866.

Muster-out to date _____, 186 .

Last paid to *Apr 30*, 1864 .

Clothing account:

Last settled _____, 186 ; drawn since \$ _____ 100

Due soldier \$ _____ 100; due U. S. \$ _____ 100

Am't for cloth'g in kind or money adv'd \$ _____ 100

Due U. S. for arms, equipments, &c., \$ _____ 100

Bounty paid \$ _____ 100; due \$ _____ 100

Remarks: *Transferred*
joined at camp in Tex. Enrolled & sub.
to draft in 12th Cavalry at time
of Enlist. Trans to Co. A 8th Reg't U.S. Col'd H.
Art'y. in 1864. Mustered Feb. 10 1866.
May 20, 66

Book mark: _____

M. H. Miller

Op

8 H. Art'y.

U.S.C.T.

Ernie Hart

Co. K, 8 Reg't U. S. Col'd H. Art'y.

Appears on **Co. Muster-out Roll**, dated
Sept 11, 1864.

Muster-out to date *Feb 10*, 1866.

Last paid to *Aug 31*, 1865.

Clothing account:

Last settled....., 186 ; drawn since \$..... 100

Due soldier \$ *20* ^{*40*}/₁₀₀; due U. S. \$..... 100

Am't for cloth'g in kind or money adv'd \$..... 100

Due U. S. for arms, equipments, &c., \$ 100

Bounty paid \$..... 100; due \$ *300* 100

Remarks: *Transferred from Co A as per S. O. No 7 K. H. Greiner 20-1864. Enrolled in 4th enrollment dist Ky. subject to death at time of enlistment.*

Book mark:

(361)

J. J. Brown

Copyist.

1958

Wyatt John

Co K, 8 U.S. Col'd H. Art'y.

Private

Private

CARD NUMBERS.

1	5748/218	26
2	5748/352	27
3	5748/492	28
4	5748/626	29
5	5748/757	30
6	5748/878	31
7	5748/996	32
8	57482098	33
9	57482195	34
10	57482435	35
11	9122767	36
12	40744978	37
13		38
14		39
15		40
16		41
17		42
18		43
19		44
20		45
21		46
22		47
23		48
24		49
25		50

Book Mark:

See also

M | 8 H. Art'y. | U.S.C.T.

John Wyatt
....., Co. *K*, 8 Reg't U.S. Col'd H. Art'y.

Appears on
Company Descriptive Book
of the organization named above.

DESCRIPTION.

Age *18* years; height *5* feet *4* inches.

Complexion *Black*

Eyes *Black*; hair *Black*

Where born *Crittenden, Ky.*

Occupation *Farmer.*

ENLISTMENT.

When *June 24*, 186*4*.

Where *Paducah*

By whom *W.H. Beggart*; term *3* y'rs.

Remarks *Died at Crittenden
U.S. Genl Hosp. Louis-
ville, Ky. of Inf. of the
Lungs June 16th 1865.*

Keeper.

W. | 8 H. Art'y. | U.S.C.T.

John F. Wyatt;
Pvt., Co. *K*, 8 Reg't U. S. Col'd H. Art'y.

Age _____ years.

Appears on

Company Muster Roll*
for *Enlistment to June 30th*, 186*4*.

Joined for duty and enrolled:

When *June 24th*, 186*4*.

Where *Paducah, Ky.*

Period *3* years.

Mustered in:

When *June 25th*, 186*4*.

Where *Paducah, Ky.*

Present or absent. *Present.*

Stoppage, \$ 100 for _____

Due Gov't \$ 100 for _____

Valuation of horse, \$ 100

Valuation of horse equipments, \$ 100

Remarks: _____

*First current roll. No muster-in roll of this company on file.

Book mark: _____

Harin

(358d)

Copyst.

W.

8 H. Art'y.

U.S.C.T.

John Hyatt,

Pvt.

Co. K, 8 Reg't U. S. Col'd H. Art'y.

Appears on

Company Muster Roll

for *July and August*, 186*4*

Present or absent *Present*

Stoppage, \$ *100* for

Due Gov't, \$ *100* for

Valuation of horse, \$ *100*

Valuation of horse equipments. \$ *100*

Remarks :

Book mark :

Harin

(358)

Copyist.

M. | 8 H. Art'y. | U.S.C.T.

John Hyatt,
Pvt., Co. K, 8 Reg't U. S. Col'd H. Art'y.

Appears on

Company Muster Roll
for *Sept and Oct*, 186*4*
Present or absent *Present*

Stoppage, \$ 100 for

Due Gov't, \$ 100 for

Valuation of horse, \$ 100

Valuation of horse equipments, \$ 100

Remarks: *Sick in quarters.*

Book mark: _____

Harin

(358)

Copyist.

5

M. | S H. Art'y. | U.S.C.T.

John Hyatt,
Pvt, Co. K, 8 Reg't U. S. Col'd H. Art'y.

Appears on

Company Muster Roll

for *Nov. and Dec.*, 1864.

Present or absent *Present*

Stoppage, \$ *100* for

Due Gov't, \$ *100* for

Valuation of horse, \$ *100*

Valuation of horse equipments. \$ *100*

Remarks: *Sick in Regimental Hospital.*

Book mark:

Harri.

W

S H. Art'y.

U.S.C.T.

John Wyatt

Priv, Co. K, 8 Reg't U. S. Col'd H. Art'y.

Appears on

Company Muster Roll

for *Jan'y. & Feby.*, 1865.

Present or absent *Present*

Stoppage, \$ *100* for

Due Gov't, \$ *100* for

Valuation of horse, \$ *100*

Valuation of horse equipments, \$ *100*

Remarks:

Sick in Post Hospl. Paducah Ky.

Book mark:

D. Maher

(358)

Copyist.

W

8 H. Art'y.

U.S.C.T.

John Wyatt

Priv., Co. K, 8 Reg't U. S. Col'd H. Art'y.

Appears on

Company Muster Roll

for March & April, 1865.

Present or absent Absent

Stoppage, \$ 100 for

Due Gov't, \$ 100 for

Valuation of horse, \$ 100

Valuation of horse equipments, \$ 100

Remarks:

Sick in Hoopl. at Paducah, Ky.

Book mark:

D. Mahor

(358)

Copyist.

W

8 H. Art'y.

U.S.C.T.

John Wyatt

Priv, Co. K, 8 Reg't U. S. Col'd H. Art'y.

Appears on

Company Muster Roll

for *May & June*, 1865.

Present or absent *Absent*

Stoppage, \$ *100* for

Due Gov't, \$ *100* for

Valuation of horse, \$ *100*

Valuation of horse equipments, \$ *100*

Remarks: *Sick in Hospl. at Paducah, Ky.*

Book mark:

D. Maher
Copyist.

W

8 H. Art'y.

U.S.C.T.

John Wyatt

Priv, Co. K, 8 Reg't U. S. Col'd H. Art'y.

Appears on

Company Muster Roll

for *July + August*, 1865.

Present or absent *Absent*

Stoppage, \$ *100* for

Due Gov't, \$ *100* for

Valuation of horse, \$ *100*

Valuation of horse equipments, \$ *100*

Remarks:

Sick in Hospl. Paducah, Ky.

Book mark:

D. Maher

(358)

Copyist.

A

S H. Art'y.

U.S.C.T.

John Wyatt

Priv, Co. K, 8 Reg't U. S. Col'd H. Art'y.

Appears on

Company Muster Roll

for *Sept + Oct*, 186*5*.

Present or absent

Stoppage, \$ *100* for

Due Gov't, \$ *100* for

Valuation of horse, \$ *100*

Valuation of horse equipments, \$ *100*

Remarks: *Died June 6/65 at Louisville Ky
2 M Stores (904)*

Book mark:

(358)

S P York

Copyist.

John Wyatt
Qtr, Co. *K*, 8 Reg't U. S. Col'd H. Art'y.

Appears on Returns as follows:

April to Sept 1863. absent sick
in hosp. Paucanah Ky
since April 7 1863.

Oct 18 63. June 6/65.
Louisville Ky. Died

Book mark : _____

Chas. Patton

W | S H. Art'y. | U.S.C.T.

John Wyatt

Priv, Co. *K*, 8 Reg't U. S. Col'd H. Art'y.

Appears on Co. Muster-out Roll, dated *Victoria Texas, Feb'y 10, 1866*.

Muster-out to date _____, 186 .

Last paid to *Oct-31, 1864*.

Clothing account:

Last settled _____, 186 ; drawn since \$ _____ 100

Due soldier \$ _____ 100; due U. S. \$ _____ 100

Am't for cloth'g in kind or money adv'd \$ _____ 100

Due U. S. for arms, equipments, &c., \$ _____ 100

Bounty paid \$ _____ 100; due \$ _____ 100

Remarks *Entered service at organization of Co as private Dec at Louisville Ky June '61 of inflammation of lungs Final Statement and Inventory of effects forwarded Oct 15 1864*

Book mark: *2489.1882*
Ag 10

(361) *D O York* Copyist.

Wyatt, John -
P Co. K, 5 Reg't USCHA.

5 Enclosures.

Bed Cards	Descriptive Lists
Burial Records 1	Final Statements 1
Certs. of Dis. for Discharge	Furloughs
C. M. Charges	Med. Des. Lists
Med. Certificates	Orders

Other papers relating to—

Admission to Hosp'l	Furlough
Casualty Sheet (Officer's)	Med. Examination
Confinement	Misc. Information
Contracts	Pay or Clothing
Death or Effects 2	Personal Reports
Descriptions	Rank
Discharge from Hosp'l	Transfer to Hosp'l
Discharge from Service	Transfer to V. R. C.
Duty	Transportation

John Wyatt
U.S. C. H. A. Sub "K"
June 6 1865
Crittenden

Transmitted
by

HOSPITAL RECORD,

SUBJECT TO THE

ORDER OF THE SURGEON GENERAL
UNITED STATES ARMY.

No. 1.

RECORD OF DEATH AND INTERMENT.

Name and number of person interred. *John Bryant*
 Number and locality of the grave . *Range 37, Grave 13.*
 Hospital number of the deceased . . *3145*
 Regiment, rank, and company . . . *8th U.S. Heavy Artillery Int. Co. "K"*
 Residence before enlistment . . .
 Conjugal condition, (and if married, } *Single; Charlotte Brazer*
 the residence of the widow) . . } *Fredonia Ky.*
 Cause of death } *Inflammation of the Lungs*
 Age of the deceased *Thirty-six (36)*
 Nativity *Kentucky*
 References and remarks }
 Date of death and burial *Died June 6* , 1865.

Duplicates sent to the Adjutant General of the United States Army, and to the Sexton of the Cemetery.

Memoranda:

REPRINT

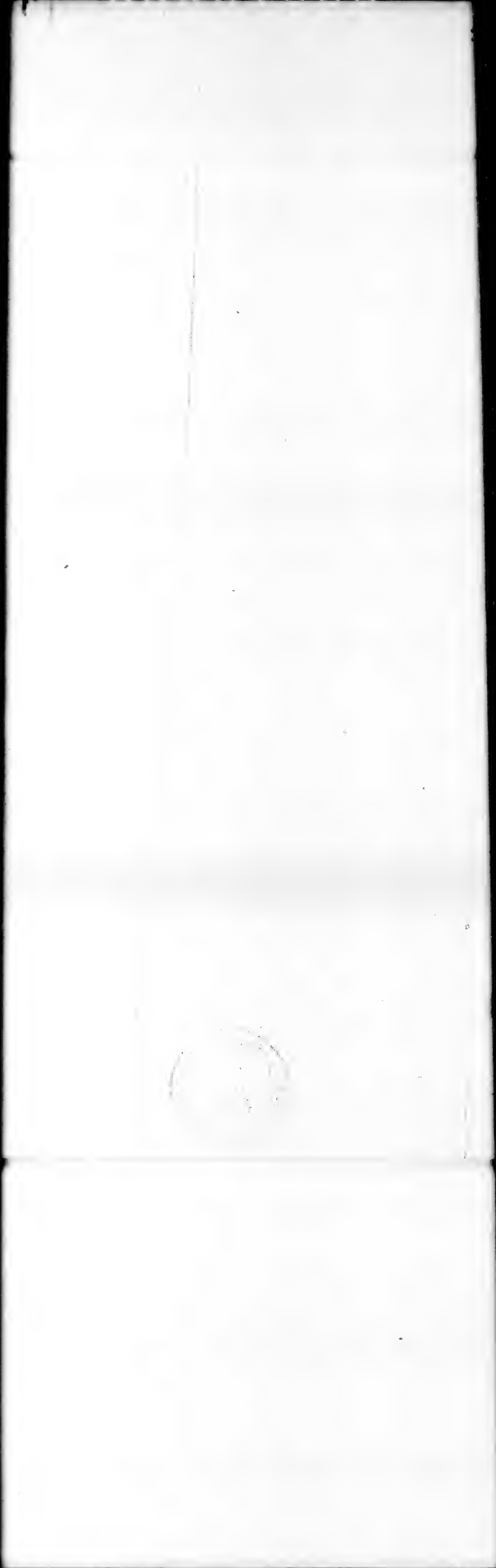

RECORD OF DEATH AND INTERMENT.

Name and number of person interred.	<i>John Hyatt</i>	
Number and locality of the grave . . .	<i>Range 37 Grave 138</i>	
Hospital number of the deceased . . .	<i>3045</i>	
Regiment, rank, and company . . .	<i>8 U.S. Col. Heavy Artillery Det. Co. "K"</i>	
Residence before enlistment . . .		
Conjugal condition, (and if married, the residence of the widow) . . .	<i>Single; Charlotte Prager, Freedonia Ky.</i>	
Cause of death	<i>Inflammation of the Lungs.</i>	
Age of the deceased	<i>Thirty six (36)</i>	
Nativity	<i>Kentucky</i>	
References and remarks		
Date of death and burial	<i>Died June 6</i>	<i>, 1865.</i>

[A duplicate of this Record has been forwarded to the Sexton, and another remains at this Hospital.]

To

Capt. H. H. Tucker

SIR:

It becomes my duty to inform you that the person above described died at this Hospital as herein stated; and that it is desired his remains should be interred with the usual military honors.

Respectfully,

R. R. Taylor
Surgeon, U. S. Army.
in charge

Resident
MILITARY HOSPITAL, Louisville, Ky. June 7, 1865

This copy of Record is to be transmitted to the Adjutant General at Washington immediately after the place of burial and the number of the grave have been ascertained and registered. The above notification is to remain attached.

FINAL STATEMENT

OF

Reg't of

VOLUNTEERS.

NOTE 1.—Two of these certificates (or duplicates) are to be given to each Volunteer Soldier or drafted man who may be discharged previously to the discharge of his company, that he may at once receive from the Paymaster the pay, &c., due him, and the captain or other COMMISSIONED officer commanding the company will certify to the act of the delivery of the duplicate certificates; on these certificates the Soldier is "entitled to" his discharge, and should also present his discharge to the Paymaster to have the payment endorsed on it. The discharge is to be given back to the Soldier by the Paymaster; the latter only retaining as his voucher the duplicate certificates.

NOTE 2.—If the Soldier is entitled to pay for the use of his horse, the Company Commander will certify to that fact on the back of both these final statements, and also to the time he has pay due for having been so mounted on his own horse.

NOTE 3.—When a Soldier is furnished with final statements, his descriptive list, if he has one, should be taken up by the officer who gives the Soldier these statements, and endorsed with a statement to this effect by the officer. This endorsement should exhibit a full statement of the time for which the Soldier was allowed pay on his final statements, the clothing account, and all other charges against him or in his favor, so as to comprise a complete exhibit of his account. It will then be transmitted to the company commander of the Soldier, who will enter all the data necessary to a full understanding of the Soldier's account on the muster roll upon which the Soldier's discharge is reported. The descriptive list will then be destroyed. The object of this is, that the remaining portion of the Soldier's account may be settled upon the receipt of these muster rolls, and the Soldier receive any pay or allowances that may be due him at the time of his discharge, and which may not appear on his final statements from the fact that his descriptive list is incomplete. These accounts for back pay, &c., are settled by the 2d Auditor of the Treasury Department.

NOTE 4.—Charges for loss or injury to ordnance, horse equipments, and other miscellaneous charges, should appear under the heading of "Other Stoppages."

NOTE 5.—Bounty paid by State authorities, and not by the United States, will not be entered on this statement.

NOTE 6.—Amounts due the Sutler and Laundress must be entered on the muster roll on which the discharge, death, desertion, &c., is reported, as well as on the final statement, otherwise the amount cannot be collected from the United States.

NOTE 7.—This blank will be used for deceased volunteers and drafted men, as well as for others.

NOTE 8.—Where a Soldier dies in Hospital or on detached service, his descriptive list, if he has one, should be sent with his final statements, in duplicate, to the Adjutant General, Washington, D. C.

A. S. Co., 13, 1865
Pay of Co. A & 2. M.
sent. of A. S. Co. sent
J. D.

ADJUTANT GENERAL'S OFFICE
Oct 27 1865
Duplicate with Inventory sent 2d Auditor.

ARTICLES OF WAR.

ART. 95. When any non-commissioned officer or soldier shall die, or be killed in the service of the United States, the then commanding officer of the troop or company shall, in the presence of two other commissioned officers, take an account of what effects he died possessed of, above his arms and accoutrements, and transmit the same to the office of the Department of War, which said effects are to be accounted for, and paid to the representatives of such deceased non-commissioned officer or soldier. And in case any of the officers, so authorized to take care of the effects of deceased officers and soldiers, should, before they have accounted to their representatives for the same, have occasion to leave the regiment or post, by preferment or otherwise, they shall, before they be permitted to quit the same, deposit in the hands of the commanding officer, or of the assistant military agent, all the effects of such deceased non-commissioned officers and soldiers, in order that the same may be secured for, and paid to, their respective representatives.

ARMY REGULATIONS—EDITION OF 1861.

DECEASED SOLDIERS.

Par. 152. Inventories of the effects of deceased non-commissioned officers and soldiers, required by the 95th Article of War, will be forwarded to the Adjutant General, by the commander of the company to which the deceased belonged, and a duplicate of the same to the colonel of the regiment. Final statements of pay, clothing, &c., will be sent with the inventories. When a soldier dies at a post or station absent from his company, it will be the duty of his immediate commander to furnish the required inventory, and, at the same time, to forward to the commanding officer of the company to which the soldier belonged, a report of his death, specifying the date, place, and cause; to what time he was last paid, and the money or other effects in his possession at the time of his decease; which report will be noted on the next muster roll of the company to which the man belonged. Each inventory will be endorsed, "Inventory of the effects of _____, late of company (—) _____ regiment of _____, who died at _____, the _____ day of _____, 186—." If a legal representative receive the effects, it will be stated in the report. If the soldier leave no effects, the fact will be reported.

Par. 153. Should the effects of a deceased non-commissioned officer or soldier not be administered upon within a short period after his decease, they shall be disposed of by a Council of Administration, under the authority of the commanding officer of the post, and the proceeds deposited with the Paymaster, to the credit of the United States, until they shall be claimed by the legal representatives of the deceased.

Par. 154. In all such cases of sales by the Council of Administration, a statement in detail, or account of the proceeds, duly certified by the Council and commanding officer, accompanied by the Paymaster's receipt for the proceeds, will be forwarded by the commanding officer to the Adjutant General. The statement will be endorsed, "Report of the proceeds of the effects of _____, late of company (—) _____ regiment of _____, who died at _____, the _____ day of _____, 186—."

NOTE 1.—The effects in all cases, when called for, should be turned over to the legal representative, without further authority from the Adjutant General. When the effects are turned over to the relatives of the deceased before these inventories are sent to the Adjutant General, their receipts therefor should be attached to the inventories. In all other cases, one copy will be sent with a letter of transmittal direct to the Adjutant General, and a duplicate retained by the officer.

NOTE 2.—Particular care should be taken to take receipts in duplicate from the Paymaster for any funds turned over to him; one copy should be sent direct to the Adjutant General and one retained by the officer.

INVENTORY OF THE EFFECTS

OF

John Hyatt
Late of Company *K*,

8 Reg't of *U.S. Cad. Inftry.*

Volunteers, who died at *Louisville Ky.*

on the *1* day of *June* 186*5*.

Inventory of the effects of John Wyatt late
 a Private of Captain W. H. M. M. M. Company H of
 the 8 Regiment of W. H. M. M. M. Volunteers, who was enrolled as
 a Private at ... in the State of ... on
 the ... day of ... 186..., and mustered into the service of the United
 States as a Private on the ... day of ... 186..., at ...
 in Company ..., ... Regiment of ... Volunteers, to serve ...
 years or during the war; he was born in ... in the State
 of ...; he was ... years of age, ... feet ... inches
 high, ... complexion, ... eyes, ... hair, and by occupation, when enrolled,
 a ...; he died in Crittenden General Hospital at
Summitville Ky on the 6 day of June 1865, by
 reason of Inflammation of the Lungs.

INVENTORY.					
ARTICLES.	No.	ARTICLES.	No.	ARTICLES.	No.
Hats.....		Pairs trousers.....	1	Knapsacks.....	1
Caps.....		Pairs flannel drawers.....			
Forage caps.....		Pairs cotton drawers.....	2		
Great coats.....	1	Flannel shirts.....	1		
Uniform coats.....		Cotton shirts.....			
Uniform jackets.....	1	Pairs boots.....			
Flannel sack coats.....		Pairs shoes.....	1		
Blouses.....		Pairs socks.....			
Stable frocks.....		Blankets.....	2		
Fatigue overalls.....		Haversacks.....			
				MONEY.	
				Specie.....	\$
				Notes.....	\$

I CERTIFY, ON HONOR, that the above inventory comprises all the effects of Privt. John Wyatt, deceased, and that the effects are in the hands of Surg. W. H. Taylor at Crittenden General Hospital, Summitville Ky to be disposed of by a Council of Administration.

(DUPLICATES.)

STATION: Summitville Ky
 DATE: June 7 1865

W. H. Taylor
 Surgeon U.S. Army
 Commanding the Company
 in charge of ...

REPORT
OF THE
PROCEEDS of the EFFECTS

OF
Wyatt, John
LATE OF
co. *A, 8 U.S.A.*
WHO DIED AT

Crittenden Hospital,
LOUISVILLE, KY.,
the *6* day of *June* 1865

PROCEEDINGS OF A COUNCIL OF ADMINISTRATION.

Convened at Louisville, Kentucky, pursuant to Special Orders. No. ²¹⁷ 187, dated Post Headquarters. Louisville, Ky. ~~Aug. 16~~ ^{Sept 16} 1865, consisting of Capt F. Dame, 72nd U. S. C. Inf., 1st Lt. J. L. Erwin, 72nd U. S. C. Inf., and 1st Lt. Basil R. Ball, 135th U. S. C. Inf., for the purpose of disposing of the effects of late *John Wyatt* of Company *N*, 8th Regiment *N. S. G. A.* Volunteer.

The Council found the effects consisted of the following articles. They were ordered to be sold at auction, which was accordingly done, and the amount set opposite the articles respectively obtained, for which the receipt of the Paymaster is annexed.

AT AUCTION.

1	Great coat,	brought,	\$
1	Uniform coat,	"	5.00
	Flannel sack coat,	"	
1	Trousers, pairs,	"	
1	Shirts,	"	
2	Drawers, pairs	"	
	Socks,	"	
1	Shoes,	"	
	Boots,	"	
2	Wool blanket,	"	
	Rubber	"	
1	Knapsack	"	
	Haversack,	"	
	Canteen,	"	
			<u>\$ 5.00</u>

All sold in one lot

Capt. 72nd Regt. U. S. C. Inf., President.

E. Kennedy Capt 72nd Regt U.S.C. Inf.
vice (the) 1st Lt. 135th Regt. U. S. C. Inf., Recorder.

APPROVED: *John O. Watkins*
Commanding Post.

PAYMASTERS RECEIPT.

RECEIVED from Capt. F. Dame, 72nd Regt. U. S. C. Inf., at Louisville, Ky. October ²⁴ 1865.....
Five Dollars and cents the result of the sale of the late *John Wyatt*
of Company *N*, 8th Regiment *N. S. G. A.* Volunteers,.....
John Knapp
PAYMASTER, UNITED STATES ARMY.

1959
Wyatt Robert

Co E D, 8 U.S. Col'd H. Art'y.

Private - Private -

CARD NUMBERS.

1	5474393	26
2	5474528	27
3	5473007	28
4	5473145	29
5	5473290	30
6	5473422	31
7	5473560	32
8	5475682	33
9	5474288	34
10	9122314	35
11	9121828	36
12	40744980	37
13		38
14		39
15		40
16		41
17		42
18		43
19		44
20		45
21		46
22		47
23		48
24		49
25		50

Book Mark: _____

See also _____

21

8 H. Art'y. U.S.C.T.

Robt Wyatt

Co. E, 8 Reg't U.S. Col'd H. Art'y.

Appears on

Company Descriptive Book

of the organization named above.

DESCRIPTION.

Age 23 years; height 5 feet 7 inches.

Complexion Pink

Eyes Pink; hair Pink

Where born Caldwell, Ky

Occupation Farmer

ENLISTMENT.

When March 10, 1864.

Where E. Davidson

By whom R. Dumm; term 3 y'rs.

Remarks: Transferred to Co D

x Remark written with lead pencil

E. J. Moreland

(383a)

Copyist.

W | *H. Artz* | U. S. C. T.

Robert Wyatt

, Co. *D &*, Reg't U. S. Col'd *H. Artz*

Appears on

Company Descriptive Book

of the organization named above.

DESCRIPTION.

Age *23* years; height *5* feet *7* inches.

Complexion *Blk*

Eyes *Blk*; hair *Blk*

Where born *Colwell Co., Ky.*

Occupation *Farmer*

ENLISTMENT.

When *Mar. 10*, 186*4*.

Where *Ft. Donelson*

By whom *Robert Gunn*; term *3* y'rs.

Remarks: *Died in Post
Hospital, Paducah, Ky.,
Jan'y 28/65. Cause
of death (Drankven)
Effects: one cap, one great
coat, one blouse, one Uni-
form jacket, one pr. pants,
two blankets, one pr. boots,
one knap sack*

Henderson

W

8 H. Art'y.

U.S.C.T.

Robert Nyath

Prk, Co. *E*, 1 Reg't Ky. H. Art'y.†

Age _____ years.

Appears on _____

Company Muster Roll*

for *Enlistment to April 30*, 1864.

Joined for duty and enrolled:

When *March 11*, 1864.

Where *H. Donelson, Tenn.*

Period *3* years.

Mustered in:

When *April 26*, 1864.

Where *Paducah, Ky.*

Present or absent *Present*

Stoppage, \$ *100* for _____

Due Gov't \$ *100* for _____

Valuation of horse, \$ *100*

Valuation of horse equipments, \$ *100*

Remarks: _____

†This organization subsequently became Co. "E", 8 Reg't U. S. Colored Heavy Artillery.

*First current roll. No muster-in roll of this company on file.

Book mark: _____

J. W. Kearney
Copyist.

(3586)

W

S H. Art'y.

U.S.C.T.

Robert Wyatt

, Co. E, 8 Reg't U. S. Col'd H. Art'y.

Appears on

Company Muster Roll

for *May and June*, 1864.

Present or absent

Stoppage, \$ 100 for

Due Gov't, \$ 100 for

Valuation of horse, \$ 100

Valuation of horse equipments, \$ 100

Remarks:

*Transferred to Co. D, 8 U.S. by order of
Col. H. W. Barry, dated Ft. Anderson, Paducah,
Ky., May 20, 1864; Special order no. 4.*

Book mark:

Jas. v. Kearny

(358)

Copyist.

H | 8 H. Art'y. | U.S.C.T.

Robert Hyatt
Pie, Co. *D*, 8 Reg't U. S. Col'd H. Art'y.

Age _____ years.

Appears on

Company Muster Roll*

for *May 1 June*, 186*4*.

Joined for duty and enrolled:

When *Mar 10*, 186*4*.

Where *A. Donaldson*

Period *3* years.

Mustered in:

When *Apr 26*, 186*4*.

Where *Paducah Ky*

Present or absent *Present*

Stoppage, \$ *100* for _____

Due Gov't \$ *100* for _____

Valuation of horse, \$ *100*

Valuation of horse equipments, \$ *100*

Remarks: *Transferred from*
Co. "E" 8th Reg't U.S. Col'd H. Art'y.

*First current roll. No muster-in roll of this company on file.

Book mark: _____

(358*d*) *Joseph Stewart*
Copist.

JAN. 14

5473007

1891

Remarks:

Ad Div. 5th U.S.C.A.H.
by order H.L. Barry
Col.

H | 8 H. Art'y. | U.S.C.T.

Robert Wyath
Private, Co. D, 8 Reg't U. S. Col'd H. Art'y.

Appears on

Company Muster Roll

for *July & Aug*, 1864.

Present or absent *

Stoppage, \$ 100 for

Due Gov't, \$ 100 for

Remarks: *Absent on detached service in mounted. Justy since Aug. 26th 1864.*

* *Various articles Preserved*
Calcutta

Book mark:

M. M. Warren

N H H I A H A

Mr. | 8 H. Art'y. | U.S.C.T.

Robert Mayall

Sgt., Co. D, 8 Reg't U. S. Col'd H. Art'y.

Appears on

Company Muster Roll

for Sept. & Oct., 1864.

Present or absent Present.

Stoppage, \$ 100 for

Due Gov't, \$ 100 for

Valuation of horse, \$ 100

Valuation of horse equipments, \$ 100

Remarks: sick in Regimental Hospital

Book mark:

J. G. White.

W

S H. Art'y.

U.S.C.T.

Robert Hyatt

Pi., Co. D, 8 Reg't U. S. Col'd H. Art'y.

Appears on

Company Muster Roll

for *Nov. & Dec.*, 186*4*.

Present or absent *Present.*

Stoppage, \$ *100* for

Due Gov't, \$ *100* for

Valuation of horse, \$ *100*

Valuation of horse equipments, \$ *100*

Remarks:

Book mark:

(358)

J. L. Smith

Copyist.

A

S H. Art'y.

U.S.C.T.

Robert Wyatt
Pvt., Co. D, 8 Reg't U. S. Col'd H. Art'y.

Appears on

Company Muster Roll

for *Jan. 7 Feb.*, 1863.

Present or absent

Stoppage, \$ *100* for

Due Gov't, \$ *100* for

Remarks: *Died at Post
Hospital Paducah
Ky. Jan. 28, 1865.*

Book mark:

J. D. Smith

(358)

Copyist.

W

8 H. Art'y.

U.S.C.T.

Robert Wyatt

Par, Co. D, 8 Reg't U. S. Col'd H. Art'y.

Appears on Returns as follows:

May 1864 May 20/64
Paducah Ky. Transferred
from Co. E to Co. D

Aug 1864 absent detached
in Mounted Service

Sept 1864 absent sick
in Hosp. at Paducah Ky.

Jan 1865. July 29/65.
Paducah. Died
at Post Hosp.

* Name also appears as Robert Wyatt

Book mark:

at Paducah

H

S H. Art'y.

U.S.C.T.

Robert Wyatt

Plt., Co. *E*, 8 Reg't U. S. Col'd H. Art'y.

Appears on **Co. Muster-out Roll**, dated

Victoria Texas, Feb. 10, 1866 .

Muster-out to date _____, 186 .

Last paid to *April 30* 1864 .

Clothing account:

Last settled _____, 186 ; drawn since \$ _____ 100

Due soldier \$ _____ 100; due U. S. \$ _____ 100

Am't for cloth'g in kind or money adv'd \$ _____ 100

Due U. S. for arms, equipments, &c., \$ _____ 100

Bounty paid \$ _____ 100; due \$ _____ 100

Remarks: *Joined Co at Original Organization as Private Transfd. from Co. E. to Co. D. by S.O. No 7 Hd. qrs. & W.S. Co. by Army May 20, 1864.*

Book mark: _____

E. C. Barnott

(361)

Copyist.

W.

8 H. Art'y.

U.S.C.T.

Robert Wyatt

C, Co. *D*, 8 Reg't U. S. Col'd H. Art'y.

Appears on Co. Muster-out Roll, dated *Victoria, B.C., Feb 10, 1864.*

Muster-out to date _____, 186 .

Last paid to *Oct 31, 1864.*

Clothing account:

Last settled _____, 186 ; drawn since \$ _____ 100

Due soldier \$ _____ 100; due U. S. \$ _____ 100

Am't for cloth'g in kind or money adv'd \$ _____ 100

Due U. S. for arms, equipments, &c., \$ _____ 100

Bounty paid \$ _____ 100; due \$ _____ 100

Remarks: *Transferred from Co Casper
I.C. No 7 Reg't 16th Dec 20th 64.
Killed Jan 28th 65, in Post
Attack Paducah, Ky, of
Charrhoca. Final Statement
found Feb 31st 65.*

Book mark: _____

C. 9023

J. J. Brown

(861)

Copyist.

NYATT, Robert

B Co.

8

Reg't U.S.C.A.A.

4 Enclosures.

Bed Cards	Descriptive Lists
Burial Records	Final Statements 2
Certs. of Dis. for Discharge	Furloughs
C. M. Charges	Med. Des. Lists
Med. Certificates	Orders

Other papers relating to—

Admission to Hosp'l	Furlough
Casualty Sheet (Officer's)	Med. Examination
Confinement	Misc. Information
Contracts	Pay or Clothing
Death or Effects	Personal Reports
Desertions	Rank
Discharge from Hosp'l	Transfer to Hosp'l
Discharge from Service	Transfer to V. R. C.
Duty	Transportation

FINAL STATEMENT

OF

Reg't of

VOLUNTEERS.

NOTE 1.—Two of these certificates (or duplicates) are to be given to each volunteer soldier who may be discharged previously to the discharge of his company, that he may at once receive from the Paymaster the pay, &c., due him, and the captain or other officer commanding the company will certify to the act of the delivery of the duplicate certificates; on these certificates the Soldier is "entitled to" his discharge, and should also present his discharge to the Paymaster to have the payment endorsed on it. The discharge is to be given back to the Soldier by the Paymaster; the latter only retaining as his voucher the duplicate certificates.

NOTE 2.—If the Soldier is entitled to pay for the use of his horse, the Company Commander will certify to that fact, and also to the time he has pay due for having been so mounted on his own horse.

NOTE 3.—Amounts due the Sutler and Laundress must be entered on the Muster Roll on which the death, desertion, &c., is reported, as well as on the final statement, otherwise the amount cannot be collected from the United States.

NOTE 4.—This blank will be used for deceased volunteers as well as others.

ADJUTANT GENERAL'S OFFICE.

April 9th 1865.

Duplicate with Inventory sent 2d Auditor.

[Handwritten signature]

[Handwritten scribble]

I certify, on honor, that Robert Wyatt a Private of
 Captain A. Lamberts Company (B) of the 8th Regiment of U.S. Colored Troops
VOLUNTEERS, of the State of _____, born in Colwell Co., State
 of Kentucky, aged 23 years; 5 feet 7 inches high; Dark complexion,
Dark eyes, Black hair, and by occupation a Farmer, having joined the company on
 its original organization at Franklin Tenn, and enrolled in it at the muster into
 the service of the United States at Paducah Ky, on the 10th day
 of March, 1864, (or was mustered in service as a recruit, by _____
 _____, at _____, on the _____ day of _____,
 186 , to serve in the Regiment,) for the term of Three Years
 and having served **HONESTLY** and **FAITHFULLY** with his Company in the Field,
 to the present date, is now entitled to a **DISCHARGE** by reason of Death

The said Robert Wyatt was last paid by Paymaster
Wm. Ferris to include the 31st day of October, 1864, and has
 pay due him from that time to the present date; he is entitled to pay and subsistence for
TRAVELING to place of enrollment and whatever other allowances are authorized to volunteer
 soldiers, or militia, so discharged. He has received 47 ⁵³/₁₀₀ dollars,
 advanced by the United States on account of **CLOTHING**. since enrollment.

There is to be stopped from him, on account of the State of _____, or other
 authorities for **CLOTHING, &c.**, received on entering service, _____₁₀₀ dollars; also,
 for expenses of **SUBSISTENCE** for **TRAVELING** from place of enrollment to the place of rendezvous,
 amounting to _____₁₀₀ dollars: and on account of the United States for **EXTRA**
CLOTHING received in kind from _____ and for other
 stoppages, viz:

_____ amounting to _____₁₀₀ dollars;
 and he has been **SUBSISTED** for **TRAVELING** to his place of enrollment, up to the _____
 _____, 186 .

He is indebted to _____, **SUTLER**, _____₁₀₀ dollars.
 He is indebted to _____, **LAUNDRESS**, _____₁₀₀ dollars.

Given in Duplicate, at Paducah Ky, this 1st day of February, 1865.

J. N. Helstrom
Private 8th U.S. Col. Troop
 Commanding Company.

Revised
FINAL STATEMENT

OF

John H. Smith
D
Reg't of *1st Regt. U.S. Cavalry*

VOLUNTEERS.

NOTE 1.—Two of these certificates (or duplicates) are to be given to each Volunteer Soldier or drafted man who may be discharged previously to the discharge of his company, that he may at once receive from the Paymaster the pay, &c., due him, and the captain or other COMMISSIONED officer commanding the company will certify to the act of the delivery of the duplicate certificates; on these certificates the Soldier is "entitled to" his discharge, and should also present his discharge to the Paymaster to have the payment endorsed on it. The discharge is to be given back to the Soldier by the Paymaster; the latter only retaining as his voucher the duplicate certificates.

NOTE 2.—If the Soldier is entitled to pay for the use of his horse, the Company Commander will certify to that fact on the back of both these final statements, and also to the time he has pay due for having been so mounted on his own horse.

NOTE 3.—When a Soldier is furnished with final statements, his descriptive list, if he has one, should be taken up by the officer who gives the Soldier these statements, and endorsed with a statement to this effect by the officer. This endorsement should exhibit a full statement of the time for which the Soldier was allowed pay on his final statements, the clothing account, and all other charges against him or in his favor, so as to comprise a complete exhibit of his account. It will then be transmitted to the company commander of the Soldier, who will enter all the data necessary to a full understanding of the Soldier's account on the muster roll upon which the Soldier's discharge is reported. The descriptive list will then be destroyed. The object of this is, that the remaining portion of the Soldier's account may be settled upon the receipt of these muster rolls, and the Soldier receive any pay or allowances that may be due him at the time of his discharge, and which may not appear on his final statements from the fact that his descriptive list is incomplete. These accounts for back pay, &c., are settled by the 2d Auditor of the Treasury Department.

NOTE 4.—Charges for loss or injury to ordnance, horse equipments, and other miscellaneous charges, should appear under the heading of "Other Stoppages."

NOTE 5.—Bounty paid by State authorities, and not by the United States, will not be entered on this statement.

NOTE 6.—Amounts due the Sutler and Laundress must be entered on the muster roll on which the discharge, death, desertion, &c., is reported, as well as on the final statement, otherwise the amount cannot be collected from the United States.

NOTE 7.—This blank will be used for deceased volunteers and drafted men, as well as for others.

NOTE 8.—Where a Soldier dies in Hospital or on detached service, his descriptive list, if he has one, should be sent with his final statements, in duplicate, to the Adjutant General, Washington, D. C.



I certify, on honor, that Robert Wyatt a Private of
Captain L. S. Gambel's Company (2) of the 8th Regiment of U. S. Colored Infantry
VOLUNTEERS, of the State of _____, born in Leavelle Co, State
of Kentucky, aged 23 years; 5 feet 7 inches high; Dark complexion,
Dark eyes, Black hair, and by occupation a Farmer, having joined the company on
its original organization at At Coulson Tenn, and enrolled in it at the muster into
the service of the United States at Paducah Ky, on the 10th day
of March, 1864; (or was mustered in service as a recruit, by _____
at _____, on the _____ day of _____,
186 , or was drafted and mustered into the service of the United States from the _____
Enrollment District of the State of _____, at _____,
on the _____ day of _____, 186 ,) to serve in the Regiment, for
the term of _____: and having served **HONESTLY** and

FAITHFULLY with his Company in the Field to the present date, is now
entitled to a **DISCHARGE** by reason of Death Jan 28 1865
at Paducah Kentucky by reason of

The said Robert Wyatt was last paid by Paymaster
Major Farrow to include the 31st day of October, 1864, and has
pay due him from that time to the present date; he is entitled to pay and subsistence for
TRAVELING to place of enrollment, and whatever other allowances are authorized to volunteer
soldiers, drafted men, or militia, so discharged. He has received from the United States **CLOTHING**
amounting to 47 ⁵³ 100 dollars, since the _____ day of Enlistment,
186 , when his clothing account was last settled. He has received from the United States
None 100 dollars advanced **BOUNTY**.

There is to be stopped from him, on account of the State of _____, or other
authorities, for **CLOTHING**, &c., received on entering service, _____ 100 dollars; and
for other stoppages, viz: _____

_____ 100 dollars.
He has been furnished with **TRANSPORTATION** in kind from the place of his discharge to
_____ ; and he has been **SUBSISTED** for **TRAVELING** to his
place of enrollment, up to the _____, 186 .

He is indebted to _____, **SUTLER**, _____ 100 dollars.

He is indebted to _____, **LAUNDRESS**, _____ 100 dollars.

Given in Duplicate, at Paducah Kentucky, this 1st day
of February, 1865.

J. N. Helstrom
Quintus B. A. H.
Commanding Company

ARTICLES OF WAR.

ART. 95. When any non-commissioned officer or soldier shall die, or be killed in the service of the United States, the then commanding officer of the troop or company shall, in the presence of two other commissioned officers, take an account of what effects he died possessed of, above his arms and accoutrements, and transmit the same to the office of the Department of War, which said effects are to be accounted for, and paid to the representatives of such deceased non-commissioned officer or soldier. And in case any of the officers, so authorized to take care of the effects of deceased officers and soldiers, should, before they have accounted to their representatives for the same, have occasion to leave the regiment or post, by preferment or otherwise, they shall, before they be permitted to quit the same, deposit in the hands of the commanding officer, or of the assistant military agent, all the effects of such deceased non-commissioned officers and soldiers, in order that the same may be secured for, and paid to, their respective representatives.

ARMY REGULATIONS—EDITION OF 1863.

DECEASED SOLDIERS.

Par. 152. Inventories of the effects of deceased non-commissioned officers and soldiers, required by the 95th Article of War, will be forwarded to the Adjutant General, by the commander of the company to which the deceased belonged, and a duplicate of the same to the colonel of the regiment. Final statements of pay, clothing, &c., in duplicate, will be sent to the Adjutant General with one copy of the inventory. When a soldier dies at a post or station absent from his company, it will be the duty of his immediate commander to furnish the required inventory and final statements, and, at the same time, to forward to the commanding officer of the company to which the soldier belonged, a report of his death, specifying the date, place, and cause; to what time he was last paid, and the money or other effects in his possession at the time of his decease; which report will be noted on the next muster roll of the company to which the man belonged. Each inventory will be endorsed, "Inventory of the effects of _____, late of company (—) _____ regiment of _____, who died at _____, the _____ day of _____, 186—." If a legal representative receive the effects, it will be stated in the report. If the soldier leave no effects, the fact will be reported.

Par. 153. Should the effects of a deceased non-commissioned officer or soldier not be administered upon within a short period after his decease, they shall be disposed of by a Council of Administration, under the authority of the commanding officer of the post, and the proceeds deposited with the Paymaster, to the credit of the United States, until they shall be claimed by the legal representatives of the deceased.

Par. 154. In all such cases of sales by the Council of Administration, a statement in detail, or account of the proceeds, duly certified by the Council and commanding officer, accompanied by the Paymaster's receipt for the proceeds, will be forwarded by the commanding officer to the Adjutant General. The statement will be endorsed, "Report of the proceeds of the effects of _____, late of company (—) _____ regiment of _____, who died at _____, the _____ day of _____, 186—."

NOTE 1.—The effects in all cases, when called for, should be turned over to the legal representative, without further authority from the Adjutant General. When the effects are turned over to the relatives of the deceased before these inventories are sent to the Adjutant General, their receipts therefor should be attached to the inventories. In all other cases, one copy will be sent with a letter of transmittal direct to the Adjutant General, and a duplicate retained by the officer.

NOTE 2.—Particular care should be taken to take receipts in duplicate from the Paymaster for any funds turned over to him; one copy should be sent direct to the Adjutant General and one retained by the officer.

INVENTORY OF THE EFFECTS

OF

Deputy

Late of Company _____

Reg't of _____

Volunteers, who died at _____

on the _____ day of _____ 1863.

JUN 12 1871

Inventory of the effects of Robert Wyatt late
a Private of Captain J. J. Lambert's Company D of
the 8th Regiment of U. S. A. Heavy Volunteers, who was enrolled as
a Private at St. Donnellson in the State of Tennessee on
the 10 day of March 1864, and mustered into the service of the United
States as a Private on the 10 day of March 1864, at Paducah Ky
in Company D, 8th Regiment of U. S. A. H. V. Volunteers, to serve Three
years or during the war; he was born in Colwell Co in the State
of Kentucky; he was 23 years of age, 5 feet 7 inches
high, Dark complexion, Dark eyes, Black hair, and by occupation, when enrolled,
a Farmer; he died in Post Hospital, at
Paducah Ky. on the 29th day of January 1865, by
reason of "Diarrhoe"

INVENTORY.					
ARTICLES.	No.	ARTICLES.	No.	ARTICLES.	No.
Hats.....		Pairs trousers.....	1	Knapsacks.....	
Caps.....		Pairs flannel drawers.....			
Forage Caps.....	1	Pairs cotton drawers.....			
Great coats.....	1	Flannel shirts.....			
Uniform coats.....		Cotton shirts.....			
Uniform jackets.....	1	Pairs boots.....	1		
Flannel sack coats.....		Pairs shoes.....			
Blouses.....	1	Pairs socks.....			
Stable frocks.....		Blankets.....	2		
Fatigue overalls.....		Haversacks.....			
				MONEY.	
					Specie.....
				Notes.....	\$

I CERTIFY, ON HONOR, that the above inventory comprises all the effects of Private
Robert Wyatt, deceased, and that the effects are in the hands
of his brother in law at Paducah Ky
to be disposed of by a Council of Administration.
and a receipt taken of him for the same, appended

(DUPLICATES.)

STATION: Paducah Ky.

DATE: February 1st 1865

[A. G. O. No. 104.]

J. M. Helstrom
1st Lieut. 8th U. S. A. H. V.

Commanding the Company.

1871
51
JUL

51

Paducah Kentucky
February 18th 1863-

Received of 1st Lieut James N. Helstrom Army
Co. "D" 8th U.S. Cav Army, Kentucky, the following articles
the effects of my Brother in Law Robert Wyatt
late of Co. "D" 8th U.S. C. a. 16., deceased,

1	one	Forage Caps
1	one	Great Coat
1	one	uniform jacket
1	one	Blouse
1	one	pair Trousers
1	one	pair Boots
2	Two	Woolen Blankets.

James N. Helstrom
his
mark

Witness
Lieut H. C. Cook
8th U.S. C. a. 16.

1960

Wyatt Thomas

Co A, 8 U.S. Col'd H. Art'y.

Private | Private

CARD NUMBERS.

1	5468101	26
2	5468214	27
3	5468349	28
4	5473013	29
5	5469755	30
6	5474286	31
7	9121825	32
8	9121273	33
9	40744979	34
10		35
11		36
12		37
13		38
14		39
15		40
16		41
17		42
18		43
19		44
20		45
21		46
22		47
23		48
24		49
25		50

Book Mark:

See also

W 8 H. Art'y. U.S.C.T.

Thomas Wyatt

, Co. *A*, 8 Reg't U.S. Col'd H. Art'y.

Appears on

Company Descriptive Book

of the organization named above.

DESCRIPTION.

Age *19* years; height *5* feet *8* inches.

Complexion *Dark*

Eyes *Dark*; hair *Dark*

Where born *Colwell, Ky.*

Occupation *Farmer*

ENLISTMENT.

When *Mar. 25*, 1864.

Where *Paducah, Ky.*

By whom *J. Dobson*; term *3* y'rs.

Remarks: *Transferred to Co. D, May 20/64*

Henderson

W. H. Artz U.S.C.T.

Thomas Wyatt

, Co. D, 8 Reg't U.S. Col'd H. Artz

Appears on

Company Descriptive Book

of the organization named above.

DESCRIPTION.

Age 18 years; height 5 feet 8 inches.

Complexion *Dark*

Eyes *Dark*; hair *Dark*

Where born *Colwell Co., Ky.*

Occupation *Farmer*

ENLISTMENT.

When *Mar. 25* 1864.

Where *Paducah, Ky.*

By whom *S. D. Obern*; term *3* y'rs.

Remarks: *Died at Hosp't No 2
Paducah, Ky. June
21/64 of Typhoid Fever*

Henderson

77. | S H. Art'y. | U.S.C.T.

Thomas Wyatt

Pvt., Co. A, 1 Reg't Ky. H. Art'y.*

Appears on

Company Muster-in and Descriptive Roll

of the organization named above. Roll dated

Paducah Ky, Apr 26, 1864.

Where born Colwell Ky

Age 18 y'rs; occupation Farmer

When enlisted Mar 25, 1864.

Where enlisted Paducah Ky

For what period enlisted 3 years.

Eyes Brk; hair Brk

Complexion Brk; height 5 ft. 8 in.

When mustered in Apr 26, 1864.

Where mustered in Paducah Ky

Bounty paid \$ 100; due \$ 100

Where credited 1st Dist Ky

Company to which assigned

Remarks:

*This organization subsequently became Co. A, 8 Reg't U. S. Colored Heavy Artillery.

Book mark:

Pandolph

W

S II. Art'y.

U.S.C.T.

Thomas Hyatt
Priv, Co. A, 1 Reg't Ky. H. Art'y.*

Appears on

Company Muster Roll

for *Enlistment to Apr 30*, 1864.

Present or absent *Present*

Stoppage, \$ *100* for

Due Gov't, \$ *100* for

Valuation of horse, \$ *100*

Valuation of horse equipments, \$ *100*

Remarks:

*This organization subsequently became Co. A, 8 Reg't U. S. Col'd Heavy Artillery.

Book mark:

Wauwington

(358)

Copyist.

Of | 8 H. Art'y. | U.S.C.T.

Thomas Wyatt
Priv., Co. A, 8 Reg't U. S. Col'd H. Art'y.

Appears on

Company Muster Roll

for May & June, 1864.

Present or absent

Stoppage, \$ 100 for

Due Gov't, \$ 100 for

Valuation of horse, \$ 100

Valuation of horse equipments, \$ 100

Remarks: Transferred to Co. D. 8th U. S. Col'd H. Art'y. per special order No. 7 dated Head Quarters 8th U. S. C. A. Heavy May 20th 64. by order of Col. H. W. Barry

Book mark:

(358) Waddington Copyist.

A

8 H. Art'y.

U.S.C.T.

Thomas Hyatt
Sir, Co. *D*, 8 Reg't U. S. Col'd H. Art'y.

Age _____ years.

Appears on

Company Muster Roll*

for *May & June*, 186*4*.

Joined for duty and enrolled:

When *Mar 25*, 186*4*.

Where *Paducah Ky*

Period *5* years.

Mustered in:

When *Apr 20*, 186*4*.

Where *Paducah Ky*

Present or absent _____

Stoppage, \$ 100 for _____

Due Gov't \$ 100 for _____

Valuation of horse, \$ 100

Valuation of horse equipments, \$ 100

Remarks: *Died at Ho. p. No. 2 Paducah Ky June*

*First current roll. No muster-in roll of this company on file.

Book mark: _____

Joseph Stewart
(3581) Copist.

JAN. 14

5473(0)13

1891

Remarks:
21. 1864. Transferred
from Co. A 1st S.O.
No. 7, Hd. Qrs. 8 U.S.
Ca. H. May. 20/64 by
order H. W. Barry Col.
inserted by camp.

24

8 H. Art'y.

U.S.C.T.

Thomas Myatt

Co. A, Co. *A*, 8 Reg't U. S. Col'd H. Art'y.

Appears on **Co. Muster-out Roll**, dated *Michigan Ter.*, *Feb. 10*, 186*4*.

Muster-out to date _____, 186*4*.

Last paid to *Apr. 20*, 186*4*.

Clothing account:

Last settled _____, 186*4*; drawn since \$ _____ 100

Due soldier \$ _____ 100; due U. S. \$ _____ 100

Am't for cloth'g in kind or money adv'd \$ _____ 100

Due U. S. for arms, equipments, &c., \$ _____ 100

Bounty paid \$ _____ 100; due \$ _____ 100

Remarks: *Transferred*

*Joined at age as priv. Enrolled & sub-
scribed in 1st reg't of Heavy Arty
of Mich. Terr. to Co. A. 8 Reg't U.S.A.
for J. C. M. G. 3rd Hd. Qrs. 8 U.S. A. H.
May 20, 64*

Book mark: _____

W. A. M. A.

71 | 8 H. Art'y. | U.S.C.T.

Thomas Wyatt

Priv., Co. D., 8 Reg't U. S. Col'd H. Art'y.

Appears on Returns as follows:

May 18 64 May 20 64
Paducah Ky Transfd
from Co A to Co D
at Post Hosp No 2
Paducah Ky

June 18 64 June 21 1864
Paducah Ky Died
at Post Hosp. No. 2

Book mark :

Chas. P. ...

3/1

S H. Art'y. U.S.C.T.

Thomas M. Smith
Co. *20*, 8 Reg't U. S. Col'd H. Art'y.

Appears on Co. Muster-out Roll, dated
Victoria B.C. Feb 10, 1866.

Muster-out to date _____, 186 .
Last paid to *Apr 30*, 1864.

Clothing account:

Last settled _____, 186 ; drawn since \$ _____ 100
Due soldier \$ _____ 100; due U. S. \$ _____ 100
Am't for cloth'g in kind or money adv'd \$ _____ 100

Due U. S. for arms, equipments, &c., \$ _____ 100

Bounty paid \$ _____ 100; due \$ _____ 100

Remarks: *Transferred per*
S.O. no 7. Ret'd. Apr 23
21" or. Died June 21 '64
in Hosp No 2 Caduceus, N.Y.
Typhoid fever. Final statements
forward.

Book mark: *2103.1882.*
297.406.

(861) *J. Brown* Copyist.

Wyatt, Thomas

B., Co. *D*, **8** *Regt* U.S.C.H.A.

Enclosures.

Bed Cards	Descriptive Lists
Burial Records	Final Statements <i>/</i>
Certs. of Dis. for Discharge	Furloughs
C. M. Charges	Med. Des. Lists
Med. Certificates	Orders

Other papers relating to—

Admission to Hosp'l	Furlough
Casualty Sheet (Officer's)	Med. Examination
Confinement	Misc. Information
Contracts	Pay or Clothing
Death or Effects <i>/</i>	Personal Reports
Desertions	Rank
Discharge from Hosp'l	Transfer to Hosp'l
Discharge from Service	Transfer to V. R. C.
Duty	Transportation
.....

✓ FINAL STATEMENT

OF

Thomas Wyatt
8th Reg't of U.S. Colored Heavy

8
VOLUNTEERS.

NOTE 1.—Two of these certificates (or duplicates) are to be given to each Volunteer Soldier or drafted man who may be discharged previously to the discharge of his company, that he may at once receive from the Paymaster the pay, &c., due him, and the captain or other COMMISSIONED officer commanding the company will certify to the act of the delivery of the duplicate certificates; on these certificates the Soldier is "entitled to" his discharge, and should also present his discharge to the Paymaster to have the payment endorsed on it. The discharge is to be given back to the Soldier by the Paymaster; the latter only retaining as his voucher the duplicate certificates.

NOTE 2.—If the Soldier is entitled to pay for the use of his horse, the Company Commander will certify to that fact on the back of both these final statements, and also to the time he has pay due for having been so mounted on his own horse.

NOTE 3.—When a Soldier is furnished with final statements, his descriptive list, if he has one, should be taken up by the officer who gives the Soldier these statements, and endorsed with a statement to this effect by the officer. This endorsement should exhibit a full statement of the time for which the Soldier was allowed pay on his final statements, the clothing account, and all other charges against him or in his favor, so as to comprise a complete exhibit of his account. It will then be transmitted to the company commander of the Soldier, who will enter all the data necessary to a full understanding of the Soldier's account on the muster roll upon which the Soldier's discharge is reported. The descriptive list will then be destroyed. The object of this is, that the remaining portion of the Soldier's account may be settled upon the receipt of these muster rolls, and the Soldier receive any pay or allowances that may be due him at the time of his discharge, and which may not appear on his final statements from the fact that his descriptive list is incomplete. These accounts for back pay, &c., are settled by the 2d Auditor of the Treasury Department.

NOTE 4.—Charges for loss or injury to ordnance, horse equipments, and other miscellaneous charges, should appear under the heading of "Other Stoppages."

NOTE 5.—Bounty paid by State authorities, and not by the United States, will not be entered on this statement.

NOTE 6.—Amounts due the Sutler and Laundress must be entered on the muster roll on which the discharge, death, desertion, &c., is reported, as well as on the final statement, otherwise the amount cannot be collected from the United States.

NOTE 7.—This blank will be used for deceased volunteers and drafted men, as well as for others.

NOTE 8.—Where a Soldier dies in Hospital or on detached service, his descriptive list, if he has one, should be sent with his final statements, in duplicate, to the Adjutant General, Washington, D. C.

ADJUTANT GENERAL'S OFFICE.

July 15th 1864

Duplicate with Inventory sent 2d Auditor.

I certify, on honor, that J. M. [unclear] a [unclear] of
 Captain [unclear] Company ([unclear]) of the [unclear] Regiment of U.S. Colored Heavy
VOLUNTEERS, of the State of [unclear], born in Calaway County, State
 of Kentucky, aged 18 years; 5 feet 1/2 inches high; [unclear] complexion,
[unclear] eyes, [unclear] hair, and by occupation a [unclear], having joined the company on
 its original organization at [unclear], and enrolled in it at the muster into
 the service of the United States at [unclear], on the 25th day
 of March, 1864, or was mustered in service as a recruit, by [unclear]
[unclear], at [unclear], on the 26th day of April,
 1864, or was drafted and mustered into the service of the United States from the
 Enrollment District of the State of [unclear], at [unclear],
 on the [unclear] day of [unclear], 186-,) to serve in the Regiment, for
 the term of [unclear]: and having served HONESTLY and
 FAITHFULLY with his Company in [unclear], to the present date, is now
 entitled to a **DISCHARGE** by reason of [unclear]
1864 of Typhoid Fever

The said [unclear] was last paid by Paymaster
[unclear] to include the 30th day of April, 186-, and has
 pay due him from that time to the present date; he is entitled to pay and subsistence for
 TRAVELING to place of enrollment, and whatever other allowances are authorized to volunteer
 soldiers, drafted men, or militia, so discharged. He has received from the United States **CLOTHING**
 amounting to Twenty Two 32 dollars, since the 25th day of March,
 1864, when his clothing account was last settled. He has received from the United States
[unclear] dollars advanced **BOUNTY**.

There is to be stopped from him, on account of the State of [unclear], or other
 authorities, for **CLOTHING**, &c., received on entering service, [unclear] dollars; and
 for other stoppages, viz: [unclear]
[unclear] dollars.

He has been furnished with TRANSPORTATION in kind from the place of his discharge to
[unclear]; and he has been SUBSISTED for TRAVELING to his
 place of enrollment, up to the [unclear], 186 .

He is indebted to [unclear], **SUTLER**, [unclear] dollars.
 He is indebted to [unclear], **LAUNDRESS**, [unclear] dollars.

Given in Duplicate, at Calumet Ky, this 30th day
 of April, 186 .

[Signature]
[Signature]
 Commanding Company

INVENTORY OF THE EFFECTS

of Pri Thomas Wyatt
late of Company (D) 8th

Regiment of U.S. Art^y who died

at Post Hosp. Paducah

the 21st day of June 1862



ARMY OF THE UNITED STATES.

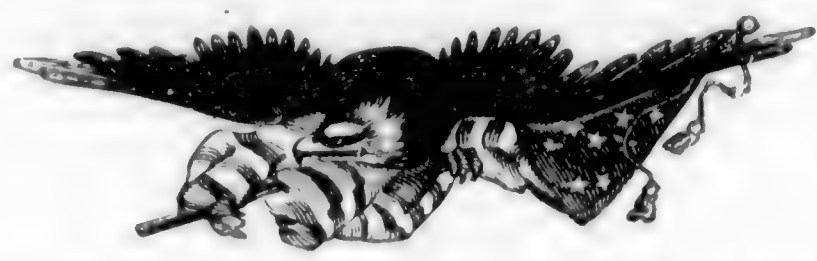

INVENTORY OF EFFECTS OF DECEASED SOLDIERS.

Private - Thomas Wyatt late of
 Company (D), of the 8th
 Captain
 Regiment *U.S.A.* was enlisted by *S. Dobson*
 on the *25th* day of *March* 1864
 to serve *3* years; he was born in *Calloway County*
 in the State of *Kentucky* is *18* years of age
5 feet *1/2* inches high, *Dark* complexion, *Dark* eyes,
Dark hair, and by occupation when enlisted a *Farmer*
 died in *Post-Hospital at Paducah Ky*
 the *21st* day of *June* 1864
 Cause of death *Typhoid Fever*

INVENTORY.

ARTICLES.	No.	Specie \$	Bank Notes \$
Hat.	1		
Cap	1		
Forage Cap.			
Great Coat.			
Uniform Coat.			
Uniform Jacket.			
Flannel Sack Coat.			
Stable Frock.			
Fatigue Overall.			
Pr. Trowsers.	1		
Pr. Flannel Drawers.	1		
Pr. Cotton Drawers.	1		
Flannel Shirts.			
Cotton Shirts.			
Pr. Boots.	1		
Pr. Shoes.	1		
Pr. Socks.	1		
Blanket.			

I CERTIFY, on honor, that the above named articles were all the effects of *Private Thomas Wyatt Co (D) 8th U.S.A.* deceased, and are in store at *Post-Hospital Paducah Ky.*

to be disposed of by a Council of Administration.

Paducah Ky.
June 22nd

W. A. Mayfield
1864 } *U. S. Surgeon in Chg.*
Post-Hospital Paducah Ky.

NOTE 1.—The Inventories of the Effects of Deceased Enlisted Men, required by the 95th Article of War, will be forwarded, as soon as practicable, by the Company, or other Commander, to the Adjutant-General of the Army, Washington, D. C., and to the Headquarters of the Regiment or Corps to which the Soldier belonged at the time of decease. (See Article XVII of Regulations.)
 NOTE 2.—With the Inventory of Effects, there will be forwarded to the Adjutant-General of the Army, Washington, D. C., duplicate Final Statements of the Deceased Soldier's Accounts with the United States.

1961

Wyatt Thomas

Co G, 8 U.S. Col'd H. Art'y.

Private

Corporal

CARD NUMBERS.

1	5477098	26
2	5477194	27
3	5477291	28
4	5477382	29
5	5477498	30
6	5477632	31
7	5477903	32
8	5478015	33
9	5478117	34
10	5478151	35
11	5477662	36
12	9122113	37
13	7486-a-1889	38
14		39
15		40
16		41
17		42
18		43
19		44
20		45
21		46
22		47
23		48
24		49
25		50

Book Mark: 7486-a-1889

See also

d 1644645 P.O. m + m

p 2532404 a 102

am. 1351482

Dr | 8 H. Art'y. | U.S.C.T.

Thomas Hyatt

Co. *A*, 8 Reg't U.S. Col'd H. Art'y.

Appears on

Company Descriptive Book

of the organization named above.

DESCRIPTION.

Age *30* years; height *5* feet *7* inches.

Complexion *Black*

Eyes *Black*; hair *Black*

Where born *Caldwell Co., Kentucky*

Occupation *Farmer*

ENLISTMENT.

When *May 28*, 186*4*.

Where *Smithland, Ky*

By whom *A. H. Ebenezer*; term *3* y'rs.

Remarks:

.....
.....
.....
.....
.....
.....

E. A. Norland

(383a)

Copyist.

W | S H. Art'y. | U.S.C.T.

Thomas Wyatt.

Pt- , Co. G, 8 Reg't U. S. Col'd H. Art'y.

Age years.

Appears on

Company Muster Roll*

for Enlistment to June 30 1864

Joined for duty and enrolled:

When May 28, 1864.

Where Smithland, Ky

Period 3 years.

Mustered in:

When June 6, 1864.

Where Paducah, Ky

Present or absent present.

Stoppage, \$ 100 for

Due Gov't \$ 100 for

Valuation of horse, \$ 100

Valuation of horse equipments, \$ 100

Remarks:

*First current roll. No muster-in roll of this company on file.

Book mark: 7486-a-1889

E. Weston

(358d)

Copyist.

Thomas Wyatt

Priv., Co. G, 8 Reg't U. S. Col'd H. Art'y.

Appears on

Company Muster Roll

for July & Aug, 1864.

Present or absent Present.

Stoppage, \$ 100 for

Due Gov't, \$ 100 for

Valuation of horse, \$ 100

Valuation of horse equipments, \$ 100

Remarks:

Book mark:

no change

M

S H. Art'y.

U.S.C.T.

Thomas Myatt

Co., Co. G, 8 Reg't U. S. Col'd H. Art'y.

Appears on

Company Muster Roll

for *Sept & Oct*, 186*4*.

Present or absent *Present*

Stoppage, \$ *100* for

Due Gov't, \$ *100* for.

Valuation of horse, \$ *100*

Valuation of horse equipments, \$ *100*

Remarks:

Book mark:

A. M. Langhli

(358)

Copyist.

94

8 H. Art'y.

U.S.C.T.

Thomas Wyatt

Capt, Co. G, 8 Reg't U. S. Col'd H. Art'y.

Appears on

Company Muster Roll

for *Nov & Dec*, 1864.

Present or absent *Present*

Stoppage, \$ *100* for

Due Gov't, \$ *100* for

Valuation of horse, \$ *100*

Valuation of horse equipments, \$ *100*

Remarks:

Book mark:

C. M. Lough

(358)

Copyist.

[Handwritten signature]

[Handwritten name], Co. G, 8 Reg't U. S. Col'd H. Art'y.

Appears on

Company Muster Roll

for *[Handwritten date]*, 186 *[Handwritten number]*.

Present or absent *[Handwritten status]*

Stoppage, \$ *[Handwritten amount]* for *[Handwritten period]*

Due Gov't, \$ *[Handwritten amount]* for *[Handwritten period]*

Valuation of horse, \$ *[Handwritten amount]*

Valuation of horse equipments, \$ *[Handwritten amount]*

Remarks: *[Handwritten notes]*

Book mark: *[Handwritten notes]*

W | **8** H. Art'y. | **U.S.C.T.**

James Keenan

W, Co. G, 8 Reg't U. S. Col'd H. Art'y.

Appears on

Company Muster Roll

for *Jan 1st*, 186 *1*.

Present or absent *Present*

Stoppage, \$ *100* for

Due Gov't, \$ *100* for

Valuation of horse, \$ *100*

Valuation of horse equipments, \$ *100*

Remarks:

Book mark : -----

W Keenan

8 H. Art'y.

U.S.C.T.

Thomas H. Hall
Co. G, 8 Reg't U. S. Col'd H. Art'y.

Appears on

Company Muster Roll

for *Sept 1 1865*, 1865.

Present or absent *Present*

Stoppage, \$ *100* for

Due Gov't, \$ *100* for

Valuation of horse, \$ *100*

Valuation of horse equipments, \$ *100*

Remarks:

Book mark:

D. M. ...

2 | 8 H. Art'y. | U.S.C.T.

Thomas Smith
....., Co. G, 8 Reg't U. S. Col'd H. Art'y.

Appears on

Company Muster Roll

for *July & Aug*, 186*3*.

Present or absent *Present*

Stoppage, \$.....100 for

Due Gov't, \$.....100 for

Valuation of horse, \$.....100

Valuation of horse equipments, \$.....100

Remarks:.....
.....
.....
.....
.....
.....
.....
.....

Book mark:.....

W. H. Brown

7 | S H. Art'y. | U.S.C.T.

Thomas Myatt

1st, Co. G, 8 Reg't U. S. Col'd H. Art'y.

Appears on

Company Muster Roll

for *July, 1863*, 186 *3*

Present or absent *Present*

Stoppage, \$ *100* for

Due Gov't, \$ *100* for

Valuation of horse, \$ *100*

Valuation of horse equipments, \$ *100*

Remarks:

Book mark:

A

S H. Art'y.

U.S.C.T.

Thomas Nyall

Cnp, Co. G, 8 Reg't U. S. Col'd H. Art'y.

Appears on

Company Muster Roll

for *Nov & Dec.*, 1865.

Present or absent *Present*

Stoppage, \$ *100* for

Due Gov't, \$ *100* for

Valuation of horse, \$ *100*

Valuation of horse equipments, \$ *100*

Remarks: *Promoted to
Corporal for Reg't
Order No 65 16
November 1865*

Book mark:

W. Lee
Copyist.

Thomas Wyatt
Capt, Co. G., 8 Reg't U. S. Col'd H. Art'y.

Appears on **Co. Muster-out Roll**, dated
Victoria Texas Feb 10, 1861.
Muster-out to date Feb 10, 1861.
Last paid to Aug 31, 1865.

Clothing account:

Last settled....., 186 ; drawn since \$..... 100
Due soldier \$..... 100; due U. S. \$..... 100
Am't for cloth'g in kind or money adv'd \$..... 100

Due U. S. for arms, equipments, &c., \$..... 100
Bounty paid \$..... 100; due \$..... 110 100

Remarks: in a journal provided to
Capt. A. W. S. Correll
and subject to draft in 1st
list of 14 or more of an
establishment

Book mark: Age 30

M. C. C.
Copyist.

W | 8 Ny. Arty U.S.C.T.

Thomas Wyatt.

Co. G, 8 Reg't U.S.C.H.A.

NOTATION.

Book mark: 7486-A-1889

War Department,
Record & Pension Division.
Adjutant General's Office,

Washington, Sept 12, 1889.

Application for certificate in lieu of lost discharge.

One Certificate furnished.

Campbell
Copyist

1962

Wyley Ben

Co 2, 8 U.S. Col'd H. Art'y.

Private

Private

CARD NUMBERS.

1	26
2	27
3	28
4	29
5	30
6	31
7	32
8	33
9	34
10	35
11	36
12	37
13	38
14	39
15	40
16	41
17	42
18	43
19	44
20	45
21	46
22	47
23	48
24	49
25	50

See Wyley Benj

Book Mark:

See also

1963

Wyley Frederick

Co. F, 8 U.S. Col'd H. Art'y.

Private

Private

CARD NUMBERS.

1	26
2	27
3	28
4	29
5	30
6	31
7	32
8	33
9	34
10	35
11	36
12	37
13	38
14	39
15	40
16	41
17	42
18	43
19	44
20	45
21	46
22	47
23	48
24	49
25	50

See Wyley Frederick

Book Mark:

See also

1964

Wiley Lewis

Co F, 8 U.S. Col'd H. Art'y.

Private

Private

CARD NUMBERS.

1	26
2	27
3	28
4	29
5	30
6	31
7	32
8	33
9	34
10	35
11	36
12	37
13	38
14	39
15	40
16	41
17	42
18	43
19	44
20	45
21	46
22	47
23	48
24	49
25	50

See Wiley Lewis

Book Mark:

See also

1965

Wyley Milton

Co F, 8 U.S. Col'd H. Art'y.

Sergeant | Sergeant

CARD NUMBERS.

1	26
2	27
3	28
4	29
5	30
6	31
7	32
8	33
9	34
10	35
11	36
12	37
13	38
14	39
15	40
16	41
17	42
18	43
19	44
20	45
21	46
22	47
23	48
24	49
25	50

See Wyley Milton

Book Mark:

See also

1966

Wiley Samuel

Co, *L*, 8 U.S. Col'd H. Art'y.

Private

Private

CARD NUMBERS.

1	26
2	27
3	28
4	29
5	30
6	31
7	32
8	33
9	34
10	35
11	36
12	37
13	38
14	39
15	40
16	41
17	42
18	43
19	44
20	45
21	46
22	47
23	48
24	49
25	50

See Wiley Samuel

Book Mark:

See also

1967
Wynn Benjamin

Co. G, 8 U.S. Col'd H. Art'y.

Private

Private

CARD NUMBERS.

1	26
2	27
3	28
4	29
5	30
6	31
7	32
8	33
9	34
10	35
11	36
12	37
13	38
14	39
15	40
16	41
17	42
18	43
19	44
20	45
21	46
22	47
23	48
24	49
25	50

See Wynn Benjamin

Book Mark:

See also

1968

Yandell, James
Co C, 8 U.S. Col'd H. Art'y.

Private | *Private*

CARD NUMBERS.

1	6467098	26
2	5467067	27
3	5471708	28
4	5471865	29
5	5467787	30
6	5472873	31
7	9121684	32
8	40744991	33
9		34
10		35
11		36
12		37
13		38
14		39
15		40
16		41
17		42
18		43
19		44
20		45
21		46
22		47
23		48
24		49
25		50

Book Mark: _____

See also _____

Y | 8 H. Art'y. | U.S.C.T.

James Gandell

....., Co., 8 Reg't U.S. Col'd H. Art'y.

Appears on

Company Descriptive Book

of the organization named above.

DESCRIPTION.

Age *19* years; height *5* feet *9 1/2* inches.

Complexion *Blk*

Eyes *Blk*; hair *Blk*

Where born *Graves Co., Ky.*

Occupation *Farm*

ENLISTMENT.

When *Aug. 22*, 186*4*.

Where *Paducah, Ky.*

By whom *R. H. Hall*; term *3* y'rs.

Remarks: *Deserted Sept. 1/64
at Paducah, Ky.*

Henderson

Of | *S. H. Arty* | **U.S.C.T.**

James Gandell
Appears with rank of *Pr* on

Muster and Descriptive Rolls of Detachments of U. S. Vols. forwarded

for the *8* Reg't U. S. Col'd *H. Arty* Roll dated
Paducah Ky, Aug. 31, 1864

Where born *Graves, Ky.*

Age *19* y'rs; occupation *Farmer*

When enlisted *Aug. 22*, 186 .

Where enlisted *Paducah, Ky.*

For what period enlisted *3* years.

Eyes *Black*; hair *Black*

Complexion *Black*; height *5 ft. 9 1/2* in.

When mustered in *Aug. 22*, 186 .

Where mustered in *Paducah*

Bounty paid \$ *100*; due \$ *100*

Where credited *Graves Co. Dist. of Ky*

Company to which assigned

Remarks :

Book mark :

(339)

Geo Bell Jr

Consist.

James Gardell

Appears with rank of *Private* on

Muster and Descriptive Roll of a Detachment of U. S. Vols. forwarded

for the 8 Reg't U. S. Col'd H. Art'y. Roll dated *Paducah, Ky, N.Y. Aug. 31, 1864.*

Where born *Groves, Ky.*

Age *19* y'rs; occupation *Farmer.*

When enlisted *Aug. 22, 1864.*

Where enlisted *Paducah, Ky.*

For what period enlisted *3* years.

Eyes *Black*; hair *Black*

Complexion *Black*; height *5 ft. 9 1/2 in.*

When mustered in *Aug. 22, 1864.*

Where mustered in *Paducah,*

Bounty paid \$ *100*; due \$ *100*

Where credited *Groves, 1st D. 24,*

Company to which assigned *C.*

Remarks:

Book mark:

Callaway

W

8 H. Art'y.

U.S.C.T.

James Yandall

Private, Co. C, 8 Reg't U. S. Col'd H. Art'y.

Appears on

Company Muster Roll

for *July & Aug*, 186*4*

Present or absent *Present*

Stoppage, \$.....*100* for

Due Gov't, \$.....*100* for

Valuation of horse, \$.....*100*

Valuation of horse equipments, \$.....*100*

Remarks:.....
.....
.....
.....
.....
.....
.....
.....
.....
.....

Book mark:.....

E. H. Lipscomb

(358)

Copyist.

Y | *83 Arty* | **U.S.C.T**

James Gandle
Rot. Co. 6, 8, Reg't U. S. Col'd *Arty*

Appears on

Company Muster Roll

for *Sept & Oct*, 1864.

Present or absent *Absent*

Stoppage, \$ *100* for

Due Gov't, \$ *100* for

Valuation of horse, \$ *100*

Valuation of horse equipments, \$ *100*

Remarks: *Deserted Sept*
1st 1864

Book mark :

E. N. Lipscomb

(358)

Copyist.

J. H. Hart U.S.C.T.

James Londell
Pvt., Co. C., 8th Reg't U. S. Col'd Hart

Appears on

Descriptive List of Deserters

dated *Paducah, Ky. Nov 10*, 1864.

Deserted:

When *Sept. 1st*, 1864.

Where *Paducah*.

Arrested:

When _____, 186 .

Where _____

Remarks: _____

Book mark: _____

(351)

J. H. Hart
Opvt.

Q

8 H. Art'y.

U.S.C.T.

James Yandle
Pvt, Co. D, 8 Reg't U. S. Col'd H. Art'y.

Appears on Returns as follows:

Sept 18 64 absent
without leave since
Sept 20 64

Oct 18 64 absent
without leave since

Book mark :

W. J. [Signature]

(546)

Copyist.

W. H. H. H. | *8 Reg't* | U.S.C.T.

James H. H. H.
Co. C, 8 Reg't U. S. Col'd

Appears on Co. Muster-out Roll, dated
Victoria Texas, Feb. 1, 1860.

Muster-out to date _____, 186 .

Last paid to *never paid*, 186 .

Clothing account:

Last settled _____, 186 ; drawn since \$ _____ 100

Due soldier \$ _____ 100; due U. S. \$ _____ 100

Am't for cloth'g in kind or money adv'd \$ _____ 100

Due U. S. for arms, equipments, &c., \$ _____ 100

Bounty paid \$ *none* 100; due \$ _____ 100

Remarks: *Entered service as vet.*
Joined Co. on duty Aug 22, 64 Enroll-
ed & subject to draft in 1st Cu Dist
of Ky. at time of enlistment. Mustered
at Paducah Ky. Sept. 1, 1864
Amount of cloth'g drawn \$19.43

Book mark: _____

(361)

W. H. H. H.
Copyist.

JAN. 14

5472873

1891

x Connected by J. Nelson etc

Gaudill, James

P. Co., *8* Reg't *U S C A*

Enclosures.

Bed Cards	Final Statements
Burial Records	Furloughs or L. of A.
Certs. of Dis. for Discharge	Med. Certificates
C. M. Charges	Med. Des. Lists
Descriptive Lists	Orders
Discharge Certificates	Pris. of War Record
Enlistment Papers	Resignations

Other papers relating to—

Admission to Hosp'l	Furlough or L. of A.
Casualty Sheet	Med. Examination
Confinement	Misc. Information
Contracts	Pay or Clothing
Death or Effects	Personal Reports
Desertion	Rank
Discharge from Hosp'l	Transfer to Hosp'l
Discharge from Service	Transfer to V. R. C.
Duty	Transportation

No. *Kind twenty five*

Wardell James

Volunteered at *Paducah Ky*

August 22 1864

By *Capt R. H. Hall*

Pro Mar, 1st Dist of Ky

J. A. U. S. C. Art. Heavy

Consent of Parent or Guardian in case of a Minor, if a Free Man, or in the case of a

United States colored troops. They will be made out in duplicate in all cases
eral, and one to accompany the accounts of the officer who pays bounty, &c.
in, must in all cases, precede payment of pay, bounty, pension, &c. A m
officer, commissary, or assistant commissary of musters, as the case may be, w
of them is given to the disbursing officer.

Ward

UNITED STATES COLORED TROOPS ENLISTMENT.

STATE OF

TOWN OF



I, James Mandell born in Graves Co
 in the State of Kentucky aged Nineteen years
 and by occupation a Farmer Do HEREBY ACKNOWLEDGE to have
 volunteered this Twenty Second day of August 1864,
 to serve as a **Soldier** in the **Army of the United States of America**, for
 the period of **THREE YEARS**, unless sooner discharged by proper authority:
 Do also agree to accept such bounty, pay, rations, and clothing, as are, or may be,
 established by law for the U. S. colored troops.

And I, James Mandell of Graves Co Ky
 do solemnly swear, that I will bear true faith and allegiance to the **United States
 of America**, and that I will serve them honestly and faithfully against all their
 enemies or opposers whomsoever; and that I will observe and obey the orders of
 the President of the United States, and the orders of the officers appointed over
 me, according to the Rules and Articles of War.

Sworn and subscribed to, at Paducah Ky
 this 22nd day of Aug 1864 } James Mandell
 mark
 Before Capt R. H. Hall
Pro Marshal Dist of Ky

I CERTIFY, ON HONOR, That I have carefully examined the above named Volunteer, agreeably to the
 General Regulations of the Army, and that, in my opinion, he is free from all bodily defects and mental infirmity,
 which would in any way disqualify him from performing the duties of a soldier.

M. H. Keenan

EXAMINING SURGEON.

I CERTIFY, ON HONOR, That I have minutely inspected the Volunteer, James Mandell
 previously to his enlistment, and that he was entirely sober when enlisted; that, to the best of my judgment and
 belief, he is of lawful age; and that, in accepting him as duly qualified to perform the duties of an able-bodied
 soldier, I have strictly observed the regulations which govern the recruiting service. This soldier has BLK
 eyes, BLK hair, BLK complexion, is face feet 5 1/2 inches high.

RECRUITING OFFICER OR AGENT.

Mustered into the United States service 22nd day of August 1864

R. H. Hall
Capt & Pro Marshal Mustered Officer.

Mustered into the service of the United States, for three years or during the war, from date of enlistment, in Company D
8th Regiment of Miss Artillery Volunteers, on the 22nd day of August, 1864, at Paducah Ky

Capt R. H. Hall
Pro Marshal
in Over-charge

NOTE 1.—This blank will be used for enlistments of United States colored troops. They will be made out in duplicate in all cases—one to accompany the recruiting return of the superintendent (not the recruiting officer) to the Adjutant General, and one to accompany the accounts of the officer who pays bounty, &c.

NOTE 2.—An enlistment holds to service. A muster-in, must in all cases, precede payment of pay, bounty, pension, &c. A muster-in roll, must in all cases, be filed in the Adjutant General's Office as evidence of muster-in. The mustering officer, commissary, or assistant commissary of musters, as the case may be, will countersign both enlistments as having mustered the soldier into the service of the United States before either of them is given to the disbursing officer.

DECLARATION OF RECRUIT.

I, James Mandell of Gravesend Ky. desiring to volunteer as a soldier in the ARMY OF THE UNITED STATES, for the term of Three Years, DO DECLARE That I am Nineteen years and months of age; that I have never been discharged from the United States service on account of disability or by sentence of a court-martial, or by order before the expiration of a term of enlistment; and I know of no impediment to my serving honestly and faithfully as a soldier for three years.

GIVEN at Paducah Ky

the 22nd day of August 1864

Witness: A. D. Ryan

James Mandell
By Mark

Volunteered at Paducah Ky
August 22 1864
Robert R. Adams
Adjutant
U. S. Army
St. Louis & St. Henry

No. Hand money fine

Consent of Parent or Guardian in case of a Minor, if a Free Man, or in the case of a Slave, of the Person to whom he owes Service:

I, Do CERTIFY, That I am the that the said is years of age; and I do freely give my CONSENT to his volunteering as a SOLDIER in the Army of the United States, for the period of THREE YEARS, under the conditions of the laws of the United States.

GIVEN at

the day of

Witness:

1969
Yeager, William

Co D, 8 U.S. Col'd H. Art'y.

Private Private

CARD NUMBERS.

1	5467069	26
2	5467100	27
3	5479964	28
4	5480109	29
5	5480240	30
6	5480370	31
7	5480490	32
8	5480605	33
9	5480713	34
10	5480818	35
11	5480920	36
12	5481019	37
13	9122630	38
14		39
15		40
16		41
17		42
18		43
19		44
20		45
21		46
22		47
23		48
24		49
25		50

Book Mark: _____

See also _____

4 | **8 H. Art'y.** | **U.S.C.T.**
William Gager
....., Co. *A*., 8 Reg't U.S. Col'd H. Art'y.

Appears on

Company Descriptive Book
of the organization named above.

DESCRIPTION.

Age *28* years; height *5* feet *9* inches.

Complexion *Black*

Eyes *Black*; hair *Black*

Where born *Union Co., Ky.*

Occupation *Farmer.*

ENLISTMENT.

When *Aug. 25*, 186 *4*.

Where *Paducah, Ky.*

By whom *L. Geo. Morrel*; term *3* y'rs.

Remarks:

.....
.....
.....
.....
.....
.....
.....
.....

(383a)

Keefe

Copyist.

7 | 8 H. Art'y. | U.S.C.T.

William Yeager.

Appears with rank of *Private* on

Muster and Descriptive Roll of a Detachment of U. S. Vols. forwarded

for the 8 Reg't U. S. Col'd H. Art'y. Roll dated

Paducah, Ky, NY Aug. 31, 1864

Where born *Union, Ky,*

Age *28* y'rs; occupation *Farmer*

When enlisted *Aug. 25*, 186 .

Where enlisted *Paducah, Ky,*

For what period enlisted *3* years.

Eyes *Black*; hair *Black*

Complexion *Black*; height *5* ft. *9* in.

When mustered in *Aug. 25*, 186 .

Where mustered in *Paducah*

Bounty paid \$ *100*; due \$ *100*

Where credited *Union, 1st D. Ky,*

Company to which assigned

Remarks :
.....
.....

Book mark :
.....

Calloway
(339) Copyist.

G. H. Artz

U.S.C.T.

William Yedger

Appears with rank of *Priv* on

Muster and Descriptive Rolls of Detachments of U. S. Vols. forwarded

for the *8* Reg't U. S. Col'd *H. Artz* Roll dated

Paducah Ky Aug. 31, 1864.

Where born *Union, Ky*

Age *28* y'rs; occupation *Farmer*

When enlisted *Aug. 25, 1864*

Where enlisted *Paducah, Ky*

For what period enlisted *3* years.

Eyes *Black*, hair *Black*

Complexion *Black*; height *5* ft. *4* in.

When mustered in *Aug. 25, 1864*

Where mustered in *Paducah*

Bounty paid \$ *100*; due \$ *100*

Where credited *Union Co. Dist. of Ky*

Company to which assigned

Remarks :

Book mark :

(339)

Geo J. Bell

Copist.

Y | 8 H. Art'y. | U.S.C.T.

William Jaeger

Quin, Co. I, 8 Reg't U. S. Col'd H. Art'y.

Appears on

Company Muster Roll

for *July & Aug*, 186*1*.

Present or absent *(Present)*

Stoppage, \$ *100* for

Due Gov't, \$ *100* for

Valuation of horse, \$ *100*

Valuation of horse equipments, \$ *100*

Remarks:

.....
.....
.....
.....
.....
.....
.....
.....
.....
.....

Book mark:

E. L. Thayer

J | 8 II. Art'y. | U.S.C.T.

William Gayer

Pvt., Co. I, 8 Reg't U. S. Col'd H. Art'y.

Appears on

Company Muster Roll

for *Sept. 1 (Oct.)*, 1864.

Present or absent *Present*

Stoppage, \$ 100 for

Due Gov't, \$ 100 for

Valuation of horse, \$ 100

Valuation of horse equipments, \$ 100

Remarks: *Sick in Reg't Hospital.*

Book mark: _____

Jenkins
Copyist.

W

S H. Art'y.

U.S.C.T.

William Gager
Priv., Co. I, 8 Reg't U. S. Col'd H. Art'y.

Appears on

Company Muster Roll

for *Nov. + Dec.*, 1864.

Present or absent *Present*

Stoppage, \$ *100* for

Due Gov't, \$ *100* for

Valuation of horse, \$ *100*

Valuation of horse equipments, \$ *100*

Remarks:

Book mark: -----

E. L. Thorton

(358)

Copyist.

RECEIVED

Y | 8 II. Art'y. | U.S.C.T.

William Yager

Me, Co. I, 8 Reg't U. S. Col'd H. Art'y.

Appears on

Company Muster Roll

for *July & Aug*, 186 *5-*

Present or absent *Present*

Stoppage, \$ 100 for

Due Gov't, \$ 100 for

Valuation of horse, \$ 100

Valuation of horse equipments, \$ 100

Remarks:

Book mark:

C. B. Sawyer

(358)

Copyist.

MAR 11 1865

4 | 8 H. Art'y. | U.S.C.T.

William Yager

Co. I, 8 Reg't U. S. Col'd H. Art'y.

Appears on

Company Muster Roll

for *Month of April*, 1865.

Present or absent *Present*

Stoppage, \$ 100 for

Due Gov't, \$ 100 for

Valuation of horse, \$ 100

Valuation of horse equipments, \$ 100

Remarks:

Book mark:

L. B. Sawyer
Copyist.

19 | 8 H. Art'y. | U.S.C.T.

William Gager
Co. I, 8 Reg't U. S. Col'd H. Art'y.

Appears on

Company Muster Roll

for May & June, 1865.

Present or absent Present

Stoppage, \$ 100 for

Due Gov't, \$ 100 for

Valuation of horse, \$ 100

Valuation of horse equipments, \$ 100

Remarks: Dr. in's for 1/2. Stable
Present

Book mark:

G. B. Sawyer
Copyist.

9 | 8 H. Art'y. | U.S.C.T.

William Yager
Co. I, 8 Reg't U.S. Col'd H. Art'y.

Appears on

Company Muster Roll

for July & August, 1865

Present or absent Present

Stoppage, \$ 100 for

Due Gov't, \$ 4 90/100 for 689 Equipm

Valuation of horse, \$ 100

Valuation of horse equipments, \$ 100

Remarks: 1/2 shelter Tent

Book mark:

L. B. Sawyer
(358) Copyist.

21

8 H. Art'y.

U.S.C.T.

William Vager

But, Co. I, 8 Reg't U. S., Col'd H. Art'y.

Appears on

Company Muster Roll

for *Sept & Oct*, 1865.

Present or absent *Present*

Stoppage, \$ 100 for

Due Gov't, \$ 100 for

Valuation of horse, \$ 100

Valuation of horse equipments, \$ 100

Remarks:

Book mark:

A. A. Kava

71

8 H. Art'y. | U.S.C.T.

William Hager
Co. I, 8 Reg't U. S. Col'd H. Art'y.

Appears on

Company Muster Roll

for Nov & Dec, 1865.

Present or absent Present

Stoppage, \$ 100 for

Due Gov't, \$ 100 for

Valuation of horse, \$ 100

Valuation of horse equipments, \$ 100

Remarks:

Book mark:

A. A. Hard

Y

S H. Art'y.

U.S.C.T.

William Yeager

Private, Co. I, 8 Reg't U. S. Col'd H. Art'y.

Appears on Co. Muster-out Roll, dated
Victoria Texas, Feb 10, 1866.

Muster-out to date Feb 10, 1866.

Last paid to Aug 31, 1865.

Clothing account:

Last settled....., 186 ; drawn since \$..... 100

Due soldier \$..... 100; due U. S. \$..... / ⁷⁵/₁₀₀

Am't for cloth'g in kind or money adv'd \$..... 100

Due U. S. for arms, equipments, &c., \$..... 100

Bounty paid \$ ~~now~~ 100; due \$ 100. ⁰⁰/₁₀₀

Remarks: Enlisted recruit
Aug 25--1864 at Paducah Ky. as herein
shown.

Book mark: 2085-1881-1622-1882-

C. J. Rozzell

(861)

Copyist.

Yeager, William

P, Co. *9*, *8* Reg't *U.S.C.H.A.*

/ **Enclosures.**

Bed Cards	Final Statements
Burial Records	Furloughs or L. of A.
Certs. of Dis. for Discharge	Med. Certificates
C. M. Charges	Med. Des. Lists
Descriptive Lists	Orders
Discharge Certificates	Pris. of War Record
Enlistment Papers	Resignations

Other papers relating to—

Admission to Hosp'l	Furlough or L. of A.
Casualty Sheet	Med. Examination
Confinement	Misc. Information
Contracts	Pay or Clothing
Death or Effects	Personal Reports
Desertion	Rank
Discharge from Hosp'l	Transfer to Hosp'l
Discharge from Service	Transfer to V. R. C.
Duty	Transportation

34

No. *Hand twenty seven*

Yeoman William

Volunteered at *Paducah Ky*

August 25th 1864

By *Capt R. A. Hall*

Pro Marshal - Dist of Ky

J. A. U. S. C. Asst. Henry

Consent of Parent or Guardian in case of a Minor, if a Free Man, or in the case of a Slave, of the Person to whom he owes Service;

United States colored troops. They will be made out in duplicate in all cases—
general, and one to accompany the accounts of the officer who pays bounty, &c.
er-in; must in all cases, precede payment of pay, bounty, pension, &c. A mus-
g officer, commissary, or assistant commissary of musters, as the case may be, will
er of them is given to the disbursing officer.

Yeoman William

UNITED STATES COLORED TROOPS ENLISTMENT.

STATE OF



TOWN OF

Kentucky *Paducah*

I, *Wager William* born in *Union Co*
in the State of *Ky* aged *Twenty eight* years
and by occupation a *Farmer* Do HEREBY ACKNOWLEDGE to have
volunteered this *Twenty fifth* day of *August* 1864,
to serve as a **Soldier** in the **Army of the United States of America**, for
the period of **THREE YEARS**, unless sooner discharged by proper authority:
Do also agree to accept such bounty, pay, rations, and clothing, as are, or may be,
established by law for the U. S. colored troops.

And I, *William Wager of Union Co Ky*
do solemnly swear, that I will bear true faith and allegiance to the **United States
of America**, and that I will serve them honestly and faithfully against all their
enemies or opposers whomsoever; and that I will observe and obey the orders of
the President of the United States, and the orders of the officers appointed over
me, according to the Rules and Articles of War.

Sworn and subscribed to, at *Paducah*
this *25th* day of *Aug* 1864, } *William Wager*
Before *Capt R. H. Hall* } *Wager*
Prov. Mar. 1st Dist. of Ky

I CERTIFY, ON HONOR, That I have carefully examined the above named Volunteer, agreeably to the
General Regulations of the Army, and that, in my opinion, he is free from all bodily defects and mental infirmity,
which would in any way disqualify him from performing the duties of a soldier.

M. H. Keed

EXAMINING SURGEON.

I CERTIFY, ON HONOR, That I have minutely inspected the Volunteer, *William Wager*
previously to his enlistment, and that he was entirely sober when enlisted; that, to the best of my judgment and
belief, he is of lawful age; and that, in accepting him as duly qualified, to perform the duties of an able-bodied
soldier, I have strictly observed the regulations which govern the recruiting service. This soldier has *Blue*
eyes, *Blue* hair, *Blue* complexion, is *Five* feet *9* inches high.

RECRUITING OFFICER OR AGENT.

Mustered into the United States service *25th* day of *August* 1864.
M. H. Keed
Capt. Prov. Mar. 1st Dist. of Ky Mustering Officer.

Mustered into the service of the United States, for three years or during the war, from date of enlistment, in Company *D*
8th Regiment of *Vol. 1st Calif. X* Volunteers, on the *25th* day of *August*, 1864 at *Paducah Ky*

Capt R. H. Hall
Prov. Mar. 1st Dist. of Ky

NOTE 1.—This blank will be used for enlistments of United States colored troops. They will be made out in duplicate in all cases—one to accompany the recruiting return of the superintendent (not the recruiting officer) to the Adjutant General, and one to accompany the accounts of the officer who pays bounty, &c.

NOTE 2.—An enlistment holds to service. A muster-in, must in all cases, precede payment of pay, bounty, pension, &c. A muster-in roll, must in all cases, be filed in the Adjutant General's Office as evidence of muster-in. The mustering officer, commissary, or assistant commissary of musters, as the case may be, will countersign both enlistments as having mustered the soldier into the service of the United States before either of them is given to the disbursing officer.

DECLARATION OF RECRUIT.

I, William Yeager of Union Co. Ky. desiring to volunteer as a soldier in the ARMY OF THE UNITED STATES, for the term of Three Years, DO DECLARE That I am Twenty eight years and months of age; that I have never been discharged from the United States service on account of disability or by sentence of a court-martial, or by order before the expiration of a term of enlistment; and I know of no impediment to my serving honestly and faithfully as a soldier for three years.

GIVEN at Paducah Ky. the 25th day of August 1864

Witness: [Signature]

William Yeager
Mark

John W. S. L. [Signature]

By [Signature]
Volunteer of Paducah Ky.
August 25th 1864
By [Signature]
Adj. Mar. W. O. [Signature]

No. Handwritten

911

Consent of Parent or Guardian in case of a Minor, if a Free Man, or in the case of a Slave, of the Person to whom he owes Service:

I, Do CERTIFY, That I am the that the said is years of age; and I do freely give my CONSENT to his volunteering as a SOLDIER in the Army of the United States, for the period of THREE YEARS, under the conditions of the laws of the United States.

GIVEN at the day of

Witness:

1970

Yeakey, Harrison

Co G, 8 U.S. Col'd H. Art'y.

Private Private

CARD NUMBERS.

1	5477104	26
2	5477199	27
3	5477295	28
4	5477386	29
5	5477508	30
6	5477641	31
7	5477910	32
8	5478022	33
9	5478130	34
10	5467683	35
11	5477755	36
12	9122130	37
13	40744990	38
14		39
15		40
16		41
17		42
18		43
19		44
20		45
21		46
22		47
23		48
24		49
25		50

Book Mark:

See also

M | 8 H. Art'y. | U.S.C.T.

Harrison Meakey

....., Co. *M*, 8 Reg't U.S. Col'd H. Art'y.

Appears on

Company Descriptive Book
of the organization named above.

DESCRIPTION.

Age *34* years; height *5* feet *3/4* inches.

Complexion *Black*

Eyes *Black*; hair *Black*

Where born *Meade Co., Kentucky*

Occupation *Farmer*

ENLISTMENT.

When *May 28*, 1864.

Where *Crittenden Co., Ky*

By whom *A. H. Spencer*; term *3* y'rs.

Remarks: *Mustered out of service*
June 11, 66 - at Fort Monroe
By order of the Secretary of War.

E. J. Moreland

(3830)

Copist.

Y | 8 H. Art'y. | U.S.C.T.

Harrison Yeakey,
Pot., Co. G, 8 Reg't U. S. Col'd H. Art'y.

Age _____ years.

Appears on

Company Muster Roll*

for Enlistment to June 30, 1864.

Joined for duty and enrolled:

When May 28, 1864.

Where Crittenden Co. Ky

Period 3 years.

Mustered in:

When June 6, 1864.

Where Paducah Ky

Present or absent Present.

Stoppage, \$ 100 for _____

Due Gov't \$ 100 for _____

Valuation of horse, \$ 100

Valuation of horse equipments, \$ 100

Remarks: _____

*First current roll. No muster-in roll of this company on file.

Book mark: _____

E. W. W. W.

(358d)

Copist.

4.

8 H. Art'y.

U.S.C.T.

Harrison Yeaky

Priv, Co. G, 8 Reg't U. S. Col'd H. Art'y.

Appears on

Company Muster Roll

for July & Aug, 1864.

Present or absent Present.

Stoppage, \$ 100 for

Due Gov't, \$ 100 for

Valuation of horse, \$ 100

Valuation of horse equipments, \$ 100

Remarks:

Book mark:

Mocha

Harrison Gabe

Am, Co. G, 8 Reg't U. S. Col'd H. Art'y.

Appears on

Company Muster Roll

for *Sept & Oct*, 1864.

Present or absent *Present*

Stoppage, \$ *100* for

Due Gov't, \$ *100* for

Valuation of horse, \$ *100*

Valuation of horse equipments, \$ *100*

Remarks:

Book mark : -----

A. M. Laughlin
Copyist.

W | 8 H. Art'y. | U.S.C.T.

Harrison Yakey

Pr, Co. G, 8 Reg't U. S. Col'd H. Art'y.

Appears on

Company Muster Roll

for *Nov 1864*, 1864.

Present or absent *Present*

Stoppage, \$ *100* for

Due Gov't, \$ *100* for

Valuation of horse, \$ *100*

Valuation of horse equipments, \$ *100*

Remarks: _____

Book mark: _____

(358)

A. M. Langhlin
Copyist.

U.S. Art'y. U.S.C.T.

William Baker

, Co. G, 8 Reg't U. S. Col'd H. Art'y.

Appears on

Company Muster Roll

for *Jan 1 1864*, 186

Present or absent *Present*

Stoppage, \$ *100* for

Due Gov't, \$ *100* for

Valuation of horse, \$ *100*

Valuation of horse equipments, \$ *100*

Remarks:

Book mark:

[Signature]

71

S H. Art'y.

U.S.C.T.

Wm. J. [unclear]

[unclear], Co. G, 8 Reg't U. S. Col'd H. Art'y.

Appears on

Company Muster Roll

for *Jan 1 1861*, 1861.

Present or absent *Present*

Stoppage, \$ *100* for

Due Gov't, \$ *100* for

Valuation of horse, \$ *100*

Valuation of horse equipments, \$ *100*

Remarks:

Book mark:

[Signature]

11

8 H. Art'y.

U.S.C.T.

James Baker

....., Co. G, 8 Reg't U. S. Col'd H. Art'y.

Appears on

Company Muster Roll

for *Jan 1*, 186*5*.

Present or absent *Present*

Stoppage, \$ *100* for

Due Gov't, \$ *100* for

Valuation of horse, \$ *100*

Valuation of horse equipments, \$ *100*

Remarks: *sent to Capt. Hall*

sent to Capt. Hall 21

105

Book mark:

James Baker

Harrison Baker

Pl, Co. G, 8 Reg't U. S. Col'd H. Art'y.

Appears on

Company Muster Roll

for *July to Aug*, 186*5*.

Present or absent *Absent*

Stoppage, \$ *100* for

Due Gov't, \$ *100* for

Valuation of horse, \$ *100*

Valuation of horse equipments, \$ *100*

Remarks: *Sold to Capt. Knapp*

Camp Lincoln Va. May

21, 1865

Book mark:

Harrison Baker

44 | 8 H. Art'y. | U.S.C.T.

William H. Hakey

1st, Co. G, 8 Reg't U. S. Col'd H. Art'y.

Appears on

Company Muster Roll

for *1st*, 186*7*.

Present or absent

Stoppage, \$ 100 for

Due Gov't, \$ 100 for

Valuation of horse, \$ 100

Valuation of horse equipments, \$ 100

Remarks: *Present*
at Camp
at ...
...

Book mark:

Y. | 8 H. Art'y. | U.S.C.T.

Harrison Yaker

Prs, Co. G, 8 Reg't U. S. Col'd H. Art'y.

Appears on Returns as follows:

May to Aug 1863. absent
sick at City Point Va
since May 21. 1863.

Sept 1863. June 11/65.
Ft Monroe Mustered
out.

Book mark :

W. P. ...

(546)

Copyist.

Y | 8th Art^y | U.S.C.T.

Harrison Yakay
Private, Co. G, 8 Reg't U. S. Col'd Art^y

Appears on a

Detachment Muster-out Roll

of the organization named above. Roll dated

Fort Monroe Va June 11, 1865.

Muster-out to date June 11, 1865.

Last paid to Oct 31, 1864.

Clothing account:

Last settled 186 ; drawn since \$ 100

Due soldier \$ 100; due U. S. \$ 100

Am't for cloth'g in kind or money adv'd \$ 57 ¹⁵/₁₀₀

Due U. S. for arms, equipments, &c., \$ 100

Bounty paid \$ 100 due \$ 100

Remarks: Harrison Yakay
has in his possession
one knapsack, one
hamrpack and one
canteen. Mustered
out by order of War

Book mark:

C. S. Rozzell

(349)

Copyist.

JAN. 14

5467685

★ 1891 ★

Dept - dated May
3 - 1865 - Patient -
U. S. Gen Hospital
Fort - Monroe Va.

27 | S H. Art'y. | U.S.C.T.

Harrison Gaby

Plt., Co. *G.*, 8 Reg't U. S. Col'd H. Art'y.

Appears on **Co. Muster-out Roll**, dated *Feb 11*, 186*6*.

Muster-out to date _____, 186 .

Last paid to *(03)*, 186 .

Clothing account:

Last settled _____, 186 ; drawn since \$ _____ 100

Due soldier \$ _____ 100; due U. S. \$ _____ 100

Am't for cloth'g in kind or money adv'd \$ _____ 100

Due U. S. for arms, equipments, &c., \$ _____ 100

Bounty paid \$ _____ 100; due \$ _____ 100

Remarks: *Discharged on account of disability*
due to wounds received at the battle of
Gettysburg, Pa. on July 3, 1863.
He was honorably discharged at
Washington, D.C. on Feb 11, 1866.

Book mark: *1190 (40)*

(361)

Melley
Copyist.
UVW

JAN. 14

5477755

1891 *

Age 34 years

1911
Young, Abram
Co H, 8 U.S. Col'd H. Art'y.

Private Private

CARD NUMBERS.

1	5466876	26
2	5467011	27
3	5478474	28
4	5478622	29
5	5478773	30
6	5478906	31
7	5479044	32
8	5479170	33
9	5479291	34
10	5479400	35
11	5479512	36
12	5479615	37
12	9121991	38
14	40744992	39
15		40
16		41
17		42
18		43
19		44
20		45
21		46
22		47
23		48
24		49
25		50

Book Mark:

See also

U | 8th Art'y | U.S.C.T.

Abram Young

, Co. H, 8 Reg't U.S. Col'd 8th Art'y.

Appears on

Company Descriptive Book

of the organization named above.

DESCRIPTION.

Age 31 years; height 5 feet 6 1/2 inches.

Complexion Black

Eyes Black; hair Black

Where born Caldwell Co., N.Y.

Occupation Farmer

ENLISTMENT.

When July 28, 1864.

Where Caducah, N.Y.

By whom R. H. Hall; term 3 y'rs.

Remarks:

A. J. Moreland

2 | 8 H. Art'y. | U.S.C.T.

Abram Young

Appears with rank of *Priv* on

Muster and Descriptive Roll of a Detachment of U. S. Vols. forwarded

for the 8 Reg't U. S. Col'd H. Art'y. Roll dated

Paducah Ky., N.Y. July 31, 1864.

Where born *Caldwell Ky.*

Age *31* y'rs; occupation *Farmer*

When enlisted *July 28*, 186 .

Where enlisted *Paducah Ky.*

For what period enlisted *3* years.

Eyes *Black*; hair *Black*

Complexion *Black*; height *5* ft. *6 1/2* in.

When mustered in *July 28*, 186 .

Where mustered in

Bounty paid \$ *100*; due \$ *100*

Where credited *Caldwell 1st Con Dist. of Ky.*

Company to which assigned *A*

Remarks :

Book mark :

A. L. Ames

(339)

Copyist.

J

8 H. Art'y.

U.S.C.T.

Abram Young

Appears with rank of _____ on

Muster and Descriptive Roll of a Detachment of U. S. Vols. forwarded

for the 8 Reg't U. S. Col'd H. Art'y. Roll dated

Paducah Ky, N.Y. Aug 1, 1864.

Where born *Caldwell Ky*

Age *31* y'rs; occupation *Farmer*

When enlisted *July 28, 1864*

Where enlisted *Paducah Ky*

For what period enlisted *3* years.

Eyes *Blk*; hair *Blk*

Complexion *Blk*; height *5 ft. 6 1/2 in.*

When mustered in *July 28, 1864*

Where mustered in *Paducah Ky*

Bounty paid \$ *100*; due \$ *100*

Where credited *Illus Ky*

Company to which assigned *H.*

Remarks: _____

Book mark: _____

Breger

Y | 8 H. Art'y. | U.S.C.T.

Abraham Young
Prvt, Co. H, 8 Reg't U. S. Col'd H. Art'y.

Appears on

Company Muster Roll

for *Dated Aug 21*, 1864.

Present or absent *Present*.

Stoppage, \$.....100 for

Due Gov't, \$.....100 for

Valuation of horse, \$.....100

Valuation of horse equipments, \$.....100

Remarks:

United States

Book mark:

S. N. ...
Copyist.

G | S H. Art'y. | U.S.C.T.

Abram Young

Pr, Co. H, 8 Reg't U. S. Col'd H. Art'y.

Appears on

Company Muster Roll
for *Sept & Oct*, 186*4*.

Present or absent. *Present*

Stoppage, \$ *100* for

Due Gov't, \$ *100* for

Valuation of horse, \$ *100*

Valuation of horse equipments, \$ *100*

Remarks: -----

Book mark: -----

E. W. Fletcher

Copyist.

Y

S H. Art'y.

U.S.C.T.

Abram Young

Art, Co. H, 8 Reg't U. S. Col'd H. Art'y.

Appears on

Company Muster Roll

for *Nov & Dec*, 1864.

Present or absent *Present*

Stoppage, \$ *100* for

Due Gov't, \$ *100* for

Valuation of horse, \$ *100*

Valuation of horse equipments, \$ *100*

Remarks:

Book mark:

S. W. Tucker

AJ | 8 H. Art'y. | U.S.C.T.

Alvin Young
Pvt, Co. H, 8 Reg't U. S. Col'd H. Art'y.

Appears on

Company Muster Roll

for *Jan. & Feb.*, 186*5*.

Present or absent *present*

Stoppage, \$ *100* for

Due Gov't, \$ *100* for

Valuation of horse, \$ *100*

Valuation of horse equipments, \$ *100*

Remarks:

Book mark:

(358) *J. E. Nichol* Copyist.

G | S H. Art'y. | **U.S.C.T.**

Abram Young

Pvt, Co. H, 8 Reg't U. S. Col'd H. Art'y.

Appears on

Company Muster Roll

for *Mch. & Apl.*, 186 *5*.

Present or absent *present*

Stoppage, \$ *100* for

Due Gov't, \$ *100* for

Valuation of horse, \$ *100*

Valuation of horse equipments, \$ *100*

Remarks:

Book mark:

(358) *J. E. Nichol* Copist.

G *H. Arty* | U.S.C.T.

Abram Young
Pvt, Co *H*, *8* Reg't U. S. Col'd *H. Arty*.

Appears on

Company Muster Roll

for *May & June*, 186*5*.

Present or absent *present*

Stoppage, \$ *100* for

Due Gov't, \$ *100* for

Valuation of horse, \$ *100*

Valuation of horse equipments, \$ *100*

Remarks:

Book mark:

(358) *J. E. Nichol* Copyist.

G | **S H. Art'y.** | **U.S.C.T.**

Abram Young
Priv, Co. H, 8 Reg't U. S. Col'd H. Art'y.

Appears on

Company Muster Roll

for *July & Aug.*, 186 *5*.

Present or absent *present*

Stoppage, \$ *100* for

Due Gov't, \$ *100* for

Valuation of horse, \$ *100*

Valuation of horse equipments, \$ *100*

Remarks:

Book mark:

(358) *J. E. Nichol* Copyist.

44 | 8 H. Art'y. | U.S.C.T.

Thomas Young

Smith, Co. H, 8 Reg't U. S. Col'd H. Art'y.

Appears on

Company Muster Roll

for *Sept & Oct*, 186*5*.

Present or absent *Present*

Stoppage, \$ 100 for

Due Gov't, \$ 100 for

Valuation of horse, \$ 100

Valuation of horse equipments, \$ 100

Remarks:

Book mark:

G. W. Meadrick

Y | 8 H. Art'y. | U.S.C.T.

Abraham Young

Priv, Co. H, 8 Reg't U. S. Col'd H. Art'y.

Appears on

Company Muster Roll

for *Nov + Dec*, 1863.

Present or absent *Present*

Stoppage, \$ *100* for

Due Gov't, \$ *100* for

Valuation of horse, \$ *100*

Valuation of horse equipments, \$ *100*

Remarks: -----

Book mark: -----

G. W. Deasrick

(358)

Copyist.

A. G. Young

Pr, Co. *A*; 8 Reg't U. S. Col'd H. Art'y.

Appears on **Returns** as follows:

Nov 1864 on duty in
Cook House

Dec 1864 to Feby 1863
Co Cook

Book mark :

W. J. Patterson

W. H. Arty U. S. C. T.

Abram Young
Priv. Co. H, 8 Reg't U. S. Col'd W. H. Arty

Appears on Co. Muster-out Roll, dated
Victoria Texas Feb 10, 1866.
Muster-out to date Feb 10, 1866.
Last paid to Aug 21, 1865.

Clothing account:

Last settled _____, 186 ; drawn since \$ 100
Due soldier \$ 2 ¹⁸/₁₀₀; due U. S. \$ 100
Am't for cloth'g in kind or money adv'd \$ 100

Due U. S. for arms, equipments, &c., \$ ³⁶/₁₀₀

Bounty paid \$ 100 due \$ ²⁰⁰/₁₀₀

Remarks: Entered service as Private
as herein shown joined in
for duty July 28th 1864 Stop
for one Waist Belt 36 ct

Book mark: _____

G. W. Deasrick
Copyist.

1

Young, Abram

P. Co., *8* Reg't *U.S.C.A.*

/ **Enclosures.**

Bed Cards	Final Statements
Burial Records	Furloughs or L. of A.
Certs. of Dis. for Discharge	Med. Certificates
C. M. Charges	Med. Des. Lists
Descriptive Lists	Orders
Discharge Certificates	Pris. of War Record
Enlistment Papers	Resignations

Other papers relating to—

Admission to Hosp'l	Furlough or L. of A.
Casualty Sheet	Med. Examination
Confinement	Misc. Information
Contracts	Pay or Clothing
Death or Effects	Personal Reports
Desertion	Rank
Discharge from Hosp'l	Transfer to Hosp'l
Discharge from Service	Transfer to V. R. C.
Duty	Transportation

No. Fifty One

Abram Young

Volunteered at Paducah, Ky.

July 28th 1864

By Capt. R. H. Hall

Prov. Mar. for 1st Dist. of Ky.

8th U.S. Colored

Consent of Parent or Guardian in case of a Minor, if a Free Man, or in the case of a Slave, of the Person to whom he owes Service:

49

of United States colored troops. They will be made out in duplicate in all cases
General, and one to accompany the accounts of the officer who pays bounty, &c.
muster-in, must in all cases, precede payment of pay, bounty, pension, &c. A m
ering officer, commissary, or assistant commissary of musters, as the case may be,
either of them is given to the disbursing officer.

UNITED STATES COLORED TROOPS ENLISTMENT.

STATE OF

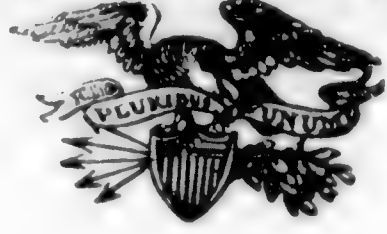

TOWN OF

Kentucky

Paducah

I, Abram Young, born in Caldwell Co.

in the State of Kentucky, aged Thirty One years

and by occupation a Farmer. Do HEREBY ACKNOWLEDGE to have volunteered this Twenty Eighth day of July, 1864,

to serve as a **Soldier** in the **Army of the United States of America**, for the period of **THREE YEARS**, unless sooner discharged by proper authority:

Do also agree to accept such bounty, pay, rations, and clothing, as are, or may be, established by law for the U. S. colored troops.

And I, Abram Young, of Caldwell Co. Ky.

do solemnly swear, that I will bear true faith and allegiance to the **United States of America**, and that I will serve them honestly and faithfully against all their enemies or opposers whomsoever; and that I will observe and obey the orders of the President of the United States, and the orders of the officers appointed over me, according to the Rules and Articles of War.

Sworn and subscribed to, at Paducah, Ky.

this 28th day of July, 1864

Before Capt. R. H. Hall

Abram Young
his mark

I CERTIFY, ON HONOR, That I have carefully examined the above named Volunteer, agreeably to the General Regulations of the Army, and that, in my opinion, he is free from all bodily defects and mental infirmity, which would in any way disqualify him from performing the duties of a soldier.

H. P. Adams

EXAMINING SURGEON.

I CERTIFY, ON HONOR, That I have minutely inspected the Volunteer, Abram Young, previously to his enlistment, and that he was entirely sober when enlisted; that, to the best of my judgment and belief, he is of lawful age; and that, in accepting him as duly qualified to perform the duties of an able-bodied soldier, I have strictly observed the regulations which govern the recruiting service. This soldier has Black eyes, Black hair, Black complexion, is Five feet 6 inches high.

RECRUITING OFFICER OR AGENT.

Mustered into the United States service 28th day of July, 1864

R. H. Hall

Mustering Officer.

Mustered into the service of the United States, for three years or during the war, from date of enlistment, in Company H of the 8th Regiment of U.S. Colored Troops, Volunteers, on the 28th day of July, 1864, at Paducah, Ky.

Capt. R. H. Hall

Capt. G. B. Marshall

1st Dist. of Ky.

NOTE 1.—This blank will be used for enlistments of United States colored troops. They will be made out in duplicate in all cases—one to accompany the recruiting return of the superintendent (not the recruiting officer) to the Adjutant General, and one to accompany the accounts of the officer who pays bounty, &c.

NOTE 2.—An enlistment holds to service. A muster-in, must in all cases, precede payment of pay, bounty, pension, &c. A muster-in roll, must in all cases, be filed in the Adjutant General's Office as evidence of muster-in. The mustering officer, commissary, or assistant commissary of musters, as the case may be, will countersign both enlistments as having mustered the soldier into the service of the United States before either of them is given to the disbursing officer.

DECLARATION OF RECRUIT.

I, Abram Young, of Caldwell Co. Ky. desiring to volunteer as a soldier in the ARMY OF THE UNITED STATES, for the term of Three Years, DO DECLARE That I am Thirty One years and months of age; that I have never been discharged from the United States service on account of disability or by sentence of a court-martial, or by order before the expiration of a term of enlistment; and I know of no impediment to my serving honestly and faithfully as a soldier for three years.

GIVEN at Paducah, McCracken Co. Ky.

the 28th day of July, 1864

Witness: Jno. P. Howard

Abram his Young
mark

Volunteered at Paducah, Ky.
July 28th 1864
By Capt. R. M. Hall
Prov. Mar. 1st Dist. of Ky.

Abram Young

No. Fifty One

St. 119, 4th Caldwell Co. Ky.

Consent of Parent or Guardian in case of a Minor, of a Free Man, or in the case of a Slave, of the Person to whom he owes Service:

I, Do CERTIFY, That I am the that the said is years of age; and I do freely give my CONSENT to his volunteering as a SOLDIER in the Army of the United States, for the period of THREE YEARS, under the conditions of the laws of the United States.

GIVEN at

the day of

Witness:

1915
Young, Benjamin
Co G, 8 U.S. Col'd H. Art'y.

Private Private

CARD NUMBERS.

1	5477103	26
2	5477198	27
3	5477294	28
4	5477385	29
5	5477507	30
6	5477640	31
7	5477915	32
8	5467672	33
9	5477754	34
10	9122129	35
11	40745009	36
12		37
13		38
14		39
15		40
16		41
17		42
18		43
19		44
20		45
21		46
22		47
23		48
24		49
25		50

Book Mark: _____

See also _____

NARRATIVE

4 | 8 H. Art'y. | U.S.C.T.

Benjamin Young

Co. G, 8 Reg't U.S. Col'd H. Art'y.

Appears on

Company Descriptive Book

of the organization named above.

DESCRIPTION.

Age 43 years; height 5 feet 2 inches.

Complexion Black

Eyes Black; hair Gray

Where born Stewart Co, Ky

Occupation Mechanic

ENLISTMENT.

When May 22d, 1864.

Where Hillman, Ky

By whom A. N. Spence; term 3 y'rs.

Remarks: Mustered out of service
May 24, 65, at Baltimore, Md.

E. A. Moreland

(383g)

Copyist.

Y | S H. Art'y. | U.S.C.T.

Benjamin Young
Priv., Co. G, 8 Reg't U. S. Col'd H. Art'y.

Age _____ years.

Appears on

Company Muster Roll*

for Enlistment to June 30, 1864.

Joined for duty and enrolled:

When May 22, 1864.

Where Hillsman Ky

Period 3 years.

Mustered in:

When June 6, 1864.

Where Paducah Ky

Present or absent present

Stoppage, \$ 100 for _____

Due Gov't \$ 100 for _____

Valuation of horse, \$ 100

Valuation of horse equipments, \$ 100

Remarks: _____

*First current roll. No muster-in roll of this company on file.

Book mark: _____

E. Winters

(358d)

Copist.

4. 8 H. Art'y. U.S.C.T.

Benjamin Young

Priv., Co. G, 8 Reg't U. S. Col'd H. Art'y.

Appears on

Company Muster Roll

for July + Aug, 1864.

Present or absent Present.

Stoppage, \$ 100 for

Due Gov't, \$ 100 for

Valuation of horse, \$ 100

Valuation of horse equipments, \$ 100

Remarks:

Book mark:

No chance

Y 8 H. Art'y. U.S.C.T.

Benjamin Young

Pr, Co. G, 8 Reg't U. S. Col'd H. Art'y.

Appears on

Company Muster Roll

for *Sept & Oct*, 186*4*.

Present or absent *Present*

Stoppage, \$ *100* for

Due Gov't, \$ *100* for

Valuation of horse, \$ *100*

Valuation of horse equipments, \$ *100*

Remarks: *Stoppage pay for one Haversack value Sixty Seven cts.*

Book mark:

W M Laughlin
Copyist.

M 8 H. Art'y. | U.S.C.T.

Benjamin Young
Co., Co. G, 8 Reg't U. S. Col'd H. Art'y.

Appears on

Company Muster Roll

for *Nov & Dec*, 1864.

Present or absent *Present*

Stoppage, \$ *100* for

Due Gov't, \$ *100* for

Valuation of horse, \$ *100*

Valuation of horse equipments, \$ *100*

Remarks:

Book mark:

(358)

C. M. Laughlin
Copyist.

71 | 8 H. Art'y. | U.S.C.T.

Benjamin Young
_____, Co. G, 8 Reg't U. S. Col'd H. Art'y.

Appears on

Company Muster Roll

for _____, 186 ⁴.

Present or absent _____

Stoppage, \$ _____ 100 for _____

Due Gov't, \$ _____ 100 for _____

Valuation of horse, \$ _____ 100

Valuation of horse equipments, \$ _____ 100

Remarks: _____

Book mark: _____

NARRATIVE

8 H. Art'y. U.S.C.T.

James A. ...

..., Co. G, 8 Reg't U. S. Col'd H. Art'y.

Appears on

Company Muster Roll

for *...*, 186*7*.

Present or absent *(10)*

Stoppage, \$ *...* 100 for *...*

Due Gov't, \$ *...* 100 for *...*

Valuation of horse, \$ *...* 100

Valuation of horse equipments, \$ *...* 100

Remarks: *...*

...

...

...

...

Book mark: *...*

(7)

7

S H. Art'y.

U.S.C.T.

John Jones

....., Co. G, 8 Reg't U. S. Col'd H. Art'y.

Appears on

Company Muster Roll

for 1861.

Present or absent.....

Stoppage, \$..... 100 for.....

Due Gov't, \$..... 100 for.....

Valuation of horse, \$..... 100

Valuation of horse equipments, \$..... 100

Remarks:.....

Mustered out of service at

Patterson Md. May 24 '68

for order of Genl (Det)

Book mark:.....

John Jones

U

8 H. Art'y.

U.S.C.T.

B. Young

Co. G, 8 Reg't U. S. Col'd H. Art'y.

Appears on Returns as follows:

Sept 15 64 on duty
Post Guard

April & May 1863: absent
sick at Baltimore Md
since April 15 1863.

June 1863 May 24/63:
Balti Md Discharged

Book mark:

Chas. Dutton

(546)

Copyist.

Y | 8. Arty. **U.S.C.T.**

Benjamin Young
Priv., Co. G, 8 Reg't U. S. Col'd Arty

Appears on a

Detachment Muster-out Roll

of the organization named above. Roll dated

Baltimore Md, May, 1865-

Muster-out to date May 24, 1865-

Last paid to Oct-31, 1864.

Clothing account:

Last settled 186 ; drawn since \$..... 100

Due soldier \$..... 100; due U. S. \$..... 100

Am't for cloth'g in kind or money adv'd \$..... 100

Due U. S. for arms, equipments, &c., \$..... 100

Bounty paid \$..... 100 due \$..... 100

Remarks: Descriptive list
silent as regards
Bounty due U. S. for
clothing over drawn
\$27.86 has in his
possession U. S. prop-
erty

Book mark:

(349)

C. S. Rozzell

Copyist.

JAN. 14

5467672

1891

erty one Knapsack
one Haversack, one
Canteen.

M.O. in accordance
with Telegram dated
A. G. O. Washington
D. C. May 4 - 1865 -

Benjamin Young
Co. *G*, 8 Reg't U. S. Co'd H. Art'y.

Appears on **Co. Muster-out Roll**, dated
Victoria Texas, *Feb 10*, 186*1*.

Muster-out to date _____, 186*1*.

Last paid to *Col 21*, 186*1*.

Clothing account:

Last settled _____, 186*1* ; drawn since \$ _____ *100*

Due soldier \$ _____ *100*; due U. S. \$ _____ *100*

Am't for cloth'g in kind or money adv'd \$ _____ *100*

Due U. S. for arms, equipments, &c., \$ _____ *100*

Bounty paid \$ _____ *100*; due \$ _____ *100*

Remarks: *was a private in*
the 8th Regt U.S. Co'd H. Art'y.
and Mustered out
at Victoria Texas
Feb 10 1861
in the 8th Regt U.S. Co'd H. Art'y.
Company but Mustered out

Book mark: *V. 93, P. 52, Co. G*

(261) _____ *over* Copyist.

JAN 14

5477754

* 1881 *

Age 43 years

1913
Young, Caborn
Co E, 8 U.S. Col'd H. Art'y.

Private Corporal

CARD NUMBERS.

1	5474395	26
2	5474495	27
3	5474623	28
4	5474652	29
5	5474777	30
6	5474902	31
7	5475024	32
8	5475142	33
9	5475258	34
10	5475369	35
11	5475473	36
12	5475561	37
13	9122326	38
14	40744993	39
15		40
16		41
17		42
18		43
19		44
20		45
21		46
22		47
23		48
24		49
25		50

Book Mark:

See also

S-684064 - P. O. M. M.

S. 1683137 P. O. M. M.

S. 2139797 P. O. M. M.

P. O. M. M. Ch. 10856 35-12-11-48
- King

U | 8 H. Art'y. | U.S.C.T.

Calvin Young

Co. *E*, 8 Reg't U.S. Col'd H. Art'y.

Appears on

Company Descriptive Book
of the organization named above.

DESCRIPTION.

Age *20* years; height *6* feet *8* inches.

Complexion *Rex*

Eyes *Rex*; hair *Rex*

Where born *Hardin Co., Tennessee*

Occupation *Fanner*

ENLISTMENT.

When *Mar. 20*, 186 *4*.

Where *Clifton*

By whom *R. Dunn*; term *3* y'rs.

Remarks:

E. A. Moreland

(383g)

Copyist.

Y

8 H. Art'y.

U.S.C.T.

Calvin Young

Rk, Co. *E*, 1 Reg't Ky. H. Art'y.†

Age _____ years.

Appears on

Company Muster Roll*

for *Enlistment to April 30*, 1864.

Joined for duty and enrolled:

When *March 30*, 1864.

Where *Clifton, Tenn.*

Period *3* years.

Mustered in:

When *April 26*, 1864.

Where *Paducah, Ky.*

Present or absent *Present*

Stoppage, \$ *100* for _____

Due Gov't \$ *100* for _____

Valuation of horse, \$ *100*

Valuation of horse equipments, \$ *100*

Remarks: _____

†This organization subsequently became Co. "E", 8 Reg't U. S. Colored Heavy Artillery.

*First current roll. No muster-in roll of this company on file.

Book mark: _____

Jas. r. Kearny

Copyist.

(358b)

Y

S H. Art'y.

U.S.C.T.

Calvin Young

Pl, Co. E, 8 Reg't U. S. Col'd H. Art'y.

Appears on

Company Muster Roll

for *May and June*, 186*4*.

Present or absent *Present*

Stoppage, \$ *100* for

Due Gov't, \$ *100* for

Valuation of horse, \$ *100*

Valuation of horse equipments, \$ *100*

Remarks:

Book mark:

Jas. v. Kearny

Copyist.

(358)

Y

8 H. Art'y.

U.S.C.T.

Calvin Young

Pl, Co. E, 8 Reg't U. S. Col'd H. Art'y.

Appears on

Company Muster Roll

for *July and Aug*, 186*4*.

Present or absent *Present*

Stoppage, \$ *100* for

Due Gov't, \$ *100* for

Valuation of horse, \$ *100*

Valuation of horse equipments, \$ *100*

Remarks:

On daily duty as mounted infantry.

Book mark:

W. v. Kearny

Copyist.

Y

S H. Art'y.

U.S.C.T.

Calvin Young

Corpl., Co. E, 8 Reg't U. S. Col'd H. Art'y.

Appears on

Company Muster Roll

for *Sept and Oct*, 1864.

Present or absent *Present*

Stoppage, \$ *100* for

Due Gov't, \$ *100* for

Valuation of horse, \$ *100*

Valuation of horse equipments, \$ *100*

Remarks:

Promoted to be Corporal, Sept. 19, 1864.

Book mark:

Jas. V. Keating

Copyist.

27

8 H. Art'y.

U.S.C.T.

Calvin Young
Corpl., Co. E, 8 Reg't U. S. Col'd H. Art'y.

Appears on

Company Muster Roll

for Nov. & Dec., 1864.

Present or absent Present

Stoppage, \$ 100 for

Due Gov't, \$ 100 for

Valuation of horse, \$ 100

Valuation of horse equipments, \$ 100

Remarks:

Book mark:

C. E. M. Laughlin

(358)

Copyst.

Y | 8 H. Art'y. | U.S.C.T.

Calvin Young
Corp., Co. E, 8 Reg't U. S. Col'd H. Art'y.

Appears on

Company Muster Roll

for *Jan. & Feb.*, 186*5*.

Present or absent *Present*

Stoppage, \$ *100* for

Due Gov't, \$ *100* for

Valuation of horse, \$ *100*

Valuation of horse equipments, \$ *100*

Remarks:

Book mark:

C. E. M. Laughlin

(358)

Copyist.

Y

S H. Art'y.

U.S.C.T.

Calvin Young
Corp; Co. E, 8 Reg't U. S. Col'd H. Art'y.

Appears on

Company Muster Roll

for Mar. & Apr., 1865.

Present or absent Present

Stoppage, \$ 100 for

Due Gov't, \$ 100 for

Valuation of horse, \$ 100

Valuation of horse equipments, \$ 100

Remarks:

Book mark:

(358) C. E. M. Laughlin Copyist.

7 | 8 H. Art'y. | U.S.C.T.

Calvin Young
Corp., Co. E, 8 Reg't U. S. Col'd H. Art'y.

Appears on

Company Muster Roll
for May & June, 1865.

Present or absent Present

Stoppage, \$ 100 for

Due Gov't, \$ 100 for

Valuation of horse, \$ 100

Valuation of horse equipments, \$ 100

Remarks:

Book mark:

(358) C. E. Laughlin Copyist.

Ny

S H. Art'y.

U.S.C.T.

Calvin Young

Capt., Co. E, 8 Reg't U. S. Col'd H. Art'y.

Appears on

Company Muster Roll

for *July & Aug*, 1865.

Present or absent *Present*

Stoppage, \$ *100* for

Due Gov't, \$ *100* for

Valuation of horse, \$ *100*

Valuation of horse equipments, \$ *100*

Remarks:

Book mark:

E. C. Carroll

y

8 H. Art'y.

U.S.C.T.

Calvin Young

Capt., Co. E, 8 Reg't U. S. Col'd H. Art'y.

Appears on

Company Muster Roll

for *Sept & Oct*, 1865.

Present or absent *Present*.

Stoppage, \$ *100* for

Due Gov't, \$ *100* for

Valuation of horse, \$ *100*

Valuation of horse equipments, \$ *100*

Remarks:

Book mark:

E. B. Carroll

(358)

Copist.

Y | 8 H. Art'y. | **U.S.C.T.**

Calvin Young
Capt., Co. E, 8 Reg't U. S. Col'd H. Art'y.

Appears on

Company Muster Roll

for *Nov & Dec*, 1865.

Present or absent *Present*

Stoppage, \$ 100 for

Due Gov't, \$ 100 for

Valuation of horse, \$ 100

Valuation of horse equipments, \$ 100

Remarks:

Book mark: _____

(358)

E. B. Carroll

Copyist.

Y | 8 H. Art'y. | U.S.C.T.

Calvin Young

Priv., Co. E, 8 Reg't U. S. Col'd H. Art'y.

Corpl

Appears on Returns as follows:

Aug 1864. On daily duty as
Mounted Infantry by order
of Col Barry

July 1865 (Corpl) Absent sick
at Indianola Tex since
July 5/65

Book mark:

Storrell

(546)

Copyist.

Y | S H. Art'y. | **U.S.C.T.**

Calvin Young
Corpl., Co. E, 8 Reg't U. S. Col'd H. Art'y.

Appears on **Co. Muster-out Roll**, dated
Victoria Texas, Feb 10, 1866.

Muster-out to date Feb 10, 1866.

Last paid to Aug 31, 1865.

Clothing account:

Last settled....., 186 ; drawn since \$..... 100

Due soldier \$..... 100; due U. S. \$..... 5 ²⁹/₁₀₀

Am't for cloth'g in kind or money adv'd \$..... 100

Due U. S. for arms, equipments, &c., \$..... 100

Bounty paid \$..... 100; due \$..... 100

Remarks: Joined at Original organ-
ization as Private Promoted
to Corporal Sept 19, 1864

Age 25 years

Book mark: V. 182, P. 35-71.

E. B. Carroll

(361)

Copyist.

19740
Young, Edward
Co G, 8 U.S. Col'd H. Art'y.

Private

CARD NUMBERS.

1	5468335	26
2	5468486	27
3	5468643	28
4	5468792	29
5	5468941	30
6	5469086	31
7	5469228	32
8	5469358	33
9	5469482	34
10	5469602	35
11	5469792	36
12	9121304	37
13	30857853	38
14	30858757	39
15	40744995	40
16		41
17		42
18		43
19		44
20		45
21		46
22		47
23		48
24		49
25		50

Book Mark:

See also

Y | 8 H. Art'y. | U.S.C.T.

Edward Young

Co. A, 8 Reg't U.S. Col'd H. Art'y.

Appears on

Company Descriptive Book

of the organization named above.

DESCRIPTION.

Age 25 years; height 5 feet 7 inches.

Complexion Black

Eyes Black; hair Brown

Where born Memphis, Tenn.

Occupation Farmer

ENLISTMENT.

When May 26, 1864.

Where Paducah, Ky.

By whom J. D. Bowen; term 3 y'rs.

Remarks: Died N. O. La.,
(Camp D'Arnyne Gen.
Hosp., Aug. 4/65

Henderson

G

| S H. Art'y. | U.S.C.T.

Edward Gony
Qvi, Co. A, 8 Reg't U. S. Col'd H. Art'y.

Appears on

Company Muster Roll

for *May & June*, 186*4*

Present or absent *Present*

Stoppage, \$.....*100* for

Due Gov't, \$.....*100* for

Valuation of horse, \$.....*100*

Valuation of horse equipments, \$.....*100*

Remarks: *Enrolled May 26 / 64*
A.M.S. June 6 / 64 at Paducah
Ky, 3 years.

Book mark:

Waddington

(358)

Copyist.

G.

| 8 H. Art'y. | U.S.C.T.

Edward Young

Private, Co. A, 8 Reg't U. S. Col'd H. Art'y.

Appears on

Company Muster Roll

for July & Aug, 1864.

Present or absent Present

Stoppage, \$ 100 for

Due Gov't, \$ 100 for

Valuation of horse, \$ 100

Valuation of horse equipments, \$ 100

Remarks:

Book mark:

Waddington

(358)

Copyist.

Y | **S H. Art'y.** | **U.S.C.T.**
Edward Young
Priv., Co. A, 8 Reg't U. S. Col'd H. Art'y.

Appears on

Company Muster Roll
for *Sept. & Oct.*, 186*4*
Present or absent *Present*

Stoppage, \$.....*100* for

Due Gov't, \$.....*100* for

Valuation of horse, \$.....*100*

Valuation of horse equipments, \$.....*100*

Remarks:.....
.....
.....
.....
.....
.....
.....
.....
.....
.....

Book mark:.....

C. R. Owen

J | 8 H. Art'y. | U.S.C.T.

Edward Young
Privt., Co. A, 8 Reg't U. S. Col'd H. Art'y.

Appears on

Company Muster Roll

for *Nov. 1 Dec.*, 1864

Present or absent *Present*

Stoppage, \$ 100 for

Due Gov't, \$ 100 for

Valuation of horse, \$ 100

Valuation of horse equipments, \$ 100

Remarks:

Book mark: -----

C.R. Owen

2

| 8 H. Art'y. | U.S.C.T.

Edward Young

Priv., Co. A, 8 Reg't U. S. Col'd H. Art'y.

Appears on

Company Muster Roll

for Jan. & Feb., 1865.

Present or absent Present-

Stoppage, \$ 100 for

Due Gov't, \$ 100 for

Valuation of horse, \$ 100

Valuation of horse equipments, \$ 100

Remarks:

Book mark:

C. R. Owen

E | 8 H. Art'y. | U.S.C.T.
Edward Young
Priv., Co. A, 8 Reg't U. S. Col'd H. Art'y.

Appears on

Company Muster Roll
for *March 7th Apr., 1863.*
Present or absent *Present,*

Stoppage, \$ *100* for

Due Gov't, \$ *100* for

Valuation of horse, \$ *100*

Valuation of horse equipments, \$ *100*

Remarks: _____

Book mark: _____

(358) *C. R. Owen* Copyist.

G. | 8 H. Art'y. | U.S.C.T.

Edmond Young
....., Co. A, 8 Reg't U. S. Col'd H. Art'y.

Appears on

Company Muster Roll

for *May 1st* Journal, 1865.

Present or absent *Absent*.

Stoppage, \$.....¹⁰⁰ for.....

Due Gov't, \$.....²³/₁₀₀ for *Ordinance*

Valuation of horse, \$.....¹⁰⁰

Valuation of horse equipments, \$.....¹⁰⁰

Remarks: *Sick at War*
Orleans, La., since
June 21, 1865.

Book mark:

A. Owen,

(358)

Copyist.

Y | *8 A A* | *US62*

Edward Young
W, Co. *A*, 8 Reg't *US62*

Appears on

Hospital Muster Roll

of Corps d'Afrique U. S. A. General Hospital,

at New Orleans, La.,

for *May & June*, 186*5*.

Attached to hospital:

When _____, 186*5*.

How employed _____

Last paid by Maj. *Finn*

to *Oct 31*, 186*4*.

Bounty paid \$ *100*; due \$ *100*

Present or absent *Present*

Remarks: _____

Book mark: _____

Edmund Young

Co. A, 8 Reg't U. S. Col'd H. Art'y.

Appears on

Company Muster Roll

for *July and Aug*, 1865 .

Present or absent *absent*

Stoppage, \$ *100* for

Due Gov't, \$ *39*/*100* for *advance*

Valuation of horse, \$ *100*

Valuation of horse equipments, \$ *100*

Remarks: *Sick at N. P. Garrison June 21, 65*

Book mark:

N. P. Merrill

Y. | 826.a. | U.S.A.

Edward Young
privt., Co. A, 18 Reg't U.S.A.

Appears on

Hospital Muster Roll

of **Corps d'Afrique U. S. A. General Hospital,**

at **New Orleans, La.,**

for July-Aug, 1865.

Attached to hospital:

When _____, 186 .

How employed _____

Last paid by Maj. _____

to _____, 186 .

Bounty paid \$ 100; due \$ 100

Present or absent _____

Remarks: Died Aug 4/65.

Book mark: _____

(343)

J. J. J.
Copyist.

Edwara Young

Pen, Co. A, 8 Reg't U. S. Col'd H. Art'y.

Appears on

Company Muster Roll

for *Sept and Oct*, 1865.

Present or absent *Absent*

Stoppage, \$ *100* for

Due Gov't, \$ *100* for

Valuation of horse, \$ *100*

Valuation of horse equipments, \$ *100*

Remarks: *Lieut at N. C. Co. since July 31. 65*

Book mark:

N. H. Merrill

Edward Young

2nd, Co. A, 8 Reg't U. S. Col'd H. Art'y.

Appears on

Company Muster Roll

for Nov and Dec, 1865.

Present or absent absent

Stoppage, \$ 100 for

Due Gov't, \$ 100 for

Valuation of horse, \$ 100

Valuation of horse equipments, \$ 100

Remarks: Disch'd at N. T. Sea Prison
May 21, 65

Book mark: _____

Nov 10 11 12

Edward Young

Priv., Co. A, 8 Reg't U. S. Col'd H. Art'y.

Appears on Returns as follows:

June to Dec 1865. absent
sick at N. Orleans La.
since June 21 1865

July 1866. Aug 4/65 N. Orleans
at Corps de Afrique
Hosp.

Book mark:

W. J. [Signature]

Edward Young

Co. *A*, 8 Reg't U. S. Col'd H. Art'y.

Appears on Co. Muster-out Roll, dated *Vienna Tex*, *Feb 10*, 186*4*.

Muster-out to date _____, 186*4*.

Last paid to *Feb 21*, 186*4*.

Clothing account:

Last settled _____, 186*4*; drawn since \$ _____ *100*

Due soldier \$ _____ *100*; due U. S. \$ _____ *100*

Am't for cloth'g in kind or money adv'd \$ _____ *100*

Due U. S. for arms, equipments, &c., \$ _____ *100*

Bounty paid \$ _____ *100*; due \$ _____ *100*

Remarks: *Wid*

*Discharged as a result of joining Co. *Y* on July
May 26 at *Wid* at Capt *McClary* as
Hosp. U. S. No. *1047* of *Medical*
Regiment *1st* *June 21* *1865*
*Fac 25**

Book mark: _____

Young, Edward
Co. A, 8 Reg't USCHA

5 Enclosures.

Bed Cards	Descriptive Lists
Burial Records 2	Final Statements 1
Certs. of Dis. for Discharge	Furloughs
C. M. Charges	Med. Des. Lists
Med. Certificates	Orders

Other papers relating to—

Admission to Hosp'l	Furlough
Casualty Sheet (Officer's)	Med. Examination
Confinement	Misc. Information
Contracts	Pay or Clothing
Death or Effects 1	Personal Reports
Descriptions	Rank
Discharge from Hosp'l	Transfer to Hosp'l
Discharge from Service	Transfer to V. R. C.
Duty	Transportation



RECORD OF DEATH AND INTERMENT.

Name and number of person interred, *Edward Young,*
 Number and locality of the grave, -
 Hospital number of the deceased, - *6097*
 Regiment, Rank, and Company, - - *8th U.S. Army, 10th Cavalry, Private in A.*
 Residence before enlistment, - - -
 Conjugal condition (and if married,)
 the residence of the widow,)
 Cause of death, } *Intermittent Fever*
 Age of the deceased, - - - - -
 Nativity, - - - - -
 References and Remarks, - - - }
 Date of death and burial, - - - *August 4th 1865*

186

[A duplicate of this Record has been forwarded to the Sexton, and the other remains at this Hospital.]

To *Adj. Genl. U.S. Army*
SIR:

It becomes my duty to inform you that the person above described died at this Hospital as herein stated: and that it is desired his remains should be interred with the usual military honors.

Respectfully,

F. E. Smith
Surgeon U. S. Army.
86 U.S. Infantry
in charge

MILITARY HOSPITAL, *Corps d' Afrique New Orleans*
La.

This copy of Record is to be transmitted to the Adjutant General at Washington immediately after the place of burial and the number of the grave have been ascertained and registered. The above notification is to remain attached.

Extract from Act of Congress.

SEC. 12. *And be it further enacted,* That the fees of agents and attorneys for making out and causing to be executed the papers necessary to establish a claim for a pension, bounty, and other allowance before the Pension Office, under this act, shall not exceed the following rates: For making out and causing to be duly executed a declaration by the applicant, with the necessary affidavits, and forwarding the same to the Pension Office, with the requisite correspondence, ten dollars; which sum shall be received by such agent or attorney in full for all services in obtaining such pension, and shall not be demanded or received, in whole or in part, until such pension shall be obtained; and the sixth and seventh sections of an act entitled "An act to grant pensions," approved July [fourteenth,] eighteen hundred and sixty-two, are hereby repealed.

SEC. 13. *And be it further enacted,* That any agent or attorney who shall, directly or indirectly, demand or receive any greater compensation for his services under this act than is prescribed in the preceding section of this act, or who shall contract or agree to prosecute any claim for a pension, bounty, or other allowance under this act, on the condition that he shall receive a per centum upon any portion of the amount of such claim, or who shall wrongfully withhold from a pensioner or other claimant the whole or any part of the pension or claim allowed and due to such pensioner or claimant, shall be deemed guilty of a high misdemeanor, and, upon conviction thereof, shall, for every such offense, be fined not exceeding three hundred dollars, or imprisoned at hard labor not exceeding two years, or both, according to the circumstances and aggravations of the offense.

Approved July 4, 1864.

NOTE. 10.—If any soldier is charged a higher fee than that allowed by the above act, he should report the fact and the name of the agent to the Adjutant General, in order that steps may be taken to have the same refunded.

ADJUTANT GENERAL'S OFFICE.

July 12. 1864

Duplicate with Inventory sent 2d Auditor.

FINAL STATEMENT.

600

OF

John Adams Jones
9th Regt of Ind. Cav. 1st Div. H.

VOLUNTEERS.

July 4, 1864

NOTE 1.—Two of these certificates (or duplicates) are to be given to each Volunteer Soldier or drafted man who may be discharged without being mustered out (Final Statements are never given to men mustered out of service.) that he may at once receive from the Paymaster the pay, &c., due to him, and the captain or other commissioned officer commanding the company will certify to the act of the delivery of the duplicate certificates; with these certificates the Soldier is "entitled to" his discharge, and should also present his discharge to the Paymaster to have the payment endorsed on it. The discharge is to be given back to the Soldier by the Paymaster; the latter only retaining as his vouchers the duplicate certificates.

NOTE 2.—If the Soldier is entitled to pay for the use of his horse, the Company Commander will certify to that fact on the back of both these final statements, and also to the time he has pay due for having been so mounted on his own horse.

NOTE 3.—When a Soldier is furnished with final statements, his descriptive list, if he has one, should be taken up by the officer who gives the Soldier these statements, and endorsed with a statement to this effect by the officer. The endorsement should exhibit a full statement of the time for which the Soldier was allowed pay on his final statements, the clothing account, and all other charges against him or in his favor, so as to comprise a complete exhibit of his account. It will then be transmitted to the Company Commander of the Soldier, who will enter all the data necessary to a full understanding of the Soldier's account on the muster roll upon which the Soldier's discharge is reported. The descriptive list will then be destroyed. The object of this is, that the remaining portion of the Soldier's account may be settled upon the receipt of these muster rolls, and the Soldier receive any pay or allowances that may be due him at the time of his discharge, and which may not appear on his last final statements from the fact that his descriptive list is incomplete. These accounts for back pay, &c., are settled by the 2d Auditor of the Treasury Department.

NOTE 4.—Charges for loss or injury to ordnance, horse equipments, and other miscellaneous charges, should appear under the heading of "Other Stoppages."

NOTE 5.—Bounty paid by State authorities, and not by the United States, will not be entered on this statement.

NOTE 6.—Amounts due the Sutler and Laundress must be entered on the muster roll on which the discharge, death, desertion, &c., is reported, as well as on the final statement, otherwise the amount cannot be collected from the United States.

NOTE 7.—This blank will be used for deceased volunteers and drafted men, as well as for others.

NOTE 8.—Where a Soldier dies in Hospital or on detached service, his descriptive list, if he has one, should be sent with his final statements, in duplicate, to the Adjutant General, Washington, D. C.

NOTE 9.—If the soldier is a drafted man or substitute, the space for time, &c., of enrolled, should contain only the word *drafted* or *substitute*, as the case may be. If the Soldier is a "VETERAN," (OR RECRUIT,) the words *as a veteran*, (or *recruit*.) as the case may be, should be interlined after the words *mustered into the service of the U. S.* A statement of all the installments of *Veteran* or *Recruit Bounty RECEIVED* by the Soldier must be made on the back of each final statement.

Jones

I certify, on honor, that Edward Young, a Private of
Captain Robinsons Company (a) of the 8th Regiment of U.S. Col^d Infy
Volunteers, of the State of _____, born in Amphers State
of Tennessee, aged 25 years; 5 feet 7 inches high; Blk complexion,
Blk eyes, Brown hair, and by occupation a Farmer, who joined for service
and was enrolled (see Note 9) on the 26th day of May, 1864, at Paducah Ky
by S Dobson, for the period of Three years, and mustered into
the service of the United States on the sixth day of June, 1864, at
Paducah Ky, by Lt M. E. Jay; and having served
HONESTLY and **FAITHFULLY** with his Company to the present date, is now entitled to a
DISCHARGE by reason of Death from Remittent Fever at New
Orleans La August 4th 1865

The said Edward Young was last paid by Paymaster
Wm H. Lewis, to include the 31st day of October, 1864, and
has pay due him from that time to the present date; he is entitled to pay and subsistence for
TRAVELING to place of enrollment, and whatever other allowances are authorized to volunteer
soldiers, drafted men, or militia, so discharged. He has received from the United States **CLOTHING**
amounting to Eighty seven $\frac{97}{100}$ dollars, since the 26th day of May,
1864, when his clothing account was last settled. He has received from the United States
_____ dollars advanced **BOUNTY**.

There is to be stopped from him, on account of the State of _____, or other
authorities, for **CLOTHING**, &c., received on entering service, _____ dollars; and
for other stoppages, viz: Charged on Descriptive Roll with 1 Knapsack, one
Haversack, 1 Canteen & One piece of Shelter Tent which was
not in his possession on Admission to Hospital _____ dollars.
He has been furnished with **TRANSPORTATION** in kind from the place of his discharge to
_____ ; and he has been **Subsisted** for **Traveling** to his
place of enrollment, up to the _____, 186 .

He is indebted to _____, **Sutler**, _____ dollars.

He is indebted to _____, **Laundress**, _____ dollars.

Given in Duplicate, at New Orleans La, this 4th day
of August 1865.

F. E. Piquette
Surgeon in Charge
~~Commanding Company~~
Corps De Afrique & Gen. Hosp.

ARTICLES OF WAR.

ART. 95. When any non-commissioned officer or soldier shall die, or be killed in the service of the United States, the then commanding officer of the troop or company shall, in the presence of two other commissioned officers, take an account of what effects he died possessed of, above his arms and accoutrements, and transmit the same to the office of the Department of War, which said effects are to be accounted for, and paid to the representatives of such deceased non-commissioned officer or soldier. And in case any of the officers, so authorized to take care of the effects of deceased officers and soldiers, should, before they have accounted to their representatives for the same, have occasion to leave the regiment or post, by preferment or otherwise, they shall, before they be permitted to quit the same, deposit in the hands of the commanding officer, or of the assistant military agent, all the effects of such deceased non-commissioned officers and soldiers, in order that the same may be secured for, and paid to, their respective representatives.

ARMY REGULATIONS—EDITION OF 1861.

DECEASED SOLDIERS.

Par. 152. Inventories of the effects of deceased non-commissioned officers and soldiers, required by the 95th Article of War, will be forwarded to the Adjutant General, by the commander of the company to which the deceased belonged, and a duplicate of the same to the colonel of the regiment. Final statements of pay, clothing, &c., will be sent with the inventories. When a soldier dies at a post or station absent from his company, it will be the duty of his immediate commander to furnish the required inventory, and, at the same time, to forward to the commanding officer of the company to which the soldier belonged, a report of his death, specifying the date, place, and cause; to what time he was last paid, and the money or other effects in his possession at the time of his decease; which report will be noted on the next muster-roll of the company to which the man belonged. Each inventory will be endorsed, "Inventory of the effects of _____, late of company (—) _____ regiment of _____, who died at _____, the _____ day of _____, 186—." If a legal representative receive the effects, it will be stated in the report. If the soldier leave no effects, the fact will be reported.

Par. 153. Should the effects of a deceased non-commissioned officer or soldier not be administered upon within a short period after his decease, they shall be disposed of by a Council of Administration, under the authority of the commanding officer of the post, and the proceeds deposited with the Paymaster, to the credit of the United States, until they shall be claimed by the legal representatives of the deceased.

Par. 154. In all such cases of sales by the Council of Administration, a statement in detail, or account of the proceeds, duly certified by the Council and commanding officer, accompanied by the Paymaster's receipt for the proceeds, will be forwarded by the commanding officer to the Adjutant General. The statement will be endorsed, "Report of the proceeds of the effects of _____, late of company (—) _____ regiment of _____, who died at _____, the _____ day of _____, 186—."

NOTE 1.—The effects in all cases, when called for, should be turned over to the legal representative, without further authority from the Adjutant General. When the effects are turned over to the relatives of the deceased before these inventories are sent to the Adjutant General, their receipts therefor should be attached to the inventories. In all other cases, one copy will be sent with a letter of transmittal direct to the Adjutant General, and a duplicate retained by the officer.

NOTE 2.—Particular care should be taken to take receipts in duplicate from the Paymaster for any funds turned over to him; one copy should be sent direct to the Adjutant General and one retained by the officer.

INVENTORY OF THE EFFECTS

OF

Priv. Edward Young

Late of Company "A"

8th Reg't of U.S. Col'd Art'y. (H)

Volunteers, who died at New Orleans La

on the 4th day of August 1865.

Extract from Act of Congress.

SEC. 12. *And be it further enacted,* That the fees of agents and attorneys for making out and causing to be executed the papers necessary to establish a claim for a pension, bounty, and other allowance before the Pension Office, under this act, shall not exceed the following rates: For making out and causing to be duly executed a declaration by the applicant, with the necessary affidavits, and forwarding the same to the Pension Office, with the requisite correspondence, ten dollars; which sum shall be received by such agent or attorney in full for all services in obtaining such pension, and shall not be demanded or received, in whole or in part, until such pension shall be obtained; and the sixth and seventh sections of an act entitled "An act to grant pensions," approved July [fourteenth,] eighteen hundred and sixty-two, are hereby repealed.

SEC. 13. *And be it further enacted,* That any agent or attorney who shall, directly or indirectly, demand or receive any greater compensation for his services under this act than is prescribed in the preceding section of this act, or who shall contract or agree to prosecute any claim for a pension, bounty, or other allowance under this act, on the condition that he shall receive a per centum upon any portion of the amount of such claim, or who shall wrongfully withhold from a pensioner or other claimant the whole or any part of the pension or claim allowed and due to such pensioner or claimant, shall be deemed guilty of a high misdemeanor, and, upon conviction thereof, shall, for every such offense, be fined not exceeding three hundred dollars, or imprisoned at hard labor not exceeding two years, or both, according to the circumstances and aggravations of the offense.

Approved July 4, 1864.

NOTE 10.—If any soldier is charged a higher fee than that allowed by the above act, he should report the fact and the name of the agent to the Adjutant General, in order that steps may be taken to have the same refunded.

FINAL STATEMENT.

Aug 4th 1865
DF

John Edward Jones
5th Reg't of N.S. Cavalry (H)

VOLUNTEERS.

NOTE 1.—Two of these certificates (or duplicates) are to be given to each Volunteer Soldier or drafted man who may be discharged without being mustered out (Final Statements are never given to men mustered out of service) that he may at once receive from the Paymaster the pay, &c., due to him, and the captain or other COMMISSIONED officer commanding the company will certify to the act of the delivery of the duplicate certificates; with these certificates the Soldier is "entitled to" his discharge, and should also present his discharge to the Paymaster to have the payment endorsed on it. The discharge is to be given back to the Soldier by the Paymaster; the latter only retaining as his vouchers the duplicate certificates.

NOTE 2.—If the Soldier is entitled to pay for the use of his horse, the Company Commander will certify to that fact on the back of both these final statements, and also to the time he has pay due for having been so mounted on his own horse.

NOTE 3.—When a Soldier is furnished with final statements, his descriptive list, if he has one, should be taken up by the officer who gives the Soldier these statements, and endorsed with a statement to this effect by the officer. The endorsement should exhibit a full statement of the time for which the Soldier was allowed pay on his final statements, the clothing account, and all other charges against him or in his favor, so as to comprise a complete exhibit of his account. It will then be transmitted to the Company Commander of the Soldier, who will enter all the data necessary to a full understanding of the Soldier's account on the muster roll upon which the Soldier's discharge is reported. The descriptive list will then be destroyed. The object of this is, that the remaining portion of the Soldier's account may be settled upon the receipt of these muster rolls, and the Soldier receive any pay or allowances that may be due him at the time of his discharge, and which may not appear on his last final statements from the fact that his descriptive list is incomplete. These accounts for back pay, &c., are settled by the 2d Auditor of the Treasury Department.

NOTE 4.—Charges for loss or injury to ordnance, horse equipments, and other miscellaneous charges, should appear under the heading of "Other Stoppages."

NOTE 5.—Bounty paid by State authorities, and not by the United States, will not be entered on this statement.

NOTE 6.—Amounts due the Sutler and Laundress must be entered on the muster roll on which the discharge, death, desertion, &c., is reported, as well as on the final statement, otherwise the amount cannot be collected from the United States.

NOTE 7.—This blank will be used for deceased volunteers and drafted men, as well as for others.

NOTE 8.—Where a Soldier dies in Hospital or on detached service, his descriptive list, if he has one, should be sent with his final statements, in duplicate, to the Adjutant General, Washington, D. C.

NOTE 9.—If the soldier is a drafted man or substitute, the space for time, &c., of enrolled, should contain only the word *drafted* or *substitute*, as the case may be. If the Soldier is a "VETERAN," (or RECRUIT,) the words *as a veteran*, (or *recruit*,) as the case may be, should be interlined after the words *mustered into the service of the U. S.* A statement of all the installments of *Veteran* or *Recruit* Bounty RECEIVED by the Soldier must be made on the back of each final statement.

Edward Young
Priv. U. S. A. C. H. A.
Aug. 4. 65.
Corps d'Afrique
New-Orleans.

HOSPITAL RECORD,

SUBJECT TO THE

ORDER OF THE SURGEON GENERAL,

UNITED STATES ARMY.

No. 1.

RECORD OF DEATH AND INTERMENT.

Name and number of person interred, *Edward Conroy*
 Number and locality of the Grave, -
 Hospital number of the deceased, - *6093*
 Regiment, Rank, and Company, - - *8 U.S. Cavalry - Private - 4.*
 Residence before enlistment, - - -
 Conjugal condition (and if married,)
 the residence of the widow,)
 Cause of death, - - - - - } *Remittent Fever*
 Age of the deceased, - - - - -
 Nativity, - - - - -
 References, and Remarks, - - - }
 Date of death and burial, - - - *August 4th 1863* 186

Duplicates sent to the Adjutant General of the United States Army, and to the Sexton of the Cemetery.

Memoranda:

1914
Young, Green
Co. 8 U.S. Col'd H. Art'y.

Private Private

CARD NUMBERS.

1	5481223	26
2	5481363	27
3	5481503	28
4	5481636	29
5	5481772	30
6	5482438	31
7	9122742	32
8	4974506	33
9	4974505	34
10		35
11		36
12		37
13		38
14		39
15		40
16		41
17		42
18		43
19		44
20		45
21		46
22		47
23		48
24		49
25		50

Book Mark:

See also

7 | 8 H. Art'y. | U.S.C.T.

Erving Young
....., Co. *H*., 8 Reg't U.S. Cold H. Art'y.

Appears on

Company Descriptive Book
of the organization named above.

DESCRIPTION.

Age *21* years; height *5* feet *7* inches.

Complexion *Black*

Eyes *Black*; hair *Black*

Where born *Caldwell, Ky.*

Occupation *Farmer*

ENLISTMENT.

When *June 24*, 186*4*.

Where *Puducak, Ky.*

By whom *W. H. Leggart*; term *3* y'rs.

Remarks *Died in Regimental
Hospital Dec. 11th 1864⁺
of Dysentery Jan. 14th
1865.*

As on roll

Keeper

Y. | 8 H. Art'y. | U.S.C.T.
Green Young.
Art. Co. K 8 Reg't U. S. Col'd H. Art'y.

Age ... years.

Appears on

Company Muster Roll*
for *Mustment to June 30th*, 1864.

Joined for duty and enrolled:

When *June 24th*, 1864.

Where *Paducah, Ky.*

Period *3* years.

Mustered in:

When *June 25th*, 1864.

Where *Paducah, Ky.*

Present or absent *Present.*

Stoppage, \$ *100* for

Due Gov't \$ *100* for

Valuation of horse, \$ *100*

Valuation of horse equipments, \$ *100*

Remarks:

*First current roll. No muster-in roll of this company on file.

Book mark:

Harin.

(358d)

Copist.

21

S H. Art'y.

U.S.C.T.

Green Young.
Pvt., Co. K, 8 Reg't U. S. Col'd H. Art'y.

Appears on

Company Muster Roll

for *July and August*, 186*4*

Present or absent *Present*

Stoppage, \$ *100* for

Due Gov't, \$ *100* for

Valuation of horse, \$ *100*

Valuation of horse equipments. \$ *100*

Remarks :
.....
.....
.....
.....
.....
.....
.....
.....
.....
.....

Book mark :

Harin.

Y. | 8 H. Art'y. | U.S.C.T.

Green Young
Pvt., Co. K, 8 Reg't U. S. Col'd H. Art'y.

Appears on

Company Muster Roll
for *Sept and Oct*, 186*4*

Present or absent *Present*

Stoppage, \$ 100 for

Due Gov't, \$ 100 for

Valuation of horse, \$ 100

Valuation of horse equipments, \$ 100

Remarks:
.....
.....
.....
.....
.....
.....
.....
.....
.....
.....

Book mark:

Harin

Y. | 8 H. Art'y. | U.S.C.T.
Green Young,
Pvt., Co. K, 8 Reg't U. S. Col'd H. Art'y.

Appears on

Company Muster Roll

for *Nov. and Dec.*, 186*4*

Present or absent *Present.*

Stoppage, \$ *100* for

Due Gov't, \$ *100* for

Valuation of horse, \$ *100*

Valuation of horse equipments, \$ *100*

Remarks: *Sick in Regimental Hospital.*

Book mark: *106655, Jan. 5th/66,*
over

Harri.

JAN. 14

5481636

1961

red, see Jan'y/65 Return.

Y | 8 H. Art'y. | U.S.C.T.

Green Young
Priv, Co. K, 8 Reg't U. S. Col'd H. Art'y.

Appears on

Company Muster Roll

for *Jan'y, & Feby.*, 1865.

Present or absent.....

Stoppage, \$.....100 for.....

Due Gov't, \$.....100 for.....

Valuation of horse, \$.....100

Valuation of horse equipments, \$.....100

Remarks:.....

Died at Hospital Paducah, Ky.
Jan'y. 11, 1865.

Book mark:.....

(358)

D. Mahor
Copyist.

Y

8 H. Art'y.

U.S.C.T.

Young

Pot, Co. *K*, 8 Reg't U. S. Col'd H. Art'y.

Appears on Returns as follows:

Aug 1864 *absent*
at Paducah Ky

Book mark : _____

Chas Patton

(546)

Copyist.

Cf | S H. Art'y. | U.S.C.T.

Ernest Young

Priv, Co *K*, 8 Reg't U. S. Col'd H. Art'y.

Appears on Returns as follows:

May 18 63 *Jan 11/ 65*

*Panama Ky. Died
in Regt Hosp.*

Book mark : _____

John Patten

(546)

Copyist.

Green Young
Priv., Co. *K*, 8 Reg't U. S. Col'd H. Art'y.

Appears on **Co. Muster-out Roll**, dated
Victoria Texas, Feby 10, 1866.

Muster-out to date _____, 186 .

Last paid to *Dec 31*, 1864.

Clothing account:

Last settled _____, 186 ; drawn since \$ _____ 100

Due soldier \$ _____ 100 ; due U. S. \$ _____ 100

Am't for cloth'g in kind or money adv'd \$ _____ 100

Due U. S. for arms, equipments, &c., \$ _____ 100

Bounty paid \$ _____ 100 ; due \$ _____ 100

Remarks *Entered service at organization of Co as private. Died at Paducah Ky June 11th 1865 of diarrhea. Final Statements and Inventory of effects forwarded Jan'y 13th 1865. Age 26 years*
Book mark: *V 97 P 176.69.106.655*

(361) *J. P. York* Copyist.

Yang Green

P. B. 8 Reg't 2/1/11

5 Enclosures.

Bed Cards	Final Statements 2
Burial Records	Furloughs or L. of A.
Certs. of Dis. for Discharge	Med. Certificates
C. M. Charges	Med. Des. Lists
Descriptive Lists	Orders
Discharge Certificates	Pris. of War Record
Enlistment Papers	Resignations

Other papers relating to—

Admission to Hosp'l	Furlough or L. of A.
Casualty Sheet	Med. Examination
Confinement	Misc. Information
Contracts	Pay or Clothing
Death or Effects 3	Personal Reports
Desertion	Rank
Discharge from Hosp'l	Transfer to Hosp'l
Discharge from Service	Transfer to V. R. C.
Duty	Transportation

James Young

Hospital 5th U.S. A. & F. Camp
Paducah Ky June 11th 1864

Capt. C. C. Conroy
at

Sir

I have the honor to
inform you that Green Young number of
your Co. died at this Hospital at
11 A.M. 10th inst.

Cause of Death Diarrhea

aid soldier was buried in front of Hospital

The remaining effects are one Cap. one
Bottle one tin of shells one tin of powder one tin of
one tin of powder one tin of powder one tin of powder
the pair of boots one pair of shoes one pair of shoes
one pair of shoes

J. C. Mc
Surgeon in Charge

FINAL STATEMENT

OF

James Green Young
8th Reg't of 25th Co. A. H. C.

VOLUNTEERS.

Armed January 11th 1865

NOTE 1.—Two of these certificates (or duplicates) are to be given to each volunteer soldier who may be discharged previously to the discharge of his company, that he may at once receive from the Paymaster the pay, &c., due him, and the captain or other officer commanding the company will certify to the act of the delivery of the duplicate certificates; on these certificates the Soldier is "entitled to" his discharge, and should also present his discharge to the Paymaster to have the payment endorsed on it. The discharge is to be given back to the Soldier by the Paymaster; the latter only retaining as his voucher the duplicate certificates.

NOTE 2.—If the Soldier is entitled to pay for the use of his horse, the Company Commander will certify to that fact, and also to the time he has pay due for having been so mounted on his own horse.

NOTE 3.—Amounts due the Sutler and Laundress must be entered on the Muster Roll on which the death, desertion, &c., is reported, as well as on the final statement, otherwise the amount cannot be collected from the United States.

NOTE 4.—This blank will be used for deceased volunteers as well as others.



I certify, on honor, that Crosby Young a Private of
 Captain John Curtis Company (A), of the 18th Regiment of U. S. Art 25
VOLUNTEERS, of the State of -----, born in Bedford Co., State
 of Virginia, aged 21 years; 5 feet 7 inches high; Black complexion,
Blue eyes, Black hair, and by occupation a farmer, having joined the company on
 its original organization at Aducan, Va., and enrolled in it at the muster into
 the service of the United States at Paducah, Ky., on the 25th day
 of June, 1864, (or was mustered in service as a recruit, by -----
-----, at -----, on the ----- day of -----,
 1864, to serve in the Regiment,) for the term of Three Years

and having served **HONESTLY** and **FAITHFULLY** with his Company in the field
 to the present date, is now entitled to a **DISCHARGE** by reason of -----

The said Crosby Young was last paid by Paymaster
----- to include the 31st day of -----, 1864, and has
 pay due him from that time to the present date; he is entitled to pay and subsistence for
TRAVELING to place of enrollment and whatever other allowances are authorized to volunteer
 soldiers, or militia, so discharged. He has received 1 ⁶⁰/₁₀₀ dollars,
 advanced by the United States on account of **CLOTHING**.

There is to be stopped from him, on account of the State of -----, or other
 authorities for **CLOTHING**, &c., received on entering service, ----- ¹⁰⁰/₁₀₀ dollars; also,
 for expenses of **SUBSISTENCE** for **TRAVELING** from place of enrollment to the place of rendezvous,
 amounting to ----- ¹⁰⁰/₁₀₀ dollars: and on account of the United States for **EXTRA**
CLOTHING received in kind from ----- and for other
 stoppages, viz:

----- amounting to ----- ¹⁰⁰/₁₀₀ dollars;
 and he has been **SUBSISTED** for **TRAVELING** to his place of enrollment, up to the -----
-----, 1864.

He is indebted to -----, **SUTLER**, ----- ¹⁰⁰/₁₀₀ dollars.
 He is indebted to -----, **LAUNDRESS**, ----- ¹⁰⁰/₁₀₀ dollars.

Given in Duplicate, at Aducan, Va., this 1st day of June, 1865.

C. J. S. Adams
 Commanding Company.

MAR 12 1865

✓ Cook

FINAL STATEMENT

OF

Frank Greene Young
8th Reg't of U. S. G. A. C.

VOLUNTEERS.

Frank Greene Young 10th / 1865

NOTE 1.—Two of these certificates (or duplicates) are to be given to each volunteer soldier who may be discharged previously to the discharge of his company, that he may at once receive from the Paymaster the pay, &c., due him, and the captain or other officer commanding the company will certify to the act of the delivery of the duplicate certificates; on these certificates the Soldier is "entitled to" his discharge, and should also present his discharge to the Paymaster to have the payment endorsed on it. The discharge is to be given back to the Soldier by the Paymaster; the latter only retaining as his voucher the duplicate certificates.

NOTE 2.—If the Soldier is entitled to pay for the use of his horse, the Company Commander will certify to that fact, and also to the time he has pay due for having been so mounted on his own horse.

NOTE 3.—Amounts due the Sutler and Laundress must be entered on the Muster Roll on which the death, desertion, &c., is reported, as well as on the final statement, otherwise the amount cannot be collected from the United States.

NOTE 4.—This blank will be used for deceased volunteers as well as others.

[OFFICE ENDORSEMENT.]

War Department,

ADJUTANT GENERAL'S OFFICE,

187
The Account of Frank Greene Young
Company, Co. "K," 8th Reg't U. S.
Col Fred A. D. ... is reported as follows:
On Company Muster Roll,
For Jan'y 1865, Jan'y 11th, 1865
Company Muster-out Roll,
Jan'y 11th, 1865
Company Descriptive Book,
186
Company Morning Reports,
186
Soldier's Final Statement,
Jan'y 10th, 1865
Soldier's Record of Death and Interment,
186
Soldier's Inventory of Effects,
186
Soldier's Certificate of Disability for Discharge,
186
Soldier's Individual Muster-out Roll,
186
Regimental Return,
For Jan'y 1865, Jan'y 11th, 1865
Regimental Quarterly Returns,
(P. O. O.) Jan'y 11th, 1865
Regimental Descriptive Book,
186
By Surgeon General,
() 186
Jan'y 11, 1865, is held to be
the correct date, and the Company Muster.....
Roll will be amended accordingly.

Handwritten notes on the left side of the page, including "A. G. O.", "Receipt for Effects", and "sent 2d Auditor".

ADJUTANT GENERAL'S OFFICE.
Jan'y 25th 1865
Duplicate with Inventory sent 2d Auditor.



Handwritten initials "Amk" and "Axe" at the bottom right of the page.

Assistant Adjutant General.

I certify, on honor, that James Jones a private of
 Captain John Cook Company (A.) of the 8th Regiment of V. G. Art. Co.
VOLUNTEERS, of the State of _____, born in Waldwell Co., State
 of Kentucky, aged 21 years; 5 feet 7 inches high; Black complexion,
Blue eyes, Black hair, and by occupation a farmer, having joined the company on
 its original organization at Paducah Ky., and enrolled in it at the muster into
 the service of the United States at Paducah Ky., on the 24th day
 of June, 1864, (or was mustered in service as a recruit, by _____
 _____, at _____, on the _____ day of _____,
 186 , to serve in the Regiment,) for the term of Three Years:

and having served **HONESTLY** and **FAITHFULLY** with his Company in the field
 to the present date, is now entitled to a **DISCHARGE** by reason of Order of the 10th
of _____ 1864, _____

The said James Jones was last paid by Paymaster
James to include the 31st day of October, 1864, and has
 pay due him from that time to the present date; he is entitled to pay and subsistence for
TRAVELING to place of enrollment and whatever other allowances are authorized to volunteer
 soldiers, or militia, so discharged. He has received 41 ⁴⁵/₁₀₀ dollars,
 advanced by the United States on account of **CLOTHING**.

There is to be stopped from him, on account of the State of _____, or other
 authorities for **CLOTHING, &c.**, received on entering service, _____ dollars; also,
 for expenses of **SUBSISTENCE** for **TRAVELING** from place of enrollment to the place of rendezvous,
 amounting to _____ dollars: and on account of the United States for **EXTRA**
CLOTHING received in kind from _____ and for other
 stoppages, viz:

_____ amounting to _____ dollars;
 and he has been **SUBSISTED** for **TRAVELING** to his place of enrollment, up to the _____
 _____, 186 .

He is indebted to _____, **SUTLER**, _____ dollars.
 He is indebted to _____, **LAUNDRESS**, _____ dollars.

Given in Duplicate, at Paducah Ky., this 4th day of January, 1865.

John Cook

 Commanding Company "A"

ARTICLES OF WAR.

ART. 95. When any non-commissioned officer or soldier shall die, or be killed in the service of the United States, the then commanding officer of the troop or company shall, in the presence of two other commissioned officers, take an account of what effects he died possessed of, above his arms and accoutrements, and transmit the same to the office of the Department of War, which said effects are to be accounted for, and paid to the representatives of such deceased non-commissioned officer or soldier. And in case any of the officers, so authorized to take care of the effects of deceased officers and soldiers, should, before they have accounted to their representatives for the same, have occasion to leave the regiment or post, by preferment or otherwise, they shall, before they be permitted to quit the same, deposit in the hands of the commanding officer, or of the assistant military agent, all the effects of such deceased non-commissioned officers and soldiers, in order that the same may be secured for, and paid to, their respective representatives.

ARMY REGULATIONS—EDITION OF 1861.

DECEASED SOLDIERS.

Par. 152. Inventories of the effects of deceased non-commissioned officers and soldiers, required by the 95th Article of War, will be forwarded to the Adjutant General, by the commander of the company to which the deceased belonged, and a duplicate of the same to the colonel of the regiment. Final statements of pay, clothing, &c., will be sent with the inventories. When a soldier dies at a post or station absent from his company, it will be the duty of his immediate commander to furnish the required inventory, and, at the same time, to forward to the commanding officer of the company to which the soldier belonged, a report of his death, specifying the date, place, and cause; to what time he was last paid, and the money or other effects in his possession at the time of his decease; which report will be noted on the next muster roll of the company to which the man belonged. Each inventory will be endorsed, "Inventory of the effects of _____, late of company (—) _____ regiment of _____, who died at _____, the _____ day of _____, 186—." If a legal representative receive the effects, it will be stated in the report. If the soldier leave no effects, the fact will be reported.

Par. 153. Should the effects of a deceased non-commissioned officer or soldier not be administered upon within a short period after his decease, they shall be disposed of by a Council of Administration, under the authority of the commanding officer of the post, and the proceeds deposited with the Paymaster, to the credit of the United States, until they shall be claimed by the legal representatives of the deceased.

Par. 154. In all such cases of sales by the Council of Administration, a statement in detail, or account of the proceeds, duly certified by the Council and commanding officer, accompanied by the Paymaster's receipt for the proceeds, will be forwarded by the commanding officer to the Adjutant General. The statement will be endorsed, "Report of the proceeds of the effects of _____, late of company (—) _____ regiment of _____, who died at _____, the _____ day of _____, 186—."

NOTE 1.—The effects in all cases, when called for, should be turned over to the legal representative, without further authority from the Adjutant General. When the effects are turned over to the relatives of the deceased before these inventories are sent to the Adjutant General, their receipts therefor should be attached to the inventories. In all other cases, one copy will be sent with a letter of transmittal direct to the Adjutant General, and a duplicate retained by the officer.

NOTE 2.—Particular care should be taken to take receipts in duplicate from the Paymaster for any funds turned over to him; one copy should be sent direct to the Adjutant General and one retained by the officer.

INVENTORY OF THE EFFECTS

OF

Private George Young

Late of Company *'K'*

8th Reg't of *U S C A H C*

Volunteers, who died at *Paducah Ky.*

on the *10th* day of *January* 1865.



INVENTORY

Inventory of the effects of Greene Young late
 a private of Captain John Coors Company "K" of
 the 8th Regiment of U. S. C. Art. Regt. Volunteers, who was enrolled as
 a Soldier at Paducah in the State of Kentucky on
 the 24th day of June 1864, and mustered into the service of the United
 States as a private on the 25th day of June 1864, at Paducah Ky
 in Company K, 8th Regiment of U. S. C. Art. Regt. Volunteers, to serve three
 years or during the war; he was born in Baldwin Co in the State
 of Kentucky; he was 21 years of age, 5 feet 7 inches
 high, fair complexion, black eyes, black hair, and by occupation, when enrolled,
 a farmer; he died in General Hospital, at
Paducah Ky on the 15th day of January 1865, by
 reason of Scarfever

INVENTORY.					
ARTICLES.	No.	ARTICLES.	No.	ARTICLES.	No.
Hats.....	/	Pairs trousers.....	/	Knapsacks.....	
Caps.....	/	Pairs flannel drawers.....	/	<u>Water</u>	/
Forage caps.....	/	Pairs cotton drawers.....	/		
Great coats.....	/	Flannel shirts.....	/		
Uniform coats.....	/	Cotton shirts.....	/		
Uniform jackets.....	/	Pairs boots.....	/		
Flannel sack coats.....	/	Pairs shoes.....	/		
Blouses.....	/	Pairs socks.....	/		
Stable frocks.....	/	Blankets.....	/		
Fatigue overalls.....	/	Haversacks.....	/		
				MONEY.	
				Specie.....	\$
				Notes.....	\$

I CERTIFY, ON HONOR, that the above inventory comprises all the effects of private
Greene Young, deceased, and that the effects are in the hands
 of Jackson Young inquiree at Paducah Ky
~~to be disposed of by a Council of Administration~~

(DUPLICATES.)

STATION: Paducah Ky
 DATE: January 14th 1865

John Coors
Capt U. S. C. Art. Regt.
 Commanding the Company. K

1917
Young Isaac

Co H, 8 U.S. Col'd H. Art'y.

Private Private

CARD NUMBERS.

1	5467099	26
2	5467068	27
3	5478473	28
4	5478623	29
5	5478774	30
6	5478918	31
7	5479670	32
8	9121992	33
9	4454996	34
10		35
11		36
12		37
13		38
14		39
15		40
16		41
17		42
18		43
19		44
20		45
21		46
22		47
23		48
24		49
25		50

Book Mark:

See also

RDP496349

R. P. 660 241

S. 2023814 P.O. man

14 | 8th Arty | U.S.C.T.

Isaac Young

Co. H, 8 Reg't U.S. Col'd 8th Arty

Appears on

Company Descriptive Book

of the organization named above.

DESCRIPTION.

Age 8 years; height 5 feet 7 inches.

Complexion Black

Eyes Black; hair Black

Where born Trimble Co., Ky.

Occupation Farmer

ENLISTMENT.

When Aug. 22, 1864.

Where Paducah, Ky.

By whom R. H. Hall; term 3 y'rs.

Remarks: Died at General Post Hospital
Paducah, Ky., Jan. 23, 1865 of
Malaria

R. H. Hall

(383a)

Copist.

Of *H. Arty* | **U.S.C.T.**

Isaac Young

Appears with rank of *Prvt* on

Muster and Descriptive Rolls of Detachments of U. S. Vols. forwarded

for the *8* Reg't U. S. Col'd *H. Arty* Roll dated

Paducah, Ky, Aug. 3, 1864

Where born *Franklin, Ky*

Age *18* y'rs; occupation *Farmer*

When enlisted *Aug. 22, 1864*

Where enlisted *Paducah, Ky*

For what period enlisted *3* years.

Eyes *Black*; hair *Black*

Complexion *Black*; height *5* ft. *4* in.

When mustered in *Aug. 22, 1864*

Where mustered in *Paducah,*

Bounty paid \$ *100*; due \$ *100*

Where credited *Union Co. Dist of Ky*

Company to which assigned

Remarks:

Book mark:

(339) *Geo J Bell Jr* *Compt.*

Y | 8 H. Art'y. | U.S.C.T.

Isaac Young

Appears with rank of Private on

Muster and Descriptive Roll of a Detachment of U. S. Vols. forwarded

for the 8 Reg't U. S. Col'd H. Art'y. Roll dated

Paducah, Ky, ~~NY~~ Aug 31, 1864.

Where born Trimble, Ky.

Age 18 y'rs; occupation Farmer

When enlisted Aug. 22, 186 .

Where enlisted Paducah, Ky.

For what period enlisted 3 years.

Eyes Black; hair Black

Complexion Black; height 5 ft. 4 in.

When mustered in Aug. 22, 186 .

Where mustered in Paducah,

Bounty paid \$ 100; due \$ 100

Where credited Union, 1st D. Ky.

Company to which assigned

Remarks :

Book mark :

Callaway Copyist.

Y. | 8 H. Art'y. | U.S.C.T.

Isaac Young

Det., Co. H, 8 Reg't U. S. Col'd H. Art'y.

Appears on

Company Muster Roll

for *Dated Aug 31*, 1864.

Present or absent *Present*

Stoppage, \$ *100* for

Due Gov't, \$ *100* for

Valuation of horse, \$ *100*

Valuation of horse equipments, \$ *100*

Remarks:

Book mark: _____

S. W. Tucker

(358)

Copyist.

Y | 8 H. Art'y. | U.S.C.T.

Isaac Young

Priv, Co. H, 8 Reg't U. S. Col'd H. Art'y.

Appears on

Company Muster Roll

for *Sept & Oct*, 1864

Present or absent *Present*

Stoppage, \$ *100* for -----

Due Gov't, \$ *100* for -----

Valuation of horse, \$ *100*

Valuation of horse equipments, \$ *100*

Remarks: -----

Book mark: -----

J. M. Tucker

Y | 8 H. Art'y. | **U.S.C.T.**

Space Young

Priv, Co. H, 8 Reg't U. S. Col'd H. Art'y.

Appears on

Company Muster Roll

for *Nov. & Dec*, 1864.

Present or absent *Present*

Stoppage, \$ *100* for

Due Gov't, \$ *100* for

Valuation of horse, \$ *100*

Valuation of horse equipments, \$ *100*

Remarks: -----

Book mark: -----

S. W. Tucker

Copyist.

M

8 H. Art'y.

U.S.C.T.

Wm Young

Pvt, Co. H, 8 Reg't U. S. Col'd H. Art'y.

Appears on

Company Muster Roll

for *Jan. & Feb.*, 1865.

Present or absent.....

Stoppage, \$.....100 for.....

Due Gov't, \$.....100 for.....

Valuation of horse, \$.....100

Valuation of horse equipments, \$.....100

Remarks: *Died in Post Hospital Jan. 23/65*

Book mark:.....

(358) *J. E. Nichol* Copyist.

Y | 8 H. Art'y. | U.S.C.T.

Isaac Young

Pr, Co. H, 8 Reg't U. S. Col'd H. Art'y.

Appears on Returns as follows:

May 18 65 Jan'y 23 65
Post Hosp Sick of
Measles

Book mark :

Chas. Carter

(546)

Copyist.

4 | 8 H. Art'y. | U.S.C.T.

Isaac Young

Co. K, 8 Reg't U. S. Col'd H. Art'y.

Appears on **Co. Muster-out Roll**, dated *Victoria Texas, Texs*, 186*6*.

Muster-out to date _____, 186 .

Last paid to *Oct 31*, 186*4*.

Clothing account:

Last settled _____, 186 ; drawn since \$ _____ 100

Due soldier \$ _____ 100; due U. S. \$ _____ 100

Am't for cloth'g in kind or money adv'd \$ _____ 100

Due U. S. for arms, equipments, &c., \$ _____ 100

Bounty paid \$ _____ 100; due \$ _____ 100

Remarks: *Entered service as Recruit as herein shown joined Co for duty Aug 22 1864 Died Reg Hosp Jan 23 1865 Mess less Inventory of final statements forwarded*

Book mark: *V. 175, P. 87, 73.*

G. W. Deabrick
(861) Copyist.

Young, Isaac
B, Co. *H*, *8* Reg't *U.S.C.H.A.*

7 Enclosures.

Bed Cards	Descriptive Lists
Burial Records	Final Statements <i>4</i>
Certs. of Dis. for Discharge	Furloughs
C. M. Charges	Med. Des. Lists
Med. Certificates	Orders

Enlistments *1*

Other papers relating to—

Admission to Hosp'l	Furlough
Casualty Sheet (Officer's)	Med. Examination
Confinement	Misc. Information
Contracts	Pay or Clothing
Death or Effects <i>2</i>	Personal Reports
Desertions	Rank
Discharge from Hosp'l	Transfer to Hosp'l
Discharge from Service	Transfer to V. R. C.
Duty	Transportation

No. *Twenty six*

Young Isaac

Volunteered at *Paducah Ky*

August 22nd 1864

By *Capt R H Hall*

Pro Mar 1st Dist of Ky

J. U. S. C. Art. Henry

Consent of Parent or Guardian in case of a Minor, if a Free Man, or in the case of a Slave, of the Person to whom he owes Service:

of United States colored troops. They will be made out in duplicate in all cases
General, and one to accompany the accounts of the officer who pays bounty, &c.
muster-in, must in all cases, precede payment of pay, bounty, pension, &c. A m
ring officer, commissary, or assistant commissary of musters, as the case may be, w
either of them is given to the disbursing officer.

UNITED STATES COLORED TROOPS ENLISTMENT.

STATE OF

TOWN OF

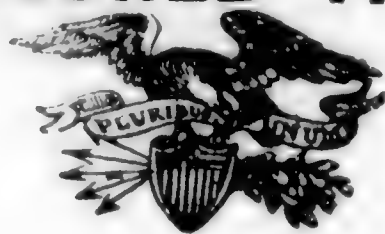

Kentucky

Paducah

I, *Young, Isaac*

born in *Frimble Co.*

in the State of *Kentucky* aged *Eighteen* years

and by occupation a *Farmer* Do HEREBY ACKNOWLEDGE to have

volunteered this *Twenty second* day of *August* 1864,

to serve as a **Soldier** in the **Army of the United States of America**, for the period of **THREE YEARS**, unless sooner discharged by proper authority:

Do also agree to accept such bounty, pay, rations, and clothing, as are, or may be, established by law for the U. S. colored troops.

And I, *Isaac Young of Union Co*

do solemnly swear, that I will bear true faith and allegiance to the **United States of America**, and that I will serve them honestly and faithfully against all their enemies or opposers whomsoever; and that I will observe and obey the orders of the President of the United States, and the orders of the officers appointed over me, according to the Rules and Articles of War.

Sworn and subscribed to, at *Paducah Ky*

this *22nd* day of *Aug* 1864,

Isaac Young
mark

Before *Capt R A Hale*

Pro Mar 1st Dist of Ky

I CERTIFY, ON HONOR, That I have carefully examined the above named Volunteer, agreeably to the General Regulations of the Army, and that, in my opinion, he is free from all bodily defects and mental infirmity, which would in any way disqualify him from performing the duties of a soldier.

M. H. Kidd

EXAMINING SURGEON.

I CERTIFY, ON HONOR, That I have minutely inspected the Volunteer, *Isaac Young* previously to his enlistment, and that he was entirely sober when enlisted; that, to the best of my judgment and belief, he is of lawful age; and that, in accepting him as duly qualified to perform the duties of an able-bodied soldier, I have strictly observed the regulations which govern the recruiting service. This soldier has *Blue* eyes, *Blue* hair, *Blue* complexion, is *five* feet *4* inches high.

RECRUITING OFFICER OR AGENT.

Mustered into the United States service *22nd* day of *August* 1864

H. H. Hale
Capt Pro Mar & Mustering Officer.

Mustered into the service of the United States, for three years or during the war, from date of enlistment, in Company *H* of the *25th* Regiment of *Volunteers*, on the *22nd* day of *August*, 1864 at *Paducah Ky*

Capt R A Hale
Pro Mar 1st Dist of Ky

111-Quar-1-1864

Note 1.—This blank will be used for enlistments of United States colored troops. They will be made out in duplicate in all cases—one to accompany the recruiting return of the superintendent (not the recruiting officer) to the Adjutant General, and one to accompany the accounts of the officer who pays bounty, &c.

Note 2.—An enlistment holds to service. A muster-in, must in all cases, precede payment of pay, bounty, pension, &c. A muster-in roll, must in all cases, be filed in the Adjutant General's Office as evidence of muster-in. The mustering officer, commissary, or assistant commissary of musters, as the case may be, will countersign both enlistments as having mustered the soldier into the service of the United States before either of them is given to the disbursing officer.

DECLARATION OF RECRUIT.

I, Isaac Young of Union Co. Ky. desiring to volunteer as a soldier in the ARMY OF THE UNITED STATES, for the term of Three Years, DO DECLARE That I am Eighteen years and months of age; that I have never been discharged from the United States service on account of disability or by sentence of a court-martial, or by order before the expiration of a term of enlistment; and I know of no impediment to my serving honestly and faithfully as a soldier for three years.

GIVEN at Paducah Ky the 22nd day of August 1864

Witness: A. J. [Signature]

Isaac Young
 By Isaac Young
 Volunteered at Paducah Ky
August 22nd 1864
By Marshal [Signature]

[Signature]

Consent of Parent or Guardian in case of a Minor, if a Free Man, or in the case of a Slave, of the Person to whom he owes Service:

I, Do CERTIFY, That I am the that the said is years of age; and I do freely give my CONSENT to his volunteering as a SOLDIER in the Army of the United States, for the period of THREE YEARS, under the conditions of the laws of the United States.

GIVEN at the day of

Witness:

FINAL STATEMENT

OF

Isaac Young
Reg't of 1st Cal Heavy

VOLUNTEERS.

June 22/81

NOTE 1.—Two of these certificates (or duplicates) are to be given to each volunteer soldier who may be discharged previously to the discharge of his company, that he may at once receive from the Paymaster the pay, &c., due him, and the captain or other officer commanding the company will certify to the act of the delivery of the duplicate certificates; on these certificates the Soldier is "entitled to" his discharge, and should also present his discharge to the Paymaster to have the payment endorsed on it. The discharge is to be given back to the Soldier by the Paymaster; the latter only retaining as his voucher the duplicate certificates.

NOTE 2.—If the Soldier is entitled to pay for the use of his horse, the Company Commander will certify to that fact, and also to the time he has pay due for having been so mounted on his own horse.

NOTE 3.—Amounts due the Sutler and Laundress must be entered on the Muster Roll on which the death, desertion, &c., is reported, as well as on the final statement, otherwise the amount cannot be collected from the United States.

NOTE 4.—This blank will be used for deceased volunteers as well as others.

ADJUTANT GENERAL'S OFFICE.

April 11 1860

Duplicate with Inventory sent 2d Adj. Gen.

[Faint handwritten notes and signatures]

I certify, on honor, that _____ a _____ of
Captain _____ Company (____) of the _____ Regiment of _____
~~VOLUNTEERS~~, of the State of _____, born in _____, State
of _____, aged _____ years; _____ feet _____ inches high; _____ complexion,
_____ eyes, _____ hair, and by occupation a _____, having joined the company ~~at~~
~~its original organization at~~ _____, and enrolled in it ~~at the muster~~ into
the service of the United States at _____, on the _____ day
of _____, 186 ~~7~~, (or was mustered in service as a recruit, by _____
_____ at _____, on the _____ day of _____,
186 ~~7~~ to serve in the Regiment,) for the term of _____:
and having served **HONESTLY** and **FAITHFULLY** with his Company in _____
to the present date, is now entitled to a **DISCHARGE** by reason of _____

The said _____ was last paid by Paymaster
_____ to include the _____ day of _____, 186 ~~7~~, and has
pay due him from that time to the ~~present date~~; he is entitled to pay and subsistence for
TRAVELING to place of enrollment and whatever other allowances are authorized to volunteer
soldiers, or militia, so discharged. He has received _____ ⁸⁵/₁₀₀ dollars,
advanced by the United States on account of **CLOTHING**.

There is to be stopped from him, on account of the State of _____, or other
authorities for **CLOTHING**, &c., received on entering service, _____ ¹⁰⁰/₁₀₀ dollars; also,
for expenses of **SUBSISTENCE** for **TRAVELING** from place of enrollment to the place of rendezvous,
amounting to _____ ¹⁰⁰/₁₀₀ dollars: and on account of the United States for **EXTRA**
CLOTHING received in kind from _____ and for other
stoppages, viz:

_____ amounting to _____ ¹⁰⁰/₁₀₀ dollars;
and he has been **SUBSISTED** for **TRAVELING** to his place of enrollment, up to the _____
_____, 186 .

He is indebted to _____, **SUTLER**, _____ ¹⁰⁰/₁₀₀ dollars.

He is indebted to _____, **LAUNDRESS**, _____ ¹⁰⁰/₁₀₀ dollars.

Given in Duplicate, at _____, this _____ day of _____, 186 .

FINAL STATEMENT

OF

Lucas Young
5th Reg't of *Mass Heavy*

VOLUNTEERS.

NOTE 1.—Two of these certificates (or duplicates) are to be given to each Volunteer Soldier or drafted man who may be discharged previously to the discharge of his company, that he may at once receive from the Paymaster the pay, &c., due him, and the captain or other COMMISSIONED officer commanding the company will certify to the act of the delivery of the duplicate certificates; on these certificates the Soldier is "entitled to" his discharge, and should also present his discharge to the Paymaster to have the payment endorsed on it. The discharge is to be given back to the Soldier by the Paymaster; the latter only retaining as his voucher the duplicate certificates.

NOTE 2.—If the Soldier is entitled to pay for the use of his horse, the Company Commander will certify to that fact on the back of both these final statements, and also to the time he has pay due for having been so mounted on his own horse.

NOTE 3.—When a Soldier is furnished with final statements, his descriptive list, if he has one, should be taken up by the officer who gives the Soldier these statements, and endorsed with a statement to this effect by the officer. This endorsement should exhibit a full statement of the time for which the Soldier was allowed pay on his final statements, the clothing account, and all other charges against him or in his favor, so as to comprise a complete exhibit of his account. It will then be transmitted to the Company Commander of the Soldier, who will enter all the data necessary to a full understanding of the Soldier's account on the muster roll upon which the Soldier's discharge is reported. The descriptive list will then be destroyed. The object of this is, that the remaining portion of the Soldier's account may be settled upon the receipt of these muster rolls, and the Soldier receive any pay or allowances that may be due him at the time of his discharge, and which may not appear on his final statements from the fact that his descriptive list is incomplete. These accounts for back pay, &c., are settled by the 2d Auditor of the Treasury Department.

NOTE 4.—Charges for loss or injury to ordnance, horse equipments, and other miscellaneous charges, should appear under the heading of "Other Stoppages."

NOTE 5.—Bounty paid by State authorities, and not by the United States, will not be entered on this statement.

NOTE 6.—Amounts due the Sutler and Laundress must be entered on the muster roll on which the discharge, death, desertion, &c., is reported, as well as on the final statement, otherwise the amount cannot be collected from the United States.

NOTE 7.—This blank will be used for deceased volunteers and drafted men, as well as for others.

NOTE 8.—Where a Soldier dies in Hospital or on detached service, his descriptive list, if he has one, should be sent with his final statements, in duplicate, to the Adjutant General, Washington, D. C.

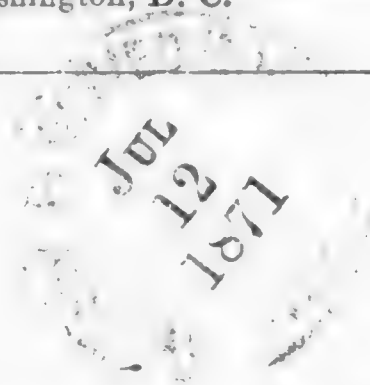

I certify, on honor, that Israel Young a Private of
 Captain H. B. ... Company (6) of the 8 Regiment of U.S.C.A.
VOLUNTEERS, of the State of ..., born in ..., State
 of ..., aged 18 years; 5 feet 4 inches high; Black complexion,
Black eyes, Black hair, and by occupation a Farmer, having joined the company on
 its original organization at ..., and enrolled in it at the muster into
 the service of the United States at Paducah Ky, on the 22 day
 of August, 1864, (or was mustered in service as a recruit, by Capt R. H. Hall
..., at Paducah Ky, on the 22 day of August,
 1864, or was drafted and mustered into the service of the United States from the
 Enrollment District of the State of ..., at ...,
 on the ... day of ..., 1864,) to serve in the Regiment, for
 the term of Three Years: and having served HONESTLY and
 FAITHFULLY with his Company in Paducah Ky to the present date, is now
 entitled to a **DISCHARGE** by reason of Death. Died at
Post Hospital Paducah Ky June 15 1865 of Measles

The said Israel Young was last paid by Paymaster
... to include the 31 day of October, 1864, and has
 pay due him from that time to the present date; he is entitled to pay and subsistence for
 TRAVELING to place of enrollment, and whatever other allowances are authorized to volunteer
 soldiers, drafted men, or militia, so discharged. He has received from the United States **CLOTHING**
 amounting to 85 88 3/100 dollars, since the 22 day of August,
 1864, when his clothing account was last settled. He has received from the United States
100 dollars advanced **BOUNTY**.

There is to be stopped from him, on account of the State of ..., or other
 authorities, for **CLOTHING**, &c., received on entering service, 100 dollars; and
 for other stoppages, viz: ...

100 dollars.
 He has been furnished with TRANSPORTATION in kind from the place of his discharge to
...; and he has been SUBSISTED for TRAVELING to his
 place of enrollment, up to the ..., 1864.

He is indebted to ..., **SUTLER**, 100 dollars.
 He is indebted to ..., **LAUNDRESS**, 100 dollars.

Given in Duplicate, at Paducah Ky, this ... day
 of ..., 1864.

...
...
 Commanding Company.

ARTICLES OF WAR.

ART. 95. When any non-commissioned officer or soldier shall die, or be killed in the service of the United States, the then commanding officer of the troop or company shall, in the presence of two other commissioned officers, take an account of what effects he died possessed of, above his arms and accoutrements, and transmit the same to the office of the Department of War, which said effects are to be accounted for, and paid to the representatives of such deceased non-commissioned officer or soldier. And in case any of the officers, so authorized to take care of the effects of deceased officers and soldiers, should, before they have accounted to their representatives for the same, have occasion to leave the regiment or post, by preferment or otherwise, they shall, before they be permitted to quit the same, deposit in the hands of the commanding officer, or of the assistant military agent, all the effects of such deceased non-commissioned officers and soldiers, in order that the same may be secured for, and paid to, their respective representatives.

ARMY REGULATIONS—EDITION OF 1863.

DECEASED SOLDIERS.

Par. 152. Inventories of the effects of deceased non-commissioned officers and soldiers, required by the 95th Article of War, will be forwarded to the Adjutant General, by the commander of the company to which the deceased belonged, and a duplicate of the same to the colonel of the regiment. Final statements of pay, clothing, &c., in duplicate, will be sent to the Adjutant General with one copy of the inventory. When a soldier dies at a post or station absent from his company, it will be the duty of his immediate commander to furnish the required inventory and final statements, and, at the same time, to forward to the commanding officer of the company to which the soldier belonged, a report of his death, specifying the date, place, and cause; to what time he was last paid, and the money or other effects in his possession at the time of his decease; which report will be noted on the next muster roll of the company to which the man belonged. Each inventory will be endorsed, "Inventory of the effects of _____, late of company (—) _____ regiment of _____, who died at _____, the _____ day of _____, 186—." If a legal representative receive the effects, it will be stated in the report. If the soldier leave no effects, the fact will be reported.

Par. 153. Should the effects of a deceased non-commissioned officer or soldier not be administered upon within a short period after his decease, they shall be disposed of by a Council of Administration, under the authority of the commanding officer of the post, and the proceeds deposited with the Paymaster, to the credit of the United States, until they shall be claimed by the legal representatives of the deceased.

Par. 154. In all such cases of sales by the Council of Administration, a statement in detail, or account of the proceeds, duly certified by the Council and commanding officer, accompanied by the Paymaster's receipt for the proceeds, will be forwarded by the commanding officer to the Adjutant General. The statement will be endorsed, "Report of the proceeds of the effects of _____, late of company (—) _____ regiment of _____, who died at _____, the _____ day of _____, 186—."

NOTE 1.—The effects in all cases, when called for, should be turned over to the legal representative, without further authority from the Adjutant General. When the effects are turned over to the relatives of the deceased before these inventories are sent to the Adjutant General, their receipts therefor should be attached to the inventories. In all other cases, one copy will be sent with a letter of transmittal direct to the Adjutant General, and a duplicate retained by the officer.

NOTE 2.—Particular care should be taken to take receipts in duplicate from the Paymaster for any funds turned over to him; one copy should be sent direct to the Adjutant General and one retained by the officer.

INVENTORY OF THE EFFECTS

OF

Isaac Young
 Late of Company *H*
 Reg't of *21st Mass*
 Volunteers, who died at *Paducah Ky*
 on the *23* day of *Jan* 186*3*.



INVENTORY

Inventory of the effects of Isaac Young late
 a Private of Captain H. B. Norton Company No. 26 of
 the 8th Regiment of U. S. C. A. V. Volunteers, who was enrolled as
 a Private at Paducah in the State of Kentucky on
 the 22nd day of August 1864, and mustered into the service of the United
 States as a Private on the 22nd day of August 1864, at Paducah Ky.
 in Company No. 26, 8th Regiment of U. S. C. A. V. Volunteers, to serve 3 Y
 years or during the war; he was born in Farrar Co in the State
 of Kentucky; he was 18 years of age, 5 feet 4 inches
 high, Black complexion, Black eyes, Black hair, and by occupation, when enrolled,
 a Farmer; he died in Post Hospital, at
Paducah Ky. on the 23rd day of January 1865; by
 reason of Measles.

INVENTORY.					
ARTICLES.	No.	ARTICLES.	No.	ARTICLES.	No.
Hats.....		Pairs trousers.....	/	Knapsacks.....	
Caps.....		Pairs flannel drawers.....		<div style="border: 1px solid black; width: 100%; height: 100%; position: relative;"> </div>	
Forage Caps.....	/	Pairs cotton drawers.....			
Great coats.....	/	Flannel shirts.....			
Uniform coats.....		Cotton shirts.....			
Uniform jackets.....	/	Pairs boots.....	/		
Flannel sack coats.....		Pairs shoes.....			
Blouses.....	/	Pairs socks.....			
Stable frocks.....		Blankets.....			
Fatigue overalls.....		Haversacks.....			
					MONEY.
					Notes..... \$

I CERTIFY, ON HONOR, that the above inventory comprises all the effects of Private Isaac Young, deceased, and that the effects are in the hands of Surgeon-in-Charge at Post Hospital, Paducah Ky. to be disposed of by a Council of Administration.

(DUPLICATES.)

STATION: Paducah Ky.

DATE: Jan 23 1865

Commanding the Company.

FINAL STATEMENT

OF

Peace Young
Reg't of *11th U.C. (Heavy)*

VOLUNTEERS.

NOTE 1.—Two of these certificates (or duplicates) are to be given to each Volunteer Soldier or drafted man who may be discharged previously to the discharge of his company, that he may at once receive from the Paymaster the pay, &c., due him, and the captain or other COMMISSIONED officer commanding the company will certify to the act of the delivery of the duplicate certificates; on these certificates the Soldier is "entitled to," his discharge, and should also present his discharge to the Paymaster to have the payment endorsed on it. The discharge is to be given back to the Soldier by the Paymaster; the latter only retaining as his voucher the duplicate certificates.

NOTE 2.—If the Soldier is entitled to pay for the use of his horse, the Company Commander will certify to that fact on the back of both these final statements, and also to the time he has pay due for having been so mounted on his own horse.

NOTE 3.—When a Soldier is furnished with final statements, his descriptive list, if he has one, should be taken up by the officer who gives the Soldier these statements, and endorsed with a statement to this effect by the officer. This endorsement should exhibit a full statement of the time for which the Soldier was allowed pay on his final statements, the clothing account, and all other charges against him or in his favor, so as to comprise a complete exhibit of his account. It will then be transmitted to the company commander of the Soldier, who will enter all the data necessary to a full understanding of the Soldier's account on the muster roll upon which the Soldier's discharge is reported. The descriptive list will then be destroyed. The object of this is, that the remaining portion of the Soldier's account may be settled upon the receipt of these muster rolls, and the Soldier receive any pay or allowances that may be due him at the time of his discharge, and which may not appear on his final statements from the fact that his descriptive list is incomplete. These accounts for back pay, &c., are settled by the 2d Auditor of the Treasury Department.

NOTE 4.—Charges for loss or injury to ordnance, horse equipments, and other miscellaneous charges, should appear under the heading of "Other Stoppages."

NOTE 5.—Bounty paid by State authorities, and not by the United States, will not be entered on this statement.

NOTE 6.—Amounts due the Sutler and Laundress must be entered on the muster roll on which the discharge, death, desertion, &c., is reported, as well as on the final statement, otherwise the amount cannot be collected from the United States.

NOTE 7.—This blank will be used for deceased volunteers and drafted men, as well as for others.

NOTE 8.—Where a Soldier dies in Hospital or on detached service, his descriptive list, if he has one, should be sent with his final statements; in duplicate, to the Adjutant General, Washington, D. C.

ADJUTANT GEN. BALDWIN

Oct 8 1865

Duplicate with Inventory sent 2d Auditor.

I certify, on honor, that Isaac Young a Private of
Captain H. B. Norton Company (H.) of the 8th Regiment of U. S. Army
~~VOLUNTEERS~~, of the State of _____, born in Trimble Co., State
of Kentucky, aged 18 years; 5 feet 4 inches high; Black complexion,
Black eyes, Black hair, and by occupation a Farmer, having joined the company on
its original organization at _____, and enrolled in it ~~at the muster~~ into
the service of the United States at Paducah Ky., on the 22^d day
of Aug, 1864; (or was mustered in service as a recruit, by Capt. R. H. Hall
_____, at Paducah Ky., on the 22^d day of Aug,
1864; or was drafted and mustered into the service of the United States from the _____
Enrollment District of the State of _____, at _____,
on the _____ day of _____, 1864;) to serve in the Regiment, for
the term of Three Years: and having served HONESTLY and
FAITHFULLY with his Company in 8th Regt. to the present date, is now
entitled to a **DISCHARGE** by reason of Death

Died at Hospital Paducah Ky Jan 23^d 1865 of Measles
The said Isaac Young was last paid by Paymaster
Wm J Fenner to include the 31st day of Oct, 1864, and has
pay due him from that time to the ^{line of Death} present date; he is entitled to pay and subsistence for
TRAVELING to place of enrollment, and whatever other allowances are authorized to volunteer
soldiers, drafted men, or militia, so discharged. He has received from the United States **CLOTHING**
amounting to \$48.85 dollars, since the 22^d day of Aug,
1864, when his clothing account was last settled. He has received from the United States
100 dollars advanced **BOUNTY**.

There is to be stopped from him, on account of the State of _____, or other
authorities, for **CLOTHING**, &c., received on entering service, _____ dollars; and
for other stoppages, viz: _____

_____ dollars.
He has been furnished with TRANSPORTATION in kind from the place of his discharge to
_____; and he has been SUBSISTED for TRAVELING to his
place of enrollment, up to the _____, 1864.

He is indebted to _____, **SUTLER**, _____ dollars.

He is indebted to _____, **LAUNDRESS**, _____ dollars.

Given in Duplicate, at Victoria Texas, this 5th day
of Sep, 1865.

H. B. Norton

Capt.

Commanding Company.

FINAL STATEMENT

OF

Isaac Young
8th Reg't of U. C. A. Heavy

VOLUNTEERS.

NOTE 1.—Two of these certificates (or duplicates) are to be given to each Volunteer Soldier or drafted man who may be discharged previously to the discharge of his company, that he may at once receive from the Paymaster the pay, &c., due him, and the captain or other COMMISSIONED officer commanding the company will certify to the act of the delivery of the duplicate certificates; on these certificates the Soldier is "entitled to," his *discharge*, and should also present his discharge to the Paymaster to have the payment endorsed on it. The discharge is to be given back to the Soldier by the Paymaster; the latter only retaining as his voucher the duplicate certificates.

NOTE 2.—If the Soldier is entitled to pay for the use of his horse, the Company Commander will certify to that fact on the back of both these final statements, and also to the time he has pay due for having been so mounted on his own horse.

NOTE 3.—When a Soldier is furnished with final statements, his descriptive list, if he has one, should be taken up by the officer who gives the Soldier these statements, and endorsed with a statement to this effect by the officer. This endorsement should exhibit a full statement of the time for which the Soldier was allowed pay on his final statements, the clothing account, and all other charges against him or in his favor, so as to comprise a complete exhibit of his account. It will then be transmitted to the company commander of the Soldier, who will enter all the data necessary to a full understanding of the Soldier's account on the muster roll upon which the Soldier's discharge is reported. The descriptive list will then be destroyed. The object of this is, that the remaining portion of the Soldier's account may be settled upon the receipt of these muster rolls, and the Soldier receive any pay or allowances that may be due him at the time of his discharge, and which may not appear on his final statements from the fact that his descriptive list is incomplete. These accounts for back pay, &c., are settled by the 2d Auditor of the Treasury Department.

NOTE 4.—Charges for loss or injury to ordnance, horse equipments, and other miscellaneous charges, should appear under the heading of "Other Stoppages."

NOTE 5.—Bounty paid by State authorities, and not by the United States, will not be entered on this statement.

NOTE 6.—Amounts due the Sutler and Laundress must be entered on the muster roll on which the discharge, death, desertion, &c., is reported, as well as on the final statement, otherwise the amount cannot be collected from the United States.

NOTE 7.—This blank will be used for deceased volunteers and drafted men, as well as for others.

NOTE 8.—Where a Soldier dies in Hospital or on detached service, his descriptive list, if he has one, should be sent with his final statements, in duplicate, to the Adjutant General, Washington, D. C.

I certify, on honor, that Isaac Young a Private of
 Captain H. B. Norton Company (H) of the 1st Regiment of U. S. Army
~~VOLUNTEERS~~, of the State of _____, born in Trimble Co, State
 of Kentucky, aged 18 years; 5 feet 4 inches high; Black complexion,
Black eyes, Black hair, and by occupation a Farmer, having joined the company ~~of~~
 its original organization at _____, and enrolled in it at the muster into
 the service of the United States at Paducah, on the 22^d day
 of Aug, 1864, ~~for~~ was mustered in service as a recruit, by Capt R. H. Hall
 _____, at Paducah Ky on the 22nd day of Aug,
 1864, ~~or was drafted and mustered into the service of the United States from the~~
 Enrollment District of the State of _____, at _____
 on the _____ day of _____, 1864,) to serve in the Regiment, for
 the term of Three Years: and having served HONESTLY and
 FAITHFULLY with his Company in 8th Regt to the present date, is now
 entitled to a **DISCHARGE** by reason of Death
Died at Hospital Paducah Ky Jan 23^d 1865 of Malaria

The said Isaac Young was last paid by Paymaster
May J. Finno to include the 31st day of Oct, 1864 and has
 pay due him from that time to the ^{time of Death} ~~present~~ date; he is entitled to pay and subsistence for
TRAVELING to place of enrollment, and whatever other allowances are authorized to volunteer
 soldiers, drafted men, or militia, so discharged. He has received from the United States **CLOTHING**
 amounting to \$ 7.85 dollars, since the 22nd day of Aug,
 1864 when ^{the time of his enlistment} ~~his clothing account~~ was last settled. He has received from the United States
 _____ 100 dollars advanced **BOUNTY**.

There is to be stopped from him, on account of the State of _____, or other
 authorities, for **CLOTHING**, &c., received on entering service, _____ 100 dollars; and
 for other stoppages, viz: _____

_____ 100 dollars.
 He has been furnished with **TRANSPORTATION** in kind from the place of his discharge to
 _____; and he has been **SUBSISTED** for **TRAVELING** to his
 place of enrollment, up to the _____, 1864.

He is indebted to _____, **SUTLER**, _____ 100 dollars.
 He is indebted to _____, **LAUNDRESS**, _____ 100 dollars.

Given in Duplicate, at Victoria Texas, this 5th day
 of Sep, 1864

H. B. Norton
Capt

 Commanding Company.

ARTICLES OF WAR.

ART. 95. When any non-commissioned officer or soldier shall die, or be killed in the service of the United States, the then commanding officer of the troop or company shall, in the presence of two other commissioned officers, take an account of what effects he died possessed of, above his arms and accoutrements, and transmit the same to the office of the Department of War, which said effects are to be accounted for, and paid to the representatives of such deceased non-commissioned officer or soldier. And in case any of the officers, so authorized to take care of the effects of deceased officers and soldiers, should, before they have accounted to their representatives for the same, have occasion to leave the regiment or post, by preferment or otherwise, they shall, before they be permitted to quit the same, deposit in the hands of the commanding officer, or of the assistant military agent, all the effects of such deceased non-commissioned officers and soldiers, in order that the same may be secured for, and paid to, their respective representatives.

ARMY REGULATIONS—EDITION OF 1861.

DECEASED SOLDIERS.

Par. 152. Inventories of the effects of deceased non-commissioned officers and soldiers, required by the 95th Article of War, will be forwarded to the Adjutant General, by the commander of the company to which the deceased belonged, and a duplicate of the same to the colonel of the regiment. Final statements of pay, clothing, &c., will be sent with the inventories. When a soldier dies at a post or station absent from his company, it will be the duty of his immediate commander to furnish the required inventory, and, at the same time, to forward to the commanding officer of the company to which the soldier belonged, a report of his death, specifying the date, place, and cause; to what time he was last paid, and the money or other effects in his possession at the time of his decease; which report will be noted on the next muster roll of the company to which the man belonged. Each inventory will be endorsed, "Inventory of the effects of _____, late of company (—) _____ regiment of _____, who died at _____, the _____ day of _____, 186—." If a legal representative receive the effects, it will be stated in the report. If the soldier leave no effects, the fact will be reported.

Par. 153. Should the effects of a deceased non-commissioned officer or soldier not be administered upon within a short period after his decease, they shall be disposed of by a Council of Administration, under the authority of the commanding officer of the post, and the proceeds deposited with the Paymaster, to the credit of the United States, until they shall be claimed by the legal representatives of the deceased.

Par. 154. In all such cases of sales by the Council of Administration, a statement in detail, or account of the proceeds, duly certified by the Council and commanding officer, accompanied by the Paymaster's receipt for the proceeds, will be forwarded by the commanding officer to the Adjutant General. The statement will be endorsed, "Report of the proceeds of the effects of _____, late of company (—) _____ regiment of _____, who died at _____, the _____ day of _____, 186—."

NOTE 1.—The effects in all cases, when called for, should be turned over to the legal representative, without further authority from the Adjutant General. When the effects are turned over to the relatives of the deceased before these inventories are sent to the Adjutant General, their receipts therefor should be attached to the inventories. In all other cases, one copy will be sent with a letter of transmittal direct to the Adjutant General, and a duplicate retained by the officer.

NOTE 2.—Particular care should be taken to take receipts in duplicate from the Paymaster for any funds turned over to him; one copy should be sent direct to the Adjutant General and one retained by the officer.

INVENTORY OF THE EFFECTS

OF

Isaac Young

Late of Company B

8 Reg't of U.S.C.A. Heavy

Volunteers, who died at Paducah Ky

on the 23^d day of Jan 1865

Inventory of the effects of Isaac Young late
 a Private of Captain H. B. Norton Company H of
 the 8 Regiment of W. C. A. Henry ~~Volunteers~~, who was enrolled as
 a Private at Paducah in the State of Ky on
 the 22nd day of Aug 1867, and mustered into the service of the United
 States as a Private on the 22 day of Aug 1867, at Paducah, Ky
 in Company A, 8th Regiment of W. C. A. Henry ~~Volunteers~~, to serve 3
 years or during the war; he was born in Trimble Co in the State
 of Kentucky; he was 18 years of age, 5 feet 4 inches
 high, Black complexion, Black eyes, Black hair, and by occupation, when enrolled,
 a Farmer; he died in Hospital, at
Paducah, Ky on the 23^d day of Jan 1865, by
 reason of Measles

INVENTORY.					
ARTICLES.	No.	ARTICLES.	No.	ARTICLES.	No.
Hats.....		Pairs trousers.....	1	Knapsacks.....	
Caps.....	1	Pairs flannel drawers.....			
Forage caps.....		Pairs cotton drawers.....			
Great coats.....	1	Flannel shirts.....			
Uniform coats.....		Cotton shirts.....			
Uniform jackets.....	1	Pairs boots.....	1		
Flannel sack coats.....		Pairs shoes.....			
Blouses.....	1	Pairs socks.....			
Stable frocks.....		Blankets.....			
Fatigue overalls.....		Haversacks.....			
				MONEY.	
					Specie.....
				Notes.....	\$

I CERTIFY, ON HONOR, that the above inventory comprises all the effects of Private
Isaac Young, deceased, and that the effects are in the hands
 of J. B. Wolff at Paducah, Ky
 to be disposed of by a Council of Administration.

(DUPLICATES.)

H. B. Norton

Capt

Commanding the Company.

STATION: Victoria Texas

DATE: sep 5 1865

1977
Young, Jackson
Co K, 8 U.S. Col'd H. Art'y.

Private Private

CARD NUMBERS.

1	5481222	26
2	5481362	27
3	5481502	28
4	5481635	29
5	5481767	30
6	5481888	31
7	5481997	32
8	5482100	33
9	5467700	34
10	5482389	35
11	9122771	36
12	33204615	37
12	40745718	38
14		39
15		40
16		41
17		42
18		43
19		44
20		45
21		46
22		47
23		48
24		49
25		50

Book Mark:

See also

4 | 8 H. Art'y. | U.S.C.T.
Jackson Young
Co. K, 8 Reg't U.S. Col'd H. Art'y.

Appears on
Company Descriptive Book
of the organization named above.

DESCRIPTION.

Age 22 years; height 5 feet 6 inches.
Complexion Black
Eyes Black; hair Black
Where born Paducah, Ky.
Occupation Farmer

ENLISTMENT.

When June 24, 1864.
Where Paducah, Ky.
By whom W. W. Beggart, term 3 y'rs.
Remarks: Discharged June 14/65 at Alexandria, Va. per G.O. 77 War Dept.

Keeper.
(383g) Copyist.

J. | 8 H. Art'y. | U.S.C.T.

Jackson Young,
Pvt., Co. *K.*, 8 Reg't U. S. Col'd H. Art'y.

Age --- years.

Appears on

Company Muster Roll*
for *Enlistment to June 30th*, 1864

Joined for duty and enrolled:

When *June 24th*, 1864.

Where *Paducah, Ky.*

Period *3* years.

Mustered in:

When *June 25th*, 1864.

Where *Paducah, Ky.*

Present or absent *Present*

Stoppage, \$ *100* for

Due Gov't \$ *100* for

Valuation of horse, \$ *100*

Valuation of horse equipments, \$ *100*

Remarks:

*First current roll. No muster-in roll of this company on file.

Book mark:

Harin

(358d)

Copyist.

Y. | 8 H. Art'y. | U.S.C.T.

Jackson Young,
Pvt., Co. K, 8 Reg't U. S. Col'd H. Art'y.

Appears on

Company Muster Roll

for *July and August, 1864*

Present or absent *Present*

Stoppage, \$ 100 for

Due Gov't, \$ 100 for

Valuation of horse, \$ 100

Valuation of horse equipments, \$ 100

Remarks :

Book mark :

Harin

(358)

Copyist.

Jackson Young
Pvt., Co. K, 8 Reg't U. S. Col'd H. Art'y.

Appears on

Company Muster Roll

for *Sept and Oct*, 186*4*

Present or absent *Present*

Stoppage, \$ *100* for

Due Gov't, \$ *100* for

Valuation of horse, \$ *100*

Valuation of horse equipments, \$ *100*

Remarks:

Book mark:

Harri

Y

S H. Art'y.

U.S.C.T.

Jackson Young
Priv, Co. K, 8 Reg't U. S. Col'd H. Art'y.

Appears on

Company Muster Roll

for *Jan'y. + Feby.*, 1865.

Present or absent *Present*

Stoppage, \$ *100* for

Due Gov't, \$ *100* for

Valuation of horse, \$ *100*

Valuation of horse equipments, \$ *100*

Remarks:

Book mark:

D. Maher

(358)

Copyist.

G. I. Hart. U.S.C.T.
Jackson Young
Priv., Co. D, 8th Reg't U.S.C.A.

Appears on

Hospital Muster Roll

of L'Ouverture U. S. A. General Hospital,

at Alexandria, Va.,

for March & April, 1865.

Attached to hospital:

When April 20, 1865.

How employed _____

Last paid by Maj. _____

to _____, 1865.

Bounty paid \$ 100; due \$ 100

Present or absent Present

Remarks: _____

Book mark: _____

E. D. Neale

Of

S H. Art'y.

U.S.C.T.

Jackson Young

Priv, Co. K, 8 Reg't U. S. Col'd H. Art'y.

Appears on

Company Muster Roll

for *March + April*, 1865.

Present or absent *Absent*

Stoppage, \$ *100* for

Due Gov't, \$ *100* for

Valuation of horse, \$ *100*

Valuation of horse equipments, \$ *100*

Remarks:

Sick in Hoeph. at Washington D.C.

Book mark:

(358)

D. Maher
Copyist.

Y

S H. Art'y.

U.S.C.T.

Jackson Young
Priv, Co. K, 8 Reg't U. S. Col'd H. Art'y.

Appears on

Company Muster Roll

for *May + June*, 1865.

Present or absent *Absent*

Stoppage, \$ 100 for

Due Gov't, \$ 100 for

Valuation of horse, \$ 100

Valuation of horse equipments, \$ 100

Remarks:

Sick in Hospl. Washington, D.C.

Book mark:

(358)

D. Maher

Copyist.

Y

8 H. Art'y.

U.S.C.T.

Jackson Young

Priv, Co. K, 8 Reg't U. S. Col'd H. Art'y.

Appears on

Company Muster Roll

for *July & August*, 1865.

Present or absent

Stoppage, \$ 100 for

Due Gov't, \$ 100 for

Valuation of horse, \$ 100

Valuation of horse equipments, \$ 100

Remarks:

*Discharged June 14, '65, at Alexandria
Va. Per. Genl. Order No 77. War Dept.*

Book mark: *4 P.M. G. Oct. 23, '65.*

(358)

D. Maher

Copyist.

Y | 8 H. Arty. - U.S.C.T.

Jackson Young
Priv, Co. K, 8 Reg't U. S. Col'd H. Arty.

Appears on a

Detachment Muster-out Roll

of the organization named above. Roll dated

Washington D.C. June 14, 1865-

Muster-out to date June 14, 1865-

Last paid to Oct 31, 1864.

Clothing account:

Last settled 186 ; drawn since \$ 100

Due soldier \$ 100; due U. S. \$ 100

Am't for cloth'g in kind or money adv'd \$ ~~100~~ 44.99

Due U. S. for arms, equipments, &c., \$ 100

Bounty paid \$ 100 due \$ 100

Remarks: Money value of clothing drawn since enlistment \$44.99. Bounty paid none.

Mustered out in compliance with par
our

Book mark:

C. S. Rozzell

(349)

Copyist.

JAN. 14

5467700

1891

b. G. O. 77 A. G. O
April 28 - 1865 -

Of | 8 H. Art'y. | U.S.C.T.

Jackson Young

Prvt, Co. K, 8 Reg't U. S. Col'd H. Art'y.

Appears on Returns as follows:

Apr to July 1863 absent
sick in Hosp. at
Washington D.C.

July 1863. June 14 1863
Washington D.C.
Discharged by order of
the War Dept.

Book mark :

Chas Patton

(546)

Copyist.

Y | S H. Art'y. | U.S.C.T.

Jackson Young
Priv, Co. K, 8 Reg't U. S. Col'd H. Art'y.

Appears on **Co. Muster-out Roll**, dated
Victoria Texas, Feb 10, 1866.

Muster-out to date _____, 186 .

Last paid to Oct 31, 1864.

Clothing account:

Last settled _____, 186 ; drawn since \$ _____ 100

Due soldier \$ _____ 100; due U. S. \$ _____ 100

Am't for cloth'g in kind or money adv'd \$ _____ 100

Due U. S. for arms, equipments, &c., \$ _____ 100

Bounty paid \$ _____ 100; due \$ _____ 100

Remarks: Entire service organization
of Co. as per discharge at Wash
ington D.C. June 14 1865 per G.O.
77 Per G. H. D. (65) 1865
Discharge and final state-
ments have been furnished
Book mark: 244, 240

(861) S. P. York Copyist.
7-22

JAN. 14

5482389

1891

Age 22 years

Young, Jackson
P, Co. *K*, **8** Regt **U.S.C. Inf.**

Enclosures.

Bed Cards <i>/</i>	Descriptive Lists
Burial Records	Final Statements
Certs. of Dis. for Discharge	Furloughs
C. M. Charges	Med. Des. Lists
Med. Certificates	Orders

Other papers relating to—

Admission to Hosp'l	Furlough
Casualty Sheet (Officer's)	Med. Examination
Confinement	Misc. Information
Contracts	Pay or Clothing
Death or Effects	Personal Reports
Desertions	Rank
Discharge from Hosp'l	Transfer to Hosp'l
Discharge from Service	Transfer to V. R. C.
Duty	Transportation

Hospital Number 1465

37

Name Jackson Young

Age 19 Nativity Kentucky

Married or Single Single

Residence Fredonia Lyon Co Ky

Post Office address of wife or nearest relative Philip Young

Fredonia Lyon Co Ky

Rank Priv. Co. 4. Regiment 8. U.S.C.T.

When admitted April 20, 1865

From what source Sol. Rest Washington

Diagnosis: (in surgical cases state explicitly seat and character of wound or injury.)

Contusion of back from fall

L'Ouverture G. H.
Alexandria, Va.

On what occasion wounded

Date

Nature of missile or weapon

1978
Young, James
Co E, 8 U.S. Col'd H. Art'y.

Private Private

CARD NUMBERS.

1	5467312	26
2	5467202	27
3	5474760	28
4	5474887	29
5	5475007	30
6	5475127	31
7	5475242	32
8	5475356	33
9	5475731	34
10	9122330	35
11	40744997	36
12		37
13		38
14		39
15		40
16		41
17		42
18		43
19		44
20		45
21		46
22		47
23		48
24		49
25		50

Book Mark: _____

See also _____

U | 8 H. Art'y. | U.S.C.T.

James Mummy

, Co. *B*, 8 Reg't U.S. Col'd H. Art'y.

Appears on

Company Descriptive Book
of the organization named above.

DESCRIPTION.

Age *18* years; height *6* feet *6 3/4* inches.

Complexion *Rdsk*

Eyes *Rdsk*; hair *Rdsk*

Where born *Ingham Co., N.Y.*

Occupation *Farmer*

ENLISTMENT.

When *Sept. 10*, 186*4*.

Where *Paducah, Ky.*

By whom *Capt. Hall*; term *3* y'rs.

Remarks: *Died May 22, 67 at Fort Bliss
Monroe, La.*

E. A. Moreland

(383g)

Copist.

James Young

Appears with rank of *Pri* on

Muster and Descriptive Roll of a Detachment of U. S. Vols. forwarded

for the 8 Reg't U. S. Col'd H. Art'y. Roll dated

Paducah, Ky; ~~Nov 30~~ *30*, 1864

Where born *Trigg, Ky.*

Age *18* y'rs; occupation *Farmer*

When enlisted *Sep 10*, 186 .

Where enlisted *Paducah, Ky.*

For what period enlisted *3* years.

Eyes *blk*; hair *blk*

Complexion *Yellow*; height *5* ft. *5³/₄* in.

When mustered in *Sep 10*, 186 .

Where mustered in *Paducah*

Bounty paid \$ *100*; due \$ *100*

Where credited *Warren Circuit Dist. Ky*

Company to which assigned *E*

Remarks :

.....

.....

Book mark :

.....

Henry J.
Copyist.

2

8 H. Art'y.

U.S.C.T.

James Young,
Private

Appears with rank of Private on

Muster and Descriptive Roll of a Detachment of U. S. Vols. forwarded

for the 8 Reg't U. S. Col'd H. Art'y. Roll dated

Paducah, Ky., ~~N.Y.~~ Sept. 30, 1864.

Where born Paducah, Ky.

Age 18 y'rs; occupation Farmer

When enlisted Sept. 10, 186 .

Where enlisted Paducah, Ky.

For what period enlisted 3 years.

Eyes Black; hair Black

Complexion Black; height 5' 5 3/4 in.

When mustered in Sept. 10, 186 .

Where mustered in Paducah

Bounty paid \$ 100; due \$ 100

Where credited M. Cracker, P. D. Ky

Company to which assigned E J

Remarks:

Book mark:

Calloway

(339)

Copyist.

Y

8 H. Art'y.

U.S.C.T.

James Young

Pl, Co. E, 8 Reg't U. S. Col'd H. Art'y.

Appears on

Company Muster Roll

for *Sept and Oct*, 186*4*.

Present or absent *Present*

Stoppage, \$ *100* for

Due Gov't, \$ *100* for

Valuation of horse, \$ *100*

Valuation of horse equipments, \$ *100*

Remarks:

Book mark:

J. V. Kearney
Copist.

Y

8 H. Art'y.

U.S.C.T.

James Young

Priv., Co. E, 8 Reg't U. S. Col'd H. Art'y.

Appears on

Company Muster Roll

for Nov. & Dec., 1864.

Present or absent Present

Stoppage, \$ 100 for

Due Gov't, \$ 100 for

Valuation of horse, \$ 100

Valuation of horse equipments, \$ 100

Remarks:

Book mark:

C. E. M. Kauplin

(358)

Copyist.

Y

S H. Art'y.

U.S.C.T.

James Young

Pvt., Co. E, 8 Reg't U. S. Col'd H. Art'y.

Appears on

Company Muster Roll

for Jan. & Feb., 1865.

Present or absent Present

Stoppage, \$ 100 for

Due Gov't, \$ 100 for

Valuation of horse, \$ 100

Valuation of horse equipments, \$ 100

Remarks:

Book mark:

(358)

C. E. M. Laughlin

Copyist.

7 | S H. Art'y. | U.S.C.T.

James Young
Priv., Co. E, 8 Reg't U. S. Col'd H. Art'y.

Appears on

Company Muster Roll

for *Mar. & Apr.*, 186*3*.

Present or absent *Present*

Stoppage, \$ *100* for

Due Gov't, \$ *100* for

Valuation of horse, \$ *100*

Valuation of horse equipments, \$ *100*

Remarks:

Book mark: -----

(358) *C. S. M. Laughlin* Copyist.

Y | 8 H. Art'y. | U.S.C.T.

James Young
Priv., Co. E, 8 Reg't U. S. Col'd H. Art'y.

Appears on

Company Muster Roll

for *May & June*, 186*5*.

Present or absent *Absent*

Stoppage, \$.....*100* for

Due Gov't, \$.....*100* for

Valuation of horse, \$.....*100*

Valuation of horse equipments, \$.....*100*

Remarks: *Absent sick.*

Book mark:

C. E. M. Laughlin
Copyist.

y

8 H. Art'y.

U.S.C.T.

James Young

Pat, Co. E, 8 Reg't U. S. Col'd H. Art'y.

Appears on

Company Muster Roll

for *July & Aug.*, 1865.

Present or absent

Stoppage, \$ *100* for

Due Gov't, \$ *100* for

Valuation of horse, \$ *100*

Valuation of horse equipments, \$ *100*

Remarks: *Died May 20th 1865
at Fortress Monroe Va.*

Book mark: *of Pensioners W O R.
Jan. 17. 68 & Feb. 69 59*

E. B. Carroll

James Young

Priv., Co. E., 8 Reg't U. S. Col'd H. Art'y.

Appears on Returns as follows:

May 18'55 absent sick
at Washington D.C. since
April 20/65.

June 18'55 absent sick
at Alexandria Va since
April 20/65.

July 18'55 May 20/65.
At Monroev Va. Sick
of disease.

Book mark:

James Young,
Pvt., Co. *E*, 8 Reg't U. S. Col'd H. Art'y.

Appears on **Co. Muster-out Roll**, dated
Victoria Texas, Feb 10, 186*6*.

Muster-out to date _____, 186 .

Last paid to *Oct 31,* 186*4*.

Clothing account:

Last settled _____, 186 ; drawn since \$ _____ 100

Due soldier \$ _____ 100; due U. S. \$ _____ 100

Am't for cloth'g in kind or money adv'd \$ _____ 100

Due U. S. for arms, equipments, &c., \$ _____ 100

Bounty paid \$ _____ 100; due \$ _____ 100

Remarks: *Entered Service as recruit*
Joined Co for duty Sept 10, 64.
Died of Pneumonia at Gen Hosp.
Ft's Monroe Va. May 20, 1865
Res. list. furnished May 15, 1865

Book mark: _____

E. Carroll

Young James
P. E. & J. USEHA
Co. Reg't

3 Enclosures.

Bed Cards	Descriptive Lists
Burial Records	Final Statements ✓
Certs. of Dis. for Discharge	Furloughs
C. M. Charges	Med. Des. Lists
Med. Certificates	Orders

Enlistment 1 ✓

Other papers relating to—

Admission to Hosp'l	Furlough
Casualty Sheet (Officer's)	Med. Examination
Confinement	Misc. Information
Contracts	Pay or Clothing
Death or Effects ✓	Personal Reports
Desertions	Rank
Discharge from Hosp'l	Transfer to Hosp'l
Discharge from Service	Transfer to V. R. C.
Duty	Transportation

ARTICLES OF WAR.

ART. 95. When any non-commissioned officer or soldier shall die, or be killed in the service of the United States, the then commanding officer of the troop or company shall, in the presence of two other commissioned officers, take an account of what effects he died possessed of, above his arms and accoutrements, and transmit the same to the office of the Department of War, which said effects are to be accounted for, and paid to the representatives of such deceased non-commissioned officer or soldier. And in case any of the officers, so authorized to take care of the effects of deceased officers and soldiers, should, before they have accounted to their representatives for the same, have occasion to leave the regiment or post, by preferment or otherwise, they shall, before they be permitted to quit the same, deposit in the hands of the commanding officer, or of the assistant military agent, all the effects of such deceased non-commissioned officers and soldiers, in order that the same may be secured for, and paid to, their respective representatives.

ARMY REGULATIONS—EDITION OF 1861.

DECEASED SOLDIERS.

Par. 152. Inventories of the effects of deceased non-commissioned officers and soldiers, required by the 95th Article of War, will be forwarded to the Adjutant General, by the commander of the company to which the deceased belonged, and a duplicate of the same to the colonel of the regiment. Final statements of pay, clothing, &c., will be sent with the inventories. When a soldier dies at a post or station absent from his company, it will be the duty of his immediate commander to furnish the required inventory, and, at the same time, to forward to the commanding officer of the company to which the soldier belonged, a report of his death, specifying the date, place, and cause; to what time he was last paid, and the money or other effects in his possession at the time of his decease; which report will be noted on the next muster roll of the company to which the man belonged. Each inventory will be endorsed, "Inventory of the effects of _____, late of company (—) _____ regiment of _____, who died at _____, the _____ day of _____, 186—." If a legal representative receive the effects, it will be stated in the report. If the soldier leave no effects, the fact will be reported.

Par. 153. Should the effects of a deceased non-commissioned officer or soldier not be administered upon within a short period after his decease, they shall be disposed of by a Council of Administration, under the authority of the commanding officer of the post, and the proceeds deposited with the Paymaster, to the credit of the United States, until they shall be claimed by the legal representatives of the deceased.

Par. 154. In all such cases of sales by the Council of Administration, a statement in detail, or account of the proceeds, duly certified by the Council and commanding officer, accompanied by the Paymaster's receipt for the proceeds, will be forwarded by the commanding officer to the Adjutant General. The statement will be endorsed, "Report of the proceeds of the effects of _____, late of company (—) _____ regiment of _____, who died at _____, the _____ day of _____, 186—."

NOTE 1.—The effects in all cases, when called for, should be turned over to the legal representative, without further authority from the Adjutant General. When the effects are turned over to the relatives of the deceased before these inventories are sent to the Adjutant General, their receipts therefor should be attached to the inventories. In all other cases, one copy will be sent with a letter of transmittal direct to the Adjutant General, and a duplicate retained by the officer.

NOTE 2.—Particular care should be taken to take receipts in duplicate from the Paymaster for any funds turned over to him; one copy should be sent direct to the Adjutant General and one retained by the officer.

INVENTORY OF THE EFFECTS

OF

Private James Young
Late of Company E

8 Reg't of 11th Mo Art

Volunteers, who died at U.S. Ho Fort Monroe Va

on the 20 day of May 1865.

duplicate copy with of statement
forwarded to A G O Washington
DC May 11th 1865

Inventory of the effects of James Gummy late
 a Private of Captain R. Sumner Company E of
 the 8 Regiment of U.S. Art Volunteers, who was enrolled as
 a Private at Paducah in the State of Kentucky on
 the 10 day of September 1864, and mustered into the service of the United
 States as a Private on the 10 day of September 1864, at Paducah Ky
 in Company E, 8 Regiment of U.S. Art Volunteers, to serve Three
 years or during the war; he was born in Waggle in the State
 of Kentucky; he was 18 years of age, 5 feet 5 3/4 inches
 high, Blk complexion, Blk eyes, Blk hair, and by occupation, when enrolled,
 a Farmer; he died in U.S. Hospital, at
Fort Monroe Va on the 24 day of May 1865, by
 reason of Pneumonia

INVENTORY.					
ARTICLES.	No.	ARTICLES.	No.	ARTICLES.	No.
Hats.....	/	Pairs trousers.....	/	Knapsacks.....	
Caps.....	/	Pairs flannel drawers.....	/		
Forage caps.....		Pairs cotton drawers.....			
Great coats.....		Flannel shirts.....	/		
Uniform coats.....		Cotton shirts.....			
Uniform jackets.....	/	Pairs boots.....	/		
Flannel sack coats.....		Pairs shoes.....			
Blouses.....		Pairs socks.....	/		
Stable frocks.....		Blankets.....			
Fatigue overalls.....		Haversacks.....			
				MONEY.	
					Specie.....
				Notes.....	\$

I CERTIFY, ON HONOR, that the above inventory comprises all the effects of James Gummy, deceased, and that the effects are in the hands
 of Col. C. M. Callahan Asst Surgeon U.S. Army at U.S. Hospital
Fort Monroe Va to be disposed of by a Council of Administration.
Called over by legal Representatives of Deceased
C. M. Callahan

(DUPLICATES.)

STATION: U.S. Artillery Fort Monroe Va.
 DATE: May 20th 1865

Asst Surgeon U.S. Army
 Commanding the Company.
Hospital

1861 2nd sent
2nd auditing

✓ FINAL STATEMENT
No. E
OF

1st Regt of Light Artillery
VOLUNTEERS.
Deceased soldier

NOTE 1.—Two of these certificates (or duplicates) are to be given to each Volunteer Soldier or drafted man who may be discharged without being mustered out (Final Statements are never given to men mustered out of service,) that he may at once receive from the Paymaster the pay, &c., due him, and the captain or other COMMISSIONED officer commanding the company will certify to the act of the delivery of the duplicate certificates; with these certificates the Soldier is "entitled to" his discharge, and should also present his discharge to the Paymaster to have the payment endorsed on it. The discharge is to be given back to the Soldier by the Paymaster; the latter only retaining as his vouchers the duplicate certificates.

NOTE 2.—If the Soldier is entitled to pay for the use of his horse, the Company Commander will certify to that fact on the back of both these final statements, and also to the time he has pay due for having been so mounted on his own horse.

NOTE 3.—When a Soldier is furnished with final statements, his descriptive list, if he has one, should be taken up by the officer who gives the Soldier these statements, and endorsed with a statement to this effect by the officer. The endorsement should exhibit a full statement of the time for which the Soldier was allowed pay on his final statements, the clothing account, and all other charges against him or in his favor, so as to comprise a complete exhibit of his account. It will then be transmitted to the Company Commander of the Soldier, who will enter all the data necessary to a full understanding of the Soldier's account on the muster roll upon which the Soldier's discharge is reported. The descriptive list will then be destroyed. The object of this is, that the remaining portion of the Soldier's account may be settled upon the receipt of these muster rolls, and the Soldier receive any pay or allowances that may be due him at the time of his discharge, and which may not appear on his last final statements from the fact that his descriptive list is incomplete. These accounts for back pay, &c., are settled by the 2d Auditor of the Treasury Department.

NOTE 4.—Charges for loss or injury to ordnance, horse equipments, and other miscellaneous charges, should appear under the heading of "Other Stoppages."

NOTE 5.—Bounty paid by State authorities, and not by the United States, will not be entered on this statement.

NOTE 6.—Amounts due the Sutler and Laundress must be entered on the muster roll on which the discharge, death, desertion, &c., is reported, as well as on the final statement, otherwise the amount cannot be collected from the United States.

NOTE 7.—This blank will be used for deceased volunteers and drafted men, as well as for officers.

NOTE 8.—Where a Soldier dies in Hospital or on detached service, his descriptive list, if he has one, should be sent with his final statements, in duplicate, to the Adjutant General, Washington, D. C.

NOTE 9.—If the soldier is a drafted man or substitute, the space for time, &c., of enrolled, should contain only the word *drafted* or *substitute*, as the case may be. If the Soldier is a "VETERAN," (or RECRUIT,) the words *as a veteran*, (or *recruit*;) as the case may be, should be inserted after the words *mustered into the service of the U. S.* A statement of all the installments of *Veteran* or *Recruit* Bounty RECEIVED by the Soldier must be made on the back of each final statement.

ADJUTANT GENERAL'S OFFICE.
May 26th 1862
Duplicate with Inventory sent 2d Auditor.

I certify, on honor, that James Gummy, a Private of
Captain A. Gummy Company (E) of the 8th Regiment of U.S. Col. Regt
VOLUNTEERS, of the State of Mississippi, born in Madison Co., State
of Mississippi, aged 18 years; 5 feet 3 3/4 inches high; Light complexion,
Blk eyes, Blk hair, and by occupation a Farmer, who joined for service
and was enrolled (see Note 9) on the 10th day of Sept, 1864, at Madison Co.
by Capt. Gummy, for the period of Three years, and mustered into
the service of the United States on the 10th day of September, 1864, at
Madison Co., by Capt. Gummy; and having served
HONESTLY and FAITHFULLY with his Company to the present date, is now entitled to a
DISCHARGE by reason of Death. Died in General Hospital
Fort Monroe Va. May 20th 1865 of Malaria

The said James Gummy was last paid by Paymaster
Prof. Gummy, to include the 31st day of October, 1864, and
has pay due him from that time to the present date; he is entitled to pay and subsistence for
TRAVELING to place of enrollment, and whatever other allowances are authorized to volunteer
soldiers, drafted men, or militia, so discharged. He has received from the United States **CLOTHING**
amounting to 100 dollars, since the _____ day of _____
1864, when his clothing account was last settled. He has received from the United States
100 dollars advanced **BOUNTY**.

There is to be stopped from him, on account of the State of _____, or other
authorities, for **CLOTHING, &c.**, received on entering service, _____ 100 dollars; and
for other stoppages, viz: One 1/2 Months

_____ 3. 10 dollars.
He has been furnished with **TRANSPORTATION** in kind from the place of his discharge to
_____ ; and he has been **SUBSISTED** for **TRAVELING** to his
place of enrollment, up to the _____, 1864.

He is indebted to _____, **SUTLER**, _____ 100 dollars.

He is indebted to _____, **LAUNDRESS**, _____ 100 dollars.

Given in Duplicate, at General Hosp Fort Monroe Va, this 30th day
of May, 1865.

E. B. Gummy
West Surgeon
Commanding Company
Hospital

185

No. Ninety Two

Young James

Volunteered at Caducah

September 10 1864

By Capt. R. A. Hill

Prov. Marshal Dist. of Ky.

James Hill

Consent of Parent or Guardian in case of a Minor, if a Free Man, or in the case of a

of them is given to the disbursing officer. officer, commissary, or assistant commissary of musters, as the case may be. A must in all cases, precede payment of pay, bounty, pension, &c. A tal, and one to accompany the accounts of the officer who pays bounty, &c. ted States colored troops. They will be made out in duplicate in all cases

UNITED STATES COLORED TROOPS ENLISTMENT.

STATE OF

TOWN OF

Kentucky



Paducah

I, *Young James* born in *Trigg Co*

in the State of *Ky* aged *Eighteen* years

and by occupation a *Farmers* Do HEREBY ACKNOWLEDGE to have volunteered this *Tenth* day of *September* 186*4*

to serve as a **Soldier** in the **Army of the United States of America**, for the period of **THREE YEARS**, unless sooner discharged by proper authority: Do also agree to accept such bounty, pay, rations, and clothing, as are, or may be, established by law for the U. S. colored troops.

And I, *James Young of M Cracker* do solemnly swear, that I will bear true faith and allegiance to the **United States of America**, and that I will serve them honestly and faithfully against all their enemies or opposers whomsoever; and that I will observe and obey the orders of the President of the United States, and the orders of the officers appointed over me, according to the Rules and Articles of War.

Sworn and subscribed to, at *Paducah Ky* this *10th* day of *Sept* 186*4* } *James Young*
Before *Capt R H Hall* } *mark*

I CERTIFY, ON HONOR, That I have carefully examined the above named Volunteer, agreeably to the General Regulations of the Army, and that, in my opinion, he is free from all bodily defects and mental infirmity, which would in any way disqualify him from performing the duties of a soldier.

M. K. Kidd

EXAMINING SURGEON.

I CERTIFY, ON HONOR, That I have minutely inspected the Volunteer, *James Young* previously to his enlistment, and that he was entirely sober when enlisted; that, to the best of my judgment and belief, he is of lawful age; and that, in accepting him as duly qualified to perform the duties of an able-bodied soldier, I have strictly observed the regulations which govern the recruiting service. This soldier has *dark* eyes, *dark* hair, *dark* complexion, is *five* feet *5 3/4* inches high.

RECRUITING OFFICER OR AGENT.

Mustered into the United States service *10th* day of *September* 186*4*

R. H. Hall
Capt. Pro Mas Mustering Officer.

Mustered into the service of the United States, for three years or during the war, from date of enlistment, in Company *C*, *8th* Regiment of *10th* *Mad* *Ar* *Volunteers*, on the *10th* day of *Sept*, 186*4* at *Paducah Ky*

R. R. Stewart
Capt. Pro Mas
Mr. Oneal

NOTE 1.—This blank will be used for enlistments of United States colored troops. They will be made out in duplicate in all cases—one to accompany the recruiting return of the superintendent (not the recruiting officer), to the Adjutant General, and one to accompany the accounts of the officer who pays bounty, &c.
NOTE 2.—An enlistment holds to service. A muster-in, must in all cases, precede payment of pay, bounty, pension, &c. A muster-in roll, must in all cases, be filed in the Adjutant General's Office as evidence of muster-in. The mustering officer, commissary, or assistant commissary of musters, as the case may be, will countersign both enlistments as having mustered the soldier into the service of the United States before either of them is given to the disbursing officer.

DECLARATION OF RECRUIT.

I, *James Young of Madras*, desiring to volunteer as a soldier in the ARMY OF THE UNITED STATES, for the term of *Three Years*, do DECLARE That I am *Eighteen* years and months of age; that I have never been discharged from the United States service on account of disability or by sentence of a court-martial, or by order before the expiration of a term of enlistment; and I know of no impediment to my serving honestly and faithfully as a soldier for three years.

GIVEN at *Paducah*

the *10th* day of *September* 1864

Witness: *[Signature]*

James Young
By *[Signature]*
Adjutant General
September 10 1864
to Genl. W. H. Powell
Department of the West
St. Louis
103

Consent of Parent or Guardian in case of a Minor, if a Free Man, or in the case of a Slave, of the Person to whom he owes Service:

I, Do CERTIFY, That I am the that the said is years of age; and I do freely give my CONSENT to his volunteering as a SOLDIER in the Army of the United States, for the period of THREE YEARS, under the conditions of the laws of the United States.

GIVEN at

the day of

Witness:

1979

Young, James
Co F, 8 U.S. Col'd H. Art'y.

Private Private

CARD NUMBERS.

1	5476299	26
2	5476427	27
3	5476834	28
4	5476641	29
5	5476742	30
6	5476843	31
7	5476933	32
8	9122482	33
9		34
10		35
11		36
12		37
13		38
14		39
15		40
16		41
17		42
18		43
19		44
20		45
21		46
22		47
23		48
24		49
25		50

Book Mark:

See also

S 445030 - P.O. aff.
S 1263918 - Aud. 10.

S. 1300703 P.O. mtrm

S. 1365456. P.O. P.S.

S 1395797 - P.O. rtd

S. 1429105. P.O. mtrm.

S 1631297 P.O. aff

Ay. 189235X

4 | 8 H. Art'y. | U.S.C.T.

James Young

Co. F, 8 Reg't U.S. Col'd H. Art'y.

Appears on

Company Descriptive Book

of the organization named above.

DESCRIPTION.

Age 17 years; height 5 feet 2 inches.

Complexion *Blk*

Eyes *Blk*; hair *Blk*

Where born *Charleston, Mo*

Occupation *Farmer*

ENLISTMENT.

When *Feb 12*, 1867

Where *Cairo, Ill*

By whom *A. Col. Low*; term *3* y'rs.

Remarks:

D. J. Moreland

Y

8 H. Art'y.

U.S.C.T.

James Young
Pvt., Co. F, 8 Reg't U. S. Col'd H. Art'y.

Appears on

Company Muster Roll

for *Jan & Feb*, 1865.

Present or absent *Present*

Stoppage, \$ *100* for

Due Gov't, \$ *100* for

Valuation of horse, \$ *100*

Valuation of horse equipments, \$ *100*

Remarks: *Enrolled Feb 1 65
at Cairo Ill + mus- in
Feb 3 65 at Paducah Ky
for 3 years*

Book mark: _____

G. W. Chase

Y | S H. Art'y. | U.S.C.T.

James Young
Prvt, Co. F, 8 Reg't U. S. Col'd H. Art'y.

Appears on

Company Muster Roll

for *March & Apr*, 186 *5*.

Present or absent *Present*

Stoppage, \$ *100* for

Due Gov't, \$ *100* for

Valuation of horse, \$ *100*

Valuation of horse equipments, \$ *100*

Remarks:
.....
.....
.....
.....
.....
.....
.....
.....
.....
.....

Book mark:

G. W. Chase

Y

S H. Art'y.

U.S.C.T.

James Young

Priv, Co. F, 8 Reg't U. S. Col'd H. Art'y.

Appears on

Company Muster Roll

for *May & June*, 186*5*.

Present or absent *Present*

Stoppage, \$ *100* for

Due Gov't, \$ *100* for

Valuation of horse, \$ *100*

Valuation of horse equipments, \$ *100*

Remarks:

Book mark:

G. W. Chase

Y

S H. Art'y.

U.S.C.T.

James Young

Priv, Co. F, 8 Reg't U. S. Col'd H. Art'y.

Appears on

Company Muster Roll

for *July 2 - Aug*, 1865.

Present or absent *Present*

Stoppage, \$ *100* for

Due Gov't, \$ *100* for

Valuation of horse, \$ *100*

Valuation of horse equipments, \$ *100*

Remarks: *Stop for 1 cartridge
Box Belt Plate*

Book mark: _____

G. W. Chase

Y | S H. Art'y. | U.S.C.T.

James Young
Private, Co. F, 8 Reg't U. S. Col'd H. Art'y.

Appears on

Company Muster Roll

for *Sept. & Oct.*, 186*5*.

Present or absent *Present*

Stoppage, \$ *100* for

Due Gov't, \$ *100* for

Valuation of horse, \$ *100*

Valuation of horse equipments, \$ *100*

Remarks:

.....
.....
.....
.....
.....
.....
.....
.....
.....
.....

Book mark:

.....

(358) *Keefe* Copyist.

Y | 8 H. Art'y. | U.S.C.T.

James Young
Private Co. F, 8 Reg't U. S. Col'd H. Art'y.

Appears on

Company Muster Roll

for *Nov. & Dec*, 1865.

Present or absent *Present*

Stoppage, \$ *100* for

Due Gov't, \$ *100* for

Valuation of horse, \$ *100*

Valuation of horse equipments, \$ *100*

Remarks: _____

Book mark: _____

(358) *Keefe* Copyist.

Y

H. Art'y.

U.S.C.T.

James Young
Private, Co. F., 8 Reg't U. S. Col'd H. Art'y.

Appears on **Co. Muster-out Roll**, dated
Victoria Texas, Feb 10, 1866.

Muster-out to date *Feb. 10, 1866.*

Last paid to *Aug 31, 1865.*

Clothing account:

Last settled....., 186 ; drawn since \$..... 100

Due soldier \$ *9 92* 100; due U. S. \$..... 100

Am't for cloth'g in kind or money adv'd \$..... 100

Due U. S. for arms, equipments, &c., \$..... 100

Bounty paid \$..... 100; due \$ *100* 100

Remarks: *Entered service as recruit. Joined Co. for duty Feb. 3rd 65.*

Age 17 years

Book mark:

(861)

Keefe

Copyist.

Young, James

Pvt, Co. *F*, *8* Reg't *156th*

3

Enclosures.

Bed Cards.....	Final Statements.....
Burial Records.....	Furloughs or L. of A.....
Certs. of Dis. for Discharge.....	Med. Certificates.....
C. M. Charges.....	Med. Des. Lists.....
Descriptive Lists.....	Orders.....
Discharge Certificates.....	Pris. of War Record.....
Enlistment Papers..... 3	Resignations.....

Other papers relating to—

Admission to Hosp'l.....	Furlough or L. of A.....
Casualty Sheet.....	Med. Examination.....
Confinement.....	Misc. Information.....
Contracts.....	Pay or Clothing.....
Death or Effects.....	Personal Reports.....
Desertion.....	Rank.....
Discharge from Hosp'l.....	Transfer to Hosp'l.....
Discharge from Service.....	Transfer to V. R. C.
Duty.....	Transportation.....

James Young

No. 15

Volunteered at Paris Ill

February 1st, 1865

By Lt Col E M Low

53 Regiment of Ill. C. Infy

..... enlistment; last served in Company ()

..... Reg't of

Discharged, 18

Enlisted for 5th Regt
U. S. C. Heavy Arty

CONSENT IN CASE OF MINOR.

for bot enlistments and re-enlistments—enlistment of veterans, &c., &c., in the volunteer
ing term of the superintendent (not the recruiting officer) to the Adjutant General, and
nd Company in which the soldier last served should be given on the back.
service. A muster-in must, in all cases, precede payment of pay, bounty, pension, &c.
ence of muster-in. The mustering officer, commissary, or assistant commissary of muster
into the service of the United States before either of them is given to the disbursing officer.

VOLUNTEER ENLISTMENT.

STATE OF

Illinois 5th Cong Dist

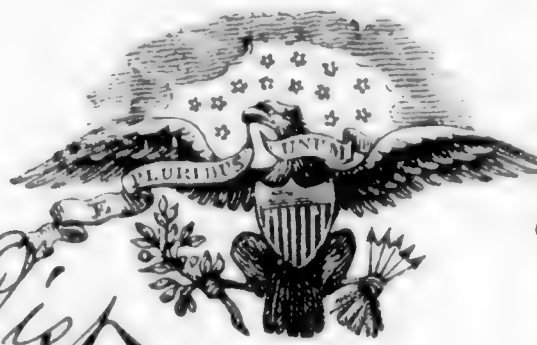

TOWN OF

*Belle Plain Township
Warshall County*

I, *James Young*, born in *Charleston Co*
in the State of *Missouri*, aged *Seventeen* years,
and by occupation a *Farmer*, Do HEREBY ACKNOWLEDGE to have
volunteered this *21st* day of *February*, 186 *5*,
to serve as a **Soldier** in the **Army of the United States of America**, for
the period of **THREE YEARS**, unless sooner discharged by proper authority:
Do also agree to accept such bounty, pay, rations, and clothing, as are, or may be,
established by law for volunteers. And I, *James Young*, do
solemnly swear, that I will bear true faith and allegiance to the **United States
of America**, and that I will serve them honestly and faithfully against all
their enemies or opposers whomsoever; and that I will observe and obey the
orders of the President of the United States, and the orders of the officers
appointed over me, according to the Rules and Articles of War.

Sworn and subscribed to, at _____
this _____ day of _____, 186 _____
BEFORE _____

James Young
Missouri

I CERTIFY, ON HONOR, That I have carefully examined the above-named Volunteer, agreeably
to the General Regulations of the Army, and that, in my opinion, he is free from all bodily defects and
mental infirmity, which would in any way disqualify him from performing the duties of a soldier.

Isaac M Neely

EXAMINING SURGEON.

12th Dist Ill

I CERTIFY, ON HONOR, That I have minutely inspected the Volunteer _____
previously to his enlistment, and that he was entirely sober when enlisted; that, to the best of my
judgment and belief, he is of lawful age; and that, in accepting him as duly qualified to perform the
duties of an able-bodied soldier, I have strictly observed the Regulations which govern the recruiting
service. This soldier has *Blue* eyes, *Blk* hair, *Blk* complexion, is *5*
feet *2* inches high.

Edw Low McCal

(T) Regiment of US C Infantry

RECRUITING OFFICER.

(A. G. O. No. 74 & 76.)

Mustered into the service of the United States, for three years or during the war, from date of enlistment, in Company _____
Regiment of _____ Volunteers, on the _____ day of _____, 186 _____, at _____

Jan 21 1865
FOR THE
1865

NOTE 1.—This blank will be used for bot. enlistments and re-enlistments—enlistment of veterans, &c., &c., in the volunteer service. They will be made out in duplicate in all cases—one to accompany the recruiting return of the superintendent (not the recruiting officer) to the Adjutant General, and one to accompany the accounts of the officer who pays bounty, &c. The Regiment and Company in which the soldier last served should be given on the back.

NOTE 2.—An enlistment holds to service. A muster-in must, in all cases, precede payment of pay, bounty, pension, &c. A muster-in roll must, in all cases, be filed in the Adjutant General's Office as evidence of muster-in. The mustering officer, commissary, or assistant commissary of musters, as the case may be, will countersign both enlistments as having mustered the soldier into the service of the United States before either of them is given to the disbursing officer.

DECLARATION OF RECRUIT.

I, *James Young*, desiring to VOLUNTEER as a Soldier in the Army of the United States, for the term of THREE YEARS, Do Declare, That I am *Seventeen* years and _____ months of age; that I have never been discharged from the United States service on account of disability or by sentence of a court martial, or by order before the expiration of a term of enlistment; and I know of no impediment to my serving honestly and faithfully as a soldier for three years.

GIVEN at *Cairo Illinois* the *1st* day of *February*, 186*0*

Witness:

J. Coules

James Young

No. *15*

James Young

W. D. C. Henry
Enlisted for 3th Regt

Discharged _____, 18

enlistment: last served in Company ()
Reg't of _____

Volunteered at *Cairo Ill*
February 1st, 1860
By *Dr. Carl B. M. Low*
55th Regiment of Miss. Infy

CONSENT IN CASE OF MINOR.

I, _____, Do CERTIFY, That I am the _____ of _____; that the said _____ is _____ years of age; and I do hereby freely give my CONSENT to his volunteering as a SOLDIER in the ARMY OF THE UNITED STATES for the period of THREE YEARS.

GIVEN at _____ the _____ day of _____

Witness:

James Young

No. 15

Volunteered at Cairo Iles

Feb 1st, 1865

By Lt Col E M Low

55 Regiment of U.S. Infantry

..... enlistment; last served in Company ()

..... Reg't of

Discharged 18

Enlisted for 5th Regt
U. S. C. Henry Alley

CONSENT IN CASE OF MINOR

both enlistment and re-enlistments—enlistment of veterans, &c., &c., in the volum
return of the superintendent (not the recruiting officer) to the Adjutant General,
company in which the soldier last served should be given on the back.
ce. A muster-in must, in all cases, precede payment of pay, bounty, pension, &
of muster-in. The mustering officer, commissary, or assistant commissary of mu
the service of the United States before either of them is given to the disbursing offic

1871
Jan 15
RECEIVED

VOLUNTEER ENLISTMENT.

STATE OF
Illinois



Belle Plain Township
TOWN OF *5th congressional dist*
Marshall County

I, *James Young*, born in *Charleston Co*
in the State of *Missouri*, aged *Seventeen* years,
and by occupation a *Farmer*, DO HEREBY ACKNOWLEDGE to have
volunteered this *Fifth* day of *February*, 186*3*.
to serve as a **Soldier** in the **Army of the United States of America**, for
the period of **THREE YEARS**, unless sooner discharged by proper authority:
Do also agree to accept such bounty, pay, rations, and clothing, as are, or may be,
established by law for volunteers. And I, *James Young*, do
solemnly swear, that I will bear true faith and allegiance to the **United States**
of America, and that I will serve them honestly and faithfully against all
their enemies or opposers whomsoever; and that I will observe and obey the
orders of the President of the United States, and the orders of the officers
appointed over me, according to the Rules and Articles of War.

Sworn and subscribed to, at _____
this _____ day of _____, 186*3*,
BEFORE _____

James Young
Mark

I CERTIFY, ON HONOR, That I have carefully examined the above-named Volunteer, agreeably
to the General Regulations of the Army, and that, in my opinion, he is free from all bodily defects and
mental infirmity, which would in any way disqualify him from performing the duties of a soldier.

Isaac M. Neely

EXAMINING SURGEON
13th Dist Ill

I CERTIFY, ON HONOR, That I have minutely inspected the Volunteer _____
previously to his enlistment, and that he was entirely sober when enlisted; that, to the best of my
judgment and belief, he is of lawful age; and that, in accepting him as duly qualified to perform the
duties of an able-bodied soldier, I have strictly observed the Regulations which govern the recruiting
service. This soldier has *Blue* eyes, *Black* hair, *Dark* complexion, is *five*
feet *two* inches high.

Edw. J. Mc Col
Regiment of *1st C Infantry*
RECRUITING OFFICER.

(A. G. O. No. 74 & 76.)

Enlisted into the service of the United States, for three years or during the war, from date of enlistment, in Company _____
Regiment of _____ Volunteers, on the _____ day of _____, 186*3*, at _____

NOTE 1.—This blank will be used for both enlistments and re-enlistments—enlistment of veterans, &c., &c., in the volunteer service. They will be made out in duplicate in all cases—one to accompany the recruiting return of the superintendent (not the recruiting officer) to the Adjutant General, and one to accompany the accounts of the officer who pays bounty, &c. The Regiment and Company in which the soldier last served should be given on the back.

NOTE 2.—An enlistment holds to service. A muster-in must, in all cases, precede payment of pay, bounty, pension, &c. A muster-in roll must, in all cases, be filed in the Adjutant General's Office as evidence of muster-in. The mustering officer, commissary, or assistant commissary of musters, as the case may be, will countersign both enlistments as having mustered the soldier into the service of the United States before either of them is given to the disbursing officer.

DECLARATION OF RECRUIT.

I, James Young, desiring to VOLUNTEER as a Soldier in the Army of the United States, for the term of THREE YEARS, Do Declare, That I am Seventeen years and _____ months of age; that I have never been discharged from the United States service on account of disability or by sentence of a court martial, or by order before the expiration of a term of enlistment; and I know of no impediment to my serving honestly and faithfully as a soldier for three years.

GIVEN at Cairo Dec the 12th day of February 1865

Witness:

D. Coates

James Young
Mark

No. 13-

Volunteered at

Cairo Dec

Feb 12th 1865

By

W. J. Coates

15th Regiment of

W. D. Drury

enlistment; last served in Company ()

Regt of _____

Discharged _____ 1865

Enlisted for 5th Regt

W. J. Coates

CONSENT IN CASE OF MINOR.

I, _____, Do CERTIFY, That I am the _____ of _____; that the said _____ is _____ years of age; and I do hereby freely give my CONSENT to his volunteering as a SOLDIER in the ARMY OF THE UNITED STATES for the period of THREE YEARS.

GIVEN at _____ the _____ day of _____

Witness:

No. 15

James Henry
Volunteered at Cairo Ill

February 1st, 1864

By Lt Col E M Seow
5th Regiment of U.S.C. Inftry

enlistment; last served in Company ()

Reg't of

Discharged , 18

Enlisted for 5th Regt
U.S.C. Heavy Arty

JUL 15 1861

CONSENT IN CASE OF MINOR.

Do CERTIFY That I am

ed for both enlistments and re-enlistments—enlistment of veterans, &c., &c., in the volun
cruting return of the superintendent (not the recruiting officer) to the Adjutant General,
and Company in which the soldier last served should be given on the back.
to service. A muster-in must, in all cases, precede payment of pay, bounty, pension, &
vidence of muster-in. The mustering officer, commissary, or assistant commissary of m
der into the service of the United States before either of them is given to the disbursing offic

3 Enl papers withdrawn from file
6 avails of James Henry Co 5th
file in folder of James Henry Co 5th

VOLUNTEER ENLISTMENT.

STATE OF

Illinois 5th Cavalry



TOWN OF

*St. Ward
Peoria City*

I, *James Young*, born in *Charleston Co*
in the State of *Missouri*, aged *Seventeen* years,
and by occupation a *Farmer*, Do HEREBY ACKNOWLEDGE to have
volunteered this *FIRST* day of *February*, 1865,
to serve as a **Soldier** in the **Army of the United States of America**, for
the period of **THREE YEARS**, unless sooner discharged by proper authority:
Do also agree to accept such bounty, pay, rations, and clothing, as are, or may be,
established by law for volunteers. And I, *James Young*, do
solemnly swear, that I will bear true faith and allegiance to the **United States**
of America, and that I will serve them honestly and faithfully against all
their enemies or opposers whomsoever; and that I will observe and obey the
orders of the President of the United States, and the orders of the officers
appointed over me, according to the Rules and Articles of War.

Sworn and subscribed to, at _____
this _____ day of _____, 186 _____,
BEFORE _____

James Young
his mark

I CERTIFY, ON HONOR, That I have carefully examined the above-named Volunteer, agreeably
to the General Regulations of the Army, and that, in my opinion, he is free from all bodily defects and
mental infirmity, which would in any way disqualify him from performing the duties of a soldier.

Isaac M Keely

EXAMINING SURGEON.

13th Dist Ill

I CERTIFY, ON HONOR, That I have minutely inspected the Volunteer
previously to his enlistment, and that he was entirely sober when enlisted; that, to the best of my
judgment and belief, he is of lawful age; and that, in accepting him as duly qualified to perform the
duties of an able-bodied soldier, I have strictly observed the Regulations which govern the recruiting
service. This soldier has *Blue* eyes, *Blue* hair, *Blue* complexion, is *five*
feet *two* inches high.

E. M. Low

Regiment of *US C Infantry*
RECRUITING OFFICER.

(A. G. O. No. 74 & 76.)

Mustered into the service of the United States, for three years or during the war, from date of enlistment, in Company _____
Regiment of _____ Volunteers, on the _____ day of _____, 186 _____, at _____

REF ID: A66666

NOTE 1.—This blank will be used for both enlistments and re-enlistments—enlistment of veterans, &c., &c., in the volunteer service. They will be made out in duplicate in all cases—one to accompany the recruiting return of the superintendent (not the recruiting officer) to the Adjutant General, and one to accompany the accounts of the officer who pays bounty, &c. The Regiment and Company in which the soldier last served should be given on the back.
NOTE 2.—An enlistment holds to service. A muster-in must, in all cases, precede payment of pay, bounty, pension, &c. A muster-in roll must, in all cases, be filed in the Adjutant General's Office as evidence of muster-in. The mustering officer, commissary, or assistant commissary of musters, as the case may be, will countersign both enlistments as having mustered the soldier into the service of the United States before either of them is given to the disbursing officer.

3 Enlistments with pay
6 months pay
bounty in full
17611

DECLARATION OF RECRUIT.

I, James Young, desiring to VOLUNTEER as a Soldier in the Army of the United States, for the term of THREE YEARS, Do Declare, That I am seventeen years and _____ months of age; that I have never been discharged from the United States service on account of disability or by sentence of a court martial, or by order before the expiration of a term of enlistment; and I know of no impediment to my serving honestly and faithfully as a soldier for three years.

GIVEN at Cairo Ill the 12th day of February, 1861

Witness: J. Coules James Young
must

No. 15-
James Young
Volunteered at Cairo Ill
February 12th 1861

By Col B. M. Brown
2^d Regt of W. I. O. Infy

..... enlistment; last served in Company ()
Reg't of ..
Discharged .., 18 ..

Indicled for 5th Regt
W. I. O. Heavy Arty

CONSENT IN CASE OF MINOR.

I, .., Do CERTIFY, That I am the .. of ..; that the said .. is .. years of age; and I do hereby freely give my CONSENT to his volunteering as a SOLDIER in the ARMY OF THE UNITED STATES for the period of THREE YEARS.

GIVEN at .. the .. day of ..

Witness: ..

1980 or James
Young, John
Co G, 8 U.S. Col'd H. Art'y.

Private

Private

CARD NUMBERS.

1	5477509	26
2	5477642	27
3	5477911	28
4	5478023	29
5	5478124	30
6	5478227	31
7	5477738.	32
8	9122131	33
9		34
10		35
11		36
12		37
13		38
14		39
15		40
16		41
17		42
18		43
19		44
20		45
21		46
22		47
23		48
24		49
25		50

Book Mark:

See also

4 | 8 H. Art'y. | U.S.C.T.

James Young

, Co. G, 8 Reg't U.S. Col'd H. Art'y.

Appears on

Company Descriptive Book

of the organization named above.

DESCRIPTION.

Age 25 years; height 5 feet 8 1/2 inches.

Complexion *Blk*

Eyes *Blk*; hair *Blk*

Where born *Memphis, Tennessee*

Occupation *Drayman*

ENLISTMENT.

When *Jan'y 31*, 1865.

Where *Cairo, Ill.*

By whom *Lt. Col. Low*; term *3* y'rs.

Remarks:

** Over James is written the word John in pencil. James cancelled by pencil mark.*

E. A. Moreland

MAR 1 1865

8 H. Art'y. | U.S.C.T.

J. James Young
Co. G, 8 Reg't U. S. Col'd H. Art'y.

Appears on

Company Muster Roll

for *Jan 31 1865*, 1865

Present or absent *Present*

Stoppage, \$ *100* for

Due Gov't, \$ *100* for

Valuation of horse, \$ *100*

Valuation of horse equipments, \$ *100*

Remarks: *Enrolled Jan 31 1865 at
Cairo Ills & m. c. same
date at Paducah Ky
3 years*

Book mark:

J. James Young

(358)

Copyist.

MAR 1874

8 H. Art'y. U.S.C.T.

James Jones
_____, Co. G, 8 Reg't U. S. Col'd H. Art'y.

Appears on

Company Muster Roll

for _____, 186

Present or absent _____

Stoppage, \$ _____ 100 for _____

Due Gov't, \$ _____ 100 for _____

Valuation of horse, \$ _____ 100

Valuation of horse equipments, \$ _____ 100

Remarks: _____

Book mark: _____

11 8 H. Art'y. | U.S.C.T.

James [unclear]
[unclear], Co. G, 8 Reg't U. S. Col'd H. Art'y.

Appears on

Company Muster Roll

for *May 1st*, 186 ³.

Present or absent *present*

Stoppage, \$ 100 for

Due Gov't, \$ 100 for

Valuation of horse, \$ 100

Valuation of horse equipments, \$ 100

Remarks: *Nothing in the [unclear]*

Accounting to [unclear]

Book mark: _____

[Signature]

Y | 8 H. Art'y. | U.S.C.T.

James Young
Pvt., Co. G, 8 Reg't U. S. Col'd H. Art'y.

Appears on

Company Muster Roll

for *July & Aug*, 186*5*.

Present or absent *Present*

Stoppage, \$ 100 for

Due Gov't, \$ 100 for

Valuation of horse, \$ 100

Valuation of horse equipments, \$ 100

Remarks: *Stoppage for one*

can't be accounted

to B's ch

Book mark:

W. J. Young

James Young

Plt, Co. G, 8 Reg't U. S. Col'd H. Art'y.

Appears on

Company Muster Roll

for *Sept 1st*, 186*4*.

Present or absent *Present*

Stoppage, \$ *100* for

Due Gov't, \$ *100* for

Valuation of horse, \$ *100*

Valuation of horse equipments, \$ *100*

Remarks:

Book mark:

Y. C.

Y | 8 H. Art'y. | U.S.C.T.

James Young

Co. G, 8 Reg't U. S. Col'd H. Art'y.

Appears on

Company Muster Roll

for Nov + Dec, 1865.

Present or absent Present.

Stoppage, \$ 100 for

Due Gov't, \$ 100 for

Valuation of horse, \$ 100

Valuation of horse equipments, \$ 100

Remarks:

Book mark:

W. H. Lee

John Henry
....., Co., 8 Reg't U. S. Col'd H. Art'y.

Appears on **Co. Muster-out Roll**, dated
7th March 1861, 186 .

Muster-out to date *7th March*, 186 .

Last paid to *1st April*, 186 .

Clothing account:

Last settled....., 186 ; drawn since \$..... 100

Due soldier \$..... ⁵⁷100; due U. S. \$..... 100

Am't for cloth'g in kind or money adv'd \$..... 100

Due U. S. for arms, equipments, &c., \$..... 100

Bounty paid \$..... 100; due \$..... ⁰⁰100

Remarks: *Discharged 22nd Nov 1861
for good service
Jan 5th 1862*

Age 25 years

Book mark: *458, 1862*

W. C. C.

1981
Young King

Co K, 8 U.S. Col'd H. Art'y.

Private Private

CARD NUMBERS.

1	5481224	26
2	5487364	27
3	5481504	28
4	5481637	29
5	5481777	30
6	5482439.	31
7	9122773	32
8	49445007	33
9		34
10		35
11		36
12		37
13		38
14		39
15		40
16		41
17		42
18		43
19		44
20		45
21		46
22		47
23		48
24		49
25		50

Book Mark:

See also

7 | 8 H. Art'y. | U.S.C.T.

King Young

Co. *B*, 8 Reg't U.S. Col'd H. Art'y.

Appears on

Company Descriptive Book

of the organization named above.

DESCRIPTION.

Age years; height feet inches.

Complexion *Black*

Eyes *Black*; hair *Black*

Where born *Caldwell Co., Ky.*

Occupation *Farmer*

ENLISTMENT.

When *June 24*, 186 *4*

Where *Paducah, Ky.*

By whom *W. W. Beggart*; term *3* y'rs.

Remarks: *Died in Past Hospital at Paducah, Ky. Jan. 21st 1865.*

Keefe

(383g)

Copist.

Y. | 8 H. Art'y. | U.S.C.T.
King Young,
Private, Co. *A*, 8 Reg't U. S. Col'd H. Art'y.

Age _____ years.

Appears on

Company Muster Roll*
for *Enlistment to June 30th*, 1864.

Joined for duty and enrolled:

When *June 24th*, 1864.

Where *Paducah, Ky.*

Period *3* years.

Mustered in

When *June 25th*, 1864.

Where *Paducah, Ky.*

Present or absent. *Present.*

Stoppage, \$ *100* for _____

Due Gov't \$ *100* for _____

Valuation of horse, \$ *100*

Valuation of horse equipments, \$ *100*

Remarks: _____

*First current roll. No muster-in roll of this company on file.

Book mark: _____

Sharin

(358d)

Copyist.

G. | 8 H. Art'y. | U.S.C.T.

King Young
Co., Co. K, 8 Reg't U. S. Col'd H. Art'y.

Appears on

Company Muster Roll

for *July and August* 186*4*

Present or absent *Present* +

Stoppage, \$ *100* for

Due Gov't, \$ *100* for

Valuation of horse, \$ *100*

Valuation of horse equipments, \$ *100*

Remarks: *Absent sick at Paducah, Ky., since Aug. 26th. 1864.*

Does not appear on Roll.

Book mark:

Harin.

Y. | 8 H. Art'y. | U.S.C.T.

King Young,
Pvt., Co. K, 8 Reg't U. S. Col'd H. Art'y.

Appears on

Company Muster Roll

for *Sept. and Oct.*, 186*4*.

Present or absent *Present*

Stoppage, \$ *100* for

Due Gov't, \$ *100* for

Valuation of horse, \$ *100*

Valuation of horse equipments, \$ *100*

Remarks:

Book mark: -----

Harin

Y. | 8 H. Art'y. | U.S.C.T.

King Young.
Pvt., Co. K, 8 Reg't U.S. Col'd H. Art'y.

Appears on

Company Muster Roll

for *Nov. and Dec.*, 186 *4*

Present or absent *Present.*

Stoppage, \$ *100* for

Due Gov't, \$ *100* for

Valuation of horse, \$ *100*

Valuation of horse equipments, \$ *100*

Remarks :

Book mark :

Tharin

Uy

S H. Art'y.

U.S.C.T.

King Young

Priv, Co. K, 8 Reg't U. S. Col'd H. Art'y.

Appears on

Company Muster Roll

for *Jan'y. + Feby.*, 1865.

Present or absent

Stoppage, \$ 100 for

Due Gov't, \$ 100 for

Valuation of horse, \$ 100

Valuation of horse equipments, \$ 100

Remarks:

*Aided at Hospital Paducah, Ky.
Jan. 21/65.*

Book mark:

(358)

D. Mahro

Copyist.

Amey Young

Priv, Co. K. 8 Reg't U. S. Col'd H. Art'y.

Appears on Returns as follows:

July 18 64 about near
at Paducah Ky.

Jan 18 65 Jan 21/65
Paducah Ky. Dred
in Post Hosp.

Book mark:

Ed. Patton

King Young
Priv., Co. *K*, 8 Reg't U. S. Col'd H. Art'y.

Appears on **Co. Muster-out Roll**, dated
Victoria Texas, *Feb 10*, 1866.
Muster-out to date _____, 186 ____.
Last paid to *Oct 31*, 1864.

Clothing account:

Last settled _____, 186 ____; drawn since \$ _____ 100
Due soldier \$ _____ 100; due U. S. \$ _____ 100
Am't for cloth'g in kind or money adv'd \$ _____ 100

Due U. S. for arms, equipments, &c., \$ _____ 100
Bounty paid \$ _____ 100; due \$ _____ 100

Remarks *Captured service organization*
of Co as private. Died at Paducah Ky
Jan'y 21 1865 of Typhoid Fever
Final Statement and Inventory of
effects forwarded Jan'y 23 1865
Age 27 years

Book mark: _____

S. P. York Copyist.

Young, King
P. Co. K, 8 Regt. 116. H. A.

5 Enclosures.

Bed Cards	Final Statements 2
Burial Records	Furloughs or L. of A.
Certs. of Dis. for Discharge	Med. Certificates
C. M. Charges	Med. Des. Lists
Descriptive Lists	Orders
Discharge Certificates	Pris. of War Record
Enlistment Papers	Resignations

Other papers relating to—

Admission to Hosp'l	Furlough or L. of A.
Casualty Sheet	Med. Examination
Confinement	Misc. Information
Contracts	Pay or Clothing
Death or Effects 3	Personal Reports
Desertion	Rank
Discharge from Hosp'l	Transfer to Hosp'l
Discharge from Service	Transfer to V. R. C.
Duty	Transportation

APR 1 1855

King George

Post & Asst. Col
Paducah Ky Jan 21 1863
Officer Comd. Co "K" 8th W. C. Artillery
Sir

I have the honor to inform you that King
young male of your Co died at this Dept
am. inst

Cause of Death Malignant Fever
Said Soldier has left the following effects
Am Cap. on Am Coats, one W. Jacket, one Blouse,
one pr Shoes,

Joel B. Jeff
Post Surgeon

FINAL STATEMENT

OF

King Young
8th Reg't of U.S. Artillery

VOLUNTEERS.

Died January 21st 1865

NOTE 1.—Two of these certificates (or duplicates) are to be given to each Volunteer Soldier or drafted man who may be discharged previously to the discharge of his company, that he may at once receive from the Paymaster the pay, &c., due him, and the captain or other COMMISSIONED officer commanding the company will certify to the act of the delivery of the duplicate certificates; on these certificates the Soldier is "entitled to" his discharge, and should also present his discharge to the Paymaster to have the payment endorsed on it. The discharge is to be given back to the Soldier by the Paymaster; the latter only retaining as his voucher the duplicate certificates.

NOTE 2.—If the Soldier is entitled to pay for the use of his horse, the Company Commander will certify to that fact on the back of both these final statements, and also to the time he has pay due for having been so mounted on his own horse.

NOTE 3.—When a Soldier is furnished with final statements, his descriptive list, if he has one, should be taken up by the officer who gives the Soldier these statements, and endorsed with a statement to this effect by the officer. This endorsement should exhibit a full statement of the time for which the Soldier was allowed pay on his final statements, the clothing account, and all other charges against him or in his favor, so as to comprise a complete exhibit of his account. It will then be transmitted to the company commander of the Soldier, who will enter all the data necessary to a full understanding of the Soldier's account on the muster roll upon which the Soldier's discharge is reported. The descriptive list will then be destroyed. The object of this is, that the remaining portion of the Soldier's account may be settled upon the receipt of these muster rolls, and the Soldier receive any pay or allowances that may be due him at the time of his discharge, and which may not appear on his final statements from the fact that his descriptive list is incomplete. These accounts for back pay, &c., are settled by the 2d Auditor of the Treasury Department.

NOTE 4.—Charges for loss or injury to ordnance, horse equipments, and other miscellaneous charges, should appear under the heading of "Other Stoppages."

NOTE 5.—Bounty paid by State authorities, and not by the United States, will not be entered on this statement.

NOTE 6.—Amounts due the Sutler and Laundress must be entered on the muster roll on which the discharge, death, desertion, &c., is reported, as well as on the final statement, otherwise the amount cannot be collected from the United States.

NOTE 7.—This blank will be used for deceased volunteers and drafted men, as well as for others.

NOTE 8.—Where a Soldier dies in Hospital or on detached service, his descriptive list, if he has one, should be sent with his final statements, in duplicate, to the Adjutant General, Washington, D. C.

A.G.O.
Receipt for effects
sent 2nd Aug.
Free

ADJUTANT GENERAL'S OFFICE.
Jan 9th 1865
Duplicate with Inventory sent 2d Auditor.

I certify, on honor, that King Young a private of
 Captain John Cooks Company (K.) of the 8th Regiment of U. S. Colored Regts.
VOLUNTEERS, of the State of _____, born in Baldwell Co., State
 of Kentucky, aged 21 years; 5 feet 6 inches high; Black complexion,
Black eyes, Black hair, and by occupation a farmer, having joined the company on
 its original organization at Paducah Ky., and enrolled in it at the muster into
 the service of the United States at Paducah Ky., on the 25th day
 of June, 1864, (or was mustered in service as a recruit, by _____
 _____, at _____, on the _____ day of _____,
 186 , or was drafted and mustered into the service of the United States from the _____
 Enrollment District of the State of _____, at _____,
 on the _____ day of _____, 186 .) to serve in the Regiment, for
 the term of Three Years: and having served **HONESTLY** and
FAITHFULLY with his Company in the 8th U. S. Colored Regt., to the present date, is now
 entitled to a **DISCHARGE** by reason of Death on the 21st day of January
1865 in Post Hospital at Paducah Ky. Cause of death
typhoid fever
 The said King Young was last paid by Paymaster
May James to include the 31st day of October, 1864, and has
 pay due him from that time to the present date; he is entitled to pay and subsistence for
TRAVELING to place of enrollment, and whatever other allowances are authorized to volunteer
 soldiers, drafted men, or militia, so discharged. He has received from the United States **CLOTHING**
 amounting to 41⁶⁹/₁₀₀ dollars, since the 24th day of June,
 1864, when he enlisted his clothing account was last settled. He has received from the United States
 _____[—]/₁₀₀ dollars advanced **BOUNTY**.

There is to be stopped from him, on account of the State of _____, or other
 authorities, for **CLOTHING**, &c., received on entering service, _____[—]/₁₀₀ dollars; and
 for other stoppages, viz: One hundred 41 cts Am arrears

_____ Amounting to 90[—]/₁₀₀ dollars.
 He has been furnished with **TRANSPORTATION** in kind from the place of his discharge to
 _____; and he has been **SUBSISTED** for **TRAVELING** to his
 place of enrollment, up to the _____, 186 .

He is indebted to _____, **SUTLER**, _____[—]/₁₀₀ dollars.
 He is indebted to _____, **LAUNDRESS**, _____[—]/₁₀₀ dollars.

Given in Duplicate, at Paducah Kentucky, this 27th day
 of January, 1865.

John Cooks
Capt 8th U. S. Colored Regt.
 Commanding Company "K."

FINAL STATEMENT

OF

King Young
Reg't of *A S Co Art H*

JUN 21 1865

VOLUNTEERS.

Given January 21 1865

NOTE 1.—Two of these certificates (or duplicates) are to be given to each Volunteer Soldier or drafted man who may be discharged previously to the discharge of his company, that he may at once receive from the Paymaster the pay, &c., due him, and the captain or other COMMISSIONED officer commanding the company will certify to the act of the delivery of the duplicate certificates; on these certificates the Soldier is "entitled to" his discharge, and should also present his discharge to the Paymaster to have the payment endorsed on it. The discharge is to be given back to the Soldier by the Paymaster; the latter only retaining as his voucher the duplicate certificates.

NOTE 2.—If the Soldier is entitled to pay for the use of his horse, the Company Commander will certify to that fact on the back of both these final statements, and also to the time he has pay due for having been so mounted on his own horse.

NOTE 3.—When a Soldier is furnished with final statements, his descriptive list, if he has one, should be taken up by the officer who gives the Soldier these statements, and endorsed with a statement to this effect by the officer. This endorsement should exhibit a full statement of the time for which the Soldier was allowed pay on his final statements, the clothing account, and all other charges against him or in his favor, so as to comprise a complete exhibit of his account. It will then be transmitted to the company commander of the Soldier, who will enter all the data necessary to a full understanding of the Soldier's account on the muster roll upon which the Soldier's discharge is reported. The descriptive list will then be destroyed. The object of this is, that the remaining portion of the Soldier's account may be settled upon the receipt of these muster rolls, and the Soldier receive any pay or allowances that may be due him at the time of his discharge, and which may not appear on his final statements from the fact that his descriptive list is incomplete. These accounts for back pay, &c., are settled by the 2d Auditor of the Treasury Department.

NOTE 4.—Charges for loss or injury to ordnance, horse equipments, and other miscellaneous charges, should appear under the heading of "Other Stoppages."

NOTE 5.—Bounty paid by State authorities, and not by the United States, will not be entered on this statement.

NOTE 6.—Amounts due the Sutler and Laundress must be entered on the muster roll on which the discharge, death, desertion, &c., is reported, as well as on the final statement, otherwise the amount cannot be collected from the United States.

NOTE 7.—This blank will be used for deceased volunteers and drafted men, as well as for others.

NOTE 8.—Where a Soldier dies in Hospital or on detached service, his descriptive list, if he has one, should be sent with his final statements, in duplicate, to the Adjutant General, Washington, D. C.

I certify, on honor, that King Young a Private of
 Captain John Cook Company (1st) of the 5th Regiment of Ind. Cav. 26
VOLUNTEERS, of the State of _____, born in Walden Co., State
 of Indiana, aged 21 years; 5 feet 6 inches high; dark complexion,
Blue eyes, Black hair, and by occupation a young man, having joined the company on
 its original organization at Paducah Ky., and enrolled in it at the muster into
 the service of the United States at Paducah Ky., on the 25th day
 of June, 1864, (or was mustered in service as a recruit, by _____
 _____, at _____, on the _____ day of _____,
 186 , or was drafted and mustered into the service of the United States from the _____
 Enrollment District of the State of _____, at _____,
 on the _____ day of _____, 186) to serve in the Regiment, for
 the term of three years : and having served HONESTLY and
 FAITHFULLY with his Company in the 8th U.S. Cav. 26 to the present date, is now
 entitled to a **DISCHARGE** by reason of death on the 21st day of January
1865 in Post Hospital at Paducah Ky Cause of Malaria

The said King Young was last paid by Paymaster
May June to include the 31st day of October, 1864, and has
 pay due him from that time to the present date; he is entitled to pay and subsistence for
 TRAVELING to place of enrollment, and whatever other allowances are authorized to volunteer
 soldiers, drafted men, or militia, so discharged. He has received from the United States **CLOTHING**
 amounting to 41 69 dollars, since the 24th day of June 1864,
 1864, when his clothing account was last settled. He has received from the United States
_____ dollars advanced **BOUNTY**.

There is to be stopped from him, on account of the State of _____, or other
 authorities, for **CLOTHING, &c.**, received on entering service, _____ dollars; and
 for other stoppages, viz: One canteen 41 Cts One canteen
49 Cts

 _____ Amounting to _____ dollars.
 He has been furnished with TRANSPORTATION in kind from the place of his discharge to
 _____; and he has been SUBSISTED for TRAVELING to his
 place of enrollment, up to the _____, 186 .

He is indebted to _____, **SUTLER**, _____ dollars.
 He is indebted to _____, **LAUNDRESS**, _____ dollars.

Given in Duplicate, at Paducah Kentucky, this 27th day
 of January, 1865.

John Cook
Capt 5th U.S. Cav. 26
 Commanding Company

ARTICLES OF WAR.

ART. 95. When any non-commissioned officer or soldier shall die, or be killed in the service of the United States, the then commanding officer of the troop or company shall, in the presence of two other commissioned officers, take an account of what effects he died possessed of, above his arms and accoutrements, and transmit the same to the office of the Department of War, which said effects are to be accounted for, and paid to the representatives of such deceased non-commissioned officer or soldier. And in case any of the officers, so authorized to take care of the effects of deceased officers and soldiers, should, before they have accounted to their representatives for the same, have occasion to leave the regiment or post, by preferment or otherwise, they shall, before they be permitted to quit the same, deposit in the hands of the commanding officer, or of the assistant military agent, all the effects of such deceased non-commissioned officers and soldiers, in order that the same may be secured for, and paid to, their respective representatives.

ARMY REGULATIONS—EDITION OF 1861.

DECEASED SOLDIERS.

Par. 152. Inventories of the effects of deceased non-commissioned officers and soldiers, required by the 95th Article of War, will be forwarded to the Adjutant General, by the commander of the company to which the deceased belonged, and a duplicate of the same to the colonel of the regiment. Final statements of pay, clothing, &c., will be sent with the inventories. When a soldier dies at a post or station absent from his company, it will be the duty of his immediate commander to furnish the required inventory, and, at the same time, to forward to the commanding officer of the company to which the soldier belonged, a report of his death, specifying the date, place, and cause; to what time he was last paid, and the money or other effects in his possession at the time of his decease; which report will be noted on the next muster roll of the company to which the man belonged. Each inventory will be endorsed, "Inventory of the effects of _____, late of company (—) _____ regiment of _____, who died at _____, the _____ day of _____, 186—." If a legal representative receive the effects, it will be stated in the report. If the soldier leave no effects, the fact will be reported.

Par. 153. Should the effects of a deceased non-commissioned officer or soldier not be administered upon within a short period after his decease, they shall be disposed of by a Council of Administration, under the authority of the commanding officer of the post, and the proceeds deposited with the Paymaster, to the credit of the United States, until they shall be claimed by the legal representatives of the deceased.

Par. 154. In all such cases of sales by the Council of Administration, a statement in detail, or account of the proceeds, duly certified by the Council and commanding officer, accompanied by the Paymaster's receipt for the proceeds, will be forwarded by the commanding officer to the Adjutant General. The statement will be endorsed, "Report of the proceeds of the effects of _____, late of company (—) _____ regiment of _____, who died at _____, the _____ day of _____, 186—."

NOTE 1.—The effects in all cases, when called for, should be turned over to the legal representative, without further authority from the Adjutant General. When the effects are turned over to the relatives of the deceased before these inventories are sent to the Adjutant General, their receipts therefor should be attached to the inventories. In all other cases, one copy will be sent with a letter of transmittal direct to the Adjutant General, and a duplicate retained by the officer.

NOTE 2.—Particular care should be taken to take receipts in duplicate from the Paymaster for any funds turned over to him; one copy should be sent direct to the Adjutant General and one retained by the officer.

INVENTORY OF THE EFFECTS

OF

King Young

Late of Company "K"

8th Reg't of U. S. C. Art. 10th

Volunteers, who died at Paducah Ky

on the 21st day of January 1865.



Inventory of the effects of King Young late
a private of Captain John Cooso Company "K" of
the 8th Regiment of U.S. Art. 26 Volunteers, who was enrolled as
a soldier at Paducah in the State of Kentucky on
the 24th day of June 1864, and mustered into the service of the United
States as a private on the 25th day of June 1864, at Paducah Ky
in Company "K", 8th Regiment of U.S. Art. 26 Volunteers, to serve three
years or during the war; he was born in Baldwell County in the State
of Kentucky; he was 21 years of age, 5 feet 6 inches
high, Black complexion, Black eyes, Black hair, and by occupation, when enrolled,
a farmer; he died in Post Hospital, at
Paducah Kentucky on the 21st day of January 1865, by
reason of Typhoid Fever

INVENTORY.					
ARTICLES.	No.	ARTICLES.	No.	ARTICLES.	No.
Hats.....		Pairs trousers.....	2	Knapsacks.....	
Caps.....		Pairs flannel drawers.....		1 Waterproof Blanket	1
Forage caps.....	1	Pairs cotton drawers.....	2		
Great coats.....	1	Flannel shirts.....			
Uniform coats.....		Cotton shirts.....	2		
Uniform jackets.....	1	Pairs boots.....			
Flannel sack coats.....		Pairs shoes.....	1		
Blouses.....	1	Pairs socks.....	2		
Stable frocks.....		Blankets <u>Hollen</u>	1		
Fatigue overalls.....		Haversacks.....			
				MONEY.	
				U.S. Currency	
				Specie.....	\$10.75
				Notes.....	\$

I CERTIFY, ON HONOR, that the above inventory comprises all the effects of King Young
of Paducah Ky at Paducah Ky, deceased, and that the effects are in the hands
of John Cooso to be disposed of by a Council of Administration.

(DUPLICATES.)

STATION :

Paducah Ky

DATE :

January 27th 1865

1 A. G. O. No. 104.

John Cooso
Capt 8th U.S. Art 26
Commanding the Company "K"



Head Quarters. Co. K. 8th W.S.B. Art.

Paducah. Ky.

Jan 24th 1865.

Received of John Cook. Capt. 8th W.S.B. Art. Comdg. Co. K. all the effects of King Young deceased, a private of his Company. This day above written.

Witness

Jackson ^{his} Young
mark

The undersigned being duly sworn, deposes and says that he is personally acquainted with King Young and Jackson Young, privates of Co. K. 8th W.S.B. Art. and has been from their birth, and known them to be brothers, and that Jackson Young is King Youngs right legal heir.

Carter ^{his} Blue
mark

Private. Co. K. 8th W.S.B. Art. (26)

Sworn and subscribed before me, at Paducah. Ky. This 24th day of January 1865.

Geo. M. Sanson
2nd Lieut. 8th W.S.B. Art. (26)

1905
Young, Thomas G.
Texas

Co. B, 8 U.S. Col'd H. Art'y.

1st Lieutenant, 1st Lieutenant

CARD NUMBERS.

1	5466757	26
2	5481769	27
3	5470457	28
4	5470584	29
5	5470828	30
6	5476430	31
7	5476541	32
8	5476648	33
9	5476762	34
10	5471291	35
11	5476848	36
12	9436846	37
13	42727355	38
14	42727442	39
15	40744999	40
16		41
17		42
18		43
19		44
20		45
21		46
22		47
23		48
24		49
25		50

Book Mark:

See also

3-2664029-P.O. Mil

S 2719690 amw D

A.S. 1341271

G. S. C. Co. N.Y. **U.S.C.T.**

Thomas L. Young,
1st, Co. *8*, Reg't U. S. Col'd *1st Reg't N.Y.*

Appears on

Regimental Descriptive Book

(List of Commissioned Officers)

of the regiment named above.

Rank *1st Lieut.*

Date of appointment *Jan 2* 186 *5*

Remarks: *Adopted from*
civil life,
Mustd into the
2nd Reg't H. Feb 1/65,

W. D. Taylor,
Copyist.

Ny | S H. Art'y. | U.S.C.T.

L. C. Young
1st. Lieut, Co. K, 8 Reg't U. S. Col'd H. Art'y.

Appears on

Company Muster Roll

for *Jan'y. & Feby.*, 1865.

Present or absent.....

Stoppage, \$..... 100 for.....

Due Gov't, \$..... 100 for.....

Valuation of horse, \$..... 100

Valuation of horse equipments, \$..... 100

Remarks:.....

*Transferred to Co. B. per S. O. No. 13,
dated N.º 2088 U. S. C. H. Art'y. Feby.*

Book mark:.....

(358)

A. Maher

Copyist.

31

8 H. Art'y.

U.S.C.T.

John W. Young

Co. B, 8 Reg't U. S. Col'd H. Art'y.

Appears on

Company Muster Roll

for July 9, 1865.

Present or absent present

Stoppage, \$ 100 for

Due Gov't, \$ 100 for

Valuation of horse, \$ 100

Valuation of horse equipments, \$ 100

Remarks: Joined for duty for
S.C. No 13 Dated March 22
8th U.S. Col'd H. Art'y. Feb 9, 1864
Signed for S.C. No 13 by
Col. Wm. H. Hunt

Book mark:

G. Rees
Copyist.

Y | S. N. Art'y | U.S.C.T.

Linus B. Young
1st Lt, Co. 8 Reg't U. S. Col'd H. Art'y

Age 26 years.

Appears on an

Individual Muster-in Roll

of the organization named above. Roll dated
Paducah, Ky, Feb 1, 186 .

Muster-in to date Feb 1, 186 .

Joined for duty and enrolled :

When Feb 1, 186 .

Where Paducah

Period 3 years.

Valuation of horse, \$ 100

Valuation of horse equipments, \$ 100

Remarks: Received & accepted
ed Commission as
1st Lieut. from Governor
of Sect. of War & went
on duty in new grade
(over)

Book mark :

W. B. L. O. Z.

JAN. 14

5466757

1891

Feb 1/65

Minister in to date
Feb 1/45

Promoted from
Citizen

Credited to Louis.
Wells, Jefferson County,
11th Cong. Dist. Ky

27 | 8 | H. A. H. 1865
Linn Co. Young
124 Co B 8 use H. A. H.

Return

of the Post of Paducah, Ky.,

for the month of July, 1865,
dated Not dated, 186 ,

shows the following with regard to the person
named above:

Post or station

Remarks: Superintending building
of new Hospt. On order of
Col Gussay
Joined from appt. Feb 1865
on Detach service

Book mark:

(545)

A Farley Copyist.

21

8 H. Art'y.

U.S.C.T.

James G. Young

Co. B, 8 Reg't U. S. Col'd H. Art'y.

Appears on

Company Muster Roll

for March and April, 1863.

Present or absent

Present

Stoppage, \$ 100 for

Due Gov't, \$ 100 for

Valuation of horse, \$ 100

Valuation of horse equipments, \$ 100

Remarks:

Retained on duty by
S.O. No 58 Dated Head Quarters
Post of Paducah Ky March
17th 1863-

Book mark:

(358)

J. E. Reeves

Copyist.

Ry | 8 H Artz | MSCY

Lunas C Young

124 Co B 8 acs H Artz

Return

of the Post of Paducah, Ky.,

for the month of

March

, 1865,

dated

April

, 1865,

shows the following with regard to the person
named above:

Post or station

Remarks:

For Duty

Book mark:

(546)

J. Farley

Copyist.

61 8th Reg't U.S.C.T

James O. Young
A, Co. B, 8 Reg't U. S. Col'd 8th Reg't

Appears on

Company Muster Roll

for May and June, 1863.

Present or absent

Stoppage, \$ 100 for

Due Gov't, \$ 100 for

Valuation of horse, \$ 100

Valuation of horse equipments, \$ 100

Remarks:
Transferred per S.O. No 29
Dated Hd Qrs 8. U.S.C. A.
the May 8th 1865

Book mark:

J. G. Reeves
Copyist.

7 | S H. Art'y. | U.S.C.T.

Lynus C. Young
1 Lieut, Co. F, 8 Reg't U. S. Col'd H. Art'y.

Appears on

Company Muster Roll

for May & June, 1865.

Present or absent Present

Stoppage, \$ 100 for

Due Gov't, \$ 100 for

Valuation of horse, \$ 100

Valuation of horse equipments, \$ 100

Remarks: Transferred from Co. B
8 U.S. Col'd H. Art'y. to Co. F
8 U.S. Col'd H. Art'y. per S.O.
No. 29, Ex. II dated Hd. Qrs.
8 U.S. Col'd H. Art'y. May 9 /65

Book mark: _____

G. W. Chase

4771450
y | S H. Art'y. | U.S.C.T.

Linus C. Young
1 Lieut, Co. F, 8 Reg't U. S. Col'd H. Art'y.

Appears on

Company Muster Roll

for *July & Aug*, 1865.

Present or absent *Present*

Stoppage, \$ 100 for

Due Gov't, \$ 100 for

Valuation of horse, \$ 100

Valuation of horse equipments, \$ 100

Remarks:

Book mark:

G. W. Chase

Y | S H. Art'y. | U.S.C.T.

Linn C. Young

Lieut, Co. F, 8 Reg't U. S. Col'd H. Art'y.

Appears on

Company Muster Roll

for *Sept. & Oct.*, 1865.

Present or absent *Absent*

Stoppage, \$ *100* for

Due Gov't, \$ *100* for

Valuation of horse, \$ *100*

Valuation of horse equipments, \$ *100*

Remarks: *Absent per Summons Genl Court Martial Jordan Co. Texas since Oct. 25th/1865.*

Book mark: _____

(358)

Keefe

Copyist.

2 | S H. Art'y. | U.S.C.T.

James C. Young

1st Lt., Co. F, 8 Reg't U. S. Col'd H. Art'y.

Appears on

Company Muster Roll

for *Nov. & Dec.*, 186*5*.

Present or absent *Present*

Stoppage, \$ *100* for

Due Gov't, \$ *100* for

Valuation of horse, \$ *100*

Valuation of horse equipments, \$ *100*

Remarks: *Pay due for commanding company from November 1st 1865 to Dec. 30th 1865 inclusive.*

Book mark: _____

(358)

Keefe
Copyist.

Y

8 H. Art'y.

U.S.C.T.

Linus Young

1st Lieut, Co. ^{K. 93} ~~H. 93~~, 8 Reg't U. S. Col'd H. Art'y.

Appears on Returns as follows:

July 1865. Transferred from Co
K to B. S. O. dated Aug 8th U.S.
CHAT. July 21/65 signed
Jas A. McBride Major

July 1865 (Co B) absent on
detailed Service Dept
Bridg. Genl. Host. -
Joined for duty from
appointment - Aug 1/65 -
Transferred from Co K to
B. for S. O. 13. R. Hayes
March 6th 1865 - Present

Nov 1865 (Co B) Present.
Transferred from Co B to
Co H. for S. O. 29 & 31.

May 20/65.
June 5th Aug 1865 Present
Sept 1865 Present May 1865
over

Book mark:

JAN. 20.

40744999

1899.

Oct 18 53 absent for
Summons of G.C.M.
Indiana vs. Pugh
for G.D. 1855. Present
for summons do.
Jan 18 56. - Present

2

8 H. Art'y.

U.S.C.T.

Simon C. Young

1st Lieut., Co. *F*, 8 Reg't U. S. Col'd H. Art'y.

Appears on **Co. Muster-out Roll**, dated *Victoria Texas, Feb 10*, 1866.

Muster-out to date *Feb 10*, 1866.

Last paid to *Aug 31*, 1865.

Clothing account:

Last settled....., 186 ; drawn since \$..... 100

Due soldier \$..... 100; due U. S. \$..... 100

Am't for cloth'g in kind or money adv'd \$..... 100

Due U. S. for arms, equipments, &c., \$..... 100

Bounty paid \$..... 100; due \$..... 100

Remarks: *Received commission from the Secy of War as 1st Lieut. 8 U.S.C. Art. Hy from civil life at Springfield, Mass. Assigned to Co. B, 8th U.S.C. Art. Hy Per S. O. (over)*

Book mark :

Keeper.

(361)

Copyist.

JAN. 14

5476848

1891 *

No. — Hd Qrs. 8th U.S.C. Art Hy
and mustered into service
as herein set forth. Trans-
ferred from Co. B. 8th U.S.C.
Art. H. to Co. F. 8th U.S.C. Art H
per S. O. No. 29 dated Hd Qrs
8th U.S.C. Art Hy, City Point, Va
May 8th 1865. Pay due for
commanding Co. from Nov.
1st '65 to Dec 30th '65.

Y | S H. Art'y. | **U.S.C.T.**

Linas C. Young
1st Lt., Co. B, 8 Reg't U. S. Col'd H. Art'y.

Appears on **Co. Muster-out Roll**, dated
Victoria, Texas, Feb. 11th, 1866.

Muster-out to date _____, 186 .

Last paid to *Apr. 20th*, 1865.

Clothing account:

Last settled _____, 186 ; drawn since \$ _____ 100

Due soldier \$ _____ 100; due U. S. \$ _____ 100

Am't for cloth'g in kind or money adv'd \$ _____ 100

Due U. S. for arms, equipments, &c., \$ _____ 100

Bounty paid \$ _____ 100; due \$ _____ 100

Remarks: *Entered service from*
Civil War. Rec'd appoint-
ment as 1st Lieut. in 8th Regt.
8th Art. H. and mustered as
herein shown and assign-
ed to duty in Co. B. 8th Art. H.
(over)

Book mark: _____

Randall

JAN. 14

5471291

1891

a. (Hy) Per. S.O. No. 9, dated
Hd. Qrs. 8th Md. C. A. Hy.
Feb. 1st 1865. Transferred
to Co. B. 8th Md. C. A. Hy.
Per. S.O. no. 13, dated Hd.
Qrs. 8th Md. C. A. (Hy) Feb. 9th
1865. Transferred to Co. F.
8th Md. C. A. (Hy) Per. S.O.
No. 29, dated Hd. Qrs. 8th Md.
C. A. (Hy) May 8. 1865.

Young, L. C.
Lt., Co. 15

8 U.S.C.H.A.
Reg't

2 Enclosures.

Bed Cards	Descriptive Lists
Burial Records	Final Statements
Certs. of Dis. for Discharge	Furloughs /
C. M. Charges	Med. Des. Lists
Med. Certificates	Orders

Other papers relating to—

Admission to Hosp'l	Furlough
Casualty Sheet (Officer's)	Med. Examination
Confinement	Misc. Information 2
Contracts	Pay or Clothing
Death or Effects	Personal Reports
Desertions	Rank
Discharge from Hosp'l	Transfer to Hosp'l
Discharge from Service	Transfer to V. R. C.
Duty	Transportation
.....

copy, c

Head Quarters 8th U.S. Army
Tulacah, July 1st 1868

Order

Private James Wanna having received an appointment
to the position of Private in the 8th U.S. Army and
is hereby ordered to report to the Head Quarters for duty,
in the 8th U.S. Army, in Co
"K."

Warrant of
W. M. Barry
Commanding 8th U.S. Army
D. S. C.
1st Lt. & Adj.

Lieut. S. G. Gray
Co "K." 8th U.S. Army

Paducah Ky.

March 28/55.

L. C. Yermie
1st. Lt. 8 us. c. arty.

• Informs that he has
been regularly mustered
and credited to Louisville
Jefferson Co. Ky.

Desires to be properly
credited to the above
State, Dist. & County

As per record
of 1/1/55.

Head Qrs. Co. B. 8th U. S. C. Artillery
Paducah Ky. Mch 28th 1865

Lt Col W. H. Sidell
Provost Marshal Genl State Ohio Ky
Sir

I have the honor to inform you that I have been regularly mustered and credited to Louisville Jefferson Co 5th Congl Dist Ky will you have the kindness to forward the County (I see) at your earliest convenience

Very respectfully
Your obtl servt
L. C. Young
P. S. 8th U. S. C. Artillery

To
W. H. Sidell Lt. Col & Prov. Marshal Genl
State Ky.

S. J. Will you have the kindness to see that I am properly credited to the above State, Dist. and County and oblige
L. C. Young

1865

S. P. Young
Lieut. 8th U.S.A.

E. P. P. 20
Headquarters 8th U.S.A.
City, Penn. Va. Apr 30. 65

Respectfully forwarded
approved

W. B. Scott
Major Command
8th U.S.A.

Headquarters City, Penn. Va
May 1. 1865

Granted.

In Order of
B. L. Brig. Genl. Russell
The Adjutant &
Capt. H. H. H.

Recd (at 2m) May 1 1865

L B 108

[Faint, mostly illegible handwritten text in the left margin]

1851
City of New York
Sept 20th 1851
J. J. Smith

I would respectfully
request a leave of absence, for two days
to visit Philadelphia for the purpose of conducting
business.

I am respectfully
Yours,
J. J. Smith

THE UNIVERSITY OF CHICAGO
LIBRARY
540 EAST 57TH STREET
CHICAGO, ILL. 60637

I, James C. Young Private 1st Co. 1st
Regiment U. S. M. M. Volunteers, being duly sworn, do

say; that I have not been responsible for any Government property whatever, for which I have not rendered all required accounts and returns; that I am not now indebted to the United States on any account whatever, and that I have rendered all reports required by Army Regulations. So help me God.

Sworn to and subscribed before me
this 12 day of March, 1866, at Louis-
ville, Ky.

James C. Young
Private 1st Co. 1st

John C. Sheets

Notary Public.



1983

Young Mark

Co C, 8 U.S. Col'd H. Art'y.

Private Private

CARD NUMBERS.

1	5467311	26
2	5467201	27
3	5474758	28
4	5474885	29
5	5475005	30
6	5475129	31
7	5475243	32
8	5475352	33
9	5475448	34
10	5475551	35
11	5475639	36
12	5467725	37
12	9122327	38
14	33204616	39
15	33207313	40
16	32205268	41
17	32205080	42
18	40745000	43
19		44
20		45
21		46
22		47
23		48
24		49
25		50

Book Mark:

See also

M | 8 H. Art'y. | U.S.C.T.

Frank Young

....., Co. *B*, 8 Reg't U.S. Col'd H. Art'y.

Appears on

Company Descriptive Book
of the organization named above.

DESCRIPTION.

Age *24* years; height *5* feet *7* inches.

Complexion *Blk*

Eyes *Blk* ; hair *Blk*

Where born *Lyon Co., Ky*

Occupation *Farmer*

ENLISTMENT.

When *Sept. 10*, 186*4*.

Where *Cadwell, Ky*

By whom *Capt Hall* ; term *3* y'rs.

Remarks:

.....
.....
.....
.....
.....
.....
.....
.....

E. J. McDaniel

Mark Young

Appears with rank of *Pri* on

Muster and Descriptive Roll of a Detachment of U. S. Vols. forwarded

for the 8 Reg't U. S. Col'd H. Art'y. Roll dated

Panueah, Ky., ~~NY~~ ^{Mo} 30, 1864.

Where born *Lyon Ky.*

Age *24* y'rs; occupation *Farmer*

When enlisted *Sep 10*, 186 .

Where enlisted *Panueah, Ky.*

For what period enlisted *3* years.

Eyes *blk*; hair *blk*

Complexion *yellow*; height *5* ft. *7* in.

When mustered in *Sep 10*, 186 .

Where mustered in *Panueah*

Bounty paid \$ *100*; due \$ *100*

Where credited *Meacham Co. ^{Ind} ~~Ind~~ Ky*

Company to which assigned *E*

Remarks :

Book mark :

Provy, J.

7 | 8 H. Art'y. | U.S.C.T.

Mark Young

Appears with rank of *Private* on

Muster and Descriptive Roll of a Detachment of U. S. Vols. forwarded

for the 8 Reg't U. S. Col'd H. Art'y. Roll dated

Paducah, Ky., N.Y. Sept. 30, 1864.

Where born *Lyon, Ky.*

Age *24* y'rs; occupation *Farmer*

When enlisted *Sept. 10*, 186 .

Where enlisted *Paducah, Ky.*

For what period enlisted *3* years.

Eyes *Black*; hair *Black*

Complexion *Black*; height *5* ft. *7* in.

When mustered in *Sept. 10*, 186 .

Where mustered in *Paducah*

Bounty paid \$ *100*; due \$ *100*

Where credited *McCracken, W.D. Ky*

Company to which assigned *G*

Remarks :

Book mark : *7 1397- Ky*

Callaway
(339) Copyist.

Y

S H. Art'y.

U.S.C.T.

Mark Young

Plk, Co. E, 8 Reg't U. S. Col'd H. Art'y.

Appears on

Company Muster Roll

for *Sept and Oct*, 186*4*.

Present or absent *Present*

Stoppage, \$ *100* for

Due Gov't, \$ *100* for

Valuation of horse, \$ *100*

Valuation of horse equipments, \$ *100*

Remarks:

Book mark:

Fair. v. Kearny
Copyist.

Y

S H. Art'y.

U.S.C.T.

Mark Young

Priv., Co. E, 8 Reg't U. S. Col'd H. Art'y.

Appears on

Company Muster Roll

for Nov. & Dec., 1864.

Present or absent Present

Stoppage, \$ 100 for

Due Gov't, \$ 100 for

Valuation of horse, \$ 100

Valuation of horse equipments, \$ 100

Remarks:

Book mark:

C. E. M. Laughlin

(358)

Copyist.

Y

8 H. Art'y.

U.S.C.T.

Mark Young
Priv., Co. E, 8 Reg't U. S. Col'd H. Art'y.

Appears on

Company Muster Roll

for Jan. & Feb., 1865.

Present or absent Present

Stoppage, \$ 100 for

Due Gov't, \$ 100 for

Valuation of horse, \$ 100

Valuation of horse equipments, \$ 100

Remarks: Due U. S. for one
Canteen and Haversack
\$1.60

Book mark:

C. E. M. Laughlin

(358)

Copyist.

7 | 8 H. Art'y. | U.S.C.T.

Mark Young
Priv., Co. E, 8 Reg't U. S. Col'd H. Art'y.

Appears on

Company Muster Roll
for Mar. & Apr., 1865.

Present or absent Absent

Stoppage, \$ 100 for

Due Gov't, \$ 100 for

Valuation of horse, \$ 100

Valuation of horse equipments, \$ 100

Remarks: Absent in
Hospital Sick at
Washington D.C.
Since Apr. 20th 64.

Book mark:

C. E. M. Laughlin
(358) Copyist.

U. S. A. Art. U. S. A. T.

Mark Young
Priv., Co. E, 8th Reg't U. S. A. Art.

Appears on

Hospital Muster Roll

of L'Ouverture U. S. A. General Hospital,

at Alexandria, Va.,

for March & April, 1865.

Attached to hospital :

When April 20, 1865.

How employed _____

Last paid by Maj. _____

to _____, 1865.

Bounty paid \$ 100; due \$ 100

Present or absent Present

Remarks: _____

Book mark: _____

J. D. Neale

Y

8 H. Art'y. U.S.C.T.

Mark Young
Priv., Co. E, 8 Reg't U. S. Col'd H. Art'y.

Appears on

Company Muster Roll

for *May & June*, 1865.

Present or absent *Absent*

Stoppage, \$ *100* for

Due Gov't, \$ *100* for

Valuation of horse, \$ *100*

Valuation of horse equipments, \$ *100*

Remarks: *Absent Sick.*

Book mark:

C. E. M. Laughlin
Copyist.

(358)

Y. J. A. U.S.C.T.
Mark Young
Priv., Co. E, 8th Reg't U.S.C.T.

Appears on

Hospital Muster Roll

of **L'Ouverture U. S. A. General Hospital,**

at **Alexandria, Va.,**

for *May & June*, 186*5*

Attached to hospital :

When *April 20*, 186*5*.

How employed _____

Last paid by Maj. _____

to _____, 186 .

Bounty paid \$ 100; due \$ 100

Present or absent *Present*

Remarks: _____

Has no des-
criptive list

Book mark: _____

W. J. Cook
Copyist.

Y | 8 H. Art'y. | U.S.C.T.

Mark Young

Plt, Co. E, 8 Reg't U. S. Col'd H. Art'y.

Appears on

Company Muster Roll

for *July + Aug.*, 1865.

Present or absent *Absent*

Stoppage, \$ *100* for

Due Gov't, \$ *100* for

Valuation of horse, \$ *100*

Valuation of horse equipments, \$ *100*

Remarks: *Sick in Hosp. at Washington D.C. Since May 24, 1865.*

Book mark:

E. C. Carroll

G. I. Hart, U.S.C.T.
Mark Young
Priv., Co. E, 8th Reg't U.S.C.A.

Appears on

Hospital Muster Roll

of L'Ouverture U. S. A. General Hospital,

at Alexandria, Va.,

for July 8, Aug.,, 1865.

Attached to hospital:

When Apr 20, 1865.

How employed _____

Last paid by Maj. Eaton

to June 30, 1865.

Bounty paid \$ 100; due \$ 100

Present or absent Present

Remarks: _____

Book mark: _____

J. D. Neale
Copyist.

Y

8 H. Art'y.

U.S.C.T.

Mark Young

Pvt., Co. E, 8 Reg't U. S. Col'd H. Art'y.

Appears on

Company Muster Roll

for *Sept & Oct*, 1865.

Present or absent *Absent*

Stoppage, \$ *100* for

Due Gov't, \$ *100* for

Valuation of horse, \$ *100*

Valuation of horse equipments, \$ *100*

Remarks: *Absent Sick at Washington D.C. Since May 20th 1865.*

Book mark:

E. Carroll

Y 1 S.A. U.S.A.

Mark Young
Priv., Co. E, 8 Reg't U.S.A.

Appears on

Hospital Muster Roll

of **Slough U. S. A. General Hospital,**

at **Alexandria, Va.,**

for Sept & Oct, 1865.

Attached to hospital:

When Sept 16, 1865.

How employed Patient

Last paid by Maj.

to, 186 .

Bounty paid \$ 100; due \$ 100

Present or absent present

Remarks:

.....
.....
.....
.....
.....
.....
.....
.....

Book mark :

(343)

J. Brown

Copyist

Y | 8 H. Art'y. | U.S.C.T.

Mark Young
Pvt., Co. E, 8 Reg't U. S. Col'd H. Art'y.

Appears on

Company Muster Roll

for *Nov & Dec*, 1865.

Present or absent *Absent*

Stoppage, \$ *100* for

Due Gov't, \$ *100* for

Valuation of horse, \$ *100*

Valuation of horse equipments, \$ *100*

Remarks: *Absent sick at Washington D.C. Since May 20th 1865.*

Book mark:

E. C. Carroll

Y | *8 H. Arty* | **U.S.C.T.**

Mark Young
Priv., Co. E., 8 Reg't U.S. Col'd H. Arty

Appears on a

List of Discharges furnished by C. M. O. of State,
under the provisions of circular dated A. G. O.,
June 29, 1865.

Discharge furnished *March 13^x*, 1866,
to date from *March 13^x*, 1866.

Remarks: *Des. List returned after discharge was furnished Paid by Maj. Eaton for May & June 1865. Clothing settled by Capt Snyder*

x *ms*

Book Mark :

S. Bureau
(360) Copyist.

U.

S H. Art'y.

U.S.C.T.

Mark Young

Co. E., 8 Reg't U. S. Col'd H. Art'y.

Appears on Returns as follows:

Asst Gen May 1863 absent
sick at Washington D.C.
since April 20/63.

June 1863 absent sick at
Alex. Va since April 24/63.

July 1863 absent sick N.O.

La. since June 21/63.

Aug 1. Oct 1863 absent sick
Alexandria Va since April
20/63.

Nov 1863 to Aug 1864 absent
sick Washington D.C.
since May 20/63.

Book mark:

Wm. J. ...

Y

H. Art'y.

U.S.C.T.

Mark Young

Plt, Co. *E*, 8 Reg't U. S. Col'd H. Art'y.

Appears on **Co. Muster-out Roll**, dated
Victoria Texas, Feb 10, 1866.

Muster-out to date _____, 186 .

Last paid to *Oct 31, 1864*.

Clothing account:

Last settled _____, 186 ; drawn since \$ _____ 100

Due soldier \$ _____ 100; due U. S. \$ _____ 100

Am't for cloth'g in kind or money adv'd \$ _____ 100

Due U. S. for arms, equipments, &c., \$ _____ 100

Bounty paid \$ _____ 100; due \$ _____ 100

Remarks: *Continued service as*
Recruit, joined Co for duty Sept
10. 1864. Absent sick at Wash,
D.C. since May 24. 65. Des. list
furnished May 24. 65. No. discharge
given. Am't of Clo. drawn in Co \$55⁰⁵
Book mark: *No. on file. Y-1397. Ky.*

E. B. Carroll

(261)

Copyist.

Young, Mark
B. Co. 8

Reg't U.S. Army

2 Enclosures.

- | | |
|------------------------------------|-------------------------|
| Bed Cards | Descriptive Lists |
| Burial Records | Final Statements |
| Certs. of Dis. for Discharge | Furloughs |
| C. M. Charges | Med. Des. Lists |
| Med. Certificates | Orders |

Existence 1

Other papers relating to—

- | | |
|----------------------------------|----------------------------|
| Admission to Hosp'l | Furlough |
| Casualty Sheet (Officer's) | Med. Examination |
| Confinement | Misc. Information |
| Contracts | Pay or Clothing |
| Death or Effects | Personal Reports |
| Desertions | Rank |
| Discharge from Hosp'l | Transfer to Hosp'l |
| Discharge from Service | Transfer to V. R. C. |
| Duty | Transportation |

MICROFILM PUBLICATION M1829

COMPILED MILITARY SERVICE RECORDS
OF VOLUNTEER UNION SOLDIERS WHO SERVED WITH
THE UNITED STATES COLORED TROOPS (USCT)
8TH REGIMENT OF HEAVY ARTILLY

PERSONAL PAPERS' TARGET SHEET

PLEASE NOTE THE CHECKED INFORMATION ABOUT THE PERSONAL PAPERS IN
THIS FILE:

- NO PERSONAL PAPERS WERE FOUND IN THIS FILE WHEN THE
RECORDS WERE ARRANGED FOR MICROFILMING.

- 3 PERSONAL PAPER(S) FOUND IN THIS FILE WHEN THE RECORDS
WERE ARRANGED FOR MICROFILMING.

UNITED STATES COLORED TROOPS ENLISTMENT.

STATE OF

TOWN OF

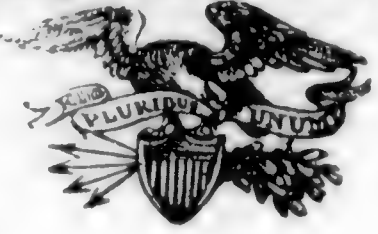

I, Young Mark born in Paducah
in the State of Kentucky aged Twenty four years
and by occupation a Farmer Do HEREBY ACKNOWLEDGE to have
volunteered this Tenth day of September 1864,

to serve as a **Soldier** in the **Army of the United States of America**, for
the period of **THREE YEARS**, unless sooner discharged by proper authority:
Do also agree to accept such bounty, pay, rations, and clothing, as are, or may be,
established by law for the U. S. colored troops.

And I, Mark Young of Paducah Co
do solemnly swear, that I will bear true faith and allegiance to the **United States
of America**, and that I will serve them honestly and faithfully against all their
enemies or opposers whomsoever; and that I will observe and obey the orders of
the President of the United States, and the orders of the officers appointed over
me, according to the Rules and Articles of War.

Sworn and subscribed to, at Paducah Ky
this 10th day of Sept 1864, } Mark Young
Before Capt. P. H. Hall } mark

I CERTIFY, ON HONOR, That I have carefully examined the above named Volunteer, agreeably to the
General Regulations of the Army, and that, in my opinion, he is free from all bodily defects and mental infirmity,
which would in any way disqualify him from performing the duties of a soldier.

M. H. Keida

EXAMINING SURGEON.

I CERTIFY, ON HONOR, That I have minutely inspected the Volunteer, Mark Young
previously to his enlistment, and that he was entirely sober when enlisted; that, to the best of my judgment and
belief, he is of lawful age; and that, in accepting him as duly qualified to perform the duties of an able-bodied
soldier, I have strictly observed the regulations which govern the recruiting service. This soldier has
eyes, Blue, hair, Black, complexion, is five feet 7 inches high.

RECRUITING OFFICER OR AGENT.

Mustered into the United States service 10th day of September 1864

P. H. Hall
Capt. Pro Mars Mustering Officer.

Mustered into the service of the United States, for three years or during the war, from date of enlistment, in Company B
Regiment of Madison Artillery Volunteers, on the 10th day of September, 1864, at Paducah Ky

Capt. P. H. Hall
Pro Mars
W. H. Keida

NOTE 1.—This blank will be used for enlistments of United States colored troops. They will be made out in duplicate in all cases—one to accompany the recruiting return of the superintendent (not the recruiting officer) to the Adjutant General, and one to accompany the accounts of the officer who pays bounty, &c.

NOTE 2.—An enlistment holds to service. A muster-in, must in all cases, precede payment of pay, bounty, pension, &c. A muster-in roll, must in all cases, be filed in the Adjutant General's Office as evidence of muster-in. The mustering officer, commissary, or assistant commissary of musters, as the case may be, will countersign both enlistments as having mustered the soldier into the service of the United States before either of them is given to the disbursing officer.

DECLARATION OF RECRUIT.

I, Martin Young of M. Gracien desiring to volunteer as a soldier in the ARMY OF THE UNITED STATES, for the term of Three Years, DO DECLARE That I am Twenty four years and months of age; that I have never been discharged from the United States service on account of disability or by sentence of a court-martial, or by order before the expiration of a term of enlistment; and I know of no impediment to my serving honestly and faithfully as a soldier for three years.

GIVEN at Paducah Ky

the 10th day of September 1864

Witness:

[Handwritten signature]

Martin Young
of M. Gracien

By John W. Gracien
Commissary of Musters
1864

No. 1115

1115

Consent of Parent or Guardian in case of a Minor, if a Free Man, or in the case of a Slave, of the Person to whom he owes Service:

I, Do CERTIFY, That I am the that the said is years of age; and I do freely give my CONSENT to his volunteering as a SOLDIER in the Army of the United States, for the period of THREE YEARS, under the conditions of the laws of the United States.

GIVEN at

the day of

Witness:

War Department,

ADJUTANT GENERAL'S OFFICE,

Washington, *March 7* 1867.

Respectfully returned to the Commission for the State of Kentucky, with the information that *Levie W Young* was enlisted at *Paducah Ky*, Sept. 10. 1864, and was mustered in as *Private* in *Co. "E"* 8th U.S. Colored Troops, Sept. 10. 1864.

1897 Ky

A. F. Richmond

W. H. G.

Asst. Adj't General.

(Original Copy) 1843

ENDORSEMENT.

1. 97
No. *1843*

APPLICATION OF

Levie W Young

OF

Muslin Young

For compensation of service of slave,

Enlisted *26th April* 1864

in *C. Co. 8th N. Artil.* Regiment
U. S. Colored Troops.

Received *25 Jan'y* 1867

Compensation awarded

186

Dollars.

President Board of Claims.

CLAIMANT'S ATTORNEYS,

J. W. Cardwell & Co
Louisville Ky

CLAIMANT'S P. O. ADDRESS,

Levie W. Young
Paducah Ky

Contract No 46 Miss List

CLAIM FOR COMPENSATION FOR ENLISTED SLAVE.

No.

I, *Jessie W. Young*, a loyal citizen, and
a resident of *Laurel* County of *McCracken* State of
Kentucky, hereby claim compensation, under the provisions of

section 24, Act approved February 24, 1864, and Section 2, Act approved July 28, 1866, for my
slave *Mark Young* enlisted *April 26th*
1864, at *Paducah Ky* by *Henry A. H.*

in the *8th Light* Regiment U. S. Colored Troops,
Co. *"C"* certificate of enlistment, and a descriptive list, as required, accompany
this application. *(I bought this slave from my father's estate and have owned him for near twenty years)*

In proof of my loyalty to the Constitution and Government of the United States, I present
the accompanying oath, which I have taken, signed and acknowledged; to be filed with this
application, in accordance with requirement of General Orders, No. 329, 1863, War Department,
Adjutant General's Office.

Jessie W. Young
Applicant.

Witness: *D. Kat. Wilson*

J. M. Woodruff

Two witnesses to
owner's signature
sign here.

Paducah Ky Dec 12th 186*6*

OATH OF ALLEGIANCE.

I, *Jessie W. Young*, the owner and claimant, do solemnly swear that the foregoing
claim is a just and true claim due to me as master and owner of the said slave, and that the facts alleged in said claim, in respect to the
draft or enlistment (as the case may be) of said slave into the military service of the United States, are true. And I do further swear that I
have never joined, or been concerned in, any insurrection or rebellion; that I have never borne arms against the United States; that I have
never given any aid, countenance, counsel or encouragement, to any person or persons engaged, or whom I had reason to believe were about to
engage, in insurrection, rebellion, or armed hostility against the United States; that I have neither sought, nor accepted, nor attempted to
exercise the functions of any office, civil or military, nor to perform any service whatever, under any authority, or pretended authority, in
hostility to the United States; that I have not yielded a voluntary support to any insurrection, rebellion, or pretended government
authority, power or constitution within the United States hostile thereto. And I do further swear that, to the best of my knowledge and
ability, I have supported and defended, and will continue to support and defend, the United States against all enemies foreign and domestic,
and that I have supported, defended and obeyed, and will continue to support, defend and obey, the Constitution and laws of the United States;
that I will bear true faith and allegiance to the same; and that I take this oath freely, without any mental reservation or purpose of
evasion: So help me God.

5 CENT STAMP. The owner } *Jessie W. Young*
signs here. }

Sworn to and subscribed before me *P. H. Yeiser Not Public*
of McCracken county

this *12th* day of *December* 186*6*
at my office *Paducah Ky*

The officer swear-
ing the owner signs
here.

P. H. Yeiser
Notary Public in & C. (L. S.)

Know all men by these Presents, that I, *Jessie W. Young* of *McCracken*
County, State of *Kentucky* do hereby constitute and appoint, with full power of
substitution and revocation, *J. K. Starnwell Dec* of the City of Louisville, in the County of Jefferson, State of Kentucky, my
true and lawful Attorneys, irrevocable, to prosecute my claims against the United States Government, for slave named *Mark*
and to receive and receipt for all orders or certificates that may be issued in payment thereof

Witness: *D. Kat. Wilson*
J. M. Woodruff

Jessie W. Young
Applicant.

50 CENT STAMP.

DIRECTIONS FOR FILLING UP THE ABOVE BLANKS.

1. Name of claimant: his name must be given in full, and he must be the owner, in his own right, of the slave claimed at the time he was mustered into the United States service, and the time application is made.
 2. Name of city or town in which claimant lives.
 3. Name of county in which claimant lives.
 4. Name of State in which claimant lives.
 5. Name of slave for whom compensation is claimed.
 6. Date of his enlistment.
 7. Where he enlisted.
 8. By whom he was enlisted.
 9. Number of Regiment to which he was assigned.
 10. Letter of Company he served in.
- NOTE.—Where there is a doubt as to the fact stated in a blank, do not fill the blank.

PROOF OF OWNERSHIP.

State of Kentucky,
County of *McCracken* } ss.

We, *John W. Caland* and *W. R. Leigh* each of lawful age, and resident citizens of the State and County aforesaid, do certify that *Jesse W. Young* of the State and County aforesaid, was on the *7th* day of *September* 186*6* the lawful owner of the Slave named *Mark Young*, referred to and described in the foregoing claim for compensation.

Two witnesses to ownership sign here.

John W. Caldwell
W. R. Leigh

Sworn to and subscribed before me, a *Notary Public* for the County of *McCracken* State of Kentucky, this, the *12th* day of *December*, 186*6* at my office *Paducah Ky*



The officer swearing the witnesses signs here.

P. D. Garrison
Notary Public L. S.

PROOF OF LOYALTY.

State of Kentucky,
County of *McCracken* } ss.

We, *John W. Caland* and *W. R. Leigh* loyal men, and each of lawful age, and resident citizens of the *Vicinity & City* of *Paducah* in the State and County aforesaid, upon our oaths declare that we have known *Jesse W. Young* a resident of the State and County aforesaid, since the 4th day of March, 1861, and know that he has firmly and faithfully maintained his or her adherence and allegiance to the Government of the United States, by defending its cause against the Government and forces of the so-called Confederate States of America, in all suitable and practicable ways, and according to his or her ability and opportunity.



John W. Caldwell
W. R. Leigh

Sworn to and subscribed before me, a *Notary Public* for the County of *McCracken* State of *Kentucky* this *12th* day of *December* 186*6* at my office *Paducah Ky*

The officer swearing the witnesses signs here.

Notary Public L. S.

W. J. Dowsley & G. W. Shirell Post Master *Woodville Ky* each of us residents of the County of *McCracken* in the State of *Kentucky* on oath state that we are and have been for *Six* years well acquainted with *Jesse W. Young* the applicant, and *John W. Caldwell* and *W. R. Leigh* his witnesses, and from our personal acquaintance with them believe their statements to be entitled to full faith and credit.

W. J. Dowsley
G. W. Shirell

Sworn to and subscribed before me, a *notary public* for the County of *McCracken* State of *Kentucky* this *24th* day of *Dec* 186*6* by *W. J. Dowsley - G. W. Shirell* the Post Master *was not sworn* *Paducah Ky*



If the applicant and his witnesses are not personally known to one or more of the Commissioners, the above certificate should be signed by citizens who are well known to the Commissioners, or by a Post Master or other Government officer; if signed by a United States officer it need not be sworn to, but if by citizens it must be sworn to. When a United States officer signs it the witnesses need not, and when the witnesses sign it the United States officer need not.

Jesse W Young

I Mark Young late a Private in Company "E" 8th Regiment, United States Colored Heavy Artillery, state under oath that before being mustered into the United States Service I was the slave of Jesse W. Young of McCracken County, State of Kentucky.

That I am personally acquainted with _____, late a _____ in Company _____ of _____ Regiment United States Colored _____, and know that before he was mustered into the United States Service, he was the slave of _____ of _____ County, State of Kentucky.

ATTEST:

L. Stat. Wilson
W. Bloomfield

Mark Young his mark

Sworn to, and subscribed in my presence, at Paducah Ky, this 15th day of December 1866

Official Signatures.

P. D. ...
P. W. ...

INSTRUCTIONS.

- 1 Name of affiant as borne on the Muster Rolls regardless of the name known by at home.
2 Rank—Private, Corporal or Sergeant.
3 Letter of Company and Number of Regiment.
4 Cavalry, Infantry or Artillery, as the case may be.
5 The name of his former owner.
6 Name of the County in which the Owner lives.
7 Name of the Soldier the affiant wishes to identify. (The name must be given as it is borne on the Muster Rolls in all cases.)
8 Names of Two disinterested witnesses.
NOTE—Where the former slave identifies himself, blank No. 7 and all below to the Sixth need not be filled up. Claimants needing more blanks can be supplied by calling on our Agent, or at the Office, No. 129 Jefferson Street, Louisville, Ky.

1904
Young Mike Michael
Co E, 8 U.S. Col'd H. Art'y.

Private Private

CARD NUMBERS.

1	5467310	26
2	5467200	27
3	5474761	28
4	5474888	29
5	5475008	30
6	5475128	31
7	5475245	32
8	5467665	33
9	5475649	34
10	9122328	35
11	40745001	36
12		37
13		38
14		39
15		40
16		41
17		42
18		43
19		44
20		45
21		46
22		47
23		48
24		49
25		50

Book Mark: E. B. 7. 12 P. 24.

See also

4 | 8 H. Art'y. | U.S.C.T.

Mike Young

, Co. E, 8 Reg't U.S. Col'd H. Art'y.

Appears on

Company Descriptive Book

of the organization named above.

DESCRIPTION.

Age 31 years; height 5 feet 7 inches.

Complexion *Blk*

Eyes *Blk*; hair *Blk*

Where born *Todd Co., Ky*

Occupation *Fanner*

ENLISTMENT.

When *Sept. 10*, 1864.

Where *Paducah, Ky*

By whom *Capt. Hall*; term *3* y'rs.

Remarks: *Discharged May 24, 65*

E. A. Moreland

(383a)

Copyist.

J | **S H. Art'y.** | **U.S.C.T.**
Mike Young

Appears with rank of *Pri* on

Muster and Descriptive Roll of a Detachment of U. S. Vols. forwarded

for the 8 Reg't U. S. Col'd H. Art'y. Roll dated

Panama Ky., N.Y. Sep 30, 1864.

Where born *Todd Ky*

Age *31* y'rs; occupation *Farmer*

When enlisted *Sep 10*, 1864.

Where enlisted *Panama Ky.*

For what period enlisted *3* years.

Eyes *Blk*; hair *Blk*

Complexion *Yellow*; height *5* ft. *7* in.

When mustered in *Sep 10*, 1864.

Where mustered in *Panama*

Bounty paid \$ *100*; due \$ *100*

Where credited *Wheeler Co. 1st Dis. Regt.*

Company to which assigned *E*

Remarks:

Book mark:

Murray Jr.
Copyist.

27

8 H. Art'y. U.S.C.T.

Mike Young

Appears with rank of Private on

Muster and Descriptive Roll of a Detachment of U. S. Vols. forwarded

for the 8 Reg't U. S. Col'd H. Art'y. Roll dated

Paduoch, Ky, N.Y. Sept 30, 1864.

Where born Todd, Ky.

Age 31 y'rs; occupation Farmer

When enlisted Sept. 10, 186 .

Where enlisted Paduoch, Ky.

For what period enlisted 3 years.

Eyes Black; hair Black

Complexion Black; height 5 ft. 7 in.

When mustered in Sept. 10, 186 .

Where mustered in Paduoch

Bounty paid \$ 100; due \$ 100

Where credited Mackin, D. Ky.

Company to which assigned B

Remarks:

Book mark:

Caesway

(339)

Copyist.

Y

S H. Art'y.

U.S.C.T.

Michael Young

Prk, Co. E, 8 Reg't U. S. Co'd H. Art'y.

Appears on

Company Muster Roll

for *Sept and Oct*, 1864.

Present or absent *Present*

Stoppage, \$ *100* for

Due Gov't, \$ *100* for

Valuation of horse, \$ *100*

Valuation of horse equipments, \$ *100*

Remarks:

Book mark:

J. v. Keamy
Copyist.

Y | S H. Art'y. | U.S.C.T.

Michael Young
Priv., Co. E, 8 Reg't U. S. Col'd H. Art'y.

Appears on

Company Muster Roll

for Nov. & Dec., 1864.

Present or absent Present

Stoppage, \$ 100 for

Due Gov't, \$ 100 for

Valuation of horse, \$ 100

Valuation of horse equipments, \$ 100

Remarks:

Book mark:

(358) C. E. M. Laughlin Copyist.

1864

Y | 8 H. Art'y. | U.S.C.T.

Michael Young
Priv., Co. E, 8 Reg't U. S. Col'd H. Art'y.

Appears on

Company Muster Roll

for *Jan. + Feb.*, 1865.

Present or absent *Present*

Stoppage, \$ *100* for

Due Gov't, \$ *100* for

Valuation of horse, \$ *100*

Valuation of horse equipments, \$ *100*

Remarks: *Due the U.S. for one canteen and one Haversack \$1.60*

Book mark:

C. E. M. Laughlin
Copyist.

(358)

Y | S H. Art'y. | U.S.C.T.

Michael Young
Priv., Co. E, 8 Reg't U. S. Col'd H. Art'y.

Appears on

Company Muster Roll

for *Mar. & Apr.*, 186*3*.

Present or absent *Present*

Stoppage, \$ 100 for

Due Gov't, \$ 100 for

Valuation of horse, \$ 100

Valuation of horse equipments, \$ 100

Remarks: *Due the U.S.
for C. and G. E. \$160
100*

Book mark: _____

C. E. M. Laughlin
Coptist.

Y

8 H. Art'y.

U.S.C.T.

Michael Young

Priv. , Co. E, 8 Reg't U. S. Col'd H. Art'y.

Appears on

Company Muster Roll

for May & June, 1865.

Present or absent

Stoppage, \$ 100 for

Due Gov't, \$ 100 for

Valuation of horse, \$ 100

Valuation of horse equipments, \$ 100

Remarks: Discharged for
Disability May 25,
1865

Book mark: Discharged May 24/65
E.B.V. 12. P. 24

C. E. M. Laughlin

(358)

Copyist.

Y. | 8 H. Art'y. | U.S.C.T.

Michael Young

Priv., Co. *E*, 8 Reg't U. S. Col'd H. Art'y.

Appears on Returns as follows:

May 18 '63 *May 24 '63:*
amb. Nicholas-Richard
for disability.

Book mark:

(546)

Wm. P. ...

Copyist.

Y 18 A. Arty | U.S.C.T.

Michael Young
Priv., Co. E, 8 Reg't U. S. Col'd A. Arty.

Appears on an

Individual Muster-out Roll

of the organization named above. Roll dated

St. Monroe, Va., June 28, 1865.

Muster-out to date June 28, 1865:

Last paid to Oct. 31, 1864.

Clothing account:

Last settled Apr. 30, 1865; drawn since \$ 100

Due soldier \$ 100; due U. S. \$ 100

Am't for cloth'g in kind or money adv'd \$ 2 32
100

Due U. S. for arms, equipments, &c., \$ 100

Bounty paid \$ 100 due \$ 100

Remarks: Due U.S. for clothing
over drawn on last settlement
Apr. 30, '65, \$24.23,
due U.S. for Q & G. C. \$1.60
Accountable for Knapsack,
Haversack & Canteen. (over)

Book mark: _____

W Beck
Copyist.

JAN. 14

5467665

1891

*mustered out by order
of War Dept. dated
May 3 '65.
Patient in U.S. Genl. Hosp.
Fort. Monroe, Va.*

14

S H. Art'y.

U.S.C.T.

Mike Young

Priv., Co. E, 8 Reg't U. S. Col'd H. Art'y.

Appears on Co. Muster-out Roll, dated
Victoria Texas, Feb 10, 1866.

Muster-out to date _____, 186 .

Last paid to Oct 31, 1864 .

Clothing account:

Last settled _____, 186 ; drawn since \$ _____ 100

Due soldier \$ _____ 100; due U. S. \$ _____ 100

Am't for cloth'g in kind or money adv'd \$ _____ 100

Due U. S. for arms, equipments, &c., \$ _____ 100

Bounty paid \$ _____ 100; due \$ _____ 100

Remarks: Entered Service as recruit
joined Co for duty Sept 10. 64.
Discharged at Camp Lincoln
Va. May 24. 65 per G.O. No 77
Par. 6 (68) War Dept. Des. list
furnished May 12. 65.

Book mark: C, D

E. C. Carroll

(261)

Copyist.

--	--	--

Young, Mike

J. E., Co. *S*, Reg't *U S C H A*

Enclosures.

Bed Cards	Final Statements
Burial Records	Furloughs or L. of A.
Certs. of Dis. for Discharge <i>/</i>	Med. Certificates
C. M. Charges	Med. Des. Lists
Descriptive Lists	Orders
Discharge Certificates	Pris. of War Record
Enlistment Papers <i>/</i>	Resignations

Other papers relating to—

Admission to Hosp'l	Furlough or L. of A.
Casualty Sheet	Med. Examination
Confinement	Misc. Information
Contracts	Pay or Clothing
Death or Effects	Personal Reports
Desertion	Rank
Discharge from Hosp'l	Transfer to Hosp'l
Discharge from Service	Transfer to V. R. C.
Duty	Transportation

NO. 120

57 U.S. 120

No. Ninety

120

Young Miss
Volunteered at Paducah Ky
September 10th 1864
By Capt R. H. Hall
Promoted 1st Lieut of Ky

Consent of Parent or Guardian in case of a Minor, or in the case of a Slave, of the Person to whom he owes Service:

I, Do CERTIFY, That I am

of United States colored troops. They will be made out in duplicate in all cases--
nt General, and one to accompany the accounts of the officer who pays bounty, &c.
muster-in, must in all cases, precede payment of pay, bounty, pension, &c. A mus-
stering officer, commissary, or assistant commissary of musters, as the case may be, will
either of them is given to the disbursing officer.

UNITED STATES COLORED TROOPS ENLISTMENT.

STATE OF

TOWN OF

Kentucky
I, *Young Mike*



Paducah
born in *Ford Co*

in the State of *Kentucky* aged *Thirty one* years
and by occupation a *Farmer* Do HEREBY ACKNOWLEDGE to have
volunteered this *Tenth* day of *September* 1864,

to serve as a **Soldier** in the **Army of the United States of America**, for
the period of **THREE YEARS**, unless sooner discharged by proper authority:
Do also agree to accept such bounty, pay, rations, and clothing, as are, or may be,
established by law for the U. S. colored troops.

And I, *Mike Young of McCracken Co*

do solemnly swear, that I will bear true faith and allegiance to the **United States of America**, and that I will serve them honestly and faithfully against all their enemies or opposers whomsoever; and that I will observe and obey the orders of the President of the United States, and the orders of the officers appointed over me, according to the Rules and Articles of War.

Sworn and subscribed to, at *Paducah Ky*
this *10th* day of *Sept* 1864, } *Mike Young*
Before *Capt. H. H. Hall* } *mark*

I CERTIFY, ON HONOR, That I have carefully examined the above named Volunteer, agreeably to the General Regulations of the Army, and that, in my opinion, he is free from all bodily defects and mental infirmity, which would in any way disqualify him from performing the duties of a soldier.

W. G. Kidd

EXAMINING SURGEON.

I CERTIFY, ON HONOR, That I have minutely inspected the Volunteer, *Mike Young* previously to his enlistment, and that he was entirely sober when enlisted; that, to the best of my judgment and belief, he is of lawful age; and that, in accepting him as duly qualified to perform the duties of an able-bodied soldier, I have strictly observed the regulations which govern the recruiting service. This soldier has *Blue* eyes, *Blue* hair, *Blue* complexion, is *5 ft 6 in* feet, *7* inches high.

RECRUITING OFFICER OR AGENT.

Mustered into the United States service *10th* day of *Sept* 1864

H. H. Hall
Capt. Pro Mars Mustered Officer.

Mustered into the service of the United States, for three years or during the war, from date of enlistment, in Company *B* of *10th* Regiment of *McCracken Co* Volunteers, on the *10th* day of *Sept* 1864 at *Paducah Ky*

Capt. H. H. Hall
10th Regt. U.S. Colored Troops

Note 1.—This blank will be used for enlistments of United States colored troops. They will be made out in duplicate in all cases—one to accompany the recruiting return of the superintendent (not the recruiting officer) to the Adjutant General, and one to accompany the accounts of the officer who pays bounty, &c.

Note 2.—An enlistment holds to service. A muster-in, must in all cases, precede payment of pay, bounty, pension, &c. A muster-in roll, must in all cases, be filed in the Adjutant General's Office as evidence of muster-in. The mustering officer, commissary, or assistant commissary of musters, as the case may be, will countersign both enlistments as having mustered the soldier into the service of the United States before either of them is given to the disbursing officer.

DECLARATION OF RECRUIT.

I, Mike Young of Paducah Ky desiring to volunteer as a soldier in the ARMY OF THE UNITED STATES, for the term of Three Years, do DECLARE That I am Thirty two years and months of age; that I have never been discharged from the United States service on account of disability or by sentence of a court-martial, or by order before the expiration of a term of enlistment; and I know of no impediment to my serving honestly and faithfully as a soldier for three years.

GIVEN at Paducah Ky the 10th day of September 1864

Witness: [Signature]

Mike Young
By [Signature]
Adjutant General
No. 120

11 11 11

Consent of Parent or Guardian in case of a Minor, if a Free Man, or in the case of a Slave, of the Person to whom he owes Service:

I, Do CERTIFY, That I am the that the said is years of age; and I do freely give my CONSENT to his volunteering as a SOLDIER in the Army of the United States, for the period of THREE YEARS, under the conditions of the laws of the United States.

GIVEN at

the day of

Witness:

War Department,

ADJUTANT GENERAL'S OFFICE,

(April 13th, 1876)
The Discharge of Michael
Louisa Pot. Co. "C" 8th Reg't U. S.
Colored Inf. No. is reported as follows:

On Company Muster Roll.	
For May + June, 1865,	May 25 th , 1865
Company Muster-out Roll.	May 24 th , 1865
Company Descriptive Book.	186
Company Morning Reports.	186
Soldier's Final Statement.	186
Soldier's Record of Death and Interment.	186
Soldier's Inventory of Effects.	186
Soldier's Certificate of Disability for Discharge.	May 24 th , 1865
Soldier's Individual Muster-out Roll.	186
Regimental Return.	May 24 th , 1865
For May, 1865,	May 24 th , 1865
Regimental Quarterly Returns.	186
Regimental Descriptive Book.	186
By Surgeon General.	186
()	186

May 24, 1865, is held to be
the correct date and the Company Muster
Roll will be amended accordingly.

Thomas M. Brewster
Assistant Adjutant General.
17th Dec 1865
24th of May 3rd 1876

NOTE 1.

The company commander will here add a statement of all the facts known to him concerning the disease or wound, or cause of disability of the soldier; the time, place, manner, and all the circumstances under which the injury occurred, or disease originated or appeared; the duty, or service, or situation of the soldier at the time the injury was received or disease contracted, stating particularly whether the injury was received or the disease contracted in the line of his duty; and whatever other facts may aid a judgment as to the cause, immediate or remote, of the disability, and the circumstances attending it.

When the facts are not known to the company commander, the certificate of any officer, or affidavit of other person having such knowledge, will be appended—as the surgeon in charge of a hospital, the officer commanding a detachment of recruits, &c., &c.

NOTE 2.

When a probable case for pension, special care must be taken to state the degree of disability—as *1/2*, *3/4*, &c., &c.; to describe particularly the disability, wound, or disease; the extent of which it deprives him of the use of any limb or faculty, or affects his health, strength, activity, constitution, or capacity to labor or earn his subsistence. The surgeon will add, from his knowledge of the facts and circumstances, and from the evidence in the case, his professional opinion of the cause or origin of the disability. In the case of discharges by Medical Inspectors, the last paragraph will state that the "discharge was given by consent of the soldier, after a personal examination, and for disability, the nature, degree, and origin of which are correctly described in the within certificate."

Par. 1260 Regulations, Edit. 1861.

Medical officers, in giving certificates of disability, are to take particular care in all cases that have not been under their charge; and especially in epilepsy, convulsions, chronic rheumatism, derangement of the urinary organs, ophthalmia, ulcers, or any obscure disease liable to be feigned or purposely produced; and in no case shall such certificate be given until after sufficient time and examination to detect any attempt at deception.

DIRECTIONS.

This certificate will be made out in duplicate by the soldier's company commander, or other officer commanding the separate detachment to which he belongs, and sent by him to the surgeon who has charge of the hospital where the soldier is sick. The surgeon will then fill out and sign the surgeon's certificate, and forward these papers to the regimental, detachment, or post commander, who will forward them, with his action endorsed thereon, through the proper channel, to his division commander; or, if the troops are not attached to a division, to his corps, department, or other commander or officer to whom the authority to discharge enlisted men may be specially delegated.

These certificates, after having received the action of the highest authority to which they are required to be sent, will be returned through the same channel to the regimental, post, or detachment commander, who will, if the discharge is authorized by the endorsement of the proper authority, sign the soldier's discharge, and the last certificate on this paper; see that the soldier is furnished with the proper final statements in duplicate, and forward BOTH of these certificates direct to the Adjutant General United States Army, at Washington, D. C.; they will not, under any circumstances, be given into the hands of the soldier.

CERTIFICATE OF DISABILITY FOR DISCHARGE

IN THE CASE OF

15058 45
11187
 Michael Young,
 Private Co. G
 Eight Reg't of Artillery (Heavy)

Ad. Qu. 25th Army Corps.

Camp Lincoln Va.

May 23rd 1865

To be discharged
 for disability

By command of

Major, Genl. Hitzel

J. J. Wheeler

Adj. Genl.

Received (A. G. Office) 186

Ent on D. R. of Cas

ADJUTANT GENERAL'S OFFICE

June 5th 1865
 Duplicate sent the Pension Office.

ARMY OF THE UNITED STATES.
CERTIFICATE
OF DISABILITY FOR DISCHARGE.

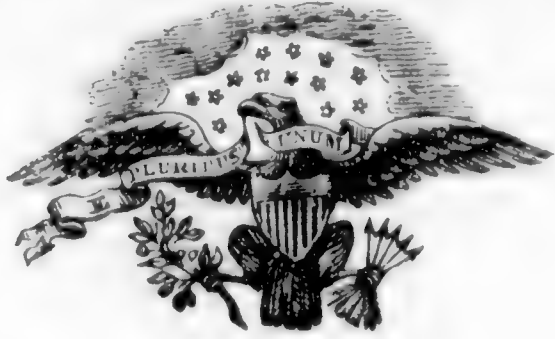

Private *Michael Young*, of Captain *R. Dunn*
 Company, ("*E*") of the *Eight* Regiment of the United States
Col. A. H. Heary was enlisted by *Capt. R. H. Hall* on *Mar 1st* at *Paducah, Ky.*
 the *Eight* Regiment of *the* at *Paducah, Ky.*
 on the *10th* day of *September*, 1865, to serve *three* years; he was born
 in *Todd County* in the State of *Kentucky*, is *31*
 years of age, *5* feet *7* inches high, *Black* complexion, *Black* eyes,
Black hair, and by occupation when enlisted a *Farmer*. During the last two
 months said soldier has been unfit for duty *days*. * *Said Soldier has*
never been fit for duty. Complaining of a bad arm
and is perfectly worthless as a Soldier

STATION: *City Point Va*
 DATE: *May 9th 1865*

Robert Dunn
Capt. 8th Reg. Artillery
 Commanding Company.

I CERTIFY, that I have carefully examined the said *Michael Young*
 of Captain *R. Dunn*'s Company, and find him incapable of performing the duties of a
 soldier because of *a severe illness he received on his shoulder in field*
is because the subject of chronic inflammation and is a
disabled from to entrenchment
City Point Va
May 9th 65

Wm. A. King, Surgeon.

DISCHARGED, this *Twenty first* day of *May*, 1865, at *Camp Lincoln*

A. W. Parry
 Colonel
 Commanding the Reg't

The Soldier desires to be addressed at

Town _____ County _____ State _____

* See Note 1 on the back of this. † See Note 2 on the back of this.

1905
Young, Ross
Co D, 8 U.S. Col'd H. Art'y.

Private

CARD NUMBERS.

1	5470037	26
2	5470179	27
3	5470321	28
4	5471241	29
5	9121508	30
6	40745002	31
7		32
8		33
9		34
10		35
11		36
12		37
13		38
14		39
15		40
16		41
17		42
18		43
19		44
20		45
21		46
22		47
23		48
24		49
25		50

Book Mark:

See also

Y | 8 H. Art'y. | U.S.C.T.

Ross Young

....., Co. *B*, 8 Reg't U.S. Col'd H. Art'y.

Appears on

Company Descriptive Book

of the organization named above.

DESCRIPTION.

Age *18* years; height *5* feet *4* inches.

Complexion *Dark*

Eyes *Dark*; hair *Dark*

Where born *Danville, Ky.*

Occupation *Farmer*

ENLISTMENT.

When *June 12th 18* 186

Where *Paducah, Ky.*

By whom *W. Coffin*; term *3* y'rs.

Remarks: *Died at Paducah, Ky. Sept. 12/64*
Cause of death, Dysentery

.....
.....
.....

Henderson

Y | 8 H. Art'y. | U.S.C.T.

Ross Young
Privt, Co. B, 8 Reg't U. S. Col'd H. Art'y.

Appears on

Company Muster Roll

for *May & June*, 186*4*.

Present or absent *Present*

Stoppage, \$ *100* for

Due Gov't, \$ *100* for

Valuation of horse, \$ *100*

Valuation of horse equipments, \$ *100*

Remarks: *Called out April 21*
64 + M.S. June 25/64 at
Paducah, Ky. 3 years

Book mark:

J. A. Boyd

(358)

Copyist.

Y | 8 H. Art'y. | U.S.C.T.

Ross Young

Print, Co. B, 8 Reg't U. S. Col'd H. Art'y.

Appears on

Company Muster Roll

for *July and Aug.*, 186 *4*

Present or absent *absent*

Stoppage, \$ *100* for

Due Gov't, \$ *100* for

Valuation of horse, \$ *100*

Valuation of horse equipments, \$ *100*

Remarks: *Absent sick at Paducah, Ky.*

Book mark:

(358)

J. M. Boyd

Copyist.

Wm 8 Ho. arty U.S.C.T

Russ Young

Pat, Co. *B*, 8 Reg't U. S. Col'd *H. arty.*

Appears on

Company Muster Roll

for *Sept. and Oct*, 1864.

Present or absent.....

Stoppage, \$..... 100 for.....

Due Gov't, \$..... 100 for.....

Valuation of horse, \$..... 100

Valuation of horse equipments, \$..... 100

Remarks: *died in Reg. Hosp.*
Sept. 12th, 1864.

Book mark:.....

J. W. Boyd

(358)

Copyist.

Cross Young
Co. B, 8 Reg't U. S. Col'd H. Art'y.

Appears on Returns as follows:

July 18 54 about sick
in Hoopl. since July 10/54

Aug 18 55 about sick in
Hoop. Paducah Ky
since Aug 26/54

Sept 18 54 Sept 12 54
Paducah. Sick of
disease

Book mark :

Wm. P. ...

Q. | S. H. Art'y. | U.S.C.T.

John Young
Sert, *Co. B*, 8 Reg't U. S. Col'd H. Art'y.

Appears on **Co. Muster-out Roll**, dated
Victoria Texas Feb. 10, 1866.

Muster-out to date _____, 186 .

Last paid to *June 30*, 1864.

Clothing account:

Last settled _____, 186 ; drawn since \$ _____ 100

Due soldier \$ _____ 100; due U. S. \$ _____ 100

Am't for cloth'g in kind or money adv'd \$ _____ 100

Due U. S. for arms, equipments, &c., \$ _____ 100

Bounty paid \$ _____ 100; due \$ _____ 100

Remarks *Entered service as recruit*
joined Co. for duty, June 12th 1864.
Died at Paducah, Ky. Sept. 12th 1864.
Cause of death, Dysentery.
Final statement & inven-
tory of effects forwarded to
(over)
Book mark: *481/83*

(361)

Randall

Copyist.

JAN. 14

5471341

1891

A. G. O. Sept. 17" 1864.

Age 18 years

MAY 1942

Young, Ross

H. S., Co. *B*, **8** U.S.C.H.A.
Reg't

3 Enclosures.

Bed Cards	Descriptive Lists
Burial Records	Final Statements <i>/</i>
Certs. of Dis. for Discharge	Furloughs
C. M. Charges	Med. Des. Lists
Med. Certificates	Orders

Other papers relating to—

Admission to Hosp'l	Furlough
Casualty Sheet (Officer's)	Med. Examination
Confinement	Misc. Information <i>/</i>
Contracts	Pay or Clothing
Death or Effects <i>/</i>	Personal Reports
Desertions	Rank
Discharge from Hosp'l	Transfer to Hosp'l
Discharge from Service	Transfer to V. R. C.
Duty	Transportation
.....

MAR 1963
MICROFILM PUBLICATION M 1829

COMPILED MILITARY SERVICE RECORDS
OF VOLUNTEER UNION SOLDIERS WHO SERVED WITH
THE UNITED STATES COLORED TROOPS (USCT)
8TH REGIMENT OF HEAVY ARTILLY

PERSONAL PAPERS' TARGET SHEET

PLEASE NOTE THE CHECKED INFORMATION ABOUT THE PERSONAL PAPERS IN
THIS FILE:

- NO PERSONAL PAPERS WERE FOUND IN THIS FILE WHEN THE
RECORDS WERE ARRANGED FOR MICROFILMING.
- 4 PERSONAL PAPER(S) FOUND IN THIS FILE WHEN THE RECORDS
WERE ARRANGED FOR MICROFILMING.

War Department,

ADJUTANT GENERAL'S OFFICE.

Washington, *March 7* 1867.

Respectfully returned to the
Commission for the State of
Kentucky,

with the information that there is
no record of enlistment or service.

of *Thos Young* in Co. "C," 8th U.S.
C. Artillery in file in this office.

A. J. R. ...

Adj. Asst. Genl.

M.H. ...
B.A.S.

ENDORSEMENT.

No. *2471*

APPLICATION OF

Thos H Young

OF

For compensation of service of slave,

Enlisted 186

in *D* Co. 8th *N. Carol.* Regiment
U. S. Colored Troops.

Received *25 Jan'y* 1867

Compensation awarded

186

Dollars.

President Board of Claims.

CLAIMANT'S ATTORNEYS,

CLAIMANT'S P. O. ADDRESS,

Paducah
McCracken Co
Ky

Contract made as T. J. Young mistake for
T. J. Young

CLAIM FOR COMPENSATION FOR ENLISTED SLAVE.

No. *1*
I, *Thomas A Young*, a loyal citizen, and
a resident of *Paducah* County of *McCracken* State of
Kentucky, hereby claim compensation, under the provisions of
section 24, Act approved February 24, 1864, and Section 2, Act approved July 28, 1866, for my
slave *Pop Young* enlisted
186 at *7*

by *8*
in the *Eighth* Regiment U. S. Colored Troops,
Co. *11* certificate of enlistment, and a descriptive list, as required, accompany
this application. *Bought three years before the war
have the bill of sale*

In proof of my loyalty to the Constitution and Government of the United States, I present
the accompanying oath, which I have taken, signed and acknowledged; to be filed with this
application, in accordance with requirement of General Orders, No. 329, 1863, War Department,
Adjutant General's Office.

Witness: *D. Nat Wilson* Applicant.
M. Blewfield
December 14th 1866
Two witnesses to
owner's signature
sign here.

PATH OF ALLEGIANCE.

Thomas A Young, the owner and claimant, do solemnly swear that the foregoing
claim is a just and true claim due to me as master and owner of the said slave, and that the facts alleged in said claim, in respect to the
draft or enlistment (as the case may be) of said slave into the military service of the United States, are true. And I do further swear that I
have never joined, or been concerned in, any insurrection or rebellion; that I have never borne arms against the United States; that I have
never given any aid, countenance, counsel or encouragement, to any person or persons engaged, or whom I had reason to believe were about to
engage, in insurrection, rebellion, or armed hostility against the United States; that I have neither sought, nor accepted, nor attempted to
exercise the functions of any office, civil or military, nor to perform any service whatever, under any authority, or pretended authority, in
hostility to the United States; that I have not yielded a voluntary support to any insurrection, rebellion, or pretended government
authority, power or constitution within the United States hostile thereto. And I do further swear that, to the best of my knowledge and
ability, I have supported and defended, and will continue to support and defend, the United States against all enemies foreign and domestic;
and that I have supported, defended and obeyed, and will continue to support, defend and obey, the Constitution and laws of the United States;
that I will bear true faith and allegiance to the same; and that I take this oath freely, without any mental reservation or purpose of
evasion: So help me God.

5 CENT STAMP.

The owner
signs here.



Sworn to and subscribed before me, *a Notary Public*
of *McCracken* County, *Ky*
this *14th* day of *December* 1866
at my office *Paducah Ky*
The officer swear-
ing the owner signs
here.
Know all men by these Presents, that I, *Thomas A Young* of *McCracken*
County, State of *Kentucky*, do hereby constitute and appoint, with full power of
substitution and revocation, *J. P. Dyess* of the City of Louisville, in the County of Jefferson, State of Kentucky, my
true and lawful Attorneys, irrevocable, to prosecute my claims against the United States Government, for slave named *Pop*
Young and to receive and receipt for all orders or certificates that may be issued in payment thereof
Witness: *D. Nat Wilson* Applicant.
M. Blewfield

50 CENT STAMP.

DIRECTIONS FOR FILLING UP THE ABOVE BLANKS.

1. Name of claimant: his name must be given in full, and he must be the owner, in his own right, of the slave claimed at the time he was mustered into the United States service, and the time application is made.
2. Name of city or town in which claimant lives.
3. Name of county in which claimant lives.
4. Name of State in which claimant lives.
5. Name of slave for whom compensation is claimed.
6. Date of his enlistment.
7. Where he enlisted.
8. By whom he was enlisted.
9. Number of Regiment to which he was assigned.
10. Letter of Company he served in.

Note.—Where there is a doubt as to the fact stated in a blank, do not fill the blank.

PROOF OF OWNERSHIP.

State of Kentucky, }
 County of McCracken } SS.

We, *E. Rudolf* and *J. E. Gibson* each of lawful age and resident citizens of the State and County aforesaid, do certify that *Thomas A Young* of the State and County aforesaid, was on the _____ day of _____ 1866, the lawful owner of the Slave named *Ross*, referred to and described in the foregoing claim for compensation.

Two witnesses to ownership sign here.

E. Rudolf
J. E. Gibson

Sworn to and subscribed before me, a *Notary Public* for the County of *McCracken* State of Kentucky, this, the *14th* day of *December*, 1866 at my office in *Paducah Ky*



The officer swearing the witnesses signs here.

P. Dyers
Notary Public *McCracken* L.S.

PROOF OF LOYALTY.

State of Kentucky, }
 County of McCracken } SS.

We, *E. Rudolf* and *J. E. Gibson* loyal men, and each of lawful age, and resident citizens of the *Vicinity* of *Paducah* in the State and County aforesaid, upon our oaths declare that we have known *Thomas A Young* a resident of the State and County aforesaid, since the 4th day of March, 1861, and know that he has firmly and faithfully maintained his or her adherence and allegiance to the Government of the United States, by defending its cause against the Government and forces of the so-called Confederate States of America, in all suitable and practicable ways, and according to his or her ability and opportunity.



E. Rudolf
J. E. Gibson

Sworn to and subscribed before me, a *Notary Public* for the County of *McCracken* State of *Kentucky* this *14th* day of *December* 1866 at my office in *Paducah Ky*

The officer swearing the witnesses signs here.

P. Dyers
Notary Public *McCracken* L.S.

W. D. Owsley & E. W. Shirell Post Master *Woodville* each of us residents of the County of *McCracken* in the State of *Kentucky* on oath state that we are and have been for *14* years well acquainted with *Thomas A Young* the applicant, and *E. Rudolf* and *J. E. Gibson* his witnesses, and from our personal acquaintance with them believe their statements to be entitled to full faith and credit.



W. D. Owsley
E. W. Shirell

Sworn to and subscribed before me, a *notary public* for the County of *McCracken* State of *Kentucky* this *24th* day of *December* 1866 - by *W. D. Owsley - E. W. Shirell* Post Master was not sworn

5 CENT STAMP

P. Dyers A P
McCracken County Ky

NOTE.—If the applicant and his witnesses are not personally known to one or more of the Commissioners, the above certificate should be signed by two citizens who are well known to the Commissioners, or by a Post Master or other Government officer; if signed by a United States officer it need not be sworn to, but if by citizens it must be sworn to. When a United States officer signs it the witnesses need not, and when the witnesses sign it the United States officer need not.

Thos Young

I Mark Young late a private in Company A
8th Regiment, United States Colored Artillery Reg, state under oath
that before being mustered into the United States Service I was the slave of
Jesse W Young of McCracken County, State of Kentucky.

That I am personally acquainted with Rob Young, late a
private in Company D of 8th Regiment United States Colored
Artillery (Heavy), and know that before he was mustered into the United
States Service, he was the slave of Thomas H Young of McCracken
County, State of Kentucky.

ATTEST:



M. Moorhead

Mark Young his Mark

Sworn to, and subscribed in my presence,
at Paducah Ky, this 15th day of December 1864

Official
Signatures,

P. D. Geiser
Notary Public Mo. & Ky.

INSTRUCTIONS.

- 1 Name of affiant as borne on the Muster Rolls regardless of the name known by at home.
- 2 Rank—Private, Corporal or Sergeant.
- 3 Letter of Company and Number of Regiment.
- 4 Cavalry, Infantry or Artillery, as the case may be.
- 5 The name of his former owner.
- 6 Name of the County in which the Owner lives.
- 7 Name of the Soldier the affiant wishes to identify. (The name must be given as it is borne on the Muster Rolls in all cases.)
- 8 Names of Two disinterested witnesses.

NOTE—Where the former slave identifies himself, blank No. 7 and all below to the Sixth need not be filled up. Claimants needing more blanks can be supplied by calling on our Agent, or at the Office, No. 129 Jefferson Street, Louisville, Ky.

ARTICLES OF WAR.

ART. 95. When any non-commissioned officer or soldier shall die, or be killed in the service of the United States, the then commanding officer of the troop or company shall, in the presence of two other commissioned officers, take an account of what effects he died possessed of, above his arms and accoutrements, and transmit the same to the office of the Department of War, which said effects are to be accounted for, and paid to the representatives of such deceased non-commissioned officer or soldier. And in case any of the officers, so authorized to take care of the effects of deceased officers and soldiers, should, before they have accounted to their representatives for the same, have occasion to leave the regiment or post, by preferment or otherwise, they shall, before they be permitted to quit the same, deposit in the hands of the commanding officer, or of the assistant military agent, all the effects of such deceased non-commissioned officers and soldiers, in order that the same may be secured for, and paid to, their respective representatives.

ARMY REGULATIONS—EDITION OF 1861.

DECEASED SOLDIERS.

Par. 152. Inventories of the effects of deceased non-commissioned officers and soldiers, required by the 95th Article of War, will be forwarded to the Adjutant General, by the commander of the company to which the deceased belonged, and a duplicate of the same to the colonel of the regiment. Final statements of pay, clothing, &c., will be sent with the inventories. When a soldier dies at a post or station absent from his company, it will be the duty of his immediate commander to furnish the required inventory, and, at the same time, to forward to the commanding officer of the company to which the soldier belonged, a report of his death, specifying the date, place, and cause; to what time he was last paid, and the money or other effects in his possession at the time of his decease; which report will be noted on the next muster roll of the company to which the man belonged. Each inventory will be endorsed, "Inventory of the effects of _____, late of company (—) _____ regiment of _____, who died at _____, the _____ day of _____, 186—." If a legal representative receive the effects, it will be stated in the report. If the soldier leave no effects, the fact will be reported.

Par. 153. Should the effects of a deceased non-commissioned officer or soldier not be administered upon within a short period after his decease, they shall be disposed of by a Council of Administration, under the authority of the commanding officer of the post, and the proceeds deposited with the Paymaster, to the credit of the United States, until they shall be claimed by the legal representatives of the deceased.

Par. 154. In all such cases of sales by the Council of Administration, a statement in detail, or account of the proceeds, duly certified by the Council and commanding officer, accompanied by the Paymaster's receipt for the proceeds, will be forwarded by the commanding officer to the Adjutant General. The statement will be endorsed, "Report of the proceeds of the effects of _____, late of company (—) _____ regiment of _____, who died at _____, the _____ day of _____, 186—."

NOTE 1.—The effects in all cases, when called for, should be turned over to the legal representative, without further authority from the Adjutant General. When the effects are turned over to the relatives of the deceased before these inventories are sent to the Adjutant General, their receipts therefor should be attached to the inventories. In all other cases, one copy will be sent with a letter of transmittal direct to the Adjutant General, and a duplicate retained by the officer.

NOTE 2.—Particular care should be taken to take receipts in duplicate from the Paymaster for any funds turned over to him; one copy should be sent direct to the Adjutant General and one retained by the officer.

INVENTORY OF THE EFFECTS

OF

Late of Company _____

Reg't of _____

Volunteers, who died at _____

on the _____ day of _____ 1864.



Inventory of the effects of James H. ... late
a Private of Captain ... Company of
the ... Regiment of ... Volunteers, who was enrolled as
a Private at ... in the State of ... on
the ... day of ... 1864, and mustered into the service of the United
States as a Private on the ... day of ... 1864, at ...
in Company ..., ... Regiment of ... Volunteers, to serve ...
years or during the war; he was born in ... in the State
of ...; he was ... years of age, 5 feet 4 inches
high, ... complexion, ... eyes, ... hair, and by occupation, when enrolled,
a ...; he died in ..., at
... on the ... day of ... 1864, by
reason of ...

INVENTORY.					
ARTICLES.	No.	ARTICLES.	No.	ARTICLES.	No.
Hats.....		Pairs trousers.....	2	Knapsacks.....	
Caps.....		Pairs flannel drawers.....			
Forage caps.....	1	Pairs cotton drawers.....			
Great coats.....		Flannel shirts.....			
Uniform coats.....		Cotton shirts.....			
Uniform jackets.....	1	Pairs boots.....			
Flannel sack coats.....		Pairs shoes.....	1		
Blouses.....		Pairs socks.....			
Stable frocks.....		Blankets.....	1		
Fatigue overalls.....		Haversacks.....			
				MONEY.	
				Specie.....	\$
				Notes.....	postage \$00 25

I CERTIFY, ON HONOR, that the above inventory comprises all the effects of James H. ...
James H. ..., deceased, and that the effects are in the hands
of Sergeant James H. ... at ...
to be disposed of by a Council of Administration.

(DUPLICATES.)

STATION : ...
DATE : Sept 17 1864

W. B. Armstrong
...
Commanding the Company.

FINAL STATEMENT

OF

Boyd Gunning
8th Reg't of *W. C. A. Henry*

VOLUNTEERS.

1000 1000

NOTE 1.—Two of these certificates (or duplicates) are to be given to each Volunteer Soldier or drafted man who may be discharged previously to the discharge of his company, that he may at once receive from the Paymaster the pay, &c., due him, and the captain or other COMMISSIONED officer commanding the company will certify to the act of the delivery of the duplicate certificates; on these certificates the Soldier is "entitled to" his discharge, and should also present his discharge to the Paymaster to have the payment endorsed on it. The discharge is to be given back to the Soldier by the Paymaster; the latter only retaining as his voucher the duplicate certificates.

NOTE 2.—If the Soldier is entitled to pay for the use of his horse, the Company Commander will certify to that fact on the back of both these final statements, and also to the time he has pay due for having been so mounted on his own horse.

NOTE 3.—When a Soldier is furnished with final statements, his descriptive list, if he has one, should be taken up by the officer who gives the Soldier these statements, and endorsed with a statement to this effect by the officer. This endorsement should exhibit a full statement of the time for which the Soldier was allowed pay on his final statements, the clothing account, and all other charges against him or in his favor, so as to comprise a complete exhibit of his account. It will then be transmitted to the company commander of the Soldier, who will enter all the data necessary to a full understanding of the Soldier's account on the muster roll upon which the Soldier's discharge is reported. The descriptive list will then be destroyed. The object of this is, that the remaining portion of the Soldier's account may be settled upon the receipt of these muster rolls, and the Soldier receive any pay or allowances that may be due him at the time of his discharge, and which may not appear on his final statements from the fact that his descriptive list is incomplete. These accounts for back pay, &c., are settled by the 2d Auditor of the Treasury Department.

NOTE 4.—Charges for loss or injury to ordnance, horse equipments, and other miscellaneous charges, should appear under the heading of "Other Stoppages."

NOTE 5.—Bounty paid by State authorities, and not by the United States, will not be entered on this statement.

NOTE 6.—Amounts due the Sutler and Laundress must be entered on the muster roll on which the discharge, death, desertion, &c., is reported, as well as on the final statement, otherwise the amount cannot be collected from the United States.

NOTE 7.—This blank will be used for deceased volunteers and drafted men, as well as for others.

NOTE 8.—Where a Soldier dies in Hospital or on detached service; his descriptive list, if he has one, should be sent with his final statements, in duplicate, to the Adjutant General, Washington, D. C.

ADJUTANT GENERAL'S OFFICE.

Oct 11 1864

Duplicate with inventory sent 2d Auditor.



I certify, on honor, that Wass James a Private of
 Captain J. M. Coffin Company (B.) of the 8th Regiment of McClintock's Heavy
~~VOLUNTEERS~~, of the State of _____, born in Lanville, State
 of Kentucky, aged 18 years; 5 feet 7 inches high; Dark complexion,
Dark eyes, Dark hair, and by occupation a Sawyer, having joined the company on
 its original organization at Paducah Ky, and enrolled in it at the muster into
 the service of the United States at Paducah Ky, on the 21st day
 of April, 1864, (or was mustered in service as a recruit, by Lieutenant
W. H. Over, at Paducah Ky on the 21st day of June,
 1864, or was drafted and mustered into the service of the United States from the _____
 Enrollment District of the State of _____, at _____,
 on the _____ day of _____, 1864), to serve in the Regiment, for
 the term of Three Years: and having served HONESTLY and
 FAITHFULLY with his Company in McClintock's Heavy to the present date, is now
 entitled to a **DISCHARGE** by reason of Death Dissementary
(Died April 13th 1864 at Paducah Ky)

The said Wass James was last paid by Paymaster
Mag James to include the 30th day of June, 1864, and has
 pay due him from that time to the present date; he is entitled to pay and subsistence for
 TRAVELING to place of enrollment, and whatever other allowances are authorized to volunteer
 soldiers, drafted men, or militia, so discharged. He has received from the United States **CLOTHING**
 amounting to Twenty Eight 48 dollars, since the _____ day of Enlistment,
 1864, when his clothing account was last settled. He has received from the United States
 _____ dollars advanced **BOUNTY**.

There is to be stopped from him, on account of the State of _____, or other
 authorities, for **CLOTHING**, &c., received on entering service, _____ dollars; and
 for other stoppages, viz: _____

_____ dollars.
 He has been furnished with TRANSPORTATION in kind from the place of his discharge to
 _____; and he has been SUBSISTED for TRAVELING to his
 place of enrollment, up to the _____, 1864.

He is indebted to _____, **SUTLER**, _____ dollars.
 He is indebted to _____, **LAUNDRESS**, _____ dollars.

Given in Duplicate, at Paducah Ky, this 21st day
 of Sept, 1864.

W. H. Armstrong
1st Lieut. & Co. of 8th Regt. A. C.
 Commanding Company

1986
Young, Rufus

Co. B, 8 U.S. Col'd H. Art'y.

Private Private

CARD NUMBERS.

1	5474396	26
2	5474531	27
3	5473108	28
4	5473147	29
5	5473293	30
6	5473426	31
7	5473556	32
8	5473683	33
9	5475685	34
10	5474289	35
11	9121834	36
12	9122325	37
13	40745003	38
14		39
15		40
16		41
17		42
18		43
19		44
20		45
21		46
22		47
23		48
24		49
25		50

Book Mark: S. B. 7. P. 280

See also

U | 8 H. Art'y. | U.S.C.T.

Cupis Morning

....., Co. *B*, 8 Reg't U.S. Col'd H. Art'y.

Appears on

Company Descriptive Book
of the organization named above.

DESCRIPTION.

Age *22* years; height *6* feet *6* inches.

Complexion *Fair*

Eyes *Blue*; hair *Blue*

Where born *Triguer Co., Ky*

Occupation *Farmer*

ENLISTMENT.

When *Mar. 20*, 186*4*.

Where *E. Donaldson*

By whom *R. Dunn*; term *3* y'rs.

Remarks: **Transferred to Co. D.*

**Remains written with lead pencil*

D. A. Moreland

(3830)

Copyist.

J. H. Artij U. S. C. T.
Profie Young
Co. D, 8 Reg't U. S. Col'd *H. Artij*

Appears on

Company Descriptive Book

of the organization named above.

DESCRIPTION.

Age *22* years; height *5* feet *6* inches.

Complexion *Brown*

Eyes *Blue*; hair *Blue*

Where born *Magg Co., Ky*

Occupation *Farmer*

ENLISTMENT.

When *Mar. 20*, 1864

Where *Ft Donelson, Tenn.*

By whom *Robert Dunn*; term *3* y'rs.

Remarks: *Died in camp,*
Mar. 5/65, Paducah,
Ky.

Henderon

Y | S H. Art'y. | U.S.C.T.

Rufus Young

1st, Co. *E*, 1 Reg't Ky. H. Art'y.†

Age years.

Appears on

Company Muster Roll*

for *Enlistment to April 30*, 1864.

Joined for duty and enrolled:

When *March 20*, 1864.

Where *H. Donelson, Tenn.*

Period *3* years.

Mustered in:

When *April 26*, 1864.

Where *Paducah, Ky.*

Present or absent *Present*

Stoppage, \$ *100* for

Due Gov't \$ *100* for

Valuation of horse, \$ *100*

Valuation of horse equipments, \$ *100*

Remarks:

†This organization subsequently became Co. *"E"*, 8 Reg't U. S. Colored Heavy Artillery.

*First current roll. No muster-in roll of this company on file.

Book mark:

(358L)

J. V. Kearny
Copyist.

Y

8 H. Art'y.

U.S.C.T.

Rufus Young

Rk, Co. E, 8 Reg't U. S. Col'd H. Art'y.

Appears on

Company Muster Roll

for *May and June*, 1864.

Present or absent

Stoppage, \$ *100* for

Due Gov't, \$ *100* for

Valuation of horse, \$ *100*

Valuation of horse equipments, \$ *100*

Remarks:

*Transferred to Co. D, 8 U.S., by order of
Col. H. W. Barry, dated Ft. Anderson, Pa-
ducal, Ky., May 20, 1864. Special order
no. 7.*

Book mark:

J. W. Kearny
Copyist.

Y | 8 H. Art'y. | U.S.C.T.

Refuse Young
Priv., Co. *D*, 8 Reg't U. S. Col'd H. Art'y.

Age -- years.

Appears on

Company Muster Roll*

for *May & June*, 186*4*.

Joined for duty and enrolled:

When *Mar 20*, 186*4*.

Where *J. J. Donelson Tenn.*

Period *3* years.

Mustered in:

When *Apr. 26*, 186*4*

Where *Paducah Ky.*

Present or absent *Present*

Stoppage, \$ *100* for

Due Gov't \$ *100* for

Valuation of horse, \$ *100*

Valuation of horse equipments, \$ *100*

Remarks: *Transferred from Co. "E" per S.O. No. 7, Hd. Qrs.*

*First current roll. No muster-in roll of this company on file.

Book mark:

(358d) *Joseph Stewart* Cop. list.

JAN. 14

5473008

1891

*8th. U.S. C. A.H. by order
H. W. Barry Col.*

Y.

8 H. Art'y.

U.S.C.T.

Rufus Young
Private, Co. D, 8 Reg't U. S. Col'd H. Art'y.

Appears on

Company Muster Roll

for *July & Aug.*, 1864.

Present or absent *

Stoppage, \$ 100 for

Due Gov't, \$ 100 for

Remarks: *Absent sick at Paducah, Ky, since the 26 of August*

* *From a roll of the 1st Reg't U.S. Col'd H. Art'y.*

Book mark:

M. M. Shaver

August Young,
Priv., Co. D, 8 Reg't U. S. Col'd H. Art'y.

Appears on

Company Muster Roll

for *Sept. & Oct.*, 186*4*.

Present or absent *Present.*

Stoppage, \$ *100* for

Due Gov't, \$ *100* for

Valuation of horse, \$ *100*

Valuation of horse equipments, \$ *100*

Remarks: *Sick in Regimental Hospital.*

Book mark:

J. S. White,

RECEIVED

G | 8 H. Art'y. | U.S.C.T.

Rufus Young

Pri., Co. D, 8 Reg't U. S. Col'd H. Art'y.

Appears on

Company Muster Roll

for *Nov. & Dec.*, 186*H*.

Present or absent *Present.*

Stoppage, \$ *100* for

Due Gov't, \$ *100* for

Valuation of horse, \$ *100*

Valuation of horse equipments, \$ *100*

Remarks:

Book mark: -----

(358)

J. Smith

Copyist.

NARRATIVE

G

8 H. Art'y.

U.S.C.T.

Rufus Young
 Pri'., Co. D, 8 Reg't U. S. Col'd H. Art'y.

Appears on

Company Muster Roll

for *Jan. 7 Feb.*, 1865.

Present or absent *Present.*

Stoppage, \$ *100* for

Due Gov't, \$ *100* for

Remarks:

Book mark:

[Signature]

(358)

Copyist.

G | 8 H. Art'y. | U.S.C.T.

Rufus Young
Pr., Co. D, 8 Reg't U. S. Col'd H. Art'y.

Appears on

Company Muster Roll

for *Mar. & Apr.*, 1865.

Present or absent

Stoppage, \$ 100 for

Due Gov't, \$ 100 for

Remarks: *Died in camp*
Padenah, Ky., March
5, 1865.

Book mark:

(358)

J. Smith

Copyist.

Ny

8 H. Art'y.

U.S.C.T.

Rufus Young

Priv, Co *D*, 8 Reg't U. S. Col'd H. Art'y.

Appears on Returns as follows:

May 1864 *May 20/64*
Panama Ky. Transf'd
from Co E to D.
about serial No 2100.
Panama Ky.

June 4 1864 *about*
serial No 2100 at
Panama Ky.

March 1865 *March 5/65*
Panama Ky. Died
in quarter Camp 8. U.S.
A.A.H.

Book mark:

John Patton

Y | S H. Art'y. | U.S.C.T.

Reufis Young

Priv., Co. *E*, 8 Reg't U. S. Col'd H. Art'y.

Appears on **Co. Muster-out Roll**, dated
Victoria Texas, Feb 10, 1866.

Muster-out to date _____, 186 .

Last paid to *April 30, 1864* .

Clothing account:

Last settled _____, 186 ; drawn since \$ _____ 100

Due soldier \$ _____ 100; due U. S. \$ _____ 100

Am't for cloth'g in kind or money adv'd \$ _____ 100

Due U. S. for arms, equipments, &c., \$ _____ 100

Bounty paid \$ _____ 100; due \$ _____ 100

Remarks: *Joined Co at Original
Organization as Private Transf.
from Co. E, to Co. D, by S.O. No
7 Hd. qrs. 8 W.S. 6 Reg. Art'y
May 20, 1864.*

Book mark : _____

E. Carroll

27

8 H. Art'y.

U.S.C.T.

Rufus Young
Co. *D*, 8 Reg't U. S. Col'd H. Art'y.

Appears on Co. Muster-out Roll, dated
Victoria, B.C., Feb 10, 186*6*.

Muster-out to date _____, 186 .

Last paid to *Oct 31,* 186*4*.

Clothing account:

Last settled _____, 186 ; drawn since \$ _____ 100

Due soldier \$ _____ 100; due U. S. \$ _____ 100

Am't for cloth'g in kind or money adv'd \$ _____ 100

Due U. S. for arms, equipments, &c., \$ _____ 100

Bounty paid \$ _____ 100; due \$ _____ 100

Remarks: *Transferred from Co E after*
S.O. no 4 Regt 26th Dec. May
20 64. Died. March 5 65,
in camp of Regt. at Paducah,
Ky. of Diarrhoea. Final
Statements found March 31 1865.

Book mark: *V 66. P. 52. 69.*
E.B. 7. P. 280.

(361) *J. J. Brown* Copyist.
8712

JAN. 14

5474289

* 1891 *

Val 2 2 years

Young, Rufus

B. Co. D, 8 Reg't U.S.C.A.

4 Enclosures.

Bed Cards	Descriptive Lists
Burial Records	Final Statements 2
Certs. of Dis. for Discharge	Furloughs
C. M. Charges	Med. Des. Lists
Med. Certificates	Orders

Other papers relating to—

Admission to Hosp'l	Furlough
Casualty Sheet (Officer's)	Med. Examination
Confinement	Misc. Information
Contracts	Pay or Clothing
Death or Effects	Personal Reports
Desertions	Rank
Discharge from Hosp'l	Transfer to Hosp'l
Discharge from Service	Transfer to V. R. C.
Duty	Transportation

ARTICLES OF WAR.

ART. 95. When any non-commissioned officer or soldier shall die, or be killed in the service of the United States, the then commanding officer of the troop or company shall, in the presence of two other commissioned officers, take an account of what effects he died possessed of, above his arms and accoutrements, and transmit the same to the office of the Department of War, which said effects are to be accounted for, and paid to the representatives of such deceased non-commissioned officer or soldier. And in case any of the officers, so authorized to take care of the effects of deceased officers and soldiers, should, before they have accounted to their representatives for the same, have occasion to leave the regiment or post, by preferment or otherwise, they shall, before they be permitted to quit the same, deposit in the hands of the commanding officer, or of the assistant military agent, all the effects of such deceased non-commissioned officers and soldiers, in order that the same may be secured for, and paid to, their respective representatives.

ARMY REGULATIONS—EDITION OF 1863.

DECEASED SOLDIERS.

Par. 152. Inventories of the effects of deceased non-commissioned officers and soldiers, required by the 95th Article of War, will be forwarded to the Adjutant General, by the commander of the company to which the deceased belonged, and a duplicate of the same to the colonel of the regiment. Final statements of pay, clothing, &c., in duplicate, will be sent to the Adjutant General with one copy of the inventory. When a soldier dies at a post or station absent from his company, it will be the duty of his immediate commander to furnish the required inventory and final statements, and, at the same time, to forward to the commanding officer of the company to which the soldier belonged, a report of his death, specifying the date, place, and cause; to what time he was last paid, and the money or other effects in his possession at the time of his decease; which report will be noted on the next muster roll of the company to which the man belonged. Each inventory will be endorsed, "Inventory of the effects of _____, late of company (—) _____ regiment of _____, who died at _____, the _____ day of _____, 186—." If a legal representative receive the effects, it will be stated in the report. If the soldier leave no effects, the fact will be reported.

Par. 153. Should the effects of a deceased non-commissioned officer or soldier not be administered upon within a short period after his decease, they shall be disposed of by a Council of Administration, under the authority of the commanding officer of the post, and the proceeds deposited with the Paymaster, to the credit of the United States, until they shall be claimed by the legal representatives of the deceased.

Par. 154. In all such cases of sales by the Council of Administration, a statement in detail, or account of the proceeds, duly certified by the Council and commanding officer, accompanied by the Paymaster's receipt for the proceeds, will be forwarded by the commanding officer to the Adjutant General. The statement will be endorsed, "Report of the proceeds of the effects of _____, late of company (—) _____ regiment of _____, who died at _____, the _____ day of _____, 186—."

NOTE 1.—The effects in all cases, when called for, should be turned over to the legal representative, without further authority from the Adjutant General. When the effects are turned over to the relatives of the deceased before these inventories are sent to the Adjutant General, their receipts therefor should be attached to the inventories. In all other cases, one copy will be sent with a letter of transmittal direct to the Adjutant General, and a duplicate retained by the officer.

NOTE 2.—Particular care should be taken to take receipts in duplicate from the Paymaster for any funds turned over to him; one copy should be sent direct to the Adjutant General and one retained by the officer.

INVENTORY OF THE EFFECTS

OF

Reuben Young

 Late of Company _____

Reg't of *19th Reg't*

Volunteers, who died at _____

on the *5* day of _____ 186*3*.

Inventory of the effects of Rufus Young late
 a Private of Captain L. P. Lambert Company "D" of
 the 8th Regiment of U. S. A. Heavy Volunteers, who was enrolled as
 a Private at Fort Donelson in the State of Tennessee on
 the 20th day of March 1864, and mustered into the service of the United
 States as a Private on the 20th day of March 1864, at Paducah Ky
 in Company "D", 8 Regiment of U. S. A. H. Volunteers, to serve Three
 years or during the war; he was born in Trigg Co. in the State
 of Kentucky; he was 22 years of age, 5 feet 6 inches
 high, _____ complexion, _____ eyes, _____ hair, and by occupation, when enrolled,
 a Farmer; he died in Quarters, at
Paducah Ky on the 5 day of March 1865, by
 reason of "Dysentery"

INVENTORY.					
ARTICLES.	No.	ARTICLES.	No.	ARTICLES.	No.
Hats.....		Pairs trousers.....		Knapsacks.....	
Caps.....		Pairs flannel drawers.....			
Forage Caps.....		Pairs cotton drawers.....			
Great coats.....		Flannel shirts.....			
Uniform coats.....		Cotton shirts.....			
Uniform jackets.....		Pairs boots.....			
Flannel sack coats.....		Pairs shoes.....	1		
Blouses.....		Pairs socks.....			
Stable frocks.....		Blankets.....	1		
Fatigue overalls.....		Haversacks.....			
				MONEY.	
				Specie.....	\$
				Notes.....	\$

I CERTIFY, ON HONOR, that the above inventory comprises all the effects of Private
Rufus Young, deceased, and that the effects are in the hands
 of his aunt Mary Mahon at Paducah Ky
 to be disposed of by a Council of Administration.
and a receipt taken of her for the same appended

(DUPLICATES.)

STATION: Paducah Ky

DATE: March 9th 1865

J. N. Helstrom
1st Lieut & U. S. A. H.
 Commanding the Company.

Paducah Kentucky
March 9th 1865

Received of 1st Lieut Jonas N. Helstrom Comd
Co^d 8th U.S. C. & A. Army Heavy the following articles
the effects of my nephew Rufus Youngs lately
deceased.

(1) one pair Shoes
(1) one Wool Blanket

Mary ^{nee} Mahan
mark

Witness

St. F. C. Cochr
8th U.S. C. & A. 26.

D

FINAL STATEMENT

OF

Per Rufus Young

54 Reg't of *11th Me*

VOLUNTEERS.

NOTE 1.—Two of these certificates (or duplicates) are to be given to each volunteer soldier who may be discharged previously to the discharge of his company, that he may at once receive from the Paymaster the pay, &c., due him, and the captain or other officer commanding the company will certify to the act of the delivery of the duplicate certificates; on these certificates the Soldier is "entitled to" his discharge, and should also present his discharge to the Paymaster to have the payment endorsed on it. The discharge is to be given back to the Soldier by the Paymaster; the latter only retaining as his voucher the duplicate certificates.

NOTE 2.—If the Soldier is entitled to pay for the use of his horse, the Company Commander will certify to that fact, and also to the time he has pay due for having been so mounted on his own horse.

NOTE 3.—Amounts due the Sutler and Laundress must be entered on the Muster Roll on which the death, desertion, &c., is reported, as well as on the final statement, otherwise the amount cannot be collected from the United States.

NOTE 4.—This blank will be used for deceased volunteers as well as others.



I certify, on honor, that Rufus Young a Private of
 Captain L. S. Gambel's Company (C) of the 8th Regiment of U.S. Cavalry
VOLUNTEERS, of the State of _____, born in Trigg Co, State
 of Kentucky, aged 22 years; 5 feet 6 inches high; Swain complexion,
Black eyes, Black hair, and by occupation a Farmer, having joined the company on
 its original organization at Ft. Donnellon Tenn, and enrolled in it at the muster into
 the service of the United States at Paducah Ky, on the 20th day
 of March, 1864, (or was mustered in service as a recruit, by _____
 _____, at _____, on the _____ day of _____
 186 , to serve in the Regiment,) for the term of Three years
 and having served **HONESTLY** and **FAITHFULLY** with his Company in the Field
 to the present date, is now entitled to a **DISCHARGE** by reason of Death
March 5th 1865 at Paducah Ky

The said Rufus Young was last paid by Paymaster
May Ferris to include the 31st day of October, 1864, and has
 pay due him from that time to the present date; he is entitled to pay and subsistence for
TRAVELING to place of enrollment and whatever other allowances are authorized to volunteer
 soldiers, or militia, so discharged. He has received 45 ⁵⁷/₁₀₀ dollars,
 advanced by the United States on account of **CLOTHING**. since Enlistment

There is to be stopped from him, on account of the State of _____, or other
 authorities for **CLOTHING**, &c., received on entering service, _____/100 dollars; also,
 for expenses of **SUBSISTENCE** for **TRAVELING** from place of enrollment to the place of rendezvous,
 amounting to _____/100 dollars: and on account of the United States for **EXTRA**
CLOTHING received in kind from _____ and for other
 stoppages, viz:

_____ amounting to _____/100 dollars;
 and he has been **SUBSISTED** for **TRAVELING** to his place of enrollment, up to the _____
 _____, 186 .

He is indebted to _____, **SUTLER**, _____/100 dollars.
 He is indebted to _____, **LAUNDRESS**, _____/100 dollars.

Given in Duplicate, at Paducah Ky, this 9 day of March, 1865.

J. N. Helstrom
Private & Co. A. B.
 Commanding Company.

5
FINAL STATEMENT

OF

Reg't of

VOLUNTEERS.

NOTE 1.—Two of these certificates (or duplicates) are to be given to each Volunteer Soldier or drafted man who may be discharged previously to the discharge of his company, that he may at once receive from the Paymaster the pay, &c., due him, and the captain or other COMMISSIONED officer commanding the company will certify to the act of the delivery of the duplicate certificates; on these certificates the Soldier is "entitled to" his discharge, and should also present his discharge to the Paymaster to have the payment endorsed on it. The discharge is to be given back to the Soldier by the Paymaster; the latter only retaining as his voucher the duplicate certificates.

NOTE 2.—If the Soldier is entitled to pay for the use of his horse, the Company Commander will certify to that fact on the back of both these final statements, and also to the time he has pay due for having been so mounted on his own horse.

NOTE 3.—When a Soldier is furnished with final statements, his descriptive list, if he has one, should be taken up by the officer who gives the Soldier these statements, and endorsed with a statement to this effect by the officer. This endorsement should exhibit a full statement of the time for which the Soldier was allowed pay on his final statements, the clothing account, and all other charges against him or in his favor, so as to comprise a complete exhibit of his account. It will then be transmitted to the Company Commander of the Soldier, who will enter all the data necessary to a full understanding of the Soldier's account on the muster roll upon which the Soldier's discharge is reported. The descriptive list will then be destroyed. The object of this is, that the remaining portion of the Soldier's account may be settled upon the receipt of these muster rolls, and the Soldier receive any pay or allowances that may be due him at the time of his discharge, and which may not appear on his final statements from the fact that his descriptive list is incomplete. These accounts for back pay, &c., are settled by the 2d Auditor of the Treasury Department.

NOTE 4.—Charges for loss or injury to ordnance, horse equipments, and other miscellaneous charges, should appear under the heading of "Other Stoppages."

NOTE 5.—Bounty paid by State authorities, and not by the United States, will not be entered on this statement.

NOTE 6.—Amounts due the Sutler and Laundress must be entered on the muster roll on which the discharge, death, desertion, &c., is reported, as well as on the final statement, otherwise the amount cannot be collected from the United States.

NOTE 7.—This blank will be used for deceased volunteers and drafted men, as well as for others.

NOTE 8.—Where a Soldier dies in Hospital or on detached service, his descriptive list, if he has one, should be sent with his final statements, in duplicate, to the Adjutant General, Washington, D. C.

ADJUTANT GENERAL'S OFFICE

April 4th 1862

Duplicate with Inventory sent 2d Auditor.

Adjutant General's Office
Washington D.C., May 7, 1862

G.O. 200.7. pay-280
The Muster-Cut Roll of Co.
"D" 9th U.S. Colored Artillery
(Regt) reports the death of
Private Rufus Young, Number

- 1862.
The Muster Roll of the
Company and the Final
Statement of the soldier
report date of death March
5, 1862. This date is held to
be correct, and the Company
Muster Cut Roll will
be completed accordingly.

J.R. Ralston
Brevet Colonel U.S.A.
In Chg Bureau Cold Strop.

Recd. of May 13. 62 in 2d aud.

Noted May 11 1862

I certify, on honor, that Rufus Young a Private of
 Captain L. J. Gambato Company (D) of the 8th Regiment of U. S. Cold Artillery
VOLUNTEERS, of the State of _____, born in Trigg Co, State
 of Kentucky, aged 22 years; 5 feet 6 inches high; Brown complexion,
Blue eyes, Black hair, and by occupation a Farmer, having joined the company on
 its original organization at Fr. P. Conellum Tenn, and enrolled in it at the muster into
 the service of the United States at Paducah Ky, on the 20th day
 of March, 1864, (or was mustered in service as a recruit, by _____
 _____, at _____, on the _____ day of _____,
 1864, or was drafted and mustered into the service of the United States from the _____
 Enrollment District of the State of _____, at _____,
 on the _____ day of _____, 1864.) to serve in the Regiment, for
 the term of Three Years: and having served **HONESTLY** and
FAITHEULLY with his Company in the Field, to the present date, is now
 entitled to a **DISCHARGE** by reason of _____

The said Rufus Young was last paid by Paymaster
Wm J. Fink to include the 31st day of October, 1864, and has
 pay due him from that time to the present date; he is entitled to pay and subsistence for
TRAVELING to place of enrollment, and whatever other allowances are authorized to volunteer
 soldiers, drafted men, or militia, so discharged. He has received from the United States **CLOTHING**
 amounting to 45 ⁵⁷/₁₀₀ dollars, since the _____ day of Enlistment,
 1864, when his clothing account was last settled. He has received from the United States
None ₁₀₀ dollars advanced **BOUNTY**.

There is to be stopped from him, on account of the State of _____, or other
 authorities, for **CLOTHING**, &c., received on entering service, _____ ₁₀₀ dollars; and
 for other stoppages, viz: _____

_____ ₁₀₀ dollars.
 He has been furnished with **TRANSPORTATION** in kind from the place of his discharge to
 _____; and he has been **SUBSISTED** for **TRAVELING** to his
 place of enrollment, up to the _____, 1864.

He is indebted to _____, **SUTLER**, _____ ₁₀₀ dollars.
 He is indebted to _____, **LAUNDRESS**, _____ ₁₀₀ dollars.

Given in Duplicate, at Paducah Kentucky, this 9th day
 of March, 1865.

J. M. Helstrom
8th U.S. Art.
 Commanding Company.

1987
Young, William
Co C, 8 U.S. Col'd H. Art'y.

Private Private

CARD NUMBERS.

1	5467313	26
2	5467203	27
3	5474759	28
4	5474886	29
5	5475006	30
6	5475126	31
7	5475241	32
8	5475351	33
9	5475447	34
10	5475550	35
11	5475638	36
12	9122329	37
13		38
14		39
15		40
16		41
17		42
18		43
19		44
20		45
21		46
22		47
23		48
24		49
25		50

Book Mark:

See also

S-1976285 P.O. W. M.

S.S. 203. 3/18/30.

M | 8 H. Art'y. | U.S.C.T.

William Young

....., Co. *E*....., 8 Reg't U.S. Col'd H. Art'y.

Appears on

Company Descriptive Book
of the organization named above.

DESCRIPTION.

Age *7* years; height *5* feet *4* inches.

Complexion *Blk*

Eyes *Blk*; hair *Blk*

Where born *Enrique Co., Ky.*

Occupation *Farmer*

ENLISTMENT.

When *Sept. 12*....., 186*4*.

Where *Paducah, Ky.*

By whom *Capt. Hall*; term *3* y'rs.

Remarks:

.....

.....

.....

.....

.....

.....

.....

.....

.....

.....

.....

.....

.....

.....

.....

.....

.....

.....

.....

.....

.....

.....

.....

.....

S. A. McFarland

2

S H. Art'y.

U.S.C.T.

William Young

Appears with rank of Private on

Muster and Descriptive Roll of a Detachment of U. S. Vols. forwarded

for the 8 Reg't U. S. Col'd H. Art'y. Roll dated

Paducah, Ky., N.Y. Sept. 30, 1864.

Where born Trigg, Ky.

Age 17 y'rs; occupation Farmer

When enlisted Sept. 12, 186 .

Where enlisted Paducah, Ky.

For what period enlisted 3 years.

Eyes Black; hair Black

Complexion Black; height 5 ft. 4 1/2 in.

When mustered in Sept. 12, 186 .

Where mustered in Paducah

Bounty paid \$ 100; due \$ 100

Where credited McCracken, Mo. Ky.

Company to which assigned E. J.

Remarks : _____

Book mark : _____

Callaway

(339)

Copyist.

J. William Young

8 II. Art'y. U.S.C.T.

Appears with rank of *Private* on

Muster and Descriptive Roll of a Detachment of U. S. Vols. forwarded

for the 8 Reg't U. S. Col'd H. Art'y. Roll dated

Paducah, Ky., N.Y. Sep 30, 1864.

Where born *Trigg, Ky.*

Age *17* y'rs; occupation *Farmer*

When enlisted *Sep 12*, 186 .

Where enlisted *Paducah, Ky.*

For what period enlisted *3* years.

Eyes *Blk*; hair *Blk*

Complexion *Yellow*; height *5 ft. 4 1/2 in.*

When mustered in *Sep 12*, 186 .

Where mustered in *Paducah*

Bounty paid \$ *100*; due \$ *100*

Where credited *W. C. Macken Co. Kentucky*

Company to which assigned *E*

Remarks:

Book mark:

Louis J. Murray, Jr.
(339) Copyist.

Y

S H. Art'y.

U.S.C.T.

William Young

Rk, Co. E, 8 Reg't U. S. Col'd H. Art'y.

Appears on

Company Muster Roll

for *Sept and Oct*, 186*4*.

Present or absent *Present*

Stoppage, \$ *100* for

Due Gov't, \$ *100* for

Valuation of horse, \$ *100*

Valuation of horse equipments, \$ *100*

Remarks:

Book mark:

Jas. V. Kearny
Copyist.

(358)

Y

8 H. Art'y.

U.S.C.T.

William Young
Priv., Co. E, 8 Reg't U. S. Col'd H. Art'y.

Appears on

Company Muster Roll

for Nov. + Dec., 1864.

Present or absent Present

Stoppage, \$ 100 for

Due Gov't, \$ 100 for

Valuation of horse, \$ 100

Valuation of horse equipments, \$ 100

Remarks:

Book mark:

C. E. M. Laughlin

(358)

Copyst.

WAR 1864

Y | S H. Art'y. | U.S.C.T.

William Young
Priv., Co. E, 8 Reg't U. S. Col'd H. Art'y.

Appears on

Company Muster Roll

for Jan. + Feb., 1865.

Present or absent Present

Stoppage, \$ 100 for

Due Gov't, \$ 100 for

Valuation of horse, \$ 100

Valuation of horse equipments, \$ 100

Remarks: Due the U.S. for
one Canteen and one
Haversack \$1.60

Book mark:

(358) L E M Laughlin
Copist.

Y | 8 H. Art'y. | U.S.C.T.

William Young
Priv., Co. E, 8 Reg't U. S. Col'd H. Art'y.

Appears on

Company Muster Roll

for Mar. & Apr. 1865.

Present or absent Present

Stoppage, \$ 100 for

Due Gov't, \$ 100 for

Valuation of horse, \$ 100

Valuation of horse equipments, \$ 100

Remarks: Due the U.S.
for 6^{mo} G. C. \$ 60 / 100

Book mark:

C. E. M. Laughlin

(358)

Copyist.

Y | 8 H. Art'y. | U.S.C.T.
William Young
Priv., Co. E, 8 Reg't U. S. Col'd H. Art'y.

Appears on

Company Muster Roll
for May & June, 1865.
Present or absent Present

Stoppage, \$ 100 for

Due Gov't, \$ 100 for

Valuation of horse, \$ 100

Valuation of horse equipments, \$ 100

Remarks: Due U. S. for
C. & G. E. \$ 60 / 100

Book mark:

(358) C. E. M. Laughlin
Copyist.

Y

8 H. Art'y.

U.S.C.T.

William Young

Pol, Co. E, 8 Reg't U. S. Col'd H. Art'y.

Appears on

Company Muster Roll

for *July & Aug*, 1865.

Present or absent *Present*

Stoppage, \$ *100* for

Due Gov't, \$ *100* for

Valuation of horse, \$ *100*

Valuation of horse equipments, \$ *100*

Remarks: *Due the U.S. for 679.6.*
\$100.

Book mark:

E. C. Carroll

Y | S H. Art'y. | U.S.C.T.

William Young

Plt, Co. E, 8 Reg't U. S. Col'd H. Art'y.

Appears on

Company Muster Roll

for *Sept & Oct*, 1865.

Present or absent *Present*

Stoppage, \$ *100* for

Due Gov't, \$ *100* for

Valuation of horse, \$ *100*

Valuation of horse equipments, \$ *100*

Remarks:

Book mark: *50402*

E. Carroll

Y | 8 H. Art'y. | U.S.C.T.

William Young

Plt, Co. E, 8 Reg't U. S. Col'd H. Art'y.

Appears on

Company Muster Roll

for *Nov & Dec*, 186*5*.

Present or absent *Present*

Stoppage, \$ *100* for

Due Gov't, \$ *100* for

Valuation of horse, \$ *100*

Valuation of horse equipments, \$ *100*

Remarks:

Book mark: _____

E. C. Carroll

W | S H. Art'y. | U.S.C.T.

William Young
Pot., Co. *C*, 8 Reg't U. S. Col'd H. Art'y.

Appears on **Co. Muster-out Roll**, dated
Victoria Texas Feb 10, 186*6*.

Muster-out to date *Feb 10*, 186*6*.

Last paid to *Aug 31*, 186*5*.

Clothing account:

Last settled....., 186 ; drawn since \$..... 100

Due soldier \$ *7* ^{*42*}/₁₀₀; due U. S. \$..... 100

Am't for cloth'g in kind or money adv'd \$..... 100

Due U. S. for arms, equipments, &c., \$..... 100

Bounty paid \$ *None* 100; due \$ *100* 100

Remarks: *Entered Service as recruit*
joined Co for duty Sept 12. 64

Book mark:

E. Carroll

Company *William*
P. C., *8* Reg't *U. S. A.*

/ **Enclosures.**

Bed Cards	Final Statements
Burial Records	Furloughs or L. of A.
Certs. of Dis. for Discharge	Med. Certificates
C. M. Charges	Med. Des. Lists
Descriptive Lists	Orders
Discharge Certificates	Pris. of War Record
Enlistment Papers	Resignations

Other papers relating to—

Admission to Hosp'l	Furlough or L. of A.
Casualty Sheet	Med. Examination
Confinement	Misc. Information
Contracts	Pay or Clothing
Death or Effects	Personal Reports
Desertion	Rank
Discharge from Hosp'l	Transfer to Hosp'l
Discharge from Service	Transfer to V. R. C.
Duty	Transportation
.....

8th 1190, 701101
151

No. Ninety three

Young William
Volunteered at Paducah Ky

September 2 18 64

By Capt R. A. Hill
Pro Marshal Court of Ky

William Hill

Consent of Parent or Guardian in case of a Minor, if a Free Man, or in the case of a Slave, of the Person to whom he owes Service:

of United States colored troops. They will be made out in duplicate in all cases—one General, and one to accompany the accounts of the officer who pays bounty, &c. A muster-roll, must in all cases, precede payment of pay, bounty, pension, &c. A muster-roll officer, commissary, or assistant commissary of musters, as the case may be, will certify of them is given to the disbursing officer.

UNITED STATES COLORED TROOPS ENLISTMENT.

STATE OF

TOWN OF



I, Young William born in Paducah
Kentucky in the State of Kentucky aged Seventeen years
and by occupation a Farmer Do HEREBY ACKNOWLEDGE to have
volunteered this Tenth day of September 1864

to serve as a **Soldier** in the **Army of the United States of America**, for
the period of **THREE YEARS**, unless sooner discharged by proper authority:
Do also agree to accept such bounty, pay, rations, and clothing, as are, or may be,
established by law for the U. S. colored troops.

And I, William Young of Paducah
do solemnly swear, that I will bear true faith and allegiance to the **United States
of America**, and that I will serve them honestly and faithfully against all their
enemies or opposers whomsoever; and that I will observe and obey the orders of
the President of the United States, and the orders of the officers appointed over
me, according to the Rules and Articles of War.

Sworn and subscribed to, at Paducah
this 12th day of Sept 1864 } William Young
Before Capt. R. S. Hall } made

I CERTIFY, ON HONOR, That I have carefully examined the above named Volunteer, agreeably to the
General Regulations of the Army, and that, in my opinion, he is free from all bodily defects and mental infirmity,
which would in any way disqualify him from performing the duties of a soldier.

EXAMINING SURGEON.

I CERTIFY, ON HONOR, That I have minutely inspected the Volunteer, William Young
previously to his enlistment, and that he was entirely sober when enlisted; that, to the best of my judgment and
belief, he is of lawful age; and that, in accepting him as duly qualified to perform the duties of an able-bodied
soldier, I have strictly observed the regulations which govern the recruiting service. This soldier has blue
eyes, blue hair, light complexion, is five feet 4 inches high.

RECRUITING OFFICER OR AGENT.

Mustered into the United States service 12th day of September 1864

R. S. Hall
Capt. Proctor Mustering Officer.

Mustered into the service of the United States, for three years or during the war, from date of enlistment, in Company C
7th Regiment of Miss. Colored Volunteers, on the 12th day of September, 1864 at Paducah

R. S. Hall
Capt. Proctor
12th Sept 1864

NOTE 1.—This blank will be used for enlistments of United States colored troops. They will be made out in duplicate in all cases—one to accompany the recruiting return of the superintendent (not the recruiting officer) to the Adjutant General, and one to accompany the accounts of the officer who pays bounty, &c.

NOTE 2.—An enlistment holds to service. A muster-in, must in all cases, precede payment of pay, bounty, pension, &c. A muster-in roll, must in all cases, be filed in the Adjutant General's Office as evidence of muster-in. The mustering officer, commissary, or assistant commissary of musters, as the case may be, will countersign both enlistments as having mustered the soldier into the service of the United States before either of them is given to the disbursing officer.

DECLARATION OF RECRUIT.

I, William Young of Moberly Mo desiring to volunteer as a soldier in the ARMY OF THE UNITED STATES, for the term of Three Years, DO DECLARE That I am Seventeen years and months of age; that I have never been discharged from the United States service on account of disability or by sentence of a court-martial, or by order before the expiration of a term of enlistment; and I know of no impediment to my serving honestly and faithfully as a soldier for three years.

GIVEN at Pudmoh St.

the 24th day of September 1864

Witness: A. J. [Signature]

William Young
Volunteer of Pudmoh St.

By Geo. H. [Signature]
[Signature]

Geo. H. [Signature]
[Signature]

No. 1111

1111
1864

Consent of Parent or Guardian in case of a Minor, if a Free Man, or in the case of a Slave, of the Person to whom he owes Service:

I, Do CERTIFY, That I am the that the said is years of age; and I do freely give my CONSENT to his volunteering as a SOLDIER in the Army of the United States, for the period of THREE YEARS, under the conditions of the laws of the United States.

GIVEN at

the day of

Witness:

1988 ma
Young, William
Co F, 8 U.S. Col'd H. Art'y.

Private

CARD NUMBERS.

1	5475952	26
2	5476079	27
3	5476189	28
4	5476298	29
5	5476426	30
6	5476533	31
7	5476640	32
8	5476741	33
9	5476842	34
10	5476932	35
11	9122481	36
12	40745004	37
13		38
14		39
15		40
16		41
17		42
18		43
19		44
20		45
21		46
22		47
23		48
24		49
25		50

Book Mark:

See also

4

8 H. Art'y.

U.S.C.T.

William Young

....., Co. *F*, 8 Reg't U.S. Col'd H. Art'y.

Appears on

Company Descriptive Book

of the organization named above.

DESCRIPTION.

Age *20* years; height *5* feet *10* inches.

Complexion *Blk*

Eyes *Blk*; hair *Blk*

Where born *Lyons Co., Kentucky*

Occupation *Fanner*

ENLISTMENT.

When *August 3rd*, 186*4*.

Where *Paducah, Ky*

By whom *Capt. Hall*; term *3* y'rs.

Remarks:

E. J. Morland

(383a)

Copyist.

W. Williams

Co. F, 8 Reg't U. S. Col'd H. Art'y.

Appears on

Company Muster Roll

for *July 1864*, 1864

Present or absent *Present*

Stoppage, \$ *100* for

Due Gov't, \$ *100* for

Valuation of horse, \$ *100*

Valuation of horse equipments, \$ *100*

Remarks: *Enrolled + mus - in Aug 64 at Caducah Ky. for 3 years*

Book mark:

J. Nelson
(358) Copyist.

W

S H. Art'y.

U.S.C.T.

William Jones

Co. F, 8 Reg't U. S. Col'd H. Art'y.

Appears on

Company Muster Roll

for *Sept 25*, 186*4*

Present or absent *Present*

Stoppage, \$ *100* for

Due Gov't, \$ *100* for

Valuation of horse, \$ *100*

Valuation of horse equipments, \$ *100*

Remarks:

Book mark:

J. Nelson
(358) Copyist.

C/

8 H. Art'y.

U.S.C.T.

William Young

Priv., Co. F, 8 Reg't U. S. Col'd H. Art'y.

Appears on

Company Muster Roll

for *Nov & Dec*, 186*4*

Present or absent *Present*

Stoppage, \$ 100 for

Due Gov't, \$ 100 for

Valuation of horse, \$ 100

Valuation of horse equipments, \$ 100

Remarks:

Book mark: -----

J. Nelson

(358)

Copyist.

Y | **S H. Art'y.** | **U.S.C.T.**

William Young
Prvt, Co. F, 8 Reg't U. S. Col'd H. Art'y.

Appears on

Company Muster Roll

for *Jan & Feb*, 186*5*.

Present or absent *Present*

Stoppage, \$ *100* for

Due Gov't, \$ *100* for

Valuation of horse, \$ *100*

Valuation of horse equipments, \$ *100*

Remarks: _____

Book mark: _____

G. W. Chase

(358)

Copyist.

Y | S H. Art'y. | U.S.C.T.

William Young
Pot, Co. F, 8 Reg't U. S. Col'd H. Art'y.

Appears on

Company Muster Roll

for *Mich & Apr*, 1865.

Present or absent *Absent*

Stoppage, \$ *100* for

Due Gov't, \$ *100* for

Valuation of horse, \$ *100*

Valuation of horse equipments, \$ *100*

Remarks: *Absent sick at Paducah, Ky, since Apr 7, 1865.*

Book mark:

G. W. Chase

Y | S H. Art'y. | U.S.C.T.

William Young
Prvt, Co. F, 8 Reg't U. S. Col'd H. Art'y.

Appears on

Company Muster Roll

for *May & June*, 186*5*

Present or absent *Absent*

Stoppage, \$ *100* for

Due Gov't, \$ *100* for

Valuation of horse, \$ *100*

Valuation of horse equipments, \$ *100*

Remarks: *Absent sick at Paducah, Ky, since Apr. 7/65.*

Book mark: _____

G. W. Chase

W | S H. Art'y. | U.S.C.T.

William Young

Prs, Co. F, 8 Reg't U. S. Col'd H. Art'y.

Appears on

Company Muster Roll

for *July & Aug*, 1865.

Present or absent *Absent*

Stoppage, \$ *100* for

Due Gov't, \$ *100* for

Valuation of horse, \$ *100*

Valuation of horse equipments, \$ *100*

Remarks: *Absent sick in hospital at Paducah, Ky, since Apr 7/65.*

Book mark: _____

G. W. Chase

(358)

Copyist.

Y

S H. Art'y.

U.S.C.T.

William Young

Private, Co. F, 8 Reg't U. S. Col'd H. Art'y.

Appears on

Company Muster Roll

for *Sept & Oct*, 186*5*.

Present or absent *Absent*

Stoppage, \$ *100* for

Due Gov't, \$ *100* for

Valuation of horse, \$ *100*

Valuation of horse equipments, \$ *100*

Remarks: *Absent sick in Hospital Paducah, Ky. since April 7th 1865.*

Book mark: _____

Keefe

(358)

Copyist.

4 | 8 H. Art'y. | U.S.C.T.

William Young

Private Co. F, 8 Reg't U. S. Col'd H. Art'y.

Appears on

Company Muster Roll

for *Nov. Dec*, 1865.

Present or absent *Absent*

Stoppage, \$ *100* for

Due Gov't, \$ *100* for

Valuation of horse, \$ *100*

Valuation of horse equipments, \$ *100*

Remarks: *Absent sick in Hospital at Paducah, Ky, since April 7, 1865.*

Book mark: _____

(358)

Keefe
Copyist.

Y. | 8 H. Art'y. | U.S.C.T.

William Young

Priv, Co. *F.*, 8 Reg't U. S. Col'd H. Art'y.

Appears on Returns as follows:

April 1863 to June 1866.
absent sick in Hosp.
at Paducah Ky since
April 1865.

Book mark:

Chas. Patton

(546)

Copyist.

2

S. H. Art'y.

U.S.C.T.

William Young
Private, Co. F, 8 Reg't U. S. Col'd H. Art'y.

Appears on **Co. Muster-out Roll**, dated

Victoria, Texas, Feb. 10, 1866.

Muster-out to date _____, 186 .

Last paid to *Oct 31*, 186 *4*.

Clothing account:

Last settled _____, 186 ; drawn since \$ _____ 100

Due soldier \$ _____ 100; due U. S. \$ _____ 100

Am't for cloth'g in kind or money adv'd \$ _____ 100

Due U. S. for arms, equipments, &c., \$ _____ 100

Bounty paid \$ _____ 100; due \$ _____ 100

Remarks: *Entered service as recruit. Joined Co. for duty Aug. 3 '64. Absent sick at Paducah, Ky. since Apl. 7, '65. Descriptive list furnished Apl. 15 '65.*

Book mark: _____

Keefe

(361)

Copyist.

JAN. 14

5476932

1891

No discharge given.

Age 20 years

Young, William
B. F. 8

Reg't U.S.C.H.A.

✓

Enclosures.

- | | |
|------------------------------------|-------------------------|
| Bed Cards | Descriptive Lists |
| Burial Records | Final Statements |
| Certs. of Dis. for Discharge | Furloughs |
| C. M. Charges | Med. Des. Lists |
| Med. Certificates | Orders |

Other papers relating to—

- | | |
|---|---------------------------|
| Admission to Hosp'l | Furlough |
| Casualty Sheet (Officer's) / | Med. Examination |
| Confinement | Misc. Information / |
| Contracts | Pay or Clothing |
| Death or Effects | Personal Reports |
| Desertions | Rank |
| Discharge from Hosp'l | Transfer to Hosp'l |
| Discharge from Service | Transfer to V. R. C. |
| Duty | Transportation |

MICROFILM PUBLICATION M 1829

COMPILED MILITARY SERVICE RECORDS
OF VOLUNTEER UNION SOLDIERS WHO SERVED WITH
THE UNITED STATES COLORED TROOPS (USCT)
8TH REGIMENT OF HEAVY ARTILLY

PERSONAL PAPERS' TARGET SHEET

PLEASE NOTE THE CHECKED INFORMATION ABOUT THE PERSONAL PAPERS IN
THIS FILE:

- NO PERSONAL PAPERS WERE FOUND IN THIS FILE WHEN THE
RECORDS WERE ARRANGED FOR MICROFILMING.
- 4 PERSONAL PAPER(S) FOUND IN THIS FILE WHEN THE RECORDS
WERE ARRANGED FOR MICROFILMING.

1
Y. 10. vol. 8. c. 7. 1870.

NOV 1869

Y. 10. vol. 3. p. 1340

Sept. 1st 1870.

*Young. Wm
late pt. Co. "A" 8th U. S. C. A. (Ky)*

*The Surgeon General in reply
to letter/returns same from the
a.s.o. of Aug. 13th 1870, reports
in case of this man.*

One enc.

*1034
24*

Recd. a.s.o. Sept 1st

Surgeon General's Office,

Record and Pension Division,

Washington, *Sept 11th*, 1869.

Respectfully returned to the Adjutant
General, U. S. Army, with report enclosed.

BY ORDER OF THE SURGEON GENERAL:

Wm. Woodworth

Bvt. Lt. Col. and Asst. Surgeon, U. S. A.
(80)

Adjutant General's Office,

Washington. Aug 13th 1870.

Surgeon General, U. S. Army,

Washington, D. C.

General:

I have the honor to request that this office be furnished such information as can be obtained from the records of your office in regard to the final disposition made of William Young, late Private Company "F", 8th U. S. C. Arty. Heavy, who is reported on the muster-out roll of his Company "Absent sick in Paducah, Ky. since April 7th 1865. No discharge furnished."

If evidence of death or discharge is found, please furnish final papers.

I have the honor to be,

Very respectfully,

Your obedient servant,

Thomas M. Vincent

Assistant Adjutant General.

1870
1.1.1.

Co F

CASUALTY SHEET

No. *1000*

William Young

Private of Company *"F"*

8th - Regiment of *U. S. C. Artillery*

State Volunteers

NATURE OF CASUALTY.

Died May 9th 1865.

CASUALTY SHEET.

Name: *William Rouns*
Rank: *Private* Company: *"F"* Regiment: *8th*
Arm: *U.S. Artillery* State: _____
Nature of Casualty: *Death*

CAUSE OF CASUALTY—(NAME OF DISEASE, &c.)

Dysentery

DEGREE OF DISABILITY.

BY WHOM CERTIFIED.

Surgeon General

U. S. Army

DATE OF DISCHARGE, DEATH, &c.

May 9th 1865

PLACE OF DISCHARGE, DEATH, &c.

General Hospital, No 3

Paducah, Ky.

BY WHOM DISCHARGED.

FROM WHAT SOURCE THIS INFORMATION WAS OBTAINED.

G. 10. Vol 8 C. D. 70.

REMARKS.

Wm J. Jones

Clerk.

On Muster-out Roll of Company "F" 8th U. S.
C. Arty. (Heavy,) Private William Young is reported
"Absent sick in Paducah, Ky. since April 9th 1865. No
discharge furnished.

The Surgeon General, U. S. Army, under date of
Sept 1st 1870, reports that this soldier died at
General Hospital, No 3, Paducah, Ky. of diarrhoea,
May 9th & 10th 1865.

It is desired to know, which of the dates of
death of this soldier, as given by the Surgeon
General, should be held as correct?

Let 9th May 65
be taken as correct date



Make Caswell shut
as usual in such cases. ^{File with}
this ^(with 2/10/70) as authority for receiving May
9th 1865 as date of death.
W.P.

MICROCOPY

1 8 1 8

ROLL

1 3

IMAGE EVALUATION TEST TARGET (QA-3)

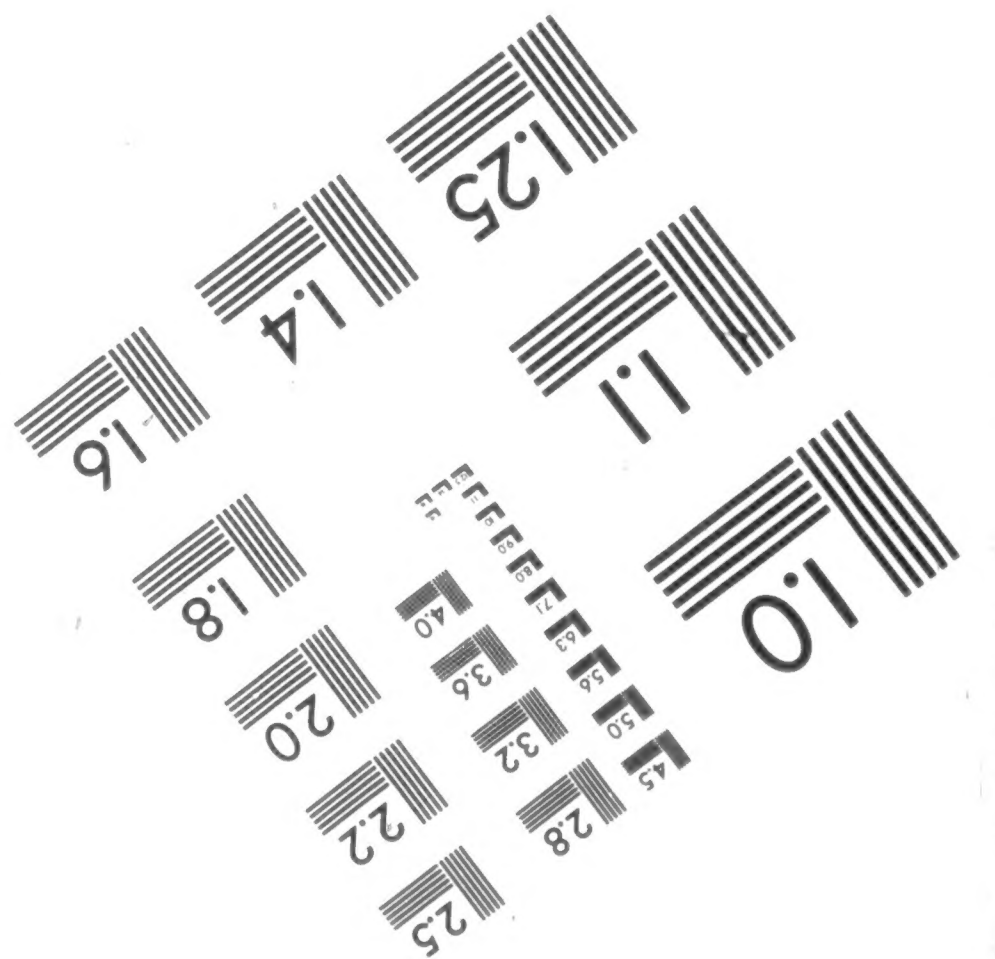
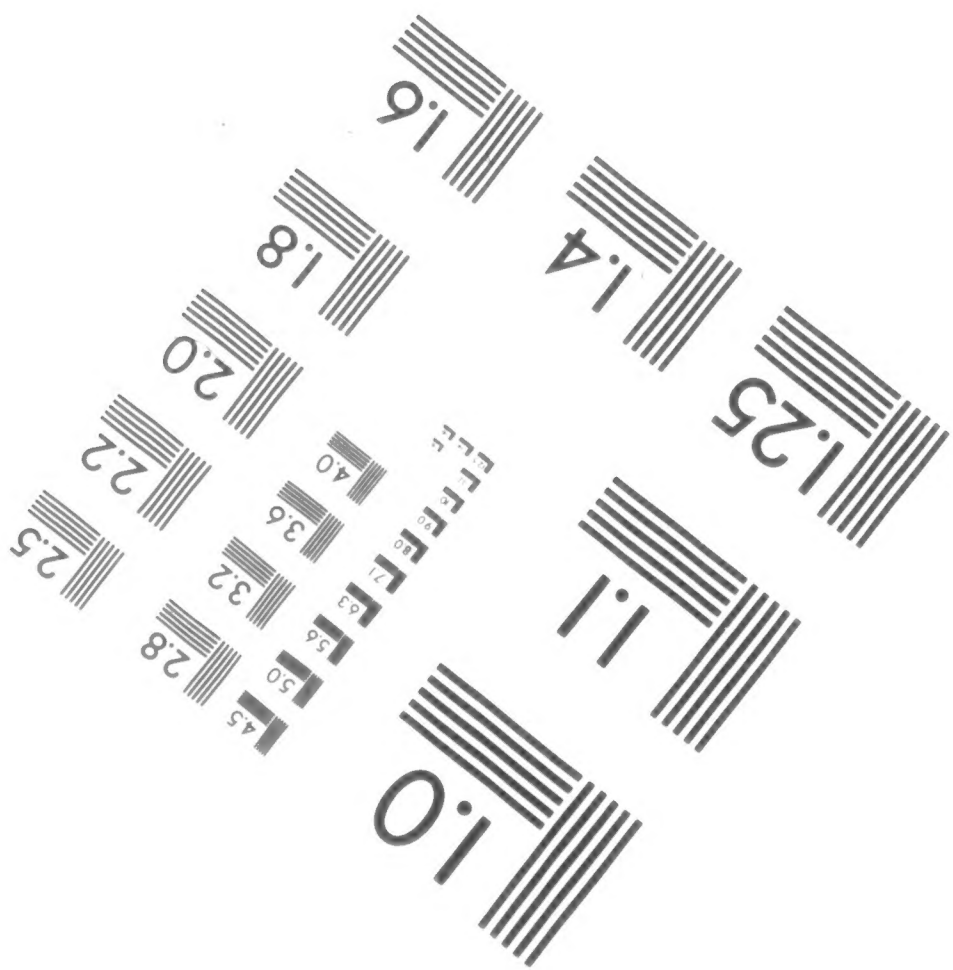
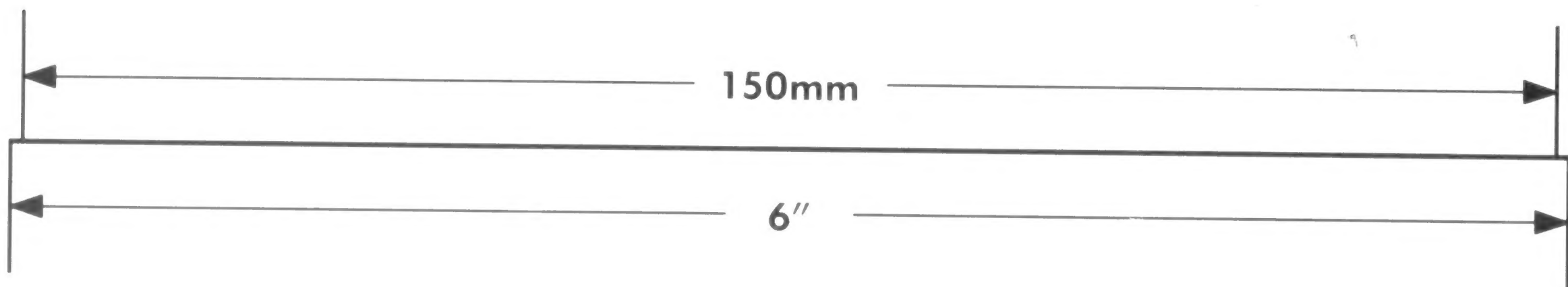
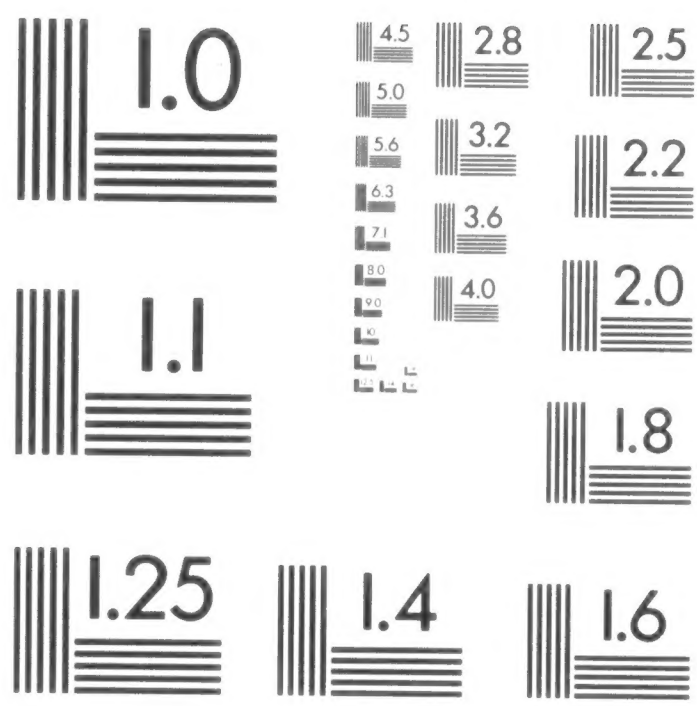
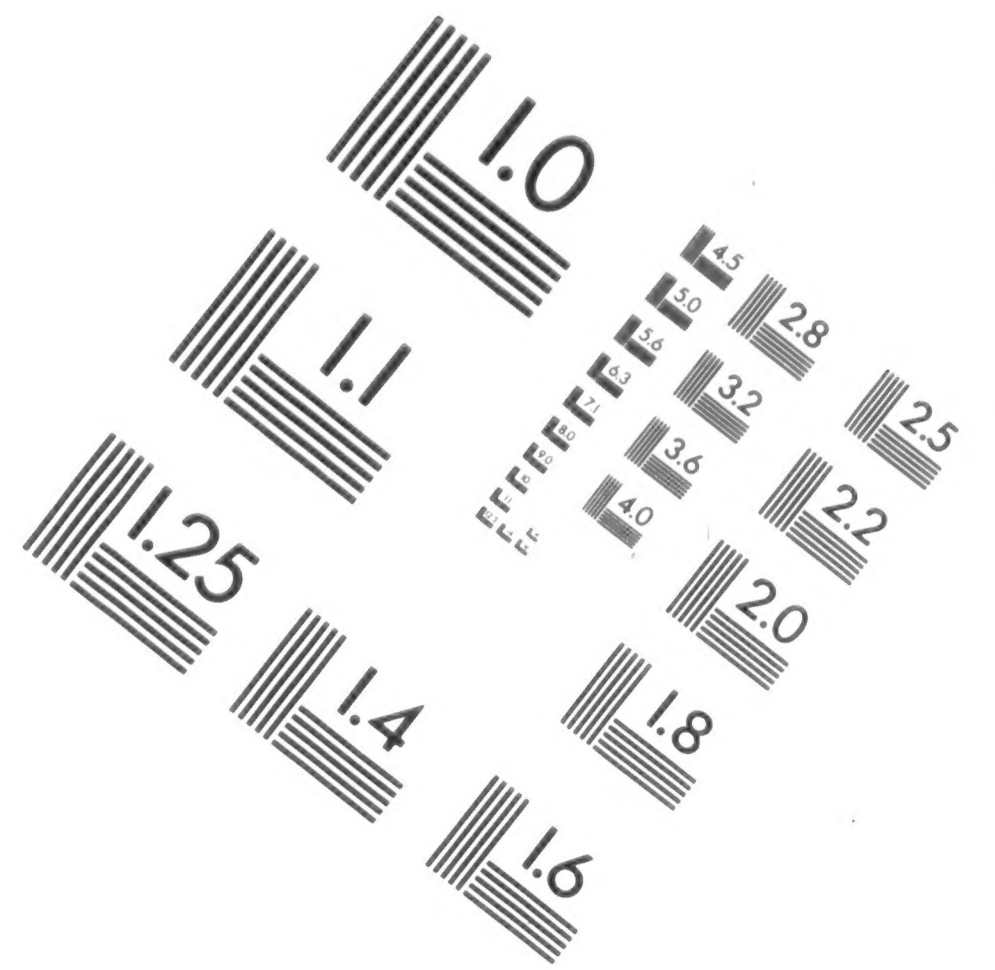
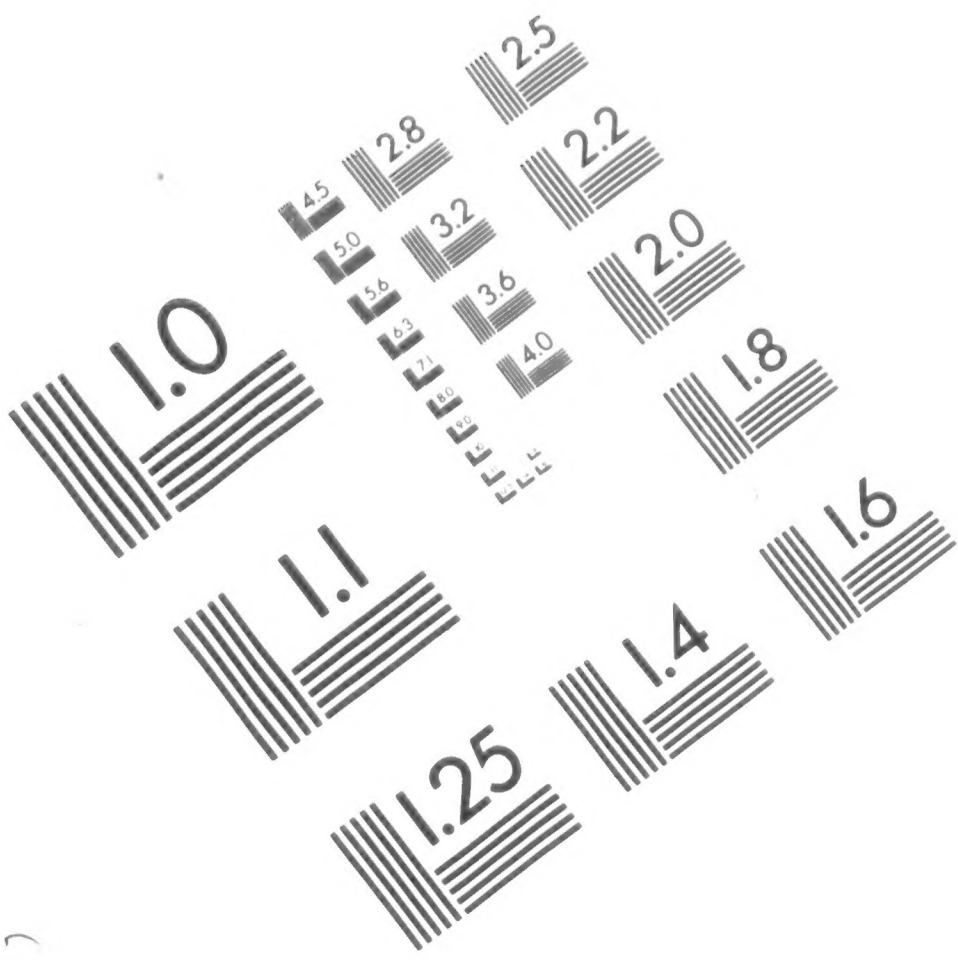

APPLIED IMAGE, Inc
 1653 East Main Street
 Rochester, NY 14609 USA
 Phone: 716/482-0300
 Fax: 716/288-5989

© 1993, Applied Image, Inc., All Rights Reserved

THE END

PLEASE

REWIND