

NATIONAL
ARCHIVES
MICROFILM
PUBLICATIONS

IMAGE EVALUATION TEST TARGET (QA-3)

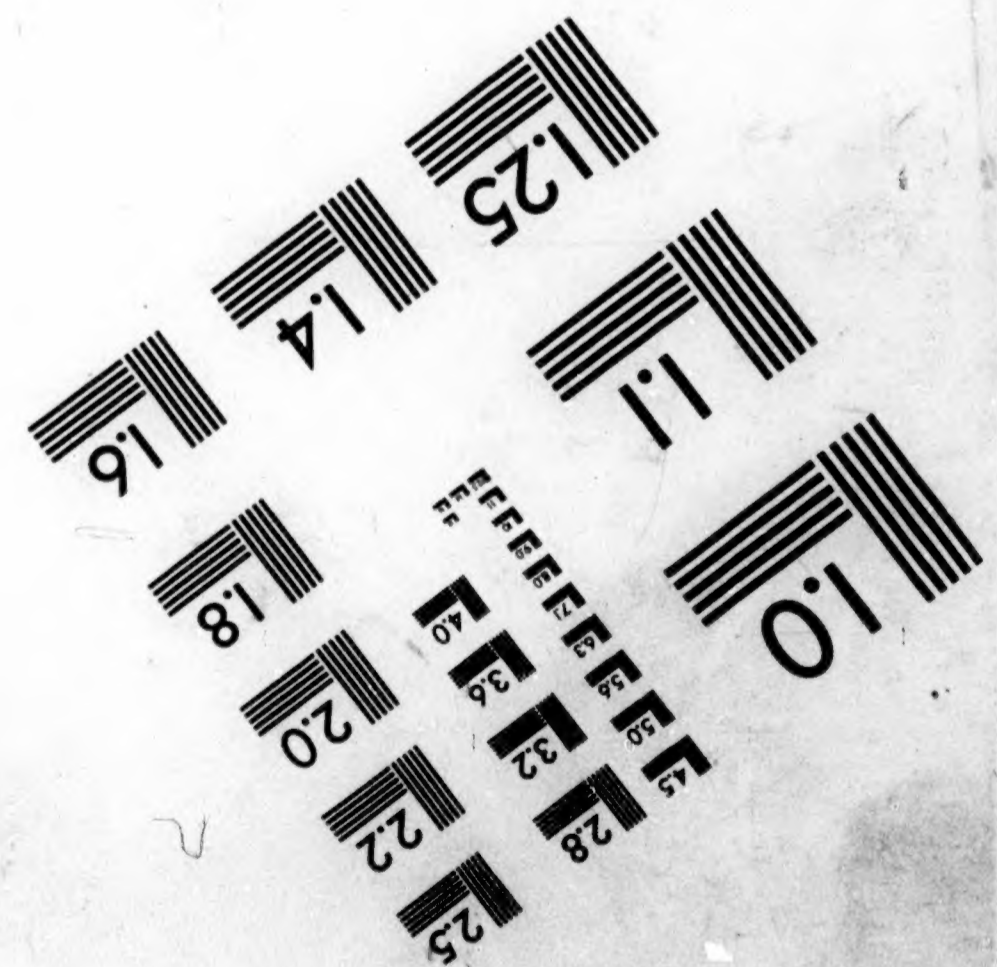
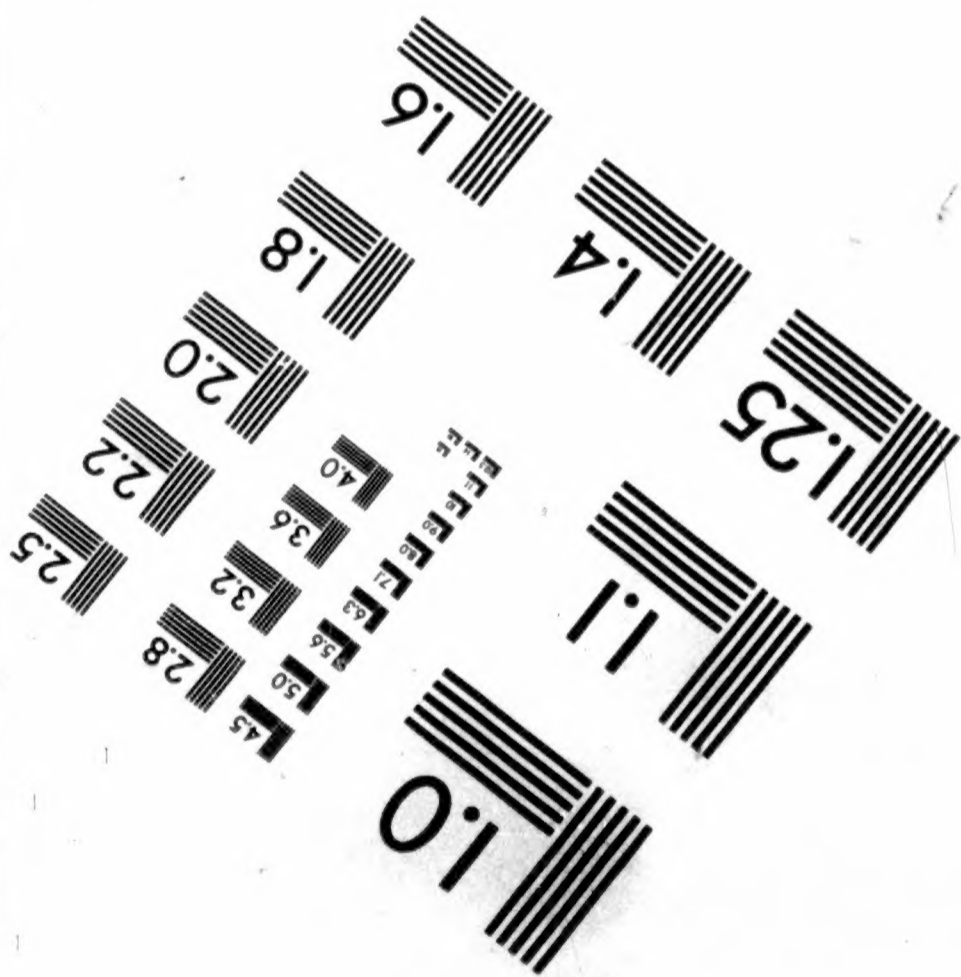
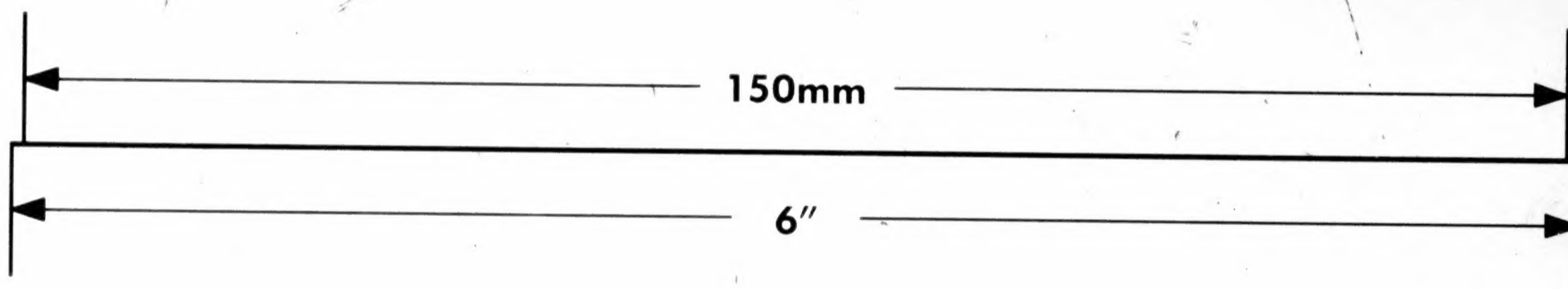
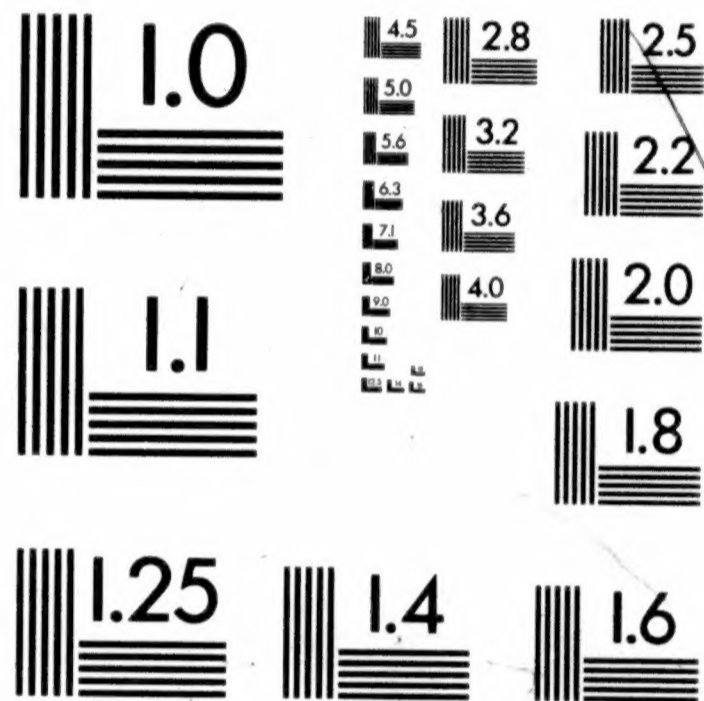
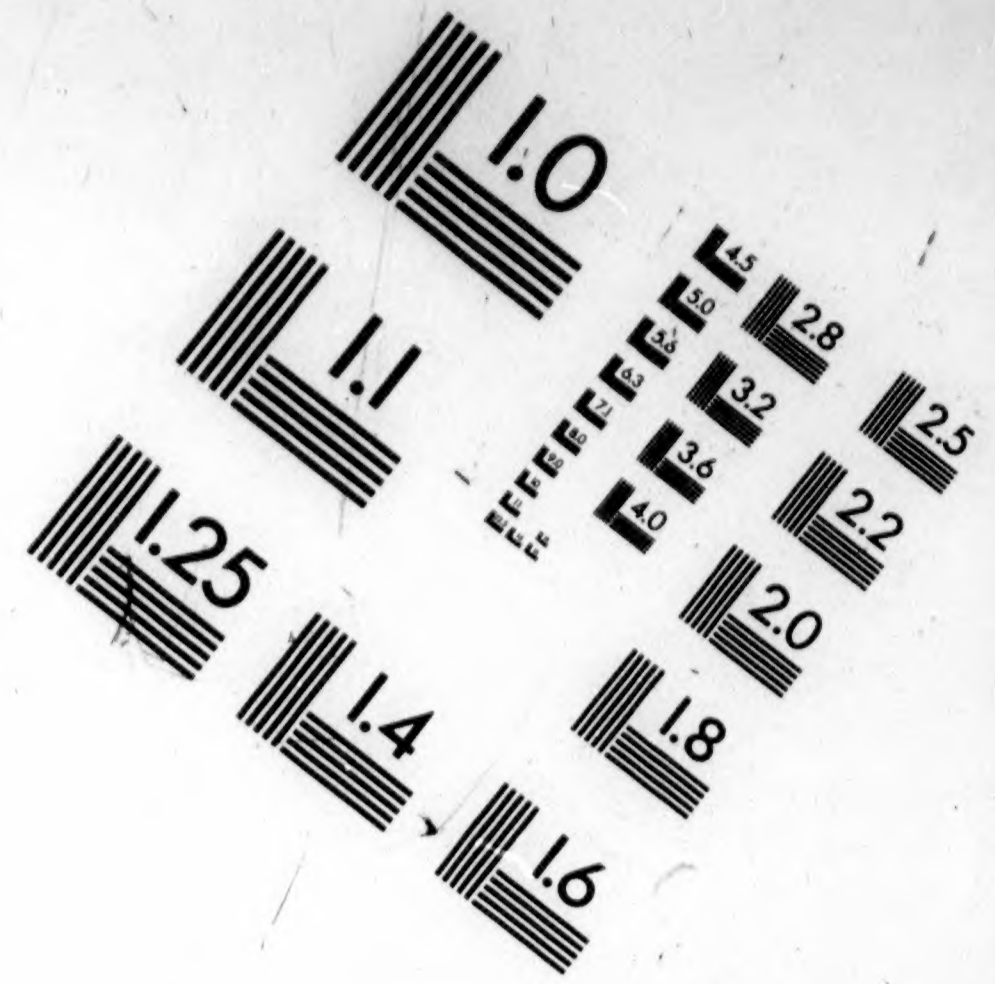
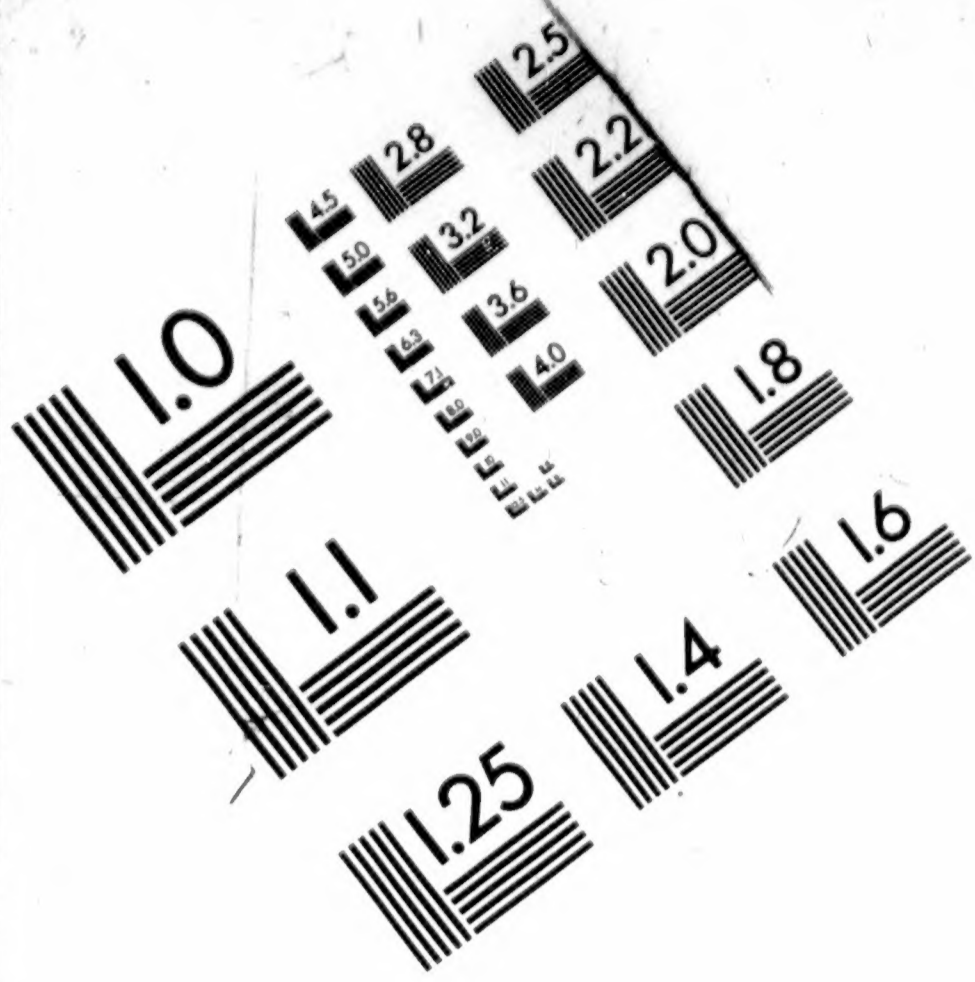

APPLIED IMAGE, Inc
1653 East Main Street
Rochester, NY 14609 USA
Phone: 716/482-0300
Fax: 716/288-5989

© 1993, Applied Image, Inc., All Rights Reserved

VW

National Archives at College Park



8601 Adelphi Road College Park MD 20740-6001

V WARE

OPERATOR

CAMERA

8-4-98

Z-4

DATE FILMED

REDUCTION RATIO

2461-0576-014-01

10X

FILM EMULSION NUMBER

M1818

167

PROJECT NUMBER

ROLL NUMBER

MICROCOPY

1 8 1 8

ROLL

1 6 7

M1818

COMPILED MILITARY SERVICE RECORDS OF
VOLUNTEER UNION SOLDIERS WHO SERVED WITH THE
UNITED STATES COLORED TROOPS:
Artillery Organizations

Introduction by Budge Weidman, Project Manager

Records prepared for microfilming by members of
the Civil War Conservation Corps

Pat Alfredson	Sue Goward*	Mary Poggioli
Phyllis Altrogge	Bert Greenstein	Peggy Pratt
Kenneth Ashton	Anne Greenwood	Ray Puzio
Sue Barnard*	Jim Harris	Sylvia Scott
Dee Benson	Walter Hayden	Lynn Shearouse
Ann N. Brown	Mary Hayden	Mary Stack-Dunne
Robert Budway	Pat Ikonen	Ben Stearns
Randy Caldwell	Dick Ives	Bill Stormer*
MaryAnn Castellana*	Sarah Jaffe	Pat Sullivan
Mary Lou Cole	Barbara Kemp	Gorman Tidball*
Giovanni Croce	Bev Manypenny	Cathy Tinston
B.H. Custer	Frank Masterson	John Toole
Bob Denney	Joe Mazur	Maryellen Toole
Richard Dow	Kathleen McCarthy	Milt Weatherhead
Earl Dunn	Sarah McDougall	Russ Weidman
Yvette Fallin	Catherine McManus	C. Lois Young
Maria Flesher	Ben Miles	Robert Young
Naomi Glass	Dave Murray	

Team leaders are indicated by the asterisk.

National Archives and Records Administration
Washington, DC
1998

INTRODUCTION

On the 299 rolls of this microfilm publication, M1818, are reproduced the compiled military service records of volunteer Union soldiers belonging to the artillery units organized for service with the United States Colored Troops (USCT). The USCT included 7 numbered cavalry regiments; 13 numbered artillery regiments plus one independent battery; 144 numbered infantry regiments; plus Brigade Bands Nos. 1 & 2 (Corps d'Afrique and US Colored Troops); Powell's Regiment Colored Infantry; Southard's Company Colored Infantry; Quartermaster Detachment; Pioneer Corps, 1st Division, 16th Army Corps; Unassigned Company A Colored Infantry; and Unassigned USCT. There are also miscellaneous service cards arranged alphabetically by surname at the end of the unit records. The records reproduced are part of the Records of the Adjutant General's Office, 1780's-1917, Record Group (RG) 94.

Background

United States Colored Troops

Since the time of the American Revolution, African Americans have volunteered to serve their country in time of war. The Civil War was no exception. Official sanction was the difficulty. In the fall of 1862 there were four Union regiments of African Americans raised in New Orleans, LA: the 1st, 2d, and 3d Louisiana Native Guard, and the 1st Louisiana Heavy Artillery (African Descent). The 1st South Carolina Infantry (African Descent) was not officially organized until January 1863; however, three companies of the regiment were on coastal expeditions as early as November 1862. Similarly, the 1st Kansas Colored Infantry was not mustered into Federal service until January 1863, even though the regiment had already participated in the action at Island Mound, MO, on October 27, 1862. These early unofficial regiments received little Federal support, but they showed the strength of the African American soldier's desire to fight for freedom.

The first official authorization to employ African Americans in Federal service was the Second Confiscation and Militia Act of July 17, 1862. This act allowed President Abraham Lincoln to receive into the military or naval service persons of African descent and gave him permission to use them for any purpose "he may judge best for the public welfare." However, the President did not authorize use of African Americans in combat until issuance of the Emancipation Proclamation on January 1, 1863.

In late January 1863, Governor John Andrew of Massachusetts received permission to raise a regiment of African American soldiers. The pace of organizing additional regiments was very slow. In March Secretary of War Edwin M. Stanton sent Gen. Lorenzo Thomas to the lower Mississippi Valley to recruit free and contraband African Americans. Thomas was given broad authority. He was to explain the administration's policy regarding African American soldiers and recruit

volunteers to raise and command them. Stanton wanted all officers of such units to be white, but that policy was softened to allow African American surgeons and chaplains. By the end of the war, in addition to the chaplains and surgeons, there were some 87 African American officers. Thomas's endeavor was very successful, and on May 22, 1863, the Bureau of Colored Troops was established to coordinate and organize regiments from all parts of the country. Created under War Department General Order No. 143, the bureau was responsible for handling "all matters relating to the organization of Colored Troops." The bureau was directly under the Adjutant General's Office and its procedures and rules were specific and strict. All African American regiments were now to be designated United States Colored Troops (USCT). At this time there were some African American regiments with state names and a few regiments in the Department of the Gulf designated as Corps d'Afrique. All these were ultimately assimilated into the USCT, even though some of the regiments, such as the 5th Massachusetts, retained their state designations.

To facilitate recruiting in the states of Maryland, Missouri, Tennessee, and eventually Kentucky, the War Department issued General Order No. 329 on October 3, 1863. Section 6 of the order stated that if any citizen should offer his or her slave for enlistment into the military service, that person would, "if such slave be accepted, receive from the recruiting officer a certificate thereof, and become entitled to compensation for the service or labor of said slave, not exceeding the sum of three hundred dollars, upon filing a valid deed of manumission and of release, and making satisfactory proof of title." For this reason, some records of manumission are contained in the compiled service records reproduced in this publication.

The USCT fought in 39 major engagements and over 400 lesser ones. Sixteen African American soldiers received Medals of Honor. As it was in other units, the death toll from disease was very high in the USCT. Deaths from disease and battle totaled 37,000. The last regiment of the USCT was mustered out of Federal service in December 1867.

Important sources for information about African American units in the Civil War are the War Department's *The War of the Rebellion: A Compilation of the Official Records of the Union and Confederate Armies* (Washington, DC: 1880-1901; reprinted Harrisburg, 1971 and 1985) and the Navy Department's *The War of the Rebellion; A Compilation of the Official Records of the Union and Confederate Navies* (Washington, DC: 1874-1922; reprinted Harrisburg, 1971 and 1985). These multivolume works contain reports of operations and other official correspondence.

U. S. Colored Heavy Artillery

1st Heavy Artillery: This regiment was organized at Knoxville, TN, between February and November 1864. It served in Knoxville, eastern Tennessee, western Virginia, northern Alabama, and western North Carolina. It was mustered out on March 31, 1866.

2d Heavy Artillery: This regiment was changed from the 2d Heavy Artillery to the 3d Heavy Artillery on April 26, 1864, and the compiled military service records appear there.

3d Heavy Artillery: Organized as the 1st Tennessee Heavy Artillery (African descent) at Memphis and Fort Pickering, TN, from June 5 to December 22, 1863, this regiment's designation was changed to the 3d United States Colored Heavy Artillery in April 1864. It served garrison duty at Fort Pickering and in defense of Memphis, TN. The unit mustered out on April 30, 1866.

4th Heavy Artillery: This unit was organized as the 2d Regiment Tennessee Heavy Artillery (African descent) from June 1863 until April 1864. It became the 4th United States Colored Heavy Artillery in April 1864. It served at Fort Halleck; Columbus, KY; and Union City, TN. The regiment had duty near Fort Donelson, TN, and moved to Pine Bluff, AR, where it was mustered out on February 25, 1866.

5th Heavy Artillery: This regiment was organized at Vicksburg, MS, between August 1863 and January 1864, as the 9th Louisiana Volunteers (African descent). Its designation was changed to the 5th Heavy Artillery in April 1864. The unit served garrison duty at Vicksburg, MS, and was mustered out on May 20, 1866.

6th Heavy Artillery: This regiment was organized as the 2d Mississippi Heavy Artillery (African descent) at Natchez, MS, from September 1863 to January 1864. It was changed to the 6th United States Colored Heavy Artillery on April 26, 1864. The unit served at Natchez, Mississippi, and Vidalia, LA. It was mustered out on May 18, 1866.

7th Heavy Artillery: The 7th Heavy Artillery was designated the 11th United States Colored Infantry (New) on January 23, 1865, and the compiled military service records appear there.

8th Heavy Artillery: This regiment was organized at Paducah, KY, from April to October 1864. It served garrison duty at Paducah and was mustered out on February 10, 1866.

9th Heavy Artillery: This regiment consisted of four companies and was organized at Clarksville and Nashville, TN, during October 1864. It was mustered out on May 5, 1865.

10th Heavy Artillery: Organization of this regiment at New Orleans, LA, began in November 1862. First designated the 1st Louisiana Heavy Artillery (African descent) in November 1863, it became the 1st Regiment Corps d'Afrique. In May 1864 the unit became the 10th United States Colored Heavy Artillery. The regiment was on garrison duty at New Orleans during its entire service. It served longer than any other USCT regiment, mustering out on February 22, 1867.

11th Heavy Artillery: This regiment was organized at Providence, RI, from August 1863 through January 1864, as the 14th Rhode Island Colored Heavy Artillery. In May 1864 it became the 11th United States Colored Heavy Artillery. The unit served garrison duty at New Orleans, LA, and was mustered out on October 2, 1865.

12th Heavy Artillery: This regiment was organized at Camp Nelson, KY, from July 1864 through July 1865. It served garrison duty at Camp Nelson, Bowling Green, and other points in the District of Kentucky. It was mustered out on April 24, 1866.

13th Heavy Artillery: This regiment was organized at Camp Nelson, KY, in June 1865, where it served garrison duty. It also served at Smithland and Lexington, KY. It was mustered out on November 18, 1865.

14th Heavy Artillery: This regiment was organized at New Bern and Morehead City, NC, from March 1864 to April 1865, as the 1st North Carolina Colored Heavy Artillery. It became the 14th United States Colored Heavy Artillery in March 1865. The unit served garrison duty at New Bern, NC, and was mustered out on December 11, 1865.

U. S. Colored Light Artillery

The 1st Regiment Light Artillery was recruited and organized under Maj. Gen. Benjamin F. Butler in December 1863. In February 1864 it was changed to Battery B of the 2d Light Artillery.

The 2d Regiment Light Artillery consisted of nine batteries, A through I, that were independently organized and deployed.

Battery A was organized at Nashville, TN, in April 1864. The battery served garrison duty at Nashville and participated in the Battle of Nashville December 15-16, 1864. It was mustered out January 13, 1866.

Battery B was organized at Fort Monroe, VA, in January and February 1864. It operated in Virginia and participated in the siege against Petersburg and Richmond. The battery was ordered to Texas in May 1865, and mustered out March 17, 1866.

Battery C was organized at Hebron's Plantation, MS, in November 1863, as the 1st Battery Louisiana Light Artillery (African descent). It was designated Battery C in April 1864. The battery had garrison duty at Goodrich Landing, Vicksburg, and Milliken's Bend. It was mustered out December 28, 1865.

Battery D was organized at Black River Bridge, MS, in December 1863, as the 2d Battery Louisiana Light Artillery (African descent). It was designated Battery D in April 1864. The battery had garrison duty at Goodrich Landing and Vicksburg, MS, and was mustered out on December 28, 1865.

Battery E was organized at Helena, AR, in December 1863, as the 3d Battery Louisiana Light Artillery (African descent). It was designated Battery E in April 1864. The battery had garrison duty at Helena, AR, and was mustered out on September 26, 1865.

Battery F was organized at Memphis, TN, in November 1863, as the Memphis Light Battery. It was designated Battery F in April 1864. The battery had garrison duty at Memphis, TN, until April 1865, when it moved to Bridgeport, AL. It was mustered out on December 28, 1865.

Battery G was organized at Hilton Head, SC, in May 1864 and had garrison duty at Hilton Head for its entire term. The battery was mustered out on August 12, 1865.

Battery H was organized at Pine Bluff, AR, in June 1864, as the 1st Arkansas Colored Battery. It was designated as Battery H in December 1864. The battery had garrison duty at Pine Bluff the entire term and was mustered out on September 14, 1865.

Battery I was organized at Memphis, TN, in April 1864. The battery had garrison duty at Memphis, TN, and operations in Mississippi. It was mustered out on January 10, 1866.

Independent Battery was organized at Leavenworth, KS, in December 1864. It had duty at Fort Leavenworth until it was mustered out on July 22, 1865.

Records Description

Compiled service records consist of a jacket-envelope for each soldier, labeled with his name, rank, unit, and card numbers. The compilation of service records of Union soldiers began in 1890 under the direction of Col. Fred C. Ainsworth, head of the Record and Pension Office of the Adjutant General's Office, Department of War. Information from muster rolls, regimental returns, descriptive books, and other records was copied verbatim onto cards. A separate card was prepared each time an individual name appeared on a document. These cards were numbered on the back, and these numbers were entered onto the outside jacket containing the cards. The carded information was verified by a separated operation of comparison; great care was taken to ensure that the cards were accurate.

A typical jacket contains card abstracts of entries found in original records relating to the soldier and original documents relating solely to that soldier. Examples of the latter include enlistment papers, substitute certificates, casualty sheets, death reports, prisoner-of-war memorandums, and correspondence. Unique to the records of the USCT are deeds of manumission, oaths of allegiance, proof of ownership, certificates of monetary award, and bills of sale. These items appear most frequently in units recruited in the border states of Kentucky, Missouri, and Maryland. These states remained in the Union but were slave states. Jackets and

cards include a section labeled "bookmark" which was reserved for cross-references to other records relating to the individual or his unit. The service records are arranged by arm of service, thereunder numerically by regiment or independent battalion or company, and thereunder alphabetically by name of the soldier. Records for officers are interfiled alphabetically by name with the records of enlisted men. If an individual served in more than one unit, which was typical for USCT officers, there will be a separate service record for each unit in which he served.

The unjacketed miscellaneous cards were accumulated by the War Department with the expectation that they would be incorporated in individual compiled service records. However, the expectation was never fulfilled, because either insufficient or contradictory information made it impossible to associate the cards or papers with a particular soldier's service records.

Related Records

Among the records of the Adjutant General's Office in the National Archives are many of the original records that were abstracted or "carded" by the Record and Pension Office. These include the individual unit's muster rolls, returns and descriptive books. Other series in RG 94 that contain information relating to volunteer Union soldiers who served with the USCT include carded records relating to Union staff officers, carded medical records of volunteer Union soldiers, unbound and bound regimental records and "record of events" cards. The regimental records of the 54th Massachusetts Infantry (Colored) have been reproduced as Microfilm Publication M1659, *Records of the Fifty-fourth Massachusetts Infantry Regiment (Colored), 1863-1865*.

The "record of events" cards include information copied from the unit's muster rolls and returns. They show the stations of the field and staff and those of the various companies of the regiment at the time the muster roll or return was prepared and sometimes mention battles, skirmishes, or other activities in which the regiment participated. The cards have been reproduced as Microfilm Publication M594, *Compiled Records Showing Service of Military Units in Volunteer Union Organizations*.

Record Group 94 also includes a card index for the USCT, reproduced as Microfilm Publication M589, *Index to Compiled Military Service Records of Volunteer Union Soldiers Who Served with U.S. Colored Troops*, which may be used to locate the regiment of USCT personnel. An index card gives the name of the soldier and his rank, as well as the unit in which he served; sometimes there is a cross-reference to his service in other units or organizations. The National Archives is continually producing microfilm publications of volunteer Union compiled military service records. A complete listing of finished publications can be found in the National Archives *Microfilm Resources for Research: A Comprehensive Catalog* which is available online at <http://www.nara.gov>.

NATIONAL ARCHIVES MICROFILM PUBLICATIONS

The Records of the Colored Troops Division, within RG 94, include division correspondence and records relating to recruiting, the appointment of officers, and the slave or free status of individuals; and a compilation of historical extracts and official papers concerning the military service of African Americans from the colonial period through the Civil War entitled *The Negro in the Military Service of the United States 1639-1886*. This compilation is reproduced as Microfilm Publication M858. The Records of the Bounty and Claims Division, also in RG 94, include correspondence of the division and records relating to bounties and claims paid to loyal owners of slaves by the Slave Claims Commissions of Delaware, Kentucky, Maryland, Missouri, Tennessee, and West Virginia.

If an application for a pension was made, the pension application case file may be among the Records of the Veterans Administration (RG 15). Indexes to the pension applications have been reproduced as Microfilm Publication T288, *General Index to Pension Files, 1861-1934*, and T289, *Organizational Index to Pension Files of Veterans Who Served Between 1861 and 1900*.

If a soldier or officer was tried before a general court-martial or if an individual or his unit was the subject of a court of inquiry or military commission, transcripts of the proceedings may be among the Records of the Office of the Judge Advocate General (Army) (RG 153). The registers to the proceedings have been reproduced as Microfilm Publication M1105, *Registers of the Records of the Proceedings of the U.S. Army General Courts-Martial, 1809-1890*.

Other record groups having information pertaining to the USCT include Records of the Bureau of Refugees, Freedmen, and Abandoned Lands (RG 105); Records of the Provost Marshal General's Bureau (Civil War) (RG 110); Records of the Accounting Officers of the Department of the Treasury (RG 217); and Records of U.S. Army Continental Commands, 1821-1920 (RG 393).

Roll list

Roll Description

1st United States Colored Heavy Artillery

- | | |
|----|---|
| 1 | Ackerson, David - Baker, Barney |
| 2 | Baker, George - Bogle, Harry |
| 3 | Bolden, Joseph - Brown, Edwin G. |
| 4 | Brown, George - Carmack, Bachus |
| 5 | Carmack, Gilbert - Cleveland, Loudon |
| 6 | Clevenger, Charles - Cune, John C. |
| 7 | Curd, George - Eblin, Richard |
| 8 | Eckles, Silas - Furbush, Lewis |
| 9 | Gaines, George - Greenleaf, Andrew |
| 10 | Greenleaf, Julius - Hart, Benjamin |
| 11 | Hartman, Henry - Hoff, David |
| 12 | Holland, John - Jackson, Thomas J. |
| 13 | Jackson, Washington - Jones, James |
| 14 | Jones, John - Ledgewood, Clayborne |
| 15 | Lee, Elhanon - Martin, Robert |
| 16 | Mason, Henry - McKenney, Elijah |
| 17 | McKinney, Lewis - Montcastle, Stewart |
| 18 | Montgomery, Alfred - Owens, Benjamin |
| 19 | Owens, Granville - Ragan, Nelson |
| 20 | Ragan, Rome - Russell, Orlando A. |
| 21 | Russell, Perry - Smith, Archie |
| 22 | Smith, Bart - Suddles, Robert |
| 23 | Summers, Joseph D. - Turner, Charles |
| 24 | Turner, Henry - Weir, Richard |
| 25 | Weir, Robert - Willis, Albert |
| 26 | Willis, Beverly S. - Zimmerman, William |

3d United States Colored Heavy Artillery

- | | |
|----|--|
| 27 | Abel, William - Armour, Lewis |
| 28 | Armstaed, William - Beaufort, Thomas |
| 29 | Beaumont, Henry - Bowler, Lafayette P. |
| 30 | Bowman, Fleming - Brummer, John E. |
| 31 | Bryan, Solon - Carter, William |
| 32 | Cartman, John - Cook, Isham |
| 33 | Cook, John - Davis, Doctor |
| 34 | Davis, George - Easen, Samuel |
| 35 | Easley, Wesley - Flinn, Clay |
| 36 | Flint, James - Gilbreth, Eli |

NATIONAL ARCHIVES MICROFILM PUBLICATIONS

Roll	Description
37	Gilbreth, Guy - Griffin, Samuel
38	Griffin, William - Harrison, James
39	Harrison, James C. - Hicks, Smith
40	Higginbottom, Nimrod - Hunt, Rubin
41	Hunt, William - Johnson, Charles
42	Johnson, Crawford - Jones, Isaac
43	Jones, Isam - Knight, Warren
44	Knox, Overton - Mabin, Baker
45	Mabin, James - McDonald, Manuel
46	McDonald, Ruben - Mills, Robert
47	Milroy, John - Nealy, Henry
48	Ned, Lewis - Patterson, Pembroke J. (Perin J.)
49	Patton, Richmond - Powers, William
50	Prewitt, Greene - Roberts, Lewis
51	Robinette, Henry - Scott, Edmond
52	Scott, Elijah - Smith, Peter
53	Smith, Randall - Tapscott, Julius
54	Tarwater, Jesse - Todd, William
55	Todd, Willis - Wallace, Robert
56	Wallace, Sandford - Wells, Duncan
57	Wells, Joseph - Williams, Guyo
58	Williams, George - Wolbrecht, Adolf
59	Wood, Charles - Young, William H.

4th United States Colored Heavy Artillery

60	Abbott, John - Barnes, Samuel
61	Barnes, Thomas - Britt, Jackson
62	Britten, Charles - Clark, Mitchell
63	Clay, Henry - Daniel, Richard
64	Daniels, William - Dyson, Jack
65	Dyson, Paul - Gardner, Riley
66	Gardner, Washington - Hall, Henry
67	Hall, Jack - Horton, Mack
68	Horton, William - Jones, Levi
69	Jones, Louis - Lewis, Stephen
70	Lewis, Thomas - McMurray, Anderson (John)
71	McMurray, George - Need, Benjamin
72	Nelson, John - Prior, Alfred
73	Prior, Gabriel - Rutland, Isaac
74	Ruttkey, Albert - Smith, Louis
75	Smith, Samuel - Turner, Frank
76	Turner, James - White, Henry
77	White, Raven - Youngs, William

NATIONAL ARCHIVES MICROFILM PUBLICATIONS

Roll Description

5th United States Colored Heavy Artillery

78 Abbott, Richard - Armstrong, William
 79 Arrindale, John B. - Bentley, Francis A.
 80 Bentley, Isam - Brooks, Lawyer
 81 Brooks, Robert - Cabin, Henry
 82 Cabin, Shadrick - Coleman, Nathan
 83 Coleman, William - Davidson, Ellis
 84 Davis, Alfred - Dodd, Taylor
 85 Dodds, Peter - Feltis, Jackson
 86 Felton, Martin - Gilford, Charles
 87 Gillespie, Gilbert - Hagan, Alex
 88 Hagans, Joseph - Hayes, John S.
 89 Haythorn, Henry - Hood, John
 90 Hooker, William - James, Warren
 91 January, Nathan - Johnson, Wiley
 92 Johnson, William - Kindley, Edward
 93 King, Elijah - Lewis, Ely J.
 94 Lewis, George W. - Manitoe, Samuel
 95 Manly, Elisha - McNeil, William
 96 McQuilley, Clayton - Mosley, Jacob
 97 Moss, Alfred - Parker, James
 98 Parker, John H. - Powell, Monroe
 99 Power, Henry - Roach, Watt
 100 Robb, Benjamin - Shaw, Barrow
 101 Shaw, James - Smith, Robert
 102 Smith, Samuel - Tate, John
 103 Taylor, Anderson - Trueman, Henry
 104 Truman, Nelson - Ward, George
 105 Ward, Jacob - West, Moses
 106 Westbrook, Ellick - Williams, John B.
 107 Williams, Jordan - Wood, Theodore
 108 Woodam, Henry - Young, William
 Miscellaneous Service Cards
 Allen, Geo. - Young, L.

6th United States Colored Heavy Artillery

109 Aaron, William - Barton, Granderson
 110 Baseman, Jerry - Bracton, John
 111 Bradford, Henry - Bush, Wilson
 112 Bustis, Mondey - Clay, Henry
 113 Clay, William - Davenport, William
 114 Davenport, Wilson - Dunbar, Newton

NATIONAL ARCHIVES MICROFILM PUBLICATIONS

Roll	Description
115	Dunbow, Hannibal - Fox, William
116	Francis, James - Green, George
117	Green, James - Harris, Hiram
118	Harris, John - Hopper, Anthony
119	Hopper, Handy - James, Joseph
120	Jasper, Samuel - Jones, John
121	Jones, Jonas - Leavitt, Charles B.
122	Lee, David - McBride, Samuel
123	McCabe, Alexander H. - Moore, Joseph
124	Moore, Manual - Owens, Willis
125	Page, Benjamin - Reece, Edward
126	Reese, William - Samuel, William
127	Sanders, Archibald - Smart, Robert
128	Smith, Aaron - Suzette, Armstead
129	Swanson, Jack - Trotter, George
130	Troyman, George - Waters, Robert
131	Waters, Wesley - Williams, Bedney
132	Williams, Benjamin - Wilson, George
133	Wilson, Guy - Young, Wesley
	Miscellaneous Service Cards
	Adams, Winder - Williams, John
8th United States Colored Heavy Artillery	
134	Abanather, Paten - Beasley, George W.
135	Beasley, Washington - Boyd, Isaac
136	Boyd, Paine - Burrill, George
137	Burris, Abram - Cofield, Henry
138	Cofield, Isaac - Davis, George
139	Davis, Jerry - Edwards, Frank
140	Edwards, Gus - Ginigan, Thomas
141	Givens, George - Hampton, Phillip
142	Hancock, James - Hodge, Cotney
143	Hodge, Gaines - Johnson, Charles
144	Johnson, Clinton - Lee, Wash
145	Leeper, Thomas - Maxwell, Henry
146	Maxwell, Samuel - Moore, Amos
147	Moore, David - Pearson, Alexander
148	Pearson, Charley - Rice, Pleasant
149	Rice, Taylor - Sherrer, Elick
150	Shirles, James - Talbot, Henry
151	Talley, William - Turner, Robert
152	Tyler, Jerry - Williams, John
153	Williams, Sam - Young, William

NATIONAL ARCHIVES MICROFILM PUBLICATIONS

Roll Description

9th United States Colored Heavy Artillery

- 154 Ailer, John - Coleman, Miles
- 155 Collins, Moses A. - Grosskopff, Edward
- 156 Grubb, Andrew - Landon, Harry
- 157 Lanier, Jesse - Payne, George
- 158 Payne, James - Tory, Madison
- 159 Toryand, Emanuel - Young, George

10th United States Colored Heavy Artillery

- 160 Aaron, Benjamin - Auguste, Daniel
- 161 Augustus, Edward - Benson, George
- 162 Bentley, William H. - Brooks, Walker
- 163 Brooks, Washington - Camel, Paul
- 164 Cameron, Henry - Coleman, James
- 165 Coleman, John - Deale, Joseph
- 166 Deale, Thomas - Ellis, Robert
- 167 Ellis, Silas - Frederick, Joseph
- 168 Freeland, Martin A. - Grandison, Alfred
- 169 Grant, Moses - Harrison, Logan
- 170 Harrison, Thomas - Hoyt, Joseph
- 171 Hubbard, Henry - Jenkins, Solomon
- 172 Jennings, Caleb - Jozen, Jules
- 173 Julia, Nora - Libscomb, George
- 174 Lightfoot, Columbus - Maryday, John
- 175 Masdael, Noel - Misker, Robert
- 176 Mitchel, Alexander - Oldham, George B.
- 177 Oliver, Emile - Purnell, John
- 178 Putnam, Winthrop D. - Robinson, Henry
- 179 Robinson, Isaac - Simmons, Owen
- 180 Simms, Amos - Spencer, John
- 181 Spriggs, Thomas - Thornton, John
- 182 Thurston, Charles - Warner, Dudley
- 183 Warner, George E. - Wesley, John
- 184 West, Alexander - Willis, Stephen
- 185 Willson, George - Zozey, Jules
- Miscellaneous Service Cards
 - Cann, Mercer - Grayson, John W.
- 186 Miscellaneous Service Cards
 - Green, Andrew P. - Rygaard, Soren
- 187 Miscellaneous Service Cards
 - Sabatier, Peter - Zevenette, Paul

NATIONAL ARCHIVES MICROFILM PUBLICATIONS

Roll Description

11th United States Colored Heavy Artillery

- 188 Abbott, George M. - Bailey, James A.
- 189 Baird, Sylvester - Boardley, James
- 190 Boardley, John W. - Brown, Nathan
- 191 Brown, Samuel - Carter, William H.
- 192 Cartright, George W. - Commings, Hugh S.
- 193 Comstock, Joseph J. - Davis, Lyman
- 194 Davis, Stephen - Dubois, James
- 195 Duesenbury, Lewis - Fletcher, Roderick S.
- 196 Fletcher, Samuel - Garrison, John
- 197 Gaskell, George L. - Groff, Joseph
- 198 Guard, Andrew - Hector, William H.
- 199 Heelms, Harkness - Howard, Richard
- 200 Howard, Thomas - Jackson, Lewis
- 201 Jackson, Norton - Johnson, Joseph W.
- 202 Johnson, Nathan - King, Cornelius
- 203 King, George - Loucks, John A.
- 204 Low, Charles H. - Miller, Benjamin
- 205 Miller, Floyd N. - Nicholas, Samuel
- 206 Nichols, Alfred - Pierce, George W.
- 207 Pierce, John B. - Reed, Washington
- 208 Reese, Edward - Sampson, William H.
- 209 Sanders, Edward - Skanks, James S.
- 210 Skanks, Thomas C. - Sommerset, Levi
- 211 Southwick, Henry K. - Taylor, Alfred M.
- 212 Taylor, Charles - Townsend, John
- 213 Tracy, John - Warren, John
- 214 Washington, George - Whiting, Joseph C., Jr.
- 215 Wigden, Cyrus B. - Wilson, Samuel
- 216 Wilson, William - Young, Francis
- Miscellaneous Service Cards
- Abbot, George W. - Dyer, William S.
- 217 Miscellaneous Service Cards
- Earl, Peter - Young, William H.

12th United States Colored Heavy Artillery

- 218 Abbott, John - Barbee, Squire
- 219 Barber, Sherwood - Boller, Jerry
- 220 Bolor, Collins - Bryant, Frederick
- 221 Bryant, Henry - Bush, Reason
- 222 Butler, Aaron - Clark, Richard
- 223 Clark, Samuel - Criffield, Lewis

NATIONAL ARCHIVES MICROFILM PUBLICATIONS

Roll	Description
224	Christopher, James - Dock, Calvin E.
225	Dodge, Henry - Farnesley, Jack
226	Farrus, Ephraim - Gaves, David
227	Gentry, George - Haggin, George
228	Haggin, Samuel - Hawkins, Robert
229	Hawkins, Thomas - Hode, Adam
230	Hodge, Charles - Jackson, Andrew
231	Jackson, Augustus - Jopee, Joseph
232	Juda, Enoch - Lewis, Windsor
233	Lidick, Randall - Maton, Levi
234	Matthews, Charles W. - Mitchell, John
235	Mitchell, Monroe - Nelson, Joseph
236	Nesbin, William - Porter, Daniel
237	Porter, William R. - Richason, Shelly
238	Richie, George - Scott, Smith
239	Scott, Stephen - Smith, Leroy
240	Smith, Lyman - Taylor, Charles
241	Taylor, Cornelius - Turner, David
242	Turner, George - Warren, James
243	Washington, Anthony - Williams, Berry
244	Williams, Charles - Woodson, David
245	Woodson, Egbert - Young, Thomas
	Miscellaneous Service Cards
	Baughman, John - Heel, Rubin
246	Miscellaneous Service Cards
	Helm, Harry - Young, Stephen
13th United States Colored Heavy Artillery	
247	Abbott, Josiah - Bell, Augustine
248	Bell, Charles - Brown, Jesse
249	Brown, Lindsay - Connor, Cyrus
250	Connor, Isaac - Dyre, George
251	Early, Edward - Ginn, Samuel
252	Ginnis, Sidney Clay - Heath, Henry
253	Heath, Lewis - Jarrett, Charles
254	Jay, Johnson - Lee, William
255	Lender, Richard - McKinney, Cass
256	McKinney, Henry Clay - Owens, Robert
257	Owens, Smith - Randolph, Loyd
258	Rankins, Archibald - Scott, Jerry
259	Scott, John - Sugg, Edmond
260	Suiter, Jacob A. - Waddie, Harry
261	Waddy, Peter - Willett, Price

NATIONAL ARCHIVES MICROFILM PUBLICATIONS

Roll	Description
262	Willett, Robert - Young, William
263	Miscellaneous Service Cards Abbott, Josiah - Yumber, Anthony

14th United States Colored Heavy Artillery

264	Acot, Isaac - Becton, Henry
265	Becton, Moses - Burke, George W.
266	Burke, William A. - Davis, Toney
267	Dean, Thomas - Fullford, William
268	Fulton, James - Hardy, William
269	Harget, Israel - Hovey, William
270	Howard, Calvin - Kensley, Silas
271	Kent, Henry - McKeever, Simon
272	McMichael, Joseph - Noble, William
273	Nobles, Charles - Randall, Evans
274	Randall, Willey - Shark, Bryant
275	Sheckelford, Daniel - Smith, Samuel
276	Smith, Sterling - Thompson, John Henry
277	Thompson, Mark - Weeks, Ezekiel
278	Weidman, Albert - Wilson, Payton
279	Wilson, Richard - Young, William
	Miscellaneous Service Cards Acott, Isaac - Young, William

2d Regiment United States Colored Light Artillery

280	Able, John - Bernard, Albert
281	Berry, Henry - Brown, Sang
282	Brown, Thomas - Clark, William
283	Clay, Henry - Disen, Henry
284	Disen, Watkins - Francis, Henry
285	Franklin, Albert - Haines, Roe
286	Haines, Thomas - Hunt, Thomas
287	Hunter, Alexander M. - Kennedy, Abram
288	Kennel, George - March, George
289	Marcy, Anthony - Mobbs, Daniel
290	Moffet, John - Pattiller, Alfred
291	Pattiller, Patrick - Richardson, Jacob
292	Ridgeway, Anthony - Smith, Louis B.
293	Smith, Minus - Tucker, Alfred

NATIONAL ARCHIVES MICROFILM PUBLICATIONS

Roll Description

- 294 Tucker, Sandy - Williams, Calvin
- 295 Williams, Charles - Zinum, John
- 296 Miscellaneous Service Cards
Abraham, Francis - Young, Ruben

Independent Battery, United States Colored Light Artillery

- 297 Alexander, John - Hancock, George W.
- 298 Hanson, Noah C. - Scott, Andrew
- 299 Scott, Reynolds - Yeager, John
Miscellaneous Service Cards
Douglass, H. Ford - Minor, P.M.

NATIONAL ARCHIVES MICROFILM PUBLICATIONS

Microfilm Publication M1818

**COMPILED MILITARY SERVICE RECORDS OF VOLUNTEER UNION
SOLDIERS WHO SERVED WITH THE UNITED STATES COLORED
TROOPS: Artillery Organizations**

Roll 167

10th United States Colored Heavy Artillery

Ellis, Silas - Frederick, Joseph

NATIONAL ARCHIVES AND RECORDS ADMINISTRATION

014
Ellis, Silas

Co L, 10 U.S. Col'd H. Art'y.

Private

Private

CARD NUMBERS.

1	5-4-7732	26
2	5-4-23	27
3	5-3-3447	28
4	5-3-35-9	29
5	5-3-3723	30
6	5-3-3447	31
7	5-3-3942	32
8	5-3-4004	33
9	5-3-404	34
10	5-3-4094	35
11	5-3-4123	36
12		37
13		38
14		39
15		40
16		41
17		42
18		43
19		44
20		45
21		46
22		47
23		48
24		49
25		50

Book Mark:

See also 77" U.S.C.I.

E. 10200 | U.S.C.T.

Silas Ellis

Co. A, 10 Reg't U. S. Col'd *Hill*

Appears on

M. and D. Roll of Men Transferred

to the organization named above,

from *Co. A, 10, U. S. Col'd Inf*

Roll dated *Camp Annapolis, 1865*

When enlisted _____, 186 .

Period for which enlisted _____ *9* years.

When mustered in *Sept 1*, 186 .

Present or absent *Present*

Company to which assigned *D*

Remarks: *Wfta,*

Book mark : _____

W. H. Scott

E 1060 U.S.C.T.

Silas Ellis
Sgt, Co A, 10 Reg't U. S. Col'd H.A.

Appears on

M. and D. Roll of Men Transferred

to the organization named above,

from 77 U.S. Col Inf

Roll dated Camp Mapekavett, 1865.

When enlisted, 186 .

Period for which enlisted 3 years.

When mustered in Sept 1, 1865.

Present or absent Present

Company to which assigned D

Remarks: Joined by transfer
from Co C. 77. U.S. C.I.
per S.O. 66 C.S. Hd Qrs
Dept of Ia

Book mark :

W. H. Scott

E | 10 H. Art'y. | U.S.C.T.

Silas Ellis

Det., Co. L, 10 Reg't U. S. Col'd H. Art'y.

Age _____ years.

Appears on

Company Muster Roll*

for Sept. & Oct., 1865.

Joined for duty and enrolled:

When _____, 186 .

Where _____

Period 3 years.

Mustered in:

When Sept. 1, 1864.

Where Lafourche D

Present or absent Present

Stoppage, \$ 100 for _____

Due Gov't, \$ 100 for _____

Valuation of horse, \$ 100

Valuation of horse equipments, \$ 100

Remarks: Drafted, Transferred,
from Co. C, 11th U.S. I.

*First current roll. No muster-in roll of this company on file.

Book mark : _____

Scherich

(3586)

Copyist.

E | 10 H. Art'y. | U.S.C.T.

Silas Ellis

Priv, Co. L, 10 Reg't U. S. Col'd H. Art'y.

Appears on

Company Muster Roll

for *Nov. & Dec.*, 1863.

Present or absent *Present*

Stoppage, \$ *100* for

Due Gov't, \$ *100* for

Valuation of horse, \$ *100*

Valuation of horse equipments, \$ *100*

Remarks:

Book mark:

Scherich

(358)

Copyist.

E | 10 H. Art'y. | U.S.C.T.

Silas Ellis

Priv., Co. L, 10 Reg't U. S. Col'd H. Art'y.

Appears on

Company Muster Roll

for Jan & Feb., 1866.

Present or absent Present

Stoppage, \$ 100 for

Due Gov't, \$ 100 for

Valuation of horse, \$ 100

Valuation of horse equipments, \$ 100

Remarks:

Book mark:

Schenck

E

10 H. Art'y.

U.S.C.T.

Silas Ellis

Priv., Co. L, 10 Reg't U. S. Col'd H. Art'y.

Appears on

Company Muster Roll

for *Mch. & Apl.*, 1866.

Present or absent *Absent*

Stoppage, \$ *100* for

Due Gov't, \$ *100* for

Valuation of horse, \$ *100*

Valuation of horse equipments, \$ *100*

Remarks: *In Confinement
at Cross Jail New
Orleans awaiting trial
by G.M.*

Book mark:

Scherich

(358)

Copyist.

E. | 10th. reg. | U.S.C.T.

Silas Ellis

Priv., Co. L, 10 Reg't U. S. Col'd Harty.

Appears on

Company Muster Roll

for May & June, 1866.

Present or absent Absent

Stoppage, \$ 100 for

Due Gov't, \$ 100 for

Valuation of horse, \$ 100

Valuation of horse equipments, \$ 100

Remarks: Absent in Confinement
since Mch. 22/66 per
sentence of S.C.M.

Book mark:

Scherich

(358)

Copyist.

E

10 H. Art'y. U.S.C.T.

Silas Ellis

Priv., Co. L, 10 Reg't U. S. Col'd H. Art'y.

Appears on

Company Muster Roll

for July & Aug, 1866.

Present or absent Absent

Stoppage, \$ 100 for

Due Gov't, \$ 100 for

Valuation of horse, \$ 100

Valuation of horse equipments, \$ 100

Remarks: Absent on Const. per sentence of G C M

Book mark:

Burnham

E

10 H. Art'y. U.S.C.T.

Silas Ellis

Prvt., Co. L, 10 Reg't U. S. Col'd H. Art'y.

Appears on

Company Muster Roll

for Sept & Oct, 1866.

Present or absent Absent

Stoppage, \$ 100 for

Due Gov't, \$ 100 for

Valuation of horse, \$ 100

Valuation of horse equipments, \$ 100

Remarks: Absent in Capt for sentence of G. C. M.

Book mark:

Burnham

E

Silas Ellis

M, Co. L, 10 Reg't U. S. Col'd H. Art'y.

Appears on

Company Muster Roll

for Nov & Dec, 1866.

Present or absent Present

Stoppage, \$ 100 for

Due Gov't, \$ 100 for

Valuation of horse, \$ 100

Valuation of horse equipments, \$ 100

Remarks: Sentenced for desertion by Genl Court Martial to 6 months Conf. at hard labor & forfeiture of 12 dollars per month of monthly pay for same period. Released Nov 28/66 by expiration of sentence

Book mark:

Burnham

E

10 H. Art'y. | U.S.C.T.

Silas Ellis

Priv., Co. L, 10 Reg't U. S. Col'd H. Art'y.

Appears on Co. Muster-out Roll, dated

Baton Rouge La, Feb 27, 1867.

Muster-out to date Feb 22, 1867.

Last paid to Dec 31, 1866.

Clothing account:

Last settled....., 186 ; drawn since \$..... 100

Due soldier \$ 8 / ⁵⁴ / 100; due U. S. \$..... 100

Am't for cloth'g in kind or money adv'd \$..... 100

Due U. S. for arms, equipments, &c., \$..... ²⁰ / 100

Bounty paid \$..... 100; due \$..... 100

Remarks: Joined by transfer from 77
U.S.C. Oct 1/65 8066 N^o 9th Dept of La
Sept 27/65 Deserted from Ft Pike
La Mar 11/66 apprehended Met 15/6
Tried by G. C. M. "Charge Desertion" found
Guilty. Sent to be Confined for 6 Mos
at Ship Island Miss La 8/12/66

Book mark: V161 P19473 ^{on}

Bumham

JAN. 16

5514123

1891

permo of pay per S.O. 188 N^o 9^o Dept
of the Gulf dated May 28/66
Released by expiration of sentence
Nov 28/66 Conscripted S.O. 106
N^o 9^o Dept of Gulf

Wason. Spain

Coz, 10 U.S. Col'd H. Art.

Private

Private

CARD NUMBERS.

1	3-5-11291	26
2	3-5-12182	27
3		28
4		29
5		30
6		31
7		32
8		33
9		34
10		35
11		36
12		37
12		38
14		39
15		40
16		41
17		42
18		43
19		44
20		45
21		46
22		47
23		48
24		49
25		50

Book Mark:

See also

E. | 10 H. Art'y. | U.S.C.T.

Charles Ellison

Priv., Co. I, 10 Reg't U. S. Col'd H. Art'y.

Age _____ years.

Appears on

Company Muster Roll*

for Enrollment to June 30, 1865.

Joined for duty and enrolled:

When _____, 186 .

Where _____

Period 1 years.

Mustered in:

When July 6, 1865.

Where Baton Rouge, La.

Present or absent _____

Stoppage, \$ 100 for _____

Due Gov't, \$ 100 for _____

Valuation of horse, \$ 100

Valuation of horse equipments, \$ 100

Remarks: Drafted. Died
in Post Hospital Ft.

*First current roll. No muster-in roll of this company on file.

Book mark : _____

(3586)

J. S. Clark
Copyist.

JAN. 16

5511291

☆ 1891 ☆

St. Philip, La. May 28, 65.

E | 10 H. Art'y. | U.S.C.T.

Charles Ellisen

Priv, Co. *J*, 10 Reg't U. S. Col'd H. Art'y.

Appears on Co. Muster-out Roll, dated *Baton Rouge La Feb 22*, 1867.

Muster-out to date _____, 186 .

Last paid to _____, 186 .

Clothing account:

Last settled _____, 186 ; drawn since \$ _____ 100

Due soldier \$ _____ 100; due U. S. \$ _____ 100

Am't for cloth'g in kind or money adv'd \$ _____ 100

Due U. S. for arms, equipments, &c., \$ _____ 100

Bounty paid \$ _____ 100; due \$ _____ 100

Remarks: *Died at Ft. St. Philip La*
May 28, 1865

(Age 18 years)

Book mark: *V 144 P 87.72*

J. M. Hance

(361)

Copyist.

Ellison, Charles

P, Co. I,

10

Reg't U.S.C.H.A.

1

Enclosures.

Bed Cards

Descriptive Lists

Burial Records

Final Statements

Certs. of Dis. for Discharge

Furloughs

C. M. Charges

Med. Des. Lists

Med. Certificates

Orders

Other papers relating to—

Admission to Hosp'l

Furlough

Casualty Sheet (Officer's)

Med. Examination

Confinement

Misc. Information

Contracts

Pay or Clothing

Death or Effects

Personal Reports

Desertions

Rank

Discharge from Hosp'l

Transfer to Hosp'l

Discharge from Service

Transfer to V. R. C.

Duty

Transportation

✓
FINAL STATEMENT

OF

Charles Ellison Parrott

10th Reg't of U.S. C. A. (21)

VOLUNTEERS.

Due March 28th 1865.

NOTE 1.—Two of these certificates (or duplicates) are to be given to each Volunteer Soldier or drafted man who may be discharged previously to the discharge of his company, that he may at once receive from the Paymaster the pay, &c., due him, and the captain or other COMMISSIONED officer commanding the company will certify to the act of the delivery of the duplicate certificates; on these certificates the Soldier is "entitled to" his *discharge*, and should also present his discharge to the Paymaster to have the payment endorsed on it. The discharge is to be given back to the Soldier by the Paymaster; the latter only retaining as his voucher the duplicate certificates.

NOTE 2.—If the Soldier is entitled to pay for the use of his horse, the Company Commander will certify to that fact on the back of both these final statements, and also to the time he has pay due for having been so mounted on his own horse.

NOTE 3.—When a Soldier is furnished with final statements, his descriptive list, if he has one, should be taken up by the officer who gives the Soldier these statements, and endorsed with a statement to this effect by the officer. This endorsement should exhibit a full statement of the time for which the Soldier was allowed pay on his final statements, the clothing account, and all other charges against him or in his favor, so as to comprise a complete exhibit of his account. It will then be transmitted to the company commander of the Soldier, who will enter all the data necessary to a full understanding of the Soldier's account on the muster roll upon which the Soldier's discharge is reported. The descriptive list will then be destroyed. The object of this is, that the remaining portion of the Soldier's account may be settled upon the receipt of these muster rolls, and the Soldier receive any pay or allowances that may be due him at the time of his discharge, and which may not appear on his final statements from the fact that his descriptive list is incomplete. These accounts for back pay, &c., are settled by the 2d Auditor of the Treasury Department.

NOTE 4.—Charges for loss or injury to ordnance, horse equipments, and other miscellaneous charges, should appear under the heading of "Other Stoppages."

NOTE 5.—Bounty paid by State authorities, and not by the United States, will not be entered on this statement.

NOTE 6.—Amounts due the Sutler and Laundress must be entered on the muster roll on which the discharge, death, desertion, &c., is reported, as well as on the final statement, otherwise the amount cannot be collected from the United States.

NOTE 7.—This blank will be used for deceased volunteers and drafted men, as well as for others.

NOTE 8.—Where a Soldier dies in Hospital or on detached service, his descriptive list, if he has one, should be sent with his final statements, in duplicate, to the Second Auditor, Washington, D. C.

ADJUTANT GENERAL'S OFFICE

June 21. 1865.

Duplicate with Inventory sent 2d Auditor.

I certify, on honor, that Charles Ellison a Private of
Captain Putnam's Company (1) of the 10th Regiment of U.S. Col'd, (M)
VOLUNTEERS, of the State of _____, born in Ornith County, State
of Mississippi, aged 18 years; 5 feet 4 1/2 inches high; Dark complexion,
Black eyes, Black hair, and by occupation a Laborer, having joined the company on
its original organization at _____, and enrolled in it at the muster into
the service of the United States at _____, on the _____ day
of _____, 186____, (or was mustered in service as a recruit, by _____
at _____, on the _____ day of _____,
186____, or was drafted and mustered into the service of the United States from the Third
Enrollment District of the State of Louisiana, at Buton Rouge,
on the Sixth day of February, 1865,) to serve in the Regiment, for
the term of One Year: and having served HONESTLY and
FAITHFULLY with his Company in _____ to the present date, is now

entitled to a **DISCHARGE** by reason of Death - Sain's Soldier died
with Phumonia in Post Hospital Post St. Philip La. Mar. 24th 1865

The said Charles Ellison had pay due him from the date of
Draft to include the _____ day of _____, 186____, and has
pay due him from that time to the present date; he is entitled to pay and subsistence for
TRAVELING to place of enrollment, and whatever other allowances are authorized to volunteer
soldiers, drafted men, or militia, so discharged. He has received from the United States **CLOTHING**
amounting to Twenty eight 46 dollars, since the Sixth day of February,
1865, when his clothing account was last settled. He has received from the United States
100 dollars advanced **BOUNTY**.

There is to be stopped from him, on account of the State of _____, or other
authorities, for **CLOTHING**, &c., received on entering service, _____ dollars; and
for other stoppages, viz: _____

_____ dollars.
He has been furnished with **TRANSPORTATION** in kind from the place of his discharge to
_____ ; and he has been **SUBSISTED** for **TRAVELING** to his
place of enrollment, up to the _____, 186____.

He is indebted to _____, **SUTLER**, _____ dollars.
He is indebted to _____, **LAUNDRESS**, _____ dollars.

Given in Duplicate, at Post St. Philip La, this 28th day
of May, 1865.

George R. Stearns
2d Lieutenant
Commanding Company.

Olison. Joseph
Co E, 10 U.S. Col'd H. Art'y

Private | Private

CARD NUMBERS.

1	5502368	26
2	5489169	27
3	5502550	28
4	5502607	29
5	5502748	30
6	5502878	31
7	5502996	32
8	5503116	33
9	5503229	34
10	5503340	35
11	5503514	36
12	5504592	37
13		38
14		39
15		40
16		41
17		42
18		43
19		44
20		45
21		46
22		47
23		48
24		49
25		50

Book Mark:

See also

E

10 H. Art'y. U.S.C.T.

Joseph Ellison

Co. E, 7 Reg't U. S. Col'd H. Art'y.*

Appears on

Company Muster-in and Descriptive Roll

of the organization named above. Roll dated

New Orleans La July 8, 1864

Where born Liberty Miss.

Age 28 y'rs; occupation Laborer

When enlisted Feb 27 1864

Where enlisted New Orleans

For what period enlisted 3 years.

Eyes Black; hair Black

Complexion Black; height 5 ft. 8 1/2 in.

When mustered in March 7 1864

Where mustered in New Orleans

Bounty paid \$ 2 100; due \$ 100

Where credited New Orleans

Company to which assigned 6

Remarks:

* This organization subsequently became Co. E, 10 Reg't U. S. Colored Heavy Artillery.

Book mark:

J. Linden Copyist.

(356d)

E. W. Holt | U.S.C.T.

Joseph Ellison
Sgt, Co. B, 10 (7th U.S.C. Inf. A) Reg't U. S. Col'd Holt

Appears on a

Detachment Muster Roll

of the organization named above

for Roll dated Apr-30, 1864.

Station De Sair, La.

Present or absent Present

Stoppage, \$ 100 for

Due Gov't, \$ 100 for

Valuation of horse, \$ 100

Valuation of horse equipments, \$ 100

Remarks:

Book mark:

W. J. Morgan

(844)

Copyist.

5

10 H. Art'y.

U.S.C.T.

Joseph Ellison
Pr., Co. E, 7 Reg't U. S. Col'd H. Art'y.*

Appears on

Company Muster Roll

for May - June, 1864.

Present or absent Present

Stoppage, \$ 100 for

Due Gov't, \$ 100 for

Valuation of horse, \$ 100

Valuation of horse equipments, \$ 100

Remarks:

* This organization subsequently became Co. 5, 10 Reg't U. S. Colored Heavy Artillery.

Book mark: -----

(358)

Linder

Copyist.

5

10 H. Art'y. U.S.C.T.

Joseph Ellison
Sgt., Co. E, 10 Reg't U. S. Col'd H. Art'y.

Appears on

Company Muster Roll

for July & Aug., 1864

Present or absent Present

Stoppage, \$ 100 for

Due Gov't, \$ 100 for

Valuation of horse, \$ 100

Valuation of horse equipments, \$ 100

Remarks:

Book mark:

(358)

Linden
Copyist.

56

10 H. Art'y. | U.S.C.T.

Joseph Ellison
Capt., Co. E, 10 Reg't U. S. Col'd H. Art'y.

Appears on

Company Muster Roll

for Sep. + Oct, 1864

Present or absent Present

Stoppage, \$ 100 for

Due Gov't, \$ 100 for

Valuation of horse, \$ 100

Valuation of horse equipments, \$ 100

Remarks:

Book mark:

(358)

Linder

Copyist.

E

10 H. Art'y. U.S.C.T.

Joseph Ellison
Cpt, Co. E, 10 Reg't U. S. Col'd H. Art'y.

Appears on

Company Muster Roll

for Nov. Dec, 1864.

Present or absent Present

Stoppage, \$ 100 for

Due Gov't, \$ 100 for

Valuation of horse, \$ 100

Valuation of horse equipments, \$ 100

Remarks: Difference of
pay from enlistment to
Apr. 30th 6. 00 per month
due. To be stopped for
ordnance cost? 204

Book mark:

(358)

J. Linden
Copyist.

E | 10 H. Art'y. | U.S.C.T.

Joseph Ellison
Pt., Co. E, 10 Reg't U. S. Col'd H. Art'y.

Appears on

Company Muster Roll

for Jan & Feb, 1865.

Present or absent Present

Stoppage, \$ 100 for

Due Gov't, \$ 100 for

Valuation of horse, \$ 100

Valuation of horse equipments, \$ 100

Remarks: At difference of pay
from enlistment to Apr.
30, 1864 \$6.00 per month
due.

Book mark:

(358)

H. E. Tyler
Copyist.

Joseph Ellison

Co. E, 10 Reg't U. S. Col'd H. Art'y.

Appears on

Company Muster Roll

for March & Apr., 1865.

Present or absent Present

Stoppage, \$ 100 for

Due Gov't, \$ 100 for

Valuation of horse, \$ 100

Valuation of horse equipments, \$ 100

Remarks: Difference of pay
from enlistment to Apr.
30, 64 \$6⁰⁰ per month
due.

Book mark:

G. C. Tyler

Copyist.

Joseph Ellison
Sgt., Co. E, 10 Reg't U. S. Col'd H. Art'y.

Appears on

Company Muster Roll

for *May & June*, 1865.

Present or absent *Present*

Stoppage, \$ 100 for

Due Gov't, \$ 100 for

Valuation of horse, \$ 100

Valuation of horse equipments, \$ 100

Remarks: *Sick in Post Hospital.*

Book mark:

(358)

E. H. Tyler

Copyist.

Joseph Ellison
Cpt., Co. E, 10 Reg't U. S. Col'd H. Art'y

Appears on

Company Muster Roll

for July & Aug., 1860.

Present or absent Present

Stoppage, \$ 100 for

Due Gov't, \$ 100 for

Valuation of horse, \$ 100

Valuation of horse equipments, \$ 100

Remarks: Due U. S. for Ord-
nance \$⁵⁷ 00. Due U. S. for
Camp & Garrison's Equipage
\$⁷⁶ 00. Sick in Post
Hospital.

Book mark:

J. C. Dyer
Copyist.

E

10 H. Art'y. U.S.C.T.

Joseph Ellison
Co. E, 10 Reg't U. S. Col'd H. Art'y

Appears on

Company Muster Roll

for Sep. & Oct., 1861.

Present or absent

Stoppage, \$ 100 for

Due Gov't, \$ 100 for

Valuation of horse, \$ 100

Valuation of horse equipments, \$ 100

Remarks: Died in Gov't Hosp.
at Fort St. Philip, Sept.
14 61 of consumption.
Final statements forward
ed Sept. 17"

Book mark:

J. C. Cyles

Copyist.

E

10 H. Art'y. | U.S.C.T.

Joseph Ellsior
Prvt., Co. *E.*, 10 Reg't U. S. Col'd H. Art'y.

Appears on **Co. Muster-out Roll**, dated
Baton Rouge, La Feb 22, 1867.

Muster-out to date _____, 186 .

Last paid to *Feb. 28*, 1865.

Clothing account:

Last settled _____, 186 ; drawn since \$ _____ 100

Due soldier \$ _____ 100; due U. S. \$ _____ 100

Am't for cloth'g in kind or money adv'd \$ _____ 100

Due U. S. for arms, equipments, &c., \$ _____ 100

Bounty paid \$ _____ 100; due \$ _____ 100

Remarks: *Joined at Org. Organs,*
as Private.

Died in Post Hospital
Fort St. Philip La. Sept.
14, 1865, of Consumption.

Book mark: _____

(361)

A. Hagan

Copyist.

Ellison, Joseph

P, Co. E, 10 Reg' U.S.C.H.A.

2 Enclosures.

Bed Cards	Descriptive Lists
Burial Records	Final Statements 2
Certs. of Dis. for Discharge	Furloughs
C. M. Charges	Med. Des. Lists
Med. Certificates	Orders

Other papers relating to—

Admission to Hosp'l	Furlough
Casualty Sheet (Officer's)	Med. Examination
Confinement	Misc. Information
Contracts	Pay or Clothing
Death or Effects	Personal Reports
Desertions	Rank
Discharge from Hosp'l	Transfer to Hosp'l
Discharge from Service	Transfer to V. R. C.
Duty	Transportation

FINAL STATEMENT

OF

Private Joseph Ellison

10th Reg't of N. S. L. Co. (Regt)

VOLUNTEERS.

Rec'd Sept 14 1865

NOTE 1.—Two of these certificates (or duplicates) are to be given to each Volunteer Soldier or drafted man who may be discharged previously to the discharge of his company, that he may at once receive from the Paymaster the pay, &c., due him, and the captain or other COMMISSIONED officer commanding the company will certify to the act of the delivery of the duplicate certificates; on these certificates the Soldier is "entitled to" his discharge, and should also present his discharge to the Paymaster to have the payment endorsed on it. The discharge is to be given back to the Soldier by the Paymaster; the latter only retaining as his voucher the duplicate certificates.

NOTE 2.—If the Soldier is entitled to pay for the use of his horse, the Company Commander will certify to that fact on the back of both these final statements, and also to the time he has pay due for having been so mounted on his own horse.

NOTE 3.—When a Soldier is furnished with final statements, his descriptive list, if he has one, should be taken up by the officer who gives the Soldier these statements, and endorsed with a statement to this effect by the officer. This endorsement should exhibit a full statement of the time for which the Soldier was allowed pay on his final statements, the clothing account, and all other charges against him or in his favor, so as to comprise a complete exhibit of his account. It will then be transmitted to the company commander of the Soldier, who will enter all the data necessary to a full understanding of the Soldier's account on the muster roll upon which the Soldier's discharge is reported. The descriptive list will then be destroyed. The object of this is, that the remaining portion of the Soldier's account may be settled upon the receipt of these muster rolls, and the Soldier receive any pay or allowances that may be due him at the time of his discharge, and which may not appear on his final statements from the fact that his descriptive list is incomplete. These accounts for back pay, &c., are settled by the 2d Auditor of the Treasury Department.

NOTE 4.—Charges for loss or injury to ordnance, horse equipments, and other miscellaneous charges, should appear under the heading of "Other Stoppages."

NOTE 5.—Bounty paid by State authorities, and not by the United States, will not be entered on this statement.

NOTE 6.—Amounts due the Sutler and Laundress must be entered on the muster roll on which the discharge, death, desertion, &c., is reported, as well as on the final statement, otherwise the amount cannot be collected from the United States.

NOTE 7.—This blank will be used for deceased volunteers and drafted men, as well as for others.

NOTE 8.—Where a Soldier dies in Hospital or on detached service, his descriptive list, if he has one, should be sent with his final statements, in duplicate, to the Second Auditor, Washington, D. C.

ADJUTANT GENERAL'S OFFICE

Sept 28. 1865

Duplicate with Inventory sent 2d Auditor.



211111

I certify, on honor, that Joseph Ellison a Private of
 Captain M. A. Ireland's Company (E) of the 10th Regiment of U.S.C. (Moz.)
VOLUNTEERS, of the State of _____, born in Siberh, State
 of Mississippi, aged 28 years; 5 feet 8 1/2 inches high; Black complexion,
Black eyes, Black hair, and by occupation a Laborer, having joined the company on
 its original organization at New Orleans La, and enrolled in it at the muster into
 the service of the United States at New Orleans La, on the 28th day
 of February, 1864, (~~or was mustered in service as a recruit, by _____~~
~~_____ at _____ on the _____ day of _____,~~
~~186~~, ~~or was drafted and mustered into the service of the United States from the _____~~
~~Enrollment District of the State of _____ at _____~~
~~on the _____ day of _____, 186~~) to serve in the Regiment, for
 the term of Three Years: and having served **HONESTLY** and
FAITHFULLY with his Company in Garrison to the present date, is now
 entitled to a **DISCHARGE** by reason of death. Died in Pest Hospital at Fort
St Philip La. Sept 14, 1865 of Consumption

The said Joseph Ellison was last paid by Paymaster
Maj McAllister to include the 28th day of February, 1865, and has
 pay due him from that time to the present date; ~~he is entitled to pay and subsistence for~~
~~TRAVELING to place of enrollment, and whatever other allowances are authorized to volunteer~~
~~soldiers, drafted men, or militia so discharged.~~ He has received from the United States **CLOTHING**
 amounting to (Twenty four) \$24 ⁵⁵/₁₀₀ dollars, since the 31st day of December,
 1864, when his clothing account was last settled. ~~He has received from the United States~~
~~_____ dollars advanced BOUNTY.~~

~~There is to be stopped from him, on account of the State of _____, or other~~
~~authorities, for CLOTHING, &c., received on entering service, _____ dollars; and~~
~~for other stoppages, viz: _____~~

~~_____ dollars.~~
~~He has been furnished with TRANSPORTATION in kind from the place of his discharge to _____~~
~~_____ and he has been SUBSISTED for TRAVELING to his~~
~~place of enrollment, up to the _____, 186~~

~~He is indebted to _____, SUTLER, _____ dollars.~~
~~He is indebted to _____, LAUNDRESS, _____ dollars.~~

Given in Duplicate, at Brushy City La, this 14th day
 of September, 1865.

Thos. V. Sickerls
Private

 Commanding Company.

FINAL STATEMENT



OF

Private Joseph Ellison

10th Reg't of *N. S. Co. A. (Hy)*

VOLUNTEERS.

NOTE 1.—Two of these certificates (or duplicates) are to be given to each Volunteer Soldier or drafted man who may be discharged previously to the discharge of his company, that he may at once receive from the Paymaster the pay, &c., due him, and the captain or other COMMISSIONED officer commanding the company will certify to the act of the delivery of the duplicate certificates; on these certificates the Soldier is "entitled to" his *discharge*, and should also present his discharge to the Paymaster to have the payment endorsed on it. The discharge is to be given back to the Soldier by the Paymaster; the latter only retaining as his voucher the duplicate certificates.

NOTE 2.—If the Soldier is entitled to pay for the use of his horse, the Company Commander will certify to that fact on the back of both these final statements, and also to the time he has pay due for having been so mounted on his own horse.

NOTE 3.—When a Soldier is furnished with final statements, his descriptive list, if he has one, should be taken up by the officer who gives the Soldier these statements, and endorsed with a statement to this effect by the officer. This endorsement should exhibit a full statement of the time for which the Soldier was allowed pay on his final statements, the clothing account, and all other charges against him or in his favor, so as to comprise a complete exhibit of his account. It will then be transmitted to the company commander of the Soldier, who will enter all the data necessary to a full understanding of the Soldier's account on the muster roll upon which the Soldier's discharge is reported. The descriptive list will then be destroyed. The object of this is, that the remaining portion of the Soldier's account may be settled upon the receipt of these muster rolls, and the Soldier receive any pay or allowances that may be due him at the time of his discharge, and which may not appear on his final statements from the fact that his descriptive list is incomplete. These accounts for back pay, &c., are settled by the 2d Auditor of the Treasury Department.

NOTE 4.—Charges for loss or injury to ordnance, horse equipments, and other miscellaneous charges, should appear under the heading of "Other Stoppages."

NOTE 5.—Bounty paid by State authorities, and not by the United States, will not be entered on this statement.

NOTE 6.—Amounts due the Sutler and Laundress must be entered on the muster roll on which the discharge, death, desertion, &c., is reported, as well as on the final statement, otherwise the amount cannot be collected from the United States.

NOTE 7.—This blank will be used for deceased volunteers and drafted men, as well as for others.

NOTE 8.—Where a Soldier dies in Hospital or on detached service, his descriptive list, if he has one, should be sent with his final statements, in duplicate, to the Second Auditor, Washington, D. C.

I certify, on honor, that Joseph Ellison a Private of
Captain M. A. Ireland's Company (E) of the 10th Regiment of U. S. Col. (M.)
VOLUNTEERS, of the State of _____, born in Liberty, State
of Mississippi, aged 28 years; 5 feet 8 1/2 inches high; Black complexion,
Black eyes, Black hair, and by occupation a Laborer, having joined the company on
its original organization at New Orleans La, and enrolled in it at the muster into
the service of the United States at New Orleans La, on the 28th day
of February, 1864, (~~or was mustered in service as a recruit, by~~
~~_____ at _____ on the _____ day of _____,~~
~~186~~, or was drafted and mustered into the service of the United States from the
Enrollment District of the State of _____, at _____,
on the _____ day of _____, 186), to serve in the Regiment, for
the term of Three Years: and having served **HONESTLY** and
FAITHFULLY with his Company in Garrison to the present date, is now
entitled to a **DISCHARGE** by reason of Death Died in Post Hosp. at
Fort St Philip La Sept 14th 1865 of Consumption.

The said Joseph Ellison was last paid by Paymaster
Wm J. McAllister to include the 28th day of February, 1865, and has
pay due him from that time to the present date; ~~he is entitled to pay and subsistence for~~
~~TRAVELING~~ to place of enrollment, and whatever other allowances are authorized to volunteer
soldiers, drafted men, or militia, so discharged. He has received from the United States **CLOTHING**
amounting to \$ 24. ⁵⁵/₁₀₀ dollars, since the 31st day of December,
1864, when his clothing account was last settled. ~~He has received from the United States~~
~~_____ dollars advanced **BOUNTY**.~~

~~There is to be stopped from him, on account of the State of _____, or other
authorities, for **CLOTHING**, &c, received on entering service, _____ dollars; and
for other stoppages, viz:~~

~~_____ dollars.
He has been furnished with **TRANSPORTATION** in kind from the place of his discharge to
_____ ; and he has been **SUBSISTED** for **TRAVELING** to his
place of enrollment, up to the _____, 186~~

~~He is indebted to _____ **SUTLER** _____ dollars.
He is indebted to _____ **LAUNDRESS** _____ dollars.~~

Given in Duplicate, at Brashear City La, this 14th day
of September, 1865.

No Effects

Wm V. Bickel
1st Lieut
Commanding Company.

Ellison, Joseph

Co E, 10 U.S. Col'd H. Art'y

Private | Private

CARD NUMBERS.

1		26
2	See Ellison, Joseph	27
3		28
4		29
5		30
6		31
7		32
8		33
9		34
10		35
11		36
12		37
13		38
14		39
15		40
16		41
17		42
18		43
19		44
20		45
21		46
22		47
23		48
24		49
25		50

Book Mark:

See also:

13	5-4-9-2-2-6-9	10
14	5-4-9-2-3-9-6	11
15	5-4-9-2-5-1-4	12
16	5-4-9-2-6-3-8	13
17	5-4-9-2-7-6-6	14
18	5-4-9-3-0-1-2	15
19	5-4-9-3-9-6-6	16
20	3-7-8-9-5-2-3	17
21	4-7-8-9-5-2-3	18
22		19
23		20

1000 Miles S. B. $\frac{15}{761}$ C.P.P.P.
 with 47 - CT - 1584

See also

E

10 H. Art'y. U.S.C.T.

Austin Ellmore

Priv, Co. A, 1 Reg't La. Col'd H. Art'y.*

Age *22* years.

Appears on

Company Muster-in Roll

of the organization named above. Roll dated

New Orleans, La, Nov. 29, 1862.

Muster-in to date *Nov. 29, 1862*

Joined for duty and enrolled:

When *Nov. 16*, 186 .

Where *New Orleans*

Period *3* years.

Valuation of horse, \$.....100

Valuation of horse equipments, \$.....100

Remarks :
.....
.....
.....

*This organization subsequently became Co. A, 10 Reg't U. S. Colored Heavy Artillery.

Book mark: *356*

(356)

Tobman

Copyist.

E

10 H. Art'y. U.S.C.T.

Austin Elmore

Priv, Co. A, 1 Reg't La. H. Art'y.*

Appears on

Company Muster Roll

for *to Dec. 31*, 1862.

Present or absent *Present*

Stoppage, \$ *100* for

Due Gov't, \$ *100* for

Valuation of horse, \$ *100*

Valuation of horse equipments, \$ *100*

Remarks:

*This organization subsequently became Co. A, 10 Reg't U. S. Col'd Heavy Artillery.

Book mark:

Tobman

(358)

Copyist.

E

10 H. Art'y. U.S.C.T.

Austin Elmore

....., Co. A, 1 Reg't La. H. Art'y.*

Appears on

Company Muster Roll

for *Jamies & Felby*, 1863.

Present or absent *Present*

Stoppage, \$.....100 for

Due Gov't, \$.....100 for

Valuation of horse, \$.....100

Valuation of horse equipments, \$.....100

Remarks:

*This organization subsequently became Co. A, 10 Reg't U. S. Col'd Heavy Artillery.

Book mark:

Tolman

E

10 H. Art'y. U.S.C.T.

Austin E. Umore

....., Co. A, 1 Reg't La. H. Art'y.*

Appears on

Company Muster Roll

for March & April, 1863.

Present or absent Present

Stoppage, \$.....100 for

Due Gov't, \$.....100 for

Valuation of horse, \$.....100

Valuation of horse equipments, \$.....100

Remarks:.....

*This organization subsequently became Co. A, 10 Reg't U. S. Col'd Heavy Artillery.

Book mark:.....

Tolman

E

10 H. Art'y. U.S.C.T.

Austin Ellmore

Priv., Co. A, 1 Reg't La. H. Art'y.*

Appears on

Company Muster Roll

for *May & June*, 1863.

Present or absent *Present*

Stoppage, \$ 100 for

Due Gov't, \$ 100 for

Valuation of horse, \$ 100

Valuation of horse equipments, \$ 100

Remarks:

*This organization subsequently became Co. A, 10 Reg't U. S. Col'd Heavy Artillery.

Book mark: -----

Tobman
Copied.

E

10 H. Art'y. U.S.C.T.

Austin Elmore

Priv., Co. A, 1 Reg't La. H. Art'y.*

Appears on

Company Muster Roll

for *July & August*, 1863.

Present or absent *Present*

Stoppage, \$ 100 for

Due Gov't, \$ 100 for

Valuation of horse, \$ 100

Valuation of horse equipments, \$ 100

Remarks:

*This organization subsequently became Co. A, 10 Reg't U.S. Col'd Heavy Artillery.

Book mark:

John
Copyst.

E

10 H. Art'y. U.S.C.T.

Austin Elmore

Priv, Co. A, 1 Reg't La. H. Art'y.*

Appears on

Company Muster Roll

for Sept & Oct, 1863.

Present or absent Present

Stoppage, \$ 100 for

Due Gov't, \$ 100 for

Valuation of horse, \$ 100

Valuation of horse equipments, \$ 100

Remarks:

*This organization subsequently became Co. A, 10 Reg't U. S. Col'd Heavy Artillery.

Book mark:

Tolman

E | 10 H. Art'y. | U.S.C.T.

Forty Lewis
(Pt. A), Co. *A*, 1 Reg't H. Art'y, Corps d'Afrique.*

Appears on

Company Muster Roll

for *Nov 1863*, 1863.

Present or absent *Present*

Stoppage, \$ *100* for

Due Gov't, \$ *100* for

Valuation of horse, \$ *100*

Valuation of horse equipments, \$ *100*

Remarks:

*This organization subsequently became Co. *A*, 10 Reg't U. S. Colored Heavy Artillery.

Book mark: -----

Rochester

E

10 H. Art'y. | U.S.C.T.

Austin Elmore

Co. A, 1 Reg't H. Art'y, Corps d'Afrique.*

Appears on

Company Muster Roll

for *Jan Feb*, 18*64*.

Present or absent *Present*

Stoppage, \$ *100* for

Due Gov't, \$ *100* for

Valuation of horse, \$ *100*

Valuation of horse equipments, \$ *100*

Remarks:

*This organization subsequently became Co. *A*, 10 Reg't U. S. Colored Heavy Artillery.

Book mark:

Proctor

(358)

Copyist.

E | 10 H. Art'y. | U.S.C.T.

Justin Elmore
Co. A, 7 Reg't U. S. Col'd H. Art'y.*

Appears on

Company Muster Roll

for *March 1864*, 1864.

Present or absent *Present*

Stoppage, \$ 100 for

Due Gov't, \$ 100 for

Valuation of horse, \$ 100

Valuation of horse equipments, \$ 100

Remarks:

* This organization subsequently became Co. *A*, 10 Reg't U. S. Colored Heavy Artillery.

Book mark:

Bocheater

E

10 H. Art'y.

U.S.C.T.

Austin Elmore
Co A, 7 Reg't U. S. Col'd H. Art'y.*

Appears on

Company Muster Roll

for *May & June*, 1864

Present or absent *Present*

Stoppage, \$.....100 for

Due Gov't, \$.....100 for

Valuation of horse, \$.....100

Valuation of horse equipments, \$.....100

Remarks:

.....
.....
.....
.....
.....

* This organization subsequently became Co *A*, 10 Reg't U. S. Colored Heavy Artillery.

Book mark:

Adutor

E | 10 H. Art'y. | U.S.C.T.

Austin Elmore
Co. A, 7 Reg't U. S. Col'd H. Art'y.*

Appears on

Company Muster Roll

for *July & Aug*, 186*4*.

Present or absent *Present*

Stoppage, \$ 100 for

Due Gov't, \$ 100 for

Valuation of horse, \$ 100

Valuation of horse equipments, \$ 100

Remarks:

* This organization subsequently became Co *A*, 10 Reg't U. S. Colored Heavy Artillery.

Book mark: _____

Becker

E | 10 H. Art'y. | U.S.C.T.

Austin Elmore
Prvt, Co. A, 10 Reg't U. S. Col'd H. Art'y.

Appears on

Company Muster Roll

for *Sept & Oct*, 1864.

Present or absent *Present*

Stoppage, \$ 100 for

Due Gov't, \$ 100 for

Valuation of horse, \$ 100

Valuation of horse equipments, \$ 100

Remarks:

Book mark: -----

Proctor

Q | 10 H. Art'y. | U.S.C.T.

Austin Elmore
2nd, Co. A, 10 Reg't U. S. Col'd H. Art'y.

Appears on

Company Muster Roll

for *W. Lee*, 1864

Present or absent *Absent*

Stoppage, \$ 100 for

Due Gov't, \$ 100 for

Valuation of horse, \$ 100

Valuation of horse equipments, \$ 100

Remarks: *On detached
Service at Battery
Septilly La. per
A. O. No. 317. H. G. No.
New Orleans dated
Dec 26, 1864*

Book mark:

(358)

Proctor
Copyist.

E | 10 H. Art'y. | U.S.C.T.

Austin Elmer

Pvt, Co. A, 10 Reg't U. S. Col'd H. Art'y.

Appears on

Company Muster Roll

for *Jan + Feb*, 1865.

Present or absent *Present*

Stoppage, \$ *100* for

Due Gov't, \$ *100* for

Valuation of horse, \$ *100*

Valuation of horse equipments, \$ *100*

Remarks: *Due Govt. for
Ordnance as per
Statement No. 20*

Book mark:

Rockator

E | 10 H. Art'y. | U.S.C.T.

Austin Elmore

Pvt., Co. A, 10 Reg't U. S. Col'd H. Art'y.

Appears on

Company Muster Roll

for *March & April*, 1865.

Present or absent *Present*

Stoppage, \$ 100 for

Due Gov't, \$ 100 for

Valuation of horse, \$ 100

Valuation of horse equipments, \$ 100

Remarks: *Due Gov't for
Ordnance as per
Statement \$0.20*

Book mark :

Bocher

E | 10 H. Art'y. | U.S.C.T.

Austin Elmer
Sgt, Co. A, 10 Reg't U. S. Col'd H. Art'y.

Appears on

Company Muster Roll

for *May & June*, 1865.

Present or absent *Present*

Stoppage, \$ 100 for

Due Gov't, \$ 100 for

Valuation of horse, \$ 100

Valuation of horse equipments, \$ 100

Remarks: *Due Gov't for
Ordinance as per
Statement \$ 0.20*

Book mark :

Rehuter

E | 10 H. Art'y. | U.S.C.T.

Justin Elmore
Pr, Co. A, 10 Reg't U. S. Col'd H. Art'y.

Appears on

Company Muster Roll

for *July & Aug*, 1865.

Present or absent *Present*

Stoppage, \$ 100 for

Due Gov't, \$ 100 for

Valuation of horse, \$ 100

Valuation of horse equipments, \$ 100

Remarks:

Book mark:

Rochester

Austin Elmore

Rif, Co. A, 10 Reg't U. S. Col'd H. Art'y.

Appears on

Company Muster Roll

for *Sept + Oct*, 1865.

Present or absent *Present*

Stoppage, \$ 100 for

Due Gov't, \$ *2* ^{*00*}/_{*100*} for *transportation furnished by G A. Norton Capt + A 2, M.*

Valuation of horse, \$ 100

Valuation of horse equipments, \$ 100

Remarks:

Book mark : -----

E | 10 H. Art'y. | U.S.C.T.

Austin Ellmore

Pvt., Co. A, 10 Reg't U. S. Col'd H. Art'y.

Appears on

Company Muster Roll

for Nov + Dec, 1865.

Present or absent

Stoppage, \$ 100 for

Due Gov't, \$ 100 for

Valuation of horse, \$ 100

Valuation of horse equipments, \$ 100

Remarks: Mustered out by reason of expiration of term of service

Book mark: Disch'd Nov 28/65 to B. 15/441 c. P. 1884

(358)

Styer Copyist.

E. 10. N. a. U.S.C.T.

Austin Ellmore

Co., 10 Reg't U. S. Col'd N. a.

Appears on a

Detachment Muster-out Roll

of the organization named above. Roll dated

New Orleans La. Nov. 28, 1865.

Muster-out to date

Nov. 28, 1865.

Last paid to

Jan. 30, 1865.

Clothing account:

Last settled _____, 186 ; drawn since \$ _____ 100

Due soldier \$ 3/65 100; due U. S. \$ _____ 100

Am't for cloth'g in kind or money adv'd \$ _____ 100

Due U. S. for arms, equipments, &c., \$ _____ 100

Bounty paid \$ _____ 100 due \$ _____ 100

Remarks: Joined at Origl. Orgn.

Stop for one Tompion
for transportation \$2.00.

Mustered out by reason of
Expiration of service

Book mark: V. 98. P. 80. 69.

Heusting

E

10 H. Art'y. U.S.C.T.

Austin Ellmore

Pvt, Co. A, 10 Reg't U. S. Col'd H. Art'y.

Appears on Co. Muster-out Roll, dated
Baton Rouge La, Feb. 22, 1867.

Muster-out to date _____, 186 .

Last paid to _____, 186 .

Clothing account:

Last settled _____, 186 ; drawn since \$ _____ 100

Due soldier \$ _____ 100; due U. S. \$ _____ 100

Am't for cloth'g in kind or money adv'd \$ _____ 100

Due U. S. for arms, equipments, &c., \$ _____ 100

Bounty paid \$ _____ 100; due \$ _____ 100

Remarks: *Joined origl. organ. Nicht
for extension of term of service
Nov. 28. 65*

Book mark: *98780 69*

Nesbitt

(361)

Copyist.

E. | 10th H.A. | U.S.C. I

Austin Ellmore

, Co. A, 10th Regt U.S.C. H.A.

NOTATION.

L.B. 15-941 with
47.6.2. 1884.

Book mark:

War Department,

Adjutant General's Office,

Washington, Jan 5th, 1884.

Mustered out with Detach-
ment November 28, 1865.

E. P. Conzieser

(438)

Copyist.

Henry William
Co. a., 10 U.S. Col'd H. Art'y

Private | *Private*

CARD NUMBERS.

1	5-489098	26
2	5-492897	27
3	5-493140	28
4	5-493281	29
5	5-493459	30
6	5-493967	31
7	5-490011	32
8		33
9		34
10		35
11		36
12		37
13		38
14		39
15		40
16		41
17		42
18		43
19		44
20		45
21		46
22		47
23		48
24		49
25		50

Book Mark:

See also *75" USC, I,*

Co
10th Art U.S.C.T.

William Elsbury

Pk, Co., *14* Reg't U. S. Col'd *Art*

Appears on

M. and D. Roll of Men Transferred

to the organization named above,

from *73 US C I*

Roll dated *Nov 18*, 186*3*.

When enlisted *May 1*, 186*3*.

Period for which enlisted *3* years.

When mustered in *Aug 21*, 186*3*.

Present or absent *Not stated*

Company to which assigned

Remarks: *Due US for*
Co's equip. lost. 74

Book mark:

J. Johnson

E

10 H. Art'y.

U.S.C.T.

William Ellsbury

Pvt., Co. A, 10 Reg't U. S. Col'd H. Art'y.

Appears on

Company Muster Roll

for Nov + Dec, 1865.

Present or absent Present

Stoppage, \$ 100 for

Due Gov't, \$ 74/100 for G & Equipage, per transfer roll

Valuation of horse, \$ 100

Valuation of horse equipments, \$ 100

Remarks: Transferred from 75 U.S.C.T. per S.O. 105 G.S. Hd Qrs Dept of War.

Book mark:

(358)

Styus Copyist.

E | 10 H. Art'y. | U.S.C.T.

William Ellsbery

Plt, Co. A, 10 Reg't U. S. Col'd H. Art'y.

Appears on

Company Muster Roll

for Jan & Feb, 1866.

Present or absent Present

Stoppage, \$ 100 for

Due Gov't, \$ 12/100 for B & S. Equipage

Valuation of horse, \$ 100

Valuation of horse equipments, \$ 100

Remarks:

Book mark:

Styer

(358)

Copyist.

E | 10 H. Art'y. | U.S.C.T.

William Ellsbery

Pl, Co. A, 10 Reg't U. S. Col'd H. Art'y.

Appears on

Company Muster Roll

for *Mar & Apr*, 186*6*.

Present or absent *Present*

Stoppage, \$ *100* for

Due Gov't, \$ *100* for

Valuation of horse, \$ *100*

Valuation of horse equipments, \$ *100*

Remarks: *Absent with leave
for muster out*

Book mark: _____

(358)

Keys
Copyist.

E | 10 H. Art'y. | U.S.C.T.

William Ellsbury

Pt, Co. A, 10 Reg't U. S. Col'd H. Art'y.

Appears on

Company Muster Roll

for May & June, 1866

Present or absent

Stoppage, \$ 100 for

Due Gov't, \$ 100 for

Valuation of horse, \$ 100

Valuation of horse equipments, \$ 100

Remarks: Disch'd April 30 '66 by reason of expiration of term of service

Book mark:

J. H. [Signature] Copyist.

(358)

William Ellsbury
Pvt, Co. A, 10 Reg't U. S. Col'd H. Art'y.

Appears on Co, Muster-out Roll, dated
Baton Rouge La, Feb 22, 1867.
Muster-out to date _____, 186 .
Last paid to _____, 186 .

Clothing account:
Last settled _____, 186 ; drawn since \$ _____ 100
Due soldier \$ _____ 100; due U. S. \$ _____ 100
Am't for cloth'g in kind or money adv'd \$ _____ 100

Due U. S. for arms, equipments, &c., \$ _____ 100
Bounty paid \$ _____ 100; due \$ _____ 100

Remarks: Transd. from 75 U.S.C.S. as Pvt.
S.A. 105 S of 65 West. Va.
Dischd. for expir. of term of
service Apr. 30/66

Book mark: 19 P 188 68.
236 P 68 76

Nesbitt

E | 10 Arty | U.S.C.T.

William Elsbury

Priv., Co. A, 10 Reg't U. S. Col'd Arty.

Appears on a

Detachment Muster-out Roll

of the organization named above. Roll dated

New Orleans, La., May 1, 1866.

Muster-out to date Apr. 30, 1866.

Last paid to Feb. 28, 1866

Clothing account:

Last settled 186 ; drawn since \$ 100

Due soldier \$ 5 ³⁵/₁₀₀; due U. S. \$ 100

Am't for cloth'g in kind or money adv'd \$ 100

Due U. S. for arms, equipments, &c., \$ 100

Bounty paid \$ 100 due \$ 100

Remarks: Joined by transfer from
E" Co. 75 U.S.C. Inf. per par. 12
G.O. 105, series of 1865, Hdqrs.
Dept. of La., Nov. 3. 1865. Muster-
ed out by reason of expira-
tion of term of service.

Book mark:

R. E. Wilson

Ellsley John

Co E, 10 U.S. Col'd H. Art'y.

Private | Private

CARD NUMBERS.

1	26
2	27
3	28
4	29
5	30
6	31
7	32
8	33
9	34
10	35
11	36
12	37
13	38
14	39
15	40
16	41
17	42
18	43
19	44
20	45
21	46
22	47
23	48
24	49
25	50

John Ellsley

Book Mark:

See also

Wesley John

Co E, 10 U.S. Col'd H. Art'y.

Private

Private

CARD NUMBERS.

1	5487117	26
2	5502369	27
3	5502675	28
4	5504589	29
5		30
6		31
7		32
8		33
9		34
10		35
11		36
12		37
13		38
14		39
15		40
16		41
17		42
18		43
19		44
20		45
21		46
22		47
23		48
24		49
25		50

Book Mark:

See also

E

10 H. Art'y. U.S.C.T.

John Elsley

Appears with rank of *Priv* on

Muster and Descriptive Roll of a Detachment of U. S. Vols. forwarded

for the *7* Reg't *U.S.C.H. Art'y*^{*} Roll dated *New Orleans La June*, 1864

Where born *La*

Age *26* y'rs; occupation *Laborer*

When enlisted *April 9th*, 1864

Where enlisted *Alexandria*

For what period enlisted *3* years.

Eyes *Dark*; hair *Dark*

Complexion *Dark*; height *5* ft. *8* in.

When mustered in *June 25th*, 1864

Where mustered in *New Orleans*

Bounty paid \$ *100*; due \$ *100*

Where credited

Company to which assigned *E*

Remarks:

**
Became 10 U.S. Cold St. Art.*

Book mark:

J. M. Williams

10 H. Art'y. U.S.C.T.

John Ellsley

Priv., Co. E, 7 Reg't U. S. Col'd H. Art'y.*

Appears on

Company Muster-in and Descriptive Roll of the organization named above. Roll dated

New Orleans La., July 5, 1864.

Where born

Md.

Age 26 yrs; occupation

Lab orer

When enlisted

Apr. 9, 1864.

Where enlisted

Alexandria

For what period enlisted

3 years.

Eyes

Dark

hair Dark

Complexion

Dark

height 5 ft. 8 in.

When mustered in

June 25, 1864.

Where mustered in

New Orleans

Bounty paid \$

2

100; due \$

100

Where credited

Alexandria

Company to which assigned

Remarks:

* This organization subsequently became Co. E, 10 Reg't U. S. Colored Heavy Artillery.

Book mark:

Linden

6

10 H. Art'y. U.S.C.T.

John Elsey
Pt, Co. E, 10 Reg't U. S. Col'd H. Art'y.

Appears on

Company Muster Roll

for *July + Aug.*, 1864.
Present or absent

Stoppage, \$ 100 for

Due Gov't, \$ 100 for

Valuation of horse, \$ 100

Valuation of horse equipments, \$ 100

Remarks: *Died July 4th 64
Hospital at New Orleans*

Book mark:

(358)

J. Miller
Copyist.

E

10 H. Art'y.

U.S.C.T.

John Ellsey
Co. *E*, 10 Reg't U. S. Col'd H. Art'y.

Appears on **Co. Muster-out Roll**, dated
Baton Rouge, La, Feb 22, 1867.
Muster-out to date _____, 186 .
Last paid to - *Not known*, 186 .

Clothing account:

Last settled _____, 186 ; drawn since \$ _____ 100

Due soldier \$ _____ 100 ; due U. S. \$ _____ 100

Am't for cloth'g in kind or money adv'd \$ _____ 100

Due U. S. for arms, equipments, &c., \$ _____ 100

Bounty paid \$ _____ 100 ; due \$ _____ 100

Remarks: *Joined at Org. Organ,*
as private,
Died in Recruiting
Depot New Orleans, La.
July 4, 1864, of Int.
fever.

Book mark : _____

(361)

O'Hagan

Copyist.

Elsley, John

P, Co. E., 10 Reg't U.S.C.H.A.

2 Enclosures.

Bed Cards	Descriptive Lists
Burial Records /	Final Statements /
Certs. of Dis. for Discharge	Furloughs
C. M. Charges	Med. Des. Lists
Med. Certificates	Orders

Other papers relating to—

Admission to Hosp'l	Furlough
Casualty Sheet (Officer's)	Med. Examination
Confinement	Misc. Information
Contracts	Pay or Clothing
Death or Effects	Personal Reports
Desertions	Rank
Discharge from Hosp'l	Transfer to Hosp'l
Discharge from Service	Transfer to V. R. C.
Duty	Transportation

✓ FINAL STATEMENT

OF

John Cobley

Co. 1st Reg't of U.S. A. Artillery
10th

VOLUNTEERS.

Recd July 4th 1864

NOTE 1.—Two of these certificates (or duplicates) are to be given to each Volunteer Soldier or drafted man who may be discharged previously to the discharge of his company, that he may at once receive from the Paymaster the pay, &c., due him, and the captain or other COMMISSIONED officer commanding the company will certify to the act of the delivery of the duplicate certificates; on these certificates the Soldier is "entitled to" his discharge, and should also present his discharge to the Paymaster to have the payment endorsed on it. The discharge is to be given back to the Soldier by the Paymaster; the latter only retaining as his voucher the duplicate certificates.

NOTE 2.—If the Soldier is entitled to pay for the use of his horse, the Company Commander will certify to that fact on the back of both these final statements, and also to the time he has pay due for having been so mounted on his own horse.

NOTE 3.—When a Soldier is furnished with final statements, his descriptive list, if he has one, should be taken up by the officer who gives the Soldier these statements, and endorsed with a statement to this effect by the officer. This endorsement should exhibit a full statement of the time for which the Soldier was allowed pay on his final statements, the clothing account, and all other charges against him or in his favor, so as to comprise a complete exhibit of his account. It will then be transmitted to the company commander of the Soldier, who will enter all the data necessary to a full understanding of the Soldier's account on the muster roll upon which the Soldier's discharge is reported. The descriptive list will then be destroyed. The object of this is, that the remaining portion of the Soldier's account may be settled upon the receipt of these muster rolls, and the Soldier receive any pay or allowances that may be due him at the time of his discharge, and which may not appear on his final statements from the fact that his descriptive list is incomplete. These accounts for back pay, &c., are settled by the 2d Auditor of the Treasury Department.

NOTE 4.—Charges for loss or injury to ordnance, horse equipments, and other miscellaneous charges, should appear under the heading of "Other Stoppages."

NOTE 5.—Bounty paid by State authorities, and not by the United States, will not be entered on this statement.

NOTE 6.—Amounts due the Sutler and Laundress must be entered on the muster roll on which the discharge, death, desertion, &c., is reported, as well as on the final statement, otherwise the amount cannot be collected from the United States.

NOTE 7.—This blank will be used for deceased volunteers and drafted men, as well as for others.

NOTE 8.—Where a Soldier dies in Hospital or on detached service, his descriptive list, if he has one, should be sent with his final statements, in duplicate, to the Second Auditor, Washington, D. C.

ADJUTANT GENERAL'S OFFICE.
July 24th 1864
Duplicate with Inventory sent 2d Auditor.



Deerbs

I certify, on honor, that John Elsley a Private of
Captain M. Hawke Company (E) of the 7th Regiment of U.S. H. Artillery (C)
VOLUNTEERS, of the State of Louisiana, born in _____, State
of Louisiana, aged 26 years; 5 feet 8 inches high; Dark complexion,
Dark eyes, Dark hair, and by occupation a Sabrer, having joined the company on
its original organization at Alexandria, and enrolled in it at the muster into
the service of the United States at New Orleans La, on the 19th day
of April, 1864, (or was mustered in service as a recruit, by _____
at _____, on the _____ day of _____,
186 , or was drafted and mustered into the service of the United States from the _____
Enrollment District of the State of _____, at _____,
on the _____ day of _____, 186), to serve in the Regiment, for
the term of three years: and having served **HONESTLY** and
FAITHFULLY with his Company in _____ to the present date, is now

entitled to a **DISCHARGE** by reason of Death - July 4th 1864
of Dist. Fever - No effects -

The said John Elsley was last paid by Paymaster
never paid to include the _____ day of _____, 186 , and has
pay due him from that time to the ^{time of death} ~~present date~~; he is entitled to pay and subsistence for
TRAVELING to place of enrollment, and whatever other allowances are authorized to volunteer
soldiers, drafted men, or militia, so discharged. He has received from the United States **CLOTHING**
amounting to No clothing 100 dollars, since the _____ day of _____,
186 , when his clothing account was last settled. He has received from the United States
100 dollars advanced **BOUNTY**.

There is to be stopped from him, on account of the State of _____, or other
authorities, for **CLOTHING**, &c., received on entering service, _____ 100 dollars; and
for other stoppages, viz: _____

_____ 100 dollars.
He has been furnished with **TRANSPORTATION** in kind from the place of his discharge to
_____; and he has been **SUBSISTED** for **TRAVELING** to his
place of enrollment, up to the _____, 186 .

He is indebted to _____, **SUTLER**, _____ 100 dollars.

He is indebted to _____, **LAUNDRESS**, _____ 100 dollars.

Given in Duplicate, at Desair Station La, this 6th day
of August, 1864

A. P. Green Lieut
U.S. Colonel A. H. Gray
Commanding Company. E

RECORD OF DEATH AND INTERMENT.

Name and number of person interred, *John Elsey*

Number and locality of the Grave, -

Hospital number of the deceased, -

Regiment, Rank, and Company, - *private Co "E" 11th Heavy Artillery*

Residence before enlistment, - - -

Conjugal condition (and if married,)
 the residence of the widow,)

Cause of death, - - - - - } *Int Fever*

Age of the deceased, - - - - - } *38) Thirty Eight years*

Nativity, - - - - -

References, and Remarks, - - - }

Date of death and burial, - - - *July 4th* 1864

(A duplicate of this Record has been forwarded to the Sexton, and the other remains at this Hospital.)

To _____

SIR :

It becomes my duty to inform you that the person above described died at this Hospital as herein stated ; and that it is desired his remains should be interred with the usual military honors.

Respectfully,

Frank Martin
 Surg. 7th Regt Arty. U.S.A. *Surgeon U.S. Army.*
in Charge
Presq Depot
U.S.A.

MILITARY HOSPITAL, _____

This copy of Record is to be transmitted to the Adjutant General at Washington immediately after the place of burial and the number of the grave have been ascertained and registered. The above notification is to remain attached.

Osney Cross

Co C, 10 U.S. Col'd H. Art'y.

Private | *Private*

CARD NUMBERS.

1	5497713	26
2	5498115-	27
3	5498218	28
4	5498315-	29
5	5498413	30
6	5498520	31
7	5498661	32
8	5498800	33
9	5498936	34
10	5499077	35
11	5499213	36
12	5499349	37
13	5499485-	38
14	5499621	39
15	5499757	40
16	5499892	41
17	5500024	42
18	5500160	43
19	5500289	44
20	5500449	45
21	5490145-	46
22		47
23		48
24		49
25		50

Book Mark:

See also

E

10 H. Art'y.

U.S.C.T.

Russ Elsey

Priv, Co. C, 1 Reg't La. Art'y, Native Guards.*

Age *18* years.

Appears on

Company Muster-in Roll

of the organization named above. Roll dated

New Orleans La, Feb 4, 1864.

Muster-in to date *Feb 4, 1864.*

Joined for duty and enrolled:

When *Jan 22, 1864.*

Where *Russ Manchac La*

Period *3* years.

Valuation of horse, \$ *100*

Valuation of horse equipments, \$ *100*

Remarks:
.....
.....
.....
.....

* This organization subsequently became Co. C, 10 Reg't U. S. Col'd Heavy Artillery.

Book mark :
.....

(356)

W. J. ...

Copyist.

E | 10 H. Art'y. | U.S.C.T.

Reps Elsey
P11, Co. C, 1 Reg't H. Art'y, Corps d'Afrique.*

Appears on

Company Muster Roll

for *Feb 4th to 27th*, 186*4*.

Present or absent *Present*

Stoppage, \$ 100 for

Due Gov't, \$ 100 for

Valuation of horse, \$ 100

Valuation of horse equipments, \$ 100

Remarks:

*This organization subsequently became Co. C, 10 Reg't U. S. Colored Heavy Artillery.

Book mark:

Elsey

E | 10 H. Art'y. | U.S.C.T.

Ross Elsey

Pvt, Co. C, 7 Reg't U. S. Col'd H. Art'y.*

Appears on

Company Muster Roll

for *Mch & Apr*, 1864

Present or absent *Present*

Stoppage, \$ 100 for

Due Gov't, \$ 100 for

Valuation of horse, \$ 100

Valuation of horse equipments, \$ 100

Remarks:

* This organization subsequently became Co. , 10 Reg't U. S. Colored Heavy Artillery.

Book mark:

(358)

J. Henderson
Copyist.

8 | 10 H. Art'y. | U.S.C.T.

Ross Elsey

Pvt., Co. C, 7 Reg't U. S. Col'd H. Art'y.*

Appears on

Company Muster Roll

for *May & June*, 1864

Present or absent *Present*

Stoppage, \$ *100* for

Due Gov't, \$ *100* for

Valuation of horse, \$ *100*

Valuation of horse equipments, \$ *100*

Remarks:

* This organization subsequently became Co. , 10 Reg't U. S. Colored Heavy Artillery.

Book mark:

(358) *J. M. ...* Copyist.

E | 10 H. Art'y. | U.S.C.T.

Ross Eley

Pvt., Co. C., 7 Reg't U. S. Col'd H. Art'y.*

Appears on

Company Muster Roll

for July & Aug 1864.

Present or absent Present

Stoppage, \$ 100 for

Due Gov't, \$ 100 for

Valuation of horse, \$ 100

Valuation of horse equipments, \$ 100

Remarks:

* This organization subsequently became Co. , 10 Reg't U. S. Colored Heavy Artillery.

Book mark:

(358)

J Underwood Copyist.

Ross Elsey

Pvt., Co. C, 10 Reg't U. S. Col'd H. Art'y.

Appears on

Company Muster Roll

for Sept 10th, 1864.

Present or absent Present

Stoppage, \$ 100 for

Due Gov't, \$ 100 for

Valuation of horse, \$ 100

Valuation of horse equipments, \$ 100

Remarks:

Book mark:

(358)

J. Hudson

Copyist.

E

10 H. Art'y. U.S.C.T.

Ross Elsy
Pvt., Co. C, 10 Reg't U. S. Col'd H. Art'y.

Appears on

Company Muster Roll

for Nov + Dec, 1864

Present or absent Present

Stoppage, \$ 100 for

Due Gov't, \$ 100 for

Valuation of horse, \$ 100

Valuation of horse equipments, \$ 100

Remarks:

Book mark:

(358)

J. Hudson
Copyist.

E

10 H. Art'y. U.S.C.T.

Ross Elsey

Pl, Co. C, 10 Reg't U. S. Col'd H. Art'y.

Appears on

Company Muster Roll

for Jan + Feb, 1865

Present or absent Present

Stoppage, \$ 100 for

Due Gov't, \$ 100 for

Valuation of horse, \$ 100

Valuation of horse equipments, \$ 100

Remarks:

Book mark:

Attende

E

10 H. Art'y. U.S.C.T.

Ross Elsey
Priv., Co. C, 10 Reg't U. S. Col'd H. Art'y.

Appears on

Company Muster Roll

for March & April, 1865.

Present or absent Present

Stoppage, \$ 100 for

Due Gov't, \$ 100 for

Valuation of horse, \$ 100

Valuation of horse equipments, \$ 100

Remarks:

Book mark:

Lamb

(358)

Copyist.

E

10 H. Art'y. U.S.C.T.

Ross Elsy

Pvt., Co. C, 10 Reg't U. S. Col'd H. Art'y.

Appears on

Company Muster Roll

for May + June, 1865.

Present or absent Present

Stoppage, \$ 100 for

Due Gov't, \$ 100 for

Valuation of horse, \$ 100

Valuation of horse equipments, \$ 100

Remarks:

[Empty lines for remarks]

Book mark:

Sallade

E

10 H. Art'y. | U.S.C.T.

Ross Eley
Plut, Co. C, 10 Reg't U. S. Col'd H. Art'y.

Appears on

Company Muster Roll

for July 1865, 1865

Present or absent Present

Stoppage, \$ 100 for

Due Gov't, \$ 100 for

Valuation of horse, \$ 100

Valuation of horse equipments, \$ 100

Remarks:

Book mark:

(358)

Dallade

Copyist.

E

10 H. Art'y. U.S.C.T.

Wm Elsey

Plt, Co. C, 10 Reg't U. S. Col'd H. Art'y.

Appears on

Company Muster Roll

for *Sept & Oct*, 186*5*.

Present or absent *Present*

Stoppage, \$ *100* for

Due Gov't, \$ *100* for

Valuation of horse, \$ *100*

Valuation of horse equipments, \$ *100*

Remarks:

Book mark:

Sallade

E

10 H. Art'y. | U.S.C.T.

Ross Elsey
Poh, Co. C, 10 Reg't U. S. Col'd H. Art'y.

Appears on

Company Muster Roll

for *Nov. and Dec.*, 1865.

Present or absent *Present*

Stoppage, \$ 100 for

Due Gov't, \$ 100 for

Valuation of horse, \$ 100

Valuation of horse equipments, \$ 100

Remarks:

Book mark:

(358)

A. J. Robbins
Copyist.

E

10 H. Art'y. U.S.C.T.

Ross Eley
Co. C, Co. C, 10 Reg't U. S. Col'd H. Art'y.

Appears on

Company Muster Roll

for *Jan. & Feb.*, 186*6*.

Present or absent *Present.*

Stoppage, \$ *100* for

Due Gov't, \$ *100* for

Valuation of horse, \$ *100*

Valuation of horse equipments, \$ *100*

Remarks:

Book mark:

A. J. Robbins

E

10 H. Art'y. U.S.C.T.

Ross Elsey

Pvt., Co. C, 10 Reg't U. S. Col'd H. Art'y.

Appears on

Company Muster Roll

for Nov. 2d Apr., 1866.

Present or absent Present

Stoppage, \$ 100 for

Due Gov't, \$ 100 for

Valuation of horse, \$ 100

Valuation of horse equipments, \$ 100

Remarks: Dis U.S. for loss of
wiper \$ $\frac{26}{100}$.

Book mark:

A. J. Robbins

(358)

Copyst.

E

10 H. Art'y. U.S.C.T.

Ross Edley

Platoon, Co. C, 10 Reg't U. S. Col'd H. Art'y.

Appears on

Company Muster Roll

for May 2nd June, 1866.

Present or absent Present.

Stoppage, \$ 100 for

Due Gov't, \$ 100 for

Valuation of horse, \$ 100

Valuation of horse equipments, \$ 100

Remarks:

Book mark:

A. J. Robbins

(358)

Copyist.

E

10 H. Art'y. | U.S.C.T.

Ross Elsey
Pr, Co. C, 10 Reg't U. S. Col'd H. Art'y.

Appears on

Company Muster Roll

for *July 2d Aug*, 186*6*.

Present or absent *Present*

Stoppage, \$ *100* for

Due Gov't, \$ *100* for

Valuation of horse, \$ *100*

Valuation of horse equipments, \$ *100*

Remarks:
.....
.....
.....
.....
.....
.....
.....
.....
.....

Book mark:

A. J. Robbins
(358) *Copyist.*

E

10 H. Art'y. U.S.C.T.

Rep Elsey

Pr, Co. C, 10 Reg't U. S. Col'd H. Art'y.

Appears on

Company Muster Roll

for *Sept & Oct*, 18*66*.

Present or absent *Present*

Stoppage, \$ *100* for

Due Gov't, \$ *100* for

Valuation of horse, \$ *100*

Valuation of horse equipments, \$ *100*

Remarks: *In Court awaiting result of trial by Genl C. M.*

Book mark:

Manning

E | 10 H. Art'y. | U.S.C.T.

Ross Eley

Pvt., Co. C, 10 Reg't U. S. Col'd H. Art'y.

Appears on

Company Muster Roll

for Nov & Dec, 1866.

Present or absent Present

Stoppage, \$ 100 for

Due Gov't, \$ 100 for

Valuation of horse, \$ 100

Valuation of horse equipments, \$ 100

Remarks: Due U.S. \$5 per
day Court Martial
for absence without
leave

Book mark:

Hammy

(358)

Copyist.

E

10 H. Art'y. U.S.C.T.

Ross Elsey

Pr., Co. C, 10 Reg't U. S. Col'd H. Art'y.

Appears on Co. Muster-out Roll, dated Baton Rouge, La, Feb 22, 1867.

Muster-out to date _____, 186 .

Last paid to _____, 186 .

Clothing account:

Last settled _____, 186 ; drawn since \$ _____ 100

Due soldier \$ _____ 100; due U. S. \$ _____ 100

Am't for cloth'g in kind or money adv'd \$ _____ 100

Due U. S. for arms, equipments, &c., \$ _____ 100

Bounty paid \$ _____ 100; due \$ _____ 100

Remarks: Joined Orig. Co. Discharged Feb. 23, 1867 by reason of expiration of term of service

x corrected by 4x

Book mark: _____

(361)

Hammer Copyist.

E | 10 Arty

U.S.C.T.

Ross Eisey

Priv., Co. E, 10 Reg't U. S. Col'd Arty

Appears on a

Detachment Muster-out Roll

of the organization named above. Roll dated

Baton Rouge, La., Feb. 3, 1867.

Muster-out to date Feb. 3, 1867.

Last paid to Dec. 31, 1866

Clothing account:

Last settled _____, 1866 ; drawn since \$ _____ 100

Due soldier \$ 92⁷⁹/₁₀₀; due U. S. \$ 71⁷⁷/₁₀₀

Am't for cloth'g in kind or money adv'd \$ _____ 100

Due U. S. for arms, equipments, &c., \$ 74/₁₀₀

Bounty paid \$ _____ 100 due \$ 300⁵/₁₀₀

Remarks: *Joined orig. org. 1st A.C.S.A. now 10 U.S.C.A. (Hy) - stop for screw driver, wiper & tompro*

Book mark: _____

R. C. Wilson

(349)

Copyist.

Y. Moses

Co *5*, 10 U.S. Col'd H. Art'y.

Private

Private

CARD NUMBERS.

1	3-4-8-7-3-6	26
2	3-3-0-3-7-6-5-	27
3	3-3-0-3-9-1-9	28
4	3-3-0-6-0-6-6	29
5	3-3-0-6-2-0-6	30
6	3-3-0-6-3-3-2	31
7	3-3-0-6-4-7-1	32
8	3-3-0-6-5-8-2	33
9	3-3-0-6-8-0-0	34
10	3-3-0-6-8-9-6	35
11		36
12		37
13		38
14		39
15		40
16		41
17		42
18		43
19		44
20		45
21		46
22		47
23		48
24		49
25		50

Book Mark:

See also *77" M. A. C. Inf.*

E 110 N. Artz. | U.S.C.T.

Moses Ely

Inf., Co. F, 10 Reg't U. S. Col'd Hartz

Appears on

M. and D. Roll of Men Transferred

to the organization named above,

from 77 Regt. U.S. C. Inf.

Roll dated Oct 1, 1865.

When enlisted March 18, 1865.

Period for which enlisted 3 years.

When mustered in March 25, 1865.

Present or absent Present

Company to which assigned F

Remarks: Joined as recruit

Apr 10 1865

Stop per sentence of
F.O.C. Sept. 14, 65 #110

Book mark:

J. W. Leonard

E

10 H. Art'y. U.S.C.T.

Moses Ely

Priv, Co. F, 10 Reg't U. S. Col'd H. Art'y.

Appears on

Company Muster Roll

for Sept & Oct, 1865.

Present or absent Present

Stoppage, \$ 100 for

Due Gov't, \$ 100 for

Valuation of horse, \$ 100

Valuation of horse equipments, \$ 100

Remarks: Transferred from Co. D 77 U.S.C.I. Oct. 1/65. Stop per sentence of J.O.C. Sept 14/65 \$10.00

Book mark:

B. G. Masdon

(358)

Copyist.

E.

10 H. Art'y. U.S.C.T.

Moses Ely.

Priv., Co. F, 10 Reg't U. S. Col'd H. Art'y.

Appears on

Company Muster Roll

for Nov & Dec, 1865.

Present or absent Present.

Stoppage, \$ 100 for

Due Gov't, \$ 100 for

Valuation of horse, \$ 100

Valuation of horse equipments, \$ 100

Remarks: Stop for sentence of F.O.C. Sept. 14. 65. \$10.

Book mark:

(358)

ash
Copyist.

E.

10 H. Art'y. U.S.C.T.

Moses Ely.

Co. F, 10 Reg't U. S. Col'd H. Art'y.

Appears on

Company Muster Roll

for Jan'y & Feby, 1866.

Present or absent Present.

Stoppage, \$ 100 for

Due Gov't, \$ 100 for

Valuation of horse, \$ 100

Valuation of horse equipments, \$ 100

Remarks:

Book mark:

(358)

Copyist.

E.

10 H. Art'y.

U.S.C.T.

Moses Ely

Pat., Co. F, 10 Reg't U. S. Col'd H. Art'y.

Appears on

Company Muster Roll

for Mar. & April, 1864.

Present or absent Present

Stoppage, \$ 100 for

Due Gov't, \$ 100 for

Valuation of horse, \$ 100

Valuation of horse equipments, \$ 100

Remarks: Present in confinement

Book mark: See G. B. M. O. 54

Copyist

JAN. 16

5506206

1891

D. Sav., June 30, 1866.

Moses Ely.

Part, Co. F, 10 Reg't U. S. Col'd H. Art'y.

Appears on

Company Muster Roll

for May & June, 1866.

Present or absent Absent.

Stoppage, \$ 100 for

Due Gov't, \$ 100 for

Valuation of horse, \$ 100

Valuation of horse equipments, \$ 100

Remarks: Absent in New Orleans, La. awaiting trial.

Book mark:

(358)

Copyist.

Moses Ely.
Pat., Co. F, 10 Reg't U. S. Col'd H. Art'y.

Appears on

Company Muster Roll

for July 7 Aug., 1866.

Present or absent Present.

Stoppage, \$ 100 for

Due Gov't, \$ 100 for

Valuation of horse, \$ 100

Valuation of horse equipments, \$ 100

Remarks: Returned to duty
Aug. 30, 66 from confine-
ment at Ship Island,
Miss.

Book mark:

E

10 H. Art'y. U.S.C.T.

Moses Ely

Bar, Co. F, 10 Reg't U. S. Col'd H. Art'y.

Appears on

Company Muster Roll

for Sept. and Oct, 1866

Present or absent Present

Stoppage, \$ 100 for

Due Gov't, \$ 100 for

Valuation of horse, \$ 100

Valuation of horse equipments, \$ 100

Remarks:

Step in loss of C and G. E.
\$ 4.80

Book mark:

House

(358)

Copyist.

E

10 H. Art'y. U.S.C.T.

Moses Ely

Prs, Co. F, 10 Reg't U. S. Col'd H. Art'y.

Appears on

Company Muster Roll

for Nov. and Dec., 1866

Present or absent Present

Stoppage, \$ 100 for

Due Gov't, \$ 100 for

Valuation of horse, \$ 100

Valuation of horse equipments, \$ 100

Remarks:

Book mark:

House

E

10 H. Art'y. U.S.C.T.

Mass Ely

Art, Co. I, 10 Reg't U. S. Col'd H. Art'y.

Appears on Co. Muster-out Roll, dated

Baron Rouge La, Feb. 22, 186 7.

Muster-out to date Feb. 22, 186 7.

Last paid to Dec 31, 186 6.

Clothing account:

Last settled, 186 ; drawn since \$ 100

Due soldier \$ 22 ⁰⁶/₁₀₀; due U. S. \$ 100

Am't for cloth'g in kind or money adv'd \$ 100

Due U. S. for arms, equipments, &c., \$ 0 ⁰⁸/₁₀₀

Bounty paid \$ 100 ⁰⁰/₁₀₀; due \$ 100 ⁰⁰/₁₀₀

Remarks: Rec'd by transfer from Co. D 77 U. S. C. I pr. S. O No. 66 Hd. Qu. Dept of La. S. of 65 Sentence by G. C. M. to 2 Mos Conft at Ship Island Miss for leaving his post

Book mark: V. 162 P. 169. 73

House

JAN. 16

5506896

1891

Pr. G. O. No. 54 Ha. 2vo
Dept of La. June 30/66.

by Peter

Co F, 10 U.S. Col'd H. Art'y.

Private

Private

CARD NUMBERS.

1	5-488735-	26
2	5-5-0 5-7 64	27
3	5-5-0 5-9 18	28
4	5-5-0 60 64	29
5	5-5-0 62 84	30
6	5-5-0 69 74	31
7	5-489946	32
8		33
9		34
10		35
11		36
12		37
13		38
14		39
15		40
16		41
17		42
18		43
19		44
20		45
21		46
22		47
23		48
24		49
25		50

Book Mark:

See also 4 + 5 C'da + 77 use!

E 10 Art'y, U.S.C.T.

Peter Ely

Inf., Co. F, 10 Reg't U. S. Col'd Art'y

Appears on

M. and D. Roll of Men Transferred

to the organization named above,

from 77 Reg't U.S. C. Inf.

Roll dated Oct 1, 1865.

When enlisted Apr 3, 1863.

Period for which enlisted 3 years.

When mustered in Apr 8, 1863.

Present or absent Present

Company to which assigned F

Remarks: Joined by Transfer
from Co "G" 5 Inf Cda Jan 2.64
Stop per sentence of F.O.C.
Sept. 14. 65 #10.111

Book mark :

(342)

J. L. Lemard

Copyist

E

10 H. Art'y. U.S.C.T.

Peter Ely
Cair, Co. F, 10 Reg't U. S. Col'd H. Art'y.

Appears on

Company Muster Roll
for Sept & Oct, 1865.

Present or absent Present

Stoppage, \$ 100 for

Due Gov't, \$ 100 for

Valuation of horse, \$ 100

Valuation of horse equipments, \$ 100

Remarks: Transferred from Co. D
77 U.S. C.T. Oct 1/65. Stop per
sentence of F.C.C. Sept 14/65
\$1000

Book mark:

B. G. Masdon

(358)

Copyist.

E.

10 H. Art'y. U.S.C.T.

Peter Ely.

Pat., Co. F, 10 Reg't U. S. Col'd H. Art'y.

Appears on

Company Muster Roll

for *Nov. & Dec.*, 1865.

Present or absent *Present*

Stoppage, \$ *100* for

Due Gov't, \$ *100* for

Valuation of horse, \$ *100*

Valuation of horse equipments, \$ *100*

Remarks: *Stop for Sentence of F.O.C. Sept. 14, 65; \$10.*

Book mark:

(358)

Crow
Copyist.

E. | 10 H. Art'y. | U.S.C.T.

Peter Ely.

Pat., Co. F, 10 Reg't U. S. Col'd H. Art'y.

Appears on

Company Muster Roll

for *Jan'y & Feby.*, 186 *6.*

Present or absent *Present.*

Stoppage, \$ *100* for

Due Gov't, \$ *100* for

Valuation of horse, \$ *100*

Valuation of horse equipments, \$ *100*

Remarks:

Book mark: *Muster out on file.*

Peter Ely

Pat., Co. F, 10 Reg't U. S. Col'd H. Art'y.

Appears on

Company Muster Roll

for *Mar & Apr.*, 1866.

Present or absent

Stoppage, \$ 100 for

Due Gov't, \$ 100 for

Valuation of horse, \$ 100

Valuation of horse equipments, \$ 100

Remarks: *Discharged.*
** Mustered out by reason*
of expiration of term of
service.

** Inspected by surgeon*

Book mark:

Robt.
Copyist.

C. | ¹⁰ Hyarty U.S.C.T.

Peter Ely

Pvt. Co. F, 10 Reg't U. S. Col'd Asty

Appears on a

Detachment Muster-out Roll

of the organization named above. Roll dated

New Orleans, La. Apr. 2, 1866.

Muster-out to date Apr. 2, 1866.

Last paid to Dec. 31, 1865

Clothing account:

Last settled 186 ; drawn since \$ 100

Due soldier \$ 6 ⁶⁷/₁₀₀; due U. S. \$ 100

Am't for cloth'g in kind or money adv'd \$ 100

Due U. S. for arms, equipments, &c., \$ ⁴³/₁₀₀

Bounty paid \$ 100 due \$ 100

Remarks: Joined 4th Inf. C.A. (76 U.S.C.S.) as recruit.

Transferred as Pvt. to 5th Inf. C.A. (77th U.S.C.S.) Dec. 63.

Transferred to 10th U.S. C.A. (Hy.) per D.O. 66 Hd.

Book mark: (over)

A. W. Reed

JAN. 15

5489946

1831

*Drs. Dept. of La, series
of 65.*

E

10 H. Art'y. | U.S.C.T.

Peter Ely
Sgt., Co F, 10 Reg't U. S. Col'd H. Art'y.

Appears on Co. Muster-out Roll, dated
Baton Rouge La., Feb 22, 1867.

Muster-out to date _____, 1867.

Last paid to Dec 31, 1865.

Clothing account:

Last settled _____, 1867; drawn since \$ 100

Due soldier \$ 100; due U. S. \$ 100

Am't for cloth'g in kind or money adv'd \$ 100

Due U. S. for arms, equipments, &c., \$ 100

Bounty paid \$ 100; due \$ 100

Remarks: Rec'd by transfer from
Co. D. 77 U.S. Cf. in S. O. No. 6a
Hd. Qu. Dept. of La. S. of 65
Discharged by expiration of
service April 2 / 66

Book mark: V 72 10 141. 69

House

Ely Peter
Co. 7, 10 Reg't U.S.C.A.

(CIVIL WAR)
(Philippine Insurrection.)

1 Inclosures.

Bed Cards	Ex. Preliminary to M. O.
Burial Records	Final Statements
Certs. of Dis. for Discharge	Fines
C. M. Charges	Furloughs or L. of A.
Descriptive Lists	Med. Certificates
Descriptive and Assign- ment Cards }	Med. Des. Lists
Discharge Certificates	Orders
Enlistment Papers	Resignations

Other papers relating to—

Admission to Hosp'l	Furlough or L. of A.
Confinement	Med. Examination
Contracts	Misc. Information
Death or Effects	Pay or Clothing
Desertion	Personal Reports
Discharge from Hosp'l	Rank
Discharge from Service	Transfer to Hosp'l
Duty	Transportation

S Sep

Statement of Service Reference Slip.

Office Co. P.

Claim No. S.O. 719210

Peter Ely
(Name.)

Co. G, 76 Reg't U.S.C.

D 77 " "

F 10 " 1st A "

To Med Div. 6-3-, 1914

For statement

No med p.p.

Johnson
P.D.

Archives Div.

Any record of trial
in Sept, 65, as of
10 Ky. arty.?

Mr. O.R.R. Div. P.D.
No record of trial found.
Harley
Per H.P.

over

Statement furnished 6-4-, 1914

P.D.

No books.

PS

Emerson. John

Co. D., 10 U.S. Col'd H. Art'y.

Private | *Private*

CARD NUMBERS.

1	5-48702f	26
2	5-5-00622	27
3	5-5-00709	28
4	5-5-007f5-	29
5	5-5-00ff4	30
6	5-5-02299	31
7		32
8		33
9		34
10		35
11		36
12		37
13		38
14		39
15		40
16		41
17		42
18		43
19		44
20		45
21		46
22		47
23		48
24		49
25		50

Book Mark:

See also

John Emerson

Appears with rank of Private on

Muster and Descriptive Roll of a Detachment of U. S. Vols. forwarded

for the ^(7th U. S. C. H. A.) 10 Reg't U. S. C. H. A. Roll dated

New Orleans La, May 7, 1864.

Where born Natchez Miss.

Age 24 y'rs; occupation Laborer

When enlisted May 5, 1864.

Where enlisted New Orleans

For what period enlisted 3 years.

Eyes Black; hair Black

Complexion Black; height 5 ft. 7 in.

When mustered in May 7, 1864.

Where mustered in New Orleans

Bounty paid \$ 100; due \$ 100

Where credited New Orleans

Company to which assigned D

Remarks :

Book mark :

Galligan

E | **10 H. Art'y.** | **U.S.C.T.**

John Emerson
P, Co. *D*, 7 Reg't U. S. Col'd H. Art'y.*

Appears on

Company Muster Roll

for *May & June*, 186*4*.

Present or absent *Present*

Stoppage, \$ *100* for

Due Gov't, \$ *100* for

Valuation of horse, \$ *100*

Valuation of horse equipments, \$ *100*

Remarks:

* This organization subsequently became Co. *D*, 10 Reg't U. S. Colored Heavy Artillery.

Book mark:

(358)

Shadbolt

Copyist.

80

10 H. Art'y.

U.S.C.T.

John Emerson

Co. D, 10 Reg't U. S. Col'd H. Art'y.

Appears on

Company Muster Roll

for July & Aug., 1864.

Present or absent Present

Stoppage, \$ 100 for

Due Gov't, \$ 100 for

Valuation of horse, \$ 100

Valuation of horse equipments, \$ 100

Remarks: Def. of pay from date of enrollment to June 30/64 \$9.00 per mo.

Book mark:

Shadbolt

E. | **10 H. Art'y.** | **U.S.C.T.**

John Emunson
.....

....., Co. D, 10 Reg't U. S. Col'd H. Art'y.

Appears on

Company Muster Roll

for *Sept + Oct*....., 186*4*.

Present or absent *Absent*.....

Stoppage, \$..... *100* for.....

Due Gov't, \$..... *100* for.....

Valuation of horse, \$..... *100*

Valuation of horse equipments, \$..... *100*

Remarks: *Sick in Corps*
d' Afrique Genl Hospital
N.O. La. since Oct. 5/64

Book mark:.....

(358)

Shadwell

Copyist.

E

10 H. Art'y. U.S.C.T.

John Emerson

Co. D, 10 Reg't U. S. Col'd H. Art'y.

Appears on

Company Muster Roll

for Nov. & Dec., 1864.

Present or absent

Stoppage, \$ 100 for

Due Gov't, \$ 100 for

Valuation of horse, \$ 100

Valuation of horse equipments, \$ 100

Remarks: Died in Corps
d'Afrique Genl Hospital
N. Orleans Nov. 17/64

Book mark:

(358)

Shadock

Copyist.

5 | 10 Hartig | **U.S.C.T.**

John Emerson
Am. Co. D, 10 Reg't U. S. Col'd Hartig

Appears on **Co. Muster-out Roll**, dated
Katon Rouge La, Feb 22, 1867.

Muster-out to date _____, 186 .

Last paid to _____, 186 .

Clothing account:

Last settled _____, 186 ; drawn since \$ _____ 100

Due soldier \$ _____ 100; due U. S. \$ _____ 100

Am't for cloth'g in kind or money adv'd \$ _____ 100

Due U. S. for arms, equipments, &c., \$ _____ 100

Bounty paid \$ _____ 100; due \$ _____ 100

Remarks: Joined Regt. Org.
Died at Katon Rouge
Nov 17/67
Final statements
found

Book mark: _____

(361)

J. L. Leman

Copyist.

Emerson, Jno.

P. N., 10 Reg'us aka,

4 Enclosures.

Bed Cards		Descriptive Lists	
Burial Records	1	Final Statements	2
Certs. of Dis. for Discharge		Furloughs	
C. M. Charges		Med. Des. Lists	
Med. Certificates		Orders	

Other papers relating to—

Admission to Hosp'l		Furlough	
Casualty Sheet (Officer's)		Med. Examination	
Confinement		Misc. Information	
Contracts		Pay or Clothing	
Death or Effects	/	Personal Reports	
Desertions		Rank	
Discharge from Hosp'l		Transfer to Hosp'l	
Discharge from Service		Transfer to V. R. C.	
Duty		Transportation	

Duplicate No 17-1804

FINAL STATEMENT

OF

Private

John Emerson

10 Reg't of *U S C S A*

VOLUNTEERS.

C. d. A. Hask

NOTE 1.—Two of these certificates (or duplicates) are to be given to each Volunteer Soldier or drafted man who may be discharged previously to the discharge of his company, that he may at once receive from the Paymaster the pay, &c., due him, and the cap'tain or other COMMISSIONED officer commanding the company will certify to the act of the delivery of the duplicate certificates; on these certificates the Soldier is "entitled to" his discharge, and should also, present his discharge to the Paymaster to have the payment endorsed on it. The discharge is to be given back to the Soldier by the Paymaster; the latter only retaining as his voucher the duplicate certificates.

NOTE 2.—If the Soldier is entitled to pay for the use of his horse, the Company Commander will certify to that fact on the back of both these final statements, and also to the time he has pay due for having been so mounted on his own horse.

NOTE 3.—When a Soldier is furnished with final statements, his descriptive list, if he has one, should be taken up by the officer who gives the Soldier these statements, and endorsed with a statement to this effect by the officer. This endorsement should exhibit a full statement of the time for which the Soldier was allowed pay on his final statements, the clothing account, and all other charges against him or in his favor, so as to comprise a complete exhibit of his account. It will then be transmitted to the company commander of the Soldier, who will enter all the data necessary to a full understanding of the Soldier's account on the muster roll upon which the Soldier's discharge is reported. The descriptive list will then be destroyed. The object of this is, that the remaining portion of the Soldier's account may be settled upon the receipt of these muster rolls, and the Soldier receive any pay or allowances that may be due him at the time of his discharge, and which may not appear on his final statements from the fact that his descriptive list is incomplete. These accounts for back pay, &c., are settled by the 2d Auditor of the Treasury Department.

NOTE 4.—Charges for loss or injury to ordnance, horse equipments, and other miscellaneous charges, should appear under the heading of "Other Stoppages."

NOTE 5.—Bounty paid by State authorities, and not by the United States, will not be entered on this statement.

NOTE 6.—Amounts due the Sutler and Laundress must be entered on the muster roll on which the discharge, death, desertion, &c., is reported, as well as on the final statement, otherwise the amount cannot be collected from the United States.

NOTE 7.—This blank will be used for deceased volunteers and drafted men, as well as for others.

NOTE 8.—Where a Soldier dies in Hospital or on detached service, his descriptive list, if he has one, should be sent with his final statements, in duplicate, to the Adjutant General, Washington, D. C.

I certify, on honor, that John Emerson a Private of
 Captain Chas A Bailey Company (D) of the 10th Regiment of U.S.C.H. Art
VOLUNTEERS, of the State of Louisiana, born in Natchez, State
 of Mississippi, aged 24 years; 5 feet 7 inches high; Blk complexion,
Blk eyes, Blk hair, and by occupation a Sabrer, having joined the company on
 its original organization at _____, and enrolled in it at the muster into
 the service of the United States at New Orleans La on the 5th day
 of May, 1864, (or was mustered in service as a recruit, by _____
 _____, at _____, on the _____ day of _____,
 186 , or was drafted and mustered into the service of the United States from the _____
 Enrollment District of the State of _____, at _____,
 on the _____ day of _____, 186) to serve in the Regiment, for
 the term of Three years; and having served **HONESTLY** and
FAITHFULLY with his Company in Dept of the Gulf to the present date, is now
 entitled to a **DISCHARGE** by reason of Death by Curram Ori's
at New Orleans La Nov 17th 1864

The said John Emerson was last paid by Paymaster
Haggerty to include the 30th day of June, 1864, and has
 pay due him from that time to the present date; he is entitled to pay and subsistence for
TRAVELING to place of enrollment, and whatever other allowances are authorized to volunteer
 soldiers, drafted men, or militia, so discharged. He has received from the United States **CLOTHING**
 amounting to Thirty five $\frac{97}{100}$ dollars, since the _____ day of Enrollment,
 1864, when his clothing account was last settled. He has received from the United States
no $\frac{0}{100}$ dollars advanced **BOUNTY**.

There is to be stopped from him, on account of the State of _____, or other
 authorities, for **CLOTHING**, &c., received on entering service, _____ dollars; and
 for other stoppages, viz: _____

_____ dollars.
 He has been furnished with **TRANSPORTATION** in kind from the place of his discharge to
 _____; and he has been **SUBSISTED** for **TRAVELING** to his
 place of enrollment, up to the _____, 186 .

He is indebted to _____, **SUTLER**, _____ dollars.

He is indebted to _____, **LAUNDRESS**, _____ dollars.

Given in Duplicate, at New Orleans La, this 17th day
 of Nov, 1864.

H.S.O

✓ FINAL STATEMENT

OF *Private*
John Emerson
10th Reg't of *U. S. C. H. art*

VOLUNTEERS.

Rec'd Nov 17th 1864

NOTE 1.—Two of these certificates (or duplicates) are to be given to each Volunteer Soldier or drafted man who may be discharged previously to the discharge of his company, that he may at once receive from the Paymaster the pay, &c., due him, and the cap'tain or other COMMISSIONED officer commanding the company will certify to the act of the delivery of the duplicate certificates; on these certificates the Soldier is "entitled to" his discharge, and should also present his discharge to the Paymaster to have the payment endorsed on it. The discharge is to be given back to the Soldier by the Paymaster; the latter only retaining as his voucher the duplicate certificates.

NOTE 2.—If the Soldier is entitled to pay for the use of his horse, the Company Commander will certify to that fact on the back of both these final statements, and also to the time he has pay due for having been so mounted on his own horse.

NOTE 3.—When a Soldier is furnished with final statements, his descriptive list, if he has one, should be taken up by the officer who gives the Soldier these statements, and endorsed with a statement to this effect by the officer. This endorsement should exhibit a full statement of the time for which the Soldier was allowed pay on his final statements, the clothing account, and all other charges against him or in his favor, so as to comprise a complete exhibit of his account. It will then be transmitted to the company commander of the Soldier, who will enter all the data necessary to a full understanding of the Soldier's account on the muster roll upon which the Soldier's discharge is reported. The descriptive list will then be destroyed. The object of this is, that the remaining portion of the Soldier's account may be settled upon the receipt of these muster rolls, and the Soldier receive any pay or allowances that may be due him at the time of his discharge, and which may not appear on his final statements from the fact that his descriptive list is incomplete. These accounts for back pay, &c., are settled by the 2d Auditor of the Treasury Department.

NOTE 4.—Charges for loss or injury to ordnance, horse equipments, and other miscellaneous charges, should appear under the heading of "Other Stoppages."

NOTE 5.—Bounty paid by State authorities, and not by the United States, will not be entered on this statement.

NOTE 6.—Amounts due the Sutler and Laundress must be entered on the muster roll on which the discharge, death, desertion, &c., is reported, as well as on the final statement, otherwise the amount cannot be collected from the United States.

NOTE 7.—This blank will be used for deceased volunteers and drafted men, as well as for others.

NOTE 8.—Where a Soldier dies in Hospital or on detached service, his descriptive list, if he has one, should be sent with his final statements, in duplicate, to the Adjutant General, Washington, D. C.

Adj. Gen. 2d Auditor

ADJUTANT GENERAL'S OFFICE
Dec 15 1864
Duplicate with Inventory sent 2d Auditor.



I certify, on honor, that John Emerson a Private of
 Captain Chas A Bailey Company (D.) of the 10th Regiment of U.S.C.A.
VOLUNTEERS, of the State of Louisiana, born in Natchez, State
 of Mississippi, aged 24 years; 5 feet 7 inches high; Blk complexion,
Blk eyes, Blk hair, and by occupation a Laborer, having joined the company on
 its original organization at _____, and enrolled in it at the muster into
 the service of the United States at New Orleans La, on the 5th day
 of May, 1864, (or was mustered in service as a recruit, by _____
 _____, at _____, on the _____ day of _____,
 186 , or was drafted and mustered into the service of the United States from the _____
 Enrollment District of the State of _____, at _____,
 on the _____ day of _____, 186) to serve in the Regiment, for
 the term of Three years; and having served HONESTLY and
 FAITHFULLY with his Company in Dept of the Gulf to the present date, is now
 entitled to a **DISCHARGE** by reason of Death by Cancerum Ovis
at New Orleans La Nov 17th 1864.

The said John Emerson was last paid by Paymaster
Haggerty to include the 30th day of June, 1864, and has
 pay due him from that time to the present date; he is entitled to pay and subsistence for
TRAVELING to place of enrollment, and whatever other allowances are authorized to volunteer
 soldiers, drafted men, or militia, so discharged. He has received from the United States **CLOTHING**
 amounting to Thirty six 97 $\frac{97}{100}$ dollars, since the _____ day of Enrollment,
 1864, when his clothing account was last settled. He has received from the United States
No $\frac{1}{100}$ dollars advanced **BOUNTY**.

There is to be stopped from him, on account of the State of _____, or other
 authorities, for **CLOTHING**, &c., received on entering service, _____ $\frac{100}{100}$ dollars; and
 for other stoppages, viz: _____

_____ $\frac{100}{100}$ dollars.
 He has been furnished with **TRANSPORTATION** in kind from the place of his discharge to
 _____; and he has been **SUBSISTED** for **TRAVELING** to his
 place of enrollment, up to the _____, 186 .

He is indebted to _____, **SUTLER**, _____ $\frac{100}{100}$ dollars.

He is indebted to _____, **LAUNDRESS**, _____ $\frac{100}{100}$ dollars.

Given in Duplicate, at New Orleans La, this 17th day
 of November, 1864.

F. E. Squette
 Surgeon in Charge C. d'Almeida Gen Hospital
 Commanding Company.

RECORD OF DEATH AND INTERMENT.

Name and number of person interred,	<i>John Emerson</i>	
Number and locality of the grave, -		
Hospital number of the deceased, -	<i>2001.</i>	
Regiment, Rank, and Company, - -	<i>10th U. S. Col. Hy. Art. - Priv. - D.</i>	
Residence before enlistment, - - -		
Conjugal condition (and if married,) the residence of the widow,)		
Cause of death,)	<i>Pancrum Ovis</i>	
Age of the deceased, - - - - -		
Nativity, - - - - -		
References and Remarks, - -)		
Date of death and burial, - - -	<i>Novbr: 17/64</i>	186

[A duplicate of this Record has been forwarded to the Sexton, and the other remains at this Hospital.]

To *Adj. General U. S. A.*
SIR :

It becomes my duty to inform you that the person above described died at this Hospital as herein stated: and that it is desired his remains should be interred with the usual military honors.

Respectfully,

J. C. Stryker *Col. Surg.*
Surgeon U. S. Army.
in charge
Corps d'Afrique Genl. Hosp.

MILITARY HOSPITAL, *Corps d'Afrique, N Orleans*
La.

This copy of Record is to be transmitted to the Adjutant General at Washington immediately after the place of burial and the number of the grave have been ascertained and registered. The above notification is to remain attached.

Triplicate

INVENTORY OF THE EFFECTS

OF

Private

John Emerson

Late of Company *D.*

10th Reg't of *2^d S. C. H. A.*

Volunteers, who died at *Camp Gen. Heintz*

on the *17th* day of *Nov* 186*4*

or be
er of
oned
his
De-
ld to
dier.
fects
ed to
at or
d to
the
oned
paid

icers
ed to
the
regi-
the
his
n the
ding
eath,
and
euse;
y to
tory
nt of
legal
the

er or
ease,
the
lepo-
they

on, a
the
cept
the
the

over
stant
e de-
their
ases,
stant

licate
ould
r.

Inventory of the effects of John Emerson late
 a Private of Captain Charles A Bailey Company "D." of
 the 10th Regiment of U.S.C.H.A. Volunteers, who was enrolled as
 a Private at New Orleans in the State of Louisiana on
 the 5th day of May 1864, and mustered into the service of the United
 States as a Private on the 7th day of May 1864, at New Orleans
 in Company "D.", 10th Regiment of U.S.C.H.A. Volunteers, to serve Three
 years or during the war; he was born in Natchez in the State
 of Mississippi; he was 24 years of age, 5 feet 7 inches
 high, Blk complexion, Blk eyes, Blk hair, and by occupation, when enrolled,
 a Labourer; he died in C. d'Afrique Gen Hospital, at
New Orleans La on the 17th day of November 1864, by
 reason of Cancer Oris

INVENTORY.					
ARTICLES.	No.	ARTICLES.	No.	ARTICLES.	No.
Hats.....		Pairs trousers.....		Knapsacks.....	
Caps.....		Pairs flannel drawers.....			
Forage caps.....		Pairs cotton drawers.....			
Great coats.....		Flannel shirts.....			
Uniform coats.....		Cotton shirts.....			
Uniform jackets.....		Pairs boots.....			
Flannel sack coats.....		Pairs shoes.....			
Blouses.....		Pairs socks.....			
Stable frocks.....		Blankets.....		MONEY.	
Fatigue overalls.....		Haversacks.....		Specie.....	\$
				Notes.....	\$

I CERTIFY, ON HONOR, that the above inventory comprises all the effects of _____
 _____, deceased, and that the effects are in the hands
 of _____ at _____
 _____ to be disposed of by a Council of Administration.

(DUPLICATES.)

STATION: New Orleans La
 DATE: Nov 17 1864

 Commanding the Company.

Wm. Owen

Co. **10 U.S. Col'd H. Art'y**

Private | *Private*

CARD NUMBERS.

1	<i>5-4-7-7-7</i>	26
2		27
3		28
4		29
5		30
6		31
7		32
8		33
9		34
10		35
11		36
12		37
13		38
14		39
15		40
16		41
17		42
18		43
19		44
20		45
21		46
22		47
23		48
24		49
25		50

Book Mark:

See also *77" U.S.C.A.*

E | 10th A. | U.S.C.T.

O'Brien, Edwin
Co., 10 Reg't U. S. Col'd 10th A.

Appears on

M. and D. Roll of Men Transferred

to the organization named above,

from 17th U.S. Col Inf

Roll dated Camp Canapeta Oct 1, 1865.

When enlisted _____, 186 .

Period for which enlisted _____ years.

When mustered in March 20, 1865.

Present or absent _____

Company to which assigned _____

Remarks: Died June 27.65
at G. A. U. S. Gen. Hos.
pital, New Orleans
La of Diarrhea,
(Dysent)

Book mark : _____

W. H. Scott

Simmons Henry

Co *E*, 10 U.S. Col'd H. Art'y.

Private

Private

CARD NUMBERS.

1	<i>5487118</i>	26
2	<i>55-0 2370</i>	27
3	<i>55-0 2686</i>	28
4	<i>55-0 45-90</i>	29
5		30
6		31
7		32
8		33
9		34
10		35
11		36
12		37
12		38
14		39
15		40
16		41
17		42
18		43
19		44
20		45
21		46
22		47
23		48
24		49
25		50

Book Mark: _____

See also _____

E | 10 H. Art'y. | U.S.C.T.

Henry Emerson

Appears with rank of *Priv* on

Muster and Descriptive Roll of a Detachment of U. S. Vols. forwarded

for the *7* Reg't *U.S.H. Art'y*^{*} Roll dated
New Orleans La, June, 1864.

Where born *La*

Age *18* y'rs; occupation *Labors*

When enlisted *April 18th*, 1864.

Where enlisted *Alexandria*

For what period enlisted *3* years.

Eyes *Dark*; hair *Dark*

Complexion *Dark*; height *5* ft. *6* in.

When mustered in *June 20th*, 1864.

Where mustered in *New Orleans*

Bounty paid \$ *100*; due \$ *100*

Where credited

Company to which assigned *E*

Remarks:

** Became 10 U.S. Art'y*

Book mark:

S. Williams

E

10 H. Art'y. U.S.C.T.

Henry Emmonds

Co. E, 7 Reg't U. S. Col'd H. Art'y.*

Appears on

Company Muster-in and Descriptive Roll

of the organization named above. Roll dated

New Orleans La. July 5, 1864.

Where born

Age 18 y'rs; occupation

When enlisted

Where enlisted

For what period enlisted

Eyes

Complexion

When mustered in

Where mustered in

Bounty paid \$

Where credited

Company to which assigned

Remarks:

* This organization subsequently became Co. E, 10 Reg't U. S. Colored Heavy Artillery.

Book mark:

(356d)

Lusiden

Copyist.

E

10 H. Art'y. U.S.C.T.

Henry Emmons
Pr, Co, E, 10 Reg't U. S. Col'd H. Art'y.

Appears on

Company Muster Roll

for July & Aug, 1864

Present or absent

Stoppage, \$ 100 for

Due Gov't, \$ 100 for

Valuation of horse, \$ 100

Valuation of horse equipments, \$ 100

Remarks: Died July 14"/64
Hospital at New Orleans

Book mark:

(358)

Grudden

Copyist.

E

10 H. Art'y. U.S.C.T.

Henry Emmons
Priv., Co. E, 10 Reg't U. S. Col'd H. Art'y.

Appears on Co. Muster-out Roll, dated
Baton Rouge, La. Feb. 22, 1867.

Muster-out to date _____, 186 .

Last paid to - *Not known*, 186 .

Clothing account:

Last settled _____, 186 ; drawn since \$ _____ 100

Due soldier \$ _____ 100; due U. S. \$ _____ 100

Am't for cloth'g in kind or money adv'd \$ _____ 100

Due U. S. for arms, equipments, &c., \$ _____ 100

Bounty paid \$ _____ 100; due \$ _____ 100

Remarks: *Joined at Org. Organs,
as private,
Died at Recruiting
Depot, New Orleans, La.
July 14/64 of Diarrhoea.*

Book mark: _____

(361)

O'Hagan

Copyist.

Emmons, Henry

P. Co. E

10

Regt

U. S. C. H. A.

4 Enclosures.

Bed Cards	Descriptive Lists
Burial Records	Final Statements /
Certs. of Dis. for Discharge	Furloughs
C. M. Charges	Med. Des. Lists
Med. Certificates	Orders

Other papers relating to—

Admission to Hosp'l	Furlough
Casualty Sheet (^{Pri} Officer's) 1	Med. Examination
Confinement	Misc. Information /
Contracts	Pay or Clothing
Death or Effects /	Personal Reports
Desertions	Rank
Discharge from Hosp'l	Transfer to Hosp'l
Discharge from Service	Transfer to V. R. C.
Duty	Transportation

2 for civil sent for to Lucy Ann. Apr 6. 66

CASUALTY SHEET

No. _____

Almond Henry

_____ of Company "E"

_____ Regiment of 11th

State Volunteers.

NATURE OF CASUALTY.

Died July 14/64.

CASUALTY SHEET.

Name: Almondo Henry

Rank: Priv Company: E Regiment: 7

Arm: U.S. Art State: _____

Nature of Casualty: Death

CAUSE OF CASUALTY—(NAME OF DISEASE, &c.)

BY WHOM DISCHARGED.

FROM WHAT SOURCE THIS INFORMATION WAS OBTAINED.

DEGREE OF DISABILITY.

Roll of Honor
La. Pg 116

BY WHOM CERTIFIED.

REMARKS.

J. Moore
A. G. M.

DATE OF DISCHARGE, DEATH, &c.

July 14, 1864

PLACE OF DISCHARGE, DEATH, &c.

Buried New Orleans, La.

J. B. Clerk.



FINAL STATEMENT

OF

Henry Emmert
Co. E - 7th Regt of W. M. D. C. A.
10th U. S.

VOLUNTEERS.

Recd July 14 1864

NOTE 1.—Two of these certificates (or duplicates) are to be given to each Volunteer Soldier or drafted man who may be discharged previously to the discharge of his company, that he may at once receive from the Paymaster the pay, &c., due him, and the captain or other COMMISSIONED officer commanding the company will certify to the act of the delivery of the duplicate certificates; on these certificates the Soldier is "entitled to" his discharge, and should also present his discharge to the Paymaster to have the payment endorsed on it. The discharge is to be given back to the Soldier by the Paymaster; the latter only retaining as his voucher the duplicate certificates.

NOTE 2.—If the Soldier is entitled to pay for the use of his horse, the Company Commander will certify to that fact on the back of both these final statements, and also to the time he has pay due for having been so mounted on his own horse.

NOTE 3.—When a Soldier is furnished with final statements, his descriptive list, if he has one, should be taken up by the officer who gives the Soldier these statements, and endorsed with a statement to this effect by the officer. This endorsement should exhibit a full statement of the time for which the Soldier was allowed pay on his final statements, the clothing account, and all other charges against him or in his favor, so as to comprise a complete exhibit of his account. It will then be transmitted to the company commander of the Soldier, who will enter all the data necessary to a full understanding of the Soldier's account on the muster roll upon which the Soldier's discharge is reported. The descriptive list will then be destroyed. The object of this is, that the remaining portion of the Soldier's account may be settled upon the receipt of these muster rolls, and the Soldier receive any pay or allowances that may be due him at the time of his discharge, and which may not appear on his final statements from the fact that his descriptive list is incomplete. These accounts for back pay, &c., are settled by the 2d Auditor of the Treasury Department.

NOTE 4.—Charges for loss or injury to ordnance, horse equipments, and other miscellaneous charges, should appear under the heading of "Other Stoppages."

NOTE 5.—Bounty paid by State authorities, and not by the United States, will not be entered on this statement.

NOTE 6.—Amounts due the Sutler and Laundress must be entered on the muster roll on which the discharge, death, desertion, &c., is reported, as well as on the final statement, otherwise the amount cannot be collected from the United States.

NOTE 7.—This blank will be used for deceased volunteers and drafted men, as well as for others.

NOTE 8.—Where a Soldier dies in Hospital or on detached service, his descriptive list, if he has one, should be sent with his final statements, in duplicate, to the Secretary of War, Washington, D. C.



20073

ADJUTANT GENERAL'S OFFICE
July 24th 1864
Duplicate with inventory sent 2d Auditor.

I certify, on honor, that Henry Emmert a Private of
 Captain M. Hawke Company (E) of the 7th Regiment of 2nd Art (Colo)
VOLUNTEERS, of the State of Louisiana, born in Louisiana, State
 of Louisiana, aged 18 years; 5 feet 6 inches high; Blk complexion,
Blk eyes, Blk hair, and by occupation a Laborer, having joined the company on
 its original organization at Alexandria, and enrolled in it at the muster into
 the service of the United States at New Orleans La on the 19th day
 of April, 1864 (or was mustered in service as a recruit, by
 _____, at _____, on the _____ day of _____,
 186 , or was drafted and mustered into the service of the United States from the _____
 Enrollment District of the State of _____, at _____,
 on the _____ day of _____, 186) to serve in the Regiment, for
 the term of Three years: and having served **HONESTLY** and
FAITHFULLY with his Company in _____ to the present date, is now

entitled to a **DISCHARGE** by reason of Death - July 14, 1864
of Dysentery - No Effects

The said Henry Emmert was last paid by Paymaster
Overfair to include the _____ day of _____, 186 , and has
 pay due him from that time to the time of death ~~present~~ date; he is entitled to pay and subsistence for
TRAVELING to place of enrollment, and whatever other allowances are authorized to volunteer
 soldiers, drafted men, or militia, so discharged. He has received from the United States **CLOTHING**
 amounting to Seventeen 72 dollars, since the 19th day of April,
 1864 when his clothing account was last settled. He has received from the United States
 _____ dollars advanced **BOUNTY**.

There is to be stopped from him, on account of the State of _____, or other
 authorities, for **CLOTHING**, &c., received on entering service, _____ dollars; and
 for other stoppages, viz: _____
 _____ dollars.

He has been furnished with **TRANSPORTATION** in kind from the place of his discharge to
 _____; and he has been **SUBSISTED** for **TRAVELING** to his
 place of enrollment, up to the _____, 186 .

He is indebted to _____, **SUTLER**, _____ dollars.
 He is indebted to _____, **LAUNDRESS**, _____ dollars.

Given in Duplicate, at St-Louis Station La, this 6th day
 of August, 1864

A. P. Mason Lt. Lieut
4th U.S. Colored Art (Heavy)

 Commanding Company. CE

E. B. S. G. O.

Surgeon General's Office,

Record and Pension Bureau

Y Ark
January 25th 1867

Respectfully returned, with Inventory of Effects enclosed, in case of the within named man.

No evidence on file from which Final Statements can be prepared.

Attention is invited to breeding and or demerit



By Order of the Surgeon

J J Woodward
Brevet Major and Assistant Surgeon, U. S. A.
H E D Duck

Surgeon General's Office,

Record and Pension Bureau,

....., 1867.

Respectfully referred to the Medical Director, Department of

These papers to be returned with report.

BY ORDER OF THE SURGEON GENERAL:

J J Woodward
Bvt. Maj. and Assistant Surgeon, U. S. A.

Headquarters Department of the Gulf,
MEDICAL DIRECTOR'S OFFICE.

New Orleans, La., Jan 3rd 1867.

RESPECTFULLY returned to the Surgeon General, U. S. A. Washington, D. C. with reference to endorsement of Capt. *Freeland*, 10th U. S. Co. Arty. Dec 22nd 66.



Freeland
Brevet Captain and Surgeon U. S. A., Medical Director.

E. B. 40 N 1

45 yrs. Co. E 10th U. S. A. (Arty.)
First Pike La
Dec. 22nd 1866

Respectfully returned with the information that the name of *Henry Almonds* does not appear in the records of Co. "E" 10th U. S. Arty. (7th U. S. Arty.) There was a Private *Henry Casumov* in Co. "E" who died at Remitting Depot Hospital in New Orleans July 14th 1864 of Diarrhoea.

Probably through an error at the Hospital the mans name was reported to be *Henry*.

Almonds If no final statements in the case of Private *Henry Casumov* have been received I will forward them at the earliest possible moment upon notification to that effect.

M. A. Freeland
Capt. 10th U. S. Arty.
Louis Co. Arty.

Henry Emerson

E. B. 133. Page 99

Hd. Qrs. 10th U. S. Col. Art. 14th.
Baton Rouge La. Dec. 15. 66

Respectfully referred to Comdg.
Officer E. Comp'y. for compliance
with within

(This to be returned)

L. R. 53. pgs 126.
By command of Brig. Genl. Hartwell
John E. Friedman
1. Lieut. & Adjutant

WAR DEPARTMENT,

ADJUTANT GENERAL'S OFFICE,

WASHINGTON, *Nov 6*, 1866.

SIR:

Final Statements in the cases of deceased soldiers are required to be sent to the Adjutant General's Office in duplicate, with one copy of the Inventory of Effects. The Descriptive List should also be sent to this Office in cases where the soldier was absent from his Company at the time of his death. Where there were no effects, it should be so stated on a blank Inventory, properly signed.

Certificates of Disability should be sent in duplicate. Special care should be taken that the date of discharge and signature of the discharging officer should be affixed.

No of the Final Statement *or* Inventory, has been received in the case of *Almond Henry Pvt.*, of Co. *E*, *7* Regiment of *US Caval.* Volunteers, whose papers were forwarded to this Office. You will please forward the missing papers without delay.

I have the honor to be, sir,

Very respectfully,

Your obedient servant,

Recd July 14. 1864
Bd Orleans.

Wm. H. Hazard

Assistant Adjutant General.
(110)

~~COMMANDING OFFICER~~

J. J. Woodward
A. S. U. S. A.

Details of Capt A Mc Allister 10th US Artillery - name is probably Henry = Emmons

afB

INVENTORY OF THE EFFECTS

OF

Private Henry Almonds

Late of Company E

7th Reg't of 2^d S. C. H. Art'y

Volunteers, who died at New Orleans La

on the 14th day of July 1864.

Surgeon General's Office,

RECORD & PENSION BUREAU,

Washington, January 23rd 1867

The within Inventory is a true copy from the records
of Receiving Detach Hospital
for Colored Troops
Corv Building New Orleans La, on file in
this Office, and contains all the information in the case that
can be found.

BY ORDER OF THE SURGEON GENERAL:



Edward

Assistant Surgeon, U. S. A.

Bruck
A. E. P.

Inventory of the effects of Henry Almonds late
 a Private of Captain _____ Company E of
 the 7th Regiment of 24th Mass. Volunteers Volunteers, who was enrolled as
 a _____ at _____ in the State of _____ on
 the _____ day of _____ 186 , and mustered into the service of the United
 States as a _____ on the _____ day of _____ 186 , at _____
 in Company _____, _____ Regiment of _____ Volunteers, to serve _____
 years or during the war; he was born in _____ in the State
 of _____; he was _____ years of age, _____ feet _____ inches
 high, _____ complexion, _____ eyes, _____ hair, and by occupation, when enrolled,
 _____; he died in hospital of Recruiting Depot for Co. 20th Regt at
Texas Building, New Orleans La on the 14th day of July 1864, by
 reason of Diarrhoea

He was admitted July 6, 1864
 Source not stated

INVENTORY.					
ARTICLES.	No.	ARTICLES.	No.	ARTICLES.	No.
Hats.....		Pairs trousers.....		Knapsacks.....	
Caps.....		Pairs flannel drawers.....			
Forage Caps.....		Pairs cotton drawers.....			
Great coats.....		Flannel shirts.....			
Uniform coats.....		Cotton shirts.....			
Uniform jackets.....		Pairs boots.....			
Flannel sack coats.....		Pairs shoes.....			
Blouses.....		Pairs socks.....			
Stable frocks.....		Blankets.....			
Fatigue overalls.....		Haversacks.....			
				MONEY.	
					Specie.....
				Notes.....	\$

I CERTIFY, ON HONOR, that the above inventory comprises all the effects of Private
Henry Almonds, deceased, and that the effects are in the hands
 of There is no evidence as to at disposition made
 _____ to be disposed of by a Council of Administration.

(DUPLICATES.)

STATION: _____

~~Commanding the Company.~~

DATE: _____

Mary Martin
No. *a.*, **10 U.S. Col'd H. Art'y.**

Private | *Private*

CARD NUMBERS.

1	5-489097	26
2	5-492898	27
3	5-493203	28
4	5-493348	29
5	5-493487	30
6	5-493608	31
7	5-493689	32
8	5-493796	33
9	5-493856	34
10		35
11		36
12		37
13		38
14		39
15		40
16		41
17		42
18		43
19		44
20		45
21		46
22		47
23		48
24		49
25		50

Book Mark:

See also 88 + 75 U.S.C. Inf.

C. V. Hall U.S.C.T.

Martin Emroy
Co., 10 Reg't U. S. Col'd *Art*

Appears on

M. and D. Roll of Men Transferred

to the organization named above,

from *73 USCS*

Roll dated *Nov 7 8*, 186*3*.

When enlisted *May 24*, 186*3*.

Period for which enlisted *3* years.

When mustered in *June 28*, 186*4*.

Present or absent *Not stated*

Company to which assigned

Remarks: *due to loss of equip. last 25th Transferred from 83 USCS Aug. 13/64 per SC No 209 dated H^q 2nd Dep't Gulf*

Book mark :

A. Johnson

E | 10 H. Art'y. | U.S.C.T.

Martin Emory

Rt, Co. A, 10 Reg't U. S. Col'd H. Art'y.

Appears on

Company Muster Roll

for Nov & Dec, 1865

Present or absent Present

Stoppage, \$ 100 for

Due Gov't, \$ 2 06/100 for Cr & Equipage, per transfer roll

Valuation of horse, \$ 100

Valuation of horse equipments, \$ 100

Remarks: Transferred from 75 US to 2 per S.O. 105 Cr. Hd. Quo. Dept. of Sea,

Book mark:

Hynes Copyist.

E | 10 H. Art'y. | U.S.C.T.

Martin Emory

Pl, Co. A, 10 Reg't U. S. Col'd H. Art'y.

Appears on

Company Muster Roll

for *Jan + Feb*, 186*6*.

Present or absent *Present*

Stoppage, \$ *100* for

Due Gov't, \$ *100* for

Valuation of horse, \$ *100*

Valuation of horse equipments, \$ *100*

Remarks:

Book mark: *1000000*

(358)

J. By...
Copyist.

E

10 H. Art'y. U.S.C.T.

Martin Emory

Prof., Co. A, 10 Reg't U. S. Col'd H. Art'y.

Appears on

Company Muster Roll

for Mar + April, 1866.

Present or absent Present

Stoppage, \$ 100 for

Due Gov't, \$ 100 for

Valuation of horse, \$ 100

Valuation of horse equipments, \$ 100

Remarks:

Book mark:

(358)

J. H. ... Copyist.

E | 10 H. Art'y. | U.S.C.T.

Martin Emory

Pvt., Co. A, 10 Reg't U. S. Col'd H. Art'y.

Appears on

Company Muster Roll

for May & June, 1866

Present or absent Present

Stoppage, \$ 100 for

Due Gov't, \$ 100 for

Valuation of horse, \$ 100

Valuation of horse equipments, \$ 100

Remarks:

Book mark:

(358)

Hyman Copyist.

10 H. Art'y. U.S.C.T.

Martin Emory

Pl, Co. A, 10 Reg't U. S. Col'd H. Art'y.

Appears on

Company Muster Roll

for July & Aug, 1866

Present or absent

Present

Stoppage, \$ 100 for

Due Gov't, \$ 100 for

Valuation of horse, \$ 100

Valuation of horse equipments, \$ 100

Remarks:

[Empty lines for remarks]

Book mark:

[Empty line for book mark]

(358)

Hyman Copyist.

6

10 H. Art'y. U.S.C.T.

Martin Emory

Pvt., Co. A, 10 Reg't U. S. Col'd H. Art'y.

Appears on

Company Muster Roll

for Sept + Oct, 1866.

Present or absent Present

Stoppage, \$ 100 for

Due Gov't, \$ 100 for

Valuation of horse, \$ 100

Valuation of horse equipments, \$ 100

Remarks:

Book mark:

Nesbitt

(358)

Copyist.

5 | 10 H. Art'y. | U.S.C.T.

Martin Emory
Pvt, Co. A, 10 Reg't U. S. Col'd H. Art'y.

Appears on

Company Muster Roll

for *Nov + Dec*, 1866.

Present or absent *Present*

Stoppage, \$ 100 for

Due Gov't, \$ 08 for *Ordnance*

Valuation of horse, \$ 100

Valuation of horse equipments, \$ 100

Remarks: _____

Book mark: _____

Nesbitt

E

10 H. Art'y. U.S.C.T.

Martin Emory

Pvt, Co. A, 10 Reg't U. S. Co'd H. Art'y.

Appears on Co. Muster-out Roll, dated Baton Rouge La, Feb 22, 1867.

Muster-out to date Feb 22, 1867.

Last paid to Dec. 31, 1866.

Clothing account:

Last settled....., 186 ; drawn since \$..... 100

Due soldier \$ 37 ⁸⁶/₁₀₀; due U. S. \$..... 100

Am't for cloth'g in kind or money adv'd \$..... 100

Due U. S. for arms, equipments, &c., \$ ^{under G.O. 101} 6 ⁶⁵/₁₀₀

Bounty paid \$ (?) ¹⁰⁰/₁₀₀; due \$ (?) ¹⁰⁰/₁₀₀

Remarks: Transfd from 75 U.S.C.S. as Pvt S.O. 105 Sep 25th Sept La.

Book mark :

Nesbitt

(361)

Copyist.

English John

Co *C*, 10 U.S. Col'd H. Art'y.

Corporal

Private

CARD NUMBERS.

1	5-4976+6	26
2	5-49+091	27
3	5-49+216	28
4	5-49+313	29
5	5-49+411	30
6	5-49+5-19	31
7	5-49+660	32
8	5-49+799	33
9	5-49+933-	34
10	5-499076	35
11	5-499212	36
12	5-499347	37
13	5-4994+4	38
14	5-499620	39
15	5-49975-6	40
16	5-499891	41
17	5-5-00114	42
18	5-5-00023	43
19	5-5-0015-9	44
20	5-5+002+8	45
21	55-00379	46
22	G-26-RCJ-1867	47
23		48
24		49
25		50

Book Mark: *G-26-RCJ-1867*

See also

John English
Corp, Co. C, 1 Reg't La. Art'y, Native Guards.*

Age *21* years.

Appears on

Company Muster-in Roll

of the organization named above. Roll dated

New Orleans La, Nov 4, 1864.

Muster-in to date *Dec 31, 1863.*

Joined for duty and enrolled:

When *Oct 26, 1863.*

Where *Plaquemine La*

Period *3* years.

Valuation of horse, \$ *100*

Valuation of horse equipments, \$ *100*

Remarks:
.....
.....
.....

* This organization subsequently became Co. C, 10 Reg't U. S. Col'd Heavy Artillery.

Book mark : *9-26-RCY-1867*

W. J. ...

E

10 H. Art'y.

U.S.C.T.

Jack English
Cup, Co. C, 1 Reg't H. Art'y, Corps d'Afrique.*

Appears on

Company Muster Roll

for *Feb 4th to 29th*, 186*4*.

Present or absent *Present*

Stoppage, \$ *100* for

Due Gov't, \$ *100* for

Valuation of horse, \$ *100*

Valuation of horse equipments, \$ *100*

Remarks: *Sick*

*This organization subsequently became Co. *E*, 10 Reg't U. S. Colored Heavy Artillery.

Book mark:

W. J. ...

E | 10 H. Art'y. | U.S.C.T.

Jack English
Pvt, Co. C, 7 Reg't U. S. Col'd H. Art'y.*

Appears on

Company Muster Roll

for *March & April* 1864.

Present or absent *Present*

Stoppage, \$ 100 for

Due Gov't, \$ 100 for

Valuation of horse, \$ 100

Valuation of horse equipments, \$ 100

Remarks:

* This organization subsequently became Co. , 10 Reg't U. S. Colored Heavy Artillery.

Book mark:

(358)

J. H. Anderson
Copyist.

Jack English
Pt, Co. E, 7 Reg't U. S. Col'd H. Art'y.*

Appears on

Company Muster Roll

for May June, 1864.

Present or absent Present

Stoppage, \$ 100 for

Due Gov't, \$ 100 for

Valuation of horse, \$ 100

Valuation of horse equipments, \$ 100

Remarks:

* This organization subsequently became Co. , 10 Reg't U. S. Colored Heavy Artillery.

Book mark:

J. Anderson Copyist.

E | 10 H. Art'y. | U.S.C.T.

Jack English
Pt., Co. G 7 Reg't U. S. Col'd H. Art'y.*

Appears on

Company Muster Roll

for July & Aug, 1864

Present or absent absent

Stoppage, \$ 100 for

Due Gov't, \$ 100 for

Valuation of horse, \$ 100

Valuation of horse equipments, \$ 100

Remarks: on Furlough
Expires Sept 5/64

* This organization subsequently became Co. , 10 Reg't U. S. Colored Heavy Artillery.

Book mark:

(358)

J. M. ...
Copyist.

8

10 H. Art'y. U.S.C.T.

Jack English
Pot, Co. C, 10 Reg't U. S. Col'd H. Art'y.

Appears on

Company Muster Roll

for Sept 10th, 1864.

Present or absent Present

Stoppage, \$ 100 for

Due Gov't, \$ 100 for

Valuation of horse, \$ 100

Valuation of horse equipments, \$ 100

Remarks:

Book mark:

(358)

J. Anderson

Copyist.

§ | 10 H. Art'y. | U.S.C.T.

Jack English
Pvt., Co. C, 10 Reg't U. S. Col'd H. Art'y.

Appears on

Company Muster Roll

for Nov & Dec, 1864

Present or absent Present

Stoppage, \$ 100 for

Due Gov't, \$ 100 for

Valuation of horse, \$ 100

Valuation of horse equipments, \$ 100

Remarks:

Book mark:

(358)

J. M. Mendenhall
Copyist.

E

10 H. Art'y. U.S.C.T.

Jack English
Pvt., Co. C, 10 Reg't U. S. Col'd H. Art'y.

Appears on

Company Muster Roll

for Jan & Feb, 1865.

Present or absent Present

Stoppage, \$ 100 for

Due Gov't, \$ 100 for

Valuation of horse, \$ 100

Valuation of horse equipments, \$ 100

Remarks:

Book mark:

Sallade

8

E

10 H. Art'y. U.S.C.T.

Jack English

Priv J, Co. C, 10 Reg't U. S. Col'd H. Art'y.

Appears on

Company Muster Roll

for Nov & Dec, 1865.

Present or absent Present

Stoppage, \$ 100 for

Due Gov't, \$ 100 for

Valuation of horse, \$ 100

Valuation of horse equipments, \$ 100

Remarks:

Book mark:

Lamb

(358)

Copyist.

E

10 H. Art'y. U.S.C.T.

Jack English
Plt., Co. C, 10 Reg't U. S. Col'd H. Art'y.

Appears on

Company Muster Roll

for May & June, 1865

Present or absent. Present

Stoppage, \$ 100 for

Due Gov't, \$ 100 for

Valuation of horse, \$ 100

Valuation of horse equipments, \$ 100

Remarks:

Book mark:

Ballade

E

10 H. Art'y. U.S.C.T.

Jack English
1st, Co. C, 10 Reg't U. S. Col'd H. Art'y.

Appears on

Company Muster Roll

for *July & Aug, 1865*

Present or absent *Present*

Stoppage, \$ 100 for

Due Gov't, \$ 100 for

Valuation of horse, \$ 100

Valuation of horse equipments, \$ 100

Remarks:

Book mark:

Ballade

E

10 H. Art'y. U.S.C.T.

Jack English
Co. C, 10 Reg't U. S. Col'd H. Art'y.

Appears on

Company Muster Roll

for Sept 20 Oct, 1865.

Present or absent Present

Stoppage, \$ 100 for

Duty, \$ 100 for

Valuation of horse, \$ 100

Valuation of horse equipments, \$ 100

Remarks:

Book mark:

Ballade

E

10 H. Art'y. U.S.C.T.

Jack English
Pot., Co. C, 10 Reg't U. S. Col'd H. Art'y.

Appears on

Company Muster Roll

for Nov. & Dec., 1865.

Present or absent Present.

Stoppage, \$ 100 for

Due Gov't, \$ 100 for

Valuation of horse, \$ 100

Valuation of horse equipments, \$ 100

Remarks:

Book mark:

A. J. Robbins

(358)

Copyist.

E

10 H. Art'y. U.S.C.T.

Jack English

Pvt., Co. C, 10 Reg't U. S. Col'd H. Art'y.

Appears on

Company Muster Roll

for Jan. & Feb., 1866

Present or absent Present

Stoppage, \$ 100 for

Due Gov't, \$ 100 for

Valuation of horse, \$ 100

Valuation of horse equipments, \$ 100

Remarks:

Book mark:

(358)

A. J. Robbins

Copyist.

E

10 H. Art'y. U.S.C.T.

Jack English

Pvt., Co. C, 10 Reg't U. S. Col'd H. Art'y.

Appears on

Company Muster Roll

for March & Apr., 1866.

Present or absent Present.

Stoppage, \$ 100 for

Due Gov't, \$ 100 for

Valuation of horse, \$ 100

Valuation of horse equipments, \$ 100

Remarks: Absent when the Co. was last paid. Due U.S. for loss of wife \$ $\frac{26}{100}$.

Book mark:

A. J. Robbins

(358)

Copyist.

E

10 H. Art'y. U.S.C.T.

Jack English

Pr., Co. C, 10 Reg't U. S. Col'd H. Art'y.

Appears on

Company Muster Roll

for May 2d June, 1866.

Present or absent Absent.

Stoppage, \$ 100 for

Due Gov't, \$ 100 for

Valuation of horse, \$ 100

Valuation of horse equipments, \$ 100

Remarks Absent with leave in
Plaquemine La. since June
26, 1866.

Book mark:

(358)

W. J. Robbins

Copyist.

E | 10 H. Art'y. | U.S.C.T.

Jack English
Pr, Co. C, 10 Reg't U. S. Col'd H. Art'y.

Appears on

Company Muster Roll
for *July & Aug.*, 1866.
Present or absent

Stoppage, \$ *100* for

Due Gov't, \$ *100* for

Valuation of horse, \$ *100*

Valuation of horse equipments, \$ *100*

Remarks: *Deserted at New Orleans*
La. July 15, 1866. Arrested
July 25, 1866.

Book mark { *26d. Ars. Dept. of the Gulf Dept.*
28, 1866. G.O. No. 7

(358) *A. J. Robbins* Copyist.

E

10 H. Art'y. | U.S.C.T.

Lack English
Bvt, Co. C, 10 Reg't U. S. Col'd H. Art'y.

Appears on

Company Muster Roll

for July and Aug., 1866.

Present or absent Present

Stoppage, \$ 100 for

Due Gov't, \$ 100 for

Valuation of horse, \$ 100

Valuation of horse equipments, \$ 100

Remarks In arrest awaiting trial for desertion.

Book mark:

A. J. Robbins

(358)

Copyist.

E

10 H. Art'y. U.S.C.T.

Jack English

Plt, Co. C, 10 Reg't U. S. Col'd H. Art'y.

Appears on

Company Muster Roll

for Sept & Oct, 1866.

Present or absent Absent

Stoppage, \$ 100 for

Due Gov't, \$ 100 for

Valuation of horse, \$ 100

Valuation of horse equipments, \$ 100

Remarks: In Comp at Ship Island Miss since Sept 28. 66 to be Compd 6 mos and forfeit \$10 per mo for same time per Sen G. C. M. sen pro in 40 U.S. Hed pro Dept of Gulf

Book mark:

Hammer

E

10 H. Art'y. U.S.C.T.

Jack English

Pr, Co. C, 10 Reg't U. S. Col'd H. Art'y.

Appears on

Company Muster Roll

for Nov & Dec, 1866.

Present or absent. Absent

Stoppage, \$ 100 for

Due Gov't, \$ 100 for

Valuation of horse, \$ 100

Valuation of horse equipments, \$ 100

Remarks: In Conf't at Ship Island, Miss, since Sept. 28th 66, to be Conf'd 6 months and forfeit \$10 per month same time per sent of Gen pro in G.O. No 7 Hed G.O. Sept of the Gulf dated Sept 28, 1866.

Book mark:

Hammer

(358)

Copyist.

E

10 H. Art'y. U.S.C.T.

Jack English

Co. C, 10 Reg't U. S. Col'd H. Art'y.

Appears on **Co. Muster-out Roll**, dated *Prater Range La, Feb 22*, 1867.

Muster-out to date _____, 186 .

Last paid to *Apr 30*, 1864 .

Clothing account:

Last settled _____, 186 ; drawn since \$ _____ 100

Due soldier \$ _____ 100; due U. S. \$ _____ 100

Am't for cloth'g in kind or money adv'd \$ _____ 100

Due U. S. for arms, equipments, &c., \$ _____ 100

Bounty paid \$ _____ 100; due \$ _____ 100

Remarks: *Joined org. Ore*
Ab. in confinement since
Sept 28, 66. Dis July 15, 1866
tried by G. C. M & sent to
six mos. Conf at ship
Idle thro' and to forfeit
over

Book mark: *dis list on file see*
26 162 P 193 73

Manning

(361)

Copyist.

JAN. 15

5500379

1891

\$10 per month for the
same time sentence
promulgated in G.O.
No 7 Hd qrs Dept. of
the Gulf dated Sept
28, 1866, No discharge
given

E. I. 10th Ho. A. / U.S.C.J.

Jack English,
Co. G, 10th Reg't U.S.C.H.A.

NOTATION.

Book mark: G-26. R. G. J. 1867

War Department,

Adjutant General's Office,

Washington, April 12th, 1867.

Call from _____

returned with report.

The above book mark was noted on rolls in order to
preserve results of search in this case.

(475)

E. P. Conroy

Copyist.

10 G, 10 U.S. Col'd H. Art'y.

Private

Private

CARD NUMBERS.

1	5-5-0 7124	26
2	5-5-0 7407	27
3	5-5-0 75-5-5	28
4	5-5-0 7702	29
5	5-5-0 7840	30
6	5-5-0 7983	31
7	5-5-0 8124	32
8	5-5-0 8256	33
9	5-5-0 8392	34
10	5-5-0 8542	35
11	5-5-0 8694	36
12	5-5-0 8841	37
12	5-5-0 8988	38
14	5-5-0 9118	39
15	5-5-0 9266	40
16	5-5-0 9375	41
17		42
18		43
19		44
20		45
21		46
22		47
23		48
24		49
25		50

Book Mark:

See also

E | 10th Mo. Arty | U. S. C. T.

Moses Enoch

Appears with rank of Pvt. on

**Muster and Descriptive Roll of a Detach-
ment of U. S. Vols. forwarded**

Organized as Co. G.

for the "10th" Reg't U. S. Col'd Mo. Roll dated

New Orleans La. Sept 20, 1864.

Where born Edenton N. C.

Age 40 y'rs; occupation Laborer

When enlisted Sept 8, 1864.

Where enlisted New Orleans La

For what period enlisted 3 years.

Eyes Blk; hair Blk

Complexion Yellow, height 5 ft. 4 in.

When mustered in Sept 20, 1864.

Where mustered in New Orleans La

Bounty paid \$ 100; due \$ 100

Where credited to New Orleans

Company to which assigned "G"

Remarks:

Book mark:

E. B. Thompson

(339)

Copyist.

E

10 H. Art'y.

U.S.C.T.

Moses Enoch
Private, Co. G, 10 Reg't U. S. Col'd H. Art'y.

Appears on

Company Muster Roll

for Sept & Oct, 1864.

Present or absent Present

Stoppage, \$ 100 for

Due Gov't, \$ 100 for

Valuation of horse, \$ 100

Valuation of horse equipments, \$ 100

Remarks:

Book mark:

E H Brown

E

10 H. Art'y.

U.S.C.T.

Moses Enoch

Pat, Co. G, 10 Reg't U. S. Col'd H. Art'y.

Appears on

Company Muster Roll

for Nov & Dec, 1864.

Present or absent

Stoppage, \$ 100 for

Due Gov't, \$ 100 for

Valuation of horse, \$ 100

Valuation of horse equipments, \$ 100

Remarks: Left in camp at New Orleans La.

Book mark:

E. N. Brown

(358)

Copyist.

E

10 H. Art'y. U.S.C.T.

Moses Enoch

Prob, Co. G, 10 Reg't U. S. Col'd H. Art'y.

Appears on

Company Muster Roll

for June & July, 1864.

Present or absent Present

Stoppage, \$ 100 for

Due Gov't, \$ 100 for

Valuation of horse, \$ 100

Valuation of horse equipments, \$ 100

Remarks:

Book mark:

F. E. Porter

E
(0)

10 H. Art'y. U.S.C.T.

Moses Enoch
Truh, Co. G, 10 Reg't U. S. Col'd H. Art'y.

Appears on

Company Muster Roll

for *Mar. + April*, 186*4*.

Present or absent *Present*

Stoppage, \$ *100* for

Due Gov't, \$ *100* for

Valuation of horse, \$ *100*

Valuation of horse equipments, \$ *100*

Remarks:

Book mark:

J. E. Porter

(358)

Copyist.

Co

10 H. Art'y. | U.S.C.T.

Moses Enoch

Prov, Co. G, 10 Reg't U. S. Col'd H. Art'y.

Appears on

Company Muster Roll

for May & June, 1865.

Present or absent Present

Stoppage, \$ 100 for

Due Gov't, \$ 100 for

Valuation of horse, \$ 100

Valuation of horse equipments, \$ 100

Remarks:

Book mark: 1000

F. E. Porter

E

10 H. Art'y. U.S.C.T.

Moses Enoch
Prof., Co. G, 10 Reg't U. S. Col'd H. Art'y.

Appears on

Company Muster Roll

for July & Aug, 1865.

Present or absent Present

Stoppage, \$ 100 for

Due Gov't, \$ 05/100 for B & G Equip

- age lost or destroyed

Valuation of horse, \$ 100

Valuation of horse equipments, \$ 100

Remarks:

Book mark:

M. E. Porter

(358)

Copyist.

E

10 H. Art'y. | U.S.C.T.

Moses Ennoch

Truh, Co. G, 10 Reg't U. S. Col'd H. Art'y.

Appears on

Company Muster Roll

for *Sept & Oct*, 186*4*.

Present or absent *Present*

Stoppage, \$ *100* for

Due Gov't, \$ *100* for

Valuation of horse, \$ *100*

Valuation of horse equipments, \$ *100*

Remarks:

Book mark:

F. E. Porter

G

10 H. Art'y. U.S.C.T.

Moses Enoch

Privt., Co. G, 10 Reg't U. S. Col'd H. Art'y.

Appears on

Company Muster Roll

for *Nov. & Dec.*, 186*5*.

Present or absent *Present*

Stoppage, \$ 100 for

Due Gov't, \$ 100 for

Valuation of horse, \$ 100

Valuation of horse equipments, \$ 100

Remarks:

Book mark:

G. Ford

E

10 H. Art'y. U.S.C.T.

Moses Crook
Cpl., Co. G, 10 Reg't U. S. Col'd H. Art'y.

Appears on

Company Muster Roll

for *Jan. & Feb.*, 1866.

Present or absent *Present*

Stoppage, \$ *100* for

Due Gov't, \$ *100* for

Valuation of horse, \$ *100*

Valuation of horse equipments, \$ *100*

Remarks:

Book mark:

(358)

G. F. W.
Copyist.

C

10 H. Art'y.

U.S.C.T.

Moses Emuch

Privt, Co. G, 10 Reg't U. S. Col'd H. Art'y.

Appears on

Company Muster Roll

for *May & June*, 186 *6*.

Present or absent *Present*

Stoppage, \$ *100* for

Due Gov't, \$ *100* for

Valuation of horse, \$ *100*

Valuation of horse equipments, \$ *100*

Remarks: *On daily duty
as member of Post
Boat crew*

Book mark:

G. Fox

Copyist.

E

10 H. Art'y. U.S.C.T.

Moses Emoch

Priv., Co. G, 10 Reg't U. S. Col'd H. Art'y.

Appears on

Company Muster Roll

for *July + Aug*, 1866.

Present or absent *Present*

Stoppage, \$ 100 for

Due Gov't, \$ 100 for

Valuation of horse, \$ 100

Valuation of horse equipments, \$ 100

Remarks: *On daily duty
as Boat crew, for ord.
lost 12¢*

Book mark:

G. Fox

(358)

Copyist.

E

10 H. Art'y.

U.S.C.T.

Moses Enoch

Sgt, Co. G, 10 Reg't U. S. Col'd H. Art'y.

Appears on

Company Muster Roll

for *Sept & Oct*, 1866.

Present or absent *Present*

Stoppage, \$ 100 for

Due Gov't, \$ 100 for

Valuation of horse, \$ 100

Valuation of horse equipments, \$ 100

Remarks:

Book mark:

Wines

E

10 H. Art'y. U.S.C.T.

Moses Enoch

Pvt., Co. G, 10 Reg't U. S. Col'd H. Art'y.

Appears on

Company Muster Roll

for Nov & Dec, 1866.

Present or absent Present

Stoppage, \$ 100 for

Due Gov't, \$ 100 for

Valuation of horse, \$ 100

Valuation of horse equipments, \$ 100

Remarks:

Book mark:

(358)

Wines

Copyist.

E | 10 H. Art'y. | U.S.C.T.

Moses Enoch

Pvt, Co. G, 10 Reg't U. S. Col'd H. Art'y.

Appears on Co. Muster-out Roll, dated

Baton Rouge, La, Feb 22, 1867.

Muster-out to date Feb 22, 1867.

Last paid to Dec 31, 1866.

Clothing account:

Last settled _____, 186 ; drawn since \$ _____ 100

Due soldier \$ 37 ⁴¹/₁₀₀; due U. S. \$ _____ 100

Am't for cloth'g in kind or money adv'd \$ _____ 100

Due U. S. for arms, equipments, &c., \$ _____ 100

Bounty paid \$ _____ 100; due \$ 2 00 ⁰⁰/₁₀₀

Remarks: Joined at Org^t, Org^{2d}.

Book mark : _____

(361)

Wines

Copyist.

Enoch, Moses

, Co. *G*, *10* Reg't *U.S.C.H.*

Enclosures.

Bed Cards	Final Statements
Burial Records	Furloughs or L. of A.
Certs. of Dis. for Discharge	Med. Certificates
C. M. Charges	Med. Des. Lists
Descriptive Lists	Orders
Discharge Certificates	Pris. of War Record
Enlistment Papers	Resignations

Other papers relating to—

Admission to Hosp'l	Furlough or L. of A.
Casualty Sheet	Med. Examination
Confinement	Misc. Information
Contracts	Pay or Clothing
Death or Effects	Personal Reports
Desertion	Rank
Discharge from Hosp'l	Transfer to Hosp'l
Discharge from Service	Transfer to V. R. C.
Duty	Transportation

NOTE 1.—This blank will be used for both enlistments and re-enlistments—enlistment of veterans, &c., &c., in the volunteer service. They will be made out, in duplicate in all cases—one to accompany the recruiting return of the superintendent (not the recruiting officer) to the Adjutant General, and one to accompany the accounts of the officer who pays bounty, &c. The Regiment and Company in which the soldier last served should be given on the back.

NOTE 2.—An enlistment holds to service. A muster-in must, in all cases, precede payment of pay, bounty, pension, &c. A muster-in roll must, in all cases, be filed in the Adjutant General's Office as evidence of muster-in. The mustering officer, commissary, or assistant commissary of musters, as the case may be, will countersign both enlistments as having mustered the soldier into the service of the United States before either of them is given to the disbursing officer.

DECLARATION OF RECRUIT.

I, Moses Enock desiring to VOLUNTEER as a Soldier in the Army of the United States, for the term of THREE YEARS, Do Declare, That I am 45 years and _____ months of age; that I have never been discharged from the United States service on account of disability or by sentence of a court martial, or by order before the expiration of a term of enlistment; and I know of no impediment to my serving honestly and faithfully as a soldier for three years.

GIVEN at New Orleans, La the 8th day of September 1864

Witness:

J. Horace McGuire Moses Enock
mont

No. 630

Moses Enock
Volunteered at New Orleans
September 8th 1864,
By Adj. McQuinn
1st Regiment of U.S.C.A.
_____ enlistment; last served in Company ()
1st Regt of U.S.C.A.
Discharged _____ 18 ____
Considered not entitled to bounty

CONSENT IN CASE OF MINOR.

I, _____ DO CERTIFY, That I am the _____ of _____; that the said _____ is _____ years of age; and I do hereby freely give my CONSENT to his volunteering as a SOLDIER in the ARMY OF THE UNITED STATES for the period of THREE YEARS.

GIVEN at _____ the _____ day of _____

Witness: _____

VOLUNTEER ENLISTMENT.

STATE OF

TOWN OF

Louisiana



New Orleans

I, *Moses Enoch* born in *Edenton*
in the State of *N.C.* aged *40* years,
and by occupation a *Teacher* Do HEREBY ACKNOWLEDGE to have
volunteered this *8th* day of *Sept* 1864
to serve as a **Soldier** in the **Army of the United States of America**, for
the period of **THREE YEARS**, unless sooner discharged by proper authority:
Do also agree to accept such bounty, pay, rations, and clothing, as are, or may be,
established by law for volunteers. And I, *Moses Enoch* do
solemnly swear, that I will bear true faith and allegiance to the **United States
of America**, and that I will serve them honestly and faithfully against all
their enemies or opposers whomsoever; and that I will observe and obey the
orders of the President of the United States, and the orders of the officers
appointed over me, according to the Rules and Articles of War.

Sworn and subscribed to, at *New Orleans*
this *8th* day of *Sept* 1864 } *Moses Enoch*
BEFORE *Horace McGinnis* } *his*
1st Lt 10th U.S.C. #4 } *mark*

I CERTIFY, ON HONOR, That I have carefully examined the above-named Volunteer, agreeably
to the General Regulations of the Army, and that, in my opinion, he is free from all bodily defects and
mental infirmity, which would in any way disqualify him from performing the duties of a soldier.

Wm. H. Master
1st Lt U.S.C. #4
EXAMINING SURGEON.

I CERTIFY, ON HONOR, That I have minutely inspected the Volunteer, *Moses Enoch*
previously to his enlistment, and that he was entirely sober when enlisted; that, to the best of my
judgment and belief, he is of lawful age; and that, in accepting him as duly qualified to perform the
duties of an able-bodied soldier, I have strictly observed the Regulations which govern the recruiting
service. This soldier has *Blk* eyes, *Blk* hair, *Fair* complexion, is *5-*
feet *4* inches high.

Horace McGinnis
1st Lt
Regiment of *USCA #4* Volunteers,
RECRUITING OFFICER.

(A. G. O. No. 74 & 76.)

Mustered into the service of the United States, for three years or during the war, from date of enlistment, in Company *A*,
10th Regiment of *Volunteers*, on the *20th* day of *Sept*, 1864, at *New Orleans*

John M. Chamberlain
Capt 10th U.S.C. #4
A. C. 2nd

051.
Orby Moses.

Co. 36, 10 U.S. Col'd H.A.

Private

Private

REFERENCE ENVELOPE.

Cards filed with

Orby Moses

true name of soldier.

Sequino. Antonio

Co *D*, 10 U.S. Col'd H. Art'y.

Sergeant | *Sergeant*

CARD NUMBERS.

1	5-5-11204	26
2	5-5-11302	27
3	5-5-11390	28
4	5-5-11608	29
5	5-5-12191	30
6		31
7		32
8		33
9		34
10		35
11		36
12		37
13		38
14		39
15		40
16		41
17		42
18		43
19		44
20		45
21		46
22		47
23		48
24		49
25		50

Book Mark:

See also

E. | 10 H. Art'y. | U.S.C.T.

Antoine Esquins
Serjt, Co. *D*, 10 Reg't U. S. Col'd H. Art'y.

Age years.

Appears on

Company Muster Roll*

for *Enrollment to June 30*, 186*5*.

Joined for duty and enrolled:

When, 186 .

Where

Period */* years.

Mustered in:

When *April 21*, 1864 .

Where *New Orleans, La.*

Present or absent *Present*

Stoppage, \$ *100* for

Due Gov't, \$ *100* for

Valuation of horse, \$ *100*

Valuation of horse equipments, \$ *100*

Remarks: *Drafted. Promoted
from Private to Serjt.*

*First current roll. No muster-in roll of this company on file.

Book mark :

O. J. Clark

(3586)

Copyist.

E.

10 H. Art'y.

U.S.C.T.

Antoine Esquino.

Sergt., Co. I, 10 Reg't U. S. Col'd H. Art'y.

Appears on

Company Muster Roll

for *July & Aug.*, 1865.

Present or absent *Present*

Stoppage, \$ *100* for

Due Gov't, \$ *100* for

Valuation of horse, \$ *100*

Valuation of horse equipments, \$ *100*

Remarks: *Appointed Sergt*
May 19, 1865 - S.O. No. 27
Ha. Grs. Regt June 28, 1865 -
due United States for orde-
nance \$ 0.86. Sick in
Grs.

Book mark:

A. S. Clark

(358)

Copyist.

E.

10 H. Art'y.

U.S.C.T.

Antoine Esquino

Sergt., Co. I, 10 Reg't U. S. Col'd H. Art'y.

Appears on

Company Muster Roll

for *Sept & Oct.*, 1865.

Present or absent *Absent*

Stoppage, \$ 100 for

Due Gov't, \$ 100 for

Valuation of horse, \$ 100

Valuation of horse equipments, \$ 100

Remarks: *Absent without leave since Oct. 28th 1865.*

Book mark:

(358)

O. J. Clark

Copyist.

E. | 10 H. Art'y. | U.S.C.T.

Antoine Esquins

Surgt., Co. I, 10 Reg't U. S. Col'd H. Art'y.

Appears on

Company Muster Roll

for *Nov. 1865*, 1865.

Present or absent

Stoppage, \$ 100 for

Due Gov't, \$ 100 for

Valuation of horse, \$ 100

Valuation of horse equipments, \$ 100

Remarks: *Deserted from leave of absence Nov. 2d 1865-*

FROM SECOND AUDITOR'S ROLL.

Book mark:

(358)

O. S. Clark

Copyist.

Antoine Esquino
Serg't Co. I, 10 Reg't U. S. Col'd H. Art'y.

Appears on Co. Muster-out Roll, dated
Baton Rouge La Feb 22, 1867.

Muster-out to date _____, 186 .

Last paid to *never paid* _____, 186 .

Clothing account:

Last settled _____, 186 ; drawn since \$ _____ 100

Due soldier \$ _____ 100; due U. S. \$ _____ 12 ²³/₁₀₀

Am't for cloth'g in kind or money adv'd \$ _____ 100

Due U. S. for arms, equipments, &c., \$ _____ 100

Bounty paid \$ _____ 100; due \$ _____ 100

Remarks: *Joined at Orgin*
Deserred at Donaldsonville
La Nov 2, 1865

(Age 24 years)

Book mark: _____

(361) *J. McHance* Copyist.

George

Co *D*, 10 U.S. Col'd H. Art'y.

Private

Corporal

CARD NUMBERS.

1	54885-14	26
2	54885-71	27
3	55115-16	28
4	551165-4	29
5	5511775-	30
6	5511875-	31
7	5511967	32
8	5512080	33
9	5489328	34
10	40745962	35
11		36
12		37
13		38
14		39
15		40
16		41
17		42
18		43
19		44
20		45
21		46
22		47
23		48
24		49
25		50

Book Mark:

See also *74" M.A.C. Inf.*

E 10th U.S.C.T.

George Essex

Priv, Co. 10 Reg't U. S. Col'd Art'y.

Appears on

M. and D. Roll of Men Transferred

to the organization named above,

from Co "K." 7th U.S. C. Inf.

Roll dated New Orleans, La. Oct 11, 1865.

When enlisted Aug 7, 1863

Period for which enlisted 3 years.

When mustered in July 28, 1864.

Present or absent

Company to which assigned

Remarks: Transf'd from Co

"L" as surplus men

Mar 9 '65 per G. O. No.

17. At 9 AM M. D. M.

July 7 '64. Free on or

before April 19, 1861

Stop for one whip +

one screw driver

Book mark :

J. W. Jones, Jr

(342)

Copyist.

E 10th U.S.C.T.

George Essex
Priv., Co. 10, Reg't U. S. Col'd St. Arty

Appears on

M. and D. Roll of Men Transferred

to the organization named above,

from Co "K" 7th U.S. C. Inf.

Roll dated New Orleans La, Oct 11, 1864

When enlisted August 7, 1863

Period for which enlisted 3 years.

When mustered in July 28, 1864

Present or absent Present

Company to which assigned

Remarks: Transf. from Co. "C" (as surplus man) Mar. 9 '65 Ser N.O. No 17 St. Louis Mo. A. O. O. M. July 7 '64. Free on or before April 19 '61. Stop for one wiper & one screw driver

Book mark :

(342)

J. W. Jones, Jr. Copyist.

E. | 10 H. Art'y. | U.S.C.T.

George Essex
Pvt., Co. I, 10 Reg't U. S. Col'd H. Art'y.

Appears on

Company Muster Roll

for *Nov. & Dec.*, 1865.

Present or absent *Present*

Stoppage, \$ *100* for

Due Gov't, \$ *100* for

Valuation of horse, \$ *100*

Valuation of horse equipments, \$ *100*

Remarks: *Transferred from*
74 U.S.C.I. per S.O. no.
84. Hd. Qrs. Dept. of
La. Oct. 11, 1865.

FROM SECOND AUDITOR'S ROLL.

Book mark:

(358)

A. L. Clark
Copyist.

E.

10 H. Art'y.

U.S.C.T.

George Essex

Priv, Co. I, 10 Reg't U. S. Col'd H. Art'y.

Appears on

Company Muster Roll

for *Jan. & Feb.*, 1866.

Present or absent *Present*

Stoppage, \$ *100* for

Due Gov't, \$ *100* for

Valuation of horse, \$ *100*

Valuation of horse equipments, \$ *100*

Remarks:

Book mark: -----

A. J. Leback

E.

10 H. Art'y.

U.S.C.T.

George Essex

Prk., Co. I, 10 Reg't U. S. Col'd H. Art'y.

Appears on

Company Muster Roll

for *March & Apr.*, 1866.

Present or absent *Present*

Stoppage, \$ *100* for

Due Gov't, \$ *100* for

Valuation of horse, \$ *100*

Valuation of horse equipments, \$ *100*

Remarks:

Book mark:

O. T. Clark

E

10 H. Art'y.

U.S.C.T.

George Essex

Corpl., Co. I, 10 Reg't U. S. Col'd H. Art'y.

Appears on

Company Muster Roll

for *May & June*, 1866.

Present or absent *Present*

Stoppage, \$ *100* for

Due Gov't, \$ *100* for

Valuation of horse, \$ *100*

Valuation of horse equipments, \$ *100*

Remarks: *Appointed Corpl
to date June 10, 1866, per
S.O. No. 12 Hd qrs. Regt.
June 10, 1866.*

Book mark: *No. on file.*

O. S. Hart

E

10 H. Art'y.

U.S.C.T.

George Essex

Co. I, Co. I, 10 Reg't U. S. Col'd H. Art'y.

Appears on

Company Muster Roll

for *July + Aug*, 1866.

Present or absent

Stoppage, \$ 100 for

Due Gov't, \$ 100 for

Valuation of horse, \$ 100

Valuation of horse equipments, \$ 100

Remarks: *Mustered out by reason of expiration of term of service to date Aug 6th 1866*

Book mark:

(358)

J. M. Hance

Copyist.

6

10 H. Art'y. | U.S.C.T.

George Essex
Corp, Co. C, 10 Reg't U. S. Col'd H. Art'y.

Appears on Returns as follows:

Aug. 1866. - Nov. Aug. 6. 66
New Orleans La.
Disch'd. expiration
of term of service.

Book mark :

E. Thomson

(546)

Copyist.

George Essex
Capt, Co., 10 Reg't U. S. Col'd H. Art'y.

Appears on **Co. Muster-out Roll**, dated
Baton Rouge La, Feb 22, 1867.

Muster-out to date, 186 .

Last paid to, 186 .

Clothing account:

Last settled, 186 ; drawn since \$ 100

Due soldier \$ 100; due U. S. \$ 100

Am't for cloth'g in kind or money adv'd \$ 100

Due U. S. for arms, equipments, &c., \$ 100

Bounty paid \$ 100; due \$ 100

Remarks: *Discharged expiration*
term of service Aug 6, 1866.

Book mark :

(361)

J. M. Hance

Copyist.

E 10 Kelly U.S.C.T.

George Essex
Copt, Co. I, 10 Reg't U. S. Col'd 36 Art.

Appears on an

Individual Muster-out Roll

of the organization named above. Roll dated

New Orleans La, Aug 6, 1866

Muster-out to date Aug. 6, 1866.

Last paid to Apr. 30, 1866.

Clothing account:

Last settled _____, 1866 ; drawn since \$ _____ 100

Due soldier \$ 81 ⁶⁸/₁₀₀ ; due U. S. \$ _____ 100

Am't for cloth'g in kind or money adv'd \$ _____ 100

Due U. S. for arms, equipments, &c., \$ 1 ⁰⁸/₁₀₀

Bounty paid \$ none 100 due \$ 100 100

Remarks: Joined by transfer from
74th U. S. Infantry Oct 11. 1865 per
SO. No 84 Hd Qrs Dept. of La. series of
1865. Free on or before April 19-
1866. Promoted to Corporal to
date June 10. 1866 per SO No 12
over

Book mark: _____

M. A. Michaels

(348)

Copyist.

JAN. 15

5489328

1891

36d Co's Regiment June 10.
1865. - Stop for Canteen
65. Screw driver 23. 1 Wiper 20.
Total 108. Mustered out
by reason of expiration of term
of service to date Aug. 6-1866

Wheridge. John
Co. B., 10 U.S. Col'd H. Art'y.

Private | *Private*

CARD NUMBERS.

1	5-494176	26
2	5-494329	27
3	5-494494	28
4	5-494655	29
5	5-494810	30
6	5-494963	31
7	5-495119	32
8	5-495275	33
9	5-495428	34
10	5-495578	35
11	5-495718	36
12	5-495872	37
13	5-496019	38
14	5-496172	39
15	5-496323	40
16	5-496472	41
17	5-496617	42
18	5-496761	43
19	5-496920	44
20	5-497102	45
21	5-497409	46
22	5-489651	47
23		48
24		49
25		50

Book Mark:

See also

C

10 H. Art'y.

U.S.C.T.

John Esteridge

Pvt., 2 Battery, La. H. Art'y, Native Guards.*

Age *27* years.

Appears on

Company Muster-in Roll

of the organization named above. Roll dated

Camp Parapet Carrollton, La., Feb. 9, 186 *3.*

Muster-in to date *Feb. 9,* 186 *3.*

Joined for duty and enrolled:

When *Aug. 11th*, 186 *2.*

Where *Camp Parapet n. Carrollton, La.*

Period *3* years.

Valuation of horse, \$.....*100*

Valuation of horse equipments, \$.....*100*

Remarks :
.....
.....
.....

* This organization subsequently became Co. B, 10 Reg't U. S. Colored Heavy Artillery.

Book mark:

Feaster

E | 10 H. Art'y. | U.S.C.T.

John Etheridge
Pvt., Co. B, 1 Reg't La. H. Art'y, Native Guards.*

Appears on

Company Muster Roll

for *Imm. Enlistment to Feb. 28, 1863.*

Present or absent *Present*

Stoppage, \$ *100* for

Due Gov't, \$ *100* for

Valuation of horse, \$ *100*

Valuation of horse equipments, \$ *100*

Remarks:

*This organization subsequently became Co. B, 10 Reg't U. S. Col'd Heavy Artillery.

Book mark:

Feaster

O

10 H. Art'y.

U.S.C.T.

John Esteridge

Pvt., Co. B, 1 Reg't La. H. Art'y, Native Guards.*

Appears on

Company Muster Roll

for *March & April*, 186*3*.

Present or absent *Present*

Stoppage, \$ *100* for

Due Gov't, \$ *100* for

Valuation of horse, \$ *100*

Valuation of horse equipments, \$ *100*

Remarks: _____

*This organization subsequently became Co. B, 10 Reg't U. S. Col'd Heavy Artillery.

Book mark: _____

Feaster

E | 10 H. Art'y. | U.S.C.T.

John Esteridge
Pvt., Co. B, 1 Reg't La. H. Art'y, Native Guards.*

Appears on

Company Muster Roll

for *May & June*, 186*3*.

Present or absent *Present*

Stoppage, \$ *100* for

Due Gov't, \$ *100* for

Valuation of horse, \$ *100*

Valuation of horse equipments, \$ *100*

Remarks:

*This organization subsequently became Co. B, 10 Reg't U. S. Col'd Heavy Artillery.

Book mark:

Feaster

(358)

Copyst.

E | 10 H. Art'y. | U.S.C.T.

John Edridge
.....
Pvt., Co. B, 1 Reg't La. H. Art'y, Native Guards.*

Appears on

Company Muster Roll

for *July 7, Aug.*, 186*8*.

Present or absent *Present*

Stoppage, \$..... *100* for

Due Gov't, \$..... *100* for

Valuation of horse, \$..... *100*

Valuation of horse equipments, \$..... *100*

Remarks:

.....
.....
.....
.....
.....
.....

*This organization subsequently became Co. B, 10 Reg't U. S. Col'd Heavy Artillery.

Book mark:

.....
Feaster
.....
(358) Copyist.

E | 10 H. Art'y. | U.S.C.T.

John Estbridge

Pvt., Co. B, 1 Reg't La. H. Art'y, Native Guards.*

Appears on

Company Muster Roll

for *July & Aug.*, 186*8*.

Present or absent *Present*

Stoppage, \$ *100* for

Due Gov't, \$ *100* for

Valuation of horse, \$ *100*

Valuation of horse equipments, \$ *100*

Remarks: -----

*This organization subsequently became Co. B, 10 Reg't U. S. Col'd Heavy Artillery.

Book mark: -----

Feaster

(358) Copyst.

E

10 H. Art'y.

U.S.C.T.

John Etheridge

Pvt., Co. B, 1 Reg't La. H. Art'y, Native Guards.*

Appears on

Company Muster Roll

for *Sept. 4; Oct.*, 186 *3*.

Present or absent *Present*

Stoppage, \$ *100* for

Due Gov't, \$ *100* for

Valuation of horse, \$ *100*

Valuation of horse equipments, \$ *100*

Remarks:

*This organization subsequently became Co. B, 10 Reg't U. S. Col'd Heavy Artillery.

Book mark:

Feaster

L

10 H. Art'y. U.S.C.T.

John Etheridge

B, Co. *B*, 1 Reg't H. Art'y, Corps d'Afrique.*

Appears on

Company Muster Roll

for *Nov. & Dec.*, 1863.

Present or absent *Present*

Stoppage, \$ *100* for

Due Gov't, \$ *100* for

Valuation of horse, \$ *100*

Valuation of horse equipments, \$ *100*

Remarks:

*This organization subsequently became Co. , 10 Reg't U. S. Colored Heavy Artillery.

Book mark:

(358)

Reif
Copyist.

6

10 H. Art'y. U.S.C.T.

John Lotheredge
Pl *B*, Co. *B*, 1 Reg't H. Art'y, Corps d'Afrique.*

Appears on

Company Muster Roll

for *Jan. & Feb.*, 186 *4*

Present or absent *Present*

Stoppage, \$ *100* for

Due Gov't, \$ *100* for

Valuation of horse, \$ *100*

Valuation of horse equipments, \$ *100*

Remarks:

*This organization subsequently became Co. *10*, 10 Reg't U. S. Colored Heavy Artillery.

Book mark:

(358)

Reif

Copyist.

E. | **10 H. Art'y.** | **U.S.C.T.**

John Etheridge
H. B., Co. *B*, 7 Reg't U. S. Col'd H. Art'y.*

Appears on

Company Muster Roll

for *Mar & Apr*, 186*4*.

Present or absent *Presents*

Stoppage, \$ 100 for

Due Gov't, \$ 100 for

Valuation of horse, \$ 100

Valuation of horse equipments, \$ 100

Remarks:

* This organization subsequently became Co. *B*, 10 Reg't U. S. Colored Heavy Artillery.

Book mark: -----

J. Richardson
(358) Copyist.

E

10 H. Art'y.

U.S.C.T.

John Etheridge

K, Co. *B*, 7 Reg't U. S. Col'd H. Art'y.*

Appears on

Company Muster Roll

for *May & June*, 186*4*.

Present or absent *Present*

Stoppage, \$ *100* for

Due Gov't, \$ *100* for

Valuation of horse, \$ *100*

Valuation of horse equipments, \$ *100*

Remarks: *Rich*

* This organization subsequently became Co. , 10 Reg't U. S. Colored Heavy Artillery.

Book mark :

(358)

Reif

Copyist.

O

10 H. Art'y. U.S.C.T.

John Otteridge
Pl, Co. B, 10 Reg't U. S. Col'd H. Art'y.

Appears on

Company Muster Roll

for *July & Aug*, 186*4*.

Present or absent *Presents*

Stoppage, \$ 100 for

Due Gov't, \$ 100 for

Valuation of horse, \$ 100

Valuation of horse equipments, \$ 100

Remarks:

Book mark:

J. H. Richardson

(358)

Copyist.

E

10 H. Art'y. U.S.C.T.

John Etheridge
Co. B, 10 Reg't U. S. Col'd H. Art'y.

Appears on

Company Muster Roll

for *Sept & Oct*, 186 *4*

Present or absent *Present*

Stoppage, \$ 100 for

Due Gov't, \$ 100 for

Valuation of horse, \$ 100

Valuation of horse equipments, \$ 100

Remarks:
.....
.....
.....
.....
.....
.....
.....
.....

Book mark:

J. P. Richardson

(358)

Copyist.

E

10 H. Art'y. U.S.C.T.

John Etheridge

Co. B, 10 Reg't U. S. Col'd H. Art'y.

Appears on

Company Muster Roll

for Nov & Dec, 1864

Present or absent Present

Stoppage, \$ 100 for

Due Gov't, \$ 100 for

Valuation of horse, \$ 100

Valuation of horse equipments, \$ 100

Remarks:

Book mark:

(358)

J. J. J. J.

Copyist.

E.

10 H. Art'y. U.S.C.T.

John Etheridge

Plat., Co. B, 10 Reg't U. S. Col'd H. Art'y.

Appears on

Company Muster Roll

for *Jan & Feb*, 1865.

Present or absent *Present*

Stoppage, \$ 100 for

Due Gov't, \$ 100 for

Valuation of horse, \$ 100

Valuation of horse equipments, \$ 100

Remarks: *Two soldiers augmented pay from Jan. 1. 1864 to May 1 1864 \$6⁰⁰ per month May and June \$7⁰⁰ per month.*

Book mark: _____

(358)

Jornier.

Copyist.

E.

10 H. Art'y. U.S.C.T.

John Etheridge

Pvt., Co. B, 10 Reg't U. S. Col'd H. Art'y.

Appears on

Company Muster Roll

for *Mar & Apr*, 1865.

Present or absent *Present*

Stoppage, \$ *100* for

Due Gov't, \$ *100* for

Valuation of horse, \$ *100*

Valuation of horse equipments, \$ *100*

Remarks:

Book mark: -----

(358)

John

Copyist.

E

10 H. Art'y. U.S.C.T.

John Etheridge

Pl., Co. B, 10 Reg't U. S. Col'd H. Art'y.

Appears on

Company Muster Roll

for *May & June*, 186*5*.

Present or absent *Present.*

Stoppage, \$ 100 for

Due Gov't, \$ 100 for

Valuation of horse, \$ 100

Valuation of horse equipments, \$ 100

Remarks:

Book mark:

(358)

J. J. J. J.

Copyist.

E

10 H. Art'y. U.S.C.T.

John Etheridge
Pat., Co. B, 10 Reg't U. S. Col'd H. Art'y.

Appears on

Company Muster Roll

for *July & Aug.*, 1865.

Present or absent *Present*

Stoppage, \$ 100 for

Due Gov't, \$ 100 for

Valuation of horse, \$ 100

Valuation of horse equipments, \$ 100

Remarks:

Book mark:

(358)

Jones

Copyist.

E

10 H. Art'y. U.S.C.T.

John Etredge

Pat., Co.'B, 10 Reg't U. S. Col'd H. Art'y.

Appears on

Company Muster Roll

for Sep. & Oct., 1865.

Present or absent Present.

Stoppage, \$ 100 for

Due Gov't, \$ 100 for

Valuation of horse, \$ 100

Valuation of horse equipments, \$ 100

Remarks:

Book mark:

(358)

Jornie

Copyist.

6

10 H. Art'y. U.S.C.T.

John Ethridge

Co. B, 10 Reg't U. S. Col'd H. Art'y.

Appears on

Company Muster Roll

for Nov. 12, 1865

Present or absent Present

Stoppage, \$ 100 for

Due Gov't, \$ 100 for

Valuation of horse, \$ 100

Valuation of horse equipments, \$ 100

Remarks:

Book mark:

(358)

Reif

Copyist.

6

10 H. Art'y. U.S.C.T.

John Etridge

Co. B, 10 Reg't U. S. Col'd H. Art'y.

Appears on

Company Muster Roll

for Jan'y. 1866, 1866

Present or absent

Stoppage, \$ 100 for

Due Gov't, \$ 100 for

Valuation of horse, \$ 100

Valuation of horse equipments, \$ 100

Remarks: Mustd. out at M.O. Sa
Feb. 8, 66 by reason of
exp. of term of service

Book mark: 7682 P.M.S. Jul,
20 66

(358)

C. King
Copyist.

E. 10 No. a. U.S.C.T.

John Etheridge

Priv., Co B., 10 Reg't U. S. Col'd No. a.

Appears on a

Detachment Muster-out Roll

of the organization named above. Roll dated

New Orleans La., Feb. 8, 1864⁺

Muster-out to date Feb. 8, 1866.

Last paid to June 30, 1865

Clothing account:

Last settled _____, 186 ; drawn since \$ _____ 100

Due soldier \$ 32 77; due U. S. \$ _____ 100

Am't for cloth'g in kind or money adv'd \$ _____ 100

Due U. S. for arms, equipments, &c., \$ _____ 100

Bounty paid \$ _____ 100 due \$ _____ 100

Remarks: *Joined at origl. Orgn.
Mustered out by reason
of Expiration of term of
Service + Cert. of Mustg.
Off. shows him M. O. Feb. 12, 1866.
+ added May 9, 93. 965*

Book mark: _____

Hawling

E | 10 H. Art'y. | U.S.C.T.

John Etheridge
Pat. Co. *B*, 10 Reg't U. S. Col'd H. Art'y.

Appears on Co. Muster-out Roll, dated
Baton Rouge, La. Feb, 1867.
Muster-out to date _____, 186 .
Last paid to _____, 186 .

Clothing account:

Last settled _____, 186 ; drawn since \$ _____ 100
Due soldier \$ _____ 100; due U. S. \$ _____ 100
Am't for cloth'g in kind or money adv'd \$ _____ 100

Due U. S. for arms, equipments, &c., \$ _____ 100

Bounty paid \$ _____ 100; due \$ _____ 100

Remarks:

*Joined org. org.
Discharged Feb. 8/66
expiration term of
service,*

Book mark: _____

(361)

Headquarters
Copyist.

Eugene Henry

Co *K*, 10 U.S. Col'd H. Art'y.

artificer

Artificer

CARD NUMBERS.

1	5-4 f 7 5-6 2	26
2	5-4 f f 7 f 0	27
3	5-4 f f 3 5-3	28
4	5-3-1 2 2 3 1	29
5	5-3-1 2 3 f 2	30
6	5-3-1 2 5-3 2	31
7	5-3-1 2 6 7 f	32
8	5-3-1 2 f 0 6	33
9	5-3-1 2 9 2 7	34
10	5-3-1 3 0 3 f	35
11	5-3-1 3 1 5-5-	36
12	5-3-1 3 2 4 7	37
13		38
14		39
15		40
16		41
17		42
18		43
19		44
20		45
21		46
22		47
23		48
24		49
25		50

Book Mark:

See also *77" M.S.C.I.*

E 10 H. A. U.S.C.T.

Henry Eugene
Priv., Co. H, 10 Reg't U. S. Col'd H. A.

Appears on

M. and D. Roll of Men Transferred

to the organization named above,

from *Co. G 4th U. S. Col'd Inf*

Roll dated *Camp Canabetsa Co.,* 186*5*

When enlisted *April 21*, 186*5*

Period for which enlisted *3* years.

When mustered in *May 8*, 186*5*

Present or absent *Present*

Company to which assigned *K*

Remarks: *Joined by transfer
from Co. D 4th U. S. C. I.
per S. O. No 35. H. A. Reg
4th U. S. C. I. dated June
24. 65,*

Book mark :

W. H. Scott

E 110 Artz | U.S.C.T.

Henry Eugene
Pm, Co., 10 Reg't U. S. Col'd Artz

Appears on

M. and D. Roll of Men Transferred

to the organization named above,

from 77 Reg't U.S. Inf

Roll dated Oct 1, 1865.

When enlisted Apr. 21, 1865.

Period for which enlisted 3 years.

When mustered in May 8, 1865.

Present or absent

Company to which assigned

Remarks: joined as recruit
May 20. 65
Transferred to Co. G 77th
U.S. Inf. June 24, 65

Book mark :

J. M. Lenoir

(342)

Copyst.

E. 1086A U.S.C.T.

Henry Eugene
Art, Co. K, 10 Reg't U. S. Col'd *HA*

Appears on

M. and D. Roll of Men Transferred

to the organization named above,

from *77 U. S. Col Inf*

Roll dated *Camp Pampunda Oct 1, 1865*.

When enlisted *Apr 21*, 186*5*.

Period for which enlisted _____ years.

When mustered in *May 2*, 186*5*.

Present or absent *Present*

Company to which assigned *H*

Remarks: *Rec'd by Transfer*
from Co G, 77 U.S.C.I.

Book mark :

W. H. Scott

E | 10 H. Art'y. | U.S.C.T.

Henry Eugene
Art'y., Co. K, 10 Reg't U. S. Col'd H. Art'y.

Age years.

Appears on

Company Muster Roll*

for Sep. & Oct., 1865.

Joined for duty and enrolled:

When Apr. 21, 1865.

Where New Orleans, La.

Period 3 years.

Mustered in:

When May 8, 1865.

Where New Orleans.

Present or absent Present

Stoppage, \$ 100 for

Due Gov't, \$ 100 for

Remarks:

* First current roll. No muster-in roll of this company on file.

Book mark:

(3586)

Hibbard
Copyist.

E

10 H. Art'y.

U.S.C.T.

Henry Eugene

Art'y. Co. K, 10 Reg't U. S. Col'd H. Art'y.

Appears on

Company Muster Roll

for Nov. Dec., 1865.

Present or absent Present

Stoppage, \$ 100 for

Due Gov't, \$ 100 for

Valuation of horse, \$ 100

Valuation of horse equipments, \$ 100

Remarks:

Book mark:

(358)

Hibbard

Copyist.

E

10 H. Art'y.

U.S.C.T.

Henry Eugene

Art'y., Co. K, 10 Reg't U. S. Col'd H. Art'y.

Appears on

Company Muster Roll

for Jan. Feb., 1866

Present or absent Present

Stoppage, \$ 100 for

Due Gov't, \$ 100 for

Valuation of horse, \$ 100

Valuation of horse equipments, \$ 100

Remarks:

Book mark:

Hubbard

(358)

Copyist.

8

10th H. Art'y.

U.S.C.T.

Henry Eugene

Art'y., Co. K, 10 Reg't U. S. Col'd H. Art'y.

Appears on

Company Muster Roll

for *Mich. 9th Cal.*, 186*6*.

Present or absent *Present*

Stoppage, \$ 100 for

Due Gov't, \$ 100 for

Valuation of horse, \$ 100

Valuation of horse equipments, \$ 100

Remarks:

Book mark:

(358)

W. H. Hibbard

Copyist.

E

10 H. Art'y.

U.S.C.T.

Henry Eugene

Artf., Co. K, 10 Reg't U. S. Col'd H. Art'y.

Appears on

Company Muster Roll

for May & June, 1866.

Present or absent Present

Stoppage, \$ 100 for

Due Gov't, \$ 100 for

Valuation of horse, \$ 100

Valuation of horse equipments, \$ 100

Remarks:

Book mark:

(358)

Hibbard

Copyist.

8

10 H. Art'y. U.S.C.T.

Henry Eugene
Art'y.; Co. K, 10 Reg't U. S. Col'd H. Art'y.

Appears on

Company Muster Roll

for July & Aug., 1866

Present or absent Present

Stoppage, \$100 for

Due Gov't, \$100 for

Valuation of horse, \$100

Valuation of horse equipments, \$100

Remarks:

Book mark:

(358)

Hibbard

Copyist.

E

10 H. Art'y.

U.S.C.T.

Henry Eugene

Artifi, Co. K, 10 Reg't U. S. Col'd H. Art'y.

Appears on

Company Muster Roll

for Sept + Oct, 1866

Present or absent Present

Stoppage, \$ 100 for

Due Gov't, \$ 100 for

Valuation of horse, \$ 100

Valuation of horse equipments, \$ 100

Remarks:

Book mark:

Floyd

(358)

Copyist.

E

10 H. Art'y. | U.S.C.T.

Henry Eugene
Artij., Co. K, 10 Reg't U. S. Col'd H. Art'y.

Appears on

Company Muster Roll

for *Nov. & Dec.*, 186*6*.

Present or absent *Present.*

Stoppage, \$ *100* for

Due Gov't, \$ *100* for

Valuation of horse, \$ *100*

Valuation of horse equipments, \$ *100*

Remarks:

Book mark:

Lloyd

(358)

Copyist.

E

10 H. Art'y. U.S.C.T.

Henry Eugene

Artfr, Co. H., 10 Reg't U. S. Col'd H. Art'y.

Appears on Co. Muster-out Roll, dated
Baton Rouge La, Feb 22, 1867.

Muster-out to date Feb 22, 1867.

Last paid to Dec 31, 1866.

Clothing account:

Last settled....., 186 ; drawn since \$.....100

Due soldier \$ 57 ²/₁₀₀; due U. S. \$.....100

Am't for cloth'g in kind or money adv'd \$.....100

Due U. S. for arms, equipments, &c., \$ 6 ²²/₁₀₀

Bounty paid \$ 100 ⁰⁰/₁₀₀; due \$ 100 ⁰⁰/₁₀₀

Remarks: Recd by transfer from Co
G. 77 U. S. C. I. Oct 1/65. Per S. O.
No. 66 Hdqrs Dept La 8/65
app artificer Oct 1/65. Recd \$100.
Bounty when mustered.

Book mark: V 234 P 88 76

Floyd

(361)

Copyist.

Eugene Peter J.

Co *D*, 10 U.S. Col'd H. Art'y

Private

Private

CARD NUMBERS.

1	5-5-11236	26
2	5-5-11330	27
3	5-5-11417	28
4	5-5-115-15-	29
5	5-5-11652	30
6	5-5-11836	31
7	5-5-12108	32
8	5-489986	33
9		34
10		35
11		36
12		37
13		38
14		39
15		40
16		41
17		42
18		43
19		44
20		45
21		46
22		47
23		48
24		49
25		50

Book Mark:

See also

E | 10 H. Art'y. | U.S.C.T.

Peter J. Eugene

Priv., Co. *D*, 10 Reg't U. S. Col'd H. Art'y.

Age years.

Appears on

Company Muster Roll*

for *Enrollment to June 30*, 1865 -

Joined for duty and enrolled:

When, 186 .

Where

Period *1* years.

Mustered in:

When *Apr. 24*, 1865 -

Where *New Orleans, La.*

Present or absent *Present*

Stoppage, \$ *100* for

Due Gov't, \$ *100* for

Valuation of horse, \$ *100*

Valuation of horse equipments, \$ *100*

Remarks: *Drafted. Com-*
mencement of first

*First current roll. No muster-in roll of this company on file.

Book mark :

O. J. Clark

(3586)

Copyist.

JAN. 16

5511236

☆ 1891 ☆

payment by time
Apr. 24, 65-

Peter J. Eugene

Priv., Co. I, 10 Reg't U. S. Col'd H. Art'y.

Appears on

Company Muster Roll

for *July & Aug.*, 1865.

Present or absent. *Present*

Stoppage, \$ *100* for

Due Gov't, \$ *100* for

Valuation of horse, \$ *100*

Valuation of horse equipments, \$ *100*

Remarks: *Sick in grs.*

Book mark: -----

O. S. Clark

Copyist.

E.

10 H. Art'y. U.S.C.T.

Peter J. Eugene

Priv., Co. I, 10 Reg't U. S. Col'd H. Art'y.

Appears on

Company Muster Roll

for *Sept. 10th*, 186*5*.

Present or absent *Present*

Stoppage, \$ 100 for

Due Gov't, \$ 100 for

Valuation of horse, \$ 100

Valuation of horse equipments, \$ 100

Remarks:

Book mark:

O. S. Clark

(358)

Copyist.

E.

10 H. Art'y.

U.S.C.T.

Oster J. Eugene

Prk., Co. I, 10 Reg't U. S. Col'd H. Art'y.

Appears on

Company Muster Roll

for *Nov. & Dec.*, 186*7*.

Present or absent *Present*

Stoppage, \$ *100* for

Due Gov't, \$ *100* for

Valuation of horse, \$ *100*

Valuation of horse equipments, \$ *100*

Remarks:

FROM SECOND AUDITOR'S ROLL.

Book mark:

O. S. Leonard

(858)

Copyist.

E

10 H. Art'y. U.S.C.T.

Peter J. Eugene

Pvt., Co. I, 10 Reg't U. S. Col'd H. Art'y.

Appears on

Company Muster Roll

for Jan. & Feb., 1866.

Present or absent Present.

Stoppage, \$ 100 for

Due Gov't, \$ 100 for

Valuation of horse, \$ 100

Valuation of horse equipments, \$ 100

Remarks:

Book mark:

A. S. Clark

(358)

Copied.

E | 10 H. Art'y. | U.S.C.T.

Peter J. Eugene
Pvt., Co. I, 10 Reg't U. S. Col'd H. Art'y.

Appears on

Company Muster Roll

for *Nov. & Apr.*, 1866.

Present or absent

Stoppage, \$ 100 for

Due Gov't, \$ 100 for

Valuation of horse, \$ 100

Valuation of horse equipments, \$ 100

Remarks: *Discharged. Mustered out by reason of expiration of term of service to date Apr. 23, 1866.*

Book mark: *Muster out on file.*

(358)

O. J. Clark

Copyist.

E.

10 H. Art'y. U.S.C.T.

Peter J. Eugene
Sgt, Co., 10 Reg't U. S. Col'd H. Art'y.

Appears on Co. Muster-out Roll, dated

Baton Rouge La. Feb 22, 1867.

Muster-out to date, 186 .

Last paid to, 186 .

Clothing account:

Last settled, 186 ; drawn since \$.....100

Due soldier \$.....100; due U. S. \$.....100

Am't for cloth'g in kind or money adv'd \$.....100

Due U. S. for arms, equipments, &c., \$.....100

Bounty paid \$.....100; due \$.....100

Remarks: *Discharged expiration*
term of service Apr. 23, 1866

Age 23 years.

Book mark:

(361)

J. M. Hance

Copyist.

E | *10 Arty* | **U.S.C.T.**

Peter J. Eugene
Priv., Co. *I*, *11* Reg't U. S. Col'd *Arty*

Appears on a

Detachment Muster-out Roll

of the organization named above. Roll dated

New Orleans, La., *Apr. 23*, 186*6*.

Muster-out to date *Apr. 23*, 186*6*.

Last paid to *Feb. 28*, 186*6*.

Clothing account:

Last settled 186 ; drawn since \$ 100

Due soldier \$ *20* ^{*11*}/₁₀₀; due U. S. \$ 100

Am't for cloth'g in kind or money adv'd \$ 100

Due U. S. for arms, equipments, &c., \$ ^{*67*}/₁₀₀

Bounty paid \$ 100 due \$ 100

Remarks: *Joined by draft. Stop for*
one canteen .67. one tom-pi-
on .02. total .67 cts.

As

Book mark:

R. E. Wilson

031
Grans. Robert

Co E, 10 U.S. Col'd H. Art'y.

Private

Private

CARD NUMBERS.

1	3-4-7-1-1-9	26
2	3-5-0-2-3-7-2	27
3	3-5-0-2-6-0-9	28
4	3-5-0-2-8-2-8	29
5	3-5-0-4-5-9-1	30
6		31
7		32
8		33
9		34
10		35
11		36
12		37
13		38
14		39
15		40
16		41
17		42
18		43
19		44
20		45
21		46
22		47
23		48
24		49
25		50

Book Mark:

See also

E | 10 H. Art'y. | U.S.C.T.

Robert Evans

Appears with rank of Priv on

Muster and Descriptive Roll of a Detachment of U. S. Vols. forwarded

for the 7 Reg't U.S.C.A. Art'y* Roll dated

New Orleans La, June, 1864.

Where born Athens Ga

Age 26 y'rs; occupation Labors

When enlisted June 24, 1864.

Where enlisted New Orleans

For what period enlisted 3 years.

Eyes Blue; hair Black

Complexion Yellow; height 5 ft. 7 in.

When mustered in June 25, 1864

Where mustered in New Orleans

Bounty paid \$ 100; due \$ 100

Where credited

Company to which assigned "E"

Remarks:

*
Became 10 U.S. Col'd H. Art

Book mark:

J. N. Williams

6

10 H. Art'y. U.S.C.T.

Robert Evans

Sgt., Co. E, 7 Reg't U. S. Col'd H. Art'y.*

Appears on

Company Muster-in and Descriptive Roll

of the organization named above. Roll dated

New Orleans La, July 8, 1864

Where born Athens Ga

Age 26 y'rs; occupation Laborer

When enlisted Apr. 28, 1864

Where enlisted New Orleans

For what period enlisted 3 years

Eyes Black; hair Black

Complexion yellow; height 5 ft. 7 in.

When mustered in June 25, 1864

Where mustered in New Orleans

Bounty paid \$ 2 100; due \$ 100

Where credited New Orleans

Company to which assigned E

Remarks:

* This organization subsequently became Co. E, 10 Reg't U. S. Colored Heavy Artillery.

Book mark:

Linden Copist.

E
6

10 H. Art'y. U.S.C.T.

Robert Evans

Post, Co. E, 10 Reg't U. S. Col'd H. Art'y.

Appears on

Company Muster Roll

for July & Aug., 1864.

Present or absent Present

Stoppage, \$ 100 for

Due Gov't, \$ 100 for

Valuation of horse, \$ 100

Valuation of horse equipments, \$ 100

Remarks: Sick in Gen Hospital at New Orleans since Aug. 27th 1864

Book mark:

(358)

J. Linden

Copyist.

E

10 H. Art'y. U.S.C.T.

Robert Evans

Pr. Co. E, 10 Reg't U. S. Col'd H. Art'y.

Appears on

Company Muster Roll

for Sep. + Oct., 1864

Present or absent

Stoppage, \$ 100 for

Due Gov't, \$ 100 for

Valuation of horse, \$ 100

Valuation of horse equipments, \$ 100

Remarks: Died in Genl Hospital New Orleans Sep. 16th 1864

Book mark:

(358)

J. Linden Copyist.

E

10 H. Art'y. U.S.C.T.

Robert Evans

Co. E, 10 Reg't U. S. Col'd H. Art'y.

Appears on **Co. Muster-out Roll**, dated
Baton Rouge, La. Feb 22, 1867.

Muster-out to date _____, 186 .

Last paid to *Never paid*, 186 .

Clothing account:

Last settled _____, 186 ; drawn since \$ _____ 100

Due soldier \$ _____ 100; due U. S. \$ _____ 100

Am't for cloth'g in kind or money adv'd \$ _____ 100

Due U. S. for arms, equipments, &c., \$ _____ 100

Bounty paid \$ _____ 100; due \$ _____ 100

Remarks: *Joined at Org. Organ. as private.*

Died in G. H. New Orleans La. Sept. 16. 1864. of Chronic Diarrhoea.

Book mark: _____

(361)

O'Hagan
Copyist.

Evans, Robert

P. Co. E., 10 Reg't U.S.C.H.A.

3 Enclosures.

Bed Cards	Descriptive Lists
Burial Records	Final Statements 2
Certs. of Dis. for Discharge	Furloughs
C. M. Charges	Med. Des. Lists
Med. Certificates	Orders

Other papers relating to—

Admission to Hosp'l	Furlough
Casualty Sheet (Officer's)	Med. Examination
Confinement	Misc. Information
Contracts	Pay or Clothing
Death or Effects /	Personal Reports
Desertions	Rank
Discharge from Hosp'l	Transfer to Hosp'l
Discharge from Service	Transfer to V. R. C.
Duty	Transportation

Triplicate Sep 16 64

FINAL STATEMENT

OF

Robert Evans Private

7th Reg't of W. S. Cal. H. Art-

VOLUNTEERS.

C. d'A Hosp

NOTE 1.—Two of these certificates (or duplicates) are to be given to each Volunteer Soldier or drafted man who may be discharged previously to the discharge of his company, that he may at once receive from the Paymaster the pay, &c., due him, and the captain or other COMMISSIONED officer commanding the company will certify to the act of the delivery of the duplicate certificates; on these certificates the Soldier is "entitled to" his discharge, and should also present his discharge to the Paymaster to have the payment endorsed on it. The discharge is to be given back to the Soldier by the Paymaster; the latter only retaining as his voucher the duplicate certificates.

NOTE 2.—If the Soldier is entitled to pay for the use of his horse, the Company Commander will certify to that fact on the back of both these final statements, and also to the time he has pay due for having been so mounted on his own horse.

NOTE 3.—When a Soldier is furnished with final statements, his descriptive list, if he has one, should be taken up by the officer who gives the Soldier these statements, and endorsed with a statement to this effect by the officer. This endorsement should exhibit a full statement of the time for which the Soldier was allowed pay on his final statements, the clothing account, and all other charges against him or in his favor, so as to comprise a complete exhibit of his account. It will then be transmitted to the company commander of the Soldier, who will enter all the data necessary to a full understanding of the Soldier's account on the muster roll upon which the Soldier's discharge is reported. The descriptive list will then be destroyed. The object of this is, that the remaining portion of the Soldier's account may be settled upon the receipt of these muster rolls, and the Soldier receive any pay or allowances that may be due him at the time of his discharge, and which may not appear on his final statements from the fact that his descriptive list is incomplete. These accounts for back pay, &c., are settled by the 2d Auditor of the Treasury Department.

NOTE 4.—Charges for loss or injury to ordnance, horse equipments, and other miscellaneous charges, should appear under the heading of "Other Stoppages."

NOTE 5.—Bounty paid by State authorities, and not by the United States, will not be entered on this statement.

NOTE 6.—Amounts due the Sutler and Laundress must be entered on the muster roll on which the discharge, death, desertion, &c., is reported, as well as on the final statement, otherwise the amount cannot be collected from the United States.

NOTE 7.—This blank will be used for deceased volunteers and drafted men, as well as for others.

NOTE 8.—Where a Soldier dies in Hospital or on detached service, his descriptive list, if he has one, should be sent with his final statements, in duplicate, to the Adjutant General, Washington, D. C.

I certify, on honor, that Robert Evans a Private of
 1st Lieut. Green Company (C) of the 7 Regiment of U.S. Col. Art.
VOLUNTEERS, of the State of _____, born in Athens, State
 of Georgia, aged 26 years; 5 feet 7 inches high; Blk complexion.
Blk eyes, Blk hair, and by occupation a Labourer, having joined the company on
 its original organization at _____, and enrolled in it at the muster into
 the service of the United States at New Orleans La., on the Twenty fourth day
 of June, 1864, (or was mustered in service as a recruit, by _____
 _____, at _____, on the _____ day of _____,
 186 _____, or was drafted and mustered into the service of the United States from the _____
 Enrollment District of the State of _____, at _____,
 on the _____ day of _____, 186 _____,) to serve in the Regiment, for
 the term of Three years: and having served **HONESTLY** and
FAITHFULLY with his Company in Depart. of the Gulf to the present date, is now
 entitled to a **DISCHARGE** by reason of Death from Diarrhoea chronic
at New Orleans La. September 16th 1864

The said Robert Evans was ^{never} last paid by Paymaster
 _____ to include the _____ day of _____, 186 _____, and has
 pay due him from that time to the present date; he is entitled to pay and subsistence for
TRAVELING to place of enrollment, and whatever other allowances are authorized to volunteer
 soldiers, drafted men, or militia, so discharged. He has received from the United States **CLOTHING**
 amounting to Thirty one $\frac{63}{100}$ dollars, since the _____ day of Enrollment,
 186 _____, when his clothing account was last settled. He has received from the United States
 _____ $\frac{x}{100}$ dollars advanced **BOUNTY**.

There is to be stopped from him, on account of the State of _____, or other
 authorities, for **CLOTHING, &c.**, received on entering service, _____ $\frac{x}{100}$ dollars; and
 for other stoppages, viz: _____
 _____ $\frac{x}{100}$ dollars.

He has been furnished with **TRANSPORTATION** in kind from the place of his discharge to
 _____; and he has been **SUBSISTED** for **TRAVELING** to his
 place of enrollment, up to the _____, 186 _____.

He is indebted to _____, **SUTLER**, _____ $\frac{x}{100}$ dollars.
 He is indebted to _____, **LAUNDRESS**, _____ $\frac{x}{100}$ dollars.

Given in Duplicate, at New Orleans La., this 16th day
 of September, 1864.

Surgeon in charge
Commanding Company
Corps d'Afrique Genl. Hospital

*Copy sent 2^d Auditor,
D.*

240

✓ FINAL STATEMENT

OF

Roberts Evans Private

*7th Reg't of M. S. Col's H. Art-
110*

VOLUNTEERS.

Disd Sept 16th 1864

NOTE 1.—Two of these certificates (or duplicates) are to be given to each Volunteer Soldier or drafted man who may be discharged previously to the discharge of his company, that he may at once receive from the Paymaster the pay, &c., due him, and the captain or other COMMISSIONED officer commanding the company will certify to the act of the delivery of the duplicate certificates; on these certificates the Soldier is "entitled to" his discharge, and should also present his discharge to the Paymaster to have the payment endorsed on it. The discharge is to be given back to the Soldier by the Paymaster; the latter only retaining as his voucher the duplicate certificates.

NOTE 2.—If the Soldier is entitled to pay for the use of his horse, the Company Commander will certify to that fact on the back of both these final statements, and also to the time he has pay due for having been so mounted on his own horse.

NOTE 3.—When a Soldier is furnished with final statements, his descriptive list, if he has one, should be taken up by the officer who gives the Soldier these statements, and endorsed with a statement to this effect by the officer. This endorsement should exhibit a full statement of the time for which the Soldier was allowed pay on his final statements, the clothing account, and all other charges against him or in his favor, so as to comprise a complete exhibit of his account. It will then be transmitted to the company commander of the Soldier, who will enter all the data necessary to a full understanding of the Soldier's account on the muster roll upon which the Soldier's discharge is reported. The descriptive list will then be destroyed. The object of this is, that the remaining portion of the Soldier's account may be settled upon the receipt of these muster rolls, and the Soldier receive any pay or allowances that may be due him at the time of his discharge, and which may not appear on his final statements from the fact that his descriptive list is incomplete. These accounts for back pay, &c., are settled by the 2d Auditor of the Treasury Department.

NOTE 4.—Charges for loss or injury to ordnance, horse equipments, and other miscellaneous charges, should appear under the heading of "Other Stoppages."

NOTE 5.—Bounty paid by State authorities, and not by the United States, will not be entered on this statement.

NOTE 6.—Amounts due the Sutler and Laundress must be entered on the muster roll on which the discharge, death, desertion, &c., is reported, as well as on the final statement, otherwise the amount cannot be collected from the United States.

NOTE 7.—This blank will be used for deceased volunteers and drafted men, as well as for others.

NOTE 8.—Where a Soldier dies in Hospital or on detached service, his descriptive list, if he has one, should be sent with his final statements, in duplicate, to the Adjutant General, Washington, D. C.

ADJUTANT GENERAL'S OFFICE.
Oct 11th 1864
Duplicate with Inventory sent 2d Auditor.

RECEIVED
OCT 11 1864
ADJUTANT GEN'L'S OFFICE

I certify, on honor, that Robert Evans a Private of
^{1st Lieut.}
~~Captain~~ A. P. Green Company (C) of the 7th Regiment of U.S. Col'd H. Art.
VOLUNTEERS, of the State of _____, born in Athens, State
of Georgia, aged 26 years; 5 feet 7 inches high; Blk complexion,
Blk eyes, Blk hair, and by occupation a Labourer, having joined the company on
its original organization at _____, and enrolled in it at the muster into
the service of the United States at New Orleans La, on the Twenty fourth day
of June, 1864, (or was mustered in service as a recruit, by _____
_____, at _____, on the _____ day of _____,
186 , or was drafted and mustered into the service of the United States from the _____
Enrollment District of the State of _____, at _____,
on the _____ day of _____, 186), to serve in the Regiment, for
the term of Three years: and having served **HONESTLY** and
FAITHFULLY with his Company in Depart of the Gulf to the present date, is now
entitled to a **DISCHARGE** by reason of Death from Diarrhoea chronic
at New Orleans La. September 16th 1864

The said Robert Evans was ^{now}~~last~~ paid by Paymaster
_____ to include the _____ day of _____, 186 , and has
pay due him from that time to the present date; he is entitled to pay and subsistence for
TRAVELING to place of enrollment, and whatever other allowances are authorized to volunteer
soldiers, drafted men, or militia, so discharged. He has received from the United States **CLOTHING**
amounting to Thirty one $\frac{63}{100}$ dollars, since the _____ day of Enrollment,
186 , when his clothing account was last settled. He has received from the United States
no $\frac{x}{100}$ dollars advanced **BOUNTY**.

There is to be stopped from him, on account of the State of _____, or other
authorities, for **CLOTHING, &c.**, received on entering service, $\frac{x}{100}$ dollars; and
for other stoppages, viz: _____

_____ $\frac{x}{100}$ dollars.
He has been furnished with **TRANSPORTATION** in kind from the place of his discharge to
_____; and he has been **SUBSISTED** for **TRAVELING** to his
place of enrollment, up to the _____, 186 .

He is indebted to _____ no, **SUTLER**, $\frac{x}{100}$ dollars.

He is indebted to _____ no, **LAUNDRESS**, $\frac{x}{100}$ dollars.

Given in Duplicate, at New Orleans La, this 16th day
of September, 1864.

J. B. Pignette
Surgeon in charge
Commanding Company
Corps d'Afrique Gen'l Hospital

Duplicate

INVENTORY OF THE EFFECTS

OF

Robert Evans Private

Late of Company C

7th Reg't of U.S. Col'd Art

Volunteers, who died at Corps d'af. Gen'l Hosp.^l
New Orleans La

on the 16 day of September 1864.

Inventory of the effects of Robert Evans late
 a Private of ^{1st Lieut} Green Company E of
 the 7th Regiment of U.S. Col's H. Art Volunteers, who was enrolled as
 a Private at New Orleans in the State of Louisiana on
 the 24 day of June 1864, and mustered into the service of the United
 States as a Private on the 25 day of June 1864, at New Orleans La
 in Company E, 7th Regiment of U.S. Col's H. Art Volunteers, to serve Three
 years or during the war; he was born in Athens in the State
 of Georgia; he was 26 years of age, 5 feet 7 inches
 high, Blk complexion, Blk eyes, Blk hair, and by occupation, when enrolled,
 a Labourer; he died in Corps d'Afrique Gen'l Hospital, at
New Orleans La on the 16th day of September 1864, by
 reason of Diarrhoea chronic

INVENTORY.					
ARTICLES.	No.	ARTICLES.	No.	ARTICLES.	No.
Hats.....		Pairs trousers.....		Knapsacks.....	
Caps.....		Pairs flannel drawers.....			
Forage caps.....		Pairs cotton drawers.....			
Great coats.....		Flannel shirts.....			
Uniform coats.....		Cotton shirts.....			
Uniform jackets.....		Pairs boots.....			
Flannel sack coats.....		Pairs shoes.....			
Blouses.....		Pairs socks.....			
Stable frocks.....		Blankets.....			
Fatigue overalls.....		Haversacks.....			
					Money.
				Specie.....	⊕
				Notes.....	⊕

I CERTIFY, ON HONOR, that the above inventory comprises all the effects of _____
 _____, deceased, and that the effects are in the hands
 of _____ at _____
 _____ to be disposed of by a Council of Administration.

(DUPLICATES.)

STATION: New Orleans La

DATE: 16th September 1864

[A. G. O. No. 104.]

Surgeon in charge
Commanding the Company.
Corps d'Afrique Gen'l Hospital

Grans. William

Co B, 10 U.S. Col'd H. Art'y

Private

Private

CARD NUMBERS.

1	5-5-0 9743	26
2	5-5-0 9899	27
3	5-5-1 0049	28
4	5-5-1 0194	29
5	5-5-1 0344	30
6	5-5-1 0495-	31
7	5-5-1 0689	32
8	5-5-1 1118	33
9	5-4-8 9938	34
10		35
11		36
12		37
13		38
14		39
15		40
16		41
17		42
18		43
19		44
20		45
21		46
22		47
23		48
24		49
25		50

Book Mark:

See also

10 H. Art'y. U.S.C.T.

William Evans

Pvt, Co. H, 10 Reg't U. S. Col'd H. Art'y

Appears on

Company Muster Roll

for March & April, 1865.

Present or absent Present

Stoppage, \$ 100 for

Due Gov't, \$ 100 for

Valuation of horse, \$ 100

Valuation of horse equipments. \$ 100

Remarks: Commencement of first payment by time (March) 30/1865 =

(Drafted - M.D. March 30/65 at New Orleans, 1st Dist. 1 year)

Book mark:

Peruington

(358)

Copyist.

E | 10 H. Art'y. | U.S.C.T.

William Evans

Pvt, Co. H, 10 Reg't U. S. Col'd H. Art'y

Appears on

Company Muster Roll

for *May & June*, 1865.

Present or absent *Present*

Stoppage, \$ *100* for

Due Gov't, \$ *100* for

Valuation of horse, \$ *100*

Valuation of horse equipments. \$ *100*

Remarks :

Book mark :

(358)

Permyngton Copyist.

E | 10 H. Art'y. | U.S.C.T.

William Evans

Pvt, Co. H, 10 Reg't U. S. Col'd H. Art'y

Appears on

Company Muster Roll

for *July & Aug*, 1865.

Present or absent *Present*

Stoppage, \$ *100* for

Due Gov't, \$ *100* for

Valuation of horse, \$ *100*

Valuation of horse equipments. \$ *100*

Remarks :

Book mark:

(358)

Pennington

Copyist.

E

10 H. Art'y. U.S.C.T.

William Evans

Pr⁵, Co. H, 10 Reg't U. S. Col'd H. Art'y

Appears on

Company Muster Roll

for Sep & Oct, 1865.

Present or absent Present

Stoppage, \$ 100 for

Due Gov't, \$ 100 for

Valuation of horse, \$ 100

Valuation of horse equipments. \$ 100

Remarks:

Book mark:

Cammack

(358)

Copyist.

E | 10 H. Art'y. | U.S.C.T.

William Evans

Pr., Co. H, 10 Reg't U. S. Col'd H. Art'y

Appears on

Company Muster Roll

for *Nov & Dec*, 1865.

Present or absent *Present*

Stoppage, \$ *100* for

Due Gov't, \$ *100* for

Valuation of horse, \$ *100*

Valuation of horse equipments. \$ *100*

Remarks :

Book mark :

(858)

Samuel P
Copyist.

E | 10 H. Art'y. | U.S.C.T.

William Evans

Pvt., Co. H, 10 Reg't U. S. Col'd H. Art'y

Appears on

Company Muster Roll

for *Jan & Feb.*, 1866.

Present or absent *Present*

Stoppage, \$ *100* for

Due Gov't, \$ *100* for

Valuation of horse, \$ *100*

Valuation of horse equipments. \$ *100*

Remarks :

Book mark :

Gammack

E | 10 H. Art'y. | U.S.C.T.

William Evans

Pvt., Co. H, 10 Reg't U. S. Col'd H. Art'y

Appears on

Company Muster Roll

for *Mch & Apr.*, 1866.

Present or absent

Stoppage, \$ 100 for

Due Gov't, \$ 100 for

Valuation of horse, \$ 100

Valuation of horse equipments. \$ 100

Remarks: *Mustered out by reason of expiration of term of service to date Mch 29, 1866*

Book mark: *V. 12. P. 183. 68.*

Cammack

(858)

Copyist.

E

10 H. Art'y. U.S.C.T.

William Evans

Co. H, 10 Reg't U. S. Col'd H. Art'y.

Appears on **Co. Muster-out Roll**, dated

Baton Rouge, La., Feb. 22, 1867.

Muster-out to date _____, 186 .

Last paid to _____, 186 .

Clothing account:

Last settled _____, 186 ; drawn since \$ _____ 100

Due soldier \$ _____ 100; due U. S. \$ _____ 100

Am't for cloth'g in kind or money adv'd \$ _____ 100

Due U. S. for arms, equipments, &c., \$ _____ 100

Bounty paid \$ _____ 100; due \$ _____ 100

Remarks: *Joined by assignment
Mustered out exp. of term
of service Mch. 29/66.*

(Age 40 years)

Book mark: *V. 12. P. 183. 68.*

(361)

Larson

Copyist.

E. 10 *Hy Artg* U.S.C.T.

William Evans

Priv., Co *A.*, *10* Reg't U. S. Col'd *Artg*

Appears on a

Detachment Muster-out Roll

of the organization named above. Roll dated

New Orleans, La. Mar. 29, 1866.

Muster-out to date *Mar. 29*, 1866.

Last paid to *Dec. 31*, 1865

Clothing account:

Last settled 186 ; drawn since \$ 100

Due soldier \$ *24 90* / 100; due U. S. \$ 100

Am't for cloth'g in kind or money adv'd \$ 100

Due U. S. for arms, equipments, &c., \$ 100

Bounty paid \$ 100 due \$ 100

Remarks: *Joined as shown.*

Book mark:

H. W. Reed

Overett Henry

Co I, 10 U.S. Col'd H. Art'y.

Private

Private

CARD NUMBERS.

1	5488501	26
2	5511609	27
3	5512198	28
4		29
5		30
6		31
7		32
8		33
9		34
10		35
11		36
12		37
13		38
14		39
15		40
16		41
17		42
18		43
19		44
20		45
21		46
22		47
23		48
24		49
25		50

Book Mark:

See also 91" + 74" use, I.

E 10th U.S.C.T.

Henry Everett
Pvt, Co. 10 Reg't U. S. Col'd N. Arty.
Appears on

M. and D. Roll of Men Transferred

to the organization named above,

from Co "B" 7th U.S. C. Inf.

Roll dated New Orleans La Oct 11, 1864

When enlisted April 11, 1864

Period for which enlisted 3 years.

When mustered in April 29, 1864

Present or absent

Company to which assigned

Remarks: Joined by trans-
fer from Co B 91
U.S. C. I. by Consolida-
tion Sept 13 '64
per G. O. No. 17 Sta-
gro Mil. Div. West
Miss, 1864. Stopped for
one Tompion R. M. 4th

Book mark: (over)

(342)

T. W. Jones, Jr
Copyist.

JAN. 15

5488501

★ 1891 ★

And One Screw driver
And C. W. R. M.

Filed with Henry Everett,

JAN. 15

5488501

★ 1891 ★

and One Screw driver
and C. W. R. M.

Filed with Henry Everett.

E.

10 H. Art'y.

U.S.C.T.

Henry Everett

Plt., Co. I, 10 Reg't U. S. Col'd H. Art'y.

Appears on

Company Muster Roll

for *Nov. & Dec.*, 1865.

Present or absent

Stoppage, \$ 100 for

Due Gov't, \$ 100 for

Valuation of horse, \$ 100

Valuation of horse equipments, \$ 100

Remarks: *Deserted. Transferred from 74 U.S.C.I. per S.O. No. 84 Hd. qrs. Dept. of La. Oct. 11, 1865. Deserted from Camp Parapet Nov. 21, 1865. Never joined Co.*

FROM SECOND AUDITOR'S ROLL.

Book mark:

O. J. Clark

(358)

Copyist.

Henry Overett

Priv, Co. *D*, 10 Reg't U. S. Col'd H. Art'y.

Appears on **Co. Muster-out Roll**, dated

Baton Rouge La Feb 22, 1867.

Muster-out to date _____, 186 .

Last paid to *June 30*, 1865 .

Clothing account:

Last settled _____, 186 ; drawn since \$ _____ 100

Due soldier \$ _____ 100; due U. S. \$ *17* ¹³/₁₀₀

Am't for cloth'g in kind or money adv'd \$ _____ 100

Due U. S. for arms, equipments, &c., \$ _____ 100

Bounty paid \$ _____ 100; due \$ _____ 100

Remarks: *formed by transfer*
from regt "USCI per S.O. No 84
Adj Gen Dept. La Oct 11. 1865
Deserted Nov 4, 1865 at Camp
Parapet La

Book mark : _____

J. M. Hance

840
Fagan. Miles

Co. 10 U.S. Col'd H. Art'y.

Private

Private

CARD NUMBERS.

1	5-488738	26
2	5-505773	27
3	5-505927	28
4	5-506074	29
5	5-506212	30
6	5-506359	31
7	5-506477	32
8	5-506589	33
9	5-506807	34
10	5-506904	35
11		36
12		37
13		38
14		39
15		40
16		41
17		42
18		43
19		44
20		45
21		46
22		47
23		48
24		49
25		50

Book Mark:

See also

77 yeady

0862034 0748
R. + P. 496724
J 1069952 P. 11/11/11
S. 1992743. C. 0044

W. G. H. K. C. V.

F 110 *Harty* | **U.S.C.T.**

Wiles Fagan

Pw, Co. *F*, 10 Reg't U. S. Col'd *Harty*

Appears on

M. and D. Roll of Men Transferred

to the organization named above,

from *77 Regt U.S. C. Inf.*

Roll dated *Oct.*, 1865.

When enlisted *Sept 1*, 1864.

Period for which enlisted *3* years.

When mustered in *Sept 1*, 1864.

Present or absent *Present*

Company to which assigned *F*

Remarks:

Book mark:

(342)

J. Leonard

Copyist

J

10 H. Art'y. U.S.C.T.

Wiler Jagan

Priv, Co. F, 10 Reg't U. S. Col'd H. Art'y.

Appears on

Company Muster Roll

for *Sept & Oct*, 1865.

Present or absent *Present*

Stoppage, \$ *100* for

Due Gov't, \$ *100* for

Valuation of horse, \$ *100*

Valuation of horse equipments, \$ *100*

Remarks: *Transferred from Co. D
77 U.S. C. I. Oct. 1/65*

Book mark:

B. G. Masdon

F.

10 H. Art'y. U.S.C.T.

Will Fagan

Pvt., Co. F, 10 Reg't U. S. Col'd H. Art'y.

Appears on

Company Muster Roll

for *Nov & Dec.*, 1865.

Present or absent *Present.*

Stoppage, \$ *100* for

Due Gov't, \$ *100* for

Valuation of horse, \$ *100*

Valuation of horse equipments, \$ *100*

Remarks:

Book mark:

(358)

W. H. C.
Copyist.

F.

10 H. Art'y. U.S.C.T.

Wiler Fagan

Priv., Co. F, 10 Reg't U. S. Col'd H. Art'y.

Appears on

Company Muster Roll

for *Jan'y & Feby.*, 186*6*.

Present or absent *Present*

Stoppage, \$ *100* for

Due Gov't, \$ *100* for

Valuation of horse, \$ *100*

Valuation of horse equipments, \$ *100*

Remarks:

Book mark:

(358)

ASH
Copyist.

F. | 10 H. Art'y. | U.S.C.T.

Wiler Fagan
Priv., Co. F, 10 Reg't U. S. Col'd H. Art'y.

Appears on

Company Muster Roll

for *March & April*, 1866.

Present or absent *Present*

Stoppage, \$ *100* for

Due Gov't, \$ *100* for

Valuation of horse, \$ *100*

Valuation of horse equipments, \$ *100*

Remarks: *Stop for loss of 1
pr. Scales 70c*

Book mark: _____

W. H. V.
Copyist.

7

10 H. Art'y. U.S.C.T.

Wiley T. Agans

Prst., Co. F, 10 Reg't U. S. Col'd H. Art'y.

Appears on

Company Muster Roll

for *May & June*, 1866.

Present or absent *Present*

Stoppage, \$ 100 for

Due Gov't, \$ 100 for

Valuation of horse, \$ 100

Valuation of horse equipments, \$ 100

Remarks:

Book mark:

(358)

Copyist.

F.

10 H. Art'y. U.S.C.T.

Wiler Fagan

Pat; Co. F, 10 Reg't U. S. Col'd H. Art'y.

Appears on

Company Muster Roll

for *July & Aug.*, 186*6*.

Present or absent *Present*

Stoppage, \$ 100 for

Due Gov't, \$ 100 for

Valuation of horse, \$ 100

Valuation of horse equipments, \$ 100

Remarks:

Book mark:

Asst. Copyist.

F

10 H. Art'y. U.S.C.T.

Wiler Jagan

Pr, Co. F, 10 Reg't U. S. Col'd H. Art'y.

Appears on

Company Muster Roll

for *Sept and Oct.*, 186*6*

Present or absent *Present*

Stoppage, \$ 100 for

Due Gov't, \$ 100 for

Valuation of horse, \$ 100

Valuation of horse equipments, \$ 100

Remarks:

Book mark:

(358)

House

Copyist.

F

10 H. Art'y. U.S.C.T.

Walter Fagan

Pat, Co. F, 10 Reg't U. S. Col'd H. Art'y.

Appears on

Company Muster Roll

for *Nov. and Dec.*, 186*6*

Present or absent *Present*

Stoppage, \$ *100* for

Due Gov't, \$ *100* for

Valuation of horse, \$ *100*

Valuation of horse equipments, \$ *100*

Remarks:

Book mark:

House

F | 10 H. Art'y. | U.S.C.T.

Walter Fagan

Pvt, Co. *F*, 10 Reg't U. S. Col'd H. Art'y.

Appears on Co. Muster-out Roll, dated *Baton Rouge La, Feb. 22*, 186 7.

Muster-out to date *Feb. 22*, 186 7.

Last paid to *Dec 31*, 186 6.

Clothing account:

Last settled _____, 186 ; drawn since \$ _____ 100

Due soldier \$ *53 93* 100; due U. S. \$ _____ 100

Am't for cloth'g in kind or money adv'd \$ _____ 100

Due U. S. for arms, equipments, &c., \$ *6 08* 100

Bounty paid \$ *none* 100; due \$ *2 00* 100

Remarks: *Rec'd by transfer from Co. D. 77 U.S.C.A. in S.O. No. 66 Hd. Qrs. Dept. of La. Conscription by G.O. No. 106 Hd. Qrs. of the Gulf. S. of 64*

Book mark:

House

Fairley, Luke

Co Q, 10 U.S. Col'd H. Art'y.

Private Private

CARD NUMBERS.

1	5488552	26
2	5508398	27
3	5508548	28
4	5508700	29
5	5508847	30
6	5508994	31
7	5509124	32
8	5509272	33
9	5509381	34
10		35
11		36
12		37
13		38
14		39
15		40
16		41
17		42
18		43
19		44
20		45
21		46
22		47
23		48
24		49
25		50

Book Mark:

See also Co H. H. ye of

R. + P. 572195

S-2042180 P.O. m m

D 2080762 P.O. aff

S-2093887 P.O. aff

S-2096063 P.O. aff

D. 2120328 P.O. aff

P.O. mil. I.C. 1061895-4.2.13 P. 24

Универсальный

J | 10th U.S.C.T.

Private, Co., *10* Reg't U. S. Corp'd *H. Artz*
Appears on

M. and D. Roll of Men Transferred

to the organization named above,

from *Co. H. 9th U.S. C. Inf.*

Roll dated *New Orleans, La Oct 11, 1860.*

When enlisted *Mar 12*, 186*0.*

Period for which enlisted *3* years.

When mustered in *Mar 20*, 186*0.*

Present or absent

Company to which assigned

Remarks: *Joined as rec'd
Stop for Haverock.*

Book mark :

(342) *J. W. Jones, Jr* Copyist.

Lupe Fairley
Co. G, 10 Reg't U. S. Col'd H. Art'y.

Appears on

Company Muster Roll

for *Nov & Dec*, 186*0*.

Present or absent *Present*

Stoppage, \$ 100 for

Due Gov't, \$ 100 for

Valuation of horse, \$ 100

Valuation of horse equipments, \$ 100

Remarks: *Transferred from*
C. F. "74th Regt. C. F. Gen. S. O."
84, dated 29th Sept. of
60.

Book mark:

G. Ford
Copyist.

F | 10 H. Art'y. | U.S.C.T.

Luke Fairley
Capt, Co. G, 10 Reg't U. S. Col'd H. Art'y.

Appears on

Company Muster Roll,

for *Jan. & Feb.*, 1866.

Present or absent *Present*

Stoppage, \$ 100 for

Due Gov't, \$ 100 for

Valuation of horse, \$ 100

Valuation of horse equipments, \$ 100

Remarks:

Book mark:

(358)

G. M.
Copyist.

F

10 H. Art'y.

U.S.C.T.

Luke Fairley

Priv, Co. G, 10 Reg't U. S. Col'd H. Art'y.

Appears on

Company Muster Roll

for *Mar. & Apr.*, 1866.

Present or absent *Present*

Stoppage, \$ 100 for

Due Gov't, \$ 100 for

Valuation of horse, \$ 100

Valuation of horse equipments, \$ 100

Remarks:

Book mark:

G. J. J.

(358)

Copyist.

F

10 H. Art'y.

U.S.C.T.

Luke Fairley

Priv, Co. G, 10 Reg't U. S. Col'd H. Art'y.

Appears on

Company Muster Roll

for *May & June*, 1866.

Present or absent *Present*

Stoppage, \$ 100 for

Due Gov't, \$ 100 for

Valuation of horse, \$ 100

Valuation of horse equipments, \$ 100

Remarks: *On daily duty
"cutting grass" on slopes*

Book mark: _____

(358)

G. Fox

Copyist.

F

10 H. Art'y.

U.S.C.T.

Lupe Fairley
Prvt, Co. G, 10 Reg't U. S. Col'd H. Art'y.

Appears on

Company Muster Roll

for *July & Aug*, 186*6*.

Present or absent *Present*

Stoppage, \$ *100* for

Due Gov't, \$ *100* for

Valuation of horse, \$ *100*

Valuation of horse equipments, \$ *100*

Remarks: *On daily duty cutting grass. For ord. lat 534*

Book mark:

(358)

G. Fox

Copyist.

J

10 H. Art'y. U.S.C.T.

Luke Parley

Pvt, Co. G, 10 Reg't U. S. Col'd H. Art'y.

Appears on

Company Muster Roll

for *Sept & Oct*, 1866.

Present or absent *Present*

Stoppage, \$ *100* for

Due Gov't, \$ *100* for

Valuation of horse, \$ *100*

Valuation of horse equipments, \$ *100*

Remarks:

Book mark:

Wines

Luke Fairley

Pvt, Co. G, 10 Reg't U. S. Col'd H. Art'y.

Appears on

Company Muster Roll

for *Nov & Dec*, 1866.

Present or absent *Present*

Stoppage, \$ *100* for

Due Gov't, \$ *100* for

Valuation of horse, \$ *100*

Valuation of horse equipments, \$ *100*

Remarks: *Due 25 for
ordnance lost 34 cents*

Book mark:

Wines

J | 10 H. Art'y. | U.S.C.T.

Luke Fairley

Pvt, Co. *G*, 10 Reg't U. S. Col'd H. Art'y.

Appears on **Co. Muster-out Roll**, dated

Baton Rouge, La, Feb. 22, 1867.

Muster-out to date *Feb. 22*, 1867.

Last paid to *Dec 31*, 1866.

Clothing account:

Last settled _____, 186 ; drawn since \$ _____ 100

Due soldier \$ *49* ^{*05*}/₁₀₀; due U. S. \$ _____ 100

Am't for cloth'g in kind or money adv'd \$ _____ 100

Due U. S. for arms, equipments, &c., \$ *6* ^{*00*}/₁₀₀

Bounty paid \$ *100* ^{*00*}/₁₀₀; due \$ *100* ^{*00*}/₁₀₀

Remarks: *joined by transfer*
from 74 N.S. Co. per D.O. No
84. Par. 5 N.Y. Qrs. Dept. La.

Book mark: _____

Wines

(361)

Copyist.

842
Fairley, Solomon

Co. E., 10 U.S. Col'd H. Art'y.

Private

Sergeant

CARD NUMBERS

1 5788542
2 5503570
3 5503688
4 5503829
5 5503964
6 5504094
7 5504221
8 5504346
9 5504446
10
11
12
13
14
15
16
17
18
19
20
21
22
23
24
25

26
27
28
29
30
31
32
33
34
35
36
37
38
39
40
41
42
43
44
45
46
47
48
49
50

Book Mark:

See also Co. F. 74th Inf. Arty

F 10th U.S.C.T.

Solomon Fairley
Priv., Co., 10 Reg't U. S. Corp'd Ft. Arty

Appears on

M. and D. Roll of Men Transferred

to the organization named above,

from Co. F. 7th U.S. C. Inf.

Roll dated New Orleans, La. Oct 11, 1864

When enlisted July 27, 1864

Period for which enlisted 3 years.

When mustered in July 27, 1864

Present or absent

Company to which assigned

Remarks: Joined as a recruit
Co. H. 2^d Inf. Cd. A.
(7th U.S. C. I.) at Ship Is.
Land, Miss. May 17 '64
Transferred to Co. F. 7th
U.S. C. I. August 30 '64

Book mark :

(342) J. W. Jones, Jr. Copyist.

F

10 H. Art'y. U.S.C.T.

Salmon Fairley

Prof, Co. E, 10 Reg't U. S. Col'd H. Art'y.

Appears on

Company Muster Roll

for Nov 2 Dec, 1865.

Present or absent Present

Stoppage, \$ 100 for

Due Gov't, \$ 100 for

Valuation of horse, \$ 100

Valuation of horse equipments, \$ 100

Remarks: Transferred from 74th U.S. Co. I. to 10th U.S. C. Art'y. per S.O. 84 Hd Qrs Dept of La Oct 11 - 1865.

Book mark:

(358)

Mark Copyist.

7

10 H. Art'y. U.S.C.T.

Salomon Farley

Capt, Co. E, 10 Reg't U. S. Col'd H. Art'y.

Appears on

Company Muster Roll

for Jan & Feb, 1866

Present or absent Present

Stoppage, \$ 100 for

Due Gov't, \$ 100 for

Valuation of horse, \$ 100

Valuation of horse equipments, \$ 100

Remarks: Promoted Capt Jan 15-15, 1866.

Book mark:

Mark Copyist.

(358)

F

10 H. Art'y. | U.S.C.T.

Solomon Fairley

Capt., Co. E, 10 Reg't U. S. Col'd H. Art'y.

Appears on

Company Muster Roll

for *March & April*, 1866.

Present or absent *Present*

Stoppage, \$.....100 for

Due Gov't, \$.....100 for

Valuation of horse, \$.....100

Valuation of horse equipments, \$.....100

Remarks:

Book mark:

Wark

(358)

Copyist.

7

10 H. Art'y.

U.S.C.T.

Salomon Fairley

Sgt, Co. E, 10 Reg't U. S. Col'd H. Art'y.

Appears on

Company Muster Roll

for *May & June*, 1866.

Present or absent *Present*

Stoppage, \$ 100 for

Due Gov't, \$ 100 for

Valuation of horse, \$ 100

Valuation of horse equipments, \$ 100

Remarks: *Promoted from Corporal
May 1st 1866.*

Book mark : _____

Wash

Copyist.

(358)

F

10 H. Art'y. U.S.C.T.

Solomon Farley

Serjt, Co. E, 10 Reg't U. S. Col'd H. Art'y.

Appears on

Company Muster Roll

for July 2 Aug, 1866.

Present or absent Present

Stoppage, \$ 100 for

Due Gov't, \$ 100 for

Valuation of horse, \$ 100

Valuation of horse equipments, \$ 100

Remarks:

Book mark:

Wark

(358)

Copyist.

F

10 H. Art'y. U.S.C.T.

Solomon Fairley

Sgt., Co. E, 10 Reg't U. S. Col'd H. Art'y.

Appears on

Company Muster Roll

for *Sept. + Oct*, 1866.

Present or absent *Present*

Stoppage, \$ *100* for

Due Gov't, \$ *100* for

Valuation of horse, \$ *100*

Valuation of horse equipments, \$ *100*

Remarks:

Book mark: -----

(358)

O'Hagan

Copyist.

J

10 H. Art'y. U.S.C.T.

Solomon Fairley

Sgt., Co. E, 10 Reg't U. S. Col'd H. Art'y.

Appears on

Company Muster Roll

for *Nov. & Dec.*, 186*6*.

Present or absent *Present*

Stoppage, \$ *100* for

Due Gov't, \$ *100* for

Valuation of horse, \$ *100*

Valuation of horse equipments, \$ *100*

Remarks:

Book mark:

O'Hagan

Copyist.

(358)

F

10 H. Art'y. U.S.C.T.

Solomon Fairley

Sgt., Co. *E*, 10 Reg't U. S. Col'd H. Art'y.

Appears on **Co. Muster-out Roll**, dated

Baton Rouge, La, Feb. 22, 1867.

Muster-out to date *Feb. 22, 1867.*

Last paid to *Dec. 31, 1866.*

Clothing account:

Last settled....., 186 ; drawn since \$..... 100

Due soldier \$ *69*^{*76*}/₁₀₀; due U. S. \$..... 100

Am't for cloth'g in kind or money adv'd \$..... 100

Due U. S. for arms, equipments, &c., \$ *9*^{*16*}/₁₀₀

Bounty paid \$..... 100; due \$ *300*^{*00*}/₁₀₀ *act of July 26, 1862*

Remarks: *Joined by transfer from Co. F, 7th U.S. Col. I per L. O. 84 Hd. Qrs. Dept. of La. Oct. 11, 1865. Private to June 15, 1866, then Corp'l. to May 1, 1866.*

Book mark:

O'Hagan

Fairley Westley

Co G, 10 U.S. Col'd H. Art'y.

Private

Private

CARD NUMBERS.

1	57488549	26
2	5508397	27
3	5508547	28
4	5508699	29
5	5508846	30
6	5508993	31
7	5509123	32
8	5509271	33
9	5509380	34
10		35
11		36
12		37
13		38
14		39
15		40
16		41
17		42
18		43
19		44
20		45
21		46
22		47
23		48
24		49
25	1	50

Book Mark:

See also

Co. H. 7th. reg. Inf.

F 10th U.S.C.T.

Wesley Fairley
1st, Co., 10th Reg't U. S. Col'd Art'y.

Appears on

M. and D. Roll of Men Transferred

to the organization named above,

from Co "H" 7th U.S. Col'd Inf

Roll dated New Orleans La. Oct 11, 1865.

When enlisted March 12, 1865.

Period for which enlisted 3 years.

When mustered in Mar 25, 1865.

Present or absent

Company to which assigned

Remarks: Joined as recd.
Stop for Staversack
Mr Carteen.

Book mark :

(342)

J. M. Jones, Jr
Copyist.

F

10 H. Art'y.

U.S.C.T.

Wesley Fairley

priv, Co. G, 10 Reg't U. S. Co'd H. Art'y.

Appears on

Company Muster Roll

for *Nov. & Dec*, 186*0*.

Present or absent *Present*

Stoppage, \$ *100* for

Due Gov't, \$ *100* for

Valuation of horse, \$ *100*

Valuation of horse equipments, \$ *100*

Remarks: *Transferred from
Co. F 74th U.S. Col. Gr. F. O.
84 dated 1st Div. Dept. of
La.*

Book mark:

(358)

G. For

Copyist.

F

10 H. Art'y.

U.S.C.T.

Wesley Fairley
Capt., Co G, 10 Reg't U. S. Col'd H. Art'y.

Appears on

Company Muster Roll

for Jan. 9 Feb., 1866.

Present or absent Present

Stoppage, \$ 100 for

Due Gov't, \$ 100 for

Valuation of horse, \$ 100

Valuation of horse equipments, \$ 100

Remarks:

Book mark:

(358)

G. F. W.
Copyist.

F

10 H. Art'y. U.S.C.T.

Wesley Fairley
Priv, Co & G, 10 Reg't U. S. Col'd H. Art'y.

Appears on

Company Muster Roll

for *Mar. 9 Apr.*, 1866.

Present or absent *Present*

Stoppage, \$ *100* for

Due Gov't, \$ *100* for

Valuation of horse, \$ *100*

Valuation of horse equipments, \$ *100*

Remarks:

Book mark:

(358)

G. F. J.
Copyist.

F

10 H. Art'y. U.S.C.T.

Wesley Fairley
Priv, Co. G, 10 Reg't U. S. Col'd H. Art'y.

Appears on

Company Muster Roll

for *May & June*, 1866.

Present or absent *Present*

Stoppage, \$ 100 for

Due Gov't, \$ 100 for

Valuation of horse, \$ 100

Valuation of horse equipments, \$ 100

Remarks:

Book mark:

G. F. W.

F

10 H. Art'y.

U.S.C.T.

Wesley Fairley
Capt, Co. G, 10 Reg't U. S. Col'd H. Art'y.

Appears on

Company Muster Roll

for July & Aug, 1866.

Present or absent Present

Stoppage, \$ 100 for

Due Gov't, \$ 100 for

Valuation of horse, \$ 100

Valuation of horse equipments, \$ 100

Remarks:

Book mark:

G. Fol
Copyist.

F

10 H. Art'y.

U.S.C.T.

Westley Fairley

Priv, Co. G, 10 Reg't U. S. Cav'd H. Art'y.

Appears on

Company Muster Roll

for *Sept & Oct*, 1866.

Present or absent *Present*

Stoppage, \$ 100 for

Due Gov't, \$ 100 for

Valuation of horse, \$ 100

Valuation of horse equipments, \$ 100

Remarks:

Book mark:

Wines

J

10 H. Art'y.

U.S.C.T.

Nestly Fairley

Pvt, Co. G, 10 Reg't U. S. Co'd H. Art'y.

Appears on

Company Muster Roll

for *Nov & Dec*, 1866.

Present or absent *Present*

Stoppage, \$ *100* for

Due Gov't, \$ *100* for

Valuation of horse, \$ *100*

Valuation of horse equipments, \$ *100*

Remarks:

Book mark:

Wines

Nestley Fairley
Co. *G*, 10 Reg't U. S. Col'd H. Art'y.

Appears on Co. Muster-out Roll, dated
Baton Rouge La, Feb 22, 1867.

Muster-out to date *Feb 22*, 1867.

Last paid to *Dec 31*, 1866.

Clothing account:

Last settled _____, 186 ; drawn since \$ _____ 100

Due soldier \$ *56* ^{*09*}/₁₀₀; due U. S. \$ _____ 100

Am't for cloth'g in kind or money adv'd \$ _____ 100

Due U. S. for arms, equipments, &c., \$ *6* ^{*00*}/₁₀₀

Bounty paid \$ *100* ^{*00*}/₁₀₀; due \$ *100* ^{*00*}/₁₀₀

Remarks: *Joined by transfer 74"*
U.S.C.T. per S.O. No. 84 Par. 5,
Hd. Qrs. Dept of La.

Book mark : _____

Wines

Fairley Wilks

Co E, 10 U.S. Col'd H. Art'y

Private

Private

CARD NUMBERS.

1	5488598	26
2	5303571	27
3	5503719	28
4	5503856	29
5	5504002	30
6	5504131	31
7	5504250	32
8	5504376	33
9	5504476	34
10		35
11		36
12		37
13		38
14		39
15		40
16		41
17		42
18		43
19		44
20		45
21		46
22		47
23		48
24		49
25		50

Book Mark:

See also Co. D. 74th Regt Inf

F 10th U.S.C.T.

William Fairley
10th Reg't U. S. Col'd Art'y

Appears on

M. and D. Roll of Men Transferred

to the organization named above,

from Co. "I" 1st U.S.C. Inf.

Roll dated New Orleans La Oct 1865.

When enlisted May 18, 1864.

Period for which enlisted 3 years.

When mustered in July 29, 1864.

Present or absent

Company to which assigned

Remarks: Joined as private
Co. "I" 2nd La Nat. Gua
rds (1st U.S.C. Inf.) as pri
vate. Transferred to Co.
"I" as surplus man by
virtue of P. O. 19 dated
At a Genl O. N. D. M. M.
July 9 '64. Free on or
Book mark: (over)

(342)

J. W. Jones, Jr. Copyist.

JAN. 15

5488598

★ 1861 ★

before April 19, 1861

F

10 H. Art'y. U.S.C.T.

Willis Fairley

Cpt., Co. E, 10 Reg't U. S. Col'd H. Art'y.

Appears on

Company Muster Roll

for Nov & Dec, 1865.

Present or absent Present

Stoppage, \$ 100 for

Due Gov't, \$ 100 for

Valuation of horse, \$ 100

Valuation of horse equipments, \$ 100

Remarks: Transferred from 94th U.S.C. I. to 10th U.S.C.A. Reg't per S.O. 84 Hd Qrs Dept of La Oct 11 - 1865.

Book mark:

(358)

Mark Copyist.

7 | 10 H. Art'y. | U.S.C.T.

Willis Fairley

Prst, Co. E, 10 Reg't U. S. Col'd H. Art'y.

Appears on

Company Muster Roll

for Jan & Feb, 1866.

Present or absent Present

Stoppage, \$ 100 for

Due Gov't, \$ 100 for

Valuation of horse, \$ 100

Valuation of horse equipments, \$ 100

Remarks:

Book mark:

Hark
Copyist.

7 | 10 H. Art'y. | U.S.C.T.

Willis Fairley

Private, Co. E, 10 Reg't U. S. Col'd H. Art'y

Appears on

Company Muster Roll

for March & April, 1866.

Present or absent Present

Stoppage, \$ 100 for

Due Gov't, \$ 100 for

Valuation of horse, \$ 100

Valuation of horse equipments, \$ 100

Remarks: Sick in quarters

Book mark:

7

10 H. Art'y.

U.S.C.T.

Willis Fairley

Pvt

, Co. E, 10 Reg't U. S. Col'd H. Art'y

Appears on

Company Muster Roll

for May 2 June, 1866.

Present or absent Present

Stoppage, \$ 100 for

Due Gov't, \$ 100 for

Valuation of horse, \$ 100

Valuation of horse equipments, \$ 100

Remarks:

Book mark:

504

Wark

Copyist.

(358)

7

10 H. Art'y. U.S.C.T.

Willis Farley

Prs, Co. E, 10 Reg't U. S. Col'd H. Art'y.

Appears on

Company Muster Roll

for July & Aug, 1866.

Present or absent Present

Stoppage, \$ 100 for

Due Gov't, \$ 100 for

Valuation of horse, \$ 100

Valuation of horse equipments, \$ 100

Remarks:

Book mark:

(358)

W. C. H. Copyist.

F

10 H. Art'y. U.S.C.T.

Willis Fairley

Plt., Co. E, 10 Reg't U. S. Col'd H. Art'y.

Appears on

Company Muster Roll

for *Sept. & Oct*, 1866.

Present or absent *Present*

Stoppage, \$ *100* for

Due Gov't, \$ *100* for

Valuation of horse, \$ *100*

Valuation of horse equipments, \$ *100*

Remarks: *Stopped for C & J. E
lost 03 on daily duty in
9 m. D. per S. O. No. 55 Hd.
Qrs. Fort Pike, La. Oct. 15. '66.
Sick in qrs.*

Book mark: *55 55 55*

O'Hagan

(358)

Copyist.

F

10 H. Art'y. U.S.C.T.

Willis Fairley

Priv. Co. E, 10 Reg't U. S. Col'd H. Art'y.

Appears on

Company Muster Roll

for *Nov & Dec*, 1866.

Present or absent *Present*

Stoppage, \$ *100* for

Due Gov't, \$ *100* for

Valuation of horse, \$ *100*

Valuation of horse equipments, \$ *100*

Remarks: *On daily Duty in
Q. M. Dept per S. O. No. 55
Hd. Qrs. Forts Pike & Macomb,
La. Oct. 15. 1866.*

Book mark:

(358)

O'Hagan

Copyist.

J

Willis Fairley

Prvt., Co. *E.*, 10 Reg't U. S. Col'd H. Art'y.

Appears on **Co. Muster-out Roll**, dated
Baton Rouge, La, Feb. 22, 1867.
Muster-out to date *Feb. 22, 1867.*
Last paid to *Dec. 31, 1866.*

Clothing account:

Last settled....., 186 ; drawn since \$.....¹⁰⁰
Due soldier \$ *10*^{*06*}/₁₀₀; due U. S. \$.....¹⁰⁰
Am't for cloth'g in kind or money adv'd \$.....¹⁰⁰

Due U. S. for arms, equipments, &c., \$ *6*^{*02*}/₁₀₀
Bounty paid \$.....¹⁰⁰; due \$ *100*^{*00*}/₁₀₀
Act of July 26 '66

Remarks: *Joined by transfer*
from Co. I. 74 U.S.C. Infy
S.O. 84 H^d 2^d Dept of La.
Oct. 11, 1865.

Bounty due soldier under
act of July 28, 1866, \$100.⁰⁰

Book mark:

(361)

O'Hagan, Copyist.

Falcon. John

Co. , 10 U.S. Col'd H. Art'y.

Private

Private

CARD NUMBERS.

1	5487858	26
2		27
3		28
4		29
5		30
6		31
7		32
8		33
9		34
10		35
11		36
12		37
13		38
14		39
15		40
16		41
17		42
18		43
19		44
20		45
21		46
22		47
23		48
24		49
25		50

Book Mark:

See also *77 U.S. 6 Aug*

A 1086 A U.S.C.T.

John Sulcon
Pot, Co., 10 Reg't U. S. Col'd Ill,

Appears on

M. and D. Roll of Men Transferred

to the organization named above,

from

Roll dated

When enlisted

Period for which enlisted

When mustered in

Present or absent

Company to which assigned

Remarks:

Discharged Oct
6. 64 by Order Maj
Gen. Hurlbut for
disability,

Name not taken up on muster
rolls of Reg't

Book mark:

Falcon Korah

Co **, 10 U.S. Col'd H. Art'y.**

Private

Private

CARD NUMBERS.

1	5487680	26
2		27
3		28
4		29
5		30
6		31
7		32
8		33
9		34
10		35
11		36
12		37
13		38
14		39
15		40
16		41
17		42
18		43
19		44
20		45
21		46
22		47
23		48
24		49
25		50

Book Mark:

See also

77 U.S. C. Inf

F 1086a U.S.C.T.

Norah Falcon
Co. *10* Reg't U. S. Col'd *Hill*

Appears on

M. and D. Roll of Men Transferred

to the organization named above,

from

44 U.S. Col Inf

Roll dated

Camp Canapetta Cal, 186*5*.

When enlisted

May 6, 186*4*.

Period for which enlisted

3 years.

When mustered in

May 12, 186*4*.

Present or absent

Company to which assigned

Remarks:

*Discharged for
Disability Oct 6, 1864
at Ft B Phillip, La
Final Statements
given,*

*name not taken up on
muster rolls of Regt*

Book mark:

Walter Scott

Falls. Alphonse

Co. E., 10 U.S. Col'd H. Art'y.

Private

Private

CARD NUMBERS.

1	5-488616	26
2	5-503574	27
3	5-503722	28
4	5-503858	29
5	5-504004	30
6	5-504133	31
7	5-504251	32
8	5-504434	33
9	5-504593	34
10		35
11		36
12		37
13		38
14		39
15		40
16		41
17		42
18		43
19		44
20		45
21		46
22		47
23		48
24		49
25		50

Book Mark:

See also Co. A. 74th Regt. Ia

J 1 Oct. d. U.S.C.T.

Alphonso Fallo
Pvt, Co. 10 Reg't U. S. Col'd St. Arty.

Appears on

M. and D. Roll of Men Transferred

to the organization named above,

from Co "A" 7th U.S.C. Inf.

Roll dated New Orleans, La, Oct 11, 1865.

When enlisted April 9, 1865.

Period for which enlisted 3 years.

When mustered in May 8, 1865.

Present or absent

Company to which assigned

Remarks: Joined as recruit
7th U.S.C. Inf.

Book mark :

(342)

J. W. Jones, Jr

Copyist.

7 | 10 H. Art'y. | U.S.C.T.

Alphuse Falls

Priv, Co. E, 10 Reg't U.S. Col'd H. Art'y.

Appears on

Company Muster Roll

for *Nov & Dec*, 1865.

Present or absent *Present*

Stoppage, \$ 100 for

Due Gov't, \$ 100 for

Valuation of horse, \$ 100

Valuation of horse equipments, \$ 100

Remarks: *Transferred from 74th
U.S.C. I. to 10th U.S.C.A. 263.
per S.O. 84 26d 2rs Dept of
War Oct 11-1865.*

Book mark: _____

(358)

Hark
Copyist.

F | 10 H. Art'y. | U.S.C.T.

Alphouse Falls

Port, Co. E, 10 Reg't U. S. Col'd H. Art'y.

Appears on

Company Muster Roll

for *Jan & Feb*, 1866.

Present or absent *Present*

Stoppage, \$ *100* for

Due Gov't, \$ *100* for

Valuation of horse, \$ *100*

Valuation of horse equipments, \$ *100*

Remarks: _____

Book mark: _____

(358)

Wart
Copyist.

7

10 H. Art'y. U.S.C.T.

Alphonzo Fallo

Put, Co. E, 10 Reg't U. S. Col'd H. Art'y

Appears on

Company Muster Roll

for *March & April*, 1866.

Present or absent *Present*

Stoppage, \$ *100* for

Due Gov't, \$ *100* for

Valuation of horse, \$ *100*

Valuation of horse equipments, \$ *100*

Remarks: *sick in quarters*

Book mark:

Wart

Copyist.

(358)

F | **10 H. Art'y.** | **U.S.C.T.**

Alphouse Falls

Rob, Co. E, 10 Reg't U. S. Col'd H. Art'y

Appears on

Company Muster Roll

for *May & June*, 186*6*.

Present or absent *Present*

Stoppage, \$ *100* for

Due Gov't, \$ *100* for

Valuation of horse, \$ *100*

Valuation of horse equipments, \$ *100*

Remarks:

Book mark:

(358)

Wark

Copyist.

7

10 H. Art'y. U.S.C.T.

Alphons Falls

Priv, Co. E, 10 Reg't U. S. Col'd H. Art'y.

Appears on

Company Muster Roll

for *July & Aug*, 186*6*.

Present or absent *Present*

Stoppage, \$ *100* for

Due Gov't, \$ *100* for

Valuation of horse, \$ *100*

Valuation of horse equipments, \$ *100*

Remarks:

Book mark:

Hark

(358)

Copyist.

F

10 H. Art'y. U.S.C.T.

Alphouse Falls

Co., Co. E, 10 Reg't U. S. Col'd H. Art'y.

Appears on

Company Muster Roll

for *Sept. & Oct*, 186*6*.

Present or absent *Present*

Stoppage, \$ *100* for

Due Gov't, \$ *100* for

Valuation of horse, \$ *100*

Valuation of horse equipments, \$ *100*

Remarks:

Book mark:

(358)

O'Hagan
Copyist.

F

10 H. Art'y.

U.S.C.T.

Alphonse Falls

Priv., Co. E, 10 Reg't U. S. Col'd H. Art'y.

Appears on

Company Muster Roll

for *Nov. & Dec.*, 1866.

Present or absent

Stoppage, \$ 100 for

Due Gov't, \$ 100 for

Valuation of horse, \$ 100

Valuation of horse equipments, \$ 100

Remarks: *Died. — Drowned in Lake Pontchartrain near Fort Pike, La. by the capsizing of a Gov't Sloop, on board of which he was on duty, Nov. 6, 1866. — Final statements forwarded, Nov. 13, 1866. — Stopped for C. & G. Co. \$2.00*

Book mark:

O'Hagan

(358)

Copyist.

A

10 H. Art'y.

U.S.C.T.

Alphonse Falls
Oct, Co. *E*, 10 Reg't U. S. Col'd H. Art'y.

Appears on **Co. Muster-out Roll**, dated
Baton Rouge La Feb 22, 1867.

Muster-out to date _____, 186 .

Last paid to *Aug. 31*, 1866 .

Clothing account:

Last settled _____, 186 ; drawn since \$ _____ 100

Due soldier \$ _____ 100; due U. S. \$ _____ 100

Am't for cloth'g in kind or money adv'd \$ _____ 100

Due U. S. for arms, equipments, &c., \$ _____ 100

Bounty paid \$ _____ 100; due \$ _____ 100

Remarks: *Joined by transfer from*
Co. A, 74 U.S.C., I. as private
S.O. N^o Dis. Dept. of La. Oct,
11, 1865. Drowned in Lake
Pontchartrain, near Fort Pike
La. Nov. 6, 1866.

Book mark: *V. 163. P. 7 '73.*
67, 1883

(361)

O'Hagan

Copyist.

Halls. Alphon

P. E., Co. *E.*, *10* *U. S. C. H. A.*
Reg't

1 Enclosures.

Bed Cards	Descriptive Lists
Burial Records	Final Statements /
Certs. of Dis. for Discharge	Furloughs
C. M. Charges	Med. Des. Lists
Med. Certificates	Orders

Other papers relating to—

Admission to Hosp'l	Furlough
Casualty Sheet (Officer's)	Med. Examination
Confinement	Misc. Information
Contracts	Pay or Clothing
Death or Effects	Personal Reports
Desertions	Rank
Discharge from Hosp'l	Transfer to Hosp'l
Discharge from Service	Transfer to V. R. C.
Duty	Transportation

enacted, That the fees of agents and causing to be executed the claim for a pension, bounty, Pension Office, under this act, rates: For making out and declaration by the applicant, and forwarding the same to the site correspondence, ten dollars; by such agent or attorney in full such pension, and shall not be le or in part, until such pension xth and seventh sections of an pensions," approved July [four- sixty-two, are hereby repealed.

enacted, That any agent or indirectly, demand or receive his services under this act than section of this act, or who shall any claim for a pension, bounty, act, on the condition that he pon any portion of the amount wrongfully withhold from a pen- hole or any part of the pension ch pensioner or claimant, shall demeanor, and, upon conviction offense, be fined not exceeding oned at hard labor not exceeding o the circumstances and aggra-

ed a higher fee than that allowed by act and the name of the agent to the os may be taken to have the same

Private A. J. ...
11th Reg't of U.S. Cavalry
VOLUNTEERS.
Rec'd Nov 11 '10

NOTE 1.—Two of these certificates (or duplicates) are to be Volunteer Soldier or drafted man who may be discharged v mustered out, (Final Statements are never given to men in service.) that he may at once receive from the Paymaster due him, and the captain or other COMMISSIONED officer com company will certify to the act of the delivery of the duplicat with these certificates the Soldier is "entitled to" his *discharge* also present his discharge to the Paymaster to have the paym on it. The discharge is to be given back to the Soldier by the the latter only retaining as his vouchers the duplicate certifi

NOTE 2.—If the Soldier is entitled to pay for the use of Company Commander will certify to that fact on the back of final statements, and also to the time he has pay due for he mounted on his own horse.

NOTE 3.—When a Soldier is furnished with final statements tive list, if he has one, should be taken up by the officer w Soldier these statements, and endorsed with a statement to the officer. The endorsement should exhibit a full statement for which the Soldier was allowed pay on his final statements account, and all other charges against him or in his favor, so a a complete exhibit of his account. It will then be transmitted pany Commander of the Soldier, who will enter all the data n full understanding of the Soldier's account on the muster roll the Soldier's discharge is reported. The descriptive list destroyed. The object of this is, that the remaining portion of account may be settled upon the receipt of these muster g Soldier receive any pay or allowances that may be due him a his discharge, and which may not appear on his last final sta the fact that his descriptive list is incomplete. These accou pay, &c., are settled by the 2d Auditor of the Treasury Depa

NOTE 4.—Charges for loss or injury to ordnance, horse equ other miscellaneous charges, should appear under the headin Stoppages."

NOTE 5.—Bounty paid by State authorities, and not by the U will not be entered on this statement.

NOTE 6.—Amounts due the Sutler and Laundress must be e muster roll on which the discharge, death, desertion, &c., is well as on the final statement, otherwise the amount cannot from the United States.

NOTE 7.—This blank will be used for deceased volunteers men, as well as for others.

NOTE 8.—Where a Soldier dies in Hospital or on detach descriptive list, if he has one, should be sent with his final s duplicate, to the Adjutant General, Washington, D. C.

NOTE 9.—If the soldier is a drafted man or substitute, the sp &c., of enrolled, should contain only the word *drafted* or *sub case* may be. If the Soldier is a "VETERAN," (or RECRUIT as a veteran, (or recruit,) as the case may be, should be int the words *mustered into the service of the U. S.* A stateme installments of *Veteran or Recruit Bounty RECEIVED* must be made on the back of each final statement.

MAILED
24
sent to Adjutant

NOV 11 1890
OFFICE

on honor, that Alphon Hall, a Private
Freeland Company (E) of the 11th Regiment of U.S.
the State of _____, born in Lafayette
ana, aged 21 years; 5 feet 5 inches high; yellow
black hair, and by occupation a laborer, who joined
(see Note 9) on the 1st day of April, 1865, at New
Orleans, for the period of three years, and
as a recruit 8th day of May
1865, by Capt. Cas. Ferrand; and

FAITHFULLY with his Company to the present date, is now
by reason of Death. He was drowned by the ship
belonging at Fort Pike on board of which he was
en route from New Orleans to Fort Pike with the
Alphon Hall was last paid
libbie, to include the 31st day of August
from that time to the present date; he is entitled to pay and
place of enrollment, and whatever other allowances are authorized
men, or militia, so discharged. He has received from the United States
86 $\frac{15}{100}$ dollars, since the enlistment day of
clothing account was never settled. He has received from the
100 dollars advanced **BOUNTY**.

be stopped from him, on account of the State of La
CLOTHING, &c., received on entering service, nothing
es, viz: for One (1) Musquet

urnished with **TRANSPORTATION** in kind from the place of his
; and he has been **SUBSISTED** for **TRA**
ent, up to the _____, 186 .

ed to John Lake Jr., **SUTLER**,
ed to _____, **LAUNDRESS**,

uplicate, at Fort Pike La, this
1866.

M. Freeland
Capt. U.S.A.
Command

070

Annex. Lewis

Co *F*, 10 U.S. Col'd H. Art'y.

Private

Private

CARD NUMBERS.

1	5487099	26
2	5504708	27
3	5504864	28
4	5504967	29
5	5505104	30
6	5505236	31
7	5505329	32
8	5505431	33
9	5505535	34
10	5505645	35
11	5505769	36
12	5505923	37
13	5506070	38
14	5506210	39
15	5506357	40
16	5506475	41
17	5506586	42
18	5506804	43
19	5506901	44
20		45
21		46
22		47
23		48
24		49
25		50

Book Mark:

See also

F

10 H. Art'y. | U.S.C.T.

Louis Farnoux

Appears with rank of Priv on

Muster and Descriptive Roll of a Detachment of U. S. Vols. forwarded

for the 7 Reg't U.S.C.H. Art'y^{*} Roll dated New Orleans La. June 4, 1864.

Where born Ark Post Ark.

Age 24 y'rs; occupation Laborer

When enlisted June 4th, 1864

Where enlisted New Orleans

For what period enlisted 3 years.

Eyes Blk; hair Blk

Complexion Blk; height 5 ft. in.

When mustered in June 4th, 1864.

Where mustered in New Orleans

Bounty paid \$ 100; due \$ 100

Where credited

Company to which assigned F

Remarks:

^{*}
Became 10 U.S. Co's H. Art'y.

Book mark:

A. M. Williams

F | 10 H. Art'y. | U.S.C.T.

Lewis Fannox
Pat., Co. *F*, 7 Reg't U. S. Col'd H. Art'y.*

Appears on

Company Muster-in and Descriptive Roll

of the organization named above. Roll dated

New Orleans La, Aug 19, 1864.

Where born *Ark. Post- Ark.*

Age *24* y'rs; occupation *Laborer*

When enlisted *June 4*, 1864.

Where enlisted *New Orleans La*

For what period enlisted *3* years.

Eyes *Blk*; hair *Black*

Complexion *Blk*; height *5* ft. - in.

When mustered in *June 4*, 1864.

Where mustered in *New Orleans La*

Bounty paid \$ *100*; due \$ *100*

Where credited *1st Enlt Dist La,*

Company to which assigned

Remarks:

* This organization subsequently became Co. *F*, 10 Reg't U. S. Colored Heavy Artillery.

Book mark:

Rounlan
(356d) Copyist.

7 | **10 H. Art'y.** | **U.S.C.T.**

Lewis Fannox

Priv., Co. 7, 7 Reg't U. S. Col'd H. Art'y.*

Appears on

Company Muster Roll

for May & June, 1864.

Present or absent Present

Stoppage, \$ 100 for

Due Gov't, \$ 100 for

Valuation of horse, \$ 100

Valuation of horse equipments, \$ 100

Remarks: _____

* This organization subsequently became Co. 7, 10 Reg't U. S. Colored Heavy Artillery.

Book mark: _____

(358)

Rosenbaum
Copyist.

F | 10 H. Art'y. | U.S.C.T.

Louis Farnox

Priv, Co. F, 10 Reg't U. S. Col'd H. Art'y.

Appears on

Company Muster Roll

for *July & August*, 186*4*.

Present or absent *Present*

Stoppage, \$.....*100* for

Due Gov't, \$.....*100* for

Valuation of horse, \$.....*100*

Valuation of horse equipments, \$.....*100*

Remarks:

Book mark:

(358)

Rosenbaum

Copyist.

F

10 H. Art'y. U.S.C.T.

Louis Lannox

Priv, Co. F, 10 Reg't U. S. Col'd H. Art'y.

Appears on

Company Muster Roll

for *Sept & Oct*, 1864.

Present or absent *Present*

Stoppage, \$ *100* for

Due Gov't, \$ *100* for

Valuation of horse, \$ *100*

Valuation of horse equipments, \$ *100*

Remarks:

Book mark:

Rosenbaum

(358)

Copyist.

Louis Farnox

Pvt., Co. F, 10 Reg't U. S. Col'd H. Art'y.

Appears on

Company Muster Roll

for Nov & Dec, 1864.

Present or absent Present

Stoppage, \$ 100 for

Due Gov't, \$ 100 for

Valuation of horse, \$ 100

Valuation of horse equipments, \$ 100

Remarks:

Book mark:

Rosenbaum

J

10 H. Art'y. U.S.C.T.

Louis Jannoy

Co. F, 10 Reg't U. S. Col'd H. Art'y.

Appears on

Company Muster Roll

for Jan 5 Feb 1865

Present or absent Present

Stoppage, \$ 100 for

Due Gov't, \$ 100 for

Valuation of horse, \$ 100

Valuation of horse equipments, \$ 100

Remarks: Difference between \$7 per mo. and authorized pay due from enlistment to Jan 30/65.

Book mark:

B G Wasdon

(358)

Copyist.

J

10 H. Art'y. U.S.C.T.

Louis Jamroy

Priv., Co. F, 10 Reg't U. S. Col'd H. Art'y.

Appears on

Company Muster Roll

for Mar & Apr, 1865

Present or absent Present

Stoppage, \$ 100 for

Due Gov't, \$ 100 for

Valuation of horse, \$ 100

Valuation of horse equipments, \$ 100

Remarks:

Book mark:

B. G. Wasdon

J

10 H. Art'y. U.S.C.T.

Louis Fannox

Priv., Co. F, 10 Reg't U. S. Col'd H. Art'y.

Appears on

Company Muster Roll

for May & June, 1865.

Present or absent

Present

Stoppage, \$ 100 for

Due Gov't, \$ 100 for

Valuation of horse, \$ 100

Valuation of horse equipments, \$ 100

Remarks: Due U.S. for Camp & Garrison Equipage \$1.68

Book mark:

B G Masdon

J | 10 H. Art'y. | U.S.C.T.

Louis Jannox

Priv., Co. F, 10 Reg't U. S. Col'd H. Art'y.

Appears on

Company Muster Roll

for date Aug 31, 1865.

Present or absent Present

Stoppage, \$ 100 for

Due Gov't, \$ 100 for

Valuation of horse, \$ 100

Valuation of horse equipments, \$ 100

Remarks:

Book mark:

By Wasdon

(358)

Copyist.

J

10 H. Art'y. U.S.C.T.

Louis Jannox

Co. F, 10 Reg't U. S. Co'd H. Art'y.

Appears on

Company Muster Roll

for Sept & Oct, 1865.

Present or absent Present

Stoppage, \$ 100 for

Due Gov't, \$ 100 for

Valuation of horse, \$ 100

Valuation of horse equipments, \$ 100

Remarks:

Book mark:

B. G. Masdon

(358)

Copyist.

F.

10 H. Art'y.

U.S.C.T.

Louis Farnos,

Priv., Co. F, 10 Reg't U. S. Col'd H. Art'y.

Appears on

Company Muster Roll

for Nov & Dec, 1865.

Present or absent Present.

Stoppage, \$0, 15/100 for ordnance.

Due Gov't, \$100 for

Valuation of horse, \$100

Valuation of horse equipments, \$100

Remarks:

Book mark:

Cash
Copyist.

Louis Farnox

Pat; Co. F, 10 Reg't U. S. Col'd H. Art'y.

Appears on

Company Muster Roll

for Jan'y & Feby., 1866.

Present or absent Present.

Stoppage, \$ 100 for

Due Gov't, \$ 100 for

Valuation of horse, \$ 100

Valuation of horse equipments, \$ 100

Remarks:

Book mark:

F. | 10 H. Art'y. | U.S.C.T.

Louis Farnox

Part., Co. F, 10 Reg't U. S. Col'd H. Art'y.

Appears on

Company Muster Roll

for *Mar. & Apr.*, 186*6*.

Present or absent *Present*

Stoppage, \$ *100* for

Due Gov't, \$ *100* for

Valuation of horse, \$ *100*

Valuation of horse equipments, \$ *100*

Remarks:

Book mark:

F.

10 H. Art'y. U.S.C.T.

Louis Tamm

Part, Co. F, 10 Reg't U. S. Col'd H. Art'y.

Appears on

Company Muster Roll

for *May & June*, 1866.

Present or absent *Present*

Stoppage, \$ *100* for

Due Gov't, \$ *100* for

Valuation of horse, \$ *100*

Valuation of horse equipments, \$ *100*

Remarks:

Book mark:

(358)

Arch.
Copyst.

F. | 10 H. Art'y. | U.S.C.T.

Louis Farnox

Priv., Co. F, 10 Reg't U. S. Col'd H. Art'y.

Appears on

Company Muster Roll

for *July & Aug.*, 186 *6*.

Present or absent *Present*

Stoppage, \$ *100* for

Due Gov't, \$ *100* for

Valuation of horse, \$ *100*

Valuation of horse equipments, \$ *100*

Remarks:

Book mark:

(358)

Ash.
Copyist.

F

10 H. Art'y. U.S.C.T.

Louis Farnox

Pr, Co. F, 10 Reg't U. S. Col'd H. Art'y.

Appears on

Company Muster Roll

for *Sept. and Oct*, 186*6*.

Present or absent *Present*

Stoppage, \$ *100* for

Due Gov't, \$ *100* for

Valuation of horse, \$ *100*

Valuation of horse equipments, \$ *100*

Remarks:

Book mark:

(358)

House

Copyist.

L

10 H. Art'y. U.S.C.T.

Louis Jannox

Co. F, 10 Reg't U. S. Col'd H. Art'y.

Appears on

Company Muster Roll

for Nov. and Dec, 1866

Present or absent Present

Stoppage, \$ 100 for

Due Gov't, \$ 100 for

Valuation of horse, \$ 100

Valuation of horse equipments, \$ 100

Remarks:

Book mark:

Horse

F

10 H. Art'y. U.S.C.T.

Louis Farnox

Plt, Co F, 10 Reg't U. S. Col'd H. Art'y.

Appears on Co. Muster-out Roll, dated
Baton Rouge La, Feb 22, 1867.

Muster-out to date Feb. 22, 1867.

Last paid to Dec. 31, 1866.

Clothing account:

Last settled _____, 186 ; drawn since \$ _____ 100

Due soldier \$ 51 ⁷⁰ / 100; due U. S. \$ _____ 100

Am't for cloth'g in kind or money adv'd \$ _____ 100

Due U. S. for arms, equipments, &c., \$ 6 ⁰⁷ / 100

Bounty paid \$ _____ 100; due \$ _____ 100

Remarks: Bounty under act of
July 26/66. 100- Bounty
under act of July 28/66
100. Joined at original
organization

Book mark : _____

House

(361)

Copyist.

077.
Fargo Forrest

Co. F, 10 U.S. Cold Lg. Arty

Private

Private

REFERENCE ENVELOPE.

Cards filed with

Fargo Morris

true name of soldier.

Fargo. Justilian

Co G, 10 U.S. Col'd H. Art'y.

Private

Private

CARD NUMBERS.

1	5507126	26
2	5507409	27
3	5507557	28
4	5507782	29
5	5509506	30
6		31
7		32
8		33
9		34
10		35
11		36
12		37
13		38
14		39
15		40
16		41
17		42
18		43
19		44
20		45
21		46
22		47
23		48
24		49
25		50

Book Mark:

See also

P. 138032 P. 090

P. 899097 P. O. mtm

Rep 376637-

Wm. H. Kew

1016 Art 7

U. S. C. T.

Justinian Furgo

Appears with rank of *Privet* on

Muster and Descriptive Roll of a Detachment of U. S. Vols. forwarded

organized as Co G
~~for the~~ *10th* Reg't U. S. Col'd *10th Art*, Roll dated
New Orleans La, Sept 20, 1864.

Where born *St James La*

Age *34* y'rs; occupation *Labourer*

When enlisted *Sept 20*, 1864.

Where enlisted *New Orleans La*

For what period enlisted *3* years.

Eyes *Brown*; hair *Black*

Complexion *Brown*; height *5 ft. 9 in.*

When mustered in *Sept 20*, 1864.

Where mustered in *New Orleans La*

Bounty paid \$ *100*; due \$ *100*

Where credited *to New Orleans La*

Company to which assigned *G.*

Remarks:

Book mark:

E. B. Thompson

A

10 H. Art'y. U.S.C.T.

Justillian Fargo
Sgt, Co. G, 10 Reg't U. S. Col'd H. Art'y.

Appears on

Company Muster Roll

for Sept & Oct, 1864.

Present or absent Present

Stoppage, \$ 100 for

Due Gov't, \$ 100 for

Valuation of horse, \$ 100

Valuation of horse equipments, \$ 100

Remarks:

Book mark:

⁵⁸
E. H. Brown

(358)

Copyist.

F

10 H. Art'y. U.S.C.T.

Justinian Fargo
Sgt., Co. G, 10 Reg't U. S. Col'd H. Art'y.

Appears on

Company Muster Roll

for *Nov & Dec*, 1864.

Present or absent

Stoppage, \$ 100 for

Due Gov't, \$ 100 for

Valuation of horse, \$ 100

Valuation of horse equipments, \$ 100

Remarks: *Absent without leave
since Dec 26/64*

Book mark:

E. H. Baird

J. | 10 H. Art'y. | U.S.C.T.

Custillian Fargo

Capt., Co. G, 10 Reg't U. S. Col'd H. Art'y.

Appears on

Company Muster Roll

for *Jan. & Feby*, 186*7*.

Present or absent

Stoppage, \$ 100 for

Due Gov't, \$ 100 for

Valuation of horse, \$ 100

Valuation of horse equipments, \$ 100

Remarks: *Deserled from*
Reg'ty Depot U.S.C.T.
No. 1st Dec 26/67. Due
U.S. for Advance
carried away \$22¹⁰

Book mark:

F. E. Porter

J | 10 H. Art'y. | U.S.C.T.

Instillian Jargo

Co. G, 10 Reg't U. S. Col'd H. Art'y.

Appears on **Co. Muster-out Roll**, dated
Baton Rouge, La, Feb 22, 1867.

Muster-out to date _____, 186 .

Last paid to _____, 186 .

Clothing account:

Last settled _____, 186 ; drawn since \$ _____ 100

Due soldier \$ _____ 100; due U. S. \$ _____ 100

Am't for cloth'g in kind or money adv'd \$ _____ 100

Due U. S. for arms, equipments, &c., \$ _____ 100

Bounty paid \$ _____ 100; due \$ _____ 100

Remarks: *Joined at org'l org'n,*
Rescued from Recruiting
depot, U.S.C.T. New Orleans,
La, Dec. 26, 1864

Book mark : _____

(361)

Mines

Copyist.

Sergeant Justice

Co. *G*, *10* Reg't *U S A*

Enclosures.

Bed Cards	Final Statements
Burial Records	Furloughs or L. of A.
Certs. of Dis. for Discharge	Med. Certificates
C. M. Charges	Med. Des. Lists
Descriptive Lists	Orders
Discharge Certificates	Pris. of War Record
Enlistment Papers <i>1</i>	Resignations

Other papers relating to—

Admission to Hosp'l	Furlough or L. of A.
Casualty Sheet	Med. Examination
Confinement	Misc. Information
Contracts	Pay or Clothing
Death or Effects	Personal Reports
Desertion	Rank
Discharge from Hosp'l	Transfer to Hosp'l
Discharge from Service	Transfer to V. R. C.
Duty	Transportation

DECLARATION OF RECRUIT.

I, Justilien Margo desiring to VOLUNTEER as a Soldier in the Army of the United States, for the term of THREE YEARS, Do Declare, That I am 34 years and 2 months of age; that I have never been discharged from the United States service on account of disability or by sentence of a court martial, or by order before the expiration of a term of enlistment; and I know of no impediment to my serving honestly and faithfully as a soldier for three years.

GIVEN at New Orleans the 20 day of Sept 1864

Witness: J. Horace McLean Justilien Margo

NOTE 1.—This blank will be used for both enlistments and re-enlistments—enlistment of veterans, &c., &c., in the volunteer service. They will be made out in duplicate in all cases—one to accompany the recruiting return of the superintendent (not the recruiting officer) to the Adjutant General, and one to accompany the accounts of the officer who pays bounty, &c. The Regiment and Company in which the soldier last served should be given on the back.

NOTE 2.—An enlistment holds to service. A muster-in must, in all cases, precede payment of pay, bounty, pension, &c. A muster-in roll must, in all cases, be filed in the Adjutant General's Office as evidence of muster-in. The mustering officer, commissary, or assistant commissary of musters, as the case may be, will countersign both enlistments as having mustered the soldier into the service of the United States before either of them is given to the disbursing officer.

No. 130

Justilien Margo
Volunteered at New Orleans, La.

Sept 20 1864
By J. H. McLean
1st Regiment of Louisiana

enlistment; last served in Company ()

1st Regt of Ala. Inf.

Discharged 18

Commissary not entitled to bounty

CONSENT IN CASE OF MINOR.

I, Do CERTIFY, That I am the of; that the said is years of age; and I do hereby freely give my CONSENT to his volunteering as a SOLDIER in the ARMY OF THE UNITED STATES for the period of THREE YEARS.

GIVEN at the day of

Witness:

VOLUNTEER ENLISTMENT.

STATE OF

TOWN OF

Louisiana

New Orleans



I, *Justellian Fargo* born in *St James*
in the State of *La.* aged *34* years,
and by occupation a *House Servant* Do HEREBY ACKNOWLEDGE to have
volunteered this *20th* day of *September* 1864,
to serve as a **Soldier** in the **Army of the United States of America**, for
the period of **THREE YEARS**, unless sooner discharged by proper authority:
Do also agree to accept such bounty, pay, rations, and clothing, as are, or may be,
established by law for volunteers. And I, *Justellian Fargo* do
solemnly swear, that I will bear true faith and allegiance to the **United States
of America**, and that I will serve them honestly and faithfully against all
their enemies or opposers whomsoever; and that I will observe and obey the
orders of the President of the United States, and the orders of the officers
appointed over me, according to the Rules and Articles of War.

Sworn and subscribed to, at *New Orleans*
this *20th* day of *Sept.* 1864,
BEFORE *J. M. Chamberlain*
Capt. A. C. W.

Justellian Fargo
Mark

I CERTIFY, ON HONOR, That I have carefully examined the above-named Volunteer, agreeably
to the General Regulations of the Army, and that, in my opinion, he is free from all bodily defects and
mental infirmity, which would in any way disqualify him from performing the duties of a soldier.

Don W. Martin
10th U. S. C. A. (H) EXAMINING SURGEON.

I CERTIFY, ON HONOR, That I have minutely inspected the Volunteer, *Justellian Fargo*
previously to his enlistment, and that he was entirely sober when enlisted, that, to the best of my
judgment and belief, he is of lawful age; and that, in accepting him as duly qualified to perform the
duties of an able-bodied soldier, I have strictly observed the Regulations which govern the recruiting
service. This soldier has *Brown* eyes, *Blk* hair, *Dark* complexion, is *5*
feet *9* inches high.

J. H. M. Quinn Rec
15th Regiment of *U. S. C. A. (H)* Volunteers,
RECRUITING OFFICER.

(A. G. O. No. 74 & 76.)

Mustered into the service of the United States, for three years or during the war, from date of enlistment, in Company *B*,
10th Regiment of *U. S. C. A. (H)* Volunteers, on the *20th* day of *Sept.*, 1864, at *New Orleans*.

J. M. Chamberlain
Capt. A. C. W.

George Morris

Co. C., 10 U.S. Col'd H. Art'y.

Private

Private

CARD NUMBERS.

1	5497584	26
2	5497828	27
3	5497991	28
4	5486576	29
5	5504707	30
6	5504812	31
7	5504862	32
8	5504966	33
9	5505103	34
10	5505235	35
11	5505328	36
12	5505430	37
13	5505534	38
14	5505644	39
15	5505768	40
16	5505922	41
17	5506069	42
18	5506209	43
19	5506355	44
20	5506474	45
21	5506585	46
22	5506803	47
23	5506900	48
24	R.P. 282,841.	49
25	R.P. 282,841.	50

Book Mark.

A33211 Recd. 1867
R.P. 282,841.

See also

1752528 2070
Rep 383209. (Pomam)
S1095990-PO aff
S1144497 Du aff
Rep 416609
S1224976 PO aff
S1234967. PO aff
S1700285 Audud

Wm P. McKee

4 | 10 H. Art'y. | U.S.C.T.

Morris Fergo

Pt, Co. C, 1 Reg't H. Art'y, Corps d'Afrique.*

Age *19* years.

Appears on

Company Muster-in Roll

of the organization named above. Roll dated

New Orleans La, Aug 17, 1863.

Muster-in to date *Aug 17, 1863.*

Joined for duty and enrolled:

When *July 1, 1863.*

Where *Camp Parapet La*

Period *3* years.

Valuation of horse, \$ 100

Valuation of horse equipments, \$ 100

Remarks:

* This organization subsequently became Co. C, 10 Reg't U. S. Colored Heavy Artillery.

Book mark: *R.I. 282841.*

(356)

W. J. ...

Copyist.

Mcarris *Yargo*
Pt, Co, C, 1 Reg't La. Art'y Native Guards.*

Appears on

Company Muster Roll

for *Aug 11th to 31st*, 186*3*

Present or absent *Present*

Stoppage, \$ *100* for

Due Gov't, \$ *100* for

Valuation of horse, \$ *100*

Valuation of horse equipments, \$ *100*

Remarks :

*This organization subsequently became Co. C, 10 Reg't U. S. Col'd Heavy Artillery.

Book mark :

Yargo

71 | 10 H. Art'y. | U.S.C.T.

Morris *Yingo*
Pvt, Co, C, -1 Reg't La. Art'y Native Guards.*

Appears on

Company Muster Roll

for *Sep 9 Oct*, 1863.

Present or absent *Present*

Stoppage, \$ *100* for

Due Gov't, \$ *100* for

Valuation of horse, \$ *100*

Valuation of horse equipments, \$ *100*

Remarks:

*Not home in subsequent
muster Co.*

*This organization subsequently became Co. C, 10 Reg't U. S. Col'd Heavy Artillery.

Book mark:

F | 10 H. Art'y. | U.S.C.T.

True name, Morris Fargo
Forrest Fargo

Appears with rank of _____ on _____

**Muster and Descriptive Roll of a Detach-
ment of U. S. Vols. forwarded**

(H. A. C. & A.)
for the 10 Reg't M. S. C. H. A. Roll dated

New Orleans La, Mch. 6, 1864.

Where born S James La

Age 21 y'rs; occupation Farmer

When enlisted Feby 27, 1864.

Where enlisted New Orleans

For what period enlisted 3 years.

Eyes Black; hair Black

Complexion Ok; height 5 ft. 7 1/2 in.

When mustered in Mch. 6, 1864.

Where mustered in New Orleans

Bounty paid \$ 100; due \$ 100

Where credited _____

Company to which assigned F

Remarks: _____

Book mark: R & P 282841.

(339)

Galligan

Copyist.

F | 10 H. Art'y. | U.S.C.T.

True name, **Morris Fargo**
Forrest Fargo

Pat, Co. *F*, 7 Reg't U. S. Col'd H. Art'y.*

Appears on

Company Muster-in and Descriptive Roll

of the organization named above. Roll dated

New Orleans La, *Aug 19*, 1864.

Where born *St James La*

Age *21* y'rs; occupation *Farmer*

When enlisted *Feb 27*, 1864.

Where enlisted *New Orleans La*

For what period enlisted *3* years.

Eyes *Blk*; hair *Black*

Complexion *Dark*; height *5* ft. *3½* in.

When mustered in *Nov 6*, 1864.

Where mustered in *New Orleans La*

Bounty paid \$ *100*; due \$ *100*

Where credited *1st Euret Dist La*

Company to which assigned

Remarks:

* This organization subsequently became Co. *F*, 10 Reg't U. S. Colored Heavy Artillery.

Book mark:

Rosenbaum

(356d)

Copyist.

F | 10 H. Art'y. | U.S.C.T.

True name *Morris Fargo*
Forest Fargo

Pol, Co. *F*, 7 Reg't U. S. Col'd H. Art'y.*

Appears on

Company Muster Roll

for *Enrolment to April 30*, 1864.

Present or absent *Present*

Stoppage, \$ 100 for

Due Gov't, \$ 100 for

Valuation of horse, \$ 100

Valuation of horse equipments, \$ 100

Remarks:

* This organization subsequently became Co. *F*, 10 Reg't U. S. Colored Heavy Artillery.

Book mark: -----

Roseclaw

F | 10 H. Art'y. | U.S.C.T.

True name, Morris Fargo
Forest Fargo

Pat, Co. *F*, 7 Reg't U. S. Col'd H. Art'y.*

Appears on

Company Muster Roll

for *May & June*, 1864.

Present or absent *Present*

Stoppage, \$ 100 for

Due Gov't, \$ 100 for

Valuation of horse, \$ 100

Valuation of horse equipments, \$ 100

Remarks:

* This organization subsequently became Co. *F*, 10 Reg't U. S. Colored Heavy Artillery.

Book mark:

(358)

Rosenbaum
Copyist.

F | 10 H. Art'y. | U.S.C.T.

True name, **Morris Fargo**
Forrest Fargo

Pvt., Co. F, 10 Reg't U. S. Col'd H. Art'y.

Appears on

Company Muster Roll

for *July & August*, 18*64*.

Present or absent *Present*

Stoppage, \$.....*100* for

Due Gov't, \$.....*100* for

Valuation of horse, \$.....*100*

Valuation of horse equipments, \$.....*100*

Remarks:.....
.....
.....
.....
.....
.....
.....
.....
.....
.....

Book mark:.....
.....

Rosenbaum

7

10 H. Art'y. U.S.C.T.

True name, Morris Fargo
Forrest Fargo

Plt, Co. F, 10 Reg't U. S. Col'd H. Art'y.

Appears on

Company Muster Roll

for *Sept & Oct*, 1864.

Present or absent *Present*

Stoppage, \$ *100* for

Due Gov't, \$ *100* for

Valuation of horse, \$ *100*

Valuation of horse equipments, \$ *100*

Remarks:

Book mark:

Rosenbaum
Copyist.

7 | 10 H. Art'y. | U.S.C.T.

True name, Morris Fargo
Forrest Fargo

Pol-, Co. F, 10 Reg't U. S. Col'd H. Art'y.

Appears on

Company Muster Roll

for *Nov & Dec*, 1864.

Present or absent *Present*

Stoppage, \$ *100* for

Due Gov't, \$ *100* for

Valuation of horse, \$ *100*

Valuation of horse equipments, \$ *100*

Remarks:

Book mark: -----

Rosenbaum

J

10 H. Art'y. U.S.C.T.

True name, Morris Fargo
Forrest Fargo

Co. F, 10 Reg't U. S. Col'd H. Art'y.

Appears on

Company Muster Roll

for Jan & Feb, 1865.

Present or absent Present

Stoppage, \$ 100 for

Due Gov't, \$ 100 for

Valuation of horse, \$ 100

Valuation of horse equipments, \$ 100

Remarks: Difference between
\$7 per mo and authorized
pay due from enlistment
to June 30/64

Book mark:

B. G. Wardon

J

10 H. Art'y. U.S.C.T.

True name, *Morris Fargo*
Forrest Fargo
Priv, Co. F, 10 Reg't U. S. Col'd H. Art'y.

Appears on

Company Muster Roll
for *Mar & Apr*, 1865.

Present or absent *Present*

Stoppage, \$ *100* for

Due Gov't, \$ *100* for

Valuation of horse, \$ *100*

Valuation of horse equipments, \$ *100*

Remarks:

Book mark:

B Y Masdon

(358)

Copyist.

Jl

10 H. Art'y. U.S.C.T.

True name, Morris Fargo

Forrest Fargo

Co. F, 10 Reg't U. S. Col'd H. Art'y.

Appears on

Company Muster Roll

for May & June, 1865.

Present or absent Present

Stoppage, \$ 100 for

Due Gov't, \$ 100 for

Valuation of horse, \$ 100

Valuation of horse equipments, \$ 100

Remarks: Due U.S. for Camp & Garrison Equipage \$ 65

Book mark:

J. G. Wasdon

J | 10 H. Art'y. | U.S.C.T.

True name, Morris Fargo
J. Ernest Fargo

Priv, Co. F, 10 Reg't U.S. Col'd H. Art'y.

Appears on

Company Muster Roll

for dated Aug 31, 1865.

Present or absent Present

Stoppage, \$ 100 for

Due Gov't, \$ 100 for

Valuation of horse, \$ 100

Valuation of horse equipments, \$ 100

Remarks:

Book mark:

R. G. Masdon

J | 10 H. Art'y. | U.S.C.T.

True name, Morris Fargo
Forrest Fargo

Priv, Co. F, 10 Reg't U.S. Col'd H. Art'y.

Appears on

Company Muster Roll

for dated Aug 31, 1865.

Present or absent Present

Stoppage, \$ 100 for

Due Gov't, \$ 100 for

Valuation of horse, \$ 100

Valuation of horse equipments, \$ 100

Remarks:

Book mark:

R. G. Masdon

J

10 H. Art'y. U.S.C.T.

True name, J Morris Fargo
J. Morris Fargo

Co. F, 10 Reg't U.S. Col'd H. Art'y.

Appears on

Company Muster Roll

for Sept & Oct, 1865.

Present or absent Present

Stoppage, \$ 100 for

Due Gov't, \$ 100 for

Valuation of horse, \$ 100

Valuation of horse equipments, \$ 100

Remarks:

Book mark:

B. G. Masdon

(358)

Copyst.

F

10 H. Art'y. U.S.C.T.

True name, Morris Fargo
Forrest Fargo.

Pat., Co. F, 10 Reg't U. S. Col'd H. Art'y.

Appears on

Company Muster Roll

for Nov & Dec, 1865.

Present or absent Present.

Stoppage, \$ 0 ⁰⁸/₁₀₀ for ordnance.

Due Gov't, \$ 100 for

Valuation of horse, \$ 100

Valuation of horse equipments, \$ 100

Remarks:

Book mark:

(358)

Copyist.

F. | 10 H. Art'y. | **U.S.C.T.**

True name, **Morris Fargo**
Forrest Fargo.

Plt., Co. F, 10 Reg't U. S. Col'd H. Art'y.

Appears on

Company Muster Roll

for *Jan'y. & Feby.*, 1866.

Present or absent *Present.*

Stoppage, \$ 100 for

Due Gov't, \$ 100 for

Valuation of horse, \$ 100

Valuation of horse equipments, \$ 100

Remarks:

Book mark: *1000000*

(858)

ash.
Copyist.

F. | 10 H. Art'y. | U.S.C.T.

True name, **Morris Fargo**
Morris Fargo

Priv., Co. F, 10 Reg't U. S. Col'd H. Art'y.

Appears on

Company Muster Roll

for *Mar & April*, 186*6*.

Present or absent *Present*

Stoppage, \$ *100* for

Due Gov't, \$ *100* for

Valuation of horse, \$ *100*

Valuation of horse equipments, \$ *100*

Remarks: *Stop for loss of
canteen 65c*

Book mark:

ash
Copyist.

F

10 H. Art'y. U.S.C.T.

True name, **Morris Fargo**
Forest Fargo

Pvt., Co. F, 10 Reg't U. S. Col'd H. Art'y.

Appears on

Company Muster Roll

for *May & June*, 1866.

Present or absent *Present*

Stoppage, \$ 100 for

Due Gov't, \$ 100 for

Valuation of horse, \$ 100

Valuation of horse equipments, \$ 100

Remarks:

Book mark:

(358)

C. S. H.
Copyist.

F. | 10 H. Art'y. | U.S.C.T.

True name, **Morris Fargo**
Forrest Fargo,
Pvt., Co. F, 10 Reg't U. S. Col'd H. Art'y.

Appears on

Company Muster Roll

for *July & Aug.*, 186*6*.

Present or absent *Present.*

Stoppage, \$ 100 for

Due Gov't, \$ 100 for

Valuation of horse, \$ 100

Valuation of horse equipments, \$ 100

Remarks:

Book mark: -----

Asst.
Copyst.

F | 10 H. Art'y. | U.S.C.T.

True name, *Morris Fargo*
Fornst Fargo

Pr, Co. F, 10 Reg't U. S. Col'd H. Art'y.

Appears on

Company Muster Roll

for *Sept. and Oct*, 186*6*

Present or absent *Present*

Stoppage, \$ *100* for

Due Gov't, \$ *100* for

Valuation of horse, \$ *100*

Valuation of horse equipments, \$ *100*

Remarks:

Book mark: -----

House

L

10 H. Art'y. U.S.C.T.

True name, Morris Fargo
Forest Fargo

Plt, Co. F, 10 Reg't U. S. Col'd H. Art'y.

Appears on

Company Muster Roll

for *Nov. and Dec*, 186*6*

Present or absent *Present*

Stoppage, \$ *100* for

Due Gov't, \$ *100* for

Valuation of horse, \$ *100*

Valuation of horse equipments, \$ *100*

Remarks:

Book mark: -----

House

F | 10 H. Art'y. | U.S.C.T.

True name, **Morris Fargo**
Fornst Fargo

Pvt, Co. *F*, 10 Reg't U. S. Col'd H. Art'y.

Appears on **Co. Muster-out Roll**, dated
Baton Rouge La Feb 22, 1867.

Muster-out to date *Feb 22*, 1867.

Last paid to *Dec 31*, 1866.

Clothing account:

Last settled....., 186 ; drawn since \$.....100

Due soldier \$ *23 83* / 100; due U. S. \$.....100

Am't for cloth'g in kind or money adv'd \$.....100

Due U. S. for arms, equipments, &c., \$ *16* / 100

Bounty paid \$.....100; due \$.....100

Remarks: *Bounty under act of July 26/66 300. Joined at original organization*

Book mark: *1273 1881*

(361)

House

Copyist.

F. | *10 H. a.* | *U.S.C.P.*

True name, *Morris Fargo*
Forest Fargo,

, Co. *F*, *10* Reg't *U.S.C.H.a.*

NOTATION.

Book mark: *R. and P. 282,841.*

Record and Pension Office,

WAR DEPARTMENT,

Washington, June 8, 1896

It has been determined from evidence before this Department that the true name of this soldier is

Morris Fargo

and a discharge certificate as of that name was furnished

to *his attorney*

on *June 8*, 189*6*, upon

application and proof of identity, under the provisions of the act of Congress, approved April 14, 1890.

The original discharge certificate of the soldier has been cancelled and filed in this office.

Estabrook,

(439)

Copyist.

F 10 N. A. U. S. P. I.

Morris Fargo

, Co. C, 1 Reg't N. A. P. I.

NOTATION.

Book mark:

R. & P. 282841

Record and Pension Office,

WAR DEPARTMENT,

Washington, Nov. 27, 1896.

It has this day (Nov. 27, 1896)

been determined by this Department from records on file that the enrollment of Forrest Fargo in Co. F, 10 U. S. P. I. A., Feb. 27, 1864, is void and of no effect because of his previous enlistment July 1, 1863, in Co. C, 1 N. A. P. I. A., and muster into service Aug. 17, 1863, under the name Morris Fargo, and that from Nov. 7, 1863, until Feb. 24, 1864, when he was assigned to Co. F, 10 U. S. P. I. A., he was undergoing punishment without

A. G. N.

loss of pay, and al-
lowances at Post Hudson,
La., pursuant to par. 7,
A.O. 278 Dept. of the
Gulf Nov. 7, 1863.

Wm. O. Ochs

Co. **10 U.S. Col'd H. Art'y**

Captain

Captain

CARD NUMBERS.

1	5488776	26
2		27
3		28
4		29
5		30
6		31
7		32
8		33
9		34
10		35
11		36
12		37
13		38
14		39
15		40
16		41
17		42
18		43
19		44
20		45
21		46
22		47
23		48
24		49
25		50

Book Mark:

See also *77 U.S. C. Inf*

F | 10 Art | U.S.C.T.

Octavius L. Faniola

Capt, Co., 10 Reg't U. S. Col'd Art,

Appears on

M. and D. Roll of Men Transferred

to the organization named above,

from 77 Regt USC Inf.

Roll dated Oct 1, 1865.

When enlisted Dec 2, 1863.

Period for which enlisted 3 years.

When mustered in Jan 2, 1864.

Present or absent

Company to which assigned

Remarks: Honorably discharged
and mustered out to
accept promotion
February 29, 1864

name not taken upon
muster rolls of Regt

Book mark :

(342)

J. W. Leman

Copist

853

Farrell James

Co C, 10 U.S. Col'd H. Art'y.

Private

Private

CARD NUMBERS.

1	5497714	26
2	5498118	27
3	5498221	28
4	5498318	29
5	5498416	30
6	5498526	31
7	5498667	32
8	5498886	33
9	5498942	34
10	5499083	35
11	5499219	36
12	5499355	37
13	5499491	38
14	5499627	39
15	5499763	40
16	5499898	41
17	5500030	42
18	5500166	43
19	5500295	44
20	5500452	45
21	5490148	46
22		47
23		48
24		49
25		50

Book Mark:

See also

7 | 10 H. Art'y. | U.S.C.T.

James Fairrell
Rt. Co. C, 1 Reg't La. Art'y, Native Guards.*

Age *24* years.

Appears on

Company Muster-in Roll

of the organization named above. Roll dated

New Orleans La, Nov 4, 1863.

Muster-in to date *Dec 31, 1863.*

Joined for duty and enrolled:

When *Nov 5, 1863.*

Where *Bayou Lafourche La*

Period *3* years.

Valuation of horse, \$ *100*

Valuation of horse equipments, \$ *100*

Remarks:

* This organization subsequently became Co. C, 10 Reg't U. S. Col'd Heavy Artillery.

Book mark:

(356)

W. J. ...

Copyist.

James W. Farrell
Pvt, Co. *C*, 1 Reg't H. Art'y, Corps d'Afrique.*

Appears on

Company Muster Roll

for *Feb 4th to 29th*, 186*1*.

Present or absent *Present*

Stoppage, \$ *100* for

Due Gov't, \$ *100* for

Valuation of horse, \$ *100*

Valuation of horse equipments, \$ *100*

Remarks:

*This organization subsequently became Co. *C*, 10 Reg't U. S. Colored Heavy Artillery.

Book mark:

W. J. ...
Copyist.

J

10 H. Art'y.

U.S.C.T.

James Farrell
Pvt, Co. *C*, 7 Reg't U. S. Col'd H. Art'y.*

Appears on

Company Muster Roll

for *Mich r ape*, 186 *4*.

Present or absent *Present*

Stoppage, \$ *100* for

Due Gov't, \$ *100* for

Valuation of horse, \$ *100*

Valuation of horse equipments, \$ *100*

Remarks:

* This organization subsequently became Co. *10*, 10 Reg't U. S. Colored Heavy Artillery.

Book mark: -----

(358)

J. Anderson
Copyist.

F

10 H. Art'y.

U.S.C.T.

James Farrell

P.V., Co. *C*, 7 Reg't U. S. Col'd H. Art'y.*

Appears on

Company Muster Roll

for *May & June*, 1864.

Present or absent *Present*

Stoppage, \$ 100 for

Due Gov't, \$ 100 for

Valuation of horse, \$ 100

Valuation of horse equipments, \$ 100

Remarks:

* This organization subsequently became Co. , 10 Reg't U. S. Colored Heavy Artillery.

Book mark:

(358)

J. Hubbard
Copyist.

J

10 H. Art'y.

U.S.C.T.

James Farrell

Priv., Co. *C*, 7 Reg't U. S. Col'd H. Art'y.*

Appears on

Company Muster Roll

for *July & Aug*, 186 *4*

Present or absent *Present*

Stoppage, \$ *100* for

Due Gov't, \$ *100* for

Valuation of horse, \$ *100*

Valuation of horse equipments, \$ *100*

Remarks:

* This organization subsequently became Co. *10*, 10 Reg't U. S. Colored Heavy Artillery.

Book mark:

(358)

J. Henderson
Copyist.

F

10 H. Art'y. U.S.C.T.

James Farrell

Pot, Co. C, 10 Reg't U. S. Col'd H. Art'y.

Appears on

Company Muster Roll

for *Sept & Oct*, 186*4*.

Present or absent *Present*

Stoppage, \$ *100* for

Due Gov't, \$ *100* for

Valuation of horse, \$ *100*

Valuation of horse equipments, \$ *100*

Remarks:

Book mark:

(358)

J. Henderson

Copyist.

J | 10 H. Art'y. | U.S.C.T.

James Farrell
Plt, Co. C, 10 Reg't U. S. Col'd H. Art'y.

Appears on

Company Muster Roll

for *Nov & Dec*, 186*4*.

Present or absent *Present*

Stoppage, \$ *100* for

Due Gov't, \$ *100* for

Valuation of horse, \$ *100*

Valuation of horse equipments, \$ *100*

Remarks:

Book mark: *358*

(358)

J. Underwood
Copyist.

F

10 H. Art'y. U.S.C.T.

James Farrell
Plt, Co. C, 10 Reg't U. S. Col'd H. Art'y.

Appears on

Company Muster Roll

for *Jan + Feb*, 186 *✓*

Present or absent *Present*

Stoppage, \$ *100* for

Due Gov't, \$ *100* for

Valuation of horse, \$ *100*

Valuation of horse equipments, \$ *100*

Remarks: *Daily duty in ord
Dept.*

Book mark:

Ballade

F

10 H. Art'y. U.S.C.T.

James Farrell
Private, Co. C, 10 Reg't U. S. Col'd H. Art'y.

Appears on

Company Muster Roll

for Month & Day, 1865.

Present or absent Present

Stoppage, \$ 100 for

Due Gov't, \$ 100 for

Valuation of horse, \$ 100

Valuation of horse equipments, \$ 100

Remarks: Daily duty
Ord Dept

Book mark:

Lamb

F

10 H. Art'y. U.S.C.T.

James Farrell
Pvt., Co. C, 10 Reg't U. S. Col'd H. Art'y.

Appears on

Company Muster Roll

for May + June, 1865.

Present or absent Present

Stoppage, \$ 100 for

Due Gov't, \$ 100 for

Valuation of horse, \$ 100

Valuation of horse equipments, \$ 100

Remarks: Daily Duty in
Ordnance Dept

Book mark:

(358)

W. H. Hall

Copyist.

F

10 H. Art'y. U.S.C.T.

James Farrell
Capt, Co. C, 10 Reg't U. S. Col'd H. Art'y.

Appears on

Company Muster Roll

for *July 1865*, 1865.

Present or absent *Present*

Stoppage, \$ 100 for

Due Gov't, \$ 100 for

Valuation of horse, \$ 100

Valuation of horse equipments, \$ 100

Remarks: *Daily duty in Ord
Dept*

Book mark:

Ballade

F

10 H. Art'y. U.S.C.T.

James Farrell
Plt, Co. C, 10 Reg't U. S. Col'd H. Art'y.

Appears on

Company Muster Roll

for *Sept & Oct*, 1865.

Present or absent *Present*

Stoppage, \$ *100* for

Due Gov't, \$ *100* for

Valuation of horse, \$ *100*

Valuation of horse equipments, \$ *100*

Remarks: *Daily duty in Ord*
Dept.

Book mark:

Sailade

J

10 H. Art'y. U.S.C.T.

James Farrell

Rob., Co. C, 10 Reg't U. S. Col'd H. Art'y.

Appears on

Company Muster Roll

for *Nov. & Dec.*, 186*5*.

Present or absent *Present*

Stoppage, \$ *100* for

Due Gov't, \$ *100* for

Valuation of horse, \$ *100*

Valuation of horse equipments, \$ *100*

Remarks: *On daily duty in
Ord. Dept.*

Book mark:

A. J. Robbins

(358)

Copyist.

J

10 H. Art'y. U.S.C.T.

James Farrell
Priv., Co. C, 10 Reg't U. S. Col'd H. Art'y.

Appears on

Company Muster Roll

for *Jan & Feb*, 186*6*.

Present or absent *Present*

Stoppage, \$ 100 for

Due Gov't, \$ 100 for

Valuation of horse, \$ 100

Valuation of horse equipments, \$ 100

Remarks:

Book mark: -----

(358)

A. J. Robbins

Copyist.

James Farrell

Pvt., Co. C, 10 Reg't U. S. Col'd H. Art'y.

Appears on

Company Muster Roll

for *Nov. 3rd* to *Apr.*, 186*6*.

Present or absent *Present*

Stoppage, \$ *100* for

Due Gov't, \$ *100* for

Valuation of horse, \$ *100*

Valuation of horse equipments, \$ *100*

Remarks: *Daily Duty in ordnance dept.*

Book mark :

A. J. Robbins

(358)

Copyist.

F

10 H. Art'y. U.S.C.T.

James Farrell

Co. C, 10 Reg't U. S. Col'd H. Art'y.

Appears on

Company Muster Roll

for May 2d June, 1864.

Present or absent Present

Stoppage, \$ 100 for

Due Gov't, \$ 100 for

Valuation of horse, \$ 100

Valuation of horse equipments, \$ 100

Remarks: Daily Duty in Ordnance Department

Book mark:

A. J. Robbins

(358)

Copyist.

F

10 H. Art'y.

U.S.C.T.

James Farrell

Priv., Co. C, 10 Reg't U. S. Col'd H. Art'y.

Appears on

Company Muster Roll

for *July & Aug.*, 186*6*.

Present or absent *Present*

Stoppage, \$ *100* for

Due Gov't, \$ *100* for

Valuation of horse, \$ *100*

Valuation of horse equipments, \$ *100*

Remarks: *daily duty in Ord.*
Sept.

Book mark:

A. J. Robbins

(358)

Copyist.

F

10 H. Art'y. U.S.C.T.

James Farrell

Priv, Co. C, 10 Reg't U. S. Col'd H. Art'y.

Appears on

Company Muster Roll

for *Sept & Oct*, 186*6*.

Present or absent *Present*

Stoppage, \$ *100* for

Due Gov't, \$ *100* for

Valuation of horse, \$ *100*

Valuation of horse equipments, \$ *100*

Remarks:

Book mark:

Hanning

F | 10 H. Art'y. | U.S.C.T.

James Farrell
Pr, Co. C, 10 Reg't U. S. Col'd H. Art'y.

Appears on

Company Muster Roll

for *Nov 20*, 186*6*.

Present or absent *Present*

Stoppage, \$ *100* for

Due Gov't, \$ *100* for

Valuation of horse, \$ *100*

Valuation of horse equipments, \$ *100*

Remarks: *Reduced to Rank, Sec. 28 66, and forfeit \$8 per sentence Field Officers Court*

Book mark:

(358)

Manning
Copyist.

7 10 Arty

U.S.C.T.

James Farrell

Priv., Co. G, 10 Reg't U. S. Col'd Arty

Appears on a

Detachment Muster-out Roll

of the organization named above. Roll dated

Baton Rouge, La, Feb. 3, 1867.

Muster-out to date Feb. 3, 1867.

Last paid to Dec. 31, 1866.

Clothing account:

Last settled _____, 1866 ; drawn since \$ _____ 100

Due soldier \$ $88 \frac{84}{100}$; due U. S. \$ $24 \frac{58}{100}$

Am't for cloth'g in kind or money adv'd \$ _____ 100

Due U. S. for arms, equipments, &c., \$ _____ $\frac{65}{100}$

Bounty paid \$ $100 \frac{00}{100}$ due \$ $100 \frac{00}{100}$

Remarks: *Joined orig. org. 1 H.A. Co. A.*

now 20 U.S.C.A. (104) - was pris. from

enrolment to Nov. 1. 1866 - then

Corp. to Dec. 28. 1866 - stop for

compass & baggage.

Book mark: _____

R. E. Wilson

(349)

Copyist.

F | 10 H. Art'y. | U.S.C.T.

James Farrell

Cpt, Co. *C*, 10 Reg't U. S. Col'd H. Art'y.

Appears on **Co. Muster-out Roll**, dated
Baton Rouge, La Feb 22, 1867.

Muster-out to date _____, 186 .

Last paid to _____, 186 .

Clothing account:

Last settled _____, 186 ; drawn since \$ _____ 100

Due soldier \$ _____ 100; due U. S. \$ _____ 100

Am't for cloth'g in kind or money adv'd \$ _____ 100

Due U. S. for arms, equipments, &c., \$ _____ 100

Bounty paid \$ _____ 100; due \$ _____ 100

Remarks: *Joined Orig Oru*
discharged Feb. 3. 1867,
by reason of expiration
of term of service

Book mark : _____

(361)

Hammond

Copyist.

Warrington, Alexander
Co. 2, 10 U.S. Col'd H. Art'y.

Private | *Private*

CARD NUMBERS.

1	5494177	26
2	5494330	27
3	5494495	28
4	5494656	29
5	5494811	30
6	5494964	31
7	5495120	32
8	5495276	33
9	5495429	34
10	5495579	35
11	5495719	36
12	5495873	37
13	5496020	38
14	5496173	39
15	5496325	40
16	5496473	41
17	5496618	42
18	5496762	43
19	5496921	44
20	5497103	45
21	5497410	46
22	5489650	47
23		48
24		49
25		50

Book Mark:

See also

F | 10 H. Art'y. | U.S.C.T.

Alexander Farrington
Pvt., 2 Battery, La. H. Art'y, Native Guards.*

Age *29* years.

Appears on

Company Muster-in Roll

of the organization named above. Roll dated
Camp Parapet
Carrollton, La., Feb. 9, 186 *3*.

Muster-in to date *Feb. 9*, 186 *3*.

Joined for duty and enrolled:

When *Jan'y 31st*, 186 *3*

Where *Camp Parapet nr. Carrollton, La*

Period *3* years.

Valuation of horse, \$.....*100*

Valuation of horse equipments, \$.....*100*

Remarks:.....
.....
.....

* This organization subsequently became Co. B, 10 Reg't U. S. Colored Heavy Artillery.

Book mark:.....
.....

Feaster

S | 10 H. Art'y. | U.S.C.T.

Alexander Farrington

Pvt., Co. B, 1 Reg't La. H. Art'y, Native Guards.*

Appears on

Company Muster Roll

for *from Enlistment to Feb. 28, 1863.*

Present or absent *Present*

Stoppage, \$ *100* for

Due Gov't, \$ *100* for

Valuation of horse, \$ *100*

Valuation of horse equipments, \$ *100*

Remarks: _____

*This organization subsequently became Co. B, 10 Reg't U. S. Col'd Heavy Artillery.

Book mark: _____

*H
P. Easter*

F

10 H. Art'y.

U.S.C.T.

Alexander Farrington

Pvt., Co. B, 1 Reg't La. H. Art'y, Native Guards.*

Appears on

Company Muster Roll

for *Mich. & Apl.*, 186*2*.

Present or absent *Present*

Stoppage, \$ *100* for

Due Gov't, \$ *100* for

Valuation of horse, \$ *100*

Valuation of horse equipments, \$ *100*

Remarks: _____

*This organization subsequently became Co. B, 10 Reg't U. S. Col'd Heavy Artillery.

Book mark: _____

Greaster

F

10 H. Art'y.

U.S.C.T.

Alexander Farrington

Pvt, Co. B, 1 Reg't La. H. Art'y, Native Guards.*

Appears on

Company Muster Roll

for *May & June*, 186*3*.

Present or absent *Present*

Stoppage, \$ *100* for

Due Gov't, \$ *100* for

Valuation of horse, \$ *100*

Valuation of horse equipments, \$ *100*

Remarks:

*This organization subsequently became Co. B, 10 Reg't U. S. Col'd Heavy Artillery.

Book mark:

Feaster

F

10 H. Art'y.

U.S.C.T.

Alexander Farrington

Plt, Co. B, 1 Reg't La. H. Art'y, Native Guards.*

Appears on

Company Muster Roll

for *July & Aug.*, 186 *F*.

Present or absent *Present*

Stoppage, \$ *100* for

Due Gov't, \$ *100* for

Valuation of horse, \$ *100*

Valuation of horse equipments, \$ *100*

Remarks: _____

*This organization subsequently became Co. B, 10 Reg't U. S. Col'd Heavy Artillery.

Book mark: _____

Heaster

F | 10 H. Art'y. | U.S.C.T.

Alexander Farrington
Pr., Co. B, 1 Reg't La. H. Art'y, Native Guards.*

Appears on

Company Muster Roll

for *Sept. & Oct.*, 186*3*.

Present or absent *Present*

Stoppage, \$ *100* for

Due Gov't, \$ *100* for

Valuation of horse, \$ *100*

Valuation of horse equipments, \$ *100*

Remarks: _____

*This organization subsequently became Co. B, 10 Reg't U. S. Col'd Heavy Artillery.

Book mark: _____

Foster

F | 10 H. Art'y. | U.S.C.T.

Alexander Farrington

P, Co. *B*, 1 Reg't H. Art'y, Corps d'Afrique.*

Appears on

Company Muster Roll

for *Nov. & Dec.*, 186*3*

Present or absent *Present*

Stoppage, \$ *100* for

Due Gov't, \$ *100* for

Valuation of horse, \$ *100*

Valuation of horse equipments, \$ *100*

Remarks:

*This organization subsequently became Co. *10* Reg't U. S. Colored Heavy Artillery.

Book mark:

(358)

Reif

Copyist.

F

10 H. Art'y. U.S.C.T.

Alexander Farrington

Pvt, Co. *B*, 1 Reg't H. Art'y, Corps d'Afrique.*

Appears on

Company Muster Roll

for *Jan, & Feb*, 186*4*.

Present or absent *Present*

Stoppage, \$ *100* for

Due Gov't, \$ *100* for

Valuation of horse, \$ *100*

Valuation of horse equipments, \$ *100*

Remarks:

*This organization subsequently became Co. *10* Reg't U. S. Colored Heavy Artillery.

Book mark:

(358)

Reif

Copyist.

F | 10 H. Art'y. | U.S.C.T.

Alexander Parvingdon

A, Co. *D*, 7 Reg't U. S. Col'd H. Art'y.*

Appears on

Company Muster Roll

for *Mar & Apr*, 1864.

Present or absent *Present*

Stoppage, \$ 100 for

Due Gov't, \$ 100 for

Valuation of horse, \$ 100

Valuation of horse equipments, \$ 100

Remarks:

* This organization subsequently became Co *A*, 10 Reg't U. S. Colored Heavy Artillery.

Book mark:

J. W. Richardson
Copyist.

D | 10 H. Art'y. | U.S.C.T.

Alexander Farrington

Pt, Co. *B*, 7 Reg't U. S. Col'd H. Art'y.*

Appears on

Company Muster Roll

for *May & June, 1864.*

Present or absent *Present*

Stoppage, \$ *100* for

Due Gov't, \$ *100* for

Valuation of horse, \$ *100*

Valuation of horse equipments, \$ *100*

Remarks:

* This organization subsequently became Co. , 10 Reg't U. S. Colored Heavy Artillery.

Book mark:

P. R. G.

F

10 H. Art'y. U.S.C.T.

Alexander Farningdon

Pt, Co. B, 10 Reg't U. S. Corp'd H. Art'y.

Appears on

Company Muster Roll

for *July & Aug*, 186*4*

Present or absent *Present*

Stoppage, \$ *100* for

Due Gov't, \$ *100* for

Valuation of horse, \$ *100*

Valuation of horse equipments, \$ *100*

Remarks:

Book mark:

(358)

J. W. Richardson
Copyist.

F

10 H. Art'y. U.S.C.T.

Alexander Harrington

A, Co. B, 10 Reg't U. S. Col'd H. Art'y.

Appears on

Company Muster Roll

for *Sept & Oct*, 186*4*.

Present or absent *Present*

Stoppage, \$ *100* for

Due Gov't, \$ *100* for

Valuation of horse, \$ *100*

Valuation of horse equipments, \$ *100*

Remarks:

Book mark:

J. H. Richardson

(358)

Copyist.

F.

10 H. Art'y. U.S.C.T.

Alex Farrington
Plt., Co. B, 10 Reg't U. S. Col'd H. Art'y.

Appears on

Company Muster Roll

for *Nov & Dec*, 186*7*.

Present or absent *Present*.

Stoppage, \$ *100* for

Due Gov't, \$ *100* for

Valuation of horse, \$ *100*

Valuation of horse equipments, \$ *100*

Remarks:

Book mark:

(358)

Gormin

Copyist.

F

10 H. Art'y. | U.S.C.T.

Alexander Farrington
Plt., Co. B, 10 Reg't U. S. Col'd H. Art'y.

Appears on

Company Muster Roll

for *Jan & Feb*, 186*5*.

Present or absent *Present*

Stoppage, \$.....*100* for

Due Gov't, \$.....*100* for

Valuation of horse, \$.....*100*

Valuation of horse equipments, \$.....*100*

Remarks: *Due soldier's unac-*
counted pay from Jan 1
1864 to May 1 1864 \$6⁰⁰
per month May & June
\$9⁰⁰ per month
Due US for Ord 23^{ct}.

Book mark:

(358)

Josner
Copyist.

5

10 H. Art'y. U.S.C.T.

Alexander Farrington

Pvt., Co. B, 10 Reg't U. S. Col'd H. Art'y.

Appears on

Company Muster Roll

for Mar & Apr, 1865.

Present or absent Present.

Stoppage, \$ 100 for

Due Gov't, \$ 100 for

Valuation of horse, \$ 100

Valuation of horse equipments, \$ 100

Remarks:

Book mark:

(358)

Jornis.

Copyist.

F.

10 H. Art'y.

U.S.C.T.

Alexander Farrington

Sgt., Co. B, 10 Reg't U. S. Col'd H. Art'y.

Appears on

Company Muster Roll

for May & June, 1865.

Present or absent Present

Stoppage, \$ 100 for

Due Gov't, \$ 100 for

Valuation of horse, \$ 100

Valuation of horse equipments, \$ 100

Remarks:

Book mark:

(358)

Jones

Copyist.

F

10 H. Art'y. U.S.C.T.

Alexander Farrington

Plt, Co. B, 10 Reg't U. S. Col'd H. Art'y.

Appears on

Company Muster Roll

for *July & Aug*, 186*5*.

Present or absent *Present*

Stoppage, \$ *100* for

Due Gov't, \$ *100* for

Valuation of horse, \$ *100*

Valuation of horse equipments, \$ *100*

Remarks:

.....
.....
.....
.....
.....
.....
.....
.....

Book mark:

(358)

Jones

Copyist.

Alexander Farrington

Plt., Co. B, 10 Reg't U. S. Col'd H. Art'y.

Appears on

Company Muster Roll

for Sep & Oct, 1865.

Present or absent Present

Stoppage, \$ 100 for

Due Gov't, \$ 100 for

Valuation of horse, \$ 100

Valuation of horse equipments, \$ 100

Remarks:

Book mark:

J. J. J. J.

F

10 H. Art'y. U.S.C.T.

Alexander Farrington

Plt

, Co. B, 10 Reg't U. S. Col'd H. Art'y.

Appears on

Company Muster Roll

for

Nov. & Dec., 1865

Present or absent

Present

Stoppage, \$

100 for

Due Gov't, \$

100 for

Valuation of horse, \$

100

Valuation of horse equipments, \$

100

Remarks:

due a.p. for ord.
, 24 lbs.

Book mark:

(358)

Reif

Copyist.

D

10 H. Art'y. U.S.C.T.

Alexander Farrington

Plt, Co. B, 10 Reg't U. S. Col'd H. Art'y.

Appears on

Company Muster Roll

for *July 1st to Feb. 1st*, 186*6*.

Present or absent

Stoppage, \$ 100 for

Due Gov't, \$ 100 for

Valuation of horse, \$ 100

Valuation of horse equipments, \$ 100

Remarks: *Mustd. out at M.O. Dec. 8 66 by reason of exp. of term of service*

Book mark: *7647 P.M.G. July 18 66*

(358)

Reif
Copyist.

F. | 10 Ne. a. | U.S.C.T.

Alexander Farrington
Priv., Co. B., 10 Reg't U. S. Col'd Ne. a.

Appears on a

Detachment Muster-out Roll

of the organization named above. Roll dated

New Orleans La., Feb. 8 1864⁺

Muster-out to date Feb. 8, 1864.

Last paid to June 30, 1865

Clothing account:

Last settled 186 ; drawn since \$ 100

Due soldier \$ 35⁵⁰/₁₀₀; due U. S. \$ 100

Am't for cloth'g in kind or money adv'd \$ 100

Due U. S. for arms, equipments, &c., \$ 100

Bounty paid \$ 100 due \$ 100

Remarks: *Joined at Origl. Orgn.
Shot for one Wiper & 2
Tompeions. Mustered
out by reason of Expe-
ration of term of service
+ Cert. of Mustg. Off. shows him N.C. Feb. 12/64*

Book mark:

+ added May 9, 93. 968

Hawling

J | 10 H. Art'y. | U.S.C.T.

Alexander Farrington
Priv, Co. *D*, 10 Reg't U. S. Col'd H. Art'y.

Appears on Co. Muster-out Roll, dated
Baton Rouge La. Feb, 1867.

Muster-out to date _____, 186 .

Last paid to _____, 186 .

Clothing account:

Last settled _____, 186 ; drawn since \$ _____ 100

Due soldier \$ _____ 100; due U. S. \$ _____ 100

Am't for cloth'g in kind or money adv'd \$ _____ 100

Due U. S. for arms, equipments, &c., \$ _____ 100

Bounty paid \$ _____ 100; due \$ _____ 100

Remarks: _____

Joined org. origin
Discharged Feb. 8/66
expiration term of
service.

Book mark: _____

(361)

Hodges
Copyist.

Farrington, Alexander

, Co. 10 Reg't USCHA

✓ Enclosures.

Bed Cards	Final Statements
Burial Records	Furloughs or L. of A.
Certs. of Dis. for Discharge	Med. Certificates
C. M. Charges	Med. Des. Lists
Descriptive Lists	Orders
Discharge Certificates	Pris. of War Record
Enlistment Papers 2	Resignations

Other papers relating to—

Admission to Hosp'l	Furlough or L. of A.
Casualty Sheet	Med. Examination
Confinement	Misc. Information
Contracts	Pay or Clothing
Death or Effects	Personal Reports
Desertion	Rank
Discharge from Hosp'l	Transfer to Hosp'l
Discharge from Service	Transfer to V. R. C.
Duty	Transportation

DECLARATION OF RECRUIT.

I, _____ desiring to ENLIST in the Army of the United States, for the term of THREE YEARS, Do declare, That I am _____ years and _____ months of age; that I have neither wife nor child; that I have never been discharged from the United States service on account of disability or by sentence of a court-martial, or by order before the expiration of a term of enlistment; and I know of no impediment to my serving honestly and faithfully as a soldier for three years.

GIVEN at _____

The _____ day of _____

Witness :

No. 114

Deborah Garrison
Enlisted at *Cambridge Mass*

Samuel S. 1863

By *2nd Lieutenant W. P. 1863*
1st Regt of Cavalry

_____ enlistment; last served in Company (—)

Regt of _____

Discharged _____ 18 _____

CONSENT IN CASE OF MINOR.

I, _____ Do CERTIFY, That I am the _____ of _____; that the said _____ is _____ years of age; and I do hereby freely give my CONSENT to his enlisting as a SOLDIER in the ARMY OF THE UNITED STATES for the period of THREE YEARS.

GIVEN at _____

The _____ day of _____

Witness :

County of
Jefferson



State of
Louisiana

I, *Alexander Harrington* born in *Baltimore*
in the State of *Maryland* aged *Twenty-Nine* years,
and by occupation a *Scholar* do hereby acknowledge to have
voluntarily enlisted this *Thirty-First* day of *January*
18*63*, as a SOLDIER in the ARMY OF THE UNITED STATES OF AMERICA, for the period
of *THREE YEARS*, unless sooner discharged by proper authority: Do also agree to
accept such bounty, pay, rations, and clothing, as are, or may be, established by law. And
I, *Alexander Harrington* do solemnly swear, that I will bear true faith
and allegiance to the UNITED STATES OF AMERICA, and that I will serve them honestly and
faithfully against all their enemies or opposers whomsoever; and that I will observe and
obey the orders of the President of the United States, and the orders of the officers
appointed over me, according to the Rules and Articles of War.

Sworn and subscribed to, at *Camp Parrot,*
this *ninth* day of *February* 18*63*,
BEFORE
J. Nygaard,
2^d Lt. N. G. Art. L. Md.

I CERTIFY, ON HONOR, That I have carefully examined the above named Recruit, agreeably to the General Regulations
of the Army, and that in my opinion he is free from all bodily defects and mental infirmity, which would, in any way, disqualify
him from performing the duties of a soldier.

Milton Chase
EXAMINING SURGEON.

I CERTIFY, ON HONOR, That I have minutely inspected the Recruit, *Alexander Harrington*
previously to his enlistment, and that he was entirely sober when enlisted; that, to the best of my judgement and belief, he is of
lawful age; and that, in accepting him as duly qualified to perform the duties of an able-bodied soldier, I have strictly observed
the Regulations which govern the recruiting service. This soldier has *Brown* eyes, *Dark* hair,
Dark complexion; is *Five* feet, *Ten* inches high.

J. Nygaard, 2^d Lieut. N. G. Art. L. Md.
RECRUITING OFFICER.

DECLARATION OF RECRUIT.

I, _____ desiring to ENLIST in the Army of the United States, for the term of THREE YEARS, Do declare, That I am _____ years and _____ months of age; that I have neither wife nor child; that I have never been discharged from the United States service on account of disability or by sentence of a court-martial, or by order before the expiration of a term of enlistment; and I know of no impediment to my serving honestly and faithfully as a soldier for three years.

GIVEN at _____
The _____ day of _____

Witness :

Discharged _____ 18—.

Reg't of _____

enlistment; last served in Company (—)

Enlisted at _____
By _____ 1863,
_____ Regiment of _____

No. _____

10 USC 312

CONSENT IN CASE OF MINOR.

I, _____ Do CERTIFY, That I am the _____ of _____; that the said _____ is _____ years of age; and I do hereby freely give my CONSENT to his enlisting as a SOLDIER in the ARMY OF THE UNITED STATES for the period of THREE YEARS.

GIVEN at _____
The _____ day of _____

Witness :

County of

Jefferson



State of

Louisiana

I, Alexander Harrington born in Baltimore
 in the State of Maryland aged Twenty-Nine years,
 and by occupation a Laborer do hereby acknowledge to have
 voluntarily enlisted this Thirty-First day of January
 1863, as a SOLDIER in the ARMY OF THE UNITED STATES OF AMERICA, for the period
 of THREE YEARS, unless sooner discharged by proper authority: Do also agree to
 accept such bounty, pay, rations, and clothing, as are, or may be, established by law. And
 I, Alexander Harrington do solemnly swear, that I will bear true faith
 and allegiance to the UNITED STATES OF AMERICA, and that I will serve them honestly and
 faithfully against all their enemies or opposers whomsoever; and that I will observe and
 obey the orders of the President of the United States, and the orders of the officers
 appointed over me, according to the Rules and Articles of War.

Sworn and subscribed to, at Carrallton, La,
Camp Parapet
 this ninth day of February 1863
 BEFORE
L. Nygaard
2^d Lt. U. S. Art. Co. No. 1

I CERTIFY, ON HONOR, That I have carefully examined the above named Recruit, agreeably to the General Regulations of the Army, and that in my opinion he is free from all bodily defects and mental infirmity, which would, in any way, disqualify him from performing the duties of a soldier.

Milton Chase

EXAMINING SURGEON.

I CERTIFY, ON HONOR, That I have minutely inspected the Recruit, Alexander Harrington
 previously to his enlistment, and that he was entirely sober when enlisted; that, to the best of my judgement and belief, he is of
 lawful age; and that, in accepting him as duly qualified to perform the duties of an able-bodied soldier, I have strictly observed
 the Regulations which govern the recruiting service. This soldier has Brown eyes, Dark hair,
Dark complexion; is Five feet, Seven inches high.

L. Nygaard 2^d Lt. U. S. Art. Co. No. 1

RECRUITING OFFICER.

Farris Jack

Co C, 10 U.S. Col'd H. Art'y.

Private

Private

CARD NUMBERS.

1	5487231	26
2	5498523	27
3	5498664	28
4	5498803	29
5	5498939	30
6	5499080	31
7	5499216	32
8	5499352	33
9	5499488	34
10	5499624	35
11	5499760	36
12	5499895	37
13	5500027	38
14	5500163	39
15	5500292	40
16	5500382	41
17		42
18		43
19		44
20		45
21		46
22		47
23		48
24		49
25		50

Book Mark:

See also

F

10 H. Art'y. | U.S.C.T.

Jack Ferris

Appears with rank of *Private* on

Muster and Descriptive Roll of a Detachment of U. S. Vols. forwarded

for the *10* Reg't *U.S.C. Art'y* Roll dated
New Orleans La, Sept 19, 1864

Where born *Richmond Va*

Age *19* y'rs; occupation *Laborer*

When enlisted *Aug 17*, 1864

Where enlisted *New Orleans La*

For what period enlisted *3* years.

Eyes *Blue*; hair *Blue*

Complexion *Dark*; height *5* ft. - in.

When mustered in *Sept 19*, 1864

Where mustered in *New Orleans*

Bounty paid \$ *100*; due \$ *300* *100*

Where credited *to New Orleans La*

Company to which assigned *C*

Remarks:

Book mark:

S. W. Williams

(339)

Copyist.

J

10 H. Art'y. U.S.C.T.

Jack Ferris
Pr, Co. C, 10 Reg't U. S. Col'd H. Art'y.

Appears on

Company Muster Roll

for *Sept & Oct*, 186 *4*.

Present or absent *Present*

Stoppage, \$ *100* for

Due Gov't, \$ *100* for

Valuation of horse, \$ *100*

Valuation of horse equipments, \$ *100*

Remarks: *\$300 Bounty due*

Book mark:

(358)

J Hudson

Copyist.

J

10 H. Art'y. U.S.C.T.

Jack Farris
Pr, Co. C, 10 Reg't U. S. Col'd H. Art'y.

Appears on

Company Muster Roll

for *Nov + Dec*, 1864

Present or absent *Present*

Stoppage, \$ 100 for

Due Gov't, \$ 100 for

Valuation of horse, \$ 100

Valuation of horse equipments, \$ 100

Remarks: *\$300. Bounty due*

Book mark:

J. Hudson
(358) Copyist.

F

10 H. Art'y. U.S.C.T.

Jack Ferris

1st Lt., Co. C, 10 Reg't U. S. Col'd H. Art'y.

Appears on

Company Muster Roll

for *Jan + Feb*, 186 *5*

Present or absent *Present*

Stoppage, \$ 100 for

Due Gov't, \$ 100 for

Valuation of horse, \$ 100

Valuation of horse equipments, \$ 100

Remarks:

Book mark:

Jallade

GF

10 H. Art'y. U.S.C.T.

Jack Farris
Priv, Co. C, 10 Reg't U. S. Col'd H. Art'y.

Appears on

Company Muster Roll

for *March & April*, 186*5*.

Present or absent *Present*

Stoppage, \$ *100* for

Due Gov't, \$ *100* for

Valuation of horse, \$ *100*

Valuation of horse equipments, \$ *100*

Remarks:

Book mark:

Lamb

(358)

Copyist.

F

10 H. Art'y. U.S.C.T.

Jack Farris
Sgt., Co. C, 10 Reg't U. S. Col'd H. Art'y.

Appears on

Company Muster Roll

for May & June, 1865.

Present or absent Present

Stoppage, \$ 100 for

Due Gov't, \$ 100 for

Valuation of horse, \$ 100

Valuation of horse equipments, \$ 100

Remarks:

Book mark:

Sallade

7

10 H. Art'y. U.S.C.T.

Maek Farrio

Put, Co. C, 10 Reg't U. S. Col'd H. Art'y.

Appears on

Company Muster Roll

for May & Aug, 1865.

Present or absent Present

Stoppage, \$ 100 for

Due Gov't, \$ 100 for

Valuation of horse, \$ 100

Valuation of horse equipments, \$ 100

Remarks: \$200. Bounty due \$100. Paid

Book mark:

Ballade

(358)

Copyist.

7

10 H. Art'y. U.S.C.T.

Jack Farris
Plt., Co. C, 10 Reg't U. S. Col'd H. Art'y.

Appears on

Company Muster Roll

for Sept & Oct, 1865.

Present or absent Present

Stoppage, \$ 100 for

Due Gov't, \$ 100 for

Valuation of horse, \$ 100

Valuation of horse equipments, \$ 100

Remarks:

Book mark:

(358)

Ballade

Copyst.

J | 10 H. Art'y. | U.S.C.T.

Jack Farris

Pvt., Co. C, 10 Reg't U. S. Col'd H. Art'y.

Appears on

Company Muster Roll

for *Nov. 2d Dec*, 186*6*.

Present or absent *Present*

Stoppage, \$ 100 for

Due Gov't, \$ 100 for

Valuation of horse, \$ 100

Valuation of horse equipments, \$ 100

Remarks:

Book mark: -----

(358)

A. J. Robbins
Copyist.

H

10 H. Art'y. U.S.C.T.

Jack Farris

Pvt., Co. C, 10 Reg't U. S. Col'd H. Art'y.

Appears on

Company Muster Roll

for *Jan & Feb.*, 186*6*.

Present or absent *Present.*

Stoppage, \$ 100 for

Due Gov't, \$ 100 for

Valuation of horse, \$ 100

Valuation of horse equipments, \$ 100

Remarks: *\$100 bounty paid
\$200 due.*

Book mark: _____

A. J. Robbins

(358)

Copyist.

G

10 H. Art'y. U.S.C.T.

Jack Farris

Priv., Co. C, 10 Reg't U. S. Col'd H. Art'y.

Appears on

Company Muster Roll

for *March & Apr.*, 186*6*

Present or absent *Present.*

Stoppage, \$ *100* for

Due Gov't, \$ *100* for

Valuation of horse, \$ *100*

Valuation of horse equipments, \$ *100*

Remarks: *Here U. S. for loss of
wiper \$ $\frac{26}{100}$.*

Book mark: _____

A. J. Robbins

(358)

Copyst.

D

10 H. Art'y. U.S.C.T.

Jack Harris

Rob., Co. C, 10 Reg't U. S. Col'd H. Art'y.

Appears on

Company Muster Roll

for May 2d June, 1866.

Present or absent Present.

Stoppage, \$ 100 for

Due Gov't, \$ 100 for

Valuation of horse, \$ 100

Valuation of horse equipments, \$ 100

Remarks: \$200 bounty paid, \$100 to be paid.

Book mark:

A. J. Robbins

(358)

Copyist.

F

10 H. Art'y. | U.S.C.T.

Jack Ferris

Plt., Co. C, 10 Reg't U. S. Col'd H. Art'y.

Appears on

Company Muster Roll

for *July & Aug.*, 186*6*.

Present or absent *Present*

Stoppage, \$ *100* for

Due Gov't, \$ *100* for

Valuation of horse, \$ *100*

Valuation of horse equipments, \$ *100*

Remarks:

Book mark:

A. J. Robbins

(358)

Copyist.

F | 10 H. Art'y. | U.S.C.T.

Jack Farrie
Pr, Co. C, 10 Reg't U. S. Col'd H. Art'y.

Appears on

Company Muster Roll

for *Sept & Oct*, 186*6*.

Present or absent *Present*

Stoppage, \$ *100* for

Due Gov't, \$ *100* for

Valuation of horse, \$ *100*

Valuation of horse equipments, \$ *100*

Remarks:

Book mark:

(358)

Hammie

Copyist.

F | 10 H. Art'y. | U.S.C.T.

Jack Jarvis
Pvt, Co. C, 10 Reg't U. S. Col'd H. Art'y.

Appears on

Company Muster Roll

for *Nov. & Dec*, 1866.

Present or absent *Present*

Stoppage, \$ 100 for

Due Gov't, \$ 100 for

Valuation of horse, \$ 100

Valuation of horse equipments, \$ 100

Remarks: *Forfeit to U.S.*
\$5 per An g. b. m
for absence without
leave

Book mark: _____

(358)

Manning
Copyist.

F | 10 H. Art'y. | U.S.C.T.

Jack Farris
Co. C, 10 Reg't U. S. Col'd H. Art'y.

Appears on Co. Muster-out Roll, dated
Baton Rouge, La, Feb 22, 1867.
Muster-out to date *Feb 22, 1867.*
Last paid to *Dec 31, 1866.*

Clothing account:

Last settled _____, 186 ; drawn since \$ _____ 100
Due soldier \$ *43* ^{*36*} / 100; due U. S. \$ _____ 100
Am't for cloth'g in kind or money adv'd \$ _____ 100

Due U. S. for arms, equipments, &c., \$ *6* / 100
Bounty paid \$ *200* / 100; due \$ _____ 100

Remarks: *Joined as recruit*
Stop for one Springfield
field Rifle & acc't
& acc'ts retained

Book mark: _____

(361)

Manning
Copyist.

Co W., 10 U.S. Col'd H. Art'y.

1st Lieutenant | *1^{er} Lieutenant*

CARD NUMBERS.

1	5487950	26	42557412
2	5487434	27	42557463
3	5514263	28	42557517
4	5514416	29	42557561
5	5514565	30	42557640
6	5514809	31	43227275
7	5514920	32	
8	5514985	33	
9	5515049	34	
10	5515116	35	
11	5515160	36	
12	D-60-03-1868	37	
13	40745983	38	
14	42728941	39	
15	42692244	40	
16	42692254	41	
17	42692257	42	
18	42692266	43	
19	42692273	44	
20	42692280	45	
21	42692287	46	
22	42692294	47	
23	42692300	48	
24	42692307	49	
25	42692313	50	

Book Mark: D-60-03-1868

See also 717th U.S. Inf
85923rd and 38th Mass Inf

A 2397897 *Handwritten*

RIP 940930

ms 940930

Al. 1776036

2

10 H. Art'y. | U.S.C.T.

George Fayon

21-, Co *M*, 10 Reg't U. S. Col'd H. Art'y.

Age years.

Appears on

Company Muster Roll*

for *Sept - Oct -*, 1865.

Joined for duty and enrolled:

When *Feb 23*, 1864.

Where *New Orleans*

Period *3* years.

Mustered in:

When *Feb 23*, 1864.

Where *New Orleans*

Present or absent *Absent -*

Stoppage, \$ *100* for

Due Gov't, \$ *100* for

Valuation of horse, \$ *100*

Valuation of horse equipments, \$ *100*

Remarks: *Reassigned to Co from
Co # 77 U.S. by consolidation
(Over)*

*First current roll. No muster-in roll of this company on file.

Book mark :

D. S. Wright

(3586)

Copyist.

JAN. 16

5514263

1891

per G.O. No 3 dated Hd
Qrs 10 U.S.C.A. Hy. Det-1, 65-
On detached Service per S.O.
283 Hd Qrs & Dist La
Det-2-65-

F 1060 | U.S.C.T.

George L. Taxon
1st Lt, Co *M*, 10 Reg't U. S. Col'd *1st*

Appears on

M. and D. Roll of Men Transferred

to the organization named above,

from *4th U.S. Cal Inf*

Roll dated *Camp Parapet*, 1865.

When enlisted *Feb 23*, 1864.

Period for which enlisted *3* years.

When mustered in *Feb 23*, 1864.

Present or absent

Company to which assigned *M*

Remarks: *Joined Service as*

Private 38th Mass Vols

at Lynnhfield Mass

July 31, 1862, Comd'g

Mustered in 1st Lieut 105th

Inftry C.S.A. Feb 23, 1864

Rec'd by transfer from

4th U.S. Cal. per S.O. 66. Dept

Book mark: *D-60-07-1868 (copy)*

W. H. Scott

JAN. 15

5487950

1891

La. Sept 22 65

F 1076, a, U.S.C.T.

G. L. Faxon
12th, Co *A*, 10 Reg't U. S. Col'd *H. L.*

Appears on

M. and D. Roll of Men Transferred

to the organization named above,

from *10th Reg't U. S. Col'd*

Roll dated *Camp Annapolis Oct 1*, 1865.

When enlisted *Feb 23*, 1864.

Period for which enlisted *3* years.

When mustered in *Feb 23*, 1864.

Present or absent *Present*

Company to which assigned *A*

Remarks: *Joined Service*

as Private at Camp

Stanton Mass July

31st 1862 Commissioned

as 1st Lieut of 13th Inf

Corp'd Afrique. And must

ered Feb 23. 1864

entitled to pay for (over)

Book mark :

W. H. Scott

JAN. 15

5487434

1891

Command of Company
since Aug 1, 1865

J. 10th Regt. Artillery U.S.C.T.

x

Taylor

1st Lt. U.S.C.T. Regt.

Return

of Camp Parapet, La.,

for the month of Oct, 1865,

dated Oct 31, 1865,

shows the following with regard to the person
named above:

Post or station _____

Remarks: _____

Janine Co. A. at Fort Mecombe

** From Remarks*

Book mark: _____

(546)

J. H. Morris

Copyist.

F 11014 aty 1216.5
L. L. Fayon
1st Lt Co H. 10th U.S. Inf.

Return

of Forts Macomb and Bienvenue, La.,

for the month of Oct, 1865,

dated Nov 1, 1865,

shows the following with regard to the person
named above:

Post or station

Remarks:

Absent, Assigned
to Company from Co. H 77
U.S. Inf. by Consolidation
in G.O. No. 3 dated 1st Dec
10. U.S. Inf. (H) Oct 1. 1865
On detached service at
New Orleans La.
Number and date of
Order unknown

Book mark:

(546)

207

Copyist.

F 110th Atty USBJ

George L Falcon
1st Lt USBJ Atty

Return

of Forts Macomb and Bienvenue, La.,

for the month of Nov 1, 1865,

dated Dec 1, 1865,

shows the following with regard to the person
named above:

Post or station _____

Remarks: Absent on detached
service per SO No 283
dated 1st Lt. Eastern
District of Louisiana Oct
2. 1865

Book mark: _____

J. M. W.

(546)

Copyist.

7 | 10 H. Art'y. | U. S. C. T.

George L Faxon

1st, Co. M, 10 Reg't U. S. Col'd H. Art'y.

Appears on

Company Muster Roll

for *Nov & Dec*, 1865.

Present or absent *Present*

Stoppage, \$ *100* for

Due Gov't, \$ *100* for

Valuation of horse, \$ *100*

Valuation of horse equipments, \$ *100*

Remarks: *Joined from detached service Dec 4, 65 on spec duty as a Q.M. & A.S. at Post since Dec 4, 65.*

Book mark:

D. W. Wright

F 110 Lt. Art'y U.S.A.
George L. Fayon
1st Lt. Co. No. 10 Regt. U.S.A. (Hvy)

Return

of Forts Macomb and Bienvenue, La.,

for the month of Dec, 1865,

dated Jan 1, 1866,

shows the following with regard to the person
named above:

Post or station

Remarks:

Present, joined
from detached service
Dec 4. 1865. On special
duty as A. G. 2nd M. and
A. B. 1. at Post Jan 20. 1866
duty at Hdqrs. Fort Macomb
La Dec 22 1865.

Book mark:

J. Miller

F 1104 Army Regt. U.S.A.
George L. Fayon
(2d Co. 110 Regt. U.S.A. (Inf))

Return

of Forts Macomb and Bienvenue, La.,

for the month of January, 1866,

dated Feb 1, 1866,

shows the following with regard to the person
named above:

Post or station

Remarks: (Present) On Special
Duty as A.A. & H. and A.S.
at Post since Dec 22. 1865-

Book mark:

W. Hill

(546)

Copyist.

7

10 H. Art'y.

U. S. C. T.

George L Fayon

1st, Co. M, 10 Reg't U. S. Col'd H. Art'y.

Appears on

Company Muster Roll

for *Jan 1st*, 1866.

Present or absent *Present*

Stoppage, \$ 100 for

Due Gov't, \$ *6 90* for *Ord*

7 48 " *6 + 4. 2*

Valuation of horse, \$ 100

Valuation of horse equipments, \$ 100

Remarks: *On Special Duty as a Quartermaster at Post since Dec 22, 65.*

Book mark:

W. Wright

(358)

Copyist.

F 110 H. Atty 195. b. T.
George L. Fayon
12th Reg U.S. Artillery

Return

of Forts Macomb and Bienvenue, La.,

for the month of ^{copy} _____, 186 ^b,

dated ^{March} _____, 186 ^b,

shows the following with regard to the person
named above:

Post or station _____

Remarks:

Present, On Special
Duty as A. A. S. M. and A. S. S.
at Port since Dec 22. 1865

Book mark: _____

(546)

J. Miller

Copyist.

F 110 H. Atty U.S. L. S.
George L. Fayon
12th Mo No Regt U.S. A (Hyl)

Return

of Forts Macomb and Bienvenue, La.,

for the month of March, 1866,

dated April 1, 1866,

shows the following with regard to the person
named above:

Post or station

Remarks:

Present on special
duty as A. A. L. M. and A. B. S.
at Fort since Dec 22. 1866

Book mark:

(546)

W. Hill

Copyist.

George L Fayon

1st, Co. M, 10 Reg't U. S. Col'd H. Art'y.

Appears on

Company Muster Roll

for *March & Apr*, 186*6*.

Present or absent *Present*

Stoppage, \$ *100* for

Due Gov't, \$ *60* ^{*95*}/₁₀₀ for *Apr*

" 7 ^{*48*}/₁₀₀ *" 66 & 48*

Valuation of horse, \$ *100*

Valuation of horse equipments, \$ *100*

Remarks: *On Special Duty -*
as C. A. G. M. & C. G. S. at post -
since Dec 22, 65 -

Book mark:

W. H. Wright

F 1104 Army U.S. A. S.
George L. Fayon
12th Co 1st Reg U.S. Cavalry

Return

of Forts Macomb and Bienvenue, La.,

for the month of April, 1866,

dated May 1, 1866,

shows the following with regard to the person
named above:

Post or station

Remarks: Present, on special
duty as A. Q. M. and
C. S. at Fort M. C.
Dec 22. 1865

Book mark:

J. Mills

(546)

Copyist.

I 11044 July 1865
x Geo L Taylor
1st Lt 10 Regt U.S. 6a. Inf.

Return

of Forts Macomb and Bienvenue, La.,

for the month of May, 1866

dated June 1, 1866

shows the following with regard to the person
named above:

Post or station

Remarks:

Present on special
duty as A.A. Lt and 4th Lt.
at Fort Mico Dec 22 1865

x Geo L Taylor

Book mark :

J. H. Mills

7

10 H. Art'y.

U. S. C. T.

George L. Fayon

Lt., Co. M, 10 Reg't U. S. Col'd H. Art'y.

Appears on

Company Muster Roll

for *May & June*, 186*6*.

Present or absent *Present*

Stoppage, \$ *100* for

Due Gov't, \$ *0* ^{*95*}/_{*100*} for *Ord*

" 7 48 " *6, 6, & 4, 8*

Valuation of horse, \$ *100*

Valuation of horse equipments, \$ *100*

Remarks: *On special duty as*
Adj. G. M. & A. S. at Post
since Dec 22, 63.

Book mark:

(358)

A. H. Wright

Copyist.

F 110 H. Army Regt
George L. Fayon
1st Lieut 6th U.S. A. Regt

Return

of Forts Macomb and Bienvenue, La.,

for the month of June, 1866,

dated July 1, 1866,

shows the following with regard to the person
named above:

Post or station

Remarks: Present. On Special
Duty as a a. a. Lt. Col. at
Post. since Dec 22. 65

Book mark:

W. H. Miller

(546)

Copyist.

F 110 H. Arty 121.6 T.
George L. Fayon
1st Lt. 10 Regt U.S. Cavalry

Return

of Forts Macomb and Bienvenue, La.,

for the month of July, 1866,

dated August 1, 1866,

shows the following with regard to the person
named above:

Post or station _____

Remarks: Present on Special
 Duty as A.A. 2nd Lt. 10
at Fort since Dec 22 65

Book mark: _____

W. Hill

(546)

Copyist.

George L Fayon

1st, Co. M, 10 Reg't U. S. Col'd H. Art'y.

Appears on

Company Muster Roll

for *July & Aug*, 1866.

Present or absent *Present*

Stoppage, \$ *100* for

Due Gov't, \$ *6* ^{*95*}/₁₀₀ for *Ord*

" " *7* ^{*48*}/₁₀₀ " *Co. M*

Valuation of horse, \$ *100*

Valuation of horse equipments, \$ *100*

Remarks: *On special duty as
a. c. g. m. & a. l. s. since
Dec 22, 65-*

Book mark:

L. T. Wright

F 110 H. Army 19th. 65.
George L. Fayon
1st Lt. 6th. 10 Reg. 19th. 65. Army

Return

of Forts Macomb and Bienvenue, La.,

for the month of August, 1866,

dated September 1, 1866,

shows the following with regard to the person
named above:

Post or station

Remarks: Present on special
duty from 2 a.m. to 6 p.m.
at Post since Dec 22, 65

Book mark:

J. M. Hill

(546)

Copyist.

J 110 Hoy Art W.S.L.J.

George B. Faxon

2^d Bieuh Co. m. 10 Regt W.S.L. Hoy Art

Return

of the Post of Baton Rouge, La.,

for the month of September, 1866,

dated September 30 1866,

shows the following with regard to the person
named above:

Post or station _____

Remarks: Present

Book mark: _____

Austin Clark.

5

10 H. Art'y. | U. S. C. T.

George S. Dixon

1 St., Co. M, 10 Reg't U. S. Col'd H. Art'y.

Appears on

Company Muster Roll

for Sep. & Oct., 1866.

Present or absent Present

Stoppage, \$ 100 for

Due Gov't, \$ 100 for

Valuation of horse, \$ 100

Valuation of horse equipments, \$ 100

Remarks:

Book mark:

Rector

J 110 Hoy art 1902.6.7.

Geo L. Jaxon

1st Lieut Co M. 10 Regt W. L. 1st Regt N.Y. art

Return

of the Post of Baton Rouge, La.,

for the month of October, 1866,

dated October 31 1866,

shows the following with regard to the person
named above:

Post or station _____

Remarks: Present

Book mark : _____

(546)

Austin Clark

Copyist.

George S. Faxon

1st, Co. M, 10 Reg't U. S. Col'd H. Art'y.

Appears on

Company Muster Roll

for Nov + Dec, 1866.

Present or absent Present.

Stoppage, \$ 100 for

Due Gov't, \$ 100 for

Valuation of horse, \$ 100

Valuation of horse equipments, \$ 100

Remarks: Due up for Ord # 695 for C & G equip. \$ 348. which this officer cannot account for

Book mark:

Rector

F 110 Hoy ark W.S.L. J.

George L. Jaxon

1st Lieut Co. M. 10 Regt W.S.L. Hoy ark

Return

of the Post of Baton Rouge, La.,

for the month of December, 1866,

dated December 31 1866,

shows the following with regard to the person
named above:

Post or station

Remarks: Present

Book mark :

Artis Clark.

(546)

Copyist.

F 110 Hoy Ark W.S. L. 7.
George L. Hapon
1st Lieut Co. M. 10 Regt W.S. L. 6. Hoy Ark

Return

of the Post of Baton Rouge, La.,
for the month of January, 1867,
dated February 1st, 1867,
shows the following with regard to the person
named above:

Post or station

Remarks: Present

Book mark :

Artis Clark.

F 110 Hwy Art W.S. G. J.

George L. Fayon

1st Gren Co. M. 10 Regt W.S. G. Hwy Art

Return

of the Post of Baton Rouge, La.,

for the month of February, 1867,

dated March 4, 1867,

shows the following with regard to the person
named above:

Post or station

Remarks: Mustered out of service in
accordance with S. O. 26. Feb 21
1867 Hd qrs Dept of the Gulf

Book mark :

Austin Clark

(546)

Copyist.

J

10 H. Art'y.

U. S. C. T.

George L. Taxon
101, Co. *M*, 10 Reg't U. S. Col'd H. Art'y.

Appears on Returns as follows:

Oct. & Nov. 1865. - Absent on det.
service as member of
Y.C.M. per S.O. 28 B
Oct. 12/65 Rec. Dr. S.
East Dist. of D.

Dec. 1865 & Jan. 1866. - Present
on special duty as A.A. S.M.

Feb. 1866. - Present on special
duty as Post Dr. M.

March to Aug. 1866. - Present on
special duty as V. H.
S.M. & V. G. S.

Sept. 1866 to Jan. 1867. - Present

Book mark:

(546)

E. J. Thornton

Copyist.

5

10 H. Art'y. U.S.C.T.

George S. Faxon

St., Co.M., 10 Reg't U. S. Col'd H. Art'y.

Appears on Co. Muster-out Roll, dated

Baton Rouge, La., Feb. 22, 1867.

Muster-out to date

* Feb. 22, 1867.

Last paid to

Dec. 31, 1866.

Clothing account:

Last settled....., 186 ; drawn since \$.....100

Due soldier \$.....100; due U. S. \$.....100

Am't for cloth'g in kind or money adv'd \$.....100

Due U. S. for arms, equipments, &c., \$.....100

Bounty paid \$.....100; due \$.....100

Remarks: joined by Arrows from 77 U.S. Co. D. per S. O. 66 Hd. Qrs. Dept. La. Sep 22/65. as 1st Entered the service July 3. '62 and mustered as Corp. at Springfield Mass in 38 Mass Vols. Aug. 26/62. Discharged from same

Book mark:

* Added by H. A. J. Aug. 3/06

Rector

F. | 10th Reg't U.S.C. & A.

George L. Fayon

, Co., 10th Reg't U.S.C. & A.

NOTATION.

Book mark: D. Co. C. J. 1868

War Department,

Adjutant General's Office,

Washington, May 29th, 1876.

See Co: 20th 38th Mass Inf 85th
U.S.C. & A. and 77th U.S.C. & A.

(438)

E. P. Conroy

Copyist.

MICROFILM PUBLICATION M 1831

COMPILED MILITARY SERVICE RECORDS
OF VOLUNTEER UNION SOLDIERS WHO SERVED WITH
THE UNITED STATES COLORED TROOPS (USCT)
10TH REGIMENT OF HEAVY ARTILLERY

PERSONAL PAPERS' TARGET SHEET

PLEASE NOTE THE CHECKED INFORMATION ABOUT THE PERSONAL PAPERS IN
THIS FILE:

- NO PERSONAL PAPERS WERE FOUND IN THIS FILE WHEN THE
RECORDS WERE ARRANGED FOR MICROFILMING.
- 9 PERSONAL PAPER(S) FOUND IN THIS FILE WHEN THE RECORDS
WERE ARRANGED FOR MICROFILMING.

Faxon Geo. L.

Co. *10* Reg't *U.S.C. 79.*

85 Enclosures.

Bed Cards	Final Statements
Burial Records	Furloughs or L. of A.
Certs. of Dis. for Discharge	Med. Certificates
C. M. Charges	Med. Des. Lists
Descriptive Lists	Orders <i>74</i>
Discharge Certificates	Pris. of War Record
Enlistment Papers	Resignations

Other papers relating to—

Admission to Hosp'l	Furlough or L. of A.
Casualty Sheet	Med. Examination
Confinement	Misc. Information <i>/</i>
Contracts	Pay or Clothing
Death or Effects	Personal Reports
Desertion	Rank
Discharge from Hosp'l	Transfer to Hosp'l
Discharge from Service	Transfer to V. R. C.
Duty	Transportation

F · 110 H. arty U.S.C.T.

Thomas L. Faxon

1 Lt 10 Regt U.S. Cold H. arty

Appears on

General Order

No. 67, dated War Department, Adjutant Gen-
eral's Office, July 16, 1867.

Appointed to be

Captain

BY BREVET

in the Volunteer Force, Army of the United
States, for faithful and meritorious
services during
the war

To date from March 13, 1865.

W. Williams

(400)

Copyist.

Headquarters
Fort Macomb La.
August 5th 1866.

Special Order,
No. 27

10 US CENTS

1st Lieut. G. L. Faxon

A. A. G. No. will proceed to the city of New Orleans
La on business connected with this Post, upon the
completion of said business to will return to this
Command.

By order of
Henry K. Baker
Captain 10th Regt. Caly
Comd'g Post

Wm. C. Rice
2nd Lieut. and Capt. Adjts

Head Quarters
Fort Macomb La
July 8th 1866.

Special Order
No. 34

10, 11, 12, 13, 14

1st Lt. G. J. Farnum A. S. C.
will proceed to the city of New Orleans on business
connected with his department, on the completion
of said business, he will return to this Post.

Order of
Henry K. Becker
Capt. 10th U. S. Artillery
Commanding Post

Wm. C. Rice
2nd Lt. 10th U. S. Artillery

Headquarters
1st Inf. Meade's La

Dec 13th 1866

Special Orders
No. 21

1st Lt. George L. Taylor 10th West
N.A. Co. will proceed to the City of New Orleans, on
business connected his department, upon the completion
of said business he will return to his command.

By order of

Capt. Henry K. Bicker.

Comdg' Post

Wm. Rice

2nd Lt. L. H. [unclear], Post Capt.

Headquarters,
Fort Macomb, La.,
May 9, 1866.

Special Orders,
No. 17

1st Lieut. George L. Faxon, 10th U.S.
Colid. Art. (Hvy.), A.A.Q.M. and A.C.S. at Post,
will proceed to New Orleans, La., for the
purpose of procuring Quartermasters and Com-
missary Stores, that are absolutely necessary
for this command.

The Quartermasters Department will
furnish the necessary transportation

By order of Captain Henry H. Bicker
Comdg. Post.

W. Forbes Wilson
2^d Lt & Pasrdayr.

Hdqs. Fort Macomb, La.
April 15, 1866

No. 929-66

Respectfully returned, By
Special Order No. 13, from these
Hdqs; and for fresh meat
and vegetables.

Capt. P. Marshall
April 18, 1866

Attn: M. B. Jones,
Captain 10th Regt.
April 1866

Respectfully returned
all items returned at
Fort Macomb last
evening

P. Marshall
Regt. 10th Regt.
P. Marshall

No. 929-66 Headquarters
Eastern Dist. of La.

Gen Order Apr. 13/66

Respectfully referred to
the commanding officer of
Fort Macomb, who will
report by what order
St. James was in this
city on the 12th inst. and
for what purpose.

10 M Sta 110

By Order of
Col. J. M. Shannon

J. M. Shannon
Lt. Col. 10th Regt.
April 1866

No. 929 66

Filed in M.

File



Headquarters,

Fort Macomb, La

April 12, 1866

Special Orders }
No. 13.

1st Lieut- George L. Faxon 10th U.S.C.A. (A.S.)
A.S. at Post will immediately proceed to New Orleans,
La., for the purpose of obtaining fresh beef and
vegetables for this command. He will return
by the 14th inst.

By order of Captain Henry K. Boker
Comdg. Post.

W. Forbes Wilson,

2^d Lieut. 10th U.S.C.A. (A.S.)

Post Adjt.

Headquarters.

Fort Macomb, La.,

January 27, 1866.

Special Orders, }
No. 4.

1st Lieut. George S. Faxon, 10th U.S. (Artillery) A.A.C.M.,
(with a boat-crew of four men), will proceed to New Orleans, La., on
business connected with his department. He has permission
to be absent for forty-eight hours.

By order of Captain Henry K. Bicker,

Comdg. Post:

W. Forbes Wilson,

2nd Lieut. & Post Adj't.

S. O.

No 1.

Fort Macomb

Special Orders

1 - 2nd

Post of Fort Macomb

Headquarters

Fort Macomb, La.

January 4, 1866

Special Orders, }
No. 1

1st Lieut. George S. Faxon, 10th U.S. C. Art. (Aq.)
Post Quartermaster (with a boat-crew of four men) will
proceed to New Orleans, La., on business connected with his
department. On the completion of which business he
will immediately return to Fort Macomb, La.

By order of Captain Henry H. Bicker,

Comdg. Post.

W. Forbes Wilson,

2^d Lieut. & Post Adjt.

Justice
No. 10 U.S. Col'd H. Art'y

Private | *Private*

CARD NUMBERS.

1	5509536	26
2	5490190	27
3	5509746	28
4	5509903	29
5	5510052	30
6	5510198	31
7	5510348	32
8	5510499	33
9	5510621	34
10	5510766	35
11	5510846	36
12	5510921	37
12	5510995	38
14	5511058	39
15		40
16		41
17		42
18		43
19		44
20		45
21		46
22		47
23		48
24		49
25		50

Book Mark:

See also

F | 10 H. Art'y. | U.S.C.T.

Gustave Fee

Pvt, Co. H, 10 Reg't U. S. Col'd H. Art'y.

Appears on

Company Muster-in and Descriptive Roll

of the organization named above. Roll dated

New Orleans La, Nov 8, 1864.

Where born *St Charles La*

Age *32* yrs; occupation *Laborer*

When enlisted *Nov 1*, 1864.

Where enlisted *New Orleans*

For what period enlisted *3* years.

Eyes *Black*; hair *Black*

Complexion *Black*; height *5* ft. *3 1/2* in.

When mustered in *Nov 8*, 1864.

Where mustered in *New Orleans*

Bounty paid \$ *100*; due \$ *100*

Where credited *1st Dist, 2nd ward, Parish of Orleans City of N. Orleans La*
Company to which assigned *H.*

Remarks: *Mustered in to date from date of Enlistment*

NEXT ROLL ON FILE FEB 1865

Book mark: _____

Perrington

(356d)

Copyist.

F | 10th N. Arty. | U.S.C.T.

Gustavus Fee

H., Co. H., 10 Reg't U. S. Col'd N. Arty.

Appears on

Descriptive List of Deserters

dated Recruiting Depot, ^{N. C.} Nov. 30 1864.

Deserted:

When Nov. 19, 1864.

Where Recruiting Depot N. C.

Arrested:

When _____, 186 .

Where _____

Remarks

Conscripted from
Woodruff's Plantation L. B.
Gustavus Fee is known
on the place as "Antoine
Stearns."

Book mark: _____

(351)

J. H. Richardson

Copyist.

F | 10 H. Art'y. | U.S.C.T.

Gustave Lee

Pvt, Co. H, 10 Reg't U. S. Col'd H. Art'y

Appears on

Company Muster Roll

for *March + April*, 1865.

Present or absent *Present*

Stoppage, \$ *100* for

Due Gov't, \$ *100* for

Valuation of horse, \$ *100*

Valuation of horse equipments. \$ *100*

Remarks: *Deserted from Co. at N.O. La. Nov. 19" 1864. Apprehended, and returned to Co. March 31" 1865.*

Book mark:

Perminington
(858) Copyist.

F

10 H. Art'y.

U.S.C.T.

Gustave Lee

Pvt, Co. H, 10 Reg't U. S. Col'd H. Art'y

Appears on

Company Master Roll

for *May & June*, 1865.

Present or absent *Present*

Stoppage, \$ 100 for

Due Gov't, \$ 100 for

Valuation of horse, \$ 100

Valuation of horse equipments. \$ 100

Remarks:

Book mark:

(358)

Pennington

Copyist

F | 10 H. Art'y. | U.S.C.T.

Gustave Lee

Priv, Co. H, 10 Reg't U. S. Col'd H. Art'y

Appears on

Company Muster Roll

for *July + Aug*, 1865:

Present or absent *Present*

Stoppage, \$ *100* for

Due Gov't, \$ *100* for

Valuation of horse, \$ *100*

Valuation of horse equipments. \$ *100*

Remarks :

Book mark :

(358)

Pennington

Copyist.

G | 10 H. Art'y. | U.S.C.T.

Gustave Fee

Pvt., Co. H, 10 Reg't U. S. Col'd H. Art'y

Appears on

Company Muster Roll

for *Sep & Oct*, 1865.

Present or absent *Present*

Stoppage, \$ 100 for

Due Gov't, \$ 100 for

Valuation of horse, \$ 100

Valuation of horse equipments. \$ 100

Remarks:

Book mark:

(858)

Gammack

Copyist.

G

10 H. Art'y.

U.S.C.T.

Gustave Lee

Priv't, Co. H, 10 Reg't U. S. Col'd H. Art'y

Appears on

Company Muster Roll

for *Nov & Dec*, 1865.

Present or absent *Present*

Stoppage, \$ 100 for

Due Gov't, \$ 100 for

Valuation of horse, \$ 100

Valuation of horse equipments. \$ 100

Remarks :

Book mark :

Samuel A

(858)

Copyist.

G

10 H. Art'y. U.S.C.T.

Gustave Fee

Pvt., Co. H, 10 Reg't U. S. Col'd H. Art'y

Appears on

Company Muster Roll

for *Jan & Feb.*, 1866.

Present or absent *Present*

Stoppage, \$ *100* for

Due Gov't, \$ *100* for

Valuation of horse, \$ *100*

Valuation of horse equipments. \$ *100*

Remarks :

Book mark :

(858)

Cammack

Copyist.

F

10 H. Art'y. U.S.C.T.

Gustave Fee

Pvt., Co. H, 10 Reg't U. S. Col'd H. Art'y

Appears on

Company Muster Roll

for *M & A*, 1866.

Present or absent *Present*

Stoppage, \$ *100* for

Due Gov't, \$ *100* for

Valuation of horse, \$ *100*

Valuation of horse equipments. \$ *100*

Remarks :

Book mark:

Gammack
Copied.

X | 10 H. Art'y. | U.S.C.T.

Gustave Lee

Cpt., Co. H, 10 Reg't U. S. Col'd H. Art'y

Appears on

Company Muster Roll

for *May & June*, 186*6*

Present or absent

Present

Stoppage, \$ *100* for

Due Gov't, \$ *100* for

Valuation of horse, \$ *100*

Valuation of horse equipments. \$ *100*

Remarks :

Book mark :

(858)

Samuel P.

Copyright.

G

10 H. Art'y. U.S.C.T.

Gustave Lee

Cpt., Co. H, 10 Reg't U. S. Col'd H. Art'y

Appears on

Company Muster Roll

for *July & Aug*, 1866.

Present or absent *Present*

Stoppage, \$ *100* for

Due Gov't, \$ *100* for

Valuation of horse, \$ *100*

Valuation of horse equipments. \$ *100*

Remarks:

Book mark:

(858)

Cammack
Copyright

F

10 H. Art'y. U.S.C.T.

Gustave Free

Pvt, Co. H, 10 Reg't U. S. Col'd H. Art'y

Appears on

Company Muster Roll

for *Sept & Oct*, 186*6*.

Present or absent *Present*

Stoppage, \$ *100* for

Due Gov't, \$ *100* for

Valuation of horse, \$ *100*

Valuation of horse equipments. \$ *100*

Remarks:

Book mark:

Lowry

(358)

Copyist.

F | 10 H. Art'y. | U.S.C.T.

Gustave Fee
Pvt., Co. H, 10 Reg't U. S. Col'd H. Art'y

Appears on

Company Muster Roll

for *Nov. & Dec*, 1866.

Present or absent *Present*

Stoppage, \$ *100* for

Due Gov't, \$ *100* for

Valuation of horse, \$ *100*

Valuation of horse equipments, \$ *100*

Remarks :

Book mark :

Lorrey

(358)

Copyist.

F | 10 H. Art'y. | U.S.C.T.

Gustave Feer
Sgt, Co. *H*, 10 Reg't U. S. Col'd H. Art'y.

Appears on **Co. Muster-out Roll**, dated
Baton Rouge, La, Feb 22, 1867.
Muster-out to date *Feb 22, 1867*.
Last paid to *Dec 31, 1866*.

Clothing account:

Last settled....., 186 ; drawn since \$..... 100
Due soldier \$ *16*/^{*16*}/₁₀₀; due U. S. \$..... 100
Am't for cloth'g in kind or money adv'd \$..... 100

Due U. S. for arms, equipments, &c., \$ *6*/^{*00*}/₁₀₀
Bounty paid \$..... 100; due \$..... 100

Remarks: *Deserted Nov. 19/64*
Apprehended Nov 31/65
and returned to duty with-
out trial by order Brig.
gen. Sherman.

Book mark :

(361)

Lowry

Copyist.

File, Gustave

, Co. *20*, *10* Reg't *U S A*

2 **Enclosures.**

Bed Cards	Final Statements
Burial Records	Furloughs or L. of A.
Certs. of Dis. for Discharge	Med. Certificates
C. M. Charges	Med. Des. Lists
Descriptive Lists	Orders
Discharge Certificates	Pris. of War Record
Enlistment Papers <i>2</i>	Resignations

Other papers relating to—

Admission to Hosp'l	Furlough or L. of A.
Casualty Sheet	Med. Examination
Confinement	Misc. Information
Contracts	Pay or Clothing
Death or Effects	Personal Reports
Desertion	Rank
Discharge from Hosp'l	Transfer to Hosp'l
Discharge from Service	Transfer to V. R. C.
Duty	Transportation

NOTE 1.—This blank will be used for both enlistments and re-enlistments—enlistment of veterans, &c., &c., in the volunteer service. They will be made out in duplicate in all cases—one to accompany the recruiting return of the superintendent (not the recruiting officer) to the Adjutant General, and one to accompany the accounts of the officer who pays bounty, &c. The Regiment and Company in which the soldier last served should be given on the back.

NOTE 2.—An enlistment holds to service. A muster-in must, in all cases, precede payment of pay, bounty, pension, &c. A muster-in roll must, in all cases, be filed in the Adjutant General's Office as evidence of muster-in. The mustering officer, commissary, or assistant commissary of musters, as the case may be, will countersign both enlistments as having mustered the soldier into the service of the United States before either of them is given to the disbursing officer.

DECLARATION OF RECRUIT.

I, Gustave Fee, desiring to VOLUNTEER as a Soldier in the Army of the United States, for the term of THREE YEARS, Do Declare, That I am 32 years and _____ months of age; that I have never been discharged from the United States service on account of disability or by sentence of a court martial, or by order before the expiration of a term of enlistment; and I know of no impediment to my serving honestly and faithfully as a soldier for three years.

GIVEN at New Orleans La the 1 day of November 1864

Witness: H. L. ... Gustave Fee
1784 11000

No. _____
Gustave Fee
Volunteered at New Orleans
Nov 1, 1864
By H. L. ...
84 Regiment of U. S. C.
Discharged _____, 18____
Reg't of _____
enlistment; last served in Company ()
...

CONSENT IN CASE OF MINOR.

I, _____, Do CERTIFY, That I am the _____ of _____; that the said _____ is _____ years of age; and I do hereby freely give my CONSENT to his volunteering as a SOLDIER in the ARMY OF THE UNITED STATES for the period of THREE YEARS.

GIVEN at _____ the _____ day of _____

Witness: _____

VOLUNTEER ENLISTMENT.

STATE OF



TOWN OF

Louisiana

New Orleans

I, *Gustave Fee*, born in *St Charles* in the State of *Louisiana*, aged *32* years, and by occupation a *Laborer*, Do HEREBY ACKNOWLEDGE to have volunteered this *First* day of *November*, 186*4* to serve as a **Soldier** in the **Army of the United States of America**, for the period of **THREE YEARS**, unless sooner discharged by proper authority: Do also agree to accept such bounty, pay, rations, and clothing, as are, or may be, established by law for volunteers. And I, *Gustave Fee*, do solemnly swear, that I will bear true faith and allegiance to the **United States of America**, and that I will serve them honestly and faithfully against all their enemies or opposers whomsoever; and that I will observe and obey the orders of the President of the United States, and the orders of the officers appointed over me, according to the Rules and Articles of War.

Sworn and subscribed to, at *New Orleans* this *1* day of *Nov*, 186*4*, BEFORE *G. T. Palmer* *1st Lt US A*

I CERTIFY, ON HONOR, That I have carefully examined the above-named Volunteer, agreeably to the General Regulations of the Army, and that, in my opinion, he is free from all bodily defects and mental infirmity, which would in any way disqualify him from performing the duties of a soldier.

Wm H. Humphrey
Surgeon
EXAMINING SURGEON.

I CERTIFY, ON HONOR, That I have minutely inspected the Volunteer *Gustave Fee* previously to his enlistment, and that he was entirely sober when enlisted; that, to the best of my judgment and belief, he is of lawful age; and that, in accepting him as duly qualified to perform the duties of an able-bodied soldier, I have strictly observed the Regulations which govern the recruiting service. This soldier has *Blue* eyes, *Blue* hair, *Blue* complexion, is *5* feet *8 1/2* inches high.

G. T. Palmer
1st Lt US A
Regiment of *USCA* Volunteers,
RECRUITING OFFICER.

(A. G. O. No. 74 & 76.)

Mustered into the service of the United States, for three years or during the war, from date of enlistment, in Company *B* of *11th* Regiment of *USCA* Volunteers, on the *8* day of *Nov* 186*4* at *New Orleans*

Wm H. Humphrey
Surgeon
Wm H. Humphrey
Surgeon
Wm H. Humphrey
Surgeon

NOTE 1.—This blank will be used for both enlistments and re-enlistments—enlistment of veterans, &c., &c., in the volunteer service. They will be made out in duplicate in all cases—one to accompany the recruiting return of the superintendent (not the recruiting officer) to the Adjutant General, and one to accompany the accounts of the officer who pays bounty, &c. The Regiment and Company in which the soldier last served should be given on the back.

NOTE 2.—An enlistment holds to service. A muster-in must, in all cases, precede payment of pay, bounty, pension, &c. A muster-in roll must, in all cases, be filed in the Adjutant General's Office as evidence of muster-in. The mustering officer, commissary, or assistant commissary of musters, as the case may be, will countersign both enlistments as having mustered the soldier into the service of the United States before either of them is given to the disbursing officer.

DECLARATION OF RECRUIT.

I, Mustave Fee, desiring to VOLUNTEER as a Soldier in the Army of the United States, for the term of THREE YEARS, Do Declare, That I am Thirty two years and _____ months of age; that I have never been discharged from the United States service on account of disability or by sentence of a court martial, or by order before the expiration of a term of enlistment; and I know of no impediment to my serving honestly and faithfully as a soldier for three years.

GIVEN at New Orleans La the 1st day of November 1864

Witness:

H. P. ...
1st Regt 84th U.S.C.S.

Volunteered at New Orleans
Mustave Fee
No. 91
By H. P. ...
84 Regiment of U.S.C.S.
Discharged _____, 1864
Company ...
to Company
enlistment; last served in Company ()
Reg't of _____

10445.6.10045

CONSENT IN CASE OF MINOR.

I, _____, Do CERTIFY, That I am the _____ of _____; that the said _____ is _____ years of age; and I do hereby freely give my CONSENT to his volunteering as a SOLDIER in the ARMY OF THE UNITED STATES for the period of THREE YEARS.

GIVEN at _____ the _____ day of _____

Witness:

VOLUNTEER ENLISTMENT.

STATE OF

TOWN OF

Louisiana



New Orleans

I, *Gustave Fee*, born in *St. Charles* in the State of *Louisiana*, aged *thirty two* years, and by occupation a *laborer*, Do HEREBY ACKNOWLEDGE to have volunteered this *first* day of *November*, 1864 to serve as a **Soldier** in the **Army of the United States of America**, for the period of **THREE YEARS**, unless sooner discharged by proper authority: Do also agree to accept such bounty, pay, rations, and clothing, as are, or may be, established by law for volunteers. And I, *Gustave Fee*, do solemnly swear, that I will bear true faith and allegiance to the **United States of America**, and that I will serve them honestly and faithfully against all their enemies or opposers whomsoever; and that I will observe and obey the orders of the President of the United States, and the orders of the officers appointed over me, according to the Rules and Articles of War.

Sworn and subscribed to, at *New Orleans* in this *1st* day of *Nov*, 1864, *Gustave Fee* BEFORE *H. P. Pannier* 1st Lt 84th U.S.C.S.

I CERTIFY, ON HONOR, That I have carefully examined the above-named Volunteer, agreeably to the General Regulations of the Army, and that, in my opinion, he is free from all bodily defects and mental infirmity, which would in any way disqualify him from performing the duties of a soldier.

Dr. W. Humphrey
Surgeon U.S.A.
EXAMINING SURGEON.

I CERTIFY, ON HONOR, That I have minutely inspected the Volunteer *Gustave Fee* previously to his enlistment, and that he was entirely sober when enlisted; that, to the best of my judgment and belief, he is of lawful age; and that, in accepting him as duly qualified to perform the duties of an able-bodied soldier, I have strictly observed the Regulations which govern the recruiting service. This soldier has *Blue* eyes, *Blue* hair, *Blue* complexion, is *5* feet *3 1/2* inches high.

H. P. Pannier
1st Lt 84th Regiment of *U.S.C.S.* Volunteers,
RECRUITING OFFICER.

(A. G. O. No. 74 & 76.)

Mustered into the service of the United States, for three years or during the war, from date of enlistment, in Company *B* of *11th* Regiment of *W. S. & B. B. B. Volunteers*, on the *8th* day of *Nov*, 1864 at *New Orleans*

John P. Pannier
Adj. & Capt. U.S.A.
all mustering officers

See Romeo

Co B, 10 U.S. Col'd H. Art'y.

Private

Private

CARD NUMBERS.

1	5509537	26
2	5509634	27
3	5509747	28
4	5509904	29
5	5510054	30
6	5510199	31
7	5510349	32
8	5510500	33
9	5510622	34
10	5510765	35
11	5510847	36
12	5510922	37
13	5510994	38
14	5511059	39
15		40
16		41
17		42
18		43
19		44
20		45
21		46
22		47
23		48
24		49
25		50

Book Mark:

See also

F | 10 H. Art'y. | U.S.C.T.

Romeo Fee

Pvt, Co. H, 10 Reg't U. S. Col'd H. Art'y.

Appears on

Company Muster-in and Descriptive Roll

of the organization named above. Roll dated

New Orleans La, Nov 8, 1864.

Where born *St Charles La.*

Age *36* y'rs; occupation *Labourer*

When enlisted *Nov 1*, 1864.

Where enlisted *New Orleans*

For what period enlisted *3* years.

Eyes *Black*; hair *Black*

Complexion *Black*; height *5* ft. *7/4* in.

When mustered in *Nov 8*, 1864.

Where mustered in *New Orleans*

Bounty paid \$ *100*; due \$ *100*

Where credited *1st Dist 2nd Ward, Parish
of Orleans City of N. Orleans La.*
Company to which assigned *H.*

Remarks: *Mustered in to
date from date
of enlistment -*
NEXT ROLL ON FILE FEB 1865

Book mark:

(356d)

Pennington

Copyist.

F | 10 H. Art'y. | U.S.C.T.

Romeo Lee

Pvt, Co. H, 10 Reg't U. S. Col'd H. Art'y

Appears on

Company Muster Roll

for *Jany & Feby*, 1865.

Present or absent *Present*

Stoppage, \$ *100* for

Due Gov't, \$ *100* for

Valuation of horse, \$ *100*

Valuation of horse equipments. \$ *100*

Remarks:

Book mark:

(358)

Permittington

Copyist.

F | 10 H. Art'y. | U.S.C.T.

Romeo Lee

Priv., Co. H, 10 Reg't U. S. Col'd H. Art'y

Appears on

Company Muster Roll

for *March & April*, 1865.

Present or absent *Present*

Stoppage, \$ 100 for

Due Gov't, \$ 100 for

Valuation of horse, \$ 100

Valuation of horse equipments. \$ 100

Remarks : _____

Book mark : _____

(358)

Carrington

Copyist.

Romeo Lee

Pvt, Co. H, 10 Reg't U. S. Col'd H. Art'y

Appears on

Company Muster Roll

for *May & June*, 1865.

Present or absent *Present*

Stoppage, \$ *100* for

Due Gov't, \$ *100* for

Valuation of horse, \$ *100*

Valuation of horse equipments. \$ *100*

Remarks :

Book mark :

Permyngton
(358) Copyist.

F

10 H. Art'y.

U.S.C.T.

Romeo Lee

Art, Co. H, 10 Reg't U. S. Col'd H. Art'y

Appears on

Company Muster Roll

for *July & Aug*, 1865.

Present or absent *Present*

Stoppage, \$ *100* for

Due Gov't, \$ *100* for

Valuation of horse, \$ *100*

Valuation of horse equipments. \$ *100*

Remarks :

Book mark :

Permittington Copyist.

(358)

G

10 H. Art'y. U.S.C.T.

Romeo Gee

Pvt., Co. H, 10 Reg't U. S. Col'd H. Art'y

Appears on

Company Muster Roll

for *Sep & Oct*, 1865.

Present or absent *Present*

Stoppage, \$ *100* for

Due Gov't, \$ *100* for

Valuation of horse, \$ *100*

Valuation of horse equipments. \$ *100*

Remarks :

Book mark :

Lammack
Copyist.

F

10 H. Art'y.

U.S.C.T.

Romeo Fee

Co., Co. H, 10 Reg't U. S. Col'd H. Art'y

Appears on

Company Muster Roll

for *Nov 1 Dec*, 1865.

Present or absent *Present*

Stoppage, \$ *100* for

Due Gov't, \$ *100* for

Valuation of horse, \$ *100*

Valuation of horse equipments. \$ *100*

Remarks :

Book mark :

Gamma
Copyst.

F

10 H. Art'y. U.S.C.T.

Romeo Fee

Pvt., Co. H, 10 Reg't U. S. Col'd H. Art'y

Appears on

Company Muster Roll

for *Jan & Feb.*, 1866.

Present or absent *Present*

Stoppage, \$ 100 for

Due Gov't, \$ 100 for

Valuation of horse, \$ 100

Valuation of horse equipments. \$ 100

Remarks :

Book mark :

(358)

Cammas
Copyist.

F

10 H. Art'y. U.S.C.T.

Romeo Lee

Priv., Co. H, 10 Reg't U. S. Col'd H. Art'y

Appears on

Company Muster Roll

for *Mth & Apr.*, 1866.

Present or absent *Present*

Stoppage, \$ 100 for

Due Gov't, \$ 100 for

Valuation of horse, \$ 100

Valuation of horse equipments. \$ 100

Remarks:

Book mark:

Gamma R

J

10 H. Art'y. U.S.C.T.

Romeo Lee

C.F., Co. H, 10 Reg't U. S. Col'd H. Art'y

Appears on

Company Muster Roll

for *May & June*, 1866.

Present or absent *Present*

Stoppage, \$ 100 for

Due Gov't, \$ 100 for

Valuation of horse, \$ 100

Valuation of horse equipments. \$ 100

Remarks:

Book mark:

Gammack

(858)

Copyist.

J

10 H. Art'y. U.S.C.T.

Pomero Lee

Pr^t, Co. H, 10 Reg't U. S. Col'd H. Art'y

Appears on

Company Muster Roll

for *July & Aug*, 1866.

Present or absent *Present*

Stoppage, \$ 100 for

Due Gov't, \$ 100 for

Valuation of horse, \$ 100

Valuation of horse equipments. \$ 100

Remarks :

Book mark :

(858)

Lamma R
Copyist.

J

10 H. Art'y.

U.S.C.T.

Romeo Lee

Pvt., Co. H, 10 Reg't U. S. Col'd H. Art'y

Appears on

Company Muster Roll

for *Sep & Oct*, 186*6*.

Present or absent *Present*

Stoppage, \$ *100* for

Due Gov't, \$ *100* for

Valuation of horse, \$ *100*

Valuation of horse equipments. \$ *100*

Remarks :

Book mark :

Lowry

(358)

Copyist.

G | 10 H. Art'y. | U.S.C.T.

Romeo Lee

Pvt., Co. H, 10 Reg't U. S. Col'd H. Art'y

Appears on

Company Muster Roll

for *Nov. & Dec*, 1866.

Present or absent *Present*

Stoppage, \$ *100* for

Due Gov't, \$ *100* for

Valuation of horse, \$ *100*

Valuation of horse equipments. \$ *100*

Remarks: *Sick in quarters.*

Book mark:

Lowry

(358)

Copyist.

G | 10 H. Art'y. | U.S.C.T.

Romeo Fee

Priv., Co. *H*, 10 Reg't U. S. Col'd H. Art'y.

Appears on **Co. Muster-out Roll**, dated
Baton Rouge, La., Feb. 22, 1867 .
Muster-out to date *Feb. 22*, 1867 .
Last paid to *Dec. 31*, 1866 .

Clothing account:

Last settled....., 186 ; drawn since \$.....¹⁰⁰

Due soldier \$ *49*¹⁰⁰; due U. S. \$.....¹⁰⁰

Am't for cloth'g in kind or money adv'd \$.....¹⁰⁰

Due U. S. for arms, equipments, &c., \$.....⁶⁰⁰¹⁰⁰

Bounty paid \$.....¹⁰⁰; due \$ *200*⁰⁰¹⁰⁰

Remarks: *Joined at orig. org.*

Book mark :

(361)

Lowry

Copyist.

Free, Romeo

, Co. 26, 10 Reg't U S A

2 Enclosures.

Bed Cards	Final Statements
Burial Records	Furloughs or L. of A.
Certs. of Dis. for Discharge	Med. Certificates
C. M. Charges	Med. Des. Lists
Descriptive Lists	Orders
Discharge Certificates	Pris. of War Record
Enlistment Papers 2	Resignations

Other papers relating to—

Admission to Hosp'l	Furlough or L. of A.
Casualty Sheet	Med. Examination
Confinement	Misc. Information
Contracts	Pay or Clothing
Death or Effects	Personal Reports
Desertion	Rank
Discharge from Hosp'l	Transfer to Hosp'l
Discharge from Service	Transfer to V. R. C.
Duty	Transportation

NOTE 1.—This blank will be used for both enlistments and re-enlistments—enlistment of veterans, &c., &c., in the volunteer service. They will be made out in duplicate in all cases—one to accompany the recruiting return of the superintendent (not the recruiting officer) to the Adjutant General, and one to accompany the accounts of the officer who pays bounty, &c. The Regiment and Company in which the soldier last served should be given on the back.

NOTE 2.—An enlistment holds to service. A muster-in must, in all cases, precede payment of pay, bounty, pension, &c. A muster-in roll must, in all cases, be filed in the Adjutant General's Office as evidence of muster-in. The mustering officer, commissary, or assistant commissary of musters, as the case may be, will countersign both enlistments as having mustered the soldier into the service of the United States before either of them is given to the disbursing officer.

DECLARATION OF RECRUIT.

I, Romeo Lee, desiring to VOLUNTEER as a Soldier in the Army of the United States, for the term of THREE YEARS, Do Declare, That I am 36 years and 2 months of age; that I have never been discharged from the United States service on account of disability or by sentence of a court martial, or by order before the expiration of a term of enlistment; and I know of no impediment to my serving honestly and faithfully as a soldier for three years.

GIVEN at New Orleans La the 21 day of November 1864

Witness: W. E. Reddy Romeo Lee
Pvt. U.S. Army Recruit

Discharged 30 months out entitled to bounty 1864
enlistment; last served in Company ()
Reg't of _____
Regiment of _____
Volunteered at New Orleans
1st November 1864
By W. E. Reddy

10 11 1864

CONSENT IN CASE OF MINOR.

I, _____, DO CERTIFY, That I am the _____ of _____; that the said _____ is _____ years of age; and I do hereby freely give my CONSENT to his volunteering as a SOLDIER in the ARMY OF THE UNITED STATES for the period of THREE YEARS.

GIVEN at _____ the _____ day of _____

Witness: _____

VOLUNTEER ENLISTMENT.

STATE OF

TOWN OF

Louisiana



New Orleans

I, *Romeo Lee*, born in *J. Charles* in the State of *Louisiana*, aged *36* years, and by occupation a *Sabrer*, Do HEREBY ACKNOWLEDGE to have volunteered this *1st* day of *November*, 1864, to serve as a **Soldier** in the **Army of the United States of America**, for the period of **THREE YEARS**, unless sooner discharged by proper authority: Do also agree to accept such bounty, pay, rations, and clothing, as are, or may be, established by law for volunteers. And I, *Romeo Lee*, do solemnly swear, that I will bear true faith and allegiance to the **United States of America**, and that I will serve them honestly and faithfully against all their enemies or opposers whomsoever; and that I will observe and obey the orders of the President of the United States, and the orders of the officers appointed over me, according to the Rules and Articles of War.

Sworn and subscribed to, at *New Orleans* this *1st* day of *Nov*, 1864, } *Romeo Lee* his mark
BEFORE *H. P. ...* mark
1st Lt 84th U.S.C.

I CERTIFY, ON HONOR, That I have carefully examined the above-named Volunteer, agreeably to the General Regulations of the Army, and that, in my opinion, he is free from all bodily defects and mental infirmity, which would in any way disqualify him from performing the duties of a soldier.

Wm M. Humphrey
Surgeon U.S.A.
EXAMINING SURGEON.

I CERTIFY, ON HONOR, That I have minutely inspected the Volunteer *Romeo Lee* previously to his enlistment, and that he was entirely sober when enlisted; that, to the best of my judgment and belief, he is of lawful age; and that, in accepting him as duly qualified to perform the duties of an able-bodied soldier, I have strictly observed the Regulations which govern the recruiting service. This soldier has *Blk* eyes, *Blk* hair, *Blk* complexion, is *5'* feet *3 1/4* inches high.

H. P. ...
1st Lt 84th U.S.C. Regiment of *U.S.C.* Volunteers,
RECRUITING OFFICER.

(A. G. O. No. 74 & 76.)

Mustered into the service of the United States, for three years or during the war, from date of enlistment, in Company *B* of *11th* Regiment of *Blk & Coy* Volunteers, on the *8* day of *Nov*, 1864, at *New Orleans*

John ...
1st Lt 84th U.S.C.
Recruiting Officer

NOTE 1.—This blank will be used for both enlistments and re-enlistments—enlistment of veterans, &c., &c., in the volunteer service. They will be made out in duplicate in all cases—one to accompany the recruiting return of the superintendent (not the recruiting officer) to the Adjutant General, and one to accompany the accounts of the officer who pays bounty, &c. The Regiment and Company in which the soldier last served should be given on the back.

NOTE 2.—An enlistment holds to service. A muster-in must, in all cases, precede payment of pay, bounty, pension, &c. A muster-in roll must, in all cases, be filed in the Adjutant General's Office as evidence of muster-in. The mustering officer, commissary, or assistant commissary of musters, as the case may be, will countersign both enlistments as having mustered the soldier into the service of the United States before either of them is given to the disbursing officer.

DECLARATION OF RECRUIT.

I, Rames Fee, desiring to VOLUNTEER as a Soldier in the Army of the United States, for the term of THREE YEARS, Do Declare, That I am 36 years and _____ months of age; that I have never been discharged from the United States service on account of disability or by sentence of a court martial, or by order before the expiration of a term of enlistment; and I know of no impediment to my serving honestly and faithfully as a soldier for three years.

GIVEN at New Orleans La the 1 day of November

Witness: A. Salminen Rames Fee
1704 1/2 St with

No. _____
Volunteered at New Orleans
Nov 1, 1888
By A. Salminen
84 Regiment of A 2000
enlistment; last served in Company ()
Reg't of _____
Discharged _____, 18 _____
Company 1704 1/2 St
to Community

CONSENT IN CASE OF MINOR.

I, _____, Do CERTIFY, That I am the _____ of _____; that the said _____ is _____ years of age; and I do hereby freely give my CONSENT to his volunteering as a SOLDIER in the ARMY OF THE UNITED STATES for the period of THREE YEARS.

GIVEN at _____ the _____ day of _____

Witness: _____

VOLUNTEER ENLISTMENT.

STATE OF

TOWN OF

Louisiana



New Orleans

I, *Romeo Fee*, born in *St Charles* in the State of *Louisiana*, aged *36* years, and by occupation a *laborer*, Do HEREBY ACKNOWLEDGE to have volunteered this *first* day of *November*, 186*4* to serve as a **Soldier** in the **Army of the United States of America**, for the period of **THREE YEARS**, unless sooner discharged by proper authority: Do also agree to accept such bounty, pay, rations, and clothing, as are, or may be, established by law for volunteers. And I, *Romeo Fee*, do solemnly swear, that I will bear true faith and allegiance to the **United States of America**, and that I will serve them honestly and faithfully against all their enemies or opposers whomsoever; and that I will observe and obey the orders of the President of the United States, and the orders of the officers appointed over me, according to the Rules and Articles of War.

Sworn and subscribed to, at *New Orleans* this *1* day of *Nov*, 186*4* } *Romeo Fee*
BEFORE *H. Palmieri* } *W. H. S. C. O.*

I CERTIFY, ON HONOR, That I have carefully examined the above-named Volunteer, agreeably to the General Regulations of the Army, and that, in my opinion, he is free from all bodily defects and mental infirmity, which would in any way disqualify him from performing the duties of a soldier.

Wm Humphrey
Surgeon
EXAMINING SURGEON.

I CERTIFY, ON HONOR, That I have minutely inspected the Volunteer *Romeo Fee* previously to his enlistment, and that he was entirely sober when enlisted; that, to the best of my judgment and belief, he is of lawful age; and that, in accepting him as duly qualified to perform the duties of an able-bodied soldier, I have strictly observed the Regulation, which govern the recruiting service. This soldier has *Blue* eyes, *Blue* hair, *Blue* complexion, is *5* feet *5/4* inches high.

H. Palmieri
W. H. S. C. O. Regiment of *U. S. C. O.* Volunteers,
RECRUITING OFFICER.

(A. G. O. No. 74 & 76.)

Mustered into the service of the United States, for three years or during the war, from date of enlistment, in Company *B* of *10* Regiment of *U. S. C. O.* Volunteers, on the *8* day of *Nov*, 186*4*, at *New Orleans*

John W. Moore
Adjutant
W. H. S. C. O.
Recruiting Officer

Felder William

Co M., 10 U.S. Col'd H. Art'y.

Private | *Private*

CARD NUMBERS.

1	<i>5488885</i>	26
2	<i>5488993</i>	27
3		28
4		29
5		30
6		31
7		32
8		33
9		34
10		35
11		36
12		37
13		38
14		39
15		40
16		41
17		42
18		43
19		44
20		45
21		46
22		47
23		48
24		49
25		50

Book Mark:

See also

7740 Infantry

F | 10th Co. Arty | U.S.C.T.

William Felder
Pt. Co. M, 10 Reg't U. S. Col'd Arty

Appears on

M. and D. Roll of Men Transferred

to the organization named above,

from 77 U. S. Col'd Inf.

Roll dated Oct. 1, 1865

When enlisted Jan. 9, 1865

Period for which enlisted 3 years.

When mustered in Jan. 17, 1865

Present or absent

Company to which assigned M

Remarks: Discharged at New Orleans La. May 24/65
Final statement given from Hoopla.

Not taken up on muster
roll of Co. M.

Book mark :

(342)

Chandler
Copyist

F 10 H. Artz. U.S.C.T.

William Felder

Pvt., Co., 10 Reg't U. S. Col'd H. Artz

Appears on

M. and D. Roll of Men Transferred

to the organization named above,

from 77th U. S. Col'd Infy.

Roll dated Oct. 1, 1865.

When enlisted Jan. 9, 1865.

Period for which enlisted 3 years.

When mustered in Jan. 17, 1865.

Present or absent

Company to which assigned

Remarks: Discharged at
New Orleans La. May 24/65.
Final Statement
given from Hospital.

Book mark :

(342)

Eastling Copyist.

Felix Julius

Co *K*, 10 U.S. Col'd H. Art'y.

Private

Private

CARD NUMBERS.

1	5488397	26
2	5487390	27
3	5512273	28
4	5512425	29
5	5512647	30
6	5513349	31
7	5489782	32
8		33
9		34
10		35
11		36
12		37
13		38
14		39
15		40
16		41
17		42
18		43
19		44
20		45
21		46
22		47
23		48
24		49
25		50

Book Mark:

See also

77. v. 10. 10. 10.

F 10 H A | **U.S.C.T.**

Jules Felix
Reg't, Co. *H*, 10 Reg't U. S. Col'd *H A*

Appears on

M. and D. Roll of Men Transferred

to the organization named above,

from *97 U.S. Col Inf*

Roll dated *Camp Canaper de Oct*, 186 *A*

When enlisted *July 16*, 186 *3*

Period for which enlisted *3* years.

When mustered in *Feb 23*, 186 *3*

Present or absent *Present*

Company to which assigned *K*

Remarks: *Rec'd by transfer
from Co *F* 97 U.S. C. I.*

Book mark : *2-23-63*

W. H. Scott
(342) Coylist

F. Foster, U.S.C.T.

Jules Felix
Priv., Co. K, 10 Reg't U. S. Col'd Infantry.

Appears on

M. and D. Roll of Men Transferred

to the organization named above,

from Co. K, 10 Reg't U. S. Col'd Inf.

Roll dated Camp Sanpedra Oct, 1865.

When enlisted Feb 16, 1863.

Period for which enlisted 3 years.

When mustered in Feb 23, 1863.

Present or absent Present

Company to which assigned K

Remarks: Rec'd by transfer
from 4th Inf. Cd. A
Dec. 63.

Book mark :

W. H. Scott

F | 10 H. Art'y. | U.S.C.T.

Jules Felix
P, Co. *K*, 10 Reg't U. S. Col'd H. Art'y.

Age years.

Appears on

Company Muster Roll*

for *Sept. & Oct., 1865.*

Joined for duty and enrolled:

When *Feb. 16*, 1863.

Where *New Orleans*

Period *3* years.

Mustered in:

When *Feb. 23*, 1863.

Where *New Orleans*

Present or absent *Present*

Stoppage, \$ *100* for

Due Gov't, \$ *100* for

Remarks:

* First current roll. No muster-in roll of this company on file.

Book mark:

(3586)

Hibbard

Copyist.

F | 10 H. Art'y. | U.S.C.T.

Jules Felix

P, Co. K, 10 Reg't U. S. Col'd H. Art'y.

Appears on

Company Muster Roll

for Nov. & Dec., 1865

Present or absent Present

Stoppage, \$ 100 for

Due Gov't, \$ 100 for

Valuation of horse, \$ 100

Valuation of horse equipments, \$ 100

Remarks: Stop \$15. due S.B. Smith
Butler.

Book mark:

Hibbard

(358)

Copyist.

↑

10 H. Art'y.

U.S.C.T.

Jules Felix

P, Co. K, 10 Reg't U. S. Col'd H. Art'y.

Appears on

Company Muster Roll

for *Jan. Feb.*, 1866.

Present or absent

Stoppage, \$ *100* for

Due Gov't, \$ *100* for

Valuation of horse, \$ *100*

Valuation of horse equipments, \$ *100*

Remarks: *Disch. by expiration of term of service.*

Book mark: *7383 P.M.G. July 13, 66.*

(358)

Hibbard

Copyist.

J

10 H. Art'y. U.S.C.T.

Julius Felix

Priv, Co. *K*, 10 Reg't U. S. Col'd H. Art'y.

Appears on **Co. Muster-out Roll**, dated
Baton Rouge La, *Feb 22*, 1867.

Muster-out to date _____, 186 .

Last paid to _____, 186 .

Clothing account:

Last settled _____, 186 ; drawn since \$ _____ 100

Due soldier \$ _____ 100; due U. S. \$ _____ 100

Am't for cloth'g in kind or money adv'd \$ _____ 100

Due U. S. for arms, equipments, &c., \$ _____ 100

Bounty paid \$ _____ 100; due \$ _____ 100

Remarks: *Recd by transfer from Co. F
77 U. S. C. I. Oct 1/65 per S. O. No. 66
Hdqrs Dept La. S. 1865. Dis by
Exp term Service Feb 15/66*

Book mark: *V 21. P. 39. 68*

Floyd

(361)

Copyist.

F 10th Reg't Asty U.S.C.T.

Jules Felix
Priv., Co. K, 10th Reg't U. S. Col'd Asty

Appears on a

Detachment Muster-out Roll

of the organization named above. Roll dated

New Orleans, La, Feb. 15, 1866.

Muster-out to date Feb. 15, 1866.

Last paid to June 30, 1865.

Clothing account:

Last settled _____, 186 ; drawn since \$ _____ 100

Due soldier \$ 16 ⁸⁸/₁₀₀; due U. S. \$ _____ 100

Am't for cloth'g in kind or money adv'd \$ _____ 100

Due U. S. for arms, equipments, &c., \$ 2 ⁴³/₁₀₀

Bounty paid \$ _____ 100 due \$ _____ 100

Remarks: Rec'd by transfer from

Co. F 77th U.S. C. I Per S. O. No. 66 S. 1865 Hd Qrs. Dept. of La. Stoppage for loss ordnance & Camp & Equipage.

Book mark: _____

A. M. Reed

Fenley Thomas

Co G, 10 U.S. Col'd H. Art'y.

Private

Private

CARD NUMBERS.

1	5507127	26
2	5507410	27
3	5507559	28
4	5507704	29
5	5507842	30
6	5507985	31
7	5508125	32
8	5508258	33
9	5508394	34
10	5508544	35
11	5508697	36
12	5508843	37
13	5508990	38
14	5509120	39
15	5509268	40
16	5509377	41
17		42
18		43
19		44
20		45
21		46
22		47
23		48
24		49
25		50

Book Mark:

See also

J. Mcarty | **U. S. C. T.**

Thomas Fenley

Appears with rank of *Pvt* on

Muster and Descriptive Roll of a Detachment of U. S. Vols. forwarded

Organized as Co. G.
for the *10th* Reg't U. S. Col'd *No. 9*. Roll dated
New Orleans La. Sept 20, 1864.

Where born *Sherville La*

Age *33* y'rs; occupation *Laborer*

When enlisted *Sept 20*, 1864.

Where enlisted *New Orleans La*

For what period enlisted *3* years.

Eyes *Brown*; hair *Blk*

Complexion *Brown*; height *5* ft. *3* in.

When mustered in *Sept 20*, 1864.

Where mustered in *New Orleans La.*

Bounty paid \$ *100*; due \$ *100*

Where credited *to New Orleans La*

Company to which assigned *G.*

Remarks:

Book mark:

E. P. Thompson

A

10 H. Art'y.

U.S.C.T.

Thomas

Finley

Pvt., Co. G, 10 Reg't U. S. Col'd H. Art'y.

Appears on

Company Muster Roll

for Sept & Oct, 1864.

Present or absent Present

Stoppage, \$ 100 for

Due Gov't, \$ 100 for

Valuation of horse, \$ 100

Valuation of horse equipments, \$ 100

Remarks:

Book mark:

E. N. Brown

F

10 H. Art'y. U.S.C.T.

Thomas Penly
Pvt., Co. G, 10 Reg't U. S. Col'd H. Art'y.

Appears on

Company Muster Roll

for Nov & Dec, 1864.

Present or absent Present

Stoppage, \$ 100 for

Due Gov't, \$ 100 for

Valuation of horse, \$ 100

Valuation of horse equipments, \$ 100

Remarks:

Book mark:

E. H. Brown

T

10 H. Art'y.

U.S.C.T.

Thomas Fenley

Prob., Co. G, 10 Reg't U. S. Col'd H. Art'y.

Appears on

Company Muster Roll

for *Jan & Feb*, 186*4*.

Present or absent *Present*

Stoppage, \$ *100* for

Due Gov't, \$ *100* for

Valuation of horse, \$ *100*

Valuation of horse equipments, \$ *100*

Remarks:

Book mark:

J. E. Porter

F

10 H. Art'y. U.S.C.T.

Thomas Fenley
Priv., Co. G, 10 Reg't U. S. Col'd H. Art'y.

Appears on

Company Muster Roll

for *Mar + April*, 1865.

Present or absent *Present*

Stoppage, \$.....100 for

Due Gov't, \$.....100 for

Valuation of horse, \$.....100

Valuation of horse equipments, \$.....100

Remarks:

Book mark:

F. E. Porter

F

10 H. Art'y. | U.S.C.T.

Thomas Fenley

Priv, Co. G, 10 Reg't U. S. Col'd H. Art'y.

Appears on

Company Muster Roll

for *May & June*, 1865.

Present or absent *Present*

Stoppage, \$.....100 for

Due Gov't, \$.....100 for

Valuation of horse, \$.....100

Valuation of horse equipments, \$.....100

Remarks:

Book mark:

J. E. Porter

J

10 H. Art'y.

U.S.C.T.

Thomas Fenley

Prov, Co. G, 10 Reg't U. S. Col'd H. Art'y.

Appears on

Company Muster Roll

for *July + Aug*, 1865.

Present or absent *Present*

Stoppage, \$ 100 for

Due Gov't, \$ $\frac{05}{100}$ for *C + G Equip*
age lost or destroyed

Valuation of horse, \$ 100

Valuation of horse equipments, \$ 100

Remarks:

Book mark:

J. E. Fortier

F

10 H. Art'y. U.S.C.T.

Thomas Tinsley

Prov., Co. G, 10 Reg't U. S. Col'd H. Art'y.

Appears on

Company Muster Roll

for *Sept & Oct*, 186*0*.

Present or absent *Present*

Stoppage, \$ *100* for

Due Gov't, \$ *100* for

Valuation of horse, \$ *100*

Valuation of horse equipments, \$ *100*

Remarks:

Book mark:

F. E. Porter

(358)

Copyist.

F

10 H. Art'y.

U.S.C.T.

Thomas Fenley

Private, Co. G, 10 Reg't U. S. Col'd H. Art'y.

Appears on

Company Muster Roll

for *Nov. & Dec*, 186*5*!

Present or absent *Present*

Stoppage, \$ 100 for

Due Gov't, \$ 100 for

Valuation of horse, \$ 100

Valuation of horse equipments, \$ 100

Remarks:

Book mark:

G. Fenley

(358)

Copyist.

F

10 H. Art'y.

U.S.C.T.

Thomas Fenley

Capt, Co. G, 10 Reg't U. S. Col'd H. Art'y.

Appears on

Company Muster Roll

for *Jan 9 Feb*, 186*6*.

Present or absent *Present*

Stoppage, \$.....100 for

Due Gov't, \$.....100 for

Valuation of horse, \$.....100

Valuation of horse equipments, \$.....100

Remarks:.....

.....
.....
.....
.....
.....
.....
.....
.....
.....
.....

Book mark:.....

G. F. W.
Copyist.

F

10 H. Art'y.

U.S.C.T.

Thomas Fenley
Privt., Co. G, 10 Reg't U. S. Col'd H. Art'y.

Appears on

Company Muster Roll

for *Mar. & Apr.*, 1866.

Present or absent *Present*

Stoppage, \$ 100 for

Due Gov't, \$ 100 for

Valuation of horse, \$ 100

Valuation of horse equipments, \$ 100

Remarks:

Book mark:

(358)

G. Fen

Copyist.

F

10 H. Art'y. U.S.C.T.

Thomas Fenley
Pvt, Co. G, 10 Reg't U. S. Col'd H. Art'y.

Appears on

Company Muster Roll

for *May & June*, 186*6*.

Present or absent *Present*

Stoppage, \$.....100 for

Due Gov't, \$.....100 for

Valuation of horse, \$.....100

Valuation of horse equipments, \$.....100

Remarks:.....

Book mark:.....

G. Fenley

Copyist.

F

10 H. Art'y.

U.S.C.T.

Thomas Fenley
Privt, Co. G, 10 Reg't U. S. Col'd H. Art'y.

Appears on

Company Muster Roll

for *July & Aug*, 1866.

Present or absent *Present*

Stoppage, \$ 100 for

Due Gov't, \$ 100 for

Valuation of horse, \$ 100

Valuation of horse equipments, \$ 100

Remarks:

Book mark: -----

G. Fenley
Copyist.

T | 10 H. Art'y. | U.S.C.T.

Thomas Finley
Co. G, 10 Reg't U. S. C&I H. Art'y.

Appears on

Company Muster Roll

for *Sept & Oct*, 1866.

Present or absent *Present*

Stoppage, \$ *100* for

Due Gov't, \$ *100* for

Valuation of horse, \$ *100*

Valuation of horse equipments, \$ *100*

Remarks:

Book mark:

Wines
Copyist.

J

10 H. Art'y.

U.S.C.T.

Thomas Penley

Priv, Co. G, 10 Reg't U. S. Col'd H. Art'y.

Appears on

Company Muster Roll

for *Nov & Dec*, 1866.

Present or absent *Present*

Stoppage, \$ *100* for

Due Gov't, \$ *100* for

Valuation of horse, \$ *100*

Valuation of horse equipments, \$ *100*

Remarks:

Book mark:

Wines

Thomas Fenley

Priv, Co. *G*, 10 Reg't U. S. Col'd H. Art'y.

Appears on **Co. Muster-out Roll**, dated

Baton Rouge La, Feb 22, 1867.

Muster-out to date *Feb 22*, 1867.

Last paid to *Dec 31*, 1866.

Clothing account:

Last settled....., 186 ; drawn since \$..... 100

Due soldier \$ *43* ^{*25*} / 100; due U. S. \$..... 100

Am't for cloth'g in kind or money adv'd \$..... 100

Due U. S. for arms, equipments, &c., \$..... *6* ^{*00*} / 100

Bounty paid \$..... 100; due \$ *200* ^{*00*} / 100

Remarks: *Joined at Org^e, Orgⁿ*

Book mark :

Finley, Thomas

Co. *G*, *10* Reg't *U.S.C.A.*

Enclosures.

Bed Cards	Final Statements
Burial Records	Furloughs or L. of A.
Certs. of Dis. for Discharge	Med. Certificates
C. M. Charges	Med. Des. Lists
Descriptive Lists	Orders
Discharge Certificates	Pris. of War Record
Enlistment Papers	Resignations

Other papers relating to—

Admission to Hosp'l	Furlough or L. of A.
Casualty Sheet	Med. Examination
Confinement	Misc. Information
Contracts	Pay or Clothing
Death or Effects	Personal Reports
Desertion	Rank
Discharge from Hosp'l	Transfer to Hosp'l
Discharge from Service	Transfer to V. R. C.
Duty	Transportation

NOTE 1.—This blank will be used for both enlistments and re-enlistments—enlistment of veterans, &c., &c., in the volunteer service. They will be made out in duplicate in all cases—one to accompany the recruiting return of the superintendent (not the recruiting officer) to the Adjutant General, and one to accompany the accounts of the officer who pays bounty, &c. The Regiment and Company in which the soldier last served should be given on the back.

NOTE 2.—An enlistment holds to service. A muster-in must, in all cases, precede payment of pay, bounty, pension, &c. A muster-in roll must, in all cases, be filed in the Adjutant General's Office as evidence of muster-in. The mustering officer, commissary, or assistant commissary of musters, as the case may be, will countersign both enlistments as having mustered the soldier into the service of the United States before either of them is given to the disbursing officer.

DECLARATION OF RECRUIT.

I, Thomas Finley desiring to VOLUNTEER as a Soldier in the Army of the United States, for the term of THREE YEARS, Do Declare, That I am 23 years and _____ months of age; that I have never been discharged from the United States service on account of disability or by sentence of a court martial, or by order before the expiration of a term of enlistment; and I know of no impediment to my serving honestly and faithfully as a soldier for three years.

GIVEN at New Orleans the 20th day of September 1864

Witness: J. Horace McGuire Thomas Finley
mark

No. 18

Thomas Finley
 Volunteered at New Orleans
San Felipe 20th 1864
 By J. H. McGuire
 Regiment of Artillery

_____ enlistment; last served in Company ()
1st Reg't of U. S. Artillery
 Discharged _____ 18 ____
Conscription not entitled to bounty

CONSENT IN CASE OF MINOR.

I, _____ Do CERTIFY, That I am the _____ of _____; that the said _____ is _____ years of age; and I do hereby freely give my CONSENT to his volunteering as a SOLDIER in the ARMY OF THE UNITED STATES for the period of THREE YEARS.

GIVEN at _____ the _____ day of _____

Witness: _____

(A. G. O. No. 74 & 75.)

VOLUNTEER ENLISTMENT.

STATE OF

Louisiana



TOWN OF

New Orleans

I, *Thomas Finley* born in *Iberville*
in the State of *La* aged *33* years,
and by occupation a *laborer* Do HEREBY ACKNOWLEDGE to have
volunteered this *20th* day of *September* 186*4*
to serve as a **Soldier** in the **Army of the United States of America**, for
the period of **THREE YEARS**, unless sooner discharged by proper authority:
Do also agree to accept such bounty, pay, rations, and clothing, as are, or may be,
established by law for volunteers. And I, *Thomas Finley* do
solemnly swear, that I will bear true faith and allegiance to the **United States
of America**, and that I will serve them honestly and faithfully against all
their enemies or opposers whomsoever; and that I will observe and obey the
orders of the President of the United States, and the orders of the officers
appointed over me, according to the Rules and Articles of War.

Sworn and subscribed to, at *New Orleans*
this *20th* day of *Sept.* 186*4*, } *Thomas Finley*
BEFORE *J. M. Chamberlain* } *mark*
Capt. U.S.A.

I CERTIFY, ON HONOR, That I have carefully examined the above-named Volunteer, agreeably
to the General Regulations of the Army, and that, in my opinion, he is free from all bodily defects and
mental infirmity, which would in any way disqualify him from performing the duties of a soldier.

W. M. Mather
11th, U. S. C. A. N. EXAMINING SURGEON.

I CERTIFY, ON HONOR, That I have minutely inspected the Volunteer, *Thomas Finley*
previously to his enlistment, and that he was entirely sober when enlisted; that, to the best of my
judgment and belief, he is of lawful age; and that, in accepting him as duly qualified to perform the
duties of an able-bodied soldier, I have strictly observed the Regulations which govern the recruiting
service. This soldier has *Brown* eyes, *Brown* hair, *Brown* complexion, is *5*
feet *3* inches high.

Horace M. Guin's Senior
15th Regiment of *U. S. C. A. N.* Volunteers,
RECRUITING OFFICER.

(A. G. O. No. 74 & 76.)

Mustered into the service of the United States, for three years or during the war, from date of enlistment, in Company *A*,
10th Regiment of *U. S. C. A. N.* Volunteers, on the *20th* day of *September*, 186*4*, at *New Orleans*

J. M. Chamberlain
Capt. 15th U. S. C. A. N.
H. S. M.

Ferguson Joseph W.

Co C., 10 U.S. Col'd H. Art'y

2nd Lieutenant | *1st Lieutenant*

CARD NUMBERS.

1	5486792	26
2	5496120	27
3	5496273	28
4	5496415	29
5	5489332	30
6	5486795	31
7	5498891	32
8	5499032	33
9	5499169	34
10	5499305	35
11	5499441	36
12	5499577	37
13	5499713	38
14	5499848	39
15	5499982	40
16	5500118	41
17	5500244	42
18	5497359	43
19	5500367	44
20	4322555	45
21		46
22		47
23		48
24		49
25		50

Book Mark:

See also

Signal Corps Co. 2.

F. 10 H. Arty. U.S.C.T.

Joseph B. Ferguson
2nd Lt. Co. B, 10 Reg't U.S. Col'd H. Arty

Age 23 years.

Appears on an

Individual Muster-in Roll

of the organization named above. Roll dated

New Orleans, La., Jan'y. 12, 1865.

Muster-in to date Jan'y. 12, 1865.

Joined for duty and enrolled:

When January 12, 1865.

Where New Orleans

Period 3 years.

Valuation of horse, \$ 100

Valuation of horse equipments, \$ 100

Remarks: Enlisted and mustered
into the Signal Corps U.S.A.
at Kopedale, Harrison Co.,
Ohio as private. Discharg-
ed as such in special
(over)

Book mark:

Philipson

JAN. 15

5486792

1891 *

X Orders No. 12, par. 5,
dated Headquarters
Dept. of the Gulf, Jan. 12th
1865 to take effect
Jan. 10th, 1865 to enable
him to accept commission.
Is mustered to fill
vacancy in Co. B. 10th No. 5.
C.A. (H) caused by dis-
missal of 1st Lt. W. H.
Bochwell.

F

10 H. Art'y. U.S.C.T.

Joseph B. Ferguson

2d Lt. Jr.; Co. B, 10 Reg't U. S. Col'd H. Art'y.

Appears on

Company Muster Roll

for *Jan & Feb*, 1865.

Present or absent *Present*

Stoppage, \$ *100* for

Due Gov't, \$ *100* for

Valuation of horse, \$ *100*

Valuation of horse equipments, \$ *100*

Remarks:

Book mark:

(358)

J. J. J.

Copyist.

5

10 H. Art'y. U.S.C.T.

Joseph F. Ferguson
Capt., Co. B, 10 Reg't U. S. Col'd H. Art'y.

Appears on

Company Muster Roll

for *Mar. & Apr.*, 1865.

Present or absent

Stoppage, \$ 100 for

Due Gov't, \$ 100 for

Valuation of horse, \$ 100

Valuation of horse equipments, \$ 100

Remarks: *Mustered Out to accept
promotion in Co. C 10 U.S.
C. Art'y (H) April 3^d 1865.*

Book mark:

(358)

J. J. Jones

Copyist.

JF

10 H. Art'y.

U.S.C.T.

Joseph B. Ferguson
2 Lieut, Co. B, 10 Reg't U. S. Col'd H. Art'y.

Appears on

Company Muster Roll

for *Mar & Apr.*, 1865.

Present or absent.....

Stoppage, \$.....100 for.....

Due Gov't, \$.....100 for.....

Valuation of horse, \$.....100

Valuation of horse equipments, \$.....100

Remarks: *Mustered out*
to accept promotion
in Co. C 10th U.S.A.
(#) April 3^d 1865

Book mark:.....

(358)

Jovier

Copyist.

F 10th. Arty U.S.C.T.

Joseph B. Ferguson
2^d Lieut., Co B, 10th Reg't U. S. Col'd C. Art.

Appears on an

Individual Muster-out Roll

of the organization named above. Roll dated

New Orleans La, Apr 2, 1865.

Muster-out to date Apr. 2, 1865.

Last paid to
Pay due from muster in as 2^d Lt 1865.

Clothing account:

Last settled 186 ; drawn since \$ 100

Due soldier \$ 100 ; due U. S. \$ 100

Am't for cloth'g in kind or money adv'd \$ 100

Due U. S. for arms, equipments, &c., \$ 100

Bounty paid \$ 100 due \$ 100

Remarks: Entered Regt as 2^d Lt
forth on this Roll. Is mustered
out to accept promotion as 1st
Lt Recd Commission as 1st
Lt from Maj. Gen. Hurlburt
April 1st 1865. Has pay due
over

Book mark:

M. A. Michaels

JAN. 15

5489332

1891

him as 2^d Lt. from
July 12th 1865 to April 2^d
1865 inclusive

Mustered out to date April
2^d 1865.

F. 10 H. Arty. U.S.C.T.

Joseph B. Ferguson
1st Lt. Co. C, 10 Reg't U.S. Col'd H. Arty.

Age 20 years.

Appears on an

Individual Muster-in Roll

of the organization named above. Roll dated

New Orleans, La., Apl. 3, 1865.

Muster-in to date Apl. 3, 1865.

Joined for duty and enrolled:

When April 3, 1865.

Where New Orleans.

Period 3 years.

Valuation of horse, \$ 100

Valuation of horse equipments, \$ 100

Remarks: Mustered-out as 2^d Lt.
Co. "B" 10^d U.S. C.A. (H) April
2^d, 1865 to accept promotion.
Rec^d Commission as 1st Lt.
from Maj. Gen. Hurlbut X
(over)

Book mark:

Philipson

JAN. 15

5486795

1891

x April 1st, 1865.

Mustered in vacancy
in Co. C. occasioned by
cashiering of 1st Lt.
Thos. Nepton.

F

10 H. Art'y. U.S.C.T.

Joseph B. Ferguson
1st Lt, Co. C, 10 Reg't U. S. Col'd H. Art'y.

Appears on

Company Muster Roll

for *March & April*, 1865.

Present or absent *Present*

Stoppage, \$ 100 for

Due Gov't, \$ 100 for

Valuation of horse, \$ 100

Valuation of horse equipments, \$ 100

Remarks: *joined for duty April 7/63 for D.O. No 18 Hd. Qrs 10th U.S. Col'd H. Art'y dated Ft. St Philip La. April 3/63 promoted from 2nd Lt Co "B" 10th U.S. Col'd H. Art'y vice Thomas Newton. Gashiered*

Book mark:

Lamb

F

10 H. Art'y. U.S.C.T.

Joseph B. Ferguson
Lieut, Co. C, 10 Reg't U. S. Col'd H. Art'y.

Appears on

Company Muster Roll

for May & June, 1865.

Present or absent Present

Stoppage, \$ 100 for

Due Gov't, \$ 100 for

Valuation of horse, \$ 100

Valuation of horse equipments, \$ 100

Remarks Acting Post Adjt Fort
Livingstone La. per S.O. No. 38
Hd Qrs Fort Livingstone La
May 1, 1865

Book mark ::

Ballade

F

10 H. Art'y. U.S.C.T.

Joseph B. Ferguson
1st Lieut, Co. C, 10 Reg't U. S. Col'd H. Art'y.

Appears on

Company Muster Roll

for July & Aug, 1865

Present or absent Present

Stoppage, \$ 100 for

Due Gov't, \$ 100 for

Valuation of horse, \$ 100

Valuation of horse equipments, \$ 100

Remarks: Post Adjt Fort
Livingston La. per Post
Order No. 38 Hd Qrs. Fort
Livingston, La. May 1, 1865

Book mark:

Ballade

F

10 H. Art'y. U.S.C.T.

Joseph B. Ferguson
Lieut, Co. C, 10 Reg't U. S. Col'd H. Art'y.

Appears on

Company Muster Roll

for Sept & Oct, 1865

Present or absent Present

Stoppage, \$ 100 for

Due Gov't, \$ 100 for

Valuation of horse, \$ 100

Valuation of horse equipments, \$ 100

Remarks: Actg Post Adjt Fort
Livingston, La, per Post
order No. 38 Hd Qrs. Fort Livingston
La. May 1st 1865

Book mark:

Ballade

(358)

Copyist.

Joseph B. Ferguson
1st Lieut, Co. C, 10 Reg't U. S. Col'd H. Art'y.

Appears on

Company Muster Roll

for *Nov. 3rd Dec.*, 1865.

Present or absent *Present.*

Stoppage, \$ *100* for

Due Gov't, \$ *100* for

Valuation of horse, \$ *100*

Valuation of horse equipments, \$ *100*

Remarks: *Assumed command
of company and post
Nov. 12, 1865*

Book mark: _____

A. J. Robbins

G

10 H. Art'y. U.S.C.T.

Joseph B. Ferguson

1st Lieut Co. C, 10 Reg't U. S. Col'd H. Art'y.

Appears on

Company Muster Roll

for *Jan. & Feb.*, 186*6*.

Present or absent *Present*

Stoppage, \$ *100* for

Due Gov't, \$ *100* for

Valuation of horse, \$ *100*

Valuation of horse equipments, \$ *100*

Remarks: *Relieved from comdr
of Co. & F. H. Livingston
Jan. 17, 1866.*

Book mark:

A. J. Robbins

F | 10 H. Art'y. | U.S.C.T.

Joseph B. Ferguson
1 Lieut, Co. C, 10 Reg't U. S. Col'd H. Art'y.

Appears on

Company Muster Roll

for *Mch. & April*, 186*6*.

Present or absent *Present*

Stoppage, \$ *100* for

Due Gov't, \$ *100* for

Valuation of horse, \$ *100*

Valuation of horse equipments, \$ *100*

Remarks: *Actg Post Adjt. Ph*
Livingston La. for Post order
Nov. 3rd dated 3rd Dec. Ph
Livingston La. May 1, 1865.

Book mark:

(358)

A. J. Robbins
Copyist.

F

10 H. Art'y. U.S.C.T.

Joseph B. Ferguson

Lieut, Co. C, 10 Reg't U. S. Col'd H. Art'y.

Appears on

Company Muster Roll

for May 24 June, 1866

Present or absent Present

Stoppage, \$ 100 for

Due Gov't, \$ 100 for

Valuation of horse, \$ 100

Valuation of horse equipments, \$ 100

Remarks: H. A. Q. M. by A. G. S. Fort Livingston La, per S.O. No. 7 dated 26th Aug Fort Livingston La. June 26, 1866.

Book mark:

A. J. Robbins

(358)

Copyst.

F

10 H. Art'y. | U.S.C.T.

Joseph B. Ferguson

1 Lieut, Co. C, 10 Reg't U. S. Col'd H. Art'y.

Appears on

Company Muster Roll

for July & Aug., 1864.

Present or absent Present

Stoppage, \$ 100 for

Due Gov't, \$ 100 for

Valuation of horse, \$ 100

Valuation of horse equipments, \$ 100

Remarks: A.A.Q. M.C.A. Co. S. Dr. Livingston La. per S.O. No 7 Ex 2 Hd. qrs. Dr. Livingston La. dated June 26, 1864.

Book mark:

A. J. Robbins

(358)

Copyist.

7 | 10 H. Art'y. | U.S.C.T.

Joseph B. Ferguson
1st Lt., Co. C, 10 Reg't U. S. Col'd H. Art'y.

Appears on

Company Muster Roll

for *Sept & Oct*, 186*6*.

Present or absent *Present*

Stoppage, \$ *100* for

Due Gov't, \$ *100* for

Valuation of horse, \$ *100*

Valuation of horse equipments, \$ *100*

Remarks: *Relieved from duty
as Act. Sgt. and Act. Corp.
Ft. Livingston, La, Sept.
20, 1866, per Ad. No 15
Hd. Qrs Ft. Livingston*

Book mark:

Manning
Copyist.

Joseph B. Ferguson
1st Lt, Co. C, 10 Reg't U. S. Col'd H. Art'y.

Appears on

Company Muster Roll

for *Nov & Dec*, 186*6*.

Present or absent *Present*

Stoppage, \$ *100* for

Due Gov't, \$ *100* for

Valuation of horse, \$ *100*

Valuation of horse equipments, \$ *100*

Remarks: *On special duty*
at Reg't Hd, 9th
Armed Div, 18. 1866. per
Ad. No 40, C. S. Hd qrs
10th U.S. C. H. Art. Dec
St. Ferguson for service
in Sub. Dept from June
26 to Sept 20. 1866. \$ 23.80

Book mark: _____

(358)

Hammer
Copyist.

Joseph B. Furgerson
2^d Lt. Co. B., 10 Reg't U. S. Col'd H. Art'y.

Appears on Co. Muster-out Roll, dated
Baton Rouge La. Feb., 1867.

Muster-out to date _____, 186 .
Last paid to _____, 186 .

Clothing account:

Last settled _____, 186 ; drawn since \$ _____ 100

Due soldier \$ _____ 100; due U. S. \$ _____ 100

Am't for cloth'g in kind or money adv'd \$ _____ 100

Due U. S. for arms, equipments, &c., \$ _____ 100

Bounty paid \$ _____ 100; due \$ _____ 100

Remarks:
Mustered out for
promotion less the 10
U.S. Art'y (Reg) April
30th 1865.

Book mark: _____

(361)

Hodges
Copyist.

F

10 H. Art'y. U.S.C.T.

Joseph B. Ferguson

1st, Co. *C*, 10 Reg't U. S. Col'd H. Art'y.
& Bot. Capt.

Appears on **Co. Muster-out Roll**, dated
Raton Range, La., Feb. 22, 1867.

Muster-out to date *Feb 22*, 1867.

Last paid to *Dec 31*, 1866.

Clothing account:

Last settled....., 186 ; drawn since \$..... 100

Due soldier \$..... 100; due U. S. \$..... 100

Am't for cloth'g in kind or money adv'd \$..... 100

Due U. S. for arms, equipments, &c., \$..... 100

Bounty paid \$..... 100; due \$..... 100

Remarks: *Enlisted and mustered*
into Signal Corps U.S.A.
as priv. Dec. 20, 63, at
Hopevale Harrison Co.
Ohio, App't 2^d Lt. 10th
U.S. Col'd Arty (Hvy) 1st
over

Book mark:

Manning

(361)

Copyist.

JAN. 15

5500367

1891

Major Genl Huntburst Janry
3. 65. Pro, 107 St, 10 US
C. A. (Hoy) March 27. 65
Service Continued

To 10th Art U.S.C.T.

Joseph B. Ferguson

1st Lt. 10 Regt U.S. Col'd Hq. Arty.

Appears on

General Order

No. 65, dated War Department, Adjutant General's Office, June 22, 1867.

Appointed to be

Captain

BY BREVET

in the Volunteer Force, Army of the United States, for gallant and meritorious services

To date from March 13, 1865.

(400)

J. A. Johnson

Copyist.

Ferguson, Joseph B.

....., Co.

10

Reg't U. S. C. H. A.

..... / Enclosures.

Bed Cards	Descriptive Lists
Burial Records	Final Statements
Certs. of Dis. for Discharge	Furloughs
C. M. Charges	Med. Des. Lists
Med. Certificates	Orders

Other papers relating to—

Admission to Hosp'l	Furlough
Casualty Sheet (Officer's)	Med. Examination
Confinement	Misc. Information
Contracts	Pay or Clothing
Death or Effects	Personal Reports
Desertions	Rank
Discharge from Hosp'l	Transfer to Hosp'l
Discharge from Service	Transfer to V. R. C.
Duty	Transportation

MICROFILM PUBLICATION M 1831

COMPILED MILITARY SERVICE RECORDS
OF VOLUNTEER UNION SOLDIERS WHO SERVED WITH
THE UNITED STATES COLORED TROOPS (USCT)
10TH REGIMENT OF HEAVY ARTILLERY

PERSONAL PAPERS' TARGET SHEET

PLEASE NOTE THE CHECKED INFORMATION ABOUT THE PERSONAL PAPERS IN
THIS FILE:



NO PERSONAL PAPERS WERE FOUND IN THIS FILE WHEN THE
RECORDS WERE ARRANGED FOR MICROFILMING.



6 PERSONAL PAPER(S) FOUND IN THIS FILE WHEN THE RECORDS
WERE ARRANGED FOR MICROFILMING.

Head Qrs. Dept. of the Gulf
New Orleans Jan'y 12th 1865

Special Orders
No. 12.

5- The following named enlisted men
are honorably discharged the service, as such, from the date set
opposite their names to enable them to accept commissions, with
condition that if not mustered in as officers under the same
they shall rejoin their former Regiments also be considered
recruiters.

* * * * *
Private Joseph B. Ferguson Signal Corps
U. S. Army January 10th 1865

* * * * *
By Command of Maj. Genl. Henscomb
(Signed) C. S. Sargent 1st Lt. 2^d La. Inf
A. A. A. General

True Copy from the original

J. W. Chamberlain

Capt. 10th U. S. C. A. & V.

A. C. W.

Mustg. officer

Port St. Philip La.

February 2. 1865

B.

40

65

Ferguson Jas. P.

2^d Lieut. Co. B. 10th U.S.C. A.H.

Requests a leave of absence of
four (4) days to visit N. Orleans
on important private business

Approved.

M. W. 13. Head quarters

Feb. 2. 1865. Port St. Philip

February 2. 1865

Respectfully forwarded to
Commanding Officer Forts
Jackson & St. Philip: approved.

Chas. A. Bailey

Capt. 10th U.S.C. A.H.

Comdg. Fort.

Head Hd. In. defenses New Orleans

Feb. 2. 1865.

Company "D"
10th U. S. C. A. (H.)
February ~~January~~ 1865

Lieut. George E. Warner
1st City Post Adjt.

Sir.

I have the honor
to request a leave of absence for ~~five~~ (4) days, to enable me
to visit the City of New Orleans for the purpose of
transacting private business requiring immediate
attention.

I am, Sir,

Very Respectfully

Your Obedient Servant

Jos. D. Ferguson

2nd Lieut Company "D"

10th U. S. C. A. (H.)

Fort St Philip La 1865
March 21st 1865

Artillery 10th U.S.C.N.
Maj E. P. Loring
Comd'g

Requests that 2^d Lieut
Joseph B. Ferguson
Co. B. be commissioned
to fill vacancy in Co. C.
of same Regt. (10th U.S.C.N.)
a) And if it be impract-
icable to commission
him before re-examination,
that he be ordered before
Board at once.
(One Enclosure)

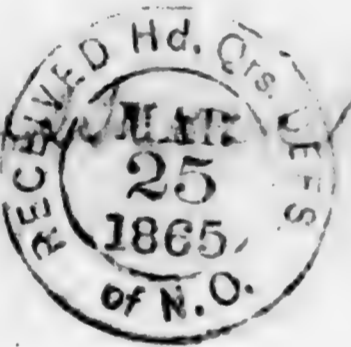
Comm

Recd Hd Qrs by mail 28-1865

Hd. Qrs. I. div. La.
March 26. 1865
L.R. 1725-65
Respectfully forwarded
Approved
W. V. Mear
P. S. C.

Headquarters 10th U.S. Colored Artillery (Heavy)
Fort St. Philip March 21. 1865

Lieut. Col. Geo. B. Drake
Assistant Adjutant General
Department of the Gulf

Sir -

I have the honor to request that
Second Lieutenant Joseph B. Ferguson
Company B. 10th U.S. Colored Artillery Heavy be
commissioned as First Lieutenant to fill vacancy
in Company "C" same regiment vice Strutton
cashiered. Lieut. Ferguson was before the
Board of Examiners in August 1864 and passed
for the grade of first lieutenant of Infantry. (Cer-
tificate enclosed) Failing to get an appointment
in an Infantry regiment he accepted a position
as Second Lieutenant in this regiment. He has
proved to be an excellent young officer and is
every way worthy of promotion. Company C.
into which I wish to muster him, has two vacan-

cies-

If it be impracticable to commission him
without re-examination I respectfully ask that
he be immediately ordered before the Board
of Examiners -

Very respectfully

Yours obt. Servt.

E. P. Loring

Maj 10th U.S. Colonel Artillery (Heavy)

Comdg Regiment

Office Board of Examiners for officers of U.S.A.
45 Carondelet St New Orleans La

Private Joseph D. Ferguson Signal Corps U.S.A. has
been examined and found competent to fill the position of
1st Lieut of Infantry

(Signed) George W. Foster
1st Lt 74th U.S. Inf
Recorder.

A true copy
E.P. Spring
Maj. 10th U.S. Colored Heavy Artillery

No. 16 - ~~Fort Livingston La~~
August 31st 1865

Terrason Joseph B.
1st Lieutenant 11th U. S. Col. (Regt)
Applies for twenty days leave of absence
with permission to apply for an extension
of ten days.

Hd-qs Fort Livingston La
Aug. 31st 1865

Approved and respectfully
forwarded to Hd-qs
Eastern District of La.

Albert Loring
Capt. 10th U. S. C. A. (Regt)
Comd'g Post.

Head Quarters Eastern Dist La
New Orleans, Sept 7th 1865.

Respectfully forwarded
approved

J. N. Merriam
Sgt. Maj. G. M. Comd'g
Hd Qs. Dept of Louisiana
New Orleans, Sept. 4th 1865

Respectfully forwarded to
Mil. Dir of the Gulf, enclosing
copy of Ex. 3, S. O. No. 48, granting
leave of absence, and recom-
mending an extension of
ten (10) days.

Ed. M. Lanby
Maj. Gen. Comd'g
S. D. 514

E

Port Livingston La
August 31st 1865

Major Wickham Hoffman
Assistant Adjutant General
Department of Louisiana

Major

I have the honor to
request a leave of absence for twenty days, with permission to apply
to the Adjutant General United States Army for an extension of
few days, to visit my home in Guernsey County Ohio for the purpose
of transacting important private business demanding immediate attention,
if the best interests of the service permit the indulgence.
I have not received a leave of absence longer than four days while
serving in the Department.

Captain Albert Loring 2nd and Lieutenant Leonard Helton are both
serving with the Infantry to which I am attached and my services
can readily be spared for the period desired.

I am, Major

Very Respectfully

Your Obedient Servant

Joseph D. Ferguson

1st Lieutenant 10th U. S. Col^l 2nd Regt. 2nd Div.

SPECIAL ORDERS, } HEADQUARTERS,
No. 48. } DEPARTMENT OF LOUISIANA,
New Orleans, La., September 4, 1865.

[Extract.]

* * * * *
3. Leave of absence for twenty (20) days is hereby granted to 1st Lieutenant *Joseph B. Ferguson*, Company "C," 10th U. S. Colored Artillery (Heavy), with recommendation to the Major-General Commanding Military Division of the Gulf for an extension of ten (10) days.
* * * * *

By order of Major-General E. R. S. CANBY :

WICKHAM HOFFMAN,
Assistant Adjutant General.

OFFICIAL:

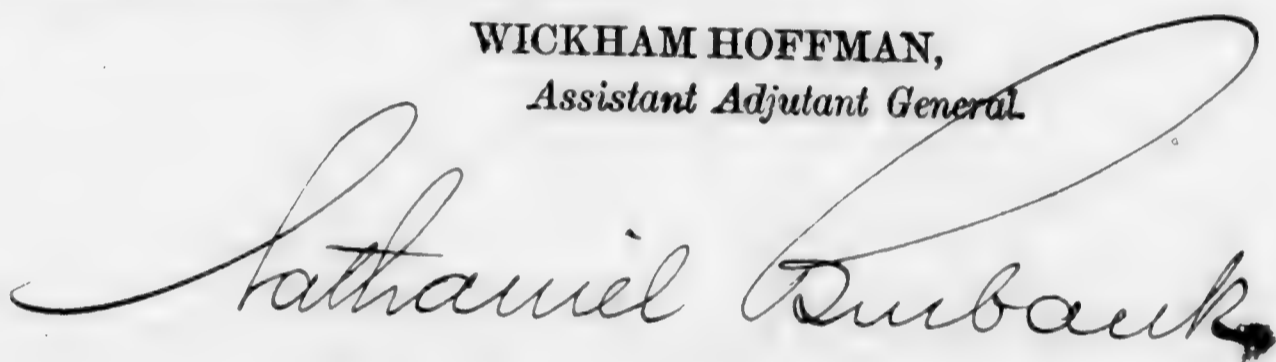

1st. Lieut., Acting Ass't Adj't General.

Ragnson. Randall
L., 10 U.S. Col'd H. Art'y.

Private | Sergeant

CARD NUMBERS.

1	5488097	26
2	5488232	27
3	5513448	28
4	5513566	29
5	5513698	30
6	5513827	31
7	5513975	32
8	5514149	33
9	5489335	34
10		35
11		36
12		37
13		38
14		39
15		40
16		41
17		42
18		43
19		44
20		45
21		46
22		47
23		48
24		49
25		50

Book Mark:

See also *C. E. ...*

F. J. Hall | U.S.C.T.

Randall Ferguson
Co. *d*, Co. *10*, Regt U. S. Col'd *Hall*,

Appears on

M. and D. Roll of Men Transferred

to the organization named above,

from *Co E 7th U.S. Col Inf*

Roll dated *Camp Sarrabeda Cal*, 186*5*.

When enlisted *June 14*, 186*3*.

Period for which enlisted *3* years.

When mustered in *Aug 19*, 186*3*.

Present or absent *Present*

Company to which assigned *L*

Remarks: *Transferred from*
4th Regt C de Afrique
Dec 12, 1863,

Book mark :

Wm Scott

J. W. H. A. U.S.C.T.

Randall Ferguson
1st, Co *L*, 10 Reg't U. S. Col'd *H. A.*

Appears on

M. and D. Roll of Men Transferred

to the organization named above,

from *97th U. S. Col Inf*

Roll dated *Camp Parapetda Oct 1, 1865*.

When enlisted *June 11*, 186 *5*.

Period for which enlisted *3* years.

When mustered in *Aug 19*, 186 *5*.

Present or absent *Present*

Company to which assigned *L*

Remarks: *Transferred from*
4th Cd. U. Rec 2. 65.
joined by transfer
from Co. E. 97th U. S. C. I.
per S. O. 66 C. S. Hd
Qrs Dept of La

Book mark :

W. H. Scott

A | 10 H. Art'y. | U.S.C.T.

Randall Ferguson
Det, Co. *L*, 10 Reg't U. S. Col'd H. Art'y.

Age years.

Appears on

Company Muster Roll*

for *Sept. & Oct.*, 186*3*!

Joined for duty and enrolled:

When *June 4*, 186*3*.

Where *Baton Rouge*

Period *1* years.

Mustered in:

When *Aug. 19*, 186*3*.

Where *Baton Rouge*

Present or absent *Present*

Stoppage, \$ *100* for

Due Gov't, \$ *100* for

Valuation of horse, \$ *100*

Valuation of horse equipments, \$ *100*

Remarks: *Transfd. from Co. E.*
77 U.S.C.

*First current roll. No muster-in roll of this company on file.

Book mark :

(3586)

Scherich

Copyist.

Randall Ferguson
Coop, Co. L, 10 Reg't U. S. Col'd H. Art'y.

Appears on

Company Muster Roll

for *Nov. & Dec.*, 1865.

Present or absent *Present*

Stoppage, \$ *100* for

Due Gov't, \$ *100* for

Valuation of horse, \$ *100*

Valuation of horse equipments, \$ *100*

Remarks: *Promoted to Corp.*
Oct. 22/65 - S. No 38 Hd. Qrs.
of Regt.

Book mark: _____

Scherich

F1 | 10 H. Art'y. | U.S.C.T.

Randall Ferguson
Cos., Co. L, 10 Reg't U. S. Col'd H. Art'y.

Appears on

Company Muster Roll

for *Jan. & Feb.*, 186*6*

Present or absent *Present*

Stoppage, \$ *100* for

Due Gov't, \$ *100* for

Valuation of horse, \$ *100*

Valuation of horse equipments, \$ *100*

Remarks: _____

Book mark: _____

Scherich

F | 10 H. Art'y. | U.S.C.T.

Randall Ferguson

Co. L, 10 Reg't U. S. Col'd H. Art'y.

Appears on

Company Muster Roll

for *Mich. & Apl., 1866.*

Present or absent *Present*

Stoppage, \$ *100* for

Due Gov't, \$ *100* for

Valuation of horse, \$ *100*

Valuation of horse equipments, \$ *100*

Remarks: _____

Book mark: *Muster out on file.*

Scherich

F 10th Art'y | U.S.C.T.

Randall Ferguson
Sgt., Co. L, 10 Reg't U. S. Col'd Art'y.

Appears on

Company Muster Roll

for *May & June*, 1866.

Present or absent.....

Stoppage, \$.....100 for.....

Due Gov't, \$.....100 for.....

Valuation of horse, \$.....100

Valuation of horse equipments, \$.....100

Remarks: *Mustered out by
reason of Ex. of term of
service to date June
3/66.*

Book mark:.....

(358)

Scherich

Copyist.

S. F. | *10th. Arty* | **U.S.C.T.**

Randall Ferguson

Sergt, Co. *L*, *10* Reg't U. S. Col'd *H. Ar.*

Appears on an

Individual Muster-out Roll

of the organization named above. Roll dated

New Orleans La, *June 3*, 1866.

Muster-out to date

June 3, 1866.

Last paid to

Apr 30, 1866.

Clothing account:

Last settled 186 ; drawn since \$ 100

Due soldier \$ *28* ^{*33*}/₁₀₀; due U. S. \$ 100

Am't for cloth'g in kind or money adv'd \$ 100

Due U. S. for arms, equipments, &c., \$ 100

Bounty paid \$ *mm* 100 due \$ *mm* 100

Remarks: *Joined as recruit in Co.*

"E" 4th. Arty transferred to 5th

Arty (77th. U.S. Inf) by reorganiza-

tion. Joined by transfer from

77th. U.S. Inf in obedience to

St 66 series of 1865 from Head-

over

Book mark:

M. A. Michaels

JAN. 15

5489335

1861

quarters Dept of La.
Mustered out by reason of
expiration of term of serv-
vice to date June 3^d 1866

F

10 H. Art'y. | U.S.C.T.

Randall Ferguson
Sergt, Co. *L*, 10 Reg't U. S. Col'd H. Art'y.

Appears on **Co. Muster-out Roll**, dated
Baton Rouge La Feb 27 1867.

Muster-out to date _____, 186 .

Last paid to _____, 186 .

Clothing account:

Last settled _____, 186 ; drawn since \$ _____ 100

Due soldier \$ _____ 100 ; due U. S. \$ _____ 100

Am't for cloth'g in kind or money adv'd \$ _____ 100

Due U. S. for arms, equipments, &c., \$ _____ 100

Bounty paid \$ _____ 100 ; due \$ _____ 100

Remarks: *Joined by transfer from*
C. L. 77 U.S.C. Oct 1 1865 S.O. 66 H² 9^{rs}
Dept of La Sept-22 1865 promoted
Corporal Oct-22 1865 Sergt April 1/66
Disch'd at New Orleans La June 3/66
at Expt of Service

Book mark: *V 24 P 198 69*

Bumham

(361)

Copyist.

Fernandez Antonio

Co G, 10 U.S. Col'd H. Art'y.

Private

Private

CARD NUMBERS.

1	5507128	26
2	5507411	27
3	5507558	28
4	5507705	29
5	5507843	30
6	5507986	31
7	5508126	32
8	5508259	33
9	5508395	34
10	5508545	35
11	5508696	36
12	5508844	37
13	5508991	38
14	5509121	39
15	5509269	40
16	5509378	41
17		42
18		43
19		44
20		45
21		46
22		47
23		48
24		49
25		50

Book Mark:

See also

J. W. Kearty U.S.C.T.

Antoine Fernandez

Appears with rank of *Pvt* on

Muster and Descriptive Roll of a Detachment of U. S. Vols. forwarded

organized as "bol's"
for the *10th* Reg't U. S. Col'd *Vol.*, Roll dated
New Orleans La Sept 20, 1864.

Where born *Havana Cuba*

Age *19* y'rs; occupation *Laborer*

When enlisted *Sept 20*, 1864.

Where enlisted *New Orleans La*

For what period enlisted *3* years.

Eyes *Blk*; hair *Blk*

Complexion *Blk*; height *5* ft. *4* in.

When mustered in *Sept 20*, 1864.

Where mustered in *New Orleans*

Bounty paid \$ *100*; due \$ *100*

Where credited *to New Orleans La*

Company to which assigned *"G"*

Remarks:

Book mark:

E. B. Thompson

A

10 H. Art'y. | U.S.C.T.

Antonio Fernandez
Priv, Co. G, 10 Reg't U. S. Col'd H. Art'y.

Appears on

Company Muster Roll

for *Sept & Oct*, 186 *4*.

Present or absent *Present*

Stoppage, \$ *100* for

Due Gov't, \$ *100* for

Valuation of horse, \$ *100*

Valuation of horse equipments, \$ *100*

Remarks:

Book mark:

E. H. Brown

A

10 H. Art'y. U.S.C.T.

Antoine Fernandez
Sot, Co. G, 10 Reg't U. S. Col'd H. Art'y.

Appears on

Company Muster Roll

for Nov & Dec, 1864.

Present or absent Present

Stoppage, \$ 100 for

Due Gov't, \$ 100 for

Valuation of horse, \$ 100

Valuation of horse equipments, \$ 100

Remarks:

Book mark:

E. H. Baum

J

10 H. Art'y. | U.S.C.T.

Antonio Fernandez
Prov, Co. G, 10 Reg't U. S. Col'd H. Art'y.

Appears on

Company Muster Roll

for *Jan & Feb*, 186*7*.

Present or absent *Present*

Stoppage, \$ *100* for

Due Gov't, \$ *100* for

Valuation of horse, \$ *100*

Valuation of horse equipments, \$ *100*

Remarks:

Book mark:

J. E. Porter

F

10 H. Art'y. U.S.C.T.

Victorine Fernandez
Prop, Co. G, 10 Reg't U. S. Col'd H. Art'y.

Appears on

Company Muster Roll

for *Mar & April*, 186*5*.

Present or absent *Present*

Stoppage, \$ *100* for

Due Gov't, \$ *100* for

Valuation of horse, \$ *100*

Valuation of horse equipments, \$ *100*

Remarks:

Book mark:

F. E. Porter

J

10 H. Art'y. U.S.C.T.

Antoine Fernandez
Prov, Co. G, 10 Reg't U. S. Col'd H. Art'y.

Appears on

Company Muster Roll

for *May & June*, 186*5*.

Present or absent *Present*

Stoppage, \$.....100 for

Due Gov't, \$.....100 for

Valuation of horse, \$.....100

Valuation of horse equipments, \$.....100

Remarks:.....

.....
.....
.....
.....
.....
.....
.....
.....
.....
.....

Book mark:.....

F. E. Porter

F

10 H. Art'y.

U.S.C.T.

Antoine Fernandez

Prov, Co. G, 10 Reg't U. S. Col'd H. Art'y.

Appears on

Company Muster Roll

for *July & Aug*, 186*5*.

Present or absent *Present*

Stoppage, \$ *100* for

Due Gov't, \$ *10* for *Gov't Equip.*

age lost or destroyed

Valuation of horse, \$ *100*

Valuation of horse equipments, \$ *100*

Remarks:

Book mark:

J. E. Porter

J

10 H. Art'y.

U.S.C.T.

Antoine Fernandez
Priv., Co. G, 10 Reg't U. S. Col'd H. Art'y.

Appears on

Company Muster Roll

for *Sept & Oct*, 186*5*.

Present or absent *Present*

Stoppage, \$ *100* for

Due Gov't, \$ *100* for

Valuation of horse, \$ *100*

Valuation of horse equipments, \$ *100*

Remarks:

Book mark:

F. E. Porter

5

10 H. Art'y.

U.S.C.T.

Armando Fernandez
Cvt., Co. G, 10 Reg't U. S. Col'd H. Art'y.

Appears on

Company Muster Roll

for *Nov. & Dec.*, 186*5*!

Present or absent *Present*

Stoppage, \$ 100 for

Due Gov't, \$ $\frac{22}{100}$ for *ord.*

Valuation of horse, \$ 100

Valuation of horse equipments, \$ 100

Remarks:

Book mark:

(358)

A. J. 704
Copyist.

J

10 H. Art'y.

U.S.C.T.

Antonio Fernandez

Pvt., Co. G, 10 Reg't U. S. Col'd H. Art'y.

Appears on

Company Muster Roll

for *Jan. & Feb.*, 186*6*.

Present or absent *Present*

Stoppage, \$ *100* for

Due Gov't, \$ *100* for

Valuation of horse, \$ *100*

Valuation of horse equipments, \$ *100*

Remarks:

Book mark:

G. Fox
Copyist.

F

10 H. Art'y. U.S.C.T.

Antoine Fernandez
Privt, Co. G, 10 Reg't U. S. Col'd H. Art'y.

Appears on

Company Muster Roll

for *Mar. 9th*, 186 *6*

Present or absent *Present*

Stoppage, \$ *2 ³⁰/₁₀₀* for *C.C. & G.E.*

Due Gov't, \$ *100* for

Valuation of horse, \$ *100*

Valuation of horse equipments, \$ *100*

Remarks: *Due M. f. for*
advance cost \$.08

Book mark:

(358)

G. Fry
Copyist.

F

10 H. Art'y.

U.S.C.T.

Antonio Fernandez

Art., Co. G, 10 Reg't U. S. Col'd H. Art'y.

Appears on

Company Muster Roll

for *May & June*, 1866.

Present or absent *Present*

Stoppage, \$ 100 for

Due Gov't, \$ 100 for

Valuation of horse, \$ 100

Valuation of horse equipments, \$ 100

Remarks:

Book mark:

(358)

G. F. W.

Copyist.

F

10 H. Art'y.

U.S.C.T.

Antoine Fernandez
Priv, Co. G, 10 Reg't U. S. Col'd H. Art'y.

Appears on

Company Muster Roll

for *July & Aug*, 1866.

Present or absent *Present*

Stoppage, \$ 100 for

Due Gov't, \$ 100 for

Valuation of horse, \$ 100

Valuation of horse equipments, \$ 100

Remarks:

Book mark: *100*

G. F. W.

F

10 H. Art'y.

U.S.C.T.

Antoine Fernandez

Sgt, Co. G, 10 Reg't U. S. Col'd H. Art'y.

Appears on

Company Muster Roll

for *Sept & Oct*, 186*6*.

Present or absent *Present*

Stoppage, \$ *100* for

Due Gov't, \$ *100* for

Valuation of horse, \$ *100*

Valuation of horse equipments, \$ *100*

Remarks:

Book mark:

Wines

A

10 H. Art'y. | U.S.C.T.

Antoine Fernandez

Priv, Co. G, 10 Reg't U. S. Col'd H. Art'y.

Appears on

Company Muster Roll

for *Nov & Dec*, 1866.

Present or absent *Present*

Stoppage, \$ *100* for

Due Gov't, \$ *100* for

Valuation of horse, \$ *100*

Valuation of horse equipments, \$ *100*

Remarks:

Book mark:

Wines

Antoine Fernandez
Pvt, Co. *G*, 10 Reg't U. S. Col'd H. Art'y.

Appears on Co. Muster-out Roll, dated
Baton Rouge La, Feb 22, 1867.

Muster-out to date *Feb 22*, 1867.

Last paid to *Dec 31*, 1866.

Clothing account:

Last settled _____, 186 ; drawn since \$ _____ $\frac{100}{100}$

Due soldier \$ *41* $\frac{01}{100}$; due U. S. \$ _____ $\frac{100}{100}$

Am't for cloth'g in kind or money adv'd \$ _____ $\frac{100}{100}$

Due U. S. for arms, equipments, &c., \$ _____ $\frac{16}{100}$

Bounty paid \$ _____ $\frac{100}{100}$; due \$ *200* $\frac{00}{100}$

Remarks: *Joined at Org 4, Org 7*
Stopped one Tompion one wiper

Book mark : _____

Fernandez, Antonio

, Co.

L

10

Reg't

USA

Enclosures.

Bed Cards	Final Statements
Burial Records	Furloughs or L. of A.
Certs. of Dis. for Discharge	Med. Certificates
C. M. Charges	Med. Des. Lists
Descriptive Lists	Orders
Discharge Certificates	Pris. of War Record
Enlistment Papers /	Resignations

Other papers relating to—

Admission to Hosp'l	Furlough or L. of A.
Casualty Sheet	Med. Examination
Confinement	Misc. Information
Contracts	Pay or Clothing
Death or Effects	Personal Reports
Desertion	Rank
Discharge from Hosp'l	Transfer to Hosp'l
Discharge from Service	Transfer to V. R. C.
Duty	Transportation

DECLARATION OF RECRUIT.

I, Antoine Hernandez desiring to VOLUNTEER as a Soldier in the Army of the United States, for the term of THREE YEARS, Do Declare, That I am 19 years and _____ months of age; that I have never been discharged from the United States service on account of disability or by sentence of a court martial, or by order before the expiration of a term of enlistment; and I know of no impediment to my serving honestly and faithfully as a soldier for three years.

GIVEN at New Orleans the 20 day of Sept 1864

Witness:

J. Horace McGuire Antoine Hernandez
Major Private

NOTE 1.—This blank will be used for both enlistments and re-enlistments—enlistment of veterans, &c., &c., in the volunteer service. They will be made out in duplicate in all cases—one to accompany the recruiting return of the superintendent (not the recruiting officer) to the Adjutant General, and one to accompany the accounts of the officer who pays bounty, &c. The Regiment and Company in which the soldier last served should be given on the back.

NOTE 2.—An enlistment holds to service. A muster-in must, in all cases, precede payment of pay, bounty, pension, &c. A muster-in roll must, in all cases, be filed in the Adjutant General's Office as evidence of muster-in. The mustering officer, commissary, or assistant commissary of musters, as the case may be, will countersign both enlistments as having mustered the soldier into the service of the United States before either of them is given to the disbursing officer.

No. 15

Antoine Hernandez
 Volunteered at New Orleans La
September 20th 1864,
 By Sgt. J. A. McGuire
10th Regiment of U. S. Vols (A)

_____ enlistment; last served in Company ()
10th Regt of U. S. Vols

Discharged _____ 18
Discharged not entitled
to Bounty

CONSENT IN CASE OF MINOR.

I, _____ DO CERTIFY, That I am the _____ of _____; that the said _____ is _____ years of age; and I do hereby freely give my CONSENT to his volunteering as a SOLDIER in the ARMY OF THE UNITED STATES for the period of THREE YEARS.

GIVEN at _____ the _____ day of _____

Witness:

VOLUNTEER ENLISTMENT.

STATE OF

TOWN OF

Louisiana



New Orleans

I, *Antonio Fernandez* born in *Havana*
in the ~~State~~ *Island* of *Cuba* aged *19* years,
and by occupation a *laborer* Do HEREBY ACKNOWLEDGE to have
volunteered this *20th* day of *Sept.* 186*4*
to serve as a **Soldier** in the **Army of the United States of America**, for
the period of **THREE YEARS**, unless sooner discharged by proper authority:
Do also agree to accept such bounty, pay, rations, and clothing, as are, or may be,
established by law for volunteers. And I, *Antonio Fernandez* do
solemnly swear, that I will bear true faith and allegiance to the **United States
of America**, and that I will serve them honestly and faithfully against all
their enemies or opposers whomsoever; and that I will observe and obey the
orders of the President of the United States, and the orders of the officers
appointed over me, according to the Rules and Articles of War.

Sworn and subscribed to, at *New Orleans*
this *20th* day of *Sept.* 186*4* } *Antonio Fernandez*
BEFORE *John W. Chamberlain* } *mark*
Capt. & A. M.

I CERTIFY, ON HONOR, That I have carefully examined the above-named Volunteer, agreeably to the General Regulations of the Army, and that, in my opinion, he is free from all bodily defects and mental infirmity, which would in any way disqualify him from performing the duties of a soldier.

W. J. Master
10th U.S.C.A. (H) EXAMINING SURGEON.

I CERTIFY, ON HONOR, That I have minutely inspected the Volunteer, *Antonio Fernandez*
previously to his enlistment, and that he was entirely sober when enlisted; that, to the best of my
judgment and belief, he is of lawful age; and that, in accepting him as duly qualified to perform the
duties of an able-bodied soldier, I have strictly observed the Regulations which govern the recruiting
service. This soldier has *Blue* eyes, *Blue* hair, *Blue* complexion, is *5*
feet *4* inches high.

J. Horace Mc Guire *Recruit*
10th Regiment of *U.S.C.A. (H)* Volunteers,
RECRUITING OFFICER.

(A. G. O. No. 74 & 76.)

Mustered into the service of the United States, for three years or during the war, from date of enlistment, in Company *G*,
10th Regiment of *U.S.C.A. (H)* Volunteers, on the *20th* day of *Sept.* 186*4*, at *New Orleans*

John W. Chamberlain
Capt. & A. M.
John W. Chamberlain
Capt. & A. M.

Ferrandi. Gustave

Co D, 10 U.S. Col'd H. Art'y.

Private

Private

CARD NUMBERS.

1	5488653	26
2	5501256	27
3	5501404	28
4	5501615	29
5	5502243	30
6	5889791	31
7	5	32
8		33
9		34
10		35
11		36
12		37
13		38
14		39
15		40
16		41
17		42
18		43
19		44
20		45
21		46
22		47
23		48
24		49
25		50

Book Mark:

See also

Co B. 77. U.S. Ar'y

F | *10. H. Art'y.* | **U.S.C.T.**

Gustave Ferrandi
Pri, Co. *K*, *10* Reg't U. S. Col'd *Harty*

Appears on

M. and D. Roll of Men Transferred

to the organization named above,

from *Co. B. 77 Reg't. U. S. C. Inf.*

Roll dated *Oct. 1*, 1865.

When enlisted *Feb. 2*, 1863.

Period for which enlisted *3* years.

When mustered in *Feb. 12*, 1863.

Present or absent *Present*

Company to which assigned *K*

Remarks: *Transferred from Co. B.*
4. Reg't. C. d. a. Dec. 2, 1863.
Stoppage 1 Bed Sack.

Book mark :

(342)

Arny

Copyist.

F

10 H. Art'y. | U.S.C.T.

Gustave Ferrande

Priv, Co. D, 10 Reg't U. S. Col'd H. Art'y.

Appears on

Company Muster Roll

for *Sept & Oct*, 186*5*.

Present or absent *Present*

Stoppage, \$ *100* for

Due Gov't, \$ *100* for

Valuation of horse, \$ *100*

Valuation of horse equipments, \$ *100*

Remarks: *Transfd from Co. B, 77 U.S.C.I., per S.O. No. 3, Hd Qrs 10 U.S.C.A.H., Camp Parapet, La., Oct. 1/6 5. Due U.S. for Camp Equipage lost \$2²⁵; for ordnance lost. 35¢.*

Book mark: _____

Patterson

(358)

Copyist.

71

10 H. Art'y. | U.S.C.T.

Gustave Ferraudi
Priv, Co. D, 10 Reg't U. S. Col'd H. Art'y.

Appears on

Company Muster Roll

for *Nov & Dec*, 1865.

Present or absent *Present*

Stoppage, \$ 100 for

Due Gov't, \$ 100 for

Valuation of horse, \$ 100

Valuation of horse equipments, \$ 100

Remarks:

Book mark: _____

W. W. Sayre

(358)

Copyist.

J

10 H. Art'y. U.S.C.T.

Gustave Ferrand

Pvt, Co. D, 10 Reg't U. S. Col'd H. Art'y.

Appears on

Company Muster Roll

for *Jan & Feb*, 186*6*

Present or absent

Stoppage, \$ 100 for

Due Gov't, \$ 100 for

Valuation of horse, \$ 100

Valuation of horse equipments, \$ 100

Remarks:

*Discharged at
New Orleans La
Feb 12.66 by reason
of expiration of
term of service*

Book mark:

W. Wayne

(358)

Copyist.

J. 10th Reg't Art'y | **U.S.C.T.**

Gustave Ferrandi

Priv., Co. *D*, *10* Reg't U. S. Col'd *Art'y*

Appears on a

Detachment Muster-out Roll

of the organization named above. Roll dated

New Orleans, La., Feb. 11, 1866.

Muster-out to date

Feb. 11, 1866.

Last paid to

June 30, 1865.

Clothing account:

Last settled 186 ; drawn since \$ 100

Due soldier \$ 100; due U. S. \$ *55-32* / 100

Am't for cloth'g in kind or money adv'd \$ 100

Due U. S. for arms, equipments, &c., \$ *2* / *77* / 100

Bounty paid \$ 100 due \$ 100

Remarks: *Joined at org'l. organ.*
of 4th Inf. C. D. A. (76th U.
S. C. I.) Transferred to 5th
Inf. C. D. A. (77th U. S. C.
I.) Dec. 2 '63 and Trans-
ferred to 10th U. S. C. A.
(over)

Book mark: _____

A. W. Reed

JF

10 H. Art'y. U.S.C.T.

Gustave Ferrandi

Co. D, 10 Reg't U. S. Col'd H. Art'y.

Appears on Co. Muster-out Roll, dated *Baton Rouge La, Feb 22, 1867.*

Muster-out to date _____, 186 .

Last paid to _____, 186 .

Clothing account:

Last settled _____, 186 ; drawn since \$ _____ 100

Due soldier \$ _____ 100; due U. S. \$ _____ 100

Am't for cloth'g in kind or money adv'd \$ _____ 100

Due U. S. for arms, equipments, &c., \$ _____ 100

Bounty paid \$ _____ 100; due \$ _____ 100

Remarks: *joined by transfer from Co. B, 7th U.S. Col'd, Oct 1/65 P.O. 66 Sept La. Sept 22/65 Dis. No. La. Feb 12/68 expiration of term of service*

Book mark: *4027. 1880*

(361)

J. M. Leonard

Copyist.

Ferry, Ohi

Co *F*, 10 U.S. Col'd H. Art'y.

Private

Private

CARD NUMBERS.

1	5487330	26
2	5504709	27
3	5504968	28
4	5507034	29
5		30
6		31
7		32
8		33
9		34
10		35
11		36
12		37
13		38
14		39
15		40
16		41
17		42
18		43
19		44
20		45
21		46
22		47
23		48
24		49
25		50

Book Mark:

See also

7 10 H. arty | U.S.C.T

Eli Ferry

Appears with rank of *Pat* on

Muster and Descriptive Roll of a Detachment of Drafted Men and Substitutes forwarded

for the *7* Reg't U.S. Col'd *H. arty* Roll dated *New Orleans La, Aug 19 1864*

Where born *Lafourche La*

Age *25* years; occupation *Laborer*

Drafted and mustered in:

When *Aug 17*, 1864.

Where *Bonima La*

Period *3* years.

Eyes *Blue*; hair *Light*

Complexion *Light*; height *5 ft. 2 in.*

Paid bounty and advance pay, \$ *100*

Bounty due \$ *100*

Where credited *Parish of Terrebonne La*

Company to which assigned *F*

Remarks:

+ Became 10 U.S. C. H. arty

Book mark:

(340)

J. J. J. J. Copyist.

F | 10 H. Art'y. | U.S.C.T.

Eli Ferry

Part, Co. *F*, 7 Reg't U. S. Col'd H. Art'y.*

Appears on

Company Muster-in and Descriptive Roll

of the organization named above. Roll dated

New Orleans La, *Aug 19*, 1864.

Where born *Safourch La*

Age *25* y'rs; occupation *Laborer*

When enlisted _____, 186 .

Where enlisted _____

For what period enlisted *3* years.

Eyes *Blue*; hair *Light*

Complexion *Light*; height *5* ft. *2* in.

When mustered in *Aug 19*, 1864.

Where mustered in *New Orleans La*

Bounty paid \$ *100*; due \$ *100*

Where credited *3rd Enlt Dist La*

Company to which assigned _____

Remarks: *Drafted*

* This organization subsequently became Co. *F*, 10 Reg't U. S. Colored Heavy Artillery.

Book mark: _____

Accountant

(356d)

Copist.

F | 10 H. Art'y. | U.S.C.T.

Eli Ferry

Pvt, Co. F, 10 Reg't U. S. Col'd H. Art'y.

Appears on

Company Muster Roll

for *July & August*, 186*4*.

Present or absent

Stoppage, \$ 100 for

Due Gov't, \$ 100 for

Valuation of horse, \$ 100

Valuation of horse equipments, \$ 100

Remarks: *Deserted from Batty
Gentilly Aug 27-1864*

Book mark:

(358)

Rosenbaum
Copied.

F

10 H. Art'y. U.S.C.T.

Eli Ferry

Pvt., Co. F, 10 Reg't U. S. Col'd H. Art'y.

Appears on Co. Muster-out Roll, dated
Baton Rouge La. Feb. 22, 1867.

Muster-out to date _____, 186 .

Last paid to *none paid* _____, 186 .

Clothing account:

Last settled _____, 186 ; drawn since \$ _____ 100

Due soldier \$ _____ 100; due U. S. \$ _____ 100

Am't for cloth'g in kind or money adv'd \$ *16 52* 100

Due U. S. for arms, equipments, &c., \$ _____ 100

Bounty paid \$ _____ 100; due \$ _____ 100

Remarks: *Joined at original
organization Deserte from
Battery Gentry La. Aug.
27/64.*

Book mark:

House

Cherry. Cistards

Co. L, 10 U.S. Col'd H. Art'y.

Private

Private

CARD NUMBERS.

1	5488234	26
2	5487733	27
3	5513449	28
4	5513599	29
5	5513726	30
6	5513899	31
7	5514185	32
8	5489862	33
9		34
10		35
11		36
12		37
13		38
14		39
15		40
16		41
17		42
18		43
19		44
20		45
21		46
22		47
23		48
24		49
25		50

Book Mark:

See also

77" use Imp

F. W. B. A. U.S.C.T.

Estimado Ferry
Vol. Co. D, 10 Reg't U. S. Col'd

Appears on

M. and D. Roll of Men Transferred

to the organization named above,

from *7th U. S. Col Inf*

Roll dated *Camp Murrells Bluff, 1865.*

When enlisted *July 21*, 186*3*

Period for which enlisted *3* years.

When mustered in *March 6*, 186*3*

Present or absent *Present*

Company to which assigned *D*

Remarks: *Transferred from*
4th Co Dec 2, 63. since
by transfer from Co
C. 7th U. S. C. I. per S. O
66 C. S. Hd Qrs Dept
of Va.

Book mark :

W. H. Scott

(342)

Copyist.

J. J. Hall, U.S.C.T.

Estanda Terry
Sgt, Co *D*, 10 Reg't U. S. Col'd *Hall*

Appears on

M. and D. Roll of Men Transferred

to the organization named above,

from *Co D 74 U.S. Col'd*

Roll dated *Camp Curupetdale*, 186 *5*.

When enlisted *July 21*, 186 *3*.

Period for which enlisted *3* years.

When mustered in *March 6*, 186 *3*.

Present or absent *Present*

Company to which assigned *D*

Remarks: *Transferred from*
4th Regt Col A Dec 2
1863 Promoted Lance
Serjt Jan 2, 1864.
reduced to Corp Feb
3, 1864. reduced to
Sgt Feb 22, 64,

Book mark :

W. H. Scott

F | 10 H. Art'y. | U.S.C.T.

Estando Ferry
Sgt, Co. *L*, 10 Reg't U. S. Col'd H. Art'y.

Age years.

Appears on

Company Muster Roll*

for *Sept. & Oct.*, 186*3*!

Joined for duty and enrolled:

When *Feb. 21*, 186*3*.

Where *New Orleans*

Period *3* years.

Mustered in:

When *Mich 6*, 186*3*.

Where *New Orleans*

Present or absent *Present*

Stoppage, \$ *100* for

Due Gov't, \$ *100* for

Valuation of horse, \$ *100*

Valuation of horse equipments, \$ *100*

Remarks: *Transf. from Co. C,
77 U.S.C.A.*

*First current roll. No muster-in roll of this company on file.

Book mark :

Scherich

(358b)

Copyist.

Estando Ferry

Plt, Co. L, 10 Reg't U. S. Col'd H. Art'y.

Appears on

Company Muster Roll

for *Nov, & Dec*, 186*5*.

Present or absent *Present*

Stoppage, \$ *100* for

Due Gov't, \$ *100* for

Valuation of horse, \$ *100*

Valuation of horse equipments, \$ *100*

Remarks:

Book mark:

Scherich

J

10 H. Art'y. U.S.C.T.

Estanto Ferry

Priv., Co. L, 10 Reg't U. S. Col'd H. Art'y.

Appears on

Company Muster Roll

for *Jan. & Feb.*, 186*6*

Present or absent *Present*

Stoppage, \$ *100* for

Due Gov't, \$ *100* for

Valuation of horse, \$ *100*

Valuation of horse equipments, \$ *100*

Remarks:

Book mark: *Muster out. on file*

Scherich

(358)

Copyist.

F

10 H. Art'y. U.S.C.T.

Estando Ferry

Qvt, Co. L, 10 Reg't U. S. Col'd H. Art'y.

Appears on

Company Muster Roll

for *March & April*, 1866.

Present or absent

Stoppage, \$ 100 for

Due Gov't, \$ 100 for

Valuation of horse, \$ 100

Valuation of horse equipments, \$ 100

Remarks: *Mustered out by
ex. of term of service
to date March 5/66.*

Book mark:

Scherich

J | 10 H. Art'y. | U.S.C.T.

Estando Fry
PA, Co. *L*, 10 Reg't U. S. Col'd H. Art'y.

Appears on **Co. Muster-out Roll**, dated
Baton Rouge La, Feb 22, 1867.

Muster-out to date 186 :

Last paid to 186 .

Clothing account:

Last settled 186 ; drawn since \$ 100

Due soldier \$ 100 ; due U. S. \$ 100

Am't for cloth'g in kind or money adv'd \$ 100

Due U. S. for arms, equipments, &c., \$ 100

Bounty paid \$ 100 ; due \$ 100

Remarks: *joined by transfer from*
Co 77 U S C I Oct 1/65 S.O. 66 N^o 9th
Left of La Sept 22/65 Dischd
N.O. La Mich 5/66 by reason of Expon
of service

Book mark: *V 24 P 211 68*

Burnham

F | ¹⁰ Hy Arty | U.S.C.T.

Setande Ferry,

Prior, Co. 2, 10 Reg't U. S. Col'd Arty.

Appears on a

Detachment Muster-out Roll

of the organization named above. Roll dated
New Orleans, La, Mar. 5, 1866.

Muster-out to date Mar. 5, 1866.

Last paid to Dec. 31, 1865

Clothing account:

Last settled _____, 186 ; drawn since \$ _____ 100

Due soldier \$ $24 \frac{61}{100}$; due U. S. \$ _____ 100

Am't for cloth'g in kind or money adv'd \$ _____ 100

Due U. S. for arms, equipments, &c., \$ _____ 100

Bounty paid \$ _____ 100 due \$ _____ 100

Remarks: *Joined at origl. orgn. of Co. C. 4th CdA. transferred to 5th CdA. (77 A.S.C.I.) by reorganization. Transferred to 10th U.S.C.A. Hy by consolidation.*

Book mark: _____

H. M. Reed

Ferry Hardy

Co G, 10 U.S. Col'd H. Art'y.

Private

Sergeant

CARD NUMBERS.

1	57486943	26
2	5507074	27
3	5507234	28
4	5507276	29
5	5507318	30
6	5507361	31
7	5507508	32
8	5507657	33
9	5507797	34
10	5507939	35
11	5508076	36
12	5508211	37
13	5508345	38
14	5508497	39
15	5508646	40
16	5508793	41
17	5508938	42
18	5509081	43
19	5509226	44
20	5509337	45
21		46
22		47
23		48
24		49
25		50

Book Mark:

See also

Hardy Ferry

Appears with rank of Private on

Muster and Descriptive Roll of a Detachment of U. S. Vols. forwarded

(H. a. c. d. a.)
for the 10 Reg't U. S. C. H. A., Roll dated

New Orleans La, Apr 3, 1864.

Where born Opelousas La.

Age 23 y'rs; occupation Laborer

When enlisted Mch. 22, 1864.

Where enlisted Alexander

For what period enlisted 3 years.

Eyes Black; hair Black

Complexion Black; height 5 ft. 8 1/4 in.

When mustered in Apr. 3, 1864.

Where mustered in New Orleans

Bounty paid \$ 100; due \$ 100

Where credited

Company to which assigned G

Remarks:

Book mark:

Galligan

J | 10 H. Art'y. | U.S.C.T.

Henry Perry

Appears with rank of *Corpl* on

Muster and Descriptive Roll of a Detachment of U. S. Vols. forwarded

organized as Co's.
for the *10* Reg't U.S. *Vol's*. Roll dated

New Orleans La, Sept 20, 1864.

Where born *Opelousas La*

Age *23* yrs; occupation *Labourer*

When enlisted *Mich 22, 1864.*

Where enlisted *Alexandria La*

For what period enlisted *3* years.

Eyes *Blk*; hair *Blk*

Complexion *Blk*; height *5 ft. 8 1/2 in.*

When mustered in *Apr 3, 1864.*

Where mustered in *New Orleans La*

Bounty paid \$ *100*; due \$ *100*

Where credited *to Alexandria Ge*

Company to which assigned *G.*

Remarks:

Book mark:

C. B. Thompson

(339)

Copyist.

A

10 H. Art'y.

U.S.C.T.

Hardy Ferry

Co. G, Co. *G*, 7 Reg't U. S. Col'd H. Art'y.*

Appears on

Company Muster Roll

for *from enrolment to April 20, 1864.*

Present or absent *Present*

Stoppage, \$ *100* for

Due Gov't, \$ *100* for

Valuation of horse, \$ *100*

Valuation of horse equipments, \$ *100*

Remarks:

* This organization subsequently became Co. *10*, 10 Reg't U. S. Colored Heavy Artillery.

Book mark:

E. H. Brewer

F

10 H. Art'y.

U.S.C.T.

Hardy Perry
Pot Co. G

, 7 Reg't U. S. Col'd H. Art'y.*

Appears on

Company Muster Roll

for May & June, 1864.

Present or absent Present

Stoppage, \$ 100 for

Due Gov't, \$ 100 for

Valuation of horse, \$ 100

Valuation of horse equipments, \$ 100

Remarks:

* This organization subsequently became Co. , 10 Reg't U. S. Colored Heavy Artillery.

Book mark:

E H Brown

(358)

Copyist.

F

10 H. Art'y. U.S.C.T.

Hardy Perry
Cot

, Co. G, 10 Reg't U. S. Col'd H. Art'y.

Appears on

Company Muster Roll

for *July & Aug*, 186*4*.

Present or absent *Present*

Stoppage, \$ 100 for

Due Gov't, \$ 100 for

Valuation of horse, \$ 100

Valuation of horse equipments, \$ 100

Remarks:

Book mark:

E. H. Brown

(358)

Copyist.

A

10 H. Art'y. U.S.C.T.

Ward Ferry

Capt., Co. G, 10 Reg't U. S. Col'd H. Art'y.

Appears on

Company Muster Roll

for Sept & Oct, 1864.

Present or absent Present

Stoppage, \$ 100 for

Due Gov't, \$ 100 for

Valuation of horse, \$ 100

Valuation of horse equipments, \$ 100

Remarks: Dif. of pay due between \$7 & \$13 from date of enlistment to May 1/64 & between \$7 & \$6 from May 1st to June 30 Promoted Capt. Sept. 20/64

Book mark:

E H Brown

F

10 H. Art'y. U.S.C.T.

Fordy *Ferry*
Orbit, Co. G, 10 Reg't U. S. Col'd H. Art'y.

Appears on

Company Muster Roll

for *Nov & Dec*, 1864.

Present or absent *Present*

Stoppage, \$ *100* for

Due Gov't, \$ *100* for

Valuation of horse, \$ *100*

Valuation of horse equipments, \$ *100*

Remarks: *Has need but \$7 per month*

Book mark:

E. H. Brown

4

Hardy Ferry
Corp., Co. G, 10 Reg't U.S. Col'd H. Art'y.
Appears on

Company Muster Roll

for June + Feb, 1863.

Present or absent Present

Stoppage, \$ 100 for

Due Gov't, \$ 100 for

Valuation of horse, \$ 100

Valuation of horse equipments, \$ 100

Remarks: Rec'd but \$ 7 for
Mo from Enrollment
to June 30/63

Book mark: 20-10-63

F. E. Porter

7

10 H. Art'y. U.S.C.T.

Hurdy Ferry

Boyer, Co. G, 10 Reg't U. S. Col'd H. Art'y.

Appears on

Company Muster Roll

for *Mar & April*, 186*5*.

Present or absent *Present*

Stoppage, \$ *100* for

Due Gov't, \$ *100* for

Valuation of horse, \$ *100*

Valuation of horse equipments, \$ *100*

Remarks: *Received but \$ 7 per
Mo from Enrollment
to June 30/64*

Book mark:

J. E. Porter

7

10 H. Art'y.

U.S.C.T.

Hardy Terry

Corps, Co. G, 10 Reg't U. S. Col'd H. Art'y.

Appears on

Company Muster Roll

for *May & June*, 186*6*.

Present or absent *Present*

Stoppage, \$ *100* for

Due Gov't, \$ *100* for

Valuation of horse, \$ *100*

Valuation of horse equipments, \$ *100*

Remarks: *Received but \$ 7 per Mo from Enrollment to June 30 per*

Book mark:

J. E. Porter

(358)

Copyist.

T.

10 H. Art'y. | U.S.C.T.

Hardy Perry
Co. G, 10 Reg't U. S. Col'd H. Art'y.

Appears on

Company Muster Roll

for *July & Aug*, 186*5*.

Present or absent *Present*

Stoppage, \$ 100 for

Due Gov't, \$ 07/100 for *C + G Equip*

Age lost or destroyed

Valuation of horse, \$ 100

Valuation of horse equipments, \$ 100

Remarks:

.....
.....
.....
.....
.....
.....
.....
.....
.....
.....

Book mark:

.....

J. E. Porter

7

10 H. Art'y. U.S.C.T.

Howard Ferry
Corp, Co. G, 10 Reg't U. S. Col'd H. Art'y.

Appears on

Company Muster Roll

for *Sept & Oct*, 186*6*.

Present or absent *Present*

Stoppage, \$ *100* for

Due Gov't, \$ *100* for

Valuation of horse, \$ *100*

Valuation of horse equipments, \$ *100*

Remarks:

Book mark:

J. E. Porter

F

10 H. Art'y.

U.S.C.T.

Hardy Ferry
Corp., Co. G, 10 Reg't U. S. Col'd H. Art'y.

Appears on

Company Muster Roll

for *Nov. & Dec.*, 186*8*

Present or absent *Present*

Stoppage, \$ *100* for

Due Gov't, \$ *100* for

Valuation of horse, \$ *100*

Valuation of horse equipments, \$ *100*

Remarks:

Book mark:

G. Fox

(358)

Copyist.

F

10 H. Art'y.

U.S.C.T.

Hardy Ferry

Capt., Co. G, 10 Reg't U. S. Col'd H. Art'y.

Appears on

Company Muster Roll

for *Jan. & Feb.*, 186*6*.

Present or absent *Present*

Stoppage, \$ *100* for

Due Gov't, \$ *100* for

Valuation of horse, \$ *100*

Valuation of horse equipments, \$ *100*

Remarks:

Book mark:

G. F. N.

(358)

Copyist.

F

10 H. Art'y. U.S.C.T.

Hardy Ferry

Corp, Co. G, 10 Reg't U. S. Col'd H. Art'y.

Appears on

Company Muster Roll

for *Mar. & Apr.*, 186*6*.

Present or absent *Present*

Stoppage, \$ 100 for

Due Gov't, \$ 100 for

Valuation of horse, \$ 100

Valuation of horse equipments, \$ 100

Remarks:

Book mark:

G. F. J.

F

10 H. Art'y. U.S.C.T.

Hardy Ferry

Cop, Co. G, 10 Reg't U. S. Col'd H. Art'y.

Appears on

Company Muster Roll

for *May & June*, 186*6*.

Present or absent *Present*

Stoppage, \$ *100* for

Due Gov't, \$ *100* for

Valuation of horse, \$ *100*

Valuation of horse equipments, \$ *100*

Remarks:

Book mark:

E. F. M.

(358)

Copyist.

7

10 H. Art'y.

U.S.C.T.

Hardy Ferry
Corp, Co. G, 10 Reg't U. S. C&d H. Art'y.

Appears on

Company Muster Roll

for *July & Aug.*, 186*6*.

Present or absent *Present*

Stoppage, \$ *100* for

Due Gov't, \$ *100* for

Valuation of horse, \$ *100*

Valuation of horse equipments, \$ *100*

Remarks:

Book mark:

(358)

G. Fry
Copyist.

F

10 H. Art'y.

U.S.C.T.

Hardy Perry

Corpl, Co. G, 10 Reg't U. S. Col'd H. Art'y.

Appears on

Company Muster Roll

for *Sept & Oct*, 1866.

Present or absent *Present*

Stoppage, \$ 100 for

Due Gov't, \$ 100 for

Valuation of horse, \$ 100

Valuation of horse equipments, \$ 100

Remarks:

Book mark:

(358)

Wines

Copyist.

J

10 H. Art'y. U.S.C.T.

Nardy Perry

Sgt., Co. G, 10 Reg't U. S. Col'd H. Art'y.

Appears on

Company Muster Roll

for *Nov & Dec*, 1866.

Present or absent *Present*

Stoppage, \$ *100* for

Due Gov't, \$ *100* for

Valuation of horse, \$ *100*

Valuation of horse equipments, \$ *100*

Remarks: *Promoted from
Corpl Nov 1/1866*

Book mark:

(358)

Wines

Copyist.

Hardy Perry

Sgt, Co. *G*, 10 Reg't U. S. Col'd H. Art'y.

Appears on **Co. Muster-out Roll**, dated

Baton Rouge La, Feb, 22, 1867.

Muster-out to date

Feb, 22, 1867.

Last paid to

Dec 31, 1866.

Clothing account:

Last settled....., 186 ; drawn since \$.....¹⁰⁰

Due soldier \$ *19*^{*81*}/₁₀₀; due U. S. \$.....¹⁰⁰

Am't for cloth'g in kind or money adv'd \$.....¹⁰⁰

Due U. S. for arms, equipments, &c., \$ *9*^{*00*}/₁₀₀

Bounty paid \$.....¹⁰⁰; due \$ *300*^{*00*}/₁₀₀

Remarks: *Joined at Org 2, Org 2,*
Pvt. to Sept. 20, 1864. Corp.
to Nov 1, 1865-

Book mark:

Wines

Jettis Jesse

Co M. F. 10 U.S. Col'd H. Art'y.

1st Lieutenant Captain.

CARD NUMBERS.

1	5488990	26
2	5488882	27
3	5488712	28
4	5505696	29
5	5505850	30
6	5506002	31
7	5506154	32
8	5506300	33
9	5506419	34
10	5506535	35
11	5506751	36
12	5506849	37
13	43223848	38
14		39
15		40
16		41
17		42
18		43
19		44
20		45
21		46
22		47
23		48
24		49
25		50

Book Mark: 1691. O. S. 85

See also 77th U. S. Infy.

RTP 716774

D2270170 Power

tel +

S.S. v. 33. 11/8/29-44.

Wm B. Loker

J

10 H. Art'y. U.S.C.T.

Jesse Feltis

Capt, Co. F, 10 Reg't U. S. Col'd H. Art'y.

Appears on

Company Muster Roll

for Sept & Oct, 1865.

Present or absent Present

Stoppage, \$ 100 for

Due Gov't, \$ 100 for

Valuation of horse, \$ 100

Valuation of horse equipments, \$ 100

Remarks: Transferred from Co. D 77 U.S.C.I. Oct. 1/65.

Book mark:

B. G. Masdon

(358)

Copyist.

Jesse Fettis

Capt., Co. F, 10 Reg't U. S. Col'd H. Art'y.

Appears on

Company Muster Roll

for Nov. & Dec., 1865.

Present or absent Present.

Stoppage, \$ 100 for

Due Gov't, \$ 100 for

Valuation of horse, \$ 100

Valuation of horse equipments, \$ 100

Remarks: On Special Duty
Commanding Post for B. O.
342, C. S. U. S. L. Co., E. Dist.
of La.

Book mark:

F

10 H. Art'y. U.S.C.T.

Jesse Fettes

Capt., Co. F, 10 Reg't U. S. Col'd H. Art'y.

Appears on

Company Muster Roll

for Jan'y & Feby., 1866.

Present or absent Present

Stoppage, \$ 100 for

Due Gov't, \$ 100 for

Valuation of horse, \$ 100

Valuation of horse equipments, \$ 100

Remarks: Special Duty Com-
mand'g Post No. S. O. 342,
No. 200, E. A. of S. A. S. '65

Book mark:

Jesse Pettis

Capt. Co. F, 10 Reg't U. S. Col'd H. Art'y.

Appears on

Company Muster Roll

for *Mar & Apr*, 1866.

Present or absent *Present*

Stoppage, \$ *100* for

Due Gov't, \$ *100* for

Valuation of horse, \$ *100*

Valuation of horse equipments, \$ *100*

Remarks: *On Special Duty
Comdg. Post.*

Book mark:

F.

10 H. Art'y. U.S.C.T.

Jease Ferris

Capt, Co. F, 10 Reg't U. S. Col'd H. Art'y.

Appears on

Company Muster Roll

for *May & June*, 186*6*.

Present or absent *Present*

Stoppage, \$ *100* for

Due Gov't, \$ *100* for

Valuation of horse, \$ *100*

Valuation of horse equipments, \$ *100*

Remarks: *Relieved from Special
duty Comd'g Post fort S.O.
No 1, 26d. Regt U.S. Forces,
Ship Island Miss, May
22, 66.*

Book mark:

(358)

Asst.
Copyist.

F

10 H. Art'y. U.S.C.T.

Jesse Feltis

Capt.; Co. F, 10 Reg't U. S. Col'd H. Art'y.

Appears on

Company Muster Roll

for *July & Aug.*, 186*6*.

Present or absent *Present*

Stoppage, \$ *100* for

Due Gov't, \$ *100* for

Valuation of horse, \$ *100*

Valuation of horse equipments, \$ *100*

Remarks:

Book mark:

(358)

ASV
Copyist.

F

10 H. Art'y. U.S.C.T.

Cessi Fetta

Capt, Co. F, 10 Reg't U. S. Col'd H. Art'y.

Appears on

Company Muster Roll

for Sept and Oct, 186 Q.

Present or absent Present

Stoppage, \$ 100 for

Due Gov't, \$ 100 for

Valuation of horse, \$ 100

Valuation of horse equipments, \$ 100

Remarks:

Book mark:

House

7

10 H. Art'y. U.S.C.T.

Jesse Feltis

Capt, Co. F, 10 Reg't U. S. Col'd H. Art'y.

Appears on

Company Muster Roll

for Nov. and Dec, 1866

Present or absent Present

Stoppage, \$ 100 for

Due Gov't, \$ 100 for

Valuation of horse, \$ 100

Valuation of horse equipments, \$ 100

Remarks:

Due for responsibility of
Bedroll and Camp
Equipage since last muster

Book mark:

House

F

10 H. Art'y. U.S.C.T.

Jesse Fetter

Capt, Co. F, 10 Reg't U. S. Col'd H. Art'y.

Appears on Co. Muster-out Roll, dated

Baton Rouge La July 22, 1867.

Muster-out to date Feb 22, 1867.

Last paid to Dec 31, 1866.

Clothing account:

Last settled, 186 ; drawn since \$ 100

Due soldier \$ 100; due U. S. \$ 100

Am't for cloth'g in kind or money adv'd \$ 100

Due U. S. for arms, equipments, &c., \$ 100

Bounty paid \$ 100; due \$ 100

Remarks: Entered U.S. Service from Civil life as Lieut 5 Inf. Co. A. Dec 8/63 Comd and mustered as Capt. Mex 9/64. Transferred from 77 U.S. C.T. to 10 U.S. C. Art'y

Book mark: x. 1691 C. 7. 82, Oms by Camp

(over)

House

JAN. 18

5506849

1891 *

(Hypod. O. No. 66 Ha. 20. Dept.
of La. * of 65. Bureau
Major to date mch 13/65

* illegible

T | 104. Art. | U.S.C.T.

Jesse Fettis
Capt. 10 Regt. U.S.C.A. Art.

Appears on

General Order

No. 65, dated War Department, Adjutant Gen-
eral's Office, June 22, 1867.

Appointed to be

Major

BY BREVET

in the Volunteer Force, Army of the United
States, for faithful and
meritorious services
during the war

To date from Mich. 13, 1865.

L. Herrera

Feltis Jesse

Capt. Co. 10th Reg't U. S. C. H. A.

1 Enclosures.

Bed Cards	Final Statements
Burial Records	Furloughs or L. of A.
Certs. of Dis. for Discharge	Med. Certificates
C. M. Charges	Med. Des. Lists
Descriptive Lists	Orders /
Discharge Certificates	Pris. of War Record
Enlistment Papers	Resignations

Other papers relating to—

Admission to Hosp'l	Furlough or L. of A.
Casualty Sheet	Med. Examination
Confinement	Misc. Information
Contracts	Pay or Clothing
Death or Effects	Personal Reports
Desertion	Rank
Discharge from Hosp'l	Transfer to Hosp'l
Discharge from Service	Transfer to V. R. C.
Duty	Transportation

20.

Fettis Jesse

Co. 10th U.S. C. H. A.

Headquarters U.S. Forces
Ship Island Miss
June 7th 1865.

Special Orders }
No 20

Capt Jesse Pettis 10th U.S.C.A. (Hq)
will at once proceed to New Orleans La in
charge of four enlisted men of this command
to be mustered out of the U.S. Service and
two prisoners whom he will deliver to the
Provost-Marshal Parish of Orleans La taking
a receipt for them.

Capt Pettis will return to this command
on or before the 13th inst.

The Quartermasters Department will furnish
the necessary transportation

Erwin F Barstow
Capt 10th U.S.C.A. (Hq)
Comd'g Det

Fickland Joseph

Co F, 10 U.S. Col'd H. Art'y.

Arm. Musician | Arm. Musician

CARD NUMBERS.

1	5488489	26
2	5490273	27
3	5512506	28
4	5490288	29
5	5490355	30
6	5489330	31
7		32
8		33
9		34
10		35
11		36
12		37
13		38
14		39
15		40
16		41
17		42
18		43
19		44
20		45
21		46
22		47
23		48
24		49
25		50

Book Mark:

See also

H. use sup

A1132017- GAR

RHP 478205

D1467158. PO. in my

D1674072. PO. total

Српска Република

J

10th U.S.C.T.

Joseph Fickland
Mus. Co., 10 Reg't U. S. Col'd *Art'y.*

Appears on

M. and D. Roll of Men Transferred

to the organization named above,

from *7th U.S. Col'd. Inf.*

Roll dated *New Orleans, La., Oct. 11, 1863.*

When enlisted *June 10*, 186*3*

Period for which enlisted *3* years.

When mustered in *Feb'y. 28*, 186*3*

Present or absent *Not Stated*

Company to which assigned

Remarks: *Joined as a re-*
cruit Co "G" 2^d La
Inf. (2^d C.H.A.) (7th
Reg't I) Musician
"G" Feb'y 28, 1863.
Principal Musician
May 27, 1863

Book mark :

(342)

J. W. Jones, Jr.
Copyist.

F | *10 Hart* | **U.S.C.T.**

Joseph Fickland

Rank *P. Mus, 10* Reg't U. S. Col'd *Hart*

Appears on

Field and Staff Muster Roll

for *Nov + Dec*, 1865.

Present or absent *Absent*

Stoppage, \$ *100* for

Due Gov't, \$ *100* for

Valuation of horse, \$ *100*

Valuation of horse equipments, \$ *100*

Remarks: *On duty with Det 10
U. S. C. A. Hq. at Ship Island*

Book mark:

Ackerman

Copyist.

F | 10 H. Art'y. | U.S.C.T.

Joseph Tickland

P. Mus., Co. K, 10 Reg't U. S. Col'd H. Art'y.

Appears on

Company Muster Roll

for Nov. & Dec., 1865.

Present or absent Present

Stoppage, \$ 100 for

Due Gov't, \$ 100 for

Valuation of horse, \$ 100

Valuation of horse equipments, \$ 100

Remarks: Attached.

No descriptive list.

x So on roll.

Book mark:

Hibbard

(358)

G. 10 Hart | **U.S.C.T.**

Joseph Fickland

Rank Pr. Mus., 10 Reg't U. S. Col'd Hart

Appears on

Field and Staff Muster Roll

for Jan & Feb, 1866.

Present or absent

Stoppage, \$ 100 for

Due Gov't, \$ 100 for

Valuation of horse, \$ 100

Valuation of horse equipments, \$ 100

Remarks: Discharged by reason
of Expiration of term of
Service.

Book mark:

A. Kerman

Copyist.

G. | *10th Art* | **U.S.C.T.**

Joseph Fickland
Rank *Private* *10th* Reg't U. S. Col'd. *10th Art*

Appears on a

Field and Staff Muster-out Roll

of the organization named above. Roll dated

Baton Rouge La, Feb 22, 1867 .

Muster-out to date , 186 .

Last paid to , 186 .

Clothing account:

Last settled , 186 ; drawn since \$ 100

Due soldier \$ 100 ; due U. S. \$ 100

Am't for cloth'g in kind or money adv'd \$ 100

Due U. S. for arms, equipments, &c., \$ 100

Bounty paid \$ 100 ; due \$ 100

Remarks: *Disch'd for expira, of*
Term of Service Jan 13/66

Book mark: *V72, P137-69*

(260)

A. Kerman

Copyist.

F 10 *H. Art* U.S.C.T.

Joseph Fickland
Principal
Whitman, Co., *10* Reg't U. S. Col'd *H. Art*

Appears on an

Individual Muster-out Roll

of the organization named above. Roll dated

New Orleans La, *Jan. 15*, 1866.

Muster-out to date *Jan. 15*, 1866.

Last paid to *June 30*, 1866.

Clothing account:

Last settled 186 ; drawn since \$ 100

Due soldier \$ *43*^{*80*}/₁₀₀; due U. S. \$ 100

Am't for cloth'g in kind or money adv'd \$ 100

Due U. S. for arms, equipments, &c., \$ 100

Bounty paid \$ 100 due \$ 100

Remarks: *Received by transfer*
from 74th U. S. C. T.

Mustered out to take effect
January 15th 1866. Expiration
of term of service

Book mark: *V. 72 P. 137 - 69.*

M. A. Michaels
(348) Copyist.

Field Theo.

Co F, 10 U.S. Col'd H. Art'y.

Corporal

Corporal

CARD NUMBERS.

1	<i>5488721</i>	26
2	<i>5505716</i>	27
3	<i>5505868</i>	28
4	<i>5506021</i>	29
5	<i>5506277</i>	30
6	<i>5506958</i>	31
7	<i>5489963</i>	32
8		33
9		34
10		35
11		36
12		37
13		38
14		39
15		40
16		41
17		42
18		43
19		44
20		45
21		46
22		47
23		48
24		49
25		50

Book Mark:

See also

77. use of

F | *111 N. Arty.* | **U.S.C.T.**

Theo. Field

Capt., Co. *F*, *111* Reg't U. S. Col'd *N. Arty*

Appears on

M. and D. Roll of Men Transferred

to the organization named above,

from *77 Reg. U.S. C. Inf*

Roll dated *Oct 1*, 1865.

When enlisted *Apr 6*, 1863.

Period for which enlisted *3* years.

When mustered in *Apr 8*, 1863.

Present or absent *Present*

Company to which assigned *F*

Remarks: *Joined by transfer*
from Co "G" 5th Inf Cda
Jan 2.64 Promoted
Capt. Oct 1.64

Book mark :

(342)

J. M. Leonard

Capt.

J

10 H. Art'y. U.S.C.T.

Theo. Field

Corp., Co. F, 10 Reg't U. S. Col'd H. Art'y.

Appears on

Company Muster Roll

for Sept & Oct, 1865.

Present or absent Present

Stoppage, \$ 100 for

Due Gov't, \$ 100 for

Valuation of horse, \$ 100

Valuation of horse equipments, \$ 100

Remarks: Transferred from Co. H
77 U.S.C.I. Oct/65.

Book mark:

R. G. Masdon

F.

10 H. Art'y. U.S.C.T.

Theo. Field.

Corpl, Co. F, 10 Reg't U. S. Col'd H. Art'y.

Appears on

Company Muster Roll

for Nov & Dec, 1865.

Present or absent Present.

Stoppage, \$ 100 for

Due Gov't, \$ 100 for

Valuation of horse, \$ 100

Valuation of horse equipments, \$ 100

Remarks:

Book mark:

(358)

Ash Copyist.

F | 10 H. Art'y. | **U.S.C.T.**

Theo. Field.

Corpl, Co. F, 10 Reg't U. S. Col'd H. Art'y.

Appears on

Company Muster Roll

for *Jan'y. & Feby.*, 1866.

Present or absent *Present.*

Stoppage, \$.....100 for.....

Due Gov't, \$.....100 for.....

Valuation of horse, \$.....100

Valuation of horse equipments, \$.....100

Remarks:.....
.....
.....
.....
.....
.....
.....
.....
.....
.....

Book mark: *Muster out on file.*

ash
Copyst.

Theo. Field

Capt., Co. F, 10 Reg't U. S. Col'd H. Art'y.

Appears on

Company Muster Roll

for *Mar. & Apr.*, 186*b.*

Present or absent

Stoppage, \$ 100 for

Due Gov't, \$ 100 for

Valuation of horse, \$ 100

Valuation of horse equipments, \$ 100

Remarks: *Mustered out by reason of expiration of term of service.*

Book mark:

F | 10 H. Art'y. | U.S.C.T.

Theo. Field

Capt., Co *F*, 10 Reg't U. S. Col'd H. Art'y.

Appears on **Co. Muster-out Roll**, dated

Baton Rouge La Feb 22, 1867.

Muster-out to date _____, 186 .

Last paid to *Dec. 31*, 1865.

Clothing account:

Last settled _____, 186 ; drawn since \$ _____ 100

Due soldier \$ _____ 100; due U. S. \$ _____ 100

Am't for cloth'g in kind or money adv'd \$ _____ 100

Due U. S. for arms, equipments, &c., \$ _____ 100

Bounty paid \$ _____ 100; due \$ _____ 100

Remarks: *Rec'd by transfer from
Co. D. 77 U.S.C. & S. O. No. 66
Hd. Qu. Dept. of La. S. of 65
Discharge by expiration
of service Apl. 5/66*

Book mark *V. 97. P. 169. 69*

House

(361)

Copyist.

F | 10 Art'y | U.S.C.T.

Theo. Field
Corp., Co. F, 10 Reg't U. S. Col'd Art'y

Appears on a

Detachment Muster-out Roll

of the organization named above. Roll dated

New Orleans, La., Apr. 9, 1864

Muster-out to date Apr. 5, 1864

Last paid to Dec. 31, 1863

Clothing account:

Last settled _____, 186 ; drawn since \$ _____ 100

Due soldier \$ 14 ⁸⁶/₁₀₀; due U. S. \$ _____ 100

Am't for cloth'g in kind or money adv'd \$ _____ 100

Due U. S. for arms, equipments, &c., \$ _____ ⁴³/₁₀₀

Bounty paid \$ _____ 100 due \$ _____ 100

Remarks: Joined 4 Inf. Co. "A" (76 U.S. C.) as recruit. Transferred as priv't. to 5 Inf. Co. "A" (77 U.S.C. V.) Dec. 63. Promoted Corp'l. Octo. 1, 1864. Transferred to 10 U.S.C. A. (Hy) per S.O. 66. Hd. Qrs.

Book mark: P. M. S. 6289 June 20/66

P. Pool

JAN. 15

5489963

1891

Dept. of La. Series of 65;
Mustered out by reason of
expiration of term of
service.

Fish John

Co. F, **10 U.S. Col'd H. Art'y.**

asst. Surgeon. asst. Surgeon.

CARD NUMBERS.

1	5486796	26
2	5495066	27
3	5495369	28
4	5490349	29
5		30
6		31
7		32
8		33
9		34
10		35
11		36
12		37
13		38
14		39
15		40
16		41
17		42
18		43
19		44
20		45
21		46
22		47
23		48
24		49
25		50

Book Mark: *3271 Q. 1886.*

See also

F. | 10 H. Art'y. | U.S.C.T.

John Fish
(1st Reg't H. Art'y. C. d'Ar.)
Det. Aug Co., 10 Reg't U. S. Col'd H. Art'y.

Age 30 years.

Appears on an

Individual Muster-in Roll

of the organization named above. Roll dated

New Orleans, La., Dec. 23, 1863.

Muster-in to date Dec. 21, 1863.

Joined for duty and enrolled:

When December 21st, 1863.

Where New Orleans.

Period 3 years.

Valuation of horse, \$ 100

Valuation of horse equipments, \$ 100

Remarks: Appointed from civil life by Major General Banks, Comd'g. Dept. of the Gulf. Original vacancy.

Book mark: 3271, C.T. 86.

Philipson

(336)

Copyist.

D

10 H. Art'y. U.S.C.T.

John Fish

Capt. ^{Pres.} B, 1 Reg't H. Art'y, Corps d'Afrique.*

Appears on

Company Muster Roll

for Nov. 1 Dec., 186 3

Present or absent Present

Stoppage, \$ 100 for

Due Gov't, \$ 100 for

Valuation of horse, \$ 100

Valuation of horse equipments, \$ 100

Remarks:

*This organization subsequently became Co. , 10 Reg't U. S. Colored Heavy Artillery.

Book mark:

Reif

(358)

Copyist.

F

10 H. Art'y. U.S.C.T.

John Fish

Asst. Surg. Co. B, 1 Reg't H. Art'y, Corps d'Afrique.*

Appears on

Company Muster Roll

for Jan. 1 to Feb., 1864.

Present or absent

Stoppage, \$ 100 for

Due Gov't, \$ 100 for

Valuation of horse, \$ 100

Valuation of horse equipments, \$ 100

Remarks: 18 Feb. 1864 relieved from duty with the company by special order of the Medical Director Hqts. of the Gulf.

* This organization subsequently became Co. , 10 Reg't U. S. Colored Heavy Artillery.

Book mark:

(358)

Perf

Copyist.

F | *106 Art* | **U.S.C.T.**

John Fish
Rank *1st Sgt 10* Reg't U. S. Col'd *A. Art*

Appears on a

Field and Staff Muster-out Roll

of the organization named above. Roll dated

Baton Rouge La, Feb 22, 1867 .

Muster-out to date _____, 186 .

Last paid to _____, 186 .

Clothing account:

Last settled _____, 186 ; drawn since \$ _____ ¹⁰⁰

Due soldier \$ _____ ¹⁰⁰ ; due U. S. \$ _____ ¹⁰⁰

Am't for cloth'g in kind or money adv'd \$ _____ ¹⁰⁰

Due U. S. for arms, equipments, &c., \$ _____ ¹⁰⁰

Bounty paid \$ _____ ¹⁰⁰ ; due \$ _____ ¹⁰⁰

Remarks: *Discharged Jan 8/64*

per S.O. 6 S. of 64 Dept of

Gulf, to accept promotion

Book mark: _____

A. Kerman

(360)

Copyist.

Fish, John

A. Surg., Co.

10

Reg't U.S.C.H.A.

3

Enclosures.

Bed Cards	Descriptive Lists
Burial Records	Final Statements
Certs. of Dis. for Discharge	Furloughs
C. M. Charges	Med. Des. Lists
Med. Certificates	Orders

Other papers relating to—

Admission to Hosp'l	Furlough
Casualty Sheet (Officer's)	Med. Examination
Confinement	Misc. Information /
Contracts	Pay or Clothing
Death or Effects	Personal Reports
Desertions	Rank <i>2</i>
Discharge from Hosp'l	Transfer to Hosp'l
Discharge from Service	Transfer to V. R. C.
Duty	Transportation

M. 689 1863

New Orleans Nov 4th 1863

R. H. Alexander
Medical Director

By virtue of the enclosed
authority of Surgeon General
Hammond U.S.A. Board of Medical Officers
Command Oct 28th 1863 to
examine applicants for
admission into Vol Med Dep
including C.D.A.

Requests that Dr Fish
be commissioned as 1st Lt Surgeon
in the 1st H.A. C.D.A.

App'd.
C.D.A.

Issued

#915 - Nov 3rd 1863

M.D.P.

~~Medical Dep Comd~~
Station to contract
for 90 beds

Issued out from Med
Dep Office

MEDICAL DIRECTOR'S OFFICE,
Headquarters, Department of the Gulf,
New Orleans, 4 Nov^r 1863.

General

By virtue of the enclosed authority from Surg. Gen. Hammond U.S.A., a Board of Medical Officers convened 28th Oct. 1863 to examine applicants for admission into Vol. Med. Dept. including Corps d'Artigue.

I have the honor to submit enclosed report as to qualification of J. Fish, and would suggest that he be commissioned as 1st Lt. Surg. in 1st Reg^t Heavy Artillery, Corps d'Artigue. Commission to date from 3 Nov. 1863.

Very respectfully
Your obed^t Serv^t
W. H. Alexander
Surgeon U.S.A.
Med. Director Dept. Gulf

Major Gen. Bank
Surg. Dept. of the Gulf.

Med. Office
Hoggs Bay
Dec 14. 1863

F. 535 M3

Camp Parapet Dec 17th 1863

Respectfully
referred to
Maj. Leason
and with
request that
the Commission
be renewed
~~by~~
Supt
West Bay

Fish John
~~1st Asst. Surg. 1st Regt. Heavy
Artillery Cal'd A.~~

Requests duplicate Commission,
the original being lost.

Commission Clerk

issue duplicate

GNL

(to be called for)

Duplicate Pass
HCA

Camp Paraput, Dec 17, 1868

Colonel:—

I have failed to receive my Commission, although a considerable period of time has now elapsed since it was forwarded to me from the Headquarters of this Department. It was sent from these Headquarters Dec. 1 1868 to Headquarters Defense New Orleans. I am informed at the office of Headquarters Defense of New Orleans that a package containing four Commissions was transmitted through that office Dec. 2, 1868, to the commanding officer at Camp Paraput. I have made inquiry at the office of Col. Kahl and find that no such package was ever received there, and nothing corresponding to it. Neither has Col. Kimball any knowledge of any such paper, or package. Col. Bangs Col 1st Regt Heavy Art'y Corp d' Afrique has never received this Commission. The above being the only persons whom I can suppose to know anything about my Commission, I am led to believe that it is lost to me, irrecoverably, and therefore respectfully pray that

that a new one may be made out
for me immediately -

I have the honor to be
Colonel, with great
Respect Your most
Obedient Servant,

John Fish, 1st Lt
Surgeon, 1st Regt Arty.
of Arty Corps of Arizone

R. St. Alexander
Medical Director
Department of the Gulf.

M

7

1864

New Orleans

January 2nd 1864

Alexander R H Surg USA
Medical Director

Recommends Asst Surg John
Fish 1st Lt. H W CDA for the
position of Surg in 17th Infy
CDA

10th U.S.C. Art. 10

Issue 1173

HCA

The 17th has a Surgeon
HCA

Issue the commission
C.S.

MEDICAL DIRECTOR'S OFFICE,
Headquarters, Department of the Gulf,
New Orleans, January 2^d 1864.

Major I have the honor to recommend
Asst. Surg. John Fish, 1st La Heavy
Artillery, Corps de Afrique, for the
position of Surgeon of the 17th Regt
Corps de Afrique.

Very Respectfully
Your Obedt Servt

[Signature]
Surgeon, U.S. Army
Med. Director

Major G. W. Lieber, U.S.A.
A. A. General,
Dept of the Gulf.

13
Camp Parapet
June 6, 1864

John Fish
1st Capt Surg.
1st H'y Arty C. d. A.

10 M. C. H. A.

Acknowledgment
of receipt of commif-
ion as Surg. 17th Inf.
C. d. A. with request
to be discharged as
Capt Surg. 1st H. Arty
C. d. A.

S. O. January 8th

Camp Paraput, Jan. 6, 1864.

Major :-

I have the honor to acknowledge the receipt of my Commission as Surgeon of the Seventeenth Regiment of Infantry, Corps d' Afrique, and respectfully request that I may be discharged from my present position as Asst Surgeon of the First Regiment of Heavy Artillery, Corps d' Afrique

Very Respectfully, your Obedt Servant

John Fiske,

1st Regt Heavy Art'y, Corps d' Af'c.

G. Norman Leiber

Acting Assistant Adj. General.

Wm. George

Co G, 10 U.S. Col'd H. Art'y

Private

Private

CARD NUMBERS.

1	5507130	26
2	5507413	27
3	5507639	28
4	5509485	29
5		30
6		31
7		32
8		33
9		34
10		35
11		36
12		37
13		38
14		39
15		40
16		41
17		42
18		43
19		44
20		45
21		46
22		47
23		48
24		49
25		50

Book Mark:

See also

J. W. Holley U.S.C.T.

George Fisher

Appears with rank of *Privet* on

Muster and Descriptive Roll of a Detachment of U. S. Vols. forwarded

organized as Co. G.
for the *10th* Reg't U. S. Col'd *Mo.* Roll dated
New Orleans La. Sept 20, 1864.

Where born *St. Marys N.C.*

Age *30* y'rs; occupation *Lumber*

When enlisted *Aug 29*, 1864.

Where enlisted *New Orleans La*

For what period enlisted *3* years.

Eyes *Blk*; hair *Blk*

Complexion *Ok*; height *5 ft. 4 in.*

When mustered in *Sept 20*, 1864.

Where mustered in *New Orleans La.*

Bounty paid \$ *100*; due \$ *100*

Where credited *to New Orleans La*

Company to which assigned *G.*

Remarks:

Book mark:

E. B. Thompson
Copyist.

A

10 H. Art'y. U.S.C.T.

George Fisher
Pot, Co. G, 10 Reg't U. S. Col'd H. Art'y.

Appears on

Company Muster Roll

for Sept & Oct, 1864.

Present or absent Present

Stoppage, \$ 100 for

Due Gov't, \$ 100 for

Valuation of horse, \$ 100

Valuation of horse equipments, \$ 100

Remarks:

Book mark:

E. H. Brown

A

10 H. Art'y.

U.S.C.T.

George Fisher

Pat, Co. G, 10 Reg't U. S. Col'd H. Art'y.

Appears on

Company Muster Roll

for *Nov Dec*, 1864.

Present or absent

Stoppage, \$ 100 for

Due Gov't, \$ 100 for

Valuation of horse, \$ 100

Valuation of horse equipments, \$ 100

Remarks: *Died in Cd. A. Genl
Hosp New Orleans La. Dec
18/64*

Book mark:

E. V. Brown

J | 10 H. Art'y. | U.S.C.T.

George Fisher

Pvt, Co. *G*, 10 Reg't U. S. Col'd H. Art'y.

Appears on **Co. Muster-out Roll**, dated

Baton Rouge La, Feb 22 1867.

Muster-out to date _____, 186 .

Last paid to _____, 186 .

Clothing account:

Last settled _____, 186 ; drawn since \$ _____ 100

Due soldier \$ _____ 100; due U. S. \$ _____ 100

Am't for cloth'g in kind or money adv'd \$ _____ 100

Due U. S. for arms, equipments, &c., \$ _____ 100

Bounty paid \$ _____ 100; due \$ _____ 100

Remarks: *Joined at argl. exp'n.*
Died in Gen Hosp. at
New Orleans, La. Dec. 18
1864

Book mark : _____

(361)

Wines

Copyist.

Fisher, Geo.

P. G., Co., 10 Reg't Musketeers

5 Enclosures.

Bed Cards		Descriptive Lists	
Burial Records	2	Final Statements	2
Certs. of Dis. for Discharge		Furloughs	
C. M. Charges		Med. Des. Lists	
Med. Certificates		Orders	

Other papers relating to—

Admission to Hosp'l		Furlough	
Casualty Sheet (Officer's)		Med. Examination	
Confinement		Misc. Information	
Contracts	1	Pay or Clothing	
Death or Effects		Personal Reports	
Desertions		Rank	
Discharge from Hosp'l		Transfer to Hosp'l	
Discharge from Service		Transfer to V. R. C.	
Duty		Transportation	

FINAL STATEMENT

OF *Private*

George Fisher

10th Reg't of *U. S. C. Art.*

VOLUNTEERS.

Oct. 17th 1864

NOTE 1.—Two of these certificates (or duplicates) are to be given to each Volunteer Soldier or drafted man who may be discharged previously to the discharge of his company, that he may at once receive from the Paymaster the pay, &c., due him, and the captain or other COMMISSIONED officer commanding the company will certify to the act of the delivery of the duplicate certificates; on these certificates the Soldier is "entitled to" his discharge, and should also present his discharge to the Paymaster to have the payment endorsed on it. The discharge is to be given back to the Soldier by the Paymaster; the latter only retaining as his voucher the duplicate certificates.

NOTE 2.—If the Soldier is entitled to pay for the use of his horse, the Company Commander will certify to that fact on the back of both these final statements, and also to the time he has pay due for having been so mounted on his own horse.

NOTE 3.—When a Soldier is furnished with final statements, his descriptive list, if he has one, should be taken up by the officer who gives the Soldier these statements, and endorsed with a statement to this effect by the officer. This endorsement should exhibit a full statement of the time for which the Soldier was allowed pay on his final statements, the clothing account, and all other charges against him or in his favor, so as to comprise a complete exhibit of his account. It will then be transmitted to the company commander of the Soldier, who will enter all the data necessary to a full understanding of the Soldier's account on the muster roll upon which the Soldier's discharge is reported. The descriptive list will then be destroyed. The object of this is, that the remaining portion of the Soldier's account may be settled upon the receipt of these muster rolls, and the Soldier receive any pay or allowances that may be due him at the time of his discharge, and which may not appear on his final statements from the fact that his descriptive list is incomplete. These accounts for back pay, &c., are settled by the 2d Auditor of the Treasury Department.

NOTE 4.—Charges for loss or injury to ordnance, horse equipments, and other miscellaneous charges, should appear under the heading of "Other Stoppages."

NOTE 5.—Bounty paid by State authorities, and not by the United States, will not be entered on this statement.

NOTE 6.—Amounts due the Sutler and Laundress must be entered on the muster roll on which the discharge, dea h. desertion, &c., is reported, as well as on the final statement, otherwise the amount cannot be collected from the United States.

NOTE 7.—This blank will be used for deceased volunteers and drafted men, as well as for others.

NOTE 8.—Where a Soldier dies in Hospital or on detached service, his descriptive list, if he has one, should be sent with his final statements, in duplicate, to the Adjutant General, Washington, D. C.

A. G. O.
Also sent 2^d Aud.
748

ADJUTANT GENERAL'S OFFICE.
Jan 14th 1865
Duplicate with Inventory sent 2d Auditor.

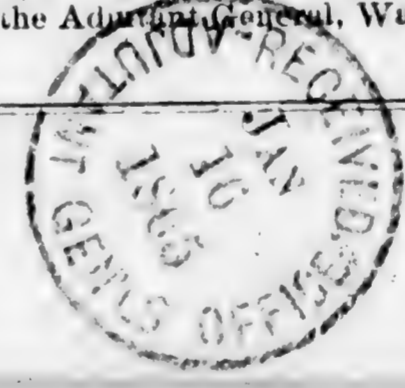

Per
J. M.

I certify, on honor, that George Fisher a Private of
Captain McGuire's Company (G.) of the 10th Regiment of U.S.C. & A.
VOLUNTEERS, of the State of Louisiana, born in St. Marys, State
of Louisiana, aged 30 years; 5 feet 4 inches high; Blk. complexion,
Blk. eyes, Blk. hair, and by occupation a Laborer, having joined the company on
its original organization at New Orleans La., and enrolled in it at the muster into
the service of the United States at New Orleans La., on the Twenty-ninth day
of August, 1864, (or was mustered in service as a recruit, by
....., at, on the day of,
1864, or was drafted and mustered into the service of the United States from the
Enrollment District of the State of, at,
on the day of, 1864,) to serve in the Regiment, for
the term of Three years: and having served **HONESTLY** and
FAITHFULLY with his Company in Dept. of the Gulf to the present date, is now
entitled to a **DISCHARGE** by reason of Death from Small Pox at
New Orleans La. December 19th 1864

The said George Fisher was ~~last~~ ^{never} paid by Paymaster
..... to include the day of 1864, and has
pay due him from that time to the present date; he is entitled to pay and subsistence for
TRAVELING to place of enrollment, and whatever other allowances are authorized to volunteer
soldiers, drafted men, or militia, so discharged. He has received from the United States **CLOTHING**
amounting to Thirty nine $\frac{13}{100}$ dollars, since the day of enrollment,
1864, when his clothing account was last settled. He has received from the United States
..... $\frac{100}{100}$ dollars advanced **BOUNTY**.

There is to be stopped from him, on account of the State of, or other
authorities, for **CLOTHING**, &c., received on entering service, $\frac{100}{100}$ dollars; and
for other stoppages, viz:

..... $\frac{100}{100}$ dollars.
He has been furnished with **TRANSPORTATION** in kind from the place of his discharge to
.....; and he has been **SUBSISTED** for **TRAVELING** to his
place of enrollment, up to the, 1864.

He is indebted to, **SUTLER**, $\frac{100}{100}$ dollars.

He is indebted to, **LAUNDRESS**, $\frac{100}{100}$ dollars.

Given in Duplicate, at New Orleans La., this 19th day
of December, 1864.

J. E. Piquette

Surgeon 86th U.S. Col. Inf. in charge
Commanding Company.
Camp d'African U.S. Gen. Hosp.

Dec 19. 1864

Impressment

FINAL STATEMENT

OF Private

George Fisher

10th Reg't of U. S. C. H. Art.

VOLUNTEERS.

C. A. Hook

NOTE 1.—Two of these certificates (or duplicates) are to be given to each Volunteer Soldier or drafted man who may be discharged previously to the discharge of his company, that he may at once receive from the Paymaster the pay, &c., due him, and the captain or other COMMISSIONED officer commanding the company will certify to the act of the delivery of the duplicate certificates; on these certificates the Soldier is "entitled to" his discharge, and should also present his discharge to the Paymaster to have the payment endorsed on it. The discharge is to be given back to the Soldier by the Paymaster; the latter only retaining as his voucher the duplicate certificates.

NOTE 2.—If the Soldier is entitled to pay for the use of his horse, the Company Commander will certify to that fact on the back of both these final statements, and also to the time he has pay due for having been so mounted on his own horse.

NOTE 3.—When a Soldier is furnished with final statements, his descriptive list, if he has one, should be taken up by the officer who gives the Soldier these statements, and endorsed with a statement to this effect by the officer. This endorsement should exhibit a full statement of the time for which the Soldier was allowed pay on his final statements, the clothing account, and all other charges against him or in his favor, so as to comprise a complete exhibit of his account. It will then be transmitted to the company commander of the Soldier, who will enter all the data necessary to a full understanding of the Soldier's account on the muster roll upon which the Soldier's discharge is reported. The descriptive list will then be destroyed. The object of this is, that the remaining portion of the Soldier's account may be settled upon the receipt of these muster rolls, and the Soldier receive any pay or allowances that may be due him at the time of his discharge, and which may not appear on his final statements from the fact that his descriptive list is incomplete. These accounts for back pay, &c., are settled by the 2d Auditor of the Treasury Department.

NOTE 4.—Charges for loss or injury to ordnance, horse equipments, and other miscellaneous charges, should appear under the heading of "Other Stoppages."

NOTE 5.—Bounty paid by State authorities, and not by the United States, will not be entered on this statement.

NOTE 6.—Amounts due the Sutler and Laundress must be entered on the muster roll on which the discharge, death, desertion, &c., is reported, as well as on the final statement; otherwise the amount cannot be collected from the United States.

NOTE 7.—This blank will be used for deceased volunteers and drafted men, as well as for others.

NOTE 8.—Where a Soldier dies in Hospital or on detached service, his descriptive list, if he has one, should be sent with his final statements, in duplicate, to the Adjutant General, Washington, D. C.

I certify, on honor, that George Fisher a Private of
Captain McGuire's Company (1st) of the 10th Regiment of U.S.C. & A.
VOLUNTEERS, of the State of Louisiana, born in St. Marys, State
of Louisiana, aged 30 years; 5 feet 4 inches high; Blk. complexion,
Blk. eyes, Blk. hair, and by occupation a Laborer, having joined the company on
its original organization at New Orleans La., and enrolled in it at the muster into
the service of the United States at New Orleans La., on the Twenty-ninth day
of August, 1864, (or was mustered in service as a recruit, by
....., at, on the day of,
1864, or was drafted and mustered into the service of the United States from the
Enrollment District of the State of, at,
on the day of, 1864) to serve in the Regiment, for
the term of Three years: and having served **HONESTLY** and
FAITHFULLY with his Company in Depart. of the Gulf to the present date, is now
entitled to a **DISCHARGE** by reason of Death from Small Pox at
New Orleans La. December 19th 1864

The said George Fisher was last paid by Paymaster
..... to include the day of, 1864, and has
pay due him from that time to the present date; he is entitled to pay and subsistence for
TRAVELING to place of enrollment, and whatever other allowances are authorized to volunteer
soldiers, drafted men, or militia, so discharged. He has received from the United States **CLOTHING**
amounting to Thirty-nine $\frac{13}{100}$ dollars, since the day of enrollment,
1864 when his clothing account was last settled. He has received from the United States
..... $\frac{100}{100}$ dollars advanced **BOUNTY**.

There is to be stopped from him, on account of the State of, or other
authorities, for **CLOTHING**, &c., received on entering service, $\frac{100}{100}$ dollars; and
for other stoppages, viz:

..... $\frac{100}{100}$ dollars.
He has been furnished with **TRANSPORTATION** in kind from the place of his discharge to
.....; and he has been **SUBSISTED** for **TRAVELING** to his
place of enrollment, up to the, 1864.

He is indebted to, **SUTLER**, $\frac{100}{100}$ dollars.

He is indebted to, **LAUNDRESS**, $\frac{100}{100}$ dollars.

Given in Duplicate, at New Orleans La., this 19th day
of December, 1864.

George Fisher
Priv. G. 10. U. S. C. & H. A.
Dec. 19. 64.

Corps d'Afrique
New-Orleans.

HOSPITAL RECORD,

SUBJECT TO THE

ORDER OF THE SURGEON GENERAL,

UNITED STATES ARMY.

RECORD OF DEATH AND INTERMENT.

Name and number of person interred,

George Fisher

Number and locality of the Grave, -

Hospital number of the deceased, -

4319

Regiment, Rank, and Company, - -

10th U.S. Col. Hy. Art. - Priv. - 5

Residence before enlistment, - - -

Conjugal condition (and if married,)

the residence of the widow,)

Cause of death, - - - - -)

Smallpox

Age of the deceased, - - - - -

Nativity, - - - - -

References, and Remarks, - - -)

Date of death and burial, - - -

Decbr 19th / 64

186

Duplicates sent to the Adjutant General of the United States Army, and to the Sexton of the Cemetery.

Memoranda:

RECORD OF DEATH AND INTERMENT.

Name and number of person interred,	<i>George Fisher</i>	
Number and locality of the grave, -		
Hospital number of the deceased, -	<i>4319</i>	
Regiment, Rank, and Company, - -	<i>10th U. S. Col. Art. - Priv. - G.</i>	
Residence before enlistment, - - -		
Conjugal condition (and if married,) the residence of the widow,)		
Cause of death,)	<i>Smallpox</i>	
Age of the deceased, - - - - -		
Nativity, - - - - -		
References and Remarks, - -)		
Date of death and burial, - - -	<i>Decbr 19th / 64</i>	186

[A duplicate of this Record has been forwarded to the Sexton, and the other remains at this Hospital.]

To *Adj. General U. S. A.*
SIR :

It becomes my duty to inform you that the person above described died at this Hospital as herein stated: and that it is desired his remains should be interred with the usual military honors.

Respectfully,

F. E. Pyne
Surgeon U. S. Army.
in charge
Corps d'Afr. Gen. Hosp.

MILITARY HOSPITAL, *Corps d'Afrique*
N Orleans La.

This copy of Record is to be transmitted to the Adjutant General at Washington immediately after the place of burial and the number of the grave have been ascertained and registered. The above notification is to remain attached.

Triplicate

INVENTORY OF THE EFFECTS

OF Private
George Fishers
Late of Company G

10th Reg't of U. S. C. Ho. Art.

Volunteers, who died at Corps d. of Gen. Hosp.
New-Orleans La
on the 19th day of December 1864.

, or be
icer of
sioned
ve his
ie De-
paid to
soldier.
ffects
nted to
ent-or
ted to
of the
sioned
d paid

officers
rded to
ch the
e regi-
th the
om his
ish the
anding
death,
id, and
e cease;
pany to
ventory
ent of
a legal
If the

icer or
e cease,
er the
s depo-
il they

ation, a
by the
receipt
to the
of the

"

ed over
djutant
the de-
l, their
r cases,
djutant

uplicate
should
cer.

Inventory of the effects of George Fisher late
 a Private of Captain G. H. McGuire Company "G." of
 the 10th Regiment of U. S. C. V. Art. Volunteers, who was enrolled as
 a Private at New Orleans in the State of Louisiana on
 the 29th day of August 1864, and mustered into the service of the United
 States as a Private on the 20th day of September 1864, at New Orleans
 in Company "G.", 10th Regiment of U. S. C. V. Art. Volunteers, to serve 3
 years or during the war; he was born in St. Marys in the State
 of Louisiana; he was 30 years of age, 5 feet 4 inches
 high, Blk. complexion, Blk. eyes, Blk. hair, and by occupation, when enrolled,
 a Laborer; he died in Camp of African Gen. Herb. at
New Orleans La. on the 19th day of December 1864, by
 reason of Small Pox.

INVENTORY.					
ARTICLES.	No.	ARTICLES.	No.	ARTICLES.	No.
Hats.....		Pairs trousers.....		Knapsacks.....	
Caps.....		Pairs flannel drawers.....			
Forage caps.....		Pairs cotton drawers.....			
Great coats.....		Flannel shirts.....			
Uniform coats.....		Cotton shirts.....			
Uniform jackets.....		Pairs boots.....			
Flannel sack coats.....		Pairs shoes.....			
Blouses.....		Pairs socks.....			
Stable frocks.....		Blankets.....		MONEY.	
Fatigue overalls.....		Haversacks.....		Specie.....	\$
				Notes.....	\$

We have no Effects

I CERTIFY, ON HONOR, that the above inventory comprises all the effects of _____
 _____, deceased, and that the effects are in the hands
 of _____ at _____
 _____ to be disposed of by a Council of Administration.

(DUPLICATES.)

STATION: New Orleans La.

DATE: December 19th 1864

 Commanding the Company.

Fisher, Peter

Coa., 10 U.S. Col'd H. Art'y

Private

Private

CARD NUMBERS.

1	5490401	26
2	5490551	27
3	5490695	28
4	5490835	29
5	5490991	30
6	5491125	31
7	5491338	32
8	5494122	33
9	2563 QJ-1879	34
10		35
11		36
12		37
13		38
14		39
15		40
16		41
17		42
18		43
19		44
20		45
21		46
22		47
23		48
24		49
25		50

Book Mark L. B. 13/20. 2563
C. G. 1879

See also

F | 10 H. Art'y. | U.S.C.T.

Peter Fisher

Priv., Co. A, 1 Reg't La. Col'd H. Art'y.*

Age 23 years.

Appears on

Company Muster-in Roll

of the organization named above. Roll dated

New Orleans, La, Nov 29 1862.

Muster-in to date Nov 29, 1862

Joined for duty and enrolled:

When Nov 16, 186 .

Where New Orleans

Period 3 years.

Valuation of horse, \$ 100

Valuation of horse equipments, \$ 100

Remarks: _____

* This organization subsequently became Co. A, 10 Reg't U. S. Colored Heavy Artillery.

Book mark: _____

(356)

John an

Copyist.

F

10 H. Art'y. U.S.C.T.

Peter Fisher

Priv, Co. A, 1 Reg't La. H. Art'y.*

Appears on

Company Muster Roll

for to Dec, 31, 1862.

Present or absent Present

Stoppage, \$ 100 for

Due Gov't, \$ 100 for

Valuation of horse, \$ 100

Valuation of horse equipments, \$ 100

Remarks: Sick in Quarters

*This organization subsequently became Co. A, 10 Reg't U. S. Col'd Heavy Artillery.

Book mark:

Tobman

Copyist.

F

10 H. Art'y. U.S.C.T.

Peter Fisher

....., Co. A, 1 Reg't La. H. Art'y.*

Appears on

Company Muster Roll

for Jan'y & Feb'y, 1863.

Present or absent Present

Stoppage, \$.....100 for

Due Gov't, \$.....100 for

Valuation of horse, \$.....100

Valuation of horse equipments, \$.....100

Remarks:.....
.....
.....
.....
.....
.....
.....
.....

*This organization subsequently became Co. A, 10 Reg't U. S. Col'd Heavy Artillery.

Book mark:.....

Tobman
Copyst.

F

10 H. Art'y. U.S.C.T.

Peter Fisher

....., Co. A, 1 Reg't La. H. Art'y.*

Appears on

Company Muster Roll

for March & April, 1863.

Present or absent Absent

Stoppage, \$.....100 for

Due Gov't, \$.....100 for

Valuation of horse, \$.....100

Valuation of horse equipments, \$.....100

Remarks: Sick in
New Orleans

*This organization subsequently became Co. A, 10 Reg't U. S. Col'd Heavy Artillery.

Book mark:

(358)

Johnson
Copyst.

F

10 H. Art'y. U.S.C.T.

Peter Fisher

Priv, Co. A, 1 Reg't La. H. Art'y.*

Appears on

Company Muster Roll

for May & June, 1863.

Present or absent Absent

Stoppage, \$.....100 for

Due Gov't, \$.....100 for

Valuation of horse, \$.....100

Valuation of horse equipments, \$.....100

Remarks: Sick in
Hospital at
New Orleans.

*This organization subsequently became Co. A, 10 Reg't U. S. Col'd Heavy Artillery.

Book mark:

Tobman
Copyst.

F

10 H. Art'y. U.S.C.T.

Peter Fisher

Priv., Co. A, 1 Reg't La. H. Art'y.*

Appears on

Company Muster Roll

for July & August, 1863.

Present or absent Absent

Stoppage, \$ 100 for

Due Gov't, \$ 100 for

Valuation of horse, \$ 100

Valuation of horse equipments, \$ 100

Remarks: sick at St. James Hospital (N.D.)

*This organization subsequently became Co. A, 10 Reg't U. S. Col'd Heavy Artillery.

Book mark:

Tobman Copyist.

F

10 H. Art'y. U.S.C.T.

Peter Fisher

Priv., Co. A, 1 Reg't La. H. Art'y.*

Appears on

Company Muster Roll

for Sept & Oct, 1863.

Present or absent

Stoppage, \$ 100 for

Due Gov't, \$ 100 for

Valuation of horse, \$ 100

Valuation of horse equipments, \$ 100

Remarks: Left sick at
St. James Hospital,
New Orleans Dec. 1862
and never reported
to his company.
Marked deserter
Sept 8. 1863.

*This organization subsequently became Co. A, 10 Reg't U. S. Col'd Heavy Artillery.

Book mark:

Tobman

(358)

Copyist.

F | 10 H. Art'y. | U.S.C.T.

Peter Fisher

Co. A, 10 Reg't U. S. Col'd H. Art'y.

Appears on **Co. Muster-out Roll**, dated
Baton Rouge La, Feb. 22, 1867.

Muster-out to date _____, 186 .

Last paid to _____, 186 .

Clothing account:

Last settled _____, 186 ; drawn since \$ _____ 100

Due soldier \$ _____ 100; due U. S. \$ _____ 100

Am't for cloth'g in kind or money adv'd \$ _____ 100

Due U. S. for arms, equipments, &c., \$ _____ 100

Bounty paid \$ _____ 100; due \$ _____ 100

Remarks: *Joined origl. orgn. Reserted*
Sept. 8. '63

Book mark: *V. 15 P. 97. 68 1472. 1878*

2563 G. 2. 79 Charge of desertion
(over)

Nesbitt

JAN. 15

5494122

★ 1891 ★

Discharged May. 20. 63 at New.
Orleans La. L.B. $\frac{13}{20}$ 2563
G. P. 79

F | 10 H.a. & S.C.T.

Peter Fisher

, Co. A, 10 Reg't U.S.C.H.a.

NOTATION.

L-B-13-120 - with

Book mark: 2563 - 6.T. 1879.

War Department,

Adjutant General's Office,

Washington, Feb. 7, 1880.

"A.G.O. charge of desertion
removed - discharged
May 20, 1863. at New
Orleans La."

S. J. Brooks

(438)

Copyist.

Fisher, William B.
Co. D., 10 U.S. Col'd H. Art'y.

Quell Sergeant Mr. Sergeant
CARD NUMBERS.

1	5-487203	26
2	5-500675	27
3	5-500751	28
4	5-500823	29
5	5-500892	30
6	5-500961	31
7	5-501042	32
8	5-501116	33
9	5-501193	34
10	5-501480	35
11	5-502224	36
12	40746000	37
13		38
14		39
15		40
16		41
17		42
18		43
19		44
20		45
21		46
22		47
23		48
24		49
25		50

Book Mark:

See also 25th Regt Bally.

Wm R Fisher

Appears with rank of _____ on

Muster and Descriptive Roll of a Detachment of U. S. Vols. forwarded

for the *7* Regt *U.S. Art'y* Roll dated

New Orleans La July 15, 1864.

Where born *Stafford N.H.*

Age *25* yrs; occupation *R.R. Conductor*

When enlisted *July 7*, 186*4*.

Where enlisted *New Orleans La*

For what period enlisted *3* years.

Eyes *Brown*; hair *Brown*

Complexion *Light*; height *5* ft. *5* in.

When mustered in *July 15*, 186*4*.

Where mustered in _____

Bounty paid \$ *100*; due \$ *100*

Where credited *New Orleans*

Company to which assigned *D*

Remarks *Discharged as Private of 25th U.S. Battery. Special orders no 148 Par 14 Dated Had Quarter Dept of War*

Book mark: _____

R. H. Fisher
Cowp Copyist.

JAN. 15

5487203

1891

Prof July 6. 1864
to enable him to re-
- establish in U.S.C.
a. (H) with view to
appointment as Q.M.
Surgeant

^x Became 10 U.S. Col Hart

J

10 H. Art'y. | U.S.C.T.

William R. Fisher

2nd, Co. D, 10 Reg't U. S. Col'd H. Art'y.

Appears on

Company Muster Roll

for *July & Aug.*, 186*4*.

Present or absent *Present*

Stoppage, \$ *100* for

Due Gov't, \$ *100* for

Valuation of horse, \$ *100*

Valuation of horse equipments, \$ *100*

Remarks *Appointed 2nd Lt. Sergt
July 15/64 per S.O. No. 48
dated Hd Qrs 7 US H. Art'y (Col'd)
July 15/64*

Book mark:

(358)

Shadock

Copyist.

J

William R. Fisher

2nd MS., Co. D, 10 Reg't U. S. Col'd H. Art'y.

Appears on

Company Muster Roll

for *Sept. & Oct.*, 186 *4*.

Present or absent *Present*

Stoppage, \$ *100* for

Due Gov't, \$ *100* for

Valuation of horse, \$ *100*

Valuation of horse equipments, \$ *100*

Remarks:

Book mark:

Shadbock

J

William R. Fisher

2nd, Co. D, 10 Reg't U. S. Col'd H. Art'y.

Appears on

Company Muster Roll

for *Nov. & Dec.*, 186*4*.

Present or absent *Present*

Stoppage, \$ *100* for

Due Gov't, \$ *100* for

Valuation of horse, \$ *100*

Valuation of horse equipments, \$ *100*

Remarks: *On duty as actg*

Port Commissary Sgt

per S.O. No. 20 dated Hd. Qrs

Port St. Philip Dec. 26/64

Book mark:

Shadwell

F

10 H. Art'y.

U.S.C.T.

William R. Fisher

2. M. Sgt, Co. D, 10 Reg't U. S. Col'd H. Art'y.

Appears on

Company Muster Roll

for *Jan & Feb*, 1865.

Present or absent *Present*

Stoppage, \$ *100* for

Due Gov't, \$ *100* for

Valuation of horse, \$ *100*

Valuation of horse equipments, \$ *100*

Remarks: *Actg Post Com. Sgt.
per S. O. No. 70, dated Hd Qrs
Fort St. Philip, Dec 26/64*

Book mark:

Patterson

(358)

Copyist.

William R. Fisher

G. M. Sgt., Co. D, 10 Reg't U. S. Col'd H. Art'y.

Appears on

Company Muster Roll

for *March - Apr*, 1865.

Present or absent *Present*

Stoppage, \$ *100* for

Due Gov't, \$ *100* for

Valuation of horse, \$ *100*

Valuation of horse equipments, \$ *100*

Remarks: *Actg Post Com'g Sgt, per. S. O. no. 70 dated Hd Qrs Fort St Philip, La, Dec 26/64.*

Book mark:

Patterson

A | 10 H. Art'y. | U.S.C.T.

Wm R. Fisher

Q. M. Sgt., Co. D, 10 Reg't U. S. Col'd H. Art'y.

Appears on

Company Muster Roll

for *May & June*, 1865.

Present or absent *Present*

Stoppage, \$ *100* for

Due Gov't, \$ *100* for

Valuation of horse, \$ *100*

Valuation of horse equipments, \$ *100*

Remarks: *Actg Post Comfy Sgt per
S.O. No. 70. dated Hd Qrs Fort
St Philip, La., Dec. 26/64.*

Book mark:

Patterson

(358)

Copyist.

F

10 H. Art'y. | U.S.C.T.

William R Fisher

G.M. Sgt., Co. D, 10 Reg't U. S. Col'd H. Art'y.

Appears on

Company Muster Roll

for *July & Aug*, 186*5*.

Present or absent *Present*

Stoppage, \$ *100* for

Due Gov't, \$ *100* for

Valuation of horse, \$ *100*

Valuation of horse equipments, \$ *100*

Remarks: *Actg Post Comp Sgt
per S.O. No. 76, Hd Qrs Fort
St. Philip, La, Dec 26/64.*

Book mark: _____

Patterson

(358)

Copyist.

A

10 H. Art'y. | U.S.C.T.

William R. Fisher

G. M. Sgt, Co. D, 10 Reg't U. S. Col'd H. Art'y.

Appears on

Company Muster Roll

for *Sept & Oct*, 186*5*.

Present or absent *Present*

Stoppage, \$ *100* for

Due Gov't, \$ *100* for

Valuation of horse, \$ *100*

Valuation of horse equipments, \$ *100*

Remarks: *Act of Post Carrying Sgt.
A. O. No. 76, Hd Qrs Ft. St. Philip,
La., Dec 26/64.*

Book mark:

Patterson

(358)

Copyist.

21

10 H. Art'y. | U.S.C.T.

William R. Fisher
2nd Lt, Co. D, 10 Reg't U. S. Col'd H. Art'y.

Appears on

Company Muster Roll
for Nov & Dec, 1865.

Present or absent.....

Stoppage, \$.....100 for.....

Due Gov't, \$.....100 for.....

Valuation of horse, \$.....100

Valuation of horse equipments, \$.....100

Remarks: Discharged Dec.
22. 65 by Co. 142 Hd
Qrs Dept of Ha.
Final statements
given

Book mark:.....

W. Mayne

(358)

Copyist.

F

10 H. Art'y. U.S.C.T.

Wm. R. Fisher

Pvt., Co. D, 10 Reg't U. S. Col'd H. Art'y.
2. m. Sgt.

Appears on Returns as follows:

July 1864 - (Pvt. Co. D, 7 Regt. U.S. Col'd H. Art'y.) Gained July 15 '64 New Orleans. Enlisted in Regt.

Dec 1864 - (2. m. Sgt. Co. D, 10 Regt. U.S. Col'd H. Art'y) - On duty actg. Post comey. Sergt. Jan. to Aug. 1865 - On duty actg. Post comey. Sergt.

Oct. Nov. 1865 - On duty actg. Post comey. Sgt.

Dec. 1865 - Res. Dec. 22/65 New Orleans. Disch'd. by S.O. 145 No. 212. Dept. of A. Dec. 22/65

Book mark:

G. Hemton

(546)

Copyist.

William R. Fisher
2nd Regt Co. D, 10 Reg't U. S. Col'd H. Art'y.

Appears on **Co. Muster-out Roll**, dated
Baton Rouge La, Feb 22, 1867.

Muster-out to date -----, 186 .

Last paid to -----, 186 .

Clothing account:

Last settled -----, 186 ; drawn since \$ ----- 100

Due soldier \$ ----- 100; due U. S. \$ ----- 100

Am't for cloth'g in kind or money adv'd \$ ----- 100

Due U. S. for arms, equipments, &c., \$ ----- 100

Bounty paid \$ ----- 100; due \$ ----- 100

Remarks: *Joined as Recruit*
App'd. 2nd Sg't July
15/64. Dis. Dec. 22/65 by
V.O. 145 Dpt La. P of 18/65
Final pmts given

Book mark: -----

J. Leonard
Copyist.

Wm.
Fisher, William R.

2nd
Lt., Co.

10

Reg't U.S.C.H.A.

1 Enclosures.

Bed Cards	Descriptive Lists
Burial Records	Final Statements
Certs. of Dis. for Discharge	Furloughs
C. M. Charges	Med. Des. Lists
Med. Certificates	Orders

Other papers relating to—

Admission to Hosp'l	Furlough
Casualty Sheet (Officer's)	Med. Examination
Confinement	Misc. Information
Contracts	Pay or Clothing
Death or Effects	Personal Reports
Desertions	Rank
Discharge from Hosp'l	Transfer to Hosp'l
Discharge from Service	Transfer to V. R. C.
Duty	Transportation

L 836 DL 1865
St. Philip Co

Dec 10th 1865
L 836 DL 1865

J. Fisher William

S. M. Sergt.

Co. D. 10th U.S. C. A. Hq.

Makes statement as to the length of time he has been in the U.S. service & requests that he be discharged the same. Has no dependents at home

Dec 13 1865

Headquarters, Eastern District of La.

New Orleans, La., Dec. 13th 1865

Respectfully Forwarded to Headquarters, Department of Louisiana.

Approved

[Signature]
Brevet Major General Commanding.

Recd DL Dec 20/65

Head. Quarters

St. Philip
December 10th 1865

Respectfully forwarded approved - the within applicant for discharge has always performed his duties faithfully & well. and as he has served over three years I would respectfully recommend that if no means obtain with the good of the service he be discharged -

[Signature]
Capt. 10th U.S. C. A. Hq.
Sandy Post

S. O. Nov. 19, 1865

Headquarters, Eastern District of La.,

New Orleans, La., Dec. 13th 1865

Respectfully referred to
Comdg. Officer 10th
U.S. C. A. Hq. (Hq.)
for remarks

BY ORDER OF BREVET MAJ. GEN. SHERMAN,

[Signature]
1st Lieutenant, A. D. C.
A. A. A. General.

Head Quarters 10th U.S. C. A. Hq.

Camp Parafit La. Dec. 17th 1865

Approved & copy

forwarded
[Signature]
Col. 10th U.S. C. A. Hq.
Comdg. Regiment

Fork In Philips Co.
December 10th 1863

May. Wickham Hoffman
A. A. G. Dep't of Ga.

Sir.

I have the honor to make the following statement ^{as} request.

I enlisted ^{as} was mustered into the 25th Battery
U. S. Vols December 12. 1862 to serve for the period of three years
unless sooner discharged. I served in the Battery until July 6. 1864
when I was discharged per S. O. N^o 178 Hd. qrs. Dep't of the Gulf New
Orleans La. July 6. 1864 to enable me to re-enlist in the 7th U. S. H
Art'y (Col'd) now the 10th U. S. C. Art'y (Hvy) with a view to my appointment
as Quarter Master Serjt in that Reg't which appointment I received.
I have served in the regiment in that capacity from July 7. 1864 to the
present time. I now request that I may be discharged on the expiration
of my terms of service dating from my muster into service Dec 12. 1862
I also have important business at home which requires my immediate
attention

I have the honor to be

very respectfully your obed^t servant

William R. Fisher

Q. M. Serjt. Co D. 10th U. S. C. Art'y (Hvy)

Wm. E. Jackson

Co H, 10 U.S. Col'd H. Art'y.

Private

Private

CARD NUMBERS.

1	5509535	26
2	5509632	27
3	5509745	28
4	5509902	29
5	5510053	30
6	5510197	31
7	5510347	32
8	5510498	33
9	5510620	34
10	5510764	35
11	5510845	36
12	5510920	37
13	5510993	38
14	5511057	39
15		40
16		41
17		42
18		43
19		44
20		45
21		46
22		47
23		48
24		49
25		50

Book Mark:

See also

F | 10 H. Art'y. | U.S.C.T.

Jacks Fiske
Capt, Co. H, 10 Reg't U. S. Col'd H. Art'y.

Appears on

Company Muster-in and Descriptive Roll
of the organization named above. Roll dated
New Orleans La, Nov 8, 1864.

Where born *Louisiana*

Age *25* y'rs; occupation *Laborer*

When enlisted *Nov 1*, 1864.

Where enlisted *New Orleans*

For what period enlisted *3* years.

Eyes *Black*; hair *Black*

Complexion *Black*, height *5 ft. 6 in.*

When mustered in *Nov 8*, 1864.

Where mustered in *New Orleans*

Bounty paid \$ *100*; due \$ *100*

Where credited *Dist-2^d Ward, Parish*
of Orleans City of N. Orleans La
Company to which assigned *H.*

Remarks: *Mustered in to*
date from date of
Enlistment

NEXT ROLL ON FILE FEB 3 1865

Book mark :

(356d)

Pennington

Copyist.

F | 10 H. Art'y. | U.S.C.T.

Jacko Fiske

Pvt, Co. H, 10 Reg't U. S. Col'd H. Art'y

Appears on

Company Muster Roll

for *Jan'y & Feb'y*, 1865-

Present or absent *Present*

Stoppage, \$ *100* for

Due Gov't, \$ *100* for

Valuation of horse, \$ *100*

Valuation of horse equipments. \$ *100*

Remarks :

Book mark :

(858)

Pennington
Coryist.

A

10 H. Art'y.

U.S.C.T.

James Fiske

Pvt, Co. H, 10 Reg't U. S. Col'd H. Art'y

Appears on

Company Muster Roll

for *March & April*, 1865.

Present or absent *Present*

Stoppage, \$ *100* for

Due Gov't, \$ *100* for

Valuation of horse, \$ *100*

Valuation of horse equipments. \$ *100*

Remarks :

Book mark :

(858)

Permittington
Copyist.

J

10 H. Art'y.

U.S.C.T.

Jacob Fiska

Pvt, Co. H, 10 Reg't U. S. Col'd H. Art'y

Appears on

Company Muster Roll

for *May & June*, 1865-

Present or absent *Present*

Stoppage, \$ *100* for

Due Gov't, \$ *100* for

Valuation of horse, \$ *100*

Valuation of horse equipments. \$ *100*

Remarks :

Book mark :

(358)

Pennington Copyist.

F

10 H. Art'y.

U.S.C.T.

James Fiske
Pvt

Co. H, 10 Reg't U. S. Col'd H. Art'y

Appears on

Company Muster Roll

for *July & Aug*, 1865.

Present or absent *Present*

Stoppage, \$ *100* for

Due Gov't, \$ *100* for

Valuation of horse, \$ *100*

Valuation of horse equipments. \$ *100*

Remarks: *Sick in quarters*

Book mark:

Pennington

(858)

Copyist.

F

10 H. Art'y. U.S.C.T.

Jack Fiske

Capt, Co. H, 10 Reg't U. S. Col'd H. Art'y

Appears on

Company Muster Roll

for *Sept & Oct*, 1865.

Present or absent *Present*

Stoppage, \$ *100* for

Due Gov't, \$ *100* for

Valuation of horse, \$ *100*

Valuation of horse equipments. \$ *100*

Remarks :

Book mark :

(358)

Cammack
Copyist.

J

10 H. Art'y. U.S.C.T.

Jacko Fiske

Co. H, Co. H, 10 Reg't U. S. Col'd H. Art'y

Appears on

Company Muster Roll

for *Nov & Dec*, 1865.

Present or absent *Present*

Stoppage, \$ 100 for

Due Gov't, \$ 100 for

Valuation of horse, \$ 100

Valuation of horse equipments. \$ 100

Remarks :

Book mark :

Gemma S

G

10 H. Art'y.

U.S.C.T.

Jacko Fiske

Co. H., Co. H, 10 Reg't U. S. Col'd H. Art'y

Appears on

Company Muster Roll

for *Jan & Feb.*, 1866.

Present or absent *Present*

Stoppage, \$ *100* for

Due Gov't, \$ *100* for

Valuation of horse, \$ *100*

Valuation of horse equipments. \$ *100*

Remarks :

Book mark :

Gammack

(358)

Copyist.

F

10 H. Art'y. U.S.C.T.

Jacko Fiske

Priv, Co. H, 10 Reg't U. S. Col'd H. Art'y

Appears on

Company Muster Roll

for *Mc & Ap^l*, 1866.

Present or absent *Present*

Stoppage, \$ *100* for

Due Gov't, \$ *100* for

Valuation of horse, \$ *100*

Valuation of horse equipments. \$ *100*

Remarks:

Book mark: *100*

Gammack

Copyist.

L

10 H. Art'y.

U.S.C.T.

Jacko Fiske

Dr.

Co. H, 10 Reg't U. S. Col'd H. Art'y

Appears on

Company Muster Roll

for

May & June, 1866.

Present or absent

Present

Stoppage, \$

100 for

Due Gov't, \$

100 for

Valuation of horse, \$

100

Valuation of horse equipments. \$

100

Remarks :

Book mark:

(358)

Lamma R
Copyist.

J | 10 H. Art'y. | U.S.C.T.

Jacko Fiske

Prvt, Co. H, 10 Reg't U. S. Col'd H. Art'y

Appears on

Company Muster Roll

for *July & Aug*, 186*6*.

Present or absent *Present*

Stoppage, \$ *100* for

Due Gov't, \$ *100* for

Valuation of horse, \$ *100*

Valuation of horse equipments. \$ *100*

Remarks :

Book mark :

Lammack
Copyright.

F

10 H. Art'y. U.S.C.T.

Jacko Fiske

Pvt, Co. H, 10 Reg't U. S. Col'd H. Art'y

Appears on

Company Muster Roll

for *Sep & Oct*, 1866.

Present or absent *Present*

Stoppage, \$ *100* for

Due Gov't, \$ *100* for

Valuation of horse, \$ *100*

Valuation of horse equipments. \$ *100*

Remarks :

Book mark :

Loumy

(358)

Copyist.

Jacko Fiske

Priv, Co. H, 10 Reg't U. S. Col'd H. Art'y

Appears on

Company Muster Roll

for *Nov. & Dec*, 186*6*.

Present or absent *Present*

Stoppage, \$ *100* for

Due Gov't, \$ *100* for

Valuation of horse, \$ *100*

Valuation of horse equipments. \$ *100*

Remarks :

Book mark :

Lowry

J. | 10 H. Art'y. | U.S.C.T.

Jacko Fiske

Priv., Co. *H.*, 10 Reg't U. S. Col'd H. Art'y.

Appears on Co. Muster-out Roll, dated

Baton Rouge, La., Feb 22, 1867 .

Muster-out to date *Feb 22*, 1867 .

Last paid to *Dec 31*, 1866 .

Clothing account:

Last settled _____, 186 ; drawn since \$ _____ 100

Due soldier \$ *39*^{*46*}/₁₀₀; due U. S. \$ _____ 100

Am't for cloth'g in kind or money adv'd \$ _____ 100

Due U. S. for arms, equipments, &c., \$ *6*^{*00*}/₁₀₀

Bounty paid \$ _____ 100; due \$ *200*^{*00*}/₁₀₀

Remarks: *Joined at orig. org.*

Book mark : _____

(361)

Lowny

Copyist.

Fiske, Jack

, Co. H, 10 Reg't U.S.C.A.

2 Enclosures.

Bed Cards	Final Statements
Burial Records	Furloughs or L. of A.
Certs. of Dis. for Discharge	Med. Certificates
C. M. Charges	Med. Des. Lists
Descriptive Lists	Orders
Discharge Certificates	Pris. of War Record
Enlistment Papers 2	Resignations

Other papers relating to—

Admission to Hosp'l	Furlough or L. of A.
Casualty Sheet	Med. Examination
Confinement	Misc. Information
Contracts	Pay or Clothing
Death or Effects	Personal Reports
Desertion	Rank
Discharge from Hosp'l	Transfer to Hosp'l
Discharge from Service	Transfer to V. R. C.
Duty	Transportation

NOTE 1.—This blank will be used for both enlistments and re-enlistments—enlistment of veterans, &c., &c., in the volunteer service. They will be made out in duplicate in all cases—one to accompany the recruiting return of the superintendent (not the recruiting officer) to the Adjutant General, and one to accompany the accounts of the officer who pays bounty, &c. The Regiment and Company in which the soldier last served should be given on the back.

NOTE 2.—An enlistment holds to service. A muster-in must, in all cases, precede payment of pay, bounty, pension, &c. A muster-in roll must, in all cases, be filed in the Adjutant General's Office as evidence of muster-in. The mustering officer, commissary, or assistant commissary of musters, as the case may be, will countersign both enlistments as having mustered the soldier into the service of the United States before either of them is given to the disbursing officer.

DECLARATION OF RECRUIT.

I, Jacko Fiske, desiring to VOLUNTEER as a Soldier in the Army of the United States, for the term of THREE YEARS, Do Declare, That I am 23 years and _____ months of age; that I have never been discharged from the United States service on account of disability or by sentence of a court martial, or by order before the expiration of a term of enlistment; and I know of no impediment to my serving honestly and faithfully as a soldier for three years.

GIVEN at New Orleans La the 1 day of November 1864

Witness: H. P. Palmer Jacko Fiske
1st Lt recruit

10 U.S. Col 3rd Army.
Nov 8 1864

No. _____
Volunteered at New Orleans
Nov 1, 1864
By H. P. Palmer
1st Regiment of U.S.C.
_____ enlistment; last served in Company ()
Reg't of _____
Discharged _____, 18____
Consent to my enlistment
by Bounty

CONSENT IN CASE OF MINOR.

I, _____, Do CERTIFY, That I am the _____ of _____; that the said _____ is _____ years of age; and I do hereby freely give my CONSENT to his volunteering as a SOLDIER in the ARMY OF THE UNITED STATES for the period of THREE YEARS.

GIVEN at _____ the _____ day of _____

Witness: _____

VOLUNTEER ENLISTMENT.

STATE OF

TOWN OF

Louisiana



New Orleans

I, *Jacks Fiske*, born in _____
in the State of *Louisiana*, aged *23* years,
and by occupation a *Laborer*, DO HEREBY ACKNOWLEDGE to have
volunteered this *First* day of *November*, 186*4*
to serve as a **Soldier** in the **Army of the United States of America**, for
the period of **THREE YEARS**, unless sooner discharged by proper authority:
Do also agree to accept such bounty, pay, rations, and clothing, as are, or may be,
established by law for volunteers. And I, *Jacks Fiske*, do
solemnly swear, that I will bear true faith and allegiance to the **United States
of America**, and that I will serve them honestly and faithfully against all
their enemies or opposers whomsoever; and that I will observe and obey the
orders of the President of the United States, and the orders of the officers
appointed over me, according to the Rules and Articles of War.

Sworn and subscribed to, at *New Orleans*
this *1* day of *Nov*, 186*4*
BEFORE *H. Ramirez*
H. Ramirez

I CERTIFY, ON HONOR, That I have carefully examined the above-named Volunteer, agreeably
to the General Regulations of the Army, and that, in my opinion, he is free from all bodily defects and
mental infirmity, which would in any way disqualify him from performing the duties of a soldier.

Chas. Humphrey
Aug 1864
EXAMINING SURGEON.

I CERTIFY, ON HONOR, That I have minutely inspected the Volunteer *Jacks Fiske*
previously to his enlistment, and that he was entirely sober when enlisted; that, to the best of my
judgment and belief, he is of lawful age; and that, in accepting him as duly qualified to perform the
duties of an able-bodied soldier, I have strictly observed the Regulations which govern the recruiting
service. This soldier has *Blue* eyes, *Blue* hair, *Blue* complexion, is *5*
feet *6* inches high.

H. Ramirez
H. Ramirez
Regiment of *USCO* Volunteers,
RECRUITING OFFICER.

(A. G. O. No. 74 & 76.)

Mustered into the service of the United States, for three years or during the war, from date of enlistment, in Company *B*
11 Regiment of *USCO* Volunteers, on the *8* day of *Nov*, 186*4* at *New Orleans*

John W. Williams
Adj. Gen.
USCO
at New Orleans

NOTE 1.—This blank will be used for both enlistments and re-enlistments—enlistment of veterans, &c., &c., in the volunteer service. They will be made out in duplicate in all cases—one to accompany the recruiting return of the superintendent (not the recruiting officer) to the Adjutant General, and one to accompany the accounts of the officer who pays bounty, &c. The Regiment and Company in which the soldier last served should be given on the back

NOTE 2.—An enlistment holds to service. A muster-in must, in all cases, precede payment of pay, bounty, pension, &c. A muster-in roll must, in all cases, be filed in the Adjutant General's Office as evidence of muster-in. The mustering officer, commissary, or assistant commissary of masters, as the case may be, will countersign both enlistments as having mustered the soldier into the service of the United States before either of them is given to the disbursing officer.

DECLARATION OF RECRUIT.

I, Jacko Fiske, desiring to VOLUNTEER as a Soldier in the Army of the United States, for the term of THREE YEARS, Do Declare, That I am Twenty five years and months of age; that I have never been discharged from the United States service on account of disability or by sentence of a court martial, or by order before the expiration of a term of enlistment; and I know of no impediment to my serving honestly and faithfully as a soldier for three years.

GIVEN at New Orleans, La the 1st day of November, 1864

Witness:

A. Salminen Jacko Fiske
1st Lieut 84th U.S.C.I. must

10 Nov 6 1864

Volunteered at New Orleans
Nov 1 1864
By A. Salminen
84 Regiment of Moors
enlistment; last served in Company ()
Regt of
Discharged 18
Consent not given
to Bureau

No. 231

CONSENT IN CASE OF MINOR.

I, , Do CERTIFY, That I am years of age; and I do hereby freely give my CONSENT to his volunteering as a SOLDIER in the ARMY OF THE UNITED STATES for the period of THREE YEARS.

GIVEN at the day of

Witness:

VOLUNTEER ENLISTMENT.

STATE OF

TOWN OF

Louisiana



New Orleans

I, *Jacks Fiske*, born in _____, in the State of *Louisiana*, aged *Twenty five* years, and by occupation a *Labourer*, Do HEREBY ACKNOWLEDGE to have volunteered this *First* day of *November* 1864 to serve as a **Soldier** in the **Army of the United States of America**, for the period of **THREE YEARS**, unless sooner discharged by proper authority: Do also agree to accept such bounty, pay, rations, and clothing, as are, or may be, established by law for volunteers. And I, *Jacks Fiske*, do solemnly swear, that I will bear true faith and allegiance to the **United States of America**, and that I will serve them honestly and faithfully against all their enemies or opposers whomsoever; and that I will observe and obey the orders of the President of the United States, and the orders of the officers appointed over me, according to the Rules and Articles of War.

Sworn and subscribed to, at *New Orleans* this *1st* day of *Nov*, 1864, *Jacks Fiske* BEFORE *H. H. Humphreys* 1st Lt. 84th U. S. C. S.

I CERTIFY, ON HONOR, That I have carefully examined the above-named Volunteer, agreeably to the General Regulations of the Army, and that, in my opinion, he is free from all bodily defects and mental infirmity, which would in any way disqualify him from performing the duties of a soldier.

H. H. Humphreys
Surgeon
EXAMINING SURGEON.

I CERTIFY, ON HONOR, That I have minutely inspected the Volunteer *Jacks Fiske* previously to his enlistment, and that he was entirely sober when enlisted; that, to the best of my judgment and belief, he is of lawful age; and that, in accepting him as duly qualified to perform the duties of an able-bodied soldier, I have strictly observed the Regulations which govern the recruiting service. This soldier has *Blue* eyes, *Black* hair, *Blue* complexion, is *5* feet *6* inches high.

H. H. Humphreys
1st Lt. 84th Regiment of *U. S. C. S.* Volunteers,
RECRUITING OFFICER.

(A. G. O. No. 74 & 76.)

Mustered into the service of the United States, for three years or during the war, from date of enlistment, in Company *B* of the *10* Regiment of *U. S. C. S.* Volunteers, on the *8* day of *Nov*, 1864, at *New Orleans*

Wm. W. Armistead
Adjutant
Wm. W. Armistead
Adjutant

18. LOUIS. COLLEGE

Private | *Private*

CARD NUMBERS.

1	5487212	26
2	5495802	27
3	5495874	28
4	5496023	29
5	5496268	30
6	5497503	31
7		32
8		33
9		34
10		35
11		36
12		37
13		38
14		39
15		40
16		41
17		42
18		43
19		44
20		45
21		46
22		47
23		48
24		49
25		50

Book Mark:

See also

Davis Fleming

Appears with rank of *Priv* on

Muster and Descriptive Roll of a Detachment of U. S. Vols. forwarded

for the *7* Reg't *U.S.C.H. art** Roll dated

New Orleans La, Aug 26, 1864.

Where born *Natches, Miss*

Age *18* y'rs; occupation *Laborer*

When enlisted *Aug 17*, 1864.

Where enlisted *Fort Stephen, Pass Machac La*

For what period enlisted *3* years.

Eyes *Brown*; hair *Dark*

Complexion *Dark*; height *5* ft. *6* in.

When mustered in *Aug 26*, 1864

Where mustered in *New Orleans*

Bounty paid \$ *100*. *100*; due \$ *200*. *100*

Where credited *to 9th Cen. Dist. La*

Company to which assigned *B*

Remarks:

Recruit Entitled to Bounty

** Become 10 U.S. Col'd H. Art.*

Book mark:

J. W. Williams

J

10 H. Art'y. U.S.C.T.

Davis Fleming

It, Co. B, 10 Reg't U. S. Cav'd H. Art'y.

Appears on

Company Muster Roll

for *July + Aug*, 186*4*.

Present or absent *Present*

Stoppage, \$ 100 for

Due Gov't, \$ 100 for

Valuation of horse, \$ 100

Valuation of horse equipments, \$ 100

Remarks *Recruit August 17 '1864 enlisted in the Company*

Book mark: _____

J. Richardson

(358)

Copyist.

F

10 H. Art'y. U.S.C.T.

Davis Fleming
Co. B, 10 Reg't U. S. Cav'd H. Art'y.

Appears on

Company Muster Roll

for *Sept & Oct*, 1864.

Present or absent *Presents*

Stoppage, \$ 100 for

Due Gov't, \$ 100 for

Valuation of horse, \$ 100

Valuation of horse equipments, \$ 100

Remarks:

Book mark:

J. H. Richardson

(358)

Copyist.

27

Davis Flemming

M., Co. B, 10 Reg't U. S. Col'd H. Art'y.

Appears on

Company Muster Roll

for *Nov & Dec*, 1864.

Present or absent *Absent*

Stoppage, \$ 100 for

Due Gov't, \$ 100 for

Valuation of horse, \$ 100

Valuation of horse equipments, \$ 100

Remarks: *In S. d. A.
Gen Hospital W. O.
since Nov 24, 1864,*

Book mark: *200003*

(358)

Jornier

Copyist.

G

10 H. Art'y. U.S.C.T.

Purvis Fleming

Priv., Co. B, 10 Reg't U. S. Col'd H. Art'y.

Appears on

Company Muster Roll

for *Jan & Feb*, 1865.

Present or absent.....

Stoppage, \$.....100 for.....

Due Gov't, \$.....100 for.....

Valuation of horse, \$.....100

Valuation of horse equipments, \$.....100

Remarks: *Died in Corps
D'Afrique Hospital
N.O. Feb 16 1865.*

Book mark:.....

(358)

Jorniv.

Copyist.

J | 10 H. Art'y. | U.S.C.T.

Davis Fleming

-----, Co. *D*, 10 Reg't U. S. Col'd H. Art'y.

Appears on **Co. Muster-out Roll**, dated
Baton Rouge La, Feb, 1867.

Muster-out to date -----, 186 .

Last paid to -----, 186 .

Clothing account:

Last settled -----, 186 ; drawn since \$ ----- 100

Due soldier \$ ----- 100; due U. S. \$ ----- 100

Am't for cloth'g in kind or money adv'd \$ ----- 100

Due U. S. for arms, equipments, &c., \$ ----- 100

Bounty paid \$ ----- 100; due \$ ----- 100

Remarks:

*Joined as a recruit
Died in Camps d'Affrique
Hospt. New Orleans La.
Feb'y 16th 1865.*

Book mark : -----

(361)

Hodges

Copyist.

Fleming, Davis
P B 1 Reg't *no. 100*
Co. ,

5 Enclosures.

Bed Cards	Descriptive Lists
Burial Records <i>1</i>	Final Statements <i>2</i>
Certs. of Dis. for Discharge	Furloughs
C. M. Charges	Med. Des. Lists
Med. Certificates	Orders

Enlist M.

Other papers relating to—

Admission to Hosp'l	Furlough
Casualty Sheet (<i>Pris</i> Officer's) <i>1</i>	Med. Examination
Confinement	Misc. Information
Contracts	Pay or Clothing
Death or Effects <i>1</i>	Personal Reports
Desertions	Rank
Discharge from Hosp'l	Transfer to Hosp'l
Discharge from Service	Transfer to V. R. C.
Duty	Transportation

NOTE 1.—This blank will be used for both enlistments and re-enlistments—enlistment of veterans, &c., &c., in the volunteer service. They will be made out in duplicate in all cases—one to accompany the recruiting return of the superintendent (not the recruiting officer) to the Adjutant General, and one to accompany the accounts of the officer who pays bounty, &c. The Regiment and Company in which the soldier last served should be given on the back.

NOTE 2.—An enlistment holds to service. A muster-in must, in all cases, precede payment of pay, bounty, pension, &c. A muster-in roll must, in all cases, be filed in the Adjutant General's Office as evidence of muster-in. The mustering officer, commissary, or assistant commissary of musters, as the case may be, will countersign both enlistments as having mustered the soldier into the service of the United States before either of them is given to the disbursing officer.

DECLARATION OF RECRUIT.

I, Davis Fleming, desiring to VOLUNTEER as a Soldier in the Army of the United States, for the term of THREE YEARS, Do Declare, That I am eighteen years and _____ months of age; that I have never been discharged from the United States service on account of disability or by sentence of a court martial, or by order before the expiration of a term of enlistment; and I know of no impediment to my serving honestly and faithfully as a soldier for three years.

GIVEN at Fort Stephens, P. M. March 24 the 17th day of August 1864

Witness:

M. Hawks
Captain Comm. U.S.A.

Davis X Fleming

No. _____

Davis Fleming
Volunteered at Case Monroe

13th August

By Capt M. Hawks

7th Regiment of Cavalry

enlistment, last served in Company ()

Regt of _____

Discharged _____, 18 _____

This Volunteer Recruit is entitled to the bounty in accordance with Circular No 27 Per Major Office Station July 19th 1864

Received from Second Auditor

August 26th, 1892.

CONSENT IN CASE OF MINOR.

I, _____, Do CERTIFY, That I am the _____ of _____; that the said _____ is _____ years of age; and I do hereby freely give my CONSENT to his volunteering as a SOLDIER in the ARMY OF THE UNITED STATES for the period of THREE YEARS.

GIVEN at _____ the _____ day of _____

Witness:

VOLUNTEER ENLISTMENT.

STATE OF

Louisiana



TOWN OF

Fort Stephens
Par Mambrac

I, Davis Fleming, born in Natchez
in the State of Mississippi, aged eighteen years,
and by occupation a Labourer, Do HEREBY ACKNOWLEDGE to have
volunteered this seventeenth day of August, 1864,
to serve as a **Soldier** in the **Army of the United States of America**, for
the period of **THREE YEARS**, unless sooner discharged by proper authority:
Do also agree to accept such bounty, pay, rations, and clothing, as are, or may be,
established by law for volunteers. And I, Davis Fleming, do
solemnly swear, that I will bear true faith and allegiance to the **United States
of America**, and that I will serve them honestly and faithfully against all
their enemies or opposers whomsoever; and that I will observe and obey the
orders of the President of the United States, and the orders of the officers
appointed over me, according to the Rules and Articles of War.

Sworn and subscribed to, at Fort Stephens
On this 17th day of August, 1864, } Davis X Fleming
BEFORE me M. Hawley
Captain Command Fort X Co B

I CERTIFY, ON HONOR, That I have carefully examined the above-named Volunteer, agreeably
to the General Regulations of the Army, and that, in my opinion, he is free from all bodily defects and
mental infirmity, which would in any way disqualify him from performing the duties of a soldier.

D. Stephens, M.D. Surg
20th U.S. Cal
EXAMINING SURGEON.

I CERTIFY, ON HONOR, That I have minutely inspected the Volunteer Davis Fleming
previously to his enlistment, and that he was entirely sober when enlisted; that, to the best of my
judgment and belief, he is of lawful age; and that, in accepting him as duly qualified to perform the
duties of an able-bodied soldier, I have strictly observed the Regulations which govern the recruiting
service. This soldier has brown eyes, dark hair, dark complexion, is five
feet six inches high.

M. Hawley, Captain
7th Regiment of U.S. Artillery
Volunteers
RECRUITING OFFICER.

(A. G. O. No. 74 & 76.)

Mustered into the service of the United States, for three years or during the war, from date of enlistment, in Company B
7th Regiment of U.S. Artillery on the 26th day of August 1864, at New Orleans

Wm. M. Blair
1st Lt. U.S. Artillery

Feb 16 '65

Final Statement
FINAL STATEMENT

OF

10. B
.....
10 Reg't of
.....

VOLUNTEERS.

C. d. A. Hays
.....

NOTE 1.—Two of these certificates (or duplicates) are to be given to each Volunteer Soldier or drafted man who may be discharged previously to the discharge of his company, that he may at once receive from the Paymaster the pay, &c., due him, and the captain or other COMMISSIONED officer commanding the company will certify to the act of the delivery of the duplicate certificates; on these certificates the Soldier is "entitled to" his *discharge*, and should also present his discharge to the Paymaster to have the payment endorsed on it. The discharge is to be given back to the Soldier by the Paymaster; the latter only retaining as his voucher the duplicate certificates.

NOTE 2.—If the Soldier is entitled to pay for the use of his horse, the Company Commander will certify to that fact on the back of both these final statements, and also to the time he has pay due for having been so mounted on his own horse.

NOTE 3.—When a Soldier is furnished with final statements, his descriptive list, if he has one, should be taken up by the officer who gives the Soldier these statements, and endorsed with a statement to this effect by the officer. This endorsement should exhibit a full statement of the time for which the Soldier was allowed pay on his final statements, the clothing account, and all other charges against him or in his favor, so as to comprise a complete exhibit of his account. It will then be transmitted to the company commander of the Soldier, who will enter all the data necessary to a full understanding of the Soldier's account on the muster roll upon which the Soldier's discharge is reported. The descriptive list will then be destroyed. The object of this is, that the remaining portion of the Soldier's account may be settled upon the receipt of these muster rolls, and the Soldier receive any pay or allowances that may be due him at the time of his discharge, and which may not appear on his final statements from the fact that his descriptive list is incomplete. These accounts for back pay, &c., are settled by the 2d Auditor of the Treasury Department.

NOTE 4.—Charges for loss or injury to ordnance, horse equipments, and other miscellaneous charges, should appear under the heading of "Other Stoppages."

NOTE 5.—Bounty paid by State authorities, and not by the United States, will not be entered on this statement.

NOTE 6.—Amounts due the Sutler and Laundress must be entered on the muster roll on which the discharge, death, desertion, &c., is reported, as well as on the final statement, otherwise the amount cannot be collected from the United States.

NOTE 7.—This blank will be used for deceased volunteers and drafted men, as well as for others.

NOTE 8.—Where a Soldier dies in Hospital or on detached service, his descriptive list, if he has one, should be sent with his final statements, in duplicate, to the Adjutant General, Washington, D. C.

I certify, on honor, that William H. ... a Private of
Captain ... Company (B) of the 11 Regiment of ...
VOLUNTEERS, of the State of ..., born in ..., State
of ..., aged ... years; 5 feet 0 inches high; ... complexion,
... eyes, ... hair, and by occupation a ..., having joined the company ~~on~~
~~its original organization~~ at ..., and enrolled in it ~~at the muster~~ into
the service of the United States at ..., on the ... day
of ..., 186 7, (~~or was mustered in service as a recruit, by~~
..., at ..., on the ... day of ...,
186 7, or was drafted and mustered into the service of the United States from the
Enrollment District of the State of ..., at ...,
on the ... day of ..., 186 ...) to serve in the Regiment, for
the term of ...: and having served **HONESTLY** and
FAITHFULLY with his Company in ... to the present date, is now
entitled to a **DISCHARGE** by reason of ...

The said ... was last paid by Paymaster
... to include the ... day of ..., 186 7, and has
pay due him from that time to the present date; he is entitled to pay and subsistence for
TRAVELING to place of enrollment, and whatever other allowances are authorized to volunteer
soldiers, drafted men, or militia, so discharged. He has received from the United States **CLOTHING**
amounting to ... 100 dollars, since the ... day of ...,
186 7, when his clothing account was last settled. He has received from the United States
... 100 dollars advanced **BOUNTY**.

There is to be stopped from him, on account of the State of ..., or other
authorities, for **CLOTHING**, &c., received on entering service, ... 100 dollars; and
for other stoppages, viz: ...

... 100 dollars.
He has been furnished with **TRANSPORTATION** in kind from the place of his discharge to
...; and he has been **SUBSISTED** for **TRAVELING** to his
place of enrollment, up to the ..., 186

He is indebted to ..., **SUTLER**, ... 100 dollars.

He is indebted to ..., **LAUNDRESS**, ... 100 dollars.

Given in Duplicate, at ..., this ... day
of ..., 186 7.

A.G.O. Dec 25th 1865
P.O. of U.S. Army
sent for \$294 and 2^o
A.G.O. 1/11

FINAL STATEMENT

OF

Davis Fleming - Co. "B"

1^o Reg't of U.S. Army

VOLUNTEERS.

Dec 16th 1865

NOTE 1.—Two of these certificates (or duplicates) are to be given to each Volunteer Soldier or drafted man who may be discharged previously to the discharge of his company, that he may at once receive from the Paymaster the pay, &c., due him, and the captain or other COMMISSIONED officer commanding the company will certify to the act of the delivery of the duplicate certificates; on these certificates the Soldier is "entitled to" his discharge, and should also present his discharge to the Paymaster to have the payment endorsed on it. The discharge is to be given back to the Soldier by the Paymaster; the latter only retaining as his voucher the duplicate certificates.

NOTE 2.—If the Soldier is entitled to pay for the use of his horse, the Company Commander will certify to that fact on the back of both these final statements, and also to the time he has pay due for having been so mounted on his own horse.

NOTE 3.—When a Soldier is furnished with final statements, his descriptive list, if he has one, should be taken up by the officer who gives the Soldier these statements, and endorsed with a statement to this effect by the officer. This endorsement should exhibit a full statement of the time for which the Soldier was allowed pay on his final statements, the clothing account, and all other charges against him or in his favor, so as to comprise a complete exhibit of his account. It will then be transmitted to the company commander of the Soldier, who will enter all the data necessary to a full understanding of the Soldier's account on the muster roll upon which the Soldier's discharge is reported. The descriptive list will then be destroyed. The object of this is, that the remaining portion of the Soldier's account may be settled upon the receipt of these muster rolls, and the Soldier receive any pay or allowances that may be due him at the time of his discharge, and which may not appear on his final statements from the fact that his descriptive list is incomplete. These accounts for back pay, &c., are settled by the 2d Auditor of the Treasury Department.

NOTE 4.—Charges for loss or injury to ordnance, horse equipments, and other miscellaneous charges, should appear under the heading of "Other Stoppages."

NOTE 5.—Bounty paid by State authorities, and not by the United States, will not be entered on this statement.

NOTE 6.—Amounts due the Sutler and Laundress must be entered on the muster roll on which the discharge, death, desertion, &c., is reported, as well as on the final statement, otherwise the amount cannot be collected from the United States.

NOTE 7.—This blank will be used for deceased volunteers and drafted men, as well as for others.

NOTE 8.—Where a Soldier dies in Hospital or on detached service, his descriptive list, if he has one, should be sent with his final statements, in duplicate, to the Second Auditor, Washington, D. C.

A.G.O.
Dec 15th 1865
1/11

ADJUTANT GENERAL'S OFFICE.
Dec 15th 1865
Duplicate with Inventory sent 2d Auditor.

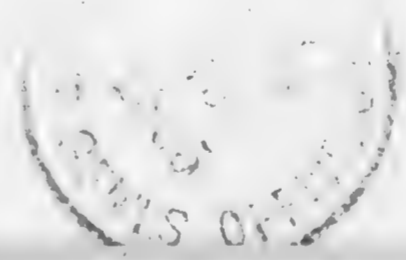

1/11

I certify, on honor, that Samuel Williams a Private of
 Captain _____ Company (B) of the 10 Regiment of Mississippi
VOLUNTEERS, of the State of Mississippi, born in Mississippi, State
 of Mississippi, aged 1 years; 5 feet 6 inches high; Light complexion,
 eyes, Blue hair, and by occupation a Farmer, having joined the company ~~on~~
~~its original organization~~ at _____, and enrolled in it ~~at the muster~~ into
 the service of the United States at _____, on the _____ day
 of _____, 186 4, (or was mustered in service as a recruit, by _____
 _____, at _____, on the _____ day of _____,
 186 4, or was drafted and mustered into the service of the United States from the _____
 Enrollment District of the State of _____, at _____,
 on the _____ day of _____, 186 4), to serve in the Regiment, for
 the term of _____: and having served **HONESTLY** and
FAITHFULLY with his Company in _____ to the present date, is now
 entitled to a **DISCHARGE** by reason of _____

The said _____ was last paid by Paymaster
Wm. Assistant to include the 31 day of August, 186 4, and has
 pay due him from that time to the present date; he is entitled to pay and subsistence for
TRAVELING to place of enrollment, and whatever other allowances are authorized to volunteer
 soldiers, drafted men, or militia, so discharged. He has received from the United States **CLOTHING**
 amounting to _____ dollars, since the _____ day of _____,
 186 4, when his clothing account was last settled. He has received from the United States
_____ dollars advanced **BOUNTY**.

There is to be stopped from him, on account of the State of _____, or other
 authorities, for **CLOTHING**, &c., received on entering service, _____ dollars; and
 for other stoppages, viz: _____
 _____ dollars.

He has been furnished with **TRANSPORTATION** in kind from the place of his discharge to
 _____; and he has been **SUBSISTED** for **TRAVELING** to his
 place of enrollment, up to the _____, 186 4.

He is indebted to _____, **SUTLER**, _____ dollars.
 He is indebted to _____, **LAUNDRESS**, _____ dollars.

Given in Duplicate, at New Orleans, this 8 day
 of September, 186 5.

J. E. Piquette

 Surgeon in Charge
 Commanding Company

Sp. Hospital

RECORD OF DEATH AND INTERMENT.

Name and number of person interred,	<i>Davis Fleming</i>
Number and locality of the grave, -	<i>4518</i>
Hospital number of the deceased, -	
Regiment, Rank, and Company, - -	<i>10th U. S. Col. Hy. Art. - Priv. - B.</i>
Residence before enlistment, - - -	
Conjugal condition (and if married,) the residence of the widow,)	
Cause of death,)	<i>Asthma</i>
Age of the deceased, - - - - -	
Nativity, - - - - -	
References and Remarks, - - }	
Date of death and burial, - - -	<i>Febr 16th / 65.</i>

186

[A duplicate of this Record has been forwarded to the Sexton, and the other remains at this Hospital.]

To *Adj. General U. S. A.*
SIR:

It becomes my duty to inform you that the person above described died at this Hospital as herein stated: and that it is desired his remains should be interred with the usual military honors.

Respectfully,

F. E. Piquette
Surgeon ⁸⁶ U. S. Army.
in charge

MILITARY HOSPITAL, *Corps d'Afrique, N. Orleans*
La.

This copy of Record is to be transmitted to the Adjutant General at Washington immediately after the place of burial and the number of the grave have been ascertained and registered. The above notification is to remain attached.

Ac. of dis. sent for Feb. 16-66

12
F. CASUALTY SHEET

No.

Davis Fleming

Priv of Company D.

10th Regiment of U.S.C.A. (Hoy.)

State Volunteers.

NATURE OF CASUALTY.

Living, Feb. 22, 1865

Died Feb. 16th 1865, see
G. 59, Vol. 3, R. C. 9, 1866,
fo. on file,
J. B.

Entou Rof
M

CASUALTY SHEET.

Name: *Davis Fleming*
Rank: *Private* Company: *1 P.* Regiment: *10.*
Arm: *U.S. Army* State: _____
Nature of Casualty: *Discharged*

CAUSE OF CASUALTY—(NAME OF DISEASE, &c.)

*Consolidation of tubes of
left lung.*

DEGREE OF DISABILITY.

BY WHOM CERTIFIED.

Maj Gen. S. A. Hurlbut.

DATE OF DISCHARGE, DEATH, &c.

July 22. 1865.

PLACE OF DISCHARGE, DEATH, &c.

Ft. St. Philip

BY WHOM DISCHARGED.

FROM WHAT SOURCE THIS INFORMATION WAS
OBTAINED.

*Mr. Munchy Rpt
Dept. of the Gulf Feb 28. 65.*

REMARKS.

[Signature]

A. J. Ball
Clerk.

Original

INVENTORY OF THE EFFECTS

James Francis Bell

Late of Company

B 3^d

Reg't of

14th Reg't of Inf. & M., 2^d Div.

Volunteers, who died at

Lebanon, Tenn.

on the

10 day of *July*

186 *5*.

, or be
icer of
sioned
ve his
e De-
paid to
oldier.
ffects
ted to
ent or
ted to
of the
sioned
l paid

fficers
led to
h the
e regi-
h the
an his
sh the
nding
leath,
l, and
ease;
ny to
ntory
nt of
legal
f the

er or
ease,
r the
depo-
they

on, a
y the
ccipt
o the
the

over
tant
o de-
their
ases,
tant

cate
ould
r.

Inventory of the effects of Samuel Manning late
 a Private of Captain _____ Company 15 of
 the 10 Regiment of 10th Mass. Vol. Volunteers, who was enrolled as
 a Private at _____ in the State of _____ on
 the 17 day of August 1864, and mustered into the service of the United
 States as a Private on the 24 day of August 1864, at _____
 in Company "B", 10 Regiment of 10th Mass. Vol. Volunteers, to serve 2
 years or during the war; he was born in _____ in the State
 of _____; he was 17 years of age, 5 feet 8 inches
 high, _____ complexion, _____ eyes, _____ hair, and by occupation, when enrolled,
 a _____; he died in _____, at
_____ on the 10 day of _____ 1864, by
 reason of Intention.

INVENTORY.						
ARTICLES.	No.	ARTICLES.	No.	ARTICLES.	No.	
Hats.....		Pairs trousers.....	/	Knapsacks.....	/	
Caps.....		Pairs flannel drawers.....			/	
Forage caps.....		Pairs cotton drawers.....			/	
Great coats.....		Flannel shirts.....			/	
Uniform coats.....		Cotton shirts.....				
Uniform jackets.....		Pairs boots.....				
Flannel sack coats.....		Pairs shoes.....				
Blouses.....		Pairs socks.....				
Stable frocks.....		Blankets.....	/	MONEY.	Specie.....	\$
Fatigue overalls.....		Haversacks.....	/		Notes.....	\$

I CERTIFY, ON HONOR, that the above inventory comprises all the effects of _____
Samuel Manning, deceased, and that the effects are in the hands
 of Samuel Manning at _____
_____ to be disposed of by a Council of Administration.

(DUPLICATES.)

STATION : _____

Commanding the Company.

DATE : 7-14-65

[A. G. O. No. 104.]

10 U.S. Col'd H. Art'y.

Private

Private

CARD NUMBERS.

1	5494178	26
2	5494331	27
3	5494496	28
4	5494657	29
5	5494812	30
6	5494965	31
7	5495121	32
8	5495277	33
9	5495518	34
10	5496021	35
11	5496176	36
12	5496328	37
12	5496476	38
14	5496621	39
15	5496765	40
16	5496924	41
17	5497106	42
18	5497413	43
19	5489653	44
20	43117728	45
21	Al 1464093	46
22		47
23		48
24		49
25		50

Book Mark:

Al 1464093

See also

A1024018. Le H. Lo.

A1624606 Po m + m

AS 1494093

Wm. G. W. W. W.

F | 10 H. Art'y. | U.S.C.T.

Harvey Fleming
Pvt., 2 Battery, La. H. Art'y, Native Guards.*

Age *38* years.

Appears on

Company Muster-in Roll

of the organization named above. Roll dated
Camp Parapet
Carrollton, La, Feb. 9, 186 *3*.

Muster-in to date *Feb. 9*, 186 *3*.

Joined for duty and enrolled:

When *Jan'y. 31st.*, 186 *3*.

Where *Camp Parapet w. Carrollton La*

Period *3* years.

Valuation of horse, \$.....*100*

Valuation of horse equipments, \$.....*100*

Remarks:.....

* This organization subsequently became Co. B, 10 Reg't U. S. Colored Heavy Artillery.

Book mark: *Ag 1464093*

Feaster

F | 10 H. Art'y. | U.S.C.T.

Harvey Fleming
Pot., Co. B, 1 Reg't La. H. Art'y, Native Guards.*

Appears on

Company Muster Roll

for *Imm. Enlistment to Feb. 28, 1863.*

Present or absent *Present*

Stoppage, \$ *100* for

Due Gov't, \$ *100* for

Valuation of horse, \$ *100*

Valuation of horse equipments, \$ *100*

Remarks: _____

*This organization subsequently became Co. B, 10 Reg't U. S. Col'd Heavy Artillery.

Book mark: _____

Feaster
(358) *Feaster* Copyist.

F

10 H. Art'y.

U.S.C.T.

Harvey Fleming

Pvt., Co. B, 1 Reg't La. H. Art'y, Native Guards.*

Appears on

Company Muster Roll

for *Mich. 4. Apl.*, 1863.

Present or absent *Present*

Stoppage, \$ 100 for

Due Gov't, \$ 100 for

Valuation of horse, \$ 100

Valuation of horse equipments, \$ 100

Remarks:

*This organization subsequently became Co. B, 10 Reg't U. S. Col'd Heavy Artillery.

Book mark: -----

Feaster

J

10 H. Art'y.

U.S.C.T.

Harvey Fleming
Pvt., Co. B, 1 Reg't La. H. Art'y, Native Guards.*

Appears on

Company Muster Roll

for *May 7, June*, 186*3*.

Present or absent *Present*

Stoppage, \$ *100* for

Due Gov't, \$ *100* for

Valuation of horse, \$ *100*

Valuation of horse equipments, \$ *100*

Remarks:

*This organization subsequently became Co. B, 10 Reg't U. S. Col'd Heavy Artillery.

Book mark:

Feaster

F | 10 H. Art'y. | U.S.C.T.

Harvey Flemming
Pop., Co. B, 1 Reg't La. H. Art'y, Native Guards.*

Appears on

Company Muster Roll

for *July 7. Aug.*, 186*J.*

Present or absent *Present*

Stoppage, \$ *100* for

Due Gov't, \$ *100* for

Valuation of horse, \$ *100*

Valuation of horse equipments, \$ *100*

Remarks: _____

*This organization subsequently became Co. B, 10 Reg't U. S. Col'd Heavy Artillery.

Book mark: _____

Feaster

F

10 H. Art'y.

U.S.C.T.

Harvey Fleming
Pl., Co. B, 1 Reg't La. H. Art'y, Native Guards.*

Appears on

Company Muster Roll

for *Sept. 4, Oct.*, 186 *3*.

Present or absent *Present*

Stoppage, \$ *100* for

Due Gov't, \$ *100* for

Valuation of horse, \$ *100*

Valuation of horse equipments, \$ *100*

Remarks: _____

*This organization subsequently became Co. B, 10 Reg't U. S. Col'd Heavy Artillery.

Book mark: _____

Fleming

D. | 10 H. Art'y. | U.S.C.T.

Harvey Fleming
Pl B, Co. B, 1 Reg't H. Art'y, Corps d'Afrique.*

Appears on

Company Muster Roll

for Nov. & Dec., 1863.

Present or absent Present

Stoppage, \$ 100 for

Due Gov't, \$ 100 for

Valuation of horse, \$ 100

Valuation of horse equipments, \$ 100

Remarks:

*This organization subsequently became Co. , 10 Reg't U. S. Colored Heavy Artillery.

Book mark:

(358)

Reif Copyist.

I | 14. Art. U.S.C. I.

Harry Fleming
Heavy Artillery Corps D'Arigue

Appears on a register of

Prisoners of War

at New Orleans, La.

When arrested _____, 186 .

By whose order *Provost Court*

Where confined *Police jail*

Charges *Disobedience of*

Orders.

When committed *Jan. 19*, 1864.

Period of sentence *For life*

Transferred:

When *Feb. 19*, 186 .

Where *Tortugas*

When released _____, 186 .

By whose order _____

Remarks: _____

Register No. 879, Dept. of the Gulf; page *47*

(689b)

J. B. Dowd

Copyst

F | 10 H. Art'y. | U.S.C.T.

Marvey Fleming
Pt, Co. B, 1 Reg't H. Art'y, Corps d'Afrique.*

Appears on

Company Muster Roll

for Jan. & Feb., 1864

Present or absent absent

Stoppage, \$ 100 for

Due Gov't, \$ 100 for

Valuation of horse, \$ 100

Valuation of horse equipments, \$ 100

Remarks: In arrest at New Orleans awaiting trial since Jan. 8 1864

*This organization subsequently became Co. , 10 Reg't U. S. Colored Heavy Artillery.

Book mark :

(358)

Reif

Copyist.

J. | 10 H. Art'y. | U.S.C.T.

Harvey Flemming

Pl, Co. B, 7 Reg't U. S. Col'd H. Art'y.*

Appears on

Company Muster Roll

for March & April, 1864.

Present or absent

Stoppage, \$ 100 for

Due Gov't, \$ 100 for

Valuation of horse, \$ 100

Valuation of horse equipments, \$ 100

Remarks: Jan'y 19 1864 sentenced by the Provost Court New Orleans to Portugal for life forfeits all pay & allowances

Next appears on roll for April Dec 1864

* This organization subsequently became Co. 10 Reg't U. S. Colored Heavy Artillery.

Book mark:

(358)

Reif

Copyist.

F

10 H. Art'y. U.S.C.T.

Harvey T. Lawrence
Pt., Co. B, 10 Reg't U. S. Col'd H. Art'y.

Appears on

Company Muster Roll

for Nov & Dec, 1864.

Present or absent

Stoppage, \$ 100 for

Due Gov't, \$ 100 for

Valuation of horse, \$ 100

Valuation of horse equipments, \$ 100

Remarks: Sentenced to
Tombstones for life
Jan, 19, 1864 Released
Dec 3 1864 per S.O
No. 327 Dated Hd
Quar Dept. of the Gulf
New Orleans Dec 3/1864

Book mark:

(358)

J. J. J. J.

Copyist.

F

10 H. Art'y. U.S.C.T.

Harvey Fleming

Pvt., Co. B, 10 Reg't U. S. Col'd H. Art'y.

Appears on

Company Muster Roll

for Jan & Feb, 1865.

Present or absent Present.

Stoppage, \$ 100 for

Due Gov't, \$ 100 for

Valuation of horse, \$ 100

Valuation of horse equipments, \$ 100

Remarks: Due soldier augmented pay from Jan 1 1864 to May 1 1864 \$6.00 per month May & June \$9.00 per month

Book mark:

Josiah

(358)

Copyist.

17

10 H. Art'y. U.S.C.T.

Harvey Fleming
Pl., Co. B, 10 Reg't U. S. Col'd H. Art'y.

Appears on

Company Muster Roll

for Mar & Apr, 1865.

Present or absent Present

Stoppage, \$ 100 for

Due Gov't, \$ 100 for

Valuation of horse, \$ 100

Valuation of horse equipments, \$ 100

Remarks:

Book mark:

(358)

J. J. Jones

Copyist.

J. | 10 H. Art'y. | U.S.C.T.

Harvey Fleming

Pl., Co. B, 10 Reg't U. S. Col'd H. Art'y.

Appears on

Company Muster Roll

for *May & June*, 1865.

Present or absent *Present*

Stoppage, \$.....100 for

Due Gov't, \$.....100 for

Valuation of horse, \$.....100

Valuation of horse equipments, \$.....100

Remarks:

Book mark:

(358)

Jornier Copyist.

F

10 H. Art'y. | U.S.C.T.

Harvey Fleming
Pvt., Co. B, 10 Reg't U. S. Col'd H. Art'y.

Appears on

Company Muster Roll

for *July & Aug.*, 186*5*

Present or absent *Present*

Stoppage, \$ 100 for

Due Gov't, \$ 100 for

Valuation of horse, \$ 100

Valuation of horse equipments, \$ 100

Remarks:

Book mark:

(358)

Jornier

Copyist.

F

10 H. Art'y. U.S.C.T.

Harvey Fleming

Pvt., Co. B, 10 Reg't U. S. Col'd H. Art'y.

Appears on

Company Muster Roll

for Sep, & Oct, 1865.

Present or absent Present

Stoppage, \$ 100 for

Due Gov't, \$ 100 for

Valuation of horse, \$ 100

Valuation of horse equipments, \$ 100

Remarks:

Book mark:

(358)

Jamies

Copyist.

D

10 H. Art'y. U.S.C.T.

Marvey Fleming

Plt, Co. B, 10 Reg't U. S. Col'd H. Art'y.

Appears on

Company Muster Roll

for *Nov. & Dec.*, 186*5*.

Present or absent *Present*

Stoppage, \$ *100* for

Due Gov't, \$ *100* for

Valuation of horse, \$ *100*

Valuation of horse equipments, \$ *100*

Remarks:

Book mark: -----

(358)

Reif

Copyist.

D

10 H. Art'y. U.S.C.T.

Harvey Fleming

Pl, Co. B, 10 Reg't U. S. Col'd H. Art'y.

Appears on

Company Muster Roll

for *Jun. 1866*, 1866

Present or absent

Stoppage, \$ 100 for

Due Gov't, \$ 100 for

Valuation of horse, \$ 100

Valuation of horse equipments, \$ 100

Remarks *Mustd. out at M.O. La
Feb. 8 66 by reason of exp.
of term of service.*

Book mark:

(358)

Reif
Copyist.

F. 10 N. a. U.S.C.T.

Harvey Fleming

Priv., Co. B, 10 Reg't U. S. Col'd N. a.

Appears on a

Detachment Muster-out Roll

of the organization named above. Roll dated

New Orleans La; Feb. 8, 1864

Muster-out to date Feb. 8, 1864.

Last paid to Jan. 30, 1865

Clothing account:

Last settled 186 ; drawn since \$ 100

Due soldier \$ 11 ⁰¹/₁₀₀; due U. S. \$ 100

Am't for cloth'g in kind or money adv'd \$ 100

Due U. S. for arms, equipments, &c., \$ 100

Bounty paid \$ 100 due \$ 100

Remarks: Joined at Orngl. Orgn
Sentenced to Tortugas for
life Jan. 19. with loss
of all pay & allowance by
Provost Court N. O. Re-
leased & returned to duty

Book mark: 4119.1880; (over)

Harvey Fleming

JAN. 15

5489653

* 1891 *

by special order No.
327 Med. Dep. of
the Gulf Dec. 3. 1864.

The unexpired portion
of the sentence is remitted
New term out by reason
of Expiration of term of
Service.

* Cert. of Mustg. Off. shows
term M.O. Feb. 12, 1866.

* added May 9, 93. GED

J | 10 H. Art'y. | U.S.C.T.

Harvey Fleming
Put, Co. *B*, 10 Reg't U. S. Col'd H. Art'y.

Appears on Co. Muster-out Roll, dated
Baton Rouge La Feb, 1867.

Muster-out to date _____, 186 .
Last paid to _____, 186 .

Clothing account:

Last settled _____, 186 ; drawn since \$ _____ 100

Due soldier \$ _____ 100; due U. S. \$ _____ 100

Am't for cloth'g in kind or money adv'd \$ _____ 100

Due U. S. for arms, equipments, &c., \$ _____ 100

Bounty paid \$ _____ 100; due \$ _____ 100

Remarks:

*found orig. orig.
Discharged Feb 8/66
expiration term of
service.*

Book mark: *4119 1880*

(361)

Hodges
Copyist.

F 10 Hy. Art. U.S.C.
Harvey Fleming
Priv., Co. B, 10 Reg't U.S.C.A.

NOTATION.

Book mark: A. G. 1464093

The Adjutant General's Office,

WAR DEPARTMENT,

Washington, Dec. 22, 1908.

It has this day (Dec. 22, 1908,) been determined by this Department from the records and from information furnished by the Auditor for the War Department, that the above-named man was discharged the service February 12, 1866, by reason of the muster out of the detachment on that date, and that so much of the detachment muster out roll as indicates that he was discharged to date from February 8, 1866, is void and without effect.

W. W. Gibson

Hemming, Harvey

P, Co *B*, *10* *Reg't* **U.S.C.H.A.**

479 Enclosures.

Bed Cards	Descriptive Lists
Burial Records	Final Statements
Certs. of Dis. for Discharge	Furloughs
C. M. Charges <i>2</i>	Med. Des. Lists
Med. Certificates	Orders <i>2</i>

Includes p 2
Other papers relating to—

Admission to Hosp'l	Furlough
Casualty Sheet (Officer's)	Med. Examination
Confinement	Misc. Information <i>2</i>
Contracts	Pay or Clothing
Death or Effects	Personal Reports
Desertions	Rank
Discharge from Hosp'l	Transfer to Hosp'l
Discharge from Service <i>1</i>	Transfer to V. R. C.
Duty	Transportation

MICROFILM PUBLICATION M 1831

COMPILED MILITARY SERVICE RECORDS
OF VOLUNTEER UNION SOLDIERS WHO SERVED WITH
THE UNITED STATES COLORED TROOPS (USCT)
10TH REGIMENT OF HEAVY ARTILLERY

PERSONAL PAPERS' TARGET SHEET

PLEASE NOTE THE CHECKED INFORMATION ABOUT THE PERSONAL PAPERS IN
THIS FILE:

NO PERSONAL PAPERS WERE FOUND IN THIS FILE WHEN THE
RECORDS WERE ARRANGED FOR MICROFILMING.

11 PERSONAL PAPER(S) FOUND IN THIS FILE WHEN THE RECORDS
WERE ARRANGED FOR MICROFILMING.

DECLARATION OF RECRUIT.

I, _____ desiring to ENLIST in the Army of the United States, for the term of THREE YEARS, Do declare, That I am _____ years and _____ months of age; that I have neither wife nor child; that I have never been discharged from the United States service on account of disability or by sentence of a court-martial, or by order before the expiration of a term of enlistment; and I know of no impediment to my serving honestly and faithfully as a soldier for three years.

GIVEN at _____

The _____ day of _____

Witness:

No. 115

Enlisted at Warren, Michigan
Cubitts Barracks, Va.

January 31st 1863,

By 2nd Lieutenant J. H. [unclear]
4th Regiment of [unclear]

enlistment; last served in Company ()

Reg't of _____

Discharged _____ 18 _____

10 228 e 14-9

CONSENT IN CASE OF MINOR.

I, _____ Do CERTIFY, That I am the _____ of _____; that the said _____ is _____ years of age; and I do hereby freely give my CONSENT to his enlisting as a SOLDIER in the ARMY OF THE UNITED STATES for the period of THREE YEARS.

GIVEN at _____

The _____ day of _____

Witness:

County of

Jefferson



State of

Louisiana

I, *Harvey Fleming* born in *Montgomery County*
in the State of *Virginia* aged *thirty five* years,
and by occupation a *laborer* do hereby acknowledge to have

voluntarily enlisted this *thirty first* day of *January*
1863, as a SOLDIER in the ARMY OF THE UNITED STATES OF AMERICA, for the period

of **THREE YEARS**, unless sooner discharged by proper authority: Do also agree to
accept such bounty, pay, rations, and clothing, as are, or may be, established by law. And

I, *Harvey Fleming* do solemnly swear, that I will bear true faith
and allegiance to the UNITED STATES OF AMERICA, and that I will serve them honestly and
faithfully against all their enemies or opposers whomsoever; and that I will observe and
obey the orders of the President of the United States, and the orders of the officers
appointed over me, according to the Rules and Articles of War.

Sworn and subscribed to, at *Carrallton, Va.*
Camp Parap.
this *ninth* day of *February* 1863
BEFORE
J. S. Hayward
2^d Lt. U. S. Art. E. Va.

I CERTIFY, ON HONOR, That I have carefully examined the above named Recruit, agreeably to the General Regulations
of the Army, and that in my opinion he is free from all bodily defects and mental infirmity, which would, in any way, disqualify
him from performing the duties of a soldier.

Milton Chase
EXAMINING SURGEON.

I CERTIFY, ON HONOR, That I have minutely inspected the Recruit, *Harvey Fleming*
previously to his enlistment, and that he was entirely sober when enlisted; that, to the best of my judgement and belief, he is of
lawful age; and that, in accepting him as duly qualified to perform the duties of an able-bodied soldier, I have strictly observed
the Regulations which govern the recruiting service. This soldier has *Brown* eyes, *Dark* hair,
Pink complexion; is *five* feet, *ten* inches high.

J. S. Hayward
2^d Lt. U. S. Art. E. Va.
RECRUITING OFFICER.

70 21573 DECLARATION OF RECRUIT. 70 21573

I, _____ desiring to ENLIST in the Army of the United States, for the term of THREE YEARS, Do declare, That I am _____ years and _____ months of age; that I have neither wife nor child; that I have never been discharged from the United States service on account of disability or by sentence of a court-martial, or by order before the expiration of a term of enlistment; and I know of no impediment to my serving honestly and faithfully as a soldier for three years.

GIVEN at _____
The _____ day of _____

Witness :

No. _____
Enlisted at Henry Henning
Frank P. H. S. Co.
By Samuel B. H. S. Co. 1863.
1st Regt of Louisiana Inf.
enlistment; last served in Company ()
Regt of _____
Discharged _____ 18 _____

10 21573

CONSENT IN CASE OF MINOR.

I, _____ Do CERTIFY, That I am the _____ of _____; that the said _____ is _____ years of age; and I do hereby freely give my CONSENT to his enlisting as a SOLDIER in the ARMY OF THE UNITED STATES for the period of THREE YEARS.

GIVEN at _____
The _____ day of _____

Witness :

County of

Jefferson

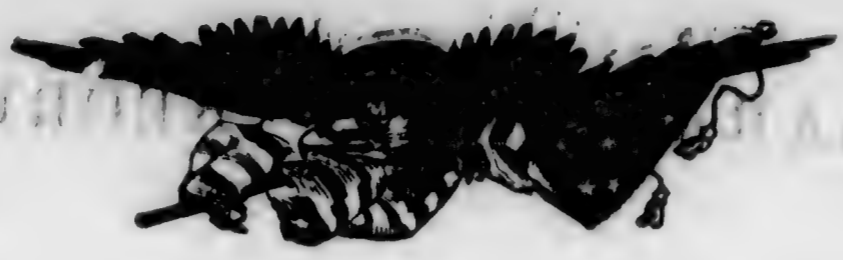

State of

Louisiana

I, *Harvey Flemings* born in *Montgomery County*
in the State of *Virginia* aged *Thirty five* years,
and by occupation a *Subvers* do hereby acknowledge to have

voluntarily enlisted this *Thirty first* day of *January*
1863, as a SOLDIER in the ARMY OF THE UNITED STATES OF AMERICA, for the period
of *THREE YEARS*, unless sooner discharged by proper authority: Do also agree to
accept such bounty, pay, rations, and clothing, as are, or may be, established by law. And

I, *Harvey Flemings* do solemnly swear, that I will bear true faith
and allegiance to the UNITED STATES OF AMERICA, and that I will serve them honestly and
faithfully against all their enemies or opposers whomsoever; and that I will observe and
obey the orders of the President of the United States, and the orders of the officers
appointed over me, according to the Rules and Articles of War.

Sworn ~~and subscribed~~ to, at *Carralton, La.*
this *ninth* day of *February* 1863 }
BEFORE *J. Nygaard*
2^d Lt. N. G. Art. E. Regt.

I CERTIFY, ON HONOR, That I have carefully examined the above named Recruit, agreeably to the General Regulations
of the Army, and that in my opinion he is free from all bodily defects and mental infirmity, which would, in any way, disqualify
him from performing the duties of a soldier.

Milton Chase
EXAMINING SURGEON.

I CERTIFY, ON HONOR, That I have minutely inspected the Recruit, *Harvey Flemings*
previously to his enlistment, and that he was entirely sober when enlisted; that, to the best of my judgement and belief, he is of
lawful age; and that, in accepting him as duly qualified to perform the duties of an able-bodied soldier, I have strictly observed
the Regulations which govern the recruiting service. This soldier has *Brown* eyes, *Dark* hair,
Dark complexion; is *five* feet, *ten* inches high.

J. Nygaard. 2^d Lieut. N. G. Art. E. Regt.
RECRUITING OFFICER.

Jan 8
Charges & Specifications
Against - Harvey Fleming
1st La Artillery C. H. A.
Copy ^{Sent to J. D. D. D.} Jan 8

10-26. S. C. Art. (764)

Filed

Sept 7/85

Charges and Specifications against Private
Harvey Flemming Company B 1st Louisiana
Regiment of Artillery

Charge 1st, Violation of the 50th Article of
War

Specification 1st-

In this that he Private Harvey Flemming
Co B 1st Louisiana Regiment of Artillery while
on Picket-Guard at- Keefe's Bayou near the
Sair Station, did leave the Picket-Post-
without leave of the corporal in Charge of
the post: this on the 23rd day of December 1863

Charge 2nd Disobedience of Orders

Specification 1st-

In this that he Private Harvey Flemming
Company B 1st Louisiana Regiment of Artillery
when ordered by his Superior Officer, Hospital
Stewart- Erastus H. Cummings Company B
1st Louisiana Regiment of Artillery commandant of the
Picket-Post at the Sair Station to observe
respect and kindness to all persons did disobey
said orders by grossly insulting and abusing three
defenseless women all this at- Keefe's Bayou
near the Sair Station on the 23 day of
December 1863

Charge 3^d conduct - to the prejudice of good
Order and Military Discipline
Specification 1st -

In this that he Private Harvey Flemming
Company B 1st Louisiana Regiment of Artillery
did grossly insult - three defenceless women. Offering
one fifty dollars to lie with her and using
indecent - language, all this at Keefers Bayou
near Le Sair Station on the 23^d day of
December 1863

Specification 2nd

In this that he Private Harvey Flemming
Company B 1st Regiment Louisiana Artillery did
represent - himself to said women to be the sergeant
in charge of the picket - station at Le Sair. And
did obtain money from them saying unless they
gave him money he would drive them into the
Swamp. all this at - Keefers Bayou near
Le Sair Station on the 23^d day of December 1863

Witnesses

Sergeant, John Henderson
Corporal, Giffin Backes
all of Company B 1st Louisiana Regiment - of Artillery
M. A. Freeland
Junior 1st Lieut - Company Co B 1st La Artillery

Campagna

Please & return
to his regiment
for duty

J. W. P.

P. O. No 30

Headquarters, Department of the Gulf,

ADJUTANT GENERAL'S OFFICE.

New Orleans, Dec 3 1864.

OFFICE MARK.

COMPENDIUM.

Date, Jan 19 1864

Protest Court

SUBJECT,

Harvey Fleming
Co. B. 1st La Heavy Art
Colored.

This man was sentenced to
Hard labor with Ball & Chain at Forty for
life, by Judge Atocha, on charge of leaving
his Picket Post & resulting a man

It is not proven that he
left his Post. He admitted offering a man
\$50- to submit to him, but offered to Violence

Some one also heard the man say that
some colored man had robbed him of \$50-

Sentence is clearly illegal as well as
unfounded in justice, unless it is sustained by fact
The man should be released.

Grant

L. 508 Dy. 1864

Fleming Hardy

B. I. J. H. V. A. C.

Provost Court

Department Gulf

Nov 29th 1864

10 USC 100

Respectfully referred to
Maj'or G. Norman Lieber
Judge Provost Court,
Department of the Gulf,
requesting attention to the
case, heresay evidence
admitted in trial, & fact
that under 2nd charge
no abusive & insulting
language is proved, the
charges referred to being
the best evidence in
the case are not called
or examined at all.

I have taken the liberty
to call the attention of
the Judge of this Court
to the case, as I have been
requested to inquire about
the case by the wife

of Fleming, (who has
been for some time
with Capt. Robinson
a. 2. M. h. O.) as a servant
she is a very respectable
colored woman.

I have taken the liberty
to call the attention of

18th N. Y. Cav + Judge Advocate
Provost Court Dept Gulf

Provost Court, Dept. Gulf
New Orleans, Nov. 30 '64

Respectfully forwarded
to Lieut. Col. Drake
A. A. General. Heresay
evidence was improperly
admitted and I think
the sentence unnecessarily
severe. I therefore take
the liberty of calling
attention to this case.

G. Norman Lieber
Major, Judge Adv.
Judge Prov. Court

Recd. Hd. Qu. Dept. Gulf. Dec. 3. 1864

United States
vs.
Harvey Fleming /c/.
Co B. 1st La. H. art.

Provost Court Dept
of the Gulf
Judge A. A. Stoika
Presiding
January 19th 1864.

Charge 1st

Leaving the picket station while
on Picket guard without leave.

Charge 2nd

Abusing three defenceless women
and using insulting and indecent language

Sergt. Anderson /c/. sworn

Between 8 and 9 o'clock
I went up to the post, the women had not got
there; When they came, they were told to stay
in the old house till day & I should bring
them to the Commander of the post.

In the morning, the women said, the prisoner
had taken about \$20. from them. He left
the picket guard without leave.

Corporal Griffin Reeks, sworn,

I was private then,
was sitting by the fire. These women came in
about 9 o'clock. The sergt told the sentry to
carry them to the old house & let them stay
till morning. The next morning, while I was

sitting by the fire with another sentry with me
the prisoner took it upon himself to interfere
with the ladies there. When the sentinel went
there, this man was standing by the young
lady, talking with her. She was crying,
The sentinel came back and called him up.
I went with him. When I started to go
I met this man coming from there. Two
of the women were crying. I went & told
the ladies not to be uneasy. This man
left his post without permission. I think
it was about a quarter of a mile. This
man went away towards the camp.

I suppose he left on account of the ladies
when the sentinel found him he was
talking to the young lady. The sentinel
told me he was interfering with the ladies.

Sergt Christ. S. Cummings sworn.

I went to the house, I understood
that some ladies had come inside the lines.
I went into the house where the ladies were,
they told me they had landed on the shore
some 5 or 6 miles above. I think two colored
persons had taken the largest part of their
money, leaving them about \$40. The
oldest commenced crying. I asked what
was the trouble, she said one of the men

had offered violence, took these women from where they were lying and threatened to shoot one if she did not comply with his wishes and offered her \$50. This man acknowledged it and said he went into the house and the woman proved herself a virtuous woman and that he offered her \$50. and she would not give way to him.

The woman would not tell any more of the story. She asked if they [men] had any right to take money from them. I think they said the man gave back \$20. When they ascertained it was all their money Harvey acknowledged the same & she got back ten Dollars of the money.

The young women told me that he took her on the lake shore & threatened to drive her outside of the lines if she did not give way to him. He asked her in the first place if she wanted to make \$50. He was under the influence of liquor.

Prisoner made statement & admitted that he made the proposal to the woman, but denied leaving duty.

Decision

To Fortugas for life, at hard labor
Ball & Chain and to be deprived of all
pay and allowances.

Certify this to be a true copy from Records
Jno. E. Casbard Clerk

Pro. C. . . . 1/64

Harry Flemming

Discharged

10 U.S.C.H.A.

Provost Court of the Department of the Gulf,

CLERK'S OFFICE.

New Orleans, Jan'y 19th 1864.

Private Harvey Fleming Heavy Artillery Corps ^{Department}
having been this day arraigned and tried upon the charge
of Disorderly Conduct disobedience of orders

and duty convicted thereof, is sentenced to be imprisoned in

Portugus

for the term
of Life hard Labor Ball & chains to forfeit to the
~~and to forfeit to the~~

United States the sum of all pay and allowances
except prison food & clothing
~~of his monthly pay, for the period of~~ months.

I certify that the above is a true copy of the minutes
of this Court

W D Conway Depy

~~W D Conway~~ Clerk.

Police Jail, New Orleans, La. Feb. 11. 1864.

Major Porter Provost Marshall,

Sir!

I hope you will not deem it impudent of my taking the liberty to write to you those few lines concerning my case.

I am a member of C. B. & H. Art;
I was arrested on the 25th of December 1863,
on a charge of leaving my Post, and taken
20 Dollars from some Confederate woman who
came across the lines from Madisonville.

I was tried on these false charges, and sentenced
to Fort Leavenworth, for life time, in irons with ball &
chain. I can prove myself clear, if you
will have the kindness to grant me a new trial,
for I had no witnesses, as I did not know
that I was allowed any, and I was not
asked for any. The same man that made
these charges against me is the man who
got the money.

Sir! Please have the kindness to grant me a
new trial and it will never be forgotten by me,
and in hope that God will answer me and
let me know, if you are pleased with my

application I am born

Very Respectfully

most humble servant

Harvey Flemming

C. B. & Co. H. A.

My witnesses,

1. John Gray, C. B. & Co. H. A.

from about the post.

2. Patrick Peirley & George C. B. & Co. H. A.

from character.

3. Mrs Blank, Citizen near our camp.

from about my leaving post.

4. Mrs Sieber, Citizen in this place.

from the same.

Asks for a new Grant.

from about the money.

Harvey Flemming

C. B. & Co. H. A.

42. John's suit

February 11, 1804

Fleming, Harvey

Gr. 1259 H. A.

Asks for a new Grant

10 WACKER

Office of Marshal

New Orleans 10th March/64

Respectfully forwarded
to Hon a a attached Judge
Proost Court Dept
of the Gulf

H. M. Porter

Major ^{and} Marshal
New Orleans

Proost Court D. G.
March 10/64

Respectfully returned.
I see no reason for a
rehearing - the facts
mentioned in the State
= ment do not bear upon
the real occurrence -

attached

H. M. Porter

St. Jefferson Fla

Sept. 7. 1864

Harvey Flemming -

1st Lieut. Col. Regt. Art. (Col'd)

complaining of having been
sentenced to the Dry Tortu-
gas, without a proper trial.

W. F. 9/14 Sept. 22^d/64

File W. D.

Genl. Jefferson Davis,
Sept. 7th/64

Hon. Edwin M. Stanton,
Secretary of War, Sir

Will please excuse the liberty I assume in thus addressing you, but knowing I have been wronged and wishing to have my grievances redressed I know of none other to apply to than you excellent

My name is Harvey Estabrook I am a private in the 1st Louisiana Artillery Col'd

My charges is 1st Robbery 2nd Deserting my post 3rd Asking a female to be my bed fellow for one evening.

Now in regard to the 1st charge I am entirely innocent as I could have proved.

Had my witnesses allowed to appear in my defense but they were not summons by the Judge Advocate

(for the reasons as I suppose) that they would convict Superior officers. In regard to the

2nd charge, I was on picket at Burnside when a number of refugees came to our lines

and wanted to pass on when I was ordered by the Sgt. command Guard to bring them in, when

To satisfy a thirst for revenge He preferred the
for mentioned Charge, In regard to the 3rd Charge
I Am Guilty, Now for this I am sentenced
to Dr. Fortugas during life at hard labor forfiting
pay and allowances, Now I have not had
at Court-Martial but simply arraigned before
a private Citizen installed as a Judge to in-
quire into Military offences, whose name is
George W. Foster, Judge in New Orleans,

Now as I have given you
a statement of my case I humbly appeal to
you to use your influence in obtaining my release
for a mitigation of punishment or a trial by a
Court-Martial, I have a wife and four
small children dependent on my labor, and in
doing any of the above you would confer
favor on one who is willing to sacrifice his life
under the Stars and Stripes of our Union

Henry ^{vis. by} ~~Stanton~~ ^{Stanton}
1st Louisiana Colonel, Fort
Dr. Fortugas Col.

To Hon. Edwin M. Stanton
Secretary of War
Washington D.C.

A. A. G. C.

Adj. Dir. Dept. of the Gulf
New Orleans Dec 3 1864

Special Order
No 327.

The following named
man Private Hardy Fleming
10th U. S. Col. Art. will
be released and returned
to duty.

327 G / 64
✓

Bot

327

Headquarters, Dept. of the Gulf
New Orleans, Dec 3d. 1864.

Special Orders

No 327. (Extract)

The unexpired portion of the sentence of Private Harvey Flemming 10th U.S. Col. Artillery, (Heavy) sentenced by the Court-Martial to imprisonment for life, at Fortugas, with Hard Labor with Ball and Chain, on the charge of leaving his Picket Post, is hereby remitted, the Court having no jurisdiction in the case, he will be at once, released and returned to duty.

By Command of Major Genl Humbert.

J. C. J. Sargent.

Mt Lt Col. J. S. and A. A. General.

Adj. Genl. Dist. of Key West Fortugas.

Key West Fla. Dec 19th 1864

Official

C. P. Tracy

Capt. 2d U.S. C. I.

a. a. a. genl.

C. C. Ft. Jefferson.

HEADQUARTERS DEPARTMENT OF THE GULF.

New Orleans, December 31, 1864.

SPECIAL ORDERS }
No. 327. }

[Extract.]

* * * * *

5. The unexpired portion of the sentence of Private Harvey Flemming, 10th U. S. Colored Artillery, (Heavy,) sentenced by the Provost Court to imprisonment for life, at Tortugas, with Hard Labor with Ball and Chain, on the charge of leaving his Picket Post, is hereby remitted, the court having no jurisdiction in the case.

He will be at once, released and returned to duty.

By COMMAND OF MAJOR GENERAL HURLBUT:

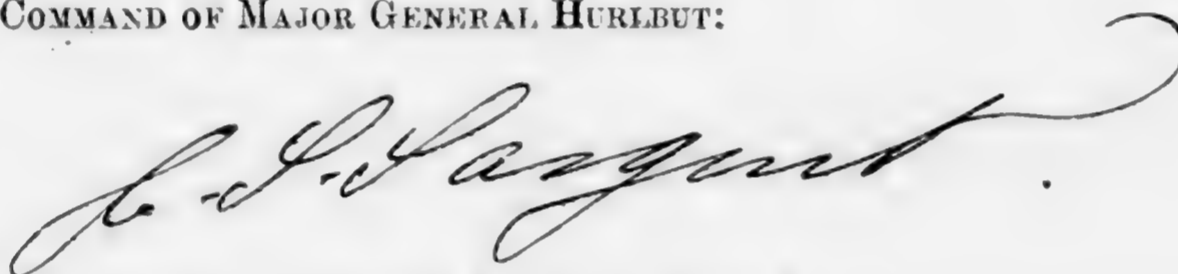

1st Lieutenant 2d La. Vols. and A. A. A. General.

Received from Archives Division
July 21, 1918.

Mr. Hurlbut, you'll

10/8, 10 U.S. Col'd H. Art'y

2" Lieutenant | 2" Lieutenant

CARD NUMBERS.

1 5486797
 2 5495968
 3 5496119
 4 5496272
 5 5496421
 6 5496567
 7 5496712
 8 5496869
 9 5489243
 10 5497024
 11 5489250
 12 5497195
 13 5489256
 14 5497212
 15 5497245
 16 5497277
 17 5497308
 18 5497329
 19 43227288
 20
 21
 22
 23
 24
 25

26
 27
 28
 29
 30
 31
 32
 33
 34
 35
 36
 37
 38
 39
 40
 41
 42
 43
 44
 45
 46
 47
 48
 49
 50

Book Mark: 1972 C.G. 1882. 431

7.10 C.G. 1873; 2933 C.G. 1887

See also Dict. Y. Batty.
26 m. y. Batty & Co

D971379- 2nd G.
C 2512104. Pomom
Habitat SEC 2-7-41

Wm J. H. K. 41

F. | 10 H. Arty | U.S.C.T.

Wilbur F. Flint

2^d Lt, Co. B, 10 Reg't U. S. Col'd H. Arty.

Age 25 years.

Appears on an

Individual Muster-in Roll

of the organization named above. Roll dated

New Orleans, La., Dec. 19, 1864.

Muster-in to date Dec. 19, 1864.

Joined for duty and enrolled:

When December 19th, 1864.

Where New Orleans, La.

Period 3 years.

Valuation of horse, \$ 100

Valuation of horse equipments, \$ 100

Remarks: Appointed 2^d Lieut.
Co. "B", 10th Reg't U.S.C.A.
(heavy) from private 21st
Battery New York Vols. X
(over)

Book mark:

Philipson

JAN. 15

5486797

418314

x Discharged in S. O. 536, dated Head Qrs. Dept. of Gulf Dec. 12th, 1864. Muster-in to date from Dec. 19th, 1864, the date upon which he reported and was assigned to duty.

Book Mark :- To complete and amend his military record, Lieut. W. F. Flint is hereby (under the permission of joint resolution of Congress, approved July 26th, 1866) mustered into the service of the United States to date Mar. 23, 1864, and out of service to date June 23, 64, and he is mustered for pay for the period covered by the above muster. See Special Order No. 149, H. O., A. G. O., March 25, 1864, on file.

10 H. Art'y. U.S.C.T.

Wilbur F. Flint

2^d Lieut, Co. B, 10 Reg't U. S. Col'd H. Art'y.

Appears on

Company Muster Roll

for *Nov & Dec*, 186*4*.

Present or absent *Present.*

Stoppage, \$ *100* for

Due Gov't, \$ *100* for

Valuation of horse, \$ *100*

Valuation of horse equipments, \$ *100*

Remarks: *Assigned to Co
Dec 19, 1864 per S.O
No 76 Dated Head
Qrs 10 USCA. (H)
New Orleans La
Dec 19 1864*

** corrected Jan 25, 1894. WGT*

Book mark:

(358)

J. J. J. J.

Copyist.

5

10 H. Art'y. U.S.C.T.

Wilbur Flint

2d Lt., Co. B, 10 Reg't U. S. Col'd H. Art'y.

Appears on

Company Muster Roll

for *Jan & Feb*, 186 ⁶.

Present or absent *Present*.

Stoppage, \$ 100 for

Due Gov't, \$ 100 for

Valuation of horse, \$ 100

Valuation of horse equipments, \$ 100

Remarks:

Book mark: -----

(358)

Josiah

Copyist.

27

10 H. Art'y. U.S.C.T.

Wilbur F. Flint

2d Lt., Co. B, 10 Reg't U. S. Col'd H. Art'y.

Appears on

Company Muster Roll

for *Mar & Apr*, 1865.

Present or absent *Present*

Stoppage, \$ 100 for

Due Gov't, \$ 100 for

Valuation of horse, \$ 100

Valuation of horse equipments, \$ 100

Remarks:

Book mark:

(358)

Johnson

Copyist.

77

10 H. Art'y. U.S.C.T.

Wilbur F. Flint

2^d Lieut, Co. B, 10 Reg't U. S. Col'd H. Art'y.

Appears on

Company Muster Roll

for *May & June*, 186*5*.

Present or absent *Present*.

Stoppage, \$ *100* for

Due Gov't, \$ *100* for

Valuation of horse, \$ *100*

Valuation of horse equipments, \$ *100*

Remarks: *In special duty as loading Officer since May 2^d 1865.*

Book mark:

(358)

E. G. Gomer

Copyist.

G. | 10 H. Art'y. | U.S.C.T.

William S. Flint

2^d Lieut., Co. B, 10 Reg't U. S. Col'd H. Art'y.

Appears on

Company Muster Roll

for *July & Aug.*, 1865.

Present or absent *Present.*

Stoppage, \$ *100* for

Due Gov't, \$ *100* for

Valuation of horse, \$ *100*

Valuation of horse equipments, \$ *100*

Remarks: *On special duty
as Boarding officer
since May 2^d 1865*

** Corrected Jan. 25, 1894. G.E.S.*

Book mark: _____

(358)

Josiah

Copyist.

37

10 H. Art'y. U.S.C.T.

Willis F. Hunt.

2^d Lt.; Co. B, 10 Reg't U. S. Col'd H. Art'y.

Appears on

Company Muster Roll

for *Sep & Oct*, 186 *6*.

Present or absent *Present*.

Stoppage, \$ *100* for

Due Gov't, \$ *100* for

Valuation of horse, \$ *100*

Valuation of horse equipments, \$ *100*

Remarks: *On special duty acting post Adjutant S.O. No 68 Hd Qrs Fort Jackson and St Philip Oct 5th 1865.*

Book mark:

Gornier.

(358)

Copyist.

F

10 H. Art'y. U.S.C.T.

Wilbur F. Flint

2451, Co. B, 10 Reg't U. S. Col'd H. Art'y.

Appears on

Company Muster Roll

for Nov. & Dec., 1865

Present or absent Present

Stoppage, \$ 100 for

Due Gov't, \$ 100 for

Valuation of horse, \$ 100

Valuation of horse equipments, \$ 100

Remarks: On special duty as acty. Post Adj. by P.O. No. 68 Md. Tro. Forts Jackson and St. Phillip dated Oct 5 1865,

Book mark:

Ref

(358)

Copyist.

F. 110 No A | U.S.C.T.

Wilbur F. Flint
2^d Lt, Co. D, 10 Reg't U. S. Col'd

Appears on a

Detachment Muster Roll

of the organization named above

for Nov. & Dec., 1865.

Station Ft. Jackson and St. Philip

Present or absent Present

Stoppage, \$ 100 for

Due Gov't, \$ 100 for

Valuation of horse, \$ 100

Valuation of horse equipments, \$ 100

Remarks: Post adjutant
A.O. 68 26^d Ans. Post
Oct. 5th 1865

Book mark:

Grogan

7.

10 H. Art'y. U.S.C.T.

Wilbur F. Flint

2421, Co. B, 10 Reg't U. S. Col'd H. Art'y.

Appears on

Company Muster Roll

for June & July, 1866.

Present or absent Present

Stoppage, \$ 100 for

Due Gov't, \$ 100 for

Valuation of horse, \$ 100

Valuation of horse equipments, \$ 100

Remarks: On special duty as
actg. Post Adj't. S.O. 68
Ad. Gns. Forts Jackson
and St. Phillip Oct 5 65.

Book mark:

(358)

Reif Copyist.

F 110 Recd | U.S.C.T.

Wilbur F. Flint
2^d Lieut, Co. 110 Reg't U. S. Col'd

Appears on a

Detachment Muster Roll

of the organization named above

for Jan. & Feb. 1866.

Station Ft. Jackson and St. Philip

Present or absent Present

Stoppage, \$ 100 for

Due Gov't, \$ 100 for

Valuation of horse, \$ 100

Valuation of horse equipments, \$ 100

Remarks: Post Adjt. Special
Order No 68 20th Dec.
Post Det. 5th 1866-

Book mark :

Carolan

(844)

Copyist.

F

10 H. Art'y. U.S.C.T.

Willard D. Flint

2481, Co. B, 10 Reg't U. S. Col'd H. Art'y.

Appears on

Company Muster Roll

for Mch & apr, 1866

Present or absent absent

Stoppage, \$ 100 for

Due Gov't, \$ 100 for

Valuation of horse, \$ 100

Valuation of horse equipments, \$ 100

Remarks: On detached service at M.O. S.O. No. 30 Md Mrs Forts Jackson & A. Phillip apr. 25 1866

Book mark:

(358)

Reif

Copyist.

F. W. H. A. | U.S.C.T.

Wilbur F. Flint
2^d Lieut, Co. D, 11th Reg't U. S. Col'd

Appears on a

Detachment Muster Roll

of the organization named above

for March + April, 1866.

Station St. Jackson and St. Philip, La.

Present or absent Absent

Stoppage, \$ 100 for

Due Gov't, \$ 100 for

Valuation of horse, \$ 100

Valuation of horse equipments, \$ 100

Remarks: Absent with leave
Co. 3^d 11th Reg't U. S. Col'd
St. Jackson and
St. Philip, La. Apr. 25-1866

Book mark :

C. Crogan
Copyist.

F

10 H. Art'y. U.S.C.T.

Wilbur F. Flint

2481, Co. B, 10 Reg't U. S. Col'd H. Art'y.

Appears on

Company Muster Roll

for May & June, 1866

Present or absent Present

Stoppage, \$ 100 for

Due Gov't, \$ 100 for

Valuation of horse, \$ 100

Valuation of horse equipments, \$ 100

Remarks: on special duty as actg. Post. Adjt. by S.O. No 68 Hd. Qrs. Ft. Jackson + St. Philips Mo.

Book mark:

(358)

Perf

Copyist.

D

10 H. Art'y. U.S.C.T.

Wilbur F. Flint

2nd Lt, Co. B, 10 Reg't U. S. Col'd H. Art'y.

Appears on

Company Muster Roll

for July & Aug, 1866

Present or absent Present

Stoppage, \$ 100 for

Due Gov't, \$ 100 for

Valuation of horse, \$ 100

Valuation of horse equipments, \$ 100

Remarks: No special duty as Post Adjt. by S.O. No 68 Hd Qrs Forts Jackson + St. Philip Sw.

Book mark:

(358)

Reif Copyist.

J.

10 H. Art'y.

U.S.C.T.

Wilbur F. Fleet

2^d Lieut, Co. B, 10 Reg't U. S. Col'd H. Art'y.

Appears on

Company Muster Roll

for *Sept. + Oct.*, 186*6*.

Present or absent *Present*

Stoppage, \$ 100 for

Due Gov't, \$ 100 for

Valuation of horse, \$ 100

Valuation of horse equipments, \$ 100

Remarks: *In arrest.*

Book mark: *5-20-1866*

Hodges
Copyist.

Wilbur F. Flint

2^d Lieut, Co. B, 10 Reg't U. S. Col'd H. Art'y.

Appears on

Company Muster Roll

for Nov. & Dec., 1866

Present or absent Present

Stoppage, \$ 100 for

Due Gov't, \$ 100 for

Valuation of horse, \$ 100

Valuation of horse equipments, \$ 100

Remarks:

On special duty as Post Adjutant Forts Jackson & St. Philip La. by G.O. no. 6 Fed. Drs. Forts Jackson & Saint Philip dated Nov. 28/66.

Book mark:

Hodges

(358)

Copyist.

F | 10 N. Arty | U.S.C.T.

Wilbur F. Flint

2 Lt 10 Regt U.S. Cold N. Arty

Appears on

General Order

No 67, dated War Department, Adjutant General's Office, July 16, 1867.

Appointed to be

First Lieutenant

BY BREVET

in the Volunteer Force, Army of the United States, for faithful and meritorious services

To date from March 13, 1865.

(400)

J. W. Williams

Copyist.

F | 10 H. Art'y. | U.S.C.T.

Wilbur
William F. Flint

2^d Lieut Co. *B*, 10 Reg't U. S. Col'd H. Art'y.

Appears on Co. Muster-out Roll, dated
Baton Rouge La, Feb, 1867.

Muster-out to date *Feb. 22*, 1867.

Last paid to *Dec. 31*, 1866.

Clothing account:

Last settled....., 186 ; drawn since \$.....100

Due soldier \$.....100; due U. S. \$.....100

Am't for cloth'g in kind or money adv'd \$.....100

Due U. S. for arms, equipments, &c., \$.....100

Bounty paid \$.....100; due \$.....100

Remarks: *Enlisted as Private*
2^d NY Batty at Rochester
NY. Sept 23/64 discharged
as such to accept app't
as set forth on this Roll
in G.O. no. 336 Dept. of

Book mark: *1972 C. 9 82 F 31*
V 10 C 9 73. - 2933-C. 9. 87

x corrected Jan. 25, 1894.

Hodges

(361)

Copyist.

JAN. 15

5497329

★ 1891 ★

the Gulf Dec. 12th 1864
service continuous. Due
\$97.50 for subsistence
and emoluments from
28th Oct. to 26th Nov. 1866,
pay only forfeited for
above period.

Flint, Wilbur H.

P., Co., 10 U.S.C.H.A.

2 Enclosures.

Bed Cards	Descriptive Lists
Burial Records	Final Statements
Certs. of Dis. for Discharge	Furloughs
C. M. Charges	Med. Des. Lists
Med. Certificates	Orders 2

Other papers relating to—

Admission to Hosp'l	Furlough
Casualty Sheet (Officer's)	Med. Examination
Confinement	Misc. Information
Contracts	Pay or Clothing
Death or Effects	Personal Reports
Desertions	Rank
Discharge from Hosp'l	Transfer to Hosp'l
Discharge from Service	Transfer to V. R. C.
Duty	Transportation

MICROFILM PUBLICATION M 1831

COMPILED MILITARY SERVICE RECORDS
OF VOLUNTEER UNION SOLDIERS WHO SERVED WITH
THE UNITED STATES COLORED TROOPS (USCT)
10TH REGIMENT OF HEAVY ARTILLERY

PERSONAL PAPERS' TARGET SHEET

PLEASE NOTE THE CHECKED INFORMATION ABOUT THE PERSONAL PAPERS IN
THIS FILE:

- NO PERSONAL PAPERS WERE FOUND IN THIS FILE WHEN THE
RECORDS WERE ARRANGED FOR MICROFILMING.
- 4 PERSONAL PAPER(S) FOUND IN THIS FILE WHEN THE RECORDS
WERE ARRANGED FOR MICROFILMING.

Head Quarters Department of the Gulf.
New Orleans December 12th 1864.

Special Orders }
No. 530.

Extract

* * * * *
3. The following named enlisted men are
honorably discharged the service as such
from the dates set opposite their names,
to enable them to accept commissions, with
condition that if not mustered in as
Officers under the same they shall remain
their former Regiments - else be considered
deserters

Private Hilber G. Smith 21st New York Battery
Nov 28th 1864.

By Command Major-General. Hurlbut -

(Signed) G. S. Sargent

1st Lieut 2d La. Vols. A. A. General

Two Copies

A. H. McDonald,
Capt. and a. e. m.
Sept 5th 1864

G. 94. 65-

Fort Jackson La.
July 7th 1865

Flint Wilbur F.
2^d Lt. Co "D." 10th U.S.C.A.

Requests a leave of absence
for four days to visit New
Orleans ~~on private~~ business,
desires it to date from the
9th inst.

S.O. No. 46 July 9. 1865

Recd. July 9th 1865

Fort Jackson La
July 7th. 1863.

Genl Geo E Harner
Post Adjutant

Sir

I must respectfully
ask for a leave of absence for four days to
enable me to visit New Orleans and private
business. I desire the leave of absence, if
granted, to date from the 9th July. for the
purpose of going per Steamer Gen. Crowell

Very Respectfully
Your obt. Servant
W. G. Gilch
2d Lt. Co B.
10th U.S. Artys.
Balg Officer

Flint, Wilbur F.

2" Lt. 10" U.S.C. Art.
(Heavy)

SPECIAL ORDERS }
No. 149. }

✓
WAR DEPARTMENT,
ADJUTANT GENERAL'S OFFICE,
Washington, March 25th, 1867.

(Extract.)

* * * * *
2. To complete and amend his military record, 2d Lieutenant
Wilbur F. Flint, 10th U. S. Colored Artillery, (Heavy,) is, under
the provisions of Joint Resolution of Congress, approved July 26th,
1866, hereby mustered into the service of the United States, to date
March 23d, 1864, and out of service to date June 23d, 1864, and he
is mustered for pay for the period covered by the above muster.

* * * * *
By order of the Secretary of War:

E. D. TOWNSEND,

Assistant Adjutant General.

OFFICIAL:

E. D. Townsend
Assistant Adjutant General.

Colonel Foster.

SPECIAL ORDERS }
No. 149. }

WAR DEPARTMENT,
ADJUTANT GENERAL'S OFFICE,
Washington, March 25th, 1867.

(Extract.)

* * * * *
2. To complete and amend his military record, 2d Lieutenant
Wilbur F. Flint, 10th U. S. Colored Artillery, (Heavy,) is, under
the provisions of Joint Resolution of Congress, approved July 26th,
1866, hereby mustered into the service of the United States, to date
March 23d, 1864, and out of service to date June 23d, 1864, and he
is mustered for pay for the period covered by the above muster.

* * * * *
By order of the Secretary of War:

E. D. TOWNSEND,
Assistant Adjutant General.

OFFICIAL:

Assistant Adjutant General.

Colonel Foster

Dup.

Resist, Justin

10 U. S. Col'd *26 Artz*

Private

Private

CARD NUMBERS.

1	5487895	26
2		27
3		28
4		29
5		30
6		31
7		32
8		33
9		34
10		35
11		36
12		37
13		38
14		39
15		40
16		41
17		42
18		43
19		44
20		45
21		46
22		47
23		48
24		49
25		50

Number of personal papers herein.....

Book Mark :

See also *Box 2, 77 U.S. Inf.*

A 1086 W | U.S.C.T.

Justin P Florent
Justese Florent
Det, Co., *10* Reg't U. S. Col'd *H.A.*

Appears on

M. and D. Roll of Men Transferred

to the organization named above

from *Co. D 7th U.S. Col Inf*

Roll dated *Camp Canapel La, La, 1864*

When enlisted *May 6*, 186*4*

Period for which enlisted *3* years.

When mustered in *May 13*, 186*4*

Present or absent

Company to which assigned

Remarks: *Dis'td May 14, 64*
from New Orleans
La,

** corrected March 22, 1894 GED*

Book mark :

W. H. Scott

Florent Justin

1015, 10 U.S. Col'd H. Art'y.

Private

Private

CARD NUMBERS.

1	5487564	26
x2	5487895	27
3	5488396	28
4	5512272	29
5	5512424	30
6	5512567	31
7	5512714	32
8	5512840	33
9	5512960	34
10	5513064	35
11	5513181	36
12	5513272	37
13		38
14		39
15		40
16		41
17		42
18		43
19		44
20	x card withdrawn & filed in envelope	
21	of Florent Justin, Unassigned,	
22	10 U.S. Col'd H. Art'y, where it properly	
23	belongs.	
24	48	Mar, 22, 1894
25	49	
	50	

Book Mark:

See also *Copy 77. ref. by*

F. 10 H. L. | U.S.C.T.

Justin Florent
Det, Co. *H*, 10 Reg't U. S. Col'd *H. L.*

Appears on

M. and D. Roll of Men Transferred

to the organization named above

from *Co. G, 4th U.S. Col. Inf.*

Roll dated *Camp Connerdale*, 1865.

When enlisted *May 7*, 1864.

Period for which enlisted *9* years.

When mustered in *May 20*, 1864.

Present or absent *Present*

Company to which assigned *A*

Remarks: *Joined at Orig'l
Organization of Co.*

Book mark :

W. H. Scott

J 1864

U.S.C.T.

Justin Florent
Priv., Co. 11, 10 Reg't U. S. Col'd La

Appears on

M. and D. Roll of Men Transferred

to the organization named above,

from *77 U.S. Col Inf*

Roll dated *Camp Parapet, La, 1864*

When enlisted *May 7*, 1864.

Period for which enlisted *3* years.

When mustered in *May 20*, 1864.

Present or absent *Present*

Company to which assigned *K*

Remarks: *Rec'd by transfer
from Co. G, 77 U.S. Col.*

Book mark :

Wm Scott

F | 10 H. Art'y. | U.S.C.T.

Justin Florent

P, Co. K, 10 Reg't U. S. Col'd H. Art'y.

Age _____ years.

Appears on

Company Muster Roll*

for Sept. & Oct., 1865.

Joined for duty and enrolled:

When Feb. 7, 1864.

Where New Orleans

Period 3 years.

Mustered in:

When May 20, 1864.

Where New Orleans

Present or absent Present-

Stoppage, \$.100 for

Due Gov't, \$.100 for

Remarks:

* First current roll. No muster-in roll of this company on file.

Book mark:

Hibbard

(358b)

Copyist.

F

10 H. Art'y.

U.S.C.T.

P. Justin Florent

, Co. K, 10 Reg't U. S. Col'd H. Art'y.

Appears on

Company Muster Roll

for Nov. & Dec., 1865

Present or absent Present

Stoppage, \$ 100 for

Due Gov't, \$ 100 for

Valuation of horse, \$ 100

Valuation of horse equipments, \$ 100

Remarks:

Book mark:

(358)

Hibbard Copyist.

J

10 H. Art'y.

U.S.C.T.

Justin Florent

, Co. K, 10 Reg't U. S. Col'd H. Art'y.

Appears on

Company Muster Roll

for Jan. Feb., 1866

Present or absent Present

Stoppage, \$ 100 for

Due Gov't, \$ 100 for

Valuation of horse, \$ 100

Valuation of horse equipments, \$ 100

Remarks:

Book mark:

H. W. ...

(358)

Copyist.

J | 10 H. Art'y. | **U.S.C.T.**

Justin Florent

P, Co. K, 10 Reg't U. S. Col'd H. Art'y.

Appears on

Company Muster Roll

for Mch. 1st, 1866

Present or absent Present

Stoppage, \$ 100 for

Due Gov't, \$ 100 for

Valuation of horse, \$ 100

Valuation of horse equipments, \$ 100

Remarks:

Book mark:

(358)

Hibbard

Copyist.

P

10 H. Art'y.

U.S.C.T.

Justin Florent

Co. K, 10 Reg't U. S. Col'd H. Art'y.

Appears on

Company Muster Roll

for May & June, 1866.

Present or absent Present

Stoppage, \$ 100 for

Due Gov't, \$ 100 for

Valuation of horse, \$ 100

Valuation of horse equipments, \$ 100

Remarks:

Book mark:

(358)

Hibbard

Copyist.

J. | 10 H. Art'y. | U.S.C.T.

Justin Florent
Priv., Co. K, 10 Reg't U. S. Col'd H. Art'y.

Appears on

Company Muster Roll

for July & Aug., 1866.

Present or absent Present

Stoppage, \$ 100 for

Due Gov't, \$ 100 for

Valuation of horse, \$ 100

Valuation of horse equipments, \$ 100

Remarks:

Book mark:

(358)

Hibbard
Copyist.

J

10 H. Art'y.

U.S.C.T.

Justin Florent

Put, Co. K, 10 Reg't U. S. Col'd H. Art'y.

Appears on

Company Muster Roll

for *Sept & Oct.*, 186*6*.

Present or absent *Present.*

Stoppage, \$ *100* for

Due Gov't, \$ *100* for

Valuation of horse, \$ *100*

Valuation of horse equipments, \$ *100*

Remarks:

Book mark:

Floyd

(358)

Copyist.

F

10 H. Art'y.

U.S.C.T.

Justin Florent

Pvt, Co. K, 10 Reg't U. S. Col'd H. Art'y.

Appears on

Company Muster Roll

for *Nov. & Dec.*, 186*6*.

Present or absent *Present.*

Stoppage, \$ 100 for

Due Gov't, \$ 100 for

Valuation of horse, \$ 100

Valuation of horse equipments, \$ 100

Remarks:

Book mark:

Floyd

(358)

Copyist.

J

10 H. Art'y. U.S.C.T.

Justin Florent

Priv, Co. *K*, 10 Reg't U. S. Col'd H. Art'y.

Appears on Co. Muster-out Roll, dated
Baton Rouge La, Feb 22, 1867.

Muster-out to date *Feb 22*, 1867.

Last paid to *Dec. 31*, 1866.

Clothing account:

Last settled _____, 186 ; drawn since \$ _____ $\frac{100}{100}$

Due soldier \$ *32* $\frac{65}{100}$; due U. S. \$ _____ $\frac{100}{100}$

Am't for cloth'g in kind or money adv'd \$ _____ $\frac{100}{100}$

Due U. S. for arms, equipments, &c., \$ *6* $\frac{31}{100}$

Bounty paid \$ _____ $\frac{100}{100}$; due \$ _____ $\frac{100}{100}$

Remarks: *Rec'd by transfer from Co*
S. 77 U. S. C. S. Oct 1/65 per
S.O. No 66 Hd qrs Dept Va
S. 1865 \$300. Bounty due under
Act of Congress July 26, 1866

Book mark: *645, 1878*

Floyd

801
Hounoy. Pope
Co 76, 10 U.S. Col'd H. Art'y.

Private Private

CARD NUMBERS.

1	5509533	26
2	5509633	27
3	5509744	28
4	5509901	29
5	5510051	30
6	5510196	31
7	5510345	32
8	5510497	33
9	5510619	34
10	5510763	35
11	5510844	36
12	5510919	37
13	5510992	38
14	5511055	39
15		40
16		41
17		42
18		43
19		44
20		45
21		46
22		47
23		48
24		49
25		50

Book Mark:

See also

F | 10 H. Art'y. | U.S.C.T.

Pope Flourney

Pvt, Co. H, 10 Reg't U. S. Col'd H. Art'y.

Appears on

Company Muster-in and Descriptive Roll

of the organization named above. Roll dated

New Orleans La, Nov 8, 1864.

Where born *?* *Kentucky*

Age *37* y'rs; occupation *Laborer*

When enlisted *Nov 2*, 1864.

Where enlisted *New Orleans*

For what period enlisted *3* years.

Eyes *Black*; hair *Black*

Complexion *Black*; height *5 ft. 7* in.

When mustered in *Nov 8*, 1864.

Where mustered in *New Orleans*

Bounty paid \$ *100*; due \$ *100*

Where credited *1 Dist, 2nd ward, Parish*

of Orleans City of N. Orleans La

Company to which assigned *H.*

Remarks: *Mustered in to*

date from date of

Enlistment-

NEXT ROLL ON FILE FEB 1865

Book mark :

Pennington

(356d)

Copyist.

A | 10 H. Art'y. | U.S.C.T.

Pope Flornoy

Pvt, Co. H, 10 Reg't U. S. Col'd H. Art'y

Appears on

Company Muster Roll

for *Jan'y & Feby*, 186*5*.

Present or absent *Present*

Stoppage, \$ *100* for

Due Gov't, \$ *100* for

Valuation of horse, \$ *100*

Valuation of horse equipments. \$ *100*

Remarks :

Book mark :

(858)

Perminington
Copyist.

F | 10 H. Art'y. | U.S.C.T.

Pope Flornoy

Pvt, Co. H, 10 Reg't U. S. Col'd H. Art'y

Appears on

Company Muster Roll

for *March & April*, 1865.

Present or absent *Present*

Stoppage, \$ *100* for

Due Gov't, \$ *100* for

Valuation of horse, \$ *100*

Valuation of horse equipments. \$ *100*

Remarks: *On daily duty
in Quarter Master's
Dept. since April
19th 1865.*

Book mark:

(858)

Pennington

Copyist.

F

10 H. Art'y.

U.S.C.T.

Pope Flornoy

Pvt, Co. H, 10 Reg't U. S. Col'd H. Art'y

Appears on

Company Muster Roll

for *May & June*, 1865.

Present or absent *Present*

Stoppage, \$ *100* for

Due Gov't, \$ *100* for

Valuation of horse, \$ *100*

Valuation of horse equipments. \$ *100*

Remarks: *Sick in quarters*

Book mark:

(358)

Pennington

Copyist.

F | 10 H. Art'y. | U.S.C.T.

Pope Flornoy

Prof, Co. H, 10 Reg't U. S. Col'd H. Art'y

Appears on

Company Muster Roll

for *July & Aug*, 1865.

Present or absent *Present*

Stoppage, \$ *100* for

Due Gov't, \$ *100* for

Valuation of horse, \$ *100*

Valuation of horse equipments. \$ *100*

Remarks :

Book mark :

(358)

Permittington

Copyist.

F

10 H. Art'y.

U.S.C.T.

Pope Flanoy

Cpt, Co. H, 10 Reg't U. S. Col'd H. Art'y

Appears on

Company Muster Roll

for *Sept Oct*, 1865.

Present or absent *Present*

Stoppage, \$ 100 for

Due Gov't, \$ 100 for

Valuation of horse, \$ 100

Valuation of horse equipments. \$ 100

Remarks :

Book mark :

Cammack

(358)

Copyist.

F

10 H. Art'y.

U.S.C.T.

Pope Flourney

Pvt., Co. H, 10 Reg't U. S. Col'd H. Art'y

Appears on

Company Muster Roll

for *Nov & Dec*, 1865.

Present or absent *Present*

Stoppage, \$ *100* for

Due Gov't, \$ *100* for

Valuation of horse, \$ *100*

Valuation of horse equipments. \$ *100*

Remarks :

Book mark :

Samuel

(358)

Copyist.

F

10 H. Art'y. U.S.C.T.

Pope Flomoy

Priv., Co. H, 10 Reg't U. S. Col'd H. Art'y

Appears on

Company Muster Roll

for *Jan & Feb.*, 1866.

Present or absent *Present*

Stoppage, \$ 100 for

Due Gov't, \$ 100 for

Valuation of horse, \$ 100

Valuation of horse equipments. \$ 100

Remarks :

Book mark :

Cammack

(858)

Copyist.

G

10 H. Art'y.

U.S.C.T.

Pope Flomoy

Private, Co. H, 10 Reg't U. S. Col'd H. Art'y

Appears on

Company Muster Roll

for *M & A*, 1866.

Present or absent *Present*

Stoppage, \$ *100* for

Due Gov't, \$ *100* for

Valuation of horse, \$ *100*

Valuation of horse equipments. \$ *100*

Remarks:

Book mark:

Cammack

(858)

Copyist.

S

10 H. Art'y. U.S.C.T.

Pope Flomoy

Co. H, Co. H, 10 Reg't U. S. Col'd H. Art'y

Appears on

Company Muster Roll

for *May & June*, 1866.

Present or absent *Present*

Stoppage, \$ *100* for

Due Gov't, \$ *100* for

Valuation of horse, \$ *100*

Valuation of horse equipments, \$ *100*

Remarks :

Book mark :

Wammack

(358)

Copyist.

J

10 H. Art'y. U.S.C.T.

John Lowrey

Cy., Co. H, 10 Reg't U. S. Col'd H. Art'y

Appears on

Company Muster Roll

for *July & Aug*, 1866.

Present or absent *Present*

Stoppage, \$ 100 for

Due Gov't, \$ 100 for

Valuation of horse, \$ 100

Valuation of horse equipments. \$ 100

Remarks :

Book mark :

Gamma R

(858)

Copyist.

4

10 H. Art'y.

U.S.C.T.

Pope Florney

Priv, Co. H, 10 Reg't U. S. Col'd H. Art'y

Appears on

Company Muster Roll

for Sep & Oct, 1866.

Present or absent Present

Stoppage, \$ 100 for

Due Gov't, \$ 100 for

Valuation of horse, \$ 100

Valuation of horse equipments. \$ 100

Remarks:

[Empty lines for remarks]

Book mark:

Lowry

(358)

Copyist.

L | 10 H. Art'y. | U.S.C.T.

Pope Flornoy
Pvt, Co. H, 10 Reg't U. S. Col'd H. Art'y

Appears on

Company Muster Roll

for *Nov. & Dec*, 1866.

Present or absent *Present*

Stoppage, \$ *100* for

Due Gov't, \$ *100* for

Valuation of horse, \$ *100*

Valuation of horse equipments. \$ *100*

Remarks: *Sick in Hospital.*

Book mark:

Lowry

Pope Flournoy
Co. H, 10 Reg't U. S. Col'd H. Art'y.

Appears on **Co. Muster-out Roll**, dated
Baton Rouge, La, Feb. 22, 1867.

Muster-out to date *Feb 22*, 1867.

Last paid to *Dec 31*, 1866.

Clothing account:

Last settled....., 186 ; drawn since \$..... 100

Due soldier \$ *42*^{*13*}/₁₀₀; due U. S. \$..... 100

Am't for cloth'g in kind or money adv'd \$..... 100

Due U. S. for arms, equipments, &c., \$ *6*^{*00*}/₁₀₀

Bounty paid \$..... 100; due \$ *200*^{*00*}/₁₀₀

Remarks: *joined at orig. org.*

Book mark:

(361)

Lowry

Copyist.

Flourney, Pope

, Co. *B*, 10 Reg't *U.S.A.*

2 Enclosures.

Bed Cards	Final Statements
Burial Records	Furloughs or L. of A.
Certs. of Dis. for Discharge	Med. Certificates
C. M. Charges	Med. Des. Lists
Descriptive Lists	Orders
Discharge Certificates	Pris. of War Record
Enlistment Papers <i>2</i>	Resignations

Other papers relating to—

Admission to Hosp'l	Furlough or L. of A.
Casualty Sheet	Med. Examination
Confinement	Misc. Information
Contracts	Pay or Clothing
Death or Effects	Personal Reports
Desertion	Rank
Discharge from Hosp'l	Transfer to Hosp'l
Discharge from Service	Transfer to V. R. C.
Duty	Transportation

NOTE 1.—This blank will be used for both enlistments and re-enlistments—enlistment of veterans, &c., &c., in the volunteer service. They will be made out in duplicate in all cases—one to accompany the recruiting return of the superintendent (not the recruiting officer) to the Adjutant General, and one to accompany the accounts of the officer who pays bounty, &c. The Regiment and Company in which the soldier last served should be given on the back.

NOTE 2.—An enlistment holds to service. A muster-in must, in all cases, precede payment of pay, bounty, pension, &c. A muster-in roll must, in all cases, be filed in the Adjutant General's Office as evidence of muster-in. The mustering officer, commissary, or assistant commissary of musters, as the case may be, will countersign both enlistments as having mustered the soldier into the service of the United States before either of them is given to the disbursing officer.

DECLARATION OF RECRUIT.

I, Pope Floarney, desiring to VOLUNTEER as a Soldier in the Army of the United States, for the term of THREE YEARS, Do Declare, That I am Thirty seven years and _____ months of age; that I have never been discharged from the United States service on account of disability or by sentence of a court martial, or by order before the expiration of a term of enlistment; and I know of no impediment to my serving honestly and faithfully as a soldier for three years.

GIVEN at New Orleans La the 2nd day of November 1864

Witness:

P. H. Lussier, Pope Floarney
1st Lieut 84th U.S.C.

16446094

No. 1326
Pope Floarney

Volunteered at New Orleans

By 2nd November, 1864

By A. L. H. Floarney

Regiment of _____

enlistment: last served in Company ()

Reg't of _____

Discharged _____, 18 _____

General's Office
to Bureau

CONSENT IN CASE OF MINOR.

I, _____, Do CERTIFY, That I am the _____ of _____; that the said _____ is _____ years of age; and I do hereby freely give my CONSENT to his volunteering as a SOLDIER in the ARMY OF THE UNITED STATES for the period of THREE YEARS.

GIVEN at _____ the _____ day of _____

Witness:

VOLUNTEER ENLISTMENT.

STATE OF

TOWN OF

Louisiana



New Orleans

Mustered into the service of the United States, for three years or during the war, from date of enlistment, in Company *B*
Regiment of *1st* *U.S.C.* Volunteers, on the *8* day of *Nov* at *New Orleans*

I, *Pope Flounery*, born in *Scott Co*
in the State of *Ky*, aged *thirty seven* years,
and by occupation a *laborer*, DO HEREBY ACKNOWLEDGE to have
volunteered this *2nd* day of *November*, 1864,
to serve as a *Soldier*, in the *Army of the United States of America*, for
the period of *THREE YEARS*, unless sooner discharged by proper authority:
Do also agree to accept such bounty, pay, rations, and clothing, as are, or may be,
established by law for volunteers. And I, *Pope Flounery*, do
solemnly swear, that I will bear true faith and allegiance to the *United States*
of America, and that I will serve them honestly and faithfully against all
their enemies or opposers whomsoever; and that I will observe and obey the
orders of the President of the United States, and the orders of the officers
appointed over me, according to the Rules and Articles of War.

Sworn and subscribed to, at *New Orleans*
this *2nd* day of *Nov*, 1864, } *Pope Flounery*
BEFORE *A. L. Linnick* } *mark*
1st Lt. 84th U.S.C.

I CERTIFY, ON HONOR, that I have carefully examined the above-named Volunteer, agreeably
to the General Regulations of the Army, and that, in my opinion, he is free from all bodily defects and
mental infirmity, which would in any way disqualify him from performing the duties of a soldier.

Wm. Humphrey
Surgeon U.S.A.
EXAMINING SURGEON.

I CERTIFY, ON HONOR, That I have minutely inspected the Volunteer *Pope Flounery*
previously to his enlistment, and that he was entirely sober when enlisted; that, to the best of my
judgment and belief, he is of lawful age; and that, in accepting him as duly qualified to perform the
duties of an able-bodied soldier, I have strictly observed the Regulations which govern the recruiting
service. This soldier has *BRN* eyes, *BRN* hair, *BRN* complexion, is *5*
feet *7* inches high.

A. L. Linnick
1st Lt. 84th U.S.C. Regiment of *U.S.C.* Volunteers,
RECRUITING OFFICER.

(A. G. O. No. 74 & 76.)

John Morrison
Adj. 1st Lt. 84th U.S.C.
Adj. Recruiting Officer

NOTE 1.—This blank will be used for both enlistments and re-enlistments—of veterans, &c., &c., in the volunteer service. They will be made out in duplicate in all cases—one to accompany the recruiting return of the superintendent (not the recruiting officer) to the Adjutant General, and one to accompany the accounts of the officer who pays bounty, &c. The Regiment and Company in which the soldier last served should be given on the back.

NOTE 2.—An enlistment holds to service. A muster-in must, in all cases, precede payment of pay, bounty, pension, &c. A muster-in roll must, in all cases, be filed in the Adjutant General's Office as evidence of muster-in. The mustering officer, commissary, or assistant commissary of musters, as the case may be, will countersign both enlistments as having mustered the soldier into the service of the United States before either of them is given to the disbursing officer.

DECLARATION OF RECRUIT.

I, Pope Henry, desiring to VOLUNTEER as a Soldier in the Army of the United States, for the term of THREE YEARS, Do Declare, That I am 27 years and _____ months of age; that I have never been discharged from the United States service on account of disability or by sentence of a court martial, or by order before the expiration of a term of enlistment; and I know of no impediment to my serving honestly and faithfully as a soldier for three years.

GIVEN at New Orleans La the 2 day of November 1864

Witness:

H. Ramirez Pope Henry
1st Lt 1st Lt

10 U.S. G. O. Henry
Nov. 8 1864

No.

Pope Henry

Volunteered at New Orleans

Nov 2 1864

By: H. Ramirez

84 Regiment of U.S.

Enlistment; last served in Company ()

Reg't of

Discharged _____, 18

H. Ramirez
1st Lt

CONSENT IN CASE OF MINOR.

I, _____, Do CERTIFY, That I am the _____ of _____; that the said _____ is _____ years of age; and I do hereby freely give my CONSENT to his volunteering as a SOLDIER in the ARMY OF THE UNITED STATES for the period of THREE YEARS.

GIVEN at _____ the _____ day of _____

Witness:

VOLUNTEER ENLISTMENT.

STATE OF

TOWN OF

Louisiana



New Orleans

I, *Pope Horney*, born in *Scott Co*
in the State of *Kentucky*, aged *37* years,
and by occupation a *laborer*. Do HEREBY ACKNOWLEDGE to have
volunteered this *2^d* day of *November*, 186*4*
to serve as a **Soldier** in the **Army of the United States of America**, for
the period of **THREE YEARS**, unless sooner discharged by proper authority:
Do also agree to accept such bounty, pay, rations, and clothing, as are, or may be,
established by law for volunteers. And I, *Pope Horney*, do
solemnly swear, that I will bear true faith and allegiance to the **United States
of America**, and that I will serve them honestly and faithfully against all
their enemies or opposers whomsoever; and that I will observe and obey the
orders of the President of the United States, and the orders of the officers
appointed over me, according to the Rules and Articles of War.

Sworn and subscribed to, at *New Orleans*
this *2* day of *Nov*, 186*4*,
BEFORE *J. Palmini* *Pope Horney*
12284 U S C O

I CERTIFY, ON HONOR, That I have carefully examined the above-named Volunteer, agreeably
to the General Regulations of the Army, and that, in my opinion, he is free from all bodily defects and
mental infirmity, which would in any way disqualify him from performing the duties of a soldier.

Orlando Humphrey

EXAMINING SURGEON.

I CERTIFY, ON HONOR, That I have minutely inspected the Volunteer *Pope Horney*
previously to his enlistment, and that he was entirely sober when enlisted; that, to the best of my
judgment and belief, he is of lawful age; and that, in accepting him as duly qualified to perform the
duties of an able-bodied soldier, I have strictly observed the Regulations which govern the recruiting
service. This soldier has *Blk* eyes, *Blk* hair, *Blk* complexion, is *5*
feet *7* inches high.

J. Palmini
12284 U S C O Regiment of *U S C O* Volunteers,
RECRUITING OFFICER.

(A. G. O. No. 74 & 76.)

Mustered into the service of the United States, for three years or during the war, from date of enlistment, in Company *B*
16 Regiment of *U S C O* Volunteers, on the *8* day of *Nov*, 186*4*

John W. ...
Adj. Gen.
U S A
at New Orleans
12284 U S C O
Recruiting Officer

Lowers. Samuel

Co. D., 10 U.S. Col'd H. Art'y

Private

Private

CARD NUMBERS.

1	5487453	26
2	5501259	27
3	5501407	28
4	5501551	29
5	5501689	30
6	5501807	31
7	5501914	32
8	5502010	33
9	5502106	34
10	5502186	35
11		36
12		37
13		38
14		39
15		40
16		41
17		42
18		43
19		44
20		45
21		46
22		47
23		48
24		49
25		50

Book Mark:

See also *Co. H. 7. 11. 12. 13. 14. 15. 16. 17. 18. 19. 20. 21. 22. 23. 24. 25. 26. 27. 28. 29. 30. 31. 32. 33. 34. 35. 36. 37. 38. 39. 40. 41. 42. 43. 44. 45. 46. 47. 48. 49. 50.*

F 10 H. A. U.S.C.T.

Samuel Flowers
Capt, Co K, 10 Reg't U. S. Col'd Ill.

Appears on

M. and D. Roll of Men Transferred

to the organization named above,

from Co H, 2nd U. S. Col'd Inf

Roll dated Camp Pampeta Cal, 1865.

When enlisted Feb'y of, 1864.

Period for which enlisted 3 years.

When mustered in March, 1864.

Present or absent Present

Company to which assigned K

Remarks: Joined the Service
as Private

Book mark :

W. H. Scott

S

10 H. Art'y. | U.S.C.T.

Samuel Flowers

Priv, Co. D, 10 Reg't U. S. Col'd H. Art'y.

Appears on

Company Muster Roll

for *Sept & Oct*, 186*5*.

Present or absent *Present*

Stoppage, \$ *100* for

Due Gov't, \$ *100* for

Valuation of horse, \$ *100*

Valuation of horse equipments, \$ *100*

Remarks: *Transfd from Co. H, 177
U.S.C.I., per S.O. No. 3, Hd Qrs, 10
U.S.C.A.H., Camp Parapet, La.,
Oct. 1/65*

Book mark: _____

Patterson

J

10 H. Art'y. | U.S.C.T.

Samuel Flowers
Pvt, Co. D, 10 Reg't U. S. Col'd H. Art'y.

Appears on

Company Muster Roll

for *Nov & Dec*, 186*5*

Present or absent *Present*

Stoppage, \$ *100* for

Due Gov't, \$ *100* for

Valuation of horse, \$ *100*

Valuation of horse equipments, \$ *100*

Remarks:

Book mark: _____

W. M. Payne

(358)

Copyright.

J | 10 H. Art'y. | U.S.C.T.

Samuel Flowers

Priv, Co. D, 10 Reg't U. S. Col'd H. Art'y.

Appears on

Company Muster Roll

for *Jan & Feb*, 186*b*.

Present or absent *Present*

Stoppage, \$ *100* for

Due Gov't, \$ *100* for

Valuation of horse, \$ *100*

Valuation of horse equipments, \$ *100*

Remarks:

Book mark:-----

M. Wayne
(358) Copied.

F

10 H. Art'y. | U.S.C.T.

Samuel Flowers

Bob, Co. D, 10 Reg't U. S. Col'd H. Art'y.

Appears on

Company Muster Roll

for *mch & apr*, 1866.

Present or absent *Present*

Stoppage, \$ *100* for

Due Gov't, \$ *100* for

Valuation of horse, \$ *100*

Valuation of horse equipments, \$ *100*

Remarks:
.....
.....
.....
.....
.....
.....
.....
.....
.....
.....

Book mark:

(358)

[Signature]

Copyist.

F

10 H. Art'y. | U.S.C.T.

Samuel Flowers

Gov, Co. D, 10 Reg't U. S. Col'd H. Art'y.

Appears on

Company Muster Roll

for *May + June*, 1866.

Present or absent *Present*

Stoppage, \$ 100 for

Due Gov't, \$ 100 for

Valuation of horse, \$ 100

Valuation of horse equipments, \$ 100

Remarks:

Book mark:

(358)

Copyist

Copyist.

J

10 H. Art'y.

U.S.C.T.

Samuel Flowers

Cpk, Co. D, 10 Reg't U. S. Col'd H. Art'y.

Appears on

Company Muster Roll

for *July & Aug*, 186*6*.

Present or absent *Present*

Stoppage, \$ *100* for

Due Gov't, \$ *100* for

Valuation of horse, \$ *100*

Valuation of horse equipments, \$ *100*

Remarks: *Daily duty compa-
ny book*

Book mark: _____

(358)

Kerry

Copyist.

Samuel Flowers
Priv, Co. D, 10 Reg't U. S. Col'd H. Art'y.

Appears on

Company Muster Roll

for Sept 1866, 1866.

Present or absent: Present

Stoppage, \$ 100 for

Due Gov't, \$ 100 for

Valuation of horse, \$ 100

Valuation of horse equipments, \$ 100

Remarks: Discharged by
Co. Capt

Book mark:

W. Leonard

J

10 H. Art'y.

U.S.C.T.

Samuel Thomas

Priv, Co. D, 10 Reg't U. S. Col'd H. Art'y.

Appears on

Company Muster Roll

for *Nov & Dec*, 186*6*.

Present or absent *Present*

Stoppage, \$ 100 for

Due Gov't, \$ 100 for

Valuation of horse, \$ 100

Valuation of horse equipments, \$ 100

Remarks: _____

Book mark: _____

(358)

J. W. Zeman

Copyist.

J

10 H. Art'y. U.S.C.T.

Samuel Flowers
Am. Co. D, 10 Reg't U. S. Col'd H. Art'y.

Appears on **Co. Muster-out Roll**, dated
Baton Rouge, La. Feb 22, 1867.

Muster-out to date *Feb 22*, 1867.

Last paid to *Dec 31*, 1866.

Clothing account:

Last settled....., 186 ; drawn since \$..... 100

Due soldier \$ *53* ^{*02*}/₁₀₀; due U. S. \$..... 100

Am't for cloth'g in kind or money adv'd \$..... 100

Due U. S. for arms, equipments, &c., \$..... ^{*600*}/₁₀₀

Bounty paid \$..... 100; due \$..... 100

Remarks: *Bounty due ask*
July 21, 1866 \$300.
joined by transfer from Co. H,
77 U.S. Inf Oct 1/65 O. O.
66 Dept La Sept 22/65
as Private.

Book mark:

(361)

J. Leonard

Copyist.

Floyd Tolbert

Co. D, 10 U.S. Col'd H. Art'y

Private

Private

CARD NUMBERS.

1	5486982	26
2	5487029	27
3	5500544	28
4	5500623	29
5	5500710	30
6	5500786	31
7	5500855	32
8	5500924	33
9	5500994	34
10	5501075	35
11	5501149	36
12	5501255	37
13	5501403	38
14	5501549	39
15	5501687	40
16	5501805	41
17	5501912	42
18	5502008	43
19	5502104	44
20	5502184	45
21	3261-6-1888	46
22		47
23		48
24		49
25		50

Book Mark: 3261. C. (E. B.) 1888.

See also

0757078. DV New
8841811. Po std.
Rep 366233-
PI 307199, and 70 n. etc.
S.O 1333566. P.O. Bundes.
R. 419. 478939

Wm. G. Hoover

Fallot Floyd

Appears with rank of _____ on

Muster and Descriptive Roll of a Detachment of U. S. Vols. forwarded

(7 U. S. C. H. A.)
for the 10 Reg't U. S. C. H. A. Roll dated

New Orleans La., Apr. 20, 1864.

Where born St. Charles La.

Age 28 y'rs; occupation Laborer

When enlisted Apr. 18, 1864.

Where enlisted New Orleans

For what period enlisted 3 years.

Eyes Black; hair Black

Complexion Black; height 5 ft. 6 in.

When mustered in Apr. 20, 1864.

Where mustered in New Orleans

Bounty paid \$ 100; due \$ 100

Where credited _____

Company to which assigned D

Remarks: _____

Book mark: 3261-6-1888

Galligan

Talbot Floyd

Appears with rank of *Private* on

Muster and Descriptive Roll of a Detachment of U. S. Vols, forwarded

(7 U. S. C. H. A.)
for the *10* Reg't *U. S. C. H. A.* Roll dated

New Orleans La., *May 7*, 1864.

Where born *St. Charles Pa Miss.*

Age *28* y'rs; occupation *Laborer*

When enlisted *Apr. 18*, 1864.

Where enlisted *New Orleans*

For what period enlisted *3* years.

Eyes *Black*; hair *Black*

Complexion *Black*; height *5 ft. 6* in.

When mustered in *Apr. 20*, 1864.

Where mustered in *New Orleans*

Bounty paid \$ *100*; due \$ *100*

Where credited *New Orleans*

Company to which assigned *D*

Remarks:

Book mark: *3261 C (E13) 1888*

Galligan

Salbot Floyd

P, Co. D, 7 Reg't U. S. Col'd H. Art'y.†

Age _____ years.

Appears on

Company Muster Roll*

for *Enrolment to Apr. 30*, 1864.

Joined for duty and enrolled:

When *Apr 18*, 1864.

Where *N. Orleans La.*

Period *3* years.

Mustered in:

When *Apr. 20*, 1864.

Where *N. Orleans*

Present or absent *Present*

Stoppage, \$ 100 for _____

Due Gov't, \$ 100 for _____

Valuation of horse, \$ 100

Valuation of horse equipments, \$ 100

Remarks : _____

† This organization subsequently became Co. D, 10 Reg't U. S. Colored Heavy Artillery.

*First current roll. No muster-in roll of this company on file.

Book mark : _____

(358d)

Shadob

Copyist.

Salbot Floyd

P, Co. *D*, 7 Reg't U. S. Col'd H. Art'y.*

Appears on

Company Muster Roll

for *May & June*, 1864.

Present or absent *Present*

Stoppage, \$ *100* for

Due Gov't, \$ *100* for

Valuation of horse, \$ *100*

Valuation of horse equipments, \$ *100*

Remarks:

* This organization subsequently became Co. *D*, 10 Reg't U. S. Colored Heavy Artillery.

Book mark: -----

(358) *Shadbolt* Copyist.

F

10 H. Art'y.

U.S.C.T.

Shadbol

P

, Co. D, 10 Reg't U. S. Col'd H. Art'y.

Appears on

Company Muster Roll

for July & Aug., 1864.

Present or absent Present

Stoppage, \$ 100 for

Due Gov't, \$ 100 for

Valuation of horse, \$ 100

Valuation of horse equipments, \$ 100

Remarks: Dif. of pay from date of enrollment to Apr. 30/64 \$6.00 per month and from May 1 to June 30/64 \$9.00 per mo.

Book mark:

(358)

Shadbol

Copyist.

J.

10 H. Art'y.

U.S.C.T.

Salbot Floyd

P, Co. D, 10 Reg't U. S. Col'd H. Art'y.

Appears on

Company Muster Roll

for *Sept. & Oct.*, 1864.

Present or absent *Present*

Stoppage, \$ *100* for

Due Gov't, \$ *100* for

Valuation of horse, \$ *100*

Valuation of horse equipments, \$ *100*

Remarks:

Book mark: -----

(358)

Shadbolt

Copyist.

Shadob

P, Co. D, 10 Reg't U. S. Col'd H. Art'y.

Appears on

Company Muster Roll

for *Nov. & Dec*, 186 *4*.

Present or absent *Present*

Stoppage, \$ *100* for

Due Gov't, \$ *100* for

Valuation of horse, \$ *100*

Valuation of horse equipments, \$ *100*

Remarks:

Book mark: _____

(358) *Shadob* Copyist.

F

10 H. Art'y.

U.S.C.T.

Falbot Floyd

Prof, Co. D, 10 Reg't U. S. Col'd H. Art'y.

Appears on

Company Muster Roll

for *Jan - Feb*, 186*5*.

Present or absent *Present*

Stoppage, \$ *100* for

Due Gov't, \$ *100* for

Valuation of horse, \$ *100*

Valuation of horse equipments, \$ *100*

Remarks: *Sick in quarters.*

Book mark: _____

Patterson

(358)

Copyist.

9

10 H. Art'y. | U.S.C.T.

Talbot Floyd
X [unclear]

Put, Co. D, 10 Reg't U. S. Col'd H. Art'y.

Appears on

Company Muster Roll

for *March & April*, 1865.

Present or absent *Present*

Stoppage, \$ *100* for

Due Gov't, \$ *100* for

Valuation of horse, \$ *100*

Valuation of horse equipments, \$ *100*

Remarks:

X Corrected Jan 19/93 [unclear]

Book mark: -----

Patterson

A

10 H. Art'y.

U.S.C.T.

Talbot Floyd

Art, Co. D, 10 Reg't U. S. Col'd H. Art'y.

Appears on

Company Muster Roll

for *May & June*, 1865.

Present or absent *Present*

Stoppage, \$ *100* for

Due Gov't, \$ *100* for

Valuation of horse, \$ *100*

Valuation of horse equipments, \$ *100*

Remarks: *Due U. S. for ordnance
lost, 45¢*

Book mark: _____

Patterson

(358)

Copyist.

F

10 H. Art'y.

U.S.C.T.

Talbot Floyd

Co. D, Co. D, 10 Reg't U. S. Col'd H. Art'y.

Appears on

Company Muster Roll

for *July & Aug*, 1865.

Present or absent *Present*

Stoppage, \$ *100* for

Due Gov't, \$ *100* for

Valuation of horse, \$ *100*

Valuation of horse equipments, \$ *100*

Remarks: *Due U. S. for Camp & Garrison Equipage. 20¢*

Book mark:

Patterson

(358)

Copyist.

A

10 H. Art'y. | U.S.C.T.

Salbot Floyd

Pr, Co. D, 10 Reg't U. S. Col'd H. Art'y.

Appears on

Company Muster Roll

for *Sept & Oct*, 186*5*.

Present or absent *Present*

Stoppage, \$ *100* for

Due Gov't, \$ *100* for

Valuation of horse, \$ *100*

Valuation of horse equipments, \$ *100*

Remarks: *Due U.S. for ordnance
lost .487.*

Book mark:

Patterson

(358)

Copyist.

Z | 10 H. Art'y. | U.S.C.T.

Halbert Floyd

Pr, Co. D, 10 Reg't U. S. Col'd H. Art'y.

Appears on

Company Muster Roll

for *Nov & Dec*, 1865.

Present or absent *Present*

Stoppage, \$ *100* for

Due Gov't, \$ *100* for

Valuation of horse, \$ *100*

Valuation of horse equipments, \$ *100*

Remarks:

Book mark:

(358)

W. W. Payne

Copyist.

71 | 10 H. Art'y. | U.S.C.T.

Salbot Floyd
Pr, Co. D, 10 Reg't U. S. Col'd H. Art'y.

Appears on

Company Muster Roll

for *Jan & Feb*, 186*b*.

Present or absent *Present*

Stoppage, \$ *100* for

Due Gov't, \$ *100* for

Valuation of horse, \$ *100*

Valuation of horse equipments, \$ *100*

Remarks: *Due U.S. for*
Ord. 48 cts

Book mark: _____

W. Wayne

(358)

Copyist.

J

Falbot Floyd

Bob, Co. D, 10 Reg't U. S. Col'd H. Art'y.

Appears on

Company Muster Roll

for *March & April*, 186*b*.

Present or absent *Present*

Stoppage, \$ *100* for

Due Gov't, \$ *100* for

Valuation of horse, \$ *100*

Valuation of horse equipments, \$ *100*

Remarks:

Book mark:

King
of

L

10 H. Art'y. | U.S.C.T.

Talbot Floyd

Priv, Co. D, 10 Reg't U. S. Col'd H. Art'y.

Appears on

Company Muster Roll

for *May & June*, 1866.

Present or absent *Present*

Stoppage, \$ *100* for

Due Gov't, \$ *100* for

Valuation of horse, \$ *100*

Valuation of horse equipments, \$ *100*

Remarks:

Book mark: -----

[Signature]

Copyist.

F

10 H. Art'y. | U.S.C.T.

Talbot Floyd

Osby, Co. D, 10 Reg't U. S. Col'd H. Art'y.

Appears on

Company Muster Roll

for *July & Aug*, 1866.

Present or absent *Present*

Stoppage, \$ *100* for

Due Gov't, \$ *100* for

Valuation of horse, \$ *100*

Valuation of horse equipments, \$ *100*

Remarks: *New Reg for Ord. # 26*

Book mark:

(358)

Osby
Copyist.

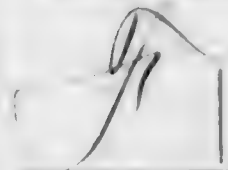

Galbraith Lloyd

Private, Co. D, 10 Reg't U. S. Col'd H. Art'y.

Appears on

Company Muster Roll

for *Sept & Oct*, 186*4*.

Present or absent *Present*

Stoppage, \$ *100* for

Due Gov't, \$ *100* for

Valuation of horse, \$ *100*

Valuation of horse equipments, \$ *100*

Remarks: *Present in
Confinement*

Book mark: _____

A. H. Leman

J

10 H. Art'y. | U.S.C.T.

Salbot Lloyd

Br, Co. D, 10 Reg't U. S. Col'd H. Art'y.

Appears on

Company Muster Roll

for *Nov + Dec*, 1866.

Present or absent *Present*

Stoppage, \$ *100* for

Due Gov't, \$ *100* for

Valuation of horse, \$ *100*

Valuation of horse equipments, \$ *100*

Remarks: *Dem. by Gen. C.M. to forfeit to the U.S. 5 of his mo. pay for one mo. G.O. 6 ca. Push of Baton Rouge*

Book mark:

(358)

J. L. Leonard
Copyist.

Robert Floyd
Co. D, 10 Reg't U. S. Col'd H. Art'y.

Appears on Co. Muster-out Roll, dated
Baton Rouge, La, Mar 22, 1867.

Muster-out to date *Mar 22*, 1867.

Last paid to *Dec 31*, 1866.

Clothing account:

Last settled....., 186 ; drawn since \$.....100

Due soldier \$ *21*^{*28*}/₁₀₀; due U. S. \$.....100

Am't for cloth'g in kind or money adv'd \$.....100

Due U. S. for arms, equipments, &c., \$.....*6*^{*00*}/₁₀₀

Bounty paid \$.....100; due \$.....100

Remarks: *Bounty due act*
July 21 1866 \$100. Bounty
due act July 28 1866
\$100. Joined org. org.
Private from enrollment

Book mark: *V182 P67.74*

J. W. Lemmas
Copyist.

F 10 H. A. U. S. C. I.
Tobias Floyd
Co. *D*, 10th Reg't *MUSCHA*,

NOTATION.

Book mark: *3261, C, 1888,*

War Department,

Adjutant General's Office,

Washington,

Aug. 17, 1888.

Application for certificate in lieu of lost discharge.

One Certificate _____ furnished.

(4766)

Griffin
Copyist.

Lucas. Cyrus

Co B., 10 U.S. Col'd H. Art'y.

Musician

Private

CARD NUMBERS.

1	5489120	26
2	5496925	27
3	5494033	28
4	5497181	29
5	5497218	30
6	5497251	31
7	5494294	32
8	5497414	33
9	5489333	34
10		35
11		36
12		37
13		38
14		39
15		40
16		41
17		42
18		43
19		44
20		45
21		46
22		47
23		48
24		49
25		50

Book Mark:

See also

75. U.S. Col'd H. Art'y

R-0349738

5737906 Sand

8840775-PO 90

1090876. PO 711111

AG. 1352376

Wm D. Tucker

S. Hart U.S.C.T.

Cyrus Plucas
Mus. Co., *70* Reg't U. S. Col'd *Hart*

Appears on

M. and D. Roll of Men Transferred

to the organization named above,

from *73 U.S.C.I.*

Roll dated *Nov 18*, 186*3*

When enlisted *Aug 12*, 186*3*

Period for which enlisted *3* years.

When mustered in *Sep 29*, 186*3*

Present or absent *Not stated*

Company to which assigned

Remarks: *Enlisted as*

musician. Transferred

from 88 U.S.C.I. per

S.O. No 209. Stated

at 1st Reg. Dept of July

Aug 13/64

Book mark :

F

10 H. Art'y. U.S.C.T.

Longus Lucas

Pl, Co. B, 10 Reg't U. S. Col'd H. Art'y.

Appears on

Company Muster Roll

for *Nov & Dec*, 1865

Present or absent *Present*

Stoppage, \$ *100* for

Due Gov't, \$ *100* for

Valuation of horse, \$ *100*

Valuation of horse equipments, \$ *100*

Remarks: *Transfd. from 75th
U.S. Inf., by P.O. No 105
Hd. Qrs. Dept. Sw. dated
Nov 3 1865.*

Book mark:

(358)

Reif

Copyist.

F

10 H. Art'y. U.S.C.T.

Byrus Lucas

Pl Co. B, 10 Reg't U. S. Col'd H. Art'y.

Appears on

Company Muster Roll

for June & July, 1866.

Present or absent Present

Stoppage, \$ 100 for

Due Gov't, \$ 100 for

Valuation of horse, \$ 100

Valuation of horse equipments, \$ 100

Remarks:

Book mark:

(358)

Reif

Copyist.

D

10 H. Art'y. U.S.C.T.

Cyrus Flucas

Pl, Co. B, 10 Reg't U. S. Col'd H. Art'y.

Appears on .

Company Muster Roll

for *March, & April*, 186*6*.

Present or absent *Present*

Stoppage, \$ *100* for

Due Gov't, \$ *100* for

Valuation of horse, \$ *100*

Valuation of horse equipments, \$ *100*

Remarks:

Book mark:

(358)

Reif

Copyist.

T

10 H. Art'y. U.S.C.T.

Cyrus Lucas

Plt, Co. B, 10 Reg't U. S. Col'd H. Art'y.

Appears on

Company Muster Roll

for *May & June, 1866*

Present or absent *Present*

Stoppage, \$ *100* for

Due Gov't, \$ *100* for

Valuation of horse, \$ *100*

Valuation of horse equipments, \$ *100*

Remarks:

Book mark: _____

(358)

Reif

Copyist.

F

10 H. Art'y. U.S.C.T.

Byron Lucas

Pl, Co. B, 10 Reg't U. S. Col'd H. Art'y.

Appears on

Company Muster Roll

for *July & Aug., 1864.*

Present or absent *Present*

Stoppage, \$ *100* for

Due Gov't, \$ *100* for

Valuation of horse, \$ *100*

Valuation of horse equipments, \$ *100*

Remarks:

Book mark:

(358)

Reif

Copyist.

J

10 H. Art'y.

U.S.C.T.

Cyrus Flucas
Pr., Co. B, 10 Reg't U. S. Col'd H. Art'y.

Appears on

Company Muster Roll

for *Sep. & Oct.*, 186*6*.

Present or absent

Stoppage, \$ 100 for

Due Gov't, \$ 100 for

Valuation of horse, \$ 100

Valuation of horse equipments, \$ 100

Remarks:
Mustered out by
reason of expiration
of term of service Sep.
28th 1866.

Book mark:

Hoag

(358)

Copyist.

F | 10 H. Art. | U.S.C.T.

Cyrus Lucas

Private, Co. B, 10 Reg't U. S. Col'd H. Art.

Appears on an

Individual Muster-out Roll

of the organization named above. Roll dated

New Orleans La, Sept 28, 1866.

Muster-out to date Sept 28, 1866.

Last paid to June 30, 1866.

Clothing account:

Last settled _____, 1866; drawn since \$ _____ 100

Due soldier \$ 14 ⁰⁵/₁₀₀; due U. S. \$ _____ 100

Am't for cloth'g in kind or money adv'd \$ _____ 100

Due U. S. for arms, equipments, &c., \$ _____ 100

Bounty paid \$ none 100 due \$ 100 100

Remarks: Joined as Musician at
org. Organ of 88th U. S. Inftry
Transferred to 75th U. S. Inftry per S.O.
No 209. Dept of the Gulf series 1864
Transferred to 10 U. S. Art
(by) per S.O. No 105 Ser. 12
over

Book mark: _____

M. A. Michaels

JAN. 15

5489333

1831

Series 1865. Dept of La.
Mustered out by reason
of expiration of term of
Service to date Sept. 28-1866

Cyrus Lucas

Pvt., Co. *B*, 10 Reg't U. S. Col'd H. Art'y.

Appears on Co. Muster-out Roll, dated
Baton Rouge, La., Feb., 1867.

Muster-out to date _____, 186 .

Last paid to _____, 186 .

Clothing account:

Last settled _____, 186 ; drawn since \$ _____ 100

Due soldier \$ _____ 100; due U. S. \$ _____ 100

Am't for cloth'g in kind or money adv'd \$ _____ 100

Due U. S. for arms, equipments, &c., \$ _____ 100

Bounty paid \$ _____ 100; due \$ _____ 100

Remarks:

*Joined by transfer
from 75 - U.S. C. I. S. O.
105 Reg. Ins. Dept of Sol.
series 1865. Discharge
Sept. 28/66 expiration term
of service.*

Book mark: *1055 1878*

Hodges

Weston, Emma
Co. I, 10 U.S. Col'd H. Art'y.

Private | *Private*

CARD NUMBERS.

1		26	
2	<i>J. Forestel</i>	27	<i>Emma</i>
3		28	
4		29	
5		30	
6		31	
7		32	
8		33	
9		34	
10		35	
11		36	
12		37	
13		38	
14		39	
15		40	
16		41	
17		42	
18		43	
19		44	
20		45	
21		46	
22		47	
23		48	
24		49	
25		50	

Book Mark:

See also *Col. 74" 49 9*

Foley, Louis

Co. D. 10 U.S. Col'd H. Art'y.

Private

Private

CARD NUMBERS.

1	52788654	26
2	5501257	27
3	5501405	28
4	5501616	29
5	5502245	30
6	5489792	31
7		32
8		33
9		34
10		35
11		36
12		37
13		38
14		39
15		40
16		41
17		42
18		43
19		44
20		45
21		46
22		47
23		48
24		49
25		50

Book Mark:

See also

Col'd H. Art'y

F | *10 N. Art'y* | **U.S.C.T.**

Louis Foley
Pri, Co. *K*, *10* Reg't U. S. Col'd *N. Art'y*

Appears on

M. and D. Roll of Men Transferred

to the organization named above,

from *Co B, 77 Regt USC Infy*

Roll dated *Oct, 1*, 1865.

When enlisted *July 2*, 1863.

Period for which enlisted *3* years.

When mustered in *July 12*, 1863.

Present or absent *Present*

Company to which assigned *K*

Remarks: *Transferred from Co. B,*
4. Regt. C^d a. Dec. 2, 63,
Stoppage 1 Bed Sack Turpess.

Book mark :

Avery

A

10 H. Art'y.

U.S.C.T.

Lewis Foley

Pr, Co. D, 10 Reg't U. S. Col'd H. Art'y.

Appears on

Company Muster Roll

for *Sept & Oct*, 186*5*.

Present or absent *Present*

Stoppage, \$ *100* for

Due Gov't, \$ *100* for

Valuation of horse, \$ *100*

Valuation of horse equipments, \$ *100*

Remarks: *Transfd from Co. B, 77 U.S.C.I., per S O No 3 148 qrs 10 U.S.C.A. (H), Camp Parapet, La., Oct. 1/6 5. Company Cook. Due U.S. for Camp Equipage, \$2²⁵; for ordnance lost .48¢*

Book mark:

Patterson

(358)

Copyist.

F

10 H. Art'y.

U.S.C.T.

Louis Daley
Priv

, Co. D, 10 Reg't U. S. Col'd H. Art'y.

Appears on

Company Muster Roll

for *Nov & Dec*, 1865.

Present or absent *Present*

Stoppage, \$ 100 for

Due Gov't, \$ 100 for

Valuation of horse, \$ 100

Valuation of horse equipments, \$ 100

Remarks: *Daily duty as*
Co. Cook

Book mark:

W. Wayne

(358)

Copyist.

L

10 H. Art'y.

U.S.C.T.

Louis Foley

PT, Co. D, 10 Reg't U. S. Col'd H. Art'y.

Appears on

Company Muster Roll

for *Jan & Feb*, 186*6*

Present or absent

Stoppage, \$ 100 for

Due Gov't, \$ 100 for

Valuation of horse, \$ 100

Valuation of horse equipments, \$ 100

Remarks: *Discharged at New Orleans da Feb 12.66 by reason of expiration of term of service*

Book mark: *6542 P.M.G. June 28.66*

(358)

W. Sayre

Copyist.

F. 10th Art'y U.S.C.T.

Louis Foley

Pvt., Co. D, 10 Reg't U. S. Col'd Art'y

Appears on a

Detachment Muster-out Roll

of the organization named above. Roll dated

New Orleans, La., Feb. 11, 1866.

Muster-out to date *Feb. 11, 1866.*

Last paid to *June 30, 1865.*

Clothing account:

Last settled _____, 1866; drawn since \$ _____ 100

Due soldier \$ *20* ^{*85*}/_{*100*}; due U. S. \$ _____ 100

Am't for cloth'g in kind or money adv'd \$ _____ 100

Due U. S. for arms, equipments, &c., \$ *2* ^{*91*}/_{*100*}

Bounty paid \$ _____ 100 due \$ _____ 100

Remarks: *Joined at orgnl. orgn of 4th. Inf. C.D.A. (76 U.S.C.I.) Transferred to 5th. Inf. C.D.A. (77th. U.S.C.I.) Dec. 2 " 63 and transferred to 10th. U.S.C.A. (over)*

Book mark: _____

A. W. Reed

JAN. 15

5489792

TEST

A. Oct. 1st, 1865, S. O. No.
66, 65, Hd. Qrs. Dept.
of La. Stoppages!
Bed sack, 3 rapiers,
1 Ac. Driver.

F
Louis Foley
Pr, Co. *D*, 10 Reg't U. S. Col'd H. Art'y.

Appears on Co. Muster-out Roll, dated
Baton Rouge, La, Febr 22, 1867.

Muster-out to date _____, 186 .

Last paid to _____, 186 .

Clothing account:

Last settled _____, 186 ; drawn since \$ _____ 100

Due soldier \$ _____ 100; due U. S. \$ _____ 100

Am't for cloth'g in kind or money adv'd \$ _____ 100

Due U. S. for arms, equipments, &c., \$ _____ 100

Bounty paid \$ _____ 100; due \$ _____ 100

Remarks: *Joined by transfer*
from Co. D. 79 U.S. Col'd H. Art'y.
S. C. 66 Sept 24
Dis. No. 14 Feb 12/66
at expiration of service.

Book mark :

J. Leonard

807

Fontainan, Martin

Co L, 10 U.S. Col'd H. Art'y.

Private

Private

CARD NUMBERS.

1	5488235	26
2	5487734	27
3	5513451	28
4	5513601	29
5	5513728	30
6	5513850	31
7	5513944	32
8	5514005	33
9	5514070	34
10	5514184	35
11		36
12		37
13		38
14		39
15		40
16		41
17		42
18		43
19		44
20		45
21		46
22		47
23		48
24		49
25		50

Book Mark:

See also 77" U.S. Col'd H. Art'y. 19" U.S. Col'd H. Art'y.
Alay

F 106a U.S.C.T.

Martin Fontaine
1st Lt; Co L, 10 Reg't U. S. Col'd

Appears on

M. and D. Roll of Men Transferred

to the organization named above,

from *7th U.S. Col Inf*

Roll dated *Camp Parapel La Oct 1865*

When enlisted *Jan 17*, 1865.

Period for which enlisted *3* years.

When mustered in *Jan 31*, 1865.

Present or absent *Present*

Company to which assigned *L*.

Remarks: *Joined as Recruit*

Joined by transfer

from Co C, 7th U.S. Col Inf,

per S.O. 66, C.S. Hdqrs

Dept of La.

Book mark :

W. H. Scott

(342)

Copyist.

F 1026A, U.S.C.T.

Martin Fontaine
Sgt, Co. *D*, 10 Reg't U. S. Col'd *10th*

Appears on

M. and D. Roll of Men Transferred

to the organization named above,

from *Co C 1st U. S. Col Inf*

Roll dated *Camp Campersa Cal*, 186*5*.

When enlisted *Jan 17*, 186*5*.

Period for which enlisted *3* years.

When mustered in *Jan 31*, 186*5*.

Present or absent *Present*

Company to which assigned *D*

Remarks: *Good as received*

Book mark :

W. H. Scott

F | 10 H. Art'y. | U.S.C.T.

Martin Fontaineau

Priv, Co. *L*, 10 Reg't U. S. Col'd H. Art'y.

Age years.

Appears on

Company Muster Roll*

for *Sept, & Oct*, 1865:

Joined for duty and enrolled:

When *Jan. 17*, 1865:

Where *New Orleans*

Period *3* years.

Mustered in:

When *Jan, 31*, 1865:

Where *New Orleans*

Present or absent *Present*

Stoppage, \$ *100* for

Due Gov't, \$ *100* for

Valuation of horse, \$ *100*

Valuation of horse equipments, \$ *100*

Remarks: *Transferred from Co. C.*

77 U.S.C.A.

*First current roll. No muster-in roll of this company on file.

Book mark:

Scherich

J

10 H. Art'y. U.S.C.T.

Martin Fontaine

Co., Co. L, 10 Reg't U. S. Col'd H. Art'y.

Appears on

Company Muster Roll

for *Nov. + Dec.*, 186*5*.

Present or absent *Present*

Stoppage, \$ *100* for

Due Gov't, \$ *100* for

Valuation of horse, \$ *100*

Valuation of horse equipments, \$ *100*

Remarks:

Book mark:

Scherich

F

10 H. Art'y. U.S.C.T.

Martin Fontana

Co, Co. L, 10 Reg't U. S. Col'd H. Art'y.

Appears on

Company Muster Roll

for *Jan & Feb*, 1866.

Present or absent *Present*

Stoppage, \$ *100* for

Due Gov't, \$ *100* for

Valuation of horse, \$ *100*

Valuation of horse equipments, \$ *100*

Remarks:

Book mark:

Scherich

(358)

Copyist.

F

10 H. Art'y. U.S.C.T.

Martin Fontanau

Priv., Co. L, 10 Reg't U. S. Col'd H. Art'y.

Appears on

Company Muster Roll

for *March & April*, 1866.

Present or absent *Present*

Stoppage, \$ *100* for

Due Gov't, \$ *100* for

Valuation of horse, \$ *100*

Valuation of horse equipments, \$ *100*

Remarks: *Stop one Mosquito net
lost \$1.80.*

Book mark:

Scherich

F 10 H. City, U.S.C.T.

Martin Fontanar
Priv., Co. D, 10 Reg't U. S. Col'd H. City,

Appears on

Company Muster Roll

for May & June, 1866

Present or absent Present

Stoppage, \$ 100 for

Due Gov't, \$ 100 for

Valuation of horse, \$ 100

Valuation of horse equipments, \$ 100

Remarks:

Book mark:

Scherich

J. | 10 H. Art'y. | U.S.C.T.

Martin Fontanian

Pvt., Co. L, 10 Reg't U. S. Col'd H. Art'y.

Appears on

Company Muster Roll

for *July & Aug*, 186*6*.

Present or absent *Present*

Stoppage, \$ *100* for

Due Gov't, \$ *100* for

Valuation of horse, \$ *100*

Valuation of horse equipments, \$ *100*

Remarks:

Book mark:

Burnham

F

10 H. Art'y. U.S.C.T.

Martin Fontainan

Priv, Co. L, 10 Reg't U. S. Col'd H. Art'y.

Appears on

Company Muster Roll

for *Sept & Oct*, 1866.

Present or absent

Stoppage, \$ 100 for

Due Gov't, \$ 100 for

Valuation of horse, \$ 100

Valuation of horse equipments, \$ 100

Remarks: *Discharged by order Sept 8/66 having been listed in the Regulars Army*

Book mark:

Burnham

(358)

Copyist.

I. | 10 H. Art'y. | U.S.C.T.

Martin Farnham
Pvt., Co. L., 10 Reg't U. S. Col'd H. Art'y.

Appears on **Co. Muster-out Roll**, dated
Bolen Rouge La Feb 22, 1867.

Muster-out to date 186 .

Last paid to 186 .

Clothing account:

Last settled 186 ; drawn since \$ 100

Due soldier \$ 100 ; due U. S. \$ 100

Am't for cloth'g in kind or money adv'd \$ 100

Due U. S. for arms, equipments, &c., \$ 100

Bounty paid \$ 100 ; due \$ 100

Remarks: *Joined by transfer from
Co E 77 U.S.C.I. Co A/65 S.O. 66 N^o
yrs Dept of La Sept 22/65 Disch'd
to enable him to enlist in 94^s
Cavalry*

Book mark :

(361)

Burnham

Copyist.

Fontainan Napoleon

Co L., 10 U.S. Col'd H. Art'y

Private

Private

CARD NUMBERS.

1	5487735	26
2	5488236	27
3	5513450	28
4	5513600	29
5	5513727	30
6	5513849	31
7	5513949	32
8	5514006	33
9	5514069	34
10	5514183	35
11		36
12		37
13		38
14		39
15		40
16		41
17		42
18		43
19		44
20		45
21		46
22		47
23		48
24		49
25		50

Book Mark:

See also

Co C. 77 up & down
9" up & down

F 1026A U.S.C.T.

Napoleon Fontaine
Reg't, *10* Reg't U. S. Col'd *1026A*

Appears on

M. and D. Roll of Men Transferred

to the organization named above,

from *77 U.S. Col Inf*

Roll dated *Camp Parapet LaCoe*, 186*5*.

When enlisted *Jan 12*, 186*5*.

Period for which enlisted *3* years.

When mustered in *Jan 31*, 186*5*.

Present or absent *Present*

Company to which assigned *D*

Remarks: *Joined as recruit
formed by transfer from
Co. C. 77 U.S. C. I. for
S. 116 C. S. Hd Qrs
Dept of La*

Book mark :

W. H. Scott

(342)

Copyist.

J. 10 H.A. U.S.C.T.

Nepoleon Fontaine
Obt, *Co A*, *10* Reg't U. S. Col'd *H.A.*

Appears on

M. and D. Roll of Men Transferred

to the organization named above,

from *Co C 1st U.S. Col Inf*

Roll dated *Camp Parapetda Oct 1*, 186*5*.

When enlisted *Jan 13*, 186*5*.

Period for which enlisted *3* years.

When mustered in *Jan 31*, 186*5*.

Present or absent *Present*

Company to which assigned *D*

Remarks: *Good recruit*

Book mark :

W. H. Scott

F

10 H. Art'y.

U.S.C.T.

Napoleon Fontaineau

Co. L, 10 Reg't U. S. Col'd H. Art'y.

Age _____ years.

Appears on

Company Muster Roll*

for *Sept. & Oct.*, 1865.

Joined for duty and enrolled:

When *Jan. 12*, 1865.

Where *New Orleans*

Period *3* years.

Mustered in:

When *Jan. 31*, 1865.

Where *New Orleans*

Present or absent *Present*

Stoppage, \$ 100 for _____

Due Gov't, \$ 100 for _____

Valuation of horse, \$ 100

Valuation of horse equipments, \$ 100

Remarks: *Transfd. from Co. C*

*7th U.S. Col. Stop for loss of Certificate
902*

*First current roll. No muster-in roll of this company on file.

Book mark : _____

Scherich

(3586)

Copyright.

J | 10 H. Art'y. | U.S.C.T.

Napoleon Fontaine

Privat

, Co. L, 10 Reg't U. S. Col'd H. Art'y.

Appears on

Company Muster Roll

for *Nov. & Dec.*, 1865.

Present or absent *Present*

Stoppage, \$ *100* for

Due Gov't, \$ *100* for

Valuation of horse, \$ *100*

Valuation of horse equipments, \$ *100*

Remarks: *Stop for 1 Centen 90c*

Book mark:

Scherich

(358)

Copyist.

F | 10 H. Art'y. | U.S.C.T.

Napoleon Fontana
Bot, Co. L, 10 Reg't U. S. Col'd H. Art'y.

Appears on

Company Muster Roll

for *Jan. & Feb.*, 186*6*

Present or absent *Present*

Stoppage, \$ *100* for

Due Gov't, \$ *100* for

Valuation of horse, \$ *100*

Valuation of horse equipments, \$ *100*

Remarks:

Book mark: -----

Scherish

(358)

Copyist.

F

10 H. Art'y. U.S.C.T.

Napoleon Fontana

Cvt, Co. L, 10 Reg't U. S. Col'd H. Art'y.

Appears on

Company Muster Roll

for *Mch. & Apl.*, 1866.

Present or absent *Present*

Stoppage, \$ 100 for

Due Gov't, \$ 100 for

Valuation of horse, \$ 100

Valuation of horse equipments, \$ 100

Remarks:

Book mark:

Scherich

F. W. Harty | U.S.C.T.

Napoleon Fontaman
Priv., Co *L*, 10 Reg't U. S. Col'd *H. Harty*.

Appears on

Company Muster Roll

for *May & June*, 186*6*.

Present or absent *Present*

Stoppage, \$ *100* for

Due Gov't, \$ *100* for

Valuation of horse, \$ *100*

Valuation of horse equipments, \$ *100*

Remarks:

Book mark:

Scherich

J.

10 H. Art'y. U.S.C.T.

Napoleon Fontanian

Pat., Co. L, 10 Reg't U. S. Col'd H. Art'y.

Appears on

Company Muster Roll

for *July & Aug*, 186*6*.

Present or absent *Present*

Stoppage, \$ 100 for

Due Gov't, \$ 100 for

Valuation of horse, \$ 100

Valuation of horse equipments, \$ 100

Remarks: _____

Book mark: _____

Burnham

(358)

Copyist.

J.

10 H. Art'y. U.S.C.T.

Napoleon Fontainau

Pvt., Co. L, 10 Reg't U. S. Col'd H. Art'y.

Appears on

Company Muster Roll

for *Sept & Oct*, 1866.

Present or absent

Stoppage, \$ 100 for

Due Gov't, \$ 100 for

Valuation of horse, \$ 100

Valuation of horse equipments, \$ 100

Remarks: *Discharged by order
Sept 8/66 having enlisted in
the Regular Army*

Book mark:

Burnham

(358)

Copyist.

J

10 H. Art'y.

U.S.C.T.

Napoleon Fontauan
P Co L, 10 Reg't U. S. Col'd H. Art'y.

Appears on Co. Muster-out Roll, dated
Balon Reuze La Feb 22, 1867.

Muster-out to date 186 .

Last paid to 186 .

Clothing account:

Last settled 186 ; drawn since \$ 100

Due soldier \$ 100 ; due U. S. \$ 100

Am't for cloth'g in kind or money adv'd \$ 100

Due U. S. for arms, equipments, &c., \$ 100

Bounty paid \$ 100 ; due \$ 100

Remarks: Joined by transfer from
Co E 77 USC Oct 1/65 SB 6640
goe Dept of La left 22/65 disch'd
to Enable him to Enlist in 9 U.S.
Cavetry

Book mark :

Burnham

(361)

Copyist.

001
Fonteneau Henry
Co, 10 U.S. Col'd H. Art'y

Private | Private

CARD NUMBERS.

1	5487591	26
2		27
3		28
4		29
5		30
6		31
7		32
8		33
9		34
10		35
11		36
12		37
13		38
14		39
15		40
16		41
17		42
18		43
19		44
20		45
21		46
22		47
23		48
24		49
25		50

Book Mark:

See also 77 U.S. 6 Inf

F 1026, A U.S.C.T.

Henry Fonteneau
Pot, Co., 10 Reg't U. S. Col'd *Hd.*

Appears on

M. and D. Roll of Men Transferred

to the organization named above,

from *C. G. 24 U. S. Col Inf*

Roll dated *Camp Braxton Va*, 1865.

When enlisted *May 16*, 1864.

Period for which enlisted *3* years.

When mustered in *May 20*, 1864.

Present or absent

Company to which assigned

Remarks: *Discharged at Ft
St Philip da Cuba by
Disability Amulst
given,*

*name not taken up on
muster rolls of Regt*

Book mark : *293100*

Wm Scott

Footman. Amos

Co . . . , **10 U.S. Col'd H. Art'y.**

Private

Private

CARD NUMBERS.

1	<i>5487885</i>	26
2		27
3		28
4		29
5		30
6		31
7		32
8		33
9		34
10		35
11		36
12		37
13		38
14		39
15		40
16		41
17		42
18		43
19		44
20		45
21		46
22		47
23		48
24		49
25		50

Book Mark:

See also *77 U.S. Co Inf*

F 10 Ha U.S.C.T.

Amos Footman
Co., Co., 10 Reg't U. S. Col'd Ha

Appears on

M. and D. Roll of Men Transferred

to the organization named above,

from 47 U. S. Col Inf

Roll dated Camp Anapetla Cal, 1864.

When enlisted May 6, 1864.

Period for which enlisted 3 years.

When mustered in May 13, 1864.

Present or absent

Company to which assigned

Remarks: Died Mch 26. 64
at Cd A U. S. Gen Hospital
New Orleans La
Small Port

name not taken up on
muster rolls of Regt

Book mark :

Wm Scott

041

Ford, Augustus

Co M., 10 U.S. Col'd H. Art'y.

Private

Private

CARD NUMBERS.

1	5487976	26
2	5288939	27
3	5288832	28
4	58-14319	29
5	5-5-14474	30
6	5-5-14788	31
7	5-5-15-240	32
8	5489732	33
9	9123652	34
10		35
11		36
12		37
13		38
14		39
15		40
16		41
17		42
18		43
19		44
20		45
21		46
22		47
23		48
24		49
25		50

Book Mark:

See also

77. use sup

P. 726038 P. m. t. m

P. 547560

51776882 P. m. t. m

P. 611757

W. H. H. K. & Co.

F | 10 H. Art'y. | U. S. C. T.

Augustus Ford

Co. M, 10 Reg't U. S. Col'd H. Art'y.

Appears on

Company Descriptive Book

of the organization named above.

DESCRIPTION.

Age *37* years; height *5* feet *8* inches.

Complexion *Dark*

Eyes *Brown*; hair *Black*

Where born *Johnson N. C.*

Occupation *Labourer*

ENLISTMENT.

When *Jan 31*, 1863.

Where *New Orleans La*

By whom *St Drew*; term *3* y'rs.

Remarks *Recd by transfer from
Co A 17 W.B.C.I for Sg. 66
Hed Pra Dept La Sept 22, 65.
Discharged and honorably
mustered out of Service
Feby 10, 1866 by reason
of expiration of term of
service*

W. H. Calloway

(383g)

Copyist.

F 106a

U.S.C.T.

Augustus Ford
Co. M, 10 Reg't U. S. Col'd Ala

Appears on

M. and D. Roll of Men Transferred

to the organization named above,

from *174 U.S. Col Inf*

Roll dated *Camp Rapids La Oct 1, 1864*

When enlisted *Jan 31*, 186 *3*

Period for which enlisted *3* years.

When mustered in *Feb 10*, 186 *3*

Present or absent

Company to which assigned *M*

Remarks: *Joined at Big Spring*
of Co. M, 4th "Ed. A. Co."
Detached Service in
St James Parish La,
Since Aug 29. 65, Rec'd
by transfer from Co
174 U.S. C. I. per S.O.
66 Dept La Sept 22. 65

Book mark :

Wm Scott

L | 10 H. Art'y. | **U.S.C.T.**

Augustus Ford
Capt., Co M, 10 Reg't U. S. Col'd H. Art'y.

Appears on

M. and D. Roll of Men Transferred

to the organization named above,

from *77th U. S. Col'd Inf'ty*

Roll dated *Oct. 1*, 1863.

When enlisted *Jan. 31*, 1863.

Period for which enlisted *3* years.

When mustered in *Feb. 10*, 1863.

Present or absent *Absent.*

Company to which assigned *M.*

Remarks: *Joined at orig. orgn.
Co "A", 4th Cd 'a. On
detached service St. James
Par. La. since Aug. 20/65.*

Book mark: *V. 5 2, P. 51. 69,*

(342)

Castling

Copyist.

F. | 10th Co. Arty | U.S.C.T.

Augustus Ford.

Pvt, Co. H, 10 Reg't U. S. Col'd Arty

Appears on

M. and D. Roll of Men Transferred

to the organization named above,

from 77th U. S. Col'd Inf.

Roll dated Oct. 6, 1865.

When enlisted Jan. 31, 1863.

Period for which enlisted 3 years.

When mustered in Feb. 10, 1863.

Present or absent Absent

Company to which assigned M

Remarks: Joined at org'l org'n

Co. A. 4th Bid A. On detached

Serv. St James Par. Ga.

since Aug. 20/65.

Book mark :

Chandler

7

10 H. Art'y.

U.S.C.T.

Augustus Ford

D, Co. *M*, 10 Reg't U. S. Col'd H. Art'y.

Age _____ years.

Appears on

Company Muster Roll*

for *Sept - Oct*, 186*3*.

Joined for duty and enrolled:

When *Jan 3*, 186*3*

Where *N Orleans La*

Period *3* years.

Mustered in:

When *Feb 3*, 186*3*

Where *N Orleans*

Present or absent *Present*

Stoppage, \$ 100 for _____

Due Gov't, \$ 100 for _____

Valuation of horse, \$ 100

Valuation of horse equipments, \$ 100

Remarks : _____

*First current roll. No muster-in roll of this company on file.

Book mark : _____

(3586)

W. H. Wright

Copyist.

Augustus Ford

P, Co. M, 10 Reg't U. S. Col'd H. Art'y.

Appears on

Company Muster Roll

for *Nov Dec*, 1865.

Present or absent *Present*

Stoppage, \$ *100* for

Due Gov't, \$ *100* for

Valuation of horse, \$ *100*

Valuation of horse equipments, \$ *100*

Remarks:

Book mark:

L. H. Wright

F | 10 H. Art'y. | U. S. C. T.

Augustus Ford

9, Co. M, 10 Reg't U. S. Col'd H. Art'y.

Appears on

Company Muster Roll

for *Jan 1st*, 186*1*.

Present or absent

Stoppage, \$ *100* for

Due Gov't, \$ *100* for

Valuation of horse, \$ *100*

Valuation of horse equipments, \$ *100*

Remarks: *Disch'd Feb 11th 61
at New Orleans La by
reason of expiration
of term of service*

Book mark:

(358)

A. H. Wright

Copyist.

F

10 H. Art'y. U.S.C.T.

Augustus Ford

Sgt., Co. M., 10 Reg't U. S. Col'd H. Art'y.

Appears on Co. Muster-out Roll, dated

Baton Rouge La, Feb 22, 1867.

Muster-out to date _____, 186 .

Last paid to _____, 186 .

Clothing account:

Last settled _____, 186 ; drawn since \$ _____ 100

Due soldier \$ _____ 100; due U. S. \$ _____ 100

Am't for cloth'g in kind or money adv'd \$ _____ 100

Due U. S. for arms, equipments, &c., \$ _____ 100

Bounty paid \$ _____ 100; due \$ _____ 100

Remarks: joined by brass from Co. A
77th S. I. Co. 5th Regt 66 21st Regt
La Sep 22/65 as Pvt. Disch'd
by reason of Exp. of term of
Service Feb 10/66.

Book mark: V. 82: P 51: 69

Rector

(361)

Copyist.

F. ¹⁰ Hy Arty U.S.C.T.

Augustus Ford.

Pvt, Co. M, 10 Reg't U. S. Col'd Arty

Appears on a

Detachment Muster-out Roll

of the organization named above. Roll dated

New Orleans La Feb 10, 1866.

Muster-out to date Feb 10, 1866.

Last paid to Feb 28, 1865

Clothing account:

Last settled 186 ; drawn since \$ 100

Due soldier \$ 46 ³⁸ / 100; due U. S. \$ 100

Am't for cloth'g in kind or money adv'd \$ 100

Due U. S. for arms, equipments, &c., \$ 100

Bounty paid \$ 100 due \$ ¹² / 100

Remarks: Joined by transfer from 77th U. S. C. I. Oct 1st 65 per S. O. No. 66, 65 Hd. Qrs. Dept. of La. Stop for two G. C. Straps.

Book mark:

H. M. Reed

892
Ford. *Harrison*

Co , 10 U.S. Col'd H. Art'y

Private | *Private*

CARD NUMBERS.

1	5487592	26
2		27
3		28
4		29
5		30
6		31
7		32
8		33
9		34
10		35
11		36
12		37
13		38
14		39
15		40
16		41
17		42
18		43
19		44
20		45
21		46
22		47
23		48
24		49
25		50

Book Mark:

See also 77 U.S.C. Sup

F. H. A. U.S.C.T.

Harrison Ford
Co., Co., 10 Reg't U. S. Col'd H.A.

Appears on

M. and D. Roll of Men Transferred

to the organization named above,

from Co., 10 Reg't U. S. Col'd Inf

Roll dated Camp Parapetda Oct 1, 1865.

When enlisted Jan 5, 1865.

Period for which enlisted 3 years.

When mustered in Jan 17, 1865.

Present or absent

Company to which assigned

Remarks: Discharged at
New Orleans La Aug 7 65
Disab'd. Amal st given

Name not taken up on
muster rolls of Reg't

Book mark :

W. H. Scott

Ford. March

Co a. , **10 U.S. Col'd H. Art'y.**

Private

Private

CARD NUMBERS.

1	5487297	26
2	5492393	27
3	5492516	28
4	5492641	29
5	5492768	30
6	5493077	31
7	5494123	32
8		33
9		34
10		35
11		36
12		37
13		38
14		39
15		40
16		41
17		42
18		43
19		44
20		45
21		46
22		47
23		48
24		49
25		50

Book Mark:

See also

Al. 1694237

Wm. H. K. K.

F | 10 H. Art'y. | U.S.C.T.

March Ford

Appears with rank of *Put* on

Muster and Descriptive Roll of a Detachment of U. S. Vols. forwarded

for the *10* Reg't *U.S.C. H. Art'y* Roll dated
New Orleans, La., Apl. 10, 1865.

Where born *Marion Co., Miss*

Age *22* y'rs; occupation *Labourer*

When enlisted *Mar 21*, 1865.

Where enlisted *New Orleans*

For what period enlisted *3* years.

Eyes *blk.*; hair *blk.*

Complexion *blk.*; height *5* ft. *5* in.

When mustered in *Apl. 10*, 1865.

Where mustered in *New Orleans*

Bounty paid \$ *100* ¹⁰⁰; due \$ *200* ¹⁰⁰

Where credited *1st Dist. 4th Ward, New Orleans, La.*

Company to which assigned

Remarks: *Entitled to the bounty provided by Cir.*

No. 27 Pro. Mar. Genl's. Office July 19/64.

Rec'd. \$100. advance bounty from St. John Hamilton 1st Inf.

U.S.A., Mustg. & Disbg. Offices Dept. of the Gulf.

Book mark:

Long

(339)

Copyist.

F | 10 H. Art'y. | U.S.C.T.

March Ford

Pvt, Co. A, 10 Reg't U. S. Col'd H. Art'y.

Appears on

Company Muster Roll

for *March 1865*, 1865.

Present or absent *Present*

Stoppage, \$ *100* for

Due Gov't, \$ *100* for

Valuation of horse, \$ *100*

Valuation of horse equipments, \$ *100*

Remarks: *Enlisted since last Muster*

Book mark:

Rochester

F | 10 H. Art'y. | U.S.C.T.

March Ford
Pvt, Co. A, 10 Reg't U. S. Col'd H. Art'y.

Appears on

Company Muster Roll

for *May & June*, 1865.

Present or absent *Present*

Stoppage, \$ 100 for

Due Gov't, \$ 100 for

Valuation of horse, \$ 100

Valuation of horse equipments, \$ 100

Remarks: *Enlisted since the
company was last
paid.*

Book mark:

Rockater

J | 10 H. Art'y. | U.S.C.T.

March Ford

J.F., Co. A, 10 Reg't U. S. Col'd H. Art'y.

Appears on

Company Muster Roll

for *July & Aug*, 1865.

Present or absent *Present*

Stoppage, \$ 100 for

Due Gov't, \$ 100 for

Valuation of horse, \$ 100

Valuation of horse equipments, \$ 100

Remarks: _____

Book mark: _____

Rockester

A | 10 H. Art'y. | U.S.C.T.

March Ford

Plt, Co. A, 10 Reg't U. S. Col'd H. Art'y.

Appears on

Company Muster Roll

for *Sept - Oct*, 1865.

Present or absent *Present*

Stoppage, \$ *100* for

Due Gov't, \$ *100* for

Valuation of horse, \$ *100*

Valuation of horse equipments, \$ *100*

Remarks:

Book mark:

(358)

H. J. ...

Copyist.

D | 10 H. Art'y. | U.S.C.T.

March Ford

Pl, Co. A, 10 Reg't U. S. Col'd H. Art'y.

Appears on

Company Muster Roll

for *Nov + Dec*, 1865.

Present or absent

Stoppage, \$ $\frac{100}{100}$ for

Due Gov't, \$ $6 \frac{65}{100}$ for *C. & G. E. For*

Ordinance #0.08.

Valuation of horse, \$ $\frac{100}{100}$

Valuation of horse equipments, \$ $\frac{100}{100}$

Remarks: *Dropped as Deserter*
Dec. 9. '65

Book mark:

(358)

Sty Copyist.

7

10 H. Art'y. U.S.C.T.

March Ford
Co. A, 10 Reg't U. S. Col'd H. Art'y.

Appears on Co. Muster-out Roll, dated
Naton Rouge La Feb. 22, 1867.

Muster-out to date _____, 186 .

Last paid to _____, 186 .

Clothing account:

Last settled _____, 186 ; drawn since \$ _____ 100

Due soldier \$ _____ 100; due U. S. \$ _____ 100

Am't for cloth'g in kind or money adv'd \$ _____ 100

Due U. S. for arms, equipments, &c., \$ _____ 100

Bounty paid \$ _____ 100; due \$ _____ 100

Remarks: *Joined as recruit*
Deserted Dec. 9. 65

Book mark: _____

(361)

Nesbitt
Copyist.

Jord Marsch

, Co. 10 Reg't U S P H A

/ Enclosures.

Bed Cards	Final Statements
Burial Records	Furloughs or L. of A
Certs. of Dis. for Discharge	Med. Certificates
C. M. Charges	Med. Des. Lists
Descriptive Lists	Orders
Discharge Certificates	Pris. of War Record
Enlistment Papers	Resignations

Other papers relating to—

Admission to Hosp'l	Furlough or L. of A
Casualty Sheet	Med. Examination
Confinement	Misc. Information
Contracts	Pay or Clothing
Death or Effects	Personal Reports
Desertion	Rank
Discharge from Hosp'l	Transfer to Hosp'l
Discharge from Service	Transfer to V. R. C.
Duty	Transportation

NOTE 1.—This blank will be used for both enlistments and re-enlistments—enlistment of veterans, &c., &c., in the volunteer service. They will be made out in duplicate in all cases—one to accompany the recruiting return of the superintendent (not the recruiting officer) to the Adjutant General, and one to accompany the accounts of the officer who pays bounty, &c. The Regiment and Company in which the soldier last served should be given on the back.

NOTE 2.—An enlistment holds to service. A muster-in must, in all cases, precede payment of pay, bounty, pension, &c. A muster-in roll must, in all cases, be filed in the Adjutant General's Office as evidence of muster-in. The mustering officer, commissary, or assistant commissary of musters, as the case may be, will countersign both enlistments as having mustered the soldier into the service of the United States before either of them is given to the disbursing officer.

DECLARATION OF RECRUIT.

I, Henry Bond, desiring to VOLUNTEER as a Soldier in the Army of the United States, for the term of THREE YEARS, Do Declare, That I am 22 years and _____ months of age; that I have never been discharged from the United States service on account of disability or by sentence of a court martial, or by order before the expiration of a term of enlistment; and I know of no impediment to my serving honestly and faithfully as a soldier for three years.

GIVEN at St. Louis, Mo. the 21st day of November 1865

Witness: John G. Friedman Henry Bond
11th Dist. 10th U. S. C. & A. D. mark

No. Henry Bond
 Volunteered at St. Louis, Mo.
November 21st 1865
 By Col. A. M. Walker
10th M. Regiment of U. S. C. & A. D.
 enlistment; last served in Company ()
 Regt of
 Discharged 18 ..
Transmitted to the Adjutant
General's Office
St. Louis, Mo. Jan. 19th 1866
 Received from Second Auditor
 October 7th. 1892.

CONSENT IN CASE OF MINOR.

I, _____, Do CERTIFY, That I am the _____ of _____; that the said _____ is _____ years of age; and I do hereby freely give my CONSENT to his volunteering as a SOLDIER in the ARMY OF THE UNITED STATES for the period of THREE YEARS.

GIVEN at _____ the _____ day of _____

Witness: _____

VOLUNTEER ENLISTMENT.

STATE OF

TOWN OF

Louisiana



St. Charles

I, *March Bond*, born in *Warren Co.* in the State of *Mississippi*, aged *twenty-two* years, and by occupation a *Labourer*, Do HEREBY ACKNOWLEDGE to have volunteered this *twenty-first* day of *March*, 1865, to serve as a **Soldier** in the **Army of the United States of America**, for the period of **THREE YEARS**, unless sooner discharged by proper authority: Do also agree to accept such bounty, pay, rations, and clothing, as are, or may be, established by law for volunteers. And I, *March Bond*, do solemnly swear, that I will bear true faith and allegiance to the **United States of America**, and that I will serve them honestly and faithfully against all their enemies or opposers whomsoever; and that I will observe and obey the orders of the President of the United States, and the orders of the officers appointed over me, according to the Rules and Articles of War.

Sworn and subscribed to, at *St. Charles* }
this *21st* day of *March*, 1865, }
BEFORE *James C. Friedman* }
1st Lt. 10th Reg. U.S.C.V.

I CERTIFY, ON HONOR, That I have carefully examined the above-named Volunteer, agreeably to the General Regulations of the Army, and that, in my opinion, he is free from all bodily defects and mental infirmity, which would in any way disqualify him from performing the duties of a soldier.

John B. Estabrook
EXAMINING SURGEON.

I CERTIFY, ON HONOR, That I have minutely inspected the Volunteer *March Bond* previously to his enlistment, and that he was entirely sober when enlisted; that, to the best of my judgment and belief, he is of lawful age; and that, in accepting him as duly qualified to perform the duties of an able-bodied soldier, I have strictly observed the Regulations which govern the recruiting service. This soldier has *Black* eyes, *Black* hair, *Black* complexion, is *five* feet *five* inches high.

Wm. Allister
10th Regiment of U.S.C.V. Volunteers,
RECRUITING OFFICER.

(A. G. O. No. 74 & 76.)

Mustered into the service of the United States, for three years or during the war, from date of enlistment, in Company *U.S.* 10th Regiment of U.S.C.V. Volunteers, on the *10th* day of *March*, 1865.

James H. Brown
Adj. Gen. U.S.A.
St. Charles, La.

Ford, Michael

Co a. , 10 U.S. Col'd H. Art'y.

Private

Private

CARD NUMBERS.

1	5487298	26
2	5492394	27
3	5492517	28
4	5492643	29
5	5492709	30
6	5493079	31
7	5494124	32
8		33
9		34
10		35
11		36
12		37
13		38
14		39
15		40
16		41
17		42
18		43
19		44
20		45
21		46
22		47
23		48
24		49
25		50

Book Mark:

See also

F | 10 H. Art'y. | U.S.C.T.

Michael Ford

Appears with rank of *Priv.* on

Muster and Descriptive Roll of a Detachment of U. S. Vols. forwarded

for the *10* Reg't *U.S.C. H. Art'y.* Roll dated
New Orleans, La., Apl. 10, 1865.

Where born *Marion Co., Miss.*

Age *19* y'rs; occupation *Laborer*

When enlisted *March 21, 1865.*

Where enlisted *New Orleans, La.*

For what period enlisted *3* years.

Eyes *blk*; hair *blk*

Complexion *blk*; height *5 ft. 5 in.*

When mustered in *Apl. 10, 1865.*

Where mustered in *New Orleans*

Bounty paid \$ *100* ¹⁰⁰; due \$ *200* ¹⁰⁰

Where credited *1st Dist, 4th Ward, New Orleans, La.*

Company to which assigned

Remarks: *Entitled to the bounty provided by*
Cir. 27 Pro. Mar. Genl's Office July 17/64. Rec'd
\$100. advance bounty from Lt. John Hamilton, 1st Inf.
U.S.A., Mustg. + Disby. Officer Dept. of the Gulf.

Book mark:

(339)

Long
Copyist.

F | 10 H. Art'y. | U.S.C.T.

Michael Ford

Co, Co. A, 10 Reg't U. S. Col'd H. Art'y.

Appears on

Company Muster Roll

for *May 4 1865*, 1865.

Present or absent *Present*

Stoppage, \$ *100* for

Due Gov't, \$ *100* for

Valuation of horse, \$ *100*

Valuation of horse equipments, \$ *100*

Remarks: *Enlisted since last Muster*

Book mark:

R. D. Doster

7 | 10 H. Art'y. | U.S.C.T.

Michael Ford

Pvt., Co. A, 10 Reg't U. S. Col'd H. Art'y.

Appears on

Company Muster Roll

for May & June, 1865

Present or absent Present

Stoppage, \$ 100 for

Due Gov't, \$ 100 for

Valuation of horse, \$ 100

Valuation of horse equipments, \$ 100

Remarks: Enlisted since the
Company was last
paid

Book mark:

Proctor

7 | 10 H. Art'y. | U.S.C.T.

Michael Ford

Pvt., Co. A, 10 Reg't U. S. Col'd H. Art'y.

Appears on

Company Muster Roll

for July & Aug, 1865.

Present or absent Present

Stoppage, \$ 100 for

Due Gov't, \$ 100 for

Valuation of horse, \$ 100

Valuation of horse equipments, \$ 100

Remarks:

Book mark:

Reuter

(358)

Copyist.

A | 10 H. Art'y. | U.S.C.T.

Michael Ford

Plt, Co. A, 10 Reg't U. S. Col'd H. Art'y.

Appears on

Company Muster Roll

for Sept & Oct, 1865.

Present or absent Present

Stoppage, \$ 100 for

Due Gov't, \$ 100 for

Valuation of horse, \$ 100

Valuation of horse equipments, \$ 100

Remarks:

Book mark:

(358)

Hynes

Copyist.

A

10 H. Art'y. U.S.C.T.

Michael Ford

Pl, Co. A, 10 Reg't U. S. Col'd H. Art'y.

Appears on

Company Muster Roll

for *Nov + Dec*, 1865.

Present or absent

Stoppage, \$ 100 for

Due Gov't, \$ *6* ^{*62*}/_{*100*} for *Cr & E for*

Ordinance \$0.08

Valuation of horse, \$ 100

Valuation of horse equipments, \$ 100

Remarks: *Dropped as Deserter Dec 9. 65*

Book mark:

Hyn

(358)

Copyist.

F | 10 H. Art'y. | U.S.C.T.

Michael Ford

Pvt, Co. *A*, 10 Reg't U. S. Col'd H. Art'y.

Appears on **Co. Muster-out Roll**, dated
Baton Rouge La, Feb 22 1867.

Muster-out to date _____, 186 .

Last paid to _____, 186 .

Clothing account:

Last settled _____, 186 ; drawn since \$ _____ 100

Due soldier \$ _____ 100 ; due U. S. \$ _____ 100

Am't for cloth'g in kind or money adv'd \$ _____ 100

Due U. S. for arms, equipments, &c., \$ _____ 100

Bounty paid \$ _____ 100 ; due \$ _____ 100

Remarks: *Same as recruit*
Deserted Dec. 9. 65

Book mark: _____

Nesbitt

(361)

Copyist.

Ford Michael

....., Co., 10 Reg't USCHA

/ Enclosures.

Bed Cards	Final Statements
Burial Records	Furloughs or L. of A.
Certs. of Dis. for Discharge	Med. Certificates
C. M. Charges	Med. Des. Lists
Descriptive Lists	Orders
Discharge Certificates	Pris. of War Record
Enlistment Papers	Resignations

Other papers relating to—

Admission to Hosp'l	Furlough or L. of A.
Casualty Sheet	Med. Examination
Confinement	Misc. Information
Contracts	Pay or Clothing
Death or Effects	Personal Reports
Desertion	Rank
Discharge from Hosp'l	Transfer to Hosp'l
Discharge from Service	Transfer to V. R. C.
Duty	Transportation

DECLARATION OF RECRUIT.

I, Michael Bond, desiring to VOLUNTEER as a Soldier in the Army of the United States, for the term of THREE YEARS, Do Declare, That I am - 10 - years and _____ months of age; that I have never been discharged from the United States service on account of disability or by sentence of a court martial, or by order before the expiration of a term of enlistment; and I know of no impediment to my serving honestly and faithfully as a soldier for three years.

GIVEN at New Orleans La the 21st day of March 1865

Witness:

John C. Friedman Michael Bond
1st Lieut. 10th U.S.C.A. 44 mail

No. Michael Bond

Volunteered at New Orleans La

March 21st, 1865

By Capt. A. W. O. Miller

10th Regiment of U.S.C.A. 44

enlistment; last served in Company ()

Regt of _____

Discharged _____, 1865

Received in title to the Army

provided by Circular No. 27 of 1865

Co. W. 10th Regt. U.S.C.A. 44

Received from Second Auditor
October 7th. 1892.

CONSENT IN CASE OF MINOR.

I, _____, Do CERTIFY, That I am the _____ of _____; that the said _____ is _____ years of age; and I do hereby freely give my CONSENT to his volunteering as a SOLDIER in the ARMY OF THE UNITED STATES for the period of THREE YEARS.

GIVEN at _____ the _____ day of _____

Witness:

(A. G. O. No. 74 & 76.)

NOTE 1.—This blank will be used for both enlistments and re-enlistments—enlistment of veterans, &c., &c., in the volunteer service. They will be made out in duplicate in all cases—one to accompany the recruiting return of the superintendent (not the recruiting officer) to the Adjutant General, and one to accompany the accounts of the officer who pays bounty, &c. The Regiment and Company in which the soldier last served should be given on the back
NOTE 2.—An enlistment holds to service. A muster-in must, in all cases, precede payment of pay, bounty, pension, &c. A muster-in roll must, in all cases, be filed in the Adjutant General's Office as evidence of muster-in. The mustering officer, commissary, or assistant commissary of musters, as the case may be, will countersign both enlistments as having mustered the soldier into the service of the United States before either of them is given to the disbursing officer.

VOLUNTEER ENLISTMENT.

STATE OF

TOWN OF

Louisiana



New Orleans

I, *Michael Bond*, born in *Marion Co* in the State of *Mississippi*, aged *nineteen* years, and by occupation a *Laborer*, Do HEREBY ACKNOWLEDGE to have volunteered this *twenty first* day of *March*, 1865, to serve as a **Soldier** in the **Army of the United States of America**, for the period of **THREE YEARS**, unless sooner discharged by proper authority: Do also agree to accept such bounty, pay, rations, and clothing, as are, or may be, established by law for volunteers. And I, *Michael Bond*, do solemnly swear, that I will bear true faith and allegiance to the **United States of America**, and that I will serve them honestly and faithfully against all their enemies or opposers whomsoever; and that I will observe and obey the orders of the President of the United States, and the orders of the officers appointed over me, according to the Rules and Articles of War.

Sworn and subscribed to, at *New Orleans La* }
 this *21st* day of *March*, 1865, } *Michael Bond*
 BEFORE *James C. Friedman* }
J. C. F. 10th U. S. C. A. 14.

I CERTIFY, ON HONOR, That I have carefully examined the above-named Volunteer, agreeably to the General Regulations of the Army, and that, in my opinion, he is free from all bodily defects and mental infirmity, which would in any way disqualify him from performing the duties of a soldier.

W. H. H. H.
Wm. H. H. H.
 EXAMINING SURGEON.

I CERTIFY, ON HONOR, That I have minutely inspected the Volunteer *Michael Bond* previously to his enlistment, and that he was entirely sober when enlisted; that, to the best of my judgment and belief, he is of lawful age; and that, in accepting him as duly qualified to perform the duties of an able-bodied soldier, I have strictly observed the Regulations which govern the recruiting service. This soldier has *Black* eyes, *Black* hair, *Dark* complexion, is *five* feet *seven* inches high.

Wm. Allison
 Capt 10th Regiment of U. S. C. A. 14th Volunteers,
 RECRUITING OFFICER.

(A. G. O. No. 74 & 76.)

Mustered into the service of the United States, for three years or during the war, from date of enlistment, in Company *C* 10th Regiment of U. S. C. A. 14th Volunteers, on the *10* day of *March* 1865 at *New Orleans La*

James C. Friedman
James C. Friedman
James C. Friedman

Ford Samuel

Co a., 10 U.S. Col'd H. Art'y.

Private

Private

CARD NUMBERS.

1	5487299	26
2	5492395	27
3	5492518	28
4	5492642	29
5	5492770	30
6	5492899	31
7	5493141	32
8	5493349	33
9	5493425	34
10	5493556	35
11	5493690	36
12	5493798	37
13	5493857	38
14		39
15		40
16		41
17		42
18		43
19		44
20		45
21		46
22		47
23		48
24		49
25		50

Book Mark:

See also

F | 10 H. Art'y. | U.S.C.T.

Samuel Ford

Appears with rank of *Pvt.* on

Muster and Descriptive Roll of a Detachment of U. S. Vols. forwarded

for the *10* Reg't *U.S.C. H. Art'y.* Roll dated
New Orleans, La., *Apr. 10,* 1865.

Where born *Marion Co., Miss.*

Age *21* y'rs; occupation *Labourer*

When enlisted *March 21,* 1865.

Where enlisted *New Orleans*

For what period enlisted *3* years.

Eyes *blk*; hair *blk*

Complexion *blk*; height *5* ft. *5* in.

When mustered in *Apr. 10,* 1865.

Where mustered in *New Orleans*

Bounty paid \$ *100* ¹⁰⁰; due \$ *200* ¹⁰⁰

Where credited *1st Dist, 4th Ward New Orleans, Lu.*

Company to which assigned

Remarks: *Entitled to the bounty provided by Cir. No. 27 Pro. Mar. Genl's Office July 19/64. Rec'd \$100. advance bounty from Lt. John Hamilton, 1st Inf., U.S. A., Mustg. & Disbg. Officer, Dept. of the Gulf.*

Book mark:

(339)

Long

Copyist.

H | 10 H. Art'y. | U.S.C.T.

Samuel Ford
Pr, Co. A, 10 Reg't U. S. Col'd H. Art'y.

Appears on

Company Muster Roll

for *Mex & Asst*, 1865.

Present or absent *Present*

Stoppage, \$ 100 for

Due Gov't, \$ 100 for

Valuation of horse, \$ 100

Valuation of horse equipments, \$ 100

Remarks: *Enlisted since last Muster*

Book mark: _____

Bechster

(358)

Copyist.

7 | 10 H. Art'y. | U.S.C.T.

Samuel Ford

Pvt, Co. A, 10 Reg't U. S. Col'd H. Art'y.

Appears on

Company Muster Roll

for *May & June*, 186*5*.

Present or absent *Present*

Stoppage, \$ 100 for

Due Gov't, \$ 100 for

Valuation of horse, \$ 100

Valuation of horse equipments, \$ 100

Remarks: *Enlisted since the
Company was last
paid*

Book mark: _____

Cocheater

F | 10 H. Art'y. | U.S.C.T.

Samuel Ford
Priv, Co. A, 10 Reg't U. S. Col'd H. Art'y.

Appears on

Company Muster Roll

for *July & Aug*, 1865.

Present or absent. *Present*

Stoppage, \$.....100 for

Due Gov't, \$.....100 for

Valuation of horse, \$.....100

Valuation of horse equipments, \$.....100.

Remarks: *Sick in Hospital*

Book mark:

Rochester

A | 10 H. Art'y. | U.S.C.T.

Samuel Ford

Pl, Co. A, 10 Reg't U. S. Col'd H. Art'y.

Appears on

Company Muster Roll

for *Sept - Oct*, 186*5*.

Present or absent *Present*

Stoppage, \$ 100 for

Due Gov't, \$ 100 for

Valuation of horse, \$ 100

Valuation of horse equipments, \$ 100

Remarks:

Book mark:

(358)

J. Byers
Copyist.

A | 10 H. Art'y. | U.S.C.T.

Samuel Ford

Plt, Co. A, 10 Reg't U. S. Col'd H. Art'y.

Appears on

Company Muster Roll

for *Nov & Dec*, 186*5*

Present or absent *Present*

Stoppage, \$ *100* for

Due Gov't, \$ *100* for

Valuation of horse, \$ *100*

Valuation of horse equipments, \$ *100*

Remarks:

Book mark:

(358)

J. H. ...
Copyist.

A

10 H. Art'y. | U.S.C.T.

Samuel Ford

Pl, Co. A, 10 Reg't U. S. Col'd H. Art'y.

Appears on

Company Muster Roll

for *Jan & Feb*, 1866.

Present or absent *Present*

Stoppage, \$ *100* for

Due Gov't, \$ *100* for

Valuation of horse, \$ *100*

Valuation of horse equipments, \$ *100*

Remarks:

Book mark:

Hyas

(358)

Copyist.

F

10 H. Art'y.

U.S.C.T.

Samuel Ford

Pol, Co. A, 10 Reg't U. S. Col'd H. Art'y.

Appears on

Company Muster Roll

for *Mar + April*, 186*6*.

Present or absent *Present*

Stoppage, \$ *100* for

Due Gov't, \$ *100* for

Valuation of horse, \$ *100*

Valuation of horse equipments, \$ *100*

Remarks:

Book mark:

(358)

Haynes

Copyist.

A | 10 H. Art'y. | U.S.C.T.

Samuel Ford

Pt A, Co. A, 10 Reg't U. S. Col'd H. Art'y.

Appears on

Company Muster Roll

for *May & June*, 186*6*.

Present or absent *Present*

Stoppage, \$ *100* for

Due Gov't, \$ *100* for

Valuation of horse, \$ *100*

Valuation of horse equipments, \$ *100*

Remarks:

Book mark:

(358)

H. Lynn
Copyist.

A

10 H. Art'y. U.S.C.T.

Samuel Ford

Pol, Co. A, 10 Reg't U. S. Col'd H. Art'y.

Appears on

Company Muster Roll

for July + Aug, 1864

Present or absent Present

Stoppage, \$ 100 for

Due Gov't, \$ 100 for

Valuation of horse, \$ 100

Valuation of horse equipments, \$ 100

Remarks:

[Empty lines for remarks]

Book mark:

[Empty line for book mark]

(358)

[Signature] Copyist.

F | 10 H. Art'y. | U.S.C.T.

Samuel Ford

Pvt, Co. A, 10 Reg't U. S. Col'd H. Art'y.

Appears on

Company Muster Roll

for *Sept + Oct*, 186*6*.

Present or absent *Present*

Stoppage, \$ *100* for

Due Gov't, \$ *100* for

Valuation of horse, \$ *100*

Valuation of horse equipments, \$ *100*

Remarks:

Book mark:

Nesbitt

(358)

Copyist.

P

10 H. Art'y. U.S.C.T.

Samuel Ford

Pvt, Co. A, 10 Reg't U. S. Col'd H. Art'y.

Appears on

Company Muster Roll

for *Nov & Dec*, 1866.

Present or absent *Present*

Stoppage, \$ *100* for

Due Gov't, \$ *100* for

Valuation of horse, \$ *100*

Valuation of horse equipments, \$ *100*

Remarks:

Book mark:

Nesbitt

(358)

Copyist.

7

10 H. Art'y. U.S.C.T.

Samuel Ford

Cvt., Co. A, 10 Reg't U. S. Col'd H. Art'y.

Appears on Co. Muster-out Roll, dated

Baton Rouge La, Feb. 22, 1867.

Muster-out to date Feb. 22, 1867.

Last paid to Dec. 31, 1866.

Clothing account:

Last settled _____, 186 ; drawn since \$ _____ 100

Due soldier \$ 56 ⁰⁴/₁₀₀; due U. S. \$ _____ 100

Am't for cloth'g in kind or money adv'd \$ _____ 100

Due U. S. for arms, equipments, &c., \$ _____ 100 ^{Under G.O. 151 6 00}

Bounty paid \$ 100 ⁰⁰/₁₀₀; due \$ 100 ⁰⁰/₁₀₀

Remarks: Joined as recruit

Book mark : _____

Nesbitt

(361)

Copyist.

Ford Samuel

Co.

10

Reg't

U.S. C.H.A.

Enclosures.

Bed Cards	Final Statements
Burial Records	Furloughs or L. of A.
Certs. of Dis. for Discharge	Med. Certificates
C. M. Charges	Med. Des. Lists
Descriptive Lists	Orders
Discharge Certificates	Pris. of War Record
Enlistment Papers	Resignations

Other papers relating to—

Admission to Hosp'l	Furlough or L. of A.
Casualty Sheet	Med. Examination
Confinement	Misc. Information
Contracts	Pay or Clothing
Death or Effects	Personal Reports
Desertion	Rank
Discharge from Hosp'l	Transfer to Hosp'l
Discharge from Service	Transfer to V. R. C.
Duty	Transportation

NOTE 1.—This blank will be used for both enlistments and re-enlistments—enlistment of veterans, &c., &c., in the volunteer service. They will be made out in duplicate in all cases—one to accompany the recruiting return of the superintendent (not the recruiting officer) to the Adjutant General, and one to accompany the accounts of the officer who pays bounty, &c. The Regiment and Company in which the soldier last served should be given on the back.

NOTE 2.—An enlistment holds to service. A muster-in must, in all cases, precede payment of pay, bounty, pension, &c. A muster-in roll must, in all cases, be filed in the Adjutant General's Office as evidence of muster-in. The mustering officer, commissary, or assistant commissary of musters, as the case may be, will countersign both enlistments as having mustered the soldier into the service of the United States before either of them is given to the disbursing officer.

DECLARATION OF RECRUIT.

I, Samuel Ford, desiring to VOLUNTEER as a Soldier in the Army of the United States, for the term of THREE YEARS, Do Declare, That I am — 21 — years and _____ months of age; that I have never been discharged from the United States service on account of disability or by sentence of a court martial, or by order before the expiration of a term of enlistment; and I know of no impediment to my serving honestly and faithfully as a soldier for three years.

GIVEN at New Orleans, La the 21st day of March 1865

Witness:

John W. Dickinson
Major 10th U. S. C. A. Regt.

Samuel Ford
 mark

No. _____

Samuel Ford

Volunteered at New Orleans, La

March 21st, 1865.

By Capt. A. W. McAlister

10th Regt. of U. S. C. A. Regt.

enlistment; last served in Company ()

Reg't of _____

Discharged _____, 18 _____

Remitted to the Secretary
of War, 27th Decr
1865. Gen. J. G. Foster

Received from Second Auditor
 October 7th, 1892.

CONSENT IN CASE OF MINOR.

I, _____, Do CERTIFY, That I am the _____ of _____; that the said _____ is _____ years of age; and I do hereby freely give my CONSENT to his volunteering as a SOLDIER in the ARMY OF THE UNITED STATES for the period of THREE YEARS.

GIVEN at _____ the _____ day of _____

Witness:

VOLUNTEER ENLISTMENT.

STATE OF

TOWN OF

Louisiana



New Orleans

I, *Samuel Bond*, born in *Warren Co* in the State of *Mississippi*, aged *Twentyfour* years, and by occupation a *Laborer*, Do HEREBY ACKNOWLEDGE to have volunteered this *Twentyfirst* day of *March*, 1865, to serve as a **Soldier** in the **Army of the United States of America**, for the period of **THREE YEARS**, unless sooner discharged by proper authority: Do also agree to accept such bounty, pay, rations, and clothing, as are, or may be, established by law for volunteers. And I, *Samuel Bond*, do solemnly swear, that I will bear true faith and allegiance to the **United States of America**, and that I will serve them honestly and faithfully against all their enemies or opposers whomsoever; and that I will observe and obey the orders of the President of the United States, and the orders of the officers appointed over me, according to the Rules and Articles of War.

Sworn and subscribed to, at *New Orleans La* this *21st* day of *March*, 1865, BEFORE *John Geo. Birden* *1st Lieut. 11th U. S. C. A. N.Y.* } *Samuel Bond* *(in presence)*

I CERTIFY, ON HONOR, That I have carefully examined the above-named Volunteer, agreeably to the General Regulations of the Army, and that, in my opinion, he is free from all bodily defects and mental infirmity, which would in any way disqualify him from performing the duties of a soldier.

J. M. Curtis
John W. Astor
EXAMINING SURGEON.

I CERTIFY, ON HONOR, That I have minutely inspected the Volunteer *Samuel Bond* previously to his enlistment, and that he was entirely sober when enlisted; that, to the best of my judgment and belief, he is of lawful age; and that, in accepting him as duly qualified to perform the duties of an able-bodied soldier, I have strictly observed the Regulations which govern the recruiting service. This soldier has *Black* eyes, *Black* hair, *Black* complexion, is *five* feet *five* inches high.

W. M. Atwater
Capt. *10th* Regiment of *U. S. C. A. N.Y.* Volunteers,
RECRUITING OFFICER.

(A. G. O. No. 74 & 76.)

Mustered into the service of the United States, for three years or during the war, from date of enlistment, in Company *A*, *10th* Regiment of *U. S. C. A. N.Y.* Volunteers, on the *10th* day of *March*, 1865, at *New Orleans La*.

John W. Astor
2nd Lieut. 10th Regt. U. S. C. A. N.Y.
John W. Astor

Foreman, William

Co M., 10 U.S. Col'd H. Art'y

Private

Private

CARD NUMBERS.

1	5487977	26
2	5488833	27
3	5488940	28
4	5514320	29
5	5514473	30
6	5514709	31
7	5514839	32
8	5514950	33
9	5515015	34
10	5515073	35
11	5515132	36
12	5515179	37
13	9123653	38
14		39
15		40
16		41
17		42
18		43
19		44
20		45
21		46
22		47
23		48
24		49
25		50

Book Mark:

See also

77 "use sup"

F | 10 H. Art'y. | U. S. C. T.

William Foreman

....., Co. *M*, 10 Reg't U. S. Col'd H. Art'y.

Appears on

Company Descriptive Book

of the organization named above.

DESCRIPTION.

Age *18* years; height *5* feet *4* inches.

Complexion *Dark*

Eyes *Black*; hair *Black*

Where born *New Orleans La.*

Occupation *Laborer*

ENLISTMENT.

When *July 18*....., 1865.

Where *New Orleans La*

By whom *Cpt McAllister*; term *3* y'rs.

Remarks: *Rec'd by transfer from
Co A 77th U.S. Col'd H. Art'y
66th Hd Qrs Dept La
Sept 22 1865*

W. M. Ashburn

F 1086a

U.S.C.T.

William Foreman
Pot, Co. M, 10 Reg't U. S. Col'd HA

Appears on

M. and D. Roll of Men Transferred

to the organization named above,

from 77 U. S. Col Inf

Roll dated Camp Parapet La Oet 1, 1865

When enlisted Feb 18, 1865

Period for which enlisted 3 years.

When mustered in March 8, 1865

Present or absent

Company to which assigned M

Remarks: joined as recruit
Lost screw driver wiper
Bugle & letter, Rec'd
by transfer from Co. H 77
U. S. C. I. For S. O. 66,
Sept da. Sept 22. 65

Book mark :

Wear Scott

(342)

Copyst.

F 1106 Artz | U.S.C.T.

William Foreman
Priv., Co. M, 10 Reg't U. S. Col'd Artz

Appears on

M. and D. Roll of Men Transferred

to the organization named above,

from 77 U. S. Col'd Inf.

Roll dated Oct. 1, 1865.

When enlisted Feb. 18, 1865.

Period for which enlisted 3 years.

When mustered in Mch. 8, 1865.

Present or absent Present

Company to which assigned M

Remarks: Joined as recruit
Last screw-driven, wiper,
bugle, letter.

Book mark :

(342)

Chandler
Coptist

F. 10 Harty, U.S.C.T.

William Foreman
Art., Co. M, 10 Reg't U. S. Col'd Harty,

Appears on

M. and D. Roll of Men Transferred

to the organization named above,

from *77th U. S. Col'd Inftry,*

Roll dated *Oct. 1,* 1865.

When enlisted *Feb. 18*, 1865.

Period for which enlisted *3* years.

When mustered in *Mich. 8*, 1865.

Present or absent *Present*

Company to which assigned *M,*

Remarks: *Joined as recruit.*

Lost screw-driver
wiper, bugle and letter.

Book mark :

Castling
(342) *Copyist.*

F | **10 H. Art'y.** | **U.S.C.T.**

William Freeman
....., Co. *M*, 10 Reg't U. S. Col'd H. Art'y.

Age years.

Appears on

Company Muster Roll*

for *Sept & Oct* 186*5*.

Joined for duty and enrolled:

When *Feb 18* 186*5*.

Where *N Orleans*

Period *3* years.

Mustered in:

When *Mar 5* 186*5*.

Where *N Orleans*

Present or absent *Present*

Stoppage, \$ *100* for

Due Gov't, \$ *100* for *Oct 5 67 92 75*

Valuation of horse, \$ *100*

Valuation of horse equipments, \$ *100*

Remarks :

*First current roll. No muster-in roll of this company on file.

Book mark :

(3586)

W. H. Wright

Copyist.

7

10 H. Art'y. | U. S. C. T.

William Foreman

P, Co. M, 10 Reg't U. S. Col'd H. Art'y.

Appears on

Company Muster Roll

for Nov & Dec, 1865:

Present or absent Present-

Stoppage, \$ 100 for

Due Gov't, \$ 43 100 for Ord

" " 5 ct 674.89

Valuation of horse, \$ 100

Valuation of horse equipments, \$ 100

Remarks:

Book mark:

W. B. Wright -

(358)

Copyist.

7 | 10 H. Art'y. | U. S. C. T.

William Foreman

P, Co. M, 10 Reg't U. S. Col'd H. Art'y.

Appears on

Company Muster Roll

for *Jan & Feb*, 186*6*.

Present or absent *Present-*

Stoppage, \$ *100* for

Due Gov't, \$ *100* for

Valuation of horse, \$ *100*

Valuation of horse equipments, \$ *100*

Remarks:

Book mark:

A. H. Wright

(358)

Copyist.

7

10 H. Art'y.

U. S. C. T.

William Foreman

P, Co. M, 10 Reg't U. S. Col'd H. Art'y.

Appears on

Company Muster Roll

for *Mar & Apr*, 186*5*.

Present or absent *Present*

Stoppage, \$ *100* for

Due Gov't, \$ *100* for

Valuation of horse, \$ *100*

Valuation of horse equipments, \$ *100*

Remarks: *Bounty Paid #100*

Due #200

Book mark:

W. B. Wright

(358)

Copyist.

7

10 H. Art'y.

U. S. C. T.

William Foreman

P, Co. M, 10 Reg't U. S. Col'd H. Art'y.

Appears on

Company Muster Roll

for *May & June*, 186*6*.

Present or absent *Present*

Stoppage, \$ *100* for

Due Gov't, \$ *100* for

Valuation of horse, \$ *100*

Valuation of horse equipments, \$ *100*

Remarks:

Book mark:

(358)

W. T. Wright

Copyist.

7

10 H. Art'y.

U. S. C. T.

William Freeman

P, Co. M, 10 Reg't U. S. Col'd H. Art'y.

Appears on

Company Muster Roll

for *July & Aug*, 186*6*.

Present or absent *Absent*

Stoppage, \$ *100* for

Due Gov't, \$ *100* for

Valuation of horse, \$ *100*

Valuation of horse equipments, \$ *100*

Remarks: *Absent on detached service in New Orleans La as recruit for 39 US Infy*

Book mark:

(358)

W. H. Wright

Copyist.

§

10 H. Art'y.

U. S. C. T.

William Foreman

Sub., Co. M, 10 Reg't U. S. Col'd H. Art'y.

Appears on

Company Muster Roll

for Sep + Oct, 1866.

Present or absent Present.

Stoppage, \$ 100 for

Due Gov't, \$ 100 for

Valuation of horse, \$ 100

Valuation of horse equipments, \$ 100

Remarks: Confined in Post Guard House, awaiting sentence for return to M. 2nd installment Bounty due \$100.00

Book mark:

Reuter

(358)

Copyist.

William Foreman

Bvt, Co. M, 10 Reg't U. S. Col'd H. Art'y.

Appears on

Company Muster Roll

for Nov & Dec, 1866.

Present or absent Present

Stoppage, \$ 100 for

Due Gov't, \$ 100 for

Valuation of horse, \$ 100

Valuation of horse equipments, \$ 100

Remarks: Forfeit ten dollars[#] 10.00
for one mo. for sentence of G. C. M.
per G. O. 6 Dtd. Lrs Post Baton
Range, La Nov 1/66.

Book mark: _____

Rector

S

10 H. Art'y. U.S.C.T.

William Foreman

Sgt., Co. M., 10 Reg't U. S. Col'd H. Art'y.

Appears on Co. Muster-out Roll, dated

Batm Rouge, La., Feb 22, 1867.

Muster-out to date Feb 22, 1867.

Last paid to Dec 31, 1866.

Clothing account:

Last settled....., 186 ; drawn since \$.....100

Due soldier \$ 12 ⁵²/₁₀₀; due U. S. \$.....100

Am't for cloth'g in kind or money adv'd \$.....100

Due U. S. for arms, equipments, &c., \$ ^{retained} 6 ⁰⁰/₁₀₀

Bounty paid \$ 200 ⁰⁰/₁₀₀; due \$ none 100

Remarks: joined by trans from Co. A. U. S. C. 2177 per S. 10 66 Dept La Sep 22/65 as Sgt.

Book mark:

Reeler

(361)

Copyist.

Forest Charles

Co A, 10 U.S. Col'd H. Art'y.

~~Private~~

Private

CARD NUMBERS.

1	5489033	26
2	5492900	27
3	5493143	28
4	5493283	29
5	5493488	30
6	5493609	31
7	5493692	32
8	5493799	33
9	5493858	34
10		35
11		36
12		37
13		38
14		39
15		40
16		41
17		42
18		43
19		44
20		45
21		46
22		47
23		48
24		49
25		50

Book Mark:

See also

75" y/c Dup

D. H. H. H. U.S.C.T.

Charles Forest
H., Co. *10*, Reg't U. S. Col'd *H. H.*

Appears on

M. and D. Roll of Men Transferred

to the organization named above,

from *75 USCI*

Roll dated *Nov 18*, 186*6*.

When enlisted _____, 186 .

Period for which enlisted *3* years.

When mustered in *Sept 26*, 186 *4*.

Present or absent *Not stated*

Company to which assigned _____

Remarks: *Recd from recruiting slip of N. O. La Oct 7/64. Assigned to Co 49 series of 64 H & Dr. 75 USCI. Given US for C & G equip. 71¢ drafted*

Book mark : _____

A. Johnson

P

10 H. Art'y. U.S.C.T.

Charles Forest

Pvt, Co. A, 10 Reg't U. S. Col'd H. Art'y.

Appears on

Company Muster Roll

for *Nov + Dec*, 1865.

Present or absent *Present*

Stoppage, \$ 100 for

Due Gov't, \$ 71 for *Co's Equipage*
per transfer Roll

Valuation of horse, \$ 100

Valuation of horse equipments, \$ 100

Remarks: *Transferred from 75 used*
per S.O. 103 Co's. Hd Qrs Dept of La.

Book mark:

Hyman
Copyist.

(358)

A

| 10 H. Art'y. | U.S.C.T.

Charles Forest

Priv, Co. A, 10 Reg't U. S. Col'd H. Art'y.

Appears on

Company Muster Roll

for *Jan + Feb*, 186*6*.

Present or absent *Present*

Stoppage, \$ *100* for

Due Gov't, \$ *100* for

Valuation of horse, \$ *100*

Valuation of horse equipments, \$ *100*

Remarks:

Book mark:

(358)

Hyman
Copyist.

A

10 H. Art'y. U.S.C.T.

Charles Forest

Pvt, Co. A, 10 Reg't U. S. Col'd H. Art'y.

Appears on

Company Muster Roll

for *Mar + Apr*, 186*6*.

Present or absent *Present*

Stoppage, \$ 100 for

Due Gov't, \$ 100 for

Valuation of horse, \$ 100

Valuation of horse equipments, \$ 100

Remarks:

Book mark:

(358)

Haynes
Copyist.

A | 10 H. Art'y. | U.S.C.T.

Charles Forest

Pl, Co. A, 10 Reg't U. S. Col'd H. Art'y.

Appears on

Company Muster Roll

for *May & June*, 186*6*.

Present or absent *Present*

Stoppage, \$ *100* for

Due Gov't, \$ *100* for

Valuation of horse, \$ *100*

Valuation of horse equipments, \$ *100*

Remarks:

Book mark:

(358)

Styer
Copyist.

F

10 H. Art'y. U.S.C.T.

Charles Horst

Pl, Co. A, 10 Reg't U. S. Col'd H. Art'y.

Appears on

Company Muster Roll

for *July & Aug*, 186*6*.

Present or absent *Present*

Stoppage, \$ 100 for

Due Gov't, \$ 100 for

Valuation of horse, \$ 100

Valuation of horse equipments, \$ 100

Remarks:

Book mark:

(358)

J. Hayes

Copyist.

F | 10 H. Art'y. | U.S.C.T.

Charles Forest

Pvt, Co. A, 10 Reg't U. S. Col'd H. Art'y.

Appears on

Company Muster Roll

for *Sept + Oct*, 186*6*.

Present or absent *Present*

Stoppage, \$ *100* for

Due Gov't, \$ *100* for

Valuation of horse, \$ *100*

Valuation of horse equipments, \$ *100*

Remarks:

Book mark:

Nesbitt

(358)

Copyist.

7

10 H. Art'y. U.S.C.T.

Charles Forest

Pvt, Co. A, 10 Reg't U. S. Col'd H. Art'y.

Appears on

Company Muster Roll

for Nov + Dec, 1866.

Present or absent Present

Stoppage, \$ 100 for

Due Gov't, \$ 100 for

Valuation of horse, \$ 100

Valuation of horse equipments, \$ 100

Remarks:

Book mark:

Nesbitt

(358)

Copyist.

7 | 10 H. Art'y. | U.S.C.T.

Charles Forest

Pvt, Co. A, 10 Reg't U. S. Col'd H. Art'y.

Appears on Co. Muster-out Roll, dated
Baton Rouge La, Feb 22, 1867.
Muster-out to date Feb 22, 1867.
Last paid to Dec 31, 1866.

Clothing account:

Last settled....., 186 ; drawn since \$..... 100

Due soldier \$ 32 ²⁹/₁₀₀; due U. S. \$..... 100

Am't for cloth'g in kind or money adv'd \$..... 100

Due U. S. for arms, equipments, &c., \$..... ^{Under 40.101} 6 ⁰⁰/₁₀₀

Bounty paid \$..... 100; due \$..... ²¹⁰/₁₀₀

Remarks: Transfd. from 75 U.S.C.T. as Pvt
S.O. 105 S of 165 Reg't La

Book mark:

Nesbitt

Copyist.

Forestall, Arthur

Co M., 10 U.S. Col'd H. Art'y.

Private

Private

CARD NUMBERS.

1	5487978	26
2	5488834	27
3	5488941	28
4	5514321	29
5	5514475	30
6	5514710	31
7	5514821	32
8	5514932	33
9	5514996	34
10	5515074	35
11	5515133	36
12	5515180	37
13	9123654	38
14		39
15		40
16		41
17		42
18		43
19		44
20		45
21		46
22		47
23		48
24		49
25		50

Book Mark:

See also

77 U.S. Col'd H. Art'y

Arthur Forester

....., Co. *M*, 10 Reg't U. S. Col'd H. Art'y.

Appears on

Company Descriptive Book

of the organization named above.

DESCRIPTION.

Age *18* years; height *5* feet *2* inches.

Complexion *Yellow*

Eyes *Brown*; hair *black*

Where born *New Orleans La*

Occupation *Laborer*

ENLISTMENT.

When *April 3*....., 1865.

Where *New Orleans La*

By whom *Capt M. Allister* term *3* y'rs.

Remarks: *Rec'd by transfer from
Co A 77th U.S. Col for S.O.
66 2nd Div. Dept La Sept
27 1865. Promoted Corp
per S.O. 8 2nd Div. 10th U.S.C.
A. Reg. Mex. 10 1866. Reduced
to the ranks per S.O. 23 2nd
Div. 10th U.S.C. (Reg) Oct 16
1866*

J. M. Calhoun

(3830)

Copist.

I 406a | U.S.C.T.

Arthur Forrestall
Co. *M*, 10 Reg't U. S. Col'd *Red*

Appears on

M. and D. Roll of Men Transferred

to the organization named above,

from *47 U. S. Col Inf*

Roll dated *Camp Pennsylvania Oct 1, 1865*

When enlisted *Apr 3*, 186*5*.

Period for which enlisted *8* years.

When mustered in *Apr 10*, 186*5*.

Present or absent

Company to which assigned *M*

Remarks: *joined as recruit,
lost driver, driver wife
Haverack & Bugle,
Rec'd by transfer from Co
No. 47 U. S. C. I. per S. O. 66
Sept 2a Sept 22. 65*

Book mark :

W. H. Scott

(342)

Copied

F. 10th. Arty | U.S.C.T.

Arthur Forestall
Pot, Cook, 10 Reg't U. S. Col'd 10. Arty

Appears on

M. and D. Roll of Men Transferred

to the organization named above,

from

77 U. S. Col'd Inf

Roll dated

Oct. 1, 1865

When enlisted

April 3, 1865

Period for which enlisted

3 years.

When mustered in

April 10, 1865

Present or absent

Present

Company to which assigned

M

Remarks:

Joined as recruit.

Got screw driver, wiper,
haversack & Bugle.

Book mark :

Chandler

(342)

Copied

F | 10 Harty | U.S.C.T.

Arthur Foustall

Capt., Co M., 10 Reg't U. S. Col'd Harty

Appears on

M. and D. Roll of Men Transferred

to the organization named above,

from 77th U.S. Col'd Inf'ty,

Roll dated Oct. 1, 1865.

When enlisted Apr. 3, 1865.

Period for which enlisted 3 years.

When mustered in Apr. 10, 1865.

Present or absent Present.

Company to which assigned M.

Remarks: Joined as recruit.

Last screw-driver,
wiper, haversack and
bugle.

Book mark :

(342)

Easterling

Copyist.

4 | 10 H. Art'y. | U.S.C.T.

Arthur Frostall
Co. 1, 10 Reg't U. S. Col'd H. Art'y.

Age _____ years.

Appears on

Company Muster Roll*

for Sept 7 Oct -, 1865.

Joined for duty and enrolled:

When Apr 3, 1865.

Where N Orleans

Period 5 years.

Mustered in:

When Apr 6, 1865.

Where N Orleans

Present or absent Present

Stoppage, \$ 100 for _____

Due Gov't, \$ 100 for cut 67 1/2 99

Valuation of horse, \$ 100

Valuation of horse equipments, \$ 100

Remarks : _____

*First current roll. No muster-in roll of this company on file.

Book mark : _____

A. T. Wright
(358b) Copyist.

7

10 H. Art'y.

U. S. C. T.

Arthur Forestall

Co. M, 10 Reg't U. S. Col'd H. Art'y.

Appears on

Company Muster Roll

for Nov Dec, 1865.

Present or absent Present

Stoppage, \$ 100 for

Due Gov't, \$ 100 for Ord

" " 99ct 604.3.

Valuation of horse, \$ 100

Valuation of horse equipments, \$ 100

Remarks:

Book mark:

W. H. Wright

(358)

Copyist.

7

10 H. Art'y.

U. S. C. T.

Arthur Forstall

, Co. M, 10 Reg't U. S. Col'd H. Art'y.

Appears on

Company Muster Roll

for Jan & Feb, 1866.

Present or absent Present-

Stoppage, \$ 100 for

Due Gov't, \$ 100 for

Valuation of horse, \$ 100

Valuation of horse equipments, \$ 100

Remarks:

Book mark:

(358)

A. J. Wright

Copyist.

7

10 H. Art'y.

U. S. C. T.

Arthur Forestell

Corn, Co. M, 10 Reg't U. S. Col'd H. Art'y.

Appears on

Company Muster Roll

for March & Apr, 1866.

Present or absent Present

Stoppage, \$ 100 for

Due Gov't, \$ 100 for

Valuation of horse, \$ 100

Valuation of horse equipments, \$ 100

Remarks: Rec'd from the spec

of the 10th Reg't U.S. Col'd H. Art'y

U.S. Col'd H. Art'y to date March 1866

Bounty Paid # 162

" " " " " " # 200

Book mark:

Arthur Forestell

Arthur Freetail

Co, Co. M, 10 Reg't U. S. Col'd H. Art'y.

Appears on

Company Muster Roll

for *May & June*, 186*0*.

Present or absent *Present*

Stoppage, \$ 100 for

Due Gov't, \$ 100 for

Valuation of horse, \$ 100

Valuation of horse equipments, \$ 100

Remarks:

Book mark:

(358)

W. H. Wright

Copyist.

Arthur Forstall

Cox, Co. M, 10 Reg't U. S. Col'd H. Art'y.

Appears on

Company Muster Roll

for July & Aug, 1860.

Present or absent Present

Stoppage, \$ 100 for

Due Gov't, \$ 100 for

Valuation of horse, \$ 100

Valuation of horse equipments, \$ 100

Remarks:

Book mark: _____

(358) W. T. Wright Copyist.

Arthur Forrestall

Priv., Co. M, 10 Reg't U. S. Col'd H. Art'y.

Appears on

Company Muster Roll

for Sep & Oct, 1866.

Present or absent Present

Stoppage, \$ 100 for

Due Gov't, \$ 100 for

Valuation of horse, \$ 100

Valuation of horse equipments, \$ 100

Remarks: Reduced to the Rank of Private per S.O. 13 H'd. Ins. 10 U.S.C. Art'y Oct 16/66. 2nd Installment Bounty due \$100.00

Book mark:

Rector

5

10 H. Art'y. | U. S. C. T.

Arthur Forestall

Sub., Co. M, 10 Reg't U. S. Col'd H. Art'y.

Appears on

Company Muster Roll

for Nov + Dec, 1866.

Present or absent Present

Stoppage, \$ 100 for

Due Gov't, \$ 100 for

Valuation of horse, \$ 100

Valuation of horse equipments, \$ 100

Remarks:

Book mark:

Rector

(358)

Copyist.



5

10 H. Art'y. U.S.C.T.

Arthur Forstatt

Priv., Co. M., 10 Reg't U. S. Col'd H. Art'y.

Appears on Co. Muster-out Roll, dated
Baton Rouge, La., Dec 22, 1867.

Muster-out to date Dec 22, 1867.

Last paid to Dec 31, 1866.

Clothing account:

Last settled....., 186 ; drawn since \$..... 100

Due soldier \$..... 100; due U. S. \$ 44 ⁰⁰/₁₀₀

Am't for cloth'g in kind or money adv'd \$..... 100

Due U. S. for arms, equipments, ^{retained} &c., \$..... 6 ⁰⁰/₁₀₀

Bounty paid \$ 200 ⁰⁰/₁₀₀; due \$ none 100

Remarks: joined by Arms from Co
"A" 77 U. S. Col'd. per S. O. 66 Dept
La Dec 22/65 as Priv.

Book mark:

Reclin

(361)

Copyist.

Forestil. Omile

Co I, 10 U.S. Col'd H. Art'y.

Private

Private

CARD NUMBERS.

1	5488583	26
2	5511520	27
3	5511733	28
4	5512111	29
5	5489337	30
6		31
7		32
8		33
9		34
10		35
11		36
12		37
13		38
14		39
15		40
16		41
17		42
18		43
19		44
20		45
21		46
22		47
23		48
24		49
25		50

Book Mark:

See also Col. 74 "refused"

F 10th U.S.C.T.

Emile Foestile
Pvt, Co., 10 Reg't U. S. Col'd St. Arty

Appears on

M. and D. Roll of Men Transferred

to the organization named above,

from Co "G" 7th U.S. C. Inf.

Roll dated New Orleans La Oct 11, 1863.

When enlisted Jan 16, 1863

Period for which enlisted 3 years.

When mustered in Feby. 8, 1863

Present or absent Present

Company to which assigned

Remarks: 10th Co "G" 2^d

La Arty. (7th U.S. C. Inf.)

as a recruit. Trans-

ferred to Co G 7th U.S.

Inf. July 25, 1864 at G. O.

Mo. Dated St. L. Dept.

W. D. M. July 7, 1864

Free on or before April

Book mark :

(342)

J. W. Jones, Jr.
Copyist.

JAN. 15

5488583

★ TEST ★

19, 1867. Due Soldier
for clothing in kind not
drawn at last settlement
A.S. S.H

J

10 H. Art'y.

U.S.C.T.

Emil Forastil

Cpt., Co. I, 10 Reg't U. S. Col'd H. Art'y.

Appears on

Company Muster Roll

for *Nov. & Dec.*, 1865.

Present or absent *Present*

Stoppage, \$ *100* for

Due Gov't, \$ *100* for

Valuation of horse, \$ *100*

Valuation of horse equipments, \$ *100*

Remarks: *Transferred from
74 U.S.Ct. per S.O. No.
84. Hd. qrs. Dept. of
La. Oct 11, 1865.*

FROM SECOND AUDITOR'S ROLL.

Book mark:

O. J. Clark

(358)

Copyist.

F

10 H. Art'y. U.S.C.T.

Emile Forestil

Prk., Co. I, 10 Reg't U. S. Col'd H. Art'y.

Appears on

Company Muster Roll

for *Jan. + Feb.*, 1866.

Present or absent

Stoppage, \$ 100 for

Due Gov't, \$ 100 for

Valuation of horse, \$ 100

Valuation of horse equipments, \$ 100

Remarks: *Discharged. Mustered out by reason of expiration of term of service to take effect Jan'y 15, 1866. final statements given.*

Book mark:

(358)

P. S. Clark

Copyist.

F | *10th Arty* | **U.S.C.T.**

Emil Forestil

Private, Co. *I*, *10* Reg't U. S. Col'd *Arty*

Appears on an

Individual Muster-out Roll

of the organization named above. Roll dated

New Orleans La., *Jan'y 15*, 186*6*.

Muster-out to date *Jan'y 15*, 186*6*.

Last paid to *June 30*, 186*6*.

Clothing account:

Last settled _____, 186 ____; drawn since \$ _____ 100

Due soldier \$ *80*^{*42*} / 100; due U. S. \$ _____ 100

Am't for cloth'g in kind or money adv'd \$ _____ 100

Due U. S. for arms, equipments, &c., \$ _____ 100

Bounty paid \$ _____ 100 due \$ *100* 100

Remarks: *Joined by transfer from*

74th U. S. Infantry Oct. 11 1865

per St. No 84 Hd Qrs Dept of

Louisiana series of 1865 Free on

or before April 29. 1866.

Mustered out by reason of

Book mark: *over*

M. A. Michaels

(348)

Copyist.

JAN. 15

5489337

1861

expiration of term of
service to take effect
Jan. 15th 1866

F | 10 H. Art'y. | U.S.C.T.

Emile Forestil

Plt., Co. I, 10 Reg't U. S. Col'd H. Art'y.

Appears on Co. Muster-out Roll, dated
Baton Rouge La, Feb 22, 1867.

Muster-out to date _____, 186 .

Last paid to _____, 186 .

Clothing account:

Last settled _____, 186 ; drawn since \$ _____ 100

Due soldier \$ _____ 100; due U. S. \$ _____ 100

Am't for cloth'g in kind or money adv'd \$ _____ 100

Due U. S. for arms, equipments, &c., \$ _____ 100

Bounty paid \$ _____ 100; due \$ _____ 100

Remarks: Discharged. Expiration
term of service Jan 15, 1866

Book mark: V 72 P 138 . 69

(361)

J. M. Hance

Copyist.

Forstall, Jack

Co *M.*, 10 U.S. Col'd H. Art'y.

Sergeant | *Sergeant*

CARD NUMBERS.

1	5487783	26
2		27
3		28
4		29
5		30
6		31
7		32
8		33
9		34
10		35
11		36
12		37
13		38
14		39
15		40
16		41
17		42
18		43
19		44
20		45
21		46
22		47
23		48
24		49
25		50

Book Mark:

See also

77th Regt @ July

F 10 H A U.S.C.T.

Jack Forrestall
Sgt, Co. *M*, 10 Reg't U. S. Col'd *H. A.*
Appears on

M. and D. Roll of Men Transferred

to the organization named above,

from *77 U.S. Col Inf*

Roll dated *Camp Conapetta Cal*, 1865.

When enlisted *May 6*, 1864.

Period for which enlisted *3* years.

When mustered in *May 13*, 1864.

Present or absent *Present*

Company to which assigned *M*

Remarks: *Joined as Private*

Promoted Corporal per

S.O. 31 Aug 26, 64,

and Sgt per S.O. 47

July 27, 65. ~~Remanded~~

Supernumery per S.O. 66

Hd Qrs Dept of da Sept 22

65. Hd Qrs 77 U.S.C.I.

Not taken up in muster rolls of Co M

Book mark:

W. H. Scott

Fortson, Franklin

Co C, 10 U.S. Col'd H. Art'y.

Private

Private

CARD NUMBERS.

1	5497716	26
2	5498117	27
3	5498220	28
4	5498317	29
5	5498415	30
6	5498525	31
7	5498666	32
8	5498805	33
9	5498941	34
10	5499082	35
11	5499218	36
12	5499354	37
13	5499490	38
14	5499626	39
15	5499762	40
16	5499897	41
17	5500029	42
18	5500165	43
19	5489265	44
20	5500294	45
21	5489282	46
22	5500457	47
23	5490147	48
24		49
25		50

Book Mark:

See also

F | 10 H. Art'y. | U.S.C.T.

Franklin Fortson,
Prf, Co. *C*, 10 Reg't U. S. Col'd H. Art'y.

Appears on **Co. Muster-out Roll**, dated
Baton Rouge, La, Feb 22, 1867.

Muster-out to date _____, 186 .

Last paid to _____, 186 .

Clothing account:

Last settled _____, 186 ; drawn since \$ _____ 100

Due soldier \$ _____ 100; due U. S. \$ _____ 100

Am't for cloth'g in kind or money adv'd \$ _____ 100

Due U. S. for arms, equipments, &c., \$ _____ 100

Bounty paid \$ _____ 100; due \$ _____ 100

Remarks: *Joined Big Ore*
Discharged Feb. 3, 1867,
by reason of expiration
of term of service

Book mark: _____

(361)

Hamm
Coptist.

41 | 10 H. Art'y. | U.S.C.T.

Franklin Fortson

Pvt., Co. C, 1 Reg't La. Art'y, Native Guards.*

Age *30* years.

Appears on

Company Muster-in Roll

of the organization named above. Roll dated

New Orleans La., Feb 4, 1864.

Muster-in to date *Feb 4, 1864.*

Joined for duty and enrolled:

When *Dec 9, 1863.*

Where *New Iberia La.*

Period *3* years.

Valuation of horse, \$ *100*

Valuation of horse equipments, \$ *100*

Remarks: _____

* This organization subsequently became Co. C, 10 Reg't U. S. Col'd Heavy Artillery.

Book mark: _____

(356)

W. J. ...

Copyist.

F | 10 H. Art'y. | U.S.C.T.

Franklin *Perlesson*
P, Co. *C*, 1 Reg't H. Art'y, Corps d'Afrique.*

Appears on

Company Muster Roll

for *Feb 4th to 29th*, 1864.

Present or absent *Absent*

Stoppage, \$ *100* for

Due Gov't, \$ *100* for

Valuation of horse, \$ *100*

Valuation of horse equipments, \$ *100*

Remarks: *Not seen Sp on No 13 Rd.*
Dis 1st Regt Art C d'A. Jan 30. 64

See letters for P

* This organization subsequently became Co. *C*, 10 Reg't U. S. Colored Heavy Artillery.

Book mark: _____

Copyist

J

10 H. Art'y.

U.S.C.T.

Portison, Franklin

Pot, Co. *C*, 7 Reg't U. S. Col'd H. Art'y.*

Appears on

Company Muster Roll

for *Mich rapel*, 186*4*.

Present or absent *Present*

Stoppage, \$ *100* for

Due Gov't, \$ *100* for

Valuation of horse, \$ *100*

Valuation of horse equipments, \$ *100*

Remarks:

* This organization subsequently became Co. *C*, 10 Reg't U. S. Colored Heavy Artillery.

Book mark:

(358)

J. Mendenhall

Copyist.

F | **10 H. Art'y.** | **U.S.C.T.**

Fortison, Franklin
Pot, Co. *C*, 7 Reg't U. S. Col'd H. Art'y.*

Appears on

Company Muster Roll

for *May June*, 1864.

Present or absent *Present*

Stoppage, \$ *100* for

Due Gov't, \$ *100* for

Valuation of horse, \$ *100*

Valuation of horse equipments, \$ *100*

Remarks:

* This organization subsequently became Co. _____, 10 Reg't U. S. Colored Heavy Artillery.

Book mark: -----

(358)

J. Henderson
Copyist.

F | 10 H. Art'y. | U.S.C.T.

Fortison, Franklin
Pvt, Co. *C*, 7 Reg't U. S. Col'd H. Art'y.*

Appears on

Company Muster Roll

for *July & Aug*, 186 *4*

Present or absent *Present*

Stoppage, \$ *100* for

Due Gov't, \$ *100* for

Valuation of horse, \$ *100*

Valuation of horse equipments, \$ *100*

Remarks: _____

* This organization subsequently became Co. _____, 10 Reg't U. S. Colored Heavy Artillery.

Book mark: _____

(358) *J. Hudson*
Copyist.

F | 10 H. Art'y. | U.S.C.T.

Franklin Fortison

Pvt., Co. C, 10 Reg't U. S. Col'd H. Art'y.

Appears on

Company Muster Roll

for *Sept 7 1864*, 1864.

Present or absent *Present*

Stoppage, \$ *100* for

Due Gov't, \$ *100* for

Valuation of horse, \$ *100*

Valuation of horse equipments, \$ *100*

Remarks:

Book mark:

(358)

J. Hudson

Copyist.

F

10 H. Art'y. U.S.C.T.

Franklin Fortison

Pvt., Co. C, 10 Reg't U. S. Col'd H. Art'y.

Appears on

Company Muster Roll

for *Nov & Dec*, 1864

Present or absent *Present*

Stoppage, \$ 100 for

Due Gov't, \$ 100 for

Valuation of horse, \$ 100

Valuation of horse equipments, \$ 100

Remarks:

Book mark:

(358)

J. Anderson
Copyist.

F

10 H. Art'y. U.S.C.T.

Franklin Fortean
Plt, Co. C, 10 Reg't U. S. Col'd H. Art'y.

Appears on

Company Muster Roll

for *Jan & Feb*, 186*5*.

Present or absent *Present*

Stoppage, \$ *100* for

Due Gov't, \$ *100* for

Valuation of horse, \$ *100*

Valuation of horse equipments, \$ *100*

Remarks:

Book mark:

W. L. Wade

(358)

Copyist.

F

10 H. Art'y.

U.S.C.T.

Franklin Fortson

Q, Co. C, 10 Reg't U. S. Col'd H. Art'y.

Appears on

Company Muster Roll

for *Moah & apl*, 186*6*.

Present or absent *Present*

Stoppage, \$ *100* for

Due Gov't, \$ *100* for

Valuation of horse, \$ *100*

Valuation of horse equipments, \$ *100*

Remarks:

Book mark:

Lamb

F

10 H. Art'y. U.S.C.T.

Franklin Fortson
Plt, Co. C, 10 Reg't U. S. Col'd H. Art'y.

Appears on

Company Muster Roll

for *May & June*, 1865.

Present or absent *Present*

Stoppage, \$ 100 for

Due Gov't, \$ 100 for

Valuation of horse, \$ 100

Valuation of horse equipments, \$ 100

Remarks:

Book mark:

Sallade

4

10 H. Art'y. U.S.C.T.

Franklin Fortean

Pat, Co. C, 10 Reg't U. S. Col'd H. Art'y.

Appears on

Company Muster Roll

for May 1865

Present or absent Present

Stoppage, \$ 100 for

Due Gov't, \$ 100 for

Valuation of horse, \$ 100

Valuation of horse equipments, \$ 100

Remarks:

Book mark:

(358)

Dallade Copyist.

F

10 H. Art'y. U.S.C.T.

Franklin Fortesau
Put, Co. C, 10 Reg't U. S. Col'd H. Art'y.

Appears on

Company Muster Roll

for *Sept & Oct*, 186*5*.

Present or absent *Present*

Stoppage, \$ 100 for

Due Gov't, \$ 100 for

Valuation of horse, \$ 100

Valuation of horse equipments, \$ 100

Remarks:

Book mark:

Callade

F

10 H. Art'y. | U.S.C.T.

Franklin Fortesan
Pvt., Co. C, 10 Reg't U. S. Col'd H. Art'y.

Appears on

Company Muster Roll

for *Nov. 3rd Dec.*, 186*5*.

Present or absent *Present*

Stoppage, \$ *100* for

Due Gov't, \$ *100* for

Valuation of horse, \$ *100*

Valuation of horse equipments, \$ *100*

Remarks:

Book mark:

(358)

A. J. Robbins

Copyist.

9

F

10 H. Art'y. U.S.C.T.

Franklin Fortesan
Pop, Co. C, 10 Reg't U. S. Col'd H. Art'y.

Appears on

Company Muster Roll

for *Jan & Feb*, 186*6*.

Present or absent *Present*

Stoppage, \$ *100* for

Due Gov't, \$ *100* for

Valuation of horse, \$ *100*

Valuation of horse equipments, \$ *100*

Remarks:

Book mark: -----

A. J. Robbins

(358)

Copyist.

F

10 H. Art'y. U.S.C.T.

Franklin Fortesan

Pop, Co. C, 10 Reg't U. S. Col'd H. Art'y.

Appears on

Company Muster Roll

for *March & April*, 186*b*.

Present or absent *Present*.

Stoppage, \$ 100 for

Due Gov't, \$ 100 for

Valuation of horse, \$ 100

Valuation of horse equipments, \$ 100

Remarks:

Book mark:

A. J. Robbins

(358)

Copyist.

F

10 H. Art'y. U.S.C.T.

Franklin Fortman

Priv., Co. C, 10 Reg't U. S. Col'd H. Art'y.

Appears on

Company Muster Roll

for May and June, 1864.

Present or absent Present.

Stoppage, \$ 100 for

Due Gov't, \$ 100 for

Valuation of horse, \$ 100

Valuation of horse equipments, \$ 100

Remarks:

Book mark:

A. J. Robbins

F | 10 H. Art'y. | U.S.C.T.

Franklin Porter

Port., Co. C, 10 Reg't U. S. Col'd H. Art'y.

Appears on

Company Muster Roll

for *July 2d Aug*, 186*6*.

Present or absent *Present*

Stoppage, \$ *100* for

Due Gov't, \$ *100* for

Valuation of horse, \$ *100*

Valuation of horse equipments, \$ *100*

Remarks:

Book mark:

A. J. Robbins

(358)

Copyist.

F | 10 H. Art'y. | U.S.C.T.

Franklin Fortson
Per, Co. C, 10 Reg't U. S. Col'd H. Art'y.

Appears on

Company Muster Roll

for *Sept & Oct*, 186*6*.

Present or absent *Absent*

Stoppage, \$ *100* for

Due Gov't, \$ *100* for

Valuation of horse, \$ *100*

Valuation of horse equipments, \$ *100*

Remarks: *On det. for at Ft*
Livingston, Va, for 20
15 C. S. Hd qrs, I N
Livingston

Book mark:

Hammer

F 110 26A U.S.C.T.

Franklin Fortson
Gm, Co. C, 10 Reg't U. S. Col'd 26A

Appears on a

Detachment Muster Roll

of the organization named above

for Sept. & Oct., 1866.

Station Ft. Livingston, Va.

Present or absent Present

Stoppage, \$ 100 for

Due Gov't, \$ 100 for

Valuation of horse, \$ 100

Valuation of horse equipments, \$ 100

Remarks:

Book mark:

Croghan

F | 10 H. Art'y. | U.S.C.T.

Franklin Fortescue
Pvt., Co. C, 10 Reg't U. S. Col'd H. Art'y.

Appears on

Company Muster Roll

for *Nov 9 Dec*, 1866.

Present or absent *Absent*

Stoppage, \$ *100* for

Due Gov't, \$ *100* for

Valuation of horse, \$ *100*

Valuation of horse equipments, \$ *100*

Remarks: *Det ser at Fort*
Livingston, La, per P.O.
No 15 C.S. Fed ops Fort
Livingston, La,

Book mark:

Manning
Copyist.

F. 1088 | U.S.C.T.

Franklin Fortson
Co. C, 10 Reg't U. S. Col'd

Appears on a

Detachment Muster Roll

of the organization named above

for Nov. & Dec., 1866.

Station Ft. Livingston La.

Present or absent Present

Stoppage, \$ 100 for

Due Gov't, \$ 100 for

Valuation of horse, \$ 100

Valuation of horse equipments, \$ 100

Remarks:

Book mark:

Grogan

F | 10 Art'y

U.S.C.T.

Franklin Fortesum

Priv., Co. C, 10 Reg't U. S. Col'd Art'y

Appears on a

Detachment Muster-out Roll

of the organization named above. Roll dated

Baton Rouge, La., Feb. 3, 1867.

Muster-out to date Feb. 3, 1867.

Last paid to Dec. 31, 1866

Clothing account:

Last settled 186 ; drawn since \$ 100

Due soldier \$ $91 \frac{36}{100}$; due U. S. \$ $25 \frac{25}{100}$

Am't for cloth'g in kind or money adv'd \$ 100

Due U. S. for arms, equipments, &c., \$ $\frac{18}{100}$

Bounty paid \$ $100 \frac{00}{100}$ due \$ $100 \frac{00}{100}$

Remarks: Joined orig. org. 1st Md. C.S.A.
now 10 U.S.C.A. (Art'y) Drop for one
gun sling & tompon

Book mark:

R. E. Wilson

(349)

Copyist.

90
Fortune Henry

Co B, 10 U.S. Col'd H. Art'y

Private

Private

CARD NUMBERS.

1	5494179	26
2	5494332	27
3	5494497	28
4	5494658	29
5	5494813	30
6	5494967	31
7	5495123	32
8	5495279	33
9	5495430	34
10	5495580	35
11	5495720	36
12	5495875	37
13	5496022	38
14	5496174	39
15	5496326	40
16	5496474	41
17	5496619	42
18	5496763	43
19	5496922	44
20	5497104	45
21	5497411	46
22	5489652	47
23		48
24		49
25		50

Book Mark:

See also

S | 10 H. Art'y. | U.S.C.T.

Henry Fortune
Pvt., 2 Battery, La. H. Art'y, Native Guards.*

Age *35* years.

Appears on

Company Muster-in Roll

of the organization named above. Roll dated
Camp Parapet
Carrollton, La., Feb. 9, 186*3*.

Muster-in to date *Feb. 9*, 186*3*.

Joined for duty and enrolled:

When *Aug. 11th*, 186*2*.

Where *Camp Parapet or Carrollton, La.*

Period *3* years.

Valuation of horse, \$ *100*

Valuation of horse equipments, \$ *100*

Remarks: _____

* This organization subsequently became Co. B, 10 Reg't U. S. Colored Heavy Artillery.

Book mark: _____

(356)

Feaster

Copyist.

S | 10 H. Art'y. | U.S.C.T.

Henry Fortune

Pvt., Co. B, 1 Reg't La. H. Art'y, Native Guards.*

Appears on

Company Muster Roll

for *from Enlistment to Feb. 28*, 1863.

Present or absent *Present*

Stoppage, \$ *100* for

Due Gov't, \$ *100* for

Valuation of horse, \$ *100*

Valuation of horse equipments, \$ *100*

Remarks:

*This organization subsequently became Co. B, 10 Reg't U. S. Col'd Heavy Artillery.

Book mark:

Feaster

F | 10 H. Art'y. | U.S.C.T.

Henry Fortune
Pot., Co. B, 1 Reg't La. H. Art'y, Native Guards.*

Appears on

Company Muster Roll

for *Mch. & April*, 186*3*.

Present or absent *Present*

Stoppage, \$ *100* for

Due Gov't, \$ *100* for

Valuation of horse, \$ *100*

Valuation of horse equipments, \$ *100*

Remarks:

*This organization subsequently became Co. B, 10 Reg't U. S. Col'd Heavy Artillery.

Book mark:

Feaster

F | 10 H. Art'y. | U.S.C.T.

Henry Fortune
Pvt., Co. B, 1 Reg't La. H. Art'y, Native Guards.*

Appears on

Company Muster Roll

for *May & June*, 186*3*.

Present or absent *Present*

Stoppage, \$ *100* for

Due Gov't, \$ *100* for

Valuation of horse, \$ *100*

Valuation of horse equipments, \$ *100*

Remarks: _____

*This organization subsequently became Co. B, 10 Reg't U. S. Col'd Heavy Artillery.

Book mark: _____

Frazer

Coryist.

F

10 H. Art'y.

U.S.C.T.

Henry Fortune

Pvt., Co. B, 1 Reg't La. H. Art'y, Native Guards.*

Appears on

Company Muster Roll

for *July 4, Aug.*, 186*3*.

Present or absent *Present*

Stoppage, \$ *100* for

Due Gov't, \$ *100* for

Valuation of horse, \$ *100*

Valuation of horse equipments, \$ *100*

Remarks:

*This organization subsequently became Co. B, 10 Reg't U. S. Col'd Heavy Artillery.

Book mark:

Feaster

A | 10 H. Art'y. | U.S.C.T.

Henry Fortune
Pvt., Co. B, 1 Reg't La. H. Art'y, Native Guards.*

Appears on

Company Muster Roll

for *Sept. & Oct.*, 186 *3*.

Present or absent *Present*

Stoppage, \$ *100* for

Due Gov't, \$ *100* for

Valuation of horse, \$ *100*

Valuation of horse equipments, \$ *100*

Remarks:

*This organization subsequently became Co. B, 10 Reg't U. S. Col'd Heavy Artillery.

Book mark:

Feaster

F

10 H. Art'y. U.S.C.T.

Henry Fortune

PA, Co. *B*, 1 Reg't H. Art'y, Corps d'Afrique.*

Appears on

Company Muster Roll

for *Nov. & Dec., 1863*

Present or absent *Present*

Stoppage, \$ *100* for

Due Gov't, \$ *100* for

Valuation of horse, \$ *100*

Valuation of horse equipments, \$ *100*

Remarks:

*This organization subsequently became Co. , 10 Reg't U. S. Colored Heavy Artillery.

Book mark:

(358)

Reif

Copyist.

J.

10 H. Art'y. U.S.C.T.

Henry Fortune

Pvt, Co. B, 1 Reg't H. Art'y, Corps d'Afrique.*

Appears on

Company Muster Roll

for Jan., & Feb., 1864.

Present or absent Present

Stoppage, \$ 100 for

Due Gov't, \$ 100 for

Valuation of horse, \$ 100

Valuation of horse equipments, \$ 100

Remarks:

*This organization subsequently became Co. , 10 Reg't U. S. Colored Heavy Artillery.

Book mark:

(358)

Reif

Copyist.

F | 10 H. Art'y. | U.S.C.T.

Henry Fortune

A, Co. *B*, 7 Reg't U. S. Col'd H. Art'y.*

Appears on

Company Muster Roll

for *Mar & Apr*, 186*4*.

Present or absent *Present*

Stoppage, \$ *100* for

Due Gov't, \$ *100* for

Valuation of horse, \$ *100*

Valuation of horse equipments, \$ *100*

Remarks: *sick*

* This organization subsequently became Co. *B*, 10 Reg't U. S. Colored Heavy Artillery.

Book mark: _____

J. Richardson

(358)

Copyist.

F | 10 H. Art'y. | U.S.C.T.

Merry Fortune

Pl, Co. 130, 7 Reg't U. S. Col'd H. Art'y.*

Appears on

Company Muster Roll

for May 1 June, 1864

Present or absent Present

Stoppage, \$ 100 for

Due Gov't, \$ 100 for

Valuation of horse, \$ 100

Valuation of horse equipments, \$ 100

Remarks:

* This organization subsequently became Co. , 10 Reg't U. S. Colored Heavy Artillery.

Book mark:

(358)

Reif

Copyist.

F | 10 H. Art'y. | U.S.C.T.

Henry Fortune

Pl., Co. B, 10 Reg't U. S. Col'd H. Art'y.

Appears on

Company Muster Roll

for *July & Aug*, 186 *4*.

Present or absent *Present*

Stoppage, \$ 100 for

Due Gov't, \$ 100 for

Valuation of horse, \$ 100

Valuation of horse equipments, \$ 100

Remarks: *Sick*

Book mark: _____

J. Richardson

Copyist.

F | 10 H. Art'y. | U.S.C.T.

Henry Fortune

H., Co. B, 10 Reg't U. S. Col'd H. Art'y.

Appears on

Company Muster Roll

for *Sept & Oct*, 186*4*.

Present or absent *Present*

Stoppage, \$ *100* for

Due Gov't, \$ *100* for

Valuation of horse, \$ *100*

Valuation of horse equipments, \$ *100*

Remarks:

Book mark:

A. Richardson

(358)

Copyist.

F.

10 H. Art'y. U.S.C.T.

Henry Fortuna

Plt., Co. B, 10 Reg't U. S. Col'd H. Art'y.

Appears on

Company Muster Roll

for *Nov & Dec*, 1864.

Present or absent *Present.*

Stoppage, \$ 100 for

Due Gov't, \$ 100 for

Valuation of horse, \$ 100

Valuation of horse equipments, \$ 100

Remarks:

Book mark: -----

(358)

Jones

Copyist.

F.

10 H. Art'y. U.S.C.T.

Henry Fortune
Pl., Co. B, 10 Reg't U. S. Col'd H. Art'y.

Appears on

Company Muster Roll

for *Jan & Feb*, 186 *5*

Present or absent *Present*

Stoppage, \$ *100* for

Due Gov't, \$ *100* for

Valuation of horse, \$ *100*

Valuation of horse equipments, \$ *100*

Remarks: *Due soldier aug-*
mented pay from Jan 1
1864 to May 1 1864 @
per month May June
99^{cs} per month
Due US for Ord 25^{cs}

Book mark: _____

James
Copyist.

Henry Fortune

Plt., Co. B, 10 Reg't U. S. Col'd H. Art'y.

Appears on

Company Muster Roll

for *Mar & Apr*, 1865.

Present or absent *Present*

Stoppage, \$ *100* for

Due Gov't, \$ *100* for

Valuation of horse, \$ *100*

Valuation of horse equipments, \$ *100*

Remarks: *Due U.S. for
Ord, 23 ct.*

Book mark:

(358)

J. J. J.

Copyist.

5

10 H. Art'y. U.S.C.T.

Henry Fortune

Pr.; Co. B, 10 Reg't U. S. Col'd H. Art'y.

Appears on

Company Muster Roll

for May & June, 1865.

Present or absent Present.

Stoppage, \$ 100 for

Due Gov't, \$ 100 for

Valuation of horse, \$ 100

Valuation of horse equipments, \$ 100

Remarks:

Book mark:

(358)

Jornier.

Copyist.

F | 10 H. Art'y. | U.S.C.T.

Henry Fortune
Pvt.; Co. B, 10 Reg't U. S. Col'd H. Art'y.

Appears on

Company Muster Roll

for July & Aug., 1865.

Present or absent Present.

Stoppage, \$ 100 for

Due Gov't, \$ 100 for

Valuation of horse, \$ 100

Valuation of horse equipments, \$ 100

Remarks: Due U.S. for
ordnance 23^{cts}.

Book mark:

(358)

Janner.

Copyist.

JF | 10 H. Art'y. | U.S.C.T.

Henry Fortman
Sgt., Co. B, 10 Reg't U. S. Col'd H. Art'y.

Appears on

Company Muster Roll

for *Sep & Oct*, 186*5*.

Present or absent *Present*

Stoppage, \$ 100 for

Due Gov't, \$ 100 for

Valuation of horse, \$ 100

Valuation of horse equipments, \$ 100

Remarks:
.....
.....
.....
.....
.....
.....
.....
.....

Book mark:

Jones
(358) Copyist.

F

10 H. Art'y. U.S.C.T.

Henry Fortune

Pvt., Co. B, 10 Reg't U. S. Col'd H. Art'y.

Appears on

Company Muster Roll

for Nov. 1 Dec. 1865

Present or absent Present

Stoppage, \$ 100 for

Due Gov't, \$ 100 for

Valuation of horse, \$ 100

Valuation of horse equipments, \$ 100

Remarks:

Book mark:

(358)

Reif

Copyist.

T.

10 H. Art'y. U.S.C.T.

Henry Fortune

Pl, Co. B, 10 Reg't U. S. Col'd H. Art'y.

Appears on

Company Muster Roll

for *Jan'y, 1866*

Present or absent

Stoppage, \$ 100 for

Due Gov't, \$ 100 for

Valuation of horse, \$ 100

Valuation of horse equipments, \$ 100

Remarks: *Mustd. out at M.O. S'a. Feb. 8 66 by reason of exp. of term of service*

Book mark: *5778 P.M. S. June 13 66*

(358)

Reif

Copyist.

J | 10 H. Art'y. | U.S.C.T.

Henry Fortune

Co. B, 10 Reg't U. S. Col'd H. Art'y.

Appears on Co. Muster-out Roll, dated

Baton Rouge, La., Feb., 1867.

Muster-out to date _____, 186 .

Last paid to _____, 186 .

Clothing account:

Last settled _____, 186 ; drawn since \$ _____ 100

Due soldier \$ _____ 100; due U. S. \$ _____ 100

Am't for cloth'g in kind or money adv'd \$ _____ 100

Due U. S. for arms, equipments, &c., \$ _____ 100

Bounty paid \$ _____ 100; due \$ _____ 100

Remarks:

Joined org. org.
Discharged Feb. 8/66
expiration term of
service.

Book mark:

Hodges

(361)

Copyist.

F. | 10 No. a. | U.S.C.T.

Henry Fortune
Pot., Co. B., 10 Reg't U. S. Col'd No. a.

Appears on a

Detachment Muster-out Roll

of the organization named above. Roll dated

New Orleans La., Feb. 8, 1864*

Muster-out to date Feb. 8, 1864.

Last paid to June 30, 1865

Clothing account:

Last settled _____, 186 ; drawn since \$ _____ 100

Due soldier \$ 31 ⁷⁵/₁₀₀; due U. S. \$ _____ 100

Am't for cloth'g in kind or money adv'd \$ _____ 100

Due U. S. for arms, equipments, &c., \$ _____ 100

Bounty paid \$ _____ 100 due \$ _____ 100

Remarks: *Joined at Origl. Orgn.
Mustered out by reason
of Expiration of term
of service. Cert. of Mustg.
Off. shows him M.O. Feb. 12, 1864
* Added May 9, 93. 2/68*

Book mark: _____

Howling

Ver. Andrew

Co B., 10 U.S. Col'd H. Art'y.

Private

Private

CARD NUMBERS.

1	5494180	26
2	5494333	27
3	5494498	28
4	5494659	29
5	5494814	30
6	5494966	31
7	5495122	32
8	5495278	33
9	5495431	34
10	5495581	35
11	5495721	36
12	5495876	37
13	5496025	38
14	5496175	39
15	5496327	40
16	5496475	41
17	5496620	42
18	5496764	43
19	5496923	44
20	5497105	45
21	5497412	46
22	5489654	47
23		48
24		49
25		50

Book Mark:

See also

F

10 H. Art'y.

U.S.C.T.

Andrew Foster

Pvt., 2 Battery, La. H. Art'y, Native Guards.*

Age *33* years.

Appears on

Company Muster-in Roll

of the organization named above, Roll dated

*Camp Parapet
Carrollton, La.*, *Feb. 9*, 186*3*.

Muster-in to date *Feb. 9*, 186*3*.

Joined for duty and enrolled:

When *Jan'y 13th.*, 186*3*.

Where *Camp Parapet, Carrollton, La.*

Period *3* years.

Valuation of horse, \$.....100

Valuation of horse equipments, \$.....100

Remarks:.....
.....
.....

* This organization subsequently became Co. B, 10 Reg't U. S. Colored Heavy Artillery.

Book mark:.....

Foster

Andrew Foster

Pvt., Co. B, 1 Reg't La. H. Art'y, Native Guards.*

Appears on

Company Muster Roll

for *Term Enlistment to Feb. 28, 1863.*

Present or absent *Present*

Stoppage, \$ *100* for

Due Gov't, \$ *100* for

Valuation of horse, \$ *100*

Valuation of horse equipments, \$ *100*

Remarks:

*This organization subsequently became Co. B, 10 Reg't U. S. Col'd Heavy Artillery.

Book mark:

Foster

F

10 H. Art'y.

U.S.C.T.

Andrew Foster

Pvt., Co. B, 1 Reg't La. H. Art'y, Native Guards.*

Appears on

Company Muster Roll

for *March & April*, 1863.

Present or absent *Present*

Stoppage, \$ *100* for

Due Gov't, \$ *100* for

Valuation of horse, \$ *100*

Valuation of horse equipments, \$ *100*

Remarks:

*This organization subsequently became Co. B, 10 Reg't U. S. Col'd Heavy Artillery.

Book mark:

Foster

F | 10 H. Art'y. | U.S.C.T.

Andrew Foster

Pvt., Co. B, 1 Reg't La. H. Art'y, Native Guards.*

Appears on

Company Muster Roll

for *May 9. June*, 186 *J.*

Present or absent *Present*

Stoppage, \$ *100* for

Due Gov't, \$ *100* for

Valuation of horse, \$ *100*

Valuation of horse equipments, \$ *100*

Remarks: -----

*This organization subsequently became Co. B, 10 Reg't U. S. Col'd Heavy Artillery.

Book mark: -----

Foster

F | 10 H. Art'y. | U.S.C.T.

Andrew Foster

Priv., Co. B, 1 Reg't La. H. Art'y, Native Guards.*

Appears on

Company Muster Roll

for *July & Aug.*, 186 *7*

Present or absent *Present*

Stoppage, \$ *100* for

Due Gov't, \$ *100* for

Valuation of horse, \$ *100*

Valuation of horse equipments, \$ *100*

Remarks: -----

*This organization subsequently became Co. B, 10 Reg't U. S. Col'd Heavy Artillery.

Book mark: -----

Foster

F | 10 H. Art'y. | U.S.C.T.

Andrew Foster

....., Co. B, 1 Reg't La. H. Art'y, Native Guards.*

Appears on

Company Muster Roll

for *Sept. 1, Oct.*, 186*3*.

Present or absent *Present*

Stoppage, \$..... 100 for.....

Due Gov't, \$..... 100 for.....

Valuation of horse, \$..... 100

Valuation of horse equipments, \$..... 100

Remarks:

*This organization subsequently became Co. B, 10 Reg't U. S. Col'd Heavy Artillery.

Book mark:

Foster

F

10 H. Art'y. | U.S.C.T.

Andrew Foster

K, Co. *B*, 1 Reg't H. Art'y, Corps d'Afrique.*

Appears on

Company Muster Roll

for *Month & Year*, 186*3*.

Present or absent *Present*

Stoppage, \$ *100* for

Due Gov't, \$ *100* for

Valuation of horse, \$ *100*

Valuation of horse equipments, \$ *100*

Remarks:

*This organization subsequently became Co. , 10 Reg't U. S. Colored Heavy Artillery.

Book mark:

(358)

Copy

Copyist.

D

10 H. Art'y. U.S.C.T.

Andrew Doster

Pt, Co., 1 Reg't H. Art'y, Corps d'Afrique.*

Appears on

Company Muster Roll

for *Jan. & Feb.*, 186*4*.

Present or absent *Present*

Stoppage, \$ *100* for

Due Gov't, \$ *100* for

Valuation of horse, \$ *100*

Valuation of horse equipments, \$ *100*

Remarks:

*This organization subsequently became Co. , 10 Reg't U. S. Colored Heavy Artillery.

Book mark:

(358)

Ref

Copyist.

F | 10 H. Art'y. | U.S.C.T.

Andrew Foster

A. D., Co. *D.*, 7 Reg't U. S. Col'd H. Art'y.*

Appears on

Company Muster Roll

for *Mar. & Apr.*, 1864.

Present or absent *Present*

Stoppage, \$ 100 for

Due Gov't, \$ 100 for

Valuation of horse, \$ 100

Valuation of horse equipments, \$ 100

Remarks:

* This organization subsequently became Co. *B.*, 10 Reg't U. S. Colored Heavy Artillery.

Book mark:

J. H. Richardson

F

10 H. Art'y.

U.S.C.T.

Andrew Foster

K, Co. *B*, 7 Reg't U. S. Col'd H. Art'y.*

Appears on

Company Muster Roll

for *May + June, 1864*

Present or absent *Present*

Stoppage, \$ 100 for

Due Gov't, \$ 100 for

Valuation of horse, \$ 100

Valuation of horse equipments, \$ 100

Remarks:

* This organization subsequently became Co. , 10 Reg't U. S. Colored Heavy Artillery.

Book mark:

(358)

Reif

Copyist.

F | 10 H. Art'y. | U.S.C.T.

Andrew Foster

Pt, Co. B, 10 Reg't U. S. Col'd H. Art'y.

Appears on

Company Muster Roll

for *July & Aug*, 186*4*.

Present or absent *Present*

Stoppage, \$ *100* for

Due Gov't, \$ *100* for

Valuation of horse, \$ *100*

Valuation of horse equipments, \$ *100*

Remarks: *Company Cook*

Book mark: _____

(358)

J. A. Richardson

Copyist.

F | 10 H. Art'y. | U.S.C.T.

Andrew Foster

Pt, Co. B, 10 Reg't U. S. Col'd H. Art'y.

Appears on

Company Muster Roll

for *Sept & Oct*, 186*4*.

Present or absent *Present*

Stoppage, \$ *100* for

Due Gov't, \$ *100* for

Valuation of horse, \$ *100*

Valuation of horse equipments, \$ *100*

Remarks:

Book mark:

J. P. Richardson

(358)

Copyist.

F.

10 H. Art'y.

U.S.C.T.

Andrew Foster

Plt., Co. B, 10 Reg't U. S. Col'd H. Art'y.

Appears on

Company Muster Roll

for *Nov & Dec*, 186*4*.

Present or absent *Present*

Stoppage, \$ 100 for

Due Gov't, \$ 100 for

Valuation of horse, \$ 100

Valuation of horse equipments, \$ 100

Remarks:

Book mark: -----

Jornier

2

10 H. Art'y. U.S.C.T.

Andrew Foster

Sgt., Co. B, 10 Reg't U. S. Col'd H. Art'y.

Appears on

Company Muster Roll

for *Jan & Feb*, 1865.

Present or absent *Present*

Stoppage, \$ *100* for

Due Gov't, \$ *100* for

Valuation of horse, \$ *100*

Valuation of horse equipments, \$ *100*

Remarks: *Our soldier aug-
mented pay from Jan!
1864 to May 1 1864
\$8⁰⁰ per month May
and June \$9⁰⁰ per
month*

Book mark:

(358)

Jornier

Copyist.

J

10 H. Art'y. U.S.C.T.

Andrew Foster

Pvt., Co. B, 10 Reg't U. S. Col'd H. Art'y.

Appears on

Company Muster Roll

for *Mar & Apr*, 1865.

Present or absent *Present*

Stoppage, \$ 100 for

Due Gov't, \$ 100 for

Valuation of horse, \$ 100

Valuation of horse equipments, \$ 100

Remarks: *(1) daily duty
Hd Qrs Boat since*

Book mark:

(358)

Jovier

Copyist.

F. | 10 H. Art'y. | U.S.C.T.

Andrew Foster

Pvt., Co. B, 10 Reg't U. S. Col'd H. Art'y.

Appears on

Company Muster Roll

for *May & June*, 186*4*.

Present or absent *Present*

Stoppage, \$ *100* for

Due Gov't, \$ *100* for

Valuation of horse, \$ *100*

Valuation of horse equipments, \$ *100*

Remarks:

Book mark:

(358)

Jones

Copyist.

F

10 H. Art'y. U.S.C.T.

Andrew Foster

Pvt.; Co. B, 10 Reg't U. S. Col'd H. Art'y.

Appears on

Company Muster Roll

for *July & Aug*, 186*5*.

Present or absent *Present.*

Stoppage, \$ 100 for

Due Gov't, \$ 100 for

Valuation of horse, \$ 100

Valuation of horse equipments, \$ 100

Remarks:

Book mark:

(358)

J. W. W.

Copyist.

F

10 H. Art'y. U.S.C.T.

Andrew Foster
Plt, Co. B, 10 Reg't U. S. Col'd H. Art'y.

Appears on

Company Muster Roll

for *Sept. & Oct*, 1865.

Present or absent *Present*

Stoppage, \$ 100 for

Due Gov't, \$ 100 for

Valuation of horse, \$ 100

Valuation of horse equipments, \$ 100

Remarks:

Book mark:

(358)

J. J. Jones
Copyist.

T

10 H. Art'y. U.S.C.T.

Andrew Foster

Pl, Co. B, 10 Reg't U. S. Col'd H. Art'y.

Appears on

Company Muster Roll

for *Nov. & Dec., 1865*

Present or absent *Present*

Stoppage, \$ *100* for

Due Gov't, \$ *100* for

Valuation of horse, \$ *100*

Valuation of horse equipments, \$ *100*

Remarks: *Due up for ord.
24 lbs.*

Book mark:

Reis

Copyist.

(358)

F

10 H. Art'y.

U.S.C.T.

Andrew Foster

Pat

, Co. B, 10 Reg't U. S. Col'd H. Art'y.

Appears on

Company Muster Roll

for

Jan'y 1st, 186*6*.

Present or absent

Stoppage, \$ 100 for

Due Gov't, \$ 100 for

Valuation of horse, \$ 100

Valuation of horse equipments, \$ 100

Remarks:

*Must'd out at M.O. S.A.
Feb. 3 66 by reason of
exp. of term of service*

Book mark:

(358)

Pat

Copyist.

F. | 10 N. a. | U.S.C.T.

Andrew Foster

Plt., Co. B., 10 Reg't U. S. Col'd N. a.

Appears on a

Detachment Muster-out Roll

of the organization named above. Roll dated

New Orleans La, Feb. 8, 1866⁺

Muster-out to date Feb. 8, 1866.

Last paid to June. 30, 1865

Clothing account:

Last settled 186 ; drawn since \$ 100

Due soldier \$ 38³² 100; due U. S. \$ 100

Am't for cloth'g in kind or money adv'd \$ 100

Due U. S. for arms, equipments, &c., \$ 100

Bounty paid \$ 100 due \$ 100

Remarks: Joined at Origl. Orgn.
Stop for one Piper &
Tompkins. Mustered
out by reason of Expira-
tion of term of service cert.
of Mustg. Off. shows him M.D. Feb. 12, 1866.

Book mark:

* Added May 9, 93. 2582

Heawling

Andrew Foster

Priv, Co. *B*, 10 Reg't U. S. Col'd H. Art'y.

Appears on Co. Muster-out Roll, dated

Baton Rouge, La. Feb., 186 *7*.

Muster-out to date _____, 186 .

Last paid to _____, 186 .

Clothing account:

Last settled _____, 186 ; drawn since \$ _____ $\overline{100}$

Due soldier \$ _____ $\overline{100}$; due U. S. \$ _____ $\overline{100}$

Am't for cloth'g in kind or money adv'd \$ _____ $\overline{100}$

Due U. S. for arms, equipments, &c., \$ _____ $\overline{100}$

Bounty paid \$ _____ $\overline{100}$; due \$ _____ $\overline{100}$

Remarks:

*Joined org. orgn
Discharged Feb. 8/66
expiration of service-*

Book mark : _____

Hodges

(361)

Copyist.

Poster Andrew

....., Co., *10th* Reg't *U.S. A.A.*

2 Enclosures.

Bed Cards	Final Statements
Burial Records	Furloughs or L. of A.
Certs. of Dis. for Discharge	Med. Certificates
C. M. Charges	Med. Des. Lists
Descriptive Lists	Orders
Discharge Certificates	Pris. of War Record
Enlistment Papers 2	Resignations

Other papers relating to—

Admission to Hosp'l	Furlough or L. of A.
Casualty Sheet	Med. Examination
Confinement	Misc. Information
Contracts	Pay or Clothing
Death or Effects	Personal Reports
Desertion	Rank
Discharge from Hosp'l	Transfer to Hosp'l
Discharge from Service	Transfer to V. R. C.
Duty	Transportation

DECLARATION OF RECRUIT.

I, _____ desiring to ENLIST in the Army of the United States, for the term of THREE YEARS, Do declare, That I am _____ years and _____ months of age; that I have neither wife nor child; that I have never been discharged from the United States service on account of disability or by sentence of a court-martial, or by order before the expiration of a term of enlistment; and I know of no impediment to my serving honestly and faithfully as a soldier for three years.

GIVEN at _____

The _____ day of _____

Witness :

No. 10

James Foster

Enlisted at *Camp Proctor, Va.*

March the 13th 1863,

By *2^d Lieut J. H. Spear*

1st Regt. of Virginia

enlistment, last served in Company (—)

Reg't of _____

Discharged _____ 18—

CONSENT IN CASE OF MINOR.

I, _____ Do CERTIFY, That I am the _____ of _____; that the said _____ is _____ years of age; and I do hereby freely give my CONSENT to his enlisting as a SOLDIER in the ARMY OF THE UNITED STATES for the period of THREE YEARS.

GIVEN at _____

The _____ day of _____

Witness :

County of
Jefferson



State of
Louisiana

I, *Andrew Foster* born in *Mathias Conthou*
in the State of *Virginia* aged *thirty three* years,
and by occupation a *laborer* do hereby acknowledge to have
voluntarily enlisted this *thirteenth* day of *January*
18 *63*, as a SOLDIER in the ARMY OF THE UNITED STATES OF AMERICA, for the period
of *THREE YEARS*, unless sooner discharged by proper authority: Do also agree to
accept such bounty, pay, rations, and clothing, as are, or may be, established by law. And
I, *Andrew Foster* do solemnly swear, that I will bear true faith
and allegiance to the UNITED STATES OF AMERICA, and that I will serve them honestly and
faithfully against all their enemies or opposers whomsoever; and that I will observe and
obey the orders of the President of the United States, and the orders of the officers
appointed over me, according to the Rules and Articles of War.

Sworn and subscribed to, at *N. Carrollton, La.*
this *ninth* day of *February*, 18*63*,
BEFORE
J. Rygaard
2^d Lt. U.S. Army

I CERTIFY, ON HONOR, That I have carefully examined the above named Recruit, agreeably to the General Regulations
of the Army, and that in my opinion he is free from all bodily defects and mental infirmity, which would, in any way, disqualify
him from performing the duties of a soldier.

W. L. S. de EXAMINING SURGEON.

I CERTIFY, ON HONOR, That I have minutely inspected the Recruit, *Andrew Foster*
previously to his enlistment, and that he was entirely sober when enlisted; that, to the best of my judgement and belief, he is of
lawful age; and that, in accepting him as duly qualified to perform the duties of an able-bodied soldier, I have strictly observed
the Regulations which govern the recruiting service. This soldier has *brown* eyes, *black* hair,
dark complexion; is *five* feet, *nine* inches high.

J. Rygaard. 2^d Lt. U.S. Army

RECRUITING OFFICER.

DECLARATION OF RECRUIT.

I, _____ desiring to ENLIST in the Army of the United States, for the term of THREE YEARS, Do declare, That I am _____ years and _____ months of age; that I have neither wife nor child; that I have never been discharged from the United States service on account of disability or by sentence of a court-martial, or by order before the expiration of a term of enlistment; and I know of no impediment to my serving honestly and faithfully as a soldier for three years.

GIVEN at _____

The _____ day of _____

Witness:

10 U S C 112

No. _____

Andrew Foster

Enlisted at *Camp Rachel, Va.*

February the 13th 1862.

By *John G. Apperson*

Ch. of 1st Regiment of Cavalry

enlistment; last served in Company ()

Reg't of _____

Discharged _____ 18 _____

CONSENT IN CASE OF MINOR.

I, _____ Do CERTIFY, That I am the _____ of _____; that the said _____ is _____ years of age; and I do hereby freely give my CONSENT to his enlisting as a SOLDIER in the ARMY OF THE UNITED STATES for the period of THREE YEARS.

GIVEN at _____

The _____ day of _____

Witness:

County of

Jefferson



State of

Louisiana

I, Andrew Postler

born in Mathias Courthouse

in the State of Virginia aged Thirty three years,

and by occupation a Laborer do hereby acknowledge to have

voluntarily enlisted this Thirteenth day of January

18 63, as a SOLDIER in the ARMY OF THE UNITED STATES OF AMERICA, for the period

of THREE YEARS, unless sooner discharged by proper authority: Do also agree to

accept such bounty, pay, rations, and clothing, as are, or may be, established by law. And

I, Andrew Postler do solemnly swear, that I will bear true faith

and allegiance to the UNITED STATES OF AMERICA, and that I will serve them honestly and

faithfully against all their enemies or opposers whomsoever; and that I will observe and

obey the orders of the President of the United States, and the orders of the officers

appointed over me, according to the Rules and Articles of War.

of Carrollton, La.

Sworn ~~and subscribed~~ to, at Camp Parapet,

this ninth day of February 1863

BEFORE

J. Rygaard
2^d Lt. U.S. Art. Co. 1st

I CERTIFY, ON HONOR, That I have carefully examined the above named Recruit, agreeably to the General Regulations of the Army, and that in my opinion he is free from all bodily defects and mental infirmity, which would, in any way, disqualify him from performing the duties of a soldier.

W. C. Gentry

EXAMINING SURGEON.

I CERTIFY, ON HONOR, That I have minutely inspected the Recruit, Andrew Postler previously to his enlistment, and that he was entirely sober when enlisted; that, to the best of my judgement and belief, he is of lawful age; and that, in accepting him as duly qualified to perform the duties of an able-bodied soldier, I have strictly observed the Regulations which govern the recruiting service. This soldier has Brown eyes, Dark hair, Dark complexion; is five feet, nine inches high.

J. Rygaard 2^d Lt. U.S. Art. Co. 1st

RECRUITING OFFICER.

Foster, George
Co. A., 10 U.S. Col'd H. Art'y.

Private

Private

CARD NUMBERS.

1	5490403	26
2	5490554	27
3	5490697	28
4	5490854	29
5	5490993	30
6	5491127	31
7	5491256	32
8	5491389	33
9	5491518	34
10	5491645	35
11	5491771	36
12	5491898	37
13	5492023	38
14	5492146	39
15	5492271	40
16	5492396	41
17	5492519	42
18	5492644	43
19	5492771	44
20	5493013	45
21	5493968	46
22	5489527	47
23	47-25-1894	48
24		49
25		50

Book Mark: L.R. 15/944, 4729.
1874

See also

F

10 H. Art'y. U.S.C.T.

George Foster
Private

, Co. A, 1 Reg't La. Col'd H. Art'y.*

Age 25 years.

Appears on

Company Muster-in Roll

of the organization named above. Roll dated

New Orleans, La. Nov. 29, 1862.

Muster-in to date Nov. 29, 1862

Joined for duty and enrolled:

When Nov. 16, 1862

Where New Orleans

Period 3 years.

Valuation of horse, \$ 100

Valuation of horse equipments, \$ 100

Remarks:

*This organization subsequently became Co. A, 10 Reg't U. S. Colored Heavy Artillery.

Book mark:

Johnson

(356)

Copyist.

71

George Foster
Priv, Co. A, 1 Reg't La. H. Art'y.*

Appears on

Company Muster Roll

for to Dec. 31, 1862

Present or absent Present

Stoppage, \$ 100 for

Due Gov't, \$ 100 for

Valuation of horse, \$ 100

Valuation of horse equipments, \$ 100

Remarks:

*This organization subsequently became Co. A, 10 Reg't U. S. Col'd Heavy Artillery.

Book mark:

(358)

Tolman
Copyist.

71

10 H. Art'y. U.S.C.T.

George Foster

....., Co. A, 1 Reg't La. H. Art'y.*

Appears on

Company Muster Roll

for Jany & Feby, 1863

Present or absent Present

Stoppage, \$.....100 for

Due Gov't, \$.....100 for

Valuation of horse, \$.....100

Valuation of horse equipments, \$.....100

Remarks:

*This organization subsequently became Co. A, 10 Reg't U. S. Col'd Heavy Artillery.

Book mark:

Tobman

F

10 H. Art'y. U.S.C.T.

George Foster

Co. A, 1 Reg't La. H. Art'y.*

Appears on

Company Muster Roll

for March & April, 1863.

Present or absent Present

Stoppage, \$ 100 for

Due Gov't, \$ 100 for

Valuation of horse, \$ 100

Valuation of horse equipments, \$ 100

Remarks:

*This organization subsequently became Co. A, 10 Reg't U. S. Col'd Heavy Artillery.

Book mark:

Tobman

(358)

Copyist.

F

10 H. Art'y. U.S.C.T.

George Foster

Priv., Co. A, 1 Reg't La. H. Art'y.*

Appears on

Company Muster Roll

for May & June, 1863.

Present or absent Present

Stoppage, \$ 100 for

Due Gov't, \$ 100 for

Valuation of horse, \$ 100

Valuation of horse equipments, \$ 100

Remarks:

*This organization subsequently became Co. A, 10 Reg't U. S. Col'd Heavy Artillery.

Book mark:

Tobman

(358)

Copyist.

F1

10 H. Art'y. U.S.C.T.

George Foster

Priv., Co. A, 1 Reg't La. H. Art'y.*

Appears on

Company Muster Roll

for July & August, 1863.

Present or absent Present

Stoppage, \$ 100 for

Due Gov't, \$ 100 for

Valuation of horse, \$ 100

Valuation of horse equipments, \$ 100

Remarks:

*This organization subsequently became Co. A, 10 Reg't U.S. Col'd Heavy Artillery.

Book mark:

Tobman

(358)

Copyist.

F

10 H. Art'y. U.S.C.T.

George Foster

Priv., Co. A, 1 Reg't La. H. Art'y.*

Appears on

Company Muster Roll

for *Sept & Oct*, 1863.

Present or absent *Present*

Stoppage, \$ 100 for

Due Gov't, \$ 100 for

Valuation of horse, \$ 100

Valuation of horse equipments, \$ 100

Remarks:

*This organization subsequently became Co. A, 10 Reg't U.S. Col'd Heavy Artillery.

Book mark:

(358)

Tobman
Copied.

7

10 H. Art'y. U.S.C.T.

George Foster

Co. A, 1 Reg't H. Art'y, Corps d'Afrique.*

Appears on

Company Muster Roll

for New York, 1863

Present or absent Present

Stoppage, \$ 100 for

Due Gov't, \$ 100 for

Valuation of horse, \$ 100

Valuation of horse equipments, \$ 100

Remarks:

*This organization subsequently became Co. A, 10 Reg't U. S. Colored Heavy Artillery.

Book mark:

Foster

F | 10 H. Art'y. | U.S.C.T.

George Foster
Art. Co. A, 1 Reg't H. Art'y, Corps d'Afrique.*

Appears on

Company Muster Roll

for *Jan & Feb*, 1864.

Present or absent *Present*

Stoppage, \$ 100 for

Due Gov't, \$ 100 for

Valuation of horse, \$ 100

Valuation of horse equipments, \$ 100

Remarks: |

*This organization subsequently became Co. *A*, 10 Reg't U. S. Colored Heavy Artillery.

Book mark:

George Foster

F | 10 H. Art'y. | U.S.C.T.

George Foster
Co. A, 7 Reg't U. S. Col'd H. Art'y.*

Appears on

Company Muster Roll

for *Mar 25*, 1864.

Present or absent *Present*

Stoppage, \$ 100 for

Due Gov't, \$ 100 for

Valuation of horse, \$ 100

Valuation of horse equipments, \$ 100

Remarks:

* This organization subsequently became Co *A*, 10 Reg't U. S. Colored Heavy Artillery.

Book mark:

Booster

F

10 H. Art'y.

U.S.C.T.

George Foster

B Co A, 7 Reg't U. S. Col'd H. Art'y.*

Appears on

Company Muster Roll

for *May & June*, 1864.

Present or absent *Present*

Stoppage, \$ 100 for

Due Gov't, \$ 100 for

Valuation of horse, \$ 100

Valuation of horse equipments, \$ 100

Remarks:

* This organization subsequently became Co *A*, 10 Reg't U. S. Colored Heavy Artillery.

Book mark:

Robert

F | 10 H. Art'y. | U.S.C.T.

George Foster

F.A., Co *A*, 7 Reg't U. S. Col'd H. Art'y.*

Appears on

Company Muster Roll

for *July & Aug*, 1864.

Present or absent *Present*

Stoppage, \$ 100 for

Due Gov't, \$ 100 for

Valuation of horse, \$ 100

Valuation of horse equipments, \$ 100

Remarks:

* This organization subsequently became Co. *A*, 10 Reg't U. S. Colored Heavy Artillery.

Book mark:

Bohater

F | 10 H. Art'y. | U.S.C.T.

George Foster
Cpl, Co. A, 10 Reg't U. S. Col'd H. Art'y.

Appears on

Company Muster Roll

for *Sept*, 1864.

Present or absent *Present*

Stoppage, \$ 100 for

Due Gov't, \$ 100 for

Valuation of horse, \$ 100

Valuation of horse equipments, \$ 100

Remarks:

Book mark:

Rocheater

7 | 10 H. Art'y. | U.S.C.T.

George Foster
Co. A, 10 Reg't U. S. Col'd H. Art'y.

Appears on

Company Muster Roll

for *C. M. Klee*, 1864.

Present or absent *Absent*

Stoppage, \$ 100 for

Due Gov't, \$ 100 for

Valuation of horse, \$ 100

Valuation of horse equipments, \$ 100

Remarks: *In Attached
Service at Battery
Gentilly, La. per
A. O. No. 317 H. G. No.
Ref. New Orleans
dated Dec. 26, 1864*

Book mark:

G. Foster

F | 10 H. Art'y. | U.S.C.T.

George Foster

Co. A, Co. A, 10 Reg't U. S. Col'd H. Art'y.

Appears on

Company Muster Roll

for *Jan + Feb*, 1865.

Present or absent *Present*

Stoppage, \$ *100* for

Due Gov't, \$ *100* for

Valuation of horse, \$ *100*

Valuation of horse equipments, \$ *100*

Remarks: *Due Gov't for
Camp and Garrison
Equipments as per
Abstract \$0.50*

Book mark:

Geo Foster

(358)

Copyist.

A | 10 H. Art'y. | U.S.C.T.

George Foster

Pvt, Co. A, 10 Reg't U. S. Col'd H. Art'y.

Appears on

Company Muster Roll

for *March 1865*, 1865.

Present or absent *Present*

Stoppage, \$ 100 for

Due Gov't, \$ 100 for

Valuation of horse, \$ 100

Valuation of horse equipments, \$ 100

Remarks *Due Gov't for Camp
and Garrison Equipage
as per C Receipt
\$0.50*

Book mark: _____

Reed

F | 10 H. Art'y. | U.S.C.T.

George Foster
G.F., Co. A, 10 Reg't U. S. Col'd H. Art'y.

Appears on

Company Muster Roll

for *May + June*, 18*65*.

Present or absent *Present*

Stoppage, \$ *100* for

Due Gov't, \$ *100* for

Valuation of horse, \$ *100*

Valuation of horse equipments, \$ *100*

Remarks: *Mus Gov't for
Camp + Garrison
Equipage as per Abstract
\$ 2.50*

Book mark:

Roberts

H | 10 H. Art'y. | U.S.C.T.

George Foster
Private, Co. A, 10 Reg't U. S. Col'd H. Art'y.

Appears on

Company Muster Roll

for *July & Aug, 1865.*

Present or absent *Present*

Stoppage, \$ 100 for

Due Gov't, \$ 100 for

Valuation of horse, \$ 100

Valuation of horse equipments, \$ 100

Remarks: _____

Book mark: _____

George Foster
(358) Copyist.

A | 10 H. Art'y. | U.S.C.T.

George Foster

Pl, Co. A, 10 Reg't U. S. Col'd H. Art'y.

Appears on

Company Muster Roll

for *Sept & Oct*, 1865.

Present or absent *Present*

Stoppage, \$ 100 for

Due Gov't, \$ 100 for

Valuation of horse, \$ 100

Valuation of horse equipments, \$ 100

Remarks:

Book mark:

(358)

Hopps

Copyist.

A | 10 H. Art'y. | U.S.C.T.

George Foster

Pal, Co. A, 10 Reg't U. S. Col'd H. Art'y.

Appears on

Company Muster Roll

for *Nov + Dec*, 1865.

Present or absent

Stoppage, \$ 100 for

Due Gov't, \$ 100 for

Valuation of horse, \$ 100

Valuation of horse equipments, \$ 100

Remarks: *Mustered out by reason of expiration of term of service*

Book mark: *Disch'd. M. 28/65 L.B. 15 47. Ct. 1864*
6570 P.M. G. June 26. '66

Hynes
Copyist.

7

10 H. Art'y. U.S.C.T.

George Foster

Pvt., Co. A, 10 Reg't U. S. Col'd H. Art'y.

Appears on Co. Muster-out Roll, dated Baton Rouge La Feb 22, 1867.

Muster-out to date _____, 186 .

Last paid to _____, 186 .

Clothing account:

Last settled _____, 186 ; drawn since \$ _____ 100

Due soldier \$ _____ 100; due U. S. \$ _____ 100

Am't for cloth'g in kind or money adv'd \$ _____ 100

Due U. S. for arms, equipments, &c., \$ _____ 100

Bounty paid \$ _____ 100; due \$ _____ 100

Remarks: Joined regt. man. Disch'd for Expon. of term of service Nov. 28. 65

Book mark: K 116 P 10 70

Nesbitt

(361)

Copyist.

T. | *10. Me. a.* | **U.S.C.T.**

George Foster
Priv., Co. A., 10 Reg't U. S. Col'd Me. a.

Appears on a

Detachment Muster-out Roll

of the organization named above. Roll dated

N. Orleans La. Nov. 28 1865.

Muster-out to date

Nov. 28 1865.

Last paid to

June 30, 1865.

Clothing account:

Last settled 186 ; drawn since \$..... 100

Due soldier \$ *20 00* 100; due U. S. \$..... 100

Am't for cloth'g in kind or money adv'd \$..... 100

Due U. S. for arms, equipments, &c., \$..... 100

Bounty paid \$..... 100 due \$..... 100

Remarks: *Joined at Orignl. Orign.*

*Mustered out by reason
of Expiration of term of
service.*

Book mark:

Heasley

(349)

Copyist.

F | 10th Va. A. | U.S.C. I

George Foster,
Co. A., 10th Reg't U.S.C. Va. A.

NOTATION.

Book mark:

L.B. 15-941 with
47.6.2. 1884.

War Department,

Adjutant General's Office,

Washington, Jan. 5th, 1884.

-----Mustered out with Detach-
ment November 28, 1865.

E. P. Linniger

(438)

Copyist.

Foster George J.

Co L, 10 U.S. Col'd H. Art'y

2nd Lieutenant 2nd Lieutenant

CARD NUMBERS.

1	5488149	26
2		27
3		28
4		29
5		30
6		31
7		32
8		33
9		34
10		35
11		36
12		37
13		38
14		39
15		40
16		41
17		42
18		43
19		44
20		45
21		46
22		47
23		48
24		49
25		50

Book Mark:

See also

Co E 74th Inf

I 1066 U.S.C.T.

George J Foster
2d Lt, Co. K, 10 Reg't U. S. Col'd Ill.

Appears on

M. and D. Roll of Men Transferred

to the organization named above,

from Co. E 4th U.S. Col Inf

Roll dated Camp Mansfield Ill, 1861

When enlisted Dec 1 1861

Period for which enlisted 3 years.

When mustered in Dec 1 1861

Present or absent

Company to which assigned

Remarks: Discharged by res

ign of resignation ac-
cepted May 16 64,
By Order Maj General
Banks,

Not taken up on rolls
of Co. E

Book mark :

W. H. Scott

400

Foster Henry

Co., 10 U.S. Col'd H. Art'y.

Imitate

Private

CARD NUMBERS.

1	5488153	26
2		27
3		28
4		29
5		30
6		31
7		32
8		33
9		34
10		35
11		36
12		37
13		38
14		39
15		40
16		41
17		42
18		43
19		44
20		45
21		46
22		47
23		48
24		49
25		50

Book Mark:

See also 77 U.S. Col'd H. Art'y

I 1086a

U.S.C.T.

Henry Foster

Co. F, Co. *10* Reg't U. S. Col'd *16th*

Appears on

M. and D. Roll of Men Transferred

to the organization named above,

from *Co. E 7th U.S. Col. Inf*

Roll dated *Camp Grapella Ala*, 186*5*.

When enlisted *January 30*, 186*5*.

Period for which enlisted *9* years.

When mustered in *July 7*, 186*5*.

Present or absent

Company to which assigned

Remarks: *Discharged for disa-*

bility June 10. 65. By

Order of Maj Gen.

Canby. Final statements

given by C. & A. G. How

New Orleans La.

name not taken up on

muster rolls of Regt

Book mark :

W. H. Scott

⁷⁰¹
Foster, Horace

Co F, 10 U.S. Col'd H. Art'y.

Private | Private

CARD NUMBERS.

1	5-488739	26
2	5-505774	27
3	5-5-05928	28
4	5-5-06075	29
5	5-5-06214	30
6	5-5-06360	31
7	5-5-06479	32
8	5-5-06590	33
9	5-5-06808	34
10	5-5-06905	35
11		36
12		37
13		38
14		39
15		40
16		41
17		42
18		43
19		44
20		45
21		46
22		47
23		48
24		49
25		50

Book Mark:

See also

77 M.C. Infy

F | *10* *Harty* | **U.S.C.T.**

Horace Foster

Am, Co. *F*, *10* Reg't U. S. Col'd *Harty*

Appears on

M. and D. Roll of Men Transferred

to the organization named above,

from *77 Regt US Inf*

Roll dated *Oct 1*, 1865.

When enlisted *Sept 1*, 1864.

Period for which enlisted *3* years.

When mustered in *Sept 1*, 1864.

Present or absent *Present*

Company to which assigned *F*

Remarks:

Book mark:

(342)

J. L. Leonard

Copist.

J

10 H. Art'y. U.S.C.T.

Horace Foster

Priv, Co. F, 10 Reg't U. S. Col'd H. Art'y.

Appears on

Company Muster Roll

for Sept & Oct, 1863

Present or absent Present

Stoppage, \$ 100 for

Due Gov't, \$ 100 for

Valuation of horse, \$ 100

Valuation of horse equipments, \$ 100

Remarks: Transferred from Co. H
77 U.S.C. Oct. 1/63

Book mark:

B. G. Wason

(358)

Copyist.

F

10 H. Art'y. U.S.C.T.

Morace Foster

Prvt., Co. F, 10 Reg't U. S. Col'd H. Art'y.

Appears on

Company Muster Roll

for *Nov & Dec.*, 1865.

Present or absent *Present.*

Stoppage, \$ *100* for

Due Gov't, \$ *100* for

Valuation of horse, \$ *100*

Valuation of horse equipments, \$ *100*

Remarks:

SPC 2633

Book mark *32*

ASH
Copyst.

F

10 H. Art'y. U.S.C.T.

Morace Foster,

Priv., Co. F, 10 Reg't U. S. Col'd H. Art'y.

Appears on

Company Muster Roll

for *Jan'y & Feby.*, 1866.

Present or absent *Present.*

Stoppage, \$ 100 for

Due Gov't, \$ 100 for

Valuation of horse, \$ 100

Valuation of horse equipments, \$ 100

Remarks:

2

Book mark:

(358)

C. W. H.
Copist.

Morace Foster

Priv., Co. F, 10 Reg't U. S. Col'd H. Art'y.

Appears on

Company Muster Roll

for *Mar & Apr.*, 1866.

Present or absent *Present.*

Stoppage, \$ 100 for

Due Gov't, \$ 100 for

Valuation of horse, \$ 100

Valuation of horse equipments, \$ 100

Remarks: *Stop for loss of 1
Haversack & 1 canteen
\$1.60.*

Book mark:

Horace Foster

Pat., Co. F, 10 Reg't U. S. Col'd H. Art'y.

Appears on

Company Muster Roll

for *May & June*, 186*6*.

Present or absent *Present*

Stoppage, \$ *100* for

Due Gov't, \$ *100* for

Valuation of horse, \$ *100*

Valuation of horse equipments, \$ *100*

Remarks:

Book mark:

A. Foster
Copyist.

F.

10 H. Art'y. U.S.C.T.

Morace Foster

Pat., Co. F, 10 Reg't U. S. Col'd H. Art'y.

Appears on

Company Muster Roll

for *July & Aug.*, 1866.

Present or absent *Present*

Stoppage, \$ 100 for

Due Gov't, \$ 100 for

Valuation of horse, \$ 100

Valuation of horse equipments, \$ 100

Remarks:

Book mark:

(358)

Asst.
Copyst.

J

10 H. Art'y. U.S.C.T.

Horace Foster

Dr, Co. F, 10 Reg't U. S. Col'd H. Art'y.

Appears on

Company Muster Roll

for *Sept. and Oct*, 186*6*

Present or absent *Present*

Stoppage, \$ 100 for

Due Gov't, \$ 100 for

Valuation of horse, \$ 100

Valuation of horse equipments, \$ 100

Remarks:

Book mark: _____

(358)

Howse

Copyist.

F

10 H. Art'y. U.S.C.T.

Horace Foster

Rt, Co. F, 10 Reg't U. S. Col'd H. Art'y.

Appears on

Company Muster Roll

for *Nov. and Dec*, 186*6*

Present or absent *Present*

Stoppage, \$ 100 for

Due Gov't, \$ 100 for

Valuation of horse, \$ 100

Valuation of horse equipments, \$ 100

Remarks:

Book mark:

House

Horace Foster

Art, Co. F, 10 Reg't U. S. Col'd H. Art'y.

Appears on Co. Muster-out Roll, dated

Baton Rouge La, Feb. 22, 186 7.

Muster-out to date Feb. 22, 186 7.

Last paid to Dec. 31, 186 6.

Clothing account:

Last settled, 186 ; drawn since \$ 100

Due soldier \$ 17 ⁰³ / 100; due U. S. \$ 100

Am't for cloth'g in kind or money adv'd \$ 100

Due U. S. for arms, equipments, &c., \$ 0 ⁰⁸ / 100

Bounty paid \$ none / 100; due \$ 200 ⁰⁰ / 100

Remarks: Rec'd by transfer from Co. E. 77 U. S. C. I. in S. O. No. 66 Hd. Qu. Dept. of La. S. of 65. Conscripted by G. O. No. 106 Hd. Qu. Dept. of the Gulf S. of 64

Book mark:

None

Foster Rufus

Co *H*, 10 U.S. Col'd H. Art'y.

Private

Private

CARD NUMBERS.

1	5488395	26
2	5487563	27
3	5512271	28
4	5512423	29
5	5512566	30
6	5512713	31
7	5512839	32
8	5512959	33
9	5513128	34
10	5513350	35
11		36
12		37
13		38
14		39
15		40
16		41
17		42
18		43
19		44
20		45
21		46
22		47
23		48
24		49
25		50

Book Mark:

See also *77. use of + 9" U.S.C.*

A 1076A U.S.C.T.

Cyrus Foster

1st, Co. *K*, *10* Reg't U. S. Col'd *H.A.*

Appears on

M. and D. Roll of Men Transferred

to the organization named above,

from *407 U.S. Col Inf*

Roll dated *Camp Parapetia Cal*, 186*5*.

When enlisted *Feb 6*, 186*4*.

Period for which enlisted *3* years.

When mustered in *May 20*, 186*4*.

Present or absent *Present*

Company to which assigned *K*

Remarks: *Rec'd by transfer from Co. K, 407 U.S. Col Inf,*

Book mark :

W. H. Scott

I 10 H.A. U.S.C.T.

Rufus Foster

Co. H, 10 Reg't U. S. Col'd H.A.

Appears on

M. and D. Roll of Men Transferred

to the organization named above,

from *Co. G, 10 Reg't U. S. Col'd*

Roll dated *Camp Danaper La Col, 1865*

When enlisted *July 6*, 186*4*

Period for which enlisted *3* years.

When mustered in *May 20*, 186*4*

Present or absent *Present*

Company to which assigned *K*

Remarks: *Joined at Original
Organization of Co taken
Prisoner at Luke, Man-
repas La Mich 13, 65.
Escaped and returned
to duty Apr 4, 65,*

Book mark : *500005*

Wm Scott

F | **10** H. Art'y. | **U.S.C.T.**

Rufus Foster

P, Co. *K*, 10 Reg't U. S. Col'd H. Art'y.

Age years.

Appears on

Company Muster Roll*

for *Sept & Oct*, 186*5*.

Joined for duty and enrolled:

When *Feb. 6*, 186*4*.

Where *Baton Rouge*

Period *3* years.

Mustered in:

When *May 20*, 186*4*.

Where *New Orleans*

Present or absent *Present*

Stoppage, \$ 100 for

Due Gov't, \$ 100 for

Remarks: *Due for commutation of rations while prisoner of war from Mch. 13, 65 to Apl. 4, 65.*

* First current roll. No muster-in roll of this company on file.

Book mark:

(3586)

Hibbard

Copyist.

J | 10 H. Art'y. | U.S.C.T.

Rufus Foster

P, Co. K, 10 Reg't U. S. Col'd H. Art'y.

Appears on

Company Muster Roll

for Nov. & Dec., 1865.

Present or absent Present

Stoppage, \$ 100 for

Due Gov't, \$ 100 for

Valuation of horse, \$ 100

Valuation of horse equipments, \$ 100

Remarks: Due for commutation of rations while prisoner of war from Mch. 13, 65 to Apl. 4, 65.

Book mark:

(358)

Hibbard

Copyist.

T

10 H. Art'y.

U.S.C.T.

Rufus Foster

P, Co. K, 10 Reg't U. S. Col'd H. Art'y.

Appears on

Company Muster Roll

for Jan. Feb., 1866

Present or absent Present

Stoppage, \$ 100 for

Due Gov't, \$ 100 for

Valuation of horse, \$ 100

Valuation of horse equipments, \$ 100

Remarks:

Book mark:

(358)

Hibbard Copyist.

P

10 H. Art'y.

U.S.C.T.

Rufus Foster

P, Co. K, 10 Reg't U. S. Col'd H. Art'y.

Appears on

Company Muster Roll

for Mch. & Apl., 1866

Present or absent Present

Stoppage, \$ 100 for

Due Gov't, \$ 100 for

Valuation of horse, \$ 100

Valuation of horse equipments, \$ 100

Remarks:

Book mark:

(358)

Hibbard

Copyist.

P | 10 H. Art'y. | U.S.C.T.

Rufus Foster

P, Co. K, 10 Reg't U. S. Col'd H. Art'y.

Appears on

Company Muster Roll

for *May & June*, 186*6*.

Present or absent *Present*

Stoppage, \$.....*100* for

Due Gov't, \$.....*100* for

Valuation of horse, \$.....*100*

Valuation of horse equipments, \$.....*100*

Remarks: *Sick in ops.*

Book mark:

(358)

Husband

Copyist.

P

10 H. Art'y.

U.S.C.T.

Rufus Foster

P

, Co. K, 10 Reg't U. S. Col'd H. Art'y.

Appears on

Company Muster Roll

for

July 1 Aug.,

186 6.

Present or absent

Present

Stoppage, \$

100 for

Due Gov't, \$

100 for

Valuation of horse, \$

100

Valuation of horse equipments, \$

100

Remarks:

Book mark:

Hubbard

(358)

Copyist.

F

10 H. Art'y.

U.S.C.T.

Rufus Foster

Put, Co. K, 10 Reg't U. S. Col'd H. Art'y.

Appears on

Company Muster Roll

for *Sept. & Oct.*, 1866.

Present or absent

Stoppage, \$ 100 for

Due Gov't, \$ 100 for

Valuation of horse, \$ 100

Valuation of horse equipments, \$ 100

Remarks: *Discharged Sept 8. 1866
to enable him to re-enlist
in the Regular Army.*

Book mark:

Floyd

(358)

Copyist.

F

10 H. Art'y. U.S.C.T.

Rufus Foster

Put, Co. *K*, 10 Reg't U. S. Col'd H. Art'y.

Appears on Co. Muster-out Roll, dated
Baton Rouge La, Feb 22, 1867.

Muster-out to date _____, 186 .

Last paid to _____, 186 .

Clothing account:

Last settled _____, 186 ; drawn since \$ _____ 100

Due soldier \$ _____ 100; due U. S. \$ _____ 100

Am't for cloth'g in kind or money adv'd \$ _____ 100

Due U. S. for arms, equipments, &c., \$ _____ 100

Bounty paid \$ _____ 100; due \$ _____ 100

Remarks: *Recd by transfer from Co G.
77 U. S. C. I. Oct 1/65 per S. O. No. 66
Hedgns Dept La S. 1865. Dis.
Service to recruit in 9 U. S. Co.
Sept 8/66*

Book mark: _____

Floyd

(361)

Copyist.

Couch. Sylpha

Co F, 10 U.S. Col'd H. Art'y.

Private

Private

CARD NUMBERS.

1	5487328	26
2	5504710	27
3	5504969	28
4	5505105	29
5	5505237	30
6	5505330	31
7	5505428	32
8	5505532	33
9	5505642	34
10	5505766	35
11	5505920	36
12	5506067	37
13	5506207	38
14	5506353	39
15	5506472	40
16	5506583	41
17	5506801	42
18	5506898	43
19		44
20		45
21		46
22		47
23		48
24		49
25		50

Book Mark:

See also

S | *106* *H. arty* | **U.S.C.T**

Sylpha Touch

Appears with rank of *Put* on

Muster and Descriptive Roll of a Detachment of Drafted Men and Substitutes forwarded

for the *7* Reg't U.S. Col'd *H. arty* Roll dated *New Orleans La, Aug 19, 1864*

Where born *Attakapas La*

Age *26* years; occupation *Laborer*

Drafted and mustered in:

When *Aug 17*, 1864.

Where *Houma La*

Period *3* years.

Eyes *Dark*; hair *Black*

Complexion *Dark*; height *5* ft. *8* in.

Paid bounty and advance pay, \$ *100*

Bounty due \$ *100*

Where credited *Parish of Terrebonne La*

Company to which assigned *F*

Remarks:

Became 10 U.S.C.H. arty

Book mark:

(340)

J. Jennings
Coptist.

F | 10 H. Art'y. | U.S.C.T.

Sylpha Fouch

Priv., Co. *F*, 7 Reg't U. S. Col'd H. Art'y.*

Appears on

Company Muster-in and Descriptive Roll

of the organization named above. Roll dated

New Orleans La, Aug 19, 1864.

Where born *Attakapas La*

Age *26* y'rs; occupation *Laborer*

When enlisted _____, 186 .

Where enlisted _____

For what period enlisted *3* years.

Eyes *Dark*; hair *Black*

Complexion *Dark*; height *5* ft. *8* in.

When mustered in *Aug 19*, 1864.

Where mustered in *New Orleans La*

Bounty paid \$ *100*; due \$ *100*

Where credited *3rd Enroll Dist La*

Company to which assigned _____

Remarks: *Drafted*

* This organization subsequently became Co. *F*, 10 Reg't U. S. Colored Heavy Artillery.

Book mark: _____

Rosenbaum

(356d)

Copyist.

Sylpha Touch

Pat, Co. F, 10 Reg't U. S. Col'd H. Art'y.

Appears on

Company Muster Roll

for July & August, 1864.

Present or absent Present

Stoppage, \$ _____ 100 for _____

Due Gov't, \$ _____ 100 for _____

Valuation of horse, \$ _____ 100

Valuation of horse equipments, \$ _____ 100

Remarks: _____

Book mark: _____

(358)

Rosenbaum
Copyist.

F | 10 H. Art'y. | **U.S.C.T.**

Sylpha Touch

Pat, Co. F, 10 Reg't U. S. Col'd H. Art'y.

Appears on

Company Muster Roll

for Sept & Oct, 1864.

Present or absent Present

Stoppage, \$ _____ 100 for _____

Due Gov't, \$ _____ 100 for _____

Valuation of horse, \$ _____ 100

Valuation of horse equipments, \$ _____ 100

Remarks: _____

Book mark: _____

(358)

Rosenbaum

Copyist.

2

F | 10 H. Art'y. | U.S.C.T.

Sypha Fouch

Pol, Co. F, 10 Reg't U. S. Col'd H. Art'y.

Appears on

Company Muster Roll

for *Nov & Dec*, 186*4*.

Present or absent *Present*

Stoppage, \$ *100* for

Due Gov't, \$ *100* for

Valuation of horse, \$ *100*

Valuation of horse equipments, \$ *100*

Remarks:

Book mark: -----

Rosenbaum
(358) Copyist.

Ji

10 H. Art'y. U.S.C.T.

Dylpha Touch

Priv, Co. F, 10 Reg't U. S. Col'd H. Art'y.

Appears on

Company Muster Roll

for Jan & Feb, 1865.

Present or absent Present

Stoppage, \$ 100 for

Due Gov't, \$ 100 for

Valuation of horse, \$ 100

Valuation of horse equipments, \$ 100

Remarks:

Book mark:

B. G. Wasdon

(358)

Copyist.

J

10 H. Art'y. U.S.C.T.

Dylpha Touch

Grw, Co. F, 10 Reg't U. S. Col'd H. Art'y.

Appears on

Company Muster Roll

for Mar & Apr, 1865.

Present or absent Present

Stoppage, \$ 100 for

Due Gov't, \$ 100 for

Valuation of horse, \$ 100

Valuation of horse equipments, \$ 100

Remarks:

Book mark:

B. S. Masdon

J

10 H. Art'y. U.S.C.T.

Sylpha Touch

Prw, Co. F, 10 Reg't U. S. Col'd H. Art'y.

Appears on

Company Muster Roll

for May & June, 1865.

Present or absent Present

Stoppage, \$ 100 for

Due Gov't, \$ 100 for

Valuation of horse, \$ 100

Valuation of horse equipments, \$ 100

Remarks: Due U.S. for Camp & Garrison Equipage \$70

Book mark:

By Masdon

J

10 H. Art'y. U.S.C.T.

Dylpha Touch

Co. F, 10 Reg't U. S. Col'd H. Art'y.

Appears on

Company Muster Roll

for dated Aug 31, 1865.

Present or absent Present

Stoppage, \$ 100 for

Due Gov't, \$ 100 for

Valuation of horse, \$ 100

Valuation of horse equipments, \$ 100

Remarks: Due U.S. for Camp D
Garrison Equipage #.01

Book mark:

B. G. Mason

J

10 H. Art'y. U.S.C.T.

Dylpha Touch

Private, Co. F, 10 Reg't U. S. Col'd H. Art'y.

Appears on

Company Muster Roll

for Sept & Oct, 1865.

Present or absent Present

Stoppage, \$ 100 for

Due Gov't, \$ 100 for

Valuation of horse, \$ 100

Valuation of horse equipments, \$ 100

Remarks:

Book mark:

B. G. Masdon

Sylvia Touch

Part, Co. F, 10 Reg't U. S. Col'd H. Art'y.

Appears on

Company Muster Roll

for *Nov. & Dec.*, 1865.

Present or absent *Present*

Stoppage, \$ *0.* $\frac{18}{100}$ for *ordnance*

Due Gov't, \$ *100* for

Valuation of horse, \$ *100*

Valuation of horse equipments, \$ *100*

Remarks: *Due U.S. for C. & G. E.*
\$0.01.

Book mark:

Sylpha Fouch,
Pat., Co. F, 10 Reg't U. S. Col'd H. Art'y.

Appears on

Company Muster Roll

for *Jan'y & Feby.*, 186*6*.

Present or absent *Present.*

Stoppage, \$ 100 for

Due Gov't, \$ 100 for

Valuation of horse, \$ 100

Valuation of horse equipments, \$ 100

Remarks:

Book mark:

Sylpha Fouch

Pat., Co. F, 10 Reg't U. S. Col'd H. Art'y.

Appears on

Company Muster Roll

for *May & April*, 186*6*.

Present or absent *Present*

Stoppage, \$ *100* for

Due Gov't, \$ *100* for

Valuation of horse, \$ *100*

Valuation of horse equipments, \$ *100*

Remarks:

Book mark: *100 100 6*

Asst.
Copyist.

F

10 H. Art'y. U.S.C.T.

Siglyphus Fouch

Prvt; Co. F, 10 Reg't U. S. Col'd H. Art'y.

Appears on

Company Muster Roll

for *May & June*, 186*6*.

Present or absent *Present*

Stoppage, \$ *100* for

Due Gov't, \$ *100* for

Valuation of horse, \$ *100*

Valuation of horse equipments, \$ *100*

Remarks:

Book mark:

(358)

Asst
Copyist.

F. | 10 H. Art'y. | **U.S.C.T.**

Sypha Fouché
Pat., Co. F, 10 Reg't U. S. Col'd H. Art'y.

Appears on

Company Muster Roll

for *July & Aug.*, 186*6*.

Present or absent *Present.*

Stoppage, \$ *100* for

Due Gov't, \$ *100* for

Valuation of horse, \$ *100*

Valuation of horse equipments, \$ *100*

Remarks:

Book mark:

(358)

Asst.
Copyist.

J

10 H. Art'y. U.S.C.T.

Sypha Fouch

Co. F, 10 Reg't U. S. Col'd H. Art'y.

Appears on

Company Muster Roll

for Sept. and Oct., 1866

Present or absent Present

Stoppage, \$ 100 for

Due Gov't, \$ 100 for

Valuation of horse, \$ 100

Valuation of horse equipments, \$ 100

Remarks:

Book mark:

Horse

(358)

Copyist.

F

10 H. Art'y. U.S.C.T.

Syepha Fouch

Prvt, Co. F, 10 Reg't U. S. Col'd H. Art'y.

Appears on

Company Muster Roll

for Nov. and Dec, 1864

Present or absent Present

Stoppage, \$ 100 for

Due Gov't, \$ 100 for

Valuation of horse, \$ 100

Valuation of horse equipments, \$ 100

Remarks:

Book mark:

House Copyist.

F

10 H. Art'y. U.S.C.T.

Alpha Fouch

Pr, Co. F, 10 Reg't U. S. Col'd H. Art'y.

Appears on Co. Muster-out Roll, dated

Baton Rouge La Feb. 22, 1867.

Muster-out to date Feb. 22, 1867.

Last paid to Dec. 31, 1866.

Clothing account:

Last settled, 186 ; drawn since \$ 100

Due soldier \$ 27 ²³/₁₀₀; due U. S. \$ 100

Am't for cloth'g in kind or money adv'd \$ 100

Due U. S. for arms, equipments, &c., \$ 0 ⁰⁸/₁₀₀

Bounty paid \$ none 100; due \$ 200 ⁰⁰/₁₀₀

Remarks: Given at original organization. Conscripted by G. O. No. 106 H. A. Ins. Dept of the Gulf. S. of 64

Book mark:

House

(361)

Copyist.

Fountaine, Garland
Co & , 10 U.S. Col'd H. Art'y

Private

Private

CARD NUMBERS.

1	5502374	26
2	5489171	27
3	5502502	28
4	5502610	29
5	5502749	30
6	5502954	31
7	5504595	32
8		33
9		34
10		35
11		36
12		37
13		38
14		39
15		40
16		41
17		42
18		43
19		44
20		45
21		46
22		47
23		48
24		49
25		50

Book Mark:

See also

F 1060 | U.S.C.T.

Garland Fontaine
Priv, Co. E, 10 Reg't U. S. Col'd (7 U.S.C. H. A.)

Appears on a

Detachment Muster Roll

of the organization named above

for Roll dated Apr-30, 1864.

Station De Fair, Ia.

Present or absent Present

Stoppage, \$ 100 for

Due Gov't, \$ 100 for

Valuation of horse, \$ 100

Valuation of horse equipments, \$ 100

Remarks:

Book mark:

Copyist

Garland Boutaine
Priv., Co. E, 7 Reg't U. S. Col'd H. Art'y.*

Appears on

Company Muster Roll

for May & June, 1864.

Present or absent Present

Stoppage, \$ 100 for

Due Gov't, \$ 100 for

Valuation of horse, \$ 100

Valuation of horse equipments, \$ 100

Remarks:

* This organization subsequently became Co. E, 10 Reg't U. S. Colored Heavy Artillery.

Book mark:

(358) Insider Copyist.

A | 10 H. Art'y. | U.S.C.T.

Garland Fontaine
Sgt, Co. E, 10 Reg't U. S. Col'd H. Art'y.

Appears on

Company Muster Roll

for *July & Aug.*, 186*4*.

Present or absent *Present*

Stoppage, \$ *100* for

Due Gov't, \$ *100* for

Valuation of horse, \$ *100*

Valuation of horse equipments, \$ *100*

Remarks:

Book mark:

(358)

Linder

Copyist.

A

10 H. Art'y. U.S.C.T.

Garland Fontaine

Prvt, Co. E, 10 Reg't U. S. Col'd H. Art'y.

Appears on

Company Muster Roll

for Sep. + Oct., 1864

Present or absent Absent

Stoppage, \$ 100 for

Due Gov't, \$ 100 for

Valuation of horse, \$ 100

Valuation of horse equipments, \$ 100

Remarks In Genl Hospital
New Orleans La since
Oct 2nd 1864

Book mark:

(358)

Grinden
Copyist.

A

10 H. Art'y. U.S.C.T.

Garland Fontaine

Art'y, Co. E, 10 Reg't U. S. Col'd H. Art'y.

Appears on

Company Muster Roll

for Nov & Dec, 1864

Present or absent

Stoppage, \$ 100 for

Due Gov't, \$ 100 for

Valuation of horse, \$ 100

Valuation of horse equipments, \$ 100

Remarks: Died Nov 25 in Gen. Hosp. at New Orleans Small Pox

Book mark:

(358)

J. J. Linden

Copyist.

J

10 H. Art'y. U.S.C.T.

Garland Pountaine
Co. E, 10 Reg't U. S. Col'd H. Art'y.

Appears on **Co. Muster-out Roll**, dated
Baton Rouge, La, Feb. 22, 1867.

Muster-out to date _____, 186 .

Last paid to *April 30*, 1864.

Clothing account:

Last settled _____, 186 ; drawn since \$ _____ 100

Due soldier \$ _____ 100; due U. S. \$ _____ 100

Am't for cloth'g in kind or money adv'd \$ _____ 100

Due U. S. for arms, equipments, &c., \$ _____ 100

Bounty paid \$ _____ 100; due \$ _____ 100

Remarks: *Joined at Org. Organo.*
as Private. Died in G. H.
New Orleans, La. Nov. 25/64.
of Small pox

Book mark : _____

(361)

O'Hagan
Copyist.

Fontaine, Garland

, Co. E, 10 Reg't uscta

4 Enclosures.

Bed Cards	Descriptive Lists
Burial Records /	Final Statements 2
Certs. of Dis. for Discharge	Furloughs
C. M. Charges	Med. Des. Lists
Med. Certificates	Orders

Other papers relating to—

Admission to Hosp'l	Furlough
Casualty Sheet (Officer's)	Med. Examination
Confinement	Misc. Information
Contracts	Pay or Clothing
Death or Effects /	Personal Reports
Desertions	Rank
Discharge from Hosp'l	Transfer to Hosp'l
Discharge from Service	Transfer to V. R. C.
Duty	Transportation

Duplicate

INVENTORY OF THE EFFECTS

OF *Private*
Garland Fontaine

Late of Company E

10th Reg't of U. S. C. H. Art

Volunteers, who died at Ed A Gen Hospital

on the 25th day of Nov 1864.

or be
cer of
sioned
ve his
e De-
paid to
oldier.
effects
ted to
ent or
ted to
of the
sioned
paid

fficers
led to
h the
e regi-
h the
m his
sb the
nding
leath,
l, and
ease;
ny to
ntory
nt of
legal
f the

er or
ease,
r the
depo-
they

on, a
y the
ceipt
o the
f the

over
utant
e de-
their
ases,
utant

icate
ould
r.

Inventory of the effects of Garland Fontaine late
 a Private of ^{1st Lieut} A. P. Green Company E of
 the 10th Regiment of U. S. C. I Volunteers, who was enrolled as
 a Private at New Orleans in the State of Louisiana on
 the 25th day of February 1864, and mustered into the service of the United
 States as a Private on the 28th day of February 1864, at New Orleans
 in Company E, 10th Regiment of U. S. C. I Volunteers, to serve Three
 years or during the war; he was born in Richmond in the State
 of Virginia; he was 30 years of age, 5 feet 6 inches
 high, Dark complexion, Dark eyes, Dark hair, and by occupation, when enrolled,
 a Labourere; he died in C. d'Affrique Gen Hospital, at
New Orleans La on the 25th day of November 1864, by
 reason of Small - Pox

INVENTORY.					
ARTICLES.	No.	ARTICLES.	No.	ARTICLES.	No.
Hats.....		Pairs trousers.....		Knapsacks.....	
Caps.....		Pairs flannel drawers.....			
Forage caps.....		Pairs cotton drawers.....			
Great coats.....		Flannel shirts.....			
Uniform coats.....		Cotton shirts.....			
Uniform jackets.....		Pairs boots.....			
Flannel sack coats.....		Pairs shoes.....			
Blouses.....		Pairs socks.....			
Stable frocks.....		Blankets.....			
Fatigue overalls.....		Haversacks.....			
				MONEY.	
				Specie.....	\$
				Notes.....	\$

I CERTIFY, ON HONOR, that the above inventory comprises all the effects of _____
 _____, deceased, and that the effects are in the hands
 of _____ at _____
 _____ to be disposed of by a Council of Administration.

(DUPLICATES.)

STATION: New Orleans La
 DATE: Nov 25th 1864

 Commanding the Company.

1490

✓ FINAL STATEMENT

OF Private
Garland Fontaine

10th Reg't of U. S. C. H. A.

VOLUNTEERS.

Disch Nov 25th 1864

NOTE 1.—Two of these certificates (or duplicates) are to be given to each Volunteer Soldier or drafted man who may be discharged previously to the discharge of his company, that he may at once receive from the Paymaster the pay, &c., due him, and the captain or other COMMISSIONED officer commanding the company will certify to the act of the delivery of the duplicate certificates; on these certificates the Soldier is "entitled to" his discharge, and should also present his discharge to the Paymaster to have the payment endorsed on it. The discharge is to be given back to the Soldier by the Paymaster; the latter only retaining as his voucher the duplicate certificates.

NOTE 2.—If the Soldier is entitled to pay for the use of his horse, the Company Commander will certify to that fact on the back of both these final statements, and also to the time he has pay due for having been so mounted on his own horse.

NOTE 3.—When a Soldier is furnished with final statements, his descriptive list, if he has one, should be taken up by the officer who gives the Soldier these statements, and endorsed with a statement to this effect by the officer. This endorsement should exhibit a full statement of the time for which the Soldier was allowed pay on his final statements, the clothing account, and all other charges against him or in his favor, so as to comprise a complete exhibit of his account. It will then be transmitted to the company commander of the Soldier, who will enter all the data necessary to a full understanding of the Soldier's account on the muster roll upon which the Soldier's discharge is reported. The descriptive list will then be destroyed. The object of this is, that the remaining portion of the Soldier's account may be settled upon the receipt of these muster rolls, and the Soldier receive any pay or allowances that may be due him at the time of his discharge, and which may not appear on his final statements from the fact that his descriptive list is incomplete. These accounts for back pay, &c., are settled by the 2d Auditor of the Treasury Department.

NOTE 4.—Charges for loss or injury to ordnance, horse equipments, and other miscellaneous charges, should appear under the heading of "Other Stoppages."

NOTE 5.—Bounty paid by State authorities, and not by the United States, will not be entered on this statement.

NOTE 6.—Amounts due the Sutler and Laundress must be entered on the muster roll on which the discharge, death, desertion, &c., is reported, as well as on the final statement, otherwise the amount cannot be collected from the United States.

NOTE 7.—This blank will be used for deceased volunteers and drafted men, as well as for others.

NOTE 8.—Where a Soldier dies in Hospital or on detached service, his descriptive list, if he has one, should be sent with his final statements, in duplicate, to the Adjutant General, Washington, D. C.

Adj. Gen.
Des. list sent 2^d Auditor
B

ADJUTANT GENERAL'S OFFICE

Dec 15 1864

Duplicate with Inventory sent 2d Auditor.



Fontaine

I certify, on honor, that Garland Fontaine a Private of
Company (E) of the 10th Regiment of U. S. C. A.
VOLUNTEERS, of the State of Louisiana, born in Richmond, State
of Virginia, aged 30 years; 5 feet 6 inches high; Dark complexion,
Dark eyes, Dark hair, and by occupation a Labourer, having joined the company on
its original organization at _____, and enrolled in it at the muster into
the service of the United States at New Orleans La, on the 25th day
of February, 1864, (or was mustered in service as a recruit, by _____
at _____, on the _____ day of _____,
186 , or was drafted and mustered into the service of the United States from the _____
Enrollment District of the State of _____, at _____,
on the _____ day of _____, 186 ,) to serve in the Regiment, for
the term of Three years; and having served HONESTLY and
FAITHFULLY with his Company in Dept of the Gulf to the present date, is now
entitled to a **DISCHARGE** by reason of Death by Small Pox
at New Orleans La Nov-25th 1864

The said Garland Fontaine was last paid by Paymaster
Preston to include the 30th day of April, 1864, and has
pay due him from that time to the present date; he is entitled to pay and subsistence for
TRAVELING to place of enrollment, and whatever other allowances are authorized to volunteer
soldiers, drafted men, or militia, so discharged. He has received from the United States **CLOTHING**
amounting to Thirty one 19 $\frac{19}{100}$ dollars, since the _____ day of Enrollment,
1864, when his clothing account was last settled. He has received from the United States
No $\frac{1}{100}$ dollars advanced **BOUNTY**.

There is to be stopped from him, on account of the State of _____, or other
authorities, for **CLOTHING**, &c., received on entering service, _____ dollars; and
for other stoppages, viz: _____

_____ dollars.
He has been furnished with **TRANSPORTATION** in kind from the place of his discharge to
_____ ; and he has been **SUBSISTED** for **TRAVELING** to his
place of enrollment, up to the _____, 186 .

He is indebted to _____, **SUTLER**, _____ dollars.

He is indebted to _____, **LAUNDRESS**, _____ dollars.

Given in Duplicate, at New Orleans La, this 25th day
of Nov, 1864.

J. E. Piquette
Surgeon Charge & Dispique Gen Hospital
Commanding Company

Duplicate *Nov 25 1864*

FINAL STATEMENT

OF *Private*
Garland Fortaine
10th Reg't of *U. S. C. H. A.*

VOLUNTEERS.

C. A. [unclear]

NOTE 1.—Two of these certificates (or duplicates) are to be given to each Volunteer Soldier or drafted man who may be discharged previously to the discharge of his company, that he may at once receive from the Paymaster the pay, &c., due him, and the captain or other COMMISSIONED officer commanding the company will certify to the act of the delivery of the duplicate certificates; on these certificates the Soldier is "entitled to" his *discharge*, and should also present his discharge to the Paymaster to have the payment endorsed on it. The discharge is to be given back to the Soldier by the Paymaster; the latter only retaining as his voucher the duplicate certificates.

NOTE 2.—If the Soldier is entitled to pay for the use of his horse, the Company Commander will certify to that fact on the back of both these final statements, and also to the time he has pay due for having been so mounted on his own horse.

NOTE 3.—When a Soldier is furnished with final statements, his descriptive list, if he has one, should be taken up by the officer who gives the Soldier these statements, and endorsed with a statement to this effect by the officer. This endorsement should exhibit a full statement of the time for which the Soldier was allowed pay on his final statements, the clothing account, and all other charges against him or in his favor, so as to comprise a complete exhibit of his account. It will then be transmitted to the company commander of the Soldier, who will enter all the data necessary to a full understanding of the Soldier's account on the muster roll upon which the Soldier's discharge is reported. The descriptive list will then be destroyed. The object of this is, that the remaining portion of the Soldier's account may be settled upon the receipt of these muster rolls, and the Soldier receive any pay or allowances that may be due him at the time of his discharge, and which may not appear on his final statements from the fact that his descriptive list is incomplete. These accounts for back pay, &c., are settled by the 2d Auditor of the Treasury Department.

NOTE 4.—Charges for loss or injury to ordnance, horse equipments, and other miscellaneous charges, should appear under the heading of "Other Stoppages."

NOTE 5.—Bounty paid by State authorities, and not by the United States, will not be entered on this statement.

NOTE 6.—Amounts due the Sutler and Laundress must be entered on the muster roll on which the discharge, death, desertion, &c., is reported, as well as on the final statement, otherwise the amount cannot be collected from the United States.

NOTE 7.—This blank will be used for deceased volunteers and drafted men, as well as for others.

NOTE 8.—Where a Soldier dies in Hospital or on detached service, his descriptive list, if he has one, should be sent with his final statements, in duplicate, to the Adjutant General, Washington, D. C.

I certify, on honor, that Garland Fontaine a Private of
 1st Lieut A. P. Green Company (E.) of the 10th Regiment of U. S. C. A.
VOLUNTEERS, of the State of Louisiana, born in Richmond, State
 of Virginia, aged 30 years; 5 feet 6 inches high; Dark complexion,
Dark eyes, Dark hair, and by occupation a Laborer, having joined the company on
 its original organization at _____, and enrolled in it at the muster into
 the service of the United States at New Orleans La., on the 25th day
 of February, 1864, (or was mustered in service as a recruit, by _____
 _____, at _____, on the _____ day of _____,
 186 _____, or was drafted and mustered into the service of the United States from the _____
 Enrollment District of the State of _____, at _____,
 on the _____ day of _____, 186 _____,) to serve in the Regiment, for
 the term of Three years; and having served **HONESTLY** and
FAITHFULLY with his Company in Dept of the Gulf to the present date, is now
 entitled to a **DISCHARGE** by reason of Death by Small Pox
at New Orleans La Nov 25th 1864

The said Garland Fontaine was last paid by Paymaster
Preston to include the 30th day of April, 1864, and has
 pay due him from that time to the present date; he is entitled to pay and subsistence for
TRAVELING to place of enrollment, and whatever other allowances are authorized to volunteer
 soldiers, drafted men, or militia, so discharged. He has received from the United States **CLOTHING**
 amounting to Thirty nine $\frac{79}{100}$ dollars, since the _____ day of Enrollment,
 1864, when his clothing account was last settled. He has received from the United States
no $\frac{0}{100}$ dollars advanced **BOUNTY**.

There is to be stopped from him, on account of the State of _____, or other
 authorities, for **CLOTHING**, &c., received on entering service, _____ $\frac{00}{100}$ dollars; and
 for other stoppages, viz: _____
 _____ $\frac{00}{100}$ dollars.

He has been furnished with **TRANSPORTATION** in kind from the place of his discharge to
 _____; and he has been **SUBSISTED** for **TRAVELING** to his
 place of enrollment, up to the _____, 186 _____.

He is indebted to _____, **SUTLER**, _____ $\frac{00}{100}$ dollars.
 He is indebted to _____, **LAUNDRESS**, _____ $\frac{00}{100}$ dollars.

Given in Duplicate, at New Orleans La, this 25th day
 of Nov, 1864

RECORD OF DEATH AND INTERMENT.

Name and number of person interred,	<i>Garland Fountain</i>	
Number and locality of the grave, -		
Hospital number of the deceased, -	<i>1992.</i>	
Regiment, Rank, and Company, - -	<i>10th U. S. Col. Hy. Art. - Priv. - C.</i>	
Residence before enlistment, - - -		
Conjugal condition (and if married,) the residence of the widow,)		
Cause of death,)	<i>Smallpox</i>	
Age of the deceased, - - - - -		
Nativity, - - - - -		
References and Remarks, - - - }		
Date of death and burial, - - -	<i>Novbr: 25th / 64.</i>	186

[A duplicate of this Record has been forwarded to the Sexton, and the other remains at this Hospital.]

To *Maj. General U.S.A.*
SIR:

It becomes my duty to inform you that the person above described died at this Hospital as herein stated: and that it is desired his remains should be interred with the usual military honors.

Respectfully,

F. E. Pyquith 86th Col. Infy
Surgeon U. S. Army.
in charge
Corps d'Afrique Genl. Hosp.

MILITARY HOSPITAL, *Corps d'Afrique, N. Orleans*
La.

This copy of Record is to be transmitted to the Adjutant General at Washington immediately after the place of burial and the number of the grave have been ascertained and registered. The above notification is to remain attached.

Fowler Jefferson

Coa. , 10 U.S. Col'd H. Art'y.

Private

Private

CARD NUMBERS.

1	5490405	26
2	5490555	27
3	5490698	28
4	5490859	29
5	5490994	30
6	5491128	31
7	5491257	32
8	5491390	33
9	5491519	34
10	5491646	35
11	5491772	36
12	5491899	37
13	5492024	38
14	5492149	39
15	5492272	40
16	5492397	41
17	5492520	42
18	5492645	43
19	5492772	44
20	5493969	45
21	5489526	46
22	47-C.T.-1884	47
23		48
24		49
25		50

Book Mark: 47-C.T.-1884.

See also

F

10 H. Art'y. U.S.C.T.

Jefferson Fowler

Private, Co. A, 1 Reg't La. Col'd H. Art'y.*

Age 25 years.

Appears on

Company Muster-in Roll

of the organization named above. Roll dated

New Orleans, La, Nov. 29, 1862.

Muster-in to date Nov 29, 1862

Joined for duty and enrolled:

When Nov 16, 1862

Where New Orleans

Period 3 years.

Valuation of horse, \$ 100

Valuation of horse equipments, \$ 100

Remarks:

*This organization subsequently became Co. A, 10 Reg't U. S. Colored Heavy Artillery.

Book mark: 47-27-1884

Tobman

(356)

Copyist.

F

Jefferson Fowler

Priv., Co. A, 1 Reg't La. H. Art'y.*

Appears on

Company Muster Roll

for to Dec. 31, 1862

Present or absent Present

Stoppage, \$ 100 for

Due Gov't, \$ 100 for

Valuation of horse, \$ 100

Valuation of horse equipments, \$ 100

Remarks:

*This organization subsequently became Co. A, 10 Reg't U. S. Col'd Heavy Artillery.

Book mark:

(358)

Johnman Copyist.

F

10 H. Art'y. U.S.C.T.

Jefferson Fowler

, Co. A, 1 Reg't La. H. Art'y.*

Appears on

Company Muster Roll

for Jany & Febry, 1863

Present or absent Present

Stoppage, \$ 100 for

Due Gov't, \$ 100 for

Valuation of horse, \$ 100

Valuation of horse equipments, \$ 100

Remarks:

*This organization subsequently became Co. A, 10 Reg't U. S. Col'd Heavy Artillery.

Book mark:

Tolman

7

10 H. Art'y. U.S.C.T.

Jefferson Fowler

....., Co. A, 1 Reg't La. H. Art'y.*

Appears on

Company Muster Roll

for *March & April*, 1863.

Present or absent *Present*

Stoppage, \$.....100 for

Due Gov't, \$.....100 for

Valuation of horse, \$.....100

Valuation of horse equipments, \$.....100

Remarks:.....
.....
.....
.....
.....
.....
.....

*This organization subsequently became Co. A, 10 Reg't U. S. Col'd Heavy Artillery.

Book mark:.....

Tobman

71

10 H. Art'y. U.S.C.T.

Jefferson Fowler

Pvt, Co. A, 1 Reg't La. H. Art'y.*

Appears on

Company Muster Roll

for *May & June*, 1863.

Present or absent *Present*

Stoppage, \$ _____ 100 for _____

Due Gov't, \$ _____ 100 for _____

Valuation of horse, \$ _____ 100

Valuation of horse equipments, \$ _____ 100

Remarks: _____

*This organization subsequently became Co. A, 10 Reg't U. S. Col'd Heavy Artillery.

Book mark: _____

(358)

Johnson
Copyst.

F1

10 H. Art'y. U.S.C.T.

Jefferson Fowler

Priv., Co. A, 1 Reg't La. H. Art'y.*

Appears on

Company Muster Roll

for July & August, 1863.

Present or absent Present

Stoppage, \$ 100 for

Due Gov't, \$ 100 for

Valuation of horse, \$ 100

Valuation of horse equipments, \$ 100

Remarks: Detailed at the Signal Gun order of Lt. Col. A. W. Benedict

*This organization subsequently became Co. A, 10 Reg't U. S. Col'd Heavy Artillery.

Book mark:

Tobinan Copyist.

F.

10 H. Art'y. U.S.C.T.

Jefferson Fowler
Priv, Co. A, 1 Reg't La. H. Art'y.*

Appears on

Company Muster Roll

for Sept & Oct, 1863.

Present or absent Present

Stoppage, \$ 100 for

Due Gov't, \$ 100 for

Valuation of horse, \$ 100

Valuation of horse equipments, \$ 100

Remarks: Detailed at
the signal gun-
order of Lt Col.
A. W. Benedict.

*This organization subsequently became Co. A, 10 Reg't U. S. Col'd Heavy Artillery.

Book mark: [faint stamp]

Tobman
Copyst.

7

10 H. Art'y. U.S.C.T.

Jefferson Fowler
Sgt., Co. A, 1 Reg't H. Art'y, Corps d'Afrique.*

Appears on

Company Muster Roll

for Nov & Dec, 1863.

Present or absent Present

Stoppage, \$ 100 for

Due Gov't, \$ 100 for

Valuation of horse, \$ 100

Valuation of horse equipments, \$ 100

Remarks: Due U.S. for
Sentences of Court
Martial \$5.00 G.O.
1245 Ft. Jackson

*This organization subsequently became Co. A, 10 Reg't U. S. Colored Heavy Artillery.

Book mark:

Rocheester

(358)

Copyist.

F | 10 H. Art'y. | U.S.C.T.

Jefferson Fowler
Co. A, 1 Reg't H. Art'y, Corps d'Afrique.*

Appears on

Company Muster Roll

for *Jan & Feb*, 1864.

Present or absent *Present*

Stoppage, \$.....100 for.....

Due Gov't, \$.....100 for.....

Valuation of horse, \$.....100

Valuation of horse equipments, \$.....100

Remarks:.....

*This organization subsequently became Co. *A*, 10 Reg't U. S. Colored Heavy Artillery.

Book mark :.....

Proctor

F | 10 H. Art'y. | U.S.C.T.

Jefferson Fowler
Co. A, 7 Reg't U. S. Col'd H. Art'y.*

Appears on

Company Muster Roll

for *March 1864*, 1864

Present or absent *Present*

Stoppage, \$ *100* for

Due Gov't, \$ *100* for

Valuation of horse, \$ *100*

Valuation of horse equipments, \$ *100*

Remarks: *Due U. S. \$5.00*
per sentence Garrison
Court Martial per
G.O. No. 45 dated Ft.
Jackson, La. Decem-
ber 4, 1863

* This organization subsequently became Co *A*, 10 Reg't U. S. Colored Heavy Artillery.

Book mark: _____

(358)

Prohester

Copyist.

F | 10 H. Art'y. | U.S.C.T.

Jefferson Fowler
Co. A, 7 Reg't U. S. Col'd H. Art'y.*

Appears on

Company Muster Roll

for *May & June*, 1864.

Present or absent *Present*

Stoppage, \$ *100* for

Due Gov't, \$ *100* for

Valuation of horse, \$ *100*

Valuation of horse equipments, \$ *100*

Remarks:

* This organization subsequently became Co. *A*, 10 Reg't U. S. Colored Heavy Artillery.

Book mark:

Co. A

F

10 H. Art'y.

U.S.C.T.

Jefferson Fowler
Co. A, 7 Reg't U. S. Col'd H. Art'y.*

Appears on

Company Muster Roll

for *July & Aug*, 186*4*.

Present or absent *Present*

Stoppage, \$ 100 for

Due Gov't, \$ 100 for

Valuation of horse, \$ 100

Valuation of horse equipments, \$ 100

Remarks:

* This organization subsequently became Co. *A*, 10 Reg't U. S. Colored Heavy Artillery.

Book mark:

Rocheester

F | 10 H. Art'y. | U.S.C.T.

Jefferson Fowler
Co. A, Co. A, 10 Reg't U. S. Col'd H. Art'y.

Appears on

Company Muster Roll

for *Sept & Oct*, 186*4*

Present or absent *Present*

Stoppage, \$ *100* for

Due Gov't, \$ *100* for

Valuation of horse, \$ *100*

Valuation of horse equipments, \$ *100*

Remarks:

Book mark: _____

(358)

Rockester

Copyist.

F | 10 H. Art'y. | U.S.C.T.

Jefferson Fowler
27, Co. A, 10 Reg't U. S. Col'd H. Art'y.

Appears on

Company Muster Roll

for *W. K. Allen*, 1864.

Present or absent *Present*

Stoppage, \$ 100 for

Due Gov't, \$ 100 for

Valuation of horse, \$ 100

Valuation of horse equipments, \$ 100

Remarks:

Book mark:

Becker

7 | 10 H. Art'y. | U.S.C.T.

Jefferson Fowler

Co. A, Co. A, 10 Reg't U. S. Col'd H. Art'y.

Appears on

Company Muster Roll

for *Jan + Feb*, 1865

Present or absent *Present*

Stoppage, \$ 100 for

Due Gov't, \$ 100 for

Valuation of horse, \$ 100

Valuation of horse equipments, \$ 100

Remarks:

Book mark:

Rochester

(358)

Copyist.

F | 10 H. Art'y. | U.S.C.T.

Jefferson Fowler
J.F., Co. A, 10 Reg't U. S. Col'd H. Art'y.

Appears on

Company Muster Roll

for *McN & Co*, 1865.

Present or absent *Present*

Stoppage, \$ 100 for

Due Gov't, \$ 100 for

Valuation of horse, \$ 100

Valuation of horse equipments, \$ 100

Remarks:

Book mark:

(358)

Rocheester

Copyist.

F | 10 H. Art'y. | U.S.C.T.

Jefferson Fowler

J.F., Co. A, 10 Reg't U. S. Col'd H. Art'y.

Appears on

Company Muster Roll

for *May & June*, 186*5*.

Present or absent *Present*

Stoppage, \$.....100 for

Due Gov't, \$.....100 for

Valuation of horse, \$.....100

Valuation of horse equipments, \$.....100

Remarks:

Book mark:

Proctor

(358)

Copyist.

F | 10 H. Art'y. | U.S.C.T.

Jefferson Fowler
F, Co. A, 10 Reg't U. S. Col'd H. Art'y.

Appears on

Company Muster Roll

for *July & Aug*, 18*65*.

Present or absent *Present*

Stoppage, \$ *100* for

Due Gov't, \$ *100* for

Valuation of horse, \$ *100*

Valuation of horse equipments, \$ *100*

Remarks: *Due Gov't for
Camp & Garrison
Equipage \$1.64*

Book mark:

Present

Jefferson Fowler

Pl, Co. A, 10 Reg't U. S. Col'd H. Art'y.

Appears on

Company Muster Roll

for *Sept & Oct*, 186*5*.

Present or absent *Present*

Stoppage, \$ 100 for

Due Gov't, \$ 100 for

Valuation of horse, \$ 100

Valuation of horse equipments, \$ 100

Remarks:

Book mark:

Styer

7

10 H. Art'y. U.S.C.T.

Jefferson Fowler
Co. A, 10 Reg't U. S. Col'd H. Art'y.

Appears on Co. Muster-out Roll, dated
Baton Rouge La, Feb. 22, 1867.

Muster-out to date _____, 186 .

Last paid to _____, 186 .

Clothing account:

Last settled _____, 186 ; drawn since \$ _____ 100

Due soldier \$ _____ 100; due U. S. \$ _____ 100

Am't for cloth'g in kind or money adv'd \$ _____ 100

Due U. S. for arms, equipments, &c., \$ _____ 100

Bounty paid \$ _____ 100; due \$ _____ 100

Remarks: Joined origl organ Dischd
for Expiration of term of service
Nov. 28. '65

Book mark: V 119 P. 88 70

(361)

Nesbitt
Copyist.

F. 10. Me. a. | U.S.C.T.

Jefferson Fowler
Reg't U. S. Col'd Me. a.

Appears on a

Detachment Muster-out Roll

of the organization named above. Roll dated

McClams Lea, Nov. 28, 1865.

Muster-out to date Nov. 28, 1865.

Last paid to Jun. 30, 1865.

Clothing account:

Last settled _____, 186 ; drawn since \$ _____ 100

Due soldier \$ 37 ²⁸/₁₀₀; due U. S. \$ _____ 100

Am't for cloth'g in kind or money adv'd \$ _____ 100

Due U. S. for arms, equipments, &c., \$ _____ 100

Bounty paid \$ _____ 100 due \$ _____ 100

Remarks: *Joined Origl. Organ.
Mustered out by reason
of expiration of term of
service*

Book mark: _____

Hawley

7 10th Reg't U.S. A. / U.S. G. I.

Jefferson Fowler

, Co. A, 10th Reg't U.S. A.

NOTATION.

Book mark:

L. B. 15-941 with
47. 6. 3. 1884

War Department,

Adjutant General's Office,

Washington, Jan. 5th, 1884.

Mustered out with Detach-
ment November 23, 1865.

E. P. Sawyer

(438)

Copyist.

Foxwell. Isaac

Co. D., 10 U.S. Col'd H. Art'y.

Private

Private

CARD NUMBERS.

1	5488653	26
2	5501258	27
3	5501406	28
4	5501550	29
5	5501688	30
6	5501806	31
7	5501913	32
8	5502009	33
9	5502105	34
10	5502185	35
11		36
12		37
13		38
14		39
15		40
16		41
17		42
18		43
19		44
20		45
21		46
22		47
23		48
24		49
25		50

Book Mark:

See also Colby. Use of Inf

1085092 Land

R. + P. 396658.

A 11475-77 Roman

Rep 418435

Q 1562991 PRR

S 2290396 Poaff

D. 2539301 PRR

D. 2548331 Poaff

A. G. 1254576

Wm. H. K. K. K.

I. | *10. N. Arty* | **U.S.C.T.**

Isaac Foxwell

Pri, Co. *K*, 10 Reg't U. S. Col'd *N. Arty*

Appears on

M. and D. Roll of Men Transferred

to the organization named above,

from *Co. B. 77 Reg't U. S. C. Inf.*

Roll dated *Oct. 1, 1865.*

When enlisted *Mar 16, 1865.*

Period for which enlisted *3* years.

When mustered in *Apr. 14, 1865.*

Present or absent *Present*

Company to which assigned *K.*

Remarks: *Joined the Co. as recruit*
Stoppage 2, weeks.

Book mark :

(342)

Avery
Coryist.

10

H. Art'y.

U.S.C.T.

Isaac Foxwell

Co. D, Co. D, 10 Reg't U. S. Col'd H. Art'y.

Appears on

Company Muster Roll

for *Sept & Oct*, 1865.

Present or absent *Present*

Stoppage, \$ *100* for

Due Gov't, \$ *100* for

Valuation of horse, \$ *100*

Valuation of horse equipments, \$ *100*

Remarks: *Transf'd from Co B 77
U.S.C.I per GO No 3 Hd Gys
10 U.S.C.A.H Camp Parapet La
Oct. 1/65. Due U.S. for ord-
nance lost. 48.*

Book mark:

Patterson

F

10 H. Art'y. | U.S.C.T.

Isaac Foxwell

Pvt, Co. D, 10 Reg't U. S. Col'd H. Art'y.

Appears on

Company Muster Roll

for *Nov & Dec*, 186 *5*

Present or absent *Present*

Stoppage, \$ *100* for

Due Gov't, \$ *100* for

Valuation of horse, \$ *100*

Valuation of horse equipments, \$ *100*

Remarks:

Book mark:

W. W. Payne

(358)

Copyist.

D | 10 H. Art'y. | U.S.C.T.

Isaac Foxwell

Pvt., Co. D, 10 Reg't U. S. Col'd H. Art'y.

Appears on

Company Muster Roll

for Jan & Feb, 1866

Present or absent Present

Stoppage, \$ 100 for

Due Gov't, \$ 100 for

Valuation of horse, \$ 100

Valuation of horse equipments, \$ 100

Remarks: Due U.S. for
Ord 48 cts

Book mark:

M. W. Payne

(358)

Copyist.

G

10 H. Art'y. | U.S.C.T.

Isaac Foxwell

Bob, Co. D, 10 Reg't U. S. Col'd H. Art'y.

Appears on

Company Muster Roll

for *March*, 1866.

Present or absent *Present*

Stoppage, \$ *100* for

Due Gov't, \$ *100* for

Valuation of horse, \$ *100*

Valuation of horse equipments, \$ *100*

Remarks:

Book mark:

Amey

J

10 H. Art'y. | U.S.C.T.

Isaac Foxwell

Qk, Co. D, 10 Reg't U. S. Col'd H. Art'y.

Appears on

Company Muster Roll

for *May & June*, 186 *6*

Present or absent *Present*

Stoppage, \$ 100 for

Due Gov't, \$ 100 for

Valuation of horse, \$ 100

Valuation of horse equipments, \$ 100

Remarks:

Book mark:

(358)

King
Copyst.

F

10 H. Art'y.

U.S.C.T.

Isaac Foxwell

Co. D, Co. D, 10 Reg't U. S. Col'd H. Art'y.

Appears on

Company Muster Roll

for *July Aug*, 186*6*.

Present or absent *Present*

Stoppage, \$ *100* for

Due Gov't, \$ *100* for

Valuation of horse, \$ *100*

Valuation of horse equipments, \$ *100*

Remarks:

Book mark: -----

(358)

[Signature]
Copyist.

J

10 H. Art'y. | U.S.C.T.

Isaac Foxwell

Co. D, 10 Reg't U. S. Col'd H. Art'y.

Appears on

Company Muster Roll

for *Sept 7 Oct*, 186*6*.

Present or absent *Present*

Stoppage, \$ *100* for

Due Gov't, \$ *100* for

Valuation of horse, \$ *100*

Valuation of horse equipments, \$ *100*

Remarks: *2d installment of Bond, \$100. due*

Book mark:

W. Leman

(358)

Copyist.

Isaac Foxwell

Private, Co. D, 10 Reg't U. S. Col'd H. Art'y.

Appears on

Company Muster Roll

for *Nov. & Dec*, 1866.

Present or absent: *Present*

Stoppage, \$ 100 for

Due Gov't, \$ 100 for

Valuation of horse, \$ 100

Valuation of horse equipments, \$ 100

Remarks:

Book mark: _____

J. M. Leonard

Copyist.

Isaac Foxwell
Priv, Co. *D*, 10 Reg't U. S. Col'd H. Art'y.

Appears on Co. Muster-out Roll, dated
Baton Rouge La, *Feb 22*, 1867.
Muster-out to date *Feb 22*, 1867.
Last paid to *Dec 31*, 1866.

Clothing account:

Last settled....., 186 ; drawn since \$.....100
Due soldier \$ *32* ^{*65*}/₁₀₀; due U. S. \$.....100
Am't for cloth'g in kind or money adv'd \$.....100

Due U. S. for arms, equipments, &c., \$.....*6* ^{*00*}/₁₀₀
Bounty paid \$ *200* ^{*XV*}/₁₀₀; due \$.....100

Remarks: *Joined by transfer*
from Co. B '77 U.S.A. 5-1/65
S.O. 66 Sept Las sep
22/65 as Private

Book mark :

J. L. Leonard
(361) Copyist.

110
Foxwell Samuel

Co F, 10 U.S. Col'd H. Art'y.

Private

Private

CARD NUMBERS.

1	5488740	26
2	5505775	27
3	5505929	28
4	5506076	29
5	5506215	30
6	5506361	31
7	5506480	32
8	5506591	33
9	5506809	34
10	5506906	35
11		36
12		37
13		38
14		39
15		40
16		41
17		42
18		43
19		44
20		45
21		46
22		47
23		48
24		49
25		50

Book Mark:

See also

77. U.S. Inf

F | 102d Art | U.S.C.T.

Amuel Foxwell

Co. F, 10 Reg't U. S. Col'd N Art.

Appears on

M. and D. Roll of Men Transferred

to the organization named above,

from 77 Regt U.S.C. Inf.

Roll dated Oct 1, 1865.

When enlisted Feb 19, 1865.

Period for which enlisted 3 years.

When mustered in Mar 8, 1865.

Present or absent Present

Company to which assigned F

Remarks: Joined as recruit
Mar 23 65

Book mark :

(342)

J. L. Linnard

Copyist.

J

10 H. Art'y. U.S.C.T.

Samuel Foxwell

Priv, Co. F, 10 Reg't U. S. Col'd H. Art'y.

Appears on

Company Muster Roll

for Sept & Oct, 1865.

Present or absent Present

Stoppage, \$ 100 for

Due Gov't, \$ 100 for

Valuation of horse, \$ 100

Valuation of horse equipments, \$ 100

Remarks: Transferred from Co. D 77 U.S.C.I. Oct. 1/65

Book mark:

R. G. Masdon

Samuel Foxwell

Pvt., Co. F, 10 Reg't U. S. Col'd H. Art'y.

Appears on

Company Muster Roll

for Nov. & Dec., 1865.

Present or absent Present

Stoppage, \$ 100 for

Due Gov't, \$ 100 for

Valuation of horse, \$ 100

Valuation of horse equipments, \$ 100

Remarks:

Book mark:

Ash
Copyist.

Samuel Foxwell

Pat., Co. F, 10 Reg't U. S. Col'd H. Art'y.

Appears on

Company Muster Roll

for *Jan'y & Feby.*, 186 *6*.

Present or absent *Present*

Stoppage, \$ *100* for

Due Gov't, \$ *100* for

Valuation of horse, \$ *100*

Valuation of horse equipments, \$ *100*

Remarks:

Book mark:

Copyist.

F | 10 H. Art'y. | U.S.C.T.

Samuel Foxwell.

Pvt., Co. F, 10 Reg't U. S. Col'd H. Art'y.

Appears on

Company Muster Roll

for *Mar & Apr.*, 186*b.*

Present or absent *Present.*

Stoppage, \$ *100* for

Due Gov't, \$ *100* for

Valuation of horse, \$ *100*

Valuation of horse equipments, \$ *100*

Remarks: *Present in confinement. Stop for loss of 1 pr. Scales 70^c.*

Book mark: *Sec G. b. M. O. 54, W.*

JAN. 16

5506215

1891

Loc., June 30, 66.

Samuel Foxwell

Priv., Co. F, 10 Reg't U. S. Col'd H. Art'y.

Appears on

Company Muster Roll

for *May & June*, 1866.

Present or absent *Absent*

Stoppage, \$ 100 for

Due Gov't, \$ 100 for

Valuation of horse, \$ 100

Valuation of horse equipments, \$ 100

Remarks: *Absent in New Orleans, La. awaiting trial.*

Book mark: *...*

Adm.
Copyist.

7

10 H. Art'y. U.S.C.T.

Samuel Foxwell

Pat., Co. F, 10 Reg't U. S. Col'd H. Art'y.

Appears on

Company Muster Roll

for July & Aug., 1864.

Present or absent Absent

Stoppage, \$ 100 for

Due Gov't, \$ 100 for

Valuation of horse, \$ 100

Valuation of horse equipments, \$ 100

Remarks: In confinement at Ship Island, Miss. for 6 mos. Loss of \$12. per Mo. G.O. 54. Dept. of Sav. June 30, 64

* Torn from Roll.

Book mark:

F

Samuel Foxwell

Pat, Co. F, 10 Reg't U. S. Col'd H. Art'y.

Appears on

Company Muster Roll

for *Sept. and Oct*, 186*6* @

Present or absent *Absent*

Stoppage, \$ *100* for

Due Gov't, \$ *100* for

Valuation of horse, \$ *100*

Valuation of horse equipments, \$ *100*

Remarks:

*In confinement at
Ship Island Miss for
C. Mos loss of \$ 12.00 ms.
see G.O. No. 54 Hd 20. Dept
of La. June 30/66*

Book mark:

House

f

10 H. Art'y. U.S.C.T.

Samuel Foxwell

Prvt, Co. F, 10 Reg't U. S. Col'd H. Art'y.

Appears on

Company Muster Roll

for *Nov. and Dec*, 186*6*.

Present or absent *Present*

Stoppage, \$ *100* for

Due Gov't, \$ *100* for

Valuation of horse, \$ *100*

Valuation of horse equipments, \$ *100*

Remarks:

*Returned to duty from
Confinement Dec. 30/66
Step \$12.00 pr mo. from
June 30/66 Ser. G. 0.54
Hd Qrs Dept. of La. 5-66*

Book mark:

House

F

10 H. Art'y. U.S.C.T.

Samuel Foxwell

Priv., Co. F, 10 Reg't U. S. Col'd H. Art'y.

Appears on Co. Muster-out Roll, dated

Baton Rouge, Feb. 22, 1867.

Muster-out to date Feb. 22, 1867.

Last paid to Dec. 31, 1866.

Clothing account:

Last settled, 186 ; drawn since \$ 100

Due soldier \$ 30 ⁷⁶/₁₀₀; due U. S. \$ 100

Am't for cloth'g in kind or money adv'd \$ 100

Due U. S. for arms, equipments, &c., \$ 0 ⁰⁸/₁₀₀

Bounty paid \$ 100 ⁰⁰/₁₀₀; due \$ 100 ⁰⁰/₁₀₀

Remarks: Rec'd by transfer from Co. E. 77 U.S. Col'd H. Art'y. sentenced by G. C. M. to 6 mos. Conft at Ship Island miss. loss of \$ 12.00

Book mark: V. 102. P 233. 73.

House

(over)

JAN. 16

5506906

1891

pr mo. fr. g. o. no. 54
Hd. Ins Dept of La. June
30/66. Rita to duty
Dec 30/66 Stoppage
made by McGibbon

San Francisco
CARD NUMBERS.

San Francisco, Cal.

- 26
- 27
- 28
- 29
- 30
- 31
- 32
- 33
- 34
- 35
- 36
- 37
- 38
- 39
- 40
- 41
- 42
- 43
- 44
- 45
- 46
- 47
- 48
- 49
- 50

Book Mark:

See also

Co. *E*, 10 U.S. Col'd H. Art'y.

Private

Private

CARD NUMBERS.

1	55-11238	26
2	55-11391	27
3	55-11418	28
4	55-11518	29
5	55-11656	30
6	55-11778	31
7	55-11915	32
8	55-12112	33
9	5490024	34
10		35
11		36
12		37
13		38
14		39
15		40
16		41
17		42
18		43
19		44
20		45
21		46
22		47
23		48
24		49
25		50

Book Mark:

See also

J | 10 H. Art'y. | U.S.C.T.

George Francis
Priv., Co. *D*, 10 Reg't U. S. Col'd H. Art'y.

Age years.

Appears on

Company Muster Roll*

for *Enrollment to June 30*, 186*5*-

Joined for duty and enrolled:

When *Drafted*, 186 .

Where

Period *1* years.

Mustered in:

When *May 6*, 186*5*-

Where *New Orleans, La.*

Present or absent *Present*

Stoppage, \$ *100* for

Due Gov't, \$ *100* for

Valuation of horse, \$ *100*

Valuation of horse equipments, \$ *100*

Remarks: *Drafted*. *Com-*
mencement of first

*First current roll. No muster-in roll of this company on file.

by W. B. H. H. H. H. H.

Book mark :

O. J. Helms

(3586)

Copyist.

payment by time
May 6, 65. Sick in
quarters.

JAN. 16

5511238

☆ 1891 ☆

F

10 H. Art'y.

U.S.C.T.

George Francis
Pvt., Co. I, 10 Reg't U. S. Col'd H. Art'y.

Appears on

Company Muster Roll

for *July & Aug.*, 1865.

Present or absent *Present*

Stoppage, \$ 100 for

Due Gov't, \$ 100 for

Valuation of horse, \$ 100

Valuation of horse equipments, \$ 100

Remarks:

Book mark: -----

O. S. Clark

Copyist.

George Francis

Prf., Co. I, 10 Reg't U. S. Col'd H. Art'y.

Appears on

Company Muster Roll

for *Sept Oct*, 186*5*.

Present or absent *Present*

Stoppage, \$ *100* for

Due Gov't, \$ *100* for

Valuation of horse, \$ *100*

Valuation of horse equipments, \$ *100*

Remarks:

Book mark:

O. S. Clark

George Francis

Priv., Co. I, 10 Reg't U. S. Col'd H. Art'y.

Appears on

Company Muster Roll

for *Nov. & Dec.*, 1865.

Present or absent *Present*

Stoppage, \$ *100* for

Due Gov't, \$ *100* for

Valuation of horse, \$ *100*

Valuation of horse equipments, \$ *100*

Remarks:

FROM SECOND AUDITOR'S ROLL.

Book mark:

(358)

A. S. [Signature]
Copyist.

F

10 H. Art'y. | U.S.C.T.

George Francis

Pvt., Co. I, 10 Reg't U. S. Col'd H. Art'y.

Appears on

Company Muster Roll

for *Jan. + Feb.*, 1866.

Present or absent *Present*

Stoppage, \$ *100* for

Due Gov't, \$ *100* for

Valuation of horse, \$ *100*

Valuation of horse equipments, \$ *100*

Remarks:

Book mark:

A. S. Clark

(358)

Copyist.

F

10 H. Art'y.

U.S.C.T.

George Francis

Pvt., Co. I, 10 Reg't U. S. Col'd H. Art'y.

Appears on

Company Muster Roll

for *Nov. & Dec.*, 1866.

Present or absent *Present*

Stoppage, \$ *100* for

Due Gov't, \$ *100* for

Valuation of horse, \$ *100*

Valuation of horse equipments, \$ *100*

Remarks:

Book mark: *Muster out on file*

O. S. Clark

F

10 H. Art'y.

U.S.C.T.

George Francis

Priv., Co. I, 10 Reg't U. S. Col'd H. Art'y.

Appears on

Company Muster Roll

for *May & June*, 1866.

Present or absent

Stoppage, \$ 100 for

Due Gov't, \$ 100 for

Valuation of horse, \$ 100

Valuation of horse equipments, \$ 100

Remarks: *Discharged.*
Mustered out by
reason of expir-
ation of term of
service to date May
5, 1866.

Book mark:

A. S. Clarke

(358)

Copyist.

G | *10 Arty* | **U.S.C.T.**

George Francis

Priv., Co. *I*, *10* Reg't U. S. Col'd *Arty*

Appears on a

Detachment Muster-out Roll

of the organization named above. Roll dated

New Orleans, La. May 5, 1866.

Muster-out to date *May 5, 1866.*

Last paid to *Feb. 28, 1866*

Clothing account:

Last settled _____, 1866 ; drawn since \$ _____ 100

Due soldier \$ *25⁶³*/₁₀₀; due U. S. \$ _____ 100

Am't for cloth'g in kind or money adv'd \$ _____ 100

Due U. S. for arms, equipments, &c., \$ _____ 100

Bounty paid \$ _____ 100 due \$ _____ 100

Remarks: *Joined by draft. Stop*
for two letters .02 cts. 2 numbers
.02 cts. one cross cannon .02 cts.
Total .11 cts

Book mark: _____

R. E. Wilson

F | 10 H. Art'y. | U.S.C.T.

George Francis

Pub. Co., 10 Reg't U. S. Col'd H. Art'y.

Appears on Co. Muster-out Roll, dated
Baton Rouge La Feb 22, 1867.

Muster-out to date _____, 186 .

Last paid to _____, 186 .

Clothing account:

Last settled _____, 186 ; drawn since \$ _____ 100

Due soldier \$ _____ 100; due U. S. \$ _____ 100

Am't for cloth'g in kind or money adv'd \$ _____ 100

Due U. S. for arms, equipments, &c., \$ _____ 100

Bounty paid \$ _____ 100; due \$ _____ 100

Remarks: Discharged expiration
term of service May 5, 1866

(Age 27 years)

Book mark: V 173 P. 179.73 210, C.T. 1886

(361)

J. McHance

Copyist.

Francis Henry

Co H, 10 U.S. Col'd H. Art'y.

Private

CARD NUMBERS.

1	5509751	26
2	5509908	27
3	5510058	28
4	5510203	29
5	5510353	30
6	5510504	31
7	5510691	32
8	5511119	33
9	5489875	34
10		35
11		36
12		37
13		38
14		39
15		40
16		41
17		42
18		43
19		44
20		45
21		46
22		47
23		48
24		49
25		50

Book Mark:

See also

Henry Francis

Priv., Co. H, 10 Reg't U. S. Col'd H. Art'y

Appears on

Company Muster Roll

for *March & April*, 1865.

Present or absent *Present*

Stoppage, \$ *100* for

Due Gov't, \$ *100* for

Valuation of horse, \$ *100*

Valuation of horse equipments. \$ *100*

Remarks: *Commencement of first payment by time March 17 1865 - sick in quarters.*

Drafted - Mustered into service March 17, 1865 at New Orleans for 1 year.

Book mark:

Perminator

F | 10 H. Art'y. | U.S.C.T.

Henry Francis

Prvt, Co. H, 10 Reg't U. S. Col'd H. Art'y

Appears on

Company Muster Roll

for *May & June*, 186*5*.

Present or absent *Present*

Stoppage, \$ *100* for

Due Gov't, \$ *100* for

Valuation of horse, \$ *100*

Valuation of horse equipments. \$ *100*

Remarks: *Stoppage for*
Ordinance 25^{cts}

Book mark:

(358)

Remington

Copyist.

F

10 H. Art'y.

U.S.C.T.

Henry Francis

Pvt, Co. H, 10 Reg't U. S. Col'd H. Art'y

Appears on

Company Muster Roll

for *July & Aug 1865*.

Present or absent *Present*

Stoppage, \$ *100* for

Due Gov't, \$ *100* for

Valuation of horse, \$ *100*

Valuation of horse equipments. \$ *100*

Remarks :

Book mark :

(358)

Pennington
Copyist.

F

10 H. Art'y. U.S.C.T.

Henry Francis

Pr't, Co. H, 10 Reg't U. S. Col'd H. Art'y

Appears on

Company Muster Roll

for *Sept & Oct*, 1865.

Present or absent *Present*

Stoppage, \$ 100 for

Due Gov't, \$ 100 for

Valuation of horse, \$ 100

Valuation of horse equipments, \$ 100

Remarks: *Sick in quarters*

Book mark:

Cammack

(858)

Copymt.

F | 10 H. Art'y. | U.S.C.T.

Henry Francis

Pr., Co. H, 10 Reg't U. S. Col'd H. Art'y

Appears on

Company Muster Roll

for *Nov & Dec*, 1865.

Present or absent *Present*

Stoppage, \$ *100* for

Due Gov't, \$ *100* for

Valuation of horse, \$ *100*

Valuation of horse equipments. \$ *100*

Remarks :

Book mark :

F

10 H. Art'y. U.S.C.T.

Henry Francis

Priv't, Co. H, 10 Reg't U. S. Col'd H. Art'y

Appears on

Company Muster Roll

for *Jan & Feb.*, 1866.

Present or absent *Present*

Stoppage, \$ *100* for

Due Gov't, \$ *100* for

Valuation of horse, \$ *100*

Valuation of horse equipments. \$ *100*

Remarks :

Book mark :

Gammack

(858)

Copyist.

F

10 H. Art'y. U.S.C.T.

Henry Francis

Priv., Co. H, 10 Reg't U. S. Col'd H. Art'y

Appears on

Company Muster Roll

for *Mch & Apr.*, 1866.

Present or absent

Stoppage, \$ 100 for

Due Gov't, \$ 100 for

Valuation of horse, \$ 100

Valuation of horse equipments. \$ 100

Remarks: *Mustered out by reason of expiration of term of service to date Mch 16. 1866*

Book mark: *V. 12. P. 188/68*

Cammack

(858)

Copyist.

F ¹⁰ | *Hy Arty* | U.S.C.T.
Henry Francis
Priv., Co. *H, 10* Reg't U. S. Col'd *Arty*

Appears on a

Detachment Muster-out Roll

of the organization named above. Roll dated

New Orleans La Mar 16, 1866.

Muster-out to date

Mar 16, 1866.

Last paid to

Dec 31, 1865

Clothing account:

Last settled 186 ; drawn since \$ 100

Due soldier \$ *21* ^{*90*}/₁₀₀; due U. S. \$ 100

Am't for cloth'g in kind or money adv'd \$ 100

Due U. S. for arms, equipments, &c., \$ 100

Bounty paid \$ 100 due \$ 100

Remarks: *Drafted in First District, New Orleans La, March 17, 1865, Knapsack Haversack and Canteen retained per G.O. No. 114, War Department, A.G.O. series (over)*

Book mark:

A. M. Reed

(349)

Copyist.

JAN. 15

5489875

1891

of 1865,

Henry Francis
Pvt, Co. *H*, 10 Reg't U. S. Col'd H. Art'y.

Appears on Co. Muster-out Roll, dated
Baton Rouge, La., Feb. 22, 1867.

Muster-out to date _____, 186 .

Last paid to _____, 186 .

Clothing account:

Last settled _____, 186 ; drawn since \$ _____ 100

Due soldier \$ _____ 100; due U. S. \$ _____ 100

Am't for cloth'g in kind or money adv'd \$ _____ 100

Due U. S. for arms, equipments, &c., \$ _____ 100

Bounty paid \$ _____ 100; due \$ _____ 100

Remarks: *Joined by assignment.
Mustered out exp. of term
of service Mch 16/66.*

Book mark: *V. 12. P. 188. 68.*

Lowny Copyist.

Francis Joseph

Co M., 10 U.S. Col'd H. Art'y.

Private

Private

CARD NUMBERS.

1	52487810	26
2	52487982	27
3	5514322	28
4	5514476	29
5	5514711	30
6	5514887	31
7	5515242	32
8	52489816	33
9	9123658	34
10		35
11		36
12		37
13		38
14		39
15		40
16		41
17		42
18		43
19		44
20		45
21		46
22		47
23		48
24		49
25		50

Book Mark:

2177, O. G. 1884

See also

77° U. S. Col'd H. Art'y

F | 10 H. Art'y. | U.S.C.T.

Joseph Francis
Co. *M*, 10 Reg't U. S. Col'd H. Art'y.

Appears on

Company Descriptive Book

of the organization named above.

DESCRIPTION.

Age *18* years; height *5* feet *8* inches.

Complexion *black*

Eyes *dark*; hair *black*

Where born *Lafouche La*

Occupation *Laborer*

ENLISTMENT.

When *Feb 27*, 1865.

Where *Dept La fouche 2^d Dist La*

By whom; term *1* y'rs.

Remarks: *Rec'd by transfer*
from Co I 11th S.C. Regt
8th 66 9th Dist La Sept
27 1865
Disch'd & honorably
mustered out of service
July 26 1866 by reason
of expiration of term of
service.

J. M. Calhoun

F 10 H A U.S.C.T.

Joseph Francis
Co. M, 10 Reg't U. S. Col'd *H. A.*

Appears on

M. and D. Roll of Men Transferred

to the organization named above,

from *77 U. S. Col Inf*

Roll dated *Camp Parapetda Ar,* 186*6*.

When enlisted _____, 186 .

Period for which enlisted _____ years.

When mustered in *Feb 27*, 186*5*.

Present or absent *Present*

Company to which assigned *M*

Remarks: *(Dtd,*

Book mark : _____

Wm Scott

I 10 H a | U.S.C.T.

Joseph Francis
Det, Co. *M*, 10 Reg't U. S. Col'd *H A*

Appears on

M. and D. Roll of Men Transferred

to the organization named above,

from *ny 4 U.S. Cal Inf*

Roll dated *Camp Parapel La Det*, 186*5*

When enlisted _____, 186 .

Period for which enlisted _____ years.

When mustered in *Feb 27*, 186*5*

Present or absent _____

Company to which assigned *M*

Remarks: *Rec'd by transfer
from Co. D ny 4 U.S.C.I.,
per S.O. 66 Sept da
Sept 22.65,*

Book mark :

Wm Scott

(342)

Copied

7 | 10 H. Art'y. | U.S.C.T.

Joseph Francis
Co. M, 10 Reg't U. S. Col'd H. Art'y.

Age _____ years.

Appears on

Company Muster Roll*

for Sept - Oct, 1865.

Joined for duty and enrolled:

When Sept, 1865.

Where _____

Period 1 years.

Mustered in:

When Feb 27, 1865.

Where Lafayette & Dist La

Present or absent Present

Stoppage, \$ 100 for _____

Due Gov't, \$ 100 for _____

Valuation of horse, \$ 100

Valuation of horse equipments, \$ 100

Remarks : _____

*First current roll. No muster-in roll of this company on file.

Book mark : _____

(3586)

J. H. Wright
Copyist.

Joseph Francis
P, Co. M, 10 Reg't U. S. Col'd H. Art'y.

Appears on

Company Muster Roll

for Mr. Dece, 1865.

Present or absent Present

Stoppage, \$ 100 for

Due Gov't, \$ 100 for

Valuation of horse, \$ 100

Valuation of horse equipments, \$ 100

Remarks:

Book mark:

J. H. Wright

7

10 H. Art'y. | U. S. C. T.

Joseph Francis

, Co. M, 10 Reg't U. S. Col'd H. Art'y.

Appears on

Company Muster Roll

for *Jan & Feb*, 1866.

Present or absent *Absent*

Stoppage, \$ 100 for

Due Gov't, \$ *5 02* 100 for *67 1/2*

Valuation of horse, \$ 100

Valuation of horse equipments, \$ 100

Remarks: *On detached service awaiting Muster at per 20571-Macomb Feb 27, 66*

Book mark: *C. R. on file*

J. H. Wright

(358)

Copyist.

Joseph Francis

J, Co. M, 10 Reg't U. S. Col'd H. Art'y.

Appears on

Company Muster Roll

for *Mar & Apr*, 186*6*.

Present or absent

Stoppage, \$ 100 for

Due Gov't, \$ 100 for

Valuation of horse, \$ 100

Valuation of horse equipments, \$ 100

Remarks: *Discharged by reason of expiration of term of service.*

Book mark:

L. E. Wright

F. 10th Arty U.S.C.T.

Joseph Francis
Priv. Co. M, 10 Reg't U. S. Col'd Arty

Appears on a

Detachment Muster-out Roll

of the organization named above. Roll dated

New Orleans La, Feb. 26, 1866.

Muster-out to date Feb. 26, 1866.

Last paid to June 30, 1865.

Clothing account:

Last settled 186 ; drawn since \$ 100

Due soldier \$ 0 ²¹/₁₀₀; due U. S. \$ 100

Am't for cloth'g in kind or money adv'd \$ 100

Due U. S. for arms, equipments, &c., \$ 5 ⁶²/₁₀₀

Bounty paid \$ None 100 due \$ None 100

Remarks: Joined by transfer from 77th U.S.C.I., Oct. 1/65 per S.O. 66 series/66 Dept. of La. Stop for 2 H.C. Straps, 1 Bed Sack & 1 Mosquito Bar.

Book mark:

A. M. Reed

F

10 H. Art'y. U.S.C.T.

Joseph Francis
Sgt., Co. M., 10 Reg't U. S. Col'd H. Art'y.

Appears on Co. Muster-out Roll, dated
Baton Rouge, La., Dec 22, 1867.

Muster-out to date _____, 186 .

Last paid to _____, 186 .

Clothing account:

Last settled _____, 186 ; drawn since \$ _____ 100

Due soldier \$ _____ 100; due U. S. \$ _____ 100

Am't for cloth'g in kind or money adv'd \$ _____ 100

Due U. S. for arms, equipments, &c., \$ _____ 100

Bounty paid \$ _____ 100; due \$ _____ 100

Remarks: joined by trans from Co. D
77 U.S.C. for 10 66 Hd. Qrs. Dept
La. Dep't as Sgt. Discharged by
reason of Exp of term of Ser-
vice Feb 26/66

Book mark: 653.1880. 2177 C.S. 1884

(361)

Reuter

Copyist.

Francis Joseph L.
Co M., 10 U.S. Col'd H. Art'y.

Private

Private

CARD NUMBERS.

1	5488835	26
2	5488942	27
3	5514323	28
4	5514477	29
5	5514789	30
6	5515241	31
7	5489734	32
8	9123655	33
9		34
10		35
11		36
12		37
13		38
14		39
15		40
16		41
17		42
18		43
19		44
20		45
21		46
22		47
23		48
24		49
25		50

Book Mark:

See also

G. 1057793) P O M M

Wm J. Parker

F | 10 H. Art'y. | U.S.C.T.

Joseph L. Francis

, Co. M, 10 Reg't U. S. Col'd H. Art'y.

Appears on

Company Descriptive Book

of the organization named above.

DESCRIPTION.

Age 22 years; height 6 feet 5 inches.

Complexion Dark

Eyes black; hair black

Where born Madison Ky.

Occupation Labour

ENLISTMENT.

When Jan 31, 1863.

Where New Orleans La

By whom Lt Drew; term 3 y'rs.

Remarks: Recd by transfer from
Co A 77 U.S.C.I. Feb 30.
66 9th Ar. Dept La Sept
22, 1866 Discharged and
honorably Mustered out
of service Feb 10 1866 by
reason of expiration of
term of service

M. Mallon

(383g)

Copyist.

A 1026

U.S.C.T.

Joseph L. Francis
Pot, Co M, 10 Reg't U. S. Col'd *Hea*

Appears on

M. and D. Roll of Men Transferred

to the organization named above,

from *74 U. S. Col Inf*

Roll dated *Camp Ampetka Oct 1, 1865*

When enlisted *Jan 31*, 186*5*

Period for which enlisted *3* years.

When mustered in *Feb 10*, 186*5*

Present or absent

Company to which assigned *M*

Remarks: *Joined at Orig
Orig Co. A 4th Ca, 4th
Art Wiper ^{4th} Bufile
Rec'd by transfer from
Co. A 74 U. S. Col. per
S.O. 66. Dept da. Sept
22. 65*

Book mark :

Wear Scott

F 10th. Arty | U.S.C.T.

Joseph G. Francis
Pvt, Co. K, 10 Reg't U. S. Col'd Arty

Appears on

M. and D. Roll of Men Transferred

to the organization named above,

from 77 U. S. Col'd Inf.

Roll dated Oct. 1, 1865.

When enlisted Jan. 31, 1863.

Period for which enlisted 3 years.

When mustered in Feb. 10, 1863.

Present or absent Present

Company to which assigned M

Remarks: Joined at Org'l orgn.
Co. H. 4th Idt.

Last Piper & Bugle.

Book mark :

L Chandler

F | *107th Arty* | **U.S.C.T.**

Joseph L. Francis
Cpt, Co *M*, *10* Reg't U. S. Col'd *H. Arty*

Appears on

M. and D. Roll of Men Transferred

to the organization named above,

from *77th U.S. Col'd Infy.*

Roll dated *Oct 1*, 186*5*.

When enlisted *Jan. 31*, 186*3*.

Period for which enlisted *3* years.

When mustered in *Jan. 31*, 186*3*.

Present or absent *Present*.

Company to which assigned *M*.

Remarks: *Joined at original organization Co. A 4th Cd. Lost wiper and bugle.*

Book mark:

(342)

Castling

Copyist.

10 H. Art'y. | U.S.C.T.

Joseph L. Francis

Co. M, 10 Reg't U. S. Col'd H. Art'y.

Age years.

Appears on

Company Muster Roll*

for *Sept - Oct -*, 186*5*.

Joined for duty and enrolled:

When *Jan 31*, 186*3*.

Where *N Orleans*

Period *3* years.

Mustered in:

When *Feb 10*, 186*3*.

Where *N Orleans*

Present or absent *Present -*

Stoppage, \$ *100* for

Due Gov't, \$ *20* for *Oct 16 & 18: 2*

Valuation of horse, \$ *100*

Valuation of horse equipments, \$ *100*

Remarks :

*First current roll. No muster-in roll of this company on file.

Book mark :

(3586)

a. H. Wright

Copyist.

7 | 10 H. Art'y. | U. S. C. T.

Joseph L Francis
Co. M, 10 Reg't U. S. Col'd H. Art'y.

Appears on

Company Muster Roll

for Nov Dec, 1865.

Present or absent Present

Stoppage, \$ 100 for

Due Gov't, \$ 20 for Ord

2 Ch. C & E

Valuation of horse, \$ 100

Valuation of horse equipments, \$ 100

Remarks:

Book mark:

(358)

A. B. Wright
Copyist.

7

10 H. Art'y.

U. S. C. T.

Joseph L Francis

Co. M, 10 Reg't U. S. Col'd H. Art'y.

Appears on

Company Muster Roll

for *Jan & Feb*, 186*6*.

Present or absent

Stoppage, \$ 100 for

Due Gov't, \$ 100 for

Valuation of horse, \$ 100

Valuation of horse equipments, \$ 100

Remarks: *Disch'd Feb 10, 66
at New Orleans La by
reason of expiration of
term of service*

Book mark:

A. W. Wright

(358)

Copyist.

F. Hy Arty U.S.C.T.

Joseph L. Francis
Privt, Co. M, 10 Reg't U. S. Col'd Arty

Appears on a

Detachment Muster-out Roll

of the organization named above. Roll dated

New Orleans La Feb. 10, 1866.

Muster-out to date Feb. 10, 1866.

Last paid to June 30, 1865

Clothing account:

Last settled _____, 1866; drawn since \$ _____ 100

Due soldier \$ ^{28 56} / 100; due U. S. \$ _____ 100

Am't for cloth'g in kind or money adv'd \$ _____ 100

Due U. S. for arms, equipments, &c., \$ ⁵⁴ / 100

Bounty paid \$ none / 100 due \$ none / 100

Remarks: Joined by transfer
from 77th U.S.C. I. Oct.
1st, 65 per S.O. No. 66, 65
Hd Qrs, Dept. of La.
Stop for two wipers, number
letter & two G.C. Straps.

Book mark: _____

A. W. Reed

J

10 H. Art'y. U.S.C.T.

Joseph S. Francis

Put. Co. M., 10 Reg't U. S. Col'd H. Art'y.

Appears on Co. Muster-out Roll, dated

Baton Rouge, La, Feb 22, 1867.

Muster-out to date _____, 186 .

Last paid to _____, 186 .

Clothing account:

Last settled _____, 186 ; drawn since \$ _____ 100

Due soldier \$ _____ 100; due U. S. \$ _____ 100

Am't for cloth'g in kind or money adv'd \$ _____ 100

Due U. S. for arms, equipments, &c., \$ _____ 100

Bounty paid \$ _____ 100; due \$ _____ 100

Remarks: joined by trans. from Co
A 77 U.S. Col'd H. Art'y. Dept
La. Sep 22/65 as Pvt
Discharged by reason of Exp.
of term of service Feb 10/66

Book mark: 472 P 125: 69

Rector

(361)

Copyist.

Francis Eli

Co F, 10 U.S. Col'd H. Art'y

Private

Private

CARD NUMBERS.

1	5487098	26
2	5504711	27
3	5504863	28
4	5504970	29
5	5505106	30
6	5505238	31
7	5505331	32
8	5505432	33
9	5505536	34
10	5505646	35
11	5505770	36
12	5505924	37
13	5506071	38
14	5506211	39
15	5506356	40
16	5506476	41
17	5506587	42
18	5506805	43
19	5506902	44
20		45
21		46
22		47
23		48
24		49
25		50

Book Mark:

See also

F

10 H. Art'y. U.S.C.T.

Eli Hancock

Art, Co. F, 10 Reg't U. S. Col'd H. Art'y.

Appears on Co. Muster-out Roll, dated

Baton Rouge La. Feb. 22, 1867.

Muster-out to date Feb. 22, 1867.

Last paid to Dec. 31, 1866.

Clothing account:

Last settled, 186 ; drawn since \$ 100

Due soldier \$ 40 ²⁰/₁₀₀; due U. S. \$ 100

Am't for cloth'g in kind or money adv'd \$ 100

Due U. S. for arms, equipments, &c., \$ 6 ¹⁰/₁₀₀

Bounty paid * 100; due \$ 100

Remarks: Bounty under act of July 26/66 100. Bounty under act of July 28/66 100. Joined at original organization

Book mark: 1070. 1882

House

F | 10 H. Art'y. | U.S.C.T.

Eli Francis

Appears with rank of *Priv* on

Muster and Descriptive Roll of a Detachment of U. S. Vols. forwarded

for the *7* Reg't *U. S. Art'y* * Roll dated

New Orleans La, June 4, 1864.

Where born *Leane River, La*

Age *29* y'rs; occupation *Labourer*

When enlisted *May 26*, 1864.

Where enlisted *New Orleans*

For what period enlisted *3* years.

Eyes *Blue*; hair *Blue*

Complexion *Blue*; height *5* ft. *2* in.

When mustered in *June 4*, 1864.

Where mustered in *New Orleans*

Bounty paid \$ *100*; due \$ *100*

Where credited

Company to which assigned *F*

Remarks:

*
Became 10 U.S. Coled H. art'y

Book mark:

S. W. Williams

(339)

Copyist.

F

10 H. Art'y.

U.S.C.T.

Eli Francois

Plt, Co. *F*, 7 Reg't U. S. Col'd H. Art'y.*

Appears on

Company Muster Roll

for *May & June*, 1864.

Present or absent *Present*

Stoppage, \$.....100 for

Due Gov't, \$.....100 for

Valuation of horse, \$.....100

Valuation of horse equipments, \$.....100

Remarks:

* This organization subsequently became Co. *F*, 10 Reg't U. S. Colored Heavy Artillery.

Book mark:

Rosenbaum

7 | 10 H. Art'y. | U.S.C.T.

Eli Francois

Pot, Co. F, 10 Reg't U. S. Col'd H. Art'y.

Appears on

Company Muster Roll

for *July & August*, 1864.

Present or absent. *Present*

Stoppage, \$.....100 for

Due Gov't, \$.....100 for

Valuation of horse, \$.....100

Valuation of horse equipments, \$.....100

Remarks:

Book mark:

(358)

Rosenbaum
Copyist.

F | 10 H. Art'y. | U.S.C.T.

Eli Francois

Pvt, Co. *F*, 7 Reg't U. S. Col'd H. Art'y.*

Appears on

Company Muster-in and Descriptive Roll

of the organization named above. Roll dated

New Orleans La, *Aug 19*, 1864.

Where born *Cane River La*

Age *29* y'rs; occupation *Salvor*

When enlisted *May 26*, 1864.

Where enlisted *New Orleans La*

For what period enlisted *3* years.

Eyes *Blk*; hair *Blk*

Complexion *Blk*; height *5* ft. *2* in.

When mustered in *June 4*, 1864.

Where mustered in *New Orleans La*

Bounty paid \$ *100*; due \$ *100*

Where credited *1st Enllt Dist La*

Company to which assigned

Remarks:

* This organization subsequently became Co. *F*, 10 Reg't U. S. Colored Heavy Artillery.

Book mark:

(356d)

Rosenbaum
Copyright.

7

10 H. Art'y. U.S.C.T.

Eli Francois

Priv., Co. F, 10 Reg't U. S. Col'd H. Art'y.

Appears on

Company Muster Roll

for Sept & Oct, 1864.

Present or absent Present

Stoppage, \$ 100 for

Due Gov't, \$ 100 for

Valuation of horse, \$ 100

Valuation of horse equipments, \$ 100

Remarks:

Book mark:

Rosenblum

(358)

Copyist.

F | 10 H. Art'y. | U.S.C.T.

Eli Francois

Pot, Co. F, 10 Reg't U. S. Col'd H. Art'y.

Appears on

Company Muster Roll

for *Nov & Dec*, 1864.

Present or absent *Present*

Stoppage, \$ *100* for

Due Gov't, \$ *100* for

Valuation of horse, \$ *100*

Valuation of horse equipments, \$ *100*

Remarks:

Book mark:

J

10 H. Art'y. U.S.C.T.

Eli Francois

Priv., Co. F, 10 Reg't U. S. Col'd H. Art'y.

Appears on

Company Muster Roll

for Jan & Feb, 1865.

Present or absent Present

Stoppage, \$ 100 for

Due Gov't, \$ 100 for

Valuation of horse, \$ 100

Valuation of horse equipments, \$ 100

Remarks: Difference between \$7 per mo. and authorized pay due from enlistment to June 30/64

Book mark:

B. G. Masdon

Copyist.

J

10 H. Art'y. U.S.C.T.

Eli Francois
Private, Co. F, 10 Reg't U. S. Col'd H. Art'y.

Appears on

Company Muster Roll
for March & April, 1865.

Present or absent Present

Stoppage, \$ 100 for

Due Gov't, \$ 100 for

Valuation of horse, \$ 100

Valuation of horse equipments, \$ 100

Remarks:

Book mark:

B. S. Masdon

(358)

Copyist.

J

10 H. Art'y. U.S.C.T.

Eli Francois

Priv., Co. F, 10 Reg't U. S. Col'd H. Art'y.

Appears on

Company Muster Roll

for May & June, 1865.

Present or absent Present

Stoppage, \$ 100 for

Due Gov't, \$ 100 for

Valuation of horse, \$ 100

Valuation of horse equipments, \$ 100

Remarks:

Book mark:

B. G. Wasdon

J

10 H. Art'y.

U.S.C.T.

Eli Francois

Priv, Co. F, 10 Reg't U. S. Col'd H. Art'y.

Appears on

Company Muster Roll

for dated Aug 31, 1865.

Present or absent Present

Stoppage, \$ 100 for

Due Gov't, \$ 100 for

Valuation of horse, \$ 100

Valuation of horse equipments, \$ 100

Remarks:

Book mark:

B G Masdon

J

10 H. Art'y. U.S.C.T.

Eli Francois

Priv, Co. F, 10 Reg't U. S. Col'd H. Art'y.

Appears on

Company Muster Roll

for Sept & Oct, 1865.

Present or absent Present

Stoppage, \$ 100 for

Due Gov't, \$ 100 for

Valuation of horse, \$ 100

Valuation of horse equipments, \$ 100

Remarks:

Book mark:

W. G. Masdon

(358)

Copyist.

7 | 10 H. Art'y. | U.S.C.T.

Eli Francois

Part; Co. F, 10 Reg't U. S. Col'd H. Art'y.

Appears on

Company Muster Roll

for Nov & Dec, 1865.

Present or absent Present

Stoppage, \$ 0. ²⁶/₁₀₀ for ordnance

Due Gov't, \$ 100 for

Valuation of horse, \$ 100

Valuation of horse equipments, \$ 100

Remarks:

Book mark:

F

10 H. Art'y. U.S.C.T.

Eli Francis

Pvt., Co. F, 10 Reg't U. S. Col'd H. Art'y.

Appears on

Company Muster Roll

for Jan'y & Feby., 1866.

Present or absent Present.

Stoppage, \$ 100 for

Due Gov't, \$ 100 for

Valuation of horse, \$ 100

Valuation of horse equipments, \$ 100

Remarks:

Book mark:

ash
Copyist.

Eli Francois

Pat., Co. F, 10 Reg't U. S. Col'd H. Art'y.

Appears on

Company Muster Roll

for *Mar & Apr.*, 1866.

Present or absent *Present.*

Stoppage, \$ 100 for

Due Gov't, \$ 100 for

Valuation of horse, \$ 100

Valuation of horse equipments, \$ 100

Remarks: *Stop for loss of 1
Haversack 95c*

Book mark: *100*

ash.
Copist.

F.

10 H. Art'y. U.S.C.T.

Eli Francon

Pat., Co. F, 10 Reg't U. S. Col'd H. Art'y.

Appears on

Company Muster Roll

for *May & June*, 186*6*.

Present or absent *Present*

Stoppage, \$ *100* for

Due Gov't, \$ *100* for

Valuation of horse, \$ *100*

Valuation of horse equipments, \$ *100*

Remarks:

Book mark:

(358)

Robt.
Copyist.

F.

10 H. Art'y.

U.S.C.T.

Eli Francois

Pvt., Co. F, 10 Reg't U. S. Col'd H. Art'y.

Appears on

Company Muster Roll

for *July & Aug.*, 186*6*.

Present or absent *Present*

Stoppage, \$ 100 for

Due Gov't, \$ 100 for

Valuation of horse, \$ 100

Valuation of horse equipments, \$ 100

Remarks:

Book mark: -----

Asst.
Copyst.

J

10 H. Art'y. U.S.C.T.

Oli Francis

But, Co. F, 10 Reg't U. S. Col'd H. Art'y.

Appears on

Company Muster Roll

for *Sept. and Oct*, 186*6*

Present or absent *Present*

Stoppage, \$ *100* for

Due Gov't, \$ *100* for

Valuation of horse, \$ *100*

Valuation of horse equipments, \$ *100*

Remarks:

Book mark:

Howe

(358)

Copyist.

F

10 H. Art'y. U.S.C.T.

Eli Francis

Pr, Co. F, 10 Reg't U. S. Col'd H. Art'y.

Appears on

Company Muster Roll

for *N.W. and Dec*, 186*6*

Present or absent *Present*

Stoppage, \$ *100* for

Due Gov't, \$ *100* for

Valuation of horse, \$ *100*

Valuation of horse equipments, \$ *100*

Remarks:

Book mark:

House

Francis. Ellice

Co , 10 U.S. Col'd H. Art'y.

Private

Private

CARD NUMBERS.

1	5487876	26
2		27
3		28
4		29
5		30
6		31
7		32
8		33
9		34
10		35
11		36
12		37
13		38
14		39
15		40
16		41
17		42
18		43
19		44
20		45
21		46
22		47
23		48
24		49
25		50

Book Mark:

See also 77 U.S. C. Inf

A 10 H A U.S.C.T.

Ellisie Francis
Pot, Co., 10 Reg't U. S. Col'd H A,

Appears on

M. and D. Roll of Men Transferred

to the organization named above,

from *of U.S. Col'd Inf*

Roll dated *Camp Parapetda Cal*, 186*5*.

When enlisted *May 6*, 186*4*.

Period for which enlisted *3* years.

When mustered in *May 13*, 186*4*

Present or absent

Company to which assigned

Remarks: *Died July 26, 64
at Ft. S. Philip of
Diarrrhea,*

*Name not taken up on
muster rolls of Regt*

Book mark :

Wm Scott

921
Francis Harry

Co , 10 U.S. Col'd H. Art'y.

Private | Private

CARD NUMBERS.

1	5487894	26
2		27
3		28
4		29
5		30
6		31
7		32
8		33
9		34
10		35
11		36
12		37
13		38
14		39
15		40
16		41
17		42
18		43
19		44
20		45
21		46
22		47
23		48
24		49
25		50

Book Mark:

See also 77 U.S. L. Inf

F. W. A. U.S.C.T.

Harry Francis
Pvt., Co. *A*, 10 Reg't U. S. Col'd *H. W.*

Appears on

M. and D. Roll of Men Transferred

to the organization named above

from

10th U.S. Col Inf

Roll dated

Camp Doniphan Mo, 186*5*.

When enlisted

May 6, 186*4*.

Period for which enlisted

3 years.

When mustered in

May 13, 186*4*.

Present or absent

Company to which assigned

Remarks:

Dest'd May 14.

*64 from New Orleans
La.*

*Name not taken up on
muster rolls of Regt*

Book mark :

W. H. Scott

Francis Normal

Co. E., 10 U.S. Col'd H. Art'y.

Private

Private

CARD NUMBERS.

1	5488617	26
2	5503573	27
3	5503721	28
4	5503951	29
5	5504594	30
6		31
7		32
8		33
9		34
10		35
11		36
12		37
13		38
14		39
15		40
16		41
17		42
18		43
19		44
20		45
21		46
22		47
23		48
24		49
25		50

Book Mark:

See also Co. A. 74th Inf. Regt.

J 10th U.S.C.T.

Starris Francois
Pvt, Co., 10 Reg't U. S. Col'd St. Arty.

Appears on

M. and D. Roll of Men Transferred

to the organization named above,

from Co "A" 7th U.S.C. Inf.

Roll dated New Orleans, La. Oct. 1/1865.

When enlisted October 1, 1863

Period for which enlisted 3 years.

When mustered in October 1, 1863

Present or absent

Company to which assigned

Remarks: Joined as recruit
Co "D" 20 Inf. Co A
(9th U.S.C. Inf) Trans-
ferred to Co "A" 7th
U.S.C. Inf. July 20
'64 per Genl Order
No 14 Hdqrs Mil. Div.
West Miss.

Book mark :

(342)

J. W. Jones, Jr

Copyist.

Norris Francois

Pvt, Co. E, 10 Reg't U. S. Col'd H. Art'y.

Appears on

Company Muster Roll

for *Mr & Sec*, 1865

Present or absent *Present*

Stoppage, \$ *100* for

Due Gov't, \$ *100* for

Valuation of horse, \$ *100*

Valuation of horse equipments, \$ *100*

Remarks: *Transferred from 74th
U.S.C.A. to 10 U.S.C.A. Regt
per S.O. Sec Dept of La
OCT 11-1865*

Book mark:

Kath

Copyist.

7

10 H. Art'y.

U.S.C.T.

Norris Francois

Pvt, Co. E, 10 Reg't U. S. Col'd H. Art'y.

Appears on

Company Muster Roll

for *Jan & Feb*, 1866.

Present or absent *Present*

Stoppage, \$ *100* for

Due Gov't, \$ *100* for

Valuation of horse, \$ *100*

Valuation of horse equipments, \$ *100*

Remarks:

Book mark: -----

Mark

(358)

Copyist.

Morris Francois

Porh, Co. E, 10 Reg't U. S. Col'd H. Art'y.

Appears on

Company Muster Roll

for *March & April*, 1866.

Present or absent

Stoppage, \$ 100 for

Due Gov't, \$ 100 for

Valuation of horse, \$ 100

Valuation of horse equipments, \$ 100

Remarks: *Died in Porh Hospital
Porh Hudson La Apr 6, 1866.
Chronic Bronchitis. Final Statements
forwarded Apr 6-1866.*

Book mark:

A

10 H. Art'y. U.S.C.T.

Norial Francois

Priv, Co. *E*, 10 Reg't U. S. Col'd H. Art'y.

Appears on **Co. Muster-out Roll**, dated

Baton Rouge, La. Feb. 22, 1867.

Muster-out to date _____, 186 .

Last paid to *Feb. 28*, 1866 .

Clothing account:

Last settled _____, 186 ; drawn since \$ _____ 100

Due soldier \$ _____ 100; due U. S. \$ _____ 100

Am't for cloth'g in kind or money adv'd \$ _____ 100

Due U. S. for arms, equipments, &c., \$ _____ 100

Bounty paid \$ _____ 100; due \$ _____ 100

Remarks: *Joined by transfer*
from Co. A, 74 U.S.C.I. as
Private. I. O. 84, N. 2, U.S.
Dept. of La. Oct. 11, 1865
Died in Post Hosp'l. Port
Hudson La. April 6, 1866

Book mark: *V. 2, P. 75. 68*

277. 101

O'Hagan

(361)

Copyist.

Francis, Morris

P, Co. E, 10 U.S.C.H.A.
Reg't

Enclosures.

Bed Cards	Descriptive Lists
Burial Records	Final Statements /
Certs. of Dis. for Discharge	Furloughs
C. M. Charges	Med. Des. Lists
Med. Certificates	Orders

Other papers relating to—

Admission to Hosp'l	Furlough
Casualty Sheet (Officer's)	Med. Examination
Confinement	Misc. Information
Contracts	Pay or Clothing
Death or Effects	Personal Reports
Desertions	Rank
Discharge from Hosp'l	Transfer to Hosp'l
Discharge from Service	Transfer to V. R. C.
Duty	Transportation

A. G. O. July 6th 1866.
Airs sent for Effects
sent 2nd class, M.

FINAL STATEMENT

OF

Privat Morris Francis C. E.

10th Reg't of U.S. Col'd. Art'y (Wg)

VOLUNTEERS.

Died Apr 6th 1866

NOTE 1.—Two of these certificates (or duplicates) are to be given to each Volunteer Soldier or drafted man who may be discharged previously to the discharge of his company, that he may at once receive from the Paymaster the pay, &c., due him, and the captain or other COMMISSIONED officer commanding the company will certify to the act of the delivery of the duplicate certificates; on these certificates the Soldier is "entitled to" his discharge, and should also present his discharge to the Paymaster to have the payment endorsed on it. The discharge is to be given back to the Soldier by the Paymaster; the latter only retaining as his voucher the duplicate certificates.

NOTE 2.—If the Soldier is entitled to pay for the use of his horse, the Company Commander will certify to that fact on the back of both these final statements, and also to the time he has pay due for having been so mounted on his own horse.

NOTE 3.—When a Soldier is furnished with final statements, his descriptive list, if he has one, should be taken up by the officer who gives the Soldier these statements, and endorsed with a statement to this effect by the officer. This endorsement should exhibit a full statement of the time for which the Soldier was allowed pay on his final statements, the clothing account, and all other charges against him or in his favor, so as to comprise a complete exhibit of his account. It will then be transmitted to the company commander of the Soldier, who will enter all the data necessary to a full understanding of the Soldier's account on the muster roll upon which the Soldier's discharge is reported. The descriptive list will then be destroyed. The object of this is, that the remaining portion of the Soldier's account may be settled upon the receipt of these muster rolls, and the Soldier receive any pay or allowances that may be due him at the time of his discharge, and which may not appear on his final statements from the fact that his descriptive list is incomplete. These accounts for back pay, &c., are settled by the 2d Auditor of the Treasury Department.

NOTE 4.—Charges for loss or injury to ordnance, horse equipments, and other miscellaneous charges, should appear under the heading of "Other Stoppages."

NOTE 5.—Bounty paid by State authorities, and not by the United States, will not be entered on this statement.

NOTE 6.—Amounts due the Sutler and Laundry must be entered on the muster roll on which the discharge, death, desertion, &c., is reported, as well as on the final statement, otherwise the amount cannot be collected from the United States.

NOTE 7.—This blank will be used for deceased volunteers and drafted men, as well as for others.

NOTE 8.—Where a Soldier dies in Hospital or on detached service, his descriptive list, if he has one, should be sent with his final statements, in duplicate, to the Adjutant General, Washington, D. C.

ADJUTANT GENERAL'S OFFICE

Apr 16th 1866

Duplicate with Inventory sent 2d Auditor.

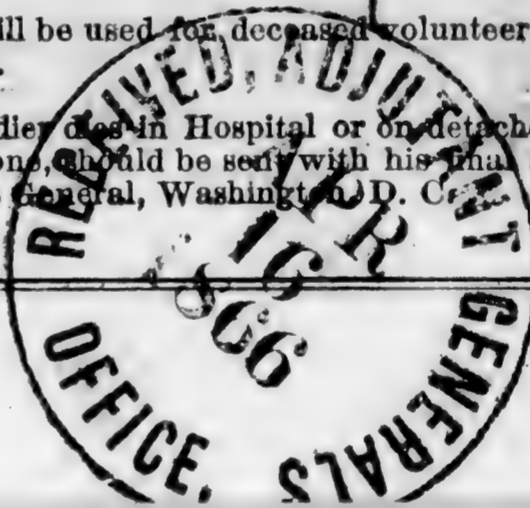

I certify, on honor, that Norris Francis a Private of
Captain V. A. Foulard Company (E.) of the 10th Regiment of U.S. (A. H.)
VOLUNTEERS, of the State of Louisiana, born in Bonfouca, State
of Louisiana, aged 18 years; 5 feet 3 inches high; Black complexion,
Black eyes, Black hair, and by occupation a Laborer, having joined the company on
its original organization at _____, and enrolled in it at the muster into
the service of the United States at _____, on the _____ day
of _____, 1863, (or was mustered in service as a recruit, by Lynn
McAllister, at New Orleans, on the 1st day of October,
1863, or was drafted and mustered into the service of the United States from the _____
Enrollment District of the State of _____, at _____,
on the _____ day of _____, 186), to serve in the Regiment, for
the term of Three Years: and having served **HONESTLY** and
FAITHFULLY with his Company in _____ to the present date, is now
entitled to a **DISCHARGE** by reason of Death due to Post Hospital
Port Hudson La. of Chronic Bronchitis April 1866

The said Private Norris Francis was last paid by Paymaster
Wm Ames to include the 28th day of February, 1866, and has
pay due him from that time to the present date; he is entitled to pay and subsistence for
TRAVELING to place of enrollment, and whatever other allowances are authorized to volunteer
soldiers, drafted men, or militia, so discharged. He has received from the United States **CLOTHING**
amounting to 95 ⁹⁵/₁₀₀ dollars, since the 31st day of August,
1864, when his clothing account was last settled. He has received from the United States
100 dollars advanced **BOUNTY**.

There is to be stopped from him, on account of the State of _____, or other
authorities, for **CLOTHING**, &c., received on entering service, _____ 100 dollars; and
for other stoppages, viz: _____
_____ 100 dollars.

He has been furnished with **TRANSPORTATION** in kind from the place of his discharge to
_____; and he has been **SUBSISTED** for **TRAVELING** to his
place of enrollment, up to the _____, 186 .

He is indebted to _____, **SUTLER**, _____ 100 dollars.

He is indebted to _____, **LAUNDRESS**, _____ 100 dollars.

Given in Duplicate, at Port Hudson La, this 7th day
of April, 1866.

John Marshall

1st Lieut. 10th U.S.C.A. (H.)
Commanding Company.

Francis Philip

Co E, 10 U.S. Col'd H. Art'y.

Private

Private

CARD NUMBERS.

1	5488618	26
2	5503572	27
3	5503720	28
4	5503857	29
5	5504003	30
6	5504132	31
7	5504330	32
8	5504549	33
9	5490091	34
10		35
11		36
12		37
13		38
14		39
15		40
16		41
17		42
18		43
19		44
20		45
21		46
22		47
23		48
24		49
25		50

Book Mark:

See also Coet. H. y/c dy

J. W. Jones, Jr. U.S.C.T.

Philip Francois
Int, Co. 110 Reg't U. S. Col'd St. Arty

Appears on

M. and D. Roll of Men Transferred

to the organization named above,

from Co. "A" 74 U.S. C. Inf.

Roll dated New Orleans, La. Oct. 11, 1865

When enlisted October 1, 1863

Period for which enlisted 3 years.

When mustered in Oct. 1, 1863

Present or absent

Company to which assigned

Remarks: Joined as recruit
Co "D" 20 Inf. Cda
(91 U.S. C. Inf) Trans-
ferred to Co "A" 74
U.S. C. Inf. July 20
'64 per Gen. Order No.
17 Hdqrs Mil. Div. of
West. Miss.

Book mark:

(342)

J. W. Jones, Jr. Copyist.

Philip Francis

Pvt, Co. E, 10 Reg't U. S. Col'd H. Art'y.

Appears on

Company Muster Roll

for Nov & Dec, 1865

Present or absent Present

Stoppage, \$ 100 for

Due Gov't, \$ 100 for

Valuation of horse, \$ 100

Valuation of horse equipments, \$ 100

Remarks: Transferred from 74th U.S.C. I. to 10 U.S.C. A. by Ser. S.O. 84. Hd Qrs Dept of La Oct 11-1865

Book mark:

Hark Copyist.

F | 10 H. Art'y. | U.S.C.T.

Philip Francis

Plt, Co. E, 10 Reg't U. S. Col'd H. Art'y.

Appears on

Company Muster Roll

for *Jan & Feb*, 1866.

Present or absent *Present*

Stoppage, \$ *100* for

Due Gov't, \$ *100* for

Valuation of horse, \$ *100*

Valuation of horse equipments, \$ *100*

Remarks:

Book mark:

(358)

Mark
Copyist.

7

10 H. Art'y.

U.S.C.T.

Philip Francisco

Pvt, Co. E, 10 Reg't U. S. Col'd H. Art'y

Appears on

Company Muster Roll

for March & April, 1866.

Present or absent Present

Stoppage, \$ 100 for

Due Gov't, \$ 100 for

Valuation of horse, \$ 100

Valuation of horse equipments, \$ 100

Remarks:

Book mark:

W. A. V.

(358)

Copyist.

7

10 H. Art'y. U.S.C.T.

Philip Francor

Pvt, Co. E, 10 Reg't U. S. Col'd H. Art'y

Appears on

Company Muster Roll

for May & June, 1866.

Present or absent Present

Stoppage, \$ 100 for

Due Gov't, \$ 100 for

Valuation of horse, \$ 100

Valuation of horse equipments, \$ 100

Remarks:

Book mark:

Wart

Copyist.

7

10 H. Art'y.

U.S.C.T.

Philip Francon

Plt, Co. E, 10 Reg't U. S. Col'd H. Art'y.

Appears on

Company Muster Roll

for *July & Aug*, 1866.

Present or absent *Present*

Stoppage, \$ *100* for

Due Gov't, \$ *100* for

Valuation of horse, \$ *100*

Valuation of horse equipments, \$ *100*

Remarks:

Book mark :

Wark
Copyist.

J | 10 H. Art'y. | U.S.C.T.

Philip Francois
Priv., Co. E, 10 Reg't U. S. Col'd H. Art'y.

Appears on

Company Muster Roll

for *Sept. & Oct.*, 186*6*.

Present or absent

Stoppage, \$ 100 for

Due Gov't, \$ 100 for

Valuation of horse, \$ 100

Valuation of horse equipments, \$ 100

Remarks: *Mustered out by reason of expiration of term of service to date Sept. 30. 1866.*

Book mark:

(358)

O'Hagan

Copyist.

Philip Francois
Priv, Co. *E*, 10 Reg't U. S. Col'd H. Art'y.

Appears on **Co. Muster-out Roll**, dated
Baton Rouge, La, Feb. 22, 1867.
Muster-out to date _____, 186 .
Last paid to _____, 186 .

Clothing account:

Last settled _____, 186 ; drawn since \$ _____ 100
Due soldier \$ _____ 100; due U. S. \$ _____ 100
Am't for cloth'g in kind or money adv'd \$ _____ 100

Due U. S. for arms, equipments, &c., \$ _____ 100
Bounty paid \$ _____ 100; due \$ _____ 100

Remarks: *Discharged by reason*
of expiration of term of
Service, Sept. 30, 1866

Book mark: *V. 2. P. 87. 68*

(361) *O. Nagard* Copyist.

7 | 10 arty | U.S.C.T.

Philip Hancock

Priv., Co. E, 10 Reg't U. S. Col'd Arty

Appears on a

Detachment Muster-out Roll

of the organization named above. Roll dated

New Orleans, La., Oct 2, 1866.

Muster-out to date Sept 30 1866.

Last paid to June 30, 1866

Clothing account:

Last settled _____, 1866 ; drawn since \$ 100

Due soldier \$ 24 ⁵⁰/₁₀₀; due U. S. \$ 100

Am't for cloth'g in kind or money adv'd \$ 100

Due U. S. for arms, equipments, &c., \$ 100

Bounty paid \$ 100 due \$ 100

Remarks: Joined by transfer from
24 U.S.C. Inftry in Louisiana
with S.C. No 84, Hdqrs Dept.
of La, Oct 11, 1865. Mustered
out by reason of expiration
of term of service.

Book mark: _____

C. M. Clark

927
Frachon Aaron

Co C, 10 U.S. Col'd H. Art'y.

Private

Private

CARD NUMBERS.

1	5487229	26
2	5498521	27
3	5498602	28
4	5498801	29
5	5498937	30
6	5499078	31
7	5499214	32
8	5499350	33
9	5499486	34
10	5499622	35
11	5499758	36
12	5499893	37
13	5500025	38
14	5300161	39
15	5500290	40
16	5500380	41
17		42
18		43
19		44
20		45
21		46
22		47
23		48
24		49
25		50

Book Mark:

See also

F

10 H. Art'y.

U.S.C.T.

Aaron Fraction

Appears with rank of *Private* on

Muster and Descriptive Roll of a Detachment of U. S. Vols. forwarded

for the *10* Reg't *U. S. C. H. Art'y* Roll dated *New Orleans La, Sept 19, 1864.*

Where born *Richmond Va*

Age *40* y'rs; occupation *Laborer*

When enlisted *Aug 21*, 1864.

Where enlisted *New Orleans La*

For what period enlisted *3* years.

Eyes *Blue*; hair *Black*

Complexion *Dun*; height *5* ft. *9* in.

When mustered in *Sept 19*, 1864

Where mustered in *New Orleans*

Bounty paid \$ *100*; due \$ *300* *100*

Where credited *to New Orleans La*

Company to which assigned *C*

Remarks:

Book mark:

J. W. Williams

(339)

Copyist.

F

10 H. Art'y. U.S.C.T.

Aaron Fraction

Pvt., Co. C, 10 Reg't U. S. Col'd H. Art'y.

Appears on

Company Muster Roll

for Sept 1864, 1864

Present or absent Present

Stoppage, \$ 100 for

Due Gov't, \$ 100 for

Valuation of horse, \$ 100

Valuation of horse equipments, \$ 100

Remarks: \$300. Bounty due

Book mark:

(358)

J. Anderson Copyist.

F

10 H. Art'y. U.S.C.T.

Aaron Fraction

Pop, Co. C, 10 Reg't U. S. Col'd H. Art'y.

Appears on

Company Muster Roll

for *Nov & Dec*, 1864.

Present or absent *Present*

Stoppage, \$.....100 for

Due Gov't, \$.....100 for

Valuation of horse, \$.....100

Valuation of horse equipments, \$.....100

Remarks: *\$300. Bounty due*

Book mark: *150004*

(358)

J. Underwood

Copyist.

F

10 H. Art'y. U.S.C.T.

Caron Fraction

Pub, Co. C, 10 Reg't U. S. Col'd H. Art'y.

Appears on

Company Muster Roll

for *Jan + Feb*, 186*5*.

Present or absent *Present*

Stoppage, \$ *100* for

Due Gov't, \$ *100* for

Valuation of horse, \$ *100*

Valuation of horse equipments, \$ *100*

Remarks:

Book mark:

Sallade

F

10 H. Art'y. U.S.C.T.

Acron Fractions

Priv., Co. C, 10 Reg't U. S. Col'd H. Art'y.

Appears on

Company Muster Roll

for March & April, 1865.

Present or absent Present

Stoppage, \$ 100 for

Due Gov't, \$ 100 for

Valuation of horse, \$ 100

Valuation of horse equipments, \$ 100

Remarks:

Book mark: 1865

Lamb

(358)

Copyist.

F

10 H. Art'y. U.S.C.T.

Aaron Fraction
Out, Co. C, 10 Reg't U. S. Col'd H. Art'y.

Appears on

Company Muster Roll

for May + June, 1865.

Present or absent Present

Stoppage, \$ 100 for

Due Gov't, \$ 100 for

Valuation of horse, \$ 100

Valuation of horse equipments, \$ 100

Remarks:

Book mark:

Sallade

(358)

Copyist.

F

10 H. Art'y. U.S.C.T.

Aaron Fraction

Plt., Co. C, 10 Reg't U. S. Col'd H. Art'y.

Appears on

Company Muster Roll

for July & Aug, 1865.

Present or absent Present

Stoppage, \$ 100 for

Due Gov't, \$ 100 for

Valuation of horse, \$ 100

Valuation of horse equipments, \$ 100

Remarks: \$200. Bounty Due
\$100. Paid

Book mark:

(358)

Ballade

Copyist.

F

10 H. Art'y. U.S.C.T.

Aaron Fraction

Plt, Co. C, 10 Reg't U. S. Col'd H. Art'y.

Appears on

Company Muster Roll

for Sept + Oct, 1865

Present or absent Present

Stoppage, \$ 100 for

Due Gov't, \$ 100 for

Valuation of horse, \$ 100

Valuation of horse equipments, \$ 100

Remarks: Daily duty as hospital cook

Book mark:

Ballade

J

10 H. Art'y. | U.S.C.T.

Aaron Fraction

Robt., Co. C, 10 Reg't U. S. Col'd H. Art'y.

Appears on

Company Muster Roll

for *Nov. 30 Dec.*, 1865.

Present or absent *Present*

Stoppage, \$ 100 for

Due Gov't, \$ 100 for

Valuation of horse, \$ 100

Valuation of horse equipments, \$ 100

Remarks:

Book mark:

A. J. Robbins

(358)

Copyist.

G

10 H. Art'y. U.S.C.T.

Aaron Graction

Pvt., Co. C, 10 Reg't U. S. Col'd H. Art'y.

Appears on

Company Muster Roll

for Jan of Feb., 1866.

Present or absent Present

Stoppage, \$ 100 for

Due Gov't, \$ 100 for

Valuation of horse, \$ 100

Valuation of horse equipments, \$ 100

Remarks: \$100 Bounty paid
\$200 due

Book mark:

A. J. Robbins

Aaron Traction

Pvt., Co. C, 10 Reg't U. S. Col'd H. Art'y.

Appears on

Company Muster Roll

for *Nov. & Dec.*, 186*6*.

Present or absent *Present*

Stoppage, \$ 100 for

Due Gov't, \$ 100 for

Valuation of horse, \$ 100

Valuation of horse equipments, \$ 100

Remarks:

Book mark: -----

(358) *A. J. Robbins* Copyist.

F

10 H. Art'y. U.S.C.T.

Aaron Fraction

Plt., Co. C, 10 Reg't U. S. Col'd H. Art'y.

Appears on

Company Muster Roll

for May and June, 1864.

Present or absent Present.

Stoppage, \$ 100 for

Due Gov't, \$ 100 for

Valuation of horse, \$ 100

Valuation of horse equipments, \$ 100

Remarks: \$200 Bounty Paid \$100 to be paid.

Book mark:

A. J. Robbins

(358)

Copyist.

F

10 H. Art'y. | U.S.C.T.

Aaron Fraction
Priv., Co. C, 10 Reg't U. S. Col'd H. Art'y.

Appears on

Company Muster Roll

for *July 3rd Aug.*, 186*6*.

Present or absent *Present*

Stoppage, \$ *100* for

Due Gov't, \$ *100* for

Valuation of horse, \$ *100*

Valuation of horse equipments, \$ *100*

Remarks:

Book mark:

(358)

A. J. Robbins

Copyist.

J

10 H. Art'y. | U.S.C.T.

Harro Fraction

Pvt., Co. C, 10 Reg't U. S. Col'd H. Art'y.

Appears on

Company Muster Roll

for *Sept & Oct*, 186*6*.

Present or absent *Present*

Stoppage, \$ *100* for

Due Gov't, \$ *100* for

Valuation of horse, \$ *100*

Valuation of horse equipments, \$ *100*

Remarks:

Book mark:

Thomas G

(358)

Copyist.

7

10 H. Art'y. U.S.C.T.

Aaron Fraction

Post, Co. C, 10 Reg't U. S. Col'd H. Art'y.

Appears on

Company Muster Roll

for *Nov. & Dec*, 1866.

Present or absent *Present*

Stoppage, \$ 100 for

Due Gov't, \$ 100 for

Valuation of horse, \$ 100

Valuation of horse equipments, \$ 100,

Remarks: *Daily duty on Post Hospital*

Book mark: _____

Mamm

(358)

Copyist.

F | 10 H. Art'y. | U.S.C.T.

Aaron Fraction
Cpt, Co. *C*, 10 Reg't U. S. Col'd H. Art'y.

Appears on **Co. Muster-out Roll**, dated
Baton Rouge, La, Feb 22, 1867.

Muster-out to date *Feb 22*, 1867.

Last paid to *Dec 31*, 1866.

Clothing account:

Last settled _____, 186 ; drawn since \$ _____ 100

Due soldier \$ *49* ^{*51*}/₁₀₀; due U. S. \$ _____ 100

Am't for cloth'g in kind or money adv'd \$ _____ 100

Due U. S. for arms, equipments, &c., \$ *6* ^{*26*}/₁₀₀

Bounty paid \$ *200* ^{*100*}/₁₀₀; due \$ _____ 100

Remarks: *Joined as recruit stop*
for wiper stop for one
Springfield Rifled
M. K. T. & Acc't retained

Book mark: *1000 / 83*

(361)

Hammer
Copyist.

Frashion, Aaron

P Co. 6, 10 Reg't uscta

2 Enclosures.

Bed Cards	Descriptive Lists
Burial Records	Final Statements
Certs. of Dis. for Discharge	Furloughs
C. M. Charges	Med. Des. Lists
Med. Certificates	Orders <i>2</i>

Other papers relating to—

Admission to Hosp'l	Furlough
Casualty Sheet (Officer's)	Med. Examination
Confinement	Misc. Information
Contracts	Pay or Clothing
Death or Effects	Personal Reports
Desertions	Rank
Discharge from Hosp'l	Transfer to Hosp'l
Discharge from Service	Transfer to V. R. C.
Duty	Transportation

1607

December 22nd 1865

Aaron Proaction
Co B 10 U.S.C. H.A.

order.

Recd. by
J. C. ...
1862

Special Court
1862

(Extract)

of the ...
Hospital ...
County ...

* * * * *

Joseph ...
County the ...

The ...
A ...

October 30th 1865.

1607

Aaron Traction
Co. 6 10 U.S.C. 76. a.

order.

Head Quarters
Fort Livingston La
October 30. 1865

Special Orders
No. 19

(Extract)

* * * * *
2. Private Aaron Fracton, Company "C"
10th U. S. Col. Arty. (Co.) is hereby detailed for duty
as Hospital Cook & will report to Dr. Redgrave W.
A. Surg. U. S. A. in charge of Post Hospital, for duty
without delay.
* * * * *

By Command of
Captain Albert Loring
Joseph S. Ferguson
1st Lieut. 10th U. S. C. A. (Co.)
Actg. Post Adjt.

Dr. Redgrave
W. A. Surg. U. S. A.
In charge of Post Hospital

Frank Gabriel

Co B, 10 U.S. Col'd H. Art'y.

Private

Private

CARD NUMBERS.

1	5509534	26
2	5490194	27
3	5511185	28
4		29
5		30
6		31
7		32
8		33
9		34
10		35
11		36
12		37
13		38
14		39
15		40
16		41
17		42
18		43
19		44
20		45
21		46
22		47
23		48
24		49
25		50

Book Mark:

See also

F | 10 H. Art'y. | U.S.C.T.

Gabriel Frank

Pvt, Co. H, 10 Reg't U. S. Col'd H. Art'y.

Appears on

Company Muster-in and Descriptive Roll
of the organization named above. Roll dated

New Orleans La, Nov 8, 1864.

Where born *S. John Baptist La.*

Age *20* y'rs; occupation *Laborer*

When enlisted *Nov 1*, 1864.

Where enlisted *New Orleans*

For what period enlisted *3* years.

Eyes *Black*; hair *Black*

Complexion *Black*; height *5 ft. 4 1/2 in.*

When mustered in *Nov 8*, 1864.

Where mustered in *New Orleans*

Bounty paid \$ *100*; due \$ *100*

Where credited *1st Dist, 2nd ward, Parish*

of Orleans, City of N. Orleans

Company to which assigned *N.*

Remarks: *Mustered in to*

date from date of

enlistment

NEXT ROLL ON FILE FEB 1865

Book mark: _____

Pennings
(356d) Copist.

F 10th H. Arty U.S.C.T.

Gabriel Frank

Pl, Co H, 10 Reg't U. S. Col'd H Arty

Appears on

Descriptive List of Deserters

dated Recruiting Depot N.O. Nov 26 1864.

Deserted:

When Nov. 25, 1864.

Where Recruiting Depot N.O.

Arrested:

When _____, 186 .

Where _____

Remarks: Conscripted from
Mayroune Plantation
A. C.

Book mark : _____

(351)

J. H. Richardson
Copyist.

F | 10 H. Art'y. | U.S.C.T.

Gabriel Frank
Pvt., Co. *H.*, 10 Reg't U. S. Col'd H. Art'y.

Appears on Co. Muster-out Roll, dated
Baton Rouge, La. Feb 22, 1867.

Muster-out to date _____, 186 .
Last paid to *Never paid,* 186 .

Clothing account:

Last settled _____, 186 ; drawn since \$ _____ 100

Due soldier \$ _____ 100; due U. S. \$ *28*²⁴/₁₀₀

Am't for cloth'g in kind or money adv'd \$ _____ 100

Due U. S. for arms, equipments, &c., \$ _____ 100

Bounty paid \$ _____ 100; due \$ _____ 100

Remarks: *Deser'd Nov. 25/64*
at New Orleans, La.

Book mark: _____

(361) _____ *Lowny* Copyist.

Frank, Gabriel

, Co. *H*, *10* Reg't *U S C A*

2 Enclosures.

Bed Cards	Final Statements
Burial Records	Furloughs or L. of A.
Certs. of Dis. for Discharge	Med. Certificates
C. M. Charges	Med. Des. Lists
Descriptive Lists	Orders
Discharge Certificates	Pris. of War Record
Enlistment Papers <i>2</i>	Resignations

Other papers relating to—

Admission to Hosp'l	Furlough or L. of A.
Casualty Sheet	Med. Examination
Confinement	Misc. Information
Contracts	Pay or Clothing
Death or Effects	Personal Reports
Desertion	Rank
Discharge from Hosp'l	Transfer to Hosp'l
Discharge from Service	Transfer to V. R. C.
Duty	Transportation

NOTE 1.—This blank will be used for both enlistments and re-enlistments—enlistment of veterans, &c., &c., in the volunteer service. They will be made out in duplicate in all cases—one to accompany the recruiting return of the superintendent (not the recruiting officer) to the Adjutant General, and one to accompany the accounts of the officer who pays bounty, &c. The Regiment and Company in which the soldier last served should be given on the back.

NOTE 2.—An enlistment holds to service. A muster-in must, in all cases, precede payment of pay, bounty, pension, &c. A muster-in roll must, in all cases, be filed in the Adjutant General's Office as evidence of muster-in. The mustering officer, commissary, or assistant commissary of musters, as the case may be, will countersign both enlistments as having mustered the soldier into the service of the United States before either of them is given to the disbursing officer.

DECLARATION OF RECRUIT.

I, Gabriel Frank, desiring to VOLUNTEER as a Soldier in the Army of the United States, for the term of THREE YEARS, Do Declare, That I am 20 years and _____ months of age; that I have never been discharged from the United States service on account of disability or by sentence of a court martial, or by order before the expiration of a term of enlistment; and I know of no impediment to my serving honestly and faithfully as a soldier for three years.

GIVEN at New Orleans La the 1 day of November 1864

Witness:

H. Palmieri, Gabriel Frank
1st Lieut U.S.C.

109116.11044

No. 543

Gabriel Frank

Volunteered at New Orleans

Nov 15, 1864

By H. A. Palmieri

84 Regiment of U.S.C.

enlistment; last served in Company ()

Reg't of

Discharged _____, 18 _____

Consent to enlistment
H. Bannery

CONSENT IN CASE OF MINOR.

I, _____, Do CERTIFY, That I am the _____ of _____; that the said _____ is _____ years of age; and I do hereby freely give my CONSENT to his volunteering as a SOLDIER in the ARMY OF THE UNITED STATES for the period of THREE YEARS.

GIVEN at _____ the _____ day of _____

Witness:

VOLUNTEER ENLISTMENT.

STATE OF

TOWN OF

Louisiana



New Orleans

I, *Gabriel Frank*, born in *St Louis Baptist* in the State of *Louisiana*, aged *20* years, and by occupation a *Laborer*, DO HEREBY ACKNOWLEDGE to have volunteered this *First* day of *November*, 1864, to serve as a **Soldier** in the **Army of the United States of America**, for the period of **THREE YEARS**, unless sooner discharged by proper authority: Do also agree to accept such bounty, pay, rations, and clothing, as are, or may be, established by law for volunteers. And I, *Gabriel Frank*, do solemnly swear, that I will bear true faith and allegiance to the **United States of America**, and that I will serve them honestly and faithfully against all their enemies or opposers whomsoever; and that I will observe and obey the orders of the President of the United States, and the orders of the officers appointed over me, according to the Rules and Articles of War.

Sworn and subscribed to, at *New Orleans* this *1* day of *Nov*, 1864

BEFORE *A. H. Ramirez*
17284 U.S.C.

Gabriel Frank
rank

I CERTIFY, ON HONOR, That I have carefully examined the above-named Volunteer, agreeably to the General Regulations of the Army, and that, in my opinion, he is free from all bodily defects and mental infirmity, which would in any way disqualify him from performing the duties of a soldier.

Abelle Humphrey
Surgeon
EXAMINING SURGEON.

I CERTIFY, ON HONOR, That I have minutely inspected the Volunteer *Gabriel Frank* previously to his enlistment, and that he was entirely sober when enlisted; that, to the best of my judgment and belief, he is of lawful age; and that, in accepting him as duly qualified to perform the duties of an able-bodied soldier, I have strictly observed the Regulations which govern the recruiting service. This soldier has *Blue* eyes, *Blue* hair, *Blue* complexion, is *5* feet *4 1/2* inches high.

A. H. Ramirez
17284 Regiment of *U.S.C.* Volunteers,
RECRUITING OFFICER.

(A. G. O. No. 74 & 76.)

Mustered into the service of the United States, for three years or during the war, from date of enlistment, in Company *H* of the *10th* Regiment of *U.S.C.* Volunteers, on the *8* day of *Nov* 1864 at *New Orleans*

John Hamilton
Adjutant
17284 U.S.C.
Recruiting Officer

NOTE 1.—This blank will be used for both enlistments and re-enlistments—enlistment of veterans, &c., &c., in the volunteer service. They will be made out in duplicate in all cases—one to accompany the recruiting return of the superintendent (not the recruiting officer) to the Adjutant General, and one to accompany the accounts of the officer who pays bounty, &c. The Regiment and Company in which the soldier last served should be given on the back.

NOTE 2.—An enlistment holds to service. A muster-in must, in all cases, precede payment of pay, bounty, pension, &c. A muster-in roll must, in all cases, be filed in the Adjutant General's Office as evidence of muster-in. The mustering officer, commissary, or assistant commissary of musters, as the case may be, will countersign both enlistments as having mustered the soldier into the service of the United States before either of them is given to the disbursing officer.

DECLARATION OF RECRUIT.

I, Gabriel Frank, desiring to VOLUNTEER as a Soldier in the Army of the United States, for the term of THREE YEARS, Do Declare, That I am 20 years and _____ months of age; that I have never been discharged from the United States service on account of disability or by sentence of a court martial, or by order before the expiration of a term of enlistment; and I know of no impediment to my serving honestly and faithfully as a soldier for three years.

GIVEN at New Orleans La the 1st day of November 1864

Witness: W. L. Ruddy, 2d Lt Gabriel Frank
1st Lt Frank

W. S. D. Out Steam

8th Nov 1864

Gabriel Frank
No. _____

Volunteered at New Orleans

1st November 1864

By A. B. Palmer

Regiment of _____

enlistment; last served in Company ()

Reg't of _____

Discharged _____, 18 _____

Consent-out-entitled
W. S. D. Out Steam

CONSENT IN CASE OF MINOR.

I, _____, Do CERTIFY, That I am the _____ of _____; that the said _____ is _____ years of age; and I do hereby freely give my CONSENT to his volunteering as a SOLDIER in the ARMY OF THE UNITED STATES for the period of THREE YEARS.

GIVEN at _____ the _____ day of _____

Witness: _____

VOLUNTEER ENLISTMENT.

STATE OF *Louisiana* TOWN OF *New Orleans*



I, *Gabriel Frank*, born in *St John Baptiste* in the State of *Louisiana*, aged *20* years, and by occupation a *Laborer*, Do HEREBY ACKNOWLEDGE to have volunteered this *1st* day of *November*, 1864, to serve as a **Soldier** in the **Army of the United States of America**, for the period of **THREE YEARS**, unless sooner discharged by proper authority: Do also agree to accept such bounty, pay, rations, and clothing, as are, or may be, established by law for volunteers. And I, *Gabriel Frank*, do solemnly swear, that I will bear true faith and allegiance to the **United States of America**, and that I will serve them honestly and faithfully against all their enemies or opposers whomsoever; and that I will observe and obey the orders of the President of the United States, and the orders of the officers appointed over me, according to the Rules and Articles of War.

Sworn and subscribed to, at *New Orleans* this *1st* day of *Nov*, 1864, *Gabriel Frank* BEFORE *H. Amicini* *1st Lieut 84th U.S.C.S.*

I CERTIFY, ON HONOR, That I have carefully examined the above-named Volunteer, agreeably to the General Regulations of the Army, and that, in my opinion, he is free from all bodily defects and mental infirmity, which would in any way disqualify him from performing the duties of a soldier.

Wm. Humphrey
Surgeon Major
EXAMINING SURGEON.

I CERTIFY, ON HONOR, That I have minutely inspected the Volunteer *Gabriel Frank* previously to his enlistment, and that he was entirely sober when enlisted; that, to the best of my judgment and belief, he is of lawful age; and that, in accepting him as duly qualified to perform the duties of an able-bodied soldier, I have strictly observed the Regulations which govern the recruiting service. This soldier has *Blue* eyes, *Blk* hair, *Dark* complexion, is *5* feet *4 1/2* inches high.

H. Amicini
1st Lieut 84th Regiment of *U.S.C.S.* Volunteers,
RECRUITING OFFICER.

(A. G. O. No. 74 & 76.)

Mustered into the service of the United States, for three years or during the war, from date of enlistment, in Company *A* of the *1st* Regiment of *Miss & Laiz* Volunteers, on the *8* day of *Nov*, 1864, at *New Orleans*

John Hamilton
1st Lieut 110th
Miss & Laiz Volunteers,
OFFICER

Frank Henry

Co **10 U.S. Col'd H. Art'y.**

Private

Private

CARD NUMBERS.

<i>5487620</i>	26
	27
	28
	29
	30
	31
	32
	33
	34
	35
	36
	37
	38
	39
	40
	41
	42
	43
	44
	45
	46
	47
	48
	49
	50

Book Mark:

See also *77 U.S. 6 Sep*

T. 10th A. U.S.C.T.

Henry Frank
Priv, Co. *10*, Reg't U. S. Col'd Infantry. *H. A.*

Appears on

M. and D. Roll of Men Transferred

to the organization named above,

from *Co. 10 U. S. Col. Inf*

Roll dated *Camp Campetula Tex*, 186*4*.

When enlisted *May 18*, 186*4*.

Period for which enlisted *3* years.

When mustered in *May 20*, 186*4*.

Present or absent

Company to which assigned

Remarks: *Found at Orig^l*
Co. 10 U. S. Col. Inf
at New Orleans La,

name not taken up
on muster rolls of Regt

Book mark :

W. H. Scott

Franklin Benjamin
Co. H., 10 U.S. Col'd H. Art'y.

Private

Private

CARD NUMBERS.

1	5487280	26
2	5509637	27
3	5509750	28
4	5509906	29
5	5510057	30
6	5510202	31
7	5510352	32
8	5510503	33
9	5510625	34
10	5510769	35
11	5510849	36
12	5510923	37
13	5510997	38
14	5511061	39
15		40
16		41
17		42
18		43
19		44
20		45
21		46
22		47
23		48
24		49
25		50

Book Mark:

See also

S-969221- P.O. M+M

0 1407324 P.O. M.O.

AS 1723859

AY. 1735735

AY. 1880192

Wm. J. Hoke

F | 10 H. Art'y. | U.S.C.T.

Benjamin Franklin

Appears with rank of *Put* on

Muster and Descriptive Roll of a Detachment of U. S. Vols. forwarded

for the *10* Reg't *U.S.C.A. Art'y.* Roll dated
New Orleans, La., Nov. 3, 1864.

Where born *Iberville Parish, La.*

Age *38* y'rs; occupation *Labourer*

When enlisted *Nov. 1, 1864.*

Where enlisted *New Orleans*

For what period enlisted *3* years.

Eyes *black*; hair *black*

Complexion *black*; height *5 ft. 6 1/2 in.*

When mustered in *Nov. 3, 1864.*

Where mustered in *New Orleans*

Bounty paid \$ *None* 100; due \$ *None* 100

Where credited *New Orleans, La.*

Company to which assigned

Remarks: *Enlisted under G.O. No. 106*
Dept. of the Gulf, ^{dated} Aug. 2/64 and
not entitled to bounty.

Jan 27/61 - next in file

Book mark:

(339)

Long

Copyist.

F | 10 H. Art'y. | U.S.C.T.

Benjamin Franklin

Pvt, Co. H, 10 Reg't U. S. Col'd H. Art'y

Appears on

Company Muster Roll

for *Jan'y & Feby*, 1865-

Present or absent *Present*

Stoppage, \$ *100* for

Due Gov't, \$ *100* for

Valuation of horse, \$ *100*

Valuation of horse equipments. \$ *100*

Remarks :

Book mark :

(858)

Permanently

Copyist.

F | 10 H. Art'y. | U.S.C.T.

Benjamin Franklin

Pr, Co. H, 10 Reg't U. S. Col'd H. Art'y

Appears on

Company Muster Roll

for *March + April*, 1865:

Present or absent *Present*

Stoppage, \$ *100* for

Due Gov't, \$ *100* for

Valuation of horse, \$ *100*

Valuation of horse equipments. \$ *100*

Remarks :

Book mark :

(358)

Permittor
Copyist.

Benjamin Franklin

Prvt, Co. H, 10 Reg't U. S. Col'd H. Art'y

Appears on

Company Muster Roll

for *May & June*, 186*5*

Present or absent *Present*

Stoppage, \$ *100* for

Due Gov't, \$ *100* for

Valuation of horse, \$ *100*

Valuation of horse equipments. \$ *100*

Remarks :

Book mark :

Pennington
(358) Copyist.

F

10 H. Art'y.

U.S.C.T.

Benjamin Franklin

Phy, Co. H, 10 Reg't U. S. Col'd H. Art'y

Appears on

Company Muster Roll

for *July & Aug*, 1865.

Present or absent

Present

Stoppage, \$ 100 for

Due Gov't, \$ 100 for

Valuation of horse, \$ 100

Valuation of horse equipments. \$ 100

Remarks :

Book mark :

(858)

Pennington

Copyist.

GF

10 H. Art'y. U.S.C.T.

Benjamin Franklin

Pr., Co. H, 10 Reg't U. S. Col'd H. Art'y

Appears on

Company Muster Roll

for *Sep & Oct*, 1865.

Present or absent *Present*

Stoppage, \$ *100* for

Due Gov't, \$ *100* for

Valuation of horse, \$ *100*

Valuation of horse equipments. \$ *100*

Remarks:

Book mark:

Gammack

(358)

Copyist.

Ch

10 H. Art'y.

U.S.C.T.

Benjamin Franklin

Prs, Co. H, 10 Reg't U. S. Col'd H. Art'y

Appears on

Company Muster Roll

for *Nov & Dec*, 1865.

Present or absent *Present*

Stoppage, \$ *100* for

Due Gov't, \$ *100* for

Valuation of horse, \$ *100*

Valuation of horse equipments. \$ *100*

Remarks :

Book mark :

Samuel

(858)

Copyist.

F

10 H. Art'y.

U.S.C.T.

Benjamin Franklin

Priv., Co. H, 10 Reg't U. S. Col'd H. Art'y

Appears on

Company Muster Roll

for *Jan & Feb.*, 1866.

Present or absent *Present*

Stoppage, \$ 100 for

Due Gov't, \$ 100 for

Valuation of horse, \$ 100

Valuation of horse equipments. \$ 100

Remarks :

Book mark :

Gamma

(858)

Copyist.

F

10 H. Art'y. U.S.C.T.

Benjamin Franklin

Co., Co. H, 10 Reg't U. S. Col'd H. Art'y

Appears on

Company Muster Roll

for *M & A*, 1866.

Present or absent *Present*

Stoppage, \$ *100* for

Due Gov't, \$ *100* for

Valuation of horse, \$ *100*

Valuation of horse equipments. \$ *100*

Remarks :

Book mark :

Cammack

F

10 H. Art'y.

U.S.C.T.

Benjamin Franklin

Co., Co. H, 10 Reg't U. S. Col'd H. Art'y

Appears on

Company Muster Roll

for *May & June*, 186*6*

Present or absent *Present*

Stoppage, \$ *100* for

Due Gov't, \$ *100* for

Valuation of horse, \$ *100*

Valuation of horse equipments. \$ *100*

Remarks :

Book mark :

Gamma R

F

10 H. Art'y. U.S.C.T.

Benjamin Franklin

Priv, Co. H, 10 Reg't U. S. Col'd H. Art'y

Appears on

Company Muster Roll

for *July & Aug*, 186*6*.

Present or absent *Present*

Stoppage, \$ *100* for

Due Gov't, \$ *100* for

Valuation of horse, \$ *100*

Valuation of horse equipments. \$ *100*

Remarks :

Book mark :

Lammac

(858)

Copyist.

F | 10 H. Art'y. | U.S.C.T.

Benjamin Franklin
Priv, Co. H, 10 Reg't U. S. Col'd H. Art'y

Appears on

Company Muster Roll

for *Sep & Oct*, 1866.

Present or absent *Present*

Stoppage, \$ *100* for

Due Gov't, \$ *100* for

Valuation of horse, \$ *100*

Valuation of horse equipments. \$ *100*

Remarks :

Book mark :

(358)

Lowry

Copyist.

F. | 10 H. Art'y. | U.S.C.T.

Benjamin Franklin
Pvt, Co. H, 10 Reg't U. S. Col'd H. Art'y

Appears on

Company Muster Roll

for *Nov. & Dec*, 1866.

Present or absent *Present*

Stoppage, \$ *100* for

Due Gov't, \$ *100* for

Valuation of horse, \$ *100*

Valuation of horse equipments. \$ *100*

Remarks :

Book mark :

(358)

Lowny

Copyist.

F

10 H. Art'y. U.S.C.T.

Benjamin Franklin
Privt, Co. N, 10 Reg't U. S. Col'd H. Art'y.

Appears on **Co. Muster-out Roll**, dated

Baton Rouge, La., Feb. 22, 1867.

Muster-out to date *Feb. 22, 1867.*

Last paid to *Dec. 31, 1866.*

Clothing account:

Last settled....., 186 ; drawn since \$..... 100

Due soldier \$ *6 31* / 100; due U. S. \$..... 100

Am't for cloth'g in kind or money adv'd \$..... 100

Due U. S. for arms, equipments, &c., \$..... *6 00* / 100

Bounty paid \$..... 100; due \$ *20 00* / 100

Remarks: *Joined at orig. org.*

Book mark :

(361)

Lowry

Copyist.

Franklin Benjamin

P, Co. *A*, **10** *Reg't* **U.S.C.H.A.**

Enclosures.

- | | |
|------------------------------|-------------------|
| Bed Cards | Descriptive Lists |
| Burial Records | Final Statements |
| Certs. of Dis. for Discharge | Furloughs |
| C. M. Charges | Med. Des. Lists |
| Med. Certificates | Orders |

Enlistments /

Other papers relating to—

- | | |
|----------------------------|----------------------|
| Admission to Hosp'l | Furlough |
| Casualty Sheet (Officer's) | Med. Examination |
| Confinement | Misc. Information |
| Contracts | Pay or Clothing |
| Death or Effects | Personal Reports |
| Desertions | Rank |
| Discharge from Hosp'l | Transfer to Hosp'l |
| Discharge from Service | Transfer to V. R. C. |
| Duty | Transportation |

NOTE 1.—This blank will be used for both enlistments and re-enlistments—enlistment of veterans, &c., &c., in the volunteer service. They will be made out in duplicate in all cases—one to accompany the recruiting return of the superintendent (not the recruiting officer) to the Adjutant General, and one to accompany the accounts of the officer who pays bounty, &c. The Regiment and Company in which the soldier last served should be given on the back.

NOTE 2.—An enlistment holds to service. A muster-in must, in all cases, precede payment of pay, bounty, pension, &c. A muster-in roll must, in all cases, be filed in the Adjutant General's Office as evidence of muster-in. The mustering officer, commissary, or assistant commissary of musters, as the case may be, will countersign both enlistments as having mustered the soldier into the service of the United States before either of them is given to the disbursing officer.

DECLARATION OF RECRUIT.

I, Ben Franklin, desiring to VOLUNTEER as a Soldier in the Army of the United States, for the term of THREE YEARS, Do Declare, That I am Thirty eight years and _____ months of age; that I have never been discharged from the United States service on account of disability or by sentence of a court martial, or by order before the expiration of a term of enlistment; and I know of no impediment to my serving honestly and faithfully as a soldier for three years.

GIVEN at New Orleans, La the 1st day of November 1864

Witness: H. Salmeron, Ben Franklin
Adjutant 84th U.S.C. mark

10 a.m. 6. 11. 64

No. 557
Ben Franklin
Volunteered at New Orleans, La.
Nov 1864, 1864,
By H. Salmeron
84th Regiment of U.S.C.
_____ enlistment; last served in Company ()
Reg't of _____
Discharged _____, 18____
Consent not witnessed
to Bounty

CONSENT IN CASE OF MINOR.

I, _____, Do CERTIFY, That I am the _____ of _____; that the said _____ is _____ years of age; and I do hereby freely give my CONSENT to his volunteering as a SOLDIER in the ARMY OF THE UNITED STATES for the period of THREE YEARS.

GIVEN at _____ the _____ day of _____

Witness: _____

(A. G. O. No. 74 & 76.)

VOLUNTEER ENLISTMENT.

STATE OF

TOWN OF

Louisiana



New Orleans

I, *Ben Franklin*, born in *Iberville* in the State of *Louisiana*, aged *thirtyeight* years, and by occupation a *Labourer*, Do HEREBY ACKNOWLEDGE to have volunteered this *first* day of *November*, 1864 to serve as a **Soldier** in the **Army of the United States of America**, for the period of **THREE YEARS**, unless sooner discharged by proper authority: Do also agree to accept such bounty, pay, rations, and clothing, as are, or may be, established by law for volunteers. And I, *Ben Franklin*, do solemnly swear, that I will bear true faith and allegiance to the **United States of America**, and that I will serve them honestly and faithfully against all their enemies or opposers whomsoever; and that I will observe and obey the orders of the President of the United States, and the orders of the officers appointed over me, according to the Rules and Articles of War.

Sworn and subscribed to, at *New Orleans*

this *1st* day of *Nov*, 1864

BEFORE

H. V. Lemmieri
1st Lieut 84th U. S. C. S.

Ben Franklin
mark

I CERTIFY, ON HONOR, That I have carefully examined the above-named Volunteer, agreeably to the General Regulations of the Army, and that, in my opinion, he is free from all bodily defects and mental infirmity, which would in any way disqualify him from performing the duties of a soldier.

Attila Henry Perry
Surgeon U.S.A.
EXAMINING SURGEON.

I CERTIFY, ON HONOR, That I have minutely inspected the Volunteer *Ben Franklin* previously to his enlistment, and that he was entirely sober when enlisted; that, to the best of my judgment and belief, he is of lawful age; and that, in accepting him as duly qualified to perform the duties of an able-bodied soldier, I have strictly observed the Regulations which govern the recruiting service. This soldier has *Blue* eyes, *Blue* hair, *Blue* complexion, is *5* feet *6 1/2* inches high.

H. V. Lemmieri
1st Lieut 84th Regiment of U. S. C. S. Volunteers,
RECRUITING OFFICER.

(A. G. O. No. 74 & 76.)

Mustered into the service of the United States, for three years or during the war, from date of enlistment, in Company
10th Regiment of *U. S. A. 106th* Volunteers, on the *3rd* day of *November*, 1864, at *New Orleans*

John W. Chamberlain
Capt 10th U. S. A. 106th
Adj. Gen.

Franklin Benjamin
Co M., 10 U.S. Col'd H. Art'y

Private

Private

CARD NUMBERS.

1	5487980	26
2	5488836	27
3	5488943	28
4	5514324	29
5	5514478	30
6	5514712	31
7	5514888	32
8	5515244	33
9	5489329	34
10	9123656	35
11		36
12		37
13		38
14		39
15		40
16		41
17		42
18		43
19		44
20		45
21		46
22		47
23		48
24		49
25		50

Book Mark:

See also

49 use of

F | 10 H. Art'y. | U. S. C. T.

Benjamin Franklin
Co. M, 10 Reg't U. S. Col'd H. Art'y.

Appears on

Company Descriptive Book

of the organization named above.

DESCRIPTION.

Age 21 years; height 5 feet 6 inches.

Complexion Black

Eyes Black; hair Black

Where born New Orleans La

Occupation Laborer

ENLISTMENT.

When March 10, 1865.

Where New Orleans La

By whom Capt M Allister term 3 y'rs.

Remarks: Rec'd by transfer from Co A
77th S. C. I. pr S. C. 66 Reg't Inf't La
Sept 21, 1865. Deserted May 28
1865 - App'd July 12, 1865 - Sen-
tenced by G. C. M. to Ship
Island with loss of \$10
per month for 6 months. Returned
from confinement pr S. C. 67
E. Dis. La. Dishonorably

(over)

W. M. Walker

MAY. 14

9123656

1891

discharged
per S.O. 72 Dept of La
July 28 1865 and
letter of instruction
from Maj Gen E.R. S,
Caulby Dec 13 1865.

F 106 a | U.S.C.T.

Benjamin Franklin
Det J, Co M, 10 Reg't U. S. Col'd Ha

Appears on

M. and D. Roll of Men Transferred

to the organization named above,

from 77 U.S. Col Inf

Roll dated Camp Maudslayi, 1865.

When enlisted March 16, 1865.

Period for which enlisted 8 years.

When mustered in March 25, 1865.

Present or absent

Company to which assigned M

Remarks: joined as recruit
Deserted New Orleans La
May 28. 65, apprehended
July 12. 65, Confined at
Ship Island, for 6 months
and forfeit \$10 per mo
by sentence G. C. M. stop
for loss of C. Ga, Equip
(over)

Book mark:

W. H. Scott

JAN. 15

5487980

1891

\$4.55 Paid by transfer from
Co A. 77 U.S. C. I. per D.O. 66
Sept da. Sept 22. 65

F 10th. Arty | U.S.C.T.

Benjamin Franklin
Pot, Co. M, 10 Reg't U. S. Col'd 10th Arty

Appears on

M. and D. Roll of Men Transferred

to the organization named above,

from 77th U. S. Col'd Inf.

Roll dated Oct. 1, 1865-

When enlisted Mch. 16, 1865-

Period for which enlisted 3 years.

When mustered in Mch. 25, 1865-

Present or absent Absent

Company to which assigned M

Remarks: Joined as recruit.

Selected New Orleans La. May
28/65. Appr. July 12/65. Confined
at Ship Island for 6 months
and forfeited \$10. per month
per sentence of G. C. M.
Stop for G. & G. Equipage
\$4.55.

Book mark :

Chandler

G | *10 H. City* | **U.S.C.T.**

Benjamin Franklin
Priv., Co. *M*, 10 Reg't U. S. Col'd *H. City*,

Appears on

M. and D. Roll of Men Transferred

to the organization named above,

from *77th U. S. Col'd Inftry*,

Roll dated *Oct. 1*, 186*5*.

When enlisted *March 16*, 186*5*.

Period for which enlisted *3* years.

When mustered in *March 25*, 186*5*.

Present or absent *Absent*.

Company to which assigned *M*.

Remarks: *Joined as recruit,*

Deserted at New Orleans,
La. May 28th/65. Appr.
July 12/65. Confin'd
at Ship Island,

Book mark :

(342)

Cartwright

Copyst.

7

10 H. Art'y. | U.S.C.T.

Benjamin Franklin

2, Co. *M*, 10 Reg't U. S. Col'd H. Art'y.

Age years.

Appears on

Company Muster Roll*

for *Sept - Oct*, 1865.

Joined for duty and enrolled:

When *Oct 15*, 1865.

Where *N Orleans*

Period years.

Mustered in:

When *Oct 25*, 1865.

Where *N Orleans*

Present or absent

Stoppage, \$ 100 for

Due Gov't, \$ *55* 100 for *cb & qe*

Valuation of horse, \$ 100

Valuation of horse equipments, \$ 100

Remarks: *Deserted May 28, 65; Appnd*

July 12, 65; Consigned (Over)

*First current roll. No muster-in roll of this company on file.

Book mark :

J. H. Wright

(358b)

Copyist.

91 16

N. 5514324

1891

per 5 months, perfect
per the per said time
per 46th sentence)

7

10 H. Art'y.

U. S. C. T.

Benjamin Franklin

Co. M, 10 Reg't U. S. Col'd H. Art'y.

Appears on

Company Muster Roll

for Apr - Dec, 1865.

Present or absent

Stoppage, \$ 100 for

Due Gov't, \$ 4 25- 100 for 67 1/2 Equip

Valuation of horse, \$ 100

Valuation of horse equipments, \$ 100

Remarks: Deserted May 28, 65-

Appr July 12, 65-

Confined for 6 months &
forfeit - \$10, pr Mo per Sen-
tence of G. C. M.

Book mark:

D. T. Wright

(358)

Copyist.

7

10 H. Art'y.

U. S. C. T.

Benjamin Franklin

P, Co. M, 10 Reg't U. S. Col'd H. Art'y.

Appears on

Company Muster Roll

for *Jan & Feb*, 1860.

Present or absent

Stoppage, \$ 100 for

Due Gov't, \$ *4* 100 for *55-66 & G. Exp.*

Valuation of horse, \$ 100

Valuation of horse equipments, \$ 100

Remarks: *Deserted May 25, 65 -
Appel July 12, 65 -
Confined for 6 Mo and
forfeit \$10, per Mo for said
time per sentence of G. C.
M.*

Book mark: *M. C. in file*

W. H. Wright

(358)

Copyist.

Benjamin Franklin

, Co. M, 10 Reg't U. S. Col'd H. Art'y.

Appears on

Company Muster Roll

for *March & Apr*, 186*2*.

Present or absent

Stoppage, \$ 100 for

Due Gov't, \$ 100 for

Valuation of horse, \$ 100

Valuation of horse equipments, \$ 100

Remarks: *Dis Honorably Dischg'd
Feb 28, 63 per S. G. Dept of
La Series 65 & letter from Gen
Canby Dec 13, 63-*

Book mark:

A. T. Wright

5

10 H. Art'y. U.S.C.T.

Benjamin Franklin

Pvt., Co.M., 10 Reg't U. S. Col'd H. Art'y.

Appears on Co. Muster-out Roll, dated

Baton Rouge, La, Feb 22, 1867.

Muster-out to date _____, 186 .

Last paid to _____, 186 .

Clothing account:

Last settled _____, 186 ; drawn since \$ _____ 100

Due soldier \$ _____ 100; due U. S. \$ _____ 100

Am't for cloth'g in kind or money adv'd \$ _____ 100

Due U. S. for arms, equipments, &c., \$ _____ 100

Bounty paid \$ _____ 100; due \$ _____ 100

Remarks: Fined by trans. from Co. A
77 U.S.C. pr. S. 10. 6. 6. H. S. Dept. Sa.
Sep 22/65 as Pvt was confined at ship's
land. Miss by sentence of G. C. M. for six
months with loss of \$10 dollars pr mo. of his
pay dishonorably discharged Feb

Book mark: _____

Receiv

JAN. 16

5515244

1891

28/66 by G. W. 72 Dept of Sa, in
accordance with an order by letter
from Star Dept.

F 10 H. Art U.S.C.T.

Benjamin Franklin
Private Co M, 10 Reg't U. S. Col'd H. Art

Appears on an

Individual Muster-out Roll

of the organization named above. Roll dated

New Orleans La, Feb 28, 1866.

Muster-out to date Feb 28, 1866.

Last paid to Never paid, 1866.

Clothing account:

Last settled Never settled; drawn since \$ 100

Due soldier \$ 100; due U. S. \$ 100

Am't for cloth'g in kind or money adv'd \$ 50 72/100

Due U. S. for arms, equipments, &c., \$ 100

Bounty paid \$ 100 100 due \$ none 100

Remarks: Deserted May 28th 1865
from N.O. La. Apprehended July 12th
1865 Sentenced by G.C.M. to be
confined at hard labor at
Ship Island Miss for six months
and forfeit to the U. S. \$10.00 pa
over

Book mark:

M. A. Michaels

JAN. 15

5489329

* 1891 *

month of his monthly pay for
same time. Released from
confinement by G.O. 76 C.S.
36th Co East Dist of Va.
Mustered out and Dishon-
orably discharged with loss
of all pay and allowances
in obedience to G.O. 72 Dept.
of Va series of 1865. and letter
of instructions from Maj.
Genl Canby Comdg Dept
of Va. dated Dec 13th 1865

Franklin George ¹²⁹

Co F, 10 U.S. Col'd H. Art'y.

Private | Private

CARD NUMBERS.

1	5488737	26
2	5505772	27
3	5505926	28
4	5506073	29
5	5506285	30
6	5506973	31
7	57489965	32
8		33
9		34
10		35
11		36
12		37
13		38
14		39
15		40
16		41
17		42
18		43
19		44
20		45
21		46
22		47
23		48
24		49
25		50

Book Mark:

See also

77. ref @ Dupy

F | *10th Army* | **U.S.C.T.**

George Franklin

Private, Co. *F*, *10* Reg't U. S. Col'd *Army*

Appears on

M. and D. Roll of Men Transferred

to the organization named above,

from *77 Reg. U.S. C. Inf.*

Roll dated *Oct 1*, 1865.

When enlisted *Apr 3*, 1863.

Period for which enlisted *3* years.

When mustered in *Apr 8*, 1863.

Present or absent *Present*

Company to which assigned *F*

Remarks: *Joined by transfer
from Co 'G' 5th Inf C.S.A
Jan 2, 64*

Book mark: *100*

J. L. Linnard

J

10 H. Art'y. U.S.C.T.

George Franklin
Carr, Co. F, 10 Reg't U. S. Col'd H. Art'y.

Appears on

Company Muster Roll

for Sept & Oct, 1865.

Present or absent Present

Stoppage, \$ 100 for

Due Gov't, \$ 100 for

Valuation of horse, \$ 100

Valuation of horse equipments, \$ 100

Remarks: Transferred from Co. D
77 U.S.C.I. Oct/65

Book mark:

B. G. Wasdon

F.

10 H. Art'y.

U.S.C.T.

George Franklin
Pvt., Co. F, 10 Reg't U. S. Col'd H. Art'y.

Appears on

Company Muster Roll

for Nov & Dec, 1865.

Present or absent Present.

Stoppage, \$ 100 for

Due Gov't, \$ 100 for

Valuation of horse, \$ 100

Valuation of horse equipments, \$ 100

Remarks: On daily duty as
Hoeph. Cook.

Book mark:

Copyist
Copyist.

F.

10 H. Art'y. U.S.C.T.

George Franklin

Part., Co. F, 10 Reg't U. S. Col'd H. Art'y.

Appears on

Company Muster Roll

for *Jan'y & Feby.*, 1866.

Present or absent *Present.*

Stoppage, \$ *100* for

Due Gov't, \$ *100* for

Valuation of horse, \$ *100*

Valuation of horse equipments, \$ *100*

Remarks: *On daily duty as
Hospital Cook.*

Book mark: *Muster out on file.*

ash.
Copyist.

F.

10 H. Art'y. U.S.C.T.

George Franklin

Pat., Co. F, 10 Reg't U. S. Col'd H. Art'y.

Appears on

Company Muster Roll

for *Mar. & Apr.*, 1866.

Present or absent

Stoppage, \$ 100 for

Due Gov't, \$ 100 for

Valuation of horse, \$ 100

Valuation of horse equipments, \$ 100

Remarks: *Discharged.*

** Mustered out by expiration
of term of service*

** Insured by Company*

Book mark:

F

10 H. Art'y. U.S.C.T.

George Franklin
Pvt., Co. F, 10 Reg't U. S. Col'd H. Art'y.

Appears on **Co. Muster-out Roll**, dated
Baton Rouge La. Feb. 22, 1867.
Muster-out to date _____, 186 .
Last paid to Dec. 31, 1865.

Clothing account:

Last settled _____, 186 ; drawn since \$ _____ 100

Due soldier \$ _____ 100; due U. S. \$ _____ 100

Am't for cloth'g in kind or money adv'd \$ _____ 100

Due U. S. for arms, equipments, &c., \$ _____ 100

Bounty paid \$ _____ 100; due \$ _____ 100

Remarks: Rec'd by transfer from
Co. D. 77 Hd. Co. p. S. O. No. 66
Hd. Qrs Dept. of La. S. of 65
Discharged by expiration of
Service Apr. 5/66

Book mark: V. 8. p. 124. 68

(361)

Home

Copyist.

Gf | *10 Arty.* | **U.S.C.T.**

George Franklin
Priv, Co. *F*, *10* Reg't U. S. Col'd. *Arty.*

Appears on a

Detachment Muster-out Roll

of the organization named above. Roll dated

New Orleans, La., *Apr. 9*, 186*6*.

Muster-out to date *Apr. 5*, 186*6*.

Last paid to *Dec. 31*, 186*5*.

Clothing account:

Last settled 186 ; drawn since \$ $\frac{100}{100}$

Due soldier \$ *22* $\frac{92}{100}$; due U. S. \$ $\frac{100}{100}$

Am't for cloth'g in kind or money adv'd \$ $\frac{100}{100}$

Due U. S. for arms, equipments, &c., \$ $\frac{43}{100}$

Bounty paid \$ $\frac{100}{100}$ due \$ $\frac{100}{100}$

Remarks: *Joined 4 Inf. Co. "A" (76*
U.S.C.T.) as recruit. Transferred
as priv. to 5 Inf. Co. A. (77 U.S.C.
T.) Dec. '63. Transferred to 10 U.S.C.
A. (144) per S.O. 66. Hd. qm. Dept.
of La. Series of '65. (over)

Book mark: *PM 6288 June 20, 1866.*

P'Pool.

JAN. 15

5489965

1891

*Mustered out by reason
of expiration of term of
service.*

930
Franklin Joseph

Co M., 10 U.S. Col'd H. Art'y.

Private

Private

CARD NUMBERS.

1	5487981	26
2	5487811	27
3	5514325	28
4	5514479	29
5	5514713	30
6	5514838	31
7	5514949	32
8	5515014	33
9	5515072	34
10	5515131	35
11	5515177	36
12	9123657	37
13		38
14		39
15		40
16		41
17		42
18		43
19		44
20		45
21		46
22		47
23		48
24		49
25		50

Book Mark:

See also 79 use of Inf

J | 10 H. Art'y. | U.S.C.T.

Joseph Franklin

Co M, 10 Reg't U. S. Col'd H. Art'y.

Appears on

Company Descriptive Book

of the organization named above.

DESCRIPTION.

Age *18* years; height *5* feet *3 1/2* inches.

Complexion *black*

Eyes *Dark*; hair *black*

Where born *Cane River La*

Occupation *Laborer*

ENLISTMENT.

When *May 6*, 186*4*.

Where *New Orleans La.*

By whom *H. C. Whitley*; term *3* y'rs.

Remarks: *Rec'd by transfer from
Co I 77 W.S.C., per S. C. Hod
Geo Dept La Sept 22/65
Confined at Ship Island
Miss per S.C. 48 Dept La for
6 months with loss of all pay
for said period - Charge sleep-
ing on Post. Joined Co from
confinement Dec 11 1866*

J. M. Calhoun

(383a)

Copyist.

A 106a | U.S.C.T.

Joseph Franklin
Det, Com, 10 Reg't U. S. Col'd *Ha*

Appears on

M. and D. Roll of Men Transferred

to the organization named above,

from *77 U. S. Col Inf*

Roll dated *Camp Parapet La Oct 1, 1864*

When enlisted *May 6*, 1864.

Period for which enlisted *3* years.

When mustered in *May 13*, 1864.

Present or absent

Company to which assigned *M*

Remarks: *formed at Orig*
Orgⁿ of Co, Reg^t 10
Transfer from Co, 77
U. S. Col, per A. O. 66
Sept 22 Sept 22, 64

Book mark :

Wear Scott

G 10 H A | U.S.C.T.

Joseph Frankling
Priv, Co. *M 10* Reg't U. S. Col'd *H A*

Appears on

M. and D. Roll of Men Transferred

to the organization named above,

from *77 U.S. Col'd Inf*

Roll dated *Camp Parapetted Pt*, 186*4*.

When enlisted *May 6*, 186*4*.

Period for which enlisted *3* years.

When mustered in *May 13*, 186*4*.

Present or absent *Present*

Company to which assigned *M*

Remarks: *Joined at Original*
Organization Co,

Book mark :

Wear Scott

7

10 H. Art'y. U.S.C.T.

Joseph Franklin
Co. M., 10 Reg't U. S. Col'd H. Art'y.

Age _____ years.

Appears on

Company Muster Roll*

for Sep - Oct, 1864.

Joined for duty and enrolled:

When May 5, 1864.

Where New Orleans

Period 3 years.

Mustered in:

When May 3, 1864.

Where New Orleans

Present or absent Present

Stoppage, \$ 100 for

Due Gov't, \$ 100 for

Valuation of horse, \$ 100

Valuation of horse equipments, \$ 100

Remarks :

*First current roll. No muster-in roll of this company on file.

Book mark :

(3586)

M. J. [Signature]

Copyist.

7

10 H. Art'y. U. S. C. T.

Joseph Franklin

, Co. M, 10 Reg't U. S. Col'd H. Art'y.

Appears on

Company Muster Roll

for Nov Dec, 1865.

Present or absent Present

Stoppage, \$ 100 for

Due Gov't, \$ 100 for

Valuation of horse, \$ 100

Valuation of horse equipments, \$ 100

Remarks:

Book mark:

W. H. Wright

(358)

Copyist.

7

10 H. Art'y.

U. S. C. T.

Joseph Franklin
P

, Co. M, 10 Reg't U. S. Col'd H. Art'y.

Appears on

Company Muster Roll

for Jan & Feb, 1860.

Present or absent Present-

Stoppage, \$ 100 for

Due Gov't, \$ 100 for

Valuation of horse, \$ 100

Valuation of horse equipments, \$ 100

Remarks:

Book mark:

J. B. Wright

(358)

Copyist.

7

10 H. Art'y. | U. S. C. T.

Joseph Franklin

, Co. M, 10 Reg't U. S. Col'd H. Art'y.

Appears on

Company Muster Roll

for *Feb & Apr*, 1860.

Present or absent *Present*

Stoppage, \$ *100* for

Due Gov't, \$ *100* for

Valuation of horse, \$ *100*

Valuation of horse equipments, \$ *100*

Remarks:

Book mark:

W. H. Wright

(358)

Copyist.

Joseph Franklin

....., Co. M, 10 Reg't U. S. Col'd H. Art'y.

Appears on

Company Muster Roll

for *May & June*, 186*6*.

Present or absent.....

Stoppage, \$.....*100* for.....

Due Gov't, \$.....*100* for.....

Valuation of horse, \$.....*100*

Valuation of horse equipments, \$.....*100*

Remarks: *Confined for 6 Mo*
per S. C. H. & Hd Qrs Dept
of La May 28, 66 with
loss of all pay for said
period

Book mark:.....

W. H. Wright

Joseph Franklin
P, Co. M, 10 Reg't U. S. Col'd H. Art'y.

Appears on

Company Muster Roll

for *July & Aug*, 1866.

Present or absent *Absent*

Stoppage, \$ *100* for

Due Gov't, \$ *100* for

Valuation of horse, \$ *100*

Valuation of horse equipments, \$ *100*

Remarks: *Confirmed for 6*
Mo with loss of all pay
for said period per
G.O. 48 Hd Qrs Dept of La
May 28, 66

Book mark:

(358)

S. T. Wright
Copyist.

§

10 H. Art'y.

U. S. C. T.

Joseph Franklin

Butt, Co. M, 10 Reg't U. S. Col'd H. Art'y.

Appears on

Company Muster Roll

for Sep + Oct, 1866.

Present or absent absent

Stoppage, \$ 100 for

Due Gov't, \$ 100 for

Valuation of horse, \$ 100

Valuation of horse equipments, \$ 100

Remarks: Computed for 6 mos with loss of all pay for said period Per G.O. H.S. O.S. L.S. Sept La May 28/66

Book mark:

Rector

Joseph Franklin

Sgt., Co. M, 10 Reg't U. S. Col'd H. Art'y.

Appears on

Company Muster Roll

for Nov + Dec, 1866.

Present or absent Present

Stoppage, \$ 100 for

Due Gov't, \$ 100 for

Valuation of horse, \$ 100

Valuation of horse equipments, \$ 100

Remarks: joined from absence
in confinement Dec. 1/66
Pay due from Feb. 28 to May
28/66 and from Nov 28/66

Book mark: _____

Rector

Franklin, Joseph

P, Co. M, 10 Reg't U.S.C. H.A.

Enclosures.

Bed Cards	Final Statements
Burial Records	Furloughs or L. of A.
Certs. of Dis. for Discharge	Med. Certificates
C. M. Charges	Med. Des. Lists
Descriptive Lists	Orders
Discharge Certificates	Pris. of War Record
Enlistment Papers	Resignations

Other papers relating to—

Admission to Hosp'l	Furlough or L. of A.
Casualty Sheet	Med. Examination
Confinement	Misc. Information
Contracts	Pay or Clothing
Death or Effects	Personal Reports
Desertion	Rank
Discharge from Hosp'l	Transfer to Hosp'l
Discharge from Service	Transfer to V. R. C.
Duty	Transportation

J. L. B. F. 189 P.M.O.

Roomer G. S. M.

New Orleans May 22nd 1861

Robinson N M

Capt^l and J. A.

Requests that Private Joseph
Franklin, Co. "M" 10th U.S. Cal. Regt, be
confined to await promulgation
of sentence.

Head Quarters, Fort Jackson, Marshals.
New Orleans, May 22^d 1868.

Maj. Am. Jackson.

Provt Marshal.

Majr - I have the honor
to request you to receive and hold in con-
finement, Private Joseph Rankin, Co. M., 15th
U.S.C.A., who is awaiting promulgation of
sentence of this court.

I am, Majr,

Very Respectfully

Yr. Obedt Servt.

W. P. Marshall
Capt. U.S.A.
J. & C.

Frazier. Noah

Co a., **10 U.S. Col'd H. Art'y.**

Private

Private

CARD NUMBERS.

1	5490404	26
2	5490553	27
3	5490797	28
4	5494100	29
5		30
6		31
7		32
8		33
9		34
10		35
11		36
12		37
13		38
14		39
15		40
16		41
17		42
18		43
19		44
20		45
21		46
22		47
23		48
24		49
25		50

Book Mark:

See also

Noah Frasier
Private; Co. A, 1 Reg't La. Col'd H. Art'y.*

Age 22 years.

Appears on

Company Muster-in Roll

of the organization named above. Roll dated

New Orleans, La. Nov. 29, 1862

Muster-in to date Nov. 29, 1862

Joined for duty and enrolled:

When Nov. 16, 1862

Where New Orleans

Period 3 years.

Valuation of horse, \$ 100

Valuation of horse equipments, \$ 100

Remarks:

* This organization subsequently became Co. A, 10 Reg't U. S. Colored Heavy Artillery.

Book mark:

Tolman

H

10 H. Art'y. U.S.C.T.

Noah Frazier

Priv, Co. A, 1 Reg't La. H. Art'y.*

Appears on

Company Muster Roll

for to Dec. 31, 1862.

Present or absent Present

Stoppage, \$ 100 for

Due Gov't, \$ 100 for

Valuation of horse, \$ 100

Valuation of horse equipments, \$ 100

Remarks: Sick in Hospital

*This organization subsequently became Co. A, 10 Reg't U. S. Col'd Heavy Artillery.

Book mark:

Tobias

Copyist.

F

10 H. Art'y. U.S.C.T.

Noah Frazier

Pvt., Co. A, 1 Reg't La. H. Art'y.*

Appears on

Company Muster Roll

for Jan'y & Feby, 1863.

Present or absent

Stoppage, \$ 100 for

Due Gov't, \$ 100 for

Valuation of horse, \$ 100

Valuation of horse equipments, \$ 100

Remarks Died in Hospital
January 18" 1863.

*This organization subsequently became Co. A, 10 Reg't U. S. Col'd Heavy Artillery.

Book mark:

(358)

Tobman

Copyist.

7

10 H. Art'y. U.S.C.T.

Noah Frazier

Pvt, Co. A, 10 Reg't U. S. Col'd H. Art'y.

Appears on Co. Muster-out Roll, dated Baton Rouge La, Feb. 22, 1867.

Muster-out to date _____, 186 .

Last paid to _____, 186 .

Clothing account:

Last settled _____, 186 ; drawn since \$ _____ 100

Due soldier \$ _____ 100; due U. S. \$ _____ 100

Am't for cloth'g in kind or money adv'd \$ _____ 100

Due U. S. for arms, equipments, &c., \$ _____ 100

Bounty paid \$ _____ 100; due \$ _____ 100

Remarks: Joined origl. regt. Rec'd Jan. 18. 63 Final statements given

Book mark: Y 15 P. 77. 68

Nesbitt

Copyist.

(361)

Frazier, Noah

P, Co.

10

Reg't

U. S. C. H. A.

/ Enclosures.

Bed Cards.....	Descriptive Lists.....
Burial Records.....	Final Statements <i>/</i>
Certs. of Dis. for Discharge.....	Furloughs.....
C. M. Charges.....	Med. Des. Lists.....
Med. Certificates.....	Orders.....

Other papers relating to—

Admission to Hosp'l.....	Furlough.....
Casualty Sheet (Officer's).....	Med. Examination.....
Confinement.....	Misc. Information.....
Contracts.....	Pay or Clothing.....
Death or Effects.....	Personal Reports.....
Desertions.....	Rank.....
Discharge from Hosp'l.....	Transfer to Hosp'l.....
Discharge from Service.....	Transfer to V. R. C.....
Duty.....	Transportation.....

B. I. 18, Vol 2, P. 6. 0. 60 ✓

FINAL STATEMENT

OF

Noah Frazier - Private

*1st Reg't of La. Inf. Art,
10th U. S.*

VOLUNTEERS.

May 11th 1865

NOTE 1.—Two of these certificates (or duplicates) are to be given to each Volunteer Soldier or drafted man who may be discharged previously to the discharge of his company, that he may at once receive from the Paymaster the pay, &c., due him, and the captain or other COMMISSIONED officer commanding the company will certify to the act of the delivery of the duplicate certificates; on these certificates the Soldier is "entitled to" his discharge, and should also present his discharge to the Paymaster to have the payment endorsed on it. The discharge is to be given back to the Soldier by the Paymaster; the latter only retaining as his voucher the duplicate certificates.

NOTE 2.—If the Soldier is entitled to pay for the use of his horse, the Company Commander will certify to that fact on the back of both these final statements, and also to the time he has pay due for having been so mounted on his own horse.

NOTE 3.—When a Soldier is furnished with final statements, his descriptive list, if he has one, should be taken up by the officer who gives the Soldier these statements, and endorsed with a statement to this effect by the officer. This endorsement should exhibit a full statement of the time for which the Soldier was allowed pay on his final statements, the clothing account, and all other charges against him or in his favor, so as to comprise a complete exhibit of his account. It will then be transmitted to the company commander of the Soldier, who will enter all the data necessary to a full understanding of the Soldier's account on the muster roll upon which the Soldier's discharge is reported. The descriptive list will then be destroyed. The object of this is, that the remaining portion of the Soldier's account may be settled upon the receipt of these muster rolls, and the Soldier receive any pay or allowances that may be due him at the time of his discharge, and which may not appear on his final statements from the fact that his descriptive list is incomplete. These accounts for back pay, &c., are settled by the 2d Auditor of the Treasury Department.

NOTE 4.—Charges for loss or injury to ordnance, horse equipments, and other miscellaneous charges, should appear under the heading of "Other Stoppages."

NOTE 5.—Bounty paid by State authorities, and not by the United States, will not be entered on this statement.

NOTE 6.—Amounts due the Sutler and Laundress must be entered on the muster roll on which the discharge, death, desertion, &c., is reported, as well as on the final statement, otherwise the amount cannot be collected from the United States.

NOTE 7.—This blank will be used for deceased volunteers and drafted men, as well as for others.

NOTE 8.—Where a Soldier dies in Hospital or on detached service, his descriptive list, if he has one, should be sent with his final statements, in duplicate, to the Second Auditor, Washington, D. C.

ADJUTANT GENERAL'S OFFICE.

May 11th 1865

Duplicate with Inventory sent 2d Auditor.

I certify, on honor, that Noah Frazier a Private of
Captain S. L. Hubbard's Company (—) of the 1st Regiment of La. Art.
VOLUNTEERS, of the State of _____, born at Bayou Boeuf, State
of Louisiana, aged 23 years; 5 feet 9 1/4 inches high; Black complexion,
Black eyes, Black hair, and by occupation a Farmer, having joined the company on
its original organization at New Orleans La. and enrolled in it at the muster into
the service of the United States at New Orleans La. on the 29th day
of November, 1862, (or was mustered in service as a recruit, by _____
_____, at _____, on the _____ day of _____,
186—, or was drafted and mustered into the service of the United States from the _____
Enrollment District of the State of _____, at _____,
on the _____ day of _____, 186—,) to serve in the Regiment, for
the term of Three Years: and having served **HONESTLY** and
FAITHFULLY with his Company in Garrison, to the present date, is now
entitled to a **DISCHARGE** by reason of Death

The said Noah Frazier has pay _____ was last paid by Paymaster
enrollment to include the 16th day of November, 1862, and has
pay due him from that time to the present date; he is entitled to pay and subsistence for
TRAVELING to place of enrollment, and whatever other allowances are authorized to volunteer
soldiers, drafted men, or militia, so discharged. He has received from the United States **CLOTHING**
amounting to Twenty-One $\frac{66}{100}$ dollars, since the 16th day of November,
1862, when his clothing account was last settled. He has received from the United States
 $\frac{100}{100}$ dollars advanced **BOUNTY**.

There is to be stopped from him, on account of the State of _____, or other
authorities, for **CLOTHING**, &c., received on entering service, _____ $\frac{100}{100}$ dollars; and
for other stoppages, viz: _____

_____ $\frac{100}{100}$ dollars.
He has been furnished with **TRANSPORTATION** in kind from the place of his discharge to
_____ ; and he has been **SUBSISTED** for **TRAVELING** to his
place of enrollment, up to the _____, 186—.

He is indebted to _____, **SUTLER**, _____ $\frac{100}{100}$ dollars.
He is indebted to _____, **LAUNDRESS**, _____ $\frac{100}{100}$ dollars.

Given in Duplicate, at Fort St. Philip La., this 18th day
of January, 1869. I certify that the above is a correct transcript
from the records of Co. "A" 10th U. S. C. A. (Hy.)

Battery Lentilly La.
April 20th 1869.

Justin E. Brown,
1st Lt. Co. "A" 10th U. S. C. A. (Hy.)
Commanding Company.

Adm. of - 1 - my 1863

954
Frazier: Thomas

Co L, 10 U.S. Col'd H. Art'y

Private

Private

CARD NUMBERS.

1	5488233	26
2	5487713	27
3	5513452	28
4	5513602	29
5	5573725	30
6	5513848	31
7	5513980	32
8	5514187	33
9	5489336	34
10		35
11		36
12		37
13		38
14		39
15		40
16		41
17		42
18		43
19		44
20		45
21		46
22		47
23		48
24		49
25		50

Book Mark:

F. 20, v. 10 @ 5. 74

See also

77. v. 10 @ 5. 74

L 106a U.S.C.T.

Thomas Frazer
Pot, Col *L*, 10 Reg't U. S. Col'd *106a*

Appears on

M. and D. Roll of Men Transferred

to the organization named above,

from *79th U.S. Col Inf*

Roll dated *Camp Snickersville, 1865*

When enlisted *June 23*, 186*5*

Period for which enlisted *3* years.

When mustered in *Aug 19*, 186*5*

Present or absent *Present*

Company to which assigned *L*

Remarks: *Transferred from #1*

Ed. H. Rec 2, 1865, joined

but transfer from Co. C, 79th

U.S.C. for S.D. 66. C.S.

Ad Gns Dept of War

Book mark :

Wheat Scott

F. J. H. A. U.S.C.T.

Thomas Frazor
Mus, Co. *L*, *10* Reg't U. S. Col'd *H. A.*

Appears on

M. and D. Roll of Men Transferred

to the organization named above,

from *Co. C, 49th U.S. Col. Inf.*

Roll dated *Camp Doniphan, Mo.*, 1865.

When enlisted *June 23*, 1863.

Period for which enlisted *0* years.

When mustered in *Aug 19*, 1863.

Present or absent *Present*

Company to which assigned *L*

Remarks: *Transferred from*
4th Reg. Co. A Dec 2, 1863
Enlisted as Private
Soldier.

Book mark :

W. H. H. H.

F1 | 10 H. Art'y. | U.S.C.T.

Thomas Frazier

Co. G, 10 Reg't U. S. Col'd H. Art'y.

Age years.

Appears on

Company Muster Roll*

for Sept. & Oct., 1863.

Joined for duty and enrolled:

When June 23, 1863.

Where Baton Rouge

Period 3 years.

Mustered in:

When Aug. 19, 1863.

Where Baton Rouge

Present or absent Present

Stoppage, \$ 100 for

Due Gov't, \$ 100 for

Valuation of horse, \$ 100

Valuation of horse equipments, \$ 100

Remarks: Transf. from Co. C, 7th U.S. Col.

*First current roll. No muster-in roll of this company on file.

Book mark :

(3586)

Scherich

Copyist.

F | 10 H. Art'y. | U.S.C.T.

Thomas Frazer

Plt, Co. L, 10 Reg't U. S. Col'd H. Art'y.

Appears on

Company Muster Roll

for *Nov. & Dec.*, 186*5*:

Present or absent *Present*

Stoppage, \$ *100* for

Due Gov't, \$ *100* for

Valuation of horse, \$ *100*

Valuation of horse equipments, \$ *100*

Remarks: _____

Book mark: _____

Scherich

F | 10 H. Art'y. | U.S.C.T.

Thomas Frazier

Pvt, Co. L, 10 Reg't U. S. Col'd H. Art'y.

Appears on

Company Muster Roll

for *Jan. & Feb.*, 186*6*

Present or absent *Present*

Stoppage, \$ *100* for

Due Gov't, \$ *100* for

Valuation of horse, \$ *100*

Valuation of horse equipments, \$ *100*

Remarks: _____

Book mark: _____

(358) *Scherich* Copyist.

F | 10 H. Art'y. | U.S.C.T.

Thomas Frazier
Out, Co. L, 10 Reg't U. S. Col'd H. Art'y.

Appears on

Company Muster Roll

for *Mch. & Apl.*, 1866.

Present or absent *Present*

Stoppage, \$ *100* for

Due Gov't, \$ *100* for

Valuation of horse, \$ *100*

Valuation of horse equipments, \$ *100*

Remarks: *Stop one Mosquito bar
lost \$1.80*

Book mark: *Muster out on file*

Scherck

(358)

Copyist.

F *10 Harty* U.S.C.T.

Thomas Frazier

Co, Co *G W* Reg't U. S. Col'd *H. Arty.*

Appears on

Company Muster Roll

for *May & June*, 1866.

Present or absent

Stoppage, \$ *100* for

Due Gov't, \$ *100* for

Valuation of horse, \$ *100*

Valuation of horse equipments, \$ *100*

Remarks: *Mustered out by
season of Ex. of term of
service to date June 22/66.*

Book mark:

Scherich

L | 10 H. Art'y. | U.S.C.T.

Thomas Frazier

Pl, *Co L*, 10 Reg't U. S. Col'd H. Art'y.

Appears on **Co. Muster-out Roll**, dated
Baton Rouge La, Feb 22, 1867.

Muster-out to date _____, 186 .

Last paid to _____, 186 .

Clothing account:

Last settled _____, 186 ; drawn since \$ _____ 100

Due soldier \$ _____ 100; due U. S. \$ _____ 100

Am't for cloth'g in kind or money adv'd \$ _____ 100

Due U. S. for arms, equipments, &c., \$ _____ 100

Bounty paid \$ _____ 100; due \$ _____ 100

Remarks: *joined by transfer from
Co E 79 USC I Oct 1/65 SO 66 P 9th
Dept of La left 22/65 Dischd at
No. La June 22/66 by reason of
Expn of term of service*

Book mark: *V 24 P 202 68*

F-25-V. 10-C.T. 74

Burnham

F | 10 H. Art. | U.S.C.T.

Thomas Frazier
Private, Co L, 10 Reg't U. S. Col'd H. Art.

Appears on an

Individual Muster-out Roll

of the organization named above. Roll dated

New Orleans La, June 22, 1866.

Muster-out to date June 22, 1866.

Last paid to Apr 30, 1866.

Clothing account:

Last settled _____, 1866 ; drawn since \$ _____ 100

Due soldier \$ 17 ⁵⁵/₁₀₀; due U. S. \$ _____ 100

Am't for cloth'g in kind or money adv'd \$ _____ 100

Due U. S. for arms, equipments, &c., \$ _____ 100

Bounty paid \$ _____ 100 due \$ _____ 100

Remarks: Joined by transfer from
Co. C 77th U. S. C. I. in obedience
to S. O. 66 series of 1865. from
H. Co. Dept of A. Mustered
out by reason of expiration of
term of service to date June 22, 1866

Book mark: _____

(348)

M. A. Michaels

Copyist.

Frazier, William

Co. F, 10 U.S. Col'd H. Art'y

Private

Private

CARD NUMBERS.

1	5487329	26
2	5504712	27
3	5504971	28
4	5505107	29
5	5505239	30
6	5505332	31
7	5505429	32
8	5505533	33
9	5505643	34
10	5505767	35
11	5505921	36
12	5506068	37
13	5506208	38
14	5506354	39
15	5506473	40
16	5506584	41
17	5506802	42
18	5506899	43
19	RtP. 433,805	44
20		45
21		46
22		47
23		48
24		49
25		50

Book Mark: RtP. 433,805

See also -

F | *10 H arty* | **U.S.C.T**

William Frazier

Appears with rank of *Pvt* on

Muster and Descriptive Roll of a Detachment of Drafted Men and Substitutes forwarded

for the *7* Reg't U.S. Col'd *H arty* Roll dated *New Orleans La, Aug 19, 1864*

Where born *Natchez Miss*

Age *35* years; occupation *Laborer*

Drafted and mustered in:

When *Aug 17*, 1864.

Where *Monroe, La*

Period *3* years.

Eyes *Dark*; hair *Black*

Complexion *Dark*; height *5 ft. 2 in.*

Paid bounty and advance pay, \$ *100*

Bounty due \$ *100*

Where credited *Parish of Terrebonne La*

Company to which assigned *F*

Remarks:

+ Became 10 U.S. H arty

Book mark: *Rt 433,805.*

(340)

Jennings

Copyist.

F | **10 H. Art'y.** | **U.S.C.T.**

William Frazier
Priv., Co. *F*, 7 Reg't U. S. Col'd H. Art'y.*

Appears on

Company Muster-in and Descriptive Roll
of the organization named above. Roll dated
New Orleans La, Aug 19, 1864.

Where born *Natchez Miss*
Age *35* y'rs; occupation *Laborer*

When enlisted _____, 186 .

Where enlisted _____

For what period enlisted *3* years.

Eyes *Dark*; hair *Black*

Complexion *Dark*; height *5* ft. *2* in.

When mustered in *Aug 19*, 1864.

Where mustered in *New Orleans La*

Bounty paid \$ *100*; due \$ *100*

Where credited *3rd Equal Dist - La*

Company to which assigned _____

Remarks: *Drafted*

* This organization subsequently became Co. *F*, 10 Reg't U. S. Colored Heavy Artillery.

Book mark: _____

(356d)

Rosenbaum
Corporal.

F

10 H. Art'y. U.S.C.T.

William Frazier

Pat., Co. F, 10 Reg't U. S. Col'd H. Art'y.

Appears on

Company Muster Roll

for July & August, 1864.

Present or absent Present

Stoppage, \$ 100 for

Due Gov't, \$ 100 for

Valuation of horse, \$ 100

Valuation of horse equipments, \$ 100

Remarks:

Book mark:

Rosenbaum

(358)

Copyist.

F | 10 H. Art'y. | U.S.C.T.

William Frazier

Pat, Co. F, 10 Reg't U. S. Col'd H. Art'y.

Appears on

Company Muster Roll

for *Sept & Oct*, 186*4*.

Present or absent *Present*

Stoppage, \$ *100* for

Due Gov't, \$ *100* for

Valuation of horse, \$ *100*

Valuation of horse equipments, \$ *100*

Remarks:

Book mark:

Rosenbaum

William Frazier

Pot, Co. F, 10 Reg't U. S. Col'd H. Art'y.

Appears on

Company Muster Roll

for *Nov & Dec*, 186*4*.

Present or absent *Present*

Stoppage, \$.....*100* for

Due Gov't, \$.....*100* for

Valuation of horse, \$.....*100*

Valuation of horse equipments, \$.....*100*

Remarks:.....

Book mark:.....

Rosenbaum

J

10 H. Art'y. U.S.C.T.

William Frazier
Priv., Co. F, 10 Reg't U. S. Col'd H. Art'y.

Appears on

Company Muster Roll

for Jan & Feb, 1865.

Present or absent Present

Stoppage, \$ 100 for

Due Gov't, \$ 100 for

Valuation of horse, \$ 100

Valuation of horse equipments, \$ 100

Remarks:

Book mark:

By Wasdon

J

10 H. Art'y. U.S.C.T.

William Frazier

Priv., Co. F, 10 Reg't U. S. Col'd H. Art'y.

Appears on

Company Muster Roll

for Mar & Apr, 1865

Present or absent Present

Stoppage, \$ 100 for

Due Gov't, \$ 100 for

Valuation of horse, \$ 100

Valuation of horse equipments, \$ 100

Remarks:

Book mark:

B. G. Masdon

(358)

Copyist.

F

10 H. Art'y. U.S.C.T.

William Frazier

Priv, Co. F, 10 Reg't U. S. Col'd H. Art'y.

Appears on

Company Muster Roll

for May 5th 1865.

Present or absent Present

Stoppage, \$ 100 for

Due Gov't, \$ 100 for

Valuation of horse, \$ 100

Valuation of horse equipments, \$ 100

Remarks: Due us for Camp & Garrison Equipage \$1.60

Book mark:

B. G. Masdon

(358)

Copyist.

J

10 H. Art'y. U.S.C.T.

William Frazier

Priv., Co. F, 10 Reg't U. S. Col'd H. Art'y.

Appears on

Company Muster Roll

for dated Aug 31, 1863.

Present or absent Present

Stoppage, \$ 100 for

Due Gov't, \$ 100 for

Valuation of horse, \$ 100

Valuation of horse equipments, \$ 100

Remarks: Due U.S. for Camp & Garrison Equipage \$95

Book mark:

B. G. Masdon

J

10 H. Art'y. U.S.C.T.

William Frazier

Priv., Co. F, 10 Reg't U. S. Col'd H. Art'y.

Appears on

Company Muster Roll

for Sept & Oct, 1865.

Present or absent Present

Stoppage, \$ 100 for

Due Gov't, \$ 100 for

Valuation of horse, \$ 100

Valuation of horse equipments, \$ 100

Remarks:

Book mark:

B. S. Masdon

(358)

Copyist.

William Frazier
Priv., Co. F, 10 Reg't U. S. Col'd H. Art'y.

Appears on

Company Muster Roll

for *Nov & Dec.*, 186*5*.

Present or absent *Present*

Stoppage, \$ *0*. ^{*08*}/_{*100*} for *ordnance*

Due Gov't, \$ *100* for

Valuation of horse, \$ *100*

Valuation of horse equipments, \$ *100*

Remarks: *Due U.S. for C. & G. E.*
\$0.95

Book mark:

100-250
100-250

ash
Copyist.

F.

10 H. Art'y. U.S.C.T.

William Frazier

Priv., Co. F, 10 Reg't U. S. Col'd H. Art'y.

Appears on

Company Muster Roll

for *Jan'y & Feby.*, 1866.

Present or absent *Present.*

Stoppage, \$ 100 for

Due Gov't, \$ 100 for

Valuation of horse, \$ 100

Valuation of horse equipments, \$ 100

Remarks:

Book mark: *100*

(358)

Copyist.

William Frazier

Pat., Co. F, 10 Reg't U. S. Col'd H. Art'y.

Appears on

Company Muster Roll

for *Mar & Apr*, 186*6*.

Present or absent *Present*

Stoppage, \$ *100* for

Due Gov't, \$ *100* for

Valuation of horse, \$ *100*

Valuation of horse equipments, \$ *100*

Remarks: *Stop for loss of 1
Haversack 95^c*

Book mark:

7

10 H. Art'y. U.S.C.T.

William Frazier

Part; Co. F, 10 Reg't U. S. Col'd H. Art'y.

Appears on

Company Muster Roll

for *May & June*, 186*6*.

Present or absent *Present*.

Stoppage, \$ 100 for

Due Gov't, \$ 100 for

Valuation of horse, \$ 100

Valuation of horse equipments, \$ 100

Remarks:

Book mark: -----

Robt.
Copyist.

F | 10 H. Art'y. | U.S.C.T.

William Frazier
Pat, Co. F, 10 Reg't U. S. Col'd H. Art'y.

Appears on

Company Muster Roll

for *July & Aug.*, 1866.

Present or absent *Present*

Stoppage, \$ *100* for

Due Gov't, \$ *100* for

Valuation of horse, \$ *100*

Valuation of horse equipments, \$ *100*

Remarks:

Book mark:

F

10 H. Art'y. U.S.C.T.

William Frazier

Priv, Co. F, 10 Reg't U. S. Col'd H. Art'y.

Appears on

Company Muster Roll

for *Sept. and Oct.*, 186*6*

Present or absent *Present*

Stoppage, \$ *100* for

Due Gov't, \$ *100* for

Valuation of horse, \$ *100*

Valuation of horse equipments, \$ *100*

Remarks:

Book mark:

House

(358)

Copyist.

F

10 H. Art'y. U.S.C.T.

William Seazier

Pvt, Co. F, 10 Reg't U. S. Col'd H. Art'y.

Appears on

Company Muster Roll

for *Nov. and Dec*, 186*6* Q.

Present or absent *Present*

Stoppage, \$ *100* for

Due Gov't, \$ *100* for

Valuation of horse, \$ *100*

Valuation of horse equipments, \$ *100*

Remarks:

Book mark: -----

House

F

William Frazier

Pvt., Co. F, 10 Reg't U. S. Col'd H. Art'y.

Appears on Co. Muster-out Roll, dated

Baton Rouge La Feb 22, 1867.

Muster-out to date Feb 22, 1867.

Last paid to Dec 31, 1866.

Clothing account:

Last settled, 186 ; drawn since \$ 100

Due soldier \$ 36 78 100; due U. S. \$ 100

Am't for cloth'g in kind or money adv'd \$ 100

Due U. S. for arms, equipments, &c., \$ 0 16 100

Bounty paid \$ none 100; due \$ 200 00 100

Remarks: Joined at original organization. Conscripted by G.O. No. 106 Hd. Qrs. Dept. of the Gulf. S. of 64

Book mark:

House

F. | 10 N.A. U.S.C.O.

William Frazier
Pvt., Co. F, 10 Reg't U.S.C.N.A.

NOTATION.

Book mark: P. & P. 433805

Record and Pension Office,

WAR DEPARTMENT,

Washington, Nov. 20, 1895.

It has this day (Nov. 20, 1895,)

been determined by this Department from evidence
furnished by the Auditor
for the War Dept., that this
man was enrolled Aug.
15, 1861.

A. G. N.

edouard...

Co *10*, 10 U.S. Col'd H. Art'y.

Private | *Private*

CARD NUMBERS.

1	5509539	26
2	5509635	27
3	5509748	28
4	5509905	29
5	5510055	30
6	5510200	31
7	5510350	32
8	5510501	33
9	5510623	34
10	5510767	35
11	5510848	36
12	5510924	37
13	5510996	38
14	5511060	39
15		40
16		41
17		42
18		43
19		44
20		45
21		46
22		47
23		48
24		49
25		50

Book Mark:

See also

F | 10 H. Art'y. | U.S.C.T.

Celestino Frederick

Prvt, Co. H, 10 Reg't U. S. Col'd H. Art'y.

Appears on

Company Muster-in and Descriptive Roll

of the organization named above. Roll dated

New Orleans La, Nov 8, 1864.

Where born *S. Charles La.*

Age *22* y'rs; occupation *Labourer*

When enlisted *Nov 2*, 1864.

Where enlisted *New Orleans*

For what period enlisted *3* years.

Eyes *Black*; hair *Black*

Complexion *Black*; height *5 ft. 7 in.*

When mustered in *Nov 8*, 1864.

Where mustered in *New Orleans*

Bounty paid \$ *100*; due \$ *100*

Where credited *District 2 ward, Parish of Orleans City of N. Orleans La*
Company to which assigned *H*

Remarks: *Mustered in to date from date of Enlistment.*

NEXT ROLL ON FILE FEB 1865

Book mark :

(356d)

Pennington

Copyist.

F

10 H. Art'y.

U.S.C.T.

Celestine Frederick

Pvt, Co. H, 10 Reg't U. S. Col'd H. Art'y

Appears on

Company Muster Roll

for *Jan'y & Feb'y*, 186*5*.

Present or absent *Present*

Stoppage, \$ *100* for

Due Gov't, \$ *100* for

Valuation of horse, \$ *100*

Valuation of horse equipments. \$ *100*

Remarks :

Book mark :

Permington

(858)

Copyist.

F | 10 H. Art'y. | U.S.C.T.

Celestine Frederick

Pvt, Co. H, 10 Reg't U. S. Col'd H. Art'y

Appears on

Company Muster Roll

for *March & April*, 1865.

Present or absent *Present*

Stoppage, \$ *100* for

Due Gov't, \$ *100* for

Valuation of horse, \$ *100*

Valuation of horse equipments. \$ *100*

Remarks :

Book mark :

(358)

Pennington
Copyist.

F

10 H. Art'y.

U.S.C.T.

Celestine Frederick

Pvt, Co. H, 10 Reg't U. S. Col'd H. Art'y

Appears on

Company Muster Roll

for *May & June*, 1865.

Present or absent *Present*

Stoppage, \$ *100* for

Due Gov't, \$ *100* for

Valuation of horse, \$ *100*

Valuation of horse equipments. \$ *100*

Remarks: *Stoppage for
Ordinance 20 Cts.*

Book mark:

Perrington

(358)

Copyist.

F

10 H. Art'y.

U.S.C.T.

Celestine Frederick

Priv

, Co. H, 10 Reg't U. S. Col'd H. Art'y

Appears on

Company Muster Roll

for *July + Aug*, 1865.

Present or absent *Present*

Stoppage, \$ *100* for

Due Gov't, \$ *100* for

Valuation of horse, \$ *100*

Valuation of horse equipments. \$ *100*

Remarks :

Book mark :

(358)

Perrington

Copyist.

G

10 H. Art'y. U.S.C.T.

Celestine Frederick

Pvt., Co. H, 10 Reg't U. S. Col'd H. Art'y

Appears on

Company Muster Roll

for *Sep & Oct*, 1865.

Present or absent *Present*

Stoppage, \$ *100* for

Due Gov't, \$ *100* for

Valuation of horse, \$ *100*

Valuation of horse equipments. \$ *100*

Remarks :

Book mark :

Cammack

(358)

Copyist

GH

10 H. Art'y.

U.S.C.T.

Belstine Frederick

Capt., Co. H, 10 Reg't U. S. Col'd H. Art'y

Appears on

Company Muster Roll

for *Nov & Dec*, 1865.

Present or absent *Present*

Stoppage, \$ 100 for

Due Gov't, \$ 100 for

Valuation of horse, \$ 100

Valuation of horse equipments. \$ 100

Remarks: *Stop for loss of
ordnance etc*

Book mark:

Samuel D

(858)

Copyist.

F

10 H. Art'y.

U.S.C.T.

Celestine Frederick

Pr^c, Co. H, 10 Reg't U. S. Col'd H. Art'y

Appears on

Company Muster Roll

for *Jan & Feb.*, 1866.

Present or absent *Present*

Stoppage, \$ 100 for

Due Gov't, \$ 100 for

Valuation of horse, \$ 100

Valuation of horse equipments. \$ 100

Remarks: *Stoppage for loss of ordnance 8 cents.*

Book mark:

Cammack

(358)

Copyist.

F

10 H. Art'y.

U.S.C.T.

Celestine Frederick

Priv., Co. H, 10 Reg't U. S. Col'd H. Art'y

Appears on

Company Muster Roll

for *Mc* *Apr*, 1866.

Present or absent *Present*

Stoppage, \$ *100* for

Due Gov't, \$ *100* for

Valuation of horse, \$ *100*

Valuation of horse equipments. \$ *100*

Remarks :

Book mark :

Samuel

(358)

Copyist.

L

10 H. Art'y.

U.S.C.T.

Celestine Frederick

Cvt., Co. H, 10 Reg't U. S. Col'd H. Art'y

Appears on

Company Muster Roll

for *May & June*, 186*6*

Present or absent *Present*

Stoppage, \$ *100* for

Due Gov't, \$ *100* for

Valuation of horse, \$ *100*

Valuation of horse equipments. \$ *100*

Remarks :

Book mark :

Cammace

(858)

Copyist.

F

10 H. Art'y.

U.S.C.T.

Celestine Frederick

Pr., Co. H, 10 Reg't U. S. Col'd H. Art'y

Appears on

Company Muster Roll

for *July 2 Aug*, 186*6*.

Present or absent *Present*

Stoppage, \$ *100* for

Due Gov't, \$ *100* for

Valuation of horse, \$ *100*

Valuation of horse equipments. \$ *100*

Remarks:

Book mark:

Lammack

(858)

Copyist.

F | 10 H. Art'y. | U.S.C.T.

Celestine Frederick
Priv, Co. H, 10 Reg't U. S. Col'd H. Art'y

Appears on

Company Muster Roll

for *Sep + Oct*, 1866.

Present or absent *Present*

Stoppage, \$ *100* for

Due Gov't, \$ *100* for

Valuation of horse, \$ *100*

Valuation of horse equipments. \$ *100*

Remarks :

Book mark:

(358)

Louny

Copyist.

F | 10 H. Art'y. | U.S.C.T.

Celestine Frederick

Pvt., Co. H, 10 Reg't U. S. Col'd H. Art'y

Appears on

Company Muster Roll

for *Nov. & Dec.*, 186*6*.

Present or absent *Present*

Stoppage, \$ *100* for

Due Gov't, \$ *100* for

Valuation of horse, \$ *100*

Valuation of horse equipments, \$ *100*

Remarks: *Stop for equipage*
5¢

Book mark:

Lowry

Celestine Frederick
Pvt, Co. *H*, 10 Reg't U. S. Col'd H. Art'y.

Appears on **Co. Muster-out Roll**, dated
Baton Rouge, La., Feb. 22, 1867.
Muster-out to date *Feb. 22*, 1867.
Last paid to *Dec. 31*, 1866.

Clothing account:

Last settled....., 186 ; drawn since \$.....100
Due soldier \$ *38*^{*40*}/₁₀₀; due U. S. \$.....100
Am't for cloth'g in kind or money adv'd \$.....100

Due U. S. for arms, equipments, &c., \$ *6*^{*00*}/₁₀₀

Bounty paid \$.....100; due \$ *200*^{*00*}/₁₀₀

Remarks: *Joined at orig. org.*

Book mark :

Lowry

Frederick, Celestine

, Co. *H*, *10* Reg't *U S A*

2 Enclosures.

Bed Cards	Final Statements
Burial Records	Furloughs or L. of A.
Certs. of Dis. for Discharge	Med. Certificates
C. M. Charges	Med. Des. Lists
Descriptive Lists	Orders
Discharge Certificates	Pris. of War Record
Enlistment Papers <i>2</i>	Resignations

Other papers relating to—

Admission to Hosp'l	Furlough or L. of A.
Casualty Sheet	Med. Examination
Confinement	Misc. Information
Contracts	Pay or Clothing
Death or Effects	Personal Reports
Desertion	Rank
Discharge from Hosp'l	Transfer to Hosp'l
Discharge from Service	Transfer to V. R. C.
Duty	Transportation

NOTE 1.—This blank will be used for both enlistments and re-enlistments—enlistment of veterans, &c., &c., in the volunteer service. They will be made out in duplicate in all cases—one to accompany the recruiting return of the superintendent (not the recruiting officer) to the Adjutant General, and one to accompany the accounts of the officer who pays bounty, &c. The Regiment and Company in which the soldier last served should be given on the back.

NOTE 2.—An enlistment holds to service. A muster-in must, in all cases, precede payment of pay, bounty, pension, &c. A muster-in roll must, in all cases, be filed in the Adjutant General's Office as evidence of muster-in. The mustering officer, commissary, or assistant commissary of musters, as the case may be, will countersign both enlistments as having mustered the soldier into the service of the United States before either of them is given to the disbursing officer.

DECLARATION OF RECRUIT.

I, Celestine Fudrick, desiring to VOLUNTEER as a Soldier in the Army of the United States, for the term of THREE YEARS, Do Declare, That I am 22 years and _____ months of age; that I have never been discharged from the United States service on account of disability or by sentence of a court martial, or by order before the expiration of a term of enlistment; and I know of no impediment to my serving honestly and faithfully as a soldier for three years.

GIVEN at New Orleans La the 2^d day of November 1864

Witness: P. F. Fudrick
1st Lt & Co

No. _____

Celestine Fudrick

Volunteered at New Orleans

Nov 2^d, 1864

By P. F. Fudrick

84 Regiment of U. S. Col

102nd Reg

enlistment; last served in Company ()

Reg't of _____

Discharged _____, 18 _____

Company 1st Lt & Co

1st Reg

CONSENT IN CASE OF MINOR.

I, _____, DO CERTIFY, That I am the _____ of _____; that the said _____ is _____ years of age; and I do hereby freely give my CONSENT to his volunteering as a SOLDIER in the ARMY OF THE UNITED STATES for the period of THREE YEARS.

GIVEN at _____ the _____ day of _____

Witness: _____

VOLUNTEER ENLISTMENT.

STATE OF Louisiana



TOWN OF New Orleans

I, Celestius Fredrick, born in St Charles in the State of La, aged Twenty two years, and by occupation a Laborer. Do HEREBY ACKNOWLEDGE to have volunteered this 2^d day of November, 1864, to serve as a **Soldier** in the **Army of the United States of America**, for the period of **THREE YEARS**, unless sooner discharged by proper authority: Do also agree to accept such bounty, pay, rations, and clothing, as are, or may be, established by law for volunteers. And I Celestius Fredrick, do solemnly swear, that I will bear true faith and allegiance to the **United States of America**, and that I will serve them honestly and faithfully against all their enemies or opposers whomsoever; and that I will observe and obey the orders of the President of the United States, and the orders of the officers appointed over me, according to the Rules and Articles of War.

Sworn and subscribed to, at New Orleans this 2^d day of November, 1864.
BEFORE M. P. Pinnick Notary

I CERTIFY, ON HONOR, That I have carefully examined the above-named Volunteer, agreeably to the General Regulations of the Army, and that, in my opinion, he is free from all bodily defects and mental infirmity, which would in any way disqualify him from performing the duties of a soldier.

Chas. W. Humphrey

EXAMINING SURGEON.

I CERTIFY, ON HONOR, That I have minutely inspected the Volunteer Celestius Fredrick previously to his enlistment, and that he was entirely sober when enlisted; that, to the best of my judgment and belief, he is of lawful age; and that, in accepting him as duly qualified to perform the duties of an able-bodied soldier, I have strictly observed the Regulations which govern the recruiting service. This soldier has Blue eyes, Brown hair, Fair complexion, is 7 feet 7 inches high.

M. P. Pinnick
11234 Regiment of USCO Volunteers,

(A. G. O. No. 74 & 76.)

RECRUITING OFFICER.

Mustered into the service of the United States, for three years or during the war, from date of enlistment, in Company B of 11234 Regiment of USCO Volunteers, on the 2^d day of November, 1864.
Chas. W. Humphrey
Examining Surgeon
M. P. Pinnick
Recruiting Officer

NOTE 1.—This blank will be used for both enlistments and re-enlistments—enlistment of veterans, &c., &c., in the volunteer service. They will be made out in duplicate in all cases—one to accompany the recruiting return of the superintendent (not the recruiting officer) to the Adjutant General, and one to accompany the accounts of the officer who pays bounty, &c. The Regiment and Company in which the soldier last served should be given on the back

NOTE 2.—An enlistment holds to service. A muster-in must, in all cases, precede payment of pay, bounty, pension, &c. A muster-in roll must, in all cases, be filed in the Adjutant General's Office as evidence of muster-in. The mustering officer, commissary, or assistant commissary of musters, as the case may be, will countersign both enlistments as having mustered the soldier into the service of the United States before either of them is given to the disbursing officer.

DECLARATION OF RECRUIT.

I, Celestine Frederick, desiring to VOLUNTEER as a Soldier in the Army of the United States, for the term of THREE YEARS, Do Declare, That I am Twenty two years and _____ months of age; that I have never been discharged from the United States service on account of disability or by sentence of a court martial, or by order before the expiration of a term of enlistment; and I know of no impediment to my serving honestly and faithfully as a soldier for three years.

GIVEN at New Orleans La the 2nd day of November 1864

Witness:

H. P. ...
1st Lieut 84th U.S.C.
Celestine Frederick
Private

10th S. B. 4105

Volunteered at New Orleans
By H. P. ..., 1864
Regiment of _____
enlistment; last served in Company ()
Reg't of _____
Discharged _____, 1864
Account mustered in
to Bureau

CONSENT IN CASE OF MINOR.

I, _____, Do CERTIFY, That I am the _____ of _____; that the said _____ is _____ years of age; and I do hereby freely give my CONSENT to his volunteering as a SOLDIER in the ARMY OF THE UNITED STATES for the period of THREE YEARS.

GIVEN at _____ the _____ day of _____

Witness:

VOLUNTEER ENLISTMENT.

STATE OF

TOWN OF

Louisiana



New Orleans

I, *Celestine Frederick*, born in *St Charles* in the State of *Louisiana*, aged *Twenty two* years, and by occupation a *Laborer*, Do HEREBY ACKNOWLEDGE to have volunteered this *2nd* day of *November*, 1864, to serve as a **Soldier** in the **Army of the United States of America**, for the period of **THREE YEARS**, unless sooner discharged by proper authority: Do also agree to accept such bounty, pay, rations, and clothing, as are, or may be, established by law for volunteers. And I, *Celestine Frederick*, do solemnly swear, that I will bear true faith and allegiance to the **United States of America**, and that I will serve them honestly and faithfully against all their enemies or opposers whomsoever; and that I will observe and obey the orders of the President of the United States, and the orders of the officers appointed over me, according to the Rules and Articles of War.

Sworn and subscribed to, at *New Orleans* this *2nd* day of *Nov*, 1864, *Celestine Frederick* BEFORE *H. A. Pammieri* *1st Lieut 84th U.S.C.I.*

I CERTIFY, ON HONOR, That I have carefully examined the above-named Volunteer, agreeably to the General Regulations of the Army, and that, in my opinion, he is free from all bodily defects and mental infirmity, which would in any way disqualify him from performing the duties of a soldier.

Wm de Kempf
Surgeon U.S.A.
EXAMINING SURGEON.

I CERTIFY, ON HONOR, That I have minutely inspected the Volunteer *Celestine Frederick* previously to his enlistment, and that he was entirely sober when enlisted; that, to the best of my judgment and belief, he is of lawful age; and that, in accepting him as duly qualified to perform the duties of an able-bodied soldier, I have strictly observed the Regulations which govern the recruiting service. This soldier has eyes, *Blk* hair, complexion, is *5* feet *7* inches high.

H. A. Pammieri
1st Lieut 84th U.S.C.I. Regiment of *U.S.C.I.* Volunteers,
RECRUITING OFFICER.

(A. G. O. No. 74 & 76.)

Mustered into the service of the United States, for three years or during the war, from date of enlistment, in Company *B* of *10* Regiment of *W. S. H. Army* Volunteers, on the *8* day of *Nov* 1864 at *New Orleans*

Wm de Kempf
Surgeon U.S.A.
H. A. Pammieri
1st Lieut 84th U.S.C.I.

Fredrick Frank

Co I, **10 U.S. Col'd H. Art'y**

Private

Private

CARD NUMBERS.

1 *5488528*
2 *5511519*
3 *5511655*
4 *5511777*
5 *5511927*
6 *5512110*
7 *5490040*
8
9
10
11
12
13
14
15
16
17
18
19
20
21
22
23
24
25

26
27
28
29
30
31
32
33
34
35
36
37
38
39
40
41
42
43
44
45
46
47
48
49
50

Book Mark:

See also

C. E. 7414 @ J. J.

S. 678553 P. 6.98
S. 89237.9 Point in Pit
R. + P. 638695
p 2551683 and

New York

J | 10th U.S.C.T.

Frank Frederick
Art, Co., 10 Reg't U. S. Col'd Art
Appears on

M. and D. Roll of Men Transferred

to the organization named above,

from *C "E" 7th U.S. C. Inf.*

Roll dated *New Orleans La. Oct. 11, 1863*

When enlisted *July 1*, 186 *3*

Period for which enlisted *3* years.

When mustered in *Nov. 14*, 186 *3*

Present or absent

Company to which assigned

Remarks: *Joined as a recruit
in Co "D" 1st Reg't La
M.V. Vols. Designation
of the Regt changed to
1st Cd. at June 6 '63 per
G. O. No 47 dated 11th
Apr Dept of the Gulf
June 6 '63. Transferred*

Book mark : *(over)*

(342) *J. W. Jones, Jr*
Copyist.

JAN. 15

5488528

1861

ed to Co "G" 20 Regt.
C.A. per S. O. No 202
dated St. L. Dep. of
the Gulf Aug 17 '63
Designation of the Regt.
changed to 9th U.S. C.A.
per Orders No 16 dat-
ed New Orleans, La Apr.
4 '64. By order of Dep.
of War transferred
to Co "E" 9th U.S. C.A.
July 20 1864 per S. O.
No 17 dated St. L. Dep.
Mil. Div. of St. Miss.
July 7 '64.

F.

10 H. Art'y.

U.S.C.T.

Frank Frederick

Pr., Co. I, 10 Reg't U. S. Col'd H. Art'y.

Appears on

Company Muster Roll

for *Nov. & Dec.*, 1865.

Present or absent *Present*

Stoppage, \$ *100* for

Due Gov't, \$ *100* for

Valuation of horse, \$ *100*

Valuation of horse equipments, \$ *100*

Remarks: *Transferred from
74 U.S.C.A. per S.O.
No. 84. Hd. Qrs. Dept.
of La. Oct. 11, 1865.*

FROM SECOND AUDITOR'S ROLL.

Book mark:

O. J. Cleary

F

10 H. Art'y. | U.S.C.T.

Frank Frederick

Cpl., Co. I, 10 Reg't U. S. Col'd H. Art'y.

Appears on

Company Muster Roll

for *Jan. & Feb.*, 1866.

Present or absent *Present*

Stoppage, \$ *100* for

Due Gov't, \$ *100* for

Valuation of horse, \$ *100*

Valuation of horse equipments, \$ *100*

Remarks:

Book mark:

O. S. Leck

(358)

Copyist.

F

10 H. Art'y.

U.S.C.T.

Frank Frederick

Plt., Co. I, 10 Reg't U. S. Col'd H. Art'y.

Appears on

Company Muster Roll

for *Mar. & Apr.*, 1866.

Present or absent *Present*

Stoppage, \$ *100* for

Due Gov't, \$ *100* for

Valuation of horse, \$ *100*

Valuation of horse equipments, \$ *100*

Remarks:

Book mark: *No. 0 on file*

O. J. Leary

(358)

Copyist.

Frank Frederick

Pvt., Co. I, 10 Reg't U. S. Col'd H. Art'y.

Appears on

Company Muster Roll

for *May & June*, 1866.

Present or absent

Stoppage, \$ 100 for

Due Gov't, \$ 100 for

Valuation of horse, \$ 100

Valuation of horse equipments, \$ 100

Remarks: *Discharged.*

Mustered out by reason of expiration of term of service to date June 30, 1866.

Book mark:

O. S. Clark

F | 10 Arty | U.S.C.T.

Frank Frederick
Priv., Co. I, 10 Reg't U. S. Col'd Arty

Appears on a

Detachment Muster-out Roll

of the organization named above. Roll dated

New Orleans, La, June 30, 1866.

Muster-out to date June 30, 1866.

Last paid to Apr. 30, 1866

Clothing account:

Last settled 186 ; drawn since \$ 100

Due soldier \$ 48 ⁵³/₁₀₀; due U. S. \$ 100

Am't for cloth'g in kind or money adv'd \$ 100

Due U. S. for arms, equipments, &c., \$ ⁵⁹/₁₀₀

Bounty paid \$ 100 due \$ 100

Remarks: Joined by transfer from 74 U.S.
Co. Inf., Oct. 11, 1865. per S.O. No. 824 Hqs.
Dept. of La. Stop for 1 miper. one
screw driver. one tom-pick
2 G.C. straps.

Book mark:

R. E. Wilson

F | 10 H. Art'y. | U.S.C.T.

Frank Frederick
Sgt., Co. *I*, 10 Reg't U. S. Col'd H. Art'y.

Appears on Co. Muster-out Roll, dated
Baton Rouge La Feb 22, 1867 .
Muster-out to date -----, 186 .
Last paid to -----, 186 .

Clothing account:

Last settled -----, 186 ; drawn since \$ ----- 100
Due soldier \$ ----- 100; due U. S. \$ ----- 100
Am't for cloth'g in kind or money adv'd \$ ----- 100

Due U. S. for arms, equipments, &c., \$ ----- 100
Bounty paid \$ ----- 100; due \$ ----- 100

Remarks: *Discharged expiration*
term of service June 30, 1866

Book mark: *V 222 P. 254.75*

(361) *J. McHance* Copyist.

Frederick Joseph

Co B., 10 U.S. Col'd H. Art'y.

Private

Private

CARD NUMBERS.

1	5494181	26
2	5494334	27
3	5494499	28
4	5494660	29
5	5494815	30
6	5494968	31
7	5495124	32
8	5495280	33
9	5495432	34
10	5495582	35
11	5495722	36
12	5495877	37
13	5496024	38
14	5496267	39
15	5497504	40
16		41
17		42
18		43
19		44
20		45
21		46
22		47
23		48
24		49
25		50

Book Mark:

See also

F | 10 H. Art'y. | U.S.C.T.

Joseph Frederick
Pot., 2 Battery, La. H. Art'y, Native Guards.*

Age *33* years.

Appears on

Company Muster-in Roll

of the organization named above. Roll dated

*Camp Parapet,
Carrollton, La., Feb. 9, 1863.*

Muster-in to date

Feb. 9, 1863.

Joined for duty and enrolled:

When *Jan'y 5th*, 1863.

Where *Camp Parapet nr. Carrollton, La.*

Period *3* years.

Valuation of horse, \$ *100*

Valuation of horse equipments, \$ *100*

Remarks:

* This organization subsequently became Co. B, 10 Reg't U. S. Colored Heavy Artillery.

Book mark:

Heaster

J

10 H. Art'y. | U.S.C.T.

Joseph Frederick

Pvt., Co. B, 1 Reg't La. H. Art'y, Native Guards.*

Appears on

Company Muster Roll

for *from Enlistment to Feb. 28, 1863.*

Present or absent *Present*

Stoppage, \$ *100* for

Due Gov't, \$ *100* for

Valuation of horse, \$ *100*

Valuation of horse equipments, \$ *100*

Remarks:

*This organization subsequently became Co. B, 10 Reg't U. S. Col'd Heavy Artillery.

Book mark: -----

Feaster

J

10 H. Art'y.

U.S.C.T.

Joseph Frederick

Priv., Co. B, 1 Reg't La. H. Art'y, Native Guards.*

Appears on

Company Muster Roll

for *Mar. 1, April*, 1863.

Present or absent *Present*

Stoppage, \$ *100* for

Due Gov't, \$ *100* for

Valuation of horse, \$ *100*

Valuation of horse equipments, \$ *100*

Remarks: _____

*This organization subsequently became Co. B, 10 Reg't U. S. Col'd Heavy Artillery.

Book mark: _____

Feaster

F | 10 H. Art'y. | U.S.C.T.

Joseph Frederick
Pt., Co. B, 1 Reg't La. H. Art'y, Native Guards.*

Appears on

Company Muster Roll

for *May & June*, 186 *J.*

Present or absent *Present*

Stoppage, \$ *100* for

Due Gov't, \$ *100* for

Valuation of horse, \$ *100*

Valuation of horse equipments, \$ *100*

Remarks: _____

*This organization subsequently became Co. B, 10 Reg't U. S. Col'd Heavy Artillery.

Book mark: _____

Feaster

J | 10 H. Art'y. | U.S.C.T.

Joseph Frederick
Pvt., Co. B, 1 Reg't La. H. Art'y, Native Guards.*

Appears on

Company Muster Roll

for *July & Aug.*, 186*3*.

Present or absent *Present*

Stoppage, \$ *100* for

Due Gov't, \$ *100* for

Valuation of horse, \$ *100*

Valuation of horse equipments, \$ *100*

Remarks: _____

*This organization subsequently became Co. B, 10 Reg't U. S. Col'd Heavy Artillery.

Book mark: _____

Feaster

F | 10 H. Art'y. | U.S.C.T.

Joseph Fredrick
Prvt., Co. B, 1 Reg't La. H. Art'y, Native Guards.*

Appears on

Company Muster Roll

for *Sept. 7, Oct.,* 186*7*.

Present or absent *Present*

Stoppage, \$ *100* for

Due Gov't, \$ *100* for

Valuation of horse, \$ *100*

Valuation of horse equipments, \$ *100*

Remarks: _____

*This organization subsequently became Co. B, 10 Reg't U. S. Col'd Heavy Artillery.

Book mark: _____

Feaster

Joseph Fredrick
Pvt., Co. B, 1 Reg't H. Art'y, Corps d'Afrique.*

Appears on

Company Muster Roll

for *Nov. & Dec.*, 1863.

Present or absent *Present*

Stoppage, \$ *100* for

Due Gov't, \$ *100* for

Valuation of horse, \$ *100*

Valuation of horse equipments, \$ *100*

Remarks:

*This organization subsequently became Co. , 10 Reg't U. S. Colored Heavy Artillery.

Book mark : -----

C. P. [Signature]
Copyist.

F.

10 H. Art'y. U.S.C.T.

Joseph Frederick

Pl, Co. *B*, 1 Reg't H. Art'y, Corps d'Afrique.*

Appears on

Company Muster Roll

for *Jan. 1* to *Feb.*, 186*4*

Present or absent *Present*

Stoppage, \$ *100* for

Due Gov't, \$ *100* for

Valuation of horse, \$ *100*

Valuation of horse equipments, \$ *100*

Remarks:

*This organization subsequently became Co. , 10 Reg't U. S. Colored Heavy Artillery.

Book mark:

Reif

(358)

Copyist.

J | 10 H. Art'y. | U.S.C.T.

Joseph Frederick
Ch. Co. D, 7 Reg't U. S. Col'd H. Art'y.*

Appears on

Company Muster Roll

for *Mass & Ape*, 1864.

Present or absent *Present*

Stoppage, \$ 100 for

Due Gov't, \$ 100 for

Valuation of horse, \$ 100

Valuation of horse equipments, \$ 100

Remarks:

* This organization subsequently became Co. *B*, 10 Reg't U. S. Colored Heavy Artillery.

Book mark : -----

J. H. Richardson
Copyist.

F

10 H. Art'y.

U.S.C.T.

Joseph Frederick

Pvt, Co. *B*, 7 Reg't U. S. Col'd H. Art'y.*

Appears on

Company Muster Roll

for *May & June*, 186*4*.

Present or absent *Present*

Stoppage, \$ *100* for

Due Gov't, \$ *100* for

Valuation of horse, \$ *100*

Valuation of horse equipments, \$ *100*

Remarks:

* This organization subsequently became Co. , 10 Reg't U. S. Colored Heavy Artillery.

Book mark:

(358)

Reif

Copyist.

F | 10 H. Art'y. | U.S.C.T.

Joseph Frederick
Co. B, 10 Reg't U. S. Col'd H. Art'y.

Appears on

Company Muster Roll

for *July & Aug*, 186 *4*
Present or absent *Present*

Stoppage, \$ 100 for

Due Gov't, \$ 100 for

Valuation of horse, \$ 100

Valuation of horse equipments, \$ 100

Remarks:

Book mark:

(358)

J. Richardson
Copyist.

10 H. Art'y. U.S.C.T.

Joseph Frederick
Co. B, 10 Reg't U. S. Col'd H. Art'y.

Appears on

Company Muster Roll

for Sept + Oct, 1864.

Present or absent Present

Stoppage, \$ 100 for

Due Gov't, \$ 100 for

Valuation of horse, \$ 100

Valuation of horse equipments, \$ 100

Remarks:

Book mark:

(358)

J. W. Richardson
Copyist.

1864

F

10 H. Art'y. U.S.C.T.

Joseph Frederick
Co. B, 10 Reg't U. S. Col'd H. Art'y.

Appears on

Company Muster Roll

for *Nov & Dec*, 186*4*.

Present or absent *Present*

Stoppage, \$ 100 for

Due Gov't, \$ 100 for

Valuation of horse, \$ 100

Valuation of horse equipments, \$ 100

Remarks:

Book mark: -----

Journal

(358)

Copyist.

Jf

10 H. Art'y. U.S.C.T.

Joseph Frederick

Pr., Co. B, 10 Reg't U. S. Col'd H. Art'y.

Appears on

Company Muster Roll

for *Jan & Feb*, 186*6*.

Present or absent

Stoppage, \$ 100 for

Due Gov't, \$ 100 for

Valuation of horse, \$ 100

Valuation of horse equipments, \$ 100

Remarks: *Died at Fort. St. Philip La Feb 10, 1865.*

Book mark:

Jones

(358)

Copyist.

J | 10 H. Art'y. | U.S.C.T.

Joseph Frederick
Priv, Co. *B*, 10 Reg't U. S. Col'd H. Art'y.

Appears on **Co. Muster-out Roll**, dated
Baton Rouge La, Feb, 1867.

Muster-out to date 186 .

Last paid to 186 .

Clothing account:

Last settled 186 ; drawn since \$ 100

Due soldier \$ 100 ; due U. S. \$ 100

Am't for cloth'g in kind or money adv'd \$ 100

Due U. S. for arms, equipments, &c., \$ 100

Bounty paid \$ 100 ; due \$ 100

Remarks:

*Joined org. org.
Died at Fort St. Phillips
La. Feby 10th 1865.*

Book mark:

V74 B 94 69.

Hodges

Frederick, Joseph

P. B., Co. B., 10 Reg't U.S.C.H.A.

2 Enclosures.

- | | |
|-----------------------------------|-------------------------|
| Bed Cards..... | Descriptive Lists..... |
| Burial Records..... | Final Statements..... / |
| Certs. of Dis. for Discharge..... | Furloughs..... |
| C. M. Charges..... | Med. Des. Lists..... |
| Med. Certificates..... | Orders..... |

Enlist pp 2

Other papers relating to—

- | | |
|---------------------------------|--------------------------|
| Admission to Hosp'l..... | Furlough..... |
| Casualty Sheet (Officer's)..... | Med. Examination..... |
| Confinement..... | Misc. Information..... |
| Contracts..... | Pay or Clothing..... |
| Death or Effects..... | Personal Reports..... |
| Desertions..... | Rank..... |
| Discharge from Hosp'l..... | Transfer to Hosp'l..... |
| Discharge from Service..... | Transfer to V. R. C..... |
| Duty..... | Transportation..... |

DECLARATION OF RECRUIT.

I, _____ desiring to ENLIST in the Army of the United States, for the term of THREE YEARS, Do declare, That I am _____ years and _____ months of age; that I have neither wife nor child; that I have never been discharged from the United States service on account of disability or by sentence of a court-martial, or by order before the expiration of a term of enlistment; and I know of no impediment to my serving honestly and faithfully as a soldier for three years.

GIVEN at _____
The _____ day of _____

Witness :

No. _____
Joseph J. Probert
Enlisted at *Camp Harriet Co,*
Albany the 5th 1863.
By *2^d Lieut. J. S. Sargent*
of 2^d Regt. Regiment of Cavalry
_____ *enlistment; last served in Company ()*
Reg't of _____
Discharged _____ 18____.

76 2554

CONSENT IN CASE OF MINOR.

I, _____ Do CERTIFY, That I am the _____ of _____; that the said _____ is _____ years of age; and I do hereby freely give my CONSENT to his enlisting as a SOLDIER in the ARMY OF THE UNITED STATES for the period of THREE YEARS.

GIVEN at _____
The _____ day of _____

Witness :

1863

County of

Jefferson



State of

Louisiana

I, Joseph Frederick born in St. John the Baptist Parish
 in the State of Louisiana aged Thirty five years,
 and by occupation a Laborer do hereby acknowledge to have
 voluntarily enlisted this fifth day of January
 1863, as a SOLDIER in the ARMY OF THE UNITED STATES OF AMERICA, for the period
 of THREE YEARS, unless sooner discharged by proper authority: Do also agree to
 accept such bounty, pay, rations, and clothing, as are, or may be, established by law. And
 I, Joseph Frederick do solemnly swear, that I will bear true faith
 and allegiance to the UNITED STATES OF AMERICA, and that I will serve them honestly and
 faithfully against all their enemies or opposers whomsoever; and that I will observe and
 obey the orders of the President of the United States, and the orders of the officers
 appointed over me, according to the Rules and Articles of War.

Sworn ~~and subscribed to~~, at Camp Parapet
 this ninth day of February 1863
 BEFORE
J. Rygaard
2^d Lt. N. G. Art. La.

I CERTIFY, ON HONOR, That I have carefully examined the above named Recruit, agreeably to the General Regulations of the Army, and that in my opinion he is free from all bodily defects and mental infirmity, which would, in any way, disqualify him from performing the duties of a soldier.

W. G. Lynde

EXAMINING SURGEON.

I CERTIFY, ON HONOR, That I have minutely inspected the Recruit, Joseph Frederick previously to his enlistment, and that he was entirely sober when enlisted; that, to the best of my judgement and belief, he is of lawful age; and that, in accepting him as duly qualified to perform the duties of an able-bodied soldier, I have strictly observed the Regulations which govern the recruiting service. This soldier has brown eyes, black hair, dark complexion; is no feet, ten inches high.

J. Rygaard. 2^d Lieut. N. G. Art. La. Vol

RECRUITING OFFICER.

DECLARATION OF RECRUIT.

I, _____ desiring to ENLIST in the Army of the United States, for the term of THREE YEARS, Do declare, That I am _____ years and _____ months of age; that I have neither wife nor child; that I have never been discharged from the United States service on account of disability or by sentence of a court-martial, or by order before the expiration of a term of enlistment; and I know of no impediment to my serving honestly and faithfully as a soldier for three years.

GIVEN at _____

The _____ day of _____

Witness :

No. 49

Joseph Frederick

Enlisted at

Camp Harriet, La

January, the 5th, 1863.

By

2d Bnt. of Agave

1st Regt. of Louisiana Art.

enlistment; last served in Company ()

Reg't of _____

Discharged _____ 18 _____

CONSENT IN CASE OF MINOR.

I, _____ Do CERTIFY, That I am the _____ of _____; that the said _____ is _____ years of age; and I do hereby freely give my CONSENT to his enlisting as a SOLDIER in the ARMY OF THE UNITED STATES for the period of THREE YEARS.

GIVEN at _____

The _____ day of _____

Witness :

NARR 1642

County of

Jefferson



State of

Louisiana

I, Joseph Frederick born in St. John the Baptist Parish

in the State of Louisiana aged Thirty five years,

and by occupation a Laborer do hereby acknowledge to have

voluntarily enlisted this fifth day of January

1863, as a SOLDIER in the ARMY OF THE UNITED STATES OF AMERICA, for the period of THREE YEARS, unless sooner discharged by proper authority: Do also agree to

accept such bounty, pay, rations, and clothing, as are, or may be, established by law. And

I, Joseph Frederick do solemnly swear, that I will bear true faith and allegiance to the UNITED STATES OF AMERICA, and that I will serve them honestly and faithfully against all their enemies or opposers whomsoever; and that I will observe and obey the orders of the President of the United States, and the orders of the officers appointed over me, according to the Rules and Articles of War.

Sworn and subscribed to, at at Carrollton,
Camp Parapet,
this ninth day of February 1863
BEFORE J. Rygaard
2d Lt. U.S. Art. & Cav.

I CERTIFY, ON HONOR, That I have carefully examined the above named Recruit, agreeably to the General Regulations of the Army, and that in my opinion he is free from all bodily defects and mental infirmity, which would, in any way, disqualify him from performing the duties of a soldier.

W. C. Lynde
EXAMINING SURGEON.

I CERTIFY, ON HONOR, That I have minutely inspected the Recruit, Joseph Frederick previously to his enlistment, and that he was entirely sober when enlisted; that, to the best of my judgement and belief, he is of lawful age; and that, in accepting him as duly qualified to perform the duties of an able-bodied soldier, I have strictly observed the Regulations which govern the recruiting service. This soldier has brown eyes, black hair, dark complexion; is five feet, ten inches high.

J. Rygaard 2d Lieut. U.S. Art. & Cav.
RECRUITING OFFICER.

V

FINAL STATEMENT

OF

Joseph Frederick
10th Reg't of W.S.C. Heavy

VOLUNTEERS.

Due July 10th 1865

NOTE 1.—Two of these certificates (or duplicates) are to be given to each Volunteer Soldier or drafted man who may be discharged previously to the discharge of his company, that he may at once receive from the Paymaster the pay, &c., due him, and the captain or other COMMISSIONED officer commanding the company will certify to the act of the delivery of the duplicate certificates; on these certificates the Soldier is "entitled to" his discharge, and should also present his discharge to the Paymaster to have the payment endorsed on it. The discharge is to be given back to the Soldier by the Paymaster; the latter only retaining as his voucher the duplicate certificates.

NOTE 2.—If the Soldier is entitled to pay for the use of his horse, the Company Commander will certify to that fact on the back of both these final statements, and also to the time he has pay due for having been so mounted on his own horse.

NOTE 3.—When a Soldier is furnished with final statements, his descriptive list, if he has one, should be taken up by the officer who gives the Soldier these statements, and endorsed with a statement to this effect by the officer. This endorsement should exhibit a full statement of the time for which the Soldier was allowed pay on his final statements, the clothing account, and all other charges against him or in his favor, so as to comprise a complete exhibit of his account. It will then be transmitted to the company commander of the Soldier, who will enter all the data necessary to a full understanding of the Soldier's account on the muster roll upon which the Soldier's discharge is reported. The descriptive list will then be destroyed. The object of this is, that the remaining portion of the Soldier's account may be settled upon the receipt of these muster rolls, and the Soldier receive any pay or allowances that may be due him at the time of his discharge, and which may not appear on his final statements from the fact that his descriptive list is incomplete. These accounts for back pay, &c., are settled by the 2d Auditor of the Treasury Department.

NOTE 4.—Charges for loss or injury to ordnance, horse equipments, and other miscellaneous charges, should appear under the heading of "Other Stoppages."

NOTE 5.—Bounty paid by State authorities, and not by the United States, will not be entered on this statement.

NOTE 6.—Amounts due the Sutler and Laundress must be entered on the muster roll on which the discharge, death, desertion, &c., is reported, as well as on the final statement, otherwise the amount cannot be collected from the United States.

NOTE 7.—This blank will be used for deceased volunteers and drafted men, as well as for others.

NOTE 8.—Where a Soldier dies in Hospital or on detached service, his descriptive list, if he has one, should be sent with his final statements, in duplicate, to the Second Auditor, Washington, D. C.

ADJUTANT GENERAL'S OFFICE.
McJ 3rd 1865.
Duplicate with Inventory sent 2d Auditor.

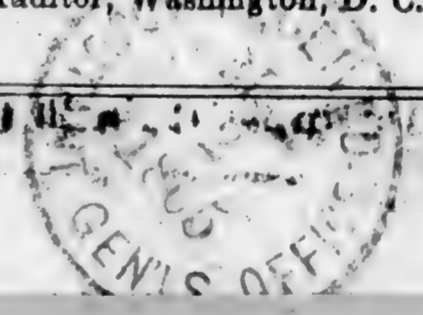

1644

I certify, on honor, that Joseph Frederick a Private of
 Captain A. M. Allister's Company (B.) of the 10th Regiment of U. S. C. Artillery Heavy
VOLUNTEERS, of the State of Louisiana, born in St. John Parish, State
 of Louisiana, aged 35 years; 5 feet 10 inches high; dark complexion,
bram eyes, black hair, and by occupation a Laborer, having joined the company on
 its original organization at Camp Parapet La, and enrolled in it at the muster into
 the service of the United States at Camp Parapet La, on the Eleventh day
 of February, 1863, (or was mustered in service as a recruit, by
 _____, at _____, on the _____ day of _____,
 1863, or was drafted and mustered into the service of the United States from the _____
 Enrollment District of the State of _____, at _____,
 on the _____ day of _____, 186), to serve in the Regiment, for
 the term of Three Years; and having served **HONESTLY** and
FAITHFULLY with his Company in the Dept of the Gulf to the present date, is now
 entitled to a **DISCHARGE** by reason of Death of Pneumonia on
the 10th day of February 1865 at Fort St Philip La

The said Joseph Frederick was last paid by Paymaster
Kimball to include the 31st day of August, 1864, and has
 pay due him from that time to the present date; he is entitled to pay and subsistence for
TRAVELING to place of enrollment, and whatever other allowances are authorized to volunteer
 soldiers, drafted men, or militia, so discharged. He has received from the United States **CLOTHING**
 amounting to Eight $\frac{1}{100}$ dollars, since the 30th day of June,
 1864, when his clothing account was last settled. He has received from the United States
no $\frac{1}{100}$ dollars advanced **BOUNTY**.

There is to be stopped from him, on account of the State of _____, or other
 authorities, for **CLOTHING**, &c., received on entering service, _____ $\frac{1}{100}$ dollars; and
 for other stoppages, viz:

I certify on honor that the above Joseph Frederick died
possessed of no effects _____ $\frac{1}{100}$ dollars.
 He has been furnished with **TRANSPORTATION** in kind from the place of his discharge to
 _____; and he has been **SUBSISTED** for **TRAVELING** to his
 place of enrollment, up to the _____, 186 .

He is indebted to Two dollars to, **SUTLER**, _____ $\frac{2.00}{100}$ dollars.
 He is indebted to _____, **LAUNDRESS**, _____ $\frac{1}{100}$ dollars.

Given in Duplicate, at Fort St Philip La, this 11th day
 of February, 1865.

Thomas M. Cormack
1st Lt 10th U.S. Artillery Reg
 Commanding Company.

MICROCOPY

18 18

ROLL

167



IMAGE EVALUATION TEST TARGET (QA-3)

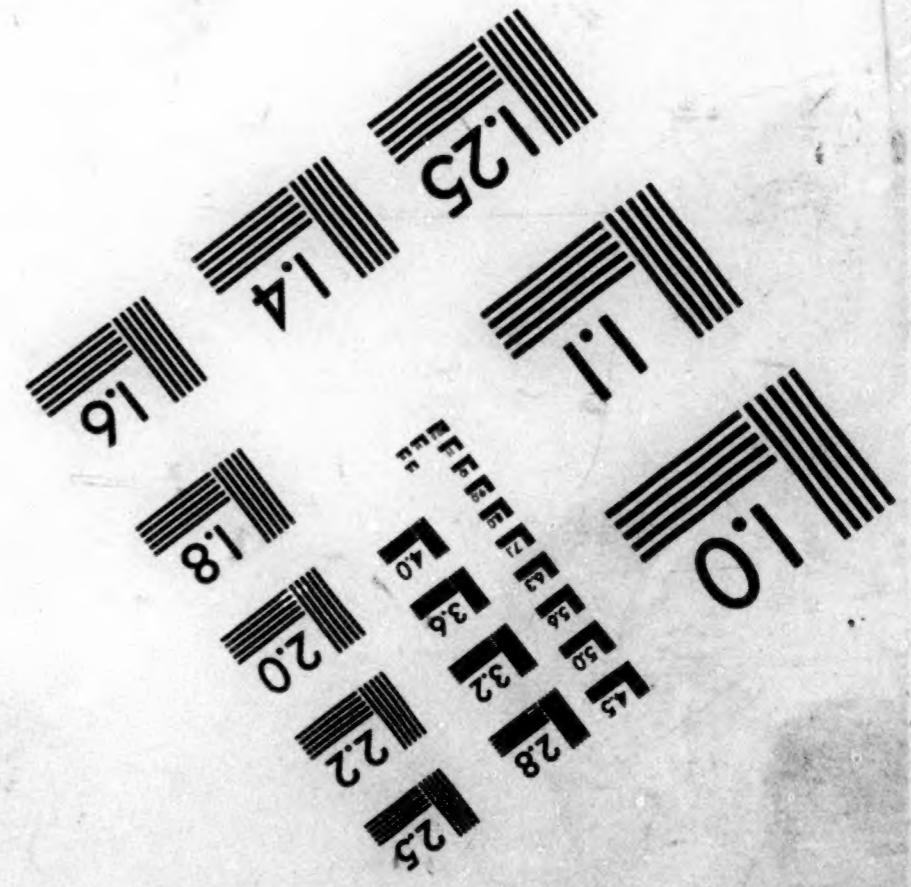
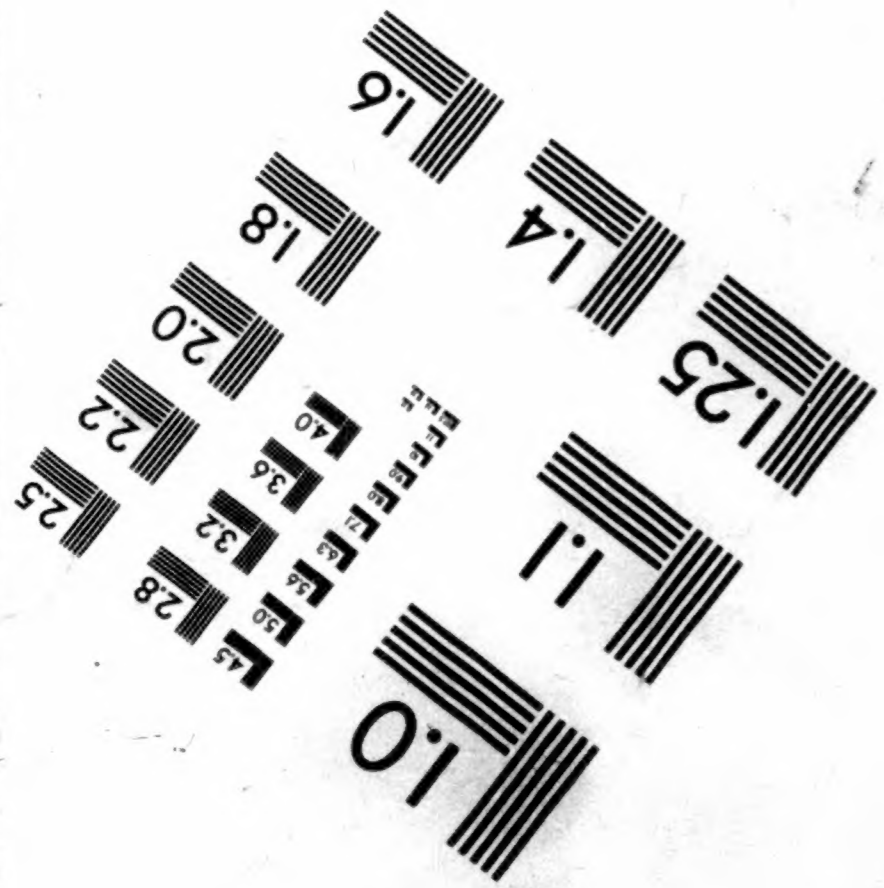
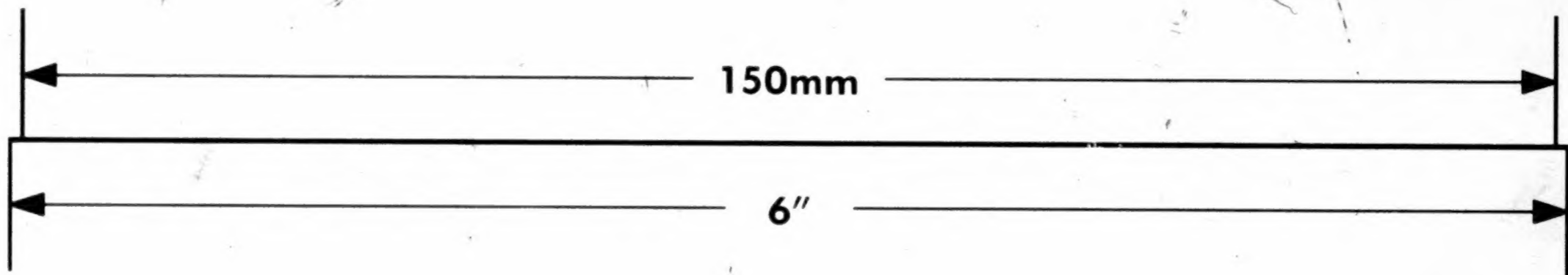
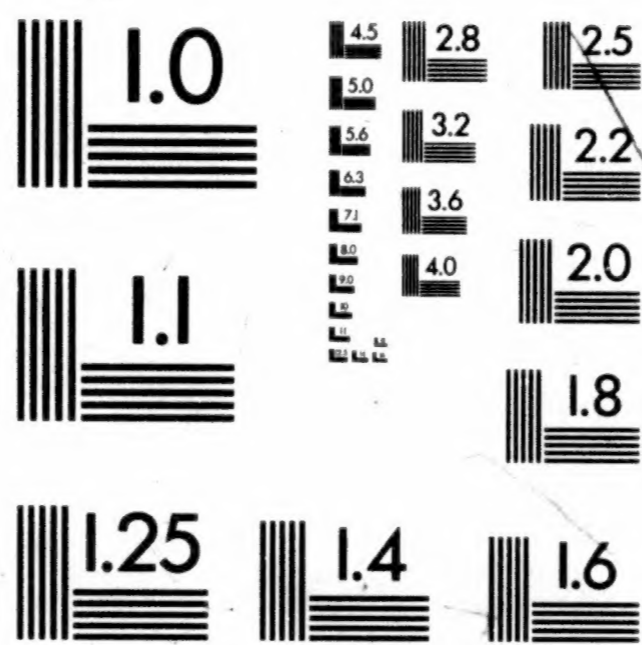
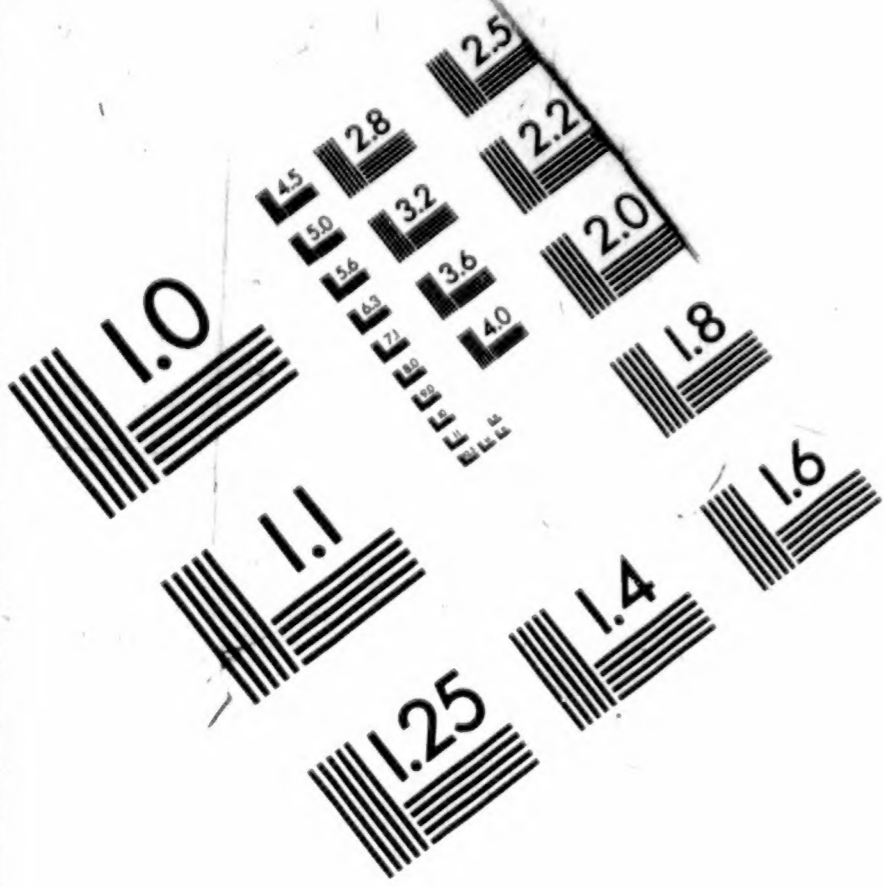

APPLIED IMAGE, Inc
 1653 East Main Street
 Rochester, NY 14609 USA
 Phone: 716/482-0300
 Fax: 716/288-5989

© 1993, Applied Image, Inc., All Rights Reserved

THE END

PLEASE

REWIND