

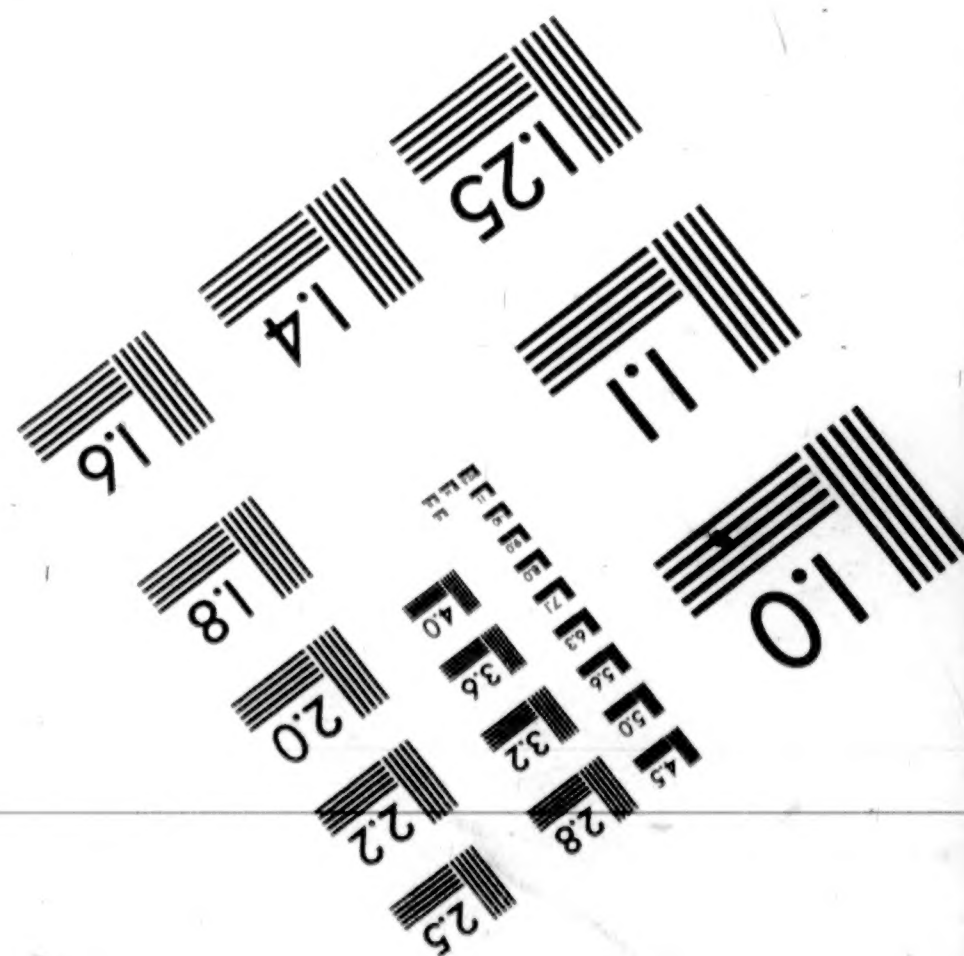

NATIONAL  
ARCHIVES  
MICROFILM  
PUBLICATIONS

# IMAGE EVALUATION TEST TARGET (QA-3)

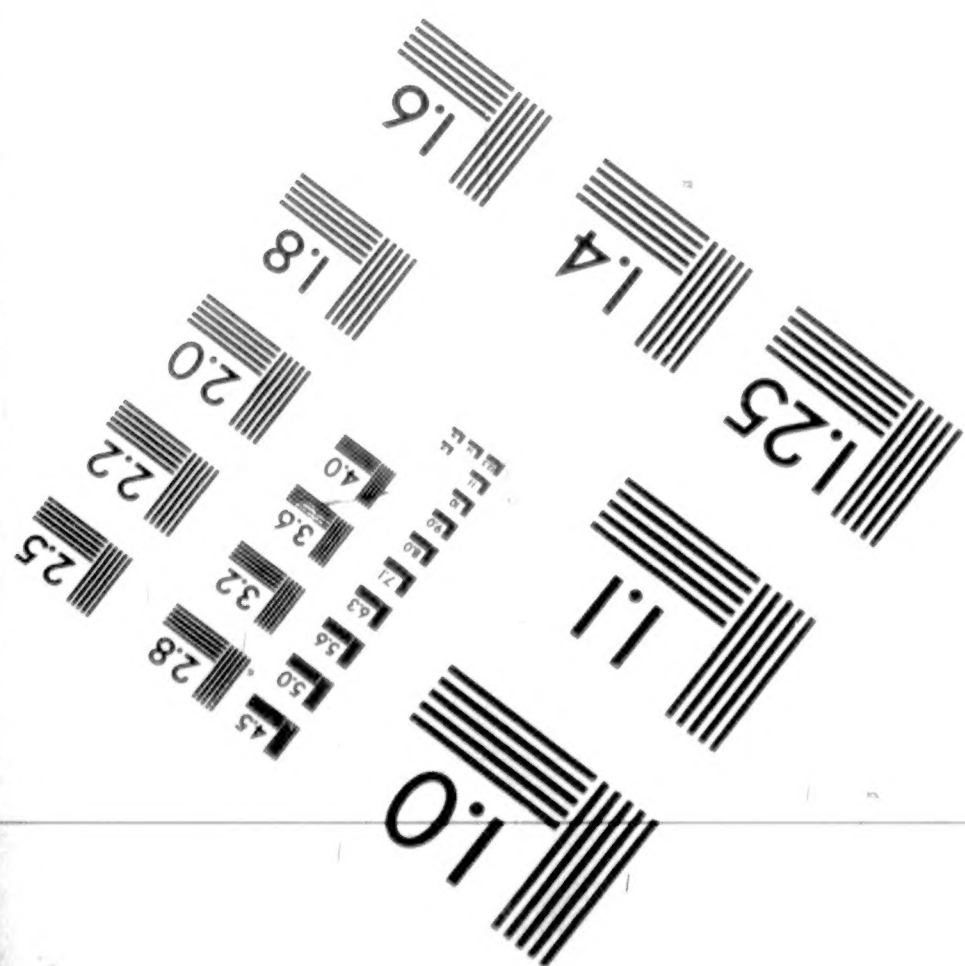
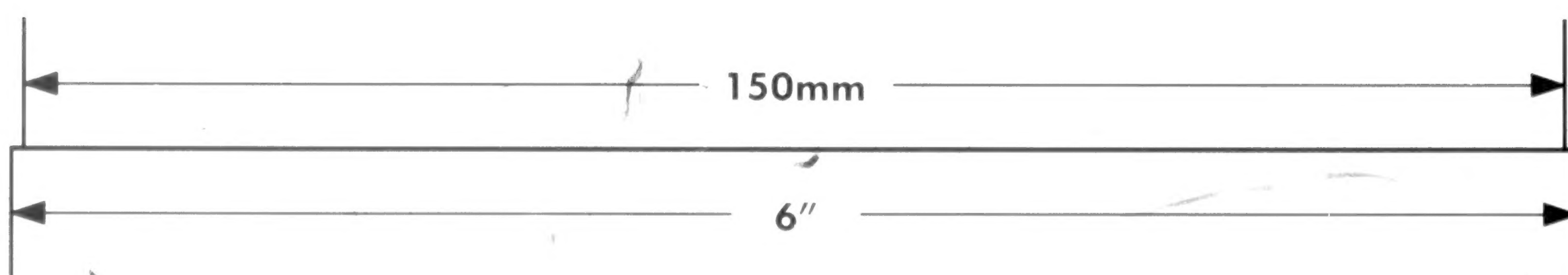
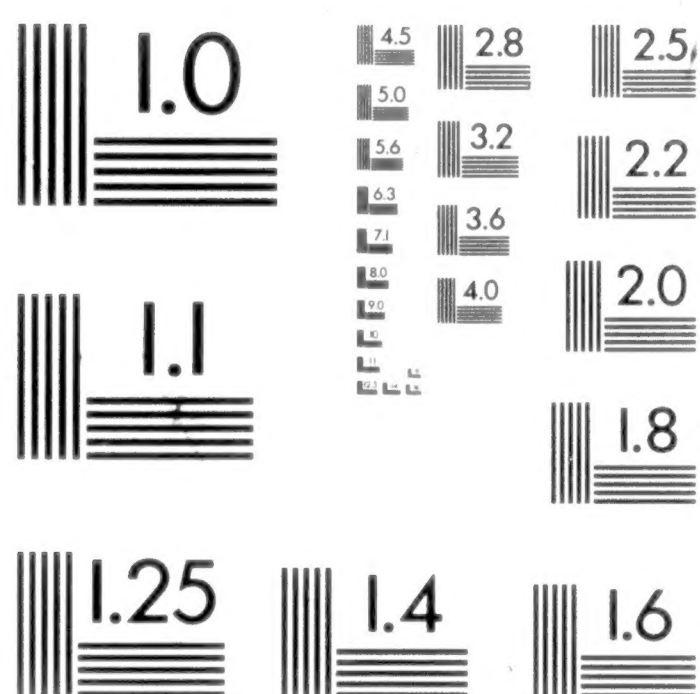
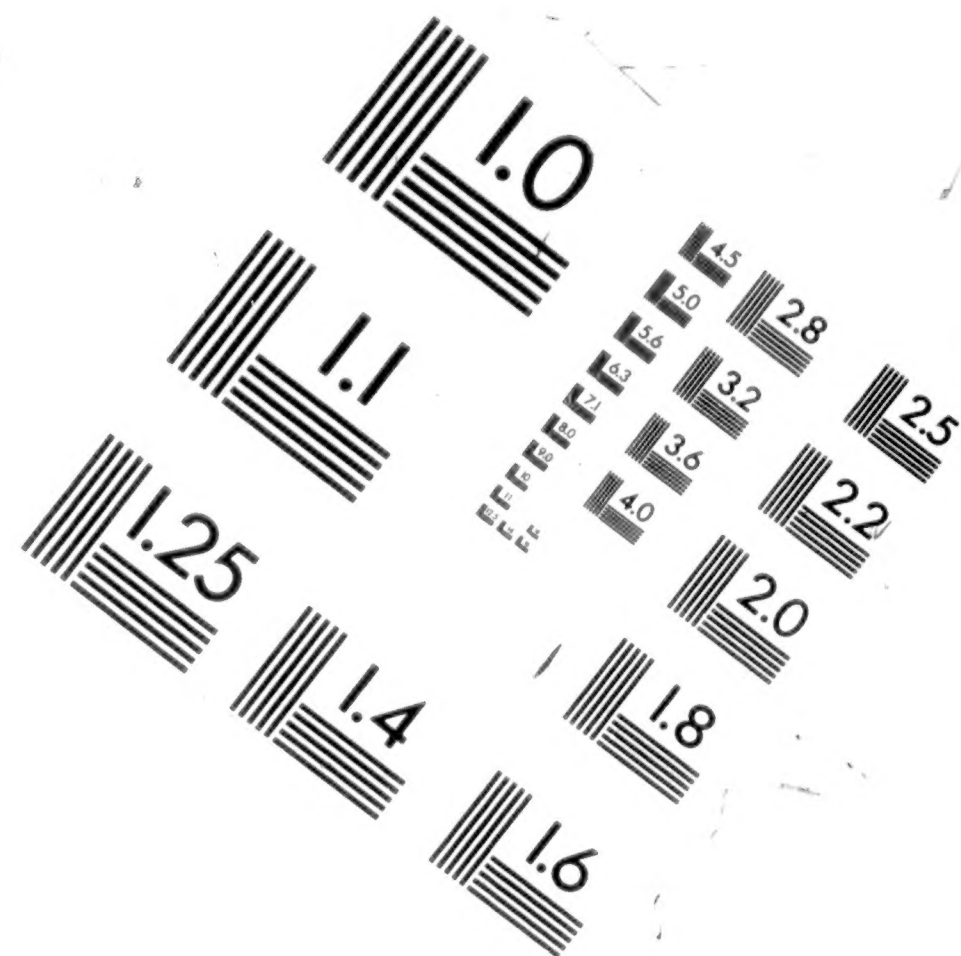
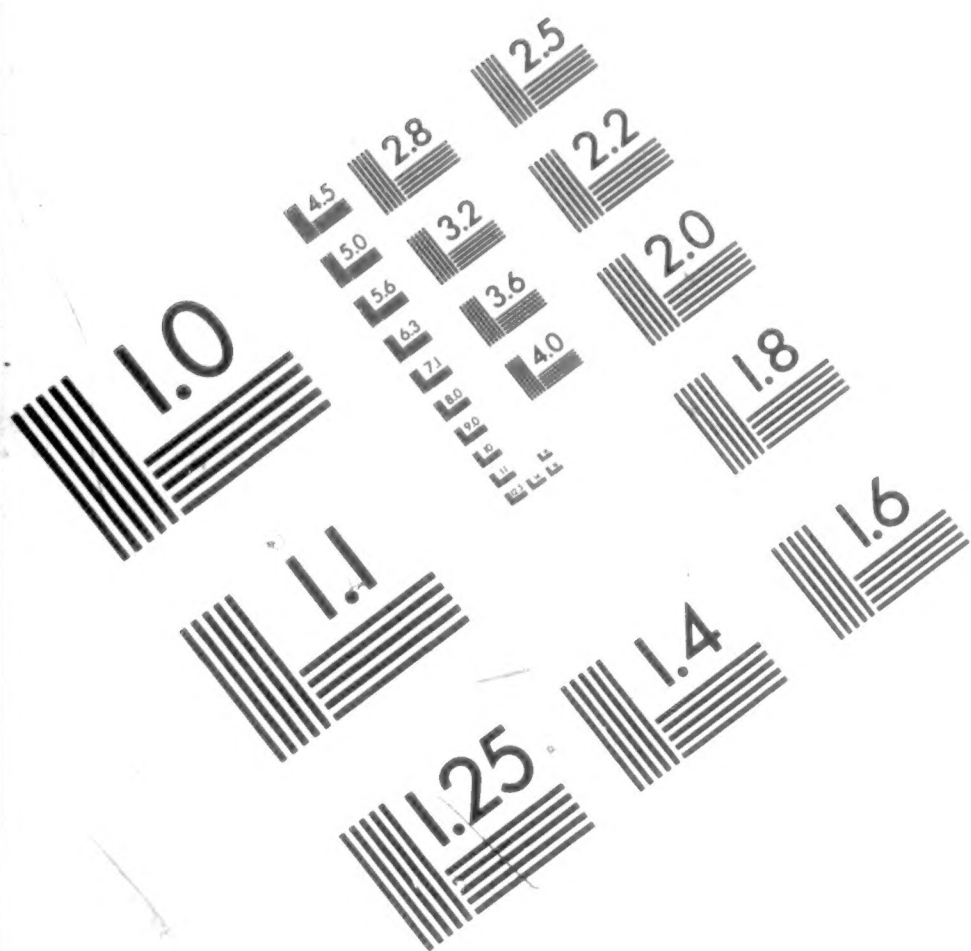

APPLIED IMAGE, Inc  
1653 East Main Street  
Rochester, NY 14609 USA  
Phone: 716/482-0300  
Fax: 716/288-5989

© 1993, Applied Image, Inc., All Rights Reserved

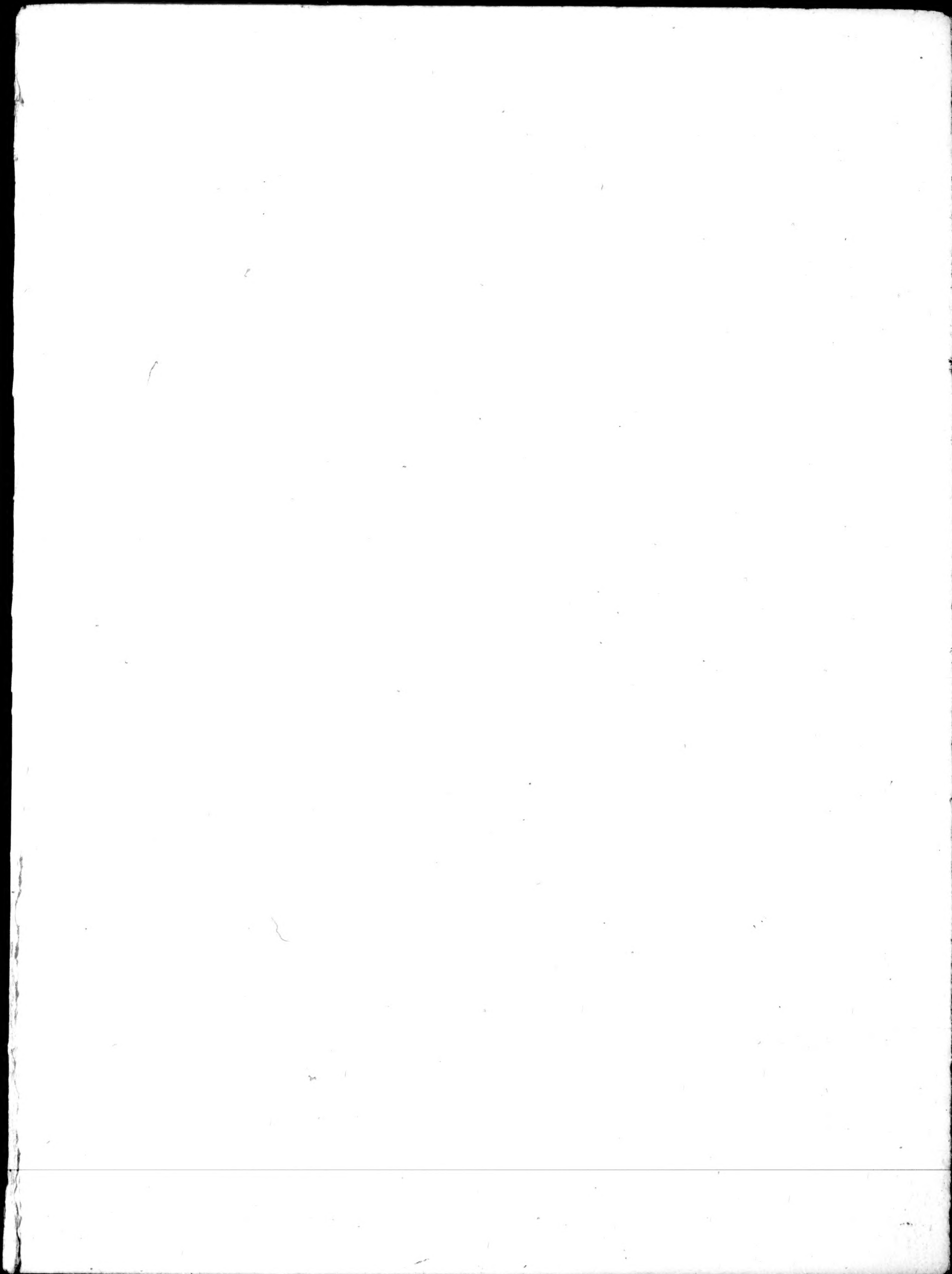

National Archives at College Park



8601 Adelphi Road College Park MD 20740-6001

Rebecca Sullivan

OPERATOR

CAMERA

August 19, 1998

DATE FILMED

REDUCTION RATIO

2461-0576-01403

FILM EMULSION NUMBER

M-1818

173

PROJECT NUMBER

ROLL NUMBER

**MICROCOPY**

**1 8 1 8**

**ROLL**

**1 7 3**

M1818

COMPILED MILITARY SERVICE RECORDS OF  
VOLUNTEER UNION SOLDIERS WHO SERVED WITH THE  
UNITED STATES COLORED TROOPS:  
Artillery Organizations

Introduction by Budge Weidman, Project Manager

Records prepared for microfilming by members of  
the Civil War Conservation Corps

Pat Alfredson	Sue Goward*	Mary Poggioli
Phyllis Altrogge	Bert Greenstein	Peggy Pratt
Kenneth Ashton	Anne Greenwood	Ray Puzio
Sue Barnard*	Jim Harris	Sylvia Scott
Dee Benson	Walter Hayden	Lynn Shearouse
Ann N. Brown	Mary Hayden	Mary Stack-Dunne
Robert Budway	Pat Ikonen	Ben Stearns
Randy Caldwell	Dick Ives	Bill Stormer*
MaryAnn Castellana*	Sarah Jaffe	Pat Sullivan
Mary Lou Cole	Barbara Kemp	Gorman Tidball*
Giovanni Croce	Bev Manypenny	Cathy Tinston
B.H. Custer	Frank Masterson	John Toole
Bob Denney	Joe Mazur	Maryellen Toole
Richard Dow	Kathleen McCarthy	Milt Weatherhead
Earl Dunn	Sarah McDougall	Russ Weidman
Yvette Fallin	Catherine McManus	C. Lois Young
Maria Flesher	Ben Miles	Robert Young
Naomi Glass	Dave Murray	

Team leaders are indicated by the asterisk.

National Archives and Records Administration  
Washington, DC  
1998

## INTRODUCTION

On the 299 rolls of this microfilm publication, M1818, are reproduced the compiled military service records of volunteer Union soldiers belonging to the artillery units organized for service with the United States Colored Troops (USCT). The USCT included 7 numbered cavalry regiments; 13 numbered artillery regiments plus one independent battery; 144 numbered infantry regiments; plus Brigade Bands Nos. 1 & 2 (Corps d'Afrique and US Colored Troops); Powell's Regiment Colored Infantry; Southard's Company Colored Infantry; Quartermaster Detachment; Pioneer Corps, 1st Division, 16th Army Corps; Unassigned Company A Colored Infantry; and Unassigned USCT. There are also miscellaneous service cards arranged alphabetically by surname at the end of the unit records. The records reproduced are part of the Records of the Adjutant General's Office, 1780's-1917, Record Group (RG) 94.

## Background

## United States Colored Troops

Since the time of the American Revolution, African Americans have volunteered to serve their country in time of war. The Civil War was no exception. Official sanction was the difficulty. In the fall of 1862 there were four Union regiments of African Americans raised in New Orleans, LA: the 1st, 2d, and 3d Louisiana Native Guard, and the 1st Louisiana Heavy Artillery (African Descent). The 1st South Carolina Infantry (African Descent) was not officially organized until January 1863; however, three companies of the regiment were on coastal expeditions as early as November 1862. Similarly, the 1st Kansas Colored Infantry was not mustered into Federal service until January 1863, even though the regiment had already participated in the action at Island Mound, MO, on October 27, 1862. These early unofficial regiments received little Federal support, but they showed the strength of the African American soldier's desire to fight for freedom.

The first official authorization to employ African Americans in Federal service was the Second Confiscation and Militia Act of July 17, 1862. This act allowed President Abraham Lincoln to receive into the military or naval service persons of African descent and gave him permission to use them for any purpose "he may judge best for the public welfare." However, the President did not authorize use of African Americans in combat until issuance of the Emancipation Proclamation on January 1, 1863.

In late January 1863, Governor John Andrew of Massachusetts received permission to raise a regiment of African American soldiers. The pace of organizing additional regiments was very slow. In March Secretary of War Edwin M. Stanton sent Gen. Lorenzo Thomas to the lower Mississippi Valley to recruit free and contraband African Americans. Thomas was given broad authority. He was to explain the administration's policy regarding African American soldiers and recruit



volunteers to raise and command them. Stanton wanted all officers of such units to be white, but that policy was softened to allow African American surgeons and chaplains. By the end of the war, in addition to the chaplains and surgeons, there were some 87 African American officers. Thomas's endeavor was very successful, and on May 22, 1863, the Bureau of Colored Troops was established to coordinate and organize regiments from all parts of the country. Created under War Department General Order No. 143, the bureau was responsible for handling "all matters relating to the organization of Colored Troops." The bureau was directly under the Adjutant General's Office and its procedures and rules were specific and strict. All African American regiments were now to be designated United States Colored Troops (USCT). At this time there were some African American regiments with state names and a few regiments in the Department of the Gulf designated as Corps d'Afrique. All these were ultimately assimilated into the USCT, even though some of the regiments, such as the 5th Massachusetts, retained their state designations.

To facilitate recruiting in the states of Maryland, Missouri, Tennessee, and eventually Kentucky, the War Department issued General Order No. 329 on October 3, 1863. Section 6 of the order stated that if any citizen should offer his or her slave for enlistment into the military service, that person would, "if such slave be accepted, receive from the recruiting officer a certificate thereof, and become entitled to compensation for the service or labor of said slave, not exceeding the sum of three hundred dollars, upon filing a valid deed of manumission and of release, and making satisfactory proof of title." For this reason, some records of manumission are contained in the compiled service records reproduced in this publication.

The USCT fought in 39 major engagements and over 400 lesser ones. Sixteen African American soldiers received Medals of Honor. As it was in other units, the death toll from disease was very high in the USCT. Deaths from disease and battle totaled 37,000. The last regiment of the USCT was mustered out of Federal service in December 1867.

Important sources for information about African American units in the Civil War are the War Department's *The War of the Rebellion: A Compilation of the Official Records of the Union and Confederate Armies* (Washington, DC: 1880-1901; reprinted Harrisburg, 1971 and 1985) and the Navy Department's *The War of the Rebellion; A Compilation of the Official Records of the Union and Confederate Navies* (Washington, DC: 1874-1922; reprinted Harrisburg, 1971 and 1985). These multivolume works contain reports of operations and other official correspondence.

#### U. S. Colored Heavy Artillery

**1st Heavy Artillery:** This regiment was organized at Knoxville, TN, between February and November 1864. It served in Knoxville, eastern Tennessee, western Virginia, northern Alabama, and western North Carolina. It was mustered out on March 31, 1866.

**2d Heavy Artillery:** This regiment was changed from the 2d Heavy Artillery to the 3d Heavy Artillery on April 26, 1864, and the compiled military service records appear there.

**3d Heavy Artillery:** Organized as the 1st Tennessee Heavy Artillery (African descent) at Memphis and Fort Pickering, TN, from June 5 to December 22, 1863, this regiment's designation was changed to the 3d United States Colored Heavy Artillery in April 1864. It served garrison duty at Fort Pickering and in defense of Memphis, TN. The unit mustered out on April 30, 1866.

**4th Heavy Artillery:** This unit was organized as the 2d Regiment Tennessee Heavy Artillery (African descent) from June 1863 until April 1864. It became the 4th United States Colored Heavy Artillery in April 1864. It served at Fort Halleck; Columbus, KY; and Union City, TN. The regiment had duty near Fort Donelson, TN, and moved to Pine Bluff, AR, where it was mustered out on February 25, 1866.

**5th Heavy Artillery:** This regiment was organized at Vicksburg, MS, between August 1863 and January 1864, as the 9th Louisiana Volunteers (African descent). Its designation was changed to the 5th Heavy Artillery in April 1864. The unit served garrison duty at Vicksburg, MS, and was mustered out on May 20, 1866.

**6th Heavy Artillery:** This regiment was organized as the 2d Mississippi Heavy Artillery (African descent) at Natchez, MS, from September 1863 to January 1864. It was changed to the 6th United States Colored Heavy Artillery on April 26, 1864. The unit served at Natchez, Mississippi, and Vidalia, LA. It was mustered out on May 18, 1866.

**7th Heavy Artillery:** The 7th Heavy Artillery was designated the 11th United States Colored Infantry (New) on January 23, 1865, and the compiled military service records appear there.

**8th Heavy Artillery:** This regiment was organized at Paducah, KY, from April to October 1864. It served garrison duty at Paducah and was mustered out on February 10, 1866.

**9th Heavy Artillery:** This regiment consisted of four companies and was organized at Clarksville and Nashville, TN, during October 1864. It was mustered out on May 5, 1865.

**10th Heavy Artillery:** Organization of this regiment at New Orleans, LA, began in November 1862. First designated the 1st Louisiana Heavy Artillery (African descent) in November 1863, it became the 1st Regiment Corps d'Afrique. In May 1864 the unit became the 10th United States Colored Heavy Artillery. The regiment was on garrison duty at New Orleans during its entire service. It served longer than any other USCT regiment, mustering out on February 22, 1867.

**11th Heavy Artillery:** This regiment was organized at Providence, RI, from August 1863 through January 1864, as the 14th Rhode Island Colored Heavy Artillery. In May 1864 it became the 11th United States Colored Heavy Artillery. The unit served garrison duty at New Orleans, LA, and was mustered out on October 2, 1865.

**12th Heavy Artillery:** This regiment was organized at Camp Nelson, KY, from July 1864 through July 1865. It served garrison duty at Camp Nelson, Bowling Green, and other points in the District of Kentucky. It was mustered out on April 24, 1866.

**13th Heavy Artillery:** This regiment was organized at Camp Nelson, KY, in June 1865, where it served garrison duty. It also served at Smithland and Lexington, KY. It was mustered out on November 18, 1865.

**14th Heavy Artillery:** This regiment was organized at New Bern and Morehead City, NC, from March 1864 to April 1865, as the 1st North Carolina Colored Heavy Artillery. It became the 14th United States Colored Heavy Artillery in March 1865. The unit served garrison duty at New Bern, NC, and was mustered out on December 11, 1865.

#### U. S. Colored Light Artillery

The 1st Regiment Light Artillery was recruited and organized under Maj. Gen. Benjamin F. Butler in December 1863. In February 1864 it was changed to Battery B of the 2d Light Artillery.

The 2d Regiment Light Artillery consisted of nine batteries, A through I, that were independently organized and deployed.

Battery A was organized at Nashville, TN, in April 1864. The battery served garrison duty at Nashville and participated in the Battle of Nashville December 15-16, 1864. It was mustered out January 13, 1866.

Battery B was organized at Fort Monroe, VA, in January and February 1864. It operated in Virginia and participated in the siege against Petersburg and Richmond. The battery was ordered to Texas in May 1865, and mustered out March 17, 1866.

Battery C was organized at Hebron's Plantation, MS, in November 1863, as the 1st Battery Louisiana Light Artillery (African descent). It was designated Battery C in April 1864. The battery had garrison duty at Goodrich Landing, Vicksburg, and Milliken's Bend. It was mustered out December 28, 1865.

Battery D was organized at Black River Bridge, MS, in December 1863, as the 2d Battery Louisiana Light Artillery (African descent). It was designated Battery D in April 1864. The battery had garrison duty at Goodrich Landing and Vicksburg, MS, and was mustered out on December 28, 1865.

Battery E was organized at Helena, AR, in December 1863, as the 3d Battery Louisiana Light Artillery (African descent). It was designated Battery E in April 1864. The battery had garrison duty at Helena, AR, and was mustered out on September 26, 1865.

Battery F was organized at Memphis, TN, in November 1863, as the Memphis Light Battery. It was designated Battery F in April 1864. The battery had garrison duty at Memphis, TN, until April 1865, when it moved to Bridgeport, AL. It was mustered out on December 28, 1865.

Battery G was organized at Hilton Head, SC, in May 1864 and had garrison duty at Hilton Head for its entire term. The battery was mustered out on August 12, 1865.

Battery H was organized at Pine Bluff, AR, in June 1864, as the 1st Arkansas Colored Battery. It was designated as Battery H in December 1864. The battery had garrison duty at Pine Bluff the entire term and was mustered out on September 14, 1865.

Battery I was organized at Memphis, TN, in April 1864. The battery had garrison duty at Memphis, TN, and operations in Mississippi. It was mustered out on January 10, 1866.

Independent Battery was organized at Leavenworth, KS, in December 1864. It had duty at Fort Leavenworth until it was mustered out on July 22, 1865.

#### Records Description

Compiled service records consist of a jacket-envelope for each soldier, labeled with his name, rank, unit, and card numbers. The compilation of service records of Union soldiers began in 1890 under the direction of Col. Fred C. Ainsworth, head of the Record and Pension Office of the Adjutant General's Office, Department of War. Information from muster rolls, regimental returns, descriptive books, and other records was copied verbatim onto cards. A separate card was prepared each time an individual name appeared on a document. These cards were numbered on the back, and these numbers were entered onto the outside jacket containing the cards. The carded information was verified by a separated operation of comparison; great care was taken to ensure that the cards were accurate.

A typical jacket contains card abstracts of entries found in original records relating to the soldier and original documents relating solely to that soldier. Examples of the latter include enlistment papers, substitute certificates, casualty sheets, death reports, prisoner-of-war memorandums, and correspondence. Unique to the records of the USCT are deeds of manumission, oaths of allegiance, proof of ownership, certificates of monetary award, and bills of sale. These items appear most frequently in units recruited in the border states of Kentucky, Missouri, and Maryland. These states remained in the Union but were slave states. Jackets and

cards include a section labeled "bookmark" which was reserved for cross-references to other records relating to the individual or his unit. The service records are arranged by arm of service, thereunder numerically by regiment or independent battalion or company, and thereunder alphabetically by name of the soldier. Records for officers are interfiled alphabetically by name with the records of enlisted men. If an individual served in more than one unit, which was typical for USCT officers, there will be a separate service record for each unit in which he served.

The unjacketed miscellaneous cards were accumulated by the War Department with the expectation that they would be incorporated in individual compiled service records. However, the expectation was never fulfilled, because either insufficient or contradictory information made it impossible to associate the cards or papers with a particular soldier's service records.

#### Related Records

Among the records of the Adjutant General's Office in the National Archives are many of the original records that were abstracted or "carded" by the Record and Pension Office. These include the individual unit's muster rolls, returns and descriptive books. Other series in RG 94 that contain information relating to volunteer Union soldiers who served with the USCT include carded records relating to Union staff officers, carded medical records of volunteer Union soldiers, unbound and bound regimental records and "record of events" cards. The regimental records of the 54th Massachusetts Infantry (Colored) have been reproduced as Microfilm Publication M1659, *Records of the Fifty-fourth Massachusetts Infantry Regiment (Colored), 1863-1865*.

The "record of events" cards include information copied from the unit's muster rolls and returns. They show the stations of the field and staff and those of the various companies of the regiment at the time the muster roll or return was prepared and sometimes mention battles, skirmishes, or other activities in which the regiment participated. The cards have been reproduced as Microfilm Publication M594, *Compiled Records Showing Service of Military Units in Volunteer Union Organizations*.

Record Group 94 also includes a card index for the USCT, reproduced as Microfilm Publication M589, *Index to Compiled Military Service Records of Volunteer Union Soldiers Who Served with U.S. Colored Troops*, which may be used to locate the regiment of USCT personnel. An index card gives the name of the soldier and his rank, as well as the unit in which he served; sometimes there is a cross-reference to his service in other units or organizations. The National Archives is continually producing microfilm publications of volunteer Union compiled military service records. A complete listing of finished publications can be found in the National Archives *Microfilm Resources for Research: A Comprehensive Catalog* which is available online at <http://www.nara.gov>.

## NATIONAL ARCHIVES MICROFILM PUBLICATIONS

The Records of the Colored Troops Division, within RG 94, include division correspondence and records relating to recruiting, the appointment of officers, and the slave or free status of individuals; and a compilation of historical extracts and official papers concerning the military service of African Americans from the colonial period through the Civil War entitled *The Negro in the Military Service of the United States 1639-1886*. This compilation is reproduced as Microfilm Publication M858. The Records of the Bounty and Claims Division, also in RG 94, include correspondence of the division and records relating to bounties and claims paid to loyal owners of slaves by the Slave Claims Commissions of Delaware, Kentucky, Maryland, Missouri, Tennessee, and West Virginia.

If an application for a pension was made, the pension application case file may be among the Records of the Veterans Administration (RG 15). Indexes to the pension applications have been reproduced as Microfilm Publication T288, *General Index to Pension Files, 1861-1934*, and T289, *Organizational Index to Pension Files of Veterans Who Served Between 1861 and 1900*.

If a soldier or officer was tried before a general court-martial or if an individual or his unit was the subject of a court of inquiry or military commission, transcripts of the proceedings may be among the Records of the Office of the Judge Advocate General (Army) (RG 153). The registers to the proceedings have been reproduced as Microfilm Publication M1105, *Registers of the Records of the Proceedings of the U.S. Army General Courts-Martial, 1809-1890*.

Other record groups having information pertaining to the USCT include Records of the Bureau of Refugees, Freedmen, and Abandoned Lands (RG 105); Records of the Provost Marshal General's Bureau (Civil War) (RG 110); Records of the Accounting Officers of the Department of the Treasury (RG 217); and Records of U.S. Army Continental Commands, 1821-1920 (RG 393).

NATIONAL ARCHIVES MICROFILM PUBLICATIONS

Roll list

Roll    Description

1st United States Colored Heavy Artillery

- 1      Ackerson, David - Baker, Barney
- 2      Baker, George - Bogle, Harry
- 3      Bolden, Joseph - Brown, Edwin G.
- 4      Brown, George - Carmack, Bachus
- 5      Carmack, Gilbert - Cleveland, Loudon
- 6      Clevenger, Charles - Cune, John C.
- 7      Curd, George - Eblin, Richard
- 8      Eckles, Silas - Furbush, Lewis
- 9      Gaines, George - Greenleaf, Andrew
- 10     Greenleaf, Julius - Hart, Benjamin
- 11     Hartman, Henry - Hoff, David
- 12     Holland, John - Jackson, Thomas J.
- 13     Jackson, Washington - Jones, James
- 14     Jones, John - Ledgewood, Clayborne
- 15     Lee, Elhanon - Martin, Robert
- 16     Mason, Henry - McKenney, Elijah
- 17     McKinney, Lewis - Montcastle, Stewart
- 18     Montgomery, Alfred - Owens, Benjamin
- 19     Owens, Granville - Ragan, Nelson
- 20     Ragan, Rome - Russell, Orlando A.
- 21     Russell, Perry - Smith, Archie
- 22     Smith, Bart - Suddles, Robert
- 23     Summers, Joseph D. - Turner, Charles
- 24     Turner, Henry - Weir, Richard
- 25     Weir, Robert - Willis, Albert
- 26     Willis, Beverly S. - Zimmerman, William

3d United States Colored Heavy Artillery

- 27     Abel, William - Armour, Lewis
- 28     Armstaed, William - Beaufort, Thomas
- 29     Beaumont, Henry - Bowler, Lafayette P.
- 30     Bowman, Fleming - Brummer, John E.
- 31     Bryan, Solon - Carter, William
- 32     Cartman, John - Cook, Isham
- 33     Cook, John - Davis, Doctor
- 34     Davis, George - Easen, Samuel
- 35     Easley, Wesley - Flinn, Clay
- 36     Flint, James - Gilbreth, Eli

NATIONAL ARCHIVES MICROFILM PUBLICATIONS

Roll	Description
37	Gilbreth, Guy - Griffin, Samuel
38	Griffin, William - Harrison, James
39	Harrison, James C. - Hicks, Smith
40	Higginbottom, Nimrod - Hunt, Rubin
41	Hunt, William - Johnson, Charles
42	Johnson, Crawford - Jones, Isaac
43	Jones, Isam - Knight, Warren
44	Knox, Overton - Mabin, Baker
45	Mabin, James - McDonald, Manuel
46	McDonald, Ruben - Mills, Robert
47	Milroy, John - Nealy, Henry
48	Ned, Lewis - Patterson, Pembroke J. (Perin J.)
49	Patton, Richmond - Powers, William
50	Prewitt, Greene - Roberts, Lewis
51	Robinette, Henry - Scott, Edmond
52	Scott, Elijah - Smith, Peter
53	Smith, Randall - Tapscott, Julius
54	Tarwater, Jesse - Todd, William
55	Todd, Willis - Wallace, Robert
56	Wallace, Sandford - Wells, Duncan
57	Wells, Joseph - Williams, Guyo
58	Williams, George - Wolbrecht, Adolf
59	Wood, Charles - Young, William H.

4th United States Colored Heavy Artillery

60	Abbott, John - Barnes, Samuel
61	Barnes, Thomas - Britt, Jackson
62	Britten, Charles - Clark, Mitchell
63	Clay, Henry - Daniel, Richard
64	Daniels, William - Dyson, Jack
65	Dyson, Paul - Gardner, Riley
66	Gardner, Washington - Hall, Henry
67	Hall, Jack - Horton, Mack
68	Horton, William - Jones, Levi
69	Jones, Louis - Lewis, Stephen
70	Lewis, Thomas - McMurray, Anderson (John)
71	McMurray, George - Need, Benjamin
72	Nelson, John - Prior, Alfred
73	Prior, Gabriel - Rutland, Isaac
74	Ruttkay, Albert - Smith, Louis
75	Smith, Samuel - Turner, Frank
76	Turner, James - White, Henry
77	White, Raven - Youngs, William



NATIONAL ARCHIVES MICROFILM PUBLICATIONS

Roll Description

5th United States Colored Heavy Artillery

78 Abbott, Richard - Armstrong, William  
 79 Arrindale, John B. - Bentley, Francis A.  
 80 Bentley, Isam - Brooks, Lawyer  
 81 Brooks, Robert - Cabin, Henry  
 82 Cabin, Shadrick - Coleman, Nathan  
 83 Coleman, William - Davidson, Ellis  
 84 Davis, Alfred - Dodd, Taylor  
 85 Dodds, Peter - Feltis, Jackson  
 86 Felton, Martin - Gilford, Charles  
 87 Gillespie, Gilbert - Hagan, Alex  
 88 Hagans, Joseph - Hayes, John S.  
 89 Haythorn, Henry - Hood, John  
 90 Hooker, William - James, Warren  
 91 January, Nathan - Johnson, Wiley  
 92 Johnson, William - Kindley, Edward  
 93 King, Elijah - Lewis, Ely J.  
 94 Lewis, George W. - Manitoie, Samuel  
 95 Manly, Elisha - McNeil, William  
 96 McQuilley, Clayton - Mosley, Jacob  
 97 Moss, Alfred - Parker, James  
 98 Parker, John H. - Powell, Monroe  
 99 Power, Henry - Roach, Watt  
 100 Robb, Benjamin - Shaw, Barrow  
 101 Shaw, James - Smith, Robert  
 102 Smith, Samuel - Tate, John  
 103 Taylor, Anderson - Trueman, Henry  
 104 Truman, Nelson - Ward, George  
 105 Ward, Jacob - West, Moses  
 106 Westbrook, Ellick - Williams, John B.  
 107 Williams, Jordan - Wood, Theodore  
 108 Woodam, Henry - Young, William  
 Miscellaneous Service Cards  
 Allen, Geo. - Young, L.

6th United States Colored Heavy Artillery

109 Aaron, William - Barton, Granderson  
 110 Baseman, Jerry - Bracton, John  
 111 Bradford, Henry - Bush, Wilson  
 112 Bustis, Mondey - Clay, Henry  
 113 Clay, William - Davenport, William  
 114 Davenport, Wilson - Dunbar, Newton

NATIONAL ARCHIVES MICROFILM PUBLICATIONS

Roll	Description
115	Dunbow, Hannibal - Fox, William
116	Francis, James - Green, George
117	Green, James - Harris, Hiram
118	Harris, John - Hopper, Anthony
119	Hopper, Handy - James, Joseph
120	Jasper, Samuel - Jones, John
121	Jones, Jonas - Leavitt, Charles B.
122	Lee, David - McBride, Samuel
123	McCabe, Alexander H. - Moore, Joseph
124	Moore, Manual - Owens, Willis
125	Page, Benjamin - Reece, Edward
126	Reese, William - Samuel, William
127	Sanders, Archibald - Smart, Robert
128	Smith, Aaron - Suzette, Armstead
129	Swanson, Jack - Trotter, George
130	Troyman, George - Waters, Robert
131	Waters, Wesley - Williams, Bedney
132	Williams, Benjamin - Wilson, George
133	Wilson, Guy - Young, Wesley
	Miscellaneous Service Cards
	Adams, Winder - Williams, John

8th United States Colored Heavy Artillery

134	Abanather, Paten - Beasley, George W.
135	Beasley, Washington - Boyd, Isaac
136	Boyd, Paine - Burrill, George
137	Burris, Abram - Cofield, Henry
138	Cofield, Isaac - Davis, George
139	Davis, Jerry - Edwards, Frank
140	Edwards, Gus - Ginigan, Thomas
141	Givens, George - Hampton, Phillip
142	Hancock, James - Hodge, Cotney
143	Hodge, Gaines - Johnson, Charles
144	Johnson, Clinton - Lee, Wash
145	Leeper, Thomas - Maxwell, Henry
146	Maxwell, Samuel - Moore, Amos
147	Moore, David - Pearson, Alexander
148	Pearson, Charley - Rice, Pleasant
149	Rice, Taylor - Sherrer, Elick
150	Shirles, James - Talbot, Henry
151	Talley, William - Turner, Robert
152	Tyler, Jerry - Williams, John
153	Williams, Sam - Young, William

NATIONAL ARCHIVES MICROFILM PUBLICATIONS

Roll	Description
	9th United States Colored Heavy Artillery
154	Ailer, John - Coleman, Miles
155	Collins, Moses A. - Grosskopff, Edward
156	Grubb, Andrew - Landon, Harry
157	Lanier, Jesse - Payne, George
158	Payne, James - Tory, Madison
159	Toryand, Emanuel - Young, George
	10th United States Colored Heavy Artillery
160	Aaron, Benjamin - Auguste, Daniel
161	Augustus, Edward - Benson, George
162	Bentley, William H. - Brooks, Walker
163	Brooks, Washington - Camel, Paul
164	Cameron, Henry - Coleman, James
165	Coleman, John - Deale, Joseph
166	Deale, Thomas - Ellis, Robert
167	Ellis, Silas - Frederick, Joseph
168	Freeland, Martin A. - Grandison, Alfred
169	Grant, Moses - Harrison, Logan
170	Harrison, Thomas - Hoyt, Joseph
171	Hubbard, Henry - Jenkins, Solomon
172	Jennings, Caleb - Jozen, Jules
173	Julia, Nora - Libscomb, George
174	Lightfoot, Columbus - Maryday, John
175	Masdael, Noel - Misker, Robert
176	Mitchel, Alexander - Oldham, George B.
177	Oliver, Emile - Purnell, John
178	Putnam, Winthrop D. - Robinson, Henry
179	Robinson, Isaac - Simmons, Owen
180	Simms, Amos - Spencer, John
181	Spriggs, Thomas - Thornton, John
182	Thurston, Charles - Warner, Dudley
183	Warner, George E. - Wesley, John
184	West, Alexander - Willis, Stephen
185	Willson, George - Zozey, Jules
	Miscellaneous Service Cards
	Cann, Mercer - Grayson, John W.
186	Miscellaneous Service Cards
	Green, Andrew P. - Rygaard, Soren
187	Miscellaneous Service Cards
	Sabatier, Peter - Zevenette, Paul

NATIONAL ARCHIVES MICROFILM PUBLICATIONS

Roll	Description
	<b>11th United States Colored Heavy Artillery</b>
188	Abbott, George M. - Bailey, James A.
189	Baird, Sylvester - Boardley, James
190	Boardley, John W. - Brown, Nathan
191	Brown, Samuel - Carter, William H.
192	Cartright, George W. - Commings, Hugh S.
193	Comstock, Joseph J. - Davis, Lyman
194	Davis, Stephen - Dubois, James
195	Duesenbury, Lewis - Fletcher, Roderick S.
196	Fletcher, Samuel - Garrison, John
197	Gaskell, George L. - Groff, Joseph
198	Guard, Andrew - Hector, William H.
199	Heelms, Harkness - Howard, Richard
200	Howard, Thomas - Jackson, Lewis
201	Jackson, Norton - Johnson, Joseph W.
202	Johnson, Nathan - King, Cornelius
203	King, George - Loucks, John A.
204	Low, Charles H. - Miller, Benjamin
205	Miller, Floyd N. - Nicholas, Samuel
206	Nichols, Alfred - Pierce, George W.
207	Pierce, John B. - Reed, Washington
208	Reese, Edward - Sampson, William H.
209	Sanders, Edward - Skanks, James S.
210	Skanks, Thomas C. - Sommerset, Levi
211	Southwick, Henry K. - Taylor, Alfred M.
212	Taylor, Charles - Townsend, John
213	Tracy, John - Warren, John
214	Washington, George - Whiting, Joseph C., Jr.
215	Wigden, Cyrus B. - Wilson, Samuel
216	Wilson, William - Young, Francis
	Miscellaneous Service Cards
	Abbot, George W. - Dyer, William S.
217	Miscellaneous Service Cards
	Earl, Peter - Young, William H.
	<b>12th United States Colored Heavy Artillery</b>
218	Abbott, John - Barbee, Squire
219	Barber, Sherwood - Boller, Jerry
220	Bolor, Collins - Bryant, Frederick
221	Bryant, Henry - Bush, Reason
222	Butler, Aaron - Clark, Richard
223	Clark, Samuel - Criffield, Lewis

NATIONAL ARCHIVES MICROFILM PUBLICATIONS

Roll	Description
224	Christopher, James - Dock, Calvin E.
225	Dodge, Henry - Farnesley, Jack
226	Farrus, Ephraim - Gaves, David
227	Gentry, George - Haggin, George
228	Haggin, Samuel - Hawkins, Robert
229	Hawkins, Thomas - Hode, Adam
230	Hodge, Charles - Jackson, Andrew
231	Jackson, Augustus - Jopee, Joseph
232	Juda, Enoch - Lewis, Windsor
233	Lidick, Randall - Maton, Levi
234	Matthews, Charles W. - Mitchell, John
235	Mitchell, Monroe - Nelson, Joseph
236	Nesbin, William - Porter, Daniel
237	Porter, William R. - Richason, Shelly
238	Richie, George - Scott, Smith
239	Scott, Stephen - Smith, Leroy
240	Smith, Lyman - Taylor, Charles
241	Taylor, Cornelius - Turner, David
242	Turner, George - Warren, James
243	Washington, Anthony - Williams, Berry
244	Williams, Charles - Woodson, David
245	Woodson, Egbert - Young, Thomas
	Miscellaneous Service Cards
	Baughman, John - Heel, Rubin
246	Miscellaneous Service Cards
	Helm, Harry - Young, Stephen
	 13th United States Colored Heavy Artillery
247	Abbott, Josiah - Bell, Augustine
248	Bell, Charles - Brown, Jesse
249	Brown, Lindsay - Connor, Cyrus
250	Connor, Isaac - Dyre, George
251	Early, Edward - Ginn, Samuel
252	Ginnis, Sidney Clay - Heath, Henry
253	Heath, Lewis - Jarrett, Charles
254	Jay, Johnson - Lee, William
255	Lender, Richard - McKinney, Cass
256	McKinney, Henry Clay - Owens, Robert
257	Owens, Smith - Randolph, Loyd
258	Rankins, Archibald - Scott, Jerry
259	Scott, John - Sugg, Edmond
260	Suiter, Jacob A. - Waddie, Harry
261	Waddy, Peter - Willett, Price

NATIONAL ARCHIVES MICROFILM PUBLICATIONS

Roll	Description
262	Willett, Robert - Young, William
263	Miscellaneous Service Cards Abbott, Josiah - Yumber, Anthony
<b>14th United States Colored Heavy Artillery</b>	
264	Acot, Isaac - Becton, Henry
265	Becton, Moses - Burke, George W.
266	Burke, William A. - Davis, Toney
267	Dean, Thomas - Fullford, William
268	Fulton, James - Hardy, William
269	Harget, Israel - Hovey, William
270	Howard, Calvin - Kensley, Silas
271	Kent, Henry - McKeever, Simon
272	McMichael, Joseph - Noble, William
273	Nobles, Charles - Randall, Evans
274	Randall, Willey - Shark, Bryant
275	Sheckelford, Daniel - Smith, Samuel
276	Smith, Sterling - Thompson, John Henry
277	Thompson, Mark - Weeks, Ezekiel
278	Weidman, Albert - Wilson, Payton
279	Wilson, Richard - Young, William
	Miscellaneous Service Cards Acott, Isaac - Young, William

**2d Regiment United States Colored Light Artillery**

280	Able, John - Bernard, Albert
281	Berry, Henry - Brown, Sang
282	Brown, Thomas - Clark, William
283	Clay, Henry - Disen, Henry
284	Disen, Watkins - Francis, Henry
285	Franklin, Albert - Haines, Roe
286	Haines, Thomas - Hunt, Thomas
287	Hunter, Alexander M. - Kennedy, Abram
288	Kennel, George - March, George
289	Marcy, Anthony - Mobbs, Daniel
290	Moffet, John - Pattiller, Alfred
291	Pattiller, Patrick - Richardson, Jacob
292	Ridgeway, Anthony - Smith, Louis B.
293	Smith, Minus - Tucker, Alfred

NATIONAL ARCHIVES MICROFILM PUBLICATIONS

Roll	Description
294	Tucker, Sandy - Williams, Calvin
295	Williams, Charles - Zinum, John
296	Miscellaneous Service Cards Abraham, Francis - Young, Ruben

Independent Battery, United States Colored Light Artillery

297	Alexander, John - Hancock, George W.
298	Hanson, Noah C. - Scott, Andrew
299	Scott, Reynolds - Yeager, John Miscellaneous Service Cards Douglass, H. Ford - Minor, P.M.

NATIONAL ARCHIVES MICROFILM PUBLICATIONS

Microfilm Publication M1818

COMPILED MILITARY SERVICE RECORDS OF VOLUNTEER UNION  
SOLDIERS WHO SERVED WITH THE UNITED STATES COLORED  
TROOPS: Artillery Organizations

Roll 173

10th United States Colored Heavy Artillery

Julia, Nora - Libscomb, George

NATIONAL ARCHIVES AND RECORDS ADMINISTRATION



1491

Julia Mora

Co E, 10 U.S. Col'd H. Art'y

Private

Private

CARD NUMBERS.

1	5497612	26
2	5497856	27
3	5498076	28
4		29
5		30
6		31
7		32
8		33
9		34
10		35
11		36
12		37
13		38
14		39
15		40
16		41
17		42
18		43
19		44
20		45
21		46
22		47
23		48
24		49
25		50

Book Mark: A 33: F. 42 R 69. 67.

See also

*S* | 10 H. Art'y. | U.S.C.T.

*Nora Julia*  
*Pt*, Co. C, 1 Reg't H. Art'y, Corps d'Afrique.\*

Age *25* years.

Appears on

**Company Muster-in Roll**

of the organization named above. Roll dated

*New Orleans La, Aug 17, 1863.*

Muster-in to date *Aug 17, 1863.*

Joined for duty and enrolled:

When *July 1, 1863.*

Where *Camp Parapet La*

Period *3* years.

Valuation of horse, \$.....100

Valuation of horse equipments, \$.....100

Remarks:.....

.....

.....

.....

\* This organization subsequently became Co. C, 10 Reg't U. S. Colored Heavy Artillery.

Book mark:.....

*W. S. Suman*

*J* | 10 H. Art'y. | U.S.C.T.

*Nora Julia*  
*Pvt.*, Co, C, 1 Reg't La. Art'y Native Guards.\*

Appears on

**Company Muster Roll**

for *Aug 11<sup>th</sup> to 31<sup>st</sup>*, 1863

Present or absent *Present*

Stoppage, \$ 100 for

Due Gov't, \$ 100 for

Valuation of horse, \$ 100

Valuation of horse equipments, \$ 100

Remarks :

\* This organization subsequently became Co. C, 10 Reg't U. S. Col'd Heavy Artillery.

Book mark :

*S* | 10 H. Art'y. | U.S.C.T.

*Nora Julia*  
*Pt*, Co, C, 1 Reg't La. Art'y Native Guards.\*

Appears on

**Company Muster Roll**

for *Sept* and *Oct*, 1863.

Present or absent

Stoppage, \$ 100 for

Due Gov't, \$ 100 for

Valuation of horse, \$ 100

Valuation of horse equipments, \$ 100

Remarks: *deserted Sept 21. 1863 and took away his arms accoutrements and clothing*

*Not done on sub. roll.*

\* This organization subsequently became Co. C, 10 Reg't U. S. Col'd Heavy Artillery.

Book mark: *A. 33. 14. R. 67. 67.*

1492  
Julien Charles  
Co & , 10 U.S. Col'd H. Art'y.

Private | Private

CARD NUMBERS.

1	5488493	26
2	5511539	27
3	5511672	28
4	5511786	29
5	5511925	30
6	3512131	31
7		32
8		33
9		34
10		35
11		36
12		37
13		38
14		39
15		40
16		41
17		42
18		43
19		44
20		45
21		46
22		47
23		48
24		49
25		50

Book Mark

See also 74 WSCJ

R+P 336930

S. 740499 RAAH

R+P 360397

S. 878644 - P. O. Omit

S-967819 - P.O. Ret. P.O.

S. 2214734 and wd

*W. H. H.*

10th U.S.C.T.

Charles Julien  
Inf, Co., 10 Reg't J. S. Col'd Artz

Appears on

**M. and D. Roll of Men Transferred**

to the organization named above,

from Co "C" 7th U.S. C. Inf.

Roll dated New Orleans, La. Oct 11, 1863

When enlisted June 16, 1863

Period for which enlisted 3 years.

When mustered in June 30, 1863

Present or absent

Company to which assigned

Remarks: Joined orig. Organ.  
as recruit Co "H" La  
M.I. (7th U.S.C.I.) Trans-  
ferred to Co "E" 20 Inf.  
Cal. (91 U.S.C.I.). Re-  
transferred to Co "C"  
7th U.S.C.I. July 20'th  
per G. O. No 17 Adyres  
(ack)

Book mark :

J. W. Jones, Jr  
Copyist.

*J.* | **10 H. Art'y.** | **U.S.C.T.**

*Charles Julien*

*Priv.*, Co. I, 10 Reg't U. S. Col'd H. Art'y.

Appears on

**Company Muster Roll**

for *Nov. & Dec.*, 1865.

Present or absent *Present*

Stoppage, \$ *100* for

Due Gov't, \$ *100* for

Valuation of horse, \$ *100*

Valuation of horse equipments, \$ *100*

Remarks: *Transferred from  
74 U.S.C. per L.O. no. 84  
Hd. qrs. Dept. of La.  
Oct. 11, 1865.*

**FROM SECOND AUDITOR'S ROLL.**

Book mark:

*O. S. Clark*



*J.* | **10 H. Art'y.** | **U.S.C.T.**

*Charles Julien*

*Pvt.*, Co. **I**, 10 Reg't U. S. Col'd H. Art'y.

Appears on

**Company Muster Roll**

for *Jan. & Feb.*, 1866.

Present or absent *Present*

Stoppage, \$ *100* for

Due Gov't, \$ *100* for

Valuation of horse, \$ *100*

Valuation of horse equipments, \$ *100*

Remarks:

Book mark:

*O. S. Belask*

*J.* | **10 H. Art'y. U.S.C.T.**

*Charles Julien*  
-----  
*Priv. I.*, Co. ...., 10 Reg't U. S. Col'd H. Art'y.

Appears on **Co. Muster-out Roll**, dated  
*Baton Rouge La, Feb 22*, 186*7*.

Muster-out to date ....., 186 .

Last paid to ....., 186 .

Clothing account:

Last settled ....., 186 ; drawn since \$.....100

Due soldier \$.....100; due U. S. \$.....100

Am't for cloth'g in kind or money adv'd \$.....100

Due U. S. for arms, equipments, &c., \$.....100

Bounty paid \$.....100; due \$.....100

Remarks: *Discharged expiration*  
*term of service June 15, 1866*

Book mark: *127 P 89. 68*

*J. M. Hance*  
-----  
(361) Copyist.

*J.* | 10 H. Art'y. | U.S.C.T.

*Charles Julian*  
*Pvt.*, Co. I, 10 Reg't U. S. Col'd H. Art'y.

Appears on

**Company Muster Roll**

for *Nov. + Apr.*, 1866.

Present or absent *Present*

Stoppage, \$ 100 for

Due Gov't, \$ 100 for

Valuation of horse, \$ 100

Valuation of horse equipments, \$ 100

Remarks:

Book mark: *Muster out on file.*

*O. S. Clark*

*J.* | 10 H. Art'y. | U.S.C.T.

*Charles Julien*  
Pvt., Co. I, 10 Reg't U. S. Col'd H. Art'y.

Appears on

**Company Muster Roll**

for *May & June*, 1866.

Present or absent

Stoppage, \$ 100 for

Due Gov't, \$ 100 for

Valuation of horse, \$ 100

Valuation of horse equipments, \$ 100

Remarks: *Discharged.*  
*Mustered out by*  
*reason of expir-*  
*ation of term of*  
*service to date June*  
*15, 1866.*

Book mark:

*O. S. Clark*

Co

S.C.T.

6

tion

1

P'd H. Art'y.

2

3

Bill

4

1866.

5

6

7

8

9

10

11

12

13

14

100

15

16

17

18

19

20

21

22

23

24

25

26

27

28

29

30

and by  
of  
me

Copyist.

**10 H. Art'y. U.S.C.T.**

*J.*  
*Charles Julien*  
Pvt., Co. *I*, 10 Reg't U. S. Col'd H. Art'y.

Appears on **Co. Muster-out Roll**, dated  
*Baton Rouge La, Feb 22*, 1867.  
Muster-out to date \_\_\_\_\_, 186 .  
Last paid to \_\_\_\_\_, 186 .

Clothing account:

Last settled \_\_\_\_\_, 186 ; drawn since \$ \_\_\_\_\_ 100  
Due soldier \$ \_\_\_\_\_ 100; due U. S. \$ \_\_\_\_\_ 100  
Am't for cloth'g in kind or money adv'd \$ \_\_\_\_\_ 100

Due U. S. for arms, equipments, &c., \$ \_\_\_\_\_ 100

Bounty paid \$ \_\_\_\_\_ 100; due \$ \_\_\_\_\_ 100

Remarks: *Discharged, expiration*  
*term of service June 15, 1866*

Book mark: *127 P. 89. 68*

(361)

*J. M. Vance*

Copyist.

1493

Juliat Laventine

Co I, 10 U.S. Col'd H. Art'y.

Private Private

CARD NUMBERS.

1	5511233	26
2	5512199	27
3		28
4		29
5		30
6		31
7		32
8		33
9		34
10		35
11		36
12		37
13		38
14		39
15		40
16		41
17		42
18		43
19		44
20		45
21		46
22		47
23		48
24		49
25		50

Book Mark:

See also

10 H. Art'y. U.S.C.T.

*J. Leonine Jalot*  
Cpt., Co. D, 10 Reg't U. S. Col'd H. Art'y.

Age . . . . . years.

Appears on

**Company Muster Roll\***

for *Enrollment to June 30*, 1865.

Joined for duty and enrolled:

When . . . . ., 186 .

Where . . . . .

Period . . . / . . . years.

Mustered in:

When *Apr. 28*, 1865.

Where *New Orleans, La.*

Present or absent . . . . .

Stoppage, \$ . . . . . 100 for . . . . .

Due Gov't, \$ . . . . . 100 for . . . . .

Valuation of horse, \$ . . . . . 100

Valuation of horse equipments, \$ . . . . . 100

Remarks: *Drafted. De-*  
*serted to a hospital*

\*First current roll. No muster-in roll of this company on file.

Book mark : . . . . .

(358b)

*J. H. Clark*  
Copyist.



*J* | **10 H. Art'y. U.S.C.T.**

*Leverine Julian*  
*Pvt*, Co. ...., 10 Reg't U. S. Col'd H. Art'y.

Appears on **Co. Muster-out Roll**, dated  
*Baton Rouge La, Feb 22*, 186*7* .  
Muster-out to date ..... 186 .  
Last paid to *no pay* paid ..... 186 .

**Clothing account:**

Last settled ..... 186 ; drawn since \$ ..... 100  
Due soldier \$ ..... 100; due U. S. \$ *23* <sup>*28*</sup> 100  
Am't for cloth'g in kind or money adv'd \$ ..... 100

Due U. S. for arms, equipments, &c., \$ ..... 100

Bounty paid \$ ..... 100; due \$ ..... 100

Remarks: *Presented for Cert'n Gen*  
*Hospital New Orleans La*  
*May 13, 1865*

*age 20*

Book mark: .....

(361) *J. Mathews* Copyist.

JAN. 16

5511293

1891

*May 12, 1865.*

1494

Keathley, John

Co *A*, 10 U.S. Col'd H. Art'y.

Private

Private

CARD NUMBERS.

1	5500798	26
2	5501079	27
3	5501153	28
4	5501283	29
5	5501453	30
6	5487477	31
7	5503257	32
8		33
9		34
10		35
11		36
12		37
13		38
14		39
15		40
16		41
17		42
18		43
19		44
20		45
21		46
22		47
23		48
24		49
25		50

Book Mark: \_\_\_\_\_

See also \_\_\_\_\_

*K* | **10 H. Art'y.** | **U.S.C.T.**

*John Keathly*  
*Priv*, Co. D, 10 Reg't U. S. Col'd H. Art'y.

Appears on

**Company Muster Roll**

for *March & Apr*, 186*5*.

Present or absent *Present*

Stoppage, \$.....*100* for.....

Due Gov't, \$.....*100* for.....

Valuation of horse, \$.....*100*

Valuation of horse equipments, \$.....*100*

Remarks: *Assigned to 10 U.S. C.*  
*Arty (H) per S. O. No. 100, dated*  
*Ad Genl Mil. Div. West Miss.,*  
*New Orleans, La. Apr 10/65.*  
*No Descriptive List furnished.*

Book mark:.....

*Pattison*

*N* | **10 H. Art'y. | U.S.C.T.**

*John Keathley*  
*1st Lt*, Co. D, 10 Reg't U. S. Col'd H. Art'y.

Appears on

**Company Muster Roll**

for *May & June*, 186*5*.

Present or absent *Present*

Stoppage, \$ *100* for

Due Gov't, \$ *100* for

Valuation of horse, \$ *100*

Valuation of horse equipments, \$ *100*

Remarks: *Assigned to 10 U. S. C. A.*  
*(H) per S. O. No. 100, Hd Qrs. Mil.*  
*Air. West Miss. Apr. 10/65.*  
*No Description List furnished.*

Book mark: \_\_\_\_\_

*J. Patterson*  
Copyist.

*K* 10 H. Art'y. | U.S.C.T.

*John Keately*  
*Plt*, Co. D, 10 Reg't U. S. Col'd H. Art'y.

Appears on

**Company Muster Roll**

for *July & Aug*, 1865.

Present or absent *Present*

Stoppage, \$ *100* for

Due Gov't, \$ *100* for

Valuation of horse, \$ *100*

Valuation of horse equipments, \$ *100*

Remarks: *Pay due from Apr 10/65.*  
*date of assignment to the Regt.*

Book mark:

*Patterson*

*10* 10 H. Art'y. U.S.C.T.

*John Keathly*  
*Pr*, Co. D, 10 Reg't U. S. Col'd H. Art'y.

Appears on

**Company Muster Roll**

for *Sept & Oct*, 186*5*.

Present or absent *Present*

Stoppage, \$ *100* for

Due Gov't, \$ *100* for

Valuation of horse, \$ *100*

Valuation of horse equipments, \$ *100*

Remarks:

Book mark:

K | 10 H. Art'y. | U.S.C.T.

John Keathley  
Pvt, Co. D, 10 Reg't U. S. Col'd H. Art'y.

Appears on

Company Muster Roll

for Nov & Dec, 1865

Present or absent

Stoppage, \$ 100 for

Due Gov't, \$ 100 for

Valuation of horse, \$ 100

Valuation of horse equipments, \$ 100

Remarks: Discharged Nov 23, 65 by reason of expiration of term of service (Enrolled Nov. 17/64, at St. Charles, Mo, & mustered in Nov. 20/64, at Benton Barracks, Mo. for 1 yr.)

Book mark:

W. M. Sayre



*A. 10 Mo. Co.* **U.S.C.T.**

*John Hentley*  
Cvt., Co. D, 10 Reg't U. S. Col'd Mo. Ar.

Appears on a

**Detachment Muster-out Roll**

of the organization named above. Roll dated

*St. Louis, Mo., Nov. 14, 1865.*

Muster-out to date *Nov. 14, 1865.*

Last paid to *June 30, 1865.*

**Clothing account:**

Last settled \_\_\_\_\_, 1865; drawn since \$ \_\_\_\_\_ 100

Due soldier \$ *19* <sup>*14*</sup>/<sub>100</sub>; due U. S. \$ \_\_\_\_\_ 100

Am't for cloth'g in kind or money adv'd \$ \_\_\_\_\_ 100

Due U. S. for arms, equipments, &c., \$ \_\_\_\_\_ 100

Bounty paid \$ *33* <sup>*33*</sup>/<sub>100</sub> due \$ *66* <sup>*66*</sup>/<sub>100</sub>

Remarks: *This man was mustered into the service as private at St. Louis, Mo. and sent to Camp Distribution Mil Div. West. Miss at Cairo, Mo. assigned to the 10 Mo. Ar.*  
(over)

Book mark: \_\_\_\_\_

*Hentley*

Copyist.

JAN 15

5489477

1901

C. C. L. (No) by J. C. No. 100  
C. W. Med. Dep. Mill Div.  
of West. Min.

*A* 10 H. Art'y. **U.S.C.T.**

*John M. ...*  
*Co. ...*, 10 Reg't U. S. Col'd H. Art'y.

Appears on **Co. Muster-out Roll**, dated  
*Patrol ...*, 186*7*.

Muster-out to date \_\_\_\_\_, 186 .

Last paid to \_\_\_\_\_, 186 .

Clothing account:

Last settled \_\_\_\_\_, 186 ; drawn since \$ \_\_\_\_\_ 100

Due soldier \$ \_\_\_\_\_ 100; due U. S. \$ \_\_\_\_\_ 100

Am't for cloth'g in kind or money adv'd \$ \_\_\_\_\_ 100

Due U. S. for arms, equipments, &c., \$ \_\_\_\_\_ 100

Bounty paid \$ \_\_\_\_\_ 100; due \$ \_\_\_\_\_ 100

Remarks: *found a ...*  
*... 1916 ...*  
*... of ...*  
*(Age 25.)*

Book mark : \_\_\_\_\_

*J. ...*  
Copyist.

1495

Kelland, James  
Co A, 10 U.S. Col'd H. Art'y.

Private Private

CARD NUMBERS.

1	26
2	27
3	28
4	29
5	30
6	31
7	32
8	33
9	34
10	35
11	36
12	37
13	38
14	39
15	40
16	41
17	42
18	43
19	44
20	45
21	46
22	47
23	48
24	49
25	50

Book Mark:

See also 77 M.S.C.I.

AY 1936877  
2209 622840.0000

W. L. B. B.  
5-23-27  
2

J. B. Dowd  
L. B.

000029

*K. M. Hart*, **U.S.C.T.**

*James Keelard*  
*Co. A, 111 Reg't U. S. Col'd N. Arty*

Appears on

**M. and D. Roll of Men Transferred**

to the organization named above.

from *7th Reg't U.S. Col'd Inf.*

Roll dated *Oct 1*, 1865.

When enlisted *Apr 7*, 1865.

Period for which enlisted *3* years.

When mustered in *May 5*, 1865.

Present or absent *Present*

Company to which assigned *A*

Remarks: *joined as new man*

*May 20. 65*

Book mark :

(342)

*J. M. Keelard*

*Captain*

K

10 H. Art'y. U.S.C.T.

James Keeland

Priv, Co. F, 10 Reg't U. S. Col'd H. Art'y.

Appears on

Company Muster Roll

for Sept & Oct, 1865.

Present or absent Present

Stoppage, \$ 100 for

Due Gov't, \$ 100 for

Valuation of horse, \$ 100

Valuation of horse equipments, \$ 100

Remarks: Transferred from Co. D  
77 U.S. C.I. Oct. 1/65.

Book mark:

B. G. Wasdon

Copyist.

*K.* 10 H. Art'y. **U.S.C.T.**

*James Keeland,*

*Pat.*, Co. F, 10 Reg't U. S. Col'd H. Art'y.

Appears on

**Company Muster Roll**

for *Nov. & Dec.*, 186*5*.

Present or absent *Present*

Stoppage, \$ *100* for

Due Gov't, \$ *100* for

Valuation of horse, \$ *100*

Valuation of horse equipments, \$ *100*

Remarks: *Stop \$ 2. Due J. Egan,*  
*Tailor*

Book mark:

*W. L.*  
Copyst.



17. **10 H. Art'y. U.S.C.T.**

*James Beckford*

*Capt.*; Co. F, 10 Reg't U. S. Col'd H. Art'y.

Appears on

**Company Muster Roll**

for *Sept 7 1864*, 186 .

Present or absent *Present*

Stoppage, \$ *100* for

Due Gov't, \$ *100* for

Valuation of horse, \$ *100*

Valuation of horse equipments, \$ *100*

Remarks:

-----  
-----  
-----  
-----  
-----  
-----  
-----  
-----

Book mark:

-----  
-----

*W. H. V.*  
Copyist.

*H.* | **10 H. Art'y. U.S.C.T.**

*James Mackay*  
*Capt.*, Co. F, 10 Reg't U. S. Col'd H. Art'y.

Appears on

**Company Muster Roll**

for *Sept 1864*, 186*4*.

Present or absent *Present*

Stoppage, \$ *100* for

Due Gov't, \$ *100* for

Valuation of horse, \$ *100*

Valuation of horse equipments, \$ *100*

Remarks: *Stop for loss 1 yr.*  
*Sealer's*

Book mark: \_\_\_\_\_

**10 H. Art'y. U.S.C.T.**

*James H. ...*  
*Co. F, 10 Reg't U. S. Col'd H. Art'y.*

Appears on

**Company Muster Roll**

for *May & June*, 186*...*

Present or absent *Present*

Stoppage, \$ *100* for

Due Gov't, \$ *100* for

Valuation of horse, \$ *100*

Valuation of horse equipments, \$ *100*

Remarks:

-----  
-----  
-----  
-----  
-----  
-----  
-----  
-----  
-----

Book mark:

-----  
-----

*11. 10/10/1864* **U.S.C.T.**

*James Williams*  
*Co. 1, 1st Reg't U. S. Col'd*

Appears on

**Company Muster Roll**

for *11/10/1864*, 186 *6*

Present or absent *Present*

Stoppage, \$ *100* for *100*

Due Gov't, \$ *100* for *100*

Valuation of horse, \$ *100*

Valuation of horse equipments, \$ *100*

Remarks: \_\_\_\_\_  
\_\_\_\_\_  
\_\_\_\_\_  
\_\_\_\_\_  
\_\_\_\_\_  
\_\_\_\_\_  
\_\_\_\_\_

Book mark: \_\_\_\_\_  
\_\_\_\_\_

10 H. Art'y. U.S.C.T.

*James Keiana*

*Prvt*, Co. F, 10 Reg't U. S. Col'd H. Art'y.

Appears on

**Company Muster Roll**

for *Sept. and Oct.*, 186*6*

Present or absent *Present*

Stoppage, \$ \_\_\_\_\_ 100 for \_\_\_\_\_

Due Gov't, \$ \_\_\_\_\_ 100 for \_\_\_\_\_

Valuation of horse, \$ \_\_\_\_\_ 100

Valuation of horse equipments, \$ \_\_\_\_\_ 100

Remarks: \_\_\_\_\_

*Step in loss of C. and G.  
E. \$ 4.80.*

Book mark: \_\_\_\_\_

*House*

Copyist.

✓ 10 H. Art'y. U.S.C.T.

*James Neiland*

*Pvt.*, Co. F, 10 Reg't U. S. Col'd H. Art'y.

Appears on

**Company Muster Roll**

for *Jan - and Feb*, 186*Q.*

Present or absent *Present*

Stoppage, \$ 100 for

Due Gov't, \$ 100 for

Valuation of horse, \$ 100

Valuation of horse equipments, \$ 100

Remarks:

Book mark:

*House*

Copyist.

10 H. Art'y. **U.S.C.T.**

*James Neiland*

*Co. F*, 10 Reg't U. S. Col'd H. Art'y.

Appears on **Co. Muster-out Roll**, dated  
*Boston August 22*, 1867.

Muster-out to date *Feb 22*, 1867.

Last paid to *Feb 3*, 1867.

Clothing account:

Last settled \_\_\_\_\_, 1867; drawn since \$ \_\_\_\_\_ 100

Due soldier \$ *100* 100; due U. S. \$ \_\_\_\_\_ 100

Am't for cloth'g in kind or money adv'd \$ \_\_\_\_\_ 100

Due U. S. for arms, equipments, &c., \$ *2 08* 100

Bounty paid \$ *100 00* 100; due \$ *100 00* 100

Remarks: *Rec'd in transfer from  
Co. G. 77 U.S. Col'd H. Art'y.  
Capt. of Co. G. 77*

Book mark: \_\_\_\_\_

*Howe*  
Copyist.

1496

Kellebrew, Marcus

Co A, 10 U.S. Col'd H. Art'y.

Private

CARD NUMBERS.

1	26
2	27
3	28
4	29
5	30
6	31
7	32
8	33
9	34
10	35
11	36
12	37
13	38
14	39
15	40
16	41
17	42
18	43
19	44
20	45
21	46
22	47
23	48
24	49
25	50

Book Mark:

See also



1497

Kelley, Edward.

Co E, 10 U.S. Col'd H. Art'y.

Ord. Sergt. U.S.A. Ord. Sergeant

CARD NUMBERS.

1	5503472	26	
2	5503520	27	
3	5503670	28	
4		29	
5		30	
6		31	
7		32	
8		33	
9		34	
10		35	
11		36	
12		37	
13		38	
14		39	
15		40	
16		41	
17		42	
18		43	
19		44	
20		45	
21		46	
22		47	
23		48	
24		49	
25		50	

Book Mark:

See also U.S.A.

10 H. Art'y. U.S.C.T.

Edward J. Vollen

Co. E, 10 Reg't U. S. Col'd H. Art'y.

Appears on

Company Muster Roll

for Sept & Oct, 1865.

Present or absent Present

Stoppage, \$ 100 for

Due Gov't, \$ 100 for

Valuation of horse, \$ 100

Valuation of horse equipments, \$ 100

Remarks: Examined to \$ 2.00 per month for 1st enlistment. Reassigned to Co. E, 10th Reg't H. Art'y. by 11 for muster (1/4) payment per roll to 10. 1865. Hdqrs. U. S. Army (Brachear) Pa. Oct. 30, 1865.

Book mark:

W. E. Tyler

Copyist.

K | 10 H. Art'y. | U.S.C.T.

Edward Kelley

Ord' Srg't <sup>U.S.A</sup> Co. E, 10 Reg't U. S. Col'd H. Art'y.

Appears on

Company Muster Roll

for Nov & Dec, 1865.

Present or absent Present

Stoppage, \$ 100 for

Due Gov't, \$ 100 for

Valuation of horse, \$ 100

Valuation of horse equipments, \$ 100

Remarks: Assigned to Co "E"  
10th U.S. Col'd H. Art'y. for muster  
and paym't per S.O. 153, 16a  
2nd U.S. Forces Brashear  
La Oct 30, 1865; entitled  
to \$2.00 per month per  
1st re enlistment

Book mark:

Warr  
Copyist.

K | 10 H. Art'y. | U.S.C.T.

Edward Kelley

Ord Sgt Co. E, 10 Reg't U. S. Col'd H. Art'y.

Appears on

Company Muster Roll

for Jan & Feb, 1866

Present or absent Present

Stoppage, \$ 100 for

Due Gov't, \$ 100 for

Valuation of horse, \$ 100

Valuation of horse equipments, \$ 100

Remarks: Assigned to Co E 10<sup>th</sup> U.S. C. A(H) for months ~~and~~ pay- ment per S.O. 153 ~~for~~ 2<sup>nd</sup> U.S. Arty. Wash DC Oct 30/85. Entitled to \$2.00 per month for first reenlistment Entitled to \$100 per month for second reenlistment since Nov 21-1865. Fifth installment \$50.00 due

Book mark:

Hart Copyist.

1498

Kemp, Stephen

Co G, 10 U.S. Col'd H. Art'y.

Private | Private

CARD NUMBERS.

1	5486952	26
2	5507155	27
3	5507243	28
4	5507285	29
5	5507325	30
6	5507433	31
7	5507579	32
8	5507725	33
9	5507920	34
10	5509460	35
11		36
12		37
13		38
14		39
15		40
16		41
17		42
18		43
19		44
20		45
21		46
22		47
23		48
24		49
25		50

Book Mark:

See also

K | 10 H. Art'y. | **U.S.C.T.**

*Stephen Kemp*

Appears with rank of *Private* on

**Muster and Descriptive Roll of a Detach-**  
**ment of U. S. Vols. forwarded**

(*H. a. c. d. a.*)  
for the *10* Reg't *U. S. C. H. A.* Roll dated

*New Orleans La, Apr. 3, 1864*

Where born *Richmond Va.*

Age *44* y'rs; occupation *Farmer*

When enlisted *Feb'y 29, 1864.*

Where enlisted *Port Hudson*

For what period enlisted *3* years.

Eyes *Black*; hair *Black*

Complexion *Black*; height *5* ft. *9 1/2* in.

When mustered in *Apr 3, 1864.*

Where mustered in *New Orleans*

Bounty paid \$ *100*; due \$ *100*

Where credited

Company to which assigned *G*

Remarks:

Book mark:

*Galligan*

*K. Hearty* | **U. S. C. T.**

*Stephen Kemp*

Appears with rank of *Priv* on

**Muster and Descriptive Roll of a Detachment of U. S. Vols. forwarded**

*organized as Co G.*

for the *10* Reg't U. S. Col'd *Vol's.* Roll dated

*New Orleans La, Sept 20, 1864.*

Where born *Richmond Va*

Age *1 1/2* y'rs; occupation *Farmer*

When enlisted *Feb 24*, 1864.

Where enlisted *Port Hudson La*

For what period enlisted *3* years.

Eyes *Blue*; hair *Blue*

Complexion *Blue*; height *5* ft. *7/2* in.

When mustered in *Apr 3*, 1864.

Where mustered in *New Orleans La*

Bounty paid \$ *100*; due \$ *100*

Where credited *to Port Hudson*

Company to which assigned *G*

Remarks:

Book mark:

*E. B. Thompson*  
Copyist.

K | **10 H. Art'y.** | **U.S.C.T.**

Stephen Kemp  
Pvt, Co. G, 7 Reg't U. S. Col'd H. Art'y.\*

Appears on

**Company Muster Roll**

for from enrolment to Apr. 30, 1864.

Present or absent Present

Stoppage, \$ 100 for

Due Gov't, \$ 100 for

Valuation of horse, \$ 100

Valuation of horse equipments, \$ 100

Remarks:

\* This organization subsequently became Co.         , 10 Reg't U. S. Colored Heavy Artillery.

Book mark:

E. H. Brown



*K* | **10 H. Art'y.** | **U.S.C.T.**

*Stephen Kemble*  
*Cot.*, Co. *G*, 7 Reg't U. S. Col'd H. Art'y.\*

Appears on

**Company Muster Roll**

for *May & June*, 1864.

Present or absent *Absent*

Stoppage, \$ 100 for

Due Gov't, \$ 100 for

Valuation of horse, \$ 100

Valuation of horse equipments, \$ 100

Remarks: *Detained at H. Q. Co  
Rec'y Service for S. S. No 15  
H. Q. Co Rec'y Depot U. S.  
C. Troops.*

\* This organization subsequently became Co. , 10 Reg't U. S. Colored Heavy Artillery.

Book mark:

*E. H. Brown*

*K* | **10 H. Art'y. | U.S.C.T.**

*Stephen Kern*  
*C.H.*, Co. G, 10 Reg't U. S. Col'd H. Art'y.

Appears on

**Company Muster Roll**

for *July & Aug*, 186*4*

Present or absent *Present*

Stoppage, \$ 100 for

Due Gov't, \$ 100 for

Valuation of horse, \$ 100

Valuation of horse equipments, \$ 100

Remarks: \_\_\_\_\_  
\_\_\_\_\_  
\_\_\_\_\_  
\_\_\_\_\_  
\_\_\_\_\_  
\_\_\_\_\_  
\_\_\_\_\_  
\_\_\_\_\_

Book mark: \_\_\_\_\_

*C.H. Bacon*  
Copyist.

*K* | 10 H. Art'y. | U.S.C.T.

*Stephen Kemper*  
*Port*, Co. G, 10 Reg't U. S. Col'd H. Art'y.

Appears on

Company Muster Roll  
for *Sept & Oct*, 1864.

Present or absent *Absent*

Stoppage, \$ 100 for

Due Gov't, \$ 100 for

Valuation of horse, \$ 100

Valuation of horse equipments, \$ 100

Remarks: *Guard on Steamer Red Chief \$6 per month due from date of enlistment to April 30, 64 \$9 per mo due from April 30 to June 30, 64*

Book mark:

*E. T. Baer*

Copyist.

*K* | 10 H. Art'y. | U.S.C.T.

*Stephen Kemp*  
*Pvt*, Co. G, 10 Reg't U. S. Col'd H. Art'y.

Appears on

**Company Muster Roll**

for *Nov Dec*, 186*4*.

Present or absent *Absent*

Stoppage, \$ 100 for

Due Gov't, \$ 100 for

Valuation of horse, \$ 100

Valuation of horse equipments, \$ 100

Remarks: *Has rec'd but \$ 7 per month Sick in Genl Hospital New Orleans La since Dec 6/64*

Book mark: \_\_\_\_\_

*E. H. Brown*

*K* | 10 H. Art'y. | U.S.C.T.

*Stephen K...*  
*Prov*, Co. G, 10 Reg't U. S. Col'd H. Art'y.

Appears on

**Company Muster Roll**

for *Jan & Feb*, 1860.

Present or absent *Absent*

Stoppage, \$ *100* for

Due Gov't, \$ *100* for

Valuation of horse, \$ *100*

Valuation of horse equipments, \$ *100*

Remarks: *Sick in Gen  
Hosp. H.O. since Dec  
6. Rec'd bill # 7 for  
Medicine Enrollment  
to Gen. 30 Jan.*

Book mark:

*J. E. Porter*

K

10 H. Art'y.

U.S.C.T.

Stephen Kemper  
Prov., Co. G, 10 Reg't U. S. Col'd H. Art'y.

Appears on

**Company Muster Roll**

for *Mar + April*, 1865.

Present or absent.....

Stoppage, \$.....100 for.....

Due Gov't, \$.....100 for.....

Valuation of horse, \$.....100

Valuation of horse equipments, \$.....100

Remarks: *Discharged from  
Gen. Hosp't W. Va.  
March 21/65 Final  
statements given  
Received but \$ 7 per  
mo from Enrollment  
to June 30/65*

*Not borne on c. m. o. roll*

Book mark: *V 27, P 184-68*

*F. E. Porter*

*H* | 10 H. Art'y. | **U.S.C.T.**

*Stephen Henry*

*Pvt*, Co. *G*, 10 Reg't U. S. Col'd H. Art'y.

Appears on **Co. Muster-out Roll**, dated

*Baton Rouge La, Feb. 27,* 1867.

Muster-out to date \_\_\_\_\_, 186 .

Last paid to \_\_\_\_\_, 186 .

Clothing account:

Last settled \_\_\_\_\_, 186 ; drawn since \$ \_\_\_\_\_ 100

Due soldier \$ \_\_\_\_\_ 100; due U. S. \$ \_\_\_\_\_ 100

Am't for cloth'g in kind or money adv'd \$ \_\_\_\_\_ 100

Due U. S. for arms, equipments, &c., \$ \_\_\_\_\_ 100

Bounty paid \$ \_\_\_\_\_ 100; due \$ \_\_\_\_\_ 100

Remarks: *Joined at org'l. org'n.*  
*Disch'd on Surg's certificate*  
*of disability from Bd a Gen.*  
*Hosp. N. Orleans Mar. 27, 1865.*

*File with Stephen Kemp.*

Book mark: *Y. 12. P. 85, 68. - Y 27. P. 184, 686.*

*Wines*

Kemp, Stephen

P. G., Co.

10

Reg't U. S. C. H. A.

1 Enclosures.

Bed Cards	Descriptive Lists
Burial Records	Final Statements
Certs. of Dis. for Discharge /	Furloughs
C. M. Charges	Med. Des. Lists
Med. Certificates	Orders

Other papers relating to—

Admission to Hosp'l	Furlough
Casualty Sheet (Officer's)	Med. Examination
Confinement	Misc. Information
Contracts	Pay or Clothing
Death or Effects	Personal Reports
Desertions	Rank
Discharge from Hosp'l	Transfer to Hosp'l
Discharge from Service	Transfer to V. R. C.
Duty	Transportation



NOTE 1.

The company commander will here add a statement of all the facts known to him concerning the disease or wound, or cause of disability of the soldier; the time, place, manner, and all the circumstances under which the injury occurred, or disease originated or appeared; the duty, or service, or situation of the soldier at the time the injury was received or disease contracted, stating particularly whether the injury was received or the disease contracted in the line of his duty; and whatever other facts may aid a judgment as to the cause, immediate or remote, of the disability, and the circumstances attending it.

When the facts are not known to the company commander, the certificate of any officer, or affidavit of other person having such knowledge, will be appended—as the surgeon in charge of a hospital, the officer commanding a detachment of recruits, &c., &c.

NOTE 2.

When a probable case for pension, special care must be taken to state the degree of disability—as  $\frac{1}{2}$ ,  $\frac{1}{3}$ , &c., &c.; to describe particularly the disability, wound, or disease; the extent to which it deprives him of the use of any limb or faculty, or affects his health, strength, activity, constitution, or capacity to labor or earn his subsistence. The surgeon will add, from his knowledge of the facts and circumstances, and from the evidence in the case, his professional opinion of the cause or origin of the disability. In the case of discharges by Medical Inspectors, the last paragraph will state that the "discharge was given by consent of the soldier, after a personal examination, and for disability, the nature, degree, and origin of which are correctly described in the within certificate."

Par. 1260 Regulations, Edit. 1861.

Medical officers, in giving certificates of disability, are to take particular care in all cases that have not been under their charge; and especially in epilepsy, convulsions, chronic rheumatism, derangement of the urinary organs, ophthalmia, ulcers, or any obscure disease liable to be feigned or purposely produced; and in no case shall such certificate be given until after sufficient time and examination to detect any attempt at deception.

DIRECTIONS.

This certificate will be made out in duplicate by the soldier's company commander, or other officer commanding the separate detachment to which he belongs, and sent by him to the surgeon who has charge of the hospital where the soldier is sick. The surgeon will then fill out and sign the surgeon's certificate, and forward these papers to the regimental, detachment, or post commander, who will forward them, with his action endorsed thereon, through the proper channel, to his division commander; or, if the troops are not attached to a division, to his corps, department, or other commander or officer to whom the authority to discharge enlisted men may be specially delegated.

These certificates, after having received the action of the highest authority to which they are required to be sent, will be returned through the same channel to the regimental, post, or detachment commander, who will, if the discharge is authorized by the endorsement of the proper authority, sign the soldier's discharge, and the last certificate on this paper; see that the soldier is furnished with the proper final statements in duplicate, and forward BOTH of these certificates direct to the Adjutant General United States Army, at Washington, D. C.; they will not, under any circumstances, be given into the hands of the soldier.

ADJUTANT GENERAL'S OFFICE

Apr 8<sup>th</sup> 1865

Duplicate sent the Pension Office.

CERTIFICATE OF DISABILITY FOR DISCHARGE

NO 143 IN THE CASE OF

Stephen Kemp  
a private Co. "G"  
10<sup>th</sup> Reg't of U.S.C. Artillery

Corps d'Afrique U.S. Gen. Hospital  
New Orleans, La. Mar 19<sup>th</sup> 1865

Approved by Board of Examination.

J. E. Piquette  
President of Board

Approved March 26 5

[Signature]

Received (A. G. Office) \_\_\_\_\_, 1865



[Signature]

Adj Gen's Dept of the Gulf  
New Orleans Mar 20<sup>th</sup> 1865

To be discharged  
By command of  
Maj. Gen. Hurlbut.

[Signature]  
Capt & Adjutant General

Adj. G. Nov 19<sup>th</sup> 1865

Copy furnished

and

Co

ARMY OF THE UNITED STATES  
 CERTIFICATE  
 OF DISABILITY FOR DISCHARGE.



Private Stephen Kemp of Captain J. Harvie  
McGuire's Company, (G.) of the Tenth Regiment of United States  
Col. Art. (H.) was enlisted by Lieut Chamberlain of  
 the \_\_\_\_\_ Regiment of \_\_\_\_\_ at Post Hudson, La.  
 on the Twenty-ninth day of February 1864, to serve three years; he was born  
 in Richmond, in the State of Virginia is Forty-four  
 years of age, 5 feet 9 1/2 inches high, Black complexion, Black eyes,  
Black hair, and by occupation when enlisted a Farmer. During the last two four  
 months said soldier has been unfit for duty 120 days.\* This soldier has been  
under medical treatment at this Hospital for nearly  
four months without any improvement. In my opinion  
he will never be able to perform the duties of a  
soldier.

STATION: Camps d'Afrique U.S. Gen. Hosp.  
 DATE: March 15th 1865 - New Orleans, La. J. E. Piquette  
Surgeon in charge  
Commanding Company.

I CERTIFY, that I have carefully examined the said Private Stephen Kemp of  
 Captain J. H. McGuire's Company, and find him incapable of performing the duties of a soldier  
 because of † Chronic Rheumatism of eighteen months standing  
& deformity of both ankle joints which existed  
prior to enlistment & is in my opinion unfit  
for any branch of service Degree of Disability A

J. Jackson  
Acting Surgeon.

DISCHARGED, this Twenty-first day of March 1865, at Camps d'Afrique  
U.S. Gen. Hospital New Orleans, La. J. E. Piquette  
Surgeon in charge.  
Commanding the Reg't.

The soldier desires to be addressed at  
 Town \_\_\_\_\_ County \_\_\_\_\_ State \_\_\_\_\_.

\* See Note 1 on the back of this. † See Note 2 on the back of this.

1499

*Kemper & Thomas*

Co<sup>d</sup>, 10 U.S. Col'd H. Art'y.

*Private Private*

CARD NUMBERS.

1	5488260	26
2	5488115	27
3	5513472	28
4	5513620	29
5	5513820	30
6	5514251	31
7		32
8		33
9		34
10		35
11		36
12		37
13		38
14		39
15		40
16		41
17		42
18		43
19		44
20		45
21		46
22		47
23		48
24		49
25		50

Book Mark:

See also 77 U.S.A.

*K 1060* U.S.C.T.

*Thomas Kemper*  
Sgt, Co *D*, 10 Reg't U. S. Col'd *Art*

Appears on

**M. and D. Roll of Men Transferred**

to the organization named above,

from *77th U. S. Col Inf*

Roll dated *Camp Parapet Salch*, 186*5*.

When enlisted *March 18*, 186*5*.

Period for which enlisted *3* years.

When mustered in *March 23*, 186*5*.

Present or absent *Absent*

Company to which assigned *D*

Remarks: *Transferred from*

*4th A. General Hospital*

*at Ft. M. since Aug*

*16.65. joined by trans*

*fer from Co E 77th U.S.C.I.*

*Regt 5066 C.S. Hd Qrs*

*Dept of La*

Book mark:

*Wear Scott*

*K. J. A.* | **U.S.C.T.**

*James Kemper*  
Cot., Co. D., 10 Reg't U. S. Col'd

Appears on

**M. and D. Roll of Men Transferred**

to the organization named above,

from *Co. E, 4th U. S. Col. Inf.*

Roll dated *Camp Campagna, Va.,* 186*4*

When enlisted *Nov 18*, 186*3*

Period for which enlisted *3* years.

When mustered in *Nov 23*, 186*3*

Present or absent *Absent*

Company to which assigned *I*

Remarks: *Transferred from*  
*4th Regt. de Afrique*  
*Dec 2, 1863. Absent*  
*sick in Camp de You*  
*Heard Aug 16. 65,*

Book mark :

*Wm Scott*

*K* | 10 H. Art'y. | U.S.C.T.

*Thomas Kemper*  
Pot., Co. G, 10 Reg't U. S. Col'd H. Art'y.

Age \_\_\_\_\_ years.

Appears on

**Company Muster Roll\***

for *Sept. & Oct.*, 186*5*.

Joined for duty and enrolled:

When *March 18*, 186*3*.

Where *New Orleans*

Period *3* years.

Mustered in:

When *March 23*, 186*3*.

Where *New Orleans*

Present or absent *Absent*

Stoppage, \$ 100 for \_\_\_\_\_

Due Gov't, \$ 100 for \_\_\_\_\_

Valuation of horse, \$ 100

Valuation of horse equipments, \$ 100

Remarks: *Transfd from Co. E. 11th USCA. - Absent sick in*

\*First current roll. No muster-in roll of this company on file.

Book mark : \_\_\_\_\_

*Scherich*

JAN. 16

5513472

1891

*U. S. A. Gen. Hosp. New Orleans  
since Aug. 16/65*

*K* | 10 H. Art'y. | U.S.C.T.

*Thomas Kemper*  
*Plt*, Co. L, 10 Reg't U. S. Col'd H. Art'y.

Appears on

**Company Muster Roll**

for *Nov. & Dec.*, 186*5*.

Present or absent *Present*

Stoppage, \$ *100* for

Due Gov't, \$ *100* for

Valuation of horse, \$ *100*

Valuation of horse equipments, \$ *100*

Remarks:

Book mark:

*Scherich*



*K* | 10 H. Art'y. | U.S.C.T.

*Thomas Kemper*  
*Priv.*, Co. L, 10 Reg't U. S. Col'd H. Art'y.

Appears on

**Company Muster Roll**

for *Jan. Feb.*, 186*6*

Present or absent.....

Stoppage, \$.....<sup>100</sup> for .....

Due Gov't, \$.....<sup>100</sup> for .....

Valuation of horse, \$.....<sup>100</sup>

Valuation of horse equipments, \$.....<sup>100</sup>

Remarks: *Died at Fort Pike*  
*La. Jan. 14/66. Murdered*  
*by Lewis Wilson of*  
*same Co.*

Book mark:.....

*Scherich*

R | 10 H. Art'y. | U.S.C.T.

Thomas Rempfer

Pvt., Co. L, 10 Reg't U. S. Col'd H. Art'y.

Appears on Co. Muster-out Roll, dated  
Baton Rouge La, Feb 22, 1867.

Muster-out to date \_\_\_\_\_, 186 .

Last paid to \_\_\_\_\_, 186 .

Clothing account:

Last settled \_\_\_\_\_, 186 ; drawn since \$ \_\_\_\_\_ 100

Due soldier \$ \_\_\_\_\_ 100; due U. S. \$ \_\_\_\_\_ 100

Am't for cloth'g in kind or money adv'd \$ \_\_\_\_\_ 100

Due U. S. for arms, equipments, &c., \$ \_\_\_\_\_ 100

Bounty paid \$ \_\_\_\_\_ 100; due \$ \_\_\_\_\_ 100

Remarks: *Joined by transfer from  
77 USCI Oct 1/65 SO66 H<sup>o</sup> g<sup>o</sup>s  
Dept of La Sept 27/65. Was murder-  
ed (shot) by Pvt Wilson Co L U S C A.  
(H<sup>y</sup>) Jan 14 1866 at Fort Pike La.  
Final statements forwarded Jan 15 1866  
Filed with Thomas Rempfer  
Book mark: 161457 247530*

Burnham

Kemper, Thomas

P., Co. L., 10 Reg't U.S.C.H.A.

Enclosures.

Bed Cards	Descriptive Lists
Burial Records	Final Statements /
Certs. of Dis. for Discharge	Furloughs
C. M. Charges	Med. Des. Lists
Med. Certificates	Orders

Other papers relating to—

Admission to Hosp'l	Furlough
Casualty Sheet (Officer's)	Med. Examination
Confinement	Misc. Information
Contracts	Pay or Clothing
Death or Effects	Personal Reports
Desertions	Rank
Discharge from Hosp'l	Transfer to Hosp'l
Discharge from Service	Transfer to V. R. C.
Duty	Transportation

*Extract from Act of Congress.*

SEC. 12. *And be it further enacted,* That the fees of agents and attorneys for making out and causing to be executed the papers necessary to establish a claim for a pension, bounty, and other allowance before the Pension Office, under this act, shall not exceed the following rates: For making out and causing to be duly executed a declaration by the applicant, with the necessary affidavits, and forwarding the same to the Pension Office, with the requisite correspondence, ten dollars; which sum shall be received by such agent or attorney in full for all services in obtaining such pension, and shall not be demanded or received, in whole or in part, until such pension shall be obtained; and the sixth and seventh sections of an act entitled "An act to grant pensions," approved July [fourteenth,] eighteen hundred and sixty-two, are hereby repealed.

SEC. 13. *And be it further enacted,* That any agent or attorney who shall, directly or indirectly, demand or receive any greater compensation for his services under this act than is prescribed in the preceding section of this act, or who shall contract or agree to prosecute any claim for a pension, bounty, or other allowance under this act, on the condition that he shall receive a per centum upon any portion of the amount of such claim, or who shall wrongfully withhold from a pensioner or other claimant the whole or any part of the pension or claim allowed and due to such pensioner or claimant, shall be deemed guilty of a high misdemeanor, and, upon conviction thereof, shall, for every such offense, be fined not exceeding three hundred dollars, or imprisoned at hard labor not exceeding two years, or both, according to the circumstances and aggravations of the offense.

Approved July 4, 1864

NOTE 10.—If any soldier is charged a higher fee than that allowed by the above act, he should report the fact and the name of the agent to the Adjutant General, in order that steps may be taken to have the same refunded.

ADJUTANT GENERAL'S OFFICE

Feb 2<sup>d</sup> 1866

Duplicate with Inventory sent 2d Auditor.

FINAL STATEMENT

OF  
*Thomas Lumpkin*  
*10<sup>th</sup> Reg't of Me. A. C.*

*Dw Jan 14<sup>th</sup> 1866*  
VOLUNTEERS.

NOTE 1.—Two of these certificates (or duplicates) are to be given to each Volunteer Soldier or drafted man who may be discharged without being mustered out (Final Statements are never given to men mustered out of service.) that he may at once receive from the Paymaster the pay, &c., due him, and the captain or other COMMISSIONED officer commanding the company will certify to the act of the delivery of the duplicate certificates; with these certificates the Soldier is "entitled to" his discharge, and should also present his discharge to the Paymaster to have the payment endorsed on it. The discharge is to be given back to the Soldier by the Paymaster, the latter only retaining as his vouchers the duplicate certificates.

NOTE 2.—If the Soldier is entitled to pay for the use of his horse, the Company Commander will certify to that fact on the back of both these final statements, and also to the time he has pay due for having been so mounted on his own horse.

NOTE 3.—When a Soldier is furnished with final statements, his descriptive list, if he has one, should be taken up by the officer who gives the Soldier these statements, and endorsed with a statement to this effect by the officer. The endorsement should exhibit a full statement of the fund for which the Soldier was allowed pay on his final statements, the clothing account, and all other charges against him or in his favor, so as to comprise a complete exhibit of his account. It will then be transmitted to the Company Commander of the Soldier, who will enter all the data necessary to a full understanding of the Soldier's account on the muster roll upon which the Soldier's discharge is reported. The descriptive list will then be destroyed. The object of this is, that the remaining portion of the Soldier's account may be settled upon the receipt of these muster rolls, and the Soldier receive any pay or allowances that may be due him at the time of his discharge, and which may not appear on his last final statements from the fact that his descriptive list is incomplete. These accounts for back pay, &c., are settled by the 2d Auditor of the Treasury Department.

NOTE 4.—Charges for loss or injury to ordnance, horse equipments, and other miscellaneous charges, should appear under the heading of "Other Stoppages."

NOTE 5.—Bounty paid by State authorities, and not by the United States, will not be entered on this statement.

NOTE 6.—Amounts due the Sutler and Laundress must be entered on the muster roll on which the discharge, death, desertion, &c., is reported, as well as on the final statement, otherwise the amount cannot be collected from the United States.

NOTE 7.—This blank will be used for deceased volunteers and drafted men, as well as for others.

NOTE 8.—Where a Soldier dies in Hospital or on detached service, his descriptive list, if he has one, should be sent with his final statements, in duplicate, to the Adjutant General, Washington, D. C.

NOTE 9.—If the soldier is a drafted man or substitute, the space for time, &c., of enrolled, should contain only the word *drafted* or *substitute*, as the case may be. If the Soldier is a "VETERAN," (or RECRUIT,) the words *as a veteran*, (or *recruit*,) as the case may be, should be interlined after the words *mustered into the service of the U. S.* A statement of all the installments of *Veteran* or *Recruit* Bounty RECEIVED by the Soldier must be made on the back of each final statement.

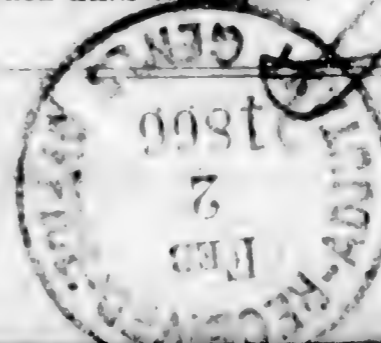

I certify, on honor, that Thomas Lumpkin, a private of  
Captain E. F. Baretton Company (L) of the 10<sup>th</sup> Regiment of Miss. Art.  
**VOLUNTEERS**, of the State of \_\_\_\_\_, born in Baltimore, State  
of Maryland, aged 26 years; 5 feet 5 inches high; dark complexion,  
brown eyes, black hair, and by occupation a labourer, who joined for service  
and was enrolled (see Note 9) on the 18 day of March, 1863, at New Orleans La.  
by Lieut. Dorellity, for the period of 3 years, and mustered into  
the service of the United States on the 23<sup>rd</sup> day of March, 1863, at  
New Orleans, by Major Piddings; and having served  
HONESTLY and FAITHFULLY with his Company to the present date, is now entitled to a  
**DISCHARGE** by reason of Death - Died in Hospital at Fort Pike La Jan 14. 66  
from wound rec. in a quarrel, at the hand of Lewis Wilson Co L 10<sup>th</sup> Miss Art.

The said Thomas Lumpkin was last paid by Paymaster  
Major Piddings, to include the 28<sup>th</sup> day of February, 1863, and  
has pay due him from that time to the present date; he is entitled to pay and subsistence for  
**TRAVELING** to place of enrollment, and whatever other allowances are authorized to volunteer  
soldiers, drafted men, or militia, so discharged. He has received from the United States **CLOTHING**  
amounting to 6  $\frac{61}{100}$  dollars, since the 30<sup>th</sup> day of June,  
1863, when his clothing account was last settled. He has received from the United States  
00  $\frac{00}{100}$  dollars advanced **BOUNTY**.

There is to be stopped from him, on account of the State of \_\_\_\_\_, or other  
authorities, for **CLOTHING, &c.**, received on entering service, 00  $\frac{00}{100}$  dollars; and  
for other stoppages, viz: \_\_\_\_\_

\_\_\_\_\_ 00  $\frac{00}{100}$  dollars.  
He has been furnished with **TRANSPORTATION** in kind from the place of his discharge to  
\_\_\_\_\_ ; and he has been **SUBSISTED** for **TRAVELING** to his  
place of enrollment, up to the \_\_\_\_\_, 186 .

He is indebted to J. B. Luke Jr, **SUTLER**, 10  $\frac{50}{100}$  dollars.

He is indebted to \_\_\_\_\_, **LAUNDRESS**, 00  $\frac{00}{100}$  dollars.

Given in Duplicate, at New Orleans La, this 15 day  
of January, 1866.

E. F. Baretton  
Capt. 10<sup>th</sup> Miss Art.  
Commanding Company.

1500  
Kempt, Stephen  
Co. ©, 10 U.S. Col'd H. Art'y.

Private Private

CARD NUMBERS.

1	5497613	26
2	5497857	27
3	5498016	28
4		29
5		30
6		31
7		32
8		33
9		34
10		35
11		36
12		37
13		38
14		39
15		40
16		41
17		42
18		43
19		44
20		45
21		46
22		47
23		48
24		49
25		50

Book Mark: A. 33 - v. 11. R. C. J. 1867

See also

*K* | 10 H. Art'y. | U.S.C.T.

*Stephen Kempel*

*Pr*, Co. C, 1 Reg't H. Art'y, Corps d'Afrique.\*

Age *31* years.

Appears on

**Company Muster-in Roll**

of the organization named above. Roll dated

*New Orleans La, Aug 17, 1863.*

Muster-in to date *Aug 17, 1863.*

Joined for duty and enrolled:

When *July 9<sup>th</sup>, 1863.*

Where *Camp Parquet La*

Period *3* years.

Valuation of horse, \$.....100

Valuation of horse equipments, \$.....100

Remarks:.....

\* This organization subsequently became Co. C, 10 Reg't U. S. Colored Heavy Artillery.

Book mark:.....

*Upstream*

*K* | 10 H. Art'y. | U.S.C.T.

*Stephen Kempt*

*Pt*, Co, C, 1 Reg't La. Art'y Native Guards.\*

Appears on

Company Muster Roll

for *Aug 11<sup>th</sup> to 31<sup>st</sup>*, 1863 .

Present or absent *Present*

Stoppage, \$ *100* for

Due Gov't, \$ *100* for

Valuation of horse, \$ *100*

Valuation of horse equipments, \$ *100*

Remarks :

\* This organization subsequently became Co. C, 10 Reg't U. S. Col'd Heavy Artillery.

Book mark :

*W. J. Kempt*



*W* | 10 H. Art'y. | U.S.C.T.

*Stephen Wempert*  
Pvt, Co, C, 1 Reg't La. Art'y Native Guards.\*

Appears on

**Company Muster Roll**

for *Sep & Oct, 1863*

Present or absent *Present*

Stoppage, \$ *100* for

Due Gov't, \$ *100* for

Valuation of horse, \$ *100*

Valuation of horse equipments, \$ *100*

Remarks:

*Not borne on subs rolls of  
regt*

\* This organization subsequently became Co. C, 10 Reg't U. S. Col'd Heavy Artillery.

Book mark:

*Wempert*

Copyist.

1501

Kentucky George

Co A, 10 U.S. Col'd H. Art'y.

Private

Private

CARD NUMBERS.

1	5489104	26
2	5492920	27
3	5493220	28
4	5493361	29
5	5493499	30
6	5493622	31
7	5493747	32
8	5490068	33
9	5494011	34
10		35
11		36
12		37
13		38
14		39
15		40
16		41
17		42
18		43
19		44
20		45
21		46
22		47
23		48
24		49
25		50

Book Mark:

See also 75 and 88 U.S.C.S.

S. 672828 P. G. 90.

S 1113257 Pomona

J. B. Dowd  
Calif

*K. 108th* **U.S.C.T.**

*George Kentuck*  
*W.*, Co., *10* Reg't U. S. Col'd *108th*

Appears on

**M. and D. Roll of Men Transferred**

to the organization named above,

from *7.5 US C I*

Roll dated *Nov 18*, 1863.

When enlisted *Aug 9*, 1863.

Period for which enlisted *3* years.

When mustered in *Sep 24*, 1863.

Present or absent *Not stated*

Company to which assigned

Remarks: *None US for C I*

*Equip. lost Transferred  
from 88 US C I Aug 13/64  
per S. O. no 209 dated  
H & Reg Dept Gulf*

Book mark:

*J. H. Johnson*

K | 10 H. Art'y. | U.S.C.T.

George Kentucky

Pl, Co. A, 10 Reg't U. S. Col'd H. Art'y.

Appears on

**Company Muster Roll**

for Nov & Dec, 1865.

Present or absent Present

Stoppage, \$ 100 for

Due Gov't, \$ 100 for Co G. Equipage,

per transfer roll

Valuation of horse, \$ 100

Valuation of horse equipments, \$ 100

Remarks: Transferred from 75 US 62  
per S.O. 105<sup>62</sup> Hd Qrs Dept of War

-----  
-----  
-----  
-----  
-----  
-----

Book mark: -----

-----  
-----

J. H. Jones  
Copyist.

K | 10 H. Art'y. | U.S.C.T.

George Kentuck

Pl, Co. A, 10 Reg't U. S. Col'd H. Art'y.

Appears on

**Company Muster Roll**

for Jan + Feb, 1866.

Present or absent

Present

Stoppage, \$ 100 for

Due Gov't, \$ 100 for

Valuation of horse, \$ 100

Valuation of horse equipments, \$ 100

Remarks:

Book mark:

Hyman

Copyist.

*K* | 10 H. Art'y. | U.S.C.T.

*George, Kentucky*

*Plt*, Co. A, 10 Reg't U. S. Col'd H. Art'y.

Appears on

**Company Muster Roll**

for *Mar - Apr*, 186*4*.

Present or absent *Present*

Stoppage, \$ *100* for

Due Gov't, \$ *100* for

Valuation of horse, \$ *100*

Valuation of horse equipments, \$ *100*

Remarks:

Book mark:

*H. J. ...*

Copyist.

*K* | 10 H. Art'y. | U.S.C.T.

*George Kentuck*  
*Pt.*, Co. A, 10 Reg't U. S. Col'd H. Art'y.

Appears on

**Company Muster Roll**

for *May + June*, 186*6*.

Present or absent *Present*

Stoppage, \$ 100 for

Due Gov't, \$ 100 for

Valuation of horse, \$ 100

Valuation of horse equipments, \$ 100

Remarks:

Book mark:

*J. Byrnes*

Copyist.



K | 10 H. Art'y. | **U.S.C.T.**

George Kentucky

Pl, Co. A, 10 Reg't U. S. Col'd H. Art'y.

Appears on

**Company Muster Roll**

for July & Aug, 1866

Present or absent Present

Stoppage, \$.....100 for .....

Due Gov't, \$.....100 for .....

Valuation of horse, \$.....100

Valuation of horse equipments, \$.....100

Remarks: .....

.....  
.....  
.....  
.....  
.....  
.....  
.....

Book mark: .....

Ayns  
Copyist.

*K* | 10 H. Art'y. | U.S.C.T.

*George Kentuck*  
*Pvt*, Co. A, 10 Reg't U. S. Col'd H. Art'y.

Appears on

**Company Muster Roll**

for *Sept + Oct*, 1866.

Present or absent

Stoppage, \$ 100 for

Due Gov't, \$ 100 for

Valuation of horse, \$ 100

Valuation of horse equipments, \$ 100

Remarks: *Date of discharge, mustered out  
Sept 23/66 by reason of expiration of  
term of service  
Paid \$100.00 bounty*

Book mark:

*Nesbitt*

K | 10 Arty U.S.C.T.

George Kentner

Wis, Co. A., 10 Reg't U. S. Col'd Arty

Appears on a

**Detachment Muster-out Roll**

of the organization named above. Roll dated

New Orleans La, Sep 24, 1866.

Muster-out to date Sep 23, 1866.

Last paid to June 30, 1866

**Clothing account:**

Last settled \_\_\_\_\_, 1866 ; drawn since \$ \_\_\_\_\_ 100

Due soldier \$ 61 <sup>76</sup>/<sub>100</sub>; due U. S. \$ \_\_\_\_\_ 100

Am't for cloth'g in kind or money adv'd \$ \_\_\_\_\_ 100

Due U. S. for arms, equipments, &c., \$ \_\_\_\_\_ 100

Bounty paid \$ \_\_\_\_\_ 100 due \$ 100 <sup>00</sup>/<sub>100</sub>

Remarks: joined orig org 89 US

C Inf. transferred to 15 USC.

So 209 per 12 series of 1864 Dept

of Gulf. transferred to 10 USC.

(H) So 105 per 12 series of 1865

Dept of La. All by reason

Book mark: \_\_\_\_\_

Edmondson

JAN. 15

5490068

1891

of expiration of term of  
service.

*K* | 10 H. Art'y. | U.S.C.T.

*George Kentuck*  
Art. Co. *A*, 10 Reg't U. S. Col'd H. Art'y.

Appears on Co. Muster-out Roll, dated  
*Baton Rouge La, Feb 22, 1867.*

Muster-out to date \_\_\_\_\_, 186 .

Last paid to \_\_\_\_\_, 186 .

Clothing account:

Last settled \_\_\_\_\_, 186 ; drawn since \$ \_\_\_\_\_ 100

Due soldier \$ \_\_\_\_\_ 100; due U. S. \$ \_\_\_\_\_ 100

Am't for cloth'g in kind or money adv'd \$ \_\_\_\_\_ 100

Due U. S. for arms, equipments, &c., \$ \_\_\_\_\_ 100

Bounty paid \$ \_\_\_\_\_ 100; due \$ \_\_\_\_\_ 100

Remarks: *Transfd. from 75 U.S.C.T. as  
Pt. S.O. 106-8 of 65 Reg't La.  
Dischd. for expan. of term of  
service Sept. 23/66*

Book mark: *V 15 P. 106. '68*

*Nesbitt*

Kenyon, Melbourne J  
Co ©, 10 U.S. Col'd H. Art'y.

Jr. Lieutenant 1<sup>st</sup> Lieutenant

CARD NUMBERS.

1	5486813	26
2	5497926.	27
3		28
4		29
5		30
6		31
7		32
8		33
9		34
10		35
11		36
12		37
13		38
14		39
15		40
16		41
17		42
18		43
19		44
20		45
21		46
22		47
23		48
24		49
25		50

Book Mark: 3822. e. J. 87.

See also 4 Wis. Car.

S. 1277151. P. M. M.

S 2666401 and M

Q. 1285681

J. B. Doud  
Ex

K. 10th. Art. U.S.C.T.

Milbourne J. Kenyon  
(Co. 6. 1st Regt. Art. C.F.A.)  
Jr. 1st. Co., 10. Reg't U. S. Col'd H. Art.

Age 24 years.

Appears on an

**Individual Muster-in Roll**

of the organization named above. Roll dated

New Orleans, La., Oct. 30, 1863.

Muster-in to date Oct. 28, 1863.

Joined for duty and enrolled:

When October 28, 1863.

Where New Orleans,

Period 3 years.

Valuation of horse, \$ 100

Valuation of horse equipments, \$ 100

Remarks: Honorably discharged as  
Sergt. 4<sup>th</sup> Wis. Cav. in Special  
order No. — Hd. Qrs. Dep. of Gulf.  
Vice Lieut. Thomas M<sup>c</sup> Cormack,  
promoted.

Book mark:

Philipson



*K* | 10 H. Art'y. | U.S.C.T.

*Wellborn J. Kenyon*  
*1st Lt*, Co, C, 1 Reg't La. Art'y Native Guards.\*

Appears on

**Company Muster Roll**

for *Sept & Oct*, 186*3*.

Present or absent *Present*

Stoppage, \$ *100* for

Due Gov't, \$ *100* for

Valuation of horse, \$ *100*

Valuation of horse equipments, \$ *100*

Remarks:

*Not borne on sub. rolls of  
reg't*

\* This organization subsequently became Co. C, 10 Reg't U. S. Col'd Heavy Artillery.

Book mark: *3822 C 3/87*

Kenyon, Melbourne J.

Co.

10 Reg't

U.S. C. A.

8 Enclosures.

Bed Cards .....	Final Statements .....
Burial Records .....	Furloughs or L. of A. ....
Certs. of Dis. for Discharge .....	Med. Certificates .....
C. M. Charges .....	Med. Des. Lists .....
Descriptive Lists .....	Orders / .....
Discharge Certificates .....	Pris. of War Record .....
Enlistment Papers .....	Resignations .....

Other papers relating to—

Admission to Hosp'l .....	Furlough or L. of A. ....
Casualty Sheet .....	Med. Examination .....
Confinement .....	Misc. Information 7 .....
Contracts .....	Pay or Clothing .....
Death or Effects .....	Personal Reports .....
Desertion .....	Rank .....
Discharge from Hosp'l .....	Transfer to Hosp'l .....
Discharge from Service / .....	Transfer to V. R. C. ....
Duty .....	Transportation .....

N. (D.G.) 82. 1864

New Orleans La  
February 13<sup>th</sup> 1864

Mr. J. Kenyon.  
Late Lieut. Col. 1<sup>st</sup> Hy. A. C. Co.

Application with Certificate  
of examination for a commission  
as 1<sup>st</sup> Lieut. in 1<sup>st</sup> Hy. Arts. C. Co.

S. S.

James  
M. H.  
James M. H.

Office of Board of Examiners,

New Orleans, La., Feb 13<sup>th</sup> 1863.

To the

Assistant Adjutant General,

Department of the Gulf.

Sir:

I hereby respectfully make application for a commission  
as 1<sup>st</sup> Lieutenant in the First  
Regiment of Heavy Artillery Corps d'Afrique, according to the certificate  
herewith enclosed.

Please send the Commission, if issued, to the following:

Address:

Care of Col J S Bange jr

Respectfully, your obdt. servt.

W J Kenyon

Approved for the First Regiment of Heavy Artillery  
Corps d'Afrique.

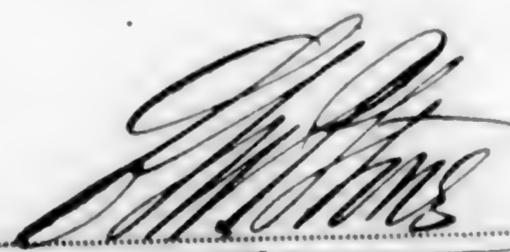

Brig. Gen. Vols., Commanding Corps d'Afrique.

Chief Staff

Camp Parapet Jan 25 1864

I am knowing to and assert the facts herein stated to be truths  
Thomas McCormack  
Sgt 1st Lt Co. B 1st La  
Reg Arty C & A

Camp Parapet  
Jan 25 1864

I am knowing to the within facts, and that they are truths; thus I assert.

Late  
Det. Battery Corp of Co. L  
1st Regt of Heavy Arty C & A

Pas Manchac  
Jan 26th

I am knowing to the facts within stated and assert them to be true.

S.O  
February 1st

M. A. Freelander  
Sgt 1st Lt Co. B  
1st La Art

N. D. G. 37 1864  
Camp Parapet  
Jan 25 1864

Kenyon M. J.  
Late for 1st Lt Col 1st NA Co A

Statement in regard to his being dismissed the service of the U.S. by S.O.

Head Quarters Dept. Gulf  
New Orleans Jan 27 1864

Respectfully referred to Lt. Col. Bangs, who will investigate the facts alleged and report whether he is or is not willing to receive this applicant as an officer of his regiment  
By command of Maj. Gen. Banks

Geo. B. Drake  
Maj. & Lt. Col.

2 53 1864  
Head Quarters 1st Lt. H. A. Co. A  
New Orleans Feb. 1st 1864

Respectfully returned to H. A. Co. A, Dept. of the Gulf. Upon investigation I learn that M. J. Kenyon reported to the Comd. office of Co. B. 1st La. H. Arty. Oct. 28. 1864 - did no duty except in making Co. papers and aiding in suppressing the mutiny of Nov. 3rd following six days after reporting for duty with the Co. - was on duty with his Co. (Co. 4th Mis. Bde) at Camp Parapet 9 months previously & is represented by the officers of Co. B. 1st H. Arty. C & A. as well qualified and of good habits. I am willing to receive Mr. Kenyon as an officer of my regiment and respectfully request that he be reinstated in his former rank if consistent with the interests of the service  
I. D. Prange  
St. Col. Comdg. Co. B. 1st La.

Camp Paraket  
Jan 25<sup>th</sup> 1864

Major Drake,  
A. A. General  
Dept. of the Gulf

Major  
I would most respectfully call the attention of the Major General commanding Dept. to a statement of my connection with Co "C" of the 1<sup>st</sup> La. Hy. Arty. C. S. A., from which I was dismissed (with others by special order No. issued from Head Quarters Dept. dated Nov 7<sup>th</sup> 1863) without any hearing, and knowing myself guiltless of any breach of trust I feel unjustly  
I was appointed 1<sup>st</sup> Lt in Co "C", and reported for duty on the 28<sup>th</sup> of October 1863, but was not mustered till on the 30<sup>th</sup> of October.

My duty until mustered and for four days following was confined to the muster and pay rolls of the company.

On the night of Nov 3<sup>d</sup>, occurred the only disturbance of the company of which I was personally

aware, and to quell which and arrest the  
mutinous men I acted to the extent of my ability

The thirty men engaged in this mutiny were the next  
day punished at the discretion of Capt. Rygaard then  
Commanding Battalion, and the balance of the company  
seemed thereafter to be quiet and orderly men

General Stone said to Lt Lawton late of Co "C", and  
who was honorably discharged (on account of being for a time  
previous sick and absent) by the same order that  
dismissed the others, that it was not one disturbance alone  
that led to the issue of the order dismissing the officers of  
the company, but that complaints of depredations committed  
by the company in its neighborhood had been reported  
for a period of several weeks. I had not begun general  
duty with the company when the last (before mentioned) disturb-  
-ance of which I believe it to be guilty occurred, and had but  
just begun such duty before my dismissal, and I  
respectfully submit this statement for decision whether or not  
it is just that I am disgraced by the action of men over  
whom I had but little or no previous command.

I hope to be restored to the service in which I have  
willingly served and would willingly serve again, but if  
that may not be, I trust that I will at least be granted

an honorable discharge, for I am certain that I do not deserve the least disgrace for any of my acts while serving my country.

I was at the time of promotion a member of Co "G" of the 4<sup>th</sup> Wisconsin Cavalry, in which I enlisted May 20<sup>th</sup> 1861, and during which time my conduct provoked neither punishment nor censure from my officers.

I have delayed making this personal statement, trusting that an application made by the officers interested in a body for a court of Inquiry would lead to the vindication of all, but so much time has elapsed since that was made that I have felt obliged to make my own statement.

I am  
Very Respectfully  
Your most Obedt. Servt  
M. J. Kenyon  
Late  
1<sup>st</sup> Lt Co "C" 1<sup>st</sup> La  
Ky. Arty C & A

To  
Major Drake  
A. A. General  
Dept. of the Gulf



It is impossible to reinstate an officer in a Corps which has been disbanded and broken up - Where a Corps disgraces itself the stain necessarily attaches itself - in appearance, at least - to all connected with it, ~~and~~ whether personally guilty, or not; and any in the Corps however innocent necessarily suffer with the guilty -

The disgrace of the acts for which this Corps was disbanded attached

attached itself not only to that Corps, but to the whole Service, and the Government itself - This officer should deem himself fortunate that circumstances can be brought to pass that he was not personally guilty and that the Service is willing to receive him back into commission - The tenor of a new commission is proof clear that the Major General Commanding does not consider him personally guilty -

File C.P.S.  
A.D. File and  
attached

N. (D.G.) 54 1864

Camp Parapet  
Feb 8<sup>th</sup> 1864

Kenyon M.J.  
Late 1<sup>st</sup> Lt Co C 1<sup>st</sup> Va cda

Statement in regard to  
his case

Camp Parapet Lu  
Feb 8<sup>th</sup> 1864

General Stone

Sir

I have received an order to report for examination as having applied for a commission, which I suppose results from a communication sent by me to Head Quarters the 27<sup>ult</sup>, from there referred to Lt. Col. Sanger Comdg 1<sup>st</sup> La Heavy Arty C S A

I do not understand that I have applied for another commission, but only to have my past character cleared from dishonor as an officer, and it appears to me that there are only two ways by which it may be fully done; one by reinstatement on my del commission and muster, the other by changing my dismissal to an honorable discharge.

Being commissioned again while yet under dismissal besides being contrary to all my ideas of Government dealing with those under its punishment, seems to me to be only partially covering the blot on my character without erasing it at all.

Besides the disgrace cast upon me by this affair I am left in very unpleasant pecuniary circumstances.

The money that I received when discharged from

my former regiment I expended in procuring a partial outfit as an officer, and the few days pay that I received as an officer was hardly enough to procure a citizen's suit, and for nearly three months I have been waiting for action to be taken on my affair at Headquarters believing that such action though delayed would be just, and result in reinstatement and pay, or in changing dismissal to honorable discharge, that I might with better spirit and with better success seek other employment.

I am already involved in debt to some extent, and if I am to be commissioned again losing past time and then wait two or three months before I can be mustered so as to draw pay again, as I shall probably have to, for the 1<sup>st</sup> La. Heavy Arty C. & A. now has a larger proportion of officers commissioned than of men enlisted, the question arises can I keep along and remain ready to accept such commission when the time comes that I may be mustered. I should however try to do so, regarding a commission as visible evidence to some extent that I was judged free from guilt, but I trust that my previous connection with the service will be just fully freed from disgrace if I am thus to enter the service again.

I was dismissed for incapacity or criminal action,

and I judge by the action already taken that you must believe me free from guilt, and deem me punished thus far unjustly. I will now report for examination to test my capacity and if establishing it I hope that you will deem me deserving of reinstatement and pay, thus fully clearing me from dishonor and relieving me from my present trying position

I may have misinterpreted the true meaning of the order for examination, and this may be annoying to you, but pleading the interest that I have at stake to excuse my doubt and anxiety, and earnestly begging your pardon for thus addressing you

I am

Very Respectfully

Your most obed<sup>t</sup> serv<sup>t</sup>

M. J. Kenyon

Late

Jr 1<sup>st</sup> Lt Co "C" 1<sup>st</sup> La

Reg. Arty C S A

Brig. Gen. Stone  
Chief of Staff  
Dept. of the Gulf

N<sup>o</sup> 29 61 1864  
Camp Parapet  
Feb 17<sup>th</sup> 1864

Memorandum  
Late Co 1<sup>st</sup> Lt Co C 1<sup>st</sup> Canada

Request that a thorough  
investigation be made in  
relation to the regiment that  
the guilty may rest on the  
right persons, and the  
innocent go free from the  
charge

Camp Parapet Feb 17<sup>th</sup> 1864

General Stone  
Chief of Staff  
Dept of the Gulf

General

I have the honor to acknowledge receipt of communication from Head Quarters of the 11<sup>th</sup> Inst.

I was very sorry to learn that the commanding General deems it right that proven and acknowledged innocence should suffer for an unfortunate connection for a short time with those who might be guilty, though the sufferer was unconscious that they were wrong in ought.

It is also very hard for one when he thinks he is suffering under wrong to deem himself very fortunate that the wrong is partly rectified for the future without any reparation for the past

I am at a loss to even conjecture what acts can have been charged to the company of a character

so foul as to cast a stain not only on all  
who were connected with it but, upon the service  
and even the Government itself

I believe that very much must have been  
charged to the company and its officers of which  
it or they were not in the least guilty, and which  
properly belongs upon the shoulders of others, some  
within the service, but more without.

I therefore earnestly request a thorough  
investigation of the whole affair that the guilt  
may be placed where it properly belongs and all  
receive justice, and I firmly believe that if the  
affair be fully investigated that it will be placed  
in such a light before the commanding General  
that he will deem the company less odious,  
and its officers worthy of more respect and  
better treatment

Hoping to be pardoned for again troubling you  
I am

Very Respectfully

Your most obedt servt

M. J. Kenyon

Late  
pr 1st Lt. Co C 1st La H. A. C. S. A

New-Orleans, La., March 1<sup>st</sup> 1864

This Certifies that W. J. Kenyon (Late Lieut Co. "B" 1<sup>st</sup> U.S. Artillery) having been duly examined before the authorized Board of Examiners according to instructions from proper authority, has been found qualified for the position of 1<sup>st</sup> Lieutenant in the First Heavy Artillery Regiment of the Corps d'Afrique, and we respectfully recommend that he receive a commission accordingly.

W. J. Kenyon  
Col. 133<sup>rd</sup> N. Y. Vols, President

Colonel 2<sup>nd</sup> Louisiana Cavalry  
Samuel C. Cosh  
1<sup>st</sup> U.S. Artillery Capt. U.S.A.  
Samuel Hamblet  
Captain 8<sup>th</sup> Inftry U.S.A.

Members of the Board.

Approved,

W. J. Kenyon

Brig. Gen'l Vol., Chief Staff  
Commanding Department of Africa



K (D.G.) 874 1864

Camp Parapel Lu  
March 14<sup>th</sup> 1864

Mr J. J. Kowalski  
Late Lt Col 6<sup>th</sup> Regt H.A.

Acknowledges the receipt  
of a commission and re-  
quests that his commission may  
be changed to an honorable  
discharge.

In company

His pay must  
come in his new  
position according  
to regulations.

CP

What order disbands him?  
JSC

S. O. W. H. McKelvey

Camp Parakee

March 14<sup>th</sup> 1864

Major Drake

A. A. General

Dept of the Gulf

Major

I have the honor to acknowledge receipt of commission dated March 3<sup>rd</sup> 1864.

I would also respectfully call the attention of the commanding General again to my case, and thus request, that as I have cleared myself from all charges against my past official conduct, that my dismissal may be changed to honorable discharge, for though believing it now to be virtually annulled it is yet dismissal, and covers the time from its issue until I may be mustered into the service again, and may be the cause of unmerited reproach many a time hereafter.

I also hope that as I have proved that I was neither criminal nor incapable, which was all of which I know of being charged, that you will not hold me in fault for being late off duty but

deem it only just that I should receive the  
pay of my rank until I may be mustered again  
as though all the time on duty, for the time off  
duty I have only used in endeavors to clear myself  
from this affair in which I believe I was involved  
by some mistake of others and not by my own  
misdoings.

I hope that as you have deemed me deserving of  
another commission that you will also deem me deserving of  
the other proofs of guiltless, which I believe necessary  
to the completion of the justice that you have seemed  
willing to render, and I trust that you will take such  
action as you may deem best to secure such completion,  
and relieve me from the torturing thought that I am  
wronged by the power to which I have ever been  
faithful and true

I am

Very Respectfully

Your most Ad<sup>t</sup> servt

W. J. Kenyon

Late

1<sup>st</sup> Lt Co "A" 1<sup>st</sup> La

Reg. Arty. C. S. A.

Headquarters Department of the Gulf

New Orleans March 16, 1864

Special Order  
11067

[ Extract ]

" Paragraph of Special Order No 278 of 1863  
from these Headquarters dismissing Lieutenant  
Wm S. Norman 1st Louisiana Heavy Artillery  
from the Service is amended so as to read that  
he will be honorably discharged from military  
service of the United States on the rebandment  
of his company

a true copy  
M. J. Kenyon  
Commissioner of the Gulf

By command of Major General Banks

Signed

Rich<sup>d</sup> B. Irwin

Assistant Adjutant General

Lieutenant Colonel  
of the 1st Louisiana Heavy Artillery  
officials

Geo B Drake  
A. A. G.

72 2 1864  
Camp Parapet, March 21, 1864  
K. D. 95 1864  
Kenyon, Lieut. M. J.  
1<sup>st</sup> H. Arty. Co. A.

Asks information regarding  
disbandment, the date of, late  
Co. C, 1<sup>st</sup> H. A. Co. A.  
one enclosure.

Hd. qrs. 1<sup>st</sup> H. A. Co. A.  
New Orleans, March 21, 1864.

Respectfully referred to Head  
quarters Department of the Gulf

J. D. Prange  
Sgt. Col. Comdr. 1<sup>st</sup> H. A. Co. A.

Recd. March 21, 1864

at 11  
Ans.  
Nov. 7, 1868  
File this  
Ans. p. 1

Camp Parapet  
March 21<sup>st</sup> 1864

Col J. S. Bruce Jr  
Comdr 1<sup>st</sup> La. Hvy. Arty

Col  
I have the honor to acknowledge  
receipt of Special Order. (Copy enclosed)  
I respectfully request information as  
to the date of disbandment of the late Co "C" of the  
1<sup>st</sup> Louisiana Heavy Artillery

I am

Very Respectfully  
Your most obedt. servt  
M. J. Kenyon

1905  
Harris, David

D, 10 U.S. Col'd H. Art'y.

Private | Private

CARD NUMBERS.

1	5487036	26
2	5500548	27
3	5500657	28
4	5502303	29
5		30
6		31
7		32
8		33
9		34
10		35
11		36
12		37
13		38
14		39
15		40
16		41
17		42
18		43
19		44
20		45
21		46
22		47
23		48
24		49
25		50

Book Mark:

See also

K | 10 H. Art'y. | **U.S.C.T.**

*David Kerrie*

Appears with rank of *Private* on

**Muster and Descriptive Roll of a Detach-**  
**ment of U. S. Vols. forwarded**

for the *10* Reg't *U. S. C. H. A.* Roll dated

*New Orleans La*, *May 7*, 1864.

Where born *No. Carolina*

Age *27* y'rs; occupation *Laborer*

When enlisted *Jan 31*, 1864.

Where enlisted *New Orleans*

For what period enlisted *3* years.

Eyes *Black*; hair *Black*

Complexion *Black*; height *5 ft. 10* in.

When mustered in *Feb. 8*, 1864

Where mustered in *New Orleans*

Bounty paid \$ *100*; due \$ *100*

Where credited *New Orleans*

Company to which assigned *D*

Remarks:

Book mark:

*Galligan*



*H.* | **10 H. Art'y.** | **U.S.C.T.**

*David Kerrie*

*P*, Co. D, 7 Reg't U. S. Col'd H. Art'y.†

Age ..... years.

Appears on

**Company Muster Roll\***

for *Enrolment to Apr. 30*, 1864.

Joined for duty and enrolled:

When *Jan. 31*, 1864.

Where *N. Orleans La.*

Period *3* years.

Mustered in:

When *Feb. 8*, 1864.

Where *N. Orleans*

Present or absent *Present*

Stoppage, \$ *100* for .....

Due Gov't, \$ *100* for .....

Valuation of horse, \$ *100*

Valuation of horse equipments, \$ *100*

Remarks : .....

† This organization subsequently became Co. D, 10 Reg't U. S. Colored Heavy Artillery.

\* First current roll. No muster-in roll of this company on file.

Book mark : .....

*Shadobolt*

*K.* | **10 H. Art'y.** | **U.S.C.T.**

*David Kerrie*

*P.*, Co. *D.*, 7 Reg't U. S. Col'd H. Art'y.\*

Appears on

**Company Muster Roll**

for *May June*, 186*4*.

Present or absent.....

Stoppage, \$.....100 for.....

Due Gov't, \$.....100 for.....

Valuation of horse, \$.....100

Valuation of horse equipments, \$.....100

Remarks *Died in Corps d'Afrique*  
*Gen'l Hosp'l New Orleans*  
*La. May 28/64*

\* This organization subsequently became Co. *D.*, 10 Reg't U. S. Colored Heavy Artillery.

Book mark :.....

*Shadwell*

*N 10 26. Arty* **U.S.C.T.**  
*David Perie*  
*Im, Co. 14* Reg't U. S. Col'd *Arty*

Appears on **Co. Muster-out Roll**, dated  
*Palmer Reg't 14*, 1867.

Muster-out to date \_\_\_\_\_, 186 .

Last paid to \_\_\_\_\_, 186 .

**Clothing account:**

Last settled \_\_\_\_\_, 186 ; drawn since \$ \_\_\_\_\_ 100

Due soldier \$ \_\_\_\_\_ 100; due U. S. \$ \_\_\_\_\_ 100

Am't for cloth'g in kind or money adv'd \$ \_\_\_\_\_ 100

Due U. S. for arms, equipments, &c., \$ \_\_\_\_\_ 100

Bounty paid \$ \_\_\_\_\_ 100; due \$ \_\_\_\_\_ 100

Remarks: *Joined 10th Reg.*

*Did not see Gen. Hooker  
NO. 14 May 28/64  
Final statements  
found*

Book mark: *Vols 9 148.73*

(861)

*J. L. Leonard*  
Copyist.

Kirke, David

P. D., Co.

10

Reg't U.S.C.H.A.

6

Enclosures.

Bed Cards	Descriptive Lists
Burial Records	Final Statements 2
Certs. of Dis. for Discharge	Furloughs
C. M. Charges	Med. Des. Lists
Med. Certificates	Orders

Other papers relating to—

Admission to Hosp'l	Furlough
Casualty Sheet ( <sup>Priv</sup> Officer's) 1	Med. Examination
Confinement	Misc. Information 1
Contracts	Pay or Clothing
Death or Effects 2	Personal Reports
Desertions	Rank
Discharge from Hosp'l	Transfer to Hosp'l
Discharge from Service	Transfer to V. R. C.
Duty	Transportation

E. B., S. G. O.

Surgeon General's Office,

Record and Pension Bureau,

7 art January 24, 1866.

Respectfully returned. The records of

the general and Corps of Surgeons  
General Hospital, San Carlos

on file in this Office, furnish no evidence con-  
cerning the within named man.

(Private David  
Hark, Co. 1st Regt. U.S. Art.)  
Inventory of Effects enclosed in case  
of Sgt David Hark, Co. 1st Regt.  
Gen. Hospital, Corps of Surgeons, from the  
records of that Hospital (to which he  
was admitted Jan 11th 1864, as Sgt  
David Hark, Co. 1st Regt. U.S. Art.)  
which furnishes no evidence to prepare  
Final Statement.

By Order of the Surgeon General

J. J. Wood

Bvt. Major and Assistant Surgeon, U. S. A.



1072

J. R. B. B. 21.

FINAL STATEMENT

OF

*David Ferris Co. G*

*10<sup>th</sup> Reg't of M. S. C. Artillery  
Co. G 7<sup>th</sup> M. S. C. Artillery (Heavy)*

*18* **VOLENTEERS.**  
*Recd May 20 1864*

NOTE 1.—Two of these certificates (or duplicates) are to be given to each Volunteer Soldier or drafted man who may be discharged previously to the discharge of his company, that he may at once receive from the Paymaster the pay, &c., due him, and the captain or other COMMISSIONED officer commanding the company will certify to the act of the delivery of the duplicate certificates; on these certificates the Soldier is "entitled to" his discharge, and should also present his discharge to the Paymaster to have the payment endorsed on it. The discharge is to be given back to the Soldier by the Paymaster; the latter only retaining as his voucher the duplicate certificates.

NOTE 2.—If the Soldier is entitled to pay for the use of his horse, the Company Commander will certify to that fact on the back of both these final statements, and also to the time he has pay due for having been so mounted on his own horse.

NOTE 3.—When a Soldier is furnished with final statements, his descriptive list, if he has one, should be taken up by the officer who gives the Soldier these statements, and endorsed with a statement to this effect: by the officer. This endorsement should exhibit a full statement of the time for which the Soldier was allowed pay on his final statements, the clothing account, and all other charges against him or in his favor, so as to comprise a complete exhibit of his account. It will then be transmitted to the company commander of the Soldier, who will enter all the data necessary to a full understanding of the Soldier's account on the muster roll upon which the Soldier's discharge is reported. The descriptive list will then be destroyed. The object of this is, that the remaining portion of the Soldier's account may be settled upon the receipt of these muster rolls, and the Soldier receive any pay or allowances that may be due him at the time of his discharge, and which may not appear on his final statements from the fact that his descriptive list is incomplete. These accounts for back pay, &c., are settled by the 2d Auditor of the Treasury Department.

NOTE 4.—Charges for loss or injury to ordnance, horse equipments, and other miscellaneous charges, should appear under the heading of "Other Stoppages."

NOTE 5.—Bounty paid by State authorities, and not by the United States, will not be entered on this statement.

NOTE 6.—Amounts due the Sutler and Laundress must be entered on the muster roll on which the discharge, death, desertion, &c., is reported, as well as on the final statement, otherwise the amount cannot be collected from the United States.

NOTE 7.—This blank will be used for deceased volunteers and drafted men, as well as for others.

NOTE 8.—Where a Soldier dies in hospital or on detached service, his descriptive list, if he has one, should be sent with his final statements; in duplicate, to the Second Auditor, Washington, D. C.

ADJUTANT GENERAL'S OFFICE.

*Oct 19 1864*

Duplicate with Inventory sent 2d Auditor.

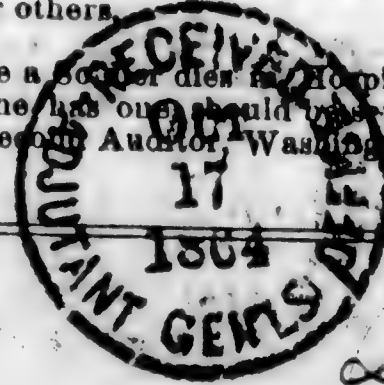

*Leitch*

I certify, on honor, that *David Kerri* a *Private* of  
 Captain *C. A. Bailey & Co.* Company (*2*) of the *10<sup>th</sup>* Regiment of *U. S. Col. Art. (Heavy)*  
**VOLUNTEERS**, of the State of *North Carolina*, born in *North Carolina*, State  
 of *North Carolina*, aged *27* years; *5* feet *10* inches high; *Dark* complexion,  
*Black* eyes, *Black* hair, and by occupation a *Farmer*, having joined the company on  
 its original organization at \_\_\_\_\_, and enrolled in it at the muster into  
 the service of the United States at \_\_\_\_\_, on the \_\_\_\_\_ day  
 of \_\_\_\_\_, 186\_\_\_\_, (or was mustered in service as a recruit, by *Captain*  
*Mr. A. Clister*, at *New Orleans La.*, on the *Eighth* day of *February*,  
 1864, or was drafted and mustered into the service of the United States from the  
 Enrollment District of the State of \_\_\_\_\_, at \_\_\_\_\_,  
 on the \_\_\_\_\_ day of \_\_\_\_\_, 186\_\_\_\_) to serve in the Regiment, for  
 the term of *Three Years*: and having served **HONESTLY** and  
**FAITHFULLY** with his Company in \_\_\_\_\_ to the present date; is now

entitled to a **DISCHARGE** by reason of *Death. Died in Corps. & Agency*  
*General Hospital N. Orleans La. May 28<sup>th</sup> 1864 of Small Pox*

The said *David Kerri* was last paid by Paymaster  
 \_\_\_\_\_ from date of  
 enrollment to include the \_\_\_\_\_ day of \_\_\_\_\_, 186\_\_\_\_, and has  
 pay due him from that time to the present date; he is entitled to pay and subsistence for  
**TRAVELING** to place of enrollment, and whatever other allowances are authorized to volunteer  
 soldiers, drafted men, or militia, so discharged. He has received from the United States **CLOTHING**  
 amounting to *Twenty one*  $\frac{21}{100}$  dollars, since the *date* day of *enrollment*,  
 186\_\_\_\_, when his clothing account was last settled. He has received from the United States  
 \_\_\_\_\_ dollars advanced **BOUNTY**.

There is to be stopped from him, on account of the State of \_\_\_\_\_, or other  
 authorities, for **CLOTHING**, &c., received on entering service, \_\_\_\_\_ dollars; and  
 for other stoppages, viz: \_\_\_\_\_  
 \_\_\_\_\_ dollars.

He has been furnished with **TRANSPORTATION** in kind from the place of his discharge to  
 \_\_\_\_\_; and he has been **SUBSISTED** for **TRAVELING** to his  
 place of enrollment, up to the \_\_\_\_\_, 186\_\_\_\_.

He is indebted to \_\_\_\_\_, **SUTLER**, \_\_\_\_\_ dollars.  
 He is indebted to \_\_\_\_\_, **LAUNDRESS**, \_\_\_\_\_ dollars.

Given in Duplicate, at *Bayou St John La.*, this *24<sup>th</sup>* day  
 of *September*, 1864.

*Charles A. Bailey*  
 \_\_\_\_\_  
 Captain  
 Commanding Company.

✓

FINAL STATEMENT

OF

*Private David Keenan*

*10<sup>th</sup>* Reg't of *U. S. Col. 8<sup>th</sup> (Heavy)*

VOLUNTEERS.

*Disd May 28<sup>th</sup> 1864*

NOTE 1.—Two of these certificates (or duplicates) are to be given to each Volunteer Soldier or drafted man who may be discharged previously to the discharge of his company, that he may at once receive from the Paymaster the pay, &c., due him, and the captain or other COMMISSIONED officer commanding the company will certify to the act of the delivery of the duplicate certificates; on these certificates the Soldier is "entitled to" his discharge, and should also present his discharge to the Paymaster to have the payment endorsed on it. The discharge is to be given back to the Soldier by the Paymaster; the latter only retaining as his voucher the duplicate certificates.

NOTE 2.—If the Soldier is entitled to pay for the use of his horse, the Company Commander will certify to that fact on the back of both these final statements, and also to the time he has pay due for having been so mounted on his own horse.

NOTE 3.—When a Soldier is furnished with final statements, his descriptive list, if he has one, should be taken up by the officer who gives the Soldier these statements, and endorsed with a statement to this effect by the officer. This endorsement should exhibit a full statement of the time for which the Soldier was allowed pay on his final statements, the clothing account, and all other charges against him or in his favor, so as to comprise a complete exhibit of his account. It will then be transmitted to the company commander of the Soldier, who will enter all the data necessary to a full understanding of the Soldier's account on the muster roll upon which the Soldier's discharge is reported. The descriptive list will then be destroyed. The object of this is, that the remaining portion of the Soldier's account may be settled upon the receipt of these muster rolls, and the Soldier receive any pay or allowances that may be due him at the time of his discharge, and which may not appear on his final statements from the fact that his descriptive list is incomplete. These accounts for back pay, &c., are settled by the 2d Auditor of the Treasury Department.

NOTE 4.—Charges for loss or injury to ordnance, horse equipments, and other miscellaneous charges, should appear under the heading of "Other Stoppages."

NOTE 5.—Bounty paid by State authorities, and not by the United States, will not be entered on this statement.

NOTE 6.—Amounts due the Sutler and Laundress must be entered on the muster roll on which the discharge, death, desertion, &c., is reported, as well as on the final statement, otherwise the amount cannot be collected from the United States.

NOTE 7.—This blank will be used for deceased volunteers and drafted men, as well as for others.

NOTE 8.—Where a Soldier dies in Hospital or on detached service, his descriptive list, if he has one, should be sent with his final statements, in duplicate, to the Second Auditor, Washington, D. C.

ADJUTANT GENERAL'S OFFICE.

*see list 1864*

Duplicate with Inventory sent 2d Auditor.

*Leuby*





I certify, on honor, that David Kerric a Private of  
 Captain C. A. Bailey's Company (2) of the 10<sup>th</sup> Regiment of U. S. C. Art. (Heavy)  
**VOLUNTEERS**, of the State of \_\_\_\_\_, born in \_\_\_\_\_, State  
 of N. Carolina, aged 27 years; 5 feet 10 inches high; Dark complexion,  
Black eyes, Black hair, and by occupation a Farmer, having joined the company on  
 its original organization at \_\_\_\_\_, and enrolled in it at the muster into  
 the service of the United States at \_\_\_\_\_, on the \_\_\_\_\_ day  
 of \_\_\_\_\_, 1864, (or was mustered in service as a recruit, by Captain  
McC. A. Clister, at N. Orleans La. on the Eighth day of February,  
 1864, or was drafted and mustered into the service of the United States from the  
 Enrollment District of the State of \_\_\_\_\_, at \_\_\_\_\_,  
 on the \_\_\_\_\_ day of \_\_\_\_\_, 1864,) to serve in the Regiment, for  
 the term of Three Years: and having served **HONESTLY** and  
**FAITHFULLY** with his Company in \_\_\_\_\_ to the present date, is now

entitled to a **DISCHARGE** by reason of death. Died in Corps d'Afrique  
Gen. Receipt N. Orleans La. May 28<sup>th</sup> 1864 of Small Pox

The said David Kerric has pay due him from Enrollment  
~~to the present date~~ to include the \_\_\_\_\_ day of \_\_\_\_\_, 1864, and has  
 pay due him from that time to the present date, he is entitled to pay and subsistence for  
**TRAVELING** to place of enrollment, and whatever other allowances are authorized to volunteer  
 soldiers, drafted men, or militia, so discharged. He has received from the United States **CLOTHING**  
 amounting to Thirty one  $\frac{21}{100}$  dollars, since the 31<sup>st</sup> day of January,  
 1864, date of Enrollment when his clothing account was last settled. He has received from the United States  
 \_\_\_\_\_ dollars advanced **BOUNTY**.

There is to be stopped from him, on account of the State of \_\_\_\_\_, or other  
 authorities, for **CLOTHING**, &c., received on entering service, \_\_\_\_\_ dollars; and  
 for other stoppages, viz: \_\_\_\_\_

\_\_\_\_\_ dollars.  
 He has been furnished with **TRANSPORTATION** in kind from the place of his discharge to  
 \_\_\_\_\_; and he has been **SUBSISTED** for **TRAVELING** to his  
 place of enrollment, up to the \_\_\_\_\_, 1864.

He is indebted to \_\_\_\_\_, **SUTLER**, \_\_\_\_\_ dollars.  
 He is indebted to \_\_\_\_\_, **LAUNDRESS**, \_\_\_\_\_ dollars.

Given in Duplicate, at Bayou St John La, this 28<sup>th</sup> day  
 of May, 1864.

C. A. Bailey  
Capt. Co. D. 10<sup>th</sup> U. S. C. Art. (H)  
 Commanding Company.

2<sup>nd</sup> post in suit for 60 days. Gen. Apr. 6. 60

CASUALTY SHEET

No. \_\_\_\_\_

David Kirk  
Priv' of Company D.  
7<sup>th</sup> Regiment of U.S.A.  
State Volunteers.

NATURE OF CASUALTY.

Died May 29<sup>th</sup> 1864

CASUALTY SHEET.

Name: David Kirk

Rank: Pvt Company: D Regiment: 7

Arm: U.S. Art State: \_\_\_\_\_

Nature of Casualty: Death

CAUSE OF CASUALTY—(NAME OF DISEASE, &c.)

BY WHOM DISCHARGED.

FROM WHAT SOURCE THIS INFORMATION WAS OBTAINED.

DEGREE OF DISABILITY.

BY WHOM CERTIFIED.

J. W. Moore  
C. G. M.

DATE OF DISCHARGE, DEATH, &c.

May 29, 1864

PLACE OF DISCHARGE, DEATH, &c.

David Kirk  
Lan Pg 127

REMARKS.

Buried New Orleans, La. \_\_\_\_\_  
Clerk.

ARTICLES OF WAR.

ART. 95. When any non-commissioned officer or soldier shall die, or be killed in the service of the United States, the then commanding officer of the troop or company shall, in the presence of two other commissioned officers, take an account of what effects he died possessed of, above his arms and accoutrements, and transmit the same to the office of the Department of War, which said effects are to be accounted for, and paid to the representatives of such deceased non-commissioned officer or soldier. And in case any of the officers, so authorized to take care of the effects of deceased officers and soldiers, should, before they have accounted to their representatives for the same, have occasion to leave the regiment or post, by preferment or otherwise, they shall, before they be permitted to quit the same, deposit in the hands of the commanding officer, or of the assistant military agent, all the effects of such deceased non-commissioned officers and soldiers, in order that the same may be secured for, and paid to, their respective representatives.

DIRECTIONS.

NOTE 1.—One copy of the inventories of the effects of deceased non-commissioned officers and soldiers, required by the 95th Article of War, will be forwarded to the Adjutant General, by the commander of the company to which the deceased belonged, and a duplicate of the same to the colonel of the regiment. Final statements of pay, clothing, &c., in duplicate, will be sent to the Adjutant General with one copy of the inventory. Both inventory and final statements should be forwarded, as a general rule, through Regimental Headquarters. When a soldier dies at a post or station absent from his company, it will be the duty of his immediate commander to furnish, direct to the Adjutant General, the required inventory and final statements, and, at the same time, to forward to the commanding officer of the company to which the soldier belonged, a report of his death, specifying the date, place, and cause; to what time he was last paid, and the money or other effects in his possession at the time of his decease; which report will be noted on the next muster roll of the company to which the man belonged. Each inventory will be endorsed, "Inventory of the effects of —, late of company (—), regiment of —, who died at —, the — day of —, 186—." If a legal representative receive the effects, it will be stated in the report. If the soldier leave no effects, the fact will be reported on the blank for inventory.

NOTE 2.—Should the effects of a deceased non-commissioned officer or soldier not be administered upon within a short period after his decease, they shall be disposed of by a Council of Administration, under the authority of the commanding officer of the post, and the proceeds deposited with the Paymaster, to the credit of the United States, until they shall be claimed by the legal representatives of the deceased.

NOTE 3.—In all such cases of sales by the Council of Administration, a statement in detail, or account of the proceeds duly certified by the Council and commanding officer, (Form 5,) accompanied by the Paymaster's receipt for the proceeds, will be forwarded by the commanding officer to the Adjutant General. The statement will be endorsed, "Report of the proceeds of the effects of —, late of company (—), regiment of —, who died at —, the — day of —, 186—."

NOTE 4.—The effects in all cases, when called for, should be turned over to the legal representative, without further authority from the Adjutant General. When the effects are turned over to the relatives of the deceased before these inventories are sent to the Adjutant General, their receipts therefor should be attached to the inventories. In all other cases, one copy will be sent with a letter of transmittal direct to the Adjutant General, and a duplicate retained by the officer.

NOTE 5.—Particular care should be taken to take receipts in duplicate from the Paymaster for any funds turned over to him; one copy should be sent direct to the Adjutant General and one retained by the officer.

*Duplicate*  
*Had no descriptive List*  
INVENTORY OF THE EFFECTS

OF

*Syrt. David Kirk*

Late of Company *C*

*1<sup>st</sup> Reg't of La. Heavy Art. Co. C. D. Arque*  
*73<sup>rd</sup> Reg't of La. Heavy Art. Co. C. D. Arque*  
Volunteers, who died at *Camp of Instruction, Hosp*

on the *28* day of *May*, 1864.

*1026 S. C. H. A.*

Surgeon General's Office,

RECORD & PENSION BUREAU,

Washington, 186

*The within Inventory is a true copy from the records*  
*of Hospital*  
*on file in*  
*this Office, and contains all the information in the case that*  
*can be found.*

BY ORDER OF THE SURGEON GENERAL:

*Bvt. Major, Assistant Surgeon, U. S. A.*

Inventory of the effects of David Kirk late  
 a Serjnt. of Captain \_\_\_\_\_ Company D of  
 the 1st Regiment of La. Heavy Art. Corps & Co. Volunteers, who was enrolled as  
 a \_\_\_\_\_ at \_\_\_\_\_ in the State of \_\_\_\_\_ on  
 the \_\_\_\_\_ day of \_\_\_\_\_ 186 , and mustered into the service of the United  
 States as a \_\_\_\_\_ on the \_\_\_\_\_ day of \_\_\_\_\_ 186 , at \_\_\_\_\_  
 in Company \_\_\_\_\_, \_\_\_\_\_ Regiment of \_\_\_\_\_ Volunteers, to serve \_\_\_\_\_  
 years or during the war; he was born in \_\_\_\_\_ in the State  
 of \_\_\_\_\_: he was \_\_\_\_\_ years of age, \_\_\_\_\_ feet \_\_\_\_\_ inches  
 high, \_\_\_\_\_ complexion, \_\_\_\_\_ eyes, \_\_\_\_\_ hair, and by occupation, when enrolled,  
 a \_\_\_\_\_; he died in Camp & Hospital Genl. Hosp., at  
New Orleans La on the 28 day of May 1864, by  
 reason of Small Pox.

INVENTORY.					
ARTICLES.	No.	ARTICLES.	No.	ARTICLES.	No.
Hats.....		Pairs trousers.....		Knapsacks.....	
Caps.....		Pairs flannel drawers.....			
Forage Caps.....		Pairs cotton drawers.....			
Great coats.....		Flannel shirts.....			
Uniform coats.....		Cotton shirts.....			
Uniform jackets.....		Pairs boots.....			
Flannel sack coats.....		Pairs shoes.....			
Blouses.....		Pairs socks.....			
Stable frocks.....		Blankets.....			
Fatigue overalls.....		Haversacks.....			
				MONEY.	
				Specie.....	\$
				Notes.....	\$

I CERTIFY, ON HONOR, that the above inventory comprises all the effects of \_\_\_\_\_  
 \_\_\_\_\_, deceased, and that the effects are in the hands  
 of \_\_\_\_\_ at \_\_\_\_\_  
 \_\_\_\_\_ to be disposed of by a Council of Administration.

(DUPLICATES.)

STATION: New Orleans La  
 DATE: May 28, 1864

Surg. & Capt. U.S. Inf. & C.  
 Commanding the Company.  
In Charge of Corps & Hospital Genl. Hosp.

[A. G. O. No. 104.]

ARTICLES OF WAR.

ART. 95. When any non-commissioned officer or soldier shall die, or be killed in the service of the United States, the then commanding officer of the troop or company shall, in the presence of two other commissioned officers, take an account of what effects he died possessed of, above his arms and accoutrements, and transmit the same to the office of the Department of War, which said effects are to be accounted for, and paid to the representatives of such deceased non-commissioned officer or soldier. And in case any of the officers, so authorized to take care of the effects of deceased officers and soldiers, should, before they have accounted to their representatives for the same, have occasion to leave the regiment or post, by preferment or otherwise, they shall, before they be permitted to quit the same, deposit in the hands of the commanding officer, or of the assistant military agent, all the effects of such deceased non-commissioned officers and soldiers, in order that the same may be secured for, and paid to, their respective representatives.

ARMY REGULATIONS—EDITION OF 1861.

DECEASED SOLDIERS.

Par. 152. Inventories of the effects of deceased non-commissioned officers and soldiers, required by the 95th Article of War, will be forwarded to the Adjutant General, by the commander of the company to which the deceased belonged, and a duplicate of the same to the colonel of the regiment. Final statements of pay, clothing, &c., will be sent with the inventories. When a soldier dies at a post or station absent from his company, it will be the duty of his immediate commander to furnish the required inventory, and, at the same time, to forward to the commanding officer of the company to which the soldier belonged, a report of his death, specifying the date, place, and cause; to what time he was last paid, and the money or other effects in his possession at the time of his decease; which report will be noted on the next muster roll of the company to which the man belonged. Each inventory will be endorsed, "Inventory of the effects of \_\_\_\_\_, late of company (—) \_\_\_\_\_ regiment of \_\_\_\_\_, who died at \_\_\_\_\_, the \_\_\_\_\_ day of \_\_\_\_\_, 186—." If a legal representative receive the effects, it will be stated in the report. If the soldier leave no effects, the fact will be reported.

Par. 153. Should the effects of a deceased non-commissioned officer or soldier not be administered upon within a short period after his decease, they shall be disposed of by a Council of Administration, under the authority of the commanding officer of the post, and the proceeds deposited with the Paymaster, to the credit of the United States, until they shall be claimed by the legal representatives of the deceased.

Par. 154. In all such cases of sales by the Council of Administration, a statement in detail, or account of the proceeds, duly certified by the Council and commanding officer, accompanied by the Paymaster's receipt for the proceeds, will be forwarded by the commanding officer to the Adjutant General. The statement will be endorsed, "Report of the proceeds of the effects of \_\_\_\_\_, late of company (—) \_\_\_\_\_ regiment of \_\_\_\_\_, who died at \_\_\_\_\_, the \_\_\_\_\_ day of \_\_\_\_\_, 186—."

NOTE 1.—The effects in all cases, when called for, should be turned over to the legal representative, without further authority from the Adjutant General. When the effects are turned over to the relatives of the deceased before these inventories are sent to the Adjutant General, their receipts therefor should be attached to the inventories. In all other cases, one copy will be sent with a letter of transmittal direct to the Adjutant General, and a duplicate retained by the officer.

NOTE 2.—Particular care should be taken to take receipts in duplicate from the Paymaster for any funds turned over to him; one copy should be sent direct to the Adjutant General and one retained by the officer.

*Duplicate*  
*Had no descriptive list*  
 INVENTORY OF THE EFFECTS

OF

*Prof David Keefe*

Late of Company *G*

*1<sup>st</sup>* Reg't of *Co. 2<sup>nd</sup> Heavy Arty*

Volunteers, who died at *Camp St. Louis*

on the *28<sup>th</sup>* day of *May* 186*4*

*Adjutant General's Office*  
*Record and Pension Division*  
*Washington D.C. Jan 24 1867*  
 This Inventory is the copy retained  
 with the records of the Corps  
*D'Afrique General Hospital*  
*New Orleans La.* filed in  
 this office and contains all  
 information in the case that  
 can be found.  
 By order of *Adjutant General*

*W. W. Wood*  
*Adjutant General*



Inventory of the effects of David Kunkle late  
 a Sergeant of Captain \_\_\_\_\_ Company D of  
 the 1st Regiment of Co. Henry C. D. Affin Volunteers, who was enrolled as  
 a \_\_\_\_\_ at \_\_\_\_\_ in the State of \_\_\_\_\_ on  
 the \_\_\_\_\_ day of \_\_\_\_\_ 186 \_\_\_\_\_, and mustered into the service of the United  
 States as a \_\_\_\_\_ on the \_\_\_\_\_ day of \_\_\_\_\_ 186 \_\_\_\_\_, at \_\_\_\_\_  
 in Company \_\_\_\_\_, \_\_\_\_\_ Regiment of \_\_\_\_\_ Volunteers, to serve \_\_\_\_\_  
 years or during the war; he was born in \_\_\_\_\_ in the State  
 of \_\_\_\_\_; he was \_\_\_\_\_ years of age, \_\_\_\_\_ feet \_\_\_\_\_ inches  
 high, \_\_\_\_\_ complexion, \_\_\_\_\_ eyes, \_\_\_\_\_ hair, and by occupation, when enrolled,  
 a \_\_\_\_\_; he died in Camp of Amique General Hospital at  
New Orleans Louisiana on the 28<sup>th</sup> day of May 1864 by  
 reason of Small-pox

INVENTORY.					
ARTICLES.	No.	ARTICLES.	No.	ARTICLES.	No.
Hats.....		Pairs trousers.....		Knapsacks.....	
Caps.....		Pairs flannel drawers.....			
Forage caps.....		Pairs cotton drawers.....			
Great coats.....		Flannel shirts.....			
Uniform coats.....		Cotton shirts.....			
Uniform jackets.....		Pairs boots.....			
Flannel sack coats.....		Pairs shoes.....			
Blouses.....		Pairs socks.....			
Stable frocks.....		Blankets.....			
Fatigue overalls.....		Haversacks.....			
				MONEY.	
				Specie.....	\$
				Notes.....	\$

I CERTIFY, ON HONOR, that the above inventory comprises all the effects of \_\_\_\_\_  
 \_\_\_\_\_, deceased, and that the effects are in the hands  
 of \_\_\_\_\_ at \_\_\_\_\_  
 \_\_\_\_\_ to be disposed of by a Council of Administration.

( DUPLICATES. )

STATION: New Orleans La

DATE: May 28<sup>th</sup> 1864

[A. G. O. No. 104.]

Surgeon H. W. ...  
 Commanding the Company.  
In Charge of Camp of Amique Genl Hospital

*Kerrick, David*

*Co 6*, 10 U.S. Col'd H. Art'y.

*Private Corporal*

CARD NUMBERS.

1	5497614	26
2	5497858	27
3	5497937	28
4		29
5		30
6		31
7		32
8		33
9		34
10		35
11		36
12		37
13		38
14		39
15		40
16		41
17		42
18		43
19		44
20		45
21		46
22		47
23		48
24		49
25		50

Book Mark: *A. 33, V. 11, R. C. J. 1867*

See also



*K* | 10 H. Art'y. | U.S.C.T.

*David Kerrick*

*Pvt.*, Co. C, 1 Reg't H. Art'y, Corps d'Afrique.\*

Age *26* years.

Appears on

**Company Muster-in Roll**

of the organization named above. Roll dated

*New Orleans La*, *Aug 17*, 1863.

Muster-in to date *Aug 17*, 1863.

Joined for duty and enrolled:

When *July 9*, 1863.

Where *Camp Parquet La*

Period *3* years.

Valuation of horse, \$.....100

Valuation of horse equipments, \$.....100

Remarks:.....

\* This organization subsequently became Co. C, 10 Reg't U. S. Colored Heavy Artillery.

Book mark:.....

*W. J. ...*

*K* | 10 H. Art'y. | U.S.C.T.

*David Kerrick*

*Pt*, Co, C, 1 Reg't La. Art'y Native Guards.\*

Appears on

**Company Muster Roll**

for *Aug 11<sup>th</sup> to 31<sup>st</sup>*; 1863.

Present or absent *Present*

Stoppage, \$ 100 for

Due Gov't, \$ 100 for

Valuation of horse, \$ 100

Valuation of horse equipments, \$ 100

Remarks :

\* This organization subsequently became Co. C, 10 Reg't U. S. Col'd Heavy Artillery.

Book mark :

*efficiency*

*K* | 10 H. Art'y. | U.S.C.T.

*David Herrick*

*Corp*, Co, C, 1 Reg't La. Art'y Native Guards.\*

Appears on

**Company Muster Roll**

for *Sep & Oct*, 1863.

Present or absent *Present*

Stoppage, \$ *100* for

Due Gov't, \$ *100* for

Valuation of horse, \$ *100*

Valuation of horse equipments, \$ *100*

Remarks :

*Not borne on Subs. Co. rolls*

*+ corrected by Messrs*

\* This organization subsequently became Co. C, 10 Reg't U. S. Col'd Heavy Artillery.

Book mark :

*W. J. ...*

Kessiah Benjamin  
Co E, 10 U.S. Col'd H. Art'y.

Private Private

CARD NUMBERS.

1	5502408	26
2	5489183	27
3	5502518	28
4	5502633	29
5	5502769	30
6	5502899	31
7	5503017	32
8	5503135	33
9	5503246	34
10	5503355	35
11	5503462	36
12	5503593	37
13	5503741	38
14	5503877	39
15	5504022	40
16	5504151	41
17	5504265	42
18	5504389	43
19	5489377	44
20	5504559	45
21	931RCJ-1864	46
22		47
23		48
24		49
25		50

Book Mark: 931 R.C.J. 1864

See also

Pat 544963

S11739076 P.O. m m

M. D. 1076274

5-2760270- Aud. W D

2. M. H. N. H. 12/8/02

J. B. Dowd  
E. m

*K* | **10 H. Art'y. | U.S.C.T.**

*Benjamin Resiah*  
*At.*, Co. *E*, 7 Reg't U. S. Col'd H. Art'y.\*

Appears on

**Company Muster-in and Descriptive Roll**  
of the organization named above. Roll dated

*New Orleans La. July 5, 1864.*

Where born *Lafourche La.*

Age *24* y'rs; occupation *Laborer*

When enlisted *Jan'y 20, 1864.*

Where enlisted *Napoleonville*

For what period enlisted *3* years.

Eyes *Black*; hair *Black*

Complexion *Black*; height *5 ft. 5 1/2* in.

When mustered in *March 7, 1864.*

Where mustered in *New Orleans*

Bounty paid \$ *2* 100; due \$ *100*

Where credited *Napoleonville*

Company to which assigned *E*

Remarks: \_\_\_\_\_

\_\_\_\_\_

\_\_\_\_\_

\_\_\_\_\_

\* This organization subsequently became Co. *D*, 10 Reg't U. S. Colored Heavy Artillery.

Book mark: \_\_\_\_\_

\_\_\_\_\_

\_\_\_\_\_

\_\_\_\_\_

*H 1026A* | U.S.C.T.

*Benjamin Hesiah*  
Priv, Co. *E 10* <sup>(7 u.s.c.10.R.)</sup> Reg't U. S. Col'd *Het*

Appears on a

**Detachment Muster Roll**

of the organization named above

for *Roll dated Apr-20, 1864.*

Station *De Sair, La.*

Present or absent *Present*

Stoppage, \$ 100 for

Due Gov't, \$ 100 for

Valuation of horse, \$ 100

Valuation of horse equipments, \$ 100

Remarks:

Book mark:

*Croghan*

K | **10 H. Art'y.** | **U.S.C.T.**

*Benjamin Kesiah*  
*B*, Co. *B*, 7 Reg't U. S. Col'd H. Art'y.\*

Appears on

**Company Muster Roll**

for *May June*, 186*4*.

Present or absent *Present*

Stoppage, \$ 100 for

Due Gov't, \$ 100 for

Valuation of horse, \$ 100

Valuation of horse equipments, \$ 100

Remarks: *Sick in Hospital  
at Greenville Ga*

\* This organization subsequently became Co. *B*, 10 Reg't U. S. Colored Heavy Artillery.

Book mark: \_\_\_\_\_

*Linden*  
Copyist.



K

10 H. Art'y. U.S.C.T.

Benjamin Kesiah  
Pvt., Co. E, 10 Reg't U. S. Col'd H. Art'y.

Appears on

Company Muster Roll

for July & Aug., 1864.

Present or absent Present

Stoppage, \$ 100 for

Due Gov't, \$ 100 for

Valuation of horse, \$ 100

Valuation of horse equipments, \$ 100

Remarks:

Book mark See letter G. 31.

R. G. 1864 No. Recd Sep. 1 1864

J. J. Jindler

Copyist.

*R* | 10 H. Art'y. | U.S.C.T.

*Benjamin Resiah*  
*R*, Co. E, 10 Reg't U. S. Col'd H. Art'y.

Appears on

**Company Muster Roll**

for *Sep. & Oct.*, 186*4*

Present or absent *Present*

Stoppage, \$.....100 for .....

Due Gov't, \$.....100 for .....

Valuation of horse, \$.....100

Valuation of horse equipments, \$.....100

Remarks: .....

Book mark: .....

*J. J. J. J.*  
Copyist.

*K* | 10 H. Art'y. | U.S.C.T.

*Benjamin Kesiah*  
*Pr.*, Co. E, 10 Reg't U. S. Col'd H. Art'y.

Appears on

**Company Muster Roll**

for *Nov. Dec*, 186*4*

Present or absent *Present*

Stoppage, \$ 100 for

Due Gov't, \$ 100 for

Valuation of horse, \$ 100

Valuation of horse equipments, \$ 100

Remarks: *Difference of pay  
from enlistment to  
Apr. 30 - \$6.00 per month  
due.*

Book mark: \_\_\_\_\_

*J. J. J. J.*

*A* | **10 H. Art'y. U.S.C.T.**

*Benjamin Desiah*  
*Priv.*, Co. E, 10 Reg't U. S. Col'd H. Art'y.

Appears on

**Company Muster Roll**

for *Jan'y & Feb.*, 186*4*.

Present or absent *Present.*

Stoppage, \$ 100 for

Due Gov't, \$ 100 for

Valuation of horse, \$ 100

Valuation of horse equipments, \$ 100

Remarks: *Differenced of pay*  
*from enlistment to Apr.*  
*30, 1864 at 600 per month*  
*due.*

Book mark:

*W. H. Taylor*

*K* | 10 H. Art'y. | U.S.C.T.

*Benjamin Kesiah*  
*Co.*, Co. E, 10 Reg't U. S. Col'd H. Art'y.

Appears on

**Company Muster Roll**

for *March & Apr.*, 1865.

Present or absent *Present*

Stoppage, \$ 100 for

Due Gov't, \$ 100 for

Valuation of horse, \$ 100

Valuation of horse equipments, \$ 100

Remarks: *Difference of pay*  
*from enlistment to Apr.*  
*30, 1864, \$6<sup>00</sup> per month*  
*paid.*

Book mark: \_\_\_\_\_

*E. J. Tyler*

*S* | **10 H. Art'y. | U.S.C.T.**

*Benjamin Kessiah*  
*W.*, Co. E, 10 Reg't U. S. Col'd H. Art'y.

Appears on

**Company Muster Roll**

for *May & June*, 186 *5*.

Present or absent *Present*

Stoppage, \$ *100* for

Due Gov't, \$ *100* for

Valuation of horse, \$ *100*

Valuation of horse equipments, \$ *100*

Remarks:

Book mark:

*G. E. Tyler*  
Copyist.

10 H. Art'y. U.S.C.T.

*W. J. ...*  
Co. E, 10 Reg't U. S. Col'd H. Art'y

Appears on

**Company Muster Roll**

for *Aug.*, 186*5*.

Present or absent *Present*

Stoppage, \$ 100 for

Due Gov't, \$ 100 for

Valuation of horse, \$ 100

Valuation of horse equipments, \$ 100

Remarks: *... U.S. for ...*

*... 07*

Book mark:

*G. E. Lyles*

Copyist.

*A* | 10 H. Art'y. | U.S.C.T.

*Benjamin St. Asah*  
*Co. E*, Co. E, 10 Reg't U. S. Col'd H. Art'y

Appears on

**Company Muster Roll**

for *Sept & Oct*, 186*5*.

Present or absent *Present*

Stoppage, \$.....100 for .....

Due Gov't, \$.....100 for .....

Valuation of horse, \$.....100

Valuation of horse equipments, \$.....100

Remarks:.....

Book mark:.....

*J. C. Tyler*



*K* | 10 H. Art'y. | U.S.C.T.

*Benjamin Kesiah*  
*Priv*, Co. E, 10 Reg't U. S. Col'd H. Art'y.

Appears on

**Company Muster Roll**

for *Nov & Dec*, 1865.

Present or absent *Present*

Stoppage, \$ 100 for

Due Gov't, \$ 100 for

Valuation of horse, \$ 100

Valuation of horse equipments, \$ 100

Remarks:

-----  
-----  
-----  
-----  
-----  
-----  
-----  
-----

Book mark:

-----

*Mark*

Copyist.

*K* | 10 H. Art'y. | **U.S.C.T.**

*Benjamin Kesiah*  
*Priv*, Co. E, 10 Reg't U. S. Col'd H. Art'y.

Appears on

**Company Muster Roll**

for *Jan & Feb*, 1866.

Present or absent *Present*

Stoppage, \$ 100 for

Due Gov't, \$ 100 for

Valuation of horse, \$ 100

Valuation of horse equipments, \$ 100

Remarks:

-----  
-----  
-----  
-----  
-----  
-----  
-----  
-----

Book mark:

-----  
-----

*Hart*  
Copyist.

*K* | 10 H. Art'y. | **U.S.C.T.**

*Benjamin Kesiah*

*Prvt*, Co. E, 10 Reg't U. S. Col'd H. Art'y

Appears on

**Company Muster Roll**

for *March & April*, 1866.

Present or absent *Present*

Stoppage, \$ *100* for

Due Gov't, \$ *100* for

Valuation of horse, \$ *100*

Valuation of horse equipments, \$ *100*

Remarks:

-----  
-----  
-----  
-----  
-----  
-----  
-----  
-----

Book mark: -----

-----

*Hark*

(358) Copyist.

K | 10 H. Art'y. | U.S.C.T.

Benjamin Kesiah

Priv., Co. E, 10 Reg't U. S. Col'd H. Art'y

Appears on

Company Muster Roll

for May & June, 1866.

Present or absent Absent

Stoppage, \$ 100 for

Due Gov't, \$ 100 for

Valuation of horse, \$ 100

Valuation of horse equipments, \$ 100

Remarks: Sentence by G.C. M. Co. to be confined at hard labor for 3 months to forfeit \$10. per month for said period G.O. 52. 26a 2nd of La June 18-1866. at Ship Island Miss

Book mark:

Mark

Copyist.

K | 10 H. Art'y. | U.S.C.T.

Benjamin Kesiah  
Priv., Co. E, 10 Reg't U. S. Col'd H. Art'y.

Appears on

**Company Muster Roll**

for July & Aug, 1866.

Present or absent Absent

Stoppage, \$ 100 for

Due Gov't, \$ 100 for

Valuation of horse, \$ 100

Valuation of horse equipments, \$ 100

Remarks: Sentence by G. C. M. to be  
confined at hard labor  
with the loss of \$ 10. per month for  
the period of 3 months & O. 63  
Had 2ms. L. on June 18. 1866.

Book mark:

Harr  
Copyist.

*K* | 10 H. Art'y. | U.S.C.T.

*Benjamin Kessiah*  
*Priv.*, Co. E, 10 Reg't U. S. Col'd H. Art'y.

Appears on

**Company Muster Roll**

for *Sept & Oct.*, 1866.

Present or absent *Present*

Stoppage, \$ *100* for

Due Gov't, \$ *100* for

Valuation of horse, \$ *100*

Valuation of horse equipments, \$ *100*

Remarks: *Sentenced by G. C. M.*  
*to be confined at hard la-*  
*bor with loss of \$10.00 per month*  
*for the period of 3 months*  
*per G. O. No. 53 Hd. Qrs. Dept. of*  
*La. June 18, 1866, confined at*  
*Ship Island, Miss.*

*Served sentence & rejoined*  
*(over)*

Book mark: \_\_\_\_\_

*O'Hagan*

JAN. 15

5504265

1891

company Sept. 22/66.  
Stopped for G. & C. lost.  
07C

*K* | 10 H. Art'y. | U.S.C.T.

*Benjamin Kesiah*  
*Priv.*, Co. E, 10 Reg't U. S. Col'd H. Art'y.

Appears on

**Company Muster Roll**

for *Nov. & Dec.*, 186 *6*.

Present or absent *Present*

Stoppage, \$ *100* for

Due Gov't, \$ *100* for

Valuation of horse, \$ *100*

Valuation of horse equipments, \$ *100*

Remarks:

Book mark:

*O'Hagan*



*K* 10 *H. Artz* U.S.C.T.

*Benjamin Kesiak*  
Private, Co. E, 10 Reg't U. S. Col'd *H. Artz*

Appears on an

**Individual Muster-out Roll**

of the organization named above. Roll dated

*New Orleans La Jan. 19, 1867.*

Muster-out to date *Jan. 19, 1867.*

Last paid to *Dec 31, 1866.*

**Clothing account:**

Last settled \_\_\_\_\_, 186 ; drawn since \$ \_\_\_\_\_ 100

Due soldier \$ \_\_\_\_\_ 100; due U. S. \$ *21* <sup>*04*</sup>/<sub>100</sub>

Am't for cloth'g in kind or money adv'd \$ \_\_\_\_\_ 100

Due U. S. for arms, equipments, &c., \$ \_\_\_\_\_ 100

Bounty paid \$ \_\_\_\_\_ 100 due \$ *300* <sup>\_\_\_\_\_</sup>/<sub>100</sub>

Remarks: *joined original organi-*  
*zation Co E 1st Heavy Art.*  
*C. d. A. 10th U.S. Colored Artz*  
*Heavy) sentenced by G. C. M.*  
*for disobedience of orders to*  
*be confined three months*  
*even*

Book mark: \_\_\_\_\_

*M. A. Michaels*

JAN. 15

5489377

1891

at hard labor with loss  
of \$10 per month per G. O.  
No 53 Headquarters De-  
partment of Pa June 18<sup>th</sup>  
1866. Served Sentence and  
rejoined Company Sep-  
tember 27<sup>th</sup> 1866 forfeited  
pay deducted on September  
and October Rolls 1866  
Mustered out by reason of  
expiration of term of service  
to date January 19<sup>th</sup> 1867

*K* | 10 H. Art'y. | U.S.C.T.

*Benjamin Kesiak*  
*Co. C.*, 10 Reg't U. S. Col'd H. Art'y.

Appears on **Co. Muster-out Roll**, dated  
*Baton Rouge, La. Feb. 22*, 1867.

Muster-out to date \_\_\_\_\_, 186 .  
Last paid to \_\_\_\_\_, 186 .

Clothing account:

Last settled \_\_\_\_\_, 186 ; drawn since \$ \_\_\_\_\_ 100  
Due soldier \$ \_\_\_\_\_ 100; due U. S. \$ \_\_\_\_\_ 100  
Am't for cloth'g in kind or money adv'd \$ \_\_\_\_\_ 100

Due U. S. for arms, equipments, &c., \$ \_\_\_\_\_ 100

Bounty paid \$ \_\_\_\_\_ 100; due \$ \_\_\_\_\_ 100

Remarks: *Discharged by reason*  
*of expiration of term of*  
*Service, Jan 17, 1867.*

Book mark: *T. 161. P. 177. 73*

*Hagan*  
Copyist.

JR. 10<sup>th</sup> Reg't U.S. & A.  
Benjamin Roesiah  
Co. I, 10<sup>th</sup> Reg't U.S. & A.

**NOTATION.**

Book mark: G. 31. R. 6. J. 1864.

**War Department,**

Adjutant General's Office,

Washington. Sept. 16<sup>th</sup> 1864.

Call from

returned with report.

The above book mark was noted on rolls in order to  
preserve results of search in this case.

E. P. Conaway, Copyist.

1506

Keyes, Oliver

Co M, 10 U.S. Col'd H. Art'y.

Private | Private

CARD NUMBERS.

1	5488903	26
2	5489011	27
3		28
4		29
5		30
6		31
7		32
8		33
9		34
10		35
11		36
12		37
13		38
14		39
15		40
16		41
17		42
18		43
19		44
20		45
21		46
22		47
23		48
24		49
25		50

Book Mark:

See also 77 U.S.C. Inf.

*K* | *10th. Arty* | **U.S.C.T.**

*Oliver Keyes*  
*Priv*, Co. *M*, *10* Reg't U. S. Col'd *10th. Arty*

Appears on

**M. and D. Roll of Men Transferred**

to the organization named above,

from *77th U. S. Col'd Inf.*

Roll dated *Oct. 1*, 186*5*.

When enlisted *April 30*, 186*5*.

Period for which enlisted *3* years.

When mustered in *May 8*, 186*5*.

Present or absent

Company to which assigned

Remarks: *Disseminated from Camp*  
*Foraper La. Aug. 26/65*

*Not taken up on rolls 10*  
*U. S. Arty.*

Book mark :

*Chandler*  
Coryist

*K* | *10 H. arty.* | **U.S.C.T.**

*Oliver Keyes*

*Pvt.*, Co. ...., *10* Reg't U. S. Col'd *H. arty.*

Appears on

**M. and D. Roll of Men Transferred**

to the organization named above,

from *77<sup>th</sup> U. S. Col'd Inftry*

Roll dated *Oct. 1*, 186*5*-

When enlisted *Apr. 30*, 186*5*-

Period for which enlisted *3* years.

When mustered in *May 8*, 186*5*-

Present or absent

Company to which assigned

Remarks: *Deserted from  
Camp Parapet, La. Aug. 26/65.*

Book mark :

(342)

*Cartelung*

Copyist

1507  
Kild, John

Co *M*, 10 U.S. Col'd H. Art'y.

*Private* | *Private*

CARD NUMBERS.

1	5-488001	26
2	5-488957	27
3	5-488849	28
4	5-5-14346	29
5	5-5-14498	30
6	5-5-14793	31
7	5-589739	32
8	5-5-15255	33
9	9123685	34
10		35
11		36
12		37
13		38
14		39
15		40
16		41
17		42
18		43
19		44
20		45
21		46
22		47
23		48
24		49
25		50

Book Mark:

See also *77 U.S.C.S.*



*K* | 10 H. Art'y. | U. S. C. T.

*John Kild*

, Co. *M*, 10 Reg't U. S. Col'd H. Art'y.

Appears on

**Company Descriptive Book**

of the organization named above.

**DESCRIPTION.**

Age *37* years; height *5* feet *9½* inches.

Complexion *Dark*

Eyes *brown*; hair *black*

Where born *Maryland*

Occupation *Labourer*

**ENLISTMENT.**

When *Jan'y 31*, 1863.

Where *New Orleans La*

By whom *Lt Drew*; term *3* y'rs.

Remarks: *Rec'd by transfer  
from Co. A. 7th U.S. Col. per  
O.C. 66 Hd Qrs Dept La  
Sept 22 1865. Discharged  
w/ honorably mustered  
out of service Feb 19/66  
by reason of expiration  
term of service*

*W. Malheur*

170 | 10 H. Art'y. | U.S.C.T.

John Field  
C. M., 10 Reg't U. S. Col'd H. Art'y.

Age ..... years.

Appears on

**Company Muster Roll\***

for Sept - Oct, 1862

Joined for duty and enrolled:

When Jan 31, 1863.

Where N Orleans

Period 3 years.

Mustered in:

When Feb 10, 1863.

Where N Orleans

Present or absent Present

Stoppage, \$ 100 for

Due Gov't, \$ 100 for

Valuation of horse, \$ 100

Valuation of horse equipments, \$ 100

Remarks :

\*First current roll. No muster-in roll of this company on file.

Book mark :

A. H. Wright

K 1056A

U.S.C.T.

John Kild  
Pvt, Co. M, 10 Reg't U. S. Col'd *Hell*

Appears on

**M. and D. Roll of Men Transferred**

to the organization named above,

from

*10th U. S. Col Inf*

Roll dated

*Camp Pampetta Oct 1, 1860*

When enlisted

*Jan 31*, 1860

Period for which enlisted

*3* years.

When mustered in

*Feb 10*, 1860

Present or absent

Company to which assigned

*M*

Remarks:

*Joined at Chig. Reg't  
of Co. A 4th Cal. A. Rec'd  
by transfer from Co. A  
10th U. S. Col. I. for S. I.  
16 Sept da Sept 22  
60,*

Book mark :

*Wear Scott*

K | 10 H. Artz, U.S.C.T.

John Kild

Pvt., Co. M, 10 Reg't U. S. Col'd H. Artz,

Appears on

**M. and D. Roll of Men Transferred**

to the organization named above,

from 77<sup>th</sup> U.S. Col'd Inftry,

Roll dated Oct. 1, 1865.

When enlisted Jan. 31, 1863.

Period for which enlisted 3 years.

When mustered in Feb. 10, 1863.

Present or absent Present.

Company to which assigned M.

Remarks: Joined at original organization of Co. "A," 4<sup>th</sup> Cd "A."

\* In "present" column "Rec'd."

Book mark:

Castling

K | 10 Ho. Arty | **U.S.C.T.**

John Kild<sup>+</sup>  
Pvt., Co. M, 10 Reg't U. S. Col'd Ho. Arty

Appears on

**M. and D. Roll of Men Transferred**

to the organization named above,

from 77 U. S. Col'd Inf.

Roll dated Oct. 1, 1865.

When enlisted Jan. 31, 1863.

Period for which enlisted 3 years.

When mustered in Febr 10, 1863.

Present or absent Present

Company to which assigned

Remarks: joined at org'l orgn  
ser. A. Kild.

+ Name appears in column  
(James Present) as John Reid.

Book mark :

*10* | **10 H. Art'y. | U. S. C. T.**

*John Wild*  
....., Co. M, 10 Reg't U. S. Col'd H. Art'y.

Appears on

**Company Muster Roll**

for *Nov & Dec*, 1865.

Present or absent *Present*

Stoppage, \$.....100 for .....

Due Gov't, \$.....100 for .....

Valuation of horse, \$.....100

Valuation of horse equipments, \$.....100

Remarks: .....

Book mark: .....

*W. H. Wright*  
.....  
Copyist.

11  
11 | 10 H. Art'y. | U. S. C. T.

~~John Hedd~~ <sup>x Killed</sup>

9, Co. M, 10 Reg't U. S. Col'd H. Art'y.

Appears on  
Company Muster Roll  
for Jan & Feb, 1860.

Present or absent

Stoppage, \$ 100 for

Due Gov't, \$ 100 for

Valuation of horse, \$ 100

Valuation of horse equipments, \$ 100

Remarks: Died Feb 10th 1860  
at New Orleans La by  
reason of Expiration  
of term of Service

x corrected by J. B. Dowd. Ex

Book mark:

J. H. Hedd  
(358) Copyist.

*Co. 10* *Hy Arty* **U.S.C.T.**

*John Kild*

*Priv, Co. M, 10* Reg't U. S. Col'd *Arty*

Appears on a

**Detachment Muster-out Roll**

of the organization named above. Roll dated

*New Orleans, La. Feb, 10*, 1866.

Muster-out to date *Feb. 10*, 1866.

Last paid to *June 30*, 1865

**Clothing account:**

Last settled \_\_\_\_\_, 1866; drawn since \$ \_\_\_\_\_ 100

Due soldier \$ *34* <sup>*78*</sup> / 100; due U. S. \$ \_\_\_\_\_ 100

Am't for cloth'g in kind or money adv'd \$ \_\_\_\_\_ 100

Due U. S. for arms, equipments, &c., \$ \_\_\_\_\_ <sup>*12*</sup> / 100

Bounty paid \$ *None* 100 due \$ *None* 100

Remarks: *Joined by transfer from 77th U.S.C. I. Oct 1st 65 - per S.O. No. 66, 65 Hd Qrs. Dept. of La. Stop for two G.C. Strafe.*

Book mark: \_\_\_\_\_

*H. W. Reed*



K | 10 H. Art'y. | U.S.C.T.

John Kild

But, Co. M, 10 Reg't U. S. Col'd H. Art'y.

Appears on **Co. Muster-out Roll**, dated

Baton Rouge La, Feb 22, 1867.

Muster-out to date \_\_\_\_\_, 186 .

Last paid to \_\_\_\_\_, 186 .

Clothing account:

Last settled \_\_\_\_\_, 186 ; drawn since \$ \_\_\_\_\_ 100

Due soldier \$ \_\_\_\_\_ 100; due U. S. \$ \_\_\_\_\_ 100

Am't for cloth'g in kind or money adv'd \$ \_\_\_\_\_ 100

Due U. S. for arms, equipments, &c., \$ \_\_\_\_\_ 100

Bounty paid \$ \_\_\_\_\_ 100; due \$ \_\_\_\_\_ 100

Remarks: joined by train from Co  
A 77 used for 56 66 850 2nd Regt  
La Sep 22/65 as But. Discharged by  
reason of Exp. of term of Service  
Feb 10/66

Book mark : \_\_\_\_\_

Rector

1500  
Killebrew Marcus

Co A, 10 U.S. Col'd H. Art'y.

Private Private

CARD NUMBERS.

1	5490440	26
2	5490590	27
3	5490734	28
4	5490890	29
5	5491026	30
6	5491161	31
7	5491289	32
8	5491422	33
9	5491549	34
10	5491676	35
11	5491802	36
12	5491928	37
13	5492053	38
14	5492178	39
15	5492300	40
16	5492425	41
17	5492548	42
18	5492674	43
19	5492801	44
20	5493039	45
21	5489554	46
22	5494012	47
23	47-ET-1884	48
24		49
25		50

Book Mark: 47-ET-1884

See also

*K* | 10 H. Art'y. | U.S.C.T.

*Marcus Killebrew*  
*Priv.*, Co. A, 1 Reg't La. Col'd H. Art'y.\*  
Age *29* years.  
Appears on

**Company Muster-in Roll**

of the organization named above. Roll dated  
*New Orleans, La. Nov. 29, 1862*  
Muster-in to date *Nov. 29, 1862.*

Joined for duty and enrolled:

When *Nov. 16*, 186 .  
Where *New Orleans*  
Period *3* years.

Valuation of horse, \$.....*100*  
Valuation of horse equipments, \$.....*100*

Remarks : .....

\*This organization subsequently became Co. A, 10 Reg't U. S. Colored Heavy Artillery.

Book mark: .....

*Tobman*  
(356) Copyist.

*K*

**10 H. Art'y. U.S.C.T.**

*Marcus Killebrew*

*Priv.*, Co. A, 1 Reg't La. H. Art'y.\*

Appears on

**Company Muster Roll**

for *to Dec. 31*, 186*2*

Present or absent *Present*

Stoppage, \$ *100* for

Due Gov't, \$ *100* for

Valuation of horse, \$ *100*

Valuation of horse equipments, \$ *100*

Remarks:

\*This organization subsequently became Co. A, 10 Reg't U. S. Col'd Heavy Artillery.

Book mark:

*Johnson*

*K* | 10 H. Art'y. | U.S.C.T.

*Marcus Killebrew*

*Priv*, Co. A, 1 Reg't La. H. Art'y.\*

Appears on

**Company Muster Roll**

for *Jas. & Kelly*, 1863.

Present or absent *Present*

Stoppage, \$.....100 for .....

Due Gov't, \$.....100 for .....

Valuation of horse, \$.....100

Valuation of horse equipments, \$.....100

Remarks: .....

\*This organization subsequently became Co. A, 10 Reg't U. S. Col'd Heavy Artillery.

Book mark: .....

*Tolman*

*K* | **10 H. Art'y. U.S.C.T.**

*Marcus Killebrew*

*Priv.*, Co. A, 1 Reg't La. H. Art'y.\*

Appears on

**Company Muster Roll**

for *March & April*, 1863.

Present or absent *Present*

Stoppage, \$.....100 for .....

Due Gov't, \$.....100 for .....

Valuation of horse, \$.....100

Valuation of horse equipments, \$.....100

Remarks: .....

\*This organization subsequently became Co. A, 10 Reg't U. S. Col'd Heavy Artillery.

Book mark: .....

*Tobman*

*K* | 10 H. Art'y. | U.S.C.T.

*Marcus Killebrew*

*Priv.*, Co. A, 1 Reg't La. H. Art'y.\*

Appears on

**Company Muster Roll**

for *May & June*, 186*3*.

Present or absent *Present*

Stoppage, \$.....*100* for .....

Due Gov't, \$.....*100* for .....

Valuation of horse, \$.....*100*

Valuation of horse equipments, \$.....*100*

Remarks:.....

.....

.....

.....

.....

.....

.....

.....

.....

.....

.....

.....

.....

\*This organization subsequently became Co. A, 10 Reg't U. S. Col'd Heavy Artillery.

K | **10 H. Art'y. U.S.C.T.**

Marcus Killebrew

Priv., Co. A, 1 Reg't La. H. Art'y.\*

Appears on

**Company Muster Roll**

for July & August, 1863.

Present or absent Present

Stoppage, \$ 100 for

Due Gov't, \$ 100 for

Valuation of horse, \$ 100

Valuation of horse equipments, \$ 100

Remarks: \_\_\_\_\_  
\_\_\_\_\_  
\_\_\_\_\_  
\_\_\_\_\_  
\_\_\_\_\_

\*This organization subsequently became Co. A, 10 Reg't U. S. Col'd Heavy Artillery.

Book mark: \_\_\_\_\_

Tolman  
Coynt.



*K* | 10 H. Art'y. | U.S.C.T.

*Marcus Killebrew*

*Priv*, Co. A, 1 Reg't La. H. Art'y.\*

Appears on

**Company Muster Roll**

for *Sept & Oct*, 1863.

Present or absent *Present*

Stoppage, \$.....100 for .....

Due Gov't, \$.....100 for .....

Valuation of horse, \$.....100

Valuation of horse equipments, \$.....100

Remarks:.....

.....

.....

.....

.....

.....

.....

\*This organization subsequently became Co. A, 10 Reg't U. S. Col'd Heavy Artillery.

Book mark:.....

*Tolman*

10 H. Art'y. | **U.S.C.T.**

Marcus Killebrew  
Sgt., Co. A, 1 Reg't H. Art'y, Corps d'Afrique.\*

Appears on

**Company Muster Roll**

for *Jan-Dec*, 1863.

Present or absent.....

Stoppage, \$..... 100 for .....

Due Gov't, \$..... 100 for .....

Valuation of horse, \$..... 100

Valuation of horse equipments, \$..... 100

Remarks:.....

\*This organization subsequently became Co. A, 10 Reg't U. S. Colored Heavy Artillery.

Book mark:.....

*Beahm*

*A* | 10 H. Art'y. | U.S.C.T.

*Marcus Hillman*  
Co. *A*, 1 Reg't H. Art'y, Corps d'Afrique.\*

Appears on

**Company Muster Roll**

for *Jan & Feb*, 1864.

Present or absent *Present*

Stoppage, \$ 100 for

Due Gov't, \$ 100 for

Valuation of horse, \$ 100

Valuation of horse equipments, \$ 100

Remarks: *A confinement*

\*This organization subsequently became Co. *A*, 10 Reg't U. S. Colored Heavy Artillery.

Book mark: \_\_\_\_\_

*Reed*

*K* | 10 H. Art'y. | U.S.C.T.

*Nathan Killebrew*

*Co. A*, 7 Reg't U. S. Col'd H. Art'y.\*

Appears on

**Company Muster Roll**

for *Nov 25* 1864

Present or absent *Present*

Stoppage, \$ 100 for

Due Gov't, \$ 100 for

Valuation of horse, \$ 100

Valuation of horse equipments, \$ 100

Remarks: *In confinement  
serving out sentence  
of Genl Court  
Martial at S.O. No. 11  
dated Hd. Qrs. Ft. Jackson,  
La. April 7, '64*

\* This organization subsequently became Co. *A*, 10 Reg't U. S. Colored Heavy Artillery.

Book mark: \_\_\_\_\_

*Co. A*

*K* | **10 H. Art'y.** | **U.S.C.T.**

*Frederick Williams*  
*Co. A*, 7 Reg't U. S. Col'd H. Art'y.\*

Appears on

**Company Muster Roll**

for *May & June*, 1864.

Present or absent *Present*

Stoppage, \$ 100 for

Due Gov't, \$ 100 for

Valuation of horse, \$ 100

Valuation of horse equipments, \$ 100

Remarks:

\* This organization subsequently became Co *A*, 10 Reg't U. S. Colored Heavy Artillery.

Book mark:

*Wm. J. ...*  
Copyist.

*K* | **10 H. Art'y. | U.S.C.T.**

*Marcus Killebrew*  
*Pvt*, Co. *A*, 7 Reg't U. S. Col'd H. Art'y.\*

Appears on

**Company Muster Roll**

for *July to Aug*, 186*4*.

Present or absent *Present*

Stoppage, \$ 100 for

Due Gov't, \$ 100 for

Valuation of horse, \$ 100

Valuation of horse equipments, \$ 100

Remarks: \_\_\_\_\_

\_\_\_\_\_

\_\_\_\_\_

\_\_\_\_\_

\_\_\_\_\_

\_\_\_\_\_

\_\_\_\_\_

\* This organization subsequently became Co. *F*, 10 Reg't U. S. Colored Heavy Artillery.

Book mark: \_\_\_\_\_

\_\_\_\_\_

*Bochester*

(358) Copyist.

*K* | 10 H. Art'y. | **U.S.C.T.**

*Marcus Killebrew*

*Bt*, Co. A, 10 Reg't U. S. Col'd H. Art'y.

Appears on

**Company Muster Roll**

for *Feb 1864*, 1864

Present or absent *Present*

Stoppage, \$ 100 for

Due Gov't, \$ 100 for

Valuation of horse, \$ 100

Valuation of horse equipments, \$ 100

Remarks:

-----  
-----  
-----  
-----  
-----  
-----  
-----  
-----

Book mark:

*Receptor*

*10* | **10 H. Art'y. U.S.C.T.**

*Marcus Killebrew*  
*Pvt*, Co. A, 10 Reg't U. S. Col'd H. Art'y.

Appears on

**Company Muster Roll**

for *21<sup>st</sup> Dec*, 1864.

Present or absent *Present*

Stoppage, \$.....100 for.....

Due Gov't, \$.....100 for.....

Valuation of horse, \$.....100

Valuation of horse equipments, \$.....100

Remarks:.....

.....  
.....  
.....  
.....  
.....  
.....

Book mark:.....

*W. J. ...*



*K* | 10 H. Art'y. | U.S.C.T.

*Marcus Kilbrow*

*Private*, Co. A, 10 Reg't U. S. Col'd H. Art'y.

Appears on

**Company Muster Roll**

for *Jan + Feb*, 1865.

Present or absent *Present*

Stoppage, \$ 100 for

Due Gov't, \$ 100 for

Valuation of horse, \$ 100

Valuation of horse equipments, \$ 100

Remarks:

Book mark:

*Geo. W. ...*

*K* | 10 H. Art'y. | U.S.C.T.

*Marcus & Killbuck*  
*Co.*, Co. A, 10 Reg't U. S. Col'd H. Art'y.

Appears on

Company Muster Roll

for *Sept 1865*, 1865.

Present or absent *Present*

Stoppage, \$ \_\_\_\_\_ 100 for \_\_\_\_\_

Due Gov't, \$ \_\_\_\_\_ 100 for \_\_\_\_\_

Valuation of horse, \$ \_\_\_\_\_ 100

Valuation of horse equipments, \$ \_\_\_\_\_ 100

Remarks: \_\_\_\_\_  
\_\_\_\_\_  
\_\_\_\_\_  
\_\_\_\_\_  
\_\_\_\_\_  
\_\_\_\_\_  
\_\_\_\_\_

Book mark: \_\_\_\_\_

*Proctor*

Copyist.

*W. E.* | 10 H. Art'y. | **U.S.C.T.**

*Marion Killbuck*

*A. F.*, Co. A, 10 Reg't U. S. Col'd H. Art'y.

Appears on

**Company Muster Roll**

for *May & June*, 186*5*

Present or absent *Present*

Stoppage, \$..... 100 for .....

Due Gov't, \$..... 100 for .....

Valuation of horse, \$..... 100

Valuation of horse equipments, \$..... 100

Remarks: .....

.....  
.....  
.....  
.....  
.....  
.....  
.....

Book mark: .....

*Reverter*

*K* | 10 H. Art'y. | U.S.C.T.

*Marcus Killbuck*  
*Art*, Co. A, 10 Reg't U. S. Col'd H. Art'y.

Appears on

**Company Muster Roll**

for

*July & Aug, 1865*

Present or absent

*Present*

Stoppage, \$ 100 for

Due Gov't, \$ 100 for

Valuation of horse, \$ 100

Valuation of horse equipments, \$ 100

Remarks:

*Aug 20th to 21st -  
Liquor & Garrison  
Cabinage \$ 2.01*

Book mark:

*Becker*

Copyist.

*K* | 10 H. Art'y. | U.S.C.T.

*Marcus Killebrew*

*Pvt*, Co. A, 10 Reg't U. S. Col'd H. Art'y.

Appears on

**Company Muster Roll**

for *Sept & Oct*, 1865.

Present or absent *Present*

Stoppage, \$ 100 for

Due Gov't, \$ 100 for

Valuation of horse, \$ 100

Valuation of horse equipments, \$ 100

Remarks:

-----  
-----  
-----  
-----  
-----  
-----  
-----

Book mark: -----

*Styres*  
Copyist.

*K* | 10 H. Art'y. | U.S.C.T.

*Marcus Kilbren*

*Plt*, Co. A, 10 Reg't U. S. Col'd H. Art'y.

Appears on

Company Muster Roll

for *Nov & Dec*, 1865.

Present or absent

Stoppage, \$ 100 for

Due Gov't, \$ 100 for

Valuation of horse, \$ 100

Valuation of horse equipments, \$ 100

Remarks: *Mustered out by reason of expiration of term of service.*

Book mark: *Disch'd Nov. 28/65 L.B. 941*  
*47 C. P. 1864*

*Hoyes*

Copyist.

*K. 10 He. a. U.S.C.T.*

*Marcus Killebrew*  
*Priv., Col., 10 Reg't U. S. Col'd He. a.*

Appears on a

**Detachment Muster-out Roll**

of the organization named above. Roll dated

*N. Orleans La. Nov. 28, 1865.*

Muster-out to date *Nov. 28, 1865.*

Last paid to *June 30, 1865.*

**Clothing account:**

Last settled \_\_\_\_\_, 186 ; drawn since \$ \_\_\_\_\_ 100

Due soldier \$ *30*<sup>*12*</sup>/<sub>100</sub>; due U. S. \$ \_\_\_\_\_ 100

Am't for cloth'g in kind or money adv'd \$ \_\_\_\_\_ 100

Due U. S. for arms, equipments, &c., \$ \_\_\_\_\_ 100

Bounty paid \$ \_\_\_\_\_ 100 due \$ \_\_\_\_\_ 100

Remarks: *Joined at Origi. Orgi.*  
*Stop for one Suspension*  
*Mustered out by reason*  
*of Expiration of term of*  
*Service*

Book mark: \_\_\_\_\_

*Hawling*

*K* | 10 H. Art'y. | U.S.C.T.

*Marcus Kellebrew*  
*Co. A*, 10 Reg't U. S. Col'd H. Art'y.

Appears on **Co. Muster-out Roll**, dated  
*Baton Rouge La, Feb 22* 1867.  
Muster-out to date \_\_\_\_\_, 186 .  
Last paid to \_\_\_\_\_, 186 .

Clothing account:

Last settled \_\_\_\_\_, 186 ; drawn since \$ \_\_\_\_\_ 100

Due soldier \$ \_\_\_\_\_ 100; due U. S. \$ \_\_\_\_\_ 100

Am't for cloth'g in kind or money adv'd \$ \_\_\_\_\_ 100

Due U. S. for arms, equipments, &c., \$ \_\_\_\_\_ 100

Bounty paid \$ \_\_\_\_\_ 100; due \$ \_\_\_\_\_ 100

Remarks: *Joined origl. regt. Michd*  
*for 3 years of term of service*  
*Nov 28. 65*

Book mark: *K 189 P 252. 74*

*Webbitt*

Copyist.



72 | 10<sup>th</sup> Ho. A. / U.S. G. J.

Marcus Rillebrew,  
Co. A, 10<sup>th</sup> Reg't U.S. G. Ho. A.

**NOTATION.**

Book mark: L.B. 15-941 with  
L. G. J. 1884.

**War Department,**

Adjutant General's Office,

Washington, Jan. 5<sup>th</sup>, 1884.

Mustered out with Detach-  
ment November 28, 1865.

E. P. Sawyer

Killebrew, Marcus,

Co. 10 Reg't U.S.C.H.A.

**Enclosures.**

Bed Cards .....	Final Statements .....
Burial Records .....	Furloughs or L. of A. ....
Certs. of Dis. for Discharge .....	Med. Certificates .....
C. M. Charges .....	Med. Des. Lists .....
Descriptive Lists .....	Orders .....
Discharge Certificates .....	Pris. of War Record .....
Enlistment Papers .....	Resignations .....

**Other papers relating to—**

Admission to Hosp'l .....	Furlough or L. of A. ....
Casualty Sheet .....	Med. Examination .....
Confinement .....	Misc. Information .....
Contracts .....	Pay or Clothing .....
Death or Effects .....	Personal Reports .....
Desertion .....	Rank .....
Discharge from Hosp'l .....	Transfer to Hosp'l .....
Discharge from Service .....	Transfer to V. R. C. ....
Duty .....	Transportation .....

Charges and  
Specifications against  
Private Marcus Willbrod  
Co. of 1<sup>st</sup> H. Art'y C. & A.

Trid. G. C. M. (no. 1.)

10 H. S. Art'y

1 Year past

Fort St. Philip

April 5/64

Approved & respectfully  
forwarded

Augustus S. Lawrence

1<sup>st</sup> Lt. 11<sup>th</sup> U. S. Infy  
Com<sup>d</sup> Col. 5<sup>th</sup> Infy

Com<sup>d</sup> of Fort

Wm. B. Put. Preston Sea

April 5, 1864

"Approved" and ordered to trial by  
G. C. M. of which Maj. Gen. Meade,  
8<sup>th</sup> Regt. Cal. is President.

By order of  
Brig. Gen. J. W. Sherman  
Wm. B. Meade  
Det. & Capt.

Charges and Specifications preferred against  
Private Marcus Killebrew Co. A. 1<sup>st</sup> Heavy Artillery Corps <sup>Afrique</sup>

Charge 1<sup>st</sup>

Disobedience of Orders — n. 4.

Specification 1<sup>st</sup> In this that he Private Marcus Killebrew  
Co. A. 1<sup>st</sup> Heavy Artillery Corps <sup>Afrique</sup> having been  
ordered by the 1<sup>st</sup> Sergeant of his company to "fall in"  
for Dress Parade did refuse to obey the order  
of the said 1<sup>st</sup> Sergeant his superior officer. This at  
Fort St. Philip La. on or about the 17<sup>th</sup> day of February 1864

Specification 2<sup>d</sup> In this that he the said Private  
Marcus Killebrew Co. A. 1<sup>st</sup> Heavy Artillery Corps <sup>Afrique</sup>  
having been ordered by Capt. E. P. Loring, his commanding  
officer, to stop talking, did refuse to obey said order,  
but did continue the use of insubordinate and insolent  
language in these words: "You may tie me hand and  
feet, but I won't fall in, without I have some shoes," or  
words of like import. This at Fort St. Philip La. on  
or about the 19<sup>th</sup> day of February 1864

Charge 2<sup>d</sup> —

n. 4.

Violation of the 44<sup>th</sup> Article of War

Specification In this that he the said Private  
Marcus Killebrew Co. A. 1<sup>st</sup> Heavy Artillery Corps <sup>Afrique</sup>  
did fail to repair to the "place of Parade" pre-  
scribed by his commanding officer. This at Fort  
St. Philip La. on or about the 19<sup>th</sup> day of February 1864

n. 4.

Witnesses

Lt. Albert Loring  
Sergeant Robert Jordan  
Corporal Bill Williams  
Sergeant Abner Samuel

} Co. A. 1<sup>st</sup> Heavy Artillery &c. &c.

E. P. Loring  
Capt. Co. A. 1<sup>st</sup> Heavy Artillery &c. &c.

*Kimball Norace &*  
**Co A, 10 U.S. Col'd H. Art'y.**

*Captain* | *Captain*

CARD NUMBERS.

1	5504642	26
2	5486814	27
3	5504901	28
4	5505056	29
5	5505191	30
6	5505285	31
7	5505378	32
8	5505483	33
9	5505593	34
10	5505848	35
11	5489376	36
12	5506946	37
13		38
14		39
15		40
16		41
17		42
18		43
19		44
20		45
21		46
22		47
23		48
24		49
25		50

Book Mark:

See also *79 U.S.C.A.*

S-1179613 and 711D  
S-2051727 P.O. man

W. B. Dowd  
Ex

*K* | 10 H. Art'y. | U.S.C.T.

<sup>x</sup> *Horace E Kimball*  
*Capt.*, Co. *F*, 7 Reg't U. S. Col'd H. Art'y.\*

Appears on

**Company Muster-in and Descriptive Roll**

of the organization named above. Roll dated

*New Orleans La*, *Aug 19*, 1864.

Where born *Clyde New York*

Age *25* y'rs; occupation *Teacher*

When listed *Aug 21*, 1864.

Where enlisted *New Orleans La*

For what period enlisted *3* years,

Eyes *Brown*; hair *Black*

Complexion *Dark*; height *6* ft. *2 3/4* in.

When mustered in *Aug 21*, 1864.

Where mustered in *New Orleans La*

Bounty paid \$ *100*; due \$ *100*

Where credited

Company to which assigned

Remarks: *Pay due from State of*  
*Muster*

\* This organization subsequently became Co. *F*, 10 Reg't U. S. Colored Heavy Artillery.

Book mark:

*Entire entry cancelled by line thro it.*

*Rosenbaum*

K. | 10 H. Arty. | **U.S.C.T.**

Horace E. Kimball  
(Co. F. 79<sup>th</sup> Regt. U.S.C. Arty (H))  
Capt., Co. ...., 10 Reg't U. S. Col'd H. Arty

Age 25 years.

Appears on an

**Individual Muster-in Roll**

of the organization named above. Roll dated

New Orleans, La., Aug. 21, 1864.

Muster-in to date Aug. 21, 1864.

Joined for duty and enrolled :

When August 21, 1864.

Where New Orleans, La.

Period 3 years.

Valuation of horse, \$.....100

Valuation of horse equipments, \$.....100

Remarks: Mustered out as Capt.  
Co. F, 79<sup>th</sup> U.S. Col'd Inftry. by  
reason of discontinuance of  
his regiment in service.

Rec-Appointment as Capt. X  
(over)

Book mark : .....

Philipson



JAN. 15

5486814

\*1891\*

x in 1<sup>st</sup> Heavy Artij. C. d'A.  
(Now 7<sup>th</sup> U.S. C. Artij (Heavy))

Jan. 6<sup>th</sup> 1864. Commission  
dated Dec. 28<sup>th</sup> 1863.

To fill original  
vacancy in Co. "F."

*K* | 10 H. Art'y. | **U.S.C.T.**

*Horace E. Kimball*

*Capt.*, Co. F, 10 Reg't U. S. Col'd H. Art'y.

Appears on

**Company Muster Roll**

for *July & August*, 1864.

Present or absent *Present*

Stoppage, \$ *100* for

Due Gov't, \$ *100* for

Valuation of horse, \$ *100*

Valuation of horse equipments, \$ *100*

Remarks:

Book mark:

*Rosenbaum*

Copyist.

*K*

10 H. Art'y. | U.S.C.T.

*Horace E. Kimball*

*Capt*, Co. F, 10 Reg't U. S. Col'd H. Art'y.

Appears on

**Company Muster Roll**

for *Sept & Oct*, 1864.

Present or absent *Present*

Stoppage, \$ *100* for

Due Gov't, \$ *100* for

Valuation of horse, \$ *100*

Valuation of horse equipments, \$ *100*

Remarks:

Book mark:

*Rosenbaum*

Copyist.

K

10 H. Art'y.

U.S.C.T.

Horace E. Kimball

Capt., Co. F, 10 Reg't U. S. Col'd H. Art'y.

Appears on

Company Muster Roll

for Nov & Dec, 1864.

Present or absent Present

Stoppage, \$ 100 for

Due Gov't, \$ 100 for

Valuation of horse, \$ 100

Valuation of horse equipments, \$ 100

Remarks:

Book mark:

Roundman Copyist.

K

10 H. Art'y. U.S.C.T.

Horace E Kimball  
Capt, Co. F, 10 Reg't U. S. Col'd H. Art'y.

Appears on

Company Muster Roll

for Jan & Feb, 1865.

Present or absent Present

Stoppage, \$ 100 for

Due Gov't, \$ 100 for

Valuation of horse, \$ 100

Valuation of horse equipments, \$ 100

Remarks:

Book mark:

B G Warden

Copyist.

K

10 H. Art'y. U.S.C.T.

Horace E. Kimball

Capt, Co. F, 10 Reg't U. S. Col'd H. Art'y.

Appears on

Company Muster Roll

for Mar & Apr, 1865.

Present or absent Present

Stoppage, \$ 100 for

Due Gov't, \$ 100 for

Valuation of horse, \$ 100

Valuation of horse equipments, \$ 100

Remarks:

[Empty lines for remarks]

Book mark:

B. G. Masdon

K

10 H. Art'y. U.S.C.T.

Horace E. Kimball

Capt, Co. F, 10 Reg't U. S. Col'd H. Art'y.

Appears on

Company Muster Roll

for May & June, 1865.

Present or absent Present

Stoppage, \$ 100 for

Due Gov't, \$ 100 for

Valuation of horse, \$ 100

Valuation of horse equipments, \$ 100

Remarks:

Book mark:

B. G. Wason

K

10 H. Art'y. U.S.C.T.

Horace E Kimball  
Capt, Co. F, 10 Reg't U. S. Col'd H. Art'y.

Appears on

Company Muster Roll

for dated Aug 31, 1865.

Present or absent Present

Stoppage, \$ 100 for

Due Gov't, \$ 100 for

Valuation of horse, \$ 100

Valuation of horse equipments, \$ 100

Remarks:

Book mark:

B G Wasdon

Copyist.



K

10 H. Art'y. U.S.C.T.

Norace E. Kimball  
Capt., Co. F, 10 Reg't U. S. Col'd H. Art'y.

Appears on

Company Muster Roll

for Sept & Oct, 1865.

Present or absent

Stoppage, \$ 100 for

Due Gov't, \$ 100 for

Valuation of horse, \$ 100

Valuation of horse equipments, \$ 100

Remarks: Honorably mustered  
out per S.O. No. 66 Ad. Lrs.  
Dept. of La. Sept. 22/65.

Book mark: P.M. Gds Dec. 2/65  
Loverd

B. G. Wasdon

JAN. 15

5505848

★ 1891 ★

1731 2<sup>nd</sup> Aud. Oct. 20/66.

R

10 H. Art'y. U.S.C.T.

Horace E. Kimball  
Capt., Co. F, 10 Reg't U. S. Col'd H. Art'y.

Appears on Co. Muster-out Roll, dated  
Boston, Aug. 22, 1867.

Muster-out to date \_\_\_\_\_, 1867.

Last paid to \_\_\_\_\_, 1865.

Clothing account:

Last settled \_\_\_\_\_, 1867; drawn since \$ \_\_\_\_\_ 100

Due soldier \$ \_\_\_\_\_ 100; due U. S. \$ \_\_\_\_\_ 100

Am't for cloth'g in kind or money adv'd \$ \_\_\_\_\_ 100

Due U. S. for arms, equipments, &c., \$ \_\_\_\_\_ 100

Bounty paid \$ \_\_\_\_\_ 100; due \$ \_\_\_\_\_ 100

Remarks: Mustered as Captain  
7 Hq. Art'y Co. A Aug. 21  
1864. Honorably mustered  
out in S.O. no. 66 Hq. 2nd  
Dept of La. S. of 65

Book mark: \_\_\_\_\_

House

*H* | *10th Art* | **U.S.C.T.**

*Horace C. Kimball*  
Capt, Co. *F*, *10* Reg't U. S. Col'd *H. Art*

Appears on an

**Individual Muster-out Roll**

of the organization named above. Roll dated

*N Orleans La* *Oct 1*, 186*5*.

Muster-out to date *Oct 1*, 186*5*!

Last paid to *June 30*, 186*5*.

**Clothing account:**

Last settled \_\_\_\_\_, 186 ; drawn since \$ \_\_\_\_\_ <sup>100</sup>

Due soldier \$ \_\_\_\_\_ <sup>100</sup>; due U. S. \$ \_\_\_\_\_ <sup>100</sup>

Am't for cloth'g in kind or money adv'd \$ \_\_\_\_\_ <sup>100</sup>

Due U. S. for arms, equipments, &c., \$ \_\_\_\_\_ <sup>100</sup>

Bounty paid \$ \_\_\_\_\_ <sup>100</sup> due \$ \_\_\_\_\_ <sup>100</sup>

Remarks: *Appointed as captain*  
*of 10th Art C. d. A. as*  
*set forth. designation of*  
*regiment subsequently*  
*changed U. S. Art (Col'd)*  
*and 10th U. S. C. A. Art. Entitled*  
*over*

Book mark: \_\_\_\_\_

*M. A. Michaels*  
Copyist.

JAN. 15

5489376

\* 1891 \*

to pay commanding Com<sup>rs</sup>  
pany from June 30-65 to  
date of discharge. Has  
made affidavit in accordance  
with Circular 33 C.S. War  
Dept. A. G. O. Honorably  
discharged and mustered  
out by reason of being  
rendered supernumerary  
by consolidation of regiment  
and in obedience to S. O. 66.  
C. S. Hd. Qrs Dept of La.  
Mustered out as ~~supernumerary~~  
ary by consolidation owing  
to reduction of the army  
his services being no longer  
required see Par. 2. S. O. 83.  
C. S. Hd Qrs Dept of Louisiana  
Muster out to take effect  
Oct 1-1865

Kimball - Horace E.

Capt. Co. F, 10<sup>th</sup> Reg't W.S. G. H. A.

13 Enclosures.

Bed Cards .....	Final Statements .....
Burial Records .....	Furloughs or L. of A. ....
Certs. of Dis. for Discharge .....	Med. Certificates .....
C. M. Charges 1 .....	Med. Des. Lists .....
Descriptive Lists .....	Orders 3 .....
Discharge Certificates .....	Pris. of War Record .....
Enlistment Papers .....	Resignations .....

Other papers relating to—

Admission to Hosp'l .....	Furlough or L. of A. ✓ .....
Casualty Sheet .....	Med. Examination .....
Confinement .....	Misc. Information 7 .....
Contracts .....	Pay or Clothing .....
Death or Effects .....	Personal Reports .....
Desertion .....	Rank 1 .....
Discharge from Hosp'l .....	Transfer to Hosp'l .....
Discharge from Service .....	Transfer to V. R. C. ....
Duty .....	Transportation .....

MICROFILM PUBLICATION M 1831

COMPILED MILITARY SERVICE RECORDS  
OF VOLUNTEER UNION SOLDIERS WHO SERVED WITH  
THE UNITED STATES COLORED TROOPS (USCT)  
10TH REGIMENT OF HEAVY ARTILLERY

PERSONAL PAPERS' TARGET SHEET

PLEASE NOTE THE CHECKED INFORMATION ABOUT THE PERSONAL PAPERS IN  
THIS FILE:

- NO PERSONAL PAPERS WERE FOUND IN THIS FILE WHEN THE  
RECORDS WERE ARRANGED FOR MICROFILMING.
- 15 PERSONAL PAPER(S) FOUND IN THIS FILE WHEN THE RECORDS  
WERE ARRANGED FOR MICROFILMING.

Genl. Bunker requests  
that Capt<sup>cy</sup> <sup>HE</sup> Kimball be  
Examined for Field positions.

Sept 7, 1864

10 W. O. A. H.

---



(Copy)

Headquarters, Department of the Gulf  
New Orleans Sept 7<sup>th</sup> 1867

Col. J. H. Lypher  
President Board of Examiners

or to  
Captain B. E. Kimball  
10<sup>th</sup> U.S. Heavy Artillery Colored, has been  
ordered before you, upon his own  
request, for examination with a  
view to obtaining a field position  
in some of the Heavy Artillery Regi-  
-ments, colored, now in service.

From my knowledge of Captain  
Kimball, I am able to bear testimony  
to his good conduct and ability both  
in the field and in camp. In the  
recruiting and organization of the  
regiment he is now attached to,  
he has shown energy and fidelity to a  
degree that merits consideration

I should be glad if he could  
receive the position he seeks

Very Respectfully  
Yours Obedt Servant

(signed)

W. P. Sanders  
Maj Genl. Comdg.

A True Copy

Geo. W. Foster Jr.

1<sup>23</sup> St. 74<sup>th</sup> N.E. Inf.

Recorder of Board

Sept 10/64

H E Kimball  
S. O. for Capt. ~~Reamblin~~ to  
appear for Examination.

10 MSON

Headquarters, Department of the Gulf,  
New Orleans, September 10<sup>th</sup> 1864.

Special Orders }  
No. 244. }

[EXTRACT.]

5. Captain Norace E. Kimball, 10<sup>th</sup> United States  
Cohort Artillery, having applied for examination  
as to his fitness for the position of Field officer  
in the United States Cohort Artillery, will report to  
the Board of Examiners, of which, Colonel J. H. Sypher,  
is President, for examination.

By command of Major General Banks:  
Col. Sypher  
Presd. Board of Examiners  
S. S. Hargrett  
Acting Assistant Adjutant General.

13 1292

Dy 1864

New Orleans Sept 24 1864

Report Board Examiners  
Col J. H. Sypher Presdt  
in case of Examination  
of Capt Horace E. Kimball  
10<sup>th</sup> USCArty

Office Board of Examiners for Officers of U.S. Troops.

45 Grandjean St. New Orleans, La. Sept. 24<sup>th</sup> 1864.

Lieut. Col. C. J. Christensen

Maj. Adj. General.

Mil. Div. West Miss.

Colonel:

The Board of Examiners,

appointed by Par. 16, Special Orders, No. 209, C.S. Dept. of the Gulf in  
obedience to General Orders No. 17<sup>th</sup> 29<sup>th</sup> Head Quarters, Military Divis-  
ion, West Mississippi, has the honor to report that they have examined  
Capt. Horace C. Kimball, 10<sup>th</sup> U.S. Art. Regt. and find that he possesses all  
the qualifications required by Articles 6, 7, Par. 2, Genl. Orders, No. 17, Head  
Quarters Military Division, West Mississippi. That he is moderately  
versed in the requirements of Art. 8, and has a fair knowl-  
edge of Art. 9. This officer presented himself for examination  
as a candidate for a Commission as Major of Artillery, he was  
not therefore examined in the requirements of Articles 10 & 11.  
The Board cannot report that Capt. H. Kimball, showed  
himself conversant with all the requirements of Genl. Order  
No. 17 but recommend him for the position for which  
he is an applicant, on the ground of General Intelligence  
and evident desire to learn. Precedence of grade to be  
determined on, and recommended in a future report.

Respectfully Submitted. (over)

Members of Board

(Signed) J. Hale Syphee, Col. & Presdt. Board  
" S. N. Wilkeson, Lt Col 11<sup>th</sup> N.Y. Cavalry  
" J. J. Smith, Capt. 97<sup>th</sup> N.Y. I. S.

(Signed) George W. Foster Jr.  
1<sup>st</sup> Lieut. 74<sup>th</sup> N.Y. I. S.

K 305 Dg 1864

Battery Gibraltar Sep 2/64

Head qrs U.S. Forces  
Lake Pontchartrain  
Lakeport Sep 7, 1864

Horace E. Kimball  
Capt-10<sup>th</sup> U.S.C. Art'y (Heavy)

Respectfully forwarded

R. B. Jones Col,  
Candy

Requests an Order to appear before  
the Board of Examiners as  
Candidate for position as  
Field officer

8 1423 64  
Via 2nd Defense New Orleans  
Sept 8<sup>th</sup> 1864

Respectfully forwarded

J. M. M. M. M.  
B. G. C.

S. O. Sept 11



Co. 10<sup>th</sup> U.S. C. Art. (Hb.)  
Battery Gentilly, La Sept 2<sup>d</sup> 1864

To

Asst. Adjt. Gen.  
Hd. Qrs. Dept of the Gulf

Sir

I have the honor, very respectfully to request an order authorizing me to appear before the Examining Board now in session at 137 Common St. whereof Col Wilkison is President as a candidate for a Field Position in the U.S. Colored Artillery (Heavy)

I have the honor to be Sir

Very Respectfully

Your Obedt. Servant

Horace Kimball

Capt 10<sup>th</sup> U.S. C. Art. (Heavy)

Hd. Qrs. Dept. of the Gulf.  
New Orleans, Oct. 6. 64.

---

Sp. Order 270 par 6.

---

Detailing Capt A. B. Fin-  
ball, 10<sup>th</sup> U. S. C. Art.  
as a Member of the Board  
of Improper Enlistments.

---

Headquarters, Department of the Gulf,

New Orleans, October 6<sup>th</sup> 1864

Special Orders }  
No. 270 }

[EXTRACT.]

C. Captain H. C. Kimball, 10<sup>th</sup> United States Colored Artillery,  
(Heavy) being unfit for field duty, but reported by the Medical  
Director as being fit for light duty, is detailed as a member of  
the Board of Improper Enlistments, appointed by Paragraph 5  
of Special Orders 1321 current series from these Headquarters,  
now in session at No. 58, Carondelet Street, New Orleans.

By command of Major General Murlbut:

Pres. of the Board,

C. S. Sargent  
1<sup>st</sup> Lieut. & Acting Assistant Adjutant General.

Battery Gentry Co  
October 25<sup>th</sup> 1864

544<sup>th</sup> St. St. St.  
Kimball Horace E.  
Capt. Co<sup>st</sup> 10<sup>th</sup> U.S.C.A. 1864

Battery Gentry Co  
Oct 25<sup>th</sup> 1864

Horace E. Kimball  
Capt. Co<sup>st</sup> 10<sup>th</sup> U.S.C.A.

Requests that he may  
be relieved from duty with  
the Board of Investigation  
of Improper Enlistments

S.O. October 27.

2120  
Adj. Defenses ~~see orders~~  
Oct 25<sup>th</sup> 1864

Respectfully forwarded  
This company is  
assigned to a fixed  
battery at Brashear.  
There are now two  
officers on duty with  
the company.

It is always important  
for the captain of a  
company to be with  
his company, but  
the Comdy. General  
can be the only proper  
judge of the necessity  
of relieving this  
officer from the  
special duty on which  
he is engaged

W. H. Mearns  
B. G. C.

Battery Dentilly Co  
October 25<sup>th</sup> 1861

Maj. Geo. B. Drake  
Asst. Adjt Gen  
Dept of the Gulf

Maj-

I have the honor,  
very respectfully, to request that  
I may be relieved from duty with  
the Board of Investigation of Improper  
Enlistments, that I may be enabled  
to assume command of my battery  
now under marching orders for  
Brushy City La.

I have the honor to be Maj

Very respectfully  
Your Obedt Servant

Horace Kimball  
Capt Co 7 10<sup>th</sup> U.S.C.A. (No.)

Headquarters, Dept of the Army.  
New Orleans, Oct 27/64.

---

Sp. Order No. 291 par 4.

---

Relieving Capt Kimball from  
duty on this Board.

---

Co. F, 10 U.S.C.D.

Headquarters, Department of the Gulf,

New Orleans, Oct 27<sup>th</sup> 1864.

Special Orders }  
No. 241. }

[EXTRACT.]

L. Captain Horace Kimball, Company  
"F," 10<sup>th</sup> United States Colored Infantry, is at  
his own request relieved from duty on  
the Board of disproprietors appointed  
by paragraph 5 of Special Orders No 132  
current series from these Headquarters  
and will without delay assume com-  
mand of his company.

By command of Major General Hurlbut:

President of the Board  
of disproprietors

C. S. Sargent  
1st Lieut. and Acting Assistant Adjutant General.  
A. S. C. }

10 U.S.A.

H. E. Knaball



Charges & Specifications preferred against Captain Horace  
E. Kimball, Company F 10<sup>th</sup> U.S. Colored Artillery (Heavy)

Charge - "Making a False Return"

Specification - In this that he Captain Horace E. Kimball,  
Company F 10<sup>th</sup> U.S. Colored Artillery (Heavy) did make a  
false return of his company for the month of October,  
1864, in the following particulars: "He reported an officer  
"Present Sick" whom he knew to be "Absent sick". He made  
his "Aggregate last report" (102) one hundred and two when  
it was only (101) one hundred and one. He returned one  
man a "Gained from desertion" whom he had never re-  
ported as a deserter. All this at Proctorville, La., on  
or about the Thirty-First day of October 1864

(Signed) E. P. Loring

Major Comd'g Regiment.

Witnesses:

E. P. Loring, Major 10<sup>th</sup> U.S. Col'd Arty (H)

Nathaniel Burbank, Surg' Arty Adj't 10<sup>th</sup> U.S. Col'd Arty (H)

2680  
Hugon Defenses <sup>64</sup> ~~was~~ <sup>than</sup>  
Dec 1<sup>st</sup> 1864

Respectfully returned  
It does not appear  
that Capt Kimball  
was guilty of a  
greater offence  
than can be proved  
- For this he is  
deserving of a  
severe reprimand  
and altho the  
charges in this  
case will not  
be brought to trial  
it must not be  
accepted as a  
precedent, ~~for~~  
A similar offence  
in others or if  
repeated by Capt  
Kimball could  
not be passed over  
without notice.

Major Loring  
action meets with  
full approval  
at these Headquarters

By order of  
Bryson Sherman  
Sergeant Speed  
C. A. M.

H. E. Kimball

10/11/64

Headquarters 10<sup>th</sup> U.S. Cold Art'y (21st)  
New Orleans Nov. 12, 1864

Capt. Frederic Speed

A. A. Genl Defences New Orleans

Sir -

I have the honor  
to return to you the explanations of Captain  
Horace E. Kimball relating to the charge made  
against him by me, wishing to call your at-  
tention to some of his statements, and to furnish  
the data from which I made the charge of "Making a  
False Return" - He says Lt. Ricout was reported  
"Absent sick", because he started with the com-  
pany for Proctorville (that was taken sick on the  
way) and agreed to be there on the 31<sup>st</sup> of Oct. 1864.  
The officers of Co. F. who advised Capt. Kimball, say  
that Lieut Ricout did not start with the Co.  
That he told Capt. Kimball he could not go  
when Capt. K. told him to "Go to Hell. God damn  
you" This in presence of enlisted men -  
Sergeant Griffie of Co. F. confirms the statement

That Lieutenant Rice did not start for  
Proctorville. hence that item of the charge  
is ~~not~~ explained away —

Hee was next charged with making his "aggregate  
last return" different from what it really  
was, and different from the last Monthly Return  
on file in this Office. Hee says the retained  
copy agrees with the one sent to this office. True  
but they ~~do~~ not agree with the Sept. Return,  
and the charge is still good that his return  
in this respect was false — I enclose the Returns  
for September and October that all may be seen.  
I also send Capt. Kimball's Tri Monthly for Oct. 10<sup>th</sup>  
over his own signature which shows that his  
last return was one hundred and two. On  
showing him this latter he was confounded  
and acknowledged that he did not know how  
that came. So that he either signed in blank  
else did not read what he was signing.

I also enclose his last Tri Monthly, which  
you will discover is grossly inaccurate.  
And so it is with most of his company  
papers. His carelessness and inefficiency  
are intolerable.

I have the honor to be  
Very respectfully  
Your obt. Servt.  
E. P. Loring  
Chas. Bonwillig Esq.

Kimball, Horace E.,

Capt. Co. F, 10 U.S.C.A. (A.)

29

Fort St. Philip Sec.  
Dec 29<sup>th</sup> 1864.

Miss A. M. Jackson  
Cindy Garrison

Dear:

I have the honor to state  
that not having a copy of the new calls for  
daily routine [having applied to the Act Post  
Office for the same] I came to the Fort this  
A.M. at about 7<sup>30</sup> and on inquiry was  
told that the 1<sup>st</sup> Call for Guardmounting  
was at 8.30 instead of it being the 2<sup>nd</sup> Call  
Acting on this information I was late  
about 10 minutes at Guardmounting.

I have the honor to be Miss

Very Respectfully

Your Obedient Servant

Horace L. Kimball

Capt Co F 10<sup>th</sup> Regt. Ill

off the day

Fort Jackson La.  
July 7<sup>th</sup> 1865

Head Quarters 10<sup>th</sup> U.S. C. A. (W.P.)  
Fort Jackson La  
July 7. 1865

Kimball Horace C.  
Capt. Co. F. 10<sup>th</sup> U.S. C. A. (W.P.)

Respectfully forwarded  
Approved

Saml. Nunn  
Lieut. Col. Comd'g. Regt.  
10<sup>th</sup> U.S. C. A. (W.P.)

Requests a leave of absence for  
(7) seven days to visit New  
Orleans to purchase mess  
stoves, clothing &c.

Head Quarters  
Forts Jackson and St. Philip  
July 7. 1865

Respectfully forwarded  
Approved

Saml. Nunn  
Lieut. Col. 10<sup>th</sup> U.S. C. A. (W.P.)  
Comd'g. Post.

Filed in

" J "

File



Fort Jackson La  
July 7<sup>th</sup> 1865

Asst. Adjt. Gen.  
So. Div. La

Sir:

I have the honor, very respectfully  
to request leave of absence for seven (7) days  
with permission to visit the city of New Orleans La  
in order to purchase clothing, mess stores and  
other necessaries of which I stand greatly in  
need.

I have had but two (2) days leave of  
absence in over a year.

One officer will be left to command my  
company.

I have the honor to be Sir,

Very Respectfully

Your Obedt. Servt

Amos E. Kimball  
Capt G 7 10<sup>th</sup> U.S. Col. Art'y (N.Y.)

N. 228 dC 1863:

P. M. Jackson Sept 30/63:

Hambler Saul  
Lt. Col 10<sup>th</sup> U.S. C. arty.

Don't know of any  
Capt who desires to go  
out of service unless  
it is Capt Kimball  
10<sup>th</sup> U.S. C. arty.  
and recommends that he  
be mustered out -

P. M. Jackson Sept 30 1863

Headquarters Forts Jackson & St Philip La  
September 25. 1865-

Wickham Hoffman  
Major & A. A. G.

Sir.

Your dispatch which only came to hand today I answer by letter as likely to reach you sooner. I do not know of any Captain desirous of going out of service unless it be Capt Kimball who forwarded his resignation a few days since & received it back disapproved. Both he & Capt Bailey have proved themselves worthy of the position. I would recommend under the circumstances that Capt Kimball be the officer selected to be mustered out

Very respectfully  
Your obed<sup>t</sup> servant  
Saml. Hamblet  
Lieut Col. Comdg 11<sup>th</sup> U. S. A. (Reg)

No 714 DL 1865.

New Orleans Sept 27/65.

Kimball H. Braen P.  
Capt 10<sup>th</sup> U.S. Artys

Forwards Comm<sup>n</sup>  
in reference to his  
com.

To be considered  
if there should be  
an opportunity of  
giving this man em-  
ployment.

Rec'd DL Oct 18<sup>th</sup> 1865.

Headquarters, Department of Louisiana,

New Orleans, La., Sept 27<sup>th</sup>, 1865.

Maj. Gen. E. R. S. Baxter,

Comd'g Dept of La.

General:

I have the honor, very respectfully to solicit your attention to the following facts. — By Spec. Ord. No. 66. Hd. Qu. Dept of La, I am ordered to be honorably mustered out of service in consequence of the consolidation of my regiment with the 77<sup>th</sup> U.S.C.S. This action was predicated upon the fact of my having tendered my resignation a short time previously, and the inference from that that I desired to leave the service. My resignation was tendered at a time when my wife, who is an orphan & has no relatives in this section of the country, was lying dangerously sick and when fears were entertained for her life. Shortly after the forwarding of that paper, she unexpectedly convalesced, and is now out of danger. I do not desire to leave the service. I am the third in seniority out of 9 Captains in the 10<sup>th</sup> U.S. Col. Art. (14<sup>th</sup>). My company has yet nearly 2 years to serve

which there are three companies (and as many Captains) whose time expires before the first of June next. One of these companies will go out in a little over two months.

Should you accord me the honor of a personal interview, General, I will be able to explain to your satisfaction my position

Shun the honor to be General

Very Respectfully,

Wm. L. G. Smith

Horace D. Kimball

Capt Co. 7. 10<sup>th</sup> U.S. Col. Art. (Reg)

209

H. G. Kimball  
Capt. 10. U.S. C. Art.

*Special Orders*  
*Southern Div La*  
*1865-*

SPECIAL ORDERS, }  
No. 209.

HEADQUARTERS, SOUTHERN DIVISION OF LOUISIANA,

*New Orleans, July 10th, 1865.*

[*Extract.*]

\* \* \* \* \*  
3. Leave of absence for seven days, with permission to visit New Orleans, is hereby granted to  
Captain *Horace G. Kimball* 10th United States Colored Heavy Artillery.  
\* \* \* \* \*

BY ORDER OF BREVET MAJOR GENERAL SHERMAN.

*William B. Sherman.*  
Major and Assistant Adjutant General.

*C. C. Fort Jackson*



DEPARTMENT OF THE ARMY

U. S. Military Telegraph Office

Capt. Kimball.

Capt. H. E. Kimball  
10 U.S.C. H.A.

*[Faint, illegible handwritten text, likely bleed-through from the reverse side of the page]*

DEPARTMENT OF THE GULF,

U. S. Military Telegraph Office,

Fort Jackson Sept 25<sup>th</sup> 1865

By Telegraph from New Orleans Sept 22<sup>nd</sup>

To Commanding Officer

Fort Jackson & St Philip  
La

B Captain

Himball with his regiment  
I do direct him to report  
in person to these Head  
Quarters <sup>immediately</sup> for special duty

Answer immediately

By command of  
Brevet Maj Genl T W Sherman  
Edward Hemenway  
A. A. G.

32 mil

*Wing Augustus*  
*Oct*, 10 U.S. Col'd H. Art'y

*Musician* | *Private*

CARD NUMBERS.

1	5489027	26
2	5492921	27
3	5493221	28
4	5493291	29
5	5493500	30
6	5493623	31
7	5493749	32
8	5490069	33
9	5494013	34
10		35
11		36
12		37
13		38
14		39
15		40
16		41
17		42
18		43
19		44
20		45
21		46
22		47
23		48
24		49
25		50

Book Mark:

See also *75 and 88 U.S.C.I.*

*R. W. Hart* U.S.C.T.

*Augustus King*  
Mus, Co., 10 Reg't U. S. Col'd *Hart*

Appears on

**M. and D. Roll of Men Transferred**

to the organization named above,

from *75 USCA*

Roll dated *Nov 18*, 186*3*.

When enlisted *Aug 11*, 186*3*.

Period for which enlisted *3* years.

When mustered in *Sep 24*, 186*3*.

Present or absent *Not stated*

Company to which assigned

Remarks: *Joined by transfer  
from 88 USCA per S. O.  
209 series of 1864. Dept Gulf  
Aug 13/64. Promoted  
to Corp mustered as  
a musician. Transfer  
before Apr 19/61. Served  
US for C + G. Eq. 03*

Book mark : .....

*J. A. Johnson*

*K* | 10 H. Art'y. | U.S.C.T.

*Augustus King*

*Pat*, Co. A, 10 Reg't U. S. Col'd H. Art'y.

Appears on

Company Muster Roll

for *Nov - Dec*, 1865.

Present or absent *Present*

Stoppage, \$ 100 for

Due Gov't, \$ 03/100 for *Co. B. Equipage*,  
*per transfer rolls*

Valuation of horse, \$ 100

Valuation of horse equipments, \$ 100

Remarks: *Transferred from 75 22562*  
*per S.O. 105 Co. B. Hd Qrs 1st Reg't*

-----  
-----  
-----  
-----  
-----

Book mark: -----

*H. King*

Copyist.

*K* | 10 H. Art'y. | U.S.C.T.

*Augustus King*

*Plt*, Co. A, 10 Reg't U. S. Col'd H. Art'y.

Appears on

Company Muster Roll

for

*Jan + Feb*, 1866.

Present or absent

*Present*

Stoppage, \$  $\frac{\quad}{100}$  for

Due Gov't, \$  $\frac{05}{100}$  for *Co. G. Equipage*

Valuation of horse, \$  $\frac{\quad}{100}$

Valuation of horse equipments, \$  $\frac{\quad}{100}$

Remarks: *Sick in Hospital*

Book mark:

*Sty*  
Copyist.

*K* | 10 H. Art'y. | U.S.C.T.

*Augustus King*

*Pl*, Co. A, 10 Reg't U. S. Col'd H. Art'y.

Appears on

**Company Muster Roll**

for *Mar & Apr*, 186 *6*.

Present or absent

*Present*

Stoppage, \$

*65*  
*100* for *Camp &*

*Garrison Equipage*

Due Gov't, \$

*100* for

Valuation of horse, \$ *100*

Valuation of horse equipments, \$ *100*

Remarks:

Book mark:

*Stym*  
Copyist.

*K* | 10 H. Art'y. | U.S.C.T.

*Augustus King*

*Pl*, Co. A, 10 Reg't U. S. Col'd H. Art'y.

Appears on

Company Muster Roll

for *May + June*, 186*6*.

Present or absent *Present*

Stoppage, \$.....100 for .....

Due Gov't, \$.....100 for .....

Valuation of horse, \$.....100

Valuation of horse equipments, \$.....100

Remarks: .....

.....  
.....  
.....  
.....  
.....  
.....  
.....  
.....

Book mark: .....

.....

*[Signature]*

Copyist.



*K* | 10 H. Art'y. | U.S.C.T.

*Augustus King*

*Pvt.*, Co. A, 10 Reg't U. S. Col'd H. Art'y.

Appears on

**Company Muster Roll**

for *July & Aug*, 186*6*.

Present or absent *Present*

Stoppage, \$.....<sup>100</sup> for .....

Due Gov't, \$.....<sup>100</sup> for .....

Valuation of horse, \$.....<sup>100</sup>

Valuation of horse equipments, \$.....<sup>100</sup>

Remarks: .....

.....  
.....  
.....  
.....  
.....  
.....

Book mark: *203255*

*Styer*  
Copyist.

*K* | 10 H. Art'y. | U.S.C.T.

*Augustus King*  
*Pvt*, Co. A, 10 Reg't U. S. Col'd H. Art'y.

Appears on

**Company Muster Roll**

for *Sept + Oct*, 186*6*.

Present or absent.....

Stoppage, \$.....*100* for.....

Due Gov't, \$.....*100* for.....

Valuation of horse, \$.....*100*

Valuation of horse equipments, \$.....*100*

Remarks: *Date of discharge, mustered out*  
*Sept. 23/66 by reason of expiration of*  
*term of service*  
*Paid \$100.00 bounty*

Book mark: *109762 A June 17. 68*

*Nesbitt*

K 10 Art'y U.S.C.T.

Augustus King

Orin, Co. A, 10 Reg't U. S. Col'd Art'y

Appears on a

**Detachment Muster-out Roll**

of the organization named above. Roll dated

New Orleans La Sept 24, 1866.

Muster-out to date Sept 23, 1866.

Last paid to June 30, 1866

**Clothing account:**

Last settled \_\_\_\_\_, 1866 ; drawn since \$ \_\_\_\_\_ 100

Due soldier \$ 29 <sup>05</sup>/<sub>100</sub>; due U. S. \$ \_\_\_\_\_ 100

Am't for cloth'g in kind or money adv'd \$ \_\_\_\_\_ 100

Due U. S. for arms, equipments, &c., \$ 3 <sup>50</sup>/<sub>100</sub>

Bounty paid \$ \_\_\_\_\_ 100 due \$ \_\_\_\_\_ 100

Remarks: joined orig org. 88 use I transferred to 75 use I \$0 209 per 12 series of 1864 Dept of Gulf transferred to 10 use A(H) \$0 105 per 12 series of 1865 Dept of La free on or before Apr 19 '61

Book mark: \_\_\_\_\_

Edmondson

Stop for 1 bed each  
MO by reason of expi-  
ration of term of service-

\*1891\*

5490069

JAN. 15

*K* | 10 H. Art'y. | U.S.C.T.

*Augustus King*  
*Pvt. Co. A*, 10 Reg't U. S. Col'd H. Art'y.

Appears on **Co. Muster-out Roll**, dated  
*Baton Rouge La, Feb 22* 1867.

Muster-out to date \_\_\_\_\_, 186 .

Last paid to \_\_\_\_\_, 186 .

**Clothing account:**

Last settled \_\_\_\_\_, 186 ; drawn since \$ \_\_\_\_\_ 100

Due soldier \$ \_\_\_\_\_ 100; due U. S. \$ \_\_\_\_\_ 100

Am't for cloth'g in kind or money adv'd \$ \_\_\_\_\_ 100

Due U. S. for arms, equipments, &c., \$ \_\_\_\_\_ 100

Bounty paid \$ \_\_\_\_\_ 100; due \$ \_\_\_\_\_ 100

Remarks: *Transfd. from 75 U.S. Col'd H. Art'y. as*  
*Pvt. S. O. 1058 of 65 Dept. La*  
*Dischd. for exp'n. of term of*  
*service Sept 23/66*

Book mark : \_\_\_\_\_

*Nesbitt*

Copyist.

1571  
King Claiborne

Co. K, 10 U.S. Col'd H. Art'y.

Private | Private

CARD NUMBERS.

1	5488410	26
2	5487398	27
3	5512285	28
4	5512439	29
5	5512578	30
6	5512723	31
7	5512848	32
8	5512969	33
9	5513071	34
10	5513187	35
11	5513278	36
12		37
13		38
14		39
15		40
16		41
17		42
18		43
19		44
20		45
21		46
22		47
23		48
24		49
25		50

Book Mark:

See also

77 U.S.A.

D-1482076-P.O.M.M.  
A 2500134 And W.D.

W3 powder  
EX

*K* | *1066* | U.S.C.T.

*Chauborne King*  
*Priv*, Co. *K*, 10 Reg't U. S. Col'd *Sea*

Appears on

**M. and D. Roll of Men Transferred**

to the organization named above,

from *7th U.S. Col Inf*

Roll dated *Camp Onondaga, 1863*

When enlisted....., 186 .

Period for which enlisted *3* years.

When mustered in *Sept 1*, 186 *4*.

Present or absent *Present*

Company to which assigned *K*

Remarks: *Rec'd by transfer*  
*from Co K 7th U.S. Col*

Book mark : .....

*W. H. Scott*



*K* | *10th A.* | **U.S.C.T.**

*Clairborn King*  
*Sgt*, Co. *K*, *10* Reg't U. S. Col'd Infantry.

Appears on

**M. and D. Roll of Men Transferred**

to the organization named above,

from *Co. G. 1st U.S. Col. Inf*

Roll dated *Camp Orapida Cal.*, 186*4*.

When enlisted *Sept 1*, 186*4*.

Period for which enlisted *3* years.

When mustered in *Sept 6*, 186*4*.

Present or absent *Present*

Company to which assigned *K*

Remarks: *Drafted, joined  
as Conscript. by G.O.  
10th A. Co. Sept 1  
Gulf. 1864.*

Book mark :

*W. H. Scott*

K | **10** H. Art'y. | **U.S.C.T.**

*Clairborne King*

*P*, Co. *K*, 10 Reg't U. S. Col'd H. Art'y.

Age ..... years.

Appears on

**Company Muster Roll\***

for *Sep. & Oct.*, 1865.

Joined for duty and enrolled:

When *Drafted*, 186 .

Where .....

Period *3* years

Mustered in:

When *Sept. 1*, 1864.

Where *New Orleans*

Present or absent *Present*

Stoppage, \$ ..... 100 for .....

Due Gov't, \$ ..... 100 for .....

Remarks : .....

\* First current roll. No muster-in roll of this company on file.

Book mark : .....

*Hibbard*

**K** | **10 H. Art'y.** | **U.S.C.T.**

*Clairborne King*

*P*, Co. K, 10 Reg't U. S. Col'd H. Art'y.

Appears on

**Company Muster Roll**

for *Nov. & Dec.*, 1865.

Present or absent *Present*

Stoppage, \$ 100 for

Due Gov't, \$ 100 for

Valuation of horse, \$ 100

Valuation of horse equipments, \$ 100

Remarks:

Book mark:

(358)

*Hubbard*  
Copyist.

**K** | **10 H. Art'y.** | **U.S.C.T.**

*Clairborne King*

*P*, Co. K, 10 Reg't U. S. Col'd H. Art'y.

Appears on

**Company Muster Roll**

for *Jan. Feb.*, 186*6*.

Present or absent *Present*

Stoppage, \$ *100* for

Due Gov't, \$ *100* for

Valuation of horse, \$ *100*

Valuation of horse equipments, \$ *100*

Remarks:

Book mark:

*Hibbard*

**K** | **10 H. Art'y.** | **U.S.C.T.**

*Oliver King*

*P*, Co. K, 10 Reg't U. S. Col'd H. Art'y.

Appears on

**Company Muster Roll**

for *Mch. 7 Apl.*, 1866.

Present or absent *Present*

Stoppage, \$ 100 for

Due Gov't, \$ 100 for

Valuation of horse, \$ 100

Valuation of horse equipments, \$ 100

Remarks:

Book mark:

*Hibbard*

Copyist.

K | **10 H. Art'y.** | **U.S.C.T.**

Clairbourn King

P, Co. K, 10 Reg't U. S. Col'd H. Art'y.

Appears on

**Company Muster Roll**

for May & June, 1866.

Present or absent Present

Stoppage, \$ 100 for

Due Gov't, \$ 100 for

Valuation of horse, \$ 100

Valuation of horse equipments, \$ 100

Remarks:

Book mark:

Hibbard Copyist.

*K* | **10 H. Art'y.** | **U.S.C.T.**

*Clairborne King*

*P*, Co. K, 10 Reg't U. S. Col'd H. Art'y.

Appears on

**Company Muster Roll**

for *July & Aug.*, 186*6*.

Present or absent *Present*

Stoppage, \$ *100* for

Due Gov't, \$ *100* for

Valuation of horse, \$ *100*

Valuation of horse equipments, \$ *100*

Remarks:

Book mark:

*Hibbard*

*H* | 10 H. Art'y. | U.S.C.T.

*Clairborne King*

*Put*, Co. K, 10 Reg't U. S. Col'd H. Art'y.

Appears on

**Company Muster Roll**

for *Sept & Oct*, 186*6*.

Present or absent. *Present.*

Stoppage, \$..... $\overline{100}$  for .....

Due Gov't, \$..... $\overline{100}$  for .....

Valuation of horse, \$..... $\overline{100}$

Valuation of horse equipments, \$..... $\overline{100}$

Remarks: .....

Book mark: .....

*Lloyd*



*H*

10 H. Art'y. U.S.C.T.

*Clairborne King*

*Put*, Co. K, 10 Reg't U. S. Col'd H. Art'y.

Appears on

Company Muster Roll

for *Nov. & Dec.*, 186*6*.

Present or absent *Present.*

Stoppage, \$ 100 for

Due Gov't, \$ 100 for

Valuation of horse, \$ 100

Valuation of horse equipments, \$ 100

Remarks:

Book mark:

*Floyd*

*K* | 10 H. Art'y. | U.S.C.T.

*Claiborne King*

*Put*, Co. *K*, 10 Reg't U. S. Col'd H. Art'y.

Appears on Co. Muster-out Roll, dated  
*Baton Rouge La*, *Feb 22*, 1867.  
Muster-out to date *Feb 22*, 1867.  
Last paid to *Dec. 31*, 1866.

Clothing account:

Last settled....., 186 ; drawn since \$.....<sup>100</sup>

Due soldier \$ *64* <sup>*69*</sup>/<sub>100</sub>; due U. S. \$.....<sup>100</sup>

Am't for cloth'g in kind or money adv'd \$.....<sup>100</sup>

Due U. S. for arms, equipments, &c., \$ *6* <sup>*24*</sup>/<sub>100</sub>

Bounty paid \$.....<sup>100</sup>; due \$ *200* <sup>100</sup>

Remarks: *Revised by transfer from Co. F  
77 U. S. C. I. Oct 11/65 per S. O. No.  
66 Hd qrs Dept La. S. 1865.  
Consript by S. O. No. 106 Hd qrs  
Dept Gulf. July 1864.*

Book mark: .....

*Floyd*

1512  
King, Edmund

Co - 10 U.S. Col'd H. Art'y.

Private

Private

CARD NUMBERS.

1	5488791.	26	
2		27	
3		28	
4		29	
5		30	
6		31	
7		32	
8		33	
9		34	
10		35	
11		36	
12		37	
13		38	
14		39	
15		40	
16		41	
17		42	
18		43	
19		44	
20		45	
21		46	
22		47	
23		48	
24		49	
25		50	

Book Mark:

See also 77 U.S.C.

*K. Volt. Art.* | **U.S.C.T.**

*Edmund King*  
Pvt., Co. ...., 10 Reg't U. S. Col'd *A. Art.*

Appears on

**M. and D. Roll of Men Transferred**

to the organization named above,

from *77 Regt. U.S. C. Inf.*

Roll dated *Oct 1*, 1865.

When enlisted *Apr 6*, 1863.

Period for which enlisted *3* years.

When mustered in *Apr 8*, 1863.

Present or absent

Company to which assigned

Remarks: *Died at Fork*  
*St Philip La April 11, 64*  
*Final statements*  
*rendered*

*Not borne on rolls 10 USC 114*

Book mark :

*J. L. ...*

1510  
King Endymion

Co<sup>d</sup>, 10 U.S. Col'd H. Art'y

Private Corporal

CARD NUMBERS.

1	5487740	26
2	5488261	27
3	5513473	28
4	5513621	29
5	5513745	30
6	5513830	31
7	5513927	32
8	5513988	33
9	5514037	34
10	5514083	35
11	5514111	36
12		37
13		38
14		39
15		40
16		41
17		42
18		43
19		44
20		45
21		46
22		47
23		48
24		49
25		50

Book Mark:

See also 77 U.S.C.I.

*N 10 H. A.* | **U.S.C.T.**

*Endymion King*  
*Pl. Co. d, 10* Reg't U. S. Col'd *10 H. A.*

Appears on

**M. and D. Roll of Men Transferred**

to the organization named above,

from *Co. C 1st U. S. Col Inf*

Roll dated *Camp Sumpster Va*, 186*5*.

When enlisted *July 23*, 186*5*.

Period for which enlisted *9* years.

When mustered in *March 8*, 186*5*.

Present or absent *Present*

Company to which assigned *L*

Remarks: *Spinal disease*

Book mark :

*W. H. Scott*

*K* *10th* *U.S.C.T.*

*Endymion King*  
*10th* *Co. D*, *10* *Reg't* *U.S. Col'd*

Appears on

**M. and D. Roll of Men Transferred**

to the organization named above

from *77th* *U.S. Col Inf*

Roll dated *Camp Parapara Oct 1*, 1865.

When enlisted *Feb 23*, 1865.

Period for which enlisted *3* years.

When mustered in *March 8*, 1865.

Present or absent *Present*

Company to which assigned *D*

Remarks: *Joined as Recruit*

*Joined as recruit*  
*from Co. C, 77th U.S.C.*  
*for 5066 C.S. Hd*  
*Dis Dept of La*

Book mark :

*Wear Scott*

*K* | **10 H. Art'y. | U.S.C.T.**

*Edymion King*  
*Sgt*, Co. *G*, 10 Reg't U. S. Col'd H. Art'y.

Age ..... years.

Appears on

**Company Muster Roll\***

for *Sept. & Oct.*, 1865.

Joined for duty and enrolled:

When *Feb. 23*, 1865.

Where *New Orleans*

Period *3* years.

Mustered in:

When *March 8*, 1863.

Where *New Orleans*

Present or absent *Present*

Stoppage, \$ *100* for .....

Due Gov't, \$ *100* for .....

Valuation of horse, \$ *100*

Valuation of horse equipments, \$ *100*

Remarks: *Transf. from Co. C,  
7th U.S. Art.*

\*First current roll. No muster-in roll of this company on file.

Book mark : .....

*Scherich*



*K* | 10 H. Art'y. | U.S.C.T.

*Eudymon King*  
*Pvt*, Co. L, 10 Reg't U. S. Col'd H. Art'y.

Appears on

**Company Muster Roll**

for *Nov. & Dec.*, 186*5*.

Present or absent *Present*

Stoppage, \$ *100* for

Due Gov't, \$ *100* for

Valuation of horse, \$ *100*

Valuation of horse equipments, \$ *100*

Remarks:

Book mark:

*Scherish*

*K* | 10 H. Art'y. | **U.S.C.T.**

*Eadynton King*  
*Pvt.*, Co. L, 10 Reg't U. S. Col'd H. Art'y.

Appears on

**Company Muster Roll**

for *Jan. & Feb.*, 1866.

Present or absent *Present*

Stoppage, \$ 100 for

Due Gov't, \$ 100 for

Valuation of horse, \$ 100

Valuation of horse equipments, \$ 100

Remarks: \_\_\_\_\_  
\_\_\_\_\_  
\_\_\_\_\_  
\_\_\_\_\_  
\_\_\_\_\_  
\_\_\_\_\_

Book mark: \_\_\_\_\_

*Scherich*

*K* | 10 H. Art'y. | U.S.C.T.

*Endymion King*  
*Corp*, Co. L, 10 Reg't U. S. Col'd H. Art'y.

Appears on

**Company Muster Roll**

for *Mch. & Apr.*, 186*6*.

Present or absent *Present*

Stoppage, \$ *100* for

Due Gov't, \$ *100* for

Valuation of horse, \$ *100*

Valuation of horse equipments, \$ *100*

Remarks: *Promoted to Corp.*  
*Mch. 1/66.*

Book mark: \_\_\_\_\_

*Scherich*

*K* | *10th. A.* | **U.S.C.T.**

*Andymion King,*  
*Coop's Co. D, 10* Reg't U. S. Col'd *H. Artz*

Appears on

**Company Muster Roll**

for *May & June*, 186*6*

Present or absent *Present*

Stoppage, \$ *100* for

Due Gov't, \$ *100* for

Valuation of horse, \$ *100*

Valuation of horse equipments, \$ *100*

Remarks:

Book mark:

*Scherich*  
Copyist.

*K* | 10 H. Art'y. | **U.S.C.T.**

*Eudymon King*  
*Capt.*, Co. L, 10 Reg't U. S. Col'd H. Art'y.

Appears on

**Company Muster Roll**

for *July & Aug*, 1866.

Present or absent *Present*

Stoppage, \$ 100 for

Due Gov't, \$ 100 for

Valuation of horse, \$ 100

Valuation of horse equipments, \$ 100

Remarks: \_\_\_\_\_  
\_\_\_\_\_  
\_\_\_\_\_  
\_\_\_\_\_  
\_\_\_\_\_  
\_\_\_\_\_  
\_\_\_\_\_

Book mark: \_\_\_\_\_

*Bunham*

Copyist.

*K* | 10 H. Art'y. | **U.S.C.T.**

*Endymion King*

*Capt.*, Co. L, 10 Reg't U. S. Col'd H. Art'y.

Appears on

**Company Muster Roll**

for *Sept & Oct*, 1866.

Present or absent *Present*

Stoppage, \$ \_\_\_\_\_ 100 for \_\_\_\_\_

Due Gov't, \$ \_\_\_\_\_ 100 for \_\_\_\_\_

Valuation of horse, \$ \_\_\_\_\_ 100

Valuation of horse equipments, \$ \_\_\_\_\_ 100

Remarks: \_\_\_\_\_  
\_\_\_\_\_  
\_\_\_\_\_  
\_\_\_\_\_  
\_\_\_\_\_  
\_\_\_\_\_  
\_\_\_\_\_  
\_\_\_\_\_

Book mark: \_\_\_\_\_

*Burnham*

*K* | 10 H. Art'y. | **U.S.C.T.**

*Endymion King*  
*Capt.*, Co. L, 10 Reg't U. S. Col'd H. Art'y.

Appears on

**Company Muster Roll**

for *Nov & Dec*, 1866.

Present or absent *Present*

Stoppage, \$ *100* for

Due Gov't, \$ *100* for

Valuation of horse, \$ *100*

Valuation of horse equipments, \$ *100*

Remarks:

Book mark:

*Burnham*

*K* | 10 H. Art'y. | U.S.C.T.

*Endymion King*  
*Capt*, Co. *L*, 10 Reg't U. S. Col'd H. Art'y.

Appears on **Co. Muster-out Roll**, dated  
*Baton Rouge La* *Feb 22*, 1867 .  
Muster-out to date *Feb 22*, 1867 .  
Last paid to *Dec 31*, 1866 .

Clothing account:

Last settled....., 186 ; drawn since \$..... 100  
Due soldier \$ *47* <sup>*92*</sup> / 100; due U. S. \$..... 100  
Am't for cloth'g in kind or money adv'd \$..... 100  
Due U. S. for arms, equipments, &c., \$ *6* <sup>*20*</sup> / 100

Bounty paid \$ *100* / 100; due \$ *100* / 100

Remarks: *joined by transfer from*  
*Co C 77 U.S.C.T. Oct 1/65 S.O. 66. #*  
*gros Dept of La Sept 22 1865 app't Capt*  
*Mar 1/66*

Book mark: *V 222 P 221 75*

*Burnham*

Copyist.



1517  
King Henry  
Co. G, 10 U.S. Col'd H. Art'y.

Private Private

CARD NUMBERS.

1	5507154	26
2	5507432	27
3	5507578	28
4	5507724	29
5	5507862	30
6	5508004	31
7	5508143	32
8	5508276	33
9	5508418	34
10	5508567	35
11	5508719	36
12	5508866	37
13	5509013	38
14	5509138	39
15	5509286	40
16	5509394	41
17		42
18		43
19		44
20		45
21		46
22		47
23		48
24		49
25		50

Book Mark:

See also

P. 611508. P.C. Aff.  
S. 634720 2 and

Edward  
L. H.

11 10. Nealty | **U. S. C. T.**

Henry King

Appears with rank of Pvt on

**Muster and Descriptive Roll of a Detach-  
ment of U. S. Vols. forwarded**

*Organized as Co G.*

~~for the~~ 10 Reg't U. S. Col'd 69. Roll dated

New Orleans La Sept 20, 1864.

Where born Eastboro Md.

Age 36 y'rs; occupation Laborer

When enlisted Aug. 18, 1864.

Where enlisted New Orleans La

For what period enlisted 3 years.

Eyes Blk; hair Blk

Complexion Darke; height 5 ft. 4 in.

When mustered in Sept 20, 1864.

Where mustered in New Orleans La

Bounty paid \$ 100; due \$ 100

Where credited to New Orleans La

Company to which assigned G.

Remarks:

Book mark:

E. B. Thompson

Copyist.

K | 10 H. Art'y. | **U.S.C.T.**

Henry King  
Pvt, Co. G, 10 Reg't U. S. Col'd H. Art'y.

Appears on

**Company Muster Roll**

for Sept & Oct, 1864.

Present or absent Present

Stoppage, \$ 100 for \_\_\_\_\_

Due Gov't, \$ 100 for \_\_\_\_\_

Valuation of horse, \$ 100

Valuation of horse equipments, \$ 100

Remarks: \_\_\_\_\_  
\_\_\_\_\_  
\_\_\_\_\_  
\_\_\_\_\_  
\_\_\_\_\_  
\_\_\_\_\_  
\_\_\_\_\_  
\_\_\_\_\_

Book mark: \_\_\_\_\_

E. H. Brown

Copyist.

*K* | 10 H. Art'y. | U.S.C.T.

*Henry King*  
*Pvt*, Co. G, 10 Reg't U. S. Col'd H. Art'y.

Appears on

**Company Muster Roll**

for *Nov & Dec*, 186 *4*.

Present or absent. *Present*

Stoppage, \$ 100 for

Due Gov't, \$ 100 for

Valuation of horse, \$ 100

Valuation of horse equipments, \$ 100

Remarks:

Book mark:

*E. H. Baum*

*10* | **10 H. Art'y. U.S.C.T.**

*Henry King*  
-----  
*Prov.*, Co. G, 10 Reg't U. S. Col'd H. Art'y.

Appears on

**Company Muster Roll**

for *Jan & Feb*, 186*5*.

Present or absent *Present*

Stoppage, \$ *100* for -----

Due Gov't, \$ *100* for -----

Valuation of horse, \$ *100*

Valuation of horse equipments, \$ *100*

Remarks: -----  
-----  
-----  
-----  
-----  
-----  
-----  
-----  
-----  
-----

Book mark: -----

*F. E. Porter*

K

10 H. Art'y.

U.S.C.T.

Henry King  
Priv., Co. G, 10 Reg't U. S. Col'd H. Art'y.

Appears on

**Company Muster Roll**

for *Mar & April*, 186*5*.

Present or absent *Present*

Stoppage, \$ *100* for

Due Gov't, \$ *100* for

Valuation of horse, \$ *100*

Valuation of horse equipments, \$ *100*

Remarks:

Book mark:

*F. E. Porter*

*10* | **10 H. Art'y. | U.S.C.T.**

*Henry King*  
*Prov.*, Co. G, 10 Reg't U. S. Col'd H. Art'y.

Appears on

**Company Muster Roll**

for *May & June*, 186*3*.

Present or absent *Present*

Stoppage, \$ *100* for

Due Gov't, \$ *100* for

Valuation of horse, \$ *100*

Valuation of horse equipments, \$ *100*

Remarks:  
\_\_\_\_\_  
\_\_\_\_\_  
\_\_\_\_\_  
\_\_\_\_\_  
\_\_\_\_\_  
\_\_\_\_\_  
\_\_\_\_\_  
\_\_\_\_\_  
\_\_\_\_\_

Book mark: \_\_\_\_\_

*F. E. Porter*



*K* | 10 H. Art'y. | U.S.C.T.

*Henry King*  
*Prov.*, Co. G, 10 Reg't U. S. Col'd H. Art'y.

Appears on

**Company Muster Roll**

for *July + Aug*, 1865.

Present or absent *Present*

Stoppage, \$ 100 for

Due Gov't, \$ 05 for *B + G Equip*

*Page lost or destroyed*

Valuation of horse, \$ 100

Valuation of horse equipments, \$ 100

Remarks:

Book mark:

*J. E. Porter*

*K*

**10 H. Art'y. U.S.C.T.**

*Henry King*  
*Priv*, Co. G, 10 Reg't U. S. Col'd H. Art'y.

Appears on

**Company Muster Roll**

for *Sept & Oct*, 186*6*.

Present or absent *Present*

Stoppage, \$ *100* for

Due Gov't, \$ *100* for

Valuation of horse, \$ *100*

Valuation of horse equipments, \$ *100*

Remarks:  
\_\_\_\_\_  
\_\_\_\_\_  
\_\_\_\_\_  
\_\_\_\_\_  
\_\_\_\_\_  
\_\_\_\_\_  
\_\_\_\_\_  
\_\_\_\_\_

Book mark: \_\_\_\_\_

*F. E. Porter*

*N* | 10 H. Art'y. | U.S.C.T.

*Henry King*  
*Quat.*, Co. G, 10 Reg't U. S. Col'd H. Art'y.

Appears on

**Company Muster Roll**

for *Nov. & Dec.*, 186*4*.

Present or absent *Present*

Stoppage, \$ *100* for

Due Gov't, \$ *100* for

Valuation of horse, \$ *100*

Valuation of horse equipments, \$ *100*

Remarks:

Book mark:

*G. Fox*

*N* | 10 H. Art'y. | U.S.C.T.

*Henry King*  
*Privt.*, Col G, 10 Reg't U. S. Col'd H. Art'y.

Appears on

**Company Muster Roll**

for *Jan. 4 Feb.*, 186*6*.

Present or absent *Present*

Stoppage, \$ 100 for

Due Gov't, \$ 100 for

Valuation of horse, \$ 100

Valuation of horse equipments, \$ 100

Remarks:

Book mark:

*G. Fox*  
Copyist.

*H*

10 H. Art'y. U.S.C.T.

*Henry King*

*Priv.*, Co. G, 10 Reg't U. S. Col'd H. Art'y.

Appears on

**Company Muster Roll**

for *Mar. & Apr.*, 1866.

Present or absent *Present*

Stoppage, \$ *60* / *100* for *C.C. & G.E.*

*lost*

Due Gov't, \$ *100* for

Valuation of horse, \$ *100*

Valuation of horse equipments, \$ *100*

Remarks:

Book mark:

*G. F. W.*

Copyist.

*K* | 10 H. Art'y. | U.S.C.T.

*Henry King*  
*Priv*, Co. G, 10 Reg't U. S. Col'd H. Art'y.

Appears on

**Company Muster Roll**

for *May + June*, 186 *6*.

Present or absent *Present*

Stoppage, \$.....100 for .....

Due Gov't, \$.....100 for .....

Valuation of horse, \$.....100

Valuation of horse equipments, \$.....100

Remarks: .....

Book mark: .....

*G. Fry*  
Copyist.

*K* | 10 H. Art'y. | U.S.C.T.

*Henry King*  
*Prvt*, Co. G, 10 Reg't U. S. Col'd H. Art'y.

Appears on

**Company Muster Roll**

for *July & Aug*, 186 *U.*

Present or absent *Present*

Stoppage, \$ *100* for

Due Gov't, \$ *100* for

Valuation of horse, \$ *100*

Valuation of horse equipments, \$ *100*

Remarks: *For rd. lost 50*

Book mark:

*G. F. W.*  
Copyist.

*K*

10 H. Art'y.

U.S.C.T.

*Henry King*

*Pvt*, Co. G, 10 Reg't U. S. Col'd H. Art'y.

Appears on

**Company Muster Roll**

for *Sept & Oct*, 1866.

Present or absent *Present*

Stoppage, \$.....100 for .....

Due Gov't, \$.....100 for .....

Valuation of horse, \$.....100

Valuation of horse equipments, \$.....100

Remarks: .....

Book mark: .....

*Wms*

Copyist.



*K* | 10 H. Art'y. | U.S.C.T.

*Henry King*  
*Pvt*, Co. G, 10 Reg't U. S. Col'd H. Art'y.

Appears on

**Company Muster Roll**

for *Nov & Dec*, 186*6*.

Present or absent *Present*

Stoppage, \$ *100* for

Due Gov't, \$ *100* for

Valuation of horse, \$ *100*

Valuation of horse equipments, \$ *100*

Remarks:

Book mark:

*Wines*

Copyist.

*N* | 10 H. Art'y. | U.S.C.T.

*Henry King*

*Pvt.*, Co. *G*, 10 Reg't U. S. Col'd H. Art'y.

Appears on **Co. Muster-out Roll**, dated  
*Baton Rouge La Feb 22*, 1867.

Muster-out to date *Feb 22*, 1867.

Last paid to *Dec 31*, 1866.

Clothing account:

Last settled....., 186 ; drawn since \$.....<sup>100</sup>

Due soldier \$ *61*<sup>*67*</sup>/<sub>100</sub>; due U. S. \$.....<sup>100</sup>

Am't for cloth'g in kind or money adv'd \$.....<sup>100</sup>

Due U. S. for arms, equipments, &c., \$.....<sup>100</sup>

Bounty paid \$.....<sup>100</sup>; due \$ *2 00*<sup>100</sup>

Remarks: *Joined at Camp Arvin*

Book mark : .....

*Wines*

1575  
*King, Morris,*

Co - **10 U.S. Col'd H. Art'y.**

*Private* | *Private*

CARD NUMBERS.

1	5487605.	26
2		27
3		28
4		29
5		30
6		31
7		32
8		33
9		34
10		35
11		36
12		37
13		38
14		39
15		40
16		41
17		42
18		43
19		44
20		45
21		46
22		47
23		48
24		49
25		50

Book Mark: \_\_\_\_\_

See also *77 W.P.A.*

N. 10 H.A. U.S.C.T.

Morris King  
Cty, Co., 10 Reg't U. S. Col'd H.A.

Appears on

**M. and D. Roll of Men Transferred**

to the organization named above,

from Coy 2 of U.S. Col'd Inf

Roll dated Camp Canapetda Cty, 1864

When enlisted, 1864

Period for which enlisted, 9 years.

When mustered in Sept, 1864

Present or absent

Company to which assigned

Remarks: Died Sept. 9, 65.  
at Camp Canapetda.  
Final etc Rendered,  
(2ftd)

Not borne on rolls 10 U.S.C.T.

Book mark:

W. H. Scott

1516

King Robert

Co E, 10 U.S. Col'd H. Art'y.

Private Private

CARD NUMBERS.

1	5-5-0 2409	26
2	5-4-8 7138	27
3	5-5-0 2690	28
4	5-5-0 4605	29
5		30
6		31
7		32
8		33
9		34
10		35
11		36
12		37
13		38
14		39
15		40
16		41
17		42
18		43
19		44
20		45
21		46
22		47
23		48
24		49
25		50

Book Mark:

See also

*K* | 10 H. Art'y. | U.S.C.T.

*Robert King*  
*Pr.*, Co. *E*, 7 Reg't U. S. Col'd H. Art'y.\*

Appears on

**Company Muster-in and Descriptive Roll**  
of the organization named above. Roll dated

*New Orleans La July 8 1864.*

Where born *La*

Age *22* y'rs; occupation *Laborer*

When enlisted *Apr 11 1864.*

Where enlisted *Alexandria*

For what period enlisted *3* years.

Eyes *Dark*; hair *Dark*

Complexion *Dark*; height *5 ft. 7 in.*

When mustered in *June 25 1864.*

Where mustered in *New Orleans*

Bounty paid \$ *2* 100; due \$ *100*

Where credited *Alexandria*

Company to which assigned *E*

Remarks:

\* This organization subsequently became Co. *E*, 10 Reg't U. S. Colored Heavy Artillery.

Book mark:

*K* | 10 H. Art'y. | U.S.C.T.

*Robert King*

Appears with rank of *Private* on

**Muster and Descriptive Roll of a Detachment of U. S. Vols. forwarded**

for the *7* Reg't *U.S. Art.\** Roll dated  
*New Orleans La, June, 1864.*

Where born *La*

Age *21* y'rs; occupation *Laborer*

When enlisted *April 18<sup>th</sup>*, 1864.

Where enlisted *Alexandria*

For what period enlisted *3* years.

Eyes *Dark*; hair *Dark*

Complexion *Dark*; height *5* ft. *7* in.

When mustered in *June 25<sup>th</sup>*, 1864.

Where mustered in *New Orleans*

Bounty paid \$ *100*; due \$ *100*

Where credited

Company to which assigned *E*

Remarks:

*\*  
Became 10 U.S. Cold H. Art.*

Book mark:

*J. W. Williams*

*K* | 10 H. Art'y. | U.S.C.T.

*Robert* *King*

*Pvt.*, Co. E, 10 Reg't U. S. Col'd H. Art'y.

Appears on

**Company Muster Roll**

for *July* *Aug*, 186*4*

Present or absent

Stoppage, \$ 100 for

Due Gov't, \$ 100 for

Valuation of horse, \$ 100

Valuation of horse equipments, \$ 100

Remarks: *Died Aug. 25<sup>th</sup> 64*  
*Gen Hospital New Orleans*

Book mark:

*Linden*  
Copyist.



*K* | 10 H. Art'y. | U.S.C.T.

*Robert King*  
-----  
*Priv*, Co. *E*, 10 Reg't U. S. Col'd H. Art'y.

Appears on **Co. Muster-out Roll**, dated  
*Baton Rouge, La. Feb. 22*, 1867.

Muster-out to date \_\_\_\_\_, 186 .

Last paid to *Not known*, 186 .

Clothing account:

Last settled \_\_\_\_\_, 186 ; drawn since \$ \_\_\_\_\_ 100

Due soldier \$ \_\_\_\_\_ 100; due U. S. \$ \_\_\_\_\_ 100

Am't for cloth'g in kind or money adv'd \$ \_\_\_\_\_ 100

Due U. S. for arms, equipments, &c., \$ \_\_\_\_\_ 100

Bounty paid \$ \_\_\_\_\_ 100; due \$ \_\_\_\_\_ 100

Remarks: *Joined at Org. Organs.*  
*as Private*

*Died in G. D. A. G. Hosp.*  
*Aug. 23, 1864, of Diarrhoea.*

Book mark: \_\_\_\_\_

*O'Hagan*

King, Robert

P. E., Co. E.

10

Reg't

U. S. C. H. A.

5

Enclosures.

Bed Cards

Descriptive Lists

Burial Records

Final Statements

Certs. of Dis. for Discharge

Furloughs

C. M. Charges

Med. Des. Lists

Med. Certificates

Orders

Other papers relating to—

Admission to Hosp'l

Furlough

Casualty Sheet (<sup>Priv.</sup> Officer's)

Med. Examination

Confinement

Misc. Information

Contracts

Pay or Clothing

Death or Effects

Personal Reports

Desertions

Rank

Discharge from Hosp'l

Transfer to Hosp'l

Discharge from Service

Transfer to V. R. C.

Duty

Transportation

2 for in sent for to Surg. Gen. Nov. 6 64

CASUALTY SHEET

No. \_\_\_\_\_

Robert King

Priv' of Company C.

4<sup>th</sup> Regiment of U.S.A.

State Volunteers.

NATURE OF CASUALTY.

Died Aug 23<sup>d</sup> 1864

CASUALTY SHEET.

Name: Robert King

Rank: Priv Company: E Regiment: 7

Arm: U.S. Art State: \_\_\_\_\_

Nature of Casualty: Death

CAUSE OF CASUALTY—(NAME OF DISEASE, &c.)

BY WHOM DISCHARGED.

FROM WHAT SOURCE THIS INFORMATION WAS OBTAINED.

DEGREE OF DISABILITY.

Rolling News  
Las 5 Pg 127

BY WHOM CERTIFIED.

REMARKS.

J. J. Wood  
1629 W.

DATE OF DISCHARGE, DEATH, &c.

Aug. 23, 1864

PLACE OF DISCHARGE, DEATH, &c.

Received New Orleans, La.

Clerk.

*App. Des. list sent 2d Auditor;*

*R.*

✓ *MSC*  
FINAL STATEMENT

OF *Private*  
*Robert King*  
7<sup>th</sup> Reg't of *U. S. C. H. Art*  
*10<sup>th</sup>*

**VOLUNTEERS.**

*Wid Aug 23<sup>rd</sup> 1864*

NOTE 1.—Two of these certificates (or duplicates) are to be given to each Volunteer Soldier or drafted man who may be discharged previously to the discharge of his company, that he may at once receive from the Paymaster the pay, &c., due him, and the cap'tain or other COMMISSIONED officer commanding the company will certify to the act of the delivery of the duplicate certificates; on these certificates the Soldier is "entitled to" his discharge, and should also present his discharge to the Paymaster to have the payment endorsed on it. The discharge is to be given back to the Soldier by the Paymaster; the latter only retaining as his voucher the duplicate certificates.

NOTE 2.—If the Soldier is entitled to pay for the use of his horse, the Company Commander will certify to that fact on the back of both these final statements, and also to the time he has pay due for having been so mounted on his own horse.

NOTE 3.—When a Soldier is furnished with final statements, his descriptive list, if he has one, should be taken up by the officer who gives the Soldier these statements, and endorsed with a statement to this effect by the officer. This endorsement should exhibit a full statement of the time for which the Soldier was allowed pay on his final statements, the clothing account, and all other charges against him or in his favor, so as to comprise a complete exhibit of his account. It will then be transmitted to the company commander of the Soldier, who will enter all the data necessary to a full understanding of the Soldier's account on the muster roll upon which the Soldier's discharge is reported. The descriptive list will then be destroyed. The object of this is, that the remaining portion of the Soldier's account may be settled upon the receipt of these muster rolls, and the Soldier receive any pay or allowances that may be due him at the time of his discharge, and which may not appear on his final statements from the fact that his descriptive list is incomplete. These accounts for back pay, &c., are settled by the 2d Auditor of the Treasury Department.

NOTE 4.—Charges for loss or injury to ordnance, horse equipments, and other miscellaneous charges, should appear under the heading of "Other Stoppages."

NOTE 5.—Bounty paid by State authorities, and not by the United States, will not be entered on this statement.

NOTE 6.—Amounts due the Sutler and Laundress must be entered on the muster roll on which the discharge, death, desertion, &c., is reported, as well as on the final statement, otherwise the amount cannot be collected from the United States.

NOTE 7.—This blank will be used for deceased volunteers and drafted men, as well as for others.

NOTE 8.—Where a Soldier dies in Hospital or on detached service, his descriptive list, if he has one, should be sent with his final statements, in duplicate, to the Adjutant General, Washington, D. C.

ADJUTANT GENERAL'S OFFICE.

*Oct 11<sup>th</sup> 1864*

Duplicate with Inventory sent 2d Auditor.



*Leuby*

I certify, on honor, that *Robert King* a *Private* of  
1st Lieut *AP Green* Company (*E*) of the *7th* Regiment of *246 Inf*  
**VOLUNTEERS**, of the State of *Louisiana*, born in *unknown*, State  
of *Louisiana*, aged *21* years; *5* feet *7* inches high; *Dark* complexion,  
*Dark* eyes, *Dark* hair, and by occupation a *Labourer*, having joined the company on  
its original organization at \_\_\_\_\_, and enrolled in it at the muster into  
the service of the United States at *Alexandria La*, on the *15th* day  
of *April*, 1864, (or was mustered in service as a recruit, by \_\_\_\_\_  
at \_\_\_\_\_, on the \_\_\_\_\_ day of \_\_\_\_\_,  
1864, or was drafted and mustered into the service of the United States from the \_\_\_\_\_  
Enrollment District of the State of \_\_\_\_\_, at \_\_\_\_\_,  
on the \_\_\_\_\_ day of \_\_\_\_\_, 1864,) to serve in the Regiment, for  
the term of *Three years*: and having served **HONESTLY** and  
**FAITHFULLY** with his Company in *Dept of the Gulf* to the present date, is now  
entitled to a **DISCHARGE** by reason of *Death*

by *Dysentery at New Orleans La 23rd Aug. 1864*

The said *Robert King* was last paid by Paymaster  
*here paid* to include the \_\_\_\_\_ day of \_\_\_\_\_, 1864, and has  
pay due him from that time to the present date; he is entitled to pay and subsistence for  
**TRAVELING** to place of enrollment, and whatever other allowances are authorized to volunteer  
soldiers, drafted men, or militia, so discharged. He has received from the United States **CLOTHING**  
amounting to *Twenty two*  $\frac{22}{100}$  dollars, since the \_\_\_\_\_ day of *Enrollment*  
1864, when his clothing account was last settled. He has received from the United States  
*Two*  $\frac{2}{100}$  dollars advanced **BOUNTY**.

There is to be stopped from him, on account of the State of \_\_\_\_\_, or other  
authorities, for **CLOTHING**, &c., received on entering service, \_\_\_\_\_  $\frac{X}{100}$  dollars; and  
for other stoppages, viz: \_\_\_\_\_  
\_\_\_\_\_  $\frac{X}{100}$  dollars.

He has been furnished with **TRANSPORTATION** in kind from the place of his discharge to  
\_\_\_\_\_; and he has been **SUBSISTED** for **TRAVELING** to his  
place of enrollment, up to the \_\_\_\_\_, 1864.

He is indebted to \_\_\_\_\_, **SUTLER**, \_\_\_\_\_  $\frac{X}{100}$  dollars.  
He is indebted to \_\_\_\_\_, **LAUNDRESS**, \_\_\_\_\_  $\frac{X}{100}$  dollars.

Given in Duplicate, at *New Orleans La*, this *23rd* day  
of *August*, 1864.

*J. E. Pyrette*  
*Surgeon Charge Camp d'Infanterie Gen Hospital*  
*Commanding Company.*

*Robert King*



COPY OF RECORD

FOR THE

ADJUTANT GENERAL U. S. ARMY.

RECORD OF DEATH AND INTERMENT.

Name and number of person interred,	<i>Robert King</i>	
Number and locality of the grave, -		
Hospital number of the deceased, -	<i>1834</i>	
Regiment, Rank, and Company, - -	<i>7th U.S. Col. H. Art. - Priv. - E.</i>	
Residence before enlistment, - - -		
Conjugal condition (and if married, ) the residence of the widow, )		
Cause of death, )	<i>Diarrhoea acuta</i>	
Age of the deceased, - - - - -		
Nativity, - - - - -		
References and Remarks, - - )		
Date of death and burial, - - -	<i>August 23/64</i>	186

[A duplicate of this Record has been forwarded to the Sexton, and the other remains at this Hospital.]

To *Adj. General M. S. A.*  
SIR:

It becomes my duty to inform you that the person above described died at this Hospital as herein stated: and that it is desired his remains should be interred with the usual military honors.

Respectfully,

*F. E. Piquette*  
Surgeon U. S. Army.  
*86th U.S. Col. Enft.*

MILITARY HOSPITAL, *Camp d'Ar. N. Orleans*  
*29*

This copy of Record is to be transmitted to the Adjutant General at Washington immediately after the place of burial and the number of the grave have been ascertained and registered. The above notification is to remain attached.



ARTICLES OF WAR.

ART. 95. When any non-commissioned officer or soldier shall die, or be killed in the service of the United States, the then commanding officer of the troop or company shall, in the presence of two other commissioned officers, take an account of what effects he died possessed of, above his arms and accoutrements, and transmit the same to the office of the Department of War, which said effects are to be accounted for, and paid to the representatives of such deceased non-commissioned officer or soldier. And in case any of the officers, so authorized to take care of the effects of deceased officers and soldiers, should, before they have accounted to their representatives for the same, have occasion to leave the regiment or post, by preferment or otherwise, they shall, before they be permitted to quit the same, deposit in the hands of the commanding officer, or of the assistant military agent, all the effects of such deceased non-commissioned officers and soldiers, in order that the same may be secured for, and paid to, their respective representatives.

DIRECTIONS.

NOTE 1.—One copy of the inventories of the effects of deceased non-commissioned officers and soldiers, required by the 95th Article of War, will be forwarded to the Adjutant General, by the commander of the company to which the deceased belonged, and a duplicate of the same to the colonel of the regiment. Final statements of pay, clothing, &c., in duplicate, will be sent to the Adjutant General with one copy of the inventory. Both inventory and final statements should be forwarded, as a general rule, through Regimental Headquarters. When a soldier dies at a post or station absent from his company, it will be the duty of his immediate commander to furnish, direct to the Adjutant General, the required inventory and final statements, and, at the same time, to forward to the commanding officer of the company to which the soldier belonged, a report of his death, specifying the date, place, and cause; to what time he was last paid, and the money or other effects in his possession at the time of his decease; which report will be noted on the next muster roll of the company to which the man belonged. Each inventory will be endorsed, "Inventory of the effects of ———, late of company (—) — regiment of ———, who died at ———, the ——— day of ———, 186—." If a legal representative receive the effects, it will be stated in the report. If the soldier leave no effects, the fact will be reported on the blank for inventory.

NOTE 2.—Should the effects of a deceased non-commissioned officer or soldier not be administered upon within a short period after his decease, they shall be disposed of by a Council of Administration, under the authority of the commanding officer of the post, and the proceeds deposited with the Paymaster, to the credit of the United States, until they shall be claimed by the legal representatives of the deceased.

NOTE 3.—In all such cases of sales by the Council of Administration, a statement in detail, or account of the proceeds duly certified by the Council and commanding officer, (Form 5.) accompanied by the Paymaster's receipt for the proceeds, will be forwarded by the commanding officer to the Adjutant General. The statement will be endorsed, "Report of the proceeds of the effects of ———, late of company (—) — regiment of ———, who died at ———, the ——— day of ———, 186—."

NOTE 4.—The effects in all cases, when called for, should be turned over to the legal representative, without further authority from the Adjutant General. When the effects are turned over to the relatives of the deceased before these inventories are sent to the Adjutant General, their receipts therefor should be attached to the inventories. In all other cases, one copy will be sent with a letter of transmittal direct to the Adjutant General, and a duplicate retained by the officer.

NOTE 5.—Particular care should be taken to take receipts in duplicate from the Paymaster for any funds turned over to him; one copy should be sent direct to the Adjutant General and one retained by the officer.

*Triplicate*

INVENTORY OF THE EFFECTS

OF

*Privt Robert King*

Late of Company *E*

*7* Reg't of *U.S. Col'd Meny Arty*

Volunteers, who died at *C.D. of Genl. Hoop*

on the *23* day of *August* 186*4*.

Surgeon General's Office,

RECORD & PENSION BUREAU,

*Washington*, 186*6*

*The within Inventory is a true copy from the records of ..... Hospital ..... on file in this Office, and contains all the information in the case that can be found.*

BY ORDER OF THE SURGEON GENERAL:

*Bvt. Major, Assistant Surgeon, U. S. A.*

Inventory of the effects of Robert King late  
 a Private of 1st Supt A. P. Green Company E of  
 the 7th Regiment of U.S.C. Heavy Art Volunteers, who was enrolled as  
 a Private at Alexandria in the State of Virginia on  
 the 18 day of April 1864, and mustered into the service of the United  
 States as a Private on the 25 day of June 1864, at New Orleans La  
 in Company E, 7th Regiment of U.S.C. Heavy Art Volunteers, to serve Three  
 years or during the war; he was born in \_\_\_\_\_ in the State  
 of Virginia: he was 21 years of age, 5 feet 7 inches  
 high, Dark complexion, Dark eyes, Dark hair, and by occupation, when enrolled,  
 a Laborer; he died in Camp d'Albique Genl Hosp, at  
New Orleans La on the 23 day of August 1864, by  
 reason of (Diarrhoea)

INVENTORY.					
ARTICLES.	No.	ARTICLES.	No.	ARTICLES.	No.
Hats.....	/	Pairs trousers.....		Knapsacks.....	/
Caps.....		Pairs flannel drawers.....		<u>Cotton</u>	/
Forage Caps.....		Pairs cotton drawers.....		<u>Rubber Blanket</u>	/
Great coats.....		Flannel shirts.....			
Uniform coats.....		Cotton shirts.....			
Uniform jackets.....		Pairs boots.....			
Flannel sack coats.....		Pairs shoes.....	/		
Blouses.....	/	Pairs socks.....			
Stable frocks.....		Blankets.....	/		
Fatigue overalls.....		Haversacks.....	/		
				MONEY.	
				Specie.....	\$
				Notes.....	\$

I CERTIFY, ON HONOR, that the above inventory comprises all the effects of Private  
Robert King, deceased, and that the effects are in the hands  
 of Surgeon in Charge at Camp d'Albique Genl Hosp  
New Orleans La to be disposed of by a Council of Administration.

(DUPLICATES.)

Sgd J. E. Pequette  
Surgeon in Charge C. C. of Genl Hosp  
 Commanding the Company.

STATION: New Orleans La

DATE: August 23 1864

*Triplicate*

ARTICLES OF WAR.

ART. 95. When any non-commissioned officer or soldier shall die, or be killed in the service of the United States, the then commanding officer of the troop or company shall, in the presence of two other commissioned officers, take an account of what effects he died possessed of, above his arms and accoutrements, and transmit the same to the office of the Department of War, which said effects are to be accounted for, and paid to the representatives of such deceased non-commissioned officer or soldier. And in case any of the officers, so authorized to take care of the effects of deceased officers and soldiers, should, before they have accounted to their representatives for the same, have occasion to leave the regiment or post, by preferment or otherwise, they shall, before they be permitted to quit the same, deposit in the hands of the commanding officer, or of the assistant military agent, all the effects of such deceased non-commissioned officers and soldiers, in order that the same may be secured for, and paid to, their respective representatives.

ARMY REGULATIONS—EDITION OF 1861.

DECEASED SOLDIERS.

Par. 152. Inventories of the effects of deceased non-commissioned officers and soldiers, required by the 95th Article of War, will be forwarded to the Adjutant General, by the commander of the company to which the deceased belonged, and a duplicate of the same to the colonel of the regiment. Final statements of pay, clothing, &c., will be sent with the inventories. When a soldier dies at a post or station absent from his company, it will be the duty of his immediate commander to furnish the required inventory, and, at the same time, to forward to the commanding officer of the company to which the soldier belonged, a report of his death, specifying the date, place, and cause; to what time he was last paid, and the money or other effects in his possession at the time of his decease; which report will be noted on the next muster roll of the company to which the man belonged. Each inventory will be endorsed, "Inventory of the effects of \_\_\_\_\_, late of company (—) \_\_\_\_\_ regiment of \_\_\_\_\_, who died at \_\_\_\_\_, the \_\_\_\_\_ day of \_\_\_\_\_, 186—." If a legal representative receive the effects, it will be stated in the report. If the soldier leave no effects, the fact will be reported.

Par. 153. Should the effects of a deceased non-commissioned officer or soldier not be administered upon within a short period after his decease, they shall be disposed of by a Council of Administration, under the authority of the commanding officer of the post, and the proceeds deposited with the Paymaster, to the credit of the United States, until they shall be claimed by the legal representatives of the deceased.

Par. 154. In all such cases of sales by the Council of Administration, a statement in detail, or account of the proceeds, duly certified by the Council and commanding officer, accompanied by the Paymaster's receipt for the proceeds, will be forwarded by the commanding officer to the Adjutant General. The statement will be endorsed, "Report of the proceeds of the effects of \_\_\_\_\_, late of company (—) \_\_\_\_\_ regiment of \_\_\_\_\_, who died at \_\_\_\_\_, the \_\_\_\_\_ day of \_\_\_\_\_, 186—."

NOTE 1.—The effects in all cases, when called for, should be turned over to the legal representative, without further authority from the Adjutant General. When the effects are turned over to the relatives of the deceased before these inventories are sent to the Adjutant General, their receipts therefor should be attached to the inventories. In all other cases, one copy will be sent with a letter of transmittal direct to the Adjutant General, and a duplicate retained by the officer.

NOTE 2.—Particular care should be taken to take receipts in duplicate from the Paymaster for any funds turned over to him; one copy should be sent direct to the Adjutant General and one retained by the officer.

INVENTORY OF THE EFFECTS

OF

*Private Robert King*

Late of Company *E*

*7* Reg't of *U. S. Col. Hart*

*Volunteers, who died at G. d. of Genl. Hoop.*

on the *23* day of *August* 186*4*.

*[Large handwritten signature]*



Inventory of the effects of Robert King late  
 a Private of Captain 1st Lieut. A. P. Green Company E of  
 the 7 Regiment of U. S. Col. Heavy Arty. Volunteers, who was enrolled as  
 a Private at Alexandria in the State of Louisiana on  
 the 18th day of April 1864, and mustered into the service of the United  
 States as a Private on the 25 day of June 1864, at New Orleans La  
 in Company E, 7 Regiment of U. S. Col. A Arty. Volunteers, to serve Three  
 years or during the war; he was born in \_\_\_\_\_ in the State  
 of Louisiana; he was 21 years of age, 5 feet 7 inches  
 high, Dark complexion, Dark eyes, Dark hair, and by occupation, when enrolled,  
 a Labourer; he died in Corps d'Afrique Seul Hospital  
New Orleans La on the 23 day of August 1864, by  
 reason of (Diarrhoea)

INVENTORY.					
ARTICLES.	No.	ARTICLES.	No.	ARTICLES.	No.
Hats.....	/	Pairs trousers.....		<del>Knapsacks.....</del>	/
Caps.....		Pairs flannel drawers.....		<del>Canteens.....</del>	/
Forage caps.....		Pairs cotton drawers.....		<u>Rubber Blanket</u> .....	/
Great coats.....		Flannel shirts.....			
Uniform coats.....		Cotton shirts.....			
Uniform jackets.....		Pairs boots.....			
Flannel sack coats.....		Pairs shoes.....	/		
Blouses.....	/	Pairs socks.....			
Stable frocks.....		Blankets.....	/	MONEY. Specie.....	\$
Fatigue overalls.....		<del>Haversacks.....</del>	/	Notes.....	\$

I CERTIFY, ON HONOR, that the above inventory comprises all the effects of Private  
Robert King, deceased, and that the effects are in the hands  
 of the Surgeon in Charge at Corps d'Afrique Seul Hospital  
New Orleans La to be disposed of by a Council of Administration.

( DUPLICATES. )

STATION: New Orleans La

DATE: August 23<sup>d</sup> 1864

F. C. Pinette  
Surgeon in Charge Corps d'Afrique Seul Hospital  
Commanding the Company.

1517

*King, Samuel*

Co - **10 U.S. Col'd H. Art'y.**

*1st Sergeant / Sergeant*

CARD NUMBERS.

1	5488632,	26
2		27
3		28
4		29
5		30
6		31
7		32
8		33
9		34
10		35
11		36
12		37
13		38
14		39
15		40
16		41
17		42
18		43
19		44
20		45
21		46
22		47
23		48
24		49
25		50

Book Mark:

See also *77 U.S.C.I.*

*H* | *10. H. Arty* | **U.S.C.T.**

*Samuel King*

*1<sup>st</sup> Supt Co.*, *10 Reg't U. S. Col'd H. Arty*

Appears on

**M. and D. Roll of Men Transferred**

to the organization named above,

from *Co. "B" 7<sup>th</sup> Reg. U.S.C. Inf.*

Roll dated *Oct. 1*, 1865.

When enlisted *Feb. 2*, 1863.

Period for which enlisted *3* years.

When mustered in *Feb. 12*, 1863.

Present or absent *Present*

Company to which assigned

Remarks: *Transferred from Co. "B" 4<sup>th</sup>*

*Reg't. Cda. Dec. 1863. as Corporal*

*promoted 1<sup>st</sup> Dec 18. 1863. Stoppage*

*1. Spring vic. Honorably discharged*

*& Mustered out by reason of being*

*undered supernumerary and in obedi-*

*ance to S.O. No. 66. C. S. H. L. Ms. Dept*

*of Louisiana. (over)*

Book mark :

*Avery*

JAN. 15

5488632

★ TEST ★

Not taken up in rolls  
to use part.

1518

King William

Co. A, 10 U.S. Col'd H. Art'y.

Private | Corporal

CARD NUMBERS.

1	5489069	26
2	5492922	27
3	5493147	28
4	5493292	29
5	5493432	30
6	5493560	31
7	5493671	32
8	5493780	33
9	5493839	34
10		35
11		36
12		37
13		38
14		39
15		40
16		41
17		42
18		43
19		44
20		45
21		46
22		47
23		48
24		49
25		50

Book Mark:

See also 75 U.S.C.I.



*10th* **U.S.C.T.**

*William King*

*Co.*, Co....., *10* Reg't U. S. Co'd *10th*

Appears on

**M. and D. Roll of Men Transferred**

to the organization named above,

from *73 US CI*

Roll dated *Nov 18*, 186*4*.

When enlisted....., 186 .

Period for which enlisted *3* years.

When mustered in *Sep 26*, 186*4*.

Present or absent *Not stated*

Company to which assigned.....

Remarks: *Credited to*

*New Orleans Drafted*

.....

.....

.....

.....

Book mark : .....

.....

*J. Johnson*

*K* | 10 H. Art'y. | U.S.C.T.

*William King*

*B*, Co. A, 10 Reg't U. S. Col'd H. Art'y.

Appears on

Company Muster Roll

for *Nov. + Dec*, 1865.

Present or absent *Present*

Stoppage, \$ 100 for

Due Gov't, \$ 100 for

Valuation of horse, \$ 100

Valuation of horse equipments, \$ 100

Remarks: *Transferred from 75 US 69.  
per S.O. 105 G.S. Hd Qrs. Dept of La*

Book mark:

*Hayes*

Copyist.

*K* | 10 H. Art'y. | U.S.C.T.

*William King*

*Pl*, Co. A, 10 Reg't U. S. Col'd H. Art'y.

Appears on

**Company Muster Roll**

for

*Jan + Feb*, 186*6*.

Present or absent

*Present*

Stoppage, \$.....100 for .....

Due Gov't, \$.....100 for .....

Valuation of horse, \$.....100

Valuation of horse equipments, \$.....100

Remarks: .....

Book mark: .....

*V. Ayo*

Copyist.

*K* | 10 H. Art'y. | **U.S.C.T.**

*William King*

*Pol*, Co. A, 10 Reg't U. S. Col'd H. Art'y.

Appears on

**Company Muster Roll**

for *Mar - April*, 186*6*.

Present or absent *Present*

Stoppage, \$ *100* for

Due Gov't, \$ *100* for

Valuation of horse, \$ *100*

Valuation of horse equipments, \$ *100*

Remarks:

Book mark:

*Hyde*  
Copyist.

*K* | 10 H. Art'y. | U.S.C.T.

*William King*

*Plt*, Co. A, 10 Reg't U. S. Col'd H. Art'y.

Appears on

**Company Muster Roll**

for

*May - June, 1864.*

Present or absent

*Present*

Stoppage, \$.....100 for

Due Gov't, \$.....100 for

Valuation of horse, \$.....100

Valuation of horse equipments, \$.....100

Remarks:

Book mark:

*I. H. ...*  
Copyist.

*K* | 10 H. Art'y. | U.S.C.T.

*William King*

*Pl*, Co. A, 10 Reg't U. S. Col'd H. Art'y.

Appears on

**Company Muster Roll**

for *July & Aug*, 186*6*.

Present, or absent *Present*

Stoppage, \$ *100* for

Due Gov't, \$ *100* for

Valuation of horse, \$ *100*

Valuation of horse equipments, \$ *100*

Remarks: *Sick in Quarters*

Book mark:

*Hyman*

*K* | 10 H. Art'y. | U.S.C.T.

*William King*  
*Corpl*, Co. A, 10 Reg't U. S. Col'd H. Art'y.

Appears on

**Company Muster Roll**

for *Sept + Oct*, 1866.

Present or absent *Present*

Stoppage, \$ *100* for

Due Gov't, \$ *100* for

Valuation of horse, \$ *100*

Valuation of horse equipments, \$ *100*

Remarks: *Private to Sept. 24. 66*

Book mark:

*Nesbitt*

*K* | 10 H. Art'y. | U.S.C.T.

*William King*  
*Corpl*, Co. A, 10 Reg't U. S. Col'd H. Art'y.

Appears on

**Company Muster Roll**

for *Nov + Dec*, 1866.

Present or absent *Present*

Stoppage, \$ 100 for

Due Gov't, \$ 100 for

Valuation of horse, \$ 100

Valuation of horse equipments, \$ 100

Remarks: \_\_\_\_\_  
\_\_\_\_\_  
\_\_\_\_\_  
\_\_\_\_\_  
\_\_\_\_\_  
\_\_\_\_\_  
\_\_\_\_\_

Book mark: \_\_\_\_\_

*Nesbitt*  
Copyist.



*R* | 10 H. Art'y. | U.S.C.T.

*William King*  
*Corpl*, Co. *A*, 10 Reg't U. S. Col'd H. Art'y.

Appears on **Co. Muster-out Roll**, dated  
*Baton Rouge La Feb. 22*, 1867.  
Muster-out to date *Feb. 22*, 1867.  
Last paid to *Dec. 31*, 1866.

Clothing account:

Last settled....., 186 ; drawn since \$.....<sup>100</sup>  
Due soldier \$ *77*<sup>*43*</sup>/<sub>100</sub>; due U. S. \$.....<sup>100</sup>  
Am't for cloth'g in kind or money adv'd \$.....<sup>100</sup>

Due U. S. for arms, equipments, &c., \$.....<sup>under G.O. 101</sup> *6*<sup>*00*</sup>/<sub>100</sub>

Bounty paid \$.....<sup>100</sup>; due \$ *200*<sup>*00*</sup>/<sub>100</sub>

Remarks: *Transf'd from 75 U.S.C. & as Pvt.*  
*S. Co. 115 S. of 65 Sept. Co. Apts*  
*Corpl Sept. 24. 66*

Book mark : .....

*Nesbitt*

1519  
Kirby & Latham

Co <sup>A</sup>, 10 U.S. Col'd H. Art'y.

Private Private

CARD NUMBERS.

1	5487341	26
2	5504740	27
3	5504999	28
4	5507046	29
5		30
6		31
7		32
8		33
9		34
10		35
11		36
12		37
12		38
14		39
15		40
16		41
17		42
18		43
19		44
20		45
21		46
22		47
23		48
24		49
25		50

Book Mark:

See also

*A* | *10 H. arty* | **U.S.C.T**

*Abram Kirby*

Appears with rank of *1st* on

**Muster and Descriptive Roll of a Detachment of Drafted Men and Substitutes forwarded**

for the *7* Reg't U.S. Col'd *H. arty* Roll dated *New Orleans La., Aug 19, 1864*

Where born *Red River La*

Age *37* years; occupation *Laborer*

**Drafted and mustered in:**

When *Aug 17*, 186*4*.

Where *Bonnie La*

Period *3* years.

Eyes *Dark*; hair *Black*

Complexion *Dark*; height *5 ft. 3 in.*

Paid bounty and advance pay, \$ *100*

Bounty due \$ *100*

Where credited *Parish of Terrebonne La*

Company to which assigned *H*

Remarks:

*Became 10 U.S.C.H. arty*

Book mark:

*Jennings*

*K* | 10 H. Art'y. | U.S.C.T.

*Abram Kirly*  
Pvt., Co. *F*, 7 Reg't U. S. Col'd H. Art'y.\*

Appears on

**Company Muster-in and Descriptive Roll**

of the organization named above. Roll dated

*New Orleans La*, Aug 19, 1864.

Where born *Red River La*

Age *37* y'rs; occupation *Laborer*

When enlisted \_\_\_\_\_, 186 .

Where enlisted \_\_\_\_\_

For what period enlisted *3* years.

Eyes *Dark*; hair *Blk*

Complexion *Dark*; height *5* ft. *3* in.

When mustered in *Aug 19*, 1864.

Where mustered in *New Orleans La*

Bounty paid \$ *100*; due \$ *100*

Where credited *2<sup>d</sup> Enrlt. Dist La*

Company to which assigned \_\_\_\_\_

Remarks: *Drafted*

\* This organization subsequently became Co. *F*, 10 Reg't U. S. Colored Heavy Artillery.

Book mark: \_\_\_\_\_

*Rosenbaum*

*K* | 10 H. Art'y. | U.S.C.T.

*Abram Kirby*

*Pol-*, Co. F, 10 Reg't U. S. Col'd H. Art'y.

Appears on

**Company Muster Roll**

for *July & August-*, 1864.

Present or absent.....

Stoppage, \$.....<sup>100</sup> for.....

Due Gov't, \$.....<sup>100</sup> for.....

Valuation of horse, \$.....<sup>100</sup>

Valuation of horse equipments, \$.....<sup>100</sup>

Remarks: *Discharged from Batty  
Gentilly Aug 30 - 1864*

Book mark:.....

*Rosenbaum*  
Copyst.

*R* | 10 H. Art'y. | U.S.C.T.

*Abraham Kirby*  
Pvt., Co. *F*, 10 Reg't U. S. Col'd H. Art'y.

Appears on Co. Muster-out Roll, dated  
*Baton Rouge La Feb 22*, 1867.

Muster-out to date \_\_\_\_\_, 186 .  
Last paid to *none paid* \_\_\_\_\_, 186 .

Clothing account:

Last settled \_\_\_\_\_, 186 ; drawn since \$ \_\_\_\_\_ 100

Due soldier \$ \_\_\_\_\_ 100; due U. S. \$ \_\_\_\_\_ 100

Am't for cloth'g in kind or money adv'd \$ *10 82* \_\_\_\_\_ 100

Due U. S. for arms, equipments, &c., \$ \_\_\_\_\_ 100

Bounty paid \$ \_\_\_\_\_ 100; due \$ \_\_\_\_\_ 100

Remarks: *Joined at original*  
*organization Resented from*  
*Battery Gentry La Aug 30*  
*1864.*

Book mark : \_\_\_\_\_

1520

*Kirkland, Dudley*

Co I, 10 U.S. Col'd H. Art'y.

*Private*

*Private*

CARD NUMBERS.

1	5488581	26
2	5511544	27
3	5511676	28
4	5511788	29
5	5511888	30
6	5511969	31
7	5512134	32
8		33
9		34
10		35
11		36
12		37
13		38
14		39
15		40
16		41
17		42
18		43
19		44
20		45
21		46
22		47
23		48
24		49
25		50

Book Mark:

See also *74 U.S.C.S.*

K | 104a. U.S.C.T.

Dudley Kirkland  
Pt, Co. D Reg't U. S. Col'd St. Arty.

Appears on

**M. and D. Roll of Men Transferred**

to the organization named above,

from Co "G" U.S. C. Inf.

Roll dated New Orleans, La Oct 11, 1865.

When enlisted Feby 8, 1865.

Period for which enlisted 3 years.

When mustered in Feby 18, 1865.

Present or absent Present

Company to which assigned

Remarks: Joined Co. "G"  
1st U.S. C. I as a re-  
cruit.

Book mark :

(342) J. W. Jones, Jr. Copyist.



*H.* | 10 H. Art'y. | U.S.C.T.

*Dudley Kirkland*  
*Pvt.*, Co. I, 10 Reg't U. S. Col'd H. Art'y.

Appears on

**Company Muster Roll**

for *Nov. & Dec.*, 1865.

Present or absent *Present*

Stoppage, \$ 100 for

Due Gov't, \$ 100 for

Valuation of horse, \$ 100

Valuation of horse equipments, \$ 100

Remarks: *Transferred*  
*from 74 U.S.C.S. per*  
*S.O. No. 84. Hd. qrs. Dept.*  
*of La. Oct. 11, 1865.*

FROM SECOND AUDITOR'S ROLL.

Book mark:

*O. J. Clark*

*A.* | **10 H. Art'y. | U.S.C.T.**

*Dudley Kirkland*  
*Priv.*, Co. I, 10 Reg't U. S. Col'd H. Art'y.

Appears on

**Company Muster Roll**

for *Jan. & Feb.*, 186*6*.

Present or absent.....

Stoppage, \$.....100 for.....

Due Gov't, \$.....100 for.....

Valuation of horse, \$.....100

Valuation of horse equipments, \$.....100

Remarks: *Stop for two Y.C.  
straps 12 cts.*

Book mark:.....

*O.S. Clark*  
Copyist.

*A.* | 10 H. Art'y. | U.S.C.T.

*Dudley Kirkland*  
*Prk.*, Co. I, 10 Reg't U. S. Col'd H. Art'y.

Appears on

**Company Muster Roll**

for *Nov. & Dec.*, 1866.

Present or absent *Present*

Stoppage, \$ *100* for

Due Gov't, \$ *100* for

Valuation of horse, \$ *100*

Valuation of horse equipments, \$ *100*

Remarks:

Book mark:

*O. S. Clark*

*A.* | 10 H. Art'y. | U.S.C.T.

*Dudley Kirkland*  
*Pvt.*, Co. I, 10 Reg't U. S. Col'd H. Art'y.

Appears on

**Company Muster Roll**

for *May & June*, 1866.

Present or absent *Present*

Stoppage, \$ 100 for

Due Gov't, \$ 100 for

Valuation of horse, \$ 100

Valuation of horse equipments, \$ 100

Remarks: *On daily duty as  
company cook.*

Book mark: \_\_\_\_\_

*O. S. Clark*

Copyist.

*K* | 10 H. Art'y. | U.S.C.T.

*Dudley Kirkland*  
*Priv*, Co. I, 10 Reg't U. S. Col'd H. Art'y.

Appears on

**Company Muster Roll**

for *July + Aug*, 1866.

Present or absent.....

Stoppage, \$..... 100 for.....

Due Gov't, \$..... 100 for.....

Valuation of horse, \$..... 100

Valuation of horse equipments, \$..... 100

Remarks: *Discharged to date*  
*Aug 24 - 1866. to re-enlist in*  
*39th U.S. Inftry*

Book mark:.....

*J. M. Hance*

*K.* | 10 H. Art'y. | U.S.C.T.

*Dudley Kirkland*

*Priv.*, Co. *I*, 10 Reg't U. S. Col'd H. Art'y.

Appears on **Co. Muster-out Roll**, dated  
*Baton Rouge La Feb 22*, 1867 .  
Muster-out to date \_\_\_\_\_, 186 .  
Last paid to \_\_\_\_\_, 186 .

Clothing account:

Last settled \_\_\_\_\_, 186 ; drawn since \$ \_\_\_\_\_ 100  
Due soldier \$ \_\_\_\_\_ 100; due U. S. \$ \_\_\_\_\_ 100  
Am't for cloth'g in kind or money adv'd \$ \_\_\_\_\_ 100

Due U. S. for arms, equipments, &c., \$ \_\_\_\_\_ 100

Bounty paid \$ \_\_\_\_\_ 100; due \$ \_\_\_\_\_ 100

Remarks: *Discharged, to enlist in*  
*39<sup>th</sup> U.S. Infy Aug 24, 1866*  
*Final statements given*

Book mark : \_\_\_\_\_

*J. M. Hance*

*134*  
Knight George W.

Co K, 10 U.S. Col'd H. Art'y.

2 Lieutenant / Lieutenant

CARD NUMBERS.

1	5488330	26
2	5487435	27
3	5512208	28
4	5512361	29
5	5512510	30
6	5512660	31
7	5512902	32
8	5513323	33
9	5489375	34
10	5486815	35
11	5506302	36
12	5506421	37
13	5506537	38
14	5506753	39
15	5506851	40
16		41
17		42
18		43
19		44
20		45
21		46
22		47
23		48
24		49
25		50

Book Mark: 1776. C. A. 84

See also 14 Maine Inf

*K 10* *Hell* U.S.C.T.

*George W. Knight*  
*2<sup>nd</sup> Lt. Co. K, 10 Reg't U. S. Col'd* *Hell*

Appears on

**M. and D. Roll of Men Transferred**

to the organization named above

from

*10<sup>th</sup> U. S. Col'd Inf*

Roll dated *Camp Parapet Salts, 1860*

When enlisted \_\_\_\_\_, 186 .

Period for which enlisted \_\_\_\_\_ *3* years.

When mustered in *Jan 20*, 186*4*.

Present or absent *Present*

Company to which assigned *K*

Remarks: *joined the service*

*as Private in "Maine*

*Infy at Lewiston Me*

*Jan 11. 1862. Com "8*

*Mustered as 2<sup>nd</sup> Lt "13"*

*Co. A Jan 20 1864 due*

*for Comdg Co B 97*

*U. S. C. I. for July 1860*

Book mark : \_\_\_\_\_

*W Hear Scott*



*K 1016 A* U.S.C.T.

*G. W. Knight*  
*2<sup>nd</sup> Lt, Co. B, 10 Reg't U. S. Col'd H. A.*

Appears on

**M. and D. Roll of Men Transferred**

to the organization named above,

from *Co. H of 4<sup>th</sup> U. S. Col'd Inf*

Roll dated *Camp Maberda Oct 1, 1865.*

When enlisted *Jan 20*, 186*4*.

Period for which enlisted *3* years.

When mustered in *Jan 20*, 186*4*.

Present or absent *Present*

Company to which assigned *B*

Remarks: *joined the Service*  
*as Private Jan 11. 1862*  
*at Newboston Maine*  
*Commissioned as 2<sup>nd</sup>*  
*Lieut. and Mustered Jan*  
*20. 1864, in 13<sup>th</sup> Inf,*  
*Camp d'Afrique Entitled*  
*to pay for Command of*  
*(1000)*

Book mark :

*W. H. Scott*

JAN. 15

5487435

1891

*Co. B. reg. U.S. C. S.  
for July. 1865*

K | 10 H. Art'y. | U.S.C.T.

Geo. W. Knight

2 Lt., Co. K, 10 Reg't U. S. Col'd H. Art'y.

Age ..... years.

Appears on

**Company Muster Roll\***

for Sept. & Oct., 1865.

Joined for duty and enrolled:

When Jan. 20, 1864.

Where New Orleans

Period 3 years

Mustered in:

When Jan. 20, 1864.

Where New Orleans

Present or absent Present

Stoppage, \$ 100 for

Due Gov't, \$ 100 for

Remarks: Due for Comdg. Co. B, 77  
U.S. C. I. for July 1865.

\* First current roll. No muster-in roll of this company on file.

Book mark : .....

(3586)

Hibbard  
Copyist.

K

10 H. Art'y.

U.S.C.T.

George W. Knight

2 Lt., Co. K, 10 Reg't U. S. Col'd H. Art'y.

Appears on

Company Muster Roll

for Nov. & Dec., 1865.

Present or absent Present

Stoppage, \$ 100 for

Due Gov't, \$ 100 for

Valuation of horse, \$ 100

Valuation of horse equipments, \$ 100

Remarks: Due for comdg, Co. B  
77 U.S.C.T. for July 1865, \$10.

Book mark:

Hibbard

K | 10 H. Art'y. | U.S.C.T.

George W. Knight  
2 Lt., Co. K, 10 Reg't U. S. Col'd H. Art'y.

Appears on

**Company Muster Roll**

for Jan. & Feb., 1866

Present or absent Present

Stoppage, \$.....100 for.....

Due Gov't, \$.....100 for.....

Valuation of horse, \$.....100

Valuation of horse equipments, \$.....100

Remarks:.....

.....  
.....  
.....  
.....  
.....  
.....  
.....  
.....

Book mark:.....

Hisbard  
Copyist.

K | 10 H. Art'y. | U.S.C.T.

*George W. Knight*  
2 Lt., Co. K, 10 Reg't U. S. Col'd H. Art'y.

Appears on

**Company Muster Roll**

for *Mch. 1st*, 1866

Present or absent *Present*

Stoppage, \$ 100 for

Due Gov't, \$ 100 for

Valuation of horse, \$ 100

Valuation of horse equipments, \$ 100

Remarks:

Book mark:

*Hibbard*  
Copyist.

K | **10 H. Art'y.** | **U.S.C.T.**

*George W. Knight*  
*2 Lt.*, Co. K, 10 Reg't U. S. Col'd H. Art'y.

Appears on

**Company Muster Roll**

for *May & June*, 186*6*.

Present or absent

Stoppage, \$ 100 for

Due Gov't, \$ 100 for

Valuation of horse, \$ 100

Valuation of horse equipments, \$ 100

Remarks: *Disch'd. to accept  
promotion June 20, 66.*

Book mark:

*Hibbard*  
Copyist.

*K* | *10 H. Art* | U.S.C.T.

*George W. Knight*

*2<sup>d</sup> Lieut, Co. K, 10 Reg't U. S. Col'd H. Art*

Appears on an

**Individual Muster-out Roll**

of the organization named above. Roll dated

*New Orleans La June 20, 1866.*

Muster-out to date

*June 20, 1866.*

Last paid to

*Apr. 30, 1866.*

**Clothing account:**

Last settled ..... 186 ; drawn since \$ ..... 100

Due soldier \$ ..... 100 ; due U. S. \$ ..... 100

Am't for cloth'g in kind or money adv'd \$ ..... 100

Due U. S. for arms, equipments, &c., \$ ..... 100

Bounty paid \$ ..... 100 due \$ ..... 100

Remarks: *Mustered out to enable  
him to accept an appointment  
as 1<sup>st</sup> Lieut in 10<sup>th</sup> U. S. Col'd Art  
Hq. Muster out to take  
effect June 20' 1866*

Book mark:

*M. A. Michaels*



*K* | 10 H. Art'y. | **U.S.C.T.**

*George W. Knight*  
*2 Lt*, Co. *K*, 10 Reg't U. S. Col'd H. Art'y.

Appears on **Co. Muster-out Roll**, dated  
*Baton Rouge La*, *Feb 22*, 186*7*.

Muster-out to date \_\_\_\_\_, 186 .

Last paid to \_\_\_\_\_, 186 .

Clothing account:

Last settled \_\_\_\_\_, 186 ; drawn since \$ \_\_\_\_\_ 100

Due soldier \$ \_\_\_\_\_ 100; due U. S. \$ \_\_\_\_\_ 100

Am't for cloth'g in kind or money adv'd \$ \_\_\_\_\_ 100

Due U. S. for arms, equipments, &c., \$ \_\_\_\_\_ 100

Bounty paid \$ \_\_\_\_\_ 100; due \$ \_\_\_\_\_ 100

Remarks: *Discharged June 20/66*  
*to accept promotion.*

Book mark : \_\_\_\_\_

K. 10 H. arty. | U.S.C.T.

George W. Knight

1st Lt., Co. F., 10 Reg't U. S. Col'd H. arty.

Age 22 years.

Appears on an

**Individual Muster-in Roll**

of the organization named above. Roll dated

New Orleans, La., June 21, 1866.

Muster-in to date June 21, 1866.

Joined for duty and enrolled:

When June 21<sup>st</sup>, 1866.

Where New Orleans, La.

Period 3 years.

Valuation of horse, \$ 100

Valuation of horse equipments, \$ 100

Remarks: Mustered out as 2<sup>d</sup>  
Lieut. Co. "K", 10<sup>th</sup> U.S. C.A. (Hq.)  
to accept promotion in  
the same regiment.

Commissioned by Sec. of X  
(over)

Book mark:

Philipson

JAN. 15

5486815

1891

X War, vice Milliken,  
resigned. Enlisted  
strength of Co. "F" (115)  
one hundred and fifteen.  
The company has two  
other officers.

10 | **10 H. Art'y.** | **U.S.C.T.**

George W. Knight  
1st., Co. F, 10 Reg't U. S. Col'd H. Art'y.

Appears on

**Company Muster Roll**

for May & June, 1866.

Present or absent Present.

Stoppage, \$ 100 for

Due Gov't, \$ 100 for

Valuation of horse, \$ 100

Valuation of horse equipments, \$ 100

Remarks: Mustered as 1st. vice  
Milliken resigned. On  
Special Duty Comdg Co. K,  
10 U.S. Col'd H. Art'y. for S.O.  
No. 28, Hd. Qrs. U.S. Forces,  
Ship Island, Miss., June  
29, 66. Due \$10. for responsai-  
bility of property Co. K, 10"

Book mark: \_\_\_\_\_

Aslv  
Coyist.

JAN. 16

5506302

★ 1891 ★

*W. S. C. A. (N.Y.) for June 66.*

K. | **10 H. Art'y.** | **U.S.C.T.**

George W. Knight,  
1st., Co. F, 10 Reg't U. S. Col'd H. Art'y.

Appears on

**Company Muster Roll**

for July & Aug., 1866.

Present or absent Present

Stoppage, \$ 100 for \_\_\_\_\_

Due Gov't, \$ 100 for \_\_\_\_\_

Valuation of horse, \$ 100

Valuation of horse equipments, \$ 100

Remarks: On Special Duty  
as Post Adjt. for S. O. P.,  
16d. Srs., U.S. Forces, Ship  
Island, Miss. Aug. 15, 66.

Book mark: \_\_\_\_\_

Asst.  
Copyist.

R

10 H. Art'y. U.S.C.T.

George W Knight  
1st, Co. F, 10 Reg't U. S. Col'd H. Art'y.

Appears on

Company Muster Roll

for Sept. and Oct., 1866

Present or absent Present

Stoppage, \$ 100 for

Due Gov't, \$ 100 for

Valuation of horse, \$ 100

Valuation of horse equipments, \$ 100

Remarks:

On special duty as Post  
Adj't pr S. O. No. 41 Hd Qrs  
U. S. Texas Ship Island  
Miss Aug. 15/66

Book mark:

Howie

R | 10 H. Art'y. | U.S.C.T.

George W. Knight  
1st., Co. F, 10 Reg't U. S. Col'd H. Art'y.

Appears on

**Company Muster Roll**

for *N.W. and Ode*, 1866

Present or absent *Present*

Stoppage, \$ 100 for

Due Gov't, \$ 100 for

Valuation of horse, \$ 100

Valuation of horse equipments, \$ 100

Remarks:

*On special duty as Post  
Adj't pr S.O. No. 41 Hd. Qrs  
U.S. Forev Ship Island  
Miss Aug. 15/66*

Book mark:

*House*



K | 10 H. Art'y. | U.S.C.T.

George W. Knight  
1st, Co. F, 10 Reg't U. S. Col'd H. Art'y.

Appears on Co. Muster-out Roll, dated

Baton Rouge La, Feb 22, 1867.

Muster-out to date

July 22, 1867.

Last paid to

Dec 31, 1866.

Clothing account:

Last settled \_\_\_\_\_, 186 ; drawn since \$ \_\_\_\_\_ 100

Due soldier \$ \_\_\_\_\_ 100; due U. S. \$ \_\_\_\_\_ 100

Am't for cloth'g in kind or money adv'd \$ \_\_\_\_\_ 100

Due U. S. for arms, equipments, &c., \$ \_\_\_\_\_ 100

Bounty paid \$ \_\_\_\_\_ 100; due \$ \_\_\_\_\_ 100

Remarks: Entered military service  
as priv 14 Me. Vols Jan 1/62  
at Lexington Me. Discharged  
as sergt Jan. 18/64 to accept  
promotion. Promoted as 2  
Lieut. Me. Co A Jan

Book mark: 1776, C. J. 8th

House

JAN. 16

5506851

\*1891\*

20/64 Transferred to  
77 u.S.C. I May 24/64  
Transferred to 10 u.S.C.A  
(Hy) Oct 1/65. promoted  
A Sient Co. I June 21,  
1866. Service continuous

Knight-George W.

Co. 10 Reg't U.S.C.H.A.

4 Enclosures.

Bed Cards .....	Final Statements .....
Burial Records .....	Furloughs or L. of A. ....
Certs. of Dis. for Discharge .....	Med. Certificates .....
C. M. Charges .....	Med. Des. Lists .....
Descriptive Lists .....	Orders 4 .....
Discharge Certificates .....	Pris. of War Record .....
Enlistment Papers .....	Resignations .....

Other papers relating to—

Admission to Hosp'l .....	Furlough or L. of A. ....
Casualty Sheet .....	Med. Examination .....
Confinement .....	Misc. Information .....
Contracts .....	Pay or Clothing .....
Death or Effects .....	Personal Reports .....
Desertion .....	Rank .....
Discharge from Hosp'l .....	Transfer to Hosp'l .....
Discharge from Service .....	Transfer to V. R. C. ....
Duty .....	Transportation .....

16.

Knights G. W.

10<sup>th</sup> U. S. Co. H. A.

Headquarters US Forces  
Ship Island Miss  
May 16<sup>th</sup> 1866

Special Orders  
No. 16.

Five days leave  
of absence is granted to 2<sup>d</sup> Lieut  
G. W. Knight Co. 10<sup>th</sup> U. S. A. I.,  
for the purpose of visiting New Orleans  
La

By Command of  
Captain Jesse Fettes  
J. T. Furtth  
1st Lieut & Post Adjt

Asst. Adjt. Genl.  
Dept. of La.

24.

Knight George W.

10<sup>th</sup> U. S. C. H. A.

Headquarters U. S. Forces  
Ship Island, Miss.  
Jan 20<sup>th</sup> 1846.

Special Order  
No. 24.

2<sup>d</sup> Lieut. George D. Straight,  
10<sup>th</sup> U. S. Col. Art. (Regt), is hereby granted  
leave of absence from this Post until  
the 2<sup>d</sup> inst, with permission to visit  
New Orleans La, for the purpose of  
being mustered in as 1<sup>st</sup> Lieut. he  
having received an appointment  
as such.

By command of Capt. E. F. Brewster:  
John F. Woodcock,  
1<sup>st</sup> Lt. 10<sup>th</sup> U. S. C. Art., Post Adjt.

S. O. No. 28.

Knight George W.

St. 10# U.S.G.M.A.



Headquarters U. S. Forces  
Ship Island Miss.,  
June 29<sup>th</sup> 1866.

Special Order  
No 28.

1<sup>st</sup> Lieut. General W. Knight,  
Co. 10<sup>th</sup> U. S. Col. (Regt.) is  
hereby relieved from duty with his com-  
pany, and will assume command  
of Co. 10<sup>th</sup>

In command of Co. 10<sup>th</sup> U. S. Col. (Regt.)  
John C. Woodard  
1<sup>st</sup> Lieut. (Col.), 10<sup>th</sup> U. S. Col.

Special Order  
No. 34

Knight George W.

Co. 10<sup>th</sup> U.S. C. H. A

Headquarters U. S. Army  
Ship Island, Miss.  
July 14<sup>th</sup> 1866.

Special Order  
No. 34.

1<sup>st</sup> Lieut. George W. Knight,  
Co. E, 10<sup>th</sup> U. S. C. A. Regt is hereby  
relieved from duty with Company E,  
and will report to his company for  
duty.

Lieut. Knight will turn over the  
public property pertaining to Co. E,  
to Capt. G. W. Goodale, Co. E, 10<sup>th</sup>  
U. S. C. A. Regt.

By command of Capt. G. W. Goodale  
G. W. Goodale  
1<sup>st</sup> Lieut. 10<sup>th</sup> U. S. C. A. Regt  
Post Capt.

H. H. Dep. of da.

1522 Co  
Labranche, Edward

Co P, 10 U.S. Col'd H. Art'y.

CARD NUMBERS.

1	26
2	27
3	28
4	29
5	30
6	31
7	32
8	33
9	34
10	35
11	36
12	37
13	38
14	39
15	40
16	41
17	42
18	43
19	44
20	45
21	46
22	47
23	48
24	49
25	50

Book Mark:

See also

1523  
Laches, Alfred

Co— 10 U.S. Col'd H. Art'y.

Private —

CARD NUMBERS.

1	5487878	26
2		27
3		28
4		29
5		30
6		31
7		32
8		33
9		34
10		35
11		36
12		37
13		38
14		39
15		40
16		41
17		42
18		43
19		44
20		45
21		46
22		47
23		48
24		49
25		50

Book Mark:

See also 77 U.S. Col'd H. Art'y.

L 10 H.A. U.S.C.T.

Alfred Laches  
Pvt, Co. ...., 10 Reg't U. S. Col'd H.A.

Appears on

**M. and D. Roll of Men Transferred**

to the organization named above,

from of U.S. Col Inf

Roll dated Camp San Pedro Oct 1, 1865.

When enlisted May 6, 1864.

Period for which enlisted 3 years.

When mustered in May 13, 1864

Present or absent .....

Company to which assigned .....

Remarks: Died Aug. 6 at  
Ft St Philip of Chronic  
Diarrhea

Not on muster rolls Regt.

Book mark : .....

Wm Scott

1524  
Lacy, William

Co A, 10 U.S. Col'd H. Art'y.

Private | Private

CARD NUMBERS.

1	3-48-9105-	26
2	3-492923	27
3	3-493222	28
4	3-493362	29
5	3-493434	30
6	3-493562	31
7	3-493700	32
8	3-493827	33
9	3-494014	34
10	3-489386	35
11		36
12		37
12		38
14		39
15		40
16		41
17		42
18		43
19		44
20		45
21		46
22		47
23		48
24		49
25		50

Book Mark: E.B. - 8.P-326

See also 75.2.5 e.3.

*S* *105th Art* **U.S.C.T.**

*William Lacy*  
*Pl*, Co., *10* Reg't U. S. Col'd *Art*

Appears on

**M. and D. Roll of Men Transferred**

to the organization named above,

from *75th U.S.C.I.*

Roll dated *Nov 18*, 186*3*.

When enlisted *Aug 10*, 186*3*.

Period for which enlisted *3* years.

When mustered in *Sep 24*, 186*3*.

Present or absent *Not stated*

Company to which assigned

Remarks: *One US for Equip*

*equip. lost. Transferred*

*from 88th U.S.C.I. Aug 13/64*

*per S.O. No 209 dated*

*At Ins. Dept Gulf*

Book mark :



*B* | 10 H. Art'y. | U.S.C.T.

*William Lacey*

*Plt*, Co. A, 10 Reg't U. S. Col'd H. Art'y.

Appears on

Company Muster Roll

for *Nov & Dec*, 1865.

Present or absent *Present*

Stoppage, \$ *100* for

Due Gov't, \$ *06* for *Co & Equipage*,  
*per transfer rolls.*

Valuation of horse, \$ *100*

Valuation of horse equipments, \$ *100*

Remarks: *Transferred from 7th US Co. I  
per S. O. 105 Co. I. Hd. Qrs. Dept of Ca.*

Book mark:

*Hynes*  
Copyist.

*L* | 10 H. Art'y. | U.S.C.T.

*William Lacy*

*Plt*, Co. A, 10 Reg't U. S. Col'd H. Art'y.

Appears on

**Company Muster Roll**

for *Jan & Feb*, 186*6*.

Present or absent *Present*

Stoppage, \$.....100 for .....

Due Gov't, \$.....100 for .....

Valuation of horse, \$.....100

Valuation of horse equipments, \$.....100

Remarks: .....

.....

.....

.....

.....

.....

.....

.....

.....

Book mark: .....

.....

.....

.....

.....

.....

.....

.....

.....

.....

*J. L. Lacy*  
Copyist.

*L* | 10 H. Art'y. | U.S.C.T.

*William Lacey*

*Pvt*, Co. A, 10 Reg't U. S. Col'd H. Art'y.

Appears on

**Company Muster Roll**

for *Mar & Apr*, 186*b*.

Present or absent *Present*

Stoppage, \$ *100* for

Due Gov't, \$ *08* for *Ordnance*

*For Camp & Garrison Equipage 12<sup>1</sup>/<sub>2</sub>*

Valuation of horse, \$ *100*

Valuation of horse equipments, \$ *100*

Remarks: *In Confinement*

Book mark: *No. 2 to Co. May 25, 66*  
*G.O. 45*

*Hynes*  
Copyist.

L | 10 H. Art'y. | U.S.C.T.

*William Lacy*

*Plt*, Co. A, 10 Reg't U. S. Col'd H. Art'y.

Appears on

**Company Muster Roll**

for *May & June*, 186*6*.

Present or absent *Absent*

Stoppage, \$ 100 for

Due Gov't, \$ 08 for *Ordnance* <sup>for</sup>

*C & G. 12¢*

Valuation of horse, \$ 100

Valuation of horse equipments, \$ 100

Remarks: *In confinement Ship  
Island pr G.O. 45 C.S. Hd  
Gns Dept. Ga.*

Book mark:

*Hym*  
Copyist.

*L* | 10 H. Art'y. | U.S.C.T.

*William Lacy*

*Pvt*, Co. A, 10 Reg't U. S. Col'd H. Art'y.

Appears on

**Company Muster Roll**

for

*July & Aug, 1866*

Present or absent

*Absent*

Stoppage, \$ 100 for

Due Gov't, \$ 100 for

Valuation of horse, \$ 100

Valuation of horse equipments, \$ 100

Remarks: *In confinement at Ship's Island pr G.O. 45 C.S. Hd. Qrs. Dept. Sea,*

Book mark:

*Joyce*  
Copyist.

L | 10 H. Art'y. | U.S.C.T.

William Lacey

Pvt, Co. A, 10 Reg't U. S. Col'd H. Art'y.

Appears on

Company Muster Roll

for Sept + Oct, 1866.

Present or absent Absent

Stoppage, \$ 100 for

Due Gov't, \$ 100 for

Valuation of horse, \$ 100

Valuation of horse equipments, \$ 100

Remarks: In confinement at Ship Island G.O. 45 U.S. Hed. Arts. Dept of War.

Book mark:

Nesbitt

Copyist.

L | 10 H. Art'y. | U.S.C.T.

William Lacy

Pvt., Co. A, 10 Reg't U. S. Col'd H. Art'y.

Appears on

Company Muster Roll

for Nov + Dec, 1866.

Present or absent

Stoppage, \$ 100 for

Due Gov't, \$ 100 for

Valuation of horse, \$ 100

Valuation of horse equipments, \$ 100

Remarks: Mustered out by reason of expiration of term of service Dec. 18 to date Sept. 23/66

Book mark:

Nesbitt

Copyist.

L | 1076a | U.S.C.T.

William Racy  
Pri, Co. A, 10 Reg't U. S. Col'd 76a

Appears on an

**Individual Muster-out Roll**

of the organization named above. Roll dated

New Orleans La, Aug 9, 1866.

Muster-out to date Aug 9, 1866.

Last paid to Dec 31, 1865.

**Clothing account:**

Last settled \_\_\_\_\_, 1866; drawn since \$ \_\_\_\_\_ 100

Due soldier \$ 5 <sup>79</sup>/<sub>100</sub>; due U. S. \$ \_\_\_\_\_ 100

Am't for cloth'g in kind or money adv'd \$ \_\_\_\_\_ 100

Due U. S. for arms, equipments, &c., \$ \_\_\_\_\_ <sup>20</sup>/<sub>100</sub>

Bounty paid \$ 100 <sub>100</sub> due \$ 100 <sub>100</sub>

Remarks: Joined by transfer  
from 75<sup>th</sup> USC @ I per SO  
105 & 12 Series of 1865 Mod  
Brs kept of La stop for (1)  
one tompon (2) two Grit  
Coat Straps, at date of (over)

Book mark: \_\_\_\_\_

R. Richardson



JAN. 15

5489386

1891

Expiration of term of Service  
was was in Confinement  
by Sentence Jail Court  
Martial G O 45 C S No 2  
Quors Dept of La which  
period of Confinement  
Expired Nov 25<sup>th</sup> 1866  
Crime Disobedience of  
Orders. Mustered out  
by reason of expiration  
of term of Service to date  
August 9<sup>th</sup> 1866

L

10 H. Art'y. U.S.C.T.

William Lacy  
Pvt, Co. A, 10 Reg't U. S. Cold H. Art'y.

Appears on Co. Muster-out Roll, dated  
Baton Rouge La, Feb. 22 1867.

Muster-out to date \_\_\_\_\_, 1867.

Last paid to \_\_\_\_\_, 1867.

Clothing account:

Last settled \_\_\_\_\_, 1867 ; drawn since \$ 100

Due soldier \$ 100; due U. S. \$ 100

Am't for cloth'g in kind or money adv'd \$ 100

Due U. S. for arms, equipments, &c., \$ 100

Bounty paid \$ 100; due \$ 100

Remarks: Transfd from 75 U.S.C.T. as  
Pvt. S.O. 105 Sept 65 Dept. La.  
Rec'd for exp'n of term of  
service Sept 23/66

Book mark: V 107 P 82. 70  
V 161 P 209. 73 (over)

Nesbitt

JAN. 15

5494014

1891

Discharged Aug 9. 66 E. B. 8.  
P. 326.

1525

Ladson, Friday

CoL, 10 U.S. Col'd H. Art'y.

Private | Sergeant

CARD NUMBERS.

1	5488264	26
2	5488117	27
3	5513474	28
4	5513565	29
5	5513699	30
6	5513825	31
7	5513974	32
8	5514148	33
9	5489390	34
10		35
11		36
12		37
13		38
14		39
15		40
16		41
17		42
18		43
19		44
20		45
21		46
22		47
23		48
24		49
25		50

Book Mark:

See also 77 U.S.C. Inf

Rep 35-9479 - (PO)  
A. 2580915 And WD

G. S. Doughty

*L. 10 H A* U.S.C.T.

*Friday Ladson*  
Reg't U. S. Col'd *H A*

Appears on

**M. and D. Roll of Men Transferred**

to the organization named above,

from *7th U. S. Col Inf*

Roll dated *Camp Pampeta Oct 1860*

When enlisted *June 18*, 186*0*

Period for which enlisted *3* years.

When mustered in *Aug 19*, 186*0*

Present or absent *Present*

Company to which assigned *L*

Remarks: *Transferred from*  
*4. Co. A Dec 2, 60*  
*by transfer from Co. E*  
*7th U. S. C. I. per S. O. 66*  
*C. S. Hd Qu Dept of*  
*La*

Book mark :

*W. H. Scott*

*L. W. Hall* U.S.C.T.

*Friday Larsen*  
*Co. D, 10* Reg't U. S. Col'd *Hall*

Appears on

**M. and D. Roll of Men Transferred**

to the organization named above,

from *Co. E 7th U.S. Col. Inf*

Roll dated *Camp Campbell Ky*, 186*5*.

When enlisted *June 18*, 186*5*.

Period for which enlisted *3* years.

When mustered in *Aug 19*, 186*5*.

Present or absent *Present*

Company to which assigned *D*

Remarks: *Transferred from*  
*4th Regt of Artillery*  
*Dec 12, 1863*

Book mark :

*W. H. Scott*

L | 10 H. Art'y. | **U.S.C.T.**

Friday Ladders

Plt., Co. L, 10 Reg't U. S. Col'd H. Art'y.

Age ..... years.

Appears on

**Company Muster Roll\***

for Sept. & Oct., 1863

Joined for duty and enrolled:

When June 18, 1863.

Where Baton Rouge

Period 3 years.

Mustered in:

When Aug. 19, 1863.

Where Baton Rouge

Present or absent Present

Stoppage, \$ 100 for .....

Due Gov't, \$ 100 for .....

Valuation of horse, \$ 100

Valuation of horse equipments, \$ 100

Remarks: Transf. from Co. E.

77 U.S.C.

\*First current roll. No muster-in roll of this company on file.

Book mark : .....

Scherich



L | 10 H. Art'y. | U.S.C.T.

Friday Ladsew  
Corp., Co. L, 10 Reg't U. S. Col'd H. Art'y.

Appears on

**Company Muster Roll**

for Nov. & Dec., 1865.

Present or absent Present

Stoppage, \$ 100 for

Due Gov't, \$ 100 for

Valuation of horse, \$ 100

Valuation of horse equipments, \$ 100

Remarks: Promoted to Corp. Oct.  
22/65. S.O. No. 38 Hd. Qrs. Regt.

Book mark:

Scherich

L | 10 H. Art'y. | U.S.C.T.

Friday Ladson  
Cp., Co. L, 10 Reg't U. S. Col'd H. Art'y.

Appears on

**Company Muster Roll**

for Jan. & Feb., 1866.

Present or absent Present

Stoppage, \$ 100 for

Due Gov't, \$ 100 for

Valuation of horse, \$ 100

Valuation of horse equipments, \$ 100

Remarks:

Book mark:

Scherich

L | 10 H. Art'y. | U.S.C.T.

Friday Ladsen

Sgt., Co. L, 10 Reg't U. S. Col'd H. Art'y.

Appears on

**Company Muster Roll**

for *March & April*, 1866

Present or absent *Present*

Stoppage, \$ *100* for

Due Gov't, \$ *100* for

Valuation of horse, \$ *100*

Valuation of horse equipments, \$ *100*

Remarks: *Promoted to Sgt.  
March 1/66.*

Book mark: *Muster out on file*

*Scherich*

L 10th Art. U.S.C.T.

Friday Ladsen  
Sgt, Co. L, 10 Reg't U. S. Col'd H. Art.

Appears on

**Company Muster Roll**

for May & June, 1866.

Present or absent

Stoppage, \$ 100 for

Due Gov't, \$ 100 for

Valuation of horse, \$ 100

Valuation of horse equipments, \$ 100

Remarks: Mustered out by  
reason of ex. of term of  
service to date from  
June 17/66.

Book mark:

Scherich

Copyist.

L | 106a | U.S.C.T.

Friday Ladser  
Serg't, Co. L, 10 Reg't U. S. Col'd 106a

Appears on an

**Individual Muster-out Roll**

of the organization named above. Roll dated

New Orleans La June 17, 1866.

Muster-out to date

June 17, 1866.

Last paid to

April 30, 1866.

**Clothing account:**

Last settled ..... 186 ; drawn since \$ ..... 100

Due soldier \$ 69 <sup>33</sup>/<sub>100</sub>; due U. S. \$ ..... 100

Am't for cloth'g in kind or money adv'd \$ ..... 100

Due U. S. for arms, equipments, &c., \$ ..... 100

Bounty paid \$ ..... 100 due \$ ..... 100

Remarks: joined as recruit

in Co E 4<sup>th</sup> C. d. a transferred

to 5 C. d. at 77 U.S.C.T. by

reorganization joined by

transfer from 77<sup>th</sup> U.S.C.T.

in obedience to S.O. (over)

Book mark: .....

R. S. Richardson

JAN. 15

5489390

1891

66 Series of 1865 - from Hd  
Qrs Dept of La,  
Mustered out by reason  
of expiration of time of  
service to date from June  
17 1866

L | 10 H. Art'y. | U.S.C.T.

Friday Lader

Serjt, Co. L., 10 Reg't U. S. Col'd H. Art'y.

Appears on Co. Muster-out Roll, dated  
Baton Rouge La., Feb 22, 1867.

Muster-out to date ..... 186 .

Last paid to ..... 186 .

Clothing account:

Last settled ..... 186 ; drawn since \$ ..... 100

Due soldier \$ ..... 100 ; due U. S. \$ ..... 100

Am't for cloth'g in kind or money adv'd \$ ..... 100

Due U. S. for arms, equipments, &c., \$ ..... 100

Bounty paid \$ ..... 100 ; due \$ ..... 100

Remarks: found by transfer from  
Co E 77 U.S.C. Oct 1 1865 SO. 66 N<sup>o</sup>  
grs Dept of La Sept 22/65 promoted  
Capt Oct 22 1865 & Serjt Mar 1/66  
Dischd at New Orleans La June 17/66  
at Expn of service

Book mark: V24 P200 68

Burnham

1526 or Charleston  
Laguerre, Colette

Co D, 10 U.S. Col'd H. Art'y.

Private | Private

CARD NUMBERS.

1	5-494224	26
2	5-494376	27
3	5-494536	28
4	5-494695	29
5	5-494850	30
6	5-495003	31
7	5-495160	32
8	5-495315	33
9	5-495468	34
10	5-495618	35
11	5-495757	36
12	5-495914	37
13	5-496059	38
14	5-496209	39
15	5-496362	40
16	5-496509	41
17	5-496651	42
18	5-496794	43
19	5-496933	44
20	5-497130	45
21	5-497441	46
22	5-489678	47
23		48
24		49
25		50

Book Mark:

See also



*L* | 10 H. Art'y. | U.S.C.T.

*Celestine Lagree*  
Pvt., 2 Battery, La. H. Art'y, Native Guards.\*

Age *27* years.

Appears on

**Company Muster-in Roll**

of the organization named above. Roll dated

*Camp Parapet,*  
*Carrollton, La., Feb. 9, 1863.*

Muster-in to date *Feb. 9, 1863.*

Joined for duty and enrolled:

When *Jan'y 13*, 1863.

Where *Camp Parapet nr. Carrollton, La.*

Period *3* years.

Valuation of horse, \$ 100

Valuation of horse equipments, \$ 100

Remarks:

\* This organization subsequently became Co. B, 10 Reg't U. S. Colored Heavy Artillery.

Book mark:

*Master*

L | 10 H. Art'y. | U.S.C.T.

*Celestine Lagree*

*Priv.*, Co. B, 1 Reg't La. H. Art'y, Native Guards.\*

Appears on

**Company Muster Roll**

for *from* *Enlistment to Feb. 28, 1863*.

Present or absent *Present*

Stoppage, \$ *100* for

Due Gov't, \$ *100* for

Valuation of horse, \$ *100*

Valuation of horse equipments, \$ *100*

Remarks:

-----  
-----  
-----  
-----  
-----  
-----

\*This organization subsequently became Co. B, 10 Reg't U. S. Col'd Heavy Artillery.

Book mark:-----

*Feaster*

*L* | 10 H. Art'y. | U.S.C.T.

*Celestine Lagrune*  
Pvt., Co. B, 1 Reg't La. H. Art'y, Native Guards.\*

Appears on

**Company Muster Roll**

for *March 4. April.*, 186 *3*.

Present or absent *Present*

Stoppage, \$ *100* for

Due Gov't, \$ *100* for

Valuation of horse, \$ *100*

Valuation of horse equipments, \$ *100*

Remarks: \_\_\_\_\_

\*This organization subsequently became Co. B, 10 Reg't U. S. Col'd Heavy Artillery.

Book mark: \_\_\_\_\_

*Feaster*

L | 10 H. Art'y. | U.S.C.T.

Celestine Lagree  
Pvt., Co. B, 1 Reg't La. H. Art'y, Native Guards.\*

Appears on

**Company Muster Roll**

for May 7, June, 1863.

Present or absent Present

Stoppage, \$ 100 for

Due Gov't, \$ 100 for

Valuation of horse, \$ 100

Valuation of horse equipments, \$ 100

Remarks: \_\_\_\_\_

\*This organization subsequently became Co. B, 10 Reg't U. S. Col'd Heavy Artillery.

Book mark: \_\_\_\_\_

Feaster

Copyist.

L | 10 H. Art'y. | U.S.C.T.

Celestine Lagrue  
Pvt., Co. B, 1 Reg't La. H. Art'y, Native Guards.\*

Appears on

**Company Muster Roll**

for July & Aug., 1863.

Present or absent Present

Stoppage, \$ 100 for

Due Gov't, \$ 100 for

Valuation of horse, \$ 100

Valuation of horse equipments, \$ 100

Remarks:

-----  
-----  
-----  
-----  
-----  
-----

\*This organization subsequently became Co. B, 10 Reg't U. S. Col'd Heavy Artillery.

Book mark: -----

Leaster

*L* | 10 H. Art'y. | U.S.C.T.

*Celestine Dequre*  
Pvt., Co. B, 1 Reg't La. H. Art'y, Native Guards.\*

Appears on

**Company Muster Roll**

for *Sept. & Oct.*, 186*2*.

Present or absent *Present*

Stoppage, \$ *100* for

Due Gov't, \$ *100* for

Valuation of horse, \$ *100*

Valuation of horse equipments, \$ *100*

Remarks:

\*This organization subsequently became Co. B, 10 Reg't U. S. Col'd Heavy Artillery.

Book mark:

*Master*

*L* | **10 H. Art'y. | U.S.C.T.**

*Celestine Sagnie*  
*Pl*, Co. *B*, 1 Reg't H. Art'y, Corps d'Afrique.\*

Appears on

**Company Muster Roll**

for *Nov. & Dec., 1863*

Present or absent *Present*

Stoppage, \$ *100* for

Due Gov't, \$ *100* for

Valuation of horse, \$ *100*

Valuation of horse equipments, \$ *100*

Remarks:

\* This organization subsequently became Co. *10*, 10 Reg't U. S. Colored Heavy Artillery.

Book mark:

*Reif*  
Copyist.

*L* | **10 H. Art'y. | U.S.C.T.**

*Celestine Lagrue*

*Pr*, Co. *B*, 1 Reg't H. Art'y, Corps d'Afrique.\*

Appears on

**Company Muster Roll**

for *Jan. & Feb*, 186*4*.

Present or absent *Present*

Stoppage, \$ *100* for

Due Gov't, \$ *100* for

Valuation of horse, \$ *100*

Valuation of horse equipments, \$ *100*

Remarks:

-----  
-----  
-----  
-----  
-----  
-----  
-----

\* This organization subsequently became Co. \_\_\_\_\_, 10 Reg't U. S. Colored Heavy Artillery.

Book mark: -----

*C. Reif*  
Copyist.



2 | 10 H. Art'y. | U.S.C.T.

Belstone Lagone

R1, Co. B, 7 Reg't U. S. Col'd H. Art'y.\*

Appears on

Company Muster Roll

for *March 1st*, 1864.

Present or absent *absent*

Stoppage, \$ *100* for

Due Gov't, \$ *100* for

Valuation of horse, \$ *100*

Valuation of horse equipments, \$ *100*

Remarks: *in Camp de Afrique  
Genl. Wash. New Orleans  
La. since April 9 1864*

\* This organization subsequently became Co. , 10 Reg't U. S. Colored Heavy Artillery.

Book mark: \_\_\_\_\_

*Ref*

2 | 10 H. Art'y. | U.S.C.T.

Celestine Sagrone

Pl, Co. B, 7 Reg't U. S. Col'd H. Art'y.\*

Appears on

**Company Muster Roll**

for May 1 June 4, 1864

Present or absent Present

Stoppage, \$ 100 for

Due Gov't, \$ 100 for

Valuation of horse, \$ 100

Valuation of horse equipments, \$ 100

Remarks Sick

\* This organization subsequently became Co. , 10 Reg't U. S. Colored Heavy Artillery.

Book mark :

Reif

*L* | **10 H. Art'y. U.S.C.T.**

*Celestin Lagrone*

*Pl*, Co. B, 10 Reg't U. S. Col'd H. Art'y.

Appears on

**Company Muster Roll**

for *July & Aug*, 186*4*.

Present or absent *Presents*

Stoppage, \$ *100* for

Due Gov't, \$ *100* for

Valuation of horse, \$ *100*

Valuation of horse equipments, \$ *100*

Remarks: *Sick*

Book mark: \_\_\_\_\_

*A. Richardson*  
Copyist.

L | 10 H. Art'y. | U.S.C.T.

*Celestin Lagrone*  
It, Co. B, 10 Reg't U. S. Col'd H. Art'y.

Appears on

**Company Muster Roll**

for *Sept & Oct*, 186*4*

Present or absent *Present*

Stoppage, \$ 100 for

Due Gov't, \$ 100 for

Valuation of horse, \$ 100

Valuation of horse equipments, \$ 100

Remarks:

Book mark:

*J. W. Richardson*  
Copyist.

*L.* | 10 H. Art'y. | U.S.C.T.

*Celestin Laguerre*

*Plat.*, Co. B, 10 Reg't U. S. Col'd H. Art'y.

Appears on

**Company Muster Roll**

for *Nov & Dec*, 186*4*.

Present or absent *Present*

Stoppage, \$ *100* for

Due Gov't, \$ *100* for

Valuation of horse, \$ *100*

Valuation of horse equipments, \$ *100*

Remarks:

Book mark:

*J. J. J. J.*

2. | 10 H. Art'y. | U.S.C.T.

*Arthur Legree*  
Pt., Co. B, 10 Reg't U. S. Col'd H. Art'y.

Appears on

**Company Muster Roll**

for *Jan & Feb*, 186 *5*.

Present or absent *Present*.

Stoppage, \$ *100* for

Due Gov't, \$ *100* for

Valuation of horse, \$ *100*

Valuation of horse equipments, \$ *100*

Remarks: *Due soldier augmented pay from Jan 1 1864 to May 1 1864 \$6 Per month May & June \$9<sup>00</sup>*

Book mark:

*J. Jones*

G, | 10 H. Art'y. | U.S.C.T.

*Celestin Laguerre*  
Pvt., Co. B, 10 Reg't U. S. Col'd H. Art'y.

Appears on

**Company Muster Roll**

for *May & Apr*, 1865.

Present or absent *Present*.

Stoppage, \$ 100 for

Due Gov't, \$ 100 for

Valuation of horse, \$ 100

Valuation of horse equipments, \$ 100

Remarks:

Book mark:

*Jornet*

*L.* | **10 H. Art'y. | U.S.C.T.**

*Celestine Legere*  
*Pvt.*, Co. B, 10 Reg't U. S. Col'd H. Art'y.

Appears on

**Company Muster Roll**

for *May & June*, 186*5*.

Present or absent *Present*

Stoppage, \$ 100 for

Due Gov't, \$ 100 for

Valuation of horse, \$ 100

Valuation of horse equipments, \$ 100

Remarks:  
\_\_\_\_\_  
\_\_\_\_\_  
\_\_\_\_\_  
\_\_\_\_\_  
\_\_\_\_\_  
\_\_\_\_\_  
\_\_\_\_\_

Book mark: \_\_\_\_\_

*Gornier*  
\_\_\_\_\_  
(358) Copyist.



*L* | 10 H. Art'y. | U.S.C.T.

*Celestine Lagrew*  
*Pvt.*, Co. B, 10 Reg't U. S. Col'd H. Art'y.

Appears on

**Company Muster Roll**

for *July & Aug*, 1865.

Present or absent *Present*

Stoppage. \$ 100 for

Due Gov't, \$ 100 for

Valuation of horse, \$ 100

Valuation of horse equipments, \$ 100

Remarks: \_\_\_\_\_  
\_\_\_\_\_  
\_\_\_\_\_  
\_\_\_\_\_  
\_\_\_\_\_  
\_\_\_\_\_  
\_\_\_\_\_

Book mark: \_\_\_\_\_

*J. J. J.*  
\_\_\_\_\_  
Copyist.

2

10 H. Art'y. U.S.C.T.

*Celestin's Lagrew*

*Priv.*, Co. B, 10 Reg't U. S. Col'd H. Art'y.

Appears on

**Company Muster Roll**

for *Sept. & Oct.*, 1865.

Present or absent *Present*

Stoppage, \$ 100 for

Due Gov't, \$ 100 for

Valuation of horse, \$ 100

Valuation of horse equipments, \$ 100

Remarks:

Book mark:

*Jones*

*L*

**10 H. Art'y. U.S.C.T.**

*Lelestone Sagrew*

*Pl*, Co. B, 10 Reg't U. S. Col'd H. Art'y.

Appears on

**Company Muster Roll**

for *Nov. & Dec., 1865*

Present or absent *Present*

Stoppage, \$ 100 for

Due Gov't, \$ 100 for

Valuation of horse, \$ 100

Valuation of horse equipments, \$ 100

Remarks:

Book mark:

*P. Reis*  
Copyist.

*L* | **10 H. Art'y. U.S.C.T.**

*Celestine Laynew*

*Pvt*, Co. B, 10 Reg't U. S. Col'd H. Art'y.

Appears on

**Company Muster Roll**

for *Jan. 1866*, 1866

Present or absent

Stoppage, \$ 100 for

Due Gov't, \$ 100 for

Valuation of horse, \$ 100

Valuation of horse equipments, \$ 100

Remarks: *Mustered out at M.O. Va. Feb. 8 66 by reason of exp. of term of service*

Book mark: *6780 P.M.S. June 28 66*

*P. R. G.*

Le. 10 No. a. U.S.C.T.

Celestine Lagrew

1st, Co. B., 10 Reg't U. S. Col'd No. a.

Appears on a

**Detachment Muster-out Roll**

of the organization named above. Roll dated

New Orleans La. Feb. 8 1866

Muster-out to date

Feb. 8 1866

Last paid to

June 30, 1865

**Clothing account:**

Last settled ..... 186 ; drawn since \$ ..... 100

Due soldier \$ 140.79; due U. S. \$ ..... 100

Am't for cloth'g in kind or money adv'd \$ ..... 100

Due U. S. for arms, equipments, &c., \$ ..... 100

Bounty paid \$ ..... 100 due \$ ..... 100

Remarks: Joined at origl. orgn.

Mustered out by reason of Expiration of term of service (Cert. of Mustg. Off. shows him M. O. Feb. 12, 1866.)

added May 12, 93. GED

Book mark: 10000

Hearing

*L* | 10 H. Art'y. | U.S.C.T.

*Charleston Sagrew*  
Pvt., Co. *D*, 10 Reg't U. S. Col'd H. Art'y.

Appears on **Co. Muster-out Roll**, dated  
*Baton Rouge La., Feb.*, 1867.

Muster-out to date ..... 186 .

Last paid to ..... 186 .

Clothing account:

Last settled ..... 186 ; drawn since \$ ..... 100

Due soldier \$ ..... 100 ; due U. S. \$ ..... 100

Am't for cloth'g in kind or money adv'd \$ ..... 100

Due U. S. for arms, equipments, &c., \$ ..... 100

Bounty paid \$ ..... 100 ; due \$ ..... 100

Remarks:

*Joined org'l. org<sup>n</sup>  
Discharged Feb'y 8/66  
expiration term of  
service.*

Book mark *207 157*

*Hodges*

Lagrove, Celestine

P, Co., 70<sup>th</sup> Reg't U.S. C & H A.

Enclosures.

Bed Cards .....	Final Statements .....
Burial Records .....	Furloughs or L. of A. ....
Certs. of Dis. for Discharge .....	Med. Certificates .....
C. M. Charges .....	Med. Des. Lists .....
Descriptive Lists .....	Orders .....
Discharge Certificates .....	Pris. of War Record .....
Enlistment Papers <input checked="" type="checkbox"/> .....	Resignations .....

Other papers relating to—

Admission to Hosp'l .....	Furlough or L. of A. ....
Casualty Sheet .....	Med. Examination .....
Confinement .....	Misc. Information .....
Contracts .....	Pay or Clothing .....
Death or Effects .....	Personal Reports .....
Desertion .....	Rank .....
Discharge from Hosp'l .....	Transfer to Hosp'l .....
Discharge from Service .....	Transfer to V. R. C. ....
Duty .....	Transportation .....

DECLARATION OF RECRUIT

I, \_\_\_\_\_ desiring to ENLIST in the Army of the United States, for the term of THREE YEARS, Do declare, That I am \_\_\_\_\_ years and \_\_\_\_\_ months of age; that I have neither wife nor child; that I have never been discharged from the United States service on account of disability or by sentence of a court-martial, or by order before the expiration of a term of enlistment; and I know of no impediment to my serving honestly and faithfully as a soldier for three years.

GIVEN at \_\_\_\_\_ and by occupation \_\_\_\_\_

The \_\_\_\_\_ day of \_\_\_\_\_

Witness :

\_\_\_\_\_ as a soldier in the Army of the United States for the period of THREE YEARS unless sooner discharged for proper cause.

Enlisted at \_\_\_\_\_  
By \_\_\_\_\_  
\_\_\_\_\_ Regiment of \_\_\_\_\_  
Discharged \_\_\_\_\_  
Regt of \_\_\_\_\_  
enlistment; last served in Company ( ) \_\_\_\_\_  
18 \_\_\_\_\_

No. 199

CONSENT IN CASE OF MINOR.

I, \_\_\_\_\_ Do CERTIFY, That I am the \_\_\_\_\_ of \_\_\_\_\_; that the said \_\_\_\_\_ is \_\_\_\_\_ years of age; and I do hereby freely give my CONSENT to his enlisting as a SOLDIER in the ARMY OF THE UNITED STATES for the period of THREE YEARS.

GIVEN at \_\_\_\_\_

The \_\_\_\_\_ day of \_\_\_\_\_

Witness :



County of

Jefferson



State of

Louisiana

I, Celestino Saguro born in St John the Baptist  
in the State of Louisiana aged Twenty Six years,  
and by occupation a Salvor do hereby acknowledge to have

voluntarily enlisted this Thirteenth day of January  
1863, as a SOLDIER in the ARMY OF THE UNITED STATES OF AMERICA, for the period  
of THREE YEARS, unless sooner discharged by proper authority: Do also agree to  
accept such bounty, pay, rations, and clothing, as are, or may be, established by law. And

I, Celestino Saguro do solemnly swear, that I will bear true faith  
and allegiance to the UNITED STATES OF AMERICA, and that I will serve them honestly and  
faithfully against all their enemies or opposers whomsoever; and that I will observe and  
obey the orders of the President of the United States, and the orders of the officers  
appointed over me, according to the Rules and Articles of War.

of Carrollton, La.

Sworn and subscribed to, at

Camp Parapet,

this ninth day of January 1863

BEFORE

L. J. Agard  
2<sup>d</sup> Lt. N. G. Art. Co. 1<sup>st</sup> Regt.

I CERTIFY, ON HONOR, That I have carefully examined the above named Recruit, agreeably to the General Regulations  
of the Army, and that in my opinion he is free from all bodily defects and mental infirmity, which would, in any way, disqualify  
him from performing the duties of a soldier.

Milton Chase

EXAMINING SURGEON.

I CERTIFY, ON HONOR, That I have minutely inspected the Recruit, Celestino Saguro  
previously to his enlistment, and that he was entirely sober when enlisted; that, to the best of my judgement and belief, he is of  
lawful age; and that, in accepting him as duly qualified to perform the duties of an able-bodied soldier, I have strictly observed  
the Regulations which govern the recruiting service. This soldier has Brown eyes, Dark hair,  
Dark complexion; is five feet, eight inches high.

L. J. Agard 2<sup>d</sup> Lieut. N. G. Art. Co. 1<sup>st</sup> Regt.

RECRUITING OFFICER.

DECLARATION OF RECRUIT.

I, \_\_\_\_\_ desiring to ENLIST in the Army of the United States, for the term of THREE YEARS, Do declare, That I am \_\_\_\_\_ years and \_\_\_\_\_ months of age; that I have neither wife nor child; that I have never been discharged from the United States service on account of disability or by sentence of a court-martial, or by order before the expiration of a term of enlistment; and I know of no impediment to my serving honestly and faithfully as a soldier for three years.

GIVEN at \_\_\_\_\_

The \_\_\_\_\_ day of \_\_\_\_\_

Witness :

No. \_\_\_\_\_

*William Farrell*  
Enlisted at *Camp Ward* the *13<sup>th</sup>* 18*63*,

By *2<sup>nd</sup> Lieutenant S. S. S. S.*  
*C. S. H. H.* Regiment of *Green Hills*

\_\_\_\_\_ enlistment; last served in Company ( )

\_\_\_\_\_ Reg't of \_\_\_\_\_

\_\_\_\_\_ Discharged \_\_\_\_\_ 18 \_\_\_\_\_

*10 W. S. R. A.*

CONSENT IN CASE OF MINOR.

I, \_\_\_\_\_ Do CERTIFY, That I am the \_\_\_\_\_ of \_\_\_\_\_; that the said \_\_\_\_\_ is \_\_\_\_\_ years of age; and I do hereby freely give my CONSENT to his enlisting as a SOLDIER in the ARMY OF THE UNITED STATES for the period of THREE YEARS.

GIVEN at \_\_\_\_\_

The \_\_\_\_\_ day of \_\_\_\_\_

Witness :

County of

*Jefferson*



State of

*Louisiana*

I, *Celestine Sugrou* born in *St John Baptist*  
in the State of *Louisiana* aged *Twenty Seven* years,  
and by occupation a *Labourer* do hereby acknowledge to have  
voluntarily enlisted this *Thirtieth* day of *January*

1863, as a SOLDIER in the ARMY OF THE UNITED STATES OF AMERICA, for the period  
of *THREE YEARS*, unless sooner discharged by proper authority: Do also agree to  
accept such bounty, pay, rations, and clothing, as are, or may be, established by law. And  
I, *Celestine Sugrou* do solemnly swear, that I will bear true faith  
and allegiance to the UNITED STATES OF AMERICA, and that I will serve them honestly and  
faithfully against all their enemies or opposers whomsoever; and that I will observe and  
obey the orders of the President of the United States, and the orders of the officers  
appointed over me, according to the Rules and Articles of War.

Sworn and subscribed to, at *Carrollton, La,*  
this *ninth* day of *February* 1863 }  
BEFORE *S. Nygaard*  
*2<sup>d</sup> Lt. U.S. Art. & M.*

I CERTIFY, ON HONOR, That I have carefully examined the above named Recruit, agreeably to the General Regulations  
of the Army, and that in my opinion he is free from all bodily defects and mental infirmity, which would, in any way, disqualify  
him from performing the duties of a soldier.

*Milton Chase*

EXAMINING SURGEON.

I CERTIFY, ON HONOR, That I have minutely inspected the Recruit, *Celestine Sugrou*  
previously to his enlistment, and that he was entirely sober when enlisted; that, to the best of my judgement and belief, he is of  
lawful age; and that, in accepting him as duly qualified to perform the duties of an able-bodied soldier, I have strictly observed  
the Regulations which govern the recruiting service. This soldier has *Brown* eyes, *Dark* hair,  
*Dark* complexion; is *five* feet, *eight* inches high.

*S. Nygaard, 2<sup>d</sup> Lieut. U.S. Art. & M.*

RECRUITING OFFICER.

152  
Lake, Abram

Co G, 10 U.S. Col'd H. Art'y.

Private

CARD NUMBERS.

1	26
2	27
3 See Surke	28 Abraham
4	29
5	30
6	31
7	32
8	33
9	34
10	35
11	36
12	37
13	38
14	39
15	40
16	41
17	42
18	43
19	44
20	45
21	46
22	47
23	48
24	49
25	50

Book Mark:

See also

1528

Laman Mitchell

Co. G, 10 U.S. Col'd H. Art'y.

CARD NUMBERS.

1	26
2	27
3 see Lamer	28 Mitchell
4	29
5	30
6	31
7	32
8	33
9	34
10	35
11	36
12	37
13	38
14	39
15	40
16	41
17	42
18	43
19	44
20	45
21	46
22	47
23	48
24	49
25	50

Book Mark:

See also

1529  
Lamar, Eli

Col , 10 U.S. Col'd H. Art'y.

Private | Private

CARD NUMBERS.

1	5497617	26
2	5497861	27
3	5498019	28
4	5497735	29
5	5498136	30
6	5498238	31
7	5498335	32
8	5498433	33
9	5498549	34
10	5498690	35
11	5498829	36
12	5498466	37
13	5499107	38
14	5499243	39
15	5499379	40
16	5499574	41
17	5499680	42
18	5499786	43
19	5499921	44
20	5-500051	45
21	5-5000186	46
22	5-5000315	47
23	5-5000469	48
24	5490163	49
25		50

Book Mark:

See also

S. 743745 - 2 Aud.  
S. 769190 - 2 Aud. (P.O.)  
S-994134 - 2 Aud.  
S-

S. E. Doughty

L | 10 H. Art'y. | U.S.C.T.

Ela Lemask  
Pvt, Co. C, 1 Reg't H. Art'y, Corps d'Afrique.\*

Age 27 years.

Appears on

**Company Muster-in Roll**

of the organization named above. Roll dated

New Orleans La, Aug 17, 1863.

Muster-in to date Aug 17, 1863.

Joined for duty and enrolled:

When June 26, 1863.

Where Camp Parapet La

Period 3 years.

Valuation of horse, \$.....100

Valuation of horse equipments, \$.....100

Remarks:.....

\* This organization subsequently became Co. C, 10 Reg't U. S. Colored Heavy Artillery.

Book mark:.....



*L* | 10 H. Art'y. | U.S.C.T.

*Oliver Lemark*  
*Pvt.*, Co, C, 1 Reg't La. Art'y Native Guards.\*

Appears on

**Company Muster Roll**

for *Aug 11<sup>th</sup> to 31<sup>st</sup>*; 1863 .

Present or absent *Present*

Stoppage, \$ *100* for

Due Gov't, \$ *100* for

Valuation of horse, \$ *100*

Valuation of horse equipments, \$ *100*

Remarks :

\* This organization subsequently became Co. C, 10 Reg't U. S. Col'd Heavy Artillery.

Book mark :

*W. J. ...*  
Copyist.

*L* | 10 H. Art'y. | U.S.C.T.

*Eli Zomark*

*Pl*, Co, C, 1 Reg't La. Art'y Native Guards.\*

Appears on

**Company Muster Roll**

for *Sept and Oct*, 1863.

Present or absent *Absent*

Stoppage, \$ *100* for

Due Gov't, \$ *100* for

Valuation of horse, \$ *100*

Valuation of horse equipments, \$ *100*

Remarks: *Absent Sick in Hospital at New Orleans*

\* This organization subsequently became Co. C, 10 Reg't U. S. Col'd Heavy Artillery.

Book mark:

*[Signature]*  
Copyist.

*L* | 10 H. Art'y. | U.S.C.T.

*Eli Lamar*

*Pvt*, Co. C, 1 Reg't La. Art'y, Native Guards.\*

Age *26* years.

Appears on

**Company Muster-in Roll**

of the organization named above. Roll dated

*New Orleans La, Feb 4, 1864.*

Muster-in to date *Feb 4, 1864.*

Joined for duty and enrolled:

When *Nov 28, 1863.*

Where *N. O., La.*

Period *3* years.

Valuation of horse, \$ *100*

Valuation of horse equipments, \$ *100*

Remarks:

\* This organization subsequently became Co. C, 10 Reg't U. S. Col'd Heavy Artillery.

Book mark:

(856)

*W. J. ...*

Copyist.

Q | 10 H. Art'y. | U.S.C.T.

*Eli Lammie*

*Pvt.*, Co. *C*, 1 Reg't H. Art'y, Corps d'Afrique.\*

Appears on

**Company Muster Roll**

for *Feb 4<sup>th</sup> to 29<sup>th</sup>*, 186*4*.

Present or absent *Present*

Stoppage, \$ 100 for

Due Gov't, \$ 100 for

Valuation of horse, \$ 100

Valuation of horse equipments, \$ 100

Remarks:

-----  
-----  
-----  
-----  
-----  
-----

\*This organization subsequently became Co. *C*, 10 Reg't U. S. Colored Heavy Artillery.

Book mark: -----

*E. Lammie*  
Copyist.

*L* | 10 H. Art'y. | U.S.C.T.

*Eli Samer*

*Pvt*, Co. *L*, 7 Reg't U. S. Col'd H. Art'y.\*

Appears on

**Company Muster Roll**

for *Nich rapl*, 1864.

Present or absent *Present*

Stoppage, \$ 100 for

Due Gov't, \$ 100 for

Valuation of horse, \$ 100

Valuation of horse equipments, \$ 100

Remarks:

\* This organization subsequently became Co. , 10 Reg't U. S. Colored Heavy Artillery.

Book mark:

*J. Hudson*  
(358) Copyist.

*L* | **10 H. Art'y.** | **U.S.C.T.**

*Eoli Lamar*

*Pvt*, Co. *C* 7 Reg't U. S. Col'd H. Art'y.\*

Appears on

**Company Muster Roll**

for *May & June*, 1864.

Present or absent *Present*

Stoppage, \$.....100 for .....

Due Gov't, \$.....100 for .....

Valuation of horse, \$.....100

Valuation of horse equipments, \$.....100

Remarks: .....

.....  
.....  
.....  
.....  
.....

\* This organization subsequently became Co. , 10 Reg't U. S. Colored Heavy Artillery.

Book mark: .....

*J. Hudson*  
Copyist.

L | **10 H. Art'y.** | **U.S.C.T.**

Eli Lamar

Pot., Co. C, 7 Reg't U. S. Col'd H. Art'y.\*

Appears on

**Company Muster Roll**

for July & Aug, 186 4

Present or absent Present

Stoppage, \$ 100 for \_\_\_\_\_

Due Gov't, \$ 100 for \_\_\_\_\_

Valuation of horse, \$ 100

Valuation of horse equipments, \$ 100

Remarks: \_\_\_\_\_  
\_\_\_\_\_  
\_\_\_\_\_  
\_\_\_\_\_  
\_\_\_\_\_

\* This organization subsequently became Co. \_\_\_\_\_, 10 Reg't U. S. Colored Heavy Artillery.

Book mark: \_\_\_\_\_

J. H. Denmark  
Copyist.

L | 10 H. Art'y. | U.S.C.T.

Eli Lamar

Priv., Co. C, 10 Reg't U. S. Col'd H. Art'y.

Appears on

**Company Muster Roll**

for Sept 10th, 1864

Present or absent Present

Stoppage, \$ 100 for

Due Gov't, \$ 100 for

Valuation of horse, \$ 100

Valuation of horse equipments, \$ 100

Remarks: D. D. Hoop Cook  
Post order no 7 Fort Liv  
ington La Oct 5/64

Book mark:

J Anderson  
Copyist.



L | 10 H. Art'y. | U.S.C.T.

Eli Lamm

Priv., Co. C, 10 Reg't U. S. Col'd H. Art'y.

Appears on

Company Muster Roll

for Nov & Dec, 1864

Present or absent Present

Stoppage, \$ 100 for

Due Gov't, \$ 100 for

Valuation of horse, \$ 100

Valuation of horse equipments, \$ 100

Remarks: Daily duty as  
hospital cook

Book mark:

J. Underwood  
Copyist.

L | 10 H. Art'y. | U.S.C.T.

Eli Lamar

Plt, Co. C, 10 Reg't U. S. Col'd H. Art'y.

Appears on

**Company Muster Roll**

for Jan & Feb, 186 ✓

Present or absent Present

Stoppage, \$ 100 for

Due Gov't, \$ 100 for

Valuation of horse, \$ 100

Valuation of horse equipments, \$ 100

Remarks: Daily duty as cook  
in hospital

Book mark:

Ballade

L | 10 H. Art'y. | U.S.C.T.

Eli Lamar

Ser., Co. C, 10 Reg't U. S. Col'd H. Art'y.

Appears on

**Company Muster Roll**

for March & April, 1865.

Present or absent Present

Stoppage, \$ 100 for

Due Gov't, \$ 100 for

Valuation of horse, \$ 100

Valuation of horse equipments, \$ 100

Remarks:

Book mark:

Lamb

*L* | 10 H. Art'y. | U.S.C.T.

*Eli Lamar*

*Pvt*, Co. C, 10 Reg't U. S. Col'd H. Art'y.

Appears on

**Company Muster Roll**

for *May & June*, 186 *5*.

Present or absent *Present*

Stoppage, \$ 100 for

Due Gov't, \$ 100 for

Valuation of horse, \$ 100

Valuation of horse equipments, \$ 100

Remarks:

-----  
-----  
-----  
-----  
-----  
-----  
-----  
-----

Book mark: -----

*Sallade*

*L* | 10 H. Art'y. | U.S.C.T.

*Eli Lamar*

*Privt*, Co. C, 10 Reg't U. S. Col'd H. Art'y.

Appears on

**Company Muster Roll**

for *July & Aug*, 186*5*.

Present or absent *Present*

Stoppage, \$ *100* for

Due Gov't, \$ *100* for

Valuation of horse, \$ *100*

Valuation of horse equipments, \$ *100*

Remarks: *Daily Duty as Hospital  
book*

Book mark:

*Ballade*

*L* | 10 H. Art'y. | U.S.C.T.

*Eli Lamar*  
*Plt*, Co. C, 10 Reg't U. S. Col'd H. Art'y.

Appears on

**Company Muster Roll**

for *Sept 1865*, 186*5*.

Present or absent *Present*

Stoppage, \$ *100* for

Due Gov't, \$ *100* for

Valuation of horse, \$ *100*

Valuation of horse equipments, \$ *100*

Remarks:

Book mark:

*Ballade*

L | 10 H. Art'y. | U.S.C.T.

Eli Lamar  
Poh, Co. C, 10 Reg't U. S. Col'd H. Art'y.

Appears on

**Company Muster Roll**

for Nov. & Dec., 1865.

Present or absent Present

Stoppage, \$ 100 for

Due Gov't, \$ 100 for

Valuation of horse, \$ 100

Valuation of horse equipments, \$ 100

Remarks:

Book mark:

H. J. Robbins

L | 10 H. Art'y. | U.S.C.T.

*Oli. Lamar*  
Pvt., Co. C, 10 Reg't U. S. Col'd H. Art'y.

Appears on

Company Muster Roll  
for *Jan. 1st Feb.*, 186*6*.  
Present or absent *Present*.

Stoppage, \$ 100 for

Due Gov't, \$ 100 for

Valuation of horse, \$ 100

Valuation of horse equipments, \$ 100

Remarks:

Book mark:

*A. J. Robbins*



L | 10 H. Art'y. | U.S.C.T.

Eli Lamer

Regt., Co. C, 10 Reg't U. S. Col'd H. Art'y.

Appears on

**Company Muster Roll**

for *March, 2d Apr.*, 186*6*.

Present or absent *Present*

Stoppage, \$ *100* for

Due Gov't, \$ *100* for

Valuation of horse, \$ *100*

Valuation of horse equipments, \$ *100*

Remarks: *daily duty as co. cook.*

Book mark:

*H. J. Robbins*

L | 10 H. Art'y. | **U.S.C.T.**

Eli Lamar  
Prvt, Co. C, 10 Reg't U. S. Col'd H. Art'y.

Appears on

**Company Muster Roll**

for May 2d June, 1864.

Present or absent Present

Stoppage, \$ 100 for

Due Gov't, \$ 100 for

Valuation of horse, \$ 100

Valuation of horse equipments, \$ 100

Remarks: Daily duty as les  
look

Book mark:

A. J. Robbins  
Copyist.

L | 10 H. Art'y. | U.S.C.T.

Eli Lamar  
Pvt., Co. C, 10 Reg't U. S. Col'd H. Art'y.

Appears on

**Company Muster Roll**

for July<sup>rd</sup> Aug, 1866.  
Present or absent Present

Stoppage, \$ 100 for \_\_\_\_\_

Due Gov't, \$ 100 for \_\_\_\_\_

Valuation of horse, \$ 100

Valuation of horse equipments, \$ 100

Remarks: \_\_\_\_\_  
\_\_\_\_\_  
\_\_\_\_\_  
\_\_\_\_\_  
\_\_\_\_\_  
\_\_\_\_\_  
\_\_\_\_\_

Book mark: \_\_\_\_\_

(358) A. J. Robbins Copyist.

*L* | **10 H. Art'y. | U.S.C.T.**

*Eli Lamar*

*Pr*, Co. C, 10 Reg't U. S. Col'd H. Art'y.

Appears on

**Company Muster Roll**

for *Sept & Oct*, 186*6*.

Present or absent *Present*

Stoppage, \$ *100* for

Due Gov't, \$ *100* for

Valuation of horse, \$ *100*

Valuation of horse equipments, \$ *100*

Remarks: *Daily duty as Company Cook*

Book mark: \_\_\_\_\_

*Hamm*

Copyist.

*L* | 10 H. Art'y. | U.S.C.T.

*Eli James*  
*Pvt*, Co. C, 10 Reg't U. S. Col'd H. Art'y.

Appears on

**Company Muster Roll**

for *Nov, Dec*, 186*6*.

Present or absent *Present*

Stoppage, \$.....<sup>100</sup> for .....

Due Gov't, \$.....<sup>100</sup> for .....

Valuation of horse, \$.....<sup>100</sup>

Valuation of horse equipments, \$.....<sup>100</sup>

Remarks: *Daily duty as  
Company Cook*

Book mark: .....

*James*  
Copt. Asst.

L. | 10 Arty | U.S.C.T.

Eli Lamar

Priv., Co. C, 10 Reg't U. S. Col'd Arty

Appears on a

**Detachment Muster-out Roll**

of the organization named above. Roll dated

Baton Rouge, La. Feb. 3, 1867.

Muster-out to date Feb. 3, 1867.

Last paid to Dec. 31, 1866

**Clothing account:**

Last settled \_\_\_\_\_, 1866; drawn since \$ \_\_\_\_\_ 100

Due soldier \$  $92 \frac{55}{100}$ ; due U. S. \$  $28 \frac{77}{100}$

Am't for cloth'g in kind or money adv'd \$ \_\_\_\_\_ 100

Due U. S. for arms, equipments, &c., \$  $\frac{26}{100}$

Bounty paid \$ \_\_\_\_\_ 100 due \$  $300 \frac{5}{100}$

Remarks: Joined orig. org. 1st A. C. A.  
now 10 U. S. C. A. (4th) Stop for  
gun sling & carb. Box plate -

Book mark: \_\_\_\_\_

R. E. Wilson

*L* | 10 H. Art'y. | U.S.C.T.

*Eli Lamar*

*Pr*, Co. *C*, 10 Reg't U. S. Col'd H. Art'y.

Appears on Co. Muster-out Roll, dated  
*Baton Rouge, La., Feb 22, 1867.*

Muster-out to date \_\_\_\_\_, 186 .

Last paid to \_\_\_\_\_, 186 .

Clothing account:

Last settled \_\_\_\_\_, 186 ; drawn since \$ \_\_\_\_\_ 100

Due soldier \$ \_\_\_\_\_ 100; due U. S. \$ \_\_\_\_\_ 100

Am't for cloth'g in kind or money adv'd \$ \_\_\_\_\_ 100

Due U. S. for arms, equipments, &c., \$ \_\_\_\_\_ 100

Bounty paid \$ \_\_\_\_\_ 100; due \$ \_\_\_\_\_ 100

Remarks: *Joined Orig. Co.*  
*discharged Feb. 3, 1867*  
*by reason of expiration*  
*of term of service*

Book mark: \_\_\_\_\_

*W. H. ...*  
Copyist.

Lamar, Eli.

P Co, 10 Reg't uscta

Enclosures.

Bed Cards

Descriptive Lists

Burial Records

Final Statements

Certs. of Dis. for Discharge

Furloughs

C. M. Charges

Med. Des. Lists

Med. Certificates

Orders

Other papers relating to—

Admission to Hosp'l

Furlough

Casualty Sheet (Officer's)

Med. Examination

Confinement

Misc. Information

Contracts

Pay or Clothing

Death or Effects

Personal Reports

Desertions

Rank

Discharge from Hosp'l

Transfer to Hosp'l

Discharge from Service

Transfer to V. R. C.

Duty

Transportation



October 30. 1865

1607

~~Albany N.Y.~~

Eli Lamar  
Co B 10 U.S.C.H.A

---

order.

Head Quarters  
Fort Livingston La  
October 30. 1865

Special Orders  
No 19

(Extract)

\* Private Eli Lamar, Company "C" 10<sup>th</sup> U. S.  
(Col<sup>d</sup> Arty (Ky)) is hereby relieved from duty in the Post  
Hospital and will report to the Commanding Officer of his  
Company for duty, without delay.

By Command of  
Captain Albert Loring  
Joseph B Ferguson  
1<sup>st</sup> Lieut 10<sup>th</sup> U. S. (Col<sup>d</sup> Arty (Ky))  
Acting Post Adjutant

A. A. Surg. Red Cross  
in Charge Post Hospital

1530  
Lambert, Sterling  
Co M, 10 U.S. Col'd H. Art'y

Private —

CARD NUMBERS.

1	5488897	26
2	5489005	27
3		28
4		29
5		30
6		31
7		32
8		33
9		34
10		35
11		36
12		37
13		38
14		39
15		40
16		41
17		42
18		43
19		44
20		45
21		46
22		47
23		48
24		49
25		50

Book Mark:

See also

77 U.S. Col'd H.

L 10<sup>th</sup> H. Arty | U.S.C.T.

Sterling Lambert  
Priv., Co. M, 110 Reg't U. S. Col'd H. Arty

Appears on

**M. and D. Roll of Men Transferred**

to the organization named above,

from 77 U. S. Col'd Inf.

Roll dated Oct. 1, 1865.

When enlisted Dec. 9, 1864.

Period for which enlisted 3 years.

When mustered in Dec. 13, 1864.

Present or absent

Company to which assigned M

Remarks: died at New Orleans  
La. May 24/65. Final  
Statement rendered.

N. W. Co. musters rolls

Book mark :

Chandler

Copyist

1531  
Lambert, Thomas

Co M, 10 U.S. Col'd H. Art'y.

Private +

CARD NUMBERS.

1	5488904	26
2	5489012	27
3		28
4		29
5		30
6		31
7		32
8		33
9		34
10		35
11		36
12		37
12		38
14		39
15		40
16		41
17		42
18		43
19		44
20		45
21		46
22		47
23		48
24		49
25		50

Book Mark:

See also 77 U.S. C. Inf.

L | 10 H. Art | **U.S.C.T.**

Thomas Lambert  
Priv., Co. M., 10 Reg't U. S. Col'd H. Art

Appears on

**M. and D. Roll of Men Transferred**

to the organization named above,

from 77 U. S. Col'd Inf.

Roll dated Oct. 1, 1865

When enlisted Dec. 9, 1864

Period for which enlisted 3 years.

When mustered in Dec. 13, 1864

Present or absent

Company to which assigned

Remarks: Deserted from Camp  
Chalmers La. June 11/65

Not on Co Muster rolls

Book mark :

Chandler

Copist.

L | 10 H. arty. | **U.S.C.T.**

Thomas Lambert  
Pvt., Co. ...., 10 Reg't U. S. Col'd Harty

Appears on

**M. and D. Roll of Men Transferred**

to the organization named above,

from 7<sup>th</sup> U. S. Col'd Inftry

Roll dated Oct. 1, 1865.

When enlisted Dec. 9, 1864.

Period for which enlisted 3 years.

When mustered in Dec. 13, 1864.

Present or absent

Company to which assigned

Remarks: Deserted from  
Camp Chalmette, La,  
June 11/65.

Book mark :

2783012

(342)

Castuling

Copyist

1532  
Lamitto, Frank

Co—, 10 U.S. Col'd H. Art'y.

Private

CARD NUMBERS.

1	5487773	26
2		27
3		28
4		29
5		30
6		31
7		32
8		
9		34
10		35
11		36
12		37
13		38
14		39
15		40
16		41
17		42
18		43
19		44
20		45
21		46
22		47
23		48
24		49
25		50

Book Mark:

See also 77 u. s. c. inf.



*L. W. A.* | **U.S.C.T.**

*Frank Sammitte*  
*1st*, Co. *10* Reg't U. S. Col'd *Hd.*

Appears on

**M. and D. Roll of Men Transferred**

to the organization named above,

from *Co. 10 1st U. S. Col'd Inf.*

Roll dated *Camp Caswell, 1865.*

When enlisted *July 18*, 1865.

Period for which enlisted *3* years.

When mustered in *March 8*, 1865.

Present or absent

Company to which assigned

Remarks: *Discharged  
General Hospital  
New Orleans La  
Apr 22. 1865. of small  
Pox. Final statements  
furnished*

*See on muster rolls Regt.*

Book mark :

*W. H. Scott*

1533  
Lamor, Eli

Co B, 10 U.S. Col'd H. Art'y.

Private | Private

CARD NUMBERS.

1		26	
2		27	
3	See Sammar	28	Eli
4		29	
5		30	
6		31	
7		32	
8		33	
9		34	
10		35	
11		36	
12		37	
13		38	
14		39	
15		40	
16		41	
17		42	
18		43	
19		44	
20		45	
21		46	
22		47	
23		48	
24		49	
25		50	

Book Mark:

See also

1534  
Lemaux, Paul

Co I, 10 U.S. Col'd H. Art'y.

Private | Private

CARD NUMBERS.

1	5511254	26
2	5511346	27
3	5511433	28
4	5511546	29
5	5511678	30
6	5511846	31
7	5512136	32
8	5489392	33
9		34
10		35
11		36
12		37
13		38
14		39
15		40
16		41
17		42
18		43
19		44
20		45
21		46
22		47
23		48
24		49
25		50

Book Mark:

See also

L. | 10 H. Art'y. | U.S.C.T.

Paul Lemaux  
Pvt., Co. D, 10 Reg't U. S. Col'd H. Art'y.

Age 24 1/2 years.

Appears on

**Company Muster Roll\***

for Enrollment to June 30, 1865.

Joined for duty and enrolled:

When \_\_\_\_\_, 1865.

Where \_\_\_\_\_

Period 1 years.

Mustered in:

When Apr. 14, 1865.

Where New Orleans, La.

Present or absent Present

Stoppage, \$ 100 for \_\_\_\_\_

Due Gov't, \$ 100 for \_\_\_\_\_

Valuation of horse, \$ 100

Valuation of horse equipments, \$ 100

Remarks: Drafted. Commencement of first

\*First current roll. No muster-in roll of this company on file.

Book mark: \_\_\_\_\_

O. J. Clark

L. | 10 H. Art'y. | U.S.C.T.

Paul L'anaux  
Prt., Co. I, 10 Reg't U. S. Col'd H. Art'y.

Appears on

**Company Muster Roll**

for July & Aug., 1865.

Present or absent Present

Stoppage, \$ 100 for

Due Gov't, \$ 100 for

Valuation of horse, \$ 100

Valuation of horse equipments, \$ 100

Remarks:

Book mark:

A. S. Clark  
Copyist.

*L.* | 10 H. Art'y. | U.S.C.T.

*Paul Lemaux*

*Pvt.*, Co. I, 10 Reg't U. S. Col'd H. Art'y.

Appears on

**Company Muster Roll**

for *Sept. & Oct.*, 1865.

Present or absent *Present*

Stoppage, \$ *100* for

Due Gov't, \$ *100* for

Valuation of horse, \$ *100*

Valuation of horse equipments, \$ *100*

Remarks: *Daily duty as ord-  
only for Prov. Marshall.*

Book mark:

*O. S. Clark*  
Coyt.

*L.* | **10 H. Art'y.** | **U.S.C.T.**

*Paul Lanoux*

*Pvt.*, Co. I, 10 Reg't U. S. Col'd H. Art'y.

Appears on

**Company Muster Roll**

for *Nov. & Dec.*, 1865:

Present or absent *Present*

Stoppage, \$ *100* for

Due Gov't, \$ *100* for

Valuation of horse, \$ *100*

Valuation of horse equipments, \$ *100*

Remarks:

FROM SECOND AUDITOR'S ROLL.

Book mark:

*O. S. Clark*

*L.* | 10 H. Art'y. | U.S.C.T.

*Paul Lemanuf*

*Priv.*, Co. I, 10 Reg't U. S. Col'd H. Art'y.

Appears on

**Company Muster Roll**

for *Jan. & Feb.*, 1866.

Present or absent *Jan. & Feb.*

Stoppage, \$ 100 for

Due Gov't, \$ 100 for

Valuation of horse, \$ 100

Valuation of horse equipments, \$ 100

Remarks:

Book mark:

*O. J. Belant*

Copyist.



L | 10 H. Art'y. | U.S.C.T.

Paul Lanoux  
Prof., Co. I, 10 Reg't U. S. Col'd H. Art'y.

Appears on

**Company Muster Roll**

for *Feb. & Apr.*, 1866.

Present or absent

Stoppage, \$ 100 for

Due Gov't, \$ 100 for

Valuation of horse, \$ 100

Valuation of horse equipments, \$ 100

Remarks: *Discharged.*

*Mustered out by reason  
of expiration of term  
of service to date Apr.  
13, 1866.*

Book mark: *Muster out on file.*

*O. J. Leland*

L | 104a | U.S.C.T.

Paul Lavauz

10<sup>th</sup> Reg't U. S. Col'd

Appears on an

**Individual Muster-out Roll**

of the organization named above. Roll dated

New Orleans La, Apr 13, 1866

Muster-out to date Apr 13, 1866

Last paid to Feb 18, 1866

**Clothing account:**

Last settled ..... 186 ; drawn since \$ ..... 100

Due soldier \$ 27 <sup>03</sup>/<sub>100</sub>; due U. S. \$ ..... 100

Am't for cloth'g in kind or money adv'd \$ ..... 100

Due U. S. for arms, equipments, &c., \$ ..... 67  
100

Bounty paid \$ ..... 100 due \$ ..... 100

Remarks: joined by draft  
stop for one canteen, 65¢  
one Tompion, 02¢ total, 67¢  
mustered out by reason of  
expiration of Term of Service  
to date Apr 13<sup>th</sup> 1866

Book mark: .....

R. Richardson

*L* | 10 H. Art'y. | **U.S.C.T.**

*Paul Sarau*

*Priv.*, Co. *I*, 10 Reg't U. S. Col'd H. Art'y.

Appears on **Co. Muster-out Roll**, dated  
*Baton Rouge La, Feb 22*, 1867.

Muster-out to date \_\_\_\_\_, 186 .

Last paid to \_\_\_\_\_, 186 .

Clothing account:

Last settled \_\_\_\_\_, 186 ; drawn since \$ \_\_\_\_\_ 100

Due soldier \$ \_\_\_\_\_ 100; due U. S. \$ \_\_\_\_\_ 100

Am't for cloth'g in kind or money adv'd \$ \_\_\_\_\_ 100

Due U. S. for arms, equipments, &c., \$ \_\_\_\_\_ 100

Bounty paid \$ \_\_\_\_\_ 100; due \$ \_\_\_\_\_ 100

Remarks: *Discharged, expiring*  
*term of service. Apr. 13, 1866*

Book mark: \_\_\_\_\_

*J. M. Hance*

1535  
Lander, George

Co — , 10 U.S. Col'd H. Art'y.

Private —

CARD NUMBERS.

1	5487496	26
2		27
3		28
4		29
5		30
6		31
7		32
8		33
9		34
10		35
11		36
12		37
13		38
14		39
15		40
16		41
17		42
18		43
19		44
20		45
21		46
22		47
23		48
24		49
25		50

Book Mark:

See also

77.2150.014

L 1086, A U.S.C.T.

George Lander  
Co., Co., 10 Reg't U. S. Col'd

Appears on

**M. and D. Roll of Men Transferred**

to the organization named above,

from Co. H, 77 U.S. Col Inf

Roll dated Camp Sumner Va, 1865.

When enlisted July 3, 1865.

Period for which enlisted 3 years.

When mustered in July 7, 1865.

Present or absent

Company to which assigned

Remarks: joined the Service

as recruit Discharged

On Surgeon's Certificate

of Disability June 23<sup>rd</sup>

1865, at New Orleans

La final Statements

rendered

is non mustered Reg't.

Book mark :

W. H. Scott

1936  
*Landers, Thomas*

*Co 3rd.*, **10 U.S. Col'd H. Art'y.**

*Asst. Surgeon* | *Asst. Surgeon*

CARD NUMBERS.

1	52486817	26
2	5490254	27
3	5490267	28
4	5490282	29
5	5490296	30
6	5490307	31
7	5490317	32
8	5490326	33
9	5490335	34
10	5490346	35
11	43227313	36
12		37
13		38
14		39
15		40
16		41
17		42
18		43
19		44
20		45
21		46
22		47
23		48
24		49
25		50

Book Mark: *563. C.S. 82.*

See also:

L. 10th H. Arty. | **U.S.C.T.**

Thomas Sanders

Asst. Surg. Co., 10 Reg't U. S. Col'd H. Arty.

Age 23 years.

Appears on an

**Individual Muster-in Roll**

of the organization named above. Roll dated

New Orleans, La., Sep. 25, 1865.

Muster-in to date Sep. 25, 1865.

Joined for duty and enrolled:

When September 25, 1865.

Where New Orleans La.

Period 3 years.

Valuation of horse, \$ 100

Valuation of horse equipments, \$ 100

Remarks: Appointed from  
civil life to Asst. Surg.  
10th U. S. C. Arty. (Heavy).  
original vacancy Sept.  
25<sup>th</sup> 1865.

Book mark:

Philipsen

L | 10 Hart | U.S.C.T.

Thomas Landers

Rank *1st Sgt* 10 Reg't U. S. Col'd *Hart*

Appears on

**Field and Staff Muster Roll**

for *Sept + Oct*, 1865.

Present or absent *Absent*

Stoppage, \$ *100* for

Due Gov't, \$ *100* for

Valuation of horse, \$ *100*

Valuation of horse equipments, \$ *100*

Remarks: *On duty with 2<sup>d</sup> Batt  
at Brashear City La.*

Book mark:

*Ackerman*

Copyist.



L 10 Hart | **U.S.C.T.**

Thomas Landers

Rank 1st Sgt, 10 Reg't U. S. Col'd Hart

Appears on

**Field and Staff Muster Roll**

for Nov + Dec, 1865.

Present or absent absent

Stoppage, \$ 100 for

Due Gov't, \$ 100 for

Valuation of horse, \$ 100

Valuation of horse equipments, \$ 100

Remarks: On duty with Det,  
10 U.S.C.A., Hy, at Brasher  
City La.

Book mark:

Ackerman

Copyright.

L | 10 H, art. U.S.C.T.

Thomas Landers

Rank 1st Surg 10 Reg't U. S. Col'd H. art.

Appears on

**Field and Staff Muster Roll**

for Jan + Feb, 1866.

Present or absent absent

Stoppage, \$ 100 for

Due Gov't, \$ 100 for

Valuation of horse, \$ 100

Valuation of horse equipments, \$ 100

Remarks: On duty with detach-  
ment 10 U. S. C. A. Ky. at  
Brashear City, La.

Book mark:

A. Kerman

Copyist.

L | 10 Hart | U.S.C.T.

Thomas Landers

Rank *1st Surg* 10 Reg't U. S. Col'd *Hart*

Appears on

**Field and Staff Muster Roll**

for *Mar & Apr*, 1866.

Present or absent *Absent*

Stoppage, \$ *100* for

Due Gov't, \$ *100* for

Valuation of horse, \$ *100*

Valuation of horse equipments, \$ *100*

Remarks: *On duty with detach-*  
*ment 10 U S C A Coy at Brash-*  
*ear City, La.*

Book mark:

*A. Kerman*

Copyist.

L | 100 Hart | U.S.C.T.

Thomas Landers

Rank *1st Sgt* Reg't U. S. Col'd *Hart*

Appears on

**Field and Staff Muster Roll**

for *May + June*, 186*6*.

Present or absent *Absent*

Stoppage, \$ *100* for

Due Gov't, \$ *100* for

Valuation of horse, \$ *100*

Valuation of horse equipments, \$ *100*

Remarks: *On duty with Co "I" at  
Beashear City, La*

Book mark:

*Ackerman*

Copyist.

L | 10 Hart | U.S.C.T.

Thomas Landers

Rank *Art-Surg 10* Reg't U. S. Col'd *Hart*

Appears on

**Field and Staff Muster Roll**

for *July + Aug*, 1866.

Present or absent *Absent*

Stoppage, \$ *100* for

Due Gov't, \$ *100* for

Valuation of horse, \$ *100*

Valuation of horse equipments, \$ *100*

Remarks: *On duty with detrit*  
*10 U.S.C., a, Key at Fort Pike*  
*La.*

Book mark:

*Ackerman*

Copyist.

L | 10 Hart | U.S.C.T.

Thomas Landers

Rank 1st Surg 10 Reg't U. S. Col'd Hart

Appears on

Field and Staff Muster Roll

for Sept + Oct, 1866.

Present or absent Absent

Stoppage, \$ 100 for

Due Gov't, \$ 100 for

Valuation of horse, \$ 100

Valuation of horse equipments, \$ 100

Remarks: On duty with detachment 10 U. S. C. A. Ky. Fort Pike La.

Book mark:

Ackerman

L | 10 Art | U.S.C.T.

Thomas Landers

Rank *Art-Surg 10* Reg't U. S. Col'd *Art*

Appears on

**Field and Staff Muster Roll**

for *Nov + Dec* 1866.

Present or absent *Absent*

Stoppage, \$ *100* for

Due Gov't, \$ *100* for

Valuation of horse, \$ *100*

Valuation of horse equipments, \$ *100*

Remarks: *On duty with detach-*  
*ment of 10 U.S.C.A. Hy*

Book mark:

*A. Kerman*

L | 10 H. arty | U.S.C.T.

Thomas Landers

Asst Surg to Regt U.S. Cold H. arty

Appears on

**General Order**

No. 67, dated War Department, Adjutant Gen-

eral's Office, July 16, 1867.

Appointed to be

Captain

**BY BREVET**

in the Volunteer Force, Army of the United  
States, for faithful and mer-  
itorious services during  
the war.

To date from

March 13, 1865.

J. N. Williams



L | 10 Hart U.S.C.T.

Thomas Landers

Rank Asst Surg 10 Reg't U. S. Col'd Hart

Appears on a

**Field and Staff Muster-out Roll**

of the organization named above. Roll dated

Baton Rouge La, Feb 22, 1867 .

Muster-out to date

Feb 22, 1867 .

Last paid to

Dec 31, 1866 .

**Clothing account:**

Last settled....., 186 ; drawn since \$.....<sup>100</sup>

Due soldier \$.....<sup>100</sup>; due U. S. \$.....<sup>100</sup>

Am't for cloth'g in kind or money adv'd \$.....<sup>100</sup>

Due U. S. for arms, equipments, &c., \$.....<sup>100</sup>

Bounty paid \$.....<sup>100</sup>; due \$.....<sup>100</sup>

Remarks: App<sup>d</sup> from civil life  
as Asst Surg. 10 U. S. Col'd (Hart)  
Commission received +  
accepted Sept 8/65 at Wash-  
ington, D.C.

Book mark: 563 C. T. 82

Ackerman

Landers, Thos

Unit  
Surq, Co.

10

Reg't

U.S.C.H.A.

3

Enclosures.

Bed Cards .....	Final Statements .....
Burial Records .....	Furloughs or L. of A. ....
Certs. of Dis. for Discharge .....	Med. Certificates .....
C. M. Charges .....	Med. Des. Lists .....
Descriptive Lists .....	Orders .....
Discharge Certificates .....	Pris. of War Record .....
Enlistment Papers .....	Resignations .....

Other papers relating to—

Admission to Hosp'l .....	Furlough or L. of A. <i>2</i> .....
Casualty Sheet .....	Med. Examination .....
Confinement .....	Misc. Information <i>1</i> .....
Contracts .....	Pay or Clothing .....
Death or Effects .....	Personal Reports .....
Desertion .....	Rank .....
Discharge from Hosp'l .....	Transfer to Hosp'l .....
Discharge from Service .....	Transfer to V. R. C. ....
Duty .....	Transportation .....

5745  
H. P. 5745  
Barashear City La.

October 18<sup>th</sup> 1863

Mr. Gardner

Apt. Surg. 10<sup>th</sup> U.S.C.A. (A.)

Requests leave of absence  
for three days to visit N. Orleans  
La. to obtain Medical and  
Hospital supplies.

Head qrs, U.S. Forces  
Barashear La. Oct. 18<sup>th</sup> 1863

Respectfully forwarded

Approved

L. Horace McQuire  
Capt 10<sup>th</sup> U.S.C.A. (A.)  
Comdg Post.

5745  
Barashear La. Oct. 18<sup>th</sup> 1863

Filed in - "J"

*[Faint, illegible handwritten text, possibly bleed-through from the reverse side of the page.]*

Brashear City La.

Oct. 18<sup>th</sup> 1863.

Sir:

I would most respectfully request a leave of absence for the period of three days to visit the city of New Orleans La. for the following reason. Having reported at this Post in compliance with Sp. Order No 84 Hd. Quarters Dept. La. dated Oct. 11<sup>th</sup> 1863. I find no Medical or Hospital <sup>stores</sup> whatever. By visiting the city of New Orleans La. I think I would be able to hasten the filling of the requisitions; as the command is much in need of the same.

I have the honor to be,

most respectfully,

Your Obedt. Servant,

Wm Sanders

Capt. Surg.

10<sup>th</sup> U. S. C. Arty. H.

E. Hemenway

Capt. Adjut. Genl.

New Orleans La.

LP 5878  
Brazhear City La.  
December 28<sup>th</sup> 1865.

Wm. Sanders  
Apt. Surg. 10<sup>th</sup> U.S.C.A. (H)

Asks for leave of absence  
of two days with permission  
to visit New Orleans.

Head qrs, U.S. Forces,  
Brazhear, La. Dec. 28<sup>th</sup> /65.

Respectfully forwarded,

Approved.

J. Horace McQuire,  
Capt 10<sup>th</sup> U.S.C.A. (H)  
Comdg Post.

E.P. 35-

L.P. 5878 of 3  
Dec. 28<sup>th</sup> /65

Filed in

"P"

DEC 28 1865  
U.S. ARMY  
HEAD QUARTERS  
BRAZHEAR, LA.

Brashear City La.

December 28<sup>th</sup> 1863

Capt. E. Hemenway:

Sir:

I have the honor  
to apply for a leave of absence of two days with  
permission to visit New Orleans on private  
business.

Very respectfully

Your Obedt. Servant

Thos Landers

Apt. Surg. 10<sup>th</sup> U.S.C. & A.

Head Quarters Landers  
Dept of Louisiana  
New Orleans Oct 17, 1862

Special Orders } extract  
No 84 } 3d.

Direct Asst Surgeon Thomas  
Landers to take post with  
a detachment of his Regt  
Staleness at Brashear City

Thomas Landers  
Sep 10 1862 City

RECEIVED  
OCT 17 1862  
HEAD QUARTERS  
DEPT OF LOUISIANA  
NEW ORLEANS

SPECIAL ORDERS, ) HEADQUARTERS,  
No. 84 ) DEPARTMENT OF LOUISIANA,  
New Orleans, La., October 11, 1865.  
[Encl.]

3. Upon the recommendation of the Medical Director of the Department of Louisiana, Assistant Surgeon *Thomas Lawlers*, 10th U. S. Colored Artillery (Heavy), will take post immediately with the detachment of his regiment stationed at Brashear City, Louisiana.

By order of Major-General E. R. S. CANBY :

WICKHAM HOFFMAN,  
Assistant Adjutant General.

OFFICIAL:

*Lathaniel Pembroke*  
1st Lieut., Acting Ass't Adj't General.

Commanding Officer  
at Forts Jackson & St. Philip,  
thru Gen. Sherman.



1531  
Landrie, John

Co A, 10 U.S. Col'd H. Art'y.

Private | Private

CARD NUMBERS.

1	5-489070	26
2	5-492924	27
3	5-493145	28
4	5-493363	29
5	5-493501	30
6	5-493561	31
7	5-493750	32
8	5-494015	33
9	5-490070	34
10		35
11		36
12		37
13		38
14		39
15		40
16		41
17		42
18		43
19		44
20		45
21		46
22		47
23		48
24		49
25		50

Book Mark:

See also 75 U.S.C.S.

P 2289146 PUMM  
P 2304113, P. O. M. H.

S. E. Smyth  
2

*S. W. M.* U.S.C.T.  
*John Sandus*  
Co., *10* Reg't U. S. Col'd *11th*

Appears on

**M. and D. Roll of Men Transferred**

to the organization named above,

from *73rd U.S.C.*

Roll dated *Nov 18*, 186*5*.

When enlisted *Aug 27*, 186*3*.

Period for which enlisted *3* years.

When mustered in *Sep 24*, 186*3*.

Present or absent *Not stated*

Company to which assigned

Remarks: *joined by*

*transfer from 88th  
C.S. Aug 13/64 from  
J. C. 209th Regt. Capt  
of Gulf*

Book mark :

*J. W. Johnson*

*6* | 10 H. Art'y. | U.S.C.T.

*John Landrie*

*RA*, Co. A, 10 Reg't U. S. Col'd H. Art'y.

Appears on

**Company Muster Roll**

for *Nov. & Dec*, 1865.

Present or absent *Present*

Stoppage, \$ 100 for

Due Gov't, \$ 100 for

Valuation of horse, \$ 100

Valuation of horse equipments, \$ 100

Remarks: *Transferred from 75<sup>th</sup> to 2<sup>d</sup>.  
for S.O. 105 to S. Hdqrs Dept of A*

Book mark:

*J. Hayes*

Copyist.

*6* | **10 H. Art'y. | U.S.C.T.**  
*John Landrie*  
*PA*, Co. A, 10 Reg't U. S. Col'd H. Art'y.

Appears on

**Company Muster Roll**

for *Jan + Feb*, 186*6*.

Present or absent *Present*

Stoppage, \$ *100* for

Due Gov't, \$ *100* for

Valuation of horse, \$ *100*

Valuation of horse equipments, \$ *100*

Remarks:

Book mark:

*Hyman*  
Copyist.

*L* | 10 H. Art'y. | U.S.C.T.

*John Landrie*

*Pr*, Co. A, 10 Reg't U. S. Col'd H. Art'y.

Appears on

**Company Muster Roll**

for *Mar + Apl*, 186*6*.

Present or absent *Present*

Stoppage, \$.....100 for .....

Due Gov't, \$.....100 for .....

Valuation of horse, \$.....100

Valuation of horse equipments, \$.....100

Remarks: .....

.....

.....

.....

.....

.....

.....

.....

Book mark: .....

.....

..... *Styer* Copyist.

*L* | **10 H. Art'y. U.S.C.T.**

*John Landrie*

*Pr*, Co. A, 10 Reg't U. S. Col'd H. Art'y.

Appears on

**Company Muster Roll**

for *May & June*, 186*6*.

Present or absent *Present*

Stoppage, \$.....100 for .....

Due Gov't, \$.....100 for .....

Valuation of horse, \$.....100

Valuation of horse equipments, \$.....100

Remarks:.....

.....

.....

.....

.....

.....

.....

.....

Book mark:.....

.....

.....

*H. J. ...*  
Copyist.

*S* 10 H. Art'y. U.S.C.T.

*John Landrie*  
*Pl*, Co. A, 10 Reg't U. S. Col'd H. Art'y.

Appears on

**Company Muster Roll**

for *July & Aug*, 186*6*.

Present or absent *Present*

Stoppage, \$.....100 for .....

Due Gov't, \$.....100 for .....

Valuation of horse, \$.....100

Valuation of horse equipments, \$.....100

Remarks: .....

Book mark: .....

*Hy*  
Copyist.



*L* | 10 H. Art'y. | U.S.C.T.

*John Landrie*

*Pvt.*, Co. A, 10 Reg't U. S. Col'd H. Art'y.

Appears on

**Company Muster Roll**

for *Sept + Oct*, 186*6*.

Present or absent

Stoppage, \$ 100 for

Due Gov't, \$ 100 for

Valuation of horse, \$ 100

Valuation of horse equipments, \$ 100

Remarks: *Date of discharge mustered out Sept 23/66 by reason of expiration of term of service & Paid \$100.00 bounty*

Book mark:

*Nesbitt*

L | 10 Arty | **U.S.C.T.**

John Landrie

Oris, Co. A., 10 Reg't U. S. Col'd Arty

Appears on a

**Detachment Muster-out Roll**

of the organization named above. Roll dated

New Orleans La Sept 24, 1866.

Muster-out to date Sept 23, 1866.

Last paid to June 30, 1866

**Clothing account:**

Last settled \_\_\_\_\_, 1866 ; drawn since \$ \_\_\_\_\_ 100

Due soldier \$ 36 <sup>78</sup>/<sub>100</sub>; due U. S. \$ \_\_\_\_\_ 100

Am't for cloth'g in kind or money adv'd \$ \_\_\_\_\_ 100

Due U. S. for arms, equipments, &c., \$ \_\_\_\_\_ 100

Bounty paid \$ \_\_\_\_\_ 100 due \$ 100 100

Remarks: joined orig org 88 USC 9  
transferred to 75 USC 9 SO 209  
par 12 Series of 1864 Dept of  
Quelf. Transferred to 10<sup>th</sup> USCA  
(H) SO 105 par 12 Series of 1865  
Dept of La. M.O. by reason

Book mark: \_\_\_\_\_

Edmondson

JAN. 15

5490070

\* 1881 \*

*of expiration of term  
of service.*

L | 10 H. Art'y. | **U.S.C.T.**

John Landrum  
Pvt. Co. A, 10 Reg't U. S. Col'd H. Art'y.

Appears on **Co. Muster-out Roll**, dated  
Baton Rouge La, Feb 22, 1867.

Muster-out to date \_\_\_\_\_, 186 .

Last paid to \_\_\_\_\_, 186 .

Clothing account:

Last settled \_\_\_\_\_, 186 ; drawn since \$ \_\_\_\_\_ 100

Due soldier \$ \_\_\_\_\_ 100; due U. S. \$ \_\_\_\_\_ 100

Am't for cloth'g in kind or money adv'd \$ \_\_\_\_\_ 100

Due U. S. for arms, equipments, &c., \$ \_\_\_\_\_ 100

Bounty paid \$ \_\_\_\_\_ 100; due \$ \_\_\_\_\_ 100

Remarks: Transfd. from 75 U.S. Co. I as  
Pvt. S. Co. 105 S of 65 Reg't La.  
Dischd. for exp'n. of term of  
service Sept 23/66

Book mark: \_\_\_\_\_

Nesbitt

Copyist.

1538

Landry, Andrew

Co I, 10 U.S. Col'd H. Art'y.

Private

Private

CARD NUMBERS.

1	5494377	26
2	5494537	27
3	5494696	28
4	5494857	29
5	5495004	30
6	5495161	31
7	5495316	32
8	5495469	33
9	5495619	34
10	5495758	35
11	5495915	36
12	5496060	37
13	5496210	38
14	5496363	39
15	5496510	40
16	5496652	41
17	5496796	42
18	5496934	43
19	5497131	44
20	5497442	45
21	5489679	46
22	5494225	47
23		48
24		49
25		50

Book Mark:

See also

D1093987 P.O. Mon  
A1483746 P.O. aff  
D. 2054738 P.O. Mon

S. S. Smyth

*L* | 10 H. Art'y. | U.S.C.T.

*Andrew Laundre*

*Pvt.*, 2 Battery, La. H. Art'y, Native Guards.\*

Age *33* years.

Appears on

**Company Muster-in Roll**

of the organization named above. Roll dated

*Camp Parapet, Carrollton, La.*, *Feb. 9*, 186*3*.

Muster-in to date

*Feb. 9*, 186*3*.

Joined for duty and enrolled:

When *Feb. 2*, 186*3*.

Where *Camp Parapet nr. Carrollton, La.*

Period *3* years.

Valuation of horse, \$.....*100*

Valuation of horse equipments, \$.....*100*

Remarks:.....

.....

.....

.....

\* This organization subsequently became Co. B, 10 Reg't U. S. Colored Heavy Artillery.

Book mark:.....

.....

*Feaster*

*L* | 10 H. Art'y. | U.S.C.T.

*Andrew Landre*

*Priv.*, Co. B, 1 Reg't La. H. Art'y, Native Guards.\*

Appears on

**Company Muster Roll**

for *from Enlistment to Feb. 28*, 1863.

Present or absent *Present*

Stoppage, \$ *100* for

Due Gov't, \$ *100* for

Valuation of horse, \$ *100*

Valuation of horse equipments, \$ *100*

Remarks:

\*This organization subsequently became Co. B, 10 Reg't U. S. Col'd Heavy Artillery.

Book mark:

*Foster*



*D* | 10 H. Art'y. | U.S.C.T.

*Andrew Landre*  
*Pvt.*, Co. B, 1 Reg't La. H. Art'y, Native Guards.\*

Appears on

**Company Muster Roll**

for *Mch. 4. Apl.*, 186*3*.

Present or absent *Present*

Stoppage, \$ *100* for

Due Gov't, \$ *100* for

Valuation of horse, \$ *100*

Valuation of horse equipments, \$ *100*

Remarks:

\*This organization subsequently became Co. B, 10 Reg't U. S. Col'd Heavy Artillery.

Book mark:

*Feaster*

L | 10 H. Art'y. | U.S.C.T.

Andrew Landre  
Pop., Co. B, 1 Reg't La. H. Art'y, Native Guards.\*

Appears on

**Company Muster Roll**

for *May 7. June, 1863.*

Present or absent *Present*

Stoppage, \$ *100* for

Due Gov't, \$ *100* for

Valuation of horse, \$ *100*

Valuation of horse equipments, \$ *100*

Remarks:

\*This organization subsequently became Co. B, 10 Reg't U. S. Col'd Heavy Artillery.

Book mark:

*Feaster*

*L* | 10 H. Art'y. | U.S.C.T.

*Andrew Landre*  
*Pvt.*, Co. B, 1 Reg't La. H. Art'y, Native Guards.\*

Appears on

**Company Muster Roll**

for *July 4. Aug.*, 1863.

Present or absent

*Present*

Stoppage, \$ *100* for

Due Gov't, \$ *100* for

Valuation of horse, \$ *100*

Valuation of horse equipments, \$ *100*

Remarks:

\*This organization subsequently became Co. B, 10 Reg't U. S. Col'd Heavy Artillery.

Book mark:

*Seaster*

*D* | 10 H. Art'y. | U.S.C.T.

*Andrew Lamdre*  
*Co. B.*, Co. B, 1 Reg't La. H. Art'y, Native Guards.\*

Appears on

**Company Muster Roll**

for *Sept. 7. Oct.*, 186*3*.

Present or absent *Present*

Stoppage, \$ *100* for

Due Gov't, \$ *100* for

Valuation of horse, \$ *100*

Valuation of horse equipments, \$ *100*

Remarks:

-----  
-----  
-----  
-----  
-----  
-----  
-----  
-----

\*This organization subsequently became Co. B, 10 Reg't U. S. Col'd Heavy Artillery.

Book mark: -----

*Heaster*

*L* | 10 H. Art'y. | U.S.C.T.

Andrew Landre

*Pt*, Co. *B*, 1 Reg't H. Art'y, Corps d'Afrique.\*

Appears on

**Company Muster Roll**

for *Nov. & Dec.*, 186 *B*.

Present or absent *Present*

Stoppage, \$ *100* for

Due Gov't, \$ *100* for

Valuation of horse, \$ *100*

Valuation of horse equipments, \$ *100*

Remarks:

-----  
-----  
-----  
-----  
-----  
-----  
-----

\* This organization subsequently became Co. , 10 Reg't U. S. Colored Heavy Artillery.

Book mark : -----

*P. R. P.*  
Copyist.

*L* | **10 H. Art'y. | U.S.C.T.**

*Edward Saunders*

*Plt*, Co. *B*, 1 Reg't H. Art'y, Corps d'Afrique.\*

Appears on

**Company Muster Roll**

for *Jan: Feb.*, 186<sup>4</sup>.

Present or absent *Present*

Stoppage, \$.....100 for .....

Due Gov't, \$.....100 for .....

Valuation of horse, \$.....100

Valuation of horse equipments, \$.....100

Remarks: .....

.....  
.....  
.....  
.....  
.....

\* This organization subsequently became Co. ...., 10 Reg't U. S. Colored Heavy Artillery.

Book mark: .....

.....  
*Reif*  
.....  
.....

2 | 10 H. Art'y. | U.S.C.T.

Andrew Sandry

Pvt, Co., 7 Reg't U. S. Col'd H. Art'y.\*

Appears on

Company Muster Roll

for *March & April*, 1864.

Present or absent *Present*

Stoppage, \$ 100 for

Due Gov't, \$ 100 for

Valuation of horse, \$ 100

Valuation of horse equipments, \$ 100

Remarks:

\* This organization subsequently became Co. , 10 Reg't U. S. Colored Heavy Artillery.

Book mark:

*R. J.*  
Copyist.

*L* | 10 H. Art'y. | U.S.C.T.

*Andrew Landry*

*R*, Co. *B*, 7 Reg't U. S. Col'd H. Art'y.\*

Appears on

**Company Muster Roll**

for *May & June*, 186*4*

Present or absent *Present*

Stoppage, \$ *100* for

Due Gov't, \$ *100* for

Valuation of horse, \$ *100*

Valuation of horse equipments, \$ *100*

Remarks:

\* This organization subsequently became Co. *10* Reg't U. S. Colored Heavy Artillery.

Book mark:

*Reg*  
Copyist.



*L* | **10 H. Art'y. U.S.C.T.**

*Andrew Landry*  
*Ph*, Co. B, 10 Reg't U. S. Col'd H. Art'y.

Appears on

**Company Muster Roll**  
for *July & Aug*, 1864.  
Present or absent *Present*

Stoppage, \$ 100 for

Due Gov't, \$ 100 for

Valuation of horse, \$ 100

Valuation of horse equipments, \$ 100

Remarks: \_\_\_\_\_  
\_\_\_\_\_  
\_\_\_\_\_  
\_\_\_\_\_  
\_\_\_\_\_  
\_\_\_\_\_

Book mark: \_\_\_\_\_

(358)

*J. A. Richardson*  
Copyist.

*L* | **10 H. Art'y. | U.S.C.T.**

*Andrew Landry*  
*A*, Co. B, 10 Reg't U. S. Col'd H. Art'y.

Appears on

**Company Muster Roll**

for *Sept & Oct*, 186*4*

Present or absent *Present*

Stoppage, \$ *100* for

Due Gov't, \$ *100* for

Valuation of horse, \$ *100*

Valuation of horse equipments, \$ *100*

Remarks:

Book mark:

*J. Richardson*

L. | 10 H. Art'y. | U.S.C.T.

*Andrew Landry*  
Pvt; Co. B, 10 Reg't U. S. Col'd H. Art'y.

Appears on

**Company Muster Roll**

for *Nov 7 Dec*, 1864.

Present or absent *Present*

Stoppage, \$ 100 for

Due Gov't, \$ 100 for

Valuation of horse, \$ 100

Valuation of horse equipments, \$ 100

Remarks:

Book mark:

*J. J. J. J.*

L. | 10 H. Art'y. | U.S.C.T.

Andrew Landre  
Pvt., Co. B, 10 Reg't U. S. Col'd H. Art'y.

Appears on

Company Muster Roll

for Jan & Feb, 1865.

Present or absent Present

Stoppage, \$ 100 for

Due Gov't, \$ 100 for

Valuation of horse, \$ 100

Valuation of horse equipments, \$ 100

Remarks: Our soldier arranged  
monthly pay from Jan 1  
1864 to May 1 1864 \$6<sup>00</sup> per  
month May & June \$9<sup>00</sup>  
C. Landre duty in  
Post Hospital Dec 21  
1865

Book mark:

J. J. J. J.

L. | **10 H. Art'y. | U.S.C.T.**

*Andrew Landry*  
*Priv.*, Co. B, 10 Reg't U. S. Col'd H. Art'y.

Appears on

**Company Muster Roll**

for *Mar & Apr.*, 1865.

Present or absent *Present*

Stoppage, \$ 100 for

Due Gov't, \$ 100 for

Valuation of horse, \$ 100

Valuation of horse equipments, \$ 100

Remarks: \_\_\_\_\_  
\_\_\_\_\_  
\_\_\_\_\_  
\_\_\_\_\_  
\_\_\_\_\_  
\_\_\_\_\_  
\_\_\_\_\_

Book mark: \_\_\_\_\_

*Josiah*  
Copyist.

L. | 10 H. Art'y. | U.S.C.T.

*Andrew Landry*  
Pvt., Co. B, 10 Reg't U. S. Col'd H. Art'y.

Appears on

**Company Muster Roll**

for *May & June*, 186*6*.

Present or absent *Present*.

Stoppage, \$ 100 for

Due Gov't, \$ 100 for

Valuation of horse, \$ 100

Valuation of horse equipments, \$ 100

Remarks: \_\_\_\_\_  
\_\_\_\_\_  
\_\_\_\_\_  
\_\_\_\_\_  
\_\_\_\_\_  
\_\_\_\_\_  
\_\_\_\_\_

Book mark: \_\_\_\_\_

*Jones*

L. | 10 H. Art'y. | U.S.C.T.

Andrew Landry  
Pt., Co. B, 10 Reg't U. S. Col'd H. Art'y.

Appears on

**Company Muster Roll**

for July & Aug, 1865.

Present or absent Present

Stoppage, \$ 100 for

Due Gov't, \$ 100 for

Valuation of horse, \$ 100

Valuation of horse equipments, \$ 100

Remarks:

Book mark:

J. J. J. J. J.  
Copyist.

L | **10 H. Art'y.** | **U.S.C.T.**

*Andrew Landry*  
*Pvt.*, Co. B, 10 Reg't U. S. Col'd H. Art'y.

Appears on

**Company Muster Roll**

for *Sep. & Oct.*, 1865.

Present or absent *Present.*

Stoppage, \$ 100 for

Due Gov't, \$ 100 for

Valuation of horse, \$ 100

Valuation of horse equipments, \$ 100

Remarks:

Book mark:

*Josiah*



*A*

**10 H. Art'y. U.S.C.T.**

*Andrew Laundry*

*Pl*, Co. B, 10 Reg't U. S. Col'd H. Art'y.

Appears on

**Company Muster Roll**

for *Nov. & Dec., 1865*

Present or absent *Present*

Stoppage, \$ 100 for

Due Gov't, \$ 100 for

Valuation of horse, \$ 100

Valuation of horse equipments, \$ 100

Remarks:

Book mark:

*Reil*

*L* | **10 H. Art'y.** | **U.S.C.T.**

*Andrew Landry*

*Pvt*, Co. B, 10 Reg't U. S. Col'd H. Art'y.

Appears on

**Company Muster Roll**

for *Jan. 1. 1866*, 186 *6*.

Present or absent.....

Stoppage, \$.....<sup>100</sup> for.....

Due Gov't, \$.....<sup>100</sup> for.....

Valuation of horse, \$.....<sup>100</sup>

Valuation of horse equipments, \$.....<sup>100</sup>

Remarks: *Must be out at M.O. S.A. Del. 8 66 by reason of exp. of term of service*

Book mark:.....

*Reif*  
Copyist.

Co. 10 Me. a. U.S.C.T.

Andrew Laundry  
Priv., Co. B., 10 Reg't U. S. Col'd Me. a.

Appears on a

**Detachment Muster-out Roll**

of the organization named above. Roll dated

New Orleans La. Feb. 8, 1866\*

Muster-out to date Feb. 8, 1866

Last paid to June 30, 1865

**Clothing account:**

Last settled ..... 186 ; drawn since \$ ..... 100

Due soldier \$ 50 76 / 100; due U. S. \$ ..... 100

Am't for cloth'g in kind or money adv'd \$ ..... 100

Due U. S. for arms, equipments, &c., \$ ..... 100

Bounty paid \$ ..... 100 due \$ ..... 100

Remarks: Joined at Origl. Orgn.

Mustered out by reason

of Expiration of term of

Service (Cert. of Mustg. In

shows time M. Feb. 12, 1866

\* added May 12, 93. G.S.

Book mark: .....

Hawling

*S* | 10 H. Art'y. | U.S.C.T.

*Andrew Sandry*  
Pvt., Co. *Q*, 10 Reg't U. S. Col'd H. Art'y.

Appears on **Co. Muster-out Roll**, dated  
*Daton Rouge La. Feb*, 1867.

Muster-out to date ..... 186 .

Last paid to ..... 186 .

**Clothing account:**

Last settled ..... 186 ; drawn since \$ ..... 100

Due soldier \$ ..... 100 ; due U. S. \$ ..... 100

Am't for cloth'g in kind or money adv'd \$ ..... 100

Due U. S. for arms, equipments, &c., \$ ..... 100

Bounty paid \$ ..... 100 ; due \$ ..... 100

Remarks: *Joined org. organ.  
Discharged Feb. 4/66  
expiration term of  
service.*

Book mark: .....

*Hodges*

Laundre. Andrew

C, Co., -10" Regt W.S. G. A.A.

**2 Enclosures.**

Bed Cards .....	Final Statements .....
Burial Records .....	Furloughs or L. of A. ....
Certs. of Dis. for Discharge .....	Med. Certificates .....
C. M. Charges .....	Med. Des. Lists .....
Descriptive Lists .....	Orders .....
Discharge Certificates .....	Pris. of War Record .....
Enlistment Papers .....	Resignations .....

**Other papers relating to—**

Admission to Hosp'l .....	Furlough or L. of A. ....
Casualty Sheet .....	Med. Examination .....
Confinement .....	Misc. Information .....
Contracts .....	Pay or Clothing .....
Death or Effects .....	Personal Reports .....
Desertion .....	Rank .....
Discharge from Hosp'l .....	Transfer to Hosp'l .....
Discharge from Service .....	Transfer to V. R. C. ....
Duty .....	Transportation .....

DECLARATION OF RECRUIT.

I, \_\_\_\_\_ desiring to ENLIST in the Army of the United States, for the term of THREE YEARS, Do declare, That I am \_\_\_\_\_ years and \_\_\_\_\_ months of age; that I have neither wife nor child; that I have never been discharged from the United States service on account of disability or by sentence of a court-martial, or by order before the expiration of a term of enlistment; and I know of no impediment to my serving honestly and faithfully as a soldier for three years.

GIVEN at \_\_\_\_\_ The \_\_\_\_\_ day of \_\_\_\_\_

Witness:

Discharged \_\_\_\_\_ 18 \_\_\_\_\_

Reg't of \_\_\_\_\_

enlistment; last served in Company ( )

By \_\_\_\_\_ Lt. Col. \_\_\_\_\_ Regiment of Louisiana 1863

Enlisted at \_\_\_\_\_

\_\_\_\_\_

\_\_\_\_\_

\_\_\_\_\_

No. 128

CONSENT IN CASE OF MINOR.

I, \_\_\_\_\_ Do CERTIFY, That I am the \_\_\_\_\_ of \_\_\_\_\_; that the said \_\_\_\_\_ is \_\_\_\_\_ years of age; and I do hereby freely give my CONSENT to his enlisting as a SOLDIER in the ARMY OF THE UNITED STATES for the period of THREE YEARS.

GIVEN at \_\_\_\_\_ The \_\_\_\_\_ day of \_\_\_\_\_

Witness:

County of

*Jefferson*



State of

*Louisiana*

I, *Andrew Saunders* born in *Charleston*

in the State of *South Carolina* aged *Twenty three* years,

and by occupation a *Suborer* do hereby acknowledge to have

voluntarily enlisted this *Second* day of *February*

18*63*, as a SOLDIER in the ARMY OF THE UNITED STATES OF AMERICA, for the period

of *THREE YEARS*, unless sooner discharged by proper authority: Do also agree to

accept such bounty, pay, rations, and clothing, as are, or may be, established by law. And

I, *Andrew Saunders* do solemnly swear, that I will bear true faith

and allegiance to the UNITED STATES OF AMERICA, and that I will serve them honestly and

faithfully against all their enemies or opposers whomsoever; and that I will observe and

obey the orders of the President of the United States, and the orders of the officers

appointed over me, according to the Rules and Articles of War.

Sworn and subscribed to, at

*Camp Parapet*  
*of Charleston La*  
this *Ninth* day of *February* 18*63*

BEFORE

*L. Nygaard*

*2<sup>nd</sup> Lieut. U. S. Army, La. Vol.*  
I CERTIFY, ON HONOR, That I have carefully examined the above named Recruit, agreeably to the General Regulations of the Army, and that in my opinion he is free from all bodily defects and mental infirmity, which would, in any way, disqualify him from performing the duties of a soldier.

*Milton Chase*

EXAMINING SURGEON.

I CERTIFY, ON HONOR, That I have minutely inspected the Recruit, *Andrew Saunders* previously to his enlistment, and that he was entirely sober when enlisted; that, to the best of my judgement and belief, he is of lawful age; and that, in accepting him as duly qualified to perform the duties of an able-bodied soldier, I have strictly observed the Regulations which govern the recruiting service. This soldier has *Brown* eyes, *Dark* hair,

*Dark* complexion; is *five* feet, *Seven* inches high.

*L. Nygaard 2<sup>nd</sup> Lieut. U. S. Army, La. Vol.*

RECRUITING OFFICER.

DECLARATION OF RECRUIT.

I, \_\_\_\_\_ desiring to ENLIST in the Army of the United States, for the term of THREE YEARS, Do declare, That I am \_\_\_\_\_ years and \_\_\_\_\_ months of age; that I have neither wife nor child; that I have never been discharged from the United States service on account of disability or, by sentence of a court-martial, or by order before the expiration of a term of enlistment; and I know of no impediment to my serving honestly and faithfully as a soldier for three years.

GIVEN at \_\_\_\_\_ The \_\_\_\_\_ day of \_\_\_\_\_

Witness:

10 U.S.C.H.A.

No. \_\_\_\_\_

Enlisted at \_\_\_\_\_

\_\_\_\_\_ 1863

By \_\_\_\_\_

\_\_\_\_\_ of \_\_\_\_\_

enlistment; last served in Company \_\_\_\_\_

Reg't of \_\_\_\_\_

Discharged \_\_\_\_\_ 18\_\_\_\_\_

CONSENT IN CASE OF MINOR.

I, \_\_\_\_\_ Do CERTIFY, That I am the \_\_\_\_\_ of \_\_\_\_\_; that the said \_\_\_\_\_ is \_\_\_\_\_ years of age; and I do hereby freely give my CONSENT to his enlisting as a SOLDIER in the ARMY OF THE UNITED STATES for the period of THREE YEARS.

GIVEN at \_\_\_\_\_ The \_\_\_\_\_ day of \_\_\_\_\_

Witness:



County of



State of

*Jefferson*

*Louisiana*

I, *Andrew Saundre* born in *Charlestown*  
in the State of *South Carolina* aged *Twenty Three* years,  
and by occupation a *Suborer* do hereby acknowledge to have  
voluntarily enlisted this *Second* day of *February*

18*63*, as a SOLDIER in the ARMY OF THE UNITED STATES OF AMERICA, for the period  
of *THREE YEARS*, unless sooner discharged by proper authority: Do also agree to  
accept such bounty, pay, rations, and clothing, as are, or may be, established by law. And  
I, *Andrew Saundre* do solemnly swear, that I will bear true faith  
and allegiance to the UNITED STATES OF AMERICA, and that I will serve them honestly and  
faithfully against all their enemies or opposers whomsoever; and that I will observe and  
obey the orders of the President of the United States, and the orders of the officers  
appointed over me, according to the Rules and Articles of War.

Sworn and subscribed to, at

this

*10th*

day of

*February* 18*63*

BEFORE

I CERTIFY, ON HONOR, That I have carefully examined the above named Recruit, agreeably to the General Regulations  
of the Army, and that in my opinion he is free from all bodily defects and mental infirmity, which would, in any way, disqualify  
him from performing the duties of a soldier.

*Milton Chase*

EXAMINING SURGEON.

I CERTIFY, ON HONOR, That I have minutely inspected the Recruit, *Andrew Saundre*  
previously to his enlistment, and that he was entirely sober when enlisted; that, to the best of my judgement and belief, he is of  
lawful age; and that, in accepting him as duly qualified to perform the duties of an able-bodied soldier, I have strictly observed  
the Regulations which govern the recruiting service. This soldier has *Brown* eyes, *Dark* hair,  
*Dark* complexion; is *five* feet, *eight* inches high.

*J. Hygards 2nd Lieut. U.S. Army*

RECRUITING OFFICER.

1539  
Landry, John S.

Co M, 10 U.S. Col'd H. Art'y.

Private

Private

CARD NUMBERS.

1	5488850	26
2	5488958	27
3	5488002	28
4	5514347	29
5	5514499	30
6	5514727	31
7	5514898	32
8	5515257	33
9	5489850	34
10	9123688	35
11		36
12		37
13		38
14		39
15		40
16		41
17		42
18		43
19		44
20		45
21		46
22		47
23		48
24		49
25		50

Book Mark:

See also 77 U.S. C. Inf.

*L* | 10 H. Art'y. | U. S. C. T.

*John B Laundry*  
\_\_\_\_\_, Co. *M*, 10 Reg't U. S. Col'd H. Art'y.

Appears on

**Company Descriptive Book**

of the organization named above.

**DESCRIPTION.**

Age *27* years; height *5* feet *3* inches.

Complexion *Dark*

Eyes *Brown*; hair *Black*

Where born *Lafouche La*

Occupation *Laborer*

**ENLISTMENT.**

When *Feb 10*, 1863.

Where *New Orleans La*

By whom *St Drew*; term *3* y'rs.

Remarks: *Rec'd by transfer  
from Co A 77 W.S.C. Ia  
B.C. 66 2nd Div Dept La  
Sept 22, 1865. Discharged  
as honorably mustered out  
of service March 5, 1866  
by reason of expiration  
of term of service*

*W. M. Mallon*

C | 10th. Arty | **U.S.C.T.**

John B. Landrey  
Priv., Co. M, 10 Reg't U. S. Col'd 16. Arty

Appears on

**M. and D. Roll of Men Transferred**

to the organization named above,

from 77 U. S. Col'd. Inf.

Roll dated Oct. 1, 1865.

When enlisted Feb. 11, 1863.

Period for which enlisted 3 years.

When mustered in Mar. 6, 1863.

Present or absent Present

Company to which assigned M

Remarks: Joined at Orgl Orgin

Co. K. 4th A. Cav. New

York, N. Y., Heavensack,

Bed sack, Scales. 2 numbers,

Bugle, and Letter.

Book mark :

C. Chandler

L | 10 H. Artz. | **U.S.C.T.**

John B. Landry  
Priv., Co. M., 10 Reg't U. S. Col'd H. Artz.

Appears on

**M. and D. Roll of Men Transferred**

to the organization named above,

from 77<sup>th</sup> W. S. Col'd Inf'ty.

Roll dated Oct. 1, 1865.

When enlisted Feb. 11, 1863.

Period for which enlisted 3 years.

When mustered in March 6, 1863.

Present or absent Present.

Company to which assigned M.

Remarks: Joined at orig. orgn.

Co. K 4<sup>th</sup> C'd A. Lost

screw-driver, wiper,

haversack, scales,

letter, bugle, two numbers,

and bed sack.

Book mark:

(342)

Partuliny

Copyist.

L 1086A

U.S.C.T.

John B. Landrey  
Priv., Co. M, 10 Reg't U. S. Col'd Hill

Appears on

**M. and D. Roll of Men Transferred**

to the organization named above,

from 244 U. S. Col Inf

Roll dated Camp Anapetda Oct 1, 1865

When enlisted Feb 10, 1865

Period for which enlisted 3 years.

When mustered in March 6, 1865

Present or absent

Company to which assigned M

Remarks: joined at Orig

Order of Co K 4 "Call

Spl. Screw Driver

Wiper Haversack

pr Seaks Bed sack

Letter Bugle And 2

numbers Recd by

transfer from Co A

Book mark : (over)

Wheat Scott

L | **10 H. Art'y. | U.S.C.T.**

John B. Landry  
C, Co. M, 10 Reg't U. S. Col'd H. Art'y.

Age ..... years.

Appears on

**Company Muster Roll\***

for Sept - Oct, 1865.

Joined for duty and enrolled:

When Feb, 1863.

Where N Orleans

Period 3 years.

Mustered in:

When Feb 5, 1863.

Where N Orleans

Present or absent Present

Stoppage, \$ 100 for .....

Due Gov't, \$ 100 for Oct 16 48 5:20

Valuation of horse, \$ 100

Valuation of horse equipments, \$ 100

Remarks : .....

\*First current roll. No muster-in roll of this company on file.

Book mark : .....

(358b)

A. H. Wright

Copyist.

*L* | 10 H. Art'y. | U. S. C. T.

*John B Landsey*  
Co. M, 10 Reg't U. S. Col'd H. Art'y.

Appears on

**Company Muster Roll**

for *Nov Dec*, 1865:

Present or absent *Present*

Stoppage, \$ 100 for

Due Gov't, \$ 100 for *Ord*

*5.20* " *Co V G E*

Valuation of horse, \$ 100

Valuation of horse equipments, \$ 100

Remarks:

-----  
-----  
-----  
-----  
-----  
-----  
-----  
-----

Book mark:

-----

*J. H. Wright*



*L* | 10 H. Art'y. | U. S. C. T.

*John B Landry*  
P, Co. M, 10 Reg't U. S. Col'd H. Art'y.

Appears on

**Company Muster Roll**

for *Jan & Feb*, 186*6*.

Present or absent *Present*

Stoppage, \$ *100* for

Due Gov't, \$ *100* for

Valuation of horse, \$ *100*

Valuation of horse equipments, \$ *100*

Remarks:

Book mark: *Muster roll on file*

*W. H. Wright*

L | 10 H. Art'y. | U. S. C. T.

John B Landry  
pl, Co. M, 10 Reg't U. S. Col'd H. Art'y.

Appears on  
**Company Muster Roll**  
for March & Apr, 1866.

Present or absent \_\_\_\_\_  
Stoppage, \$ \_\_\_\_\_ 100 for \_\_\_\_\_

Due Gov't, \$ \_\_\_\_\_ 100 for \_\_\_\_\_

Valuation of horse, \$ \_\_\_\_\_ 100  
Valuation of horse equipments, \$ \_\_\_\_\_ 100

Remarks: Disch'd by reason of  
expiration of term of  
service

Book mark: Disch. Mar 5, 66 213  
15/99

W. H. Wright  
Copyist.

Lt | <sup>10</sup> *Hy Arty* | U.S.C.T.

*John B. Landry*  
Priv. Co. *M, 10* Reg't U. S. Col'd *Arty*

Appears on a

**Detachment Muster-out Roll**

of the organization named above. Roll dated

*New Orleans La, Mar. 5, 1866.*

Muster-out to date *Mar. 5, 1866.*

Last paid to *Dec. 31, 1865.*

**Clothing account:**

Last settled ..... 186 ; drawn since \$ ..... 100

Due soldier \$ *4* <sup>*00*</sup> / 100; due U. S. \$ ..... 100

Am't for cloth'g in kind or money adv'd \$ ..... 100

Due U. S. for arms, equipments, &c., \$ *1* / <sup>*5*</sup> 100

Bounty paid \$ *none* / 100 due \$ *none* / 100

Remarks: *Joined by transfer from 77th U. S. C. I. Oct. 1st. 1865 per S. O. No. 66 Hd. Qrs. Dept. of La. Sept. 22<sup>nd</sup> 1865. Stop for screw driver one pair private (over)*

Book mark: .....

*A. W. Reed*

JAN. 15

5489850

\* 1891 \*

*Shoulder scales and  
two great coat straps.*

2

10 H. Art'y. U.S.C.T.

John B. Landry

But., Co. M., 10 Reg't U. S. Col'd H. Art'y.

Appears on Co. Muster-out Roll, dated

Baton Rouge, La., Feb. 22, 1867.

Muster-out to date \_\_\_\_\_, 186 .

Last paid to \_\_\_\_\_, 186 .

Clothing account:

Last settled \_\_\_\_\_, 186 ; drawn since \$ \_\_\_\_\_ 100

Due soldier \$ \_\_\_\_\_ 100 ; due U. S. \$ \_\_\_\_\_ 100

Am't for cloth'g in kind or money adv'd \$ \_\_\_\_\_ 100

Due U. S. for arms, equipments, &c., \$ \_\_\_\_\_ 100

Bounty paid \$ \_\_\_\_\_ 100 ; due \$ \_\_\_\_\_ 100

Remarks: joined by trans. from Co. A  
77th Reg't for 10.66.65. Dis. Dept  
La. Sep 22/65 as But. Dischg by  
reason of Exp. of term of service  
Mar 5/66.

Book mark: V 52: P 1969.

Butler

1570  
Landry Richard

Co A, 10 U.S. Col'd H. Art'y.

Private | Private

CARD NUMBERS.

1	5-489130	26
2	5-492925	27
3	5-493224	28
4	5-493293	29
5	5-493502	30
6	5-493624	31
7	5-493701	32
8	5-493807	33
9	5-493866	34
10		35
11		36
12		37
13		38
14		39
15		40
16		41
17		42
18		43
19		44
20		45
21		46
22		47
23		48
24		49
25		50

Book Mark:

See also 75. U.S.C. 9

*L. Wash* **U.S.C.T.**  
*Richard Landry*  
*Pt.*, Co. ...., *10* Reg't U. S. Col'd *Wash*

Appears on

**M. and D. Roll of Men Transferred**

to the organization named above,

from *75 USA CD*

Roll dated *Nov 18*, 186*3*

When enlisted....., 186 .

Period for which enlisted *3* years.

When mustered in *Oct 4*, 186*4*.

Present or absent *Not stated*

Company to which assigned.....

Remarks: *Drafted 40*

*No 106 from Hd Qrs  
Dep't Gulf Aug 2/64  
Credited to N.O.  
Dues 10¢ for Camp  
Equipage \$ 2.03*

Book mark : .....

*J. A. Johnson*

*L* | 10 H. Art'y. | U.S.C.T.

*Richard Laundry*

*Pr*, Co. A, 10 Reg't U. S. Col'd H. Art'y.

Appears on

**Company Muster Roll**

for *Nov & Dec*, 1865.

Present or absent *Present*

Stoppage, \$ *100* for

Due Gov't, \$ *2* <sup>*63*</sup>/<sub>*100*</sub> for *Co & G. Equipage*  
*per transfer rolls*

Valuation of horse, \$ *100*

Valuation of horse equipments, \$ *100*

Remarks: *Transferred from 75 U.S.C.T.*  
*per S.O. 105 C.S. Hd qrs Dept of La.*

Book mark:

*Stymer*  
Copyist.



*L* | 10 H. Art'y. | U.S.C.T.

*Richard Laundry*

*Pl*, Co. A, 10 Reg't U. S. Col'd H. Art'y.

Appears on

**Company Muster Roll**

for

*Jan & Feb*, 186*6*.

Present or absent

*Present*

Stoppage, \$ 100 for

Due Gov't, \$ 100 for

Valuation of horse, \$ 100

Valuation of horse equipments, \$ 100

Remarks:

-----  
-----  
-----  
-----  
-----  
-----  
-----  
-----

Book mark:

-----

*Styer*  
Copyist.

*L* | 10 H. Art'y. | U.S.C.T.

*Richard Laundry*

*Plt*, Co. A, 10 Reg't U. S. Col'd H. Art'y.

Appears on

**Company Muster Roll**

for *Mar & Apr*, 186*6*.

Present or absent *Present*

Stoppage, \$ 100 for

Due Gov't, \$ 06 for *Ordnance*

*For Camp & Garrison Equipag 5¢*

Valuation of horse, \$ 100

Valuation of horse equipments, \$ 100

Remarks:

-----  
-----  
-----  
-----  
-----  
-----  
-----  
-----

Book mark:

-----

*Hyman*  
-----  
Copyist.

*S* | 10 H. Art'y. | U.S.C.T.  
Richard Laundry  
*Pf*, Co. A, 10 Reg't U. S. Col'd H. Art'y.

Appears on

Company Muster Roll

for *May & June, 1866*

Present or absent *Present*

Stoppage, \$ 100 for

Due Gov't, \$ 100 for

Valuation of horse, \$ 100

Valuation of horse equipments, \$ 100

Remarks:

Book mark:

*H. J. ...*  
Copyist.

*L* | 10 H. Art'y. | U.S.C.T.

*Richard Laundry*

*Prvt*, Co. A, 10 Reg't U. S. Col'd H. Art'y.

Appears on

**Company Muster Roll**

for *July & Aug*, 186*b*.

Present or absent *Present*

Stoppage, \$ *100* for

Due Gov't, \$ *100* for

Valuation of horse, \$ *100*

Valuation of horse equipments, \$ *100*

Remarks:

-----  
-----  
-----  
-----  
-----  
-----  
-----  
-----

Book mark: -----

-----

*Styus*

L | 10 H. Art'y. | U.S.C.T.

Richard Landry  
Pvt., Co. A, 10 Reg't U. S. Col'd H. Art'y.

Appears on

**Company Muster Roll**

for Sept & Oct, 1866.

Present or absent Present

Stoppage, \$ 100 for

Due Gov't, \$ 08/100 for Ordnance and  
Camp Garrison equipage

Valuation of horse, \$ 100

Valuation of horse equipments, \$ 100

Remarks: Stop for one Tompion

Book mark:

Nesbitt

L | 10 H. Art'y. | U.S.C.T.

Richard Sandy  
Pvt., Co. A, 10 Reg't U. S. Col'd H. Art'y.

Appears on

**Company Muster Roll**

for Nov & Dec, 1866.

Present or absent Present

Stoppage, \$ 100 for

Due Gov't, \$ 100 for

Valuation of horse, \$ 100

Valuation of horse equipments, \$ 100

Remarks:

Book mark:

Nesbitt

L | 10 H. Art'y. | U.S.C.T.

Richard Landry  
Pvt, Co. A., 10 Reg't U. S. Col'd H. Art'y.

Appears on Co. Muster-out Roll, dated  
Baton Rouge La., Feb. 22, 1867.  
Muster-out to date Feb. 22, 1867.  
Last paid to Dec. 31, 1866.

Clothing account:

Last settled \_\_\_\_\_, 186 ; drawn since \$ \_\_\_\_\_ 100

Due soldier \$ 44 <sup>71</sup>/<sub>100</sub>; due U. S. \$ \_\_\_\_\_ 100

Am't for cloth'g in kind or money adv'd \$ \_\_\_\_\_ 100

Due U. S. for arms, equipments, &c., \$ <sup>under A.O. 101</sup> 6 <sup>00</sup>/<sub>100</sub>

Bounty paid \$ \_\_\_\_\_ 100; due \$ 200 <sup>00</sup>/<sub>100</sub>

Remarks: Transfd. from 75 U.S. Co. I as Pvt. S.O.  
105 S of 65 Dept La.

Book mark : \_\_\_\_\_

Nesbitt

Copyist.

1541

Landry, Tom

Co. A, 10 U.S. Col'd H. Art'y.

Private

Private

CARD NUMBERS.

1	5-48 9131	26
2	5-49 2926	27
3	5-49 3223	28
4	5-49 3364	29
5	5-49 3503	30
6	5-49 3625	31
7	5-49 3702	32
8	5-49 3808	33
9	5-49 3867	34
10		35
11		36
12		37
13		38
14		39
15		40
16		41
17		42
18		43
19		44
20		45
21		46
22		47
23		48
24		49
25		50

Book Mark:

See also 75 W. S. C. 2.



S. 864700 - P.O. app

S. 111 9101 P.O. m m

D. 1285147 Prod W.D.

D. 1314530. and W.D.

R. 412 445 779.

S. P. Doughty

*S* *10th* ~~10th~~ **U.S.C.T.**

*Tom Landry*

*A*, Co., *10* Reg't U. S. Col'd *10th*

Appears on

**M. and D. Roll of Men Transferred**

to the organization named above,

from *73rd* *USA* *Col*

Roll dated *Nov 18*, 186*5*.

When enlisted....., 186 .

Period for which enlisted *3* years.

When mustered in *Oct 4*, 186*4*.

Present or absent *Not stated*

Company to which assigned.....

Remarks: *Drafted per G.O.*

*No 106 from Hd Qrs.*

*Dept. Gulf Aug 2/64*

*Credited to M. O.*

Book mark : .....

*J. A. Johnson*

*L* | 10 H. Art'y. | U.S.C.T.

*Tom Laundry*  
*Pl*, Co. A, 10 Reg't U. S. Col'd H. Art'y.

Appears on

**Company Muster Roll**

for *Nov + Dec*, 1865.

Present or absent *Present*

Stoppage, \$ 100 for

Due Gov't, \$ 100 for

Valuation of horse, \$ 100

Valuation of horse equipments, \$ 100

Remarks: *Transferred from 75, 21569  
per S.O. 105 C.S. It is also kept of*

Book mark:

*Stepes*

Copyist.

*L* | 10 H. Art'y. | U.S.C.T.

*Tom Landry*

*Pl*, Co. A, 10 Reg't U. S. Col'd H. Art'y.

Appears on

**Company Muster Roll**

for *Jan + Feb*, 186*6*.

Present or absent *Present*

Stoppage, \$ 100 for

Due Gov't, \$ 100 for

Valuation of horse, \$ 100

Valuation of horse equipments, \$ 100

Remarks:

Book mark:

*J. H. ...*

Copyist.

*L* | 10 H. Art'y. | U.S.C.T.

*Tom Laundry*

*Prvt*, Co. A, 10 Reg't U. S. Col'd H. Art'y.

Appears on

**Company Muster Roll**

for *Mar & Apr*, 186*b*.

Present or absent *Present*

Stoppage, \$ *100* for

Due Gov't, \$ *100* for

Valuation of horse, \$ *100*

Valuation of horse equipments, \$ *100*

Remarks:

Book mark:

*Hyman*  
Copyist.

*S* | 10 H. Art'y. | U.S.C.T.

*Tom Laundry*

*Plt*, Co. A, 10 Reg't U. S. Col'd H. Art'y.

Appears on

**Company Muster Roll**

for *May & June*, 186*6*

Present or absent *Present*

Stoppage, \$ 100 for

Due Gov't, \$ 100 for

Valuation of horse, \$ 100

Valuation of horse equipments, \$ 100

Remarks: \_\_\_\_\_  
\_\_\_\_\_  
\_\_\_\_\_  
\_\_\_\_\_  
\_\_\_\_\_  
\_\_\_\_\_

Book mark: \_\_\_\_\_

*Hym* Copyist.

*L* | 10 H. Art'y. | U.S.C.T.

*Tom Laundry*

*Plt*, Co. A, 10 Reg't U. S. Col'd H. Art'y.

Appears on

**Company Muster Roll**

for *July & Aug*, 186*6*.

Present or absent *Present*

Stoppage, \$ *100* for

Due Gov't, \$ *100* for

Valuation of horse, \$ *100*

Valuation of horse equipments, \$ *100*

Remarks:

-----  
-----  
-----  
-----  
-----  
-----  
-----  
-----

Book mark:

-----  
-----

*Hynes*

Copyist.

L | 10 H. Art'y. | U.S.C.T.

Tom Sandry

Pvt., Co. A, 10 Reg't U. S. Col'd H. Art'y.

Appears on

**Company Muster Roll**

for Sept & Oct, 1866.

Present or absent Present

Stoppage, \$ 100 for

Due Gov't, \$ 17 for Ordnance and  
Camp Garrison equipage

Valuation of horse, \$ 100

Valuation of horse equipments, \$ 100

Remarks: On daily duty as Co.  
Cook.

Stop for one cartridge box  
belt plate and one Tompion

Book mark:

Nesbitt

Copyist.



L | 10 H. Art'y. | U.S.C.T.

Tom Landry

Prk, Co. A, 10 Reg't U. S. Col'd H. Art'y.

Appears on

Company Muster Roll

for Nov & Dec, 1866.

Present or absent Present

Stoppage, \$ 100 for

Due Gov't, \$ 45 for camp and

Garrison equipage

Valuation of horse, \$ 100

Valuation of horse equipments, \$ 100

Remarks:

Book mark:

Nesbitt

L | 10 H. Art'y. | U.S.C.T.

*John Landry*  
Pvt, Co. A, 10 Reg't U. S. Col'd H. Art'y.

Appears on Co. Muster-out Roll, dated  
*Baton Rouge La, Feb. 22, 1867.*  
Muster-out to date *Feb. 22, 1867.*  
Last paid to *Dec. 31, 1866.*

Clothing account:

Last settled....., 186 ; drawn since \$.....<sup>100</sup>  
Due soldier \$ *54<sup>21</sup>*/<sub>100</sub>; due U. S. \$.....<sup>100</sup>  
Am't for cloth'g in kind or money adv'd \$.....<sup>100</sup>

Due U. S. for arms, equipments, &c., \$.....<sup>100</sup> *Under G.O. 101 6<sup>00</sup>*

Bounty paid \$.....<sup>100</sup>; due \$.....<sup>100</sup> *200<sup>00</sup>*

Remarks: *Transfd. from 75 U.S.C. as Pvt.  
S.O. 105-8 of 65 Dept La.*

Book mark : .....

*Nesbitt*

Copyist.

542  
Lane, Edmore

Co A, 10 U.S. Col'd H. Art'y.

Private | Private

CARD NUMBERS.

1	5-489138	26
2	5-492927	27
3	5-493225	28
4	5-493365	29
5	5-493504	30
6	5-493626	31
7	5-493751	32
8	5-494016	33
9	5-490071	34
10		35
11		36
12		37
12		38
14		39
15		40
16		41
17		42
18		43
19		44
20		45
21		46
22		47
23		48
24		49
25		50

Book Mark:

See also 75 used

*L. W. Hart* U.S.C.T.

*Admiral Lane*  
*H.*, Co., *10* Reg't U. S. Col'd *Hart*

Appears on

**M. and D. Roll of Men Transferred**

to the organization named above,

from *73 USCI*

Roll dated *Nov 18*, 186*6*.

When enlisted *Aug 10*, 186*3*.

Period for which enlisted *3* years.

When mustered in *Sep 24*, 186*3*.

Present or absent

Company to which assigned

Remarks: *See US for C*

*4133 Transferred from*  
*88 USI Aug 13/64 per*  
*SO No 209 S 1864 Sept*  
*Gulf.*

Book mark :

*J. A. Johnson*

*L* | 10 H. Art'y. | U.S.C.T.

*Edmore Lane*

*Plt*, Co. A, 10 Reg't U. S. Col'd H. Art'y.

Appears on

Company Muster Roll

for *Nov & Dec*, 1865.

Present or absent *Present*

Stoppage, \$ 100 for

Due Gov't, \$ *1* <sup>*33*</sup>/<sub>*100*</sub> for *C & G. Equipage,*  
*per transfer rolls.*

Valuation of horse, \$ 100

Valuation of horse equipments, \$ 100

Remarks: *Transferred from 75. 21869*  
*per S.O. 105 C.S. Hd Qrs Dept of War*

Book mark: \_\_\_\_\_

*L* | 10 H. Art'y. | U.S.C.T.

*Edmore Lane*

*Pl*, Co. A, 10 Reg't U. S. Col'd H. Art'y.

Appears on

**Company Muster Roll**

for *Jan & Feb*, 186*6*.

Present or absent *Present*

Stoppage, \$.....100 for.....

Due Gov't, \$.....100 for.....

Valuation of horse, \$.....100

Valuation of horse equipments, \$.....100

Remarks:.....

Book mark:.....

*L* | 10 H. Art'y. | U.S.C.T.

*Edmore Lane*

*PT*, Co. A, 10 Reg't U. S. Col'd H. Art'y.

Appears on

Company Muster Roll

for *Mar + Apr.*, 186*6*.

Present or absent *Present*

Stoppage, \$ *100* for

Due Gov't, \$ *100* for

Valuation of horse, \$ *100*

Valuation of horse equipments, \$ *100*

Remarks: \_\_\_\_\_  
\_\_\_\_\_  
\_\_\_\_\_  
\_\_\_\_\_  
\_\_\_\_\_  
\_\_\_\_\_

Book mark: \_\_\_\_\_

*Hyn*  
Copyist.

*L* | 10 H. Art'y. | U.S.C.T.

*Edmore Lane*

*Pl*, Co. A, 10 Reg't U. S. Col'd H. Art'y.

Appears on

**Company Muster Roll**

for *May & June, 1866*

Present or absent *Present*

Stoppage, \$ 100 for

Due Gov't, \$ 100 for

Valuation of horse, \$ 100

Valuation of horse equipments, \$ 100

Remarks:

Book mark:

*W. H. ...*



L | 10 H. Art'y. | **U.S.C.T.**

Edmon Lane  
Rh, Co. A, 10 Reg't U. S. Col'd H. Art'y.

Appears on

**Company Muster Roll**

for July & Aug, 1866

Present or absent Present

Stoppage, \$ 100 for

Due Gov't, \$ 100 for

Valuation of horse, \$ 100

Valuation of horse equipments, \$ 100

Remarks:

Book mark:

Hyman  
Copyist.

L | 10 H. Art'y. | U.S.C.T.

Edmore Lane

Pvt., Co. A, 10 Reg't U. S. Col'd H. Art'y.

Appears on

Company Muster Roll

for Sept & Oct, 1866.

Present or absent

Stoppage, \$ 100 for

Due Gov't, \$ 100 for

Valuation of horse, \$ 100

Valuation of horse equipments, \$ 100

Remarks: Note of discharge mustered  
out Sept 23/66 by reason of expiration  
of term of service

Paid \$100.00 bounty

Book mark:

Nesbitt

Copyist.

L | 75 | U.S.C.T.

Edmund Lane.

Pr., Co. G., 75 Reg't U. S. Colored Inf.

Appears on Returns as follows:

Aug. 1864 - Gain: By  
transfer Aug 13-64  
Morganza. Transfd  
from 88. U.S.C.I. per  
S.O. No. 209 dated  
Hd. Qrs. Dept. of the  
Gulf Aug. 5-1864.

Oct 1864. On duty.  
Provoost duty.

Dec 1864 - Absent on  
Provoost duty since  
Oct 13/64.

Jan 1865. Absent on  
Pro. duty per S.O. 82  
dated Hd. Qrs. No.  
Horses Morganza  
La. Oct 13/64.

Book mark:

H. H. Ellis  
Copyist.

L | 10 H. Art'y. | U.S.C.T.

Edmore Lane  
Pvt, Co. A, 10 Reg't U. S. Col'd H. Art'y.

Appears on Returns as follows:

Sept-1866 Absent- On Det Ser  
for Muster Out per SO  
167 Adgns Fort Jackson  
and St-Philip's

Oct-1866 Loss Sept-23/66  
New Orleans La Discharge  
Expiration of Term of Service

Book mark:

Alley  
Copyist.

L 10 Artz U.S.C.T.

Edmond Lauer

Orin, Co. A, 10 Reg't U. S. Col'd Artz

Appears on a

**Detachment Muster-out Roll**

of the organization named above. Roll dated

New Orleans La Sept 24, 1866.

Muster-out to date Sept 23, 1866.

Last paid to June 30, 1866

**Clothing account:**

Last settled ..... 186 ; drawn since \$ ..... 100

Due soldier \$ 16<sup>05</sup>/<sub>100</sub>; due U. S. \$ ..... 100

Am't for cloth'g in kind or money adv'd \$ ..... 100

Due U. S. for arms, equipments, &c., \$ 1<sup>00</sup>/<sub>100</sub>

Bounty paid \$ ..... 100 due \$ 100<sup>00</sup>/<sub>100</sub>

Remarks: joined orig org 88 USC Inf  
transferred to 75 USC 10209  
Jan 12 series of 1864 Dept of  
Ist. Transferred to 10 USC (H)  
Jan 12 series of 1865 Dept of  
La. Stop for Haverman,

Book mark: .....

Edmond Lauer

L | 10 H. Art'y. | U.S.C.T.

Edmore Lane

Pvt, Co. A, 10 Reg't U. S. Col'd H. Art'y.

Appears on Co. Muster-out Roll, dated  
Baton Rouge La, Feb 22, 1867.

Muster-out to date \_\_\_\_\_, 186 .

Last paid to \_\_\_\_\_, 186 .

Clothing account:

Last settled \_\_\_\_\_, 186 ; drawn since \$ \_\_\_\_\_ 100

Due soldier \$ \_\_\_\_\_ 100; due U. S. \$ \_\_\_\_\_ 100

Am't for cloth'g in kind or money adv'd \$ \_\_\_\_\_ 100

Due U. S. for arms, equipments, &c., \$ \_\_\_\_\_ 100

Bounty paid \$ \_\_\_\_\_ 100; due \$ \_\_\_\_\_ 100

Remarks: Transfd. from 75. U.S.C.T. as  
Pvt. S. O. 105 S of 65 Dept. La  
Dischd. for expen. of term of  
service Sept. 23/66

Book mark: V95 P. 95. 68

Nesbitt

JAN. 15

5490071

\* 1891 \*

1 Tompion. M.O. by reason  
of expiration of term  
of service.

1543  
Lang, Samuel

Co D, 10 U.S. Col'd H. Art'y.

Private

CARD NUMBERS.

1	26
2	27
3 See Sorey	28 Samuel
4	29
5	30
6	31
7	32
8	33
9	34
10	35
11	36
12	37
13	38
14	39
15	40
16	41
17	42
18	43
19	44
20	45
21	46
22	47
23	48
24	49
25	50

Book Mark:

See also



1544  
Lamm, Nora

Co M, 10 U.S. Col'd H. Art'y.

Private

CARD NUMBERS.

1	5488898	26
2	5489006	27
3		28
4		29
5		30
6		31
7		32
8		33
9		34
10		35
11		36
12		37
13		38
14		39
15		40
16		41
17		42
18		43
19		44
20		45
21		46
22		47
23		48
24		49
25		50

Book Mark:

See also 77. u. s. c. inf

L | 10<sup>th</sup> H. Arty | **U.S.C.T.**

Arona Leonos  
Priv. Co. 10 Reg't U. S. Col'd H. Arty

Appears on

**M. and D. Roll of Men Transferred**

to the organization named above,

from 77<sup>th</sup> U. S. Col'd Inf.

Roll dated Oct. 1, 1865.

When enlisted Feb. 21, 1863.

Period for which enlisted 3 years.

When mustered in Mar. 6, 1863.

Present or absent

Company to which assigned

Remarks: died at New Orleans

La. April 11/65. Final  
Statement rendered.

N. A. on rolls C. M.

Book mark:

Chandler

L | 10 H. Artz | **U.S.C.T.**

Nora Larso

Artz, Co. ...., 10 Reg't U. S. Col'd H. Artz

Appears on

**M. and D. Roll of Men Transferred**

to the organization named above,

from 77<sup>th</sup> U. S. Col'd Inftry.

Roll dated Oct. 1, 1863.

When enlisted Feb. 21, 1863.

Period for which enlisted 3 years.

When mustered in March 6, 1863.

Present or absent

Company to which assigned

Remarks: Died at New Orleans

La. April 11/65. Final  
Statements rendered.

Book mark:

77<sup>th</sup> U. S. Col'd Inftry

2880002

Cartelung

1545  
Lapine, Jules

Co D, 10 U.S. Col'd H. Art'y.

Private

Private

CARD NUMBERS.

1	5-5-11 257	26
2	5-5-11 349	27
3	5-5-11 436	28
4	5-5-11 549	29
5	5-5-11 680	30
6	5-5-11 848	31
7	5-5-12 139	32
8	5-4-89987	33
9		34
10		35
11		36
12		37
13		38
14		39
15		40
16		41
17		42
18		43
19		44
20		45
21		46
22		47
23		48
24		49
25		50

Book Mark:

See also

S 811851 - Ro90  
D. 1031063 P.O. m.m.  
A 1296415 P.O. off/b

S. S. Douglas

L. | 10 H. Art'y. | U.S.C.T.

Julius Lapine  
Cpt., Co. D, 10 Reg't U. S. Col'd H. Art'y.

Age 42 years.

Appears on

Company Muster Roll\*

for Enrollment to June 30, 1865.

Joined for duty and enrolled:

When \_\_\_\_\_, 1865.

Where \_\_\_\_\_

Period 1 years.

Mustered in:

When Apr. 24, 1865.

Where New Orleans, La.

Present or absent Present.

Stoppage, \$ 100 for \_\_\_\_\_

Due Gov't, \$ 100 for \_\_\_\_\_

Valuation of horse, \$ 100

Valuation of horse equipments, \$ 100

Remarks: Drafted. Commencement of first

\*First current roll. No muster-in roll of this company on file.

Book mark: \_\_\_\_\_

O. J. Clark

JAN. 18

5511257

1891

*payment by time*

*Apr. 24, 65.*

*L.* | **10 H. Art'y.** | **U.S.C.T.**

*Jules Lapine*

*Prvt.*, Co. I, 10 Reg't U. S. Col'd H. Art'y.

Appears on

**Company Muster Roll**

for *July + Aug.*, 186*5*.

Present or absent *Present*

Stoppage, \$ *100* for

Due Gov't, \$ *100* for

Valuation of horse, \$ *100*

Valuation of horse equipments, \$ *100*

Remarks:

Book mark:

*A. S. Clark*



*L.* | **10 H. Art'y.** | **U.S.C.T.**

*Jules Lapine*  
-----  
*Priv.*, Co. I, 10 Reg't U. S. Col'd H. Art'y.

Appears on

**Company Muster Roll**

for *Sept. 10th.*, 186*5*.

Present or absent *Present*

Stoppage, \$ 100 for

Due Gov't, \$ 100 for

Valuation of horse, \$ 100

Valuation of horse equipments, \$ 100

Remarks: -----  
-----  
-----  
-----  
-----  
-----  
-----  
-----  
-----  
-----

Book mark: -----  
-----

L. | 10 H. Art'y. | U.S.C.T.

*Jules Lapine*

*Priv.*, Co. I, 10 Reg't U. S. Col'd H. Art'y.

Appears on

**Company Muster Roll**

for *Nov. & Dec.*, 1865.

Present or absent *Present*

Stoppage, \$ 100 for

Due Gov't, \$ 100 for

Valuation of horse, \$ 100

Valuation of horse equipments, \$ 100

Remarks:

FROM SECOND AUDITOR'S ROLL.

Book mark:

*O. S. LeLark*

L. | 10 H. Art'y. | **U.S.C.T.**

*Jules Lapine*

*Prk.*, Co. I, 10 Reg't U. S. Col'd H. Art'y.

Appears on

**Company Muster Roll**

for *Jan. & Feb.*, 1866.

Present or absent *Present*

Stoppage, \$ 100 for

Due Gov't, \$ 100 for

Valuation of horse, \$ 100

Valuation of horse equipments, \$ 100

Remarks:

Book mark:

*O. S. Clark*

Copyist.

L. | 10 H. Art'y. | U.S.C.T.

Jules Lapine

Plt., Co. I, 10 Reg't U. S. Col'd H. Art'y.

Appears on

Company Muster Roll

for Nov. & Apr., 1866.

Present or absent

Stoppage, \$ 100 for

Due Gov't, \$ 100 for

Valuation of horse, \$ 100

Valuation of horse equipments, \$ 100

Remarks: Discharged. Mustered out by reason of expiration of term of service to date Apr. 23, 1866.

Book mark: Mustered out on file.

O. S. Clark

Copyist.

L. 10 Arty | **U.S.C.T.**

Jules Lapine  
Priv., Co. I, 10 Reg't U. S. Col'd Arty

Appears on a

**Detachment Muster-out Roll**

of the organization named above. Roll dated

New Orleans, La., Apr. 23, 1866.

Muster-out to date Apr. 23, 1866.

Last paid to Feb. 28, 1866.

**Clothing account:**

Last settled \_\_\_\_\_, 1866 ; drawn since \$ \_\_\_\_\_  $\frac{100}{100}$

Due soldier \$ 21<sup>28</sup>/100; due U. S. \$ \_\_\_\_\_  $\frac{100}{100}$

Am't for cloth'g in kind or money adv'd \$ \_\_\_\_\_  $\frac{100}{100}$

Due U. S. for arms, equipments, &c., \$ \_\_\_\_\_  $\frac{18}{100}$

Bounty paid \$ \_\_\_\_\_  $\frac{100}{100}$  due \$ \_\_\_\_\_  $\frac{100}{100}$

Remarks: Discharged by draft. Stop for

one Temp. 12¢ one Gun

slung 16¢ total 18cts

Book mark: \_\_\_\_\_

R. E. Wilson

*S* | **10 H. Art'y. | U.S.C.T.**

*Jules Sapme*

*Pvt*, Co. *I*, 10 Reg't U. S. Col'd H. Art'y.

Appears on **Co. Muster-out Roll**, dated  
*Baton Rouge La Feb 22*, 1867.

Muster-out to date \_\_\_\_\_, 186 .

Last paid to \_\_\_\_\_, 186 .

Clothing account:

Last settled \_\_\_\_\_, 186 ; drawn since \$ \_\_\_\_\_ 100

Due soldier \$ \_\_\_\_\_ 100; due U. S. \$ \_\_\_\_\_ 100

Am't for cloth'g in kind or money adv'd \$ \_\_\_\_\_ 100

Due U. S. for arms, equipments, &c., \$ \_\_\_\_\_ 100

Bounty paid \$ \_\_\_\_\_ 100; due \$ \_\_\_\_\_ 100

Remarks: *Discharged expiration*  
*term of service April 23, 1866*

Book mark : \_\_\_\_\_

(361) *J. M. Hance* Copyist.

1546  
Lasana, William

Co I, 10 U.S. Col'd H. Art'y.

Private | Corporal

CARD NUMBERS.

1	5488580	26
2	5511551	27
3	5511682	28
4	5511791	29
5	5511873	30
6	5511966	31
7	5512081	32
8		33
9		34
10		35
11		36
12		37
13		38
14		39
15		40
16		41
17		42
18		43
19		44
20		45
21		46
22		47
23		48
24		49
25		50

Book Mark:

See also 74. U.S.C. Inf.

L 10 A. U. S. C. T.

William Lasana  
Pvt, Co. ...., 10 Reg't U. S. Col'd St. Astor

Appears on

**M. and D. Roll of Men Transferred**

to the organization named above,

from Co. G 7th U.S. Cal. Inf.

Roll dated New Orleans, La Oct 11, 1865.

When enlisted Feby 8, 1865.

Period for which enlisted 3 years.

When mustered in Feby 18, 1865.

Present or absent Present

Company to which assigned

Remarks: Joined Co "G" 7th U.S. Cal. Inf. as a recruit

Book mark :

T. W. Jones, Jr  
Copyist.



L. | 10 H. Art'y. | U.S.C.T.

*William Lasanna*

*Pvt.*, Co. I, 10 Reg't U. S. Col'd H. Art'y.

Appears on

**Company Muster Roll**

for *Nov. & Dec.*, 1865

Present or absent *Present*

Stoppage, \$ *100* for

Due Gov't, \$ *100* for

Valuation of horse, \$ *100*

Valuation of horse equipments, \$ *100*

Remarks: *Transferred from  
74 U.S.C.I. per S.O. No.  
84 Hd. Qrs. Dept  
of La. Oct. 11, 1865.*

FROM SECOND AUDITOR'S ROLL.

Book mark:

*O. J. Lelark*

L. | 10 H. Art'y. | U.S.C.T.

William Lasanna  
Pvt., Co. I, 10 Reg't U. S. Col'd H. Art'y.

Appears on

**Company Muster Roll**

for Jan. + Feb., 1866.

Present or absent Present

Stoppage, \$ 100 for

Due Gov't, \$ 100 for

Valuation of horse, \$ 100

Valuation of horse equipments, \$ 100

Remarks: Sick in Quarters

Book mark:

O. J. Leant

*L.* | 10 H. Art'y. | U.S.C.T.

*William Lasana*

*Plt.*, Co. I, 10 Reg't U. S. Col'd H. Art'y.

Appears on

**Company Muster Roll**

for *March & Apr.*, 1866.

Present or absent *Present*

Stoppage, \$ *100* for

Due Gov't, \$ *100* for

Valuation of horse, \$ *100*

Valuation of horse equipments, \$ *100*

Remarks:

Book mark:

*O. S. Clark*

L.

10 H. Art'y.

U.S.C.T.

William Lasana

Corpl, Co. I, 10 Reg't U. S. Col'd H. Art'y.

Appears on

Company Muster Roll

for May & June, 1866.

Present or absent Present

Stoppage, \$ 100 for

Due Gov't, \$ 100 for

Valuation of horse, \$ 100

Valuation of horse equipments, \$ 100

Remarks: Appointed Corp'l to date May 15-66. per S.O. No. 12 Hd. Qrs. Regt. June 10, 1866.

Book mark:

A. S. Clark

Copyist.

*L* | 10 H. Art'y. | U.S.C.T.

*William Lasana*

*Cop*, Co. I, 10 Reg't U. S. Col'd H. Art'y.

Appears on

**Company Muster Roll**

for *July & Aug*, 1866.

Present or absent

Stoppage, \$ 100 for

Due Gov't, \$ 100 for

Valuation of horse, \$ 100

Valuation of horse equipments, \$ 100

Remarks: *Discharged to date Aug 24, 1866. to re-enlist in 39th U.S. Infy.*

Book mark:

*J. M. Hance*

Copyist.

*L* 10 H. Art'y. | U.S.C.T.

*William Sasana*  
Cmpt, Co. *I*, 10 Reg't U. S. Col'd H. Art'y.

Appears on Co. Muster-out Roll, dated  
*Baton Rouge La, Feb 22*, 1867.

Muster-out to date \_\_\_\_\_, 186 .

Last paid to \_\_\_\_\_, 186 .

Clothing account:

Last settled \_\_\_\_\_, 186 ; drawn since \$ \_\_\_\_\_ 100

Due soldier \$ \_\_\_\_\_ 100; due U. S. \$ \_\_\_\_\_ 100

Am't for cloth'g in kind or money adv'd \$ \_\_\_\_\_ 100

Due U. S. for arms, equipments, &c., \$ \_\_\_\_\_ 100

Bounty paid \$ \_\_\_\_\_ 100; due \$ \_\_\_\_\_ 100

Remarks: *Discharged to enlist*  
*in 39" U.S. Inf Aug 24 1866*  
*Final Statements given*

Book mark: *V 172. P. 205. 73*

*J. McHance*

1547  
La Strappi, Steven

Co—, 10 U.S. Col'd H. Art'y.

Private | —

CARD NUMBERS.

1	5487593	26
2		27
3		28
4		29
5		30
6		31
7		32
8		33
9		34
10		35
11		36
12		37
13		38
14		39
15		40
16		41
17		42
18		43
19		44
20		45
21		46
22		47
23		48
24		49
25		50

Book Mark:

See also 77.2.5. C. Inf.

L 1086A, U.S.C.T.

Estime Lastrappig  
Pot, Co., 10 Reg't U. S. Col'd

Appears on

**M. and D. Roll of Men Transferred**

to the organization named above,

from Co. G, 4th U. S. Col Inf

Roll dated Camp Ampetda Cal, 1865

When enlisted, 1865

Period for which enlisted 3 years.

When mustered in Sept 1, 1865

Present or absent

Company to which assigned

Remarks: Discharged at  
New Orleans La July 15  
65. Disability. Final  
statements given (Opta)

Not on muster rolls Regt

Book mark :

W. H. Scott



1548  
Larkins, Travis

Co. C, 10 U.S. Col'd H. Art'y.

Private | Private

CARD NUMBERS.

1	5487236	26
2	5498552	27
3	5498693	28
4	5498832	29
5	5498969	30
6	5499110	31
7	5499246	32
8	5499383	33
9	5499517	34
10	5499652	35
11	5499788	36
12	5499923	37
13	5500053	38
14	5500188	39
15	5500317	40
16	5500388	41
17		42
18		43
19		44
20		45
21		46
22		47
23		48
24		49
25		50

Book Mark:

See also:

1307399 - P.O. M+M

Hds. checked - 4/16/40 - HLL

S.S. Smyth

2

*L* | 10 H. Art'y. | U.S.C.T.

*Favis Perkins*

Appears with rank of *Priv* on

**Muster and Descriptive Roll of a Detachment of U. S. Vols. forwarded**

for the *10* Reg't *USCA City* Roll dated  
*New Orleans La, Sept 19, 1864.*

Where born *New Orleans La*

Age *20* y'rs; occupation *Labourer*

When enlisted *Aug 15, 1864.*

Where enlisted *New Orleans La*

For what period enlisted *3* years.

Eyes *Black*; hair *Black*

Complexion *Dark*; height *5-8* in.

When mustered in *Sept 19, 1864.*

Where mustered in *New Orleans*

Bounty paid \$ *100*; due \$ *300* *100*

Where credited *to New Orleans La*

Company to which assigned *C*

Remarks:

Book mark:

*J. W. Williams*

L | 10 H. Art'y. | U.S.C.T.

Francis Larkins  
Pot., Co. C, 10 Reg't U. S. Col'd H. Art'y.

Appears on

**Company Muster Roll**

for Sept 20th, 1864.

Present or absent Present

Stoppage, \$ 100 for

Due Gov't, \$ 100 for

Valuation of horse, \$ 100

Valuation of horse equipments, \$ 100

Remarks: \$ 300 Bounty due

Book mark:

J. Hudson  
Copyist.

*L* | **10 H. Art'y. | U.S.C.T.**

*James Larkins*

*Pvt.*, Co. C, 10 Reg't U. S. Col'd H. Art'y.

Appears on

**Company Muster Roll**

for *Nov & Dec*, 186*4*.

Present or absent *Present*

Stoppage, \$.....100 for .....

Due Gov't, \$.....100 for .....

Valuation of horse, \$.....100

Valuation of horse equipments, \$.....100

Remarks: *\$300 Bounty due  
Sick in Hospital*

Book mark: *20590*

*J. H. [Signature]*

L | 10 H. Art'y. | **U.S.C.T.**

Travis Larkin  
Co. C, 10 Reg't U. S. Col'd H. Art'y.

Appears on

**Company Muster Roll**

for Jan & Feb, 1865.

Present or absent Present

Stoppage, \$ 100 for

Due Gov't, \$ 100 for

Valuation of horse, \$ 100

Valuation of horse equipments, \$ 100

Remarks:

Book mark:

Dallade

L | 10 H. Art'y. | U.S.C.T.

Travis Larkins  
Lieut., Co. C, 10 Reg't U. S. Col'd H. Art'y.

Appears on

**Company Muster Roll**

for *March & April*, 1865.

Present or absent *Present*

Stoppage, \$ 100 for

Due Gov't, \$ 100 for

Valuation of horse, \$ 100

Valuation of horse equipments, \$ 100

Remarks:

Book mark: *1000*

*Lamb*

L | 10 H. Art'y. | U.S.C.T.

Travis Larkins  
Pat, Co. C, 10 Reg't U. S. Col'd H. Art'y.

Appears on

**Company Muster Roll**

for *May & June*, 1865.

Present or absent *Present*

Stoppage, \$ 100 for

Due Gov't, \$ 100 for

Valuation of horse, \$ 100

Valuation of horse equipments, \$ 100

Remarks:

Book mark:

*Sallade*



4 | 10 H. Art'y. | U.S.C.T.

Travis Larkin  
vt., Co. C, 10 Reg't U. S. Col'd H. Art'y.

Appears on

**Company Muster Roll**

for July & Aug., 1865

Present or absent Present

Stoppage, \$ 100 for \_\_\_\_\_

Due Gov't, \$ 100 for \_\_\_\_\_

Valuation of horse, \$ 100

Valuation of horse equipments, \$ 100

Remarks: \$200. Bounty due \$140. paid

Book mark: \_\_\_\_\_

Callade

*L* | **10 H. Art'y. U.S.C.T.**

*Travis Larkins*  
*Sgt.*, Co. C, 10 Reg't U. S. Col'd H. Art'y.

Appears on

**Company Muster Roll**

for *Sept & Oct*, 186*5*.

Present or absent *Present*

Stoppage, \$ *100* for

Due Gov't, \$ *100* for

Valuation of horse, \$ *100*

Valuation of horse equipments, \$ *100*

Remarks:

Book mark:

*Ballade*

*L* | 10 H. Art'y. | U.S.C.T.

*Travis Larkins*  
*Pvt*, Co. C, 10 Reg't U. S. Col'd H. Art'y.

Appears on

**Company Muster Roll**

for *Nov & Dec*, 1865.

Present or absent *Present*

Stoppage, \$ 100 for

Due Gov't, \$ 100 for

Valuation of horse, \$ 100

Valuation of horse equipments, \$ 100

Remarks:  
\_\_\_\_\_  
\_\_\_\_\_  
\_\_\_\_\_  
\_\_\_\_\_  
\_\_\_\_\_  
\_\_\_\_\_

Book mark: \_\_\_\_\_

*A. J. Robbins*  
Copyist.

L | 10 H. Art'y. | U.S.C.T.

Gravis Larkins

Pvt., Co. C, 10 Reg't U. S. Col'd H. Art'y.

Appears on

**Company Muster Roll**

for Jan. & Feb., 1866.

Present or absent Present

Stoppage, \$ 100 for

Due Gov't, \$ 100 for

Valuation of horse, \$ 100

Valuation of horse equipments, \$ 100

Remarks: \$100 bounty paid

\$200 due

Book mark:

A. J. Robbins

L | 10 H. Art'y. | U.S.C.T.

Travis Larkins

Priv., Co. C, 10 Reg't U. S. Col'd H. Art'y.

Appears on

Company Muster Roll

for March & April, 1866.

Present or absent Present

Stoppage, \$ 100 for

Due Gov't, \$ 100 for

Valuation of horse, \$ 100

Valuation of horse equipments, \$ 100

Remarks: Due U.S. for Loss  
of rifle wrench \$25

Book mark:

A. J. Robbins

L | 10 H. Art'y. | U.S.C.T.

Travis Larkins

Priv., Co. C, 10 Reg't U. S. Col'd H. Art'y.

Appears on

**Company Muster Roll**

for May 2d June, 1866.

Present or absent Present

Stoppage, \$ 100 for

Due Gov't, \$ 100 for

Valuation of horse, \$ 100

Valuation of horse equipments, \$ 100

Remarks \$200 bounty paid, \$100 to be paid.

Book mark: \_\_\_\_\_

A. J. Robbins  
Copyist.

L | **10 H. Art'y. | U.S.C.T.**

David Larkin

Pvt., Co. C, 10 Reg't U. S. Col'd H. Art'y.

Appears on

**Company Muster Roll**

for July & Aug., 1866

Present or absent Present

Stoppage, \$ 100 for

Due Gov't, \$ 100 for

Valuation of horse, \$ 100

Valuation of horse equipments, \$ 100

Remarks: \_\_\_\_\_  
\_\_\_\_\_  
\_\_\_\_\_  
\_\_\_\_\_  
\_\_\_\_\_  
\_\_\_\_\_

Book mark: \_\_\_\_\_

A. J. Robbins

*L* | 10 H. Art'y. | U.S.C.T.

*Francis Larkin*  
*Pr*, Co. C, 10 Reg't U. S. Col'd H. Art'y.

Appears on

**Company Muster Roll**

for *Sept & Oct*, 186*6*.

Present or absent *Present*

Stoppage, \$.....*100* for .....

Due Gov't, \$.....*100* for .....

Valuation of horse, \$.....*100*

Valuation of horse equipments, \$.....*100*

Remarks: .....

Book mark: .....

*Hammond*  
Copyist.



*L* | 10 H. Art'y. | U.S.C.T.

*Francis Larkine*  
*Pvt*, Co. C, 10 Reg't U. S. Col'd H. Art'y.

Appears on

**Company Muster Roll**

for *Nov & Dec*, 186*6*.

Present or absent *Present*

Stoppage, \$ *100* for

Due Gov't, \$ *100* for

Valuation of horse, \$ *100*

Valuation of horse equipments, \$ *100*

Remarks: *Due U.S. for  
loss of Canteen  
& Haversack \$1.30*

Book mark: \_\_\_\_\_

*Hammer*

L | 10 H. Art'y. | U.S.C.T.

James Larkins,  
Pvt., Co. C, 10 Reg't U. S. Col'd H. Art'y.

Appears on Co. Muster-out Roll, dated  
Baton Rouge, La., Feb 22, 1867.

Muster-out to date Feb 22, 1867.

Last paid to Dec 31, 1866.

Clothing account:

Last settled \_\_\_\_\_, 186 ; drawn since \$ \_\_\_\_\_ 100

Due soldier \$ 21 <sup>45</sup> / 100; due U. S. \$ \_\_\_\_\_ 100

Am't for cloth'g in kind or money adv'd \$ \_\_\_\_\_ 100

Due U. S. for arms, equipments, &c., \$ 6 <sup>46</sup> / 100

Bounty paid \$ 200 / 100; due \$ \_\_\_\_\_ 100

Remarks: Joined as recruit stop  
for screw driver and  
Cone wrench stop  
for one Enfield Rifle MKC  
& acc'ts retained

Book mark: \_\_\_\_\_

Manning  
Copyist.

1549  
Larmah, John

Col, 10 U.S. Col'd H. Art'y.

Private | Private

CARD NUMBERS.

1 5497616	26
2 5497860	27
3 5498018	28
4	29
5	30
6	31
7	32
8	33
9	34
10	35
11	36
12	37
13	38
14	39
15	40
16	41
17	42
18	43
19	44
20	45
21	46
22	47
23	48
24	49
25	50

Book Mark: A. 33 - U. S. R. C. S. 1867.

See also

*L* | 10 H. Art'y. | U.S.C.T.

*John Larmack*  
.....  
*Priv.*, Co. C, 1 Reg't H. Art'y, Corps d'Afrique.\*

Age *28* years.

Appears on

**Company Muster-in Roll**

of the organization named above. Roll dated

.....  
*New Orleans La, Aug 17, 1863.*

Muster-in to date *Aug 17, 1863.*

Joined for duty and enrolled:

When *June 27, 1863.*

Where *Camp Parapet - La*

Period *3* years.

Valuation of horse, \$.....100

Valuation of horse equipments, \$.....100

Remarks:.....  
.....  
.....  
.....

\* This organization subsequently became Co. C, 10 Reg't U. S. Colored Heavy Artillery.

Book mark:.....  
.....

*W. J. ...*

*L* | 10 H. Art'y. | U.S.C.T.

*John Larmack*  
*M*, Co, C, 1 Reg't La. Art'y Native Guards.\*

Appears on

Company Muster Roll

for *Aug 11<sup>th</sup> to 31<sup>st</sup>, 1863*

Present or absent

*Present*

Stoppage, \$ 100 for

Due Gov't, \$ 100 for

Valuation of horse, \$ 100

Valuation of horse equipments, \$ 100

Remarks:

\* This organization subsequently became Co. C, 10 Reg't U. S. Col'd Heavy Artillery.

Book mark:

*L* | **10 H. Art'y. U.S.C.T.**

*Pl.* *John Lammah*  
Co, C, 1 Reg't La. Art'y Native Guards.\*

Appears on

**Company Muster Roll**

for *Sept and Oct., 1863*

Present or absent *Present*

Stoppage, \$ *100* for

Due Gov't, \$ *100* for

Valuation of horse, \$ *100*

Valuation of horse equipments, \$ *100*

Remarks:

*Not on sub rolls.*

\* This organization subsequently became Co. C, 10 Reg't U. S. Col'd Heavy Artillery.

Book mark:

*W. J. ...*

Lawner John

P. Co. *C.*, 10 U.S.C.H.A.  
Regt

*2* Enclosures.

Bed Cards	Descriptive Lists
Burial Records	Final Statements
Certs. of Dis. for Discharge	Furloughs
C. M. Charges	Med. Des. Lists
Med. Certificates	Orders

Other papers relating to—

Admission to Hosp'l	Furlough
Casualty Sheet ( <i>Prv</i> Officer's) <i>1</i>	Med. Examination
Confinement	Misc. Information <i>1</i>
Contracts	Pay or Clothing
Death or Effects	Personal Reports
Desertions	Rank
Discharge from Hosp'l	Transfer to Hosp'l
Discharge from Service	Transfer to V. R. C.
Duty	Transportation

Recd for Mch 25, 67

CASUALTY SHEET

No.

Completed

John Lawrence

Pvt. of Company C

10<sup>th</sup> art

1<sup>st</sup> Regiment of Cavalry

State Volunteers.

NATURE OF CASUALTY.

Killed. Dec. 24, 1863.



*32*

CASUALTY SHEET.

Name: *John Lawrence*

Rank: *Private* Company: *C* Regiment: *1<sup>st</sup>*

Arm: *Camp d'Arms* State: \_\_\_\_\_

Nature of Casualty: *Death*

CAUSE OF CASUALTY—(NAME OF DISEASE, &c.)

*Acute Diarrhoea*

BY WHOM DISCHARGED.

FROM WHAT SOURCE THIS INFORMATION WAS OBTAINED.

*Roll of Honor. Sa  
pg 209*

DEGREE OF DISABILITY.

BY WHOM CERTIFIED.

*J. M. Moore  
a.g.m.*

REMARKS.

DATE OF DISCHARGE, DEATH, &c.

*Dec 24 1863.*

PLACE OF DISCHARGE, DEATH, &c.

*Port Hudson, La.  
(Buried)  
Port Hudson,  
La.*

*A. J. Ball*  
Clerk.

Surgeon General's Office,

Record and Pension Division,

10000 Aug 13<sup>th</sup>, 1867.

Respectfully returned to *Asst. Surg.*

*Genl. J. W. Suggard, S. G. I.*  
*It appears from the records of*  
*Genl. Nathl. Pat. Henshaw, S. G. I.*  
*that Priv. John Duane, Co. C,*  
*1<sup>st</sup> Art. Corps de Sigeur, was admitted*  
*Dec. 21, 1863, and died Dec.*  
*24, 1863, of "Scute. Diarrhoea".*  
*No evidence from which the*  
*desired final papers can be*  
*prepared.*

RECEIVED  
AUG  
13  
1867

BY ORDER OF THE SURGEON GENERAL:

*J. J. Woodward*

Brevet Lt. Col. and Asst. Surgeon, U. S. A.

(50)

*J. W. S. C.*

R. of A., Vol. 7 No. 1608

NO. 1608  
VOL. 7

RECEIVED  
AUG 13 1867  
S. G. O.

WAR DEPARTMENT,

ADJUTANT GENERAL'S OFFICE,

WASHINGTON, *March 25*, 1867.

SIR:

Final Statements in the cases of deceased soldiers are required to be sent to the Adjutant General's Office in duplicate, with one copy of the Inventory of Effects. The Descriptive List should also be sent to this Office in cases where the soldier was absent from his Company at the time of his death. Where there were no effects, it should be so stated on a blank Inventory, properly signed.

Certificates of Disability should be sent in duplicate. Special care should be taken that the date of discharge and signature of the discharging officer should be affixed.

*No* of the Final Statement *or* Inventory, has been received in the case of *John Laurier, Private*, of Co. *B*, *1<sup>st</sup>* Regiment of *Corp. d'art.* Volunteers, whose papers were forwarded to this Office. You will please forward the missing papers without delay.

I have the honor to be, sir,

Very respectfully,

Your obedient servant,

*Recd. Dec. 24, 1863.*  
*(Bd.) Port Hudson.*  
*Sa.*

*W. B. Hayward*

Assistant Adjutant General.

(110)

~~COMMANDING OFFICER~~

*J. J. Woodward*  
*A. S. U. S. A.*

*A. J. P.*

# MODEL FOR SET OF PAPERS FOR A DECEASED SOLDIER.

## FORM 1.—FINAL STATEMENT.

I CERTIFY, ON HONOR, that *John Smith*, a Private of Captain J. Brown's Company, (A.) of the 1st Regiment of Pennsylvania Volunteers, of the State of Pennsylvania, born in Pittsburg, State of Pennsylvania, aged 21 years, 5 feet 10 inches high, light complexion, blue eyes, dark hair, and by occupation a Farmer, having joined the Company on its original organization at Pittsburg, and enrolled in it at the muster into the service of the United States at Pittsburg, on the 1st day of July, 1861, (or was mustered in service as a recruit, by \_\_\_\_\_, at \_\_\_\_\_, on the \_\_\_\_\_ day of \_\_\_\_\_, 186—, or was drafted and mustered into the service of the United States from the \_\_\_\_\_ Enrollment District of the State of \_\_\_\_\_, at \_\_\_\_\_, on the \_\_\_\_\_ day of \_\_\_\_\_, 186—,) to serve in the Regiment for the term of Three Years, and having served *honestly and faithfully* with his Company in the field to the present date, is now entitled to a DISCHARGE by reason of death. Died in Regimental Hospital, Fort Brown, Texas, December 31, 1863, of typhoid fever.

The said John Smith was last paid by Paymaster Major Morse, to include the 31st day of October, 1863, and has pay due him from that time to the present date. He is entitled to pay and subsistence for *traveling* to place of enrollment, and whatever other allowances are authorized to volunteer soldiers, drafted men, or militia, so discharged. He has received from the United States *clothing* amounting to 20<sup>00</sup>/<sub>100</sub> dollars, since the 31st day of December, 1862, when his clothing account was last settled. He has received from the United States 25<sup>00</sup>/<sub>100</sub> dollars advanced *bounty*.

There is to be stopped from him on account of the State of \_\_\_\_\_, or other authorities, for *clothing, &c.*, received on entering service, nothing, <sup>00</sup>/<sub>100</sub> dollars; and for other stoppages, viz: nothing, <sup>00</sup>/<sub>100</sub> dollars. He has been furnished with no *transportation* in kind from the place of his discharge to \_\_\_\_\_; and he has not been *subsisted* for *traveling* to his place of enrollment up to the \_\_\_\_\_, 186—.

He is indebted to \_\_\_\_\_, Sutler, \_\_\_\_\_ <sup>00</sup>/<sub>100</sub> dollars.

He is indebted to \_\_\_\_\_, Laundress, \_\_\_\_\_ <sup>00</sup>/<sub>100</sub> dollars.

GIVEN, IN DUPLICATE, at Fort Brown, Texas, this 31st day of December, 1863.

JAMES BROWN,  
Captain Co. A, 1st Penn. Vols.,  
Commanding Company.

## FORM 2.

INVENTORY of the effects of John Smith, late a Private of Captain J. Brown's Company, (A.) of the 1st Regiment of Pennsylvania Volunteers, who was enrolled as a Private at Pittsburg, in the State of Pennsylvania, on the 1st day of July, 1861, and mustered into the service of the United States as a Private on the 1st day of July, 1861, at Pittsburg, in Company A, 1st Regiment of Pennsylvania Volunteers, to serve three years or during the war. He was born in Pittsburg, in the State of Pennsylvania; he was 21 years of age, 5 feet 10 inches high, light complexion, blue eyes, dark hair, and by occupation, when enrolled, a Farmer. He died in Regimental Hospital, at Fort Brown, Texas, on the 31st day of December, 1863, of typhoid fever.

INVENTORY.					
ARTICLES.	NO.	ARTICLES.	NO.	ARTICLES.	NO.
Hats.....		Pairs trousers.....		Knapsacks.....	
Caps.....		Pairs flannel drawers.....			
Forage caps.....		Pairs cotton drawers.....		Watch, silver.....	1
Great coats.....	1	Flannel shirts.....	1		
Uniform coats.....		Cotton shirts.....			
Uniform jackets.....		Pairs boots.....			
Flannel sack coats.....		Pairs shoes.....			
Blouses.....		Pairs socks.....			
Stable frocks.....		Blankets.....			
Fatigue overalls.....		Haversacks.....			
				MONEY:	
				Specie.....	\$2 00
				Notes.....	\$50 00

I CERTIFY, ON HONOR, that the above inventory comprises all the effects of Private John Smith, deceased, and that the effects are in the hands of Captain J. Brown, at Fort Brown, Texas, to be disposed of by a Council of Administration, except the money, which has been turned over to Major Wm. C. Morse, Paymaster, U. S. Army, whose receipt is hereto annexed.\*

STATION: Fort Brown, Texas.

DATE: December 31, 1863.

(Duplications.)

JAMES BROWN,  
Captain Co. A, 1st Penn. Vols.,  
Commanding the Company.

\* NOTE.—If the effects have been turned over to relatives of deceased, so state on certificate, instead of "in the hands of Captain," &c., and give the names of the persons, and their relation to the deceased person.

## FORM 3.—HEIR'S RECEIPT FOR EFFECTS.

RECEIVED of Captain John Brown, Company A, 1st Regiment of Pennsylvania Volunteers, the following effects of Private John Smith, late of Company A, 1st Regiment of Pennsylvania Volunteers, now deceased, which I claim as his wife:

1 great coat, 1 flannel shirt, 1 silver watch, fifty dollars in notes, and two dollars in specie.

MARY SMITH.

## FORM 4.—PAYMASTER'S RECEIPT FOR MONEY.

RECEIVED, this 31st day of December, 1863, at Fort Brown, Texas, of Captain James Brown, of Company A, 1st Pennsylvania Volunteers, fifty dollars in Treasury notes and two dollars in specie, the property of the late Private John Smith, of Company A, 1st Pennsylvania Volunteers, who died at Fort Brown, Texas, on the 31st day of December, 1863.

WM. C. MORSE, Paymaster, U. S. A.

## FORM 5.—PROCEEDINGS OF A COUNCIL OF ADMINISTRATION,

Convened at Fort Brown, Texas, pursuant to Orders, No. 1, dated Post Headquarters, Fort Brown, Texas, January 2, 1864—consisting of Captain James Keith, Company C, 1st Pennsylvania Volunteers; Captain John Brown, Company D, 1st Pennsylvania Volunteers; and Lieutenant William Roe, Company E, 1st Pennsylvania Volunteers—for the purpose of disposing of the effects of the late John Smith, of Company A, 1st Pennsylvania Volunteers:

The Council found that the effects consisted of the following articles. They were ordered to be sold at auction, which was accordingly done, and the amount set opposite the articles respectively obtained, for which the receipt of the Paymaster is annexed:

### AT AUCTION.

1 shirt brought.....	\$1 00
1 great coat ".....	2 50
1 silver watch ".....	25 00
	\$28 50

JAMES KEITH,  
Capt. Co. C, 1st Penn. Vols., President.  
WILLIAM ROE,  
Lieut. Co. E, 1st Penn. Vols., Recorder.

APPROVED: JOHN SANDERS,  
Colonel 1st Penn. Vols.,  
Commanding Post.

## FORM 6.—PAYMASTER'S RECEIPT.

RECEIVED from Captain John Brown, Company A, 1st Pennsylvania Volunteers, at Fort Brown, Texas, January 10, 1864, twenty-eight dollars and fifty cents, the result of the sale of the effects of the late Private John Smith, of Company A, 1st Pennsylvania Volunteers.

WM. C. MORSE, Paymaster U. S. Army.

## ARTICLES OF WAR.

ART. 95. When any non-commissioned officer or soldier shall die, or be killed in the service of the United States, the then commanding officer of the troop or company shall, in the presence of two other commissioned officers, take an account of what effects he died possessed of, above his arms and accoutrements, and transmit the same to the office of the Department of War, which said effects are to be accounted for, and paid to the representatives of such deceased non-commissioned officer or soldier. And in case any of the officers, so authorized to take care of the effects of deceased officers and soldiers, should, before they have accounted to their representatives for the same, have occasion to leave the regiment or post, by preference or otherwise, they shall, before they be permitted to quit the same, deposit in the hands of the commanding officer, or of the assistant military agent, all the effects of such deceased non-commissioned officers and soldiers, in order that the same may be secured for, and paid to, their respective representatives.

### DIRECTIONS.

NOTE 1.—One copy of the inventories of the effects of deceased non-commissioned officers and soldiers, required by the 95th Article of War, will be forwarded to the Adjutant General, by the commander of the company to which the deceased belonged, and a duplicate of the same to the clerk of the regiment. Final statements of pay, clothing, &c., in duplicate, will be sent to the Adjutant General with one copy of the inventory. Both inventory and final statements should be forwarded, as a general rule, through Regimental Headquarters. When a soldier dies at a post or station absent from his company, it will be the duty of his immediate commander to furnish, direct to the Adjutant General, the required inventory and final statements, and, at the same time, to forward to the commanding officer of the company to which the soldier belonged, a report of his death, specifying the date, place, and cause; to what time he was last paid, and the money or other effects in his possession at the time of his decease; which report will be noted on the next muster roll of the company to which the man belonged. Each inventory will be endorsed "Inventory of the effects of \_\_\_\_\_, late of company (—) \_\_\_\_\_ regiment of \_\_\_\_\_, who died at \_\_\_\_\_ the \_\_\_\_\_ day of \_\_\_\_\_, 186—." If a legal representative receive the effects, it will be stated in the report. If the soldier leave no effects, the fact will be reported on the blank for inventory.

NOTE 2.—Should the effects of a deceased non-commissioned officer or soldier not be administered upon within a short period after his decease, they shall be disposed of by a Council of Administration under the authority of the commanding officer of the post, and the proceeds deposited with the Paymaster, to the credit of the United States, until they shall be claimed by the legal representatives of the deceased. This should be done according to Forms 5 and 6, and one copy of each sent to the Adjutant General. No copy of the order convening the board is required, the approval of the commanding officer being sufficient.

NOTE 3.—In all such cases of sales by the Council of Administration, a statement in detail, or account of the proceeds duly certified by the Council and commanding officer, (Form 5), accompanied by the Paymaster's receipt of the proceeds, will be forwarded by the commanding officer to the Adjutant General. The statement will be endorsed "Report of the proceeds of the effects of \_\_\_\_\_, late of company (—) \_\_\_\_\_ regiment of \_\_\_\_\_, who died at \_\_\_\_\_ the \_\_\_\_\_ day of \_\_\_\_\_, 186—."

NOTE 4.—The effects in all cases, when called for, should be turned over to the legal representative, without further authority from the Adjutant General. When the effects are turned over to the relatives of the deceased before these inventories are sent to the Adjutant General, their receipts therefor should be attached to the inventories. In all other cases, one copy will be sent with a letter of transmittal direct to the Adjutant General, and a duplicate retained by the officer.

NOTE 5.—Particular care should be taken to take receipts in duplicate from the Paymaster for any funds turned over to him; one copy should be sent direct to the Adjutant General, and one retained by the officer.

NOTE 6.—Where a soldier dies in hospital or on detached service, his descriptive list, if he has one, should be sent with his final statements, in duplicate, to the Adjutant General, Washington, D. C.

NOTE 7.—Form 1 will be forwarded in duplicate to the Adjutant General, through Regimental Headquarters, as soon as possible after the death of the soldier, accompanied by one copy of Forms 2 and 3, or 4, as the case may require. A duplicate of the inventory (Form 2) should be retained until the articles are finally disposed of.

NOTE 8.—The papers for each man should be made SEPARATELY for each man, and, when possible, fastened together. This is especially necessary, and must be done in all cases. The papers cannot be properly disposed of at the Adjutant General's Office unless this is done, and must be returned for correction.

NOTE 9.—Where there are no line officers, as for instance, a general hospital without a line officer to command the guard, the Council of Administration may be made up from other commissioned officers, in the same way as prescribed for line officers.

NOTE 10.—Where a soldier dies away from his company or regiment, and the officer having charge of him cannot furnish Final Statements by reason of not being able to obtain a Descriptive List, he should notify the regimental or company commander, (giving him full particulars as to history and description of the man, as far as possible,) whose duty it will then be, in such case, to furnish the necessary papers from the best data he can obtain.

1550  
Larner, Mitchel

Co G, 10 U.S. Col'd H. Art'y.

Private | Private

CARD NUMBERS.

1 5488560	26
2 5508423	27
3 5508571	28
4 5508723	29
5 5508870	30
6 5509017	31
7 5509141	32
8 5509289	33
9 5509397	34
10	35
11	36
12	37
12	38
14	39
15	40
16	41
17	42
18	43
19	44
20	45
21	46
22	47
23	48
24	49
25	50

Book Mark:

See also 74 U.S.C. Inf.

A. 2314963 PONTON

D 2400031 AWD

G. S. Doughty

D | 10 St. A. | U.S.C.T.

Mitchell Laman  
Priv., Co., 10 Reg't U. S. Col'd St. A.

Appears on

**M. and D. Roll of Men Transferred**

to the organization named above,

from Co "B" 9th U.S. Col'd Inf.

Roll dated New Orleans, La. Oct 11, 1864

When enlisted April 1, 1864

Period for which enlisted 3 years.

When mustered in April 29, 1864

Present or absent

Company to which assigned

Remarks: Joined as recruit  
Co "D" 9th U.S. Col'd Inf. Trans-  
ferred to Co "B" 9th U.S. Col'd  
July 20 '64 Ser G. O.  
Nov 17 Stagnos M. D.  
St. Mv. Stagnos for one  
Mosquito Bar lost

Book mark:

(342)

J. W. Jones, Jr.  
Coppist

10 H. Art'y. U.S.C.T.

*L*  
*Mitchell Larnar*  
*Capt.*, Co. G, 10 Reg't U. S. Col'd H. Art'y.

Appears on

**Company Muster Roll**

for *Nov: & Dec.*, 186*0*^.

Present or absent *Present*

Stoppage, \$ *100* for

Due Gov't, \$ *100* for

Valuation of horse, \$ *100*

Valuation of horse equipments, \$ *100*

Remarks: *Transferred from*  
*Co. B. 74th U.S. Col'd H. Art'y.*  
*84, dated Hd Quarters Dept.*  
*H.A.*

Book mark:

*G. F. H.*



L | 10 H. Art'y. | U.S.C.T.

*Mitchel Lamer*

*Priv.*, Co. G, 10 Reg't U. S. Col'd H. Art'y.

Appears on

**Company Muster Roll**

for *Jan. & Feb.*, 186*6*.

Present or absent *Present*

Stoppage, \$ 100 for

Due Gov't, \$ 100 for

Valuation of horse, \$ 100

Valuation of horse equipments, \$ 100

Remarks:

-----  
-----  
-----  
-----  
-----  
-----  
-----  
-----  
-----  
-----

Book mark:

-----  
*G. Fox*  
-----

*L* | 10 H. Art'y. | U.S.C.T.

*Mitchell Larner*

*Privt*, Co. G, 10 Reg't U. S. Col'd H. Art'y.

Appears on

**Company Muster Roll**

for *Mar. & Apr.*, 186 *6*.

Present or absent *Present*

Stoppage, \$ *100* for

Due Gov't, \$ *100* for

Valuation of horse, \$ *100*

Valuation of horse equipments, \$ *100*

Remarks:

Book mark:

*G. F. W.*

L

10 H. Art'y. U.S.C.T.

Mitchell Larnas

Cvt., Co. G, 10 Reg't U. S. Col'd H. Art'y.

Appears on

Company Muster Roll

for May + June, 1866.

Present or absent Present

Stoppage, \$ 100 for

Due Gov't, \$ 100 for

Valuation of horse, \$ 100

Valuation of horse equipments, \$ 100

Remarks:

Book mark:

G. F. M.

*L*

10 H. Art'y. U.S.C.T.

*Mitchel Larmer*

*Priv*, Co. G, 10 Reg't U. S. Col'd H. Art'y.

Appears on

**Company Muster Roll**

for *July 1862*, 1862

Present or absent *Present*

Stoppage, \$ *100* for

Due Gov't, \$ *100* for

Valuation of horse, \$ *100*

Valuation of horse equipments, \$ *100*

Remarks:

Book mark:

*G. Foy*

*L* | 10 H. Art'y. | U.S.C.T.

*Mitchell Larner*

*Pvt*, Co. G, 10 Reg't U. S. Col'd H. Art'y.

Appears on

**Company Muster Roll**

for *Sept & Oct*, 1866.

Present or absent *Present*

Stoppage, \$.....100 for .....

Due Gov't, \$.....100 for .....

Valuation of horse, \$.....100

Valuation of horse equipments, \$.....100

Remarks: .....

Book mark: .....

*Wines*

Copyist.

L

10 H. Art'y.

U.S.C.T.

Mitchell Larner

Pvt., Co. G, 10 Reg't U. S. Col'd H. Art'y.

Appears on

Company Muster Roll

for Nov & Dec, 1866.

Present or absent Present

Stoppage, \$ 100 for

Due Gov't, \$ 100 for

Valuation of horse, \$ 100

Valuation of horse equipments, \$ 100

Remarks:

Book mark:

Wines

*L* | 10 H. Art'y. | U.S.C.T.

*Mitchel Larner*

*Pvt*, Co. *G*, 10 Reg't U. S. Col'd H. Art'y.

Appears on Co. Muster-out Roll, dated

*Baton Rouge La, Feb 27*, 1867.

Muster-out to date

*Feb 27*, 1867.

Last paid to

*Dec 31*, 1866.

Clothing account:

Last settled ..... , 186 ; drawn since \$ .....  $\frac{100}{100}$

Due soldier \$  $41 \frac{14}{100}$ ; due U. S. \$ .....  $\frac{100}{100}$

Am't for cloth'g in kind or money adv'd \$ .....  $\frac{100}{100}$

Due U. S. for arms, equipments, &c., \$  $6 \frac{16}{100}$

Bounty paid \$  $100 \frac{00}{100}$ ; due \$  $100 \frac{00}{100}$

Remarks: *Joined by transfer*

*from 74<sup>th</sup> U.S.C. per S.O.*

*No. 84 Par. 5 N'd Gas dept of*

*La. Stopped for one Tompion*

*one wipes*

Book mark : .....

*Wines*

153100 Series  
La Touche, Lewis

Co E, 10 U.S. Col'd H. Art'y.

Private

Private

CARD NUMBERS.

1	5487139	26
2	5502414	27
3	5502634	28
4	5502773	29
5	5502903	30
6	5503074	31
7	5504607	32
8		33
9		34
10		35
11		36
12		37
13		38
14		39
15		40
16		41
17		42
18		43
19		44
20		45
21		46
22		47
23		48
24		49
25		50

Book Mark:

See also



*L* | 10 H. Art'y. | U.S.C.T.

*Louis LaRough*

Appears with rank of *Priv* on

**Muster and Descriptive Roll of a Detachment of U. S. Vols. forwarded**

for the *7* Reg't *U.S.G.H. Art.\** Roll dated

*New Orleans La, June, 1864.*

Where born *Natchitoches La.*

Age *23* y'rs; occupation *Labors*

When enlisted *April 28*, 1864.

Where enlisted *Alexandria*

For what period enlisted *3* years.

Eyes *Grey*; hair *Light*

Complexion *Light*; height *5* ft. *4*/<sub>4</sub> in.

When mustered in *June 18*, 1864.

Where mustered in *New Orleans*

Bounty paid \$ *100*; due \$ *100*

Where credited

Company to which assigned *E*

Remarks:

*\* Became 10 U.S. Cold F. Art*

Book mark:

*J. M. Williams*

*L* | **10 H. Art'y. U.S.C.T.**

*Lewis LaRough*  
*Priv.*, Co. *E*, 7 Reg't U. S. Col'd H. Art'y.\*

Appears on

**Company Muster-in and Descriptive Roll**

of the organization named above. Roll dated

*New Orleans La, July 5, 1864*

Where born *Natchitoches La*

Age *23* y'rs; occupation *Laborer*

When enlisted *Apr. 28, 1864*

Where enlisted *Alexandria*

For what period enlisted *3* years.

Eyes *Gray*; hair *light*

Complexion *light*; height *5 ft. 4 1/4* in.

When mustered in *June 18, 1864*

Where mustered in *New Orleans*

Bounty paid \$ *2* 100; due \$ *100*

Where credited *Alexandria*

Company to which assigned *E*

Remarks:

\* This organization subsequently became Co. *E*, 10 Reg't U. S. Colored Heavy Artillery.

Book mark:

*J. S. S. S.*  
Coryist.

*L* | 10 H. Art'y. | U.S.C.T.

*Louis La Rouch*  
Pvt., Co. E, 10 Reg't U. S. Col'd H. Art'y.

Appears on

**Company Muster Roll**

for *July & Aug.*, 186*6*.

Present or absent *Absent*

Stoppage, \$.....100 for.....

Due Gov't, \$.....100 for.....

Valuation of horse, \$.....100

Valuation of horse equipments, \$.....100

Remarks: *Sick in Hospital at  
New Orleans, date un-  
known*

Book mark: .....

*Linder*  
Copyist.

*L* | 10 H. Art'y. | U.S.C.T.

*Louis Larough*  
Pt., Co. E, 10 Reg't U. S. Col'd H. Art'y.

Appears on

**Company Muster Roll**

for *Sep. + Oct.*, 186*U.*

Present or absent *Absent*

Stoppage, \$.....100 for .....

Due Gov't, \$.....100 for .....

Valuation of horse, \$.....100

Valuation of horse equipments, \$.....100

Remarks: *In Genl Hospital  
New Orleans Date un  
known*

Book mark : .....

*J. Miller*  
Copyist.

*L* | 10 H. Art'y. | U.S.C.T.

*Louis La Roush*  
Prvt, Co. E, 10 Reg't U. S. Col'd H. Art'y.

Appears on

**Company Muster Roll**

for *Nov* *Dec*, 186*4*.

Present or absent *Absent*

Stoppage, \$ 100 for

Due Gov't, \$ 100 for

Valuation of horse, \$ 100

Valuation of horse equipments, \$ 100

Remarks: *In Gen Hosp New Orleans date unknown*

Book mark: *1000*

*Linden*  
Copyist.

L | 10 H. Art'y. | U.S.C.T.

Louis Larough  
Pvt., Co. E, 10 Reg't U. S. Col'd H. Art'y.

Appears on

**Company Muster Roll**

for Jan. & Feb., 1865.

Present or absent

Stoppage, \$ 100 for

Due Gov't, \$ 100 for

Valuation of horse, \$ 100

Valuation of horse equipments, \$ 100

Remarks: Died in the Corps  
of Africa Gen. Hospital,  
New Orleans, July 12, 1864,  
notice of the death re-  
ceived Feb. 19, 1865.

Book mark:

G. E. Syles  
Copyist.

*L* | 10 H. Art'y. | U.S.C.T.

*Lewis Larough*  
Co. *E.*, 10 Reg't U. S. Col'd H. Art'y.

Appears on Co. Muster-out Roll, dated  
*Baton Rouge, La, Feb 22, 1867.*

Muster-out to date \_\_\_\_\_, 186 .

Last paid to *Not known*, 186 .

Clothing account:

Last settled \_\_\_\_\_, 186 ; drawn since \$ \_\_\_\_\_ 100

Due soldier \$ \_\_\_\_\_ 100; due U. S. \$ \_\_\_\_\_ 100

Am't for cloth'g in kind or money adv'd \$ \_\_\_\_\_ 100

Due U. S. for arms, equipments, &c., \$ \_\_\_\_\_ 100

Bounty paid \$ \_\_\_\_\_ 100; due \$ \_\_\_\_\_ 100

Remarks: *Joined at Org. Orgau,*  
*as Private*  
*Died in C. D. A. G. H.*  
*July 12 1864,*

Book mark: \_\_\_\_\_

Larough, Louis  
P, Co. E., 10 U.S.C.H.A.

2 Enclosures.

Bed Cards	Descriptive Lists
Burial Records	Final Statements /
Certs. of Dis. for Discharge	Furloughs
C. M. Charges	Med. Des. Lists
Med. Certificates	Orders

Other papers relating to—

Admission to Hosp'l	Furlough
Casualty Sheet (Officer's)	Med. Examination
Confinement	Misc. Information /
Contracts	Pay or Clothing
Death or Effects	Personal Reports
Desertions	Rank
Discharge from Hosp'l	Transfer to Hosp'l
Discharge from Service	Transfer to V. R. C.
Duty	Transportation



Fort St Philip La  
July 22<sup>nd</sup> 1865

Respectfully referred to Surgeon in charge  
of C. B. A. Gen. Hosp.

No notice of death of within named  
man was received until Feb. 18<sup>th</sup> 1865.  
Descriptive list was sent with this man  
to Hosp and I suppose that his final  
statements - had been made out and forwarded  
by the Surgeon in charge. If not please forward  
them at once, or send me account of  
clothing & pay due by him in Hospital  
and I will do so.

Respectfully.

Thos. Dickels P<sup>vt</sup> Sick  
Comd'g Co E 10<sup>th</sup> U.S. Col'd Art. (Heavy)

Corps De Afrique U.S. Gen Hosp  
New Orleans La July 27<sup>th</sup> 1865

Respectfully returned with the information  
that the records of this Hospital, show that  
Louis Larouge Priv. B<sup>th</sup> Co, 4<sup>th</sup> U.S. Col'd Cav  
was admitted as a patient July 9<sup>th</sup> 1864  
He died July 12<sup>th</sup> 1864 of Typhoid Fever  
without a Descriptive Roll, He had no effect,  
He received no pay or clothing while a patient  
at this Hosp. There is evidently an Error in the  
records in regard to the Organization to  
which he belonged. which accounts for the  
non receipt of Notification of Death by  
Company Commander

F. E. Squeth  
Surgeon in Charge

WAR DEPARTMENT,

ADJUTANT GENERAL'S OFFICE,

WASHINGTON, *July 1*, 1865.

SIR:

Final Statements in the cases of deceased soldiers are required to be sent to the Adjutant General's Office in duplicate, with one copy of the Inventory of Effects. The Descriptive List should also be sent to this Office in cases where the soldier was absent from his Company at the time of his death. Where there were no effects, it should be so stated on a blank Inventory, properly signed.

Certificates of Disability should be sent in duplicate. Special care should be taken that the date of discharge and signature of the discharging officer should be affixed.

*No* of the Final Statement *No* Inventory, has been received in the case of *Louis Laragh*, of Co. *"E"*, *10* Regiment of *U. S. Col. Artillery (Heavy)* Volunteers, whose papers were ~~forwarded to this Office~~. You will please forward the missing papers without delay.

I have the honor to be, sir,

Very respectfully,

Your obedient servant,

*T. C. Hayward*

Assistant Adjutant General.  
(110)

COMMANDING OFFICER

*Co. "E" 10 U. S. Colored Artillery (Heavy)*  
*Fort St Philip, La.*

*Information of death taken from*  
*Quarterly Return of Deceased Soldiers.*

*A. J. H.*



FINAL STATEMENT

OF

*Private Louis Larough*

*10<sup>th</sup> Reg't of U. S. C. Art. (Heavy)*

**VOLUNTEERS.**

*Disch July 13/62*

NOTE 1.—Two of these certificates (or duplicates) are to be given to each Volunteer Soldier or drafted man who may be discharged previously to the discharge of his company, that he may at once receive from the Paymaster the pay, &c., due him, and the captain or other COMMISSIONED officer commanding the company will certify to the act of the delivery of the duplicate certificates; on these certificates the Soldier is "entitled to" his discharge, and should also present his discharge to the Paymaster to have the payment endorsed on it. The discharge is to be given back to the Soldier by the Paymaster; the latter only retaining as his voucher the duplicate certificates.

NOTE 2.—If the Soldier is entitled to pay for the use of his horse, the Company Commander will certify to that fact on the back of both these final statements, and also to the time he has pay due for having been so mounted on his own horse.

NOTE 3.—When a Soldier is furnished with final statements, his descriptive list, if he has one, should be taken up by the officer who gives the Soldier these statements, and endorsed with a statement to this effect by the officer. This endorsement should exhibit a full statement of the time for which the Soldier was allowed pay on his final statements, the clothing account, and all other charges against him or in his favor, so as to comprise a complete exhibit of his account. It will then be transmitted to the company commander of the Soldier, who will enter all the data necessary to a full understanding of the Soldier's account on the muster roll upon which the Soldier's discharge is reported. The descriptive list will then be destroyed. The object of this is, that the remaining portion of the Soldier's account may be settled upon the receipt of these muster rolls, and the Soldier receive any pay or allowances that may be due him at the time of his discharge, and which may not appear on his final statements from the fact that his descriptive list is incomplete. These accounts for back pay, &c., are settled by the 2d Auditor of the Treasury Department.

NOTE 4.—Charges for loss or injury to ordnance, horse equipments, and other miscellaneous charges, should appear under the heading of "Other Stoppages."

NOTE 5.—Bounty paid by State authorities, and not by the United States, will not be entered on this statement.

NOTE 6.—Amounts due the Sutler and Laundress must be entered on the muster roll on which the discharge, death, desertion, &c., is reported, as well as on the final statement, otherwise the amount cannot be collected from the United States.

NOTE 7.—This blank will be used for deceased volunteers and drafted men, as well as for others.

NOTE 8.—Where a Soldier dies in Hospital or on detached service, his descriptive list, if he has one, should be sent with his final statements, in duplicate, to the Second Auditor, Washington, D. C.

ADJUTANT GENERAL'S OFFICE

*Aug 15<sup>th</sup> 1862*

Duplicate with Inventory sent 23<sup>rd</sup> for.

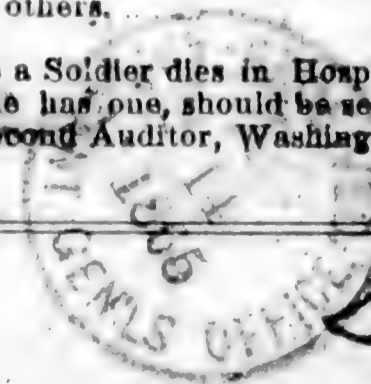

*J. M. H. A.*

I certify, on honor, that Louis Larough a Private of  
 Captain M. Hawke's Company (E) of the 10th Regiment of U. S. Col'd Art. (Heavy)  
**VOLUNTEERS**, of the State of \_\_\_\_\_, born in Natchitoches, State  
 of Louisiana, aged 23 years; 5 feet 4 1/4 inches high; Light complexion,  
Gray eyes, Light hair, and by occupation a Laborer, having <sup>subscribed for</sup> joined the company ~~on~~  
 its original organization at New Orleans, La. April 28th 1864, and enrolled in it at the muster into  
 the service of the United States at New Orleans, on the 18th day  
 of June, 1864, (or was mustered in service as a recruit, by \_\_\_\_\_  
 \_\_\_\_\_, at \_\_\_\_\_, on the \_\_\_\_\_ day of \_\_\_\_\_,  
 186, or was drafted and mustered into the service of the United States from the \_\_\_\_\_  
 Enrollment District of the State of \_\_\_\_\_, at \_\_\_\_\_,  
 on the \_\_\_\_\_ day of \_\_\_\_\_, 186;) to serve in the Regiment, for  
 the term of Three Years: and having served **HONESTLY** and  
**FAITHFULLY** with his Company ~~in~~ until July 12th 1864 (date of death) to the present date, is now  
 entitled to a **DISCHARGE** by reason of Death. Died in Corp. S. A. F. in Gen. Hosp.  
New Orleans, July 12th 1864 of Typhoid Fever

The said Louis Larough was last paid by Paymaster  
never paid to include the \_\_\_\_\_ day of \_\_\_\_\_, 186, and has  
 pay due him from that time to the present date; he is entitled to pay and subsistence for  
**TRAVELING** to place of enrollment, and whatever other allowances are authorized to volunteer  
 soldiers, drafted men, or militia, so discharged. He has received from the United States **CLOTHING**  
 amounting to 16 <sup>90</sup>/<sub>100</sub> dollars, since the \_\_\_\_\_ day of enlistment,  
 186, when his clothing account was last settled. He has received from the United States  
 \_\_\_\_\_ dollars advanced **BOUNTY**.

There is to be stopped from him, on account of the State of \_\_\_\_\_, or other  
 authorities, for **CLOTHING**, &c., received on entering service, \_\_\_\_\_ dollars; and  
 for other stoppages, viz: \_\_\_\_\_

\_\_\_\_\_ dollars.  
 He has been furnished with **TRANSPORTATION** in kind from the place of his discharge to  
 \_\_\_\_\_; and he has been **SUBSISTED** for **TRAVELING** to his  
 place of enrollment, up to the \_\_\_\_\_, 186.

He is indebted to \_\_\_\_\_, **SUTLER**, \_\_\_\_\_ dollars.  
 He is indebted to \_\_\_\_\_, **LAUNDRESS**, \_\_\_\_\_ dollars.

Given in Duplicate, at Fort W. Philip, La., this 5th day  
 of August, 1864.

W. V. Dickel  
Private 10th U.S.C. (A.H.)  
 "E"  
 Commanding Company. E.

1552  
Lattin, August

Co A, 10 U.S. Col'd H. Art'y.

Private | Private

CARD NUMBERS.

1	5489071	26
2	5493080	27
3	5494127	28
4		29
5		30
6		31
7		32
8		33
9		34
10		35
11		36
12		37
13		38
14		39
15		40
16		41
17		42
18		43
19		44
20		45
21		46
22		47
23		48
24		49
25		50

Book Mark:

See also 75. U.S.C.A

*S<sup>d</sup> 10th Mass* **U.S.C.T.**  
*August Satullo*  
*P. Co.*, Co. ...., *10* Reg't U. S. Col'd *Mass*

Appears on

**M. and D. Roll of Men Transferred**

to the organization named above,

from *76 MSC I*

Roll dated *Nov 18*, 186*3*.

When enlisted ....., 186 .

Period for which enlisted *3* years.

When mustered in *Sep 23*, 186*4*.

Present or absent *Not stated*

Company to which assigned .....

Remarks: *Credited to*  
*New Orleans*  
*Drafted*

Book mark .....

*J. A. Johnson*  
(342) *Copyist.*

*S* | 10 H. Art'y. | U.S.C.T.

*August Lattin*

*Prs*, Co. A, 10 Reg't U. S. Col'd H. Art'y.

Appears on

**Company Muster Roll**

for *Nov + Dec*, 1865.

Present or absent.....

Stoppage, \$.....<sup>100</sup> for.....

Due Gov't, \$ *3* <sup>*10*</sup>/<sub>*100*</sub> for *Q + G Equipage*

Valuation of horse, \$.....<sup>100</sup>

Valuation of horse equipments, \$.....<sup>100</sup>

Remarks: *Cropped as Deserter Dec. 9. 65*  
*Transferred from 75 NS 68 for \$0.105.*  
*Std Geo Dept Sea,*

Book mark:.....

*Hypis*  
Copyist.



L | 10 H. Art'y. | U.S.C.T.

August Lattile  
Priv., Co. A, 10 Reg't U. S. Col'd H. Art'y.

Appears on Co. Muster-out Roll, dated  
Baton Rouge La, Feb. 22, 1867.

Muster-out to date \_\_\_\_\_, 186 .

Last paid to \_\_\_\_\_, 186 .

Clothing account:

Last settled \_\_\_\_\_, 186 ; drawn since \$ \_\_\_\_\_ 100

Due soldier \$ \_\_\_\_\_ 100; due U. S. \$ \_\_\_\_\_ 100

Am't for cloth'g in kind or money adv'd \$ \_\_\_\_\_ 100

Due U. S. for arms, equipments, &c., \$ \_\_\_\_\_ 100

Bounty paid \$ \_\_\_\_\_ 100; due \$ \_\_\_\_\_ 100

Remarks: Transfd. from 75 U.S. Col'd as  
Priv. S. Co. 105 S. Col'd Dept. Va.  
Deserted Dec. 9. '65

Book mark : \_\_\_\_\_

Nesbitt

Copyist.

1553

*Laundre, Andrew*

*Co D*, 10 U.S. Col'd H. Art'y.

*Private*

CARD NUMBERS.

1	26
2	27
3	28 <i>Andrew</i>
4	29
5	30
6	31
7	32
8	33
9	34
10	35
11	36
12	37
13	38
14	39
15	40
16	41
17	42
18	43
19	44
20	45
21	46
22	47
23	48
24	49
25	50

Book Mark:

See also

1554  
Laurent, Jean P.

Co M, 10 U.S. Col'd H. Art'y.

Colonel | 1<sup>st</sup> Sergeant

CARD NUMBERS.

1	5487968	26
2	5488922	27
3	5488816	28
4	5514280	29
5	5514432	30
6	5514575	31
7	5514812	32
8	5514922	33
9	5514987	34
10	5515651	35
11	5515112	36
12	5515161	37
13	4123686	38
14		39
15		40
16		41
17		42
18	1	43
19		44
20		45
21		46
22		47
23		48
24		49
25		50

Book Mark:

See also 77 U.S.C. Inf.

L | 10 H. Art'y. | U.S.C.T.

Jean B Laurentz  
Co. M, 10 Reg't U. S. Col'd H. Art'y.

Appears on

**Company Descriptive Book**

of the organization named above.

**DESCRIPTION.**

Age 41 years; height 5 feet 8 inches.

Complexion Black

Eyes Black; hair black

Where born New Orleans La

Occupation Painter

**ENLISTMENT.**

When February 14, 1865.

Where New Orleans La

By whom Capt McAllister, term 3 y'rs.

Remarks: Rec'd by transfer from  
Co A 77 U.S. C.S. per S.O.  
66 Hed In Dept La Sept 22 66  
Promoted 1st Sgt per S.O.  
No 8 Hed gns Co 1st U.S. A Reg  
March 18 1866

W. McAllister

L 106a U.S.C.T.

Jeau B Laurent  
Corp, Co M, 10 Reg't U. S. Col'd Ha

Appears on

**M. and D. Roll of Men Transferred**

to the organization named above,

from 44 U. S. Col Inf

Roll dated Camp Parapet Lalet, 1865.

When enlisted Feb 14, 1865.

Period for which enlisted 3 years.

When mustered in March 8, 1865.

Present or absent

Company to which assigned M

Remarks: James as recruit

Received by transfer from  
Co A 44 U. S. C. I. per  
S. O. 66 Dept of War Sept  
22, 65

Book mark :

W. H. Scott

L 10 H. Artz **U.S.C.T.**

Jean B. Laurent  
Capt., Co. M., 10 Reg't U. S. Col'd H. Artz

Appears on

**M. and D. Roll of Men Transferred**

to the organization named above,

from 77<sup>th</sup> U. S. Col'd Inftry.

Roll dated Oct. 1, 1865.

When enlisted Feb. 14, 1865.

Period for which enlisted 3 years.

When mustered in March 8, 1865.

Present or absent Present.

Company to which assigned M.

Remarks: Joined as recruit.

Book mark : \_\_\_\_\_

Easterling Copyist.

L 10<sup>th</sup> Arty | **U.S.C.T.**

Jean B. Laurent  
Capt, Co. M, 10 Reg't U. S. Col'd 76 Arty

Appears on

**M. and D. Roll of Men Transferred**

to the organization named above,

from 77 U. S. Col'd Inf.

Roll dated Oct. 1, 1865

When enlisted Feb. 14, 1865

Period for which enlisted 3 years.

When mustered in March 8, 1865

Present or absent Present

Company to which assigned M

Remarks: Joined as recruit

Book mark :

L. Chandler

*L* | 10 H. Art'y. | U.S.C.T.

*Dean*  
*James B. Lambert*  
Cor, Co. M, 10 Reg't U. S. Col'd H. Art'y.

Age ..... years.

Appears on

**Company Muster Roll\***

for *Sept - Oct*, 1865.

Joined for duty and enrolled:

When *Feb 14*, 1865.

Where *New Orleans*

Period *3* years.

Mustered in:

When *March 8*, 1865.

Where *New Orleans*

Present or absent *Present*

Stoppage, \$ *100* for

Due Gov't, \$ *100* for

Valuation of horse, \$ *100*

Valuation of horse equipments, \$ *100*

Remarks: *Pro Cor July 27, 65*

*By S. L. Dougherty*

\*First current roll. No muster-in roll of this company on file.

Book mark : .....



*L* | 10 H. Art'y. | U. S. C. T.

*Jean B Laurent*  
Cor, Co. M, 10 Reg't U. S. Col'd H. Art'y.

Appears on

Company Muster Roll

for *Nov Dec*, 1865:

Present or absent *Present*

Stoppage, \$ 100 for

Due Gov't, \$ 100 for

Valuation of horse, \$ 100

Valuation of horse equipments, \$ 100

Remarks: *Provided Cor per  
S.O. Ad ops 17 U.S. 62  
July 27 65*

Book mark:

*A. H. Knight*

*L* | 10 H. Art'y. | U. S. C. T.

*Jean B Laurent-*  
Co. M, 10 Reg't U. S. Col'd H. Art'y.

Appears on

**Company Muster Roll**

for *June & Feb*, 186*6*.

Present or absent *Present-*

Stoppage, \$ *100* for

Due Gov't, \$ *100* for

Valuation of horse, \$ *100*

Valuation of horse equipments, \$ *100*

Remarks:

Book mark:

*W. T. Wright*  
(358) Copyist.

L | 10 H. Art'y. | U. S. C. T.

Levin B. Lawrence  
1st Sgt, Co. M, 10 Reg't U. S. Col'd H. Art'y.

Appears on

**Company Muster Roll**

for March & April, 1866.

Present or absent Present

Stoppage, \$ 100 for

Due Gov't, \$ 100 for

Valuation of horse, \$ 100

Valuation of horse equipments, \$ 100

Remarks: Exp from Co for  
S. C. No 8 dated Hd Qrs 10th Reg  
Co. Art'y, to date - mch 1, 66  
Bounty paid #100, Due #200

Book mark: \_\_\_\_\_

W. H. Wright

L | 10 H. Art'y. | U. S. C. T.

Jean B. Leonard  
1 Sgt., Co. M, 10 Reg't U. S. Col'd H. Art'y.

Appears on

**Company Muster Roll**

for May & June, 1866.

Present or absent Present

Stoppage, \$ 100 for

Due Gov't, \$ 100 for

Valuation of horse, \$ 100

Valuation of horse equipments, \$ 100

Remarks:

-----  
-----  
-----  
-----  
-----  
-----  
-----  
-----

Book mark: -----

A. H. Knight  
(358) Copyist.

*L* | 10 H. Art'y. | U. S. C. T.

*Geo. B. Farnsworth*  
*Sgt.*, Co. M, 10 Reg't U. S. Col'd H. Art'y.

Appears on

**Company Muster Roll**

for *July & Aug*, 186*6*.

Present or absent *Present*

Stoppage, \$ 100 for

Due Gov't, \$ 100 for

Valuation of horse, \$ 100

Valuation of horse equipments, \$ 100

Remarks:  
-----  
-----  
-----  
-----  
-----  
-----  
-----  
-----

Book mark: -----

*A. H. Wright*  
(358) Copyst.

2 | 10 H. Art'y. | U. S. C. T.

Jean B. Laurentz  
Sgt., Co. M, 10 Reg't U. S. Col'd H. Art'y.

Appears on

**Company Muster Roll**

for Sept + Oct, 1866.

Present or absent Present

Stoppage, \$ 100 for

Due Gov't, \$ 100 for

Valuation of horse, \$ 100

Valuation of horse equipments, \$ 100

Remarks: \_\_\_\_\_  
\_\_\_\_\_  
\_\_\_\_\_  
\_\_\_\_\_  
\_\_\_\_\_  
\_\_\_\_\_  
\_\_\_\_\_

Book mark: \_\_\_\_\_

Reitor

2 | 10 H. Art'y. | U. S. C. T.

Jean B. Laurent

Sgt., Co. M, 10 Reg't U. S. Col'd H. Art'y.

Appears on

**Company Muster Roll**

for Nov + Dec, 1866.

Present or absent Present.

Stoppage, \$ 100 for

Due Gov't, \$ 100 for

Valuation of horse, \$ 100

Valuation of horse equipments, \$ 100

Remarks:

Book mark:

Rec'd

2 | 10 H. Art'y. | U.S.C.T.

Jean B Laurent

Serg. Co. M., 10 Reg't U. S. Col'd H. Art'y.

Appears on Co. Muster-out Roll, dated

Baton Rouge, La., Feb 22, 1867.

Muster-out to date Feb 22, 1867.

Last paid to Dec 31, 1866.

Clothing account:

Last settled \_\_\_\_\_, 186 ; drawn since \$ \_\_\_\_\_ 100

Due soldier \$ 30 <sup>16</sup>/<sub>100</sub>; due U. S. \$ \_\_\_\_\_ 100

Am't for cloth'g in kind or money adv'd \$ \_\_\_\_\_ 100

Due U. S. for arms, equipments, &c., \$ 9 <sup>00</sup>/<sub>100</sub>

Bounty paid \$ 200 <sup>00</sup>/<sub>100</sub>; due \$ \_\_\_\_\_ 100

Remarks: joined by transfer from

Co. A. 77 U.S. Inf. as Corp per S. O.

66. His dis. sept. Co. Sep 22/65.

Commodore 1864. Mar 10 1866.

Book mark: \_\_\_\_\_

Rector



7555

Lauton, James M., Jr.

Co C, 10 U.S. Col'd H. Art'y.

CARD NUMBERS.

1	26
2	27
3 see Lauton	28 James M. Jr.
4	29
5	30
6	31
7	32
8	33
9	34
10	35
11	36
12	37
13	38
14	39
15	40
16	41
17	42
18	43
19	44
20	45
21	46
22	47
23	48
24	49
25	50

Book Mark:

See also

1556

Laverne Joseph

Co G, 10 U.S. Col'd H. Art'y.

CARD NUMBERS.

1	26
2	27
3	28
4	29
5	30
6	31
7	32
8	33
9	34
10	35
11	36
12	37
13	38
14	39
15	40
16	41
17	42
18	43
19	44
20	45
21	46
22	47
23	48
24	49
25	50

Book Mark:

See also

1557  
Larigme, Henry  
Co I, 10 U.S. Col'd H. Art'y.

Private | Private

CARD NUMBERS.

1	5488553	26
2	5511550	27
3	5511681	28
4	5511789	29
5	5511890	30
6	5511947	31
7	5511987	32
8	5512022	33
9	5512200	34
10		35
11		36
12		37
13		38
14		39
15		40
16		41
17		42
18		43
19		44
20		45
21		46
22		47
23		48
24		49
25		50

Book Mark:

See also 74 U.S.C. Inf

L | 10 St. A. | U.S.C.T.

Henry Lavigne  
Pvt, Co. J, 10 Reg't U. S. Col'd St. A.

Appears on

**M. and D. Roll of Men Transferred**

to the organization named above,

from Co "E" 1st U.S. C. Inf.

Roll dated New Orleans, La, Oct 11, 1865.

When enlisted August 30, 1862.

Period for which enlisted 3 years.

When mustered in Sept. 27, 1862.

Present or absent

Company to which assigned

Remarks: Joined at Org. Org<sup>n</sup>  
Co "D", 1st La. M. G. (73<sup>d</sup>?  
U.S. C. I.) Transf<sup>d</sup> to 20  
Inf. Co. A, (9) U.S. C. I.  
Sept, '63 per O. O. No.  
2012 Std. G. O. 163.  
Transf<sup>d</sup> to 1st U.S. C. I.  
Co "E", July 20 '64 per  
Book mark: (over)

J. W. Jones, Jr

JAN. 15

5488553

1891

G. O. No 17 Stogro (Mie.  
Div. West Miss. 16th Serg.  
to Sept 14 '63. Deserted  
Sept 14 '63 Apprehended  
Oct. 21 '63, reduced to  
the ranks from Serg.  
and sentenced to confine-  
ment at hard labor  
at such place as the  
Comdg. Genl. may di-  
rect for the space of  
two years per G. O. No  
66 Stogro Dep. of M.  
La. Dec 16 '63. Now un-  
dergoing sentence at  
Fort Jefferson. Transf.  
to make good time lost  
by desertion.

L. | 10 H. Art'y. | U.S.C.T.

Henry Lavigne  
Pvt., Co. I, 10 Reg't U. S. Col'd H. Art'y.

Appears on

**Company Muster Roll**

for Nov. & Dec., 1865

Present or absent Absent

Stoppage, \$ 100 for

Due Gov't, \$ 100 for

FROM SECOND AUDITOR'S ROLL.

Valuation of horse, \$ 100

Valuation of horse equipments, \$ 100

Remarks: Transferred from  
74 U.S.C.I. per S.O. No. 84  
Hd. qrs. Dept. of La.  
Oct. 11, 1865 - Sentenced  
by G.C.M. for desertion  
to be confined at hard la-  
bor 2 years per G.O. 66 Hd.  
qrs. defenses of N. Orleans  
(over)

Book mark: R

O. S. Clark

JAN. 16

5511550

1891

*Remarks continued:  
Dec. 16, 1863 at Fort Jefferson Fla.*

L. | 10 H. Art'y. | **U.S.C.T.**

Henry Lavigne

Pvt., Co. I, 10 Reg't U. S. Col'd H. Art'y.

Appears on

**Company Muster Roll**

for Jan. + Feb., 1866.

Present or absent

Stoppage, \$ 100 for

Due Gov't, \$ 100 for

Valuation of horse, \$ 100

Valuation of horse equipments, \$ 100

Remarks: Sentenced for deser-  
tion by G.O. M. to be con-  
fined at hard labor for  
2 years per G.O. M. 66.  
Had gns. def. of New-  
Orleans, Dec. 16, 1863, at  
Fort Jefferson Fla.

Book mark:

O. S. Clark



L. | 10 H. Art'y. | U.S.C.T.

*Henry Lavigne*

*Prvt.*, Co. I, 10 Reg't U. S. Col'd H. Art'y.

Appears on

**Company Muster Roll**

for *March & April*, 1866.

Present or absent *Absent*

Stoppage, \$ *100* for

Due Gov't, \$ *100* for

Valuation of horse, \$ *100*

Valuation of horse equipments, \$ *100*

Remarks: *In confinement at Ft. Jefferson Fla. for two years per G.O. No. 66 Hd. Qu. Dep. of New Orleans Dec. 16, 1863.*

Book mark: *Des List on file in Mis Box*

*O. S. Clark*

L | 10 H. Art'y. | U.S.C.T.

Henry Lavigne

Pvt., Co. I, 10 Reg't U. S. Col'd H. Art'y.

Appears on

**Company Muster Roll**

for May & June, 1866.

Present or absent Absent

Stoppage, \$ 100 for

Due Gov't, \$ 100 for

Valuation of horse, \$ 100

Valuation of horse equipments, \$ 100

Remarks: In confinement  
at Ft. Jefferson Fla. for  
2 years per G.O. No. 66 Hd.  
qrs. def. of A.O. Dec. 12 1865.

Book mark:

O. J. Clark

Copyist.

*L* | **10 H. Art'y. | U.S.C.T.**

*Henry Lavigne*  
*Priv*, Co. I, 10 Reg't U. S. Col'd H. Art'y.

Appears on

**Company Muster Roll**

for *July + Aug*, 1866.

Present or absent *Absent*

Stoppage, \$ *100* for

Due Gov't, \$ *100* for

Valuation of horse, \$ *100*

Valuation of horse equipments, \$ *100*

Remarks: *In confinement at Ft Jefferson Fla for 2 years per G.O No 66 Hd qrs Def of New Orleans Dec 16, 1863*

Book mark:

*J. M. Hance*  
(358) Copied.

*L* 10 H. Art'y. | U.S.C.T.

*Henry Savigne*  
Pvt, Co. I, 10 Reg't U. S. Col'd H. Art'y.

Appears on

**Company Muster Roll**

for *Sept & Oct*, 1866.

Present or absent *Absent*

Stoppage, \$ \_\_\_\_\_ 100 for \_\_\_\_\_

Due Gov't, \$ \_\_\_\_\_ 100 for \_\_\_\_\_

Valuation of horse, \$ \_\_\_\_\_ 100

Valuation of horse equipments, \$ \_\_\_\_\_ 100

Remarks: *In confinement*  
*at Ft. Jefferson Fla*  
*for 2 years per G. O. No 66*  
*H. G. Sec of S. C. Dec*  
*16 1863*

Book mark: \_\_\_\_\_

*J. M. Hance*  
Copyist.

L | **10 H. Art'y. | U.S.C.T.**

*Henry Savigne*  
*Pvt*, Co. I, 10 Reg't U. S. Col'd H. Art'y.

Appears on

**Company Muster Roll**

for *Nov & Dec*, 1866.

Present or absent *Absent*

Stoppage, \$ 100 for

Due Gov't, \$ 100 for

Valuation of horse, \$ 100

Valuation of horse equipments, \$ 100

Remarks: *In confinement*  
*at Ft Jefferson Fla. per*  
*2 yrs per G.O. No 66 Hd*  
*qrs. Div. of N.O Dec 16. 1865*

Book mark: \_\_\_\_\_

*J. M. Vance*  
Copyist.

L | 10 H. Curtis | U.S.C.T.

Henry Savigne

Priv. Co. I, 10<sup>th</sup> Reg't U. S. Col'd *art'y*

Appears on Co. Muster-out Roll, dated  
Baton Rouge, La., Feb 22, 1867.

Muster-out to date \_\_\_\_\_, 1867.

Last paid to *April 30*, 1867<sup>+</sup>.

Clothing account:

Last settled \_\_\_\_\_, 1867; drawn since \$ \_\_\_\_\_ 100

Due soldier \$ *18* <sup>82</sup>/<sub>100</sub>; due U. S. \$ \_\_\_\_\_ 100

Am't for cloth'g in kind or money adv'd \$ \_\_\_\_\_ 100

Due U. S. for arms, equipments, &c., \$ \_\_\_\_\_ 100

Bounty paid \$ \_\_\_\_\_ 100; due \$ \_\_\_\_\_ 100

Remarks: *Issued by transfr. from 74<sup>th</sup> U.S.C.I.*  
*per S.O. No 84. Hd Qrs Dept of La Oct 11, 1865*  
*as in confinement at Ft. Jefferson Fla for 3*  
*years per G.O. No 66 Hd Qrs Dep of New Orleans*  
*Dec 16, 1863 Dropped as deserter Jan 18, 1867*  
*+ Roll Form*

Book mark: *V161 P153 73*

1558

Lawrence, Anthony

Co I, 10 U.S. Col'd H. Art'y.

Private

Corporal

CARD NUMBERS.

1	5-494226	26
2	5-494379	27
3	5-494454	28
4	5-494538	29
5	5-494621	30
6	5-494776	31
7	5-494930	32
8	5-495087	33
9	5-495242	34
10	5-495389	35
11	5-495541	36
12	5-495677	37
13	5-495827	38
14	5-495978	39
15	5-496130	40
16	5-496283	41
17	5-496432	42
18	5-496577	43
19	5-496723	44
20	5-496881	45
21	5-497068	46
22	5-497371	47
23	5-489616	48
24		49
25		50

Book Mark:

See also

*D* | 10 H. Art'y. | U.S.C.T.

*Anthony Lawrence*  
*Priv.*, 2 Battery, La. H. Art'y, Native Guards.\*

Age *33* years.

Appears on

**Company Muster-in Roll**

of the organization named above. Roll dated  
*Camp Parapet, Carrollton, La., Feb. 9*, 186*3*.

Muster-in to date

*Feb. 9*, 186*3*.

Joined for duty and enrolled:

When

*Dec. 4*

, 186*2*.

Where

*Camp Parapet, Carrollton, La.*

Period

*3*

years.

Valuation of horse, \$.....*100*

Valuation of horse equipments, \$.....*100*

Remarks:

\* This organization subsequently became Co. B, 10 Reg't U. S. Colored Heavy Artillery.

Book mark:

*Feaster*



*L* | 10 H. Art'y. | U.S.C.T.

*Anthony Lawrence*  
Priv., Co. B, 1 Reg't La. H. Art'y, Native Guards.\*

Appears on

**Company Muster Roll**

for *Jim. Enlistment to Feb. 28, 1863.*

Present or absent *Present*

Stoppage, \$ *100* for

Due Gov't, \$ *100* for

Valuation of horse, \$ *100*

Valuation of horse equipments, \$ *100*

Remarks:

\*This organization subsequently became Co. B, 10 Reg't U. S. Col'd Heavy Artillery.

Book mark:

*Feaster*

D | 10 H. Art'y. | U.S.C.T.

*Anthony Lawrence*  
Copt'l, Co. B, 1 Reg't La. H. Art'y, Native Guards.\*

Appears on

**Company Muster Roll**

for *March 7, April*, 1863.

Present or absent

*Present*

Stoppage, \$ 100 for

Due Gov't, \$ 100 for

Valuation of horse, \$ 100

Valuation of horse equipments, \$ 100

Remarks:

\*This organization subsequently became Co. B, 10 Reg't U. S. Col'd Heavy Artillery.

Book mark:

*Feaster*

L | 10 H. Art'y. | U.S.C.T.

*Anthony Lawrence*  
Sgt., Co. B, 1 Reg't La. H. Art'y, Native Guards.\*

Appears on

**Company Muster Roll**

for *Mar. & Apr.*, 186 *3*.

Present or absent .....

Stoppage, \$ ..... 100 for .....

Due Gov't, \$ ..... 100 for .....

Valuation of horse, \$ ..... 100

Valuation of horse equipments, \$ ..... 100

Remarks: *Error - 4<sup>th</sup> Corporal. See first page.*

*Entry, except remark, cancelled by line.*

\*This organization subsequently became Co. B, 10 Reg't U. S. Col'd Heavy Artillery.

Book mark: .....

*Heaster*

*L* | 10 H. Art'y. | U.S.C.T.

*Anthony Lawrence*  
Corpl., Co. B, 1 Reg't La. H. Art'y, Native Guards.\*

Appears on

**Company Muster Roll**

for *May & June*, 186 *7*.

Present or absent *Present*

Stoppage, \$ *100* for

Due Gov't, \$ *100* for

Valuation of horse, \$ *100*

Valuation of horse equipments, \$ *100*

Remarks:

\*This organization subsequently became Co. B, 10 Reg't U. S. Col'd Heavy Artillery.

Book mark:

*Feaster*

*L* | 10 H. Art'y. | U.S.C.T.

*Anthony Lawrence*  
Corpl., Co. B, 1 Reg't La. H. Art'y, Native Guards.\*

Appears on

**Company Muster Roll**

for *July & Aug.*, 186*5*.

Present or absent *Present*

Stoppage, \$ *100* for

Due Gov't, \$ *100* for

Valuation of horse, \$ *100*

Valuation of horse equipments, \$ *100*

Remarks:

\*This organization subsequently became Co. B, 10 Reg't U. S. Col'd Heavy Artillery.

Book mark:

*Feaster*

*L* | 10 H. Art'y. | U.S.C.T.

*Anthony Lawrence*  
Corpl., Co. B, 1 Reg't La. H. Art'y, Native Guards.\*

Appears on

**Company Muster Roll**

for *Sept. 4. Oct.*, 186 *3*.

Present or absent *Present*

Stoppage, \$ *100* for

Due Gov't, \$ *100* for

Valuation of horse, \$ *100*

Valuation of horse equipments, \$ *100*

Remarks:

\*This organization subsequently became Co. B, 10 Reg't U. S. Col'd Heavy Artillery.

Book mark: *1000*

*Feaster*

2 | 10 H. Art'y. | U.S.C.T.

Anthony Lawrence

1st Lt., Co. B, 1 Reg't H. Art'y, Corps d'Afrique.\*

Appears on

**Company Muster Roll**

for Nov. & Dec., 1863.

Present or absent Present

Stoppage, \$ 100 for

Due Gov't, \$ 100 for

Valuation of horse, \$ 100

Valuation of horse equipments, \$ 100

Remarks:

\*This organization subsequently became Co. , 10 Reg't U. S. Colored Heavy Artillery.

Book mark:

*C. P. [Signature]*  
Copyist.

*L* | **10 H. Art'y.** | **U.S.C.T.**

*Anthony Lawrence*  
*Cpl*, Co. *B*, 1 Reg't H. Art'y, Corps d'Afrique.\*

Appears on

**Company Muster Roll**

for *Jan'y & Feb.*, 186*4*.

Present or absent *Present*

Stoppage, \$ *100* for

Due Gov't, \$ *100* for

Valuation of horse, \$ *100*

Valuation of horse equipments, \$ *100*

Remarks:

\*This organization subsequently became Co. *10* Reg't U. S. Colored Heavy Artillery.

Book mark:

*Reif*



*L* | **10 H. Art'y.** | **U.S.C.T.**

*Anthony Lawrence*

*Corp*, Co. *B*, 7 Reg't U. S. Col'd H. Art'y.\*

Appears on

**Company Muster Roll**

for *Mar & Apr*, 1864

Present or absent *Present*

Stoppage, \$ 100 for

Due Gov't, \$ 100 for

Valuation of horse, \$ 100

Valuation of horse equipments, \$ 100

Remarks:

\* This organization subsequently became Co. *B*, 10 Reg't U. S. Colored Heavy Artillery.

Book mark:

*J. W. Richardson*

L | 10 H. Art'y. | U.S.C.T.

Anthony Lawrence

lpl, Co. B, 7 Reg't U. S. Col'd H. Art'y.\*

Appears on

Company Muster Roll

for May 1 June 4, 1864

Present or absent Present

Stoppage, \$ 100 for

Due Gov't, \$ 100 for

Valuation of horse, \$ 100

Valuation of horse equipments, \$ 100

Remarks:

\* This organization subsequently became Co. , 10 Reg't U. S. Colored Heavy Artillery.

Book mark:

Copyist.

*L.* | **10 H. Art'y. U.S.C.T.**

*Anthony Lawrence*  
*Corp.*, Co. B, 10 Reg't U. S. Col'd H. Art'y.

Appears on

**Company Muster Roll**

for *July & Aug*, 186*4*.

Present or absent *Present*

Stoppage, \$ 100 for

Due Gov't, \$ 100 for

Valuation of horse, \$ 100

Valuation of horse equipments, \$ 100

Remarks: \_\_\_\_\_  
\_\_\_\_\_  
\_\_\_\_\_  
\_\_\_\_\_  
\_\_\_\_\_  
\_\_\_\_\_

Book mark: \_\_\_\_\_

*J. Richardson*  
Copyist.

*L* | **10 H. Art'y. U.S.C.T.**

*Anthony Lawrence*  
*Corp*, Co. B, 10 Reg't U. S. Col'd H. Art'y.

Appears on

**Company Muster Roll**  
for *Sept & Oct*, 1864.

Present or absent *Present*

Stoppage, \$ 100 for

Due Gov't, \$ 100 for

Valuation of horse, \$ 100

Valuation of horse equipments, \$ 100

Remarks:

Book mark:

(358)

*J. W. Richardson*  
Copyist.

*G.* | **10 H. Art'y. | U.S.C.T.**

*Anthony Lawrence*  
*Corpl.*, Co. B, 10 Reg't U. S. Col'd H. Art'y.

Appears on

**Company Muster Roll**

for *Nov & Dec*, 186*4*.

Present or absent *Present.*

Stoppage, \$ 100 for

Due Gov't, \$ 100 for

Valuation of horse, \$ 100

Valuation of horse equipments, \$ 100

Remarks:

Book mark:

*Jornes*

10 H. Art'y. U.S.C.T.

*Anthony Lawrence*  
Cohler, Co. B, 10 Reg't U. S. Col'd H. Art'y.

Appears on

**Company Muster Roll**

for *Jan & Feb*, 1865.

Present or absent *Present.*

Stoppage, \$ 100 for

Due Gov't, \$ 100 for

Valuation of horse, \$ 100

Valuation of horse equipments, \$ 100

Remarks: *Dis soldier aug  
presented pay from  
Jan 1 1864 to May 1  
1864 \$60 Per month  
May & June \$11 per  
month*

Book mark:

*G.* | **10 H. Art'y. | U.S.C.T.**

*Anthony Lawrence*  
Copt., Co. B, 10 Reg't U. S. Col'd H. Art'y.

Appears on

**Company Muster Roll**

for *Mar & Apr.*, 186*5*.

Present or absent *Present.*

Stoppage, \$ 100 for

Due Gov't, \$ 100 for

Valuation of horse, \$ 100

Valuation of horse equipments, \$ 100

Remarks: \_\_\_\_\_  
\_\_\_\_\_  
\_\_\_\_\_  
\_\_\_\_\_  
\_\_\_\_\_  
\_\_\_\_\_  
\_\_\_\_\_

Book mark: \_\_\_\_\_

(358) *Jordan* Copyist.

L. | 10 H. Art'y. | U.S.C.T.

*Anthony Lawrence*

*Capt.*, Co. B, 10 Reg't U. S. Col'd H. Art'y.

Appears on

**Company Muster Roll**

for *May + June*, 186<sup>5</sup>.

Present or absent *Present*

Stoppage, \$ 100 for

Due Gov't, \$ 100 for

Valuation of horse, \$ 100

Valuation of horse equipments, \$ 100

Remarks:

Book mark:

*June*  
Copyist.



2

10 H. Art'y. U.S.C.T.

Anthony Lawrence  
Capt., Co. B, 10 Reg't U. S. Col'd H. Art'y.

Appears on

Company Muster Roll

for July & Aug, 1865.

Present or absent Present

Stoppage, \$ 100 for

Due Gov't, \$ 100 for

Valuation of horse, \$ 100

Valuation of horse equipments, \$ 100

Remarks:

Book mark:

Bukman, Capt

L. | **10 H. Art'y. U.S.C.T.**

Anthony Lawrence  
Corpl.; Co. B, 10 Reg't U. S. Col'd H. Art'y.

Appears on

**Company Muster Roll**

for Sept + Oct., 1864.

Present or absent Present

Stoppage, \$ 100 for \_\_\_\_\_

Due Gov't, \$ 100 for \_\_\_\_\_

Valuation of horse, \$ 100

Valuation of horse equipments, \$ 100

Remarks: \_\_\_\_\_  
\_\_\_\_\_  
\_\_\_\_\_  
\_\_\_\_\_  
\_\_\_\_\_  
\_\_\_\_\_  
\_\_\_\_\_

Book mark: \_\_\_\_\_

J. W. W.

*L*

**10 H. Art'y. U.S.C.T.**

*Anthony Lawrence*

*1st*, Co. B, 10 Reg't U. S. Col'd H. Art'y.

Appears on

**Company Muster Roll**

for *Nov. 1 Dec., 1865*

Present or absent *Present*

Stoppage, \$ 100 for

Due Gov't, \$ 100 for

Valuation of horse, \$ 100

Valuation of horse equipments, \$ 100

Remarks:

Book mark:

*Reif*  
Copyist.

2 | 10 H. Art'y. | U.S.C.T.

Anthony Lawrence  
Capt, Co. B, 10 Reg't U. S. Col'd H. Art'y.

Appears on

Company Muster Roll

for Jan'y. 1<sup>st</sup> to Feb. 1<sup>st</sup>, 1866.

Present or absent \_\_\_\_\_

Stoppage, \$ \_\_\_\_\_ 100 for \_\_\_\_\_

Due Gov't, \$ \_\_\_\_\_ 100 for \_\_\_\_\_

Valuation of horse, \$ \_\_\_\_\_ 100

Valuation of horse equipments, \$ \_\_\_\_\_ 100

Remarks: Mustd. out at M.O.  
1<sup>st</sup> Feb. 8 66 by reason  
of exp. of term of service

Book mark: \_\_\_\_\_

*Reif*

Copyist.

L. 10 H. a. U.S.C.T.

Anthony Lawrence  
Corps, Co. B., 10 Reg't U. S. Col'd H. a.

Appears on a

**Detachment Muster-out Roll**

of the organization named above. Roll dated

*N. Orleans La. Feb. 8, 1866.*

Muster-out to date *Feb. 8, 1866.*

Last paid to *June 30, 1865*

**Clothing account:**

Last settled \_\_\_\_\_, 186 ; drawn since \$ \_\_\_\_\_ 100

Due soldier \$ *37 47*; due U. S. \$ \_\_\_\_\_ 100

Am't for cloth'g in kind or money adv'd \$ \_\_\_\_\_ 100

Due U. S. for arms, equipments, &c., \$ \_\_\_\_\_ 100

Bounty paid \$ \_\_\_\_\_ 100 due \$ \_\_\_\_\_ 100

Remarks: *Joined at Orignl. Orgn.*

*Vol. to June 21, 1863.*

*Mustered out by reason  
of Expiration of term of  
service \* Cert. of Mustg. Off.  
showed him M. O. Feb. 12, 1866.*

Book mark: \_\_\_\_\_

*\* Added May 9, 93 JED*

*Keawling*

*L* | 10 H. Art'y. | U.S.C.T.

*Anthony Lawrence*  
*Corple B*, Co. *B*, 10 Reg't U. S. Col'd H. Art'y.

Appears on Co. Muster-out Roll, dated  
*Baton Rouge La Feb.*, 186 *7*.

Muster-out to date \_\_\_\_\_, 186 .  
Last paid to \_\_\_\_\_, 186 .

Clothing account:

Last settled \_\_\_\_\_, 186 ; drawn since \$ \_\_\_\_\_ 100  
Due soldier \$ \_\_\_\_\_ 100; due U. S. \$ \_\_\_\_\_ 100  
Am't for cloth'g in kind or money adv'd \$ \_\_\_\_\_ 100

Due U. S. for arms, equipments, &c., \$ \_\_\_\_\_ 100  
Bounty paid \$ \_\_\_\_\_ 100; due \$ \_\_\_\_\_ 100

Remarks: \_\_\_\_\_  
*Joined or at organ*  
*Discharged Feb. 8/66*  
*expiration term of*  
*service.*

Book mark: \_\_\_\_\_

*Hodges*  
Copyist.

Lawrence, Anthony

, Co.

10<sup>th</sup>

Reg't

W.S. Co., Pa.

Enclosures.

Bed Cards .....	Final Statements .....
Burial Records .....	Furloughs or L. of A. ....
Certs. of Dis. for Discharge .....	Med. Certificates .....
C. M. Charges .....	Med. Des. Lists .....
Descriptive Lists .....	Orders .....
Discharge Certificates .....	Pris. of War Record .....
Enlistment Papers .....	Resignations .....

Other papers relating to—

Admission to Hosp'l .....	Furlough or L. of A. ....
Casualty Sheet .....	Med. Examination .....
Confinement .....	Misc. Information .....
Contracts .....	Pay or Clothing .....
Death or Effects .....	Personal Reports .....
Desertion .....	Rank .....
Discharge from Hosp'l .....	Transfer to Hosp'l .....
Discharge from Service .....	Transfer to V. R. C. ....
Duty .....	Transportation .....

DECLARATION OF RECRUIT.

I, \_\_\_\_\_ desiring to ENLIST in the Army of the United States, for the term of THREE YEARS, Do declare, That I am \_\_\_\_\_ years and \_\_\_\_\_ months of age; that I have neither wife nor child; that I have never been discharged from the United States service on account of disability or by sentence of a court-martial, or by order before the expiration of a term of enlistment; and I know of no impediment to my serving honestly and faithfully as a soldier for three years.

GIVEN at \_\_\_\_\_  
The \_\_\_\_\_ day of \_\_\_\_\_

Witness:

\_\_\_\_\_

\_\_\_\_\_

\_\_\_\_\_

\_\_\_\_\_

\_\_\_\_\_

\_\_\_\_\_

\_\_\_\_\_

\_\_\_\_\_

No. \_\_\_\_\_  
Enlisted at St. Louis  
December 4 1862  
By Wm. H. ...  
1st Regiment of Missouri  
10 W.S. ...  
Discharged \_\_\_\_\_ 18\_\_\_\_  
Regt of \_\_\_\_\_  
enlistment; last served in Company ( )

CONSENT IN CASE OF MINOR.

I, \_\_\_\_\_ Do CERTIFY, That I am the \_\_\_\_\_ of \_\_\_\_\_; that the said \_\_\_\_\_ is \_\_\_\_\_ years of age; and I do hereby freely give my CONSENT to his enlisting as a SOLDIER in the ARMY OF THE UNITED STATES for the period of THREE YEARS.

GIVEN at \_\_\_\_\_  
The \_\_\_\_\_ day of \_\_\_\_\_

Witness:



County of

*Jefferson*



State of

*Louisiana*

I, *Anthony Lawrence* born in *Algiers*

in the State of *Louisiana* aged *Thirty Three* years,

and by occupation a *Laborer* do hereby acknowledge to have

voluntarily enlisted this *Fourth* day of *December*

18 *61*, as a SOLDIER in the ARMY OF THE UNITED STATES OF AMERICA, for the period of *THREE YEARS*, unless sooner discharged by proper authority: Do also agree to

accept such bounty, pay, rations, and clothing, as are, or may be, established by law. And

I, *Anthony Lawrence* do solemnly swear, that I will bear true faith and allegiance to the UNITED STATES OF AMERICA, and that I will serve them honestly and

faithfully against all their enemies or opposers whomsoever; and that I will observe and

obey the orders of the President of the United States, and the orders of the officers

appointed over me, according to the Rules and Articles of War.

Sworn ~~and subscribed~~ to, at

*of Carrollton, La,*

*Camp Paraput,*

this *ninth* day of *February* 18*61*,

BEFORE

*J. Rygaard*  
*2<sup>d</sup> Lt. N. G. Art. La. Vol.*

I CERTIFY, ON HONOR, That I have carefully examined the above named Recruit, agreeably to the General Regulations of the Army, and that in my opinion he is free from all bodily defects and mental infirmity, which would, in any way, disqualify him from performing the duties of a soldier.

*W. C. Lynde*

EXAMINING SURGEON.

I CERTIFY, ON HONOR, That I have minutely inspected the Recruit, *Anthony Lawrence* previously to his enlistment, and that he was entirely sober when enlisted; that, to the best of my judgment and belief, he is of lawful age; and that, in accepting him as duly qualified to perform the duties of an able-bodied soldier, I have strictly observed the Regulations which govern the recruiting service. This soldier has *Brown* eyes, *Dark* hair,

*Dark* complexion; is *Five* feet, *Six* inches high.

*J. Rygaard* *2<sup>d</sup> Lieut. N. G. Art. La. Vol.*

RECRUITING OFFICER.

DECLARATION OF RECRUIT.

I, \_\_\_\_\_ desiring to ENLIST in the Army of the United States, for the term of THREE YEARS, Do declare, That I am \_\_\_\_\_ years and \_\_\_\_\_ months of age; that I have neither wife nor child; that I have never been discharged from the United States service on account of disability or by sentence of a court-martial, or by order before the expiration of a term of enlistment; and I know of no impediment to my serving honestly and faithfully as a soldier for three years.

GIVEN at \_\_\_\_\_  
The \_\_\_\_\_ day of \_\_\_\_\_

Witness :

No. 21.

*Anthony Lawrence*

Enlisted at *Cambridgeport*

*December 14 1862*

By *Wm. H. Hubbard*

*Adjutant* Regiment of *Massachusetts*

enlistment; last served in Company ( )

Reg't of \_\_\_\_\_

Discharged \_\_\_\_\_ 18\_\_

CONSENT IN CASE OF MINOR.

I, \_\_\_\_\_ Do CERTIFY, That I am the \_\_\_\_\_ of \_\_\_\_\_; that the said \_\_\_\_\_ is \_\_\_\_\_ years of age; and I do hereby freely give my CONSENT to his enlisting as a SOLDIER in the ARMY OF THE UNITED STATES for the period of THREE YEARS.

GIVEN at \_\_\_\_\_  
The \_\_\_\_\_ day of \_\_\_\_\_

Witness :

County of



State of

*Jefferson*

*Louisiana*

I, *Anthony Lawrence* born in *Algiers*  
in the State of *Louisiana* aged *Thirty Three* years,  
and by occupation a *Laborer* do hereby acknowledge to have  
voluntarily enlisted this *Tenth* day of *December*

18*62*, as a SOLDIER in the ARMY OF THE UNITED STATES OF AMERICA, for the period  
of *THREE YEARS*, unless sooner discharged by proper authority: Do also agree to

accept such bounty, pay, rations, and clothing, as are, or may be, established by law. And

I, *Anthony Lawrence* do solemnly swear, that I will bear true faith  
and allegiance to the UNITED STATES OF AMERICA, and that I will serve them honestly and  
faithfully against all their enemies or opposers whomsoever; and that I will observe and  
obey the orders of the President of the United States, and the orders of the officers  
appointed over me, according to the Rules and Articles of War.

Sworn ~~and subscribed~~ to, at *Camp Parapet,*  
this *ninth* day of *February* 18*63*  
BEFORE *J. Rygaard*  
*2d Lt. U.S. Army*

I CERTIFY, ON HONOR, That I have carefully examined the above named Recruit, agreeably to the General Regulations  
of the Army, and that in my opinion he is free from all bodily defects and mental infirmity, which would, in any way, disqualify  
him from performing the duties of a soldier.

*W. Lynde*

EXAMINING SURGEON.

I CERTIFY, ON HONOR, That I have minutely inspected the Recruit, *Anthony Lawrence*  
previously to his enlistment, and that he was entirely sober when enlisted; that, to the best of my judgement and belief, he is of  
lawful age; and that, in accepting him as duly qualified to perform the duties of an able-bodied soldier, I have strictly observed  
the Regulations which govern the recruiting service. This soldier has *Brown* eyes, *Dark* hair,  
*Dark* complexion; is *Five* feet, *Six* inches high.

*J. Rygaard. 2d Lieut. U.S. Army*

RECRUITING OFFICER.

7559  
Lawrence, Edward

Co *A*, 10 U.S. Col'd H. Art'y.

Private | Private

CARD NUMBERS.

1	55-09781	26
2	55-09935	27
3	55-10086	28
4	55-10230	29
5	55-10388	30
6	55-10529	31
7	55-10706	32
8	55-11139	33
9	5489949	34
10		35
11		36
12		37
13		38
14		39
15		40
16		41
17		42
18		43
19		44
20		45
21		46
22		47
23		48
24		49
25		50

Book Mark: \_\_\_\_\_

See also \_\_\_\_\_

L | 10 H. Art'y. | U.S.C.T.

Edward Lawrence

Pvt., Co. H, 10 Reg't U. S. Col'd H. Art'y

Appears on

**Company Muster Roll**

for *March & April, 1865.*

Present or absent *Present*

Stoppage, \$ 100 for

Due Gov't, \$ 100 for

Valuation of horse, \$ 100

Valuation of horse equipments. \$ 100

Remarks: *Commencement  
of first payment  
by time April 3<sup>rd</sup>  
1865*

Book mark:

*Permanently*

L 10 H. Art'y. U.S.C.T.

Edward Lawrence

Pvt., Co. H, 10 Reg't U. S. Col'd H. Art'y

Appears on

Company Muster Roll

for May & June, 1865.

Present or absent Present

Stoppage, \$ 100 for

Due Gov't, \$ 100 for

Valuation of horse, \$ 100

Valuation of horse equipments, \$ 100

Remarks: Stoppage for  
Drummer 2<sup>ds</sup>

Book mark:

Pennington  
Copyist.

*L* | 10 H. Art'y. | U.S.C.T.

*Edward Lawrence*

*Pvt*, Co. H, 10 Reg't U. S. Col'd H. Art'y

Appears on

**Company Muster Roll**

for *July & Aug*, 1865:

Present or absent *Present*

Stoppage, \$ *100* for

Due Gov't, \$ *100* for

Valuation of horse, \$ *100*

Valuation of horse equipments. \$ *100*

Remarks: *Sick in quarters*

Book mark:

*Perrington*

*L* | 10 H. Art'y. | U.S.C.T.

*Edward Lawrence*

*Priv't*, Co. H, 10 Reg't U. S. ~~Sold~~ H. Art'y

Appears on

**Company Muster Roll**

for *Sept & Oct*, 1865.

Present or absent *Present*

Stoppage, \$ *100* for

Due Gov't, \$ *100* for

Valuation of horse, \$ *100*

Valuation of horse equipments, \$ *100*

Remarks: *Sick in quarters*

Book mark:

*Cammack*

Copyist.



*L* | 10 H. Art'y. | U.S.C.T.

*Edward Lawrence*

*Pr*, Co. H, 10 Reg't U. S. Col'd H. Art'y

Appears on

**Company Muster Roll**

for *Nov & Dec*, 1865.

Present or absent *Present*

Stoppage, \$ 100 for

Due Gov't, \$ 100 for

Valuation of horse, \$ 100

Valuation of horse equipments. \$ 100

Remarks :

Book mark :

*Samuel R*

*L* | 10 H. Art'y. | U.S.C.T.

*Edward Lawrence*

*Priv.*, Co. H, 10 Reg't U. S. Col'd H. Art'y

Appears on

**Company Muster Roll**

for *Jan & Feb., 1866.*

Present or absent *Present*

Stoppage, \$ *100* for

Due Gov't, \$ *100* for

Valuation of horse, \$ *100*

Valuation of horse equipments. \$ *100*

Remarks: *Stop page for loss of insurance & cents*

Book mark:

*Sammack*

*L* | 10 H. Art'y. | U.S.C.T.

*Edward Lawrence*

*Priv.*, Co. H, 10 Reg't U. S. Col'd H. Art'y

Appears on

**Company Muster Roll**

for *Mch & Apr.*, 1866.

Present or absent

Stoppage, \$ 100 for

Due Gov't, \$ 100 for

Valuation of horse, \$ 100

Valuation of horse equipments. \$ 100

Remarks: *Mustered out by reason of expiration of term of service to date April 2, 1866*

Book mark:

*Cammack*

Copyist.

L. <sup>10</sup> *Hy Arty* U.S.C.T.

*Edward Laurence*

*Pvt.*, Co. *A.*, <sup>10</sup> Reg't U. S. Co'l'd *Arty*

Appears on a

**Detachment Muster-out Roll**

of the organization named above. Roll dated

*New Orleans, La. Apr. 2*, 1866.

Muster-out to date *Apr. 2*, 1866.

Last paid to *Dec. 31*, 1865

**Clothing account:**

Last settled \_\_\_\_\_, 1866; drawn since \$ \_\_\_\_\_ 100

Due soldier \$ *24 27* / 100; due U. S. \$ \_\_\_\_\_ 100

Am't for cloth'g in kind or money adv'd \$ \_\_\_\_\_ 100

Due U. S. for arms, equipments, &c., \$ \_\_\_\_\_ 100

Bounty paid \$ \_\_\_\_\_ 100 due \$ \_\_\_\_\_ 100

Remarks: *joined as shown.*

\_\_\_\_\_

*ag.*

\_\_\_\_\_

Book mark: \_\_\_\_\_

*H. W. Reed,*

L | 10 H. Art'y. | U.S.C.T.

Edward Lawrence

Priv., Co. H., 10 Reg't U. S. Col'd H. Art'y.

Appears on Co. Muster-out Roll, dated

Baton Rouge, La. Feb. 22, 1867.

Muster-out to date \_\_\_\_\_, 186 .

Last paid to \_\_\_\_\_, 186 .

Clothing account:

Last settled \_\_\_\_\_, 186 ; drawn since \$ \_\_\_\_\_ 100

Due soldier \$ \_\_\_\_\_ 100; due U. S. \$ \_\_\_\_\_ 100

Am't for cloth'g in kind or money adv'd \$ \_\_\_\_\_ 100

Due U. S. for arms, equipments, &c., \$ \_\_\_\_\_ 100

Bounty paid \$ \_\_\_\_\_ 100; due \$ \_\_\_\_\_ 100

Remarks: Joined by assignment  
Mustered out exp. of term  
of service Apl. 2/66.

Reg. 45. Drafted & kept at Camp  
65. New Orleans, La. 1865

Book mark: \_\_\_\_\_

Lowry

1560  
Lawrence, Joseph  
Co—, 10 U.S. Col'd H. Art'y.

Private —

CARD NUMBERS.

1	5487414	26
2		27
3		28
4		29
5		30
6		31
7		32
8		33
9		34
10		35
11		36
12		37
13		38
14		39
15		40
16		41
17		42
18		43
19		44
20		45
21		46
22		47
23		48
24		49
25		50

Book Mark:

See also 77. 243 C. inf

L 1026A U.S.C.T.

Joseph Lawrence  
Co., Co., 10 Reg't U. S. Col'd H.A.

Appears on

**M. and D. Roll of Men Transferred**

to the organization named above,

from Co 1st Reg't U.S. Col Inf

Roll dated Camp Mansfield, 1865.

When enlisted Feb 11, 1863.

Period for which enlisted 2 years.

When mustered in Feb 23, 1863.

Present or absent

Company to which assigned

Remarks: Discharged for  
disability Sept 14, 65.  
by Order Maj Gen  
Canby.

Not on muster rolls Reg't

Book mark :

W. H. Scott

1566  
Lawton, James M., Jr.

Co C, 10 U.S. Col'd H. Art'y.

2<sup>d</sup> Lieutenant | 2<sup>d</sup> Lieutenant

CARD NUMBERS.

1	5486876	26
2	5497776	27
3	5497927	28
4		29
5		30
6		31
7		32
8		33
9		34
10		35
11		36
12		37
13		38
14		39
15		40
16		41
17		42
18		43
19		44
20		45
21		46
22		47
23		48
24		49
25		50

Book Mark:

See also



N. 2960 377 Audubon  
No. 1688 461.

C. S. Doughty

S. 10 H. Art'y. | U.S.C.T.

James M. Lawton Jr.  
1st Lt. Co., 10 Reg't U. S. Col'd H. Art'y.  
1st Sa. N. Y. Art'y.

Age 21 years.

Appears on an

**Individual Muster-in Roll**

of the organization named above. Roll dated

New Orleans, Aug. 24, 1863.

Muster-in to date Aug. 19, 1863.

Joined for duty and enrolled:

When August 24, 1863.

Where New Orleans

Period 3 years.

Valuation of horse, \$ 100

Valuation of horse equipments, \$ 100

Remarks: Promoted from private in the 38th Mass. Vol. to an original vacancy in the 1st Sa. N. Y. Artillery. Discharged from service as private over

Book mark:

Philipsen

JAN. 15

5486816

1891

X by Special Order No.  
204. Hd. Gr. Dept. of the  
Gulf.

L | 10 H. Art'y. | U.S.C.T.

*James M. Linton Jr*  
2<sup>d</sup> Lt., Co, C, 1 Reg't La. Art'y Native Guards.\*

Appears on

**Company Muster Roll**

for *Aug 11<sup>th</sup> to 31<sup>st</sup>*, 1863.

Present or absent *Present*

Stoppage, \$ 100 for

Due Gov't, \$ 100 for

Valuation of horse, \$ 100

Valuation of horse equipments, \$ 100

Remarks :

\* This organization subsequently became Co. C, 10 Reg't U. S. Col'd Heavy Artillery.

Book mark :

*James M. Linton Jr*

*L* | 10 H. Art'y. | U.S.C.T.

*James M. Laurin Jr*  
2<sup>d</sup> Lt, Co, C, 1 Reg't La. Art'y Native Guards.\*

Appears on

**Company Muster Roll**

for *Sept + Oct, 1863*

Present or absent *absent*

Stoppage, \$ *100* for

Due Gov't, \$ *100* for

Valuation of horse, \$ *100*

Valuation of horse equipments, \$ *100*

Remarks: *Absent Sick in Hos-  
pital at New Orleans*

*Also on sub. rolls.*

\* This organization subsequently became Co. C, 10 Reg't U. S. Col'd Heavy Artillery.

Book mark: \_\_\_\_\_

*Efferman*  
Coryist.

1562  
Layman, John

Co M, 10 U.S. Col'd H. Art'y.

Private

CARD NUMBERS.

1	26
2	27
3 See Suezaim	28 John
4	29
5	30
6	31
7	32
8	33
9	34
10	35
11	36
12	37
13	38
14	39
15	40
16	41
17	42
18	43
19	44
20	45
21	46
22	47
23	48
24	49
25	50

Book Mark:

See also

1563  
Leadbetter, Robert

Co—, 10 U.S. Col'd H. Art'y.

Private

—

CARD NUMBERS.

1	5488782	26
2		27
3		28
4		29
5		30
6		31
7		32
8		33
9		34
10		35
11		36
12		37
13		38
14		39
15		40
16		41
17		42
18		43
19		44
20		45
21		46
22		47
23		48
24		49
25		50

Book Mark:

See also

77.21.3.1.171

L 111 N. Art'y | **U.S.C.T.**

Robert Leadbetter

Inf., Co., 111 Reg't U. S. Col'd N. Art'y

Appears on

**M. and D. Roll of Men Transferred**

to the organization named above,

from 77 Reg't U.S. C. Inf.

Roll dated Oct 1, 1865.

When enlisted Mar 11, 1863.

Period for which enlisted 3 years.

When mustered in Mar 23, 1863.

Present or absent

Company to which assigned

Remarks: Discharged for  
disability June 11. 65 from  
U.S. C. Inf., Gen Hosp N.O  
Medical statements given  
by Dr Piquette

Not on muster rolls Reg't

Book mark:

J. W. Leman



1364

Leatherbury, James H.

Co I, 10 U.S. Col'd H. Art'y.

Musician

Musician

CARD NUMBERS.

1	5488572	26
2	5488575	27
3	5511487	28
4	5511604	29
5	5511764	30
6	5511878	31
7	5511937	32
8	5511978	33
9	5512013	34
10	5512083	35
11	5489391	36
12		37
13		38
14		39
15		40
16		41
17		42
18		43
19		44
20		45
21		46
22		47
23		48
24		49
25		50

Book Mark:

See also

S. 11771799 P. Amm  
D. 2793909 And NLS

S. F. Wright  
2

L ) O/Ha U.S.C.T.

James St. Leatherbury  
Maj<sup>r</sup> Co., 10 Reg't U. S. Col'd N. G.

Appears on

**M. and D. Roll of Men Transferred**

to the organization named above,

from Co. "K" 7<sup>th</sup> U.S. C. Inf.

Roll dated New Orleans La. Oct 11, 1865.

When enlisted Jan'y 16, 1864.

Period for which enlisted 3 years.

When mustered in May 28, 1864.

Present or absent

Company to which assigned

Remarks: Joined as recruit.  
Freedom or before April  
19, 1861. Stop for some  
Staverock

Book mark :

(342)

J. W. Jones, Jr.  
Copyst.

L 10th U.S.C.T.

James St. Leatherbury  
Muss, Co., 10 Reg't U. S. Col'd St. Arky.

Appears on

**M. and D. Roll of Men Transferred**

to the organization named above,

from Co "K" 74 U.S. I. Inf.

Roll dated New Orleans, La. Oct. 11, 1865.

When enlisted Jan'y 10, 1864.

Period for which enlisted 3 years.

When mustered in May 28, 1864.

Present or absent

Company to which assigned

Remarks: Joined as recruit  
Free on or before April  
19 '61. Stopped for one  
Starersock.

Book mark :

J. St. Jones, Jr.

L. | 10 H. Art'y. | U.S.C.T.

James H. Leatherbury  
Mus., Co. I, 10 Reg't U. S. Col'd H. Art'y.

Appears on

**Company Muster Roll**

for Nov. 10<sup>th</sup> Dec., 1865.

Present or absent Present

Stoppage, \$ 100 for

Due Gov't, \$ 100 for

Valuation of horse, \$ 100

Valuation of horse equipments, \$ 100

Remarks: Transferred from  
74 Used per O. No. 84  
Hd. qrs. Dept. of La. Oct.  
11, 1865.

FROM SECOND AUDITOR'S ROLL.

Book mark:

O. S. Clark  
Copist.

*J.*

10 H. Art'y.

U.S.C.T.

*James H. Leatherby*

*Mus.*, Co. I, 10 Reg't U. S. Col'd H. Art'y.

Appears on

**Company Muster Roll**

for *Jan. & Feb.*, 1866.

Present or absent *Present*

Stoppage, \$ 100 for

Due Gov't, \$ 100 for

Valuation of horse, \$ 100

Valuation of horse equipments, \$ 100

Remarks:

Book mark:

*O. S. Leback*

L. | 10 H. Art'y. | U.S.C.T.

*James H. Leatherbury*  
Musician, Co. I, 10 Reg't U. S. Col'd H. Art'y.

Appears on

**Company Muster Roll**

for *Mar. & Apr.*, 1866.

Present or absent *Present*

Stoppage, \$ *100* for

Due Gov't, \$ *100* for

Valuation of horse, \$ *100*

Valuation of horse equipments, \$ *100*

Remarks:

Book mark:

*J. S. Clark*

L. | **10 H. Art'y.** | **U.S.C.T.**

James N. Leatherbury  
News., Co. I, 10 Reg't U. S. Col'd H. Art'y.

Appears on

**Company Muster Roll**

for May + June, 1866.

Present or absent Present

Stoppa, \$ 100 for \_\_\_\_\_

Due Gov't, \$ 100 for \_\_\_\_\_

Valuation of horse, \$ 100

Valuation of horse equipments, \$ 100

Remarks: \_\_\_\_\_  
\_\_\_\_\_  
\_\_\_\_\_  
\_\_\_\_\_  
\_\_\_\_\_  
\_\_\_\_\_  
\_\_\_\_\_

Book mark: \_\_\_\_\_  
\_\_\_\_\_

O. J. Clark  
Copyist.



*L* | **10 H. Art'y. | U.S.C.T.**

*James H. Leatherburry*  
*Mus.*, Co. I, 10 Reg't U. S. Col'd H. Art'y.

Appears on

**Company Muster Roll**

for *July + Aug*, 186*6*.

Present or absent *Present*

Stoppage, \$ *100* for

Due Gov't, \$ *100* for

Valuation of horse, \$ *100*

Valuation of horse equipments, \$ *100*

Remarks:

Book mark:

*J. M. Vance*  
Copyst.

L | **10 H. Art'y.** | **U.S.C.T.**

*James H. Leatherburry*  
Mus, Co. I, 10 Reg't U. S. Col'd H. Art'y.

Appears on

**Company Muster Roll**

for *Sept. and Oct*, 186*6*.

Present or absent *Present*

Stoppage, \$ 100 for

Due Gov't, \$ 100 for

Valuation of horse, \$ 100

Valuation of horse equipments, \$ 100

Remarks:

Book mark:

*J. M. Stance*

*L* | **10 H. Art'y. | U.S.C.T.**

*Samuel C. Leatherbury*  
Mus., Co. I, 10 Reg't U. S. Col'd H. Art'y.

Appears on

**Company Muster Roll**

for *Nov. & Dec*, 1866.

Present or absent *Present*

Stoppage, \$ 100 for

Due Gov't, \$ 100 for

Valuation of horse, \$ 100

Valuation of horse equipments, \$ 100

Remarks:  
\_\_\_\_\_  
\_\_\_\_\_  
\_\_\_\_\_  
\_\_\_\_\_  
\_\_\_\_\_  
\_\_\_\_\_

Book mark: \_\_\_\_\_

*J. M. Hance*

D | 10 No A | U.S.C.T.

James W. Leatherbury  
Mus, Co. I, 10 Reg't U. S. Col'd No A

Appears on an

**Individual Muster-out Roll**

of the organization named above. Roll dated

New Orleans La Jan 9, 1867.

Muster-out to date

Jan 9, 1867.

Last paid to

Oct 31, 1866.

**Clothing account:**

Last settled ..... 186 ; drawn since \$ ..... 100

Due soldier \$  $17 \frac{65}{100}$ ; due U. S. \$ ..... 100

Am't for cloth'g in kind or money adv'd \$ ..... 100

Due U. S. for arms, equipments, &c., \$ ..... 100

Bounty paid \$ ..... 100 due \$ 300 100

Remarks: Coined by transfer  
from 74<sup>th</sup> U.S. I per S O  
No 84 No d gns Dept of La  
Oct 11, 1865. Mustered out by  
reason of expiration of term of  
service to date Jan 9<sup>th</sup> 1867

Book mark: \_\_\_\_\_

R. Richardson

L | 10 H. Art'y. | U.S.C.T.

James H. Leatherbury  
Musician, Co. I, 10 Reg't U. S. Col'd H. Art'y.

Appears on Co. Muster-out Roll, dated  
Patrol Range Ia, Feb 22, 1867.

Muster-out to date \_\_\_\_\_, 186 .

Last paid to \_\_\_\_\_, 186 .

Clothing account:

Last settled \_\_\_\_\_, 186 ; drawn since \$ \_\_\_\_\_ 100

Due soldier \$ \_\_\_\_\_ 100; due U. S. \$ \_\_\_\_\_ 100

Am't for cloth'g in kind or money adv'd \$ \_\_\_\_\_ 100

Due U. S. for arms, equipments, &c., \$ \_\_\_\_\_ 100

Bounty paid \$ \_\_\_\_\_ 100; due \$ \_\_\_\_\_ 100

Remarks: Discharged expiration  
term of service Jan. 9, 1867

Book mark: M.O. on file

(361)

J. M. Hance  
Copyist.

1565  
LePine, Lewis

Co L, 10 U.S. Col'd H. Art'y.

Colonel Corporal

CARD NUMBERS.

1	5488078	26
2	5488194	27
3	5513410	28
4	5513562	29
5	5513695	30
6	5513890	31
7	5514157	32
8	5489882	33
9		34
10		35
11		36
12		37
13		38
14		39
15		40
16		41
17		42
18		43
19		44
20		45
21		46
22		47
23		48
24		49
25		50

Book Mark:

See also 77 U.S. Col'd H. Art'y

S. Wash, D. C. **U.S.C.T.**

Lewis DeBane  
Corp, Co. K, 10 Reg't U. S. Col'd K.A.

Appears on

**M. and D. Roll of Men Transferred**

to the organization named above,

from Co. E 4th U. S. Col'd Inf

Roll dated Camp Parapet, 1865.

When enlisted March 18, 1865.

Period for which enlisted 3 years.

When mustered in March 23, 1865.

Present or absent Present

Company to which assigned L

Remarks: Transferred from  
4th Reg't C de Afrique  
Dec 12, 63, Demotte  
Corp Apr 1, 65 pers. O.  
Moist Hd Qrs 24  
U.S.C.T. New Orleans  
La

Book mark :

W. H. Scott

*L* 10 H.A. **U.S.C.T.**

*Lewis Libanus*  
*Cop*, Co. *d*, 10 Reg't U. S. Col'd *H.A.*

Appears on

**M. and D. Roll of Men Transferred**

to the organization named above,

from *99 U.S. Col Inftry*

Roll dated *Camp Parapet La Oct 11*, 186*5*.

When enlisted *March 18*, 186*3*.

Period for which enlisted *3* years.

When mustered in *March 23*, 186*3*.

Present or absent *Present*

Company to which assigned *L*

Remarks: *Transferred from*

*Co. A Dec 2. 63. abpt'd*

*Cop Apr 1. 65. joined by*

*transfer from Co. E. 99*

*U.S. C. I. per S.O. 66 C.S.*

*Had Ars Dept of La*

Book mark :

*W. Har Scott*



L | 10 H. Art'y. | **U.S.C.T.**

Lewis LeBarre

Capt., Co. L, 10 Reg't U. S. Col'd H. Art'y.

Age ..... years.

Appears on

**Company Muster Roll\***

for Sept. & Oct., 1865.

Joined for duty and enrolled:

When Mich. 18, 1863.

Where New Orleans

Period 3 years.

Mustered in:

When Mich. 23, 1863.

Where New Orleans

Present or absent Present

Stoppage, \$ 100 for .....

Due Gov't, \$ 100 for .....

Valuation of horse, \$ 100

Valuation of horse equipments, \$ 100

Remarks: Transf. from Co. E.  
77 U.S.C.A.

\*First current roll. No muster-in roll of this company on file.

Book mark : .....

Scherich

(358b)

Copyist.

*L* | 10 H. Art'y. | U.S.C.T.

*Lewis LeBarre*

*Corp*, Co. L, 10 Reg't U. S. Col'd H. Art'y.

Appears on

**Company Muster Roll**

for *Nov. & Dec.*, 186*5*.

Present or absent *Present*

Stoppage, \$ 100 for

Due Gov't, \$ 100 for

Valuation of horse, \$ 100

Valuation of horse equipments, \$ 100

Remarks:

Book mark:

*Scherich*

L | 10 H. Art'y. | **U.S.C.T.**

Lewis Le Bane

Cop., Co. L, 10 Reg't U. S. Col'd H. Art'y.

Appears on

**Company Muster Roll**

for Jan. & Feb., 1866.

Present or absent Present

Stoppage, \$ 100 for

Due Gov't, \$ 100 for

Valuation of horse, \$ 100

Valuation of horse equipments, \$ 100

Remarks: \_\_\_\_\_  
\_\_\_\_\_  
\_\_\_\_\_  
\_\_\_\_\_  
\_\_\_\_\_  
\_\_\_\_\_  
\_\_\_\_\_

Book mark: \_\_\_\_\_

Scherich

L | 10 H. Art'y. | U.S.C.T.

Lewis Le Bane

Corp, Co. L, 10 Reg't U. S. Col'd H. Art'y.

Appears on

Company Muster Roll

for *Mich. & Apl.*, 1866.

Present or absent

Stoppage, \$ 100 for

Due Gov't, \$ 100 for

Valuation of horse, \$ 100

Valuation of horse equipments, \$ 100

Remarks: *Mustered by reason  
of Ex. of term of service  
to date Mich. 17/66.*

Book mark: *Muster out on file*

*Scherich*

L. <sup>10</sup> Ky Arty U.S.C.T.

Lewis Le Barr

Corpl, Co. B, 10 Reg't U. S. Col'd Arty

Appears on a

**Detachment Muster-out Roll**

of the organization named above. Roll dated  
New Orleans La, Mar. 17, 1866.

Muster-out to date Mar. 17, 1866.

Last paid to Dec. 31, 1865

**Clothing account:**

Last settled \_\_\_\_\_, 1866; drawn since \$ \_\_\_\_\_ 100

Due soldier \$ <sup>36</sup> <sub>100</sub> <sup>87</sup>; due U. S. \$ \_\_\_\_\_ 100

Am't for cloth'g in kind or money adv'd \$ \_\_\_\_\_ 100

Due U. S. for arms, equipments, &c., \$ \_\_\_\_\_ 100

Bounty paid \$ \_\_\_\_\_ 100 due \$ \_\_\_\_\_ 100

Remarks: *Joined as recruit in Co. E, 4<sup>th</sup> C. d. A transferred to 5<sup>th</sup> C. d. A (77<sup>th</sup> U. S. C. I.) by reorganization, transferred as Corporal to 10<sup>th</sup> U. S. C. A (Ky.) by consolidation, (over)*

Book mark: \_\_\_\_\_

*H. W. Reed*

JAN. 15

5489882

\* 1891 \*

*in compliance  
with S. O. 66, series  
1865 Hd Qrs. Dept of  
La.*

L | **10 H. Art'y.** | **U.S.C.T.**

Louis Le Bam

Capt, Co. L, 10 Reg't U. S. Col'd H. Art'y.

Appears on **Co. Muster-out Roll**, dated  
Baton Rouge La, Feb 22, 1867.

Muster-out to date \_\_\_\_\_, 186 .

Last paid to \_\_\_\_\_, 186 .

Clothing account:

Last settled \_\_\_\_\_, 186 ; drawn since \$ \_\_\_\_\_ 100

Due soldier \$ \_\_\_\_\_ 100; due U. S. \$ \_\_\_\_\_ 100

Am't for cloth'g in kind or money adv'd \$ \_\_\_\_\_ 100

Due U. S. for arms, equipments, &c., \$ \_\_\_\_\_ 100

Bounty paid \$ \_\_\_\_\_ 100; due \$ \_\_\_\_\_ 100

Remarks: Joined by transfer from Co E  
77 U.S.C.I. as Capt Oct 1/65 SO. 66  
At Gros Dett of La Sept 22/65. Disch'd  
at New Orleans La Mar 17 1866  
by reason of E from of service

Book mark: \_\_\_\_\_

Bunham

1566  
Lebarron, Felix

Co I, 10 U.S. Col'd H. Art'y.

Private

Private

CARD NUMBERS.

1	5511253	26
2	5511345	27
3	5511432	28
4	5511545	29
5	5511677	30
6	5511790	31
7	5511918	32
8	5512135	33
9	5490020.	34
10		35
11		36
12		37
13		38
14		39
15		40
16		41
17		42
18		43
19		44
20		45
21		46
22		47
23		48
24		49
25		50

Book Mark:

See also



L. | 10 H. Art'y. | U.S.C.T.

Felix Lebarrow  
Pvt., Co D, 10 Reg't U. S. Col'd H. Art'y.

Age 36 years.

Appears on

**Company Muster Roll\***

for Enrollment to June 30, 1865.

Joined for duty and enrolled:

When \_\_\_\_\_, 186 .

Where \_\_\_\_\_

Period 1 years.

Mustered in:

When May 5, 1865.

Where New Orleans, La.

Present or absent Present.

Stoppage, \$ 100 for \_\_\_\_\_

Due Gov't, \$ 100 for \_\_\_\_\_

Valuation of horse, \$ 100

Valuation of horse equipments, \$ 100

Remarks: Drafted. Com-  
mencement of first

\*First current roll. No muster-in roll of this company on file.

Book mark : \_\_\_\_\_

O. S. Clark

JAN. 16

5511253

1891

payment by time  
May 5, 65.

L. | **10 H. Art'y.** | **U.S.C.T.**

*Felix Lebaron*

*Prvt.*, Co. I, 10 Reg't U. S. Col'd H. Art'y.

Appears on

**Company Muster Roll**

for *July & Aug.*, 1865.

Present or absent *Present*

Stoppage, \$ \_\_\_\_\_ 100 for \_\_\_\_\_

Due Gov't, \$ \_\_\_\_\_ 100 for \_\_\_\_\_

Valuation of horse, \$ \_\_\_\_\_ 100

Valuation of horse equipments, \$ \_\_\_\_\_ 100

Remarks: \_\_\_\_\_  
\_\_\_\_\_  
\_\_\_\_\_  
\_\_\_\_\_  
\_\_\_\_\_  
\_\_\_\_\_  
\_\_\_\_\_  
\_\_\_\_\_

Book mark: \_\_\_\_\_

*O. S. Clark*

Copyist.

*L.* | 10 H. Art'y. | U.S.C.T.

*Felix Lebaron*

*Pr.*, Co. I, 10 Reg't U. S. Col'd H. Art'y.

Appears on

**Company Muster Roll**

for *Sept. & Oct.*, 1865.

Present or absent *Present*

Stoppage, \$ 100 for

Due Gov't, \$ 100 for

Valuation of horse, \$ 100

Valuation of horse equipments, \$ 100

Remarks: *L*

Book mark:

*O. S. Clark*

*L.* | **10 H. Art'y.** | **U.S.C.T.**

*Felix Lebarrow*

*Prst.*, Co. I, 10 Reg't U. S. Col'd H. Art'y.

Appears on

**Company Muster Roll**

for *Nov. & Dec.*, 1865.

Present or absent *Present*

Stoppage, \$ 100 for

Due Gov't, \$ 100 for

Valuation of horse, \$ 100

Valuation of horse equipments, \$ 100

Remarks:

**FROM SECOND AUDITOR'S ROLL.**

Book mark:

*O. J. Lebarrow*

*L.* | **10 H. Art'y.** | **U.S.C.T.**

*Felix Lefarrow*

*Priv.*, Co. I, 10 Reg't U. S. Col'd H. Art'y.

Appears on

**Company Muster Roll**

for *Jan. & Feb.*, 1866.

Present or absent *Present*

Stoppage, \$ *100* for

Due Gov't, \$ *100* for

Valuation of horse, \$ *100*

Valuation of horse equipments, \$ *100*

Remarks:

Book mark:

*A. S. Clark*

Copyist.

L. | 10 H. Art'y. | U.S.C.T.

*Felix Lebaron*

*Pol.*, Co. I, 10 Reg't U. S. Col'd H. Art'y.

Appears on

**Company Muster Roll**

for *Nov. & Apr.*, 1866.

Present or absent *Present*

Stoppage, \$ *100* for

Due Gov't, \$ *100* for

Valuation of horse, \$ *100*

Valuation of horse equipments, \$ *100*

Remarks:

Book mark: *Muster out on file.*

*O. S. Lebaron*

L. | 10 H. Art'y. | U.S.C.T.

Felix Labaron

Priv., Co. I, 10 Reg't U. S. Col'd H. Art'y.

Appears on

Company Muster Roll

for May + June, 1866.

Present or absent

Stoppage, \$ 100 for

Due Gov't, \$ 100 for

Valuation of horse, \$ 100

Valuation of horse equipments, \$ 100

Remarks: Discharged.  
Mustered out by  
reason of expiration  
of term of service  
to date May 4, 1866.

Book mark:

O. S. Clark

Copyist.



L | 10 Arty | U.S.C.T.

Felix Labaron

Priv., Co. I, 10 Reg't U. S. Col'd Arty

Appears on a

**Detachment Muster-out Roll**

of the organization named above. Roll dated

New Orleans, La May 4, 1866.

Muster-out to date

May 4, 1866.

Last paid to

Feb. 28, 1866

**Clothing account:**

Last settled \_\_\_\_\_, 1866; drawn since \$ \_\_\_\_\_ 100

Due soldier \$  $25 \frac{33}{100}$ ; due U. S. \$ \_\_\_\_\_ 100

Am't for cloth'g in kind or money adv'd \$ \_\_\_\_\_ 100

Due U. S. for arms, equipments, &c., \$ \_\_\_\_\_ 100

Bounty paid \$ \_\_\_\_\_ 100 due \$ \_\_\_\_\_ 100

Remarks: *Joined by draft. Stop*

*for 2 letters .02¢ 2 numbers .02¢*

*one cross cannon .02¢ - total 06¢*

Book mark: \_\_\_\_\_

R. E. Wilson

Copyist.

*L* | **10 H. Art'y. | U.S.C.T.**

*Felix Sebaron*

*Plt.*, Co. *I*, 10 Reg't U. S. Col'd H. Art'y.

Appears on **Co. Muster-out Roll**, dated  
*Baton Rouge La, Feb 22*, 186*7*.

Muster-out to date \_\_\_\_\_, 186 .

Last paid to \_\_\_\_\_, 186 .

Clothing account:

Last settled \_\_\_\_\_, 186 ; drawn since \$ \_\_\_\_\_ <sup>100</sup>

Due soldier \$ \_\_\_\_\_ <sup>100</sup>; due U. S. \$ \_\_\_\_\_ <sup>100</sup>

Am't for cloth'g in kind or money adv'd \$ \_\_\_\_\_ <sup>100</sup>

Due U. S. for arms, equipments, &c., \$ \_\_\_\_\_ <sup>100</sup>

Bounty paid \$ \_\_\_\_\_ <sup>100</sup>; due \$ \_\_\_\_\_ <sup>100</sup>

Remarks: *Discharged, expiration*  
*term of service May 4 1866*

Book mark : \_\_\_\_\_

*J. M. Hance*

1567

Leberne Joseph

Co G, 10 U.S. Col'd H. Art'y.

CARD NUMBERS.

1		26	
2		27	
3	See Leberne	28	Joseph.
4		29	
5		30	
6		31	
7		32	
8		33	
9		34	
10		35	
11		36	
12		37	
13		38	
14		39	
15		40	
16		41	
17		42	
18		43	
19		44	
20		45	
21		46	
22		47	
23		48	
24		49	
25		50	

Book Mark:

See also

156  
Lebranch, Edward

Co B, 10 U.S. Col'd H. Art'y.

Private

Private

CARD NUMBERS.

1	5494227	26
2	5494378	27
3	5494539	28
4	5494697	29
5	5494852	30
6	5495005	31
7	5495162	32
8	5495317	33
9	5495467	34
10	5495617	35
11	5495756	36
12	5495913	37
13	5496058	38
14	5496208	39
15	5496361	40
16	5496508	41
17	5496650	42
18	5496793	43
19	5496952	44
20	5497129	45
21	5497443	46
22	5489677	47
23		48
24		49
25		50

Book Mark:

See also

L | 10 H. Art'y. | U.S.C.T.

Edward Lebranche

Pvt., 2 Battery, La. H. Art'y, Native Guards.\*

Age 26 years.

Appears on

Company Muster-in Roll

of the organization named above. Roll dated

Camp Parapet, Carrollton, La., Feb. 9, 1863.

Muster-in to date Feb. 9, 1863.

Joined for duty and enrolled:

When Jan'y 3, 1863.

Where Camp Parapet, Carrollton, La.

Period 3 years.

Valuation of horse, \$ 100

Valuation of horse equipments, \$ 100

Remarks:

\* This organization subsequently became Co. B, 10 Reg't U. S. Colored Heavy Artillery.

Book mark:

Feaster

*L* | 10 H. Art'y. | U.S.C.T.

*Edward Lebranche*

*Pvt.*, Co. B, 1 Reg't La. H. Art'y, Native Guards.\*

Appears on

**Company Muster Roll**

for *from Enlistment to Feb. 28*, 1863.

Present or absent *Present*

Stoppage, \$ *100* for

Due Gov't, \$ *100* for

Valuation of horse, \$ *100*

Valuation of horse equipments, \$ *100*

Remarks:

\*This organization subsequently became Co. B, 10 Reg't U. S. Col'd Heavy Artillery.

Book mark:

*Feaster*

L | 10 H. Art'y. | U.S.C.T.

Edward Lebranche

Pvt., Co. B, 1 Reg't La. H. Art'y, Native Guards.\*

Appears on

**Company Muster Roll**

for Feb. 7. Apl., 186 3.

Present or absent Present

Stoppage, \$ 100 for

Due Gov't, \$ 100 for

Valuation of horse, \$ 100

Valuation of horse equipments, \$ 100

Remarks:

\*This organization subsequently became Co. B, 10 Reg't U. S. Col'd Heavy Artillery.

Book mark:

Feaster

Copyist.

*L* | 10 H. Art'y. | U.S.C.T.

*Edward Debranch*

*Pvt.*, Co. B, 1 Reg't La. H. Art'y, Native Guards.\*

Appears on

**Company Muster Roll**

for *May 4. June*, 186*3*.

Present or absent *Present*

Stoppage, \$ *100* for

Due Gov't, \$ *100* for

Valuation of horse, \$ *100*

Valuation of horse equipments, \$ *100*

Remarks: \_\_\_\_\_  
\_\_\_\_\_  
\_\_\_\_\_  
\_\_\_\_\_  
\_\_\_\_\_

\*This organization subsequently became Co. B, 10 Reg't U. S. Col'd Heavy Artillery.

Book mark: \_\_\_\_\_

*Feaster*

Copyist.



L | 10 H. Art'y. | U.S.C.T.

Edward Lebranch  
Pvt., Co. B, 1 Reg't La. H. Art'y, Native Guards.\*

Appears on

**Company Muster Roll**

for July 4. Aug., 186 3.

Present or absent Present

Stoppage, \$ 100 for

Due Gov't, \$ 100 for

Valuation of horse, \$ 100

Valuation of horse equipments, \$ 100

Remarks: \_\_\_\_\_  
\_\_\_\_\_  
\_\_\_\_\_  
\_\_\_\_\_  
\_\_\_\_\_

\*This organization subsequently became Co. B, 10 Reg't U. S. Col'd Heavy Artillery.

Book mark: \_\_\_\_\_

Easter

*L* | 10 H. Art'y. | U.S.C.T.

*Edward Lebranch*  
*Priv.*, Co. B, 1 Reg't La. H. Art'y, Native Guards.\*

Appears on

**Company Muster Roll**

for *Sept. 7. Oct.*, 186 *3*.

Present or absent *Present*

Stoppage, \$..... 100 for .....

Due Gov't, \$..... 100 for .....

Valuation of horse, \$..... 100

Valuation of horse equipments, \$..... 100

Remarks: .....

\*This organization subsequently became Co. B, 10 Reg't U. S. Col'd Heavy Artillery.

Book mark: .....

*Feaster*

*S* | 10 H. Art'y. | U.S.C.T.

*Edward Sebranch*

*Pl*, Co. *B*, 1 Reg't H. Art'y, Corps d'Afrique.\*

Appears on

**Company Muster Roll**

for *Nov. & Dec., 1863*

Present or absent *Present*

Stoppage, \$ 100 for

Due Gov't, \$ 100 for

Valuation of horse, \$ 100

Valuation of horse equipments, \$ 100

Remarks:

\* This organization subsequently became Co. *B*, 10 Reg't U. S. Colored Heavy Artillery.

Book mark:

*Reif*

*L* | 10 H. Art'y. | U.S.C.T.

*Edward Lebranch*

*Plt*, Co. *B*, 1 Reg't H. Art'y, Corps d'Afrique.\*

Appears on

**Company Muster Roll**

for *Jan. & Feb.*, 186*4*.

Present or absent *Present*

Stoppage, \$ 100 for

Due Gov't, \$ 100 for

Valuation of horse, \$ 100

Valuation of horse equipments, \$ 100

Remarks: *Sick in Co. Hosp.*

\* This organization subsequently became Co. \_\_\_\_\_, 10 Reg't U. S. Colored Heavy Artillery.

Book mark: \_\_\_\_\_

*Reif*

L | **10 H. Art'y.** | **U.S.C.T.**

Edward Labranche

Pvt, Co. B, 7 Reg't U. S. Col'd H. Art'y.\*

Appears on

**Company Muster Roll**

for March & April, 1864.

Present or absent Present

Stoppage, \$ 100 for \_\_\_\_\_

Due Gov't, \$ 100 for \_\_\_\_\_

Valuation of horse, \$ 100

Valuation of horse equipments, \$ 100

Remarks: \_\_\_\_\_  
\_\_\_\_\_  
\_\_\_\_\_  
\_\_\_\_\_  
\_\_\_\_\_

\* This organization subsequently became Co. \_\_\_\_\_, 10 Reg't U. S. Colored Heavy Artillery.

Book mark: \_\_\_\_\_

Ref

*E* | **10 H. Art'y.** | **U.S.C.T.**

*Edward Sabranche*

*Pvt*, Co. *B*, 7 Reg't U. S. Col'd H. Art'y.\*

Appears on

**Company Muster Roll**

for *May 1 June*, 186 *4*

Present or absent *Present*

Stoppage, \$ *100* for

Due Gov't, \$ *100* for

Valuation of horse, \$ *100*

Valuation of horse equipments, \$ *100*

Remarks:

\* This organization subsequently became Co. *10*, 10 Reg't U. S. Colored Heavy Artillery.

Book mark:

*C. Reif*

*L* | **10 H. Art'y. | U.S.C.T.**

*Edward Sabanches*  
*H.*, Co. B, 10 Reg't U. S. Col'd H. Art'y.

Appears on

**Company Muster Roll**

for *July & Aug*, 186*4*.

Present or absent *Present*

Stoppage, \$ 100 for

Due Gov't, \$ 100 for

Valuation of horse, \$ 100

Valuation of horse equipments, \$ 100

Remarks:

Book mark:

(358)

*J. H. Richardson*  
Copyist.

*L* | **10 H. Art'y. U.S.C.T.**

*Edward Sabranche*  
*Pt*, Co. B, 10 Reg't U. S. Col'd H. Art'y.

Appears on

**Company Muster Roll**

for *Sept & Oct* ....., 186*4*

Present or absent *Present*

Stoppage, \$ ..... 100 for .....

Due Gov't, \$ ..... 100 for .....

Valuation of horse, \$ ..... 100

Valuation of horse equipments, \$ ..... 100

Remarks: .....

Book mark: .....

*J. Richardson*



L. | 10 H. Art'y. | U.S.C.T.

Edward Lebranch  
Pvt., Co. B, 10 Reg't U. S. Col'd H. Art'y.

Appears on

**Company Muster Roll**

for Nov & Dec, 1864.

Present or absent Present.

Stoppage, \$ 100 for

Due Gov't, \$ 100 for

Valuation of horse, \$ 100

Valuation of horse equipments, \$ 100

Remarks:

Book mark:

Jones

L | 10 H. Art'y. | U.S.C.T.

Edward Lebranch  
Priv., Co. B, 10 Reg't U. S. Col'd H. Art'y.

Appears on

**Company Muster Roll**

for Jan & Feb, 1865.

Present or absent Present

Stoppage, \$ 100 for

Due Gov't, \$ 100 for

Valuation of horse, \$ 100

Valuation of horse equipments, \$ 100

Remarks: This soldier augmented pay from Jan 1 1864 to May 1 1864 \$6<sup>00</sup> per month May & June \$9<sup>00</sup> per month.

Book mark:

J. J. Jones

L. | 10 H. Art'y. | U.S.C.T.

*Edward Lebranch*

*Priv.*, Co. B, 10 Reg't U. S. Col'd H. Art'y.

Appears on

**Company Muster Roll**

for *Mar & Apr*, 1865.

Present or absent

*Present.*

Stoppage, \$ 100 for

Due Gov't, \$ 100 for

Valuation of horse, \$ 100

Valuation of horse equipments, \$ 100

Remarks: *in daily duty since March 2, 1865,*

Book mark:

*Joiner*

*L.* | **10 H. Art'y.** | **U.S.C.T.**

*Edward Labranch*

*Pvt.*, Co. B, 10 Reg't U. S. Col'd H. Art'y.

Appears on

**Company Muster Roll**

for *May & June*, 186*5*.

Present or absent *Present*

Stoppage, \$ 100 for

Due Gov't, \$ 100 for

Valuation of horse, \$ 100

Valuation of horse equipments, \$ 100

Remarks:

Book mark:

*J. Jones*

L. | **10 H. Art'y.** | **U.S.C.T.**

Edward Lebranch

Pvt., Co. B, 10 Reg't U. S. Col'd H. Art'y.

Appears on

**Company Muster Roll**

for July & Aug, 1865.

Present or absent Present

Stoppage, \$ 100 for \_\_\_\_\_

Due Gov't, \$ 100 for \_\_\_\_\_

Valuation of horse, \$ 100

Valuation of horse equipments, \$ 100

Remarks: \_\_\_\_\_  
\_\_\_\_\_  
\_\_\_\_\_  
\_\_\_\_\_  
\_\_\_\_\_  
\_\_\_\_\_  
\_\_\_\_\_

Book mark: \_\_\_\_\_

J. J. Jones Copyist.

2

10 H. Art'y. U.S.C.T.

Edward Lebranch

Pvt., Co. B, 10 Reg't U. S. Col'd H. Art'y.

Appears on

Company Muster Roll

for Sep. & Oct., 1865.

Present or absent Present

Stoppage, \$ 100 for

Due Gov't, \$ 100 for

Valuation of horse, \$ 100

Valuation of horse equipments, \$ 100

Remarks:

Book mark:

J. W. Jones

2

10 H. Art'y. U.S.C.T.

Edward Delranch

Pvt., Co. B, 10 Reg't U. S. Col'd H. Art'y.

Appears on

Company Muster Roll

for Nov. & Dec., 1865

Present or absent Present

Stoppage, \$ 100 for

Due Gov't, \$ 100 for

Valuation of horse, \$ 100

Valuation of horse equipments, \$ 100

Remarks:

Book mark:

Reif

L | 10 H. Art'y. | U.S.C.T.

Edward Lebranch

PM, Co. B, 10 Reg't U. S. Col'd H. Art'y.

Appears on

Company Muster Roll

for Jan'y. & Feb., 1866.

Present or absent

Stoppage, \$ 100 for

Due Gov't, \$ 100 for

Valuation of horse, \$ 100

Valuation of horse equipments, \$ 100

Remarks: Mustd. out at M. G. S. Co. Feb. 8 66 by reason of exp. of term of service

Book mark: 6779 P.M.S. June 28 66

Reif



Co. | 10 Mo. a. | U.S.C.T.

Edward Solbranch  
Mo., Co B., 10 Reg't U. S. Col'd Mo. a.

Appears on a

**Detachment Muster-out Roll**

of the organization named above. Roll dated

New Orleans La, Feb. 8, 1866<sup>x</sup>

Muster-out to date

Feb. 8, 1866

Last paid to

June 30, 1866

**Clothing account:**

Last settled ..... 186 ; drawn since \$ ..... 100

Due soldier \$ 59 79; due U. S. \$ ..... 100

Am't for cloth'g in kind or money adv'd \$ ..... 100

Due U. S. for arms, equipments, &c., \$ ..... 100

Bounty paid \$ ..... 100 due \$ ..... 100

Remarks: *Joined at origl. Orgn.  
Mustered out by reason  
of Expiration of term of  
service (Cert. of Mustg. Of-  
ficer shows him M.C. Feb. 12,  
1866.) \* Added May 12, 93. GED*

Book mark: .....

L | 10 H. Art'y. | U.S.C.T.

Edward Lebranch

Priv. Co. D, 10 Reg't U. S. Col'd H. Art'y.

Appears on **Co. Muster-out Roll**, dated  
Baton Rouge, La. Feb, 1867.

Muster-out to date \_\_\_\_\_, 186 .

Last paid to \_\_\_\_\_, 186 .

**Clothing account:**

Last settled \_\_\_\_\_, 186 ; drawn since \$ \_\_\_\_\_ 100

Due soldier \$ \_\_\_\_\_ 100; due U. S. \$ \_\_\_\_\_ 100

Am't for cloth'g in kind or money adv'd \$ \_\_\_\_\_ 100

Due U. S. for arms, equipments, &c., \$ \_\_\_\_\_ 100

Bounty paid \$ \_\_\_\_\_ 100; due \$ \_\_\_\_\_ 100

Remarks:  
Joined org't. org'n  
Discharged Feb. 8/66  
expiration term of  
service.

Book mark: \_\_\_\_\_

Hodges  
Copyist.

Lebranche Edward

, Co. 10<sup>th</sup> Reg't W.S. 6<sup>th</sup> A.

Enclosures.

Bed Cards .....	Final Statements .....
Burial Records .....	Furloughs or L. of A .....
Certs. of Dis. for Discharge .....	Med. Certificates .....
C. M. Charges .....	Med. Des. Lists .....
Descriptive Lists .....	Orders .....
Discharge Certificates .....	Pris. of War Record .....
Enlistment Papers <input checked="" type="checkbox"/> .....	Resignations .....

Other papers relating to—

Admission to Hosp'l .....	Furlough or L. of A .....
Casualty Sheet .....	Med. Examination .....
Confinement .....	Misc. Information .....
Contracts .....	Pay or Clothing .....
Death or Effects .....	Personal Reports .....
Desertion .....	Rank .....
Discharge from Hosp'l .....	Transfer to Hosp'l .....
Discharge from Service .....	Transfer to V. R. C. .....
Duty .....	Transportation .....

County of  
*Jefferson*



State of  
*Louisiana*

I, *Edward Lebranche* born in *St. John the Baptist Parish,*  
in the State of *Louisiana* aged *Twenty six* years,  
and by occupation a *Laborer* do hereby acknowledge to have  
voluntarily enlisted this *fifth* day of *January*  
18*63*, as a SOLDIER in the ARMY OF THE UNITED STATES OF AMERICA, for the period  
of *THREE YEARS*, unless sooner discharged by proper authority: Do also agree to  
accept such bounty, pay, rations, and clothing, as are, or may be, established by law. And  
I, *Edward Lebranche* do solemnly swear, that I will bear true faith  
and allegiance to the UNITED STATES OF AMERICA, and that I will serve them honestly and  
faithfully against all their enemies or opposers whomsoever; and that I will observe and  
obey the orders of the President of the United States, and the orders of the officers  
appointed over me, according to the Rules and Articles of War.

Sworn and subscribed to, at *of Carrollton, La.*  
*Camp Parapet,*  
this *ninth* day of *February* 18*63*,  
BEFORE *J. Rygaard*  
*2d Lt. U.S. Vol.*

I CERTIFY, ON HONOR, That I have carefully examined the above named Recruit, agreeably to the General Regulations  
of the Army, and that in my opinion he is free from all bodily defects and mental infirmity, which would, in any way, disqualify  
him from performing the duties of a soldier.

*W. DeLoach*

EXAMINING SURGEON.

I CERTIFY, ON HONOR, That I have minutely inspected the Recruit, *Edward Lebranche*  
previously to his enlistment, and that he was entirely sober when enlisted; that, to the best of my judgement and belief, he is of  
lawful age; and that, in accepting him as duly qualified to perform the duties of an able-bodied soldier, I have strictly observed  
the Regulations which govern the recruiting service. This soldier has *brown* eyes, *black* hair,  
*dark* complexion; is *five* feet, *nine* inches high.

*J. Rygaard, 2d Lieut. U.S. Vol.*

RECRUITING OFFICER.

DECLARATION OF RECRUIT.

I, \_\_\_\_\_ desiring to ENLIST in the Army of the United States, for the term of THREE YEARS, Do declare, That I am \_\_\_\_\_ years and \_\_\_\_\_ months of age; that I have neither wife nor child; that I have never been discharged from the United States service on account of disability or by sentence of a court-martial, or by order before the expiration of a term of enlistment; and I know of no impediment to my serving honestly and faithfully as a soldier for three years.

GIVEN at \_\_\_\_\_  
The \_\_\_\_\_ day of \_\_\_\_\_

Witness :

No. \_\_\_\_\_

*Edward J. Braviche*

Enlisted at *Camp Parshut Pa.*

*March 14<sup>th</sup> 1863,*

By *Lt. J. J. Hayward*

*of 1<sup>st</sup> Regt. of Louisiana Art.*

*10 MS C 11a*

\_\_\_\_\_ enlistment; last served in Company \_\_\_\_\_

\_\_\_\_\_ Reg't of \_\_\_\_\_

\_\_\_\_\_ Discharged \_\_\_\_\_ 18\_\_\_\_

CONSENT IN CASE OF MINOR.

I, \_\_\_\_\_ Do CERTIFY, That I am the \_\_\_\_\_ of \_\_\_\_\_; that the said \_\_\_\_\_ is \_\_\_\_\_ years of age; and I do hereby freely give my CONSENT to his enlisting as a SOLDIER in the ARMY OF THE UNITED STATES for the period of THREE YEARS.

GIVEN at \_\_\_\_\_  
The \_\_\_\_\_ day of \_\_\_\_\_

Witness :

County of

*Jefferson*



State of

*Louisiana*

I, *Edward Lebranche* born in *the Parish of St. John the Baptist*

in the State of *Louisiana* aged *Twenty six* years,

and by occupation a *Laborer* do hereby acknowledge to have

voluntarily enlisted this *fifth* day of *January*

18 *63*, as a SOLDIER in the ARMY OF THE UNITED STATES OF AMERICA, for the period

of *THREE YEARS*, unless sooner discharged by proper authority: Do also agree to accept such bounty, pay, rations, and clothing, as are, or may be, established by law. And

I, *Edward Lebranche* do solemnly swear, that I will bear true faith and allegiance to the UNITED STATES OF AMERICA, and that I will serve them honestly and faithfully against all their enemies or opposers whomsoever; and that I will observe and obey the orders of the President of the United States, and the orders of the officers appointed over me, according to the Rules and Articles of War.

*of Carrollton, La.*

Sworn and subscribed to, at *Camp Parapet*

this *ninth* day of *February* 18*63*

BEFORE

*J. Rygaard*  
*2d Lt. N. G. Art. La.*

I CERTIFY, ON HONOR, That I have carefully examined the above named Recruit, agreeably to the General Regulations of the Army, and that in my opinion he is free from all bodily defects and mental infirmity, which would, in any way, disqualify him from performing the duties of a soldier.

*W. L. ...*

EXAMINING SURGEON.

I CERTIFY, ON HONOR, That I have minutely inspected the Recruit, *Edward Lebranche* previously to his enlistment, and that he was entirely sober when enlisted; that, to the best of my judgement and belief, he is of lawful age; and that, in accepting him as duly qualified to perform the duties of an able-bodied soldier, I have strictly observed the Regulations which govern the recruiting service. This soldier has *brown* eyes, *black* hair,

*dark* complexion; is *five* feet, *nine* inches high.

*J. Rygaard, 2d Lieut. N. G. Art. La.*

RECRUITING OFFICER.

DECLARATION OF RECRUIT.

I, \_\_\_\_\_ desiring to ENLIST in the Army of the United States, for the term of THREE YEARS, Do declare, That I am \_\_\_\_\_ years and \_\_\_\_\_ months of age; that I have neither wife nor child; that I have never been discharged from the United States service on account of disability or by sentence of a court-martial, or by order before the expiration of a term of enlistment; and I know of no impediment to my serving honestly and faithfully as a soldier for three years.

GIVEN at \_\_\_\_\_  
The \_\_\_\_\_ day of \_\_\_\_\_

Witness :

No. 52  
Enlisted at Camp Harbison, *Edward Schramke*  
By 2nd Lieut. J. H. *Harmon* *Mc 24* 1857,  
*Regiment of Louisiana Artillery*  
\_\_\_\_\_ *enlistment; last served in Company*  
Reg't of \_\_\_\_\_  
Discharged \_\_\_\_\_ 18\_\_\_\_\_

CONSENT IN CASE OF MINOR.

I, \_\_\_\_\_ Do CERTIFY, That I am the \_\_\_\_\_ of \_\_\_\_\_; that the said \_\_\_\_\_ is \_\_\_\_\_ years of age; and I do hereby freely give my CONSENT to his enlisting as a SOLDIER in the ARMY OF THE UNITED STATES for the period of THREE YEARS.

GIVEN at \_\_\_\_\_  
The \_\_\_\_\_ day of \_\_\_\_\_

Witness :

1569  
Lecompte, Joseph  
Co K, 10 U.S. Col'd H. Art'y.

Private | Private

CARD NUMBERS.

1	5488416	26
2	5487649	27
3	5512291	28
4	5512445	29
5	5512583	30
6	5512728	31
7	5512852	32
8	5512973	33
9	5513675	34
10	5513191	35
11	5513282	36
12		37
13		38
14		39
15		40
16		41
17		42
18		43
19		44
20		45
21		46
22		47
23		48
24		49
25		50

Book Mark: \_\_\_\_\_

See also 77 U.S. C. Inf.



R. & P. 461256

D. 1793588 P.O. money

D. 2627127 P.O. 

C. E. Dwyer

L | 10 H. Art'y. | U.S.C.T.

Joseph Lecompt  
P, Co. K., 10 Reg't U. S. Col'd H. Art'y.

Age ..... years.

Appears on

**Company Muster Roll\***

for Sept. - Oct., 1865.

Joined for duty and enrolled:

When May 6, 1864.

Where New Orleans, La.

Period 3 years

Mustered in:

When May 12, 1864.

Where New Orleans

Present or absent Present

Stoppage, \$ 100 for

Due Gov't, \$ 100 for

Remarks: Stop 1 Sacksack, 1 wiper,  
\$3.70

\* First current roll. No muster-in roll of this company on file.

Book mark:

Wissard

L 1060A U.S.C.T.

Joseph Lecompte  
Priv., Co. K, 10 Reg't U. S. Col'd 76A

Appears on

**M. and D. Roll of Men Transferred**

to the organization named above,

from 47 U.S. Col Inf

Roll dated Camp Canapeta Ala, 1864

When enlisted May 6, 1864

Period for which enlisted 3 years.

When mustered in May 12, 1864

Present or absent Present

Company to which assigned K

Remarks: Rec'd by transfer  
from Co K, 47 U.S.C.I.  
Stop for 1 wiper, 1 Bed  
Lock,

Book mark :

Wheat Scott

L 10 H. A. U.S.C.T.

Joseph Leconte  
Priv., Co. K, 10 Reg't U. S. Col'd Ill.,

Appears on

**M. and D. Roll of Men Transferred**

to the organization named above,

from 10<sup>th</sup> U.S. Col Inf

Roll dated Camp Anapet La Vera, 1864.

When enlisted May 6, 1864.

Period for which enlisted 3 years.

When mustered in May 12, 1864.

Present or absent Present

Company to which assigned K

Remarks: Joined Co. at Org

Org<sup>n</sup> stoppage for  
wiper and Bedsock,

Book mark :

W. H. Scott

L

10 H. Art'y. U.S.C.T.

Joseph Lecompt.

P, Co. K, 10 Reg't U. S. Col'd H. Art'y.

Appears on

Company Muster Roll

for Nov. & Dec., 1865.

Present or absent Present

Stoppage, \$ 100 for

Due Gov't, \$ 100 for

Valuation of horse, \$ 100

Valuation of horse equipments, \$ 100

Remarks: Stop for ordnance, camp  
& e. lost - \$ 3.70

Book mark:

Hibbard

Copyist.

26

10 H. Art'y. U.S.C.T.

Joseph Lecompte

Co. K, 10 Reg't U. S. Col'd H. Art'y.

Appears on

Company Muster Roll

for Jan. Feb., 1866

Present or absent Present

Stoppage, \$ 100 for

Due Gov't, \$ 100 for

Valuation of horse, \$ 100

Valuation of horse equipments, \$ 100

Remarks:

Book mark:

Hibbard

Copyist.

L

10 H. Art'y.

U.S.C.T.

P Joseph Lecompt  
Co. K, 10 Reg't U. S. Col'd H. Art'y.

Appears on

Company Muster Roll

for Mch. & Apl., 1866

Present or absent Present

Stoppage, \$ 100 for

Due Gov't, \$ 100 for

Valuation of horse, \$ 100

Valuation of horse equipments, \$ 100

Remarks:

Book mark:

Hibbard

Copyist.

L

10 H. Art'y.

U.S.C.T.

P Joseph Leconte

, Co. K, 10 Reg't U. S. Col'd H. Art'y.

Appears on

Company Muster Roll

for May & June, 1866.

Present or absent Present

Stoppage, \$ 100 for

Due Gov't, \$ 100 for

Valuation of horse, \$ 100

Valuation of horse equipments, \$ 100

Remarks:

Book mark:

Histard

Copyist.



L | 10 H. Art'y. | U.S.C.T.

Joseph Lecompt

, Co. K, 10 Reg't U. S. Col'd H. Art'y.

Appears on

**Company Muster Roll**

for July & Aug., 1866.

Present or absent Present

Stoppage, \$ 100 for

Due Gov't, \$ 100 for

Valuation of horse, \$ 100

Valuation of horse equipments, \$ 100

Remarks:

Book mark:

Hibbard

Copyist.

*Lo*

**10 H. Art'y. U.S.C.T.**

*Joseph Leconte*

*Priv*, Co. K, 10 Reg't U. S. Col'd H. Art'y.

Appears on

**Company Muster Roll**

for *Sept & Oct*, 186*6*.

Present or absent *Present*

Stoppage, \$ *100* for

Due Gov't, \$ *100* for

Valuation of horse, \$ *100*

Valuation of horse equipments, \$ *100*

Remarks:

Book mark:

*Lloyd*

*Lo*

10 H. Art'y.

U.S.C.T.

*Joseph Recoupti*  
*Put*, Co. K, 10 Reg't U. S. Col'd H. Art'y.

Appears on

Company Muster Roll

for *Nov. & Dec.*, 1866.

Present or absent *Present.*

Stoppage, \$ *100* for

Due Gov't, \$ *100* for

Valuation of horse, \$ *100*

Valuation of horse equipments, \$ *100*

Remarks:

Book mark:

*Floyd*

Copyist.

Lo

10 H. Art'y. U.S.C.T.

Joseph Leconte  
Pvt., Co. K., 10 Reg't U. S. Col'd H. Art'y.

Appears on Co. Muster-out Roll, dated  
Baton Rouge La Feb 22, 1867.

Muster-out to date Feb 22, 1867.

Last paid to Dec. 31, 1866.

Clothing account:

Last settled \_\_\_\_\_, 186 ; drawn since \$ \_\_\_\_\_ 100

Due soldier \$ 64 <sup>79</sup> / 100; due U. S. \$ \_\_\_\_\_ 100

Am't for cloth'g in kind or money adv'd \$ \_\_\_\_\_ 100

Due U. S. for arms, equipments, &c., \$ 6 \_\_\_\_\_ 100

Bounty paid \$ \_\_\_\_\_ 100; due \$ \_\_\_\_\_ 100

Remarks: Recd by transfer from Co. K  
77. U. S. C. I. Oct 1/65 per S. O. No. 66  
Hod qrs Dept La S. 1865 Due \$100.  
Bounty under Act of Congress July 26<sup>th</sup>  
1866, Due \$100. Bounty under Act of  
Congress July 28, 1866.

Book mark: \_\_\_\_\_

Floyd

1570 or Valin  
Lecour, Valaine

Co K, 10 U.S. Col'd H. Art'y.

Private | Private

CARD NUMBERS.

1	5487647	26
2	5488414	27
3	5512289	28
4	5512443	29
5	5512581	30
6	5512726	31
7	5512850	32
8	5512971	33
9	5513074	34
10	5513189	35
11	5513280	36
12		37
13		38
14		39
15		40
16		41
17		42
18		43
19		44
20		45
21		46
22		47
23		48
24		49
25		50

Book Mark:

See also

77 m.s.c. inf

L 10 10 U.S.C.T.

Yahin Lecour  
Co. K, 10 Reg't U. S. Col'd

Appears on

**M. and D. Roll of Men Transferred**

to the organization named above,

from 74 U.S. Col Inf

Roll dated Camp Onapoda Cal, 1864

When enlisted May 6, 1864

Period for which enlisted 3 years.

When mustered in May 12, 1864

Present or absent Present

Company to which assigned K

Remarks: Joined Co at Orig  
On 11<sup>th</sup> Stoppage for  
Red Sack and  
Haversack. To forfeit  
to U.S. 10<sup>th</sup> of dollars  
of monthly pay for  
One month Sentence  
of F. D. Court

Book mark :

W. H. Scott

L 1026 a | U.S.C.T.

Julesin Le Couer  
Priv., Co. K, 10 Reg't U. S. Col'd H.A.

Appears on

**M. and D. Roll of Men Transferred**

to the organization named above,

from 77 U.S. Col Inf

Roll dated Camp Parapuka Oct 11, 1864

When enlisted May 6, 1864

Period for which enlisted 3 years.

When mustered in May 12, 1864

Present or absent Present

Company to which assigned K

Remarks: Rec'd by transfer fr

Co K, 77 U.S. Col

stop for 1 Bed Lock

1 H Sack. stop per

sentence F.O.C. 10/8

Book mark :

W. H. Scott

Lo | **10 H. Art'y.** | **U.S.C.T.**

Nabin Lecour

P, Co. K, 10 Reg't U. S. Col'd H. Art'y.

Age ..... years.

Appears on

**Company Muster Roll\***

for Sep. 1 Oct., 1865.

Joined for duty and enrolled:

When May 6., 1864.

Where New Orleans, La.

Period 3 years

Mustered in:

When May 12., 1864.

Where New Orleans.

Present or absent Present

Stoppage, \$ 100 for

Due Gov't, \$ 100 for

Remarks Stop 1 Bedpack, 1 Haversack,

4.45 Stop sentence F. O.

Court \$10.

\* First current roll. No muster-in roll of this company on file.

Book mark : .....

Hibbard

Copyist.



L | 10 H. Art'y. | U.S.C.T.

Valsin Lecour

P, Co. K, 10 Reg't U. S. Col'd H. Art'y.

Appears on

Company Muster Roll

for Nov. & Dec., 1865

Present or absent Present

Stoppage, \$ 100 for

Due Gov't, \$ 100 for

Valuation of horse, \$ 100

Valuation of horse equipments, \$ 100

Remarks Stop for O. G. E. lost \$4.<sup>45</sup>  
Stop per pen. P. O. C. \$10.

Book mark:

Hibbard  
Copyist.

L

10 H. Art'y.

U.S.C.T.

*Valsin Lecour*

P, Co. K, 10 Reg't U. S. Col'd H. Art'y.

Appears on

**Company Muster Roll**

for *Jan. Feb.*, 186*6*

Present or absent. *Present*

Stoppage, \$ 100 for

Due Gov't, \$ 100 for

Valuation of horse, \$ 100

Valuation of horse equipments, \$ 100

Remarks:

-----  
-----  
-----  
-----  
-----  
-----  
-----  
-----

Book mark: -----

*Hibbard*

Copyist.

L | 10 H. Art'y. | U.S.C.T.

Valsin Lecour

P, Co. K, 10 Reg't U. S. Col'd H. Art'y.

Appears on

Company Muster Roll

for Feb. 7<sup>th</sup>, 1866.

Present or absent Present

Stoppage, \$ 100 for

Due Gov't, \$ 100 for

Valuation of horse, \$ 100

Valuation of horse equipments, \$ 100

Remarks: Sick in hosp.

Book mark:

Hibbard

Copyist.

*L* | 10 H. Art'y. | U.S.C.T.

*Valsin Lecour*

*P*, Co. K, 10 Reg't U. S. Col'd H. Art'y.

Appears on

**Company Muster Roll**

for *May & June*, 1866.

Present or absent *Present*

Stoppage, \$ \_\_\_\_\_  $\overline{100}$  for \_\_\_\_\_

Due Gov't, \$ \_\_\_\_\_  $\overline{100}$  for \_\_\_\_\_

Valuation of horse, \$ \_\_\_\_\_  $\overline{100}$

Valuation of horse equipments, \$ \_\_\_\_\_  $\overline{100}$

Remarks: *Sick in hospital.*

Book mark: \_\_\_\_\_

*Hibbard*  
Copyist.

L | 10 H. Art'y. | U.S.C.T.

Valsin Lecour

P, Co. K, 10 Reg't U. S. Col'd H. Art'y.

Appears on

Company Muster Roll

for July & Aug., 1866.

Present or absent Present

Stoppage, \$ 100 for

Due Gov't, \$ 100 for

Valuation of horse, \$ 100

Valuation of horse equipments, \$ 100

Remarks: Sick in Post-Hospital

Book mark:

Hibbard Copyist.

*L* | 10 H. Art'y. | U.S.C.T.

*Valsin Lecour*

*Put*, Co. K, 10 Reg't U. S. Col'd H. Art'y.

Appears on

**Company Muster Roll**

for *Sept. + Oct.*, 186*6*.

Present or absent *Present.*

Stoppage, \$ *100* for

Due Gov't, \$ *100* for

Valuation of horse, \$ *100*

Valuation of horse equipments, \$ *100*

Remarks: *Sick in Post Hospital*

Book mark: \_\_\_\_\_

*Floyd*

*Lo* | 10 H. Art'y. | U.S.C.T.

*Valcin Lecour*

*Put*, Co. K, 10 Reg't U. S. Col'd H. Art'y.

Appears on

**Company Muster Roll**

for *Nov. 7 Dec*, 1866.

Present or absent *Present*

Stoppage, \$ 100 for

Due Gov't, \$ 100 for

Valuation of horse, \$ 100

Valuation of horse equipments, \$ 100

Remarks: *Sick in Hospital,*

Book mark: \_\_\_\_\_

*L*

10 H. Art'y. U.S.C.T.

*Valcine Lecour*

*Put*, Co. *K*, 10 Reg't U. S. Col'd H. Art'y.

Appears on Co. Muster-out Roll, dated  
*Baton Rouge La, Feb 22, 1867.*

Muster-out to date *Feb 22, 1867.*

Last paid to *Dec. 31, 1866.*

Clothing account:

Last settled \_\_\_\_\_, 186 ; drawn since \$ \_\_\_\_\_ 100

Due soldier \$ *61* <sup>*13*</sup>/<sub>100</sub>; due U. S. \$ \_\_\_\_\_ 100

Am't for cloth'g in kind or money adv'd \$ \_\_\_\_\_ 100

Due U. S. for arms, equipments, &c., \$ *6* <sup>*31*</sup>/<sub>100</sub>

Bounty paid \$ \_\_\_\_\_ 100; due \$ \_\_\_\_\_ 100

Remarks: *Recd by transfer from Co K*  
*77 U. S. C. I. Oct 1/65 per S.O. No. 66*  
*Hodges Dept La, S. 1865, Due \$100. Bounty*  
*under Act of Congress July 26. 1866.*  
*Due \$100. Bounty under Act of*  
*Congress July 28. 1866*

Book mark: *2904. 1878*

*Floyd*



1571  
Leder, John

Co M, 10 U.S. Col'd H. Art'y.

Private —

CARD NUMBERS.

1	5488905	26
2	5489013	27
3		28
4		29
5		30
6		31
7		32
8		33
9		34
10		35
11		36
12		37
13		38
14		39
15		40
16		41
17		42
18		43
19		44
20		45
21		46
22		47
23		48
24		49
25		50

Book Mark:

See also 77 u.s.c. dt

L | 10 H. Artz | **U.S.C.T.**

John Leder

Pvt., Co. ...., 10 Reg't U. S. Col'd H. Artz,

Appears on

**M. and D. Roll of Men Transferred**

to the organization named above,

from

77<sup>th</sup> U. S. Col'd Inftry

Roll dated

Oct. 1, 1863.

When enlisted

Jan. 6, 1865.

Period for which enlisted

3 years.

When mustered in

Jan. 17, 1865.

Present or absent

Company to which assigned

Remarks:

Deserted at

New Orleans, La.

March, 28/65.

Book mark :

RECORDED  
INDEXED

Castling

L | 10<sup>th</sup> H. Arty | U.S.C.T.

John Loder  
Priv., Co. M., 10 Reg't U. S. Col'd H. Arty

Appears on

**M. and D. Roll of Men Transferred**

to the organization named above,

from 77 U. S. Col'd Inf.

Roll dated Oct 1, 1865

When enlisted Jan. 6, 1865

Period for which enlisted 3 years.

When mustered in Jan. 17, 1865

Present or absent

Company to which assigned

Remarks: Deserted from New Orleans, La. Mch. 28/65.

N. A. Co. mustered rolls.

Book mark :

Chandler  
Coryist

Lee, Alfred <sup>15712</sup>

Co. 10 U.S. Col'd H. Art'y.

Private

Private

CARD NUMBERS.

1	5511255	26
2	5511347	27
3	5511434	28
4	5511547	29
5	5511740	30
6	5512187	31
7	5489778	32
8		33
9		34
10		35
11		36
12		37
13		38
14		39
15		40
16		41
17		42
18		43
19		44
20		45
21		46
22		47
23		48
24		49
25		50

Book Mark:

See also

*L.* | **10 H. Art'y. | U.S.C.T.**

*Alfred Lee*  
*Pvt., Co. D,* 10 Reg't U. S. Col'd H. Art'y.

Age *40* years.

Appears on

**Company Muster Roll\***

for *Enrollment to June 30,* 186*5-*

Joined for duty and enrolled:

When \_\_\_\_\_, 186 .

Where \_\_\_\_\_

Period *1* years.

Mustered in:

When *Feb'y 15-*, 186*5-*

Where *Baton Rouge, La.*

Present or absent *Present*

Stoppage, \$ *100* for \_\_\_\_\_

Due Gov't, \$ *100* for \_\_\_\_\_

Valuation of horse, \$ *100*

Valuation of horse equipments, \$ *100*

Remarks: *Drafted. Com-*  
*mencement of first*

\*First current roll. No muster-in roll of this company on file.

Book mark : \_\_\_\_\_

*A. S. Clark*

JAN. 16

5511255

1891

*payment by time*  
*Feb. 15, 65-*

L. | 10 H. Art'y. | U.S.C.T.

*Alfred Lee*

*Pos.*, Co. I, 10 Reg't U. S. Col'd H. Art'y.

Appears on

**Company Muster Roll**

for *July & Aug.*, 1865.

Present or absent *Present*

Stoppage, \$ 100 for

Due Gov't, \$ 100 for

Valuation of horse, \$ 100

Valuation of horse equipments, \$ 100

Remarks:

Book mark:

*O. J. Clark*

L. | **10 H. Art'y.** | **U.S.C.T.**

Alfred Lee

Priv., Co. I, 10 Reg't U. S. Col'd H. Art'y.

Appears on

**Company Muster Roll**

for Sept. 10th, 1865.

Present or absent Present

Stoppage, \$ 100 for

Due Gov't, \$ 100 for

Valuation of horse, \$ 100

Valuation of horse equipments, \$ 100

Remarks:

Book mark:

A. S. Clark



*L.* | **10 H. Art'y. | U.S.C.T.**

*Alfred Lee*  
-----  
*Priv.*, Co. I, 10 Reg't U. S. Col'd H. Art'y.

Appears on

**Company Muster Roll**

for *Nov. & Dec.*, 186<sup>5</sup>-

Present or absent *Present*

Stoppage, \$ 100 for -----

Due Gov't, \$ 100 for -----

Valuation of horse, \$ 100

Valuation of horse equipments, \$ 100

Remarks: -----

-----

-----

-----

-----

**FROM SECOND AUDITOR'S ROLL.**

-----

-----

Book mark: -----

-----

-----

-----

L. | 10 H. Art'y. | U.S.C.T.

Alfred Lee

Priv., Co. I, 10 Reg't U. S. Col'd H. Art'y.

Appears on

**Company Muster Roll**

for Jan. + Feb., 1866.

Present or absent

Stoppage, \$ 100 for

Due Gov't, \$ 100 for

Valuation of horse, \$ 100

Valuation of horse equipments, \$ 100

Remarks: Discharged. Mustered out by reason of expiration of term of service to take effect Feb. 14 1866. final statements given.

Book mark:

O. J. Clark

L. 10<sup>th</sup> Arty U.S.C.T.

Alfred Lee,

Priv., Co. I, 10<sup>th</sup> Reg't U. S. Col'd Arty

Appears on a

**Detachment Muster-out Roll**

of the organization named above. Roll dated

New Orleans La Feb. 14, 1866.

Muster-out to date Feb. 14, 1866.

Last paid to June 30, 1865.

**Clothing account:**

Last settled \_\_\_\_\_, 186\_\_\_; drawn since \$ \_\_\_\_\_ 100

Due soldier \$ 16 <sup>15</sup>/<sub>100</sub>; due U. S. \$ \_\_\_\_\_ 100

Am't for cloth'g in kind or money adv'd \$ \_\_\_\_\_ 100

Due U. S. for arms, equipments, &c., \$ 2 <sup>00</sup>/<sub>100</sub>

Bounty paid \$ none <sup>100</sup>/<sub>100</sub> due \$ none <sup>100</sup>/<sub>100</sub>

Remarks: joined by Draft Stop  
for (1) Mosquito Bar lost  
2.00

Book mark: \_\_\_\_\_

A. M. Reed

Copyist.

10 H. Art'y. U.S.C.T.

Alfred Lee

Priv., Co., 10 Reg't U. S. Col'd H. Art'y.

Appears on Co. Muster-out Roll, dated Baton Rouge La, Feb 22, 1867.

Muster-out to date \_\_\_\_\_, 186 .

Last paid to \_\_\_\_\_, 186 .

Clothing account:

Last settled \_\_\_\_\_, 186 ; drawn since \$ \_\_\_\_\_ 100

Due soldier \$ \_\_\_\_\_ 100; due U. S. \$ \_\_\_\_\_ 100

Am't for cloth'g in kind or money adv'd \$ \_\_\_\_\_ 100

Due U. S. for arms, equipments, &c., \$ \_\_\_\_\_ 100

Bounty paid \$ \_\_\_\_\_ 100; due \$ \_\_\_\_\_ 100

Remarks: Discharged expiration term of service Feb 14, 1866

Book mark: V 12 P 134. 68

(361)

J. M. Vance

Copyist.

1573  
Lee Dennis

Co — , 10 U.S. Col'd H. Art'y.

Private | —

CARD NUMBERS.

1 5488993	26
2	27
3	28
4	29
5	30
6	31
7	32
8	33
9	34
10	35
11	36
12	37
13	38
14	39
15	40
16	41
17	42
18	43
19	44
20	45
21	46
22	47
23	48
24	49
25	50

Book Mark:

See also 77. U.S. C. Inf.

L 10 N. Arty. **U.S.C.T.**

Jamies Lee

Pw, Co., 10 Reg't U. S. Col'd N. Arty

Appears on

**M. and D. Roll of Men Transferred**

to the organization named above,

from 77 Regt, U.S. C. Inf.

Roll dated Oct 1, 1865.

When enlisted Aug 1, 1863.

Period for which enlisted 3 years.

When mustered in Aug 19, 1863.

Present or absent

Company to which assigned

Remarks: died at Fort

St Philip, La June 14. 64

Final statements

rendered

Not on records Regt.

Book mark :

J. W. Leonard

1574  
Lee, Dennis

Co D, 10 U.S. Col'd H. Art'y.

Private

Private

CARD NUMBERS.

1	5487140	26
2	5502413	27
3	5502635	28
4	5502772	29
5	5502902	30
6	5503018	31
7	5503136	32
8	5503247	33
9	5503356	34
10	5503463	35
11	5503596	36
12	5503744	37
13	5503879	38
14	5504024	39
15	5504153	40
16	5504267	41
17	5504391	42
18	5504489	43
19		44
20		45
21		46
22		47
23		48
24		49
25		50

Book Mark:

See also

*L* | 10 H. Art'y. | U.S.C.T.

*Dennis Lee*

Appears with rank of *Priv* on

**Muster and Descriptive Roll of a Detachment of U. S. Vols. forwarded**

for the *7* Reg't *U.S. Art.\** Roll dated  
*New Orleans La, June, 1864.*

Where born *Alexandria, La.*

Age *18* y'rs; occupation *Labour*

When enlisted *June 24, 1864.*

Where enlisted *New Orleans*

For what period enlisted *3* years.

Eyes *Blue*; hair *Black.*

Complexion *Blue*; height *5* ft. *2* in.

When mustered in *June 25, 1864.*

Where mustered in *New Orleans*

Bounty paid \$ *100*; due \$ *100*

Where credited

Company to which assigned *E*

Remarks:

*\*  
Became 10 U.S. Cold H. Art.*

Book mark:

*J. Williams*



*L* | **10 H. Art'y. | U.S.C.T.**

*Dennis Lee*

*Grh.*, Co. *E*, 7 Reg't U. S. Col'd H. Art'y.\*

Appears on

**Company Muster-in and Descriptive Roll**

of the organization named above. Roll dated

*New Orleans La. July 8, 1864*

Where born *New Orleans La.*

Age *18* y'rs; occupation *Laborer*

When enlisted *June 24, 1864*

Where enlisted *New Orleans*

For what period enlisted *3* years.

Eyes *Black*; hair *Black*

Complexion *Black*; height *5 ft. 2 in.*

When mustered in *June 25, 1864*

Where mustered in *New Orleans*

Bounty paid \$ *2* 100; due \$ *100*

Where credited *New Orleans*

Company to which assigned *E*

Remarks:

\* This organization subsequently became Co. *E*, 10 Reg't U. S. Colored Heavy Artillery.

Book mark:

*Linden*  
Copist.

*L* | 10 H. Art'y. | U.S.C.T.

*Dennis Lee*

*Priv*; Co. E, 10 Reg't U. S. Col'd H. Art'y.

Appears on

**Company Muster Roll**

for *July + Aug.*, 186*4*

Present or absent *Present*

Stoppage, \$.....*100* for .....

Due Gov't, \$.....*100* for .....

Valuation of horse, \$.....*100*

Valuation of horse equipments, \$.....*100*

Remarks:.....  
.....  
.....  
.....  
.....  
.....  
.....  
.....

Book mark:.....

*Linden*  
Copyist.

*L* | 10 H. Art'y. | U.S.C.T.

*Dennis Lee*

*Pat*, Co. E, 10 Reg't U. S. Col'd H. Art'y.

Appears on

**Company Muster Roll**

for *Sep + Oct.*, 1864.

Present or absent *Present*

Stoppage, \$ 100 for

Due Gov't, \$ 100 for

Valuation of horse, \$ 100

Valuation of horse equipments, \$ 100

Remarks:

-----  
-----  
-----  
-----  
-----  
-----  
-----  
-----  
-----

Book mark: -----

*Linden*  
Copyist.

*L* | 10 H. Art'y. | **U.S.C.T.**

*Dennis Lee*

*Plt.*, Co. E, 10 Reg't U. S. Col'd H. Art'y.

Appears on

**Company Muster Roll**

for *Nov. Dec.*, 186*4*.

Present or absent *Present*

Stoppage, \$ 100 for

Due Gov't, \$ 100 for

Valuation of horse, \$ 100

Valuation of horse equipments, \$ 100

Remarks:

Book mark:

*Linden*  
Copyist.

Lo | 10 H. Art'y. | U.S.C.T.

Dennis Lee  
Cpl., Co. E, 10 Reg't U. S. Col'd H. Art'y.

Appears on

**Company Muster Roll**

for Jan. & Feb., 1865.

Present or absent Present.

Stoppage, \$ 100 for

Due Gov't, \$ 100 for

Valuation of horse, \$ 100

Valuation of horse equipments, \$ 100

Remarks: For ordnance  
lost 10 d. for ordnance  
lost 29 d

Book mark:

M. E. Tyler

*L* | 10 H. Art'y. | U.S.C.T.

*Dennis Lee*

*Out*, Co. E, 10 Reg't U. S. Col'd H. Art'y.

Appears on

**Company Muster Roll**

for *March & Apr*, 1865.

Present or absent *Present*

Stoppage, \$ 100 for

Due Gov't, \$ 100 for

Valuation of horse, \$ 100

Valuation of horse equipments, \$ 100

Remarks:

Book mark:

*G. C. Tyler*  
Copyist.

2

10 H. Art'y. U.S.C.T.

*Dennis Lee*

*Priv.*, Co. E, 10 Reg't U. S. Col'd H. Art'y.

Appears on

**Company Muster Roll**

for *May & June*, 1865.

Present or absent *Present*

Stoppage, \$ 100 for

Due Gov't, \$ 100 for

Valuation of horse, \$ 100

Valuation of horse equipments, \$ 100

Remarks:

-----  
-----  
-----  
-----  
-----  
-----  
-----  
-----

Book mark: -----

-----  
*G. H. Taylor*  
-----  
Copyist.

10 H. Art'y. | U.S.C.T.

*Dennis Lee*

*Capt.*, Co. E, 10 Reg't U. S. Col'd H. Art'y

Appears on

**Company Muster Roll**

for *July & Aug.*, 186*2*.

Present or absent *Present.*

Stoppage, \$ *100* for

Due Gov't, \$ *100* for

Valuation of horse, \$ *100*

Valuation of horse equipments, \$ *100*

Remarks: *Due U.S. for Cash*  
*cancel'd <sup>27</sup> 100. Due U.S. for*  
*Camp - Garrison Equipage*  
*\$ 10*

Book mark:

*J. C. Taylor*

Copyist.



10 H. Art'y. U.S.C.T.

*Almond Lee*

*Plt*, Co. E, 10 Reg't U. S. Col'd H. Art'y

Appears on

**Company Muster Roll**

for *Sept. & Oct.*, 186*5*.

Present or absent *Present*

Stoppage, \$ 100 for

Due Gov't, \$ 100 for

Valuation of horse, \$ 100

Valuation of horse equipments, \$ 100

Remarks:

Book mark:

*G. H. Lyles*

*L* | 10 H. Art'y. | U.S.C.T.

*Dennis Lee*

*Pvt*, Co. E, 10 Reg't U. S. Col'd H. Art'y.

Appears on

**Company Muster Roll**

for *Nov 2 Dec*, 1865.

Present or absent *Present*

Stoppage, \$ 100 for

Due Gov't, \$ 100 for

Valuation of horse, \$ 100

Valuation of horse equipments, \$ 100

Remarks:

Book mark:

*Hart*  
Copyist.

L | 10 H. Art'y. | U.S.C.T.

Dennis Lee

Pr, Co. E, 10 Reg't U. S. Col'd H. Art'y.

Appears on

**Company Muster Roll**

for Jan & Feb, 1866.

Present or absent Present

Stoppage, \$ 100 for

Due Gov't, \$ 100 for

Valuation of horse, \$ 100

Valuation of horse equipments, \$ 100

Remarks:

Book mark:

Went

*L* | 10 H. Art'y. | U.S.C.T.

*Dennis Lee*

*Pvt*, Co. E, 10 Reg't U. S. Col'd H. Art'y

Appears on

**Company Muster Roll**

for *March & April*, 1866.

Present or absent *Present*

Stoppage, \$ 100 for

Due Gov't, \$ 100 for

Valuation of horse, \$ 100

Valuation of horse equipments, \$ 100

Remarks:

-----  
-----  
-----  
-----  
-----  
-----  
-----  
-----

Book mark: -----

-----

*Wark*  
Copyist.

*L* | 10 H. Art'y. | U.S.C.T.

*Dennis Lee*

*Pvt*, Co. E, 10 Reg't U. S. Col'd H. Art'y

Appears on

**Company Muster Roll**

for *May & June*, 1866.

Present or absent *Present*

Stoppage, \$.....<sup>100</sup> for .....

Due Gov't, \$.....<sup>100</sup> for .....

Valuation of horse, \$.....<sup>100</sup>

Valuation of horse equipments, \$.....<sup>100</sup>

Remarks:.....

Book mark:.....

*Wark*

Copyist.

L | 10 H. Art'y. | U.S.C.T.

Dennis Lee

Pvt, Co. E, 10 Reg't U. S. Col'd H. Art'y.

Appears on

Company Muster Roll

for July & Aug, 1866.

Present or absent Present

Stoppage, \$ 100 for

Due Gov't, \$ 100 for

Valuation of horse, \$ 100  
Valuation of horse equipments, \$ 100

Remarks:

Book mark:

Warr  
Copyist.

*L* | 10 H. Art'y. | U.S.C.T.

*Dennis Lee*

*Priv.*, Co. E, 10 Reg't U. S. Col'd H. Art'y.

Appears on

**Company Muster Roll**

for *Sept. & Oct.*, 1866.

Present or absent *Present*

Stoppage, \$ *100* for

Due Gov't, \$ *100* for

Valuation of horse, \$ *100*

Valuation of horse equipments, \$ *100*

Remarks: *Stopped for Ord. lost*  
*34*

Book mark:

*O'Hagan,*

Copyist.

*L* | 10 H. Art'y. | **U.S.C.T.**

*Dennis Lee*

*Priv.*, Co. E, 10 Reg't U. S. Col'd H. Art'y.

Appears on

**Company Muster Roll**

for *Nov. & Dec.*, 186*6*.

Present or absent *Present*

Stoppage, \$ *100* for

Due Gov't, \$ *100* for

Valuation of horse, \$ *100*

Valuation of horse equipments, \$ *100*

Remarks:

Book mark:

*O'Hagan*

Copyist.



*L* | 10 H. Art'y. | U.S.C.T.

*Dennis Lee*

*Priv.*, Co. *E*, 10 Reg't U. S. Col'd H. Art'y.

Appears on **Co. Muster-out Roll**, dated  
*Baton Rouge, La. Feb. 22, 1867.*

Muster-out to date *Feb. 22, 1867.*

Last paid to *Dec. 31, 1866.*

Clothing account:

Last settled \_\_\_\_\_, 186 ; drawn since \$ \_\_\_\_\_ 100

Due soldier \$ *26*<sup>*65*</sup>/<sub>100</sub>; due U. S. \$ \_\_\_\_\_ 100

Am't for cloth'g in kind or money adv'd \$ \_\_\_\_\_ 100

Due U. S. for arms, equipments, &c., \$ *6*<sup>*12*</sup>/<sub>100</sub>

Bounty paid \$ \_\_\_\_\_ 100; due \$ \_\_\_\_\_ 100

Remarks: *Joined org. organ.*  
*as Private.*

Book mark: *V. B. P. 74. 68*

*O. Hagan*

1575  
Lee, Eugene

Co. G, 10 U.S. Col'd H. Art'y.

Private | Private

CARD NUMBERS.

1	5497615	26
2	5497859	27
3	5498017	28
4	5486954	29
5	3507157	30
6	5507220	31
7	5507265	32
8	5507326	33
9	5507435	34
10	5507641	35
11	5509492	36
12	RbJ. 498.502	37
13		38
14		39
15		40
16		41
17		42
18		43
19		44
20		45
21		46
22		47
23		48
24		49
25		50

# added by amok Jan. 28, 1897.

Book Mark: RbJ. 498.502.

See also

S. 1523906 and N. 10,  
R. 49 8502  
S. 1565660 Pomona  
S. 1677515 and N. 10

G. E. Doughty  
2

*L* | 10 H. Art'y. | U.S.C.T.

*Eugene Lee*  
*Pvt*, Co. C, 1 Reg't H. Art'y, Corps d'Afrique.\*

Age *29* years.

Appears on

**Company Muster-in Roll**

of the organization named above. Roll dated

*New Orleans La*, *Aug 17*, 1863.

Muster-in to date *Aug 17*, 1863.

Joined for duty and enrolled:

When *July 9*, 1863.

Where *Camp Parapet La*

Period *3* years.

Valuation of horse, \$ *100*

Valuation of horse equipments, \$ *100*

Remarks: \_\_\_\_\_

\* This organization subsequently became Co. C, 10 Reg't U. S. Colored Heavy Artillery

Book mark: *Reel 498, 502.*

*W. J. [Signature]*

*L* | 10 H. Art'y. | U.S.C.T.

*Eugene Lee*  
*Pl*, Co, C, 1 Reg't La. Art'y Native Guards.\*

Appears on

**Company Muster Roll**

for *Aug 11<sup>th</sup> to 31<sup>st</sup>*; 1863 .

Present or absent *Present*

Stoppage, \$ 100 for

Due Gov't, \$ 100 for

Valuation of horse, \$ 100

Valuation of horse equipments, \$ 100

Remarks :

\* This organization subsequently became Co. C, 10 Reg't U. S. Col'd Heavy Artillery.

Book mark :

*W. J. ...*

*L* | 10 H. Art'y. | U.S.C.T.

*Engine Lee*  
*Pvt.*, Co, C, 1 Reg't La. Art'y Native Guards.\*

Appears on

**Company Muster Roll**

for *Sept and Oct*, 1863.

Present or absent *Present*

Stoppage, \$ *100* for

Due Gov't, \$ *100* for

Valuation of horse, \$ *100*

Valuation of horse equipments, \$ *100*

Remarks:

\* This organization subsequently became Co. C, 10 Reg't U. S. Col'd Heavy Artillery.

Book mark:

L | 10 H. Art'y. | U.S.C.T.

Eugene Lee

Appears with rank of *Private* on

**Muster and Descriptive Roll of a Detachment of U. S. Vols. forwarded**

for the *10<sup>th</sup> (H. A. C. d. a.)* Reg't *N. S. C. H. A.* Roll dated

*New Orleans La., Apr. 3, 1864.*

Where born *Baton Rouge La.*

Age *20* yrs; occupation *Farmer*

When enlisted *Feb. 29, 1864.*

Where enlisted *Port Hudson*

For what period enlisted *3* years.

Eyes *Black*; hair *Black*

Complexion *Black*; height *5* ft. *4* in.

When mustered in *Apr. 3, 1864.*

Where mustered in *New Orleans*

Bounty paid \$ *100*; due \$ *100*

Where credited

Company to which assigned *G*

Remarks:

Book mark:

*Galligan*

L. 1106a U.S.C.T.

Eugene Lee

Appears with rank of Pvt on

**Muster and Descriptive Roll of a Detachment of U. S. Vols. forwarded**

*organized as Co. G.*

for the 10 Reg't U. S. Col'd No. 2, Roll dated

New Orleans La, Sept 20, 1864.

Where born Baton Rouge La.

Age 20 y'rs; occupation Farmer

When enlisted Feb. 29, 1864.

Where enlisted Port Henderson

For what period enlisted 3 years.

Eyes Blue; hair Blue

Complexion Blue; height 5 ft. 11 in.

When mustered in Sept 3, 1864.

Where mustered in New Orleans La

Bounty paid \$ 100; due \$ 100

Where credited to Port Henderson

Company to which assigned G.

Remarks:

Book mark:

E. B. Thompson  
Copyist.



L | **10 H. Art'y.** | **U.S.C.T.**

Eugene Lee  
Capt., Co. G, 7 Reg't U. S. Col'd H. Art'y.\*

Appears on

**Company Muster Roll**

for From enrolment to April 20, 1864.

Present or absent Present

Stoppage, \$ 100 for

Due Gov't, \$ 100 for

Valuation of horse, \$ 100

Valuation of horse equipments, \$ 100

Remarks:

\* This organization subsequently became Co. , 10 Reg't U. S. Colored Heavy Artillery.

Book mark:

E. H. Brown

L | **10 H. Art'y.** | **U.S.C.T.**

Engene Lee  
Co. H, Co....., 7 Reg't U. S. Col'd H. Art'y.\*

Appears on

**Company Muster Roll**

for May + June, 1864.

Present or absent Present

Stoppage, \$.....100 for .....

Due Gov't, \$.....100 for .....

Valuation of horse, \$.....100

Valuation of horse equipments, \$.....100

Remarks: .....

\* This organization subsequently became Co. ...., 10 Reg't U. S. Colored Heavy Artillery.

Book mark: .....

E. H. Brown

10 H. Art'y. U.S.C.T.

*2*  
*2*  
*Engene Lee*  
*Cpt*, Co. G, 10 Reg't U. S. Col'd H. Art'y.

Appears on

**Company Muster Roll**

for *July & Aug*, 186*4*.

Present or absent *Present*

Stoppage, \$ *100* for

Due Gov't, \$ *100* for

Valuation of horse, \$ *100*

Valuation of horse equipments, \$ *100*

Remarks: *Reduced from Corp*  
*July 10/64*

Book mark:

*E. H. Barran*

Copyist.

L | 10 H. Art'y. | U.S.C.T.

Eugene Lee  
Pat., Co. G, 10 Reg't U. S. Col'd H. Art'y.

Appears on

**Company Muster Roll**

for Sept & Oct, 1864.

Present or absent Absent

Stoppage, \$ 100 for

Due Gov't, \$ 100 for

Valuation of horse, \$ 100

Valuation of horse equipments, \$ 100

Remarks: Absent guard on Steamer  
Red Chief \$ 6 per mo. due from date  
of enlistment to April 30/64 \$ 9 per  
mo from April 30/64 to June 30/64

Book mark:

E. H. Burns

L | 10 H. Art'y. | U.S.C.T.

Eugene Lee  
Sgt., Co. G, 10 Reg't U. S. Col'd H. Art'y.

Appears on

Company Muster Roll  
for Nov & Dec, 1864.

Present or absent

Stoppage, \$ 100 for

Due Gov't, \$ 100 for

Valuation of horse, \$ 100

Valuation of horse equipments, \$ 100

Remarks: Has rec'd but \$ 7 per month. Died at Cd A. Gen Hospital. New Orleans La. Dec 12/64

Book mark:

E. N. Brown  
Copyist.

L | 10 H. Art'y. | U.S.C.T.

Eugene Lee

Pvt., Co. G, 10 Reg't U. S. Col'd H. Art'y.

Appears on Co. Muster-out Roll, dated  
Baton Rouge, La., Feb 22, 1867.

Muster-out to date \_\_\_\_\_, 186 .

Last paid to \_\_\_\_\_, 186 .

Clothing account:

Last settled \_\_\_\_\_, 186 ; drawn since \$ \_\_\_\_\_ 100

Due soldier \$ \_\_\_\_\_ 100; due U. S. \$ \_\_\_\_\_ 100

Am't for cloth'g in kind or money adv'd \$ \_\_\_\_\_ 100

Due U. S. for arms, equipments, &c., \$ \_\_\_\_\_ 100

Bounty paid \$ \_\_\_\_\_ 100; due \$ \_\_\_\_\_ 100

Remarks: *Joined at Arg'l. Ar'y'n,*  
*App. Corp'l Apr. 3, 1864. Re-*  
*duced to ranks July 10, 1864*  
*Died, Dec. 12, 1864,*

Book mark : \_\_\_\_\_

Wines

S. 10 N. A. U. S. A.

Eugene Lee

Priv., Co. C, 1 Reg't N. A. Corps  
d'Afrique.

**NOTATION.**

Book mark: P. & P. 498502

**Record and Pension Office,**

WAR DEPARTMENT,

Washington. Nov. 15, 1897.

It has this day ( Nov. 15, 1897 )

been determined by this Department from the records that the enrollment of this soldier Feb. 29, 1864, in Co. G, 7<sup>th</sup> U. S. A. Artillery, and his muster into service Apr. 3, 1864, are void, and of no effect, because of his previous enlistment and muster into service in Co. C, 1<sup>st</sup> U. S. A. Artillery, Corps d'Afrique.

It has also been determined that from Nov. 7, 1863, until Feb. 29, 1864, when he was assigned to Co. G, 7<sup>th</sup> U. S. A. Artillery, the

A. G. N. <sup>over</sup>

soldier was at Port  
Hudson, La., undergoing  
punishment without  
loss of pay or allowances  
pursuant to par. 7, S. O.  
#278, Dept. of the Gulf, dated  
Nov. 7, 1863.



Lee, Eugene  
P. G. 18 Reg't uscta  
, Co. ,

4 Enclosures.

Bed Cards	Descriptive Lists
Burial Records 2	Final Statements 1
Certs. of Dis. for Discharge	Furloughs
C. M. Charges	Med. Des. Lists
Med. Certificates	Orders

Other papers relating to—

Admission to Hosp'l	Furlough
Casualty Sheet (Officer's)	Med. Examination
Confinement	Misc. Information
Contracts	Pay or Clothing
Death or Effects 1	Personal Reports
Desertions	Rank
Discharge from Hosp'l	Transfer to Hosp'l
Discharge from Service	Transfer to V. R. C.
Duty	Transportation

✓  
FINAL STATEMENT

OF

*Company Lee Co. E.*

*10<sup>th</sup> Reg't of U.S. Art'y (Hq.)*

**VOLUNTEERS.**

*Due Dec 12<sup>th</sup> 1864*

NOTE 1.—Two of these certificates (or duplicates) are to be given to each Volunteer Soldier or drafted man who may be discharged previously to the discharge of his company, that he may at once receive from the Paymaster the pay, &c., due him, and the captain or other COMMISSIONED officer commanding the company will certify to the act of the delivery of the duplicate certificates; on these certificates the Soldier is "entitled to" his discharge, and should also present his discharge to the Paymaster to have the payment endorsed on it. The discharge is to be given back to the Soldier by the Paymaster; the latter only retaining as his voucher the duplicate certificates.

NOTE 2.—If the Soldier is entitled to pay for the use of his horse, the Company Commander will certify to that fact on the back of both these final statements, and also to the time he has pay due for having been so mounted on his own horse.

NOTE 3.—When a Soldier is furnished with final statements, his descriptive list, if he has one, should be taken up by the officer who gives the Soldier these statements, and endorsed with a statement to this effect by the officer. This endorsement should exhibit a full statement of the time for which the Soldier was allowed pay on his final statements, the clothing account, and all other charges against him or in his favor, so as to comprise a complete exhibit of his account. It will then be transmitted to the company commander of the Soldier, who will enter all the data necessary to a full understanding of the Soldier's account on the muster roll upon which the Soldier's discharge is reported. The descriptive list will then be destroyed. The object of this is, that the remaining portion of the Soldier's account may be settled upon the receipt of these muster rolls, and the Soldier receive any pay or allowances that may be due him at the time of his discharge, and which may not appear on his final statements from the fact that his descriptive list is incomplete. These accounts for back pay, &c., are settled by the 2d Auditor of the Treasury Department.

NOTE 4.—Charges for loss or injury to ordnance, horse equipments, and other miscellaneous charges, should appear under the heading of "Other Stoppages."

NOTE 5.—Bounty paid by State authorities, and not by the United States, will not be entered on this statement.

NOTE 6.—Amounts due the Sutler and Laundress must be entered on the muster roll on which the discharge, death, desertion, &c., is reported, as well as on the final statement, otherwise the amount cannot be collected from the United States.

NOTE 7.—This blank will be used for deceased volunteers and drafted men, as well as for others.

NOTE 8.—Where a Soldier dies in Hospital or on detached service, his descriptive list, if he has one, should be sent with his final statements, in duplicate, to the Adjutant General, Washington, D. C.

ADJUTANT GENERAL'S OFFICE

*July 30<sup>th</sup> 1865.*

Duplicate with Inventory sent 2d Auditor.



I certify, on honor, that Eugene Lee a Private of  
Captain J. H. McGuire Company (G.) of the 10<sup>th</sup> Regiment of U. S. Art'y (Hq)  
**VOLUNTEERS**, of the State of \_\_\_\_\_, born in Baton Rouge, State  
of Louisiana, aged 20 years; 5 feet 4 inches high, Black complexion,  
Black eyes, Black hair, and by occupation a Tanner, having joined the company on  
its original organization at New Orleans La, and enrolled in it at the muster into  
the service of the United States at New Orleans La, on the Third day  
of April, 1864, <sup>and</sup> ~~or~~ was mustered in service as a recruit, by Lieut  
Chamberlain, at Port Hudson on the 29<sup>th</sup> day of February,  
1864, ~~or was drafted and mustered into the service of the United States from the~~  
~~Enrollment District of the State of \_\_\_\_\_, at \_\_\_\_\_,~~  
~~on the \_\_\_\_\_ day of \_\_\_\_\_, 186 \_\_\_\_\_,~~ to serve in the Regiment, for  
the term of Three Years: and having served **HONESTLY** and  
**FAITHFULLY** with his Company in Said Regiment to the present date, is now  
entitled to a **DISCHARGE** by reason of Deaths in Corps d'Afrique  
U. S. Gen. Hospital at New Orleans Dec 12<sup>th</sup> 1864 of Small Pox

The said Private Eugene Lee was last paid by Paymaster  
Maj Haggerty to include the 30<sup>th</sup> day of June, 1864, and has  
pay due him from that time to the present date; ~~he is entitled to pay and subsistence for~~  
~~TRAVELING~~ to place of enrollment, and whatever other allowances are authorized to volunteer  
soldiers, drafted men, or militia, so discharged. He has received from the United States **CLOTHING**  
amounting to 5-4 <sup>72</sup>/<sub>100</sub> dollars, since the \_\_\_\_\_ day of Enrollment  
186, when his clothing account was last settled. ~~He has received from the United States~~  
~~\_\_\_\_\_ dollars advanced BOUNTY.~~

There is to be stopped from him, on account of the State of \_\_\_\_\_, or other  
authorities, for **CLOTHING**, &c., received on entering service, \_\_\_\_\_ <sup>100</sup>/<sub>100</sub> dollars; and  
for other stoppages, viz: \_\_\_\_\_

\_\_\_\_\_ <sup>100</sup>/<sub>100</sub> dollars.  
He has been furnished with **TRANSPORTATION** in kind from the place of his discharge to  
\_\_\_\_\_ ; and he has been **SUBSISTED** for **TRAVELING** to his  
place of enrollment, up to the \_\_\_\_\_, 1864.

He is indebted to F. Cleveland, **SUTLER**, 5 <sup>00</sup>/<sub>100</sub> dollars.

He is indebted to \_\_\_\_\_, **LAUNDRESS**, \_\_\_\_\_ <sup>00</sup>/<sub>100</sub> dollars.

Given in Duplicate, at New Orleans La, this 17<sup>th</sup> day  
of December, 1864.

J. Horace McGuire  
Captain

Commanding Company.

Eugene Lee  
Priv. G. W. U. S. C. H. A.  
Dec. 12. 64.  
Corps d'Afrique  
New-Orleans.

HOSPITAL RECORD,

SUBJECT TO THE

ORDER OF THE SURGEON GENERAL,

UNITED STATES ARMY.

21

No. 1.

RECORD OF DEATH AND INTERMENT.

Name and number of person interred,

Engene Lee

Number and locality of the Grave, -

Hospital number of the deceased, -

2293

Regiment, Rank, and Company, - -

10<sup>th</sup> U.S.H. Art. Private. "G."

Residence before enlistment, - - -

Conjugal condition (and if married, )

the residence of the widow, )

Cause of death, - - - - - )

Small Pox

Age of the deceased, - - - - -

Nativity, - - - - -

References, and Remarks, - - - )

Date of death and burial, - - -

Dec. 12<sup>th</sup> 1864.

186

Duplicates sent to the Adjutant General of the United States Army, and to the Sexton of the Cemetery.

Memoranda:

## RECORD OF DEATH AND INTERMENT.

Name and number of person interred,	<i>Eugene Lee</i>	
Number and locality of the grave, -		
Hospital number of the deceased, -	<i>2293</i>	
Regiment, Rank, and Company, - -	<i>10<sup>th</sup> U.S. Col. N. Art. Private 'G..</i>	
Residence before enlistment, - - -		
Conjugal condition (and if married, ) the residence of the widow, )		
Cause of death, )	<i>Small Pox.</i>	
Age of the deceased, - - - - -		
Nativity, - - - - -		
References and Remarks, - - }		
Date of death and burial, - - -	<i>December 12<sup>th</sup></i>	<i>1864</i>

[A duplicate of this Record has been forwarded to the Sexton, and the other remains at this Hospital.]

To *Adj. General U.S.A.*

SIR:

It becomes my duty to inform you that the person above described died at this Hospital as herein stated: and that it is desired his remains should be interred with the usual military honors.

Respectfully,

*J. E. Piquette*  
Surgeon U. S. Army.

MILITARY HOSPITAL, *Cornel D. Abrique*  
*New Orleans La.*

This copy of Record is to be transmitted to the Adjutant General at Washington immediately after the place of burial and the number of the grave have been ascertained and registered. The above notification is to remain attached.

ARTICLES OF WAR.

ART. 95. When any non-commissioned officer or soldier shall die, or be killed in the service of the United States, the then commanding officer of the troop or company shall, in the presence of two other commissioned officers, take an account of what effects he died possessed of, above his arms and accoutrements, and transmit the same to the office of the Department of War, which said effects are to be accounted for, and paid to the representatives of such deceased non-commissioned officer or soldier. And in case any of the officers, so authorized to take care of the effects of deceased officers and soldiers, should, before they have accounted to their representatives for the same, have occasion to leave the regiment or post, by preferment or otherwise, they shall, before they be permitted to quit the same, deposit in the hands of the commanding officer, or of the assistant military agent, all the effects of such deceased non-commissioned officers and soldiers, in order that the same may be secured for, and paid to, their respective representatives.

ARMY REGULATIONS—EDITION OF 1861.

DECEASED SOLDIERS.

Par. 152. Inventories of the effects of deceased non-commissioned officers and soldiers, required by the 95th Article of War, will be forwarded to the Adjutant General, by the commander of the company to which the deceased belonged, and a duplicate of the same to the colonel of the regiment. Final statements of pay, clothing, &c., will be sent with the inventories. When a soldier dies at a post or station absent from his company, it will be the duty of his immediate commander to furnish the required inventory, and, at the same time, to forward to the commanding officer of the company to which the soldier belonged, a report of his death, specifying the date, place, and cause; to what time he was last paid, and the money or other effects in his possession at the time of his decease; which report will be noted on the next muster roll of the company to which the man belonged. Each inventory will be endorsed, "Inventory of the effects of \_\_\_\_\_, late of company (—) \_\_\_\_\_ regiment of \_\_\_\_\_, who died at \_\_\_\_\_, the \_\_\_\_\_ day of \_\_\_\_\_, 186—." If a legal representative receive the effects, it will be stated in the report. If the soldier leave no effects, the fact will be reported.

Par. 153. Should the effects of a deceased non-commissioned officer or soldier not be administered upon within a short period after his decease, they shall be disposed of by a Council of Administration, under the authority of the commanding officer of the post, and the proceeds deposited with the Paymaster, to the credit of the United States, until they shall be claimed by the legal representatives of the deceased.

Par. 154. In all such cases of sales by the Council of Administration, a statement in detail, or account of the proceeds, duly certified by the Council and commanding officer, accompanied by the Paymaster's receipt for the proceeds, will be forwarded by the commanding officer to the Adjutant General. The statement will be endorsed, "Report of the proceeds of the effects of \_\_\_\_\_, late of company (—) \_\_\_\_\_ regiment of \_\_\_\_\_, who died at \_\_\_\_\_, the \_\_\_\_\_ day of \_\_\_\_\_, 186—."

NOTE 1.—The effects in all cases, when called for, should be turned over to the legal representative, without further authority from the Adjutant General. When the effects are turned over to the relatives of the deceased before these inventories are sent to the Adjutant General, their receipts therefor should be attached to the inventories. In all other cases, one copy will be sent with a letter of transmittal direct to the Adjutant General, and a duplicate retained by the officer.

NOTE 2.—Particular care should be taken to take receipts in duplicate from the Paymaster for any funds turned over to him; one copy should be sent direct to the Adjutant General and one retained by the officer.

*Duplicate*  
No Description List  
INVENTORY OF THE EFFECTS

OF

*Engene Lee*

Late of Company "G"

10<sup>th</sup> Reg't of U.S. Col. N. Art.

Volunteers, who died at New Orleans La.

on the 12<sup>th</sup> day of Dec. 1864

*[Handwritten signature]*





1576  
Lee, Frank

Co A, 10 U.S. Col'd H. Art'y.

Private

Private

CARD NUMBERS.

1	5489139	26
2	5492928	27
3	5493226	28
4	5493295	29
5	5493505	30
6	5493627	31
7	5493752	32
8	5494017	33
9	5490072	34
10		35
11		36
12		37
13		38
14		39
15		40
16		41
17		42
18		43
19		44
20		45
21		46
22		47
23		48
24		49
25		50

Book Mark:

See also 75. U.S.C.D.

S. 1344978 And MS.

S. 1360567. P.O. vicinity P. Ave.

P 1418405 And MS.

G. S. Doughty

*S* *William* **U.S.C.T.**

*Frank Lee*

*C*, Co., *10* Reg't U. S. Col'd *Art*

Appears on

**M. and D. Roll of Men Transferred**

to the organization named above,

from *73 USCS*

Roll dated *Nov 18*, 186*3*.

When enlisted *Aug 12*, 186*3*.

Period for which enlisted *3* years.

When mustered in *Sep 24*, 186*3*.

Present or absent *Not stated*

Company to which assigned

Remarks: *Due to S. O. No 209 S. 1864*

*forwarded to 73 USCS Aug 13/64*  
*per S. O. No 209 S. 1864*  
*Dept Gulf*

Book mark :

*J. Johnson*

*6* | 10 H. Art'y. | U.S.C.T.

*Frank Lee*

*PM*, Co. A, 10 Reg't U. S. Col'd H. Art'y.

Appears on

**Company Muster Roll**

for *Nov & Dec*, 1865.

Present or absent *Present*

Stoppage, \$ *100* for

Due Gov't, \$ *3* <sup>*33*</sup>/<sub>*100*</sub> for *C. & E. \$ 313*

*for Ordnance 20¢ per transfer rolls*

Valuation of horse, \$ *100*

Valuation of horse equipments, \$ *100*

Remarks: *Transferred from 75 U.S. to 2*  
*per S.O. 105, C.S. Hd Qrs Dept of War*

Book mark:

*Aty*

*S* | 10 H. Art'y. | U.S.C.T.

*Frank Lee*

*Pl*, Co. A, 10 Reg't U. S. Col'd H. Art'y.

Appears on

**Company Muster Roll**

for *Jan + Feb*, 186*6*.

Present or absent *Present*

Stoppage, \$ 100 for

Due Gov't, \$ 100 for

Valuation of horse, \$ 100

Valuation of horse equipments, \$ 100

Remarks:

-----  
-----  
-----  
-----  
-----  
-----  
-----  
-----  
-----

Book mark:

-----  
-----

*Stym*  
Copyist.

L | 10 H. Art'y. | **U.S.C.T.**

*Frank Lee*

*Pvt*, Co. A, 10 Reg't U. S. Col'd H. Art'y.

Appears on

**Company Muster Roll**

for *Mar & Apr*, 186*b*.

Present or absent *Present*

Stoppage, \$ 100 for

Due Gov't, \$ 70 for *Camp & Garrison*

*Equipage*

Valuation of horse, \$ 100

Valuation of horse equipments, \$ 100

Remarks:

-----  
-----  
-----  
-----  
-----  
-----  
-----  
-----

Book mark: -----

*Royce*

Copyist.

*L* | 10 H. Art'y. | U.S.C.T.

*Frank Lee*

*Plt*, Co. A, 10 Reg't U. S. Col'd H. Art'y.

Appears on

Company Muster Roll

for

*May & June, 1866*

Present or absent

*Present*

Stoppage, \$ 100 for

Due Gov't, \$ 100 for

Valuation of horse, \$ 100

Valuation of horse equipments, \$ 100

Remarks:

Book mark:

*H. J. ...*

Copyist.

*B* | 10 H. Art'y. | U.S.C.T.

*Frank Lee*

*Pvt.*, Co. A, 10 Reg't U. S. Col'd H. Art'y.

Appears on

**Company Muster Roll**

for *July & Aug, 1866.*

Present or absent *Present*

Stoppage, \$ 100 for

Due Gov't, \$ 100 for

Valuation of horse, \$ 100

Valuation of horse equipments, \$ 100

Remarks:

Book mark:

*Hyman*  
Copyist.



L | 10 H. Art'y. | U.S.C.T.

Frank Lee

Pvt., Co. A, 10 Reg't U. S. Col'd H. Art'y.

Appears on

Company Muster Roll

for Sept & Oct, 1866.

Present or absent

Stoppage, \$ 100 for

Due Gov't, \$ 100 for

Valuation of horse, \$ 100

Valuation of horse equipments, \$ 100

Remarks: Date of discharge, mustered out  
Sept 23/66 by reason of expiration of term  
of service  
Paid \$100.00 bounty

Book mark:

Nesbitt

Copyist.

L | 10 Arty | U.S.C.T.

Frank Lee

Priv., Co. A, 10 Reg't U. S. Col'd Arty

Appears on a

**Detachment Muster-out Roll**

of the organization named above. Roll dated

New Orleans La, Sep 24, 1866.

Muster-out to date Sep 23, 1866.

Last paid to June 30, 1866

**Clothing account:**

Last settled ..... 186 ; drawn since \$ ..... 100

Due soldier \$ <sup>313</sup> <sup>314</sup> / 100; due U. S. \$ ..... 100

Am't for cloth'g in kind or money adv'd \$ ..... 100

Due U. S. for arms, equipments, &c., \$ 1 <sup>08</sup> / 100

Bounty paid \$ ..... 100 due \$ 100 / 100

Remarks: Joined Orig Org  
88 U. S. C. I, Transferred  
to 75<sup>th</sup> U. S. C. I, D.O. 209  
par 12, Series of 1864  
Dept of Gulf. Trans-  
ferred to 10 U. S. C. A.  
Cover

Book mark: .....

Lamb

JAN. 15

5490072

★ 1831 ★

(26) S.O. 105 par 12  
Series of 1865 Dept of  
La. Stop for one  
tompis

Mustered out by rea-  
son of expiration of  
term of service to date  
Sep 23 " 1866

*L* | 10 H. Art'y. | U.S.C.T.

*Frank Lee*

*Pvt.*, Co. *A*, 10 Reg't U. S. Col'd H. Art'y.

Appears on Co. Muster-out Roll, dated  
*Baton Rouge La Feb. 22* 1867.

Muster-out to date \_\_\_\_\_, 186 .

Last paid to \_\_\_\_\_, 186 .

Clothing account:

Last settled \_\_\_\_\_, 186 ; drawn since \$ \_\_\_\_\_ 100

Due soldier \$ \_\_\_\_\_ 100; due U. S. \$ \_\_\_\_\_ 100

Am't for cloth'g in kind or money adv'd \$ \_\_\_\_\_ 100

Due U. S. for arms, equipments, &c., \$ \_\_\_\_\_ 100

Bounty paid \$ \_\_\_\_\_ 100; due \$ \_\_\_\_\_ 100

Remarks: *Transfd from 75 U.S.C.S. as*  
*Pvt. S. Co. 105 S. of 65 Reg't. La.*  
*Dischd for expn. of term of service*  
*Sept. 23. 66*

Book mark: *V. 105 P. 3. 69*

*Nesbitt*

1511  
LEE, George

Co L, 10 U.S. Col'd H. Art'y.

Private | Private

CARD NUMBERS.

1	5488267	26
2	5488764	27
3	5513475	28
4	5513622	29
5	5513749	30
6	5513864	31
7	5513956	32
8	5514016	33
9	5514075	34
10	5514201	35
11		36
12		37
13		38
14		39
15		40
16		41
17		42
18		43
19		44
20		45
21		46
22		47
23		48
24		49
25		50

Book Mark:

See also 77 m.s.c. inf

*L 1026a* U.S.C.T.

*George Lee*

*Plt*, *Co D*, *10* Reg't U. S. Col'd *H.A.*

Appears on

**M. and D. Roll of Men Transferred**

to the organization named above,

from

*77 U.S. Col Inf*

Roll dated

*Camp Pmaphu Oct*, 186*5*.

When enlisted

*Apr 1*, 186*5*.

Period for which enlisted

*3* years.

When mustered in

*Apr 10*, 186*5*.

Present or absent

*Present*

Company to which assigned

*L*

Remarks:

*Joined as recruit  
joined by transfer  
from Co D. of 77 U.S.  
C.I. per S.O. 66 C.S.  
La Qrs Dept of La*

Book mark :

*Wheat Scott*

L 10 N. artz | **U.S.C.T.**

George Lee

Pr., Co. L, 10 Reg't U. S. Col'd N. artz.

Appears on

**M. and D. Roll of Men Transferred**

to the organization named above,

from 77 Regt U.S. Inf

Roll dated Oct 1, 1865.

When enlisted Apr 1, 1865.

Period for which enlisted 3 years.

When mustered in Apr 10, 1865.

Present or absent Present

Company to which assigned L

Remarks: joined as recruit  
Apr. 25. 65

Book mark :

J. L. Leonard

*L* | 10 H. Art'y. | U.S.C.T.

*George Lee*  
-----  
*Privt.*, Co. *L*, 10 Reg't U. S. Col'd H. Art'y.

Age ----- years.

Appears on

**Company Muster Roll\***

for *Sept. & Oct.*, 1865.

Joined for duty and enrolled:

When *Apr. 1*, 1865.

Where *New Orleans*

Period *3* years.

Mustered in:

When *Apr. 10*, 1865.

Where *New Orleans*

Present or absent *Present*

Stoppage, \$ *100* for -----

Due Gov't, \$ *100* for -----

Valuation of horse, \$ *100*

Valuation of horse equipments, \$ *100*

Remarks: *Transfd. from Co. D.*  
*77 U.S.C.*

\*First current roll. No muster-in roll of this company on file.

Book mark : -----

(3586)

*Scherich*

Copyist.



*L* | 10 H. Art'y. | **U.S.C.T.**

*George Lee*

*Plt*, Co. L, 10 Reg't U. S. Col'd H. Art'y.

Appears on

**Company Muster Roll**

for *Nov. & Dec*, 1863.

Present or absent *Present*

Stoppage, \$ 100 for

Due Gov't, \$ 100 for

Valuation of horse, \$ 100

Valuation of horse equipments, \$ 100

Remarks: \_\_\_\_\_  
\_\_\_\_\_  
\_\_\_\_\_  
\_\_\_\_\_  
\_\_\_\_\_  
\_\_\_\_\_

Book mark: \_\_\_\_\_

*Scherich*

L | 10 H. Art'y. | U.S.C.T.

George Lee

Det., Co. L, 10 Reg't U. S. Col'd H. Art'y.

Appears on

**Company Muster Roll**

for Jan. & Feb., 1866

Present or absent Present

Stoppage, \$ 100 for

Due Gov't, \$ 100 for

Valuation of horse, \$ 100

Valuation of horse equipments, \$ 100

Remarks:

Book mark:

Scherich

L 10 H. Art'y. U.S.C.T.

George Lee

Priv., Co. L, 10 Reg't U. S. Col'd H. Art'y.

Appears on

Company Muster Roll

for Mch. & Apl., 1866.

Present or absent Present

Stoppage, \$ 100 for

Due Gov't, \$ 100 for

Valuation of horse, \$ 100

Valuation of horse equipments, \$ 100

Remarks: stop for one Haversack  
lost 75¢ one canteen  
90¢ = \$1.85.

Book mark: \_\_\_\_\_

Scherich

*L* | *10th Art'y* | **U.S.C.T.**

*George Lee*

*Priv*, Co. *L*, *10* Reg't U. S. Col'd *10th Art'y*

Appears on

**Company Muster Roll**

for *May & June*, 186*6*.

Present or absent *Present*

Stoppage, \$ *100* for

Due Gov't, \$ *100* for

Valuation of horse, \$ *100*

Valuation of horse equipments, \$ *100*

Remarks:

Book mark:

*Scherrich*

*L* | 10 H. Art'y. | U.S.C.T.

*George Lee*

*Pat.*, Co. L, 10 Reg't U. S. Col'd H. Art'y.

Appears on

**Company Muster Roll**

for *July & Aug*, 186*6*.

Present or absent *Present*

Stoppage, \$ *100* for

Due Gov't, \$ *100* for

Valuation of horse, \$ *100*

Valuation of horse equipments, \$ *100*

Remarks:

Book mark:

*Burnham*

L 10 H. Art'y. U.S.C.T.

George Lee

Private, Co. L, 10 Reg't U. S. Col'd H. Art'y.

Appears on

Company Muster Roll

for Sept & Oct, 1866

Present or absent

Stoppage, \$ 100 for

Due Gov't, \$ 100 for

Valuation of horse, \$ 100

Valuation of horse equipments, \$ 100

Remarks: Discharged by order  
Sept. 8/66 having been tested  
in the regular Army

Book mark:

Burnham

L | 10 H. Art'y. | U.S.C.T.

George Lee  
Pvt., Co. L., 10 Reg't U. S. Col'd H. Art'y.

Appears on Co. Muster-out Roll, dated  
Baton Rouge La Feb 22, 1867.

Muster-out to date \_\_\_\_\_, 186 .

Last paid to \_\_\_\_\_, 186 .

Clothing account:

Last settled \_\_\_\_\_, 186 ; drawn since \$ \_\_\_\_\_ 100

Due soldier \$ \_\_\_\_\_ 100 ; due U. S. \$ \_\_\_\_\_ 100

Am't for cloth'g in kind or money adv'd \$ \_\_\_\_\_ 100

Due U. S. for arms, equipments, &c., \$ \_\_\_\_\_ 100

Bounty paid \$ \_\_\_\_\_ 100 ; due \$ \_\_\_\_\_ 100

Remarks: *Joined by transfer from  
77 USC 2 Oct 1, 65 30 66 Hd Qrs Dept.  
of La Sept 22/65 - Disch'd at N.O.  
La Sept 8/1866 to enable him to  
enlist in 9 US Cavalry*

Book mark: \_\_\_\_\_

Burnham

1578  
Lee, Johnson

Co. F, 10 U.S. Col'd H. Art'y

Private | Private

CARD NUMBERS.

1	5-487245	26
2	5-504742	27
3	5-505000	28
4	5-505160	29
5	5-507045	30
6		31
7		32
8		33
9		34
10		35
11		36
12		37
13		38
14		39
15		40
16		41
17		42
18		43
19		44
20		45
21		46
22		47
23		48
24		49
25		50

Book Mark:

See also



L<sup>o</sup> 10 H. Arty | U.S.C.T

Johnson Lee

Appears with rank of *Priv* on

**Muster and Descriptive Roll of a Detachment of Drafted Men and Substitutes forwarded**

for the 7 Reg't U.S. Col'd *H Arty* Roll dated *New Orleans La., Aug 19, 1864*

Where born *Terrebonne La*

Age *19* years; occupation *Laborer*

**Drafted and mustered in:**

When *Aug 17*, 1864.

Where *Bourne La*

Period *3* years.

Eyes *Dark*; hair *Black*

Complexion *Dark*; height *5 ft. 8 in.*

Paid bounty and advance pay, \$ *100*

Bounty due \$ *100*

Where credited *Parish of Terrebonne La*

Company to which assigned *F*

Remarks:

*Became 10 U.S.C.H Arty*

Book mark:

L | 10 H. Art'y. | U.S.C.T.

Johnson Lee

Pvt., Co. F, 7 Reg't U. S. Col'd H. Art'y.\*

Appears on

**Company Muster-in and Descriptive Roll**

of the organization named above. Roll dated

New Orleans La, Aug 19, 1864.

Where born Terrebonne La

Age 19 y'rs; occupation Laborer

When enlisted \_\_\_\_\_, 186 .

Where enlisted \_\_\_\_\_

For what period enlisted 3 years.

Eyes Dark; hair Blk

Complexion Dark; height 5 ft. 8 in.

When mustered in Aug 19, 1864.

Where mustered in New Orleans La

Bounty paid \$ 100; due \$ 100

Where credited 3<sup>rd</sup> Emitt Dist La.

Company to which assigned \_\_\_\_\_

Remarks: drafted

\* This organization subsequently became Co. F, 10 Reg't U. S. Colored Heavy Artillery.

Book mark: \_\_\_\_\_

Rosenbaum

*L*

10 H. Art'y. | **U.S.C.T.**

*Johnson Lee*

*Pvt.*, Co. F, 10 Reg't U. S. Col'd H. Art'y.

Appears on

**Company Muster Roll**

for *July & August*, 1864.

Present or absent *Present*

Stoppage, \$.....100 for .....

Due Gov't, \$.....100 for .....

Valuation of horse, \$.....100

Valuation of horse equipments, \$.....100

Remarks: .....

Book mark: .....

*Rosenbaum*

Copyist.

*L*

10 H. Art'y. U.S.C.T.

*Johnson Lee*  
Pvt., Co. F, 10 Reg't U. S. Col'd H. Art'y.

Appears on

**Company Muster Roll**

for *Sept & Oct*, 1864.

Present or absent.....

Stoppage, \$.....100 for.....

Due Gov't, \$.....100 for.....

Valuation of horse, \$.....100

Valuation of horse equipments, \$.....100

Remarks: *Deserted from Battery  
Gentilly Sept 4 - 1864*

Book mark:.....

*Rosenbaum*

L | 10 H. Art'y. | U.S.C.T.

Johnson Lee

Pvt., Co F, 10 Reg't U. S. Col'd H. Art'y.

Appears on Co. Muster-out Roll, dated

Baton Rouge La. Feb 22, 1867.

Muster-out to date \_\_\_\_\_, 1867 .

Last paid to \_\_\_\_\_, 1867 .

Clothing account:

Last settled \_\_\_\_\_, 1867 ; drawn since \$ \_\_\_\_\_ 100

Due soldier \$ \_\_\_\_\_ 100; due U. S. \$ \_\_\_\_\_ 100

Am't for cloth'g in kind or money adv'd \$ 10 08 / 100

Due U. S. for arms, equipments, &c., \$ \_\_\_\_\_ 100

Bounty paid \$ \_\_\_\_\_ 100; due \$ \_\_\_\_\_ 100

Remarks: joined at original organization. Deserted from Battery Gettily La. Sept 4/64

Book mark: \_\_\_\_\_

House

1519  
Lee, Michael

Co B, 10 U.S. Col'd H. Art'y

Private

Private

CARD NUMBERS.

1	5497737	26
2	5498137	27
3	5498239	28
4	5498336	29
5	5498434	30
6	5498550	31
7	5498691	32
8	5498830	33
9	5498967	34
10	5499108	35
11	5499244	36
12	5499380	37
13	5499515	38
14	5499651	39
15	5499787	40
16	5499922	41
17	5500052	42
18	5500187	43
19	5489269	44
20	5500316	45
21	5489285	46
22	5500470	47
23	5490164	48
24		49
25		50

Book Mark:

See also

*L* | 10 H. Art'y. | U.S.C.T.

*Michael Lee*  
Pvt., Co. C, 1 Reg't La. Art'y, Native Guards.\*

Age *30* years.

Appears on

**Company Muster-in Roll**

of the organization named above. Roll dated

*New Orleans La, Feb 4, 1864.*

Muster-in to date *Feb 4, 1864.*

Joined for duty and enrolled:

When *Oct 4, 1863.*

Where *N. O. La*

Period *3* years.

Valuation of horse, \$ *100*

Valuation of horse equipments, \$ *100*

Remarks: \_\_\_\_\_  
\_\_\_\_\_  
\_\_\_\_\_  
\_\_\_\_\_

\* This organization subsequently became Co. C, 10 Reg't U. S. Col'd Heavy Artillery.

Book mark : \_\_\_\_\_

*W. J. ...*

L | 10 H. Art'y. | **U.S.C.T.**

*Michael Lee*

*Pr*, Co. *C*, 1 Reg't H. Art'y, Corps d'Afrique.\*

Appears on

**Company Muster Roll**

for *Feb 4<sup>th</sup> to 29<sup>th</sup>*, 1864.

Present or absent *Absent*

Stoppage, \$ 100 for

Due Gov't, \$ 100 for

Valuation of horse, \$ 100

Valuation of horse equipments, \$ 100

Remarks: *Det Ser Sp Cr. No 13*  
*Med Drs 1<sup>st</sup> Regt Art Serv 30*  
*64*

\* This organization subsequently became Co. *C*, 10 Reg't U. S. Colored Heavy Artillery.

Book mark: \_\_\_\_\_

*W. J. [Signature]*



L | 10 H. Art'y. | U.S.C.T.

Michael Lee

Pvt, Co. C, 7 Reg't U. S. Col'd H. Art'y.\*

Appears on

**Company Muster Roll**

for Mich & apl, 1864

Present or absent absent

Stoppage, \$ 100 for

Due Gov't, \$ 100 for

Valuation of horse, \$ 100

Valuation of horse equipments, \$ 100

Remarks: Det. Serv. Sp. Or. No.  
13 Hd. Qrs 1st H. Art.  
6 d - A Jan 30/64

\* This organization subsequently became Co. , 10 Reg't U. S. Colored Heavy Artillery.

Book mark:

(358)

J. H. Anderson  
Copyist.

L | **10 H. Art'y.** | **U.S.C.T.**

Michael Lee

Priv, Co. C, 7 Reg't U. S. Col'd H. Art'y.\*

Appears on

**Company Muster Roll**

for May & June, 1864.

Present or absent Present

Stoppage, \$ 100 for

Due Gov't, \$ 100 for

Valuation of horse, \$ 100

Valuation of horse equipments, \$ 100

Remarks:

\* This organization subsequently became Co.       , 10 Reg't U. S. Colored Heavy Artillery.

Book mark:

J. Anderson  
Copyist.

L | **10 H. Art'y.** | **U.S.C.T.**

*Michael Lee*

*Pvt.*, Co. *L*, 7 Reg't U. S. Col'd H. Art'y.\*

Appears on

**Company Muster Roll**

for *July & Aug*, 186*4*.

Present or absent *Present*

Stoppage, \$ 100 for

Due Gov't, \$ 100 for

Valuation of horse, \$ 100

Valuation of horse equipments, \$ 100

Remarks: *sick*

\* This organization subsequently became Co. *10* Reg't U. S. Colored Heavy Artillery.

Book mark: \_\_\_\_\_

(358)

*J. M. ...*  
Copyist.

L | 10 H. Art'y. | U.S.C.T.

Michael Lee

Priv., Co. C, 10 Reg't U. S. Col'd H. Art'y.

Appears on

**Company Muster Roll**

for Sept + Oct, 1868.

Present or absent Present

Stoppage, \$ 100 for

Due Gov't, \$ 100 for

Valuation of horse, \$ 100

Valuation of horse equipments, \$ 100

Remarks: D. D. a c Sergt  
Post order no 7 Fort  
Livingston La Oct 5/69

Book mark:

J. H. Anderson  
Copyist.

L | 10 H. Art'y. | U.S.C.T.

Michael Lee  
Pvt., Co. C, 10 Reg't U. S. Col'd H. Art'y.

Appears on

**Company Muster Roll**

for Nov & Dec, 1864.

Present or absent Present

Stoppage, \$ 100 for

Due Gov't, \$ 100 for

Valuation of horse, \$ 100

Valuation of horse equipments, \$ 100

Remarks: Due U.S. for  
Haversack \$ 50

Book mark:

J. Anderson  
Coyist.

*U*

**10 H. Art'y. U.S.C.T.**

*Michael Lee*  
*Plt*, Co. C, 10 Reg't U. S. Col'd H. Art'y.

Appears on

**Company Muster Roll**

for *Jan + Feb*, 186*5*.

Present or absent *Present*

Stoppage, \$ 100 for

Due Gov't, \$ 100 for

Valuation of horse, \$ 100

Valuation of horse equipments, \$ 100

Remarks: *Due U.S. for Haw \$ 100*

Book mark:

*Ballade*

L | 10 H. Art'y. | U.S.C.T.

Michael Lee

Priv., Co. C, 10 Reg't U. S. Col'd H. Art'y.

Appears on

**Company Muster Roll**

for *March & April*, 1863.

Present or absent *Present*

Stoppage, \$ 100 for

Due Gov't, \$ 100 for

Valuation of horse, \$ 100

Valuation of horse equipments, \$ 100

Remarks:

Book mark:

*Lauby*

Copyist.

*L* | **10 H. Art'y. U.S.C.T.**

*Michael Lee*  
*Pvt*, Co. C, 10 Reg't U. S. Col'd H. Art'y.

Appears on

**Company Muster Roll**

for *May & June*, 186*5*.

Present or absent *Present*

Stoppage, \$ 100 for

Due Gov't, \$ 100 for

Valuation of horse, \$ 100

Valuation of horse equipments, \$ 100

Remarks:

Book mark:

*Ballade*



L | 10 H. Art'y. | **U.S.C.T.**

Michael Lee  
Plt, Co. C, 10 Reg't U. S. Col'd H. Art'y.

Appears on

**Company Muster Roll**

for July & Aug, 1865.

Present or absent Present

Stoppage, \$ 100 for

Due Gov't, \$ 100 for

Valuation of horse, \$ 100

Valuation of horse equipments, \$ 100

Remarks:

Book mark:

Ballade

L | 10 H. Art'y. | U.S.C.T.

Michael Lee  
Plt, Co. C, 10 Reg't U. S. Col'd H. Art'y.

Appears on

**Company Muster Roll**

for Sept & Oct, 1865

Present or absent Present

Stoppage, \$ 100 for

Due Gov't, \$ 100 for

Valuation of horse, \$ 100

Valuation of horse equipments, \$ 100

Remarks: Daily duty in crew  
Sept.

Book mark: \_\_\_\_\_

Pallade

*L* | 10 H. Art'y. | U.S.C.T.

*Michael Lee*

*Pvt.*, Co. C, 10 Reg't U. S. Col'd H. Art'y.

Appears on

**Company Muster Roll**

for *Nov. & Dec.*, 186*5*.

Present or absent *Present*

Stoppage, \$ 100 for

Due Gov't, \$ 100 for

Valuation of horse, \$ 100

Valuation of horse equipments, \$ 100

Remarks: *On daily duty  
in Commissary Dept.*

Book mark: \_\_\_\_\_

*A. J. Robbins*  
(358) Copyist.

*L* | 10 H. Art'y. | U.S.C.T.

*Michael Lee*  
Priv., Co. C, 10 Reg't U. S. Col'd H. Art'y.

Appears on

for *Jan & Feb.*, 186*b.*  
Company Muster Roll  
Present or absent *Present*

Stoppage, \$ *100* for

Due Gov't, \$ *100* for

Valuation of horse, \$ *100*

Valuation of horse equipments, \$ *100*

Remarks:

Book mark:

*A. J. Robbins*  
Copyist.

L | 10 H. Art'y. | **U.S.C.T.**

*Michael Lee*

*Pvt.*, Co. C, 10 Reg't U. S. Col'd H. Art'y.

Appears on

**Company Muster Roll**

for *Mo. & Apr.*, 186*b.*

Present or absent *Present.*

Stoppage, \$.....<sup>100</sup> for .....

Due Gov't, \$.....<sup>100</sup> for .....

Valuation of horse, \$.....<sup>100</sup>

Valuation of horse equipments, \$.....<sup>100</sup>

Remarks: *daily duty in  
Commissary Dept.*

Book mark: .....

*A. J. Robbins*

Copyist.

L | 10 H. Art'y. | **U.S.C.T.**

Michael Lee

Private, Co. C, 10 Reg't U. S. Col'd H. Art'y.

Appears on

**Company Muster Roll**

for May 2nd June, 1866.

Present or absent Present

Stoppage, \$ 100 for

Due Gov't, \$ 100 for

Valuation of horse, \$ 100

Valuation of horse equipments, \$ 100

Remarks: Daily Duty in Commissary Department.

Book mark: \_\_\_\_\_

A. J. Robbins  
Copyist.

L | 10 H. Art'y. | U.S.C.T.

Michael Lee  
Svt., Co. C, 10 Reg't U. S. Col'd H. Art'y.

Appears on

**Company Muster Roll**

for July 24 Aug 6, 1866

Present or absent Present

Stoppage, \$ 100 for

Due Gov't, \$ 100 for

Valuation of horse, \$ 100

Valuation of horse equipments, \$ 100

Remarks:

Book mark:

A. J. Robbins  
Copyist.

*L* | 10 H. Art'y. | U.S.C.T.

*Michael Lee*  
*Pr*, Co. C, 10 Reg't U. S. Col'd H. Art'y.

Appears on

**Company Muster Roll**

for *Sept & Oct*, 186*6*.

Present or absent *Absent*

Stoppage, \$ *100* for

Due Gov't, \$ *100* for

Valuation of horse, \$ *100*

Valuation of horse equipments, \$ *100*

Remarks: *On det serv at  
Ft. Livingston, Pa. per  
S.O. 15 C.S. Hd. Qrs  
Ft. Livingston*

Book mark:

*Hammer*

Copyist.



*L 1060A* U.S.C.T.

*Michael Lee*  
*Pr*, Co. *C*, *10* Reg't U. S. Col'd *Hob*

Appears on a

**Detachment Muster Roll**

of the organization named above

for *Sept. & Oct.*, 186*6*.

Station *Fort Sumter, S.C.*

Present or absent *Present*

Stoppage, \$ *100* for

Due Gov't, \$ *100* for

Valuation of horse, \$ *100*

Valuation of horse equipments, \$ *100*

Remarks:

Book mark:

*Grogan*

*L* | 10 H. Art'y. | U.S.C.T.

*Michael Lee*

*Pvt*, Co. C, 10 Reg't U. S. Col'd H. Art'y.

Appears on

**Company Muster Roll**

for *Nov & Dec*, 186*6*.

Present or absent *Absent*

Stoppage, \$ *100* for

Due Gov't, \$ *100* for

Valuation of horse, \$ *100*

Valuation of horse equipments, \$ *100*

Remarks: *Det serv at Fort  
Livingston, La, per  
S.O. No 15 C.S. Hd, Gps  
Fort Livingston, La*

Book mark:

*Hamm*  
Copyist.

*L. W. Holt* U.S.C.T.

*Michael Lee*  
*Priv*, Co. *C*, *10* Reg't U. S. Col'd *H*

Appears on a

**Detachment Muster Roll**

of the organization named above

for *Nov. & Dec.*, 18*66*.

Station *Ft. Livingston La.*

Present or absent *Present*

Stoppage, \$ 100 for

Due Gov't, \$ 100 for

Valuation of horse, \$ 100

Valuation of horse equipments, \$ 100

Remarks: *In Arrest*

Book mark :

*Grogan*

L | 10 Arty | U.S.C.T.

Michael Lee

Priv., Co. C, 10 Reg't U. S. Col'd Arty

Appears on a

**Detachment Muster-out Roll**

of the organization named above. Roll dated

Baton Rouge, La. Feb. 3, 1867.

Muster-out to date

Feb. 3, 1867.

Last paid to

Dec. 31, 1866.

**Clothing account:**

Last settled ..... 186 ; drawn since \$ ..... 100

Due soldier \$  $89 \frac{20}{100}$ ; due U. S. \$  $22 \frac{10}{100}$

Am't for cloth'g in kind or money adv'd \$ ..... 100

Due U. S. for arms, equipments, &c., \$ .....  $\frac{28}{100}$

Bounty paid \$  $100 \frac{00}{100}$  due \$  $100 \frac{00}{100}$

Remarks: Jones orig. org. 11th A. C. S. A.  
now 10 U. S. C. A. (1841). Stop for  
rifer & tompon.

Book mark: .....

R. C. Wilson

L | 10 H. Art'y. | U.S.C.T.

Michael Lee

Cor., Co. C, 10 Reg't U. S. Col'd H. Art'y.

Appears on Co. Muster-out Roll, dated  
Baton Rouge, La, Feb 22, 1867.

Muster-out to date \_\_\_\_\_, 186 .

Last paid to \_\_\_\_\_, 186 .

Clothing account:

Last settled \_\_\_\_\_, 186 ; drawn since \$ \_\_\_\_\_ 100

Due soldier \$ \_\_\_\_\_ 100; due U. S. \$ \_\_\_\_\_ 100

Am't for cloth'g in kind or money adv'd \$ \_\_\_\_\_ 100

Due U. S. for arms, equipments, &c., \$ \_\_\_\_\_ 100

Bounty paid \$ \_\_\_\_\_ 100; due \$ \_\_\_\_\_ 100

Remarks: Joined Orig Co  
Discharged Feb 3, 1867  
by reason of expiration  
of term of service

Book mark : \_\_\_\_\_

(361)

Hamming  
Copyist.

1500  
Lee, Peter

Co. H, 10 U.S. Col'd H. Art'y.

Private | Private

CARD NUMBERS.

1	5487466	26
2	5510231	27
3	5510381	28
4	5510528	29
5	5510634	30
6	5510778	31
7	5510858	32
8	5510933	33
9	5511026	34
10	5511141	35
11		36
12		37
13		38
14		39
15		40
16		41
17		42
18		43
19		44
20		45
21		46
22		47
23		48
24		49
25		50

Book Mark:

See also 77. U.S. Col. Inf

L 1076. A, U.S.C.T.

Peter Lee

Pvt, Co I, 10 Reg't U. S. Col'd H.A.

Appears on

**M. and D. Roll of Men Transferred**

to the organization named above,

from Co H, 10th U.S. Col'd Inf

Roll dated Camp Tumpet de la C., 1865.

When enlisted Mich 19, 1865.

Period for which enlisted 3 years.

When mustered in Mich 20, 1865.

Present or absent Present

Company to which assigned I

Remarks: joined the service as  
permit stoppage,  
wiper

Book mark :

W. H. Scott

*A* | 10 H. Art'y. | U.S.C.T.

*Peter Lee*

*Pvt.*, Co. H, 10 Reg't U. S. ~~C.~~ H. Art'y

Appears on

**Company Muster Roll**

for *Sep & Oct.*, 1865.

Present or absent *Present*

Stoppage, \$ *100* for

Due Gov't, \$ *100* for

Valuation of horse, \$ *100*

Valuation of horse equipments. \$ *100*

Remarks: *Due U.S. Advance  
lost \$0.20<sup>100</sup> transferred  
from Co. G. 77 U.S.C.T.  
per G.O. No 3 Wa Dis 10 US  
C.A. (H.) dated Camp  
Parapet Oct. 1. 1865.*

Book mark:

*Gammack*



*L* | 10 H. Art'y. | U.S.C.T.

*Peter Lee*

*Priv.*, Co. H, 10 Reg't U. S. Corp'd H. Art'y

Appears on

**Company Muster Roll**

for *Nov & Dec*, 1865.

Present or absent *Present*

Stoppage, \$ 100 for

Due Gov't, \$ 100 for

Valuation of horse, \$ 100

Valuation of horse equipments. \$ 100

Remarks :

-----  
-----  
-----  
-----  
-----  
-----  
-----  
-----

Book mark : -----

-----

*Sammack*

*L* | 10 H. Art'y. | U.S.C.T.

*Peter Lee*

*Pvt.*, Co. H, 10 Reg't U. S. Col'd H. Art'y

Appears on

**Company Muster Roll**

for *Jan & Feb.*, 1866.

Present or absent *Present*

Stoppage, \$ *100* for

Due Gov't, \$ *100* for

Valuation of horse, \$ *100*

Valuation of horse equipments. \$ *100*

Remarks:

Book mark:

*Tammack*  
Copyst.

*L* | 10 H. Art'y. | U.S.C.T.

*Peter Lee*

*Pvt.*, Co. H, 10 Reg't U. S. Col'd H. Art'y

Appears on

Company Muster Roll

for *M<sup>th</sup> & Apr.*, 1866.

Present or absent *Present*

Stoppage, \$ 100 for

Due Gov't, \$ 100 for

Valuation of horse, \$ 100

Valuation of horse equipments. \$ 100

Remarks :

Book mark :

*Cammack*

*L* | 10 H. Art'y. | U.S.C.T.

*Peter Lee*

*Cpt.*, Co. H, 10 Reg't U. S. Col'd H. Art'y

Appears on

**Company Muster Roll**

for *May June*, 1866.

Present or absent *Present*

Stoppage, \$ *100* for

Due Gov't, \$ *100* for

Valuation of horse, \$ *100*

Valuation of horse equipments. \$ *100*

Remarks :

Book mark :

*Samuel*

*L* | 10 H. Art'y. | U.S.C.T.

*Peter Lee*

*Pr<sup>c</sup>*, Co. H, 10 Reg't U. S. Col'd H. Art'y

Appears on

**Company Muster Roll**

for *July & Aug*, 1866.

Present or absent *Present*

Stoppage, \$ *100* for

Due Gov't, \$ *100* for

Valuation of horse, \$ *100*

Valuation of horse equipments. \$ *100*

Remarks:

Book mark:

*Gammal*  
Coylist.

L | 10 H. Art'y. | U.S.C.T.

Peter Lee

Priv., Co. H, 10 Reg't U. S. Col'd H. Art'y

Appears on

Company Muster Roll

for Sep & Oct, 1866.

Present or absent Absent

Stoppage, \$ 100 for

Due Gov't, \$ 100 for

Valuation of horse, \$ 100

Valuation of horse equipments. \$ 100

Remarks: Absent at New Orleans, La. per S.O. No. 72, Hd. Qrs. Forts Jackson & St. Philip Oct 1/66.

Book mark:

Lowry

L | 10 H. Art'y. | U.S.C.T.

Peter Lee

Priv., Co. H, 10 Reg't U. S. Col'd H. Art'y

Appears on

**Company Muster Roll**

for Nov. & Dec, 1866.

Present or absent

Stoppage, \$ 100 for

Due Gov't, \$ 100 for

Valuation of horse, \$ 100

Valuation of horse equipments, \$ 100

Remarks: Discharged Oct 6/66  
to enable him to re-en-  
list in the 7th U.S. Cav.  
Final statements given.

Book mark:

Lowry

L | 10 H. Art'y. | U.S.C.T.

Peter Lee

Pvt., Co. H., 10 Reg't U. S. Col'd H. Art'y.

Appears on Co. Muster-out Roll, dated

Baton Rouge, La. Feb. 22, 1867.

Muster-out to date \_\_\_\_\_, 186 .

Last paid to \_\_\_\_\_, 186 .

Clothing account:

Last settled \_\_\_\_\_, 186 ; drawn since \$ \_\_\_\_\_ 100

Due soldier \$ \_\_\_\_\_ 100; due U. S. \$ \_\_\_\_\_ 100

Am't for cloth'g in kind or money adv'd \$ \_\_\_\_\_ 100

Due U. S. for arms, equipments, &c., \$ \_\_\_\_\_ 100

Bounty paid \$ \_\_\_\_\_ 100; due \$ \_\_\_\_\_ 100

Remarks: *Joined by transfer  
from 77<sup>th</sup> U. S. I.  
Disch'd to enlist in U. S. Cav.  
Oct 16/66.*

*Final statements given.*

Book mark: *3108/83.*



1501  
Lee, Robert

Co F, 10 U.S. Col'd H. Art'y.

Private | Private

CARD NUMBERS.

1	5-3-0 4741	26
2	5-4-8 7185	27
3	5-5-0 5-0 0 1	28
4	5-5-0 5-1 8 6	29
5	5-5-0 7048	30
6		31
7		32
8		33
9		34
10		35
11		36
12		37
13		38
14		39
15		40
16		41
17		42
18		43
19		44
20		45
21		46
22		47
23		48
24		49
25		50

Book Mark:

See also

L | **10 H. Art'y. | U.S.C.T.**

Robert Lee

Pvt, Co. F, 7 Reg't U. S. Col'd H. Art'y.\*

Appears on

**Company Muster-in and Descriptive Roll**

of the organization named above. Roll dated

New Orleans La, Aug 19, 1864.

Where born Loudon Co. Va

Age 25 y'rs; occupation Blacksmith

When enlisted Aug 8, 1864.

Where enlisted New Orleans La

For what period enlisted 3 years.

Eyes Blk; hair Blk

Complexion Blk; height 5 ft. 6 in.

When mustered in Aug 19, 1864.

Where mustered in New Orleans La

Bounty paid \$ 100 100; due \$ 200 100

Where credited 1st Enroll Dist La

Company to which assigned \_\_\_\_\_

Remarks Recruit-entitled to Bounty

\* This organization subsequently became Co. F, 10 Reg't U. S. Colored Heavy Artillery.

Book mark : \_\_\_\_\_

Rosenbaum

*L* | 10 H. Art'y. | U.S.C.T.

*Robert Lee*

Appears with rank of *Priv* on

**Muster and Descriptive Roll of a Detach-**

**ment of U. S. Vols. forwarded**

for the *7* Reg't *U.S.C.H. Art'y*<sup>\*</sup> Roll dated  
*New Orleans La, Aug 19, 1864.*

Where born *London Co. Va*

Age *25* y'rs; occupation *Blacksmith*

When enlisted *Aug 8*, 1864.

Where enlisted *New Orleans*

For what period enlisted *3* years.

Eyes *Blk*; hair *Blk*

Complexion *Blk*; height *5* ft. *6* in.

When mustered in *Aug 19*, 1864.

Where mustered in *New Orleans*

Bounty paid \$ *100.00*; due \$ *200.00*

Where credited *To New Orleans*

Company to which assigned *F*

Remarks:

*Recruit Entitled to Bounty*

*\* Became U.S.C.H. Art'y.*

Book mark:

*J. M. Williams*

*L* | 10 H. Art'y. | U.S.C.T.

*Robert Lee*

*Pvt.*, Co. F, 10 Reg't U. S. Col'd H. Art'y.

Appears on

**Company Muster Roll**

for *July & August*, 1864.

Present or absent *Present*

Stoppage, \$ *50* for

Due Gov't, \$ *100* for

Valuation of horse, \$ *100*

Valuation of horse equipments, \$ *100*

Remarks:

Book mark:

*Rosenbaum*  
Copyst.

*L* | 10 H. Art'y. | U.S.C.T.

*Robert Lee*

*Pol-*, Co. F, 10 Reg't U. S. Col'd H. Art'y.

Appears on

**Company Muster Roll**

for *Sept & Oct*, 1864.

Present or absent.....

Stoppage, \$.....<sup>100</sup> for.....

Due Gov't, \$.....<sup>100</sup> for.....

Valuation of horse, \$.....<sup>100</sup>

Valuation of horse equipments, \$.....<sup>100</sup>

Remarks: *Deserted from Battery  
Gentilly Oct 6 - 1864*

Book mark:.....

*Rosenblum*

Copyist.

L

10 H. Art'y. U.S.C.T.

Robert Lee

Pvt., Co. I, 10 Reg't U. S. Col'd H. Art'y.

Appears on Co. Muster-out Roll, dated Baton Rouge La Feb 22, 1867.

Muster-out to date \_\_\_\_\_, 186 .

Last paid to *never paid* \_\_\_\_\_, 186 .

Clothing account:

Last settled \_\_\_\_\_, 186 ; drawn since \$ \_\_\_\_\_ 100

Due soldier \$ \_\_\_\_\_ 100; due U. S. \$ \_\_\_\_\_ 100

Am't for cloth'g in kind or money adv'd \$ 14 <sup>60</sup> 100

Due U. S. for arms, equipments, &c., \$ \_\_\_\_\_ 100

Bounty paid \$ 100 <sup>100</sup>; due \$ \_\_\_\_\_ 100

Remarks: *joined at original organization Deserted from Battery Gentry La. Oct. 6/64*

Book mark: \_\_\_\_\_

*House*

1582

Lee, Samuel

Co A, 10 U.S. Col'd H. Art'y

Private

Private

CARD NUMBERS.

1	5509778	26
2	5509932	27
3	5510782	28
4	5510227	29
5	5510377	30
6	5510525	31
7	5510704	32
8	5511140	33
9	5489956	34
10		35
11		36
12		37
13		38 /
14		39
15		40
16		41
17		42
18		43
19		44
20		45
21		46
22		47
23		48
24		49
25		50

Book Mark:

See also

S-285-3560 P.O. Mt  
S-2977063 P.O. Pitt

C. E. Doughty



*L* 10 H. Art'y. U.S.C.T.

*Samuel Lee*

*Pvt*, Co. H, 10 Reg't U. S. Col'd H. Art'y

Appears on

**Company Muster Roll**

for *March & April*, 1865.

Present or absent *Present*

Stoppage, \$ 100 for

Due Gov't, \$ 100 for

Valuation of horse, \$ 100

Valuation of horse equipments. \$ 100

Remarks: *Commencement of first payment by time April 5<sup>th</sup> 1865.*

Book mark:

(858)

*Pennington* Copyist.

*L* | 10 H. Art'y. | U.S.C.T.

*Samuel Lee*

*Pvt*, Co. H, 10 Reg't U. S. Col'd H. Art'y

Appears on

**Company Muster Roll**

for *May & June*, 1865.

Present or absent *Present*

Stoppage, \$ *100* for

Due Gov't, \$ *100* for

Valuation of horse, \$ *100*

Valuation of horse equipments. \$ *100*

Remarks: *Stoppage for  
Ordinance 45<sup>cts</sup> stop-  
page for Camp &  
Garrison Equipage  
2<sup>cts</sup>*

Book mark:

*Perrington*

*L* | 10 H. Art'y. | U.S.C.T.

*Samuel Lee*

*Pvt.*, Co. H, 10 Reg't U. S. Col'd H. Art'y

Appears on

**Company Muster Roll**

for *July & Aug.*, 1865.

Present or absent *Present*

Stoppage, \$ *100* for

Due Gov't, \$ *100* for

Valuation of horse, \$ *100*

Valuation of horse equipments. \$ *100*

Remarks:

Book mark:

*Permyington*  
Copyst.

*S* | 10 H. Art'y. | U.S.C.T.

*Samuel Lee*

*Pvt.*, Co. H, 10 Reg't U. S. Col'd H. Art'y

Appears on

**Company Muster Roll**

for *Sep & Oct*, 1865.

Present or absent *Present*

Stoppage, \$ *100* for

Due Gov't, \$ *100* for

Valuation of horse, \$ *100*

Valuation of horse equipments, \$ *100*

Remarks: *Sick in quarters*

Book mark:

*Wammach*

*L* | 10 H. Art'y. | U.S.C.T.

*Samuel Lee*

*Pr.*, Co. H, 10 Reg't U. S. Col'd H. Art'y

Appears on

**Company Muster Roll**

for *Nov 9 Dec*, 1865.

Present or absent *Present*

Stoppage, \$ 100 for

Due Gov't, \$ 100 for

Valuation of horse, \$ 100

Valuation of horse equipments. \$ 100

Remarks :

Book mark :

*Gammal*

*L* | 10 H. Art'y. | U.S.C.T.

*Samuel Lee*

*Priv.*, Co. H, 10 Reg't U. S. Col'd H. Art'y

Appears on

**Company Muster Roll**

for

*Jan & Feb.*, 186*6*.

Present or absent

*Present*

Stoppage, \$ 100 for

Due Gov't, \$ 100 for

Valuation of horse, \$ 100

Valuation of horse equipments. \$ 100

Remarks :

Book mark :

*L* | 10 H. Art'y. | U.S.C.T.

*Samuel Lee*

*Priv.*, Co. H, 10 Reg't U. S. Col'd H. Art'y

Appears on

**Company Muster Roll**

for *March & April*, 1866.

Present or absent

Stoppage, \$ 100 for

Due Gov't, \$ 100 for

Valuation of horse, \$ 100

Valuation of horse equipments, \$ 100

Remarks: *Mustered out by reason of expiration of term of service to date April 4, 1866*

Book mark:

*Gamma CR*

9 | 10 Art | **U.S.C.T.**

Samuel Lee

Orin, Co. H., 10 Reg't U. S. Col'd Art

Appears on a

**Detachment Muster-out Roll**

of the organization named above. Roll dated

New Orleans La, Apr 6, 1866.

Muster-out to date Apr 4, 1866.

Last paid to Dec 31, 1865

**Clothing account:**

Last settled \_\_\_\_\_, 186 ; drawn since \$ \_\_\_\_\_ 100

Due soldier \$ 26<sup>29</sup>/<sub>100</sub>; due U. S. \$ \_\_\_\_\_ 100

Am't for cloth'g in kind or money adv'd \$ \_\_\_\_\_ 100

Due U. S. for arms, equipments, &c., \$ \_\_\_\_\_ 100

Bounty paid \$ \_\_\_\_\_ 100 due \$ \_\_\_\_\_ 100

Remarks: Gained as substitute for Joseph Jones  
Drafted in 1st District  
New Orleans La Apr 5, 1865  
Mustered out by reason of  
expiration of term of  
service.

Book mark: \_\_\_\_\_

Edmondson



*L* | 10 H. Art'y. | U.S.C.T.

*Samuel Lee*

*Priv., Co. H*, 10 Reg't U. S. Col'd H. Art'y.

Appears on **Co. Muster-out Roll**, dated

*Baton Rouge, La., Feb. 22, 1867*.

Muster-out to date \_\_\_\_\_, 186 .

Last paid to \_\_\_\_\_, 186 .

Clothing account:

Last settled \_\_\_\_\_, 186 ; drawn since \$ \_\_\_\_\_ 100

Due soldier \$ \_\_\_\_\_ 100; due U. S. \$ \_\_\_\_\_ 100

Am't for cloth'g in kind or money adv'd \$ \_\_\_\_\_ 100

Due U. S. for arms, equipments, &c., \$ \_\_\_\_\_ 100

Bounty paid \$ \_\_\_\_\_ 100; due \$ \_\_\_\_\_ 100

Remarks: *joined by assignment  
mustered out exp. of term  
of service Apr. 4/66.*

*Ag. 23 - Sub. M. C. 5. 65  
New Orleans Sa. 1st 1815 -*

Book mark: *7/188. P. 16. 7 1/2*

*Lowry*

Copyist.

Lee, Samuel

....., Co. ...., 10 Reg't U.S.C.  
N.Y. Arty.

..... Inclosures.

Bed Cards .....	Final Statements .....
Burial Records .....	Furloughs or L. of A. ....
Certs. of Dis. for Discharge .....	Med. Certificates .....
C. M. Charges .....	Med. Des. Lists .....
Descriptive Lists .....	Orders .....
Discharge Certificates .....	Pris. of War Record .....
Enlistment Papers .....	Resignations .....

Other papers relating; to—

Admission to Hosp'l .....	Furlough or L. of A. ....
Casualty Sheet .....	Med. Examination .....
Confinement .....	Misc. Information .....
Contracts .....	Pay or Clothing .....
Death or Effects .....	Personal Reports .....
Desertion .....	Rank .....
Discharge from Hosp'l .....	Transfer to Hosp'l .....
Discharge from Service .....	Transfer to V. R. C. ....
Duty .....	Transportation .....

MICROFILM PUBLICATION M.1831

COMPILED MILITARY SERVICE RECORDS  
OF VOLUNTEER UNION SOLDIERS WHO SERVED WITH  
THE UNITED STATES COLORED TROOPS (USCT)  
10TH REGIMENT OF HEAVY ARTILLERY

PERSONAL PAPERS' TARGET SHEET

PLEASE NOTE THE CHECKED INFORMATION ABOUT THE PERSONAL PAPERS IN  
THIS FILE:

- NO PERSONAL PAPERS WERE FOUND IN THIS FILE WHEN THE  
RECORDS WERE ARRANGED FOR MICROFILMING.
- 1 PERSONAL PAPER(S) FOUND IN THIS FILE WHEN THE RECORDS  
WERE ARRANGED FOR MICROFILMING.

42<sup>1</sup>/<sub>2</sub> No 1319  
Louisiana

(Form 39.)

**Substitute Volunteer Enlistment**

of *Samuel Lee*

enrolled in *First Dist*

*March 16th* 1865

for *Joseph Tour*

enrolled in *First Dist.*

*November 8th* 1865

Mustered & accepted  
into the service of  
the United States to  
serve one year or  
during the War.

(Form No. 39.)

### SUBSTITUTE VOLUNTEER ENLISTMENT.

STATE OF LOUISIANA, PARISH OF Orleans  
 I, Samuel Lee born in the State of Barbadoes N. I.  
 aged twenty three years, and by occupation a teamster  
 do hereby acknowledge to have agreed with Joseph Tours Esq., of  
New Orleans to become his Substitute in the MILITARY SERVICE for a sufficient  
 consideration paid and delivered to me on the fifth day of April 1865  
 and having thus agreed with said Joseph Tours I do hereby acknowledge  
 to have enlisted this fifth day of April 1865 to serve as a  
**SOLDIER** in the **Army of the United States of America** for the period of one (1) years, unless  
 sooner discharged by proper authority: I do also agree to accept such Bounty, Pay, Rations and Clothing, as  
 are, or may be, established by law for soldiers. And I do solemnly swear that I will bear true and faithful  
 allegiance to the United States of America: that I will serve them honestly and faithfully against all their  
 enemies or opposers whomsoever: And that I will observe and obey the orders of the President of the United  
 States, and the orders of the officers appointed over me, according to the Rules and Articles of War.  
 Sworn and subscribed to, at New Orleans  
 this fifth day of April 1865, } Samuel Lee  
 BEFORE mk

WE CERTIFY ON HONOR, That we have carefully examined the above named Volunteer Substitute  
 agreeably to the Regulations, and that in our opinion he is free from all bodily defects, and mental infirmity which  
 would in any way disqualify him from performing the duties of a soldier: that he was entirely sober when  
 Enlisted, that he is of lawful age—not under 18 years—and that in accepting him, as duly qualified to perform  
 the duties of an able bodied Soldier, and as a substitute in lieu of Joseph Tours  
 drafted\* in First Dist Mar 21st 1865 we have strictly observed the Regulations  
 which govern in such cases. This Soldier has blue eyes, black hair, black complexion,  
 is five feet seven inches high.

Edw. T. ...  
 Post Marshal.  
Geo. W. ...  
 Commissioner of Board.  
Geo. W. ...  
 Surgeon of Board.

BOARD OF ENLISTMENT OF First District of New Orleans

\*When the substitute is offered by a person who has not been drafted, leave this Blank.

#### Declaration of Substitute.

I, Samuel Lee desiring to enlist in the Army of the United  
 States for one (1) years, do declare that I am twenty three years and \_\_\_\_\_ months  
 of age, that I have never been discharged from the service on account of disability or by sentence of a Court  
 Martial, and I know of no impediment to my serving honestly and faithfully as a Soldier for three years.

Given at New Orleans this fifth day of April 1865.

Witness \_\_\_\_\_

Samuel Lee  
 mk

583  
Lee, Thomas

Co #, 10 U.S. Col'd H. Art'y

Private

Private

CARD NUMBERS.

1	5-4-8-7-6-3	26
2	5-5-0-3-1-6	27
3	5-5-0-5-9-6-9	28
4	5-5-0-6-1-5	29
5	5-5-0-6-2-4-4	30
6	5-5-0-6-3-8-9	31
7	5-5-0-6-5-0-8	32
8	5-5-0-6-7-4-0	33
9	5-5-0-6-9-9-2	34
10		35
11		36
12		37
13		38
14		39
15		40
16		41
17		42
18		43
19		44
20		45
21		46
22		47
23		48
24		49
25		50

Book Mark:

See also 77. U.S. C. Inf.

L 10 Hart U.S.C.T.

Thomas Lee  
Gm, Co. A, 10 Reg't U. S. Col'd Hart

Appears on

**M. and D. Roll of Men Transferred**

to the organization named above,

from 77 Reg. U.S. C. Inf

Roll dated Oct 1, 1865.

When enlisted Jan 25, 1865.

Period for which enlisted 3 years.

When mustered in Feb 7, 1865.

Present or absent Present

Company to which assigned F

Remarks: joined as recruit  
Feb. 18, 65

Book mark :

J. L. Lemar

L

10 H. Art'y. U.S.C.T.

Thomas Lee

Priv., Co. F, 10 Reg't U. S. Col'd H. Art'y.

Appears on

Company Muster Roll  
for Sept & Oct, 1865.

Present or absent Present

Stoppage, \$ 100 for

Due Gov't, \$ 100 for

Valuation of horse, \$ 100

Valuation of horse equipments, \$ 100

Remarks: Transferred from C.D.  
77 n.s. C.D. Oct 1/65.

Book mark:

B. S. Masdon



L. | 10 H. Art'y. | U.S.C.T.

Thomas Lee.

Priv., Co. F, 10 Reg't U. S. Col'd H. Art'y.

Appears on

**Company Muster Roll**

for Nov & Dec., 1865.

Present or absent Present.

Stoppage, \$ 100 for

Due Gov't, \$ 100 for

Valuation of horse, \$ 100

Valuation of horse equipments, \$ 100

Remarks:

Book mark:

Ash.  
Copyist.

*L.* | **10 H. Art'y. | U.S.C.T.**

*Thomas Lee.*

*Pat.*, Co. F, 10 Reg't U. S. Col'd H. Art'y.

Appears on

**Company Muster Roll**

for *Jan'y. & Feby.*, 1866.

Present or absent *Present.*

Stoppage, \$ 100 for

Due Gov't, \$ 100 for

Valuation of horse, \$ 100

Valuation of horse equipments, \$ 100

Remarks:

Book mark:

L. | **10 H. Art'y. | U.S.C.T.**

*Thomas Lee.*

*Priv.*, Co. F, 10 Reg't U. S. Col'd H. Art'y.

Appears on

**Company Muster Roll**

for *Mar & Apr.*, 1866.

Present or absent *Present.*

Stoppage, \$ 100 for

Due Gov't, \$ 100 for

Valuation of horse, \$ 100

Valuation of horse equipments, \$ 100

Remarks: *Stop for loss of 1  
Haversack & canteen  
\$1.60.*

Book mark: \_\_\_\_\_

*L.* | **10 H. Art'y.** | **U.S.C.T.**

*Thomas Lee.*

*Pat.*; Co. F, 10 Reg't U. S. Col'd H. Art'y.

Appears on

**Company Muster Roll**

for *May & June*, 186*6*.

Present or absent *Present.*

Stoppage, \$ 100 for

Due Gov't, \$ 100 for

Valuation of horse, \$ 100

Valuation of horse equipments, \$ 100

Remarks:

-----  
-----  
-----  
-----  
-----  
-----  
-----  
-----  
-----  
-----

Book mark: -----

*C. O. H.*  
Copyist.

*L. Wharty* U.S.C.T.

*Thomas Lee*

*Privat.*, Co. *F*, *10* Reg't U. S. Col'd *Wharty*

Appears on

**Company Muster Roll**

for *July & Aug.*, 186*6*.

Present or absent *Present*

Stoppage, \$ *100* for

Due Gov't, \$ *100* for

Valuation of horse, \$ *100*

Valuation of horse equipments, \$ *100*

Remarks:

Book mark:

L

10 H. Art'y. U.S.C.T.

Thomas Lee

Pat, Co. F, 10 Reg't U. S. Col'd H. Art'y.

Appears on

Company Muster Roll

for Sept. and Oct., 1866

Present or absent

Stoppage, \$ 100 for

Due Gov't, \$ 100 for

Valuation of horse, \$ 100

Valuation of horse equipments, \$ 100

Remarks:

Discharged by reason of re-enlistment in the Regular Army Sept. 8/66

Book mark: 2<sup>d</sup> and 5252 . 8

House

L | 10 H. Art'y. | U.S.C.T.

Thomas Lee

Priv., Co. F., 10 Reg't U. S. Col'd H. Art'y.

Appears on Co. Muster-out Roll, dated  
Baton Rouge La. Feb 22, 1867.

Muster-out to date \_\_\_\_\_, 186 .

Last paid to June 30, 1866.

Clothing account:

Last settled \_\_\_\_\_, 186 ; drawn since \$ \_\_\_\_\_ 100

Due soldier \$ \_\_\_\_\_ 100; due U. S. \$ \_\_\_\_\_ 100

Am't for cloth'g in kind or money adv'd \$ \_\_\_\_\_ 100

Due U. S. for arms, equipments, &c., \$ \_\_\_\_\_ 100

Bounty paid \$ \_\_\_\_\_ 100; due \$ \_\_\_\_\_ 100

Remarks: Rec'd by transfer from  
Co. D. 77 U.S.C.I. in S.O. No.  
66 Hd. Qu. Dept. of La. S. of 65  
Discharge by re-enlistment  
in U.S.A. Sept. 8/66

Book mark. B. and 5252 Oct. 30/67

Howe

1584  
*Legrand, Celestine*

*Co D*, 10 U.S. Col'd H. Art'y

CARD NUMBERS.

1	26
2	27
3 <i>See Sagone</i>	28 <i>Celestine</i>
4	29
5	30
6	31
7	32
8	33
9	34
10	35
11	36
12	37
13	38
14	39
15	40
16	41
17	42
18	43
19	44
20	45
21	46
22	47
23	48
24	49
25	50

Book Mark:

See also



1589  
Lemah, Ala

Co C, 10 U.S. Col'd H. Art'y

Private

CARD NUMBERS.

1	26
2	27
3 See Summary	28 Eli
4	29
5	30
6	31
7	32
8	33
9	34
10	35
11	36
12	37
13	38
14	39
15	40
16	41
17	42
18	43
19	44
20	45
21	46
22	47
23	48
24	49
25	50

Book Mark:

See also

1586  
Lemie, David

Co A, 10 U.S. Col'd H. Art'y.

Private | Private

CARD NUMBERS.

1	5488415	26
2	5487648	27
3	5512290	28
4	5512444	29
5	5512582	30
6	5512727	31
7	5512851	32
8	5512972	33
9	5513073	34
10	5513190	35
11	5513281	36
12		37
13		38
14		39
15		40
16		41
17		42
18		43
19		44
20		45
21		46
22		47
23		48
24		49
25		50

Book Mark:

See also 77 U.S.C. Inf.

L 1076 a | **U.S.C.T.**

David Lennie  
Priv., Co. K, 10 Reg't U. S. Col'd Ca

Appears on

**M. and D. Roll of Men Transferred**

to the organization named above,

from 4<sup>th</sup> U. S. Col Inf

Roll dated Camp Mapelela Oct., 1864

When enlisted May 6, 1864

Period for which enlisted 3 years.

When mustered in May 12, 1864

Present or absent Present

Company to which assigned K

Remarks: Rec'd by transfer  
from Co K, 4<sup>th</sup> U. S.  
C. I. slop, wiper,  
bed sack

Book mark :

W. H. Scott

L 10 H.A. U.S.C.T.

David Lennie  
Co. K, 10 Reg't U. S. Col'd H.A.

Appears on

**M. and D. Roll of Men Transferred**

to the organization named above,

from 74 U. S. Col Inf

Roll dated Camp Pikesville, 1865.

When enlisted May 6, 1864.

Period for which enlisted 3 years.

When mustered in May 12, 1864.

Present or absent Present

Company to which assigned K

Remarks: joined Co at Original Organization, stoppage for wiper and Bedsack,

Book mark :

W. H. Scott

20 | 10 H. Art'y. | U.S.C.T.

David Lennie

P, Co. K., 10 Reg't U. S. Col'd H. Art'y.

Age ..... years.

Appears on

Company Muster Roll\*

for Sep. to Oct., 1865.

Joined for duty and enrolled:

When May 6, 1864.

Where New Orleans, La.

Period 3 years

Mustered in:

When May 12, 1864.

Where New Orleans.

Present or absent Present

Stoppage, \$ 100 for

Due Gov't, \$ 100 for

Remarks: Stop 1 bedsack, 1 wrapper,  
\$3.70

\* First current roll. No muster-in roll of this company on file.

Book mark :

Hibbard

L | 10 H. Art'y. | U.S.C.T.

David Lennie

P, Co. K, 10 Reg't U. S. Col'd H. Art'y.

Appears on

Company Muster Roll

for Nov. & Dec., 1865

Present or absent Present

Stoppage, \$ 100 for

Due Gov't, \$ 100 for

Valuation of horse, \$ 100

Valuation of horse equipments, \$ 100

Remarks: Stop for Ordnance,  
Camp & G.E. lost \$ 3.70

Book mark:

Hibbard

L

10 H. Art'y.

U.S.C.T.

David Lennie

P

, Co. K, 10 Reg't U. S. Col'd H. Art'y.

Appears on

Company Muster Roll

for

Jan. & Feb.

, 1866

Present or absent

Present

Stoppage, \$

100 for

Due Gov't, \$

100 for

Valuation of horse, \$

100

Valuation of horse equipments, \$

100

Remarks:

Book mark:

Hibbard

Copyist.

L | 10 H. Art'y. | U.S.C.T.

David Lemie

P, Co. K, 10 Reg't U. S. Col'd H. Art'y.

Appears on

**Company Muster Roll**

for Mch. & Apr., 1866

Present or absent Present

Stoppage, \$.....100 for .....

Due Gov't, \$.....100 for .....

Valuation of horse, \$.....100

Valuation of horse equipments, \$.....100

Remarks: .....

Book mark: .....

Hibbard



L

10 H. Art'y.

U.S.C.T.

David Lemie

P, Co. K, 10 Reg't U. S. Col'd H. Art'y.

Appears on

Company Muster Roll

for May & June, 1866.

Present or absent Present

Stoppage, \$ 100 for

Due Gov't, \$ 100 for

Valuation of horse, \$ 100

Valuation of horse equipments, \$ 100

Remarks:

Book mark:

Hibbard

Copyist.

*L* | **10 H. Art'y.** | **U.S.C.T.**

*David Lemie*

*P*, Co. K, 10 Reg't U. S. Col'd H. Art'y.

Appears on

**Company Muster Roll**

for *July & Aug.*, 186*6*.

Present or absent *Present*

Stoppage, \$ *100* for

Due Gov't, \$ *100* for

Valuation of horse, \$ *100*

Valuation of horse equipments, \$ *100*

Remarks:

Book mark:

*Hibbard*

*Lo*

10 H. Art'y.

U.S.C.T.

*David Rennie*

*Put*, Co. K, 10 Reg't U. S. Col'd H. Art'y.

Appears on

**Company Muster Roll**

for *Sept. & Oct.*, 186*6*.

Present or absent *Present.*

Stoppage, \$ 100 for

Due Gov't, \$ 100 for

Valuation of horse, \$ 100

Valuation of horse equipments, \$ 100

Remarks:

Book mark:

*Floyd*

*Lo*

**10 H. Art'y. U.S.C.T.**

*David Lemie*

*Put*, Co. K, 10 Reg't U. S. Col'd H. Art'y.

Appears on

**Company Muster Roll**

for *Nov. & Dec.*, 186*6*

Present or absent *Present*

Stoppage, \$ 100 for

Due Gov't, \$ 100 for

Valuation of horse, \$ 100

Valuation of horse equipments, \$ 100

Remarks:

-----  
-----  
-----  
-----  
-----  
-----  
-----  
-----

Book mark:

-----

*Floyd*

*Lo*

10 H. Art'y. U.S.C.T.

*David Lennie*

*Put*, Co. *H*, 10 Reg't U. S. Col'd H. Art'y.

Appears on Co. Muster-out Roll, dated  
*Baton Rouge La, Feb 22*, 1867.

Muster-out to date *Feb 22*, 1867.

Last paid to *Dec. 31*, 1866.

Clothing account:

Last settled....., 186 ; drawn since \$..... 100

Due soldier \$ *48* <sup>*17*</sup> / 100; due U. S. \$..... 100

Am't for cloth'g in kind or money adv'd \$..... 100

Due U. S. for arms, equipments, &c., \$ *6* <sup>*22*</sup> / 100

Bounty paid \$..... 100; due \$..... 100

Remarks: *Recd by transfer from Co. H*  
*77 U. S. C. S. Oct 1/65 per S. O. No.*  
*106 Hd qrs Dept Va S. 1865. Due*  
*\$100. Bounty under Act of Congress*  
*July 26. 1866. Due \$100. Bounty under*  
*Act of Congress July 28. 1866.*

Book mark : .....

*Floyd*

1587

Lennans, Frank

Co A, 10 U.S. Col'd H. Art'y

Private

Private

CARD NUMBERS.

1 31509780  
 2 5509933  
 3 5510084  
 4 5510229  
 5 5510379  
 6 5510527  
 7 5510707  
 8 5511137  
 9 5489383  
 10  
 11  
 12  
 13  
 14  
 15  
 16  
 17  
 18  
 19  
 20  
 21  
 22  
 23  
 24  
 25

26  
 27  
 28  
 29  
 30  
 31  
 32  
 33  
 34  
 35  
 36  
 37  
 38  
 39  
 40  
 41  
 42  
 43  
 44  
 45  
 46  
 47  
 48  
 49  
 50

Book Mark:

See also

L | 10 H. Art'y. | U.S.C.T.

Frank Lemmans

Pvt., Co. H, 10 Reg't U. S. Col'd H. Art'y

Appears on

**Company Muster Roll**

for *March + April*, 1865.

Present or absent *Present*

Stoppage, \$ *100* for

Due Gov't, \$ *100* for

Valuation of horse, \$ *100*

Valuation of horse equipments. \$ *100*

Remarks: *Commencement of first payment by time March 29<sup>th</sup> 1865. Sick in quarters*

Book mark:

*Pennings*  
Copyst.

*L* | 10 H. Art'y. | U.S.C.T.

*Frank Lemmans*

*Pvt*, Co. H, 10 Reg't U. S. Col'd H. Art'y

Appears on

**Company Muster Roll**

for *May & June*, 186*5*.

Present or absent *Present*

Stoppage, \$ *100* for

Due Gov't, \$ *100* for

Valuation of horse, \$ *100*

Valuation of horse equipments. \$ *100*

Remarks: *Stoppage for  
Ordinance 43<sup>rd</sup>*

Book mark:

*Perminator*  
(358) Copyist.



*L* | 10 H. Art'y. | U.S.C.T.

*Frank Lemman*

*Pvt.*, Co. H, 10 Reg't U. S. Col'd H. Art'y

Appears on

**Company Muster Roll**

for *July & Aug.*, 1865.

Present or absent

*Present*

Stoppage, \$ *100* for

Due Gov't, \$ *100* for

Valuation of horse, \$ *100*

Valuation of horse equipments. \$ *100*

Remarks:

Book mark:

*Perrington*

*L* | 10 H. Art'y. | U.S.C.T.

*Frank Lemmans*

*Priv.*, Co. H, 10 Reg't U. S. Col'd H. Art'y

Appears on

**Company Muster Roll**

for *Sep & Oct*, 1865.

Present or absent *Present*

Stoppage, \$ *100* for

Due Gov't, \$ *100* for

Valuation of horse, \$ *100*

Valuation of horse equipments. \$ *100*

Remarks :

-----  
-----  
-----  
-----  
-----  
-----  
-----  
-----

Book mark : -----

*Gammack*

2 | 10 H. Art'y. | U.S.C.T.

Frank Lemmans  
Capt., Co. H, 10 Reg't U. S. Col'd H. Art'y

Appears on

**Company Muster Roll**

for Nov & Dec, 1865.

Present or absent Present

Stoppage, \$ 100 for

Due Gov't, \$ 100 for

Valuation of horse, \$ 100

Valuation of horse equipments, \$ 100

Remarks: Stop for loss of  
allowance 34c

Book mark:

Samuel

*L* | 10 H. Art'y. | U.S.C.T.

*Frank Lemmans*

*Priv.*, Co. H, 10 Reg't U. S. Col'd H. Art'y

Appears on

**Company Muster Roll**

for

*Jan & Feb., 1866.*

Present or absent

*Present*

Stoppage, \$ 100 for

Due Gov't, \$ 100 for

Valuation of horse, \$ 100

Valuation of horse equipments, \$ 100

Remarks:

*Stoppage for loss  
of Mosquito Bar \$2.00*

Book mark:

*Lamma*

*L* | 10 H. Art'y. | U.S.C.T.

*Frank Lennans*

*Co.*, Co. H, 10 Reg't U. S. Col'd H. Art'y

Appears on

Company Muster Roll

for *Mch & Apr*, 1866.

Present or absent

Stoppage, \$ 100 for

Due Gov't, \$ 100 for

Valuation of horse, \$ 100

Valuation of horse equipments. \$ 100

Remarks: *Mustered out by reason of expiration of term of service to date March 28. 1866*

Book mark:

*Gammal*

L | 1076a | U.S.C.T.

Frank Lannans

Priv, Co. H, 10 Reg't U. S. Col'd H A

Appears on an

**Individual Muster-out Roll**

of the organization named above. Roll dated

New Orleans La, Mch 28, 1866.

Muster-out to date Mch 28, 1866.

Last paid to Dec 31, 1865.

**Clothing account:**

Last settled ..... 186 ; drawn since \$ ..... 100

Due soldier \$ 21 <sup>41</sup>/<sub>100</sub>; due U. S. \$ ..... 100

Am't for cloth'g in kind or money adv'd \$ ..... 100

Due U. S. for arms, equipments, &c., \$ ..... 100

Bounty paid \$ ..... 100 due \$ ..... 100

Remarks: *Joined as shown*

*Mustered out by reason of  
Expiration of Term of Service  
to date March 28<sup>th</sup> 1866*

Book mark:

*R. Richardson*

L | 10 H. Art'y. | U.S.C.T.

Frank Lemmans

Priv., Co. H., 10 Reg't U. S. Col'd H. Art'y.

Appears on Co. Muster-out Roll, dated  
Baton Rouge, La., Feb. 22, 1867.

Muster-out to date \_\_\_\_\_, 186 .

Last paid to \_\_\_\_\_, 186 .

Clothing account:

Last settled \_\_\_\_\_, 186 ; drawn since \$ \_\_\_\_\_ 100

Due soldier \$ \_\_\_\_\_ 100; due U. S. \$ \_\_\_\_\_ 100

Am't for cloth'g in kind or money adv'd \$ \_\_\_\_\_ 100

Due U. S. for arms, equipments, &c., \$ \_\_\_\_\_ 100

Bounty paid \$ \_\_\_\_\_ 100; due \$ \_\_\_\_\_ 100

Remarks: *Joined by assignment.  
Mustered out exp. of term  
of service Feb 28/66.*

*Co. 20 - Drafted & M'd Nov.  
29 65 - New Orleans La. 1 yr 1 mo*

Book mark: *V. 72. P. 123. 69.*

Lewny

(361)

Copyist.

1588

Leon Robert

COL, 10 U.S. Col'd H. Art'y.

Private

Private

CARD NUMBERS.

5-4-8-8-2-6-2	26
5-4-8-7-7-4-1	27
5-3-1-3-3-3-7	28
5-3-1-4-2-5-2	29
	30
	31
	32
	33
	34
	35
	36
	37
	38
	39
	40
	41
	42
	43
	44
	45
	46
	47
	48
	49
	50

Book Mark:

See also 77-U.S. C. Inf.



*L. 107th* U.S.C.T.  
*Robert Leon*  
*Bt*, Co. *L*, 11<sup>th</sup> Reg't U. S. Col'd *H A*

Appears on

**M. and D. Roll of Men Transferred**

to the organization named above,

from *77 U.S. Col Inf*

Roll dated *Camp Ponape La Ocell*, 1865.

When enlisted *Feb 16*, 1865.

Period for which enlisted *3* years.

When mustered in *March 8*, 1865.

Present or absent *Absent*

Company to which assigned *L*

Remarks: *Joined as recruit*

*Absent sick in Cd A  
Gen Hospital N.V.*

*since July 8.65 joined  
by transfer from Co. C,  
77 U.S. C. I. per S.O. 66.  
C.S. Hd Qrs Dept of  
La*

Book mark :

*W. H. Scott*

Copyist.

*L. W. Hall* U.S.C.T.

*Robert Leon*  
*Co. 10*, Co. *10*, Reg't U. S. Col'd *10th*

Appears on

**M. and D. Roll of Men Transferred**

to the organization named above,

from *Co. 10 11th U. S. Col. Inf.*

Roll dated *Camp Empressa Va.*, 186*5*.

When enlisted *July 16*, 186*5*.

Period for which enlisted *3* years.

When mustered in *March 8*, 186*5*.

Present or absent *Absent*

Company to which assigned *K*

Remarks: *General assignment*  
*Went sick in U. S.*  
*at a Gen Hospital*  
*New Orleans since*  
*July 8, 1865*

Book mark :

*W. H. Scott*

L | **10 H. Art'y.** | **U.S.C.T.**

Robert Leon

Priv., Co. L, 10 Reg't U. S. Col'd H. Art'y.

Age ..... years.

Appears on

**Company Muster Roll\***

for Sept. & Oct., 1865.

Joined for duty and enrolled:

When Feb. 16, 1865.

Where New Orleans

Period 3 years

Mustered in:

When March 8, 1865.

Where New Orleans

Present or absent.....

Stoppage, \$.....100 for.....

Due Gov't, \$.....100 for.....

Remarks: Transferred from Co. C 77th U.S.  
Co. Died in C. & A. Gen. Hosp.  
New Orleans Oct. 29/65.

\* First current roll. No muster-in roll of this company on file.

Book mark: .....

Scherich

L | 10 H. Art'y. | U.S.C.T.

Robert Leon

Plt., Co. L., 10 Reg't U. S. Col'd H. Art'y.

Appears on Co. Muster-out Roll, dated  
Baton Rouge La, Feb 22, 1867.

Muster-out to date \_\_\_\_\_, 186 .

Last paid to \_\_\_\_\_, 186 .

Clothing account:

Last settled \_\_\_\_\_, 186 ; drawn since \$ \_\_\_\_\_ 100

Due soldier \$ \_\_\_\_\_ 100; due U. S. \$ \_\_\_\_\_ 100

Am't for cloth'g in kind or money adv'd \$ \_\_\_\_\_ 100

Due U. S. for arms, equipments, &c., \$ \_\_\_\_\_ 100

Bounty paid \$ \_\_\_\_\_ 100; due \$ \_\_\_\_\_ 100

Remarks: *Joined by transfer from  
77 U.S.C.I. Oct 1 1865 SP. 66 N<sup>o</sup> Gro  
Dept of La Sept 22 1865. Died of  
Pneumonia in C. A. Genl Hospt  
N O La Oct 21 1865*

Book mark : \_\_\_\_\_

Burnham

Leon, Robert

P. Co. L., 10 U.S.C.H.A.

1 Enclosures.

Bed Cards	Descriptive Lists
Burial Records	Final Statements /
Certs. of Dis. for Discharge	Furloughs
C. M. Charges	Med. Des. Lists
Med. Certificates	Orders

Other papers relating to—

Admission to Hosp'l	Furlough
Casualty Sheet (Officer's)	Med. Examination
Confinement	Misc. Information
Contracts	Pay or Clothing
Death or Effects	Personal Reports
Desertions	Rank
Discharge from Hosp'l	Transfer to Hosp'l
Discharge from Service	Transfer to V. R. C.
Duty	Transportation

*Extract from Act of Congress.*

SEC. 12. *And be it further enacted,* That the fees of agents and attorneys for making out and causing to be executed the papers necessary to establish a claim for a pension, bounty, and other allowance before the Pension Office, under this act, shall not exceed the following rates: For making out and causing to be duly executed a declaration by the applicant, with the necessary affidavits, and forwarding the same to the Pension Office, with the requisite correspondence, ten dollars; which sum shall be received by such agent or attorney in full for all services in obtaining such pension, and shall not be demanded or received, in whole or in part, until such pension shall be obtained; and the sixth and seventh sections of an act entitled "An act to grant pensions," approved July [fourteenth,] eighteen hundred and sixty-two, are hereby repealed.

SEC. 13. *And be it further enacted,* That any agent or attorney who shall, directly or indirectly, demand or receive any greater compensation for his services under this act than is prescribed in the preceding section of this act, or who shall contract or agree to prosecute any claim for a pension, bounty, or other allowance under this act, on the condition that he shall receive a per centum upon any portion of the amount of such claim, or who shall wrongfully withhold from a pensioner or other claimant the whole or any part of the pension or claim allowed and due to such pensioner or claimant, shall be deemed guilty of a high misdemeanor, and, upon conviction thereof, shall, for every such offense, be fined not exceeding three hundred dollars, or imprisoned at hard labor not exceeding two years, or both, according to the circumstances and aggravations of the offense.

Approved July 4, 1864.

NOTE 10.—If any soldier is charged a higher fee than that allowed by the above act, he should report the fact and the name of the agent to the Adjutant General, in order that steps may be taken to have the same refunded.

ADJUTANT GENERAL'S OFFICE

March 21 1866

Duplicate with inventory sent 2d Auditor.

✓  
FINAL STATEMENT

OF  
*Robert Leon*  
*10<sup>th</sup> Reg't of W. T. A. (W. T. A.)*  
VOLUNTEERS.  
*Died Oct 21 1865*

NOTE 1.—Two of these certificates (or duplicates) are to be given to each Volunteer Soldier or drafted man who may be discharged without being mustered out (Final Statements are never given to men mustered out of service,) that he may at once receive from the Paymaster the pay, &c., due him, and the captain or other COMMISSIONED officer commanding the company will certify to the act of the delivery of the duplicate certificates; with these certificates the Soldier is "entitled to" his discharge, and should also present his discharge to the Paymaster to have the payment endorsed on it. The discharge is to be given back to the Soldier by the Paymaster; the latter only retaining as his vouchers the duplicate certificates.

NOTE 2.—If the Soldier is entitled to pay for the use of his horse, the Company Commander will certify to that fact on the back of both these final statements, and also to the time he has pay due for having been so mounted on his own horse.

NOTE 3.—When a Soldier is furnished with final statements, his descriptive list, if he has one, should be taken up by the officer who gives the Soldier these statements, and endorsed with a statement to this effect by the officer. The endorsement should exhibit a full statement of the time for which the Soldier was allowed pay on his final statements, the clothing account, and all other charges against him or in his favor, so as to comprise a complete exhibit of his account. It will then be transmitted to the Company Commander of the Soldier, who will enter all the data necessary to a full understanding of the Soldier's account on the muster roll upon which the Soldier's discharge is reported. The descriptive list will then be destroyed. The object of this is, that the remaining portion of the Soldier's account may be settled upon the receipt of these muster rolls, and the Soldier receive any pay or allowances that may be due him at the time of his discharge, and which may not appear on his last final statements from the fact that his descriptive list is incomplete. These accounts for back pay, &c., are settled by the 2d Auditor of the Treasury Department.

NOTE 4.—Charges for loss or injury to ordnance, horse equipments, and other miscellaneous charges, should appear under the heading of "Other Stoppages."

NOTE 5.—Bounty paid by State authorities, and not by the United States, will not be entered on this statement.

NOTE 6.—Amounts due the Sutler and Laundress must be entered on the muster roll on which the discharge, death, desertion, &c., is reported, as well as on the final statement, otherwise the amount cannot be collected from the United States.

NOTE 7.—This blank will be used for deceased volunteers and drafted men, as well as for others.

NOTE 8.—Where a Soldier dies in Hospital or on detached service, his descriptive list, if he has one, should be sent with his final statements, in duplicate, to the Adjutant General, Washington, D. C.

NOTE 9.—If the soldier is a drafted man or substitute, the space for time, &c., of enrolled, should contain only the word *drafted* or *substitute*, as the case may be. If the Soldier is a "VETERAN," (or RECRUIT,) the words *as a veteran*, (or *recruit*,) as the case may be, should be interlined after the words *mustered into the service of the U. S.* A statement of all the installments of *Veteran* or *Recruit Bounty RECEIVED* by the Soldier must be made on the back of each final statement.

MAR 20 1866

I certify, on honor, that Robert Leon, a private of  
Captain E. J. Dunston Company (D) of the 10 Regiment of 10th Regt. Ala.  
**VOLUNTEERS**, of the State of \_\_\_\_\_, born in New Orleans, State  
of Louisiana, aged 20 years; 5 feet 4 inches high; dark complexion,  
black eyes, black hair, and by occupation a laborer, who joined for service  
and was enrolled (see Note 9) on the 16 day of February, 1865, at New Orleans La  
by Capt. Mc Allister, for the period of Three years, and mustered into  
the service of the United States on the 16th day of March, 1865, at  
New Orleans La by Lieut. Hamilton; and having served  
HONESTLY and FAITHFULLY with his Company to the present date, is now entitled to a  
**DISCHARGE** by reason of death. He died in P. I. A. Ins.  
Hosp. New Orleans, Oct. 24, 1865 of Pneumonia

The said Robert Leon was last paid by Paymaster  
now paid, to include the \_\_\_\_\_ day of \_\_\_\_\_, 1865, and  
has pay due him from that time to the present date; he is entitled to pay and subsistence for  
**TRAVELING** to place of enrollment, and whatever other allowances are authorized to volunteer  
soldiers, drafted men, or militia, so discharged. He has received from the United States **CLOTHING**  
amounting to 27 <sup>96</sup>/<sub>100</sub> dollars, since the 16 day of February,  
1865, when his clothing account was last settled. He has received from the United States  
100 <sup>00</sup>/<sub>100</sub> dollars advanced **BOUNTY**.

There is to be stopped from him, on account of the State of \_\_\_\_\_, or other  
authorities, for **CLOTHING, &c.**, received on entering service, 00 <sup>00</sup>/<sub>100</sub> dollars; and  
for other stoppages, viz: \_\_\_\_\_

\_\_\_\_\_ 00 <sup>00</sup>/<sub>100</sub> dollars.  
He has been furnished with **TRANSPORTATION** in kind from the place of his discharge to  
\_\_\_\_\_; and he has been **SUBSISTED** for **TRAVELING** to his  
place of enrollment, up to the \_\_\_\_\_, 1865.

He is indebted to \_\_\_\_\_, **SUTLER**, 00 <sup>00</sup>/<sub>100</sub> dollars.

He is indebted to \_\_\_\_\_, **LAUNDRESS**, 00 <sup>00</sup>/<sub>100</sub> dollars.

Given in Duplicate, at Fort Pike La, this 8 day  
of March, 1866.

Edwin J. Dunston

Capt. 10th Regt. Ala.  
Commanding Company.

1588  
Leonard, Joseph

Co K, D, 10 U.S. Col'd H. Art'y.

Private      Corporal

CARD NUMBERS.

1	5488665	26
2	5501287	27
3	5501361	28
4	5501610	29
5	5502229	30
6	5489788	31
7		32
8		33
9		34
10		35
11		36
12		37
13		38
14		39
15		40
16		41
17		42
18		43
19		44
20		45
21		46
22		47
23		48
24		49
25		50

Book Mark:

See also 77 u.s.c.m.



S 73453 R. P. Reld

REP 357568

P. 1886006 P. O. un

REP 618408

S 22800 29 and W. D.

C. E. Doughty  
2

L. | 10. H. Art'y | U.S.C.T.

Joseph Leonard  
Pri, Co. K, 10 Reg't U. S. Col'd H. Art'y

Appears on

**M. and D. Roll of Men Transferred**

to the organization named above,

from Co. B, 77. Reg't U. S. C. Inf

Roll dated Oct. 1, 1865.

When enlisted Feb. 2, 1863.

Period for which enlisted 3 years.

When mustered in Feb. 12, 1863.

Present or absent Present

Company to which assigned K

Remarks: Transferred from Co. B.

4. Reg't C<sup>d</sup> A. Dec 2, 63.

Stop's 1 Musquete Bar.

Sentence by J. C. C. to forfeit  
\$10. of his monthly pay for the  
period of (1) one month.

Book mark :

L | 10 H. Art'y. | U.S.C.T.

Joseph Lemard  
Priv., Co. D, 10 Reg't U. S. Col'd H. Art'y.

Appears on

**Company Muster Roll**

for Sept + Oct, 1865.

Present or absent Present

Stoppage, \$ 100 for

Due Gov't, \$ 100 for

Valuation of horse, \$ 100

Valuation of horse equipments, \$ 100

Remarks: Transfd from Co. B, 77  
U.S.C.I., per G.O. No. 3, Hd Qrs. 10  
U.S.C.A.H., Camp Parapet, La.,  
Oct 1/65. Due U.S. for ordnance lost  
26¢; for Camp Equipage \$1.70. To forfeit  
\$10 of Monthly pay for period of 1 month  
by sentence of Field Officers Court.

Book mark:

Patterson

*L* | 10 H. Art'y. | U.S.C.T.

*Joseph Leonard*  
*Capt*, Co. D, 10 Reg't U. S. Col'd H. Art'y.

Appears on

**Company Muster Roll**

for *Nov & Dec*, 1865.

Present or absent *Present*

Stoppage, \$ 100 for

Due Gov't, \$ 100 for

Valuation of horse, \$ 100

Valuation of horse equipments, \$ 100

Remarks *Promoted from*  
*Priv. Nov 3. 65 by*  
*Col. No 1 Hd Qrs.*  
*3 Batt 10<sup>th</sup> U.S.C.A.*  
*H. Post Jackson*  
*La. Nov. 12. 65*

Book mark: \_\_\_\_\_

*W. W. Sayre*

L

10 H. Art'y.

U.S.C.T.

Joseph Leonard  
Cope, Co. D, 10 Reg't U. S. Col'd H. Art'y.

Appears on

Company Muster Roll

for Jan & Feb, 1866.

Present or absent

Stoppage, \$ 100 for

Due Gov't, \$ 100 for

Valuation of horse, \$ 100

Valuation of horse equipments, \$ 100

Remarks: Discharged at  
N. O. La. Feb 19, 66  
by reason of ex-  
piration of term  
of service

Book mark:

W. W. Wray

L | 10th Artz | U.S.C.T.

Joseph Leonard  
Confel., Co. D., 10 Reg't U. S. Col'd Artz.

Appears on a

**Detachment Muster-out Roll**

of the organization named above. Roll dated

New Orleans La., Feb. 11, 1866.

Muster-out to date Feb. 11, 1866.

Last paid to June 30, 1865.

**Clothing account:**

Last settled \_\_\_\_\_, 1866; drawn since \$ \_\_\_\_\_ 100

Due soldier \$ 55 <sup>79</sup> / 100; due U. S. \$ \_\_\_\_\_ 100

Am't for cloth'g in kind or money adv'd \$ \_\_\_\_\_ 100

Due U. S. for arms, equipments, &c., \$ 1 <sup>96</sup> / 100

Bounty paid \$ None 100 due \$ 100 <sup>00</sup> / 100

Remarks: Joined at org. org<sup>n</sup>  
of 4<sup>th</sup>. Inf. C. D. A. (76<sup>th</sup> M.  
S. C. I.) Transferred to 5<sup>th</sup>.  
Inf. C. D. A. (77<sup>th</sup> M. S. C.  
I.) Dec. 2<sup>nd</sup> '63 and trans-  
ferred to 10<sup>th</sup>. U. S. C. A.  
(over)

Book mark: \_\_\_\_\_

A. W. Reed

JAN. 15

5489788

1861

A. Oct. 1<sup>st</sup>. 1865, S.O. No.  
66, 65, Hd, Ins, Dept. of  
La, Private to Nov. 3<sup>rd</sup>. 65.  
Stoppages 1 mosq. Bar.  
1 Sc. Driver 1 wiper. Sen-  
tenced by F. O. C. to forfeit  
Ten dollars per month  
of monthly pay for the  
period of one month,  
Free on or before Oct.  
14 1861.

*L* | 10 · H. Art'y. | U.S.C.T.

*Joseph Leonard*  
Cpl, Co. D, 10 Reg't U. S. Col'd H. Art'y.

Appears on Co. Muster-out Roll, dated  
*Bataun Rouge, La, Feb. 22, 1867.*

Muster-out to date \_\_\_\_\_, 186 .  
Last paid to \_\_\_\_\_, 186 .

Clothing account:

Last settled \_\_\_\_\_, 186 ; drawn since \$ \_\_\_\_\_ 100

Due soldier \$ \_\_\_\_\_ 100; due U. S. \$ \_\_\_\_\_ 100

Am't for cloth'g in kind or money adv'd \$ \_\_\_\_\_ 100

Due U. S. for arms, equipments, &c., \$ \_\_\_\_\_ 100

Bounty paid \$ \_\_\_\_\_ 100; due \$ \_\_\_\_\_ 100

Remarks: *joined by transfer*  
*from Co. B. 77 U.S.C. Oct. 1/65*  
*to Co. D. La Sept 22/65*  
*prom to priv 3/65 then Corp*  
*dis no. La Feb 12/66*  
*Expiration of service*

Book mark : \_\_\_\_\_

*J. Leonard*  
Copyist.



1590  
Lorris, Wesley

Co A M, 10 U.S. Col'd H. Art'y.

Corporal

Private

CARD NUMBERS.

1	5-488638	26
2	5-492803	27
3	5-492852	28
4	5-494128	29
5		30
6		31
7		32
8		33
9		34
10		35
11		36
12		37
13		38
14		39
15		40
16		41
17		42
18		43
19		44
20		45
21		46
22		47
23		48
24		49
25		50

Book Mark:

See also 77.2.5.C.27

D | 10. H. Artz | **U.S.C.T.**

Wesley Leonis  
Capt, Co. M, 10 Reg't U. S. Col'd H. Artz

Appears on

**M. and D. Roll of Men Transferred**

to the organization named above,

from Co. B, 77 Reg. U.S.C. Infy

Roll dated Oct. 1, 1865.

When enlisted June 16, 1863.

Period for which enlisted 3 years.

When mustered in Aug 19, 1863.

Present or absent Present

Company to which assigned M.

Remarks: Transferred from Co. D

5 Regt. Cda. Jan. 2. 1864. as

private. promoted June 24. 1865

Stoppage 1 Bed Sack.

Book mark :

L | 10 H. Art'y. | U.S.C.T.

Wesley Lewis

Prvt, Co. A, 10 Reg't U. S. Col'd H. Art'y.

Appears on

Company Muster Roll

for Sept & Oct, 1865.

Present or absent Absent

Stoppage, \$ 100 for

Due Gov't, \$ 100 for

Valuation of horse, \$ 100

Valuation of horse equipments, \$ 100

Remarks: Transferred from 77<sup>th</sup> Ill S.C. per S.O. 68. Hd Qrs Dept Louisiana Sept 22 '65. Deserted Reduced from Corporal Oct. 5, 1865 for absence without leave

Book mark:

Hynes Copyist.

*L* | 10 H. Art'y. | U.S.C.T.

*Wesley Lewis*

*Pat*, Co. A, 10 Reg't U. S. Col'd H. Art'y.

Appears on

**Company Muster Roll**

for *Sept & Oct*, 186*5*.

Present or absent

Stoppage, \$ *2*  $\frac{25}{100}$  for *per transfer roll Bedsack*

Due Gov't, \$ *100* for

Valuation of horse, \$ *100*

Valuation of horse equipments, \$ *100*

Remarks: *Transferred from 77<sup>th</sup> S.C.I. per S.O. 66 Hd. Qrs Dept La, Dropped as deserter Oct 1. 1865 never joined the Co.*

Book mark:

*Hys*  
Copyist.

L | 10 H. Art'y. | U.S.C.T.

Wesley Leonis  
Pvt, Co. A, 10 Reg't U. S. Col'd H. Art'y.

Appears on Co. Muster-out Roll, dated  
Baton Rouge La, Feb 22, 1867.  
Muster-out to date \_\_\_\_\_, 186 .  
Last paid to \_\_\_\_\_, 186 .

Clothing account:

Last settled \_\_\_\_\_, 186 ; drawn since \$ \_\_\_\_\_ 100  
Due soldier \$ \_\_\_\_\_ 100; due U. S. \$ \_\_\_\_\_ 100  
Am't for cloth'g in kind or money adv'd \$ \_\_\_\_\_ 100

Due U. S. for arms, equipments, &c., \$ \_\_\_\_\_ 100

Bounty paid \$ \_\_\_\_\_ 100; due \$ \_\_\_\_\_ 100

Remarks: Transfd from 77 U.S.C.S. as  
Corp. S.O. 66 S of 65 Dept. La.  
Reduced Oct. 4/65 Mustered Oct.  
14, 65

Book mark :

Wesbitt

15879  
Leperre, Victor

Co D, 10 U.S. Col'd H. Art'y.

Private

Private

CARD NUMBERS.

5486985	26
5487037	27
5500550	28
5500630	29
5500715	30
5500791	31
5500854	32
5500928	33
5501030	34
5502258	35
	36
	37
	38
	39
	40
	41
	42
	43
	44
	45
	46
	47
	48
	49
	50

Book Mark:

See also

L | 10 H. Art'y. | **U.S.C.T.**

*Victor Lepere*

Appears with rank of \_\_\_\_\_ on

**Muster and Descriptive Roll of a Detach-  
ment of U. S. Vols. forwarded**

for the <sup>(7 U. S. C. H. A.)</sup> 10 Reg't <sup>U. S. C. H. A.</sup> Roll dated

*New Orleans La., Apr. 20, 1864.*

Where born *St Landry La.*

Age *22* yrs; occupation *Laborer*

When enlisted *Mch. 22, 1864.*

Where enlisted *Alexandria*

For what period enlisted *3* years.

Eyes *Black*; hair *Black*

Complexion *Black*; height *5* ft. *3 $\frac{3}{4}$*  in.

When mustered in *Apr. 20, 1864.*

Where mustered in *New Orleans*

Bounty paid \$ *100*; due \$ *100*

Where credited \_\_\_\_\_

Company to which assigned *D*

Remarks: \_\_\_\_\_

\_\_\_\_\_

\_\_\_\_\_

\_\_\_\_\_

Book mark: \_\_\_\_\_

\_\_\_\_\_

*Galligan*

L | 10 H. Art'y. | U.S.C.T.

Victor Lepore

Appears with rank of *Private* on

**Muster and Descriptive Roll of a Detachment of U. S. Vols. forwarded**

for the *10* Reg't <sup>(9 M.S. C.H.A.)</sup> *M.S.C.H.A.* Roll dated

*New Orleans La, May 7, 1864*

Where born *St. Landry La.*

Age *22* y'rs; occupation *Laborer*

When enlisted *Mar. 22 1864*

Where enlisted *Alexandria*

For what period enlisted *3* years.

Eyes *Black*; hair *Black*

Complexion *Black*; height *5* ft. *3 3/4* in.

When mustered in *Apr. 20, 1864*

Where mustered in *New Orleans*

Bounty paid \$ *100*; due \$ *100*

Where credited *Alexandria*

Company to which assigned *D*

Remarks:

Book mark:

*Galligan*



L. | **10 H. Art'y.** | **U.S.C.T.**

Victor Lepere

P, Co. D, 7 Reg't U. S. Col'd H. Art'y.†

Age \_\_\_\_\_ years.

Appears on

**Company Muster Roll\***

for Enrolment to Apr. 30, 1864.

Joined for duty and enrolled:

When Mar. 22, 1864.

Where Alexandria La.

Period 3 years.

Mustered in:

When Apr. 20, 1864.

Where N. Orleans

Present or absent Present

Stoppage, \$ 100 for \_\_\_\_\_

Due Gov't, \$ 100 for \_\_\_\_\_

Valuation of horse, \$ 100

Valuation of horse equipments, \$ 100

Remarks : \_\_\_\_\_

† This organization subsequently became Co. D, 10 Reg't U. S. Colored Heavy Artillery.

\* First current roll. No muster-in roll of this company on file.

Book mark : \_\_\_\_\_

(358d)

Shadbolt

Copyist.

L. | **10 H. Art'y.** | **U.S.C.T.**

Victor Lepere

P, Co. D, 7 Reg't U. S. Col'd H. Art'y.\*

Appears on

**Company Muster Roll**

for May & June, 1864.

Present or absent Present

Stoppage, \$.....100 for .....

Due Gov't, \$.....100 for .....

Valuation of horse, \$.....100

Valuation of horse equipments, \$.....100

Remarks:.....

.....

.....

.....

.....

.....

.....

\* This organization subsequently became Co. D, 10 Reg't U. S. Colored Heavy Artillery.

Book mark:.....

Shadbolt

L. | 10 H. Art'y. | U.S.C.T.

*Victor Lepere*

*P*, Co. D, 10 Reg't U. S. Col'd H. Art'y.

Appears on

**Company Muster Roll**

for *July & Aug.*, 186*4*.

Present or absent *Present*

Stoppage, \$ *100* for

Due Gov't, \$ *100* for

Valuation of horse, \$ *100*

Valuation of horse equipments, \$ *100*

Remarks *Dif. of pay from date of enrollment to Apr. 30/64 \$6<sup>00</sup> per month and from May 1" to June 30/64 \$9<sup>00</sup> per month*

Book mark:

*Shadobolt*

L. | 10 H. Art'y. | U.S.C.T.

Victor Lepere

P, Co. D, 10 Reg't U. S. Col'd H. Art'y.

Appears on

**Company Muster Roll**

for Sept. + Oct., 1864.

Present or absent Absent

Stoppage, \$ 100 for

Due Gov't, \$ 100 for

Valuation of horse, \$ 100

Valuation of horse equipments, \$ 100

Remarks: Sick in Corps  
d'Afrique Genl Hospit  
N.C. Launce Oct. 17/64

Book mark:

Shadbolt

L. | 10 H. Art'y. | U.S.C.T.

Victor Lepere

P, Co. D, 10 Reg't U. S. Col'd H. Art'y.

Appears on

**Company Muster Roll**

for Nov. & Dec., 1864.

Present or absent absent

Stoppage, \$ 100 for

Due Gov't, \$ 100 for

Valuation of horse, \$ 100

Valuation of horse equipments, \$ 100

Remarks: Sick in Corps  
d'Afrique Genl Hosp'l  
N. Orleans La. since  
Oct. 1/64

Book mark:

Shadbolt

L | 10 H. Art'y. | U.S.C.T.

Victor Leperes  
Pvt., Co. D, 10 Reg't U. S. Col'd H. Art'y.

Appears on

**Company Muster Roll**

for Jan & Feb, 1865.

Present or absent Absent

Stoppage, \$ 100 for

Due Gov't, \$ 100 for

Valuation of horse, \$ 100

Valuation of horse equipments, \$ 100

Remarks: Sick in Corps d'  
Afrigue Genl Hosp., New  
Orleans, La., since Oct. 1/64.

Book mark:

Patterson

L | 10 H. Art'y. | U.S.C.T.

Victor Lepere

Prt, Co. D, 10 Reg't U. S. Col'd H. Art'y.

Appears on

**Company Muster Roll**

for *March - April*, 1865.

Present or absent

Stoppage, \$ 100 for

Due Gov't, \$ 100 for

Valuation of horse, \$ 100

Valuation of horse equipments, \$ 100

Remarks: *Discharged the services from C. d. A. Genl Hosp., New Orleans, La. Feb. 28/65, on Certificate of Disability. Final Statements were given him*

Book mark:

*Patterson*

*L* | 10 H. Art'y. | U.S.C.T.

*Victor Lepore*  
*Im, Co. D,* 10 Reg't U. S. Col'd H. Art'y.

Appears on **Co. Muster-out Roll**, dated  
*Baton Rouge La, Feb 22,* 1867.

Muster-out to date \_\_\_\_\_, 186 .

Last paid to \_\_\_\_\_, 186 .

Clothing account:

Last settled \_\_\_\_\_, 186 ; drawn since \$ \_\_\_\_\_ 100

Due soldier \$ \_\_\_\_\_ 100; due U. S. \$ \_\_\_\_\_ 100

Am't for cloth'g in kind or money adv'd \$ \_\_\_\_\_ 100

Due U. S. for arms, equipments, &c., \$ \_\_\_\_\_ 100

Bounty paid \$ \_\_\_\_\_ 100; due \$ \_\_\_\_\_ 100

Remarks: *Joined at Orgl. Coy,*  
*Dis. Co. d a Genl Hospit.*  
*No. La Feb 27/65 for*  
*Disability, Final*  
*Statements given*

Book mark : \_\_\_\_\_

(361)

*J. J. J. J. J.*  
Copyist.



Lepere, Victor

P. O., Co. D, 10 U. S. C. H. A.  
Reg't

/ Enclosures.

Bed Cards	Descriptive Lists
Burial Records	Final Statements
Certs. of Dis. for Discharge /	Furloughs
C. M. Charges	Med. Des. Lists
Med. Certificates	Orders

Other papers relating to—

Admission to Hosp'l	Furlough
Casualty Sheet (Officer's)	Med. Examination
Confinement	Misc. Information
Contracts	Pay or Clothing
Death or Effects	Personal Reports
Desertions	Rank
Discharge from Hosp'l	Transfer to Hosp'l
Discharge from Service	Transfer to V. R. C.
Duty	Transportation

NOTE 1.

The company commander will here add a statement of all the facts known to him concerning the disease or wound, or cause of disability of the soldier; the time, place, manner, and all the circumstances under which the injury occurred, or disease originated or appeared; the duty, or service, or situation of the soldier at the time the injury was received or disease contracted, stating particularly whether the injury was received or the disease contracted in the line of his duty; and whatever other facts may aid a judgment as to the cause, immediate or remote, of the disability, and the circumstances attending it.

When the facts are not known to the company commander, the certificate of any officer, or affidavit of other person having such knowledge, will be appended—as the surgeon in charge of a hospital, the officer commanding a detachment of recruits, &c., &c.

NOTE 2.

When a probable case for pension, special care must be taken to state the degree of disability—as  $\frac{1}{2}$ ,  $\frac{3}{4}$ , &c., &c.; to describe particularly the disability, wound, or disease; the extent to which it deprives him of the use of any limb or faculty, or affects his health, strength, activity, constitution, or capacity to labor or earn his subsistence. The surgeon will add, from his knowledge of the facts and circumstances, and from the evidence in the case, his professional opinion of the cause or origin of the disability. In the case of discharges by Medical Inspectors, the last paragraph will state that the "discharge was given by consent of the soldier, after a personal examination, and for disability, the nature, degree, and origin of which are correctly described in the within certificate."

Par. 1260 Regulations, Edit. 1861.

Medical officers, in giving certificates of disability, are to take particular care in all cases that have not been under their charge; and especially in epilepsy, convulsions, chronic rheumatism, derangement of the urinary organs, ophthalmia, ulcers, or any obscure disease liable to be feigned or purposely produced; and in no case shall such certificate be given until after sufficient time and examination to detect any attempt at deception.

DIRECTIONS.

This certificate will be made out in duplicate by the soldier's company commander, or other officer commanding the separate detachment to which he belongs, and sent by him to the surgeon who has charge of the hospital where the soldier is sick. The surgeon will then fill out and sign the surgeon's certificate, and forward these papers to the regimental, detachment, or post commander, who will forward them, with his action endorsed thereon, through the proper channel, to his division commander; or, if the troops are not attached to a division, to his corps, department, or other commander or officer to whom the authority to discharge enlisted men may be specially delegated.

These certificates, after having received the action of the highest authority to which they are required to be sent, will be returned through the same channel to the regimental, post, or detachment commander, who will, if the discharge is authorized by the endorsement of the proper authority, sign the soldier's discharge, and the last certificate on this paper; see that the soldier is furnished with the proper final statements in duplicate, and forward BOTH of these certificates direct to the Adjutant General, United States Army, at Washington, D. C.; they will not, under any circumstances, be given into the hands of the soldier.

ADJUTANT GENERAL'S OFFICE.

Feb 21<sup>st</sup> 1865.

Duplicate with Inventory sent 2d Auditor.

CERTIFICATE OF DISABILITY FOR DISCHARGE

IN THE CASE OF

Victor Lepere

a private Co. "D"

10<sup>th</sup> Reg't of U.S.C. Afr. (h)

Comd' Officr U.S. Gen. Wash.  
New Orleans La.

February 25<sup>th</sup> 1865

Approved by board of examination.

F. E. Piquette  
President of board.

Approved Feb 25 1865

M. Alexander

Received (A. G. Office) 1865

Estab. C. R. Co.

DMTA  
1865  
ADJUTANT GENERAL'S OFFICE

Head Qrs Dept of the Gulf  
New Orleans Feb 26<sup>th</sup> 1865

To be discharged  
By command of  
Maj. Gen. Hurlbut.

J. A. Hope  
Capt & A. A. General

**ARMY OF THE UNITED STATES**  
**CERTIFICATE**  
**OF DISABILITY FOR DISCHARGE.**



Private Victor Lepere of Captain Charles  
C. Bailey's Company, (D) of the Tenth Regiment of United States  
Col. Arb. (H.) was enlisted by Lieut. Sickles of  
the \_\_\_\_\_ Regiment of \_\_\_\_\_ at Alexandria La.  
on the Twentysecond day of March 1864, to serve Three years; he was born  
in St. Landry in the State of Louisiana is Twentytwo  
years of age, Five feet 3<sup>3</sup>/<sub>4</sub> inches high, Black complexion, Black eyes,  
Black hair, and by occupation when enlisted a Laborer During the last <sup>five</sup> ~~two~~  
months said soldier has been unfit for duty 150 days.\* This soldier has been  
under medical treatment at this hospital for nearly  
five months with no beneficial results. He is  
in my opinion entirely unfit to perform the duties  
of a soldier.

STATION: Corps d'Afrique U.S. Gen. Hosp. New Orleans La.  
DATE: February 24<sup>th</sup> 1865

F. E. Piquette  
Surgeon in charge,  
Commanding Company.

I CERTIFY, that I have carefully examined the said Victor Lepere of  
Captain C. A. Bailey's Company, and find him incapable of performing the duties of a soldier  
because of Chronic bronchitis and rheumatism  
which he contracted previous to enlistment  
He is unfit for any branch of the military service  
Disability None

G. M. Melson  
Adj. Asst. Surgeon. U.S.A.

DISCHARGED, this Twentyseventh day of February 1865, at Corps d'Afrique  
U.S. Gen. Hospital New Orleans La.

F. E. Piquette  
Surgeon in charge  
Commanding the Reg't.

The soldier desires to be addressed at  
Town \_\_\_\_\_ County \_\_\_\_\_ State \_\_\_\_\_

\* See Note 1 on the back of this. † See Note 2 on the back of this.

1592  
Leroc, Thaddens  
Co A, 10 U.S. Col'd H. Art'y.

Private | Private

CARD NUMBERS.

1	5488411	26
2	5487568	27
3	5512286	28
4	5512440	29
5	5512579	30
6	5512725	31
7	5512905	32
8	5513385	33
9		34
10		35
11		36
12		37
13		38
14		39
15		40
16		41
17		42
18		43
19		44
20		45
21		46
22		47
23		48
24		49
25		50

Book Mark:

See also 77.21.5. Col. Inf.

L 10 Ha | U.S.C.T.

Thaddeus Leroc  
Priv., Co. K, 10 Reg't U. S. Col'd Ha

Appears on

**M. and D. Roll of Men Transferred**

to the organization named above,

from 74th U.S. Col Inf.

Roll dated Camp Parapet La Ar., 1864

When enlisted ..... , 186 .

Period for which enlisted ..... 3 years.

When mustered in Sept 1, 1864.

Present or absent Present

Company to which assigned K

Remarks: Rec'd by transfer fr  
Co, G, 74th U.S. C. I. stop  
for 1 m Bar, for 5 scales

Book mark : 210574

W. H. Scott

L. J. H. A. U.S.C.T.

Madison Leroc  
Cot, Co H, 10 Reg't U. S. Col'd Hd,

Appears on

**M. and D. Roll of Men Transferred**

to the organization named above,

from Co G 1st U.S. Col Inf

Roll dated Camp Campida Oct, 1865.

When enlisted \_\_\_\_\_, 186 .

Period for which enlisted 3 years.

When mustered in Sept, 1864.

Present or absent Present

Company to which assigned K

Remarks:

Stop for mus  
Bar 1/2 pr Shoulder  
Scalps lost  
(Drafted)

Book mark: EXP-103

W. H. Scott

*L* | 10 H. Art'y. | **U.S.C.T.**

*Thadders Leroc*

*P*, Co. *K*, 10 Reg't U. S. Col'd H. Art'y.

Age ..... years.

Appears on

**Company Muster Roll\***

for *Sep. & Oct.*, 186*5*.

Joined for duty and enrolled:

When *Drafted*, 186

Where .....

Period *3* years

Mustered in:

When *Sept. 1*, 186*4*.

Where *New Orleans*

Present or absent *Present*

Stoppage, \$ *100* for .....

Due Gov't, \$ *100* for .....

Remarks *Stop 1 Mosquito bar, 1 pr. shoulder scales 2. 69*

\* First current roll. No muster-in roll of this company on file.

Book mark: .....

(3586)

*Hibbard*

Copyist.

L | 10 H. Art'y. | U.S.C.T.

Thaddens Leroc

P, Co. K, 10 Reg't U. S. Col'd H. Art'y.

Appears on

**Company Muster Roll**

for Nov. & Dec., 1865.

Present or absent Absent

Stoppage, \$ 100 for

Due Gov't, \$ 100 for

Valuation of horse, \$ 100

Valuation of horse equipments, \$ 100

Remarks: On det. service at  
Camp Parapel, La. per S.O.  
No. 57, Hdqrs. 10 U.S.C.H.A.  
Stop for Camp & G.E. 2.69

Book mark:

Hibbard

Copyist.



L | 10 H. Art'y. | U.S.C.T.

Thaddens Leroc

P, Co. K, 10 Reg't U. S. Col'd H. Art'y.

Appears on

Company Muster Roll

for Nov. & Dec., 1865.

Present or absent Absent

Stoppage, \$ 100 for

Due Gov't, \$ 100 for

Valuation of horse, \$ 100

Valuation of horse equipments, \$ 100

Remarks: On det. service at  
Camp Parapet, La. per S.O.  
No. 57, Hdqrs. 10 U.S.C.H.A.  
Stop for Camp & G.E. 2.69

Book mark:

Hibbard  
Copyist.

*Lo*

10 H. Art'y.

U.S.C.T.

*Thaddeus Leroc*

*P*, Co. K, 10 Reg't U. S. Col'd H. Art'y.

Appears on

**Company Muster Roll**

for *Jan. & Feb.*, 186*6*

Present or absent *Absent*

Stoppage, \$ *100* for

Due Gov't, \$ *100* for

Valuation of horse, \$ *100*

Valuation of horse equipments, \$ *100*

Remarks: *Absent on detached service at Camp Parapet, La. per S.O. No. 57 Hdqrs. 10 U.S. C.H.A. Dec. 15, 65.*

Book mark:

*Nibbard*

Copyist.

Lo | 10 H. Art'y. | **U.S.C.T.**

Thaddeus Leroc

P, Co. K, 10 Reg't U. S. Col'd H. Art'y.

Appears on

**Company Muster Roll**

for Mch. 7<sup>th</sup> Apl., 1866.

Present or absent Absent

Stoppage, \$ 100 for

Due Gov't, \$ 100 for

Valuation of horse, \$ 100

Valuation of horse equipments, \$ 100

Remarks: On det. duty at N.O.  
Loc. since Dec. 15, 65, pr S.O.  
No. 57, Hdqrs. 10 U.S.C.H.A.

Book mark:

Hubbard

L

10 H. Art'y.

U.S.C.T.

Thaddeus Leroc

P

, Co. K, 10 Reg't U. S. Col'd H. Art'y.

Appears on

Company Muster Roll

for May & June, 1866.

Present or absent.

Stoppage, \$ 100 for

Due Gov't, \$ 100 for

Valuation of horse, \$ 100

Valuation of horse equipments, \$ 100

Remarks: Died Apl. 16, 1866.

Final statements given.

Book mark: 144.582 H.B.V.

Hibbard

Lo | 10 H. Art'y. | **U.S.C.T.**

Thaddeus Herwe

Put, Co. K, 10 Reg't U. S. Col'd H. Art'y.

Appears on **Co. Muster-out Roll**, dated  
Baton Rouge La, Feb 22, 1867.

Muster-out to date \_\_\_\_\_, 186 .

Last paid to \_\_\_\_\_, 186 .

Clothing account:

Last settled \_\_\_\_\_, 186 ; drawn since \$ \_\_\_\_\_ 100

Due soldier \$ \_\_\_\_\_ 100; due U. S. \$ \_\_\_\_\_ 100

Am't for cloth'g in kind or money adv'd \$ \_\_\_\_\_ 100

Due U. S. for arms, equipments, &c., \$ \_\_\_\_\_ 100

Bounty paid \$ \_\_\_\_\_ 100; due \$ \_\_\_\_\_ 100

Remarks: Rec'd by transfer from Co G  
77 U. S. C. I. Oct 1/65 per S. O. 40.66  
Hodgins West La. S. 1865 died in  
N. O. La. April 16/66

Book mark: \_\_\_\_\_

Le Roche, Thaddeus

P., Co. K., 10 U.S.C.H.A.

2 Enclosures.

Bed Cards	Descriptive Lists
Burial Records	Final Statements /
Certs. of Dis. for Discharge	Furloughs
C. M. Charges	Med. Des. Lists
Med. Certificates	Orders

Other papers relating to—

Admission to Hosp'l	Furlough
Casualty Sheet ( <i>Priv</i> Officer's) 1	Med. Examination
Confinement	Misc. Information
Contracts	Pay or Clothing
Death or Effects	Personal Reports
Desertions	Rank
Discharge from Hosp'l	Transfer to Hosp'l
Discharge from Service	Transfer to V. R. C.
Duty	Transportation

A.G.O. May 23/66  
Recd List sent 2' Aud,  
MA

No inv. of effects can  
be obtained see  
No. 265, Vol 4 R.O. 3, 1866

## FINAL STATEMENT

OF  
Maddeus Leroc  
10<sup>th</sup> Reg't of U.S. Artillery  
Company "F"  
**VOLUNTEERS.**  
Died Apr 16" 1866

NOTE 1.—Two of these certificates (or duplicates) are to be given to each Volunteer Soldier or drafted man who may be discharged without being mustered out (Final Statements are never given to men mustered out of service) that he may at once receive from the Paymaster the pay, &c., due him, and the captain or other COMMISSIONED officer commanding the company will certify to the act of the delivery of the duplicate certificates; with these certificates the Soldier is "entitled to" his discharge, and should also present his discharge to the Paymaster to have the payment endorsed on it. The discharge is to be given back to the Soldier by the Paymaster; the latter only retaining as his vouchers the duplicate certificates.

NOTE 2.—If the Soldier is entitled to pay for the use of his horse, the Company Commander will certify to that fact on the back of both these final statements, and also to the time he has pay due for having been so mounted on his own horse.

NOTE 3.—When a Soldier is furnished with final statements, his descriptive list, if he has one, should be taken up by the officer who gives the Soldier these statements, and endorsed with a statement to this effect by the officer. The endorsement should exhibit a full statement of the time for which the Soldier was allowed pay on his final statements, the clothing account, and all other charges against him or in his favor, so as to comprise a complete exhibit of his account. It will then be transmitted to the Company Commander of the Soldier, who will enter all the data necessary to a full understanding of the Soldier's account on the muster roll upon which the Soldier's discharge is reported. The descriptive list will then be destroyed. The object of this is, that the remaining portion of the Soldier's account may be settled upon the receipt of these muster rolls, and the Soldier receive any pay or allowances that may be due him at the time of his discharge, and which may not appear on his last final statements from the fact that his descriptive list is incomplete. These accounts for back pay, &c., are settled by the 2d Auditor of the Treasury Department.

NOTE 4.—Charges for loss or injury to ordnance, horse equipments, and other miscellaneous charges, should appear under the heading of "Other Stoppages."

NOTE 5.—Bounty paid by State authorities, and not by the United States, will not be entered on this statement.

NOTE 6.—Amounts due the Sutler and Laundress must be entered on the muster roll on which the discharge, death, desertion, &c., is reported, as well as on the final statement, otherwise the amount cannot be collected from the United States.

NOTE 7.—This blank will be used for deceased volunteers and drafted men, as well as for others.

NOTE 8.—When a Soldier dies in Hospital or on detached service, his descriptive list, if he has one, should be sent with his final statements, in duplicate, to the Adjutant General, Washington, D. C.

NOTE 9.—If the soldier is a drafted man or substitute, the space for time, &c., of enrolled, should contain only the word *drafted* or *substitute*, as the case may be. If the Soldier is a "VETERAN," (or RECRUIT,) the words as a *veteran*, (or *recruit*,) as the case may be, should be interlined after the words *mustered into the service of the U. S.* A statement of all the installments of *Post or Recruit Bounty RECEIVED* by the Soldier must be made on the back of each final statement.

ADJUTANT GENERAL'S OFFICE

May 23<sup>d</sup> 1866

Duplicate with Inventory sent 2d Auditor.

I certify, on honor, that Maddeus Leroc, a Private of  
 Captain G. A. Goodale's Company (K) of the 10th Regiment of U.S.A. (V.)  
**VOLUNTEERS**, of the State of \_\_\_\_\_, born in Newport, State  
 of North Carolina, aged 33 years; 5 feet 6 1/2 inches high; Dark complexion,  
Dark eyes, Dark hair, and by occupation a Laborer, who joined for service  
 and was enrolled (see Note 9) on the was day of Drafted, 1865, at New Orleans La  
 by \_\_\_\_\_, for the period of Three years, and mustered into  
 the service of the United States ~~from~~ the First day of September, 1864 at  
 \_\_\_\_\_, by from New Orleans District La; and having served  
 HONESTLY and FAITHFULLY with his Company to the present date, is now entitled to a  
**DISCHARGE**, by reason of Death. Died from small pox at New Orleans La. April 16/66 while on detach. duty at Rept. N. C. Div.

"An Effects"  
 "An Effects"

The said Maddeus Leroc was last paid by Paymaster  
Major Osborne, to include the 31 day of December, 1865, and  
 has pay due him from that time to the present date; he is entitled to pay and subsistence for  
**TRAVELING** to place of enrollment, and whatever other allowances are authorized to volunteer  
 soldiers, drafted men, or militia, so discharged. He has received from the United States **CLOTHING**  
 amounting to Seven & 45/100 dollars, since the 31st day of December,  
 1865, when his clothing account was last settled. He has received from the United States  
 \_\_\_\_\_ 100 dollars advanced **BOUNTY**.

There is to be stopped from him, on account of the State of \_\_\_\_\_, or other  
 authorities, for **CLOTHING**, &c., received on entering service, \_\_\_\_\_ 100 dollars; and  
 for other stoppages, viz: \_\_\_\_\_

\_\_\_\_\_ 100 dollars.  
 He has been furnished with **TRANSPORTATION** in kind from the place of his discharge to  
 \_\_\_\_\_; and he has been **SUBSISTED** for **TRAVELING** to his  
 place of enrollment, up to the \_\_\_\_\_, 1865.

He is indebted to \_\_\_\_\_, **SUTLER**, \_\_\_\_\_ 100 dollars.  
 He is indebted to \_\_\_\_\_, **LAUNDRESS**, \_\_\_\_\_ 100 dollars.

Given in Duplicate, at Ship Island Miss., this 5th day  
 of May, 1866.

Greenleaf A. Goodale  
Capt Co's 10th Regt. (V.)  
 Commanding Company.



CASUALTY SHEET

No. \_\_\_\_\_

*Thos. F. Roche*

*Private* of Company \_\_\_\_\_

*10<sup>th</sup>* Regiment of *21. S. C. V.*

*State Volunteers.*

---

---

NATURE OF CASUALTY.

\_\_\_\_\_

CASUALTY SHEET.

Name: *Mad L. Locke*

Rank: *Private* Company: \_\_\_\_\_ Regiment: *10<sup>th</sup>*

Arm: *U. S. C. Artillery* State: \_\_\_\_\_

Nature of Casualty: *Death*

CAUSE OF CASUALTY—(NAME OF DISEASE, &c.)

*"Small Pox"*

DEGREE OF DISABILITY.

BY WHOM CERTIFIED.

*J. P. Dexter*  
*Capt & A. G. M.*

DATE OF DISCHARGE, DEATH, &c.

*April 16<sup>th</sup> 1866*

PLACE OF DISCHARGE, DEATH, &c.

*C. A. U. S. A. Genl Hosp.*

*New Orleans, La.*

BY WHOM DISCHARGED.

FROM WHAT SOURCE THIS INFORMATION WAS OBTAINED.

*Abstract of burials at*  
*"Monument Cemetery" New*

REMARKS.

*Orleans, La., for month*  
*of April, 1866.*

*"Colored Soldiers"*

*J. P. [Signature]*  
*Clerk.*

1593  
Lewis, John

Co—, 10 U.S. Col'd H. Art'y.

Private | —

CARD NUMBERS.

1	5487896	26
2		27
3		28
4		29
5		30
6		31
7		32
8		33
9		34
10		35
11		36
12		37
13		38
14		39
15		40
16		41
17		42
18		43
19		44
20		45
21		46
22		47
23		48
24		49
25		50

Book Mark:

See also 77 U.S. Col'd H. Art'y.

L 1026 A U.S.C.T.

John Lewis  
Det., Co., 10 Reg't U. S. Col'd H.A.

Appears on

**M. and D. Roll of Men Transferred**

to the organization named above

from

Roll dated Camp Anapetla Oct 1, 1865.

When enlisted May 6, 1864.

Period for which enlisted 3 years.

When mustered in May 13, 1864.

Present or absent

Company to which assigned

Remarks: Deserted Oct 20,  
64. from New Orleans  
La.

Not on muster rolls Reg't.

Book mark :

W. H. Scott

1894  
Levant, Joseph  
Col. , 10 U.S. Col'd H. Art'y.

Private

CARD NUMBERS.

1	26
2	27
3 du Soverne	28 Joseph
4	29
5	30
6	31
7	32
8	33
9	34
10	35
11	36
12	37
13	38
14	39
15	40
16	41
17	42
18	43
19	44
20	45
21	46
22	47
23	48
24	49
25	50

Book Mark:

See also

*Leverme, Joseph*

*Co G*, **10 U.S. Col'd H. Art'y**

*Private*

*Private*

CARD NUMBERS.

1	5-48695-3	26
2	5-5-0715-6	27
3	5-5-07244	28
4	5-5-07286	29
5	5-5-07327	30
6	5-5-07434	31
7	5-5-07580	32
8	5-5-07726	33
9	5-5-07863	34
10	5-5-08005	35
11	5-5-08144	36
12	5-5-08277	37
13	5-5-08419	38
14	5-5-08568	39
15	5-5-08720	40
16	5-5-08869	41
17	5-5-09014	42
18	5-5-09139	43
19	5-5-09287	44
20	5-5-09395	45
21		46
22		47
23		48
24		49
25		50

Book Mark:

See also

51137.398 P.O. number

013827.94 P.O. #

A. E. Douglas

L | 10 H. Art'y. | U.S.C.T.

Joseph Levant  
Appears with rank of *Private* on

**Muster and Descriptive Roll of a Detachment of U. S. Vols. forwarded**

(H. A. C. A. A.)  
for the *10* Reg't *U. S. C. H. A.* Roll dated

*New Orleans La*, *Apr 3*, 1864.

Where born *S<sup>t</sup> Landry La*

Age *37* y'rs; occupation *Laborer*

When enlisted *Mch. 22*, 1864.

Where enlisted *Alexandria*

For what period enlisted *3* years.

Eyes *Black*; hair *Black*

Complexion *Black*; height *5* ft. *6½* in.

When mustered in *Apr. 3*, 1864.

Where mustered in *New Orleans*

Bounty paid \$ *100*; due \$ *100*

Where credited

Company to which assigned *G*

Remarks:

Book mark:

*Galligan*



L | **10 H. Art'y.** | **U.S.C.T.**

*Joseph Levesque*  
*Cot*, Co. *G*, 7 Reg't U. S. Col'd H. Art'y.\*

Appears on

**Company Muster Roll**

for *from enrolment to* *Apr. 20*, 1864.

Present or absent *Present*

Stoppage, \$ 100 for

Due Gov't, \$ 100 for

Valuation of horse, \$ 100

Valuation of horse equipments, \$ 100

Remarks:

\* This organization subsequently became Co. *10* Reg't U. S. Colored Heavy Artillery.

Book mark:

*E. W. Brown*

L | **10 H. Art'y.** | **U.S.C.T.**

Joseph Levene  
Capt, Co. G, 7 Reg't U. S. Col'd H. Art'y.\*

Appears on

**Company Muster Roll**

for May & June, 1864.

Present or absent Present

Stoppage, \$ 100 for \_\_\_\_\_

Due Gov't, \$ 100 for \_\_\_\_\_

Valuation of horse, \$ 100

Valuation of horse equipments, \$ 100

Remarks: \_\_\_\_\_

\* This organization subsequently became Co. \_\_\_\_\_, 10 Reg't U. S. Colored Heavy Artillery.

Book mark: \_\_\_\_\_

E. H. Brown

Copyist.

L | 10 H. Art'y. | U.S.C.T.

Joseph Levene  
Cot, Co. G, 10 Reg't U. S. Col'd H. Art'y.

Appears on

**Company Muster Roll**

for July & Aug, 186 4

Present or absent Present

Stoppage, \$ 100 for

Due Gov't, \$ 100 for

Valuation of horse, \$ 100

Valuation of horse equipments, \$ 100

Remarks: \_\_\_\_\_  
\_\_\_\_\_  
\_\_\_\_\_  
\_\_\_\_\_  
\_\_\_\_\_  
\_\_\_\_\_  
\_\_\_\_\_  
\_\_\_\_\_  
\_\_\_\_\_

Book mark: \_\_\_\_\_

E. F. Brown

L 10. 16. 1864 **U. S. C. T.**

Joseph Levrerne  
Appears with rank of Priv on

**Muster and Descriptive Roll of a Detach-  
ment of U. S. Vols. forwarded**

*Organized as Co G.*  
~~for the~~ 10 Reg't U. S. Col'd 16. a. Roll dated

New Orleans La Sept 20, 1864.

Where born St Landry La

Age 27 y'rs; occupation Labourer

When enlisted March 22, 1864.

Where enlisted Alexandria La

For what period enlisted 3 years.

Eyes Blk; hair Blk

Complexion Blk; height 5 ft. 6 1/2 in.

When mustered in Apr 3, 1864.

Where mustered in New Orleans La

Bounty paid \$ 100; due \$ 100

Where credited to Alexandria La

Company to which assigned G.

Remarks:

Book mark:

E. D. Thompson  
Copyist.

*L* | **10 H. Art'y. | U.S.C.T.**

*Joseph Levene*  
*Pat*, Co. G, 10 Reg't U. S. Col'd H. Art'y.

Appears on

**Company Muster Roll**

for *Sept & Oct*, 186 *4*.

Present or absent *Present*

Stoppage, \$ *100* for

Due Gov't, \$ *100* for

Valuation of horse, \$ *100*

Valuation of horse equipments, \$ *100*

Remarks: *6. per mo due from date of enlistment to April 30 64 \$9. per mo due from April 30 to June 30 64*

Book mark:

*E. N. Brown*

L | 10 H. Art'y. | U.S.C.T.

Joseph Lereyne  
Sgt., Co. G, 10 Reg't U. S. Col'd H. Art'y.

Appears on

**Company Muster Roll**

for *Nov & Dec*, 1864.

Present or absent

Stoppage, \$ 100 for

Due Gov't, \$ 100 for

Valuation of horse, \$ 100

Valuation of horse equipments, \$ 100

Remarks: *Has rec'd but \$ 7 per month.*  
*Left in camp at New Orleans La*

Book mark:

*E. H. Brown*

L

10 H. Art'y.

U.S.C.T.

Joseph Leberne  
Priv., Co. G, 10 Reg't U. S. Col'd H. Art'y.

Appears on

**Company Muster Roll**

for Jan + Feby, 1865.

Present or absent Present

Stoppage, \$ 100 for

Due Gov't, \$ 100 for

Valuation of horse, \$ 100

Valuation of horse equipments, \$ 100

Remarks: Re cid. but of 7 pr  
Mo from Enrollment  
to June 30/64

Book mark:

J. E. Porter

Q

10 H. Art'y.

U.S.C.T.

Joseph Severne  
Sergeant, Co. G, 10 Reg't U. S. Col'd H. Art'y.

Appears on

**Company Muster Roll**

for Mar & April, 1865.

Present or absent Present

Stoppage, \$ 100 for

Due Gov't, \$ 100 for

Valuation of horse, \$ 100

Valuation of horse equipments, \$ 100

Remarks: Received but \$7 for  
Mo from Enrollment  
to June 30/64

Book mark:

J. E. Porter

Copyist.



5 | **10 H. Art'y. U.S.C.T.**

*Joseph Levermore*  
*Prov*, Co. G, 10 Reg't U. S. Col'd H. Art'y.

Appears on

**Company Muster Roll**

for *May & June*, 186*3*.

Present or absent *Absent*

Stoppage, \$ 100 for

Due Gov't, \$ 100 for

Valuation of horse, \$ 100

Valuation of horse equipments, \$ 100

Remarks: *Received bill \$ 7 per*  
*Mo from Enrollment*  
*to June 30/63*  
*Absent sick in C.D.A.*  
*Gen Wash Field*  
*Washington*

Book mark:

*J. E. Carter*

Copyist.

L

10 H. Art'y.

U.S.C.T.

Joseph Leverne  
Prof., Co. G, 10 Reg't U. S. Col'd H. Art'y.

Appears on

**Company Muster Roll**

for July & Aug., 1865.

Present or absent

Present

Stoppage, \$ 100 for

Due Gov't, \$ 07/100 for G & Equip

age lost or destroyed

Valuation of horse, \$ 100

Valuation of horse equipments, \$ 100

Remarks:

Book mark:

J. E. Porter

Copyist.

10 | 10 H. Art'y. | **U.S.C.T.**

*Joseph Leverne*  
*Prov*, Co. G, 10 Reg't U. S. Col'd H. Art'y.

Appears on

**Company Muster Roll**

for *Sept + Oct*, 186*5*.

Present or absent *Present*

Stoppage, \$ 100 for

Due Gov't, \$ 100 for

Valuation of horse, \$ 100

Valuation of horse equipments, \$ 100

Remarks:  
\_\_\_\_\_  
\_\_\_\_\_  
\_\_\_\_\_  
\_\_\_\_\_  
\_\_\_\_\_  
\_\_\_\_\_  
\_\_\_\_\_

Book mark: \_\_\_\_\_

*J. E. Porter*

Copyist.

L | 10 H. Art'y. | U.S.C.T.

Joseph Leverne  
Priv., Co. G, 10 Reg't U. S. Col'd H. Art'y.

Appears on

**Company Muster Roll**

for Nov. & Dec., 1861

Present or absent Present

Stoppage, \$ 100 for

Due Gov't, \$ 100 for

Valuation of horse, \$ 100

Valuation of horse equipments, \$ 100

Remarks:

Book mark:

G. J. M.

Copyist.

L

10 H. Art'y.

U.S.C.T.

Joseph Severne  
Capt., Co. G, 10 Reg't U. S. Col'd H. Art'y.

Appears on

**Company Muster Roll**

for Jan. 9 Feb. 1866.

Present or absent Present

Stoppage, \$ 100 for

Due Gov't, \$ 100 for

Valuation of horse, \$ 100

Valuation of horse equipments, \$ 100

Remarks:

-----  
-----  
-----  
-----  
-----  
-----  
-----  
-----  
-----

Book mark:

-----

G. F. M.  
Copyist.

L

10 H. Art'y.

U.S.C.T.

*Joseph Laverne*

*Private*, Co. G, 10 Reg't U. S. Col'd H. Art'y.

Appears on

**Company Muster Roll**

for *Mar. & Apr.*, 1866.

Present or absent *Present*

Stoppage, \$ *2*<sup>*25*</sup>/<sub>100</sub> for *C.C. & G.C.*

*lost*

Due Gov't, \$ *1*<sup>*00*</sup>/<sub>100</sub> for

Valuation of horse, \$ *1*<sup>*00*</sup>/<sub>100</sub>

Valuation of horse equipments, \$ *1*<sup>*00*</sup>/<sub>100</sub>

Remarks: *On special duty as Hosp. nurse*

Book mark: \_\_\_\_\_

*G. Fox*

Copyist.

*L* | 10 H. Art'y. | U.S.C.T.

*Joseph Severne*  
*Prvt*, Co. G, 10 Reg't U. S. Col'd H. Art'y.

Appears on

**Company Muster Roll**

for *May & June*, 186*6*.

Present or absent *Present*

Stoppage, \$.....100 for .....

Due Gov't, \$.....100 for .....

Valuation of horse, \$.....100

Valuation of horse equipments, \$.....100

Remarks: .....

Book mark: .....

*G. F. M.*  
Copyist.

*L* | 10 H. Art'y. | **U.S.C.T.**

*Joseph Severne*  
*Capt*, Co. G, 10 Reg't U. S. Col'd H. Art'y.

Appears on

**Company Muster Roll**

for *July & Aug.*, 186*6*

Present or absent *Present*

Stoppage, \$ 100 for

Due Gov't, \$ 100 for

Valuation of horse, \$ 100

Valuation of horse equipments, \$ 100

Remarks:  
\_\_\_\_\_  
\_\_\_\_\_  
\_\_\_\_\_  
\_\_\_\_\_  
\_\_\_\_\_  
\_\_\_\_\_  
\_\_\_\_\_

Book mark: \_\_\_\_\_

*G. F. M.*  
Coyist.



L | **10 H. Art'y. | U.S.C.T.**

Joseph Severene  
Pvt., Co. G, 10 Reg't U. S. Col'd H. Art'y.

Appears on

**Company Muster Roll**

for Sept & Oct, 1866.

Present or absent Present

Stoppage, \$ 100 for

Due Gov't, \$ 100 for

Valuation of horse, \$ 100

Valuation of horse equipments, \$ 100

Remarks: Sick in Hospital

Book mark: \_\_\_\_\_

Wines

Copyist.

L

10 H. Art'y.

U.S.C.T.

Joseph Leverne

Pvt, Co. G, 10 Reg't U. S. Col'd H. Art'y.

Appears on

**Company Muster Roll**

for Nov & Dec, 1866.

Present or absent Present

Stoppage, \$ 100 for

Due Gov't, \$ 100 for

Valuation of horse, \$ 100

Valuation of horse equipments, \$ 100

Remarks: Due US. for arq  
rancer lost 34 cents

Book mark:

Wines

Copyist.

L | 10 H. Art'y. | U.S.C.T.

Joseph Lesurme  
Pvt, Co. G, 10 Reg't U. S. Col'd H. Art'y.

Appears on **Co. Muster-out Roll**, dated  
Baton Rouge La, Feb 22, 1867.

Muster-out to date Feb 22, 1867.

Last paid to Dec 31, 1866.

Clothing account:

Last settled \_\_\_\_\_, 186 ; drawn since \$ \_\_\_\_\_ <sup>100</sup>/<sub>100</sub>  
Due soldier \$ 31 <sup>02</sup>/<sub>100</sub>; due U. S. \$ \_\_\_\_\_ <sup>100</sup>/<sub>100</sub>  
Am't for cloth'g in kind or money adv'd \$ \_\_\_\_\_ <sup>100</sup>/<sub>100</sub>

Due U. S. for arms, equipments, &c., \$ 6 <sup>00</sup>/<sub>100</sub>

Bounty paid \$ \_\_\_\_\_ <sup>100</sup>/<sub>100</sub>; due \$ 300 <sup>00</sup>/<sub>100</sub>

Remarks: Joined at Org<sup>l</sup> Org<sup>n</sup>

Book mark: \_\_\_\_\_

\_\_\_\_\_  
Copyist.

Levy, William

Co *D*, 10 U.S. Col'd H. Art'y.

Private

Private

CARD NUMBERS.

1	5-494228	26
2	5-494380	27
3	5-494540	28
4	5-494698	29
5	5-494853	30
6	5-495006	31
7	5-495163	32
8	5-495318	33
9	5-495470	34
10	5-495620	35
11	5-495759	36
12	5-495916	37
13	5-496061	38
14	5-496211	39
15	5-496364	40
16	5-496511	41
17	5-496653	42
18	5-496795	43
19	5-496955	44
20	5-497132	45
21	5-497444	46
22	5-489680	47
23		48
24		49
25		50

Book Mark:

See also

*a* | **10 H. Art'y. | U.S.C.T.**

*William Levy*

*Priv.*, 2 Battery, La. H. Art'y, Native Guards.\*

Age *33* years.

Appears on

**Company Muster-in Roll**

of the organization named above. Roll dated  
*Camp Parapet, Carrollton, La., Feb. 9, 1863.*

Muster-in to date *Feb. 9, 1863.*

Joined for duty and enrolled:

When *Jan'y 13*, 1863.

Where *Camp Parapet in Carrollton, La.*

Period *3* years.

Valuation of horse, \$ 100

Valuation of horse equipments, \$ 100

Remarks: \_\_\_\_\_  
\_\_\_\_\_  
\_\_\_\_\_

\* This organization subsequently became Co. B, 10 Reg't U. S. Colored Heavy Artillery.

Book mark: \_\_\_\_\_

*Heaster*

2 | 10 H. Art'y. | U.S.C.T.

*William Levy*  
-----  
*Pvt.*, Co. B, 1 Reg't La. H. Art'y, Native Guards.\*

Appears on

**Company Muster Roll**

for *from Enlistment to Feb. 28*, 186 *3*.

Present or absent *Present*

Stoppage, \$ *100* for

Due Gov't, \$ *100* for

Valuation of horse, \$ *100*

Valuation of horse equipments, \$ *100*

Remarks: -----  
-----  
-----  
-----  
-----  
-----  
-----  
-----

\*This organization subsequently became Co. B, 10 Reg't U. S. Col'd Heavy Artillery.

Book mark: -----

*Feaster*

L | 10 H. Art'y. | U.S.C.T.

*William Levy*  
Pvt., Co. B, 1 Reg't La. H. Art'y, Native Guards.\*

Appears on

**Company Muster Roll**

for *March & April*, 186*3*.

Present or absent *Present*

Stoppage, \$ *100* for

Due Gov't, \$ *100* for

Valuation of horse, \$ *100*

Valuation of horse equipments, \$ *100*

Remarks:

\*This organization subsequently became Co. B, 10 Reg't U. S. Col'd Heavy Artillery.

Book mark:

*Feaster*

*L* | 10 H. Art'y. | U.S.C.T.

*William Levy*

*Co.*, Co. B, 1 Reg't La. H. Art'y, Native Guards.\*

Appears on

**Company Muster Roll**

for *May & June*, 186*3*.

Present or absent

*Present*

Stoppage, \$ *100* for

Due Gov't, \$ *100* for

Valuation of horse, \$ *100*

Valuation of horse equipments, \$ *100*

Remarks:

\*This organization subsequently became Co. B, 10 Reg't U. S. Col'd Heavy Artillery.

Book mark:

*Feaster*



*L* | 10 H. Art'y. | U.S.C.T.

*William Levy*  
*Pvt.*, Co. B, 1 Reg't La. H. Art'y, Native Guards.\*

Appears on

**Company Muster Roll**

for *July 4, Aug.*, 1863.

Present or absent *Present*

Stoppage, \$ *100* for

Due Gov't, \$ *100* for

Valuation of horse, \$ *100*

Valuation of horse equipments, \$ *100*

Remarks:

\*This organization subsequently became Co. B, 10 Reg't U. S. Col'd Heavy Artillery.

Book mark:

*Feaster*

*L* | 10 H. Art'y. | U.S.C.T.

*William Levy*  
Pvt., Co. B, 1 Reg't La. H. Art'y, Native Guards.\*

Appears on

**Company Muster Roll**

for *Sept. 4. Oct.*, 186*3*.

Present or absent *Present*

Stoppage, \$ *100* for

Due Gov't, \$ *100* for

Valuation of horse, \$ *100*

Valuation of horse equipments, \$ *100*

Remarks:

\*This organization subsequently became Co. B, 10 Reg't U. S. Col'd Heavy Artillery.

Book mark: \_\_\_\_\_

*Foster*

*L* | 10 H. Art'y. | U.S.C.T.

*William Levy*

*Pvt*, Co. *B*, 1 Reg't H. Art'y, Corps d'Afrique.\*

Appears on

**Company Muster Roll**

for *Nov. & Dec*, 186*3*.

Present or absent *Present*

Stoppage, \$ *100* for

Due Gov't, \$ *100* for

Valuation of horse, \$ *100*

Valuation of horse equipments, \$ *100*

Remarks:

\*This organization subsequently became Co. *10*, 10 Reg't U. S. Colored Heavy Artillery.

Book mark:

*Ref*

*L* | **10 H. Art'y. | U.S.C.T.**

*William Levy*  
*Pl*, Co. *B*, 1 Reg't H. Art'y, Corps d'Afrique.\*

Appears on

**Company Muster Roll**

for *Jan - 1* *Feb.* 186 *4*.

Present or absent *Present*

Stoppage, \$ *100* for

Due Gov't, \$ *100* for

Valuation of horse, \$ *100*

Valuation of horse equipments, \$ *100*

Remarks:

\*This organization subsequently became Co. , 10 Reg't U. S. Colored Heavy Artillery.

Book mark:

*Reif*

*S* | **10 H. Art'y.** | **U.S.C.T.**

*William Levy*

*Pt*, Co. *B*, 7 Reg't U. S. Col'd H. Art'y.\*

Appears on

**Company Muster Roll**

for *March & April*, 186*4*.

Present or absent *Present*

Stoppage, \$ *100* for

Due Gov't, \$ *100* for

Valuation of horse, \$ *100*

Valuation of horse equipments, \$ *100*

Remarks:

\* This organization subsequently became Co. *10* Reg't U. S. Colored Heavy Artillery.

Book mark:

*Reis*

Copyist.

L | 10 H. Art'y. | U.S.C.T.

William Levy

Pvt, Co. B, 7 Reg't U. S. Col'd H. Art'y.\*

Appears on

Company Muster Roll

for May & June, 1864.

Present or absent Present

Stoppage, \$ 100 for

Due Gov't, \$ 100 for

Valuation of horse, \$ 100

Valuation of horse equipments, \$ 100

Remarks:

\* This organization subsequently became Co. , 10 Reg't U. S. Colored Heavy Artillery.

Book mark:

C. Reif

*L* | 10 H. Art'y. | U.S.C.T.

*William Levy*  
*Pt*, Co. B, 10 Reg't U. S. Col'd H. Art'y.

Appears on

**Company Muster Roll**

for *July + Aug*, 186*4*

Present or absent *Present*

Stoppage, \$ 100 for

Due Gov't, \$ 100 for

Valuation of horse, \$ 100

Valuation of horse equipments, \$ 100

Remarks:

Book mark:

*A. Richardson*  
Copyst.

*L* | 10 H. Art'y. | U.S.C.T.

*William Levy*

*Pl*, Co. B, 10 Reg't U. S. Col'd H. Art'y.

Appears on

**Company Muster Roll**

for *Sept & Oct*, 186*4*.

Present or absent *Present*

Stoppage, \$ *100* for

Due Gov't, \$ *100* for

Valuation of horse, \$ *100*

Valuation of horse equipments, \$ *100*

Remarks:

Book mark:

*J. Richardson*



2 | 10 H. Art'y. | U.S.C.T.

*William Levy*

*Pvt*, Co. B, 10 Reg't U. S. Col'd H. Art'y.

Appears on

**Company Muster Roll**

for *Nov & Dec*, 1864.

Present or absent *Present*.

Stoppage, \$ 100 for

Due Gov't, \$ 100 for

Valuation of horse, \$ 100

Valuation of horse equipments, \$ 100

Remarks: *On daily  
duty at post  
hospital since  
Dec. 22. 1864*

Book mark:

*Jorris*

L. | 10 H. Art'y. | U.S.C.T.

William Levy  
Pvt., Co. B, 10 Reg't U. S. Col'd H. Art'y.

Appears on

**Company Muster Roll**

for Jan & Feb, 1865.  
Present or absent Present.

Stoppage, \$ 100 for

Due Gov't, \$ 100 for

Valuation of horse, \$ 100

Valuation of horse equipments, \$ 100

Remarks: Due soldier augment-  
ed pay from Jan 1, 1864 to  
May 1, 1864, \$6.00 per month  
May & June \$9.00

Book mark: \_\_\_\_\_

L | 10 H. Art'y. | U.S.C.T.

*William Levy*  
Pt., Co. B, 10 Reg't U. S. Col'd H. Art'y.

Appears on

**Company Muster Roll**

for *Mar & Apr*, 1865.

Present or absent *Present.*

Stoppage, \$ 100 for

Due Gov't, \$ 100 for

Valuation of horse, \$ 100

Valuation of horse equipments, \$ 100

Remarks: *On daily duty  
at Hospital since  
Mar 2, 1865.*

Book mark: \_\_\_\_\_

*Jones*  
(358) Copyist.

*L.* | **10 H. Art'y. | U.S.C.T.**

*William Levy*  
*Prst*, Co. B, 10 Reg't U. S. Col'd H. Art'y.

Appears on

**Company Muster Roll**

for *May & June*, 1865.

Present or absent *Present*.

Stoppage, \$.....100 for .....

Due Gov't, \$.....100 for .....

Valuation of horse, \$.....100

Valuation of horse equipments, \$.....100

Remarks: *On daily duty  
at Post Hospital  
since Dec 27/1864*

Book mark: .....

*J. Owen.*  
Copyist.

L | 10 H. Art'y. | U.S.C.T.

*William Levy*  
Pvt., Co. B, 10 Reg't U. S. Col'd H. Art'y.

Appears on

**Company Muster Roll**

for *July & Aug*, 186*5*.

Present or absent *Present*.

Stoppage, \$ 100 for

Due Gov't, \$ 100 for

Valuation of horse, \$ 100

Valuation of horse equipments, \$ 100

Remarks:

Book mark:

*Jovier*

Q. | **10 H. Art'y. | U.S.C.T.**

William Levy  
Pvt., Co. B, 10 Reg't U. S. Col'd H. Art'y.

Appears on

**Company Muster Roll**  
for Sep. & Oct., 1865.

Present or absent Present.

Stoppage, \$.....100 for .....

Due Gov't, \$.....100 for .....

Valuation of horse, \$.....100

Valuation of horse equipments, \$.....100

Remarks:.....  
.....  
.....  
.....  
.....  
.....  
.....  
.....  
.....  
.....

Book mark:.....

Jones

*L*

**10 H. Art'y. U.S.C.T.**

*William Levy*

*Pvt*

Co. B, 10 Reg't U. S. Col'd H. Art'y.

Appears on

**Company Muster Roll**

for *Nov & Dec*, 1865.

Present or absent *Present*

Stoppage, \$ 100 for

Due Gov't, \$ 100 for

Valuation of horse, \$ 100

Valuation of horse equipments, \$ 100

Remarks:

-----  
-----  
-----  
-----  
-----  
-----  
-----  
-----  
-----

Book mark:

-----

*W. Levy*

*A*

**10 H. Art'y. U.S.C.T.**

*William Levy*

*Pl*

Co. B, 10 Reg't U. S. Col'd H. Art'y.

Appears on

**Company Muster Roll**

for

*July. & Oct., 1866*

Present or absent

Stoppage, \$ 100 for

Due Gov't, \$ 100 for

Valuation of horse, \$ 100

Valuation of horse equipments, \$ 100

Remarks:

*Mustd out at M.O. La  
Del. 3 66 by reason of  
exp. of term of service*

Book mark:

*Plif*



Co. | 10 Me. a. | **U.S.C.T.**

William Levy

Plt., Co. B., 10 Reg't U. S. Col'd Me. a.

Appears on a

**Detachment Muster-out Roll**

of the organization named above. Roll dated

New Orleans La. Feb. 8, 1864

Muster-out to date Feb. 8, 1864

Last paid to June 30, 1865

**Clothing account:**

Last settled ..... 186 ; drawn since \$ ..... 100

Due soldier \$ 76 <sup>57c</sup> / 100; due U. S. \$ ..... 100

Am't for cloth'g in kind or money adv'd \$ ..... 100

Due U. S. for arms, equipments, &c., \$ ..... 100

Bounty paid \$ ..... 100 due \$ ..... 100

Remarks: *joined at origl. orgn.*

*Mustered out by reason*

*of Expiration of term*

*of service (Cert. of Mustg.*

*Off. shows time M.O. Feb. 12,*

*1864. \* added May 12, 93, GED*

Book mark: .....

*Howling*

*L* | 10 H. Art'y. | U.S.C.T.

*William Sevey*  
Pvt, Co. *D*, 10 Reg't U. S. Col'd H. Art'y.

Appears on **Co. Muster-out Roll**, dated  
*Baton Rouge La, Feb*, 1867.

Muster-out to date \_\_\_\_\_, 186 .

Last paid to \_\_\_\_\_, 186 .

Clothing account:

Last settled \_\_\_\_\_, 186 ; drawn since \$ \_\_\_\_\_ 100

Due soldier \$ \_\_\_\_\_ 100 ; due U. S. \$ \_\_\_\_\_ 100

Am't for cloth'g in kind or money adv'd \$ \_\_\_\_\_ 100

Due U. S. for arms, equipments, &c., \$ \_\_\_\_\_ 100

Bounty paid \$ \_\_\_\_\_ 100 ; due \$ \_\_\_\_\_ 100

Remarks:

*Joined org'l. org'n.  
Discharged Feb. 8/66  
expiration term of  
service.*

Book mark: \_\_\_\_\_

*Hodges*  
Copyist.

Levy, William

, Co. 10<sup>th</sup> Reg't W.S. B.A.

2 Enclosures.

Bed Cards .....	Final Statements .....
Burial Records .....	Furloughs or L. of A. ....
Certs. of Dis. for Discharge .....	Med. Certificates .....
C. M. Charges .....	Med. Des. Lists .....
Descriptive Lists .....	Orders .....
Discharge Certificates .....	Pris. of War Record .....
Enlistment Papers ..... 2	Resignations .....

Other papers relating to—

Admission to Hosp'l .....	Furlough or L. of A. ....
Casualty Sheet .....	Med. Examination .....
Confinement .....	Misc. Information .....
Contracts .....	Pay or Clothing .....
Death or Effects .....	Personal Reports .....
Desertion .....	Rank .....
Discharge from Hosp'l .....	Transfer to Hosp'l .....
Discharge from Service .....	Transfer to V. R. C. ....
Duty .....	Transportation .....

**DECLARATION OF RECRUIT.**

I, \_\_\_\_\_ desiring  
to ENLIST in the **Army of the United States**, for the term of **THREE YEARS**, Do declare, That I am  
\_\_\_\_\_ years and \_\_\_\_\_ months of age; that I have neither  
wife nor child; that I have never been discharged from the United States service on account of disability or by  
sentence of a court-martial, or by order before the expiration of a term of enlistment; and I know of no impediment  
to my serving honestly and faithfully as a soldier for three years.

GIVEN at \_\_\_\_\_  
The \_\_\_\_\_ day of \_\_\_\_\_

Witness: \_\_\_\_\_

I, \_\_\_\_\_ do hereby certify that the above is a true and correct copy of the original as it appears in the files of the \_\_\_\_\_

No. 90

Enlisted at Chickasha, Okla.

By 2nd Lieut. J. H. Gardner

1st Regt. of Cavalry

1863

Discharged \_\_\_\_\_

Reg't of \_\_\_\_\_

enlistment; last served in Company ( ) \_\_\_\_\_

18

**CONSENT IN CASE OF MINOR.**

I, \_\_\_\_\_ Do CERTIFY, That I am the  
of \_\_\_\_\_; that the  
said \_\_\_\_\_ is \_\_\_\_\_ years of age; and I  
do hereby freely give my CONSENT to his enlisting as a SOLDIER in the ARMY OF THE UNITED STATES for the period of  
**THREE YEARS.**

GIVEN at \_\_\_\_\_  
The \_\_\_\_\_ day of \_\_\_\_\_

Witness: \_\_\_\_\_

County of

*Jefferson*



State of

*Louisiana*

I, *William Levy* born in *Jackson County*

in the State of *Kentucky* aged *thirty three* years,

and by occupation a *Laborer* do hereby acknowledge to have

voluntarily enlisted this *thirteenth* day of *January*

18 *63*, as a SOLDIER in the ARMY OF THE UNITED STATES OF AMERICA, for the period of *THREE YEARS*, unless sooner discharged by proper authority: Do also agree to

accept such bounty, pay, rations, and clothing, as are, or may be, established by law. And

I, *William Levy* do solemnly swear, that I will bear true faith

and allegiance to the UNITED STATES OF AMERICA, and that I will serve them honestly and

faithfully against all their enemies or opposers whomsoever; and that I will observe and

obey the orders of the President of the United States, and the orders of the officers

appointed over me, according to the Rules and Articles of War.

Sworn and subscribed to, at

*Carrollton, Ga.*

this *ninth* day of

*Camp Parapet,*  
*February 1863*

BEFORE

*J. Rygaard*  
*2<sup>d</sup> Lt. U.S. Art. Co. No. 1*

I CERTIFY, ON HONOR, That I have carefully examined the above named Recruit, agreeably to the General Regulations of the Army, and that in my opinion he is free from all bodily defects and mental infirmity, which would, in any way, disqualify him from performing the duties of a soldier.

*W. Lynde*

EXAMINING SURGEON.

I CERTIFY, ON HONOR, That I have minutely inspected the Recruit, *William Levy* previously to his enlistment, and that he was entirely sober when enlisted; that, to the best of my judgement and belief, he is of lawful age; and that, in accepting him as duly qualified to perform the duties of an able-bodied soldier, I have strictly observed the Regulations which govern the recruiting service. This soldier has *brown* eyes, *black* hair,

*dark* complexion; is *five* feet, *ten* inches high.

*J. Rygaard, 2<sup>d</sup> Lieut. U.S. Art. Co. No. 1*

RECRUITING OFFICER.

**DECLARATION OF RECRUIT.**

I, \_\_\_\_\_ desiring  
 to ENLIST in the **Army of the United States**, for the term of **THREE YEARS**, Do declare, That I am  
 \_\_\_\_\_ years and \_\_\_\_\_ months of age; that I have neither  
 wife nor child; that I have never been discharged from the United States service on account of disability or by  
 sentence of a court-martial, or by order before the expiration of a term of enlistment; and I know of no impediment  
 to my serving honestly and faithfully as a soldier for three years.

GIVEN at \_\_\_\_\_  
 The \_\_\_\_\_ day of \_\_\_\_\_

Witness :

\_\_\_\_\_

\_\_\_\_\_

\_\_\_\_\_

\_\_\_\_\_

\_\_\_\_\_

\_\_\_\_\_

\_\_\_\_\_

\_\_\_\_\_

\_\_\_\_\_

\_\_\_\_\_

\_\_\_\_\_

Discharged \_\_\_\_\_ 18

Regt of \_\_\_\_\_

enlistment; last served in Company ( ) \_\_\_\_\_

By W. G. H. J. Regent of Louisiana

Enlisted at Laurens, S. C. January the 13<sup>th</sup> 1863

William Gray

No. \_\_\_\_\_

10 W. C. H. A.

**CONSENT IN CASE OF MINOR.**

I, \_\_\_\_\_ Do CERTIFY, That I am the  
 \_\_\_\_\_ of \_\_\_\_\_; that the  
 said \_\_\_\_\_ is \_\_\_\_\_ years of age; and I  
 do hereby freely give my CONSENT to his enlisting as a SOLDIER in the ARMY OF THE UNITED STATES for the period of  
**THREE YEARS.**

GIVEN at \_\_\_\_\_

The \_\_\_\_\_ day of \_\_\_\_\_

Witness :

\_\_\_\_\_

County of

Jefferson



State of

Louisiana

I, William Levy born in Jackson County

in the State of Kentucky aged thirty three years,

and by occupation a Laborer do hereby acknowledge to have

voluntarily enlisted this thirteenth day of January

1863, as a SOLDIER in the ARMY OF THE UNITED STATES OF AMERICA, for the period of THREE YEARS, unless sooner discharged by proper authority: Do also agree to

accept such bounty, pay, rations, and clothing, as are, or may be, established by law. And

I, William Levy do solemnly swear, that I will bear true faith

and allegiance to the UNITED STATES OF AMERICA, and that I will serve them honestly and

faithfully against all their enemies or opposers whomsoever; and that I will observe and

obey the orders of the President of the United States, and the orders of the officers

appointed over me, according to the Rules and Articles of War.

Sworn and subscribed to, at

this ninth day of

BEFORE

of Carrollton, La.  
Camp Parapet,  
January 1863  
J. Rygaard  
2<sup>d</sup> Lt. 1<sup>st</sup> Reg. U.S. Col.

I CERTIFY, ON HONOR, That I have carefully examined the above named Recruit, agreeably to the General Regulations of the Army, and that in my opinion he is free from all bodily defects and mental infirmity, which would, in any way, disqualify him from performing the duties of a soldier.

W. C. Lynde EXAMINING SURGEON.

I CERTIFY, ON HONOR, That I have minutely inspected the Recruit, William Levy previously to his enlistment, and that he was entirely sober when enlisted; that, to the best of my judgement and belief, he is of lawful age; and that, in accepting him as duly qualified to perform the duties of an able-bodied soldier, I have strictly observed the Regulations which govern the recruiting service. This soldier has brown eyes, black hair,

dark complexion; is five feet, ten inches high.

J. Rygaard, 2<sup>d</sup> Lieut. of U.S. Col.

RECRUITING OFFICER.

1591  
Lewis, Adam

Co *A*, 10 U.S. Col'd H. Art'y.

Private | Private

CARD NUMBERS.

1	5487344	26
2	5-5-0 4743	27
3	5-5-0 5-0-0 2	28
4	5-5-0 5-1 2 0	29
5	5-5-0 5-2 5-3	30
6	5-5-0 5-3 4 7	31
7	5-5-0 5-4 5-1	32
8	5-5-0 5-5-5 6	33
9	5-5-0 5-6 6 5	34
10	5-5-0 5-8 1 3	35
11	5-5-0 5-9 6 7	36
12	5-5-0 6 1 1 2	37
13	5-5-0 6 2 4 2	38
14	5-5-0 6 3 8 7	39
15	5-5-0 6 5-0 6	40
16	5-5-0 6 7 1 2	41
17	5-5-0 6 8 3 0	42
18	5-5-0 6 9 2 7	43
19	R. P 488 162	44
20		45
21		46
22		47
23		48
24		49
25		50

Book Mark: R. P 488 162

See also



A 1479260. and w N  
S 1482791 and w. D.  
R. & P. 488162  
Q 1505003 P. O. M. M.  
S. 2017281 P. O. aff  
R & P. 648544-

C. S. Smyth  
2

L 10 Henry U.S.C.T

Adam Lewis

Appears with rank of Privat on

**Muster and Descriptive Roll of a Detachment of Drafted Men and Substitutes forwarded**

for the 7 Reg't U.S. Col'd Harty Roll dated New Orleans La, Aug 19 1864

Where born Edenton N.C.

Age 25 years; occupation Laborer

**Drafted and mustered in:**

When Aug 17, 1864.

Where Houma La

Period 3 years.

Eyes Dark; hair Black

Complexion Dark; height ft. in.

Paid bounty and advance pay, \$ 100

Bounty due \$ 100

Where credited Parish of Terrebonne La

Company to which assigned F

**Remarks:**

Because 10 U.S.C.H. Arty

Book mark: R.P. 488 162

L | **10 H. Art'y.** | **U.S.C.T.**

Adam Lewis

Pvt, Co. F, 7 Reg't U. S. Col'd H. Art'y.\*

Appears on

**Company Muster-in and Descriptive Roll**

of the organization named above. Roll dated

New Orleans La, Aug 19, 1864.

Where born Edenton, N.C.

Age 25 -y'rs; occupation Laborer

When enlisted \_\_\_\_\_, 186 .

Where enlisted \_\_\_\_\_

For what period enlisted 3 years.

Eyes dark; hair Blk

Complexion dark; height 5 ft. 3 in.

When mustered in Aug 19, 1864.

Where mustered in New Orleans La

Bounty paid \$ 100; due \$ 100

Where credited 3<sup>rd</sup> Enlt Dist La

Company to which assigned \_\_\_\_\_

Remarks: drafted

\* This organization subsequently became Co. F, 10 Reg't U. S. Colored Heavy Artillery.

Book mark: \_\_\_\_\_

Rosenbaum

*L* | 10 H. Art'y. | **U.S.C.T.**

*Adam Lewis*

*Pvt*, Co. F, 10 Reg't U. S. Col'd H. Art'y.

Appears on

**Company Muster Roll**

for *July & August*, 1864.

Present or absent *Present*

Stoppage, \$.....100 for .....

Due Gov't, \$.....100 for .....

Valuation of horse, \$.....100

Valuation of horse equipments, \$.....100

Remarks: .....

Book mark: .....

*Rosenbaum*  
Copyst.

*L* | 10 H. Art'y. | U.S.C.T.

*Adam Lewis*

*Priv*, Co. F, 10 Reg't U. S. Col'd H. Art'y.

Appears on

**Company Muster Roll**

for *Sept & Oct*, 1864.

Present or absent *Present*

Stoppage, \$ 100 for

Due Gov't, \$ 100 for

Valuation of horse, \$ 100

Valuation of horse equipments, \$ 100

Remarks:  
\_\_\_\_\_  
\_\_\_\_\_  
\_\_\_\_\_  
\_\_\_\_\_  
\_\_\_\_\_  
\_\_\_\_\_  
\_\_\_\_\_

Book mark: \_\_\_\_\_

*Rosenbaum*

*L*

10 H. Art'y. U.S.C.T.

*Adam Lewis*

*Pvt.*, Co. F, 10 Reg't U. S. Col'd H. Art'y.

Appears on

**Company Muster Roll**

for *Nov & Dec*, 1864.

Present or absent *Present*

Stoppage, \$ 100 for

Due Gov't, \$ 100 for

Valuation of horse, \$ 100

Valuation of horse equipments, \$ 100

Remarks:

Book mark:

*Rosenbaum*

Copyist.

L | 10 H. Art'y. | U.S.C.T.

Adam Lewis

Private, Co. F, 10 Reg't U. S. Col'd H. Art'y.

Appears on

**Company Muster Roll**

for Jan & Feb, 1865.

Present or absent Present

Stoppage, \$ 100 for

Due Gov't, \$ 100 for

Valuation of horse, \$ 100

Valuation of horse equipments, \$ 100

Remarks: On daily duty as  
Camp Cook.

Book mark:

B. G. Masdon

L

10 H. Art'y. U.S.C.T.

Adam Lewis

Private, Co. F, 10 Reg't U. S. Col'd H. Art'y.

Appears on

Company Muster Roll

for March & April, 1865.

Present or absent Present

Stoppage, \$ 100 for

Due Gov't, \$ 100 for

Valuation of horse, \$ 100

Valuation of horse equipments, \$ 100

Remarks: On daily duty as Company Cook.

Book mark:

R. G. Masdon



L

10 H. Art'y. U.S.C.T.

Adam Lewis

Priv., Co. F, 10 Reg't U. S. Col'd H. Art'y.

Appears on

Company Muster Roll

for May & June, 1865.

Present or absent Present

Stoppage, \$ 100 for

Due Gov't, \$ 100 for

Valuation of horse, \$ 100

Valuation of horse equipments, \$ 100

Remarks:

[Empty lines for remarks]

Book mark:

B. G. Wadon

L

10 H. Art'y. U.S.C.T.

Adam Lewis

Priv, Co. F, 10 Reg't U. S. Col'd H. Art'y.

Appears on

Company Muster Roll

for dated Aug 31, 1865.

Present or absent

Present

Stoppage, \$ 100 for

Due Gov't, \$ 100 for

Valuation of horse, \$ 100

Valuation of horse equipments, \$ 100

Remarks:

Book mark:

B. G. Masdon

Copyst.

L | 10 H. Art'y. | U.S.C.T.

Adam Lewis

Pain, Co. F, 10 Reg't U. S. Col'd H. Art'y.

Appears on

Company Muster Roll  
for Sept & Oct, 1865.

Present or absent Present

Stoppage, \$ 100 for

Due Gov't, \$ 100 for

Valuation of horse, \$ 100

Valuation of horse equipments, \$ 100

Remarks:

Book mark:

B. W. Masdon

Copyist.

L. | 10 H. Art'y. | U.S.C.T.

*Adam Lewis*

*Pvt.*, Co. F, 10 Reg't U. S. Col'd H. Art'y.

Appears on

**Company Muster Roll**

for *Nov & Dec*, 1865.

Present or absent *Present*

Stoppage, \$ 100 for

Due Gov't, \$ 100 for

Valuation of horse, \$ 100

Valuation of horse equipments, \$ 100

Remarks:

-----  
-----  
-----  
-----  
-----  
-----  
-----  
-----  
-----

Book mark: *30778*

*Adw.*  
Copyst.

L. | 10 H. Art'y. | U.S.C.T.

*Adam Lewis*

*Pat.*, Co. F, 10 Reg't U. S. Col'd H. Art'y.

Appears on

**Company Muster Roll**

for *Jan'y & Feby.*, 1866.

Present or absent *Present*

Stoppage, \$ 100 for

Due Gov't, \$ 100 for

Valuation of horse, \$ 100

Valuation of horse equipments, \$ 100

Remarks:

Book mark:

*Ash*  
Copied.

L. | 10 H. Art'y. | U.S.C.T.

*Adam Lewis*

*Pat.*, Co. F, 10 Reg't U. S. Col'd H. Art'y.

Appears on

**Company Muster Roll**

for *Jan'y & Feby.*, 186*6*.

Present or absent *Present*

Stoppage, \$ 100 for

Due Gov't, \$ 100 for

Valuation of horse, \$ 100

Valuation of horse equipments, \$ 100

Remarks:

-----  
-----  
-----  
-----  
-----  
-----  
-----  
-----

Book mark: -----  
-----

*Asht.*  
Copied.

*L.* | **10 H. Art'y.** | **U.S.C.T.**

*Adam Lewis*

*Priv.*, Co. F, 10 Reg't U. S. Col'd H. Art'y.

Appears on

**Company Muster Roll**

for *Mar & Apr.*, 1866.

Present or absent *Present*

Stoppage, \$ 100 for

Due Gov't, \$ 100 for

Valuation of horse, \$ 100

Valuation of horse equipments, \$ 100

Remarks:

Book mark:

L | **10 H. Art'y.** | **U.S.C.T.**

Adam Lewis,

Priv., Co. F, 10 Reg't U. S. Col'd H. Art'y.

Appears on

**Company Muster Roll**

for May & June, 1866.

Present or absent Present

Stoppage, \$ 100 for

Due Gov't, \$ 100 for

Valuation of horse, \$ 100

Valuation of horse equipments, \$ 100

Remarks:

Book mark:



L. 10<sup>th</sup> B. Art'y U.S.C.T.

Adam Lewis  
Privat, Co. F, 10 Reg't U. S. Col'd Barty

Appears on

**Company Muster Roll**

for July & Aug., 1866.

Present or absent Present

Stoppage, \$ 100 for

Due Gov't, \$ 100 for

Valuation of horse, \$ 100

Valuation of horse equipments, \$ 100

Remarks:

Book mark:

L

10 H. Art'y. U.S.C.T.

Adam Lewis

Pvt., Co. F, 10 Reg't U. S. Col'd H. Art'y.

Appears on

Company Muster Roll

for Sept. and Oct., 1866

Present or absent Present

Stoppage, \$ 100 for

Due Gov't, \$ 100 for

Valuation of horse, \$ 100

Valuation of horse equipments, \$ 100

Remarks:

Book mark:

House

L | 10 H. Art'y. | U.S.C.T.

Adam Lewis

Pat., Co. F, 10 Reg't U. S. Col'd H. Art'y.

Appears on

Company Muster Roll

for Nov- and Dec, 1866

Present or absent Present

Stoppage, \$ 100 for

Due Gov't, \$ 100 for

Valuation of horse, \$ 100

Valuation of horse equipments, \$ 100

Remarks:

Book mark:

House

L

10 H. Art'y.

U.S.C.T.

Adam Lewis

Priv., Co. F., 10 Reg't U. S. Col'd H. Art'y.

Appears on Co. Muster-out Roll, dated

Barren Range La Feb 22, 1867.

Muster-out to date Feb. 22, 1867.

Last paid to Dec 31, 1866.

Clothing account:

Last settled \_\_\_\_\_, 186 ; drawn since \$ \_\_\_\_\_ 100

Due soldier \$ 66 <sup>64</sup> / 100; due U. S. \$ \_\_\_\_\_ 100

Am't for cloth'g in kind or money adv'd \$ \_\_\_\_\_ 100

Due U. S. for arms, equipments, &c., \$ 6 <sup>00</sup> / 100

Bounty paid \$ None / 100; due \$ 200 <sup>00</sup> / 100

Remarks: joined at original organization. Conscripted by G. O. No. 106 Hd. Qrs Dept. of the Gulf. of 64

Book mark: V. 232. P 98. 76

House

L 10 H.A. U.S.C.T.

Adam Lewis  
priv., Co. F, 10 Reg't U.S.C. H.A.

**NOTATION.**

Book mark: R + P. 488162

**Record and Pension Office,**

WAR DEPARTMENT,

Washington, July 28, 1897.

It has this day ( July 28, 1897, )

been determined by this Department from the records and from information furnished by the Auditor for the War Department that this soldier was enrolled August 15, 1864

Camp

1598  
Lewis, Alexander  
Co L, 10 U.S. Col'd H. Art'y.

Private | Private

CARD NUMBERS.

1	5488116	26
2	5488265	27
3	5513476	28
4	5513623	29
5	5513746	30
6	5513862	31
7	5513954	32
8	5514014	33
9	5514053	34
10	5514099	35
11	5514127	36
12		37
13		38
14		39
15		40
16		41
17		42
18		43
19		44
20		45
21		46
22		47
23		48
24		49
25		50

Book Mark:

See also 77. U.S.C. Inf.

A. 816307 P.O. in the  
921427 - P.O. Ass.  
A135-9168 and Wd

C. S. Doughty  
R

L 1026 A U.S.C.T.

Alexander Lewis  
Pot., Co. A., 10 Reg't U. S. Col'd

Appears on

**M. and D. Roll of Men Transferred**

to the organization named above,

from 77 U.S. Col. Inf

Roll dated Camp Manapa La Oct 1, 1865.

When enlisted Jan 27, 1865.

Period for which enlisted 3 years.

When mustered in Jan 31, 1865.

Present or absent Present

Company to which assigned L

Remarks: joined as Recruit

joined by transfer  
from Co E. 77 U.S.C.I.  
per D.O. 66 C.S. Hd Qrs  
Dept of La

Book mark :

W. H. Scott



*L. 10th R* **U.S.C.T.**

*Alexander Lewis*  
*1st*, Co. *C*, *10* Reg't U. S. Col'd *10th*,

Appears on

**M. and D. Roll of Men Transferred**

to the organization named above,

from *10th Reg't U.S. Col'd Inf*

Roll dated *Camp Parakeha Ga*, 186*5*.

When enlisted *Jan 22*, 186*5*.

Period for which enlisted \_\_\_\_\_ years.

When mustered in *Jan 31*, 186*5*.

Present or absent *Present*

Company to which assigned *A*

Remarks: *Transferred from*

*Recruiting Depot*

\_\_\_\_\_

\_\_\_\_\_

\_\_\_\_\_

\_\_\_\_\_

\_\_\_\_\_

Book mark : \_\_\_\_\_

\_\_\_\_\_

*W. H. Scott*

L | 10 H. Art'y. | U.S.C.T.

Alexander Lewis  
Priv., Co. L, 10 Reg't U. S. Col'd H. Art'y.

Age ..... years.

Appears on

Company Muster Roll\*

for Sept. & Oct., 1865.

Joined for duty and enrolled:

When Jan. 22, 1865.

Where New Orleans

Period 3 years.

Mustered in:

When Jan. 31, 1865.

Where New Orleans

Present or absent Present

Stoppage, \$ 100 for

Due Gov't, \$ 100 for

Valuation of horse, \$ 100

Valuation of horse equipments, \$ 100

Remarks: Transf. from Co. E.

77 U.S. Col. - Stop for loss of haw  
sack & canteen \$ 1.85.

\*First current roll. No muster-in roll of this company on file.

Book mark :

Scherich

*L* | 10 H. Art'y. | U.S.C.T.

*Alexander Lewis*  
*Pvt*, Co. L, 10 Reg't U. S. Col'd H. Art'y.

Appears on

**Company Muster Roll**

for *Nov. & Dec.*, 1863.

Present or absent *Present*

Stoppage, \$ 100 for

Due Gov't, \$ 100 for

Valuation of horse, \$ 100

Valuation of horse equipments, \$ 100

Remarks: *Stop for 1 Haversack  
& 1 Canteen \$1.85.*

Book mark: \_\_\_\_\_

*Scherich*

*L* | **10 H. Art'y. U.S.C.T.**

*Alexander Lewis*  
*Pos*, Co. L, 10 Reg't U. S. Col'd H. Art'y.

Appears on

**Company Muster Roll**

for *Jan. & Feb.*, 1866.

Present or absent *Present*

Stoppage, \$ 100 for

Due Gov't, \$ 100 for

Valuation of horse, \$ 100

Valuation of horse equipments, \$ 100

Remarks:

Book mark:

*Scherich*

L

10 H. Art'y. U.S.C.T.

Alexander Lewis  
PT, Co. L, 10 Reg't U. S. Col'd H. Art'y.

Appears on

Company Muster Roll

for *Mich. & Apl.*, 1866

Present or absent *Present*

Stoppage, \$ 100 for

Due Gov't, \$ 100 for

Valuation of horse, \$ 100

Valuation of horse equipments, \$ 100

Remarks:

-----  
-----  
-----  
-----  
-----  
-----  
-----  
-----

Book mark:

*Scherich*

L 10th. Art. U.S.C.T.

Alexander Lewis  
Priv., Co. L, 10 Reg't U. S. Col'd Art.,

Appears on

**Company Muster Roll**

for May & June, 1866.

Present or absent Present

Stoppage, \$ 100 for

Due Gov't, \$ 100 for

Valuation of horse, \$ 100

Valuation of horse equipments, \$ 100

Remarks:

Book mark:

Scherich

L

10 H. Art'y. U.S.C.T.

Alexander Lewis

Plt., Co. L, 10 Reg't U. S. Col'd H. Art'y.

Appears on

Company Muster Roll

for July & Aug, 1866

Present or absent Present

Stoppage, \$ 100 for

Due Gov't, \$ 100 for

Valuation of horse, \$ 100

Valuation of horse equipments, \$ 100

Remarks:

Book mark:

Burnham

*L* | 10 H. Art'y. | U.S.C.T.

*Alexander Lewis*

*Plt.*, Co. L, 10 Reg't U. S. Col'd H. Art'y.

Appears on

Company Muster Roll

for *Sept & Oct*, 1866.

Present or absent *Present*

Stoppage, \$ *100* for

Due Gov't, \$ *100* for

Valuation of horse, \$ *100*

Valuation of horse equipments, \$ *100*

Remarks:

Book mark:

*Burnham*



L | 10 H. Art'y. | **U.S.C.T.**

Alexander Lewis

Plt, Co. L, 10 Reg't U. S. Col'd H. Art'y.

Appears on

**Company Muster Roll**

for Nov & Dec, 1866.

Present or absent Present

Stoppage, \$ 100 for

Due Gov't, \$ 100 for

Valuation of horse, \$ 100

Valuation of horse equipments, \$ 100

Remarks: \_\_\_\_\_  
\_\_\_\_\_  
\_\_\_\_\_  
\_\_\_\_\_  
\_\_\_\_\_  
\_\_\_\_\_  
\_\_\_\_\_  
\_\_\_\_\_

Book mark: \_\_\_\_\_

Burnham

L | 10 H. Art'y. | U.S.C.T.

Alexander Lewis  
Pvt., Co. L, 10 Reg't U. S. Col'd H. Art'y.

Appears on Co. Muster-out Roll, dated  
Baton Rouge La, Feb 22, 1867.

Muster-out to date Feb 22, 1867.

Last paid to Dec 31, 1866.

Clothing account:

Last settled....., 186 ; drawn since \$.....<sup>100</sup>

Due soldier \$ 27 <sup>83</sup>/<sub>100</sub>; due U. S. \$.....<sup>100</sup>

Am't for cloth'g in kind or money adv'd \$.....<sup>100</sup>

Due U. S. for arms, equipments, &c., \$ 6 <sup>20</sup>/<sub>100</sub>

Bounty paid \$ 100 <sup>60</sup>/<sub>100</sub>; due \$ 100 <sup>60</sup>/<sub>100</sub>

Remarks: joined by transfer from Co  
E 77 U.S.C., Oct 1/65 SO 66 No 9  
Dep't La sept. 22/65

Book mark:

Burnham

1899  
Lewis, Claiborne

Co E, 10 U.S. Col'd H. Art'y.

Private

Private

CARD NUMBERS.

1 5502410	26
2 5484184	27
3 5502519	28
4 5502691	29
5 5504656	30
	31
	32
	33
	34
	35
	36
	37
	38
	39
	40
	41
	42
	43
	44
	45
	46
	47
	48
	49
	50

Book Mark:

See also

*L* | **10 H. Art'y. | U.S.C.T.**

*Blairborne Lewis*  
*Prvt.*, Co. *E*, 7 Reg't U. S. Col'd H. Art'y.\*

Appears on

**Company Muster-in and Descriptive Roll**

of the organization named above. Roll dated

*New Orleans La, July 8, 1864*

Where born *Jefferson Miss*

Age *21* y'rs; occupation *Laborer*

When enlisted *Feb 2, 1864*

Where enlisted *New Orleans*

For what period enlisted *3* years.

Eyes *Black*; hair *Black*

Complexion *Black*; height *5* ft, *6 1/2* in.

When mustered in *Nov 7, 1864*

Where mustered in *New Orleans*

Bounty paid \$ *2* 100; due \$ *100*

Where credited *New Orleans*

Company to which assigned *E*

Remarks: \_\_\_\_\_

\_\_\_\_\_

\_\_\_\_\_

\* This organization subsequently became Co. *E*, 10 Reg't U. S. Colored Heavy Artillery.

Book mark: \_\_\_\_\_

\_\_\_\_\_

*L. Snider*  
Copist.

L. M. A. | **U.S.C.T.**

Clayborne Lewis  
Priv, Co. E, 11<sup>th</sup> Reg't U. S. Col'd <sup>(74. S. C. H. H.)</sup> Hott

Appears on a

**Detachment Muster Roll**

of the organization named above

for Roll dated Apr-30, 1864.

Station De Sair, La.

Present or absent Absent

Stoppage, \$ 100 for

Due Gov't, \$ 100 for

Valuation of horse, \$ 100

Valuation of horse equipments, \$ 100

Remarks: Sick in Small Pox

Hospital at New Orleans

since April 16<sup>th</sup> 1864

Book mark : \_\_\_\_\_

Croghan

J   | **10 H. Art'y.** | **U.S.C.T.**

*Claybourne Lewis*  
*Prk. Co. 5, 7 Reg't U. S. Col'd H. Art'y.\**

Appears on

**Company Muster Roll**

for *May & June*, 186*6*

Present or absent *Absent*

Stoppage, \$           100 for           

Due Gov't, \$           100 for           

Valuation of horse, \$           100

Valuation of horse equipments, \$           100

Remarks: *To be stopped*  
*from pay for ordnance*  
*lost for by three cents.*  
*Absent sick*

\* This organization subsequently became Co. *5*, 10 Reg't U. S. Colored Heavy Artillery.

Book mark:           

*Linden*  
Copyist.

*L* | 10 H. Art'y. | U.S.C.T.

*Claybourne Lewis*  
Sgt., Co. E, 10 Reg't U. S. Col'd H. Art'y.

Appears on

**Company Muster Roll**

for *July & Aug.*, 186*4*  
Present or absent

Stoppage, \$ 100 for

Due Gov't, \$ 100 for

Valuation of horse, \$ 100

Valuation of horse equipments, \$ 100

Remarks: *Died June 7<sup>th</sup> 64  
Gen Hospital New Or-  
leans (Notice received  
Aug. 25/64)*

Book mark:

*Linden*  
Copyist.

*L* | 10 H. Art'y. | **U.S.C.T.**

*Caliborne Lewis*  
*Priv*, Co. *E*, 10 Reg't U. S. Col'd H. Art'y.

Appears on **Co. Muster-out Roll**, dated  
*Baton Rouge La., Feb. 22, 1867.*

Muster-out to date \_\_\_\_\_, 186 .

Last paid to *Not Known*, 186 .

Clothing account:

Last settled \_\_\_\_\_, 186 ; drawn since \$ \_\_\_\_\_ 100

Due soldier \$ \_\_\_\_\_ 100; due U. S. \$ \_\_\_\_\_ 100

Am't for cloth'g in kind or money adv'd \$ \_\_\_\_\_ 100

Due U. S. for arms, equipments, &c., \$ \_\_\_\_\_ 100

Bounty paid \$ \_\_\_\_\_ 100; due \$ \_\_\_\_\_ 100

Remarks: *Joined at Big Camp*  
*as Private*

*Died in C. D. A. G. H.*  
*June 7, 1864, of Small Pox.*

Book mark : \_\_\_\_\_



Clayborne, Lewis

J. E., Co. E., 10 Reg't U.S.C.H.A.

3

Enclosures.

Bed Cards	Descriptive Lists
Burial Records	Final Statements /
Certs. of Dis. for Discharge	Furloughs
C. M. Charges	Med. Des. Lists
Med. Certificates	Orders

Other papers relating to—

Admission to Hosp'l	Furlough
Casualty Sheet (Officer's)	Med. Examination
Confinement	Misc. Information
Contracts	Pay or Clothing
Death or Effects 2	Personal Reports
Desertions	Rank
Discharge from Hosp'l	Transfer to Hosp'l
Discharge from Service	Transfer to V. R. C.
Duty	Transportation

*A. S. C.*  
*10th Reg't of U.S. Artillery*



**FINAL STATEMENT**

*10th U.S. Artillery* OF *Puralo*  
*Lewis Clayborne*  
*7th Reg't of U.S. Artillery*

**VOLUNTEERS.**

*Rec'd June 7th 1864*

NOTE 1.—Two of these certificates (or duplicates) are to be given to each Volunteer Soldier or drafted man who may be discharged previously to the discharge of his company, that he may at once receive from the Paymaster the pay, &c., due him, and the captain or other COMMISSIONED officer commanding the company will certify to the act of the delivery of the duplicate certificates; on these certificates the Soldier is "entitled to" his discharge, and should also present his discharge to the Paymaster to have the payment endorsed on it. The discharge is to be given back to the Soldier by the Paymaster; the latter only retaining as his voucher the duplicate certificates.

NOTE 2.—If the Soldier is entitled to pay for the use of his horse, the Company Commander will certify to that fact on the back of both these final statements, and also to the time he has pay due for having been so mounted on his own horse.

NOTE 3.—When a Soldier is furnished with final statements, his descriptive list, if he has one, should be taken up by the officer who gives the Soldier these statements, and endorsed with a statement to this effect by the officer. This endorsement should exhibit a full statement of the time for which the Soldier was allowed pay on his final statements, the clothing account, and all other charges against him or in his favor, so as to comprise a complete exhibit of his account. It will then be transmitted to the company commander of the Soldier, who will enter all the data necessary to a full understanding of the Soldier's account on the muster roll upon which the Soldier's discharge is reported. The descriptive list will then be destroyed. The object of this is, that the remaining portion of the Soldier's account may be settled upon the receipt of these muster rolls, and the Soldier receive any pay or allowances that may be due him at the time of his discharge, and which may not appear on his final statements from the fact that his descriptive list is incomplete. These accounts for back pay, &c., are settled by the 2d Auditor of the Treasury Department.

NOTE 4.—Charges for loss or injury to ordnance, horse equipments, and other miscellaneous charges, should appear under the heading of "Other Stoppages."

NOTE 5.—Bounty paid by State authorities, and not by the United States, will not be entered on this statement.

NOTE 6.—Amounts due the Sutler and Laundress must be entered on the muster roll on which the discharge, death, desertion, &c., is reported, as well as on the final statement, otherwise the amount cannot be collected from the United States.

NOTE 7.—This blank will be used for deceased volunteers and drafted men, as well as for others.

NOTE 8.—Where a Soldier dies in Hospital or on detached service, his descriptive list, if he has one, should be sent with his final statements, in duplicate, to the Adjutant General, Washington, D. C.

ADJUTANT GENERAL'S OFFICE.

*Sept 9th 1864*

Duplicate with Inventory sent 2d Auditor.



I certify, on honor, that Louis Clayborne a Private of  
Lieut. A. P. Green Company (C.) of the 7th Regiment of U. S. C. H. Art.

**VOLUNTEERS**, of the State of \_\_\_\_\_, born in Jefferson, State  
of Mississippi, aged 21 years; 5 feet 5 1/2 inches high; Blk complexion,  
Blk eyes, Blk hair, and by occupation a Farmer, having joined the company on  
its original organization at \_\_\_\_\_, and enrolled in it at the muster into  
the service of the United States at New Orleans La, on the 7th day  
of March, 186 4, (or was mustered in service as a recruit, by \_\_\_\_\_,  
at \_\_\_\_\_, on the \_\_\_\_\_ day of \_\_\_\_\_,  
186 \_\_\_\_\_, or was drafted and mustered into the service of the United States from the \_\_\_\_\_  
Enrollment District of the State of \_\_\_\_\_, at \_\_\_\_\_,  
on the \_\_\_\_\_ day of \_\_\_\_\_, 186 \_\_\_\_\_,) to serve in the Regiment, for  
the term of 3 Years: and having served **HONESTLY** and  
**FAITHFULLY** with his Company in Dep't. of the Gulf to the present date, is now  
entitled to **DISCHARGE** by reason of Death from Disease  
(Died June 7th 1864 see Inventory) Small Pox.

The said Louis Clayborne was last paid by Paymaster  
Never Paid to include the \_\_\_\_\_ day of \_\_\_\_\_, 186 \_\_\_\_\_, and has  
pay due him from that time to the present date; he is entitled to pay and subsistence for  
**TRAVELING** to place of enrollment, and whatever other allowances are authorized to volunteer  
soldiers, drafted men, or militia, so discharged. He has received from the United States **CLOTHING**  
amounting to Twenty three 78 dollars, since the \_\_\_\_\_ day of Enrollment,  
186 \_\_\_\_\_, when his clothing account was last settled. He has received from the United States  
\_\_\_\_\_ dollars advanced **BOUNTY**.

There is to be stopped from him, on account of the State of \_\_\_\_\_, or other  
authorities, for **CLOTHING**, &c., received on entering service, \_\_\_\_\_ dollars; and  
for other stoppages, viz: \_\_\_\_\_

\_\_\_\_\_ dollars.  
He has been furnished with **TRANSPORTATION** in kind from the place of his discharge to  
\_\_\_\_\_; and he has been **SUBSISTED** for **TRAVELING** to his  
place of enrollment, up to the \_\_\_\_\_, 186 \_\_\_\_\_.

He is indebted to \_\_\_\_\_, **SUTLER**, \_\_\_\_\_ dollars.

He is indebted to \_\_\_\_\_, **LAUNDRESS**, \_\_\_\_\_ dollars.

Given in Duplicate, at New Orleans La, this \_\_\_\_\_ day  
of June, 186 4.

J. E. Piquette  
Surgeon in charge  
Commanding Company.  
c D'Arques San Hostp

No. d. A. Genl. Hoopfer  
New Orleans La

ARTICLES OF WAR.

ART. 95. When any non-commissioned officer or soldier shall die, or be killed in the service of the United States, the then commanding officer of the troop or company shall, in the presence of two other commissioned officers, take an account of what effects he died possessed of, above his arms and accoutrements, and transmit the same to the office of the Department of War, which said effects are to be accounted for, and paid to the representatives of such deceased non-commissioned officer or soldier. And in case any of the officers, so authorized to take care of the effects of deceased officers and soldiers, should, before they have accounted to their representatives for the same, have occasion to leave the regiment or post, by preferment or otherwise, they shall, before they be permitted to quit the same, deposit in the hands of the commanding officer, or of the assistant military agent, all the effects of such deceased non-commissioned officers and soldiers, in order that the same may be secured for, and paid to, their respective representatives.

DIRECTIONS.

NOTE 1.—One copy of the inventories of the effects of deceased non-commissioned officers and soldiers, required by the 95th Article of War, will be forwarded to the Adjutant General, by the commander of the company to which the deceased belonged, and a duplicate of the same to the colonel of the regiment. Final statements of pay, clothing, &c., in duplicate, will be sent to the Adjutant General with one copy of the inventory. Both inventory and final statements should be forwarded, as a general rule, through Regimental Headquarters. When a soldier dies at a post or station absent from his company, it will be the duty of his immediate commander to furnish, direct to the Adjutant General, the required inventory and final statements, and, at the same time, to forward to the commanding officer of the company to which the soldier belonged, a report of his death, specifying the date, place, and cause; to what time he was last paid, and the money or other effects in his possession at the time of his decease; which report will be noted on the next muster roll of the company to which the man belonged. Each inventory will be endorsed, "Inventory of the effects of \_\_\_\_\_, late of company (—) — regiment of —, who died at —, the — day of —, 186—." If a legal representative receive the effects, it will be stated in the report. If the soldier leave no effects, the fact will be reported on the blank for inventory.

NOTE 2.—Should the effects of a deceased non-commissioned officer or soldier not be administered upon within a short period after his decease, they shall be disposed of by a Council of Administration, under the authority of the commanding officer of the post, and the proceeds deposited with the Paymaster, to the credit of the United States, until they shall be claimed by the legal representatives of the deceased.

NOTE 3.—In all such cases of sales by the Council of Administration, a statement in detail, or account of the proceeds duly certified by the Council and commanding officer, (Form 5.) accompanied by the Paymaster's receipt for the proceeds, will be forwarded by the commanding officer to the Adjutant General. The statement will be endorsed, "Report of the proceeds of the effects of \_\_\_\_\_, late of company (—) — regiment of —, who died at —, the — day of —, 186—."

NOTE 4.—The effects in all cases, when called for, should be turned over to the legal representative, without further authority from the Adjutant General. When the effects are turned over to the relatives of the deceased before these inventories are sent to the Adjutant General, their receipts therefor should be attached to the inventories. In all other cases, one copy will be sent with a letter of transmittal direct to the Adjutant General, and a duplicate retained by the officer.

NOTE 5.—Particular care should be taken to take receipts in duplicate from the Paymaster for any funds turned over to him; one copy should be sent direct to the Adjutant General and one retained by the officer.

INVENTORY OF THE EFFECTS

OF  
*Private Lewis Claybarn*  
 Late of Company *E*  
*1<sup>st</sup>* Reg't of *Maj. Genl. H. Art*  
 Volunteers, who died at *New Orleans La*  
 on the *1<sup>st</sup>* day of *June* 186*4*

Surgeon General's Office,

RECORD & PENSION BUREAU,

*Washington, January 14<sup>th</sup> 1867*

The within Inventory is a true copy from the records  
*of Surgeon D. Miquel Genl. Hospital*  
*New Orleans La*, on file in  
 this Office, and contains all the information in the case that  
 can be found.

BY ORDER OF THE SURGEON GENERAL:

*J. J. Woodward*  
 RECEIVED ADJUTANT GENERAL'S OFFICE  
 JAN 15 1867  
 Lt. Major, Assistant Surgeon, U. S. A.

Inventory of the effects of Lewis Claborn late  
 a Private of Captain \_\_\_\_\_ Company E of  
 the 7th Regiment of W. Vol. Co. Art Volunteers, who was enrolled as  
 a \_\_\_\_\_ at \_\_\_\_\_ in the State of \_\_\_\_\_ on  
 the \_\_\_\_\_ day of \_\_\_\_\_ 186 , and mustered into the service of the United  
 States as a \_\_\_\_\_ on the \_\_\_\_\_ day of \_\_\_\_\_ 186 , at \_\_\_\_\_  
 in Company \_\_\_\_\_, \_\_\_\_\_ Regiment of \_\_\_\_\_ Volunteers, to serve \_\_\_\_\_  
 years or during the war; he was born in \_\_\_\_\_ in the State  
 of \_\_\_\_\_: he was \_\_\_\_\_ years of age, \_\_\_\_\_ feet \_\_\_\_\_ inches  
 high, \_\_\_\_\_ complexion, \_\_\_\_\_ eyes, \_\_\_\_\_ hair, and by occupation, when enrolled,  
 a \_\_\_\_\_; he died in San Pedro de Abasco Genl Hospital at  
New Orleans La on the 7th day of June 1864, by  
 reason of Small Pox

Evidence of disposition made of effects

Admitted April 26th 1864

INVENTORY.					
ARTICLES.	No.	ARTICLES.	No.	ARTICLES.	No.
Hats.....		Pairs trousers.....	/	Knapsacks.....	
Caps.....		Pairs flannel drawers.....			
Forage Caps.....		Pairs cotton drawers.....			
Great coats.....		Flannel shirts.....			
Uniform coats.....		Cotton shirts.....			
Uniform jackets.....		Pairs boots.....			
Flannel sack coats.....		Pairs shoes.....	/		
Blouses.....	/	Pairs socks.....			
Stable frocks.....		Blankets.....			
Fatigue overalls.....		Haversacks.....			
				MONEY.	
				Specie.....	\$
				Notes.....	\$

I CERTIFY, ON HONOR, that the above inventory comprises all the effects of \_\_\_\_\_  
 \_\_\_\_\_, deceased, and that the effects are in the hands  
 of \_\_\_\_\_ at \_\_\_\_\_  
 \_\_\_\_\_ to be disposed of by a Council of Administration.

(DUPLICATES.)

STATION: \_\_\_\_\_

\_\_\_\_\_ Commanding the Company.

DATE: \_\_\_\_\_

ARTICLES OF WAR.

ART. 95. When any non-commissioned officer or soldier shall die, or be killed in the service of the United States, the then commanding officer of the troop or company shall, in the presence of two other commissioned officers, take an account of what effects he died possessed of, above his arms and accoutrements, and transmit the same to the office of the Department of War, which said effects are to be accounted for, and paid to the representatives of such deceased non-commissioned officer or soldier. And in case any of the officers, so authorized to take care of the effects of deceased officers and soldiers, should, before they have accounted to their representatives for the same, have occasion to leave the regiment or post, by preferment or otherwise, they shall, before they be permitted to quit the same, deposit in the hands of the commanding officer, or of the assistant military agent, all the effects of such deceased non-commissioned officers and soldiers, in order that the same may be secured for, and paid to, their respective representatives.

ARMY REGULATIONS—EDITION OF 1861.

DECEASED SOLDIERS.

Par. 152. Inventories of the effects of deceased non-commissioned officers and soldiers, required by the 95th Article of War, will be forwarded to the Adjutant General, by the commander of the company to which the deceased belonged, and a duplicate of the same to the colonel of the regiment. Final statements of pay, clothing, &c., will be sent with the inventories. When a soldier dies at a post or station absent from his company, it will be the duty of his immediate commander to furnish the required inventory, and, at the same time, to forward to the commanding officer of the company to which the soldier belonged, a report of his death, specifying the date, place, and cause; to what time he was last paid, and the money or other effects in his possession at the time of his decease; which report will be noted on the next muster roll of the company to which the man belonged. Each inventory will be endorsed, "Inventory of the effects of \_\_\_\_\_, late of company (—) \_\_\_\_\_ regiment of \_\_\_\_\_, who died at \_\_\_\_\_, the \_\_\_\_\_ day of \_\_\_\_\_, 186—." If a legal representative receive the effects, it will be stated in the report. If the soldier leave no effects, the fact will be reported.

Par. 153. Should the effects of a deceased non-commissioned officer or soldier not be administered upon within a short period after his decease, they shall be disposed of by a Council of Administration, under the authority of the commanding officer of the post, and the proceeds deposited with the Paymaster, to the credit of the United States, until they shall be claimed by the legal representatives of the deceased.

Par. 154. In all such cases of sales by the Council of Administration, a statement in detail, or account of the proceeds, duly certified by the Council and commanding officer, accompanied by the Paymaster's receipt for the proceeds, will be forwarded by the commanding officer to the Adjutant General. The statement will be endorsed, "Report of the proceeds of the effects of \_\_\_\_\_, late of company (—) \_\_\_\_\_ regiment of \_\_\_\_\_, who died at \_\_\_\_\_, the \_\_\_\_\_ day of \_\_\_\_\_, 186—."

NOTE 1.—The effects in all cases, when called for, should be turned over to the legal representative, without further authority from the Adjutant General. When the effects are turned over to the relatives of the deceased before these inventories are sent to the Adjutant General, their receipts therefor should be attached to the inventories. In all other cases, one copy will be sent with a letter of transmittal direct to the Adjutant General, and a duplicate retained by the officer.

NOTE 2.—Particular care should be taken to take receipts in duplicate from the Paymaster for any funds turned over to him; one copy should be sent direct to the Adjutant General and one retained by the officer.

*Duplicate*  
*Had no Descriptive List*  
INVENTORY OF THE EFFECTS

OF

*Private Lewis Clayborn*

Late of Company *E*

*16*  
Reg't of *U.S. Heavy Artillery Colored*

Volunteers, who died at *Leeds & Spivey Hill*

on the *7<sup>th</sup>* day of *June* 186*4*

Inventory of the effects of Lewis Clayborn late  
 a Private of Captain \_\_\_\_\_ Company E of  
 the 1st Regiment of U.S. Heavy Artillery Colored Volunteers, who was enrolled as  
 a \_\_\_\_\_ at \_\_\_\_\_ in the State of \_\_\_\_\_ on  
 the \_\_\_\_\_ day of \_\_\_\_\_ 186 , and mustered into the service of the United  
 States as a \_\_\_\_\_ on the \_\_\_\_\_ day of \_\_\_\_\_ 186 , at \_\_\_\_\_  
 in Company \_\_\_\_\_, \_\_\_\_\_ Regiment of \_\_\_\_\_ Volunteers, to serve \_\_\_\_\_  
 years or during the war; he was born in \_\_\_\_\_ in the State  
 of \_\_\_\_\_; he was \_\_\_\_\_ years of age, \_\_\_\_\_ feet \_\_\_\_\_ inches  
 high, \_\_\_\_\_ complexion, \_\_\_\_\_ eyes, \_\_\_\_\_ hair, and by occupation, when enrolled,  
 a \_\_\_\_\_; he died in Camps d' Afrique Genl Hospital at  
New Orleans Louisiana on the 7<sup>th</sup> day of June 1864, by  
 reason of Small-pox

INVENTORY.					
ARTICLES.	No.	ARTICLES.	No.	ARTICLES.	No.
Hats.....	<u>e</u>	Pairs trousers.....	<u>1</u>	Knapsacks.....	
Caps.....	<u>e</u>	Pairs flannel drawers.....	<u>e</u>		
Forage caps.....	<u>e</u>	Pairs cotton drawers.....	<u>e</u>		
Great coats.....	<u>e</u>	Flannel shirts.....	<u>e</u>		
Uniform coats.....	<u>e</u>	Cotton shirts.....	<u>e</u>		
Uniform jackets.....	<u>e</u>	Pairs boots.....	<u>e</u>		
Flannel sack coats.....	<u>e</u>	Pairs shoes.....	<u>1</u>		
Blouses.....	<u>1</u>	Pairs socks.....	<u>e</u>		
Stable frocks.....	<u>e</u>	Blankets.....	<u>e</u>		
Fatigue overalls.....	<u>e</u>	Haversacks.....	<u>e</u>		
				MONEY.	
				Specie.....	<u>0</u>
				Notes.....	<u>0</u>

I CERTIFY, ON HONOR, that the above inventory comprises all the effects of Private  
Lewis Clayborn, deceased, and that the effects are in the hands  
 of Surgeon in Charge at Camps d' Afrique Genl Hospital  
New Orleans Louisiana to be disposed of by a Council of Administration.

( DUPLICATES. )

STATION: New Orleans La  
 DATE: 7<sup>th</sup> June 1864

Surgeon 86<sup>th</sup> Regt U.S. Colored Infantry  
 Commanding the Company.  
In Charge of Camps d' Afrique Genl Hospital

<sup>1600</sup>  
Lewis, Dennis

Co D, 10 U.S. Col'd H. Art'y

Private | Private

CARD NUMBERS.

1	5-494229	26
2	5-494381	27
3	5-494541	28
4	5-494699	29
5	5-494854	30
6	5-495007	31
7	5-495164	32
8	5-495319	33
9	5-495471	34
10	5-495621	35
11	5-495760	36
12	5-495917	37
13	5-496062	38
14	5-496260	39
15	5-497445	40
16		41
17		42
18		43
19		44
20		45
21		46
22		47
23		48
24		49
25		50

Book Mark: S.B.V.10.12.934

See also



1858434 P.O. aff

D 1820866 P.O. aff

A 1837953 P.O. aff

J 1841757 P.O. aff

C. S. Doughty

2



*L* | 10 H. Art'y. | U.S.C.T.

*Dennis Lewis*

*Pvt.*, Co. B, 1 Reg't La. H. Art'y, Native Guards.\*

Appears on

**Company Muster Roll**

for *from Enlistment to Feb. 28, 1863.*

Present or absent *Present*

Stoppage, \$ *100* for

Due Gov't, \$ *100* for

Valuation of horse, \$ *100*

Valuation of horse equipments, \$ *100*

Remarks:

\*This organization subsequently became Co. B, 10 Reg't U. S. Col'd Heavy Artillery.

Book mark:

*Heaster*

*L* | 10 H. Art'y. | U.S.C.T.

*Dennis Lewis*  
*Co. B.*, Co. B, 1 Reg't La. H. Art'y, Native Guards.\*

Appears on

**Company Muster Roll**

for *March & April*, 186 *3*.

Present or absent *Present*

Stoppage, \$ *100* for

Due Gov't, \$ *100* for

Valuation of horse, \$ *100*

Valuation of horse equipments, \$ *100*

Remarks: \_\_\_\_\_  
\_\_\_\_\_  
\_\_\_\_\_  
\_\_\_\_\_  
\_\_\_\_\_  
\_\_\_\_\_

\*This organization subsequently became Co. B, 10 Reg't U. S. Col'd Heavy Artillery.

Book mark: \_\_\_\_\_

*F. Easter*

L | 10 H. Art'y. | U.S.C.T.

*Dennis Lewis*  
Pot., Co. B, 1 Reg't La. H. Art'y, Native Guards.\*

Appears on

**Company Muster Roll**

for *May & June*, 186*3*.

Present or absent *Present*

Stoppage, \$ *100* for

Due Gov't, \$ *100* for

Valuation of horse, \$ *100*

Valuation of horse equipments, \$ *100*

Remarks:

\*This organization subsequently became Co. B, 10 Reg't U. S. Col'd Heavy Artillery.

Book mark:

*Feaster*

2 | 10 H. Art'y. | U.S.C.T.

*Jimmie Lewis*  
Col., Co. B, 1 Reg't La. H. Art'y, Native Guards.\*

Appears on

**Company Muster Roll**

for *July & Aug.*, 186 *3*.

Present or absent *Present*

Stoppage, \$ *100* for

Due Gov't, \$ *100* for

Valuation of horse, \$ *100*

Valuation of horse equipments, \$ *100*

Remarks:

\*This organization subsequently became Co. B, 10 Reg't U. S. Col'd Heavy Artillery.

Book mark:

*Feaster*

*D* | 10 H. Art'y. | U.S.C.T.

*Jennies Lewis*  
Co. B, 1 Reg't La. H. Art'y, Native Guards.\*

Appears on

**Company Muster Roll**

for *Sept. & Oct.*, 186 *3*.

Present or absent *Present*

Stoppage, \$ *100* for

Due Gov't, \$ *100* for

Valuation of horse, \$ *100*

Valuation of horse equipments, \$ *100*

Remarks:

\*This organization subsequently became Co. B, 10 Reg't U. S. Col'd Heavy Artillery.

Book mark:

*Spaster*

L | 10 H. Art'y. | U.S.C.T.

*Jennio Lewis*

*P*, Co. *B*, 1 Reg't H. Art'y, Corps d'Afrique.\*

Appears on

**Company Muster Roll**

for *Nov. & Dec.*, 186*3*.

Present or absent *Present*

Stoppage, \$ 100 for

Due Gov't, \$ 100 for

Valuation of horse, \$ 100

Valuation of horse equipments, \$ 100

Remarks:

\*This organization subsequently became Co. , 10 Reg't U. S. Colored Heavy Artillery.

Book mark:

*Alif*  
Copyist.



L | 10 H. Art'y. | U.S.C.T.

Dennis Lewis

Pl, Co. B, 1 Reg't H. Art'y, Corps d'Afrique.\*

Appears on

**Company Muster Roll**

for Jan. 1, Feb., 1864.

Present or absent Present

Stoppage, \$ 100 for

Due Gov't, \$ 100 for

Valuation of horse, \$ 100

Valuation of horse equipments, \$ 100

Remarks:

\*This organization subsequently became Co. , 10 Reg't U. S. Colored Heavy Artillery.

Book mark:

(358)

Ref

Copyist.

L | 10 H. Art'y. | U.S.C.T.

*Dennis Lewis*

*Pl*, Co. *B*, 7 Reg't U. S. Col'd H. Art'y.\*

Appears on

**Company Muster Roll**

for *Mich. & Apr.*, 186*4*.

Present or absent *Present*

Stoppage, \$ *100* for

Due Gov't, \$ *100* for

Valuation of horse, \$ *100*

Valuation of horse equipments, \$ *100*

Remarks: *Company book*

\* This organization subsequently became Co. , 10 Reg't U. S. Colored Heavy Artillery.

Book mark: \_\_\_\_\_

*Reif*  
Copyist.

*L* | 10 H. Art'y. | U.S.C.T.

*Dennis Lewis*

*Pt*, Co. *B*, 7 Reg't U. S. Col'd H. Art'y.\*

Appears on

**Company Muster Roll**

for *May & June, 1864*

Present or absent *Present*

Stoppage, \$ 100 for

Due Gov't, \$ 100 for

Valuation of horse, \$ 100

Valuation of horse equipments, \$ 100

Remarks:

\* This organization subsequently became Co. , 10 Reg't U. S. Colored Heavy Artillery.

Book mark:

*Ref*

*L/* | **10 H. Art'y. U.S.C.T.**

*Amos Lewis*  
*A.*, Co. B, 10 Reg't U. S. Col'd H. Art'y.

Appears on

**Company Muster Roll**

for *July & Aug*, 186*4*

Present or absent *Present*

Stoppage, \$ 100 for

Due Gov't, \$ 100 for

Valuation of horse, \$ 100

Valuation of horse equipments, \$ 100

Remarks: *Sick*

Book mark: \_\_\_\_\_

*J. Richardson*  
Copyist.

*L* | **10 H. Art'y. | U.S.C.T.**

*Dennis Lewis*  
*A*, Co. B, 10 Reg't U. S. Col'd H. Art'y.

Appears on

**Company Muster Roll**  
for *Sept & Oct*, 186*4*.

Present or absent *Present*

Stoppage, \$ 100 for

Due Gov't, \$ 100 for

Valuation of horse, \$ 100

Valuation of horse equipments, \$ 100

Remarks: \_\_\_\_\_  
\_\_\_\_\_  
\_\_\_\_\_  
\_\_\_\_\_  
\_\_\_\_\_  
\_\_\_\_\_

Book mark: \_\_\_\_\_

*J. Richardson*  
(358) *J. Richardson* Copyist.

*L* | **10 H. Art'y. | U.S.C.T.**

*Dennis Lewis*

*Pvt*, Co. B, 10 Reg't U. S. Col'd H. Art'y.

Appears on

**Company Muster Roll**

for *Nov & Dec*, 186*4*.

Present or absent *Present*

Stoppage, \$.....*100* for .....

Due Gov't, \$.....*100* for .....

Valuation of horse, \$.....*100*

Valuation of horse equipments, \$.....*100*

Remarks: .....

.....  
.....  
.....  
.....  
.....  
.....  
.....  
.....

Book mark: .....

*Josiah*

*S.* | **10 H. Art'y.** | **U.S.C.T.**

*Jimmie Lewis*

*Pvt.*, Co. B, 10 Reg't U. S. Col'd H. Art'y.

Appears on

**Company Muster Roll**

for *Jan & Feb*, 1865.

Present or absent

Stoppage, \$ 100 for

Due Gov't, \$ 100 for

Valuation of horse, \$ 100

Valuation of horse equipments, \$ 100

Remarks: *Discharged Feb 23*

*1865 on Surg's certificate*

*of disability at New*

*Orleans La.*

Book mark:

*Jimmie*

*L* | 10 H. Art'y. | U.S.C.T.

*Dennis Lewis*  
*Put*, Co. *D*, 10 Reg't U. S. Col'd H. Art'y.

Appears on **Co. Muster-out Roll**, dated  
*Baton Rouge La. Feb.*, 1867.

Muster-out to date ..... 186 .

Last paid to ..... 186 .

**Clothing account:**

Last settled ..... 186 ; drawn since \$ ..... 100

Due soldier \$ ..... 100 ; due U. S. \$ ..... 100

Am't for cloth'g in kind or money adv'd \$ ..... 100

Due U. S. for arms, equipments, &c., \$ ..... 100

Bounty paid \$ ..... 100 ; due \$ ..... 100

**Remarks:**

*Joined org'l. orgn.  
Discharged Feb'y 26/65  
on Surgeon's Certificate  
of disability.*

Book mark:

*199.346  
V211 P.236.74  
Discharged Feb. 23, 1865 - E. B. V. 10 P. 934*

*Hodges*

Copyist.



Lewis, Dennis

P, Co. B, 10 U.S.C.H.A.  
Regt

1 Enclosures.

Bed Cards	Descriptive Lists
Burial Records	Final Statements
Certs. of Dis. for Discharge	Furloughs
C. M. Charges	Med. Des. Lists
Med. Certificates	Orders

Other papers relating to—

Admission to Hosp'l	Furlough
Casualty Sheet (Officer's)	Med. Examination
Confinement	Misc. Information
Contracts	Pay or Clothing
Death or Effects	Personal Reports
Desertions	Rank
Discharge from Hosp'l	Transfer to Hosp'l
Discharge from Service	Transfer to V. R. C.
Duty	Transportation

[OFFICE INDORSEMENT.]

# War Department.

ADJUTANT GENERAL'S OFFICE,

December 5<sup>th</sup>, 1874

The discharge of Dennis Lewis  
Private, Co. B., 10<sup>th</sup> Reg't U. S.  
Colored Inf. (Hvy), is reported as follows:

- On Company Muster Roll.
- For Jan. & Feb., 1865, Feb. 23<sup>d</sup>, 1865
- Company Muster-out Roll.
- February 26<sup>th</sup>, 1865
- Company Descriptive Book. ...., 186
- Company Morning Reports. ...., 186
- Soldier's Final Statement. ...., 186
- Soldier's Record of Death and Interment. ...., 186
- Soldier's Inventory of Effects. ...., 186
- Soldier's Certificate of Disability for Discharge.
- February 23<sup>d</sup>, 1865
- Soldier's Individual Muster-out Roll. ...., 186
- Regimental Return.
- For ....., 186, ....., 186
- Regimental Quarterly Returns. ...., 186
- Regimental Descriptive Book. ...., 186
- By Surgeon General. ...., 186
- (.....), 186
- February 23<sup>d</sup>, 1865; is held to be the correct date, and the Company Muster-out Roll will be amended accordingly.

*Thomas M. Sweet*  
 11 per letter of Jan 6 1875  
 Assistant Adjutant General.  
 Noted 234. to 2<sup>d</sup> Auditor  
 T.M.

NOTE 1.

The company commander will here add a statement of all the facts known to him concerning the disease or wound, or cause of disability of the soldier; the time, place, manner, and all the circumstances under which the injury occurred, or disease originated or appeared; the duty, or service, or situation of the soldier at the time the injury was received or disease contracted, stating particularly whether the injury was received or the disease contracted in the line of his duty; and whatever other facts may aid a judgment as to the cause, immediate or remote, of the disability, and the circumstances attending it.

When the facts are not known to the company commander, the certificate of any officer, or affidavit of other person having such knowledge, will be appended—as the surgeon in charge of a hospital, the officer commanding a detachment of recruits, &c., &c.

NOTE 2.

When a probable case for pension, special care must be taken to state the degree of disability—as 1, 2, &c., &c.; to describe particularly the disability, wound, or disease; the extent of which it deprives him of the use of any limb or faculty, or affects his health, strength, activity, constitution, or capacity to labor or earn his subsistence. The surgeon will add, from his knowledge of the facts and circumstances, and from the evidence in the case, his professional opinion of the cause or origin of the disability. In the case of discharges by Medical Inspectors, the last paragraph will state that the "discharge was given by consent of the soldier, after a personal examination, and for disability, the nature, degree, and origin of which are correctly described in the within certificate."

Par. 1260 Regulations, Edit. 1861.

Medical officers, in giving certificates of disability, are to take particular care in all cases that have not been under their charge; and especially in epilepsy, convulsions, chronic rheumatism, derangement of the urinary organs, ophthalmia, ulcers, or any obscure disease liable to be feigned or purposely produced; and in no case shall such certificate be given until after sufficient time and examination to detect any attempt at deception.

DIRECTIONS.

This certificate will be made out in duplicate by the soldier's company commander, or other officer commanding the separate detachment to which he belongs, and sent by him to the surgeon who has charge of the hospital where the soldier is sick. The surgeon will then fill out and sign the surgeon's certificate, and forward these papers to the regimental, detachment, or post commander, who will forward them, with his action endorsed thereon, through the proper channel, to his division commander; or, if the troops are not attached to a division, to his corps, department, or other commander or officer to whom the authority to discharge enlisted men may be specially delegated.

These certificates, after having received the action of the highest authority to which they are required to be sent, will be returned through the same channel to the regimental, post, or detachment commander, who will, if the discharge is authorized by the endorsement of the proper authority, sign the soldier's discharge, and the last certificate on this paper; see that the soldier is furnished with the proper final statements in duplicate, and forward BOTH of these certificates direct to the Adjutant General United States Army, at Washington, D. C.; they will not, under any circumstances, be given into the hands of the soldier.

ADJUTANT GENERAL'S OFFICE

Feb 11 1865

Duplicate sent the Pension Office.

CERTIFICATE OF DISABILITY FOR DISCHARGE  
IN THE CASE OF

*2930-3 1865 29*  
Dennis Lewis  
a Private of Co. B  
10<sup>th</sup> Reg't of U.S.C. Art. (2)

Cornel Aubignie U.S. Gen. Hosp.  
New Orleans La.  
February 21/65

Approved by board of examination  
F. E. Pywette  
President of board.

~~1203~~ ~~29~~ 1879  
(2. Endmt.)

Approved Feb. 22 5

*R. A. Blenman*

Received A. G. Office, 1865



*Head Qrs Dept of the Gulf  
New Orleans Feb 22 1865*

*To be discharged  
By command of  
Maj. Genl. Hurlbut,*

*J. Stone  
Capt & Adj. General*

# ARMY OF THE UNITED STATES.

## CERTIFICATE

### OF DISABILITY FOR DISCHARGE.



Private Dennis Lewis, of Captain Arthur McAllister's Company, (B) of the Tenth Regiment of the United States Colored (H) was enlisted by 2<sup>d</sup> Lieut. S. Rygard of the 1<sup>st</sup> Regiment of Miss. Inf. Regt. at Camp Parapet La on the eleventh day of August, 1862, to serve three years; he was born in Taylor County in the State of Kentucky, is thirty six years of age, five feet seven half inches high, dark complexion, brown eyes, dark hair, and by occupation when enlisted a Laborer. During the last two months said soldier has been unfit for duty 60 days.\* This soldier has been entirely unfit for duty for the above named period in consequence of disease contracted before enlistment.

STATION: Fort St Philip La  
 DATE: February 13<sup>th</sup> 1865

Thomas M. Cornack  
1<sup>st</sup> Lieut 10<sup>th</sup> U.S.C. Artillery  
 Commanding Company.

I CERTIFY, that I have carefully examined the said Private Dennis Lewis of Captain Arthur McAllister's Company, and find him incapable of performing the duties of a soldier because of † Fistula in Ano which renders him miserable and unfit for duty. He is unfit for the Medical Corp. Disability three months (3)

William A. Whitted 10<sup>th</sup> U.S.C. Artillery  
 Surgeon.

DISCHARGED, this 23 day of February, 1865, at Fort St Philip La  
without hospital near camp.  
F. E. Piquette  
 Commanding the Reg't.

The Soldier desires to be addressed at  
 Town \_\_\_\_\_ County \_\_\_\_\_ State \_\_\_\_\_

\* See Note 1 on the back of this. † See Note 2 on the back of this.

1601  
Lewis, Edward

Co F, 10 U.S. Col'd H. Art'y

Private | Private

CARD NUMBERS.

1	5488760	26
2	5505814	27
3	5505968	28
4	5506113	29
5	5506294	30
6	5506990	31
7	5489893	32
8		33
9		34
10		35
11		36
12		37
13		38
14		39
15		40
16		41
17		42
18		43
19		44
20		45
21		46
22		47
23		48
24		49
25		50

Book Mark:

See also 77. U.S.C. Inf

S. 1356366 P D M M  
# 2581896 And WD

G. S. Doughty  
2

L 110 *Art'y* | **U.S.C.T.**

*Edward Lewis*

*Pr*, Co. *B*, 10 Reg't U. S. Col'd *Art'y*

Appears on

**M. and D. Roll of Men Transferred**

to the organization named above,

from *77 Reg U.S. C. Inf.*

Roll dated *Oct 1*, 1865.

When enlisted *Mar 18*, 1863.

Period for which enlisted *3* years.

When mustered in *Mar 23*, 1863.

Present or absent *Present*

Company to which assigned *B*

Remarks: *Joined by transfer from 4<sup>th</sup> Inf Cda Dec. 8, 63*

Book mark :

*J. W. Hemant*

L

10 H. Art'y. U.S.C.T.

Edward Lewis

Priv, Co. F, 10 Reg't U. S. Col'd H. Art'y.

Appears on

Company Muster Roll

for Sept & Oct, 1865

Present or absent Present

Stoppage, \$ 100 for

Due Gov't, \$ 100 for

Valuation of horse, \$ 100

Valuation of horse equipments, \$ 100

Remarks: Transferred from Co. D 77 U.S. C.I. Oct 1/65 On daily duty as Co. Cook.

Book mark:

B. G. Masdon



L. | 10 H. Art'y. | U.S.C.T.

Edward Lewis

Priv., Co. F, 10 Reg't U. S. Col'd H. Art'y.

Appears on

**Company Muster Roll**

for Nov. & Dec., 1865.

Present or absent Present.

Stoppage, \$ 100 for

Due Gov't, \$ 100 for

Valuation of horse, \$ 100

Valuation of horse equipments, \$ 100

Remarks: On daily duty as  
Co. Cook. Stop \$4 due  
J. Egan Tailor

Book mark:

L. | 10 H. Art'y. | U.S.C.T.

Edward Lewis

Pvt., Co. F, 10 Reg't U. S. Col'd H. Art'y.

Appears on

**Company Muster Roll**

for Jan'y & Feby., 1866.

Present or absent Present.

Stoppage, \$ 100 for

Due Gov't, \$ 100 for

Valuation of horse, \$ 100

Valuation of horse equipments, \$ 100

Remarks: On daily duty as  
cook.

Book mark: Mustered out on file.

Asst.  
Copyist.

L. | 10 H. Art'y. | U.S.C.T.

*Edward Lewis*

*Priv.*, Co. F, 10 Reg't U. S. Col'd H. Art'y.

Appears on

**Company Muster Roll**

for *Mar & April*, 1866.

Present or absent

Stoppage, \$ 100 for

Due Gov't, \$ 100 for

Valuation of horse, \$ 100

Valuation of horse equipments, \$ 100

Remarks: *Mustered out by reason of expiration of term of service.*

Book mark:

*ASL*  
Copyist.

L

10 H. Art'y. U.S.C.T.

Edward Lewis

Priv., Co. F., 10 Reg't U. S. Col'd H. Art'y.

Appears on Co. Muster-out Roll, dated

Baton Rouge La., Feb. 22, 186 .

Muster-out to date \_\_\_\_\_, 186 .

Last paid to Dec 31 \_\_\_\_\_, 1865 .

Clothing account:

Last settled \_\_\_\_\_, 186 ; drawn since \$ \_\_\_\_\_ 100

Due soldier \$ \_\_\_\_\_ 100; due U. S. \$ \_\_\_\_\_ 100

Am't for cloth'g in kind or money adv'd \$ \_\_\_\_\_ 100

Due U. S. for arms, equipments, &c., \$ \_\_\_\_\_ 100

Bounty paid \$ \_\_\_\_\_ 100; due \$ \_\_\_\_\_ 100

Remarks: Rec'd by transfer from

Co. D. 77 U. S. C. I. pr. S. O. No.

66 Hd Qrs Dept. of La. S. of 65

Discharge by expiration  
of service Mch 17/66.

Book mark: W. S. P. 148 68

House

L <sup>10</sup> Hy Arty U.S.C.T.

Edward Lewis

Pvt, Co. F, 10 Reg't U. S. Col'd Arty

Appears on a

**Detachment Muster-out Roll**

of the organization named above. Roll dated

New Orleans La. <sup>March 17</sup> 1866.

Muster-out to date <sup>March 17</sup> 1866.

Last paid to <sup>Dec. 31</sup> 1865

**Clothing account:**

Last settled ..... 186 ; drawn since \$ ..... 100

Due soldier \$ <sup>1</sup> <sup>28</sup> / 100 ; due U. S. \$ ..... 100

Am't for cloth'g in kind or money adv'd \$ ..... 100

Due U. S. for arms, equipments, &c., \$ ..... 100

Bounty paid \$ ..... 100 due \$ ..... 100

Remarks: Enlisted as recruit  
in 4<sup>th</sup> Inf. Cd. A. (76<sup>th</sup> U.  
S. C. I.) Transferred as Pvt.  
to 5<sup>th</sup> Inf. Cd. A. (77<sup>th</sup> U. S. C. I.)  
December 1863. Transferred  
from 77<sup>th</sup> U. S. C. I. per S. O.  
(over)

Book mark: .....

H. H. Reed

JAN. 15

5489893

★ 1891 ★

66. Ad. Drs. Dept. of La.  
series of 65.

1902  
Lewis, Elijah

Co E, 10 U.S. Col'd H. Art'y.

Private | Corporal

CARD NUMBERS.

15488610	26
15503547	27
15503745	28
15503880	29
15504025	30
15504154	31
15504268	32
15504354	33
15504454	34
	35
	36
	37
	38
	39
	40
	41
	42
	43
	44
	45
	46
	47
	48
	49
	50

Book Mark:

See also 74. U.S.C. Inf.

Rep 365614-

D. 2259104 P. O. M M  
4290 6013 acid 112

S. R. Doughty



L 10th. U.S.C.T.

Elijah Lewis  
Pvt, Co. 10 Reg't U. S. Col'd Art. Arty

Appears on

**M. and D. Roll of Men Transferred**

to the organization named above,

from Co "A" 7th U.S. C. Inf.

Roll dated New Orleans, La. 11/1865.

When enlisted Dec 25<sup>th</sup>, 1864.

Period for which enlisted 3 years.

When mustered in Jan 3, 1865.

Present or absent

Company to which assigned

Remarks: Joined as recruit  
Co "A" 7th U.S. C. Inf.

Book mark :

(342) T. W. Jones, Jr. Copyist.

L | 10 H. Art'y. | U.S.C.T.

Elijah Lewis  
Priv, Co. E, 10 Reg't U. S. Col'd H. Art'y.

Appears on

**Company Muster Roll**

for Nov & Dec, 186 5

Present or absent Present

Stoppage, \$ 100 for

Due Gov't, \$ 100 for

Valuation of horse, \$ 100

Valuation of horse equipments, \$ 100

Remarks: Transferred from 74<sup>th</sup>  
U.S.C.I. to 10<sup>th</sup> U.S.C.A. Reg.  
per S.O. 84 Hd Qrs Dept of  
La Oct 11 - 1865

Book mark: \_\_\_\_\_

L | 10 H. Art'y. | U.S.C.T.

Elijah Lewis  
Pvt, Co. E, 10 Reg't U. S. Col'd H. Art'y.

Appears on

**Company Muster Roll**

for Jan & Feb, 1866.

Present or absent Present

Stoppage, \$ 100 for

Due Gov't, \$ 100 for

Valuation of horse, \$ 100

Valuation of horse equipments, \$ 100

Remarks:

Book mark:

L | 10 H. Art'y. | U.S.C.T.

Elijah Lewis

Priv, Co. E, 10 Reg't U. S. Col'd H. Art'y

Appears on

**Company Muster Roll**

for March & April, 1866.

Present or absent Present

Stoppage, \$ 100 for

Due Gov't, \$ 100 for

Valuation of horse, \$ 100

Valuation of horse equipments, \$ 100

Remarks:

.....  
.....  
.....  
.....  
.....  
.....  
.....

Book mark:

.....

Hart

L | 10 H. Art'y. | U.S.C.T.

Elijah Lewis

Pvt, Co. E, 10 Reg't U. S. Col'd H. Art'y

Appears on

**Company Muster Roll**

for May & June, 1866.

Present or absent Present

Stoppage, \$ 100 for

Due Gov't, \$ 100 for

Valuation of horse, \$ 100

Valuation of horse equipments, \$ 100

Remarks: Due Soldier \$100. 2<sup>d</sup>  
installment of bounty per  
circ 27 Pro War Gen  
Office July 19-1864

Book mark: \_\_\_\_\_

Hart

Copyist.

L [ 10 H. Art'y. | U.S.C.T.

*Elijah Lewis*

*Pvt.*, Co. E, 10 Reg't U. S. Col'd H. Art'y.

Appears on

**Company Muster Roll**

for *July & Aug*, 1866.

Present or absent *Present*

Stoppage, \$ *100* for

Due Gov't, \$ *100* for

Valuation of horse, \$ *100*

Valuation of horse equipments, \$ *100*

Remarks:

Book mark:

*Harr*

*L* | **10 H. Art'y. | U.S.C.T.**

*Elijah Lewis*  
*Pvt.*, Co. E, 10 Reg't U. S. Col'd H. Art'y.

Appears on

**Company Muster Roll**

for *Sept & Oct*, 1866.

Present or absent *Present*

Stoppage, \$ 100 for

Due Gov't, \$ 100 for

Valuation of horse, \$ 100

Valuation of horse equipments, \$ 100

Remarks:  
\_\_\_\_\_  
\_\_\_\_\_  
\_\_\_\_\_  
\_\_\_\_\_  
\_\_\_\_\_  
\_\_\_\_\_  
\_\_\_\_\_  
\_\_\_\_\_

Book mark: \_\_\_\_\_

*O'Hagan*, Copyist.

*L* | 10 H. Art'y. | U.S.C.T.

*Elijah Lewis*  
Corp, Co. E, 10 Reg't U. S. Col'd H. Art'y.

Appears on

**Company Muster Roll**

for *Nov. & Dec.*, 1866.

Present or absent *Present*

Stoppage, \$ *100* for

Due Gov't, \$ *100* for

Valuation of horse, \$ *100*

Valuation of horse equipments, \$ *100*

Remarks: *Promoted Corporal*  
*Nov. 1, 1866.*

Book mark: *3000*



*L* | 10 H. Art'y. | U.S.C.T.

*Elijah Lewis*  
Corp, Co. *E*, 10 Reg't U. S. Col'd H. Art'y.

Appears on **Co. Muster-out Roll**, dated  
*Baton Rouge, La, Feb. 22,* 1867.  
Muster-out to date *Feb 22,* 1867.  
Last paid to *Dec 31,* 1866.

Clothing account:

Last settled....., 186 ; drawn since \$.....<sup>100</sup>  
Due soldier \$ *60*<sup>65</sup>/<sub>100</sub>; due U. S. \$.....<sup>100</sup>  
Am't for cloth'g in kind or money adv'd \$.....<sup>100</sup>

Due U. S. for arms, equipments, &c., \$ *6*<sup>10</sup>/<sub>100</sub>  
Bounty paid \$ *200*<sup>00</sup>/<sub>100</sub>; due \$.....<sup>100</sup>

Remarks: *Joined by transfer*  
*from Co. A, 7th U.S.C. Inf't,*  
*S. O. 84 Hd. Qrs. Dept. of La.*  
*Oct. 11, 1865. Private to Nov.*  
*1, 1866.*

Book mark: .....

(361) *O'Hagan* Copyist.

1603  
*Lewis, Florence*

Co. **10 U.S. Col'd H. Art'y.**

*Private*

CARD NUMBERS.

1	5487881	26
2		27
3		28
4		29
5		30
6		31
7		32
8		33
9		34
10		35
11		36
12		37
13		38
14		39
15		40
16		41
17		42
18		43
19		44
20		45
21		46
22		47
23		48
24		49
25		50

Book Mark:

See also *77. u.s.c.m.f.*

L 10 H.A. U.S.C.T.

Flourine Lewis  
Pot, Co., 10 Reg't U. S. Col'd H.A.

Appears on

**M. and D. Roll of Men Transferred**

to the organization named above,

from 1774 U.S. Col of Inf

Roll dated Camp Sanpedro, 1864.

When enlisted May 6, 1864

Period for which enlisted 3 years.

When mustered in May 13, 1864

Present or absent

Company to which assigned

Remarks: Died Sept 5, 64  
at St. Philip's  
Chronic Pneumonia

Not on muster rolls Regt.

Book mark:

W. H. Scott

1604  
Lewis, George

Co—, 10 U.S. Col'd H. Art'y.

Private

CARD NUMBERS.

1 5488783

26

27

28

29

30

31

32

33

34

35

36

37

38

39

40

41

42

43

44

45

46

47

48

49

50

Book Mark:

See also 77. m. s. c. inf.

L 111 N Art U.S.C.T.

George Lewis

Prw, Co., 111 Reg't U. S. Col'd N Art

Appears on

**M. and D. Roll of Men Transferred**

to the organization named above,

from 77 Reg. U.S.C. Inf

Roll dated Oct 1, 1865.

When enlisted Feb 24, 1863.

Period for which enlisted 3 years.

When mustered in Mar 20, 1863.

Present or absent

Company to which assigned

Remarks: Discharged for

Disability June 14, 65  
from U.S. Cad. Genl.  
Hosp. M. D.

Final statements given  
by Dr. Piquette

Not on muster roll Reg't

Book mark :

J. W. Leonard

1600  
Lewis, George

Col, 10 U.S. Col'd H. Art'y.

Private

Confidential

CARD NUMBERS.

1	5497736	26
2	5498175	27
3	5498435	28
4	5498551	29
5	5498692	30
6	5498831	31
7	5498968	32
8	5499109	33
9	5499245	34
10	5499382	35
11	5499516	36
12	5499653	37
13	5499789	38
14	5499924	39
15	5500054	40
16	5500189	41
17	5500260	42
18	5500427	43
19	5490125	44
20		45
21		46
22		47
23		48
24		49
25		50

Book Mark:

See also

*L* | 10 H. Art'y. | U.S.C.T.

*George Lewis*

*Pvt.*, Co. C, 1 Reg't La. Art'y, Native Guards.\*

Age *22* years.

Appears on

**Company Muster-in Roll**

of the organization named above. Roll dated

*New Orleans La. Feb 4, 1864.*

Muster-in to date *Feb 4, 1864.*

Joined for duty and enrolled:

When *Jan 10, 1864.*

Where *N. O. La.*

Period *3* years.

Valuation of horse, \$ *100*

Valuation of horse equipments, \$ *100*

Remarks:

\* This organization subsequently became Co. C, 10 Reg't U. S. Col'd Heavy Artillery.

Book mark:

(856)

*W. J. ...*

Copyist.

L | 10 H. Art'y. | **U.S.C.T.**

*George Lewis*

*D*, Co. *C*, 1 Reg't H. Art'y, Corps d'Afrique.\*

Appears on

**Company Muster Roll**

for *Feb 4<sup>th</sup> to 29<sup>th</sup>*, 186*4*.

Present or absent

Stoppage, \$ 100 for

Due Gov't, \$ 100 for

Valuation of horse, \$ 100

Valuation of horse equipments, \$ 100

Remarks: *Deserted from New Orleans La. Feb 17, 64*

*Aug 31. be next on which time*

\*This organization subsequently became Co. *C*, 10 Reg't U. S. Colored Heavy Artillery.

Book mark:

*effman*



L | **10 H. Art'y.** | **U.S.C.T.**

George Lewis

Pvt., Co. L, 7 Reg't U. S. Col'd H. Art'y.\*

Appears on

**Company Muster Roll**

for July & Aug, 186 4

Present or absent Present

Stoppage, \$.....100 for .....

Due Gov't, \$.....100 for .....

Valuation of horse, \$.....100

Valuation of horse equipments, \$.....100

Remarks:.....

\* This organization subsequently became Co. ...., 10 Reg't U. S. Colored Heavy Artillery.

Book mark:.....

J. Anderson  
Copyist.

L | 10 H. Art'y. | **U.S.C.T.**

George Lewis  
Priv., Co. C, 10 Reg't U. S. Col'd H. Art'y.

Appears on

**Company Muster Roll**

for Sept & Oct, 186 4

Present or absent Present

Stoppage, \$ 100 for

Due Gov't, \$ 100 for

Valuation of horse, \$ 100

Valuation of horse equipments, \$ 100

Remarks:

Book mark:

J. Hudson  
Coyist.

*L* | 10 H. Art'y. | U.S.C.T.

*George Lewis*  
*Priv.*, Co. C, 10 Reg't U. S. Col'd H. Art'y.

Appears on

**Company Muster Roll**

for *Nov & Dec, 1864*

Present or absent *Present*

Stoppage, \$.....<sup>100</sup> for.....

Due Gov't, \$.....<sup>100</sup> for.....

Valuation of horse, \$.....<sup>100</sup>

Valuation of horse equipments, \$.....<sup>100</sup>

Remarks:.....

Book mark:.....

*J. H. Underwood*  
Copyist.

*L* | **10 H. Art'y. | U.S.C.T.**

*George Lewis*  
*Plt*, Co. C, 10 Reg't U. S. Col'd H. Art'y.

Appears on

**Company Muster Roll**

for *Jan & Feb*, 186*5*.

Present or absent *Present*

Stoppage, \$.....100 for .....

Due Gov't, \$.....100 for .....

Valuation of horse, \$.....100

Valuation of horse equipments, \$.....100

Remarks: .....

.....  
.....  
.....  
.....  
.....  
.....  
.....  
.....

Book mark: .....

*Dallade*

L | 10 H. Art'y. | U.S.C.T.

George Lewis  
Priv., Co. C, 10 Reg't U. S. Col'd H. Art'y.

Appears on

**Company Muster Roll**

for March & April, 1865.

Present or absent Present

Stoppage, \$ 100 for

Due Gov't, \$ 100 for

Valuation of horse, \$ 100

Valuation of horse equipments, \$ 100

Remarks:

Book mark:

Lamb

L | 10 H. Art'y. | U.S.C.T.

George Lewis  
Pat., Co. C, 10 Reg't U. S. Col'd H. Art'y.

Appears on

**Company Muster Roll**

for May & June, 1865.

Present or absent Present

Stoppage, \$ 100 for \_\_\_\_\_

Due Gov't, \$ 100 for \_\_\_\_\_

Valuation of horse, \$ 100

Valuation of horse equipments, \$ 100

Remarks: \_\_\_\_\_  
\_\_\_\_\_  
\_\_\_\_\_  
\_\_\_\_\_  
\_\_\_\_\_  
\_\_\_\_\_  
\_\_\_\_\_  
\_\_\_\_\_

Book mark: \_\_\_\_\_

Sallade  
Coyist.

*4* | **10 H. Art'y. | U.S.C.T.**

*George Lewis*  
*Pat*, Co. C, 10 Reg't U. S. Col'd H. Art'y.

Appears on

**Company Muster Roll**

for *July & Aug*, 186 *5*.

Present or absent *Present*

Stoppage, \$.....*100* for .....

Due Gov't, \$.....*100* for .....

Valuation of horse, \$.....*100*

Valuation of horse equipments, \$.....*100*

Remarks: .....

Book mark: .....

*Dallade*

*L* | 10 H. Art'y. | U.S.C.T.

*George Lewis*  
*Pvt*, Co. C, 10 Reg't U. S. Col'd H. Art'y.

Appears on

**Company Muster Roll**

for *Sept & Oct*, 186*5*.

Present or absent *Present*

Stoppage, \$.....100 for .....

Due Gov't, \$.....100 for .....

Valuation of horse, \$.....100

Valuation of horse equipments, \$.....100

Remarks: .....

.....

.....

.....

.....

.....

.....

.....

.....

Book mark: .....

.....

.....

.....

.....

.....

*Dallade*



L | 10 H. Art'y. | **U.S.C.T.**

George Lewis  
Pvt., Co. C, 10 Reg't U. S. Col'd H. Art'y.

Appears on

**Company Muster Roll**

for Nov. & Dec., 1865.

Present or absent Present

Stoppage, \$ 100 for

Due Gov't, \$ 100 for

Valuation of horse, \$ 100

Valuation of horse equipments, \$ 100

Remarks:

Book mark:

A. J. Robbins

Copyist.

L | 10 H. Art'y. | **U.S.C.T.**

George Lewis  
Pvt., Co. C, 10 Reg't U. S. Col'd H. Art'y.

Appears on

**Company Muster Roll**  
for Jan. & Feb., 1866.  
Present or absent Present

Stoppage, \$.....100 for .....

Due Gov't, \$.....100 for .....

Valuation of horse, \$.....100

Valuation of horse equipments, \$.....100

Remarks: .....

Book mark: .....

A. J. Robbins  
Copyist.

*L* | 10 H. Art'y. | U.S.C.T.

*George Lewis*  
*Pvt.*, Co. C, 10 Reg't U. S. Col'd H. Art'y.

Appears on

**Company Muster Roll**

for *Mich. & Apr.*, 186*b*.

Present or absent *Present.*

Stoppage, \$ 100 for

Due Gov't, \$ 100 for

Valuation of horse, \$ 100

Valuation of horse equipments, \$ 100

Remarks:

Book mark:

*A. J. Robbins*

L | 10 H. Art'y. | U.S.C.T.

George Lewis  
Pvt., Co. C, 10 Reg't U. S. Col'd H. Art'y.

Appears on

**Company Muster Roll**

for May 2d June, 1866.

Present or absent Present

Stoppage, \$ 100 for

Due Gov't, \$ 100 for

Valuation of horse, \$ 100

Valuation of horse equipments, \$ 100

Remarks:

Book mark:

A. J. Robbins  
Copyist.

L | 10 H. Art'y. | U.S.C.T.

George Lewis  
Pot, Co. C, 10 Reg't U. S. Col'd H. Art'y.

Appears on

Company Muster Roll  
for July 2d Aug, 1860.  
Present or absent Present

Stoppage, \$ 100 for

Due Gov't, \$ 100 for

Valuation of horse, \$ 100

Valuation of horse equipments, \$ 100

Remarks:

Book mark:

(358)

A. J. Robbins

Copyist.

*L* | **10 H. Art'y. U.S.C.T.**

*George Lewis*  
*Prs*, Co. C, 10 Reg't U. S. Col'd H. Art'y.

Appears on

**Company Muster Roll**

for *Sept & Oct*, 18*66*.

Present or absent *Present*

Stoppage, \$.....100 for.....

Due Gov't, \$.....100 for.....

Valuation of horse, \$.....100

Valuation of horse equipments, \$.....100

Remarks:.....  
.....  
.....  
.....  
.....  
.....  
.....

Book mark:.....

*Hamm*  
Copyist.

*S* | 10 H. Art'y. | U.S.C.T.

*George Lewis*  
*Capt.*, Co. C, 10 Reg't U. S. Col'd H. Art'y.

Appears on

**Company Muster Roll**

for *Nov. 1866*, 1866.

Present or absent *Present*

Stoppage, \$ 100 for

Due Gov't, \$ 100 for

Valuation of horse, \$ 100

Valuation of horse equipments, \$ 100

Remarks: *Appointed Corp*  
*Nov 1. 1866 from*  
*private vice Wilson*  
*Appointed Serjt*

Book mark: \_\_\_\_\_

*Manning*  
Capt.

L 10 Arty

U.S.C.T.

George Lewis  
Corp., Co. B, 10 Reg't U. S. Col'd Arty

Appears on a

**Detachment Muster-out Roll**

of the organization named above. Roll dated

Baton Rouge, La., Feb. 3, 1867.

Muster-out to date Feb. 3, 1867.

Last paid to Dec. 31, 1866

**Clothing account:**

Last settled ..... 186 ; drawn since \$..... 100

Due soldier \$ 92 <sup>94</sup>/<sub>100</sub>; due U. S. \$ 22 <sup>37</sup>/<sub>100</sub>

Am't for cloth'g in kind or money adv'd \$..... 100

Due U. S. for arms, equipments, &c., \$..... 100

Bounty paid \$..... 100 due \$ 300 <sup>—</sup>/<sub>100</sub>

Remarks: Joined orig. org. 1 N.A. C & A.

Now 10 U.S. C.A. (Arty) was private

from enrolment to Nov. 1, 1866.

Book mark: .....

R. E. Wilson



*S* | 10 H. Art'y. | U.S.C.T.

*George Lewis*

*Co. C*, 10 Reg't U. S. Col'd H. Art'y.

Appears on **Co. Muster-out Roll**, dated  
*Baton Rouge, La, Feb 22*, 1867.

Muster-out to date \_\_\_\_\_, 186 .

Last paid to \_\_\_\_\_, 186 .

Clothing account:

Last settled \_\_\_\_\_, 186 ; drawn since \$ \_\_\_\_\_ 100

Due soldier \$ \_\_\_\_\_ 100; due U. S. \$ \_\_\_\_\_ 100

Am't for cloth'g in kind or money adv'd \$ \_\_\_\_\_ 100

Due U. S. for arms, equipments, &c., \$ \_\_\_\_\_ 100

Bounty paid \$ \_\_\_\_\_ 100; due \$ \_\_\_\_\_ 100

Remarks: *Joined Orig Co  
discharged Feb 3, 1867  
by reason of expiration  
of term of service*

Book mark: \_\_\_\_\_

1606  
Lewis, George

10 U.S. Col'd H. Art'y.

Private

Private

CARD NUMBERS.

1	5488550	26
2	5508422	27
3	5508573	28
4	5508724	29
5	5508871	30
6	5509071	31
7	5509461	32
8	5489385	33
9		34
10		35
11		36
12		37
13		38
14		39
15		40
16		41
17		42
18		43
19		44
20		45
21		46
22		47
23		48
24		49
25		50

Book Mark: E. B. 7. p. 458

See also 74 U.S.C. Inf.

S. 1250320 P. O. Mon  
Q 2838528 P. Ret.

G. S. Doughty

L 10th U.S.C.T.

George Lewis  
1st, Co. 10 Reg't U. S. Col'd St. Ariz

Appears on

**M. and D. Roll of Men Transferred**

to the organization named above,

from Co "A" 7th U.S. Col. Inf.

Roll dated New Orleans La Oct 11, 1863

When enlisted July 10, 1863

Period for which enlisted 3 years.

When mustered in Dec. 3, 1863

Present or absent

Company to which assigned

Remarks: Joined as a  
rec'd. Stgd for Stav-  
ersack. Freed on or  
before April 19 '61

Book mark :

J. W. Jones, Jr.  
Copyist.

10 H. Art'y. U.S.C.T.

*George Lewis*  
Pvt., Co. G, 10 Reg't U. S. Col'd H. Art'y.

Appears on

**Company Muster Roll**

for *Nov. & Dec.*, 186*5*.

Present or absent *Present*

Stoppage, \$ *100* for

Due Gov't, \$ *100* for

Valuation of horse, \$ *100*

Valuation of horse equipments, \$ *100*

Remarks: *Transferred from*  
*Co. F, 74th U.S.C. Inf. S. S.*  
*84, dated 1st Mars. Sept.*  
*of La.*

Book mark:

*G. F. J.*  
Copyist.

L | 10 H. Art'y. | U.S.C.T.

*George Lewis*  
*Capt.*, Co. G, 10 Reg't U. S. Col'd H. Art'y.

Appears on

**Company Muster Roll**

for *Jan 9 Feb.*, 186*6*.

Present or absent *Present*

Stoppage, \$.....100 for .....

Due Gov't, \$.....100 for .....

Valuation of horse, \$.....100

Valuation of horse equipments, \$.....100

Remarks: .....

.....  
.....  
.....  
.....  
.....  
.....  
.....  
.....

Book mark: .....

.....

*G. Fox*  
Copyist.

L | 10 H. Art'y. | U.S.C.T.

*George Lewis*  
*Capt*, Co. G, 10 Reg't U. S. Col'd H. Art'y.

Appears on

**Company Muster Roll**

for *Mar. & Apr.*, 1866.

Present or absent *Present*

Stoppage, \$.....100 for .....

Due Gov't, \$.....100 for .....

Valuation of horse, \$.....100

Valuation of horse equipments, \$.....100

Remarks: .....

Book mark: .....

*G. F. W.*

*L. 10th May* U.S.C.T.

*George Lewis.*

*Priv*, Co. *B*, *10th* Reg't U. S. Col'd *Army*.

Appears on

**Company Muster Roll**

for *May & June*, 186*6*

Present or absent *Present*

Stoppage, \$.....100 for .....

Due Gov't, \$.....100 for .....

Valuation of horse, \$.....100

Valuation of horse equipments, \$.....100

Remarks: *On daily duty as  
Member of Port Boat  
Crew*

Book mark: .....

*R. W. Fish*  
*Comp.* Copyright



*L* | 10 H. Art'y. | U.S.C.T.

*George Lewis*  
*Priv*, Co. G, 10 Reg't U. S. Col'd H. Art'y.

Appears on

**Company Muster Roll**

for *July & Aug*, 186*6*.

Present or absent.....

Stoppage, \$.....*100* for.....

Due Gov't, \$.....*100* for.....

Valuation of horse, \$.....*100*

Valuation of horse equipments, \$.....*100*

Remarks: *Discharged by reason of expiration of term of service. Mustered out to date July 14 1861.*

Book mark: *see ERB V. 72 458*

*G. Fox*  
Copyist.

L | 10 HA | U.S.C.T.

George Lewis  
Priv, Co. G, 10 Reg't U. S. Col'd HA

Appears on an

**Individual Muster-out Roll**

of the organization named above. Roll dated

New Orleans La July 14, 1866.

Muster-out to date

July 14, 1866.

Last paid to

April 30, 1866.

**Clothing account:**

Last settled ..... 186 ; drawn since \$ ..... 100

Due soldier \$ 27 <sup>48</sup> / 100; due U. S. \$ ..... 100

Am't for cloth'g in kind or money adv'd \$ ..... 100

Due U. S. for arms, equipments, &c., \$ ..... 100

Bounty paid \$ ..... 100 due \$ 100 / 100

Remarks: joined by transfer  
from 74<sup>th</sup> US Col'd Infantry  
Oct 11<sup>th</sup> 1865 per S.O. no 84  
Hodgins Dept La Series of  
1865 Free on or before  
April 19<sup>th</sup> 1861 (over)

Book mark: Y79.P 117:69

R. S. Richardson

JAN. 15

5489385

1891

mustered out by reason  
of expiration of term  
of service to date  
July 14<sup>th</sup> 1866

L | 10 H. Art'y. | U.S.C.T.

George Lewis

Pvt., Co. G, 10 Reg't U. S. Col'd H. Art'y.

Appears on Co. Muster-out Roll, dated  
Baton Rouge, La., Feb 27, 1867.

Muster-out to date \_\_\_\_\_, 186 .

Last paid to \_\_\_\_\_, 186 .

Clothing account:

Last settled \_\_\_\_\_, 186 ; drawn since \$ \_\_\_\_\_ 100

Due soldier \$ \_\_\_\_\_ 100; due U. S. \$ \_\_\_\_\_ 100

Am't for cloth'g in kind or money adv'd \$ \_\_\_\_\_ 100

Due U. S. for arms, equipments, &c., \$ \_\_\_\_\_ 100

Bounty paid \$ \_\_\_\_\_ 100; due \$ \_\_\_\_\_ 100

Remarks: *Joined by transfer Co. G, 74<sup>th</sup> U.S.C.T., per S.O. No. 84. 1<sup>st</sup> Ar. Dept. of La. Discharge by reason of expiration of term of service July 15, 1866.*

Book mark: *V. 79 P. 117. 6-2-1866. B. V. (over)*

*Wines*

JAN. 16

5509461

1891

Book marks

7, P 458, - Dischgd by  
reason of expiration of  
term of service July, 14,  
1866.

5491270	37
5491424	38
5491550	39
5491678	40
5491803	41
5491930	42
5492054	43
5492179	44
5492301	45
5492426	46
5492549	47
5492673	48
5492800	49
5493040	50
5494018	51
5495555	52
47 - 29 - 1884	

Book Mark. 47 C. P. - 84

S. 585530 2 Airt.  
D1046287 - Po age.

D1414096 P. m. r. m.  
av. 201. 1-3-31. 24

G. S. Dwyer  
2

*L* | **10 H. Art'y.** | **U.S.C.T.**

*Henry Lewis*

*Priv*, Co. A, 1 Reg't La. Col'd H. Art'y.\*

Age *30* years.

Appears on

**Company Muster-in Roll**

of the organization named above. Roll dated

*New Orleans, La. Nov. 29* 186*2*

Muster-in to date

*Nov. 29*, 186*2*

Joined for duty and enrolled:

When *Nov. 16*....., 186 .

Where *New Orleans*.....

Period *3* years.

Valuation of horse, \$.....*100*

Valuation of horse equipments, \$.....*100*

Remarks:.....

\* This organization subsequently became Co. A, 10 Reg't U. S. Colored Heavy Artillery.

Book mark:.....

*Tolman*



*L* | 10 H. Art'y. | U.S.C.T.

*Henry Lewis*

*Priv*, Co. A, 1 Reg't La. H. Art'y.\*

Appears on

**Company Muster Roll**

for *to Dec. 31*, 1862.

Present or absent *Present*

Stoppage, \$ *100* for

Due Gov't, \$ *100* for

Valuation of horse, \$ *100*

Valuation of horse equipments, \$ *100*

Remarks:

\*This organization subsequently became Co. A, 10 Reg't U. S. Col'd Heavy Artillery.

Book mark:

*Tolman*

Copyist.

L | 10 H. Art'y. | U.S.C.T.

Henry Lewis

Priv., Co. A, 1 Reg't La. H. Art'y.\*

Appears on

**Company Muster Roll**

for Jan'y & Feb'y, 1863.

Present or absent Present

Stoppage, \$ 100 for

Due Gov't, \$ 100 for

Valuation of horse, \$ 100

Valuation of horse equipments, \$ 100

Remarks: \_\_\_\_\_

\_\_\_\_\_

\_\_\_\_\_

\_\_\_\_\_

\_\_\_\_\_

\_\_\_\_\_

\*This organization subsequently became Co. A, 10 Reg't U. S. Col'd Heavy Artillery.

Book mark: \_\_\_\_\_

\_\_\_\_\_

Tobman

*L* | **10 H. Art'y. | U.S.C.T.**

*Henry Lewis*

*Priv.*, Co. A, 1 Reg't La. H. Art'y.\*

Appears on

**Company Muster Roll**

for *March & April*, 186*3*.

Present or absent *Present*

Stoppage, \$.....100 for .....

Due Gov't, \$.....100 for .....

Valuation of horse, \$.....100

Valuation of horse equipments, \$.....100

Remarks:.....

.....  
.....  
.....  
.....  
.....  
.....

\*This organization subsequently became Co. A, 10 Reg't U. S. Col'd Heavy Artillery.

Book mark:.....

.....

*Johnson*

*L* | 10 H. Art'y. | **U.S.C.T.**

*Henry Lewis*

*Priv.*, Co. A, 1 Reg't La. H. Art'y.\*

Appears on

**Company Muster Roll**

for *May & June*, 1863.

Present or absent *Present*

Stoppage, \$..... $\overline{100}$  for .....

Due Gov't, \$..... $\overline{100}$  for .....

Valuation of horse, \$..... $\overline{100}$

Valuation of horse equipments, \$..... $\overline{100}$

Remarks: .....

\*This organization subsequently became Co. A, 10 Reg't U. S. Col'd Heavy Artillery.

Book mark: .....

L

10 H. Art'y.

U.S.C.T.

Henry Lewis

Priv., Co. A, 1 Reg't La. H. Art'y.\*

Appears on

Company Muster Roll

for July & August, 1863.

Present or absent Present

Stoppage, \$ 100 for

Due Gov't, \$ 100 for

Valuation of horse, \$ 100

Valuation of horse equipments, \$ 100

Remarks:

\*This organization subsequently became Co. A, 10 Reg't U.S. Col'd Heavy Artillery.

Book mark:

Johnson

L | 10 H. Art'y. | U.S.C.T.

Henry Lewis

Priv., Co. A, 1 Reg't La. H. Art'y.\*

Appears on

**Company Muster Roll**

for Sept & Oct, 1863.

Present or absent Present

Stoppage, \$ 100 for

Due Gov't, \$ 100 for

Valuation of horse, \$ 100

Valuation of horse equipments, \$ 100

Remarks:

\*This organization subsequently became Co. A. 10 Reg't U. S. Col'd Heavy Artillery.

Book mark:

Johnson  
Copied.

*L* | 10 H. Art'y. | U.S.C.T.

*Henry Lewis*  
*Sgt.*, Co. *A*, 1 Reg't H. Art'y, Corps d'Afrique.\*

Appears on

**Company Muster Roll**

for *Nov & Dec*, 1863

Present or absent *Present*

Stoppage, \$ 100 for

Due Gov't, \$ 100 for

Valuation of horse, \$ 100

Valuation of horse equipments, \$ 100

Remarks:

\*This organization subsequently became Co. *A*, 10 Reg't U. S. Colored Heavy Artillery.

Book mark: *5*

*Robert*  
Copyist.

*L* | 10 H. Art'y. | U.S.C.T.

*Henry Lewis*  
Pvt., Co. *A*, 1 Reg't H. Art'y, Corps d'Afrique.\*

Appears on

**Company Muster Roll**

for *Jan + Feb*, 1864.

Present or absent *Present*

Stoppage, \$ 100 for

Due Gov't, \$ 100 for

Valuation of horse, \$ 100

Valuation of horse equipments, \$ 100

Remarks:

-----  
-----  
-----  
-----  
-----

\*This organization subsequently became Co. *A*, 10 Reg't U. S. Colored Heavy Artillery.

Book mark: -----

*Boester*



*L* | 10 H. Art'y. | U.S.C.T.

*Henry Lewis*  
*Pvt*, Co. *F*, 7 Reg't U. S. Col'd H. Art'y.\*

Appears on

**Company Muster Roll**

for *March 1864*, 186*4*.

Present or absent *Present*

Stoppage, \$ 100 for

Due Gov't, \$ 100 for

Valuation of horse, \$ 100

Valuation of horse equipments, \$ 100

Remarks: *In confinement*  
*serving out sentence*  
*of Gen's Court Martial*  
*per GO No 11 dated*  
*Ms. G. St. Jackson, La.*  
*April 4. 1864*

\* This organization subsequently became Co. *F*, 10 Reg't U. S. Colored Heavy Artillery.

Book mark: \_\_\_\_\_

*Reuter*

*L* | 10 H. Art'y. | U.S.C.T.

*Henry Lewis*  
*Co. A*, 7 Reg't U. S. Col'd H. Art'y.\*

Appears on

**Company Muster Roll**

for *May & June*, 1864

Present or absent *Present*

Stoppage, \$ 100 for

Due Gov't, \$ 100 for

Valuation of horse, \$ 100

Valuation of horse equipments, \$ 100

Remarks: *Sick in quarters*

\* This organization subsequently became Co. *A*, 10 Reg't U. S. Colored Heavy Artillery.

Book mark: \_\_\_\_\_

*Bochester*

L | 10 H. Art'y. | U.S.C.T.

Henry Lewis

Pvt, Co. A, 7 Reg't U. S. Col'd H. Art'y.\*

Appears on

Company Muster Roll

for July & Aug, 1864.

Present or absent Present

Stoppage, \$ 100 for

Due Gov't, \$ 100 for

Valuation of horse, \$ 100

Valuation of horse equipments, \$ 100

Remarks:

\* This organization subsequently became Co. A, 10 Reg't U. S. Colored Heavy Artillery.

Book mark:

Proctor

*L* | 10 H. Art'y. | U.S.C.T.

*Henry Lewis*  
*Pvt*, Co. A, 10 Reg't U. S. Col'd H. Art'y.

Appears on

**Company Muster Roll**

for *Sept & Oct*, 1864.

Present or absent *Present*

Stoppage, \$ 100 for

Due Gov't, \$ 100 for

Valuation of horse, \$ 100

Valuation of horse equipments, \$ 100

Remarks: \_\_\_\_\_  
\_\_\_\_\_  
\_\_\_\_\_  
\_\_\_\_\_  
\_\_\_\_\_  
\_\_\_\_\_

Book mark: \_\_\_\_\_

*Beuster*

*L* | 10 H. Art'y. | U.S.C.T.

*Henry Lewis*  
*Plt*, Co. A, 10 Reg't U. S. Col'd H. Art'y.

Appears on

**Company Muster Roll**

for *Sept*, 1864.

Present or absent *Present*

Stoppage, \$ 100 for

Due Gov't, \$ 100 for

Valuation of horse, \$ 100

Valuation of horse equipments, \$ 100

Remarks:

Book mark:

*Rochester*

Copyist.

*L* | 10 H. Art'y. | U.S.C.T.

*Henry Lewis*

*Priv*, Co. A, 10 Reg't U. S. Col'd H. Art'y.

Appears on

**Company Muster Roll**

for: *Jan & Feb*, 18*65*.

Present or absent: *Present*

Stoppage, \$ \_\_\_\_\_  $\overline{100}$  for \_\_\_\_\_

Due Gov't, \$ \_\_\_\_\_  $\overline{100}$  for \_\_\_\_\_

Valuation of horse, \$ \_\_\_\_\_  $\overline{100}$

Valuation of horse equipments, \$ \_\_\_\_\_  $\overline{100}$

Remarks: \_\_\_\_\_  
\_\_\_\_\_  
\_\_\_\_\_  
\_\_\_\_\_  
\_\_\_\_\_  
\_\_\_\_\_  
\_\_\_\_\_

Book mark: \_\_\_\_\_

*Proctor*

Copyist.

*L* | 10 H. Art'y. | U.S.C.T.

*Henry Lewis*  
*Pvt*, Co. A, 10 Reg't U. S. Col'd H. Art'y.

Appears on

for **Company Muster Roll** *March 1865*, 1865.

Present or absent *Present*

Stoppage, \$ 100 for

Due Gov't, \$ 100 for

Valuation of horse, \$ 100

Valuation of horse equipments, \$ 100

Remarks: \_\_\_\_\_  
\_\_\_\_\_  
\_\_\_\_\_  
\_\_\_\_\_  
\_\_\_\_\_  
\_\_\_\_\_

Book mark: \_\_\_\_\_

*Robert*  
\_\_\_\_\_

*L* | 10 H. Art'y. | U.S.C.T.

*Henry Lewis*  
*Pr*, Co. A, 10 Reg't U. S. Col'd H. Art'y.

Appears on

**Company Muster Roll**

for *May & June, 1865.*

Present or absent *Present*

Stoppage, \$ 100 for

Due Gov't, \$ 100 for

Valuation of horse, \$ 100

Valuation of horse equipments, \$ 100

Remarks: *Sick in Quarters*

Book mark:

*Reckister*



*L* | 10 H. Art'y. | U.S.C.T.

*Henry Lewis*  
*Prvt*, Co. A, 10 Reg't U. S. Col'd H. Art'y.

Appears on

**Company Muster Roll**

for *July & Aug*, 1865.

Present or absent *Present*

Stoppage, \$.....100 for .....

Due Gov't, \$.....100 for .....

Valuation of horse, \$.....100

Valuation of horse equipments, \$.....100

Remarks: .....

.....  
.....  
.....  
.....  
.....  
.....  
.....

Book mark: .....

*Prvt*

*L* | 10 H. Art'y. | U.S.C.T.

*Henry Lewis*

*Pr*, Co. A, 10 Reg't U. S. Col'd H. Art'y.

Appears on

**Company Muster Roll**

for *Sept - Oct*, 1865.

Present or absent *Present*

Stoppage, \$ 100 for

Due Gov't, \$ 100 for

Valuation of horse, \$ 100

Valuation of horse equipments, \$ 100

Remarks:

Book mark:

*Hyp*

Copyist.

*L* | 10 H. Art'y. | U.S.C.T.

*Henry Lewis*

*Pl*, Co. A, 10 Reg't U. S. Col'd H. Art'y.

Appears on

**Company Muster Roll**

for *Nov + Dec*, 1865.

Present or absent

Stoppage, \$ 100 for

Due Gov't, \$ 100 for

Valuation of horse, \$ 100

Valuation of horse equipments, \$ 100

Remarks: *Mustered out by reason of expiration of term of service*

Book mark: *Mischd Nov 28/65 L.B. 15/44*

*47 C.P. 1884*

*Hoyes*  
Copyist.

L | 10 H. Art'y. | U.S.C.T.

Henry Lewis  
Priv. Co. A, 10 Reg't U. S. Col'd H. Art'y.

Appears on Co. Muster-out Roll, dated  
Baton Rouge La, Feb. 22, 1867.

Muster-out to date \_\_\_\_\_, 186 .

Last paid to \_\_\_\_\_, 186 .

Clothing account:

Last settled \_\_\_\_\_, 186 ; drawn since \$ \_\_\_\_\_ 100

Due soldier \$ \_\_\_\_\_ 100 ; due U. S. \$ \_\_\_\_\_ 100

Am't for cloth'g in kind or money adv'd \$ \_\_\_\_\_ 100

Due U. S. for arms, equipments, &c., \$ \_\_\_\_\_ 100

Bounty paid \$ \_\_\_\_\_ 100 ; due \$ \_\_\_\_\_ 100

Remarks: Joined origl. orgn. Dischd.  
for Exprn. of term of service Nov.  
28.65

Book mark : \_\_\_\_\_

Nesbitt

Copyist.

L. | 10. No. a. | U.S.C.T.

Henry Lewis  
Co., Co., 10 Reg't U. S. Col'd No. a.

Appears on a

**Detachment Muster-out Roll**

of the organization named above. Roll dated

*N. Orleans La. Nov. 28, 1865.*

Muster-out to date *Nov. 28, 1865.*

Last paid to *June 30, 1865.*

**Clothing account:**

Last settled \_\_\_\_\_, 186 ; drawn since \$ \_\_\_\_\_ 100

Due soldier \$ *31 48* / 100; due U. S. \$ \_\_\_\_\_ 100

Am't for cloth'g in kind or money adv'd \$ \_\_\_\_\_ 100

Due U. S. for arms, equipments, &c., \$ \_\_\_\_\_ 100

Bounty paid \$ \_\_\_\_\_ 100 due \$ \_\_\_\_\_ 100

Remarks: *Joined at Orig. Orgn.  
Mustered out by reason  
of Expiration of term of  
Service.*

Book mark: \_\_\_\_\_

*Hawling*

L 1 10<sup>th</sup> W.A. / U.S. G.I.

Henry Lewis

, Co. A, 40<sup>th</sup> Reg't U.S. G.I.

**NOTATION.**

Book mark:

L.B. 15-941 with  
47. G.I. 1864.

**War Department,**

Adjutant General's Office,

Washington, Jan. 5<sup>th</sup>, 1864.

Mustered out with Detach-  
ment November 28, 1865.

E. P. Conroy

Lewis, Henry

Co.

10

Reg't

U.S.C. H.A.

1 Enclosures.

Bed Cards .....	Final Statements .....
Burial Records .....	Furloughs or L. of A. ....
Certs. of Dis. for Discharge .....	Med. Certificates .....
C. M. Charges .....	Med. Des. Lists .....
Descriptive Lists .....	Orders .....
Discharge Certificates .....	Pris. of War Record .....
Enlistment Papers .....	Resignations .....

Other papers relating to—

Admission to Hosp'l .....	Furlough or L. of A. ....
Casualty Sheet .....	Med. Examination .....
Confinement .....	Misc. Information .....
Contracts .....	Pay or Clothing .....
Death or Effects .....	Personal Reports .....
Desertion .....	Rank .....
Discharge from Hosp'l .....	Transfer to Hosp'l .....
Discharge from Service .....	Transfer to V. R. C. ....
Duty .....	Transportation .....

Head qrs

Fort St Philip

March 21.

Approved & respectfully  
forwarded

Charles Hartwell

1<sup>st</sup> Lt. 11<sup>th</sup> Regt Infy

Commanding

Adj. Gen. Fort Berensson Tex.

April 5, 1864

App'd acct ordered to trial by  
court martial of which Maj. G. Meade  
5<sup>th</sup> Regt Cav is President

By order of

Brig. Gen. W. Sherman

Major G. Marshall

Adj. Gen.

Charge and  
specifications against  
Private Henry Lewis

~~Co. A. 1<sup>st</sup> Heavy Artillery~~

~~6<sup>th</sup> Corps A. Artillery~~

LOUISIANA

(No. 4.)

~~W. S. A.~~



Charge and Specifications prepared  
against Private Henry Lewis, Company A,  
First Regiment Heavy Artillery Corps, d. Afrique,

Charge - Disobedience of Orders -  
Specification 1<sup>st</sup> - In that the Private  
Henry Lewis Company A, 1<sup>st</sup> Regiment Heavy  
Artillery Corps d. Afrique, having been ordered  
by Capt. E. P. Loring, his commanding officer,  
to bring his gun to a "charge Bayonet",  
did refuse to obey said order. This at  
Dress Parade at Fort St. Philip, Louisiana,  
on the evening of March 20<sup>th</sup> 1864.

Specification 2<sup>d</sup>. In that the said  
Private Henry Lewis, Company A, 1<sup>st</sup> Regiment  
Heavy Artillery Corps d. Afrique, having been  
ordered by Capt. E. P. Loring, his commanding  
officer, to "close up" to his proper position  
in the ranks, did refuse to obey said  
order. This at Dress Parade at Fort St. Philip  
Louisiana, on the evening of March 20<sup>th</sup> 1864.

Over

Witnesses -

1<sup>st</sup> Lieut. G. A. Goodall, Co. E. 5<sup>th</sup> Infantry

Corps d. Afrique -

1<sup>st</sup> Lieut. Albert Loring, Co. A. 1<sup>st</sup> Heavy Artillery Corps d. Afrique

2<sup>d</sup> Lieut. Justin E. Brown, " " " " "

Sergeant Joshua Alger, " " " " "

E. P. Loring

Capt. Co. A. 1<sup>st</sup> Heavy Artillery

Corps d. Afrique

1605  
Lewro, John  
Co—, 10 U.S. Col'd H. Art'y.

Private | —

CARD NUMBERS.

15 4 8 7 8 9 9	26
	27
	28
	29
	30
	31
	32
	33
	34
	35
	36
	37
	38
	39
	40
	41
	42
	43
	44
	45
	46
	47
	48
	49
	50

Book Mark:

See also 77. U.S.C. Inf

*L. J. H. A.* | **U.S.C.T.**

*John Lewis*  
*Pot*, Co. ...., *10* Reg't U. S. Col'd *30th*

Appears on

**M. and D. Roll of Men Transferred**

to the organization named above,

from

*10th U. S. Col Inf*  
*Camp Anapetah*, 186*5*.

Roll dated

When enlisted ..... , 186 .

Period for which enlisted ..... years.

When mustered in *March*, 186*5*.

Present or absent .....

Company to which assigned .....

Remarks: *Deserted Apr 22*

*65. from de Bail la*

*(25th)*

*Not on muster rolls Regt*

Book mark : .....

*W. H. Scott*

Lewis, John

Co A, 10 U.S. Col'd H. Art'y

Private

Private

CARD NUMBERS.

1	5-491208	26
2	5-491291	27
3	5-491425	28
4	5-491531	29
5	5-491677	30
6	5-491804	31
7	5-491929	32
8	5-492035	33
9	5-492180	34
10	5-492302	35
11	5-492427	36
12	5-492550	37
13	5-492675	38
14	5-492802	39
15	5-493091	40
16	5-493227	41
17	5-493294	42
18	5-493506	43
19	5-493636	44
20	5-494019	45
21	5-490044	46
22	L-90-03-1875	47
23		48
24		49
25		50

Book Mark: L-90-03-1875

See also

L | 10 H. Art'y. | U.S.C.T.

John Lewis  
Priv, Co. A, 1 Reg't La. H. Art'y.\*

Appears on

**Company Muster Roll**

for July & August, 1863.

Present or absent Present

Stoppage, \$ 100 for

Due Gov't, \$ 100 for

Valuation of horse, \$ 100

Valuation of horse equipments, \$ 100

Remarks Enlisted since  
last payment

Ag. 20  
Enrolled & M. July 10-63  
7p St. Phillip 3 yrs

\*This organization subsequently became Co. A, 10 Reg't U. S. Col'd Heavy Artillery.

Book mark: \_\_\_\_\_

Johnson

*L* | 10 H. Art'y. | U.S.C.T.

*John Lewis*

*Priv*, Co. A, 1 Reg't La. H. Art'y.\*

Appears on

**Company Muster Roll**

for *Sept & Oct*, 1863.

Present or absent *Present*

Stoppage, \$.....100 for.....

Due Gov't, \$.....100 for.....

Valuation of horse, \$.....100

Valuation of horse equipments, \$.....100

Remarks:.....

\*This organization subsequently became Co. A. 10 Reg't U. S. Col'd Heavy Artillery.

Book mark:.....

*L* | 10 H. Art'y. | U.S.C.T.

*John Lewis*  
*Co. A*, 1 Reg't H. Art'y, Corps d'Afrique.\*

Appears on

**Company Muster Roll**

for *Nov 1863*, 186*3*.

Present or absent *Present*

Stoppage, \$ 100 for \_\_\_\_\_

Due Gov't, \$ 100 for \_\_\_\_\_

Valuation of horse, \$ 100

Valuation of horse equipments, \$ 100

Remarks: \_\_\_\_\_

\*This organization subsequently became Co. *A*, 10 Reg't U. S. Colored Heavy Artillery.

Book mark: \_\_\_\_\_

*Robert*



*L* | 10 H. Art'y. | U.S.C.T.

*John Lewis*  
Art., Co. *A*, 1 Reg't H. Art'y, Corps d'Afrique.\*

Appears on

**Company Muster Roll**

for *Jan + Feb*, 1864.

Present or absent *Present*

Stoppage, \$ 100 for

Due Gov't, \$ 100 for

Valuation of horse, \$ 100

Valuation of horse equipments, \$ 100

Remarks: \_\_\_\_\_  
\_\_\_\_\_  
\_\_\_\_\_  
\_\_\_\_\_  
\_\_\_\_\_

\*This organization subsequently became Co. *A*, 10 Reg't U. S. Colored Heavy Artillery.

Book mark: \_\_\_\_\_

*W. J. [Signature]*

Copyist.

*L* | 10 H. Art'y. | U.S.C.T.

*John Lewis*  
*Co. A*, 7 Reg't U. S. Col'd H. Art'y.\*

Appears on

**Company Muster Roll**

for *March 1864*, 1864.

Present or absent *Present*

Stoppage, \$ 100 for

Due Gov't, \$ 100 for

Valuation of horse, \$ 100

Valuation of horse equipments, \$ 100

Remarks:

\* This organization subsequently became Co. *A*, 10 Reg't U. S. Colored Heavy Artillery.

Book mark:

*Bochater*

*L* | 10 H. Art'y. | U.S.C.T.

*John Lewis*  
*Sgt, Co. A, 7 Reg't U. S. Col'd H. Art'y.\**

Appears on

**Company Muster Roll**

for

*May & June, 1864.*

Present or absent

*Present*

Stoppage, \$

100 for

Due Gov't, \$

100 for

Valuation of horse, \$

100

Valuation of horse equipments, \$

100

Remarks:

\* This organization subsequently became Co. *A*, 10 Reg't U. S. Colored Heavy Artillery.

Book mark:

*Bohannon*

Copyist.

*L* | **10 H. Art'y.** | **U.S.C.T.**

*John Lewis*  
*Plt*, Co. *A*, 7 Reg't U. S. Col'd H. Art'y.\*

Appears on

**Company Muster Roll**

for *July + Aug*, 186*7*.

Present or absent *Present*

Stoppage, \$.....100 for .....

Due Gov't, \$.....100 for .....

Valuation of horse, \$.....100

Valuation of horse equipments, \$.....100

Remarks: .....

\* This organization subsequently became Co. *A*, 10 Reg't U. S. Colored Heavy Artillery.

Book mark: .....

*Rooster*

L | 10 H. Art'y. | **U.S.C.T.**

*John Lewis*  
*Prvt*, Co. A, 10 Reg't U. S. Col'd H. Art'y.

Appears on

**Company Muster Roll**

for *Sept & Oct*, 1864.

Present or absent *Present*

Stoppage, \$ 100 for \_\_\_\_\_

Due Gov't, \$ 100 for \_\_\_\_\_

Valuation of horse, \$ 100

Valuation of horse equipments, \$ 100

Remarks: \_\_\_\_\_  
\_\_\_\_\_  
\_\_\_\_\_  
\_\_\_\_\_  
\_\_\_\_\_  
\_\_\_\_\_

Book mark: \_\_\_\_\_

*Boehmer*

Copyist.

*L* | 10 H. Art'y. | U.S.C.T.

*John Lewis*  
*Pvt.*, Co. A, 10 Reg't U. S. Col'd H. Art'y.

Appears on

**Company Muster Roll**

for *Nov & Dec*, 1864.

Present or absent *Absent*

Stoppage, \$ 100 for

Due Gov't, \$ 100 for

Valuation of horse, \$ 100

Valuation of horse equipments, \$ 100

Remarks: *On detached  
Service at Battery  
Septilly, La. per  
S.O. No. 317 Ad.  
Pres. Dep. New Orleans  
dated Dec 26, 1864*

Book mark: \_\_\_\_\_

*Co. A*

*L* | 10 H. Art'y. | U.S.C.T.

*John Lewis*  
*Plt*, Co. A, 10 Reg't U. S. Col'd H. Art'y.

Appears on

**Company Muster Roll**

for *Jan + Feb*, 1865.

Present or absent *Present*

Stoppage, \$ 100 for

Due Gov't, \$ 100 for

Valuation of horse, \$ 100

Valuation of horse equipments, \$ 100

Remarks:

-----  
-----  
-----  
-----  
-----  
-----  
-----  
-----

Book mark:

*Proctor*

*L* | 10 H. Art'y. | U.S.C.T.

*John Lewis*  
*Art*, Co. A, 10 Reg't U. S. Col'd H. Art'y.

Appears on

Company Muster Roll

for

*Montpel*, 1865

Present or absent

*Present*

Stoppage, \$

100 for

Due Gov't, \$

100 for

Valuation of horse, \$

100

Valuation of horse equipments, \$

100

Remarks:

Book mark:

*Bohner*

Copyist.



L | 10 H. Art'y. | U.S.C.T.

*John Lewis*

*Co.*, Co. A, 10 Reg't U. S. Col'd H. Art'y.

Appears on

**Company Muster Roll**

for *May & June*, 1865.

Present or absent *Present*

Stoppage, \$ 100 for

Due Gov't, \$ 100 for

Valuation of horse, \$ 100

Valuation of horse equipments, \$ 100

Remarks *Sick in Quarters*

Book mark:

*Proctor*

Copyist.

*L.* | 10 H. Art'y. | U.S.C.T.

*John Lewis*  
*Art.*, Co. A, 10 Reg't U. S. Col'd H. Art'y.

Appears on

**Company Muster Roll**

for *July & Aug*, 1865.

Present or absent *Present*

Stoppage, \$ 100 for

Due Gov't, \$ 100 for

Valuation of horse, \$ 100

Valuation of horse equipments, \$ 100

Remarks: *Due Gov't for  
Camp & Garrison  
Equipage \$3.67*

Book mark: \_\_\_\_\_

*Reedster*

Copyist.

*b* | 10 H. Art'y. | U.S.C.T.

*John Lewis*

*Pat*, Co. A, 10 Reg't U. S. Col'd H. Art'y.

Appears on

**Company Muster Roll**

for *Sept + Oct*, 1865.

Present or absent *Present*

Stoppage, \$.....100 for .....

Due Gov't, \$.....100 for .....

Valuation of horse, \$.....100

Valuation of horse equipments, \$.....100

Remarks:.....

Book mark:.....

*Hijus* Copyist.

*6* | 10 H. Art'y. | U.S.C.T.

*John Lewis*

*Plt*, Co. A, 10 Reg't U. S. Col'd H. Art'y.

Appears on

**Company Muster Roll**

for *Nov & Dec*, 186*5*.

Present or absent *Present*

Stoppage, \$.....100 for .....

Due Gov't, \$.....100 for .....

Valuation of horse, \$.....100

Valuation of horse equipments, \$.....100

Remarks: .....

.....  
.....  
.....  
.....  
.....  
.....  
.....  
.....

Book mark: .....

.....

*Hynes*  
Copyist.

*b* | 10 H. Art'y. | U.S.C.T.

*John Lewis*

*Pl*, Co. A, 10 Reg't U. S. Col'd H. Art'y.

Appears on

Company Muster Roll

for *Jan - Feb*, 186*6*.

Present or absent *Present*

Stoppage, \$ *100* for

Due Gov't, \$ *3* <sup>*57*</sup>/<sub>*100*</sub> for *C & Equipage*

Valuation of horse, \$ *100*

Valuation of horse equipments, \$ *100*

Remarks:

Book mark:

*Hys*  
Copyist.

*B* | 10 H. Art'y. | U.S.C.T.

*John Lewis*

*Pl*, Co. A, 10 Reg't U. S. Col'd H. Art'y.

Appears on

Company Muster Roll

for *Mar + Apr*, 186 *6*.

Present or absent *Present*

Stoppage, \$ 100 for

Due Gov't, \$ 08 for *Ordnance, For*

*Camp + Garrison Equipage 5*

Valuation of horse, \$ 100

Valuation of horse equipments, \$ 100

Remarks:

Book mark:

*Heyman*  
Copyist.

*S* | 10 H. Art'y. | **U.S.C.T.**

*John Lewis*  
*Pr*, Co. A, 10 Reg't U. S. Col'd H. Art'y.

Appears on

**Company Muster Roll**

for *May - June*, 186*6*.

Present or absent *Pr*

Stoppage, \$ 100 for

Due Gov't, \$ 100 for

Valuation of horse, \$ 100

Valuation of horse equipments, \$ 100

Remarks:

-----  
-----  
-----  
-----  
-----  
-----  
-----  
-----

Book mark: -----

-----

*Hejin*  
Copyist.

*L* | *10 N.Y. Arty* | **U.S.C.T.**

*John Lewis*

*Pvt*, Co. *A*, *10* Reg't U. S. Col'd *N.Y. Arty*

Appears on

**Company Muster Roll**

for *July + Aug*, 186*6*.

Present or absent

Stoppage, \$ 100 for

Due Gov't, \$ 100 for

Valuation of horse, \$ 100

Valuation of horse equipments, \$ 100

Remarks: *Discharged June 30. 1866.*  
*by reason of expiration of term of*  
*service*

Book mark: *Discharged July 2/66 E.B.V. 12.*  
*P. 518*

*Hyman*

Copyist.



2 | 10 Art | U.S.C.T.

John Lewis

Pvt, Co. A, 10 Reg't U. S. Col'd Art'y

Appears on a

**Detachment Muster-out Roll**

of the organization named above. Roll dated

New Orleans La, July 13, 1866.

Muster-out to date July 9, 1866.

Last paid to Apr 30, 1866

**Clothing account:**

Last settled \_\_\_\_\_, 186 ; drawn since \$ \_\_\_\_\_ 100

Due soldier \$ 9 <sup>84</sup> / 100; due U. S. \$ \_\_\_\_\_ 100

Am't for cloth'g in kind or money adv'd \$ \_\_\_\_\_ 100

Due U. S. for arms, equipments, &c., \$ 5 <sup>66</sup> / 100

Bounty paid \$ \_\_\_\_\_ 100 due \$ \_\_\_\_\_ 100

Remarks: Joined as Recruit.

Stop for two tompons one mosquito bar and one bed sack

Mustered out by reason of expiration of term of service to date July 9. 1866

Book mark:

A 6600

L | 10 H. Art'y. | U.S.C.T.

John Lewis  
P.M.A., Co. A, 10 Reg't U. S. Col'd H. Art'y.

Appears on Co. Muster-out Roll, dated  
Baton Rouge La, Feb 22, 1867.

Muster-out to date \_\_\_\_\_, 186 .

Last paid to \_\_\_\_\_, 186 .

Clothing account:

Last settled \_\_\_\_\_, 186 ; drawn since \$ \_\_\_\_\_ 100

Due soldier \$ \_\_\_\_\_ 100; due U. S. \$ \_\_\_\_\_ 100

Am't for cloth'g in kind or money adv'd \$ \_\_\_\_\_ 100

Due U. S. for arms, equipments, &c., \$ \_\_\_\_\_ 100

Bounty paid \$ \_\_\_\_\_ 100; due \$ \_\_\_\_\_ 100

Remarks: Joined as recruit. Discht  
for Expon. of term of service  
July 9. 66

Book mark: V 223 P 300. 75.

L. 90 V 11 b. 7. 75

Nesbitt

L. | 10. Hy duty. | Wc P.

John Lewis.

, Co. A., 10<sup>th</sup> Reg't Wc Hy duty.

**NOTATION.**

E.B. 11.518 L. 90. C. P. 1875.

Book mark:

**War Department,**

Adjutant General's Office,

Washington, *December 18<sup>th</sup>*, 1875.

*Discharged July 9. 1866.*

*A. M. Muzzy.*

Copyist.

Lewis, John

Co D, 10 U.S. Col'd H. Art'y

Private

Private

CARD NUMBERS.

1	5494230	26
2	5494382	27
3	5494542	28
4	5494700	29
5	5494855	30
6	5495008	31
7	5495213	32
8	5497520	33
9	Rt. 248,352	34
10		35
11		36
12		37
13		38
14		39
15		40
16		41
17		42
18		43
19		44
20		45
21		46
22		47
23		48
24		49
25		50

Book Mark: 242,620

See also

R.P. 637403

S. S. Dwyer  
2

*L* | 10 H. Art'y. | U.S.C.T.

*John Lewis*

*Plt.*, 2 Battery, La. H. Art'y, Native Guards.\*

Age *24* years.

Appears on

**Company Muster-in Roll**

of the organization named above. Roll dated

*Camp Parapet*  
*Carrollton, La., Feb. 9,* 186*3.*

Muster-in to date *Feb. 9,* 186*3.*

Joined for duty and enrolled:

When *Dec. 4*, 186*2.*

Where *Camp Parapet nr. Carrollton, La.,*

Period *3* years.

Valuation of horse, \$.....100

Valuation of horse equipments, \$.....100

Remarks:.....

.....

.....

.....

.....

.....

.....

.....

.....

.....

.....

.....

.....

.....

.....

.....

.....

.....

.....

.....

.....

\* This organization subsequently became Co. B, 10 Reg't U. S. Colored Heavy Artillery.

Book mark: *R.P. See 248352*

*Heaster*

*L* | 10 H. Art'y. | U.S.C.T.

*John Lewis*

*Priv.*, Co. B, 1 Reg't La. H. Art'y, Native Guards.\*

Appears on

**Company Muster Roll**

for *Jim. Enlistment to Feb. 28*, 186*8*.

Present or absent *Present*

Stoppage, \$ *100* for

Due Gov't, \$ *100* for

Valuation of horse, \$ *100*

Valuation of horse equipments, \$ *100*

Remarks: \_\_\_\_\_

\*This organization subsequently became Co. B, 10 Reg't U. S. Col'd Heavy Artillery.

Book mark: \_\_\_\_\_

*Peaster*

| **10 H. Art'y.** | **U.S.C.T.**

John Lewis  
Pvt., Co. B, 1 Reg't La. H. Art'y, Native Guards.\*

Appears on

**Company Muster Roll**

for March 7. April., 1863.

Present or absent Present

Stoppage, \$          100 for         

Due Gov't, \$          100 for         

Valuation of horse, \$          100

Valuation of horse equipments, \$          100

Remarks:           
          
          
          
          
          
          
        

\*This organization subsequently became Co. B, 10 Reg't U. S. Col'd Heavy Artillery.

Book mark:         

Feaster



*D* | 10 H. Art'y. | U.S.C.T.

*John Lewis*  
Pvt., Co. B, 1 Reg't La. H. Art'y, Native Guards.\*

Appears on

**Company Muster Roll**

for *May & June*, 186 *J.*

Present or absent *Present*

Stoppage, \$ *100* for

Due Gov't, \$ *100* for

Valuation of horse, \$ *100*

Valuation of horse equipments, \$ *100*

Remarks:

\*This organization subsequently became Co. B, 10 Reg't U. S. Col'd Heavy Artillery.

Book mark:

*Foster*

*D* | 10 H. Art'y. | U.S.C.T.

*John Lewis*  
-----  
*Pvt.*, Co. B, 1 Reg't La. H. Art'y, Native Guards.\*

Appears on

**Company Muster Roll**

for *July & Aug.*, 186 *3*.

Present or absent *Present*

Stoppage, \$ *100* for -----

Due Gov't, \$ *100* for -----

Valuation of horse, \$ *100*

Valuation of horse equipments, \$ *100*

Remarks: -----  
-----  
-----  
-----  
-----  
-----  
-----

\*This organization subsequently became Co. B, 10 Reg't U. S. Col'd Heavy Artillery.

Book mark: -----

*Feaster*

*L* | 10 H. Art'y. | U.S.C.T.

*John Lewis*

*Priv.*, Co. B, 1 Reg't La. H. Art'y, Native Guards.\*

Appears on

**Company Muster Roll**

for *Sept. 4. Oct.*, 186*7*.

Present or absent *Present*

Stoppage, \$ *100* for

Due Gov't, \$ *100* for

Valuation of horse, \$ *100*

Valuation of horse equipments, \$ *100*

Remarks:

\*This organization subsequently became Co. B, 10 Reg't U. S. Col'd Heavy Artillery.

Book mark:

*Feaster*

L | 10 H. Art'y. | U.S.C.T.

*John Lewis*  
Pvt, Co. B, 1 Reg't H. Art'y, Corps d'Afrique.\*

Appears on

**Company Muster Roll**

for *Nov. 1 Dec*, 1863.

Present or absent

Stoppage, \$ 100 for

Due Gov't, \$ 100 for

Valuation of horse, \$ 100

Valuation of horse equipments, \$ 100

Remarks: *Deserted with arms  
& accoutrements & clothing  
complete.*

\*This organization subsequently became Co. , 10 Reg't U. S. Colored Heavy Artillery.

Book mark :

*Reif*

*L* | 10 H. Art'y. | U.S.C.T.

*John Lewis*  
Pvt, Co. *D*, 10 Reg't U. S. Col'd H. Art'y.

Appears on **Co. Muster-out Roll**, dated  
*Baton Rouge La, Feb*, 1867.

Muster-out to date ..... 186 .

Last paid to ..... 186 .

Clothing account:

Last settled ..... 186 ; drawn since \$ ..... 100

Due soldier \$ ..... 100; due U. S. \$ *27* <sup>*93*</sup> / 100

Am't for cloth'g in kind or money adv'd \$ ..... 100

Due U. S. for arms, equipments, &c., \$ ..... 100

Bounty paid \$ ..... 100; due \$ ..... 100

Remarks:

*Joined org. orgn  
Deserted Nov. 30 1863  
at Camp Parapet La.*

Book mark:

*R.P. 248352*

*Hodges*

Copyist.

L 110 Na. 1215, Colord

John Lewis

, Co. B, 10<sup>th</sup> Reg't U.S.C.A.

**NOTATION.**

Book mark: 242650

**War Department,**

**Record and Pension Division,**

Washington, Aug 28, 1896

Application for removal of the charge of desertion  
and for an honorable discharge has been denied.

B. G. Cole

RAP 248352

Lewis - John  
C., Co. B, 10<sup>th</sup> Reg't W.S. C. H. A.

**3 Enclosures.**

Bed Cards .....	Final Statements .....
Burial Records .....	Furloughs or L. of A. ....
Certs. of Dis. for Discharge .....	Med. Certificates .....
C. M. Charges .....	Med. Des. Lists .....
Descriptive Lists ..... 1	Orders .....
Discharge Certificates .....	Pris. of War Record .....
Enlistment Papers ..... 2	Resignations .....

Other papers relating to—

Admission to Hosp'l .....	Furlough or L. of A. ....
Casualty Sheet .....	Med. Examination .....
Confinement .....	Misc. Information .....
Contracts .....	Pay or Clothing .....
Death or Effects .....	Personal Reports .....
Desertion .....	Rank .....
Discharge from Hosp'l .....	Transfer to Hosp'l .....
Discharge from Service .....	Transfer to V. R. C. ....
Duty .....	Transportation .....



DECLARATION OF RECRUIT.

I, \_\_\_\_\_ desiring to ENLIST in the Army of the United States, for the term of THREE YEARS, Do declare, That I am \_\_\_\_\_ years and \_\_\_\_\_ months of age; that I have neither wife nor child; that I have never been discharged from the United States service on account of disability or by sentence of a court-martial, or by order before the expiration of a term of enlistment; and I know of no impediment to my serving honestly and faithfully as a soldier for three years.

GIVEN at \_\_\_\_\_  
The \_\_\_\_\_ day of \_\_\_\_\_

Witness:

S  
10 USECHA

No. \_\_\_\_\_  
Enlisted at St. Louis  
December 4 1867,  
By Wm. H. [unclear]  
of [unclear]  
\_\_\_\_\_ enlistment; last served in Company \_\_\_\_\_  
Reg't of \_\_\_\_\_  
Discharged \_\_\_\_\_ 18\_\_\_\_

CONSENT IN CASE OF MINOR.

I, \_\_\_\_\_ Do CERTIFY, That I am the \_\_\_\_\_ of \_\_\_\_\_; that the said \_\_\_\_\_ is \_\_\_\_\_ years of age; and I do hereby freely give my CONSENT to his enlisting as a SOLDIER in the ARMY OF THE UNITED STATES for the period of THREE YEARS.

GIVEN at \_\_\_\_\_  
The \_\_\_\_\_ day of \_\_\_\_\_

Witness:

County of  
*Jefferson*



State of  
*Louisiana*

I, *John Lewis* born in *St. John Baptist Parish*  
in the State of *Louisiana* aged *Twenty Two* years,  
and by occupation a *Laborer* do hereby acknowledge to have  
voluntarily enlisted this *Tenth* day of *December*

18*62*, as a SOLDIER in the ARMY OF THE UNITED STATES OF AMERICA, for the period  
of *THREE YEARS*, unless sooner discharged by proper authority: Do also agree to  
accept such bounty, pay, rations, and clothing, as are, or may be, established by law. And  
I, *John Lewis* do solemnly swear, that I will bear true faith  
and allegiance to the UNITED STATES OF AMERICA, and that I will serve them honestly and  
faithfully against all their enemies or opposers whomsoever; and that I will observe and  
obey the orders of the President of the United States, and the orders of the officers  
appointed over me, according to the Rules and Articles of War.

Sworn and subscribed to, at *Camp Parapet,*  
this *ninth* day of *February* 18*62*,  
BEFORE *J. Nygaard,*  
*2<sup>d</sup> Lt. U. S. Army*

I CERTIFY, ON HONOR, That I have carefully examined the above named Recruit, agreeably to the General Regulations  
of the Army, and that in my opinion he is free from all bodily defects and mental infirmity, which would, in any way, disqualify  
him from performing the duties of a soldier.

*W. C. Lippard*

EXAMINING SURGEON.

I CERTIFY, ON HONOR, That I have minutely inspected the Recruit, *John Lewis*  
previously to his enlistment, and that he was entirely sober when enlisted; that, to the best of my judgement and belief, he is of  
lawful age; and that, in accepting him as duly qualified to perform the duties of an able-bodied soldier, I have strictly observed  
the Regulations which govern the recruiting service. This soldier has *Brown* eyes, *Dark* hair,  
*Dark* complexion; is *Five* feet, *Seven* inches high.

*J. Nygaard, 2<sup>d</sup> Lt. U. S. Army*

RECRUITING OFFICER.

DECLARATION OF RECRUIT.

I, \_\_\_\_\_ desiring to ENLIST in the Army of the United States, for the term of THREE YEARS, Do declare, That I am \_\_\_\_\_ years and \_\_\_\_\_ months of age; that I have neither wife nor child; that I have never been discharged from the United States service on account of disability or by sentence of a court-martial, or by order before the expiration of a term of enlistment; and I know of no impediment to my serving honestly and faithfully as a soldier for three years.

GIVEN at \_\_\_\_\_

The \_\_\_\_\_ day of \_\_\_\_\_

Witness:

\_\_\_\_\_

\_\_\_\_\_

\_\_\_\_\_

\_\_\_\_\_

\_\_\_\_\_

\_\_\_\_\_

\_\_\_\_\_

\_\_\_\_\_

\_\_\_\_\_

\_\_\_\_\_

\_\_\_\_\_

\_\_\_\_\_

\_\_\_\_\_

\_\_\_\_\_

\_\_\_\_\_

\_\_\_\_\_

\_\_\_\_\_

\_\_\_\_\_

\_\_\_\_\_

\_\_\_\_\_

\_\_\_\_\_

\_\_\_\_\_

\_\_\_\_\_

\_\_\_\_\_

\_\_\_\_\_

\_\_\_\_\_

\_\_\_\_\_

\_\_\_\_\_

No. 212  
Enlisted at Franklin, Pa  
December 29 1862.  
By 2d Lieutenant J. H. Leonard  
1st Infantry Regiment of Pennsylvania

enlistment; last served in Company ( )  
Reg't of \_\_\_\_\_  
Discharged \_\_\_\_\_ 18\_\_\_\_

CONSENT IN CASE OF MINOR.

I, \_\_\_\_\_ Do CERTIFY, That I am the \_\_\_\_\_ of \_\_\_\_\_; that the said \_\_\_\_\_ is \_\_\_\_\_ years of age; and I do hereby freely give my CONSENT to his enlisting as a SOLDIER in the ARMY OF THE UNITED STATES for the period of THREE YEARS.

GIVEN at \_\_\_\_\_

The \_\_\_\_\_ day of \_\_\_\_\_

Witness:

\_\_\_\_\_

\_\_\_\_\_

\_\_\_\_\_

\_\_\_\_\_

\_\_\_\_\_

\_\_\_\_\_

\_\_\_\_\_

\_\_\_\_\_

\_\_\_\_\_

County of

Jefferson



State of

Louisiana

I, John Lewis born in St. John Baptiste Parish  
in the State of Louisiana aged Twenty Four years,

and by occupation a Laborer do hereby acknowledge to have

voluntarily enlisted this Fourth day of December

1862, as a SOLDIER in the ARMY OF THE UNITED STATES OF AMERICA, for the period

of THREE YEARS, unless sooner discharged by proper authority: Do also agree to accept such bounty, pay, rations, and clothing, as are, or may be, established by law. And

I, John Lewis do solemnly swear, that I will bear true faith and allegiance to the UNITED STATES OF AMERICA, and that I will serve them honestly and

faithfully against all their enemies or opposers whomsoever; and that I will observe and

obey the orders of the President of the United States, and the orders of the officers

appointed over me, according to the Rules and Articles of War.

Sworn and subscribed to, at Camp Parapet,  
of Carrollton, La.

this ninth day of February 1862,

BEFORE

L. Nygaard  
2081 N. 9. 1/2 E. 10th St.

I CERTIFY, ON HONOR, That I have carefully examined the above named Recruit, agreeably to the General Regulations of the Army, and that in my opinion he is free from all bodily defects and mental infirmity, which would, in any way, disqualify him from performing the duties of a soldier.

W. C. Goyne EXAMINING SURGEON.

I CERTIFY, ON HONOR, That I have minutely inspected the Recruit, John Lewis previously to his enlistment, and that he was entirely sober when enlisted; that, to the best of my judgement and belief, he is of lawful age; and that, in accepting him as duly qualified to perform the duties of an able-bodied soldier, I have strictly observed the Regulations which govern the recruiting service. This soldier has Brown eyes, Dark hair, Dark complexion; is Five feet, Seven inches high.

L. Nygaard, 2nd Lieut. N. G. Arty. La. 10th

RECRUITING OFFICER.

VOLUNTEER DESCRIPTIVE LIST and Account of Pay and Clothing of *Private John Lewis, Co B. 1<sup>st</sup> Regt Heavy Art La Native Guards.*

No.	NAMES.	RANK.	DESCRIPTION.					WHERE BORN.		OCCUPATION.	ENROLLED. (For Drafted Men, see note 10.)			MUSTERED IN. (For Drafted Men, see note 10.)				LAST PAID.		BOUNTY.		REMARKS.
			Years of age.	Eyes.	Hair.	Complexion.	Feet.	Inches.	State or Kingdom.		Town or county.	When.	Where. (Town and State)	By whom.	When.	Where. (Town and State)	By whom. (In the case of drafted men, from what enrollment district)	Period.	By paymaster.	To what time.	Paid \$ (See note 2.)	
248352 8-27-90	1. Lewis John	Private	29	brown	Dark	Dark	5 7/8	Louisiana	St John the Baptist	Laborer	Dec 4. 1862	Camp Parapet La	Lt. Lind J. Pygand	Feb 9. 1863	Camp Parapet La	Major Giddings	3 years	Maj. Section	Oct 31. 1863			Deceased November 30. 1863 from Camp Parapet, near Carrollton La; his whereabouts unknown

This soldier has been paid at the rate of \$ 6.50 monthly until April 30<sup>th</sup> 1863 and at \$ 7.00 for the balance; — there were retained for clothing allowance, respectively \$ 3.50 and \$ 3.00 monthly. — He has received Clothings to the amount of seventy one Dollars 24/100 (\$ 71.24)

NOTES.

- The amount of any extra pay for which the soldier may be mustered, *et. gr.* as Acting Hospital Steward, as Saddler, &c., and which may be still due him, must be carefully noted.
- In the column headed "BOUNTY PAID," must be entered the whole amount *Acherio* paid him; in that of "BOUNTY DUE," the whole amount yet due him. Bounty paid by State authorities, and not by the United States, will not be entered on this statement.
- Stoppages for loss or damage done to arms, or other public property, must be noted, and the articles, and particular damage to each, specified. When stoppages are due, under sentence of a Court Martial, a transcript of the same must be entered here; and the amount already stopped must be carefully stated.
- In every case of desertion, the date, and that of delivery, or apprehension, must be given, together with a correct transcript of the order of sentence or pardon.
- A careful settlement of the man's CLOTHING ACCOUNT must be made, to date, and the amount DUE TO, or FROM him must be precisely stated.
- Should the man have been engaged in any action or skirmish, it must be mentioned, together with date and place. A full and particular mention will be made of any wounds he may have received in action, or other injury, whilst in the line of his duty.
- If the soldier is entitled to pay for the use of his horse, the company commander will certify to that fact on this list, and also to the time he has pay due for having been so mounted on his own horse.
- When a soldier is furnished with final statements, his descriptive list, if he has one, should be taken up by the officer who gives the soldier these statements, and endorsed with a statement to this effect by the officer. This endorsement should exhibit a full statement of the time for which the soldier was allowed pay on his final statements, the clothing account, and all other charges against him or in his favor, so as to comprise a complete exhibit of his account. It will then be transmitted to the company commander of the soldier, who will enter all the data necessary to a full understanding of the soldier's account on the muster roll upon which the soldier's discharge is reported. The descriptive list will then be destroyed. The object of this is, that the remaining portion of the soldier's account may be settled upon the receipt of these muster rolls, and the soldier receive any pay or allowances that may be due him at the time of his discharge, and which may not appear on his final statements from the fact that his descriptive list is incomplete. These accounts for back pay, &c., are settled by the 3d Auditor of the Treasury Department.
- Where a soldier dies in Hospital or on detached service, his descriptive list, if he has one, should be sent with his final statements, in duplicate, to the Second Auditor, Washington, D. C.
- Men drafted will be considered as mustered in from the date of their draft, and will be mustered for pay on the usual rolls for Volunteers. On the same line as the soldier's name, under the heading "Joined for Duty and Enrolled.—Commencement of First Payment by Fines," will be written the word *drafted*; and under the heading "When Mustered in," will be given the date when the soldier was drafted; under "Where Mustered in," will be given the place from which drafted; under the heading "By whom Mustered in," will be given the No. of the Enrollment District from which he was drafted, and the State to which it belongs, thus: 4th D. Mass.; (meaning 4th Enrollment District, State of Massachusetts.)
- A separate descriptive list should, as a general rule, be given for each man.
- Descriptive lists must, in all cases, be signed by COMMISSIONED officers; not by enlisted men acting as such.

I CERTIFY that the above is a correct transcript from the Records of *Co B. Heavy Artillery La Native Guards, near Co B. 10<sup>th</sup> U. S. Cal Artillery (187)*

STATION: *Fort Stephens, La*  
 DATE: *November 9<sup>th</sup> 1864*  
*Mo. Hauke*  
 Captain  
 Commanding the Company.

1611  
Lewis, John

Col , 10 U.S. Col'd H. Art'y.

Private | Private

CARD NUMBERS.

1 5497618	26
2 5497862	27
3 5498020	28
4	29
5	30
6	31
7	32
8	33
9	34
10	35
11	36
12	37
13	38
14	39
15	40
16	41
17	42
18	43
19	44
20	45
21	46
22	47
23	48
24	49
25	50

Book Mark: Q. 33 - U. 11 - R. C. S. 67.

See also

*L* | 10 H. Art'y. | U.S.C.T.

*Pl* *John Louis*

Co. C, 1 Reg't H. Art'y, Corps d'Afrique.\*

Age *26* years.

Appears on

**Company Muster-in Roll**

of the organization named above. Roll dated

*New Orleans La, Aug 17, 1863.*

Muster-in to date *Aug 17, 1863.*

Joined for duty and enrolled:

When *July 7<sup>th</sup>, 1863.*

Where *Camp Parapet La*

Period *3* years.

Valuation of horse, \$.....100

Valuation of horse equipments, \$.....100

Remarks:.....  
.....  
.....

\* This organization subsequently became Co. C, 10 Reg't U. S. Colored Heavy Artillery.

Book mark:.....  
.....

*L* | 10 H. Art'y. | U.S.C.T.

*Pr* *John Lewis*  
Co, C, 1 Reg't La. Art'y Native Guards.\*

Appears on

**Company Muster Roll**

for *Aug 11<sup>th</sup> to 31<sup>st</sup>*; 1863 .

Present or absent *Present*

Stoppage, \$ *100* for

Due Gov't, \$ *100* for

Valuation of horse, \$ *100*

Valuation of horse equipments, \$ *100*

Remarks :

\* This organization subsequently became Co. C, 10 Reg't U. S. Col'd Heavy Artillery.

Book mark :

*W. J. ...*



*L* | 10 H. Art'y. | U.S.C.T.

*John Lewis*  
*Pvt*, Co, C, 1 Reg't La. Art'y Native Guards.\*

Appears on

**Company Muster Roll**

for *Sept and Oct, 1863*

Present or absent *Present*

Stoppage, \$ *100* for

Due Gov't, \$ *100* for

Valuation of horse, \$ *100*

Valuation of horse equipments, \$ *100*

Remarks:

*Not on sub. rolls*

\* This organization subsequently became Co. C, 10 Reg't U. S. Col'd Heavy Artillery.

Book mark:

*W. J. ...*

Lewis, John

Co E, 10 U.S. Col'd H. Art'y.

Private

Private

CARD NUMBERS.

1 550 2412	26
2 5489185	27
3 550 2520	28
4 550 2636	29
5 550 2770	30
6 550 2900	31
7 550 3020	32
8 550 3138	33
9 550 3249	34
10 550 3358	35
11 550 3465	36
12 550 3545	37
13 550 3743	38
14 550 3878	39
15 550 4023	40
16 550 4152	41
17 550 4266	42
18 550 4390	43
19 550 4488	44
20	45
21	46
22	47
23	48
24	49
25	50

Book Mark:

See also:

D862 599 *common*  
P. 2165465 P.O. Ret.

G.S. Doughty  
2

*L* | **10 H. Art'y. | U.S.C.T.**

*John Lewis*  
*Prst*, Co. *E*, 7 Reg't U. S. Col'd H. Art'y.\*

Appears on

**Company Muster-in and Descriptive Roll**

of the organization named above. Roll dated

*New Orleans, La. July 5, 1864.*

Where born *Michoud, La.*

Age *18* y'rs; occupation *Laborer*

When enlisted *Feb. 15, 1864.*

Where enlisted *New Orleans*

For what period enlisted *3* years.

Eyes *Black*; hair *Black*

Complexion *Black*; height *5 ft. 6 in.*

When mustered in *Feb. 7, 1864.*

Where mustered in *New Orleans*

Bounty paid \$ *2* 100; due \$ *100*

Where credited *New Orleans*

Company to which assigned *E*

Remarks:

\* This organization subsequently became Co. *E*, 10 Reg't U. S. Colored Heavy Artillery.

Book mark:

*Linden*

S. M. A. | U.S.C.T.

John Lewis  
Priv., Co. E, 11<sup>(74. S. C. I. D. A)</sup> Reg't U. S. Col'd Hof

Appears on a

**Detachment Muster Roll**

of the organization named above

for Roll dated Apr 30, 1864.

Station De Sais, La.

Present or absent Present

Stoppage, \$ 100 for

Due Gov't, \$ 100 for

Valuation of horse, \$ 100

Valuation of horse equipments, \$ 100

Remarks:

Book mark:

A. rogan

*L* | 10 H. Art'y. | U.S.C.T.

*John Lewis*  
Art., Co. *E*, 7 Reg't U. S. Col'd H. Art'y.\*

Appears on

**Company Muster Roll**

for *May June*, 186*4*.

Present or absent *Present*

Stoppage, \$ \_\_\_\_\_ *100* for \_\_\_\_\_

Due Gov't, \$ \_\_\_\_\_ *100* for \_\_\_\_\_

Valuation of horse, \$ \_\_\_\_\_ *100*

Valuation of horse equipments, \$ \_\_\_\_\_ *100*

Remarks: \_\_\_\_\_  
\_\_\_\_\_  
\_\_\_\_\_  
\_\_\_\_\_  
\_\_\_\_\_

\* This organization subsequently became Co. *E*, 10 Reg't U. S. Colored Heavy Artillery.

Book mark: \_\_\_\_\_

*Linden*  
Copyist.

*L* | 10 H. Art'y. | U.S.C.T.

*John Lewis*  
Pt., Co. E, 10 Reg't U. S. Col'd H. Art'y.

Appears on

**Company Muster Roll**

for *July & Aug.*, 186*4*.

Present or absent *Present*

Stoppage, \$.....*100* for.....

Due Gov't, \$.....*100* for.....

Valuation of horse, \$.....*100*

Valuation of horse equipments, \$.....*100*

Remarks: *Sick in Quarters*

Book mark:.....

*Linden*  
Copyist.

*L* | 10 H. Art'y. | U.S.C.T.

*John Louis*  
Pr. Co. E, 10 Reg't U. S. Col'd H. Art'y.

Appears on

**Company Muster Roll**

for *Sep. + Oct*, 186 *6*

Present or absent *Present*

Stoppage, \$ *100* for

Due Gov't, \$ *100* for

Valuation of horse, \$ *100*

Valuation of horse equipments, \$ *100*

Remarks:

Book mark:

*Louder*  
Copyist.





2 | **10 H. Art'y. | U.S.C.T.**

John Louis  
Co., Co. E, 10 Reg't U. S. Col'd H. Art'y.

Appears on

**Company Muster Roll**

for Jan & Feb, 1865.

Present or absent Present

Stoppage, \$ 100 for

Due Gov't, \$ 100 for

Valuation of horse, \$ 100

Valuation of horse equipments, \$ 100

Remarks: difference of pay  
from enlistment to Apr  
30, 1864, \$ 6.00 per month  
due

Book mark:

[Signature]

Copyist.

*S* | **10 H. Art'y. | U.S.C.T.**

*John Louis*  
*Co. E*, Co. E, 10 Reg't U. S. Col'd H. Art'y.

Appears on

**Company Muster Roll**

for *March & April*, 1865.

Present or absent *Present*

Stoppage, \$ 100 for

Due Gov't, \$ 100 for

Valuation of horse, \$ 100

Valuation of horse equipments, \$ 100

Remarks: *Difference of pay*  
*from enlistment to Apr.*  
*30, 1864, \$6.00 per month*  
*due.*

Book mark: \_\_\_\_\_

*W. C. Tyler*  
Copyist.

L | 10 H. Art'y. | U.S.C.T.

*John Louis*  
-----  
*Priv.*, Co. E, 10 Reg't U. S. Col'd H. Art'y.

Appears on

**Company Muster Roll**

for *May & June* -----, 186*5*.

Present or absent *Present* -----

Stoppage, \$ ----- 100 for -----

Due Gov't, \$ ----- 100 for -----

Valuation of horse, \$ ----- 100

Valuation of horse equipments, \$ ----- 100

Remarks: -----  
-----  
-----  
-----  
-----  
-----  
-----  
-----  
-----  
-----

Book mark: -----  
-----

*G. C. Tyler*  
-----  
Copyist.

2 | 10 H. Art'y. | U.S.C.T.

*John Lewis*  
-----  
*Col.*-----, Co. E, 10 Reg't U. S. Col'd H. Art'y

Appears on

**Company Muster Roll**

for *July + Aug*-----, 186*5*.

Present or absent *Present*-----

Stoppage, \$-----100 for-----

Due Gov't, \$-----100 for-----

Valuation of horse, \$-----100

Valuation of horse equipments, \$-----100

Remarks: *at use U.S. Col'd H. Art'y*  
*transf. \$ 40*  
-----  
-----  
-----  
-----  
-----

Book mark:-----

-----  
*[Signature]*  
-----  
Copyist.

*D* | **10 H. Art'y. U.S.C.T.**

*John Lewis*  
*Capt.*, Co. E, 10 Reg't U. S. Col'd H. Art'y

Appears on

**Company Muster Roll**

for *Sept & Oct*, 1865.

Present or absent *Present*

Stoppage, \$ 100 for

Due Gov't, \$ 100 for

Valuation of horse, \$ 100

Valuation of horse equipments, \$ 100

Remarks:

Book mark:

*G. J. [unclear]*

L | 10 H. Art'y. | **U.S.C.T.**

John Lewis  
Priv, Co. E, 10 Reg't U. S. Col'd H. Art'y.

Appears on

**Company Muster Roll**

for Nov Dec, 1865.

Present or absent Present

Stoppage, \$ 100 for

Due Gov't, \$ 100 for

Valuation of horse, \$ 100

Valuation of horse equipments, \$ 100

Remarks:

Book mark:

Hark  
Copyist.

*L* | 10 H. Art'y. | U.S.C.T.

*John Lewis*  
*Pr*, Co. E, 10 Reg't U. S. Col'd H. Art'y.

Appears on

**Company Muster Roll**

for *Jan & Feb*, 1866.

Present or absent *Present*

Stoppage, \$ 100 for

Due Gov't, \$ 100 for

Valuation of horse, \$ 100

Valuation of horse equipments, \$ 100

Remarks: \_\_\_\_\_  
\_\_\_\_\_  
\_\_\_\_\_  
\_\_\_\_\_  
\_\_\_\_\_  
\_\_\_\_\_  
\_\_\_\_\_  
\_\_\_\_\_

Book mark: \_\_\_\_\_

*Hart*

Copyist.



*L* | 10 H. Art'y. | U.S.C.T.

*John Lewis*

*Priv*, Co. E, 10 Reg't U. S. Col'd H. Art'y

Appears on

**Company Muster Roll**

for *March + April*, 1866.

Present or absent *Present*

Stoppage, \$ *100* for

Due Gov't, \$ *100* for

Valuation of horse, \$ *100*

Valuation of horse equipments, \$ *100*

Remarks:

Book mark:

*Mark*

Copyist.

L | 10 H. Art'y. | **U.S.C.T.**

*John Lewis*

*Priv*, Co. E, 10 Reg't U. S. Col'd H. Art'y

Appears on

**Company Muster Roll**

for *May & June*, 186*6*.

Present or absent *Present*

Stoppage, \$ *100* for

Due Gov't, \$ *100* for

Valuation of horse, \$ *100*

Valuation of horse equipments, \$ *100*

Remarks:

Book mark:

*Wark*

Copyist.

*L* | 10 H. Art'y. | **U.S.C.T.**

*John Lewis*

*Regt*, Co. E, 10 Reg't U. S. Col'd H. Art'y.

Appears on

**Company Muster Roll**

for *July & Aug*, 1866.

Present or absent *Present*

Stoppage, \$ 100 for

Due Gov't, \$ 100 for

Valuation of horse, \$ 100

Valuation of horse equipments, \$ 100

Remarks:

Book mark:

*Mark*

Copyist.

*L* | 10 H. Art'y. | U.S.C.T.

*John Lewis*  
*Pvt.*, Co. E, 10 Reg't U. S. Col'd H. Art'y.

Appears on

**Company Muster Roll**

for *Sept. & Oct.*, 1866.

Present or absent *Present*

Stoppage, \$ 100 for

Due Gov't, \$ 100 for

Valuation of horse, \$ 100

Valuation of horse equipments, \$ 100

Remarks:

Book mark:

*O'Hagan* Copyist.

*L* | 10 H. Art'y. | U.S.C.T.

*John Lewis*  
*Pr.*, Co. E, 10 Reg't U. S. Col'd H. Art'y.

Appears on

**Company Muster Roll**

for *Nov. & Dec.*, 186*6*.

Present or absent *Present*

Stoppage, \$ 100 for

Due Gov't, \$ 100 for

Valuation of horse, \$ 100

Valuation of horse equipments, \$ 100

Remarks:

Book mark:

*O'Hagan*

Copyist.

*L* | 10 H. Art'y. | U.S.C.T.

*John Lewis*  
Pvt., Co. E., 10 Reg't U. S. Col'd H. Art'y.

Appears on Co. Muster-out Roll, dated  
*Baton Rouge, La, Feb 22* 1867.  
Muster-out to date *Feb. 22* 1867.  
Last paid to *Dec 31*, 1866.

Clothing account:

Last settled ....., 186 ; drawn since \$ ..... 100  
Due soldier \$ *18.65* / 100; due U. S. \$ ..... 100  
Am't for cloth'g in kind or money adv'd \$ ..... 100

Due U. S. for arms, equipments, &c., \$ *6.02* / 100  
Bounty paid \$ ..... 100; due \$ *300.00* / 100  
*Act of July 26. 66*

Remarks: *Joined Reg. Organ.*  
*as private*

Book mark: .....

1610  
Lewis, John

Co F, 10 U.S. Col'd H. Art'y.

Private | Private

CARD NUMBERS.

1	5-4 f 6 f f 7	26
2	5-5-0 4 6 5-3	27
3	5-5-0 4 f 2 3	28
4	5-5-0 4 f 7 9	29
5	5-5-0 4 9 1 2	30
6	5-5-0 5-0 6 7	31
7	5-5-0 5-2 0 1	32
8	5-5-0 5-3 4 f	33
9	5-5-0 5 4 5-0	34
10	5-5-0 5-5-5-5	35
11	5-5-0 5-6 6 4	36
12	5-5-0 5 f 1 1	37
13	5-5-0 5-9 6 5	38
14	5-5-0 6 1 1 1	39
15	5-5-0 6 2 4 0	40
16	5-5-0 6 3 f 6	41
17	5-5-0 6 5-0 5	42
18	5-5-0 6 7 1 1	43
19	5-5-0 6 f 2 9	44
20	5-5-0 6 9 2 6	45
21		46
22		47
23		48
24		49
25		50

Book Mark:

See also

Q. 1493816 POWERS

G. S. Doughty  
2



*L* | 10 H. Art'y. | U.S.C.T.

*John Lewis*

*Corpl*, Co. *F*, 7 Reg't U. S. Col'd H. Art'y.\*

Appears on

**Company Muster-in and Descriptive Roll**

of the organization named above. Roll dated

*New Orleans La*, Aug 19, 1864.

Where born *St Martins La*

Age *27* y'rs; occupation *Farmer*

When enlisted *Feb 27*, 1864.

Where enlisted *New Orleans La*

For what period enlisted *3* years.

Eyes *Blk*; hair *Blk*

Complexion *Dark*; height *5* ft. *6 1/2* in.

When mustered in *March 6*, 1864.

Where mustered in *New Orleans La*

Bounty paid \$ *100*; due \$ *100*

Where credited *1st Eurlt Dist La*

Company to which assigned

Remarks:

\* This organization subsequently became Co. *F*, 10 Reg't U. S. Colored Heavy Artillery.

Book mark:

*Rosenbaum*

L | 10 H. Art'y. | U.S.C.T.

John Lewis

Appears with rank of \_\_\_\_\_ on

**Muster and Descriptive Roll of a Detachment of U. S. Vols. forwarded**

for the 10 Reg't <sup>(10 H. A. C. d. a.)</sup> U. S. C. H. A. Roll dated

New Orleans La., Mch 6, 1864.

Where born S Martins La

Age 27 y'rs; occupation Farmer

When enlisted Feb'y 27, 1864.

Where enlisted New Orleans

For what period enlisted 3 years.

Eyes Black; hair Black

Complexion *DK*; height 5 ft. 6 1/2 in.

When mustered in Mch 6, 1864.

Where mustered in New Orleans

Bounty paid \$ 100; due \$ 100

Where credited \_\_\_\_\_

Company to which assigned F

Remarks: \_\_\_\_\_  
\_\_\_\_\_  
\_\_\_\_\_

Book mark: \_\_\_\_\_

Galligan

*J*

10 H. Art'y.

U.S.C.T.

*John Lewis*

*Priv.*, Co. *F*, 7 Reg't U. S. Col'd H. Art'y.\*

Appears on

**Company Muster Roll**

for *Enrolment to April 30*, 1864.

Present or absent *Present*

Stoppage, \$.....100 for .....

Due Gov't, \$.....100 for .....

Valuation of horse, \$.....100

Valuation of horse equipments, \$.....100

Remarks: .....

\* This organization subsequently became Co. *F*, 10 Reg't U. S. Colored Heavy Artillery.

Book mark: .....

*Rosenbaum*

Y | 10 H. Art'y. | U.S.C.T.

John Lewis  
Pvt., Co. F., 7 Reg't U. S. Col'd H. Art'y.\*

Appears on

**Company Muster Roll**

for May & June, 1864.

Present or absent Present

Stoppage, \$ 100 for

Due Gov't, \$ 100 for

Valuation of horse, \$ 100

Valuation of horse equipments, \$ 100

Remarks:

\* This organization subsequently became Co. F, 10 Reg't U. S. Colored Heavy Artillery.

Book mark:

Rosenbaum  
Copyist.

*L* | 10 H. Art'y. | U.S.C.T.

*John Lewis*  
*Capt*, Co. F, 10 Reg't U. S. Col'd H. Art'y.

Appears on

**Company Muster Roll**

for *July & August*, 1864.

Present or absent *Present*

Stoppage, \$.....100 for .....

Due Gov't, \$.....100 for .....

Valuation of horse, \$.....100

Valuation of horse equipments, \$.....100

Remarks: *Appointed Aug 19-64*

Book mark: .....

*Rosenbaum*

*L* | 10 H. Art'y. | **U.S.C.T.**

*John Lewis*  
*Capt*, Co. F, 10 Reg't U. S. Col'd H. Art'y.

Appears on

**Company Muster Roll**

for *Sept - Oct*, 1864.

Present or absent *Present*

Stoppage, \$ 100 for

Due Gov't, \$ 100 for

Valuation of horse, \$ 100

Valuation of horse equipments, \$ 100

Remarks:

Book mark:

*Rosenblum*

Copyist.

L | 10 H. Art'y. | U.S.C.T.

*John Lewis*  
Corpl, Co. F, 10 Reg't U. S. Col'd H. Art'y.

Appears on

**Company Muster Roll**

for *Nov & Dec*, 1864.

Present or absent *Present*

Stoppage, \$.....<sup>100</sup> for .....

Due Gov't, \$.....<sup>100</sup> for .....

Valuation of horse, \$.....<sup>100</sup>

Valuation of horse equipments, \$.....<sup>100</sup>

Remarks: .....

Book mark: .....

*Rosenbaum*

L

10 H. Art'y. U.S.C.T.

John Lewis  
Private, Co. F, 10 Reg't U. S. Col'd H. Art'y.

Appears on

Company Muster Roll

for Jan to Feb, 1865.

Present or absent Present

Stoppage, \$ 100 for

Due Gov't, \$ 100 for

Valuation of horse, \$ 100

Valuation of horse equipments, \$ 100

Remarks: Difference between  
\$7 per mo and authorized  
pay due from enlistment  
to June 30/65

Book mark:

B. G. Warden



L

10 H. Art'y. U.S.C.T.

John Lewis

Co. F, 10 Reg't U. S. Col'd H. Art'y.

Appears on

Company Muster Roll

for March, April, 1865.

Present or absent Present

Stoppage, \$ 100 for

Due Gov't, \$ 100 for

Valuation of horse, \$ 100

Valuation of horse equipments, \$ 100

Remarks:

Book mark:

B G Masdon

Copyst.

L

10 H. Art'y. U.S.C.T.

John Lewis

Priv., Co. F, 10 Reg't U. S. Col'd H. Art'y.

Appears on

Company Muster Roll

for May & June, 1865.

Present or absent Present

Stoppage, \$ 100 for

Due Gov't, \$ 100 for

Valuation of horse, \$ 100

Valuation of horse equipments, \$ 100

Remarks: Due U.S. for Camp & Garrison Equipage \$72

Book mark:

B. S. Masdon

L | 10 H. Art'y. | U.S.C.T.

John Lewis

Private, Co. F, 10 Reg't U. S. Col'd H. Art'y.

Appears on

Company Muster Roll

for date Aug 31, 1865.

Present or absent Present

Stoppage, \$ 100 for

Due Gov't, \$ 100 for

Valuation of horse, \$ 100

Valuation of horse equipments, \$ 100

Remarks: Due U.S. for Camp  
& Garrison Equipage  
\$65

Book mark:

B. W. Wadson

L

10 H. Art'y. U.S.C.T.

John Lewis 1st  
Priv, Co. F, 10 Reg't U. S. Col'd H. Art'y.

Appears on

Company Muster Roll

for Sept & Oct, 1865.

Present or absent Present

Stoppage, \$ 100 for

Due Gov't, \$ 100 for

Valuation of horse, \$ 100

Valuation of horse equipments, \$ 100

Remarks:

-----  
-----  
-----  
-----  
-----  
-----  
-----  
-----

Book mark: -----

B. H. Masson

Copyist.

L. | 10 H. Art'y. | U.S.C.T.

John Lewis, et

Pat., Co. F, 10 Reg't U. S. Col'd H. Art'y.

Appears on

**Company Muster Roll**

for Nov. 7 Dec., 1865.

Present or absent Present.

Stoppage, \$0. <sup>08</sup>/<sub>100</sub> for Ordnances!

Due Gov't, \$100 for

Valuation of horse, \$100

Valuation of horse equipments, \$100

Remarks: Due U.S. for b. & G.E.  
\$0.65.

Book mark:

Ash  
Copyist.

L. | 10 H. Art'y. | U.S.C.T.

*John Lewis 1st*

*Q. M. T.*, Co. F, 10 Reg't U. S. Col'd H. Art'y.

Appears on

**Company Muster Roll**

for *Jan'y & Feby.*, 1866.

Present or absent *Present*

Stoppage, \$ 100 for

Due Gov't, \$ 100 for

Valuation of horse, \$ 100

Valuation of horse equipments, \$ 100

Remarks:

Book mark:

L. | **10 H. Art'y.** | **U.S.C.T.**

*John Lewis 1st*

*Pat.*, Co. F, 10 Reg't U. S. Col'd H. Art'y.

Appears on

**Company Muster Roll**

for *Mar 7 April*, 186*6*.

Present or absent *Present*

Stoppage, \$ 100 for

Due Gov't, \$ 100 for

Valuation of horse, \$ 100

Valuation of horse equipments, \$ 100

Remarks:

Book mark: *711532*

*Cash.*  
Copyst.

L.

10 H. Art'y. U.S.C.T.

John Lewis

Part., Co. F, 10 Reg't U. S. Col'd H. Art'y.

Appears on

Company Muster Roll

for May & June, 1866.

Present or absent Present

Stoppage, \$ 100 for

Due Gov't, \$ 100 for

Valuation of horse, \$ 100

Valuation of horse equipments, \$ 100

Remarks:

Book mark:

Copyist.



L. 10 *Vol.* **U.S.C.T.**

*John Lewis*

*Pat.*, Co. *F*, *10* Reg't U. S. Col'd *Arty*

Appears on

**Company Muster Roll**

for *July & Aug.*, 186*6*.

Present or absent *Present.*

Stoppage, \$ *100* for

Due Gov't, \$ *100* for

Valuation of horse, \$ *100*

Valuation of horse equipments, \$ *100*

Remarks:

Book mark:

L

10 H. Art'y. U.S.C.T.

John Lewis

Dr, Co. F, 10 Reg't U. S. Col'd H. Art'y.

Appears on

Company Muster Roll

for Sept. and Oct, 1866

Present or absent Present

Stoppage, \$ 100 for

Due Gov't, \$ 100 for

Valuation of horse, \$ 100

Valuation of horse equipments, \$ 100

Remarks:

Book mark:

House

L

10 H. Art'y. U.S.C.T.

John Lewis

Prst, Co. F, 10 Reg't U. S. Col'd H. Art'y.

Appears on

Company Muster Roll

for Nov. and Dec, 1866

Present or absent Present

Stoppage, \$ 100 for

Due Gov't, \$ 100 for

Valuation of horse, \$ 100

Valuation of horse equipments, \$ 100

Remarks:

[Empty lines for remarks]

Book mark:

House

L | 10 H. Art'y. | U.S.C.T.

John Lewis

Pvt., Co. F., 10 Reg't U. S. Col'd H. Art'y.

Appears on Co. Muster-out Roll, dated

Daton Range La, Feb 22, 1867.

Muster-out to date Feb 22, 1867.

Last paid to Dec. 31, 1866.

Clothing account:

Last settled....., 186 ; drawn since \$.....100

Due soldier \$ 55 <sup>95</sup> / 100; due U. S. \$.....100

Am't for cloth'g in kind or money adv'd \$.....100

Due U. S. for arms, equipments, &c., \$ 6 <sup>00</sup> / 100

Bounty paid \$.....100; due \$.....100

Remarks: Bounty under act  
of July 26/66 300.  
Joined at original organ-  
ization promoted Corp'l  
Aug. 19/64. Reassigned to  
the same Feb 4/65

Book mark : .....

House

*Lewis, John*

*Co A*, 10 U.S. Col'd H. Art'y.

*Private*

*Private*

CARD NUMBERS.

1	5509779	26
2	5509934	27
3	5510083.	28
4	5510228	29
5	5510378	30
6	5510526	31
7	5510705	32
8	5511136	33
9	5489382,	34
10		35
11		36
12		37
13		38
14		39
15		40
16		41
17		42
18		43
19		44
20		45
21		46
22		47
23		48
24		49
25		50

Book Mark:

See also

*L* | 10 H. Art'y. | U.S.C.T.

*John Lewis*  
-----  
*Pvt*, Co. H, 10 Reg't U. S. Col'd H. Art'y

Appears on

**Company Muster Roll**

for *March + April*, 1865.

Present or absent *Present*

Stoppage, \$ 100 for

Due Gov't, \$ 100 for

Valuation of horse, \$ 100

Valuation of horse equipments. \$ 100

Remarks: *Arrangement  
of first payment  
by time March  
31"/1865*

Book mark: \_\_\_\_\_

*Perminington*  
-----  
Copyist.

*L* | **10 H. Art'y.** | **U.S.C.T.**

*John Lewis*

*Pvt*, Co. H, 10 Reg't U. S. Col'd H. Art'y

Appears on

**Company Muster Roll**

for *May & June*, 1865:

Present or absent *Present*

Stoppage, \$ *100* for

Due Gov't, \$ *100* for

Valuation of horse, \$ *100*

Valuation of horse equipments. \$ *100*

Remarks :

Book mark :

*Permitt*

L | 10 H. Art'y. | **U.S.C.T.**

John Lewis

Pvt., Co. H, 10 Reg't U. S. Col'd H. Art'y

Appears on

**Company Muster Roll**

for July & Aug, 1865.

Present or absent Present

Stoppage, \$ 100 for

Due Gov't, \$ 100 for

Valuation of horse, \$ 100

Valuation of horse equipments. \$ 100

Remarks :

Book mark :

Pennington  
Copyist.



*L* | 10 H. Art'y. | U.S.C.T.

*John Lewis*

*Pr't*, Co. H, 10 Reg't U. S. Col'd H. Art'y

Appears on

**Company Muster Roll**

for *Sep & Oct*, 1865.

Present or absent *Present*

Stoppage, \$ 100 for

Due Gov't, \$ 100 for

Valuation of horse, \$ 100

Valuation of horse equipments. \$ 100

Remarks :

Book mark :

*Wammack*

*S* | **10 H. Art'y.** | **U.S.C.T.**

*John Lewis*  
*Priv.*, Co. H, 10 Reg't U. S. Col'd H. Art'y

Appears on

**Company Muster Roll**

for *Nov + Dec*, 1865.

Present or absent *Present*

Stoppage, \$ *100* for

Due Gov't, \$ *100* for

Valuation of horse, \$ *100*

Valuation of horse equipments, \$ *100*

Remarks :

Book mark :

*L* | **10 H. Art'y.** | **U.S.C.T.**

*John Lewis*

*Priv.*, Co. H, 10 Reg't U. S. Col'd H. Art'y

Appears on

**Company Muster Roll**

for *Jan & Feb.*, 186*6*.

Present or absent *Present*

Stoppage, \$ *100* for

Due Gov't, \$ *100* for

Valuation of horse, \$ *100*

Valuation of horse equipments. \$ *100*

Remarks:

Book mark: *11502*

*L* | 10 H. Art'y. | U.S.C.T.

*John Lewis*

*Pvt.*, Co. H, 10 Reg't U. S. Col'd H. Art'y

Appears on

Company Muster Roll

for *Mch & Apr.*, 1866.

Present or absent

Stoppage, \$ 100 for

Due Gov't, \$ 100 for

Valuation of horse, \$ 100

Valuation of horse equipments, \$ 100

Remarks: *Mustered out by reason of expiration of term of service to date March 31. 1866*

Book mark:

*Gammal*

L 10 H a | U.S.C.T.

John Lewis  
Priv, Co. H, 10 Reg't U. S. Col'd 16 A

Appears on an

**Individual Muster-out Roll**

of the organization named above. Roll dated

New Orleans, March 30, 1866.

Muster-out to date March 30, 1866.

Last paid to Dec 31, 1865.

**Clothing account:**

Last settled \_\_\_\_\_, 1866; drawn since \$ 100

Due soldier \$ 25<sup>18</sup>/<sub>100</sub>; due U. S. \$ 100

Am't for cloth'g in kind or money adv'd \$ 100

Due U. S. for arms, equipments, &c., \$ 100

Bounty paid \$ 100 due \$ 100

Remarks: Joined as shown  
Mustered out by reason of Expi-  
ration of Term of Service  
to date March 30<sup>th</sup> 1866

Book mark:

R. Richardson

*L* | 10 H. Art'y. | U.S.C.T.

*John Lewis*  
Pvt., Co. *H*, 10 Reg't U. S. Col'd H. Art'y.

Appears on Co. Muster-out Roll, dated  
*Baton Rouge, La. Feb. 22,* 1867 .

Muster-out to date \_\_\_\_\_, 186 .

Last paid to \_\_\_\_\_, 186 .

Clothing account:

Last settled \_\_\_\_\_, 186 ; drawn since \$ \_\_\_\_\_ 100

Due soldier \$ \_\_\_\_\_ 100; due U. S. \$ \_\_\_\_\_ 100

Am't for cloth'g in kind or money adv'd \$ \_\_\_\_\_ 100

Due U. S. for arms, equipments, &c., \$ \_\_\_\_\_ 100

Bounty paid \$ \_\_\_\_\_ 100; due \$ \_\_\_\_\_ 100

Remarks: *joined by assignment*  
*Mustered out exp. of term*  
*of service Meh. 30/66.*

*Aug. 28 - Drafted to Me. Mar. 31.*  
*65. New Orleans Sa. by. 1866*

Book mark : \_\_\_\_\_

*Lewis, John (2d)*

*Co F*, 10 U.S. Col'd H. Art'y.

*Private*

*Private*

CARD NUMBERS.

1	5-4-8-8-7-6-1	26
2	5-5-0-5-8-1-2	27
3	5-5-0-5-9-6-6	28
4	5-5-0-6-1-1-0	29
5	5-5-0-6-2-4-1	30
6	5-5-0-6-4-1-8	31
7	5-5-0-6-9-9-1	32
8	5-4-9-0-0-3-4	33
9		34
10		35
11		36
12		37
13		38
14		39
15		40
16		41
17		42
18		43
19		44
20		45
21		46
22		47
23		48
24		49
25		50

Book Mark:

See also 77 U.S.C. Inf.

L 10th Art. | **U.S.C.T.**

John Lewis  
Cm, Co. F, 10 Reg't U. S. Col'd Art.

Appears on

**M. and D. Roll of Men Transferred**

to the organization named above,

from 77 Regt U.S.C. Inf.

Roll dated Oct 1, 1865.

When enlisted June 3, 1863.

Period for which enlisted 3 years.

When mustered in Aug 19, 1863

Present or absent Present

Company to which assigned D

Remarks: Joined by transfer  
from Co G 5th Inf C.S.A. Jan  
2.64

Book mark : 70

J. W. Leonard



L

10 H. Art'y. U.S.C.T.

John Lewis 2nd  
Priv

, Co. F, 10 Reg't U. S. Col'd H. Art'y.

Appears on

Company Muster Roll

for Sept & Oct, 1865.

Present or absent Present

Stoppage, \$ 100 for

Due Gov't, \$ 100 for

Valuation of horse, \$ 100

Valuation of horse equipments, \$ 100

Remarks: Transferred from Co. D  
77 U.S. C. I. Oct 1/65

Book mark:

R. G. Wadson

L. | 10 H. Art'y. | U.S.C.T.

John Lewis 2<sup>nd</sup>

Pat., Co. F, 10 Reg't U. S. Col'd H. Art'y.

Appears on

**Company Muster Roll**

for Nov & Dec., 1865.

Present or absent Present.

Stoppage, \$ 100 for

Due Gov't, \$ 100 for

Valuation of horse, \$ 100

Valuation of horse equipments, \$ 100

Remarks: Stop \$4. due J. Eggar,  
Tailor.

Book mark:

ash

*L.* | **10 H. Art'y.** | **U.S.C.T.**

*John Lewis 2d*

*Pat.*, Co. F, 10 Reg't U. S. Col'd H. Art'y.

Appears on

**Company Muster Roll**

for *Jan'y & Feby*, 186*6*.

Present or absent *Present*

Stoppage, \$ *100* for

Due Gov't, \$ *100* for

Valuation of horse, \$ *100*

Valuation of horse equipments, \$ *100*

Remarks:

Book mark:

L. | 10 H. Art'y. | U.S.C.T.

*John Lewis 2<sup>d</sup>*

*Part.*, Co. F, 10 Reg't U. S. Col'd H. Art'y.

Appears on

**Company Muster Roll**

for *Mar. & Apr.*, 1866.

Present or absent *Present*

Stoppage, \$ 100 for

Due Gov't, \$ 100 for

Valuation of horse, \$ 100

Valuation of horse equipments, \$ 100

Remarks:

Book mark: *Muster out on file.*

*Asst.*  
Copied.

L. | 10 H. Art'y. | U.S.C.T.

*Johnson Lewis*

*Pat.*, Co. F, 10 Reg't U. S. Col'd H. Art'y.

Appears on

**Company Muster Roll**

for *May & June*, 1866.

Present or absent

Stoppage, \$ 100 for

Due Gov't, \$ 100 for

Valuation of horse, \$ 100

Valuation of horse equipments, \$ 100

Remarks: *Mustered out by expiration of service.*

Book mark:

*Ash*  
Copied.

L | 10 H. Art'y. | U.S.C.T.

John Lewis, 2nd  
Pvt., Co. F, 10 Reg't U. S. Col'd H. Art'y.

Appears on Co. Muster-out Roll, dated  
Baton Rouge La Feb 22, 1867.

Muster-out to date \_\_\_\_\_, 1867.

Last paid to April 30, 1867.

Clothing account:

Last settled \_\_\_\_\_, 1867; drawn since \$ \_\_\_\_\_ 100

Due soldier \$ \_\_\_\_\_ 100; due U. S. \$ \_\_\_\_\_ 100

Am't for cloth'g in kind or money adv'd \$ \_\_\_\_\_ 100

Due U. S. for arms, equipments, &c., \$ \_\_\_\_\_ 100

Bounty paid \$ \_\_\_\_\_ 100; due \$ \_\_\_\_\_ 100

Remarks: Rec'd by transfer from es-  
D. 77 U. S. Col. pr. S. O. No 66  
Ha. 2nd Dept of La. S. of 65  
Discharged by expiration of  
service June 2/66

Book mark: V. 81. P. 83. 69

House

L | 10 Arty | U.S.C.T.

John Lewis 2d.

Pvt., Co. F, 10 Reg't U. S. Col'd Arty

Appears on a

**Detachment Muster-out Roll**

of the organization named above. Roll dated

New Orleans, La., June 2, 1866.

Muster-out to date June 2, 1866.

Last paid to Apr. 30, 1866

**Clothing account:**

Last settled \_\_\_\_\_, 1866 ; drawn since \$ \_\_\_\_\_ 100

Due soldier \$  $8\frac{90}{100}$ ; due U. S. \$ \_\_\_\_\_ 100

Am't for cloth'g in kind or money adv'd \$ \_\_\_\_\_ 100

Due U. S. for arms, equipments, &c., \$ \_\_\_\_\_ 100

Bounty paid \$ \_\_\_\_\_ 100 due \$ \_\_\_\_\_ 100

Remarks: *Joined 4 Inf. Co. A. (76 U.S.C.S.)*

*as recruit transferred to 5 Inf. Co. A.*

*77 (U.S.C.S.) Dec. '63 transferred to 10 U.S.C.A. (44)*

*per A.O. 66 Hdqrs. Dept. of La. series of 1865.*

Book mark: \_\_\_\_\_

R. E. Wilson

Copyist.

1616  
Lewis, John J.  
Co I, 10 U.S. Col'd H. Art'y.

Private | Private

CARD NUMBERS.

1	5511256	26
2	5511348	27
3	5511435	28
4	5511548	29
5	5511679	30
6	5511847	31
7	5512138	32
8	5489980	33
9		34
10		35
11		36
12		37
13		38
14		39
15		40
16		41
17		42
18		43
19		44
20		45
21		46
22		47
23		48
24		49
25		50

Book Mark:

See also



S. 743 379 P.O. M. & M.

Q 1512680 P.O. aff

C. E. Doughty

L. | 10 H. Art'y. | U.S.C.T.

John J. Lewis  
Pt., Co., 10 Reg't U. S. Col'd H. Art'y.

Age 30 years.

Appears on

**Company Muster Roll\***

for Enrollment to June 30, 1865.

Joined for duty and enrolled:

When \_\_\_\_\_, 186

Where \_\_\_\_\_

Period 1 years.

Mustered in:

When Apr. 21, 1865.

Where New Orleans, La.

Present or absent Present

Stoppage, \$ 100 for

Due Gov't, \$ 100 for

Valuation of horse, \$ 100

Valuation of horse equipments, \$ 100

Remarks: Drafted. Com-  
mencement of first

\*First current roll. No muster-in roll of this company on file.

Book mark : \_\_\_\_\_

O. J. Leart

JAN. 16

5511256

1891

*payment by time*

*Apr. 21, 65.*

L. | 10 H. Art'y. | U.S.C.T.

*John J. Lewis*

*Priv.*, Co. I, 10 Reg't U. S. Col'd H. Art'y.

Appears on

**Company Muster Roll**

for *July & Aug.*, 186*5*.

Present or absent *Present*

Stoppage, \$ *100* for

Due Gov't, \$ *100* for

Valuation of horse, \$ *100*

Valuation of horse equipments, \$ *100*

Remarks: *Due United States  
for Ordnance \$ 0.23.*

Book mark:

*A. S. Clark*

Copyist.

*L.* | **10 H. Art'y.** | **U.S.C.T.**

*John J. Lewis*

*Priv.*, Co. I, 10 Reg't U. S. Col'd H. Art'y.

Appears on

**Company Muster Roll**

for *Sept. + Oct.*, 1865.

Present or absent *Present*

Stoppage, \$ 100 for

Due Gov't, \$ 100 for

Valuation of horse, \$ 100

Valuation of horse equipments, \$ 100

Remarks:

Book mark:

*O. S. Clark*

Copyist.

L. | 10 H. Art'y. | U.S.C.T.

*John J. Lewis*

*Pvt.*, Co. I, 10 Reg't U. S. Col'd H. Art'y.

Appears on

**Company Muster Roll**

for *Nov. & Dec.*, 186*5*.

Present or absent *Present*

Stoppage, \$ 100 for

Due Gov't, \$ 100 for

Valuation of horse, \$ 100

Valuation of horse equipments, \$ 100

Remarks:

FROM SECOND AUDITOR'S ROLL.

Book mark:

*O. J. Clark*

Copyist.

*L.* | **10 H. Art'y.** | **U.S.C.T.**

*John J. Lewis*  
*Prvt.*, Co. I, 10 Reg't U. S. Col'd H. Art'y.

Appears on

**Company Muster Roll**

for *Jan. & Feb.*, 1866.

Present or absent *Present*

Stoppage, \$ 100 for

Due Gov't, \$ 100 for

Valuation of horse, \$ 100

Valuation of horse equipments, \$ 100

Remarks:

Book mark:

*O. S. Clark*

Copyist.

L. | 10 H. Art'y. | **U.S.C.T.**

John J. Lewis  
Pvt., Co. I, 10 Reg't U. S. Col'd H. Art'y.

Appears on

**Company Muster Roll**

for March & Apr., 1866.

Present or absent.....

Stoppage, \$.....<sup>100</sup> for.....

Due Gov't, \$.....<sup>100</sup> for.....

Valuation of horse, \$.....<sup>100</sup>

Valuation of horse equipments, \$.....<sup>100</sup>

Remarks: Discharged. Must-  
ered out by reason of ex-  
piration of term of ser-  
vice to date Apr. 20,  
1866.

Book mark: Mustered out on file.

O. S. Clark

Copyist.



*L* | *10 Arty* | **U.S.C.T.**

*John I Lewis*  
*Priv., Co. I, 11 Reg't U. S. Col'd Arty*

Appears on a

**Detachment Muster-out Roll**

of the organization named above. Roll dated

*New Orleans, La, Apr. 20, 1866.*

Muster-out to date

*Apr. 20, 1866.*

Last paid to

*Feb. 28, 1866*

**Clothing account:**

Last settled ..... 186 ; drawn since \$ ..... 100

Due soldier \$ *21 <sup>86</sup>/<sub>100</sub>*; due U. S. \$ ..... 100

Am't for cloth'g in kind or money adv'd \$ ..... 100

Due U. S. for arms, equipments, &c., \$ ..... *97*/<sub>100</sub>

Bounty paid \$ ..... 100 due \$ ..... 100

Remarks: *Joined by draft. Stop*  
*for one Haversack 95¢. one*  
*campion .02¢ total .97 cts*

Book mark: .....

*R. E. Wilson*

L | 10 H. Art'y. | U.S.C.T.

*John J. Lewis*  
-----  
*Co.*, 10 Reg't U. S. Col'd H. Art'y.

Appears on **Co. Muster-out Roll**, dated  
*Baton Rouge La, Feb 22, 1867.*

Muster-out to date -----, 186 .

Last paid to -----, 186 .

Clothing account:

Last settled -----, 186 ; drawn since \$ ----- 100

Due soldier \$ ----- 100; due U. S. \$ ----- 100

Am't for cloth'g in kind or money adv'd \$ ----- 100

Due U. S. for arms, equipments, &c., \$ ----- 100

Bounty paid \$ ----- 100; due \$ ----- 100

Remarks: *Discharged, expiration*  
*term of service Apr, 20, 1866*

Book mark : -----

*J. M. Hance*  
-----

1871  
Lewis, Milton

Co M, 10 U.S. Col'd H. Art'y

Musician

Musician

CARD NUMBERS.

1	5487917	26
2	5488923	27
3	5488815	28
4	5514287	29
5	5514440	30
6	5514582	31
7	5514825	32
8	5514938	33
9	5515003	34
10	5515063	35
11	5515123	36
12	5515217	37
13	5489393	38
14	9129687	39
15		40
16		41
17		42
18		43
19		44
20		45
21		46
22		47
23		48
24		49
25		50

Book Mark:

See also

77 U.S. Col'd H. Art'y

L | 10 H. Art'y. | U. S. C. T.

Milton Lewis

Co. M, 10 Reg't U. S. Col'd H. Art'y.

Appears on

**Company Descriptive Book**

of the organization named above.

**DESCRIPTION.**

Age 3 years; height 5 feet inches.

Complexion Dark

Eyes brown; hair black

Where born St James La.

Occupation Servant

**ENLISTMENT.**

When Dec 25, 1863.

Where Fort St Philip

By whom Col. Hartwell, term 3 y'rs.

Remarks: Rec'd. by transfer from  
Co. A, 77 U. S. C. I. for  
S. O., 66 7th Dist. Dept. La  
Sept 22 65. Musician  
Discharged and honorably  
mustered out of service  
Dec 24 1866 by reason  
of expiration of term of  
service.

W. Nealhorn

L | 10th a | U.S.C.T.

Milton Lewis  
Musc, Co M, 10 Reg't U. S. Col'd HA

Appears on

**M. and D. Roll of Men Transferred**

to the organization named above,

from 147 U. S. Col'd

Roll dated Camp Parapet Oct, 1865.

When enlisted Dec 20, 1863.

Period for which enlisted 3 years.

When mustered in Jan 16, 1864.

Present or absent

Company to which assigned M

Remarks: Joined as Recruit  
Co A 5th Ca A Lost bat-  
ter Head. Haversack  
bugle letter & 2 nam-  
bers Rec'd by transfer  
from Co A 1st U.S. I.  
per S.O. 66 Sept 22  
Sept 22. 65

Book mark: 200114

W. H. S. S. S.

L | 10 H. Art'y. | **U.S.C.T.**

Milton Lewis

Drummes Co. M., 10. Reg't U. S. Col'd H. Art'y

Appears on

**M. and D. Roll of Men Transferred**

to the organization named above,

from 77<sup>th</sup> U. S. Col'd Inf'y.

Roll dated Oct. 1, 1865.

When enlisted Dec. 25, 1863.

Period for which enlisted 3 years.

When mustered in Jan. 16, 1864.

Present or absent Present.

Company to which assigned M.

Remarks: Joined as recruit,

Co. "A", 5<sup>th</sup> Col'd A. Lost

bathe-head, haversack,

bugle, letter, and two

numbers.

Book mark :

L | 10<sup>th</sup> Co. Arty | U.S.C.T.

Milton Lewis

Drummer, Co. K, 10 Reg't U. S. Col'd Arty

Appears on

**M. and D. Roll of Men Transferred**

to the organization named above,

from 77<sup>th</sup> U. S. Col'd Inf.

Roll dated Oct. 1, 1865

When enlisted Dec. 25, 1863

Period for which enlisted 3 years

When mustered in Jan. 16, 1864

Present or absent Present

Company to which assigned K

Remarks: joined as recruit

Co. K, 5<sup>th</sup> Col'd A.

Lost button head, haversack,

bugle, letter and two

numbers.

Book mark :

L Chandler

Copyist

L | 10 H. Art'y. | U.S.C.T.

Milton Lewis

Mus. Coll., 10 Reg't U. S. Col'd H. Art'y.

Age \_\_\_\_\_ years.

Appears on

Company Muster Roll\*

for Sept - & Oct - , 1865.

Joined for duty and enrolled:

When Dec 20 , 1863.

Where Fort-St-Philip

Period 3 years.

Mustered in:

When Jan 10 , 1864.

Where Fort-St-Philip

Present or absent Present

Stoppage, \$ 100 for

Due Gov't, \$ 46 100 for 6 & 1/2.

Valuation of horse, \$ 100

Valuation of horse equipments, \$ 100

Remarks :

\*First current roll. No muster-in roll of this company on file.

Book mark :

M. Wright



L | 10 H. Art'y. | U. S. C. T.

*Milton Lewis*

*Musicians* Co. M, 10 Reg't U. S. Col'd H. Art'y.

Appears on

Company Muster Roll

for *Mr. Rice*, 1865.

Present or absent *Present*

Stoppage, \$ 100 for

Due Gov't, \$ *2* <sup>*46*</sup>/<sub>*100*</sub> for *604 Equip*

Valuation of horse, \$ 100

Valuation of horse equipments, \$ 100

Remarks:

Book mark:

*W. H. Wright*

*L* | 10 H. Art'y. | U. S. C. T.

*Milton Lewis*

*Munie*, Co. M, 10 Reg't U. S. Col'd H. Art'y.

Appears on

**Company Muster Roll**

for *Jan & Feb*, 186*6*.

Present or absent *Present*

Stoppage, \$.....100 for .....

Due Gov't, \$.....100 for .....

Valuation of horse, \$.....100

Valuation of horse equipments, \$.....100

Remarks: .....

.....  
.....  
.....  
.....  
.....  
.....  
.....

Book mark: .....

*J. H. Bryant*

L

10 H. Art'y.

U. S. C. T.

Milton Lewis

Mine, Co. M, 10 Reg't U. S. Col'd H. Art'y.

Appears on

Company Muster Roll

for Feb & Apr, 1866.

Present or absent Present

Stoppage, \$ 100 for

Due Gov't, \$ 100 for

Valuation of horse, \$ 100

Valuation of horse equipments, \$ 100

Remarks:

Book mark:

W. H. Wright

*L* | 10 H. Art'y. | U. S. C. T.

*Milton Lewis*

*Mason*, Co. M, 10 Reg't U. S. Col'd H. Art'y.

Appears on

**Company Muster Roll**

for *May & June*, 186*6*.

Present or absent *Present*

Stoppage, \$.....*100* for .....

Due Gov't, \$.....*100* for .....

Valuation of horse, \$.....*100*

Valuation of horse equipments, \$.....*100*

Remarks: .....

Book mark: .....

*A. H. Wright*

L | 10 H. Art'y. | U. S. C. T.

William Lewis

Music, Co. M, 10 Reg't U. S. Col'd H. Art'y.

Appears on

**Company Muster Roll**

for July & Aug, 1866.

Present or absent Present

Stoppage, \$ 100 for

Due Gov't, \$ 100 for

Valuation of horse, \$ 100

Valuation of horse equipments, \$ 100

Remarks: \_\_\_\_\_  
\_\_\_\_\_  
\_\_\_\_\_  
\_\_\_\_\_  
\_\_\_\_\_  
\_\_\_\_\_  
\_\_\_\_\_

Book mark: \_\_\_\_\_

L. H. Wright  
Copyist.

2. | **10 H. Art'y.** | **U. S. C. T.**

Milton Lewis

Musin, Co. M, 10 Reg't U. S. Col'd H. Art'y.

Appears on

**Company Muster Roll**

for Sept + Oct, 1866.

Present or absent Present

Stoppage, \$ 100 for

Due Gov't, \$ 100 for

Valuation of horse, \$ 100

Valuation of horse equipments, \$ 100

Remarks:

Book mark:

Rector

2

10 H. Art'y.

U. S. C. T.

Milton Lewis

Mus'n, Co. M, 10 Reg't U. S. Col'd H. Art'y.

Appears on

Company Muster Roll

for Nov + Dec, 1866.

Present or absent Present

Stoppage, \$ 100 for

Due Gov't, \$ 100 for

Valuation of horse, \$ 100

Valuation of horse equipments, \$ 100

Remarks: Forfeit ten dollars \$10.00 for one mo. per sentence of Civil Officers Court for G. O. 1 Std 2nd Post, Baton Rouge, La Dec 28/66

Book mark:

Rector

L 110 No a | U.S.C.T.

Milton Lewis

Musician, Co. M, 10 Reg't U. S. Col'd No a

Appears on an

**Individual Muster-out Roll**

of the organization named above. Roll dated

Baton Rouge La due 24, 1866

Muster-out to date due 24, 1866

Last paid to Oct 31, 1866

**Clothing account:**

Last settled ..... 186 ; drawn since \$ ..... 100

Due soldier \$ 13 <sup>04</sup> / 100; due U. S. \$ ..... 100

Am't for cloth'g in kind or money adv'd \$ ..... 100

Due U. S. for arms, equipments, &c., \$ ..... 100

Bounty paid \$ ..... 100 due \$ 300 / 100

Remarks: Joined by transfer from  
the 77<sup>th</sup> USC Infy pr 5066  
Had yrs kept La Sept 22/66  
Forfeit \$10. pr sentence  
Field Officers Court pr 40  
Had Drs Pat Baton Rouge La Dec 28/66

Book mark:

R. Richardson



2 | 10 H. Art'y. | U.S.C.T.

Millon Lewis

Mus'n, Co. M., 10 Reg't U. S. Col'd H. Art'y.

Appears on Co. Muster-out Roll, dated

Baton Rouge La., Feb 22, 1867.

Muster-out to date ..... 186 .

Last paid to ..... 186 .

Clothing account:

Last settled ..... 186 ; drawn since \$ ..... 100

Due soldier \$ ..... 100; due U. S. \$ ..... 100

Am't for cloth'g in kind or money adv'd \$ ..... 100

Due U. S. for arms, equipments, &c., \$ ..... 100

Bounty paid \$ ..... 100; due \$ ..... 100

Remarks: *prom'd by Arms. from Co. A  
77 U.S.C. for \$ 10.00 21st Dec 1865  
La Sep 22/65 as Mus'n. Disch'd by rea-  
son of Expiration of term of service  
Dec 24/66*

Book mark: *V. 11. 2. P. 245-73 M. W. sa file.*

*Reuter*

1650  
Lewis, Nelson

Co *N*<sup>o</sup>, 10 U.S. Col'd H. Art'y.

Private

Private

CARD NUMBERS.

1	5509777	26
2	5509931	27
3	5510081	28
4	5510226	29
5	5510376	30
6	5510524	31
7	5510702	32
8	5511134	33
9	5489381	34
10		35
11		36
12		37
13		38
14		39
15		40
16		41
17		42
18		43
19		44
20		45
21		46
22		47
23		48
24		49
25		50

Book Mark:

See also

L | **10 H. Art'y.** | **U.S.C.T.**

Nelson Lewis

Pvt, Co. H, 10 Reg't U. S. Col'd H. Art'y

Appears on

**Company Muster Roll**

for March & April, 1865.

Present or absent Present

Stoppage, \$ 100 for

Due Gov't, \$ 100 for

Valuation of horse, \$ 100

Valuation of horse equipments. \$ 100

Remarks: Commencement  
of first payment  
by time March 7<sup>o</sup>  
1865

Book mark:

Pennings Copyist.

*L* 10 H. Art'y. | U.S.C.T.

*Nelson Lewis*

*Pvt*, Co. H, 10 Reg't U. S. Col'd H. Art'y

Appears on

**Company Muster Roll**

for *May & June*, 1865.

Present or absent *Present*

Stoppage, \$ 100 for

Due Gov't, \$ 100 for

Valuation of horse, \$ 100

Valuation of horse equipments. \$ 100

Remarks :

Book mark :

*Pennington*

*L* | 10 H. Art'y. | U.S.C.T.

*Nelson Lewis*

*Pvt*, Co. H, 10 Reg't U. S. Col'd H. Art'y

Appears on

**Company Muster Roll**

for *July & Aug*, 1865.

Present or absent *Present*

Stoppage, \$ *100* for

Due Gov't, \$ *100* for

Valuation of horse, \$ *100*

Valuation of horse equipments. \$ *100*

Remarks: *Sick in quarters*

Book mark:

*Perrington* Copyist.

*L* | 10 H. Art'y. | U.S.C.T.

*Nelson Lewis*

*Priv't*, Co. H, 10 Reg't U. S. Col'd H. Art'y

Appears on

**Company Muster Roll**

for *Sept & Oct*, 1865.

Present or absent *Present*

Stoppage, \$ *100* for

Due Gov't, \$ *100* for

Valuation of horse, \$ *100*

Valuation of horse equipments, \$ *100*

Remarks: *Sick in Post Hosp.*

Book mark:

*Gammack*

*L* | 10 H. Art'y. | U.S.C.T.

*Nelson Lewis*

*Pvt*, Co. H, 10 Reg't U. S. Col'd H. Art'y

Appears on

**Company Muster Roll**

for *Nov & Dec*, 1865.

Present or absent *Present*

Stoppage, \$ *100* for

Due Gov't, \$ *100* for

Valuation of horse, \$ *100*

Valuation of horse equipments. \$ *100*

Remarks :

-----  
-----  
-----  
-----  
-----  
-----  
-----  
-----  
-----  
-----

Book mark :-----

*Samuel R*  
Copyist.

*L* | 10 H. Art'y. | U.S.C.T.

*Nelson Lewis*

*Pvt.*, Co. H, 10 Reg't U. S. Col'd H. Art'y

Appears on

**Company Muster Roll**

for *Jan & Feb.*, 1866.

Present or absent *Present*

Stoppage, \$ *100* for

Due Gov't, \$ *100* for

Valuation of horse, \$ *100*

Valuation of horse equipments. \$ *100*

Remarks:

Book mark:

*Carman*

Copyist.



*L* | 10 H. Art'y. | U.S.C.T.

*Nelson Lewis*

*Pvt.*, Co. H, 10 Reg't U. S. Col'd H. Art'y

Appears on

**Company Muster Roll**

for *Mch & Apr.*, 1866.

Present or absent.....

Stoppage, \$ 100 for.....

Due Gov't, \$ 100 for.....

Valuation of horse, \$ 100

Valuation of horse equipments. \$ 100

Remarks: *Mustered out by reason of expiration of term of service to date March 6 1866*

Book mark:.....

*Lamma R*  
Copyist.

L | 10 No a | U.S.C.T.

Nelson Lewis

Pri, Co. No. 10 Reg't U. S. Col'd. Ha

Appears on an

**Individual Muster-out Roll**

of the organization named above. Roll dated

New Orleans La Mch 6, 1866.

Muster-out to date Mch 6, 1866.

Last paid to Dec 31, 1865.

**Clothing account:**

Last settled ..... 186 ; drawn since \$ ..... 100

Due soldier \$ 17 <sup>50</sup> / 100; due U. S. \$ ..... 100

Am't for cloth'g in kind or money adv'd \$ ..... 100

Due U. S. for arms, equipments, &c., \$ ..... 100

Bounty paid \$ ..... 100 due \$ ..... 100

Remarks: Drafted in 1<sup>st</sup> list

New Orleans La March 7, 1865

Rucksack, Haversack and Canteen

retained per G.O. No. 114 War

Department a 40 Series of

1865 (over)

Book mark: V66 P 59, 69.

R. S. Richardson

*L* | 10 H. Art'y. | U.S.C.T.

*Nelson Lewis*

*Pvt*, Co. *H*, 10 Reg't U. S. Col'd H. Art'y.

Appears on Co. Muster-out Roll, dated

*Baton Rouge, La. Feb. 22, 1867*.

Muster-out to date \_\_\_\_\_, 186 .

Last paid to \_\_\_\_\_, 186 .

Clothing account:

Last settled \_\_\_\_\_, 186 ; drawn since \$ \_\_\_\_\_ 100

Due soldier \$ \_\_\_\_\_ 100; due U. S. \$ \_\_\_\_\_ 100

Am't for cloth'g in kind or money adv'd \$ \_\_\_\_\_ 100

Due U. S. for arms, equipments, &c., \$ \_\_\_\_\_ 100

Bounty paid \$ \_\_\_\_\_ 100; due \$ \_\_\_\_\_ 100

Remarks: *joined by assignment*  
*Mustered out exp. of term*  
*of service March 6/66.*

*Ag. 32 drafted & M. Mar. 7*  
*65 New Orleans 1 yr.*

Book mark: *V. 66. P. 59. 69*

*Loung*

JAN. 15

5489381

\* 1891 \*

Mustered out by reason  
of expiration of term of  
service to date mch  
6<sup>th</sup> 1866

Lewis, Peter

Co D, 10 U.S. Col'd H. Art'y.

Private | Corporal

CARD NUMBERS.

3-4-94231	26
5-4-94383	27
5-4-94543	28
5-4-94619	29
5-4-94774	30
5-4-94928	31
5-4-95085	32
5-4-95240	33
5-4-95390	34
5-4-95542	35
5-4-95681	36
5-4-95831	37
5-4-95981	38
5-4-96134	39
5-4-96287	40
5-4-96436	41
5-4-96581	42
5-4-96727	43
5-4-96883	44
5-4-97070	45
5-4-97373	46
5-4-89618	47
	48
	49
	50

Book Mark:

See also

*L* | 10 H. Art'y. | U.S.C.T.

*Peter Lewis*

*Pvt.*, 2 Battery, La. H. Art'y, Native Guards.\*

Age *31* years.

Appears on

**Company Muster-in Roll**

of the organization named above. Roll dated

*Camp Parapet, Carrollton, La., Feb. 9*, 186*2*.

Muster-in to date

*Feb. 9*, 186*2*.

Joined for duty and enrolled:

When *Dec. 4*, 186*2*.

Where *Camp Parapet, Carrollton, La.*

Period *3* years.

Valuation of horse, \$.....*100*

Valuation of horse equipments, \$.....*100*

Remarks:.....

\* This organization subsequently became Co. B, 10 Reg't U. S. Colored Heavy Artillery.

Book mark:.....

*Fraste*

*L.* | **10 H. Art'y.** | **U.S.C.T.**

*Peter Lewis*

*Pvt.*, Co. B, 1 Reg't La. H. Art'y, Native Guards.\*

Appears on

**Company Muster Roll**

for *June Enlistment to Feb. 28*, 1863.

Present or absent *Present*

Stoppage, \$ *100* for

Due Gov't, \$ *100* for

Valuation of horse, \$ *100*

Valuation of horse equipments, \$ *100*

Remarks:

-----  
-----  
-----  
-----  
-----  
-----  
-----  
-----

\*This organization subsequently became Co. B, 10 Reg't U. S. Col'd Heavy Artillery.

Book mark:-----

*Feaster*

L | 10 H. Art'y. | U.S.C.T.

*Peter Lewis*

*Pvt.*, Co. B, 1 Reg't La. H. Art'y, Native Guards.\*

Appears on

**Company Muster Roll**

for *March 4. April*, 186 *2*.

Present or absent *Present*

Stoppage, \$ *100* for

Due Gov't, \$ *100* for

Valuation of horse, \$ *100*

Valuation of horse equipments, \$ *100*

Remarks:

\*This organization subsequently became Co. B, 10 Reg't U. S. Col'd Heavy Artillery.

Book mark:

*Coaster*



*D* | 10 H. Art'y. | U.S.C.T.

*Peter Lewis*

*Coytl*, Co. B, 1 Reg't La. H. Art'y, Native Guards.\*

Appears on

**Company Muster Roll**

for *May 4. June*, 186*3*.

Present or absent *Present*

Stoppage, \$ *100* for

Due Gov't, \$ *100* for

Valuation of horse, \$ *100*

Valuation of horse equipments, \$ *100*

Remarks:

\*This organization subsequently became Co. B, 10 Reg't U. S. Col'd Heavy Artillery.

Book mark:

*Feaster*

L | 10 H. Art'y. | U.S.C.T.

Peter Lewis

Corpl., Co. B, 1 Reg't La. H. Art'y, Native Guards.\*

Appears on

**Company Muster Roll**

for July 4. Aug., 1863.

Present or absent Present

Stoppage, \$ 100 for

Due Gov't, \$ 100 for

Valuation of horse, \$ 100

Valuation of horse equipments, \$ 100

Remarks:

\*This organization subsequently became Co. B, 10 Reg't U. S. Col'd Heavy Artillery.

Book mark:

Feaster

L | 10 H. Art'y. | U.S.C.T.

*Peter Lewis*

*Corpl.*, Co. B, 1 Reg't La. H. Art'y, Native Guards.\*

Appears on

**Company Muster Roll**

for *Sept. 7, Oct.*, 186*3*.

Present or absent *Present*

Stoppage, \$ *100* for

Due Gov't, \$ *100* for

Valuation of horse, \$ *100*

Valuation of horse equipments, \$ *100*

Remarks: \_\_\_\_\_  
\_\_\_\_\_  
\_\_\_\_\_  
\_\_\_\_\_  
\_\_\_\_\_  
\_\_\_\_\_

\*This organization subsequently became Co. B, 10 Reg't U. S. Col'd Heavy Artillery.

Book mark: \_\_\_\_\_

*Feaster*

*L* | 10 H. Art'y. | U.S.C.T.

*Peter Lewis*

*Cpl*, Co. *B*, 1 Reg't H. Art'y, Corps d'Afrique.\*

Appears on

**Company Muster Roll**

for *Nov. & Dec*, 186<sup>3</sup>.

Present or absent *Present*

Stoppage, \$ *100* for

Due Gov't, \$ *100* for

Valuation of horse, \$ *100*

Valuation of horse equipments, \$ *100*

Remarks:

\*This organization subsequently became Co. *10* Reg't U. S. Colored Heavy Artillery.

Book mark:

*Copy*

L | 10 H. Art'y. | U.S.C.T.

Peter Lewis

4th, Co. B, 1 Reg't H. Art'y, Corps d'Afrique.\*

Appears on

Company Muster Roll

for Jan. & Feb., 1864.

Present or absent Present

Stoppage, \$ 100 for

Due Gov't, \$ 100 for

Valuation of horse, \$ 100

Valuation of horse equipments, \$ 100

Remarks:

\* This organization subsequently became Co. , 10 Reg't U. S. Colored Heavy Artillery.

Book mark:

Reif

Copyist.

*L* | **10 H. Art'y.** | **U.S.C.T.**

*Peter Lewis*  
-----  
*Corp.*, Co. *B*, 7 Reg't U. S. Col'd H. Art'y.\*

Appears on

**Company Muster Roll**  
for *Mar & Apr*, 1864

Present or absent *Presents*

Stoppage, \$ *100* for

Due Gov't, \$ *100* for

Valuation of horse, \$ *100*

Valuation of horse equipments, \$ *100*

Remarks: -----  
-----  
-----  
-----  
-----  
-----  
-----

\* This organization subsequently became Co. *B*, 10 Reg't U. S. Colored Heavy Artillery.

Book mark: -----

*J. W. Richardson*  
-----  
Copyist.

*L* | **10 H. Art'y.** | **U.S.C.T.**

*Peter Lewis*

*Lpt*, Co. *B*, 7 Reg't U. S. Col'd H. Art'y.\*

Appears on

**Company Muster Roll**

for *May & June*, 186 *4*.

Present or absent *Present*

Stoppage, \$ *100* for

Due Gov't, \$ *100* for

Valuation of horse, \$ *100*

Valuation of horse equipments, \$ *100*

Remarks: *Asst. to Co. Mr. Sgt.*

\* This organization subsequently became Co. , 10 Reg't U. S. Colored Heavy Artillery.

Book mark: \_\_\_\_\_

*P. Lewis*  
Copyist.

*L* | 10 H. Art'y. | U.S.C.T.

*Peter Lewis*  
*Corp.*, Co. B, 10 Reg't U. S. Col'd H. Art'y.

Appears on

**Company Muster Roll**

for *July + Aug*, 186*4*.

Present or absent *Present*

Stoppage, \$ 100 for

Due Gov't, \$ 100 for

Valuation of horse, \$ 100

Valuation of horse equipments, \$ 100

Remarks:

Book mark:

*J. W. Richardson*  
Copyist.



L | 10 H. Art'y. | U.S.C.T.

Peter Lewis  
Corp., Co. B, 10 Reg't U. S. Col'd H. Art'y.

Appears on

Company Muster Roll

for Sept & Oct, 1864

Present or absent Present

Stoppage, \$ 100 for

Due Gov't, \$ 100 for

Valuation of horse, \$ 100

Valuation of horse equipments, \$ 100

Remarks: Assistant to Quar-  
ter master Sergeant

Book mark:

(358)

J. W. Richardson  
Copyist.

*L* | **10 H. Art'y. U.S.C.T.**

*Peter Lewis*  
Copl., Co. B, 10 Reg't U. S. Col'd H. Art'y.

Appears on

**Company Muster Roll**

for *Nov & Dec*, 1864.

Present or absent *Present*

Stoppage, \$ 100 for

Due Gov't, \$ 100 for

Valuation of horse, \$ 100

Valuation of horse equipments, \$ 100

Remarks:

Book mark: *100*

*J. J. J.*

10 H. Art'y. U.S.C.T.

*Peter Lewis*  
Coph., Co. B, 10 Reg't U. S. Col'd H. Art'y.

Appears on

**Company Muster Roll**

for *Jan + Feb*, 186*5*.

Present or absent *Present*.

Stoppage, \$ 100 for

Due Gov't, \$ 100 for

Valuation of horse, \$ 100

Valuation of horse equipments, \$ 100

Remarks: *Our soldier aug-  
mented pay from  
Jan 1 1864 to May  
1864 \$6<sup>00</sup> per month  
May + June \$11<sup>00</sup> per month.  
Due U.S. for ordinance 23¢.*

Book mark:

*Joiner*

L. | 10 H. Art'y. | U.S.C.T.

*Peter Lewis*  
Copt., Co. B, 10 Reg't U. S. Col'd H. Art'y.

Appears on

**Company Muster Roll**

for *May & Apr*, 1865.

Present or absent *Present.*

Stoppage, \$ 100 for

Due Gov't, \$ 100 for

Valuation of horse, \$ 100

Valuation of horse equipments, \$ 100

Remarks: *In daily duty  
in Co. Kitchen since  
Apr 10<sup>th</sup> 1865. Due  
WS for Ord 23cts*

Book mark: \_\_\_\_\_

*Jones*

L. | 10 H. Art'y. | U.S.C.T.

Peter Lewis

Capt., Co. B, 10 Reg't U. S. Col'd H. Art'y.

Appears on

**Company Muster Roll**

for *May & June*, 1865.

Present or absent *Present*

Stoppage, \$ 100 for

Due Gov't, \$ 100 for

Valuation of horse, \$ 100

Valuation of horse equipments, \$ 100

Remarks: *On daily duty  
in Company kitchen  
since April 11th, 1865.*

Book mark: \_\_\_\_\_

*J. J. J. J.*

L. | 10 H. Art'y. | U.S.C.T.

*Peter Lewis*

*Capt.*, Co. B, 10 Reg't U. S. Col'd H. Art'y.

Appears on

**Company Muster Roll**

for *July & Aug*, 1865.

Present or absent *Present*

Stoppage, \$ 100 for

Due Gov't, \$ 100 for

Valuation of horse, \$ 100

Valuation of horse equipments, \$ 100

Remarks: *Paid U.S. for  
ordnance 23 lbs.*

Book mark: \_\_\_\_\_

*J. J. J. J.*

*L* | **10 H. Art'y. U.S.C.T.**

*Peter Lewis*  
-----  
*Co. B*, Co. B, 10 Reg't U. S. Col'd H. Art'y.

Appears on

**Company Muster Roll**  
for *Sept & Oct*, 1865.

Present or absent *Present*

Stoppage, \$-----100 for -----

Due Gov't, \$-----100 for -----

Valuation of horse, \$-----100

Valuation of horse equipments, \$-----100

Remarks:-----  
-----  
-----  
-----  
-----  
-----  
-----  
-----  
-----  
-----

Book mark:-----  
-----

*J. J. Jones*  
-----  
Copyist.

L

10 H. Art'y. U.S.C.T.

Peter Lewis

lft, Co. B, 10 Reg't U. S. Col'd H. Art'y.

Appears on

Company Muster Roll

for Nov. & Dec, 1865.

Present or absent Present

Stoppage, \$ 100 for

Due Gov't, \$ 100 for

Valuation of horse, \$ 100

Valuation of horse equipments, \$ 100

Remarks:

Book mark:

Reif

Copyist.



2

10 H. Art'y. U.S.C.T.

Peter Lewis

1st Lt., Co. B, 10 Reg't U. S. Col'd H. Art'y.

Appears on

Company Muster Roll

for July - Dec., 1866.

Present or absent

Stoppage, \$ 100 for

Due Gov't, \$ 100 for

Valuation of horse, \$ 100

Valuation of horse equipments, \$ 100

Remarks: Must'd. out at M.O. Jan. Dec. 8 66 By reason of exp. of term of service

Book mark: 7541 P.M.B. July 14 66

C. P. [Signature]

Co. | 10 Mo. a. | U.S.C.T.

Peter Lewis  
Corpl. Co B., 10 Reg't U. S. Col'd Mo. a.

Appears on a

**Detachment Muster-out Roll**

of the organization named above. Roll dated

N. Orleans La., Feb. 8, 1864<sup>x</sup>

Muster-out to date

Feb. 8, 1864.

Last paid to

June 30, 1865-

**Clothing account:**

Last settled ..... 186 ; drawn since \$ ..... 100

Due soldier \$ 26 <sup>22</sup>/<sub>100</sub>; due U. S. \$ ..... 100

Am't for cloth'g in kind or money adv'd \$ ..... 100

Due U. S. for arms, equipments, &c., \$ ..... 100

Bounty paid \$ ..... 100 due \$ ..... 100

Remarks: *Joined at Orign. Orgn.*

*Prs. to June 21, 1863*

*Mustered out by reason  
of Expiration of term of  
service & Cert of Must'g. Co.*

*shows him M. Feb. 12, 1864*

Book mark:

*\* Added May 9, 93 GED*

*Howling*

*L* | 10 H. Art'y. | U.S.C.T.

*Peter Lewis*

*Corpl. B*, Co. *B*, 10 Reg't U. S. Col'd H. Art'y.

Appears on Co. Muster-out Roll, dated

*Baton Rouge La. Feb.*, 1867.

Muster-out to date \_\_\_\_\_, 1867.

Last paid to \_\_\_\_\_, 1867.

Clothing account:

Last settled \_\_\_\_\_, 1867; drawn since \$ \_\_\_\_\_<sup>100</sup>

Due soldier \$ \_\_\_\_\_<sup>100</sup>; due U. S. \$ \_\_\_\_\_<sup>100</sup>

Am't for cloth'g in kind or money adv'd \$ \_\_\_\_\_<sup>100</sup>

Due U. S. for arms, equipments, &c., \$ \_\_\_\_\_<sup>100</sup>

Bounty paid \$ \_\_\_\_\_<sup>100</sup>; due \$ \_\_\_\_\_<sup>100</sup>

Remarks:

*Joined org'l. organ.  
Discharged Feb. 8/66  
expiration term of  
service.*

Book mark: *V107 P87 70 PR37  
P113 76*

(361)

*Hodges*  
Copyist.

Lewis - Peter

, Co. 10<sup>th</sup> Reg't W.S. B. A. A.

Enclosures.

Bed Cards .....	Final Statements .....
Burial Records .....	Furloughs or L. of A. ....
Certs. of Dis. for Discharge .....	Med. Certificates .....
C. M. Charges .....	Med. Des. Lists .....
Descriptive Lists .....	Orders .....
Discharge Certificates .....	Pris. of War Record .....
Enlistment Papers <input checked="" type="checkbox"/> .....	Resignations .....

Other papers relating to—

Admission to Hosp'l .....	Furlough or L. of A. ....
Casualty Sheet .....	Med. Examination .....
Confinement .....	Misc. Information .....
Contracts .....	Pay or Clothing .....
Death or Effects .....	Personal Reports .....
Desertion .....	Rank .....
Discharge from Hosp'l .....	Transfer to Hosp'l .....
Discharge from Service .....	Transfer to V. R. C. ....
Duty .....	Transportation .....

DECLARATION OF RECRUIT.

I, \_\_\_\_\_ desiring to ENLIST in the Army of the United States, for the term of THREE YEARS, Do declare, That I am \_\_\_\_\_ years and \_\_\_\_\_ months of age; that I have neither wife nor child; that I have never been discharged from the United States service on account of disability or by sentence of a court-martial, or by order before the expiration of a term of enlistment; and I know of no impediment to my serving honestly and faithfully as a soldier for three years.

GIVEN at \_\_\_\_\_  
The \_\_\_\_\_ day of \_\_\_\_\_

Witness:

\_\_\_\_\_

\_\_\_\_\_

\_\_\_\_\_

\_\_\_\_\_

\_\_\_\_\_

\_\_\_\_\_

\_\_\_\_\_

\_\_\_\_\_

\_\_\_\_\_

\_\_\_\_\_

\_\_\_\_\_

\_\_\_\_\_

\_\_\_\_\_

\_\_\_\_\_

\_\_\_\_\_

\_\_\_\_\_

\_\_\_\_\_

\_\_\_\_\_

\_\_\_\_\_

\_\_\_\_\_

\_\_\_\_\_

\_\_\_\_\_

\_\_\_\_\_

\_\_\_\_\_

No. 23.

*Peter Lewis*

Enlisted at *Camp Baraboo, Wis.*

*December 1862.*

By *2nd Lieutenant S. H. [unclear]*

*Regiment of [unclear]*

enlistment; last served in Company ( )

Reg't of \_\_\_\_\_

Discharged \_\_\_\_\_ 18\_\_\_\_\_

CONSENT IN CASE OF MINOR.

I, \_\_\_\_\_ Do CERTIFY, That I am the \_\_\_\_\_ of \_\_\_\_\_; that the said \_\_\_\_\_ is \_\_\_\_\_ years of age; and I do hereby freely give my CONSENT to his enlisting as a SOLDIER in the ARMY OF THE UNITED STATES for the period of THREE YEARS.

GIVEN at \_\_\_\_\_  
The \_\_\_\_\_ day of \_\_\_\_\_

Witness:

\_\_\_\_\_

\_\_\_\_\_

\_\_\_\_\_

\_\_\_\_\_

\_\_\_\_\_

\_\_\_\_\_

\_\_\_\_\_

County of

*Jefferson*



State of

*Louisiana*

I, *Peter Lewis* born in *Lake County*

in the State of *North Carolina* aged *thirty one* years,

and by occupation a *laborer* do hereby acknowledge to have

voluntarily enlisted this *fourth* day of *December*

18*62*, as a SOLDIER in the ARMY OF THE UNITED STATES OF AMERICA, for the period

of *THREE YEARS*, unless sooner discharged by proper authority: Do also agree to

accept such bounty, pay, rations, and clothing, as are, or may be, established by law. And

I, *Peter Lewis* do solemnly swear, that I will bear true faith

and allégiance to the UNITED STATES OF AMERICA, and that I will serve them honestly and

faithfully against all their enemies or opposers whomsoever; and that I will observe and

obey the orders of the President of the United States, and the orders of the officers

appointed over me, according to the Rules and Articles of War.

Sworn and subscribed to, at *of Carrollton, La. Camp Parapet,*  
this *ninth* day of *February* 18*62*  
BEFORE *J. Nygaard*  
*2nd Lt. U.S. Army La. Vol.*

I CERTIFY, ON HONOR, That I have carefully examined the above named Recruit, agreeably to the General Regulations of the Army, and that in my opinion he is free from all bodily defects and mental infirmity, which would, in any way, disqualify him from performing the duties of a soldier.

*W. C. Lynde*  
EXAMINING SURGEON.

I CERTIFY, ON HONOR, That I have minutely inspected the Recruit, *Peter Lewis* previously to his enlistment, and that he was entirely sober when enlisted; that, to the best of my judgement and belief, he is of lawful age; and that, in accepting him as duly qualified to perform the duties of an able-bodied soldier, I have strictly observed the Regulations which govern the recruiting service. This soldier has *Brown* eyes, *Dark* hair, *Dark* complexion; is *five* feet, *seven* inches high.

*J. Nygaard. 2nd Lieut. U.S. Army La. Vol.*

RECRUITING OFFICER.

DECLARATION OF RECRUIT.

I, \_\_\_\_\_ desiring to ENLIST in the Army of the United States, for the term of THREE YEARS, Do declare, That I am \_\_\_\_\_ years and \_\_\_\_\_ months of age; that I have neither wife nor child; that I have never been discharged from the United States service on account of disability or by sentence of a court-martial, or by order before the expiration of a term of enlistment; and I know of no impediment to my serving honestly and faithfully as a soldier for three years.

GIVEN at \_\_\_\_\_  
The \_\_\_\_\_ day of \_\_\_\_\_

Witness:

10 W S E 74 a  
No. \_\_\_\_\_

*John Lewis*

Enlisted at *Franklin, Pa*

*December 4 1862,*

By *Adjutant of Regiment*

*W. S. G. of 1st Regiment of Ind. Inf.*

enlistment; last served in Company ( )

Reg't of \_\_\_\_\_

Discharged \_\_\_\_\_ 18\_\_\_\_

CONSENT IN CASE OF MINOR.

I, \_\_\_\_\_ Do CERTIFY, That I am the \_\_\_\_\_ of \_\_\_\_\_; that the said \_\_\_\_\_ is \_\_\_\_\_ years of age; and I do hereby freely give my CONSENT to his enlisting as a SOLDIER in the ARMY OF THE UNITED STATES for the period of THREE YEARS.

GIVEN at \_\_\_\_\_  
The \_\_\_\_\_ day of \_\_\_\_\_

Witness:

County of

*Jefferson*

State of

*Louisiana*

I, *Peter Lewis* born in *Lape County*

in the State of *North Carolina* aged *Thirty one* years,

and by occupation a *Labourer* do hereby acknowledge to have

voluntarily enlisted this *Fourth* day of *December*

1862, as a SOLDIER in the ARMY OF THE UNITED STATES OF AMERICA, for the period

of *THREE YEARS*, unless sooner discharged by proper authority: Do also agree to

accept such bounty, pay, rations, and clothing, as are, or may be, established by law. And

I, *Peter Lewis* do solemnly swear, that I will bear true faith

and allegiance to the UNITED STATES OF AMERICA, and that I will serve them honestly and

faithfully against all their enemies or opposers whomsoever; and that I will observe and

obey the orders of the President of the United States, and the orders of the officers

appointed over me, according to the Rules and Articles of War.

Sworn and subscribed to, at *Camp Parapet, of Carrallton Co.*  
this *ninth* day of *February* 1862  
BEFORE *J. Rygaard*  
*2nd Lt. U.S. Army*

I CERTIFY, ON HONOR, That I have carefully examined the above named Recruit, agreeably to the General Regulations of the Army, and that in my opinion he is free from all bodily defects and mental infirmity, which would, in any way, disqualify him from performing the duties of a soldier.

*W. C. Long* EXAMINING SURGEON.

I CERTIFY, ON HONOR, That I have minutely inspected the Recruit, *Peter Lewis* previously to his enlistment, and that he was entirely sober when enlisted; that, to the best of my judgement and belief, he is of lawful age; and that, in accepting him as duly qualified to perform the duties of an able-bodied soldier, I have strictly observed the Regulations which govern the recruiting service. This soldier has *Brown* eyes, *Dark* hair, *Dark* complexion; is *five* feet, *Six* inches high.

*J. Rygaard. 2nd Lieut. U.S. Army*

RECRUITING OFFICER.



1620  
Lewis, Philip

Co A, 10 U.S. Col'd H. Art'y.

Private

Private

CARD NUMBERS.

1	5489106	26
2	5493092	27
3	5493228	28
4	5493296	29
5	5493507	30
6	5493563	31
7	5493753	32
8	5494020	33
9	5490078	34
10		35
11		36
12		37
13		38
14		39
15		40
16		41
17		42
18		43
19		44
20		45
21		46
22		47
23		48
24		49
25		50

Book Mark: 75. U.S.C. Inf.

See also

Q. 2126319 printu

P2906158 a c d 712

Q41628672

S. S. vel. Bw - 6-18-28 - Jane

P.O. - N.O. 1615159 Ret'd 10/3/28 saw

S. S. Doughty  
2

*S* *100th* **U.S.C.T.**

*Phillip Lewis*

*M*, Co., *10* Reg't U. S. Col'd *100th*

Appears on

**M. and D. Roll of Men Transferred**

to the organization named above,

from *75 US C I*

Roll dated *Nov 18*, 186*5*.

When enlisted *Aug 27*, 186*3*.

Period for which enlisted *3* years.

When mustered in *Sep 24*, 186*3*.

Present or absent *Not stated*

Company to which assigned

Remarks: *See US for C & G*

*equip. lost 06. Transfd*

*from 88 US C I Aug 13/64*

*per S. O. No 209 dated*

*H & Irs. Dept Gulf*

Book mark :

*J. Johnson*

*L* | 10 H. Art'y. | U.S.C.T.

*Philip Lewis*

*Pl*, Co. A, 10 Reg't U. S. Col'd H. Art'y.

Appears on

**Company Muster Roll**

for *Nov & Dec*, 186*5*.

Present or absent *Present*

Stoppage, \$ 100 for

Due Gov't, \$ 06 for *6 + G.E.*,

*per transfer rolls*

Valuation of horse, \$ 100

Valuation of horse equipments, \$ 100

Remarks: *Transferred from 75 US 69,  
per S. O 105 C.S., Hd Qrs. Dept of Sea*

Book mark:

*J. H. ...*  
Copyist.

L | 10 H. Art'y. | **U.S.C.T.**

Philip Lewis

Pl, Co. A, 10 Reg't U. S. Col'd H. Art'y.

Appears on

**Company Muster Roll**

for

Jan + Feb, 1866.

Present or absent

Present

Stoppage, \$ 100 for

Due Gov't, \$ 100 for

Valuation of horse, \$ 100

Valuation of horse equipments, \$ 100

Remarks:

Book mark:

H. J. [Signature]  
Copyist.

*L* | 10 H. Art'y. | U.S.C.T.

*Philip Lewis*

*Priv.*, Co. A, 10 Reg't U. S. Col'd H. Art'y.

Appears on

**Company Muster Roll**

for *Mar + April*, 186*6*.

Present or absent *Present*

Stoppage, \$ *100* for

Due Gov't, \$ *100* for

Valuation of horse, \$ *100*

Valuation of horse equipments, \$ *100*

Remarks: \_\_\_\_\_  
\_\_\_\_\_  
\_\_\_\_\_  
\_\_\_\_\_  
\_\_\_\_\_  
\_\_\_\_\_  
\_\_\_\_\_  
\_\_\_\_\_

Book mark: \_\_\_\_\_  
\_\_\_\_\_

*H. J. [Signature]*

*S* | 10 H. Art'y. | U.S.C.T.

*Philip Lewis*

*Pvt*, Co. A, 10 Reg't U. S. Col'd H. Art'y.

Appears on

**Company Muster Roll**

for

*May & June, 1866.*

Present or absent

*Present*

Stoppage, \$ 100 for

Due Gov't, \$ 100 for

Valuation of horse, \$ 100

Valuation of horse equipments, \$ 100

Remarks:

Book mark:

*Steph*

Copyist.

*L* | 10 H. Art'y. | U.S.C.T.

*Philip Lewis*  
*Pvt*, Co. A, 10 Reg't U. S. Col'd H. Art'y.

Appears on  
**Company Muster Roll**  
for *July & Aug*, 186*6*.  
Present or absent *Present*

Stoppage, \$.....100 for .....

Due Gov't, \$.....100 for .....

Valuation of horse, \$.....100

Valuation of horse equipments, \$.....100

Remarks: .....

Book mark: .....

.....  
*[Signature]*  
Copyist.



L | 10 H. Art'y. | U.S.C.T.

Philip Lewis

Priv., Co. A, 10 Reg't U. S. Col'd H. Art'y.

Appears on

**Company Muster Roll**

for Sept & Oct, 1866.

Present or absent

Stoppage, \$ 100 for

Due Gov't, \$ 100 for

Valuation of horse, \$ 100

Valuation of horse equipments, \$ 100

Remarks: Date of discharge mustered out  
Sept. 23/66 by reason of expiration of  
term of service  
Paid \$100.00 bounty

Book mark:

Nesbitt

L | 10 Arty | U.S.C.T.

Philip Lewis  
Priv., Co. A, 10 Reg't U. S. Col'd Art

Appears on a

**Detachment Muster-out Roll**

of the organization named above. Roll dated

New Orleans La, Sept 24, 1866.

Muster-out to date Sept 23, 1866.

Last paid to June 30, 1866

**Clothing account:**

Last settled \_\_\_\_\_, 1866 ; drawn since \$ \_\_\_\_\_ 100

Due soldier \$ 47 <sup>91</sup>/<sub>100</sub>; due U. S. \$ \_\_\_\_\_ 100

Am't for cloth'g in kind or money adv'd \$ \_\_\_\_\_ 100

Due U. S. for arms, equipments, &c., \$ \_\_\_\_\_ 100

Bounty paid \$ \_\_\_\_\_ 100 due \$ 100 100

Remarks: Joined Orig Org  
88 U. S. C. I. Transferred  
to 75<sup>th</sup> U. S. C. I. S. O. 209  
for series of 1864 Dept  
of Gulf. Transferred to  
10 U. S. C. A. (H) S. O. 105  
over

Book mark: \_\_\_\_\_

Lamb

JAN. 15

5490073

1891

par 12 Series of 1865  
Dept of War.  
Mustered out by rea-  
son of expiration of  
term of service to date  
Sept 23, 1866

*L* | 10 H. Art'y. | U.S.C.T.

*Phillip Lewis*

*Pvt.*, Co. *A*, 10 Reg't U. S. Col'd H. Art'y.

Appears on **Co. Muster-out Roll**, dated  
*Baton Rouge La, Feb 22* 1867.

Muster-out to date ..... 186 .

Last paid to ..... 186 .

Clothing account:

Last settled ..... 186 ; drawn since \$ ..... 100

Due soldier \$ ..... 100 ; due U. S. \$ ..... 100

Am't for cloth'g in kind or money adv'd \$ ..... 100

Due U. S. for arms, equipments, &c., \$ ..... 100

Bounty paid \$ ..... 100 ; due \$ ..... 100

Remarks: *Transfd. from 75 U.S. & S. as Pvt.*  
*S. O. 105 - S. O. 105 - Dept. La*  
*Disch'd for exp'n of term of*  
*service Sept 23/66*

Book mark: *V 15 P 96. 68*

*Nesbitt*

Copyist.

*Leese, Robert*

Co A, 10 U.S. Col'd H. Art'y.

*Private* | *Sergeant*

CARD NUMBERS.

1	5489025	26
2	<del>5573537</del>	27
3	5492463	28
4	5493143	29
5	5493325	30
6	5493467	31
7	5493543	32
8	5493723	33
9	5493904	34
10	5490044	35
11		36
12		37
13		38
14		39
15		40
16		41
17		42
18		43
19		44
20		45
21		46

2 x Card withdrawn and filed in  
 3 envelope of Leese, Robert, Co. A,  
 4 where it properly belongs  
 5 July 31 1904 G.E.S.

Book Mark:

See also 75 U.S.C.D.

*L* *100th* **U.S.C.T.**

*Robert Lewis*  
*Sgt.*, Co. ...., *10* Reg't U. S. Col'd *100th*

Appears on

**M. and D. Roll of Men Transferred**

to the organization named above,

from *75 USCI*

Roll dated *Nov 18*, 186*5*.

When enlisted *Aug 12*, 186*3*.

Period for which enlisted *3* years.

When mustered in *Sep 24*, 186*3*.

Present or absent *Not stated*

Company to which assigned .....

Remarks: *Joined by*

*transfer from 88 USCI*

*per S.O 209 series of 1864*

*Dept. of the Gulf Aug 13/64*

*Promoted to Corp. Aug*

*13/64 per S.O no 39 series of 1864*

*Ad. Drs 75 US. CI. Promoted*

*to 1 serg. Aug 5/65 per S.O 209*

Book mark: .....

*(over)*

*J. A. Johnson*

JAN. 15

5489025

★ 1891 ★

C. S. Ho Day 76 US C  
due US for ordnance

\$1.30

*S* | 10 H. Art'y. | U.S.C.T.

*Robert Lewis*

*S/pt*, Co. A, 10 Reg't U. S. Col'd H. Art'y.

Appears on

Company Muster Roll

for *Nov. & Dec*, 1865.

Present or absent *Present*

Stoppage, \$ 100 for

Due Gov't, \$ 100 for *Ordnance*

*per transfer roll*

Valuation of horse, \$ 100

Valuation of horse equipments, \$ 100

Remarks: *Transferred from 75 US Art'y  
per S.O. 105 G. S. Hd Qrs Dept of Sea.*

Book mark:

*Hoyes*

Copyist.



L | 10 H. Art'y. | **U.S.C.T.**

*Robert Lewis*

*Sngl*, Co. A, 10 Reg't U. S. Col'd H. Art'y.

Appears on

**Company Muster Roll**

for *Jan + Feb*, 186*6*.

Present or absent *Present*

Stoppage, \$ 100 for

Due Gov't, \$ 100 for

Valuation of horse, \$ 100

Valuation of horse equipments, \$ 100

Remarks:

-----  
-----  
-----  
-----  
-----  
-----  
-----  
-----

Book mark:

-----

*Styus*  
Copyist.

*L* | 10 H. Art'y. | U.S.C.T.

*Robert Lewis*

*Sgt*, Co. A, 10 Reg't U. S. Col'd H. Art'y.

Appears on

**Company Muster Roll**

for *Mar + Apr*, 186*b*.

Present or absent *Present*

Stoppage, \$ 100 for

Due Gov't, \$ 100 for

Valuation of horse, \$ 100

Valuation of horse equipments, \$ 100

Remarks:

Book mark:

*Hyman*  
Copyist.

L | 10 H. Art'y. | U.S.C.T.

Robert Lewis

Serg't, Co. A, 10 Reg't U. S. Col'd H. Art'y.

Appears on

**Company Muster Roll**

for May & June, 1866.

Present or absent Present

Stoppage, \$ 100 for

Due Gov't, \$ 100 for

Valuation of horse, \$ 100

Valuation of horse equipments, \$ 100

Remarks: \_\_\_\_\_  
\_\_\_\_\_  
\_\_\_\_\_  
\_\_\_\_\_  
\_\_\_\_\_  
\_\_\_\_\_  
\_\_\_\_\_

Book mark: \_\_\_\_\_

Styger  
Copyist.

*L* | 10 H. Art'y. | U.S.C.T.

*Robert Lewis*

*Sgt*, Co. A, 10 Reg't U. S. Col'd H. Art'y.

Appears on

**Company Muster Roll**

for *July & Aug*, 186*6*.

Present or absent *Present*

Stoppage, \$ 100 for

Due Gov't, \$ 100 for

Valuation of horse, \$ 100

Valuation of horse equipments, \$ 100

Remarks:

-----  
-----  
-----  
-----  
-----  
-----  
-----  
-----

Book mark: -----

-----  
-----  
*Hyer*  
-----

L | 10 H. Art'y. | U.S.C.T.

Robert Lewis  
Sgt., Co. A, 10 Reg't U. S. Col'd H. Art'y.

Appears on

**Company Muster Roll**

for Sept + Oct, 1866.

Present or absent

Stoppage, \$ 100 for

Due Gov't, \$ 100 for

Valuation of horse, \$ 100

Valuation of horse equipments, \$ 100

Remarks: Note of discharge mustered  
out Sept. 23. 66 by reason of ex-  
piration of term of service  
Paid \$ 100.00 bounty

Book mark:

Nesbitt

Copyist.

L | 10 H. Art'y. | U.S.C.T.

Robert Lewis

Sgt, Co. A, 10 Reg't U. S. Col'd H. Art'y.

Appears on Co. Muster-out Roll, dated  
Baton Rouge La Feb 22, 1867.

Muster-out to date \_\_\_\_\_, 186 .

Last paid to \_\_\_\_\_, 186 .

Clothing account:

Last settled \_\_\_\_\_, 186 ; drawn since \$ \_\_\_\_\_ 100

Due soldier \$ \_\_\_\_\_ 100 ; due U. S. \$ \_\_\_\_\_ 100

Am't for cloth'g in kind or money adv'd \$ \_\_\_\_\_ 100

Due U. S. for arms, equipments, &c., \$ \_\_\_\_\_ 100

Bounty paid \$ \_\_\_\_\_ 100 ; due \$ \_\_\_\_\_ 100

Remarks: Transf. from 75 U.S.C. I. as  
Sgt. S. Co. 105 S of 65 Regt. Ia  
Dischd. for expen. of term of  
service Sept. 23/68

Book mark: V 107 P 76 70

Nesbitt

L | 10 Arty | U.S.C.T.

Robert Lewis

Serg, Co. A, 10 Reg't U. S. Col'd Arty

Appears on a

**Detachment Muster-out Roll**

of the organization named above. Roll dated

New Orleans, La, Sept. 24, 1866.

Muster-out to date

Sept. 23, 1866.

Last paid to

June 30, 1866

**Clothing account:**

Last settled \_\_\_\_\_, 1866 ; drawn since \$ \_\_\_\_\_ 100

Due soldier \$  $34\frac{82}{100}$ ; due U. S. \$ \_\_\_\_\_ 100

Am't for cloth'g in kind or money adv'd \$ \_\_\_\_\_ 100

Due U. S. for arms, equipments, &c., \$ \_\_\_\_\_ 100

Bounty paid \$ \_\_\_\_\_ 100 due \$  $100\frac{5}{100}$

Remarks: Joined orig. org. 88

U. S. C. A. - Transferred to 75 U. S.

C. A. A. O. 209 par. 12, series of 1864, Dept. of Gulf. Trans-

ferred to 10 U. S. C. A. (H.) A. O. 105 par. 12, series of 1865

Book mark: V 107 p. 76. 70  
10 ver 1

R. E. Wilson

Copyist.

JAN. 15

5490048

1861

Drpt. of La. Private to  
Aug. 13. 1864. Corp. to Aug.  
15. 1865. Mustered out  
by reason of expira-  
tion of term of ser-  
vice.



1622  
Lewis, Samuel

Co A, 10 U.S. Col'd H. Art'y.

Private | Private

CARD NUMBERS.

1	5487399	26
2	5488413	27
3	5512288	28
4	5512441	29
5	5513650	30
6	5513357	31
7	5489770	32
8		33
9		34
10		35
11		36
12		37
13		38
14		39
15		40
16		41
17		42
18		43
19		44
20		45
21		46
22		47
23		48
24		49
25		50

Book Mark:

See also 77 U.S.C. Inf.

*S. 1086A.* U.S.C.T.

*Samuel Lewis*  
*Co. K, 10* Reg't U. S. Col'd Infantry.

Appears on

**M. and D. Roll of Men Transferred**

to the organization named above

from

Roll dated

When enlisted

Period for which enlisted

When mustered in

Present or absent

Company to which assigned

Remarks

*Rec'd by transfer  
from 4<sup>th</sup> Inf Cd A  
Dec. 63.*

Book mark :

L 10 Ha | **U.S.C.T.**

Samuel Lewis  
Co. K, 10 Reg't U. S. Col'd Ha

Appears on

**M. and D. Roll of Men Transferred**

to the organization named above,

from 77th U.S. Col Inf

Roll dated Camp Parapet No 10th, 1865.

When enlisted Feb 11, 1863.

Period for which enlisted 3 years.

When mustered in Feb 23, 1863.

Present or absent Present

Company to which assigned K

Remarks: Rec'd by transfer  
Co 77th U.S. Col

Book mark:

Wear Scotch

Co | **10 H. Art'y.** | **U.S.C.T.**

Samuel Lewis

P, Co. K, 10 Reg't U. S. Col'd H. Art'y.

Age ..... years.

Appears on

**Company Muster Roll\***

for Sept. 7 Oct. 1, 1865.

Joined for duty and enrolled:

When Feb. 11, 1863.

Where New Orleans, La.

Period 3 years

Mustered in:

When Feb. 23, 1863.

Where New Orleans.

Present or absent Present

Stoppage, \$ 100 for

Due Gov't, \$ 100 for

Remarks:

\* First current roll. No muster-in roll of this company on file.

Book mark:

(3586)

Hibbard

Copyist.

L

10 H. Art'y.

U.S.C.T.

Samuel Lewis

P, Co. K, 10 Reg't U. S. Col'd H. Art'y.

Appears on

Company Muster Roll

for Nov. & Dec., 1865

Present or absent Present

Stoppage, \$ 100 for

Due Gov't, \$ 100 for

Valuation of horse, \$ 100

Valuation of horse equipments, \$ 100

Remarks:

Book mark:

Hibbard

L

10 H. Art'y.

U.S.C.T.

Samuel Lewis

P, Co. K, 10 Reg't U. S. Col'd H. Art'y.

Appears on

Company Muster Roll

for Jan. Feb., 1866.

Present or absent

Stoppage, \$ 100 for

Due Gov't, \$ 100 for

Valuation of horse, \$ 100

Valuation of horse equipments, \$ 100

Remarks: Discharged by expiration of term of service.

Book mark:

Hibbard

Copyist.

L. 10<sup>th</sup> Reg't Art'y | U.S.C.T.

Samuel Lewis  
Priv., Co. K, 10<sup>th</sup> Reg't U. S. Col'd Art'y

Appears on a

**Detachment Muster-out Roll**

of the organization named above. Roll dated

New Orleans, La., Feb. 10, 1866.

Muster-out to date Feb. 10, 1866.

Last paid to June 30, 1865.

**Clothing account:**

Last settled \_\_\_\_\_, 1866; drawn since \$ \_\_\_\_\_ 100

Due soldier \$ 22 <sup>97</sup>/<sub>100</sub>; due U. S. \$ \_\_\_\_\_ 100

Am't for cloth'g in kind or money adv'd \$ \_\_\_\_\_ 100

Due U. S. for arms, equipments, &c., \$ 2 <sup>00</sup>/<sub>100</sub>

Bounty paid \$ \_\_\_\_\_ 100 due \$ \_\_\_\_\_ 100

Remarks: Rec'd by transfer from  
Co. F, 77<sup>th</sup> U.S. Col. Per S.O. 66d.  
1865 Dept. of La. Stoppage  
for loss of ordnance and  
camp and H. Equipage.

Book mark: \_\_\_\_\_

H. W. Reed

*L*

10 H. Art'y.

U.S.C.T.

*Samuel Lewis*

*Put*, Co. *K*, 10 Reg't U. S. Col'd H. Art'y.

Appears on **Co. Muster-out Roll**, dated  
*Baton Rouge La*, *Feb 22*, 1867.

Muster-out to date \_\_\_\_\_, 186 .

Last paid to \_\_\_\_\_, 186 .

Clothing account:

Last settled \_\_\_\_\_, 186 ; drawn since \$ \_\_\_\_\_ 100

Due soldier \$ \_\_\_\_\_ 100; due U. S. \$ \_\_\_\_\_ 100

Am't for cloth'g in kind or money adv'd \$ \_\_\_\_\_ 100

Due U. S. for arms, equipments, &c., \$ \_\_\_\_\_ 100

Bounty paid \$ \_\_\_\_\_ 100; due \$ \_\_\_\_\_ 100

Remarks: *Recd by transfer from Leo*  
*L. 77 U. S. C. I. Oct 1/65. per S. C.*  
*No. 66 Hodqrs Dept La S. 1865.*  
*Dis by exp term Service Feb 10/66*

Book mark: \_\_\_\_\_

*Floyd*



1623  
Lewis, Sandy

Co. 4, 10 U.S. Col'd H. Art'y.

Private

Corporal

CARD NUMBERS.

1	5507158	26
2	5507436	27
3	5507581	28
4	5507727	29
5	5507864	30
6	5507946	31
7	5508882	32
8	5508216	33
9	5508349	34
10	5508588	35
11	5508648	36
12	5508795	37
13	5508942	38
14	5509191	39
15	5509448	40
16		41
17		42
18		43
19		44
20		45
21		46
22		47
23		48
24		49
25		50

Book Mark:

See also

0748034 Pogo  
1972065 = Pomon

C. E. Doughty

L 10. Hart | U.S.C.T.

Landy Lewis

Appears with rank of Pvt on

**Muster and Descriptive Roll of a Detachment of U. S. Vols. forwarded**

*Organized as Co G.*

for the 10 Reg't U. S. Col'd No 2. Roll dated

New Orleans La, Sept 20, 1864.

Where born Ascension La

Age 18 y'rs; occupation Laborer

When enlisted Sept 20, 1864.

Where enlisted New Orleans La

For what period enlisted 3 years.

Eyes Brown; hair Black

Complexion Dark; height 5 ft. 4 in.

When mustered in Sept 20, 1864.

Where mustered in New Orleans La

Bounty paid \$ 100; due \$ 100

Where credited to New Orleans La

Company to which assigned G.

Remarks:

Book mark:

E. B. Thompson  
Copyist.

L | 10 H. Art'y. | **U.S.C.T.**

Jandy Louis  
Pot, Co. G, 10 Reg't U. S. Col'd H. Art'y.

Appears on  
**Company Muster Roll**  
for Sept & Oct, 1864.

Present or absent Present

Stoppage, \$ 100 for

Due Gov't, \$ 100 for

Valuation of horse, \$ 100

Valuation of horse equipments, \$ 100

Remarks:  
\_\_\_\_\_  
\_\_\_\_\_  
\_\_\_\_\_  
\_\_\_\_\_  
\_\_\_\_\_  
\_\_\_\_\_  
\_\_\_\_\_  
\_\_\_\_\_

Book mark: \_\_\_\_\_

E. H. Brown

L. | 10 H. Art'y. | U.S.C.T.

Sandy Lewis  
Capt, Co. G, 10 Reg't U. S. Col'd H. Art'y.

Appears on

**Company Muster Roll**

for Nov Dec, 186 4.

Present or absent. Present

Stoppage, \$ 100 for \_\_\_\_\_

Due Gov't, \$ 100 for \_\_\_\_\_

Valuation of horse, \$ 100

Valuation of horse equipments, \$ 100

Remarks: \_\_\_\_\_  
\_\_\_\_\_  
\_\_\_\_\_  
\_\_\_\_\_  
\_\_\_\_\_  
\_\_\_\_\_  
\_\_\_\_\_  
\_\_\_\_\_  
\_\_\_\_\_

Book mark: \_\_\_\_\_

E. H. Brown

L

10 H. Art'y.

U.S.C.T.

*Sandy Lewis*  
Troop, Co. G, 10 Reg't U. S. Col'd H. Art'y.

Appears on

**Company Muster Roll**

for *Jan & Feb*, 186*7*.

Present or absent *Present*

Stoppage, \$ 100 for

Due Gov't, \$ 100 for

Valuation of horse, \$ 100

Valuation of horse equipments, \$ 100

Remarks:

-----  
-----  
-----  
-----  
-----  
-----  
-----  
-----  
-----  
-----

Book mark:

-----

*T. S. Porter*

L

10 H. Art'y.

U.S.C.T.

Sandy Lewis  
Troop, Co. G, 10 Reg't U. S. Col'd H. Art'y.

Appears on

**Company Muster Roll**

for *Mar + April*, 186*5*.

Present or absent *Present*

Stoppage, \$ 100 for

Due Gov't, \$ 100 for

Valuation of horse, \$ 100

Valuation of horse equipments, \$ 100

Remarks:

Book mark:

*J. E. Porter*

Copyist.

L

10 H. Art'y.

U.S.C.T.

*Sandy Lewis*

*Corp*, Co. G, 10 Reg't U. S. Col'd H. Art'y.

Appears on

**Company Muster Roll**

for *May & June*, 186*6*.

Present or absent *Present*

Stoppage, \$ *100* for

Due Gov't, \$ *100* for

Valuation of horse, \$ *100*

Valuation of horse equipments, \$ *100*

Remarks: *Promoted to be  
Corp'l from June  
28, 1865*

Book mark:

*J. E. Porter*

Copyist.



L | 10 H. Art'y. | U.S.C.T.

Sandy Lewis  
Corps, Co. G, 10 Reg't U. S. Col'd H. Art'y.

Appears on

**Company Muster Roll**

for July & Aug, 1865.

Present or absent Present

Stoppage, \$ 100 for

Due Gov't, \$ 10/100 for C & G Equip

age lost or destroyed

Valuation of horse, \$ 100

Valuation of horse equipments, \$ 100

Remarks: Promoted to

Corfil June 28, 1865

Book mark:

F. E. Porter

Copyist.

L | 10 H. Art'y. | U.S.C.T.

*Sandy Lewis*

*Co. G, 10 Reg't U. S. Col'd H. Art'y.*

Appears on

**Company Muster Roll**

for *Sept & Oct*, 186*5*.

Present or absent *Present*

Stoppage, \$ *100* for

Due Gov't, \$ *100* for

Valuation of horse, \$ *100*

Valuation of horse equipments, \$ *100*

Remarks:

Book mark:

*J. E. Porter*

10 H. Art'y. U.S.C.T.

*L*

*Gandy Lewis*

*Corp*, Co. G, 10 Reg't U. S. Col'd H. Art'y.

Appears on

**Company Muster Roll**

for *Nov. 4 Dec*, 186*5*

Present or absent *Present*

Stoppage, \$ 100 for

Due Gov't, \$ 100 for

Valuation of horse, \$ 100

Valuation of horse equipments, \$ 100

Remarks:

-----  
-----  
-----  
-----  
-----  
-----  
-----  
-----  
-----  
-----

Book mark:

-----

*G. M.*

Copyist.

L

10 H. Art'y.

U.S.C.T.

*Sandy Lewis*

*Capt.*, Co. *G*, 10 Reg't U. S. Col'd H. Art'y.

Appears on

**Company Muster Roll**

for *Jan. & Feb.*, 186*6*.

Present or absent *Present*

Stoppage, \$ *100* for

Due Gov't, \$ *100* for

Valuation of horse, \$ *100*

Valuation of horse equipments, \$ *100*

Remarks:

-----  
-----  
-----  
-----  
-----  
-----  
-----  
-----

Book mark: -----

-----

*G. M.*

*L* | 10 H. Art'y. | U.S.C.T.

*Sandy Lewis*

*Corp*, Co. G, 10 Reg't U. S. Col'd H. Art'y.

Appears on

**Company Muster Roll**

for *Mar. 9 Apr.*, 186*6*.

Present or absent *Present*

Stoppage, \$ *65* for *C.C. & G.E.*

*lost*

Due Gov't, \$ *100* for

Valuation of horse, \$ *100*

Valuation of horse equipments, \$ *100*

Remarks:

Book mark:

*G. M.*

Copyist.

*L*

10 H. Art'y.

U.S.C.T.

*Sandy Lewis*

*Cop.*, Co. G, 10 Reg't U. S. Col'd H. Art'y.

Appears on

Company Muster Roll

for

~~*Jan. & Feb.*~~ *May & June*, 1860.

Present or absent

*Present*

Stoppage, \$

100 for

Due Gov't, \$

100 for

Valuation of horse, \$

100

Valuation of horse equipments, \$

100

Remarks:

*By S. E. Doughty*

Book mark:

*G. F. W.*

*L* | 10 H. Art'y. | U.S.C.T.

*Sandy Lewis*  
*Cope*, Co. C, 10 Reg't U. S. Col'd H. Art'y.

Appears on

**Company Muster Roll**

for *July & Aug*, 186*6*.

Present or absent *Present*

Stoppage, \$.....100 for .....

Due Gov't, \$.....100 for .....

Valuation of horse, \$.....100

Valuation of horse equipments, \$.....100

Remarks:.....

.....

.....

.....

.....

.....

.....

.....

.....

.....

.....

.....

*G. Fox*  
Copyist.

L | 10 H. Art'y. | U.S.C.T.

*Sandy Lewis*

*Corpl*, Co. G, 10 Reg't U. S. Col'd H. Art'y.

Appears on

**Company Muster Roll**

for *Sept & Oct*, 1866.

Present or absent.....

Stoppage, \$.....100 for.....

Due Gov't, \$.....100 for.....

Valuation of horse, \$.....100

Valuation of horse equipments, \$.....100

Remarks: *Reenlisted & Mustered out date Sept 4<sup>th</sup> pursuant with instructions from A. G. O. War Dept. dated Aug. 31, 1866.*

Book mark:.....



L | 10 H. Art'y. | U.S.C.T.

Sandy Lewis

Cpl, Co. G, 10 Reg't U. S. Col'd H. Art'y.

Appears on Co. Muster-out Roll, dated

Baton Rouge, La, Feb 22, 1867.

Muster-out to date \_\_\_\_\_, 186 .

Last paid to \_\_\_\_\_, 186 .

Clothing account:

Last settled \_\_\_\_\_, 186 ; drawn since \$ \_\_\_\_\_ 100

Due soldier \$ \_\_\_\_\_ 100; due U. S. \$ \_\_\_\_\_ 100

Am't for cloth'g in kind or money adv'd \$ \_\_\_\_\_ 100

Due U. S. for arms, equipments, &c., \$ \_\_\_\_\_ 100

Bounty paid \$ \_\_\_\_\_ 100; due \$ \_\_\_\_\_ 100

Remarks: *Joined at Capt. Co. Reg't.*

*Promoted to Copt. June 28, 1865,*

*Reenlisted & mustered out*

*Sept 4, 1866, per instructions*

*A. G. O. War Dept. Aug 3, 1866*

Book mark: *V. 1. 2. 1. P. 390. 77.*

*Wines*

Lewis, Sandy

P, Co. G, 10<sup>th</sup> Reg't U.S.C.H.A.

/ Enclosures.

Bed Cards .....	Final Statements .....
Burial Records .....	Furloughs or L. of A. ....
Certs. of Dis. for Discharge .....	Med. Certificates .....
C. M. Charges .....	Med. Des. Lists .....
Descriptive Lists .....	Orders .....
Discharge Certificates .....	Pris. of War Record .....
Enlistment Papers / .....	Resignations .....

Other papers relating to—

Admission to Hosp'l .....	Furlough or L. of A. ....
Casualty Sheet .....	Med. Examination .....
Confinement .....	Misc. Information .....
Contracts .....	Pay or Clothing .....
Death or Effects .....	Personal Reports .....
Desertion .....	Rank .....
Discharge from Hosp'l .....	Transfer to Hosp'l .....
Discharge from Service .....	Transfer to V. R. C. ....
Duty .....	Transportation .....

NOTE 1.—This blank will be used for both enlistments and re-enlistments—enlistment of veterans, &c., &c., in the volunteer service. They will be made out in duplicate in all cases—one to accompany the recruiting return of the superintendent (not the recruiting officer) to the Adjutant General, and one to accompany the accounts of the officer who pays bounty, &c. The Regiment and Company in which the soldier last served should be given on the back.

NOTE 2.—An enlistment holds to service. A muster-in must, in all cases, precede payment of pay, bounty, pension, &c. A muster-in roll must, in all cases, be filed in the Adjutant General's Office as evidence of muster-in. The mustering officer, commissary, or assistant commissary of musters, as the case may be, will countersign both enlistments as having mustered the soldier into the service of the United States before either of them is given to the disbursing officer.

DECLARATION OF RECRUIT.

I, Sandy Lewis desiring to VOLUNTEER as a Soldier in the Army of the United States, for the term of THREE YEARS, Do Declare, That I am 18 years and \_\_\_\_\_ months of age; that I have never been discharged from the United States service on account of disability or by sentence of a court martial, or by order before the expiration of a term of enlistment; and I know of no impediment to my serving honestly and faithfully as a soldier for three years.

GIVEN at New Orleans the 20<sup>th</sup> day of September 1864

Witness: J. Horace McGuire Sandy Lewis  
mother

No. 57

Sandy Lewis  
 Volunteered at New Orleans  
Dec. 21<sup>st</sup> 1864  
 By Saml. J. McGuire  
11<sup>th</sup> Regiment of Louisiana

\_\_\_\_\_ enlistment; last served in Company ( )  
11<sup>th</sup> Regt of Louisiana  
 Discharged 18  
enlisted to Country

CONSENT IN CASE OF MINOR.

I, \_\_\_\_\_ Do CERTIFY, That I am the \_\_\_\_\_ of \_\_\_\_\_; that the said \_\_\_\_\_ is \_\_\_\_\_ years of age; and I do hereby freely give my CONSENT to his volunteering as a SOLDIER in the ARMY OF THE UNITED STATES for the period of THREE YEARS.

GIVEN at \_\_\_\_\_ the \_\_\_\_\_ day of \_\_\_\_\_

Witness: \_\_\_\_\_

VOLUNTEER ENLISTMENT.

STATE OF

TOWN OF

Louisiana



New Orleans

I, Sandy Lewis born in Ascension Parish  
in the State of La aged 18 years,  
and by occupation a laborer Do HEREBY ACKNOWLEDGE to have  
volunteered this 20<sup>th</sup> day of September 1864,  
to serve as a **Soldier** in the Army of the **United States of America**, for  
the period of **THREE YEARS**, unless sooner discharged by proper authority:  
Do also agree to accept such bounty, pay, rations, and clothing, as are, or may be,  
established by law for volunteers. And I, Sandy Lewis do  
solemnly swear, that I will bear true faith and allegiance to the **United States**  
**of America**, and that I will serve them honestly and faithfully against all  
their enemies or opposers whomsoever; and that I will observe and obey the  
orders of the President of the United States, and the orders of the officers  
appointed over me, according to the Rules and Articles of War.

Sworn and subscribed to, at New Orleans  
this 20<sup>th</sup> day of Sept. 1864, } Sandy Lewis  
BEFORE John N. Chamberlain } mark  
Capt. U.S.A.

I CERTIFY, ON HONOR, That I have carefully examined the above-named Volunteer, agreeably  
to the General Regulations of the Army, and that, in my opinion, he is free from all bodily defects and  
mental infirmity, which would in any way disqualify him from performing the duties of a soldier.

W. H. Martin  
10<sup>th</sup> U.S.C.A. (A) EXAMINING SURGEON.

I CERTIFY, ON HONOR, That I have minutely inspected the Volunteer, Sandy Lewis  
previously to his enlistment, and that he was entirely sober when enlisted; that, to the best of my  
judgment and belief, he is of lawful age; and that, in accepting him as duly qualified to perform the  
duties of an able-bodied soldier, I have strictly observed the Regulations which govern the recruiting  
service. This soldier has Brown eyes, Blk hair, Dark complexion, is 5-  
feet 4 inches high.

J. Horace McGuire 1<sup>st</sup> Lieut  
10<sup>th</sup> Regiment of U.S. Army Volunteers,  
RECRUITING OFFICER.

Mustered into the service of the United States, for three years or during the war, from date of enlistment, in Company B,  
10<sup>th</sup> Regiment of U.S. Army Volunteers, on the 20<sup>th</sup> day of Sept., 1864, at New Orleans

John N. Chamberlain  
Capt. 10<sup>th</sup> U.S. Army

1627  
Lewis, Spencer

Co L, 10 U.S. Col'd H. Art'y.

Private

Private

CARD NUMBERS.

1	5488762	26
2	5488266	27
3	5513477	28
4	5513624	29
5	5513747	30
6	5513863	31
7	5513955	32
8	5514015	33
9	5514073	34
10	5514200	35
11	L-7-CJ-1872	36
12		37
13		38
14		39
15		40
16		41
17		42
18		43
19		44
20		45
21		46
22		47
23		48
24		49
25		50

Book Mark: L-7-CJ-1872

See also 77. U.S.C. Inf

Rep 361727 -

\$829114 - Rogo

S1034498 do m m

S10641447 P. aff

S. 1213005 P.O. Ret'd

S1238720 audited.

\$1937983 - P.O. aff.

S-1969788 P.O. aff

G. S. Smyth  
2

*L* *W* *U* *S* *C* *T* **U.S.C.T.**  
*Spencer Lewis*  
*Det, Co A, 10 Reg't U. S. Col'd* *H* *U*

Appears on

**M. and D. Roll of Men Transferred**

to the organization named above,

from

Roll dated

When enlisted

Period for which enlisted

When mustered in

Present or absent

Company to which assigned

Remarks:

*Joined as Recruit*  
*Joined by transfer from*  
*Co D, 707 U. S. C. I.,*  
*per S.O. 66 C. S. H. D.*  
*Ins Dept of La*

Book mark :

*W. H. Scott*

L | 10 H. Art'y. | U.S.C.T.

Spencer Lewis  
Capt., Co. L, 10 Reg't U. S. Col'd H. Art'y.

Age ..... years.

Appears on

Company Muster Roll\*

for Sept. & Oct., 1865.

Joined for duty and enrolled:

When Apt. 7, 1865.

Where New Orleans

Period 3 years.

Mustered in:

When May 8, 1865.

Where New Orleans

Present or absent Present

Stoppage, \$ 100 for

Due Gov't, \$ 100 for

Valuation of horse, \$ 100

Valuation of horse equipments, \$ 100

Remarks: Transf. from Co. C  
14 U.S.C.

\*First current roll. No muster-in roll of this company on file.

Book mark :

Scherich



*L* | 10 H. Art'y. | U.S.C.T.

*Spencer Lewis*  
*Pvt*, Co. L, 10 Reg't U. S. Col'd H. Art'y.

Appears on

**Company Muster Roll**

for *Mo. & Apl.*, 1866.

Present or absent *Present*

Stoppage, \$ *100* for

Due Gov't, \$ *100* for

Valuation of horse, \$ *100*

Valuation of horse equipments, \$ *100*

Remarks:  
-----  
-----  
-----  
-----  
-----  
-----  
-----  
-----

Book mark: -----

*Scherick*

*L* *10th. arty.* **U.S.C.T.**

*Spencer Lewis*  
*Priv.*, Co. *L*, *10* Reg't U. S. Col'd *11th. arty.*

Appears on

**Company Muster Roll**

for *May & June*, 186 *6*.

Present or absent *Present*

Stoppage, \$ *100* for

Due Gov't, \$ *100* for

Valuation of horse, \$ *100*

Valuation of horse equipments, \$ *100*

Remarks:

Book mark:

*Scherish*

*L* | 10 H. Art'y. | U.S.C.T.

*Spencer Lewis*

*Priv*, Co. L, 10 Reg't U. S. Col'd H. Art'y.

Appears on

**Company Muster Roll**

for *July & Aug*, 1866.

Present or absent *Present*

Stoppage, \$ *100* for

Due Gov't, \$ *100* for

Valuation of horse, \$ *100*

Valuation of horse equipments, \$ *100*

Remarks:

Book mark:

*Bumhan*

L | 10 H. Art'y. | U.S.C.T.

*Spencer Lewis*

*Plt*, Co. L, 10 Reg't U. S. Col'd H. Art'y.

Appears on

**Company Muster Roll**

for *Sept & Oct*, 186*6*.

Present or absent

Stoppage, \$ 100 for

Due Gov't, \$ 100 for

Valuation of horse, \$ 100

Valuation of horse equipments, \$ 100

Remarks: *Discharged by Order  
Sept 8/66 having reenlisted in  
the Regular Army*

Book mark:

*Burnham*

L<sup>o</sup> | 1st H. Art<sup>y</sup> | U.S.C.T.

Spencer Lewis

Priv, Co. L, 10 Reg't U. S. Col'd Harty

Appears on

**M. and D. Roll of Men Transferred**

to the organization named above,

from 77 Regt U.S. @ Inf.

Roll dated Oct 1, 1865.

When enlisted Apr 7, 1865.

Period for which enlisted 3 years.

When mustered in May 8, 1865.

Present or absent Present

Company to which assigned L

Remarks: joined as recruit  
May 20, 65

Book mark: L7-CJ-1872

J. M. Lennard

*L* | 10 H. Art'y. | **U.S.C.T.**

*Spencer Lewis*  
*Plt*, Co. L, 10 Reg't U. S. Col'd H. Art'y.

Appears on

**Company Muster Roll**

for *Nov. & Dec.*, 1863.

Present or absent *Present*

Stoppage, \$ 100 for

Due Gov't, \$ 100 for

Valuation of horse, \$ 100

Valuation of horse equipments, \$ 100

Remarks:

Book mark:

*Scherich*

L. | 10 H. Art'y. | U.S.C.T.

Spencer Lewis

Co. L, 10 Reg't U. S. Col'd H. Art'y.

Appears on

**Company Muster Roll**

for Jan. & Feb., 1866

Present or absent Present

Stoppage, \$ 100 for

Due Gov't, \$ 100 for

Valuation of horse, \$ 100

Valuation of horse equipments, \$ 100

Remarks:

Book mark:

Scherich

L | 10 H. Art'y. | U.S.C.T.

Spencer Lewis

Priv., Co. L, 10 Reg't U. S. Col'd H. Art'y.

Appears on Co. Muster-out Roll, dated  
Baton Rouge La., Feb 22, 1867.

Muster-out to date \_\_\_\_\_, 186 .

Last paid to \_\_\_\_\_, 186 .

Clothing account:

Last settled \_\_\_\_\_, 186 ; drawn since \$ \_\_\_\_\_ 100

Due soldier \$ \_\_\_\_\_ 100 ; due U. S. \$ \_\_\_\_\_ 100

Am't for cloth'g in kind or money adv'd \$ \_\_\_\_\_ 100

Due U. S. for arms, equipments, &c., \$ \_\_\_\_\_ 100

Bounty paid \$ \_\_\_\_\_ 100 ; due \$ \_\_\_\_\_ 100

Remarks: *Joined by transfer from  
Co D 77 U.S.C.I. Oct 11/65 SO. 66  
#290 Dept of La Sept 22/65 Disch'd  
at N.O. La Sept 8/66 to enable him  
to enlist in 9 U.S. Cavalry*

Book mark: *Discharged Sept 8 1866*

*L 909 C I 72 V 139 P 181 72*

*Burnham*



L. | 10 Hy Arty. | Ufe 9.

Spencer Lewis

, Co. L., 10 Reg't Ufe Hy Arty

**NOTATION.**

Book mark: L. J. C. D. 1872

**War Department,**

Adjutant General's Office,

Washington, February 19<sup>th</sup>, 1872.

Discharged September 8<sup>th</sup> 1866.

A. M. Muzzey

Copyist.

1625  
Lewis, William

Co D, 10 U.S. Col'd H. Art'y.

~~Private~~

Corporal

CARD NUMBERS.

1	5-571008	26
2	5-571082	27
3	5-571156	28
4	5-571286	29
5	5-571429	30
6	5-571567	31
7	5-571784	32
8	5-571821	33
9	5-571927	34
10	5-571985	35
11	5-572082	36
12	5-572163	37
13		38
14		39
15		40
16		41
17		42
18		43
19		44
20		45
21		46
22		47
23		48
24		49
25		50

Book Mark:

See also

S-2230980 10 min

0.2342022 ~~0.2342022~~ W.D.

S. S. Doughty  
2

L | 10 H. Art'y. | U.S.C.T.

William Lewis

Pvt., Co. D, 10 Reg't U. S. Col'd H. Art'y.

Appears on

**Company Muster Roll**

for     Mch & Apr    , 1865.

Present or absent     Present    

Stoppage, \$     100     for

Due Gov't, \$     100     for

Valuation of horse, \$     100    

Valuation of horse equipments, \$     100    

Remarks: Assigned to 10 U. S. C.  
Art'y (H) per S. O. No. 100 dated  
Hd Qrs Mil. Div. West Miss.,  
New Orleans La, Apr 10/65.  
No Descriptive List furnished.  
Sick in quarters.

Book mark: \_\_\_\_\_

    Patterson     Copyist.

L | 10 H. Art'y. | U.S.C.T.

William Lewis

Pvt., Co. D, 10 Reg't U. S. Col'd H. Art'y.

Appears on

**Company Muster Roll**

for *May & June*, 1865.

Present or absent *Present*

Stoppage, \$ 100 for

Due Gov't, \$ 100 for

Valuation of horse, \$ 100

Valuation of horse equipments, \$ 100

Remarks: *Sick in Qrs. Assigned to 10 U.S.C.A. (H.) per S.O. No. 100, Hd Qrs. Mil. Div. West Miss., Apr 10/65. No Descriptive List furnished.*

Book mark: \_\_\_\_\_

*Patterson*

*L* | 10 H. Art'y. | U.S.C.T.

*William Lewis*

*Pvt*, Co. D, 10 Reg't U. S. Col'd H. Art'y.

Appears on

**Company Muster Roll**

for *July & Aug*, 186*5*.

Present or absent *Present*

Stoppage, \$ *100* for

Due Gov't, \$ *100* for

Valuation of horse, \$ *100*

Valuation of horse equipments, \$ *100*

Remarks: *Pay due from Apr 10/65,  
date of assignment to the Regt.  
Sick in Quarters. Due U.S.,  
for Camp & Garrison Equipage. 19¢.*

Book mark: \_\_\_\_\_

*Patterson*

*L* | 10 H. Art'y. | U.S.C.T.

*William Lewis*

*Priv*, Co. D, 10 Reg't U. S. Col'd H. Art'y.

Appears on

**Company Muster Roll**

for *Sept & Oct*, 1865.

Present or absent *Present*

Stoppage, \$ 100 for

Due Gov't, \$ 100 for

Valuation of horse, \$ 100

Valuation of horse equipments, \$ 100

Remarks:

Book mark:

*Patterson*

Copyist.

*L* | 10 H. Art'y. | U.S.C.T.

*William Lewis*  
*Pr*, Co. D, 10 Reg't U. S. Col'd H. Art'y.

Appears on

**Company Muster Roll**

for *Nov & Dec*, 1865

Present or absent *Present*

Stoppage, \$ 100 for

Due Gov't, \$ 100 for

Valuation of horse, \$ 100

Valuation of horse equipments, \$ 100

Remarks: *Due U.S. for*  
*Ord. No. 16; for*  
*Camp Equipage*  
*No. 86*

Book mark: \_\_\_\_\_

*M. Wayne*  
(858) Copied.



L

10 H. Art'y. | U.S.C.T.

William Lewis  
Pvt, Co. D, 10 Reg't U. S. Col'd H. Art'y.

Appears on

Company Muster Roll

for Jan & Feb, 1866.

Present or absent Present

Stoppage, \$ 100 for

Due Gov't, \$ 100 for

Valuation of horse, \$ 100

Valuation of horse equipments, \$ 100

Remarks:

Book mark:

W. W. Mayne  
Copied.

L | 10 H. Art'y. | U.S.C.T.

William Lewis

Pvt., Co. D, 10 Reg't U. S. Col'd H. Art'y.

Appears on

Company Muster Roll

for *March & Apr*, 1866.

Present or absent *Present*

Stoppage, \$ *100* for

Due Gov't, \$ *100* for

Valuation of horse, \$ *100*

Valuation of horse equipments, \$ *100*

Remarks:

Book mark:

*[Signature]*  
Copyright.

*L* | **10 H. Art'y. | U.S.C.T.**

*William Lewis*

*Cot*, Co. D, 10 Reg't U. S. Col'd H. Art'y.

Appears on

**Company Muster Roll**

for *May & June*, 186*6*.

Present or absent *Present*

Stoppage, \$ *100* for

Due Gov't, \$ *100* for

Valuation of horse, \$ *100*

Valuation of horse equipments, \$ *100*

Remarks: \_\_\_\_\_  
\_\_\_\_\_  
\_\_\_\_\_  
\_\_\_\_\_  
\_\_\_\_\_  
\_\_\_\_\_

Book mark: \_\_\_\_\_

*Copyist*  
Copyist.

L | 10 H. Art'y. | U.S.C.T.

*William Lewis*

*Cook*, Co. D, 10 Reg't U. S. Col'd H. Art'y.

Appears on

**Company Muster Roll**

for *July & Aug*, 1866.

Present or absent *Present*

Stoppage, \$ *100* for

Due Gov't, \$ *100* for

Valuation of horse, \$ *100*

Valuation of horse equipments, \$ *100*

Remarks: *Due U.S. for Ord #16*

Book mark: \_\_\_\_\_

*[Signature]*  
Copyist.

L | 10 H. Art'y. | U.S.C.T.

William Lewis

Corp., Co. D, 10 Reg't U. S. Col'd H. Art'y.

Appears on

Company Muster Roll

for Sept 1866, 1866

Present or absent Present

Stoppage, \$ 100 for

Due Gov't, \$ 100 for

Valuation of horse, \$ 100

Valuation of horse equipments, \$ 100

Remarks: App promoted to dat Oct 1'66 per SO No 23 Ad. Pers. 10 USCA, H Baton Rouge Oct 16 66

Book mark:

J. H. Lemmon

*L* **10 H. Art'y. | U.S.C.T.**

*William Lewis*  
*Comdr.*, Co. D, 10 Reg't U. S. Col'd H. Art'y.

Appears on

**Company Muster Roll**

for *Nov. & Dec*, 186*6*

Present or absent *Present*

Stoppage, \$ 100 for

Due Gov't, \$ 100 for

Valuation of horse, \$ 100

Valuation of horse equipments, \$ 100

Remarks:  
\_\_\_\_\_  
\_\_\_\_\_  
\_\_\_\_\_  
\_\_\_\_\_  
\_\_\_\_\_  
\_\_\_\_\_

Book mark: \_\_\_\_\_

*W. Lewis*  
\_\_\_\_\_  
\_\_\_\_\_  
\_\_\_\_\_

L | 10 H. Art'y. | U.S.C.T.

William Lewis  
Corp, Co., 10 Reg't U. S. Col'd H. Art'y.

Appears on Co. Muster-out Roll, dated  
Baton Rouge, La. Feb 22, 1867.

Muster-out to date Feb 22, 1867.

Last paid to Dec 31, 1866.

Clothing account:

Last settled \_\_\_\_\_, 186 ; drawn since \$ \_\_\_\_\_ 100

Due soldier \$ \_\_\_\_\_ 100; due U. S. \$ \_\_\_\_\_ 100  
47

Am't for cloth'g in kind or money adv'd \$ \_\_\_\_\_ 100

Due U. S. for arms, equipments, &c., \$ \_\_\_\_\_ 6 50  
100

Bounty paid \$ \_\_\_\_\_ 100<sup>xx</sup>; due \$ \_\_\_\_\_ 100<sup>xx</sup>

Remarks: joined as Recruit  
no descriptive list fur-  
nished. App'd. Ensl.  
Oct 1/66

Ag 23. Enrolled Jan 18-65 St  
Louis 3<sup>rd</sup> Inf. Feb 27 65  
Benton Barracks

Book mark: \_\_\_\_\_

(361) *J. Leonard* Copyist.

1626  
Lewis, William

Co A & D, 10 U.S. Col'd H. Art'y.

Private

Private

CARD NUMBERS.

1	5-487465	26
2	5-5-10232	27
3	5-5-10382	28
4	5-5-10530	29
5	5-5-10635	30
6	5-5-10779	31
7	5-5-10859	32
8	5-5-10934	33
9	5-5-11006	34
10	5-5-11138	35
11	5-489384	36
12		37
13		38
14		39
15		40
16		41
17		42
18		43
19		44
20		45
21		46
22		47
23		48
24		49
25		50

Book Mark:

See also 77. U.S.C.S.



S. 928115 Pouton  
A2879382 Pout.

S. 3137423 P. O. Rock.

S. E. Douglas  
2

L 108, A, U.S.C.T.

William Lewis  
Priv, Co. I, 10 Reg't U. S. Col'd 8, A

Appears on

**M. and D. Roll of Men Transferred**

to the organization named above,

from Co. B. 4th U. S. Col. Inf

Roll dated Camp Canandaigua, 1864

When enlisted Feb 6, 1864

Period for which enlisted 3 years.

When mustered in March 11, 1864

Present or absent Present

Company to which assigned I

Remarks: Joined the Service

as Private Stoppage

1 Set Cap trimmings

2. Wrench

Book mark :

W. H. Scott

*L* | 10 H. Art'y. | U.S.C.T.

*William Lewis*

*Priv.*, Co. H, 10 Reg't U. S. Col'd H. Art'y

Appears on

**Company Muster Roll**

for *Sept & Oct*, 1865.

Present or absent *Present*

Stoppage, \$ *100* for

Due Gov't, \$ *100* for

Valuation of horse, \$ *100*

Valuation of horse equipments, \$ *100*

Remarks: *Due U.S. for Camp  
equipage & ordnance 31 ct  
(lost) Transferred from Co H  
77 U.S.C.T. per G. O. No 3  
Adm 10 U.S.C.A (A.)  
Camp Parapet Oct 1. 1865.*

Book mark:

*Gamma*

Copyist.

*L* | 10 H. Art'y. | U.S.C.T.

*William Lewis*

*Pr.*, Co. H, 10 Reg't U. S. Col'd H. Art'y

Appears on

**Company Muster Roll**

for *Nov & Dec*, 1865.

Present or absent *Present*

Stoppage, \$ *100* for

Due Gov't, \$ *100* for

Valuation of horse, \$ *100*

Valuation of horse equipments. \$ *100*

Remarks :

Book mark :

*Gammack*

Copyist.

*L* | 10 H. Art'y. | U.S.C.T.

*William Lewis*

*Pr.*, Co. H, 10 Reg't U. S. Co'd H. Art'y

Appears on

**Company Muster Roll**

for *Jan & Feb.*, 1866.

Present or absent *Present*

Stoppage, \$ 100 for

Due Gov't, \$ 100 for

Valuation of horse, \$ 100

Valuation of horse equipments. \$ 100

Remarks :

Book mark :

*Samuel R*

Copyist.

*L* | 10 H. Art'y. | U.S.C.T.

*William Lewis*

*Priv.*, Co. H, 10 Reg't U. S. Col'd H. Art'y

Appears on

**Company Muster Roll**

for *M & V Ap<sup>l</sup>*, 1866.

Present or absent *Present*

Stoppage, \$ *100* for

Due Gov't, \$ *100* for

Valuation of horse, \$ *100*

Valuation of horse equipments. \$ *100*

Remarks:

Book mark:

*Leammack*

Copyist.

*L* | 10 H. Art'y. | U.S.C.T.

*William Louis*

*Capt*, Co. H, 10 Reg't U. S. Col'd H. Art'y

Appears on

**Company Muster Roll**

for *May & June*, 1866.

Present or absent *Present*

Stoppage, \$ *100* for

Due Gov't, \$ *100* for

Valuation of horse, \$ *100*

Valuation of horse equipments. \$ *100*

Remarks :  
\_\_\_\_\_  
\_\_\_\_\_  
\_\_\_\_\_  
\_\_\_\_\_  
\_\_\_\_\_

Book mark : \_\_\_\_\_

*Samuel*  
Copyright.

L | 10 H. Art'y. | U.S.C.T.

William Lewis

Pvt., Co. H, 10 Reg't U. S. Col'd H. Art'y

Appears on

**Company Muster Roll**

for July & Aug, 1866.

Present or absent Present

Stoppage, \$ 100 for

Due Gov't, \$ 100 for

Valuation of horse, \$ 100

Valuation of horse equipments. \$ 100

Remarks:

Book mark:

Gammack



L | 10 H. Art'y. | **U.S.C.T.**

William Lewis  
Pvt, Co. H, 10 Reg't U. S. Col'd H. Art'y

Appears on

**Company Muster Roll**

for Sept & Oct, 1866.

Present or absent Present

Stoppage, \$ 100 for

Due Gov't, \$ 100 for

Valuation of horse, \$ 100

Valuation of horse equipments. \$ 100

Remarks: \_\_\_\_\_  
\_\_\_\_\_  
\_\_\_\_\_  
\_\_\_\_\_  
\_\_\_\_\_  
\_\_\_\_\_

Book mark: \_\_\_\_\_

Lowry  
Copyist.

L | 10 H. Art'y. | U.S.C.T.

William Lewis  
Pvt., Co. H, 10 Reg't U. S. Col'd H. Art'y

Appears on

**Company Muster Roll**

for Nov. & Dec., 1866.

Present or absent Present

Stoppage, \$ 100 for

Due Gov't, \$ 100 for

Valuation of horse, \$ 100

Valuation of horse equipments. \$ 100

Remarks: Stop for equi-  
page 59.

Book mark:

Loumy

*L* | 10 H. Art'y. | U.S.C.T.

*William Lewis*  
*Prof. Co. H., 10 Reg't U. S. Col'd H. Art'y.*

Appears on **Co. Muster-out Roll**, dated  
*Baton Rouge, La. Feb. 22, 1867*.

Muster-out to date -----, 186 .

Last paid to -----, 186 .

Clothing account:

Last settled -----, 186 ; drawn since \$ ----- 100

Due soldier \$ ----- 100; due U. S. \$ ----- 100

Am't for cloth'g in kind or money adv'd \$ ----- 100

Due U. S. for arms, equipments, &c., \$ ----- 100

Bounty paid \$ ----- 100; due \$ ----- 100

Remarks: *joined by transfer*  
*from 77th U. S. I.*  
*Mustered out exp of term*  
*of service Feb. 5/67*

Book mark: *M. O. on file*

L | 10 Ma | U.S.C.T.

William Lewis

Priv, Co. H, 10 Reg't U. S. Col'd H A

Appears on an

**Individual Muster-out Roll**

of the organization named above. Roll dated

Baton Rouge La Feb 5, 1867.

Muster-out to date Feb 5, 1867.

Last paid to Dec 31, 1866.

**Clothing account:**

Last settled ..... 186 ; drawn since \$ ..... 100

Due soldier \$ 48 <sup>95</sup>/<sub>100</sub>; due U. S. \$ ..... 100

Am't for cloth'g in kind or money adv'd \$ ..... 100

Due U. S. for arms, equipments, &c., \$ ..... 6 <sup>00</sup>/<sub>100</sub>

Bounty paid \$ ..... 100 due \$ 300 <sup>00</sup>/<sub>100</sub>

Remarks: Joined by transfer  
from 77<sup>th</sup> U.S. I by virtue  
of SO No 66 Hd Qrs Dept of  
La 1865 Private from enlist-  
ment. Has obtained no

Bounty (over)

Book mark: .....

R. Richardson

JAN. 15

5489384

\* 1891 \*

Mustered out by reason  
of expiration of term  
of service to date Feb 5  
1867

*Letton, Joseph*

Co *E*, 10 U.S. Col'd H. Art'y

*Private*

*Private*

CARD NUMBERS.

1	5-5-82411	26
2	5-489186	27
3	5-5-825-21	28
4	5-5-82637	29
5	5-5-82771	30
6	5-5-82901	31
7	5-5-83019	32
8	5-5-83137	33
9	5-5-83248	34
10	5-5-83357	35
11	5-5-83464	36
12	5-5-83594	37
13	5-5-83742	38
14	5-5-83946	39
15	5-5-845-5-8	40
16		41
17		42
18		43
19		44
20		45
21		46
22		47
23		48
24		49
25		50

Book Mark: .....

See also .....

*L* | **10 H. Art'y. U.S.C.T.**

*Joseph Lexton*  
Prk., Co. *E*, 7 Reg't U. S. Col'd H. Art'y.\*

Appears on

**Company Muster-in and Descriptive Roll**

of the organization named above. Roll dated

*New Orleans La, July 8, 1864.*

Where born *New Orleans La.*

Age *19* y'rs; occupation *Labourer*

When enlisted *Feb 14, 1864.*

Where enlisted *New Orleans*

For what period enlisted *3* years.

Eyes *Black*; hair *Black*

Complexion *Black*; height *5 ft 7 in.*

When mustered in *March 7, 1864.*

Where mustered in *New Orleans*

Bounty paid \$ *2* 100; due \$ *100*

Where credited *New Orleans*

Company to which assigned *E*

Remarks:

\* This organization subsequently became Co. *E*, 10 Reg't U. S. Colored Heavy Artillery.

Book mark:

L WMA | U.S.C.T.

Joseph Sexton  
7th U.S.C.T. (7th U.S.C.T. B.)  
Gov, Co. B, 1st Reg't U. S. Col'd WMA

Appears on a

**Detachment Muster Roll**

of the organization named above

for Roll dated Apr-30, 1864.

Station De Fair La.

Present or absent Present

Stoppage, \$ 100 for

Due Gov't, \$ 100 for

Valuation of horse, \$ 100

Valuation of horse equipments, \$ 100

Remarks:

Book mark:

Grogan



9 | **10 H. Art'y.** | **U.S.C.T.**

*Joseph Linton*

*Plt.*, Co. *E*, 7 Reg't U. S. Col'd H. Art'y.\*

Appears on

**Company Muster Roll**

for *May & June, 1864*

Present or absent *Present*

Stoppage, \$ 100 for

Due Gov't, \$ 100 for

Valuation of horse, \$ 100

Valuation of horse equipments, \$ 100

Remarks: *To be stopped from pay for ordnance lost twenty cents*

\* This organization subsequently became Co. *E*, 10 Reg't U. S. Colored Heavy Artillery.

Book mark: \_\_\_\_\_

*Linton*

Copyist.

*L* | 10 H. Art'y. | **U.S.C.T.**

*Joseph Linton*  
Pvt., Co. E, 10 Reg't U. S. Col'd H. Art'y.

Appears on

**Company Muster Roll**

for *July* ~~*Aug.*~~, 186*4*

Present or absent *Present*

Stoppage, \$ \_\_\_\_\_ *100* for \_\_\_\_\_

Due Gov't, \$ \_\_\_\_\_ *100* for \_\_\_\_\_

Valuation of horse, \$ \_\_\_\_\_ *100*

Valuation of horse equipments, \$ \_\_\_\_\_ *100*

Remarks: \_\_\_\_\_  
\_\_\_\_\_  
\_\_\_\_\_  
\_\_\_\_\_  
\_\_\_\_\_  
\_\_\_\_\_  
\_\_\_\_\_  
\_\_\_\_\_

Book mark: \_\_\_\_\_

*Linton*  
Copyist.

*J* | 10 H. Art'y. | U.S.C.T.

*Joseph Sexton*  
Co. E, 10 Reg't U. S. Col'd H. Art'y.

Appears on

**Company Muster Roll**

for *Sep. + Oct*, 186*4*.

Present or absent *Present*

Stoppage, \$ 100 for

Due Gov't, \$ 100 for

Valuation of horse, \$ 100

Valuation of horse equipments, \$ 100

Remarks: \_\_\_\_\_  
\_\_\_\_\_  
\_\_\_\_\_  
\_\_\_\_\_  
\_\_\_\_\_  
\_\_\_\_\_  
\_\_\_\_\_

Book mark: \_\_\_\_\_

*J. S. Sinden*  
Copyist.

*J* | **10 H. Art'y. | U.S.C.T.**

*Joseph Weston*  
*Plt.*, Co. E, 10 Reg't U. S. Col'd H. Art'y.

Appears on

**Company Muster Roll**

for *Nov* *4* *Dec*, 186*4*.

Present or absent *Present*

Stoppage, \$ 100 for

Due Gov't, \$ 100 for

Valuation of horse, \$ 100

Valuation of horse equipments, \$ 100

Remarks: *Difference of pay*  
*from enlistment to*  
*Apr 30 1864 per month*  
*due*

Book mark: *100*

*J. Weston*

*L* | 10 H. Art'y. | U.S.C.T.

*Joseph Sexton*

*Sgt.*, Co. E, 10 Reg't U. S. Col'd H. Art'y.

Appears on

**Company Muster Roll**

for *Jan. & Feb.*, 186*0*.

Present or absent *Present*

Stoppage, \$ *100* for

Due Gov't, \$ *100* for

Valuation of horse, \$ *100*

Valuation of horse equipments, \$ *100*

Remarks: *Difference of pay  
from enlistment to Apr.  
30, 1864, \$6.00 per month  
due*

Book mark: \_\_\_\_\_

*G. C. Tyler*

Copyist.

L | 10 H. Art'y. | U.S.C.T.

Joseph Linton

Cvt., Co. E, 10 Reg't U. S. Col'd H. Art'y.

Appears on

**Company Muster Roll**

for March & Apr., 1865.

Present or absent Present.

Stoppage, \$ 100 for

Due Gov't, \$ 100 for

Valuation of horse, \$ 100

Valuation of horse equipments, \$ 100

Remarks: Differenced of pay  
from enlistment to Apr.  
30 1864, \$6.00 per month  
due.

Book mark: \_\_\_\_\_

W. C. Tyler

Copyist.

L

10 H. Art'y. U.S.C.T.

Joseph Sexton  
Capt., Co. E, 10 Reg't U. S. Col'd H. Art'y.

Appears on

Company Muster Roll

for May & June, 1865.

Present or absent Present.

Stoppage, \$ 100 for

Due Gov't, \$ 100 for

Valuation of horse, \$ 100

Valuation of horse equipments, \$ 100

Remarks:

Book mark:

W. C. Tyler

*D* | **10 H. Art'y. | U.S.C.T.**

*Joseph Lexton*  
....., Co. E, 10 Reg't U. S. Col'd H. Art'y

Appears on

**Company Muster Roll**

for *July & Aug.*....., 186*0*.

Present or absent *Present.*.....

Stoppage, \$..... *100* for .....

Due Gov't, \$..... *100* for .....

Valuation of horse, \$..... *100*

Valuation of horse equipments, \$..... *100*

Remarks: *Due U.S. for Ordnance*  
*57. Due U.S. for Camp &*  
*Carrison's Equipage \$ 19*  
*100*

Book mark:.....

*J. E. Tyler*

Copyist.



10 H. Art'y. U.S.C.T.

Joseph [unclear]  
[unclear], Co. E, 10 Reg't U. S. Col'd H. Art'y

Appears on

**Company Muster Roll**

for Sept. & Oct., 1861.

Present or absent Present

Expense, \$ 100 for

Due Gov't, \$ 100 for

Valuation of horse, \$ 100

Valuation of horse equipments, \$ 100

Remarks:

Book mark:

L | 10 H. Art'y. | **U.S.C.T.**

Joseph Lexton  
Priv, Co. E, 10 Reg't U. S. Col'd H. Art'y.

Appears on

**Company Muster Roll**

for Nov & Dec, 1865.

Present or absent Present

Stoppage, \$ 100 for

Due Gov't, \$ 100 for

Valuation of horse, \$ 100

Valuation of horse equipments, \$ 100

Remarks:

Book mark:

Wark  
Copyist.

L | 10 H. Art'y. | **U.S.C.T.**

Joseph Lexton  
Plt, Co. E, 10 Reg't U. S. Col'd H. Art'y.

Appears on

**Company Muster Roll**

for Jan - Feb, 1866.

Present or absent Present

Stoppage, \$ 100 for

Due Gov't, \$ 100 for

Valuation of horse, \$ 100

Valuation of horse equipments, \$ 100

Remarks: \_\_\_\_\_  
\_\_\_\_\_  
\_\_\_\_\_  
\_\_\_\_\_  
\_\_\_\_\_  
\_\_\_\_\_  
\_\_\_\_\_

Book mark: \_\_\_\_\_  
\_\_\_\_\_

Walt  
Copyist.

L | **10 H. Art'y.** | **U.S.C.T.**

*Joseph Lerton*

*Priv*, Co. E, 10 Reg't U. S. Col'd H. Art'y.

Appears on

**Company Muster Roll**

for *March & April*, 1866.

Present or absent.....

Stoppage, \$.....<sup>100</sup> for.....

Due Gov't, \$.....<sup>100</sup> for.....

Valuation of horse, \$.....<sup>100</sup>

Valuation of horse equipments, \$.....<sup>100</sup>

Remarks: *Discharged on Surgeon's certificate of disability and statements given Apr 24, 1866*

Book mark:.....

*Hark*  
Copyist.

*L* | 10 H. Art'y. | U.S.C.T.

*Joseph Sexton*  
Sext, Co. *E*, 10 Reg't U. S. Col'd H. Art'y.

Appears on **Co. Muster-out Roll**, dated  
*Baton Rouge, La. Feb. 22*, 186*7*.

Muster-out to date \_\_\_\_\_, 186 .

Last paid to \_\_\_\_\_, 186 .

Clothing account:

Last settled \_\_\_\_\_, 186 ; drawn since \$ \_\_\_\_\_ 100

Due soldier \$ \_\_\_\_\_ 100; due U. S. \$ \_\_\_\_\_ 100

Am't for cloth'g in kind or money adv'd \$ \_\_\_\_\_ 100

Due U. S. for arms, equipments, &c., \$ \_\_\_\_\_ 100

Bounty paid \$ \_\_\_\_\_ 100; due \$ \_\_\_\_\_ 100

Remarks: *Discharged & final  
statements given April  
24, 1866 on Surg. Certf.  
of Disability.*

Book mark: *11.532, 2<sup>d</sup> A. Aug. 14/68*

Sexton, Joseph

P. Co. E., 10 U. S. C. H. A.  
Reg't

Enclosures.

Bed Cards	Descriptive Lists
Burial Records	Final Statements
Certs. of Dis. for Discharge /	Furloughs
C. M. Charges	Med. Des. Lists
Med. Certificates	Orders

Other papers relating to—

Admission to Hosp'l	Furlough
Casualty Sheet (Officer's)	Med. Examination
Confinement	Misc. Information
Contracts	Pay or Clothing
Death or Effects	Personal Reports
Desertions	Rank
Discharge from Hosp'l	Transfer to Hosp'l
Discharge from Service	Transfer to V. R. C.
Duty	Transportation

NOTE 1

The company commander will here add a statement of all the facts known to him concerning the disease or wound, or cause of disability of the soldier; the time, place, manner, and all the circumstances under which the injury occurred, or disease originated or appeared; the duty, or service, or situation of the soldier at the time the injury was received or disease contracted, stating particularly whether the injury was received or the disease contracted in the line of his duty; and whatever other facts may aid a judgment as to the cause, immediate or remote, of the disability, and the circumstances attending it.

When the facts are not known to the company commander, the certificate of any officer, or affidavit of other person having such knowledge, will be appended—as the surgeon in charge of a hospital, the officer commanding a detachment of recruits, &c., &c.

NOTE 2.

When a probable case for pension, special care must be taken to state the degree of disability—as  $\frac{1}{2}$ ,  $\frac{1}{3}$ , &c., &c.; to describe particularly the disability, wound, or disease; the extent of which it deprives him of the use of any limb or faculty, or affects his health, strength, activity, constitution, or capacity to labor or earn his subsistence. The surgeon will add, from his knowledge of the facts and circumstances, and from the evidence in the case, his professional opinion of the cause or origin of the disability. In the case of discharges by Medical Inspectors, the last paragraph will state that the "discharge was given by consent of the soldier, after a personal examination, and for disability, the nature, degree, and origin of which are correctly described in the within certificate."

Par. 1260 Regulations, Edit. 1861.

Medical officers, in giving certificates of disability, are to take particular care in all cases that have not been under their charge; and especially in epilepsy, convulsions, chronic rheumatism, derangement of the urinary organs, ophthalmia, ulcers, or any obscure disease liable to be feigned or purposely produced; and in no case shall such certificate be given until after sufficient time and examination to detect any attempt at deception.

DIRECTIONS.

This certificate will be made out in duplicate by the soldier's company commander, or other officer commanding the separate detachment to which he belongs, and sent by him to the surgeon who has charge of the hospital where the soldier is sick. The surgeon will then fill out and sign the surgeon's certificate, and forward these papers to the regimental, detachment, or post commander, who will forward them, with his action endorsed thereon, through the proper channel, to his division commander; or, if the troops are not attached to a division, to his corps, department, or other commander or officer to whom the authority to discharge enlisted men may be specially delegated.

These certificates, after having received the action of the highest authority to which they are required to be sent, will be returned through the same channel to the regimental, post, or detachment commander, who will, if the discharge is authorized by the endorsement of the proper authority, sign the soldier's discharge, and the last certificate on this paper; see that the soldier is furnished with the proper final statements in duplicate, and forward BOTH of these certificates direct to the Adjutant General, United States Army, at Washington, D. C.; they will not, under any circumstances, be given into the hands of the soldier.

ADJ. GEN. OFFICE  
May 15<sup>th</sup> 1866  
Duplicate sent to Pension Comm.

CERTIFICATE OF DISABILITY FOR DISCHARGE

IN THE CASE OF

Joseph Layton  
Private Co. "E"  
Tenth Reg't of 1st (A.S.)

Headqrs. East Dist of La.  
New Orleans April 9<sup>th</sup> 1866  
No. 911-66.

Respectfully forwarded to Head  
Quarters Dept. of Louisiana  
Approved

*[Handwritten signature]*



Office)

Arthur O. Poffley

Headquarters, Department of Louisiana,  
New Orleans, La., April 15<sup>th</sup> 1866.  
To be discharged.

By order of Major-General E. R. S. CANBY:

Louis H. Caylor  
1st Lieut., Brevet Captain and A. A. G.

New Orleans La. April 15<sup>th</sup> 6.  
Respectfully returned to the  
Assistant Adjutant General,  
Dept. of Louisiana.  
Approved

*[Handwritten signature]*  
Capt. & Surg. U. S. A.  
Medical Director

# ARMY OF THE UNITED STATES.

## CERTIFICATE

### OF DISABILITY FOR DISCHARGE.



Private Joseph Layton, of Captain Martin A. Greenland Company, ("E") of the 5th Regiment of the United States was enlisted by Samuel Nichols of the 10th Regiment of Infantry at New Orleans La on the 14th day of February, 1867, to serve 3 years; he was born in New Orleans in the State of Louisiana, is Musteen (19) years of age, 5 feet 3 3/4 inches high, Yellow complexion, Black eyes, Black hair, and by occupation when enlisted a Laborer. During the last two months said soldier has been unfit for duty 60 days.\*

*This soldier has done but little duty for the past 18 months I believe the rupture had occurred before his enlistment though it did not then disable him as now as he is totally unfit to perform any duty as a soldier.*

STATION: Fort Hudson La  
 DATE: March 31st 1866

John Marshall  
 1st Lieut 10th Regt (A) Inf  
 Commanding Company.

I CERTIFY, that I have carefully examined the said Joseph Layton a Private of Captain Greenland's Company, and find him incapable of performing the duties of a soldier because of Inguinal Hernia. Existed prior to enlistment, but has probably become enlarged by service. Unfit for Invalid Corps. Degree of Disability (1/3) one third

J. H. Jenkins Jr.  
 Lt. Surgeon.  
 In chg. Detachment

DISCHARGED, this Twentyfourth day of April, 1866, at Fort Hudson La

E. P. Lorenz  
 Major  
 Commanding the Regt.  
*setch*

The Soldier desires to be addressed at  
 Town \_\_\_\_\_ County \_\_\_\_\_ State \_\_\_\_\_

\* See Note 1 on the back of this. † See Note 2 on the back of this.  
 [A. G. O. No. 100 & 101—First.] [DUPLICATES.]



162  
Lobby, Thomas J.  
Co D, 10 U.S. Col'd H. Art'y.

Acty. 1<sup>st</sup> Sargent.

Acty. 1<sup>st</sup> Sargent.

CARD NUMBERS.

1	5-494911	26
2	5-495069	27
3	5-495224	28
4	5-495376	29
5	5-495528	30
6		31
7		32
8		33
9		34
10		35
11		36
12		37
13		38
14		39
15		40
16		41
17		42
18		43
19		44
20		45
21		46
22		47
23		48
24		49
25		50

Book Mark:

See also Co C. 12 Maine

U. 1933746

G. E. Doughty  
2

L

10 H. Art'y.

U.S.C.T.

Thomas J. Libby

Acting  
1st. Sergt., Co. B, 1 Reg't La. H. Art'y, Native Guards.\*

Appears on

**Company Muster Roll**

for Sept. & Oct., 1863.

Present or absent Present

Stoppage, \$ 100 for

Due Gov't, \$ 100 for

Valuation of horse, \$ 100

Valuation of horse equipments, \$ 100

Remarks: Detached as Actg.  
Orderly Sergt. by Col.  
Skinnerball, comdg. Post.

\*This organization subsequently became Co. B, 10 Reg't U. S. Col'd Heavy Artillery.

Book mark:

Feaster

L | 10 H. Art'y. | U.S.C.T.

Thomas G. Libby

1 Sgt., Co., 1 Reg't H. Art'y, Corps d'Afrique.\*

Appears on

**Company Muster Roll**

for Nov. & Dec., 1863.

Present or absent Present

Stoppage, \$ 100 for

Due Gov't, \$ 100 for

Valuation of horse, \$ 100

Valuation of horse equipments, \$ 100

Remarks:

\*This organization subsequently became Co., 10 Reg't U. S. Colored Heavy Artillery.

Book mark:

Reif

*L* | 10 H. Art'y. | **U.S.C.T.**

*Thomas J. Sibly*  
1<sup>st</sup> Sgt, Co. *B*, 1 Reg't H. Art'y, Corps d'Afrique.\*

Appears on

**Company Muster Roll**

for *Jun. 1 - Feb. 1, 1864*

Present or absent *Present*

Stoppage, \$ *100* for

Due Gov't, \$ *100* for

Valuation of horse, \$ *100*

Valuation of horse equipments, \$ *100*

Remarks:

\*This organization subsequently became Co. *10*, 10 Reg't U. S. Colored Heavy Artillery.

Book mark:

*Reif*

L | 10 H. Art'y. | U.S.C.T.

Thomas J. Libby  
1<sup>st</sup> Lt., Co. D, 7 Reg't U. S. Col'd H. Art'y.\*

Appears on

**Company Muster Roll**

for *Mar & Apr*, 1864.

Present or absent *Present*

Stoppage, \$ 100 for

Due Gov't, \$ 100 for

Valuation of horse, \$ 100

Valuation of horse equipments, \$ 100

Remarks: *Detached from Co. C  
12<sup>th</sup> Maine Vols. by special  
order of Colonel Comant  
at Paraguet (October 12, 1863)*

\* This organization subsequently became Co. B, 10 Reg't U. S. Colored Heavy Artillery.

Book mark: \_\_\_\_\_

*J. H. Richardson*  
Copyist.

2 | 10 H. Art'y. | U.S.C.T.

Thomas J. Libby

Act. 1 Sglt Co. B, 7 Reg't U. S. Col'd H. Art'y.\*

Appears on

**Company Muster Roll**

for May & June, 1864

Present or absent

Present

Stoppage, \$ 100 for

Due Gov't, \$ 100 for

Valuation of horse, \$ 100

Valuation of horse equipments, \$ 100

Remarks: Oct. 12 1863 by order of  
the Colonel Comdr at Parapet  
Detached from Co. B. 12 Maine  
Vals. for duty as actg. First  
Serjt. in this Co B

\* This organization subsequently became Co. , 10 Reg't U. S. Colored Heavy Artillery.

Book mark :

Reif

*Libly, Thos J*  
*Sgt. Co. B, 16<sup>th</sup> Reg't U.S.A.*

*1* Enclosures.

Bed Cards .....	Final Statements .....
Burial Records .....	Furloughs or L. of A .....
Certs. of Dis. for Discharge .....	Med. Certificates .....
C. M. Charges .....	Med. Des. Lists .....
Descriptive Lists .....	Orders .....
Discharge Certificates .....	Pris. of War Record .....
Enlistment Papers .....	Resignations .....

Other papers relating to—

Admission to Hosp'l .....	Furlough or L. of A .....
Casualty Sheet .....	Med. Examination .....
Confinement .....	Misc. Information / .....
Contracts .....	Pay or Clothing .....
Death or Effects .....	Personal Reports .....
Desertion .....	Rank .....
Discharge from Hosp'l .....	Transfer to Hosp'l .....
Discharge from Service .....	Transfer to V. R. C. .....
Duty .....	Transportation .....



288  
Camp Parapet Dec. 24<sup>th</sup>

Thomas J. Libbey 1<sup>st</sup> Sergt.  
Co. B. 1<sup>st</sup> H. A.  
C. S. A.

Applies for a position as  
line officer in 1<sup>st</sup> H. A.  
C. S. A.

a 6 1863  
Head Quarters 1<sup>st</sup> H. A. C. S. A.  
New Orleans Dec. 26<sup>th</sup> 1863

Respectfully forwarded to Hdqrs.  
Dept. of the Gulf with request  
that the applicants be ordered  
before the Board of Examiners  
of which Col. L. H. D. Currie  
is President

J. D. Drango  
1<sup>st</sup> Col. comd'g.  
1<sup>st</sup> H. A. C. S. A.

S. O. Dec 28<sup>th</sup>

Camp Parapet Louisiana  
Dec. 24<sup>th</sup> 1863

Colonel I have the honor hereby most respectfully to apply to you for position as a line Officer in your Regiment, such a one as (after examination) may be deemed competent to fill.

Should the Colonel favor my wish, I beg to request that I may be ordered before the Board of examination at the earliest day convenient.

I beg in conclusion to state that I am a Private of the 12<sup>th</sup> Maine Vols, and since Oct. 14<sup>th</sup> 1863 have been Actg. Orderly Sergr. of Company B 1<sup>st</sup> La Artillery, C. D. A.

I have the honor to be Colonel  
most respectfully  
Your Obedt. Servt.

Thomas G. Libby  
Actg. 1<sup>st</sup> Sergr. Co. B. 1<sup>st</sup> La  
Heavy Artillery C. D. A.

By

Colonel Bangs  
Commanding  
1<sup>st</sup> La Heavy Artillery

1629  
*Libscomb, George*

Co A, 10 U.S. Col'd H. Art'y.

*Private* | *Private*

CARD NUMBERS.

1	5490439	26
2	5490592	27
3	5490800	28
4	5494106	29
5		30
6		31
7		32
8		33
9		34
10		35
11		36
12		37
13		38
14		39
15		40
16		41
17		42
18		43
19		44
20		45
21		46
22		47
23		48
24		49
25		50

Book Mark:

See also

*L* | 10 H. Art'y. | U.S.C.T.

*George Libscomb*  
Priv., Co. A, 1 Reg't La. Col'd H. Art'y.\*  
Age *31* years.

Appears on

**Company Muster-in Roll**

of the organization named above. Roll dated

*New Orleans, La. Nov. 29, 1862.*

Muster-in to date *Nov. 29, 1862.*

Joined for duty and enrolled:

When *Nov. 16*, 186 .

Where *New Orleans*

Period *3* years.

Valuation of horse, \$.....*100*

Valuation of horse equipments, \$.....*100*

Remarks: .....

.....

.....

\*This organization subsequently became Co. A, 10 Reg't U. S. Colored Heavy Artillery.

Book mark: .....

.....

*L* | **10 H. Art'y. | U.S.C.T.**

*George Libscomb*

*Priv.*, Co. A, 1 Reg't La. H. Art'y.\*

Appears on

**Company Muster Roll**

for *to Dec 31*, 1862.

Present or absent *Present*

Stoppage, \$ *100* for

Due Gov't, \$ *100* for

Valuation of horse, \$ *100*

Valuation of horse equipments, \$ *100*

Remarks:

\*This organization subsequently became Co. A, 10 Reg't U. S. Col'd Heavy Artillery.

Book mark:

*John*

L | **10 H. Art'y. | U.S.C.T.**

George Libscomb  
Priv., Co. A, 1 Reg't La. H. Art'y.\*

Appears on

**Company Muster Roll**

for Jany & Feby, 1863.

Present or absent

Stoppage, \$ 100 for

Due Gov't, \$ 100 for

Valuation of horse, \$ 100

Valuation of horse equipments, \$ 100

Remarks

Died in Hospital  
January 16" 1863

\*This organization subsequently became Co. A, 10 Reg't U. S. Col'd Heavy Artillery.

Book mark:

Tobman

L

10 H. Art'y. U.S.C.T.

George Libscomb  
Pvt, Co. A, 10 Reg't U. S. Col'd H. Art'y.

Appears on Co. Muster-out Roll, dated  
Baton Rouge La, Feb. 22, 1867.

Muster-out to date ..... 186 .

Last paid to ..... 186 .

Clothing account:

Last settled ..... 186 ; drawn since \$ ..... 100

Due soldier \$ ..... 100; due U. S. \$ ..... 100

Am't for cloth'g in kind or money adv'd \$ ..... 100

Due U. S. for arms, equipments, &c., \$ ..... 100

Bounty paid \$ ..... 100; due \$ ..... 100

Remarks: *Joined origl orgn. Died  
Jan. 16. 63. Final statements  
Given*

Book mark : .....

*Nesbitt*

*Libscomb George*

*P*, Co. , 10 Regt S. C. H. A.

/ Enclosures.

Bed Cards	Descriptive Lists
Burial Records	Final Statements /
Certs. of Dis. for Discharge	Furloughs
C. M. Charges	Med. Des. Lists
Med. Certificates	Orders

Other papers relating to—

Admission to Hosp'l	Furlough
Casualty Sheet (Officer's)	Med. Examination
Confinement	Misc. Information
Contracts	Pay or Clothing
Death or Effects	Personal Reports
Desertions	Rank
Discharge from Hosp'l	Transfer to Hosp'l
Discharge from Service	Transfer to V. R. C.
Duty	Transportation



B. 218, Vol. 2, C. 9, 1865

# FINAL STATEMENT

OF

*George Liebecomb - Private*

*1<sup>st</sup> Reg't of La. Hy. Art.*  
*10<sup>th</sup> Div.*

**VOLUNTEERS.**

NOTE 1.—Two of these certificates (or duplicates) are to be given to each Volunteer Soldier or drafted man who may be discharged previously to the discharge of his company, that he may at once receive from the Paymaster the pay, &c., due him, and the captain or other COMMISSIONED officer commanding the company will certify to the act of the delivery of the duplicate certificates; on these certificates the Soldier is "entitled to" his discharge, and should also present his discharge to the Paymaster to have the payment endorsed on it. The discharge is to be given back to the Soldier by the Paymaster; the latter only retaining as his voucher the duplicate certificates.

NOTE 2.—If the Soldier is entitled to pay for the use of his horse, the Company Commander will certify to that fact on the back of both these final statements, and also to the time he has pay due for having been so mounted on his own horse.

NOTE 3.—When a Soldier is furnished with final statements, his descriptive list, if he has one, should be taken up by the officer who gives the Soldier these statements, and endorsed with a statement to this effect by the officer. This endorsement should exhibit a full statement of the time for which the Soldier was allowed pay on his final statements, the clothing account, and all other charges against him or in his favor, so as to comprise a complete exhibit of his account. It will then be transmitted to the company commander of the Soldier, who will enter all the data necessary to a full understanding of the Soldier's account on the muster roll upon which the Soldier's discharge is reported. The descriptive list will then be destroyed. The object of this is, that the remaining portion of the Soldier's account may be settled upon the receipt of these muster rolls, and the Soldier receive any pay or allowances that may be due him at the time of his discharge, and which may not appear on his final statements from the fact that his descriptive list is incomplete. These accounts for back pay, &c., are settled by the 2d Auditor of the Treasury Department.

NOTE 4.—Charges for loss or injury to ordnance, horse equipments, and other miscellaneous charges, should appear under the heading of "Other Stoppages."

NOTE 5.—Bounty paid by State authorities, and not by the United States, will not be entered on this statement.

NOTE 6.—Amounts due the Sutler and Laundress must be entered on the muster roll on which the discharge, death, desertion, &c., is reported, as well as on the final statement, otherwise the amount cannot be collected from the United States.

NOTE 7.—This blank will be used for deceased volunteers and drafted men, as well as for others.

NOTE 8.—Where a Soldier dies in Hospital or on detached service, his descriptive list, if he has one, should be sent with his final statements, in duplicate, to the Second Auditor, Washington, D. C.

ADJUTANT GENERAL'S OFFICE.

*May 11" 1865*

Duplicate with Inventory sent 2d Auditor.

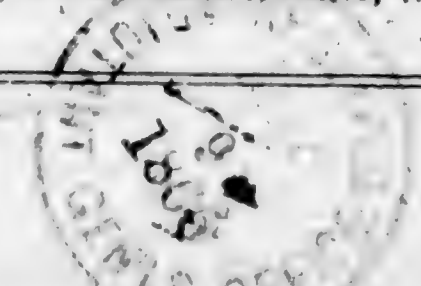

*George Liebecomb*

I certify, on honor, that George Libscomb a Private of  
 Captain S. L. Hubbard's Company (—) of the 1st Regiment of La. Art.  
**VOLUNTEERS**, of the State of \_\_\_\_\_, born at Bayou Boef, State  
 of Louisiana, aged 31 years; 5 feet 7 1/2 inches high; Black complexion,  
Black eyes, Black hair, and by occupation a Farmer, having joined the company on  
 its original organization at New Orleans La. and enrolled in it at the muster into  
 the service of the United States at New Orleans La., on the 29th day  
 of November, 1862, (or was mustered in service as a recruit, by \_\_\_\_\_  
 \_\_\_\_\_, at \_\_\_\_\_, on the \_\_\_\_\_ day of \_\_\_\_\_,  
 186—, or was drafted and mustered into the service of the United States from the \_\_\_\_\_  
 Enrollment District of the State of \_\_\_\_\_, at \_\_\_\_\_,  
 on the \_\_\_\_\_ day of \_\_\_\_\_, 186—) to serve in the Regiment, for  
 the term of Three Years: and having served **HONESTLY** and  
**FAITHFULLY** with his Company in Garrison to the present date, is now  
 entitled to a **DISCHARGE** by reason of Death

The said George Libscomb - has pay due from was last paid by Paymaster  
enrollment to include the 16th day of November, 1862, and has  
 pay due him from that time to the present date; he is entitled to pay and subsistence for  
**TRAVELING** to place of enrollment, and whatever other allowances are authorized to volunteer  
 soldiers, drafted men, or militia, so discharged. \* He has received from the United States **CLOTHING**  
 amounting to Twenty One  $\frac{00}{100}$  dollars, since the 16th day of November,  
 1862, when his clothing account was last settled. He has received from the United States  
 \_\_\_\_\_  $\frac{00}{100}$  dollars advanced **BOUNTY**.

There is to be stopped from him, on account of the State of \_\_\_\_\_, or other  
 authorities, for **CLOTHING**, &c., received on entering service, \_\_\_\_\_  $\frac{00}{100}$  dollars; and  
 for other stoppages, viz: \_\_\_\_\_  
 \_\_\_\_\_  $\frac{00}{100}$  dollars.

He has been furnished with **TRANSPORTATION** in kind from the place of his discharge to  
 \_\_\_\_\_; and he has been **SUBSISTED** for **TRAVELING** to his  
 place of enrollment, up to the \_\_\_\_\_, 186—.

He is indebted to \_\_\_\_\_, **SUTLER**, \_\_\_\_\_  $\frac{00}{100}$  dollars.

He is indebted to \_\_\_\_\_, **LAUNDRESS**, \_\_\_\_\_  $\frac{00}{100}$  dollars.

Given in Duplicate, at Fort St. Philip La., this 16th day  
 of January, 1863. I certify that the above is a correct transcript  
 from the records of Co. "A" 10th U.S.C. (Art.)

Battery Gentilly La.  
April 20th 1863

Justin C. Brown.  
1st Lt. Co. "A" 10th U.S.C. (Art.)  
 Commanding Company.

A. G. O. No. 95—First.  
 Number 744

# MICROCOPY

1

8

1

8

# ROLL

1

7

3

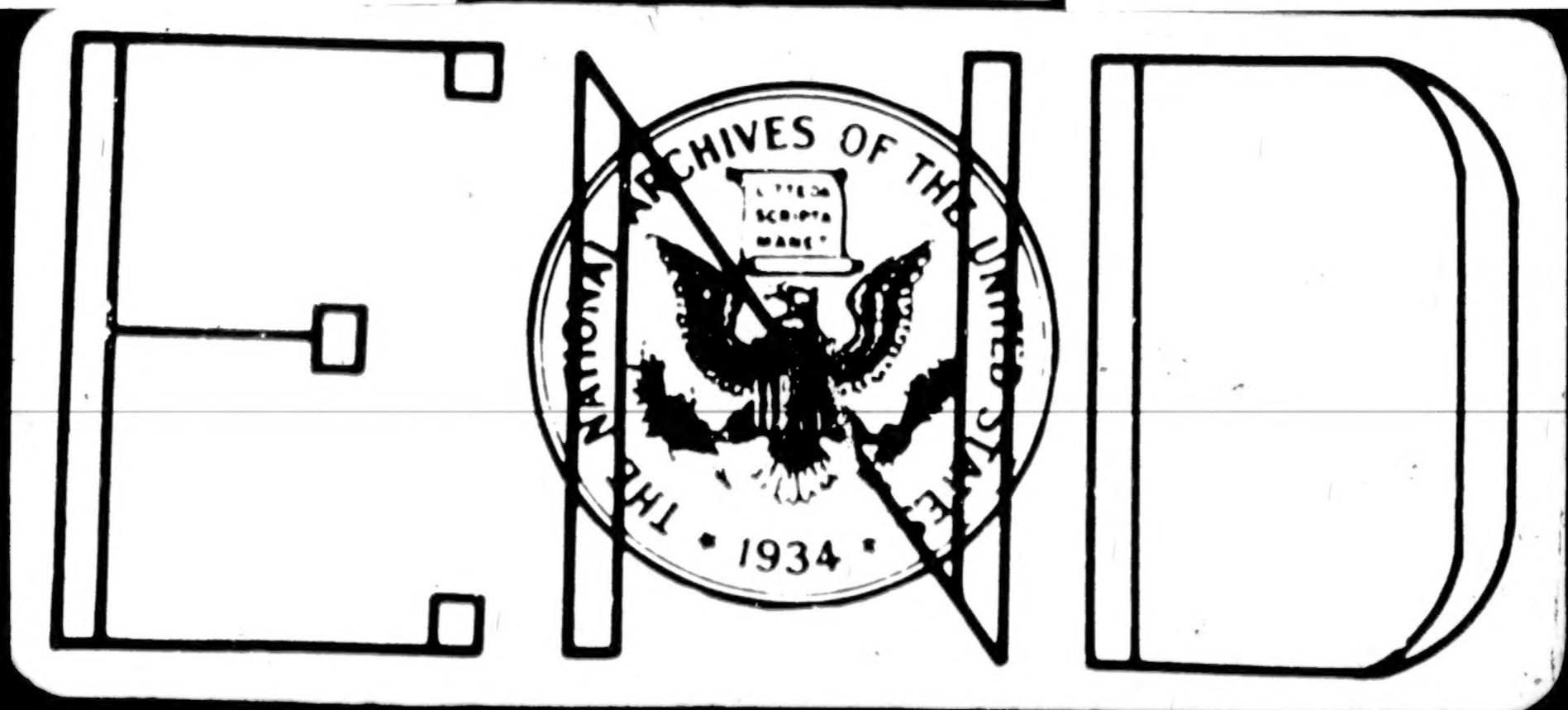

# IMAGE EVALUATION TEST TARGET (QA-3)

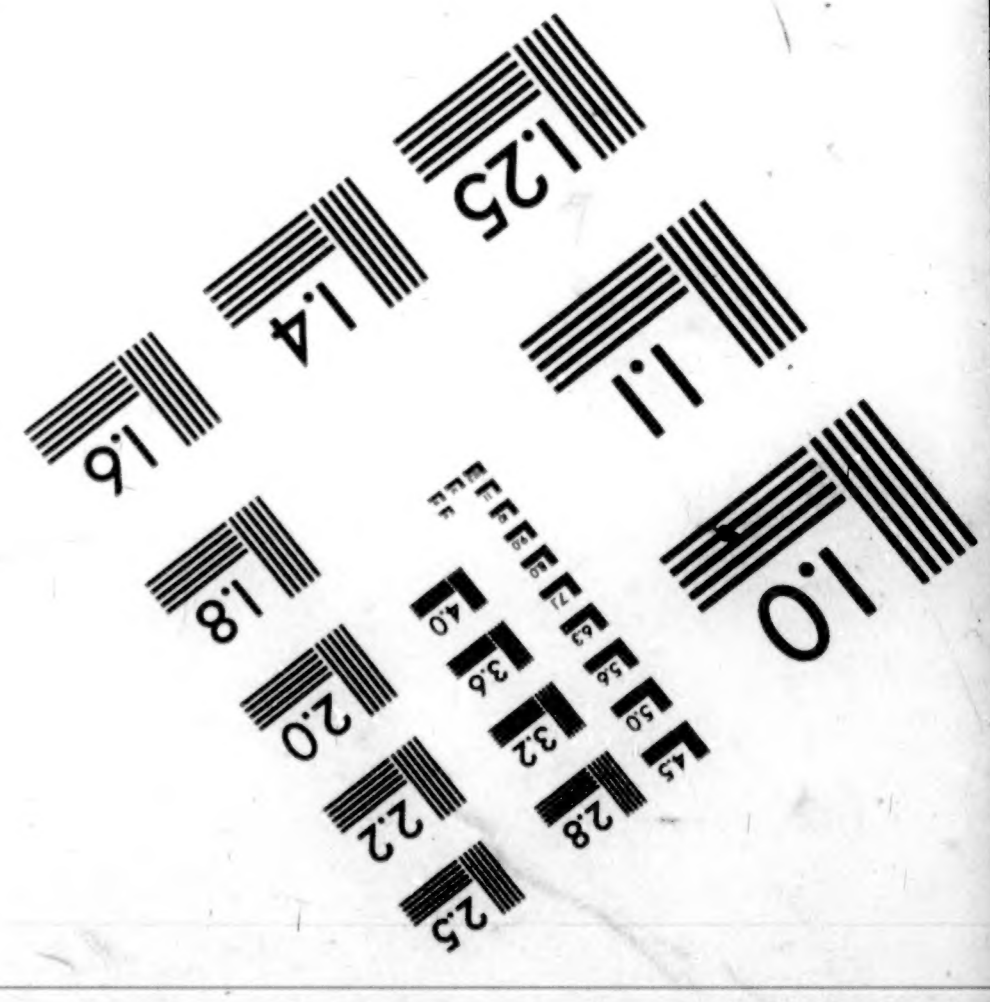
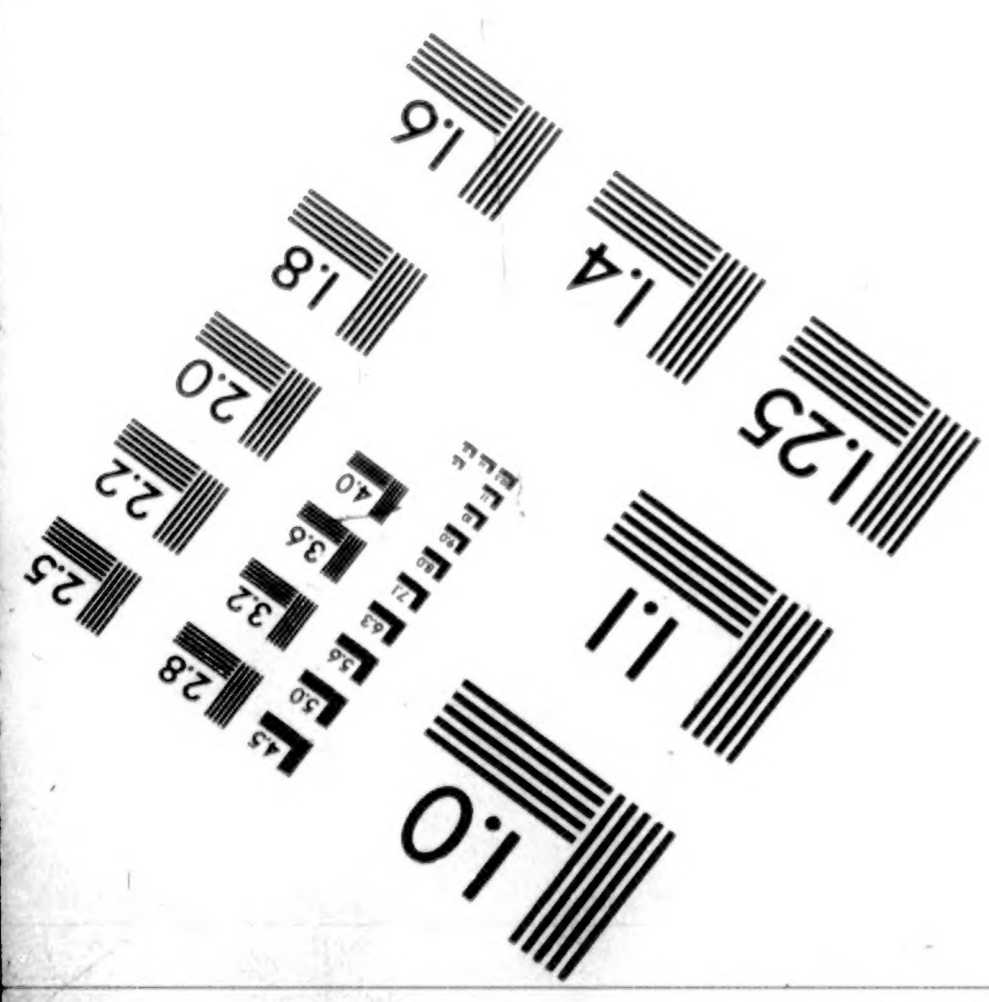
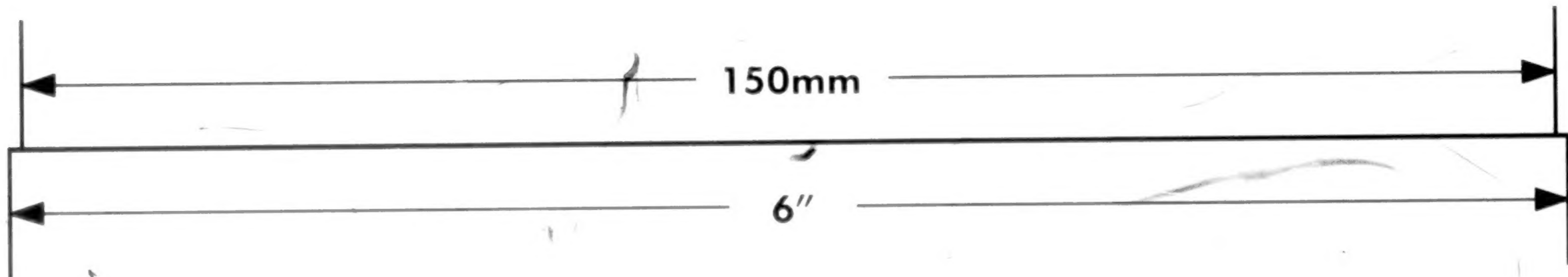
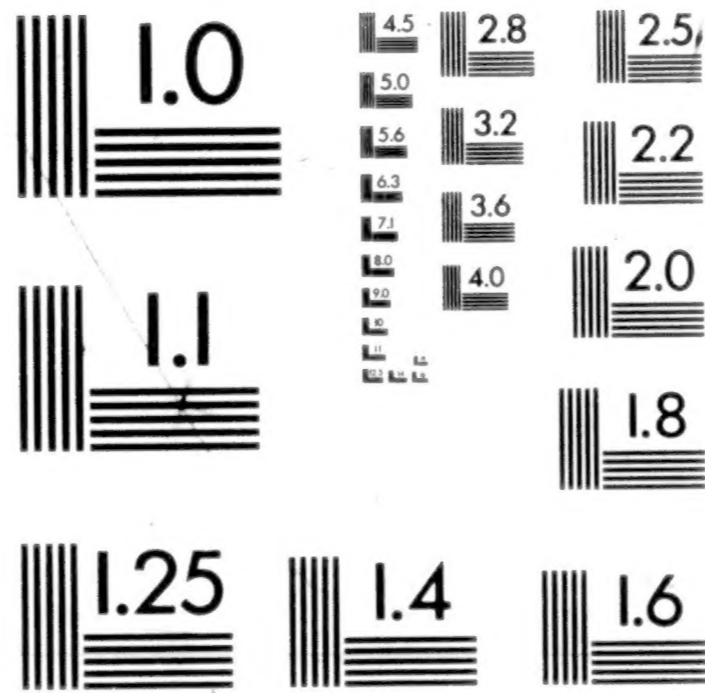
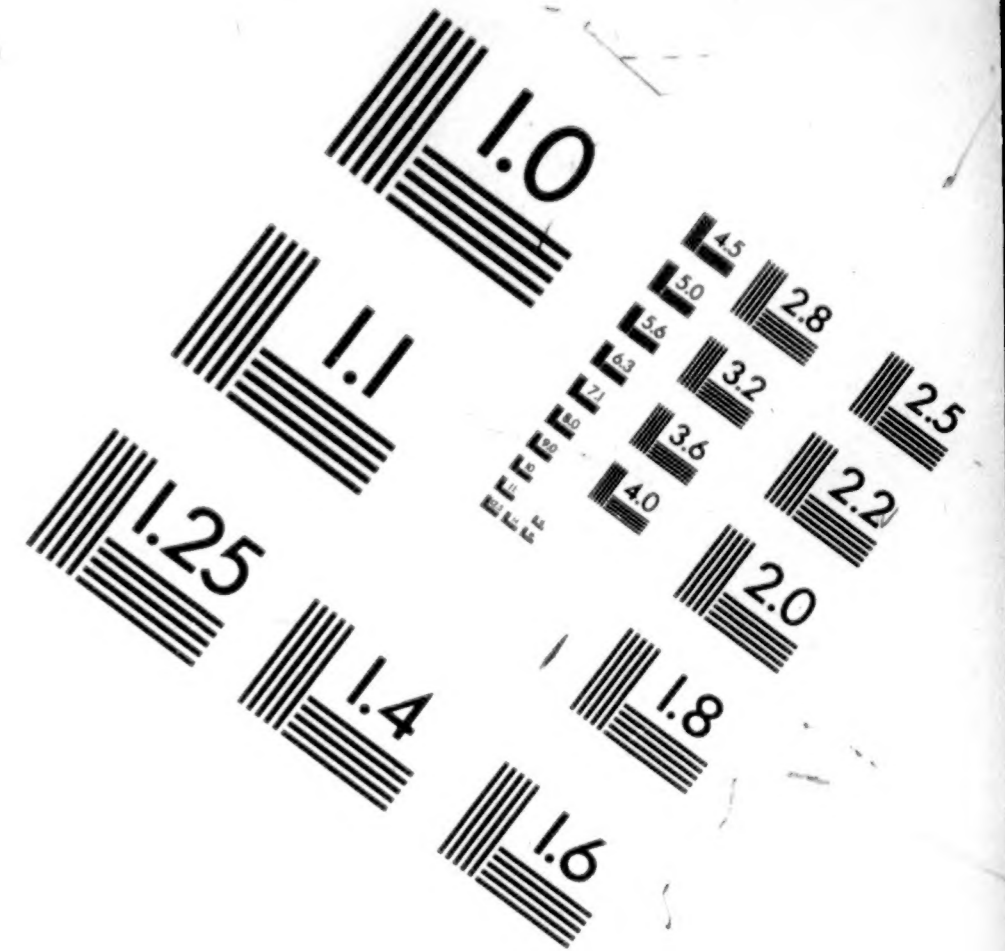
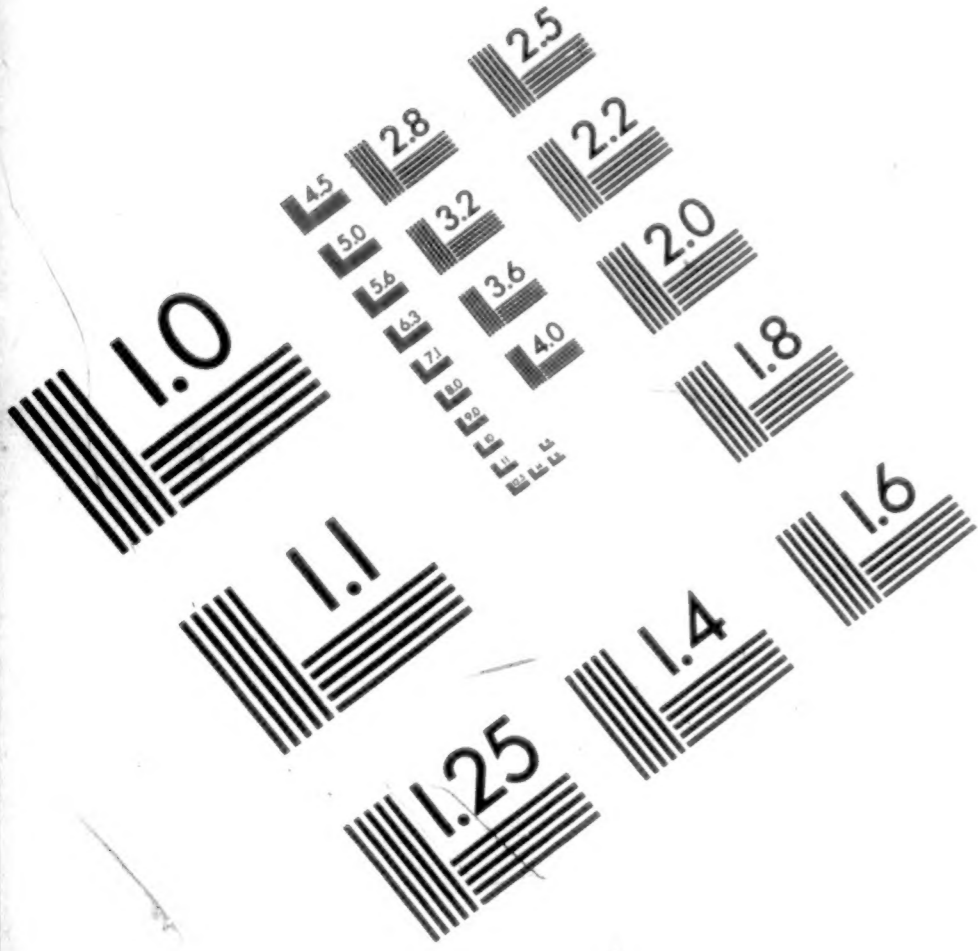

APPLIED IMAGE, Inc  
1653 East Main Street  
Rochester, NY 14609 USA  
Phone: 716/482-0300  
Fax: 716/288-5989

© 1993, Applied Image, Inc., All Rights Reserved

**THE END**

**PLEASE**

**REWIND**