

**NATIONAL
ARCHIVES
MICROFILM
PUBLICATIONS**

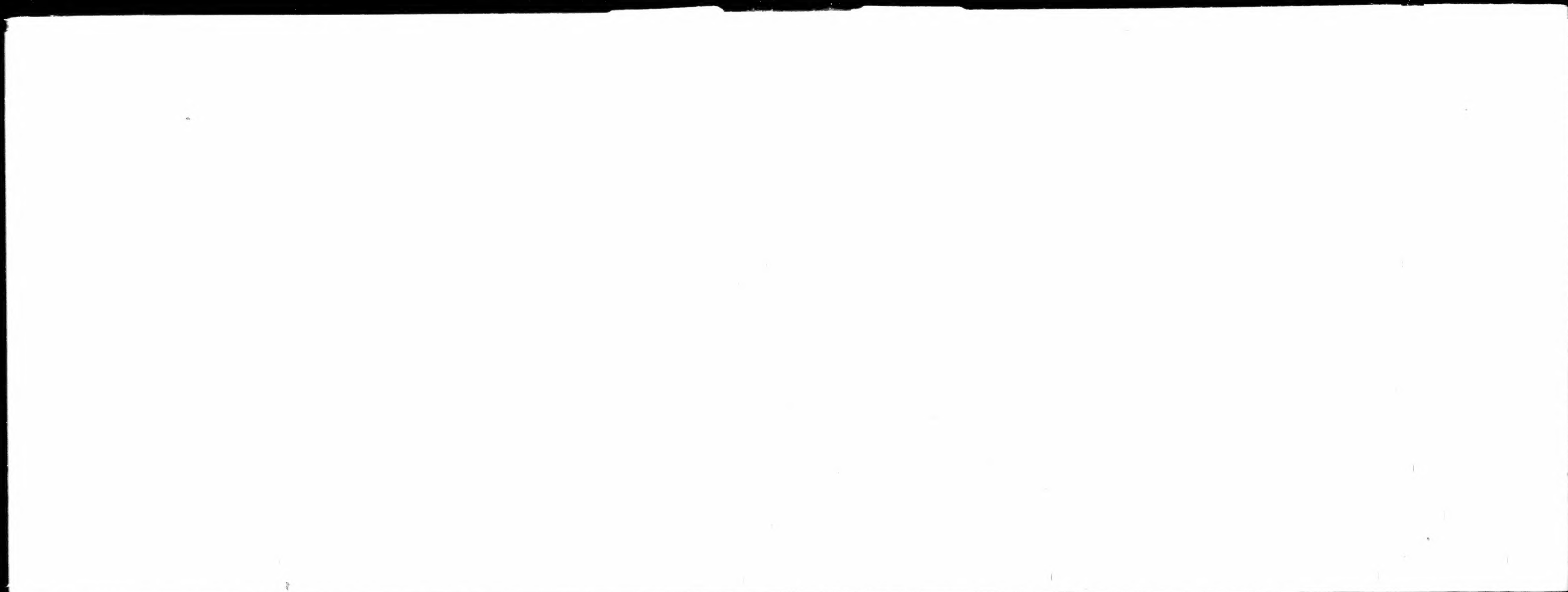
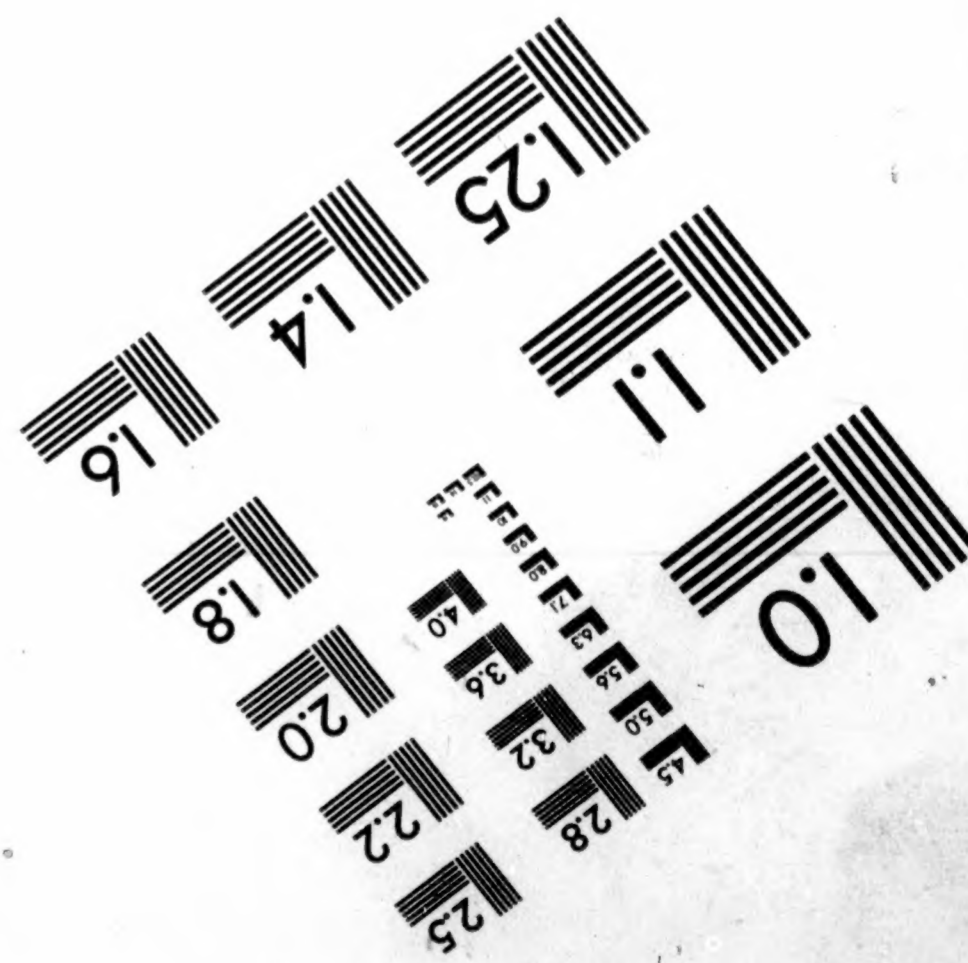
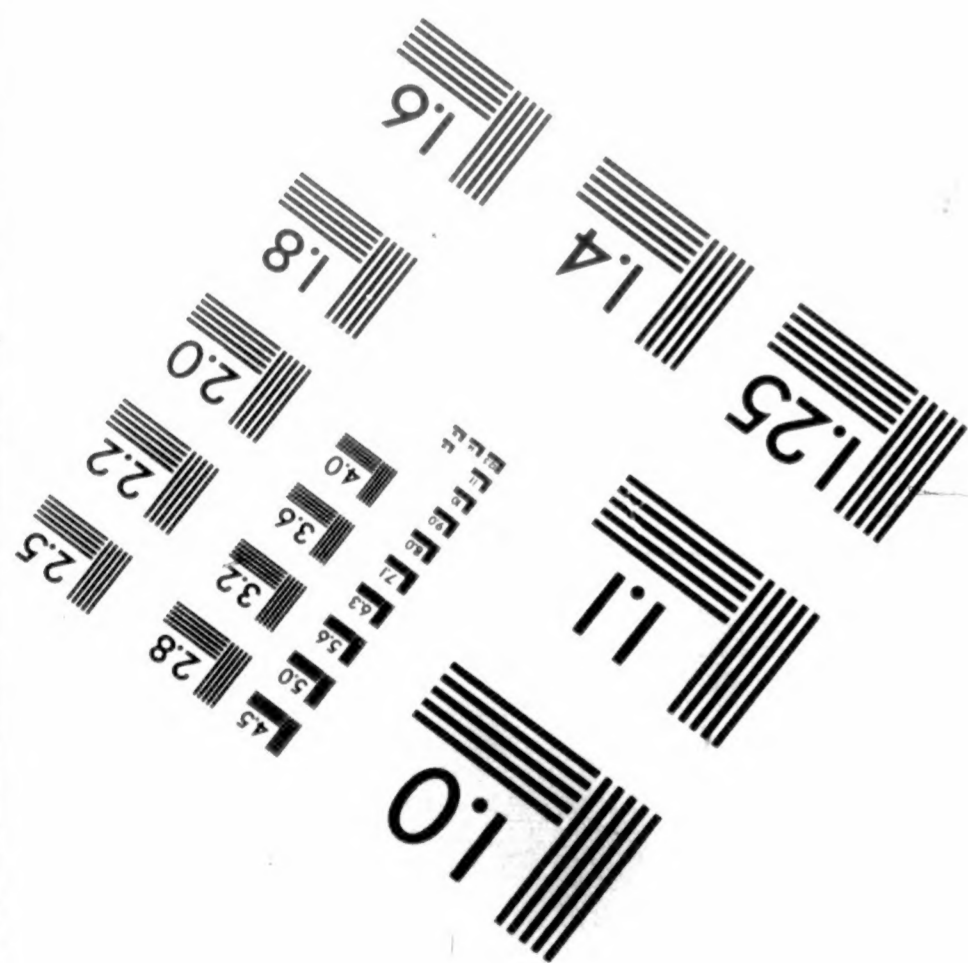
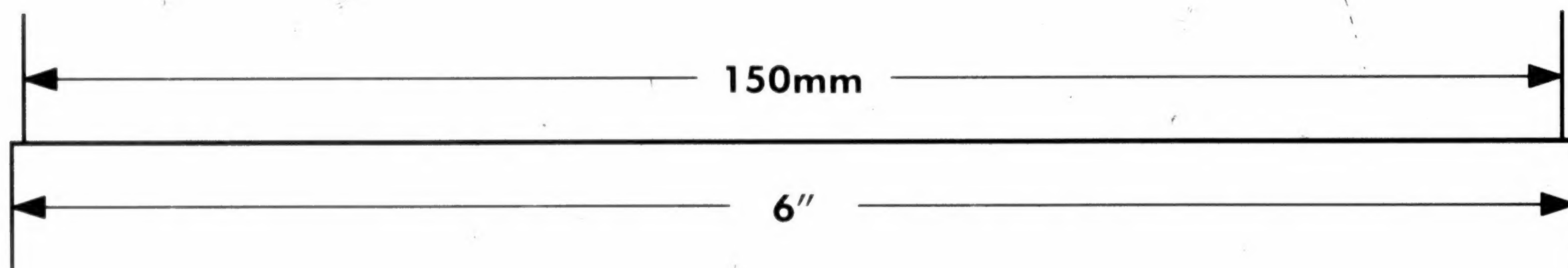
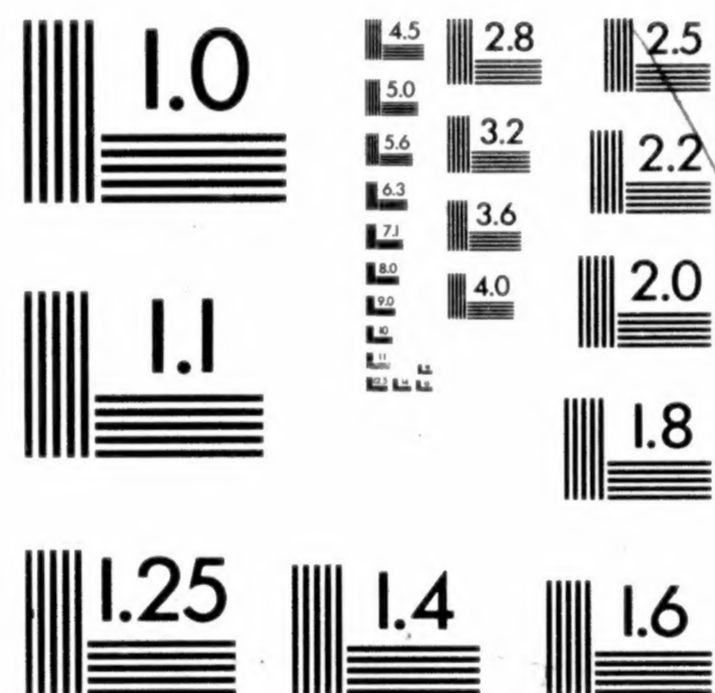
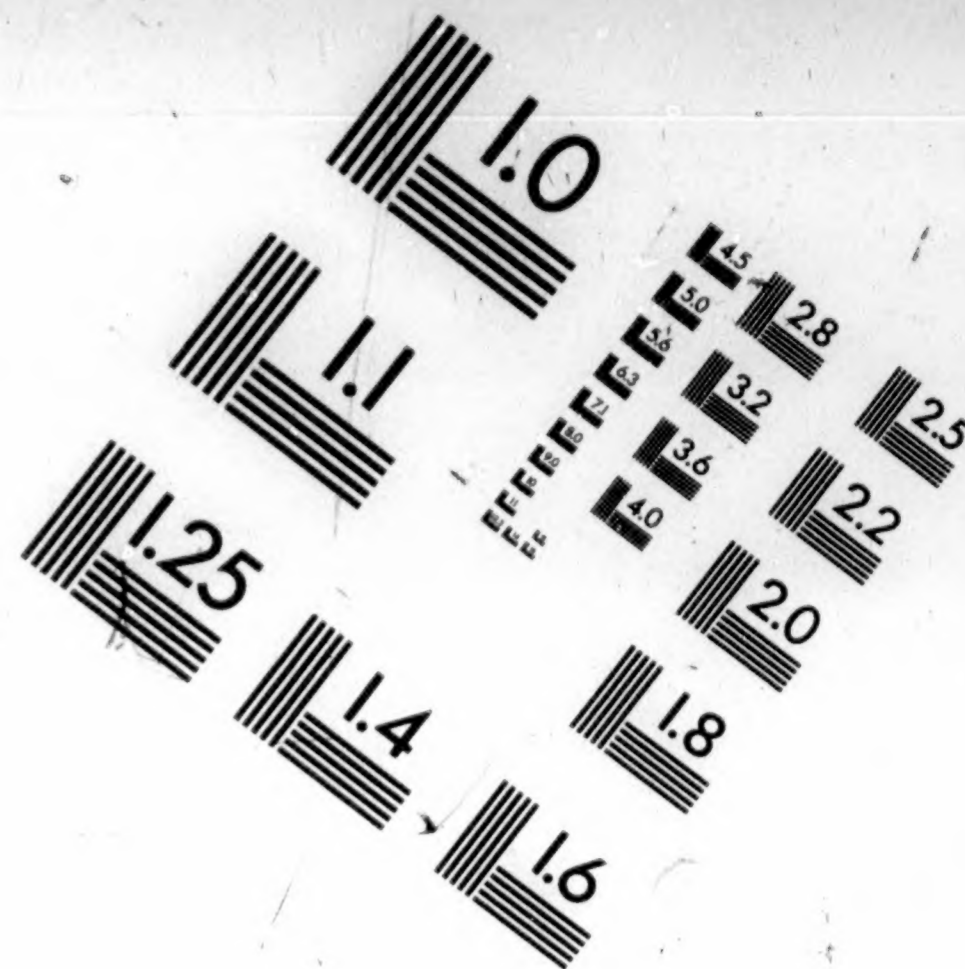
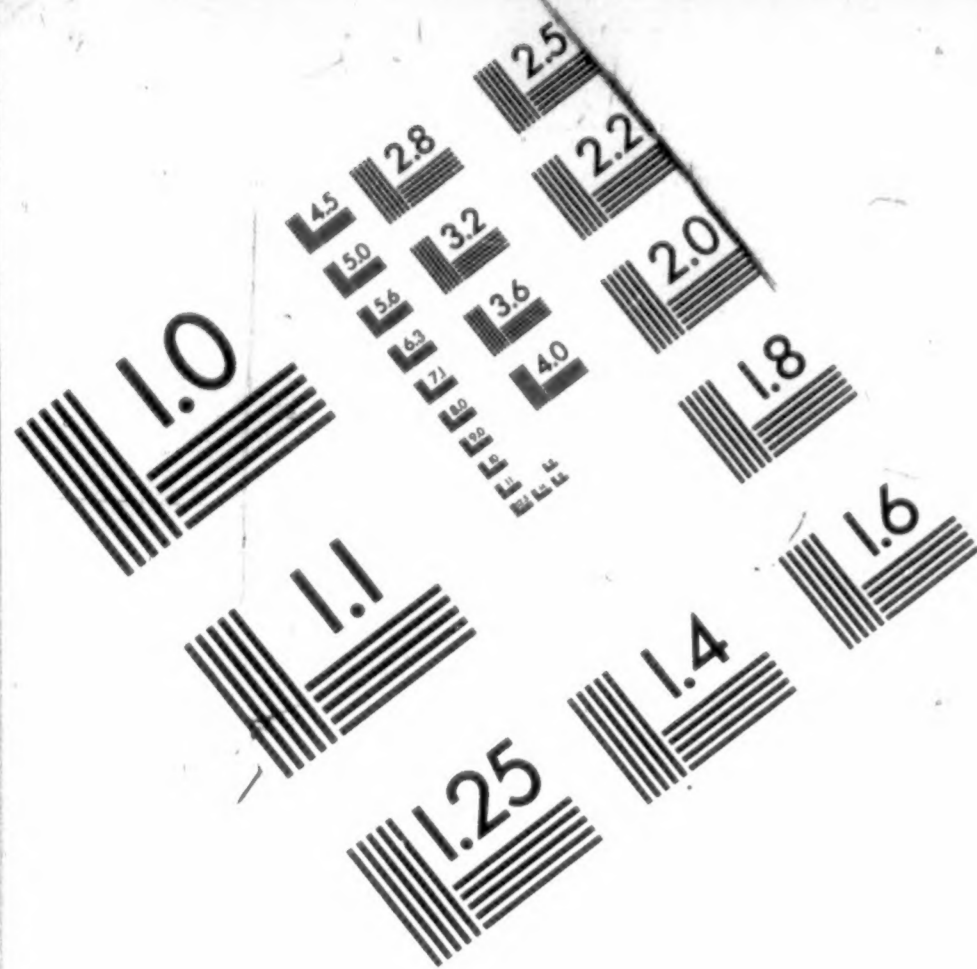

IMAGE EVALUATION TEST TARGET (QA-3)



APPLIED IMAGE, Inc
1653 East Main Street
Rochester, NY 14609 USA
Phone: 716/482-0300
Fax: 716/288-5989

© 1993, Applied Image, Inc., All Rights Reserved

VW

National Archives at College Park



8601 Adelphi Road College Park MD 20740-6001

V WARE

OPERATOR

CAMERA

8-13-98

Z-4

DATE FILMED

REDUCTION RATIO

2461-0576-014-01

10X

FILM EMULSION NUMBER

M1818

177

PROJECT NUMBER

ROLL NUMBER

MICROCOPY

18 18

ROLL

17 7

M1818

COMPILED MILITARY SERVICE RECORDS OF
VOLUNTEER UNION SOLDIERS WHO SERVED WITH THE
UNITED STATES COLORED TROOPS:
Artillery Organizations

Introduction by Budge Weidman, Project Manager

Records prepared for microfilming by members of
the Civil War Conservation Corps

Pat Alfredson	Sue Goward*	Mary Poggioli
Phyllis Altrogge	Bert Greenstein	Peggy Pratt
Kenneth Ashton	Anne Greenwood	Ray Puzio
Sue Barnard*	Jim Harris	Sylvia Scott
Dee Benson	Walter Hayden	Lynn Shearouse
Ann N. Brown	Mary Hayden	Mary Stack-Dunne
Robert Budway	Pat Ikonen	Ben Stearns
Randy Caldwell	Dick Ives	Bill Stormer*
MaryAnn Castellana*	Sarah Jaffe	Pat Sullivan
Mary Lou Cole	Barbara Kemp	Gorman Tidball*
Giovanni Croce	Bev Manypenny	Cathy Tinston
B.H. Custer	Frank Masterson	John Toole
Bob Denney	Joe Mazur	Maryellen Toole
Richard Dow	Kathleen McCarthy	Milt Weatherhead
Earl Dunn	Sarah McDougall	Russ Weidman
Yvette Fallin	Catherine McManus	C. Lois Young
Maria Flesher	Ben Miles	Robert Young
Naomi Glass	Dave Murray	

Team leaders are indicated by the asterisk.

National Archives and Records Administration
Washington, DC
1998

INTRODUCTION

On the 299 rolls of this microfilm publication, M1818, are reproduced the compiled military service records of volunteer Union soldiers belonging to the artillery units organized for service with the United States Colored Troops (USCT). The USCT included 7 numbered cavalry regiments; 13 numbered artillery regiments plus one independent battery; 144 numbered infantry regiments; plus Brigade Bands Nos. 1 & 2 (Corps d'Afrique and US Colored Troops); Powell's Regiment Colored Infantry; Southard's Company Colored Infantry; Quartermaster Detachment; Pioneer Corps, 1st Division, 16th Army Corps; Unassigned Company A Colored Infantry; and Unassigned USCT. There are also miscellaneous service cards arranged alphabetically by surname at the end of the unit records. The records reproduced are part of the Records of the Adjutant General's Office, 1780's-1917, Record Group (RG) 94.

Background

United States Colored Troops

Since the time of the American Revolution, African Americans have volunteered to serve their country in time of war. The Civil War was no exception. Official sanction was the difficulty. In the fall of 1862 there were four Union regiments of African Americans raised in New Orleans, LA: the 1st, 2d, and 3d Louisiana Native Guard, and the 1st Louisiana Heavy Artillery (African Descent). The 1st South Carolina Infantry (African Descent) was not officially organized until January 1863; however, three companies of the regiment were on coastal expeditions as early as November 1862. Similarly, the 1st Kansas Colored Infantry was not mustered into Federal service until January 1863, even though the regiment had already participated in the action at Island Mound, MO, on October 27, 1862. These early unofficial regiments received little Federal support, but they showed the strength of the African American soldier's desire to fight for freedom.

The first official authorization to employ African Americans in Federal service was the Second Confiscation and Militia Act of July 17, 1862. This act allowed President Abraham Lincoln to receive into the military or naval service persons of African descent and gave him permission to use them for any purpose "he may judge best for the public welfare." However, the President did not authorize use of African Americans in combat until issuance of the Emancipation Proclamation on January 1, 1863.

In late January 1863, Governor John Andrew of Massachusetts received permission to raise a regiment of African American soldiers. The pace of organizing additional regiments was very slow. In March Secretary of War Edwin M. Stanton sent Gen. Lorenzo Thomas to the lower Mississippi Valley to recruit free and contraband African Americans. Thomas was given broad authority. He was to explain the administration's policy regarding African American soldiers and recruit

volunteers to raise and command them. Stanton wanted all officers of such units to be white, but that policy was softened to allow African American surgeons and chaplains. By the end of the war, in addition to the chaplains and surgeons, there were some 87 African American officers. Thomas's endeavor was very successful, and on May 22, 1863, the Bureau of Colored Troops was established to coordinate and organize regiments from all parts of the country. Created under War Department General Order No. 143, the bureau was responsible for handling "all matters relating to the organization of Colored Troops." The bureau was directly under the Adjutant General's Office and its procedures and rules were specific and strict. All African American regiments were now to be designated United States Colored Troops (USCT). At this time there were some African American regiments with state names and a few regiments in the Department of the Gulf designated as Corps d'Afrique. All these were ultimately assimilated into the USCT, even though some of the regiments, such as the 5th Massachusetts, retained their state designations.

To facilitate recruiting in the states of Maryland, Missouri, Tennessee, and eventually Kentucky, the War Department issued General Order No. 329 on October 3, 1863. Section 6 of the order stated that if any citizen should offer his or her slave for enlistment into the military service, that person would, "if such slave be accepted, receive from the recruiting officer a certificate thereof, and become entitled to compensation for the service or labor of said slave, not exceeding the sum of three hundred dollars, upon filing a valid deed of manumission and of release, and making satisfactory proof of title." For this reason, some records of manumission are contained in the compiled service records reproduced in this publication.

The USCT fought in 39 major engagements and over 400 lesser ones. Sixteen African American soldiers received Medals of Honor. As it was in other units, the death toll from disease was very high in the USCT. Deaths from disease and battle totaled 37,000. The last regiment of the USCT was mustered out of Federal service in December 1867.

Important sources for information about African American units in the Civil War are the War Department's *The War of the Rebellion: A Compilation of the Official Records of the Union and Confederate Armies* (Washington, DC: 1880-1901; reprinted Harrisburg, 1971 and 1985) and the Navy Department's *The War of the Rebellion: A Compilation of the Official Records of the Union and Confederate Navies* (Washington, DC: 1874-1922; reprinted Harrisburg, 1971 and 1985). These multivolume works contain reports of operations and other official correspondence.

U. S. Colored Heavy Artillery

1st Heavy Artillery: This regiment was organized at Knoxville, TN, between February and November 1864. It served in Knoxville, eastern Tennessee, western Virginia, northern Alabama, and western North Carolina. It was mustered out on March 31, 1866.

2d Heavy Artillery: This regiment was changed from the 2d Heavy Artillery to the 3d Heavy Artillery on April 26, 1864, and the compiled military service records appear there.

3d Heavy Artillery: Organized as the 1st Tennessee Heavy Artillery (African descent) at Memphis and Fort Pickering, TN, from June 5 to December 22, 1863, this regiment's designation was changed to the 3d United States Colored Heavy Artillery in April 1864. It served garrison duty at Fort Pickering and in defense of Memphis, TN. The unit mustered out on April 30, 1866.

4th Heavy Artillery: This unit was organized as the 2d Regiment Tennessee Heavy Artillery (African descent) from June 1863 until April 1864. It became the 4th United States Colored Heavy Artillery in April 1864. It served at Fort Halleck; Columbus, KY; and Union City, TN. The regiment had duty near Fort Donelson, TN, and moved to Pine Bluff, AR, where it was mustered out on February 25, 1866.

5th Heavy Artillery: This regiment was organized at Vicksburg, MS, between August 1863 and January 1864, as the 9th Louisiana Volunteers (African descent). Its designation was changed to the 5th Heavy Artillery in April 1864. The unit served garrison duty at Vicksburg, MS, and was mustered out on May 20, 1866.

6th Heavy Artillery: This regiment was organized as the 2d Mississippi Heavy Artillery (African descent) at Natchez, MS, from September 1863 to January 1864. It was changed to the 6th United States Colored Heavy Artillery on April 26, 1864. The unit served at Natchez, Mississippi, and Vidalia, LA. It was mustered out on May 18, 1866.

7th Heavy Artillery: The 7th Heavy Artillery was designated the 11th United States Colored Infantry (New) on January 23, 1865, and the compiled military service records appear there.

8th Heavy Artillery: This regiment was organized at Paducah, KY, from April to October 1864. It served garrison duty at Paducah and was mustered out on February 10, 1866.

9th Heavy Artillery: This regiment consisted of four companies and was organized at Clarksville and Nashville, TN, during October 1864. It was mustered out on May 5, 1865.

10th Heavy Artillery: Organization of this regiment at New Orleans, LA, began in November 1862. First designated the 1st Louisiana Heavy Artillery (African descent) in November 1863, it became the 1st Regiment Corps d'Afrique. In May 1864 the unit became the 10th United States Colored Heavy Artillery. The regiment was on garrison duty at New Orleans during its entire service. It served longer than any other USCT regiment, mustering out on February 22, 1867.

11th Heavy Artillery: This regiment was organized at Providence, RI, from August 1863 through January 1864, as the 14th Rhode Island Colored Heavy Artillery. In May 1864 it became the 11th United States Colored Heavy Artillery. The unit served garrison duty at New Orleans, LA, and was mustered out on October 2, 1865.

12th Heavy Artillery: This regiment was organized at Camp Nelson, KY, from July 1864 through July 1865. It served garrison duty at Camp Nelson, Bowling Green, and other points in the District of Kentucky. It was mustered out on April 24, 1866.

13th Heavy Artillery: This regiment was organized at Camp Nelson, KY, in June 1865, where it served garrison duty. It also served at Smithland and Lexington, KY. It was mustered out on November 18, 1865.

14th Heavy Artillery: This regiment was organized at New Bern and Morehead City, NC, from March 1864 to April 1865, as the 1st North Carolina Colored Heavy Artillery. It became the 14th United States Colored Heavy Artillery in March 1865. The unit served garrison duty at New Bern, NC, and was mustered out on December 11, 1865.

U. S. Colored Light Artillery

The 1st Regiment Light Artillery was recruited and organized under Maj. Gen. Benjamin F. Butler in December 1863. In February 1864 it was changed to Battery B of the 2d Light Artillery.

The 2d Regiment Light Artillery consisted of nine batteries, A through I, that were independently organized and deployed.

Battery A was organized at Nashville, TN, in April 1864. The battery served garrison duty at Nashville and participated in the Battle of Nashville December 15-16, 1864. It was mustered out January 13, 1866.

Battery B was organized at Fort Monroe, VA, in January and February 1864. It operated in Virginia and participated in the siege against Petersburg and Richmond. The battery was ordered to Texas in May 1865, and mustered out March 17, 1866.

Battery C was organized at Hebron's Plantation, MS, in November 1863, as the 1st Battery Louisiana Light Artillery (African descent). It was designated Battery C in April 1864. The battery had garrison duty at Goodrich Landing, Vicksburg, and Milliken's Bend. It was mustered out December 28, 1865.

Battery D was organized at Black River Bridge, MS, in December 1863, as the 2d Battery Louisiana Light Artillery (African descent). It was designated Battery D in April 1864. The battery had garrison duty at Goodrich Landing and Vicksburg, MS, and was mustered out on December 28, 1865.

Battery E was organized at Helena, AR, in December 1863, as the 3d Battery Louisiana Light Artillery (African descent). It was designated Battery E in April 1864. The battery had garrison duty at Helena, AR, and was mustered out on September 26, 1865.

Battery F was organized at Memphis, TN, in November 1863, as the Memphis Light Battery. It was designated Battery F in April 1864. The battery had garrison duty at Memphis, TN, until April 1865, when it moved to Bridgeport, AL. It was mustered out on December 28, 1865.

Battery G was organized at Hilton Head, SC, in May 1864 and had garrison duty at Hilton Head for its entire term. The battery was mustered out on August 12, 1865.

Battery H was organized at Pine Bluff, AR, in June 1864, as the 1st Arkansas Colored Battery. It was designated as Battery H in December 1864. The battery had garrison duty at Pine Bluff the entire term and was mustered out on September 14, 1865.

Battery I was organized at Memphis, TN, in April 1864. The battery had garrison duty at Memphis, TN, and operations in Mississippi. It was mustered out on January 10, 1866.

Independent Battery was organized at Leavenworth, KS, in December 1864. It had duty at Fort Leavenworth until it was mustered out on July 22, 1865.

Records Description

Compiled service records consist of a jacket-envelope for each soldier, labeled with his name, rank, unit, and card numbers. The compilation of service records of Union soldiers began in 1890 under the direction of Col. Fred C. Ainsworth, head of the Record and Pension Office of the Adjutant General's Office, Department of War. Information from muster rolls, regimental returns, descriptive books, and other records was copied verbatim onto cards. A separate card was prepared each time an individual name appeared on a document. These cards were numbered on the back, and these numbers were entered onto the outside jacket containing the cards. The carded information was verified by a separated operation of comparison; great care was taken to ensure that the cards were accurate.

A typical jacket contains card abstracts of entries found in original records relating to the soldier and original documents relating solely to that soldier. Examples of the latter include enlistment papers, substitute certificates, casualty sheets, death reports, prisoner-of-war memorandums, and correspondence. Unique to the records of the USCT are deeds of manumission, oaths of allegiance, proof of ownership, certificates of monetary award, and bills of sale. These items appear most frequently in units recruited in the border states of Kentucky, Missouri, and Maryland. These states remained in the Union but were slave states. Jackets and

cards include a section labeled "bookmark" which was reserved for cross-references to other records relating to the individual or his unit. The service records are arranged by arm of service, thereunder numerically by regiment or independent battalion or company, and thereunder alphabetically by name of the soldier. Records for officers are interfiled alphabetically by name with the records of enlisted men. If an individual served in more than one unit, which was typical for USCT officers, there will be a separate service record for each unit in which he served.

The unjacketed miscellaneous cards were accumulated by the War Department with the expectation that they would be incorporated in individual compiled service records. However, the expectation was never fulfilled, because either insufficient or contradictory information made it impossible to associate the cards or papers with a particular soldier's service records.

Related Records

Among the records of the Adjutant General's Office in the National Archives are many of the original records that were abstracted or "carded" by the Record and Pension Office. These include the individual unit's muster rolls, returns and descriptive books. Other series in RG 94 that contain information relating to volunteer Union soldiers who served with the USCT include carded records relating to Union staff officers, carded medical records of volunteer Union soldiers, unbound and bound regimental records and "record of events" cards. The regimental records of the 54th Massachusetts Infantry (Colored) have been reproduced as Microfilm Publication M1659, *Records of the Fifty-fourth Massachusetts Infantry Regiment (Colored), 1863-1865*.

The "record of events" cards include information copied from the unit's muster rolls and returns. They show the stations of the field and staff and those of the various companies of the regiment at the time the muster roll or return was prepared and sometimes mention battles, skirmishes, or other activities in which the regiment participated. The cards have been reproduced as Microfilm Publication M594, *Compiled Records Showing Service of Military Units in Volunteer Union Organizations*.

Record Group 94 also includes a card index for the USCT, reproduced as Microfilm Publication M589, *Index to Compiled Military Service Records of Volunteer Union Soldiers Who Served with U.S. Colored Troops*, which may be used to locate the regiment of USCT personnel. An index card gives the name of the soldier and his rank, as well as the unit in which he served; sometimes there is a cross-reference to his service in other units or organizations. The National Archives is continually producing microfilm publications of volunteer Union compiled military service records. A complete listing of finished publications can be found in the National Archives *Microfilm Resources for Research: A Comprehensive Catalog* which is available online at <http://www.nara.gov>.

The Records of the Colored Troops Division, within RG 94, include division correspondence and records relating to recruiting, the appointment of officers, and the slave or free status of individuals; and a compilation of historical extracts and official papers concerning the military service of African Americans from the colonial period through the Civil War entitled *The Negro in the Military Service of the United States 1639-1886*. This compilation is reproduced as Microfilm Publication M858. The Records of the Bounty and Claims Division, also in RG 94, include correspondence of the division and records relating to bounties and claims paid to loyal owners of slaves by the Slave Claims Commissions of Delaware, Kentucky, Maryland, Missouri, Tennessee, and West Virginia.

If an application for a pension was made, the pension application case file may be among the Records of the Veterans Administration (RG 15). Indexes to the pension applications have been reproduced as Microfilm Publication T288, *General Index to Pension Files, 1861-1934*, and T289, *Organizational Index to Pension Files of Veterans Who Served Between 1861 and 1900*.

If a soldier or officer was tried before a general court-martial or if an individual or his unit was the subject of a court of inquiry or military commission, transcripts of the proceedings may be among the Records of the Office of the Judge Advocate General (Army) (RG 153). The registers to the proceedings have been reproduced as Microfilm Publication M1105, *Registers of the Records of the Proceedings of the U.S. Army General Courts-Martial, 1809-1890*.

Other record groups having information pertaining to the USCT include Records of the Bureau of Refugees, Freedmen, and Abandoned Lands (RG 105); Records of the Provost Marshal General's Bureau (Civil War) (RG 110); Records of the Accounting Officers of the Department of the Treasury (RG 217); and Records of U.S. Army Continental Commands, 1821-1920 (RG 393).

Roll list

Roll Description

1st United States Colored Heavy Artillery

- | | |
|----|---|
| 1 | Ackerson, David - Baker, Barney |
| 2 | Baker, George - Bogle, Harry |
| 3 | Bolden, Joseph - Brown, Edwin G. |
| 4 | Brown, George - Carmack, Bachus |
| 5 | Carmack, Gilbert - Cleveland, Loudon |
| 6 | Clevenger, Charles - Cune, John C. |
| 7 | Curd, George - Eblin, Richard |
| 8 | Eckles, Silas - Furbush, Lewis |
| 9 | Gaines, George - Greenleaf, Andrew |
| 10 | Greenleaf, Julius - Hart, Benjamin |
| 11 | Hartman, Henry - Hoff, David |
| 12 | Holland, John - Jackson, Thomas J. |
| 13 | Jackson, Washington - Jones, James |
| 14 | Jones, John - Ledgewood, Clayborne |
| 15 | Lee, Elhanon - Martin, Robert |
| 16 | Mason, Henry - McKenney, Elijah |
| 17 | McKinney, Lewis - Montcastle, Stewart |
| 18 | Montgomery, Alfred - Owens, Benjamin |
| 19 | Owens, Granville - Ragan, Nelson |
| 20 | Ragan, Rome - Russell, Orlando A. |
| 21 | Russell, Perry - Smith, Archie |
| 22 | Smith, Bart - Suddles, Robert |
| 23 | Summers, Joseph D. - Turner, Charles |
| 24 | Turner, Henry - Weir, Richard |
| 25 | Weir, Robert - Willis, Albert |
| 26 | Willis, Beverly S. - Zimmerman, William |

3d United States Colored Heavy Artillery

- | | |
|----|--|
| 27 | Abel, William - Armour, Lewis |
| 28 | Armstaed, William - Beaufort, Thomas |
| 29 | Beaumont, Henry - Bowler, Lafayette P. |
| 30 | Bowman, Fleming - Brummer, John E. |
| 31 | Bryan, Solon - Carter, William |
| 32 | Cartman, John - Cook, Isham |
| 33 | Cook, John - Davis, Doctor |
| 34 | Davis, George - Easen, Samuel |
| 35 | Easley, Wesley - Flinn, Clay |
| 36 | Flint, James - Gilbreth, Eli |

Roll	Description
37	Gilbreth, Guy - Griffin, Samuel
38	Griffin, William - Harrison, James
39	Harrison, James C. - Hicks, Smith
40	Higginbottom, Nimrod - Hunt, Rubin
41	Hunt, William - Johnson, Charles
42	Johnson, Crawford - Jones, Isaac
43	Jones, Isam - Knight, Warren
44	Knox, Overton - Mabin, Baker
45	Mabin, James - McDonald, Manuel
46	McDonald, Ruben - Mills, Robert
47	Milroy, John - Nealy, Henry
48	Ned, Lewis - Patterson, Pembroke J. (Perin J.)
49	Patton, Richmond - Powers, William
50	Prewitt, Greene - Roberts, Lewis
51	Robinette, Henry - Scott, Edmond
52	Scott, Elijah - Smith, Peter
53	Smith, Randall - Tapscott, Julius
54	Tarwater, Jesse - Todd, William
55	Todd, Willis - Wallace, Robert
56	Wallace, Sandford - Wells, Duncan
57	Wells, Joseph - Williams, Guyo
58	Williams, George - Wolbrecht, Adolf
59	Wood, Charles - Young, William H.

4th United States Colored Heavy Artillery

60	Abbott, John - Barnes, Samuel
61	Barnes, Thomas - Britt, Jackson
62	Britten, Charles - Clark, Mitchell
63	Clay, Henry - Daniel, Richard
64	Daniels, William - Dyson, Jack
65	Dyson, Paul - Gardner, Riley
66	Gardner, Washington - Hall, Henry
67	Hall, Jack - Horton, Mack
68	Horton, William - Jones, Levi
69	Jones, Louis - Lewis, Stephen
70	Lewis, Thomas - McMurray, Anderson (John)
71	McMurray, George - Need, Benjamin
72	Nelson, John - Prior, Alfred
73	Prior, Gabriel - Rutland, Isaac
74	Ruttkey, Albert - Smith, Louis
75	Smith, Samuel - Turner, Frank
76	Turner, James - White, Henry
77	White, Raven - Youngs, William

Roll Description

5th United States Colored Heavy Artillery

- 78 Abbott, Richard - Armstrong, William
- 79 Arrindale, John B. - Bentley, Francis A.
- 80 Bentley, Isam - Brooks, Lawyer
- 81 Brooks, Robert - Cabin, Henry
- 82 Cabin, Shadrick - Coleman, Nathan
- 83 Coleman, William - Davidson, Ellis
- 84 Davis, Alfred - Dodd, Taylor
- 85 Dodds, Peter - Feltis, Jackson
- 86 Felton, Martin - Gilford, Charles
- 87 Gillespie, Gilbert - Hagan, Alex
- 88 Hagans, Joseph - Hayes, John S.
- 89 Haythorn, Henry - Hood, John
- 90 Hooker, William - James, Warren
- 91 January, Nathan - Johnson, Wiley
- 92 Johnson, William - Kindley, Edward
- 93 King, Elijah - Lewis, Ely J.
- 94 Lewis, George W. - Manitoie, Samuel
- 95 Manly, Elisha - McNeil, William
- 96 McQuilley, Clayton - Mosley, Jacob
- 97 Moss, Alfred - Parker, James
- 98 Parker, John H. - Powell, Monroe
- 99 Power, Henry - Roach, Watt
- 100 Robb, Benjamin - Shaw, Barrow
- 101 Shaw, James - Smith, Robert
- 102 Smith, Samuel - Tate, John
- 103 Taylor, Anderson - Trueman, Henry
- 104 Truman, Nelson - Ward, George
- 105 Ward, Jacob - West, Moses
- 106 Westbrook, Ellick - Williams, John B.
- 107 Williams, Jordan - Wood, Theodore
- 108 Woodam, Henry - Young, William
- Miscellaneous Service Cards
- Allen, Geo. - Young, L.

6th United States Colored Heavy Artillery

- 109 Aaron, William - Barton, Granderson
- 110 Baseman, Jerry - Bracton, John
- 111 Bradford, Henry - Bush, Wilson
- 112 Bustis, Mondey - Clay, Henry
- 113 Clay, William - Davenport, William
- 114 Davenport, Wilson - Dunbar, Newton

Roll	Description
115	Dunbow, Hannibal - Fox, William
116	Francis, James - Green, George
117	Green, James - Harris, Hiram
118	Harris, John - Hopper, Anthony
119	Hopper, Handy - James, Joseph
120	Jasper, Samuel - Jones, John
121	Jones, Jonas - Leavitt, Charles B.
122	Lee, David - McBride, Samuel
123	McCabe, Alexander H. - Moore, Joseph
124	Moore, Manual - Owens, Willis
125	Page, Benjamin - Reece, Edward
126	Reese, William - Samuel, William
127	Sanders, Archibald - Smart, Robert
128	Smith, Aaron - Suzette, Armstead
129	Swanson, Jack - Trotter, George
130	Troyman, George - Waters, Robert
131	Waters, Wesley - Williams, Bedney
132	Williams, Benjamin - Wilson, George
133	Wilson, Guy - Young, Wesley
	Miscellaneous Service Cards
	Adams, Winder - Williams, John

8th United States Colored Heavy Artillery

134	Abanather, Paten - Beasley, George W.
135	Beasley, Washington - Boyd, Isaac
136	Boyd, Paine - Burrill, George
137	Burris, Abram - Cofield, Henry
138	Cofield, Isaac - Davis, George
139	Davis, Jerry - Edwards, Frank
140	Edwards, Gus - Ginigan, Thomas
141	Givens, George - Hampton, Phillip
142	Hancock, James - Hodge, Cotney
143	Hodge, Gaines - Johnson, Charles
144	Johnson, Clinton - Lee, Wash
145	Leeper, Thomas - Maxwell, Henry
146	Maxwell, Samuel - Moore, Amos
147	Moore, David - Pearson, Alexander
148	Pearson, Charley - Rice, Pleasant
149	Rice, Taylor - Sherrer, Elick
150	Shirles, James - Talbot, Henry
151	Talley, William - Turner, Robert
152	Tyler, Jerry - Williams, John
153	Williams, Sam - Young, William

Roll	Description
9th United States Colored Heavy Artillery	
154	Ailer, John - Coleman, Miles
155	Collins, Moses A. - Grosskopff, Edward
156	Grubb, Andrew - Landon, Harry
157	Lanier, Jesse - Payne, George
158	Payne, James - Tory, Madison
159	Toryand, Emanuel - Young, George
10th United States Colored Heavy Artillery	
160	Aaron, Benjamin - Auguste, Daniel
161	Augustus, Edward - Benson, George
162	Bentley, William H. - Brooks, Walker
163	Brooks, Washington - Camel, Paul
164	Cameron, Henry - Coleman, James
165	Coleman, John - Deale, Joseph
166	Deale, Thomas - Ellis, Robert
167	Ellis, Silas - Frederick, Joseph
168	Freeland, Martin A. - Grandison, Alfred
169	Grant, Moses - Harrison, Logan
170	Harrison, Thomas - Hoyt, Joseph
171	Hubbard, Henry - Jenkins, Solomon
172	Jennings, Caleb - Jozen, Jules
173	Julia, Nora - Libscomb, George
174	Lightfoot, Columbus - Maryday, John
175	Masdael, Noel - Misker, Robert
176	Mitchel, Alexander - Oldham, George B.
177	Oliver, Emile - Purnell, John
178	Putnam, Winthrop D. - Robinson, Henry
179	Robinson, Isaac - Simmons, Owen
180	Simms, Amos - Spencer, John
181	Spriggs, Thomas - Thornton, John
182	Thurston, Charles - Warner, Dudley
183	Warner, George E. - Wesley, John
184	West, Alexander - Willis, Stephen
185	Willson, George - Zozey, Jules
	Miscellaneous Service Cards
	Cann, Mercer - Grayson, John W.
186	Miscellaneous Service Cards
	Green, Andrew P. - Rygaard, Soren
187	Miscellaneous Service Cards
	Sabatier, Peter - Zevenette, Paul

Roll	Description
11th United States Colored Heavy Artillery	
188	Abbott, George M. - Bailey, James A.
189	Baird, Sylvester - Boardley, James
190	Boardley, John W. - Brown, Nathan
191	Brown, Samuel - Carter, William H.
192	Cartright, George W. - Commings, Hugh S.
193	Comstock, Joseph J. - Davis, Lyman
194	Davis, Stephen - Dubois, James
195	Duesenbury, Lewis - Fletcher, Roderick S.
196	Fletcher, Samuel - Garrison, John
197	Gaskell, George L. - Groff, Joseph
198	Guard, Andrew - Hector, William H.
199	Heelms, Harkness - Howard, Richard
200	Howard, Thomas - Jackson, Lewis
201	Jackson, Norton - Johnson, Joseph W.
202	Johnson, Nathan - King, Cornelius
203	King, George - Loucks, John A.
204	Low, Charles H. - Miller, Benjamin
205	Miller, Floyd N. - Nicholas, Samuel
206	Nichols, Alfred - Pierce, George W.
207	Pierce, John B. - Reed, Washington
208	Reese, Edward - Sampson, William H.
209	Sanders, Edward - Skanks, James S.
210	Skanks, Thomas C. - Sommerset, Levi
211	Southwick, Henry K. - Taylor, Alfred M.
212	Taylor, Charles - Townsend, John
213	Tracy, John - Warren, John
214	Washington, George - Whiting, Joseph C., Jr.
215	Wigden, Cyrus B. - Wilson, Samuel
216	Wilson, William - Young, Francis
	Miscellaneous Service Cards
	Abbot, George W. - Dyer, William S.
217	Miscellaneous Service Cards
	Earl, Peter - Young, William H.
12th United States Colored Heavy Artillery	
218	Abbott, John - Barbee, Squire
219	Barber, Sherwood - Boller, Jerry
220	Bolor, Collins - Bryant, Frederick
221	Bryant, Henry - Bush, Reason
222	Butler, Aaron - Clark, Richard
223	Clark, Samuel - Criffield, Lewis

Roll	Description
224	Christopher, James - Dock, Calvin E.
225	Dodge, Henry - Farnesley, Jack
226	Farrus, Ephraim - Gaves, David
227	Gentry, George - Haggin, George
228	Haggin, Samuel - Hawkins, Robert
229	Hawkins, Thomas - Hode, Adam
230	Hodge, Charles - Jackson, Andrew
231	Jackson, Augustus - Jopee, Joseph
232	Juda, Enoch - Lewis, Windsor
233	Lidick, Randall - Maton, Levi
234	Matthews, Charles W. - Mitchell, John
235	Mitchell, Monroe - Nelson, Joseph
236	Nesbin, William - Porter, Daniel
237	Porter, William R. - Richason, Shelly
238	Richie, George - Scott, Smith
239	Scott, Stephen - Smith, Leroy
240	Smith, Lyman - Taylor, Charles
241	Taylor, Cornelius - Turner, David
242	Turner, George - Warren, James
243	Washington, Anthony - Williams, Berry
244	Williams, Charles - Woodson, David
245	Woodson, Egbert - Young, Thomas
	Miscellaneous Service Cards
	Baughman, John - Heel, Rubin
246	Miscellaneous Service Cards
	Helm, Harry - Young, Stephen
13th United States Colored Heavy Artillery	
247	Abbott, Josiah - Bell, Augustine
248	Bell, Charles - Brown, Jesse
249	Brown, Lindsay - Connor, Cyrus
250	Connor, Isaac - Dyre, George
251	Early, Edward - Ginn, Samuel
252	Ginnis, Sidney Clay - Heath, Henry
253	Heath, Lewis - Jarrett, Charles
254	Jay, Johnson - Lee, William
255	Lender, Richard - McKinney, Cass
256	McKinney, Henry Clay - Owens, Robert
257	Owens, Smith - Randolph, Loyd
258	Rankins, Archibald - Scott, Jerry
259	Scott, John - Sugg, Edmond
260	Suiter, Jacob A. - Waddie, Harry
261	Waddy, Peter - Willett, Price

Roll	Description
262	Willett, Robert - Young, William
263	Miscellaneous Service Cards Abbott, Josiah - Yumber, Anthony

14th United States Colored Heavy Artillery

264	Acot, Isaac - Becton, Henry
265	Becton, Moses - Burke, George W.
266	Burke, William A. - Davis, Toney
267	Dean, Thomas - Fullford, William
268	Fulton, James - Hardy, William
269	Harget, Israel - Hovey, William
270	Howard, Calvin - Kensley, Silas
271	Kent, Henry - McKeever, Simon
272	McMichael, Joseph - Noble, William
273	Nobles, Charles - Randall, Evans
274	Randall, Willey - Shark, Bryant
275	Sheckelford, Daniel - Smith, Samuel
276	Smith, Sterling - Thompson, John Henry
277	Thompson, Mark - Weeks, Ezekiel
278	Weidman, Albert - Wilson, Payton
279	Wilson, Richard - Young, William
	Miscellaneous Service Cards Acott, Isaac - Young, William

2d Regiment United States Colored Light Artillery

280	Able, John - Bernard, Albert
281	Berry, Henry - Brown, Sang
282	Brown, Thomas - Clark, William
283	Clay, Henry - Disen, Henry
284	Disen, Watkins - Francis, Henry
285	Franklin, Albert - Haines, Roe
286	Haines, Thomas - Hunt, Thomas
287	Hunter, Alexander M. - Kennedy, Abram
288	Kennel, George - March, George
289	Marcy, Anthony - Mobbs, Daniel
290	Moffet, John - Pattiller, Alfred
291	Pattiller, Patrick - Richardson, Jacob
292	Ridgeway, Anthony - Smith, Louis B.
293	Smith, Minus - Tucker, Alfred

Roll Description

- 294 Tucker, Sandy - Williams, Calvin
- 295 Williams, Charles - Zinum, John
- 296 Miscellaneous Service Cards
Abraham, Francis - Young, Ruben

Independent Battery, United States Colored Light Artillery

- 297 Alexander, John - Hancock, George W.
- 298 Hanson, Noah C. - Scott, Andrew
- 299 Scott, Reynolds - Yeager, John
Miscellaneous Service Cards
Douglass, H. Ford - Minor, P.M.

NATIONAL ARCHIVES MICROFILM PUBLICATION

Microfilm Publication M1818

**SELECTED MILITARY SERVICE RECORDS OF VOLUNTEER UNION
MEMBERS WHO SERVED WITH THE UNITED STATES COLORED
SERVICES: Artillery Organizations**

United States Colored Heavy Artillery

Oliver, Emile - Purnell, John

NATIONAL ARCHIVES AND RECORDS ADMINISTRATION

NATIONAL ARCHIVES MICROFILM PUBLICATIONS

Microfilm Publication M1818

**COMPILED MILITARY SERVICE RECORDS OF VOLUNTEER UNION
SOLDIERS WHO SERVED WITH THE UNITED STATES COLORED
TROOPS: Artillery Organizations**

Roll 177

10th United States Colored Heavy Artillery

Oliver, Emile - Purnell, John

NATIONAL ARCHIVES AND RECORDS ADMINISTRATION

10 U.S. Col'd H. Art'y

Musician Private

CARD NUMBERS.

1	5-509700	26
2	5-509859	27
3	5-510009	28
4	5-510153	29
5	5-510305	30
6	5-510456	31
7	5-510672	32
8	5-511147	33
9	5-489947	34
10		35
11		36
12		37
13		38
14		39
15		40
16		41
17		42
18		43
19		44
20		45
21		46
22		47
23		48
24		49
25		50

Book Mark:

See also

Emile Oliver

Musicians Co. H, 10 Reg't U. S. Col'd H. Art'y

Appears on

Company Muster Roll

for *March & April*, 1865

Present or absent *Present*

Stoppage, \$ *100* for

Due Gov't, \$ *100* for

Valuation of horse, \$ *100*

Valuation of horse equipments. \$ *100*

Remarks: *Commencement of first payment by time April 3 1865*

Drafted & shipped April 3/65 New Orleans (M)

Book mark:

(858)

Pennington
Copyist.

D

10 H. Art'y.

U.S.C.T.

Emile Oliver

musician, Co. H, 10 Reg't U. S. Col'd H. Art'y

Appears on

Company Muster Roll

for *May & June*, 1865.

Present or absent *Present*

Stoppage, \$ 100 for

Due Gov't, \$ 100 for

Valuation of horse, \$ 100

Valuation of horse equipments. \$ 100

Remarks :

Book mark :

Pennings

(358)

Copyist.

C

10 H. Art'y.

U.S.C.T.

Emile Oliver

Musician, Co. H, 10 Reg't U. S. Col'd H. Art'y

Appears on

Company Muster Roll

for *July & Aug*, 1865.

Present or absent *Present*

Stoppage, \$ 100 for

Due Gov't, \$ 100 for

Valuation of horse, \$ 100

Valuation of horse equipments. \$ 100

Remarks: *c*

Book mark:

(358)

Perrington

Copyist.

O

10 H. Art'y. U.S.C.T.

Emile Olivier

Musca, Co. H, 10 Reg't U. S. Col'd H. Art'y

Appears on

Company Muster Roll

for *Sep & Oct*, 1865.

Present or absent *Present*

Stoppage, \$ *100* for

Due Gov't, \$ *100* for

Valuation of horse, \$ *100*

Valuation of horse equipments. \$ *100*

Remarks :

Book mark :

Samuel R

(858)

Copyist.

O

10 H. Art'y. | U.S.C.T.

Emile Oliver

Musé, Co. H, 10 Reg't U. S. Col'd H. Art'y

Appears on

Company Muster Roll

for *Nov & Dec*, 1865.

Present or absent *Present*

Stoppage, \$ 100 for

Due Gov't, \$ 100 for

Valuation of horse, \$ 100

Valuation of horse equipments. \$ 100

Remarks :

Book mark :

Gamma CR

(358)

Copyist.

O

10 H. Art'y. U.S.C.T.

Emile Oliver

Musci, Co. H, 10 Reg't U. S. Col'd H. Art'y

Appears on

Company Muster Roll

for *Jan Feb*, 1866.

Present or absent *Present*

Stoppage, \$ *100* for

Due Gov't, \$ *100* for

Valuation of horse, \$ *100*

Valuation of horse equipments. \$ *100*

Remarks :

Book mark :

E. Amack

(858)

Copyist.

O

10 H. Art'y. U.S.C.T.

Emile Oliver

Muscm Co. H, 10 Reg't U. S. Col'd H. Art'y

Appears on

Company Muster Roll

for Mch & Apr, 1866.

Present or absent

Stoppage, \$ 100 for

Due Gov't, \$ 100 for

Valuation of horse, \$ 100

Valuation of horse equipments. \$ 100

Remarks: Mustered out by reason of expiration of term of service to date April 2^d 1866

Book mark: V. 12. P. 197/68

Lammack

(858)

Copyist.

O. ¹⁰ *Hy Arty* U.S.C.T.

Emile Oliver

Priv., Co *H*, *10* Reg't U. S. Col'd *Arty*

Appears on a

Detachment Muster-out Roll

of the organization named above. Roll dated

New Orleans La, Apr. 2, 186 *6*.

Muster-out to date

Apr. 2, 186 *6*.

Last paid to

Dec. 31, 186 *5*

Clothing account:

Last settled 186 ; drawn since \$ 100

Due soldier \$ *26* ^{*9*}/₁₀₀; due U. S. \$ 100

Am't for cloth'g in kind or money adv'd \$ 100

Due U. S. for arms, equipments, &c., \$ 100

Bounty paid \$ 100 due \$ 100

Remarks: *Joined as shown.*

Book mark:

A. M. Reed

O

10 H. Art'y. U.S.C.T.

Emile Oliver

Pvt, Co. H., 10 Reg't U. S. Col'd H. Art'y.

Appears on Co. Muster-out Roll, dated

Baton Rouge, La., Feb. 22, 1867.

Muster-out to date _____, 186 .

Last paid to _____, 186 .

Clothing account:

Last settled _____, 186 ; drawn since \$ _____ 100

Due soldier \$ _____ 100; due U. S. \$ _____ 100

Am't for cloth'g in kind or money adv'd \$ _____ 100

Due U. S. for arms, equipments, &c., \$ _____ 100

Bounty paid \$ _____ 100; due \$ _____ 100

Remarks: *Joined by assignment.*

Mustered out exp of term

of service Apr. 2/66.

Book mark: *V. 12. P. 197-18.*

(361)

Lawry

Copyist.

100.001111

Private

Private

CARD NUMBERS.

1	5489075,	26
2	5492939,	27
3	5493151.	28
4	5493300.	29
5	5493438.	30
6	5493575.	31
7	5494037.	32
8	5490043.	33
9		34
10		35
11		36
12		37
13		38
14		39
15		40
16		41
17		42
18		43
19		44
20		45
21		46
22		47
23		48
24		49
25		50

Book-Mark:

See also

45 21 09

C. W. Hart U.S.C.T.

Augustus Neal
P. Co., Co., *10* Reg't U. S. Col'd *Hart*

Appears on

M. and D. Roll of Men Transferred

to the organization named above,

from *76 U.S. I*

Roll dated *Nov 18*, 186*3*,

When enlisted *July 10*, 186*3*.

Period for which enlisted *3* years.

When mustered in *Sep 29*, 186*3*.

Present or absent *Not stated*

Company to which assigned

Remarks: *Joined as recruit*

Book mark :

Q

10 H. Art'y. U.S.C.T.

Augustus O'Neal

Plt, Co. A, 10 Reg't U. S. Col'd H. Art'y.

Appears on

Company Muster Roll

for Nov & Dec, 1865.

Present or absent Present

Stoppage, \$ 100 for

Due Gov't, \$ 100 for

Valuation of horse, \$ 100

Valuation of horse equipments, \$ 100

Remarks: Transferred from 75th S.C.I. per S.O. 105 to S. Hed Geo Dept of War.

Book mark:

J. Ayres

(358)

Copyist.

Augustus O'Neal

Plt., Co. A, 10 Reg't U. S. Col'd H. Art'y.

Appears on

Company Muster Roll

for Jan + Feb, 1866

Present or absent Present

Stoppage, \$ 100 for

Due Gov't, \$ 100 for

Valuation of horse, \$ 100

Valuation of horse equipments, \$ 100

Remarks:

Book mark:

(358)

J. Byrd Copyist.

Augustus O'Neal

Pvt, Co. A, 10 Reg't U. S. Col'd H. Art'y.

Appears on

Company Muster Roll

for *Mar + Apr*, 186*b*.

Present or absent *Present*

Stoppage, \$ *100* for

Due Gov't, \$ *100* for

Valuation of horse, \$ *100*

Valuation of horse equipments, \$ *100*

Remarks:

Book mark: -----

[Signature]
Copyist.

Q

10 H. Art'y. U.S.C.T.

Augustus O'Neal

Pl Co. A, 10 Reg't U. S. Col'd H. Art'y.

Appears on

Company Muster Roll

for May & June, 1866.

Present or absent Present

Stoppage, \$ 100 for

Due Gov't, \$ 100 for

Valuation of horse, \$ 100

Valuation of horse equipments, \$ 100

Remarks:

Book mark:

Hyman

(358)

Copyist.

0 | 10 Art | U.S.C.T.

Augustus O'Neal

Priv, Co. A, 10 Reg't U. S. Col'd Art

Appears on a

Detachment Muster-out Roll

of the organization named above. Roll dated

New Orleans La, July 13, 1866.

Muster-out to date July 9, 1866.

Last paid to Apr 30, 1866.

Clothing account:

Last settled _____, 1866 ; drawn since \$ _____ 100

Due soldier \$ 11 ⁴¹/₁₀₀; due U. S. \$ _____ 100

Am't for cloth'g in kind or money adv'd \$ _____ 100

Due U. S. for arms, equipments, &c., \$ _____ ¹⁶/₁₀₀

Bounty paid \$ _____ 100 due \$ _____ 100

Remarks: joined by transfer from Co E
75 U S Col (3rd Inf Cd'A) per Spec Ord
No 105 par 12 Series of 1865 Dept of La
Stop for two Impious
Mustered out by reason of Expiration
of term of service

Book mark: _____

Abbott

O

| 10 H. Arty | U.S.C.T.

Augustus O'Neal
Pvt, Co. A, 10 Reg't U. S. Col'd H. Arty

Appears on

Company Muster Roll

for July & Aug, 1866.

Present or absent

Stoppage, \$ 100 for

Due Gov't, \$ 100 for

Valuation of horse, \$ 100

Valuation of horse equipments, \$ 100

Remarks: Discharged July 9, 1866
by reason of expiration of term
of service

Book mark:

Styer

Copyist.

Augustus O Heil

Pvt, Co. A, 10 Reg't U. S. Col'd H. Art'y.

Appears on Co. Muster-out Roll, dated
Baton Rouge La, Feb. 22, 1867.

Muster-out to date _____, 186 .

Last paid to _____, 186 .

Clothing account:

Last settled _____, 186 ; drawn since \$ _____ 100

Due soldier \$ _____ 100; due U. S. \$ _____ 100

Am't for cloth'g in kind or money adv'd \$ _____ 100

Due U. S. for arms, equipments, &c., \$ _____ 100

Bounty paid \$ _____ 100; due \$ _____ 100

Remarks: Transfd. from 75 U.S.C.I.
as Pvt. S. Ochs of 65 Regt. La
Dischd for expn. of term of
service July 9. 1866

Book mark: V 134 P 183 72

V 217 P. 287. 75

Nesbitt

Smith | *Smith*

CARD NUMBERS. .

486986	26
487058	27
5500569	28
5500641	29
5500726	30
5500816	31
5502311	32
	33
	34
10	35
11	36
12	37
13	38
14	39
15	40
16	41
17	42
18	43
19	44
20	45
21	46
22	47
23	48
24	49
25	50

Book Mark:

See also

O | 10 H. Art'y. | U.S.C.T.

Taylor O'Neil

....., Co. D, 7 Reg't U. S. Col'd H. Art'y.†

Age years.

Appears on

Company Muster Roll*

for *Enrolment to apr. 30*, 1864.

Joined for duty and enrolled:

When *Apr. 8*, 1864.

Where *N. Orleans La.*

Period *3* years.

Mustered in:

When *Apr. 20*, 1864.

Where *N. Orleans*

Present or absent *Present*

Stoppage, \$ *100* for

Due Gov't, \$ *100* for

Valuation of horse, \$ *100*

Valuation of horse equipments, \$ *100*

Remarks :

† This organization subsequently became Co. D, 10 Reg't U. S. Colored Heavy Artillery.

*First current roll: No muster-in roll of this company on file.

Book mark :

(358d)

Shadbolt

Copyist.

Taylor O'Neil

Appears with rank of Private on

Muster and Descriptive Roll of a Detachment of U. S. Vols. forwarded

for the 10 ^(7th U. S. C. H. A.) Reg't U. S. C. H. A. Roll dated

New Orleans La, May 7, 1864.

Where born Baton Rouge La.

Age 18 y'rs; occupation Labourer

When enlisted Apr. 8, 1864.

Where enlisted New Orleans

For what period enlisted 3 years.

Eyes Black; hair Black

Complexion Black; height 5 ft. 7 in.

When mustered in Apr. 20, 1864.

Where mustered in New Orleans

Bounty paid \$ 100; due \$ 100

Where credited New Orleans

Company to which assigned B

Remarks:

Book mark:

Galligan

Taylor O'Neil

Appears with rank of _____ on

Muster and Descriptive Roll of a Detachment of U. S. Vols. forwarded

(7th U. S. C. H. A.)

for the 10 Reg't U. S. C. H. A. Roll dated

New Orleans La., Apr. 20, 1864.

Where born Bayou Boeuf La.

Age 18 y'rs; occupation Laborer

When enlisted Apr. 8, 1864.

Where enlisted New Orleans

For what period enlisted 3 years.

Eyes Black; hair Black

Complexion Black; height 5 ft. 7 in.

When mustered in Apr. 20, 1864.

Where mustered in New Orleans

Bounty paid \$ 100; due \$ 100

Where credited _____

Company to which assigned D

Remarks: _____

Book mark: _____

Galligan

B

10 H. Art'y.

U.S.C.T.

Taylor B Neil

P, Co. *D*, 7 Reg't U. S. Col'd H. Art'y.*

Appears on

Company Muster Roll

for *May & June*, 186*7*.

Present or absent *Absent*

Stoppage, \$ *100* for

Due Gov't, \$ *100* for

Valuation of horse, \$ *100*

Valuation of horse equipments, \$ *100*

Remarks *Sick in Corps. d Afrique*
Genl. Hosp'l New Orleans
La. since Apr. 30/64

* This organization subsequently became Co. *D*, 10 Reg't U. S. Colored Heavy Artillery.

Book mark: _____

Shadbolt

Q

10 H. Art'y.

U.S.C.T.

Taylor B. Neil
P

, Co. D, 10 Reg't U. S. Col'd H. Art'y.

Appears on

Company Muster Roll

for July & Aug., 1864.

Present or absent Absent

Stoppage, \$ 100 for

Due Gov't, \$ 100 for

Valuation of horse, \$ 100

Valuation of horse equipments, \$ 100

Remarks Sick in C. d' Afrique
Genl. Hosp'l N.O. La. since
Apr. 30/64

Book mark:

(358)

Shadbolt

Copyist.

Taylor O'Neil

Co. D, 10 Reg't U. S. Col'd H. Art'y.

Appears on

Company Muster Roll

for Sept. + Oct., 1864.

Present or absent

Stoppage, \$ 100 for

Due Gov't, \$ 100 for

Valuation of horse, \$ 100

Valuation of horse equipments, \$ 100

Remarks: Died in C. d. A. Genl Hospital N. O. La. May 16/64

Book mark:

Shadbovt

O W. Harty | U.S.C.T.

Taylor O'Neil

Co. D, 14 Reg't U. S. Col'd N. Art'y

Appears on Co. Muster-out Roll, dated
Benton Range, La., Feb 22, 1867.

Muster-out to date _____, 186 .

Last paid to _____, 186 .

Clothing account:

Last settled _____, 186 ; drawn since \$ _____ 100

Due soldier \$ _____ 100; due U. S. \$ _____ 100

Am't for cloth'g in kind or money adv'd \$ _____ 100

Due U. S. for arms, equipments, &c., \$ _____ 100

Bounty paid \$ _____ 100; due \$ _____ 100

Remarks: joined Org. Org.
Died Oct 1st Gen. War.
Nov. 16/64
Final statements
ford

Book mark: _____

(361)

J. W. Leonard

Copyist.

O'Neil, Thomas

P, Co. D, 10th Reg't U.S.C.V.

5 Enclosures.

Bed Cards	Final Statements 2
Burial Records 1	Furloughs or L. of A.
Certs. of Dis. for Discharge	Med. Certificates
C. M. Charges	Med. Des. Lists
Descriptive Lists	Orders
Discharge Certificates	Pris. of War Record
Enlistment Papers	Resignations

Other papers relating to—

Admission to Hosp'l	Furlough or L. of A.
Casualty Sheet 1	Med. Examination
Confinement	Misc. Information
Contracts	Pay or Clothing
Death or Effects 1	Personal Reports
Desertion	Rank
Discharge from Hosp'l	Transfer to Hosp'l
Discharge from Service	Transfer to V. R. C.
Duty	Transportation

✓ FINAL STATEMENT

OF
Thomas Dwyer O'Neil
Private (Co. D)

10th Reg't of U. S. C. *1st (Heavy)*
Co. D 7th U. S. Col. Art (Heavy)

10 VOLUNTEERS.
Rec'd May 16 1864

NOTE 1.—Two of these certificates (or duplicates) are to be given to each Volunteer Soldier or drafted man who may be discharged previously to the discharge of his company, that he may at once receive from the Paymaster the pay, &c., due him, and the captain or other COMMISSIONED officer commanding the company will certify to the act of the delivery of the duplicate certificates; on these certificates the Soldier is "entitled to" his discharge, and should also present his discharge to the Paymaster to have the payment endorsed on it. The discharge is to be given back to the Soldier by the Paymaster; the latter only retaining as his voucher the duplicate certificates.

NOTE 2.—If the Soldier is entitled to pay for the use of his horse, the Company Commander will certify to that fact on the back of both these final statements, and also to the time he has pay due for having been so mounted on his own horse.

NOTE 3.—When a Soldier is furnished with final statements, his descriptive list, if he has one, should be taken up by the officer who gives the Soldier these statements, and endorsed with a statement to this effect by the officer. This endorsement should exhibit a full statement of the time for which the Soldier was allowed pay on his final statements, the clothing account, and all other charges against him or in his favor, so as to comprise a complete exhibit of his account. It will then be transmitted to the company commander of the Soldier, who will enter all the data necessary to a full understanding of the Soldier's account on the muster roll upon which the Soldier's discharge is reported. The descriptive list will then be destroyed. The object of this is, that the remaining portion of the Soldier's account may be settled upon the receipt of these muster rolls, and the Soldier receive any pay or allowances that may be due him at the time of his discharge, and which may not appear on his final statements from the fact that his descriptive list is incomplete. These accounts for back pay, &c., are settled by the 2d Auditor of the Treasury Department.

NOTE 4.—Charges for loss or injury to ordnance, horse equipments, and other miscellaneous charges, should appear under the heading of "Other Stoppages."

NOTE 5.—Bounty paid by State authorities, and not by the United States, will not be entered on this statement.

NOTE 6.—Amounts due the Sutler and Laundress must be entered on the muster roll on which the discharge, death, desertion, &c., is reported, as well as on the final statement, otherwise the amount cannot be collected from the United States.

NOTE 7.—This blank will be used for deceased volunteers and drafted men, as well as for others.

NOTE 8.—Where a Soldier dies in Hospital or on detached service, his descriptive list, if he has one, should be sent with his final statements, in duplicate, to the Second Auditor, Washington, D. C.

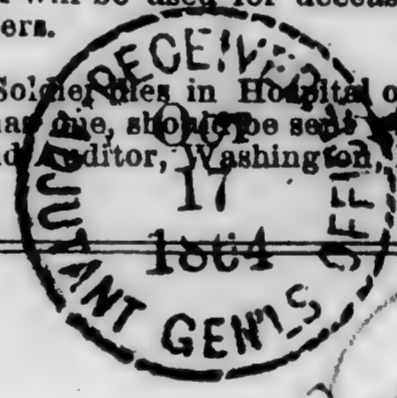

Deuts

ADJUTANT GENERAL'S OFFICE
Oct 19 1864
Duplicate with Inventory sent 2d Auditor.

(Proper name Taylor O'Neil)

I certify, on honor, that Thomas O'Neil a Private of
Captain C. A. Bailey's Company (D) of the 10th Regiment of U. S. Col. Art (Heavy)
Volunteers, of the State of La, born in Baton Rouge, State
of Louisiana, aged 18 years; 5 feet 1 inches high; Black complexion,
Black eyes, Black hair, and by occupation a Laborer, having joined the company on
its original organization at _____, and enrolled in it at the muster into
the service of the United States at _____, on the _____ day
of _____, 1864, (or was mustered in service as a recruit, by Lieutenant
Chamberlain, at N. Orleans, La. on the 20th day of April,
1864, or was drafted and mustered into the service of the United States from the
Enrollment District of the State of _____, at _____,
on the _____ day of _____, 1864,) to serve in the Regiment, for
the term of Three Years: and having served **HONESTLY** and
FAITHFULLY with his Company in _____ to the present date, is now
entitled to a **DISCHARGE** by reason of death. Died in Camp de Afrique
General Hospital N. Orleans May 16th 1864 of Small Pox

The said Thomas O'Neil has pay due him was last paid by Paymaster
at date of death to include the _____ day of _____, 1864, and has
pay due him from that time to the present date; he is entitled to pay and subsistence for
TRAVELING to place of enrollment, and whatever other allowances are authorized to volunteer
soldiers, drafted men, or militia, so discharged. He has received from the United States **CLOTHING**
amounting to Twenty five $\frac{82}{100}$ dollars, since the _____ day of Enrollment,
1864, when his clothing account was last settled. He has received from the United States
_____ dollars advanced **BOUNTY**.

There is to be stopped from him, on account of the State of _____, or other
authorities, for **CLOTHING**, &c., received on entering service, _____ dollars; and
for other stoppages, viz: _____
_____ dollars.

He has been furnished with **TRANSPORTATION** in kind from the place of his discharge to _____;
and he has been **SUBSISTED** for **TRAVELING** to his
place of enrollment, up to the _____, 1864.

He is indebted to _____, **SUTLER**, _____ dollars.

He is indebted to _____, **LAUNDRESS**, _____ dollars.

Given in Duplicate, at Baton Rouge La, this 1st day
of October, 1864.

Charles A. Bailey
Captain
Commanding Company 10th
U. S. Col. Art (Heavy)

✓

FINAL STATEMENT

OF

Private William Octave

1st Reg't of La. Heavy Art'y 6th A.
10

VOLUNTEERS.

Died January 26th 1864

NOTE 1.—Two of these certificates (or duplicates) are to be given to each Volunteer Soldier or drafted man who may be discharged previously to the discharge of his company, that he may at once receive from the Paymaster the pay, &c., due him, and the captain or other COMMISSIONED officer commanding the company will certify to the act of the delivery of the duplicate certificates; on these certificates the Soldier is "entitled to" his discharge, and should also present his discharge to the Paymaster to have the payment endorsed on it. The discharge is to be given back to the Soldier by the Paymaster; the latter only retaining as his voucher the duplicate certificates.

NOTE 2.—If the Soldier is entitled to pay for the use of his horse, the Company Commander will certify to that fact on the back of both these final statements, and also to the time he has pay due for having been so mounted on his own horse.

NOTE 3.—When a Soldier is furnished with final statements, his descriptive list, if he has one, should be taken up by the officer who gives the Soldier these statements, and endorsed with a statement to this effect by the officer. This endorsement should exhibit a full statement of the time for which the Soldier was allowed pay on his final statements, the clothing account, and all other charges against him or in his favor, so as to comprise a complete exhibit of his account. It will then be transmitted to the company commander of the Soldier, who will enter all the data necessary to a full understanding of the Soldier's account on the muster roll upon which the Soldier's discharge is reported. The descriptive list will then be destroyed. The object of this is, that the remaining portion of the Soldier's account may be settled upon the receipt of these muster rolls, and the Soldier receive any pay or allowances that may be due him at the time of his discharge, and which may not appear on his final statements from the fact that his descriptive list is incomplete. These accounts for back pay, &c., are settled by the 2d Auditor of the Treasury Department.

NOTE 4.—Charges for loss or injury to ordnance, horse equipments, and other miscellaneous charges, should appear under the heading of "Other Stoppages."

NOTE 5.—Bounty paid by State authorities, and not by the United States, will not be entered on this statement.

NOTE 6.—Amounts due the Sutler and Laundress must be entered on the muster roll on which the discharge, death, desertion, &c., is reported, as well as on the final statement, otherwise the amount cannot be collected from the United States.

NOTE 7.—This blank will be used for deceased volunteers and drafted men, as well as for others.

NOTE 8.—Where a Soldier dies in Hospital or on detached service, his descriptive list, if he has one, should be sent with his final statements, in duplicate, to the Second Auditor, Washington, D. C.

I certify, on honor that the said private William Octave died, leaving no effect

Thos. M. Cormack
Sr. 1st Lieut.
Company

Respectfully
and from of death
W. Dept.

A. G. O. F. W. Taggart
March 18th 64. A. A. [unclear]

ADJUTANT GENERAL'S OFFICE.
April 18th 1864.
Duplicate with Inventory sent 2d Auditor.

Place of death
A. G. O.

I certify, on honor, that William Octave a private of
 Captain A. McAllister's Company (B) of the 1st Regiment of La. Vol. Art. Co. S. A.
VOLUNTEERS, of the State of Louisiana, born in Shelby County, State
 of Kentucky, aged 30 years; 5 feet 8½ inches high; dark complexion,
brown eyes, black hair, and by occupation a Laborer, having joined the company on
 its original organization at Camp Parapet Carrolton La., and enrolled in it at the muster into
 the service of the United States at Camp Parapet Carrolton La., on the thirteenth day
 of January, 1863, (~~or was mustered in service as a recruit, by~~
~~....., at, on the day of~~
 186- , or was drafted and mustered into the service of the United States from the
 Enrollment District of the State of, at,
 on the day of, 186-) to serve in the Regiment, for
 the term of three years: and having served HONESTLY and
 FAITHFULLY with his Company ~~in~~ to the present date, is now
 entitled to a **DISCHARGE** by reason of death at Camp Parapet
La. this 26th day of January 1864

The said William Octave was last paid by Paymaster
Maj Preston to include the 21st day of October, 1863, and has
 pay due him from that time to the present date; ~~he is entitled to pay and subsistence for~~
~~TRAVELING to place of enrollment, and whatever other allowances are authorized to volunteer~~
~~soldiers, drafted men, or militia, so discharged.~~ He has received from the United States **CLOTHING**
 amounting to Sixty Two $\frac{42}{100}$ dollars, since the 13th day of January,
 1863, when his clothing account was last settled. ~~He has received from the United States~~
~~..... $\frac{100}{100}$ dollars advanced BOUNTY.~~

There is to be stopped from him, ~~on account of the State of, or other~~
~~authorities, for CLOTHING, &c, received on entering service,~~ $\frac{100}{100}$ dollars; and
 for other stoppages, viz: for clothing overdrawn

Five $\frac{11}{100}$ dollars.
~~He has been furnished with TRANSPORTATION in kind from the place of his discharge to~~
~~.....; and he has been SUBSISTED for TRAVELING to his~~
~~place of enrollment, up to the, 186- .~~

He is indebted to, **SUTLER,** $\frac{100}{100}$ dollars.
 He is indebted to, **LAUNDRESS,** $\frac{100}{100}$ dollars.

Given in Duplicate, at Camp Parapet Carrolton La., this 27th day
 of January, 1864.

Thos. W. Cormack
Sr. 1st Lieut.
 Commanding Company

2 p. & inv. sent for to Surg. Gen. Nov. 6.

CASUALTY SHEET

No. _____

Thomas O'Neil

Private of Company _____

7th Regiment of U.S.C.A.

State Volunteers.

NATURE OF CASUALTY.

Died May 16th 1864

CASUALTY SHEET.

Name: *Thomas O'Neil*

Rank: *Priv* Company: _____ Regiment: *7*

Arm: *U.S. Art* State: _____

Nature of Casualty: *death*

CAUSE OF CASUALTY—(NAME OF DISEASE, &c.)

BY WHOM DISCHARGED.

FROM WHAT SOURCE THIS INFORMATION WAS OBTAINED.

DEGREE OF DISABILITY.

BY WHOM CERTIFIED.

J. M. Moore
A. G. M.

Roll of Honor
Vol *Pg. 131*

REMARKS.

PLACE OF DISCHARGE, DEATH, &c.

May 16, 1864

Buried New Orleans
La.

J. P.
Clerk.

RECORD OF DEATH AND INTERMENT.

Name and number of person interred,	<i>Thomas D. Hill</i>	
Number and locality of the Grave, - -		
Hospital number of the deceased, - -	<i>1157.</i>	
Regiment, rank, and company, - -	<i>Private 7th U. S. Art.</i>	
Residence before enlistment, - - -		
Conjugal condition, (and if married,) the residence of the widow,)		
Cause of death, - - - - -	<i>Smallpox</i>	
Age of the deceased, - - - - -		
Nativity, - - - - -		
References and remarks, - - - - }		
Date of death and burial, - - - -	<i>May 16th 64.</i>	186 .

(A duplicate of this Record has been forwarded to the Sexton, and another remains at this Hospital.)

To *Adjutant General U.S.A.*
SIR:

It becomes my duty to inform you that the person above described died at this Hospital as herein stated; that it is desired his remains should be interred with the usual military honors.

Respectfully,

F. E. Pyriette
Surgeon U. S. Army. *Alona*

Capt. d'Arigue
MILITARY HOSPITAL, *New Orleans, La.*

This copy of Record is to be transmitted to the Adjutant General at Washington immediately after the place of burial and the number of grave have been ascertained and registered. The above notification is to remain attached.

Triplicate

INVENTORY OF THE EFFECTS

OF *Thos. O'Steil*

Private Thomas O'Steil

Late of Company _____

7th Reg't of *U.S. Heavy Arty Colored*

Volunteers, who died at Corps d'Afrique Genl

on the *16th* day of *May* 186*4*.

Surgeon General's Office,

RECORD & PENSION BUREAU,

Washington, ----- *186*

The within Inventory is a true copy from the records
of..... *Hospital*
....., on file in
this Office, and contains all the information in the case that
can be found.

BY ORDER OF THE SURGEON GENERAL:

Bvt. Major, Assistant Surgeon, U. S. A.

Sept 18/

Copy.

Vol. 4. No. 1082

die, or be
officer of
omissioned
above his
of the De-
ad paid to
or soldier.
the effects
ounted to
giment or
mitted to
or of the
omissioned
, and paid

ased non-
e of War,
er of the
e same to
g, &c., in
y of the
arded, as
oldier dies
uty of his
al, the re-
o forward
belonged,
what time
on at the
uster roll
y will be
company
of _____,
stated in
ported on

officer or
decease,
nder the
ceeds de-
until they

tration, a
l by the
Paymas-
manding
ed, "Re-
any (-,)
186-."

be turned
n the Ad-
res of the
eral, their
her cases,
Adjutant

uplicate
y should
fficer.

Inventory of the effects of Thomas Duil late
 a Private of Captain _____ Company D of
 the 7th Regiment of U. S. Heavy Arty Colored volunteers, who was enrolled as
 a _____ at _____ in the State of _____ on
 the _____ day of _____ 186 , and mustered into the service of the United
 States as a _____ on the _____ day of _____ 186 , at _____
 in Company _____, _____ Regiment of _____ Volunteers, to serve _____
 years or during the war; he was born in _____ in the State
 of _____; he was _____ years of age, _____ feet _____ inches
 high, _____ complexion, _____ eyes, _____ hair, and by occupation, when enrolled,
 a _____; he died in Corps d'Afrique Genl. Hospital, at
New Orleans Louisiana on the 16th day of May 1864, by
 reason of Small Pox

INVENTORY.					
ARTICLES.	No.	ARTICLES.	No.	ARTICLES.	No.
Hats.....		Pairs trousers.....		Knapsacks.....	
Caps.....		Pairs flannel drawers.....		<i>No Effects</i>	
Forage caps.....		Pairs cotton drawers.....			
Great coats.....		Flannel shirts.....			
Uniform coats.....		Cotton shirts.....			
Uniform jackets.....		Pairs boots.....			
Flannel sack coats.....		Pairs shoes.....			
Blouses.....		Pairs socks.....			
Stable frocks.....		Blankets.....			
Fatigue overalls.....		Haversacks.....			
					MONEY.
				Specie.....	\$
				Notes.....	\$

I CERTIFY, ON HONOR, that the above inventory comprises all the effects of _____
 _____, deceased, and that the effects are in the hands
 of _____ at _____
 _____ to be disposed of by a Council of Administration.

(DUPLICATES.)

STATION: New Orleans La.

DATE: 16th May 1864

[A. G. O. No. 104.]

Surgeon U. S. Inftry. Colored
 Commanding the Company.
In charge of Corps d'Afrique
Genl. Hospital

Duplicate

INVENTORY OF THE EFFECTS

OF

Private Thomas Paul

Late of Company *D*

7th Reg't of *U.S. Heavy Arty Col*

Volunteers, who died at *Camp D. A. Genl Hosp*

on the *16th* day of *May* 1864.

*Surgeon General's Office
Record and Pension Division
Washington D.C. Jan 23rd 1867*

*This Inventory is the copy
retained with the records of
the Camp D. A. Genl Hospital
New Orleans, La., filed in this
office, and contains all information
in the *REPORT* can be found
By Order of the *Surgeon General**

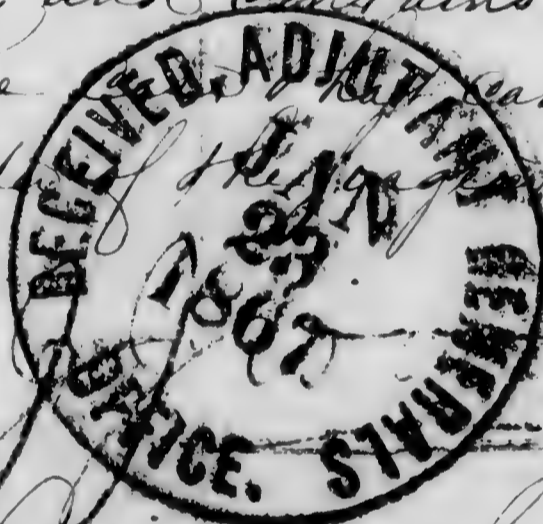

*By Order of the Surgeon General
Bvt Maj & Asst Surg. U.S.A.*

Vol. IV. No 1082

...dier shall die, or be
...manding officer of
...other commissioned
...essed of, above his
...e office of the De-
...ted for, and paid to
...d officer or soldier.
...care of the effects
...have accounted to
...ve the regiment or
...ey be permitted to
...g officer, or of the
...l non-commissioned
...ured for, and paid

1861.

...mmissioned officers
...ll be forwarded to
...pany to which the
...olonel of the regi-
...be sent with the
...on absent from his
...nder to furnish the
...o the commanding
...report of his death,
...was last paid, and
...ue of his decease;
...of the company to
...orsed, "Inventory
...regiment of
...186-." If a legal
...he report. If the

...mmissioned officer or
...a'ter his decease,
...ration, under the
...he proceeds depo-
...States, until they
...eased.

...Administration, a
...y certified by the
...aymaster's receipt
...ing officer to the
..."Report of the
...pany (-) -
...186-."

...ould be turned over
...from the Adjutant
...atives of the de-
...ant General, their
...In all other cases,
...t to the Adjutant

...ceipts in duplicate
...one copy should
...by the officer.

see endorsed.

Inventory of the effects of Thomas Duell late
 a Private of Captain _____ Company 10 of
 the 7th Regiment of U.S. Heavy Artillery Volunteers, who was enrolled as
 a _____ at _____ in the State of _____ on
 the _____ day of _____ 186 , and mustered into the service of the United
 States as a _____ on the _____ day of _____ 186 , at _____
 in Company _____, _____ Regiment of _____ Volunteers, to serve _____
 years or during the war; he was born in _____ in the State
 of _____; he was _____ years of age, _____ feet _____ inches
 high, _____ complexion, _____ eyes, _____ hair, and by occupation, when enrolled,
 a _____; he died in Camp of Major General Hospital, at
New Orleans Louisiana on the 16th day of May 1864, by
 reason of Small pox

INVENTORY.					
ARTICLES.	No.	ARTICLES.	No.	ARTICLES.	No.
Hats.....		Pairs trousers.....		Knapsacks.....	
Caps.....		Pairs flannel drawers.....			
Forage caps.....		Pairs cotton drawers.....			
Great coats.....		Flannel shirts.....			
Uniform coats.....		Cotton shirts.....			
Uniform jackets.....		Pairs boots.....			
Flannel sack coats.....		Pairs shoes.....			
Blouses.....		Pairs socks.....			
Stable frocks.....		Blankets.....			
Fatigue overalls.....		Haversacks.....			
				MONEY.	
				Specie.....	\$
				Notes.....	\$

I CERTIFY, ON HONOR, that the above inventory comprises all the effects of _____
 _____, deceased, and that the effects are in the hands
 of _____ at _____
 _____ to be disposed of by a Council of Administration.

(DUPLICATES.)

STATION: New Orleans La

DATE: 16th May 1864

[A. G. O. No. 104.]

Surgeon 86th Regt U.S. Inftry. Orleans
 Commanding the Company.
In Charge of Camp. A. H. H. H. H.

Private

CARD NUMBERS.

5497637

5497881

5498036

26

27

28

29

30

31

32

33

34

35

36

37

38

39

40

41

42

43

44

45

46

47

48

49

50

Book Mark:

A-33-RCJ.64

See also

James Ostebutt

Pr, Co. C, 1 Reg't H. Art'y, Corps d'Afrique.*

Age *28* years.

Appears on

Company Muster-in Roll

of the organization named above. Roll dated

New Orleans La, Aug 17, 1863.

Muster-in to date *Aug 17, 1863.*

Joined for duty and enrolled:

When *July 31, 1863.*

Where *Camp Parapel La*

Period *3* years.

Valuation of horse, \$ *100*

Valuation of horse equipments, \$ *100*

Remarks:

* This organization subsequently became Co. C, 10 Reg't U. S. Colored Heavy Artillery.

Book mark:-----

W. J. ...

James C. Stebbins
Pr., Co, C, 1 Reg't La. Art'y Native Guards.*

Appears on

Company Muster Roll

for *Aug 11th to 31st*, 1863 .

Present or absent *Present*

Stoppage, \$ 100 for

Due Gov't, \$ 100 for

Valuation of horse, \$ 100

Valuation of horse equipments, \$ 100

Remarks :

* This organization subsequently became Co. C, 10 Reg't U. S. Col'd Heavy Artillery.

Book mark : -----

W. S. Sherman
(358) Copyist.

James Ortebutt

Pvt, Co, C, 1 Reg't La. Art'y Native Guards.*

Appears on

Company Muster Roll

for ----- *Sep & Oct*, 1863 .

Present or absent ----- *Present*

Stoppage, \$ ----- 100 for -----

Due Gov't, \$ ----- 100 for -----

Valuation of horse, \$ ----- 100

Valuation of horse equipments, \$ ----- 100

Remarks: -----

not on sub. rolls of Co.

* This organization subsequently became Co. C, 10 Reg't U. S. Col'd Heavy Artillery.

Book mark ----- *A 33 - R.C.T. 67*

----- *assumed* -----

Private

Collection

CARD NUMBERS.

1	5489190	26
2	5502526	27
3	5502642	28
4	5502779	29
5	5502909	30
6	5502974	31
7	5503094	32
8	5503207	33
9	5503318	34
10	5503428	35
11	5503542	36
12	5503691	37
13	5503833	38
14	5503978	39
15	5504108	40
16	5504232	41
17	5504358	42
18	5504458	43
19	5486906	44
20	5502337	45
21	40745474	46
22		47
23		48
24		49
25		50

Book Mark:

See also

R.P. 726 453
D. 2295-773 Poaff

Thought
ep

70
X

Boumer Anvit

Appears with rank of _____ on _____

Muster and Descriptive Roll of a Detachment of U. S. Vols. forwarded

(H.A.C. & A.)
for the 10 Reg't M.S.C.H.A. Roll dated

New Orleans La, Mch 6, 1864.

Where born Iberville La

Age 25 y'rs; occupation _____

When enlisted Mch 7, 1864.

Where enlisted New Orleans

For what period enlisted 3 years.

Eyes Black; hair Black

Complexion Dark; height 5 ft. 3 1/2 in.

When mustered in Mar. 7, 1864.

Where mustered in New Orleans

Bounty paid \$ 100; due \$ 100

Where credited _____

Company to which assigned E

Remarks: _____

Not borne on subs. rolls of Co

Book mark: _____

Galligan

C. W. H. A. | U.S.C.T.

James Orvick
Pais, Co. *E*, *10* (7th U.S.C.H.A.) Reg't U. S. Col'd *H. A.*

Appears on a

Detachment Muster Roll

of the organization named above

for *Roll dated Apr 30, 1864.*

Station *De Fair, La.*

Present or absent *Present*

Stoppage, \$ 100 for

Due Gov't, \$ 100 for

Valuation of horse, \$ 100

Valuation of horse equipments, \$ 100

Remarks:

Book mark:

Cooper

07

10 H. Art'y.

U.S.C.T.

Bonner *Orwait*

Pl., Co. *E*, 7 Reg't U. S. Col'd H. Art'y.*

Appears on

Company Muster Roll

for *May & June*, 186*4*

Present or absent *Present*

Stoppage, \$ *100* for

Due Gov't, \$ *100* for

Valuation of horse, \$ *100*

Valuation of horse equipments, \$ *100*

Remarks: *Enrolled & M/ in
Mar 7/64 New Orleans
3 yrs.*

* This organization subsequently became Co. *E*, 10 Reg't U. S. Colored Heavy Artillery.

Book mark: _____

(358)

Linden

Copyist.

A | 10 H. Art'y. | U.S.C.T.

Pomer *Amrit*
Prk, Co *D*, 7 Reg't U. S. Col'd H. Art'y.*

Appears on

Company Muster-in and Descriptive Roll
of the organization named above. Roll dated

New Orleans La, July 8, 1864

Where born *Sterrville La.*

Age *25* y'rs; occupation *Laborer*

When enlisted *March 7, 1864.*

Where enlisted *New Orleans*

For what period enlisted *3* years.

Eyes *Black*; hair *Black*

Complexion *Dark*; height *5* ft. *3 1/2* in.

When mustered in *March 7, 1864.*

Where mustered in *New Orleans*

Bounty paid \$ *2* 100; due \$ *100*

Where credited *New Orleans*

Company to which assigned *D*

Remarks: _____

* This organization subsequently became Co. *D*, 10 Reg't U. S. Colored Heavy Artillery.

Book mark: _____

Linden
(356d) Copyist.

0

10 H. Art'y. U.S.C.T.

Gonner *Orwait*

Art. Co. E, 10 Reg't U. S. Col'd H. Art'y.

Appears on

Company Muster Roll

for *July* & *Aug.*, 186 *6*.

Present or absent *Present*

Stoppage, \$ 100 for

Due Gov't, \$ 100 for

Valuation of horse, \$ 100

Valuation of horse equipments, \$ 100

Remarks:

Book mark:

(358)

Linden
Copyist.

O

10 H. Art'y. | U.S.C.T.

Bonner *Orwait*

Plt., Co. E, 10 Reg't U. S. Col'd H. Art'y.

Appears on

Company Muster Roll

for *Apr* *1864*, 186 *4*.

Present or absent *Present*

Stoppage, \$ *100* for

Due Gov't, \$ *100* for

Valuation of horse, \$ *100*

Valuation of horse equipments, \$ *100*

Remarks:

Book mark:

Linden

(358)

Copyist.

0 | 10 H. Art'y. | U.S.C.T.

Pomer *Swait*

Prk, Co. E, 10 Reg't U. S. Col'd H. Art'y.

Appears on

Company Muster Roll

for *Nov Dec*, 186*4*.

Present or absent *Present*

Stoppage, \$ *100* for

Due Gov't, \$ *100* for

Valuation of horse, \$ *100*

Valuation of horse equipments, \$ *100*

Remarks: *Difference of pay from enlistment to Apl 30 \$6.00 per month due*

Book mark:

Linden

0

10 H. Art'y. U.S.C.T.

Bonner Orwait

Artif., Co. E, 10 Reg't U. S. Col'd H. Art'y.

Appears on

Company Muster Roll

for *Jan, & Feb.*, 1865.

Present or absent *Present.*

Stoppage, \$ 100 for

Due Gov't, \$ 100 for

Valuation of horse, \$ 100

Valuation of horse equipments, \$ 100

Remarks: *January 1, 1865 - appointed artificer. Difference of pay from enlistment to Apr. 30, 1864, \$6⁰⁰ per month due.*

Book mark:

G. E. Tyler

(358)

Copyist.

Bonner Orwait

Artif., Co. E, 10 Reg't U. S. Col'd H. Art'y.

Appears on

Company Muster Roll

for *March & Apr.*, 1865.

Present or absent *Present.*

Stoppage, \$ 100 for

Due Gov't, \$ 100 for

Valuation of horse, \$ 100

Valuation of horse equipments, \$ 100

Remarks: *Difference of pay
from enlistment to Apr.
30, 1864 \$ 6.00 per month
due.*

Book mark: _____

G. S. Tyler
Copyist.

Bonner Crowat

Artif., Co. E, 10 Reg't U. S. Col'd H. Art'y.

Appears on

Company Muster Roll

for *May & June*, 1865.

Present or absent *Present*

Stoppage, \$ 100 for

Due Gov't, \$ 100 for

Valuation of horse, \$ 100

Valuation of horse equipments, \$ 100

Remarks:

Book mark:

G. C. Syles

Sommer Orwait
Artificer, Co. E, 10 Reg't U. S. Col'd H. Art'y

Appears on

Company Muster Roll

for *July & Aug.*, 186*5*.

Present or absent *Present*

Stoppage, \$ 100 for

Due Gov't, \$ 100 for

Valuation of horse, \$ 100

Valuation of horse equipments, \$ 100

Remarks:

Book mark: -----

(358)

G. H. Tyler
Copyist.

Ernest Orwait

Artif., Co. E, 10 Reg't U. S. Col'd H. Art'y.

Appears on

Company Muster Roll

for *Sept. & Oct.*, 186*5*.

Present or absent *Present*

Stoppage, \$ 100 for

Due Gov't, \$ 100 for

Valuation of horse, \$ 100

Valuation of horse equipments, \$ 100

Remarks:

Book mark:

G. E. Tyler

Banner Orwain

Artificer, Co. E, 10 Reg't U. S. Col'd H. Art'y.

Appears on

Company Muster Roll

for Nov & Dec, 1865.

Present or absent Present

Stoppage, \$ 100 for

Due Gov't, \$ 100 for

Valuation of horse, \$ 100

Valuation of horse equipments, \$ 100

Remarks:

Book mark:

Wash
Copyist.

0

10 H. Art'y. U.S.C.T.

Bonner Orwait

Artificer, Co. E, 10 Reg't U. S. Col'd H. Art'y.

Appears on

Company Muster Roll

for Jan & Feb, 1866.

Present or absent Present

Stoppage, \$ 100 for

Due Gov't, \$ 100 for

Valuation of horse, \$ 100

Valuation of horse equipments, \$ 100

Remarks:

Book mark:

Bank

Copyist.

0

10 H. Art'y. U.S.C.T.

Bonner Orwain

artificer, Co. E, 10 Reg't U. S. Col'd H. Art'y.

Appears on

Company Muster Roll

for March - April, 1866.

Present or absent Present

Stoppage, \$ 100 for

Due Gov't, \$ 100 for

Valuation of horse, \$ 100

Valuation of horse equipments, \$ 100

Remarks:

Book mark:

Wark Copyist.

Bonner Orwait

artificer, Co. E, 10 Reg't U. S. Col'd H. Art'y.

Appears on

Company Muster Roll

for *May & June*, 1866.

Present or absent *Present*

Stoppage, \$ 100 for

Due Gov't, \$ 100 for

Valuation of horse, \$ 100

Valuation of horse equipments, \$ 100

Remarks:

Book mark:

Hark

Copyist.

0

10 H. Art'y. U.S.C.T.

Bonner Orvick

Artificer, Co. E, 10 Reg't U. S. Col'd H. Art'y.

Appears on

Company Muster Roll

for July & Aug, 1866.

Present or absent Present

Stoppage, \$ 100 for

Due Gov't, \$ 100 for

Valuation of horse, \$ 100

Valuation of horse equipments, \$ 100

Remarks:

Book mark:

Bar

O

10 H. Art'y. U.S.C.T.

Bonner Orwait

Artificer Co. E, 10 Reg't U. S. Col'd H. Art'y.

Appears on

Company Muster Roll

for *Sept. + Oct.*, 1866.

Present or absent *Present*

Stoppage, \$ 100 for

Due Gov't, \$ 100 for

Valuation of horse, \$ 100

Valuation of horse equipments, \$ 100

Remarks:

Book mark: *358*

O'Hagan

(358)

Copyist.

O

10 H. Art'y. U.S.C.T.

Bonner Orwait

Artif, Co. E, 10 Reg't U. S. Col'd H. Art'y.

Appears on

Company Muster Roll

for Nov & Dec, 1866.

Present or absent Present

Stoppage, \$ 100 for

Due Gov't, \$ 100 for

Valuation of horse, \$ 100

Valuation of horse equipments, \$ 100

Remarks:

Book mark:

O'Hagan

(358)

Copyist.

A

10 H. Art'y.

U.S.C.T.

Bonner Annot

Priv., Co. E, 10 Reg't U. S. Col'd H. Art'y.

Appears on Returns as follows:

July 1864; (7 Reg't U.S. Col'd H. Art'y)
Gain Mar 7/64 New Orleans
Enlisted in Regt

Book mark :

(546)

J. H. Hendley

Copyist.

O

10 H. Art'y. U.S.C.T.

Bonner Orwait

Artif, Co. E, 10 Reg't U. S. Col'd H. Art'y.

Appears on Co. Muster-out Roll, dated

Baton Rouge, La, Feb 22, 1867.

Muster-out to date

Feb. 22, 1867.

Last paid to

Dec 31, 1866.

Clothing account:

Last settled....., 186 ; drawn since \$.....100

Due soldier \$ 78 ⁴³/₁₀₀; due U. S. \$.....100

Am't for cloth'g in kind or money adv'd \$.....100

Due U. S. for arms, equipments, &c., \$.....6. ⁰⁸/₁₀₀

Bounty paid \$.....100; due \$ 300. ⁰⁰/₁₀₀

Remarks: Joined org. organ.

Appointed Artificer Jan 1. 1865.

Book mark:

O'Hagan

(361)

Copyist.

Quarto

Artificer

GARD NUMBERS.

	5486922.	26
	5502424.	27
	5489189.	28
	5502525.	29
	5502641.	30
	5502778.	31
	5502908.	32
	5503025.	33
	5503143.	34
10	5503254.	35
11	5503363.	36
12	5503470.	37
13	5503607.	38
14	5503755.	39
15	5503890.	40
16	5503979.	41
17	5504109.	42
18	5504233.	43
19	5504359.	44
20	5504459.	45
21		46
22		47
23		48
24		49
25		50

Book Mark:

See also

Joseph Twait

Plt., Co. E, 7 Reg't U. S. Col'd H. Art'y.*

Appears on

Company Muster-in and Descriptive Roll of the organization named above. Roll dated

New Orleans La, July 6, 1864.

Where born

Age 23 y'rs; occupation Laborer

When enlisted

March 7, 1864.

Where enlisted

New Orleans

For what period enlisted

3 years.

Eyes Black; hair Black

Complexion Black; height 5 ft. in.

When mustered in

March 7, 1864.

Where mustered in

New Orleans

Bounty paid \$ 200; due \$ 100

Where credited

New Orleans

Company to which assigned

E

Remarks:

* This organization subsequently became Co. E, 10 Reg't U. S. Colored Heavy Artillery.

Book mark:

Linden

Joseph Oviatt

Appears with rank of _____ on

Muster and Descriptive Roll of a Detachment of U. S. Vols. forwarded

for the 10 Reg't ^(I H. a. c. d. a.) U. S. C. H. a. Roll dated

New Orleans La, Mch 6, 1864.

Where born Iberville La

Age 43 y'rs; occupation _____

When enlisted Mar. 7, 1864.

Where enlisted New Orleans

For what period enlisted 3 years.

Eyes Black; hair Black

Complexion Black; height 5 ft. 4 1/2 in.

When mustered in Mar 7, 1864.

Where mustered in New Orleans

Bounty paid \$ 100; due \$ 100

Where credited _____

Company to which assigned E

Remarks: _____

Book mark: _____

Galligan

O 10260A | U.S.C.T.

Joseph Orvait
Orvait, Co. *B.*, *10* ^(7 U.S.C. 11. A.) Reg't U. S. Col'd *10260A*

Appears on a

Detachment Muster Roll

of the organization named above

for *Roll dated Apr 30*, 1864.

Station *De Fair, Pa*

Present or absent *Present*

Stoppage, \$ *100* for

Due Gov't, \$ *100* for

Valuation of horse, \$ *100*

Valuation of horse equipments, \$ *100*

Remarks:

Book mark:

Croghan

(844)

Copyist.

J

10 H. Art'y.

U.S.C.T.

Joseph Trowait
Dr, Co. *E*, 7 Reg't U. S. Col'd H. Art'y.*

Appears on

Company Muster Roll

for *May & June*, 186*4*.

Present or absent *Present*

Stoppage, \$ *100* for

Due Gov't, \$ *100* for

Valuation of horse, \$ *100*

Valuation of horse equipments, \$ *100*

Remarks:

* This organization subsequently became Co. *E*, 10 Reg't U. S. Colored Heavy Artillery.

Book mark: -----

(358) *Linden* Copyist.

10 H. Art'y. | U.S.C.T.

Joseph Trwait

Plt, Co. E, 10 Reg't U. S. Col'd H. Art'y.

Appears on

Company Muster Roll

for July & Aug., 1864

Present or absent Present

Stoppage, \$ 100 for

Due Gov't, \$ 100 for

Valuation of horse, \$ 100

Valuation of horse equipments, \$ 100

Remarks:

Book mark:

(358)

L. S. Rider
Copyist.

Joseph Trwait
Pt. Co. E, 10 Reg't U. S. Col'd H. Art'y.

Appears on

Company Muster Roll

for Sep. + Oct., 1864

Present or absent Present

Stoppage, \$ 100 for

Due Gov't, \$ 100 for

Valuation of horse, \$ 100

Valuation of horse equipments, \$ 100

Remarks:

Book mark:

J. L. Linder
Copyist.

Joseph - Cwait
Sgt, Co. E, 10 Reg't U. S. Col'd H. Art'y.

Appears on

Company Muster Roll

for Nov Dec, 1864

Present or absent Present

Stoppage, \$ 100 for

Due Gov't, \$ 100 for

Valuation of horse, \$ 100

Valuation of horse equipments, \$ 100

Remarks: Difference of pay
from enlistment to Apl
30th \$6.00 per month, due

Book mark:

(358)

J. Linden

Copyist.

Joseph Onvait
Sgt., Co. E, 10 Reg't U. S. Col'd H. Art'y.

Appears on

Company Muster Roll

for Jan. & Feb., 1864.

Present or absent Present.

Stoppage, \$ 100 for

Due Gov't, \$ 100 for

Valuation of horse, \$ 100

Valuation of horse equipments, \$ 100

Remarks: Difference of pay
from enlistment to
Apr. 30, 1864 per month
due.

Book mark: 100000

J. H. Tyler
Copyist.

Joseph Orwait

Co. E, 10 Reg't U. S. Col'd H. Art'y.

Appears on

Company Muster Roll

for March & Apr., 1865.

Present or absent Present

Stoppage, \$ 100 for

Due Gov't, \$ 100 for

Valuation of horse, \$ 100

Valuation of horse equipments, \$ 100

Remarks: Difference of pay
from enlistment to Apr.
30, 1864, \$6⁰⁰ per month
due.

Book mark:

J. E. Tyler

Copyist.

Joseph Orwait

Co. E, 10 Reg't U. S. Col'd H. Art'y.

Appears on

Company Muster Roll

for May & June, 1865.

Present or absent Present.

Stoppage, \$ 100 for

Due Gov't, \$ 100 for

Valuation of horse, \$ 100

Valuation of horse equipments, \$ 100

Remarks:

Book mark:

G. C. Tyler

Joseph Orwait
Co., Co. E, 10 Reg't U. S. Col'd H. Art'y

Appears on

Company Muster Roll

for *July & Aug.*, 186*5*.

Present or absent *Present*

Stoppage, \$ *100* for

Due Gov't, \$ *100* for

Valuation of horse, \$ *100*

Valuation of horse equipments, \$ *100*

Remarks:

Book mark:

G. E. Taylor
Copyist.

Joseph Cowart

Capt., Co. E, 10 Reg't U. S. Col'd H. Art'y.

Appears on

Company Muster Roll

for *Sept. & Oct*, 186*5*.

Present or absent *Present*

Stoppage, \$ _____ *100* for _____

Due Gov't, \$ _____ *100* for _____

Valuation of horse, \$ _____ *100*

Valuation of horse equipments, \$ _____ *100*

Remarks: _____

Book mark: _____

[Signature]

Joseph Orvaih

Pvt., Co. E, 10 Reg't U. S. Col'd H. Art'y.

Appears on

Company Muster Roll

for *Nov 2 Dec*, 186 *5*.

Present or absent *Present*

Stoppage, \$ *100* for

Due Gov't, \$ *100* for

Valuation of horse, \$ *100*

Valuation of horse equipments, \$ *100*

Remarks:

Book mark:

Wark
Copyist.

Joseph Orwain
Pvt, Co. E, 10 Reg't U. S. Col'd H. Art'y.

Appears on

Company Muster Roll

for *Jan & Feb*, 1866.

Present or absent *Present*

Stoppage, \$ 100 for

Due Gov't, \$ 100 for

Valuation of horse, \$ 100

Valuation of horse equipments, \$ 100

Remarks: _____

Book mark: _____

Kant
Copyist.

0

10 H. Art'y. U.S.C.T.

Joseph Orwain

Pr, Co. E, 10 Reg't U. S. Col'd H. Art'y.

Appears on

Company Muster Roll

for March & April, 1866.

Present or absent Present

Stoppage, \$ 100 for

Due Gov't, \$ 100 for

Valuation of horse, \$ 100

Valuation of horse equipments, \$ 100

Remarks:

Book mark:

Ward

Copyist.

0

Joseph Orwain

Artificer, Co. E, 10 Reg't U. S. Col'd H. Art'y.

Appears on

Company Muster Roll

for May & June, 1866.

Present or absent Present

Stoppage, \$ 100 for

Due Gov't, \$ 100 for

Valuation of horse, \$ 100

Valuation of horse equipments, \$ 100

Remarks: Appointed artificer May 1st 1866.

Book mark:

Hart

Copyist.

0

10 H. Art'y. U.S.C.T.

Joseph Orwait

Artificer, Co. E, 10 Reg't U. S. Col'd H. Art'y.

Appears on

Company Muster Roll

for July 2 Aug, 1866.

Present or absent Present

Stoppage, \$ 100 for

Due Gov't, \$ 100 for

Valuation of horse, \$ 100

Valuation of horse equipments, \$ 100

Remarks:

Book mark:

Wash

Copyist.

O

10 H. Art'y. U.S.C.T.

Joseph Orwait
Artificer, Co. E, 10 Reg't U. S. Col'd H. Art'y.

Appears on

Company Muster Roll

for *Sept. & Oct.*, 186 *6*.

Present or absent *Present*

Stoppage, \$ *100* for

Due Gov't, \$ *100* for

Valuation of horse, \$ *100*

Valuation of horse equipments, \$ *100*

Remarks:

Book mark: *100 100*

(358)

O. Hagan

Copyist.

A

10 H. Art'y. | U.S.C.T.

Joseph O'wait
Artif Co. E, 10 Reg't U. S. Col'd H. Art'y.

Appears on

Company Muster Roll

for *Nov. & Dec.*, 1866.

Present or absent *Present*

Stoppage, \$ *100* for

Due Gov't, \$ *100* for

Valuation of horse, \$ *100*

Valuation of horse equipments, \$ *100*

Remarks:

Book mark:

O'Hagan

Copyist.

Joseph Orwait
Artif., Co. *E*, 10 Reg't U. S. Col'd H. Art'y.

Appears on Co. Muster-out Roll, dated
Baton Rouge, La Feb 22, 1867.
Muster-out to date *Feb 22*, 1867.
Last paid to *Dec 31*, 1866.

Clothing account:

Last settled....., 186 ; drawn since \$.....100
Due soldier \$ *78 29*/₁₀₀; due U. S. \$.....100
Am't for cloth'g in kind or money adv'd \$.....100

Due U. S. for arms, equipments, &c., \$ *6. 14*/₁₀₀
Act of July 26. '66
Bounty paid \$.....100; due \$ *300*/₁₀₀

Remarks: *Joined org. organ.*
Appointed Artificer May
1, 1866

Book mark :

O'Hagan
Copyist.

10 U.S. Col'd H. Arty

Private

Private

CARD NUMBERS.

1	5497638.	26
2	5497882.	27
3	5498037.	28
4		29
5		30
6		31
7		32
8		33
9		34
10		35
11		36
12		37
13		38
14		39
15		40
16		41
17		42
18		43
19		44
20		45
21		46
22		47
23		48
24		49
25		50

Book Mark *A-33-Rec. 67.*

See also

0 | 10 H. Art'y. | U.S.C.T.

Renn Orutt

Pvt, Co. C, 1 Reg't H. Art'y, Corps d'Afrique.*

Age *28* years.

Appears on

Company Muster-in Roll

of the organization named above. Roll dated

New Orleans La, *Aug 17*, 186*3*.

Muster-in to date *Aug 17*, 186*3*.

Joined for duty and enrolled:

When *June 27*, 186*3*.

Where *Camp Parapet La*

Period *3* years.

Valuation of horse, \$.....100

Valuation of horse equipments, \$.....100

Remarks:.....
.....
.....

* This organization subsequently became Co. C, 10 Reg't U. S. Colored Heavy Artillery.

Book mark:.....
.....

(356)

W. S. Freeman

Copyist.

Bonn Orutt

Pvt, Co, C, 1 Reg't La. Art'y Native Guards.*

Appears on

Company Muster Roll

for *Aug 11th to 31st*, 1863.

Present or absent *Present*

Stoppage, \$ *100* for

Due Gov't, \$ *100* for

Valuation of horse, \$ *100*

Valuation of horse equipments, \$ *100*

Remarks :

* This organization subsequently became Co. C, 10 Reg't U. S. Col'd Heavy Artillery.

Book mark :

W. J. ...

O | 10 H. Art'y. | U.S.C.T.

John Orritt

Plt, Co, C, 1 Reg't La. Art'y Native Guards.*

Appears on

Company Muster Roll

for *Sep & Oct*, 186*3*.

Present or absent *Present*

Stoppage, \$ *100* for

Due Gov't, \$ *100* for

Valuation of horse, \$ *100*

Valuation of horse equipments, \$ *100*

Remarks:

not borne on sub-rolls of Co.

* This organization subsequently became Co. C, 10 Reg't U. S. Col'd Heavy Artillery.

Book mark *A-33-RCF. 67*

W. J. ...

6, 10 U.S. Col'd H. Art'y.

Private

CARD NUMBERS.

1	5497639.	26
2	5497883.	27
3	5498038.	28
4		29
5		30
6		31
7		32
8		33
9		34
10		35
11		36
12		37
13		38
14		39
15		40
16		41
17		42
18		43
19		44
20		45
21		46
22		47
23		48
24		49
25		50

Book Marks A-33-Rec't 67.

See also

O | 10 H. Art'y. | U.S.C.T.

Franklin Orrell

Pvt., Co. C, 1 Reg't H. Art'y, Corps d'Afrique.*

Age *36* years.

Appears on

Company Muster-in Roll

of the organization named above. Roll dated

New Orleans La, *Aug 17*, 1863.

Muster-in to date

Aug 17, 1863.

Joined for duty and enrolled:

When *June 27*, 1863.

Where *Camp Parquet La*

Period *3* years.

Valuation of horse, \$ *100*

Valuation of horse equipments, \$ *100*

Remarks:

* This organization subsequently became Co. C, 10 Reg't U. S. Colored Heavy Artillery.

Book mark:

(356)

U.S. Army

Copyist.

O | 10 H. Art'y. | U.S.C.T.

Franklin Cruik
Pt., Co, C, 1 Reg't La. Art'y Native Guards.*

Appears on

Company Muster Roll

for *Aug 11th to 31st*, 1863 .

Present or absent *Present*

Stoppage, \$ 100 for

Due Gov't, \$ 100 for

Valuation of horse, \$ 100

Valuation of horse equipments, \$ 100

Remarks :

* This organization subsequently became Co. C, 10 Reg't U. S. Col'd Heavy Artillery.

Book mark :

(358) *W. J. Sumner* Copyist.

Franklin Orvitt

Pt, Co, C, 1 Reg't La. Art'y Native Guards.*

Appears on

Company Muster Roll

for *Sep + Oct*, 186*3*.

Present or absent *Present*

Stoppage, \$ *100* for

Due Gov't, \$ *100* for

Valuation of horse, \$ *100*

Valuation of horse equipments, \$ *100*

Remarks :

not home on sub rolls

* This organization subsequently became Co. C, 10 Reg't U. S. Col'd Heavy Artillery.

Book mark *A-33-REG. 64*

W. H. ...

10, 10 U.S. Col'd H. Art'y

Private

Private

CARD NUMBERS.

1	5497640	26
2	5497884	27
3	5498039	28
4		29
5		30
6		31
7		32
8		33
9		34
10		35
11		36
12		37
13		38
14		39
15		40
16		41
17		42
18		43
19		44
20		45
21		46
22		47
23		48
24		49
25		50

Book Mark *A-33-RCY. 67.*

See also

Private Joseph Courtt
Co. C, 1 Reg't H. Art'y, Corps d'Afrique.*

Age *32* years.

Appears on

Company Muster-in Roll

of the organization named above. Roll dated

New Orleans La, Aug 17, 1863.

Muster-in to date *Aug 17, 1863.*

Joined for duty and enrolled:

When *June 27, 1863.*

Where *Camp Parapet La*

Period *3* years.

Valuation of horse, \$ *100*

Valuation of horse equipments, \$ *100*

Remarks:

* This organization subsequently became Co. C, 10 Reg't U. S. Colored Heavy Artillery.

Book mark:

(356) *W. J. ...* Copyist.

Joseph Orutt
Pvt., Co, C, 1 Reg't La. Art'y Native Guards.*

Appears on

Company Muster Roll

for *Aug 11th to 31st*, 1863 .

Present or absent *Present*

Stoppage, \$ 100 for

Due Gov't, \$ 100 for

Valuation of horse, \$ 100

Valuation of horse equipments, \$ 100

Remarks :

* This organization subsequently became Co. C, 10 Reg't U. S. Col'd Heavy Artillery.

Book mark :

W. J. [Signature]

Joseph Orvitt
Pvt, Co, C, 1 Reg't La. Art'y Native Guards.*

Appears on

Company Muster Roll

for *Sep & Oct*, 1863.

Present or absent *Present*

Stoppage, \$ 100 for

Due Gov't, \$ 100 for

Valuation of horse, \$ 100

Valuation of horse equipments, \$ 100

Remarks:

Not home on sub rolls of Co.

* This organization subsequently became Co. C, 10 Reg't U. S. Col'd Heavy Artillery.

Book mark *A-33-RCY 67*

10 U.S. Col'd H. Art'y

Private | Private

CARD NUMBERS.

1	5497641	26
2	5497885	27
3	5497931	28
4		29
5		30
6		31
7		32
8		33
9		34
10		35
11		36
12		37
13		38
14		39
15		40
16		41
17		42
18		43
19		44
20		45
21		46
22		47
23		48
24		49
25		50

Book Mark *A-33-Rec'y 64*

See also

Q | 10 H. Art'y. | U.S.C.T.

William Osbourne

Pvt, Co. C, 1 Reg't H. Art'y, Corps d'Afrique.*

Age *20* years.

Appears on

Company Muster-in Roll

of the organization named above. Roll dated

New Orleans La, Aug 17, 1863.

Muster-in to date

Aug 17, 1863.

Joined for duty and enrolled:

When *July 1, 1863.*

Where *Camp Parapet La*

Period *3* years.

Valuation of horse, \$ *100*

Valuation of horse equipments, \$ *100*

Remarks:

* This organization subsequently became Co. C, 10 Reg't U. S. Colored Heavy Artillery.

Book mark:

(356)

Wm Osbourne

Copyist.

O | 10 H. Art'y. | U.S.C.T.

William Osborne

Bt, Co, C, 1 Reg't La. Art'y Native Guards.*

Appears on

Company Muster Roll

for *Aug 11th to 31st*, 1863 .

Present or absent *Present*

Stoppage, \$ 100 for

Due Gov't, \$ 100 for

Valuation of horse, \$ 100

Valuation of horse equipments, \$ 100

Remarks :

* This organization subsequently became Co. C, 10 Reg't U. S. Col'd Heavy Artillery.

Book mark : -----

Uffelman

O | 10 H. Art'y. | U.S.C.T.

William Osborn

Sgt, Co, C, 1 Reg't La. Art'y Native Guards.*

Appears on

Company Muster Roll

for *Sep^{and} Oct*, 186*3*.

Present or absent *absent*

Stoppage, \$ *100* for

Due Gov't, \$ *100* for

Valuation of horse, \$ *100*

Valuation of horse equipments, \$ *100*

Remarks: *absent Sick in Hos-
pital at New Orleans*

not come on sub. Rolls of Co.

* This organization subsequently became Co. C, 10 Reg't U. S. Col'd Heavy Artillery.

Book mark: *A 33-R.C.T. 69.*

eyfeman

10 U.S. COY. ILL. ARTY.

Private | Private

CARD NUMBERS.

1	5379790.	26
2	5509942.	27
3	5510090.	28
4	5510240.	29
5	5510390.	30
6	5510538.	31
7	5510712.	32
8	5511148.	33
9	5489950.	34
10	40746773	35
11		36
12		37
13		38
14		39
15		40
16		41
17		42
18		43
19		44
20		45
21		46
22		47
23		48
24		49
25		50

Book Mark:

See also

Gaynes

S. 1197597 P.O. number

A 2057583 P.O. number

S-2914558 - Audited

P.O. number, 6/15/1961, 8.17.1961

Q | 10 H. Art'y. | U.S.C.T.

Alfred Otis

Pvt, Co. H, 10 Reg't U. S. Col'd H. Art'y

Appears on

Company Muster Roll

for *March & April*, 1865.

Present or absent *Present*

Stoppage, \$ *100* for

Due Gov't, \$ *100* for

Valuation of horse, \$ *100*

Valuation of horse equipments. \$ *100*

Remarks: *Commencement of first payment by time April 3rd 1865.*

(D^d after 4th in April 3/65 present Orleans 1st)

Book mark:

Permynter
(858) Copyist.

Q | 10 H. Art'y. | U.S.C.T.

Alfred Otis

Pvt, Co. H, 10 Reg't U. S. Col'd H. Art'y

Appears on

Company Muster Roll

for *May & June*, 1865.

Present or absent *Present*

Stoppage, \$ *100* for

Due Gov't, \$ *100* for

Valuation of horse, \$ *100*

Valuation of horse equipments. \$ *100*

Remarks :

Book mark :

Pennington
(858) Copyst.

O | 10 H. Art'y. | U.S.C.T.

Alfred Otis

Prvt, Co. H, 10 Reg't U. S. Col'd H. Art'y

Appears on

Company Muster Roll

for July & Aug, 1865.

Present or absent Present

Stoppage, \$ 100 for

Due Gov't, \$ 100 for

Valuation of horse, \$ 100

Valuation of horse equipments, \$ 100

Remarks:

Book mark:

(358)

Permyington

Copyist.

O

10 H. Art'y. U.S.C.T.

Alfred Otis

Priv., Co. H, 10 Reg't U. S. Col'd H. Art'y

Appears on

Company Muster Roll

for Sep & Oct, 1865

Present or absent Present

Stoppage, \$ 100 for

Due Gov't, \$ 100 for

Valuation of horse, \$ 100

Valuation of horse equipments. \$ 100

Remarks:

Book mark:

Samuel
copyist.

O

10 H. Art'y. | U.S.C.T.

Alfred Otis

Priv., Co. H, 10 Reg't U. S. Col'd H. Art'y

Appears on

Company Muster Roll

for *Nov + Dec*, 1865.

Present or absent *Present*

Stoppage, \$ 100 for

Due Gov't, \$ 100 for

Valuation of horse, \$ 100

Valuation of horse equipments. \$ 100

Remarks :

Book mark :

Emma P

(858)

Copyist.

O | 10 H. Art'y. | U.S.C.T.

Alfred Otis

Priv., Co. H, 10 Reg't U. S. Col'd H. Art'y

Appears on

Company Muster Roll

for *Jan & Feb.*, 186*6*.

Present or absent *Present*

Stoppage, \$ *100* for

Due Gov't, \$ *100* for

Valuation of horse, \$ *100*

Valuation of horse equipments. \$ *100*

Remarks: *Stoppage for loss
of ordnance & tents*

Book mark: *1000*

Gammack

O

10 H. Art'y. | U.S.C.T.

Alfred Otis

Priv., Co. H, 10 Reg't U. S. Col'd H. Art'y

Appears on

Company Muster Roll

for Mch & Apl, 1866.

Present or absent

Stoppage, \$ 100 for

Due Gov't, \$ 100 for

Valuation of horse, \$ 100

Valuation of horse equipments. \$ 100

Remarks: Mustered out by reason of expiration of term of service to date April 2, 1866

Book mark:

Samuel R

(858)

Copyist.

0

10 H. Art'y. U.S.C.T.

Alfred Otis
Priv, Co A, 10 Reg't U. S. Col'd H. Art'y.

Appears on Returns as follows:

Apr 1865 Gain Apr 15/65 New Orleans
Recruit from Depot

Apr 1866 Loss Apr 7/66 New Orleans
dischgd expiration of term of
service

Book mark :

(546)

J. H. Anderson

Copyist.

O. ¹⁰ *Hy Arty* U.S.C.T.

Alfred Otis

Pvt., Co. *H.*, ¹⁰ Reg't U. S. Col'd *Arty*

Appears on a

Detachment Muster-out Roll

of the organization named above. Roll dated

New Orleans, La. Apr. 2, 1866.

Muster-out to date

Apr. 2, 1866.
Dec. 31, 1865

Clothing account:

Last settled _____, 1866 ; drawn since \$ _____ 100

Due soldier \$ *25-73* / 100 ; due U. S. \$ _____ 100

Am't for cloth'g in kind or money adv'd \$ _____ 100

Due U. S. for arms, equipments, &c., \$ _____ 100

Bounty paid \$ _____ 100 due \$ _____ 100

Remarks: *Joined, as shown.*

Book mark:

A. W. Reed,

C

10 H. Art'y. U.S.C.T.

Alfred Otis
Pvt., Co. H, 10 Reg't U. S. Col'd H. Art'y.

Appears on Co. Muster-out Roll, dated
Baton Rouge, La., Feb. 22, 1867.

Muster-out to date _____, 186 .

Last paid to _____, 186 .

Clothing account:

Last settled _____, 186 ; drawn since \$ _____ 100

Due soldier \$ _____ 100 ; due U. S. \$ _____ 100

Am't for cloth'g in kind or money adv'd \$ _____ 100

Due U. S. for arms, equipments, &c., \$ _____ 100

Bounty paid \$ _____ 100 ; due \$ _____ 100

Remarks: *joined by assignment
Mustered out exp. of term
of service Apr 2/86.*

Book mark : _____

(361)

Lowry

Copyist.

10 U.S. Col'd H. Art'y

Private

Private

CARD NUMBERS.

1	5486959.	26
2	5507170.	27
3	5507249.	28
4	5507291.	29
5	5507331.	30
6	5507446.	31
7	5507592.	32
8	5507738.	33
9	5507876.	34
10	5508016.	35
11	5508155.	36
12	5508287.	37
13	5508435.	38
14	5508583.	39
15	5508736.	40
16	5508883.	41
17	5509029.	42
18	5509151.	43
19	5509298.	44
20	5509406.	45
21		46
22		47
23		48
24		49
25		50

Book Mark:

See also:

0

10 H. Art'y.

U.S.C.T.

Franklin Owail

Appears with rank of *Private* on

Muster and Descriptive Roll of a Detachment of U. S. Vols. forwarded

for the *10* Reg't ^(H. A. C. A.) *M. S. C. H. A.* Roll dated

New Orleans La, Apr 3, 1864.

Where born *Iberville La*

Age *45* y'rs; occupation *Laborer*

When enlisted *Mch. 7, 1864.*

Where enlisted *New Orleans*

For what period enlisted *3* years.

Eyes *Black*; hair *Black*

Complexion *Black*; height *5* ft. *2 1/2* in.

When mustered in *Apr. 3, 1864.*

Where mustered in *New Orleans*

Bounty paid \$ *100*; due \$ *100*

Where credited

Company to which assigned *G*

Remarks:

Book mark:

Galligan

(839)

Copyist.

Franklin Owait

Priv., Co. G., 7 Reg't U. S. Col'd H. Art'y.*

Appears on

Company Muster Roll

for From enrollment to April 20, 1864.

Present or absent Present

Stoppage, \$ 100 for

Due Gov't, \$ 100 for

Valuation of horse, \$ 100

Valuation of horse equipments, \$ 100

Remarks:

* This organization subsequently became Co. , 10 Reg't U. S. Colored Heavy Artillery.

Book mark:

E. H. Brown

Franklin Owait

Pot, Co. D, 7 Reg't U. S. Col'd H. Art'y.*

Appears on

Company Muster Roll

for May & June, 1864.

Present or absent Present

Stoppage, \$ 100 for

Due Gov't, \$ 100 for

Valuation of horse, \$ 100

Valuation of horse equipments, \$ 100

Remarks:

* This organization subsequently became Co. , 10 Reg't U. S. Colored Heavy Artillery.

Book mark:

E. H. Brown

0

10 H. Art'y. U.S.C.T.

Franklin Owait

Cot., Co. G, 10 Reg't U. S. Col'd H. Art'y.

Appears on

Company Muster Roll

for July & Aug, 1864

Present or absent Present

Stoppage, \$ 100 for

Due Gov't, \$ 100 for

Valuation of horse, \$ 100

Valuation of horse equipments, \$ 100

Remarks:

Book mark:

EMB wmw

O | 10. H. arty. | U. S. C. T.

Franklin Owait

Appears with rank of *Priv* on

Muster and Descriptive Roll of a Detachment of U. S. Vols. forwarded

Organized as Co G.

~~for the~~ 10. Reg't U. S. Col'd *H. A.*: Roll dated

New Orleans La, Sept. 20, 1864.

Where born *Acerville La*

Age *45* y'rs; occupation *Laborer*

When enlisted *March 7.*, 1864.

Where enlisted *New Orleans La*

For what period enlisted *3* years.

Eyes *Blue*; hair *Blue*

Complexion *Blue*; height *5 ft. 2 1/2 in.*

When mustered in *April 3*, 1864.

Where mustered in *New Orleans La*

Bounty paid \$ *100*; due \$ *100*

Where credited *to New Orleans La*

Company to which assigned *G.*

Remarks:

Book mark:

C. B. Thompson
Copyist.

0

10 H. Art'y. U.S.C.T.

Franklin Oviatt

Pvt., Co. G, 10 Reg't U. S. Col'd H. Art'y.

Appears on

Company Muster Roll

for Sept. & Oct., 1864.

Present or absent Absent

Stoppage, \$ 100 for

Due Gov't, \$ 100 for

Valuation of horse, \$ 100

Valuation of horse equipments, \$ 100

Remarks: Absent guard on Steamer Red Chief \$ 6. pr mo. due from date of enlistment to April 30/64. \$ 9 pr mo. due from April 30 to June 30th 1864

Book mark:

E. T. Brown

0

10 H. Art'y. | U.S.C.T.

Franklin Owait

Pvt, Co. G, 10 Reg't U. S. Col'd H. Art'y.

Appears on

Company Muster Roll

for Nov & Dec, 1864.

Present or absent Present

Stoppage, \$ 100 for

Due Gov't, \$ 100 for

Valuation of horse, \$ 100

Valuation of horse equipments, \$ 100

Remarks: Has recd but \$ 7. per month

Book mark:

E. H. Brown

0

10 H. Art'y. U.S.C.T.

Franklin Orvait

Prov., Co. G, 10 Reg't U. S. Col'd H. Art'y.

Appears on

Company Muster Roll

for Jan + July, 1865.

Present or absent Present

Stoppage, \$ 100 for

Due Gov't, \$ 100 for

Valuation of horse, \$ 100

Valuation of horse equipments, \$ 100

Remarks: Rec'd but \$ 7 for
Mo from Enrollment
to June - 30/64

Book mark:

F. E. Porter

0

10 H. Art'y. | U.S.C.T.

Franklin Orwait

Prob, Co. G, 10 Reg't U. S. Col'd H. Art'y.

Appears on

Company Muster Roll

for *Mar & April*, 1865.

Present or absent *Present*

Stoppage, \$ *100* for

Due Gov't, \$ *100* for

Valuation of horse, \$ *100*

Valuation of horse equipments, \$ *100*

Remarks: *Received but \$7 per
Mo from Enrollment
to June 30/64*

Book mark:

J. E. Porter

Q

10 H. Art'y. | U.S.C.T.

Franklin Await

Prob, Co. G, 10 Reg't U. S. Col'd H. Art'y.

Appears on

Company Muster Roll

for May & June, 1865.

Present or absent Present

Stoppage, \$ 100 for

Due Gov't, \$ 100 for

Valuation of horse, \$ 100

Valuation of horse equipments, \$ 100

Remarks: Received but \$ 7 per
Mo from Enrollment
to June 30/65

Book mark:

J. E. Porter

0

10 H. Art'y. U.S.C.T.

Franklin Owait

Prov, Co. G, 10 Reg't U. S. Col'd H. Art'y.

Appears on

Company Muster Roll

for July & Aug, 1865.

Present or absent Present

Stoppage, \$ 100 for

Due Gov't, \$ 05/100 for B & G Equip

age lost or destroyed

Valuation of horse, \$ 100

Valuation of horse equipments, \$ 100

Remarks:

Book mark:

F. E. Porter

Q

10 H. Art'y. U.S.C.T.

Franklin Await

Prov, Co. G, 10 Reg't U. S. Col'd H. Art'y.

Appears on

Company Muster Roll

for Sept & Oct, 1865.

Present or absent Present

Stoppage, \$ 100 for

Due Gov't, \$ 100 for

Valuation of horse, \$ 100

Valuation of horse equipments, \$ 100

Remarks:

Book mark:

J. E. Porter

C

10 H. Art'y. | U.S.C.T.

Franklin Quait
Capt, Co. G, 10 Reg't U. S. Col'd H. Art'y.

Appears on

Company Muster Roll

for *Nov. 4 Dec.*, 186*4*.

Present or absent *Present*

Stoppage, \$ 100 for

Due Gov't, \$ 100 for

Valuation of horse, \$ 100

Valuation of horse equipments, \$ 100

Remarks:

Book mark:

(358)

G. F. M.
Copyist.

0

10 H. Art'y. U.S.C.T.

Franklin Owait
Qut, Co. G, 10 Reg't U. S. Col'd H. Art'y.

Appears on

Company Muster Roll

for *Jan & Feb*, 1866.

Present or absent *Present*

Stoppage, \$ *100* for

Due Gov't, \$ *100* for

Valuation of horse, \$ *100*

Valuation of horse equipments, \$ *100*

Remarks:

Book mark:

E. J. M.

0

10 H. Art'y. U.S.C.T.

Franklin Quait
Priv., Co. G, 10 Reg't U. S. Col'd H. Art'y.

Appears on

Company Muster Roll

for Mar 9 Apr., 1866.

Present or absent Present

Stoppage, \$ 95/100 for C.C. & G.E

Lat

Due Gov't, \$ 100 for

Valuation of horse, \$ 100

Valuation of horse equipments, \$ 100

Remarks:

Book mark:

G. Fox

0

10 H. Art'y.

U.S.C.T.

Franklin O'Neil
Prvt, Co. G, 10 Reg't U. S. Col'd H. Art'y.

Appears on

Company Muster Roll

for *May + June*, 1866.

Present or absent *Present*

Stoppage, \$ 100 for

Due Gov't, \$ 100 for

Valuation of horse, \$ 100

Valuation of horse equipments, \$ 100

Remarks:

Book mark:

G. J. W.

(358)

Copyist.

0

10 H. Art'y.

U.S.C.T.

Franklin Orwait
Prst, Co. G, 10 Reg't U. S. Col'd H. Art'y.

Appears on

Company Muster Roll

for *July & Aug*, 1860.

Present or absent *Present*

Stoppage, \$ 100 for

Due Gov't, \$ 100 for

Valuation of horse, \$ 100

Valuation of horse equipments, \$ 100

Remarks:

Book mark:

(358)

G. F. M.
Copyist.

C

10 H. Art'y.

U.S.C.T.

Franklin Orwait

Pr, Co. G, 10 Reg't U. S. Col'd H. Art'y.

Appears on

Company Muster Roll

for *Sept & Oct*, 1866.

Present or absent *Present*

Stoppage, \$ 100 for

Due Gov't, \$ 100 for

Valuation of horse, \$ 100

Valuation of horse equipments, \$ 100

Remarks: *On A. D. as Company*
Co. G

Book mark:

Wines

O. | 10 H. Art'y. | U.S.C.T.

Franklin Cwait

Pvt, Co. G, 10 Reg't U. S. Col'd H. Art'y.

Appears on

Company Muster Roll

for *Nov & Dec*, 186*6*.

Present or absent *Present*

Stoppage, \$ *100* for

Due Gov't, \$ *100* for

Valuation of horse, \$ *100*

Valuation of horse equipments, \$ *100*

Remarks: *On daily duty as
Company Cook*

Book mark: *100*

Wines

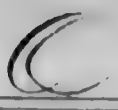

Franklin Arwait

Pvt, Co. *G*, 10 Reg't U. S. Col'd H. Art'y.

Appears on **Co. Muster-out Roll**, dated

Baton Rouge La, Feb 22, 1867.

Muster-out to date

Feb 22, 1867.

Last paid to

Dec 31, 1866.

Clothing account:

Last settled....., 186 ; drawn since \$.....¹⁰⁰

Due soldier \$ *82*^{*53*}/₁₀₀; due U. S. \$.....¹⁰⁰

Am't for cloth'g in kind or money adv'd \$.....¹⁰⁰

Due U. S. for arms, equipments, &c., \$.....⁶/₁₀₀

Bounty paid \$.....¹⁰⁰; due \$ *300*^{*00*}/₁₀₀

Remarks: *Joined at Org^l, Org²*

Book mark:

Ulines

10 U.S. Col'd H. Am.

Private | *Private*

CARD NUMBERS.

Reference Envelope

- 1
- 2
- 3
- 4
- 5
- 6
- 7
- 8
- 9
- 10
- 11
- 12
- 13
- 14
- 15
- 16
- 17
- 18
- 19
- 20
- 21
- 22
- 23
- 24
- 25

- 26
- 27
- 28
- 29
- 30
- 31
- 32
- 33
- 34
- 35
- 36
- 37
- 38
- 39
- 40
- 41
- 42
- 43
- 44
- 45
- 46
- 47
- 48
- 49
- 50

Book Mark:

See also *77 U.S. Col'd H. Am.*

J. J. Mann
No. 8, 10 U.S. Col'd H. Art's

Private | *Private*

CARD NUMBERS.

1	5488605	26
2	5503609	27
3	5503757	28
4	5503953	29
5	5504641	30
6	R & P 388799	31
7		32
8		33
9		34
10		35
11		36
12		37
13		38
14		39
15		40
16		41
17		42
18		43
19		44
20		45
21		46
22		47
23		48
24		49
25		50

Book Mark: *R & P 388799*

See also *74 use, Inf*

19
Hayden
4

Rep 388799-

A. 1090724 Aud. N. L.

A. 1123315 P. O. M. M.

S 1230924 Aud. N. L.

0

1st. U. S. C. T.

Frank Osby
Pt., Co., 10 Reg't U. S. Col'd St. Arky.

Appears on

M. and D. Roll of Men Transferred

to the organization named above,

from Co. "A" 7th U.S. Inf.

Roll dated New Orleans, La., Oct. 11, 1865

When enlisted April 1, 1864

Period for which enlisted 3 years.

When mustered in April 29, 1864

Present or absent

Company to which assigned

Remarks: Joined as recruit
Co. "B" 20 Inf. led a.
(9) U.S. Inf. Trans?
to Co. "A" 7th U.S. Inf.
July 20 '64 per G. O.
No. 17. Signal Mil. Div.
of West Ohio.

Book mark: R. O. 388799

(342)

J. W. Jones, Jr.
Copyist.

Frank Oxley

Pvt, Co. E, 10 Reg't U. S. Col'd H. Art'y.

Appears on

Company Muster Roll

for Nov & Dec, 1865.

Present or absent Present

Stoppage, \$ 100 for

Due Gov't, \$ 100 for

Valuation of horse, \$ 100

Valuation of horse equipments, \$ 100

Remarks: Transferred from 74th U.S.C. I. to 10th U.S.C.A. Regt, per S.O. 84 Hd Qrs Dept of La Oct 11-1865.

Book mark:

Hark Copyist.

0

10 H. Art'y. U.S.C.T.

Frank Oxley

Pvt, Co. E, 10 Reg't U. S. Col'd H. Art'y.

Appears on

Company Muster Roll

for Jan & Feb, 1866

Present or absent Present

Stoppage, \$ 100 for

Due Gov't, \$ 100 for

Valuation of horse, \$ 100

Valuation of horse equipments, \$ 100

Remarks:

Book mark:

Hart

Copyist.

(358)

0

10 H. Art'y. U.S.C.T.

Frank Oxley

Pvt, Co. E, 10 Reg't U. S. Col'd H. Art'y.

Appears on

Company Muster Roll

for March & April, 1866.

Present or absent

Stoppage, \$ 100 for

Due Gov't, \$ 100 for

Valuation of horse, \$ 100

Valuation of horse equipments, \$ 100

Remarks: Deserted at Port Hudson
La March 6-1866.

Book mark:

Mark

Copyist.

(358)

O | *10 N. Arty.* | **U.S.C.T.**

Frank Orley
Port, Co. *E*, *10* Reg't U. S. Col'd *N. Arty.*

Appears on **Co. Muster-out Roll**, dated
Baton Rouge, La, Feb. 22, 186*7*.

Muster-out to date _____, 186 .

Last paid to *Dec. 31*, 1865 .

Clothing account:

Last settled _____, 186 ; drawn since \$ _____ 100

Due soldier \$ _____ 100; due U. S. \$ _____ 100

Am't for cloth'g in kind or money adv'd \$ _____ 100

Due U. S. for arms, equipments, &c., \$ _____ 100

Bounty paid \$ _____ 100; due \$ _____ 100

Remarks: *Joined by transfer*
from 74 U.S. C. I. per
L. O. 811 N. Arty. Dept. of
La. Oct. 11, 1865. Deserted
from company at Port
Hudson La. Mch. 6, 186 ?

Book mark: _____

O'Hagan

O. 10 N. A. U.S.A.

Frank Oxley
Pvt., Co. E, 10 Reg't U.S.A.

NOTATION.

Book mark: R. P. 388799

Record and Pension Office,

WAR DEPARTMENT,

Washington, Sept. 13, 1894.

The charge of desertion of
March 6, 1866

against this man is removed and he is discharged
to date March 6, 1866, under the pro-
visions of the act of Congress, approved March 2, 1889.

Discharge certificate furnished by War Department

Sept. 13, 1894.

A. G. M.

10 U.S. Col'd H. Army

Private

Private

CARD NUMBERS.

1	5487511.	26
2		27
3		28
4		29
5		30
6		31
7		32
8		33
9		34
10		35
11		36
12		37
13		38
14		39
15		40
16		41
17		42
18		43
19		44
20		45
21		46
22		47
23		48
24		49
25		50

Book Mark:

See also Leo H. 77 U.S.C. Sup

P | 10th A. | U.S.C.T.

William Cadon
Co., Co., 10 Reg't U. S. Col'd

Appears on

M. and D. Roll of Men Transferred

to the organization named above,

from Co. H, 10th U.S. Col'd Inf

Roll dated Camp Milledale, 1864.

When enlisted Sept 1, 1864.

Period for which enlisted 9 years.

When mustered in Sept 1, 1864.

Present or absent

Company to which assigned

Remarks: Drafted by name
to Company, Sept 8. 64
Died at C. & G. U. S. Gen
Hosp. New Orleans on
Dec 10. 64 Final state-
ments rendered,
name not taken up on
muster rolls of Regt

Book mark:

Wm Scott

Private
Co G., 10 U.S. Col'd H. Art'y

Private

Private

CARD NUMBERS.

1	5486960	26
2	5507172	27
3	5507250	28
4	5507292	29
5	5507332	30
6	5507447	31
7	5507593	32
8	5507739	33
9	5507877	34
10	5508017	35
11	5508156	36
12	5508289	37
13	5508436	38
14	5508585	39
15	5508737	40
16	5508885	41
17	5509030	42
18	5509150	43
19	5509299	44
20	5509407	45
21		46
22		47
23		48
24		49
25		50

Book Mark:

See also

Richard Paine

Appears with rank of Private on

Muster and Descriptive Roll of a Detachment of U. S. Vols. forwarded

(H. a. c. & a.)
for the 10 Reg't U. S. C. H. A. Roll dated

New Orleans La, Apr. 3, 1864.

Where born Wilmington N. C.

Age 35 y'rs; occupation Farmer

When enlisted Mch. 22 1864.

Where enlisted Alexandria

For what period enlisted 3 years.

Eyes Black; hair Black

Complexion Black; height 5 ft. 3 in.

When mustered in Apr. 3, 1864.

Where mustered in New Orleans

Bounty paid \$ 100; due \$ 100

Where credited

Company to which assigned G

Remarks:

Book mark:

Galligan

P 10. Hart | U. S. C. T.

Richard Paine

Appears with rank of Pvt on

Muster and Descriptive Roll of a Detachment of U. S. Vols. forwarded

Organized at Co G for the 10th Reg't U. S. Col'd H. A. I. Roll dated New Orleans La Sept. 20, 1864.

Where born Wilmington N. C.

Age 35 y'rs; occupation Laborer

When enlisted March 22, 1864.

Where enlisted Alexandria

For what period enlisted 3 years.

Eyes Blue; hair Blue

Complexion Blue; height 5 ft. 3 in.

When mustered in April 3, 1864.

Where mustered in New Orleans La

Bounty paid \$ 100; due \$ 100

Where credited to Alexandria La

Company to which assigned G.

Remarks:

Book mark:

E. B. Thompson

C

10 H. Art'y.

U.S.C.T.

Richard Caine

Co. G, 7 Reg't U. S. Col'd H. Art'y.*

Appears on

Company Muster Roll

for *Term enrollment to April 30*, 1864.

Present or absent *Present*

Stoppage, \$ *100* for

Due Gov't, \$ *100* for

Valuation of horse, \$ *100*

Valuation of horse equipments, \$ *100*

Remarks:

* This organization subsequently became Co. , 10 Reg't U. S. Colored Heavy Artillery.

Book mark: -----

E. H. Brown

P | 10 H. Art'y. | U.S.C.T.

Richard Paine
Pot, Co. G, 7 Reg't U. S. Col'd H. Art'y.*

Appears on

Company Muster Roll

for May & June, 1864.

Present or absent Present

Stoppage, \$ 100 for

Due Gov't, \$ 100 for

Valuation of horse, \$ 100

Valuation of horse equipments, \$ 100

Remarks:

* This organization subsequently became Co. _____, 10 Reg't U. S. Colored Heavy Artillery.

Book mark: _____

(358)

E. H. Brown.

Copyist.

P

10 H. Art'y. U.S.C.T.

Richard Gaine

Cot, Co. G, 10 Reg't U. S. Col'd H. Art'y.

Appears on

Company Muster Roll

for July & Aug, 1864.

Present or absent Present

Stoppage, \$100 for

Due Gov't, \$100 for

Valuation of horse, \$100

Valuation of horse equipments, \$100

Remarks:

Book mark:

C. H. Brown

9

10 H. Art'y. U.S.C.T.

Richard Paine

Pvt., Co. G, 10 Reg't U. S. Col'd H. Art'y.

Appears on

Company Muster Roll

for Sept & Oct, 1864.

Present or absent Absent

Stoppage, \$ 100 for

Due Gov't, \$ 100 for

Valuation of horse, \$ 100

Valuation of horse equipments, \$ 100

Remarks: Absent guard on Steamer Red Chief \$ 6 per mo due from date of enlistment to April 20/64 \$ 9 per mo due from April 20 to June 20/64

Book mark:

E. H. Brown

P

10 H. Art'y.

U.S.C.T.

Richard Paine

Pat., Co. G, 10 Reg't U. S. Col'd H. Art'y.

Appears on

Company Muster Roll

for Nov & Dec, 1864.

Present or absent Present

Stoppage, \$ 100 for

Due Gov't, \$ 100 for

Valuation of horse, \$ 100

Valuation of horse equipments, \$ 100

Remarks: Has rec'd but \$ 7 per month

Book mark:

E. H. Brown

9

10 H. Art'y.

U.S.C.T.

Richard Paine

Prof, Co. G, 10 Reg't U. S. Col'd H. Art'y.

Appears on

Company Muster Roll

for Jan & Feb, 1865.

Present or absent Present

Stoppage, \$ 100 for

Due Gov't, \$ 100 for

Valuation of horse, \$ 100

Valuation of horse equipments, \$ 100

Remarks: Rec'd. but \$ 7 for
Mo from Enrollment
to June 30/65

Book mark:

J. E. Porter

P

10 H. Art'y. U.S.C.T.

Richard Paine

Priv, Co. G, 10 Reg't U. S. Col'd H. Art'y.

Appears on

Company Muster Roll

for Mar + April, 1865.

Present or absent Present

Stoppage, \$ 100 for

Due Gov't, \$ 100 for

Valuation of horse, \$ 100

Valuation of horse equipments, \$ 100

Remarks: Received, but \$ 7 per
Mozum Enrollment
to June 30/64

Book mark:

F. E. Porter

P

10 H. Art'y. U.S.C.T.

Richard Paine

Priv., Co. G, 10 Reg't U. S. Col'd H. Art'y.

Appears on

Company Muster Roll

for May & June, 1863.

Present or absent Present

Stoppage, \$ 100 for

Due Gov't, \$ 100 for

Valuation of horse, \$ 100

Valuation of horse equipments, \$ 100

Remarks: Received but \$ 7 pr. Mo from Enrollment to June 30/63

Book mark:

J. E. Porter

P

10 H. Art'y.

U.S.C.T.

Richard Taine

Prof, Co. G, 10 Reg't U. S. Col'd H. Art'y.

Appears on

Company Muster Roll

for July & Aug, 1865.

Present or absent Present

Stoppage, \$ 100 for

Due Gov't, \$ 05/100 for C + G Equip

- age lost or destroyed

Valuation of horse, \$ 100

Valuation of horse equipments, \$ 100

Remarks:

Book mark:

J. E. Porter

7

10 H. Art'y. U.S.C.T.

Richard Paine

Prov, Co. G, 10 Reg't U. S. Col'd H. Art'y.

Appears on

Company Muster Roll

for Sept + Oct, 1865.

Present or absent Present

Stoppage, \$ 100 for

Due Gov't, \$ 100 for

Valuation of horse, \$ 100

Valuation of horse equipments, \$ 100

Remarks:

Book mark:

J. E. Porter

P

10 H. Art'y. | U.S.C.T.

Richard Daine

Prvt, Co. G, 10 Reg't U. S. Col'd H. Art'y.

Appears on

Company Muster Roll

for *Nov. 9 Dec.*, 186*1*.

Present or absent *Present*

Stoppage, \$.....100 for

Due Gov't, \$.....100 for

Valuation of horse, \$.....100

Valuation of horse equipments, \$.....100

Remarks:

Book mark:

E. F. J.

P

10 H. Art'y. U.S.C.T.

Richard Paine

Priv., Co. G, 10 Reg't U. S. Col'd H. Art'y.

Appears on

Company Muster Roll

for Jan 9 Feb., 1866.

Present or absent Present

Stoppage, \$ 100 for

Due Gov't, \$ 100 for

Valuation of horse, \$ 100

Valuation of horse equipments, \$ 100

Remarks:

Book mark:

G. Fry

(358)

Copyist.

P

10 H. Art'y. U.S.C.T.

Richard Paine
Pvt., Co. G, 10 Reg't U. S. Col'd H. Art'y.

Appears on

Company Muster Roll

for Mar. & Apr., 1864.

Present or absent Present

Stoppage, \$ 1 ⁶⁰/₁₀₀ for C.C. & G.E. lost

Due Gov't, \$ 100 for

Valuation of horse, \$ 100

Valuation of horse equipments, \$ 100

Remarks:

Book mark:

(358)

G. F. W.

Copyist.

P

10 H. Art'y. U.S.C.T.

Richard Paine
Pvt, Co. G, 10 Reg't U. S. Col'd H. Art'y.

Appears on

Company Muster Roll

for May & June, 1866.

Present or absent Present

Stoppage, \$ 100 for

Due Gov't, \$ 100 for

Valuation of horse, \$ 100

Valuation of horse equipments, \$ 100

Remarks:

Book mark:

G. Fry

P

10 H. Art'y. | U.S.C.T.

Richard Cairn

Cpt, Co. G, 10 Reg't U. S. Col'd H. Art'y.

Appears on

Company Muster Roll

for *July & Aug*, 186*6*.

Present or absent *Present*

Stoppage, \$ *100* for

Due Gov't, \$ *100* for

Valuation of horse, \$ *100*

Valuation of horse equipments, \$ *100*

Remarks:

Book mark:

G. Fry

Copyist.

(358)

P

10 H. Art'y. U.S.C.T.

Richard Pain

Pvt, Co. G, 10 Reg't U. S. Col'd H. Art'y.

Appears on

Company Muster Roll

for *Sept & Oct*, 186 *6*

Present or absent *Present*

Stoppage, \$ *100* for

Due Gov't, \$ *100* for

Valuation of horse, \$ *100*

Valuation of horse equipments, \$ *100*

Remarks:

Book mark:

Wirus

P

10 H. Art'y.

U.S.C.T.

Richard Pain

Pvt, Co. G, 10 Reg't U. S. Col'd H. Art'y.

Appears on

Company Muster Roll

for *Nov & Dec*, 1866.

Present or absent *Present*

Stoppage, \$ 100 for

Due Gov't, \$ 100 for

Valuation of horse, \$ 100

Valuation of horse equipments, \$ 100

Remarks:

Book mark:

Wines

P

10 H. Art'y. U.S.C.T.

Richard Paine

PT, Co. G, 10 Reg't U. S. Col'd H. Art'y.

Appears on Co. Muster-out Roll, dated

Baton Rouge, La, Feb. 22, 1867.

Muster-out to date Feb. 22, 1867.

Last paid to Dec 31, 1866.

Clothing account:

Last settled, 186 ; drawn since \$ 100

Due soldier \$ 19 ¹⁸/₁₀₀; due U. S. \$ 100

Am't for cloth'g in kind or money adv'd \$ 100

Due U. S. for arms, equipments, &c., \$ 6 ⁰⁰/₁₀₀

Bounty paid \$ 100; due \$ 300 ⁰⁰/₁₀₀

Remarks: Joined at Arq ¹/₂₁ Arq ²/₂₁

Book mark:

Mines

10 U.S. Col'd H. Art

Private

Private

CARD NUMBERS.

1	5487657	26
2	5488436	27
3	5512310	28
4	5512463	29
5	5512600	30
6	5512746	31
7	5512868	32
8	5512989	33
9	5513089	34
10	5513204	35
11	5513295	36
12		37
13		38
14		39
15		40
16		41
17		42
18		43
19		44
20		45
21		46
22		47
23		48
24		49
25		50

Book Mark:

See also

77 U.S. 6 Inf

P. W. A. | **U.S.C.T.**

Frederick Palmer
Cor., Co. *K*, 10 Reg't U. S. Col'd *H.A.*

Appears on

M. and D. Roll of Men Transferred

to the organization named above,

from *77 U.S. Col Inf*

Roll dated *Camp Sarpanda Okla*, 1865.

When enlisted *May 6*, 1864.

Period for which enlisted *3* years.

When mustered in *May 12*, 1864.

Present or absent *Present*

Company to which assigned *K*

Remarks: *Joined Co at Original Organization*

Book mark :

W. H. Scott

P. W. H. a | **U.S.C.T.**

Frederick Palmer
Priv, Co. *K*, 10 Reg't U. S. Col'd *H. a*

Appears on

M. and D. Roll of Men Transferred

to the organization named above,

from *77 U. S. Col Inf*

Roll dated *Camp Piquette La Oct 1*, 186*5*.

When enlisted *May 6*, 186*4*.

Period for which enlisted *3* years.

When mustered in *May 12*, 186*4*.

Present or absent *Present*

Company to which assigned *K*

Remarks: *Rec'd by transfer*
from Co K. 77 U. S. Col

Book mark : *2481023*

W. H. Scott

P | 10 H. Art'y. | U.S.C.T.

Frederick Palmer

P, Co. K, 10 Reg't U. S. Col'd H. Art'y.

Age years.

Appears on

Company Muster Roll*

for Sept. & Oct., 1865.

Joined for duty and enrolled:

When May 6, 1864.

Where New Orleans La.

Period 3 years

Mustered in:

When May 12, 1864.

Where New Orleans

Present or absent Present-

Stoppage, \$ 100 for

Due Gov't, \$ 100 for

Remarks:

* First current roll. No muster-in roll of this company on file.

Book mark:

(3586)

Hibbard

Copyist.

P

10 H. Art'y.

U.S.C.T.

Frederic Palmer

P

, Co. K, 10 Reg't U. S. Col'd H. Art'y.

Appears on

Company Muster Roll

for Nov. & Dec., 1865.

Present or absent Present

Stoppage, \$ 100 for

Due Gov't, \$ 100 for

Valuation of horse, \$ 100

Valuation of horse equipments, \$ 100

Remarks:

Book mark:

Hibbard

Cpyist.

(358)

P

10 H. Art'y.

U.S.C.T.

Frederic Palmer

P

, Co. K, 10 Reg't U. S. Col'd H. Art'y.

Appears on

Company Muster Roll

for Jan. Feb., 1866.

Present or absent Present

Stoppage, \$ 100 for

Due Gov't, \$ 100 for

Valuation of horse, \$ 100

Valuation of horse equipments, \$ 100

Remarks:

Book mark: 2000

(358)

Hubbard Copyist.

P | 10 H. Art'y. | U.S.C.T.

Frederic Palmer

P, Co. K, 10 Reg't U. S. Col'd H. Art'y.

Appears on

Company Muster Roll

for *Mich. & Apl.*, 1866.

Present or absent *Present*

Stoppage, \$ 100 for

Due Gov't, \$ 100 for

Valuation of horse, \$ 100

Valuation of horse equipments, \$ 100

Remarks:

Book mark:

Hebbard

P

10 H. Art'y.

U.S.C.T.

Frederic Palmer

P

, Co. K, 10 Reg't U. S. Col'd H. Art'y.

Appears on

Company Muster Roll

for May & June, 1866

Present or absent Present-

Stoppage, \$ 100 for

Due Gov't, \$ 100 for

Valuation of horse, \$ 100

Valuation of horse equipments, \$ 100

Remarks:

Book mark:

Hibbard

(358)

Copyist.

P | 10 H. Art'y. | U.S.C.T.

Frederick Palmer

P, Co. K, 10 Reg't U. S. Col'd H. Art'y.

Appears on

Company Muster Roll

for July & Aug., 1866.

Present or absent Present

Stoppage, \$ 100 for

Due Gov't, \$ 100 for

Valuation of horse, \$ 100

Valuation of horse equipments, \$ 100

Remarks:

Book mark:

Hibbard

(358)

Copyist.

P

10 H. Art'y. U.S.C.T.

Frederick Palmer

Pat, Co. K, 10 Reg't U. S. Col'd H. Art'y.

Appears on

Company Muster Roll

for Sept & Oct, 1866.

Present or absent Present.

Stoppage, \$ 100 for

Due Gov't, \$ 100 for

Valuation of horse, \$ 100

Valuation of horse equipments, \$ 100

Remarks:

Book mark:

Floyd

P

10 H. Art'y. U.S.C.T.

Frederick Palmer

Put, Co. K, 10 Reg't U. S. Col'd H. Art'y.

Appears on

Company Muster Roll

for Nov & Dec, 1866

Present or absent Present

Stoppage, \$ 100 for

Due Gov't, \$ 100 for

Valuation of horse, \$ 100

Valuation of horse equipments, \$ 100

Remarks:

Book mark:

Floyd

P

10 H. Art'y. U.S.C.T.

Frederick Palmer

Put, Co. K, 10 Reg't U. S. Col'd H. Art'y.

Appears on Co. Muster-out Roll, dated Baton Rouge La, Feb 22, 1867.

Muster-out to date Feb 22, 1867.

Last paid to Dec 31, 1866.

Clothing account:

Last settled, 186 ; drawn since \$ 100

Due soldier \$ 68 100; due U. S. \$ 100

Am't for cloth'g in kind or money adv'd \$ 100

Due U. S. for arms, equipments, &c., \$ 6 22 100

Bounty paid \$ 100; due \$ 100

Remarks: Rec'd by transfer from Co K 77 U. S. C. I. Oct 1/65. per S. O. No 66 Rodgers Dept, La, S. 1865. \$100. Bounty due under Act of Congress July 26/66. \$100. Bounty due under Act of Congress July 28/66.

Book mark:

Floyd

10 U.S. Col'd H. Army

Private

Private

CARD NUMBERS.

1	5511267	26
2	5511379	27
3	5512155	28
4		29
5		30
6		31
7		32
8		33
9		34
10		35
11		36
12		37
13		38
14		39
15		40
16		41
17		42
18		43
19		44
20		45
21		46
22		47
23		48
24		49
25		50

Book Mark:

See also

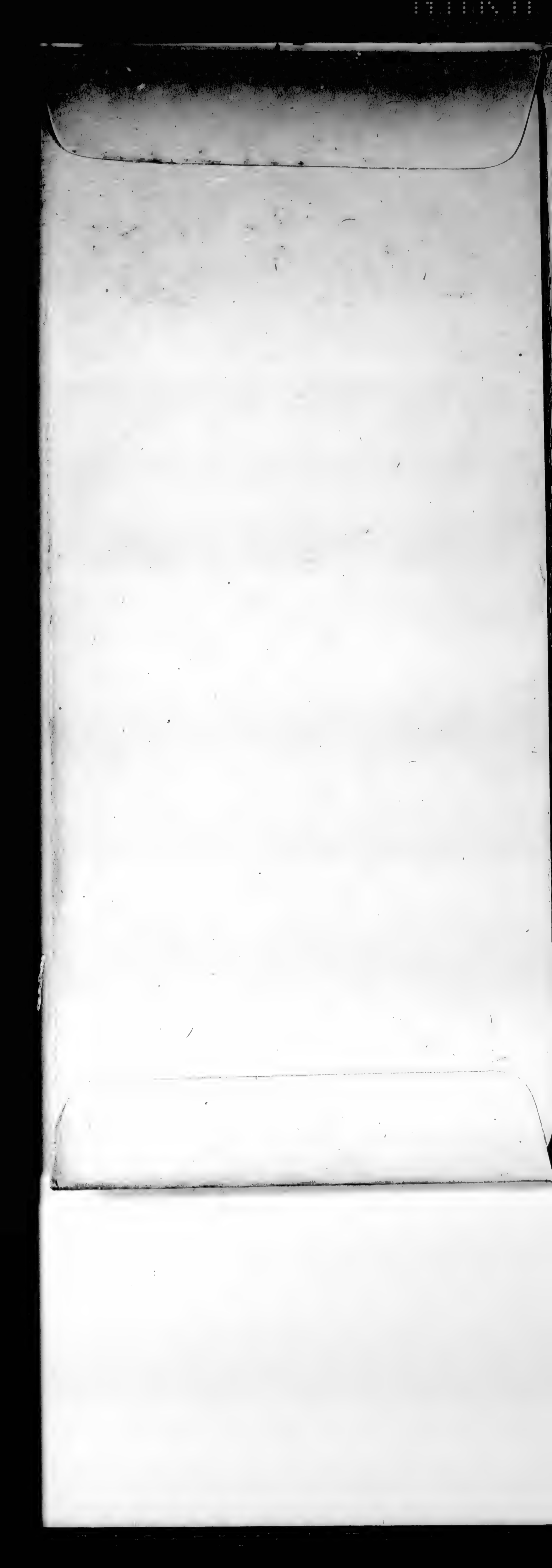

J. 2107989 And. N.S.

S. 2117598 And N.S. (Draft)

J. 2181974 PONTANA

D. 2196664 P.O. RETA

R.P. 721510

P

10 H. Art'y. U.S.C.T.

James Palmer
Pvt, Co. I, 10 Reg't U. S. Col'd H. Art'y.

Age _____ years.

Appears on

Company Muster Roll*

for Enrollment to June 30, 1865.

Joined for duty and enrolled:

When _____, 186 .

Where _____

Period / years.

Mustered in:

When Apr. 26, 1865.

Where New Orleans, La.

Present or absent Not stated.

Stoppage, \$ 100 for

Due Gov't, \$ 100 for

Valuation of horse, \$ 100

Valuation of horse equipments, \$ 100

Remarks: Drafted.

*First current roll. No muster-in roll of this company on file.

Book mark:

(3586)

O. J. Clark Copyist

P

10 H. Art'y.

U.S.C.T.

James Palmer

Prvt., Co. I, 10 Reg't U. S. Col'd H. Art'y.

Appears on

Company Muster Roll

for *July & Aug.*, 1865.

Present or absent

Stoppage, \$ 100 for

Due Gov't, \$ 100 for

Valuation of horse, \$ 100

Valuation of horse equipments, \$ 100

Remarks: *Discharged from
G. d'a Genl Hospital New
Orleans La. on Surgeons
Certificate of Disability
Aug. 7 1865.*

Book mark:

v. s. blank

(358)

Copyist.

James Palmer
Priv. Co. C, 10 Reg't U. S. Col'd H. Art'y.

Appears on **Co. Muster-out Roll**, dated
Baton Rouge La. Feb. 22, 1867 .

Muster-out to date _____, 186 .

Last paid to _____, 186 .

Clothing account:

Last settled _____, 186 ; drawn since \$ _____ 100

Due soldier \$ _____ 100 ; due U. S. \$ _____ 100

Am't for cloth'g in kind or money adv'd \$ _____ 100

Due U. S. for arms, equipments, &c., \$ _____ 100

Bounty paid \$ _____ 100 ; due \$ _____ 100

Remarks: *Discharged Aug of 1865*
from U.S. C. & A. Gen. Hospital
at New Orleans La. on
Surgeon's Certificate of disability
(Age 44 yrs)

Book mark: *C. D.*

(361) *J. M. Vance* Copyist.

Palmer, James

P, Co. I, 10 Reg' U.S.C.H.A.

2 Enclosures.

Bed Cards	Descriptive Lists
Burial Records	Final Statements
Certs. of Dis. for Discharge /	Furloughs
C. M. Charges	Med. Des. Lists
Med. Certificates	Orders

Other papers relating to—

Admission to Hosp'l	Furlough
Casualty Sheet (^{Priv} Officer's) /	Med. Examination
Confinement	Misc. Information /
Contracts	Pay or Clothing
Death or Effects	Personal Reports
Desertions	Rank
Discharge from Hosp'l	Transfer to Hosp'l
Discharge from Service	Transfer to V. R. C.
Duty /	Transportation

MICROFILM PUBLICATION M 1831

COMPILED MILITARY SERVICE RECORDS
OF VOLUNTEER UNION SOLDIERS WHO SERVED WITH
THE UNITED STATES COLORED TROOPS (USCT)
10TH REGIMENT OF HEAVY ARTILLERY

PERSONAL PAPERS' TARGET SHEET

PLEASE NOTE THE CHECKED INFORMATION ABOUT THE PERSONAL PAPERS IN
THIS FILE:

- NO PERSONAL PAPERS WERE FOUND IN THIS FILE WHEN THE
RECORDS WERE ARRANGED FOR MICROFILMING.
- 7 PERSONAL PAPER(S) FOUND IN THIS FILE WHEN THE RECORDS
WERE ARRANGED FOR MICROFILMING.

La 3^e 1922 J. C. H. H. H. H.

S.O. 148 D.G. 1865

Palmer James
10th Heavy

Capt Stone
Will you please
make the detail.
S

1861

James Palmer
10th Heavy
S.O. 148 D.G. 1865

James Palmer
10th Heavy
S.O. 148 D.G. 1865

S.O. May 16, 1865

Recd Rec Des 24 May 18 1865

Board of Education for Freedmen,

Department of the Gulf.

New Orleans, May 13th 1865.

J Schuyler Crosby
St. Louis & N. M.

Hd 2nd Wpt of Sub.

Colonel.

I have the
honor to request that private
James Palmer, 10th Reg. Heavy Art. be
detailed for duty at this office.

Very Respectfully

W. B. Rush. Plunkly

Chairman.

DESCRIPTIVE LIST

OF

Private James Palmer
10th Reg't U.S. A. Co. F

Received at Corps d'Armee General
Hospital June 28th, 1865.

EXTRACT FROM PAR. 1250, REVISED REGULATIONS.

"When a soldier in Hospital is detached from his Company, so as not to be mustered with it for pay, his Company Commander shall certify and send to the Hospital his Descriptive List and Account of Pay and Clothing, containing all necessary information relating to his account with the United States."

Corps d'Armee GENERAL HOSPITAL,
New Orleans La
July 8th, 1865.

SIR:

In accordance with the above extract from General Regulations, I respectfully request you will forward to my address the Descriptive List of the within-named soldier now in this Hospital.

The utmost particularity is required in date of last payment and money value of clothing.

By order of the Surgeon in charge:

J. E. Piquette
Surgeon in Charge

To Commandant Co. "F"

10th Reg't U.S. A.

J. Palmer
10 usata

10th U. S. Col. (Inf.) (New)

Adj. Gts. So. Div of La.

New Orleans July 14th 1865.

L. A. 3774 — 65

Respy referred to Comdg Officer
10th U. S. C. A. (Gey) who will cause
the within descriptive lists to
be properly filled out, and returned
to these Gts as soon as possible.

By Order of

Brevet Maj. Gen. F. W. Sherman

William Sherman

Major & A. A. G.

Corps d'Afrique U. S. General Hospital,

New Orleans, La. July 31st 1865

Commanding Officer:

F Company... *10th* Regiment U. S. Colored *Heavy Artillery*

SIR:

I have the honor to inform you that the following named enlisted men of your command are patients at this U. S. General Hospital.

F. E. PIQUETTE,

Surgeon in charge.

NAMES.	RANK.	CO.	REGIMENT	REMARKS.
<i>James Palmer</i>	<i>Private</i>	<i>F</i>	<i>10th U. S. Col. Art.</i>	

Cur of dis cert for May 7, 66

CASUALTY SHEET

No. _____

James Palmer

Pvt of Company D

10 Regiment of USCAV

State Volunteers.

NATURE OF CASUALTY.

Missing Aug. 3, 1865,

CASUALTY SHEET.

Name: James Palmer

Rank: 1st Lt. Company: I Regiment: 10

Arm: U.S. Army, N. State: _____

Nature of Casualty: _____

CAUSE OF CASUALTY—(NAME OF DISEASE, &c.)

Phthisis Pulmonalis.

DEGREE OF DISABILITY.

BY WHOM CERTIFIED.

Maj. Gen. E. R. Stanby.
Army Dept.

DATE OF DISCHARGE, DEATH, &c.

Aug 3. 1865.

PLACE OF DISCHARGE, DEATH, &c.

BY WHOM DISCHARGED.

FROM WHAT SOURCE THIS INFORMATION WAS OBTAINED.

Tri Mo. Rept. Dept. Louisiana

Augt. 10. 1865.

REMARKS.

Sent to C. D. A. Dept.

A. S. Fall.

Clerk.

NOTE 1.

The company commander will here add a statement of all the facts known to him concerning the disease or wound, or cause of disability of the soldier; the time, place, manner, and all the circumstances under which the injury occurred, or disease originated or appeared; the duty, or service, or situation of the soldier at the time the injury was received or disease contracted, stating particularly whether the injury was received or the disease contracted in the line of his duty; and whatever other facts may aid a judgment as to the cause, immediate or remote, of the disability, and the circumstances attending it.

When the facts are not known to the company commander, the certificate of any officer, or affidavit of other person having such knowledge, will be appended—as the surgeon in charge of a hospital, the officer commanding a detachment of recruits, &c., &c.

NOTE 2.

When a probable case for pension, special care must be taken to state the degree of disability—as 1/2, 3/4, &c., &c.; to describe particularly the disability, wound, or disease; the extent of which it deprives him of the use of any limb or faculty, or affects his health, strength, activity, constitution, or capacity to labor or earn his subsistence. The surgeon will add, from his knowledge of the facts and circumstances, and from the evidence in the case, his professional opinion of the cause or origin of the disability. In the case of discharges by Medical Inspectors, the last paragraph will state that the "discharge was given by consent of the soldier, after a personal examination, and for disability, the nature, degree, and origin of which are correctly described in the within certificate."

Par. 1260 Regulations, Edit. 1861.

Medical officers, in giving certificates of disability, are to take particular care in all cases that have not been under their charge; and especially in epilepsy, convulsions, chronic rheumatism, derangement of the urinary organs, ophthalmia, ulcers, or any obscure disease liable to be feigned or purposely produced; and in no case shall such certificate be given until after sufficient time and examination to detect any attempt at deception.

DIRECTIONS.

This certificate will be made out in duplicate by the soldier's company commander, or other officer commanding the separate detachment to which he belongs, and sent by him to the surgeon who has charge of the hospital where the soldier is sick. The surgeon will then fill out and sign the surgeon's certificate, and forward these papers to the regimental, detachment, or post commander, who will forward them, with his action endorsed thereon, through the proper channel, to his division commander; or, if the troops are not attached to a division, to his corps, department, or other commander or officer to whom the authority to discharge enlisted men may be specially delegated.

These certificates, after having received the action of the highest authority to which they are required to be sent, will be returned through the same channel to the regimental, post, or detachment commander, who will, if the discharge is authorized by the endorsement of the proper authority, sign the soldier's discharge, and the last certificate on this paper; see that the soldier is furnished with the proper final statements in duplicate, and forward BOTH of these certificates direct to the Adjutant General United States Army, at Washington, D. C., there to be filed, under any circumstances to be given.

ADJUTANT GENERAL'S OFFICE

May 29 1860

Duplicate sent the Pension Office

P 473 1865 24
CERTIFICATE OF DISABILITY FOR DISCHARGE

IN THE CASE OF

James Palmer
a Private Co. A

10th Reg't of U.S. Col. (M.A.)
Corps De Afrique U.S. Gen. Hosp.
New Orleans La July 25th 1865
Approved by Board of Examination

F. E. Pyette
President of Board

Approved
M. W. Mahon
Surgeon U.S. Vol
Pres. Board

Med. Dir's Dept. La. & Texas
Med. Director's Office
Approved Aug. 2. 65.
M. W. Alexander
Surgeon U.S. Army
Med. Director

Received (Office) 186
AUG 21 1865
ADJUTANT GEN'L OFFICE
E. J. [Signature]

Ad-q'r's, Dep't of Louisiana and Texas,

New Orleans, La., August 3rd 1865.

To be discharged.

By order of Major General E. R. S. Canby:
E. J. Garrett
Captain and A. D. C.

ARMY OF THE UNITED STATES.

CERTIFICATE

OF DISABILITY FOR DISCHARGE.



Priv. James Palmer, of Captain S. H. Stearns,
 Company, (I) of Fourth Regiment of the United States
Col'd Arty (H) was enlisted by Drafted of
 the Fourth Regiment of New Orleans La
 on the Twenty Sixth day of April, 1865, to serve Three years; he was born
 in New Orleans in the State of Louisiana, is Forty four
 years of age, Five feet 8 1/2 inches high, Blk complexion, Blk eyes,
Blk hair, and by occupation when enlisted a Blacksmith. During the last two
 months said soldier has been unfit for duty 60 days.*

STATION: Corps De Afrique, U.S. Gen Hosp.
 DATE: New Orleans La July 25th 1865.

F. E. Piquette
 Surgeon in Charge
 Commanding Company.

I CERTIFY that I have carefully examined the said James Palmer private
 of Captain George R. Stearns Company, and find him incapable of performing the duties of a
 soldier because of Phthisis Pulmonalis incipient - contracted
prior to enlistment - rendering him unfit for any
branch of military service Degree of disability 0

J. Jackson
Act. Supt. Surgeon. U.S.A.

DISCHARGED, this Seventh day of August, 1865, at Corps De Afrique
U.S. Gen. Hospital New Orleans La.

F. E. Piquette
 Surgeon in Charge
 Commanding the Reg't.

The Soldier desires to be addressed at

Town _____ County _____ State _____

* See Note 1 on the back of this. † See Note 2 on the back of this.

U.S. Col'd H. Art'y

Private.

Private.

CARD NUMBERS.

1	5497748.	26
2	5498148.	27
3	5498249.	28
4	5498346.	29
5	5498445.	30
6	5498567.	31
7	5498708.	32
8	5498847.	33
9	5498983.	34
10	5499124.	35
11	5499260.	36
12	5499396.	37
13	5499531.	38
14	5499668.	39
15	5499802.	40
16	5499937.	41
17	5500067.	42
18	5500202.	43
19	5489272.	44
20	5500328.	45
21	5489288.	46
22	5500477.	47
23	5490171.	48
24		49
25		50

Book Mark:

See also

M J Worey

J

45.

8595016 - Rang

A1313261 - P.O. Mon

A1764076 aud. w.d.

A1917425 Subw

RPO609469

P | 10 H. Art'y. | U.S.C.T.

Sancho Panza
.....
P....., Co. C, 1 Reg't La. Art'y, Native Guards.*

Age *24* years.

Appears on

Company Muster-in Roll

of the organization named above. Roll dated

New Orleans Ga, *Feb 4*, 186*4*.

Muster-in to date *Dec 31*, 186*3*.

Joined for duty and enrolled:

When *Oct 29*, 186*3*.

Where *Perquimans Ga*

Period *3* years.

Valuation of horse, \$.....*100*

Valuation of horse equipments, \$.....*100*

Remarks:.....
.....
.....
.....

* This organization subsequently became Co. C, 10 Reg't U. S. Col'd Heavy Artillery.

Book mark :

(356)

effman

Copyist.

P | 10 H. Art'y. | U.S.C.T.

Sancho Panza

Pt, Co. *C*, 1 Reg't H. Art'y, Corps d'Afrique.*

Appears on

Company Muster Roll

for *Feb 4th to 29th*, 186*4*.

Present or absent *Present*

Stoppage, \$ *100* for

Due Gov't, \$ *100* for

Valuation of horse, \$ *100*

Valuation of horse equipments, \$ *100*

Remarks:

*This organization subsequently became Co. *C*, 10 Reg't U. S. Colored Heavy Artillery.

Book mark: _____

W. J. ...

P | 10 H. Art'y. | U.S.C.T.

Sanchez Pausa
Co. C, 7 Reg't U. S. Col'd H. Art'y.*

Appears on

Company Muster Roll

for *Mich & apl*, 1864.

Present or absent *Present*

Stoppage, \$ 100 for

Due Gov't, \$ 100 for

Valuation of horse, \$ 100

Valuation of horse equipments, \$ 100

Remarks:

* This organization subsequently became Co. , 10 Reg't U. S. Colored Heavy Artillery.

Book mark:

(358)

J. L. ...
Copyist.

P | 10 H. Art'y. | U.S.C.T.

Sancho Panga
Pvt., Co. C, 7 Reg't U. S. Col'd H. Art'y.*

Appears on

Company Muster Roll

for May to June 1864

Present or absent Present

Stoppage, \$ 100 for

Due Gov't, \$ 100 for

Valuation of horse, \$ 100

Valuation of horse equipments, \$ 100

Remarks:

* This organization subsequently became Co. , 10 Reg't U. S. Colored Heavy Artillery.

Book mark: _____

(358) J. Henderson Copyist.

P | 10 H. Art'y. | U.S.C.T.

Sancho Panza
Pvt., Co. G 10 Reg't U. S. Col'd H. Art'y.*

Appears on

Company Muster Roll

for July to Aug, 1864

Present or absent Present

Stoppage, \$ 100 for

Due Gov't, \$ 100 for

Valuation of horse, \$ 100

Valuation of horse equipments, \$ 100

Remarks:

* This organization subsequently became Co. , 10 Reg't U. S. Colored Heavy Artillery.

Book mark:

(358) J. Anderson Copyist.

P | 10 H. Art'y. | U.S.C.T.

Sancho Panza
Pot., Co. C, 10 Reg't U. S. Col'd H. Art'y.

Appears on

Company Muster Roll

for Sept & Oct, 1864

Present or absent Present

Stoppage, \$ 100 for

Due Gov't, \$ 100 for

Valuation of horse, \$ 100

Valuation of horse equipments, \$ 100

Remarks:

Book mark:

(358)

J. Underwood
Copyist.

P | 10 H. Art'y. | U.S.C.T.

Sancho Parry

Prt., Co. C, 10 Reg't U. S. Col'd H. Art'y.

Appears on

Company Muster Roll

for Nov. & Dec., 1864.

Present or absent Present

Stoppage, \$ 100 for

Due Gov't, \$ 100 for

Valuation of horse, \$ 100

Valuation of horse equipments, \$ 100

Remarks:

Book mark:

(358)

J. M. ...
Copyist.

P

10 H. Art'y. U.S.C.T.

Sancho Paury
Pvt, Co. C, 10 Reg't U. S. Col'd H. Art'y.

Appears on

Company Muster Roll

for Jan & Feb, 1865.

Present or absent Present

Stoppage, \$ 100 for

Due Gov't, \$ 100 for

Valuation of horse, \$ 100

Valuation of horse equipments, \$ 100

Remarks:

Book mark:

Dallade

P | 10 H. Art'y. | U.S.C.T.

Sancho Panzy

Pvt., Co. C, 10 Reg't U. S. Col'd H. Art'y.

Appears on

Company Muster Roll

for *March & April*, 186*5*:

Present or absent *Present.*

Stoppage, \$ 100 for

Due Gov't, \$ 100 for

Valuation of horse, \$ 100

Valuation of horse equipments, \$ 100

Remarks:

Book mark:

Lucas.

P

10 H. Art'y. U.S.C.T.

Waucho Panzy
Sgt, Co. C, 10 Reg't U. S. Col'd H. Art'y.

Appears on

Company Muster Roll

for *May & June, 1865.*

Present or absent *Present*

Stoppage, \$ *100* for

Due Gov't, \$ *100* for

Valuation of horse, \$ *100*

Valuation of horse equipments, \$ *100*

Remarks:

Book mark:

(358)

Ballade

Copyist.

P

10 H. Art'y. U.S.C.T.

Baueho Pauza
Sgt., Co. C, 10 Reg't U. S. Col'd H. Art'y.

Appears on

Company Muster Roll

for *July Aug*, 186 *5*

Present or absent *Present*

Stoppage, \$ *100* for

Due Gov't, \$ *100* for

Valuation of horse, \$ *100*

Valuation of horse equipments, \$ *100*

Remarks:

Book mark:

Ballade

P

10 H. Art'y. | U.S.C.T.

Sancho Pauza
Sgt., Co. C, 10 Reg't U. S. Col'd H. Art'y.

Appears on

Company Muster Roll

for *Sept Oct*, 186*5*

Present or absent *Present*

Stoppage, \$ *100* for

Due Gov't, \$ *100* for

Valuation of horse, \$ *100*

Valuation of horse equipments, \$ *100*

Remarks:

Book mark:

Gallade

P

10 H. Art'y. U.S.C.T.

Sancho Panta

Pvt., Co. C, 10 Reg't U. S. Col'd H. Art'y.

Appears on

Company Muster Roll

for Nov. & Dec., 1865.

Present or absent Present.

Stoppage, \$ 100 for

Due Gov't, \$ 100 for

Valuation of horse, \$ 100

Valuation of horse equipments, \$ 100

Remarks:

Book mark:

A. J. Robbins

(358)

Copyist.

P

10 H. Art'y. U.S.C.T.

Sancho Panza
Priv., Co. C, 10 Reg't U. S. Col'd H. Art'y.

Appears on

Company Muster Roll

for Jan. 1 of Feb., 1866.

Present or absent Present.

Stoppage, \$ 100 for

Due Gov't, \$ 100 for

Valuation of horse, \$ 100

Valuation of horse equipments, \$ 100

Remarks:

Book mark:

H. J. Robbins

(358)

Copyist.

P

10 H. Art'y. U.S.C.T.

Sancho Panza

Pvt., Co. C, 10 Reg't U. S. Col'd H. Art'y.

Appears on

Company Muster Roll

for March 2d, 1866.

Present or absent Present.

Stoppage, \$ 100 for

Due Gov't, \$ 100 for

Valuation of horse, \$ 100

Valuation of horse equipments, \$ 100

Remarks:

Book mark:

A. J. Robbins

(358)

Copyist.

P

| 10 H. Art'y. | U.S.C.T.

Sancho Panza

Pvt., Co. C, 10 Reg't U. S. Col'd H. Art'y.

Appears on

Company Muster Roll

for May 21 June, 1864.

Present or absent Present

Stoppage, \$ 100 for

Due Gov't, \$ 100 for

Valuation of horse, \$ 100

Valuation of horse equipments, \$ 100

Remarks:

Book mark:

A. J. Robbins

(358)

Copyist.

P

10 H. Art'y. | U.S.C.T.

Sancho Panza
Plt., Co. C, 10 Reg't U. S. Col'd H. Art'y.

Appears on

Company Muster Roll

for July & Aug., 1866.

Present or absent Present

Stoppage, \$ 100 for

Due Gov't, \$ 100 for

Valuation of horse, \$ 100

Valuation of horse equipments, \$ 100

Remarks:

Book mark:

(358)

A. J. Robbins
Copyist.

P

10 H. Art'y. | U.S.C.T.

Sancho Pantal

Pr., Co. C, 10 Reg't U. S. Col'd H. Art'y.

Appears on

Company Muster Roll

for Sept & Oct, 1866.

Present or absent Absent

Stoppage, \$ 100 for

Due Gov't, \$ 100 for

Valuation of horse, \$ 100

Valuation of horse equipments, \$ 100

Remarks: On det ser with
Ft. Livingston La, per
Co. 15 C.S. Hd Qrs Ft
Livingston

Book mark:

Hanning

(358)

Copyist.

P 110 H A | U.S.C.T.

Lauch Jauza
Priv, Co. *C 10*, Reg't U. S. Col'd *H A*

Appears on a

Detachment Muster Roll

of the organization named above

for *Sept. & Oct.*, 186*6*.

Station *Ft. Linnigstone Pa.*

Present or absent *Present*

Stoppage, \$ 100 for

Due Gov't, \$ 100 for

Valuation of horse, \$ 100

Valuation of horse equipments, \$ 100

Remarks:

Book mark:

Grogan

P

10 H. Art'y. U.S.C.T.

Sancho Pariza

Pvt., Co. C, 10 Reg't U. S. Col'd H. Art'y.

Appears on

Company Muster Roll

for *Nov. 1st*, 186*6*.

Present or absent *Absent*

Stoppage, \$ *100* for

Due Gov't, \$ *100* for

Valuation of horse, \$ *100*

Valuation of horse equipments, \$ *100*

Remarks: *Det serv at Fort
Livingston, La. per
S.O. No 15 C.S. Hd
qrs Fort Livingston*

Book mark:

Hammer
Copyist.

P 10 *Net* | **U.S.C.T.**

Sancho Panga
Priv, Co. *C*, *10* Reg't U. S. Col'd *Net*

Appears on a

Detachment Muster Roll

of the organization named above

for *Nov. & Dec.*, 186*6*.

Station *St. Vincent Is.*

Present or absent *Present*

Stoppage, \$ *100* for

Due Gov't, \$ *100* for

Valuation of horse, \$ *100*

Valuation of horse equipments, \$ *100*

Remarks:

Book mark:

Grogan

P | 10 Arty | U.S.C.T.

Sancho Panza

Priv., Co. C, 10 Reg't U. S. Col'd Arty

Appears on a

Detachment Muster-out Roll

of the organization named above. Roll dated

Baton Rouge, La. Feb. 3, 1867.

Muster-out to date Feb. 3, 1867.

Last paid to Dec. 31, 1866.

Clothing account:

Last settled _____, 186 ; drawn since \$ _____ 100

Due soldier \$ 86 ²⁷/₁₀₀; due U. S. \$ 19 ⁶⁹/₁₀₀

Am't for cloth'g in kind or money adv'd \$ _____ 100

Due U. S. for arms, equipments, &c., \$ _____ ⁰²/₁₀₀

Bounty paid \$ 100 ⁰⁰/₁₀₀ due \$ 100 ⁰⁰/₁₀₀

Remarks: Joined orig. org. 1st A. Col. now 10 U.S. Col'd Arty. Stop for transportation.

Book mark:

R. E. Wilson

P

10 H. Art'y. U.S.C.T.

Sancho Panza

Co. C, 10 Reg't U. S. Col'd H. Art'y.

Appears on **Co. Muster-out Roll**, dated *Baton Rouge, La, Feb 22*, 1867.

Muster-out to date _____, 186 .

Last paid to _____, 186 .

Clothing account:

Last settled _____, 186 ; drawn since \$ _____ 100

Due soldier \$ _____ 100; due U. S. \$ _____ 100

Am't for cloth'g in kind or money adv'd \$ _____ 100

Due U. S. for arms, equipments, &c., \$ _____ 100

Bounty paid \$ _____ 100; due \$ _____ 100

Remarks: *Joined Orig. Co
discharged Feb 3, 1867
by reason of expiration
of term of service*

Book mark : _____

Manning

(361)

Copyist.

Private Private

CARD NUMBERS.

5494243	26
5494395	27
5494553	28
5494710	29
5494865	30
5495017	31
5495173	32
5495327	33
5495479	34
5495629	35
5495768	36
5495938	37
5496075	38
5496225	39
5496379	40
5496526	41
5496666	42
5496810	43
5496969	44
5497141	45
5497456	46
5489689	47
	48
	49
	50

Book Mark:

See also

P | 10 H. Art'y. | U.S.C.T.

Alfred Parker

Pvt, 2 Battery, La. H. Art'y, Native Guards.*

Age *26* years.

Appears on

Company Muster-in Roll

of the organization named above. Roll dated

Camp Parapet, Carrollton, La., Feb. 9, 1863.

Muster-in to date

Feb. 9, 1863.

Joined for duty and enrolled:

When

Dec. 10

, 186*2*.

Where

Camp Parapet nr. Carrollton, La.

Period

3

years.

Valuation of horse, \$.....100

Valuation of horse equipments, \$.....100

Remarks:

* This organization subsequently became Co. B, 10 Reg't U. S. Colored Heavy Artillery.

Book mark:

Leaster

P | 10 H. Art'y. | U.S.C.T.

Alfred Parker

Pvt., Co. B, 1 Reg't La. H. Art'y, Native Guards.*

Appears on

Company Muster Roll

for *Term. Enlistment to Feb. 28*, 186 *J.*

Present or absent *Present*

Stoppage, \$ *100* for

Due Gov't, \$ *100* for

Valuation of horse, \$ *100*

Valuation of horse equipments, \$ *100*

Remarks: _____

*This organization subsequently became Co. B, 10 Reg't U. S. Col'd Heavy Artillery.

Book mark: _____

Feaster

P | 10 H. Art'y. | U.S.C.T.

Alfred Parker
Sgt., Co. B, 1 Reg't La. H. Art'y, Native Guards.*

Appears on

Company Muster Roll

for *March & April*, 186*3*.

Present or absent *Present*

Stoppage, \$ *100* for

Due Gov't, \$ *100* for

Valuation of horse, \$ *100*

Valuation of horse equipments, \$ *100*

Remarks:

*This organization subsequently became Co. B, 10 Reg't U. S. Col'd Heavy Artillery.

Book mark:

Feaster

P

10 H. Art'y.

U.S.C.T.

Alfred Parker
Pvt., Co. B, 1 Reg't La. H. Art'y, Native Guards.*

Appears on

Company Muster Roll

for *May & June*, 186 *3*.

Present or absent *Present*

Stoppage, \$ *100* for

Due Gov't, \$ *100* for

Valuation of horse, \$ *100*

Valuation of horse equipments, \$ *100*

Remarks: _____

*This organization subsequently became Co. B, 10 Reg't U. S. Col'd Heavy Artillery.

Book mark: _____

Foster

P | 10 H. Art'y. | U.S.C.T.

Alfred Parker

Pop, Co. B, 1 Reg't La. H. Art'y, Native Guards.*

Appears on

Company Muster Roll

for July 4, Aug., 1863.

Present or absent Present

Stoppage, \$ 100 for

Due Gov't, \$ 100 for

Valuation of horse, \$ 100

Valuation of horse equipments, \$ 100

Remarks:

*This organization subsequently became Co. B, 10 Reg't U. S. Col'd Heavy Artillery.

Book mark:

Paster

P

10 H. Art'y.

U.S.C.T.

Alfred Parker

Pvt., Co. B, 1 Reg't La. H. Art'y, Native Guards.*

Appears on

Company Muster Roll

for Sept. 4, Oct., 1863.

Present or absent Present

Stoppage, \$ 100 for

Due Gov't, \$ 100 for

Valuation of horse, \$ 100

Valuation of horse equipments, \$ 100

Remarks:

*This organization subsequently became Co. B, 10 Reg't U. S. Col'd Heavy Artillery.

Book mark:

Feaster

P

10 H. Art'y. U.S.C.T.

Alfred Parker

Pvt., Co. B, 1 Reg't H. Art'y, Corps d'Afrique.*

Appears on

Company Muster Roll

for Nov. & Dec., 1863.

Present or absent Present

Stoppage, \$ 100 for

Due Gov't, \$ 100 for

Valuation of horse, \$ 100

Valuation of horse equipments, \$ 100

Remarks:

* This organization subsequently became Co. , 10 Reg't U. S. Colored Heavy Artillery.

Book mark:

(358)

Reif

Copyist.

P

10 H. Art'y. | U.S.C.T.

alfred Parker

Pl Co. B, 1 Reg't H. Art'y, Corps d'Afrique.*

Appears on

Company Muster Roll

for Jan. & Feb., 1864.

Present or absent Present

Stoppage, \$ 100 for

Due Gov't, \$ 100 for

Valuation of horse, \$ 100

Valuation of horse equipments, \$ 100

Remarks:

* This organization subsequently became Co. , 10 Reg't U. S. Colored Heavy Artillery.

Book mark:

(358)

Reif Copyist.

P | 10 H. Art'y. | U.S.C.T.

Alfred Parker

Pt, Co. B, 7 Reg't U. S. Col'd H. Art'y.*

Appears on

Company Muster Roll

for ... Mch. & Apr., 1864.

Present or absent ... Present

Stoppage, \$... 100 for

Due Gov't, \$... 100 for

Valuation of horse, \$... 100

Valuation of horse equipments, \$... 100

Remarks ... Company
lost

* This organization subsequently became Co. , 10 Reg't U. S. Colored Heavy Artillery.

Book mark:

Reif

P | 10 H. Art'y. | U.S.C.T.

Alfred Parker

Pt, Co. B, 7 Reg't U. S. Col'd H. Art'y.*

Appears on

Company Muster Roll

for May & June, 1864.

Present or absent Present

Stoppage, \$ 100 for

Due Gov't, \$ 100 for

Valuation of horse, \$ 100

Valuation of horse equipments, \$ 100

Remarks:

* This organization subsequently became Co. , 10 Reg't U. S. Colored Heavy Artillery.

Book mark:

(358)

Reif

Copyist.

P

10 H. Art'y. U.S.C.T.

Alfred Parker

Co. B, 10 Reg't U. S. Col'd H. Art'y.

Appears on

Company Muster Roll

for July & Aug, 1864.

Present or absent Present

Stoppage, \$ 100 for

Due Gov't, \$ 100 for

Valuation of horse, \$ 100

Valuation of horse equipments, \$ 100

Remarks:

Book mark:

M. Richardson

(358)

Copyist.

P

10 H. Art'y. U.S.C.T.

Alfred Parker

Pt., Co. B, 10 Reg't U. S. Col'd H. Art'y.

Appears on

Company Muster Roll

for *Sept & Oct*, 186*4*.

Present or absent *Present*

Stoppage, \$ 100 for

Due Gov't, \$ 100 for

Valuation of horse, \$ 100

Valuation of horse equipments, \$ 100

Remarks:

Book mark:

J. Richardson

(358)

Copyist.

Alfred Parker

Priv., Co. B, 10 Reg't U. S. Col'd H. Art'y.

Appears on

Company Muster Roll

for *Nov & Dec*, 186*4*.

Present or absent *Present*

Stoppage, \$ 100 for

Due Gov't, \$ 100 for

Valuation of horse, \$ 100

Valuation of horse equipments, \$ 100

Remarks:

Book mark:

Jornier

J.P.

10 H. Art'y. U.S.C.T.

Alfred Parker

Pvt., Co. B, 10 Reg't U. S. Col'd H. Art'y.

Appears on

Company Muster Roll

for *Jan & Feb*, 1865.

Present or absent *Present.*

Stoppage, \$ 100 for

Due Gov't, \$ 100 for

Valuation of horse, \$ 100

Valuation of horse equipments, \$ 100

Remarks: *due soldier aug-
mented pay from
Jan 1, 1864 to May 1,
1864 \$6⁰⁰ per month, May
and June \$9⁰⁰ per month*

Book mark:

Jornier.

P.

10 H. Art'y. | U.S.C.T.

Alfred Parker

Pvt., Co. B, 10 Reg't U. S. Col'd H. Art'y.

Appears on

Company Muster Roll

for *May & Apr.*, 186*5*.

Present or absent *Present*

Stoppage, \$ 100 for

Due Gov't, \$ 100 for

Valuation of horse, \$ 100

Valuation of horse equipments, \$ 100

Remarks:

Book mark:

Josiah

P

10 H. Art'y. | U.S.C.T.

Alfred Parker

Pvt., Co. B, 10 Reg't U. S. Col'd H. Art'y.

Appears on

Company Muster Roll

for *May & June*, 186*5*.

Present or absent *Present*

Stoppage, \$ *100* for

Due Gov't, \$ *100* for

Valuation of horse, \$ *100*

Valuation of horse equipments, \$ *100*

Remarks:

Book mark:

Jovier

P. | 10 H. Art'y. | U.S.C.T.

Alfred Parker
Rt., Co. B, 10 Reg't U. S. Col'd H. Art'y.

Appears on

Company Muster Roll

for *July & Aug*, 1865.

Present or absent *Present*.

Stoppage, \$ 100 for

Due Gov't, \$ 100 for

Valuation of horse, \$ 100

Valuation of horse equipments, \$ 100

Remarks:
.....
.....
.....
.....
.....
.....
.....
.....
.....
.....

Book mark:

(358)

Jornis

Copyist.

P.

10 H. Art'y.

U.S.C.T.

Alfred Parker

Pvt., Co. B, 10 Reg't U. S. Col'd H. Art'y.

Appears on

Company Muster Roll

for *Sept & Oct.*, 1863.

Present or absent *Present.*

Stoppage, \$.....100 for

Due Gov't, \$.....100 for

Valuation of horse, \$.....100

Valuation of horse equipments, \$.....100

Remarks:.....

Book mark:.....

Jones

P

10 H. Art'y. U.S.C.T.

Alfred Parker

Pl

, Co. B, 10 Reg't U. S. Col'd H. Art'y.

Appears on

Company Muster Roll

for

Nov. & Dec., 1865

Present or absent

Present

Stoppage, \$

100 for

Due Gov't, \$

100 for

Valuation of horse, \$

100

Valuation of horse equipments, \$

100

Remarks:

Book mark:

(358)

Reif

Copyist.

P

10 H. Art'y.

U.S.C.T.

Alfred Parker

Pr

, Co. B, 10 Reg't U. S. Col'd H. Art'y.

Appears on

Company Muster Roll

for

Jan. & Feb.

, 186 1.

Present or absent

Stoppage, \$

100 for

Due Gov't, \$

100 for

Valuation of horse, \$

100

Valuation of horse equipments, \$

100

Remarks

Mustd. out at M. O. S. a. Feb. 8 66 by reason of exp. of term of service.

Book mark:

Reif

(358)

Copyist.

Alfred Parker

Co. B, 10 Reg't U. S. Col'd H. Art'y.

Appears on Co. Muster-out Roll, dated

Baton Rouge La, Feb, 1867.

Muster-out to date 186 .

Last paid to 186 .

Clothing account:

Last settled 186 ; drawn since \$ 100

Due soldier \$ 100 ; due U. S. \$ 100

Am't for cloth'g in kind or money adv'd \$ 100

Due U. S. for arms, equipments, &c., \$ 100

Bounty paid \$ 100 ; due \$ 100

Remarks:

Joined org. organ.
Discharged Feb. 8/66
expiration term of
service.

Book mark:

Hodges

Copyist.

P. | 10 Me. a. | U.S.C.T.

Alfred Parker

Priv., Co. B., 10 Reg't U. S. Col'd Me. a.

Appears on a

Detachment Muster-out Roll

of the organization named above. Roll dated

New Orleans La. Feb. 8, 1866.*

Muster-out to date

Feb. 8, 1866.

Last paid to

June 30, 1865

Clothing account:

Last settled _____, 186 ; drawn since \$ 100

Due soldier \$ 13 ³⁴/₁₀₀; due U. S. \$ 100

Am't for cloth'g in kind or money adv'd \$ 100

Due U. S. for arms, equipments, &c., \$ 100

Bounty paid \$ 100 due \$ 100

Remarks: Joined at origl. Orgn.

Mustered out by reason of
Expiration of term of
service* (Cert. of Mustg.
Off. shows him M.O. Feb. 12,
1866.) * Added May 12, 93. E.S.J.

Book mark:

Heasling

Parker, Alford

, Co. 10th Reg't U.S.C.H.A.

Enclosures.

Bed Cards	Final Statements
Burial Records	Furloughs or L. of A.
Certs. of Dis. for Discharge	Med. Certificates
C. M. Charges	Med. Des. Lists
Descriptive Lists	Orders
Discharge Certificates	Pris. of War Record
Enlistment Papers 2	Resignations

Other papers relating to—

Admission to Hosp'l	Furlough or L. of A.
Casualty Sheet	Med. Examination
Confinement	Misc. Information
Contracts	Pay or Clothing
Death or Effects	Personal Reports
Desertion	Rank
Discharge from Hosp'l	Transfer to Hosp'l
Discharge from Service	Transfer to V. R. C.
Duty	Transportation

10 state DECLARATION OF RECRUIT.

I, _____ desiring to ENLIST in the Army of the United States, for the term of THREE YEARS, Do declare, That I am _____ years and _____ months of age; that I have neither wife nor child; that I have never been discharged from the United States service on account of disability or by sentence of a court-martial, or by order before the expiration of a term of enlistment; and I know of no impediment to my serving honestly and faithfully as a soldier for three years.

GIVEN at _____
The _____ day of _____

Witness:

No. _____
Attest _____
Enlisted at _____
December the 10th 1862,
By 2^d Lieutenant J. P. [unclear]
1st U.S. Artillery Regiment of _____
10-2550-111
enlistment; last served in Company []
Reg't of _____
Discharged _____ 18

CONSENT IN CASE OF MINOR.

I, _____ Do CERTIFY, That I am the _____ of _____; that the said _____ is _____ years of age; and I do hereby freely give my CONSENT to his enlisting as a SOLDIER in the ARMY OF THE UNITED STATES for the period of THREE YEARS.

GIVEN at _____
The _____ day of _____

Witness:

County of



State of

Jefferson

Louisiana

I, *Alfred Parker* born in *Franklin County*

in the State of *North Carolina* aged *Twenty Six* years,

and by occupation a *Laborer* do hereby acknowledge to have

voluntarily enlisted this *Tenth* day of *December*

18*62*, as a SOLDIER in the ARMY OF THE UNITED STATES OF AMERICA, for the period of *THREE YEARS*, unless sooner discharged by proper authority: Do also agree to accept such bounty, pay, rations, and clothing, as are, or may be, established by law. And

I, *Alfred Parker* do solemnly swear, that I will bear true faith and allegiance to the UNITED STATES OF AMERICA, and that I will serve them honestly and faithfully against all their enemies or opposers whomsoever; and that I will observe and obey the orders of the President of the United States, and the orders of the officers appointed over me, according to the Rules and Articles of War.

Sworn and subscribed to, at *Carrollton, La.*
this *ninth* day of *February* 18*62*
BEFORE *J. H. G. ...*

I CERTIFY, ON HONOR, That I have carefully examined the above named Recruit, agreeably to the General Regulations of the Army, and that in my opinion he is free from all bodily defects and mental infirmity, which would, in any way, disqualify him from performing the duties of a soldier.

W. C. Lynde EXAMINING SURGEON.

I CERTIFY, ON HONOR, That I have minutely inspected the Recruit, *Alfred Parker* previously to his enlistment, and that he was entirely sober when enlisted; that, to the best of my judgement and belief, he is of lawful age; and that, in accepting him as duly qualified to perform the duties of an able-bodied soldier, I have strictly observed the Regulations which govern the recruiting service. This soldier has *Brown* eyes, *Dark* hair, *Dark* complexion; is *five* feet, *seven* inches high.

J. H. G. ... 2nd Lieut. U. S. Army
RECRUITING OFFICER.

10 21613 DECLARATION OF RECRUIT. 10 111102

I, _____ desiring to ENLIST in the Army of the United States, for the term of THREE YEARS, Do declare, That I am _____ years and _____ months of age; that I have neither wife nor child; that I have never been discharged from the United States service on account of disability or by sentence of a court-martial, or by order before the expiration of a term of enlistment; and I know of no impediment to my serving honestly and faithfully as a soldier for three years.

GIVEN at _____
The _____ day of _____

Witness:

No. 28

Wm. P. Parker

Enlisted at *Company Paraph. Co*

December the 10th 1862,

By *2^d Lieutenant J. S. Gardner*

1st City Regiment of Louisiana U.S.

enlistment; last served in Company ()

Reg't of _____

Discharged _____ 18 _____

CONSENT IN CASE OF MINOR.

I, _____ Do CERTIFY, That I am the _____ of _____; that the said _____ is _____ years of age; and I do hereby freely give my CONSENT to his enlisting as a SOLDIER in the ARMY OF THE UNITED STATES for the period of THREE YEARS.

GIVEN at _____
The _____ day of _____

Witness:

County of

Jefferson

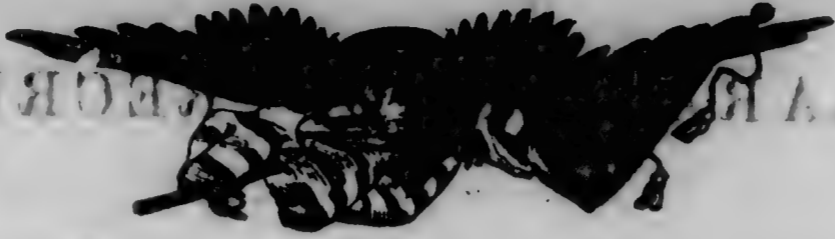

State of

Louisiana

I, *Alfred Parker* born in *Franklin County*
in the State of *North Carolina* aged *Twenty Six* years,
and by occupation a *Laborer* do hereby acknowledge to have
voluntarily enlisted this *Tenth* day of *December*

18*62*, as a SOLDIER in the ARMY OF THE UNITED STATES OF AMERICA, for the period
of **THREE YEARS**, unless sooner discharged by proper authority: Do also agree to
accept such bounty, pay, rations, and clothing, as are, or may be, established by law. And
I, *Alfred Parker* do solemnly swear, that I will bear true faith
and allegiance to the UNITED STATES OF AMERICA, and that I will serve them honestly and
faithfully against all their enemies or opposers whomsoever; and that I will observe and
obey the orders of the President of the United States, and the orders of the officers
appointed over me, according to the Rules and Articles of War.

Sworn ~~and subscribed~~ to, at *Camp Parapet,*
this *ninth* day of *February*, 18*63*,
BEFORE
J. Rygaard
2^d Lt. N. G. Art. Co. 1st Regt.

I CERTIFY, ON HONOR, That I have carefully examined the above named Recruit, agreeably to the General Regulations
of the Army, and that in my opinion he is free from all bodily defects and mental infirmity, which would, in any way, disqualify
him from performing the duties of a soldier.

W. C. Lyman EXAMINING SURGEON.

I CERTIFY, ON HONOR, That I have minutely inspected the Recruit, *Alfred Parker*
previously to his enlistment, and that he was entirely sober when enlisted; that, to the best of my judgement and belief, he is of
lawful age; and that, in accepting him as duly qualified to perform the duties of an able-bodied soldier, I have strictly observed
the Regulations which govern the recruiting service. This soldier has *Brown* eyes, *Dark* hair,
Dark complexion; is *Five* feet, *Five* inches high.

J. Rygaard, 2^d Lieut. N. G. Art. Co. 1st Regt.
RECRUITING OFFICER.

Private

Private

CARD NUMBERS.

54875251

	26
	27
	28
	29
	30
	31
	32
	33
	34
10	35
11	36
12	37
13	38
14	39
15	40
16	41
17	42
18	43
19	44
20	45
21	46
22	47
23	48
24	49
25	50

Book Mark:

See also 77 U.S.C. Sup

P 10 H. A. U.S.C.T.

Benjamin Carker
Co., Co., 10 Reg't U. S. Col'd

Appears on

M. and D. Roll of Men Transferred

to the organization named above,

from Co. H, 10 Reg't U. S. Col'd

Roll dated Camp Parapeta Cal., 1865.

When enlisted July 7, 1864.

Period for which enlisted 3 years.

When mustered in March 11, 1864.

Present or absent

Company to which assigned

Remarks: Joined the Ser-

vice as Private Desert-

ed at Camp Parapeta

Ca July 2. 65. Stoppage,

Haversack, 1 pr Blanket

straps, 1 set Capt trimmings

1 wiper, 1 One wrench

name not taken up on muster

rolls of Regt

Book mark:

W. H. Scott

10 U.S. Col'd H. Army

Private Private

CARD NUMBERS.

1	5494244	26
2	5494396	27
3	5494554	28
4	5494711	29
5	5494866	30
6	5495018	31
7	5495174	32
8	5495368	33
9	5497514	34
10		35
11		36
12		37
13		38
14		39
15		40
16		41
17		42
18		43
19		44
20		45
21		46
22		47
23		48
24		49
25		50

Book Mark:

See also

P | 10 H. Art'y. | U.S.C.T.

Benjamin Parker

Pvt., 2 Battery, La. H. Art'y, Native Guards.*

Age *34* years.

Appears on

Company Muster-in Roll

of the organization named above. Roll dated

Camp Parapet, Carrollton, La., Feb. 9, 1863.

Muster-in to date *Feb. 9, 1863.*

Joined for duty and enrolled:

When *July 13, 1863.*

Where *Camp Parapet, Carrollton, La.*

Period *3* years.

Valuation of horse, \$.....100

Valuation of horse equipments, \$.....100

Remarks :
.....
.....
.....

* This organization subsequently became Co. B, 10 Reg't U. S. Colored Heavy Artillery.

Book mark :
.....
.....

Master

P

10 H. Art'y.

U.S.C.T.

Benjamin Parker

Pvt., Co. B, 1 Reg't La. H. Art'y, Native Guards.*

Appears on

Company Muster Roll

for *from Enlistment to Feb. 28*, 1863.

Present or absent *Present*

Stoppage, \$ *100* for

Due Gov't, \$ *100* for

Valuation of horse, \$ *100*

Valuation of horse equipments, \$ *100*

Remarks:

*This organization subsequently became Co. B, 10 Reg't U. S. Col'd Heavy Artillery.

Book mark:

Feaster

P

10 H. Art'y.

U.S.C.T.

Benjamin Parker
Pvt., Co. B, 1 Reg't La. H. Art'y, Native Guards.*

Appears on

Company Muster Roll

for *Mar. 4. Apl.*, 186 *3*.

Present or absent *Present*

Stoppage, \$ *100* for

Due Gov't, \$ *100* for

Valuation of horse, \$ *100*

Valuation of horse equipments, \$ *100*

Remarks: _____

*This organization subsequently became Co. B, 10 Reg't U. S. Col'd Heavy Artillery.

Book mark: _____

Feaster

(358)

Copyist.

P

10 H. Art'y.

U.S.C.T.

Benjamin Parker
Pvt., Co. B, 1 Reg't La. H. Art'y, Native Guards.*

Appears on

Company Muster Roll

for *May & June*, 186*3*.

Present or absent *Present*

Stoppage, \$ *100* for

Due Gov't, \$ *100* for

Valuation of horse, \$ *100*

Valuation of horse equipments, \$ *100*

Remarks:

*This organization subsequently became Co. B, 10 Reg't U. S. Col'd Heavy Artillery.

Book mark:

Feaster

P

10 H. Art'y.

U.S.C.T.

Benjamin Parker
Pvt., Co. B, 1 Reg't La. H. Art'y, Native Guards.*

Appears on

Company Muster Roll

for July 4, Aug., 1863.

Present or absent Present

Stoppage, \$ 100 for

Due Gov't, \$ 100 for

Valuation of horse, \$ 100

Valuation of horse equipments, \$ 100

Remarks:

*This organization subsequently became Co. B, 10 Reg't U. S. Col'd Heavy Artillery.

Book mark:

Feaster

P | 10 H. Art'y. | U.S.C.T.

Benjamin Parker
Sgt., Co. B, 1 Reg't La. H. Art'y, Native Guards.*

Appears on

Company Muster Roll

for *Sept. 4, Oct.*, 186*3*.

Present or absent *Present*

Stoppage, \$ *100* for

Due Gov't, \$ *100* for

Valuation of horse, \$ *100*

Valuation of horse equipments, \$ *100*

Remarks: _____

*This organization subsequently became Co. B, 10 Reg't U. S. Col'd Heavy Artillery.

Book mark: *100013*

Feaster

P

10 H. Art'y. U.S.C.T.

Benjamin Parker

P1, Co. B, 1 Reg't H. Art'y, Corps d'Afrique.*

Appears on

Company Muster Roll

for Nov. 1 Dec., 1863

Present or absent Present

Stoppage, \$ 100 for

Due Gov't, \$ 100 for

Valuation of horse, \$ 100

Valuation of horse equipments, \$ 100

Remarks:

* This organization subsequently became Co. , 10 Reg't U. S. Colored Heavy Artillery.

Book mark:

P. R. Copyist.

P | 10 H. Art'y. | U.S.C.T.

Benjamin Parker

Pvt., Co. B, 1 Reg't H. Art'y, Corps d'Afrique.*

Appears on

Company Muster Roll

for Jan. & Feb., 1864

Present or absent

Stoppage, \$ 100 for

Due Gov't, \$ 100 for

Valuation of horse, \$ 100

Valuation of horse equipments, \$ 100

Remarks: DIED 20 Jan. 1864 died of wounds recd. by accident died in Campy. Hosp. at Camp Parapet La.

*This organization subsequently became Co. , 10 Reg't U. S. Colored Heavy Artillery.

Book mark:

(358)

Reif

Copyist.

P | 10 H. Art'y. | U.S.C.T.

Benjamin Parker
Co. *B*, 10 Reg't U. S. Col'd H. Art'y.

Appears on **Co. Muster-out Roll**, dated
Baton Rouge, La., Feb., 1867.

Muster-out to date 186 .

Last paid to 186 .

Clothing account:

Last settled 186 ; drawn since \$ 100

Due soldier \$ 100 ; due U. S. \$ 100

Am't for cloth'g in kind or money adv'd \$ 100

Due U. S. for arms, equipments, &c., \$ 100

Bounty paid \$ 100 ; due \$ 100

Remarks:

*Joined org'l. org'n
Died at Camp Parapet
La. Jan. 20th 1867*

Book mark:

Hodges

(361)

Copyist.

Parker, Benjamin

P., Co. B, 10th Reg't U.S.C.A.

4 Enclosures.

Bed Cards	Final Statements 2
Burial Records	Furloughs or L. of A
Certs. of Dis. for Discharge	Med. Certificates
C. M. Charges	Med. Des. Lists
Descriptive Lists	Orders
Discharge Certificates	Pris. of War Record
Enlistment Papers 2	Resignations

Other papers relating to—

Admission to Hosp'l	Furlough or L. of A
Casualty Sheet	Med. Examination
Confinement	Misc. Information
Contracts	Pay or Clothing
Death or Effects	Personal Reports
Desertion	Rank
Discharge from Hosp'l	Transfer to Hosp'l
Discharge from Service	Transfer to V. R. C.
Duty	Transportation

To state **DECLARATION OF RECRUIT.** To whom

I, _____ desiring to ENLIST in the Army of the United States, for the term of THREE YEARS, Do declare, That I am _____ years and _____ months of age; that I have neither wife nor child; that I have never been discharged from the United States service on account of disability or by sentence of a court-martial, or by order before the expiration of a term of enlistment; and I know of no impediment to my serving honestly and faithfully as a soldier for three years.

GIVEN at _____

The _____ day of _____

Witness:

No. 95

Benjamin Parker

Enlisted at Camp Sabat. N. H.

January the 13th 1863.

By 2nd Lieut. J. Appaer

1st Lt. Regiment of Wisconsin Volunteers

enlistment; last served in Company ()

Reg't of _____

Discharged _____ 18 _____

CONSENT IN CASE OF MINOR.

I, _____ Do CERTIFY, That I am the _____ of _____; that the said _____ is _____ years of age; and I do hereby freely give my CONSENT to his enlisting as a SOLDIER in the ARMY OF THE UNITED STATES for the period of THREE YEARS.

GIVEN at _____

The _____ day of _____

Witness:

County of
Jefferson



State of
Louisiana

I, *Benjamin Parker* born in *Norfolk County*
in the State of *Virginia* aged *thirty four* years,
and by occupation a *Laborer* do hereby acknowledge to have
voluntarily enlisted this *thirtieth* day of *January*

18 *63*, as a SOLDIER in the ARMY OF THE UNITED STATES OF AMERICA, for the period
of *THREE YEARS*, unless sooner discharged by proper authority: Do also agree to
accept such bounty, pay, rations, and clothing, as are, or may be, established by law. And
I, *Benjamin Parker* do solemnly swear, that I will bear true faith
and allegiance to the UNITED STATES OF AMERICA, and that I will serve them honestly and
faithfully against all their enemies or opposers whomsoever; and that I will observe and
obey the orders of the President of the United States, and the orders of ~~the~~ officers
appointed over me, according to the Rules and Articles of War.

Sworn and subscribed to, at *Carrollton, La.,*
this *ninth* day of *February* 18*63*
BEFORE
J. Aagaard
2nd Lt. U.S. Army

I CERTIFY, ON HONOR, That I have carefully examined the above named Recruit, agreeably to the General Regulations
of the Army, and that in my opinion he is free from all bodily defects and mental infirmity, which would, in any way, disqualify
him from performing the duties of a soldier.

W. L. Ligon EXAMINING SURGEON.

I CERTIFY, ON HONOR, That I have minutely inspected the Recruit, *Benjamin Parker*
previously to his enlistment, and that he was entirely sober when enlisted; that, to the best of my judgement and belief, he is of
lawful age; and that, in accepting him as duly qualified to perform the duties of an able-bodied soldier, I have strictly observed
the Regulations which govern the recruiting service. This soldier has *brown* eyes, *black* hair,
dark complexion; is *five* feet, *eight* inches high.

J. Aagaard 2nd Lt. U.S. Army
RECRUITING OFFICER.

to state **DECLARATION OF RECRUIT.** to state

I, _____ desiring to ENLIST in the Army of the United States, for the term of THREE YEARS, Do declare, That I am _____ years and _____ months of age; that I have neither wife nor child; that I have never been discharged from the United States service on account of disability or by sentence of a court-martial, or by order before the expiration of a term of enlistment; and I know of no impediment to my serving honestly and faithfully as a soldier for three years.

GIVEN at _____

The _____ day of _____

Witness:

No. _____

Benjamin Walker

Enlisted at *Camp Parrot Va*

January the 19th 1863.

By *J. B. Smith. G. Appana*

1st Regt. of Louisiana Art

10-2867-A

enlistment; last served in Company ()

Regt of _____

Discharged _____ 18 _____

CONSENT IN CASE OF MINOR.

I, _____ Do CERTIFY, That I am the _____ of _____; that the said _____ is _____ years of age; and I do hereby freely give my CONSENT to his enlisting as a SOLDIER in the ARMY OF THE UNITED STATES for the period of THREE YEARS.

GIVEN at _____

The _____ day of _____

Witness:

County of
T Jefferson



State of
Louisiana

I, *Benjamin Parker* born in *Norfolk County*
in the State of *Virginia* aged *thirty four* years,
and by occupation a *Laborer* do hereby acknowledge to have
voluntarily enlisted this *thirtieth* day of *January*

18 *63*, as a SOLDIER in the ARMY OF THE UNITED STATES OF AMERICA, for the period
of *THREE YEARS*, unless sooner discharged by proper authority: Do also agree to
accept such bounty, pay, rations, and clothing, as are, or may be, established by law. And
I, *Benjamin Parker* do solemnly swear, that I will bear true faith
and allegiance to the UNITED STATES OF AMERICA, and that I will serve them honestly and
faithfully against all their enemies or opposers whomsoever; and that I will observe and
obey the orders of the President of the United States, and the orders of the officers
appointed over me, according to the Rules and Articles of War.

Sworn and subscribed to, at *of Carrollton, La.,*
Camp Parapet
this *ninth* day of *February* 18 *63*
BEFORE
J. Rygaard
2nd Lt. U.S. Art. Co. Va.

I CERTIFY, ON HONOR, That I have carefully examined the above named Recruit, agreeably to the General Regulations
of the Army, and that in my opinion he is free from all bodily defects and mental infirmity, which would, in any way, disqualify
him from performing the duties of a soldier.

W. L. Lynn EXAMINING SURGEON.

I CERTIFY, ON HONOR, That I have minutely inspected the Recruit, *Benjamin Parker*
previously to his enlistment, and that he was entirely sober when enlisted; that, to the best of my judgement and belief, he is of
lawful age; and that, in accepting him as duly qualified to perform the duties of an able-bodied soldier, I have strictly observed
the Regulations which govern the recruiting service. This soldier has *brown* eyes, *black* hair,
dark complexion; is *five* feet, *eight* inches high.

J. Rygaard 2nd Lieut. U.S. Art. Co. Va.
RECRUITING OFFICER.

✓
FINAL STATEMENT

Private Benjamin Parker

1st Reg't of 8th Art. C. S. A.

10.

10. B
VOLUNTEERS.

Benjamin Parker

NOTE 1.—Two of these certificates (or duplicates) are to be given to each Volunteer Soldier or drafted man who may be discharged previously to the discharge of his company, that he may at once receive from the Paymaster the pay, &c., due him, and the captain or other COMMISSIONED officer commanding the company will certify to the act of the delivery of the duplicate certificates; on these certificates the Soldier is "entitled to" his discharge, and should also present his discharge to the Paymaster to have the payment endorsed on it. The discharge is to be given back to the Soldier by the Paymaster; the latter only retaining as his voucher the duplicate certificates.

NOTE 2.—If the Soldier is entitled to pay for the use of his horse, the Company Commander will certify to that fact on the back of both these final statements, and also to the time he has pay due for having been so mounted on his own horse.

NOTE 3.—When a Soldier is furnished with final statements, his descriptive list, if he has one, should be taken up by the officer who gives the Soldier these statements, and endorsed with a statement to this effect by the officer. This endorsement should exhibit a full statement of the time for which the Soldier was allowed pay on his final statements, the clothing account, and all other charges against him or in his favor, so as to comprise a complete exhibit of his account. It will then be transmitted to the company commander of the Soldier, who will enter all the data necessary to a full understanding of the Soldier's account on the muster roll upon which the Soldier's discharge is reported. The descriptive list will then be destroyed. The object of this is, that the remaining portion of the Soldier's account may be settled upon the receipt of these muster rolls, and the Soldier receive any pay or allowances that may be due him at the time of his discharge, and which may not appear on his final statements from the fact that his descriptive list is incomplete. These accounts for back pay, &c., are settled by the 2d Auditor of the Treasury Department.

NOTE 4.—Charges for loss or injury to ordnance, horse equipments, and other miscellaneous charges, should appear under the heading of "Other Stoppages."

NOTE 5.—Bounty paid by State authorities, and not by the United States, will not be entered on this statement.

NOTE 6.—Amounts due the Sutler and Laundress must be entered on the muster roll on which the discharge, death, desertion, &c., is reported, as well as on the final statement, otherwise the amount cannot be collected from the United States.

NOTE 7.—This blank will be used for deceased volunteers and drafted men, as well as for others.

NOTE 8.—Where a Soldier dies in Hospital or on detached service, his descriptive list, if he has one, should be sent with his final statements, in duplicate, to the Second Auditor, Washington, D. C.

ADJUTANT GENERAL'S OFFICE

DEC 3rd 1864

Duplicate with Inventory sent 2d Auditor.

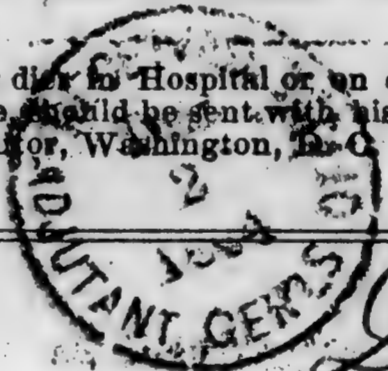

I certify, on honor, that Benjamin Parker a Private of
 Captain M. Allister's Company (B) of the 1st Regiment of Artillery
VOLUNTEERS, of the State of Virginia, born in Norfolk County, State
 of Virginia, aged 35 years; 5 feet 8 inches high; Dark complexion,
~~blue~~ eyes, Dark hair, and by occupation a Laborer, having joined the company on
 its original organization at Camp Parapet, near Carrollton, La., and enrolled in it at the muster into
 the service of the United States at said Camp Parapet, La., on the thirteenth
 day of January, 1863, (~~or was mustered in service as a recruit, by~~
 _____, at _____, on the _____ day of _____,
 186____, or was drafted and mustered into the service of the United States from the
 Enrollment District of the State of _____, at _____,
 on the _____ day of _____, 186____,) to serve in the Regiment, for
 the term of three years: and having served HONESTLY and
 FAITHFULLY with his Company in _____ to the present date, is now
 entitled to a **DISCHARGE** by reason of Death. Died in the Company Hospital
at Camp Parapet, La. January 20th 1864 of wound received by accident

The said Benjamin Parker was last paid by Paymaster
Major Preston to include the 31st day of October, 1863, and has
 pay due him from that time to the ^{Date of his Death} present date; ~~he is entitled to pay and subsistence for~~
~~TRAVELING~~ to place of enrollment, and whatever other allowances are authorized to volunteer
~~soldiers, drafted men, or militia, so discharged.~~ He has received from the United States **CLOTHING**
 amounting to fifty nine $\frac{21}{100}$ dollars, since the 13th day of January,
 1863, when his clothing account was last settled. He has received from the United States
 _____ dollars advanced **BOUNTY**.

~~There is to be stopped from him, on account of the State of _____, or other
 authorities, for CLOTHING, &c., received on entering service, _____ dollars; and
 for other stoppages, viz: _____~~

~~_____ dollars.
 He has been furnished with TRANSPORTATION in kind from the place of his discharge to
 _____; and he has been SUBSISTED for TRAVELING to his
 place of enrollment, up to the _____, 186____.~~

~~He is indebted to _____, **SUTLER**, _____ dollars.
 He is indebted to _____, **LAUNDRESS**, _____ dollars~~

Given in Duplicate, at Fort Stephens, Pass Manchac, La., this 18th day
 of November, 1864.

M. Hanks

 Captain
 For Commanding Company.

I certify, on honor, that the
 said Private Benjamin
 Parker, died, leaving no
 effects. Thos. McCormack
 Sr. 1st Lieut
 Comd'g Company

Respectfully certified for date
 and place of death.
 Wm. S. C. A. C. Genl.
 March 18th 1864.

ADJUTANT GENERAL'S OFFICE.
 April 18th 1864.
 Duplicate with Inventory sent 2d Auditor.

✓ FINAL STATEMENT

OF

Private Benjamin Parker
 1st Reg't of La. Heavy Arty. U. S. A.

VOLUNTEERS.

Died January 30, 1864.

NOTE 1.—Two of these certificates (or duplicates) are to be given to each Volunteer Soldier or drafted man who may be discharged previously to the discharge of his company, that he may at once receive from the Paymaster the pay, &c., due him, and the captain or other COMMISSIONED officer commanding the company will certify to the act of the delivery of the duplicate certificates; on these certificates the Soldier is "entitled to" his discharge, and should also present his discharge to the Paymaster to have the payment endorsed on it. The discharge is to be given back to the Soldier by the Paymaster; the latter only retaining as his voucher the duplicate certificates.

NOTE 2.—If the Soldier is entitled to pay for the use of his horse, the Company Commander will certify to that fact on the back of both these final statements, and also to the time he has pay due for having been so mounted on his own horse.

NOTE 3.—When a Soldier is furnished with final statements, his descriptive list, if he has one, should be taken up by the officer who gives the Soldier these statements, and endorsed with a statement to this effect by the officer. This endorsement should exhibit a full statement of the time for which the Soldier was allowed pay on his final statements, the clothing account, and all other charges against him or in his favor, so as to comprise a complete exhibit of his account. It will then be transmitted to the company commander of the Soldier, who will enter all the data necessary to a full understanding of the Soldier's account on the muster roll upon which the Soldier's discharge is reported. The descriptive list will then be destroyed. The object of this is, that the remaining portion of the Soldier's account may be settled upon the receipt of these muster rolls, and the Soldier receive any pay or allowances that may be due him at the time of his discharge, and which may not appear on his final statements from the fact that his descriptive list is incomplete. These accounts for back pay, &c., are settled by the 2d Auditor of the Treasury Department.

NOTE 4.—Charges for loss or injury to ordnance, horse equipments, and other miscellaneous charges, should appear under the heading of "Other Stoppages."

NOTE 5.—Bounty paid by State authorities, and not by the United States, will not be entered on this statement.

NOTE 6.—Amounts due the Sutler and Laundress must be entered on the muster roll on which the discharge, death, desertion, &c., is reported, as well as on the final statement, otherwise the amount cannot be collected from the United States.

NOTE 7.—This blank will be used for deceased volunteers and drafted men, as well as for others.

NOTE 8.—Where a Soldier dies in Hospital or on detached service, his descriptive list, if he has one, should be sent with his final statements, in duplicate, to the Second Auditor, Washington, D. C.

For date & place of
 death

I certify, on honor, that Benjamin Parker a private of
Captain A. McAllister's Company (13) of the 1st Regiment of La. Vol. Art'y. U. S. A.
VOLUNTEERS, of the State of Louisiana, born in Stafford County, State
of Virginia, aged 34 years; 5 feet 8 inches high; dark complexion,
brown eyes, black hair, and by occupation a Laborer, having joined the company on
its original organization at Camp Parapet Carrolton La., and enrolled in it at the muster into
the service of the United States at Camp Parapet Carrolton La., on the thirteenth day
of January, 1863, (~~or was mustered in service as a recruit, by~~
~~at~~, ~~on the~~ day of
1863, or was drafted and mustered into the service of the United States from the
Enrollment District of the State of ~~at~~,
on the day of 1863,) to serve in the Regiment, for
the term of three years: and having served **HONESTLY** and
FAITHFULLY with his Company ~~in~~ to the present date, is now
entitled to a **DISCHARGE** by reason of death at Camp Parapet
La. this 21st day of January 1864

The said Benjamin Parker was last paid by Paymaster
Maj. Frost to include the 31st day of October, 1863, and has
pay due him from that time to the present date; ~~he is entitled to pay and subsistence for~~
~~TRAVELING~~ to place of enrollment, and whatever other allowances are authorized to volunteer
soldiers, drafted men, or militia, so discharged. He has received from the United States **CLOTHING**
amounting to Fifty Eight 99 ¹⁰⁰ dollars, since the 13th day of January,
1863, ~~when his clothing account was last settled. He has received from the United States~~
~~100~~ dollars advanced **BOUNTY**.

There is to be stopped from him, on account of the State of ~~or other~~
authorities, for ~~CLOTHING, &c, received on entering service,~~ ¹⁰⁰ dollars; and
for other stoppages, viz: for clothing overdrawn

Three ¹⁰⁰ 63 dollars.
~~He has been furnished with TRANSPORTATION in kind from the place of his discharge to~~
~~place of enrollment, up to the~~, 1863.

~~He is indebted to~~ GUTLER, ¹⁰⁰ dollars.

~~He is indebted to~~ LAUNDRESS, ¹⁰⁰ dollars.

Given in Duplicate, at Camp Parapet Carrolton La., this 21st day
of January, 1864.

Thos. M. Comstock
Sr. 1st Lieut.
Commanding Company

U.S. COIN

Private

Private

CARD NUMBERS.

1	5494245	26
2	5494397	27
3	5494555	28
4	5494713	29
5	5494868	30
6	5495020	31
7	5495176	32
8	5495328	33
9	5495480	34
10	5495630	35
11	5495769	36
12	5495931	37
13	5496076	38
14	5496224	39
15	5496378	40
16	5496525	41
17	5496667	42
18	5496811	43
19	5496970	44
20	5497142	45
21	5497457	46
22	5489690	47
23		48
24		49
25		50

Book Mark:

See also

P | 10 H. Art'y. | U.S.C.T.

George Parker

Pvt., 2 Battery, La. H. Art'y, Native Guards.*

Age 28 years.

Appears on

Company Muster-in Roll

of the organization named above. Roll dated

Camp Parapet, Carrollton, La., Feb. 9, 1863.

Muster-in to date

Feb. 9, 1863.

Joined for duty and enrolled:

When Jan'y 12, 1863.

Where Camp Parapet, Carrollton, La.

Period 3 years.

Valuation of horse, \$ 100

Valuation of horse equipments, \$ 100

Remarks:

* This organization subsequently became Co. B, 10 Reg't U. S. Colored Heavy Artillery.

Book mark:

Heuster

P | 10 H. Art'y. | U.S.C.T.

George Parker
Pvt., Co. B, 1 Reg't La. H. Art'y, Native Guards.*

Appears on

Company Muster Roll

for *from Enlistment to Feb. 28*, 1863.

Present or absent *Present*

Stoppage, \$ *100* for

Due Gov't, \$ *100* for

Valuation of horse, \$ *100*

Valuation of horse equipments, \$ *100*

Remarks: _____

*This organization subsequently became Co. B, 10 Reg't U. S. Col'd Heavy Artillery.

Book mark: _____

Feaster

P

10 H. Art'y.

U.S.C.T.

George Parker

Pvt., Co. B, 1 Reg't La. H. Art'y, Native Guards.*

Appears on

Company Muster Roll

for *Mar. 1. Apl.*, 186 *3.*

Present or absent *Present*

Stoppage, \$ *100* for

Due Gov't, \$ *100* for

Valuation of horse, \$ *100*

Valuation of horse equipments, \$ *100*

Remarks: _____

*This organization subsequently became Co. B, 10 Reg't U. S. Col'd Heavy Artillery.

Book mark: _____

Teaster

P

10 H. Art'y.

U.S.C.T.

George Parker

Pvt., Co. B, 1 Reg't La. H. Art'y, Native Guards.*

Appears on

Company Muster Roll

for *May & June*, 186*3*.

Present or absent *Present*

Stoppage, \$ *100* for

Due Gov't, \$ *100* for

Valuation of horse, \$ *100*

Valuation of horse equipments, \$ *100*

Remarks:

*This organization subsequently became Co. B, 10 Reg't U. S. Col'd Heavy Artillery.

Book mark:

Feaster

(358)

Copyist.

3

P | 10 H. Art'y. | U.S.C.T.

George Parker

Pvt., Co. B, 1 Reg't La. H. Art'y, Native Guards.*

Appears on

Company Muster Roll

for *July 4, Aug.*, 186*3*.

Present or absent *Present*

Stoppage, \$ *100* for

Due Gov't, \$ *100* for

Valuation of horse, \$ *100*

Valuation of horse equipments, \$ *100*

Remarks: -----

*This organization subsequently became Co. B, 10 Reg't U. S. Col'd Heavy Artillery.

Book mark: -----

Feaster

P

10 H. Art'y.

U.S.C.T.

George Parker

Pvt., Co. B, 1 Reg't La. H. Art'y, Native Guards.*

Appears on

Company Muster Roll

for *Sept. 1. Oct.*, 186*3*.

Present or absent *Present*

Stoppage, \$ *100* for

Due Gov't, \$ *100* for

Valuation of horse, \$ *100*

Valuation of horse equipments, \$ *100*

Remarks: _____

*This organization subsequently became Co. B, 10 Reg't U. S. Col'd Heavy Artillery.

Book mark: _____

Feaster

P

10 H. Art'y. | U.S.C.T.

George Parker

B, Co. B, 1 Reg't H. Art'y, Corps d'Afrique.*

Appears on

Company Muster Roll

for Nov: 1 Dec, 1863.

Present or absent Present

Stoppage, \$ 100 for

Due Gov't, \$ 100 for

Valuation of horse, \$ 100

Valuation of horse equipments, \$ 100

Remarks:

* This organization subsequently became Co. , 10 Reg't U. S. Colored Heavy Artillery.

Book mark:

Reif

P | 10 H. Art'y. | U.S.C.T.

George Parker
Pvt., Co. B, 1 Reg't H. Art'y, Corps d'Afrique.*

Appears on

Company Muster Roll

for Jan. & Feb., 1864.

Present or absent Present

Stoppage, \$ 100 for

Due Gov't, \$ 100 for

Valuation of horse, \$ 100

Valuation of horse equipments, \$ 100

Remarks:

*This organization subsequently became Co. , 10 Reg't U. S. Colored Heavy Artillery.

Book mark:

Reif

P | 10 H. Art'y. | U.S.C.T.

George Parker

Pvt., Co. B, 7 Reg't U. S. Col'd H. Art'y.*

Appears on

Company Muster Roll

for Mch. & Apr., 1864.

Present or absent Present

Stoppage, \$ 100 for

Due Gov't, \$ 100 for

Valuation of horse, \$ 100

Valuation of horse equipments, \$ 100

Remarks:

* This organization subsequently became Co. , 10 Reg't U. S. Colored Heavy Artillery.

Book mark:

P. Reif

P | 10 H. Art'y. | U.S.C.T.

George Parker

Pvt, Co. B, 7 Reg't U. S. Col'd H. Art'y.*

. Appears on

Company Muster Roll

for May 1 June, 1864

Present or absent Present

Stoppage, \$ 100 for

Due Gov't, \$ 100 for

Valuation of horse, \$ 100

Valuation of horse equipments, \$ 100

Remarks:

* This organization subsequently became Co. , 10 Reg't U. S. Colored Heavy Artillery.

Book mark:

(358)

Reif

Copyist.

P | 10 H. Art'y. | U.S.C.T.

George Parker

Pt, Co. B, 7 Reg't U. S. Col'd H. Art'y.*

Appears on

Company Muster Roll

for May 1 June, 1864

Present or absent Present

Stoppage, \$ 100 for

Due Gov't, \$ 100 for

Valuation of horse, \$ 100

Valuation of horse equipments, \$ 100

Remarks:

* This organization subsequently became Co. , 10 Reg't U. S. Colored Heavy Artillery.

Book mark:

(358)

Perf

Copyist.

P | 10 H. Art'y. | U.S.C.T.

George Parker

Pl, Co. B, 10 Reg't U. S. Col'd H. Art'y.

Appears on

Company Muster Roll

for *July & Aug*, 186*4*.

Present or absent *Present*

Stoppage, \$ 100 for

Due Gov't, \$ 100 for

Valuation of horse, \$ 100

Valuation of horse equipments, \$ 100

Remarks:

Book mark:

J. H. Richardson

(358)

Copyist.

P

10 H. Art'y. U.S.C.T.

George Parker

Pl, Co. B, 10 Reg't U. S. Col'd H. Art'y.

Appears on

Company Muster Roll

for Sept & Oct, 1864

Present or absent Present

Stoppage, \$ 100 for

Due Gov't, \$ 100 for

Valuation of horse, \$ 100

Valuation of horse equipments, \$ 100

Remarks:

Book mark:

J. Richardson

(358)

Copyist.

P. | 10 H. Art'y. | U.S.C.T.

George Parker

Pvt., Co. B, 10 Reg't U. S. Col'd H. Art'y.

Appears on

Company Muster Roll

for *Nov & Dec*, 186*4*.

Present or absent *Present*.

Stoppage, \$ 100 for

Due Gov't, \$ 100 for

Valuation of horse, \$ 100

Valuation of horse equipments, \$ 100

Remarks:

Book mark:

(358)

Jornis

Copyist.

P

10 H. Art'y. U.S.C.T.

George Parker

Pvt., Co. B, 10 Reg't U. S. Col'd H. Art'y.

Appears on

Company Muster Roll

for Jan & Feb, 1865.

Present or absent Present

Stoppage, \$ 100 for

Due Gov't, \$ 100 for

Valuation of horse, \$ 100

Valuation of horse equipments, \$ 100

Remarks: Due soldier augmented pay from Jan 1864 to May 1, 1864, 6⁰⁰ per month May & June 9⁰⁰ per month. Due U.S. for Ord 23^{cts}

Book mark:

J. J. J. J.

(358)

Copyist.

P | 10 H. Art'y. | U.S.C.T.

George Parker

Pvt., Co. B, 10 Reg't U. S. Col'd H. Art'y.

Appears on

Company Muster Roll

for *Mar & Apr.*, 1865.

Present or absent *Present.*

Stoppage, \$ 100 for

Due Gov't, \$ 100 for

Valuation of horse, \$ 100

Valuation of horse equipments, \$ 100

Remarks: *Paid W.S. for
Ord. 23 etc.*

Book mark: _____

(358)

Janner

Copyist.

P.

10 H. Art'y. U.S.C.T.

George Parker

Pvt., Co. B, 10 Reg't U. S. Col'd H. Art'y.

Appears on

Company Muster Roll

for *May & June*, 186 *5*.

Present or absent *Present*

Stoppage, \$ *100* for

Due Gov't, \$ *100* for

Valuation of horse, \$ *100*

Valuation of horse equipments, \$ *100*

Remarks:

Book mark: -----

(358)

Joiner

Copyist.

P

10 H. Art'y. | U.S.C.T.

George Parker

Plt., Co. B, 10 Reg't U. S. Col'd H. Art'y.

Appears on

Company Muster Roll

for *July & Aug*, 1865.

Present or absent *Present*.

Stoppage, \$ *100* for

Due Gov't, \$ *100* for

Valuation of horse, \$ *100*

Valuation of horse equipments, \$ *100*

Remarks: *Dr W for
Ordinance 23 lbs.*

Book mark: _____

(358)

J. J. J.
Copyist.

P. | 10 H. Art'y. | U.S.C.T.

George Parker
Pvt., Co. B, 10 Reg't U. S. Col'd H. Art'y.

Appears on

Company Muster Roll
for *Sep & Oct.*, 1865.

Present or absent *Present*

Stoppage, \$ 100 for

Due Gov't, \$ 100 for

Valuation of horse, \$ 100

Valuation of horse equipments, \$ 100

Remarks:

Book mark:

(358)

Jornier.

Copyist.

P

10 H. Art'y. U.S.C.T.

George Parker

Plt, Co. B, 10 Reg't U. S. Col'd H. Art'y.

Appears on

Company Muster Roll

for

Nov. & Dec., 1865

Present or absent

Present

Stoppage, \$ 100 for

Due Gov't, \$ 100 for

Valuation of horse, \$ 100

Valuation of horse equipments, \$ 100

Remarks

Due us. for ar'd.
24 cts.

Book mark:

(358)

Reif

Copyist.

B

10 H. Art'y. U.S.C.T.

George Parker

Pvt, Co. B, 10 Reg't U. S. Col'd H. Art'y.

Appears on

Company Muster Roll

for Jun. 1st to Feb. 1st, 1866

Present or absent

Stoppage, \$ 100 for

Due Gov't, \$ 100 for

Valuation of horse, \$ 100

Valuation of horse equipments, \$ 100

Remarks: Must. out at Md. Sta. Feb. 8 66 by reason of exp. of term of service

Book mark: 5634 P.M.G. June 1 66

(358)

Ref

Copyist.

P | 10 H. Art'y. | U.S.C.T.

George Parker

Priv. Co. B, 10 Reg't U. S. Col'd H. Art'y.

Appears on **Co. Muster-out Roll**, dated
Baton Rouge, La., Feb., 1867.

Muster-out to date , 186 .

Last paid to , 186 .

Clothing account:

Last settled , 186 ; drawn since \$ 100

Due soldier \$ 100 ; due U. S. \$ 100

Am't for cloth'g in kind or money adv'd \$ 100

Due U. S. for arms, equipments, &c., \$ 100

Bounty paid \$ 100 ; due \$ 100

Remarks:

*Joined org'l. organ.
Discharged Feb. 8/66
expiration term of
service.*

Book mark :

(361)

Hodges

Copyist.

P. 10 No. a. | U.S.C.T.

George Parker
Capt., Co. B., 10 Reg't U. S. Col'd No. a.

Appears on a

Detachment Muster-out Roll

of the organization named above. Roll dated

New Orleans La., Feb. 8, 1866.

Muster-out to date Feb. 8, 1866.

Last paid to June 30, 1865

Clothing account:

Last settled 186 ; drawn since \$ 100

Due soldier \$ 25 ⁵³/₁₀₀; due U. S. \$ 100

Am't for cloth'g in kind or money adv'd \$ 100

Due U. S. for arms, equipments, &c., \$ 100

Bounty paid \$ 100 due \$ 100

Remarks: *Joined at origl. orgn.
Hof for 1 Wiper 2 Tompions
Mustered out by reason
of Expiration of term of
service (Cert. of Mustg. Roll
shows him M.O. Feb. 19, 1866)*

Book mark:

* Added May 12, '93. G.E.S.

Hearding

Parker George
Johnson, Benjamin

_____, Co. _____, _____ Reg't _____

----- **Enclosures.** -----

Bed Cards	Final Statements
Burial Records	Furloughs or L. of A.
Certs. of Dis. for Discharge	Med. Certificates
C. M. Charges	Med. Des. Lists
Descriptive Lists	Orders
Discharge Certificates	Pris. of War Record
Enlistment Papers	Resignations

Other papers relating to—

Admission to Hosp'l	Furlough or L. of A.
Casualty Sheet	Med. Examination
Confinement	Misc. Information
Contracts	Pay or Clothing
Death or Effects	Personal Reports
Desertion	Rank
Discharge from Hosp'l	Transfer to Hosp'l
Discharge from Service	Transfer to V. R. C.
Duty	Transportation
.....

Parker, George

, Co.

10th

Regt

U.S.C. & G.

2 Enclosures.

Bed Cards	Final Statements
Burial Records	Furloughs or L. of A
Certs. of Dis. for Discharge	Med. Certificates
C. M. Charges	Med. Des. Lists
Descriptive Lists	Orders
Discharge Certificates	Pris. of War Record
Enlistment Papers 2	Resignations

Other papers relating to—

Admission to Hosp'l	Furlough or L. of A
Casualty Sheet	Med. Examination
Confinement	Misc. Information
Contracts	Pay or Clothing
Death or Effects	Personal Reports
Desertion	Rank
Discharge from Hosp'l	Transfer to Hosp'l
Discharge from Service	Transfer to V. R. C.
Duty	Transportation

MICROFILM PUBLICATION M 1831

COMPILED MILITARY SERVICE RECORDS
OF VOLUNTEER UNION SOLDIERS WHO SERVED WITH
THE UNITED STATES COLORED TROOPS (USCT)
10TH REGIMENT OF HEAVY ARTILLERY

PERSONAL PAPERS' TARGET SHEET

PLEASE NOTE THE CHECKED INFORMATION ABOUT THE PERSONAL PAPERS IN
THIS FILE:

- NO PERSONAL PAPERS WERE FOUND IN THIS FILE WHEN THE
RECORDS WERE ARRANGED FOR MICROFILMING.
- 4 PERSONAL PAPER(S) FOUND IN THIS FILE WHEN THE RECORDS
WERE ARRANGED FOR MICROFILMING.

DECLARATION OF RECRUIT.

I, _____ desiring to ENLIST in the Army of the United States, for the term of THREE YEARS, Do declare, That I am _____ years and _____ months of age; that I have neither wife nor child; that I have never been discharged from the United States service on account of disability or by sentence of a court-martial, or by order before the expiration of a term of enlistment; and I know of no impediment to my serving honestly and faithfully as a soldier for three years.

GIVEN at _____

The _____ day of _____

Witness :

No. _____

George Parker

Enlisted at *Camp Parshet Co.*

Sumner the 12th 1863,

By *2d Lieut. of Regt*

1st Regt. of Louisiana Artillery

10-28-63

enlistment; last served in Company ()

Regt of _____

Discharged _____ 18 _____

George Parker

CONSENT IN CASE OF MINOR.

I, _____ Do CERTIFY, That I am the _____ of _____; that the said _____ is _____ years of age; and I do hereby freely give my CONSENT to his enlisting as a SOLDIER in the ARMY OF THE UNITED STATES for the period of THREE YEARS.

GIVEN at _____

The _____ day of _____

Witness :

County of

Jefferson



State of

Louisiana

I, *George Parker*

born in *H. James Parish*

in the State of *Louisiana* aged *Twenty Eight* years,

and by occupation a *Laborer* do hereby acknowledge to have

voluntarily enlisted this *Twelfth* day of *January*

18 *63*, as a SOLDIER in the ARMY OF THE UNITED STATES OF AMERICA, for the period

of *THREE YEARS*, unless sooner discharged by proper authority: Do also agree to

accept such bounty, pay, rations, and clothing, as are, or may be, established by law. And

I, *George Parker* do solemnly swear, that I will bear true faith

and allegiance to the UNITED STATES OF AMERICA, and that I will serve them honestly and

faithfully against all their enemies or opposers whomsoever; and that I will observe and

obey the orders of the President of the United States, and the orders of the officers

appointed over me, according to the Rules and Articles of War.

Sworn and subscribed to, at *Camp Parapet*,
this *ninth* day of *February* 18*63*
BEFORE
J. J. Gaard
Lt. Col. U.S.A.

I CERTIFY, ON HONOR, That I have carefully examined the above named Recruit, agreeably to the General Regulations of the Army, and that in my opinion he is free from all bodily defects and mental infirmity, which would, in any way, disqualify him from performing the duties of a soldier.

[Signature]
EXAMINING SURGEON.

I CERTIFY, ON HONOR, That I have minutely inspected the Recruit, *George Parker* previously to his enlistment, and that he was entirely sober when enlisted; that, to the best of my judgement and belief, he is of lawful age; and that, in accepting him as duly qualified to perform the duties of an able-bodied soldier, I have strictly observed the Regulations which govern the recruiting service. This soldier has *green* eyes, *black* hair, *dark* complexion; is *five* feet, *seven* inches high.

J. J. Gaard
RECRUITING OFFICER.

10 22018 DECLARATION OF RECRUIT. 10 22018

I, _____ desiring to ENLIST in the Army of the United States, for the term of THREE YEARS, Do declare, That I am _____ years and _____ months of age; that I have neither wife nor child; that I have never been discharged from the United States service on account of disability or by sentence of a court-martial, or by order before the expiration of a term of enlistment; and I know of no impediment to my serving honestly and faithfully as a soldier for three years.

GIVEN at _____

The _____ day of _____

Witness:

No. 79

George Walker

Enlisted at Camp St. Robert La.

Sumner the 20th 1867.

By 2nd Lieut. J. S. ...

1st Regt. Louisiana Artillery

enlistment; last served in Company ()

Reg't of _____

Discharged _____ 18_____

CONSENT IN CASE OF MINOR.

I, _____ Do CERTIFY, That I am the _____ of _____; that the said _____ is _____ years of age; and I do hereby freely give my CONSENT to his enlisting as a SOLDIER in the ARMY OF THE UNITED STATES for the period of THREE YEARS.

GIVEN at _____

The _____ day of _____

Witness:

County of

Jefferson



State of

Louisiana

I,

George Parker

born in

St. James Parish

in the State of

Louisiana

aged

Twenty eight

years,

and by occupation a

Laborer

do hereby acknowledge to have

voluntarily enlisted this

Twelfth

day of

January

18*63*, as a SOLDIER in the ARMY OF THE UNITED STATES OF AMERICA, for the period of *THREE YEARS*, unless sooner discharged by proper authority: Do also agree to accept such bounty, pay, rations, and clothing, as are, or may be, established by law. And

I, *George Parker* do solemnly swear, that I will bear true faith and allegiance to the UNITED STATES OF AMERICA, and that I will serve them honestly and faithfully against all their enemies or opposers whomsoever; and that I will observe and obey the orders of the President of the United States, and the orders of the officers appointed over me, according to the Rules and Articles of War.

Sworn and subscribed to, at

Camp Parapet, La.

this *ninth* day of

February 18*63*

BEFORE

S. Rygaard
2^d Lt. U.S. Art. Co. Vol.

I CERTIFY, ON HONOR, That I have carefully examined the above named Recruit, agreeably to the General Regulations of the Army, and that in my opinion he is free from all bodily defects and mental infirmity, which would, in any way, disqualify him from performing the duties of a soldier.

EXAMINING SURGEON.

I CERTIFY, ON HONOR, That I have minutely inspected the Recruit,

George Parker

previously to his enlistment, and that he was entirely sober when enlisted; that, to the best of my judgement and belief, he is of lawful age; and that, in accepting him as duly qualified to perform the duties of an able-bodied soldier, I have strictly observed the Regulations which govern the recruiting service. This soldier has *brown* eyes, *black* hair, *dark* complexion; is *five* feet, *seven* inches high.

S. Rygaard 2^d Lt. U.S. Art. Co. Vol.

RECRUITING OFFICER.

Fort Stephens, Pass Manchac
May 24th 1864

Private George Parker, alias Benjamin Johnson,
(this last his true name) of Company B. 7th U. S. Heavy
Artillery (colored) has leave to marry with Jane
Johnson, residing in the Parish of Jefferson
Mo. Haulle

Captain Command'g Comp^y B.
7th U. S. H. Art. (colored).

Marriage Certificate
of Benj Johnson
to Jane Johnson
May 25, 1864
Co B 7 U. S. Regt.

Marriage Certificate.

No. 1

The State of Louisiana.

Parish of Jefferson

I J. M. Guilletant - Provost Marshal
of the Parish of Jefferson - - - do
hereby Certify that I have this twenty fifth day of
May A. D., One Thousand Eight Hundred and
Sixty Four in the Parish of Jefferson
joined in the Bonds of Matrimony?

Benj. Johnson Co B 7th USHA

Jane Johnson

In Testimony Whereof, I, the the undersigned, Provost
Marshal for the Parish aforesaid have signed my name.

J. M. Guilletant

Provost Marshal.

ma. *captain*
CARD NUMBERS.

7701

- 26
- 27
- 28
- 29
- 30
- 31
- 32
- 33
- 34
- 35
- 36
- 37
- 38
- 39
- 40
- 41
- 42
- 43
- 44
- 45
- 46
- 47
- 48
- 49
- 50

Book Mark:

See also *Co C 77 U.S.C. Inf*

P 10260 U.S.C.T.

James Parker

Capt, Co., Reg't U. S. Col'd 10th

Appears on

M. and D. Roll of Men Transferred

to the organization named above,

from Co B 7th U.S. Col Inf

Roll dated Camp Cananda Co 1, 1865.

When enlisted , 186 .

Period for which enlisted years.

When mustered in Jan 2, 1865.

Present or absent Present

Company to which assigned

Remarks: Appointed from

Co B 7th U.S. Col Inf

Co B 7th U.S. Col Inf

Co B 7th U.S. Col Inf

Co B 7th U.S. Col Inf

Co B 7th U.S. Col Inf

Co B 7th U.S. Col Inf

Co B 7th U.S. Col Inf

Co B 7th U.S. Col Inf

Co B 7th U.S. Col Inf

Co B 7th U.S. Col Inf

Co B 7th U.S. Col Inf

Co B 7th U.S. Col Inf

Co B 7th U.S. Col Inf

Co B 7th U.S. Col Inf

Co B 7th U.S. Col Inf

Co B 7th U.S. Col Inf

Co B 7th U.S. Col Inf

Co B 7th U.S. Col Inf

Co B 7th U.S. Col Inf

Co B 7th U.S. Col Inf

Co B 7th U.S. Col Inf

Co B 7th U.S. Col Inf

Co B 7th U.S. Col Inf

Co B 7th U.S. Col Inf

S.O. 7070 Ha Ore
U.S. Forces Camp
Carpet Honorably dis-
charged, and mustered
out by reason of being
rendered Superfluous
by consolidation of
Regt and in obedience
to S.O. 7066. Ha Ore
Department of Louisiana

JAN. 15

5487701

1891

10 U.S. Col'd H. Art'y

Private | Private.

CARD NUMBERS.

1	5488675.	26
2	5501307.	27
3	5501448.	28
4	5501586.	29
5	5501745.	30
6	5502268.	31
7	5489918.	32
8		33
9		34
10		35
11		36
12		37
13		38
14		39
15		40
16		41
17		42
18		43
19		44
20		45
21		46
22		47
23		48
24		49
25		50

Book Mark:

See also 77 U.S. C. I.

R 3722141

21572061 P. O. M. M.

S 2019845 P. O. M.

S-2059791 P. O. M.

2.2292695 G. A. R.

M. J. Worley
J 47

P | 10 H. Artz | U.S.C.T.

James Parker

Pri., Co. K, 10 Reg't U. S. Col'd H. Artz

Appears on

M. and D. Roll of Men Transferred

to the organization named above,

from Co. B, 77 Reg't U.S. C. Inf

Roll dated Oct. 1, 1865.

When enlisted Mar 18, 1863.

Period for which enlisted 3 years.

When mustered in Mar 13, 1863.

Present or absent Present

Company to which assigned K.

Remarks: Transferred from Co. I, 5 Reg't. C^d. A. Jan. 2, 64. Stop gr. 1. Musquete Bar / Screw driver 1. wiper.

Book mark :

Avery

P | 10 H. Art'y. | U.S.C.T.

James Parker
Pvt., Co. D, 10 Reg't U. S. Col'd H. Art'y.

Appears on

Company Muster Roll

for *Sept & Oct*, 1865.

Present or absent *Present*

Stoppage, \$ *100* for

Due Gov't, \$ *100* for

Valuation of horse, \$ *100*

Valuation of horse equipments, \$ *100*

Remarks: *Transfd from Co B, 77
U.S.C.I. per G.O. No. 3, Hd Qrs
10 U.S.C.A.H. Camp Parapet, La.,
Oct 1/65. Due U.S. for Camp
Equipage \$1⁷⁰, for ~~advance~~
lost .69¢*

Book mark:

Patterson

P

10 H. Art'y. | U.S.C.T.

James Parker

Prvt, Co. D, 10 Reg't U. S. Col'd H. Art'y.

Appears on

Company Master Roll

for Nov 24th, 1865.

Present or absent Present

Stoppage, \$ 100 for

Due Gov't, \$ 100 for

Valuation of horse, \$ 100

Valuation of horse equipments, \$ 100

Remarks:

Book mark:

W. W. Wayne Copyist.

P

10 H. Art'y.

U.S.C.T.

James Parker

Pvt

, Co. D, 10 Reg't U. S. Col'd H. Art'y.

Appears on

Company Muster Roll

for Jan & Feb, 1866

Present or absent Present

Stoppage, \$ 100 for

Due Gov't, \$ 100 for

Valuation of horse, \$ 100

Valuation of horse equipments, \$ 100

Remarks: Due U.S. for
Camp Exp. \$ 1.70.
for Ord 169cts

Book mark:

W. Wayne

(358)

Copyist.

P

10 H. Art'y. | U.S.C.T.

James Parker

Co. D, 10 Reg't U. S. Col'd H. Art'y.

Appears on

Company Muster Roll

for Mch 23/66, 1866.

Present or absent.

Stoppage, \$ 100 for

Due Gov't, \$ 100 for

Valuation of horse, \$ 100

Valuation of horse equipments, \$ 100

Remarks: Discharged at New Orleans, La. Mch 23/66 by reason of expiration of term of service

Book mark:

(358)

Copyist.

P

10 H. Art'y. U.S.C.T.

James Parker

Co. D, 10 Reg't U. S. Col'd H. Art'y.

Appears on Co. Muster-out Roll, dated Baton Rouge La, Feb 22, 1867.

Muster-out to date _____, 186 .

Last paid to _____, 186 .

Clothing account:

Last settled _____, 186 ; drawn since \$ _____ 100

Due soldier \$ _____ 100; due U. S. \$ _____ 100

Am't for cloth'g in kind or money adv'd \$ _____ 100

Due U. S. for arms, equipments, &c., \$ _____ 100

Bounty paid \$ _____ 100; due \$ _____ 100

Remarks: Joined by transfer from Co. B. 7th U.S. Col'd H. Art'y. Sept 22/65. Dis. no. La Sept 23/66 ex. of term of serv.

Book mark: _____

(861)

J. Leonard

Copyist.

P. | *10th Reg't U.S. Col'd Arty* | U.S.C.T.

James Parker
Arty, Co. D, 10th Reg't U. S. Col'd Arty

Appears on a

Detachment Muster-out Roll

of the organization named above. Roll dated

New Orleans La Mar, 22, 1866.

Muster-out to date *Mar, 22, 1866.*

Last paid to *Dec, 31, 1865*

Clothing account:

Last settled 186 ; drawn since \$ 100

Due soldier \$ *19 41* / 100; due U. S. \$ 100

Am't for cloth'g in kind or money adv'd \$ 100

Due U. S. for arms, equipments, &c., \$ *2 39* / 100

Bounty paid \$ 100 due \$ 100

Remarks: *Joined original organization of 4th Cd A. (76 U.S. I.) Transferred to 5th Cd A. (77 U.S. I.) Dec. 2nd, 1863, Transferred to 10th U.S. C. A. H. Oct. 1st.*

Book mark: *(over)*

H. N. Reed

JAN. 15

5489918

★ 1891 ★

1865- per S. O. No. 66 Series
of 1865 Hd Qrs, Dept.
of La. Stoppages, one
mosquito bar, two
screw drivers & two wipers.

10 U.S. Col'd H. Art'y.

Private Private.

CARD NUMBERS.

1	5494246	26
2	5494398	27
3	5494556	28
4	5494714	29
5	5494869	30
6	5495021	31
7	5495177	32
8	5495329	33
9	5495481	34
10	5495631	35
11	5495770	36
12	5495932	37
13	5496077	38
14	5496226	39
15	5496380	40
16	5496527	41
17	5496669	42
18	5496812	43
19	5496971	44
20	5497143	45
21	5497458	46
22	5489691	47
23		48
24		49
25		50

Book Mark:

See also

S-960756-PO mem

R. P. 645-287

M. J. Worley
J
4r.

P | 10 H. Art'y. | U.S.C.T.

Moses Parker

Pvt., 2 Battery, La. H. Art'y, Native Guards.*

Age 29 years.

Appears on

Company Muster-in Roll

of the organization named above. Roll dated

Camp Parapet, Carrollton, La., Feb. 9, 1863.

Muster-in to date Feb. 9, 1863.

Joined for duty and enrolled:

When July 13, 1863.

Where Camp Parapet, Carrollton, La.

Period 3 years.

Valuation of horse, \$ 100

Valuation of horse equipments, \$ 100

Remarks:

* This organization subsequently became Co. B, 10 Reg't U. S. Colored Heavy Artillery.

Book mark:

Heaster

P | 10 H. Art'y. | U.S.C.T.

Moses Parker

Priv., Co. B, 1 Reg't La. H. Art'y, Native Guards.*

Appears on

Company Muster Roll

for *Imm. Enlistment to Feb. 28*, 1863.

Present or absent *Present*

Stoppage, \$ *100* for

Due Gov't, \$ *100* for

Valuation of horse, \$ *100*

Valuation of horse equipments, \$ *100*

Remarks:

*This organization subsequently became Co. B, 10 Reg't U. S. Col'd Heavy Artillery.

Book mark:

Peaster

P

10 H. Art'y.

U.S.C.T.

Moses Parker

Pvt., Co. B, 1 Reg't La. H. Art'y, Native Guards.*

Appears on

Company Muster Roll

for , 186 *3*.

Present or absent *Present*

Stoppage, \$ 100 for

Due Gov't, \$ 100 for

Valuation of horse, \$ 100

Valuation of horse equipments, \$ 100

Remarks:

*This organization subsequently became Co. B, 10 Reg't U. S. Col'd Heavy Artillery.

Book mark:

Feaster

P

10 H. Art'y.

U.S.C.T.

Moses Parker

Pvt., Co. B, 1 Reg't La. H. Art'y, Native Guards.*

Appears on

Company Muster Roll

for May 7. June, 1863.

Present or absent Present

Stoppage, \$ 100 for

Due Gov't, \$ 100 for

Valuation of horse, \$ 100

Valuation of horse equipments, \$ 100

Remarks:

*This organization subsequently became Co. B, 10 Reg't U. S. Col'd Heavy Artillery.

Book mark:

Feaster

P | 10 H. Art'y. | U.S.C.T.

Moses Parker

Pvt., Co. B, 1 Reg't La. H. Art'y, Native Guards.*

Appears on

Company Muster Roll

for July 4, Aug., 1863.

Present or absent Present.

Stoppage, \$ 100 for

Due Gov't, \$ 100 for

Valuation of horse, \$ 100

Valuation of horse equipments, \$ 100

Remarks:

*This organization subsequently became Co. B, 10 Reg't U. S. Col'd Heavy Artillery.

Book mark:

Feaster

P

10 H. Art'y.

U.S.C.T.

Moses Parker

Co. B, 1 Reg't La. H. Art'y, Native Guards.*

Appears on

Company Muster Roll

for Sept. 4, Oct. 1863.

Present or absent Present

Stoppage, \$ 100 for

Due Gov't, \$ 100 for

Valuation of horse, \$ 100

Valuation of horse equipments, \$ 100

Remarks:

*This organization subsequently became Co. B, 10 Reg't U. S. Col'd Heavy Artillery.

Book mark:

Master

P

10 H. Art'y. | U.S.C.T.

Moses Parker

Pt, Co. B, 1 Reg't H. Art'y, Corps d'Afrique.*

Appears on

Company Muster Roll

for Nov. 1 Dec; 1863.

Present or absent Present

Stoppage, \$ 100 for

Due Gov't, \$ 100 for

Valuation of horse, \$ 100

Valuation of horse equipments, \$ 100

Remarks:

*This organization subsequently became Co. , 10 Reg't U. S. Colored Heavy Artillery.

Book mark:

P. R. G.

P | 10 H. Art'y. | U.S.C.T.

Moses Parker

Pvt, Co. B, 1 Reg't H. Art'y, Corps d'Afrique.*

Appears on

Company Muster Roll

for Jan. 1 to Feb. 1, 1864

Present or absent Present

Stoppage, \$ 100 for

Due Gov't, \$ 100 for

Valuation of horse, \$ 100

Valuation of horse equipments, \$ 100

Remarks:

* This organization subsequently became Co. , 10 Reg't U. S. Colored Heavy Artillery.

Book mark:

(358)

C. R. King

Copyist.

P | 10 H. Art'y. | U.S.C.T.

Moses Parker

Pl, Co. B, 7 Reg't U. S. Col'd H. Art'y.*

Appears on

Company Muster Roll

for March & April, 1864

Present or absent Present

Stoppage, \$ 100 for

Due Gov't, \$ 100 for

Valuation of horse, \$ 100

Valuation of horse equipments, \$ 100

Remarks:

* This organization subsequently became Co. , 10 Reg't U. S. Colored Heavy Artillery.

Book mark:

(358)

Park

Copyist.

P | 10 H. Art'y. | U.S.C.T.

Moses Parker

Pt, Co. B, 7 Reg't U. S. Col'd H. Art'y.*

Appears on

Company Muster Roll

for May & June, 1864.

Present or absent Present

Stoppage, \$ 100 for

Due Gov't, \$ 100 for

Valuation of horse, \$ 100

Valuation of horse equipments, \$ 100

Remarks:

* This organization subsequently became Co. , 10 Reg't U. S. Colored Heavy Artillery.

Book mark:

(Ref)

F

10 H. Art'y.

U.S.C.T.

Moses Parker

Pt., Co. B, 10 Reg't U. S. Col'd H. Art'y.

Appears on

Company Muster Roll

for *July & Aug*, 186*4*

Present or absent *Present*

Stoppage, \$ 100 for

Due Gov't, \$ 100 for

Valuation of horse, \$ 100

Valuation of horse equipments, \$ 100

Remarks: *Sick*

Book mark:

J. Richardson

(358)

Copyist.

P

10 H. Art'y. U.S.C.T.

Moses Parker

Co. B, 10 Reg't U. S. Col'd H. Art'y.

Appears on

Company Muster Roll

for Sept & Oct, 1864.

Present or absent Present

Stoppage, \$ 100 for

Due Gov't, \$ 100 for

Valuation of horse, \$ 100

Valuation of horse equipments, \$ 100

Remarks:

Book mark:

J. A. Richardson

(358)

Copyist.

J.P.

10 H. Art'y. U.S.C.T.

Moses Parker

Plt., Co. B, 10 Reg't U. S. Col'd H. Art'y.

Appears on

Company Muster Roll

for *Nov & Dec*, 186*4*.

Present or absent *Present.*

Stoppage, \$ *100* for

Due Gov't, \$ *100* for

Valuation of horse, \$ *100*

Valuation of horse equipments, \$ *100*

Remarks:

Book mark:

(358)

Jornier

Copyist.

P.

10 H. Art'y. U.S.C.T.

Moses Parker
Pvt., Co. B, 10 Reg't U. S. Col'd H. Art'y.

Appears on

Company Muster Roll

for Jan & Feb, 1865.

Present or absent Present

Stoppage, \$ 100 for

Due Gov't, \$ 100 for

Valuation of horse, \$ 100

Valuation of horse equipments, \$ 100

Remarks: Our soldier augmented pay from Jan 1, 1864 to May 1, 1864 \$6⁰⁰ per month, May & June \$9⁰⁰ per month.

Book mark:

J. J. J. J.

(358)

Copyist.

P | 10 H. Art'y. | U.S.C.T.

Moses Parker
Pvt., Co. B, 10 Reg't U. S. Col'd H. Art'y.

Appears on

Company Muster Roll

for *Mar & Apr*, 1865.

Present or absent *Present*.

Stoppage, \$ 100 for

Due Gov't, \$ 100 for

Valuation of horse, \$ 100

Valuation of horse equipments, \$ 100

Remarks:

Book mark: -----

(358) *J. J. J. J.* Copyist.

P.

10 H. Art'y. U.S.C.T.

Moses Parker

Pvt., Co. B, 10 Reg't U. S. Col'd H. Art'y.

Appears on

Company Muster Roll

for May & June, 1865.

Present or absent Present

Stoppage, \$ 100 for

Due Gov't, \$ 100 for

Valuation of horse, \$ 100

Valuation of horse equipments, \$ 100

Remarks:

Book mark:

J. J. J. J.

Moses Parker

Pvt., Co. B, 10 Reg't U. S. Col'd H. Art'y.

Appears on

Company Muster Roll

for July & Aug., 1863.

Present or absent Present.

Stoppage, \$ 100 for

Due Gov't, \$ 100 for

Valuation of horse, \$ 100

Valuation of horse equipments, \$ 100

Remarks:

Book mark:

J. J. J. J.

P.

10 H. Art'y. U.S.C.T.

Moses Parker

Priv., Co. B, 10 Reg't U. S. Col'd H. Art'y.

Appears on

Company Muster Roll

for Sep. & Oct., 1865.

Present or absent Present

Stoppage, \$ 100 for

Due Gov't, \$ 100 for

Valuation of horse, \$ 100

Valuation of horse equipments, \$ 100

Remarks:

Book mark:

(358)

Jones

Copyist.

P

10 H. Art'y. U.S.C.T.

Moses Parker

Pvt, Co. B, 10 Reg't U. S. Col'd H. Art'y.

Appears on

Company Muster Roll

for Nov & Dec, 1865

Present or absent Present

Stoppage, \$ 100 for

Due Gov't, \$ 100 for

Valuation of horse, \$ 100

Valuation of horse equipments, \$ 100

Remarks: Due us for Ard. 24 cts,

Book mark:

P. R. f

(358)

Copyist.

P

10 H. Art'y. U.S.C.T.

Amos Parker

P

, Co. B, 10 Reg't U. S. Col'd H. Art'y.

Appears on

Company Muster Roll

for

Jan. 1st to Feb. 1st, 1866.

Present or absent

Stoppage, \$ 100 for

Due Gov't, \$ 100 for

Valuation of horse, \$ 100

Valuation of horse equipments, \$ 100

Remarks

Must be out at M.D. Sec. Feb. 8 66 by reason of exp. of term of service

Book mark:

(358)

Reif

Copyist.

P | 10 H. Art'y. | U.S.C.T.

Moses Parker

Priv. Co. B, 10 Reg't U. S. Col'd H. Art'y.

Appears on Co. Muster-out Roll, dated

Baton Rouge, La., Feb, 1867.

Muster-out to date 186 .

Last paid to 186 .

Clothing account:

Last settled 186 ; drawn since \$ 100

Due soldier \$ 100 ; due U. S. \$ 100

Am't for cloth'g in kind or money adv'd \$ 100

Due U. S. for arms, equipments, &c., \$ 100

Bounty paid \$ 100 ; due \$ 100

Remarks:

Joined org'l. org'n
Discharged Feb 8/66
expiration term of
service.

Book mark: V. 34 P. 92 72.

Hodges
Copyist.

P. 10 No. a. U.S.C.T.

Moses Parker

Priv., Co. B., 10 Reg't U. S. Col'd No. a.

Appears on a

Detachment Muster-out Roll

of the organization named above. Roll dated

New Orleans La. Feb. 8, 1864.

Muster-out to date

Feb. 8, 1864.

Last paid to

June 30, 1865

Clothing account:

Last settled 186 ; drawn since \$ 100

Due soldier \$ 26 ⁴⁹/₁₀₀; due U. S. \$ 100

Am't for cloth'g in kind or money adv'd \$ 100

Due U. S. for arms, equipments, &c., \$ 100

Bounty paid \$ 100 due \$ 100

Remarks: Joined at Orign. Orgn
Stop for 1 Niper & Tompions
Mustered out by reason of
Expiration of term of
service (Cert. of Mustg. Of-
ficer shows him M. O. Feb. 12, 1864)

Book mark:

* Added May 12, 93. GED

Howling

Parker, Moses

....., Co., 10th Reg't U.S.C. & G.

✓ Enclosures.

Bed Cards	Final Statements
Burial Records	Furloughs or L. of A.
Certs. of Dis. for Discharge	Med. Certificates
C. M. Charges	Med. Des. Lists
Descriptive Lists	Orders
Discharge Certificates	Pris. of War Record
Enlistment Papers <i>2</i>	Resignations

Other papers relating to—

Admission to Hosp'l	Furlough or L. of A.
Casualty Sheet	Med. Examination
Confinement	Misc. Information
Contracts	Pay or Clothing
Death or Effects	Personal Reports
Desertion	Rank
Discharge from Hosp'l	Transfer to Hosp'l
Discharge from Service	Transfer to V. R. C.
Duty	Transportation

DECLARATION OF RECRUIT.

I, _____ desiring to ENLIST in the Army of the United States, for the term of THREE YEARS, Do declare, That I am _____ years and _____ months of age; that I have neither wife nor child; that I have never been discharged from the United States service on account of disability or by sentence of a court-martial, or by order before the expiration of a term of enlistment; and I know of no impediment to my serving honestly and faithfully as a soldier for three years.

GIVEN at _____ The _____ day of _____

Witness: _____

No. _____
Enlisted at Company Parapet, Va.
January the 1st 1863,
By 2d Lieut. J. P. G. and
1st Sgt. Regiment of Virginia
10 243 200, 2
Discharged _____ 18 _____
enlistment; last served in Company _____
Reg't of _____

CONSENT IN CASE OF MINOR.

I, _____ Do CERTIFY, That I am the _____ of _____; that the said _____ is _____ years of age; and I do hereby freely give my CONSENT to his enlisting as a SOLDIER in the ARMY OF THE UNITED STATES for the period of THREE YEARS.

GIVEN at _____ The _____ day of _____

Witness: _____

County of

Jefferson



State of

Louisiana

I, *Moses Parker*

born in *Amberland County*

in the State of *Virginia* aged *Twenty nine* years,

and by occupation a *Laborer* do hereby acknowledge to have

voluntarily enlisted this *Thirteenth* day of *January*

18 *63*, as a SOLDIER in the ARMY OF THE UNITED STATES OF AMERICA, for the period

of *THREE YEARS*, unless sooner discharged by proper authority: Do also agree to

accept such bounty, pay, rations, and clothing, as are, or may be, established by law. And

I, *Moses Parker* do solemnly swear, that I will bear true faith

and allegiance to the UNITED STATES OF AMERICA, and that I will serve them honestly and

faithfully against all their enemies or opposers whomsoever; and that I will observe and

obey the orders of the President of the United States, and the orders of the officers

appointed over me, according to the Rules and Articles of War.

of Carrollton, La.

Sworn and subscribed to, at *Camp Parapet*
this *ninth* day of *February* 18*63*

BEFORE
J. Rygaard
2d Lt. N.Y. Art. Regts

I CERTIFY, ON HONOR, That I have carefully examined the above named Recruit, agreeably to the General Regulations of the Army, and that in my opinion he is free from all bodily defects and mental infirmity, which would, in any way, disqualify him from performing the duties of a soldier.

W. C. Lynde

EXAMINING SURGEON.

I CERTIFY, ON HONOR, That I have minutely inspected the Recruit, *Moses Parker* previously to his enlistment, and that he was entirely sober when enlisted; that, to the best of my judgement and belief, he is of lawful age; and that, in accepting him as duly qualified to perform the duties of an able-bodied soldier, I have strictly observed the Regulations which govern the recruiting service. This soldier has *brown* eyes, *black* hair, *dark* complexion; is *five* feet, *eight 1/2* inches high.

J. Rygaard
2d Lt. N.Y. Art. Regts

RECRUITING OFFICER.

DECLARATION OF RECRUIT.

I, _____ desiring to ENLIST in the Army of the United States, for the term of THREE YEARS, Do declare, That I am _____ years and _____ months of age; that I have neither wife nor child; that I have never been discharged from the United States service on account of disability or by sentence of a court-martial, or by order before the expiration of a term of enlistment; and I know of no impediment to my serving honestly and faithfully as a soldier for three years.

GIVEN at _____

The _____ day of _____

Witness:

Enlisted at Camp Parapet, Va.
By 2nd Lieut. J. H. Spence
Department of Virginia
No. 96.
Reg't of _____
Discharged _____ 18
enlistment; last served in Company _____

CONSENT IN CASE OF MINOR.

I, _____ Do CERTIFY, That I am the _____ of _____; that the said _____ is _____ years of age; and I do hereby freely give my CONSENT to his enlisting as a SOLDIER in the ARMY OF THE UNITED STATES for the period of THREE YEARS.

GIVEN at _____

The _____ day of _____

Witness:

County of

Jefferson



State of

Louisiana

I, *Moses Parker*

born in *Cumberland County*

in the State of *Virginia* aged *Twenty nine* years,

and by occupation a *Laborer* do hereby acknowledge to have

voluntarily enlisted this *thirteenth* day of *January*

18 *63*, as a SOLDIER in the ARMY OF THE UNITED STATES OF AMERICA, for the period of *THREE YEARS*, unless sooner discharged by proper authority: Do also agree to

accept such bounty, pay, rations, and clothing, as are, or may be, established by law. And

I, *Moses Parker* do solemnly swear, that I will bear true faith

and allegiance to the UNITED STATES OF AMERICA, and that I will serve them honestly and

faithfully against all their enemies or opposers whomsoever; and that I will observe and

obey the orders of the President of the United States, and the orders of the officers

appointed over me, according to the Rules and Articles of War.

Sworn and subscribed to, at

of Carrollton La.

Camp Paraput,

this *ninth* day of *February* 18*63*

BEFORE

*J. Rygaard
2^d Lt. N.G. Art. Co. Vol.*

I CERTIFY, ON HONOR, That I have carefully examined the above named Recruit, agreeably to the General Regulations of the Army, and that in my opinion he is free from all bodily defects and mental infirmity, which would, in any way, disqualify him from performing the duties of a soldier.

W. C. Lynne

EXAMINING SURGEON.

I CERTIFY, ON HONOR, That I have minutely inspected the Recruit, *Moses Parker* previously to his enlistment, and that he was entirely sober when enlisted; that, to the best of my judgement and belief, he is of lawful age; and that, in accepting him as duly qualified to perform the duties of an able-bodied soldier, I have strictly observed the Regulations which govern the recruiting service. This soldier has *brown* eyes, *black* hair, *dark* complexion; is *five* feet, *eight 1/2* inches high.

J. Rygaard. 2^d Lieut. N.G. Art. Co. La.

RECRUITING OFFICER.

U.S. CO'D I. A.

Private

Sergeant

CARD NUMBERS.

5459055	26
5492940	27
5493152	28
5493301	29
5493439	30
5493633	31
5493668	32
5493777	33
5493836	34
	35
	36
	37
	38
	39
	40
	41
	42
	43
	44
	45
	46
	47
	48
	49
	50

Book Mark:

See also 75-26.5.69

J 10 *Mar* U.S.C.T.

Paul Parker

H., Co., *10* Reg't U. S. Col'd *Mar*

Appears on

M. and D. Roll of Men Transferred

to the organization named above,

from *70 1st Col*

Roll dated *Nov 18*, 186*3*.

When enlisted *Sep 23*, 186*4*.

Period for which enlisted *3* years.

When mustered in *Sep 23*, 186*4*.

Present or absent *Not stated*

Company to which assigned

Remarks: *Drafted per*

*G.O. 106 dated H & D Reg
Sept 25/64*

Book mark :

J A Johnson

(342)

Copyist.

P

10 H. Art'y. U.S.C.T.

Paul Parker

Plt, Co. A, 10 Reg't U. S. Col'd H. Art'y.

Appears on

Company Muster Roll

for Nov & Dec, 1865.

Present or absent Present

Stoppage, \$ 100 for

Due Gov't, \$ 100 for

Valuation of horse, \$ 100

Valuation of horse equipments, \$ 100

Remarks: Transferred from 75
U.S.C. I. per S.O. 105, 68. 1st
Gps Dept. of Sea.

Book mark:

(358)

Keyes Copyist.

P

10 H. Art'y.

U.S.C.T.

Paul Parker

Ptk, Co. A, 10 Reg't U. S. Col'd H. Art'y.

Appears on

Company Muster Roll

for Jan + Feb, 1866.

Present or absent Present

Stoppage, \$ 100 for

Due Gov't, \$ 100 for

Valuation of horse, \$ 100

Valuation of horse equipments, \$ 100

Remarks:

[Empty lines for remarks]

Book mark:

(358)

[Signature]

Copyist.

P | 10 H. Art'y. | U.S.C.T.

Paul Parker

Plt, Co. A, 10 Reg't U. S. Col'd H. Art'y.

Appears on

Company Muster Roll

for *Mar - April*, 1866.

Present or absent *Present*

Stoppage, \$ *100* for

Due Gov't, \$ *100* for

Valuation of horse, \$ *100*

Valuation of horse equipments, \$ *100*

Remarks:

Book mark:

(358)

J. H. ...
Copyist.

P | 10 H. Art'y. | U.S.C.T.

Paul Parker

P/, Co. A, 10 Reg't U. S. Col'd H. Art'y.

Appears on

Company Muster Roll

for *May & June, 1866*

Present or absent *Present*

Stoppage, \$ 100 for

Due Gov't, \$ 100 for

Valuation of horse, \$ 100

Valuation of horse equipments, \$ 100

Remarks:

Book mark: -----

(358)

H. J. ...
Copyist.

P | 10 H. Art'y. | U.S.C.T.

Paul Parker

Pl, Co. A, 10 Reg't U. S. Col'd H. Art'y.

Appears on

Company Muster Roll

for *July & Aug, 1866*

Present or absent *Present*

Stoppage, \$ *100* for

Due Gov't, \$ *100* for

Valuation of horse, \$ *100*

Valuation of horse equipments, \$ *100*

Remarks:

Book mark:

(358)

Hyman
Copyist.

P | 10 H. Art'y. | U.S.C.T.

Paul Parker

Sgt, Co. A, 10 Reg't U. S. Col'd H. Art'y.

Appears on

Company Muster Roll

for Sept & Oct, 1866.

Present or absent Present

Stoppage, \$ 100 for

Due Gov't, \$ 100 for

Valuation of horse, \$ 100

Valuation of horse equipments, \$ 100

Remarks: Private to Sept. 24. 66

Book mark:

Nesbitt

Copyist.

(358)

P | 10 H. Art'y. | U.S.C.T.

Paul Parker

Sgt, Co. A, 10 Reg't U. S. Col'd H. Art'y.

Appears on

Company Muster Roll

for Nov & Dec, 1866.

Present or absent Present

Stoppage, \$ 100 for

Due Gov't, \$ 100 for

Valuation of horse, \$ 100

Valuation of horse equipments, \$ 100

Remarks:

Book mark:

Resbitt
Copyist.

(358)

P

10 H. Art'y. U.S.C.T.

Paul Parker

Sgt, Co....., 10 Reg't U. S. Col'd H. Art'y.

Appears on Co. Muster-out Roll, dated Baton Rouge La, Feb 22, 1867.

Muster-out to date Feb 22, 1867.

Last paid to Dec. 31, 1866.

Clothing account:

Last settled....., 186 ; drawn since \$ 100

Due soldier \$ 60 72 / 100; due U. S. \$ 100

Am't for cloth'g in kind or money adv'd \$ 100

Due U. S. for arms, equipments, &c., \$ 9 11 / 100 ^{under G. O. 101}

Bounty paid \$ 100; due \$ 2 11 / 100

Remarks: Transf. from 75 U.S. C. I. as Pvt. S. O. 165 Sol 65 Dept. La. App'td Sgt. Sept. 24. '66

Book mark :

Nesbitt

(361)

Copyist.

Forster William
Co *B*, 10 U.S. Col'd H. Art'y

Private | *Private*

CARD NUMBERS.

1	5494247	26
2	5494399	27
3	5494557	28
4	5494715	29
5	5494870	30
6	5495022	31
7	5495178	32
8	5495330	33
9	5495482	34
10	5495632	35
11	5495771	36
12	5495933	37
13	5496078	38
14	5496228	39
15	5496381	40
16	5496528	41
17	5496670	42
18	5496813	43
19	5496972	44
20	5497144	45
21	5497459	46
22	5489692	47
23		48
24		49
25		50

Book Mark: _____

See also _____

P | 10 H. Art'y. | U.S.C.T.

William Parker

Pvt., 2 Battery, La. H. Art'y, Native Guards.*

Age *30* years.

Appears on

Company Muster-in Roll

of the organization named above. Roll dated

Camp Parapet, Carrollton La., Feb. 9, 186*3*.

Muster-in to date

Feb. 9, 186*3*.

Joined for duty and enrolled:

When *Dec. 10*, 186*2*.

Where *Camp Parapet, Carrollton La.*

Period *3* years.

Valuation of horse, \$ *100*

Valuation of horse equipments, \$ *100*

Remarks:

* This organization subsequently became Co. B, 10 Reg't U. S. Colored Heavy Artillery.

Book mark:

Peaster

P

10 H. Art'y.

U.S.C.T.

William Parker

Pvt., Co. B, 1 Reg't La. H. Art'y, Native Guards.*

Appears on

Company Muster Roll

for *from Enlistment to Feb. 28*, 1863.

Present or absent *Present*

Stoppage, \$ *100* for

Due Gov't, \$ *100* for

Valuation of horse, \$ *100*

Valuation of horse equipments, \$ *100*

Remarks:

*This organization subsequently became Co. B, 10 Reg't U. S. Col'd Heavy Artillery.

Book mark:

Feaster

P

10 H. Art'y.

U.S.C.T.

William Parker

Pvt., Co. B, 1 Reg't La. H. Art'y, Native Guards.*

Appears on

Company Muster Roll

for Mch. 7. Apl. 1863.

Present or absent Present

Stoppage, \$ 100 for

Due Gov't, \$ 100 for

Valuation of horse, \$ 100

Valuation of horse equipments, \$ 100

Remarks:

*This organization subsequently became Co. B, 10 Reg't U. S. Col'd Heavy Artillery.

Book mark:

Feaster

P

10 H. Art'y.

U.S.C.T.

William Parker

Pvt., Co. B, 1 Reg't La. H. Art'y, Native Guards.*

Appears on

Company Muster Roll

for May & June, 1863.

Present or absent Present

Stoppage, \$ 100 for

Due Gov't, \$ 100 for

Valuation of horse, \$ 100

Valuation of horse equipments, \$ 100

Remarks:

*This organization subsequently became Co. B, 10 Reg't U. S. Col'd Heavy Artillery.

Book mark:

Spaster

P | 10 H. Art'y. | U.S.C.T.

William Parker
Pvt., Co. B, 1 Reg't La. H. Art'y, Native Guards.*

Appears on

Company Muster Roll

for *July 4, Aug.*, 186*3*.

Present or absent *Present*

Stoppage, \$ *100* for

Due Gov't, \$ *100* for

Valuation of horse, \$ *100*

Valuation of horse equipments, \$ *100*

Remarks: _____

*This organization subsequently became Co. B, 10 Reg't U. S. Col'd Heavy Artillery.

Book mark: _____

Feaster

P

10 H. Art'y.

U.S.C.T.

William Parker

Pl., Co. B, 1 Reg't La. H. Art'y, Native Guards.*

Appears on

Company Muster Roll

for Sept. 7, Oct., 1867.

Present or absent Present

Stoppage, \$ 100 for

Due Gov't, \$ 100 for

Valuation of horse, \$ 100

Valuation of horse equipments, \$ 100

Remarks:

*This organization subsequently became Co. B, 10 Reg't U. S. Col'd Heavy Artillery.

Book mark:

Feaster

P | 10 H. Art'y. | U.S.C.T.

William Parker

Pvt, Co. B, 1 Reg't H. Art'y, Corps d'Afrique.*

Appears on

Company Muster Roll

for Nov. & Dec., 1863

Present or absent Present

Stoppage, \$ 100 for

Due Gov't, \$ 100 for

Valuation of horse, \$ 100

Valuation of horse equipments, \$ 100

Remarks:

*This organization subsequently became Co. , 10 Reg't U. S. Colored Heavy Artillery.

Book mark:

Reif

P

10 H. Art'y. U.S.C.T.

William Parker

Pl, Co. B, 1 Reg't H. Art'y, Corps d'Afrique.*

Appears on

Company Muster Roll

for Jun. & Jul., 1864

Present or absent Present

Stoppage, \$ 100 for

Due Gov't, \$ 100 for

Valuation of horse, \$ 100

Valuation of horse equipments, \$ 100

Remarks:

*This organization subsequently became Co. , 10 Reg't U. S. Colored Heavy Artillery.

Book mark:

Reif

Copyist.

P

10 H. Art'y.

U.S.C.T.

William Parker

Pd

B

, Co. B, 7 Reg't U. S. Col'd H. Art'y.*

Appears on

Company Muster Roll

for

Mch. 1st, 1864

Present or absent

Present

Stoppage, \$

100 for

Due Gov't, \$

100 for

Valuation of horse, \$

100

Valuation of horse equipments, \$

100

Remarks:

Assistant to Mr. Mr. Sgt.

* This organization subsequently became Co. Colored Heavy Artillery.

, 10 Reg't U. S.

Book mark:

(358)

O. Reif

Copyist.

P | 10 H. Art'y. | U.S.C.T.

William Parker

Pt, Co. B, 7 Reg't U. S. Col'd H. Art'y.*

Appears on

Company Muster Roll

for May & June, 1864

Present or absent Present

Stoppage, \$ 100 for

Due Gov't, \$ 100 for

Valuation of horse, \$ 100

Valuation of horse equipments, \$ 100

Remarks:

* This organization subsequently became Co. , 10 Reg't U. S. Colored Heavy Artillery.

Book mark:

(358)

Perif

Copyist.

P

10 H. Art'y.

U.S.C.T.

William Parker

A, Co. B, 10 Reg't U. S. Col'd H. Art'y.

Appears on

Company Muster Roll

for July & Aug, 1864.

Present or absent Present

Stoppage, \$ 100 for

Due Gov't, \$ 100 for

Valuation of horse, \$ 100

Valuation of horse equipments, \$ 100

Remarks:

Book mark:

J. Richardson

(358)

Copyist.

P

10 H. Art'y.

U.S.C.T.

William Parker

Co. B, 10 Reg't U. S. Col'd H. Art'y.

Appears on

Company Muster Roll

for Sept & Oct, 1864.

Present or absent Presents

Stoppage, \$ 100 for

Due Gov't, \$ 100 for

Valuation of horse, \$ 100

Valuation of horse equipments, \$ 100

Remarks:

Book mark:

J. H. Richardson

(358)

Copyist.

P.

10 H. Art'y.

U.S.C.T.

William Parker

Pat., Co. B, 10 Reg't U. S. Col'd H. Art'y.

Appears on

Company Muster Roll

for *Nov. & Dec*, 186*4*.

Present or absent *Present.*

Stoppage, \$ 100 for

Due Gov't, \$ 100 for

Valuation of horse, \$ 100

Valuation of horse equipments, \$ 100

Remarks:

Book mark: *Present*

(358)

Jornier

Copyist.

P | 10 H. Art'y. | U.S.C.T.

William Parker
Pt., Co. B, 10 Reg't U. S. Col'd H. Art'y.

Appears on

Company Muster Roll

for Jan & Feb, 1865

Present or absent Present

Stoppage, \$ 100 for

Due Gov't, \$ 100 for

Valuation of horse, \$ 100

Valuation of horse equipments, \$ 100

Remarks: Priv soldier aug-
mented pay from
Jan 1, 1864 to May
1, 1864 \$6.00 per
month. May and June
\$9.00 per month.

Book mark:

(358)

J. J. J. J.

Copyist.

W.P.

10 H. Art'y. | U.S.C.T.

William Parker

Pvt.; Co. B, 10 Reg't U. S. Col'd H. Art'y.

Appears on

Company Muster Roll

for *Mar & Apr*, 186*5*.

Present or absent *Present*

Stoppage, \$ 100 for

Due Gov't, \$ 100 for

Valuation of horse, \$ 100

Valuation of horse equipments, \$ 100

Remarks:

Book mark:

Jamies

(358)

Copyist.

P. | 10 H. Art'y. | U.S.C.T.

William Parker

Pvt., Co. B, 10 Reg't U. S. Col'd H. Art'y.

Appears on

Company Muster Roll

for *May & June*, 1865.

Present or absent *Present*

Stoppage, \$ 100 for

Due Gov't, \$ 100 for

Valuation of horse, \$ 100

Valuation of horse equipments, \$ 100

Remarks:

Book mark:

(358)

Joiner

Copyist.

P.

10 H. Art'y. U.S.C.T.

William Parker

Priv., Co. B, 10 Reg't U. S. Col'd H. Art'y.

Appears on

Company Muster Roll

for *July & Aug.*, 1865.

Present or absent *Present.*

Stoppage, \$ 100 for

Due Gov't, \$ 100 for

Valuation of horse, \$ 100

Valuation of horse equipments, \$ 100

Remarks:

Book mark:

(358) *J. J. J. J.* Copyist.

P.

10 H. Art'y.

U.S.C.T.

William Parker

Pat., Co. B, 10 Reg't U. S. Col'd H. Art'y.

Appears on

Company Muster Roll

for *Sept & Oct*, 1865.

Present or absent *Present*

Stoppage, \$ 100 for

Due Gov't, \$ 100 for

Valuation of horse, \$ 100

Valuation of horse equipments, \$ 100

Remarks:

Book mark:

Josner

P

10 H. Art'y. U.S.C.T.

William Parker

Plt, Co. B, 10 Reg't U. S. Col'd H. Art'y.

Appears on

Company Muster Roll

for Nov. 1 Dec., 1865.

Present or absent Present

Stoppage, \$ 100 for

Due Gov't, \$ 100 for

Valuation of horse, \$ 100

Valuation of horse equipments, \$ 100

Remarks:

[Empty lines for remarks]

Book mark:

(358)

Reis

Copyist.

P

10 H. Art'y. U.S.C.T.

William Parker

Pl

, Co. B, 10 Reg't U. S. Col'd H. Art'y.

Appears on

Company Muster Roll

for Jan. & Dec., 1866.

Present or absent

Stoppage, \$ 100 for

Due Gov't, \$ 100 for

Valuation of horse, \$ 100

Valuation of horse equipments, \$ 100

Remarks: Must'd out at M.O. in Dec. & 66 by reason of exp. of term of service

Book mark:

(358)

Ref

Copyist.

P

10 H. Art'y.

U.S.C.T.

William Parker

Co. D, 10 Reg't U. S. Col'd H. Art'y.

Appears on Co. Muster-out Roll, dated

Baton Rouge La, Feb., 1867.

Muster-out to date 186 .

Last paid to 186 .

Clothing account:

Last settled 186 ; drawn since \$ 100

Due soldier \$ 100 ; due U. S. \$ 100

Am't for cloth'g in kind or money adv'd \$ 100

Due U. S. for arms, equipments, &c., \$ 100

Bounty paid \$ 100 ; due \$ 100

Remarks:

Joined org'l. org'n.
Discharged Feb. 8/66
expiration term of
service.

Book mark:

Hedges

(361)

Copyist.

P. 10 Me. a. U.S.C.T.

William Parker

Pvt., Co. B., 10 Reg't U. S. Col'd Me. a.

Appears on a

Detachment Muster-out Roll

of the organization named above. Roll dated

New Orleans La, Feb. 8, 1864.*

Muster-out to date Feb. 8, 1864.

Last paid to June 30, 1865

Clothing account:

Last settled 186 ; drawn since \$ 100

Due soldier \$ 5-⁴⁶/₁₀₀; due U. S. \$ 100

Am't for cloth'g in kind or money adv'd \$ 100

Due U. S. for arms, equipments, &c., \$ 100

Bounty paid \$ 100 due \$ 100

Remarks: *Joined at Orign. Orign.
Mustered out by reason
of Expiration of term of
service (Cert. of Mustg. Off.
shows him M.O. Feb. 12, 1864.)*

** Added May 12, 93, YBT*

Book mark:

Hawling

Parker, William

, Co.

10th Reg't U.S.C.V.

2

Enclosures.

Bed Cards	Final Statements
Burial Records	Furloughs or L. of A
Certs. of Dis. for Discharge	Med. Certificates
C. M. Charges	Med. Des. Lists
Descriptive Lists	Orders
Discharge Certificates	Pris. of War Record
Enlistment Papers <i>2</i>	Resignations

Other papers relating to—

Admission to Hosp'l	Furlough or L. of A
Casualty Sheet	Med. Examination
Confinement	Misc. Information
Contracts	Pay or Clothing
Death or Effects	Personal Reports
Desertion	Rank
Discharge from Hosp'l	Transfer to Hosp'l
Discharge from Service	Transfer to V. R. C.
Duty	Transportation

DECLARATION OF RECRUIT.

I, _____ desiring to ENLIST in the Army of the United States, for the term of THREE YEARS, Do declare, That I am _____ years and _____ months of age; that I have neither wife nor child; that I have never been discharged from the United States service on account of disability or by sentence of a court-martial, or by order before the expiration of a term of enlistment; and I know of no impediment to my serving honestly and faithfully as a soldier for three years.

GIVEN at _____
The _____ day of _____

Witness: _____

No. 29

William Parker

Enlisted at *Quincy, Pa.*

December 19 1863

By *2nd Lieutenant J. H. Howard*

1st Infantry Regiment of Pennsylvania

enlistment; last served in Company ()

Reg't of _____

Discharged _____ 18 _____

CONSENT IN CASE OF MINOR.

I, _____ Do CERTIFY, That I am the _____ of _____; that the said _____ is _____ years of age; and I do hereby freely give my CONSENT to his enlisting as a SOLDIER in the ARMY OF THE UNITED STATES for the period of THREE YEARS.

GIVEN at _____
The _____ day of _____

Witness: _____

County of

State of



Jefferson
I, William Parker born in Norfolk County
in the State of Virginia aged Thirty years,
and by occupation a Labourer do hereby acknowledge to have
voluntarily enlisted this Tenth day of December

1862, as a SOLDIER in the ARMY OF THE UNITED STATES OF AMERICA, for the period
of THREE YEARS, unless sooner discharged by proper authority: Do also agree to
accept such bounty, pay, rations, and clothing, as are, or may be, established by law. And
I, William Parker do solemnly swear, that I will bear true faith
and allegiance to the UNITED STATES OF AMERICA, and that I will serve them honestly and
faithfully against all their enemies or opposers whomsoever; and that I will observe and
obey the orders of the President of the United States, and the orders of the officers
appointed over me, according to the Rules and Articles of War.

Sworn ~~and subscribed~~ to, at Camp Parapit,
this tenth day of February 1863,
BEFORE J. Rygaard,
2nd Lt. U. S. A. Co. 1st Regt.

I CERTIFY, ON HONOR, That I have carefully examined the above named Recruit, agreeably to the General Regulations
of the Army, and that in my opinion he is free from all bodily defects and mental infirmity, which would, in any way, disqualify
him from performing the duties of a soldier.

W. C. Leppard EXAMINING SURGEON.

I CERTIFY, ON HONOR, That I have minutely inspected the Recruit, William Parker
previously to his enlistment, and that he was entirely sober when enlisted; that, to the best of my judgement and belief, he is of
lawful age; and that, in accepting him as duly qualified to perform the duties of an able-bodied soldier, I have strictly observed
the Regulations which govern the recruiting service. This soldier has Brown eyes, Dark hair,
Dark complexion; is five feet, Eight inches high.

J. Rygaard, 2nd Lieut. U. S. A. Co. 1st Regt.

RECRUITING OFFICER.

DECLARATION OF RECRUIT.

I, _____ desiring to ENLIST in the Army of the United States, for the term of THREE YEARS, Do declare, That I am _____ years and _____ months of age; that I have neither wife nor child; that I have never been discharged from the United States service on account of disability or by sentence of a court-martial, or by order before the expiration of a term of enlistment; and I know of no impediment to my serving honestly and faithfully as a soldier for three years.

GIVEN at _____

The _____ day of _____

Witness:

No. _____

William Parker

Enlisted at Camp Parke, Pa

December 11th 1862

By Lieutenant J. H. ...

14th Regt of Indiana Inf

10 248,000

enlistment; last served in Company (—)

Regt of _____

Discharged _____ 18__

CONSENT IN CASE OF MINOR.

I, _____ Do CERTIFY, That I am the _____ of _____; that the said _____ is _____ years of age; and I do hereby freely give my CONSENT to his enlisting as a SOLDIER in the ARMY OF THE UNITED STATES for the period of THREE YEARS.

GIVEN at _____

The _____ day of _____

Witness:

County of

Jefferson



State of

Louisiana

I, *William Parker* born in *Kempock County*
in the State of *Virginia* aged *Thirty* years,
and by occupation a *Laborer* do hereby acknowledge to have
voluntarily enlisted this *Tenth* day of *December*

18*62*, as a SOLDIER in the ARMY OF THE UNITED STATES OF AMERICA, for the period
of *THREE YEARS*, unless sooner discharged by proper authority: Do also agree to
accept such bounty, pay, rations, and clothing, as are, or may be, established by law. And
I, *William Parker* do solemnly swear, that I will bear true faith
and allegiance to the UNITED STATES OF AMERICA, and that I will serve them honestly and
faithfully against all their enemies or opposers whomsoever; and that I will observe and
obey the orders of the President of the United States, and the orders of the officers
appointed over me, according to the Rules and Articles of War.

Sworn and subscribed to, at

of Carrollton, La.
Camp Parapet,
this *tenth* day of *February*, 18*63*
J. Rygaard
2^d Lieut. U.S. Army, La. Vols.

BEFORE

I CERTIFY, ON HONOR, That I have carefully examined the above named Recruit, agreeably to the General Regulations
of the Army, and that in my opinion he is free from all bodily defects and mental infirmity, which would, in any way, disqualify
him from performing the duties of a soldier.

W. C. Lynde

EXAMINING SURGEON.

I CERTIFY, ON HONOR, That I have minutely inspected the Recruit, *William Parker*
previously to his enlistment, and that he was entirely sober when enlisted; that, to the best of my judgement and belief, he is of
lawful age; and that, in accepting him as duly qualified to perform the duties of an able-bodied soldier, I have strictly observed
the Regulations which govern the recruiting service. This soldier has *Brown* eyes, *Dark* hair,
Dark complexion; is *five* feet, *Eighty* inches high.

J. Rygaard, 2^d Lieut. U.S. Army, La. Vols.

RECRUITING OFFICER.

Private

Private

CARD NUMBERS.

5487189	26
5504759	27
5505018	28
5505176	29
5507051	30
	31
	32
	33
	34
	35
	36
	37
	38
	39
	40
	41
	42
	43
	44
	45
	46
	47
	48
	49
	50

Book Mark:

See also

U.S. HOLDINGS

Private

Private

CARD NUMBERS.

5487189	26
5504759	27
5505018	28
5505176	29
5507051	30
	31
	32
	33
	34
	35
	36
	37
	38
	39
	40
	41
	42
	43
	44
	45
	46
	47
	48
	49
	50

Book Mark:

See also

M. S. 944180
M. S. 1119623

M. S. Worley
Jr.

P | 10 H. Art'y. | U.S.C.T.

William Parker

Pol-, Co. F, 10 Reg't U. S. Col'd H. Art'y.

Appears on

Company Muster Roll

for *July & August*, 1864.

Present or absent *Present*

Stoppage, \$ *100* for

Due Gov't, \$ *100* for

Valuation of horse, \$ *100*

Valuation of horse equipments, \$ *100*

Remarks:

Book mark:

Rosenbaum
Copyst.

P

10 H. Art'y. | U.S.C.T.

William Parker

Appears with rank of *Pvt* on

Muster and Descriptive Roll of a Detachment of U. S. Vols. forwarded

for the *7* Reg't *U.S.C. H. Art'y** Roll dated *New Orleans La, Aug. 19, 1864.*

Where born *Ma.*

Age *29* y'rs; occupation *Laborer*

When enlisted *Aug 6*, 1864.

Where enlisted *Houma La*

For what period enlisted *3* years.

Eyes *Dark*; hair *Blk*

Complexion *Dark*; height *5* ft. *8* in.

When mustered in *Aug 19*, 1864.

Where mustered in *New Orleans*

Bounty paid \$ *100* ¹⁰⁰; due \$ *200* ¹⁰⁰

Where credited *to Houma La*

Company to which assigned *2*

Remarks: *Recruit Entitled to Bounty*

* *Became 10 U.S. C. H. Art'y.*

Book mark:

J. W. Williams

(339)

Copyist.

P | 10 H. Art'y. | U.S.C.T.

William Parker

Pvt., Co. F, 7 Reg't U. S. Col'd H. Art'y.*

Appears on

Company Muster-in and Descriptive Roll

of the organization named above. Roll dated

New Orleans La, Aug 19, 1864.

Where born ——— Mol

Age 29 y'rs; occupation Laborer

When enlisted Aug 6, 1864.

Where enlisted Monrovia La

For what period enlisted 3 years.

Eyes dark; hair Blk

Complexion dark; height 5 ft. 8 in.

When mustered in Aug 19, 1864.

Where mustered in New Orleans La

Bounty paid \$ 100 100; due \$ ~~100~~ 100

Where credited 2nd Enroll Dist La

Company to which assigned

Remarks: Recruit entitled to Bounty

* This organization subsequently became Co. F, 10 Reg't U. S. Colored Heavy Artillery.

Book mark:

Rosenbaum

(356d)

Copyist.

P | 10 H. Art'y. | U.S.C.T.

William Parker

Priv., Co. F, 10 Reg't U. S. Col'd H. Art'y.

Appears on

Company Muster Roll

for Sept & Oct, 1864.

Present or absent

Stoppage, \$ 100 for

Due Gov't, \$ 100 for

Valuation of horse, \$ 100

Valuation of horse equipments, \$ 100

Remarks: Deserted from Battery
Gentilly Sept 15-1864

Book mark:

P

10 H. Art'y. U.S.C.T.

William
~~Frederick~~ Parker

priv, Co. F, 10 Reg't U. S. Col'd H. Art'y.

Appears on Co. Muster-out Roll, dated
Baton Rouge La, Feb 22, 1867.

Muster-out to date _____, 1867 .

Last paid to *sum paid* _____, 1867 .

Clothing account:

Last settled _____, 1867 ; drawn since \$ _____ 100

Due soldier \$ _____ 100; due U. S. \$ _____ 100

Am't for cloth'g in kind or money adv'd \$ 14 ⁶⁰ 100

Due U. S. for arms, equipments, &c., \$ _____ 100

Bounty paid \$ 100 ⁵⁰ 100; due \$ _____ 100

Remarks: *Joined at original
organization. Deserted from
Battery Grenville La. Sept. 10
1864*

Wounded by Worey 9/3

Book mark: _____

House

10 U.S. Col'd. H. Art'y

Private Private

CARD NUMBERS.

1	5490456	26
2	5490609	27
3	5490749	28
4	5490905	29
5	5491040	30
6	5491174	31
7	5491300	32
8	5491434	33
9	5491561	34
10	5491688	35
11	5491814	36
12	5491940	37
13	5492065	38
14	5492190	39
15	5492313	40
16	5492437	41
17	5492561	42
18	5492686	43
19	5492814	44
20	5493050	45
21	5494038	46
22	5489565	47
23	47-25-1844	48
24		49
25		50

Book Mark: L13 - $\frac{15}{44}$ 426 J - 1844

See also

P | 10 H. Art'y. | U.S.C.T.

Daniel Parks

....., Co. A, 1 Reg't La. Col'd H. Art'y.*

Age 23 years.

Appears on

Company Muster-in Roll

of the organization named above. Roll dated

New Orleans, La., Nov. 29, 1862.

Muster-in to date Nov. 29, 1862.

Joined for duty and enrolled:

When Nov. 16, 1862.

Where New Orleans

Period 3 years.

Valuation of horse, \$ 100

Valuation of horse equipments, \$ 100

Remarks:

*This organization subsequently became Co. A, 10 Reg't U. S. Colored Heavy Artillery.

Book mark:

Tobman

(356)

Copyist.

P

10 H. Art'y. U.S.C.T.

Daniel Parks

Priv, Co. A, 1 Reg't La. H. Art'y.*

Appears on

Company Muster Roll

for to Dec 31, 1862

Present or absent Present

Stoppage, \$ 100 for

Due Gov't, \$ 100 for

Valuation of horse, \$ 100

Valuation of horse equipments, \$ 100

Remarks:

*This organization subsequently became Co. A, 10 Reg't U. S. Col'd Heavy Artillery.

Book mark:

Tobman

7

10 H. Art'y. U.S.C.T.

Daniel Park

Priv., Co. A, 1 Reg't La. H. Art'y.*

Appears on

Company Muster Roll

for Jan'y & Feb'y, 1863.

Present or absent Present

Stoppage, \$ 100 for

Due Gov't, \$ 100 for

Valuation of horse, \$ 100

Valuation of horse equipments, \$ 100

Remarks:

*This organization subsequently became Co. A, 10 Reg't U. S. Col'd Heavy Artillery.

Book mark:

Tobman

P

10 H. Art'y. U.S.C.T.

Daniel Parks

Priv., Co. A, 1 Reg't La. H. Art'y.*

Appears on

Company Muster Roll

for March & April, 1863.

Present or absent Present

Stoppage, \$ 100 for

Due Gov't, \$ 100 for

Valuation of horse, \$ 100

Valuation of horse equipments, \$ 100

Remarks:

*This organization subsequently became Co. A, 10 Reg't U. S. Col'd Heavy Artillery.

Book mark:

Johnan

P

10 H. Art'y.

U.S.C.T.

Daniel Parks

Priv, Co. A, 1 Reg't La. H. Art'y.*

Appears on

Company Muster Roll

for May & June, 1863.

Present or absent Present

Stoppage, \$ 100 for

Due Gov't, \$ 100 for

Valuation of horse, \$ 100

Valuation of horse equipments, \$ 100

Remarks:

*This organization subsequently became Co. A, 10 Reg't U.S. Col'd Heavy Artillery.

Book mark:

Tobman

P

10 H. Art'y.

U.S.C.T.

Daniel Parks

Priv., Co. A, 1 Reg't La. H. Art'y.*

Appears on

Company Muster Roll

for July & August, 1863.

Present or absent. Present

Stoppage, \$ 100 for

Due Gov't, \$ 100 for

Valuation of horse, \$ 100

Valuation of horse equipments, \$ 100

Remarks:

*This organization subsequently became Co. A, 10 Reg't U. S. Col'd Heavy Artillery.

Book mark:

Tolman

Copyist.

P

10 H. Art'y. U.S.C.T.

Daniel Parks

Priv, Co. A, 1 Reg't La. H. Art'y.*

Appears on

Company Muster Roll

for Sept & Oct, 1863.

Present or absent Present

Stoppage, \$ 100 for

Due Gov't, \$ 100 for

Valuation of horse, \$ 100

Valuation of horse equipments, \$ 100

Remarks:

*This organization subsequently became Co. A, 10 Reg't U. S. Col'd Heavy Artillery.

Book mark: 18701358

Tobman
Copyright.

C

10 H. Art'y. | U.S.C.T.

Daniel Parks

Co. A, 1 Reg't H. Art'y, Corps d'Afrique.*

Appears on

Company Muster Roll

for *Nov & Dec*, 186*3*

Present or absent *Present*

Stoppage, \$ *100* for

Due Gov't, \$ *100* for

Valuation of horse, \$ *100*

Valuation of horse equipments, \$ *100*

Remarks:

*This organization subsequently became Co. *A*, 10 Reg't U. S. Colored Heavy Artillery.

Book mark:

Rochester

P

10 H. Art'y. U.S.C.T.

Samuel Parks
Pot, Co. A, 1 Reg't H. Art'y, Corps d'Afrique.*

Appears on

Company Muster Roll

for Jan + Feb, 1864.

Present or absent Present

Stoppage, \$ 100 for

Due Gov't, \$ 100 for

Valuation of horse, \$ 100

Valuation of horse equipments, \$ 100

Remarks:

*This organization subsequently became Co. A, 10 Reg't U. S. Colored Heavy Artillery.

Book mark:

Proctor

P | 10 H. Art'y. | U.S.C.T.

Daniel Parks
Sgt., Co. A, 7 Reg't U. S. Col'd H. Art'y.*

Appears on

Company Muster Roll

for *March 1864*, 1864.

Present or absent *Present*

Stoppage, \$ 100 for

Due Gov't, \$ 100 for

Valuation of horse, \$ 100

Valuation of horse equipments, \$ 100

Remarks:

* This organization subsequently became Co. A, 10 Reg't U. S. Colored Heavy Artillery.

Book mark:

R. S. [Signature]

(358)

Copyist.

P | 10 H. Art'y. | U.S.C.T.

James Parks
Sgt., Co. A, 7 Reg't U. S. Col'd H. Art'y.*

Appears on

Company Muster Roll

for May & June, 1864

Present or absent Present

Stoppage, \$ 100 for

Due Gov't, \$ 100 for

Valuation of horse, \$ 100

Valuation of horse equipments, \$ 100

Remarks:

* This organization subsequently became Co. A, 10 Reg't U. S. Colored Heavy Artillery.

Book mark:

Proctor

P | 10 H. Art'y. | U.S.C.T.

Daniel Parks
Cpt., Co. A, 7 Reg't U. S. Col'd H. Art'y.*

Appears on

Company Muster Roll

for July & Aug, 1864

Present or absent Present

Stoppage, \$ 100 for

Due Gov't, \$ 100 for

Valuation of horse, \$ 100

Valuation of horse equipments, \$ 100

Remarks: Sick in quarters

* This organization subsequently became Co. A, 10 Reg't U. S. Colored Heavy Artillery.

Book mark:

Proctor

P

10 H. Art'y. | U.S.C.T.

Daniel Parks

Plt., Co. A, 10 Reg't U. S. Col'd H. Art'y.

Appears on

Company Muster Roll

for Sep & Oct, 1864.

Present or absent Present

Stoppage, \$ 100 for

Due Gov't, \$ 100 for

Valuation of horse, \$ 100

Valuation of horse equipments, \$ 100

Remarks:

Book mark:

Boerater

P

10 H. Art'y. U.S.C.T.

Daniel Parks

Pvt., Co. A, 10 Reg't U. S. Col'd H. Art'y.

Appears on

Company Muster Roll

for [Signature], 1864

Present or absent Present

Stoppage, \$ 100 for

Due Gov't, \$ 100 for

Valuation of horse, \$ 100

Valuation of horse equipments, \$ 100

Remarks:

Book mark:

[Signature]

P

10 H. Art'y. | U.S.C.T.

Daniel Parks

Co. A, 10 Reg't U. S. Col'd H. Art'y.

Appears on

Company Muster Roll

for Jan & Feb, 1865.

Present or absent Present

Stoppage, \$ 100 for

Due Gov't, \$ 100 for

Valuation of horse, \$ 100

Valuation of horse equipments, \$ 100

Remarks: Due Gov't for
Camp and Garrison
Equipage as per
Abstract #0.16

Book mark:

Reharter

P | 10 H. Art'y. | U.S.C.T.

Daniel Parks

Pvt, Co. A, 10 Reg't U. S. Col'd H. Art'y.

Appears on

Company Muster Roll

for *March 1865*, 1865.

Present or absent *Present*

Stoppage, \$ 100 for

Due Gov't, \$ 100 for

Valuation of horse, \$ 100

Valuation of horse equipments, \$ 100

Remarks: *Due Gov't for
Camp and Garrison
Equipments as per
Abstract \$ 0.16*

Book mark:

Proctor

(358)

Copyist.

P | 10 H. Art'y. | U.S.C.T.

Daniel Parks

Pvt., Co. A, 10 Reg't U. S. Col'd H. Art'y.

Appears on

Company Muster Roll

for *May & June*, 1865.

Present or absent *Present*

Stoppage, \$ *100* for

Due Gov't, \$ *100* for

Valuation of horse, \$ *100*

Valuation of horse equipments, \$ *100*

Remarks: *Due Gov't for
Camp & Garrison
Equipage as per
Abstract \$0.16*

Book mark:

P. S. S. S.

P | 10 H. Art'y. | U.S.C.T.

Daniel Parks

Pvt, Co. A, 10 Reg't U. S. Col'd H. Art'y.

Appears on

Company Muster Roll

for *July & Aug*, 186*5*

Present or absent *Present*

Stoppage, \$ 100 for

Due Gov't, \$ 100 for

Valuation of horse, \$ 100

Valuation of horse equipments, \$ 100

Remarks:

Book mark:

Reharter

Daniel Parks

Pl, Co. A, 10 Reg't U. S. Col'd H. Art'y.

Appears on

Company Muster Roll

for Sept & Oct, 1865.

Present or absent Present

Stoppage, \$ 100 for

Due Gov't, \$ 100 for

Valuation of horse, \$ 100

Valuation of horse equipments, \$ 100

Remarks:

Book mark:

Hyman

Copyist.

P. | 10 Mo. a. | U.S.C.T.

Janiel Parks

Pos., Co. A., 10 Reg't U. S. Col'd Mo. a.

Appears on a

Detachment Muster-out Roll

of the organization named above. Roll dated

N. Orleans La. Nov. 28 1865

Muster-out to date *Nov. 28, 1865*

Last paid to *June 30, 1865*

Clothing account:

Last settled , 186 ; drawn since \$ 100

Due soldier \$ 100; due U. S. \$ 1 ²⁵/₁₀₀

Am't for cloth'g in kind or money adv'd \$ 100

Due U. S. for arms, equipments, &c., \$ 100

Bounty paid \$ 100 due \$ 100

Remarks: *Joined at origl. Orgn.
Stop for two Tompions
one Hearletter two Hear
numbers. Mustered
out by reason of Expiration
of term of service*

Book mark:

Hawling

(349)

Copyist.

P | 10 H. Art'y. | U.S.C.T.

Daniel Parks

Pl, Co. A, 10 Reg't U. S. Col'd H. Art'y.

Appears on

Company Muster Roll

for *Nov + Dec*, 186 *6*.

Present or absent

Stoppage, \$ *100* for

Due Gov't, \$ *100* for

Valuation of horse, \$ *100*

Valuation of horse equipments, \$ *100*

Remarks: *Mustered out by reason of expiration of term of service.*

Book mark: *Disch'd. Nov 28/65 ~~6~~ 13 ¹⁵ 941 47*

C.P. 1884

(358)

Hyun

Copyist.

P

10 H. Art'y. U.S.C.T.

Daniel Parks

Pvt, Co. A, 10 Reg't U. S. Col'd H. Art'y.

Appears on Co. Muster-out Roll, dated Baton Rouge La, Feb. 22, 1867.

Muster-out to date _____, 186 .

Last paid to _____, 186 .

Clothing account:

Last settled _____, 186 ; drawn since \$ _____ 100

Due soldier \$ _____ 100; due U. S. \$ _____ 100

Am't for cloth'g in kind or money adv'd \$ _____ 100

Due U. S. for arms, equipments, &c., \$ _____ 100

Bounty paid \$ _____ 100; due \$ _____ 100

Remarks: Joined orig reg. Dischd for Exprn. of term of service Nov. 28. 67

Book mark:

Nesbitt

Copyist.

(361)

P. 1 10th H. A. / U.S. G. J.

Daniel Parks

, Co. A, 10th Reg't U.S. G. H. A.

NOTATION.

Book mark:

L.B. 15-941 with
47.6.3.1884.

War Department,

Adjutant General's Office,

Washington, Jan. 5th, 1864.

Mustered out with Detach-
ment November 28, 1865.

E. P. Conroyer

(438)

Copyist.

U.S. Gold & S.

Private

Private

CARD NUMBERS.

5488968	26
5488860	27
5488022	28
5514366	29
5514561	30
5515308	31
9123708	32
	33
	34
	35
	36
	37
	38
	39
	40
	41
	42
	43
	44
	45
	46
	47
	48
	49
	50

Book Mark:

See also 77 U.S. C. I

P | 10 H. Art'y. | U. S. C. T.

William Parker

Co. M, 10 Reg't U. S. Col'd H. Art'y.

Appears on

Company Descriptive Book

of the organization named above.

DESCRIPTION.

Age 31 years; height 5 feet 3 inches.

Complexion black

Eyes black; hair black

Where born St Helena Afr

Occupation Cook

ENLISTMENT.

When Jan 3, 1865

Where New Orleans La

By whom Capt M. Allist; term 3 y'rs.

Remarks: Rec'd by transfer from Co A 77 W. S. C. Inf. per B. G. 66. Hd Qrs. Dept La. Sept 22, 1865. Deserted from Fort Mason La. Dec 1st 1866

J. M. Calloway

P | 10 H. Art'y. | U.S.C.T.

William Parks

P, Co. *M*, 10 Reg't U. S. Col'd H. Art'y.

Age years.

Appears on

Company Muster Roll*

for *Sept - Oct*, 186*5*.

Joined for duty and enrolled:

When *Jan 3*, 186*5*.

Where *N Orleans*

Period *3* years.

Mustered in:

When *Jan 17*, 186*5*.

Where *N Orleans*

Present or absent *Present*

Stoppage, \$ *100* for

Due Gov't, \$ *20* for *Ord*

Valuation of horse, \$ *100*

Valuation of horse equipments, \$ *100*

Remarks :

*First current roll. No muster-in roll of this company on file.

Book mark :

A. T. Wright

P | 10 H. arty | U.S.C.T.

William Parks

Pvt., Co M., 10 Reg't U. S. Col'd H. arty

Appears on

M. and D. Roll of Men Transferred

to the organization named above,

from 77th W. S. Col'd Inf'ty,

Roll dated Oct. 1, 1865.

When enlisted Jan. 3, 1865.

Period for which enlisted 3 years.

When mustered in Jan. 17, 1865.

Present or absent Present.

Company to which assigned M.

Remarks: Joined as recruit,
Lost wife.

Book mark :

Castling

(342)

Copyist.

P | 10th Arty | U.S.C.T.

William Parks

1st, Co. K, 10 Reg't U. S. Col'd Arty

Appears on

M. and D. Roll of Men Transferred

to the organization named above,

from 77 U. S. Col'd Inf.

Roll dated Oct. 1, 1865

When enlisted Jan. 3, 1865

Period for which enlisted 3 years

When mustered in Jan. 17, 1865

Present or absent Present

Company to which assigned M

Remarks: Joined as recruit
Lost wife.

Book mark :

L Chandler

P 1026a U.S.C.T.

William Parks
Cot., Co. M, 10 Reg't U. S. Col'd

Appears on

M. and D. Roll of Men Transferred

to the organization named above,

from 1/07 U.S. Col Inf

Roll dated Camp Onapeta Oct 1, 1865.

When enlisted Jan 3, 1865.

Period for which enlisted 9 years.

When mustered in Jan 17, 1865.

Present or absent

Company to which assigned M

Remarks: joined as recruit
Sed wiper Paid by
transfer from Co A
of 9 U.S. C. I. per S.O.
66 Dept da Sept 22,
65.

Book mark :

W. H. Scott

P

10 H. Art'y.

U. S. C. T.

William Parkes

P, Co. M, 10 Reg't U. S. Col'd H. Art'y.

Appears on

Company Muster Roll

for Apr & Dec, 1865.

Present or absent

Stoppage, \$ 100 for

Due Gov't, \$ 22 ³²/₁₀₀ for Ord

" 5.57 " 6 & 4, E.

Valuation of horse, \$ 100

Valuation of horse equipments, \$ 100

Remarks: Desertion from Fort
Macomb Dec 1, 65

Book mark:

W. H. Wright

(358)

Copyist.

8

10 H. Art'y. U.S.C.T.

William Parks

Priv., Co.M., 10 Reg't U. S. Col'd H. Art'y.

Appears on Co. Muster-out Roll, dated

Patm Rouge, La, Feb 22, 1867.

Muster-out to date _____, 186 .

Last paid to _____, 186 .

Clothing account:

Last settled _____, 186 ; drawn since \$ _____ 100

Due soldier \$ 16 ⁷⁸/₁₀₀; due U. S. \$ _____ 100

Am't for cloth'g in kind or money adv'd \$ _____ 100

Due U. S. for arms, equipments, &c., \$ _____ 100

Bounty paid \$ 100 ⁰⁰/₁₀₀; due \$ _____ 100

Remarks: joined by trans from Co
A 77 U S C 5 per S U 66 245 lbs
Dept La Sep 24/65 as Priv Muster
from Fort Macomb, La Dec 1/65.

Book mark:

Reed

Private Private

CARD NUMBERS.

1	5487470	26
2	5496815	27
3	5496974	28
4	5497043	29
5	5497190	30
6	5497227	31
7	5497260	32
8	5497305	33
9	5497339	34
10		35
11		36
12		37
13		38
14		39
15		40
16		41
17		42
18		43
19		44
20		45
21		46
22		47
23		48
24		49
25		50

Book Mark:

See also 77 U.S. 6 Inf

MS. 1174412

M. D. Worley
J 42

P.

10 H. Art'y.

U.S.C.T.

Coleman Parson

Pvt., Co. B, 10 Reg't U. S. Col'd H. Art'y.

Appears on

Company Muster Roll

for Sep & Oct., 1865.

Present or absent Present.

Stoppage, \$ 100 for

Due Gov't, \$ 100 for

Valuation of horse, \$ 100

Valuation of horse equipments, \$ 100

Remarks: Transferred from 77th U.S.
Cmp. to Co B 10th U.S. CA Hz
per S. O. No 277 Hdqrs East Dist.
La Sep. 25 1865.

Book mark:

J. J. J. J.

(358)

Copyist.

O | 10th U.S. | U.S.C.T.

Colman Parsons
Capt., Co. L, 10 Reg't U. S. Col'd

Appears on

M. and D. Roll of Men Transferred

to the organization named above

from Co. H, 24th U.S. Col'd Inf

Roll dated Camp Parapet La Gr., 1864.

When enlisted Sept 1, 1864.

Period for which enlisted 3 years.

When mustered in Sept 1, 1864.

Present or absent Present

Company to which assigned L

Remarks: Drafted assigned
to Co Sept 8. 1864.

Book mark :

W. H. Scott

P

10 H. Art'y.

U.S.C.T.

Soldierman Parson

Plt

, Co. B, 10 Reg't U. S. Col'd H. Art'y.

Appears on

Company Muster Roll

for

Nov. 1 Dec. 1865

Present or absent

Present

Stoppage, \$

100 for

Due Gov't, \$

100 for

Valuation of horse, \$

100

Valuation of horse equipments, \$

100

Remarks:

Sick in Post Hosp.

Book mark:

(358)

Reif

Copyist.

P

10 H. Art'y. U.S.C.T.

Colman Parson

Pl, Co. B, 10 Reg't U. S. Col'd H. Art'y.

Appears on

Company Muster Roll

for *July & Feb*, 1866.

Present or absent *Present*

Stoppage, \$ *100* for

Due Gov't, \$ *100* for

Valuation of horse, \$ *100*

Valuation of horse equipments, \$ *100*

Remarks: *Sick in Hospital.*

Book mark:

(358)

Reif

Copyist.

P

10 H. Art'y.

U.S.C.T.

Coleman Parson

P1

, Co. B, 10 Reg't U. S. Col'd H. Art'y.

Appears on

Company Muster Roll

for

March, 1 April, 1861.

Present or absent

Present

Stoppage, \$

100 for

Due Gov't, \$

100 for

Valuation of horse, \$

100

Valuation of horse equipments, \$

100

Remarks:

Sick in Hospital.

Book mark:

(358)

Reif

Copyist.

P

10 H. Art'y. U.S.C.T.

Coleman Parsons

Pt

, Co. B, 10 Reg't U. S. Col'd H. Art'y.

Appears on

Company Muster Roll

for May & June, 1864

Present or absent Present

Stoppage, \$ 100 for

Due Gov't, \$ 100 for

Valuation of horse, \$ 100

Valuation of horse equipments, \$ 100

Remarks: Sick in Post Hospital.

Book mark:

(358)

Reif

Copyist.

P

10 H. Art'y.

U.S.C.T.

William Parsons

Pl, Co. B, 10 Reg't U. S. Col'd H. Art'y.

Appears on

Company Muster Roll

for July & Aug, 1866

Present or absent Present

Stoppage, \$ 100 for

Due Gov't, \$ 100 for

Valuation of horse, \$ 100

Valuation of horse equipments, \$ 100

Remarks: Sick in Post Hospital

Book mark:

Reif

(358)

Copyist.

P

10 H. Art'y. | U.S.C.T.

Coleman Parsons

Pr, Co. B, 10 Reg't U. S. Col'd H. Art'y.

Appears on

Company Muster Roll

for *Sep. & Oct.*, 186*6*.

Present or absent

Stoppage, \$ 100 for

Due Gov't, \$ 100 for

Valuation of horse, \$ 100

Valuation of horse equipments, \$ 100

Remarks:

*Deserted while
on furlough Sept. 27,
1866.*

Book mark:

Hodge

(358)

Copyist.

P

10 H. Art'y. | U.S.C.T.

Coleman Parsons

Co. B, 10 Reg't U. S. Col'd H. Art'y.

Appears on Co. Muster-out Roll, dated

Baton Rouge La. Feb., 1867.

Muster-out to date *Feb. 22*, 1867.

Last paid to *June 30*, 1866.

Clothing account:

Last settled....., 186 ; drawn since \$.....100

Due soldier \$ *83 2/100*; due U. S. \$.....100

Am't for cloth'g in kind or money adv'd \$.....100

Due U. S. for arms, equipments, &c., \$.....100

Bounty paid \$.....100; due \$.....100

Remarks: *joined by transfer*

from 77 U.S. C.S. Feb. 66

Held in Dept. of La. Sept.

22/65. Deserted Sept. 27/66

Returned Jan. 13/67 ordered

to duty without trial S.O.

Book mark: *2143. 1881* (over)

Rodgers

(361)

Copyist.

JAN. 15

5497339

☆ 1831 ☆

17. Dept. of the Gulf
Jan. 23/1867 with loss
of pay and allowance
during period of absence

Parsons Coleman

Co.

Reg't

/ Enclosures.

Bed Cards	Final Statements
Burial Records	Furloughs or L. of A.
Certs. of Dis. for Discharge	Med. Certificates
C. M. Charges	Med. Des. Lists
Descriptive Lists	Orders
Discharge Certificates	Pris. of War Record
Enlistment Papers	Resignations

Other papers relating to—

Admission to Hosp'l	Furlough or L. of A.
Casualty Sheet	Med. Examination
Confinement	Misc. Information
Contracts	Pay or Clothing
Death or Effects	Personal Reports
Desertion	Rank
Discharge from Hosp'l	Transfer to Hosp'l
Discharge from Service	Transfer to V. R. C.
Duty	Transportation

No. 17. Dist. La. 1867.

P. O. No. 32 -

Fort Saint Philip La.
Jan'y 19th 1867

Hannum Silas

2^d Lieut 10th U.S.C.A.

Requests that Private Coleman
Parsons Co D - 10th U.S.C.A. reported
as a deserter may be restored to
duty without trial.



S. C. Jan'y 23/67

Headquarters
Fort's Jackson & St Philip
Jan'y 19th 1867

Respectfully forwarded
Approved

Sam'l Hannum
Sinh. Co. 10th U.S.C.A.
Breuch Lieut. U.S.C.
Company Post

Hd. Qrs. Dist of Louisiana,
New Orleans, Jan. 22, 1867.
Respectfully forwarded
to Headquarters Depart-
ment of the Gulf. This
man's regiment being
about to be mustered out
of service, and no court
martial existing in this

District to my him,
it is recommended
that he be restored to
duty without trial,
with condition that
he forfeit all pay
and allowances dur-
ing the time absent
without leave - viz:
from the 27th of Sep-
tember 1866 to the 13th
of January 1867.

J. H. Moore
Brig Major Gen. Co. 89th U.S. Infy
Commandant of Louisiana
E. B. A. 73

Jan'y 23 1867
Recommended by
deut. Major

Fort Saint Philp Louisiana
January 19th 1867

Brevet Major General J. S. Hartouff
Assistant Adjutant General
Department of the Gulf

Sir

I have the honor to request that Private Coleman Parsons Company B, 10th U. S. Colored Artillery (Heavy), reported as a deserter, may be restored to duty without trial; in consideration of the circumstances narrated below; he having voluntarily returned to his company.

This man is very old and infirm and is afflicted with chronic rheumatism, and has been under treatment for the same, in Post Hospital for more than a year. At the request of the Surgeon in charge of Post Hospital, a furlough for (7) seven days was given him September 21st 1866; as he did not return at the expiration of his furlough, he was reported absent without leave for a time, and finally dropped as a deserter at the Bi Monthly muster. October 31st 1866. On the 13th of January 1867 he voluntarily returned to his.

company. On investigation I learn that after he received his furlough certain parties represented to him that he was authorized to absent himself until he was able to perform efficient duty as a soldier.

I have ample evidence that improper representations were made to him; and as he returned in good faith as soon as able to travel, I request his restoration to duty without trial.

I am Sir

Very Respectfully

Silas Hannum

1st Supt. 10th U.S. Colored Artillery
Commanding Company B.

Alcal. Alms
J., 10 U.S. Col'd H. Art'y

Bugler | *Bugler*

CARD NUMBERS.

1	5488499	26
2	5511486	27
3	5511633	28
4	5511765	29
5	5511877	30
6	5511936	31
7	5512003	32
8	5512084	33
9	5489420	34
10		35
11		36
12		37
13		38
14		39
15	1	40
16		41
17		42
18		43
19		44
20		45
21		46
22		47
23		48
24		49
25		50

Book Mark:

See also *Co D. 74 U.S. 6 Inf*

P

10th U.S.C.T.

Albert Pascal

Bugby Co., 10 Reg't U. S. Col'd St. Arty
Appears on

M. and D. Roll of Men Transferred

to the organization named above,

from Co "D" 74th U.S. Inf.

Roll dated New Orleans, La, Oct 1, 1863

When enlisted Sept 7, 1863

Period for which enlisted 3 years.

When mustered in Oct 1, 1863

Present or absent

Company to which assigned

Remarks: Joined as a recruit
in Co H 20th Inf. Cal.
Desq. of Regt. Changed
to 74th U.S. Inf. per Order
of Sec of War No 16
dated N.O. La April
11 '64. Transferred to
Co "D," 74th U.S. Inf. by
over

Book mark :

J. W. Jones, Jr
Copyist.

JAN. 15

5488499

★ 1881 ★

Consolidation July 20
1864 Ser G. O. No 17
Std. Ins. Mil. Div.
West Miss 1864.

P

10 H. Art'y. | U.S.C.T.

Albert Pascal

Bigler, Co. I, 10 Reg't U. S. Col'd H. Art'y.

Appears on

Company Muster Roll

for *Nov. & Dec.*, 1865 :-

Present or absent *Present*

Stoppage, \$ *100* for

Due Gov't, \$ *100* for

Valuation of horse, \$ *100*

Valuation of horse equipments, \$ *100*

Remarks: *Transferred from
74 Ufc.I. per S.O. No. 84 Hd.
Qrs. Dept. of La. Oct 11,
1865.*

FROM SECOND AUDITOR'S ROLL.

Book mark:

(858)

A. J. Clarke
Copyst.

P

10 H. Art'y. | U.S.C.T.

Albert Pascal

Bugler, Co. I, 10 Reg't U. S. Col'd H. Art'y.

Appears on

Company Muster Roll

for *Jan. & Feb.*, 1866 .

Present or absent *Present*

Stoppage, \$ *100* for

Due Gov't, \$ *100* for

Valuation of horse, \$ *100*

Valuation of horse equipments, \$ *100*

Remarks:

Book mark:

O. J. Clark

(358)

Copyist.

P.

10 H. Art'y.

U.S.C.T.

Albert Pascal

Bugler, Co. I, 10 Reg't U. S. Col'd H. Art'y.

Appears on

Company Muster Roll

for *Mar. & Apr.*, 1866.

Present or absent *Present*

Stoppage, \$ *100* for

Due Gov't, \$ *100* for

Valuation of horse, \$ *100*

Valuation of horse equipments, \$ *100*

Remarks:

Book mark:

V. J. Clark

P

10 H. Art'y. | U.S.C.T.

Albert Pascal

Bugler, Co. I, 10 Reg't U. S. Col'd H. Art'y.

Appears on

Company Muster Roll

for *May & June*, 1866.

Present or absent *Present*

Stoppage, \$ *100* for

Due Gov't, \$ *100* for

Valuation of horse, \$ *100*

Valuation of horse equipments, \$ *100*

Remarks:

Book mark:

(358)

O. J. Clark

Copyist.

P | 10 H. Art'y. | U.S.C.T.

Albert Pascal

Inglis, Co. I, 10 Reg't U. S. Col'd H. Art'y.

Appears on

Company Muster Roll

for July + Aug, 1866.

Present or absent Present

Stoppage, \$ 100 for

Due Gov't, \$ 100 for

Valuation of horse, \$ 100

Valuation of horse equipments, \$ 100

Remarks:

Book mark:

(358)

J. M. Stance

Copyist.

P | 1076a | U.S.C.T.

Albert Pascal

Bugler, Co. I, 10 Reg't U. S. Col'd 76a

Appears on an

Individual Muster-out Roll

of the organization named above. Roll dated

New Orleans La Sept 6, 1866.

Muster-out to date Sep 6, 1866.

Last paid to June 30, 1866.

Clothing account:

Last settled _____, 1866 ; drawn since \$ _____ 100

Due soldier \$ _____ 100; due U. S. \$ 11 04 / 100

Am't for cloth'g in kind or money adv'd \$ _____ 100

Due U. S. for arms, equipments, &c., \$ _____ 100

Bounty paid \$ _____ 100 due \$ 100 100

Remarks: Joined by transfer from 9th US C Infantry Oct 11, 1865 per S.O. No 84 Hedgers Dept La Series of 1865 Free on or before April 19, 1866 (over)

Book mark: _____

R. Richardson

JAN. 15

5489420

1891

Mustered out by
reason of expiration of
term of service to date
Sept 6th 1866

P

10 H. Art'y.

U.S.C.T.

Albert Pascal

Bugler, Co. I, 10 Reg't U. S. Col'd H. Art'y.

Appears on

Company Muster Roll

for *Sept + Oct*, 1866.

Present or absent.....

Stoppage, \$.....100 for.....

Due Gov't, \$.....100 for.....

Valuation of horse, \$.....100

Valuation of horse equipments, \$.....100

Remarks: *Mustered out by reason of expiration of term of Service to date Sept 6, 1866*

Book mark:.....

(358)

J. M. Stance

Copyist.

P

10 H. Art'y. | U.S.C.T.

Albert Pascal

Buyles, Co. I, 10 Reg't U. S. Col'd H. Art'y.

Appears on Co. Muster-out Roll, dated *Baton Rouge La, Feb 22*, 1867.

Muster-out to date _____, 186 .

Last paid to _____, 186 .

Clothing account:

Last settled _____, 186 ; drawn since \$ _____ 100

Due soldier \$ _____ 100; due U. S. \$ _____ 100

Am't for cloth'g in kind or money adv'd \$ _____ 100

Due U. S. for arms, equipments, &c., \$ _____ 100

Bounty paid \$ _____ 100; due \$ _____ 100

Remarks: *Discharged, expiration term of service ~~1866~~ 1866*

Book mark: _____

(361)

J. M. Hance

Copyist.

, 10 U.S. Col'd H. Art'y

Private Private

CARD NUMBERS.

1	5487469	26
2	5510243	27
3	5510393	28
4	5510540	29
5	5510640	30
6	5510784	31
7	5510862	32
8	5510937	33
9	5511009	34
10	5511150	35
11	5490112	36
12		37
12		38
14		39
15		40
16		41
17		42
18		43
19		44
20		45
21		46
22		47
23		48
24		49
25		50

Book Mark:

See also Co H. 77 U.S.C.I

P

10 H. Art'y.

U.S.C.T.

Eli Patterson

Pvt., Co. H, 10 Reg't U. S. Col'd H. Art'y

Appears on

Company Muster Roll

for *Sep & Oct*, 1865.

Present or absent *Present*

Stoppage, \$ *100* for

Due Gov't, \$ *100* for

Valuation of horse, \$ *100*

Valuation of horse equipments, \$ *100*

Remarks: *Transferred from Co. K
77 U.S.C. for G.O. No 3
No. 10 U.S. Col'd H.
Camp Maper Oct-1-65*

Book mark:

Wm. A. R.

(358)

Copyist.

O 10th A. U.S.C.T.

Eli Patterson
Co. I, 10 Reg't U. S. Col'd *H.A.*

Appears on

M. and D. Roll of Men Transferred

to the organization named above

from *Co. I, 10 Reg't U. S. Col'd*

Roll dated *Camp Canby 1st, 1865*

When enlisted *July 7*, 1864.

Period for which enlisted *3* years.

When mustered in *May 11*, 1864.

Present or absent *Present*

Company to which assigned *I*

Remarks: *Joined the Service
as Private,*

Book mark :

W. H. Scott

JP

10 H. Art'y.

U.S.C.T.

Eli Patterson

Cvt., Co. H, 10 Reg't U. S. Col'd H. Art'y

Appears on

Company Muster Roll

for *Nov, Dec*, 1865.

Present or absent *Present*

Stoppage, \$ 100 for

Due Gov't, \$ 100 for

Valuation of horse, \$ 100

Valuation of horse equipments. \$ 100

Remarks :

Book mark :

Gammack

(358)

Copy

P

10 H. Art'y.

U.S.C.T.

Eli Patterson

Priv., Co. H, 10 Reg't U. S. Col'd H. Art'y

Appears on

Company Muster Roll

for *Jan & Feb.*, 1866.

Present or absent *Present*

Stoppage, \$ *100* for

Due Gov't, \$ *100* for

Valuation of horse, \$ *100*

Valuation of horse equipments. \$ *100*

Remarks:

Book mark:

Cammack

(858)

Copyist.

P | 10 H. Art'y. | U.S.C.T.

Eli Patterson

Capt., Co. H, 10 Reg't U. S. Col'd H. Art'y

Appears on

Company Muster Roll

for *Mo. Apr.*, 1866.

Present or absent *Present*

Stoppage, \$ 100 for

Due Gov't, \$ 100 for

Valuation of horse, \$ 100

Valuation of horse equipments. \$ 100

Remarks :

Book mark:

Gammack

(858)

Copyist.

10

10 H. Art'y.

U.S.C.T.

Eli Patterson

Capt., Co. H, 10 Reg't U. S. Col'd H. Art'y

Appears on

Company Muster Roll

for *May & June*, 1866.

Present or absent *Present*

Stoppage, \$ *100* for

Due Gov't, \$ *100* for

Valuation of horse, \$ *100*

Valuation of horse equipments. \$ *100*

Remarks :

Book mark :

Camina

(358)

Copyist.

P

10 H. Art'y.

U.S.C.T.

Eli Patterson

Privé, Co. H, 10 Reg't U. S. Col'd H. Art'y

Appears on

Company Muster Roll

for *July & Aug.*, 186*6*.

Present or absent *Present*

Stoppage, \$ *100* for

Due Gov't, \$ *100* for

Valuation of horse, \$ *100*

Valuation of horse equipments. \$ *100*

Remarks :

Book mark :

Lammack

(858)

Copyist.

P

10 H. Art'y.

U.S.C.T.

Eli Patterson

Priv, Co. H, 10 Reg't U. S. Col'd H. Art'y

Appears on

Company Muster Roll

for Sep & Oct, 1866.

Present or absent Present

Stoppage, \$ 100 for

Due Gov't, \$ 100 for

Valuation of horse, \$ 100

Valuation of horse equipments. \$ 100

Remarks:

Book mark:

Lowry

(358)

Copyist.

P | 10 H. Art'y. | U.S.C.T.

Eli Patterson

Pvt, Co. H, 10 Reg't U. S. Col'd H. Art'y

Appears on

Company Muster Roll

for *Nov. & Dec*, 186*6*.

Present or absent *Present*

Stoppage, \$ *100* for

Due Gov't, \$ *100* for

Valuation of horse, \$ *100*

Valuation of horse equipments. \$ *100*

Remarks: *Stop. for equi-
page 52.*

Book mark:

Lowry

(358)

Copyist.

P | *10 Arty* | **U.S.C.T.**

Eli Patterson

Priv., Co. *A*, *10* Reg't U. S. Col'd *Arty*

Appears on a

Detachment Muster-out Roll

of the organization named above. Roll dated

New Orleans, La., *Feb. 6*, 1867.

Muster-out to date *Feb. 6*, 1867.

Last paid to *Dec. 31*, 1866

Clothing account:

Last settled 186 ; drawn since \$ 100

Due soldier \$ *59*^{*44*}/₁₀₀; due U. S. \$ 100

Am't for cloth'g in kind or money adv'd \$ 100

Due U. S. for arms, equipments, &c., \$ *1*^{*00*}/₁₀₀

Bounty paid \$ 100 due \$ *310*^{*50*}/₁₀₀

Remarks: *Joined by transfer*

from 77 U.S. C. Arty. by virtue

of S.O. No. 16 Hdqrs. Dept. of La. 1865.

Private from enrolment. Has

received no bounty.

Book mark:

R. C. Wilson

(349)

Copyist.

Eli Patterson

Priv. Co. H., 10 Reg't U. S. Col'd H. Art'y.

Appears on **Co. Muster-out Roll**, dated
Baton Rouge, La., Feb. 22, 1867.

Muster-out to date _____, 186 .

Last paid to _____, 186 .

Clothing account:

Last settled _____, 186 ; drawn since \$ _____ 100

Due soldier \$ _____ 100; due U. S. \$ _____ 100

Am't for cloth'g in kind or money adv'd \$ _____ 100

Due U. S. for arms, equipments, &c., \$ _____ 100

Bounty paid \$ _____ 100; due \$ _____ 100

Remarks: *Joined by transfer
from 77th U. S. I.
Mustered out exp. of term
of service Feb. 6/67.*

Book mark: *M. O. on file.*

(361)

Lowry
Copyist.

10 U.S. Col'd H. Art'y

Private.

Private

CARD NUMBERS.

5488890	26
5488997	27
	28
	29
	30
	31
	32
	33
	34
	35
	36
	37
	38
	39
	40
	41
	42
	43
	44
	45
	46
	47
	48
	49
	50

Book Mark:

See also *77 U.S. 6 Sep*

P | 10th Co. Arty | U.S.C.T.

James Patterson
Private, Co. K, 10 Reg't U. S. Col'd H. Arty

Appears on

M. and D. Roll of Men Transferred

to the organization named above,

from 77 U. S. Col'd Inf.

Roll dated Oct. 1, 1865.

When enlisted Feb. 20, 1863.

Period for which enlisted 3 years.

When mustered in Mch. 6, 1863.

Present or absent

Company to which assigned K

Remarks: discharged at New

Orleans La. Aug. 19/65.

Final Statement given

from Hospital.

Name not taken upon

muster rolls of Regt

Book mark :

Chandler

P | 10 H. Artz | U.S.C.T.

Jamies Patterson
Pt., Co., 10 Reg't U. S. Col'd H. Artz.

Appears on

M. and D. Roll of Men Transferred

to the organization named above,

from 77th U. S. Col'd Infy.

Roll dated Oct. 1, 1865.

When enlisted Feb. 20, 186 .

Period for which enlisted 3 years.

When mustered in March 6, 1863.

Present or absent

Company to which assigned

Remarks: Discharged at
New Orleans La.
Aug. 19/65. Final
Statement given
from Hospital.

Book mark : ~~James Patterson~~

(342) Easterling Copyist.

Co. A., 10 U.S. Col'd B. Arty

Private

Private

CARD NUMBERS.

1	5490463	26
2	5490615	27
3	5490756	28
4	5490911	29
5	5491047	30
6	5491182	31
7	5491301	32
8	5491435	33
9	5491562	34
10	5491689	35
11	5491815	36
12	5491941	37
13	5492066	38
14	5492191	39
15	5492312	40
16	5492438	41
17	5492564	42
18	5492687	43
19	5492815	44
20	5493051	45
21	5489566	46
22	5494039	47
23	47-21-1884	48
24		49
25		50

Book Mark: L B - $\frac{16}{441}$ 47 65 - 1884

See also

P

10 H. Art'y. | U.S.C.T.

Sippy Patterson

Co. A, 1 Reg't La. Col'd H. Art'y.*

Age 44 years.

Appears on

Company Muster-in Roll

of the organization named above. Roll dated

New Orleans, La. Nov. 29, 1862.

Muster-in to date

Nov. 29, 1862.

Joined for duty and enrolled:

When Nov. 16, 1862.

Where New Orleans

Period 3 years.

Valuation of horse, \$100

Valuation of horse equipments, \$100

Remarks:

* This organization subsequently became Co. A, 10 Reg't U. S. Colored Heavy Artillery.

Book mark:

Johnson

P

Sippy Patterson

Priv, Co. A, 1 Reg't La. H. Art'y.*

Appears on

Company Muster Roll

for *to Dec, 31, 1862*

Present or absent *Present*

Stoppage, \$ *100* for

Due Gov't, \$ *100* for

Valuation of horse, \$ *100*

Valuation of horse equipments, \$ *100*

Remarks: *Sick in Quarters*

*This organization subsequently became Co. A, 10 Reg't U. S. Col'd Heavy Artillery.

Book mark:

Tobman

Copyist.

P

10 H. Art'y. U.S.C.T.

Sibly Patterson

Co. A, 1 Reg't La. H. Art'y.*

Appears on

Company Muster Roll

for Jan'y & Feby, 1863.

Present or absent Present

Stoppage, \$ 100 for

Due Gov't, \$ 100 for

Valuation of horse, \$ 100

Valuation of horse equipments, \$ 100

Remarks:

*This organization subsequently became Co. A, 10 Reg't U.S. Col'd Heavy Artillery.

Book mark:

Tolman

P

10 H. Art'y.

U.S.C.T.

Sippy Patterson
Priv., Co. A, 1 Reg't La. H. Art'y.*

Appears on

Company Muster Roll

for March & April, 1863.

Present or absent Present

Stoppage, \$ 100 for

Due Gov't, \$ 100 for

Valuation of horse, \$ 100

Valuation of horse equipments, \$ 100

Remarks:

*This organization subsequently became Co. A, 10 Reg't U. S. Col'd Heavy Artillery.

Book mark:

Tobman
Copied.

P

10 H. Art'y. U.S.C.T.

Sippy Patterson

Priv., Co. A, 1 Reg't La. H. Art'y.*

Appears on

Company Muster Roll

for May & June, 1863.

Present or absent Present

Stoppage, \$ 100 for

Due Gov't, \$ 100 for

Valuation of horse, \$ 100

Valuation of horse equipments, \$ 100

Remarks: Detailed in Boat crew

*This organization subsequently became Co. A, 10 Reg't U. S. Col'd Heavy Artillery.

Book mark:

Tobman

P

10 H. Art'y.

U.S.C.T.

Sippy Patterson

Priv, Co. A, 1 Reg't La. H. Art'y.*

Appears on

Company Muster Roll

for *July & August*, 1863.

Present or absent *Present*

Stoppage, \$ 100 for

Due Gov't, \$ 100 for

Valuation of horse, \$ 100

Valuation of horse equipments, \$ 100

Remarks: _____

*This organization subsequently became Co. A, 10 Reg't U. S. Col'd Heavy Artillery.

Book mark: _____

Toman

P

10 H. Art'y. U.S.C.T.

Scipio Patterson

Priv, Co. A, 1 Reg't La. H. Art'y.*

Appears on

Company Muster Roll

for Sept & Oct, 1863.

Present or absent Present

Stoppage, \$ 100 for

Due Gov't, \$ 100 for

Valuation of horse, \$ 100

Valuation of horse equipments, \$ 100

Remarks:

*This organization subsequently became Co. A, 10 Reg't U. S. Col'd Heavy Artillery.

Book mark:

Tobman

P

10 H. Art'y. | U.S.C.T.

Scipio Patterson

Art'y, Co. A, 1 Reg't H. Art'y, Corps d'Afrique.*

Appears on

Company Muster Roll

for *Nov 1863*, 1863.

Present or absent *Present*

Stoppage, \$ *100* for

Due Gov't, \$ *100* for

Valuation of horse, \$ *100*

Valuation of horse equipments, \$ *100*

Remarks:

*This organization subsequently became Co. A, 10 Reg't U. S. Colored Heavy Artillery.

Book mark:

Beuster

P

10 H. Art'y. U.S.C.T.

Scipio Patterson
Art. Co. A, 1 Reg't H. Art'y, Corps d'Afrique.*

Appears on

Company Muster Roll

for Jan + Feb, 1864

Present or absent Present

Stoppage, \$ 100 for

Due Gov't, \$ 100 for

Valuation of horse, \$ 100

Valuation of horse equipments, \$ 100

Remarks:

*This organization subsequently became Co. A, 10 Reg't U. S. Colored Heavy Artillery.

Book mark:

Proctor

P | 10 H. Art'y. | U.S.C.T.

Scipio Patterson
Art., Co. *A*, 7 Reg't U. S. Col'd H. Art'y.*

Appears on

Company Muster Roll

for *McIntosh*, 1864.

Present or absent *Present*

Stoppage, \$ 100 for

Due Gov't, \$ 100 for

Valuation of horse, \$ 100

Valuation of horse equipments, \$ 100

Remarks:

* This organization subsequently became Co. *A*, 10 Reg't U. S. Colored Heavy Artillery.

Book mark: -----

Becker

P | 10 H. Art'y. | U.S.C.T.

Scipio Patterson
Co. A, 7 Reg't U. S. Col'd H. Art'y.*

Appears on

Company Muster Roll

for *May & June, 1864*

Present or absent *Present*

Stoppage, \$ *100* for

Due Gov't, \$ *100* for

Valuation of horse, \$ *100*

Valuation of horse equipments, \$ *100*

Remarks: *In confinement*

* This organization subsequently became *Co. A*, 10 Reg't U. S. Colored Heavy Artillery.

Book mark:

Rochester

P | 10 H. Art'y. | U.S.C.T.

Scipio Patterson

Co A, 7 Reg't U. S. Col'd H. Art'y.*

Appears on

Company Muster Roll

for *July & Aug*, 186*4*.

Present or absent *Present*

Stoppage, \$ *100* for

Due Gov't, \$ *100* for

Valuation of horse, \$ *100*

Valuation of horse equipments, \$ *100*

Remarks: *In arrest when last mustered*

* This organization subsequently became Co *A*, 10 Reg't U. S. Colored Heavy Artillery.

Book mark: _____

Recheester

P

10 H. Art'y. | U.S.C.T.

Scipio Patterson

Pvt., Co. A, 10 Reg't U. S. Col'd H. Art'y.

Appears on

Company Muster Roll

for Sept, 1864

Present or absent Present

Stoppage, \$ 100 for

Due Gov't, \$ 100 for

Valuation of horse, \$ 100

Valuation of horse equipments, \$ 100

Remarks:

Book mark:

Rechner

(358)

Copyist.

P | 10 H. Art'y. | U.S.C.T.

Scipio Patterson

Pvt., Co. A, 10 Reg't U. S. Col'd H. Art'y.

Appears on

Company Muster Roll

for Dec, 1864

Present or absent Present

Stoppage, \$ 100 for

Due Gov't, \$ 100 for

Valuation of horse, \$ 100

Valuation of horse equipments, \$ 100

Remarks:

Book mark:

Prohester

2

10 H. Art'y. | U.S.C.T.

Scipio Patterson
Co. A, 10 Reg't U. S. Col'd H. Art'y.

Appears on

Company Muster Roll

for Jan + Feb, 1865.

Present or absent Present

Stoppage, \$ 100 for

Due Gov't, \$ 100 for

Valuation of horse, \$ 100

Valuation of horse equipments, \$ 100

Remarks: In arrears

Book mark:

Bohannon

(358)

Copyist.

P | 10 H. Art'y. | U.S.C.T.

Scipio Patterson
Cpt, Co. A, 10 Reg't U. S. Col'd H. Art'y.

Appears on

Company Muster Roll

for *Mex & Cal*, 1865.

Present or absent *Present*

Stoppage, \$ 100 for

Due Gov't, \$ 100 for

Valuation of horse, \$ 100

Valuation of horse equipments, \$ 100

Remarks:

Book mark: -----

Rehner

Scipio Patterson

Co. A, 10 Reg't U. S. Col'd H. Art'y.

Appears on

Company Muster Roll

for *May & June, 1865.*

Present or absent *Present*

Stoppage, \$ 100 for

Due Gov't, \$ 100 for

Valuation of horse, \$ 100

Valuation of horse equipments, \$ 100

Remarks:

Book mark:

Proctor

P | 10 H. Art'y. | U.S.C.T.

Scipio Patterson

Co. A, 10 Reg't U. S. Col'd H. Art'y.

Appears on

Company Muster Roll

for July & Aug, 1865

Present or absent Present

Stoppage, \$ 100 for

Due Gov't, \$ 100 for

Valuation of horse, \$ 100

Valuation of horse equipments, \$ 100

Remarks: New York for
Camp & Garrison
Equipage \$ 2.01

Book mark:

Reister

(358)

Copyist.

P | 10 H. Art'y. | U.S.C.T.

Scipio Patterson

Plt, Co. A, 10 Reg't U. S. Col'd H. Art'y.

Appears on

Company Muster Roll

for *Sept - Oct*, 1865.

Present or absent *Present*

Stoppage, \$ *100* for

Due Gov't, \$ *100* for

Valuation of horse, \$ *100*

Valuation of horse equipments, \$ *100*

Remarks:

Book mark:

Hoyes

P. 10 No. a. U.S.C.T.

Sippy Patterson
Pol., Co. A, 10 Reg't U. S. Col'd No. a.

Appears on a

Detachment Muster-out Roll

of the organization named above. Roll dated

N. Orleans La. Nov. 28, 1865.

Muster-out to date *Nov. 28, 1865.*

Last paid to *June 30, 1865.*

Clothing account:

Last settled 186 ; drawn since \$ 100

Due soldier \$ *35.97*, due U. S. \$ 100

Am't for cloth'g in kind or money adv'd \$ 100

Due U. S. for arms, equipments, &c., \$ 100

Bounty paid \$ 100 due \$ 100

Remarks: *Joined at origl Orgn.
Stop for one Tompion
Mustered out by reason
of Expiration of term
of service*

Book mark:

Hawley

P | 10 H. Art'y. | U.S.C.T.

Sippy Paterson

Plt, Co. A, 10 Reg't U. S. Col'd H. Art'y.

Appears on

Company Muster Roll

for Nov & Dec, 1865.

Present or absent

Stoppage, \$ 100 for

Due Gov't, \$ 100 for

Valuation of horse, \$ 100

Valuation of horse equipments, \$ 100

Remarks: Mustered out by reason of expiration of term of service

Corrected by Worley Exr.

Book mark: Disch'd Nov 28/65 L.B. 15 47

C.R. 1884

Hynes

(358)

Copyist.

P

10 H. Art'y. U.S.C.T.

Sippy Patterson
Pvt, Co. A, 10 Reg't U. S. Col'd H. Art'y.

Appears on Co. Muster-out Roll, dated
Baton Rouge La Feb. 22, 1867.

Muster-out to date _____, 186 .

Last paid to _____, 186 .

Clothing account:

Last settled _____, 186 ; drawn since \$ _____ 100

Due soldier \$ _____ 100; due U. S. \$ _____ 100

Am't for cloth'g in kind or money adv'd \$ _____ 100

Due U. S. for arms, equipments, &c., \$ _____ 100

Bounty paid \$ _____ 100; due \$ _____ 100

Remarks: Joined orig. orgn. Discht
for Expen. of term of service
Nov. 28. 65

Book mark: V 165 P 236. 73

Nesbitt
Copyist.

P. 10th H.A. / U.S. 6th

Siphon Patterson

, Co. A, 10th Reg't U.S. 6th H.A.

NOTATION.

L.B. 15-941 with

Book mark:

47.6.3.1884

War Department,

Adjutant General's Office,

Washington, Jan. 5th, 1884.

~~Mustered out with Detach-~~
~~ment November 28, 1865.~~

E. P. Conroy

(438)

Copyist.

100.011110

Private Private

CARD NUMBERS.

1	5489054	26
2	5492941	27
3	5493257	28
4	5493302	29
5	5493512	30
6	5493567	31
7	5493707	32
8	5493813	33
9	5493871	34
10		35
11		36
12		37
13		38
14		39
15		40
16		41
17		42
18		43
19		44
20		45
21		46
22		47
23		48
24		49
25		50

Book Mark:

See also 75 U.S.G.S

P 10th Art U.S.C.T.

Washington Patterson
Co., 10 Reg't U. S. Col'd

Appears on

M. and D. Roll of Men Transferred

to the organization named above,

from 73 U.S.C.I.

Roll dated Nov 18, 1865

When enlisted Sep 26, 1864

Period for which enlisted 3 years.

When mustered in Sep 26, 1864

Present or absent Not stated

Company to which assigned

Remarks: Drafted per G.O. 106

Dated 11th Dec 1864
Aug 2/64 due U.S. for C & E
75-55 Due U.S. for ordnance
229

Book mark :

J. A. Johnson

(342)

Copyist.

P

10 H. Art'y.

U.S.C.T.

Washington Patterson

Plt, Co. A, 10 Reg't U. S. Col'd H. Art'y.

Appears on

Company Muster Roll

for Nov & Dec, 1865.

Present or absent Present

Stoppage, \$ 100 for

Due Gov't, \$ 5 77/100 for C. & G. E. \$ 5.55

for Ord. 22¢ per transfer rolls,

Valuation of horse, \$ 100

Valuation of horse equipments, \$ 100

Remarks: Transferred from 75
U.S.C.I. per S.O. B.S. Hd
Qrs Dept of War

Book mark:

J. H. Jones

Copyist.

(358)

P

10 H. Art'y. U.S.C.T.

Washington Patterson

Pl, Co. A, 10 Reg't U. S. Col'd H. Art'y.

Appears on

Company Muster Roll

for Jan + Feb, 1866.

Present or absent Present

Stoppage, \$ 100 for

Due Gov't, \$ 100 for

Valuation of horse, \$ 100

Valuation of horse equipments, \$ 100

Remarks:

Book mark:

(358)

Styde

Copyist.

P

10 H. Art'y. U.S.C.T.

Washington Patterson

Plt, Co. A, 10 Reg't U. S. Col'd H. Art'y.

Appears on

Company Muster Roll

for *Mar - Apr*, 186*6*.

Present or absent *Present*

Stoppage, \$ 100 for

Due Gov't, \$ 100 for

Valuation of horse, \$ 100

Valuation of horse equipments, \$ 100

Remarks:

Book mark:

(358)

J. Byers
Copyist.

P

10 H. Art'y. | U.S.C.T.

Washington Patterson

Plat, Co. A, 10 Reg't U. S. Col'd H. Art'y.

Appears on

Company Muster Roll

for

May & June, 1866.

Present or absent

Present

Stoppage, \$

100 for

Due Gov't, \$

100 for

Valuation of horse, \$

100

Valuation of horse equipments, \$

100

Remarks:

Book mark:

Styus

Copyist.

P

10 H. Art'y. U.S.C.T.

Washington Patterson

Pvt., Co. A, 10 Reg't U. S. Col'd H. Art'y.

Appears on

Company Muster Roll

for July & Aug, 1866

Present or absent Present

Stoppage, \$ 100 for

Due Gov't, \$ 100 for

Valuation of horse, \$ 100

Valuation of horse equipments, \$ 100

Remarks:

Book mark:

H. J. ... Copyist.

(358)

P | 10 H. Art'y. | U.S.C.T.

Washington Patterson

Priv., Co. A, 10 Reg't U. S. Col'd H. Art'y.

Appears on

Company Muster Roll

for Sept & Oct, 1866.

Present or absent Present

Stoppage, \$ 100 for

Due Gov't, \$ 3 58/100 for Ordnance and

Camp Garrison equipage

Valuation of horse, \$ 100

Valuation of horse equipments, \$ 100

Remarks: Stop for one Bed sack
and one Tompion

Book mark:

Nesbitt

Copyist.

P | 10 H. Art'y. | U.S.C.T.

Washington Patterson

Pvt., Co. A, 10 Reg't U. S. Col'd H. Art'y.

Appears on

Company Muster Roll

for Nov Dec, 1866.

Present or absent Present

Stoppage, \$ 100 for

Due Gov't, \$ 3 50/100 for Camp and Garrison equipage

Valuation of horse, \$ 100

Valuation of horse equipments, \$ 100

Remarks:

Book mark:

Nesbitt

P

10 H. Art'y. U.S.C.T.

Washington Patterson

Pvt, Co. A, 10 Reg't U. S. Col'd H. Art'y.

Appears on Co. Muster-out Roll, dated

Baton Rouge La, Feb 22, 1867.

Muster-out to date Feb 22, 1867.

Last paid to Dec. 31, 1866.

Clothing account:

Last settled, 186 ; drawn since \$ 100

Due soldier \$ 25 ³⁷/₁₀₀; due U. S. \$ 100

Am't for cloth'g in kind or money adv'd \$ 100

Due U. S. for arms, equipments, &c., \$ ^{under A. O. 101} 6 ⁰⁰/₁₀₀

Bounty paid \$ 100; due \$ ^{2 11}/₁₀₀

Remarks: Transf'd from 75 U.S. Col'd H. Art'y. Co. A, 10 Reg't of '65 Dept. La.

Book mark:

Nesbitt

(361)

Copyist.

Private Private

CARD NUMBERS.

5507173	26
5507449	27
5507594	28
5507740	29
5507879	30
5508019	31
5508158	32
5508291	33
5508438	34
5508587	35
5508739	36
5508886	37
5509032	38
5509155	39
5509301	40
5509409	41
	42
	43
	44
	45
	46
	47
	48
	49
	50

Book Mark:

See also

S-97265-0-P.O. mm

D. 2162978 P.O. off

D. 2187490 P.O. off

S. 2187496 " "

D. 2228255 " "

D. 2454781 And. w. d

ay. 1259132

N. J. Worley
J
247

P | 10. Hartly | U.S.C.T.

John Paul

Appears with rank of Pvt on

Muster and Descriptive Roll of a Detachment of U. S. Vols. forwarded

Organized as Co's. for the 10. Reg't U. S. Col'd H. A. Roll dated New Orleans La, Sept 20, 1864.

Where born St James La

Age 25 y'rs; occupation Laborer

When enlisted Sept 20, 1864.

Where enlisted New Orleans La

For what period enlisted 3 years.

Eyes Blk; hair Blk

Complexion Dark; height 5 ft. 5/2 in.

When mustered in Sept 20, 1864.

Where mustered in New Orleans La

Bounty paid \$ 100; due \$ 100

Where credited to New Orleans La

Company to which assigned G.

Remarks:

Book mark:

E. B. Thompson

P

10 H. Art'y. | U.S.C.T.

John Paul
Pvt., Co. G, 10 Reg't U. S. Col'd H. Art'y.

Appears on

Company Muster Roll

for Sept & Oct, 1864.

Present or absent Present

Stoppage, \$ 100 for

Due Gov't, \$ 100 for

Valuation of horse, \$ 100

Valuation of horse equipments, \$ 100

Remarks:

Book mark:

E. H. Brown

P

10 H. Art'y. | U.S.C.T.

John Paul

Co, Co. G, 10 Reg't U. S. Col'd H. Art'y.

Appears on

Company Muster Roll

for *Nov & Dec*, 1864.

Present or absent *Present*

Stoppage, \$ 100 for

Due Gov't, \$ 100 for

Valuation of horse, \$ 100

Valuation of horse equipments, \$ 100

Remarks:

Book mark:

E H Bowen

(358)

Copyist.

C

10 H. Art'y. | U.S.C.T.

John Paul

Pres., Co. G, 10 Reg't U. S. Col'd H. Art'y.

Appears on

Company Muster Roll

for *Jan & Feb*, 1865.

Present or absent *Present*

Stoppage, \$ 100 for

Due Gov't, \$ 100 for

Valuation of horse, \$ 100

Valuation of horse equipments, \$ 100

Remarks:-----

Book mark:-----

J. E. Porter

(358)

Copyist.

P

10 H. Art'y. | U.S.C.T.

John Paul

Prof., Co. G, 10 Reg't U. S. Col'd H. Art'y.

Appears on

Company Muster Roll

for *Mar & April*, 1865.

Present or absent *Present*

Stoppage, \$.....100 for

Due Gov't, \$.....100 for

Valuation of horse, \$.....100

Valuation of horse equipments, \$.....100

Remarks:

Book mark:

F. E. Porter

(358)

Copyist.

9

10 H. Art'y. U.S.C.T.

John Paul
Priv., Co. G, 10 Reg't U. S. Col'd H. Art'y.

Appears on

Company Muster Roll

for May & June, 1865.

Present or absent Present

Stoppage, \$ 100 for

Due Gov't, \$ 100 for

Valuation of horse, \$ 100

Valuation of horse equipments, \$ 100

Remarks:

Book mark:

J. E. Porter

P

10 H. Art'y. U.S.C.T.

John Paul
Prov, Co. G, 10 Reg't U. S. Col'd H. Art'y.

Appears on

Company Muster Roll

for July & Aug, 1865.

Present or absent Present

Stoppage, \$ 100 for

Due Gov't, \$ 10/100 for 104 Equip't

age lost or destroyed

Valuation of horse, \$ 100

Valuation of horse equipments, \$ 100

Remarks:

Book mark:

J. E. Porter

P

10 H. Art'y. U.S.C.T.

John Paul
Priv, Co. G, 10 Reg't U. S. Col'd H. Art'y.

Appears on

Company Muster Roll

for Sept & Oct, 1863.

Present or absent Present

Stoppage, \$ 100 for

Due Gov't, \$ 100 for

Valuation of horse, \$ 100

Valuation of horse equipments, \$ 100

Remarks:

Book mark: 109830

F. E. Porter

P

10 H. Art'y. U.S.C.T.

John Paul

Capt., Co. G, 10 Reg't U. S. Col'd H. Art'y.

Appears on

Company Muster Roll

for *Nov. & Dec.*, 186*5*.

Present or absent *Present*

Stoppage, \$.....100 for

Due Gov't, \$.....100 for

Valuation of horse, \$.....100

Valuation of horse equipments, \$.....100

Remarks:.....

Book mark:.....

G. F. J.

Copyist.

P

10 H. Art'y. U.S.C.T.

John Paul

Capt., Co. G, 10 Reg't U. S. Col'd H. Art'y.

Appears on

Company Muster Roll

for *Jan & Feb.*, 186*6*.

Present or absent *Present*

Stoppage, \$ *100* for

Due Gov't, \$ *100* for

Valuation of horse, \$ *100*

Valuation of horse equipments, \$ *100*

Remarks:

Book mark:

(358)

G. F. M.

Copyist.

P.

10 H. Art'y.

U.S.C.T.

John Paul

Capt., Co. G, 10 Reg't U. S. Col'd H. Art'y.

Appears on

Company Muster Roll

for *Mar. & Apr.*, 186*6*.

Present or absent *Present*

Stoppage, \$ 100 for

Due Gov't, \$ 70/100 for *C. C. & G. E*

lost

Valuation of horse, \$ 100

Valuation of horse equipments, \$ 100

Remarks: _____

Book mark: _____

G. Fry

P

10 H. Art'y. | U.S.C.T.

John Paul
Prvt, Co. G, 10 Reg't U. S. Col'd H. Art'y.

Appears on

Company Muster Roll

for *May & June*, 186*6*.

Present or absent *Present*

Stoppage, \$.....100 for

Due Gov't, \$.....100 for

Valuation of horse, \$.....100

Valuation of horse equipments, \$.....100

Remarks:.....

Book mark:.....

(358)

G. F. N.

Copyist.

P

10 H. Art'y. U.S.C.T.

John Paul
Co. G, 10 Reg't U. S. Col'd H. Art'y.

Appears on

Company Muster Roll

for *July & Aug*, 186*6*.

Present or absent *Present*

Stoppage, \$ 100 for

Due Gov't, \$ 100 for

Valuation of horse, \$ 100

Valuation of horse equipments, \$ 100

Remarks:

Book mark:

G. F. N.
Copyist.

P

10 H. Art'y. | U.S.C.T.

John Paul

Pvt, Co. G, 10 Reg't U. S. Col'd H. Art'y.

Appears on

Company Muster Roll

for *Sept & Oct*, 1866.

Present or absent *Present*

Stoppage, \$ *100* for

Due Gov't, \$ *100* for

Valuation of horse, \$ *100*

Valuation of horse equipments, \$ *100*

Remarks:

Book mark:

Wines

P

10 H. Art'y. U.S.C.T.

John Paul

Pvt, Co. G, 10 Reg't U. S. Col'd H. Art'y.

Appears on

Company Muster Roll

for Nov & Dec, 1866.

Present or absent Present

Stoppage, \$ 100 for

Due Gov't, \$ 100 for

Valuation of horse, \$ 100

Valuation of horse equipments, \$ 100

Remarks:

Book mark:

Wines

P

10 H. Art'y. U.S.C.T.

John Paul

Co. G, 10 Reg't U. S. Col'd H. Art'y.

Appears on Co. Muster-out Roll, dated *Baton Rouge La, Feb 22*, 1867.

Muster-out to date *Feb 22*, 1867.

Last paid to *Dec 31*, 1866.

Clothing account:

Last settled....., 186 ; drawn since \$.....¹⁰⁰

Due soldier \$ *1/6*²¹/₁₀₀; due U. S. \$.....¹⁰⁰

Am't for cloth'g in kind or money adv'd \$.....¹⁰⁰

Due U. S. for arms, equipments, &c., \$.....⁶/₁₀₀

Bounty paid \$.....¹⁰⁰; due \$ *2 00*⁰⁰/₁₀₀

Remarks: *Joined at Asg't, Ariz.*

Book mark :

(361)

Wines

Copyist.

John, Paul

, Co. G, 10th Reg't U.S. C.A.A

1 Enclosures.

Bed Cards	Final Statements
Burial Records	Furloughs or L. of A.
Certs. of Dis. for Discharge	Med. Certificates
C. M. Charges	Med. Des. Lists
Descriptive Lists	Orders
Discharge Certificates	Pris. of War Record
Enlistment Papers	Resignations

Other papers relating to—

Admission to Hosp'l	Furlough or L. of A.
Casualty Sheet	Med. Examination
Confinement	Misc. Information
Contracts	Pay or Clothing
Death or Effects	Personal Reports
Desertion	Rank
Discharge from Hosp'l	Transfer to Hosp'l
Discharge from Service	Transfer to V. R. C.
Duty	Transportation

NOTE 1.—This blank will be used for both enlistments and re-enlistments—enlistment of veterans, &c., &c., in the volunteer service. They will be made out in duplicate in all cases—one to accompany the recruiting return of the superintendent (not the recruiting officer) to the Adjutant General, and one to accompany the accounts of the officer who pays bounty, &c. The Regiment and Company in which the soldier last served should be given on the back.

NOTE 2.—An enlistment holds to service. A muster-in must, in all cases, precede payment of pay, bounty, pension, &c. A muster-in roll must, in all cases, be filed in the Adjutant General's Office as evidence of muster-in. The mustering officer, commissary, or assistant commissary of musters, as the case may be, will countersign both enlistments as having mustered the soldier into the service of the United States before either of them is given to the disbursing officer.

DECLARATION OF RECRUIT.

I, Paul John desiring

to VOLUNTEER as a Soldier in the Army of the United States, for the term of THREE YEARS, Do Declare, That I am 25 years and _____ months of age; that I have never been discharged from the United States service on account of disability or by sentence of a court martial, or by order before the expiration of a term of enlistment; and I know of no impediment to my serving honestly and faithfully as a soldier for three years.

GIVEN at New Orleans the 20th day of September

Witness: J. Horace McGuire Paul John
his father

No. 85

Paul John
 Volunteered at New Orleans
20th Sept 1864
 By J. H. McGuire
1st Regt of Col. A.

enlistment; last served in Company ()
1st Regt of Col. A.
 Discharged 18
amount not entitled to
Bounty.

CONSENT IN CASE OF MINOR.

I, _____ Do CERTIFY, That I am
 the _____ of _____; that the
 said _____ is _____ years of age; and I
 do hereby freely give my CONSENT to his volunteering as a SOLDIER in the ARMY OF THE UNITED STATES for the period of THREE YEARS.

GIVEN at _____
 the _____ day of _____

Witness: _____

VOLUNTEER ENLISTMENT.

STATE OF

TOWN OF

Louisiana

New Orleans



I, Paul John born in St James Parish
 in the State of La. aged 25 years,
 and by occupation a laborer Do HEREBY ACKNOWLEDGE to have
 volunteered this 20th day of September 1864,
 to serve as a **Soldier** in the **Army of the United States of America**, for
 the period of **THREE YEARS**, unless sooner discharged by proper authority:
 Do also agree to accept such bounty, pay, rations, and clothing, as are, or may be,
 established by law for volunteers. And I, Paul John do
 solemnly swear, that I will bear true faith and allegiance to the **United States**
of America, and that I will serve them honestly and faithfully against all
 their enemies or opposers whomsoever; and that I will observe and obey the
 orders of the President of the United States, and the orders of the officers
 appointed over me, according to the Rules and Articles of War.

Sworn and subscribed to, at New Orleans
 this 20th day of Sept. 1864 } Paul John his
 BEFORE John N. Chamberlain } mark
Capt. & A. C. M.

I CERTIFY, ON HONOR, That I have carefully examined the above-named Volunteer, agreeably to the General Regulations of the Army, and that, in my opinion, he is free from all bodily defects and mental infirmity, which would in any way disqualify him from performing the duties of a soldier.

W. M. Mathis
 10th U. S. C. A. (1864) EXAMINING SURGEON.

I CERTIFY, ON HONOR, That I have minutely inspected the Volunteer, Paul John
 previously to his enlistment, and that he was entirely sober when enlisted; that, to the best of my
 judgment and belief, he is of lawful age; and that, in accepting him as duly qualified to perform the
 duties of an able-bodied soldier, I have strictly observed the Regulations which govern the recruiting
 service. This soldier has blue eyes, blue hair, dark complexion, is 5
 feet 5/2 inches high.

J. Horace McGuire
 10th Regiment of U. S. C. A. Volunteers,
 RECRUITING OFFICER.

Mustered into the service of the United States, for three years or during the war, from date of enlistment, in Company A
10th Regiment of U. S. C. A. (1864) Volunteers, on the 20th day of Sept., 1864, at New Orleans

John N. Chamberlain
 Capt. 10th U. S. C. A. (1864)
 A. C. M.

10 U.S. Col'd H. Art'y

Private | *Private*

CARD NUMBERS.

1	5497643	26
2	5497886	27
3	5498041	28
4	1522-CJ-1862	29
5		30
6		31
7		32
8		33
9		34
10		35
11		36
12		37
13		38
14		39
15		40
16		41
17		42
18		43
19		44
20		45
21		46
22		47
23		48
24		49
25		50

Book Mark: 1522 - CJ - 82 r
U - 33 U - 11 REF - 1867

See also

P | 10 H. Art'y. | U.S.C.T.

Polite Paul

Pt, Co. C, 1 Reg't H. Art'y, Corps d'Afrique.*

Age *28* years.

Appears on

Company Muster-in Roll

of the organization named above. Roll dated

New Orleans La, Aug 17 1863.

Muster-in to date *Aug 17*, 1863.

Joined for duty and enrolled:

When *July 7*, 1863.

Where *Camp. Sarapet La*

Period *3* years.

Valuation of horse, \$ *100*

Valuation of horse equipments, \$ *100*

Remarks:

* This organization subsequently became Co. C, 10 Reg't U. S. Colored Heavy Artillery.

Book mark: -----

efferman

P | 10 H. Art'y. | U.S.C.T.

Police - Paul

Pt, Co, C, 1 Reg't La. Art'y Native Guards.*

Appears on

Company Muster Roll

for *Aug 11th to 31st*; 186*3*.

Present or absent *Present*

Stoppage, \$ *100* for

Due Gov't, \$ *100* for

Valuation of horse, \$ *100*

Valuation of horse equipments, \$ *100*

Remarks :

* This organization subsequently became Co. C, 10 Reg't U. S. Col'd Heavy Artillery.

Book mark :

(358)

W. J. ...

Copyist.

P | 10 H. Art'y. | U.S.C.T.

Pte. Polite Paul

Pte., Co, C, 1 Reg't La. Art'y Native Guards.*

Appears on

Company Muster Roll

for *Sep & Oct*, 186*3*.

Present or absent *Present*

Stoppage, \$ 100 for

Due Gov't, \$ 100 for

Valuation of horse, \$ 100

Valuation of horse equipments, \$ 100

Remarks :

Not on sub. rolls of Co

* This organization subsequently became Co. C, 10 Reg't U. S. Col'd Heavy Artillery.

Book mark : *L. 522, C. 5. 82.*, *N. 94. P.*

(over)

W. J. S. S. S.

JAN. 15

5498040

* 1891 *

164.69

P. 1 10th Reg't U.S. A.

Polite Paul

, Co. B, 10th Reg't U.S. A.

NOTATION.

Book mark:

1522.6.3 1882
~~V77 P164-69. A33 V11 REC 1867~~

War Department,

Adjutant General's Office,

Washington,

July 11th, 1882.

"Discharged Nov 7th, 1863."

(438)

E. P. Conaway

Copyist.

Co. C., 10 U.S. Col'd H. Art'y

Private

Private

CARD NUMBERS.

1	5487243	26
2	5498571	27
3	5498712	28
4	5498851	29
5	5498988	30
6	5499128	31
7	5499264	32
8	5499400	33
9	5499535	34
10	5499672	35
11	5499806	36
12	5499941	37
13	5500071	38
14	5500206	39
15	5489273	40
16	5500333	41
17	5489289	42
18	5500395	43
19		44
20		45
21		46
22		47
23		48
24		49
25		50

Book Mark:

See also

P

10 H. Art'y. | U.S.C.T.

Islam Paum

Appears with rank of Private on

Muster and Descriptive Roll of a Detachment of U. S. Vols. forwarded

for the 10 Reg't U.S.C.H. Art'y Roll dated New Orleans La, Sept 19, 1864.

Where born Clinton La

Age 18 y'rs; occupation Labors

When enlisted Aug 30, 1864

Where enlisted New Orleans La

For what period enlisted 3 years.

Eyes Blue; hair Blue

Complexion Dark; height 5 ft. 2 in.

When mustered in Sept 19, 1864.

Where mustered in New Orleans

Bounty paid \$ 100; due \$ 300 100

Where credited to New Orleans La

Company to which assigned le

Remarks :

Book mark :

S. W. Williams

P

10 H. Art'y. | U.S.C.T.

Islam Pann

Priv., Co. C, 10 Reg't U. S. Col'd H. Art'y.

Appears on

Company Muster Roll

for Sept 10th, 1864

Present or absent Present

Stoppage, \$ 100 for

Due Gov't, \$ 100 for

Valuation of horse, \$ 100

Valuation of horse equipments, \$ 100

Remarks: \$300 Bounty due

Book mark:

2508250

(358)

J. Anderson Copyist.

P | 10 H. Art'y. | U.S.C.T.

Islam Parson

Pvt., Co. C, 10 Reg't U. S. Col'd H. Art'y.

Appears on

Company Muster Roll

for Nov & Dec, 1864

Present or absent Present

Stoppage, \$ 100 for

Due Gov't, \$ 100 for

Valuation of horse, \$ 100

Valuation of horse equipments, \$ 100

Remarks: \$300. Bounty
- due

Book mark: 2334

(358)

J. Henderson

Copyist.

P

10 H. Art'y. U.S.C.T.

Isaac Paum
Sgt., Co. C, 10 Reg't U. S. Col'd H. Art'y.

Appears on

Company Muster Roll

for Jan & Feb, 1864

Present or absent Present

Stoppage, \$ 100 for

Due Gov't, \$ 100 for

Valuation of horse, \$ 100

Valuation of horse equipments, \$ 100

Remarks:

Book mark:

Callade

P

10 H. Art'y. U.S.C.T.

Islam Paum

Plt., Co. C, 10 Reg't U. S. Col'd H. Art'y.

Appears on

Company Muster Roll

for March & April, 1865.

Present or absent Present

Stoppage, \$ 100 for

Due Gov't, \$ 100 for

Valuation of horse, \$ 100

Valuation of horse equipments, \$ 100

Remarks:

Book mark:

Lucas

P

10 H. Art'y. U.S.C.T.

Islam Paul

Pvt., Co. C, 10 Reg't U. S. Col'd H. Art'y.

Appears on

Company Muster Roll

for May + June, 1865

Present or absent Present

Stoppage, \$ 100 for

Due Gov't, \$ 100 for

Valuation of horse, \$ 100

Valuation of horse equipments, \$ 100

Remarks:

Book mark:

(358)

Ballade

Copyist.

P

10 H. Art'y. U.S.C.T.

Isaac Pann

Co. C, 10 Reg't U. S. Col'd H. Art'y.

Appears on

Company Muster Roll

for July & Aug, 1865.

Present or absent Present

Stoppage, \$ 100 for

Due Gov't, \$ 100 for

Valuation of horse, \$ 100

Valuation of horse equipments, \$ 100

Remarks: \$200 bounty due. \$100 paid

Book mark:

Ballade

P

10 H. Art'y. | U.S.C.T.

Isaac Pann

Pvt, Co. C, 10 Reg't U. S. Col'd H. Art'y.

Appears on

Company Muster Roll

for *Sept to Oct*, 186*5*.

Present or absent *Present*

Stoppage, \$ *100* for

Due Gov't, \$ *100* for

Valuation of horse, \$ *100*

Valuation of horse equipments, \$ *100*

Remarks:

Book mark:

Dallade

P

10 H. Art'y. U.S.C.T.

Islam Pann

Pvt., Co. C, 10 Reg't U. S. Col'd H. Art'y.

Appears on

Company Muster Roll

for Nov. 1st Dec., 1865.

Present or absent Present.

Stoppage, \$ 100 for

Due Gov't, \$ 100 for

Valuation of horse, \$ 100

Valuation of horse equipments, \$ 100

Remarks:

Book mark:

A. J. Robbins

(358)

Copyist.

P

10 H. Art'y. U.S.C.T.

Islam Pamm

Poh, Co. C, 10 Reg't U. S. Col'd H. Art'y.

Appears on

Company Muster Roll

for Jan. and Feb., 1866.

Present or absent Present.

Stoppage, \$ 100 for

Due Gov't, \$ 100 for

Valuation of horse, \$ 100

Valuation of horse equipments, \$ 100

Remarks: \$100 bounty paid
\$200 due

Book mark:

A. J. Robbins

(358)

Copyist.

P

10 H. Art'y. U.S.C.T.

Islam Pann

Priv., Co. C, 10 Reg't U. S. Col'd H. Art'y.

Appears on

Company Muster Roll

for *Mo. V. Apr.*, 1866.

Present or absent *Present*

Stoppage, \$ 100 for

Due Gov't, \$ 100 for

Valuation of horse, \$ 100

Valuation of horse equipments, \$ 100

Remarks: *Due U.S. for loss of
wiper & wrench \$72
100.*

Book mark:

A. J. Robbins

(358)

Copyist.

P

10 H. Art'y.

U.S.C.T.

William Cannon

Plt, Co. C, 10 Reg't U. S. Col'd H. Art'y.

Appears on

Company Muster Roll

for *May 2d June*, 186*4*.

Present or absent *Present*

Stoppage, \$ *100* for

Due Gov't, \$ *100* for

Valuation of horse, \$ *100*

Valuation of horse equipments, \$ *100*

Remarks: *\$200 bounty paid, \$100 to be paid.*

Book mark:

(358)

A. J. Robbins

Copyist.

P

10 H. Art'y. | U.S.C.T.

Islam Pann

Priv., Co. C, 10 Reg't U. S. Col'd H. Art'y.

Appears on

Company Muster Roll

for July 20 Aug 1, 1866.

Present or absent Present.

Stoppage, \$ 100 for

Due Gov't, \$ 100 for

Valuation of horse, \$ 100

Valuation of horse equipments, \$ 100

Remarks:

Book mark:

A. J. Robbins

(358)

Copyist.

P

10 H. Art'y. U.S.C.T.

Islam Baum

P, Co. C, 10 Reg't U. S. Col'd H. Art'y.

Appears on

Company Muster Roll

for *Sept & Oct*, 186*6*.

Present or absent *Absent*

Stoppage, \$ *100* for

Due Gov't, \$ *100* for

Valuation of horse, \$ *100*

Valuation of horse equipments, \$ *100*

Remarks: *On det ser at Ft
Livingston, La, per
A.O. 15 C.S. Hd, Geo
Ft Livingston*

Book mark:

Manning

S 1026A U.S.C.T.

Selam Tamm
Tris, Co. *C*, *10* Reg't U. S. Col'd *26A*

Appears on a

Detachment Muster Roll

of the organization named above

for *Sept. + Oct.*, 1866.

Station *Ft. Livingston, Pa.*

Present or absent *Present*

Stoppage, \$ *100* for

Due Gov't, \$ *100* for

Valuation of horse, \$ *100*

Valuation of horse equipments, \$ *100*

Remarks:

Book mark:

Grogan

(844)

Copyist.

P

10 H. Art'y. U.S.C.T.

Islam Purney

Pvt., Co. C, 10 Reg't U. S. Col'd H. Art'y.

Appears on

Company Muster Roll

for Nov 9 Dec, 1864.

Present or absent Absent

Stoppage, \$ 100 for

Due Gov't, \$ 100 for

Valuation of horse, \$ 100

Valuation of horse equipments, \$ 100

Remarks: Det Ser at Fort Livingstone, Sa, per S.O. No 15 C.S. Hd Qrs Fort Livingstone

Book mark:

Hammer

P 116A U.S.C.T.

John Penn
Qui, Co. *C*, *10* Reg't U. S. Col'd *Ad*

Appears on a

Detachment Muster Roll

of the organization named above

for *Nov. & Dec.*, 186*6*.

Station *H. Livingston La.*

Present or absent *Present*

Stoppage, \$ *100* for

Due Gov't, \$ *100* for

Valuation of horse, \$ *100*

Valuation of horse equipments, \$ *100*

Remarks: *Cook for Detachment*

Book mark:

(844)

Grogan

Copyist.

Islam Parris
Pvt, Co. C., 10 Reg't U. S. Col'd H. Art'y.

Appears on Co. Muster-out Roll, dated
Raton Range, La, Feb 22, 1867.

Muster-out to date Feb 22, 1867.

Last paid to Dec 31, 1866.

Clothing account:

Last settled....., 186 ; drawn since \$.....100

Due soldier \$ 20 ⁸⁹/₁₀₀; due U. S. \$.....100

Am't for cloth'g in kind or money adv'd \$.....100

Due U. S. for arms, equipments, &c., \$ 7 ¹⁶/₁₀₀

Bounty paid \$ 200 ¹⁰⁰/₁₀₀; due \$.....100

Remarks: Joined as recruit.
Stop for one pair
Scales stop for horse
driver stop for one Exp
Rifled musket & accoutre-
ments retained

Book mark :

(361)

Manning
Copyist.

U.S. GOVERNMENT

Private | *Private*

CARD NUMBERS.

1	5504460	26
2	5487349	27
3	5505019	28
4	5505177	29
5	5505465	30
6	5505568	31
7	5505677	32
8	5505829	33
9	5505983	34
10	5506128	35
11	5506254	36
12	5506398	37
13	5506517	38
14	5506719	39
15	5506836	40
16	5506933	41
17		42
18		43
19		44
20		45
21		46
22		47
23		48
24		49
25		50

Book Mark:

See also

P | 10 H. Art'y. | U.S.C.T.

Joseph S Payden
Pvt, Co. F, 7 Reg't U. S. Col'd H. Art'y.*

Appears on

Company Muster-in and Descriptive Roll
of the organization named above. Roll dated
New Orleans La, Aug 19, 1864.

Where born Lafourche La

Age 22 y'rs; occupation Laborer

When enlisted _____, 186 .

Where enlisted _____

For what period enlisted 3 years.

Eyes Dark; hair Blk

Complexion Dark; height 5 ft. 10 in.

When mustered in Aug 19, 1864.

Where mustered in New Orleans La.

Bounty paid \$ 100; due \$ 100

Where credited 3rd Cavlt Dist La

Company to which assigned _____

Remarks: Drafted

* This organization subsequently became Co. F, 10 Reg't U. S. Colored Heavy Artillery.

Book mark: _____

(356d)

Rosenbaum

Copyist.

S | *10 Harty* | **U.S.C.T**

Joseph L. Payden

Appears with rank of *Priv* on

Muster and Descriptive Roll of a Detachment of Drafted Men and Substitutes forwarded

for the *7* Reg't U.S. Col'd *Harty* Roll dated *New Orleans La*, Aug 19, 186*4*

Where born *Lafourche La*

Age *22* years; occupation *Laborer*

Drafted and mustered in:

When *Aug 17*, 186*4*.

Where *Houma La*

Period *3* years.

Eyes *Dark*; hair *Black*

Complexion *Dark*; height *5 ft. 4 in.*

Paid bounty and advance pay, \$ *100*

Bounty due \$ *100*

Where credited *Parish of Terrebonne La*

Company to which assigned *F*

Remarks:

Became 10 U.S. C. H. Art'y

Book mark:

(340)

Jennings

Copyist.

P

10 H. Art'y. U.S.C.T.

Joseph L. Payden

Priv., Co. F, 10 Reg't U. S. Col'd H. Art'y.

Appears on

Company Muster Roll

for July & August, 1864.

Present or absent Present

Stoppage, \$ 100 for

Due Gov't, \$ 100 for

Valuation of horse, \$ 100

Valuation of horse equipments, \$ 100

Remarks:

Book mark:

Rosenbaum

(358)

Copyist.

P

10 H. Art'y. U.S.C.T.

Joseph L. Payden

Pvt., Co. F, 10 Reg't U. S. Col'd H. Art'y.

Appears on

Company Muster Roll

for Sept & Oct, 1864.

Present or absent

Stoppage, \$ 100 for

Due Gov't, \$ 100 for

Valuation of horse, \$ 100

Valuation of horse equipments, \$ 100

Remarks: Deserted from Battery
Gentilly Sept-15-1864

Book mark:

Rosenbaum
Copyist.

P

Joseph L. Gayden

Priv., Co. F, 10 Reg't U. S. Col'd H. Art'y.

Appears on

Company Muster Roll

for March April, 1865.

Present or absent Present

Stoppage, \$ 100 for

Due Gov't, \$ 100 for

Valuation of horse, \$ 100

Valuation of horse equipments, \$ 100

Remarks Deserted Sept 15/64
Ret'd from desertion April 15/65.
Ret'd to duty by S.O. 135 Ex 2
Ad. Ins. De. Div. / La.

Book mark:

B. G. Wasdon

J

10 H. Art'y. | U.S.C.T.

Joseph L. Payden

Private, Co. F, 10 Reg't U. S. Col'd H. Art'y.

Appears on

Company Muster Roll

for *May & June*, 186*5*.

Present or absent *Present*

Stoppage, \$ *100* for

Due Gov't, \$ *100* for

Valuation of horse, \$ *100*

Valuation of horse equipments, \$ *100*

Remarks:

Book mark:

B. G. Masdon

P

10 H. Art'y. U.S.C.T.

Joseph L Payden

Priv., Co. F, 10 Reg't U. S. Col'd H. Art'y.

Appears on

Company Muster Roll

for dated Aug 31, 1865.

Present or absent Present

Stoppage, \$ 100 for

Due Gov't, \$ 100 for

Valuation of horse, \$ 100

Valuation of horse equipments, \$ 100

Remarks: Due U.S. for Camp & Garrison Equipage \$.65

Book mark:

R. G. Masdon

P

10 H. Art'y. U.S.C.T.

Joseph L Payden

Co. F, 10 Reg't U. S. Col'd H. Art'y.

Appears on

Company Muster Roll

for Sept & Oct, 1865.

Present or absent Present

Stoppage, \$ 100 for

Due Gov't, \$ 100 for

Valuation of horse, \$ 100

Valuation of horse equipments, \$ 100

Remarks:

Book mark:

B G Masdon

P.

10 H. Art'y. | U.S.C.T.

Joseph La Payden

Priv., Co. F, 10 Reg't U. S. Col'd H. Art'y.

Appears on

Company Muster Roll

for Nov. & Dec., 1865.

Present or absent Present

Stoppage, \$ 0. ²⁶/₁₀₀ for Ordnances

Due Gov't, \$ 100 for

Valuation of horse, \$ 100

Valuation of horse equipments, \$ 100

Remarks: Due U.S. for B. & G. E.
\$0.65

Book mark:

(358)

Asst. Copyist.

P.

10 H. Art'y. U.S.C.T.

Joseph L. Payden.

Part; Co. F, 10 Reg't U. S. Col'd H. Art'y.

Appears on

Company Muster Roll

for Jan'y & Feby, 1866.

Present or absent Present.

Stoppage, \$ 100 for

Due Gov't, \$ 100 for

Valuation of horse, \$ 100

Valuation of horse equipments, \$ 100

Remarks:

Book mark:

Colt.
Copyist.

P

10 H. Art'y. | U.S.C.T.

Joseph L. Payden

Pat., Co. F, 10 Reg't U. S. Col'd H. Art'y.

Appears on

Company Muster Roll

for Mar & Apr, 1866.

Present or absent Present

Stoppage, \$ 100 for

Due Gov't, \$ 100 for

Valuation of horse, \$ 100

Valuation of horse equipments, \$ 100

Remarks:

[Empty lines for remarks]

Book mark:

[Faint handwritten text]

Copyist

P.

10 H. Art'y. | U.S.C.T.

Joseph L. Payden

Privt, Co. F, 10 Reg't U. S. Col'd H. Art'y.

Appears on

Company Muster Roll

for *May & June*, 186*6*.

Present or absent *Present*

Stoppage, \$ *100* for

Due Gov't, \$ *100* for

Valuation of horse, \$ *100*

Valuation of horse equipments, \$ *100*

Remarks:

Book mark: -----

ASH
Copist.

P. 10th Arty U.S.C.T.

Joseph S. Payden.
Priv., Co. F, 10 Reg't U. S. Col'd 10th Arty

Appears on

Company Muster Roll

for July & Aug, 1866.

Present or absent Present.

Stoppage, \$ 100 for

Due Gov't, \$ 100 for

Valuation of horse, \$ 100

Valuation of horse equipments, \$ 100

Remarks:

Book mark:

2

Joseph L. Payden

Prvt, Co. F, 10 Reg't U. S. Col'd H. Art'y.

Appears on

Company Muster Roll

for Sept. and Oct., 1866.

Present or absent Present

Stoppage, \$ 100 for

Due Gov't, \$ 100 for

Valuation of horse, \$ 100

Valuation of horse equipments, \$ 100

Remarks:

Book mark:

House

P

10 H. Art'y. U.S.C.T.

Joseph L. Payden

Pat., Co. F, 10 Reg't U. S. Col'd H. Art'y.

Appears on

Company Muster Roll

for Nov. and Dec., 1866

Present or absent Present

Stoppage, \$ 100 for

Due Gov't, \$ 100 for

Valuation of horse, \$ 100

Valuation of horse equipments, \$ 100

Remarks:

Book mark:

House

P

10 H. Art'y. U.S.C.T.

Joseph L. Payden

Art, Co. F, 10 Reg't U. S. Col'd H. Art'y.

Appears on Co. Muster-out Roll, dated

Baton Rouge La Feb. 22, 1867.

Muster-out to date Feb. 22, 1867.

Last paid to Dec. 31, 1866.

Clothing account:

Last settled, 186 ; drawn since \$ 100

Due soldier \$ 29 07 100; due U. S. \$ 100

Am't for cloth'g in kind or money adv'd \$ 100

Due U. S. for arms, equipments, &c., \$ 6 15 100

Bounty paid \$ 100; due \$ 100

Remarks: Joined at original organization. Deserted from Battery Gentry La. Sept. 15/64. Appeared April 11/65. Conscription by G. O. No. 106 Hd. Qrs Dept. of the Gulf. S. of 64

Book mark: V 122. P 277. 71

Howe

A., 10 U.S. Col'd H. Art'y

Private | Private.

CARD NUMBERS.

1	5490459	26
2	5490613	27
3	5490753	28
4	5490908	29
5	5491044	30
6	5491178	31
7	5491302	32
8	5491436	33
9	5491563	34
10	5491690	35
11	5491816	36
12	5491942	37
13	5492068	38
14	5492192	39
15	5492314	40
16	5492439	41
17	5492563	42
18	5492688	43
19	5492816	44
20	5493052	45
21	5474040	46
22	5489567	47
23	47-21-1884	48
24		49
25		50

Book Mark: 213 - $\frac{15}{941}$ 47 - 65 - 1884

See also

P

10 H. Art'y. U.S.C.T.

John Peare

Co. A, 1 Reg't La. Col'd H. Art'y.*

Age 27 years.

Appears on

Company Muster-in Roll

of the organization named above. Roll dated

New Orleans, La. Nov 29, 1862.

Muster-in to date Nov. 29 1862.

Joined for duty and enrolled:

When Nov. 16, 1862.

Where New Orleans

Period 3 years.

Valuation of horse, \$ 100

Valuation of horse equipments, \$ 100

Remarks:

*This organization subsequently became Co. A, 10 Reg't U. S. Colored Heavy Artillery.

Book mark:

Johnson

(356)

Copyist.

P

10 H. Art'y. U.S.C.T.

John Peare

Priv, Co. A, 1 Reg't La. H. Art'y.*

Appears on

Company Muster Roll

for to Dec 31, 1862

Present or absent Present

Stoppage, \$ 100 for

Due Gov't, \$ 100 for

Valuation of horse, \$ 100

Valuation of horse equipments, \$ 100

Remarks:

*This organization subsequently became Co. A. 10 Reg't U. S. Col'd Heavy Artillery.

Book mark:

Johnman

P | 10 H. Art'y. | U.S.C.T.

John Peare
Priv., Co. A, 1 Reg't La. H. Art'y.*

Appears on

Company Muster Roll
for *Jamie & Kelly*, 1863.

Present or absent *Present*

Stoppage, \$ 100 for

Due Gov't, \$ 100 for

Valuation of horse, \$ 100

Valuation of horse equipments, \$ 100

Remarks:

*This organization subsequently became Co. A, 10 Reg't U. S. Col'd Heavy Artillery.

Book mark: _____

Johnson
Copied.

P

10 H. Art'y. U.S.C.T.

John Peare

Priv, Co. A, 1 Reg't La. H. Art'y.*

Appears on

Company Muster Roll

for March & April, 1863.

Present or absent Present

Stoppage, \$ 100 for

Due Gov't, \$ 100 for

Valuation of horse, \$ 100

Valuation of horse equipments, \$ 100

Remarks:

*This organization subsequently became Co. A, 10 Reg't U. S. Col'd Heavy Artillery.

Book mark:

Tolman

John Peare

Priv, Co. A, 1 Reg't La. H. Art'y.*

Appears on

Company Muster Roll

for May & June, 1863.

Present or absent Present

Stoppage, \$ 100 for

Due Gov't, \$ 100 for

Valuation of horse, \$ 100

Valuation of horse equipments, \$ 100

Remarks:

*This organization subsequently became Co. A, 10 Reg't U. S. Col'd Heavy Artillery.

Book mark:

Tolman Copyist.

P

10 H. Art'y.

U.S.C.T.

John Peare

Priv, Co. A, 1 Reg't La. H. Art'y.*

Appears on

Company Muster Roll

for July & August, 1863.

Present or absent Present

Stoppage, \$ 100 for

Due Gov't, \$ 100 for

Valuation of horse, \$ 100

Valuation of horse equipments, \$ 100

Remarks:

*This organization subsequently became Co. A, 10 Reg't U. S. Col'd Heavy Artillery.

Book mark:

Tobin

Copyist.

P

10 H. Art'y. U.S.C.T.

John Peare

Priv., Co. A, 1 Reg't La. H. Art'y.*

Appears on

Company Muster Roll

for Sept & Oct, 1863.

Present or absent Present

Stoppage, \$ 100 for

Due Gov't, \$ 100 for

Valuation of horse, \$ 100

Valuation of horse equipments, \$ 100

Remarks:

*This organization subsequently became Co. A, 10 Reg't U. S. Col'd Heavy Artillery.

Book mark:

RECEIVED

Tolman Copyist.

9 | 10 H. Art'y. | U.S.C.T.

John Peare
Co. A, 1 Reg't H. Art'y, Corps d'Afrique.*

Appears on

Company Muster Roll
for *Nov Dec*, 1863

Present or absent *Present*

Stoppage, \$ 100 for

Due Gov't, \$ 100 for

Valuation of horse, \$ 100

Valuation of horse equipments, \$ 100

Remarks:

*This organization subsequently became Co. *A*, 10 Reg't U. S. Colored Heavy Artillery.

Book mark: -----

Beuster

P

10 H. Art'y. | U.S.C.T.

John Pears
Co. A, 1 Reg't H. Art'y, Corps d'Afrique.*

Appears on

Company Muster Roll

for Jan + Feb, 1864.

Present or absent Present

Stoppage, \$ 100 for

Due Gov't, \$ 100 for

Valuation of horse, \$ 100

Valuation of horse equipments, \$ 100

Remarks:

*This organization subsequently became Co. A, 10 Reg't U. S. Colored Heavy Artillery.

Book mark:

Proctor

John Pears
Sgt, Co. A, 7 Reg't U. S. Col'd H. Art'y.*

Appears on

Company Muster Roll

for March 25, 1864.

Present or absent Present

Stoppage, \$ 100 for

Due Gov't, \$ 100 for

Valuation of horse, \$ 100

Valuation of horse equipments, \$ 100

Remarks:

* This organization subsequently became Co. A, 10 Reg't U. S. Colored Heavy Artillery.

Book mark:

Robuster

P

10 H. Art'y.

U.S.C.T.

John Peary
Ct., Co. A, 7 Reg't U. S. Col'd H. Art'y.*

Appears on

Company Muster Roll

for *May & June*, 1864.

Present or absent *Present*

Stoppage, \$ 100 for

Due Gov't, \$ 100 for

Valuation of horse, \$ 100

Valuation of horse equipments, \$ 100

Remarks:

* This organization subsequently became Co. *A*, 10 Reg't U. S. Colored Heavy Artillery.

Book mark:

Rocheester

P | 10 H. Art'y. | U.S.C.T.

John Peary
Art, Co. A, 7 Reg't U. S. Col'd H. Art'y.*

Appears on

Company Muster Roll

for July & Aug, 1864.

Present or absent Present

Stoppage, \$ 100 for

Due Gov't, \$ 100 for

Valuation of horse, \$ 100

Valuation of horse equipments, \$ 100

Remarks:

* This organization subsequently became Co. A, 10 Reg't U. S. Colored Heavy Artillery.

Book mark:

Bochster

P | 10 H. Art'y. | U.S.C.T.

John Peare
Pvt., Co. A, 10 Reg't U. S. Col'd H. Art'y.

Appears on

Company Muster Roll

for Sep & Oct, 1864

Present or absent Present

Stoppage, \$ 100 for

Due Gov't, \$ 100 for

Valuation of horse, \$ 100

Valuation of horse equipments, \$ 100

Remarks:

Book mark:

Proctor

John Peare
Pvt, Co. A, 10 Reg't U. S. Col'd H. Art'y.

Appears on

Company Muster Roll

for *Nov & Dec*, 1864.

Present or absent *Present*

Stoppage, \$ 100 for

Due Gov't, \$ 100 for

Valuation of horse, \$ 100

Valuation of horse equipments, \$ 100

Remarks:

Book mark:

Bohater

P

10 H. Art'y. | U.S.C.T.

John Pears

Pvt., Co. A, 10 Reg't U. S. Col'd H. Art'y.

Appears on

Company Muster Roll

for *Jan + Feb*, 1865.

Present or absent *Present*

Stoppage, \$ 100 for

Due Gov't, \$ 100 for

Valuation of horse, \$ 100

Valuation of horse equipments, \$ 100

Remarks: *Due Gov't for*

camp and Garrison
Equipage as per Abstract
\$1.76

Book mark:

Bochner

10 H. Art'y. | U.S.C.T.

John Peary

Co. A, Co. A, 10 Reg't U. S. Col'd H. Art'y.

Appears on

Company Muster Roll

for *Mexico*, 1865.

Present or absent *Present*

Stoppage, \$ 100 for

Due Gov't, \$ 100 for

Valuation of horse, \$ 100

Valuation of horse equipments, \$ 100

Remarks: *Due Gov't for
Camp and Garrison
Equipage as per
Contract #176*

Book mark:

Rochester

P | 10 H. Art'y. | U.S.C.T.

John Peare
Art, Co. A, 10 Reg't U. S. Col'd H. Art'y.

Appears on

Company Muster Roll

for May & June, 1865.

Present or absent Present

Stoppage, \$ 100 for

Due Gov't, \$ 100 for

Valuation of horse, \$ 100

Valuation of horse equipments, \$ 100

Remarks: Due Gov't for
Camp & Garrison
Equipages as per
Abstract \$1.76

Book mark:

W. H. Carter

P | 10 H. Art'y. | U.S.C.T.

John Pease
Plt, Co. A, 10 Reg't U. S. Col'd H. Art'y.

Appears on

Company Muster Roll

for *July & Aug, 1865*

Present or absent *Present*

Stoppage, \$ 100 for

Due Gov't, \$ 100 for

Valuation of horse, \$ 100

Valuation of horse equipments, \$ 100

Remarks:

Book mark: _____

(358)

Pease

Copyist.

P

10 H. Art'y.

U.S.C.T.

John Peare

Plt, Co. A, 10 Reg't U. S. Col'd H. Art'y.

Appears on

Company Muster Roll

for Sept & Oct, 1865.

Present or absent Present

Stoppage, \$ 100 for

Due Gov't, \$ 100 for

Valuation of horse, \$ 100

Valuation of horse equipments, \$ 100

Remarks:

Book mark:

(358)

Stymer

Copyist.

P | 10 H. Art'y. | U.S.C.T.

John Peure

Plt., Co. A, 10 Reg't U. S. Col'd H. Art'y.

Appears on

Company Muster Roll

for Nov + Dec, 1865.

Present or absent

Stoppage, \$ 100 for

Due Gov't, \$ 100 for

Valuation of horse, \$ 100

Valuation of horse equipments, \$ 100

Remarks: Mustered out by reason of expiration of term of service

Book mark: Disch'd Nov. 28/65 L.B. 15/271, 47 C.P. 1884

(358)

Sign

Copyist.

P. | 10 Mo. a. | U.S.C.T.

John Plare

Por., Col., 10 Reg't U. S. Col'd Mo. a.

Appears on a

Detachment Muster-out Roll

of the organization named above. Roll dated

N. Orleans La. Nov. 28, 1865.

Muster-out to date *Nov. 28, 1865.*

Last paid to *June 30, 1865*

Clothing account:

Last settled _____, 186 ; drawn since \$ _____ 100

Due soldier \$ *27²⁶*/₁₀₀; due U. S. \$ _____ 100

Am't for cloth'g in kind or money adv'd \$ _____ 100

Due U. S. for arms, equipments, &c., \$ _____ 100

Bounty paid \$ _____ 100 due \$ _____ 100

Remarks: *Joined at origl. Orgn.
Mustered out by reason
of expiration of term of
service*

Book mark:

J. Newling
Copyist.

John Pearce
Co. A, 10 Reg't U. S. Col'd H. Art'y.

Appears on **Co. Muster-out Roll**, dated
Baton Rouge La, Feb. 22 1867.

Muster-out to date 186 .
Last paid to 186 .

Clothing account:

Last settled 186 ; drawn since \$ 100

Due soldier \$ 100 ; due U. S. \$ 100

Am't for cloth'g in kind or money adv'd \$ 100

Due U. S. for arms, equipments, &c., \$ 100

Bounty paid \$ 100 ; due \$ 100

Remarks: *Joined orig. orgn. Dischd.
for Expan. of term of service
Nov. 28. 65*

Book mark:

Nesbitt

Copyist.

P. 1 10th Ho. A. / U.S. 6th J.

John Pare,
Co. A, 10th Reg't U.S. 6th Ho. A.

NOTATION.

Book mark: L. B. 15-941 with
47. 6. J. 1884.

War Department,

Adjutant General's Office,

Washington, Jan 5th, 1884.

Mustered out with Detach-
ment November 28, 1865.

E. P. Conrazier

(438)

Copyist.

Private. Primitives

CARD NUMBERS.

487526

- 26
- 27
- 28
- 29
- 30
- 31
- 32
- 33
- 34
- 35
- 36
- 37
- 38
- 39
- 40
- 41
- 42
- 43
- 44
- 45
- 46
- 47
- 48
- 49
- 50

Book Mark:

See also Co. N. 77 U.S. 6 Id.

W. S. C. T. | U.S.C.T.

John P. Scott
Pvt, Co., *10* Reg't U. S. Col'd *H. L.*

Appears on

M. and D. Roll of Men Transferred

to the organization named above,

from *C. H. 9th U. S. Col. Inf*

Roll dated *Camp Curpers Co.,* 186*2*.

When enlisted *July 14*, 186*4*.

Period for which enlisted *3* years.

When mustered in *March 11*, 186*4*.

Present or absent

Company to which assigned

Remarks: *Joined the Ser-
vice as Pvt. Deserted
at New Orleans
May 24, 1864.*

*Name not taken up on
muster rolls of Regt*

Book mark : *2483254*

W. S. C. T.

L. 10 U.S. Col'd H. Art'y.

Private Private

CARD NUMBERS.

1 5488127
2 5488282
3 5513491
4 5513637
5 5513759
6 5513907
7 5514211
8 5489953

26
27
28
29
30
31
32
33
34
35
36
37
38
39
40
41
42
43
44
45
46
47
48
49
50

Book Mark:

See also 77 U.S. G. Inf

P. J. H. A. | **U.S.C.T.**

Simon Penny
Co. D, 10 Reg't U. S. Col'd *H. A.*

Appears on

M. and D. Roll of Men Transferred

to the organization named above,

from *Co. E 11th U.S. Col. Inf*

Roll dated *Camp Canby Oct 1, 1865*

When enlisted *Apr 6*, 186*5*

Period for which enlisted *3* years.

When mustered in *Apr 8*, 186*5*

Present or absent *Present*

Company to which assigned *D*

Remarks: *Transferred from*
4th Regt. C. de Arrique
Dec. 12, 1863,

Book mark :

W. H. Scott

P 1056a U.S.C.T.

Simon Perry
Pot, Co. *d*, 10 Reg't U. S. Col'd *H.W.*

Appears on

M. and D. Roll of Men Transferred

to the organization named above,

from *7th U.S. Col Inf*

Roll dated *Camp Parapet La Oct 11*, 186*5*

When enlisted *Apr 6*, 186*5*

Period for which enlisted *3* years.

When mustered in *Apr 8*, 186*5*

Present or absent *Present*

Company to which assigned *L*

Remarks *Transferred from 4th*

*Co. A. Dec 2, 63 joined
by transfer from Co E
7th U.S. Col. Inf per S.O.
G. C. S. Hd Qrs Dept
of La*

Book mark :

W. H. Scott

P | 10 H. Art'y. | U.S.C.T.

Simon Penny
Co. G, 10 Reg't U. S. Col'd H. Art'y.

Age _____ years.

Appears on _____

Company Muster Roll*

for *Sept. & Oct.*, 186*3*.

Joined for duty and enrolled:

When *Apr. 6*, 186*3*.

Where *New Orleans*

Period *3* years.

Mustered in:

When *Apr. 8*, 186*3*.

Where *New Orleans*

Present or absent *Present*

Stoppage, \$ *100* for _____

Due Gov't, \$ *100* for _____

Valuation of horse, \$ *100*

Valuation of horse equipments, \$ *100*

Remarks: *Transf. from Co. E,
74 U.S.C.*

*First current roll. No muster-in roll of this company on file.

Book mark: _____

(358b)

Schurich

Copyist.

P

10 H. Art'y. U.S.C.T.

Simon Perry

Co. L, 10 Reg't U. S. Col'd H. Art'y.

Appears on

Company Muster Roll

for Nov. & Dec., 1865.

Present or absent Present

Stoppage, \$ 100 for

Due Gov't, \$ 100 for

Valuation of horse, \$ 100

Valuation of horse equipments, \$ 100

Remarks:

Book mark:

Scherich

P

10 H. Art'y. U.S.C.T.

Simon Perry

Co. L, 10 Reg't U. S. Col'd H. Art'y.

Appears on

Company Muster Roll

for Jan & Feb, 1866

Present or absent Present

Stoppage, \$ 100 for

Due Gov't, \$ 100 for

Valuation of horse, \$ 100

Valuation of horse equipments, \$ 100

Remarks:

Book mark:

Scherich

P 108 Army U.S.C.T.

Simon Perry
Pvt, Co. L, 10 Reg't U. S. Col'd Army

Appears on

Company Muster Roll

for *Mo. & Apl.*, 1866

Present or absent

Stoppage, \$ 100 for

Due Gov't, \$ 100 for

Valuation of horse, \$ 100

Valuation of horse equipments, \$ 100

Remarks: *Mustered out by
ex. of term of service
to date Apl. 3/66.*

Book mark: *Muster out on file.*

Schuch

P | 10 Arty. | U.S.C.T.

Simon Penny

Priv., Co. *L.*, 10 Reg't U. S. Col'd *Arty.*

Appears on a

Detachment Muster-out Roll

of the organization named above. Roll dated

New Orleans, La., *Apr. 5*, 1866.

Muster-out to date *Apr. 5*, 1866.

Last paid to *Dec. 31*, 1865

Clothing account:

Last settled 186 ; drawn since \$ 100

Due soldier \$ *70*^{*81*}/₁₀₀; due U. S. \$ 100

Am't for cloth'g in kind or money adv'd \$ 100

Due U. S. for arms, equipments, &c., \$ 100

Bounty paid \$ 100 due \$ 100

Remarks: *Joined as recruit in*

Co. E. 4 C.A.; transferred to C.A.

(77 U.S.C.I.) by reorganization; joined

by transfer from Co. E. (77 U.S.C.I.)

in obedience to S.O. 66 series of 1865.

from Hdqrs. Dept. of La.

Book mark:

R. E. Wilson

P

10 H. Art'y.

U.S.C.T.

Simon Perry

Pvt., Co. L., 10 Reg't U. S. Col'd H. Art'y.

Appears on Co. Muster-out Roll, dated

Baton Rouge La., Feb 22, 1867.

Muster-out to date _____, 186 .

Last paid to _____, 186 .

Clothing account:

Last settled _____, 186 ; drawn since \$ _____ 100

Due soldier \$ _____ 100 ; due U. S. \$ _____ 100

Am't for cloth'g in kind or money adv'd \$ _____ 100

Due U. S. for arms, equipments, &c., \$ _____ 100

Bounty paid \$ _____ 100 ; due \$ _____ 100

Remarks: joined by transfer from
97 U.S.C.I., Oct 1/65 S.O. 667 Regt. Dpt.
of La Sept 22 1865 Disch'd at N.O. La
April 5 1866 Ex of service

Book mark: V 24 P ~~208~~ 68

Burnham

George
10 U.S. Col'd H. Art.

Private

Private

CARD NUMBERS.

1	5511266	26
2	5511358	27
3	5511445	28
4	5511570	29
5	5511696	30
6	5511855	31
7	5512154	32
8	5489994	33
9		34
10		35
11		36
12		37
13		38
14		39
15		40
16		41
17		42
18		43
19		44
20		45
21		46
22		47
23		48
24		49
25		50

Book Mark:

See also:

P

10 H. Art'y. | U.S.C.T.

George Penry

Pvt., Co. *D*, 10 Reg't U. S. Col'd H. Art'y.

Age years.

Appears on

Company Muster Roll*

for *Enrollment to June 30*, 186*5*-.

Joined for duty and enrolled:

When, 186 .

Where

Period *1* years.

Mustered in:

When *Apr. 27*, 186*5*.

Where *New Orleans, La.*

Present or absent *Present.*

Stoppage, \$ *100* for

Due Gov't, \$ *100* for

Valuation of horse, \$ *100*

Valuation of horse equipments, \$ *100*

Remarks: *Substitute. Com-*
mencement of first

*First current roll. No muster-in roll of this company on file.

Book mark :

(3586)

O. J. Clark
Copyist.

JAN. 16

5511266

1891

payment by time
Apr. 27, 65-

P.

10 H. Art'y. | U.S.C.T.

George Perry

Pr., Co. I, 10 Reg't U. S. Col'd H. Art'y.

Appears on

Company Muster Roll

for *July & Aug.*, 1865.

Present or absent *Present*

Stoppage, \$ 100 for

Due Gov't, \$ 100 for

Valuation of horse, \$ 100

Valuation of horse equipments, \$ 100

Remarks: *Sick in gr.*

Book mark:

A. S. Clark

(358)

Copyist.

P.

10 H. Art'y.

U.S.C.T.

George Perry

Priv., Co. I, 10 Reg't U. S. Col'd H. Art'y.

Appears on

Company Muster Roll

for *Sept. & Oct.*, 186*5*.

Present or absent *Present*

Stoppage, \$ 100 for

Due Gov't, \$ 100 for

Valuation of horse, \$ 100

Valuation of horse equipments, \$ 100

Remarks:

Book mark:

O.S. Clark

(358)

Copyist.

P.

10 H. Art'y.

U.S.C.T.

George Perry

Priv., Co. I, 10 Reg't U. S. Col'd H. Art'y.

Appears on

Company Muster Roll

for *Nov. & Dec.*, 1865.

Present or absent *Present*

Stoppage, \$ 100 for

Due Gov't, \$ 100 for

Valuation of horse, \$ 100

Valuation of horse equipments, \$ 100

Remarks:

FROM SECOND AUDITOR'S ROLL.

Book mark:

J. S. Kellogg

P

10 H. Art'y.

U.S.C.T.

George Perry

Pvt., Co. I, 10 Reg't U. S. Col'd H. Art'y.

Appears on

Company Muster Roll

for Jan. & Feb., 1866.

Present or absent Present

Stoppage, \$ 100 for

Due Gov't, \$ 100 for

Valuation of horse, \$ 100

Valuation of horse equipments, \$ 100

Remarks: Strip for one letter 1 ct two numbers
2 cts one Cross Cannon 2 cts two
Gle Straps 12 cts Total 17 cts

Book mark:

O. S. Kelark

P

10 H. Art'y. U.S.C.T.

George Jerry

Pvt., Co. I, 10 Reg't U. S. Col'd H. Art'y.

Appears on

Company Muster Roll

for Feb. & Apr., 1866.

Present or absent

Stoppage, \$ 100 for

Due Gov't, \$ 100 for

Valuation of horse, \$ 100

Valuation of horse equipments, \$ 100

Remarks: Discharged.

Mustered out by reason of expiration of term of service to date Apr. 26, 1866

Book mark: Mustered out on file

O. J. Clark

George Perry

Pat. Co. I, 10 Reg't U. S. Col'd H. Art'y.

Appears on **Co. Muster-out Roll**, dated *Baton Rouge La, Feb 22*, 1867 .

Muster-out to date _____, 186 .

Last paid to _____, 186 .

Clothing account:

Last settled _____, 186 ; drawn since \$ _____ 100

Due soldier \$ _____ 100; due U. S. \$ _____ 100

Am't for cloth'g in kind or money adv'd \$ _____ 100

Due U. S. for arms, equipments, &c., \$ _____ 100

Bounty paid \$ _____ 100; due \$ _____ 100

Remarks: *Discharged expiration term of service April 26, 1866*

Book mark : _____

J. M. Vance

P 10 Arty.

U.S.C.T.

George Perry

Priv., Co. I, 10 Reg't U. S. Col'd Arty

Appears on a

Detachment Muster-out Roll

of the organization named above. Roll dated

New Orleans, La., Apr. 26, 1866.

Muster-out to date Apr. 26, 1866.

Last paid to Feb. 28, 1866

Clothing account:

Last settled _____, 1866 ; drawn since \$ _____ 100

Due soldier \$ $8 \frac{36}{100}$; due U. S. \$ _____ 100

Am't for cloth'g in kind or money adv'd \$ _____ 100

Due U. S. for arms, equipments, &c., \$ $2 \frac{16}{100}$

Bounty paid \$ _____ 100 due \$ _____ 100

Remarks: Joined by draft. Stop for
2 letters .02¢. Two g. b. straps .12¢. one
Mmo. bar \$2.00 one tompro .02¢.
total \$2.16.

(Age 20 yrs)

Book mark:

R. E. Wilson

M., 10 U.S. Col'd H. Art'y

Private | Private

CARD NUMBERS.

5487832	26
5488023	27
5514367	28
5514517	29
5514743	30
5514879	31
5515267	32
5489810	33
9123710	34
	35
	36
	37
	38
	39
	40
	41
	42
	43
	44
	45
	46
	47
	48
	49
	50

Book Mark:

See also 77 U.S. C O

P | 10 H. Art'y. | U. S. C. T.

Wade Penson

Co M, 10 Reg't U. S. Col'd H. Art'y.

Appears on

Company Descriptive Book

of the organization named above.

DESCRIPTION.

Age 28 years; height 5 feet 10 inches.

Complexion black

Eyes dark; hair black

Where born Laurens S. C.

Occupation Laborer

ENLISTMENT.

When July 15, 1865.

Where Drafted Thibodaux 2^d Dist.

By whom; term 1 y'rs.

Remarks: Rec'd by transfer from
Co I 77 W. S. Col. per S. C.
66 2^d Dist Dept La Sept
22 1865

Discharged and honorably
mustered out of service
July 14, 1866 by reason
of expiration of term
of service.

W. Mallon

P | *106a* | **U.S.C.T.**

Wade Penson
Priv, Co. *M*, 10 Reg't U. S. Col'd *6a*

Appears on

M. and D. Roll of Men Transferred

to the organization named above,

from *of U. S. Col Inf*

Roll dated *Camp Campetda Cal*, 186*5*.

When enlisted _____, 186 .

Period for which enlisted _____ years.

When mustered in *Feb 15*, 186*5*.

Present or absent *Present*

Company to which assigned *M*

Remarks: *(After)*

Book mark: _____

Walter Scott

P 1086A U.S.C.T.

Wade Penson
Col, Co M, 10 Reg't U. S. Col'd Hll

Appears on

M. and D. Roll of Men Transferred

to the organization named above,

from 77th U.S. Col Inf

Roll dated Camp Annapolis, 1865.

When enlisted, 186 .

Period for which enlisted 1 years.

When mustered in Feb 15, 1865.

Present or absent

Company to which assigned M

Remarks: Rec'd by transfer
from Co I, 77th U.S. Col
per S.O. 66 Dept da
Sept 22, 65,

Book mark :

Wm S. Scott

P

10 H. Art'y. | U.S.C.T.

Wade Person

P, Co. *M*, 10 Reg't U. S. Col'd H. Art'y.

Age years.

Appears on

Company Muster Roll*

for *Sept - Oct*, 186*5*.

Joined for duty and enrolled:

When *Sept*, 186*5*.

Where

Period *1* years.

Mustered in:

When *Feb 15*, 186*5*.

Where *Third camp & Dist La*

Present or absent *Present*

Stoppage, \$ *100* for

Due Gov't, \$ *100* for

Valuation of horse, \$ *100*

Valuation of horse equipments, \$ *100*

Remarks :

*First current roll. No muster-in roll of this company on file.

Book mark :

(3586)

W. H. Wright

Copyist.

P

10 H. Art'y.

U. S. C. T.

Madison Benson

P, Co. M, 10 Reg't U. S. Col'd H. Art'y.

Appears on

Company Muster Roll

for Nov Dec, 1865.

Present or absent Present

Stoppage, \$ 100 for

Due Gov't, \$ 100 for

Valuation of horse, \$ 100

Valuation of horse equipments, \$ 100

Remarks:

[Empty lines for remarks]

Book mark:

[Empty line for book mark]

D. H. Wright

(358)

Copist.

P

10 H. Art'y.

U. S. C. T.

Wade Penner

P, Co. M, 10 Reg't U. S. Col'd H. Art'y.

Appears on

Company Muster Roll

for *Jan & Feb*, 1866.

Present or absent *Absent*

Stoppage, \$ *5* ^{*02*} _{*100*} for *Feb & Mar*

Due Gov't, \$ *100* for

Valuation of horse, \$ *100*

Valuation of horse equipments, \$ *100*

Remarks: *On detached service awaiting Muster roll - per G.O. & Ft. Mearns Feb 27, 1866*

Book mark: *Muster roll on file*

A. J. Wright

Wm. P. Brown

D, Co. M, 10 Reg't U. S. Col'd H. Art'y.

Appears on

Company Muster Roll

for *Feb & Apr*, 186*6*.

Present or absent

Stoppage, \$ 100 for

Due Gov't, \$ 100 for

Valuation of horse, \$ 100

Valuation of horse equipments, \$ 100

Remarks: *Disch'd by reason of expiration of term of service*

Book mark:

A. H. Wright

8

Wade Benson

Priv., Co.M., 10 Reg't U. S. Col'd H. Art'y.

Appears on Co. Muster-out Roll, dated

Baton Rouge, La., Dec 27, 1867.

Muster-out to date _____, 186 .

Last paid to _____, 186 .

Clothing account:

Last settled _____, 186 ; drawn since \$ _____ 100

Due soldier \$ _____ 100; due U. S. \$ _____ 100

Am't for cloth'g in kind or money adv'd \$ _____ 100

Due U. S. for arms, equipments, &c., \$ _____ 100

Bounty paid \$ _____ 100; due \$ _____ 100

Remarks: joined by trans from Co. D
77 U.S. Col'd for Dec 66 250 lbs. Dept. Co.
Sep 22/65 as Priv. W. S. C. by reason
of Exp. of term of Service
Feb 14/66.

Book mark:

Rector

¹⁰
P. *Hy Arty* | U.S.C.T.

Wade Penson

Pvt, Co. *M 10* Reg't U. S. Col'd *Arty*

Appears on a

Detachment Muster-out Roll

of the organization named above. Roll dated

New Orleans, La, Feb. 14, 1866.

Muster-out to date

Feb. 14, 1866.

Last paid to

June 30, 1865.

Clothing account:

Last settled 186 ; drawn since \$ $\frac{100}{100}$

Due soldier \$ $\frac{30}{100}$; due U. S. \$ $\frac{100}{100}$

Am't for cloth'g in kind or money adv'd \$ $\frac{100}{100}$

Due U. S. for arms, equipments, &c., \$ $\frac{5}{100}$ $\frac{62}{100}$

Bounty paid \$ *None* $\frac{100}{100}$ due \$ *None* $\frac{100}{100}$

Remarks:

Joined by transfer from 77th U.S.C.I. Oct. 1 /65 per S.O. 66 series /65 Dept. of La. Stop for 2 H. C. Straps, 1 Bed Sack, 1 Mosquito Bar.

Book mark:

A. M. Reed

(349)

Copyist.

10 U.S. COI & H. A.

Private | *Private*

CARD NUMBERS.

1	487906.	26
2		27
3		28
4		29
5		30
6		31
7		32
8		33
9		34
10		35
11		36
12		37
13		38
14		39
15		40
16		41
17		42
18		43
19		44
20		45
21		46
22		47
23		48
24		49
25		50

Book Mark:

See also

77 U.S. 6 Sup

C 1026 A U.S.C.T.

John Perkins
Det, Co., *10* Reg't U. S. Col'd *H A*

Appears on

M. and D. Roll of Men Transferred

to the organization named above,

from *1026 U.S. Col Inf*

Roll dated *Camp Onapet d Det*, 186*5*.

When enlisted , 186*5* .

Period for which enlisted / years.

When mustered in *July 15*, 186*5*.

Present or absent

Company to which assigned

Remarks: *Deserted June 21. 65*
from Camp Chalmette
(Osta)

Name not taken up on
muster rolls as per

Book mark :

W. H. Scott

10 U.S. Col'd H.

Private

Private

CARD NUMBERS.

1	5490462	26
2	5490614	27
3	5490755	28
4	5490910	29
5	5491046	30
6	5491180	31
7	5491303	32
8	5491437	33
9	5491564	34
10	5491691	35
11	5491817	36
12	5491943	37
13	5492067	38
14	5492193	39
15	5492315	40
16	5492440	41
17	5492564	42
18	5492689	43
19	5492817	44
20	5493053	45
21	5494041	46
22	5489568	47
23	47-25-1884	48
24		49
25		50

Book Mark: 213 - $\frac{15}{941}$ 47 65 - 1884

See also

P

10 H. Art'y. | U.S.C.T.

Squire Perkins

....., Co. A, 1 Reg't La. Col'd H. Art'y.*

Age *22* years.

Appears on

Company Muster-in Roll

of the organization named above. Roll dated

New Orleans, La., Nov. 29, 1862

Muster-in to date *Nov. 29, 1862*

Joined for duty and enrolled:

When *Nov. 16*....., 186 .

Where *New Orleans*.....

Period *3* years.

Valuation of horse, \$.....100

Valuation of horse equipments, \$.....100

Remarks :
.....
.....
.....

*This organization subsequently became Co. A, 10 Reg't U. S. Colored Heavy Artillery.

Book mark :.....

(356)

Johnson

Copyist.

Squire Perkins

Priv., Co. A, 1 Reg't La. H. Art'y.*

Appears on

Company Muster Roll

for to Dec. 31, 1862

Present or absent Absent

Stoppage, \$ 100 for

Due Gov't, \$ 100 for

Valuation of horse, \$ 100

Valuation of horse equipments, \$ 100

Remarks: Absent Sick in St. James Hospital, New Orleans, La.

*This organization subsequently became Co. A, 10 Reg't U. S. Col'd Heavy Artillery.

Book mark:

Tobman

P

10 H. Art'y. U.S.C.T.

Squire Perkins

Priv, Co. A, 1 Reg't La. H. Art'y.*

Appears on

Company Muster Roll

for Jan'y & Feby, 1863.

Present or absent Absent

Stoppage, \$ 100 for

Due Gov't, \$ 100 for

Valuation of horse, \$ 100

Valuation of horse equipments, \$ 100

Remarks: Sick at St. James Hospital, N.O.

*This organization subsequently became Co. A, 10 Reg't U. S. Col'd Heavy Artillery.

Book mark:

(358)

Tobman

Copyright.

P

10 H. Art'y. U.S.C.T.

Squire Perkins

Priv., Co. A, 1 Reg't La. H. Art'y.*

Appears on

Company Muster Roll

for March & April, 1863.

Present or absent Present

Stoppage, \$ 100 for

Due Gov't, \$ 100 for

Valuation of horse, \$ 100

Valuation of horse equipments, \$ 100

Remarks:

*This organization subsequently became Co. A, 10 Reg't U. S. Col'd Heavy Artillery.

Book mark:

Tobman

P

10 H. Art'y. U.S.C.T.

Squire Perkins

Priv., Co. A, 1 Reg't La. H. Art'y.*

Appears on

Company Muster Roll

for May & June, 1863.

Present or absent Present

Stoppage, \$ 100 for

Due Gov't, \$ 100 for

Valuation of horse, \$ 100

Valuation of horse equipments, \$ 100

Remarks:

*This organization subsequently became Co. A, 10 Reg't U. S. Col'd Heavy Artillery.

Book mark:

Tobman

P

Squire Perkins

Priv., Co. A, 1 Reg't La. H. Art'y.*

Appears on

Company Muster Roll

for July & August, 1863.

Present or absent Present

Stoppage, \$ 100 for

Due Gov't, \$ 100 for

Valuation of horse, \$ 100

Valuation of horse equipments, \$ 100

Remarks:

*This organization subsequently became Co. A, 10 Reg't U. S. Col'd Heavy Artillery.

Book mark:

Tobman

P

10 H. Art'y.

U.S.C.T.

Squire Perkins

Priv, Co. A, 1 Reg't La. H. Art'y.*

Appears on

Company Muster Roll

for Sept & Oct, 1863.

Present or absent Present

Stoppage, \$ 100 for

Due Gov't, \$ 100 for

Valuation of horse, \$ 100

Valuation of horse equipments, \$ 100

Remarks:

*This organization subsequently became Co. A, 10 Reg't U. S. Col'd Heavy Artillery.

Book mark:

Johnson
Copyst.

P

10 H. Art'y. | U.S.C.T.

Squire Perkins
Co. A, 1 Reg't H. Art'y, Corps d'Afrique.*

Appears on

Company Muster Roll

for *Nov Dec*, 1863.

Present or absent *Present*

Stoppage, \$ *100* for

Due Gov't, \$ *100* for

Valuation of horse, \$ *100*

Valuation of horse equipments, \$ *100*

Remarks: *Sick in quarters*

*This organization subsequently became Co. A, 10 Reg't U. S. Colored Heavy Artillery.

Book mark:

Bohater

P

10 H. Art'y. | U.S.C.T.

Squire Perkins
Co. A, 1 Reg't H. Art'y, Corps d'Afrique.*

Appears on

Company Muster Roll

for Jan & Feb, 1864

Present or absent Present

Stoppage, \$ 100 for

Due Gov't, \$ 100 for

Valuation of horse, \$ 100

Valuation of horse equipments, \$ 100

Remarks:

*This organization subsequently became Co. A, 10 Reg't U. S. Colored Heavy Artillery.

Book mark :

Rocheater

P | 10 H. Art'y. | U.S.C.T.

Lewis Perkins
Co. A, 7 Reg't U. S. Col'd H. Art'y.*

Appears on

Company Muster Roll

for *March 1864*, 1864.

Present or absent *Present*

Stoppage, \$ 100 for

Due Gov't, \$ 100 for

Valuation of horse, \$ 100

Valuation of horse equipments, \$ 100

Remarks:

* This organization subsequently became Co. *A*, 10 Reg't U. S. Colored Heavy Artillery.

Book mark:

P | 10 H. Art'y. | U.S.C.T.

Squire Perkins
Art. Co. A, 7 Reg't U. S. Col'd H. Art'y.*

Appears on

Company Muster Roll

for May & June, 1864.

Present or absent Present

Stoppage, \$ 100 for

Due Gov't, \$ 100 for

Valuation of horse, \$ 100

Valuation of horse equipments, \$ 100

Remarks: Sick in quarters

* This organization subsequently became Co. A, 10 Reg't U. S. Colored Heavy Artillery.

Book mark: _____

Perkins

P

10 H. Art'y.

U.S.C.T.

Squire Perkins

Art. Co. A, 7 Reg't U. S. Col'd H. Art'y.*

Appears on

Company Muster Roll

for July & Aug, 1864.

Present or absent Present

Stoppage, \$ 100 for

Due Gov't, \$ 100 for

Valuation of horse, \$ 100

Valuation of horse equipments, \$ 100

Remarks: Sick in quarters

* This organization subsequently became Co. A, 10 Reg't U. S. Colored Heavy Artillery.

Book mark:

Perkins

P | 10 H. Art'y. | U.S.C.T.

Squire Perkins

Plt, Co. A, 10 Reg't U. S. Col'd H. Art'y.

Appears on

Company Muster Roll

for *Sept & Oct*, 1864.

Present or absent *Present*

Stoppage, \$ 100 for

Due Gov't, \$ 100 for

Valuation of horse, \$ 100

Valuation of horse equipments, \$ 100

Remarks:

Book mark:

Proctor

P | 10 H. Art'y. | U.S.C.T.

Squire Perkins

Co. A, 10 Reg't U. S. Col'd H. Art'y.

Appears on

Company Muster Roll

for *Nov 1864*, 1864

Present or absent *Present*

Stoppage, \$ 100 for

Due Gov't, \$ 100 for

Valuation of horse, \$ 100

Valuation of horse equipments, \$ 100

Remarks:

Book mark:

Perkins

P | 10 H. Art'y. | U.S.C.T.

Squire Perkins

PT, Co. A, 10 Reg't U. S. Col'd H. Art'y.

Appears on

Company Muster Roll

for *Jan + Feb*, 1865.

Present or absent *Present*

Stoppage, \$ 100 for

Due Gov't, \$ 100 for

Valuation of horse, \$ 100

Valuation of horse equipments, \$ 100

Remarks:

Book mark:

Perkins

P | 10 H. Art'y. | U.S.C.T.

Squire Perkins

Co., Co. A, 10 Reg't U. S. Col'd H. Art'y.

Appears on

Company Muster Roll

for *March 1865*, 1865.

Present or absent *Present*

Stoppage, \$ 100 for

Due Gov't, \$ 100 for

Valuation of horse, \$ 100

Valuation of horse equipments, \$ 100

Remarks:

Book mark:

Perkins

P | 10 H. Art'y. | U.S.C.T.

Squire Perkins
Pvt, Co. A, 10 Reg't U. S. Col'd H. Art'y.

Appears on

Company Muster Roll

for *May & June, 1865.*

Present or absent *Present*

Stoppage, \$ 100 for

Due Gov't, \$ 100 for

Valuation of horse, \$ 100

Valuation of horse equipments, \$ 100

Remarks:

Book mark: -----

Perkins

P

10 H. Art'y. U.S.C.T.

Squire Perkins
Pvt., Co. A, 10 Reg't U. S. Col'd H. Art'y.

Appears on

Company Muster Roll

for July & Aug, 1865.

Present or absent Present

Stoppage, \$ 100 for

Due Gov't, \$ 100 for

Valuation of horse, \$ 100

Valuation of horse equipments, \$ 100

Remarks:

Book mark:

Perkins

(358)

Copyist.

P

| 10 H. Art'y. | U.S.C.T.

Squire Perkins

Pvt, Co. A, 10 Reg't U. S. Col'd H. Art'y.

Appears on

Company Muster Roll

for *Sept. Oct*, 1865.

Present or absent *Present*

Stoppage, \$ *100* for

Due Gov't, \$ *100* for

Valuation of horse, \$ *100*

Valuation of horse equipments, \$ *100*

Remarks:

Book mark :

(358)

H. J. ...
Copyist.

P | 10 H. Art'y. | U.S.C.T.

Squire Perkins

Co. A, 10 Reg't U. S. Col'd H. Art'y.

Appears on

Company Muster Roll

for Nov & Dec, 1865.

Present or absent

Stoppage, \$ 100 for

Due Gov't, \$ 100 for

Valuation of horse, \$ 100

Valuation of horse equipments, \$ 100

Remarks: Mustered out by reason of expiration of term of service

Corrected by Worley 47.

Book mark: Dischd. Nov 28/65 to B. 15 47

1864

Copyist.

(358)

P. 10 No. a. U.S.C.T.

Squire Perkins

Co. A., 10 Reg't U. S. Col'd No. a.

Appears on a

Detachment Muster-out Roll

of the organization named above. Roll dated

N. Orleans La, Nov. 28, 1865.

Muster-out to date *Nov. 28, 1865.*

Last paid to *June 30, 1865.*

Clothing account:

Last settled _____, 186 ____; drawn since \$ _____ 100

Due soldier \$ *36 ⁴⁹/₁₀₀*; due U. S. \$ _____ 100

Am't for cloth'g in kind or money adv'd \$ _____ 100

Due U. S. for arms, equipments, &c., \$ _____ 100

Bounty paid \$ _____ 100 due \$ _____ 100

Remarks: *Joined at orig. orgn.*

*Mustered out by reason
of Expiration of term of
service*

Book mark: _____

(349)

Hawling

Copyist.

Squire Perkins
Art. Co. A, 10 Reg't U. S. Col'd H. Art'y.

Appears on Co. Muster-out Roll, dated
Baton Rouge La, Feb. 22 1867.

Muster-out to date _____, 186 .

Last paid to _____, 186 .

Clothing account:

Last settled _____, 186 ; drawn since \$ _____ 100

Due soldier \$ _____ 100; due U. S. \$ _____ 100

Am't for cloth'g in kind or money adv'd \$ _____ 100

Due U. S. for arms, equipments, &c., \$ _____ 100

Bounty paid \$ _____ 100; due \$ _____ 100

Remarks: Joined orig. organ Dischs
for Expan of term of service
Nov 28. 65

Book mark:

Nesbitt

P. 1 10th Regt. U.S. A. 1865

Squire Perkins

, Co. A, 10th Regt. U.S. A.

NOTATION.

Book mark:

L.B. 15-941 with
47.63.1884.

War Department,

Adjutant General's Office,

Washington, Jan 5, 1884.

Mustered out with Detach-
ment November 28, 1865.

E. P. Conzajer,

(438)

Copyist.

Private

Private

CARD NUMBERS.

487610.

- 25
- 27
- 28
- 29
- 30
- 31
- 32
- 33
- 34
- 35
- 36
- 37
- 38
- 39
- 40
- 41
- 42
- 43
- 44
- 45
- 46
- 47
- 48
- 49
- 50

Book Mark:

See also see 4. 77 U.S. G.I.

C 10th A. U.S.C.T.

Alexander Pero

Cot, Co. _____, *10* Reg't U. S. Col'd *Infantry*.

Appears on

M. and D. Roll of Men Transferred

to the organization named above,

from *Coy. 10th U.S. Col'd Inf*

Roll dated *Camp Cooper Tex*, 1865.

When enlisted *May 16*, 1864.

Period for which enlisted *3* years.

When mustered in *May 20*, 1864.

Present or absent _____

Company to which assigned _____

Remarks: *Died June 24, 64, at Ft. M. Philip
da. Final etc Rem.*

*Name not taken up on
muster rolls of Regt*

Book mark: _____

W. H. ...

10 U.S. Col'd H. Art

Private Private

CARD NUMBERS.

5489022	26
5492942	27
5493371	28
5493440	29
5493634	30
5493708	31
5493814	32
5493153	33
5493872	34
	35
	36
	37
	38
	39
	40
	41
	42
	43
	44
	45
	46
	47
	48
	49
	50

Book Mark:

See also

75. U. S. G. I.

S 893 329 Po now
R. & P. 484 254

NJ Worley
47.

S 893 329 Po mon
R. & P. 484 254

NJ Worley

47.

P 10 *Nov* U.S.C.T.

Zeno Perrette
D, Co., *10* Reg't U. S. Col'd *A* *Act*

Appears on

M. and D. Roll of Men Transferred

to the organization named above,

from *73 U.S.C.*

Roll dated *Nov 18*, 186*9*,

When enlisted *Sep 26*, 186*4*.

Period for which enlisted *3* years.

When mustered in *Sep 26*, 186*4*.

Present or absent *Not stated*

Company to which assigned

Remarks: *Drafted Sep 26/64*
and accredited to N.O.
not entitled to bounty

Filed with Zeno Perrette

Book mark :

A. Johnson

Beno Perrette
Co. A, 10 Reg't U. S. Col'd H. Art'y.

Appears on

Company Muster Roll

for *Nov + Dec*, 186*5*.

Present or absent *Present*

Stoppage, \$ *100* for

Due Gov't, \$ *100* for

Valuation of horse, \$ *100*

Valuation of horse equipments, \$ *100*

Remarks: *Transferred from 75
U.S.C.T. per S.O. 105. C.S. Hd
Gen. Dept of War*

Book mark:

Pino Perrette

P.P., Co. A, 10 Reg't U. S. Col'd H. Art'y.

Appears on

Company Muster Roll

for *Jan + Feb*, 186*6*.

Present or absent *Present*

Stoppage, \$ 100 for

Due Gov't, \$ $\frac{65}{100}$ for *C + G Equipage*

Valuation of horse, \$ 100

Valuation of horse equipments, \$ 100

Remarks:

Book mark: -----

Hyne

P | 10 H. Art'y. | U.S.C.T.

Benno Parette

Pr, Co. A, 10 Reg't U. S. Col'd H. Art'y.

Appears on

Company Muster Roll

for *Mar + Apr*, 186*6*.

Present or absent *Present*

Stoppage, \$ 100 for

Due Gov't, \$ 100 for

Valuation of horse, \$ 100

Valuation of horse equipments, \$ 100

Remarks:

Book mark:

(358)

Styer
Copyist.

P

10 H. Art'y.

U.S.C.T.

Gen Perrette

Co. A, 10 Reg't U. S. Col'd H. Art'y.

Appears on

Company Muster Roll

for *May & June*, 186*6*.

Present or absent *Present*

Stoppage, \$ 100 for

Due Gov't, \$ 100 for

Valuation of horse, \$ 100

Valuation of horse equipments, \$ 100

Remarks:

Book mark:

[Signature]

(358)

Copyist.

P

10 H. Art'y. U.S.C.T.

Zeno Perrette
Z

Co. A, 10 Reg't U. S. Col'd H. Art'y.

Appears on

Company Muster Roll

for *May & June*, 186*6*.

Present or absent *Present*

Stoppage, \$ 100 for

Due Gov't, \$ 100 for

Valuation of horse, \$ 100

Valuation of horse equipments, \$ 100

Remarks:

Book mark:

[Signature]

P

10 H. Art'y. U.S.C.T.

Beno Perrette

Pl, Co. A, 10 Reg't U. S. Col'd H. Art'y.

Appears on

Company Muster Roll

for *July & Aug*, 186*6*

Present or absent *Present*

Stoppage, \$ *100* for *1*

Due Gov't, \$ *100* for *1*

Valuation of horse, \$ *100*

Valuation of horse equipments, \$ *100*

Remarks:

Book mark:

H. J. ...

Copyist.

(358)

P | 10 H. Art'y. | U.S.C.T.

Zeno Perrete

Co. A, 10 Reg't U. S. Col'd H. Art'y.

Appears on

Company Muster Roll

for Sept + Oct, 1866.

Present or absent Present

Stoppage, \$ 100 for

Due Gov't, \$ 2 ⁰⁰/₁₀₀ for

Ordnance and
Camp Garrison equipage

Valuation of horse, \$ 100

Valuation of horse equipments, \$ 100

Remarks: Stop for one Mosquito bar
Sick in quarters

Book mark:

Nesbitt

P

10 H. Art'y. | U.S.C.T.

Zeno Perrette

Pvt

, Co. A, 10 Reg't U. S. Col'd H. Art'y.

Appears on

Company Muster Roll

for

Nov & Dec, 1866.

Present or absent

Present

Stoppage, \$

100 for

Due Gov't, \$

2⁰⁰ for Camp and Garrison equipage

Valuation of horse, \$

100

Valuation of horse equipments, \$

100

Remarks:

Book mark:

Nesbitt

(358)

Copyist.

Zeno Perrette

Pvt., Co. *A*, 10 Reg't U. S. Col'd H. Art'y.

Appears on Co. Muster-out Roll, dated
Baton Rouge La, *Feb. 22*, 1867.
 Muster-out to date *Feb. 22*, 1867.
 Last paid to *Dec. 31*, 1866.

Clothing account:

Last settled _____, 186 ; drawn since \$ 100
 Due soldier \$ 23 ^{*07*} 100; due U. S. \$ 100
 Am't for cloth'g in kind or money adv'd \$ 100

Due U. S. for arms, equipments, &c., \$ 6 ^{*under G.O. 101*} 100

Bounty paid \$ 100; due \$ 200 ^{*00*} 100

Remarks: *Transfd. from 75 U.S.C.T. as Pvt.*
S.O. 105 S. of 65 Sept. 66.

Book mark :

Nesbitt

10 U.S. Col'd H.A.

Corporal | *Corporal*
CARD NUMBERS.

de Pierre

Louis A

26

27

28

29

30

31

32

33

34

35

36

37

38

39

40

41

42

43

44

45

46

47

48

49

50

Book Mark:

See also

U.S. COLLEGE

Private | *Quinn*

CARD NUMBERS.

488709

26

27

28

29

30

31

32

33

34

35

36

37

38

39

40

41

42

43

44

45

46

47

48

49

50

Book Mark:

See also *See B. 77 U.S.*

P 10. N. Arty | U.S.C.T.

Granison Perry

Pr. Co. K, 10 Reg't U. S. Col'd N. Arty

Appears on

M. and D. Roll of Men Transferred

to the organization named above,

from Co. B. 77 Reg't U.S.C. Inf

Roll dated Oct. 1, 1865.

When enlisted Apr. 21, 1865.

Period for which enlisted 3 years.

When mustered in May 8, 1865.

Present or absent

Company to which assigned K

Remarks: Died at. Cd-a, Gen Hosp. A.C. Final statements rendered.

name not taken up on muster rolls of Regt

Book mark :

(342)

Avery

Copyist.

10 U.S. GOLD

Private Private

CARD NUMBERS.

1	5487747	26
2	5488283	27
3	5513492	28
4	5513638	29
5	5513806	30
6	5514210	31
7	5489825	32
8		33
9		34
10		35
11		36
12		37
13		38
14		39
15		40
16		41
17		42
18		43
19		44
20		45
21		46
22		47
23		48
24		49
25		50

Book Mark:

See also 77 U.S. G.S.

P | *1026A*, U.S.C.T.

Gustav Perry
Co, Co. *A*, *10* Reg't U. S. Col'd *1011*

Appears on

M. and D. Roll of Men Transferred

to the organization named above,

from *Co 4th U. S. Col Inf*

Roll dated *Camp Donipedia Co*, 186*5*.

When enlisted *July 11*, 186*3*.

Period for which enlisted *3* years.

When mustered in *July 18*, 186*3*.

Present or absent *Present*

Company to which assigned *D*

Remarks: *Transferred from
4th Reg't Co A Dec 2, 63*

Book mark :

W. H. Scott

P 1086a U.S.C.T.

Gustav Perry
Co. L, 10 Reg't U. S. Col'd H.W.

Appears on

M. and D. Roll of Men Transferred

to the organization named above,

from 77 U.S. Col Inf

Roll dated Camp Parapetada Oct, 1865.

When enlisted Feb 11, 1863.

Period for which enlisted 8 years.

When mustered in Feb 18, 1863.

Present or absent Present

Company to which assigned L

Remarks: Transferred from 1st
Co. H. Dec 2, 63, joined
by transfer from
Co. C. 77 U.S. Col. per S.O.
66. C. S. Hd. Qu. Dept
of War,

Book mark :

W. H. Scott

P

10 H. Art'y. | U.S.C.T.

Gustave Perry
Sgt., Co. G, 10 Reg't U. S. Col'd H. Art'y.

Age years.

Appears on

Company Muster Roll*

for *Sept. & Oct.*, 1863.

Joined for duty and enrolled:

When *Feb. 11*, 1863.

Where *New Orleans*

Period *3* years.

Mustered in:

When *Feb. 18*, 1863.

Where *New Orleans*

Present or absent *Present*

Stoppage, \$ *100* for

Due Gov't, \$ *100* for

Valuation of horse, \$ *100*

Valuation of horse equipments, \$ *100*

Remarks: *Transfd. from Co. C
79 U.S.C.T.*

*First current roll. No muster-in roll of this company on file.

Book mark :

Scherich

P

10 H. Art'y. U.S.C.T.

Gustav Perry

Pvt., Co. L, 10 Reg't U. S. Col'd H. Art'y.

Appears on

Company Muster Roll

for Nov. & Dec., 1865.

Present or absent Present

Stoppage, \$ 100 for

Due Gov't, \$ 100 for

Valuation of horse, \$ 100

Valuation of horse equipments, \$ 100

Remarks:

Book mark:

Schenich

P

10 H. Art'y. U.S.C.T.

Gustav Perry

Priv., Co. L, 10 Reg't U. S. Col'd H. Art'y.

Appears on

Company Muster Roll

for Jan. & Feb., 1866.

Present or absent

Stoppage, \$ 100 for

Due Gov't, \$ 100 for

Valuation of horse, \$ 100

Valuation of horse equipments, \$ 100

Remarks: Mustered out by reason of Ex. of Service to date Feb. 17/66.

Book mark: Mustered out on file.

Scherich

P. ¹⁰ Hy Arty U.S.C.T.

Gustave Perry

Priv., Co. L, 10 Reg't U. S. Col'd Arty

Appears on a

Detachment Muster-out Roll

of the organization named above. Roll dated

New Orleans, La, Feb. 17, 1866.

Muster-out to date Feb. 17, 1866.

Last paid to June 30, 1865

Clothing account:

Last settled _____, 186 ; drawn since \$ _____ 100

Due soldier \$ ⁵⁰ ₁₀₀ ⁹²; due U. S. \$ _____ 100

Am't for cloth'g in kind or money adv'd \$ _____ 100

Due U. S. for arms, equipments, &c., \$ _____ 100

Bounty paid \$ _____ 100 due \$ _____ 100

Remarks: *Joined at origl, orgn. of Co. C, 4" Cd'A, transferred to 5" Cd'a, (77" U.S.C.I.) by reorganization, Transferred to 10" U.S.C. A. Hy by consolidation.*

Book mark: _____

A. W. Reed

P

10 H. Art'y.

U.S.C.T.

Gustave Perry

Plt, Co. *L*, 10 Reg't U. S. Col'd H. Art'y.

Appears on **Co. Muster-out Roll**, dated

Baton Rouge La Feb 22, 1867.

Muster-out to date 186 .

Last paid to 186 .

Clothing account:

Last settled 186 ; drawn since \$ 100

Due soldier \$ 100 ; due U. S. \$ 100

Am't for cloth'g in kind or money adv'd \$ 100

Due U. S. for arms, equipments, &c., \$ 100

Bounty paid \$ 100 ; due \$ 100

Remarks: *Joined by transfer from
77 U.S.C.I. Oct 1/65 S.O. 667P
90s Dist of La Sept 22/65 Disch'd
at N.O. La Feb 17/66 Ex of service*

Book mark: *V 24 P 234 69*

Burnham

10 U.S. Col'd R.

Private Private

CARD NUMBERS.

5490461	26
5490612	27
5490754	28
5490909	29
5491045	30
5491179	31
5491305	32
5491438	33
5491565	34
5491692	35
5491818	36
5491944	37
5492069	38
5492194	39
5492316	40
5492441	41
5492565	42
5492690	43
5492818	44
5493054	45
5494042	46
5489570	47
47 - 27 - 1884	48
	49
	50

Book Mark: 213. $\frac{19}{941}$ 47 65-1884

See also

R. + P. 504115
D. 1548471 Roman
S 1719221 Roman

MS Worley
P 47

9 | 10 H. Art'y. | U.S.C.T.

Lubin Perry

....., Co. A, 1 Reg't La. Col'd H. Art'y.*

Age *22* years.

Appears on

Company Muster-in Roll

of the organization named above. Roll dated

New Orleans, La. Nov. 29, 1862.

Muster-in to date *Nov. 29, 1862.*

Joined for duty and enrolled:

When *Nov. 16*....., 186 .

Where *New Orleans*.....

Period *3* years.

Valuation of horse, \$.....*100*

Valuation of horse equipments, \$.....*100*

Remarks:.....
.....
.....

* This organization subsequently became Co. A, 10 Reg't U. S. Colored Heavy Artillery.

Book mark:.....

Polman
.....
Copyist.

P | 10 H. Art'y. | U.S.C.T.

Luben Perry
Priv, Co. A, 1 Reg't La. H. Art'y.*

Appears on

Company Muster Roll

for *to Dec. 31, 1862*

Present or absent *Present*

Stoppage, \$ *100* for

Due Gov't, \$ *100* for

Valuation of horse, \$ *100*

Valuation of horse equipments, \$ *100*

Remarks:

*This organization subsequently became Co. A, 10 Reg't U. S. Col'd Heavy Artillery.

Book mark:

T. L. ...
Copyist.

P

10 H. Art'y. U.S.C.T.

Lubin Perry

Priv, Co. A, 1 Reg't La. H. Art'y.*

Appears on

Company Muster Roll

for Jarvis & Healy, 1863.

Present or absent Present

Stoppage, \$ 100 for

Due Gov't, \$ 100 for

Valuation of horse, \$ 100

Valuation of horse equipments, \$ 100

Remarks:

*This organization subsequently became Co. A, 10 Reg't U. S. Col'd Heavy Artillery.

Book mark:

Tobman

P | 10 H. Art'y. | U.S.C.T.

Lubin Perry

Pvt., Co. A, 1 Reg't La. H. Art'y.*

Appears on

Company Muster Roll

for March & April, 1863.

Present or absent. Absent

Stoppage, \$ 100 for

Due Gov't, \$ 100 for

Valuation of horse, \$ 100

Valuation of horse equipments, \$ 100

Remarks: In confinement =
ment since March 11th
1863.

*This organization subsequently became Co. A, 10 Reg't U. S. Col'd Heavy Artillery.

Book mark:

Tobman

P | 10 H. Art'y. | U.S.C.T.

Lubin Perry

Pvt., Co. A, 1 Reg't La. H. Art'y.*

Appears on

Company Muster Roll

for *May & June*, 1863.

Present or absent *Present*

Stoppage, \$ *100* for

Due Gov't, \$ *100* for

Valuation of horse, \$ *100*

Valuation of horse equipments, \$ *100*

Remarks: *Sentenced by General Court Martial to three months hard labor from May 15-1863 and to forfeit five dollars per month (over)*

*This organization subsequently became Co. A, 10 Reg't U. S. Col'd Heavy Artillery.

Book mark: _____

Tolman

JAN. 15

5491045

★ 1891 ★

*of his pay during
that period.*

Lubin Perry
Pvt., Co. A, 1 Reg't La. H. Art'y.*

Appears on

Company Muster Roll

for *July & August*, 1863.

Present or absent. *Present*

Stoppage, \$ *100* for

Due Gov't, \$ *100* for

Valuation of horse, \$ *100*

Valuation of horse equipments, \$ *100*

Remarks: *Was in arrest
at time of last
payment. Was par-
doned by Maj Genl
Banks August 8th 1863*

*This organization subsequently became Co. A, 10 Reg't U.S. Col'd Heavy Artillery.

Book mark: _____

P | 10 H. Art'y. | U.S.C.T.

Lubin Perry

Priv, Co. A, 1 Reg't La. H. Art'y.*

Appears on

Company Muster Roll

for Sept & Oct, 1863.

Present or absent Present

Stoppage, \$.....100 for

Due Gov't, \$.....100 for

Valuation of horse, \$.....100

Valuation of horse equipments, \$.....100

Remarks:.....

.....
.....
.....
.....
.....
.....

*This organization subsequently became Co. A. 10 Reg't U. S. Col'd Heavy Artillery.

Book mark:.....

.....

Tohman
Copied.

P | 10 H. Art'y. | U.S.C.T.

Tubey Perry

Art. Co., 1 Reg't H. Art'y, Corps d'Afrique.*

Appears on

Company Muster Roll

for *Mr. Lee*, 1863

Present or absent *Present*

Stoppage, \$ 100 for

Due Gov't, \$ 100 for

Valuation of horse, \$ 100

Valuation of horse equipments, \$ 100

Remarks: *Sick in quarters*

*This organization subsequently became Co. *A*, 10 Reg't U. S. Colored Heavy Artillery.

Book mark: _____

Rooster

P | 10 H. Art'y. | U.S.C.T.

Zuben Perry

Art. Co. A, 1 Reg't H. Art'y, Corps d'Afrique.*

Appears on

Company Muster Roll

for *Jan & Feb*, 1864

Present or absent *Present*

Stoppage, \$ 100 for

Due Gov't, \$ 100 for

Valuation of horse, \$ 100

Valuation of horse equipments, \$ 100

Remarks: *Sick in quarters*

*This organization subsequently became Co *A*, 10 Reg't U. S. Colored Heavy Artillery.

Book mark:

Rochester

P | 10 H. Art'y. | U.S.C.T.

Subon Perry

Co. A, 7 Reg't U. S. Col'd H. Art'y.*

Appears on

Company Muster Roll

for *March 1864*, 1864.

Present or absent *Present*

Stoppage, \$ 100 for

Due Gov't, \$ 100 for

Valuation of horse, \$ 100

Valuation of horse equipments, \$ 100

Remarks:

* This organization subsequently became *Co. A*, 10 Reg't U. S. Colored Heavy Artillery.

Book mark: -----

Co. A

P | 10 H. Art'y. | U.S.C.T.

Tubin Perry

Pvt., Co. *A*, 7 Reg't U. S. Col'd H. Art'y.*

Appears on

Company Muster Roll

for *May & June*, 1864.

Present or absent *Present*

Stoppage, \$ 100 for

Due Gov't, \$ 100 for

Valuation of horse, \$ 100

Valuation of horse equipments, \$ 100

Remarks:

* This organization subsequently became Co. *A*, 10 Reg't U. S. Colored Heavy Artillery.

Book mark:

Booster

P | 10 H. Art'y. | U.S.C.T.

Luben Perry
Co. A, 7 Reg't U. S. Col'd H. Art'y.*

Appears on

Company Muster Roll

for July & Aug, 1864.

Present or absent Present

Stoppage, \$ 100 for

Due Gov't, \$ 100 for

Valuation of horse, \$ 100

Valuation of horse equipments, \$ 100

Remarks:

* This organization subsequently became Co. A, 10 Reg't U. S. Colored Heavy Artillery.

Book mark:

Rochester

P | 10 H. Art'y. | U.S.C.T.

Luben Perry
Pvt., Co. A, 10 Reg't U. S. Col'd H. Art'y.

Appears on

Company Muster Roll

for *Sept & Oct*, 186*4*

Present or absent *Present*

Stoppage, \$ 100 for

Due Gov't, \$ 100 for

Valuation of horse, \$ 100

Valuation of horse equipments, \$ 100

Remarks: _____

Book mark: _____

(358)

Acceptor
Copyist.

P | 10 H. Art'y. | U.S.C.T.

Lubin Perry

Art., Co. A, 10 Reg't U. S. Col'd H. Art'y.

Appears on

Company Muster Roll

for Nov & Dec, 1864.

Present or absent Present

Stoppage, \$ 100 for

Due Gov't, \$ 100 for

Valuation of horse, \$ 100

Valuation of horse equipments, \$ 100

Remarks:

Book mark:

Boehmer

P | 10 H. Art'y. | U.S.C.T.

Luben Perry
Pvt, Co. A, 10 Reg't U. S. Col'd H. Art'y.

Appears on

Company Muster Roll

for *Jan + Feb*, 1865.

Present or absent *Present*

Stoppage, \$ *100* for

Due Gov't, \$ *100* for

Valuation of horse, \$ *100*

Valuation of horse equipments, \$ *100*

Remarks: *In arrest*

Book mark:

Rochester

P | 10 H. Art'y. | U.S.C.T.

Luben Perry

Pvt., Co. A, 10 Reg't U. S. Col'd H. Art'y.

Appears on

Company Muster Roll

for *Month of April*, 1865.

Present or absent *Present*

Stoppage, \$.....100 for

Due Gov't, \$.....100 for

Valuation of horse, \$.....100

Valuation of horse equipments, \$.....100

Remarks:

Book mark:

Archester

P | 10 H. Art'y. | U.S.C.T.

Luben Perry

Pvt, Co. A, 10 Reg't U. S. Col'd H. Art'y.

Appears on

Company Muster Roll

for *May & June 1865*

Present or absent *Present*

Stoppage, \$ 100 for

Due Gov't, \$ 100 for

Valuation of horse, \$ 100

Valuation of horse equipments, \$ 100

Remarks:

Book mark:

Recharter

P | 10 H. Art'y. | U.S.C.T.

Luben Perry
Art., Co. A, 10 Reg't U. S. Col'd H. Art'y.

Appears on

Company Muster Roll

for *July & Aug*, 1865.

Present or absent *Present*

Stoppage, \$ 100 for

Due Gov't, \$ 100 for

Valuation of horse, \$ 100

Valuation of horse equipments, \$ 100

Remarks:

Book mark:

Rochester

(358)

Copyist.

P | 10 H. Art'y. | U.S.C.T.

Luben Perry

Pat, Co. A, 10 Reg't U. S. Col'd H. Art'y.

Appears on

Company Muster Roll

for *Sept + Oct*, 1865.

Present or absent *Present*

Stoppage, \$ 100 for

Due Gov't, \$ 100 for

Valuation of horse, \$ 100

Valuation of horse equipments, \$ 100

Remarks:

Book mark:

(358)

Styus

Copyist.

P

10 H. Art'y. U.S.C.T.

Lubin Perry

Pl, Co. A, 10 Reg't U. S. Col'd H. Art'y.

Appears on

Company Muster Roll

for *Nov + Dec*, 1865.

Present or absent

Stoppage, \$ 100 for

Due Gov't, \$ 100 for

Valuation of horse, \$ 100

Valuation of horse equipments, \$ 100

Remarks: *Mustered out by reason of expiration of term of service*

Book mark: *Disch'd Nov 28/65 Lt B. 15 441*
47 c.p. 1864

(358)

H. J. ...

Copyist.

P. 10 No. a. U.S.C.T.

Lubin Perry

Priv., Co. A., 10 Reg't U. S. Col' No. a.

Appears on a

Detachment Muster-out Roll

of the organization named above. Roll dated

N. Orleans La. Nov. 28, 1865.

Muster-out to date *Nov. 28, 1865.*

Last paid to *June 30, 1865*

Clothing account:

Last settled _____, 186 ; drawn since \$ _____ 100

Due soldier \$ *30 83* / 100; due U. S. \$ _____ 100

Am't for cloth'g in kind or money adv'd \$ _____ 100

Due U. S. for arms, equipments, &c., \$ _____ 100

Bounty paid \$ _____ 100 due \$ _____ 100

Remarks: *Joined at Origl. Orgn.
Stop for one Tompson
Mustered out of service
by reason of Expiration
of term of service*

Book mark: _____

(349)

Neasling

Copyist.

Lubin Perry
Pt. Co. A, 10 Reg't U. S. Col'd H. Art'y.

Appears on Co. Muster-out Roll, dated
Baton Rouge La, Feb. 22 1867.

Muster-out to date _____, 186 .

Last paid to _____, 186 .

Clothing account:

Last settled _____, 186 ; drawn since \$ _____ 100

Due soldier \$ _____ 100; due U. S. \$ _____ 100

Am't for cloth'g in kind or money adv'd \$ _____ 100

Due U. S. for arms, equipments, &c., \$ _____ 100

Bounty paid \$ _____ 100; due \$ _____ 100

Remarks: *Joined orig. regt. Disch'd
for Expan of term of service
Nov. 28. 65*

Book mark: *V. 116 P. 11. 70*

Nesbitt
Copyist.

P. 1 10th Reg't U.S. Col.

Lubin Perry

, Co. A, 10th Reg't U.S. Col.

NOTATION.

Book mark: L.B. 15-491 with
47.6.3.1884.

War Department,

Adjutant General's Office,

Washington, Jan 5th, 1884.

~~Mustered out with Detach-~~
~~ment November 28, 1865.~~

E. P. Conroy

(438)

Copyist.

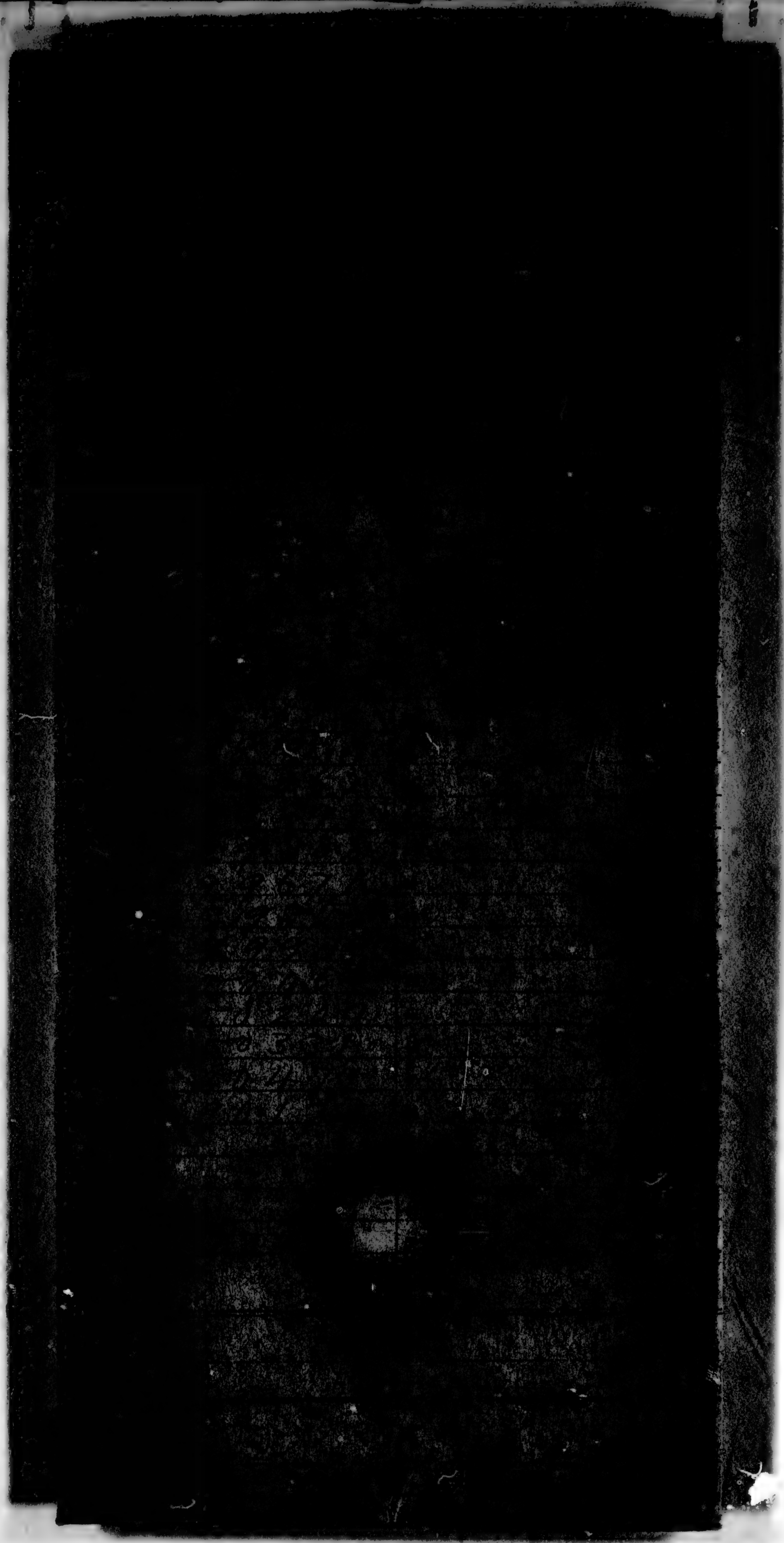

P | 10 H. Art'y. | U.S.C.T.

Lugar Peter

....., Co. C, 1 Reg't La. Art'y, Native Guards.*

Age *18* years.

Appears on

Company Muster-in Roll

of the organization named above. Roll dated

New Orleans La, Feb 4, 1864.

Muster-in to date *Dec 31, 1863.*

Joined for duty and enrolled:

When *Oct 26, 1863.*

Where *Prichard La*

Period *3* years.

Valuation of horse, \$.....*100*

Valuation of horse equipments, \$.....*100*

Remarks:.....
.....
.....

* This organization subsequently became Co. C, 10 Reg't U. S. Col'd Heavy Artillery.

Book mark :.....

(356)

W. J. ...

Copyist.

P | 10 H. Art'y. | U.S.C.T.

Lugen Peter

Pt., Co. C, 1 Reg't H. Art'y, Corps d'Afrique.*

Appears on

Company Muster Roll

for Feb 4th to 29th, 1861

Present or absent Present

Stoppage, \$ 100 for

Due Gov't, \$ 100 for

Valuation of horse, \$ 100

Valuation of horse equipments, \$ 100

Remarks:

*This organization subsequently became Co. E, 10 Reg't U. S. Colored Heavy Artillery.

Book mark:

Copyist

P | 10 H. Art'y. | U.S.C.T.

Lugar Peter

Pvt, Co. *C*, 7 Reg't U. S. Col'd H. Art'y.*

Appears on

Company Muster Roll

for *Mich & apl*, 186*4*.

Present or absent. *Present*

Stoppage, \$.....*100* for

Due Gov't, \$.....*100* for

Valuation of horse, \$.....*100*

Valuation of horse equipments, \$.....*100*

Remarks:

.....
.....
.....
.....
.....
.....

* This organization subsequently became Co., 10 Reg't U. S. Colored Heavy Artillery.

Book mark:

.....

(358)

J. Anderson
Copyist.

P | 10 H. Art'y. | U.S.C.T.

Lingar Peter

Pr, Col., 7 Reg't U. S. Col'd H. Art'y.*

Appears on

Company Muster Roll

for *May June*, 186*4*.

Present or absent *Present*

Stoppage, \$.....*100* for

Due Gov't, \$.....*100* for

Valuation of horse, \$.....*100*

Valuation of horse equipments, \$.....*100*

Remarks:.....

* This organization subsequently became Co. , 10 Reg't U. S. Colored Heavy Artillery.

Book mark:.....

(358)

J. M. ...
Copyist.

P | 10 H. Art'y. | U.S.C.T.

Lingar Peter

Pratt, Co. C, 7 Reg't U. S. Col'd H. Art'y.*

Appears on

Company Muster Roll

for July & Aug, 1864.

Present or absent Present

Stoppage, \$ 100 for

Due Gov't, \$ 100 for

Valuation of horse, \$ 100

Valuation of horse equipments, \$ 100

Remarks: Sick

* This organization subsequently became Co. , 10 Reg't U. S. Colored Heavy Artillery.

Book mark:

(358)

J. H. H. Copyist.

P | 10 H. Art'y. | U.S.C.T.

Lugar Peter

Prvt, Co. C, 10 Reg't U. S. Col'd H. Art'y.

Appears on

Company Muster Roll

for Sept & Oct, 1864

Present or absent Present

Stoppage, \$ 100 for

Due Gov't, \$ 100 for

Valuation of horse, \$ 100

Valuation of horse equipments, \$ 100

Remarks:

Book mark:

(358)

J. Mendenhall
Copyst.

Sugar Peter

Pvt., Co. C, 10 Reg't U. S. Col'd H. Art'y.

Appears on

Company Muster Roll

for *Nov & Dec*, 186*7*

Present or absent *Present*

Stoppage, \$.....*100* for

Due Gov't, \$.....*100* for

Valuation of horse, \$.....*100*

Valuation of horse equipments, \$.....*100*

Remarks:.....

Book mark:.....

J. Anderson
Coryist.

P

10 H. Art'y. U.S.C.T.

Sugar Peter

Pull, Co. C, 10 Reg't U. S. Col'd H. Art'y.

Appears on

Company Muster Roll

for *Jan & Feb*, 186*5*.

Present or absent *Present*

Stoppage, \$ *100* for

Due Gov't, \$ *100* for

Valuation of horse, \$ *100*

Valuation of horse equipments, \$ *100*

Remarks:

Book mark:

(358)

Pallade

Copyist.

Lugar Peter

Pr-, Co. C, 10 Reg't U. S. Col'd H. Art'y.

Appears on

Company Muster Roll

for *March & April*, 186*5*

Present or absent *Present*

Stoppage, \$ *100* for

Due Gov't, \$ *100* for

Valuation of horse, \$ *100*

Valuation of horse equipments, \$ *100*

Remarks:

Book mark:

Lucas

P

10 H. Art'y. U.S.C.T.

Lugar Peter

Pvt., Co. C, 10 Reg't U. S. Col'd H. Art'y.

Appears on

Company Muster Roll

for *May + June*, 186*5*.

Present or absent *Present*

Stoppage, \$ *100* for

Due Gov't, \$ *100* for

Valuation of horse, \$ *100*

Valuation of horse equipments, \$ *100*

Remarks:

Book mark: *...*

(358)

Ballade

Copyist.

Q | 10 H. Art'y. | U.S.C.T.

Lugar Peter
Put., Co. C, 10 Reg't U. S. Col'd H. Art'y.

Appears on

Company Muster Roll

for *July & Aug*, 186 *5*.

Present or absent *Present*

Stoppage, \$ *100* for

Due Gov't, \$ *100* for

Valuation of horse, \$ *100*

Valuation of horse equipments, \$ *100*

Remarks:

Book mark:

Dallade

P | 10 H. Art'y. | U.S.C.T.

Lugar Peter
Put, Co. C, 10 Reg't U. S. Col'd H. Art'y.

Appears on

Company Muster Roll

for *Sept & Oct*, 186*5*.

Present or absent *Present*

Stoppage, \$ *100* for

Due Gov't, \$ *100* for

Valuation of horse, \$ *100*

Valuation of horse equipments, \$ *100*

Remarks: *Due U.S. \$ 1. ³⁰/₁₀₀ for loss of Canteen & Haversack*

Book mark:

Ballade

P

10 H. Art'y. U.S.C.T.

Lugar Peter

Priv., Co. C, 10 Reg't U. S. Col'd H. Art'y.

Appears on

Company Muster Roll

for Nov 24 Dec 1865.

Present or absent Present

Stoppage, \$ 100 for

Due Gov't, \$ 100 for

Valuation of horse, \$ 100

Valuation of horse equipments, \$ 100

Remarks: Rec'd U.S. for loss of
Canteen & Haversack 30/100

Book mark:

A. J. Robbins

P | 10 H. Art'y. | U.S.C.T.

Luzar Peter
Pvt., Co. C, 10 Reg't U. S. Col'd H. Art'y.

Appears on

Company Muster Roll
for *Jan. 27 Feb.*, 186*6*.

Present or absent *Present*

Stoppage, \$ *100* for

Due Gov't, \$ *100* for

Valuation of horse, \$ *100*

Valuation of horse equipments, \$ *100*

Remarks:

Book mark:

(358)

A. J. Robbins

Copyst.

P | 10 H. Art'y. | U.S.C.T.

Ingar Peters

Pvt., Co. C, 10 Reg't U. S. Col'd H. Art'y.

Appears on

Company Muster Roll

for *March & April*, 1866.

Present or absent *Present.*

Stoppage, \$ *100* for

Due Gov't, \$ *100* for

Valuation of horse, \$ *100*

Valuation of horse equipments, \$ *100*

Remarks: *Due U. S. for loss of wife \$26/100.*

Book mark:

A. J. Robbins

P | 10 H. Art'y. | U.S.C.T.

Lugar Peter
Poh, Co. C, 10 Reg't U. S. Col'd H. Art'y.

Appears on

Company Muster Roll

for May 2d June, 1866.

Present or absent Present

Stoppage, \$ 100 for

Due Gov't, \$ 100 for

Valuation of horse, \$ 100

Valuation of horse equipments, \$ 100

Remarks:

Book mark:

A. J. Robbins

(358)

Copyist.

Lugar Peter
P.L., Co. C, 10 Reg't U. S. Col'd H. Art'y.

Appears on

Company Muster Roll

for July 2d Aug., 1866.

Present or absent Present

Stoppage, \$ 100 for

Due Gov't, \$ 100 for

Valuation of horse, \$ 100

Valuation of horse equipments, \$ 100

Remarks:

Book mark:

A. J. Robbins
Copyist.

P | 10 H. Art'y. | U.S.C.T.

Sugar Peter

Pvt, Co. C, 10 Reg't U. S. Col'd H. Art'y.

Appears on

Company Muster Roll

for *Sept & Oct*, 1866.

Present or absent *Present*

Stoppage, \$.....100 for

Due Gov't, \$.....100 for

Valuation of horse, \$.....100

Valuation of horse equipments, \$.....100

Remarks:.....

Book mark:.....

(358)

Manning
Copyist.

P

10 H. Art'y. U.S.C.T.

Sugar Peter

Pvt, Co. C, 10 Reg't U. S. Col'd H. Art'y.

Appears on

Company Muster Roll

for *Nov & Dec*, 186*6*.

Present or absent *Present*

Stoppage, \$ *100* for

Due Gov't, \$ *100* for

Valuation of horse, \$ *100*

Valuation of horse equipments, \$ *100*

Remarks: *due U.S. for
loss of companion
1 ²/₁₀₀*

Book mark:

Hammer

P

10 H. Art'y. U.S.C.T.

Lugar Peter

Cor., Co. *C*, 10 Reg't U. S. Col'd H. Art'y.

Appears on **Co. Muster-out Roll**, dated

Baton Rouge, La., Feb. 22, 1867.

Muster-out to date _____, 186 .

Last paid to _____, 186 .

Clothing account:

Last settled _____, 186 ; drawn since \$ _____ 100

Due soldier \$ _____ 100; due U. S. \$ _____ 100

Am't for cloth'g in kind or money adv'd \$ _____ 100

Due U. S. for arms, equipments, &c., \$ _____ 100

Bounty paid \$ _____ 100; due \$ _____ 100

Remarks: *Joined Regt Osee*
Discharged Feb. 3, 1867
by reason of expiration
of term of
service

Book mark: _____

(361)

Manning
Const.

P | 10 Arty | U.S.C.T.

Lugar Peter

Priv., Co. G, 11 Reg't U. S. Col'd Arty

Appears on a

Detachment Muster-out Roll

of the organization named above. Roll dated

Baton Rouge, La Feb. 3, 1867.

Muster-out to date Feb. 3, 1867.

Last paid to Dec. 31, 1866

Clothing account:

Last settled 186 ; drawn since \$ 100

Due soldier \$ 87 ⁷⁹/₁₀₀; due U. S. \$ 45 ²⁰/₁₀₀

Am't for cloth'g in kind or money adv'd \$ 100

Due U. S. for arms, equipments, &c., \$ 74 ²⁴/₁₀₀

Bounty paid \$ 100 ⁰⁰/₁₀₀ due \$ 100 ⁰⁰/₁₀₀

Remarks: *Joined orig. org. 11th U.S. Col'd Arty
now 11th U.S. C.A. (11th) stop for
screw driver, ripper & tompron*

Book mark: 1136- 1878

A. E. Wilson

(349)

Copyist.

10 Apr 1950

Peter, Sigas

Co. C 10 J.S.C.H.A. Reg't

Enclosures.

Bed Cards	Descriptive Lists
Burial Records	Final Statements
Certs. of Dis. for Discharge	Furloughs
C. M. Charges	Med. Des. Lists
Med. Certificates	Orders

Other papers relating to—

Admission to Hosp'l	Furlough
Casualty Sheet (Officer's)	Med. Examination
Confinement	Misc. Information
Contracts	Pay or Clothing
Death or Effects	Personal Reports
Desertions	Rank
Discharge from Hosp'l	Transfer to Hosp'l
Discharge from Service	Transfer to V. R. C.
Duty	Transportation

Name of Hospital, *Camp A. Aguirre*
 Name of Patient, *Ligas Peter*
 Disease or Injury, *Subeola*
 Result, *Cured*
 Date of Transmission, *April 18th 1864*

REMARKS AS TO CONDITION OF PATIENT, &c.	DIET.	TREATMENT.	DATE.
<i>Ligas Peter</i> <i>10 U.S. H. A.</i> <i>1 La H. A.</i>	<i>La Reg 94</i>		

MEDICAL DESCRIPTIVE LIST.

Ward A., Bed General Hospital at New Orleans La
 Name Ligas Peter, Age, Rank, Co. B, Regiment 1st He Artill.
 Disease or Injury, Rubola
 Result, Recovery
 [Name of attending Medical Officer.]
Geo. O. Dalton A. A. Surg. USA
 DATE OF { Admission, December 23^d /63
 Return to duty, cured, February 1st /64
 Furlough,
 Discharge from service,
 Transfer to another Hospital,
 Death,

NOTE.—When a patient is first received into a General Hospital, the entries on this Descriptive List will be commenced. All important changes in his condition will be noted on it, (in ink,) from time to time, by the Surgeon in charge of the Ward. When the patient has been wounded, the date and character of the wound will be stated, the nature of the operation, (if any,) and, above all, the result. In case of transfer, this list will be sent, through the Officer in charge of the transportation, or failing one, by mail, to the Surgeon in charge of the Hospital receiving the patient. When this Medical History shall have been completed, by the cure, discharge, furlough, or death of the patient, it will, with the treatment and result carefully noted, be transmitted directly to the Surgeon General.

DATE.	TREATMENT.	DIET.	REMARKS AS TO CONDITION OF PATIENT, &c.
	<p><i>Rest, S, D, & confinement to Ward during & for a few days after the eruption.</i></p>		<p><i>Rubola, mild & without complications.</i></p>

U.S. GOV'T PRINTING OFFICE

Private | *Private*

CARD NUMBERS.

1	5511268	26
2	5511359	27
3	5511446	28
4	5511572	29
5	5511697	30
6	5511799	31
7	5511917	32
8	5512156	33
9	5490019	34
10		35
11		36
12		37
13		38
14		39
15		40
16		41
17		42
18		43
19		44
20		45
21		46
22		47
23		48
24		49
25		50

Book Mark:

See also

S. 1150116. P.O. Ret.

O. 2297671 And WO

RTP 75-8021

MS Worley

47.

P | 10 H. Art'y. | U.S.C.T.

Paul Peter

Prk., Co. *D*, 10 Reg't U. S. Col'd H. Art'y.

Age years.

Appears on

Company Muster Roll*

for *Enrollment to June 30*, 186*5*.

Joined for duty and enrolled:

When, 186 .

Where

Period *1* years.

Mustered in:

When *May 3*, 186*5*.

Where *New Orleans, La.*

Present or absent *Present.*

Stoppage, \$ *100* for

Due Gov't, \$ *100* for

Valuation of horse, \$ *100*

Valuation of horse equipments, \$ *100*

Remarks: *Drafted. Com-*
mencement of first

*First current roll. No muster-in roll of this company on file.

Book mark :

O. S. Clark
(3586) Copyist.

JAN. 16

5511268

1891

payment by time May
3, 65. On daily duty
as les. cook.

P

10 H. Art'y.

U.S.C.T.

Paul Peter

Priv., Co. I, 10 Reg't U. S. Col'd H. Art'y.

Appears on

Company Muster Roll

for *July & Aug.*, 186*5*.

Present or absent *Present*

Stoppage, \$ *100* for

Due Gov't, \$ *100* for

Valuation of horse, \$ *100*

Valuation of horse equipments, \$ *100*

Remarks: *Daily duty as com-
pany cook.*

Book mark:

A. S. Mark

P.

10 H. Art'y.

U.S.C.T.

Paul Peter

Pvt., Co. I, 10 Reg't U. S. Col'd H. Art'y.

Appears on

Company Muster Roll

for *Sept. 10th.*, 186*5*.

Present or absent *Present*

Stoppage, \$ *100* for

Due Gov't, \$ *100* for

Valuation of horse, \$ *100*

Valuation of horse equipments, \$ *100*

Remarks: *On daily duty as
company cook.*

Book mark:

(358)

O. T. Clark

Copyist.

Paul Peter

Priv., Co. I, 10 Reg't U. S. Col'd H. Art'y.

Appears on

Company Muster Roll

for Nov. & Dec., 1865.

Present or absent Present

Stoppage, \$ 100 for

Due Gov't, \$ 100 for

Valuation of horse, \$ 100

Valuation of horse equipments, \$ 100

Remarks: On daily duty as company cook.

FROM SECOND AUDITOR'S ROLL.

Book mark:

O. S. Clark

P

10 H. Art'y.

U.S.C.T.

Paul Peter

Prk., Co. I, 10 Reg't U. S. Col'd H. Art'y.

Appears on

Company Muster Roll

for Jan + Feb., 1866.

Present or absent Present

Stoppage, \$ 100 for

Due Gov't, \$ 100 for

Valuation of horse, \$ 100

Valuation of horse equipments, \$ 100

Remarks: On daily duty as
Co. book.

Book mark:

A. S. Clark

P.

10 H. Art'y.

U.S.C.T.

Paul Peter

Pvt., Co. I, 10 Reg't U. S. Col'd H. Art'y.

Appears on

Company Muster Roll

for *March & Apr.*, 1866.

Present or absent *Present*

Stoppage, \$ *100* for

Due Gov't, \$ *100* for

Valuation of horse, \$ *100*

Valuation of horse equipments, \$ *100*

Remarks: *On daily duty as
company cook.*

Book mark: *Muster out on file*

O. S. Clark

(358)

Copyist.

P

10 H. Art'y.

U.S.C.T.

Paul Peter

Prk., Co. I, 10 Reg't U. S. Col'd H. Art'y.

Appears on

Company Muster Roll

for May & June, 1866.

Present or absent

Stoppage, \$ 100 for

Due Gov't, \$ 100 for

Valuation of horse, \$ 100

Valuation of horse equipments, \$ 100

Remarks: Discharged.
Mustered out by
reason of expira-
tion of term of ser-
vice to date May
2, 1866.

Book mark:

O. S. Clark

Copyist.

(358)

F

Paul Peter

Priv. Co. A, 10 Reg't U. S. Col'd H. Art'y.

Appears on **Co. Muster-out Roll**, dated *Baton Rouge La, Feb 22*, 1867.

Muster-out to date _____, 186 .

Last paid to _____, 186 .

Clothing account:

Last settled _____, 186 ; drawn since \$ _____ 100

Due soldier \$ _____ 100; due U. S. \$ _____ 100

Am't for cloth'g in kind or money adv'd \$ _____ 100

Due U. S. for arms, equipments, &c., \$ _____ 100

Bounty paid \$ _____ 100; due \$ _____ 100

Remarks: *Discharged, expiration
term of service May 2, 1866
(age 32 yrs)*

Book mark: _____

(361)

J. M. Hance

Copyist.

P | 10 Art'y | U.S.C.T.

Peter, Paul

Priv., Co. I, 10 Reg't U. S. Col'd Art'y

Appears on a

Detachment Muster-out Roll

of the organization named above. Roll dated

New Orleans, La, May 2, 1866.

Muster-out to date

May 2, 1866.

Last paid to

Feb 28, 1866

Clothing account:

Last settled 186 ; drawn since \$ 100

Due soldier \$ 29 ²⁷/₁₀₀; due U. S. \$ 100

Am't for cloth'g in kind or money adv'd \$ 100

Due U. S. for arms, equipments, &c., \$ 100

Bounty paid \$ 100 due \$ 100

Remarks: Joined by draft.

Book mark:

R. E. Wilson

Private

Private

CARD NUMBERS.

5487512

	26
	27
	28
	29
	30
	31
	32
	33
	34
	35
	36
	37
	38
	39
	40
	41
	42
	43
	44
	45
	46
	47
	48
	49
	50

Book Mark:

See also *Vol. H. 77 U.S.C. Sup.*

P | *10 H A* | U.S.C.T.

Simon Peter

Co., Co., *10* Reg't U. S. Col'd *H.A.*

Appears on

M. and D. Roll of Men Transferred

to the organization named above,

from *Co. H. 4th U.S. Col Inf*

Roll dated *Camp Parapet d. Cal.*, 186*5*.

When enlisted *Sept 1*, 186*4*.

Period for which enlisted *3* years.

When mustered in *Sept 1*, 186*4*.

Present or absent

Company to which assigned

Remarks: *Drafted. Assigned*

to Co. Sept. 8. 1864.

Died at Ca. H. U.S. Gen

Hosp New Orleans La

Dec. 15. 64 Final

statements rendered

name not taken upon

muster rolls of Regt

Book mark : *108421*

W. H. Scott

Waters, Charles

Co *G*, 10 U.S. Col'd H. Art'y.

Private

Private

- CARD NUMBERS.

1	5486962.	26
2	5507171.	27
3	5507251.	28
4	5507293.	29
5	5507333.	30
6	5507448.	31
7	5507595.	32
8	5507741.	33
9	5507878.	34
10	5508018.	35
11	5508157.	36
12	5508290.	37
13	5508437.	38
14	5508586.	39
15	5508738.	40
16	5508884.	41
17	5509031.	42
18	5509152.	43
19	5509300.	44
20	5509408.	45
21		46
22		47
23		48
24		49
25		50

Book Mark: _____

See also _____

S1083791 - Pomona
S1284881 - P.O. Rd

S-2970402 - M. L. W. -
A.S. 1712179

M. J. Worley
J
49.

Charles Peters

Appears with rank of Private on

Muster and Descriptive Roll of a Detachment of U. S. Vols. forwarded

for the 10 Reg't N. S. C. H. A. Roll dated

New Orleans La, Apr. 3, 1864

Where born Attakias N.C.

Age 22 yrs; occupation Servant

When enlisted Mar. 29, 1864.

Where enlisted Port Hudson

For what period enlisted 3 years.

Eyes Black; hair Black

Complexion Black; height 5 ft. 5 1/2 in.

When mustered in Apr. 3, 1864.

Where mustered in New Orleans

Bounty paid \$ 100; due \$ 100

Where credited

Company to which assigned G

Remarks:

Book mark:

Galligan

9

10 H. Art'y.

U.S.C.T.

Charles Peters

Co. G, 7 Reg't U. S. Col'd H. Art'y.*

Appears on

Company Muster Roll

for term enrollment to Ad. 30, 1864.

Present or absent Present

Stoppage, \$ 100 for

Due Gov't, \$ 100 for

Valuation of horse, \$ 100

Valuation of horse equipments, \$ 100

Remarks:

* This organization subsequently became Co. , 10 Reg't U. S. Colored Heavy Artillery.

Book mark:

E. H. Brown

©

10 H. Art'y.

U.S.C.T.

Charles Peters

Co. G, 7 Reg't U. S. Col'd H. Art'y.*

Appears on

Company Muster Roll

for May & June, 1864.

Present or absent Present

Stoppage, \$ 100 for

Due Gov't, \$ 100 for

Valuation of horse, \$ 100

Valuation of horse equipments, \$ 100

Remarks:

* This organization subsequently became Co. , 10 Reg't U. S. Colored Heavy Artillery.

Book mark:

E. N. Brown

(358)

Copyist.

P

10 H. Art'y. U.S.C.T.

Charles Peter
Pot, Co. G, 10 Reg't U. S. Col'd H. Art'y.

Appears on

Company Muster Roll

for July & Aug, 1864.

Present or absent Present

Stoppage, \$ 100 for

Due Gov't, \$ 100 for

Valuation of horse, \$ 100

Valuation of horse equipments, \$ 100

Remarks:

Book mark:

E. H. Brown

P

110. Harty

U. S. C. T.

Charles Peters

Appears with rank of Pvt on

Muster and Descriptive Roll of a Detachment of U. S. Vols. forwarded

Organized as Co G.

~~for the~~ 10 Reg't U. S. Col'd H. A. Roll dated

New Orleans La Sept 20, 1864.

Where born *Watauga La*

Age 22 y'rs; occupation *Farmer*

When enlisted *Feb 29*, 1864.

Where enlisted *Port Hudson*

For what period enlisted 3 years.

Eyes *Blue*; hair *Blue*

Complexion *Blue*; height 5 ft. 5 1/2 in.

When mustered in *Apr 3*, 1864.

Where mustered in *New Orleans La*

Bounty paid \$ 100; due \$ 100

Where credited *to Port Hudson La*

Company to which assigned *G.*

Remarks:

Book mark:

E. B. Thompson

P

10 H. Art'y. U.S.C.T.

Charles Peters

Prvt., Co. G, 10 Reg't U. S. Col'd H. Art'y.

Appears on

Company Muster Roll

for Sept. & Oct., 1864.

Present or absent Absent

Stoppage, \$ 100 for

Due Gov't, \$ 100 for

Valuation of horse, \$ 100

Valuation of horse equipments, \$ 100

Remarks: Absent guard on Steamer Red Chief \$ 6. per mo. due from date of enlistment to April 30/64 \$ 9. per mo. due from April 30/64 to June 30/64

Book mark:

E. T. Brown

P

10 H. Art'y.

U.S.C.T.

Charles Peters

Pvt., Co. G, 10 Reg't U. S. Col'd H. Art'y.

Appears on

Company Muster Roll

for Nov Dec, 1864.

Present or absent Present

Stoppage, \$ 100 for

Due Gov't, \$ 100 for

Valuation of horse, \$ 100

Valuation of horse equipments, \$ 100

Remarks: Has rec'd but \$ 7 per month

Book mark:

E. H. Brown

9

10 H. Art'y. U.S.C.T.

Charles Peters

Prof, Co. G, 10 Reg't U. S. Col'd H. Art'y.

Appears on

Company Muster Roll

for Jan + Feby, 1865.

Present or absent Present

Stoppage, \$ 100 for

Due Gov't, \$ 100 for

Valuation of horse, \$ 100

Valuation of horse equipments, \$ 100

Remarks: Rec'd but \$ 7 per Mo from Enrollment to June 30/64

Book mark:

F. E. Porter

C

Charles Peters

Prof., Co. G, 10 Reg't U. S. Col'd H. Art'y.

Appears on

Company Muster Roll

for Mar & April, 1865.

Present or absent Present

Stoppage, \$ 100 for

Due Gov't, \$ 100 for

Valuation of horse, \$ 100

Valuation of horse equipments, \$ 100

Remarks: Rec'd but \$7 per Mo from Enrollment to June 30/65

Book mark:

F. E. Porter

P

10 H. Art'y. U.S.C.T.

Charles Peters

Prop, Co. G, 10 Reg't U. S. Col'd H. Art'y.

Appears on

Company Muster Roll

for May & June, 1865.

Present or absent Present

Stoppage, \$ 100 for

Due Gov't, \$ 100 for

Valuation of horse, \$ 100

Valuation of horse equipments, \$ 100

Remarks: Received but \$7 per
Mo from Enrollment
to June 30/65

Book mark:

F. E. Porter

P

10 H. Art'y. U.S.C.T.

Charles Peters

Prvt., Co. G, 10 Reg't U. S. Col'd H. Art'y.

Appears on

Company Muster Roll

for July & Aug, 1865.

Present or absent Present

Stoppage, \$ 100 for

Due Gov't, \$ 09/100 for C+G Equip

age lost or destroyed

Valuation of horse, \$ 100

Valuation of horse equipments, \$ 100

Remarks:

Book mark:

J. E. Porter

7

10 H. Art'y. U.S.C.T.

Charles Peters

Priv., Co. G, 10 Reg't U. S. Col'd H. Art'y.

Appears on

Company Muster Roll

for Sept & Oct, 1865.

Present or absent Present

Stoppage, \$ 100 for

Due Gov't, \$ 100 for

Valuation of horse, \$ 100

Valuation of horse equipments, \$ 100

Remarks:

Book mark:

J. E. Fortner

P

10 H. Art'y. U.S.C.T.

Charles Peters
Prvt., Co. G, 10 Reg't U. S. Col'd H. Art'y.

Appears on

Company Muster Roll

for *Nov. & Dec.*, 186*2*.

Present or absent *Present*

Stoppage, \$ 100 for

Due Gov't, \$ 45/100 for *red.*

Valuation of horse, \$ 100

Valuation of horse equipments, \$ 100

Remarks:

Book mark:

G. F. M.

P

10 H. Art'y. | U.S.C.T.

Charles Peters
Priv, Co. G, 10 Reg't U. S. Col'd H. Art'y.

Appears on

Company Muster Roll

for *Jan. & Feb.*, 1866.

Present or absent *Present*

Stoppage, \$.....100 for

Due Gov't, \$.....100 for

Valuation of horse, \$.....100

Valuation of horse equipments, \$.....100

Remarks:

Book mark:

(358)

E. F. M.
Copyist.

P

10 H. Art'y. | U.S.C.T.

Charles Peters

Capt, Co. G, 10 Reg't U. S. Col'd H. Art'y.

Appears on

Company Muster Roll

for *Mar. & Apr.*, 1866.

Present or absent *Present*

Stoppage, \$ *1⁹⁰*/₁₀₀ for *C.C. & G.E. lost*

Due Gov't, \$ *100* for

Valuation of horse, \$ *100*

Valuation of horse equipments, \$ *100*

Remarks:

Book mark:

(358)

G. F. W.

Copyist.

P

10 H. Art'y. U.S.C.T.

Charles Peters
Sgt., Co. G, 10 Reg't U. S. Col'd H. Art'y.

Appears on

Company Muster Roll

for *May & June*, 1866.

Present or absent *Present*

Stoppage, \$ 100 for

Due Gov't, \$ 100 for

Valuation of horse, \$ 100

Valuation of horse equipments, \$ 100

Remarks:

Book mark:

G. Fry

(358)

Copyist.

P

10 H. Art'y.

U.S.C.T.

Charles Peters
Private, Co. G, 10 Reg't U. S. Col'd H. Art'y.

Appears on

Company Muster Roll

for *July & Aug.*, 186*6*.

Present or absent *Present*

Stoppage, \$ *100* for

Due Gov't, \$ *100* for

Valuation of horse, \$ *100*

Valuation of horse equipments, \$ *100*

Remarks:

Book mark:

G. Fry

Copyist.

P

10 H. Art'y. U.S.C.T.

Charles Peters

Pvt, Co. G, 10 Reg't U. S. Col'd H. Art'y.

Appears on

Company Muster Roll

for Sept & Oct, 1866.

Present or absent Present

Stoppage, \$ 100 for

Due Gov't, \$ 100 for

Valuation of horse, \$ 100

Valuation of horse equipments, \$ 100

Remarks:

Book mark:

Wines

S

10 H. Art'y. U.S.C.T.

Charles Peters

Prvt, Co. G, 10 Reg't U. S. Col'd H. Art'y.

Appears on

Company Muster Roll

for *Nov & Dec*, 186*6*.

Present or absent *Present*

Stoppage, \$.....100 for

Due Gov't, \$.....100 for

Valuation of horse, \$.....100

Valuation of horse equipments, \$.....100

Remarks:.....

Book mark:.....

Mines

Charles Peter

Priv., Co. *G*, 10 Reg't U. S. Col'd H. Art'y.

Appears on Co. Muster-out Roll, dated *Baton Rouge, La, Feb 27, 1867.*

Muster-out to date *Feb 27, 1867.*

Last paid to *Dec 31, 1866.*

Clothing account:

Last settled _____, 186 ; drawn since \$ _____ 100

Due soldier \$ *38* ^{*60*}/₁₀₀; due U. S. \$ _____ 100

Am't for cloth'g in kind or money adv'd \$ _____ 100

Due U. S. for arms, equipments, &c., \$ *6* ^{*00*}/₁₀₀

Bounty paid \$ _____ 100; due \$ *3* ^{*00*}/₁₀₀

Remarks: *Joined at Org^l, Orgⁿ*

Book mark: _____

Wines

N. 10 U.S. Col'd H. Art'y.

Private Private

CARD NUMBERS.

1	55-09562	26
2	55-09653	27
3	55-09791	28
4	55-09943	29
5	55-10092	30
6	55-10241	31
7	55-10391	32
8	55-10539	33
9	55-10639	34
10	55-10783	35
11	55-10888	36
12	55-11192	37
12	R & P 507.381.	38
14		39
15		40
16		41
17		42
18		43
19		44
20		45
21		46
22		47
23		48
24		49
25		50

Book Mark: R & P 507.381.

See also

R.P. 507381

M.P. Worley
J
47

P | 10 H. Art'y. | U.S.C.T.

Pierre Peters

Priv., Co. H, 10 Reg't U. S. Col'd H. Art'y.

Appears on

Company Muster-in and Descriptive Roll

of the organization named above. Roll dated

New Orleans La Nov 8, 1864.

Where born St. Charles La

Age 24 y'rs; occupation Laborer

When enlisted Nov 2, 1864.

Where enlisted New Orleans

For what period enlisted 3 years.

Eyes Black; hair Black

Complexion Black; height 5 ft. 10 in.

When mustered in Nov 8, 1864.

Where mustered in New Orleans

Bounty paid \$ 100; due \$ 100

Where credited 1st Dist. 2nd ward, Parish of Orleans, City of N. Orleans La.

Company to which assigned A.

Remarks: mustered in to date from date of Enlistment

NEXT ROLL ON FILE FEB 1865

Book mark: R.D. 507381.

Perrinington

(356d)

Copyist.

P

10 H. Art'y.

U.S.C.T.

Pierre Peter

Pvt

Co. H, 10 Reg't U. S. Col'd H. Art'y

Appears on

Company Muster Roll

for *Jan'y & Feb'y*, 1865.

Present or absent *Present*

Stoppage, \$ 100 for

Due Gov't, \$ 100 for

Valuation of horse, \$ 100

Valuation of horse equipments. \$ 100

Remarks :

Book mark :

Perrington

(358)

Copyist.

P | 10 H. Art'y. | U.S.C.T.

Pierre Peter

Pvt, Co. H, 10 Reg't U. S. Col'd H. Art'y

Appears on

Company Muster Roll

for *March & April*, 1865:

Present or absent *Present*

Stoppage, \$ *100* for

Due Gov't, \$ *100* for

Valuation of horse, \$ *100*

Valuation of horse equipments. \$ *100*

Remarks:

Book mark:

(858)

Perrington
Copyist.

P

10 H. Art'y.

U.S.C.T.

Pierre Peter

Priv., Co. H, 10 Reg't U. S. Col'd H. Art'y

Appears on

Company Muster Roll

for May & June, 1865.

Present or absent Present

Stoppage, \$ 100 for

Due Gov't, \$ 100 for

Valuation of horse, \$ 100

Valuation of horse equipments. \$ 100

Remarks:

Book mark:

Permynter

(358)

Copyist.

P | 10 H. Art'y. | U.S.C.T.

Pierre Peter

Pvt, Co. H, 10 Reg't U. S. Col'd H. Art'y

Appears on

Company Muster Roll

for *July & Aug*, 1865:

Present or absent *Present*

Stoppage, \$ *100* for

Due Gov't, \$ *100* for

Valuation of horse, \$ *100*

Valuation of horse equipments. \$ *100*

Remarks :

Book mark :

(358)

Perrington

Copyist.

P

10 H. Art'y.

U.S.C.T.

Peter Pierre

Privt., Co. H, 10 Reg't U. S. Col'd H. Art'y

Appears on

Company Muster Roll

for *Sep & Oct*, 1865.

Present or absent *Present*

Stoppage, \$ *100* for

Due Gov't, \$ *100* for

Valuation of horse, \$ *100*

Valuation of horse equipments. \$ *100*

Remarks :

Book mark :

(858)

Samuel P
Copyist.

P

10 H. Art'y. U.S.C.T.

Peter Pierre

Pvt., Co. H, 10 Reg't U. S. Col'd H. Art'y

Appears on

Company Muster Roll

for *Nov 9 Dec*, 1865.

Present or absent *Present*

Stoppage, \$ 100 for

Due Gov't, \$ 100 for

Valuation of horse, \$ 100

Valuation of horse equipments. \$ 100

Remarks :

Book mark :

Gammack

P

10 H. Art'y.

U.S.C.T.

Piero Peter

Priv., Co. H, 10 Reg't U. S. Col'd H. Art'y

Appears on

Company Muster Roll

for *Jan & Feb.*, 186*6*

Present or absent *Present*

Stoppage, \$ *100* for

Due Gov't, \$ *100* for

Valuation of horse, \$ *100*

Valuation of horse equipments. \$ *100*

Remarks :

Book mark :

Sammack

P

10 H. Art'y.

U.S.C.T.

Pierre Peter

Priv., Co. H, 10 Reg't U. S. Col'd H. Art'y

Appears on

Company Muster Roll

for *Mch & Apr.*, 1866

Present or absent *Present*

Stoppage, \$ *100* for

Due Gov't, \$ *100* for

Valuation of horse, \$ *100*

Valuation of horse equipments. \$ *100*

Remarks:

Book mark:

Loammack

(858)

Copyist.

P

10 H. Art'y.

U.S.C.T.

Pierre Peter

Cpt., Co. H, 10 Reg't U. S. Col'd H. Art'y

Appears on

Company Muster Roll

for *May & June*, 186*6*.

Present or absent *Present*

Stoppage, \$ *100* for

Due Gov't, \$ *100* for

Valuation of horse, \$ *100*

Valuation of horse equipments. \$ *100*

Remarks :

Book mark :

Gammack

(858)

Copyist.

P

10 H. Art'y.

U.S.C.T.

Pierre Peter

Co. H, 10 Reg't U. S. Col'd H. Art'y

Appears on

Company Muster Roll

for July & Aug, 1866.

Present or absent

Stoppage, \$ 100 for

Due Gov't, \$ 100 for

Valuation of horse, \$ 100

Valuation of horse equipments, \$ 100

Remarks: Deserted from Company at Fort Jackson La Aug 17th 1866.

Book mark:

(858)

Gamma R

Copyist.

P

10 H. Art'y. U.S.C.T.

Pierre Peter

Pvt, Co. H., 10 Reg't U. S. Col'd H. Art'y.

Appears on Co. Muster-out Roll, dated

Baton Rouge, La., Feb. 22, 1867.

Muster-out to date _____, 186 .

Last paid to June 30, 186(*).

Clothing account:

Last settled _____, 186 ; drawn since \$ _____ 100

Due soldier \$ 2 / 10 / 100; due U. S. \$ _____ 100

Am't for cloth'g in kind or money adv'd \$ _____ 100

Due U. S. for arms, equipments, &c., \$ _____ 100

Bounty paid \$ _____ 100; due \$ _____ 100

Remarks: Deserted Aug. 17/66 at Ft. Jackson, La.

*Roll torn.

Book mark:

Lowry

(361)

Copyist.

P 10 N.A. U.S.C.

Pierre Peters

, Co. N., 10 Reg't U.S.C. N.A.

NOTATION.

Book mark: R. & P. 507381

Record and Pension Office,

WAR DEPARTMENT,

Washington, April 6, 1898.

Application for removal of the charge of desertion and
for an honorable discharge has been denied.

A.G.M.

(437)

Copyist.

Peters, Pierre

O, Co. H, 10th Reg't U. S. A.

2 Enclosures.

Bed Cards	Final Statements
Burial Records	Furloughs or L. of A.
Certs. of Dis. for Discharge	Med. Certificates
C. M. Charges	Med. Des. Lists
Descriptive Lists	Orders
Discharge Certificates	Pris. of War Record
Enlistment Papers 2	Resignations

Other papers relating to—

Admission to Hosp'l	Furlough or L. of A.
Casualty Sheet	Med. Examination
Confinement	Misc. Information
Contracts	Pay or Clothing
Death or Effects	Personal Reports
Desertion	Rank
Discharge from Hosp'l	Transfer to Hosp'l
Discharge from Service	Transfer to V. R. C.
Duty	Transportation

NOTE 1.—This blank will be used for both enlistments and re-enlistments—enlistment of veterans, &c., &c., in the volunteer service. They will be made out in duplicate in all cases—one to accompany the recruiting return of the superintendent (not the recruiting officer) to the Adjutant General, and one to accompany the accounts of the officer who pays bounty, &c. The Regiment and Company in which the soldier last served should be given on the back.

NOTE 2.—An enlistment holds to service. A muster-in must, in all cases, precede payment of pay, bounty, pension, &c. A muster-in roll must, in all cases, be filed in the Adjutant General's Office as evidence of muster-in. The mustering officer, commissary, or assistant commissary of musters, as the case may be, will countersign both enlistments as having mustered the soldier into the service of the United States before either of them is given to the disbursing officer.

DECLARATION OF RECRUIT.

I, Pierre Peter, desiring to VOLUNTEER as a Soldier in the Army of the United States, for the term of THREE YEARS, Do Declare, That I am 24 years and _____ months of age; that I have never been discharged from the United States service on account of disability or by sentence of a court martial, or by order before the expiration of a term of enlistment; and I know of no impediment to my serving honestly and faithfully as a soldier for three years.

GIVEN at New Orleans La the 2 day of November 1864

Witness:

M. Palmieri Pierre Peter
Witness Wak

107180269
No. 570
Pierre Peter
Volunteered at New Orleans
Nov 2, 1864
By M. Palmieri
84 Regiment of A. J. C. O.
enlistment; last served in Company ()
Regt of _____
Discharged _____, 18____
Company H 1st Louisiana
Co Battery

CONSENT IN CASE OF MINOR.

I, _____, Do CERTIFY, That I am _____ the _____ of _____; that the said _____ is _____ years of age; and I do hereby freely give my CONSENT to his volunteering as a SOLDIER in the ARMY OF THE UNITED STATES for the period of THREE YEARS.

GIVEN at _____ the _____ day of _____

Witness:

VOLUNTEER ENLISTMENT.

STATE OF

TOWN OF

Louisiana

New Orleans



I, *Pierre Peter*, born in *St Charles* in the State of *Louisiana*, aged *24* years, and by occupation a *Laborer*, Do HEREBY ACKNOWLEDGE to have volunteered this *second* day of *November*, 186*4*, to serve as a **Soldier** in the **Army of the United States of America**, for the period of **THREE YEARS**, unless sooner discharged by proper authority: Do also agree to accept such bounty, pay, rations, and clothing, as are, or may be, established by law for volunteers. And I, *Pierre Peter*, do solemnly swear, that I will bear true faith and allegiance to the **United States of America**, and that I will serve them honestly and faithfully against all their enemies or opposers whomsoever; and that I will observe and obey the orders of the President of the United States, and the orders of the officers appointed over me, according to the Rules and Articles of War.

Sworn and subscribed to, at *New Orleans* this *2* day of *Nov*, 186*4*, BEFORE *H. Palmieri*

I CERTIFY, ON HONOR, That I have carefully examined the above-named Volunteer, agreeably to the General Regulations of the Army, and that, in my opinion, he is free from all bodily defects and mental infirmity, which would in any way disqualify him from performing the duties of a soldier.

W. H. Humphrey

EXAMINING SURGEON.

I CERTIFY, ON HONOR, That I have minutely inspected the Volunteer *Pierre Peter* previously to his enlistment, and that he was entirely sober when enlisted; that, to the best of my judgment and belief, he is of lawful age; and that, in accepting him as duly qualified to perform the duties of an able-bodied soldier, I have strictly observed the Regulations which govern the recruiting service. This soldier has *Blue* eyes, *Blue* hair, *Blue* complexion, is *5* feet *10* inches high.

H. Palmieri
1284 Regiment of *USCO* Volunteers,

RECRUITING OFFICER.

(A. G. O. No. 74 & 76.)

Mustered into the service of the United States, for three years or during the war, from date of enlistment, in Company *76* of the *10* Regiment of *USCO* Volunteers, on the *8* day of *Nov* 186*4*, at *New Orleans*

John W. Hamilton
1st Lt. 1284 USCO
W. H. Humphrey

NOTE 1.—This blank will be used for both enlistments and re-enlistments—enlistment of veterans, &c., &c., in the volunteer service. They will be made out in duplicate in all cases—one to accompany the recruiting return of the superintendent (not the recruiting officer) to the Adjutant General, and one to accompany the accounts of the officer who pays bounty, &c. The Regiment and Company in which the soldier last served should be given on the back

NOTE 2.—An enlistment holds to service. A muster-in must, in all cases, precede payment of pay, bounty, pension, &c. A muster-in roll must, in all cases, be filed in the Adjutant General's Office as evidence of muster-in. The mustering officer, commissary, or assistant commissary of musters, as the case may be, will countersign both enlistments as having mustered the soldier into the service of the United States before either of them is given to the disbursing officer.

DECLARATION OF RECRUIT.

I, Pierre Peters, desiring to VOLUNTEER as a Soldier in the Army of the United States, for the term of THREE YEARS, Do Declare, That I am Twenty four years and _____ months of age; that I have never been discharged from the United States service on account of disability or by sentence of a court martial, or by order before the expiration of a term of enlistment; and I know of no impediment to my serving honestly and faithfully as a soldier for three years.

GIVEN at New Orleans La the 2nd day of November 1864

Witness: A. P. P. P., Pierre Peters



Discharged _____, 18 _____
Conscripted in Louisiana
to Bounty

enlistment; last served in Company ()
Reg't of _____

10 WA 250A
Regiment of _____

By Dr. G. H. P. P., 1864

Volunteered at New Orleans

No. _____
Pierre Peters

CONSENT IN CASE OF MINOR.

I, _____, Do CERTIFY, That I am _____ the _____ of _____; that the said _____ is _____ years of age; and I do hereby freely give my CONSENT to his volunteering as a SOLDIER in the ARMY OF THE UNITED STATES for the period of THREE YEARS.

GIVEN at _____ the _____ day of _____

Witness: _____

VOLUNTEER ENLISTMENT.

STATE OF

TOWN OF

Louisiana



New Orleans

I, Pierre Peters, born in St Charles in the State of Louisiana, aged twenty four years, and by occupation a Laborer, Do HEREBY ACKNOWLEDGE to have volunteered this 2nd day of November, 1864, to serve as a Soldier in the Army of the United States of America, for the period of THREE YEARS, unless sooner discharged by proper authority: Do also agree to accept such bounty, pay, rations, and clothing, as are, or may be, established by law for volunteers. And I, Pierre Peters, do solemnly swear, that I will bear true faith and allegiance to the United States of America, and that I will serve them honestly and faithfully against all their enemies or opposers whomsoever; and that I will observe and obey the orders of the President of the United States, and the orders of the officers appointed over me, according to the Rules and Articles of War.

Sworn and subscribed to, at New Orleans this 2nd day of Nov, 1864, before St. Leger, 1st Lieut 84th U.S.C.

I CERTIFY, ON HONOR, That I have carefully examined the above-named Volunteer, agreeably to the General Regulations of the Army, and that, in my opinion, he is free from all bodily defects and mental infirmity, which would in any way disqualify him from performing the duties of a soldier.

Wm. H. Humphrey Surgeon U.S.A. EXAMINING SURGEON.

I CERTIFY, ON HONOR, That I have minutely inspected the Volunteer Pierre Peters previously to his enlistment, and that he was entirely sober when enlisted; that, to the best of my judgment and belief, he is of lawful age; and that, in accepting him as duly qualified to perform the duties of an able-bodied soldier, I have strictly observed the Regulations which govern the recruiting service. This soldier has Blue eyes, Blk hair, Fair complexion, is 5 feet 10 inches high.

St. Leger, 1st Lieut 84th U.S.C. Volunteers, RECRUITING OFFICER.

(A. G. O. No. 74 & 76.)

Mustered into the service of the United States, for three years or during the war, from date of enlistment, in Company 76 10 Regiment of 26th & 75th Volunteers, on the 8 day of Nov 1864 at New Orleans

John H. ... 1st Lieut 84th U.S.C. ...

C. , 10 U.S. Col'd H. Art

Private | Private.

CARD NUMBERS.

1	5487150.	26
2	5502427	27
3	5502694	28
4	5504612.	29
5		30
6		31
7		32
8		33
9		34
10		35
11		36
12		37
13		38
14		39
15		40
16		41
17		42
18		43
19		44
20		45
21		46
22		47
23		48
24		49
25		50

Book Mark:

See also

P

10 H. Art'y. | U.S.C.T.

Richmond Peters

Co. 6, 7 Reg't U. S. Col'd H. Art'y.*

Appears on

Company Muster-in and Descriptive Roll

of the organization named above. Roll dated

New Orleans La July 3, 1864.

Where born Missis

Age 25 y'rs; occupation Laborer

When enlisted April, 1864.

Where enlisted Alexandria

For what period enlisted 3 years.

Eyes Dark; hair Dark

Complexion Dark; height 5 ft. 6 in.

When mustered in June 25, 1864.

Where mustered in New Orleans

Bounty paid \$ 2 100; due \$ 100

Where credited Alexandria

Company to which assigned 6

Remarks:

* This organization subsequently became Co. 8, 10 Reg't U. S. Colored Heavy Artillery.

Book mark:

(356d)

Grider

Copyist.

P

10 H. Art'y. U.S.C.T.

Richmond Peters

Appears with rank of Priv on

Muster and Descriptive Roll of a Detachment of U. S. Vols. forwarded

for the 7 Reg't U. S. H. Art* Roll dated New Orleans La, June, 1864.

Where born Miss.

Age 25 y'rs; occupation Labors

When enlisted April 19, 1864.

Where enlisted Alexandria

For what period enlisted 3 years.

Eyes Dark; hair Dark

Complexion Dark; height 5 ft. 6 in.

When mustered in June 25, 1864.

Where mustered in New Orleans

Bounty paid \$ 100; due \$ 100

Where credited

Company to which assigned E

Remarks:

* Became 10 U. S. Cold H. Art.

Book mark:

S. M. Williams

P

10 H. Art'y. U.S.C.T.

Richmond Peters

Prs., Co. E, 10 Reg't U. S. Col'd H. Art'y.

Appears on

Company Muster Roll

for July Aug, 1864

Present or absent

Stoppage, \$ 100 for

Due Gov't, \$ 100 for

Valuation of horse, \$ 100

Valuation of horse equipments, \$ 100

Remarks: Died Aug 16 64
De Sair Station La.

Book mark:

(358)

Luider

Copyist.

P | 10 H. Art'y. | U.S.C.T.

Richmond Peters
Priv, Co. *E*, 10 Reg't U. S. Col'd H. Art'y.

Appears on Co. Muster-out Roll, dated
Baton Rouge, La, Feb. 22, 1867.

Muster-out to date _____, 186 .

Last paid to *Never paid*, 186 .

Clothing account:

Last settled _____, 186 ; drawn since \$ _____ 100

Due soldier \$ _____ 100; due U. S. \$ _____ 100

Am't for cloth'g in kind or money adv'd \$ _____ 100

Due U. S. for arms, equipments, &c., \$ _____ 100

Bounty paid \$ _____ 100; due \$ _____ 100

Remarks: *Joined at Org, Organs,*
as Private.

Died in camp de Saint
La. Aug. 16, 1864, of
Diarrhoea.

Book mark: _____

(361)

O'Hagan
Copyist.

Peters, Richmond

P, Co. E, 10 Reg't U.S.C.H.A.

/ Enclosures.

Bed Cards	Descriptive Lists
Burial Records	Final Statements /
Certs. of Dis. for Discharge	Furloughs
C. M. Charges	Med. Des. Lists
Med. Certificates	Orders

Other papers relating to—

Admission to Hosp'l	Furlough
Casualty Sheet (Officer's)	Med. Examination
Confinement	Misc. Information
Contracts	Pay or Clothing
Death or Effects	Personal Reports
Desertions	Rank
Discharge from Hosp'l	Transfer to Hosp'l
Discharge from Service	Transfer to V. R. C.
Duty	Transportation

FINAL STATEMENT

OF

✓
Richmond Peters
Company
7th Reg't of U. S. Col. A. S. (743)
10. 26. S.

VOLUNTEERS!

Disch. Aug 11 1864

NOTE 1.—Two of these certificates (or duplicates) are to be given to each Volunteer Soldier or drafted man who may be discharged previously to the discharge of his company, that he may at once receive from the Paymaster the pay, &c., due him, and the captain or other COMMISSIONED officer commanding the company will certify to the act of the delivery of the duplicate certificates; on these certificates the Soldier is "entitled to" his discharge, and should also present his discharge to the Paymaster to have the payment endorsed on it. The discharge is to be given back to the Soldier by the Paymaster; the latter only retaining as his voucher the duplicate certificates.

NOTE 2.—If the Soldier is entitled to pay for the use of his horse, the Company Commander will certify to that fact on the back of both these final statements, and also to the time he has pay due for having been so mounted on his own horse.

NOTE 3.—When a Soldier is furnished with final statements, his descriptive list, if he has one, should be taken up by the officer who gives the Soldier these statements, and endorsed with a statement to this effect by the officer. This endorsement should exhibit a full statement of the time for which the Soldier was allowed pay on his final statements, the clothing account, and all other charges against him or in his favor, so as to comprise a complete exhibit of his account. It will then be transmitted to the company commander of the Soldier, who will enter all the data necessary to a full understanding of the Soldier's account on the muster roll upon which the Soldier's discharge is reported. The descriptive list will then be destroyed. The object of this is, that the remaining portion of the Soldier's account may be settled upon the receipt of these muster rolls, and the Soldier receive any pay or allowances that may be due him at the time of his discharge, and which may not appear on his final statements from the fact that his descriptive list is incomplete. These accounts for back pay, &c., are settled by the 2d Auditor of the Treasury Department.

NOTE 4.—Charges for loss or injury to ordnance, horse equipments, and other miscellaneous charges, should appear under the heading of "Other Stoppages."

NOTE 5.—Bounty paid by State authorities, and not by the United States, will not be entered on this statement.

NOTE 6.—Amounts due the Sutler and Laundress must be entered on the muster roll on which the discharge, death, desertion, &c., is reported, as well as on the final statement, otherwise the amount cannot be collected from the United States.

NOTE 7.—This blank will be used for deceased volunteers and drafted men, as well as for others.

NOTE 8.—Where a Soldier dies in Hospital or on detached service, his descriptive list, if he has one, should be sent with his final statements, in duplicate, to the Second Auditor, Washington, D. C.

ADJUTANT GENERAL'S OFFICE.
Sept 5th 1864
Duplicate with inventory sent 2d Auditor.

RECEIVED
ADJUTANT GEN'L'S OFFICE
SEPT 5 1864

Peters

I certify, on honor, that Richmond Peters Private of
Captain M. Hawke Company (E) of the 7th Regiment of U.S. Col. Arty (Heavy)
VOLUNTEERS, of the State of _____, born in _____, State
of Mississippi; aged 25 years; 5 feet 6 inches high; Dark complexion,
Dark eyes, Dark hair, and by occupation a Laborer, having joined the company on
its original organization at New Orleans, and enrolled in it at the muster into
the service of the United States at April, on the 19th day
of April, 1864, (or was mustered in service as a recruit, by A. C. Chamberlain
A. C. Master at New Orleans on the 25th day of January
1864, or was drafted and mustered into the service of the United States from the _____
Enrollment District of the State of _____, at _____,
on the _____ day of _____, 186) to serve in the Regiment, for
the term of Three Years; and having served HONESTLY and
FAITHFULLY with his Company in Garrison to the present date, is now
entitled to **DISCHARGE** by reason of Death - Died this
11th day of August - 1864 - of Typhoid - No effects

The said Richmond Peters was ~~last~~ ^{never} paid, by Paymaster
_____ to include the _____ day of _____, 186 ~~and~~ ^{he} has
pay due him from ~~that~~ ^{the time of enlistment} time to the present date; he is entitled to pay and subsistence for
TRAVELING to place of enrollment, and whatever other allowances are authorized to volunteer
soldiers, drafted men, or militia, so discharged. He has received from the United States **CLOTHING**
amounting to 4 8 42/₁₀₀ dollars, since the 19th day of April,
1864, when his clothing account was last settled. He has received from the United States
_____ 100 dollars advanced **BOUNTY**.

There is to be stopped from him, on account of the State of _____, or other
authorities, for **CLOTHING**, &c., received on entering service, _____ 100 dollars; and
for other stoppages, viz: _____
_____ 100 dollars.

He has been furnished with **TRANSPORTATION** in kind from the place of his discharge to
_____ ; and he has been **SUBSISTED** for **TRAVELING** to his
place of enrollment, up to the _____, 186 .

He is indebted to _____, **SUTLER**, _____ 100 dollars.
He is indebted to _____, **LAUNDRESS**, _____ 100 dollars.

Given in Duplicate, at De. Surr Station La, this 16th day
of August, 1864.

A. Phoenix 1st Lieut
7th U.S. Col. Arty (Heavy)
Commanding Company.

U.S. SOLDIER

Private

1st Sergeant

CARD NUMBERS.

1	5487266	26
2	5495819	27
3	5495970	28
4	5496121	29
5	5496274	30
6	5496423	31
7	5496568	32
8	5496859	33
9	5497360	34
10		35
11		36
12		37
13		38
14		39
15		40
16		41
17		42
18		43
19		44
20		45
21		46
22		47
23		48
24		49
25		50

Book Mark:

See also

P

10 H. Art'y. U.S.C.T.

Victor Armand Peyroux

Appears with rank of Priv. on

Muster and Descriptive Roll of a Detachment of U. S. Vols. forwarded

for the 10 Reg't U.S. Col'd H. Art'y. Roll dated New Orleans, La., Oct. 5, 1864.

Where born New Orleans, La.

Age 26 y'rs; occupation Fireworks maker

When enlisted Oct. 1st, 1864.

Where enlisted New Orleans, La.

For what period enlisted 3 years.

Eyes Brown; hair light

Complexion dark; height 5 ft. 11 in.

When mustered in Oct. 5th, 1864.

Where mustered in New Orleans

Bounty paid \$ 100; due \$ 300 100

Where credited

Company to which assigned B

Remarks: Credited to New Orleans, La.

Recruit entitled to bounty

provided for in circular No. 27 Office

Proc. Mar. Genl. dated July 19/64.

Book mark:

Long

Copyist.

(339)

S

10 H. Art'y. U.S.C.T.

V. Armand Peyroux
1st Sgt., Co. B, 10 Reg't U. S. Col'd H. Art'y.

Appears on

Company Muster Roll

for *Sept & Oct*, 186*4*

Present or absent *Present*

Stoppage, \$ 100 for

Due Gov't, \$ 100 for

Valuation of horse, \$ 100

Valuation of horse equipments, \$ 100

Remarks: *Enlisted Oct 1st 1864,*
mustered in Oct 5th 1864 as
Orderly Sergeant

Book mark: _____

(358)

J. A. Richardson
Copyist.

P.

10 H. Art'y. U.S.C.T.

V. Armond Peyraux

1st Sergt., Co. B, 10 Reg't U. S. Col'd H. Art'y.

Appears on

Company Muster Roll

for *Nov & Dec*, 186*4*.

Present or absent *Present*.

Stoppage, \$ *100* for

Due Gov't, \$ *100* for

Valuation of horse, \$ *100*

Valuation of horse equipments, \$ *100*

Remarks: *This recruit is entitled to the bounty provided for in circular No 27. Office Br. Major Genl Dated July 19th 1864*

Book mark:

(358)

Jones

Copyist.

G.

10 H. Art'y. U.S.C.T.

V. Amard Peyron

Sergt., Co. B, 10 Reg't U. S. Col'd H. Art'y.

Appears on

Company Muster Roll

for *Jan & Feb*, 1865.

Present or absent *Present*.

Stoppage, \$ *100* for

Due Gov't, \$ *100* for

Valuation of horse, \$ *100*

Valuation of horse equipments, \$ *100*

Remarks: *This soldier is entitled to the Bounty provided for in Cir No 27 O.P.M.G. dated July 19 1864*

Book mark:

(358)

Jornier

Copyist.

P.

10 H. Art'y. U.S.C.T.

Armand Peyroux

1st Sergt, Co. B, 10 Reg't U. S. Col'd H. Art'y.

Appears on

Company Muster Roll

for Mar & Apr, 1865.

Present or absent Present

Stoppage, \$ 100 for

Due Gov't, \$ 100 for

Valuation of horse, \$ 100

Valuation of horse equipments, \$ 100

Remarks: Sick in Lrs.

Book mark:

(358)

Jones

Copyist.

P.

10 H. Art'y.

U.S.C.T.

Victor Armand Peyroux
1st Sergt.; Co. B, 10 Reg't U. S. Col'd H. Art'y.

Appears on

Company Muster Roll

for *May & June*, 1865.

Present or absent *Present.*

Stoppage, \$ *100* for

Due Gov't, \$ *100* for

Valuation of horse, \$ *100*

Valuation of horse equipments, \$ *100*

Remarks:

Book mark: -----

(358)

Jamies

Copyist.

P.

10 H. Art'y. U.S.C.T.

V. Armand Peyroux
1st Sergt, Co. B, 10 Reg't U. S. Col'd H. Art'y.

Appears on

Company Muster Roll

for July & Aug., 1865.

Present or absent Present

Stoppage, \$ 100 for

Due Gov't, \$ 100 for

Valuation of horse, \$ 100

Valuation of horse equipments, \$ 100

Remarks: Is entitled to
the bounty provided
for in circular No 27
O.P.M.Sd dated July
19/64.

Book mark:

(358)

Jornier

Copyist.

P.

10 H. Art'y. U.S.C.T.

Victor Armand Peyroux

~~1st Lt.~~ 1st Lt. Sgt.

Co. B, 10 Reg't U. S. Col'd H. Art'y.

Appears on

Company Muster Roll

for Sept & Oct., 1865.

Present or absent

Stoppage, \$ 100 for

Due Gov't, \$ 100 for

Valuation of horse, \$ 100

Valuation of horse equipments, \$ 100

Remarks: Discharged on
Surg. certificate of
Disability Sept. 19th
1865. Final statements
given. Due U.S.
for Ordnance 35 cts
charged on final
statements.

76 received by Worley 47.
Book mark:

J. J. J.

P

10 H. Art'y. U.S.C.T.

Victor Armand Peyroux
1st Sgt, Co. P, 10 Reg't U. S. Col'd H. Art'y.

Appears on Co. Muster-out Roll, dated
Baton Rouge, La. Feb, 1867.

Muster-out to date _____, 186 .

Last paid to _____, 186 .

Clothing account:

Last settled _____, 186 ; drawn since \$ _____ 100

Due soldier \$ _____ 100; due U. S. \$ _____ 100

Am't for cloth'g in kind or money adv'd \$ _____ 100

Due U. S. for arms, equipments, &c., \$ _____ 100

Bounty paid \$ _____ 100; due \$ _____ 100

Remarks:

Joined as recruit
Prot to Oct. 12/64.
Discharged Sept 19/65
on Certificate of Dis-
ability.

Book mark: _____

Hodges

(361)

Copyist.

Peyproux, Victor Armand

1 Sgt, Co. B, 10 U.S.C.H.A.

3

Enclosures.

Bed Cards	Descriptive Lists
Burial Records	Final Statements
Certs. of Dis. for Discharge /	Furloughs
C. M. Charges	Med. Des. Lists
Med. Certificates	Orders
<i>Enlist. Papers</i> 2	

Other papers relating to—

Admission to Hosp'l	Furlough
Casualty Sheet (Officer's)	Med. Examination
Confinement	Misc. Information
Contracts	Pay or Clothing
Death or Effects	Personal Reports
Desertions	Rank
Discharge from Hosp'l	Transfer to Hosp'l
Discharge from Service	Transfer to V. R. C.
Duty	Transportation

DECLARATION OF RECRUIT.

* Victor Armand Peyroux desiring to VOLUNTEER as a Soldier in the Army of the United States, for the term of THREE YEARS, Do Declare, That I am Twenty Six years and _____ months of age; that I have never been discharged from the United States service on account of disability or by sentence of a court martial, or by order before the expiration of a term of enlistment; and I know of no impediment to my serving honestly and faithfully as a soldier for three years.

GIVEN at New Orleans, La. the First day of October, 1864

Witness:

Attest: [Signature]
 Secy. Co. G. 10th US Col. Artillery

V. A. Peyroux

NOTE 1.—This blank will be used for both enlistments and re-enlistments—enlistment of veterans, &c., &c., in the volunteer service. They will be made out in duplicate in all cases—one to accompany the recruiting return of the superintendent (not the recruiting officer) to the Adjutant General and one to accompany the accounts of the officer who pays bounty, &c. The Regiment and Company in which the soldier last served should be given on the back.

NOTE 2.—An enlistment holds to service. A muster-in must, in all cases, precede payment of pay, bounty, pension, &c. A muster-in roll must, in all cases, be filed in the Adjutant General's Office as evidence of muster-in. The mustering officer, commissary, or assistant commissary of musters, as the case may be, will countersign both enlistments as having mustered the soldier into the service of the United States before either of them is given to the disbursing officer.

Recruit attested to [Signature] by Ser. No. 27 Office No. [Signature] Mar. General July 19. 1864.

enlistment; last served in Company ()
10th Reg't of U. S. Col. Artillery
 Discharged _____ 1864

By Sisur Chas. S. Dearing
 10th Regiment of U. S. Col. Artillery

V. A. Peyroux
 Volunteered at New Orleans, La.

No. 1078

CONSENT IN CASE OF MINOR.

I, _____ Do CERTIFY, That I am _____; that the _____ of _____; that the _____ is _____ years of age; and I do hereby freely give my CONSENT to his volunteering as a SOLDIER in the ARMY OF THE UNITED STATES for the period of THREE YEARS.

GIVEN at _____ the _____ day of _____

Witness: _____

VOLUNTEER ENLISTMENT.

STATE OF



CITY OF

Louisiana

New Orleans

I, Victor Armand Peyroux born in New Orleans in the State of Louisiana aged Twenty-Six years, and by occupation a Fire Works Maker Do HEREBY ACKNOWLEDGE to have volunteered this First day of October 1864, to serve as a Soldier in the Army of the United States of America, for the period of THREE YEARS, unless sooner discharged by proper authority: Do also agree to accept such bounty, pay, rations, and clothing, as are, or may be, established by law for volunteers. And I, Victor Armand Peyroux do solemnly swear, that I will bear true faith and allegiance to the United States of America, and that I will serve them honestly and faithfully against all their enemies or opposers whomsoever; and that I will observe and obey the orders of the President of the United States, and the orders of the officers appointed over me, according to the Rules and Articles of War.

Sworn and subscribed to, at New Orleans, La. this First day of October 1864 } V. A. Peyroux
BEFORE J. N. Chaubulain
Capt. 10th U. S. Col. Artillery

I CERTIFY, ON HONOR, That I have carefully examined the above-named Volunteer, agreeably to the General Regulations of the Army, and that, in my opinion, he is free from all bodily defects and mental infirmity, which would in any way disqualify him from performing the duties of a soldier.

Wm. H. Mather
Camp 10 Reg. U.S.C. Artillery
EXAMINING SURGEON.

I CERTIFY, ON HONOR, That I have minutely inspected the Volunteer, V. A. Peyroux previously to his enlistment, and that he was entirely sober when enlisted; that, to the best of my judgment and belief, he is of lawful age; and that, in accepting him as duly qualified to perform the duties of an able-bodied soldier, I have strictly observed the Regulations which govern the recruiting service. This soldier has Brown eyes, light hair, dark complexion, is Five feet Eleven inches high.

Charles S. Leering Lieut. Col. 10th Regiment of U.S. Col. Artillery (Head)
RECRUITING OFFICER.

(A. G. O. No. 74 & 76.)

Mustered into the service of the United States, for three years or during the war, from date of enlistment, in Company D of the 10th Regiment of U. S. Col. Artillery Volunteers, on the 5th day of October, 1864, at New Orleans.

J. N. Chaubulain
Capt. 10th U. S. Col. Artillery
Mustering Officer

DECLARATION OF RECRUIT.

I, Victor Armand Peyroux desiring to VOLUNTEER as a Soldier in the Army of the United States, for the term of THREE YEARS, Do Declare, That I am Twenty-Six years and _____ months of age; that I have never been discharged from the United States service on account of disability or by sentence of a court martial, or by order before the expiration of a term of enlistment; and I know of no impediment to my serving honestly and faithfully as a soldier for three years.

GIVEN at New Orleans, La the First day of October 1864

Witness:

Nathaniel Bustank
1st Lieut Co. 31st U.S. Col. Art. (H.Y.)

V. A. Peyroux

No.

V. A. Peyroux
Volunteered at New Orleans, La

October 1st 1864,

By Lieut Charles S. Deising

10th Regiment of U.S. Col. Art. (H.Y.)

enlistment; last served in Company ()

Reg't of _____

Discharged _____ 18 _____

Recruit entitled to Bounty
by Gen. No 27 office Pro
War Gen'l dated July 19th
1864

CONSENT IN CASE OF MINOR.

I, _____ Do CERTIFY, That I am the _____ of _____; that the said _____ is _____ years of age; and I do hereby freely give my CONSENT to his volunteering as a SOLDIER in the ARMY OF THE UNITED STATES for the period of THREE YEARS.

GIVEN at _____ the _____ day of _____

Witness:

NOTE 1.—This blank will be used for both enlistments and re-enlistments—enlistment of veterans, &c., &c., in the volunteer service. They will be made out in duplicate in all cases—one to accompany the recruiting return of the superintendent (not the recruiting officer) to the Adjutant General, and one to accompany the accounts of the officer who pays bounty, &c. The Regiment and Company in which the soldier last served should be given on the back.

NOTE 2.—An enlistment holds to service. A muster-in must, in all cases, precede payment of pay, bounty, pension, &c. A muster-in roll must, in all cases, be filed in the Adjutant General's Office as evidence of muster-in. The mustering officer, commissary, or assistant commissary of musters, as the case may be, will countersign both enlistments as having mustered the soldier into the service of the United States before either of them is given to the disbursing officer.

VOLUNTEER ENLISTMENT.

STATE OF



TOWN OF

Louisiana

New Orleans

I, Victor Armand Peyroux born in New Orleans in the State of Louisiana aged twenty-six years, and by occupation a Fireworks maker Do HEREBY ACKNOWLEDGE to have volunteered this First day of October 1864 to serve as a **Soldier** in the **Army of the United States of America**, for the period of **THREE YEARS**, unless sooner discharged by proper authority: Do also agree to accept such bounty, pay, rations, and clothing, as are, or may be, established by law for volunteers. And I, Victor Armand Peyroux do solemnly swear, that I will bear true faith and allegiance to the **United States of America**, and that I will serve them honestly and faithfully against all their enemies or opposers whomsoever; and that I will observe and obey the orders of the President of the United States, and the orders of the officers appointed over me, according to the Rules and Articles of War.

Sworn and subscribed to, at New Orleans, La this First day of October 1864, BEFORE J. N. Chambulain Capt. 10th U. S. C. A. W. A. C. M.

I CERTIFY, ON HONOR, That I have carefully examined the above-named Volunteer, agreeably to the General Regulations of the Army, and that, in my opinion, he is free from all bodily defects and mental infirmity, which would in any way disqualify him from performing the duties of a soldier.

W. H. Mather
Chap. 10 Reg. U. S. A. 44
EXAMINING SURGEON.

I CERTIFY, ON HONOR, That I have minutely inspected the Volunteer, V. A. Peyroux previously to his enlistment, and that he was entirely sober when enlisted; that, to the best of my judgment and belief, he is of lawful age; and that, in accepting him as duly qualified to perform the duties of an able-bodied soldier, I have strictly observed the Regulations which govern the recruiting service. This soldier has Brown eyes, Light hair, Dark complexion, is Five feet Eleven inches high.

Chas. S. Seuring Lieut. Co. 10th Regiment of U. S. C. A. 44
RECRUITING OFFICER.

Mustered into the service of the United States, for three years or during the war, from date of enlistment, in Company D, 10th Regiment of U. S. C. A. 44 Volunteers, on the 5th day of October, 1864, at New Orleans.

J. N. Chambulain
Capt. 10th U. S. C. A. W. A. C. M.

Mustered

NOTE 1.

The company commander will here add a statement of all the facts known to him concerning the disease or wound, or cause of disability of the soldier; the time, place, manner, and all the circumstances under which the injury occurred, or disease originated or appeared; the duty, or service, or situation of the soldier at the time the injury was received or disease contracted, stating particularly whether the injury was received or the disease contracted in the line of his duty; and whatever other facts may aid a judgment as to the cause, immediate or remote, of the disability, and the circumstances attending it.

When the facts are not known to the company commander, the certificate of any officer, or affidavit of other person having such knowledge, will be appended—as the surgeon in charge of a hospital, the officer commanding a detachment of recruits, &c., &c.

NOTE 2.

When a probable case for pension, special care must be taken to state the degree of disability—as 1/2, 1/3, &c., &c.; to describe particularly the disability, wound, or disease; the extent of which it deprives him of the use of any limb or faculty, or affects his health, strength, activity, constitution, or capacity to labor or earn his subsistence. The surgeon will add, from his knowledge of the facts and circumstances, and from the evidence in the case, his professional opinion of the cause or origin of the disability. In the case of discharges by Medical Inspectors, the last paragraph will state that the "discharge was given by consent of the soldier, after a personal examination, and for disability, the nature, degree, and origin of which are correctly described in the within certificate."

Par. 1260 Regulations, Edit. 1861.

Medical officers, in giving certificates of disability, are to take particular care in all cases that have not been under their charge; and especially in epilepsy, convulsions, chronic rheumatism, derangement of the urinary organs, ophthalmia, ulcers, or any obscure disease liable to be feigned or purposely produced; and in no case shall such certificate be given until after sufficient time and examination to detect any attempt at deception.

DIRECTIONS.

This certificate will be made out in duplicate by the soldier's company commander, or other officer commanding the separate detachment to which he belongs, and sent by him to the surgeon who has charge of the hospital where the soldier is sick. The surgeon will then fill out and sign the surgeon's certificate, and forward these papers to the regimental, detachment, or post commander, who will forward them, with his action endorsed thereon, through the proper channel, to his division commander; or, if the troops are not attached to a division, to his corps, department, or other commander or officer to whom the authority to discharge enlisted men may be specially delegated.

These certificates, after having received the action of the highest authority to which they are required to be sent, will be returned through the same channel to the regimental, post, or detachment commander, who will, if the discharge is authorized by the endorsement of the proper authority, sign the soldier's discharge, and the last certificate on this paper; see that the soldier is furnished with the proper final statements in duplicate, and forward BOTH of these certificates direct to the Adjutant General United States Army, at Washington, D. C.; they will not, under any circumstances, be given into the hands of the soldier.

Duplicate sent the Pension Office.

✓
PHYH 25
of Dis

1865
CERTIFICATE OF DISABILITY FOR DISCHARGE
IN THE CASE OF

Victor A. Peyraup
1st Sergeant Co. 1 B
Tenth Regt of U.S.C.A.

Medical Director's Office
Headquarters, Dept of Louisiana
New Orleans, Sept 10, 1865

Respectfully forwarded to the
Adjutant General of the Dept
Approved

J. Lawrence Sheldon
Adjutant Surgeon U.S. Army
Acty Medical Director

Sheldon

Headquarters, Department of Louisiana,
New Orleans, La, September 12 1865.

To be discharged

By order of the Adjutant General U.S. Army:
E. J. [Signature]
Rec [Signature] Captain and A. G.

Done at Philadelphia Sept 8th 1865

Respectfully forwarded
Approved

William H. Gatter
Surgeon 10th U.S.C.A.
Senior Surgeon to the
Commander Gen Jackson
at Philadelphia

ARMY OF THE UNITED STATES.

CERTIFICATE

OF DISABILITY  FOR DISCHARGE.

1st Sergeant Victor Armand Peyroux, of Captain Arthur McAllister Company, (B) of the Tenth Regiment of the United States Co. Art & Heavy was enlisted by Lieut. Daring of the Tenth Regiment of U. S. Art & Heavy New Orleans on the First day of October, 1864, to serve three years; he was born in New Orleans in the State of Louisiana, is Twenty Seven years of age, 5 feet 11 inches high, Dark complexion, Brown eyes, light hair, and by occupation when enlisted a Finerworks Maker. During the last ~~two~~ eight months said soldier has been unfit for duty 200 days. * he is worthless as a soldier and I think his disease was not contracted in discharge of his duty.

STATION: Fort Jackson La
 DATE: September 8th 1865

W. W. Cormack
1st Lieut. U. S. A., & H
 Commanding Company.

I CERTIFY, that I have carefully examined the said Victor Arman Peyroux of Captain Arthur McAllister's Company, and find him incapable of performing the duties of a soldier because of Bronchial Phthisis and Chronic Laryngitis. His voice is almost destroyed, and he is frequently afflicted by severe attacks of hectic fever. During the past eight months he has been unable to perform the duties of a soldier, though he has made repeated attempts and showed great desire to do so. His application for discharge was delayed till the present by his extreme reticence to quit the service. I consider him utterly worthless as a soldier

Degree of Disability 3/4

James Mc Nutt
 Act. Asst. Surgeon. U. S. A.

DISCHARGED, this 19th day of September, 1865 at Fort Jackson La

Samuel Hancher
Lt. Col
 Commanding the Reg't.

The Soldier desires to be addressed at

Town _____ County _____ State _____

* See Note 1 on the back of this. † See Note 2 on the back of this.

No. 10 U.S. Col & H. Art'y

Private Private

CARD NUMBERS.

1	5509792	26
2	5509944	27
3	5510093	28
4	5510242	29
5	5510392	30
6	5510541	31
7	5510713	32
8	5511149	33
9	5489943	34
10		35
11		36
12		37
13		38
14		39
15		40
16		41
17		42
18		43
19		44
20		45
21		46
22		47
23		48
24		49
25		50

Book Mark:

See also

Louis Philips

Pvt., Co. H, 10 Reg't U. S. Col'd H. Art'y

Appears on

Company Muster Roll

for *March & April, 1865*

Present or absent *Present*

Stoppage, \$ *100* for

Due Gov't, \$ *100* for

Valuation of horse, \$ *100*

Valuation of horse equipments. \$ *100*

Remarks: *Commencement of first payment by time April 1st 1865 - (Drafted - must in April 1. 65 - at New Orleans La for 1 yr) Name appears in present - Column as Lewis Philips.*

Book mark:

Permyngton Copyist.

P | 10 H. Art'y. | U.S.C.T.

Lewis Phillips

Pvt., Co. H, 10 Reg't U. S. Col'd H. Art'y

Appears on

Company Muster Roll

for *May & June*, 1865.

Present or absent *Present*

Stoppage, \$ *100* for

Due Gov't, \$ *100* for

Valuation of horse, \$ *100*

Valuation of horse equipments. \$ *100*

Remarks: *Stoppage for
Ordinance 45^{cts}*

Book mark:

(358)

Perrin
Copyist.

P | 10 H. Art'y. | U.S.C.T.

Louis Philips

Pvt, Co. H, 10 Reg't U. S. Col'd H. Art'y

Appears on

Company Muster Roll

for *July & Aug*, 1865.

Present or absent *Present*

Stoppage, \$ *100* for

Due Gov't, \$ *100* for

Valuation of horse, \$ *100*

Valuation of horse equipments. \$ *100*

Remarks:

Book mark:

(358)

Pennington

Copyist.

P

10 H. Art'y. | U.S.C.T.

Lewis Philips

Pvt., Co. H, 10 Reg't U. S. Col'd H. Art'y

Appears on

Company Muster Roll

for *Sep & Oct*, 1865.

Present or absent *Present*

Stoppage, \$ 100 for

Due Gov't, \$ 100 for

Valuation of horse, \$ 100

Valuation of horse equipments. \$ 100

Remarks :

Book mark :

Gammal

(858)

Copyist.

JP

10 H. Art'y.

U.S.C.T.

Louis Philips

Pvt., Co. H, 10 Reg't U. S. Col'd H. Art'y

Appears on

Company Muster Roll

for *Nov & Dec*, 1865.

Present or absent *Present*

Stoppage, \$ *100* for

Due Gov't, \$ *100* for

Valuation of horse, \$ *100*

Valuation of horse equipments. \$ *100*

Remarks: *Stop for loss of
Or An an ee 34^e*

Book mark:

Gamma R

P

10 H. Art'y.

U.S.C.T.

Louis Phillips

Pvt., Co. H, 10 Reg't U. S. Col'd H. Art'y

Appears on

Company Muster Roll

for

Jan & Feb., 1866.

Present or absent

Present

Stoppage, \$ 100 for

Due Gov't, \$ 100 for

Valuation of horse, \$ 100

Valuation of horse equipments. \$ 100

Remarks :

Book mark :

Lammack

(858)

Copyist.

P

10 H. Art'y.

U.S.C.T.

Lewis Philips

Priv

, Co. H, 10 Reg't U. S. Col'd H. Art'y

Appears on

Company Muster Roll

for

March 1866

, 1866

Present or absent

Stoppage, \$ 100 for

Due Gov't, \$ 100 for

Valuation of horse, \$ 100

Valuation of horse equipments. \$ 100

Remarks:

Mustered out by reason of expiration of term of service to date March 31, 1866.

Book mark:

V. 12. P 198. 68

(858)

Cammack

Copyst.

P. ¹⁰ *Hy Asty* U.S.C.T.

Louis Phillips

Priv., Co. *A*, *10* Reg't U. S. Col'd *Asty*

Appears on a

Detachment Muster-out Roll

of the organization named above. Roll dated

New Orleans La. Mar. 31, 1866.

Muster-out to date *Mar. 31*, 1866.

Last paid to *Dec. 31*, 1865

Clothing account:

Last settled _____, 1866 ; drawn since \$ _____ 100

Due soldier \$ *23* ^{*38*} / 100; due U. S. \$ _____ 100

Am't for cloth'g in kind or money adv'd \$ _____ 100

Due U. S. for arms, equipments, &c., \$ _____ 100

Bounty paid \$ _____ 100 due \$ _____ 100

Remarks: *Joined as shown.*

Book mark: _____

A. A. Reed

(349)

Copyist.

P

10 H. Art'y. U.S.C.T.

Lewis Philips

Priv., Co. H., 10 Reg't U. S. Col'd H. Art'y.

Appears on Co. Muster-out Roll, dated
Baton Rouge, La. Feb. 22, 1867.

Muster-out to date _____, 186 .

Last paid to _____, 186 .

Clothing account:

Last settled _____, 186 ; drawn since \$ _____ 100

Due soldier \$ _____ 100; due U. S. \$ _____ 100

Am't for cloth'g in kind or money adv'd \$ _____ 100

Due U. S. for arms, equipments, &c., \$ _____ 100

Bounty paid \$ _____ 100; due \$ _____ 100

Remarks: *joined by assignment
mustered out exp. of term
of service Feb 3/66.
(Age 22 yrs)*

Book mark: *V. 12 P. 198-68*

(361)

Lowny

Copyist.

Co. F., 10 U.S. Col'd H. Art'y

Private | Private.

CARD NUMBERS.

1	5487190	26
2	5504761	27
3	5505020	28
4	5505131	29
5	5505264	30
6	5505359	31
7	5505462	32
8	5505567	33
9	5505676	34
10	5505828	35
11	5505982	36
12	5506126	37
13	5506253	38
14	5506397	39
15	5506516	40
16	5506718	41
17	5506835	42
18	5506932	43
19		44
20		45
21		46
22		47
23		48
24		49
25		50

Book Mark:

See also

P

10 H. Art'y. U.S.C.T.

Victor P Hill

Appears with rank of Priv on

Muster and Descriptive Roll of a Detachment of U. S. Vols. forwarded

for the 7 Reg't U.S.C.H. Art'y* Roll dated

New Orleans La, Aug 19, 1864.

Where born New Orleans La.

Age 18 y'rs; occupation Laborer

When enlisted Aug 15, 1864.

Where enlisted New Orleans

For what period enlisted 3 years.

Eyes Blk; hair Blk

Complexion Dark; height 5 ft. 4 in.

When mustered in Aug 19, 1864.

Where mustered in New Orleans

Bounty paid \$ 100 ¹⁰⁰; due \$ 200 ¹⁰⁰

Where credited to New Orleans

Company to which assigned F

Remarks: Recruit Entitled to Bounty,

* Became 10 U.S.C.H. Art'y.

Book mark:

S.M. Williams

P | 10 H. Art'y. | U.S.C.T.

Victor Phill

Privt, Co. *F*, 7 Reg't U. S. Col'd H. Art'y.*

Appears on

Company Muster-in and Descriptive Roll

of the organization named above. Roll dated

New Orleans La, *Aug 19*, 1864.

Where born *New Orleans La*

Age *18* y'rs; occupation *Laborer*

When enlisted *Aug 15*, 1864.

Where enlisted *New Orleans La*

For what period enlisted *3* years.

Eyes *Blk*; hair *Blk*

Complexion *Dark*; height *5* ft. *4* in.

When mustered in *Aug 19*, 1864.

Where mustered in *New Orleans La*

Bounty paid \$ *100* ¹⁰⁰; due \$ *200* ¹⁰⁰

Where credited *1st Enroll-dist. La*

Company to which assigned

Remarks *Recruit-entitled to Bounty*

* This organization subsequently became Co. *F*, 10 Reg't U. S. Colored Heavy Artillery.

Book mark:

Rosenbaum

(356d)

Copyst.

P

10 H. Art'y. U.S.C.T.

Victor Phill

Priv., Co. F, 10 Reg't U. S. Col'd H. Art'y.

Appears on

Company Muster Roll

for July & August, 1864.

Present or absent Present

Stoppage, \$ 100 for

Due Gov't, \$ 100 for

Valuation of horse, \$ 100

Valuation of horse equipments, \$ 100

Remarks:

Book mark:

Rosenbaum

(358)

Copyist.

P

10 H. Art'y. U.S.C.T.

Victor Phill

Pvt., Co. F, 10 Reg't U. S. Col'd H. Art'y.

Appears on

Company Muster Roll

for Sept & Oct, 1864.

Present or absent Present

Stoppage, \$ 100 for

Due Gov't, \$ 100 for

Valuation of horse, \$ 100

Valuation of horse equipments, \$ 100

Remarks:

[Empty lines for remarks]

Book mark:

Rosenbaum

Copyist.

Victor Phill

Pot, Co. F, 10 Reg't U. S. Col'd H. Art'y.

Appears on

Company Muster Roll

for *Nov & Dec*, 1864.

Present or absent *Present*

Stoppage, \$ *100* for

Due Gov't, \$ *100* for

Valuation of horse, \$ *100*

Valuation of horse equipments, \$ *100*

Remarks: *Due U.S. for 1 Bay't
Scabbard & Frog \$.56*

Book mark:

Rosenbaum

P

10 H. Art'y. | U.S.C.T.

Victor Phill

Priv, Co. F, 10 Reg't U. S. Col'd H. Art'y.

Appears on

Company Muster Roll

for Jan & Feb, 1865.

Present or absent Present

Stoppage, \$ 100 for

Due Gov't, \$ 100 for

Valuation of horse, \$ 100

Valuation of horse equipments, \$ 100

Remarks:

Book mark:

R. S. Wadon

(358)

Copyist.

P

10 H. Art'y. U.S.C.T.

Victor Phill

Quin, Co. F, 10 Reg't U. S. Col'd H. Art'y.

Appears on

Company Muster Roll

for March April, 1863.

Present or absent Present

Stoppage, \$ 100 for

Due Gov't, \$ 100 for

Valuation of horse, \$ 100

Valuation of horse equipments, \$ 100

Remarks:

Book mark:

B. G. Masdon

(358)

Copyist.

P

10 H. Art'y. U.S.C.T.

Victor Phill

Priv, Co. F, 10 Reg't U. S. Col'd H. Art'y.

Appears on

Company Muster Roll

for May & June, 1865.

Present or absent Present

Stoppage, \$ 100 for

Due Gov't, \$ 100 for

Valuation of horse, \$ 100

Valuation of horse equipments, \$ 100

Remarks: Due \$300 Bounty

Book mark:

B G Hasdon

P

10 H. Art'y. U.S.C.T.

Victor Phill

Priv., Co. F, 10 Reg't U. S. Col'd H. Art'y.

Appears on

Company Muster Roll

for dated Aug 31, 1865.

Present or absent Present

Stoppage, \$ 100 for

Due Gov't, \$ 100 for

Valuation of horse, \$ 100

Valuation of horse equipments, \$ 100

Remarks: Due \$300 Bounty
Due U.S. for Camp & Garrison
son Equipage \$95

Book mark:

B G Masdon

Copyist.

P

10 H. Art'y. U.S.C.T.

Victor Phill

Priv., Co. F, 10 Reg't U. S. Col'd H. Art'y.

Appears on

Company Muster Roll

for Sept & Oct, 1865.

Present or absent Present

Stoppage, \$ 100 for

Due Gov't, \$ 100 for

Valuation of horse, \$ 100

Valuation of horse equipments, \$ 100

Remarks:

Book mark:

B G Masdon

(358)

Copyist.

P.

10 H. Art'y. U.S.C.T.

Victor Phill

Pat., Co. F, 10 Reg't U. S. Col'd H. Art'y.

Appears on

Company Muster Roll

for Nov & Dec, 1865.

Present or absent Present.

Stoppage, \$ 0. ⁰⁸/₁₀₀ for Ordnance.

Due Gov't, \$ 100 for

Valuation of horse, \$ 100

Valuation of horse equipments; \$ 100

Remarks: Due U.S. for G & E.
\$0.95

Book mark:

P.

10 H. Art'y. | U.S.C.T.

Victor Phill

Pvt., Co. F, 10 Reg't U. S. Col'd H. Art'y.

Appears on

Company Muster Roll

for *Jan'y & Feby.*, 186*5*.

Present or absent *Present.*

Stoppage, \$ 100 for

Due Gov't, \$ 100 for

Valuation of horse, \$ 100

Valuation of horse equipments, \$ 100

Remarks:

Book mark:

(358)

Ash
Copyist.

P. | 10 H. Art'y. | U.S.C.T.

Victor Phill

Pvt., Co. F, 10 Reg't U. S. Col'd H. Art'y.

Appears on

Company Muster Roll

for *Mar & Apr*, 1866.

Present or absent *Present*

Stoppage, \$ *100* for

Due Gov't, \$ *100* for

Valuation of horse, \$ *100*

Valuation of horse equipments, \$ *100*

Remarks:

Book mark: -----

C. O. L.
Copyst.

P

10 H. Art'y. U.S.C.T.

Victor Phill

Pat., Co. F, 10 Reg't U. S. Col'd H. Art'y.

Appears on

Company Muster Roll

for May & June, 1866.

Present or absent Present

Stoppage, \$ 100 for

Due Gov't, \$ 100 for

Valuation of horse, \$ 100

Valuation of horse equipments, \$ 100

Remarks: Sick in Quarters.

Book mark:

(358)

Crow Copyist.

P. 10th Art'y U.S.C.T.

Victor Phill
Capt., Co. F, 10 Reg't U. S. Col'd Art'y

Appears on

Company Muster Roll

for July & Aug., 1866.

Present or absent Present.

Stoppage, \$ 100 for

Due Gov't, \$ 100 for

Valuation of horse, \$ 100

Valuation of horse equipments, \$ 100

Remarks:

Book mark:

2

10 H. Art'y. U.S.C.T.

Victor Phil

Prt, Co. F, 10 Reg't U. S. Col'd H. Art'y.

Appears on

Company Muster Roll

for Sept. and Oct, 1866

Present or absent Present

Stoppage, \$ 100 for

Due Gov't, \$ 100 for

Valuation of horse, \$ 100

Valuation of horse equipments, \$ 100

Remarks:

[Empty lines for remarks]

Book mark:

[Empty line for book mark]

House

P

10 H. Art'y. U.S.C.T.

Victor Phil

Pr, Co. F, 10 Reg't U. S. Col'd H. Art'y.

Appears on

Company Muster Roll

for Nov. and Dec., 1860

Present or absent Present

Stoppage, \$ 100 for

Due Gov't, \$ 100 for

Valuation of horse, \$ 100

Valuation of horse equipments, \$ 100

Remarks:

Book mark:

House

P

10 H. Art'y. U.S.C.T.

Victor Phill

Pvt, Co F, 10 Reg't U. S. Col'd H. Art'y.

Appears on Co. Muster-out Roll, dated

Baton Rouge La Feb 22 1867.

Muster-out to date Feb 22, 1867.

Last paid to Dec. 31, 1866.

Clothing account:

Last settled, 186 ; drawn since \$ 100

Due soldier \$ 22 ³⁷ / 100; due U. S. \$ 100

Am't for cloth'g in kind or money adv'd \$ 100

Due U. S. for arms, equipments, &c., \$ 6 / 100

Bounty paid \$ 100 / 100; due \$ 100 / 100

Remarks:

Joined at original organization

Book mark: 4231 1880

House

J., 10 U.S. Col'd H. Art'y

Private | *Private*

CARD NUMBERS.

1	5488577	26
2	5511577	27
3	5511698	28
4	5511856	29
5	5512157	30
6	5489974	31
7		32
8		33
9		34
10		35
11		36
12		37
13		38
14		39
15		40
16		41
17		42
18		43
19		44
20		45
21		46
22		47
23		48
24		49
25		50

Book Mark:

See also

74 U.S. to Sup

P

10th d. U.S.C.T.

John Phillip
Pat. Co., 10 Reg't U. S. Col'd St. Arty
Appears on

M. and D. Roll of Men Transferred

to the organization named above,

from Co. "G" 7th U.S. Col. Inf.

Roll dated New Orleans, La Oct 11, 1865.

When enlisted April 19, 1863

Period for which enlisted 3 years.

When mustered in Dec. 8, 1863

Present or absent Present

Company to which assigned

Remarks: Joined Co. G 2^d
La N. Y. (7th U.S. Col. Inf.)
as a recruit. Trans-
ferred to Co. "G" 7th
U.S. Col. Inf. July 25, 1864
S. O. No 17 dated St. L.
Sept 17, 1864
Present on or before April 19, 1865

Book mark :

(342)

J. M. Jones, Jr

Copyist.

P.

10 H. Art'y.

U.S.C.T.

John Phillip

Prvt., Co. I, 10 Reg't U. S. Col'd H. Art'y.

Appears on

Company Muster Roll

for *Apr. & Dec.*, 1865.

Present or absent *Present*

Stoppage, \$ *100* for

Due Gov't, \$ *100* for

Valuation of horse, \$ *100*

Valuation of horse equipments, \$ *100*

Remarks: *Transferred from
74 U.S.C.I. per I.O. no. 84
Hd. qrs. Dept. of La. Oct.
11, 1865.*

FROM SECOND AUDITOR'S ROLL.

Book mark:

O.S. Clark

(358)

Copyist.

P

10 H. Art'y. | U.S.C.T.

John Philip

Prk., Co. I, 10 Reg't U. S. Col'd H. Art'y.

Appears on

Company Muster Roll

for *Jan & Feb.*, 1866.

Present or absent *Present*

Stoppage, \$ *100* for

Due Gov't, \$ *100* for

Valuation of horse, \$ *100*

Valuation of horse equipments, \$ *100*

Remarks:

Book mark:

A. S. Blank

P.

10 H. Art'y.

U.S.C.T.

John Phillip

Pvt., Co. I, 10 Reg't U. S. Col'd H. Art'y.

Appears on

Company Muster Roll

for *March & Apr.*, 1866.

Present or absent

Stoppage, \$ 100 for

Due Gov't, \$ 100 for

Valuation of horse, \$ 100

Valuation of horse equipments, \$ 100

Remarks: *Discharged. Mustered out by reason of expiration of term of service to date Apr. 18. 1866.*

Book mark: *Mustered out on file.*

P. S. Clark

(358)

Copyist.

P | 10 Arty | U.S.C.T.

John Phillips

Priv., Co. I, 10 Reg't U. S. Col'd Arty

Appears on a

Detachment Muster-out Roll

of the organization named above. Roll dated

New Orleans, La., Apr. 18, 1866.

Muster-out to date Apr. 18, 1866.

Last paid to Feb. 28, 1866

Clothing account:

Last settled _____, 1866 ; drawn since \$ _____ 100

Due soldier \$ $46 \frac{54}{100}$; due U. S. \$ _____ 100

Am't for cloth'g in kind or money adv'd \$ _____ 100

Due U. S. for arms, equipments, &c., \$ $\frac{44}{100}$

Bounty paid \$ _____ 100 due \$ $111 \frac{7}{100}$

Remarks: Joined as a recruit. Free

on or before Apr. 19, '61. Transferred

from Co. G, 74 U.S.C.I. to Co. I, 10 U.S.

C.A. (149). per A.O. No. 84 Hdqrs. Dept. of Sa.

Oct. 11, '65. Stop for 2 months. 02¢ one

Tompon 02¢ - 1 cap box 40¢ - total 44¢

Book mark: _____

R. E. Wilson

John Phillip
Sub. Co., 10 Reg't U. S. Col'd H. Art'y.

Appears on Co. Muster-out Roll, dated
Baton Rouge La Feb 22, 1867.

Muster-out to date _____, 186 .

Last paid to _____, 186 .

Clothing account:

Last settled _____, 186 ; drawn since \$ _____ $\overline{100}$

Due soldier \$ _____ $\overline{100}$; due U. S. \$ _____ $\overline{100}$

Am't for cloth'g in kind or money adv'd \$ _____ $\overline{100}$

Due U. S. for arms, equipments, &c., \$ _____ $\overline{100}$

Bounty paid \$ _____ $\overline{100}$; due \$ _____ $\overline{100}$

Remarks: *Discharged, expiration*
term of service April 18, 1866

Book mark: _____

(361)

J. McHance
Copyist.

Co. A., 10 U.S. Col'd H. Arty

Private | Corporal.

CARD NUMBERS.

1	5489045	26
2	5493093	27
3	5493236	28
4	5493372	29
5	5493513	30
6	5493635	31
7	5493675	32
8	5493784	33
9	5493843	34
10		35
11		36
12		37
12		38
14		39
15		40
16		41
17		42
18		43
19		44
20		45
21		46
22		47
23		48
24		49
25		50

Book Mark:

See also 75-U.S. 6 S

P *100 Hart* | **U.S.C.T.**

Charles Phillips

A., Co., *10* Reg't U. S. Col'd *Hart*

Appears on

M. and D. Roll of Men Transferred

to the organization named above,

from *75th U.S.I.*

Roll dated *Nov 18*, 186*3*.

When enlisted, 186 .

Period for which enlisted *3* years.

When mustered in *Oct 3*, 186 *4*.

Present or absent *Not stated*

Company to which assigned

Remarks: *Drafted Oct 3/64*

& acc to M. O. not

entitled to bounty

.....
.....
.....
.....

Book mark :

J. Johnson

P | 10 H. Art'y. | U.S.C.T.

Charles Phillips

Plt., Co. A, 10 Reg't U. S. Col'd H. Art'y.

Appears on

Company Muster Roll

for Nov & Dec, 1865

Present or absent Present

Stoppage, \$ 100 for

Due Gov't, \$ 100 for

Valuation of horse, \$ 100

Valuation of horse equipments, \$ 100

Remarks: Transferred from 78 U.S.C.I. per S.O. 105 G.S. Hd Qrs Dept. of Sea,

Book mark:

(358)

J. H. [Signature] Copyist.

P

10 H. Art'y.

U.S.C.T.

Charles Phillips

Pl, Co. A, 10 Reg't U. S. Col'd H. Art'y.

Appears on

Company Muster Roll

for Jan & Feb, 1866.

Present or absent Present

Stoppage, \$ 100 for

Due Gov't, \$ 100 for

Valuation of horse, \$ 100

Valuation of horse equipments, \$ 100

Remarks:

Book mark:

(358)

Hyman Copyist.

P | 10 H. Art'y. | U.S.C.T.

Charles Phillips

Pt, Co. A, 10 Reg't U. S. Col'd H. Art'y.

Appears on

Company Muster Roll

for *Mar & Apr*, 186*6*.

Present or absent *Present*

Stoppage, \$ *100* for

Due Gov't, \$ *100* for

Valuation of horse, \$ *100*

Valuation of horse equipments, \$ *100*

Remarks:

Book mark: -----

H. J. ...

P

10 H. Art'y. U.S.C.T.

Charles Phillips

Pvt, Co. A, 10 Reg't U. S. Col'd H. Art'y.

Appears on

Company Muster Roll

for May & June, 1866.

Present or absent Present

Stoppage, \$ 100 for

Due Gov't, \$ 100 for

Valuation of horse, \$ 100

Valuation of horse equipments, \$ 100

Remarks:

Book mark:

(358)

Styus Copyist.

P

10 H. Art'y. | U.S.C.T.

Charles Phillips

P/ Co. A, 10 Reg't U. S. Col'd H. Art'y.

Appears on

Company Muster Roll

for

July & Aug, 1864
Present

Present or absent

Stoppage, \$ 100 for

Due Gov't, \$ 100 for

Valuation of horse, \$ 100

Valuation of horse equipments, \$ 100

Remarks:

Book mark:

Hym
Copyist.

(358)

P | 10 H. Art'y. | U.S.C.T.

Charles Philips

Corpl, Co. A, 10 Reg't U. S. Col'd H. Art'y.

Appears on

Company Muster Roll

for Sept & Oct, 1866.

Present or absent Present

Stoppage, \$ 100 for

Due Gov't, \$ 45 for Camp, ordnance and Garrison equipage

Valuation of horse, \$ 100

Valuation of horse equipments, \$ 100

Remarks: Private to Sept. 24 '66
Stop for one letter one crossed
cannon + two numbers

Book mark:

Nesbitt

P | 10 H. Art'y. | U.S.C.T.

Charles Phillips

Corpl, Co. A, 10 Reg't U. S. Col'd H. Art'y.

Appears on

Company Muster Roll

for Nov & Dec, 1866.

Present or absent Present

Stoppage, \$ 100 for

Due Gov't, \$ 100 for

Valuation of horse, \$ 100

Valuation of horse equipments, \$ 100

Remarks:

Book mark:

Nesbitt

Copyist.

Charles Phillips
Corpl. Co. A, 10 Reg't U. S. Col'd H. Art'y.

Appears on Co. Muster-out Roll, dated
Baton Rouge La, Feb 22, 1867.
Muster-out to date Feb 22, 1867.
Last paid to Dec 31, 1866.

Clothing account:

Last settled _____, 186 ; drawn since \$ _____ 100
Due soldier \$ 56 ²³/₁₀₀; due U. S. \$ _____ 100
Am't for cloth'g in kind or money adv'd \$ _____ 100

Due U. S. for arms, equipments, &c., \$ ^{under U. S. 101} 6 ⁰⁰/₁₀₀
Bounty paid \$ _____ 100; due \$ 200 ⁰⁰/₁₀₀

Remarks: Transf. from 75 U.S.C.S. as Pl.
D.C. 115 S of 65- Dept. sa. App'ts. Corp
Sept. 24, 66

Book mark : _____

Nesbitt
Copyist.

Co. D., 10 U.S. Col'd H. Arty

Private. Private.

CARD NUMBERS.

1	5494248	26
2	5494400	27
3	5494457	28
4	5494712	29
5	5494867	30
6	5495019	31
7	5495175	32
8	5495331	33
9	5495483	34
10	5495633	35
11	5495772	36
12	5495934	37
13	5496079	38
14	5496227	39
15	5496382	40
16	5496529	41
17	5496671	42
18	5496814	43
19	5496973	44
20	5497145	45
21	5497460	46
22	5489694	47
23		48
24		49
25		50

Book Mark:

See also

P | 10 H. Art'y. | U.S.C.T.

Christie Phillippe

Cot., 2 Battery, La. H. Art'y, Native Guards.*

Age *25* years.

Appears on

Company Muster-in Roll

of the organization named above. Roll dated

Camp Parapet, Carrollton, La., Feb. 9, 186*3*.

Muster-in to date *Feb. 9*, 186*3*.

Joined for duty and enrolled:

When *Jan'y 13*, 186*3*.

Where *Camp Parapet or Carrollton, La.*

Period *3* years.

Valuation of horse, \$.....*100*

Valuation of horse equipments, \$.....*100*

Remarks:

* This organization subsequently became Co. B, 10 Reg't U. S. Colored Heavy Artillery.

Book mark:

Feaster

P | 10 H. Art'y. | U.S.C.T.

Christie Phillippe
Pot., Co. B, 1 Reg't La. H. Art'y, Native Guards.*

Appears on

Company Muster Roll

for *Ann. Enlistment to Feb. 28, 1863.*

Present or absent *Present.*

Stoppage, \$ 100 for

Due Gov't, \$ 100 for

Valuation of horse, \$ 100

Valuation of horse equipments, \$ 100

Remarks:

*This organization subsequently became Co. B, 10 Reg't U. S. Col'd Heavy Artillery.

Book mark:

Feaster

P

10 H. Art'y. U.S.C.T.

Christie Phillippe

Corpl., Co. B, 1 Reg't La. H. Art'y, Native Guards.*

Appears on

Company Muster Roll

for Mch. & Apl., 1863.

Present or absent Present

Stoppage, \$ 100 for

Due Gov't, \$ 100 for

Valuation of horse, \$ 100

Valuation of horse equipments, \$ 100

Remarks:

*This organization subsequently became Co. B, 10 Reg't U. S. Col'd Heavy Artillery.

Book mark:

Feaster

P | 10 H. Art'y. | U.S.C.T.

Christie Phillippe

Pvt., Co. B, 1 Reg't La. H. Art'y, Native Guards.*

Appears on

Company Muster Roll

for *May & June*, 186 *3*.

Present or absent *Present*

Stoppage, \$ *100* for

Due Gov't, \$ *100* for

Valuation of horse, \$ *100*

Valuation of horse equipments, \$ *100*

Remarks: _____

*This organization subsequently became Co. B, 10 Reg't U. S. Col'd Heavy Artillery.

Book mark: _____

Feaster

P | 10 H. Art'y. | U.S.C.T.

Christie Phillippe

Pvt., Co. B, 1 Reg't La. H. Art'y, Native Guards.*

Appears on

Company Muster Roll

for July 7, Aug. 1867.

Present or absent Present

Stoppage, \$ 100 for

Due Gov't, \$ 100 for

Valuation of horse, \$ 100

Valuation of horse equipments, \$ 100

Remarks:

*This organization subsequently became Co. B, 10 Reg't U. S. Col'd Heavy Artillery.

Book mark:

Fester

J

10 H. Art'y.

U.S.C.T.

Christi Phillipi

Pvt., Co. B, 1 Reg't La. H. Art'y, Native Guards.*

Appears on

Company Muster Roll

for *Sept. & Oct.*, 186 *3*.

Present or absent *Present*

Stoppage, \$ *100* for

Due Gov't, \$ *100* for

Valuation of horse, \$ *100*

Valuation of horse equipments, \$ *100*

Remarks:

*This organization subsequently became Co. B, 10 Reg't U. S. Col'd Heavy Artillery.

Book mark:

502548

Feaster

P

10 H. Art'y. U.S.C.T.

Christe Phillip

Pvt, Co. B, 1 Reg't H. Art'y, Corps d'Afrique.*

Appears on

Company Muster Roll

for Nov. 1 Dec., 1863.

Present or absent Present

Stoppage, \$ 100 for

Due Gov't, \$ 100 for

Valuation of horse, \$ 100

Valuation of horse equipments, \$ 100

Remarks:

* This organization subsequently became Co. , 10 Reg't U. S. Colored Heavy Artillery.

Book mark:

(358)

Copyist.

P

10 H. Art'y. | U.S.C.T.

Christo Philip

P1, Co. B, 1 Reg't H. Art'y, Corps d'Afrique.*

Appears on

Company Muster Roll

for Jan. 1 - Feb. 1, 1864

Present or absent Present

Stoppage, \$ 100 for

Due Gov't, \$ 100 for

Valuation of horse, \$ 100

Valuation of horse equipments, \$ 100

Remarks: Sick in Co. Hospital.

*This organization subsequently became Co. , 10 Reg't U. S. Colored Heavy Artillery.

Book mark:

Ref

P

10 H. Art'y.

U.S.C.T.

Christo Phillippe

R1, Co. B, 7 Reg't U. S. Col'd H. Art'y.*

Appears on

Company Muster Roll

for March, 1864

Present or absent Present

Stoppage, \$ 100 for

Due Gov't, \$ 100 for

Valuation of horse, \$ 100

Valuation of horse equipments, \$ 100

Remarks:

* This organization subsequently became Co. , 10 Reg't U. S. Colored Heavy Artillery.

Book mark:

(358)

Reif

Copyist.

P | 10 H. Art'y. | U.S.C.T.

Christie Phillippe

PA, Co. B, 7 Reg't U. S. Col'd H. Art'y.*

Appears on

Company Muster Roll

for May & June, 1864.

Present or absent Present

Stoppage, \$ 100 for

Due Gov't, \$ 100 for

Valuation of horse, \$ 100

Valuation of horse equipments, \$ 100

Remarks:

* This organization subsequently became Co. , 10 Reg't U. S. Colored Heavy Artillery.

Book mark:

(358)

Ref

Copyist.

S

10 H. Art'y.

U.S.C.T.

Christie Phillips

Pl, Co. B, 10 Reg't U. S. Col'd H. Art'y.

Appears on

Company Muster Roll

for *July & Aug*, 186*4*.

Present or absent *Present*

Stoppage, \$ 100 for

Due Gov't, \$ 100 for

Valuation of horse, \$ 100

Valuation of horse equipments, \$ 100

Remarks:

Book mark:

J. W. Richardson

(358)

Copyist.

P

10 H. Art'y. U.S.C.T.

Christie Phillippe

It, Co. B, 10 Reg't U. S. Col'd H. Art'y.

Appears on

Company Muster Roll

for Sept & Oct, 1864.

Present or absent Present

Stoppage, \$ 100 for

Due Gov't, \$ 100 for

Valuation of horse, \$ 100

Valuation of horse equipments, \$ 100

Remarks:

Book mark:

J. Richardson Copyist.

P.

10 H. Art'y.

U.S.C.T.

Christian Phillipps.

Pvt., Co. B, 10 Reg't U. S. Col'd H. Art'y.

Appears on

Company Muster Roll

for *Nov & Dec*, 186*4*

Present or absent *Present*

Stoppage, \$ *100* for

Due Gov't, \$ *100* for

Valuation of horse, \$ *100*

Valuation of horse equipments, \$ *100*

Remarks: *On daily duty at signal gun since Dec 27 1864.*

Book mark: *7*

J. J. Jones

(358)

Copyist.

P.

10 H. Art'y. U.S.C.T.

Christie Philip

Pt., Co. B, 10 Reg't U. S. Col'd H. Art'y.

Appears on

Company Muster Roll

for Jan & Feb, 1865

Present or absent Present

Stoppage, \$ 100 for

Due Gov't, \$ 100 for

Valuation of horse, \$ 100

Valuation of horse equipments, \$ 100

Remarks: Due soldiers augmented pay from Jan 1 1864 to May 1 1864, \$6.00 per month. May & June \$9.00 per month. Due U.S. for Ord. 23^{cts}.

Book mark:

(358)

Jovier

Copyist.

Christie Philip
Priv., Co. B, 10 Reg't U. S. Col'd H. Art'y.

Appears on

Company Muster Roll

for *Mar & Apr*, 186 *5*.

Present or absent *Present*.

Stoppage, \$ *100* for

Due Gov't, \$ *100* for

Valuation of horse, \$ *100*

Valuation of horse equipments, \$ *100*

Remarks:

Book mark: -----

Joiner

P. | 10 H. Art'y. | U.S.C.T.

Christie Phillips

Pvt., Co. B, 10 Reg't U. S. Col'd H. Art'y.

Appears on

Company Muster Roll

for *May & June*, 1865.

Present or absent *Present*

Stoppage, \$ 100 for

Due Gov't, \$ 100 for

Valuation of horse, \$ 100

Valuation of horse equipments, \$ 100

Remarks: *Sick in quarters*

Book mark: _____

Jovier

Christe Phillip

Pvt., Co. B, 10 Reg't U. S. Col'd H. Art'y.

Appears on

Company Muster Roll

for *July + Aug*, 1865.

Present or absent *Present.*

Stoppage, \$ *100* for

Due Gov't, \$ *100* for

Valuation of horse, \$ *100*

Valuation of horse equipments, \$ *100*

Remarks: _____

Book mark: _____

(358)

Horner

Copyist.

P. | 10 H. Art'y. | U.S.C.T.

Christee Phillip
Pvt., Co. B, 10 Reg't U. S. Col'd H. Art'y.

Appears on

Company Muster Roll

for *Sep & Oct.*, 186*5*.

Present or absent *Present.*

Stoppage, \$.....100 for

Due Gov't, \$.....100 for

Valuation of horse, \$.....100

Valuation of horse equipments, \$.....100

Remarks:.....

.....
.....
.....
.....
.....
.....
.....
.....
.....

Book mark:.....

.....
Jornier.
.....

P

10 H. Art'y. U.S.C.T.

Christie Phillip

Pl, Co. B, 10 Reg't U. S. Col'd H. Art'y.

Appears on

Company Muster Roll

for

Nov. & Dec, 1865.

Present or absent

Present

Stoppage, \$

100 for

Due Gov't, \$

100 for

Valuation of horse, \$

100

Valuation of horse equipments, \$

100

Remarks:

Book mark:

(358)

Reif

Copyist.

P

10 H. Art'y. U.S.C.T.

Christie Phillip

Pt., Co. B, 10 Reg't U. S. Col'd H. Art'y.

Appears on

Company Muster Roll

for Jun. & Dec., 1866

Present or absent

Stoppage, \$ 100 for

Due Gov't, \$ 100 for

Valuation of horse, \$ 100

Valuation of horse equipments, \$ 100

Remarks: Must'd out at N.O. La
Feb, 8 66 by reason of exp.
of term of service

Book mark:

D. P. P.

(358)

Copyist.

P. | 10. No. a. | U.S.C.T.

Christie Phillip
Priv., Co. B., 10 Reg't U. S. Col'd No. a.

Appears on a

Detachment Muster-out Roll

of the organization named above. Roll dated

New Orleans La. Feb. 8, 1866.

Muster-out to date Feb. 8, 1866.

Last paid to June 30, 1865

Clothing account:

Last settled 186 ; drawn since \$ 100

Due soldier \$ 2 ⁵⁹/₁₀₀; due U. S. \$ 100

Am't for cloth'g in kind or money adv'd \$ 100

Due U. S. for arms, equipments, &c., \$ 100

Bounty paid \$ 100 due \$ 100

Remarks: *Joined at origl. orgn
Mustered out by reason
of Expiration of term of
Service (Cert. of Mustg. Of-
ficer shows him M. O. Feb. 12, 1866.)
* added May 12, 93. GES*

Book mark:

(349) *Heasley* Copyist.

P | 10 H. Art'y. | U.S.C.T.

Christie Phillip
Co. D, 10 Reg't U. S. Col'd H. Art'y.

Appears on Co. Muster-out Roll, dated
Baton Rouge La. Feb, 1867.

Muster-out to date _____, 186 .

Last paid to _____, 186 .

Clothing account:

Last settled _____, 186 ; drawn since \$ _____ 100

Due soldier \$ _____ 100 ; due U. S. \$ _____ 100

Am't for cloth'g in kind or money adv'd \$ _____ 100

Due U. S. for arms, equipments, &c., \$ _____ 100

Bounty paid \$ _____ 100 ; due \$ _____ 100

Remarks:

Joined org'l. org'n
Discharged Feb. 8/67
expiration term of
service.

Book mark:

Headquarters
Copyist.

Phillippe, Christie

, Co.

111th Reg't U. S. C. H. A.

2

Enclosures.

Bed Cards	Final Statements
Burial Records	Furloughs or L. of A.
Certs. of Dis. for Discharge	Med. Certificates
C. M. Charges	Med. Des. Lists
Descriptive Lists	Orders
Discharge Certificates	Pris. of War Record
Enlistment Papers	Resignations

Other papers relating to—

Admission to Hosp'l	Furlough or L. of A.
Casualty Sheet	Med. Examination
Confinement	Misc. Information
Contracts	Pay or Clothing
Death or Effects	Personal Reports
Desertion	Rank
Discharge from Hosp'l	Transfer to Hosp'l
Discharge from Service	Transfer to V. R. C.
Duty	Transportation

DECLARATION OF RECRUIT.

I, _____ desiring to ENLIST in the Army of the United States, for the term of THREE YEARS, Do declare, That I am _____ years and _____ months of age; that I have neither wife nor child; that I have never been discharged from the United States service on account of disability or by sentence of a court-martial, or by order before the expiration of a term of enlistment; and I know of no impediment to my serving honestly and faithfully as a soldier for three years.

GIVEN at _____
The _____ day of _____

Witness :

No. 97

Christie Phillips
Enlisted at Carroll, Maryland, Pa.
January the 15th 1863.
By 2^d Lieut. J. M. G. ...
1st U.S. Regt. of Dragoon

enlistment; last served in Company ()
Reg't of _____
Discharged _____ 18____

CONSENT IN CASE OF MINOR.

I, _____ Do CERTIFY, That I am the _____ of _____; that the said _____ is _____ years of age; and I do hereby freely give my CONSENT to his enlisting as a SOLDIER in the ARMY OF THE UNITED STATES for the period of THREE YEARS.

GIVEN at _____
The _____ day of _____

Witness :

County of
Jefferson



State of
Louisiana

I, *Christie Phillippe* born in *New Orleans*
in the State of *Louisiana* aged *Twenty five* years,
and by occupation a *Laborer* do hereby acknowledge to have
voluntarily enlisted this *Thirtieth* day of *January*
18*63*, as a SOLDIER in the ARMY OF THE UNITED STATES OF AMERICA, for the period
of *THREE YEARS*, unless sooner discharged by proper authority: Do also agree to
accept such bounty, pay, rations, and clothing, as are, or may be, established by law. And
I, *Christie Phillippe* do solemnly swear, that I will bear true faith
and allegiance to the UNITED STATES OF AMERICA, and that I will serve them honestly and
faithfully against all their enemies or opposers whomsoever; and that I will observe and
obey the orders of the President of the United States, and the orders of the officers
appointed over me, according to the Rules and Articles of War.

Sworn and subscribed to, at *Carrollton, La.,*
this *ninth* day of *February* 18*63*
BEFORE
J. Rygaard
2nd Lt. U.S. Army. C. Col.

I CERTIFY, ON HONOR, That I have carefully examined the above named Recruit, agreeably to the General Regulations of the Army, and that in my opinion he is free from all bodily defects and mental infirmity, which would, in any way, disqualify him from performing the duties of a soldier.

W. C. Lynde EXAMINING SURGEON.

I CERTIFY, ON HONOR, That I have minutely inspected the Recruit, *Christie Phillippe* previously to his enlistment, and that he was entirely sober when enlisted; that, to the best of my judgement and belief, he is of lawful age; and that, in accepting him as duly qualified to perform the duties of an able-bodied soldier, I have strictly observed the Regulations which govern the recruiting service. This soldier has *brown* eyes, *black* hair, *dark* complexion; is *five* feet, *nine* inches high.

J. Rygaard 2nd Lieut. U.S. Army. C. Col.
RECRUITING OFFICER.

10 21612 DECLARATION OF RECRUIT. 10 41003

I, _____ desiring to ENLIST in the Army of the United States, for the term of THREE YEARS, Do declare, That I am _____ years and _____ months of age; that I have neither wife nor child; that I have never been discharged from the United States service on account of disability or by sentence of a court-martial, or by order before the expiration of a term of enlistment; and I know of no impediment to my serving honestly and faithfully as a soldier for three years.

GIVEN at _____
The _____ day of _____

Witness: _____

10 2002KA

No. _____

Christie Th. W. W. W.

Enlisted at *Camp Parabet. La.*

January the 13th 1863.

By *2nd Lieut. J. H. G. G. G.*

Company of Louisiana Co.

enlistment; last served in Company ()

Reg't of _____

Discharged _____ 18 _____

CONSENT IN CASE OF MINOR.

I, _____ Do CERTIFY, That I am the _____ of _____; that the said _____ is _____ years of age; and I do hereby freely give my CONSENT to his enlisting as a SOLDIER in the ARMY OF THE UNITED STATES for the period of THREE YEARS.

GIVEN at _____
The _____ day of _____

Witness: _____

County of

Jefferson



State of

Louisiana

I, *Christie Phillippe* born in *New Orleans*
 in the State of *Louisiana* aged *Twenty five* years,
 and by occupation a *Laborer* do hereby acknowledge to have
 voluntarily enlisted this *Thirteenth* day of *January*
 18 *63*, as a SOLDIER in the ARMY OF THE UNITED STATES OF AMERICA, for the period
 of *THREE YEARS*, unless sooner discharged by proper authority: Do also agree to
 accept such bounty, pay, rations, and clothing, as are, or may be, established by law. And
 I, *Christie Phillippe* do solemnly swear, that I will bear true faith
 and allegiance to the UNITED STATES OF AMERICA, and that I will serve them honestly and
 faithfully against all their enemies or opposers whomsoever; and that I will observe and
 obey the orders of the President of the United States, and the orders of the officers
 appointed over me, according to the Rules and Articles of War.

Sworn ~~and subscribed~~ to, at *of Carrollton, La.*
Camp Parapet,
 this *ninth* day of *February* 18*63*
 BEFORE *J. Rygaard*
2^d Lt. U.S. Art. Co.

I CERTIFY, ON HONOR, That I have carefully examined the above named Recruit, agreeably to the General Regulations of the Army, and that in my opinion he is free from all bodily defects and mental infirmity, which would, in any way, disqualify him from performing the duties of a soldier.

W. C. Lynde EXAMINING SURGEON.

I CERTIFY, ON HONOR, That I have minutely inspected the Recruit, *Christie Phillippe* previously to his enlistment, and that he was entirely sober when enlisted; that, to the best of my judgement and belief, he is of lawful age; and that, in accepting him as duly qualified to perform the duties of an able-bodied soldier, I have strictly observed the Regulations which govern the recruiting service. This soldier has *brown* eyes, *black* hair, *dark* complexion; is *five* feet, *nine* inches high.

J. Rygaard 2^d Lieut. U.S. Art. Co.
 RECRUITING OFFICER.

W., 10 U.S. CoI'd H. Army

Private

Private

CARD NUMBERS.

1	5487472	26
2	5510244	27
3	5510395	28
4	5510542	29
5	5510641	30
6	5510785	31
7	5510863	32
8	5510938	33
9	5511010	34
10	5511071	35
11		36
12		37
13		38
14		39
15		40
16		41
17		42
18		43
19		44
20		45
21		46
22		47
23		48
24		49
25		50

Book Mark:

See also

77 W.S. 6 I

I *10 H.A.* | U.S.C.T.

John Phillips
Co, Co *10* Reg't U. S. Col'd *H.A.*

Appears on

M. and D. Roll of Men Transferred

to the organization named above,

from *Co H, 10th U.S. Col'd Inf*

Roll dated *Camp Capersa 21*, 186*4*.

When enlisted *Sept 1*, 186*4*.

Period for which enlisted *3* years.

When mustered in *Sept 1*, 186*4*.

Present or absent *Present*

Company to which assigned *I*

Remarks: *Drafted, Assigned to Co Sept. 8. 1864*

Book mark :

W. H. Scott

J.P.

10 H. Art'y. U.S.C.T.

John Philipos
Pvt., Co. H, 10 Reg't U. S. Col'd H. Art'y

Appears on

Company Muster Roll

for *Sep & Oct*, 1865.

Present or absent *Present*

Stoppage, \$ *100* for

Due Gov't, \$ *100* for

Valuation of horse, \$ *100*

Valuation of horse equipments. \$ *100*

Remarks: *Transferred from Co. H.*
77 U.S.C.R. per G.O. No 3
Ad. In 10 U.S.C. A. H
Camp Prochet Oct 1, 65

Book mark:

(858)

Samuel P.
Coyist.

JP

10 H. Art'y.

U.S.C.T.

John Phillips

Co. H, Co. H, 10 Reg't U. S. Col'd H. Art'y

Appears on

Company Muster Roll

for *Nov 9 Dec*, 1865.

Present or absent *Present*

Stoppage, \$ 100 for

Due Gov't, \$ 100 for

Valuation of horse, \$ 100

Valuation of horse equipments. \$ 100

Remarks :

Book mark :

(858)

Cammack
Copyist.

P

10 H. Art'y.

U.S.C.T.

John Philips

Pvt.

Co. H, 10 Reg't U. S. Col'd H. Art'y

Appears on

Company Muster Roll

for *Jan & Feb.*, 1866.

Present or absent *Present*

Stoppage, \$ 100 for

Due Gov't, \$ 100 for

Valuation of horse, \$ 100

Valuation of horse equipments, \$ 100

Remarks:

Book mark:

Lammie

(858)

Copyist.

P

10 H. Art'y. U.S.C.T.

John I Philips

Pvt., Co. H, 10 Reg't U. S. Col'd H. Art'y

Appears on

Company Muster Roll

for *M & Ap.*, 1866.

Present or absent *Present*

Stoppage, \$ 100 for

Due Gov't, \$ 100 for

Valuation of horse, \$ 100

Valuation of horse equipments. \$ 100

Remarks :

Book mark :

Gammal

(858)

Copyist.

90

10 H. Art'y.

U.S.C.T.

John Philips

Co., Co. H, 10 Reg't U. S. Col'd H. Art'y

Appears on

Company Muster Roll

for *May & June*, 186*6*.

Present or absent *Present*

Stoppage, \$ *100* for

Due Gov't, \$ *100* for

Valuation of horse, \$ *100*

Valuation of horse equipments. \$ *100*

Remarks :

Book mark :

(358)

Samuel
Copyist

P

10 H. Art'y. U.S.C.T.

John Philips

Pvt., Co. H, 10 Reg't U. S. Col'd H. Art'y

Appears on

Company Muster Roll

for *July & Aug*, 1866.

Present or absent *Present*

Stoppage, \$ *100* for

Due Gov't, \$ *100* for

Valuation of horse, \$ *100*

Valuation of horse equipments. \$ *100*

Remarks :

Book mark :

Cammack

(858)

Copyist.

P

10 H. Art'y.

U.S.C.T.

John Philips

Co. H, 10 Reg't U. S. Col'd H. Art'y

Appears on

Company Muster Roll

for Sep & Oct, 1866.

Present or absent Present

Stoppage, \$ 100 for

Due Gov't, \$ 100 for

Valuation of horse, \$ 100

Valuation of horse equipments. \$ 100

Remarks:

Book mark:

Lowry

(858)

Copyist.

P

10 H. Art'y.

U.S.C.T.

John Philips

Co. H, 10 Reg't U. S. Col'd H. Art'y

Appears on

Company Muster Roll

for Nov. & Dec, 1866.

Present or absent Present

Stoppage, \$ 100 for

Due Gov't, \$ 100 for

Valuation of horse, \$ 100

Valuation of horse equipments. \$ 100

Remarks: Stop for equi-
page 52.

Book mark:

Lowry

(358)

Copyist.

P

10 H. Art'y. U.S.C.T.

John Phillips
Pvt., Co. H., 10 Reg't U. S. Col'd H. Art'y.

Appears on Co. Muster-out Roll, dated
Baton Rouge, La., Feb. 22, 1867.
Muster-out to date Feb. 22, 1867.
Last paid to Dec. 31, 1866.

Clothing account:

Last settled _____, 186 ; drawn since \$ 100
Due soldier \$ 55 ⁸⁸ / 100; due U. S. \$ 100
Am't for cloth'g in kind or money adv'd \$ 100

Due U. S. for arms, equipments, &c., \$ 6 ⁰⁰ / 100

Bounty paid \$ 100; due \$ 20 ⁰⁰ / 100

Remarks: Transferred from 77th S. I. (S. O. 66, Dep't of La. '65)
Conscripted under G. O. 106
Sept' Gulf 1864.

Book mark: V. 152. P. 206. 73. (over)

(361)

Loony

Copyist.

JAN. 18

5511071

1891

V. 230. P. 176. 76.

2nd Lieutenant - 2nd Lieutenant

CARD NUMBERS.

1	5487853	26
2		27
3		28
4		29
5		30
6		31
7		32
8		33
9		34
10		35
11		36
12		37
13		38
14		39
15		40
16		41
17		42
18		43
19		44
20		45
21		46
22		47
23		48
24		49
25		50

Book Mark:

See also *77 U.S. C. Inf*

P 1026 A U.S.C.T.

John B Phillips
10 Reg't U. S. Col'd

Appears on

M. and D. Roll of Men Transferred

to the organization named above,

from 77 U. S. Col Inf

Roll dated Camp Campetada Tex, 1864.

When enlisted, 1864.

Period for which enlisted years.

When mustered in Apr 20, 1864.

Present or absent

Company to which assigned

Remarks: Resigned and discharged
per S.O. 124 dated Hd
Qrs Dept of the Gulf
May 31 60,

name not taken up
in muster rolls of Regt

Book mark:

W. H. Scott

Co. Co., 10 U.S. Col'd H. Art'y

Private Private.

CARD NUMBERS.

1	5487242	26
2	5498570	27
3	5498711	28
4	5498850	29
5	5498987	30
6	5499127	31
7	5499263	32
8	5499399	33
9	5499534	34
10	5499671	35
11	5499805	36
12	5499940	37
13	5500770	38
14	5500205	39
15	5500332	40
16	5500394	41
17		42
18		43
19		44
20		45
21		46
22		47
23		48
24		49
25		50

Book Mark:

See also

P

10 H. Art'y. | U.S.C.T.

Nelson Phillips

Appears with rank of Priv on

Muster and Descriptive Roll of a Detachment of U. S. Vols. forwarded

for the 10 Reg't U.S.C.H. Art'y Roll dated New Orleans La, Sept 19, 1864

Where born La fouch La

Age 21 y'rs; occupation Laborer

When enlisted Aug 15, 1864.

Where enlisted New Orleans La

For what period enlisted 3 years.

Eyes Black; hair Black

Complexion Dark; height 5 ft. 3 1/2 in.

When mustered in Sept 19, 1864.

Where mustered in New Orleans

Bounty paid \$ 100; due \$ 300 100

Where credited to New Orleans La

Company to which assigned le

Remarks :

Book mark :

S. W. Williams

Nelson Phillips

Pat., Co. C, 10 Reg't U. S. Col'd H. Art'y.

Appears on

Company Muster Roll

for Sept 1000, 1864.

Present or absent Present

Stoppage, \$ 100 for

Due Gov't, \$ 100 for

Valuation of horse, \$ 100

Valuation of horse equipments, \$ 100

Remarks: \$300 Bounty due

Book mark: 2309250

J. Anderson Copyist.

P

10 H. Art'y. U.S.C.T.

Nelson Phillips

Pot., Co. C, 10 Reg't U. S. Col'd H. Art'y.

Appears on

Company Muster Roll

for Nov & Dec, 1864

Present or absent Present

Stoppage, \$ 100 for

Due Gov't, \$ 100 for

Valuation of horse, \$ 100

Valuation of horse equipments, \$ 100

Remarks: \$300 Bountty due

Book mark:

(358)

J. Anderson Copyist.

P

10 H. Art'y. U.S.C.T.

Nelson Phillips
Pvt., Co. C, 10 Reg't U. S. Col'd H. Art'y.

Appears on

Company Muster Roll

for Jan & Feb, 1865.

Present or absent Present

Stoppage, \$ 100 for

Due Gov't, \$ 100 for

Valuation of horse, \$ 100

Valuation of horse equipments, \$ 100

Remarks:

Book mark:

Gallade

P

10 H. Art'y. | U.S.C.T.

Nelson Phillips

Priv., Co. C, 10 Reg't U. S. Col'd H. Art'y.

Appears on

Company Muster Roll

for *March & April*, 1865.

Present or absent *Present*

Stoppage, \$ 100 for

Due Gov't, \$ 100 for

Valuation of horse, \$ 100

Valuation of horse equipments, \$ 100

Remarks:

Book mark:

Lucas

P

10 H. Art'y. U.S.C.T.

Nelson Phillips

Pvt., Co. C, 10 Reg't U. S. Col'd H. Art'y.

Appears on

Company Muster Roll

for May & June, 1865

Present or absent Present

Stoppage, \$ 100 for

Due Gov't, \$ 100 for

Valuation of horse, \$ 100

Valuation of horse equipments, \$ 100

Remarks:

Book mark:

Ballade

20

10 H. Art'y. | U.S.C.T.

Nelson Phillips
Sgt., Co. C, 10 Reg't U. S. Col'd H. Art'y.

Appears on

Company Muster Roll

for July & Aug, 1865.

Present or absent Present

Stoppage, \$ 100 for

Due Gov't, \$ 100 for

Valuation of horse, \$ 100

Valuation of horse equipments, \$ 100

Remarks: \$200. Bounty due. \$100. paid

Book mark:

(358)

Ballade Copyist.

P

10 H. Art'y. U.S.C.T.

Nelson Phillips
Pvt, Co. C, 10 Reg't U. S. Col'd H. Art'y.

Appears on

Company Muster Roll

for Sept Oct, 1865.

Present or absent Present

Stoppage, \$ 100 for

Due Gov't, \$ 100 for

Valuation of horse, \$ 100

Valuation of horse equipments, \$ 100

Remarks:

Book mark:

Dallade

P

10 H. Art'y. U.S.C.T.

Nelson Phillips
Pvt., Co. C, 10 Reg't U. S. Col'd H. Art'y.

Appears on

Company Muster Roll

for Nov. 24 Dec., 1865.

Present or absent Present.

Stoppage, \$ 100 for

Due Gov't, \$ 100 for

Valuation of horse, \$ 100

Valuation of horse equipments, \$ 100

Remarks:

Book mark:

(358)

A. J. Robbins

Copyist.

P

10 H. Art'y. U.S.C.T.

Nelson Phillips

Co. C, 10 Reg't U. S. Col'd H. Art'y.

Appears on

Company Muster Roll

for Jan. & Feb., 1866.

Present or absent Present.

Stoppage, \$ 100 for

Due Gov't, \$ 100 for

Valuation of horse, \$ 100

Valuation of horse equipments, \$ 100

Remarks: \$100 bounty paid, \$200 due.

Book mark:

A. J. Robbins

(358)

Copyist.

P

10 H. Art'y. U.S.C.T.

Wilson Phillips

Ph, Co. C, 10 Reg't U. S. Col'd H. Art'y.

Appears on

Company Muster Roll

for *March & April*, 186*6*.

Present or absent *Present*

Stoppage, \$ *100* for

Due Gov't, \$ *100* for

Valuation of horse, \$ *100*

Valuation of horse equipments, \$ *100*

Remarks: *Due U. S. for loss of
wiper \$ $\frac{25}{100}$*

Book mark:

A. J. Robbins

(358)

Copyist.

P

10 H. Art'y. | U.S.C.T.

Nelson Phillippe
Priv., Co. C, 10 Reg't U. S. Col'd H. Art'y.

Appears on

Company Muster Roll

for May 2d June, 1864.

Present or absent Present

Stoppage, \$ 100 for

Due Gov't, \$ 100 for

Valuation of horse, \$ 100

Valuation of horse equipments, \$ 100

Remarks: \$200 Bounty paid, \$100 to be paid.

Book mark:

(358)

A. J. Robbins

Copyist.

P

10 H. Art'y. | U.S.C.T.

Nelson Phillippe

Co. C, 10 Reg't U. S. Col'd H. Art'y.

Appears on

Company Muster Roll

for July 2d Aug., 1866

Present or absent Present

Stoppage, \$ 100 for

Due Gov't, \$ 100 for

Valuation of horse, \$ 100

Valuation of horse equipments, \$ 100

Remarks:

Book mark:

(358)

A. J. Robbins

Copyist.

P

10 H. Art'y. | U.S.C.T.

Alvan Phillips

Pr, Co. C, 10 Reg't U. S. Col'd H. Art'y.

Appears on

Company Muster Roll

for *Sept & Oct*, 186*6*.

Present or absent *Present*

Stoppage, \$ *100* for

Due Gov't, \$ *100* for

Valuation of horse, \$ *100*

Valuation of horse equipments, \$ *100*

Remarks:

Book mark:

Hamm
Copyist.

P

10 H. Art'y. U.S.C.T.

Nelson Phillips

Pr, Co. C, 10 Reg't U. S. Col'd H. Art'y.

Appears on

Company Muster Roll

for Nov, & Dec, 1866

Present or absent Present

Stoppage, \$ 100 for

Due Gov't, \$ 100 for

Valuation of horse, \$ 100

Valuation of horse equipments, \$ 100

Remarks:

Book mark:

Hammer

P | 10 H. Art'y. | U.S.C.T.

Nelson Phillips
Por, Co. C, 10 Reg't U. S. Col'd H. Art'y.

Appears on Co. Muster-out Roll, dated
Baton Rouge, La, Feb 22, 1867.

Muster-out to date Feb 22, 1867.

Last paid to Dec 31, 1866.

Clothing account:

Last settled _____, 186 ; drawn since \$ _____ 100

Due soldier \$ $\frac{57}{100}$ $\frac{56}{100}$; due U. S. \$ _____ 100

Am't for cloth'g in kind or money adv'd \$ _____ 100

Due U. S. for arms, equipments, &c., \$ $\frac{6}{100}$

Bounty paid \$ $\frac{200}{100}$; due \$ _____ 100

Remarks: Joined as recruit
Stop for one Springfield
Rifled musket and
accoutrements retained

Book mark : _____

(361)

Manning
Copyist.

Co. A., 10 U.S. Col'd H. Ar.

Private | Private.

CARD NUMBERS.

1	5490460	26
2	5490611	27
3	5490752	28
4	5490907	29
5	5491043	30
6	5491177	31
7	5491306	32
8	5491439	33
9	5491566	34
10	5491693	35
11	5491819	36
12	5491945	37
13	5492070	38
14	5492195	39
15	5492317	40
16	5492442	41
17	5492592	42
18	5492710	43
19		44
20		45
21		46
22		47
23		48
24		49
25		50

Book Mark:

See also

P

10 H. Art'y. U.S.C.T.

Willis Phillips

Co. A, 1 Reg't La. Col'd H. Art'y.*

Age 38 years.

Appears on

Company Muster-in Roll

of the organization named above. Roll dated

New Orleans, La, Nov. 29, 1862.

Muster-in to date Nov. 29, 1862.

Joined for duty and enrolled:

When Nov. 16, 1862.

Where New Orleans

Period 3 years.

Valuation of horse, \$ 100

Valuation of horse equipments, \$ 100

Remarks:

* This organization subsequently became Co. A, 10 Reg't U. S. Colored Heavy Artillery.

Book mark:

(356)

Tobman

Copyist.

P

10 H. Art'y. U.S.C.T.

Willis Phillips

Priv, Co. A, 1 Reg't La. H. Art'y.*

Appears on

Company Muster Roll

for to Dec. 31, 1862

Present or absent Present

Stoppage, \$ 100 for

Due Gov't, \$ 100 for

Valuation of horse, \$ 100

Valuation of horse equipments, \$ 100

Remarks:

*This organization subsequently became Co. A, 10 Reg't U. S. Col'd Heavy Artillery.

Book mark:

Tobman

P

10 H. Art'y. U.S.C.T.

Willis Phillips

Priv, Co. A, 1 Reg't La. H. Art'y.*

Appears on

Company Muster Roll

for Jan'y & Feby, 1863.

Present or absent Present

Stoppage, \$ 100 for

Due Gov't, \$ 100 for

Valuation of horse, \$ 100

Valuation of horse equipments, \$ 100

Remarks:

*This organization subsequently became Co. A, 10 Reg't U. S. Col'd Heavy Artillery.

Book mark:

Tolman

P | 10 H. Art'y. | U.S.C.T.

Willis Phillips

Priv., Co. A, 1 Reg't La. H. Art'y.*

Appears on

Company Muster Roll

for March & April, 1863.

Present or absent Present

Stoppage, \$.....100 for

Due Gov't, \$.....100 for

Valuation of horse, \$.....100

Valuation of horse equipments, \$.....100

Remarks:.....
.....
.....
.....
.....
.....
.....
.....

*This organization subsequently became Co. A, 10 Reg't U. S. Col'd Heavy Artillery.

Book mark:.....

(358) Johnson Copyist.

P

10 H. Art'y. U.S.C.T.

Willis Phillips

Priv., Co. A, 1 Reg't La. H. Art'y.*

Appears on

Company Muster Roll

for May & June, 1863.

Present or absent Present

Stoppage, \$ 100 for

Due Gov't, \$ 100 for

Valuation of horse, \$ 100

Valuation of horse equipments, \$ 100

Remarks:

*This organization subsequently became Co. A, 10 Reg't U. S. Col'd Heavy Artillery.

Book mark:

Tolman

(358)

Copyist.

D

10 H. Art'y. U.S.C.T.

Willis Phillips

Priv, Co. A, 1 Reg't La. H. Art'y.*

Appears on

Company Muster Roll

for July & August, 1863.

Present or absent Present

Stoppage, \$ 100 for

Due Gov't, \$ 100 for

Valuation of horse, \$ 100

Valuation of horse equipments, \$ 100

Remarks:

*This organization subsequently became Co. A, 10 Reg't U. S. Col'd Heavy Artillery.

Book mark:

Johnson

(358)

Copyist.

P

10 H. Art'y. U.S.C.T.

Willis Phillips

Priv., Co. A, 1 Reg't La. H. Art'y.*

Appears on

Company Muster Roll

for Sept & Oct, 1863.

Present or absent Present

Stoppage, \$ 100 for

Due Gov't, \$ 100 for

Valuation of horse, \$ 100

Valuation of horse equipments, \$ 100

Remarks:

*This organization subsequently became Co. A, 10 Reg't U. S. Col'd Heavy Artillery.

Book mark:

Johnson

Copyist.

P

10 H. Art'y. | U.S.C.T.

Willie Phillips

Co. A, 1 Reg't H. Art'y, Corps d'Afrique.*

Appears on

Company Muster Roll

for *Nov Dec*, 1863

Present or absent *Present*

Stoppage, \$ 100 for

Due Gov't, \$ 100 for

Valuation of horse, \$ 100

Valuation of horse equipments, \$ 100

Remarks:

*This organization subsequently became Co. A, 10 Reg't U. S. Colored Heavy Artillery.

Book mark:

Roberts

P

10 H. Art'y. | U.S.C.T.

Willis Phillips
Art., Co. A, 1 Reg't H. Art'y, Corps d'Afrique.*

Appears on

Company Muster Roll

for Jan & Feb, 1864

Present or absent Present

Stoppage, \$ 100 for

Due Gov't, \$ 100 for

Valuation of horse, \$ 100

Valuation of horse equipments, \$ 100

Remarks: Sick in hospital

* This organization subsequently became Co. A, 10 Reg't U. S. Colored Heavy Artillery.

Book mark:

Bohner

P

10 H. Art'y.

U.S.C.T.

William Phillips
Ft. A, Co. A, 7 Reg't U. S. Col'd H. Art'y.*

Appears on

Company Muster Roll

for *Michxels*, 1864.

Present or absent *Present*

Stoppage, \$ 100 for

Due Gov't, \$ 100 for

Valuation of horse, \$ 100

Valuation of horse equipments, \$ 100

Remarks:

* This organization subsequently became Co. *A*, 10 Reg't U. S. Colored Heavy Artillery.

Book mark:

Co. A

P

10 H. Art'y.

U.S.C.T.

William Phillips
Pt. A, Co. A, 7 Reg't U. S. Col'd H. Art'y.*

Appears on

Company Muster Roll

for May & June, 1864.

Present or absent Present

Stoppage, \$ 100 for

Due Gov't, \$ 100 for

Valuation of horse, \$ 100

Valuation of horse equipments, \$ 100

Remarks:

* This organization subsequently became Co. A, 10 Reg't U. S. Colored Heavy Artillery.

Book mark:

Robertson

P

10 H. Art'y.

U.S.C.T.

Willis Phillips
Art A, 7 Reg't U. S. Col'd H. Art'y.*

Appears on

Company Muster Roll

for July & Aug, 1864.

Present or absent Present

Stoppage, \$ 100 for

Due Gov't, \$ 100 for

Valuation of horse, \$ 100

Valuation of horse equipments, \$ 100

Remarks:

* This organization subsequently became Co. A, 10 Reg't U. S. Colored Heavy Artillery.

Book mark:

Becker

P | 10 H. Art'y. | U.S.C.T.

Willis Phillips

Pvt., Co. A, 10 Reg't U. S. Col'd H. Art'y.

Appears on

Company Muster Roll

for Sept Oct, 1864

Present or absent Present

Stoppage, \$ 100 for

Due Gov't, \$ 100 for

Valuation of horse, \$ 100

Valuation of horse equipments, \$ 100

Remarks:

Book mark:

Recorder

(358)

Copyist.

Willis Phillips
Plt, Co. A, 10 Reg't U. S. Col'd H. Art'y.

Appears on

Company Muster Roll

for *W. Lee*, 186*4*.

Present or absent *Present*

Stoppage, \$ 100 for

Due Gov't, \$ 100 for

Valuation of horse, \$ 100

Valuation of horse equipments, \$ 100

Remarks:

Book mark:-----

Rochester

P | 10 H. Art'y. | U.S.C.T.

Willis Phillips

Pvt, Co. A, 10 Reg't U. S. Col'd H. Art'y.

Appears on

Company Muster Roll

for *Jan & Feb*, 1865.

Present or absent *Present*

Stoppage, \$ *100* for

Due Gov't, \$ *100* for

Valuation of horse, \$ *100*

Valuation of horse equipments, \$ *100*

Remarks:

Book mark: -----

Reister

P

10 H. Art'y. U.S.C.T.

William Phillips

Co. A, 10 Reg't U. S. Col'd H. Art'y.

Appears on

Company Muster Roll

for *March & April*, 1865

Present or absent *Present*

Stoppage, \$ 100 for

Due Gov't, \$ 100 for

Valuation of horse, \$ 100

Valuation of horse equipments, \$ 100

Remarks:

Book mark:

Becker

P | 10 H. Art'y. | U.S.C.T.

William Phillips

Co., Co. A, 10 Reg't U. S. Col'd H. Art'y.

Appears on

Company Muster Roll

for *May & June, 1865*

Present or absent

Stoppage, \$ 100 for

Due Gov't, \$ 100 for

Valuation of horse, \$ 100

Valuation of horse equipments, \$ 100

Remarks: *Died May 15, 1865
at Ft Jackson of
disease. Final
Statement given*

Book mark:

Proctor

(358)

Copyist.

P | 10 H. Art'y. | U.S.C.T.

Willis Phillips
Pvt, Co. A, 10 Reg't U. S. Col'd H. Art'y.

Appears on Co. Muster-out Roll, dated
Baton Rouge La Feb. 22 1867.

Muster-out to date _____, 186 .

Last paid to _____, 186 .

Clothing account:

Last settled _____, 186 ; drawn since \$ _____ 100

Due soldier \$ _____ 100; due U. S. \$ _____ 100

Am't for cloth'g in kind or money adv'd \$ _____ 100

Due U. S. for arms, equipments, &c., \$ _____ 100

Bounty paid \$ _____ 100; due \$ _____ 100

Remarks: *Joined origl. orgn. Died
May 15. 65 Final statements
given*

Book mark: *V 117 P. 344. 70*

Nesbitt

Phillips, Willis

D, Co. A, 10 Reg't U.S. Artillery

2 Enclosures.

Bed Cards	Descriptive Lists
Burial Records /	Final Statements /
Certs. of Dis. for Discharge	Furloughs
C. M. Charges	Med. Des. Lists
Med. Certificates	Orders

Other papers relating to—

Admission to Hosp'l	Furlough
Casualty Sheet (Officer's)	Med. Examination
Confinement	Misc. Information
Contracts	Pay or Clothing
Death or Effects	Personal Reports
Desertions	Rank
Discharge from Hosp'l	Transfer to Hosp'l
Discharge from Service	Transfer to V. R. C.
Duty	Transportation

Willis Phillips
Pat Leo A. 10 U.S.C. York
Died May 15 '65

HOSPITAL RECORD,

SUBJECT TO THE

ORDER OF THE SURGEON GENERAL

UNITED STATES ARMY.

P

RECORD OF DEATH AND INTERMENT.

Name and number of person interred.	<i>William ...</i>	<i>2.</i>
Number and locality of the grave . . .	<i>Cemetery at Fort Jackson, La.</i>	
Hospital number of the deceased . . .	<i>344</i>	
Regiment, rank, and company . . .	<i>10th U.S. Inf., Pvt. Co. 4.</i>	
Residence before enlistment . . .	<i>Hopkins Plantation, Bayou Lafourche</i>	
Conjugal condition, (and if married,) the residence of the widow) . . .	<i>Single</i>	
Cause of death	<i>Septicemia</i>	
Age of the deceased		
Nativity	<i>Virginia</i>	
References and remarks		
Date of death and burial	<i>May 1, 1862</i>	<i>, 1862</i>

Duplicates sent to the Adjutant General of the United States Army, and to the Sexton of the Cemetery.

Memoranda:

FINAL STATEMENT

OF

Private Willis Phillips

10th Reg't of U.S. Col'd Arty (Hq)

VOLUNTEERS.

Dead May 15th 1865

NOTE 1.—Two of these certificates (or duplicates) are to be given to each Volunteer Soldier or drafted man who may be discharged previously to the discharge of his company, that he may at once receive from the Paymaster the pay, &c., due him, and the captain or other COMMISSIONED officer commanding the company will certify to the act of the delivery of the duplicate certificates; on these certificates the Soldier is "entitled to" his discharge, and should also present his discharge to the Paymaster to have the payment endorsed on it. The discharge is to be given back to the Soldier by the Paymaster; the latter only retaining as his voucher

back pay, &c., are settled by the

NOTE 4.—Charges for loss or injury to ordnance, horse equipments, and other miscellaneous charges, should appear under the heading of "Other Stoppages."

NOTE 5.—Bounty paid by State authorities, and not by the United States, will not be entered on this statement.

NOTE 6.—Amounts due the Sutler and Laundress must be entered on the muster roll on which the discharge, death, desertion, &c., is reported, as well as on the final statement, otherwise the amount cannot be collected from the United States.

NOTE 7.—This blank will be used for deceased volunteers and drafted men, as well as for others.

NOTE 8.—Where a Soldier dies in Hospital or on detached service, his descriptive list, if he has one, should be sent with his final statements, in duplicate, to the Adjutant General, Washington, D. C.



Leuby

ADJUTANT GENERAL'S OFFICE.

May 30th 1865

Duplicate with Inventory sent 2d Auditor.

I certify, on honor, that Willis Phillips a Private of
 Captain J. W. Chamberlain's Company (A) of the 10th U.S. Regiment of Col^d Art^y (Heavy)
VOLUNTEERS, of the State of _____, born in Bayou Boeuf, State
 of Louisiana, aged 27 years; 5 feet 8 1/2 inches high; Black complexion,
Black eyes, Black hair, and by occupation a Farmer, having joined the company on
 its original organization at New Orleans La and enrolled in it at the muster into
 the service of the United States at New Orleans La, on the Twenty ninth day
 of November, 1862, (or was mustered in service as a recruit, by _____
 _____, at _____, on the _____ day of _____,
 186 _____, or was drafted and mustered into the service of the United States from the _____
 Enrollment District of the State of _____, at _____,
 on the _____ day of _____, 186 _____) to serve in the Regiment, for
 the term of Three Years: and having served **HONESTLY** and
FAITHFULLY with his Company in the 10th U.S. Col^d Art^y (H) to the present date, is now
 entitled to a **DISCHARGE** by reason of Death
(Died May 15, 1865 see Inventory)

The said Private Willis Phillips was last paid by Paymaster
Maj' Dolman to include the 31st day of August, 1864, and has
 pay due him from that time to the present date; he is entitled to pay and subsistence for
TRAVELING to place of enrollment, and whatever other allowances are authorized to volunteer
 soldiers, drafted men, or militia, so discharged. He has received from the United States **CLOTHING**
 amounting to Thirteen ²⁴/₁₀₀ dollars, since the 31st day of December,
 1864, when his clothing account was last settled. He has received from the United States
 _____ ¹⁰⁰/₁₀₀ dollars advanced **BOUNTY**.

There is to be stopped from him, on account of the State of _____, or other
 authorities, for **CLOTHING**, &c., received on entering service, _____ ¹⁰⁰/₁₀₀ dollars; and
 for other stoppages, viz: _____

_____ ¹⁰⁰/₁₀₀ dollars.
 He has been furnished with **TRANSPORTATION** in kind from the place of his discharge to
 _____; and he has been **SUBSISTED** for **TRAVELING** to his
 place of enrollment, up to the _____, 186 _____.

He is indebted to _____, **SUTLER**, _____ ¹⁰⁰/₁₀₀ dollars.
 He is indebted to _____, **LAUNDRESS**, _____ ¹⁰⁰/₁₀₀ dollars.

Given in Duplicate, at Fort Jackson La, this 15th day
 of May, 1865

Justin E. Brown
1st Lt. Col. 10th U.S. Col^d Art^y (H)
 Commanding Company.

Corporal

Reynolds

CARD NUMBERS.

1	55-11210	26
2	55-11308	27
3	55-11396	28
4	55-11473	29
5	55-11622	30
6	55-11822	31
7	55-12063	32
8	5489999	33
9		34
10		35
11		36
12		37
13		38
14		39
15		40
16		41
17		42
18		43
19		44
20		45
21		46
22		47
23		48
24		49
25		50

Book Mark:

See also

P

10 H. Art'y. | U.S.C.T.

Gabriel Pichou

Capt, Co. I, 10 Reg't U. S. Col'd H. Art'y.

Age years.

Appears on

Company Muster Roll*

for Enrollment to June 30, 1865.

Joined for duty and enrolled:

When, 186 .

Where

Period / years.

Mustered in:

When Apr. 29, 1865.

Where New Orleans, La.

Present or absent Present

Stoppage, \$ 100 for

Due Gov't, \$ 100 for

Valuation of horse, \$ 100

Valuation of horse equipments, \$ 100

Remarks: Drafted, Promoted from Private to

*First current roll. No muster-in roll of this company on file.

Book mark :

O. J. Clark

(3586)

Copyist.

JAN. 16

5511210

1891

Corp's to date from May
19, 65 - by order of Capt.
Bailey. Commence-
ment of first payment
by time Apr. 29, 65 -
Sick in quarters.

P.

10 H. Art'y.

U.S.C.T.

Gabriel Pichou

Corpl., Co. I, 10 Reg't U. S. Col'd H. Art'y.

Appears on

Company Muster Roll

for July & Aug., 1865.

Present or absent Present

Stoppage, \$ 100 for

Due Gov't, \$ 100 for

Valuation of horse, \$ 100

Valuation of horse equipments, \$ 100

Remarks: Appointed corporal to date May 19, 1865 - SO. No. 27, Hd. Qrs. Regt. June 28, 1865.

Book mark:

(858)

O. S. Clark

Copyist.

P.

10 H. Art'y.

U.S.C.T.

Gabriel Tichon

Corpl, Co. I, 10 Reg't U. S. Col'd H. Art'y.

Appears on

Company Muster Roll

for *Sept + Oct.*, 186*5*.

Present or absent *Present*

Stoppage, \$ *100* for

Due Gov't, \$ *100* for

Valuation of horse, \$ *100*

Valuation of horse equipments, \$ *100*

Remarks:

Book mark:

O.S. Clark

(358)

Copyist.

P.

10 H. Art'y.

U.S.C.T.

Gabriel Pichon

Srjt, Co. I, 10 Reg't U. S. Col'd H. Art'y.

Appears on

Company Muster Roll

for *for & ore.*, 1865-

Present or absent *Present*

Stoppage, \$ 100 for

Due Gov't, \$ 100 for

Valuation of horse, \$ 100

Valuation of horse equipments, \$ 100

Remarks: *Promoted from Corporal Nov. 20, 1865-*

FROM SECOND AUDITOR'S ROLL.

Book mark:

O. S. Clark

(358)

Copyist.

Gabriel Pichou
Sergt., Co. I, 10 Reg't U. S. Col'd H. Art'y.

Appears on

Company Muster Roll

for *Jan. & Feb.*, 1866.

Present or absent *Present*

Stoppage, \$ 100 for

Due Gov't, \$ 100 for

Valuation of horse, \$ 100

Valuation of horse equipments, \$ 100

Remarks:

Book mark: -----

(358) *A. S. Clark* Copyist.

P

10 H. Art'y.

U.S.C.T.

Gabriel Pichou

Srgrt., Co. I, 10 Reg't U. S. Col'd H. Art'y.

Appears on

Company Muster Roll

for *March & Apr.*, 1866.

Present or absent

Stoppage, \$ 100 for

Due Gov't, \$ 100 for

Valuation of horse, \$ 100

Valuation of horse equipments, \$ 100

Remarks: *Discharged. Mustered out by reason of expiration of term of service to date Apr. 28, 1866.*

Book mark: *Muster out on file.*

O. J. Clark

P

10 H. Art'y. U.S.C.T.

Gabriel Picheon

Serjt, Co. *I*, 10 Reg't U. S. Col'd H. Art'y.

Appears on **Co. Muster-out Roll**, dated

Baton Rouge La, *Feb 22*, 1867.

Muster-out to date _____, 186 .

Last paid to _____, 186 .

Clothing account:

Last settled _____, 186 ; drawn since \$ _____ 100

Due soldier \$ _____ 100; due U. S. \$ _____ 100

Am't for cloth'g in kind or money adv'd \$ _____ 100

Due U. S. for arms, equipments, &c., \$ _____ 100

Bounty paid \$ _____ 100; due \$ _____ 100

Remarks: *Discharged. Expiration*
term of Service April 28, 1866
(Age 23 yrs)

Book mark : _____

(361)

J. M. Hance

Copyist.

P | 10 Arty | U.S.C.T.

Gabriel Pichon

Serg., Co. D, 10 Reg't U. S. Col'd Arty.

Appears on a

Detachment Muster-out Roll

of the organization named above. Roll dated
New Orleans La., Apr. 28, 1866.

Muster-out to date Apr. 28, 1866.

Last paid to Feb. 28, 1866

Clothing account:

Last settled _____, 1866 ; drawn since \$ _____ 100

Due soldier \$ ³⁹ 31/100 ; due U. S. \$ _____ 100

Am't for cloth'g in kind or money adv'd \$ _____ 100

Due U. S. for arms, equipments, &c., \$ _____ 100

Bounty paid \$ _____ 100 due \$ _____ 100

Remarks: Joined by draft. Appoint-
ed Corp. to date May 19, 1865 per A.O.
No. 27 Hqrs Regt. June 28, 1865
Promoted Sergt. to date Nov. 20,
1865. per A.O. No. Hqrs Regt.

Book mark: _____

R. E. Wilson

Co., 10 U.S. Col'd H. Army

Private | *Private*

CARD NUMBERS.

1	5497752	26
2	5498151	27
3	5498252	28
4	5498349	29
5	5498448	30
6	5498493	31
7	5498633	32
8	5498772	33
9	5498990	34
10	5499130	35
11	5499266	36
12	5499402	37
13	5499537	38
14	5499674	39
15	5499808	40
16	5499943	41
17	5500073	42
18	5500208	43
19	5500335	44
20	5500480	45
21	5490174	46
22		47
23		48
24		49
25		50

Book Mark:

See also

P | 10 H. Art'y. | U.S.C.T.

Francis Pickett

Pvt., Co. C, 1 Reg't La. Art'y, Native Guards.*

Age *18* years.

Appears on

Company Muster-in Roll

of the organization named above. Roll dated

New Orleans La, Feb 4, 1864.

Muster-in to date *Dec 31, 1863.*

Joined for duty and enrolled:

When *Nov 7, 1863.*

Where *Pragueville La*

Period *3* years.

Valuation of horse, \$ *100*

Valuation of horse equipments, \$ *100*

Remarks:
.....
.....
.....

* This organization subsequently became Co. C, 10 Reg't U. S. Col'd Heavy Artillery.

Book mark :
.....

W. J. ...

P | 10 H. Art'y. | U.S.C.T.

Francis Regier

Pt, Co. *C*, 1 Reg't H. Art'y, Corps d'Afrique.*

Appears on

Company Muster Roll

for *Feb 4th to 29th*, 186*4*.

Present or absent *Present*

Stoppage, \$ *100* for

Due Gov't, \$ *100* for

Valuation of horse, \$ *100*

Valuation of horse equipments, \$ *100*

Remarks:

*This organization subsequently became Co. *C*, 10 Reg't U. S. Colored Heavy Artillery.

Book mark: -----

Francis Regier
Copyist.

Francis Piquet
Pot., Co. *L*, 7 Reg't U. S. Col'd H. Art'y.*

Appears on

Company Muster Roll

for *Nich & apl*, 186*4*.

Present or absent *Present*

Stoppage, \$ 100 for

Due Gov't, \$ 100 for

Valuation of horse, \$ 100

Valuation of horse equipments, \$ 100

Remarks:

* This organization subsequently became Co. , 10 Reg't U. S. Colored Heavy Artillery.

Book mark:

(358)

J. Henderson
Copyist.

P | 10 H. Art'y. | U.S.C.T.

Francis Piguet
Pvt., Co. L., 7 Reg't U. S. Col'd H. Art'y.*

Appears on

Company Muster Roll

for *Mayo June*, 1864.

Present or absent *Present*

Stoppage, \$ 100 for

Due Gov't, \$ 100 for

Valuation of horse, \$ 100

Valuation of horse equipments, \$ 100

Remarks:

* This organization subsequently became Co. _____, 10 Reg't U. S. Colored Heavy Artillery.

Book mark: _____

(358) *J. Anderson* Copyist.

P | 10 H. Art'y. | U.S.C.T.

Frances Pignet
Pvt, Co. G, 7 Reg't U. S. Col'd H. Art'y.*

Appears on

Company Muster Roll

for July & Aug, 1864.

Present or absent Present

Stoppage, \$ 100 for

Due Gov't, \$ 100 for

Valuation of horse, \$ 100

Valuation of horse equipments, \$ 100

Remarks: Due U.S. for
ord. \$0.02

* This organization subsequently became Co. , 10 Reg't U. S. Colored Heavy Artillery.

Book mark :

(358) J. Anderson Copyist.

P | 10 H. Art'y. | U.S.C.T.

Francis Piquet
Corp., Co. C, 10 Reg't U. S. Col'd H. Art'y.

Appears on

Company Muster Roll

for Sept 1864, 1864

Present or absent Present

Stoppage, \$ 100 for

Due Gov't, \$ 100 for

Valuation of horse, \$ 100

Valuation of horse equipments, \$ 100

Remarks: Promoted Corp'l
Sept 18/64
Due U.S. for ord.
\$0.52

Book mark:

(358)

J. M. Anderson
Copyist.

P | 10 H. Art'y. | U.S.C.T.

Francis Pickett

Capt., Co. C, 10 Reg't U. S. Col'd H. Art'y.

Appears on

Company Muster Roll

for Nov & Dec, 1864

Present or absent Present

Stoppage, \$ 100 for

Due Gov't, \$ 100 for

Valuation of horse, \$ 100

Valuation of horse equipments, \$ 100

Remarks: Due U.S. for
ord. \$ 0.02

Promoted Capt. Sept
1864

Book mark:

(358)

J. Underwood

Copyist.

P

10 H. Art'y. | U.S.C.T.

Francis Pickett
Corp., Co. C, 10 Reg't U. S. Col'd H. Art'y.

Appears on

Company Muster Roll

for Jan & Feb, 1865

Present or absent Present

Stoppage, \$ 100 for

Due Gov't, \$ 100 for

Valuation of horse, \$ 100

Valuation of horse equipments, \$ 100

Remarks:

Book mark:

Wallace

P

10 H. Art'y.

U.S.C.T.

Francis Pickett

Priv., Co. C, 10 Reg't U. S. Col'd H. Art'y.

Appears on

Company Muster Roll

for Mch + Apl , 1865

Present or absent Present

Stoppage, \$ 100 for

Due Gov't, \$ 100 for

Valuation of horse, \$ 100

Valuation of horse equipments, \$ 100

Remarks: Reduced to private
 from Capt Mch 21. 1865

Book mark:

Lucas

P

10 H. Art'y. U.S.C.T.

Francis Pickett
Pvt., Co. C, 10 Reg't U. S. Col'd H. Art'y.

Appears on

Company Muster Roll

for May & June, 1865.

Present or absent Present

Stoppage, \$ 100 for

Due Gov't, \$ 100 for

Valuation of horse, \$ 100

Valuation of horse equipments, \$ 100

Remarks:

Book mark:

Ballade

P

10 H. Art'y. | U.S.C.T.

Francis Pickett

1st, Co. C, 10 Reg't U. S. Col'd H. Art'y.

Appears on

Company Muster Roll

for July & Aug, 1865.

Present or absent Present

Stoppage, \$ 100 for

Due Gov't, \$ 100 for

Valuation of horse, \$ 100

Valuation of horse equipments, \$ 100

Remarks: Reduced from Corp'l
March 21, 1865

Book mark:

Ballade

P

10 H. Art'y. | U.S.C.T.

Francis Pickett

But, Co. C, 10 Reg't U. S. Col'd H. Art'y.

Appears on

Company Muster Roll

for Sept & Oct, 1865

Present or absent Present

Stoppage, \$ 100 for

Due Gov't, \$ 100 for

Valuation of horse, \$ 100

Valuation of horse equipments, \$ 100

Remarks:

Book mark:

Ballade

P

10 H. Art'y. U.S.C.T.

Francis Pickett

Pop., Co. C, 10 Reg't U. S. Col'd H. Art'y.

Appears on

Company Muster Roll

for Nov. 1st Dec., 1865.

Present or absent Present

Stoppage, \$ 100 for

Due Gov't, \$ 100 for

Valuation of horse, \$ 100

Valuation of horse equipments, \$ 100

Remarks: Reduced to the rank from Capt. Nov. 21, 1865.

Book mark:

A. J. Robbins

(358)

Copyist.

P

10 H. Art'y. U.S.C.T.

Francis Pickel

Pvt., Co. C, 10 Reg't U. S. Col'd H. Art'y.

Appears on

Company Muster Roll

for Jan. 2d Feb., 1866.

Present or absent Present

Stoppage, \$ 100 for

Due Gov't, \$ 100 for

Valuation of horse, \$ 100

Valuation of horse equipments, \$ 100

Remarks:

Book mark:

A. J. Robbins

(358)

Copyist.

P

10 H. Art'y. | U.S.C.T.

Francis Picket

Pch., Co. C, 10 Reg't U. S. Col'd H. Art'y.

Appears on

Company Muster Roll

for *Mch. 2d Apr.*, 186*6*.

Present or absent *Present.*

Stoppage, \$ 100 for

Due Gov't, \$ 100 for

Valuation of horse, \$ 100

Valuation of horse equipments, \$ 100

Remarks: *due U. S. for loss of
wifer \$ $\frac{26}{100}$.*

Book mark:

A. J. Robbins

(358)

Copyist.

P

10 H. Art'y.

U.S.C.T.

Francis Pickett

Pvt., Co. C, 10 Reg't U. S. Col'd H. Art'y.

Appears on

Company Muster Roll

for May and June, 1866.

Present or absent Present

Stoppage, \$ 100 for

Due Gov't, \$ 100 for

Valuation of horse, \$ 100

Valuation of horse equipments, \$ 100

Remarks:

Book mark:

A. J. Robbins

(358)

Copyist.

P

| 10 H. Art'y. | U.S.C.T.

Francis Pickett

Pvt., Co. C, 10 Reg't U. S. Col'd H. Art'y.

Appears on

Company Muster Roll

for July 2d Aug., 1866.

Present or absent Present

Stoppage, \$ 100 for

Due Gov't, \$ 100 for

Valuation of horse, \$ 100

Valuation of horse equipments, \$ 100

Remarks:

Book mark:

(358)

A. J. Robbins

Copyist.

P

10 H. Art'y. U.S.C.T.

Francis Pickett

Pvt., Co. C, 10 Reg't U. S. Col'd H. Art'y.

Appears on

Company Muster Roll

for Sept & Oct, 1866.

Present or absent Present

Stoppage, \$ 100 for

Due Gov't, \$ 100 for

Valuation of horse, \$ 100

Valuation of horse equipments, \$ 100

Remarks:

Book mark:

Hammer Copyist.

P

10 H. Art'y. U.S.C.T.

Francis Pickett

Priv., Co. C, 10 Reg't U. S. Col'd H. Art'y.

Appears on

Company Muster Roll

for Nov & Dec, 1866.

Present or absent Present

Stoppage, \$ 100 for

Due Gov't, \$ 100 for

Valuation of horse, \$ 100

Valuation of horse equipments, \$ 100

Remarks: Due 20 for fees of lampoon & 2/100

Book mark:

Hamming

(358)

Copyist.

P

10 H. Art'y. U.S.C.T.

Francis Pickett

Pvt., Co. C, 10 Reg't U. S. Col'd H. Art'y.

Appears on Co. Muster-out Roll, dated Boston Range, Feb 22, 1867.

Muster-out to date _____, 186 .

Last paid to _____, 186 .

Clothing account:

Last settled _____, 186 ; drawn since \$ _____ 100

Due soldier \$ _____ 100; due U. S. \$ _____ 100

Am't for cloth'g in kind or money adv'd \$ _____ 100

Due U. S. for arms, equipments, &c., \$ _____ 100

Bounty paid \$ _____ 100; due \$ _____ 100

Remarks: joined Orig Reg
Discharged Feb 3, 1867
by reason of expiration
of term of service

Book mark: _____

(361)

Meanning

Copyist.

P | 10 Arty | U.S.C.T.

Francis Pickett

Priv., Co. G, 10 Reg't U. S. Col'd Arty

Appears on a

Detachment Muster-out Roll

of the organization named above. Roll dated

Baton Rouge, La. Feb. 3, 1867.

Muster-out to date Feb. 3, 1867.

Last paid to Dec. 31, 1866

Clothing account:

Last settled _____, 186 ; drawn since \$ _____ 100

Due soldier \$ $89 \frac{04}{100}$; due U. S. \$ $52 \frac{79}{100}$

Am't for cloth'g in kind or money adv'd \$ _____ 100

Due U. S. for arms, equipments, &c., \$ _____ $\frac{28}{100}$

Bounty paid \$ $100 \frac{00}{100}$ due \$ $100 \frac{00}{100}$

Remarks: *Joined orig. org. 11th A. Cda.
now 10 U.S.C.A. (11th) Stop for
tombstone & riper.*

Book mark:

A. E. Wilson

(349)

Copyist.

Private Private

CARD NUMBERS.

1	5488556	26
2	5508442	27
3	5508591	28
4	5508743	29
5	5508890	30
6	5309036	31
7	5309206	32
8	5509463	33
9	5490100	34
10		35
11		36
12		37
13		38
14		39
15		40
16		41
17		42
18		43
19		44
20		45
21		46
22		47
23		48
24		49
25		50

Book Mark:

See also 6073.74 U.S. C. Sup

2 | 10 St. A. U.S.C.T.

John Purie (2nd)
Inf., Co., 10 Reg't U. S. Col'd St. A.

Appears on

M. and D. Roll of Men Transferred

to the organization named above,

from Co "D" 94th U.S. C. Inf.

Roll dated New Orleans, La. Oct 11, 1863

When enlisted Oct: 1, 1863

Period for which enlisted 3 years.

When mustered in Oct: 1, 1863

Present or absent

Company to which assigned

Remarks: Jones as recruit
Co. "C" 20 Inf. Co. A.
(9) U.S. C. Inf. Transf'd
to Co. "D" 94 U.S. C. Inf.
July 20 64 per G. O.
Maj. J. H. Stoggs M. D.
St. M.

Filed with John Pierce

Book mark:

J. W. Jones, Jr
(342) Copyist

P

10 H. Art'y.

U.S.C.T.

John Pierre
Privé, Co. G, 10 Reg't U. S. Col'd H. Art'y.

Appears on

Company Muster Roll

for *Nov. & Dec*, 186*5*.

Present or absent *Present*

Stoppage, \$ *100* for

Due Gov't, \$ *100* for

Valuation of horse, \$ *100*

Valuation of horse equipments, \$ *100*

Remarks: *Transferred from*
Co. B 74th U.S. C. I. Co. f. s.
84, dated 1st June Dept.
of A.

Book mark :

G. M.

P

10 H. Art'y.

U.S.C.T.

John Pierce

Priv., Co. G, 10 Reg't U. S. Col'd H. Art'y.

Appears on

Company Muster Roll

for *Jan. & Feb.*, 1866.

Present or absent *Present*

Stoppage, \$ *100* for

Due Gov't, \$ *100* for

Valuation of horse, \$ *100*

Valuation of horse equipments, \$ *100*

Remarks:

Book mark:

(358)

G. Fol
Copyist.

P

10 H. Art'y. U.S.C.T.

John Pierre
Pvt., Co. G, 10 Reg't U. S. Col'd H. Art'y.

Appears on

Company Muster Roll

for Mar. 9 Apr., 1866.

Present or absent Present

Stoppage, \$ 100 for

Due Gov't, \$ 100 for

Valuation of horse, \$ 100

Valuation of horse equipments, \$ 100

Remarks:

Book mark:

(358)

G. Fox

Copyist.

P

10 H. Art'y.

U.S.C.T.

John Pierre

Pvt, Co. G, 10 Reg't U. S. Col'd H. Art'y.

Appears on

Company Muster Roll

for *May & June*, 186*6*.

Present or absent *Present*

Stoppage, \$.....100 for

Due Gov't, \$.....100 for

Valuation of horse, \$.....100

Valuation of horse equipments, \$.....100

Remarks:.....

Book mark:.....

G. Fry

P

10 H. Art'y. | U.S.C.T.

John Pierre
Cvt, Co. G, 10 Reg't U. S. Col'd H. Art'y.

Appears on

Company Muster Roll

for *July & Aug*, 186*6*.

Present or absent *Present*

Stoppage, \$ *100* for

Due Gov't, \$ *100* for

Valuation of horse, \$ *100*

Valuation of horse equipments, \$ *100*

Remarks:

Book mark:

(358)

G. J. N.

Copyist.

P

10 H. Art'y. U.S.C.T.

John Pierre

Priv., Co. G, 10 Reg't U. S. Col'd H. Art'y.

Appears on

Company Muster Roll

for Sept & Oct, 1866.

Present or absent

Stoppage, \$ 100 for

Due Gov't, \$ 100 for

Valuation of horse, \$ 100

Valuation of horse equipments, \$ 100

Remarks: Mustered out by reason of expiration of term of service to date Sept. 30, 1866.

Book mark: M.O. on file

Wines

John Piere

Pvt, Co. *G*, 10 Reg't U. S. Col'd H. Art'y.

Appears on **Co. Muster-out Roll**, dated *Baton Rouge La, Feb. 22*, 1867.

Muster-out to date _____, 186 .

Last paid to _____, 186 .

Clothing account:

Last settled _____, 186 ; drawn since \$ _____ 100

Due soldier \$ _____ 100; due U. S. \$ _____ 100

Am't for cloth'g in kind or money adv'd \$ _____ 100

Due U. S. for arms, equipments, &c., \$ _____ 100

Bounty paid \$ _____ 100; due \$ _____ 100

Remarks: *Joined by transfer from
74" U.S.C. per S.O. No. 54 Par. 5,
Hd Qrs Dept of La. Discharged
by reason of expiration of
term of service Sept. 30, 1866*

Book mark: *723 P. 739. 68-V 56 P 244. 69,*

Wines

P | 10 Arty | U.S.C.T.

John Pierre

Reg't U. S. Col'd Arty
Co. G, 10

Appears on a

Detachment Muster-out Roll

of the organization named above. Roll dated

New Orleans La, Oct 3, 1866.

Muster-out to date Sept 30, 1866.

Last paid to June 30, 1866.

Clothing account:

Last settled _____, 186 ; drawn since \$ _____ 100

Due soldier \$ 24 ⁶⁰/₁₀₀; due U. S. \$ _____ 100

Am't for cloth'g in kind or money adv'd \$ _____ 100

Due U. S. for arms, equipments, &c., \$ _____ 100

Bounty paid \$ _____ 100 due \$ 100 ¹⁰⁰/₁₀₀

Remarks: Joined by Transfer from 74 U S
C.I. Oct 11- 1865 per SO no 84
45 Qrs Dept of La Series of 1865
Mustered out by reason of
Expiration of Term of Service

Book mark: _____

Abbott

U.S. Col'd E.

Corporal

Corporal

CARD NUMBERS.

1	5511211	26
2	5511309	27
3	5511397	28
4	5511476	29
5	5511625	30
6	5511825	31
7	5512073	32
8	3490001	33
9	40746818	34
10		35
11		36
12		37
13		38
14		39
15		40
16		41
17		42
18		43
19		44
20		45
21		46
22		47
23		48
24		49
25		50

Book Mark:

See also

P.O. No. 10 1224325 9/25/10
P.O. No. 10 224325 9/25/10
P.O. No. 10 224325 9/25/10

M.S. Worley
47

P.

10 H. Art'y.

U.S.C.T.

Louis A. Pierrie

Capt., Co. I., 10 Reg't U. S. Col'd H. Art'y.

Age years.

Appears on

Company Muster Roll*

for Enrollment to June 30, 1865.

Joined for duty and enrolled:

When, 186 .

Where

Period / years.

Mustered in:

When May 1, 1865.

Where New Orleans, La.

Present or absent Present.

Stoppage, \$ 100 for

Due Gov't, \$ 100 for

Valuation of horse, \$ 100

Valuation of horse equipments, \$ 100

Remarks: Drafted. Promoted from Private to Capt.

*First current roll. No muster-in roll of this company on file.

Book mark :

O. S. Clark

(3586)

Copyist.

JAN. 16

5511211

★ 1891 ★

To date from May
19, 65 - by order of Capt.
Bailey. Commence-
ment of first payment
by time May 1, 65.

P.

10 H. Art'y.

U.S.C.T.

Louis A. Tierrie

Corpl., Co. I, 10 Reg't U. S. Col'd H. Art'y.

Appears on

Company Muster Roll

for *July & Aug.*, 1865.

Present or absent *Present*

Stoppage, \$ *100* for

Due Gov't, \$ *100* for

Valuation of horse, \$ *100*

Valuation of horse equipments, \$ *100*

Remarks: *Appointed Corporal to date May 19, 1865 O.O. No. 27, Hd. Qrs. Regt, June 28, 1865.*

Book mark:

(358)

A. S. Clark

Copyright.

P | 10 H. Art'y. | U.S.C.T.

+ Louis A
~~Gabriel~~ Pierre

Corpl., Co. I, 10 Reg't U. S. Col'd H. Art'y.

Appears on

Company Muster Roll

for *Sept. + Oct.*, 186*5*.

Present or absent *Present*

Stoppage, \$ *100* for

Due Gov't, \$ *100* for

Valuation of horse, \$ *100*

Valuation of horse equipments, \$ *100*

Remarks:

+ borrowed by Worley 42

Book mark:

A. S. Clark

P

10 H. Art'y.

U.S.C.T.

Louis F. Pirrie

Corpl., Co. I, 10 Reg't U. S. Col'd H. Art'y.

Appears on

Company Muster Roll

for Nov. 1865, 1865

Present or absent Present

Stoppage, \$ 100 for

Due Gov't, \$ 100 for

Valuation of horse, \$ 100

Valuation of horse equipments, \$ 100

Remarks:

FROM SECOND AUDITOR'S ROLL.

Book mark:

A. S. Clark

(358)

Copyist.

P

10 H. Art'y.

U.S.C.T.

Louis A. Pirrie

Corpl., Co. I, 10 Reg't U. S. Col'd H. Art'y.

Appears on

Company Muster Roll

for Jan. & Feb., 1866.

Present or absent Present

Stoppage, \$ 100 for

Due Gov't, \$ 100 for

Valuation of horse, \$ 100

Valuation of horse equipments, \$ 100

Remarks:

Book mark:

A. Clark

(358)

Copyist.

P

10 H. Art'y. | U.S.C.T.

Louis A. Pierre

Capt., Co. I, 10 Reg't U. S. Col'd H. Art'y.

Appears on

Company Muster Roll

for March & Apr., 1866.

Present or absent

Stoppage, \$ 100 for

Due Gov't, \$ 100 for

Valuation of horse, \$ 100

Valuation of horse equipments, \$ 100

Remarks: Discharged. Mustered out by reason of expiration of term of service to date Apr. 30, 1866.

Book mark: Mustered out on file.

O. J. Leary

(358)

Copyist.

P | 10 Arty | U.S.C.T.

Lewis A. Perrie

Corp, Co. I, 10 Reg't U. S. Col'd Arty

Appears on a

Detachment Muster-out Roll

of the organization named above. Roll dated

New Orleans, La., Apr. 30, 1866.

Muster-out to date Apr. 30, 1866.

Last paid to Feb. 28, 1866.

Clothing account:

Last settled _____, 1866 ; drawn since \$ _____ 100

Due soldier \$ 32 ⁴³/₁₀₀; due U. S. \$ _____ 100

Am't for cloth'g in kind or money adv'd \$ _____ 100

Due U. S. for arms, equipments, &c., \$ _____ ²²/₁₀₀

Bounty paid \$ _____ 100 due \$ _____ 100

Remarks: Joined by draft. Appointed
Simpl. to date May 19, 1865. per A. O.
No. 27 H's G's. Regt. June 28, 1865. Stop
for one tom-pion .02cts. one ripper
20cts. Total 22cts.

Filed with Louis A. Perrie

Book mark: _____

R. E. Wilson

P

10 H. Art'y. | U. S. C. T.

Louis A. Pierrie

Priv., Co. I, 10 Reg't U. S. Col'd H. Art'y.

Capt

Appears on Returns as follows:

May 1865 Gain May 1/65 N. Orleans
Recruit from Depot

Apr 1866 (Copy) Loss: Apr 30/66 New
Orleans also chgd expiration
of term of service

Book mark:

[Signature]

(546)

Copyist.

P

10 H. Art'y. U.S.C.T.

Louis A. Pierre

Capt., Co. I, 10 Reg't U. S. Col'd H. Art'y.

Appears on Co. Muster-out Roll, dated
Baton Rouge La., Feb 22, 1867.

Muster-out to date _____, 186 .

Last paid to _____, 186 .

Clothing account:

Last settled _____, 186 ; drawn since \$ _____ 100

Due soldier \$ _____ 100; due U. S. \$ _____ 100

Am't for cloth'g in kind or money adv'd \$ _____ 100

Due U. S. for arms, equipments, &c., \$ _____ 100

Bounty paid \$ _____ 100; due \$ _____ 100

Remarks: Discharged. Expiration
term of service Apr 30, 1866
(age 30 yrs)

Book mark : _____

(361)

J. M. Hance

Copyist.

Piessie Louis A

Co. I, 10 Reg't USC 7th

(CIVIL WAR)
(Philippine Insurrection.)

1 Inclosures.

Bed Cards	Ex. Preliminary to M. O.
Burial Records	Final Statements
Certs. of Dis. for Discharge	Fines
C. M. Charges	Furloughs or L. of A.
Descriptive Lists	Med. Certificates
Descriptive and Assign- ment Cards }	Med. Des. Lists
Discharge Certificates	Orders
Enlistment Papers	Resignations

Other papers relating to—

Admission to Hosp'l	Furlough or L. of A.
Confinement	Med. Examination
Contracts	Misc. Information
Death or Effects	Pay or Clothing
Desertion	Personal Reports
Discharge from Hosp'l	Rank
Discharge from Service	Transfer to Hosp'l
Duty	Transportation

2 of 2 Ref Slip 2

MICROFILM PUBLICATION M 1831

COMPILED MILITARY SERVICE RECORDS
OF VOLUNTEER UNION SOLDIERS WHO SERVED WITH
THE UNITED STATES COLORED TROOPS (USCT)
10TH REGIMENT OF HEAVY ARTILLERY

PERSONAL PAPERS' TARGET SHEET

PLEASE NOTE THE CHECKED INFORMATION ABOUT THE PERSONAL PAPERS IN
THIS FILE:

- NO PERSONAL PAPERS WERE FOUND IN THIS FILE WHEN THE
RECORDS WERE ARRANGED FOR MICROFILMING.
- 2 PERSONAL PAPER(S) FOUND IN THIS FILE WHEN THE RECORDS
WERE ARRANGED FOR MICROFILMING.

Statement of Service Reference Slip.

Office Pension

Claim No. I. O. 1224325

Louis A. Pierrie
(Name.)

Co. I & K 10 Reg't U.S.C., N.A.

To Med Div. Nov 1, 1913

For Stmp.

No. Med rps.
7a.
A

Med. statement
made.
✓ 2 cards rec'd

Statement furnished Nov 1, 1913

(Form 447, A. G. O.)
Ed. Mar. 12-20,000.

J. S. F. S.

W-241

Statement of Service Reference Slip.

Office Pension

Claim No TO. 1224925

Louis A Purvie
(Name.)

S, Co. 10 Reg't USCVA

To Arch Div. 9-26, 1913

For name of former
owner Johnson
MS

RR Div.

Name of former
owner not found.

Williamson
Ullmer

Statement furnished Sept 26, 1913

J.H.

A, 10 U.S. Col'd H. Art'y

Private

Private

CARD NUMBERS.

1		26
2		27
3	<i>See Pipes</i>	28 <i>Parleton</i>
4		29
5		30
6		31
7		32
8		33
9		34
10		35
11		36
12		37
13		38
14		39
15		40
16		41
17		42
18		43
19		44
20		45
21		46
22		47
23		48
24		49
25		50

Book Mark:

See also 75- U.S. I.

One Jones

Co A., 10 U.S. Col'd H. Art'y.

Private | *Private*

CARD NUMBERS.

1	5489107	26
2	5492943	27
3	5493154	28
4	5493373	29
5	5493441	30
6	5493630	31
7	5493758	32
8	5494043	33
9	5490075	34
10		35
11		36
12		37
13		38
14		39
15		40
16		41
17		42
18		43
19		44
20		45
21		46
22		47
23		48
24		49
25		50

Book Mark:

See also *75-U.S.C.I.*

P. J. H. H. H. U.S.C.T.

John J. J. J.

Co., Co., *10* Reg't U. S. Col'd *Ala.*

Appears on

M. and D. Roll of Men Transferred

to the organization named above,

from *76 USCI*

Roll dated *Nov 18*, 186*3*.

When enlisted *Aug 10*, 186*3*.

Period for which enlisted *3* years.

When mustered in *Sep 24*, 186*3*.

Present or absent *Not stated*

Company to which assigned

Remarks: *Transferred*

*from 88 USCI
Aug 13/64 from S. C.
No 209 dated No 2
Sept Gulf*

Book mark :

J. Johnson

(342)

Copyist.

John Pauer

Plt, Co. A, 10 Reg't U. S. Col'd H. Art'y.

Appears on

Company Muster Roll

for Nov & Dec, 1865.

Present or absent Present

Stoppage, \$ 100 for

Due Gov't, \$ 100 for

Valuation of horse, \$ 100

Valuation of horse equipments, \$ 100

Remarks: Transferred from 75
U.S. Co. I. per S.O. 105 to 81st
Geo Regt of Sec.

Book mark:

Stygar
Copyist.

P

10 H. Art'y. | U.S.C.T.

John Piner

Plt, Co. A, 10 Reg't U. S. Col'd H. Art'y.

Appears on

Company Muster Roll

for *Jan - Feb*, 186*6*.

Present or absent *Present*

Stoppage, \$ *100* for

Due Gov't, \$ *100* for

Valuation of horse, \$ *100*

Valuation of horse equipments, \$ *100*

Remarks:

Book mark:

Styer
Copyist.

John Pines

Pl, Co. A, 10 Reg't U. S. Col'd H. Art'y.

Appears on

Company Muster Roll

for *Mar + Apr*, 186*6*.

Present or absent *Present*

Stoppage, \$ 100 for

Due Gov't, \$ 100 for

Valuation of horse, \$ 100

Valuation of horse equipments, \$ 100

Remarks: _____

Book mark: _____

J. H. ...

P

10 H. Art'y. U.S.C.T.

John Piner

Pl, Co. A, 10 Reg't U. S. Col'd H. Art'y.

Appears on

Company Muster Roll

for May + June, 1866.

Present or absent Present

Stoppage, \$ 100 for

Due Gov't, \$ 100 for

Valuation of horse, \$ 100

Valuation of horse equipments, \$ 100

Remarks:

Book mark:

Hyman

P 10 H. Art'y. U.S.C.T.

John Piner

Pvt, Co. A, 10 Reg't U. S. Col'd H. Art'y.

Appears on

Company Muster Roll

for *July & Aug, 1866*

Present or absent *Present*

Stoppage, \$ *100* for

Due Gov't, \$ *100* for

Valuation of horse, \$ *100*

Valuation of horse equipments, \$ *100*

Remarks:

Book mark:

(358)

Hynes

Copyist.

9 | 10 Arty | U.S.C.T.

John Peuer

Arty, Co. A, 10 Reg't U. S. Col'd Arty

Appears on a

Detachment Muster-out Roll

of the organization named above. Roll dated

New Orleans La, Sept 24 1866.

Muster-out to date Sep 23, 1866.

Last paid to June 30, 1866

Clothing account:

Last settled _____, 1866 ; drawn since \$ _____ 100

Due soldier \$ 31 ⁰⁸/₁₀₀; due U. S. \$ _____ 100

Am't for cloth'g in kind or money adv'd \$ _____ 100

Due U. S. for arms, equipments, &c., \$ _____ ⁹⁵/₁₀₀

Bounty paid \$ _____ 100 due \$ 100 100

Remarks: joined Orig Org
88 U. S. C. I. Transferred
to 45 U. S. C. I. S. O. 209
par 12 series of 1864 Dep
of Gulf. Transferred to
10 U. S. C. A. (H.) S. O. 105
Cover

Book mark: _____

Lamb

JAN. 15

5490075

★ 1891 ★

par 12 Series of 1860
Dept of La. Stop for
one Haversack

Mustered out by rea-
son of expiration of
term of service, to date
Sept 23, 1866

P | 10 H. Art'y. | U.S.C.T.

John Piner

Pvt, Co. A, 10 Reg't U. S. Col'd H. Art'y.

Appears on

Company Muster Roll

for *Sept & Oct*, 1866.

Present or absent

Stoppage, \$ *100* for

Due Gov't, \$ *100* for

Valuation of horse, \$ *100*

Valuation of horse equipments, \$ *100*

Remarks: *Date of discharge. Mustered out
by reason of expiration of term of service
Sept. 23/66.
Paid \$100.00 ~~amount~~*

Book mark:

Nesbitt

P

10 H. Art'y. U.S.C.T.

John Pine
Pvt. A, Co. A, 10 Reg't U. S. Col'd H. Art'y.

Appears on Co. Muster-out Roll, dated
Baton Rouge La, Feb. 22, 1867.

Muster-out to date _____, 186 .

Last paid to _____, 186 .

Clothing account:

Last settled _____, 186 ; drawn since \$ _____ 100

Due soldier \$ _____ 100; due U. S. \$ _____ 100

Am't for cloth'g in kind or money adv'd \$ _____ 100

Due U. S. for arms, equipments, &c., \$ _____ 100

Bounty paid \$ _____ 100; due \$ _____ 100

Remarks: Transfd. from 75 U.S.C.S. as Pvt.
S.C. 105-8 of 65 Dept. La.
Disch'd from expun. of term
of service Sept. 23/60

Book mark: V 15 P 93. 68

Nesbitt

(361)

Copyist.

10 U.S. Col'd H. Art'y

Private

Private

CARD NUMBERS.

1		26
2		27
3	<i>See Pringston Edward</i>	28
4		29
5		30
6		31
7		32
8		33
9		34
10		35
11		36
12		37
13		38
14		39
15		40
16		41
17		42
18		43
19		44
20		45
21		46
22		47
23		48
24		49
25		50

Book Mark:

See also 77 U.S. 6 Inf

Co M, 10 U.S. Col'd H. Art

Private

Private

CARD NUMBERS.

1	26
2	27
3	28
4	29
5	30
6	31
7	32
8	33
9	34
10	35
11	36
12	37
13	38
14	39
15	40
16	41
17	42
18	43
19	44
20	45
21	46
22	47
23	48
24	49
25	50

See Pickney Wallace

Book Mark:

See also 77 U.S. 68

Co *M*, 10 U.S. Co'd H. Art'y

Private | *Private*

CARD NUMBERS.

1	5488025	26
2	5487834	27
3	5514368	28
4	5514518	29
5	5514744	30
6	5514882	31
7	5515266	32
8	5489811	33
9	9123712	34
10		35
11		36
12		37
13		38
14		39
15		40
16		41
17		42
18		43
19		44
20		45
21		46
22		47
23		48
24		49
25		50

Book Mark:

See also *77 U.S. 69*

51771-575-00 m m
RSP 531759

MS Worley
47.

P | 10 H. Art'y. | U. S. C. T.

Wallace Pinkney

Co. M, 10 Reg't U. S. Col'd H. Art'y.

Appears on

Company Descriptive Book

of the organization named above.

DESCRIPTION.

Age 25 years; height 5 feet 7 inches.

Complexion Black

Eyes Dark; hair black

Where born Tallahassee Fla

Occupation Laborer

ENLISTMENT.

When Feb 15, 1865.

Where Drafted Thibodaux 2^d Dist La

By whom; term 1 y'rs.

Remarks: Recd by transfer from Co. D 77th U. S. Col. per O. O. 66. Hd Qrs Dept La Sept 22 1865. Discharged and honorably mustered out of service Feb 14, 1866 by reason of expiration of term of service.

W. Malheur

(383g)

Copyist.

P | 10 H. Art'y. | U.S.C.T.

William Pinkney
P, Co. M., 10 Reg't U. S. Col'd H. Art'y.

Age years.

Appears on

Company Muster Roll*

for *Sept - Oct*, 186*5*.

Joined for duty and enrolled:

When *Sept*, 186*5*.

Where

Period *1* years.

Mustered in:

When *Feb 15*, 186*5*.

Where *Thibodaux 2 Dist La*

Present or absent *Present*

Stoppage, \$ *100* for

Due Gov't, \$ *100* for

Valuation of horse, \$ *100*

Valuation of horse equipments, \$ *100*

Remarks :

*First current roll. No muster-in roll of this company on file.

Book mark :

(3586)

W. H. Wright

Copyist.

O 10 H A U.S.C.T.

Wallace Pinkney
Capt, Co M, 10 Reg't U. S. Col'd H.A.

Appears on

M. and D. Roll of Men Transferred

to the organization named above,

from 77 U.S. Col Inf

Roll dated Camp Pickett Oct 11, 1865.

When enlisted, 186 .

Period for which enlisted years.

When mustered in July 15, 1865.

Present or absent

Company to which assigned M

Remarks: Rec'd by transfer
from Co, 77 U.S. Col, I,
per S.O. 66 Dept da
Sept 22, 65

Book mark :

W. H. Scott

P 10 H A, U.S.C.T.

Palace Pinkney
Co M, 10 Reg't U. S. Col'd H A

Appears on

M. and D. Roll of Men Transferred

to the organization named above,

from

77 U.S. Col Inf

Roll dated

Camp Canapetda Oct, 1865

When enlisted

, 186 .

Period for which enlisted

1 years.

When mustered in

Feb 15, 1865

Present or absent

Present

Company to which assigned

M

Remarks:

(Aft)

Book mark :

W. H. Scott

P

10 H. Art'y.

U. S. C. T.

Wallace Pinkney

P, Co. M, 10 Reg't U. S. Col'd H. Art'y.

Appears on

Company Muster Roll

for Nov 1 Dec, 1865.

Present or absent Present-

Stoppage, \$ 100 for

Due Gov't, \$ 100 for

Valuation of horse, \$ 100

Valuation of horse equipments, \$ 100

Remarks:

Book mark:

A. H. Wright

(358)

Copyist.

P.

10 H. Art'y. | U. S. C. T.

Wallace Pinkney

P., Co. M, 10 Reg't U. S. Col'd H. Art'y.

Appears on

Company Muster Roll

for *Jan & Feb*, 186*6*.

Present or absent *Absent*

Stoppage, \$ *5* ^{*02*}/_{*100*} for *Ch. & G. & C.*

Due Gov't, \$ *100* for

Valuation of horse, \$ *100*

Valuation of horse equipments, \$ *100*

Remarks: *On detached service awaiting mustered per S. G. & H. Macomb Feb 27, 66*

Book mark: *Muster roll on file*

J. H. Wright

P. ¹⁰ *Hy Arty* | U.S.C.T.

Wallace Pinkney
Co. *10* Reg't U. S. Col'd *Arty*

Appears on a

Detachment Muster-out Roll

of the organization named above. Roll dated

New Orleans La, Feb. 14, 1866.

Muster-out to date *Feb. 14*, 1866.

Last paid to *June 30*, 1865.

Clothing account:

Last settled _____, 186 ; drawn since \$ _____ ¹⁰⁰

Due soldier \$ *7* ^{*47*} _{*100*}; due U. S. \$ _____ ¹⁰⁰

Am't for cloth'g in kind or money adv'd \$ _____ ¹⁰⁰

Due U. S. for arms, equipments, &c., \$ *5* ^{*62*} _{*100*}

Bounty paid \$ *None* _{*100*} due \$ *None* _{*100*}

Remarks: *Joined by transfer*
from 27th U.S.C., Oct. 1
1865 per S.O. 66 series/65.
Dept. of Ca. Stop for 2
G.C. Straps, 1 Bed sack,
& 1 Mosquito Bar.

Book mark: _____

A. M. Reed

P

10 H. Art'y. | U. S. C. T.

Mallac Pinkney

P, Co. M, 10 Reg't U. S. Col'd H. Art'y.

Appears on

Company Muster Roll

for *Mon 1 Apr*, 186*6*.

Present or absent.....

Stoppage, \$.....100 for.....

Due Gov't, \$.....100 for.....

Valuation of horse, \$.....100

Valuation of horse equipments, \$.....100

Remarks: *Disch'd by reason of expiration of term of service*

Book mark:.....

(358)

J. W. Wright

Copyist.

8

Wallace Pinkney

Sgt., Co. M., 10 Reg't U. S. Col'd H. Art'y.

Appears on Co. Muster-out Roll, dated

Baton Rouge La, Feb 22, 1867.

Muster-out to date _____, 186 .

Last paid to _____, 186 .

Clothing account:

Last settled _____, 186 ; drawn since \$ _____ 100

Due soldier \$ _____ 100; due U. S. \$ _____ 100

Am't for cloth'g in kind or money adv'd \$ _____ 100

Due U. S. for arms, equipments, &c., \$ _____ 100

Bounty paid \$ _____ 100; due \$ _____ 100

Remarks: joined by trans from

77 US 69 for 26 66. 26 Dec. 1866

Ca. dep 22/67 as Sgt. Disch'd by

reason of Exp of term of service

Feb 14/66.

Book mark:

Reuter

No. J., 10 U.S. CO. REG. ATT.

Private Private

CARD NUMBERS.

1	5488494	26
2	5511573	27
3	5511746	28
4	5512158	29
5	5489601	30
6	5489422	31
7		32
8		33
9		34
10		35
11		36
12		37
13		38
14		39
15		40
16		41
17		42
18		43
19		44
20		45
21		46
22		47
23		48
24		49
25		50

Book Mark:

See also 74 U.S. 6 Sup

P

10th U.S.C.T.

Thomas Pinta

*P*rt, Co., *10* Reg't U. S. Col'd *St. Arty.*

Appears on

M. and D. Roll of Men Transferred

to the organization named above,

from *Co "C" 7th U.S. Inf.*

Roll dated *New Orleans, La Oct 11, 1865.*

When enlisted *Jan 3^d*, 186*3*

Period for which enlisted *3* years.

When mustered in *Feb 28*, 186*3*

Present or absent

Company to which assigned

Remarks: *Joined orig. Organ*
as recruit Co "D"
La. Mil. (7th U.S. Inf.)
Transferred to Co "E"
20. Inf. Cd A (9th U.S. Inf.)
Retransferred to 7th
U.S. Inf July 20 '64
Per G.O. Messy Mil.

Book mark : *(over)*

J. M. Jones, Jr

JAN. 15

5488494

★ 1891 ★

Div of West Miss.

P.

10 H. Art'y.

U.S.C.T.

Thomas Pinta

Pvt., Co. I, 10 Reg't U. S. Col'd H. Art'y.

Appears on

Company Muster Roll

for Nov. & Dec., 1865.

Present or absent Present

Stoppage, \$ 100 for

Due Gov't, \$ 100 for

Valuation of horse, \$ 100

Valuation of horse equipments, \$ 100

Remarks: Transferred from
74 U.S. C.I. per S.O. No. 84
Hd. qrs. Dept. of La.
Oct. 11, 1865.

FROM SECOND AUDITOR'S ROLL.

Book mark:

O.S. Clark

(858)

Copyist.

D | 1076a | U.S.C.T.

Thomas Pinta

Pri, Co. I, 10 Reg't U. S. Col'd 76a

Appears on an

Individual Muster-out Roll

of the organization named above. Roll dated

New Orleans La. July 2, 1866.

Muster-out to date July 2, 1866.

Last paid to June 30, 1865.

Clothing account:

Last settled 186 ; drawn since \$ 100

Due soldier \$ 100; due U. S. \$ 8 12 / 100

Am't for cloth'g in kind or money adv'd \$ 100

Due U. S. for arms, equipments, &c., \$ 100

Bounty paid \$ none / 100 due \$ none / 100

Remarks: joined by transfer
from 24 US C Infantry Oct
11th 1865 per S.O. no. 84 Series
of 1865 76d gns Dept of
Louisiana, mustered out
by reason of (over)

Book mark:

R. Richardson

JAN. 15

5489422

★ 1891 ★

*of expiration of term of
service to take effect
Jan 2nd 1866*

P. | 10 He. a. | U.S.C.T.

* Thomas Pinta

Plt., Co. I., 10 Reg't U. S. Col'd He. a.

Appears on a

Detachment Muster-out Roll

of the organization named above. Roll dated

New Orleans La, Jan. 2, 1864.

Muster-out to date Jan. 2, 1864.

Last paid to June 30, 1865

Clothing account:

Last settled _____, 186 ; drawn since \$ _____ 100

Due soldier \$ _____ 100; due U. S. \$ _____ 8 ¹²/₁₀₀

Am't for cloth'g in kind or money adv'd \$ _____ 100

Due U. S. for arms, equipments, &c., \$ _____ 100

Bounty paid \$ None. 100 due \$ None. 100

Remarks: *Joined by transfer*

from 74 He. U. S. Col., Oct. 11, 1865

per U. S. O. No. 84 S. of 1865

Ad. Serv. Dept. of Sea.

* *Entire entry canceled by*

line

Book mark: _____

Hawling

P

10 H. Art'y.

U.S.C.T.

Thomas Pinta

Pvt., Co. I, 10 Reg't U. S. Col'd H. Art'y.

Appears on

Company Muster Roll

for Jan. & Feb., 1866.

Present or absent

Stoppage, \$ 100 for

Due Gov't, \$ 100 for

Valuation of horse, \$ 100

Valuation of horse equipments, \$ 100

Remarks: Discharged. Mustered out by reason of expiration of term of service to take effect Jan'y 3^d 1866. final statements given.

Book mark:

O. J. Clark

P.

10 H. Art'y.

U.S.C.T.

Thomas Linta

Pat. Co., 10 Reg't U. S. Col'd H. Art'y.

Appears on **Co. Muster-out Roll**, dated
Baton Rouge La Feb. 22, 1867.

Muster-out to date _____, 186 .

Last paid to _____, 186 .

Clothing account:

Last settled _____, 186 ; drawn since \$ _____ 100

Due soldier \$ _____ 100; due U. S. \$ _____ 100

Am't for cloth'g in kind or money adv'd \$ _____ 100

Due U. S. for arms, equipments, &c., \$ _____ 100

Bounty paid \$ _____ 100; due \$ _____ 100

Remarks: *Discharged expiration
term of service Jan 2, 1866*

Book mark: _____

(361)

J. M. Hance

Copyist.

Co. A., 10 U.S. Col'd H. Art'y.

Private

Private

CARD NUMBERS.

1	5489087	26
2	5492944	27
3	5493237	28
4	5493374	29
5	5493442	30
6	5493637	31
7	5493759	32
8	5494044	33
9	5490105	34
10		35
11		36
12		37
13		38
14		39
15		40
16		41
17		42
18		43
19		44
20		45
21		46
22		47
23		48
24		49
25		50

Book Mark:

See also 75-26561

P. VanHorn U.S.C.T.

Tarleton Rufus
H., Co., 10 Reg't U. S. Col'd

Appears on

M. and D. Roll of Men Transferred

to the organization named above,

from 73 U.S.A.I.

Roll dated Nov 18, 1863.

When enlisted Aug 10, 1863.

Period for which enlisted 3 years.

When mustered in Oct 16, 1863.

Present or absent Not stated

Company to which assigned

Remarks: Transfd. from
88 U.S.C.I. per S.O. No
209 Ex. 12 Hd Qrs.
Dept of the Gulf Aug 5/64

Book mark :

J. A. Johnson Copyist.

P

10 H. Art'y. U.S.C.T.

Parlston Pipes

Pat, Co. A, 10 Reg't U. S. Col'd H. Art'y.

Appears on

Company Muster Roll

for Nov & Dec, 1865.

Present or absent Present

Stoppage, \$ 100 for

Due Gov't, \$ 100 for

Valuation of horse, \$ 100

Valuation of horse equipments, \$ 100

Remarks: Transferred from 75 U.S.C.T. per S.O. 105 C.S. 114 from Dept. of Sea.

Book mark:

(358)

J. H. Jones Copyist.

P

10 H. Art'y. U.S.C.T.

Parleton Pipes

Pol, Co. A, 10 Reg't U. S. Col'd H. Art'y.

Appears on

Company Muster Roll

for *Jan - Feb*, 186*6*.

Present or absent *Present*

Stoppage, \$ *100* for

Due Gov't, \$ *100* for

Valuation of horse, \$ *100*

Valuation of horse equipments, \$ *100*

Remarks:

Book mark:

Hyas

P | 10 H. Art'y. | U.S.C.T.

Farleton Pipes

Pl, Co. A, 10 Reg't U. S. Col'd H. Art'y.

Appears on

Company Muster Roll

for *Mar & Apr*, 186*b*.

Present or absent *Present*

Stoppage, \$ *100* for

Due Gov't, \$ *100* for

Valuation of horse, \$ *100*

Valuation of horse equipments, \$ *100*

Remarks: *On daily duty in 2 M.
Dept*

Book mark: _____

(358)

Styus

Copyist.

P | 10 H. Art'y. | U.S.C.T.

Parleton Pipes

Pl, Co. A, 10 Reg't U. S. Col'd H. Art'y.

Appears on

Company Muster Roll

for May & June, 1866.

Present or absent Present

Stoppage, \$ 100 for

Due Gov't, \$ 100 for

Valuation of horse, \$ 100

Valuation of horse equipments, \$ 100

Remarks:

Book mark:

Hynes

(358)

Copyist.

P

10 H. Art'y. U.S.C.T.

Parleton Pipes

Pl, Co. A, 10 Reg't U. S. Col'd H. Art'y.

Appears on

Company Muster Roll

for July & Aug, 1864.

Present or absent Present

Stoppage, \$ 100 for

Due Gov't, \$ 100 for

Valuation of horse, \$ 100

Valuation of horse equipments, \$ 100

Remarks:

Book mark:

Styus

Copyist.

(358)

P | 10 H. Art'y. | U.S.C.T.

Parleton Pipes

Pvt., Co. A, 10 Reg't U. S. Col'd H. Art'y.

Appears on

Company Muster Roll

for Sept & Oct, 1866.

Present or absent

Stoppage, \$ 100 for

Due Gov't, \$ 100 for

Valuation of horse, \$ 100

Valuation of horse equipments, \$ 100

Remarks: Date of discharge mustered out Oct. 15/66 by reason of expiration of term of service
Paid \$100.00 bounty

Book mark:

Nesbitt

(358)

Copyist.

P | 10 Art | U.S.C.T.

Jarleton Phipps

Pvt, Co. A, 10 Reg't U. S. Col'd Art

Appears on a

Detachment Muster-out Roll

of the organization named above. Roll dated

New Orleans La, Oct 16, 1866.

Muster-out to date Oct 15, 1866.

Last paid to Aug 31, 1866.

Clothing account:

Last settled _____, 186 ; drawn since \$ _____ 100

Due soldier \$ 43 ⁰⁶/₁₀₀; due U. S. \$ _____ 100

Am't for cloth'g in kind or money adv'd \$ _____ 100

Due U. S. for arms, equipments, &c., \$ _____ ⁰⁸/₁₀₀

Bounty paid \$ _____ 100 due \$ 100 _____ 100

Remarks: Joined by transfer from 75 US 69 per SO 105. par 12 Series of 1865 Dept of La. Stop for one Tompion Mustered out by reason of Expiration of term of Service

Book mark: _____

Abbott

P

10 H. Art'y. U.S.C.T.

Parleton Pipes
Priv. Co. A, 10 Reg't U. S. Col'd H. Art'y.

Appears on Co. Muster-out Roll, dated
Baton Rouge La, Feb. 22, 1867.

Muster-out to date _____, 186 .

Last paid to _____, 186 .

Clothing account:

Last settled _____, 186 ; drawn since \$ _____ 100

Due soldier \$ _____ 100; due U. S. \$ _____ 100

Am't for cloth'g in kind or money adv'd \$ _____ 100

Due U. S. for arms, equipments, &c., \$ _____ 100

Bounty paid \$ _____ 100; due \$ _____ 100

Remarks: Transfd from 75 U.S.C.T. as
Priv. S.O. 105 S of 65 - Dept. Ga.
Dischd for expen. of term of
service Oct. 15. 66

Book mark: V 15 P. 81. 68

Nesbitt

(361)

Copyist.

No. 6, 10 U.S. Col'd H. Art

Private | Private

CARD NUMBERS.

1		26	
2		27	
3	<i>See Pickett</i>	28	<i>Francis</i>
4		29	
5		30	
6		31	
7		32	
8		33	
9		34	
10		35	
11		36	
12		37	
13		38	
14		39	
15		40	
16		41	
17		42	
18		43	
19		44	
20		45	
21		46	
22		47	
23		48	
24		49	
25		50	

Book Mark:

See also

Co *G.*, 10 U.S. Col'd H. Art'y.

Private | *Private*

CARD NUMBERS.

1	5507175	26
2	5507451	27
3	5507597	28
4	5507743	29
5	5507881	30
6	5508022	31
7	5508160	32
8	5508330	33
9	5509508	34
10		35
11		36
12		37
13		38
14		39
15		40
16		41
17		42
18		43
19		44
20		45
21		46
22		47
23		48
24		49
25		50

Book Mark:

See also

P 10 Harty | U.S.C.T.

Philip Pitman

Appears with rank of Pvt. on

Muster and Descriptive Roll of a Detachment of U. S. Vols. forwarded

Organized as Co. G.

for the 10 Reg't U. S. Col'd H.A. Roll dated

New Orleans La. Sept. 20, 1864.

Where born Napaalinnville La

Age 22 y'rs; occupation Laborer

When enlisted Aug. 18, 1864.

Where enlisted New Orleans La

For what period enlisted 3 years.

Eyes Blue; hair Blue

Complexion Dark; height 5 ft. 7 in.

When mustered in Sept 20, 1864.

Where mustered in New Orleans La

Bounty paid \$ 100; due \$ 100

Where credited to New Orleans La

Company to which assigned G.

Remarks:

Book mark:

E. B. Thompson

(339)

Copyist.

P

10 H. Art'y. | U.S.C.T.

Philip Pitman

Co. G, 10 Reg't U. S. Col'd H. Art'y.

Appears on

Company Muster Roll

for Sept & Oct, 1864.

Present or absent Present

Stoppage, \$ 100 for

Due Gov't, \$ 100 for

Valuation of horse, \$ 100

Valuation of horse equipments, \$ 100

Remarks:

Book mark:

E. F. Brown

P

10 H. Art'y. | U.S.C.T.

Philip Pitman

Pat, Co. G, 10 Reg't U. S. Col'd H. Art'y.

Appears on

Company Muster Roll

for Nov & Dec, 1864

Present or absent Present

Stoppage, \$ 100 for

Due Gov't, \$ 100 for

Valuation of horse, \$ 100

Valuation of horse equipments, \$ 100

Remarks:

Book mark:

E. H. Brown

(358)

Copyist.

P

10 H. Art'y. U.S.C.T.

Philip Pitman
Prof., Co. G, 10 Reg't U. S. Col'd H. Art'y.

Appears on

Company Muster Roll

for Jan & Feb'y, 1865.

Present or absent Present

Stoppage, \$ 100 for

Due Gov't, \$ 100 for

Valuation of horse, \$ 100

Valuation of horse equipments, \$ 100

Remarks:

Book mark:

E. Porter

P

10 H. Art'y. U.S.C.T.

Philip Pittman

Prof, Co. G, 10 Reg't U. S. Col'd H. Art'y.

Appears on

Company Muster Roll

for Mar & April, 1865.

Present or absent Present

Stoppage, \$ 100 for

Due Gov't, \$ 100 for

Valuation of horse, \$ 100

Valuation of horse equipments, \$ 100

Remarks:

Book mark:

J. E. Porter

P

10 H. Art'y. U.S.C.T.

Philip Pitman
Troop, Co. G, 10 Reg't U. S. Col'd H. Art'y.

Appears on

Company Muster Roll

for May & June, 1865.

Present or absent Present

Stoppage, \$ 100 for

Due Gov't, \$ 100 for

Valuation of horse, \$ 100

Valuation of horse equipments, \$ 100

Remarks:

Book mark:

J. E. Porter

Philip Pitman
Troop, Co. G, 10 Reg't U. S. Col'd H. Art'y.

Appears on

Company Muster Roll

for July & Aug, 1865.

Present or absent Absent

Stoppage, \$ 100 for

Due Gov't, \$ 10/100 for b & g Equip
age lost or destroyed

Valuation of horse, \$ 100

Valuation of horse equipments, \$ 100

Remarks: Absent without
leave since Aug
20, 1865

Book mark:

J. E. Porter

P

10 H. Art'y. U.S.C.T.

Philip Pittman
Prov, Co. G, 10 Reg't U. S. Col'd H. Art'y.

Appears on

Company Muster Roll

for *Sept & Oct*, 1865.

Present or absent

Stoppage, \$ 100 for

Due Gov't, \$ 100 for

Valuation of horse, \$ 100

Valuation of horse equipments, \$ 100

Remarks: *Deserted Sept-*
ember 12" 1865-

Book mark:

10350

J. E. Porter

(358)

Copyist.

Philip Pitman

Art, Co. *G*, 10 Reg't U. S. Col'd H. Art'y.

Appears on Co. Muster-out Roll, dated
Baton Rouge La, Feb 22, 1867.

Muster-out to date _____, 186 .

Last paid to _____, 186 .

Clothing account:

Last settled _____, 186 ; drawn since \$ _____ 100

Due soldier \$ _____ 100; due U. S. \$ _____ 100

Am't for cloth'g in kind or money adv'd \$ _____ 100

Due U. S. for arms, equipments, &c., \$ _____ 100

Bounty paid \$ _____ 100; due \$ _____ 100

Remarks: *Joined at Orgl. org'n,*
Deserted Sept. 12th 1865

Book mark : _____

W. J. ...

Edward J. ...
Co E., 10 U.S. Col'd H. Art'y

Private | *Private*

CARD NUMBERS.

1	6-5-0 2426	26
2	5-4-8 9191	27
3	5-5-0 2527	28
4	5-5-0 2644	29
5	5-5-0 2780	30
6	5-5-0 2910	31
7	5-5-0 3026	32
8	5-5-0 3144	33
9	5-5-0 3255	34
10	5-5-0 3364	35
11	5-5-0 3471	36
12	5-5-0 3610	37
13	5-5-0 3758	38
14	5-5-0 3892	39
15	5-5-0 4035	40
16	5-5-0 4164	41
17	5-5-0 4277	42
18	5-5-0 4400	43
19	5-5-0 4498	44
20		45
21		46
22		47
23		48
24		49
25		50

Book Mark:

See also:

P WMA | U.S.C.T.

John Pleasant
Co. *E 10* (7 U. S. C. H. A.) Reg't U. S. Col'd *WMA*

Appears on a

Detachment Muster Roll

of the organization named above

for *Roll date, Apr-30*, 1864.

Station *De Sair, La.*

Present or absent *Present*

Stoppage, \$ 100 for

Due Gov't, \$ 100 for

Valuation of horse, \$ 100

Valuation of horse equipments, \$ 100

Remarks:

Book mark:

Grogan

P | 10 H. Art'y. | U.S.C.T.

John Pleasant

Private; Co. B, 7 Reg't U. S. Col'd H. Art'y.*

Appears on

Company Muster Roll

for May + June, 1864.

Present or absent Present

Stoppage, \$ 100 for

Due Gov't, \$ 100 for

Valuation of horse, \$ 100

Valuation of horse equipments, \$ 100

Remarks:

* This organization subsequently became Co. B, 10 Reg't U. S. Colored Heavy Artillery.

Book mark:

(358)

Linden

Copyist.

P

10 H. Art'y. | U.S.C.T.

John Pleasant

Dr., Co. E, 10 Reg't U. S. Col'd H. Art'y.

Appears on

Company Muster Roll

for *July* & *Aug*, 186*4*.

Present or absent *Present*

Stoppage, \$ 100 for

Due Gov't, \$ 100 for

Valuation of horse, \$ 100

Valuation of horse equipments, \$ 100

Remarks:

Book mark:

(358)

J. Under
Copyist.

John Pleasant
Gt, Co. E, 10 Reg't U. S. Col'd H. Art'y.

Appears on

Company Muster Roll

for Sep + Oct, 1864

Present or absent Present

Stoppage, \$ 100 for

Due Gov't, \$ 100 for

Valuation of horse, \$ 100

Valuation of horse equipments, \$ 100

Remarks:

Book mark:

Linden
Copyist.

P

10 H. Art'y. U.S.C.T.

John Pleasant
Sgt, Co. E, 10 Reg't U. S. Col'd H. Art'y.

Appears on

Company Muster Roll

for Nov Dec, 1864

Present or absent Present

Stoppage, \$ 100 for

Due Gov't, \$ 100 for

Valuation of horse, \$ 100

Valuation of horse equipments, \$ 100

Remarks:

Book mark:

(358)

Linden

Copyist.

9

10 H. Art'y. U.S.C.T.

John Pleasant

Co. E, 10 Reg't U. S. Col'd H. Art'y.

Appears on

Company Muster Roll

for Jan. & Feb., 1865.

Present or absent Present

Stoppage, \$ 100 for

Due Gov't, \$ 100 for

Valuation of horse, \$ 100

Valuation of horse equipments, \$ 100

Remarks:

Book mark: 1005

(358)

J. C. Tyler Copyist.

P

10 H. Art'y. U.S.C.T.

John Pleasant
Pvt., Co. E, 10 Reg't U. S. Col'd H. Art'y.

Appears on

Company Muster Roll

for March & April, 1862.

Present or absent Present

Stoppage, \$ 100 for

Due Gov't, \$ 100 for

Valuation of horse, \$ 100

Valuation of horse equipments, \$ 100

Remarks: Sick in Quarters

Book mark:

(358)

W. H. [Signature]

Copyist.

J | 10 H. Art'y. | U.S.C.T.

John Pleasant
....., Co. E, 10 Reg't U. S. Col'd H. Art'y.

Appears on

Company Muster Roll

for *May & June*, 186*5*.

Present or absent *Present*

Stoppage, \$.....¹⁰⁰ for

Due Gov't, \$.....¹⁰⁰ for

Valuation of horse, \$.....¹⁰⁰

Valuation of horse equipments, \$.....¹⁰⁰

Remarks:

Book mark:

(358)

G. E. Tyler
.....
Copyist.

P

10 H. Art'y. | U.S.C.T.

John Pleasant

Govt., Co. E, 10 Reg't U. S. Col'd H. Art'y

Appears on

Company Muster Roll

for *July & Aug.*, 1865.

Present or absent *Present.*

Stoppage, \$ *100* for

Due Gov't, \$ *100* for

Valuation of horse, \$ *100*

Valuation of horse equipments, \$ *100*

Remarks: -----

Book mark: *3000*

(358)

J. C. Tyler

Copyist.

F | 10 H. Art'y. | U.S.C.T.

John Pleasant
....., Co. E, 10 Reg't U. S. Col'd H. Art'y

Appears on

Company Muster Roll

for *Sept. & Oct.*, 186*6*.

Present or absent *Present*

Stoppage, \$ *100* for

Due Gov't, \$ *100* for

Valuation of horse, \$ *100*

Valuation of horse equipments, \$ *100*

Remarks:

Book mark:

.....
[Signature]
Copyist.

P

10 H. Art'y. U.S.C.T.

John Pleasant

Co. E, 10 Reg't U. S. Col'd H. Art'y.

Appears on

Company Muster Roll

for Nov 2 Dec, 1865

Present or absent Present

Stoppage, \$ 100 for

Due Gov't, \$ 100 for

Valuation of horse, \$ 100

Valuation of horse equipments, \$ 100

Remarks: Due U.S. for camp and
harness & gear age book 5-2

Book mark:

(358)

Kash
Copyist.

John Pleasant

Priv., Co. E, 10 Reg't U. S. Col'd H. Art'y.

Appears on

Company Muster Roll

for *Jan & Feb*, 1866.

Present or absent *Present*

Stoppage, \$ 100 for

Due Gov't, \$ 100 for

Valuation of horse, \$ 100

Valuation of horse equipments, \$ 100

Remarks:

Book mark: -----

P

10 H. Art'y. U.S.C.T.

John Pleasant

Priv, Co. E, 10 Reg't U. S. Col'd H. Art'y.

Appears on

Company Muster Roll

for March & April, 1866

Present or absent Present

Stoppage, \$ 100 for

Due Gov't, \$ 100 for

Valuation of horse, \$ 100

Valuation of horse equipments, \$ 100

Remarks:

Book mark:

Hart Copyist.

P

10 H. Art'y. U.S.C.T.

John Pleasant

Priv, Co. E, 10 Reg't U. S. Col'd H. Art'y

Appears on

Company Muster Roll

for May & June, 1866.

Present or absent Present

Stoppage, \$ 100 for

Due Gov't, \$ 100 for

Valuation of horse, \$ 100

Valuation of horse equipments, \$ 100

Remarks: Sick in Quarters

Book mark:

Wash

P

10 H. Art'y. | U.S.C.T.

John Pleasant

Pvt, Co. E, 10 Reg't U. S. Col'd H. Art'y.

Appears on

Company Muster Roll

for July & Aug, 1866.

Present or absent Present

Stoppage, \$ 100 for

Due Gov't, \$ 100 for

Valuation of horse, \$ 100

Valuation of horse equipments, \$ 100

Remarks:

Book mark:

Wark

Copyist.

P

10 H. Art'y. U.S.C.T.

John Pleasant
Pat., Co. E, 10 Reg't U. S. Col'd H. Art'y.

Appears on

Company Muster Roll

for *Sept & Oct*, 186*6*.

Present or absent *Present*

Stoppage, \$ *100* for

Due Gov't, \$ *100* for

Valuation of horse, \$ *100*

Valuation of horse equipments, \$ *100*

Remarks:

Book mark:

(358)

O'Hagan
Copyist.

R

10 H. Art'y. U.S.C.T.

John Reasant

Priv, Co. E, 10 Reg't U. S. Col'd H. Art'y.

Appears on

Company Muster Roll

for *Nov. & Dec.*, 186*6*.

Present or absent *Present*

Stoppage, \$ *100* for

Due Gov't, \$ *100* for

Valuation of horse, \$ *100*

Valuation of horse equipments, \$ *100*

Remarks:

Book mark:

(358)

O'Hagan

Copyist.

P

10 H. Art'y. U.S.C.T.

John Pleasant
Co. E, 10 Reg't U. S. Col'd H. Art'y.

Appears on Co. Muster-out Roll, dated
Baton Rouge, La, Feb. 22, 1867.
Muster-out to date *Feb. 22, 1867.*
Last paid to *Dec. 31, 1866.*

Clothing account:

Last settled _____, 186 ; drawn since \$ _____ 100
Due soldier \$ *24* ^{*33*}/₁₀₀; due U. S. \$ _____ 100
Am't for cloth'g in kind or money adv'd \$ _____ 100

Due U. S. for arms, equipments, &c., \$ *6* ^{*02*}/₁₀₀
act of July 26. 1860
Bounty paid \$ _____ 100; due \$ *300.* ^{*00*}/₁₀₀

Remarks: *Joined Org. Organ*
as private,

Book mark : _____

(361)

O'Hagan

Copyist.

Co. K., 10 U.S. Col'd H. Arty

Private. Private.

CARD NUMBERS.

1	5487655	26
2	5488434	27
3	5512308	28
4	5512461	29
5	5512598	30
6	5512743	31
7	5512865	32
8	5512988	33
9	5513087	34
10	5513202	35
11	5513293	36
12		37
12		38
14		39
15		40
16		41
17		42
18		43
19		44
20		45
21		46
22		47
23		48
24		49
25		50

Book Mark:

See also 77 U.S. 6 Sep

M. J. Worley

f 47.

S-887885 - P.O. - M.V. M.

P.O. miss of 924.068 4/26/16 JMS

P | 10 H. Art'y. | U.S.C.T.

John B. Pleasant-

P, Co. K, 10 Reg't U. S. Col'd H. Art'y.

Age years.

Appears on

Company Muster Roll*

for Sep. & Oct., 1865.

Joined for duty and enrolled:

When May 6, 1864.

Where New Orleans, La.

Period 3 years

Mustered in:

When May 12, 1864.

Where New Orleans

Present or absent Present

Stoppage, \$ 100 for

Due Gov't, \$ 100 for

Remarks: Stop 1 Mosquito bar,
1 wiper, \$2.20

* First current roll. No muster-in roll of this company on file.

Book mark:

(3586)

Hibbard

Copyist.

O 10th A. U.S.C.T.

John S. Pleasant
Det, Co K, 10 Reg't U. S. Col'd Ill

Appears on

M. and D. Roll of Men Transferred

to the organization named above

from 47 U.S. Col Imp

Roll dated Camp Canby, 1864

When enlisted May 6, 1864

Period for which enlisted 3 years.

When mustered in May 12, 1864

Present or absent Present

Company to which assigned K

Remarks: Joined Co at Org
inal Organization
stoppage for winter and
March to Bar. App't a
Corporal. Aug 26. 1864
Reduced Apr 1. 65

Book mark :

W. H. Scott

O V H a | U.S.C.T.

John B. Pleasant
Co. K, 10 Reg't U. S. Col'd Ha

Appears on

M. and D. Roll of Men Transferred

to the organization named above,

from 47 U.S. Col Inf

Roll dated Camp Parapetia Oct 1, 1864

When enlisted May 6, 1864

Period for which enlisted 3 years.

When mustered in May 12, 1864

Present or absent Present

Company to which assigned K

Remarks: Rec'd by transfer fr
Co K 47 U.S. C. I. stop
stop for 1 wiper 17th
Bar

Book mark :

W. H. Scott

P

10 H. Art'y.

U.S.C.T.

John B. Pleasant

P, Co. K, 10 Reg't U. S. Col'd H. Art'y.

Appears on

Company Muster Roll

for Nov. + Dec., 1865

Present or absent Present

Stoppage, \$ 100 for

Due Gov't, \$ 100 for

Valuation of horse, \$ 100

Valuation of horse equipments, \$ 100

Remarks: Step for ordnance Camp
H. E. lost - \$ 2.20

Book mark:

Hibbard

(358)

Copyist.

P

10 H. Art'y.

U.S.C.T.

P John B. Pleasant
Co. K, 10 Reg't U. S. Col'd H. Art'y.

Appears on

Company Muster Roll

for Jan. 1st Feb. 1866

Present or absent Present

Stoppage, \$ 100 for

Due Gov't, \$ 100 for

Valuation of horse, \$ 100

Valuation of horse equipments, \$ 100

Remarks:

Book mark:

(358)

Hibbard
Copyist.

P | 10 H. Art'y. | U.S.C.T.

John B. Pleasant
P, Co. K, 10 Reg't U. S. Col'd H. Art'y.

Appears on

Company Muster Roll

for Mich. 9 Apl., 186 6

Present or absent Present

Stoppage, \$ 100 for

Due Gov't, \$ 100 for

Valuation of horse, \$ 100

Valuation of horse equipments, \$ 100

Remarks:

Book mark:

(358)

Wibbard
Copyist.

P

10 H. Art'y. U.S.C.T.

John B. Pleasant

Co. K, 10 Reg't U. S. Col'd H. Art'y.

Appears on

Company Muster Roll

for May & June, 1866.

Present or absent Present

Stoppage, \$ 100 for

Due Gov't, \$ 100 for

Valuation of horse, \$ 100

Valuation of horse equipments, \$ 100

Remarks:

Book mark:

(358)

Hibbard Copyist.

P | 10 H. Art'y. | U.S.C.T.

John B. Pleasant
P, Co. K, 10 Reg't U. S. Col'd H. Art'y.

Appears on

Company Muster Roll

for July & Aug., 1866.

Present or absent Present

Stoppage, \$ 100 for

Due Gov't, \$ 100 for

Valuation of horse, \$ 100

Valuation of horse equipments, \$ 100

Remarks:

Book mark:

(358)

Hibbard Copyist.

P

10 H. Art'y. U.S.C.T.

John B. Pleasant

Put, Co. K, 10 Reg't U. S. Col'd H. Art'y.

Appears on

Company Muster Roll

for Sept. & Oct., 1866

Present or absent Present

Stoppage, \$ 100 for

Due Gov't, \$ 100 for

Valuation of horse, \$ 100

Valuation of horse equipments, \$ 100

Remarks:

Book mark:

Floyd

P

10 H. Art'y. U.S.C.T.

John B. Pleasant
Pvt., Co. K, 10 Reg't U. S. Col'd H. Art'y.

Appears on

Company Muster Roll

for Nov. 7 Dec., 1866.

Present or absent Presents

Stoppage, \$ 100 for

Due Gov't, \$ 100 for

Valuation of horse, \$ 100

Valuation of horse equipments, \$ 100

Remarks:

Book mark:

Floyd

P

10 H. Art'y. U.S.C.T.

John B. Pleasant
Pvt., Co. K., 10 Reg't U. S. Col'd H. Art'y.

Appears on Co. Muster-out Roll, dated
Baton Rouge La, Feb 22, 1867.
Muster-out to date Feb 22, 1867.
Last paid to Dec. 31, 1866.

Clothing account:

Last settled....., 186 ; drawn since \$.....100

Due soldier \$ 38 ⁵⁰/₁₀₀; due U. S. \$.....100

Am't for cloth'g in kind or money adv'd \$.....100

Due U. S. for arms, equipments, &c., \$ 6 ²²/₁₀₀

Bounty paid \$.....100; due \$.....100

Remarks: Rec'd by transfer from Co.,
K., 77 U. S. C. I., Oct 1/65 for \$100.
No. 66 Hdqrs Dept La, S. 1865-
\$100. Bounty due under Act of
Congress July 26/66. \$100 Bounty
due under Act of Congress July 28/66

Book mark :

(361)

Floyd

Copyist.

Co. K. 100 Reg't U.S. Army

1 Inclosures.

Bed Cards	Final Statements
Burial Records	Furloughs or L. of A.
Certs. of Dis. for Disch	Med. Certificates
C. M. Charges	Med. Des. Lists
Descriptive Lists	Orders
Discharge Certificates	Pris. of War Record
Enlistment Papers	Resignations

Other papers relating to—

Admission to Hosp'l	Furlough or L. of A.
Casualty Sheet	Med. Examination
Confinement	Misc. Information
Contracts	Pay or Clothing
Death or Effects	Personal Reports
Desertion	Rank
Discharge from Hosp'l	Transfer to Hosp'l
Discharge from Service	Transfer to V. R. C.
Duty	Transportation
S. of S. Ref. Slips. /	

Statement of Service Reference Slip.

Office Pension

Claim No. CT 924068

John B. Pleasant
was. (1866) 1866 1866
Co. 76; 77 Reg't USC 7A

To Med Rec 4/26, 1916

For history

no med for pro
Johnson
N.H. 7A.

No medical record found.

Statement furnished APR 26 1916, 1916

Ken.

Co. K., 10 U.S. Col'd R. Art.

Private | Corporal.

CARD NUMBERS.

1	5488433	26
2	5487654	27
3	5512307	28
4	5512460	29
5	5512597	30
6	5512677	31
7	5512804	32
8	5512924	33
9	5513120	34
10	5513330	35
11		36
12		37 -
12		38
14		39
15		40
16		41
17		42
18		43
19		44
20		45
21		46
22		47
23		48
24		49
25		50

Book Mark:

See also 77 U.S. 6 Inf

P 108a | **U.S.C.T.**

Joseph Pleasant
Priv, Co K, 10 Reg't U. S. Col'd 108a

Appears on

M. and D. Roll of Men Transferred

to the organization named above,

from 47 U. S. Col Inf

Roll dated Camp Maper 2 Oct 1, 1864

When enlisted May 6, 1867.

Period for which enlisted 3 years.

When mustered in May 12, 1864.

Present or absent Present

Company to which assigned K

Remarks: Rec'd by transfer fr

Co K, 47 U. S. C. I., stop
1 wiper & 5 driver

Book mark :

W. H. Scott

P | 10 H U U.S.C.T.

Joseph Pleasant
Priv., Co. K, 10 Reg't U. S. Col'd

Appears on

M. and D. Roll of Men Transferred

to the organization named above,

from 7th U.S. Col Inf

Roll dated Camp Canapet da Oct 1, 1865

When enlisted May 6, 1864

Period for which enlisted 9 years.

When mustered in May 12, 1864

Present or absent Present

Company to which assigned K

Remarks: formed Co at
Ordnance Organization
stoppage for wipers
screw drivers and cone
wrench

Book mark :

Wilbur Scott

P | 10 H. Art'y. | U.S.C.T.

Joseph Pleasant
P, Co. K., 10 Reg't U. S. Col'd H. Art'y.

Age years.

Appears on

Company Muster Roll*

for Sep. to Oct., 1865.

Joined for duty and enrolled:

When May 6, 1864.

Where New Orleans, La.

Period 3 years

Mustered in:

When May 12, 1864.

Where New Orleans

Present or absent Present

Stoppage, \$ 100 for

Due Gov't, \$ 100 for

Remarks: Stop iniper, lacrim driver,
43 cts. On daily duty as
orderly.

* First current roll. No muster-in roll of this company on file.

Book mark: 356

(3586)

Hibbard
Copyist.

P

10 H. Art'y.

U.S.C.T.

Joseph Pleasant

Co. K, 10 Reg't U. S. Col'd H. Art'y.

Appears on

Company Muster Roll

for Nov. & Dec., 1865

Present or absent Present

Stoppage, \$ 100 for

Due Gov't, \$ 100 for

Valuation of horse, \$ 100

Valuation of horse equipments, \$ 100

Remarks: Stop for Ordnance
lost - 43 cts.

Book mark:

(358)

Hibbard
Copyist.

P

10 H. Art'y.

U.S.C.T.

Joseph Pleasant

Co. K, 10 Reg't U. S. Col'd H. Art'y.

Appears on

Company Muster Roll

for Jan. Feb., 1866.

Present or absent Present

Stoppage, \$ 100 for

Due Gov't, \$ 100 for

Valuation of horse, \$ 100

Valuation of horse equipments, \$ 100

Remarks:

Book mark:

(358)

Hibbard Copyist.

P

10 H. Art'y. U.S.C.T.

Joseph Pleasant
Corp., Co. K, 10 Reg't U. S. Col'd H. Art'y.

Appears on

Company Muster Roll

for Feb. 7th Apl., 1866.

Present or absent Present

Stoppage, \$ 100 for

Due Gov't, \$ 100 for

Valuation of horse, \$ 100

Valuation of horse equipments, \$ 100

Remarks: Stop for 1 H Sack & 1 Canteen
lost \$1.60 Promoted for Port. to date
Apr. 1, 66 per S.O. No. 9, Hdqrs. 10 U.S.
C.H.A.

Book mark:

(358)

Hittard

Copyist.

P

10 H. Art'y.

U.S.C.T.

Joseph Pleasant
Corp., Co. K, 10 Reg't U. S. Col'd H. Art'y.

Appears on

Company Muster Roll

for May & June, 1866

Present or absent Present

Stoppage, \$ 100 for

Due Gov't, \$ 100 for

Valuation of horse, \$ 100

Valuation of horse equipments, \$ 100

Remarks:

Book mark:

(358)

Hisbard
Copyist.

P

10 H. Art'y. U.S.C.T.

Joseph Pleasant
Corp., Co. K, 10 Reg't U. S. Col'd H. Art'y.

Appears on

Company Muster Roll

for July & Aug., 1866.

Present or absent Absent

Stoppage, \$ 100 for

Due Gov't, \$ 100 for

Valuation of horse, \$ 100

Valuation of horse equipments, \$ 100

Remarks: On detach'd duty at
New Orleans, La. since Aug.
28, 1866.

Book mark:

Wibbard

(358)

Copyist.

P

10 H. Art'y. U.S.C.T.

Joseph Pleasant
Corpl., Co. K, 10 Reg't U. S. Col'd H. Art'y.

Appears on

Company Muster Roll

for Sept. & Oct., 1866.

Present or absent

Stoppage, \$ 100 for

Due Gov't, \$ 100 for

Valuation of horse, \$ 100

Valuation of horse equipments, \$ 100

Remarks: Discharged Sept 8. 1866
to enable him to re-enlist
in the regular army.

Book mark:

Floyd

P

10 H. Art'y. U.S.C.T.

Joseph Pleasant
Co. K, 10 Reg't U. S. Col'd H. Art'y.

Appears on Co. Muster-out Roll, dated
Baton Rouge La, Feb 22, 1867.

Muster-out to date -----, 186 .

Last paid to -----, 186 .

Clothing account:

Last settled -----, 186 ; drawn since \$ ----- 100

Due soldier \$ ----- 100; due U. S. \$ ----- 100

Am't for cloth'g in kind or money adv'd \$ ----- 100

Due U. S. for arms, equipments, &c., \$ ----- 100

Bounty paid \$ ----- 100; due \$ ----- 100

Remarks: Recd by transfer from
Co K 77 U. S. C. I., Oct 1/65 per
S. O. no 66 Hd qrs Dept La S. 1865-
Pro corp Apr 1/66. Dis service Sept 8/66
to reenlist in 9 U. S. C.

Book mark: -----

(361)

Lloyd

Copyist.

A. 10 U.S. Col'd H. Army

Private Private

CARD NUMBERS.

1	5490458	26
2	5490610	27
3	5490751	28
4	5490906	29
5	5491041	30
6	5491196	31
7	5491304	32
8	5491441	33
9	5491567	34
10	5491694	35
11	5491820	36
12	5491946	37
13	5492071	38
14	5492196	39
15	5492318	40
16	5492443	41
17	5492556	42
18	5492691	43
19	5492819	44
20	5493055	45
21	5494045	46
22	5489569	47
23	47-29-1884	48
24		49
25		50

Book Mark: 213 $\frac{15}{941}$ 47 65-1884

See also

P

10 H. Art'y. | U.S.C.T.

Adams Plenty

....., Co. A, 1 Reg't La. Col'd H. Art'y.*

Age 23 years.

Appears on

Company Muster-in Roll

of the organization named above. Roll dated

New Orleans, La. Nov. 29, 1862.

Muster-in to date *Nov. 29, 1862.*

Joined for duty and enrolled:

When *Nov. 16*....., 186 .

Where *New Orleans*

Period 3 years.

Valuation of horse, \$.....100

Valuation of horse equipments, \$.....100

Remarks:.....

* This organization subsequently became Co. A, 10 Reg't U. S. Colored Heavy Artillery.

Book mark:.....

Johnson

(356)

Copyist.

P

10 H. Art'y. | U.S.C.T.

Adams Plenty

Priv, Co. A, 1 Reg't La. H. Art'y.*

Appears on

Company Muster Roll

for to Dec. 31, 186 2

Present or absent Present

Stoppage, \$ 100 for

Due Gov't, \$ 100 for

Valuation of horse, \$ 100

Valuation of horse equipments, \$ 100

Remarks:

*This organization subsequently became Co. A. 10 Reg't U.S. Col'd Heavy Artillery.

Book mark:

Tolman

P

10 H. Art'y. U.S.C.T.

Adams Plenty

Priv. Co. A, 1 Reg't La. H. Art'y.*

Appears on

Company Muster Roll

for *Jasny & Fieby*, 1863

Present or absent *Present*

Stoppage, \$ 100 for

Due Gov't, \$ 100 for

Valuation of horse, \$ 100

Valuation of horse equipments, \$ 100

Remarks:

*This organization subsequently became Co. A, 10 Reg't U. S. Col'd Heavy Artillery.

Book mark:

Tobman

P

10 H. Art'y. U.S.C.T.

Adams Plenty

Priv., Co. A, 1 Reg't La. H. Art'y.*

Appears on

Company Muster Roll

for March & April, 1863.

Present or absent Present

Stoppage, \$ 100 for

Due Gov't, \$ 100 for

Valuation of horse, \$ 100

Valuation of horse equipments, \$ 100

Remarks: Sick in Hospital

*This organization subsequently became Co. A, 10 Reg't U. S. Col'd Heavy Artillery.

Book mark:

Tobman

Adams Plenty

Priv., Co. A, 1 Reg't La. H. Art'y.*

Appears on

Company Muster Roll

for May & June, 1863.

Present or absent Present

Stoppage, \$ 100 for

Due Gov't, \$ 100 for

Valuation of horse, \$ 100

Valuation of horse equipments, \$ 100

Remarks:

*This organization subsequently became Co. A, 10 Reg't U. S. Col'd Heavy Artillery.

Book mark:

Tobman Copyist.

P

10 H. Art'y.

U.S.C.T.

Adam Plenty

Priv., Co. A, 1 Reg't La. H. Art'y.*

Appears on

Company Muster Roll

for July & August, 1863.

Present or absent Present

Stoppage, \$ 100 for

Due Gov't, \$ 100 for

Valuation of horse, \$ 100

Valuation of horse equipments, \$ 100

Remarks:

*This organization subsequently became Co. A, 10 Reg't U. S. Col'd Heavy Artillery.

Book mark:

RECEIVED

Tolman

Copyist.

Adams Plenty
Priv., Co. A, 1 Reg't La. H. Art'y.*

Appears on

Company Muster Roll

for Sept & Oct, 1863

Present or absent Present

Stoppage, \$ 100 for

Due Gov't, \$ 100 for

Valuation of horse, \$ 100

Valuation of horse equipments, \$ 100

Remarks:

*This organization subsequently became Co. A, 10 Reg't U. S. Col'd Heavy Artillery.

Book mark:

Johnman
Copied.

P

10 H. Art'y. | U.S.C.T.

Adams Plenty

Co. A, 1 Reg't H. Art'y, Corps d'Afrique.*

Appears on

Company Muster Roll

for *Nov Dec*, 1863

Present or absent *Present*

Stoppage, \$ 100 for

Due Gov't, \$ 100 for

Valuation of horse, \$ 100

Valuation of horse equipments, \$ 100

Remarks:

*This organization subsequently became Co. A, 10 Reg't U. S. Colored Heavy Artillery.

Book mark:

Becherter

P

10 H. Art'y. U.S.C.T.

Adams Plenty

Pvt, Co. A, 1 Reg't H. Art'y, Corps d'Afrique.*

Appears on

Company Muster Roll

for Jan & Feb, 1864

Present or absent Present

Stoppage, \$ 100 for

Due Gov't, \$ 100 for

Valuation of horse, \$ 100

Valuation of horse equipments, \$ 100

Remarks:

*This organization subsequently became Co. A, 10 Reg't U. S. Colored Heavy Artillery.

Book mark:

Proctor

P | 10 H. Art'y. | U.S.C.T.

Adams Plenty
Art., Co. A., 7 Reg't U. S. Col'd H. Art'y.*

Appears on

Company Muster Roll

for *McKees*, 1864.

Present or absent *Present*

Stoppage, \$ 100 for

Due Gov't, \$ 100 for

Valuation of horse, \$ 100

Valuation of horse equipments, \$ 100

Remarks:

* This organization subsequently became Co. A, 10 Reg't U. S. Colored Heavy Artillery.

Book mark:

Adams

P

10 H. Art'y.

U.S.C.T.

Adam Peuty

Co. A, 7 Reg't U. S. Col'd H. Art'y.*

Appears on

Company Muster Roll

for *May June*, 1864.

Present or absent *Present*

Stoppage, \$ *100* for

Due Gov't, \$ *100* for

Valuation of horse, \$ *100*

Valuation of horse equipments, \$ *100*

Remarks:

* This organization subsequently became Co. *A*, 10 Reg't U. S. Colored Heavy Artillery.

Book mark: -----

Proctor

P | 10 H. Art'y. | U.S.C.T.

Adams Plenty

Pvt. Co. A, 7 Reg't U. S. Col'd H. Art'y.*

Appears on

Company Muster Roll

for July to Aug, 1864.

Present or absent Present

Stoppage, \$ 100 for

Due Gov't, \$ 100 for

Valuation of horse, \$ 100

Valuation of horse equipments, \$ 100

Remarks: Sick in quarters

* This organization subsequently became Co. A, 10 Reg't U. S. Colored Heavy Artillery.

Book mark:

Bohner

P

10 H. Art'y. U.S.C.T.

Adams Plenty

Co. A, 10 Reg't U. S. Col'd H. Art'y.

Appears on

Company Muster Roll

for Sept/Oct, 1864

Present or absent Present

Stoppage, \$ 100 for

Due Gov't, \$ 100 for

Valuation of horse, \$ 100

Valuation of horse equipments, \$ 100

Remarks: Sick in quarters

Book mark:

Beister

Adams Plenty
Sgt., Co. A, 10 Reg't U. S. Col'd H. Art'y.

Appears on

Company Muster Roll

for *Nov Dec*, 1864.

Present or absent *Absent*

Stoppage, \$ 100 for

Due Gov't, \$ 100 for

Valuation of horse, \$ 100

Valuation of horse equipments, \$ 100

Remarks: *In Detached
Service at Battery
Leutelly La. for S. O.
No 317 Hd. Qrs. Reg.
New Orleans dated
Dec, 26, 1864*

Book mark:

Proctor

P | 10 H. Art'y. | U.S.C.T.

Adams-Plenty

Plenty, Co. A, 10 Reg't U. S. Col'd H. Art'y.

Appears on

Company Muster Roll

for *Jan + Feb*, 1865.

Present or absent *Present*

Stoppage, \$ 100 for

Due Gov't, \$ 100 for

Valuation of horse, \$ 100

Valuation of horse equipments, \$ 100

Remarks:

Book mark:

Rochester

(358)

Copyist.

P | 10 H. Art'y. | U.S.C.T.

Adams Plenty

Plenty, Co. A, 10 Reg't U. S. Col'd H. Art'y.

Appears on

Company Muster Roll

for *March 1865*, 1865.

Present or absent *Present*

Stoppage, \$ 100 for

Due Gov't, \$ 100 for

Valuation of horse, \$ 100

Valuation of horse equipments, \$ 100

Remarks:

Book mark:

Proctor

P | 10 H. Art'y. | U.S.C.T.

Adams Plenty

Art, Co. A, 10 Reg't U. S. Col'd H. Art'y.

Appears on

Company Muster Roll

for *May & June, 1865*

Present or absent *Present*

Stoppage, \$ 100 for

Due Gov't, \$ 100 for

Valuation of horse, \$ 100

Valuation of horse equipments, \$ 100

Remarks: _____

Book mark: _____

Pro Seester

P | 10 H. Art'y. | U.S.C.T.

Adams Plenty
Pvt, Co. A, 10 Reg't U. S. Col'd H. Art'y.

Appears on

Company Muster Roll

for *July & Aug*, 186*5*.

Present or absent *Present*

Stoppage, \$ 100 for

Due Gov't, \$ 100 for

Valuation of horse, \$ 100

Valuation of horse equipments, \$ 100

Remarks:

Book mark:

Bochester

P

| 10 H. Art'y. | U.S.C.T.

Adams Plenty

Plt, Co. A, 10 Reg't U. S. Col'd H. Art'y.

Appears on

Company Muster Roll

for *Sept & Oct*, 1865.

Present or absent *Present*

Stoppage, \$ 100 for

Due Gov't, \$ 100 for

Valuation of horse, \$ 100

Valuation of horse equipments, \$ 100

Remarks:

Book mark:

(358)

Hym Copyist.

D | 10 H. Art'y. | U.S.C.T.

Adams Plenty

Pl, Co. A, 10 Reg't U. S. Col'd H. Art'y.

Appears on

Company Muster Roll

for *Nov & Dec*, 1865.

Present or absent

Stoppage, \$ 100 for

Due Gov't, \$ 100 for

Valuation of horse, \$ 100

Valuation of horse equipments, \$ 100

Remarks: *Mustered out by reason of expiration of term of service*

Book mark: *Disch'd Nov. 28/65 to B. 13. 47*

C.P. 1884

(358)

J. Byrnes
Copyist.

P. 10 Me. a. U.S.C.T.

Adams Plenty

Col., Co. A., 10 Reg't U. S. Col'd Me. a.

Appears on a

Detachment Muster-out Roll

of the organization named above. Roll dated

N. Orleans La. Nov. 28 1865.

Muster-out to date Nov. 28, 1865.

Last paid to June 30, 1865

Clothing account:

Last settled _____, 186 ; drawn since \$ 100

Due soldier \$ 3 ³³/₁₀₀; due U. S. \$ 100

Am't for cloth'g in kind or money adv'd \$ 100

Due U. S. for arms, equipments, &c., \$ 100

Bounty paid \$ 100 due \$ 100

Remarks: *Joined at origl. Orgn.
Mustered out by reason
of Expiration of term of
service*

Book mark: _____

Hawley

P

10 H. Art'y. U.S.C.T.

* Adams Plenty
Pvt, Co. A, 10 Reg't U. S. Col'd H. Art'y.

Appears on Co. Muster-out Roll, dated
Baton Rouge La, Feb. 22 1867.

Muster-out to date _____, 186 .

Last paid to _____, 186 .

Clothing account:

Last settled _____, 186 ; drawn since \$ _____ 100

Due soldier \$ _____ 100; due U. S. \$ _____ 100

Am't for cloth'g in kind or money adv'd \$ _____ 100

Due U. S. for arms, equipments, &c., \$ _____ 100

Bounty paid \$ _____ 100; due \$ _____ 100

Remarks: *Joined origl. orgn.
disch'd for expn'd of term of
service Nov. 28. 65*

** Taken from roll of Nov + Dec. 65*

Book mark: _____

Nesbitt

(361)

Copyist.

P. 1 10th Regt U.S. I

Adams Plenty

, Co. "A", 10th Regt U.S. I

NOTATION.

Book mark: 2. B. 15-491 with
47. 6. 3. 1864

War Department,

Adjutant General's Office,

Washington, Jan. 5th, 1864.

Mustered out with Detach-
ment November 28, 1865.

E. P. Conroy

Surgeon.

Surgeon

CARD NUMBERS.

1	5488480	26
2		27
3		28
4		29
5		30
6		31
7		32
8		33
9		34
10		35
11		36
12		37
13		38
14		39
15		40
16		41
17		42
18		43
19		44
20		45
21		46
22		47
23		48
24		49
25		50

Book Mark:

See also *77 U.S. 6 Inf*

P | 10 H.A. | U.S.C.T.

John Pindexter
Surq, Co., 10 Reg't U. S. Col'd H. Arty

Appears on

M. and D. Roll of Men Transferred

to the organization named above,

from 77 U.S., Col. Inf.

Roll dated Camp Parapet Oct. 5, 1865.

When enlisted Jan 5, 1864.

Period for which enlisted 3 years.

When mustered in Jan 5, 1864.

Present or absent Present.

Company to which assigned

Remarks: Was mustered into

the service as 1 Asst. Surq.

87 Ill. Vols. Oct. 12, 62 to date

from Sept. 5, 62. Was ap-

pointed Surq. 5 C. d' A. Jan.

5, 64. Rendered supernumer-

ary by consolidation with

Book mark : (over)

(342)

A. A. Hall

Copyist
Camp.

JAN. 15

5488480

★ 1891 ★

the 10 U. S. C. H. A. and
honorably mustered out
in S. O. No. 66 Sept. 22,
'65 Hd. Qrs. Dept. of La.

Name not taken up
in muster rolls of
Regt.

U.S. Col'd H. Art

Private

Private

CARD NUMBERS.

1	5497753	26
2	5498152	27
3	5498253	28
4	5498350	29
5	5498449	30
6	5498573	31
7	5498714	32
8	5498853	33
9	5498912	34
10	5499052	35
11	5499187	36
12	5499323	37
13	5499459	38
14	5599595	39
15	5499731	40
16	5499866	41
17	5499999	42
18	5500209	43
19	5500336	44
20	5500481	45
21	5490175	46
22	R.P. 511.149.	47
23		48
24		49
25		50

Book Mark: R.P. 511.149.

See also:

J. G. Knight
Esq.

S 1457100 G.A.R.
S 15-18373 P.O.M.M.
Rep. 511.149.

A 1632956 and WD
S-1636079- and M.D.
Rep. 555253.

A1963937 PO MMV
A1963960 PO aff

2

10 H. Art'y.

U.S.C.T.

Correct name, Nelson Poirier,

Nelson Poirier

Pvt., Co. C, 1 Reg't La. Art'y, Native Guards.*

Age *17* years.

Appears on

Company Muster-in Roll

of the organization named above. Roll dated

New Orleans La., Feb 4, 1864.

Muster-in to date

Feb 4, 1864.

Joined for duty and enrolled:

When

Jan 14, 1864.

Where

N.O., La.

Period

3 years.

Valuation of horse, \$ 100

Valuation of horse equipments, \$ 100

Remarks:

* This organization subsequently became Co. C, 10 Reg't U. S. Col'd Heavy Artillery.

Book mark:

R.A. 511,149.

W. J. ...

2 | 10 H. Art'y. | U.S.C.T.

Correct name, Nelson Poirier,

Nelson Quarra

B, Co. *C*, 1 Reg't H. Art'y, Corps d'Afrique.*

Appears on

Company Muster Roll

for *Feb 4th to 29th*, 186*4*.

Present or absent *Present*

Stoppage, \$ 100 for

Due Gov't, \$ 100 for

Valuation of horse, \$ 100

Valuation of horse equipments, \$ 100

Remarks:

*This organization subsequently became Co. *B*, 10 Reg't U. S. Colored Heavy Artillery.

Book mark:

W. J. ...

2 | **10 H. Art'y.** | **U.S.C.T.**

Correct name, Nelson Poirier,
Nelson Duana

Det, Co. L, 7 Reg't U. S. Col'd H. Art'y.*

Appears on

Company Muster Roll

for Michapel, 186 8

Present or absent absent

Stoppage, \$.....100 for

Due Gov't, \$.....100 for

Valuation of horse, \$.....100

Valuation of horse equipments, \$.....100

Remarks: On furlough
time expires May 8
1864

* This organization subsequently became Co., 10 Reg't U. S. Colored Heavy Artillery.

Book mark:

(358) J. M. ... Copyist.

L | **10 H. Art'y.** | **U.S.C.T.**

Correct name, Nelson Poirier.
Nelson Guarna

Pvt, Co L, 7 Reg't U. S. Col'd H. Art'y.*

Appears on

Company Muster Roll

for May & June, 1864.

Present or absent Present

Stoppage, \$ 100 for

Due Gov't, \$ 100 for

Valuation of horse, \$ 100

Valuation of horse equipments, \$ 100

Remarks:

* This organization subsequently became Co. , 10 Reg't U. S. Colored Heavy Artillery.

Book mark:

(358)

J. Woodward
Copyist.

2

10 H. Art'y.

U.S.C.T.

Correct name Nelson Poirier.

Nelson *Marina*

Pvt, Co. *C*, 7 Reg't U. S. Col'd H. Art'y.*

Appears on

Company Muster Roll

for *July & Aug*, 186*4*

Present or absent *Present*

Stoppage, \$ *100* for

Due Gov't, \$ *100* for

Valuation of horse, \$ *100*

Valuation of horse equipments, \$ *100*

Remarks:

* This organization subsequently became Co. , 10 Reg't U. S. Colored Heavy Artillery.

Book mark:

(358)

J. Hudson
Copyist.

L

10 H. Art'y. U.S.C.T.

Correct name: Nelson Poirier.
Nelson Luanna

Pvt., Co. C, 10 Reg't U. S. Col'd H. Art'y.

Appears on

Company Muster Roll

for Sept & Oct, 1864.

Present or absent Present

Stoppage, \$ 100 for

Due Gov't, \$ 100 for

Valuation of horse, \$ 100

Valuation of horse equipments, \$ 100

Remarks: D.D. Hosp't attendant
Fort Livingston La Post
order no 7 Oct 5/64

Book mark:

(358)

J. Hudson
Copyist.

2

10 H. Art'y. | U.S.C.T.

Correct name, Nelson Poirier,
Nelson Guarrir

Pot, Co. C, 10 Reg't U. S. Col'd H. Art'y.

Appears on

Company Muster Roll

for *Nov & Dec*, 186*4*

Present or absent *Preston*

Stoppage, \$ *100* for

Due Gov't, \$ *100* for

Valuation of horse, \$ *100*

Valuation of horse equipments, \$ *100*

Remarks:

Book mark:

(358)

J. Anderson
Copyist.

2

10 H. Art'y. U.S.C.T.

Correct name, Nelson Poirier.

Nelson Poirier

Pat, Co. C, 10 Reg't U. S. Col'd H. Art'y.

Appears on

Company Muster Roll

for *Jan & Feb*, 186 *5*.

Present or absent *Present*

Stoppage, \$ *100* for

Due Gov't, \$ *100* for

Valuation of horse, \$ *100*

Valuation of horse equipments, \$ *100*

Remarks:

Book mark:

Dallade

2

10 H. Art'y. | U.S.C.T.

Correct name, Nelson Poirier.
Nelson Poirier

Coop., Co. C, 10 Reg't U. S. Col'd H. Art'y.

Appears on

Company Muster Roll

for Mech & Apl, 1865.

Present or absent Present

Stoppage, \$ 100 for

Due Gov't, \$ 100 for

Valuation of horse, \$ 100

Valuation of horse equipments, \$ 100

Remarks: Appointed Coop
Apl 5, 1865

Book mark:

257021

Lamb

2

10 H. Art'y. U.S.C.T.

Correct name, Nelson Poirier.

Nelson Poirier

Corp, Co. C, 10 Reg't U. S. Col'd H. Art'y.

Appears on

Company Muster Roll

for *May & June*, 1865.

Present or absent. *Present*

Stoppage, \$.....100 for.....

Due Gov't, \$.....100 for.....

Valuation of horse, \$.....100

Valuation of horse equipments, \$.....100

Remarks:.....

Book mark:.....

Sallade

2

10 H. Art'y. U.S.C.T.

Correct name, Nelson Poirier.

Nelson Quarrer

Capt, Co. C, 10 Reg't U. S. Col'd H. Art'y.

Appears on

Company Muster Roll

for *July & Aug*, 1865.

Present or absent *Present*

Stoppage, \$ *100* for

Due Gov't, \$ *100* for

Valuation of horse, \$ *100*

Valuation of horse equipments, \$ *100*

Remarks: *Appointed Capt April
1865 from private vice
Maggas reduced.*

Book mark:

(358)

Dallade

Copyst.

2

10 H. Art'y. U.S.C.T.

Correct name, Nelson Poirier,
Nelson Quarier

Corp., Co. C, 10 Reg't U. S. Col'd H. Art'y.

Appears on

Company Muster Roll

for Sept + Oct, 1865.

Present or absent Present

Stoppage, \$ 100 for

Due Gov't, \$ 100 for

Valuation of horse, \$ 100

Valuation of horse equipments, \$ 100

Remarks:

Book mark:

Ballade

Q

10 H. Art'y. U.S.C.T.

Correct name, Nelson Poirier,

Nelson Quarrier

Corpl, Co. C, 10 Reg't U. S. Col'd H. Art'y.

Appears on

Company Muster Roll

for *Nov 3rd Dec*, 1865.

Present or absent *Present*

Stoppage, \$ 100 for

Due Gov't, \$ 100 for

Valuation of horse, \$ 100

Valuation of horse equipments, \$ 100

Remarks: *Apptd Corpl April 5, 1865*

Book mark:

A. J. Robbins

(358)

Copyist.

Q | 10 H. Art'y. | U.S.C.T.

Correct name, Nelson Poirier,

Nelson Quarrier
Corp., Co. C, 10 Reg't U. S. Col'd H. Art'y.

Appears on

Company Muster Roll

for *Jan. & Feb.*, 186*6*.

Present or absent *Present*

Stoppage, \$ 100 for

Due Gov't, \$ 100 for

Valuation of horse, \$ 100

Valuation of horse equipments, \$ 100

Remarks:

Book mark:

(358)

A. J. Robbins

Copyist.

Q | **10 H. Art'y.** | **U.S.C.T.**

Correct name, **Nelson Poirier,**
Nelson Quarer

Coiff, Co. C, 10 Reg't U. S. Col'd H. Art'y.

Appears on

Company Muster Roll

for *McH. 3d Apr*, 186*6*.

Present or absent *Present*

Stoppage, \$ *100* for

Due Gov't, \$ *100* for

Valuation of horse, \$ *100*

Valuation of horse equipments, \$ *100*

Remarks:

Book mark: -----

(358)

A. J. Robbins
Copyist.

2

10 H. Art'y. U.S.C.T.

Correct name, Nelson Poirier.

Nelson Quarrel

Corpl, Co. C, 10 Reg't U. S. Col'd H. Art'y.

Appears on

Company Muster Roll

for *May 2d June*, 186*6*.

Present or absent *Present*

Stoppage, \$ 100 for

Due Gov't, \$ 100 for

Valuation of horse, \$ 100

Valuation of horse equipments, \$ 100

Remarks:

Book mark:

A. J. Robbins

(358)

Copyist.

Q | 10 H. Art'y. | U.S.C.T.

Correct name, Nelson Poirier,

Nelson Quarier

Capt, Co. C, 10 Reg't U. S. Col'd H. Art'y.

Appears on

Company Muster Roll

for July 2d Aug, 1866.

Present or absent Present

Stoppage, \$ 100 for

Due Gov't, \$ 100 for

Valuation of horse, \$ 100

Valuation of horse equipments, \$ 100

Remarks:

Book mark:

(358)

A. J. Robbins
Copyist.

B

10 H. Art'y. U.S.C.T.

Correct name, Nelson Poirier.

Nelson Poirier

Pr, Co. C, 10 Reg't U. S. Col'd H. Art'y.

Appears on

Company Muster Roll

for *Sept & Oct*, 1866.

Present or absent *Present*

Stoppage, \$ 100 for

Due Gov't, \$ 100 for

Valuation of horse, \$ 100

Valuation of horse equipments, \$ 100

Remarks: *Reduced to
the rank of sergeant
8, 1866,*

Book mark:

Hammer

D

10 H. Art'y. U.S.C.T.

Correct name, Nelson Poirier.

Nelson Poirier

Pvt, Co. C, 10 Reg't U. S. Col'd H. Art'y.

Appears on

Company Muster Roll

for *Nov & Dec*, 186*6*.

Present or absent *Present*

Stoppage, \$ 100 for

Due Gov't, \$ 100 for

Valuation of horse, \$ 100

Valuation of horse equipments, \$ 100

Remarks: *due \$20 for loss of lampion & 200*

Book mark:

Manning
Copyist.

Q | 10 Arty | U.S.C.T.

Correct name, Nelson Poirier.

Nelson Quana

Civ., Co. C, 10 Reg't U. S. Col'd Arty

Appears on a

Detachment Muster-out Roll

of the organization named above. Roll dated

Baton Rouge, La. Feb. 3, 1867.

Muster-out to date Feb. 3, 1867.

Last paid to Dec. 31, 1866

Clothing account:

Last settled _____, 1866 ; drawn since \$ _____ 100

Due soldier \$ 93 ¹⁴/₁₀₀; due U. S. \$ 61 ¹⁴/₁₀₀

Am't for cloth'g in kind or money adv'd \$ _____ 100

Due U. S. for arms, equipments, &c., \$ _____ ⁷⁴/₁₀₀

Bounty paid \$ _____ 100 due \$ 300 ⁰⁰/₁₀₀

Remarks: Joined orig. org. 1st A.C.S.A. now
10 U.S.C.A. (Arty). Stop for peren drove
wiper + trumpet - was first from
enrolment to Sept. 18. 1864. Then
Corp. to Mch. 21. 1865

Book mark: 855 - 1878

R. E. Wilson

D | 10 H. Art'y. | U.S.C.T.

Correct name, Nelson Poirier.

Nelson Poirier
Pot., Co. *C*, 10 Reg't U.S. Col'd H. Art'y.

Appears on Co. Muster-out Roll, dated
Baton Rouge, La, Feb 22, 1867.

Muster-out to date _____, 186 .

Last paid to _____, 186 .

Clothing account:

Last settled _____, 186 ; drawn since \$ _____ 100

Due soldier \$ _____ 100; due U. S. \$ _____ 100

Am't for cloth'g in kind or money adv'd \$ _____ 100

Due U. S. for arms, equipments, &c., \$ _____ 100

Bounty paid \$ _____ 100; due \$ _____ 100

Remarks: *Joined Orig Ocu*
Discharged Feb 3, 1867
by reason of expira-
tion of term of service

Book mark: *885 1878*

Manning
(361) Copyist.

P. 110 N.A. U.S.O.I.

Correct name, Nelson Poirier.

Nelson Quasia

, Co. C, 110 Reg't U.S.O.N.A.

NOTATION.

Book mark: P. & P. 511149

Record and Pension Office,

WAR DEPARTMENT,

Washington, *March 2*, 1898.

It has this day (*March 2*, 1898)

been determined by this Department from *widuci*
submitted that the *correct*
name of this soldier is
Nelson Poirier.

AGN

(440)

Copyist.

Private.

Private

CARD NUMBERS.

1	5-487159	26
2	5-5-07 842	27
3	6-5-00 727	28
4	5-5-07 801	29
5	5-5-00 869	30
6	5-5-00 938	31
7	5-5-01 011	32
8	5-5-01 092	33
9	5-5-01 166	34
10	5-5-01 305	35
11	5-5-01 446	36
12	5-5-01 584	37
13	5-5-01 718	38
14	5-5-01 833	39
15	5-5-01 939	40
16	5-5-02 126	41
17	5-5-02 030	42
18	5-5-02 206.	43
19		44
20		45
21		46
22		47
23		48
24		49
25		50

Book Mark:

See also

Edward Polk

Appears with rank of *Private* on

Muster and Descriptive Roll of a Detachment of U. S. Vols. forwarded

(7th U. S. C. H. A.)
for the *10* Reg't *U. S. C. H. A.* Roll dated

New Orleans La., May 7, 1864.

Where born *Memphis Tennessee*

Age *40* y'rs; occupation *Laborer*

When enlisted *May 2, 1864.*

Where enlisted *New Orleans*

For what period enlisted *3* years.

Eyes *Black*; hair *Black*

Complexion *Black*; height *5 ft. 4 1/2 in.*

When mustered in *May 7, 1864.*

Where mustered in *New Orleans*

Bounty paid \$ *100*; due \$ *100*

Where credited *New Orleans*

Company to which assigned *D*

Remarks:

Book mark:

Galligan

Edward Polk

P, Co. D, 7 Reg't U. S. Col'd H. Art'y.*

Appears on

Company Muster Roll

for May & June, 1864.

Present or absent Present

Stoppage, \$ 100 for

Due Gov't, \$ 100 for

Valuation of horse, \$ 100

Valuation of horse equipments, \$ 100

Remarks:

* This organization subsequently became Co. D, 10 Reg't U. S. Colored Heavy Artillery.

Book mark:

Shadbolt

Edward Polk

P, Co. D, 10 Reg't U. S. Col'd H. Art'y.

Appears on

Company Muster Roll

for July & Aug., 1864.

Present or absent Present

Stoppage, \$ 100 for

Due Gov't, \$ 100 for

Valuation of horse, \$ 100

Valuation of horse equipments, \$ 100

Remarks: Dif. of pay from date of enrollment to June 30/64 \$9.00 per Mo.

Book mark:

Shadbolt

P

10 H. Art'y. | U.S.C.T.

Edward Polk

P

, Co. D, 10 Reg't U. S. Col'd H. Art'y.

Appears on

Company Muster Roll

for Sept. & Oct., 1864.

Present or absent Present

Stoppage, \$ 100 for

Due Gov't, \$ 100 for

Valuation of horse, \$ 100

Valuation of horse equipments, \$ 100

Remarks:

Book mark:

(358)

Shadbolt

Copyist.

P

10 H. Art'y. | U.S.C.T.

Edward Polk

P

, Co. D, 10 Reg't U. S. Col'd H. Art'y.

Appears on

Company Muster Roll

for *Nov. & Dec.*, 1864.

Present or absent *Present*

Stoppage, \$ 100 for

Due Gov't, \$ 100 for

Valuation of horse, \$ 100

Valuation of horse equipments, \$ 100

Remarks: *In Post Hospital*

Book mark:

(358)

Shadbolt

Copyist.

P

10 H. Art'y. | U.S.C.T.

Edward Polk

Art., Co. D, 10 Reg't U. S. Col'd H. Art'y.

Appears on

Company Muster Roll

for Jan & Feb, 1865.

Present or absent Present

Stoppage, \$ 100 for

Due Gov't, \$ 100 for

Valuation of horse, \$ 100

Valuation of horse equipments, \$ 100

Remarks:

Book mark:

Patterson

(358)

Copyist.

P | 10 H. Art'y. | U.S.C.T.

Edward Polk

Priv, Co. D, 10 Reg't U. S. Col'd H. Art'y.

Appears on

Company Muster Roll

for *March & Apr*, 186*5*.

Present or absent *Present*

Stoppage, \$ 100 for

Due Gov't, \$ 100 for

Valuation of horse, \$ 100

Valuation of horse equipments, \$ 100

Remarks: *Sick in quarters.*

Book mark: _____

Patterson

(358)

Copyist.

P

10 H. Art'y. | U.S.C.T.

Edward Polk

Pvt., Co. D, 10 Reg't U. S. Col'd H. Art'y.

Appears on

Company Muster Roll

for May & June, 1865.

Present or absent Present

Stoppage, \$ 100 for

Due Gov't, \$ 100 for

Valuation of horse, \$ 100

Valuation of horse equipments, \$ 100

Remarks:

Book mark:

Patterson

(358)

Copyist.

P

10 H. Art'y.

U.S.C.T.

Edward Polk

Priv., Co. D, 10 Reg't U. S. Col'd H. Art'y.

Appears on

Company Muster Roll

for July & Aug, 1865.

Present or absent Present

Stoppage, \$ 100 for

Due Gov't, \$ 100 for

Valuation of horse, \$ 100

Valuation of horse equipments, \$ 100

Remarks: Due U.S. for Camp & Garrison equipage. 23¢

Book mark:

J. L. Latham

(358)

Copyist.

P

10 H. Art'y. | U.S.C.T.

Edward Polk

Priv., Co. D, 10 Reg't U. S. Col'd H. Art'y.

Appears on

Company Muster Roll

for Sept & Oct, 1865.

Present or absent Present

Stoppage, \$ 100 for

Due Gov't, \$ 100 for

Valuation of horse, \$ 100

Valuation of horse equipments, \$ 100

Remarks:

Book mark:

Patterson

(358)

Copied.

P | 10 H. Art'y. | U.S.C.T.

Edward Polk

Pvt, Co. D, 10 Reg't U. S. Col'd H. Art'y.

Appears on

Company Muster Roll

for Nov & Dec, 1865.

Present or absent Present

Stoppage, \$ 100 for

Due Gov't, \$ 100 for

Valuation of horse, \$ 100

Valuation of horse equipments, \$ 100

Remarks: Due U.S. for Camp Equipage \$2.09

Book mark:

M. Wayne

(358)

Copyright.

P

10 H. Art'y. U.S.C.T.

Edward Polk

Pvt, Co. D, 10 Reg't U. S. Col'd H. Art'y.

Appears on

Company Muster Roll

for Jan & Feb, 1866.

Present or absent Present

Stoppage, \$ 100 for

Due Gov't, \$ 100 for

Valuation of horse, \$ 100

Valuation of horse equipments, \$ 100

Remarks:

Book mark:

M. Wayne

(358)

Copyist.

P

10 H. Art'y. | U.S.C.T.

Edward Polk

Polk, Co. D, 10 Reg't U. S. Col'd H. Art'y.

Appears on

Company Muster Roll

for *March & Apr*, 1866.

Present or absent *Present*

Stoppage, \$ 100 for

Due Gov't, \$ 100 for

Valuation of horse, \$ 100

Valuation of horse equipments, \$ 100

Remarks:

Book mark:

(358)

Polk Copyist.

P

10 H. Art'y.

U.S.C.T.

Edward Polk

Polk, Co. D, 10 Reg't U. S. Col'd H. Art'y.

Appears on

Company Muster Roll

for May & June, 1866

Present or absent Present

Stoppage, \$ 100 for

Due Gov't, \$ 100 for

Valuation of horse, \$ 100

Valuation of horse equipments, \$ 100

Remarks:

Book mark:

(358)

Copyist

Copyist.

P

10 H. Art'y. | U.S.C.T.

Edward Polk

Osh, Co. D, 10 Reg't U. S. Col'd H. Art'y.

Appears on

Company Muster Roll

for July & Aug, 1866.

Present or absent Present

Stoppage, \$ 100 for

Due Gov't, \$ 100 for

Valuation of horse, \$ 100

Valuation of horse equipments, \$ 100

Remarks: Due Hd. for Ord. #116

Book mark:

(358)

Copyist.

P

10 H. Art'y. | U.S.C.T.

Edward Polk

Priv., Co. D, 10 Reg't U. S. Col'd H. Art'y.

Appears on

Company Muster Roll

for Nov. & Dec., 1866.

Present or absent Present

Stoppage, \$ 100 for

Due Gov't, \$ 100 for

Valuation of horse, \$ 100

Valuation of horse equipments, \$ 100

Remarks: Due U.S. for Ord. 40ct

Book mark:

(358)

J. W. Leonard

Copist.

P

10 H. Art'y. | U.S.C.T.

Edward Polk

Private, Co. D, 10 Reg't U. S. Col'd H. Art'y.

Appears on

Company Muster Roll

for *Sept & Oct*, 186*6*.

Present or absent: *Present*

Stoppage, \$ *100* for

Due Gov't, \$ *100* for

Valuation of horse, \$ *100*

Valuation of horse equipments, \$ *100*

Remarks:

Book mark:

J. L. ...

(358)

Copyist.

P

10 H. Art'y. | U.S.C.T.

Edward Polk

Pw., Co. D, 10 Reg't U. S. Col'd H. Art'y.

Appears on Co. Muster-out Roll, dated Baton Rouge, La, Feb. 22, 1867.

Muster-out to date Feb. 22, 1867.

Last paid to Dec 31, 1866.

Clothing account:

Last settled....., 186 ; drawn since \$.....100

Due soldier \$ 38 27/100; due U. S. \$.....100

Am't for cloth'g in kind or money adv'd \$.....100

Due U. S. for arms, equipments, &c., \$ 6 08/100

Bounty paid \$.....100; due \$.....100

Remarks: Bounty due Act July 21, 1866 \$100. Bounty due Act July 28, 1866, 100

Joined Regt. Org. Private from enrollment stopped for one week

Book mark:

(361)

J. W. Leonard

Copyist.

Q. 100. 200. H. A.

Private | Private

CARD NUMBERS.

5489133	26
5492945	27
5493155	28
5493303	29
5493443	30
5493582	31
5494130	32
	33
	34
	35
	36
	37
	38
	39
	40
	41
	42
	43
	44
	45
	46
	47
	48
	49
	50

Book Mark:

See also 75 U.S. 6 J

MS Worley
J 47.

Q. 1755091

P. W. Hall U. S. C. T.

James Folk
Pl., Co., *10* Reg't U. S. Col'd *1st*

Appears on

M. and D. Roll of Men Transferred

to the organization named above,

from *7th MA Col*

Roll dated *Mar 18*, 186*3*.

When enlisted....., 186 .

Period for which enlisted *3* years.

When mustered in *Oct 4*, 186*4*.

Present or absent *Not stated*

Company to which assigned.....

Remarks: *Drafted per*

G.O. No 106 from
H & J. Reg. 21st Gulf
Aug 2 64. Credited
to H. O. Lee U.S.
for ordnance \$0.32
+ camp equipage \$2.98 sent
to G. H. N. O Sept. 18/65. Des. List given

Book mark :

J. A. Johnson

James Polk

Prof., Co. A, 10 Reg't U. S. Col'd H. Art'y.

Appears on

Company Muster Roll

for Nov. & Dec, 1865.

Present or absent Absent

Stoppage, \$ 100 for

Due Gov't, \$ 3 ²⁰/₁₀₀ for C. & G. E. \$2.98

Ordinance \$0.22 per transfer rolls.

Valuation of horse, \$ 100

Valuation of horse equipments, \$ 100

Remarks: Transferred from 75 U.S. C. I. per S.O. 105, C.S. Hd. Dept of War, Absent pick in New Orleans

Book mark:

James

Copyist.

P | 10 H. Art'y. | U.S.C.T.

James Polk

Pol, Co. A, 10 Reg't U. S. Col'd H. Art'y.

Appears on

Company Muster Roll

for Jan + Feb, 1866.

Present or absent Absent

Stoppage, \$ 100 for

Due Gov't, \$ 100 for

Valuation of horse, \$ 100

Valuation of horse equipments, \$ 100

Remarks: Absent in Gen Hosp
N. O. La. since Sept 18. 65

Book mark:

Styus

James Polk

R. J., Co. A, 10 Reg't U. S. Col'd H. Art'y.

Appears on

Company Muster Roll

for *Mar & Apr*, 186*6*.

Present or absent *Absent*

Stoppage, \$ *100* for

Due Gov't, \$ *100* for

Valuation of horse, \$ *100*

Valuation of horse equipments, \$ *100*

Remarks: *Absent in Genl Hqs at
New Orleans, La since Sept
18. 1865*

Book mark:

(358)

Hym
Copyist.

D

10 H. Art'y. | U.S.C.T.

James Polk

Pl, Co. A, 10 Reg't U. S. Col'd H. Art'y.

Appears on

Company Muster Roll

for *May & June, 1866.*

Present or absent *Absent*

Stoppage, \$ *100* for

Due Gov't, \$ *100* for

Valuation of horse, \$ *100*

Valuation of horse equipments, \$ *100*

Remarks: *In Gen Hosp No. since
Sep 18. 65*

Book mark:

(358)

Ayer

Copyist.

P

10 St. Ardy

U.S.C.T.

James Polk
Pol., Co. A, 10 Reg't U. S. Col'd St. Ardy

Appears on

Company Muster Roll

for

July & Aug., 1866.

Present or absent

Stoppage, \$ 100 for

Due Gov't, \$ 100 for

Valuation of horse, \$ 100

Valuation of horse equipments, \$ 100

Remarks: Dropped as a deserter
Aug. 23/66. transfd to Co as absent
sick & never found

Book mark:

(358)

Styger

Copyist.

P

10 H. Art'y. U.S.C.T.

James Polk

Art. Co. A., 10 Reg't U. S. Col'd H. Art'y.

Appears on Co. Muster-out Roll, dated
Baton Rouge La., Feb. 22, 1867.

Muster-out to date _____, 186 .

Last paid to _____, 186 .

Clothing account:

Last settled _____, 186 ; drawn since \$ _____ 100

Due soldier \$ _____ 100; due U. S. \$ _____ 100

Am't for cloth'g in kind or money adv'd \$ _____ 100

Due U. S. for arms, equipments, &c., \$ _____ 100

Bounty paid \$ _____ 100; due \$ _____ 100

Remarks: Transfd from 75 U.S. C.S. as Pvt.
S. O. 105 Sol 65 Dept. La
Deserted Aug. 23 '66

Book mark: Y162 P. 203. 73

Nesbitt

(361)

Copyist.

Co. 10 U.S. Col'd H. Ar.

Private. Private.

CARD NUMBERS.

1	5497751	26
2	5498149	27
3	5498250	28
4	5498347	29
5	5498446	30
6	5498568	31
7	5498709	32
8	5498848	33
9	5498985	34
10	5499125	35
11	5499261	36
12	5499397	37
13	5499532	38
14	5499669	39
15	5499803	40
16	5499938	41
17	5500068	42
18	5500203	43
19	5500330	44
20	5500478	45
21	5490172	46
22	40746828	47
23		48
24		49
25		50

Book Mark:

See also

P | 10 H. Art'y. | U.S.C.T.

James R. Peck

Pl, Co. C, 1 Reg't La. Art'y, Native Guards.*

Age *18* years.

Appears on

Company Muster-in Roll

of the organization named above. Roll dated

New Orleans La, Feb 4, 1864.

Muster-in to date *Feb 4, 1864.*

Joined for duty and enrolled:

When *Jan 25, 1864.*

Where *N. O. La*

Period *3* years.

Valuation of horse, \$ *100*

Valuation of horse equipments, \$ *100*

Remarks:

* This organization subsequently became Co. C, 10 Reg't U. S. Col'd Heavy Artillery.

Book mark:

(356)

eyfeman

Copyist.

P | 10 H. Art'y. | U.S.C.T.

James W. Polk
Plt, Co. *C*, 1 Reg't H. Art'y, Corps d'Afrique.*

Appears on

Company Muster Roll

for *Feb 4" to 29"*, 186*1/2*

Present or absent *Present*

Stoppage, \$ *100* for

Due Gov't, \$ *100* for

Valuation of horse, \$ *100*

Valuation of horse equipments, \$ *100*

Remarks:

*This organization subsequently became Co. *C*, 10 Reg't U. S. Colored Heavy Artillery.

Book mark:

(358)

W. J. ...

Copyist.

P | 10 H. Art'y. | U.S.C.T.

James K Polk
Pvt, Co. C, 7 Reg't U. S. Col'd H. Art'y.*

Appears on

Company Muster Roll

for March & April, 1864.

Present or absent Present

Stoppage, \$.....100 for

Due Gov't, \$.....100 for

Valuation of horse, \$.....100

Valuation of horse equipments, \$.....100

Remarks:

* This organization subsequently became Co., 10 Reg't U. S. Colored Heavy Artillery.

Book mark:

(358)

J. Anderson
Copyist.

P

10 H. Art'y.

U.S.C.T.

James K Polk

Polk, Co. C., 7 Reg't U. S. Col'd H. Art'y.*

Appears on

Company Muster Roll

for May June, 1864.

Present or absent Present

Stoppage, \$ 100 for

Due Gov't, \$ 100 for

Valuation of horse, \$ 100

Valuation of horse equipments, \$ 100

Remarks:

* This organization subsequently became Co. , 10 Reg't U. S. Colored Heavy Artillery.

Book mark:

J. Hudson Copyist.

P

10 H. Art'y.

U.S.C.T.

James K Polk

Pvt., Co. C., 7 Reg't U. S. Col'd H. Art'y.*

Appears on

Company Muster Roll

for July & Aug, 1864.

Present or absent Present

Stoppage, \$ 100 for

Due Gov't, \$ 100 for

Valuation of horse, \$ 100

Valuation of horse equipments, \$ 100

Remarks:

* This organization subsequently became Co. , 10 Reg't U. S. Colored Heavy Artillery.

Book mark :

(358)

J. Henderson Copyist.

P | 10 H. Art'y. | U.S.C.T.

James K Polk

Co. C, 10 Reg't U. S. Col'd H. Art'y.

Appears on

Company Muster Roll

for Sept 10th, 1864

Present or absent Present

Stoppage, \$ 100 for

Due Gov't, \$ 100 for

Valuation of horse, \$ 100

Valuation of horse equipments, \$ 100

Remarks:

Book mark:

(358)

J Underman
Coryist.

P

10 H. Art'y. | U.S.C.T.

James R Polk
Polk, Co. C, 10 Reg't U. S. Col'd H. Art'y.

Appears on

Company Muster Roll

for *Nov & Dec*, 1864.

Present or absent *Present*

Stoppage, \$ 100 for

Due Gov't, \$ 100 for

Valuation of horse, \$ 100

Valuation of horse equipments, \$ 100

Remarks:

Book mark:

(358)

J. Anderson
Copyist.

P

10 H. Art'y. | U.S.C.T.

James K Polk
Rut, Co. C, 10 Reg't U. S. Col'd H. Art'y.

Appears on

Company Muster Roll

for *Jan & Feb*, 186*5*.

Present or absent *Present*

Stoppage, \$ *100* for

Due Gov't, \$ *100* for

Valuation of horse, \$ *100*

Valuation of horse equipments, \$ *100*

Remarks: *In court awaiting trial by G. C. M.*

Book mark:

Ballade

P

10 H. Art'y. U.S.C.T.

James K Polk

Prvt, Co. C, 10 Reg't U. S. Col'd H. Art'y.

Appears on

Company Muster Roll

for *March + April*, 1865.

Present or absent

Stoppage, \$ 100 for

Due Gov't, \$ 100 for

Valuation of horse, \$ 100

Valuation of horse equipments, \$ 100

Remarks: *In confinement at New Orleans La awaiting sentence of G. C. M.*

Book mark:

Lucas

P

10 H. Art'y. U.S.C.T.

James K. Polk

Plt., Co. C, 10 Reg't U. S. Col'd H. Art'y.

Appears on

Company Muster Roll

for May & June, 1865

Present or absent Present

Stoppage, \$ 100 for

Due Gov't, \$ 100 for

Valuation of horse, \$ 100

Valuation of horse equipments, \$ 100

Remarks: To forfeit all pay for 2 months per G. O. per Genl Order No. 16 Hd. Qu. 8th Div. La. Apr 17/65. Joined from absent in arrest May 4. 1865.

Book mark:

Dallade

(358)

Copyist.

P

10 H. Art'y. U.S.C.T.

James A Polk

Reg't, Co. C, 10 Reg't U. S. Col'd H. Art'y.

Appears on

Company Muster Roll

for July 1865, 1865.

Present or absent Present

Stoppage, \$ 100 for

Due Gov't, \$ 100 for

Valuation of horse, \$ 100

Valuation of horse equipments, \$ 100

Remarks: To forfeit all pay for two months per G.O. No. 16 Hd Qrs So. Div. of La. Apr 17. 1865

Book mark:

(358)

Dallade

Copyist.

P

10 H. Art'y. | U.S.C.T.

James K. Polk

Reg't, Co. C, 10 Reg't U. S. Col'd H. Art'y.

Appears on

Company Muster Roll

for Sept Oct, 1865

Present or absent Not stated

Stoppage, \$ 100 for

Due Gov't, \$ 100 for

Valuation of horse, \$ 100

Valuation of horse equipments, \$ 100

Remarks:

[Empty lines for remarks]

Book mark:

[Faint stamp]

Callade

P

10 H. Art'y. U.S.C.T.

James K. Polk

Polk, Co. C, 10 Reg't U. S. Col'd H. Art'y.

Appears on

Company Muster Roll

for Nov. 1st Dec., 1865.

Present or absent Present

Stoppage, \$ 100 for

Due Gov't, \$ 100 for

Valuation of horse, \$ 100

Valuation of horse equipments, \$ 100

Remarks:

Book mark:

A. J. Robbins

P

10 H. Art'y. U.S.C.T.

James K. Polk

Priv., Co. C, 10 Reg't U. S. Col'd H. Art'y.

Appears on

Company Muster Roll

for Jan. and Feb., 1866

Present or absent Present

Stoppage, \$ 100 for

Due Gov't, \$ 100 for

Valuation of horse, \$ 100

Valuation of horse equipments, \$ 100

Remarks:

Book mark:

(358) A. J. Robbins Copyist.

P

10 H. Art'y. U.S.C.T.

James K. Polk

Polk, Co. C, 10 Reg't U. S. Col'd H. Art'y.

Appears on

Company Muster Roll

for *March & April*, 186*6*.

Present or absent *Present*

Stoppage, \$ 100 for

Due Gov't, \$ 100 for

Valuation of horse, \$ 100

Valuation of horse equipments, \$ 100

Remarks:

Book mark:

A. J. Robbins

(358)

Copyist.

P

10 H. Art'y. | U.S.C.T.

James H. Polk
Polk, Co. C, 10 Reg't U. S. Col'd H. Art'y.

Appears on

Company Muster Roll

for May 2d June, 1866.

Present or absent Present

Stoppage, \$ 100 for

Due Gov't, \$ 100 for

Valuation of horse, \$ 100

Valuation of horse equipments, \$ 100

Remarks:

Book mark:

(358)

A. J. Robbins
Copyist.

P

10 H. Art'y. | U.S.C.T.

James K. Colk

Pvt., Co. C, 10 Reg't U. S. Col'd H. Art'y.

Appears on

Company Muster Roll

for July 2d Aug., 1864.

Present or absent Present

Stoppage, \$ 100 for

Due Gov't, \$ 100 for

Valuation of horse, \$ 100

Valuation of horse equipments, \$ 100

Remarks:

Book mark:

A. J. Robbins

(358)

Copyist.

P

10 H. Art'y. U.S.C.T.

James H Polk

Pr, Co. C, 10 Reg't U. S. Col'd H. Art'y.

Appears on

Company Muster Roll

for *Sept & Oct*, 186*6*.

Present or absent *Present*

Stoppage, \$.....100 for

Due Gov't, \$.....100 for

Valuation of horse, \$.....100

Valuation of horse equipments, \$.....100

Remarks:.....

.....

.....

.....

.....

.....

.....

.....

Book mark:.....

.....

Hammer
Copyist.

P

10 H. Art'y. U.S.C.T.

James N. Polk

Pvt., Co. C, 10 Reg't U. S. Col'd H. Art'y.

Appears on

Company Muster Roll

for Nov & Dec, 1866

Present or absent Present

Stoppage, \$ 100 for

Due Gov't, \$ 100 for

Valuation of horse, \$ 100

Valuation of horse equipments, \$ 100

Remarks: due U.S. for loss of ~~uniform~~ & 2/100

Book mark:

(358)

Hammer Copyist.

P

10 H. Art'y.

U. S. C. T.

James K. Polk
Capt. Co., 10 Reg't U. S. Col'd H. Art'y.

Appears on Returns as follows:

Jan'y 1864 (10 H. Art'y. Corps d'Afrique)
Gained Jan'y 10 New Orleans Recruit
from Depot

Mar' 1865 (10 U.S. Col'd H. Art'y) Absent in confine-
ment since Mar' 1865 awaiting
sentence of Gen'l Court Martial

Apr' 1865 Absent in confinement at N.
Orleans since Mar' 1865

Oct' 1865 Absent on furlough since Oct
30/65

Book mark:

Stottrell

(546)

Copyist.

P | 10 Arty | U.S.C.T.

James H. Polk

Priv., Co. E, 10 Reg't U. S. Col'd Arty

Appears on a

Detachment Muster-out Roll

of the organization named above. Roll dated

Baton Rouge, La. Feb. 3, 1867.

Muster-out to date Feb. 3, 1867.

Last paid to Dec. 31, 1866

Clothing account:

Last settled _____, 186 ____; drawn since \$ _____ 100

Due soldier \$ $92 \frac{40}{100}$; due U. S. \$ $30 \frac{25}{100}$

Am't for cloth'g in kind or money adv'd \$ _____ 100

Due U. S. for arms, equipments, &c., \$ $\frac{74}{100}$

Bounty paid \$ _____ 100 due \$ $300 \frac{5}{100}$

Remarks: *Joined orig. org. 1st A. C. A. now 10 U.S.C.A. (Arty). Stop for screws driver, niper & temp-in.*

Book mark: _____

R. E. Wilson

P

10 H. Art'y. U.S.C.T.

James N. Polk
Pr., Co. L., 10 Reg't U. S. Col'd H. Art'y.

Appears on Co. Muster-out Roll, dated
Baton Rouge, La., Feb 22, 1867.

Muster-out to date 186 .
Last paid to 186 .

Clothing account:

Last settled 186 ; drawn since \$ 100

Due soldier \$ 100; due U. S. \$ 100

Am't for cloth'g in kind or money adv'd \$ 100

Due U. S. for arms, equipments, &c., \$ 100

Bounty paid \$ 100; due \$ 100

Remarks: James N. Polk
Discharged Feb 9, 1867
by reason of expiration
of term of service

Book mark:

Hamming

Polk Jas R.

Co.....

Reg't.....

2 Enclosures.

Bed Cards	Final Statements
Burial Records	Furloughs or L. of A
Certs. of Dis. for Discharge	Med. Certificates
C. M. Charges	Med. Des. Lists
Descriptive Lists	Orders
Discharge Certificates	Pris. of War Record
Enlistment Papers	Resignations

Other papers relating to—

Admission to Hosp'l	Furlough or L. of A
Casualty Sheet	Med. Examination
Confinement <i>2</i>	Misc. Information
Contracts	Pay or Clothing
Death or Effects	Personal Reports
Desertion	Rank
Discharge from Hosp'l	Transfer to Hosp'l
Discharge from Service	Transfer to V. R. C.
Duty	Transportation

Jan. K. P. Allen

10 W. C. H. A.

Alvarez

Office Provost Marshal, Parish of Orleans,

No. 67 CARONDELET STREET.

New Orleans, March 4 1865.

TO THE KEEPER OF THE

Police Jail

Sir:

Upon receipt of this, you will confine the lady

of

James N. Polk

C. C. 10th St. N. O.

to be held

BY ORDER OF

By Genl. Sherman

R. J. Bearden
Capt 2^d Regt. U. S. A.
Provost Marshal.

Office Provost Marshal, Parish of Orleans,

No. 67 CARONDELET STREET,

New Orleans, May 3^d 1860

TO THE KEEPER OF THE

Sir:

Police Jail

Upon receipt of this, you will release the lady

of James H. Polix Ser. C 10 Upl. H.W.

By order of

[Handwritten Signature]
Capt. H. M. Vols. Capt. Provost Marshal.

Univ. of

Conform

CARD NUMBERS.

1	5497750	26
2	5498147	27
3	5498248	28
4	5498345	29
5	5498444	30
6	5498566	31
7	5498707	32
8	5498846	33
9	5498982	34
10	5499123	35
11	5499259	36
12	5499395	37
12	5499530	38
14	5499667	39
15	5499801	40
16	5499936	41
17	5500066	42
18	5500201	43
19	5500265	44
20	5500431	45
21	5490129	46
22		47
23		48
24		49
25		50

Book Mark:

See also

P | 10 H. Art'y. | U.S.C.T.

Wellington . Pollard

Pvt., Co. C, 1 Reg't La. Art'y, Native Guards.*

Age *27* years.

Appears on

Company Muster-in Roll

of the organization named above. Roll dated

New Orleans La, Feb 4, 1864.

Muster-in to date *Feb 4, 1864.*

Joined for duty and enrolled:

When *Oct 22, 1863.*

Where *Pragueville La*

Period *3* years.

Valuation of horse, \$ *100*

Valuation of horse equipments, \$ *100*

Remarks:

* This organization subsequently became Co. C, 10 Reg't U. S. Col'd Heavy Artillery.

Book mark:

(356)

W. J. ...

Copyist.

Wellington Pollard

Pvt., Co. *C*, 1 Reg't H. Art'y, Corps d'Afrique.*

Appears on

Company Muster Roll

for *Feb 4th to 29th*, 186*1/2*

Present or absent *Present*

Stoppage, \$ *100* for

Due Gov't, \$ *100* for

Valuation of horse, \$ *100*

Valuation of horse equipments, \$ *100*

Remarks:

*This organization subsequently became Co. *C*, 10 Reg't U. S. Colored Heavy Artillery.

Book mark: _____

W. J. ...

P | 10 H. Art'y. | U.S.C.T.

Wellington Pollard

Pvt., Co. C., 7 Reg't U. S. Col'd H. Art'y.*

Appears on

Company Muster Roll

for March, 1864.

Present or absent Present

Stoppage, \$ 100 for

Due Gov't, \$ 100 for

Valuation of horse, \$ 100

Valuation of horse equipments, \$ 100

Remarks:

* This organization subsequently became Co. , 10 Reg't U. S. Colored Heavy Artillery.

Book mark:

(358)

J. Henderson
Copyist.

P | 10 H. Art'y. | U.S.C.T.

Wellington Pollard
Priv., Co. G, 7 Reg't U. S. Col'd H. Art'y.*

Appears on

Company Muster Roll

for *May June*, 1864.

Present or absent *Present*

Stoppage, \$ 100 for

Due Gov't, \$ 100 for

Valuation of horse, \$ 100

Valuation of horse equipments, \$ 100

Remarks:

* This organization subsequently became Co. , 10 Reg't U. S. Colored Heavy Artillery.

Book mark:

(358)

J. Anderson
Copyist.

P | 10 H. Art'y. | U.S.C.T.

Wellington Pollard

Pat, Co. G 7 Reg't U. S. Col'd H. Art'y.*

Appears on

Company Muster Roll

for July & Aug, 1864.

Present or absent Present

Stoppage, \$ 100 for

Due Gov't, \$ 100 for

Valuation of horse, \$ 100

Valuation of horse equipments, \$ 100

Remarks:

[Empty lines for remarks]

* This organization subsequently became Co. , 10 Reg't U. S. Colored Heavy Artillery.

Book mark:

J. Underwood Copyist.

P

10 H. Art'y. U.S.C.T.

Wellington Pollard

Port, Co. E, 10 Reg't U. S. Col'd H. Art'y.

Appears on

Company Muster Roll

for Sept 20th, 1864

Present or absent Present

Stoppage, \$ 100 for

Due Gov't, \$ 100 for

Valuation of horse, \$ 100

Valuation of horse equipments, \$ 100

Remarks:

Book mark:

J. H. Anderson

P | 10 H. Art'y. | U.S.C.T.

Wellington Pollard
Pt. C, Co. C, 10 Reg't U. S. Col'd H. Art'y.

Appears on

Company Muster Roll

for *Nov & Dec*, 18*64*.

Present or absent *Present*

Stoppage, \$ 100 for

Due Gov't, \$ 100 for

Valuation of horse, \$ 100

Valuation of horse equipments, \$ 100

Remarks:

Book mark:

(358)

J. Underwood
Copyist.

P

10 H. Art'y. U.S.C.T.

Wellington Pollard

Pat., Co. C, 10 Reg't U. S. Col'd H. Art'y.

Appears on

Company Muster Roll

for Jan & Feb, 1865

Present or absent Present

Stoppage, \$ 100 for

Due Gov't, \$ 100 for

Valuation of horse, \$ 100

Valuation of horse equipments, \$ 100

Remarks:

Book mark:

(358)

Pollard

Copyst.

P

10 H. Art'y. | U.S.C.T.

Wellington Pollard

Plt., Co. C, 10 Reg't U. S. Col'd H. Art'y.

Appears on

Company Muster Roll

for March & April, 1865.

Present or absent Present

Stoppage, \$ 100 for

Due Gov't, \$ 100 for

Valuation of horse, \$ 100

Valuation of horse equipments, \$ 100

Remarks:

Book mark: 100

Lucas

P

10 H. Art'y. U.S.C.T.

Wellington Pollard

Co. C, 10 Reg't U. S. Col'd H. Art'y.

Appears on

Company Muster Roll

for *May + June*, 186*5*.

Present or absent *Present*

Stoppage, \$ *100* for

Due Gov't, \$ *100* for

Valuation of horse, \$ *100*

Valuation of horse equipments, \$ *100*

Remarks:

Book mark:

Ballade

P

10 H. Art'y. U.S.C.T.

Wellington Pollard

But, Co. C, 10 Reg't U. S. Col'd H. Art'y.

Appears on

Company Muster Roll

for *July & Aug*, 186*5*.

Present or absent *Present*

Stoppage, \$ *100* for

Due Gov't, \$ *100* for

Valuation of horse, \$ *100*

Valuation of horse equipments, \$ *100*

Remarks:

Book mark :

(358)

Ballade

Copyist.

P

10 H. Art'y. | U.S.C.T.

Wellington Pollard

Plt., Co. C, 10 Reg't U. S. Col'd H. Art'y.

Appears on

Company Muster Roll

for Sept & Oct, 1865.

Present or absent Present

Stoppage, \$ 100 for

Due Gov't, \$ 100 for

Valuation of horse, \$ 100

Valuation of horse equipments, \$ 100

Remarks:

Book mark:

Pollard

P

10 H. Art'y. U.S.C.T.

Wellington Pollard

Pol., Co. C, 10 Reg't U. S. Col'd H. Art'y.

Appears on

Company Muster Roll

for Nov 5th Dec., 1865.

Present or absent Present.

Stoppage, \$ 100 for

Due Gov't, \$ 100 for

Valuation of horse, \$ 100

Valuation of horse equipments, \$ 100

Remarks:

Book mark:

A. J. Robbins

(358)

Copyist.

P

10 H. Art'y. U.S.C.T.

Wellington Pollard

Pvt., Co. C, 10 Reg't U. S. Col'd H. Art'y.

Appears on

Company Muster Roll

for Jan. & Feb., 1866.

Present or absent Present.

Stoppage, \$ 100 for

Due Gov't, \$ 100 for

Valuation of horse, \$ 100

Valuation of horse equipments, \$ 100

Remarks:

Book mark:

A. J. Robbins

(358)

Copyist.

P

10 H. Art'y. U.S.C.T.

Wellington Pollard.

Co. C, 10 Reg't U. S. Col'd H. Art'y.

Appears on

Company Muster Roll

for *March & Apr.*, 186*6*.

Present or absent *Present*

Stoppage, \$ *100* for

Due Gov't, \$ *100* for

Valuation of horse, \$ *100*

Valuation of horse equipments, \$ *100*

Remarks:

Book mark:

A. J. Robbins

(358)

Copyist.

P

10 H. Art'y. | U.S.C.T.

Wellington Pollard

Pol, Co. C, 10 Reg't U. S. Col'd H. Art'y.

Appears on

Company Muster Roll

for May 2nd June, 1866.

Present or absent Present

Stoppage, \$ 100 for

Due Gov't, \$ 100 for

Valuation of horse, \$ 100

Valuation of horse equipments, \$ 100

Remarks:

Book mark:

A. J. Robbins

(358)

Copyist.

P

| 10 H. Art'y. | U.S.C.T.

Wellington Pollard

Pvt., Co. C, 10 Reg't U. S. Col'd H. Art'y.

Appears on

Company Muster Roll

for July 2d Aug., 1864.

Present or absent Present

Stoppage, \$ 100 for

Due Gov't, \$ 100 for

Valuation of horse, \$ 100

Valuation of horse equipments, \$ 100

Remarks:

Book mark:

A. J. Robbins

(358)

Copyist.

P

10 H. Art'y. | U.S.C.T.

Wellington Pollard

Pr, Co. C, 10 Reg't U. S. Col'd H. Art'y.

Appears on

Company Muster Roll

for *Sept & Oct*, 186*6*.

Present or absent *Present*

Stoppage, \$ *100* for

Due Gov't, \$ *100* for

Valuation of horse, \$ *100*

Valuation of horse equipments, \$ *100*

Remarks:

Book mark:

(358)

Hammer
Copyist.

P

10 H. Art'y. U.S.C.T.

Wellington Pollard

Capt., Co. C, 10 Reg't U. S. Col'd H. Art'y.

Appears on

Company Muster Roll

for Nov. & Dec, 1866.

Present or absent Present

Stoppage, \$ 100 for

Due Gov't, \$ 100 for

Valuation of horse, \$ 100

Valuation of horse equipments, \$ 100

Remarks: Appointed Capt. to date Dec, 25, 66, from private vice Farrell reduced

Book mark:

Hammer Capt.

P | 10 Art'y | U.S.C.T.

Wellington Pollard
Corp., Co. *P*, 10 Reg't U. S. Col'd Art'y

Appears on a

Detachment Muster-out Roll

of the organization named above. Roll dated

Baton Rouge, La. Feb. 3, 1867.

Muster-out to date *Feb. 3, 1867.*

Last paid to *Dec. 31, 1866.*

Clothing account:

Last settled _____, 186 ; drawn since \$ _____ ¹⁰⁰

Due soldier \$ *87* ^{*88*}/₁₀₀; due U. S. \$ *41* ^{*26*}/₁₀₀

Am't for cloth'g in kind or money adv'd \$ _____ ¹⁰⁰

Due U. S. for arms, equipments, &c., \$ _____ ¹⁰⁰

Bounty paid \$ *100* ^{*00*}/₁₀₀ due \$ *100* ^{*00*}/₁₀₀

Remarks: *Joined orig org. 1 N.A. Co. A.
now 10 U.S. Co. (H) was private
from enrolment to Dec. 29, 1866.*

Book mark: *628- 1878*

R. E. Wilson

AP

10 H. Art'y. U.S.C.T.

Foltard
Wellington, Colored

Corpl, Co. *C*, 10 Reg't U. S. Col'd H. Art'y.

Appears on Co. Muster-out Roll, dated
Baton Rouge, La, Feby 22, 186 .

Muster-out to date -----, 186 .

Last paid to -----, 186 .

Clothing account:

Last settled -----, 186 ; drawn since \$ ----- 100

Due soldier \$ ----- 100; due U. S. \$ ----- 100

Am't for cloth'g in kind or money adv'd \$ ----- 100

Due U. S. for arms, equipments, &c., \$ ----- 100

Bounty paid \$ ----- 100; due \$ ----- 100

Remarks: *Joined Orig Oru*
Discharged Feby 3, 1864
by reason of expiration
of term of service
** corrected by Stokes*

Book mark: *628 1878*

(361)

Hammer
Copyist.

U.S. 6

Private

Private

CARD NUMBERS.

5487656	26
5488435	27
5512309	28
5512462	29
5512599	30
5512744	31
5512867	32
5512987	33
5513088	34
5513203	35
5513294	36

26
27
28
29
30
31
32
33
34
35
36
37
38
39
40
41
42
43
44
45
46
47
48
49
50

Book Mark:

See also 77 U.S. 6 Sup

1086a U.S.C.T.

Wilson Poole
Cot, Co K, 10 Reg't U. S. Col'd 8th

Appears on

M. and D. Roll of Men Transferred

to the organization named above,

from 7th U.S. Col Inf

Roll dated Camp Carapissa Cal, 1865.

When enlisted May 6, 1864.

Period for which enlisted 3 years.

When mustered in May 12, 1864.

Present or absent Present

Company to which assigned K

Remarks: Joined Co at Orig
inal Organization
stoppage for 1 Screw
Driver & line wrench
and Canteen.

Book mark :

W. H. Scott

O W H a | **U.S.C.T.**

Miriam Pooli

Priv., Co. K, 10 Reg't U. S. Col'd Ha

Appears on

M. and D. Roll of Men Transferred

to the organization named above,

from 744 U. S. Col Inf

Roll dated Camp Parapet 1st, 186 4

When enlisted May 6, 186 4

Period for which enlisted 3 years.

When mustered in May 12, 186 4

Present or absent Present

Company to which assigned K

Remarks: Rec'd by transfer

from Co K, 744 U.S.C.I.

stop 1st driver / Can-

teen,

Book mark :

Mean Scotch

P | 10 H. Art'y. | U.S.C.T.

Wilson Paule

P, Co. K., 10 Reg't U. S. Col'd H. Art'y.

Age years.

Appears on

Company Muster Roll*

for Sep. & Oct., 1865.

Joined for duty and enrolled:

When May 6, 1864.

Where New Orleans, La.

Period 3 years

Mustered in:

When May 12, 1864.

Where New Orleans

Present or absent Present

Stoppage, \$ 1.00 for

Due Gov't, \$ 1.00 for

Remarks: Stop 1 screw driver,
1 Canteen \$1.18

* First current roll. No muster-in roll of this company on file.

Book mark :

(3586)

Hibbard

Copyist.

P

10 H. Art'y.

U.S.C.T.

Wilson Poole

P, Co. K, 10 Reg't U. S. Col'd H. Art'y.

Appears on

Company Muster Roll

for Nov. & Dec., 1865.

Present or absent Present-

Stoppage, \$ 100 for

Due Gov't, \$ 100 for

Valuation of horse, \$ 100

Valuation of horse equipments, \$ 100

Remarks: Stop for ordnance
Camp Hs. & lost \$1.18

Book mark:

(358)

Hibbard

Copyist.

P

10 H. Art'y.

U.S.C.T.

Wilson Poole

P, Co. K, 10 Reg't U. S. Col'd H. Art'y.

Appears on

Company Muster Roll

for Jan. Feb., 1866.

Present or absent Present

Stoppage, \$ 100 for

Due Gov't, \$ 100 for

Valuation of horse, \$ 100

Valuation of horse equipments, \$ 100

Remarks:

Book mark:

Hibbard Copyist.

P | 10 H. Art'y. | U.S.C.T.

Wilson Poole

P., Co. K, 10 Reg't U. S. Col'd H. Art'y.

Appears on

Company Muster Roll

for *Mch. 7th Apl.*, 186*6*.

Present or absent *Present*

Stoppage, \$ *100* for

Due Gov't, \$ *100* for

Valuation of horse, \$ *100*

Valuation of horse equipments, \$ *100*

Remarks:

Book mark:

(358)

Hibbard

Copyist.

P

10 H. Art'y. U.S.C.T.

Wilson Poole

P

, Co. K, 10 Reg't U. S. Col'd H. Art'y.

Appears on

Company Muster Roll

for May June, 1866

Present or absent Present

Stoppage, \$ 100 for

Due Gov't, \$ 100 for

Valuation of horse, \$ 100

Valuation of horse equipments, \$ 100

Remarks:

Book mark:

Hibbard Copyist.

(358)

P | 10 H. Art'y. | U.S.C.T.

Wilson Poole

P, Co. K, 10 Reg't U. S. Col'd H. Art'y.

Appears on

Company Muster Roll

for July & Aug., 1866.

Present or absent Present

Stoppage, \$ 100 for

Due Gov't, \$ 100 for

Valuation of horse, \$ 100

Valuation of horse equipments, \$ 100

Remarks:

Book mark:

Hibbard

(358)

Copyist.

P

10 H. Art'y. U.S.C.T.

Wilson Poole

Put, Co. K, 10 Reg't U. S. Col'd H. Art'y.

Appears on

Company Muster Roll

for Sept & Oct, 1866

Present or absent Present.

Stoppage, \$ 100 for

Due Gov't, \$ 100 for

Valuation of horse, \$ 100

Valuation of horse equipments, \$ 100

Remarks:

Book mark:

Lloyd

(358)

Copyist.

P

10 H. Art'y. U.S.C.T.

Wilson Poole

Put, Co. K, 10 Reg't U. S. Col'd H. Art'y.

Appears on

Company Muster Roll

for Nov. & Dec., 1866

Present or absent Present.

Stoppage, \$ 100 for

Due Gov't, \$ 100 for

Valuation of horse, \$ 100

Valuation of horse equipments, \$ 100

Remarks:

Book mark:

Lloyd

(358)

Copyist.

P

10 H. Art'y. U.S.C.T.

Wilson Poole

Put, Co. K, 10 Reg't U. S. Col'd H. Art'y.

Appears on Co. Muster-out Roll, dated Baton Rouge La, Feb 22, 1867.

Muster-out to date Feb 22, 1867.

Last paid to Dec 31, 1866.

Clothing account:

Last settled, 186 ; drawn since \$ 100

Due soldier \$ 56 96 / 100; due U. S. \$ 100

Am't for cloth'g in kind or money adv'd \$ 100

Due U. S. for arms, equipments, &c., \$ 6 30 / 100

Bounty paid \$ 100; due \$ 100

Remarks: Recd by transfer from Co K, 77 U. S. Co. I, Oct 1/65 per S. O. No. 66. Recd for kept La. S. 1865. \$100. Bounty due under Act of Congress July 26/66. \$100. Bounty due under Act of Congress July 28/66.

Book mark:

Floyd

10 9, 10 U.S. Col'd H. Army.

Private

Private

CARD NUMBERS.

1	5507174	26
2	5507450	27
3	5507596	28
4	5507742	29
5	5507880	30
6	5508020	31
7	5508159	32
8	5508292	33
9	5508439	34
10	5508588	35
11	5508740	36
12	5508887	37
13	5509033	38
14	5509154	39
15	5509302	40
16	5509410	41
17		42
18		43
19		44
20		45
21		46
22		47
23		48
24		49
25		50

Book Mark:

See also

P 110.H. art. y | U.S.C.T.

Marshall Pope

Appears with rank of Pvt on

Muster and Descriptive Roll of a Detachment of U. S. Vols. forwarded

Organized as Co G.
for the 10th Reg't U. S. Col'd H A. Roll dated
New Orleans La Sept 20 1864.

Where born Point Canpee La

Age 20 y'rs; occupation Laborer

When enlisted Sept 20, 1864.

Where enlisted New Orleans La

For what period enlisted 3 years.

Eyes Black; hair Black

Complexion Black; height 5 ft. 7 in.

When mustered in Sept 20, 1864.

Where mustered in New Orleans La

Bounty paid \$ 100; due \$ 100

Where credited to New Orleans

Company to which assigned

Remarks:

Book mark:

E. D. Thompson

P

10 H. Art'y.

U.S.C.T.

Marshal Pope

Pvt., Co. G, 10 Reg't U. S. Col'd H. Art'y.

Appears on

Company Muster Roll

for Sept & Oct, 1864.

Present or absent Present

Stoppage, \$ 100 for

Due Gov't, \$ 100 for

Valuation of horse, \$ 100

Valuation of horse equipments, \$ 100

Remarks:

Book mark:

E. H. Brown.

P

10 H. Art'y. | U.S.C.T.

Marshal Pope

Pvt, Co. G, 10 Reg't U. S. Col'd H. Art'y.

Appears on

Company Muster Roll

for *Nov & Dec*, 186*4*.

Present or absent *Present*

Stoppage, \$ *100* for

Due Gov't, \$ *100* for

Valuation of horse, \$ *100*

Valuation of horse equipments, \$ *100*

Remarks:

Book mark:

E. H. Brown

P

10 H. Art'y. | U.S.C.T.

Marshall Pope

Troop, Co. G, 10 Reg't U. S. Col'd H. Art'y.

Appears on

Company Muster Roll

for Jan & Feby, 1865.

Present or absent Present

Stoppage, \$ 100 for

Due Gov't, \$ 100 for

Valuation of horse, \$ 100

Valuation of horse equipments, \$ 100

Remarks:

Book mark:

J. E. Porter

P

10 H. Art'y. | U.S.C.T.

Marshall Pope
Prof., Co. G, 10 Reg't U. S. Col'd H. Art'y.

Appears on

Company Muster Roll

for *Mar & April*, 186*15*.

Present or absent *Present*

Stoppage, \$ 100 for

Due Gov't, \$ 100 for

Valuation of horse, \$ 100

Valuation of horse equipments, \$ 100

Remarks:

Book mark:

J. E. Porter

Q

10 H. Art'y.

U.S.C.T.

Marshall Pope

Prov, Co. G, 10 Reg't U. S. Col'd H. Art'y.

Appears on

Company Muster Roll

for May & June, 1865.

Present or absent Present

Stoppage, \$ 100 for

Due Gov't, \$ 100 for

Valuation of horse, \$ 100

Valuation of horse equipments, \$ 100

Remarks:

Book mark:

H. E. Porter

9

Marshall Pope
Prof., Co. G, 10 Reg't U. S. Col'd H. Art'y.

Appears on

Company Muster Roll

for July & Aug, 1865.

Present or absent Present

Stoppage, \$.....100 for

Due Gov't, \$..... $\frac{10}{100}$ for B & G Equip

age lost or destroyed

Valuation of horse, \$.....100

Valuation of horse equipments, \$.....100

Remarks:.....

.....

.....

.....

.....

.....

.....

.....

.....

.....

.....

.....

.....

.....

.....

.....

.....

.....

.....

.....

.....

.....

.....

.....

.....

J. E. Porter

P

10 H. Art'y. U.S.C.T.

Marshall Pope
Prof., Co. G, 10 Reg't U. S. Col'd H. Art'y.

Appears on

Company Muster Roll

for Sept + Oct, 1865.

Present or absent Present

Stoppage, \$ 100 for

Due Gov't, \$ 100 for

Valuation of horse, \$ 100

Valuation of horse equipments, \$ 100

Remarks: Due U.S. for
Transportation
furnished by
Q.M. Dept \$11.50

Book mark:

J. E. Porter

P

10 H. Art'y.

U.S.C.T.

Marshall Pope

Priv't, Co. G, 10 Reg't U. S. Col'd H. Art'y.

Appears on

Company Muster Roll

for *Nov: & Dec.*, 186*5*!

Present or absent *Present*

Stoppage, \$ 100 for

Due Gov't, \$ 100 for

Valuation of horse, \$ 100

Valuation of horse equipments, \$ 100

Remarks: *Due P. of for trans-
portation furnished
in I.M. Dept. 8/15*

Book mark:

G Fox

P

10 H. Art'y.

U.S.C.T.

Marshal Pope

Priv, Co. G, 10 Reg't U. S. Col'd H. Art'y.

Appears on

Company Muster Roll

for *Jan. & Feb.*, 1866.

Present or absent *Present*

Stoppage, \$.....¹⁰⁰ for

Due Gov't, \$.....¹⁰⁰ for

Valuation of horse, \$.....¹⁰⁰

Valuation of horse equipments, \$.....¹⁰⁰

Remarks:.....

.....

.....

.....

.....

.....

.....

.....

.....

.....

.....

.....

.....

.....

.....

.....

.....

.....

.....

.....

.....

.....

.....

.....

.....

.....

G. F. W.
Copyist.

P

10 H. Art'y. U.S.C.T.

Marshall Pope
Pvt., Co. G, 10 Reg't U. S. Col'd H. Art'y.

Appears on

Company Muster Roll

for Mar. & Apr., 1866.

Present or absent Present

Stoppage, \$ 100 for

Due Gov't, \$ 100 for

Valuation of horse, \$ 100

Valuation of horse equipments, \$ 100

Remarks:

Book mark:

(358)

G. Fox

Copyist.

P

10 H. Art'y.

U.S.C.T.

Marshal Pope

Priv., Co. G, 10 Reg't U. S. Col'd H. Art'y.

Appears on

Company Muster Roll

for May & June, 1866.

Present or absent Present

Stoppage, \$ 100 for

Due Gov't, \$ 100 for

Valuation of horse, \$ 100

Valuation of horse equipments, \$ 100

Remarks:

Book mark:

G. F. M.

P

10 H. Art'y.

U.S.C.T.

Marshal Cope

Capt., Co. G, 10 Reg't U. S. Col'd H. Art'y.

Appears on

Company Muster Roll

for *July & Aug*, 186 *6*

Present or absent *Present*

Stoppage, \$.....100 for

Due Gov't, \$.....100 for

Valuation of horse, \$.....100

Valuation of horse equipments, \$.....100

Remarks:.....
.....
.....
.....
.....
.....
.....
.....
.....
.....

Book mark:.....

G. F. W.

P

10 H. Art'y.

U.S.C.T.

Marshall Pope

Pvt, Co. G, 10 Reg't U. S. Col'd H. Art'y.

Appears on

Company Muster Roll

for *Sept & Oct*, 1866.

Present or absent *Present*

Stoppage, \$ 100 for

Due Gov't, \$ 100 for

Valuation of horse, \$ 100

Valuation of horse equipments, \$ 100

Remarks:

Book mark:

Wines

P

10 H. Art'y.

U.S.C.T.

Marshall Pope

Pvt, Co. G, 10 Reg't U. S. Col'd H. Art'y.

Appears on

Company Muster Roll

for *Nov & Dec*, 1866.

Present or absent *Present*

Stoppage, \$ *100* for

Due Gov't, \$ *100* for

Valuation of horse, \$ *100*

Valuation of horse equipments, \$ *100*

Remarks:

Book mark; *100*

Wines

P

10 H. Art'y.

U.S.C.T.

Marshall Pope

Pvt, Co. *G*, 10 Reg't U. S. Col'd H. Art'y.

Appears on **Co. Muster-out Roll**, dated

Baton Rouge La, Feb 22, 1867.

Muster-out to date

Feb 22, 1867.

Last paid to

Dec 31, 1866.

Clothing account:

Last settled....., 186 ; drawn since \$.....¹⁰⁰

Due soldier \$ *42*^{*04*}/₁₀₀; due U. S. \$.....¹⁰⁰

Am't for cloth'g in kind or money adv'd \$.....¹⁰⁰

Due U. S. for arms, equipments, &c., \$.....^{6 08}/₁₀₀

Bounty paid \$.....¹⁰⁰; due \$ *2 00*^{*00*}/₁₀₀

Remarks: *Joined at Argle, Argn,*
Stopped one tompon

Book mark :

Wine

Pope, Marshall

O, Co. G, 10th Reg't U.S.A.

1 Enclosures.

Bed Cards	Final Statements
Burial Records	Furloughs or L. of A.
Certs. of Dis. for Discharge	Med. Certificates
C. M. Charges	Med. Des. Lists
Descriptive Lists	Orders
Discharge Certificates	Pris. of War Record
Enlistment Papers	Resignations

Other papers relating to—

Admission to Hosp'l	Furlough or L. of A.
Casualty Sheet	Med. Examination
Confinement	Misc. Information
Contracts	Pay or Clothing
Death or Effects	Personal Reports
Desertion	Rank
Discharge from Hosp'l	Transfer to Hosp'l
Discharge from Service	Transfer to V. R. C.
Duty	Transportation

DECLARATION OF RECRUIT.

I, Marshall Pope desiring

to VOLUNTEER as a Soldier in the Army of the United States, for the term of THREE YEARS,
Do Declare, That I am 20 years and months
of age; that I have never been discharged from the United States service on account of disability or
by sentence of a court martial, or by order before the expiration of a term of enlistment; and I know
of no impediment to my serving honestly and faithfully as a soldier for three years.

GIVEN at New Orleans
the 20 day of Sept 1864

Witness: J. Horace M. Guiz Marshall Pope
mark

NOTE 1.—This blank will be used for both enlistments and re-enlistments—enlistment of veterans, &c., &c., in the volunteer service. They will be made out in duplicate in all cases—one to accompany the recruiting return of the superintendent (not the recruiting officer) to the Adjutant General, and one to accompany the accounts of the officer who pays bounty, &c. The Regiment and Company in which the soldier last served should be given on the back.
NOTE 2.—An enlistment holds to service. A muster-in must, in all cases, precede payment of pay, bounty, pension, &c. A muster-in roll must, in all cases, be filed in the Adjutant General's Office as evidence of muster-in. The mustering officer, commissary, or assistant commissary of musters, as the case may be, will countersign both enlistments as having mustered the soldier into the service of the United States before either of them is given to the disbursing officer.

No. 87
Marshall Pope
Volunteered at New Orleans La
September 20th 1864
By Genl. G. B. McGuire
10th Regiment of W. V. G. Artillery (H)

enlistment; last served in Company ()
10th Regt of W. V. G. Artillery
Discharged 18
Bonus not entitled
to Bounty

CONSENT IN CASE OF MINOR.

I, Do CERTIFY, That I am
the of ; that the
said is years of age; and I
do hereby freely give my CONSENT to his volunteering as a SOLDIER in the ARMY OF THE UNITED
STATES for the period of THREE YEARS.

GIVEN at
the day of

Witness:

(A. G. O. No. 74 & 76.)

VOLUNTEER ENLISTMENT.

STATE OF



TOWN OF

Louisiana

New Orleans

I, Marshall Pope born in Point Coupee Parish

in the State of La. aged 20 years,

and by occupation a laborer Do HEREBY ACKNOWLEDGE to have volunteered this 25th day of Sept. 1864,

to serve as a **Soldier** in the **Army of the United States of America**, for the period of **THREE YEARS**, unless sooner discharged by proper authority:

Do also agree to accept such bounty, pay, rations, and clothing, as are, or may be, established by law for volunteers. And I, Marshall Pope do

solemnly swear, that I will bear true faith and allegiance to the **United States of America**, and that I will serve them honestly and faithfully against all

their enemies or opposers whomsoever; and that I will observe and obey the orders of the President of the United States, and the orders of the officers

appointed over me, according to the Rules and Articles of War.

Sworn and subscribed to, at New Orleans }
this 25th day of Sept. 1864 } Marshall Pope
BEFORE J. W. Chamberlain }
Capt. & Comd. } not

I CERTIFY, ON HONOR, That I have carefully examined the above-named Volunteer, agreeably to the General Regulations of the Army, and that, in my opinion, he is free from all bodily defects and mental infirmity, which would in any way disqualify him from performing the duties of a soldier.

[Signature]
10th U. S. C. A. (N) EXAMINING SURGEON.

I CERTIFY, ON HONOR, That I have minutely inspected the Volunteer, Marshall Pope previously to his enlistment, and that he was entirely sober when enlisted; that, to the best of my judgment and belief, he is of lawful age; and that, in accepting him as duly qualified to perform the duties of an able-bodied soldier, I have strictly observed the Regulations which govern the recruiting service. This soldier has Blue eyes, Blue hair, Blue complexion, is 5- feet 7 inches high.

J. Horace M. Guire Ret
1st Regiment of U. S. A. (26) Volunteers,
RECRUITING OFFICER.

(A. G. O. No. 74 & 76.)

Mustered into the service of the United States, for three years or during the war, from date of enlistment, in Company C. of the 1st Regiment of U. S. A. (26) Volunteers, on the 25th day of Sept. 1864, at New Orleans

J. W. Chamberlain
10th U. S. C. A. (N)
A. C. W.

Fowler. Lewis.

Co. D., 10 U.S. Col'd H. Art'y

Private | *Private.*

CARD NUMBERS.

1	5488676.	86
2	5501308.	87
3	5501449.	88
4	5501587.	89
5	5501720.	90
6	5501834.	91
7	5501940.	92
8	5502031.	93
9	5502127.	94
10	5502207.	95
11		96
12		97
13		98
14		99
15		40
16		41
17		42
18		43
19		44
20		45
21		46
22		47
23		48
24		49
25		50

Book Mark:

See also *77 U.S. G. I.*

P | 10 36 Aug | U.S.C.T.

Louis Poplar
Pri., Co. K, 10 Reg't U. S. Col'd Hartz

Appears on

M. and D. Roll of Men Transferred

to the organization named above,

from Co. B, 77 Reg't U.S.C. Inf.

Roll dated Oct. 1, 1865.

When enlisted Feb. 10, 1865.

Period for which enlisted 3 years.

When mustered in Mar 25, 1865.

Present or absent Present

Company to which assigned K.

Remarks: joined the Co. as recruit
Strip of 1 Musquet Bar
1 set Cap Primings

Book mark :

P

10 H. Art'y.

U.S.C.T.

Louis Popler

Priv., Co. D, 10 Reg't U. S. Col'd H. Art'y.

Appears on

Company Muster Roll

for Sept & Oct, 1865.

Present or absent Present

Stoppage, \$ 100 for

Due Gov't, \$ 100 for

Valuation of horse, \$ 100

Valuation of horse equipments, \$ 100

Remarks: Transf'd from Co B, 77 U.S.C.I. per G.O. No. 3, Hd Qrs. 10 U.S.C.A.H., Camp Parapet, La., Oct 1/65. Due U.S. for Camp Equipage \$176.

Book mark:

Patterson

(358)

Copyist.

P | 10 H. Art'y. | U.S.C.T.

Louis Popler
Pvt, Co. D, 10 Reg't U. S. Col'd H. Art'y.

Appears on

Company Muster Roll
for *Nov 1865*, 1865

Present or absent *Present*

Stoppage, \$ 100 for

Due Gov't, \$ 100 for

Valuation of horse, \$ 100

Valuation of horse equipments, \$ 100

Remarks:
.....
.....
.....
.....
.....
.....
.....
.....

Book mark:

M. M. Daye
(358) Copyist.

P

10 H. Art'y. | U.S.C.T.

Louis Popler
Pvt., Co. D, 10 Reg't U. S. Col'd H. Art'y.

Appears on

Company Muster Roll

for Jan 9 Feb, 1866

Present or absent Present

Stoppage, \$ 100 for

Due Gov't, \$ 100 for

Valuation of horse, \$ 100

Valuation of horse equipments, \$ 100

Remarks: Due U.S. for
Camp Exp. \$ 1.76

Book mark:

W. W. Mayre

(358)

Copyist.

9

10 H. Art'y. | U.S.C.T.

Louis Popler

Popler, Co. D, 10 Reg't U. S. Col'd H. Art'y.

Appears on

Company Muster Roll

for *March*, 1866.

Present or absent *Present*

Stoppage, \$ 100 for

Due Gov't, \$ 100 for

Valuation of horse, \$ 100

Valuation of horse equipments, \$ 100

Remarks:

Book mark:

(358)

Copyist.

D

Louis Poplar

Co. D, 10 Reg't U. S. Col'd H. Art'y.

Appears on

Company Muster Roll

for *May, June, 1866.*

Present or absent *Present*

Stoppage, \$ *100* for

Due Gov't, \$ *100* for

Valuation of horse, \$ *100*

Valuation of horse equipments, \$ *100*

Remarks:

Book mark:

(358)

Henry
Copyist.

P

10 H. Art'y.

U.S.C.T.

Louis Popler

Co. D, 10 Reg't U. S. Col'd H. Art'y.

Appears on

Company Muster Roll

for July & Aug, 1866.

Present or absent Present

Stoppage, \$ 100 for

Due Gov't, \$ 100 for

Valuation of horse, \$ 100

Valuation of horse equipments, \$ 100

Remarks: Present sick

2"Inst. of Bty \$100. due

Book mark:

(358)

King Copyist.

9

10 H. Art'y. | U.S.C.T.

Louis Popler

Co. D, 10 Reg't U. S. Col'd H. Art'y.

Appears on

Company Muster Roll

for Sept 10th, 1866.

Present or absent Present

Stoppage, \$ 100 for

Due Gov't, \$ 100 for

Valuation of horse, \$ 100

Valuation of horse equipments, \$ 100

Remarks: Present sick

Book mark:

(358)

J. W. [Signature]
Copyst.

P

10 H. Art'y. | U.S.C.T.

Louis Popler

1st Reg't, Co. D, 10 Reg't U. S. Col'd H. Art'y.

Appears on

Company Muster Roll

for *Nov. & Dec.*, 186*6*.

Present or absent *Present*

Stoppage, \$ *100* for

Due Gov't, \$ *100* for

Valuation of horse, \$ *100*

Valuation of horse equipments, \$ *100*

Remarks: *Sick in Quarters*

Book mark: _____

(358)

J. L. ...

Copyist.

P

10 H. Art'y. U.S.C.T.

Lewis Popler

Co. D., 10 Reg't U. S. Col'd H. Art'y.

Appears on Co. Muster-out Roll, dated

Baton Rouge La, Feb 22, 1867.

Muster-out to date

Feb 22, 1867.

Last paid to

Dec 31, 1866.

Clothing account:

Last settled....., 186 ; drawn since \$.....100

Due soldier \$ 17 ⁹⁹/₁₀₀; due U. S. \$.....100

Am't for cloth'g in kind or money adv'd \$.....100

Due U. S. for arms, equipments, &c., \$.....6 ⁰⁰/₁₀₀

Bounty paid \$ 200 ^{XX}/₁₀₀; due \$.....100

Remarks: joined by transfer from
Co. B, 77 U.S.C. Oct 1/65 P.O.
Joseph La Sept 22/65 as
private

Book mark:

(361)

J. Leonard

Copyist.

Co. I., 10 U.S. Col'd H.A.

Private | Private

CARD NUMBERS.

1	5511265	26
2	5511357	27
3	5511444	28
4	5511569	29
5	5511747	30
6	5512153	31
7	3489787	32
8		33
9		34
10		35
11		36
12		37
13		38
14		39
15		40
16		41
17		42
18		43
19		44
20		45
21		46
22		47
23		48
24		49
25		50

Book Mark:

See also

P.

10 H. Art'y. | U.S.C.T.

Lucian Populus

Pvt., Co. *D.*, 10 Reg't U. S. Col'd H. Art'y.

Age years.

Appears on

Company Muster Roll*

for *Enrollment to June 30*, 186*5*.

Joined for duty and enrolled:

When, 186 .

Where

Period *1* years.

Mustered in:

When *July 17*, 186*5*.

Where *New Orleans, La.*

Present or absent *Present.*

Stoppage, \$ *100* for

Due Gov't, \$ *100* for

Valuation of horse, \$ *100*

Valuation of horse equipments, \$ *100*

Remarks: *Drafted. Com-*
mencement of first

*First current roll. No muster-in roll of this company on file.

Book mark :

(3586)

O. S. Clark
Copyist.

JAN. 16

5511265

1891

payment by time Feb.
17, 65.

Lucien Populus

Pop., Co. I, 10 Reg't U. S. Col'd H. Art'y.

Appears on

Company Muster Roll

for *July & Aug.*, 186*5*.

Present or absent. *Present*

Stoppage, \$ *100* for

Due Gov't, \$ *100* for

Valuation of horse, \$ *100*

Valuation of horse equipments, \$ *100*

Remarks:

Book mark:

A. S. Lehart

P

10 H. Art'y. | U.S.C.T.

Lucien Populas

Prst., Co. I, 10 Reg't U. S. Col'd H. Art'y.

Appears on

Company Muster Roll

for *Sept. to Oct.*, 186*5*.

Present or absent *Present*

Stoppage, \$ 100 for

Due Gov't, \$ 100 for

Valuation of horse, \$ 100

Valuation of horse equipments, \$ 100

Remarks:

Book mark:

(358)

O.S. Lelark

Copyist.

P.

10 H. Art'y. U.S.C.T.

Lucien Populus

Priv., Co. I, 10 Reg't U. S. Col'd H. Art'y.

Appears on

Company Muster Roll

for Nov. 10th, 1865.

Present or absent Present

Stoppage, \$ 100 for

Due Gov't, \$ 100 for

Valuation of horse, \$ 100

Valuation of horse equipments, \$ 100

Remarks: Sick in quarters.

FROM SECOND AUDITOR'S ROLL.

Book mark:

O.S. Blank

Copyist.

P | 10 H. Art'y. | U.S.C.T.

Lucius Papulus

Priv., Co. I, 10 Reg't U. S. Col'd H. Art'y.

Appears on

Company Muster Roll

for Jan. & Feb., 1866.

Present or absent

Stoppage, \$ 100 for

Due Gov't, \$ 100 for

Valuation of horse, \$ 100

Valuation of horse equipments, \$ 100

Remarks: Discharged. Mustered out by reason of expiration of term of service to take effect Feb. 16, 1866. final statements given.

Book mark:

J. J. Clark

(358)

Copyist.

J.

10 H. Art'y. U.S.C.T.

Lucien Populus

Pat. Co. I, 10 Reg't U. S. Col'd H. Art'y.

Appears on **Co. Muster-out Roll**, dated *Baton Rouge La, Feb 22, 1867*.

Muster-out to date _____, 186 .

Last paid to _____, 186 .

Clothing account:

Last settled _____, 186 ; drawn since \$ _____ 100

Due soldier \$ _____ 100; due U. S. \$ _____ 100

Am't for cloth'g in kind or money adv'd \$ _____ 100

Due U. S. for arms, equipments, &c., \$ _____ 100

Bounty paid \$ _____ 100; due \$ _____ 100

Remarks: *Discharged Expiration*
term of service Feb 16, 1866
(age 38 yrs.)

Book mark: _____

(361)

J. M. Vance

Copyist.

P. 10th Reg't U.S.C.T.

Lucius Populus

Pvt., Co. I, 10th Reg't U. S. Col'd *Art.*

Appears on a

Detachment Muster-out Roll

of the organization named above. Roll dated

New Orleans La Feb 16, 1866.

Muster-out to date *Feb 16*, 1866.

Last paid to *June 30*, 1866.

Clothing account:

Last settled _____, 186 ; drawn since \$ _____ 100

Due soldier \$ *15-41* / 100; due U. S. \$ _____ 100

Am't for cloth'g in kind or money adv'd \$ _____ 100

Due U. S. for arms, equipments, &c., \$ _____ 100

Bounty paid \$ *none* / 100 due \$ *none* / 100

Remarks: *Joined by Draft.*

Book mark: _____

A. W. Reed

Co. *B*, 10 U.S. Col'd H. Art'y

Artificer

Artificer

CARD NUMBERS.

1	5507082	26
2	5507369	27
3	5507517	28
4	5507665	29
5	5507805	30
6	5507949	31
7	5508088	32
8	5508221	33
9	5508356	34
10	5508507	35
11	5508658	36
12	5508805	37
12	5508952	38
14	5509092	39
15	5509239	40
16	5509350	41
17	40746834	42
18		43
19		44
20		45
21		46
22		47
23		48
24		49
25		50

Book Mark:

See also

P | 10 H. Art'y. | U.S.C.T.

Eugene Porche

Appears with rank of *Artificer* on

Muster and Descriptive Roll of a Detachment of U. S. Vols. forwarded

organized as Co. G. U.S. Col'd Regt. Roll dated
~~for the~~ *10th Reg't U.S. Col'd Regt.*

New Orleans La. Sept. 20, 1864.

Where born *Lafourche La.*

Age *26* y'rs; occupation *Blacksmith*

When enlisted *Aug. 18*, 1864.

Where enlisted *New Orleans La.*

For what period enlisted *3* years.

Eyes *Blk*; hair *Blk*

Complexion *Yellow*; height *5* ft. *6* in.

When mustered in *Sept. 20*, 1864.

Where mustered in *New Orleans La.*

Bounty paid \$ *100*; due \$ *100*

Where credited *to New Orleans La.*

Company to which assigned *G.*

Remarks:

Book mark:

E. B. Thompson
Copyist.

P

10 H. Art'y.

U.S.C.T.

Eugene Porche

Artifer, Co. G, 10 Reg't U. S. Col'd H. Art'y.

Appears on

Company Muster Roll

for *Sept & Oct*, 1864.

Present or absent *Present*

Stoppage, \$ 100 for

Due Gov't, \$ 100 for

Valuation of horse, \$ 100

Valuation of horse equipments, \$ 100

Remarks: *Appointed Artificer*
Sept 20/64

Book mark:

E. H. Brown

P

10 H. Art'y. U.S.C.T.

Eugene Poche
Art., Co. G, 10 Reg't U. S. Col'd H. Art'y.

Appears on

Company Muster Roll

for *Nov Dec*, 1864.

Present or absent *Present*

Stoppage, \$ *100* for

Due Gov't, \$ *100* for

Valuation of horse, \$ *100*

Valuation of horse equipments, \$ *100*

Remarks:

Book mark:

E. H. Brown

P

10 H. Art'y. U.S.C.T.

Eugene Forche
Art'y, Co. G, 10 Reg't U. S. Col'd H. Art'y.

Appears on

Company Muster Roll

for *Jan + Feby*, 1865.

Present or absent *Present*

Stoppage, \$ 100 for

Due Gov't, \$ 100 for

Valuation of horse, \$ 100

Valuation of horse equipments, \$ 100

Remarks:

Book mark:

F. E. Porter

C

10 H. Art'y. U.S.C.T.

Eugene Porche
Art'y, Co. G, 10 Reg't U. S. Col'd H. Art'y.

Appears on

Company Muster Roll

for *Mar + April*, 186*5*.

Present or absent. *Present*

Stoppage, \$ *100* for

Due Gov't, \$ *100* for

Valuation of horse, \$ *100*

Valuation of horse equipments, \$ *100*

Remarks:

Book mark:

J. E. Porter

P

10 H. Art'y. | U.S.C.T.

Eugene Porche
Art'y, Co. G, 10 Reg't U. S. Col'd H. Art'y.

Appears on

Company Muster Roll

for *May & June*, 186*6*.

Present or absent *Present*

Stoppage, \$.....100 for

Due Gov't, \$.....100 for

Valuation of horse, \$.....100

Valuation of horse equipments, \$.....100

Remarks:

Book mark:

F. E. Porter

P

10 H. Art'y. U.S.C.T.

Engene Porche
Art'y, Co. G, 10 Reg't U. S. Col'd H. Art'y.

Appears on

Company Muster Roll

for *July & Aug*, 186*5*.

Present or absent *Present*

Stoppage, \$ 100 for

Due Gov't, \$ $\frac{05}{100}$ for *C & G Equip*

age lost or destroyed

Valuation of horse, \$ 100

Valuation of horse equipments, \$ 100

Remarks:

Book mark:

J. E. Porter

(358)

Copyist.

P

10 H. Art'y.

U.S.C.T.

Engine Porche
Art, Co. G, 10 Reg't U. S. Col'd H. Art'y.

Appears on

Company Muster Roll

for Sept & Oct, 1865.

Present or absent Present

Stoppage, \$ 100 for

Due Gov't, \$ 100 for

Valuation of horse, \$ 100

Valuation of horse equipments, \$ 100

Remarks:

Book mark:

J. E. Porter

C

10 H. Art'y.

U.S.C.T.

Eugene Porche
Dr., Co. G, 10 Reg't U. S. Col'd H. Art'y.

Appears on

Company Muster Roll

for *Nov. & Feb. Dec.*, 1865.

Present or absent *Present*

Stoppage, \$ 100 for

Due Gov't, \$ 100 for

Valuation of horse, \$ 100

Valuation of horse equipments, \$ 100

Remarks:

* *Corrected Apr. 4, 94. GED*

Book mark: -----

(358)

G. F. M.
Copyist.

0

Eugene Porche
Art, Co. G, 10 Reg't U. S. Col'd H. Art'y.

Appears on

Company Muster Roll

for *Jan. & Feb.*, 1866.

Present or absent *Present*

Stoppage, \$ 100 for

Due Gov't, \$ 100 for

Valuation of horse, \$ 100

Valuation of horse equipments, \$ 100

Remarks:

Book mark: -----

E. Porche

P

10 H. Art'y. | U.S.C.T.

Eugene Porche

Art., Co. G, 10 Reg't U. S. Col'd H. Art'y.

Appears on

Company Muster Roll

for *Mar. 9 Apr.*, 186*6*.

Present or absent *Present*

Stoppage, \$ *1*^{*60*}/_{*100*} for *C.C. & G.E.*
lost

Due Gov't, \$ *1*^{*00*}/_{*100*} for

Valuation of horse, \$ *1*^{*00*}/_{*100*}

Valuation of horse equipments, \$ *1*^{*00*}/_{*100*}

Remarks:

Book mark:

G. For

(358)

Copyist.

P

10 H. Art'y. U.S.C.T.

Engene Porche

Art, Co. G, 10 Reg't U. S. Col'd H. Art'y.

Appears on

Company Muster Roll

for *May & June*, 186*6*.

Present or absent *Present*

Stoppage, \$ *100* for

Due Gov't, \$ *100* for

Valuation of horse, \$ *100*

Valuation of horse equipments, \$ *100*

Remarks:

Book mark:

E. For

(358)

Copyist.

P

10 H. Art'y.

U.S.C.T.

Eugene Porche
Art'y., Co. G, 10 Reg't U. S. Col'd H. Art'y.

Appears on

Company Muster Roll

for *July & Aug.*, 186*6*.

Present or absent *Present*

Stoppage, \$ *100* for

Due Gov't, \$ *100* for

Valuation of horse, \$ *100*

Valuation of horse equipments, \$ *100*

Remarks:

Book mark:

G. Fox
Copyist.

S | 10 H. Art'y. | U.S.C.T.

Eugene Porche

Artificer, Co. G, 10 Reg't U. S. Col'd H. Art'y.

Appears on

Company Muster Roll

for *Sept & Oct*, 186*6*.

Present or absent *Present*

Stoppage, \$.....100 for

Due Gov't, \$.....100 for

Valuation of horse, \$.....100

Valuation of horse equipments, \$.....100

Remarks:

.....
.....
.....
.....
.....
.....
.....
.....
.....
.....
.....
.....

Book mark:

.....

Wines
Copyist.

P

10 H. Art'y.

U.S.C.T.

Eugene Porche

Artificer, Co. G, 10 Reg't U. S. Col'd H. Art'y.

Appears on

Company Muster Roll

for *Nov & Dec*, 186*6*.

Present or absent *Present*

Stoppage, \$ *100* for

Due Gov't, \$ *100* for

Valuation of horse, \$ *100*

Valuation of horse equipments, \$ *100*

Remarks: *Due 25¢ for Ordnance
lost 16 cents*

Book mark:

Wines

P

10 H. Art'y.

U.S.C.T.

Eugene Porche

Post, Co. G, 10 Reg't U. S. Col'd H. Art'y.

Appears on Returns as follows:

Sept 1864. Gains Sept 20/64 New Orleans, Mustered in Regt.

Jan'y 1865 Absent with leave furlough to expire Feby 30/65 (Post)

Book mark :

Stonwell

(546)

Copyist.

Eugene Porche

Art'y Co. G, 10 Reg't U. S. Col'd H. Art'y.

Appears on Co. Muster-out Roll, dated

Baton Rouge, La, Feb 22, 1867.

Muster-out to date Feb 22, 1867.

Last paid to Dec 31, 1866.

Clothing account:

Last settled....., 186 ; drawn since \$.....100

Due soldier \$ 46 ⁶⁶/₁₀₀; due U. S. \$.....100

Am't for cloth'g in kind or money adv'd \$.....100

Due U. S. for arms, equipments, &c., \$ 6 ⁰⁰/₁₀₀

Bounty paid \$.....100; due \$ 200 ⁰⁰/₁₀₀

Remarks: Joined at Arg. ²/₁₁ Arg. ²¹/₁₁

Book mark :

W. S. ...

Archer & Co.

No. *10* U.S. Col'd H. Art.

Artificer

Artificer

CARD NUMBERS.

1	5507083	26
2	5507370	27
3	5507518	28
4	5507666	29
5	5507806	30
6	5507950	31
7	5508089	32
8	5508222	33
9	5508357	34
10	5508508	35
11	5508659	36
12	5508806	37
12	5508953	38
14	5509091	39
15	5509241	40
16	5509351	41
17		42
18		43
19		44
20		45
21		46
22		47
23		48
24		49
25		50

Book Mark: _____

See also _____

Mr Worley
J

4/7.

R & P 629992

S. 1970439 Common

S. 2006167 Common.

P

10 H. Art'y.

U.S.C.T.

Tellesfare Porche

Appears with rank of Artificer on

Muster and Descriptive Roll of a Detachment of U. S. Vols. forwarded

organized as Col. for the 10th Reg't U.S. C.M.A. Roll dated

New Orleans La, Sept 20, 1864.

Where born Lafourche La

Age 28 y'rs; occupation Carpenter

When enlisted Aug 18, 1864.

Where enlisted New Orleans La.

For what period enlisted 3 years.

Eyes Dark; hair Dark

Complexion Yellow; height 5 ft. 5 in.

When mustered in Sept. 20, 1864.

Where mustered in New Orleans

Bounty paid \$ 100; due \$ 100

Where credited to New Orleans

Company to which assigned G.

Remarks:

Book mark:

E. B. Thompson

(339)

Copyist.

P

10 H. Art'y. U.S.C.T.

Tellesford Porche
Art., Co. G, 10 Reg't U. S. Col'd H. Art'y.

Appears on

Company Muster Roll

for Sept & Oct, 1864.

Present or absent Present

Stoppage, \$ 100 for

Due Gov't, \$ 100 for

Valuation of horse, \$ 100

Valuation of horse equipments, \$ 100

Remarks: Appointed Artificer
Sept. 20/64

Book mark:

E. H. Brown

P

10 H. Art'y.

U.S.C.T.

Tellesfaw Poche
Art., Co. G, 10 Reg't U. S. Col'd H. Art'y.

Appears on

Company Muster Roll

for *Nov Dec*, 186 ⁴/₄.

Present or absent *Present*

Stoppage, \$ 100 for

Due Gov't, \$ 100 for

Valuation of horse, \$ 100

Valuation of horse equipments, \$ 100

Remarks:

Book mark:

E. H. Brown

P

10 H. Art'y. U.S.C.T.

Tellesman Porche
Art'ry, Co. G, 10 Reg't U. S. Col'd H. Art'y.

Appears on

Company Muster Roll

for Jan & Feb'y, 1865.

Present or absent Present

Stoppage, \$ 100 for

Due Gov't, \$ 100 for

Valuation of horse, \$ 100

Valuation of horse equipments, \$ 100

Remarks:

Book mark:

J. E. Porter

P

10 H. Art'y. U.S.C.T.

Tellesford Porche

(Art'ry), Co. G, 10 Reg't U. S. Col'd H. Art'y.

Appears on

Company Muster Roll

for Mar & April, 1865.

Present or absent Present

Stoppage, \$ 100 for

Due Gov't, \$ 100 for

Valuation of horse, \$ 100

Valuation of horse equipments, \$ 100

Remarks:

Book mark:

J. E. Porter

P

10 H. Art'y. U.S.C.T.

Jellesum Torche

Art'y, Co. G, 10 Reg't U. S. Col'd H. Art'y.

Appears on

Company Muster Roll

for May & June, 1864.

Present or absent Present

Stoppage, \$ 100 for

Due Gov't, \$ 100 for

Valuation of horse, \$ 100

Valuation of horse equipments, \$ 100

Remarks:

Book mark:

J. E. Porter

C

10 H. Art'y. | U.S.C.T.

Tellosan Porche

Art'y, Co. G, 10 Reg't U. S. Col'd H. Art'y.

Appears on

Company Muster Roll

for *July & Aug*, 1865.

Present or absent *Present*

Stoppage, \$ 100 for

Due Gov't, \$ ⁰⁵/₁₀₀ for *Co & Equip*

age lost or destroyed

Valuation of horse, \$ 100

Valuation of horse equipments, \$ 100

Remarks:

Book mark:

J. E. Porter

C

10 H. Art'y. | U.S.C.T.

Tellesfan Porchie

Art'y, Co. G, 10 Reg't U. S. Col'd H. Art'y.

Appears on

Company Muster Roll

for Sept & Oct, 1866.

Present or absent Present

Stoppage, \$ 100 for

Due Gov't, \$ 100 for

Valuation of horse, \$ 100

Valuation of horse equipments, \$ 100

Remarks:

Book mark:

J. E. Porter

(358)

Copyist.

O

10 H. Art'y.

U.S.C.T.

Jellison Perche

Art, Co. G, 10 Reg't U. S. Col'd H. Art'y.

Appears on

Company Muster Roll

for *Nov. 4 Dec.*, 1860

Present or absent *Present*

Stoppage, \$ *100* for

Due Gov't, \$ *20*/₁₀₀ for *rd*

Valuation of horse, \$ *100*

Valuation of horse equipments, \$ *100*

Remarks:

Book mark:

(358)

G. Fox
Copyist.

P

10 H. Art'y.

U.S.C.T.

Jellusau Porche

Art, Co. G, 10 Reg't U. S. Col'd H. Art'y.

Appears on

Company Muster Roll

for *Jan. & Feb.*, 186*6*.

Present or absent *Present*

Stoppage, \$ 100 for

Due Gov't, \$ 100 for

Valuation of horse, \$ 100

Valuation of horse equipments, \$ 100

Remarks:

Book mark:

G. F. M.

(358)

Copyist.

P

10 H. Art'y. | U.S.C.T.

Telluspan Proche
Art., Co. G, 10 Reg't U. S. Col'd H. Art'y.

Appears on

Company Muster Roll

for *Mar. & Apr., 1866.*

Present or absent *Present*

Stoppage, \$ 100 for

Due Gov't, \$ 100 for

Valuation of horse, \$ 100

Valuation of horse equipments, \$ 100

Remarks:

Book mark:

(358)

G. F. W.

Copyist.

P

10 H. Art'y.

U.S.C.T.

Jellissau Porche

Art., Co. G, 10 Reg't U. S. Col'd H. Art'y.

Appears on

Company Muster Roll

for *May & June*, 1866.

Present or absent *Present*

Stoppage, \$ 100 for

Due Gov't, \$ 100 for

Valuation of horse, \$ 100

Valuation of horse equipments, \$ 100

Remarks:

Book mark:

G. Fox

(358)

Copyist.

P

10 H. Art'y.

U.S.C.T.

Gilfan Porehe

art., Co. G, 10 Reg't U. S. Col'd H. Art'y.

Appears on

Company Muster Roll

for *July & Aug*, 186*6*.

Present or absent *Present*

Stoppage, \$ *100* for

Due Gov't, \$ *100* for

Valuation of horse, \$ *100*

Valuation of horse equipments, \$ *100*

Remarks: *On daily duty
in L. M. Dept.*

Book mark:

(358)

G. Fox

Copyist.

P

10 H. Art'y. U.S.C.T.

Tellesau Porche

Captain, Co. G, 10 Reg't U. S. Col'd H. Art'y.

Appears on

Company Muster Roll

for Sept & Oct, 1866.

Present or absent Present

Stoppage, \$ 100 for

Due Gov't, \$ 100 for

Valuation of horse, \$ 100

Valuation of horse equipments, \$ 100

Remarks:

Book mark:

Wines

P

10 H. Art'y. U.S.C.T.

Tellesfair Poche

Artificer, Co. G, 10 Reg't U. S. Col'd H. Art'y.

Appears on

Company Muster Roll

for Nov & Dec, 1866.

Present or absent Present

Stoppage, \$ 100 for

Due Gov't, \$ 100 for

Valuation of horse, \$ 100

Valuation of horse equipments, \$ 100

Remarks: On daily duty as
Carpenter in Q.M. Dept.
due U.S. for Ordnance
.08

Book mark:

Wines

Bellefleur Porche

Artfer, Co. G, 10 Reg't U. S. Col'd H. Art'y.

Appears on **Co. Muster-out Roll**, dated

Baton Rouge, La, Feb 27, 1867.

Muster-out to date *Feb 27*, 1867.

Last paid to *Dec 31*, 1866.

Clothing account:

Last settled _____, 186 ; drawn since \$ _____ 100

Due soldier \$ *51* ^{*09*} / 100; due U. S. \$ _____ 100

Am't for cloth'g in kind or money adv'd \$ _____ 100

Due U. S. for arms, equipments, &c., \$ _____ 100

Bounty paid \$ _____ 100; due \$ *200* 100

Remarks: *Joined at Arg^l Argⁿ*

Book mark:

(361)

Wires

Copyist.

Co. A, 10 U.S. Col'd H. Art.

Private.

Private

CARD NUMBERS,

1	26
2	27
3	28
4	29
5	30
6	31
7	32
8	33
9	34
10	35
11	36
12	37
13	38
14	39
15	40
16	41
17	42
18	43
19	44
20	45
21	46
22	47
23	48
24	49
25	50

Book Mark:

See also 7526.5. L. J.

620. 10 U.S. Col'd H. Ar

Private | Private.

CARD NUMBERS.

1	5488674	26
2	5501306	27
3	5501447	28
4	5501585	29
5	5501719	30
6	5501858	31
7	5502269	32
8	5489418	33
9		34
10		35
11		36
12		37
13		38
14		39
15		40
16		41
17		42
18		43
19		44
20		45
21		46
22		47
23		48
24		49
25		50

Book Mark:

See also ~~see~~ 73 77 U.S.G.

Albert Porter

Priv., Co. D, 10 Reg't U. S. Col'd H. Art'y.

Appears on

Company Muster Roll

for Sept & Oct, 1865.

Present or absent Present

Stoppage, \$ 100 for

Due Gov't, \$ 100 for

Valuation of horse, \$ 100

Valuation of horse equipments, \$ 100

Remarks: Transfd from Co., B., 77
U.S.C.I. per G.O. No. 3, Hdqrs 10
U.S.C.A.(H), Camp Parapet, Ca.,
Oct 1/65. Due U.S. for Camp
Equipage \$170

Book mark:

J. Patterson

P | *10. H. arty* | **U.S.C.T.**

Albert Porter

Pri, Co. *K*, *10* Reg't U. S. Col'd *H. Arty*

Appears on

M. and D. Roll of Men Transferred

to the organization named above,

from *Co B. 77. Reg't. M. D. C. Inf.*

Roll dated *Oct. 15*, 1865.

When enlisted *June 16*, 1863.

Period for which enlisted *3* years.

When mustered in *Aug 19*, 1863.

Present or absent *Present*

Company to which assigned *K*

Remarks: *Transferred from Co. I.*

5 Reg't. Co. A. Jan. 7. 64

Stop go / Musquete Bar

Book mark :

Avery

P

10 H. Art'y. | U.S.C.T.

Albert Porter
Pvt, Co. D, 10 Reg't U. S. Col'd H. Art'y.

Appears on

Company Muster Roll

for Nov 04th, 1865

Present or absent Present

Stoppage, \$ 100 for

Due Gov't, \$ 100 for

Valuation of horse, \$ 100

Valuation of horse equipments, \$ 100

Remarks:

Book mark:

M. Sayre
Copyist.

(358)

P

10 H. Art'y. | U.S.C.T.

Albort Porter

Pvt, Co. D, 10 Reg't U. S. Col'd H. Art'y.

Appears on

Company Muster Roll

for Jan Feb, 1866.

Present or absent Present

Stoppage, \$ 100 for

Due Gov't, \$ 100 for

Valuation of horse, \$ 100

Valuation of horse equipments, \$ 100

Remarks: Due U.S. for
Camp Exp. \$ 1.70

Book mark:

W. Mayne

(358)

Copyist.

P

10 H. Art'y.

U.S.C.T.

Albert Porter

Popl, Co. D, 10 Reg't U. S. Col'd H. Art'y.

Appears on

Company Muster Roll

for *March & April*, 1866.

Present or absent *Present*

Stoppage, \$ 100 for

Due Gov't, \$ 100 for

Valuation of horse, \$ 100

Valuation of horse equipments, \$ 100

Remarks:

Book mark: *Muster out on file*

Popl

P

10 H. Art'y. | U.S.C.T.

Albert Porter

Co. D, 10 Reg't U. S. Col'd H. Art'y.

Appears on

Company Muster Roll

for May & June, 1866.

Present or absent

Stoppage, \$ 100 for

Due Gov't, \$ 100 for

Valuation of horse, \$ 100

Valuation of horse equipments, \$ 100

Remarks: Disch'd at M.O. La June 18/66 (to date June 17/66) by reason Exp term of service to date June 17/66

Book mark:

(358)

Army Copyist.

I | 1076a | U.S.C.T.

Albert Porter

Priv, Co. D, 10 Reg't U. S. Col'd 76a

Appears on an

Individual Muster-out Roll

of the organization named above. Roll dated

New Orleans La June 15, 1866.

Muster-out to date June 15, 1866.

Last paid to Apr 30, 1866.

Clothing account:

Last settled _____, 1866; drawn since \$ _____ 100

Due soldier \$ $29 \frac{68}{100}$; due U. S. \$ _____ 100

Am't for cloth'g in kind or money adv'd \$ _____ 100

Due U. S. for arms, equipments, &c., \$ _____ 100

Bounty paid \$ _____ 100 due \$ _____ 100

Remarks: *Joined 4cd*

(76 USC I) as a recruit

transferred to 5cd

(77 USC I) Dec 2, 1863,

transferred to 10 USC (6)

Oct 1st 1865 (over)

Book mark: _____

R. Richardson

JAN. 15

5489419

★ 1891 ★

pr SO no 66 Helgers
Capt of Pa Series of 1865
mustered out by reason
of expiration of term of
service to date June
15, 1866

P

10 H. Art'y. U.S.C.T.

Albert Porter

Inv. Co. D, 10 Reg't U. S. Col'd H. Art'y.

Appears on Co. Muster-out Roll, dated

Patm Regt La. Feb 22, 1867.

Muster-out to date _____, 186 .

Last paid to _____, 186 .

Clothing account:

Last settled _____, 186 ; drawn since \$ _____ 100

Due soldier \$ _____ 100; due U. S. \$ _____ 100

Am't for cloth'g in kind or money adv'd \$ _____ 100

Due U. S. for arms, equipments, &c., \$ _____ 100

Bounty paid \$ _____ 100; due \$ _____ 100

Remarks: joined by transfer from Co. B, 47 U.S. Col'd, Oct 1/65. P.O. 66. Dispt for Sep. 22/65. Dis. notice June 15/66. Exp. of term of serv.

Book mark: _____

(361)

J. M. Leonard

Copyist.

Co. G., 10 U.S. Col'd H. Art.

Private Private

CARD NUMBERS.

1	5507176	26
2	5507452	27
3	5507598	28
4	5507744	29
5	5507882	30
6	5508021	31
7	5508161	32
8	5508293	33
9	5508440	34
10	5508589	35
11	5508741	36
12	5508888	37
13	5509034	38
14	5509153	39
15	5509303	40
16	5509411	41
17		42
18		43
19		44
20		45
21		46
22		47
23		48
24		49
25		50

Book Mark:

See also

P

10. Heavy

U.S.C.T.

John Porter

Appears with rank of Pvt on

Muster and Descriptive Roll of a Detachment of U. S. Vols. forwarded

Orquindas Co G.
for the *10* Reg't U. S. Col'd *H. A.* Roll dated *New Orleans La Sept. 20, 1861.*

Where born *Bayou Sara La*

Age *21* y'rs; occupation *Laborer*

When enlisted *Aug 4*, 1861.

Where enlisted *New Orleans La*

For what period enlisted *3* years.

Eyes *Blue*; hair *Blue*

Complexion *Dark*; height *5* ft. *4 1/2* in.

When mustered in *Sept 20*, 1861.

Where mustered in *New Orleans La*

Bounty paid \$ *100*; due \$ *100*

Where credited *to New Orleans La*

Company to which assigned *G.*

Remarks:

Book mark:

E. B. Thompson
Copyist.

Q

10 H. Art'y.

U.S.C.T.

John Porter
Sgt

Co. G, 10 Reg't U. S. Col'd H. Art'y.

Appears on

Company Muster Roll

for Sept. & Oct., 1864.

Present or absent Present

Stoppage, \$ 100 for

Due Gov't, \$ 100 for

Valuation of horse, \$ 100

Valuation of horse equipments, \$ 100

Remarks:

Book mark:

E. H. Brown

P

10 H. Art'y. | U.S.C.T.

John Porter

Co. G, 10 Reg't U. S. Col'd H. Art'y.

Appears on

Company Muster Roll

for Nov & Dec, 1864

Present or absent Present

Stoppage, \$ 100 for

Due Gov't, \$ 100 for

Valuation of horse, \$ 100

Valuation of horse equipments, \$ 100

Remarks:

Book mark:

C. H. Brown

P

10 H. Art'y. U.S.C.T.

John Porter
Prof, Co. G, 10 Reg't U. S. Col'd H. Art'y.

Appears on

Company Muster Roll

for Jan & Feby, 1865.

Present or absent Present

Stoppage, \$ 100 for

Due Gov't, \$ 100 for

Valuation of horse, \$ 100

Valuation of horse equipments, \$ 100

Remarks:

Book mark:

J. E. Porter

P

10 H. Art'y. | U.S.C.T.

John Porter
Prof., Co. G, 10 Reg't U. S. Col'd H. Art'y.

Appears on

Company Muster Roll

for *Mar & April*, 1865.

Present or absent *Present*

Stoppage, \$.....100 for

Due Gov't, \$.....100 for

Valuation of horse, \$.....100

Valuation of horse equipments, \$.....100

Remarks:

Book mark:

J. E. Porter

P

John Porter
Prof., Co. G, 10 Reg't U. S. Col'd H. Art'y.

Appears on

Company Muster Roll

for *May & June*, 186*5*.

Present or absent *Present*

Stoppage, \$.....*100* for

Due Gov't, \$.....*100* for

Valuation of horse, \$.....*100*

Valuation of horse equipments, \$.....*100*

Remarks:

Book mark:

F. E. Porter

①

10 H. Art'y. U.S.C.T.

John Porter
Prof, Co. G, 10 Reg't U. S. Col'd H. Art'y.

Appears on

Company Muster Roll

for July & Aug, 1865.

Present or absent Present

Stoppage, \$ 100 for

Due Gov't, \$ 05/100 for C & G Equip
age lost or destroyed

Valuation of horse, \$ 100

Valuation of horse equipments, \$ 100

Remarks:

Book mark:

J. E. Porter

P

10 H. Art'y. U.S.C.T.

John Porter

Prof, Co. G, 10 Reg't U. S. Col'd H. Art'y.

Appears on

Company Muster Roll

for Sept & Oct, 1865.

Present or absent Present

Stoppage, \$ 100 for

Due Gov't, \$ 100 for

Valuation of horse, \$ 100

Valuation of horse equipments, \$ 100

Remarks:

Book mark:

J. E. Porter

P

10 H. Art'y.

U.S.C.T.

John Porter
Cpt., Co. G, 10 Reg't U. S. Col'd H. Art'y.

Appears on

Company Muster Roll

for *Nov. & Dec*, 1865.

Present or absent *Present*

Stoppage, \$ *100* for

Due Gov't, \$ *100* for

Valuation of horse, \$ *100*

Valuation of horse equipments, \$ *100*

Remarks:

Book mark:

G. F. W.

P

10 H. Art'y. U.S.C.T.

John Porter
Privt, Co. G, 10 Reg't U. S. Col'd H. Art'y.

Appears on

Company Muster Roll

for *Jan. & Feb.*, 186*6*.

Present or absent *Present*

Stoppage, \$ *100* for

Due Gov't, \$ *100* for

Valuation of horse, \$ *100*

Valuation of horse equipments, \$ *100*

Remarks: _____

Book mark: _____

G. Fine
Copyist.

C

10 H. Art'y.

U.S.C.T.

John Pope

Capt., Co. G, 10 Reg't U. S. Col'd H. Art'y.

Appears on

Company Muster Roll

for *Mar. & Apr.*, 1866.

Present or absent *Present*

Stoppage, \$.....100 for

Due Gov't, \$.....100 for

Valuation of horse, \$.....100

Valuation of horse equipments, \$.....100

Remarks:

.....
.....
.....
.....
.....
.....
.....
.....
.....
.....

Book mark:

.....

(358)

G. F.

Copyist.

P

10 H. Art'y. U.S.C.T.

John Porter

Privt, Co. G, 10 Reg't U. S. Col'd H. Art'y.

Appears on

Company Muster Roll

for *May & June*, 186*6*.

Present or absent *Present*

Stoppage, \$ *100* for -----

Due Gov't, \$ *100* for -----

Valuation of horse, \$ *100*

Valuation of horse equipments, \$ *100*

Remarks: -----

Book mark: -----

G. F. -

P

10 H. Art'y. U.S.C.T.

John Porter
Cpt., Co. G, 10 Reg't U. S. Col'd H. Art'y.

Appears on

Company Muster Roll

for *July & Aug*, 1860.

Present or absent *Present*

Stoppage, \$ 100 for

Due Gov't, \$ 100 for

Valuation of horse, \$ 100

Valuation of horse equipments, \$ 100

Remarks:

Book mark:

G. Fry

(358)

Copyist.

P

10 H. Art'y. | U.S.C.T.

John Porter

Pvt., Co. G, 10 Reg't U. S. Col'd H. Art'y.

Appears on

Company Muster Roll

for *Sept & Oct*, 186 *6*.

Present or absent. *Present*

Stoppage, \$.....*100* for

Due Gov't, \$.....*100* for

Valuation of horse, \$.....*100*

Valuation of horse equipments, \$.....*100*

Remarks:.....

Book mark:.....

Wines

P

10 H. Art'y.

U.S.C.T.

John Porter

Pvt, Co. G, 10 Reg't U. S. Col'd H. Art'y.

Appears on

Company Muster Roll

for *Nov & Dec*, 1866.

Present or absent *Present*

Stoppage, \$ *100* for

Due Gov't, \$ *100* for

Valuation of horse, \$ *100*

Valuation of horse equipments, \$ *100*

Remarks:

Book mark:

Wines

John Porter

Pvt, Co. *G*, 10 Reg't U. S. Col'd H. Art'y.

Appears on **Co. Muster-out Roll**, dated
Baton Rouge La, Feb 22, 1867.

Muster-out to date *Feb 22*, 1867.

Last paid to *Dec 31*, 1866.

Clothing account:

Last settled _____, 186 ; drawn since \$ _____ $\frac{100}{100}$

Due soldier \$ *36* $\frac{06}{100}$; due U. S. \$ _____ $\frac{100}{100}$

Am't for cloth'g in kind or money adv'd \$ _____ $\frac{100}{100}$

Due U. S. for arms, equipments, &c., \$ *6* $\frac{08}{100}$

Bounty paid \$ _____ $\frac{100}{100}$; due \$ *2* $\frac{00}{100}$

Remarks: *Joined at Orgt, Orgt*
Stopped one term pion

Book mark : _____

Co J.A., 10 U.S. Col'd H. Art'y

Private Private

CARD NUMBERS.

1	5487473	26
2	5510245	27
3	5510394	28
4	5510543	29
5	5510642	30
6	5510808	31
7	5511190	32
8	R.P. 348,530.	33
9		34
10		35
11		36
12		37
12		38
14		39
15		40
16		41
17		42
18		43
19		44
20		45
21		46
22		47
23		48
24		49
25		50

Book Mark: R.P. 348,530.

See also

N. J. Worrey
J

44.

S. 7 43990 P 040

R. P 348530.

S-989271 - p.o. m m

S 135-0658 P.O. aff

S. 1380742. P.O. affs.

A 2.636604 a u w

9 | 10 H.A. | U.S.C.T.

Orse Porter

Co. I, 10 Reg't U. S. Col'd H.A.

Appears on

M. and D. Roll of Men Transferred

to the organization named above,

from Co. H. 4th U.S. Col'd

Roll dated Camp Campida Co., 1864.

When enlisted Sept 1, 1864.

Period for which enlisted 3 years.

When mustered in Sept 1, 1864.

Present or absent Present

Company to which assigned I

Remarks: Drafted Assigned to Co. Sept 8. 1864

Book mark: R + P. 348, 530.

W. H. Scott

P

10 H. Art'y.

U.S.C.T.

Orney Porter

Pvt, Co. H, 10 Reg't U. S. Col'd H. Art'y

Appears on

Company Muster Roll

for *Sep & Oct*, 1865.

Present or absent *Present*

Stoppage, \$ *100* for

Due Gov't, \$ *100* for

Valuation of horse, \$ *100*

Valuation of horse equipments, \$ *100*

Remarks: *Transferred from Co. A
77 U.S.C. I per G.O. No 3
Ad Dis 10. U.S. C.A.A.
Camp Parapet Oct 1. 65*

Book mark:

(858)

Lamm a C
Copyist.

P

10 H. Art'y.

U.S.C.T.

Osse Porter

Co. H, Co. H, 10 Reg't U. S. Col'd H. Art'y

Appears on

Company Muster Roll

for *Nov & Dec*, 1865.

Present or absent *Present*

Stoppage, \$ 100 for

Due Gov't, \$ 100 for

Valuation of horse, \$ 100

Valuation of horse equipments. \$ 100

Remarks:

Book mark:

Sammack

P

10 H. Art'y.

U.S.C.T.

Ose Porter

Pvt

, Co. H, 10 Reg't U. S. Col'd H. Art'y

Appears on

Company Muster Roll

for

Jan & Feb., 1866.

Present or absent

Present

Stoppage, \$ 100 for

Due Gov't, \$ 100 for

Valuation of horse, \$ 100

Valuation of horse equipments. \$ 100

Remarks :

Book mark :

10005

Cammaer

(858)

Copyist.

P

10 H. Art'y.

U.S.C.T.

Osse Porter

Pvt., Co. H, 10 Reg't U. S. Col'd H. Art'y

Appears on

Company Muster Roll

for *M & A*, 1866.

Present or absent *Present*

Stoppage, \$ 100 for

Due Gov't, \$ 100 for

Valuation of horse, \$ 100

Valuation of horse equipments, \$ 100

Remarks:

Book mark:

Cammack

(858)

Copyist.

P

10 H. Art'y.

U.S.C.T.

Ose Porter

Priv., Co. H, 10 Reg't U. S. Col'd H. Art'y

Appears on

Company Muster Roll

for *May & June, 1866.*

Present or absent

Stoppage, \$ 100 for

Due Gov't, \$ 100 for

Valuation of horse, \$ 100

Valuation of horse equipments. \$ 100

Remarks: *Deserted from
Company at Fort
Jackson La May 27. 1866*

Book mark:

Bammack

(858)

Copyist.

P

10 H. Art'y. | U.S.C.T.

Osse Porter

Priv., Co. H., 10 Reg't U. S. Col'd H. Art'y.

Appears on Co. Muster-out Roll, dated

Baton Rouge, La, Feb. 22, 1867.

Muster-out to date _____, 186 .

Last paid to Feb. 28, 1866 .

Clothing account:

Last settled _____, 186 ; drawn since \$ _____ 100

Due soldier \$ 9 ¹⁷/₁₀₀; due U. S. \$ _____ 100

Am't for cloth'g in kind or money adv'd \$ _____ 100

Due U. S. for arms, equipments, &c., \$ _____ 100

Bounty paid \$ _____ 100; due \$ _____ 100

Remarks: Deserted May 27/66
at Ft. Jackson, La

Book mark: V. 162, P. 183. 73.

Lacey

(361)

Copyist.

P 10 N.A. U.S.C.A.
Ossey Porter
Pt. N. 10 Reg't U.S.C.A.

NOTATION.

Book mark:

Paul J. 348530

War Department,
Record and Pension Division,
Washington, Oct. 25, 1892

The charge

of desertion
of May 27, 1866

against this man is removed and he is discharged
to date May 27, 1866, under the pro-
visions of the act of Congress, approved March 2, 1889.

Discharge certificate furnished by War Department

prepared & filed
Oct. 25, 1892.

(443)

Griffin

Copyist.

10 U.S. Col'd H.

Private | *Pres*

CARD NUMBERS.

1	5487513	26
2		27
3		28
4		29
5		30
6		31
7		32
8		33
9		34
10		35
11		36
12		37
13		38
14		39
15		40
16		41
17		42
18		43
19		44
20		45
21		46
22		47
23		48
24		49
25		50

Book Mark:

See also

P | *10 H.A.* | U.S.C.T.

Amias Pruder
Co., Co. *10* Reg't U. S. Col'd *H.A.*

Appears on

M. and D. Roll of Men Transferred

to the organization named above,

from

Roll dated *Camp Campida Cal.*, 186*5*.

When enlisted *Sept 1*, 186*4*.

Period for which enlisted *9* years.

When mustered in *Sept 1*, 186*4*.

Present or absent

Company to which assigned

Remarks:

Drafted Assigned
to Co. Sept. 8. 1864
Died at Camp Campida
Gen Hosp. New Orleans
Dec. 21, 1864.
Final Statements
rendered. Name not
taken up on muster rolls of Regt

Book mark :

(342)

W. H. Scott

Copyist.

10 U.S. Col'd H. Art

Private

Private

CARD NUMBERS.

1	26
2	27
3	28
4	29
5	30
6	31
7	32
8	33
9	34
10	35
11	36
12	37
13	38
14	39
15	40
16	41
17	42
18	43
19	44
20	45
21	46
22	47
23	48
24	49
25	50

See Prudham Joseph

Book Mark:

See also

J., 10 U.S. COPT d H. A.

Corporal

Corporal

CARD NUMBERS.

1	5511213	26
2	5511310	27
3	5511398	28
4	5511477	29
5	5511626	30
6	5511826	31
7	5512070	32
8	5489981	33
9		34
10		35
11		36
12		37
13		38
14		39
15		40
16		41
17		42
18		43
19		44
20		45
21		46
22		47
23		48
24		49
25		50

Book Mark:

See also:

P.

10 H. Art'y. U.S.C.T.

Peter D. Pratt

Corp'l, Co. I, 10 Reg't U. S. Col'd H. Art'y.

Age years.

Appears on

Company Muster Roll*

for Enrollment to June 30, 1865.

Joined for duty and enrolled:

When, 186 .

Where

Period / years.

Mustered in:

When Apr. 22, 1865.

Where New Orleans, La.

Present or absent Present

Stoppage, \$ 100 for

Due Gov't, \$ 100 for

Valuation of horse, \$ 100

Valuation of horse equipments, \$ 100

Remarks: Drafted. Promoted from Private to

*First current roll. No muster-in roll of this company on file.

Book mark :

O. J. Clear

(3586)

Copyist.

JAN. 16

5511213

1891

Corps to date from
May 19, 65 - by order
of Capt. Bailey. Com-
mencement of first
payment by time Apr.
22, 65.

Peter D. Pratt

Corpl., Co. I, 10 Reg't U. S. Col'd H. Art'y.

Appears on

Company Muster Roll

for *July & Aug.*, 1865.

Present or absent *Present*

Stoppage, \$ *100* for

Due Gov't, \$ *100* for

Valuation of horse, \$ *100*

Valuation of horse equipments, \$ *100*

Remarks: *Appointed Cor-
poral to date May 19,
1865 S.O. No. 27, Hd. Qrs.
Regt. June 28, 1865. Sick
in Qrs.*

Book mark: _____

O. S. Cleant

P

10 H. Art'y. U.S.C.T.

Peter W. Pratt

Corpl, Co. I, 10 Reg't U. S. Col'd H. Art'y.

Appears on

Company Muster Roll

for Sept. & Oct., 1865.

Present or absent Present

Stoppage, \$ 100 for

Due Gov't, \$ 100 for

Valuation of horse, \$ 100

Valuation of horse equipments, \$ 100

Remarks:

Book mark:

(358)

O. S. Leiant

Copyist.

P

10 H. Art'y.

U.S.C.T.

Peter D. Pratt

Corfil, Co. I, 10 Reg't U. S. Col'd H. Art'y.

Appears on

Company Muster Roll

for *Apr. 1865*, 1865.

Present or absent *Present*

Stoppage, \$ *100* for

Due Gov't, \$ *100* for

Valuation of horse, \$ *100*

Valuation of horse equipments, \$ *100*

Remarks:

FROM SECOND AUDITOR'S ROLL.

Book mark:

O. J. Clark

Copyist.

P

10 H. Art'y. | U.S.C.T.

Peter D. Pratt

Company, Co. I, 10 Reg't U. S. Col'd H. Art'y.

Appears on

Company Muster Roll

for *Jan. & Feb.*, 1866.

Present or absent *Present*

Stoppage, \$ *100* for

Due Gov't, \$ *100* for

Valuation of horse, \$ *100*

Valuation of horse equipments, \$ *100*

Remarks:

Book mark:

O. S. Clark

(358)

Copyist.

Peter W. Pratt

Corp'l, Co. I, 10 Reg't U. S. Col'd H. Art'y.

Appears on

Company Muster Roll

for *March & Apr.*, 1866.

Present or absent

Stoppage, \$ 100 for

Due Gov't, \$ 100 for

Valuation of horse, \$ 100

Valuation of horse equipments, \$ 100

Remarks: *Discharged. Mustered out by reason of expiration of term of service to date Apr. 21, 1866.*

Book mark: *Muster out on file.*

P. J. Lelark

P | 10 Arty | U.S.C.T.

Peter D Pratt

Corpl, Co. "I", 10 Reg't U. S. Col'd Arty

Appears on a

Detachment Muster-out Roll

of the organization named above. Roll dated

New Orleans, La., Apr. 21, 1866.

Muster-out to date Apr. 21, 1866.

Last paid to Feb. 28, 1866

Clothing account:

Last settled 186 ; drawn since \$ 100

Due soldier \$ 20 ⁰⁴/₁₀₀; due U. S. \$ 100

Am't for cloth'g in kind or money adv'd \$ 100

Due U. S. for arms, equipments, &c., \$ ¹⁵/₁₀₀

Bounty paid \$ 100 due \$ 100

Remarks: Joined by draft. Appointed
Corpl. to date May 19. 1865. per S.O.
No. 27 H. gen. Regt. June 28. 1865.
Stop for one tampon .02¢ - one
ball screw .13¢ - total 15¢ -
(Age 20 yrs)

Book mark:

R. E. Wilson

Peter D Pratt

Capt, Co. I, 10 Reg't U. S. Col'd H. Art'y.

Appears on Co. Muster-out Roll, dated Baton Rouge La, Feb 22, 1867.

Muster-out to date _____, 186 .

Last paid to _____, 186 .

Clothing account:

Last settled _____, 186 ; drawn since \$ _____ 100

Due soldier \$ _____ 100; due U. S. \$ _____ 100

Am't for cloth'g in kind or money adv'd \$ _____ 100

Due U. S. for arms, equipments, &c., \$ _____ 100

Bounty paid \$ _____ 100; due \$ _____ 100

Remarks: Discharged expiration term of service Apr. 21, 1866

Book mark : _____

(361)

J. M. Hance

Copyist.

10 U.S. Col'd H. Art

Private

Private

CARD NUMBERS.

1	26
2	27
3	28
4	29
5	30
6	31
7	32
8	33
9	34
10	35
11	36
12	37
13	38
14	39
15	40
16	41
17	42
18	43
19	44
20	45
21	46
22	47
23	48
24	49
25	50

See Prudham Abraham

Book Mark:

See also

Prudham John

Co *E*, 10 U.S. Col'd H. Art'y

Private

Private

CARD NUMBERS.

1	26
2	27
3 <i>Prudham John</i>	
4	29
5	30
6	31
7	32
8	33
9	34
10	35
11	36
12	37
13	38
14	39
15	40
16	41
17	42
18	43
19	44
20	45
21	46
22	47
23	48
24	49
25	50

Book Mark:

See also

Widdham Joseph
Co E, 10 U.S. Col'd H. Art'y

Private

Private

CARD NUMBERS.

1		26
2		27
3	<i>See Prudham Joseph</i>	28
4		29
5		30
6		31
7		32
8		33
9		34
10		35
11		36
12		37
13		38
14		39
15		40
16		41
17		42
18		43
19		44
20		45
21		46
22		47
23		48
24		49
25		50

Book Mark:

See also

Prudham

No 6, 10 U.S. Col'd H. Art

Private

Private

CARD NUMBERS.

1	26
2	27
3	28
4	29
5	30
6	31
7	32
8	33
9	34
10	35
11	36
12	37
13	38
14	39
15	40
16	41
17	42
18	43
19	44
20	45
21	46
22	47
23	48
24	49
25	50

See Prudham Carter

Book Mark:

See also

Prudham New

Co. E, 10 U.S. Col'd H. Art'y

Private

Private

CARD NUMBERS.

1		26
2		27
3	<i>In Prudham Henry</i>	
4		29
5		30
6		31
7		32
8		33
9		34
10		35
11		36
12		37
13		38
14		39
15		40
16		41
17		42
18		43
19		44
20		45
21		46
22		47
23		48
24		49
25		50

Book Mark:

See also

William John

Co. , 10 U.S. Col'd H. Art'y

Private

Private

CARD NUMBERS.

1	5487864,	26
2		27
3		28
4		29
5		30
6		31
7		32
8		33
9		34
10		35
11		36
12		37
13		38
14		39
15		40
16		41
17		42
18		43
19		44
20		45
21		46
22		47
23		48
24		49
25		50

Book Mark:

See also *77 U.S. 6 Sep*

C | *10th* | **U.S.C.T.**

John Preston
10th Reg't U. S. Col'd *10th*

Appears on

M. and D. Roll of Men Transferred

to the organization named above,

from *10th U.S. Col'd Inf*

Roll dated *Camp Parapetda Ok*, 186*5*.

When enlisted _____, 186 .

Period for which enlisted _____ years.

When mustered in *Feb 27*, 186*5*.

Present or absent _____

Company to which assigned _____

Remarks: *Discharged Aug 16. By Order Maj Gen Canby for disability. (Afta)*

Name not taken up on muster rolls of Regt

Book mark : *21 1899*

Wm Scott

No. 10 U.S. Col'd H. Art'y.

Private | Private

CARD NUMBERS.

1	5487244	26
2	5498572	27
3	5498713	28
4	5498852	29
5	5498989	30
6	5499129	31
7	5499265	32
8	5499401	33
9	5499536	34
10	5499673	35
11	5499807	36
12	5499942	37
13	5500072	38
14	5500207	39
15	5489274	40
16	5500384	41
17	5489290	42
18	5500396	43
19		44
20		45
21		46
22		47
23		48
24		49
25		50

Book Mark:

See also:

P

10 H. Art'y. U.S.C.T.

Williams Preston

Appears with rank of *Private* on

Muster and Descriptive Roll of a Detachment of U. S. Vols. forwarded

for the *10* Reg't *U. S. C. H. Art'y* Roll dated

New Orleans La, Sept 19, 1864

Where born *New Orleans La*

Age *31* y'rs; occupation *Laborer*

When enlisted *Aug 14*, 1864.

Where enlisted *New Orleans La*

For what period enlisted *3* years.

Eyes *Blue*; hair *Blue*

Complexion *Dark*; height *5* ft. *2* in.

When mustered in *Sept 19*, 1864.

Where mustered in *New Orleans*

Bounty paid \$ *100*; due \$ *300* *100*

Where credited *to New Orleans La*

Company to which assigned *C*

Remarks:

Book mark:

J. W. Williams

P | 10 H. Art'y. | U.S.C.T.

William Preston

Pvt, Co. C, 10 Reg't U. S. Col'd H. Art'y.

Appears on

Company Muster Roll

for Sept 10th, 1864

Present or absent Present

Stoppage, \$ 100 for

Due Gov't, \$ 100 for

Valuation of horse, \$ 100

Valuation of horse equipments, \$ 100

Remarks: \$300. Bounty due

Book mark:

(358)

J. Anderson Copyist.

P | 10 H. Art'y. | U.S.C.T.

William Preston

Priv., Co. C, 10 Reg't U. S. Col'd H. Art'y.

Appears on

Company Muster Roll

for Nov & Dec, 1864

Present or absent Present

Stoppage, \$ 100 for

Due Gov't, \$ 100 for

Valuation of horse, \$ 100

Valuation of horse equipments, \$ 100

Remarks: \$ 300. Bounty
- due

Book mark: 25473

(358)

J. H. ...
Copyist.

P

10 H. Art'y. U.S.C.T.

William Preston

Pvt., Co. C, 10 Reg't U. S. Col'd H. Art'y.

Appears on

Company Muster Roll

for *Jan & Feb*, 186*5*.

Present or absent *Present*

Stoppage, \$ 100 for

Due Gov't, \$ 100 for

Valuation of horse, \$ 100

Valuation of horse equipments, \$ 100

Remarks:

Book mark:

Ballade

P

10 H. Art'y. U.S.C.T.

William Preston

Pvt., Co. C, 10 Reg't U. S. Col'd H. Art'y.

Appears on

Company Muster Roll

for March - April, 186 J.

Present or absent Present

Stoppage, \$ 100 for

Due Gov't, \$ 100 for

Valuation of horse, \$ 100

Valuation of horse equipments, \$ 100

Remarks:

Book mark:

Lucas

P

10 H. Art'y. U.S.C.T.

William Preston

Sgt, Co. C, 10 Reg't U. S. Col'd H. Art'y.

Appears on

Company Muster Roll

for *May + June*, 186 *5*.

Present or absent *Present*

Stoppage, \$ *100* for

Due Gov't, \$ *100* for

Valuation of horse, \$ *100*

Valuation of horse equipments, \$ *100*

Remarks:

Book mark:

(358)

Ballade

Copyist.

P

10 H. Art'y. U.S.C.T.

William Preston

Pat, Co. C, 10 Reg't U. S. Col'd H. Art'y.

Appears on

Company Muster Roll

for Mey & Avey, 1865

Present or absent Present

Stoppage, \$ 100 for

Due Gov't, \$ 100 for

Valuation of horse, \$ 100

Valuation of horse equipments, \$ 100

Remarks: \$200 Bounty due, \$100 paid

Book mark:

(358)

Callade

Copyist.

P

10 H. Art'y. | U.S.C.T.

William Preston
Priv, Co. C, 10 Reg't U. S. Col'd H. Art'y.

Appears on

Company Muster Roll

for *Sept & Oct*, 186 *5*

Present or absent *Present*

Stoppage, \$ 100 for

Due Gov't, \$ 100 for

Valuation of horse, \$ 100

Valuation of horse equipments, \$ 100

Remarks:

Book mark:

(358)

Ballade
Copyist.

P

10 H. Art'y. U.S.C.T.

William Preston

Poh, Co. C, 10 Reg't U. S. Col'd H. Art'y.

Appears on

Company Muster Roll

for Nov. 1865

Present or absent Present

Stoppage, \$ 100 for

Due Gov't, \$ 100 for

Valuation of horse, \$ 100

Valuation of horse equipments, \$ 100

Remarks:

Book mark:

A. J. Robbins

(358)

Copyist.

P

10 H. Art'y. U.S.C.T.

William Preston

Pvt., Co. C, 10 Reg't U. S. Col'd H. Art'y.

Appears on

Company Muster Roll

for Jan. & Feb., 1866.

Present or absent Present

Stoppage, \$ 100 for

Due Gov't, \$ 100 for

Valuation of horse, \$ 100

Valuation of horse equipments, \$ 100

Remarks: \$100 bounty paid
\$200 due.

Book mark:

A. J. Robbins

(358)

Copyist.

P

10 H. Art'y. U.S.C.T.

William Preston

Pvt., Co. C, 10 Reg't U. S. Col'd H. Art'y.

Appears on

Company Muster Roll

for Mch. & Apr., 1866.

Present or absent Present

Stoppage, \$ 100 for

Due Gov't, \$ 100 for

Valuation of horse, \$ 100

Valuation of horse equipments, \$ 100

Remarks:

Book mark:

A. J. Robbins

(358)

Copyist.

P

William Preston

Plt., Co. C, 10 Reg't U. S. Col'd H. Art'y.

Appears on

Company Muster Roll

for May 2d June, 1864.

Present or absent Present.

Stoppage, \$ 100 for

Due Gov't, \$ 100 for

Valuation of horse, \$ 100

Valuation of horse equipments, \$ 100

Remarks: \$200 bounty paid, \$100 to be paid.

Book mark:

A. J. Robbins

P

| 10 H. Art'y. | U.S.C.T.

William Preston

Private, Co. C, 10 Reg't U. S. Col'd H. Art'y.

Appears on

Company Muster Roll

for July 2d Aug., 1866.

Present or absent Present

Stoppage, \$ 100 for

Due Gov't, \$ 100 for

Valuation of horse, \$ 100

Valuation of horse equipments, \$ 100

Remarks:

Book mark:

A. J. Robbins

(358)

Copyist.

P

10 H. Art'y. U.S.C.T.

William Reston

Prs, Co. C, 10 Reg't U. S. Col'd H. Art'y.

Appears on

Company Muster Roll

for Sept & Oct, 1866.

Present or absent Absent

Stoppage, \$ 100 for

Due Gov't, \$ 100 for

Valuation of horse, \$ 100

Valuation of horse equipments, \$ 100

Remarks: On det. serv at Ft
Lorington, Ga, for 20
15 C.S. Old Gns Ft
Lorington

Book mark:

Hamming

P 110 H.A. U.S.C.T.

William Preston
Qui, Co. *C*, *10* Reg't U. S. Col'd *H.A.*

Appears on a

Detachment Muster Roll

of the organization named above

for *Sept. & Oct.*, 186*6*.

Station *St. Livingston, La.*

Present or absent *Present*

Stoppage, \$ *100* for

Due Gov't, \$ *100* for

Valuation of horse, \$ *100*

Valuation of horse equipments, \$ *100*

Remarks:

Book mark:

(844)

Grogan

Copyist.

P

10 H. Art'y. U.S.C.T.

William Preston

Post, Co. C, 10 Reg't U. S. Col'd H. Art'y.

Appears on

Company Muster Roll

for Jan & Dec, 1866.

Present or absent Absent

Stoppage, \$ 100 for

Due Gov't, \$ 100 for

Valuation of horse, \$ 100

Valuation of horse equipments, \$ 100

Remarks: det serv at Fort
Sivington, Va, per
P.O. No 15 C.S. Red
gns Fort Sivington

Book mark:

Mann
Copyist.

P 140 HA | U.S.C.T.

William Preston
Priv, Co. *C*, *10* Reg't U. S. Col'd *HA*

Appears on a

Detachment Muster Roll

of the organization named above

for *Nov. & Dec.*, 186*6*.

Station *H. Springtown, Pa.*

Present or absent *Present*

Stoppage, \$ *100* for

Due Gov't, \$ *100* for

Valuation of horse, \$ *100*

Valuation of horse equipments, \$ *100*

Remarks:

Book mark:

Grogan

(244)

Copyist.

P | 10 H. Art'y. | U.S.C.T.

William Rector
Pr, Co. C, 10 Reg't U. S. Col'd H. Art'y.

Appears on Co. Muster-out Roll, dated
Baton Rouge, La., Feb 22, 1867.
Muster-out to date *Feb 22, 1867.*
Last paid to *Dec 31, 1866.*

Clothing account:

Last settled....., 186 ; drawn since \$..... $\frac{100}{100}$
Duc soldier \$ *67* $\frac{13}{100}$; due U. S. \$..... $\frac{100}{100}$
Am't for cloth'g in kind or money adv'd \$..... $\frac{100}{100}$

Due U. S. for arms, equipments, &c., \$ *7* $\frac{16}{100}$

Bounty paid \$ *200* $\frac{100}{100}$; due \$..... $\frac{100}{100}$

Remarks: *Joined as recruit*
Stop for one pair shoes
Stop for screw driver
Stop for Enfield Rifle
AK & acct retained

Book mark :

(361)

Hamming
Copyist.

10 U.S. Col'd H. Art

Private Private

CARD NUMBERS.

1		26
2		27
3	In Prison	28 August
4		29
5		30
6		31
7		32
8		33
9		34
10		35
11		36
12		37
13		38
14		39
15		40
16		41
17		42
18		43
19		44
20		45
21		46
22		47
23		48
24		49
25		50

Book Mark: A-33-V-11 Ref-157

See also

Private
Co *W.*, 10 U.S. Col'd H. Art'y

Private | *Private*

CARD NUMBERS.

1	5509560	26
2	5490192	27
3	5511191	28
4		29
5		30
6		31
7		32
8		33
9		34
10		35
11		36
12		37
13		38
14		39
15		40
16		41
17		42
18		43
19		44
20		45
21		46
22		47
23		48
24		49
25		50

Book Mark: _____

See also _____

P | 10 H. Art'y. | U.S.C.T.

Basil Price

Pvt, Co. H, 10 Reg't U. S. Col'd H. Art'y.

Appears on

Company Muster-in and Descriptive Roll
of the organization named above. Roll dated
New Orleans La, Nov 8, 1864.

Where born *St Charles La.*

Age *40* y'rs; occupation *Laborer*

When enlisted *Nov 2*, 1864.

Where enlisted *New Orleans*

For what period enlisted *3* years.

Eyes *Black*; hair *Black*

Complexion *Black*; height *5* ft. *1* in.

When mustered in *Nov 8*, 1864.

Where mustered in *New Orleans*

Bounty paid \$ *100*; due \$ *100*

Where credited *Dist. 2nd ward, Parish of Orleans, City of N. Orleans La*
Company to which assigned *A.*

Remarks: *Mustered in to date from date of Enlistment.*
NEXT ROLL ON FILE FEB 1865

Book mark:

Permyington
(356d) Copyist.

P | *10th Arty.* | **U.S.C.T.**

Basil Price

Pt, Co *H.*, *10* Reg't U. S. Col'd *H. Arty.*

Appears on

Descriptive List of Deserters

dated *Recruiting Depot N.O. Nov 3* 186*4*.

Deserted:

When *Nov. 19*, 186*4*.

Where *Recruiting Depot N.O.*

Arrested:

When _____, 186 .

Where _____

Remarks: *Transcribed from
Woodruff's Plantation,
S.B.*

Book mark: _____

(851)

J. H. Richardson

Copyist.

J

10 H. Art'y. U.S.C.T.

Basile Price

Pvt, Co. *H*, 10 Reg't U. S. Col'd H. Art'y.

Appears on **Co. Muster-out Roll**, dated

Baton Rouge, La., Feb. 22, 1867.

Muster-out to date _____, 186 .

Last paid to *Never paid*, 186 .

Clothing account:

Last settled _____, 186 ; drawn since \$ _____ 100

Due soldier \$ _____ 100; due U. S. \$ *23* 100

Am't for cloth'g in kind or money adv'd \$ _____ 100

Due U. S. for arms, equipments, &c., \$ _____ 100

Bounty paid \$ _____ 100; due \$ _____ 100

Remarks: *Deserted Nov. 19/64*
at New Orleans, La.

Book mark: _____

Lowry

(361)

Copyist.

Price, Basil

, Co. *26*, *10*" Reg't *M. E. A.*

2 Enclosures.

Bed Cards	Final Statements
Burial Records	Furloughs or L. of A.
Certs. of Dis. for Discharge	Med. Certificates
C. M. Charges	Med. Des. Lists
Descriptive Lists	Orders
Discharge Certificates	Pris. of War Record
Enlistment Papers <i>2</i>	Resignations

Other papers relating to—

Admission to Hosp'l	Furlough or L. of A.
Casualty Sheet	Med. Examination
Confinement	Misc. Information
Contracts	Pay or Clothing
Death or Effects	Personal Reports
Desertion	Rank
Discharge from Hosp'l	Transfer to Hosp'l
Discharge from Service	Transfer to V. R. C.
Duty	Transportation

NOTE 1.—This blank will be used for both enlistments and re-enlistments—enlistment of veterans, &c., &c., in the volunteer service. They will be made out in duplicate in all cases—one to accompany the recruiting return of the superintendent (not the recruiting officer) to the Adjutant General, and one to accompany the accounts of the officer who pays bounty, &c. The Regiment and Company in which the soldier last served should be given on the back.

NOTE 2.—An enlistment holds to service. A muster-in must, in all cases, precede payment of pay, bounty, pension, &c. A muster-in roll must, in all cases, be filed in the Adjutant General's Office as evidence of muster-in. The mustering officer, commissary, or assistant commissary of musters, as the case may be, will countersign both enlistments as having mustered the soldier into the service of the United States before either of them is given to the disbursing officer.

DECLARATION OF RECRUIT.

I, Rasil Price, desiring to VOLUNTEER as a Soldier of the Army of the United States, for the term of THREE YEARS, Do Declare, That I am Forty years and _____ months of age; that I have never been discharged from the United States service on account of disability or by sentence of a court martial, or by order before the expiration of a term of enlistment; and I know of no impediment to my serving honestly and faithfully as a soldier for three years.

GIVEN at New Orleans La the 2 day of November 1864

Witness:

R. L. Linnick Rasil Price
1st Lt 1st Regt

No. 15074
Rasil Price
Volunteered at New Orleans
Nov 2, 1864
By R. L. Linnick
1st Lt 1st Regt
_____ Regiment of _____
_____ enlistment; last served in Company ()
_____ Reg't of _____
Discharged _____, 18____
Company 1st Regt
1st Battalion

CONSENT IN CASE OF MINOR.

I, _____, Do CERTIFY, That I am the _____ of _____; that the said _____ is _____ years of age; and I do hereby freely give my CONSENT to his volunteering as a SOLDIER in the ARMY OF THE UNITED STATES for the period of THREE YEARS.

GIVEN at _____ the _____ day of _____

Witness:

VOLUNTEER ENLISTMENT.

STATE OF

Louisiana



TOWN OF

New Orleans

I, Basil Price, born in St. Charles, Louisiana, aged 30 years, and by occupation a Laborer, Do HEREBY ACKNOWLEDGE to have volunteered this 1st day of November 1864, to serve as a Soldier in the Army of the United States of America, for the period of THREE YEARS, unless sooner discharged by proper authority: Do also agree to accept such bounty, pay, rations, and clothing as are, or may be, established by law for volunteers. And I, Basil Price, do solemnly swear, that I will bear true faith and allegiance to the United States of America, and that I will serve them honestly and faithfully against all their enemies or opposers whomsoever; and that I will observe and obey the orders of the President of the United States, and the orders of the officers appointed over me, according to the Rules and Articles of War.

Sworn and subscribed to, at New Orleans, this 2nd day of November 1864, BEFORE H. F. Farris, Examining Surgeon, Basil Price

I CERTIFY, ON HONOR, That I have carefully examined the above-named Volunteer, agreeably to the General Regulations of the Army, and that, in my opinion, he is free from all bodily defects and mental infirmity, which would in any way disqualify him from performing the duties of a soldier.

Orville Humphrey

EXAMINING SURGEON.

I CERTIFY, ON HONOR, That I have minutely inspected the Volunteer Basil Price previously to his enlistment, and that he was entirely sober when enlisted; that, to the best of my judgment and belief, he is of lawful age; and that, in accepting him as duly qualified to perform the duties of an able-bodied soldier, I have strictly observed the Regulations which govern the recruiting service. This soldier has Blue eyes, Dark hair, Dark complexion, is 5 feet 7 inches high.

H. F. Farris, Recruiting Officer, 1864 Regiment of U.S.C. Volunteers.

(A. G. O. No. 74 & 76.)

RECRUITING OFFICER.

Mustered into the service of the United States, for three years or during the war, from date of enlistment, in Company 7th Regiment of 11th Mass. Volunteers, on the 8th day of Nov 1864 at New Orleans

John W. Hamilton, Acting Officer

NOTE 1.—This blank will be used for both enlistments and re-enlistments—enlistment of veterans, &c., &c., in the volunteer service. They will be made out in duplicate in all cases—one to accompany the recruiting return of the superintendent (not the recruiting officer) to the Adjutant General, and one to accompany the accounts of the officer who pays bounty, &c. The Regiment and Company in which the soldier last served should be given on the back.

NOTE 2.—An enlistment holds to service. A muster-in must, in all cases, precede payment of pay, bounty, pension, &c. A muster-in roll must, in all cases, be filed in the Adjutant General's Office as evidence of muster-in. The mustering officer, commissary, or assistant commissary of musters, as the case may be, will countersign both enlistments as having mustered the soldier into the service of the United States before either of them is given to the disbursing officer.

DECLARATION OF RECRUIT.

I, Basil Price, desiring to VOLUNTEER as a Soldier in the Army of the United States, for the term of THREE YEARS, Do Declare, That I am Forty years and _____ months of age; that I have never been discharged from the United States service on account of disability or by sentence of a court martial, or by order before the expiration of a term of enlistment; and I know of no impediment to my serving honestly and faithfully as a soldier for three years.

GIVEN at New Orleans La the 2nd day of November 1864

Witness:

H. Robbins Basil Price
1st Lieut U.S.C. Price

Basil Price No. _____

Volunteered at New Orleans

2nd November, 1864

By H. Robbins

Regiment of

10th Mass

enlistment; last served in Company ()

Reg't of

Discharged _____, 18 _____

Company
10th Mass

CONSENT IN CASE OF MINOR.

I, _____, Do CERTIFY, That I am the _____ of _____; that the said _____ is _____ years of age; and I do hereby freely give my CONSENT to his volunteering as a SOLDIER in the ARMY OF THE UNITED STATES for the period of THREE YEARS.

GIVEN at _____ the _____ day of _____

Witness:

VOLUNTEER ENLISTMENT.

STATE OF

Louisiana



TOWN OF

New Orleans

I, Basil Price, born in St Charles in the State of Louisiana, aged Forty years, and by occupation a Laborer, DO HEREBY ACKNOWLEDGE to have volunteered this 2nd day of November, 1864, to serve as a Soldier in the Army of the United States of America, for the period of THREE YEARS, unless sooner discharged by proper authority: Do also agree to accept such bounty, pay, rations, and clothing, as are, or may be, established by law for volunteers. And I, Basil Price, do solemnly swear, that I will bear true faith and allegiance to the United States of America, and that I will serve them honestly and faithfully against all their enemies or opposers whomsoever; and that I will observe and obey the orders of the President of the United States, and the orders of the officers appointed over me, according to the Rules and Articles of War.

Sworn and subscribed to, at New Orleans, this 2nd day of Nov, 1864, BEFORE J. H. Harrison, 1st Lieut U.S.C., Basil Price mark

I CERTIFY, ON HONOR, That I have carefully examined the above-named Volunteer, agreeably to the General Regulations of the Army, and that, in my opinion, he is free from all bodily defects and mental infirmity, which would in any way disqualify him from performing the duties of a soldier.

Wm M. Humphrey Surgeon U.S.A. EXAMINING SURGEON.

I CERTIFY, ON HONOR, That I have minutely inspected the Volunteer Basil Price previously to his enlistment, and that he was entirely sober when enlisted; that, to the best of my judgment and belief, he is of lawful age; and that, in accepting him as duly qualified to perform the duties of an able-bodied soldier, I have strictly observed the Regulations which govern the recruiting service. This soldier has Blue eyes, Blue hair, Blue complexion, is 6 feet 1 inches high.

J. H. Harrison 1st Lieut 84th Regiment of U.S.C. Volunteers, RECRUITING OFFICER.

(A. G. O. No. 74 & 76.)

Mustered into the service of the United States, for three years or during the war, from date of enlistment, in Company 26th Regiment of U.S.C. Volunteers, on the 8th day of Nov, 1864, at New Orleans

John Harrison 1st Lieut 84th U.S.C. All mustered then

Private Company

CARD NUMBERS.

1	5490457	26
2	5490608	27
3	5490750	28
4	5490904	29
5	5491042	30
6	5491175	31
7	5491307	32
8	5491440	33
9	5491568	34
10	5491695	35
11	5491821	36
12	5491866	37
13	5491991	38
14	5492116	39
15	5492239	40
16	5492361	41
17	5492483	42
18	5492609	43
19	5492733	44
20	5492992	45
21	5493913	46
22	5489497	47
23	47-ct-1884	48
24		49
25		50

Book Mark: $\frac{213 \cdot 15}{951}$ 47-ct-1884

See also

MS Worley
J
Gr.

0793988 Proof

REP401151-

P. 2317526 P. 2317526

Q 2371109 and Q 2371109

P | 10 H. Art'y. | U.S.C.T.

Buck Price

....., Co. A, 1 Reg't La. Col'd H. Art'y.*

Age 30 years.

Appears on

Company Muster-in Roll

of the organization named above. Roll dated

New Orleans, La. Nov. 29, 1862.

Muster-in to date Nov. 29, 1862.

Joined for duty and enrolled:

When Nov. 16, 1862.

Where New Orleans

Period 3 years.

Valuation of horse, \$100

Valuation of horse equipments, \$100

Remarks:

* This organization subsequently became Co. A, 10 Reg't U. S. Colored Heavy Artillery.

Book mark:

Johnson

(356)

Copyist.

P

10 H. Art'y. U.S.C.T.

Buck Price

Price Co. A, 1 Reg't La. H. Art'y.*

Appears on

Company Muster Roll

for to Dec. 31, 1862

Present or absent Present

Stoppage, \$ 100 for

Due Gov't, \$ 100 for

Valuation of horse, \$ 100

Valuation of horse equipments, \$ 100

Remarks:

*This organization subsequently became Co. A, 10 Reg't U. S. Col'd Heavy Artillery.

Book mark:

Tobman

Copyright.

P

10 H. Art'y. U.S.C.T.

Buck Price

Price, Co. A, 1 Reg't La. H. Art'y.*

Appears on

Company Muster Roll

for Jan'y & Feb'y, 1863.

Present or absent Present

Stoppage, \$ 100 for

Due Gov't, \$ 100 for

Valuation of horse, \$ 100

Valuation of horse equipments, \$ 100

Remarks:

*This organization subsequently became Co. A, 10 Reg't U. S. Col'd Heavy Artillery.

Book mark:

Tobman

P

10 H. Art'y. U.S.C.T.

Buck Price

Price, Co. A, 1 Reg't La. H. Art'y.*

Appears on

Company Muster Roll

for March & April, 1863.

Present or absent Present

Stoppage, \$ 100 for

Due Gov't, \$ 100 for

Valuation of horse, \$ 100

Valuation of horse equipments, \$ 100

Remarks:

*This organization subsequently became Co. A, 10 Reg't U. S. Col'd Heavy Artillery.

Book mark:

Johnson

P

10 H. Art'y. U.S.C.T.

Buck Price

Price, Co. A, 1 Reg't La. H. Art'y.*

Appears on

Company Muster Roll

for May & June, 1863.

Present or absent Present

Stoppage, \$ 100 for

Due Gov't, \$ 100 for

Valuation of horse, \$ 100

Valuation of horse equipments, \$ 100

Remarks:

*This organization subsequently became Co. A, 10 Reg't U. S. Col'd Heavy Artillery.

Book mark:

Johnson Copyist.

Buck Price

Price, Co. A, 1 Reg't La. H. Art'y.*

Appears on

Company Muster Roll

for July & August, 1863.

Present or absent Present

Stoppage, \$ 100 for

Due Gov't, \$ 100 for

Valuation of horse, \$ 100

Valuation of horse equipments, \$ 100

Remarks:

*This organization subsequently became Co. A, 10 Reg't U. S. Col'd Heavy Artillery.

Book mark:

Johnman
Copyright.

P

10 H. Art'y.

U.S.C.T.

Buck Price

Priv, Co. A, 1 Reg't La. H. Art'y.*

Appears on

Company Muster Roll

for Sept & Oct, 1863.

Present or absent Present

Stoppage, \$ 100 for

Due Gov't, \$ 100 for

Valuation of horse, \$ 100

Valuation of horse equipments, \$ 100

Remarks:

*This organization subsequently became Co. A. 10 Reg't U. S. Col'd Heavy Artillery.

Book mark:

Tolman

10 H. Art'y. | U.S.C.T.

Buck Price
Co. A, 1 Reg't H. Art'y, Corps d'Afrique.*

Appears on

Company Muster Roll

for *Nov 1863*, 1863.

Present or absent *Present*

Stoppage, \$ *100* for

Due Gov't, \$ *100* for

Valuation of horse, \$ *100*

Valuation of horse equipments, \$ *100*

Remarks:

*This organization subsequently became Co. A, 10 Reg't U. S. Colored Heavy Artillery.

Book mark:

Beckwith

3

10 H. Art'y. | U.S.C.T.

Buck Price
Art. Co. A, 1 Reg't H. Art'y, Corps d'Afrique.*

Appears on

Company Muster Roll

for *Jan & Feb*, 1864.

Present or absent *Present*

Stoppage, \$ *100* for

Due Gov't, \$ *100* for

Valuation of horse, \$ *100*

Valuation of horse equipments, \$ *100*

Remarks:

*This organization subsequently became Co. *A*, 10 Reg't U. S. Colored Heavy Artillery.

Book mark:

W. H. Chester
Copyist.

P | 10 H. Art'y. | U.S.C.T.

Buck Price
Art. Co. *A*, 7 Reg't U. S. Col'd H. Art'y.*

Appears on

Company Muster Roll
for *McIntosh*, 1864.

Present or absent *Present*

Stoppage, \$ 100 for

Due Gov't, \$ 100 for

Valuation of horse, \$ 100

Valuation of horse equipments, \$ 100

Remarks:

* This organization subsequently became Co. *A*, 10 Reg't U. S. Colored Heavy Artillery.

Book mark: -----

W. Deater

Copyist.

2

10 H. Art'y.

U.S.C.T.

Duck Price

Co. A, 7 Reg't U. S. Col'd H. Art'y.*

Appears on

Company Muster Roll

for *May & June*, 1864.

Present or absent *Present*

Stoppage, \$ *100* for

Due Gov't, \$ *100* for

Valuation of horse, \$ *100*

Valuation of horse equipments, \$ *100*

Remarks: *Sick in Hospital*

* This organization subsequently became Co. *A*, 10 Reg't U. S. Colored Heavy Artillery.

Book mark:

Reuter

P

10 H. Art'y.

U.S.C.T.

Buck Price

Corpl, Co. A, 7 Reg't U. S. Col'd H. Art'y.*

Appears on

Company Muster Roll

for July & Aug, 1864

Present or absent Present

Stoppage, \$ 100 for

Due Gov't, \$ 100 for

Valuation of horse, \$ 100

Valuation of horse equipments, \$ 100

Remarks: Promoted to Corporal July 1st. 1864

* This organization subsequently became Co. A, 10 Reg't U. S. Colored Heavy Artillery.

Book mark:

Proctor

(358)

Copyst.

3

P | 10 H. Art'y. | U.S.C.T.

Buck Price

Capt., Co. A, 10 Reg't U. S. Col'd H. Art'y.

Appears on

Company Muster Roll

for Sept 1864

Present or absent Present

Stoppage, \$ 100 for

Due Gov't, \$ 100 for

Valuation of horse, \$ 100

Valuation of horse equipments, \$ 100

Remarks:

Book mark:

Becker

P | 10 H. Art'y. | U.S.C.T.

Buck Price
Corp, Co. A, 10 Reg't U. S. Col'd H. Art'y.

Appears on

Company Muster Roll

for M. Price, 1864.

Present or absent Present

Stoppage, \$ 100 for

Due Gov't, \$ 100 for

Valuation of horse, \$ 100

Valuation of horse equipments, \$ 100

Remarks:

Book mark:

Price

(358)

Copyist.

P | 10 H. Art'y. | U.S.C.T.

Buck Price
Empl, Co. A, 10 Reg't U. S. Col'd H. Art'y.

Appears on

Company Muster Roll

for Jan + Feb, 1865.

Present or absent Present

Stoppage, \$ 100 for

Due Gov't, \$ 100 for

Valuation of horse, \$ 100

Valuation of horse equipments, \$ 100

Remarks: Due Gov't for
Ordnance as per state-
ment \$1.20 for
Camp and Garrison
Equipage as per
Abstract \$2.31

Book mark:

Rochester

(358)

Copyist.

P

10 H. Art'y. U.S.C.T.

Duck Price

Comp, Co. A, 10 Reg't U. S. Col'd H. Art'y.

Appears on

Company Muster Roll

for *March 1865*, 186⁵.

Present or absent *Present*

Stoppage, \$ 100 for

Due Gov't, \$ 100 for

Valuation of horse, \$ 100

Valuation of horse equipments, \$ 100

Remarks: *Due Gov't for
Ordnance as per
Statement \$1.20 for
Camp and Garrison
Equipage as per
Abstract \$2.31*

Book mark:

Recketer

Quick Price

Comp, Co. A, 10 Reg't U. S. Col'd H. Art'y.

Appears on

Company Muster Roll

for *May & June*, 1865.

Present or absent *Present*

Stoppage, \$ *100* for

Due Gov't, \$ *100* for

Valuation of horse, \$ *100*

Valuation of horse equipments, \$ *100*

Remarks: *Mis. Govt. for
Ordnance as per
Statement - \$1.20 -
for Camp and
Expenses Equipage as
per Abstract \$2.31*

Book mark:

Proctor

P | 10 H. Art'y. | U.S.C.T.

Buck Price

Corp., Co. A, 10 Reg't U. S. Col'd H. Art'y.

Appears on

Company Muster Roll

for *July & Aug*, 1865.

Present or absent *Present*

Stoppage, \$ 100 for

Due Gov't, \$ 100 for

Valuation of horse, \$ 100

Valuation of horse equipments, \$ 100

Remarks:

Book mark:

Present

Buck Price

Capt, Co. A, 10 Reg't U. S. Col'd H. Art'y.

Appears on

Company Muster Roll

for *Sept + Oct*, 1865.

Present or absent *Present*

Stoppage, \$ 100 for

Due Gov't, \$ 100 for

Valuation of horse, \$ 100

Valuation of horse equipments, \$ 100

Remarks:

Book mark:

Hynes
Copyist.

P

10 H. Art'y.

U.S.C.T.

Buck Rice

Capt., Co. A, 10 Reg't U. S. Col'd H. Art'y.

Appears on

Company Muster Roll

for Nov & Dec, 1865.

Present or absent

Stoppage, \$ 100 for

Due Gov't, \$ 100 for

Valuation of horse, \$ 100

Valuation of horse equipments, \$ 100

Remarks: Mustered out by reason of expiration of term of service.

Thornfield by Worley 47.

Book mark: Discharge Nov. 28. 1865 to B.

157 971 ~~C.P. 1884~~ 47-69-1884

Haynes

(358)

Copyist.

P. | 10. No. a. | U.S.C.T.

Quack Price

Corpl, Co. A., 10. Reg't U. S. Col'd N. C.

Appears on a

Detachment Muster-out Roll

of the organization named above. Roll dated

N. Orleans La., Nov. 28, 1865.

Muster-out to date *Nov. 28, 1865.*

Last paid to *June 30, 1865.*

Clothing account:

Last settled _____, 186 ; drawn since \$ _____ 100

Due soldier \$ _____ ⁸⁰ 100; due U. S. \$ _____ 100

Am't for cloth'g in kind or money adv'd \$ _____ 100

Due U. S. for arms, equipments, &c., \$ _____ 100

Bounty paid \$ _____ 100 due \$ _____ 100

Remarks: *Joined at Origl. Regt. Pvt. to July 1, 1864. Stop for one Tompion. Mustered out by reason of expiration of term of service.*

Book mark: _____

(349)

Hawley

Copyist.

P

10 H. Art'y. | U.S.C.T.

Buck Price

Corpl Co. A, 10 Reg't U. S. Col'd H. Art'y.

Appears on Co. Muster-out Roll, dated
Baton Rouge La Feb 22 1867.

Muster-out to date _____, 186 .

Last paid to _____, 186 .

Clothing account:

Last settled _____, 186 ; drawn since \$ _____ 100

Due soldier \$ _____ 100; due U. S. \$ _____ 100

Am't for cloth'g in kind or money adv'd \$ _____ 100

Due U. S. for arms, equipments, &c., \$ _____ 100

Bounty paid \$ _____ 100; due \$ _____ 100

Remarks: *Joined org'l orgn. Aft'd
Corpl July 1/65
Disch'd for exp'n. of term of
service Nov 28. 65*

Book mark : _____

Nesbitt

(361)

Copyist.

10th Regt U.S.C.
10th Regt U.S.C.
Back Price
Co. A, 10th Regt U.S.C. & A.

NOTATION.

Book mark: L.B. 15-941 with
47.6.3. 1884.

War Department,

Adjutant General's Office,

Washington, Jan. 5, 1884.

Mustered out with Detach-
ment November 28, 1865.

(438)

E. P. Conner.

Copyist.

U.S. Col'd H

Private Invoice

CARD NUMBERS.

5487471	26
5496816	27
5496975	28
5497044	29
5497191	30
5497228	31
5497261	32
5497288	33
5497318	34
5497340	35
	36
	37
	38
	39
	40
	41
	42
	43
	44
	45
	46
	47
	48
	49
	50

Book Mark:

See also 77 US. G. Inf

P | *10 H.A.* | U.S.C.T.

Edward Pringston
Co. L, 10 Regt U. S. Col'd

Appears on

M. and D. Roll of Men Transferred

to the organization named above,

from *Co. B. 9th U.S. Col Inf*

Roll dated *Camp Campuda Oct 1*, 186*0*.

When enlisted *Sept 1*, 186*4*.

Period for which enlisted *3* years.

When mustered in *Sept 1*, 186*4*.

Present or absent *Present*

Company to which assigned *L*

Remarks: *Drafted. Assigned to Co Sept. 8. 1864. Stoppage / Caution*

Filed with Edward Pringston

Book mark :

Wm Scott

P. | 10 H. Art'y. | U.S.C.T.

Edward Pringston

Priv., Co. B, 10 Reg't U. S. Col'd H. Art'y.

Appears on

Company Muster Roll

for Sep. & Oct., 1864.

Present or absent Present.

Stoppage, \$ 100 for

Due Gov't, \$ 100 for

Valuation of horse, \$ 100

Valuation of horse equipments, \$ 100

Remarks: Transferred from 77 US. C. Inf. to Co B 10th USCA Hy. pers. D. No 277 Hdqrs Est Dist. La Sep 25th 1865.

Book mark:

Jossier.

P

10 H. Art'y. U.S.C.T.

Edward Pringston

Pt

, Co. B, 10 Reg't U. S. Col'd H. Art'y.

Appears on

Company Muster Roll

for Nov & Dec, 1865

Present or absent Present

Stoppage, \$ 100 for

Due Gov't, \$ 100 for

Valuation of horse, \$ 100

Valuation of horse equipments, \$ 100

Remarks:

Book mark:

P. Reif

(358)

Copyist.

P

10 H. Art'y. U.S.C.T.

Edward Pringston

Pat, Co. B, 10 Reg't U. S. Col'd H. Art'y.

Appears on

Company Muster Roll

for Jan'y & Feb, 1866.

Present or absent Present

Stoppage, \$ 100 for

Due Gov't, \$ 100 for

Valuation of horse, \$ 100

Valuation of horse equipments, \$ 100

Remarks:

Book mark:

(358)

Copyist.

P

10 H. Art'y. U.S.C.T.

Edward Pringston

Pvt, Co. B, 10 Reg't U. S. Col'd H. Art'y.

Appears on

Company Muster Roll

for Mch. & apr, 1866

Present or absent Present

Stoppage, \$ 100 for

Due Gov't, \$ 100 for

Valuation of horse, \$ 100

Valuation of horse equipments, \$ 100

Remarks: Has pay due him from Sept. 1 64 to June 30 1865. Transfd. from 77 U.S.C.I. Sept. 30 65 & never paid. entered on rolls of Oct. 31 as paid to June 30 1865 Stoppage 1 hundred on transfer Roll

Book mark:

Reif

P

10 H. Art'y. U.S.C.T.

Edward Pringston

Pvt, Co. B, 10 Reg't U. S. Col'd H. Art'y.

Appears on

Company Muster Roll

for May & June, 1864

Present or absent Present

Stoppage, \$ 100 for

Due Gov't, \$ 100 for

Valuation of horse, \$ 100

Valuation of horse equipments, \$ 100

Remarks:

Book mark:

(358)

Reif

Copyist.

P

10 H. Art'y. U.S.C.T.

Edward Pringston

Pr, Co. B, 10 Reg't U. S. Col'd H. Art'y.

Appears on

Company Muster Roll

for July. & Aug., 1866

Present or absent Present

Stoppage, \$ 100 for

Due Gov't, \$ 100 for

Valuation of horse, \$ 100

Valuation of horse equipments, \$ 100

Remarks:

Book mark:

Reif

P

10 H. Art'y.

U.S.C.T.

Edward Pringston
Pri, Co. B, 10 Reg't U. S. Col'd H. Art'y.

Appears on

Company Muster Roll

for Sep. & Oct., 1866.

Present or absent Present

Stoppage, \$ 100 for

Due Gov't, \$ 100 for

Valuation of horse, \$ 100

Valuation of horse equipments, \$ 100

Remarks:

Book mark:

(358)

Hodgins
Copyist.

P

10 H. Art'y.

U.S.C.T.

Edward Pringston
Pri, Co. B, 10 Reg't U. S. Col'd H. Art'y.

Appears on

Company Muster Roll

for Nov. & Dec., 1866.

Present or absent Present

Stoppage, \$ 100 for

Due Gov't, \$ 100 for

Valuation of horse, \$ 100

Valuation of horse equipments, \$ 100

Remarks:

Due Soldier on
acct. of clothing
\$23.93

Book mark:

Hodges
Copyist.

P

10 H. Art'y. U.S.C.T.

Edward Pringston

Priv., Co. B, 10 Reg't U. S. Col'd H. Art'y.

Appears on Co. Muster-out Roll, dated

Baton Rouge La, Feb., 1867.

Muster-out to date Feb 22, 1867.

Last paid to Dec. 31, 1866.

Clothing account:

Last settled, 186 ; drawn since \$ 100

Due soldier \$ 56 ⁴⁵/₁₀₀; due U. S. \$ 100

Am't for cloth'g in kind or money adv'd \$ 100

Due U. S. for arms, equipments, &c., \$ 6 ⁰⁰/₁₀₀

Bounty paid \$ none ⁰⁰/₁₀₀; due \$ 200 ⁰⁰/₁₀₀

Remarks: joined by transfer

from 77 U.S. C.S. G.O. 66

Recd. Ins. Dept. of La.

Sept. 22/65 - Strip for 1

Spfd Rifle Musket 1

Bayonet Scabbard 1 Cap

Book mark: 709 1879 244 459 (over)

Hodges

(361)

Copyist.

JAN. 15

5497340

★ 1891 ★

Pouch, Cart Box, Cart
Box Plate, Gun Slung
; Waist Belt, Waist
Belt Plate, retained for
G.O. 101 War Dept., Series
1865.

6, 10 U.S. Gold L.

Private.

CARD NUMBERS.

1	5497642	26
2	5497887	27
3	5498041	28
		29
		30
		31
		32
		33
		34
		35
		36
		37
		38
		39
		40
		41
		42
		43
		44
		45
		46
		47
		48
		49
		50

Book Mark: A-33-V-11 Re. J-1867

See also

P | 10 H. Art'y. | U.S.C.T.

August Piton

Pit, Co. C, 1 Reg't H. Art'y, Corps d'Afrique.*

Age 19 years.

Appears on

Company Muster-in Roll

of the organization named above. Roll dated

New Orleans La, Aug 17, 1863.

Muster-in to date Aug 17, 1863.

Joined for duty and enrolled:

When June 24, 1863.

Where Camp Parquet La

Period 3 years.

Valuation of horse, \$ 100

Valuation of horse equipments, \$ 100

Remarks:

* This organization subsequently became Co. C, 10 Reg't U. S. Colored Heavy Artillery.

Book mark:

(356)

Effern

Copyist.

August Britton

P, Co, C, 1 Reg't La. Art'y Native Guards.*

Appears on

Company Muster Roll

for *Aug 11th to 31st 1863*

Present or absent *Present*

Stoppage, \$ *100* for

Due Gov't, \$ *100* for

Valuation of horse, \$ *100*

Valuation of horse equipments, \$ *100*

Remarks :

Filed with August Britton

* This organization subsequently became Co. C, 10 Reg't U. S. Col'd Heavy Artillery.

Book mark :

Assess

P | 10 H. Art'y. | U.S.C.T.

August Priton

Pvt, Co, C, 1 Reg't La. Art'y Native Guards.*

Appears on

Company Muster Roll

for *Sep. Oct*, 1863.

Present or absent *Present*

Stoppage, \$ *100* for

Due Gov't, \$ *100* for

Valuation of horse, \$ *100*

Valuation of horse equipments, \$ *100*

Remarks:

*Filed with August Priton
not on sub. rolls of Co*

* This organization subsequently became Co. C, 10 Reg't U. S. Col'd Heavy Artillery.

Book mark:

W. J. ...

into

Prime

CARD NUMBERS.

	26
	27
<i>in Provant Eugene</i>	28
	29
	30
	31
	32
	33
	34
	35
	36
	37
	38
	39
	40
	41
	42
	43
	44
	45
	46
	47
	48
	49
	50

Book Mark:

see also

U.S. GOVERNMENT

Orderly Book
CARD NUMBERS.

1	5514409	26
2	5514557	27
3	5514773	28
4	5514871	29
5	5514981	30
6	5515045	31
7		32
8		33
9		34
10		35
11		36
12		37
13		38
14		39
15		40
16		41
17		42
18		43
19		44
20		45
21		46
22		47
23		48
24		49
25		50

Book Mark:

See also *U.S. Army*

Charles Prozig

Crdgt Co. M., 10 Reg't U. S. Col'd H. Art'y.

Age years.

Appears on

Company Muster Roll*

for Sept - Oct, 1865.

Joined for duty and enrolled:

When Sept 1, 1865.

Where New Orleans

Period 3 years.

Mustered in:

When, 186 ..

Where

Present or absent Present

Stoppage, \$ 100 for

Due Gov't, \$ 100 for

Remarks: # A. due per Mo for 3
re Enlistment - Attached to Co
Co. 50. 65 - Hd Qrs Ft Mauerbach Oct
26. 65. Pay due from Enlistment -

* First current roll. No muster-in roll of this company on file.

Book mark:

W. H. Wright
(3586) Copyist.

P

10 H. Art'y. | U. S. C. T.

Charles Possie

Ord. Sgt., Co. M, 10 Reg't U. S. Col'd H. Art'y.

Appears on

Company Muster Roll

for Mr. V. Dee, 1865.

Present or absent Present-

Stoppage, \$ 100 for

Due Gov't, \$ 100 for

Valuation of horse, \$ 100

Valuation of horse equipments, \$ 100

Remarks: For H. re enlist # H. per Mr. attached to Co per S. Q. B. Adgns Fort Macomb La Oct-25-65

Book mark:

J. H. Wright

(358)

Copyist.

P

10 H. Art'y. | U. S. C. T.

Charles Rossig

Ordnance, Co. M, 10 Reg't U. S. Col'd H. Art'y.

Appears on

Company Muster Roll

for *Jan & Feb*, 186*6*.

Present or absent *Present*

Stoppage, \$ *100* for

Due Gov't, \$ *100* for

Valuation of horse, \$ *100*

Valuation of horse equipments, \$ *100*

Remarks: *For 3 re enlistment -
Hi for Mo*

Book mark:

W. H. Wright

P

10 H. Art'y. | U. S. C. T.

Charles Rossig

Crd Sgt., Co. M, 10 Reg't U. S. Col'd H. Art'y.

Appears on

Company Muster Roll

for March & Apr, 1866.

Present or absent Present

Stoppage, \$ 100 for

Due Gov't, \$ 100 for

Valuation of horse, \$ 100

Valuation of horse equipments, \$ 100

Remarks: Dec for 3 Re Enlistment:
#4 per Month
Attached.

By comparison

Book mark:

at 1/2 night

P

10 H. Art'y. | U. S. C. T.

Charles Rossig

Cad Sgt, Co. M, 10 Reg't U. S. Col'd H. Art'y.

Appears on

Company Muster Roll

for *May & June*, 186*6*.

Present or absent *Present*

Stoppage, \$ *100* for

Due Gov't, \$ *100* for

Valuation of horse, \$ *100*

Valuation of horse equipments, \$ *100*

Remarks: *Due for 3 Re-Enlist-
4.⁰⁰ per Month*

Book mark:

S. H. Wright

(358)

Copyist.

Charles Rossig

Ord Sjt, Co. M, 10 Reg't U. S. Col'd H. Art'y.

Appears on

Company Muster Roll

for *July & Aug*, 186*6*.

Present or absent

Stoppage, \$ 100 for

Due Gov't, \$ 100 for

Valuation of horse, \$ 100

Valuation of horse equipments, \$ 100

Remarks: *For 3 Re-Enlistment*
H. per Mo
Attached

Ad out by company

Book mark:

V. H. Wright

U.S. Col'd

Private | Private

CARD NUMBERS

5487879.

- 26
- 27
- 28
- 29
- 30
- 31
- 32
- 33
- 34
- 35
- 36
- 37
- 38
- 39
- 40
- 41
- 42
- 43
- 44
- 45
- 46
- 47
- 48
- 49
- 50

Book Mark:

See also 77 U.S. G. Sup

P | 10 H.A. | U.S.C.T.

Monday Prothro
Co., Co. 10 Reg't U. S. Col'd H.A.

Appears on

M. and D. Roll of Men Transferred

to the organization named above,

from *reg't U. S. Col'd Inf.*

Roll dated *Camp Parapetda 11*, 186*4*.

When enlisted *May 6*, 186*4*.

Period for which enlisted *3* years.

When mustered in *May 13*, 186*4*.

Present or absent

Company to which assigned

Remarks: *Died Aug 8. 64 at
St Phillip's da of
Disease of the heart*

*name not taken up
on muster rolls of Regt*

Book mark :

W. H. Scott

Co. M., 10 U.S. Col'd H. Art

Private

Private

CARD NUMBERS.

1	5488021.	26
2	5487831.	27
3	5514369.	28
4	5514519.	29
5	5514745.	30
6	5514857.	31
7	5514968.	32
8	5515033.	33
9	5515107.	34
10	5515299.	35
11	9123709.	36
12		37
12		38
14		39
15		40
16		41
17		42
18		43
19		44
20		45
21		46
22		47
23		48
24		49
25		50

Book Mark:

See also *77 U.S. G. I.*

M. J. Worley

47.

S. 1411475 and W. 9
S. 1424330 POM, Y.M.
R. 500700
S. 1664834 P.O. aff

P | 10 H. Art'y. | U.S.C.T.

Caesar Pondhomme

....., Co. M, 10 Reg't U. S. Col'd H. Art'y.

Appears on

Company Descriptive Book

of the organization named above.

DESCRIPTION.

Age 38 years; height 5 feet 6 inches.

Complexion *black*

Eyes *dark*; hair *black*

Where born *Natchitoches La*

Occupation *Laborer*

ENLISTMENT.

When *May 6*, 1864.

Where *New Orleans La*

By whom *J. H. Darling*; term *3* y'rs.

Remarks: *Recd by transfer from
Co I 77 W. S. C. I. per S/O 66
Hd Qrs Dept La Sept 22
1865. Died in Post Hospital
Baton Rouge La Oct. 9, 1866
of Cholera Final Statement
rendered*

W. M. Callorn

(383g)

Copyist.

P | 10 H. Art'y. | U.S.C.T.

Seamus Pondhomme

P, Co. *M*, 10 Reg't U. S. Col'd H. Art'y.

Age years.

Appears on

Company Muster Roll*

for *Sept - Oct*, 186*5*.

Joined for duty and enrolled:

When *May 6*, 186*4*.

Where *N Orleans*

Period *3* years.

Mustered in:

When *May 13*, 186*4*.

Where *N Orleans*

Present or absent *Present*

Stoppage, \$ *100* for

Due Gov't, \$ *100* for

Valuation of horse, \$ *100*

Valuation of horse equipments, \$ *100*

Remarks :
.....
.....

*First current roll. No muster-in roll of this company on file.

Book mark :
.....

A. H. Wright

Q 1076A U.S.C.T.

Leasar Proudhomme
Priv, Co M, 10 Reg't U. S. Col'd *Holl*

Appears on

M. and D. Roll of Men Transferred

to the organization named above,

from *4th U.S. Col Inf*

Roll dated *Camp Onapitda Oct 1, 1865*

When enlisted *May 6*, 186*4*

Period for which enlisted *3* years.

When mustered in *May 13*, 186*4*

Present or absent

Company to which assigned *M*

Remarks: *Rec'd by transfer*
from Co D. 4th U.S. Col.
per S.O. 66. d/Sept 22
Sept 22, 65.

Book mark :

W. H. Scott

O 106a U.S.C.T.

Ceasar Proudhomme
Priv., Co. M 10 Reg't U. S. Col'd 106

Appears on

M. and D. Roll of Men Transferred

to the organization named above,

from 24 U. S. Col. Inf

Roll dated Camp Parapet, Va., 1864.

When enlisted May 6, 1864.

Period for which enlisted 3 years.

When mustered in May 13, 1864.

Present or absent Present

Company to which assigned M

Remarks: Joined at Orig
Organization of Co

Book mark :

Wm Scott

P

10 H. Art'y. | U. S. C. T.

Cesar Proudhomme

P, Co. M, 10 Reg't U. S. Col'd H. Art'y.

Appears on

Company Muster Roll

for Nov & Dec, 1865.

Present or absent Present-

Stoppage, \$ 100 for

Due Gov't, \$ 100 for

Valuation of horse, \$ 100

Valuation of horse equipments, \$ 100

Remarks:

Book mark:

(358)

A. T. Wright-

Copyist.

P

| 10 H. Art'y. | U. S. C. T.

Cesar Pouchomme

P, Co. M, 10 Reg't U. S. Col'd H. Art'y.

Appears on

Company Muster Roll

for *Jan & Feb*, 186*6*.

Present or absent *Present*

Stoppage, \$ *100* for

Due Gov't, \$ *100* for

Valuation of horse, \$ *100*

Valuation of horse equipments, \$ *100*

Remarks:

Book mark:

(358)

W. H. H. H. H.

Copyist.

P

10 H. Art'y. | U. S. C. T.

Cesar Pouchomme

P, Co. M, 10 Reg't U. S. Col'd H. Art'y.

Appears on

Company Muster Roll

for *March & Apr*, 186*6*.

Present or absent *Present*

Stoppage, \$ 100 for

Due Gov't, \$ 100 for

Valuation of horse, \$ 100

Valuation of horse equipments, \$ 100

Remarks:

Book mark: -----

(358)

W. H. Wright

Copyist.

Cesar Pondhomme

P, Co. M, 10 Reg't U. S. Col'd H. Art'y.

Appears on

Company Muster Roll

for *May & June*, 186*6*.

Present or absent *Present*

Stoppage, \$ *100* for

Due Gov't, \$ *100* for

Valuation of horse, \$ *100*

Valuation of horse equipments, \$ *100*

Remarks:

Book mark:

L. H. Wright

P

10 H. Art'y. | U. S. C. T.

Caesar Pondhomme

P, Co. M, 10 Reg't U. S. Col'd H. Art'y.

Appears on

Company Muster Roll

for July & Aug, 1866.

Present or absent Present

Stoppage, \$ 100 for

Due Gov't, \$ 100 for

Valuation of horse, \$ 100

Valuation of horse equipments, \$ 100

Remarks:

Book mark:

W. T. Wright

(358)

Copyist.

B

10 H. Art'y. | U. S. C. T.

Cesar Broudhomme

But., Co. M, 10 Reg't U. S. Col'd H. Art'y.

Appears on

Company Muster Roll

for Sep & Oct, 1866.

Present or absent

Stoppage, \$ 100 for

Due Gov't, \$ 100 for

Valuation of horse, \$ 100

Valuation of horse equipments, \$ 100

Remarks: Died in Post Hospital
Baton Rouge, La. Oct 9/66. of
Cholera. Final statement for-
warded.

Book mark:

Rever

9

Caeser Broudhomme

Sgt., Co. M, 10 Reg't U. S. Col'd H. Art'y.

Appears on Co. Muster-out Roll, dated

Baton Rouge La, Feb 27 1867.

Muster-out to date _____, 186 .

Last paid to _____, 186 .

Clothing account:

Last settled _____, 186 ; drawn since \$ _____ 100

Due soldier \$ _____ 100; due U. S. \$ _____ 100

Am't for cloth'g in kind or money adv'd \$ _____ 100

Due U. S. for arms, equipments, &c., \$ _____ 100

Bounty paid \$ _____ 100; due \$ _____ 100

Remarks: joined by brass from Co. D

77 U.S. for S.W. Co. 66 Ho Dept

La Dep 22/65 as Pvt killed at

Post Stop. at Baton Rouge La Oct

9/66. Final statements rendered

Book mark: V 115 P 203. 70

Reuter

Pondhonne, Leaver

P. Co. M, 10 Reg' uscta

2 Enclosures.

Red Cards	Descriptive Lists
Burial Records <i>1</i>	Final Statements <i>1</i>
Certs. of Dis. for Discharge	Furloughs
C. M. Charges	Med. Des. Lists
Med. Certificates	Orders

Other papers relating to—

Admission to Hosp'l	Furlough
Casualty Sheet (Officer's)	Med. Examination
Confinement	Misc. Information
Contracts	Pay or Clothing
Death or Effects	Personal Reports
Desertions	Rank
Discharge from Hosp'l	Transfer to Hosp'l
Discharge from Service	Transfer to V. R. C.
Duty	Transportation

Ceaser Proudhonius
Pt. M 10 yca (H.A.)
Oct. 9. 1866.

Baton Rouge
La.

Div sent for 400 Oct 22, 66

FINAL STATEMENT

OF
Oran Touchman of "M" Co
10th Reg't of MeCA (Hq)

VOLUNTEERS.
Aud Oct 9th 1866

NOTE 1.—Two of these certificates (or duplicates) are to be given to each Volunteer Soldier or drafted man who may be discharged previously to the discharge of his company, that he may at once receive from the Paymaster the pay, &c., due him, and the cap'tain or other COMMISSIONED officer commanding the company will certify to the act of the delivery of the duplicate certificates; on these certificates the Soldier is "entitled to" his discharge, and should also present his discharge to the Paymaster to have the payment endorsed on it. The discharge is to be given back to the Soldier by the Paymaster; the latter only retaining as his voucher the duplicate certificates.

NOTE 2.—If the Soldier is entitled to pay for the use of his horse, the Company Commander will certify to that fact on the back of both these final statements, and also to the time he has pay due for having been so mounted on his own horse.

NOTE 3.—When a Soldier is furnished with final statements, his descriptive list, if he has one, should be taken up by the officer who gives the Soldier these statements, and endorsed with a statement to this effect by the officer. This endorsement should exhibit a full statement of the time for which the Soldier was allowed pay on his final statements, the clothing account, and all other charges against him or in his favor, so as to comprise a complete exhibit of his account. It will then be transmitted to the company commander of the Soldier, who will enter all the data necessary to a full understanding of the Soldier's account on the muster roll upon which the Soldier's discharge is reported. The descriptive list will then be destroyed. The object of this is, that the remaining portion of the Soldier's account may be settled upon the receipt of these muster rolls, and the Soldier receive any pay or allowances that may be due him at the time of his discharge, and which may not appear on his final statements from the fact that his descriptive list is incomplete. These accounts for back pay, &c., are settled by the 2d Auditor of the Treasury Department.

NOTE 4.—Charges for loss or injury to ordnance, horse equipments, and other miscellaneous charges, should appear under the heading of "Other Stoppages."

NOTE 5.—Bounty paid by State authorities, and not by the United States, will not be entered on this statement.

NOTE 6.—Amounts due the Sutler and Laundress must be entered on the muster roll on which the discharge, death, desertion, &c., is reported, as well as on the final statement, otherwise the amount cannot be collected from the United States.

NOTE 7.—This blank will be used for deceased volunteers and drafted men, as well as for others.

NOTE 8.—Where a Soldier dies in Hospital or on detached service, his descriptive list, if he has one, should be sent with his final statements, in duplicate, to the Adjutant General, Washington, D. C.

ADJUTANT GENERAL
Dec 10th 1866
Duplicate with inventory sent 2d Auditor.

RECEIVED
OCT 20 1866
OFFICE OF THE ADJUTANT GENERAL

[Handwritten signature]

I certify, on honor, that Casa Touchonne, Private of
Captain A. S. Pickens Company (M) of the 10th Regiment of U. S. C. Artillery
VOLUNTEERS, of the State of _____, born in La Chesapeake, State
of Louisiana, aged 38 years; 5 feet 6 inches high; Dark complexion.
Dark eyes, Black hair, and by occupation a Labourer, having joined the company on
its original organization at _____, and enrolled in it at the muster into
the service of the United States at _____, on the _____ day

of _____, 1864, or was mustered in service as a recruit, by Quintus
Chamberlain, at New Orleans, on the 1st day of May,
1864; or was drafted and mustered into the service of the United States from the _____
Enrollment District of the State of _____, at _____,
on the _____ day of _____, 186 , to serve in the Regiment, for
the term of Three years; and having served **HONESTLY** and
FAITHFULLY with his Company in Dept of the Gulf to the present date, is now
entitled to a **DISCHARGE** by reason of Death.

Headquarters Baton Rouge La Oct 9th 1866 of Cholera
The said Casa Touchonne was last paid by Paymaster
Wm. C. Gutter to include the 31st day of June, 1866, and has
pay due him from that time to the present date; he is entitled to pay and subsistence for
TRAVELING to place of enrollment, and whatever other allowances are authorized to volunteer
soldiers, drafted men, or militia, so discharged. He has received from the United States **CLOTHING**
amounting to _____ 100 dollars, since the _____ day of _____,
186 , when his clothing account was last settled. He has received from the United States
_____ 100 dollars advanced **BOUNTY**.

There is to be stopped from him, on account of the State of _____, or other
authorities, for **CLOTHING**, &c., received on entering service, _____ 100 dollars; and
for other stoppages, viz:

Due soldier for clothing not drawn, 24th two 1/2 yrs Colours 4th 1/2 yrs
_____ 100 dollars.

He has been furnished with **TRANSPORTATION** in kind from the place of his discharge to
_____ ; and he has been **SUBSISTED** for **TRAVELING** to his
place of enrollment, up to the _____, 186 .

He is indebted to _____, **SUTLER**, _____ 100 dollars.

He is indebted to _____, **LAUNDRESS**, _____ 100 dollars.

Given in Duplicate, at Baton Rouge La, this 9th day
of October, 1866.

Henry A. Dixon
Captain 10th U.S. Art.
Commanding Company.

10 U.S. Col'd H. A.

Private

Private

CARD NUMBERS.

1	5486961	26
2	5507078	27
3	5507252	28
4	5507294	29
5	5507334	30
6	5507365	31
7	5507511	32
8	5507659	33
9	5507800	34
10	5507943	35
11	5508080	36
12	5508214	37
13	5508441	38
14	5508590	39
15	5508742	40
16	5508889	41
17	5509035	42
18	5509156	43
19	5509304	44
20	5509412	45
21		46
22		47
23		48
24		49
25		50

Book Mark:

See also

Eugene Provost

Appears with rank of Private on

Muster and Descriptive Roll of a Detachment of U. S. Vols. forwarded

(I H. a. c. d. a.)
for the 10 Reg't U. S. C. H. a. Roll dated

New Orleans La, Apr 3, 1864.

Where born Opelousas La.

Age 20 yrs; occupation Laborer

When enlisted Mch. 29, 1864.

Where enlisted New Orleans

For what period enlisted 3 years.

Eyes Black; hair Black

Complexion Black; height 5 ft. 5 1/2 in.

When mustered in Apr. 3, 1864.

Where mustered in New Orleans

Bounty paid \$ 100; due \$ 100

Where credited

Company to which assigned G

Remarks:

Filed ^{11/11} Eugene Provost

Book mark:

Galligan

⁶⁰
Eugene Provant
Co. G, 7 Reg't U. S. Col'd H. Art'y.*

Appears on
Company Muster Roll
for term enrollment to Apr 30, 1864.

Present or absent Present

Stoppage, \$ 100 for

Due Gov't, \$ 100 for

Valuation of horse, \$ 100

Valuation of horse equipments, \$ 100

Remarks:

* This organization subsequently became Co. , 10 Reg't U. S. Colored Heavy Artillery.

Book mark: -----

E. H. Bann
(358) Copyist.

C

10 H. Art'y.

U.S.C.T.

Eugene Provant
Pt. Co. E, 7 Reg't U. S. Col'd H. Art'y.*

Appears on

Company Muster Roll

for *May & June*, 186*4*.

Present or absent *Present*

Stoppage, \$ 100 for

Due Gov't, \$ 100 for

Valuation of horse, \$ 100

Valuation of horse equipments, \$ 100

Remarks:

* This organization subsequently became Co. , 10 Reg't U. S. Colored Heavy Artillery.

Book mark:

E. H. Brown

(358)

Copyist.

P

10 H. Art'y. U.S.C.T.

Eugene Provant

Co. G, 10 Reg't U. S. Col'd H. Art'y.

Appears on

Company Muster Roll

for July & Aug, 1864.

Present or absent Present

Stoppage, \$ 100 for

Due Gov't, \$ 100 for

Valuation of horse, \$ 100

Valuation of horse equipments, \$ 100

Remarks:

Book mark:

E. H. Brown

P

10 H. Art'y. | U.S.C.T.

Eugene Provant

Appears with rank of *serge* on

Muster and Descriptive Roll of a Detachment of U. S. Vols. forwarded

organized as Co G.
for the *10th* Reg't *U.S. Col'd Hea.* Roll dated

New Orleans La. Sept 20, 1864.

Where born *Opaloussa La*

Age *20* y'rs; occupation *servant*

When enlisted *Feb 29*, 1864.

Where enlisted *New Orleans*

For what period enlisted *3* years.

Eyes *Blk*; hair *Blk*

Complexion *Yellow*; height *5* ft. *5 1/2* in.

When mustered in *Apr 3*, 1864.

Where mustered in *New Orleans*

Bounty paid \$ *100*; due \$ *100*

Where credited *to New Orleans*

Company to which assigned *G.*

Remarks:

Filed with Eugene Provant

Book mark:

E. B. Thompson
Copyist.

(339)

P

10 H. Art'y. U.S.C.T.

Eugene Provant
Capt., Co. G, 10 Reg't U. S. Col'd H. Art'y.

Appears on

Company Muster Roll

for Sept + Oct, 1864.

Present or absent Present

Stoppage, \$100 for

Due Gov't, \$100 for

Valuation of horse, \$100

Valuation of horse equipments, \$100

Remarks: Diff. of pay due between \$7
& \$13 from date of enlistment to May 1/64
& between \$7 & \$6 from May 1 to June
30. Promoted Capt Sept 20/64

Book mark:

E. H. Brown

P

10 H. Art'y. | U.S.C.T.

Eugene Prvant

Capt., Co. G, 10 Reg't U. S. Col'd H. Art'y.

Appears on

Company Muster Roll

for Nov Dec, 1864.

Present or absent Present

Stoppage, \$ 100 for

Due Gov't, \$ 100 for

Valuation of horse, \$ 100

Valuation of horse equipments, \$ 100

Remarks: Has rec'd but \$ 7. per month.

Book mark:

E. H. Brown.

9

10 H. Art'y.

U.S.C.T.

Engene Provant
Co. G, Co. G, 10 Reg't U. S. Col'd H. Art'y.

Appears on

Company Muster Roll

for *Jan & Feby*, 1865.

Present or absent *Present*

Stoppage, \$ 100 for

Due Gov't, \$ 100 for

Valuation of horse, \$ 100

Valuation of horse equipments, \$ 100

Remarks: *Rec'd. but \$ 7 pr*
Mo. from Enrollment
to June 30/64

Book mark: *1000000*

J. E. Porter

P

10 H. Art'y. U.S.C.T.

Engene Provant

Co. G, 10 Reg't U. S. Col'd H. Art'y.

Appears on

Company Muster Roll

for Mar & April, 1863.

Present or absent Present

Stoppage, \$ 100 for

Due Gov't, \$ 100 for

Valuation of horse, \$ 100

Valuation of horse equipments, \$ 100

Remarks: Received but 7 per Mo from Enrollment to June 30/64

Book mark:

F. E. Porter

P

10 H. Art'y. U.S.C.T.

Engine Provant
Corp., Co. G, 10 Reg't U. S. Col'd H. Art'y.

Appears on

Company Muster Roll

for May & June, 1865.

Present or absent Present

Stoppage, \$ 100 for

Due Gov't, \$ 100 for

Valuation of horse, \$ 100

Valuation of horse equipments, \$ 100

Remarks: Received but \$7 per
Mo from Enrollment
to June 30/65

Book mark:

F. E. Porter

(358)

Copyist.

P

10 H. Art'y.

U.S.C.T.

Engine Provant
Corp, Co. G, 10 Reg't U. S. Col'd H. Art'y.

Appears on

Company Muster Roll

for *July & Aug*, 186*5*.

Present or absent *Present*

Stoppage, \$ 100 for

Due Gov't, \$ $\frac{07}{100}$ for *6 & 9 Equip*

age lost or destroyed

Valuation of horse, \$ 100

Valuation of horse equipments, \$ 100

Remarks:

Book mark: -----

J. E. Porter

P

10 H. Art'y. | U.S.C.T.

Emogene Provant
Corpl, Co. G, 10 Reg't U. S. Col'd H. Art'y.

Appears on

Company Muster Roll

for *Sept & Oct*, 186*5*.

Present or absent *Present*

Stoppage, \$ *100* for

Due Gov't, \$ *100* for

Valuation of horse, \$ *100*

Valuation of horse equipments, \$ *100*

Remarks:

Book mark:

F. E. Porter

BP

10 H. Art'y.

U.S.C.T.

Eugene Prorant
Prorant
Prorant
Co. G, 10 Reg't U. S. Col'd H. Art'y.

Appears on

Company Muster Roll

for *Nov: 4 Dec.*, 186*0*.

Present or absent *Present*

Stoppage, \$ *100* for

Due Gov't, \$ *100* for

Valuation of horse, \$ *100*

Valuation of horse equipments, \$ *100*

Remarks: *Reduced from*
Corp. Dec. 25, 1865

borned by Worley 27.

Book mark:

G. Fox

(358)

Copyist.

P

10 H. Art'y. U.S.C.T.

Eugene Provan

Privt, Co. G, 10 Reg't U. S. Col'd H. Art'y.

Appears on

Company Muster Roll

for *Jan. & Feb.*, 1866.

Present or absent *Present*

Stoppage, \$ *100* for

Due Gov't, \$ *100* for

Valuation of horse, \$ *100*

Valuation of horse equipments, \$ *100*

Remarks:

Book mark:

G. Fry

P

10 H. Art'y. U.S.C.T.

Eugene Provant
Co. G, 10 Reg't U. S. Col'd H. Art'y.

Appears on

Company Muster Roll

for Mar. 9 Apr., 1866.

Present or absent Present

Stoppage, \$ 160/100 for C.C. & G.E.
lost

Due Gov't, \$ 100 for

Valuation of horse, \$ 100

Valuation of horse equipments, \$ 100

Remarks:

Book mark:

G. F. W.

(358)

Copyist.

P

10 H. Art'y. | U.S.C.T.

Eugene Provant
Priv, Co. G, 10 Reg't U. S. Col'd H. Art'y.

Appears on

Company Muster Roll

for *May & June*, 1866.

Present or absent *Present*

Stoppage, \$ *100* for

Due Gov't, \$ *100* for

Valuation of horse, \$ *100*

Valuation of horse equipments, \$ *100*

Remarks:

Book mark:

G. F. M.

P

10 H. Art'y.

U.S.C.T.

Eugene Provant

Priv, Co. G, 10 Reg't U. S. Col'd H. Art'y.

Appears on

Company Muster Roll

for *July & Aug*, 186*6*.

Present or absent *Present*

Stoppage, \$.....*100* for

Due Gov't, \$.....*100* for

Valuation of horse, \$.....*100*

Valuation of horse equipments, \$.....*100*

Remarks:.....

Book mark:.....

(358)

G. Fri

Copyist.

P

10 H. Art'y.

U.S.C.T.

Eugene Provand
Pvt, Co. G, 10 Reg't U. S. Col'd H. Art'y.

Appears on

Company Muster Roll

for *Sept & Oct*, 1866.

Present or absent *Present*

Stoppage, \$.....100 for

Due Gov't, \$.....100 for

Valuation of horse, \$.....100

Valuation of horse equipments, \$.....100

Remarks:

Book mark:

Wines

P

10 H. Art'y.

U.S.C.T.

Eugene Provant

Pvt, Co. G, 10 Reg't U. S. Col'd H. Art'y.

Appears on

Company Muster Roll

for Nov & Dec, 1866.

Present or absent Present

Stoppage, \$ 100 for

Due Gov't, \$ 100 for

Valuation of horse, \$ 100

Valuation of horse equipments, \$ 100

Remarks:

Book mark:

Wines

P

10 H. Art'y. U.S.C.T.

Eugene Provant

Pvt, Co. G, 10 Reg't U. S. Col'd H. Art'y.

Appears on Co. Muster-out Roll, dated

Baton Rouge La, Feb 22, 1867.

Muster-out to date Feb 22, 1867.

Last paid to Dec 31, 1866.

Clothing account:

Last settled....., 186 ; drawn since \$.....100

Due soldier \$ 73 ⁶³/₁₀₀; due U. S. \$.....100

Am't for cloth'g in kind or money adv'd \$.....100

Due U. S. for arms, equipments, &c., \$.....6 ⁰⁰/₁₀₀

Bounty paid \$.....100; due \$ 300 ⁰⁰/₁₀₀

Remarks: Joined at Arpt, Arpt, Arpt, Pvt. to Sept 20, 1864. Corp to Dec 25, 1865

Book mark:

Wines

Private

Private

CARD NUMBERS.

1	5497644	26
2	5497888	27
3	5498042	28
4		29
5		30
6		31
7		32
8		33
9		34
10		35
11		36
12		37
13		38
14		39
15		40
16		41
17		42
18		43
19		44
20		45
21		46
22		47
23		48
24		49
25		50

Book Mark: A-33-V-11 RCD-1867

See also

P | 10 H. Art'y. | U.S.C.T.

Engene Perent

Pr, Co. C, 1 Reg't H. Art'y, Corps d'Afrique.*

Age *21* years.

Appears on

Company Muster-in Roll

of the organization named above. Roll dated

• *New Orleans La*, *Aug 17*, 1863.

Muster-in to date *Aug 17*, 1863.

Joined for duty and enrolled:

When *June 23*, 1863.

Where *Camp Perent La*

Period *3* years.

Valuation of horse, \$ *100*

Valuation of horse equipments, \$ *100*

Remarks: _____

* This organization subsequently became Co. C, 10 Reg't U. S. Colored Heavy Artillery.

Book mark: _____

Esperance

P | 10 H. Art'y. | U.S.C.T.

Engine - Present

Pvt., Co, C, 1 Reg't La. Art'y Native Guards.*

Appears on

Company Muster Roll

for *Aug 11th to 31st*, 1863 .

Present or absent *Present*

Stoppage, \$ 100 for

Due Gov't, \$ 100 for

Valuation of horse, \$ 100

Valuation of horse equipments, \$ 100

Remarks : _____

* This organization subsequently became Co. C, 10 Reg't U. S. Col'd Heavy Artillery.

Book mark : _____

Efficiency

Eugene . Parent

Pvt, Co, C, 1 Reg't La. Art'y Native Guards.*

Appears on

Company Muster Roll

for *Sept & Oct*, 1863 .

Present or absent *Present*

Stoppage, \$ *100* for

Due Gov't, \$ *100* for

Valuation of horse, \$ *100*

Valuation of horse equipments, \$ *100*

Remarks :

Not on Sub. rolls of Co

* This organization subsequently became Co. C, 10 Reg't U. S. Col'd Heavy Artillery.

Book mark :

W. J. ...

10 U.S. Col'd H. A.

Private

Private

CARD NUMBERS.

1	26
2	27
3	28
4	29
5	30
6	31
7	32
8	33
9	34
10	35
11	36
12	37
13	38
14	39
15	40
16	41
17	42
18	43
19	44
20	45
21	46
22	47
23	48
24	49
25	50

Le Provant Eugene

Book Mark:

See also

Co G, 10 U.S. Col'd H. Art

Private

Private

CARD NUMBERS.

1	26
2	27
3	28
4	29
5	30
6	31
7	32
8	33
9	34
10	35
11	36
12	37
13	38
14	39
15	40
16	41
17	42
18	43
19	44
20	45
21	46
22	47
23	48
24	49
25	50

Le Provant Eugene

Book Mark:

See also

Private Private

CARD NUMBERS.

1	5487104	26
2	5504762	27
3	5504890	28
4	5505021	29
5	5505132	30
6	5505266	31
7	5505360	32
8	5505464	33
9	5489227	34
10	5505569	35
11	5489232	36
12	5505678	37
13	5489235	38
14	5505830	39
15	5505984	40
16	5506129	41
17	5506255	42
18	5506399	43
19	5489260	44
20	5506518	45
21	5506720	46
22	5506837	47
23	5506934	48
24		49
25		50

Book Mark:

See also

P

10 H. Art'y. U.S.C.T.

Alexander Gunden

Appears with rank of *Priv* on

Muster and Descriptive Roll of a Detachment of U. S. Vols. forwarded

for the *7* Reg't *U.S.C.H. Art'y** Roll dated

New Orleans La, June 4, 1864.

Where born *Natchitoches La*

Age *25* y'rs; occupation *Labourer*

When enlisted *May 26*, 1864

Where enlisted *New Orleans*

For what period enlisted *3* years.

Eyes *Blk*; hair *Blk*

Complexion *Blk*; height *5* ft. *8* in.

When mustered in *June 4*, 1864.

Where mustered in *New Orleans*

Bounty paid \$ *100*; due \$ *100*

Where credited

Company to which assigned

Remarks:

*

Became 10 U.S. Cold H. Art'y

Book mark:

S. Williams

P | 10 H. Art'y. | U.S.C.T.

Alexander Pouden

Pvt., Co. *F*, 7 Reg't U. S. Col'd H. Art'y.*

Appears on

Company Muster-in and Descriptive Roll
of the organization named above. Roll dated

New Orleans La, Aug 19, 1864.

Where born *Natchitoches La*

Age *23* y'rs; occupation *Laborer*

When enlisted *May 26*, 1864.

Where enlisted *New Orleans La*

For what period enlisted *3* years.

Eyes *Blk*; hair *Blk*

Complexion *Blk*; height *5* ft. *8* in.

When mustered in *June 4*, 1864.

Where mustered in *New Orleans La*

Bounty paid \$ *100*; due \$ *100*

Where credited *1st Enrlt Dist La*

Company to which assigned

Remarks:

* This organization subsequently became Co. *F*, 10 Reg't U. S. Colored Heavy Artillery.

Book mark:

Rosenbaum

(356d)

Copyist.

P

10 H. Art'y.

U.S.C.T.

Alexander Poudem

Pvt., Co. F., 7 Reg't U. S. Col'd H. Art'y.*

Appears on

Company Muster Roll

for May & June, 1864.

Present or absent. Absent

Stoppage, \$ 100 for

Due Gov't, \$ 100 for

Valuation of horse, \$ 100

Valuation of horse equipments, \$ 100

Remarks: Detached in Recruiting Depot U. S. C. T. New Orleans La by special orders No 39. Hd Qrs 7th U. S. H. A. June 10-64

* This organization subsequently became Co. F, 10 Reg't U. S. Colored Heavy Artillery.

Book mark:

Rosenbaum

(358)

Copyist.

P

10 H. Art'y. U.S.C.T.

Alexander Pouders

Private, Co. F, 10 Reg't U. S. Col'd H. Art'y.

Appears on

Company Muster Roll

for July & August, 1864.

Present or absent Absent

Stoppage, \$ 100 for

Due Gov't, \$ 100 for

Valuation of horse, \$ 100

Valuation of horse equipments, \$ 100

Remarks: On detached duty at Recty Depot U.S.C.T. N.C. since June 10-1864

Book mark:

Rosenbaum

P

10 H. Art'y. U.S.C.T.

Alexander Prudem

Pvt., Co. F, 10 Reg't U. S. Col'd H. Art'y.

Appears on

Company Muster Roll

for Sept & Oct, 1864.

Present or absent Absent

Stoppage, \$ 100 for

Due Gov't, \$ 100 for

Valuation of horse, \$ 100

Valuation of horse equipments, \$ 100

Remarks: On detached service at Rectg depot U.S.C.T. since June 10-1864

Book mark:

Rosenbaum

P

10 H. Art'y. U.S.C.T.

Alexander Pruden

Pvt., Co. F, 10 Reg't U. S. Col'd H. Art'y.

Appears on

Company Muster Roll

for Nov & Dec, 1864.

Present or absent absent

Stoppage, \$ 100 for

Due Gov't, \$ 100 for

Valuation of horse, \$ 100

Valuation of horse equipments, \$ 100

Remarks: On detached service at
Rec'g depot. U.S. C.T. A.C.
La since June 10-1864
S.O. 39 Ext Hd Lrs 7 U.S.
A.A.(C)

Book mark:

Rosenbaum

P

10 H. Art'y. U.S.C.T.

Alexander Baudem

Priv., Co. F, 10 Reg't U. S. Col'd H. Art'y.

Appears on

Company Muster Roll

for Jan & Feb, 1865.

Present or absent Absent

Stoppage, \$ 100 for

Due Gov't, \$ 100 for

Valuation of horse, \$ 100

Valuation of horse equipments, \$ 100

Remarks: On detached service at Rectg Depot U.S.C.T., N.C., La., since June 10/64 S.C. Ex. 1 Ad. Trs. 7th U.S.N.A. (C.)

Book mark:

B G Masdon

P

10 H. Art'y. U.S.C.T.

Alexander Pruden

Priv., Co. F, 10 Reg't U. S. Col'd H. Art'y.

Appears on

Company Muster Roll

for *March April*, 1865.

Present or absent *Absent*

Stoppage, \$ *100* for

Due Gov't, \$ *100* for

Valuation of horse, \$ *100*

Valuation of horse equipments, \$ *100*

Remarks: *On detached service
at Recty Depot N.O. La,
per S.O. 54 Ex 1 Ad. Lrs,
Dept. Gulf Feb. 26/65*

Book mark:

B G Wasdon

(358)

Copyist.

I | *10th Reg't* | **U.S.C.T.**

Alexander Prudent
Priv, Co. *D*, *10* Reg't U. S. Col'd *10th*

Appears on a

Detachment Muster Roll

of the organization named above

for *March & April*, 1865.

Station *New Orleans, La*

Present or absent *Present*

Stoppage, \$ *100* for

Due Gov't, \$ *100* for

Valuation of horse, \$ *100*

Valuation of horse equipments, \$ *100*

Remarks: *Detached from Co D*
10th U.S. Col'd Army (Heavy)
by A.O. No. 5471 Ans. Dept
of the Gulf Feb. 26, 1865

Book mark:

(844)

Croghan

Copyist.

P

10 H. Art'y. U.S.C.T.

Alexander Pruden
Priv., Co. F, 10 Reg't U. S. Col'd H. Art'y.

Appears on

Company Muster Roll

for May & June, 1865.

Present or absent Absent

Stoppage, \$ 100 for

Due Gov't, \$ 100 for

Valuation of horse, \$ 100

Valuation of horse equipments, \$ 100

Remarks: On detached service
at Rect's Depot, U.S.C.T.,
N.D., La. per S.O. 54 E. Hd.
2nd Dept. Gulf Feb 18/65

Book mark:

B G Wason

P 110 H A U.S.C.T.

Alexander Pruden
Priv., Co. E, 10 Reg't U. S. Col'd H A

Appears on a

Detachment Muster Roll

of the organization named above

for May & June, 1865.

Station New Orleans, La.

Present or absent Present

Stoppage, \$ 100 for

Due Gov't, \$ 100 for

Valuation of horse, \$ 100

Valuation of horse equipments, \$ 100

Remarks: Detailed by virtue
of the following order H A
Br. Div. G. New Orleans, La
Feb. 26, 1865, Special order
(nr)

Book mark:

(844)

Croghan
Copyist.

JAN. 15

5489232

* 1881 *

No. 54. The following
named enlisted men of the
10th U. S. C. A. (74th) are detached
from their Regiment and
assigned to duty at the Recruit-
ing Depot in this city for
U. S. Colored Troops, Private
William Russell, Co. F., and
Alexander Funder Co. F. By
Command of Major General
Hewlbert - J. C. Stone, Capt
and adjt. - General

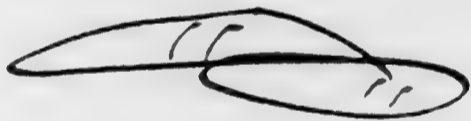

P

Alexander Pruden

Pruden, Co. F, 10 Reg't U. S. Col'd H. Art'y.

Appears on

Company Muster Roll

for dated Aug 31, 1865.

Present or absent Absent

Stoppage, \$ 100 for

Due Gov't, \$ 100 for

Valuation of horse, \$ 100

Valuation of horse equipments, \$ 100

Remarks: On detached service at mustering-out depot N.O. La, per D.O. 54 Ex 1 Hd. Qrs. Dept Gulf, dated New Orleans, La. Feb 26/65

Book mark:

B G Warden

P 110 H A | U.S.C.T.

Alexander Pruden
Priv, Co., 10 Reg't U. S. Col'd H A

Appears on a

Detachment Muster Roll

of the organization named above

for July & August, 1865.

Station New Orleans La

Present or absent Present

Stoppage, \$ 100 for

Due Gov't, \$ 100 for

Valuation of horse, \$ 100

Valuation of horse equipments, \$ 100

Remarks: Detailed for duty
by special order No. 54 da-
ted 26th Ans. Dept. of the Gulf
Feb. 26, 1865 - by order Major
(arr)

Book mark:

Corogan

(244)

Copyist.

JAN. 15

5489235

★ TEST ★

1

General Howlbest at
the Muster out Buddy-
vone, New Orleans, La.

[Signature]

0

10 H. Art'y. U.S.C.T.

Alexander Pruden

Pruden, Co. F, 10 Reg't U. S. Col'd H. Art'y.

Appears on

Company Muster Roll

for Sept & Oct, 1865.

Present or absent Absent

Stoppage, \$ 100 for

Due Gov't, \$ 100 for

Valuation of horse, \$ 100

Valuation of horse equipments, \$ 100

Remarks: On detached service at Mustering-out depot N.O. per S.O. No. 54 Hd. Qrs. Dept of the Gulf Feb. 26/65.

Book mark:

B. G. Wasson

(358)

Copyist.

P.

10 H. Art'y. U.S.C.T.

Alexander Paudens

Pat., Co. F, 10 Reg't U. S. Col'd H. Art'y.

Appears on

Company Muster Roll

for Nov. & Dec., 1865.

Present or absent Absent.

Stoppage, \$ 100 for

Due Gov't, \$ 100 for

Valuation of horse, \$ 100

Valuation of horse equipments, \$ 100

Remarks: On Detached Service at Mustering Depot, N. Orleans for S.O. 54, 2nd. 2000, D. G., Feb. 26, 65.

Book mark:

Ash Copyist.

P.

10 H. Art'y. | U.S.C.T.

Alexander Prudem.

Pvt., Co. F, 10 Reg't U. S. Col'd H. Art'y.

Appears on

Company Muster Roll

for Jan'y & Feby., 1866.

Present or absent Absent.

Stoppage, \$ 100 for

Due Gov't, \$ 100 for

Valuation of horse, \$ 100

Valuation of horse equipments, \$ 100

Remarks: On Detached Service
at New Orleans for S.O.
54 Vol. Troop, W. G. Feby 26.
65.

Book mark: 2000

Aoh.

(358)

Copyist.

P. | 10 H. Art'y. | U.S.C.T.

Alexander Paudens

Priv., Co. F, 10 Reg't U. S. Col'd H. Art'y.

Appears on

Company Muster Roll

for Mar. & April, 1866.

Present or absent Absent

Stoppage, \$ 100 for

Due Gov't, \$ 100 for

Valuation of horse, \$ 100

Valuation of horse equipments, \$ 100

Remarks: On Detached Service
in N.O. pr. S.O. No. 54,
W.D. Co., D.C., Feby. 28, 65.

Book mark: _____

P

10 H. Art'y. U.S.C.T.

Alexander Prudent

Part., Co. F, 10 Reg't U. S. Col'd H. Art'y.

Appears on

Company Muster Roll

for May & June, 1866.

Present or absent Absent

Stoppage, \$ 100 for

Due Gov't, \$ 100 for

Valuation of horse, \$ 100

Valuation of horse equipments, \$ 100

Remarks: On Detached Service in New Orleans, La. for S. O. No. 54 10d Lons, Dept. of the Gulf, Feb 26 65.

Book mark:

P 10 26 A | U.S.C.T.

Alexander Gruen
Pvt, Co F, 10 Reg't U. S. Col'd 26 A

Appears on a

Detachment Muster Roll

of the organization named above

for *May & June*, 1866.

Station *New Orleans, La*

Present or absent *Present*

Stoppage, \$ 100 for

Due Gov't, \$ 100 for

Valuation of horse, \$ 100

Valuation of horse equipments, \$ 100

Remarks: *Detailed for duty as
Teamster by S.O. No. 54 dated
26-6-66 Dept. of the Gulf Feb.
26-1865 at the Mustering Dept.*

Book mark:

Croghan

(844)

Copyist.

P. | 10th Art'y | U.S.C.T.

Alexander Pender.
Part; Co. F, 10 Reg't U. S. Col'd 7th Art'y

Appears on

Company Muster Roll

for July & Aug., 1866.

Present or absent Absent

Stoppage, \$ 100 for

Due Gov't, \$ 100 for

Valuation of horse, \$ 100

Valuation of horse equipments, \$ 100

Remarks: On Det. Service in
N. O. pr. S. O. 54 76th Ltrs.
Dept. of the Gulf, Feb. 26.
'65.

Book mark:

10

10 H. Art'y. U.S.C.T.

Alexander Radem

Plt, Co. F, 10 Reg't U. S. Col'd H. Art'y.

Appears on

Company Muster Roll

for Sept. and Oct., 1866

Present or absent Absent

Stoppage, \$ 100 for

Due Gov't, \$ 100 for

Valuation of horse, \$ 100

Valuation of horse equipments, \$ 100

Remarks:

on det. in R. O. p. S. O. No. 54 Dept. of the Gulf July 26 / 65

Book mark:

House

P

10 H. Art'y. U.S.C.T.

Alexander Pradem

Pvt, Co. F, 10 Reg't U. S. Col'd H. Art'y.

Appears on

Company Muster Roll

for Nov. and Dec, 186 Q.

Present or absent Absent

Stoppage, \$ 100 for

Due Gov't, \$ 100 for

Valuation of horse, \$ 100

Valuation of horse equipments, \$ 100

Remarks:

On detached service in
M.O. pr. S.O. No. 544
2nd Regt of the Grub. Feb
26/65

Book mark:

House

P

Alexander Pruden

B Co., 10 Reg't U. S. Col'd H. Art'y.

Appears on Co. Muster-out Roll, dated

Baton Rouge La Feb 22, 1867.

Muster-out to date Feb. 22, 1867.

Last paid to Dec 31, 1866.

Clothing account:

Last settled, 186 ; drawn since \$ 100

Due soldier \$ 110 ⁵⁰/₁₀₀; due U. S. \$ 100

Am't for cloth'g in kind or money adv'd \$ 100

Due U. S. for arms, equipments, &c., \$ 0 ¹⁵/₁₀₀

Bounty paid \$ 100; due \$ 100

Remarks: Bounty under act of July 20/66 100. Bounty under act of July 28, 66 100. Joined at original organization

Book mark:

House

Pandora Alexander

_____, Co. _____, _____ } Reg't *U S C H A*

1 Enclosures.

Bed Cards.....	Final Statements.....
Burial Records.....	Furloughs or L. of A.....
Certs. of Dis. for Discharge.....	Med. Certificates.....
C. M. Charges.....	Med. Des. Lists.....
Descriptive Lists.....	Orders.....
Discharge Certificates.....	Pris. of War Record.....
Enlistment Papers.....	Resignations.....

Other papers relating to—

Admission to Hosp'l.....	Furlough or L. of A.....
Casualty Sheet.....	Med. Examination.....
Confinement.....	Misc. Information <i>1</i>
Contracts.....	Pay or Clothing.....
Death or Effects.....	Personal Reports.....
Desertion.....	Rank.....
Discharge from Hosp'l.....	Transfer to Hosp'l.....
Discharge from Service.....	Transfer to V. R. C.....
Duty.....	Transportation.....
.....

R. 6.

1864.

New Orleans, June 8, 1864

Chas. H. Roberts
A. A. G. M. Recig Dept.

Requests Private Alexander
Phidam may be detailed
to his department.

7 U.S. H. A. (C.)

Recruiting depot. U. S. C. Troops
St. Charles La June 7th 1864

Col. S. S. Tamm.

Sup^{er} of Recruiting ^{Service} ~~Depot~~ U. S. C. Troops

Colonel.

I would request of You to detail
to My department, Alexander Prudom 7th U. S.
Heavy Artillery (Colonel), as he is a valuable man
to take care of My Stables.

Very Respectfully -
Your Obedt. Servant.
Chas^{les} H. Roberts
1st Lt. U. S. A.
Recruiting Depot
U. S. Colored Troops.

Co. E., 10 U.S. Col'd H.A.

Private.

Private

CARD NUMBERS.

1	5487147	26
2	5502430	27
3	5502646	28
4	5502782	29
5	5502912	30
6	5503027	31
7	5503145	32
8	5503256	33
9	5503365	34
10	5503472	35
11	5503612	36
12	5503760	37
13	5503894	38
14	5504037	39
15	5504166	40
16	5504279	41
17	5504402	42
18	5504500.	43
19		44
20		45
21		46
22		47
23		48
24		49
25		50

Book Mark:

See also

P

10 H. Art'y. U.S.C.T.

Abraham Prudham

Appears with rank of *Pvt* on

Muster and Descriptive Roll of a Detachment of U. S. Vols. forwarded

for the *7* Reg't *U.S.C.H. Art** Roll dated *New Orleans La, June, 1864*

Where born *Natchitoches, La*

Age *33* y'rs; occupation *Laborer*

When enlisted *April 28, 1864*

Where enlisted *Alexandria*

For what period enlisted *3* years.

Eyes *Blue*; hair *Blue*

Complexion *Blue*; height *5 ft. 6 1/4 in.*

When mustered in *June 18th, 1864*

Where mustered in *New Orleans*

Bounty paid \$ *100*; due \$ *100*

Where credited

Company to which assigned *"E"*

Remarks:

**
Became 10 U.S. Cold H. Art.*

Book mark:

S. W. Williams

(339)

Copyist.

P | 10 H. Art'y. | U.S.C.T.

Abraham Freedham
Pvt., Co. *E*, 7 Reg't U. S. Col'd H. Art'y.*

Appears on

Company Muster-in and Descriptive Roll
of the organization named above. Roll dated

New Orleans La July 5, 1864

Where born *Natchitoches La.*

Age *35* y'rs; occupation *Laborer*

When enlisted *Apr 25, 1864*

Where enlisted *Alexandria*

For what period enlisted *3* years.

Eyes *Black*; hair *Black*

Complexion *Black*; height *5 ft. 6 1/4 in.*

When mustered in *June 5, 1864*

Where mustered in *New Orleans*

Bounty paid \$ *2* 100; due \$ *100*

Where credited *Alexandria*

Company to which assigned *E*

Remarks: _____

Filed with Abraham Freedham

* This organization subsequently became Co. *E*, 10 Reg't U. S. Colored Heavy Artillery.

Book mark: _____

J. Linden
(356d) *Copist.*

P

10 H. Art'y. U.S.C.T.

Abraham Ludham

Prk Co. E, 10 Reg't U. S. Col'd H. Art'y.

Appears on

Company Muster Roll

for *July + Aug.*, 186*4*.

Present or absent *Present*

Stoppage, \$ 100 for

Due Gov't, \$ 100 for

Valuation of horse, \$ 100

Valuation of horse equipments, \$ 100

Remarks:

Book mark:

(358)

Ludham

Copyist.

P | 10 H. Art'y. | U.S.C.T.

Abraham Rudham

Pvt, Co. E, 10 Reg't U. S. Col'd H. Art'y.

Appears on

Company Muster Roll

for Sep. + Oct., 1864

Present or absent Present

Stoppage, \$ 100 for

Due Gov't, \$ 100 for

Valuation of horse, \$ 100

Valuation of horse equipments, \$ 100

Remarks:

Book mark:

(358)

Linden Copyist.

P

10 H. Art'y. | U.S.C.T.

Abraham Prudden

Pvt., Co. E, 10 Reg't U. S. Col'd H. Art'y.

Appears on

Company Muster Roll

for Nov Dec, 1864.

Present or absent Present

Stoppage, \$ 100 for

Due Gov't, \$ 100 for

Valuation of horse, \$ 100

Valuation of horse equipments, \$ 100

Remarks:

Book mark:

(358)

Linden

Copyist.

P

10 H. Art'y. U.S.C.T.

Abraham Cudham

Cvt., Co. E, 10 Reg't U. S. Col'd H. Art'y.

Appears on

Company Muster Roll

for Jan & Feb, 1865.

Present or absent Present

Stoppage, \$ 100 for

Due Gov't, \$ 100 for

Valuation of horse, \$ 100

Valuation of horse equipments, \$ 100

Remarks:

Book mark:

1865

J. C. Tyler

(358)

Copyist.

Abraham Gudham

Oct., Co. E, 10 Reg't U. S. Col'd H. Art'y.

Appears on

Company Muster Roll

for *March & Apr.*, 186*0*.

Present or absent *Present.*

Stoppage, \$ *100* for

Due Gov't, \$ *100* for

Valuation of horse, \$ *100*

Valuation of horse equipments, \$ *100*

Remarks:

Book mark:

J. H. Tyler

7

10 H. Art'y. U.S.C.T.

Abraham Gudham
Co., Co. E, 10 Reg't U. S. Col'd H. Art'y.

Appears on

Company Muster Roll

for May & June, 1865.

Present or absent Present

Stoppage, \$ 100 for

Due Gov't, \$ 100 for

Valuation of horse, \$ 100

Valuation of horse equipments, \$ 100

Remarks:

Book mark:

(358)

G. C. Tyler

Copyist.

9

10 H. Art'y. U.S.C.T.

Abraham Prudham

Prudham, Co. E, 10 Reg't U. S. Col'd H. Art'y

Appears on

Company Muster Roll

for July & Aug., 1865.

Present or absent Present

Stoppage, \$ 100 for

Due Gov't, \$ 100 for

Valuation of horse, \$ 100

Valuation of horse equipments, \$ 100

Remarks:

Book mark:

(358)

G. S. Tyler

Copyist.

Abraham Prudham
Co., Co. E, 10 Reg't U. S. Col'd H. Art'y

Appears on

Company Muster Roll

for *Sept. & Oct.*, 186*0*.

Present or absent *Present.*

Stoppage, \$ *100* for

Due Gov't, \$ *100* for

Valuation of horse, \$ *100*

Valuation of horse equipments, \$ *100*

Remarks:

Book mark:

[Signature]

P | 10 H. Art'y. | U.S.C.T.

Abraham Prudham

Priv., Co. E, 10 Reg't U. S. Col'd H. Art'y.

Appears on

Company Muster Roll

for *Nov & Dec*, 1865.

Present or absent *Present*

Stoppage, \$ 100 for

Due Gov't, \$ 100 for

Valuation of horse, \$ 100

Valuation of horse equipments, \$ 100

Remarks:

Book mark:

(358)

Hashi
Copyist.

P

10 H. Art'y. | U.S.C.T.

Abraham Prudham

Priv, Co. E, 10 Reg't U. S. Col'd H. Art'y.

Appears on

Company Muster Roll

for Jan & Feb, 1866.

Present or absent Present

Stoppage, \$ 100 for

Due Gov't, \$ 100 for

Valuation of horse, \$ 100

Valuation of horse equipments, \$ 100

Remarks:

Book mark:

Hart

Copyist.

(358)

P

10 H. Art'y. U.S.C.T.

Abraham Prudham

Pvt, Co. E, 10 Reg't U. S. Col'd H. Art'y.

Appears on

Company Muster Roll

for March & April, 1866.

Present or absent Present

Stoppage, \$ 100 for

Due Gov't, \$ 100 for

Valuation of horse, \$ 100

Valuation of horse equipments, \$ 100

Remarks:

Book mark:

Hart

Copyist.

P

10 H. Art'y. U.S.C.T.

Abraham Budham

Priv, Co. E, 10 Reg't U. S. Col'd H. Art'y

Appears on

Company Muster Roll

for May & June, 1866.

Present or absent Present

Stoppage, \$ 100 for

Due Gov't, \$ 100 for

Valuation of horse, \$ 100

Valuation of horse equipments, \$ 100

Remarks:

Book mark:

W. A. V.

P

10 H. Art'y. U.S.C.T.

Abraham Prudham

Pvt, Co. E, 10 Reg't U. S. Col'd H. Art'y.

Appears on

Company Muster Roll

for July & Aug, 1866.

Present or absent Present

Stoppage, \$ 100 for

Due Gov't, \$ 100 for

Valuation of horse, \$ 100

Valuation of horse equipments, \$ 100

Remarks:

Book mark:

Hart

J

10 H. Art'y. U.S.C.T.

Abraham Rudham

Priv, Co. E, 10 Reg't U. S. Col'd H. Art'y.

Appears on

Company Muster Roll

for *Sept. & Oct.*, 1866.

Present or absent *Present*

Stoppage, \$ *100* for

Due Gov't, \$ *100* for

Valuation of horse, \$ *100*

Valuation of horse equipments, \$ *100*

Remarks:

Book mark:

O'Hagan

(358)

Copyist.

J

10 H. Art'y. U.S.C.T.

Abraham Judham
Priv., Co. E, 10 Reg't U. S. Col'd H. Art'y.

Appears on

Company Muster Roll

for *Nov. & Dec.*, 186*6*.

Present or absent *Present*

Stoppage, \$ 100 for

Due Gov't, \$ 100 for

Valuation of horse, \$ 100

Valuation of horse equipments, \$ 100

Remarks:

Book mark: *...*

(358)

O'Hagan

Copyist.

D

10 H. Art'y. U.S.C.T.

Abraham Pughan

Co. E, 10 Reg't U. S. Col'd H. Art'y.

Appears on **Co. Muster-out Roll**, dated *Baton Rouge, La, Feb. 22, 1867*.

Muster-out to date *Feb. 22, 1867*.

Last paid to *Dec. 31, 1866*.

Clothing account:

Last settled....., 186 ; drawn since \$..... 100

Due soldier \$ *46.73* / 100; due U. S. \$..... 100

Am't for cloth'g in kind or money adv'd \$..... 100

Due U. S. for arms, equipments, &c., \$ *6.02* / 100

Bounty paid \$..... 100; due \$ *100.00* / 100
Act of July 26. '66

Remarks: *Joined org. organ, as private.*

Bounty due soldier under act of July 28. 1866 \$100.00

Book mark: *.....*

(361)

A. Hagan

Copyist.

U.S. 001

Private | Private

CARD NUMBERS.

1	5-487146	26
2	5-502431	27
3	5-504499	28
4	5-504401	29
5	5-504278	30
6	5-504165	31
7	5-504036	32
8	5-503893	33
9	5-503759	34
10	5-503611	35
11	5-503473	36
12	5-503366	37
13	5-503257	38
14	5-503146	39
15	5-503028	40
16	5-502911	41
17	5-502781	42
18	5-502645	43
19		44
20		45
21		46
22		47
23		48
24		49
25		50

Book Mark: _____

See also _____

9

10 H. Art'y. U.S.C.T.

Charles Prouham

Appears with rank of *Priv* on

Muster and Descriptive Roll of a Detachment of U. S. Vols. forwarded

for the *7* Reg't *U.S.C.H. Art^{*}* Roll dated *New Orleans La, June, 1864.*

Where born *Natchitoches, La*

Age *25* y'rs; occupation *Labors*

When enlisted *April 28*, 1864.

Where enlisted *Alexandria*

For what period enlisted *3* years.

Eyes *Blue*; hair *Blue*

Complexion *Blue*; height *5* ft. *4 3/4* in.

When mustered in *June 15*, 1864.

Where mustered in *New Orleans*

Bounty paid \$ *100*; due \$ *100*

Where credited

Company to which assigned *E*

Remarks:

**
Became 10 U.S. Cold F. Art*

Book mark:

J.W. Williams

J

10 H. Art'y. | U.S.C.T.

Carter Prudham

Co. E, 7 Reg't U. S. Col'd H. Art'y.*

Appears on

Company Muster-in and Descriptive Roll

of the organization named above. Roll dated

New Orleans La July 5 1864

Where born *Natchitoches La.*

Age *25* y'rs; occupation *Laborer*

When enlisted *Apr 20 1864*

Where enlisted *Alexandria*

For what period enlisted *3* years.

Eyes *Black*; hair *Black*

Complexion *Black*; height *5 ft. 4 3/4* in.

When mustered in *June 10 1864*

Where mustered in *New Orleans*

Bounty paid \$ *2* 100; due \$ *100*

Where credited *Alexandria*

Company to which assigned *E*

Remarks: _____

Filed with Carter Prudham

* This organization subsequently became Co. *E*, 10 Reg't U. S. Colored Heavy Artillery.

Book mark: _____

(356d)

Linden

Copyist.

P

10 H. Art'y. U.S.C.T.

Barter Rudham

1st Co. E, 10 Reg't U. S. Col'd H. Art'y.

Appears on

Company Muster Roll

for *July* ~~*Aug.*~~, 186 *6*.

Present or absent *Present*

Stoppage, \$ *100* for

Due Gov't, \$ *100* for

Valuation of horse, \$ *100*

Valuation of horse equipments, \$ *100*

Remarks:

Book mark:

(358)

Linden
Copyist.

P

10 H. Art'y. U.S.C.T.

Carter Pughan

Prk, Co. E, 10 Reg't U. S. Col'd H. Art'y.

Appears on

Company Muster Roll

for Sep. + Oct., 1864

Present or absent Absent

Stoppage, \$ 100 for

Due Gov't, \$ 100 for

Valuation of horse, \$ 100

Valuation of horse equipments, \$ 100

Remarks: In Gen'l Hospital, New Orleans since Sep. 6th 1864

Book mark:

(358)

Linden

Copyist.

P

10 H. Art'y. U.S.C.T.

Barter Rudham

Pvt; Co. E, 10 Reg't U. S. Col'd H. Art'y.

Appears on

Company Muster Roll

for Nov Dec, 1864.

Present or absent Present

Stoppage, \$ 100 for

Due Gov't, \$ 100 for

Valuation of horse, \$ 100

Valuation of horse equipments, \$ 100

Remarks:

Book mark: 23270

(358)

Linder Copyist.

P

10 H. Art'y. | U.S.C.T.

Carter Prudham

Co., Co. E, 10 Reg't U. S. Col'd H. Art'y.

Appears on

Company Muster Roll

for Jan. & Feb., 1861.

Present or absent Present

Stoppage, \$ 100 for

Due Gov't, \$ 100 for

Valuation of horse, \$ 100

Valuation of horse equipments, \$ 100

Remarks:

Book mark:

(358)

G. E. Tyler

Copyist.

Carter Gudham

Cvt., Co. E, 10 Reg't U. S. Col'd H. Art'y.

Appears on

Company Muster Roll

for *Mch. & Apr.*, 1865.

Present or absent *Present*

Stoppage, \$ 100 for

Due Gov't, \$ 100 for

Valuation of horse, \$ 100

Valuation of horse equipments, \$ 100

Remarks:

Book mark: -----

L. E. Tyler

Carter Prudham
Cvt., Co. E, 10 Reg't U. S. Col'd H. Art'y.

Appears on

Company Muster Roll

for May & June, 1865.

Present or absent Present.

Stoppage, \$ 100 for

Due Gov't, \$ 100 for

Valuation of horse, \$ 100

Valuation of horse equipments, \$ 100

Remarks:

Book mark:

(358) G. E. Dyer Copyist.

2

10 H. Art'y. U.S.C.T.

Carter Prudham

Co., Co. E, 10 Reg't U. S. Col'd H. Art'y

Appears on

Company Muster Roll

for July & Aug., 1865

Present or absent Present

Stoppage, \$ 100 for

Due Gov't, \$ 100 for

Valuation of horse, \$ 100

Valuation of horse equipments, \$ 100

Remarks:

Book mark:

G. C. Tyler

(358)

Copyist.

Parter Prudham

Co. E, 10 Reg't U. S. Col'd H. Art'y

Appears on

Company Muster Roll

for Sept & Oct, 1863

Present or absent Present

Stoppage, \$ 100 for

Due Gov't, \$ 100 for

Valuation of horse, \$ 100

Valuation of horse equipments, \$ 100

Remarks:

Book mark:

J. E. Tyler

P

10 H. Art'y. U.S.C.T.

Barter Prudham

Pvt, Co. E, 10 Reg't U. S. Col'd H. Art'y.

Appears on

Company Muster Roll

for Nov - Dec, 1865.

Present or absent Present

Stoppage, \$ 100 for

Due Gov't, \$ 100 for

Valuation of horse, \$ 100

Valuation of horse equipments, \$ 100

Remarks:

Book mark:

(358)

Barter
Copyist.

Barter Prudham

Co. E, 10 Reg't U. S. Col'd H. Art'y.

Appears on

Company Muster Roll

for Jan & Feb, 1866.

Present or absent Present

Stoppage, \$ 100 for

Due Gov't, \$ 100 for

Valuation of horse, \$ 100

Valuation of horse equipments, \$ 100

Remarks:

Book mark:

(358)

Mark
Copyist.

P

10 H. Art'y. | U.S.C.T.

Barter Prichard

Priv., Co. E, 10 Reg't U. S. Col'd H. Art'y.

Appears on

Company Muster Roll

for March & April, 1866.

Present or absent Present

Stoppage, \$ 100 for

Due Gov't, \$ 100 for

Valuation of horse, \$ 100

Valuation of horse equipments, \$ 100

Remarks: Sick in Post Hospital

Book mark:

Kant

(358)

Copyist.

P | 10 H. Art'y. | U.S.C.T.

Carte Prudham

Prudham, Co. E, 10 Reg't U. S. Col'd H. Art'y

Appears on

Company Muster Roll

for May & June, 1866.

Present or absent Present

Stoppage, \$ 100 for

Due Gov't, \$ 100 for

Valuation of horse, \$ 100

Valuation of horse equipments, \$ 100

Remarks:

Book mark:

Wark

(358)

Copyist.

P

10 H. Art'y. U.S.C.T.

Carter Prudham

Prk, Co. E, 10 Reg't U. S. Col'd H. Art'y.

Appears on

Company Muster Roll

for July & Aug, 1866.

Present or absent Present

Stoppage, \$ 100 for

Due Gov't, \$ 100 for

Valuation of horse, \$ 100

Valuation of horse equipments, \$ 100

Remarks:

Book mark:

Mark

(358)

Copyist.

P

10 H. Art'y. U.S.C.T.

Carter Rudham

Pvt., Co. E, 10 Reg't U. S. Col'd H. Art'y.

Appears on

Company Muster Roll

for *Sept. & Oct*, 1866.

Present or absent *Present*

Stoppage, \$ 100 for

Due Gov't, \$ 100 for

Valuation of horse, \$ 100

Valuation of horse equipments, \$ 100

Remarks:

Book mark:

O'Hagan

Copyist.

J

10 H. Art'y. U.S.C.T.

Carter Ludham

Priv., Co. E, 10 Reg't U. S. Col'd H. Art'y.

Appears on

Company Muster Roll

for *Nov. & Dec.*, 186*6*.

Present or absent *Present*

Stoppage, \$ *100* for

Due Gov't, \$ *100* for

Valuation of horse, \$ *100*

Valuation of horse equipments, \$ *100*

Remarks: *On daily Duty as Co. Cook since Dec. 20, 1866.*

Book mark:

O'Hagan

(358)

Copyist.

J

10 H. Art'y. U.S.C.T.

Carter Judham

Co., Co. *E*, 10 Reg't U. S. Col'd H. Art'y.

Appears on Co. Muster-out Roll, dated

Baton Rouge, La Feb 22, 1867.

Muster-out to date *Feb. 22, 1867.*

Last paid to *Dec. 31, 1866.*

Clothing account:

Last settled _____, 186 ; drawn since \$ _____ 100

Due soldier \$ *60. ⁰⁵ / 100*; due U. S. \$ _____ 100

Am't for cloth'g in kind or money adv'd \$ _____ 100

Due U. S. for arms, equipments, &c., \$ *60 ⁰⁵ / 100*

Bounty paid \$ _____ 100; due \$ *100 / 100*

Remarks: *Joined org. organ. as Private.*

Bounty due soldier under Act. of July 28, 1866 \$100.⁰⁰

Book mark: _____

(361)

O'Hagan

Copyist.

E., 10 U.S. Col'd H. Art

Private | *Private*

CARD NUMBERS.

1	5-487145	26
2	5-502432	27
3	5-502695	28
4	5-504611	29
5		30
6		31
7		32
8		33
9		34
10		35
11		36
12		37
13		38
14		39
15		40
16		41
17		42
18		43
19		44
20		45
21		46
22		47
23		48
24		49
25		50

Book Mark: _____

See also _____

9

10 H. Art'y. U.S.C.T.

Henry Prudham

Appears with rank of *Priv* on

Muster and Descriptive Roll of a Detachment of U. S. Vols. forwarded

for the *7* Reg't *U.S.G.H. Art.** Roll dated

New Orleans La, June, 1864

Where born *Natchitoches La*

Age *25* y'rs; occupation *Laborer*

When enlisted *April 25th, 1864.*

Where enlisted *Alexandria*

For what period enlisted *3* years.

Eyes *Blue*; hair *Blue*

Complexion *Blue*; height *5* ft. *6 1/2* in.

When mustered in *June 18, 1864.*

Where mustered in *New Orleans*

Bounty paid \$ *100*; due \$ *100*

Where credited

Company to which assigned *E*

Remarks:

**
Became 10 U.S. Civil H. Art.*

Book mark:

J. M. Williams

P

10 H. Art'y. U.S.C.T.

Henry Freedman
Co. E, 7 Reg't U. S. Col'd H. Art'y.*

Appears on

Company Muster-in and Descriptive Roll
of the organization named above. Roll dated

New Orleans July 8, 1864

Where born Natchitoches La.

Age 25 y'rs; occupation Laborer

When enlisted Apr 28 1864

Where enlisted Alexandria

For what period enlisted 3 years.

Eyes Black; hair Black

Complexion Black; height 5 ft. 6 1/2 in.

When mustered in June 18, 1864

Where mustered in New Orleans

Bounty paid \$ 2 100; due \$ 100

Where credited Alexandria

Company to which assigned E

Remarks:

Filed with Henry Freedman

* This organization subsequently became Co. E, 10 Reg't U. S. Colored Heavy Artillery.

Book mark:

Luiden

(356d)

Copyist.

Henry Prudham
Sgt., Co. E, 10 Reg't U. S. Col'd H. Art'y.

Appears on

Company Muster Roll

for July to Aug, 1864

Present or absent

Stoppage, \$ 100 for

Due Gov't, \$ 100 for

Valuation of horse, \$ 100

Valuation of horse equipments, \$ 100

Remarks: Died July 21st 64
De Sair Station La.

Book mark:

(358)

Insider
Copyist.

J

10 H. Art'y. | U.S.C.T.

Henry Judham
Priv., Co. *E*, 10 Reg't U. S. Col'd H. Art'y.

Appears on Co. Muster-out Roll, dated
Baton Rouge, La., Feb. 22, 1867.

Muster-out to date _____, 186 .

Last paid to *never paid*, 186 .

Clothing account:

Last settled _____, 186 ; drawn since \$ _____ 100

Due soldier \$ _____ 100; due U. S. \$ _____ 100

Am't for cloth'g in kind or money adv'd \$ _____ 100

Due U. S. for arms, equipments, &c., \$ _____ 100

Bounty paid \$ _____ 100; due \$ _____ 100

Remarks: *Joined at Org. Orgaw,*
as private.

Died in camp DeSain
La. July 24, 1864 of
Dysentery.

Book mark: *V. 84. P. 64. 89*
148600

(361)

O'Hagan

Copyist.

Prudham, Henry

P, Co. *E*, 10 *U.S.C.H.A.*
Reg't

1 Enclosures.

Bed Cards.....	Descriptive Lists.....
Burial Records.....	Final Statements <i>/</i>
Certs. of Dis. for Discharge.....	Furloughs.....
C. M. Charges.....	Med. Des. Lists.....
Med. Certificates.....	Orders.....

Other papers relating to—

Admission to Hosp'l.....	Furlough.....
Casualty Sheet (Officer's).....	Med. Examination.....
Confinement.....	Misc. Information.....
Contracts.....	Pay or Clothing.....
Death or Effects.....	Personal Reports.....
Desertions.....	Rank.....
Discharge from Hosp'l.....	Transfer to Hosp'l.....
Discharge from Service.....	Transfer to V. R. C.....
Duty.....	Transportation.....

✓
FINAL STATEMENT

OF

Henry Prudham - Private
Co. E. 4th Reg't of U.S. Heavy Artillery (C.R.)
7th Louisiana
10th Vol.
VOLUNTEERS.
And July 21st 1864

NOTE 1.—Two of these certificates (or duplicates) are to be given to each Volunteer Soldier or drafted man who may be discharged previously to the discharge of his company, that he may at once receive from the Paymaster the pay, &c., due him, and the captain or other COMMISSIONED officer commanding the company will certify to the act of the delivery of the duplicate certificates; on these certificates the Soldier is "entitled to" his discharge, and should also present his discharge to the Paymaster to have the payment endorsed on it. The discharge is to be given back to the Soldier by the Paymaster; the latter only retaining as his voucher the duplicate certificates.

NOTE 2.—If the Soldier is entitled to pay for the use of his horse, the Company Commander will certify to that fact on the back of both these final statements, and also to the time he has pay due for having been so mounted on his own horse.

NOTE 3.—When a Soldier is furnished with final statements, his descriptive list, if he has one, should be taken up by the officer who gives the Soldier these statements, and endorsed with a statement to this effect by the officer. This endorsement should exhibit a full statement of the time for which the Soldier was allowed pay on his final statements, the clothing account, and all other charges against him or in his favor, so as to comprise a complete exhibit of his account. It will then be transmitted to the company commander of the Soldier, who will enter all the data necessary to a full understanding of the Soldier's account on the muster roll upon which the Soldier's discharge is reported. The descriptive list will then be destroyed. The object of this is, that the remaining portion of the Soldier's account may be settled upon the receipt of these muster rolls, and the Soldier receive any pay or allowances that may be due him at the time of his discharge, and which may not appear on his final statements from the fact that his descriptive list is incomplete. These accounts for back pay, &c., are settled by the 2d Auditor of the Treasury Department.

NOTE 4.—Charges for loss or injury to ordnance, horse equipments, and other miscellaneous charges, should appear under the heading of "Other Stoppages."

NOTE 5.—Bounty paid by State authorities, and not by the United States, will not be entered on this statement.

NOTE 6.—Amounts due the Sutler and Laundress must be entered on the muster roll on which the discharge, death, desertion, &c., is reported, as well as on the final statement, otherwise the amount cannot be collected from the United States.

NOTE 7.—This blank will be used for deceased volunteers and drafted men, as well as for others.

NOTE 8.—Where a Soldier dies in Hospital or on detached service, his descriptive list, if he has one, should be sent with his final statements, in duplicate, to the Second Auditor, Washington, D. C.

ADJUTANT GENERAL'S OFFICE.

Co. E. 4th 1864

Duplicate with Inventory sent 2d Auditor.

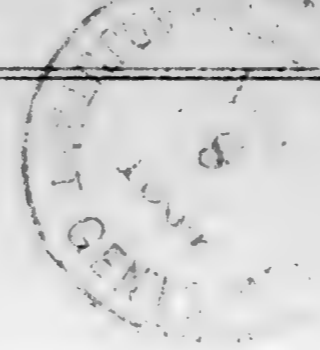

20043

I certify, on honor, that Henry Budham a Private of
 Captain M. Hawke Company (E) of the 7th Regiment of U.S. Heavy Artillery (Colo)
~~VOLUNTEERS~~; of the State of Louisiana, born in Katchitoches, State
 of Louisiana, aged 25 years; 5 feet 6 1/2 inches high; Blk- complexion,
Blk- eyes, Blk- hair, and by occupation a Labourer, having joined the company on
 its original organization at New Orleans-La., and enrolled in it at the muster into
 the service of the United States at Alexandria La., on the 18th day
 of April, 1864, (or was mustered in service as a recruit, by
 _____, at _____, on the _____ day of _____,
 186 , or was drafted and mustered into the service of the United States from the _____
 Enrollment District of the State of _____, at _____,
 on the _____ day of _____, 186) to serve in the Regiment, for
 the term of Three years: and having served **HONESTLY** and
FAITHFULLY with his Company in the Gulf Dept. to the present date, is now
 entitled to a **DISCHARGE** by reason of Death

(Died July 21st 1864 see inventory)

The said Henry Budham was last paid by Paymaster
Never Paid to include the _____ day of _____, 186 , and has
 pay due him from that time to the present date; he is entitled to pay and subsistence for
TRAVELING to place of enrollment, and whatever other allowances are authorized to volunteer
 soldiers, drafted men, or militia, so discharged. He has received from the United States **CLOTHING**
 amounting to Seventeen & 90^{cts} dollars, since the 18th day of April,
 1864, when his clothing account was last settled. He has received from the United States
 _____ dollars advanced **BOUNTY**.

There is to be stopped from him, on account of the State of _____, or other
 authorities, for **CLOTHING**, &c., received on entering service, _____ dollars; and
 for other stoppages, viz: _____

_____ dollars.
 He has been furnished with **TRANSPORTATION** in kind from the place of his discharge to
 _____; and he has been **SUBSISTED** for **TRAVELING** to his
 place of enrollment, up to the _____, 186 .

He is indebted to _____, **SUTLER**, _____ dollars.
 He is indebted to _____, **LAUNDRESS**, _____ dollars.

Given in Duplicate, at "De-Pair-Station" La., this 21st day
 of July, 1864

A. Phoen 1st Lieut
7th U.S. Heavy Artillery (Colo)
 Commanding Company. Co E

Co. E., 10 U.S. Col'd H. Art.

Private. | Corporal.

CARD NUMBERS.

1	5-487148	26
2	5-502428	27
3	5-502647	28
4	5-502783	29
5	5-502913	30
6	5-503029	31
7	5-503147	32
8	5-503258	33
9	5-503367	34
10	5-503474	35
11	5-503613	36
12	5-503761	37
13	5-503895	38
14	5-503974	39
15	5-504104	40
16	5-504229	41
17	5-504353	42
18	5-504453	43
19		44
20		45
21		46
22		47
23		48
24		49
25		50

Book Mark:

See also

P

10 H. Art'y.

U.S.C.T.

John Prudham

Appears with rank of Pvt on

Muster and Descriptive Roll of a Detachment of U. S. Vols. forwarded

for the 7 Reg't U.S.G.H. Art* Roll dated New Orleans La, June, 1864.

Where born Natchitoches La

Age 40 y'rs; occupation Labors

When enlisted April 28, 1864.

Where enlisted Alexandria

For what period enlisted 3 years.

Eyes Blue; hair Blue

Complexion Blue; height 5 ft. 6 in.

When mustered in June 18, 1864.

Where mustered in New Orleans

Bounty paid \$ 100; due \$ 100

Where credited

Company to which assigned E

Remarks:

*

Became 10 U.S. Cold H. Art.

Book mark:

S.W. Williams

(339)

Copyist.

P

| 10 H. Art'y. | U.S.C.T.

John Greedham

Art., Co. E, 7 Reg't U. S. Col'd H. Art'y.*

Appears on

Company Muster-in and Descriptive Roll

of the organization named above. Roll dated

New Orleans La. July 8, 1864.

Where born Natchitoches La.

Age 41 y'rs; occupation Laborer

When enlisted Apr. 24, 1864.

Where enlisted Alexandria

For what period enlisted 3 years.

Eyes Black; hair Black

Complexion Black; height 5 ft. 6 in.

When mustered in June 15, 1864.

Where mustered in New Orleans

Bounty paid \$ 200; due \$ 100

Where credited Alexandria

Company to which assigned E

Remarks:

* This organization subsequently became Co. E, 10 Reg't U. S. Colored Heavy Artillery.

Book mark:

(356d)

J. Greedham

Copist.

P | 10 H. Art'y. | U.S.C.T.

John Prudham
Sgt, Co. E, 10 Reg't U. S. Col'd H. Art'y.

Appears on

Company Muster Roll

for *July* & *Aug.*, 186*4*.

Present or absent *Present*

Stoppage, \$ 100 for

Due Gov't, \$ 100 for

Valuation of horse, \$ 100

Valuation of horse equipments, \$ 100

Remarks:

Book mark: -----

(358)

Pruden

Copyist.

P

10 H. Art'y. U.S.C.T.

John Prudham
Pt., Co. E, 10 Reg't U. S. Col'd H. Art'y.

Appears on

Company Muster Roll

for Sep. + Oct., 1864.

Present or absent Present

Stoppage, \$ 100 for

Due Gov't, \$ 100 for

Valuation of horse, \$ 100

Valuation of horse equipments, \$ 100

Remarks:

Book mark:

(358)

Luider

Copyist.

P

10 H. Art'y. | U.S.C.T.

John Prudham
Pl, Co. E, 10 Reg't U. S. Col'd H. Art'y.

Appears on

Company Muster Roll

for *Nov Dec*, 186*4*

Present or absent. *Present*

Stoppage, \$ *100* for

Due Gov't, \$ *100* for

Valuation of horse, \$ *100*

Valuation of horse equipments, \$ *100*

Remarks:

Book mark: *100*

Linder

9

John Graham

Co. E, 10 Reg't U. S. Col'd H. Art'y.

Appears on

Company Muster Roll

for Jan & Feb, 1862.

Present or absent Present

Stoppage, \$ 100 for

Due Gov't, \$ 100 for

Valuation of horse, \$ 100

Valuation of horse equipments, \$ 100

Remarks:

Book mark:

Copyist.

P | 10 H. Art'y. | U.S.C.T.

John Prudham
Cpl., Co. E, 10 Reg't U. S. Col'd H. Art'y.

Appears on

Company Muster Roll

for *March & Apr.*, 1865.

Present or absent *Present*

Stoppage, \$ *100* for

Due Gov't, \$ *100* for

Valuation of horse, \$ *100*

Valuation of horse equipments, \$ *100*

Remarks:.....

Book mark:.....

(358)

G. C. Tyler
Copyist.

John Rudham

Sgt., Co. E, 10 Reg't U. S. Col'd H. Art'y.

Appears on

Company Muster Roll

for *May & June*, 186*0*.

Present or absent *Present.*

Stoppage, \$ *100* for

Due Gov't, \$ *100* for

Valuation of horse, \$ *100*

Valuation of horse equipments, \$ *100*

Remarks: *Sick in Post Hospital.*

Book mark:

G. E. Tyler

John Prudham

Capt., Co. E, 10 Reg't U. S. Col'd H. Art'y

Appears on

Company Muster Roll

for *July & Aug*, 186*2*.

Present or absent *Present*

Stoppage, \$ *100* for

Due Gov't, \$ *100* for

Valuation of horse, \$ *100*

Valuation of horse equipments, \$ *100*

Remarks:

Book mark:

E. E. Lyles

John Gudham
....., Co. E, 10 Reg't U. S. Col'd H. Art'y

Appears on

Company Muster Roll

for *Sept. & Oct.*....., 186*0*.

Present or absent *Present.*.....

Stoppage, \$.....¹⁰⁰ for

Due Gov't, \$.....¹⁰⁰ for

Valuation of horse, \$.....¹⁰⁰

Valuation of horse equipments, \$.....¹⁰⁰

Remarks:.....
.....
.....
.....
.....
.....
.....
.....
.....

Book mark:.....

G. D. Jones

P

10 H. Art'y. U.S.C.T.

John Prudham

Priv, Co. E, 10 Reg't U. S. Col'd H. Art'y.

Appears on

Company Muster Roll

for Nov & Dec, 1865

Present or absent Present

Stoppage, \$ 100 for

Due Gov't, \$ 100 for

Valuation of horse, \$ 100

Valuation of horse equipments, \$ 100

Remarks:

Book mark:

Hart

Copyist.

P

10 H. Art'y. U.S.C.T.

John Prudham

Priv., Co. E, 10 Reg't U. S. Col'd H. Art'y.

Appears on

Company Muster Roll

for Jan & Feb, 1866.

Present or absent Present

Stoppage, \$ 100 for

Due Gov't, \$ 100 for

Valuation of horse, \$ 100

Valuation of horse equipments, \$ 100

Remarks:

Book mark:

Hart

Copyist.

(358)

P

10 H. Art'y. U.S.C.T.

John Prudham

Pvt, Co. E, 10 Reg't U. S. Col'd H. Art'y.

Appears on

Company Muster Roll

for March & April, 1866.

Present or absent Present

Stoppage, \$ 100 for

Due Gov't, \$ 100 for

Valuation of horse, \$ 100

Valuation of horse equipments, \$ 100

Remarks:

Book mark:

Hart Copyist.

P

John Pennington

Capt, Co. E, 10 Reg't U. S. Col'd H. Art'y.

Appears on

Company Muster Roll

for *May & June*, 1866.

Present or absent *Present*

Stoppage, \$ *100* for

Due Gov't, \$ *100* for

Valuation of horse, \$ *100*

Valuation of horse equipments, \$ *100*

Remarks: *Promoted May 1st 1866*

Book mark: _____

Wash

Copyist.

P

10 H. Art'y. | U.S.C.T.

John Prichard

Capt., Co. E, 10 Reg't U. S. Col'd H. Art'y.

Appears on

Company Muster Roll

for *July & Aug*, 186*6*.

Present or absent *Present*

Stoppage, \$ *100* for

Due Gov't, \$ *100* for

Valuation of horse, \$ *100*

Valuation of horse equipments, \$ *100*

Remarks:

Book mark:

Wark

(358)

Copyist.

J

10 H. Art'y.

U.S.C.T.

John Rudham
Corp, Co. E, 10 Reg't U. S. Col'd H. Art'y.

Appears on

Company Muster Roll

for *Sept. + Oct*, 1866.

Present or absent *Present*

Stoppage, \$ 100 for

Due Gov't, \$ 100 for

Valuation of horse, \$ 100

Valuation of horse equipments, \$ 100

Remarks:

Book mark:

(358)

O'Hagan

Copyist.

J

10 H. Art'y. U.S.C.T.

John Prudham
Corp, Co. E, 10 Reg't U. S. Col'd H. Art'y.

Appears on

Company Muster Roll

for *Nov. & Dec.*, 1866.

Present or absent *Present*

Stoppage, \$ *100* for

Due Gov't, \$ *100* for

Valuation of horse, \$ *100*

Valuation of horse equipments, \$ *100*

Remarks:

Book mark:

O'Nagano,

(358)

Copyist.

P

10 H. Art'y. U.S.C.T.

John Rudham
Corp, Co. E, 10 Reg't U. S. Col'd H. Art'y.

Appears on Co. Muster-out Roll, dated
Baton Rouge, La. Feb 22, 1867.
Muster-out to date *Feb. 22, 1867.*
Last paid to *Dec 31, 1866.*

Clothing account:

Last settled....., 186 ; drawn since \$.....100
Due soldier \$ *62*⁶⁶/₁₀₀; due U. S. \$.....100
Am't for cloth'g in kind or money adv'd \$.....100

Due U. S. for arms, equipments, &c., \$ *6*¹⁰/₁₀₀
Bounty paid \$.....100; due \$ *100*⁰⁰/₁₀₀
act of July 26, '66

Remarks: *Joined org. organ.*
Private to May 1, 1865.
Bounty due Soldier mu-
der Act of July 28/66, \$100.⁰⁰

Book mark: *V. 34 P. 185. 72*

(361)

O'Hagan
Copyist.

Co E., 10 U.S. Col'd H. Art

Private | Private

CARD NUMBERS.

1	5-487149	26
2	5-502429	27
3	5-502648	28
4	5-502784	29
5	5-502914	30
6	5-503030	31
7	5-503148	32
8	5-503259	33
9	5-503368	34
10	5-503475	35
11	5-503614	36
12	5-503762	37
13	5-503896	38
14	5-504038	39
15	5-504167	40
16	5-504280	41
17	5-504403	42
18	5-504501	43
19		44
20		45
21		46
22		47
23		48
24		49
25		50

Book Mark:

See also

P

10 H. Art'y. U.S.C.T.

Joseph Prudham
Pvt

Appears with rank of on

Muster and Descriptive Roll of a Detachment of U. S. Vols. forwarded

for the 7 Reg't U.S.C.H. Art^{*} Roll dated

New Orleans La, June, 1864.

Where born Natchitoches La

Age 21 y'rs; occupation Laborer

When enlisted April 25, 1864.

Where enlisted Alexandria

For what period enlisted 3 years.

Eyes Blue; hair Blue

Complexion Dark; height 5 ft 7 1/2 in.

When mustered in June 18, 1864.

Where mustered in New Orleans

Bounty paid \$ 100; due \$ 100

Where credited

Company to which assigned E

Remarks:

*
Became 10 U.S. Cold H. Art.

Book mark:

J. M. Williams

J

10 H. Art'y. | U.S.C.T.

Joseph Prudham

Prudham, Co. *E*, 7 Reg't U. S. Col'd H. Art'y.*

Appears on

Company Muster-in and Descriptive Roll

of the organization named above. Roll dated

New Orleans La. July 5, 1864.

Where born *Natchitoches La.*

Age *21* y'rs; occupation *Laborer*

When enlisted *Apr. 25* 1864.

Where enlisted *Alexandria*

For what period enlisted *3* years.

Eyes *Black*; hair *Black*

Complexion *Dark*; height *5 ft. 7 1/2* in.

When mustered in *June 15, 1864.*

Where mustered in *New Orleans*

Bounty paid \$ *2* 100; due \$ *100*

Where credited *Alexandria*

Company to which assigned

Remarks:

Filed with Joseph Prudham

* This organization subsequently became Co. *E*, 10 Reg't U. S. Colored Heavy Artillery.

Book mark:

Linden

(356d)

Copyist.

J

10 H. Art'y. U.S.C.T.

Joseph Rudham

Plt., Co. E, 10 Reg't U. S. Col'd H. Art'y.

Appears on

Company Muster Roll

for *July* ~~*Aug.*~~, 186 *4*

Present or absent *Present*

Stoppage, \$ *100* for

Due Gov't, \$ *100* for

Valuation of horse, \$ *100*

Valuation of horse equipments, \$ *100*

Remarks:

Filed with Joseph Rudham

Book mark:

(358)

Linden
Copyist.

P

10 H. Art'y. U.S.C.T.

Joseph Prudham

Pr.; Co. E, 10 Reg't U. S. Col'd H. Art'y.

Appears on

Company Muster Roll

for *Sep.* + *Oct.*, 186*4*.

Present or absent *Present*

Stoppage, \$ 100 for

Due Gov't, \$ 100 for

Valuation of horse, \$ 100

Valuation of horse equipments, \$ 100

Remarks:

Book mark:

(358)

Linden

Copyist.

Joseph Prudham
Det. Co. E, 10 Reg't U. S. Col'd H. Art'y.

Appears on

Company Muster Roll

for Nov. & Dec., 1864.

Present or absent Present

Stoppage, \$ 100 for

Due Gov't, \$ 100 for

Valuation of horse, \$ 100

Valuation of horse equipments, \$ 100

Remarks:

Book mark:

Luider

Joseph Gudham
Co., Co. E, 10 Reg't U. S. Col'd H. Art'y.

Appears on

Company Muster Roll

for Jan & Feb, 1865.

Present or absent Present

Stoppage, \$ 100 for

Due Gov't, \$ 100 for

Valuation of horse, \$ 100

Valuation of horse equipments, \$ 100

Remarks:

Book mark:

G. C. Gyles

7

10 H. Art'y. U.S.C.T.

Joseph Prudham

Plk., Co. E, 10 Reg't U. S. Col'd H. Art'y.

Appears on

Company Muster Roll

for May & June, 1865.

Present or absent Present.

Stoppage, \$ 100 for

Due Gov't, \$ 100 for

Valuation of horse, \$ 100

Valuation of horse equipments, \$ 100

Remarks:

Book mark:

(358)

G. H. Giles

Copyist.

Joseph Rudham
Co. E, 10 Reg't U. S. Col'd H. Art'y.

Appears on

Company Muster Roll

for March & April, 1862.

Present or absent Present

Stoppage, \$ 100 for

Due Gov't, \$ 100 for

Valuation of horse, \$ 100

Valuation of horse equipments, \$ 100

Remarks:

Book mark: _____

G. C. Tyler
Copyist.

J

10 H. Art'y. U.S.C.T.

Joseph Rudham
Co., Co. E, 10 Reg't U. S. Col'd H. Art'y

Appears on

Company Muster Roll

for July & Aug, 1865.

Present or absent Present

Stoppage, \$ 100 for

Due Gov't, \$ 100 for

Valuation of horse, \$ 100

Valuation of horse equipments, \$ 100

Remarks: Due U.S. for
Ordinance # 43
100

Book mark:

(358)

G. E. Syles

Copyist.

9

10 H. Art'y. U.S.C.T.

Joseph Pruthman
Capt., Co. E, 10 Reg't U. S. Col'd H. Art'y

Appears on

Company Muster Roll

for Sept. & Oct., 1867

Present or absent Present

Stoppage, \$ 100 for

Due Gov't, \$ 100 for

Valuation of horse, \$ 100

Valuation of horse equipments, \$ 100

Remarks:

Book mark:

(358)

E. J. Taylor

Copyist.

P

10 H. Art'y. U.S.C.T.

Joseph Prudham

Pvt, Co. E, 10 Reg't U. S. Col'd H. Art'y.

Appears on

Company Muster Roll

for Jan & Feb, 1866.

Present or absent Present

Stoppage, \$ 100 for

Due Gov't, \$ 100 for

Valuation of horse, \$ 100

Valuation of horse equipments, \$ 100

Remarks:

Book mark:

(358)

Heart Copyist.

P

10 H. Art'y. U.S.C.T.

Joseph Prudham

Pvt, Co. E, 10 Reg't U. S. Col'd H. Art'y.

Appears on

Company Muster Roll

for Nov 2 Dec, 1865.

Present or absent Present

Stoppage, \$ 100 for

Due Gov't, \$ 100 for

Valuation of horse, \$ 100

Valuation of horse equipments, \$ 100

Remarks:

[Empty lines for remarks]

Book mark:

[Empty line for book mark]

Hark

Copyist.

P

10 H. Art'y. | U.S.C.T.

Joseph Prudham

Pvt, Co. E, 10 Reg't U. S. Col'd H. Art'y.

Appears on

Company Muster Roll

for *March & April*, 1866.

Present or absent *Present*

Stoppage, \$ 100 for

Due Gov't, \$ 100 for

Valuation of horse, \$ 100

Valuation of horse equipments, \$ 100

Remarks:

Book mark:

Wash

(358)

Copyist.

P

10 H. Art'y. U.S.C.T.

Joseph Prudham

Priv., Co. E, 10 Reg't U. S. Col'd H. Art'y

Appears on

Company Muster Roll

for May & June, 1866.

Present or absent Present

Stoppage, \$ 100 for

Due Gov't, \$ 100 for

Valuation of horse, \$ 100

Valuation of horse equipments, \$ 100

Remarks:

Book mark:

Warr

(358)

Copyist.

P

10 H. Art'y. U.S.C.T.

Joseph Prudham

Pvt, Co. E, 10 Reg't U. S. Col'd H. Art'y.

Appears on

Company Muster Roll

for July & Aug, 1866.

Present or absent Absent

Stoppage, \$ 100 for

Due Gov't, \$ 100 for

Valuation of horse, \$ 100

Valuation of horse equipments, \$ 100

Remarks: Absent in New Orleans as witness before G. C. M. Since Aug 18-1866.

Book mark:

Wark

Copyist.

J

10 H. Art'y. U.S.C.T.

Joseph Rudham
Co. E, 10 Reg't U. S. Col'd H. Art'y.

Appears on

Company Muster Roll

for *Sept. & Oct.*, 1866.

Present or absent *P*

Stoppage, \$ 100 for

Due Gov't, \$ 100 for

Valuation of horse, \$ 100

Valuation of horse equipments, \$ 100

Remarks:

Book mark:

P

10 H. Art'y. U.S.C.T.

Joseph Rudham

Plt, Co. E, 10 Reg't U. S. Col'd H. Art'y.

Appears on

Company Muster Roll

for *Nov. & Dec.*, 186*6*.

Present or absent *Present*

Stoppage, \$ *100* for

Due Gov't, \$ *100* for

Valuation of horse, \$ *100*

Valuation of horse equipments, \$ *100*

Remarks:

Book mark:

O'Hagan

(358)

Copyist.

J

10 H. Art'y. U.S.C.T.

Joseph Rudhaw
Priv, Co. *E*, 10 Reg't U. S. Col'd H. Art'y.

Appears on **Co. Muster-out Roll**, dated
Baton Rouge, La., Feb. 28, 1867.

Muster-out to date *Feb. 28, 1867.*

Last paid to *Dec. 31, 1866.*

Clothing account:

Last settled _____, 186 ; drawn since \$ _____ 100

Due soldier \$ *12* ^{*23*}/₁₀₀; due U. S. \$ _____ 100

Am't for cloth'g in kind or money adv'd \$ _____ 100

Due U. S. for arms, equipments, &c., \$ *6* ^{*02*}/₁₀₀

act of July 26, '66
Bounty paid \$ _____ 100, due \$ *100.* ^{*00*}/₁₀₀

Remarks: *Joined reg. organ as private*

Bounty due soldier under act of July 28 1866.
\$100.⁰⁰

Book mark: *148600 Feb. 5, 68.*
288, 1881.

(361)

O'Hagan

Copyist.

10 U.S. Co'd H.A.

Private

Private

CARD NUMBERS.

	26
	27
See Pruton	28 August
	29
	30
	31
	32
	33
	34
10	35
11	36
12	37
13	38
14	39
15	40
16	41
17	42
18	43
19	44
20	45
21	46
22	47
23	48
24	49
25	50

Book Mark: A-33-V-11-RC.P-187

See also

Private.

Page

CARD NUMBERS.

487905.

- 26
- 27
- 28
- 29
- 30
- 31
- 32
- 33
- 34
- 35
- 36
- 37
- 38
- 39
- 40
- 41
- 42
- 43
- 44
- 45
- 46
- 47
- 48
- 49
- 50

Book Mark:

See also 77 U.S. G. Sup

P 10 H A U.S.C.T.

Garrison Pugh
Pot, Co., 10 Reg't U.S. Col'd H A

Appears on

M. and D. Roll of Men Transferred

to the organization named above,

from 77 U.S. Col Inf

Roll dated Camp Maperda, 1860.

When enlisted, 1860.

Period for which enlisted 1 years.

When mustered in Feb 22, 1860.

Present or absent

Company to which assigned

Remarks: Dest'd June 15
65. from Camp Chal
metteda. (D.H.A.)

Name not taken up on
muster rolls of Pugh

Book mark:

W. H. A.

10 U.S. Col'd II

Private Private

CARD NUMBERS.

1	5488024	26
2	5487833	27
3	5514413	28
4	5515307	29
5	9123711	30
6		31
7		32
8		33
9		34
10		35
11		36
12		37
13		38
14		39
15		40
16		41
17		42
18		43
19		44
20		45
21		46
22		47
23		48
24		49
25		50

Book Mark:

See also 77 U.S.C.S

P | 10 H. Art'y. | U. S. C. T.

Julius Pugh
Co. M, 10 Reg't U. S. Col'd H. Art'y.

Appears on

Company Descriptive Book

of the organization named above.

DESCRIPTION.

Age 38 years; height 5 feet 10 inches.

Complexion black

Eyes dark; hair black

Where born Virginia

Occupation Laborer

ENLISTMENT.

When Feb 27, 1865.

Where Drafted Lafayette 2 Dist La

By whom ; term 1 y'rs.

Remarks: Rec'd by transfer from
Co. A 77 U.S.C. I. per S.O. 66
Had in Sept La Sept 22, 1865 -
Deserted from Camp
Carabet La Oct 1, 1866

(383a)

McAlister
Copyist.

O 106A U.S.C.T.

Julius Pugh
Pot, Co. M, 10 Reg't U. S. Col'd HA

Appears on

M. and D. Roll of Men Transferred

to the organization named above,

from 27th U. S. Col Inf

Roll dated Camp Anapetda Okla, 1866.

When enlisted _____, 186 .

Period for which enlisted _____ years.

When mustered in July 27, 186

Present or absent _____

Company to which assigned M

Remarks: Went without leave,

Book mark : _____

W. H. Scott

C 1026A U.S.C.T.

Julius Pugh
Sgt, Co. M, 10 Reg't U. S. Col'd

Appears on

M. and D. Roll of Men Transferred

to the organization named above,

from

Roll dated

When enlisted

Period for which enlisted

When mustered in

Present or absent

Company to which assigned

Remarks:

of U.S. Col'd Inf
Camp Canapeta, 1865

1 years.

Feb 27, 1865

Absent

1st

Absent without leave

Book mark :

Wm Scott

P | 10 H. Art'y. | U.S.C.T.

Julius Pugh
Co. *M*, 10 Reg't U. S. Col'd H. Art'y.

Age years.

Appears on

Company Muster Roll*

for *Sept - Oct*, 186*5*.

Joined for duty and enrolled:

When *Sept*, 186 .

Where

Period *1* years.

Mustered in:

When *Feb 27*, 186*3*.

Where *Lafayette 2 Dist La*

Present or absent

Stoppage, \$ *22* ^{*50*}/₁₀₀ for *Ord. 674 E. 13:27*

Due Gov't, \$ *100* for

Remarks: *Deserted at Camp Parapet
La Oct 4 65*

* First current roll. No muster-in roll of this company on file.

Book mark:

(3586)

A. M. Wright
Copyist.

B

10 H. Art'y. | U.S.C.T.

Julius Pugh

But., Co. M., 10 Reg't U. S. Col'd H. Art'y.

Appears on Co. Muster-out Roll, dated

Baton Rouge La, Feb 22, 1867.

Muster-out to date _____, 186 .

Last paid to _____, 186 .

Clothing account:

Last settled _____, 186 ; drawn since \$ _____ 100

Due soldier \$ 14 ⁶⁴/₁₀₀; due U. S. \$ _____ 100

Am't for cloth'g in kind or money adv'd \$ _____ 100

Due U. S. for arms, equipments, &c., \$ _____ 100

Bounty paid \$ None 100; due \$ _____ 100

Remarks: joined by traces from Co. I. 77 U.S. for S. 10. 66. 1st. Reg. Dept. La Sep 22/65 as But. Deserter from Camp Parapet La Oct 1/65.

Book mark: V. 116. 2. P. 171. 23. 943. 179

Reuter

(361)

Copyist.

Private.

Price

CARD NUMBERS.

	26
<i>Le Pere</i>	<i>John</i>
	27
	28
	29
	30
	31
	32
	33
	34
	35
	36
	37
	38
	39
	40
	41
	42
	43
	44
	45
	46
	47
	48
	49
	50

Book Mark:

See also *Vol B: 74 U.S.C. Sup*

A., 10 U.S. 001 00

Private

Private

CARD NUMBERS.

1	5489076	26
2	5492946	27
3	5493156	28
4	5493375	29
5	5493444	30
6	5493698	31
7	5493909	32
8	5493815	33
9	5493843	34
10		35
11		36
12		37
13		38
14		39
15		40
16		41
17		42
18		43
19		44
20		45
21		46
22		47
23		48
24		49
25		50

Book Mark:

See also 75 U.S. 6 I

J. Van Hook U.S.C.T.

John Sumrell
Co., *10* Reg't U. S. Col'd *Miss*

Appears on

M. and D. Roll of Men Transferred

to the organization named above,

from *73 USA C I*

Roll dated *Nov 18*, 186*3*

When enlisted _____, 186 .

Period for which enlisted *3* years.

When mustered in *Sep 23*, 186 *4*.

Present or absent *Not stated*

Company to which assigned _____

Remarks: *Credited to*

New Orleans

Drafted

Book mark : _____

J. Van Hook
(342) Copyist.

P | 10 H. Art'y. | U.S.C.T.

John Purnell
Pvt, Co. A, 10 Reg't U. S. Col'd H. Art'y.

Appears on

Company Muster Roll

for *Nov + Dec*, 1865.

Present or absent *Present*

Stoppage, \$ 100 for

Due Gov't, \$ 100 for

Valuation of horse, \$ 100

Valuation of horse equipments, \$ 100

Remarks: *Transferred from 75th*
U.S.C.P. per S.O. 105 C.S. Hd
Geo Dept of Ca,

Book mark:

(358)

Styus

Copyist.

P | 10 H. Art'y. | U.S.C.T.

John Purnell
Pr, Co. A, 10 Reg't U. S. Col'd H. Art'y.

Appears on

Company Muster Roll

for *Jan + Feb*, 1866.

Present or absent *Present*

Stoppage, \$ *100* for

Due Gov't, \$ *100* for

Valuation of horse, \$ *100*

Valuation of horse equipments, \$ *100*

Remarks: *On daily duty as company
Cook*

Book mark: *3025*

(358)

Hynes
Copyist.

P

10 H. Art'y. | U.S.C.T.

John Purnell
Pl

Co. A, 10 Reg't U. S. Col'd H. Art'y.

Appears on

Company Muster Roll

for Mar + April, 1866.

Present or absent Present

Stoppage, \$ 100 for

Due Gov't, \$ 100 for

Valuation of horse, \$ 100

Valuation of horse equipments, \$ 100

Remarks: On daily duty as Co. Cook

Book mark:

Styus

Copyist.

(358)

P | 10 H. Art'y. | U.S.C.T.

John Purnell

P, Co. A, 10 Reg't U. S. Col'd H. Art'y.

Appears on

Company Muster Roll

for *May + June, 1866*

Present or absent *Present*

Stoppage, \$ *100* for

Due Gov't, \$ *100* for

Valuation of horse, \$ *100*

Valuation of horse equipments, \$ *100*

Remarks: *Daily duty Co. Cook*

Book mark:

Hyman
Copyist.

P | 10 H. Art'y. | U.S.C.T.

John Purnell

Pl, Co. A, 10 Reg't U. S. Col'd H. Art'y.

Appears on

Company Muster Roll

for *July & Aug, 1866*

Present or absent *Present*

Stoppage, \$ *100* for

Due Gov't, \$ *100* for

Valuation of horse, \$ *100*

Valuation of horse equipments, \$ *100*

Remarks: *On daily duty as Co. Cook*

Book mark: _____

(358)

Heizer
Copyist.

P

10 H. Art'y. U.S.C.T.

John Cunnell

Co. A, 10 Reg't U. S. Col'd H. Art'y.

Appears on

Company Muster Roll

for Sept & Oct, 1866.

Present or absent Present

Stoppage, \$ 100 for

Due Gov't, \$ 100 for

Valuation of horse, \$ 100

Valuation of horse equipments, \$ 100

Remarks: In daily duty as les. cook

Book mark:

Nesbitt

(358)

Copyist.

P | 10 H. Art'y. | U.S.C.T.

John Purnell

Co. A, 10 Reg't U. S. Col'd H. Art'y.

Appears on

Company Muster Roll

for Nov & Dec, 1866.

Present or absent Present

Stoppage, \$ 100 for

Due Gov't, \$ 100 for

Valuation of horse, \$ 100

Valuation of horse equipments, \$ 100

Remarks: On daily duty as les. book

Book mark:

Nesbitt

Copyist.

John Purnell
Pvt., Co. A., 10 Reg't U. S. Col'd H. Art'y.

Appears on Co. Muster-out Roll, dated
Baton Rouge La, Feb. 22, 1867.
Muster-out to date Feb. 22, 1867.
Last paid to Dec. 31, 1866.

Clothing account:

Last settled....., 186 ; drawn since \$.....100
Due soldier \$ 84 ¹¹/₁₀₀; due U. S. \$.....100
Am't for cloth'g in kind or money adv'd \$.....100

Due U. S. for arms, equipments, &c., \$.....6 ¹⁷/₁₀₀
Under G.O. 101

Bounty paid \$.....100; due \$ 24 ¹¹/₁₀₀

Remarks: *Transfd. from 75 U.S. Col'd H. Art'y.
S.C. 105 S of 25 Reg't. Sa.*

Book mark :

Nesbitt
Copyist.

MICROCOPY

18 18

ROLL

17

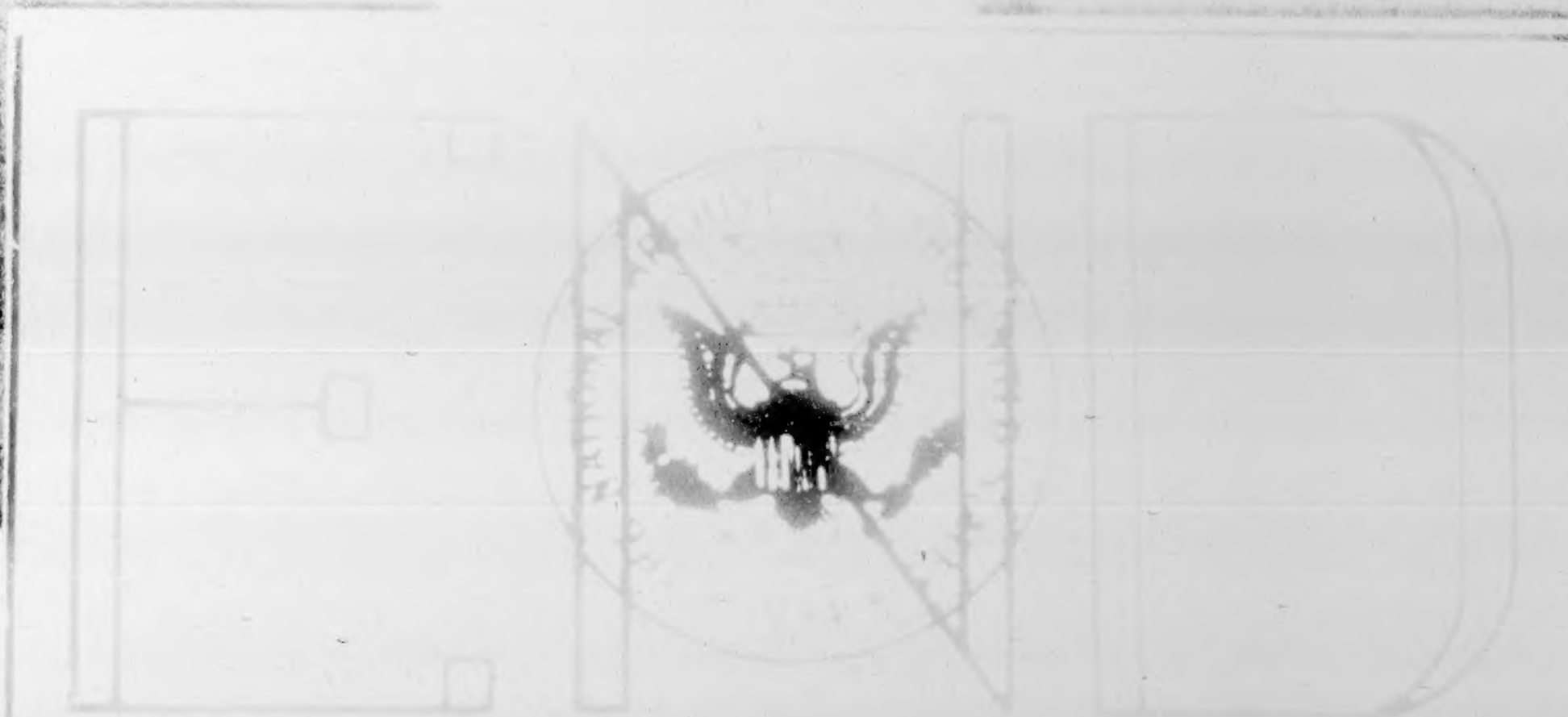
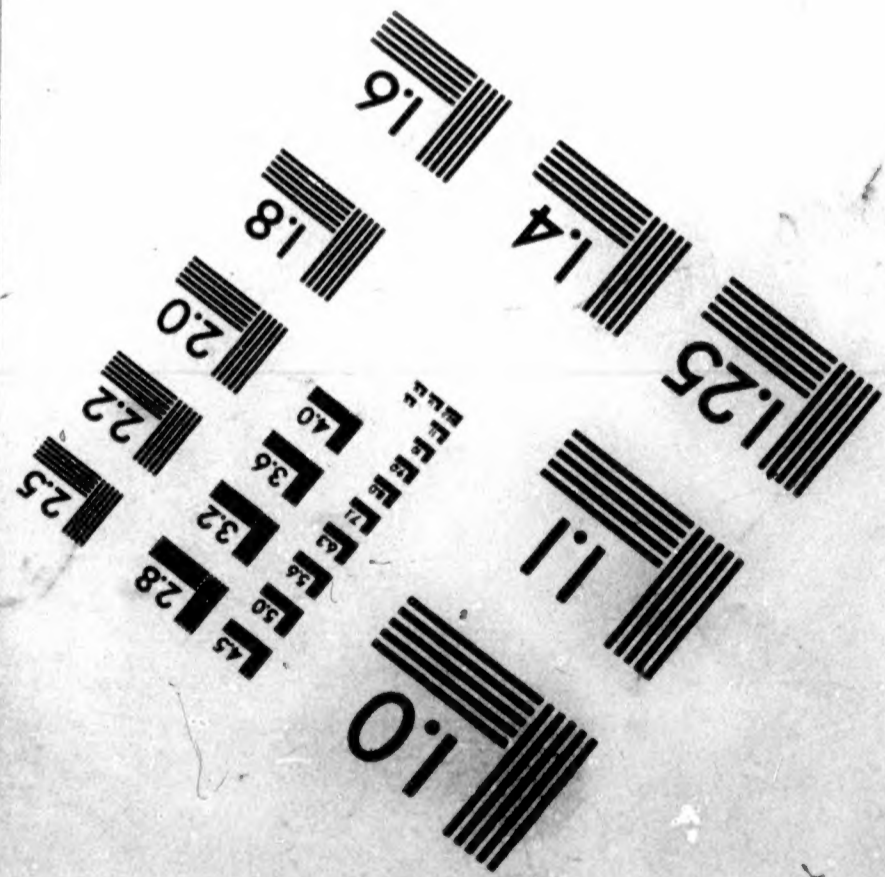
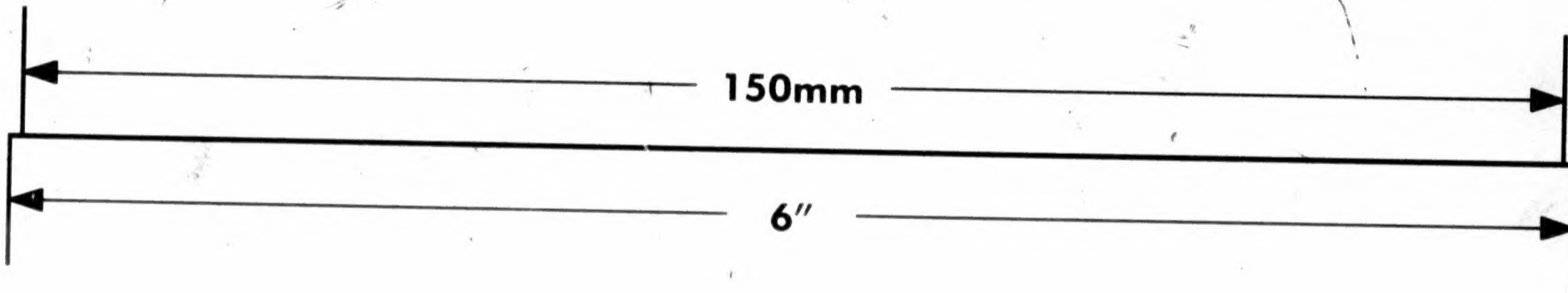
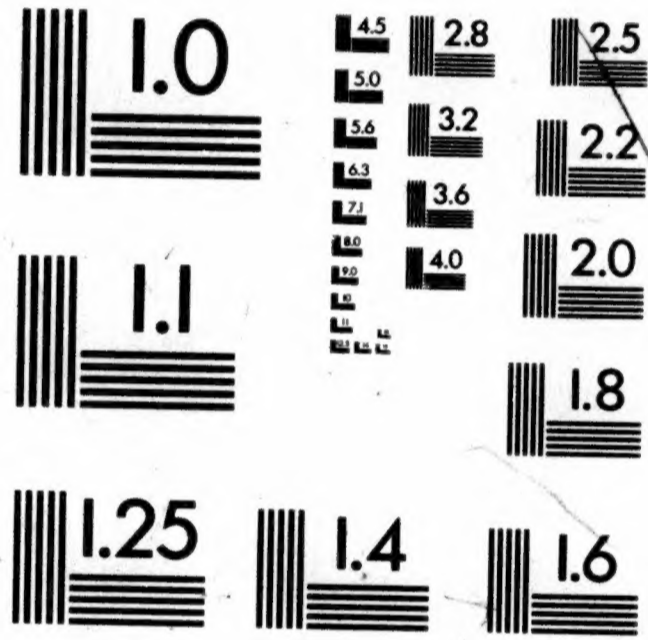
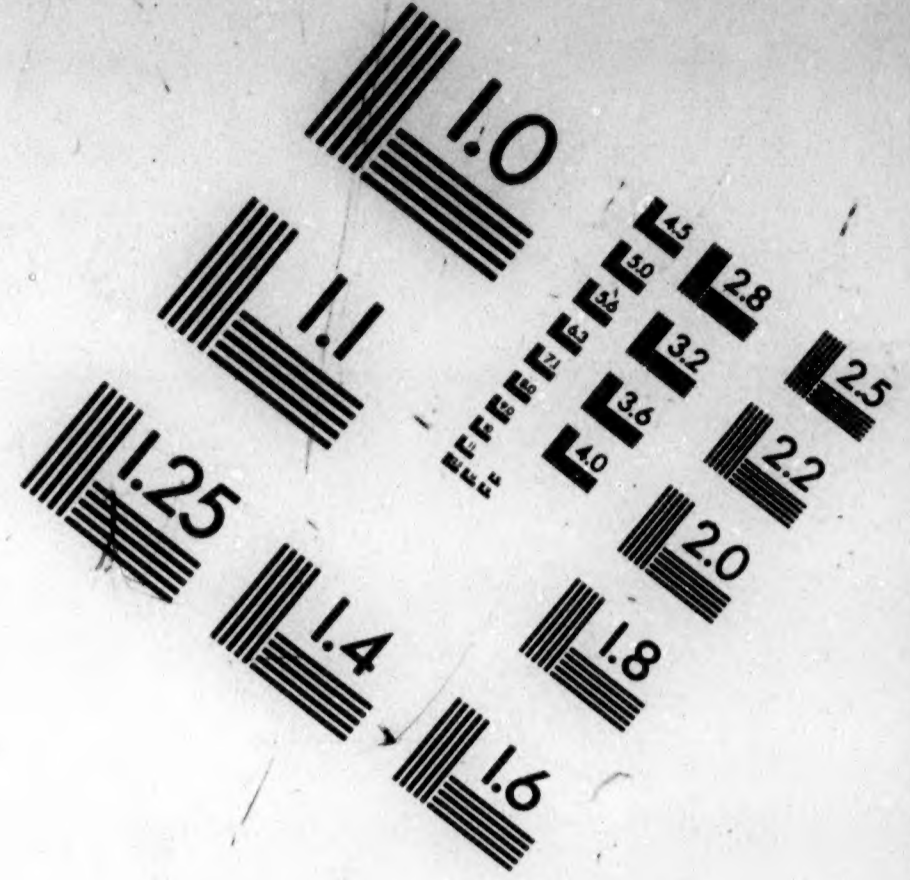
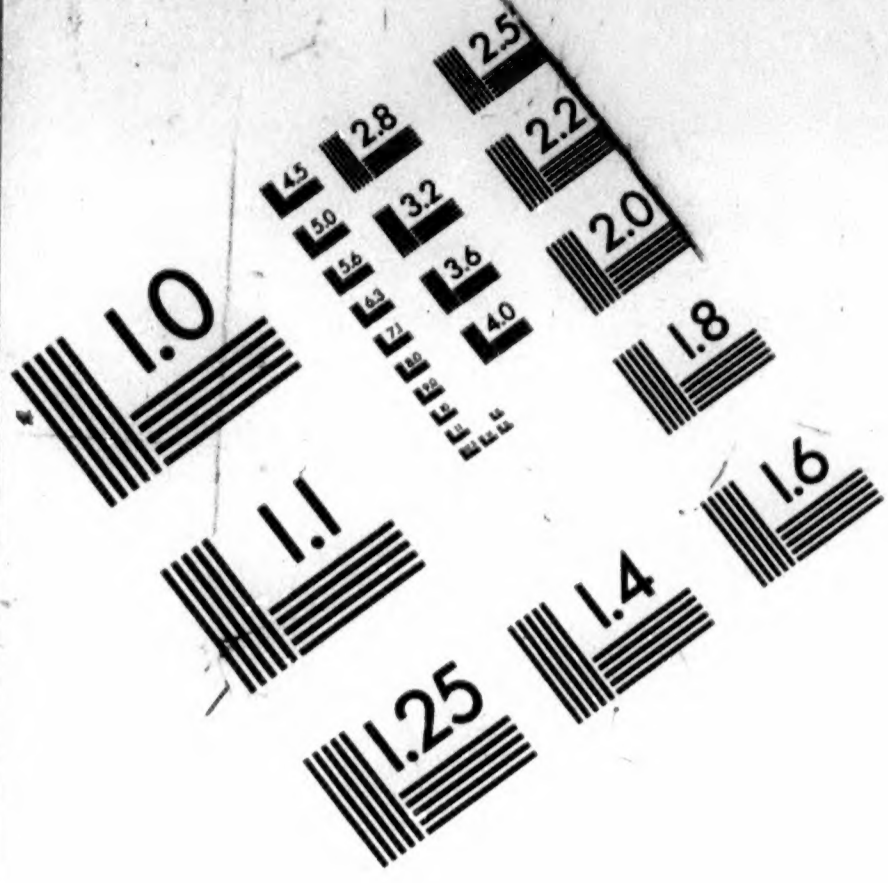
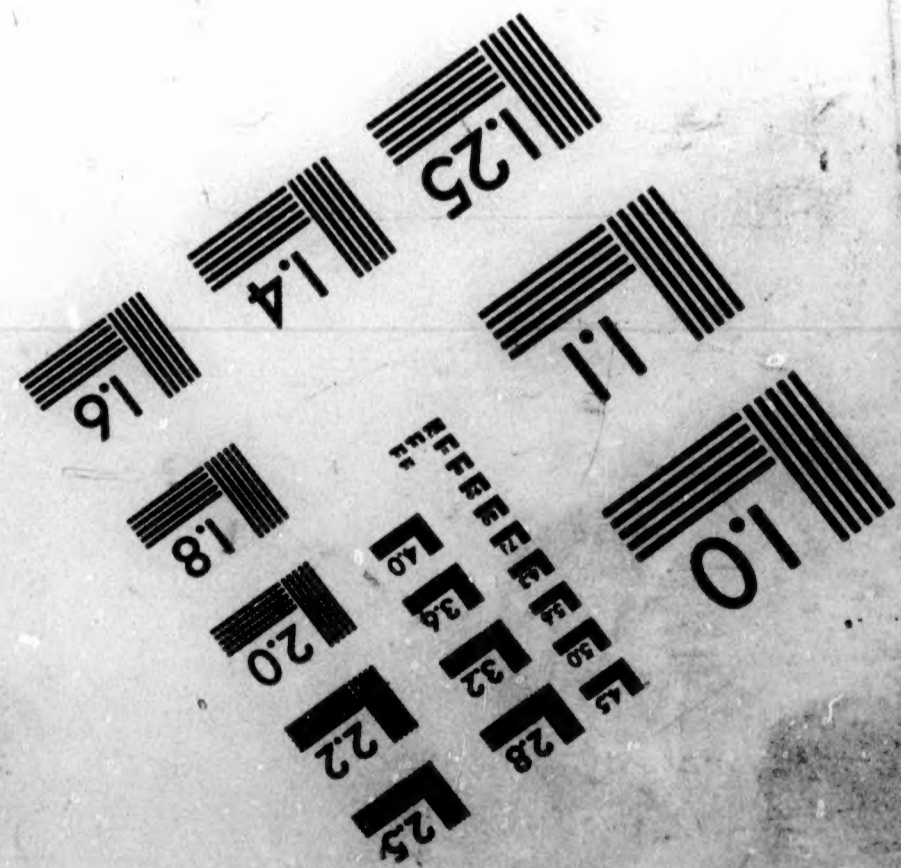

IMAGE EVALUATION
TEST TARGET (QA-3)



APPLIED IMAGE, Inc
1653 East Main Street
Rochester, NY 14609 USA
Phone: 716/482-0300
Fax: 716/288-5989

© 1993, Applied Image, Inc., All Rights Reserved



THE END

PLEASE

REWIND