

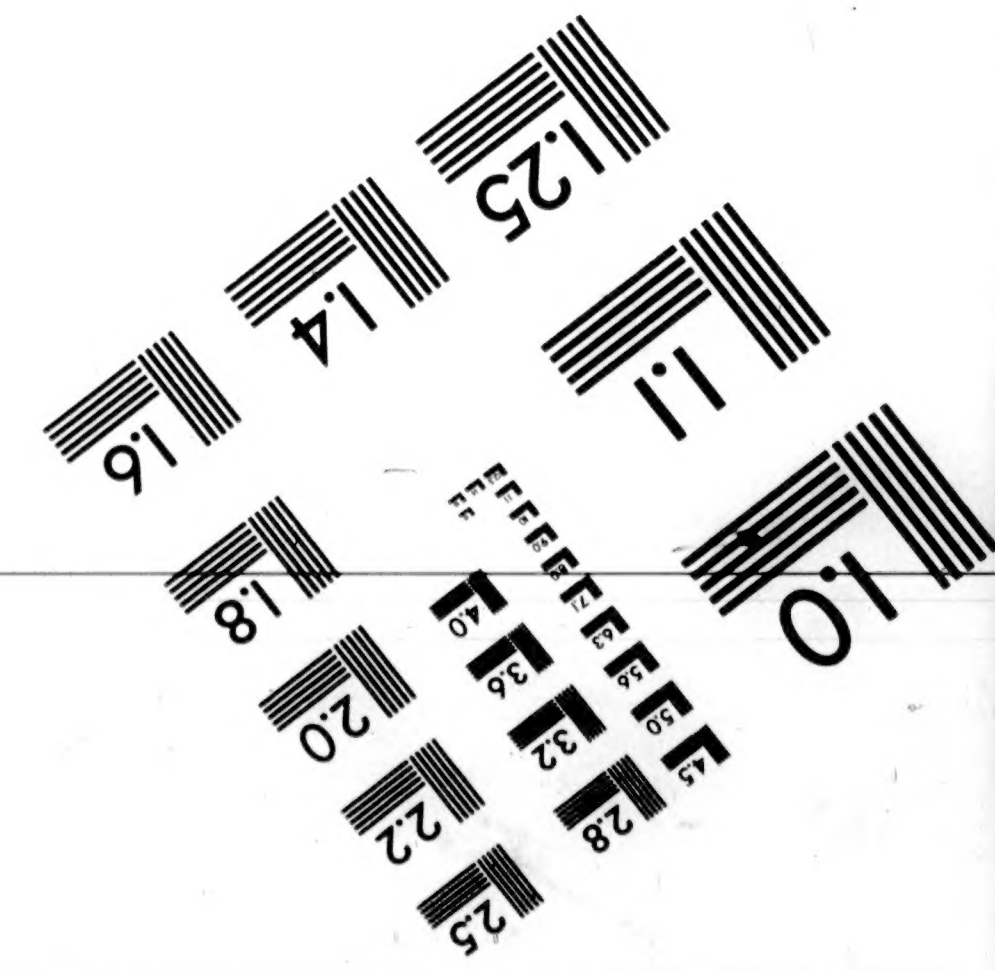

NATIONAL  
ARCHIVES  
MICROFILM  
PUBLICATIONS

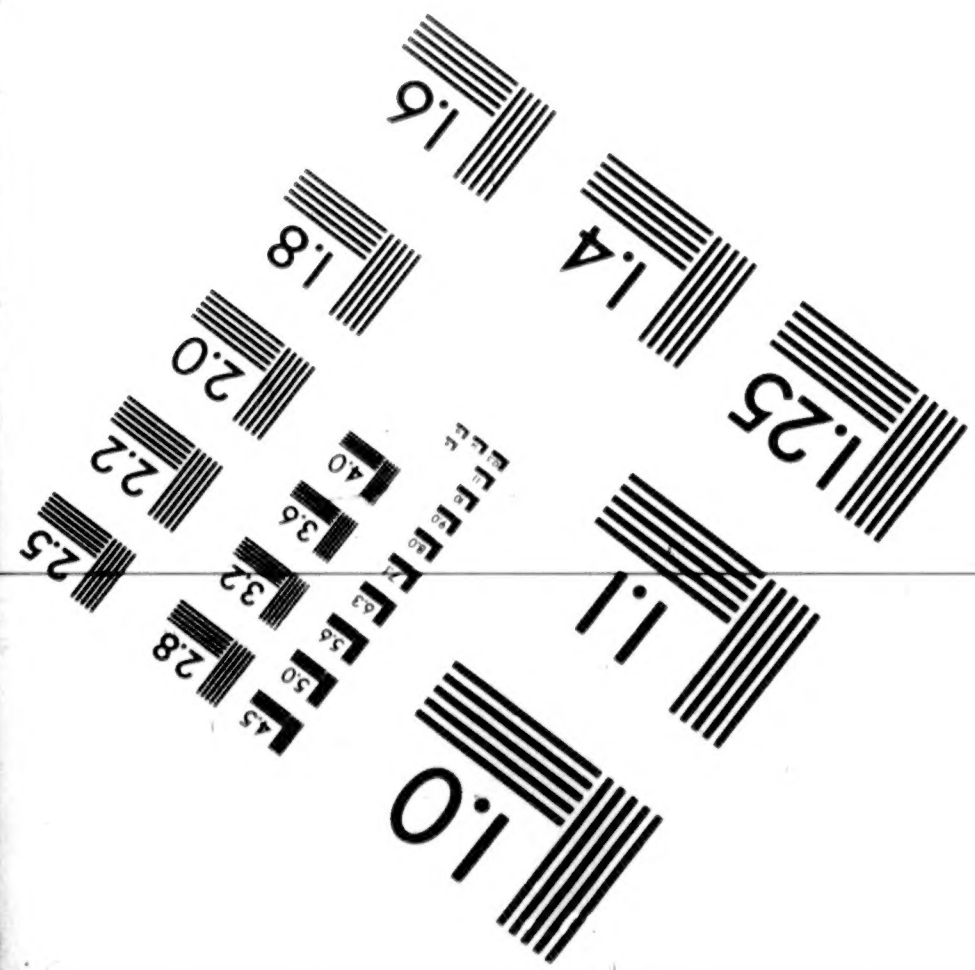

# IMAGE EVALUATION TEST TARGET (QA-3)

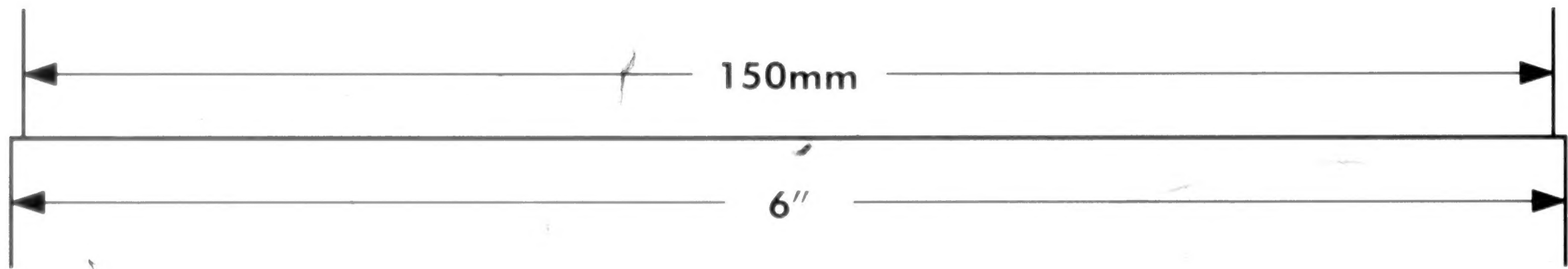
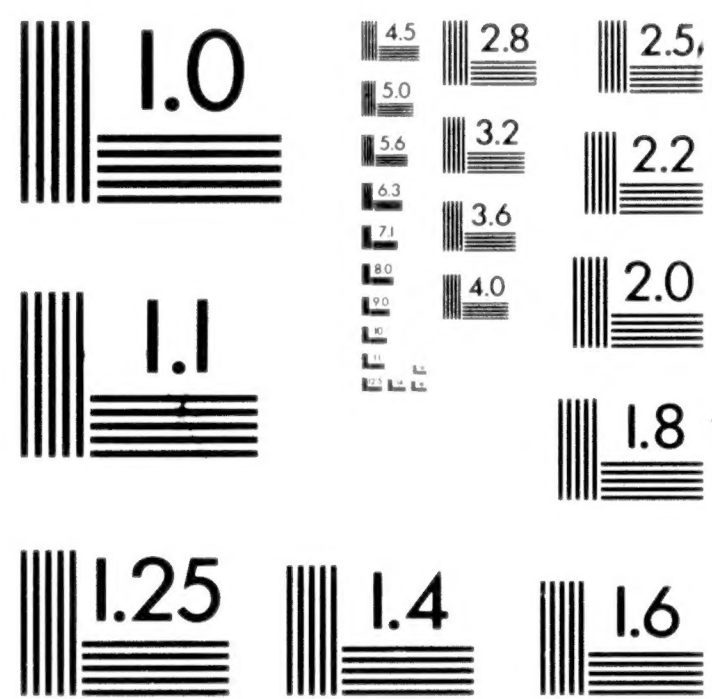
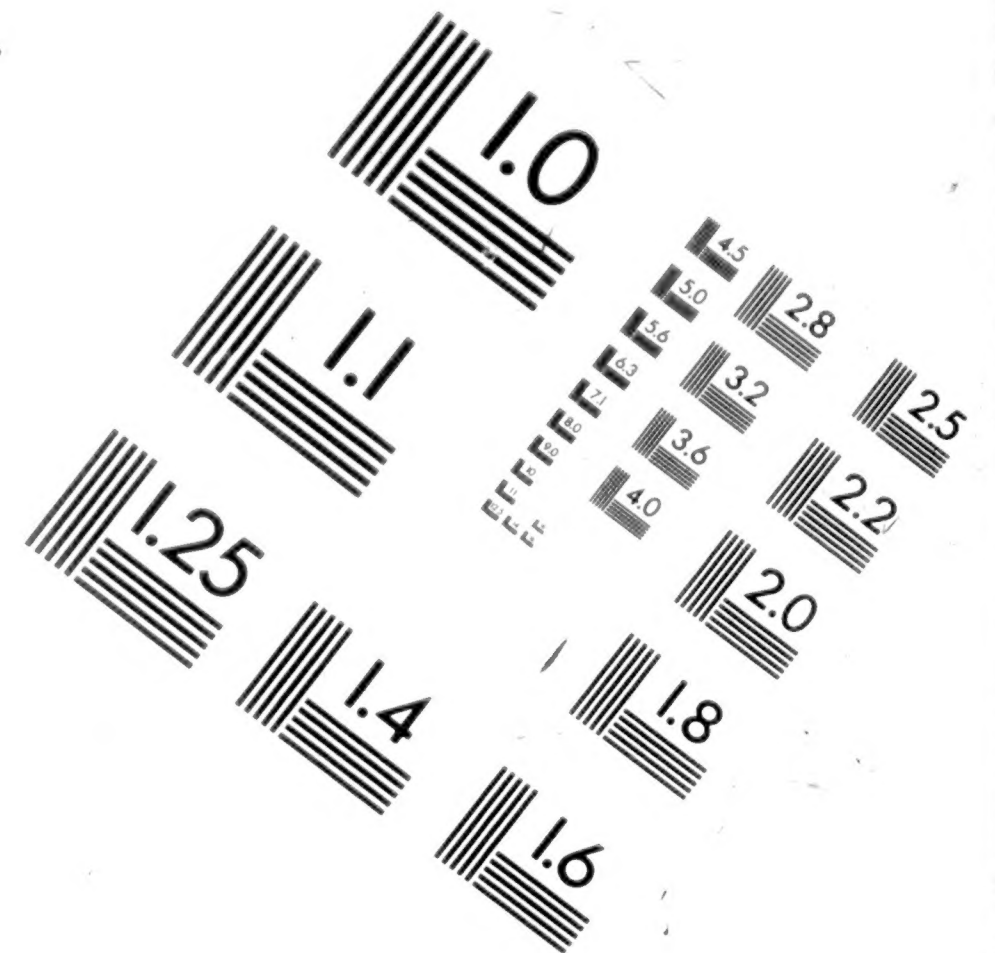
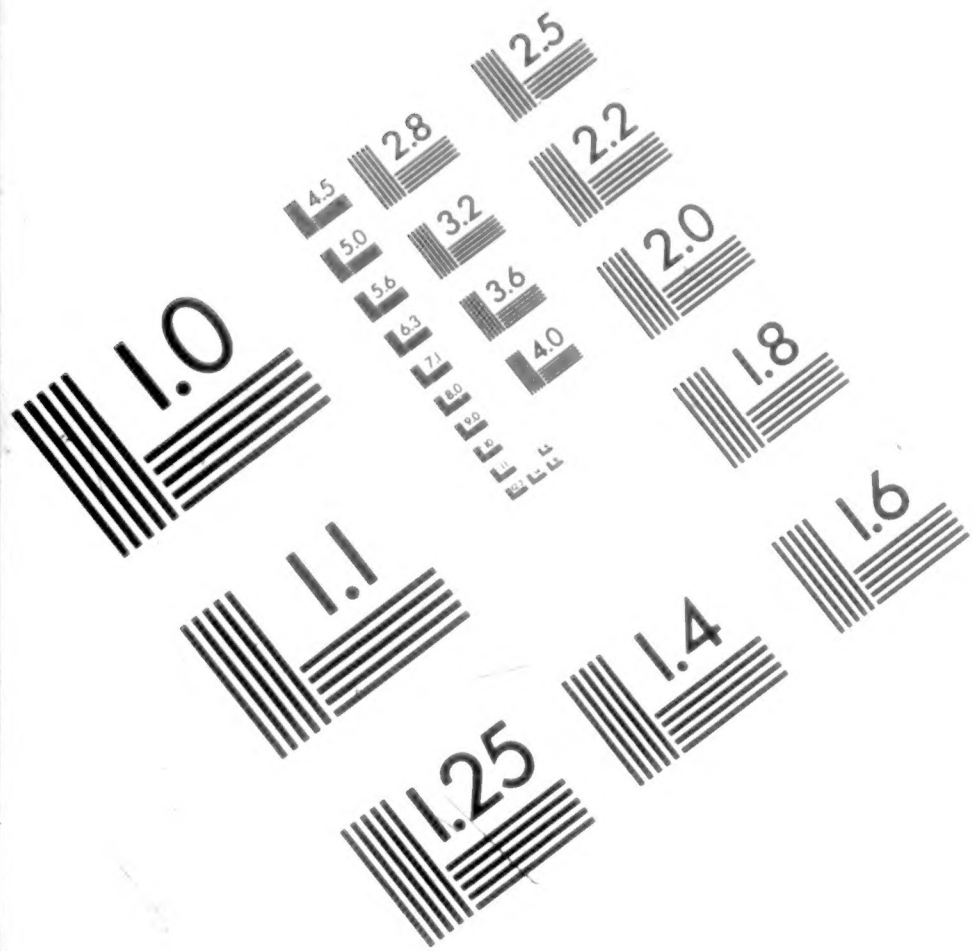

APPLIED IMAGE, Inc  
1653 East Main Street  
Rochester, NY 14609 USA  
Phone: 716/482-0300  
Fax: 716/288-5989

© 1993, Applied Image, Inc., All Rights Reserved

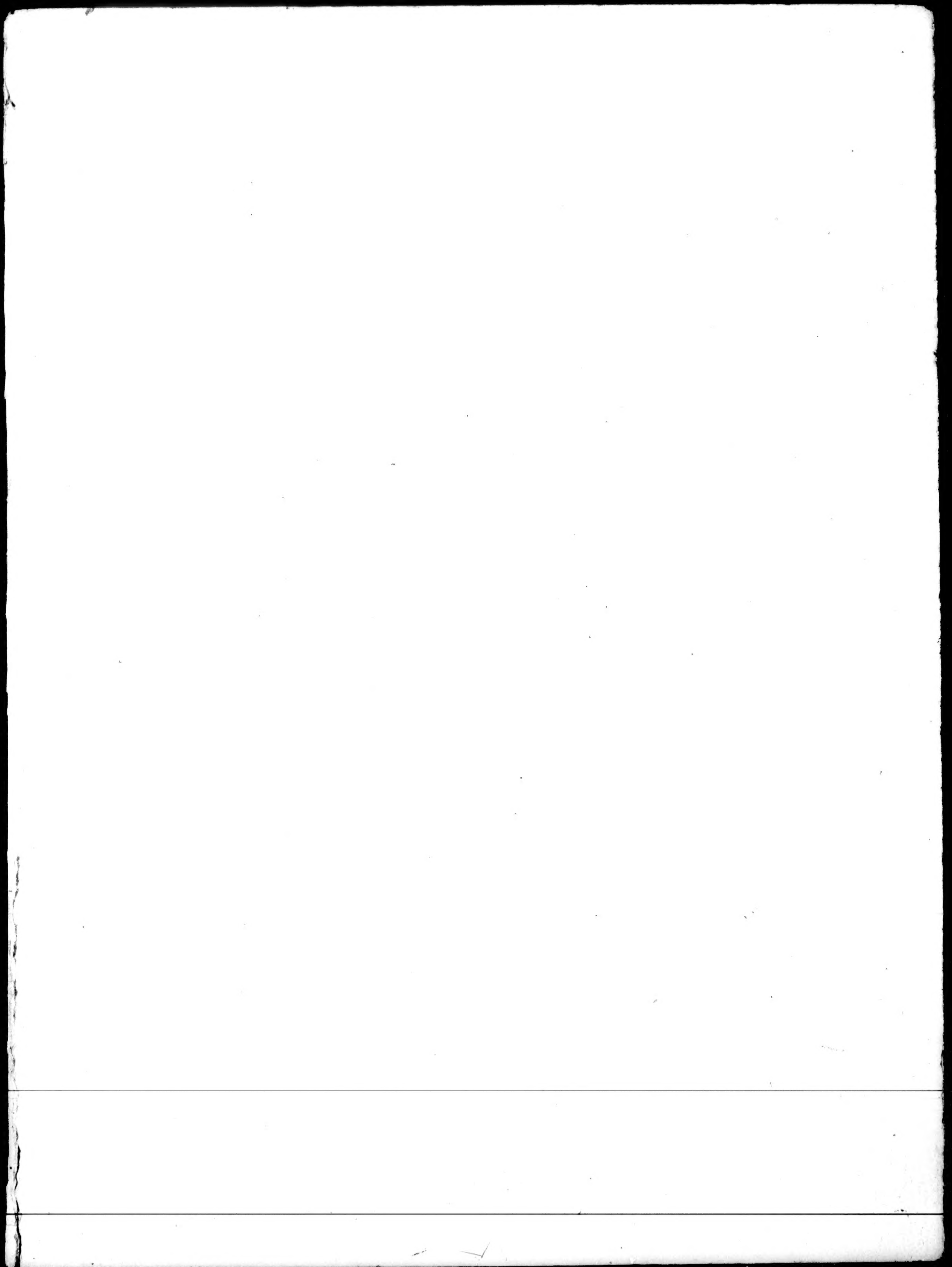

National Archives at College Park



8601 Adelphi Road College Park MD 20740-6001

Rebecca Sullivan

OPERATOR

CAMERA

September 2, 1998 10

DATE FILMED

REDUCTION RATIO

2461-0576-014-01

FILM EMULSION NUMBER

M-1818

215

PROJECT NUMBER

ROLL NUMBER

MICROCOPY

1 8 1 8

ROLL

2 1 5



**NATIONAL ARCHIVES MICROFILM PUBLICATIONS**

M1818

**COMPILED MILITARY SERVICE RECORDS OF  
VOLUNTEER UNION SOLDIERS WHO SERVED WITH THE  
UNITED STATES COLORED TROOPS:  
Artillery Organizations**

Introduction by Budge Weidman, Project Manager

Records prepared for microfilming by members of  
the Civil War Conservation Corps

Pat Alfredson	Sue Goward*	Mary Poggioli
Phyllis Altrogge	Bert Greenstein	Peggy Pratt
Kenneth Ashton	Anne Greenwood	Ray Puzio
Sue Barnard*	Jim Harris	Sylvia Scott
Dee Benson	Walter Hayden	Lynn Shearouse
Ann N. Brown	Mary Hayden	Mary Stack-Dunne
Robert Budway	Pat Ikonen	Ben Stearns
Randy Caldwell	Dick Ives	Bill Stormer*
MaryAnn Castellana*	Sarah Jaffe	Pat Sullivan
Mary Lou Cole	Barbara Kemp	Gorman Tidball*
Giovanni Croce	Bev Manypenny	Cathy Tinston
B.H. Custer	Frank Masterson	John Toole
Bob Denney	Joe Mazur	Maryellen Toole
Richard Dow	Kathleen McCarthy	Milt Weatherhead
Earl Dunn	Sarah McDougall	Russ Weidman
Yvette Fallin	Catherine McManus	C. Lois Young
Maria Flesher	Ben Miles	Robert Young
Naomi Glass	Dave Murray	

Team leaders are indicated by the asterisk.

National Archives and Records Administration  
Washington, DC  
1998

## INTRODUCTION

On the 299 rolls of this microfilm publication, M1818, are reproduced the compiled military service records of volunteer Union soldiers belonging to the artillery units organized for service with the United States Colored Troops (USCT). The USCT included 7 numbered cavalry regiments; 13 numbered artillery regiments plus one independent battery; 144 numbered infantry regiments; plus Brigade Bands Nos. 1 & 2 (Corps d'Afrique and US Colored Troops); Powell's Regiment Colored Infantry; Southard's Company Colored Infantry; Quartermaster Detachment; Pioneer Corps, 1st Division, 16th Army Corps; Unassigned Company A Colored Infantry; and Unassigned USCT. There are also miscellaneous service cards arranged alphabetically by surname at the end of the unit records. The records reproduced are part of the Records of the Adjutant General's Office, 1780's-1917, Record Group (RG) 94.

## Background

## United States Colored Troops

Since the time of the American Revolution, African Americans have volunteered to serve their country in time of war. The Civil War was no exception. Official sanction was the difficulty. In the fall of 1862 there were four Union regiments of African Americans raised in New Orleans, LA: the 1st, 2d, and 3d Louisiana Native Guard, and the 1st Louisiana Heavy Artillery (African Descent). The 1st South Carolina Infantry (African Descent) was not officially organized until January 1863; however, three companies of the regiment were on coastal expeditions as early as November 1862. Similarly, the 1st Kansas Colored Infantry was not mustered into Federal service until January 1863, even though the regiment had already participated in the action at Island Mound, MO, on October 27, 1862. These early unofficial regiments received little Federal support, but they showed the strength of the African American soldier's desire to fight for freedom.

The first official authorization to employ African Americans in Federal service was the Second Confiscation and Militia Act of July 17, 1862. This act allowed President Abraham Lincoln to receive into the military or naval service persons of African descent and gave him permission to use them for any purpose "he may judge best for the public welfare." However, the President did not authorize use of African Americans in combat until issuance of the Emancipation Proclamation on January 1, 1863.

In late January 1863, Governor John Andrew of Massachusetts received permission to raise a regiment of African American soldiers. The pace of organizing additional regiments was very slow. In March Secretary of War Edwin M. Stanton sent Gen. Lorenzo Thomas to the lower Mississippi Valley to recruit free and contraband African Americans. Thomas was given broad authority. He was to explain the administration's policy regarding African American soldiers and recruit



volunteers to raise and command them. Stanton wanted all officers of such units to be white, but that policy was softened to allow African American surgeons and chaplains. By the end of the war, in addition to the chaplains and surgeons, there were some 87 African American officers. Thomas's endeavor was very successful, and on May 22, 1863, the Bureau of Colored Troops was established to coordinate and organize regiments from all parts of the country. Created under War Department General Order No. 143, the bureau was responsible for handling "all matters relating to the organization of Colored Troops." The bureau was directly under the Adjutant General's Office and its procedures and rules were specific and strict. All African American regiments were now to be designated United States Colored Troops (USCT). At this time there were some African American regiments with state names and a few regiments in the Department of the Gulf designated as Corps d'Afrique. All these were ultimately assimilated into the USCT, even though some of the regiments, such as the 5th Massachusetts, retained their state designations.

To facilitate recruiting in the states of Maryland, Missouri, Tennessee, and eventually Kentucky, the War Department issued General Order No. 329 on October 3, 1863. Section 6 of the order stated that if any citizen should offer his or her slave for enlistment into the military service, that person would, "if such slave be accepted, receive from the recruiting officer a certificate thereof, and become entitled to compensation for the service or labor of said slave, not exceeding the sum of three hundred dollars, upon filing a valid deed of manumission and of release, and making satisfactory proof of title." For this reason, some records of manumission are contained in the compiled service records reproduced in this publication.

The USCT fought in 39 major engagements and over 400 lesser ones. Sixteen African American soldiers received Medals of Honor. As it was in other units, the death toll from disease was very high in the USCT. Deaths from disease and battle totaled 37,000. The last regiment of the USCT was mustered out of Federal service in December 1867.

Important sources for information about African American units in the Civil War are the War Department's *The War of the Rebellion: A Compilation of the Official Records of the Union and Confederate Armies* (Washington, DC: 1880-1901; reprinted Harrisburg, 1971 and 1985) and the Navy Department's *The War of the Rebellion: A Compilation of the Official Records of the Union and Confederate Navies* (Washington, DC: 1874-1922; reprinted Harrisburg, 1971 and 1985). These multivolume works contain reports of operations and other official correspondence.

#### U. S. Colored Heavy Artillery

**1st Heavy Artillery:** This regiment was organized at Knoxville, TN, between February and November 1864. It served in Knoxville, eastern Tennessee, western Virginia, northern Alabama, and western North Carolina. It was mustered out on March 31, 1866.



**2d Heavy Artillery:** This regiment was changed from the 2d Heavy Artillery to the 3d Heavy Artillery on April 26, 1864, and the compiled military service records appear there.

**3d Heavy Artillery:** Organized as the 1st Tennessee Heavy Artillery (African descent) at Memphis and Fort Pickering, TN, from June 5 to December 22, 1863, this regiment's designation was changed to the 3d United States Colored Heavy Artillery in April 1864. It served garrison duty at Fort Pickering and in defense of Memphis, TN. The unit mustered out on April 30, 1866.

**4th Heavy Artillery:** This unit was organized as the 2d Regiment Tennessee Heavy Artillery (African descent) from June 1863 until April 1864. It became the 4th United States Colored Heavy Artillery in April 1864. It served at Fort Halleck; Columbus, KY; and Union City, TN. The regiment had duty near Fort Donelson, TN, and moved to Pine Bluff, AR, where it was mustered out on February 25, 1866.

**5th Heavy Artillery:** This regiment was organized at Vicksburg, MS, between August 1863 and January 1864, as the 9th Louisiana Volunteers (African descent). Its designation was changed to the 5th Heavy Artillery in April 1864. The unit served garrison duty at Vicksburg, MS, and was mustered out on May 20, 1866.

**6th Heavy Artillery:** This regiment was organized as the 2d Mississippi Heavy Artillery (African descent) at Natchez, MS, from September 1863 to January 1864. It was changed to the 6th United States Colored Heavy Artillery on April 26, 1864. The unit served at Natchez, Mississippi, and Vidalia, LA. It was mustered out on May 18, 1866.

**7th Heavy Artillery:** The 7th Heavy Artillery was designated the 11th United States Colored Infantry (New) on January 23, 1865, and the compiled military service records appear there.

**8th Heavy Artillery:** This regiment was organized at Paducah, KY, from April to October 1864. It served garrison duty at Paducah and was mustered out on February 10, 1866.

**9th Heavy Artillery:** This regiment consisted of four companies and was organized at Clarksville and Nashville, TN, during October 1864. It was mustered out on May 5, 1865.

**10th Heavy Artillery:** Organization of this regiment at New Orleans, LA, began in November 1862. First designated the 1st Louisiana Heavy Artillery (African descent) in November 1863, it became the 1st Regiment Corps d'Afrique. In May 1864 the unit became the 10th United States Colored Heavy Artillery. The regiment was on garrison duty at New Orleans during its entire service. It served longer than any other USCT regiment, mustering out on February 22, 1867.



**11th Heavy Artillery:** This regiment was organized at Providence, RI, from August 1863 through January 1864, as the 14th Rhode Island Colored Heavy Artillery. In May 1864 it became the 11th United States Colored Heavy Artillery. The unit served garrison duty at New Orleans, LA, and was mustered out on October 2, 1865.

**12th Heavy Artillery:** This regiment was organized at Camp Nelson, KY, from July 1864 through July 1865. It served garrison duty at Camp Nelson, Bowling Green, and other points in the District of Kentucky. It was mustered out on April 24, 1866.

**13th Heavy Artillery:** This regiment was organized at Camp Nelson, KY, in June 1865, where it served garrison duty. It also served at Smithland and Lexington, KY. It was mustered out on November 18, 1865.

**14th Heavy Artillery:** This regiment was organized at New Bern and Morehead City, NC, from March 1864 to April 1865, as the 1st North Carolina Colored Heavy Artillery. It became the 14th United States Colored Heavy Artillery in March 1865. The unit served garrison duty at New Bern, NC, and was mustered out on December 11, 1865.

#### U. S. Colored Light Artillery

The 1st Regiment Light Artillery was recruited and organized under Maj. Gen. Benjamin F. Butler in December 1863. In February 1864 it was changed to Battery B of the 2d Light Artillery.

The 2d Regiment Light Artillery consisted of nine batteries, A through I, that were independently organized and deployed.

Battery A was organized at Nashville, TN, in April 1864. The battery served garrison duty at Nashville and participated in the Battle of Nashville December 15-16, 1864. It was mustered out January 13, 1866.

Battery B was organized at Fort Monroe, VA, in January and February 1864. It operated in Virginia and participated in the siege against Petersburg and Richmond. The battery was ordered to Texas in May 1865, and mustered out March 17, 1866.

Battery C was organized at Hebron's Plantation, MS, in November 1863, as the 1st Battery Louisiana Light Artillery (African descent). It was designated Battery C in April 1864. The battery had garrison duty at Goodrich Landing, Vicksburg, and Milliken's Bend. It was mustered out December 28, 1865.

Battery D was organized at Black River Bridge, MS, in December 1863, as the 2d Battery Louisiana Light Artillery (African descent). It was designated Battery D in April 1864. The battery had garrison duty at Goodrich Landing and Vicksburg, MS, and was mustered out on December 28, 1865.

Battery E was organized at Helena, AR, in December 1863, as the 3d Battery Louisiana Light Artillery (African descent). It was designated Battery E in April 1864. The battery had garrison duty at Helena, AR, and was mustered out on September 26, 1865.

Battery F was organized at Memphis, TN, in November 1863, as the Memphis Light Battery. It was designated Battery F in April 1864. The battery had garrison duty at Memphis, TN, until April 1865, when it moved to Bridgeport, AL. It was mustered out on December 28, 1865.

Battery G was organized at Hilton Head, SC, in May 1864 and had garrison duty at Hilton Head for its entire term. The battery was mustered out on August 12, 1865.

Battery H was organized at Pine Bluff, AR, in June 1864, as the 1st Arkansas Colored Battery. It was designated as Battery H in December 1864. The battery had garrison duty at Pine Bluff the entire term and was mustered out on September 14, 1865.

Battery I was organized at Memphis, TN, in April 1864. The battery had garrison duty at Memphis, TN, and operations in Mississippi. It was mustered out on January 10, 1866.

Independent Battery was organized at Leavenworth, KS, in December 1864. It had duty at Fort Leavenworth until it was mustered out on July 22, 1865.

#### Records Description

Compiled service records consist of a jacket-envelope for each soldier, labeled with his name, rank, unit, and card numbers. The compilation of service records of Union soldiers began in 1890 under the direction of Col. Fred C. Ainsworth, head of the Record and Pension Office of the Adjutant General's Office, Department of War. Information from muster rolls, regimental returns, descriptive books, and other records was copied verbatim onto cards. A separate card was prepared each time an individual name appeared on a document. These cards were numbered on the back, and these numbers were entered onto the outside jacket containing the cards. The carded information was verified by a separated operation of comparison; great care was taken to ensure that the cards were accurate.

A typical jacket contains card abstracts of entries found in original records relating to the soldier and original documents relating solely to that soldier. Examples of the latter include enlistment papers, substitute certificates, casualty sheets, death reports, prisoner-of-war memorandums, and correspondence. Unique to the records of the USCT are deeds of manumission, oaths of allegiance, proof of ownership, certificates of monetary award, and bills of sale. These items appear most frequently in units recruited in the border states of Kentucky, Missouri, and Maryland. These states remained in the Union but were slave states. Jackets and



cards include a section labeled "bookmark" which was reserved for cross-references to other records relating to the individual or his unit. The service records are arranged by arm of service, thereunder numerically by regiment or independent battalion or company, and thereunder alphabetically by name of the soldier. Records for officers are interfiled alphabetically by name with the records of enlisted men. If an individual served in more than one unit, which was typical for USCT officers, there will be a separate service record for each unit in which he served.

The unjacketed miscellaneous cards were accumulated by the War Department with the expectation that they would be incorporated in individual compiled service records. However, the expectation was never fulfilled, because either insufficient or contradictory information made it impossible to associate the cards or papers with a particular soldier's service records.

#### Related Records

Among the records of the Adjutant General's Office in the National Archives are many of the original records that were abstracted or "carded" by the Record and Pension Office. These include the individual unit's muster rolls, returns and descriptive books. Other series in RG 94 that contain information relating to volunteer Union soldiers who served with the USCT include carded records relating to Union staff officers, carded medical records of volunteer Union soldiers, unbound and bound regimental records and "record of events" cards. The regimental records of the 54th Massachusetts Infantry (Colored) have been reproduced as Microfilm Publication M1659, *Records of the Fifty-fourth Massachusetts Infantry Regiment (Colored), 1863-1865*.

The "record of events" cards include information copied from the unit's muster rolls and returns. They show the stations of the field and staff and those of the various companies of the regiment at the time the muster roll or return was prepared and sometimes mention battles, skirmishes, or other activities in which the regiment participated. The cards have been reproduced as Microfilm Publication M594, *Compiled Records Showing Service of Military Units in Volunteer Union Organizations*.

Record Group 94 also includes a card index for the USCT, reproduced as Microfilm Publication M589, *Index to Compiled Military Service Records of Volunteer Union Soldiers Who Served with U.S. Colored Troops*, which may be used to locate the regiment of USCT personnel. An index card gives the name of the soldier and his rank, as well as the unit in which he served; sometimes there is a cross-reference to his service in other units or organizations. The National Archives is continually producing microfilm publications of volunteer Union compiled military service records. A complete listing of finished publications can be found in the National Archives *Microfilm Resources for Research: A Comprehensive Catalog* which is available online at <http://www.nara.gov>.

The Records of the Colored Troops Division, within RG 94, include division correspondence and records relating to recruiting, the appointment of officers, and the slave or free status of individuals; and a compilation of historical extracts and official papers concerning the military service of African Americans from the colonial period through the Civil War entitled *The Negro in the Military Service of the United States 1639-1886*. This compilation is reproduced as Microfilm Publication M858. The Records of the Bounty and Claims Division, also in RG 94, include correspondence of the division and records relating to bounties and claims paid to loyal owners of slaves by the Slave Claims Commissions of Delaware, Kentucky, Maryland, Missouri, Tennessee, and West Virginia.

If an application for a pension was made, the pension application case file may be among the Records of the Veterans Administration (RG 15). Indexes to the pension applications have been reproduced as Microfilm Publication T288, *General Index to Pension Files, 1861-1934*, and T289, *Organizational Index to Pension Files of Veterans Who Served Between 1861 and 1900*.

If a soldier or officer was tried before a general court-martial or if an individual or his unit was the subject of a court of inquiry or military commission, transcripts of the proceedings may be among the Records of the Office of the Judge Advocate General (Army) (RG 153). The registers to the proceedings have been reproduced as Microfilm Publication M1105, *Registers of the Records of the Proceedings of the U.S. Army General Courts-Martial, 1809-1890*.

Other record groups having information pertaining to the USCT include Records of the Bureau of Refugees, Freedmen, and Abandoned Lands (RG 105); Records of the Provost Marshal General's Bureau (Civil War) (RG 110); Records of the Accounting Officers of the Department of the Treasury (RG 217); and Records of U.S. Army Continental Commands, 1821-1920 (RG 393).



NATIONAL ARCHIVES MICROFILM PUBLICATIONS

Roll list

Roll Description

1st United States Colored Heavy Artillery

- |    |   |
|----|---|
| 1  | Ackerson, David - Baker, Barney         |
| 2  | Baker, George - Bogle, Harry            |
| 3  | Bolden, Joseph - Brown, Edwin G.        |
| 4  | Brown, George - Carmack, Bachus         |
| 5  | Carmack, Gilbert - Cleveland, Loudon    |
| 6  | Clevenger, Charles - Cune, John C.      |
| 7  | Curd, George - Eblin, Richard           |
| 8  | Eckles, Silas - Furbush, Lewis          |
| 9  | Gaines, George - Greenleaf, Andrew      |
| 10 | Greenleaf, Julius - Hart, Benjamin      |
| 11 | Hartman, Henry - Hoff, David            |
| 12 | Holland, John - Jackson, Thomas J.      |
| 13 | Jackson, Washington - Jones, James      |
| 14 | Jones, John - Ledgewood, Clayborne      |
| 15 | Lee, Elhanon - Martin, Robert           |
| 16 | Mason, Henry - McKenney, Elijah         |
| 17 | McKinney, Lewis - Montcastle, Stewart   |
| 18 | Montgomery, Alfred - Owens, Benjamin    |
| 19 | Owens, Granville - Ragan, Nelson        |
| 20 | Ragan, Rome - Russell, Orlando A.       |
| 21 | Russell, Perry - Smith, Archie          |
| 22 | Smith, Bart - Suddles, Robert           |
| 23 | Summers, Joseph D. - Turner, Charles    |
| 24 | Turner, Henry - Weir, Richard           |
| 25 | Weir, Robert - Willis, Albert           |
| 26 | Willis, Beverly S. - Zimmerman, William |

3d United States Colored Heavy Artillery

- |    |  |
|----|--|
| 27 | Abel, William - Armour, Lewis          |
| 28 | Armstaed, William - Beaufort, Thomas   |
| 29 | Beaumont, Henry - Bowler, Lafayette P. |
| 30 | Bowman, Fleming - Brummer, John E.     |
| 31 | Bryan, Solon - Carter, William         |
| 32 | Cartman, John - Cook, Isham            |
| 33 | Cook, John - Davis, Doctor             |
| 34 | Davis, George - Easen, Samuel          |
| 35 | Easley, Wesley - Flinn, Clay           |
| 36 | Flint, James - Gilbreth, Eli           |

NATIONAL ARCHIVES MICROFILM PUBLICATIONS

Roll	Description
37	Gilbreth, Guy - Griffin, Samuel
38	Griffin, William - Harrison, James
39	Harrison, James C. - Hicks, Smith
40	Higginbottom, Nimrod - Hunt, Rubin
41	Hunt, William - Johnson, Charles
42	Johnson, Crawford - Jones, Isaac
43	Jones, Isam - Knight, Warren
44	Knox, Overton - Mabin, Baker
45	Mabin, James - McDonald, Manuel
46	McDonald, Ruben - Mills, Robert
47	Milroy, John - Nealy, Henry
48	Ned, Lewis - Patterson, Pembroke J. (Perin J.)
49	Patton, Richmond - Powers, William
50	Prewitt, Greene - Roberts, Lewis
51	Robinette, Henry - Scott, Edmond
52	Scott, Elijah - Smith, Peter
53	Smith, Randall - Tapscott, Julius
54	Tarwater, Jesse - Todd, William
55	Todd, Willis - Wallace, Robert
56	Wallace, Sandford - Wells, Duncan
57	Wells, Joseph - Williams, Guyo
58	Williams, George - Wolbrecht, Adolf
59	Wood, Charles - Young, William H.

4th United States Colored Heavy Artillery

60	Abbott, John - Barnes, Samuel
61	Barnes, Thomas - Britt, Jackson
62	Britten, Charles - Clark, Mitchell
63	Clay, Henry - Daniel, Richard
64	Daniels, William - Dyson, Jack
65	Dyson, Paul - Gardner, Riley
66	Gardner, Washington - Hall, Henry
67	Hall, Jack - Horton, Mack
68	Horton, William - Jones, Levi
69	Jones, Louis - Lewis, Stephen
70	Lewis, Thomas - McMurray, Anderson (John)
71	McMurray, George - Need, Benjamin
72	Nelson, John - Prior, Alfred
73	Prior, Gabriel - Rutland, Isaac
74	Ruttkey, Albert - Smith, Louis
75	Smith, Samuel - Turner, Frank
76	Turner, James - White, Henry
77	White, Raven - Youngs, William

NATIONAL ARCHIVES MICROFILM PUBLICATIONS

Roll Description

5th United States Colored Heavy Artillery

78 Abbott, Richard - Armstrong, William  
 79 Arrindale, John B. - Bentley, Francis A.  
 80 Bentley, Isam - Brooks, Lawyer  
 81 Brooks, Robert - Cabin, Henry  
 82 Cabin, Shadrick - Coleman, Nathan  
 83 Coleman, William - Davidson, Ellis  
 84 Davis, Alfred - Dodd, Taylor  
 85 Dodds, Peter - Feltis, Jackson  
 86 Felton, Martin - Gilford, Charles  
 87 Gillespie, Gilbert - Hagan, Alex  
 88 Hagans, Joseph - Hayes, John S.  
 89 Haythorn, Henry - Hood, John  
 90 Hooker, William - James, Warren  
 91 January, Nathan - Johnson, Wiley  
 92 Johnson, William - Kindley, Edward  
 93 King, Elijah - Lewis, Ely J.  
 94 Lewis, George W. - Manito, Samuel  
 95 Manly, Elisha - McNeil, William  
 96 McQuilley, Clayton - Mosley, Jacob  
 97 Moss, Alfred - Parker, James  
 98 Parker, John H. - Powell, Monroe  
 99 Power, Henry - Roach, Watt  
 100 Robb, Benjamin - Shaw, Barrow  
 101 Shaw, James - Smith, Robert  
 102 Smith, Samuel - Tate, John  
 103 Taylor, Anderson - Trueman, Henry  
 104 Truman, Nelson - Ward, George  
 105 Ward, Jacob - West, Moses  
 106 Westbrook, Ellick - Williams, John B.  
 107 Williams, Jordan - Wood, Theodore  
 108 Woodam, Henry - Young, William  
 Miscellaneous Service Cards  
 Allen, Geo. - Young, L.

6th United States Colored Heavy Artillery

109 Aaron, William - Barton, Granderson  
 110 Baseman, Jerry - Bracton, John  
 111 Bradford, Henry - Bush, Wilson  
 112 Bustis, Mondey - Clay, Henry  
 113 Clay, William - Davenport, William  
 114 Davenport, Wilson - Dunbar, Newton



NATIONAL ARCHIVES MICROFILM PUBLICATIONS

Roll	Description
115	Dunbow, Hannibal - Fox, William
116	Francis, James - Green, George
117	Green, James - Harris, Hiram
118	Harris, John - Hopper, Anthony
119	Hopper, Handy - James, Joseph
120	Jasper, Samuel - Jones, John
121	Jones, Jonas - Leavitt, Charles B.
122	Lee, David - McBride, Samuel
123	McCabe, Alexander H. - Moore, Joseph
124	Moore, Manual - Owens, Willis
125	Page, Benjamin - Reece, Edward
126	Reese, William - Samuel, William
127	Sanders, Archibald - Smart, Robert
128	Smith, Aaron - Suzette, Armstead
129	Swanson, Jack - Trotter, George
130	Troyman, George - Waters, Robert
131	Waters, Wesley - Williams, Bedney
132	Williams, Benjamin - Wilson, George
133	Wilson, Guy - Young, Wesley
	Miscellaneous Service Cards
	Adams, Winder - Williams, John

8th United States Colored Heavy Artillery

134	Abanather, Paten - Beasley, George W.
135	Beasley, Washington - Boyd, Isaac
136	Boyd, Paine - Burrill, George
137	Burris, Abram - Cofield, Henry
138	Cofield, Isaac - Davis, George
139	Davis, Jerry - Edwards, Frank
140	Edwards, Gus - Ginigan, Thomas
141	Givens, George - Hampton, Phillip
142	Hancock, James - Hodge, Cotney
143	Hodge, Gaines - Johnson, Charles
144	Johnson, Clinton - Lee, Wash
145	Leeper, Thomas - Maxwell, Henry
146	Maxwell, Samuel - Moore, Amos
147	Moore, David - Pearson, Alexander
148	Pearson, Charley - Rice, Pleasant
149	Rice, Taylor - Sherrer, Elick
150	Shirles, James - Talbot, Henry
151	Talley, William - Turner, Robert
152	Tyler, Jerry - Williams, John
153	Williams, Sam - Young, William



NATIONAL ARCHIVES MICROFILM PUBLICATIONS

Roll Description

9th United States Colored Heavy Artillery

- 154 Ailer, John - Coleman, Miles
- 155 Collins, Moses A. - Grosskopff, Edward
- 156 Grubb, Andrew - Landon, Harry
- 157 Lanier, Jesse - Payne, George
- 158 Payne, James - Tory, Madison
- 159 Toryand, Emanuel - Young, George

10th United States Colored Heavy Artillery

- 160 Aaron, Benjamin - Auguste, Daniel
- 161 Augustus, Edward - Benson, George
- 162 Bentley, William H. - Brooks, Walker
- 163 Brooks, Washington - Camel, Paul
- 164 Cameron, Henry - Coleman, James
- 165 Coleman, John - Deale, Joseph
- 166 Deale, Thomas - Ellis, Robert
- 167 Ellis, Silas - Frederick, Joseph
- 168 Freeland, Martin A. - Grandison, Alfred
- 169 Grant, Moses - Harrison, Logan
- 170 Harrison, Thomas - Hoyt, Joseph
- 171 Hubbard, Henry - Jenkins, Solomon
- 172 Jennings, Caleb - Jozen, Jules
- 173 Julia, Nora - Libscomb, George
- 174 Lightfoot, Columbus - Maryday, John
- 175 Masdael, Noel - Misker, Robert
- 176 Mitchel, Alexander - Oldham, George B.
- 177 Oliver, Emile - Purnell, John
- 178 Putnam, Winthrop D. - Robinson, Henry
- 179 Robinson, Isaac - Simmons, Owen
- 180 Simms, Amos - Spencer, John
- 181 Spriggs, Thomas - Thornton, John
- 182 Thurston, Charles - Warner, Dudley
- 183 Warner, George E. - Wesley, John
- 184 West, Alexander - Willis, Stephen
- 185 Willson, George - Zozey, Jules
- Miscellaneous Service Cards
  - Cann, Mercer - Grayson, John W.
- 186 Miscellaneous Service Cards
  - Green, Andrew P. - Rygaard, Soren
- 187 Miscellaneous Service Cards
  - Sabatier, Peter - Zevenette, Paul

NATIONAL ARCHIVES MICROFILM PUBLICATIONS

Roll Description

11th United States Colored Heavy Artillery

- 188 Abbott, George M. - Bailey, James A.
- 189 Baird, Sylvester - Boardley, James
- 190 Boardley, John W. - Brown, Nathan
- 191 Brown, Samuel - Carter, William H.
- 192 Cartright, George W. - Commings, Hugh S.
- 193 Comstock, Joseph J. - Davis, Lyman
- 194 Davis, Stephen - Dubois, James
- 195 Duesenbury, Lewis - Fletcher, Roderick S.
- 196 Fletcher, Samuel - Garrison, John
- 197 Gaskell, George L. - Groff, Joseph
- 198 Guard, Andrew - Hector, William H.
- 199 Heelms, Harkness - Howard, Richard
- 200 Howard, Thomas - Jackson, Lewis
- 201 Jackson, Norton - Johnson, Joseph W.
- 202 Johnson, Nathan - King, Cornelius
- 203 King, George - Loucks, John A.
- 204 Low, Charles H. - Miller, Benjamin
- 205 Miller, Floyd N. - Nicholas, Samuel
- 206 Nichols, Alfred - Pierce, George W.
- 207 Pierce, John B. - Reed, Washington
- 208 Reese, Edward - Sampson, William H.
- 209 Sanders, Edward - Skanks, James S.
- 210 Skanks, Thomas C. - Sommerset, Levi
- 211 Southwick, Henry K. - Taylor, Alfred M.
- 212 Taylor, Charles - Townsend, John
- 213 Tracy, John - Warren, John
- 214 Washington, George - Whiting, Joseph C., Jr.
- 215 Wigden, Cyrus B. - Wilson, Samuel
- 216 Wilson, William - Young, Francis
- Miscellaneous Service Cards  
Abbot, George W. - Dyer, William S.
- 217 Miscellaneous Service Cards  
Earl, Peter - Young, William H.

12th United States Colored Heavy Artillery

- 218 Abbott, John - Barbee, Squire
- 219 Barber, Sherwood - Boller, Jerry
- 220 Bolor, Collins - Bryant, Frederick
- 221 Bryant, Henry - Bush, Reason
- 222 Butler, Aaron - Clark, Richard
- 223 Clark, Samuel - Criffield, Lewis

NATIONAL ARCHIVES MICROFILM PUBLICATIONS

Roll	Description
224	Christopher, James - Dock, Calvin E.
225	Dodge, Henry - Farnesley, Jack
226	Farrus, Ephraim - Gaves, David
227	Gentry, George - Haggin, George
228	Haggin, Samuel - Hawkins, Robert
229	Hawkins, Thomas - Hode, Adam
230	Hodge, Charles - Jackson, Andrew
231	Jackson, Augustus - Jopee, Joseph
232	Juda, Enoch - Lewis, Windsor
233	Lidick, Randall - Maton, Levi
234	Matthews, Charles W. - Mitchell, John
235	Mitchell, Monroe - Nelson, Joseph
236	Nesbin, William - Porter, Daniel
237	Porter, William R. - Richason, Shelly
238	Richie, George - Scott, Smith
239	Scott, Stephen - Smith, Leroy
240	Smith, Lyman - Taylor, Charles
241	Taylor, Cornelius - Turner, David
242	Turner, George - Warren, James
243	Washington, Anthony - Williams, Berry
244	Williams, Charles - Woodson, David
245	Woodson, Egbert - Young, Thomas
	Miscellaneous Service Cards
	Baughman, John - Heel, Rubin
246	Miscellaneous Service Cards
	Helm, Harry - Young, Stephen
	<b>13th United States Colored Heavy Artillery</b>
247	Abbott, Josiah - Bell, Augustine
248	Bell, Charles - Brown, Jesse
249	Brown, Lindsay - Connor, Cyrus
250	Connor, Isaac - Dyre, George
251	Early, Edward - Ginn, Samuel
252	Ginnis, Sidney Clay - Heath, Henry
253	Heath, Lewis - Jarrett, Charles
254	Jay, Johnson - Lee, William
255	Lender, Richard - McKinney, Cass
256	McKinney, Henry Clay - Owens, Robert
257	Owens, Smith - Randolph, Loyd
258	Rankins, Archibald - Scott, Jerry
259	Scott, John - Sugg, Edmond
260	Suiter, Jacob A. - Waddie, Harry
261	Waddy, Peter - Willett, Price



NATIONAL ARCHIVES MICROFILM PUBLICATIONS

Roll	Description
262	Willett, Robert - Young, William
263	Miscellaneous Service Cards Abbott, Josiah - Yumber, Anthony

14th United States Colored Heavy Artillery

264	Acot, Isaac - Becton, Henry
265	Becton, Moses - Burke, George W.
266	Burke, William A. - Davis, Toney
267	Dean, Thomas - Fullford, William
268	Fulton, James - Hardy, William
269	Harget, Israel - Hovey, William
270	Howard, Calvin - Kensley, Silas
271	Kent, Henry - McKeever, Simon
272	McMichael, Joseph - Noble, William
273	Nobles, Charles - Randall, Evans
274	Randall, Willey - Shark, Bryant
275	Sheckelford, Daniel - Smith, Samuel
276	Smith, Sterling - Thompson, John Henry
277	Thompson, Mark - Weeks, Ezekiel
278	Weidman, Albert - Wilson, Payton
279	Wilson, Richard - Young, William Miscellaneous Service Cards Acott, Isaac - Young, William

2d Regiment United States Colored Light Artillery

280	Able, John - Bernard, Albert
281	Berry, Henry - Brown, Sang
282	Brown, Thomas - Clark, William
283	Clay, Henry - Disen, Henry
284	Disen, Watkins - Francis, Henry
285	Franklin, Albert - Haines, Roe
286	Haines, Thomas - Hunt, Thomas
287	Hunter, Alexander M. - Kennedy, Abram
288	Kennel, George - March, George
289	Marcy, Anthony - Mobbs, Daniel
290	Moffet, John - Pattiller, Alfred
291	Pattiller, Patrick - Richardson, Jacob
292	Ridgeway, Anthony - Smith, Louis B.
293	Smith, Minus - Tucker, Alfred

NATIONAL ARCHIVES MICROFILM PUBLICATIONS

Roll	Description
294	Tucker, Sandy - Williams, Calvin
295	Williams, Charles - Zinum, John
296	Miscellaneous Service Cards Abraham, Francis - Young, Ruben

Independent Battery, United States Colored Light Artillery

297	Alexander, John - Hancock, George W.
298	Hanson, Noah C. - Scott, Andrew
299	Scott, Reynolds - Yeager, John Miscellaneous Service Cards Douglass, H. Ford - Minor, P.M.

NATIONAL ARCHIVES MICROFILM PUBLICATIONS

Microfilm Publication M1818

COMPILED MILITARY SERVICE RECORDS OF VOLUNTEER UNION  
SOLDIERS WHO SERVED WITH THE UNITED STATES COLORED  
TROOPS: Artillery Organizations

Roll 215

11th United States Colored Heavy Artillery

Wigden, Cyrus B. - Wilson, Samuel

1995  
Higden Cyrus B.  
Co K, 11 U.S. Col'd H. Art'y.

Private | Private

CARD NUMBERS.

1	6197974	26
2	6198117	27
3	6198260	28
4	6198423	29
5	6198576	30
6	6198733	31
7	6198873	32
8	6199016	33
9	6199152	34
10	6199285	35
11	6199407	36
12	6199530	37
12	6199648	38
14	9125731	39
15		40
16		41
17		42
18		43
19		44
20		45
21		46
22		47
23		48
24		49
25		50

Book Mark:

V. 113. P. 40. 70. + V. 114.  
P. 12. 70

See also



*W* | **11 H. Art'y. | U.S.C.T.**

*Cyrus B. Wigden*  
....., Co. *K*, 11 Reg't U. S. Col'd H. Art'y.

Appears on

**Company Descriptive Book**

of the organization named above.

**DESCRIPTION.**

Age *35* years; height *5* feet *3 1/2* inches.

Complexion *OK*

Eyes *OK*; hair *Dark*

Where born *Geneva N.Y.*

Occupation *Farmer*

**ENLISTMENT.**

When *Nov 28*, 186 .

Where *Prov A. I.*

By whom *J. B. Engly*; term *3* y'rs.

Remarks:

*Griffith*



*M* | 11 H. Art'y. | U.S.C.T.

*Cyrus B. Wigden*

*R*, Co. *K*, 14 Reg't R. I. Col'd H. Art'y.\*

Age *35* years.

Appears on

**Company Muster-in Roll**

of the organization named above. Roll dated

*Cpr. nr. Providence R. I., Dec 17, 1863.*

Muster-in to date *Dec 17, 1863.*

Joined for duty and enrolled:

When *Nov 28, 1863.*

Where *Providence R. I.*

Period *3* years.

Valuation of horse, \$.....*100*

Valuation of horse equipments, \$.....*100*

Remarks:.....

.....

.....

.....

\* This organization subsequently became Co. *K*, 11 Reg't U. S. Colored Heavy Artillery.

Book mark:.....

*J. H. Stewart*

(356)

Copyist.

*W* 11 H. Art'y. | **U.S.C.T.**

*Cyrus B. Wigden*  
*PC*, Co. K, 14 Reg't R. I. Col'd H. Art'y.\*

Appears on

**Company Muster Roll**

for *Dec 17 to Dec 31*, 186*3*.

Present or absent *Present*

Stoppage, \$ *100* for

Due Gov't, \$ *100* for

Valuation of horse, \$ *100*

Valuation of horse equipments, \$ *100*

Remarks:  
-----  
-----  
-----  
-----  
-----  
-----  
-----  
-----

\*This organization subsequently became Co. K, 11 Reg't U. S. Colored Heavy Artillery.

Book mark : -----

*J. Stewart*  
-----  
(358) Copyist.

W | 11 H. Art'y. | U.S.C.T.

Cyrus B. Wigden  
Pt, Co. K, 14 Reg't R. I. Col'd H. Art'y.\*

Appears on

**Company Muster Roll**

for Jan & Feb, 1864.

Present or absent Present

Stoppage, \$ 100 for

Due Gov't, \$ 100 for

Valuation of horse, \$ 100

Valuation of horse equipments, \$ 100

Remarks:

\*This organization subsequently became Co. K, 11 Reg't U. S. Colored Heavy Artillery.

Book mark:

J. H. Sewall

*W* | 11 H. Art'y. | U.S.C.T.

*Cyrus B. Wigden*  
Pt, Co. K, 14 Reg't R. I. Col'd H. Art'y.\*

Appears on

Company Muster Roll

for *Mch & apr* 1864.

Present or absent

*Present*

Stoppage, \$ 100 for

Due Gov't, \$ 100 for

Valuation of horse, \$ 100

Valuation of horse equipments, \$ 100

Remarks:

\*This organization subsequently became Co. K, 11 Reg't U. S. Colored Heavy Artillery.

Book mark:

*J. Stewart*

(358)

Copyist.



*W* | 11 H. Art'y. | U.S.C.T.

*Cyrus B. Wigden*  
*Co. K*, 8 Reg't U. S. Col'd H. Art'y.\*

Appears on

**Company Muster Roll**

for *May & June*, 186*4*.

Present or absent *Present*

Stoppage, \$ 100 for

Due Gov't, \$ 100 for

Valuation of horse, \$ 100

Valuation of horse equipments, \$ 100

Remarks: \_\_\_\_\_  
\_\_\_\_\_  
\_\_\_\_\_  
\_\_\_\_\_  
\_\_\_\_\_

† This organization subsequently became *K*, 11 Reg't U. S. Colored Heavy Artillery.

Book mark: \_\_\_\_\_

*Steward*  
Copyist.

*W* | **11 H. Art'y.** | **U.S.C.T.**

*Cyrus B. Wigden*  
*Prvt*, Co. K, 11 Reg't U. S. Col'd H. Art'y.

Appears on

**Company Muster Roll**

for *July & Aug*, 186*4*.  
Present or absent *Present*

Stoppage, \$.....100 for .....

Due Gov't, \$.....100 for .....

Valuation of horse, \$.....100

Valuation of horse equipments, \$.....100

Remarks: *Free on 19 April 64!*  
*\$6 per month due from*  
*enlistment to April*  
*30/64*

Book mark: .....

*Wigden*

*N* | 11 H. Art'y. | U.S.C.T.

*Cyrus B. Wigden*  
*Capt.*, Co. K, 11 Reg't U. S. Col'd H. Art'y.

Appears on

Company Muster Roll  
for *Sept & Oct*, 186*4*.  
Present or absent *Present*

Stoppage, \$.....100 for .....

Due Gov't, \$.....20 for *Ord.*

Valuation of horse, \$.....100

Valuation of horse equipments, \$.....100

Remarks:.....  
.....  
.....  
.....  
.....  
.....  
.....  
.....

Book mark:.....

*Steward*

*M* 11 H. Art'y. U.S.C.T.

*Cyrus B Wigden*  
*Pr*, Co. K, 11 Reg't U. S. Col'd H. Art'y.

Appears on

**Company Muster Roll**  
for *Nov 1st*, 186*4*.

Present or absent *Present*

Stoppage, \$ *100* for

Due Gov't, \$ *21*/<sub>100</sub> for *Ordinance*.

Valuation of horse, \$ *100*

Valuation of horse equipments, \$ *100*

Remarks:  
-----  
-----  
-----  
-----  
-----  
-----  
-----  
-----

Book mark: -----

*Steward*  
Copyist.



*W* | 11 H. Art'y. | U.S.C.T.

*Cyrus B Wigden*  
Co. K, 11 Reg't U. S. Col'd H. Art'y.

Appears on

**Company Muster Roll**

for

*Jan & Feb, 1865.*

Present or absent

*Present.*

Stoppage, \$

$\frac{100}{100}$  for

Due Gov't, \$

$\frac{21}{100}$  for

*Ordinance.*

Valuation of horse, \$

$\frac{100}{100}$

Valuation of horse equipments, \$

$\frac{100}{100}$

Remarks:

Book mark:

*Steward*

*M* 11 H. Art'y. U.S.C.T.

*Cyrus B Wigdon*  
Co. K, 11 Reg't U. S. Col'd H. Art'y.

Appears on

Company Muster Roll  
for *March & April, 1865.*

Present or absent *Present*

Stoppage, \$ 100 for

Due Gov't, \$ 21/100 for *Ordnance*

Valuation of horse, \$ 100

Valuation of horse equipments, \$ 100

Remarks: *Due U.S. for*  
*C. & G. P. 02 etc.*

Book mark :

*M* | 11 H. Art'y. | U.S.C.T.

*Cyrus B. Wigden*

*Priv*, Co. K, 11 Reg't U. S. Col'd H. Art'y.

Appears on

**Company Muster Roll**

for *May & June*, 186*5*.

Present or absent *Present*

Stoppage, \$ *100* for

Due Gov't, \$ *1* <sup>*02*</sup>/<sub>*100*</sub> for *C & G E*

Valuation of horse, \$ *100*

Valuation of horse equipments, \$ *100*

Remarks:

-----  
-----  
-----  
-----  
-----  
-----  
-----  
-----

Book mark:

-----  
-----

*Spucher*

*N* | 11 H. Art'y. | U.S.C.T.

*Cyrus P Wigdon*  
*Pvt*, Co. K, 11 Reg't U. S. Col'd H. Art'y.

Appears on

**Company Muster Roll**

for *July & Aug*, 1865.

Present or absent *Present*

Stoppage, \$ *100* for

Due Gov't, \$ *102* for *C & G E*

*lost and destroyed*

Valuation of horse, \$ *100*

Valuation of horse equipments, \$ *100*

Remarks:  
\_\_\_\_\_  
\_\_\_\_\_  
\_\_\_\_\_  
\_\_\_\_\_  
\_\_\_\_\_  
\_\_\_\_\_

Book mark: \_\_\_\_\_

*Spruce*



*H* | 11 H. Art'y. | U.S.C.T.

*Cyrus Higden*  
Pvt., Co. *K*, 11 Reg't U. S. Col'd H. Art'y.

Appears on Co. Muster-out Roll, dated  
*New Orleans, La, Oct. 2, 1865.*

Muster-out to date *Oct. 2, 1865.*

Last paid to *Feb. 28, 1865.*

Clothing account:

Last settled....., 186 ; drawn since \$.....<sup>100</sup>

Due soldier \$ *7*<sup>36</sup>.....<sup>100</sup>; due U. S. \$.....<sup>100</sup>

Am't for cloth'g in kind or money adv'd \$.....<sup>100</sup>

Due U. S. for arms, equipments, &c., \$ *7*<sup>32</sup>.....<sup>100</sup>

Bounty paid \$ *None* <sup>100</sup>; due \$ *100* <sup>100</sup>

Remarks: *Joined at Orig. Organ.*

*Stop 1 Mosquito bar, 2 nos. ~~4 nos.~~*

*1 Musket & Equipments retained.*

Book mark: *V113, P. 40. 70.*

*V117. P. 12. 70.*

*Spencer*



*Migden, Cyrus D.*

*D.*, Co., *11* Reg't *U.S.C.H.A.*

**Enclosures.**

Bed Cards .....	Final Statements .....
Burial Records .....	Furloughs or L. of A. ....
Certs. of Dis. for Discharge .....	Med. Certificates .....
C. M. Charges .....	Med. Des. Lists .....
Descriptive Lists .....	Orders .....
Discharge Certificates .....	Pris. of War Record .....
Enlistment Papers .....	Resignations .....

**Other papers relating to—**

Admission to Hosp'l .....	Furlough or L. of A. ....
Casualty Sheet .....	Med. Examination .....
Confinement .....	Misc. Information .....
Contracts .....	Pay or Clothing .....
Death or Effects .....	Personal Reports .....
Desertion .....	Rank .....
Discharge from Hosp'l .....	Transfer to Hosp'l .....
Discharge from Service .....	Transfer to V. R. C. ....
Duty .....	Transportation .....

DECLARATION OF RECRUIT.

I, Cyrus B. Meigs desiring to VOLUNTEER as a Soldier in the ARMY OF THE UNITED STATES, for the term of 3 years do declare that I am 25 years and 0 months of age; that I have never been discharged from the United States service on account of disability or by sentence of a court martial, or by order, before the expiration of a term of enlistment; and I know of no impediment to my serving honestly and faithfully as a soldier for 3 years

Given at Providence  
The 28<sup>th</sup> day of Nov 1863

Witness:  
P. A. Walker

Cyrus B. Meigs

No. 86

Volunteered at Providence

Nov 28<sup>th</sup> 1863,

By Major J. C. Sawyer  
14<sup>th</sup> Regiment of Ry City

11<sup>th</sup> W.D. Co. 11<sup>th</sup> Regt.

enlistment; last served in Company ( )

Regt of

Discharged

18



CONSENT IN CASE OF MINOR.

I, \_\_\_\_\_ of \_\_\_\_\_ is \_\_\_\_\_ years of age; and I do hereby freely give my CONSENT to his volunteering as a SOLDIER in the ARMY OF THE UNITED STATES for the period of \_\_\_\_\_

Given at \_\_\_\_\_  
The \_\_\_\_\_ day of \_\_\_\_\_

Witness:



VOLUNTEER ENLISTMENT.

State of *Rhode Island* Town of *Providence*



I, *Cyrus B. Migan* born in *Sumner* in the State of *R. I.* aged *35* years, and by occupation a *Farmer* DO HEREBY ACKNOWLEDGE to have volunteered this *28<sup>th</sup>* day of *Nov* 18*63* to serve as a SOLDIER in the ARMY OF THE UNITED STATES

OF AMERICA, for the period of *3 year*, unless sooner discharged by proper authority: Do also agree to accept such bounty, pay, rations and clothing, as are, or may be, established, by law for volunteers. And I, *Cyrus B. Migan* do solemnly swear, that I will bear true faith and allegiance to the *United States of America*, and that I will serve them honestly and faithfully against all their enemies or opposers whomsoever; and that I will observe and obey the orders of the President of the United States, and the orders of the officers appointed over me, according to the Rules and Articles of War.

Sworn and Subscribed to, at *Providence* this *28<sup>th</sup>* day of *Nov* 18*63* BEFORE *Mr John Leboyer Public Notary*

*Cyrus B. Migan*

I CERTIFY, ON HONOR, That I have carefully examined the above-named Volunteer, agreeable to the General Regulations of the Army, and that, in my opinion, he is free from all bodily defects and mental infirmity, which would, in any way, disqualify him from performing the duties of a soldier.

*Johnson Gardner M.D.*

EXAMINING SURGEON.

I CERTIFY, ON HONOR, That I have minutely inspected the Volunteer, *Cyrus B. Migan* previously to his enlistment, and that he was entirely sober when enlisted; that to the best of my judgment and belief, he is of lawful age; and that, in accepting him as duly qualified to perform the duties of an able-bodied soldier, I have strictly observed the Regulations which govern the recruiting service. This soldier has *Dark* eyes *Black* hair *Dark* complexion, is *5* feet, *3 1/2* inches high.

*Major 14<sup>th</sup>* Regiment of *City* Volunteers,

RECRUITING OFFICER.

1990

*Wigden William A.*

**Co. K, 11 U.S. Col'd H. Art'y.**

*Private*

*Private*

CARD NUMBERS.

1	6197975.	26
2	6198118	27
3	6198261.	28
4	6198424.	29
5	6198577.	30
6	6198734.	31
7	6198874.	32
8	6199017.	33
9	6199153.	34
10	6199286.	35
11	6199408.	36
12	6199531.	37
13	6199649.	38
14	9125732	39
15		40
16		41
17		42
18		43
19		44
20		45
21		46
22		47
23		48
24		49
25		50

Book Mark:

See also



*W* | **11 H. Art'y. U.S.C.T.**

*William A Wigden*  
....., Co *K*, 11 Reg't U. S. Col'd H. Art'y.

Appears on  
**Company Descriptive Book**  
of the organization named above.

**DESCRIPTION.**

Age *23* years; height *5* feet *3 1/2* inches.

Complexion *DK*

Eyes *DK*; hair *Blk*

Where born *Geneva N.Y.*

Occupation *Farmer*

**ENLISTMENT.**

When *Nov 28*, 186 .

Where *Crov A.I.*

By whom *J. C. Engly*; term *3* y'rs.

Remarks:

.....  
.....  
.....  
.....  
.....  
.....  
.....  
.....  
.....  
.....

*Giffitch*

*W* | 11 H. Art'y. | U.S.C.T.

*William S. Wigden*

*Pt*, Co. *K*, 14 Reg't R. I. Col'd H. Art'y.\*

Age *23* years.

Appears on

**Company Muster-in Roll**

of the organization named above. Roll dated

*Cp. nr. Providence R.I., Dec 17, 1863.*

Muster-in to date *Dec 17, 1863.*

Joined for duty and enrolled:

When *Nov 28*, 1863.

Where *Providence R.I.*

Period *3* years.

Valuation of horse, \$.....*100*

Valuation of horse equipments, \$.....*100*

Remarks:.....

\* This organization subsequently became Co. *K*, 11 Reg't U. S. Colored Heavy Artillery.

Book mark:.....

(356)

*W. Stewart*

Copyist.

*W* | 11 H. Art'y. | U.S.C.T.

*William A. Wigden*

*Pt*, Co. K, 14 Reg't R. I. Col'd H. Art'y.\*

Appears on

**Company Muster Roll**

for *Dec 17 to Dec 31*, 1863.

Present or absent *Present*

Stoppage, \$ *100* for

Due Gov't, \$ *100* for

Valuation of horse, \$ *100*

Valuation of horse equipments, \$ *100*

Remarks:

\*This organization subsequently became Co. K, 11 Reg't U. S. Colored Heavy Artillery.

Book mark:

*J. Stewart*

(358)

Copyist.

*W* | 11 H. Art'y. | U.S.C.T.

*William A. Higden*  
Pt., Co. K, 14 Reg't R. I. Col'd H. Art'y.\*

Appears on

Company Muster Roll  
for *Jan & Feb*, 1864.  
Present or absent. *Present*

Stoppage, \$.....100 for .....

Due Gov't, \$.....100 for .....

Valuation of horse, \$.....100

Valuation of horse equipments, \$.....100

Remarks: .....

\*This organization subsequently became Co. K, 11 Reg't U. S. Colored Heavy Artillery.

Book mark: .....

(358)

*J. H. Stewart*

Copyist.



*W* | **11 H. Art'y.** | **U.S.C.T.**

*William A. Wigden*  
*Pt*, Co. K, 14 Reg't R. I. Col'd H. Art'y.\*

Appears on

**Company Muster Roll**  
for *Mch & apr*, 1864.

Present or absent *Present*

Stoppage, \$ 100 for

Due Gov't, \$ 100 for

Valuation of horse, \$ 100

Valuation of horse equipments, \$ 100

Remarks: *Stop for gun sling \$16*

\*This organization subsequently became Co. K, 11 Reg't U. S. Colored Heavy Artillery.

Book mark: \_\_\_\_\_

*J. Stewart*

*W* | 11 H. Art'y. | U.S.C.T.

*Wm A. Wiggins*  
*Pvt*, Co. *K*, 8 Reg't U. S. Col'd H. Art'y.\*

Appears on

Company Muster Roll  
for *May & June*, 1864.  
Present or absent *Present*

Stoppage, \$ *100* for

Due Gov't, \$ *100* for

Valuation of horse, \$ *100*

Valuation of horse equipments, \$ *100*

Remarks:

† This organization subsequently became *K* Co. 21 Reg't U. S. Colored Heavy Artillery.

Book mark:

(358)

*Sturms*  
Copyist.

*W* 11 H. Art'y. | U.S.C.T.

*William W. Sigden*  
Co. K, 11 Reg't U. S. Col'd H. Art'y.

Appears on

**Company Muster Roll**

for *July & Aug*, 186*4*.

Present or absent *Present*

Stoppage, \$ 100 for

Due Gov't, \$ 100 for

Valuation of horse, \$ 100

Valuation of horse equipments, \$ 100

Remarks: *In U.S. Gen'l  
Hospital New Orleans  
La since July  
20/64 thru on 19/64  
\$6 per mo due from  
mch to April 30/64.*

Book mark:

*W. W. Sigden*



*W* | 11 H. Art'y. | U.S.C.T.

*William A Wigden*  
Pvt, Co. K, 11 Reg't U. S. Col'd H. Art'y.

Appears on

**Company Muster Roll**

for *Sept & Oct*, 186*4*.

Present or absent *Present*

Stoppage, \$ \_\_\_\_\_ *100* for \_\_\_\_\_

Due Gov't, \$ \_\_\_\_\_ *100* for \_\_\_\_\_

Valuation of horse, \$ \_\_\_\_\_ *100*

Valuation of horse equipments, \$ \_\_\_\_\_ *100*

Remarks: *Oct 27/64 re-  
turned to Co  
from U.S. Gen. Hos-  
pital, New Orleans  
La.*

Book mark: \_\_\_\_\_

*Steward*

Copyist.

*W* | 11 H. Art'y. | U.S.C.T.

*William A Wigden*  
*Pvt*, Co. K, 11 Reg't U. S. Col'd H. Art'y.

Appears on

**Company Muster Roll**

for *Port J. C.*, 1864

Present or absent *Present*

Stoppage, \$.....100 for .....

Due Gov't, \$.....100 for .....

Valuation of horse, \$.....100

Valuation of horse equipments, \$.....100

Remarks: .....

.....

.....

.....

.....

.....

.....

.....

.....

.....

.....

.....

.....

.....

.....

.....

.....

.....

*Stewart*  
Copyist.

*W* | 11 H. Art'y. | U.S.C.T.

*William A Wigden*  
Co. K, 11 Reg't U. S. Col'd H. Art'y.

Appears on

**Company Muster Roll**

for *Jan & Feb*, 186*5*.

Present or absent *Present*

Stoppage, \$.....100 for .....

Due Gov't, \$.....100 for .....

Valuation of horse, \$.....100

Valuation of horse equipments, \$.....100

Remarks: *\$6.00 per month due*  
*from enlistment to*  
*April 30/64 free on*  
*April 19/61.*

Book mark: .....

*Stewart*  
Copyist.



*W* | 11 H. Art'y. | U.S.C.T.

*Wm A Wigdon*

*Prvt*, Co. K, 11 Reg't U. S. Col'd H. Art'y.

Appears on

Company Muster Roll

for *March April*, 1865.

Present or absent *Present*

Stoppage, \$ \_\_\_\_\_  $\overline{100}$  for \_\_\_\_\_

Due Gov't, \$ \_\_\_\_\_  $\overline{100}$  for *C & G E*

Valuation of horse, \$ \_\_\_\_\_  $\overline{100}$

Valuation of horse equipments, \$ \_\_\_\_\_  $\overline{100}$

Remarks: *\$ 0.00 per month due from enlistment to April 30/64 true April 19/64*

Book mark: \_\_\_\_\_

*Wm A Wigdon*

*H* | 11 H. Art'y. | U.S.C.T.

*William A. Higden*

*Pr*, Co. K, 11 Reg't U. S. Col'd H. Art'y.

Appears on

+ Company Muster Roll

for *May + June*, 186*9*.

Present or absent *Present*

Stoppage, \$ 100 for

Due Gov't, \$ 100 for

Valuation of horse, \$ 100

Valuation of horse equipments, \$ 100

Remarks:

+ Insured by  
*J. O. Miller. Co.*

Book mark:

*M* | 11 H. Art'y. | U.S.C.T.

*William A. Higden*  
*Priv*, Co. K, 11 Reg't U. S. Col'd H. Art'y.

Appears on

**Company Muster Roll**

for *July & Aug.*, 186*5*.

Present or absent *Present*

Stoppage, \$ *100* for

Due Gov't, \$ *01* for *C & G E*

*lost and destroyed*

Valuation of horse, \$ *100*

Valuation of horse equipments, \$ *100*

Remarks: *Loss of \$100 by sentence*  
*Gen. C. M. S. O. #200. Hd. Qu.*  
*S. Div. La.*

*Due U. S. for Ordnance*  
*lost and destroyed 43d*

Book mark: *43d*

*Sprucker*



*M-* | 11 H. Art'y. | U.S.C.T.

*William A. Higden*  
Pvt., Co. *K*, 11 Reg't U. S. Col'd H. Art'y.

Appears on Co. Muster-out Roll, dated  
*New Orleans, La, Oct. 2*, 1865.

Muster-out to date *Oct 2*, 1865.

Last paid to *Feb. 28*, 1865.

Clothing account:

Last settled....., 186 ; drawn since \$.....<sup>100</sup>

Due soldier \$ *3* <sup>*57*</sup>/<sub>100</sub>; due U. S. \$.....<sup>100</sup>

Am't for cloth'g in kind or money adv'd \$.....<sup>100</sup>

Due U. S. for arms, equipments, &c., \$ *7* <sup>*44*</sup>/<sub>100</sub>

Bounty paid \$ *None* <sup>*100*</sup>/<sub>100</sub>; due \$ *100* <sup>*00*</sup>/<sub>100</sub>

Remarks: *Joined at Orig. Reg'mt*  
*Shop 1 Whip, 1 screw driver, 1 Mos-*  
*quito Bar, 1 Letter "K" lost.*

*1 Musket & Equipments retained*  
*\$5 stopped by Sen. Gen. C. M.*  
*S.O. #200, Hd. Qu. S.D. La.*

Book mark: *315. 362.*

Wigden W<sup>m</sup> A

Co. H

11 Reg't U.S.C.H.A

3

Enclosures.

Bed Cards .....	Final Statements .....
Burial Records .....	Furloughs or L. of A .....
Certs. of Dis. for Discharge .....	Med. Certificates .....
C. M. Charges .....	Med. Des. Lists .....
Descriptive Lists .....	Orders .....
Discharge Certificates .....	Pris. of War Record .....
Enlistment Papers .....	Resignations .....

Other papers relating to—

Admission to Hosp'l .....	Furlough or L. of A .....
Casualty Sheet .....	Med. Examination .....
Confinement .....	Misc. Information 2 .....
Contracts .....	Pay or Clothing .....
Death or Effects .....	Personal Reports .....
Desertion .....	Rank .....
Discharge from Hosp'l .....	Transfer to Hosp'l .....
Discharge from Service .....	Transfer to V. R. C. .....
Duty .....	Transportation .....

DECLARATION OF RECRUIT.

I, William A. Mygden desiring to VOLUNTEER as a Soldier in the ARMY OF THE UNITED STATES, for the term of 3 year do declare that I am 25 years and 0 months of age; that I have never been discharged from the United States service on account of disability or by sentence of a court martial, or by order, before the expiration of a term of enlistment; and I know of no impediment to my serving honestly and faithfully as a soldier for 0 year

Given at Bridgman  
The 28<sup>th</sup> day of Nov 18 65

Witness: E. A. Mather William A. Mygden  
Mather

11206722

No. 87

William A. Mygden

Volunteered at Bridgman

Nov 28<sup>th</sup> 1865

By Wm J. C. Sawyer

14<sup>th</sup> Regiment of Artillery

enlistment; last served in Company ( )

Reg't of

Discharged 18

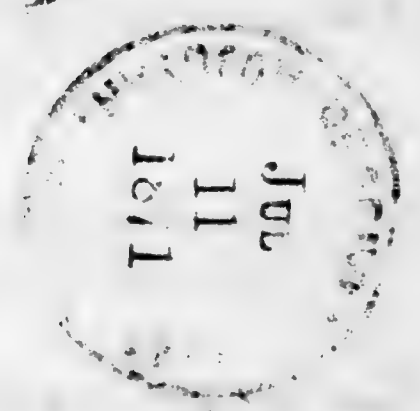

CONSENT IN CASE OF MINOR.

I, \_\_\_\_\_ of \_\_\_\_\_ is \_\_\_\_\_ years of age; and I do hereby freely give my CONSENT to his volunteering as a SOLDIER in the ARMY OF THE UNITED STATES for the period of \_\_\_\_\_

Given at \_\_\_\_\_  
The \_\_\_\_\_ day of \_\_\_\_\_

Witness:



VOLUNTEER ENLISTMENT.

State of *Rhode Island* Town of *Providence*



I, *William A. Migan* born in *Geneva*  
in the State of *R. I.* aged *23* years, and by occupation  
a *Farm*

DO HEREBY ACKNOWLEDGE to have volunteered this *28<sup>th</sup>*  
day of *Nov* 18 *63* to serve as a SOLDIER in the ARMY OF THE UNITED STATES  
OF AMERICA, for the period of *3 year*, unless sooner discharged by proper authority:

Do also agree to accept such bounty, pay, rations and clothing, as are, or may be, established, by law for  
volunteers. And I, *William A. Migan* do solemnly swear, that I will bear  
true faith and allegiance to the *United States of America*, and that I will serve them honestly and faith-  
fully against all their enemies or opposers whomsoever; and that I will observe and obey the orders of the  
President of the United States, and the orders of the officers appointed over me, according to the Rules  
and Articles of War.

Sworn and Subscribed to, at *Providence*  
this *28<sup>th</sup>* day of *Nov* 18 *63*  
BEFORE *Mr John L. Myers Publick* *Mrs William A. Migan*  
*(Mark)*

I CERTIFY, ON HONOR, That I have carefully examined the above-named Volunteer, agreeable to the General Regulations of  
the Army, and that, in my opinion, he is free from all bodily defects and mental infirmity, which would, in any way, disqualify him  
from performing the duties of a soldier.

*Johnson Andrew M.D.*

EXAMINING SURGEON.

I CERTIFY, ON HONOR, That I have minutely inspected the Volunteer, *William A. Migan*  
previously to his enlistment, and that he was entirely sober when enlisted; that to the best of my judgment and belief, he is of  
lawful age; and that, in accepting him as duly qualified to perform the duties of an able-bodied soldier, I have strictly observed the  
Regulations which govern the recruiting service. This soldier has *Dark* eyes *Black* hair  
*Dark* complexion, is *5* feet, *3 1/2* inches high.

*May 14<sup>th</sup>* Regiment of *By City* Volunteers,

RECRUITING OFFICER.

Hd. Qrs. U.S. Forces  
Camp Pucaput May 24/64

Whiteman, T. J. -  
Capt. & U.S.A. Genl -  
Carrollton Dist.

reads Private W. A.  
Wigden Co. K for  
Confinement, hav-  
ing been arrested  
under suspicious  
Circumstances -

Recd May 24<sup>th</sup> 64



Headquarters U. S. Forces  
Camp Parapet La May 24<sup>th</sup> 1865

Commanding Officer  
3<sup>d</sup> Batt 11<sup>th</sup> U. S. A. (N)

Sir,

By direction of the Colonel Commanding  
I send you private Wm. A. Trigden Co. "K"  
of your Battalion arrested under circum-  
stances warranting the suspicion

That he is implicated in the robbery  
of to day or yesterday. You will take  
such measures as will secure him  
for examination to morrow when  
the Ordely returns from Gen. Sherman  
Ad. Srs.

Respectfully your very Ob<sup>d</sup>. Serv<sup>t</sup>  
J. P. Whiteman  
Capt. U. S. A. Gen<sup>l</sup>



Mr Ellsworth

William A. Wigden

(Co. K. 11 U.S.C.A. Army)

Adjutant General's Office,

COLORED TROOPS BRANCH,

January 12<sup>th</sup>, 1876

Mr. Ellertson Vol.                      C. T., 187

Wanted in the case of

William B. Wigden, Co. K,

11 Reg't

U.S. Army

Copy of S.O. No. 201.

Musters Roll for July and August 1865 reports him Present. Loss of \$5.00 by sentence Gen. O.M. S.O. No. 201 Ad. Gen. S. Div. of La.

Respectfully,

W. A. Woodward, Chief Clerk.  
P. H.

Adjutant General's Office,

Div. of Discontinued Bands.

Jan 21<sup>st</sup>, 1876.

Vol.                      C. T., 187

Reply in case of

William A. Wigden, Co. N,

11 Reg't

U.S. Army

S.O. No. 201. A.C. Southern Div. of La. June 27<sup>th</sup> 1865. Charge - Conduct to the prejudice of good order and military discipline in N. Orleans without pass. Findings - Guilty. Sentence - To forfeit to the U.S. five dollars of his monthly pay. Approved.

as.



Wiley Henry

Co 2, 11 U.S. Col'd H. Art'y.

Private

Private

CARD NUMBERS.

1	6196181	26
2	6196191	27
3	6196330	28
4	6196626	29
5	6196780	30
6	6196926	31
7	6197068	32
8	6197211	33
9	6197334	34
10	6181837	35
11	6197454	36
12	6197567	37
13	6197677	38
14	6197783	39
15	9125572	40
16		41
17		42
18		43
19		44
20		45
21		46
22		47
23		48
24		49
25		50

Book Mark

P. 34 Mb

V. 11. P. 452. 70. V. 237.

See also



*W* | 11 H. Art'y. | U.S.C.T.

*Henry Wiley*

Co. *D*, 11 Reg't U. S. Col'd H. Art'y.

Appears on

**Company Descriptive Book**

of the organization named above.

**DESCRIPTION.**

Age *28* years; height *5* feet *3* inches.

Complexion *African*

Eyes *dk*; hair *Blk*

Where born *Millsburg Ky*

Occupation *Farmer*

**ENLISTMENT.**

When *Nov 25*, 186 .

Where *Prov R. I.*

By whom *J. Engly*; term *3* y'rs.

Remarks: *Deserted March 30, 1864*  
*from Camp Bailey R. I.*  
*Retaken April 3, 1864*

*Giffith*

Copist.

*M* | 11 H. Art'y. | U.S.C.T.

*Henry Wiley*

*Pvt*, Co. *C*, 14 Reg't R. I. Col'd H. Art'y.\*

Age *28* years.

Appears on

**Company Muster-in Roll**

of the organization named above. Roll dated

*Providence R.I. Nov 28*, 186*3*.

Muster-in to date *Nov 28*, 186*3*.

Joined for duty and enrolled:

When *Nov. 25*, 186*3*.

Where *Providence R.I.*

Period *3* years.

Valuation of horse, \$.....*100*

Valuation of horse equipments, \$.....*100*

Remarks: *2nd Dist. R.I.*

\* This organization subsequently became Co. *C*, 11 Reg't U. S. Colored Heavy Artillery.

Book mark:.....

*A. A. Harper*

*M*

11 H. Art'y.

U.S.C.T.

*Henry Wiley*  
*Lt. Sg't*, Co. I, 14 Reg't R. I. Col'd H. Art'y.\*

Appears on

**Company Muster Roll**

for *Nov 28 to Dec 31*, 186*3*.

Present or absent *Present*

Stoppage, \$ 100 for

Due Gov't, \$ 100 for

Valuation of horse, \$ 100

Valuation of horse equipments, \$ 100

Remarks: *Appointed Lt. Sg't Dec 15 1863*

\*This organization subsequently became Co. I, 11 Reg't U. S. Col'd Heavy Artillery.

Book mark:

*E. A. Harper*



*W* | 11 H. Art'y. | U.S.C.T.

*Henry Wiley*  
*2nd Lt* Co. I, 14 Reg't R. I. Col'd H. Art'y.\*

Appears on

**Company Muster Roll**

for *Jan & Feb*, 1864.

Present or absent. *Present*

Stoppage, \$ 100 for

Due Gov't, \$ 100 for

Valuation of horse, \$ 100

Valuation of horse equipments, \$ 100

Remarks: *Appointed 2nd Lt.*  
*Serge Dec 10 1863*

\*This organization subsequently became Co. I, 11 Reg't U. S. Col'd Heavy Artillery.

Book mark:

*C. F. Harper*

*W* | 11 H. Art'y. | U.S.C.T.

*Henry Wiley*  
*2nd Lt* Co. I, 14 Reg't R. I. Col'd H. Art'y.\*

Appears on

**Company Muster Roll**

for *Jan & Feb*, 1864.

Present or absent *Present*

Stoppage, \$ *100* for

Due Gov't, \$ *100* for

Valuation of horse, \$ *100*

Valuation of horse equipments, \$ *100*

Remarks: *Appointed 2nd Lt.  
Sergey Dec 10 1863*

\*This organization subsequently became Co. I, 11 Reg't U. S. Col'd Heavy Artillery.

Book mark:

*C. F. Haizer*

*M*

11 H. Art'y.

U.S.C.T.

*Henry Wiley*

*Priv*, Co. I, 14 Reg't R. I. Col'd H. Art'y.\*

Appears on

**Company Muster Roll**

for *March & April*, 1864.

Present or absent *Present*

Stoppage, \$ 100 for

Due Gov't, \$ 43 for *Ordinance*  
*& Carb Ammo*

Valuation of horse, \$ 100

Valuation of horse equipments, \$ 100

Remarks: *Paid for apprehension from deserting \$30.00 Reduc'd to Rank I. M. Sgt. April 1, 1864 per J. O.*

\*This organization subsequently became Co. I, 11 Reg't U. S. Col'd Heavy Artillery.

Book mark: \_\_\_\_\_

*C. A. Mayer*

(358)

Copyist.



W | 11 H. Art'y. | U.S.C.T.

Henry Wiley

Priv., Co. I, 8 Reg't U. S. Col'd H. Art'y.\*

Appears on

Company Muster Roll

for May & June, 1864.

Present or absent Present

Stoppage, \$ 43 for Ordnance  
100

Due Gov't, \$ 100 for

Valuation of horse, \$ 100

Valuation of horse equipments, \$ 100

Remarks: Paid for apprehension  
from desertion \$30  
Returned to Co by order  
of Court-Martial with-  
out further reduction of  
pay or emoluments

† This organization subsequently became Co. I, 11 Reg't U. S. Colored Heavy Artillery.

Book mark:

C. A. Harper

*W* | 11 H. Art'y. | U. S. C. T.

*Henry Wiley*  
Private, Co. I, 11 Reg't U. S. Col'd H. Art'y.

Appears on

Company Muster Roll

for *July & Aug.*, 1864.

Present or absent *Present*.

Stoppage, \$ *100* for

Due Gov't, \$ *43/100* for *Ordnance* *43*  
*And Camp & G. Equip. 49.*

Valuation of horse, \$ *100*

Valuation of horse equipments, \$ *100*

Remarks: *Paid for apprehension*  
*\$ 30. Forfeited all pay due*  
*from Aug. 3-1864 to February*  
*3-1865. By Sentence of G.C.M.*

Book mark:

*M. A. Michael*  
Copyist.

W | 11 H. Art'y. | U. S. C. T.

Henry Wiley

Private, Co. I, 11 Reg't U. S. Col'd H. Art'y.

Appears on

Company Muster Roll

for Sept & Oct, 1864.

Present or absent Present

Stoppage, \$ 100 for

Due Gov't, \$ <sup>43/100</sup> <sub>49/100</sub> for Ordnance <sup>48</sup>  
for Camp & Garrison Equipage <sup>49</sup>

Valuation of horse, \$ 100

Valuation of horse equipments, \$ 100

Remarks: Paid for apprehension  
from desertion \$30. Forfeited  
all pay due from Aug. 3<sup>d</sup>  
to Feb. 3<sup>d</sup> 65 by sentence of  
G. C. M.

Book mark:

M. A. Michaels



*W* | 11 H. Art'y. | U. S. C. T.

*Henry Wiley*

*Private*, Co. I, 11 Reg't U. S. Col'd H. Art'y.

Appears on

Company Muster Roll

for *Nov & Dec*, 1864.

Present or absent *Present*

Stoppage, \$ *100* for

Due Gov't, \$ *43/100* for *Ordnance* *49*

*Camp & Garrison Equipage* *49*

Valuation of horse, \$ *100*

Valuation of horse equipments, \$ *100*

Remarks: *Paid for apprehension from desertion \$30. Forfeited all pay due from Aug. 3<sup>d</sup> 1864 to February 3<sup>d</sup> 1865 by sentence of G. C. M.*

Book mark:

*M. A. Michaels*

Copyist.

*M* 11 *H. Artz* U.S.C.T.

*Henry Wiley*

*2nd Reg't U. S. Col'd* *H. Artz*

Appears on

**Descriptive List of Deserters**

dated *Jan. 1*, 186*5*.

Deserted:

When *March 30*, 186*4*.

Where *Camp Bailey, R.I.*

Arrested:

When ....., 186 .

Where .....

Remarks: *Apprehended from  
desertion Apr. 3, '64.  
Tried and sentenced by  
G. C. M. G. O. 19th Id. Reg't.  
Dep. N. O., 1864.*

Book mark: .....

*M. O. Gilbert*

*W* | 11 H. Art'y. | U. S. C. T.

*Henry Wiley*  
Private, Co. I, 11 Reg't U. S. Col'd H. Art'y.

Appears on

Company Muster Roll

for *Jan'y & Febr.*, 186*S*.

Present or absent *Present*

Stoppage, \$ *100* for

Due Gov't, \$ *49/100* for *Camp Garrison*

*Equipage* *49* *Ordnance* *75*

Valuation of horse, \$ *100*

Valuation of horse equipments, \$ *100*

Remarks: *Paid for apprehension from desertion \$30. Forfeited all pay due from Aug. 3/64 to Feb 3-65 by sentence G. C. M. G. O. 31 Series 64 H. C. Def. New Orleans. Free April 19 1861.*

Book mark:

*M. A. Michaels*



*H* | 11 H. Art'y. | U. S. C. T.

*Henry Wiley*

*Priv*, Co. I, 11 Reg't U. S. Col'd H. Art'y.

Appears on

Company Muster Roll

for *March & Apr*, 1865

Present or absent *present*

Stoppage, \$ *49 00* for *E*

\* *for ordnance*

Due Gov't, \$ 100 for

Valuation of horse, \$ 100

Valuation of horse equipments, \$ 100

Remarks: *Paid for apprehension  
from desertion #30. forfeited all  
pay due from Aug 3, 64,  
to Feb 5, 65 by \* G. C. M.  
4031720 Sep 70, Sept  
1<sup>st</sup> 64, Free Apr 19, 61.*

\* *Torn from roll.*

Book mark:

(358)

*Moy*

Copyist.

W | 11 H. Art'y. | U. S. C. T.

Henry Wiley  
Pvt.

Co. I, 11 Reg't U. S. Col'd H. Art'y.

Appears on

Company Muster Roll

for May & June, 1865

Present or absent Present

Stoppage, \$ 100 for

Due Gov't, \$ 49 100 for Copye lost & destroyed

Valuation of horse, \$ 100

Valuation of horse equipments, \$ 100

Remarks: Paid for apprehension from desertion \$30. Apprehended Apr 2. 64. Tried by G.C.M. for desertion, was found not guilty, but was sentenced to forfeit 6 months pay for absence without leave from Aug 31. 64 to Feb 3. 65. F.O. no 30 Helge of U.O. Sept 1. 64. Fee Apr 19. 61. Due us for Ordnance 75 cts

Book mark:

Donnelly

W | 11 H. Art'y. | U. S. C. T.

Henry Wiley

Pri, Co. I, 11 Reg't U. S. Col'd H. Art'y.

Appears on

Company Muster Roll

for July & Aug, 1865.

Present or absent Present.

Stoppage, \$ 100 for

Due Gov't, \$ 50 100 for C 792

Lost or destroyed

Valuation of horse, \$ 100

Valuation of horse equipments, \$ 100

Remarks: Paid for apprehension from desertion \$30. Tried by G.C.M. for desertion was found not guilty, but was sentenced to forfeit 6 months pay for absence without leave from Aug 3. 64 to Feb 3. 65. Apprehended Apr 2. 64 G.O. No 31 2nd 2nd Reg of NO. Rept 1. 64. Free Apr 19. 61  
Dine us for Ordnance 75 cts  
Book mark:

Donnelly



W | 11 H. Art'y. | U.S.C.T.

Henry Wiley

Pvt., Co. D, 11 Reg't U. S. Col'd H. Art'y.

Appears on Co. Muster-out Roll, dated  
Camp Parapet La, Oct 2, 1865.

Muster-out to date Oct 2, 1865.

Last paid to Never paid, 186 .

Clothing account:

Last settled....., 186 ; drawn since \$.....<sup>100</sup>

Due soldier \$.....<sup>100</sup>; due U. S. \$ 61 <sup>34</sup>/<sub>100</sub>

Am't for cloth'g in kind or money adv'd \$.....<sup>100</sup>

Due U. S. for arms, equipments, &c., \$ <sup>1</sup>/<sub>100</sub> <sup>26</sup>  
" " " " " retained \$ 6  
Bounty paid \$ None <sup>100</sup>; due \$ 100 <sup>100</sup>

Remarks: Joined at org. orgn. 1 Musket  
& set of accoutrements retained.  
Lat ordnance & Camp & Garrison Equi-  
page. Stopped for apprehension as  
a deserter \$ 30. Tried by G.C.M. for  
desertion, was found not guilty

Book mark: T 114, P 452, 70 (over)  
V 237, P 34, 76

Donnelly

JAN. 15

6197783

1891\*

but was sentenced to forfeit 6  
months pay for absence without  
leave from Aug 3. 64 to Feb 3. 65.  
G. O. no 31 Hd 20 Def of N.O.  
dated Sept 1. 64. Apprehended  
Apr 2. 64. Free Apr 19. 61.  
Prio to Dec 9. 63. Appointed  
2. m. Sept Dec 10. 63. Re-  
duces to Prio Mar 31. 64

Wiley Henry

P., Co.

11 Reg't

U.S.C.A.

2 Enclosures.

Bed Cards .....	Final Statements .....
Burial Records .....	Furloughs or L. of A. ....
Certs. of Dis. for Discharge .....	Med. Certificates .....
C. M. Charges .....	Med. Des. Lists .....
Descriptive Lists .....	Orders .....
Discharge Certificates .....	Pris. of War Record .....
Enlistment Papers .....	Resignations .....

Other papers relating to—

Admission to Hosp'l .....	Furlough or L. of A. ....
Casualty Sheet .....	Med. Examination .....
Confinement .....	Misc. Information .....
Contracts .....	Pay or Clothing .....
Death or Effects .....	Personal Reports .....
Desertion .....	Rank .....
Discharge from Hosp'l .....	Transfer to Hosp'l .....
Discharge from Service .....	Transfer to V. R. C. ....
Duty .....	Transportation .....



DECLARATION OF RECRUIT.

I, Henry Wiley desiring to VOLUNTEER as a Soldier in the ARMY OF THE UNITED STATES, for the term of 3 years do declare that I am 28 years and 0 months of age; that I have never been discharged from the United States service on account of disability or by sentence of a court martial, or by order, before the expiration of a term of enlistment; and I know of no impediment to my serving honestly and faithfully as a soldier for 3 years

Given at Providence  
The 25<sup>th</sup> day of Nov 1863

Witness:  
L. A. Walker

Henry Wiley



Discharged ..... 18

Regt of .....

enlistment; last served in Company ( )

By Mary J. C. Sawyer  
14<sup>th</sup> Regiment of Ordnance

Nov 25<sup>th</sup> 1863,

Volunteered at Providence  
Henry Wiley

No. 84  
11245678

CONSENT IN CASE OF MINOR.

I, \_\_\_\_\_ of \_\_\_\_\_ is \_\_\_\_\_ years of age; and I do hereby freely give my CONSENT to his volunteering as a SOLDIER in the ARMY OF THE UNITED STATES for the period of \_\_\_\_\_

Given at \_\_\_\_\_  
The \_\_\_\_\_ day of \_\_\_\_\_

Witness:

VOLUNTEER ENLISTMENT.



State of

Town of

Rhode Island

Providence

I, Henry Wiley, born in Milford aged 28 years, and by occupation a Grocer DO HEREBY ACKNOWLEDGE to have volunteered this 25th day of Nov 1863 to serve as a SOLDIER in the ARMY OF THE UNITED STATES OF AMERICA, for the period of 3 years, unless sooner discharged by proper authority:

Do also agree to accept such bounty, pay, rations and clothing, as are, or may be, established, by law for volunteers. And I, Henry Wiley do solemnly swear, that I will bear true faith and allegiance to the United States of America, and that I will serve them honestly and faithfully against all their enemies or opposers whomsoever; and that I will observe and obey the orders of the President of the United States, and the orders of the officers appointed over me, according to the Rules and Articles of War.

Sworn and Subscribed to, at Providence this 25th day of Nov 1863.

Henry Wiley

BEFORE J. M. Gardner, Justice of the Peace

I CERTIFY, ON HONOR, That I have carefully examined the above-named Volunteer, agreeable to the General Regulations of the Army, and that, in my opinion, he is free from all bodily defects and mental infirmity, which would, in any way, disqualify him from performing the duties of a soldier.

Johnson Gardner M.D.

EXAMINING SURGEON.

I CERTIFY, ON HONOR, That I have minutely inspected the Volunteer, Henry Wiley previously to his enlistment, and that he was entirely sober when enlisted; that to the best of my judgment and belief, he is of lawful age; and that, in accepting him as duly qualified to perform the duties of an able-bodied soldier, I have strictly observed the Regulations which govern the recruiting service. This soldier has Dark eyes black hair

African complexion, is 5 feet, 9 inches high.

Regiment of 14th Regt of Artillery Volunteers.

RECRUITING OFFICER.



M. Ellertson

Henry Wilson

C. S. 11 N. O. C. City



19-106-20

Adjutant General's Office,

COLORED TROOPS BRANCH,

Nov 13<sup>th</sup>, 1875

Mr. Ollivier Vol. C. T., 187

Wanted in the case of Henry Wiley, Co. I,  
11 Reg't U.S.C.A. (Col)

Information in regard to desertion when returned  
and if tried

Must be paid for March and April '75 reports  
him. Present with remarks "Paid for apprehension  
from desertion \$30.00"

Respectfully,

L. A. Woodward

Chief Clerk.

J. A. Dalton

Adjutant General's Office,

Division of Discontinued Commands,

Nov 29<sup>th</sup>, 1875

Vol. C. T., 187

Reply in case of Henry Wiley, Co. I,

11 "Reg't U.S.C.A. (Col)

O.O. No 19 Hdqrs Defenses New Orleans July 4. 1864 -  
Charg 1<sup>st</sup> - Conduct prejudicial to good order and military  
discipline - 2<sup>d</sup> Forgery - 3<sup>rd</sup> Aiding desertion -  
4<sup>th</sup> Desertion - Findings - 1<sup>st</sup> & 2<sup>d</sup> Charges - Guilty -  
3<sup>rd</sup> Not guilty - 4<sup>th</sup> - Not guilty of desertion but guilty of  
absence without leave - Sentence - "To be removed to  
the ranks and serve 6 months without pay, thirty days  
of the time at hard labor with ball and chains -"  
Approved - Tried at G.M. Serg's Co. D' 14<sup>th</sup> R.I. Reg't -

C.P.K.

1990  
Wilkins William E.

Co A, 11 U.S. Col'd H. Art'y.

Private | Private

CARD NUMBERS.

1	6181258	26
2	6181245	27
3	6181231	28
4	6182980	29
5	6183107	30
6	6183229	31
7	6183337	32
8	6183447	33
9	6183552	34
10	6183659	35
11	6183765	36
12	9123916	37
13	9124086	38
14	329.46225	39
15		40
16		41
17		42
18		43
19		44
20		45
21		46
22		47
23		48
24		49
25		50

Book Mark:

See also



*A* | 11 H. Art'y. | U.S.C.T.

*William C. Wilkins*

....., Co. *A*, 11 Reg't U. S. Col'd H. Art'y.

Appears on

**Company Descriptive Book**

of the organization named above.

**DESCRIPTION.**

Age *18* years; height *5* feet *2* inches.

Complexion *Dark*

Eyes *Dark*; hair *Dark*

Where born *Portsmouth Va*

Occupation *Walter*

**ENLISTMENT.**

When *May 10*....., 186*4*.

Where *1<sup>st</sup> Dist. Me*

By whom *C. H. Doughty*; term *3* y'rs.

Remarks: .....

.....  
.....  
.....  
.....  
.....  
.....  
.....  
.....  
.....  
.....

*James*

(383v)

Copist.



*H* | 11 H. Art'y. | U.S.C.T.

*William E. Watkins*

....., Co. *A*, 11 Reg't U. S. Col'd H. Art'y.

Appears on

**Company Descriptive Book**

of the organization named above.

**DESCRIPTION.**

Age *18* years; height *5*<sup>*2*</sup> feet *2* inches.

Complexion *OK*

Eyes *OK*; hair *OK*

Where born *Portsmouth Va*

Occupation *Miller*

**ENLISTMENT.**

When *May 10*, 186*4*.

Where *1<sup>st</sup> Dist Va*

By whom *Ch Douglas*; term *3* y'rs.

Remarks: .....

.....

.....

.....

.....

.....

.....

.....

.....

.....

.....

.....

.....

.....

.....

.....

.....

.....

.....

.....

.....

.....

.....

.....

.....

*Jones*

24

11 H. Art'y. | U.S.C.T.

William E. Wilkins

Appears with rank of *Private* on

**Muster and Descriptive Roll of a Detachment of U. S. Vols. forwarded**

for the *11* Reg't *U.S.C.A.* Roll dated

*Portland Me, May 18*, 1864.

Where born *Portsmouth Va*

Age *18* y'rs; occupation *Water*

When enlisted *May 18*, 1864.

Where enlisted *Portland*

For what period enlisted *3* years.

Eyes *Blk*; hair *Blk*

Complexion *Tan*; height *5* ft. *2* in.

When mustered in *May 18*, 1864.

Where mustered in *Portland*

Bounty paid \$ *100*; due \$ *100*

Where credited *Linnick*

Company to which assigned

Remarks: *14 R. I. H. Artillery*

*not Vet*

Book mark:

*W. E. Wilkins*

*A* | 11 H. Art'y. | U.S.C.T.

*William E. Wilkins*

Appears with rank of *Prvt* on

**Muster and Descriptive Roll of a Detach-**  
**ment of U. S. Vols. forwarded**

for the *14<sup>th</sup> R. I. Cavalry (Arty)*  
*11* Reg't *U.S.C.T. Arty.* Roll dated

*Portsmouth M<sup>e</sup> James*, 1864.

Where born *Portsmouth Va*

Age *18* y'rs; occupation *Waiter*

When enlisted *May 18*, 1864.

Where enlisted *Portsmouth M<sup>e</sup>*

For what period enlisted *3* years.

Eyes *blk*; hair *blk*

Complexion *Tan*; height *5* ft. *2* in.

When mustered in *May 18*, 1864.

Where mustered in *S. M<sup>e</sup>*

Bounty paid \$ *25*<sup>100</sup>; due \$ *75*<sup>100</sup>

Where credited

Company to which assigned

Remarks: *Not Veteran*

*One months advance*

*pay \$13 paid*

Book mark:

*Devo*



W. H. Hart. U.S. Co.

William E. Wilkins

Appears with rank of *Prnt* on

**Muster and Descriptive Roll of a Detachment of U. S. Vols. forwarded**

for the *(14 R. I. Co. U. S. Army)* *U. S. Army* Roll dated

*Portland Me June 7, 1864.*

Where born *Portsmouth Va*

Age *18* y'rs; occupation *Wagoner*

When enlisted *May 18*, 1864.

Where enlisted *Portland Me*

For what period enlisted *3* years.

Eyes *blue*; hair *black*

Complexion *Good*; height *5* ft. *2* in.

When mustered in *May 18*, 1864.

Where mustered in *Engl. Div. Me*

Bounty paid \$ *25*/<sub>100</sub>; due \$ *75*/<sub>100</sub>

Where credited

Company to which assigned

Remarks: *Not Vet. One m's adv. pay \$13 paid.*

*\*Inserted by Comparer.*

Book mark:

*W. H. Hart*

11  
W 114 H. Art. U.S.C.T.

Wm E. Wilkins

Appears with rank of Private on  
**Muster and Descriptive Roll of a Detach-  
ment of U. S. Vols. forwarded**

for the 114 Reg't R. I. Hart Cold Roll dated

Hart Island N.Y.N. June 24, 1864.

Where born Portsmouth Va

Age 18 y'rs; occupation Waiter

When enlisted May 18, 1864

Where enlisted 1st Dist Me

For what period enlisted 3 years.

Eyes Blk; hair Blk

Complexion Cold; height 5 ft. 2 in.

When mustered in \_\_\_\_\_, 1864

Where mustered in \_\_\_\_\_

Bounty paid \$ 38 <sup>100</sup>; due \$ 100

Where credited \_\_\_\_\_

Company to which assigned \_\_\_\_\_

Remarks: \_\_\_\_\_

\_\_\_\_\_

\_\_\_\_\_

\_\_\_\_\_

\_\_\_\_\_

\_\_\_\_\_

Book mark: \_\_\_\_\_

\_\_\_\_\_

\_\_\_\_\_

\_\_\_\_\_

*W.* | 11 H. Art'y. | U.S.C.T.

*William C. Wilkins*  
*Pl.*, Co. A, 11 Reg't U. S. Col'd H. Art'y.

Appears on

**Company Muster Roll**  
for *July & Aug.*, 1864.  
Present or absent *Present*

Stoppage, \$ 100 for

Due Gov't, \$ 100 for

Valuation of horse, \$ 100

Valuation of horse equipments, \$ 100

Remarks: *Assigned to Co. S. C.*  
*No 39 1st. Cav. 8th Dist. Va.*  
*July 20. 64*  
*Disced April. 19/61*

Book mark: \_\_\_\_\_

*[Signature]* Copyist.



*W.* | **11 H. Art'y. U.S.C.T.**

*William B. Wilkins*  
*W.*, Co. A, 11 Reg't U. S. Col'd H. Art'y.

Appears on

**Company Muster Roll**

for *Sept. & Oct.*, 186*4*.

Present or absent *Present*

Stoppage, \$ 100 for

Due Gov't, \$ 100 for

Valuation of horse, \$ 100

Valuation of horse equipments, \$ 100

Remarks:

Book mark:

*W. B. Wilkins*  
Copyst.

*W.*

11 H. Art'y. U.S.C.T.

*William C. Wilkins*  
*Co. A, 11 Reg't U. S. Col'd H. Art'y.*

Appears on

**Company Muster Roll**

for *Nov. & Dec.*, 1864.

Present or absent *Present*

Stoppage, \$  $\frac{20}{100}$  for *Ordnance*

~~18~~  $\frac{18}{100}$  " *Co. & G.C.*

Due Gov't, \$  $\frac{100}{100}$  for

Valuation of horse, \$  $\frac{100}{100}$

Valuation of horse equipments, \$  $\frac{100}{100}$

Remarks:  
-----  
-----  
-----  
-----  
-----  
-----  
-----  
-----

Book mark: -----

*[Signature]*

*C.* | 11 H. Art'y. | U.S.C.T.

*William B. Wilson*

*Pl.*, Co. A, 11 Reg't U. S. Col'd H. Art'y.

Appears on

Company Muster Roll  
for *Jan. & Feb.*, 1865.

Present or absent *Present*

Stoppage, \$ *20* for *Ordnance*

*18*, *6. & 4. 6.*

Due Gov't, \$ *100* for

Valuation of horse, \$ *100*

Valuation of horse equipments, \$ *100*

Remarks:

Book mark:

*[Signature]*



*Pl.*

11 H. Art'y. | U.S.C.T.

*William B. Wilkins*

*Pl.*, Co. A, 11 Reg't U. S. Col'd H. Art'y.

Appears on

**Company Muster Roll**

for *March & April*, 1865.

Present or absent *Present*

Stoppage, \$ *20* / *100* for *Adman's*

*18* " *B. & G. B.*

Due Gov't, \$ *100* for

Valuation of horse, \$ *100*

Valuation of horse equipments, \$ *100*

Remarks:

Book mark:

*[Signature]*

*W.* | 11 H. Art'y. | U.S.C.T.

*William E. Wilkine,*

*Priv.*, Co. A, 11 Reg't U. S. Col'd H. Art'y.

Appears on

**Company Muster Roll**

for *May<sup>4<sup>th</sup></sup> June*, 1865.

Present or absent *Present.*

Stoppage, \$.....100 for .....

Due Gov't, \$.....100 for .....

Valuation of horse, \$.....100

Valuation of horse equipments, \$.....100

Remarks:.....

Book mark:.....

*R. Brauner*

Copyist.

*W.* | 11 H. Art'y. | U.S.C.T.

*William E. Wilkerson,*  
*Priv.,* Co. A, 11 Reg't U. S. Col'd H. Art'y.

Appears on

**Company Muster Roll**

for *July<sup>4<sup>th</sup></sup> August*, 1865.

Present or absent *Presents*

Stoppage, \$.....100 for .....

Due Gov't, \$.....100 for .....

Valuation of horse, \$.....100

Valuation of horse equipments, \$.....100

Remarks: .....

.....

.....

.....

.....

.....

.....

Book mark: .....

.....

.....

*R. E. Gammeter*  
Copyst.



*W.* | 11 H. Art'y. | U.S.C.T.

*William E. Wilkins,*

*Priv., Co. A, 11 Reg't U. S. Col'd H. Art'y.*

Appears on **Co. Muster-out Roll**, dated

*New Orleans, La., Oct. 2, 1865.*

Muster-out to date *Oct. 2, 1865.*

Last paid to *Feb. 28 1865.*

Clothing account:

Last settled....., 186 ; drawn since \$.....<sup>100</sup>

Due soldier \$.....<sup>100</sup>; due U. S. \$ *49.<sup>14</sup>/<sub>100</sub>*

Am't for cloth'g in kind or money adv'd \$.....<sup>100</sup>

Due U. S. for arms, equipments, &c., \$ *6.<sup>00</sup>/<sub>100</sub>*

Bounty paid \$.....<sup>100</sup>; due \$ *100.<sup>00</sup>/<sub>100</sub>*

Remarks: *Joined as Recruit.*

*Stopped 1 Bedstead.*

*Stopped for 1 Musket and*

*Accoutrements retained.*

Book mark : .....

*W. E. Greener*

11 U.S.C. N.A.

Wilkins, John E.

14 Reg't P.S.N.A.

3 Enclosures.

Bed Cards	Final Statements
Burial Records	Furloughs or L. of A.
Certs. of Dis. for Discharge	Med. Certificates
C. M. Charges	Med. Des. Lists
Descriptive Lists	Orders
Discharge Certificates	Pris. of War Record
Enlistment Papers	Resignations

Other papers relating to—

Admission to Hosp'l	Furlough or L. of A.
Casualty Sheet	Med. Examination
Confinement	Misc. Information
Contracts	Pay or Clothing
Death or Effects	Personal Reports
Desertion	Rank
Discharge from Hosp'l	Transfer to Hosp'l
Discharge from Service	Transfer to V. R. C.
Duty	Transportation



NOTE 1.—This blank will be used for both enlistments and re-enlistments—enlistment of veterans, &c., in the volunteer service. They will be made out in triplicate in all cases—one to accompany the recruiting return of the superintendent (or recruiting officer) to the Adjutant General of the Army, one to accompany the accounts of the officer who pays bounty, and one for the Adjutant General of the State. The Regiment and Company in which the soldier last served should be given on the back.

NOTE 2.—An enlistment holds to service. A muster-in must, in all cases, precede payment of pay, pension, &c. A muster-in roll must, in all cases, be filed in the Adjutant General's Office as evidence of muster-in. The mustering officer, esay, or assistant commissary of musters, as the case may be, will countersign all the enlistments as having mustered the soldier into the service of the United States before either of them is given to the disbursing officer.

APRIL 1868. THIS PAPER WAS FORMERLY  
 FILED IN THE ENLISTMENT DIV. R. & P. O.

DECLARATION OF RECRUIT.

I, *William E Wilkins* desiring to VOLUNTEER as a soldier in the ARMY OF THE UNITED STATES, for the term of THREE YEARS, DO DECLARE, That I am *Eighteen* years and months of age; that I have never been discharged from the United States service on account of disability or by sentence of a court martial, or by order before the expiration of a term of enlistment: and I know of no impediment to my serving honestly and faithfully as a soldier for three years.

GIVEN at *Portland* the *17<sup>th</sup>* day of *May* 1864  
 Witness: *James Callaway* *William E Wilkins*

14 R. I. N. A.  
 No. *58*  
*William E Wilkins*  
 Volunteered at *Portland*  
*May 18<sup>th</sup> 1864*  
 By *Chas. H. Y. one day* 1864  
*12th R. I.* Regiment of *Volunteers*  
 Discharged *First* enlistment; last served in Co. ( )  
 Regiment of  
 186

CONSENT IN CASE OF MINOR.

I, *James Davis* Do CERTIFY, That I am the *Guardian* of *William E Wilkins*; that the said *William E Wilkins* is *Eighteen* years of age; and I do hereby freely give my CONSENT to his volunteering as a SOLDIER in the ARMY OF THE UNITED STATES for the period of THREE YEARS.

GIVEN at *Portland* the *17<sup>th</sup>* day of *May* 1864  
 Witness: *James Callaway* *James Davis*



*Wm E Wilkins*

# VOLUNTEER ENLISTMENT.

STATE OF

*Maine*



CITY OF

*Portland*

I, *William E Wilkins* born in *Portsmouth*  
 in the State of *Virginia* aged *Eighteen* years,  
 and by occupation a *Waiter* DO HEREBY ACKNOWLEDGE to have  
 volunteered this *17<sup>th</sup>* day of *May* 186*4*,  
 to serve as a **Soldier** in the Army of the United States of America, for the  
 period of **THREE YEARS**, unless sooner discharged by proper authority: Do also  
 agree to accept such bounty, pay, rations, and clothing, as are, or may be, estab-  
 lished by law for volunteers. And I, *William E Wilkins* do  
 solemnly swear, that I will bear true faith and allegiance to the **United States**  
**of America**, and that I will serve them honestly and faithfully against all their  
 enemies or opposers whomsoever; and that I will observe and obey the orders of  
 the President of the United States, and the orders of the officers appointed over  
 me, according to the Rules and Articles of War.

Sworn and subscribed to, at *Portland*  
 this *17<sup>th</sup>* day of *May* 186*4*. } *Wm E Wilkins*  
 BEFORE *Charles H Doughty*

I CERTIFY, ON HONOR, That I have carefully examined the above named Volunteer,  
 agreeably to the General Regulations of the Army, and that in my opinion he is free from all  
 bodily defects and mental infirmity, which would, in any way, disqualify him from performing  
 the duties of a soldier.

*Chas H Thomas*

EXAMINING SURGEON.

I CERTIFY, ON HONOR. That I have minutely inspected the Volunteer, *Wm E Wilkins*  
 previously to his enlistment, and that he was entirely sober when enlisted: that, to the best  
 of my judgment and belief, he is of lawful age: and that, in accepting him as duly qualified  
 to perform the duties of an able-bodied soldier, I have strictly observed the Regulations  
 which govern the recruiting service. This soldier has *Black* EYES, *Black* HAIR,  
*Black* COMPLEXION, is *5* FEET *2* INCHES high.

Regiment of

Volunteers,

*Charles H Doughty*

RECRUITING OFFICER.

NOTE.—The Recruiting Officer will here enter the soldier's residence, and state whether married or single.

This soldier is a resident of *Portland, Me* and is *Single*

Mustered into the service of the United States, in Company *H* the *18<sup>th</sup>* day of *May* 186*4* at *Portland, Me*

Regiment of *Heavy Artillery* Volunteers, on

*Charles H Doughty*



NOTE 1.—This blank will be used for both enlistments and re-enlistments—enlistment of veterans, &c., &c., in the volunteer service. They will be made out in triplicate in all cases—one to accompany the recruiting return of the superintendent (not the recruiting officer) to the Adjutant General of the Army, one to accompany the accounts of the officer who pays bounty, and one for the Adjutant General of the State. The Regiment and Company in which the soldier last served should be given on the back.

NOTE 2.—An enlistment holds to service. A muster-in must, in all cases, precede payment of pay, bounty, pension, &c. A muster-in roll must, in all cases, be filed in the Adjutant General's Office as evidence of muster-in. The mustering officer, commissary, or assistant commissary of musters, as the case may be, will countersign all the enlistments as having mustered the soldier into the service of the United States before either of them is given to the disbursing officer.

DECLARATION OF RECRUIT.

I, *William E. Wilkins* desiring to VOLUNTEER as a soldier in the ARMY OF THE UNITED STATES, for the term of THREE YEARS, DO DECLARE, That I am *Eighteen* years and months of age; that I have never been discharged from the United States service on account of disability or by sentence of a court martial, or by order before the expiration of a term of enlistment: and I know of no impediment to my serving honestly and faithfully as a soldier for three years.

GIVEN at *Portland* the *17<sup>th</sup>* day of *May* 186*4*

Witness: *James Callaway*

*Wm E. Wilkins*

Discharged

186

Regiment of

*First* enlistment; last served in Co. ( )

*14<sup>th</sup> A. I.* Regiment of *A. Artillery*

By *Capt Robert H. Dougherty*

*May 18<sup>th</sup>* 186*4*

Volunteered at *Portland*

*William E. Wilkins*

No. *5785*

*W/64*

CONSENT IN CASE OF MINOR.

I, *James Davis* Do CERTIFY, That I am the *Guardian* of *William E. Wilkins*; that the said *William E. Wilkins* is *Eighteen* years of age; and I do hereby freely give my consent to his volunteering as a SOLDIER in the ARMY OF THE UNITED STATES for the period of THREE YEARS.

GIVEN at *Portland* the *17<sup>th</sup>* day of *May* 186*4*

Witness:

*James Callaway*

*James Davis*



*Rec'd at Portland*

# VOLUNTEER ENLISTMENT.

STATE OF



CITY OF TOWN OF

*Maine*

*Portland*

I, *William E. Wilkins* born in *Portland*  
 in the State of *Virginia* aged *Twenty seven* years,  
 and by occupation a *Waiter* Do HEREBY ACKNOWLEDGE to have  
 volunteered this *17<sup>th</sup>* day of *May* 1864,  
 to serve as a **Soldier** in the **Army of the United States of America**, for the  
 period of **THREE YEARS**, unless sooner discharged by proper authority: Do also  
 agree to accept such bounty, pay, rations, and clothing, as are, or may be, estab-  
 lished by law for volunteers. And I, *William E. Wilkins* do  
 solemnly swear, that I will bear true faith and allegiance to the **United States**  
**of America**, and that I will serve them honestly and faithfully against all their  
 enemies or opposers whomsoever; and that I will observe and obey the orders of  
 the President of the United States, and the orders of the officers appointed over  
 me, according to the Rules and Articles of War.

Sworn and subscribed to, at *Portland*  
 this *18<sup>th</sup>* day of *May* 1864. } *Wm E. Wilkins*  
 BEFORE *Charles H. Doughty*

I CERTIFY, ON HONOR, That I have carefully examined the above named Volunteer,  
 agreeably to the General Regulations of the Army, and that in my opinion he is free from all  
 bodily defects and mental infirmity, which would, in any way, disqualify him from performing  
 the duties of a soldier.

*Chas. H. Doughty*  
 EXAMINING SURGEON.

I CERTIFY, ON HONOR, That I have minutely inspected the Volunteer, *Wm E. Wilkins*  
 previously to his enlistment, and that he was entirely sober when enlisted: that, to the best  
 of my judgment and belief, he is of lawful age: and that, in accepting him as duly qualified  
 to perform the duties of an able-bodied soldier, I have strictly observed the Regulations  
 which govern the recruiting service. This soldier has *Black* EYES, *Black* HAIR,  
*Black* COMPLEXION, is *6* FEET *2* INCHES high.

Regiment of *14<sup>th</sup> P. O.* Volunteers,  
*Charles H. Doughty* RECRUITING OFFICER.

Mustered into the service of the United States, in Company  
 the *18<sup>th</sup>* day of *May* 1864, at *Portland*

*14<sup>th</sup> P. O.* Regiment of *Heavy Artillery* Volunteers, on

*Charles H. Doughty*  
 Capt. *Wm. P. Mann*  
*14<sup>th</sup> P. O. Maine*

NOTE.—The Recruiting Officer will here enter the soldier's residence, and state whether \*married or single.

This soldier is a resident of *Portland* and is *Single*

*Presented by Wm. P. Mann*



Wm E. Wilkins  
14 R. I. H. A.,

11 A. S. O. 71. 1st.

file

Hd Qrs. Department of the East,  
New York City

W. 25th. (June) 25<sup>th</sup> 1864

East Dept of  
Maj Genl Dix.

Ordering medical examinations  
of Priv. W. E. Wilkins under  
charge of Lieut. H. L. Lawton 31<sup>st</sup> U.S.  
wishes report: whether this man is  
fit for the service, and detain  
him until further orders.

Head Qrs Draft Rendezvous  
Hart Island N.Y.C.

June 27<sup>th</sup> 1864.

Respectfully forwarded  
to Department Hd Qrs.

Wilkins was forwarded  
to his regiment in the  
Dept of the Gulf, on the  
24<sup>th</sup> inst.

N. T. Jackson  
Breg Genl Col

F. B. (Recd. Hd Qrs D.E.) July 19<sup>th</sup> 1864.

Head Quarters, Department of the East,

New York City, 25 June 1864.

Brig Genl A. J. Jackson,  
Com<sup>d</sup> of Forts Island,

General:

A recruit of the 14<sup>th</sup> R. I. Artillery, <sup>named Wm E. Watkins</sup> who states that he is under charge of Lieut Henry S. Lawton, Com<sup>d</sup> Detachment of 31<sup>st</sup> U. S. Col<sup>d</sup> Troop, on Forts Island, complains to the Com<sup>d</sup> General that he was defrauded of his bounty at Portland, Maine. He states that he is 15 years old, was enlisted at Portland, on the 18<sup>th</sup> May last, & presents a printed paper from the H<sup>on</sup> Sec<sup>y</sup> of Brig Genl Peice, Com<sup>d</sup> Camp Meigs, Readville, Mass., showing that upon an examination by the Medical Commission appointed by the Commander in Chief, through the Surgeon General, he was declared unfit to perform the duties of a soldier because of "Immaturity", and freed from his enlistment in the 5<sup>th</sup> Mass<sup>ts</sup> Cavalry.

You will please have a medical examination made of this recruit and report whether he is fit for the service; and detain him until further orders.

By command of Maj Genl Dix  
Chas A. Joline,  
Maj & A.D.C.



1944

Wilkinson Thomas A.

Co H, 11 U.S. Col'd H. Art'y.

Private

Sergeant

CARD NUMBERS.

1	6194390	26
2	6194396	27
3	6194542	28
4	6194688	29
5	6194829	30
6	6194969	31
7	6195105	32
8	6195241	33
9	6195374	34
10	6195503	35
11	6195641	36
12	6195767	37
13	6195893	38
14	9125429	39
15		40
16		41
17		42
18		43
19		44
20		45
21		46
22		47
23		48
24		49
25		50

Book Mark:

See also



*W* | **11 H. Art'y. | U.S.C.T.**

*Thomas A. Wilkinson*

....., Co. *H*, 11 Reg't U. S. Col'd H. Art'y.

Appears on

**Company Descriptive Book**

of the organization named above.

**DESCRIPTION.**

Age *31* years; height *6* feet *1/2* inches.

Complexion *Blk*

Eyes *Blk*; hair *Blk*

Where born *Chambersburg, Pa*

Occupation *Farmer*

**ENLISTMENT.**

When *Nov 5*, 186 *3*.

Where *Prov. R.I.*

By whom *J. Engler*; term *3* y'rs.

Remarks *Appointed 1st*

*Sgt Nov 23/63. Re-*

*duced to Sergeant,*

*May 12/64*

*W. F. Roe*

*N.* | **11 H. Art'y.** | **U.S.C.T.**

*Thomas A. Wilkinson,*

*Pvt.*, Co. *H.*, 14 Reg't R. I. Col'd H. Art'y.\*

Age *31* years.

Appears on

**Company Muster-in Roll**

of the organization named above. Roll dated  
*Providence R.I., Nov. 23,* 1863.

Muster-in to date *Nov. 23,* 1863.

Joined for duty and enrolled:

When *Nov. 5*, 1863.

Where *Providence R.I.*

Period *3* years.

Valuation of horse, \$.....100

Valuation of horse equipments, \$.....100

Remarks: *Residence Prov*  
*idence R.I.*

\* This organization subsequently became Co. *H.*, 11 Reg't U. S. Colored Heavy Artillery.

Book mark:.....

*Perry*

*N.* | 11 H. Art'y. | U.S.C.T.

*Thomas A. Wilkinson,*

*Pvt.*, Co. *H.*, 14 Reg't R. I. Col'd H. Art'y.\*

Age *31* years.

Appears on

**Company Muster-in Roll**

of the organization named above. Roll dated  
*Providence R.I., Nov. 23,* 1863.

Muster-in to date *Nov. 23,* 1863.

Joined for duty and enrolled:

When *Nov. 5*, 1863.

Where *Providence R.I.*

Period *3* years.

Valuation of horse, \$.....100

Valuation of horse equipments, \$.....100

Remarks: *Residence Prov*  
*idence R.I.*

\* This organization subsequently became Co. *H.*, 11 Reg't U. S. Colored Heavy Artillery.

Book mark:.....



*A.* | 11 H. Art'y. | U.S.C.T.

*Thomas A. Wilkinson*  
*1<sup>st</sup> Sgt*, Co. H, 14 Reg't R. I. Col'd H. Art'y.\*

Appears on

**Company Muster Roll**

for *23 Nov. to 31 Dec*, 1863.

Present or absent *Present*

Stoppage, \$.....100 for .....

Due Gov't, \$.....100 for .....

Valuation of horse, \$.....100

Valuation of horse equipments, \$.....100

Remarks: *Promoted from private to 1<sup>st</sup> Sgt, Dec. 1<sup>st</sup>, 1863*

\*This organization subsequently became Co. H, 11 Reg't U. S. Colored Heavy Artillery.

Book mark: .....

*Cerry*

*W*

**11 H. Art'y. U.S.C.T.**

*Thomas A. Wilkinson*  
*1st Sgt*, Co. H, 14 Reg't R. I. Col'd H. Art'y.\*

Appears on

**Company Muster Roll**

for *Jan & Feb*, 186*4*.

Present or absent *Present*

Stoppage, \$ *100* for

Due Gov't, \$ *100* for

Valuation of horse, \$ *100*

Valuation of horse equipments, \$ *100*

Remarks: *Promoted from Private Dec 1, 1863*

\*This organization subsequently became Co. II, 11 Reg't U. S. Colored Heavy Artillery.

Book mark: \_\_\_\_\_

*Cerry*

*71* | 11 H. Art'y. | U.S.C.T.

*Thomas A. Wilkinson*

*1<sup>st</sup> Sgt*, Co. H, 14 Reg't R. I. Col'd H. Art'y.\*

Appears on

**Company Muster Roll**

for *Mch. & Apl*, 1864.

Present or absent *Present*

Stoppage, \$ 100 for

Due Gov't, \$ 100 for

Valuation of horse, \$ 100

Valuation of horse equipments, \$ 100

Remarks: *Promoted from private Decr, 1863*

\*This organization subsequently became Co. H, 11 U. S. Col'd H. Art'y

Book mark: \_\_\_\_\_

*Perry*

Copyist.



*A.* | 11 H. Art'y. | U.S.C.T.

*Thomas A. Wilkinson*  
Sgt., Co. *H*, 8 Reg't U. S. Col'd H. Art'y.\*

Appears on

**Company Muster Roll**

for *May & June*, 1864.

Present or absent *Present*

Stoppage, \$ 100 for

Due Gov't, \$ 100 for

Valuation of horse, \$ 100

Valuation of horse equipments, \$ 100

Remarks: *Appointed 1<sup>st</sup> Sgt.  
Dec. 1<sup>st</sup> 1863. Reduced  
to sergt. May 12<sup>th</sup> per  
S. O. No. 26. On de-  
tached service with  
Prov. Guard in Plaque-  
mine per S. O. No. 37*

† This organization subsequently became Co. *H*, 11 Reg't U. S. Colored Heavy Artillery.

Book mark:

*Perry*

*W* | 11 H. Art'y. | U.S.C.T.

*Thomas A. Wilkinson*

*Serg't*, Co. H, 11 Reg't U. S. Col'd H. Art'y.

Appears on

**Company Muster Roll**

for *July + Aug.*, 186*4*.

Present or absent *Present*

Stoppage, \$ *100* for

Due Gov't, \$ *100* for

Valuation of horse, \$ *100*

Valuation of horse equipments, \$ *100*

Remarks: *Appointed 1st Serg't*  
*Dec. 1st/63. \* Stop for*  
*ball screw 13, Canteen*  
*41, Shaverack 45.*  
*Reduced to Serg't May*  
*17/64 per special order*  
*no. 26. Stop for sash*  
*+ pick 45.*  
*Free April 19, 1861.*

Book mark: \_\_\_\_\_

*W* | **11 H. Art'y. U.S.C.T.**

*Thomas A Wilkinson*  
*Serg't*, Co. H, 11 Reg't U. S. Col'd H. Art'y.  
Appears on

**Company Muster Roll**

for *Dated Oct. 31, 1864.*

Present or absent *Present*

Stoppage, \$ *100* for

Due Gov't, \$ *100* for

Valuation of horse, \$ *100*

Valuation of horse equipments, \$ *100*

Remarks: *Appointed 1st Serg't*  
*Nov. 23/63. Reduced to*  
*Serg't May 12/64 per*  
*S.O. #26 Stop for cap*  
*pouch & pick 45-*  
*from Apr. 19, 1861.*

Book mark: *1000*

*W. H. Tyler*



*W*

11 H. Art'y.

U.S.C.T.

*Thomas G. Wilkinson*

*Serjt*, Co. H, 11 Reg't U. S. Col'd H. Art'y.

Appears on

**Company Muster Roll**

for *Nov & Dec*, 186 *4*.

Present or absent. *Present*

Stoppage, \$ *100* for

Due Gov't, \$ *100* for

Valuation of horse, \$ *100*

Valuation of horse equipments, \$ *100*

Remarks: *Appointed 1st Serjt  
Nov, 23/63 Reduced to  
serjt May 12/64 by  
order Col. Sypher.  
I stop for cap pouch &  
pick 45.*

Book mark:

*W A Tyler*

*W*

11 H. Art'y.

U.S.C.T.

*Thomas A. Wilkinson*

*Serg't*, Co. H, 11 Reg't U. S. Col'd H. Art'y.

Appears on

**Company Muster Roll**

for *Jan Feb*, 1865.

Present or absent *Present*

Stoppage, \$ 100 for

Due Gov't, \$ 100 for

Valuation of horse, \$ 100

Valuation of horse equipments, \$ 100

Remarks:

Book mark:

*W. A. Tyler*

*W*

**11 H. Art'y. U.S.C.T.**

*Thomas G. Wilkinson*

*Sgt*, Co. H, 11 Reg't U. S. Col'd H. Art'y.

Appears on

**Company Muster Roll**

for *March to Apr*, 186 *3*.

Present or absent *Present*

Stoppage, \$ *100* for

Due Gov't, \$ *100* for

Valuation of horse, \$ *100*

Valuation of horse equipments, \$ *100*

Remarks:

Book mark:

*W A Tyler*



*M.*

11 H. Art'y. U.S.C.T.

*Thomas Wilkinson*

*Serjt.*, Co. H, 11 Reg't U. S. Col'd H. Art'y.

Appears on

**Company Muster Roll**

for *Mayaud June*, 1860.

Present or absent *Present*

Stoppage, \$ 100 for

Due Gov't, \$ 100 for

Valuation of horse, \$ 100

Valuation of horse equipments, \$ 100

Remarks: *Stop for 2 h.c.*  
*Straps "*

Book mark:

*Phelps*

*W.*

**11 H. Art'y. U.S.C.T.**

*Thomas A. Wilkinson*

*Sergh*, Co. H, 11 Reg't U. S. Col'd H. Art'y.

Appears on

**Company Muster Roll**

for *July and Aug.*, 186*5*.

Present or absent *Present*

Stoppage, \$.....*100* for .....

Due Gov't, \$.....*100* for .....

Valuation of horse, \$.....*100*

Valuation of horse equipments, \$.....*100*

Remarks: .....

Book mark: .....

*Phelps*

*W* | 11 H. Art'y. | U.S.C.T.

*Thomas A. Wilkinson*  
Sergeant, Co. H., 11 Reg't U. S. Col'd H. Art'y.

Appears on **Co. Muster-out Roll**, dated  
*New Orleans La., Oct. 2*, 1865.

Muster-out to date *Oct. 2*, 1865.

Last paid to *June 30*, 1865.

**Clothing account:**

Last settled....., 186 ; drawn since \$..... 100

Due soldier \$..... 100; due U. S. \$ *20* <sup>53</sup>/<sub>100</sub>

Am't for cloth'g in kind or money adv'd \$..... 100

Due U. S. for arms, equipments, &c., \$..... 100

Bounty paid \$ *00* <sup>100</sup>/<sub>100</sub>; due \$ *100* <sup>100</sup>/<sub>100</sub>

Remarks: *joined at origl origin.*  
*Appointed 1st Serge nt Nov 23<sup>d</sup>*  
*1863 Reduced to Serge nt*  
*May 17, 1864*

Book mark: .....

*Rhett*



Wilkinson, Thos. A.

Sgt. 74, 11 Reg't U.S.C.A.

2 Enclosures.

Bed Cards	Final Statements
Burial Records	Furloughs or L. of A.
Certs. of Dis. for Discharge	Med. Certificates
C. M. Charges	Med. Des. Lists
Descriptive Lists	Orders
Discharge Certificates	Pris. of War Record
Enlistment Papers 1	Resignations

Other papers relating to—

Admission to Hosp'l	Furlough or L. of A. 1
Casualty Sheet	Med. Examination
Confinement	Misc. Information 2
Contracts	Pay or Clothing
Death or Effects	Personal Reports
Desertion	Rank
Discharge from Hosp'l	Transfer to Hosp'l
Discharge from Service	Transfer to V. R. C.
Duty	Transportation

**DECLARATION OF RECRUIT.**  
 I, Thomas A. Wilkinson do VOLUNTEER as a Soldier in the ARMY OF THE UNITED STATES, for the term of three years and three months of age; that I have never been discharged from the United States service on account of disability or by sentence of a court martial, or by order, before the expiration of a term of enlistment; and I know of no impediment to my serving honestly and faithfully as a soldier for

Given at St. Louis  
 The 11th day of July 1863

Witness:  
G. H. Wilson

Thomas A. Wilkinson

11200 C. H. C.

No.

809

Thomas A. Wilkinson

Volunteered at

St. Louis, Mo.

1863

By

Wm. J. B. Smith

Regiment of

1st Regt. Ill. Cav.

enlistment; last served in Company ( )

Reg't of

Discharged



18

**CONSENT IN CASE OF MINOR.**

I, \_\_\_\_\_ of \_\_\_\_\_ is \_\_\_\_\_ years of age; and I do hereby freely give my CONSENT to his volunteering as a SOLDIER in the ARMY OF THE UNITED STATES for the period of \_\_\_\_\_

Do CERTIFY that I am the \_\_\_\_\_; that the said

Given at

The \_\_\_\_\_ day of \_\_\_\_\_

Witness



# VOLUNTEER ENLISTMENT.

State of  
*Rhode Island*



Town of  
*Providence*

I, *Thomas Wilkinson* born in *Chambersburg*  
in the State of *Pa* aged *31* years, and by occupation  
a *Farmer*

DO HEREBY ACKNOWLEDGE to have volunteered this *5<sup>th</sup>*  
day of *Nov* 1863 to serve as a SOLDIER in the ARMY OF THE UNITED STATES  
OF AMERICA, for the period of *three years* unless sooner discharged by proper authority:

Do also agree to accept such bounty, pay, rations and clothing, as are, or may be, established, by law for  
volunteers. And I, do solemnly swear, that I will bear  
true faith and allegiance to the *United States of America*, and that I will serve them honestly and faith-  
fully against all their enemies or opposers whomsoever; and that I will observe and obey the orders of the  
President of the United States, and the orders of the officers appointed over me, according to the Rules  
and Articles of War.

Sworn and Subscribed to, at *Providence*  
this *5<sup>th</sup>* day of *Nov* 1863 *Thomas A. Wilkinson*  
BEFORE *John H. ...*

I CERTIFY, ON HONOR, That I have carefully examined the above-named Volunteer, agreeable to the General Regulations of  
the Army, and that, in my opinion, he is free from all bodily defects and mental infirmity, which would, in any way, disqualify him  
from performing the duties of a soldier.

*John H. ...*

EXAMINING SURGEON.

I CERTIFY, ON HONOR, That I have minutely inspected the Volunteer,  
previously to his enlistment, and that he was entirely sober when enlisted; that to the best of my judgment and belief, he is of  
lawful age; and that, in accepting him as duly qualified to perform the duties of an able-bodied soldier, I have strictly observed the  
Regulations which govern the recruiting service. This soldier has *Dark* eyes, *Dark* hair,  
*Dark* complexion, is *5* feet, *6 1/2* inches high.

*Thomas S. Wilkinson*

*14<sup>th</sup> Regt of ...* Volunteers,

RECRUITING OFFICER.



Hd Qr Pr Guard  
B-1-42-H. Sept 9. 1864

Gaskell Robert S.  
1st Lt 11<sup>th</sup> U.S. C.A. (H)  
Com of Pr. Guard

Request that Simp  
Thomas Wilkerson  
of H. Co 11<sup>th</sup> U.S. C.A.  
be ordered to appear  
before him in reference  
to selling cotton to  
Genl Voight &c

Recd 9<sup>th</sup> Sept. 1864

Head-Quarters, Provost Guard  
Piquemine La. Sept. 9th. 1864.

Sir:

I would respectfully  
ask of you, to cause Sergt.  
Charles Wilkinson Co. 4th, 11th, Regt.  
U. S. C. Art. (Heavy) to appear at my  
Office this afternoon at 5 o'clock  
to enable me to investigate a  
case relative to his receiving money  
for some cotton belonging to  
other parties.

I have the honor to be  
Most Respectfully

Yours Obedt Servant  
Robert J. Gaskill  
Adj. Lieut Comdg. Provost Guard



Adj. Gen. Provost Guard  
Regiment La  
B. 1 Sept 70, 1864

Joshua Jones &  
PL. 11500ca (H)  
Com. ad Prov. Guard

Report that, agree-  
able to instructions, he  
has investigated the  
matter of Cotton Selling  
by Sergt Williamson  
formerly of the Prov.  
Guard, and of the 2<sup>d</sup>  
Regt. 11500ca (N) and  
does not find that  
the Sergt. has been guilty  
of any intentional offense.  
The Cotton having been  
given to him by parties  
who recovered it from a  
wreck which had been  
abandoned <sup>and</sup> near which  
his guard was posted.

Recd Sep 16, 1864



Head-Quarters. Provost Guard  
Piquerrine La. Sept. 10<sup>th</sup> 1864.

Sir:—

I have the honor to state to you that I have investigated the case relative to Sergt. Wilkinson's receiving money from a person for cotton belonging to other parties and that the circumstances are these. A party had been sent up here from New Orleans to get everything of any value from the wreck of the Steamer C. H. Russell, that was destroyed by fire at the Landing. After taking out considerable cotton from her hold they returned to New Orleans. It was thought they had taken everything they intended to, and different persons went to Capt. Wilkinson asking him if they could have the privilege of digging for more cotton. He told them they could and all of them gave him a portion of what they secured, which added together he.

sold to Mr. Bright for twenty-seven (27) dollars. Said cotton was afterward seized by parties pretending to have bought what remained in the week and Mr. Bright lost his cotton and 27 dollars.

Serjt. Wilkinson has promised to refund the money to Mr. Bright as soon as he receives his pay.

Leaving the case to your consideration.

I remain

Your most Obedt Servant

To D. C. Whidney      Robert S. Gaskill  
1st Lieut & Port Adjt.      1st Lieut Comdg. Prov. Guard



263.

<sup>81</sup> Plaquemine La <sup>1865</sup>

May 21<sup>st</sup> 1865

Milkinson Thomas A.

Sergt. Co. H. 11<sup>th</sup> U.S. Cal. Art.

Applies for a furlough  
of seven (7) days for the  
purpose of visiting Thib-  
odaux La. on business

Plaquemine La  
May 21. 1865

Respectfully forwarded  
approved. I desire to send  
Sergt Milkinson to Thib-  
odaux to get my trunk  
sword and belt which  
are there, being unable  
to get them in any  
other way.

J. M. Adema  
Capt Co. H. 11<sup>th</sup> U.S. Cal.

Recd P.H.C. May 22 1865.

M. Quar 2<sup>nd</sup> Bat 11<sup>th</sup> U.S. Cal  
Plaquemine La May 21<sup>st</sup> 1865

Respectfully forwarded  
Approved

R. Q. Swan  
Major 11<sup>th</sup> U.S. Cal  
Comd'g Bat

Furlough granted from  
May 26<sup>th</sup> to May 31<sup>st</sup> 1865



Camp Shaw May 21<sup>st</sup> / 1865

C/o Lt G. W. Barney

Act. Post Adjt.

Sir

I have the honor to  
apply for a furlough of five days for the pur-  
pose of visiting Thibodaux on business—  
I would further state that I have been  
in the service more than eighteen months  
and have not been absent from my  
company a single day—

I have the honor  
to be Sir

Your most

obdt<sup>d</sup> Servt

Thomas A. Wilkinson

Serjt Co. H. 11<sup>th</sup> U.S. A. (Reg)

2000

Williams Abraham

Co. C, 11 U.S. Col'd H. Art'y.

Private | Private.

CARD NUMBERS.

1	6185643	26
2	6185790	27
3	6185931	28
4	6186074	29
5	6186206	30
6	6186341	31
7	6187165	32
8	9124514	33
9		34
10		35
11		36
12		37
13		38
14		39
15		40
16		41
17		42
18		43
19		44
20		45
21		46
22		47
23		48
24		49
25		50

Book Mark:

See also

*W* | 11 H. Art'y. | U.S.C.T.

*Abraham Williams*

....., Co. *C*, 11 Reg't U. S. Col'd H. Art'y.

Appears on

**Company Descriptive Book**

of the organization named above.

**DESCRIPTION.**

Age *20* years; height *5* feet *5* inches.

Complexion *DK mulatto*

Eyes *DK Hazel*; hair *Blk*

Where born *Bay Ridge N.Y.*

Occupation *Farmer*

**ENLISTMENT.**

When *Sept 1*, 186*3*.

Where *Prov. R I*

By whom *May Sampson*; term *3* y'rs.

Remarks: *I sent descriptive list Aug 4/65 to corp Drayner Que Hope. Stop for C\$49.50 sent July 25/65 to adjt Que U.S.C.T. Final statements in duplicate. Stop for C\$49.50 near final. Sent final statement & inventory of effects to Hd Qrs adjt. Jan 26. 65. No effects. Died at*

*James*



MAY. 14

9124514

\* 1891 \*

*Corps De Afrique Sen  
Hospice Aug 3/64 17  
Small foot*

*W* | 11 H. Art'y. | U.S.C.T.

*Abraham Williams*

*Priv*, Co. *C*, 14 Reg't R. I. Col'd H. Art'y.\*

Age *20* years.

Appears on

**Company Muster-in Roll**

of the organization named above. Roll dated

*Providence R. I., Sep 14, 1863.*

Muster-in to date *Sep 14, 1863.*

Joined for duty and enrolled:

When *Sept 1st*, 1863.

Where *Providence R. I.*

Period *3* years.

Valuation of horse, \$.....*100*

Valuation of horse equipments, \$.....*100*

Remarks :.....  
.....  
.....

\* This organization subsequently became Co. *C*, 11 Reg't U. S. Colored Heavy Artillery.

Book mark :.....

*Valentine*

*W* | **11 H. Art'y: U.S.C.T.**

*Abraham Williams*  
*Priv.,* Co. C, 14 Reg't R. I. Col'd H. Art'y.\*

Appears on

**Company Muster Roll**

for *Sept 14. to Dec. 31, 1863*.

Present or absent *Present.*

Stoppage, \$ 100 for

Due Gov't, \$ 100 for

Valuation of house, \$ 100

Valuation of horse equipments, \$ 100

Remarks: \_\_\_\_\_  
\_\_\_\_\_  
\_\_\_\_\_  
\_\_\_\_\_  
\_\_\_\_\_

\*This organization subsequently became Co. C, 11 Reg't U. S. Colored Heavy Artillery.

Book mark: \_\_\_\_\_

*Valentine*



*N* | 11 H. Art'y. | U.S.C.T.

*Araham Williams*

*Priv*, Co. C, 14 Reg't R. I. Col'd H. Art'y.\*

Appears on

**Company Muster Roll**

for *Jan. & Feb.*, 1864.

Present or absent *Present*

Stoppage, \$ 100 for

Due Gov't, \$ 100 for

Valuation of horse, \$ 100

Valuation of horse equipments, \$ 100

Remarks: \_\_\_\_\_

\*This organization subsequently became Co. C, 11 Reg't U. S. Colored Heavy Artillery.

Book mark: \_\_\_\_\_

*Valentine*

*W* | **11 H. Art'y. | U.S.C.T.**

*Abraham Williams*

*Priv*, Co. *C*, 8 Reg't U. S. Col'd H. Art'y.\*

Appears on

**Company Muster Roll**

for *March & Apr*, 1864.

Present or absent *Present*

Stoppage, \$ *100* for

Due Gov't, \$ *100* for

Valuation of horse, \$ *100*

Valuation of horse equipments, \$ *100*

Remarks:

*Stop for C. & G Equipage*  
*509*

\*This organization subsequently became Co. *C*, 11 Reg't U. S. Colored Heavy Artillery.

Book mark:

*Valentine*

*M* | 11 H. Art'y. | U.S.C.T.

*Abraham Williams*

*Priv. Co. C*, 8 Reg't U. S. Col'd H. Art'y.\*

Appears on

**Company Muster Roll**

for *May & June*, 1864.

Present or absent *Present*.

Stoppage, \$ 100 for

Due Gov't, \$ 100 for

Valuation of horse, \$ 100

Valuation of horse equipments, \$ 100

Remarks:

*Stoppage for C. & G.  
Equipage 50¢*

† This organization subsequently became Co. *C*, 11 Reg't U. S. Colored Heavy Artillery.

Book mark:

*Valentine*

Copyist.



A | **11 H. Art'y. U.S.C.T.**

*Abraham Williams*

*Co. C*, Co. C, 11 Reg't U. S. Col'd H. Art'y.

Appears on

**Company Muster Roll**

for *July & Aug*, 186*4*.

Present or absent

Stoppage, \$ 100 for

Due Gov't, \$ 100 for

Valuation of horse, \$ 100

Valuation of horse equipments, \$ 100

Remarks *Stoppage for  
Co & H E 5000 Aid Corps  
at Afrigue Gu. No. 314  
11. La. Aug 3, 64 Free  
Apr 19. 61*

Book mark:

*Amund*

*W* | 11 H. Art'y. | U.S.C.T.

*Abraham Williams*  
*Pvt.*, Co. *C*, 11 Reg't U. S. Col'd H. Art'y.

Appears on **Co. Muster-out Roll**, dated  
*New Orleans La, Oct. 2, 1865.*

Muster-out to date ..... 186 .  
Last paid to ..... 186 .

**Clothing account:**

Last settled ..... 186 ; drawn since \$ ..... 100

Due soldier \$ ..... 100 ; due U. S. \$ ..... 100

Am't for cloth'g in kind or money adv'd \$ ..... 100

Due U. S. for arms, equipments, &c., \$ ..... 100

Bounty paid \$ ..... 100 ; due \$ ..... 100

Remarks: *joined Regt. Argn. ...*  
*Wid at L D A Hospit.*  
*N. O. La. Aug. 3. 64.*  
*Invy. + Final Stmt. sent.*

Book mark : .....

*Bliss*  
Copyist.

Williams, Abraham

D, Co. C, 11 Reg't U.S.C.H.A.

Enclosures.

Bed Cards .....	Final Statements .....
Burial Records .....	Furloughs or L. of A .....
Certs. of Dis. for Discharge .....	Med. Certificates .....
C. M. Charges .....	Med. Des. Lists .....
Descriptive Lists .....	Orders .....
Discharge Certificates .....	Pris. of War Record .....
Enlistment Papers .....	Resignations .....

Other papers relating to—

Admission to Hosp'l .....	Furlough or L. of A .....
Casualty Sheet .....	Med. Examination .....
Confinement .....	Misc. Information .....
Contracts .....	Pay or Clothing .....
Death or Effects .....	Personal Reports .....
Desertion .....	Rank .....
Discharge from Hosp'l .....	Transfer to Hosp'l .....
Discharge from Service .....	Transfer to V. R. C. .....
Duty .....	Transportation .....



DECLARATION OF RECRUIT.

I, *Abraham Williams* desiring to VOLUNTEER as a Soldier in the ARMY OF THE UNITED STATES, for the term of *three years* do declare that I am *20* years and *5* months of age; that I have never been discharged from the United States service on account of disability or by sentence of a court martial, or by order, before the expiration of a term of enlistment; and I know of no impediment to my serving honestly and faithfully as a soldier for *3* years

Given at *Providence* Sept  
The *12* day of *August* 1863

Witness: *Mr H H Stone*

*Abraham Williams*  
Recruit

Discharged

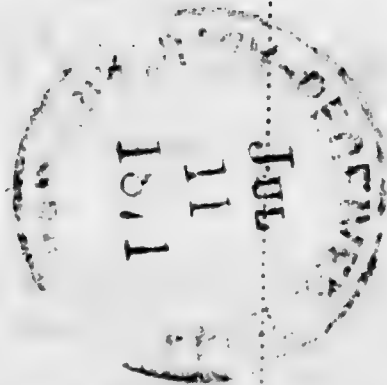

18

Regt of

enlistment; last served in Company (

*11th & 8th*

Regiment of

By *Major Samuel*

*Sept 1st* 1863

Volunteered at

*Providence*

No. *210*

CONSENT IN CASE OF MINOR.

I, \_\_\_\_\_ of \_\_\_\_\_ is \_\_\_\_\_ years of age; and I do hereby freely give my CONSENT to his volunteering as a SOLDIER in the ARMY OF THE UNITED STATES for the period of \_\_\_\_\_

Given at \_\_\_\_\_  
The \_\_\_\_\_ day of \_\_\_\_\_

Witness:

Do CERTIFY that I am the \_\_\_\_\_; that the said is \_\_\_\_\_

VOLUNTEER ENLISTMENT.



State of Rhode Island

Town of Providence

I, Abraham Williams born in Bay Ridge in the State of New York aged 20 years, and by occupation a former

DO HEREBY ACKNOWLEDGE to have volunteered this 18th day of Sept 1863 to serve as a SOLDIER in the ARMY OF THE UNITED STATES OF AMERICA, for the period of three years, unless sooner discharged by proper authority:

Do also agree to accept such bounty, pay, rations and clothing, as are, or may be, established, by law for volunteers. And I, Abraham Williams do solemnly swear, that I will bear true faith and allegiance to the United States of America, and that I will serve them honestly and faithfully against all their enemies or opposers whomsoever; and that I will observe and obey the orders of the President of the United States, and the orders of the officers appointed over me, according to the Rules and Articles of War.

Sworn and Subscribed to, at Providence this 18th day of Sept 1863 BEFORE S. P. Leonard Major 1st Regt

I CERTIFY, ON HONOR, That I have carefully examined the above-named Volunteer, agreeable to the General Regulations of the Army, and that, in my opinion, he is free from all bodily defects and mental infirmity, which would, in any way, disqualify him from performing the duties of a soldier.

Signature of Examining Surgeon

EXAMINING SURGEON.

I CERTIFY, ON HONOR, That I have minutely inspected the Volunteer, previously to his enlistment, and that he was entirely sober when enlisted; that to the best of my judgment and belief, he is of lawful age; and that, in accepting him as duly qualified to perform the duties of an able-bodied soldier, I have strictly observed the Regulations which govern the recruiting service. This soldier has dark complexion, is 5 feet, 5 inches high, dark hair, eyes dark hair.

1st Col. Battalion R. I. Volunteers

RECRUITING OFFICER.



CASUALTY SHEET

No. \_\_\_\_\_

*Abraham Williams*

*Priv*

of Company

*C*

*14* Regiment of *R. I. Art.*

State Volunteers.

*11 art*

NATURE OF CASUALTY.

*Died Aug. 3, 1864*



CASUALTY SHEET.

Name: *Abraham Williams*

Rank: *Priv* Company: *C* Regiment: *14*

Arm: *R. I. C. art* State: \_\_\_\_\_

Nature of Casualty: *Death*

CAUSE OF CASUALTY—(NAME OF DISEASE, &C.)

BY WHOM DISCHARGED.

FROM WHAT SOURCE THIS INFORMATION WAS OBTAINED.

DEGREE OF DISABILITY.

BY WHOM CERTIFIED.

REMARKS.

*Jas M Moore*  
*A. G. M.*

DATE OF DISCHARGE, DEATH, &c.

*Aug. 3, 1864*

PLACE OF DISCHARGE, DEATH, &c.

*Roll of Honor*  
*Louisiana Pg. 134*

*J. P.*

Clerk.

(170)

*Buried*

*New Orleans, Lu*

43  
3-1864

ARTICLES OF WAR.

ART. 95. When any non-commissioned officer or soldier shall die, or be killed in the service of the United States, the then commanding officer of the troop or company shall, in the presence of two other commissioned officers, take an account of what effects he died possessed of, above his arms and accoutrements, and transmit the same to the office of the Department of War, which said effects are to be accounted for, and paid to the representatives of such deceased non-commissioned officer or soldier. And in case any of the officers, so authorized to take care of the effects of deceased officers and soldiers, should, before they have accounted to their representatives for the same, have occasion to leave the regiment or post, by preferment or otherwise, they shall, before they be permitted to quit the same, deposit in the hands of the commanding officer, or of the assistant military agent, all the effects of such deceased non-commissioned officers and soldiers, in order that the same may be secured for, and paid to, their respective representatives.

ARMY REGULATIONS—EDITION OF 1861.

DECEASED SOLDIERS.

Par. 152. Inventories of the effects of deceased non-commissioned officers and soldiers, required by the 95th Article of War, will be forwarded to the Adjutant General, by the commander of the company to which the deceased belonged, and a duplicate of the same to the colonel of the regiment. Final statements of pay, clothing, &c., will be sent with the inventories. When a soldier dies at a post or station absent from his company, it will be the duty of his immediate commander to furnish the required inventory, and, at the same time, to forward to the commanding officer of the company to which the soldier belonged, a report of his death, specifying the date, place, and cause; to what time he was last paid, and the money or other effects in his possession at the time of his decease; which report will be noted on the next muster roll of the company to which the man belonged. Each inventory will be endorsed, "Inventory of the effects of \_\_\_\_\_, late of company (—) \_\_\_\_\_ regiment of \_\_\_\_\_, who died at \_\_\_\_\_, the \_\_\_\_\_ day of \_\_\_\_\_, 186—." If a legal representative receive the effects, it will be stated in the report. If the soldier leave no effects, the fact will be reported.

Par. 153. Should the effects of a deceased non-commissioned officer or soldier not be administered upon within a short period after his decease, they shall be disposed of by a Council of Administration, under the authority of the commanding officer of the post, and the proceeds deposited with the Paymaster, to the credit of the United States, until they shall be claimed by the legal representatives of the deceased.

Par. 154. In all such cases of sales by the Council of Administration, a statement in detail, or account of the proceeds, duly certified by the Council and commanding officer, accompanied by the Paymaster's receipt for the proceeds, will be forwarded by the commanding officer to the Adjutant General. The statement will be endorsed, "Report of the proceeds of the effects of \_\_\_\_\_, late of company (—) \_\_\_\_\_ regiment of \_\_\_\_\_, who died at \_\_\_\_\_, the \_\_\_\_\_ day of \_\_\_\_\_, 186—."

NOTE 1.—The effects in all cases, when called for, should be turned over to the legal representative, without further authority from the Adjutant General. When the effects are turned over to the relatives of the deceased before these inventories are sent to the Adjutant General, their receipts therefor should be attached to the inventories. In all other cases, one copy will be sent with a letter of transmittal direct to the Adjutant General, and a duplicate retained by the officer.

NOTE 2.—Particular care should be taken to take receipts in duplicate from the Paymaster for any funds turned over to him; one copy should be sent direct to the Adjutant General and one retained by the officer.

INVENTORY OF THE EFFECTS

OF

Abraham Williams

Late of Company C

11<sup>th</sup> Reg't of 1<sup>st</sup> Col A Key

Volunteers, who died at New Orleans

on the 3<sup>d</sup> day of August 1864.



Rec'd Feb. 3, 1865 - P. 11-2



Inventory of the effects of Abraham Williams late  
 a Private of Captain George Bucklin's Company C of  
 the 11<sup>th</sup> Regiment of W. Col. Art. Reg. Volunteers, who was enrolled as  
 a Private at Providence in the State of Rhode Island on  
 the 1<sup>st</sup> day of September 1863, and mustered into the service of the United  
 States as a Private on the 14<sup>th</sup> day of September 1863, at Prov. R.I.  
 in Company C, 11<sup>th</sup> Regiment of W. Col. Art. Reg. Volunteers, to serve Three  
 years or during the war; he was born in Way Mills in the State  
 of New York; he was 20 years of age, 5 feet 5 inches  
 high, Black complexion, Brown eyes, Black hair, and by occupation, when enrolled,  
 a Farmer; he died in Corps de Afrique Genl Hospital at  
New Orleans La on the Third day of August 1864, by  
 reason of Small Pox

INVENTORY.					
ARTICLES.	No.	ARTICLES.	No.	ARTICLES.	No.
Hats.....		Pairs trousers.....		Knapsacks.....	
Caps.....		Pairs flannel drawers.....		<i>No Effects</i>	
Forage caps.....		Pairs cotton drawers.....			
Great coats.....		Flannel shirts.....			
Uniform coats.....		Cotton shirts.....			
Uniform jackets.....		Pairs boots.....			
Flannel sack coats.....		Pairs shoes.....			
Blouses.....		Pairs socks.....			
Stable frocks.....		Blankets.....			
Fatigue overalls.....		Haversacks.....			
					MONEY.
				Specie.....	\$
				Notes.....	\$

I CERTIFY, ON HONOR, that the above inventory comprises all the effects of .....,  
 deceased, and that the effects are in the hands  
 of ..... at .....,  
 to be disposed of by a Council of Administration.

*I certify that this is a true copy of Inventory of Effects received for Corps de Afrique  
 Genl Hospital*  
 (DUPLICATES.)

George Bucklin  
Capt 11<sup>th</sup> US Col Art Reg.  
 Commanding the Company.

STATION Fort Jackson La

DATE: January 3<sup>rd</sup> 1865



ARTICLES OF WAR.

ART. 95. When any non-commissioned officer or soldier shall die, or be killed in the service of the United States, the then commanding officer of the troop or company shall, in the presence of two other commissioned officers, take an account of what effects he died possessed of, above his arms and accoutrements, and transmit the same to the office of the Department of War, which said effects are to be accounted for, and paid to the representatives of such deceased non-commissioned officer or soldier. And in case any of the officers, so authorized to take care of the effects of deceased officers and soldiers, should, before they have accounted to their representatives for the same, have occasion to leave the regiment or post, by preferment or otherwise, they shall, before they be permitted to quit the same, deposit in the hands of the commanding officer, or of the assistant military agent, all the effects of such deceased non-commissioned officers and soldiers, in order that the same may be secured for, and paid to, their respective representatives.

ARMY REGULATIONS—EDITION OF 1861.

DECEASED SOLDIERS.

Par. 152. Inventories of the effects of deceased non-commissioned officers and soldiers, required by the 95th Article of War, will be forwarded to the Adjutant General, by the commander of the company to which the deceased belonged, and a duplicate of the same to the colonel of the regiment. Final statements of pay, clothing, &c., will be sent with the inventories. When a soldier dies at a post or station absent from his company, it will be the duty of his immediate commander to furnish the required inventory, and, at the same time, to forward to the commanding officer of the company to which the soldier belonged, a report of his death, specifying the date, place, and cause; to what time he was last paid, and the money or other effects in his possession at the time of his decease; which report will be noted on the next muster roll of the company to which the man belonged. Each inventory will be endorsed, "Inventory of the effects of \_\_\_\_\_, late of company (—) \_\_\_\_\_ regiment of \_\_\_\_\_, who died at \_\_\_\_\_, the \_\_\_\_\_ day of \_\_\_\_\_, 186—." If a legal representative receive the effects, it will be stated in the report. If the soldier leave no effects, the fact will be reported.

Par. 153. Should the effects of a deceased non-commissioned officer or soldier not be administered upon within a short period after his decease, they shall be disposed of by a Council of Administration, under the authority of the commanding officer of the post, and the proceeds deposited with the Paymaster, to the credit of the United States, until they shall be claimed by the legal representatives of the deceased.

Par. 154. In all such cases of sales by the Council of Administration, a statement in detail, or account of the proceeds, duly certified by the Council and commanding officer, accompanied by the Paymaster's receipt for the proceeds, will be forwarded by the commanding officer to the Adjutant General. The statement will be endorsed, "Report of the proceeds of the effects of \_\_\_\_\_, late of company (—) \_\_\_\_\_ regiment of \_\_\_\_\_, who died at \_\_\_\_\_, the \_\_\_\_\_ day of \_\_\_\_\_, 186—."

NOTE 1.—The effects in all cases, when called for, should be turned over to the legal representative, without further authority from the Adjutant General. When the effects are turned over to the relatives of the deceased before these inventories are sent to the Adjutant General, their receipts therefor should be attached to the inventories. In all other cases, one copy will be sent with a letter of transmittal direct to the Adjutant General, and a duplicate retained by the officer.

NOTE 2.—Particular care should be taken to take receipts in duplicate from the Paymaster for any funds turned over to him; one copy should be sent direct to the Adjutant General and one retained by the officer.

*Triplianke*  
~~*Had in Receipt*~~

INVENTORY OF THE EFFECTS

OF

*Private Abraham Williams*

Late of Company "C"

14<sup>th</sup> Reg't of 2<sup>d</sup> S. C. A. Army

Volunteers, who died at Camp Dispersal Co. Fla.  
on the 3<sup>rd</sup> day of August 1864.

*11<sup>th</sup> U. S. C. J.*





43

3<sup>rd</sup> - 1864

## FINAL STATEMENT

OF

*Abraham Williams*

11<sup>th</sup> Reg't of *1st Col A Reg*

### VOLUNTEERS.

NOTE 1.—Two of these certificates (or duplicates) are to be given to each Volunteer Soldier or drafted man who may be discharged previously to the discharge of his company, that he may at once receive from the Paymaster the pay, &c., due him, and the captain or other COMMISSIONED officer commanding the company will certify to the act of the delivery of the duplicate certificates; on these certificates the Soldier is "entitled to" his discharge, and should also present his discharge to the Paymaster to have the payment endorsed on it. The discharge is to be given back to the Soldier by the Paymaster; the latter only retaining as his voucher the duplicate certificates.

NOTE 2.—If the Soldier is entitled to pay for the use of his horse, the Company Commander will certify to that fact on the back of both these final statements, and also to the time he has pay due for having been so mounted on his own horse.

NOTE 3.—When a Soldier is furnished with final statements, his descriptive list, if he has one, should be taken up by the officer who gives the Soldier these statements, and endorsed with a statement to this effect by the officer. This endorsement should exhibit a full statement of the time for which the Soldier was allowed pay on his final statements, the clothing account, and all other charges against him or in his favor, so as to comprise a complete exhibit of his account. It will then be transmitted to the company commander of the Soldier, who will enter all the data necessary to a full understanding of the Soldier's account on the muster roll upon which the Soldier's discharge is reported. The descriptive list will then be destroyed. The object of this is, that the remaining portion of the Soldier's account may be settled upon the receipt of these muster rolls, and the Soldier receive any pay or allowances that may be due him at the time of his discharge, and which may not appear on his final statements from the fact that his descriptive list is incomplete. These accounts for back pay, &c., are settled by the 2d Auditor of the Treasury Department.

NOTE 4.—Charges for loss or injury to ordnance, horse equipments, and other miscellaneous charges, should appear under the heading of "Other Stoppages."

NOTE 5.—Bounty paid by State authorities, and not by the United States, will not be entered on this statement.

NOTE 6.—Amounts due the Sutler and Laundress must be entered on the muster roll on which the discharge, death, desertion, &c., is reported, as well as on the final statement, otherwise the amount cannot be collected from the United States.

NOTE 7.—This blank will be used for deceased volunteers and drafted men, as well as for others.

NOTE 8.—Where a Soldier dies in Hospital or on detached service, his descriptive list, if he has one, should be sent with his final statements, in duplicate, to the Adjutant General, Washington, D. C.

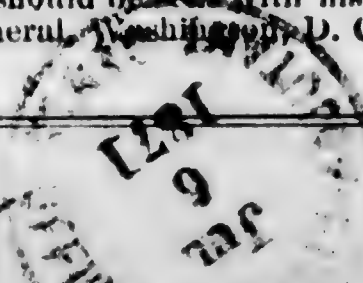

1864  
Rec'd Feb. 3. 1865 P. H. 2



I certify, on honor, that Abraham Williams, Private of  
Captain George Bucklin Company (C) of the 11th Regiment of U.S.A. He  
**VOLUNTEERS**, of the State of Rhode Island, born in Bay Ridge, State  
of New York, aged 20 years; 5 feet 5 inches high; Black complexion,  
Dark eyes, Black hair, and by occupation a Farmer, having joined the company on  
its original organization at Providence R.I., and enrolled in it at the muster into  
the service of the United States at Providence R.I., on the fourteenth day  
of September, 1863, (or was mustered in service as a recruit, by Maj. J. P. A.  
Chow R.I., on the first day of September  
1863, or was drafted and mustered into the service of the United States from the  
Enrollment District of the State of \_\_\_\_\_, at \_\_\_\_\_,  
on the \_\_\_\_\_ day of \_\_\_\_\_, 1863), to serve in the Regiment, for

the term of Three years: and having served **HONESTLY** and  
**FAITHFULLY** with his Company in The field to the present date, is now  
entitled to a **DISCHARGE** by reason of Death at Cape Pelagique Genl  
Hospital N. C. on August 3<sup>d</sup> 1864 of Small Pox  
The said Abraham Williams was <sup>never</sup> last paid by Paymaster  
\_\_\_\_\_ to include the \_\_\_\_\_ day of \_\_\_\_\_, 1863, and has  
pay due him from that time to the present date; he is entitled to pay and subsistence for  
**TRAVELING** to place of enrollment, and whatever other allowances are authorized to volunteer  
soldiers, drafted men, or militia, so discharged. He has received from the United States **CLOTHING**  
amounting to Seventeen  $\frac{5}{100}$  dollars, since the first day of September,  
1863, when his clothing account was last settled. He has received from the United States  
\_\_\_\_\_  $\frac{100}{100}$  dollars advanced **BOUNTY**.

There is to be stopped from him, on account of the State of Rhode Island, or other  
authorities, for **CLOTHING**, &c., received on entering service, Thirty  $\frac{00}{100}$  dollars; and  
for other stoppages, viz: \_\_\_\_\_

For Camp & Garrison Equipage \_\_\_\_\_  $\frac{20}{100}$  dollars.  
He has been furnished with **TRANSPORTATION** in kind from the place of his discharge to  
\_\_\_\_\_ ; and he has been **SUBSISTED** for **TRAVELING** to his  
place of enrollment, up to the \_\_\_\_\_, 1863.

He is indebted to \_\_\_\_\_, **SUTLER**, \_\_\_\_\_  $\frac{100}{100}$  dollars.

He is indebted to \_\_\_\_\_, **LAUNDRESS**, \_\_\_\_\_  $\frac{100}{100}$  dollars.

Given in Duplicate, at Fort Worth Va, this 25<sup>th</sup> day  
of January, 1865.

George Bucklin  
Capt 11<sup>th</sup> U.S. Vols  
Commanding Company

*Duplicate No 3<sup>rd</sup> 1864*

FINAL STATEMENT

OF *Private*

*Abraham Williams*

*18<sup>th</sup>* Reg't of *U. S. C. H. Art*

**VOLUNTEERS.**

*C. d'A. Hoop*

NOTE 1.—Two of these certificates (or duplicates) are to be given to each Volunteer Soldier or drafted man who may be discharged previously to the discharge of his company, that he may at once receive from the Paymaster the pay, &c., due him, and the cap'tain or other COMMISSIONED officer commanding the company will certify to the act of the delivery of the duplicate certificates; on these certificates the Soldier is "entitled to" his discharge, and should also present his discharge to the Paymaster to have the payment endorsed on it. The discharge is to be given back to the Soldier by the Paymaster; the latter only retaining as his voucher the duplicate certificates.

NOTE 2.—If the Soldier is entitled to pay for the use of his horse, the Company Commander will certify to that fact on the back of both these final statements, and also to the time he has pay due for having been so mounted on his own horse.

NOTE 3.—When a Soldier is furnished with final statements, his descriptive list, if he has one, should be taken up by the officer who gives the Soldier these statements, and endorsed with a statement to this effect by the officer. This endorsement should exhibit a full statement of the time for which the Soldier was allowed pay on his final statements, the clothing account, and all other charges against him or in his favor, so as to comprise a complete exhibit of his account. It will then be transmitted to the company commander of the Soldier, who will enter all the data necessary to a full understanding of the Soldier's account on the muster roll upon which the Soldier's discharge is reported. The descriptive list will then be destroyed. The object of this is, that the remaining portion of the Soldier's account may be settled upon the receipt of these muster rolls, and the Soldier receive any pay or allowances that may be due him at the time of his discharge, and which may not appear on his final statements from the fact that his descriptive list is incomplete. These accounts for back pay, &c., are settled by the 2d Auditor of the Treasury Department.

NOTE 4.—Charges for loss or injury to ordnance, horse equipments, and other miscellaneous charges, should appear under the heading of "Other Stoppages."

NOTE 5.—Bounty paid by State authorities, and not by the United States, will not be entered on this statement.

NOTE 6.—Amounts due the Sutler and Laundress must be entered on the muster roll on which the discharge, death, desertion, &c., is reported, as well as on the final statement, otherwise the amount cannot be collected from the United States.

NOTE 7.—This blank will be used for deceased volunteers and drafted men, as well as for others.

NOTE 8.—Where a Soldier dies in Hospital or on detached service, his descriptive list, if he has one, should be sent with his final statements, in duplicate, to the Adjutant General, Washington, D. C.



I certify, on honor, that Abraham William a Private of  
Captain Leopoldus Company (C) of the 87<sup>th</sup> Regiment of U. S. C. Hartz  
**VOLUNTEERS**, of the State of Rhode Island, born in Day Ridge, State  
of N. York, aged 20 years; 5 feet 5 inches high; mulatto complexion,  
hazel eyes, Blk hair, and by occupation a Farmer, having joined the company on  
its original organization at Prov. R. I., and enrolled in it at the muster into  
the service of the United States at Prov. R. I., on the 1 day  
of Sept, 1863, (or was mustered in service as a recruit, by  
, at , on the day of  
186 , or was drafted and mustered into the service of the United States from the  
Enrollment District of the State of , at  
on the day of , 186 ) to serve in the Regiment, for  
the term of 1 Years; and having served **HONESTLY** and  
**FAITHFULLY** with his Company in Dept of the Gulf to the present date, is now  
entitled to a **DISCHARGE** by reason of Death from Disease

The said Abraham William was last paid by Paymaster  
Never Paid to include the day of , 186 , and has  
pay due him from that time to the present date; he is entitled to pay and subsistence for  
**TRAVELING** to place of enrollment, and whatever other allowances are authorized to volunteer  
soldiers, drafted men, or militia, so discharged. He has received from the United States **CLOTHING**  
amounting to Forty four  $\frac{12}{100}$  dollars, since the day of Enrollment  
186 , when his clothing account was last settled. He has received from the United States  
No  $\frac{7}{100}$  dollars advanced **BOUNTY**.

There is to be stopped from him, on account of the State of United States, or other  
authorities, for **CLOTHING**, &c., received on entering service,  $\frac{100}{100}$  dollars; and  
for other stoppages, viz: Loss of camp & Garrison Equipage. \$11.06

$\frac{100}{100}$  dollars.

He has been furnished with **TRANSPORTATION** in kind from the place of his discharge to  
; and he has been **SUBSISTED** for **TRAVELING** to his  
place of enrollment, up to the , 186 .

He is indebted to , **SUTLER**,  $\frac{100}{100}$  dollars.

He is indebted to , **LAUNDRESS**,  $\frac{100}{100}$  dollars.

Given in Duplicate, at New Orleans La, this 3<sup>rd</sup> day  
of Aug, 1864

J. E. Pyquette  
Surgeon in ch. Cap. D. N. L. Smith  
Commanding Company



# FINAL STATEMENT

OF

*Abraham Williams*  
11<sup>th</sup> Reg't of *U.S. Col A. Key*

## VOLUNTEERS.

NOTE 1.—Two of these certificates (or duplicates) are to be given to each Volunteer Soldier or drafted man who may be discharged previously to the discharge of his company, that he may at once receive from the Paymaster the pay, &c., due him, and the captain or other COMMISSIONED officer commanding the company will certify to the act of the delivery of the duplicate certificates; on these certificates the Soldier is "entitled to" his discharge, and should also present his discharge to the Paymaster to have the payment endorsed on it. The discharge is to be given back to the Soldier by the Paymaster; the latter only retaining as his voucher the duplicate certificates.

NOTE 2.—If the Soldier is entitled to pay for the use of his horse, the Company Commander will certify to that fact on the back of both these final statements, and also to the time he has pay due for having been so mounted on his own horse.

NOTE 3.—When a Soldier is furnished with final statements, his descriptive list, if he has one, should be taken up by the officer who gives the Soldier these statements, and endorsed with a statement to this effect by the officer. This endorsement should exhibit a full statement of the time for which the Soldier was allowed pay on his final statements, the clothing account, and all other charges against him or in his favor, so as to comprise a complete exhibit of his account. It will then be transmitted to the company commander of the Soldier, who will enter all the data necessary to a full understanding of the Soldier's account on the muster roll upon which the Soldier's discharge is reported. The descriptive list will then be destroyed. The object of this is, that the remaining portion of the Soldier's account may be settled upon the receipt of these muster rolls, and the Soldier receive any pay or allowances that may be due him at the time of his discharge, and which may not appear on his final statements from the fact that his descriptive list is incomplete. These accounts for back pay, &c., are settled by the 2d Auditor of the Treasury Department.

NOTE 4.—Charges for loss or injury to ordnance, horse equipments, and other miscellaneous charges, should appear under the heading of "Other Stoppages."

NOTE 5.—Bounty paid by State authorities, and not by the United States, will not be entered on this statement.

NOTE 6.—Amounts due the Sutler and Laundress must be entered on the muster roll on which the discharge, death, desertion, &c., is reported, as well as on the final statement, otherwise the amount cannot be collected from the United States.

NOTE 7.—This blank will be used for deceased volunteers and drafted men, as well as for others.

NOTE 8.—Where a Soldier dies in Hospital or on detached service, his descriptive list, if he has one, should be sent with his final statements, in duplicate, to the Adjutant General, Washington, D. C.





I certify, on honor, that Abraham Williams Private of  
Captain George Bucklin Company (C) of the 11<sup>th</sup> Regiment of U.S.A. Key  
**VOLUNTEERS**, of the State of Rhode Island, born in Dry Ridge, State  
of New York, aged 20 years; 5 feet 5 inches high; Black complexion,  
Dark eyes, Black hair, and by occupation a Farmer, having joined the company on  
its original organization at Providence R.I., and enrolled in it at the muster into  
the service of the United States at Providence R.I., on the fourteenth day  
of September, 1863, (or was mustered in service as a recruit, by Wesley Sanford  
at Providence R.I., on the first day of September,  
1863, or was drafted and mustered into the service of the United States from the  
Enrollment District of the State of \_\_\_\_\_, at \_\_\_\_\_,  
on the \_\_\_\_\_ day of \_\_\_\_\_, 186 ,) to serve in the Regiment, for  
the term of Three Years: and having served HONESTLY and  
FAITHFULLY with his Company in the field to the present date, is now

entitled to a **DISCHARGE** by reason of Death Died at Camp de Afrique Genl  
Hospital R.C. La August 3<sup>rd</sup> 1864 of small pox  
The said Abraham Williams was last paid by Paymaster  
\_\_\_\_\_ to include the \_\_\_\_\_ day of \_\_\_\_\_, 186 , and has  
pay due him from that time to the present date; he is entitled to pay and subsistence for  
TRAVELING to place of enrollment, and whatever other allowances are authorized to volunteer  
soldiers, drafted men, or militia, so discharged. He has received from the United States **CLOTHING**  
amounting to Seventeen  $\frac{5}{100}$  dollars, since the first day of September,  
1863, when his clothing account was last settled. He has received from the United States  
100 dollars advanced **BOUNTY**.

There is to be stopped from him, on account of the State of Rhode Island, or other  
authorities, for **CLOTHING**, &c., received on entering service, Thirty six  $\frac{18}{100}$  dollars; and  
for other stoppages, viz: \_\_\_\_\_

for Camp & Garrison Equipage  $\frac{50}{100}$  dollars.  
He has been furnished with **TRANSPORTATION** in kind from the place of his discharge to  
\_\_\_\_\_; and he has been **SUBSISTED** for **TRAVELING** to his  
place of enrollment, up to the \_\_\_\_\_, 186 .

He is indebted to \_\_\_\_\_, **SUTLER**, \_\_\_\_\_ dollars.  
He is indebted to \_\_\_\_\_, **LAUNDRESS**, \_\_\_\_\_ dollars.

Given in Duplicate, at Fort Jackson La, this 25<sup>th</sup> day  
of January, 1864.

George Bucklin  
Capt 11<sup>th</sup> U.S.C.A.  
Commanding Company



Also.  
Last list sent 2<sup>d</sup> Auditor,

Adj. Gen. Mar. 25, 1865  
F. S. + inv. sent 2<sup>d</sup> Auditor

Also

FINAL STATEMENT

OF Private  
Abraham Williams

P Reg't of U. S. C. H. Art

11. U. S.

VOLUNTEERS.

Dud Aug 3<sup>rd</sup> 1864

NOTE 1.—Two of these certificates (or duplicates) are to be given to each Volunteer Soldier or drafted man who may be discharged previously to the discharge of his company, that he may at once receive from the Paymaster the pay, &c., due him, and the captain or other COMMISSIONED officer commanding the company will certify to the act of the delivery of the duplicate certificates; on these certificates the Soldier is "entitled to" his discharge, and should also present his discharge to the Paymaster to have the payment endorsed on it. The discharge is to be given back to the Soldier by the Paymaster; the latter only retaining as his voucher the duplicate certificates.

NOTE 2.—If the Soldier is entitled to pay for the use of his horse, the Company Commander will certify to that fact on the back of both these final statements, and also to the time he has pay due for having been so mounted on his own horse.

NOTE 3.—When a Soldier is furnished with final statements, his descriptive list, if he has one, should be taken up by the officer who gives the Soldier these statements, and endorsed with a statement to this effect by the officer. This endorsement should exhibit a full statement of the time for which the Soldier was allowed pay on his final statements, the clothing account, and all other charges against him or in his favor, so as to comprise a complete exhibit of his account. It will then be transmitted to the company commander of the Soldier, who will enter all the data necessary to a full understanding of the Soldier's account on the muster roll upon which the Soldier's discharge is reported. The descriptive list will then be destroyed. The object of this is, that the remaining portion of the Soldier's account may be settled upon the receipt of these muster rolls, and the Soldier receive any pay or allowances that may be due him at the time of his discharge, and which may not appear on his final statements from the fact that his descriptive list is incomplete. These accounts for back pay, &c., are settled by the 2d Auditor of the Treasury Department.

NOTE 4.—Charges for loss or injury to ordnance, horse equipments, and other miscellaneous charges, should appear under the heading of "Other Stoppages."

NOTE 5.—Bounty paid by State authorities, and not by the United States, will not be entered on this statement.

NOTE 6.—Amounts due the Sutler and Laundress must be entered on the muster roll on which the discharge, death, desertion, &c., is reported, as well as on the final statement, otherwise the amount cannot be collected from the United States.

NOTE 7.—This blank will be used for deceased volunteers and drafted men, as well as for others.

NOTE 8.—Where a Soldier dies in Hospital or on detached service, his descriptive list, if he has one, should be sent with his final statements, in duplicate, to the Adjutant General, Washington, D. C.

ADJUTANT GENERAL'S OFFICE.

Call 11<sup>th</sup> 1864

Duplicate with Inventory sent 2d Auditor.



Auto



I certify, on honor, that Abraham William a Private of  
 Captain George Bucklin Company (C) of the 8<sup>th</sup> Regiment of U. S. Col. Art  
**VOLUNTEERS**, of the State of Rhode Island, born in Bay Ridge; State  
 of N. York, aged 20 years; 5 feet 5 inches high; mulatto complexion.  
Hazel eyes, Blk hair, and by occupation a Farmer, having joined the company on  
 its original organization at Prov. R. I., and enrolled in it at the muster into  
 the service of the United States at Providence R. I., on the 8<sup>th</sup> day  
 of Sept., 1863, (or was mustered in service as a recruit, by  
 \_\_\_\_\_, at \_\_\_\_\_, on the \_\_\_\_\_ day of \_\_\_\_\_,  
 186  , or was drafted and mustered into the service of the United States from the \_\_\_\_\_  
 Enrollment District of the State of \_\_\_\_\_, at \_\_\_\_\_,  
 on the \_\_\_\_\_ day of \_\_\_\_\_, 186  ), to serve in the Regiment, for  
 the term of 3 Years: and having served **HONESTLY** and  
**FAITHFULLY** with his Company in Sept of the Gulf to the present date, is now

entitled to a **DISCHARGE** by reason of "Death from Disease"  
Small pox, at New Orleans La. August 3<sup>d</sup> 1864.

The said Abraham William was last paid by Paymaster  
Never Paid to include the \_\_\_\_\_ day of \_\_\_\_\_, 186  , and has  
 pay due him from that time to the present date; he is entitled to pay and subsistence for  
**TRAVELING** to place of enrollment, and whatever other allowances are authorized to volunteer  
 soldiers, drafted men, or militia, so discharged. He has received from the United States **CLOTHING**  
 amounting to Fifty four  $\frac{12}{100}$  dollars, since the \_\_\_\_\_ day of Enrollment  
 1863, when his clothing account was last settled. He has received from the United States  
no  $\frac{0}{100}$  dollars advanced **BOUNTY**.

There is to be stopped from him, on account of the State of United States, or other  
 authorities, for **CLOTHING, &c.**, received on entering service, \_\_\_\_\_ dollars; and  
 for other stoppages, viz: Loss of Camp & Garrison Equipage - 50<sup>cts</sup>  
 \_\_\_\_\_ dollars.

He has been furnished with **TRANSPORTATION** in kind from the place of his discharge to  
 \_\_\_\_\_; and he has been **SUBSISTED** for **TRAVELING** to his  
 place of enrollment, up to the \_\_\_\_\_, 186  .

He is indebted to \_\_\_\_\_, **SUTLER**, \_\_\_\_\_  $\frac{0}{100}$  dollars.  
 He is indebted to \_\_\_\_\_, **LAUNDRESS**, \_\_\_\_\_  $\frac{0}{100}$  dollars.

Given in Duplicate, at New Orleans La, this 3<sup>rd</sup> day  
 of Sept., 1864

F. E. Pyramette  
 Surgeon in Charge Corps U. S. Art  
 Commanding Company

2001

*William Abraham*

Co *F.*, **11 U.S. Col'd H. Art'y.**

*Private. Private.*

CARD NUMBERS.

1	6190812	26
2	6190958	27
3	6191105	28
4	6191245	29
5	6191390	30
6	6191527	31
7	6191658	32
8	6191787	33
9	6191909	34
10	6192042	35
11	6192168	36
12	6192296	37
13	6192419	38
14	9125112	39
15		40
16		41
17		42
18		43
19		44
20		45
21		46
22		47
23		48
24		49
25		50

Book Mark: *200.403*

See also



*N* | 11 H. Art'y. | U.S.C.T.

*Abram Williams*

....., Co. *F*, 11 Reg't U. S. Col'd H. Art'y.

Appears on

**Company Descriptive Book**

of the organization named above.

**DESCRIPTION.**

Age *23* years; height *5* feet *5 2* inches.

Complexion *dk.*

Eyes *dk.*; hair *dk.*

Where born *Saratoga, New York.*

Occupation *Writer.*

**ENLISTMENT.**

When *Oct 10*, 1863.

Where *Prov., R.I.*

By whom *J. C. Engley*; term *3* y'rs.

Remarks:

*O. J. Markle.*



*W* | 11 H. Art'y. | U.S.C.T.

*Abraham Williams*  
*Pai*, Co. *F*, 14 Reg't R. I. Col'd H. Art'y.\*

Age *29* years.

Appears on

**Company Muster-in Roll**

of the organization named above. Roll dated  
*Providence R.I., Oct 20*, 1863.

Muster-in to date *Oct 20*, 1863.

Joined for duty and enrolled:

When *Oct 10*, 1863.

Where *Providence R.I.*

Period *3* years.

Valuation of horse, \$.....100

Valuation of horse equipments, \$.....100

Remarks:.....

.....

.....

.....

.....

.....

\* This organization subsequently became Co. *F*, 11 Reg't U. S. Colored Heavy Artillery.

Book mark:.....

.....

.....

.....

.....

.....

.....

.....

.....

.....

.....

.....

.....

.....

.....

*A. Neal*

*24* | **11 H. Art'y.** | **U.S.C.T.**

*Abraham Williams*  
*Tai*, Co. F, 14 Reg't R. I. Col'd H. Art'y.\*

Appears on

**Company Muster Roll**

for *Oct 20 to Dec 31*, 186*7*.

Present or absent *Present*

Stoppage, \$.....100 for .....

Due Gov't, \$.....100 for .....

Valuation of horse, \$.....100

Valuation of horse equipments, \$.....100

Remarks:.....  
.....  
.....  
.....  
.....  
.....  
.....  
.....

\* This organization subsequently became Co. F, 11 Reg't U. S. Colored Heavy Artillery.

Book mark:.....

*J. Neal*

*W* | 11 H. Art'y. | U.S.C.T.

*Abram Williams*  
Pr', Co. F, 14 Reg't R. I. Col'd H. Art'y.\*

Appears on

**Company Muster Roll**

for *Jan & Feb*, 1864

Present or absent *Present*

Stoppage, \$.....100 for .....

Due Gov't, \$.....100 for .....

Valuation of horse, \$.....100

Valuation of horse equipments, \$.....100

Remarks: .....

\* This organization subsequently became Co. F, 11 Reg't U. S. Colored Heavy Artillery.

Book mark: .....

(358)

*Mual*

Copyist.



*W* | 11 H. Art'y. | U.S.C.T.

*Abraham Williams*  
Pr', Co. F, 14 Reg't R. I. Col'd H. Art'y.\*

Appears on

**Company Muster Roll**

for *Max + Apr*, 186 *4*

Present or absent *Present*

Stoppage, \$ 100 for

Due Gov't, \$ 100 for

Valuation of horse, \$ 100

Valuation of horse equipments, \$ 100

Remarks:

\* This organization subsequently became Co., F. 11 Reg't U. S. Colored Heavy Artillery.

Book mark:

*I Neal*

(358)

Copyist.

*2* | 11 H. Art'y. | U.S.C.T.

*Abraham Williams*  
*Priv*, Co. *F/8* Reg't U. S. Col'd H. Art'y.\*

Appears on

**Company Muster Roll**

for *Nov & Dec*, 1864.

Present or absent *Present*

Stoppage, \$ 100 for

Due Gov't, \$ 100 for

Valuation of horse, \$ 100

Valuation of horse equipments, \$ 100

Remarks: *Stop for one*  
*wiper.*

† This organization subsequently became Co. *F*, 11 Reg't U. S. Colored Heavy Artillery.

Book mark:

*H. Neal*

*W* | 11 H. Art'y. | U.S.C.T.

*Abram Williams*

*Priv.*, Co. F, 11 Reg't U. S. Col'd H. Art'y.

Appears on

**Company Muster Roll**

for *July and Aug.*, 1864.

Present or absent *Present*.

Stoppage, \$ 100 for

Due Gov't, \$ 100 for

Valuation of horse, \$ 100

Valuation of horse equipments, \$ 100

Remarks: *Stop for wiper. 20*  
*Free April 19/61.*

Book mark: \_\_\_\_\_

*Exline*



*N* | 11 H. Art'y. | U.S.C.T.

*Abram Williams.*

*Pvt.*, Co. F, 11 Reg't U. S. Col'd H. Art'y.

Appears on

**Company Muster Roll**

for *Sept. and Oct.*, 1864.

Present or absent *Present.*

Stoppage, \$ *100* for

Due Gov't, \$ *100* for

Valuation of horse, \$ *100*

Valuation of horse equipments, \$ *100*

Remarks: *Stop for wiper .20*  
*Free April 19/61.*

Book mark: \_\_\_\_\_

*Online.*

*W* | 11 H. Art'y. | U.S.C.T.

*Abram Williams.*  
*Art.*, Co. F, 11 Reg't U. S. Col'd H. Art'y.

Appears on

**Company Muster Roll**

for *Nov. and Dec.*, 1864.

Present or absent *Present.*

Stoppage, \$ *100* for

Due Gov't, \$ *100* for

Valuation of horse, \$ *100*

Valuation of horse equipments, \$ *100*

Remarks: *Stop for wiper. 20*  
*waist belt. 38 haversack. 49*  
*canteen. 41, Free April 19/6!*

Book mark: .....

*Online.*

*W* | 11 H. Art'y. | U.S.C.T.

*Abram Williams.*

*Pvt.*, Co. F, 11 Reg't U. S. Col'd H. Art'y.

Appears on

**Company Muster Roll**

for *Jan. and Feb.*, 1865.

Present or absent *Present.*

Stoppage, \$ *100* for

Due Gov't, \$ *100* for

Valuation of horse, \$ *100*

Valuation of horse equipments, \$ *100*

Remarks: *Stop for waist belt. 38  
haversack. 49 canteen. 41*

Book mark: \_\_\_\_\_

*Exline.*



*W* | 11 H. Art'y. | U.S.C.T.

*Abram Williams*

*Pvt.*, Co. F, 11 Reg't U. S. Col'd H. Art'y.

Appears on

**Company Muster Roll**

for *Mar. and Apr.*, 1865.

Present or absent *Present.*

Stoppage, \$ 100 for

Due Gov't, \$ 100 for

Valuation of horse, \$ 100

Valuation of horse equipments, \$ 100

Remarks: *Stop for waist belt. 38*  
*haversack. 49 canteen. 41*

Book mark: \_\_\_\_\_

*Online.*

*M.* | 11 H. Art'y. | U.S.C.T.

*Abram Williams*  
*Priv.*, Co. F, 11 Reg't U. S. Col'd H. Art'y.

Appears on

**Company Muster Roll**

for *May & June*, 1865.

Present or absent *Present*

Stoppage, \$ 100 for

Due Gov't, \$ 100 for

Valuation of horse, \$ 100

Valuation of horse equipments, \$ 100

Remarks: *Stop for Mos.*  
*War \$1.50*

Book mark: \_\_\_\_\_

*Leib*

*W.* | **11 H. Art'y. | U.S.C.T.**

*Abram Williams*  
*Priv*, Co. F, 11 Reg't U. S. Col'd H. Art'y.

Appears on

**Company Muster Roll**

for *July & Aug, 1865.*

Present or absent *Present*

Stoppage, \$ 100 for

Due Gov't, \$ 100 for

Valuation of horse, \$ 100

Valuation of horse equipments, \$ 100

Remarks:

Book mark:

*Leib*  
Copied.



*W* | 11 H. Art'y. | U.S.C.T.

*Abram Williams*  
*Priv. Co. F*, 11 Reg't U. S. Col'd H. Art'y.

Appears on Co. Muster-out Roll, dated

*New Orleans, La. Oct. 2*, 1865.

Muster-out to date

*Oct. 2*, 1865.

Last paid to

*June 30*, 1865.

Clothing account:

Last settled....., 186 ; drawn since \$.....<sup>100</sup>

Due soldier \$ *16.08*<sup>100</sup>; due U. S. \$.....<sup>100</sup>

Am't for cloth'g in kind or money adv'd \$.....<sup>100</sup>

Due U. S. for arms, equipments, &c., \$ *6.00*<sup>100</sup>

Bounty paid *None*<sup>100</sup>; due \$ *100.00*<sup>100</sup>

Remarks: *Joined at Orgin.  
Orgin. + Stop. for mus +  
Bet + acc'ts. retained.*

Book mark: *300. 403*

Williams, Abram  
Co. Reg't U.S.C.T.

Enclosures.

Bed Cards	Final Statements
Burial Records	Furloughs or L. of A.
Certs. of Dis. for Discharge	Med. Certificates
C. M. Charges	Med. Des. Lists
Descriptive Lists	Orders
Discharge Certificates	Pris. of War Record
Enlistment Papers	Resignations

Other papers relating to—

Admission to Hosp'l	Furlough or L. of A.
Casualty Sheet	Med. Examination
Confinement	Misc. Information
Contracts	Pay or Clothing
Death or Effects	Personal Reports
Desertion	Rank
Discharge from Hosp'l	Transfer to Hosp'l
Discharge from Service	Transfer to V. R. C.
Duty	Transportation

DECLARATION OF RECRUIT.

I, *Alvan Williams* desiring to VOLUNTEER as a Soldier in the ARMY OF THE UNITED STATES, for the term of *Three Years* do declare that I am *23* years and months of age; that I have never been discharged from the United States service on account of disability or by sentence of a court martial, or by order, before the expiration of a term of enlistment; and I know of no impediment to my serving honestly and faithfully as a soldier for *Three Years*

Given at *Port Pidgeon*  
The *10* day of *Oct.* 18*63*

Witness:

*J. M. ...* *Alvan Williams*

*Alvan Williams*  
No. *91*

Volunteered at *Port Pidgeon*

*Oct. 10* 18*63*

By *J. B. ...*

Regiment of

enlistment; last served in Company (

Reg't of

Discharged

18



CONSENT IN CASE OF MINOR.

I, \_\_\_\_\_ of \_\_\_\_\_ is \_\_\_\_\_ years of age; and I do hereby freely give my CONSENT to his volunteering as a SOLDIER in the ARMY OF THE UNITED STATES for the period of \_\_\_\_\_

Given at \_\_\_\_\_  
The \_\_\_\_\_ day of \_\_\_\_\_

Witness:



VOLUNTEER ENLISTMENT.



State of *Rhode Island* Town of *Providence*  
I, *Abram Williams* born in *Saratoga*  
in the State of *New York* aged *23* years, and by occupation  
a *farmer* DO HEREBY ACKNOWLEDGE to have volunteered this *10*  
day of *October* 18 *63* to serve as a SOLDIER in the ARMY OF THE UNITED STATES

OF AMERICA, for the period of *Three Years*, unless sooner discharged by proper authority:  
Do also agree to accept such bounty, pay, rations and clothing, as are, or may be, established, by law for  
volunteers. And I, *Abram Williams* do solemnly swear, that I will bear  
true faith and allegiance to the *United States of America*, and that I will serve them honestly and faith-  
fully against all their enemies or opposers whomsoever; and that I will observe and obey the orders of the  
President of the United States, and the orders of the officers appointed over me, according to the Rules  
and Articles of War.

Sworn and Subscribed to, at *Providence* *Abram Williams*  
this *10* day of *Oct* 18 *63*  
BEFORE *J. P. Lounsbury*

I CERTIFY, ON HONOR, That I have carefully examined the above-named Volunteer, agreeable to the General Regulations of  
the Army, and that, in my opinion, he is free from all bodily defects and mental infirmity, which would, in any way, disqualify him  
from performing the duties of a soldier.

*Johnson Gardner M.D.*

EXAMINING SURGEON.

I CERTIFY, ON HONOR, That I have minutely inspected the Volunteer, *Abram Williams*  
previously to his enlistment, and that he was entirely sober when enlisted; that to the best of my judgment and belief, he is of  
lawful age; and that, in accepting him as duly qualified to perform the duties of an able-bodied soldier, I have strictly observed the  
Regulations which govern the recruiting service. This soldier has  
*Dark* complexion, is *five* feet, *5 1/2* inches high. *Blue* eyes *Blue* hair

Regiment of

Volunteers,

RECRUITING OFFICER.

*Williams Alanna*

**Co. Co., 11 U.S. Col'd H. Art'y.**

*2<sup>d</sup> Lieutenant* | *2<sup>d</sup> Lieutenant*

**CARD NUMBERS.**

1	6181061	26
2	6181062	27
3	6186220	28
4	6186381	29
5	6186471	30
6	6186585	31
7	6186691	32
8	6186801	33
9	6186913	34
10	6187023	35
11	9437017	36
12	9437043	37
13	9437077	38
14		39
15		40
16		41
17		42
18		43
19		44
20		45
21		46
22		47
23		48
24		49
25		50

Book Mark: *222-b. J. 88.*  
*W. 165 - C. 7 - 64.*

See also *1<sup>st</sup> R. S. Lt. Art'y*



S-1118103 - P.O. aff

S-1118099 - P.O. aff

R + P691969

S 2598265 - P.O. aff

John Miller Esq



W 1176A U.S.C.T.

Hanson A. Williams  
2<sup>d</sup> Lt., Co. C, 11<sup>th</sup> 8<sup>th</sup> U.S.C. Art Reg't U. S. Col'd

Age 21 years.

Appears on an

**Individual Muster-in Roll**

of the organization named above. Roll dated  
New Orleans La, Aug. 11<sup>th</sup>, 1864.

Muster-in to date Aug. 11, 1864

Joined for duty and enrolled:

When Aug. 11, 1864.

Where New Orleans

Period 3 years.

Valuation of horse, \$ 100

Valuation of horse equipments, \$ 100

Remarks: Discharged as  
Sergeant A. B. 1<sup>st</sup> Reg't  
Light Artillery in S. V. No.  
182 War Dept. dated May  
20<sup>th</sup> 1864 to accept pro =  
(over)

Book mark:

Boyan

JAN. 14

6181061

★1891★

Notion, Mustered  
into Co. C. as 2<sup>d</sup>  
Sergeant - vice St. Walter  
Wheeler resigned March  
22. 1864.

Mustered into date  
Aug 11<sup>th</sup> 1864



W 11 Co A U.S.C.T.

Manson A. Williams  
2<sup>d</sup> Lieut. Co. C, 11 Reg't U. S. Col'd Co A

Age 21 years.

Appears on an

**Individual Muster-in Roll**

of the organization named above. Roll dated

New Orleans La, Oct. 19, 1864.

Muster-in to date July 12, 1864.

Joined for duty and enrolled:

When July 12, 1864.

Where Providence R. I.

Period 1 years.

Valuation of horse, \$ 100

Valuation of horse equipments, \$ 100

Remarks: Remustered by  
direction of the Secy of  
War contained in letter  
to Capt. Sheldon Stinson  
Com Muster Dept of the  
War

Book mark:

Grogan



JAN. 14

6181062

1891

Camp dated War Dept  
A.S.O. Washng in D.C.  
Sept. 7, 1864 signed  
by O.W. Foster A. A. Gen.  
Vols.

Commenced to date  
July 12<sup>th</sup> 1864

*A* 11 H. Art'y. U.S.C.T.

*Wm. H. Williams*

*21st* Co. C. 11 Regt U. S. Cav H. Art'y.

Appears on

**Company Muster Roll**

for *July 1st 1864*

Present *Williams*

Stipage \$ *100* for

Due *100* for

Valuation of horse \$ *100*

Valuation of horse equipments \$ *100*

Remarks *Admitted to the  
Company Special  
order No 1000 21st  
Aug 4 64*

Book mark: \_\_\_\_\_

*Williams*

77 11 H Army U.S.C.T.

Alanson A Williams  
2nd Lt, Co. 6, 11 Reg't U. S. Col'd H Army

Appears on

**Company Muster Roll**

for Sept & Oct, 1864

Present or absent Present

Stoppage, \$ 100 for

Due Gov't, \$ 100 for

Valuation of horse, \$ 100

Valuation of horse equipments, \$ 100

Remarks: Remustered to date  
July 12/64 by Mr Chamberlain  
Capt 104501st at G.O. La. 01/19/64

Book mark:

Remuster  
Company Copyist.



*W* | **11 H. Art'y. U.S.C.T.**

*Mason & Williams*  
*2<sup>d</sup> Lt*, Co. C, 11 Reg't U. S. Col'd H. Art'y.

Appears on

**Company Muster Roll**

for *W & W*, 186*4*

Present or absent *Present*

Stoppage, \$ *100* for

Due Gov't, \$ *100* for

Valuation of horse, \$ *100*

Valuation of horse equipments, \$ *100*

Remarks: *Remustered in date*  
*July 20<sup>th</sup> by J. W.*  
*Chamburlain Capt 10*  
*USCA & A.D. La Oct 14 64*

Book mark:

*W*

11 | 11 H. Art'y. | **U.S.C.T.**

*Clawson Williams*

*2 Lt.*, Co. C, 11 Reg't U. S. Col'd H. Art'y.

Appears on

**Company Muster Roll**

for *Jan & Feb*, 1863.

Present or absent *Present*

Stoppage, \$ 100 for

Due Gov't, \$ 100 for

Valuation of horse, \$ 100

Valuation of horse equipments, \$ 100

Remarks: *Arrested & detained  
July 24 by Capt  
W. Chamberlain on the  
La & Orleans La 30th  
1864*

Book mark: \_\_\_\_\_

*Quinn*  
Coyist.

*N* | 11 H. Art'y. | U.S.C.T.

*Mason & Williams*

*2d Lt*, Co. C, 11 Reg't U. S. Col'd H. Art'y.

Appears on

**Company Muster Roll**

for *May & Apr*, 186*5*?

Present or absent *Present*

Stoppage, \$ *100* for

Due Gov't, \$ *100* for

Valuation of horse, \$ *100*

Valuation of horse equipments, \$ *100*

Remarks: *Presented in full  
July 12, 64 / W. Chamberlain  
Captions can be obtained  
La. Oct 14, 64*

Book mark:

*[Signature]*



*M* | 11 H. Art'y. | **U.S.C.T.**

*Alanson A. Williams*  
*2<sup>d</sup> Lt*, Co. C, 11 Reg't U. S. Col'd H. Art'y.

Appears on

**Company Muster Roll**

for *May and June*, 1865.

Present or absent *Present*

Stoppage, \$ 100 for

Due Gov't, \$ 100 for

Valuation of horse, \$ 100

Valuation of horse equipments, \$ 100

Remarks: *Remustered to date*  
*July 12/64 by Capt. J.*  
*W. Chamberlain 10<sup>th</sup> U.S.*  
*C. A. H. New Orleans La.*  
*Oct. 14/64.*

Book mark: \_\_\_\_\_

*Miss*

*M*

11 H. Art'y. **U.S.C.T.**

*Alanson A. Williams*

*2<sup>d</sup> Lt*, Co. C, 11 Reg't U. S. Col'd H. Art'y.

Appears on

**Company Muster Roll**

for *July and Aug.*, 1865.

Present or absent *Present*

Stoppage, \$ 100 for

Due Gov't, \$ 100 for

Valuation of horse, \$ 100

Valuation of horse equipments, \$ 100

Remarks: *Remustered to date  
July 12. 1864 by Capt.  
J. H. Chamberlain 10 U.S.  
C. & H. New Orleans Oct.  
14. 1864*

Book mark: \_\_\_\_\_

*Bliss*

Copyist.

*M* | 11 H. Art'y. | U.S.C.T.

*Alanson A. Williams*  
*29th*, Co. *C*, 11 Reg't U. S. Col'd H. Art'y.

Appears on **Co. Muster-out Roll**, dated  
*New Orleans La, Oct. 2, 1865*.

Muster-out to date *Oct. 2, 1865*.

Last paid to *Apr. 30, 1865*.

Clothing account:

Last settled....., 186 ; drawn since \$..... 100

Due soldier \$..... 100; due U. S. \$..... 100

Am't for cloth'g in kind or money adv'd \$..... 100

Due U. S. for arms, equipments, &c., \$..... 100

Bounty paid \$..... 100; due \$..... 100

Remarks: *Due one mos. pay*  
*remustered back by order*  
*from War Dept. entitled*  
*to 3 mos. pay as provided*  
*in G.O. No. 45 U.S. War*  
*Dept.*

Book mark: *1222 G. I. 83*

*Bliss*



U. S. Army. U. S. C. ?

Alanson J. Williams

2<sup>d</sup> Lt., Co., 11 Reg't U. S. Col'd N. Art.

Appears on

**Regimental Descriptive Book**

(List of Commissioned Officers)

of the regiment named above.

Rank 2<sup>d</sup> Lieut.

Date of appointment May - 18 - , 1864.

Remarks: Reinstated to

July - 12 - 1864. Reported  
for duty Aug. 15 - 1864.

per S. O. No. 44. Au. qu.

5<sup>th</sup>. U. S. C. A. Art.

Born in Killingly, Conn. Res-  
ident of Prov. R. I. originally  
entered the service Aug. 13 -

1861 - as private Batt. B.

1<sup>st</sup>. R. I. L. A. Made succes-  
sively Corp. Sgt. 1<sup>st</sup>. Sgt.

took part in Ball's Bluff,  
Siege of Yorktown, Fair Oaks.

(over)

F. A. Wright

JUN-2

9437043

#1891\*

Savage Station, Glen Dale,  
White Oak Swamp, Malvern  
Hill, Antietam, Fredericks-  
burgh, Chancellorsville,  
Gettysburg, Bristow Sta-  
tion, Wilderness, Spott-  
sylvania, Potomac, North  
Anna, Coal Harbor.

Wounded in chin at  
Fredericksburg. Reëlected

Dec. 18-1868. Reel.

appointment July-2-

Disc. June-5-1863.

No. 111 H. Art. U. S. C. T.

Alanson A. Williams

2 Lt., Co., 11 Reg't U. S. Col'd H. Art.

Appears on

**Regimental Descriptive Book**

(List of Commissioned Officers)

of the regiment named above.

Rank

2d. Lt.

Date of appointment

July-12-1864

Remarks:

Mustered May-18-1864.

Born in Killingly, Conn.

Permanent resident of  
Prov. R. I. age when ap-

pointed 21. originally

entered the service as

Private in Batt. B 1st.

R. I. L. A. Aug-13-1861.

Made successively Corp.

Sgt. - 1st. Sgt. reenlist-

ed Dec. 18-1863. discharg-

ed June-5-1864. to ac-

cept appointment in

(over)

F. A. Wright



JUN.-2

9437071

\* 1891 \*

11 W. S. C. A. (Hy). Present  
at Ball's Bluff, Siege of  
Yorktown, Fair Oaks-  
Savage Station, Glen  
Dale, White Oak Swamp,  
Malvern Hill, Antietam  
Fredericksburgh, Chan-  
cellorsville, Gettysburgh,  
Bristow Station, Wil-  
derness, Spotsylvania,  
Po River, North Anna,  
Coast Harbor.

11 | 11 N. Arty | W. S. C. I.  
Alanson A. Williams  
2d Lt., Co. ...., 11 Reg't W. S. Col'd N. Arty.

Appears on

**Regimental Descriptive Book**

(List of Commissioned Officers)

of the regiment named above.

Rank

2nd Lieut.  
Changed to 1st Lieut. July 29, 1864 to 2nd Lt. Jan. 7, 65 - DR. 22-57-65

Date of appointment

Aug. 11, 1864.

Remarks:

Age 21, Born in

Hillingsley, Conn.

Permanent Resident

Proc. R. I. Original

Entry Private Battery

"B" 1st R. I. L. A.

Coopl, Sergt. & 1st.

Sergt. Reen listed Dec.

18, 1863, Discharged

June - 5 - 1864 to accept

commission in 14th R. I.

H. A. Engaged at Ball's

Bluff, Yorktown, (large

of) 1st Co., Savage

P. A. Wright

JUN.-2  
9437017  
\*1891\*

Station, Glen Dale,  
White Oak Swamp, Mal-  
vern Hill, Antietam,  
Fredericksburg, Chan-  
cellorsville, Gettysburg,  
Paiscow Station, Mil-  
deness, Spottsylvania,  
To River, - North An-  
na, Coal Harbor,  
Had at Fredericks-  
burg in chin.



Williams, Alanson A

1st, Co. B, 11 Reg't U.S.C.H.A.

Enclosures.

Bed Cards	Descriptive Lists
Burial Records	Final Statements
Certs. of Dis. for Discharge	Furloughs
C. M. Charges	Med. Des. Lists
Med. Certificates	Orders <b>f</b>

Other papers relating to—

Admission to Hosp'l	Furlough <b>3</b>
Casualty Sheet (Officer's)	Med. Examination
Confinement	Misc. Information <b>2</b>
Contracts	Pay or Clothing <b>1</b>
Death or Effects	Personal Reports
Desertions	Rank
Discharge from Hosp'l	Transfer to Hosp'l
Discharge from Service <b>/</b>	Transfer to V. R. C.
Duty	Transportation

OATH OF IDENTITY.

of the town of \_\_\_\_\_  
County of \_\_\_\_\_ in the State of \_\_\_\_\_

On this \_\_\_\_\_ day of \_\_\_\_\_ in the year  
one thousand eight hundred and sixty \_\_\_\_\_ personally appeared  
before me, the undersigned, a Justice of the Peace for the county  
and \_\_\_\_\_ above mentioned,

who, being duly sworn according to law, declares that he is the  
identical \_\_\_\_\_ who was  
a \_\_\_\_\_ in the company commanded by  
Captain \_\_\_\_\_ in the regiment,  
\_\_\_\_\_ commanded by \_\_\_\_\_;

that he enlisted on the \_\_\_\_\_ day of \_\_\_\_\_  
for the term of \_\_\_\_\_ and was discharged  
at \_\_\_\_\_ on the \_\_\_\_\_ day  
of \_\_\_\_\_ by reason of \_\_\_\_\_

Sworn and subscribed to before me the day and year above written.

I certify that \_\_\_\_\_ before  
whom the above affidavit purports to have been made, is a Justice of  
the Peace duly authorized to administer oaths, and that the above is  
his signature

In witness whereof, I have hereunto set my hand and affixed my  
official seal, this \_\_\_\_\_ day of \_\_\_\_\_  
in the year \_\_\_\_\_  
at \_\_\_\_\_ in the State of \_\_\_\_\_

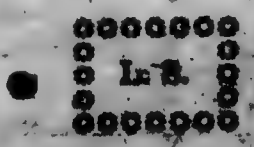

Clerk of the \_\_\_\_\_



To all whom it may Concern.



Know ye, That Manson A Williams a  
First Sergeant of Captain F. Fred Brown's  
Company, (B), First Regiment of R. I. Light Artillery  
VOLUNTEERS who was enrolled on the Eighteenth day of December  
one thousand eight hundred and Sixty three to serve Three years or  
during the war, is hereby **Discharged** from the service of the United States,  
this Fifth day of June, 1864, at Camp near  
Coal Harbor Va by reason of S.O. War Dept. dated May 20<sup>th</sup> 1864  
(No objection to his being re-enlisted is known to exist.)

Said Manson A. Williams was born in Killingly  
in the State of Connecticut, is 21 years of age,  
5 feet 7 1/2 inches high, Light complexion, Dark Blue eyes,  
Brown hair, and by occupation, when enrolled, a Jeweller

Given at Camp near Coal Harbor Va this (5<sup>th</sup>) Fifth day of  
June 1864.

(Signed) F. Fred Brown

Captain 1<sup>st</sup> R. I. Light Art.  
Commanding the Regt  
Battery B

\* This sentence will be erased should there be anything  
in the conduct or physical condition of the soldier  
rendering him unfit for the Army.

[A. G. O. No 99.]

a true copy  
J. W. Chamberlain  
1<sup>st</sup> Lieut and Adj. Gen.



Adj. Insp. 8<sup>th</sup> W. I. C. A. Hy,  
Camp Parapet. Va.  
Aug. 11. 1864.

---

Special Order }  
No 44. }

---

assigns Ind<sup>y</sup> Lt. Alanson  
A. Williams to Co. C.

---

Hd Qrs 1<sup>st</sup> U.S. Col (Reg)  
Camp Stamps La Aug. 11. 1864

Special Orders  
No 44

Extract.

V. 2<sup>d</sup> Lt. Hanson & A Williams having  
reported to these Hd Qrs. for duty under  
instructions from the War Dept. U.S.G.  
Washington D.C. dated May 21. 1864 is  
hereby assigned to Co. C. vice 2<sup>d</sup> Lt. Wal-  
ter Wheeler - resigned and honorably dis-  
charged, March 28, 1864. He will  
report for duty without unnecessary  
delay to Major Jos J. Comstock Jr.  
Commanding 1<sup>st</sup> Batt., 8<sup>th</sup> U.S. Col (Reg)  
at Fort Jackson La -

The Quarter Masters Department  
will furnish the necessary transportation  
from —

+ + + +

By order of Lt Col Melan Quill  
Com-dy Regt  
Henry Martin Esq  
Adjutant

C. O. Co C  
1<sup>st</sup> Batt

ALTERATIONS in the List of Officers—Continued.

RANK.

NAME.

DATE.

1st Batt 11th US C Arty (Cof)  
August

Williams, William S  
2 Lieut

DIED:

DISMISSED:



ALTERATIONS in the List of Officers of 1st Batt. 11th U. S. C. A. (Heavy)  
 during the month of August 1864.

To be sent in to Headquarters immediately after the end of each month, from every Corps, Division or Brigade Headquarters, and also from every Regiment, Battalion or Battery. If no changes have occurred, write NONE across the page.

RANK.	NAME.	DATE.
<b>PROMOTED:</b>		
<b>APPOINTED:</b>		
2nd Lt.	Alanson S. Williams.	1864.
<b>RESIGNED:</b>		

ALTERATIONS in the List of Officers—Continued.

	RANK.	NAME.	DATE.
		DIED:	
<p>105. Batt 11th U.S.C. Arty (Reg) August</p>	<p>Williams, Adams S 2 Lieut</p>	DISMISSED:	
		DISCHARGED:	

*J. H. ... Major  
Com manding.*

December 1864 217

Port Jackson La.  
Dec. 9. 1864

Williams A.A.  
2. Lt. H. W., & Co. (Hq.)

Requests leave of absence for  
four days to visit N. Orleans  
on private business

Approved.  
J. H. W. 10/100. Dec 9. 1864

Recd. Hd. Qrs. Dec 9. 1864

To Lt. Col. W. B. Atch, H. W., & Co.,  
Port Jackson, La.  
Dec. 10. 1864.

Respectfully forwarded approved  
J. H. W. 10/100.  
Major Emory.



Fort Jackson La  
December 9<sup>th</sup> 1864

Sir  
I have the honor to request a leave  
of absence for four days for the purpose of visiting  
New Orleans on private business

Very respectfully  
Your obedient servant  
Alanson A. Williams  
2<sup>nd</sup> Lt. Co. C. 11<sup>th</sup> U.S. C. A. Regt.

Lieut. Newhall  
Adjutant General

Approved  
George Bucklin  
Capt 11<sup>th</sup> U.S. C. A. Regt.  
Comd'g Co. C.

K. G. Reg. No. 36, D. 3 B

31 October 1864 176

Fort. Jackson La  
Oct. 18<sup>th</sup> 1864

Williams, A. A.  
Lieut. 11<sup>th</sup> U.S. Cav.

Requests leave of absence  
for four days to proceed  
to New Orleans for the  
purpose of being re-  
mustered

Approved  
J. C. 76. Oct. 11 1864

Oct 11<sup>th</sup> 1864

Dr. W. Jackson  
for  
Oct. 11<sup>th</sup> 1864

Approved & Respectedly  
Commanded  
J. J. Comstock  
(Major Comd)

Went to  
the

Fort Jackson La. Oct. 18. 1864.

Sir,

I have the honor to request a leave of absence for four days, for the purpose of going to New Orleans, to be remustered.

I have not received a leave of absence since joining the Battalion.

Captain Geo. Bucklin is serving with the company to which I am attached, and my services can readily be spared for the period desired.

Very respectfully, your obedient servant,

My address St Charles

C. H. Benson, Williams

Hotel

Lt. Co. C. 11<sup>th</sup> U. S. Arty (Mty)

Lieut. Jeph. Brown -

Post. Adjt.



a

86

65

adjutant Genl's Office  
Washington D.C.

Jan. 7. 1868

Sargant J. W.  
A. Genl. Vols.

States that the muster in  
<sup>Alamogordo</sup>  
of Lieut. Williams was  
changed from Aug 11<sup>th</sup>  
to July 12. 1864

Recd. Hed. Ins. 12<sup>th</sup> Batt. A. H. W. Co. (4<sup>th</sup>)

July 2. 1868

Adjutant General's Office  
Washington D.C.  
Jan. 7. 1865

Sir,  
I have the honor to inform you that  
the date of muster into service of  
Hanson A. Williams as a 2<sup>d</sup> Lieuten-  
ant in the Cleveport Regt. of U.S. Army  
(Reg) Volunteers, made by Lieut. Geo.  
Chamberlain Asst. Commissary of  
Musters. — is changed from  
Aug. 11. 1864 to July 12. 1864

I am Sir, very respectfully  
Yours, Sir,

J. D. Saggard  
Asst. Adj. Gen. Vol

To Com. as of,

11. U.S.A. 104  
Ivan Adams La

Hon. 11. U.S.A. 104  
Summit La Jan 30. 1865

Official

By order of  
Col. J. D. Saggard

To Com. as of Office Camp, Regt. 104  
1st Lt. & Asst

15 Barr. 11. U.S.A. 104  
Ivan Adams La



No. 295. D.G. 1865  
No. 39 J.C. G. 1865  
No. 39 J.C. G. 1865  
New Orleans April 8. 65

The Minister. W.C.  
Paymaster U.S.A.

Submits statement in the  
case of Supt. A.A. Williams  
W.C.S.A.

Head Quarters,  
Dep't. of the Gulf  
New Orleans April 11. 65  
Respectfully referred to  
Maj. Gen. Winston Chief  
Paym. Dist. of the Gulf  
The end of the Asst. Inspector  
Genl. of the Dept is approved  
and will be carried into  
effect.

By Command of  
Maj. Genl. Hurlbut  
E. Stone  
Capt. U.S.A.  
Recd. Apr. 11. 1865  
Apr 8. 1865

Office A & Lane D.G.  
New Orleans & Report  
Respectfully forwarded to  
Maj. Genl. Hurlbut &  
recommended that this  
matter be investigated by  
Maj. Winston Senior  
Pay Master U.S.A. and also  
recommened that the  
150 cents be refunded  
to Supt. A.A. Williams  
W.C.S.A. by the  
party who cashed his  
account.

W. H. Hurlbut  
L. C. A. D. G.  
Chief Paym.

Office Chief Pay Master  
Dist of the Gulf  
New Orleans April 10. 65

Respectfully returned to the  
General Commanding with the  
remark that after an interview  
with Major McCallister Adjt.  
Pay Master U.S.A. I am  
satisfied that Major McCallister  
was in no way implicated in the  
within matter other than to  
assist Supt. Williams to get his  
pay.

The transaction between  
Supt. Williams and Major Hurlbut  
is a business one which  
his Dept. has no right to  
interfere with.

M. H. Hurlbut  
Chief Pay Master  
Dist of the Gulf.



New Quarters,

Dept. of the Gulf

New Orleans Apr. 11 1855

Respectfully returned to  
Lieut. Col. W. H. Thurston  
Asst. Inspector General  
of the Dept. no further  
action will be taken.

By Command of  
Maj. Genl. Hurlbut:

*E. J. Stone*  
Captain A. A. C.

Office Pay Department,

New Orleans April 8<sup>th</sup> 1865.

Colonel

St. A. Williams 11<sup>th</sup> U. S. Heavy  
Arty (Colored) called on me at my  
office several days since presenting  
a Letter of Introduction requesting me  
to give him any assistance in my power  
which afforded me such pleasure and a  
great deal of trouble to do

But St. Williams informed me he was  
entirely out of funds and wished to  
get his pay <sup>and</sup> cashed, & that he  
would make out and certify his account  
if he could get some one to cash it. He  
said he knew no one that would be likely  
to have the money and would take it  
as a special favor if I would negotiate  
it for him at 15 per cent discount and  
pay him the balance after deducting  
the percentage, I was in no way interested  
in the transaction further than <sup>specifying</sup>  
about the hour making out the account and



Coming around getting it Cashed so  
for which the Genl<sup>l</sup> appeared at the  
time to be very much obliged and his  
action in the matter since proves to a  
mistrust that he was obliged as I tried  
every way without <sup>positively</sup> refusing to have  
any thing to do with it, though it has been  
my custom since we have been out of  
funds in this District to render officers  
every assistance in my power to get their  
pay accounts Cashed -

I have since calling on Genl<sup>l</sup> this  
morning seen Mr George A How - the party  
who Cashed the account he has no  
objections to return the account on the  
Lieutenant refunding the amt paid him  
but does not care to invest in pay  
accounts or any other military security  
at present

Most Respectfully

Your obt Servt

W. M. Elliston  
Paymaster

To  
Col. W. H. Thurston  
Inspector G



N<sup>o</sup> 2<sup>o</sup> U. S. Forces  
Proskhar City La  
June 9<sup>th</sup> 1865

---

General Order  
No 21

---

Details Lieut A. C. Williams  
A. D. C. at this N<sup>o</sup> 2<sup>o</sup>

---

Rec<sup>d</sup> N<sup>o</sup> 2<sup>o</sup> Battalion  
June 9<sup>th</sup> 1865.

Head Quarters W. S. Forces  
Brush Creek June 9 - 1865

General Order  
No 21

Second Lieut A. A. Williams Co "C"  
11th U.S. C.A. is hereby announced as Aid-de-camp  
at these Head Quarters. He will be obeyed and respected  
accordingly.

By Order of  
R. F. Watkins  
Col 98th U.S. C.A.  
Commandy Post

W. W. Greer  
Adjutant and Post-Adj.

Co. 1st Bull 11th U.S. C.A.

Head Quarters U.S. Army  
Bryashead Ln  
June 18-1863

William A. A

2nd Lt. U.S. Army & ADC.

Requests Leave of Absence for  
Ten Days with permission to  
visit New Orleans.

130

Head Quarters U.S. Army  
Bryashead Ln  
June 18-1863

Respectfully forwarded  
Approved

u

Col. F. Atkins  
Adj. Gen. U.S. Army

Gen. G. S. (136) (1863) L.H.



Head Quarters U. S. Forces  
Washington June 18. 1862-

Capt. B. B. Campbell,  
Adj. Dir. of Ordnance

Sir. I have the honor to  
request a leave of absence for four days.  
with permission to visit the City of  
New Orleans, upon important business.

I am Sir,  
Very Respectfully  
Your Obedt Servt.

C. Harrison A. Williams  
2<sup>d</sup> Lt. 11<sup>th</sup> U. S. C. A. H.  
And A. D. C.

N<sup>o</sup> 210 U. S. Forces  
Brashear City La  
June 26<sup>th</sup> 1865.

---

Special Order }  
No 106 } Extract

---

a. a.  
Relieve 2<sup>d</sup> Lt Williams from  
Duty as A. D. C.

---

cc N<sup>o</sup> 210 Battalion  
June 26<sup>th</sup> 1865.



Headquarters U. S. Forces

Boresburg Luzerne 26-63-

Special Order

No 116 - Extra -

2 - 2<sup>d</sup> Lt A. A. Willingham <sup>(1100800)</sup> at his own request, is hereby relieved from duty as A.D.C. at this post.

Lt Willingham will at once report for duty to his company commander.

By Order of  
R. T. Atteridge  
Lt Col & U.S.C.,  
Commanding Post

W. M. Givins  
3<sup>d</sup> Lt Major

C. O. 1<sup>st</sup> Battal  
Boresburg



N<sup>o</sup> 2 U.S. Forces  
Brockton La  
Sept 13<sup>th</sup> 1865.

Special Order  
No 139.

Grants leave of absence to  
Lieut A. A. Williams ~~111<sup>th</sup> Regt~~  
for (4) four days.

See Order -

Hq. U.S. Forces  
Barracks La. Sept 12<sup>th</sup> 1865.

Special Order  
No 139

Leave of absence for four (4) days, is  
hereby granted Lieut A. A. Williams, 11<sup>th</sup> U.S. Cal. with  
permission to visit New Orleans La. on business,  
private.

Official  
Co. H. Needen  
1<sup>st</sup> Lieut. 11<sup>th</sup> U.S. Cal.  
Post Adjutant.

By Order of  
Maj. A. J. Fitzwater.  
11<sup>th</sup> U.S. Cal. and Army Post.  
Co. H. Needen  
1<sup>st</sup> Lieut. and Post Adj.

*Williams Alexander*  
Co. G., 11 U.S. Col'd H. Art'y.

*Private.* | *2nd Sergeant.*

CARD NUMBERS.

6192611	26
6192618	27
6192764	28
6192910	29
6193050	30
6193191	31
6193327	32
6193457	33
6193585	34
6193712	35
6193844	36
6194090	37
6194216	38
9125281	39
	40
	41
	42
	43
	44
	45
	46
	47
	48
	49
	50

Book Mark:

*V. 161. P. 44. 73. 268-*

See also



*W* | 11 H. Art'y. | U. S. C. T.

*Alexander T. Williams*

Co. *G*, 11 Reg't U. S. Col'd H. Art'y.

Appears on

**Company Descriptive Book**

of the organization named above.

**DESCRIPTION.**

Age *27* years; height *5* feet *5 1/2* inches.

Complexion *Dark*.

Eyes *Brown*; hair *Blk*.

Where born *Connecticut*.

Occupation *Warrisher*.

**ENLISTMENT.**

When *Oct. 7*, 186*3*.

Where *Prov., R. I.*

By whom *J. C. Engley*; term *3* y'rs.

Remarks: *Discharged July 10, 1865*  
*on surgeon's certificate of dis-*  
*ability by order of M. J. Gen.*  
*E. R. S. Canby Comdg Dept.*  
*of Gulf.*

*J. Markle,*

W. | 11 H. Art'y. | U.S.C.T.

Alexander J. Williams

Pvt. G, Co. G, 14 Reg't R. I. Col'd H. Art'y.\*

Age 27 years.

Appears on

**Company Muster-in Roll**

of the organization named above. Roll dated

Providence, R. I. Nov. 4, 1863.

Muster-in to date

Nov. 4, 1863.

Joined for duty and enrolled:

When Oct. 7, 1863.

Where Prov R. I.

Period 3 years.

Valuation of horse, \$ 100

Valuation of horse equipments, \$ 100

Remarks:

\* This organization subsequently became Co. G, 11 Reg't U. S. Colored Heavy Artillery.

Book mark:

Ramsey  
Copyist.

W. | 11 H. Art'y. | U.S.C.T.

Alexander J. Williams

L.M. Sgt, Co. G, 14 Reg't R. I. Col'd H. Art'y.\*

Appears on

**Company Muster Roll**

for Nov 4 to Dec. 31, 1863.

Present or absent. Absent.

Stoppage, \$ 100 for

Due Gov't, \$ 100 for

Valuation of horse, \$ 100

Valuation of horse equipments, \$ 100

Remarks: Promoted from Pvt.  
Nov. 10/63.  
On detached service at  
Maj. Engley's office, since  
Nov. 29/63.

\* This organization subsequently became Co. G, 11 Reg't U. S. Colored Heavy Artillery.

Book mark: \_\_\_\_\_

Ramsey  
Copyst.



W

11 H. Art'y. U.S.C.T.

Alexander J. Williams  
2. M. Sgt, Co. G, 14 Reg't R. I. Col'd H. Art'y.\*

Appears on

Company Muster Roll

for Jan & Feb, 1864

Present or absent Present

Stoppage, \$ 100 for

Due Gov't, \$ 100 for

Valuation of horse, \$ 100

Valuation of horse equipments, \$ 100

Remarks: App'd 2. M. Sgt.  
Nov. 10/63.

\* This organization subsequently became Co. G, 11 Reg't U. S. Colored Heavy Artillery.

Book mark:

Ramsey  
Copyist.

W.

11 H. Art'y. U.S.C.T.

Alexander J Williams  
L.M. Seryt Co. G, 14 Reg't R. I. Col'd H. Art'y.\*

Appears on

Company Muster Roll

for Mar & Apr, 1864.

Present or absent Present.

Stoppage, \$ 100 for

Due Gov't, \$ 100 for

Valuation of horse, \$ 100

Valuation of horse equipments, \$ 100

Remarks: App'd L.M. Seryt.  
Nov. 10/63.

\* This organization subsequently became Co. G, 11 Reg't U. S. Colored Heavy Artillery.

Book mark:

Ramsey

W.

11 H. Art'y. U.S.C.T.

Alexander J. Williams

L.M. Sgt. Co. G, 8 Reg't U. S. Col'd H. Art'y.\*

Appears on

Company Muster Roll

for May & June, 1864.

Present or absent Present.

Stoppage, \$ 100 for

Due Gov't, \$ 100 for

Valuation of horse, \$ 100

Valuation of horse equipments, \$ 100

Remarks: Appointed L.M. Serg't. Nov. 10/63.

† This organization subsequently became Co. G, 11 Reg't U. S. Colored Heavy Artillery.

Book mark:

Ramsey Copyist.



21/2 | **11 H. Art'y. | U.S.C.T.**

*Alexander J. Williams*

*D. M. Lee* Co. G, 11 Reg't U. S. Col'd H. Art'y.

Appears on

**Company Muster Roll**

for *July & Aug.*, 186*4*.

Present or absent *Present.*

Stoppage, \$ 100 for

Due Gov't, \$ 100 for

Valuation of horse, \$ 100

Valuation of horse equipments, \$ 100

Remarks: *Appointed Dr. Mr.*  
*Serg't Nov. 10, 1863.*

Book mark: \_\_\_\_\_

*Sitter.*

*W.* | **11 H. Art'y. U.S.C.T.**

*Alexander Williams*

*Q. M. Ser,* Co. G, 11 Reg't U. S. Col'd H. Art'y.

Appears on

**Company Muster Roll**

for *Sept. & Oct.*, 1864.

Present or absent *Present.*

Stoppage, \$ *100* for

Due Gov't, \$ *100* for

Valuation of horse, \$ *100*

Valuation of horse equipments, \$ *100*

Remarks: *Free Am. 19/61.*  
*Appnt'd Q. M. Ser'gt*  
*Nov. 10, 1863. Stbr*  
*for 1 Cross Cannon. 02*

Book mark: \_\_\_\_\_

*Sitter*

*W.* | 11 H. Art'y. | **U.S.C.T.**

*Alexander J. Williams.*

*Q.M.S.*, Co. G, 11 Reg't U. S. Col'd H. Art'y.

Appears on

**Company Muster Roll**

for *Nov. & Dec.*, 1864.

Present or absent *Present.*

Stoppage, \$ *100* for

Due Gov't, \$ *100* for

Valuation of horse, \$ *100*

Valuation of horse equipments, \$ *100*

Remarks: *Appointed Q.M.S.*  
*Serjt' Nov. 10, 1863.*  
*Shot for Cross Can.*  
*32*

Book mark: \_\_\_\_\_

*Sitter.*



Q. | **11 H. Art'y. | U.S.C.T.**

Alexander T. Williams.

Q.M.S., Co. G, 11 Reg't U. S. Col'd H. Art'y.

Appears on

**Company Muster Roll**

for Jan. & Feb., 1865.

Present or absent Present.

Stoppage, \$ 100 for

Due Gov't, \$ 100 for

Valuation of horse, \$ 100

Valuation of horse equipments, \$ 100

Remarks: Stop for 1 Cross  
Can. 02 1 hr. scales  
50

Book mark: \_\_\_\_\_

Sitter.

*M.*

11 H. Art'y. U.S.C.T.

*Alexander T. Williams*

*QMS*, Co. G, 11 Reg't U. S. Col'd H. Art'y.

Appears on

**Company Muster Roll**

for *Mar. & Apr.*, 1865.

Present or absent *Present.*

Stoppage, \$ *100* for

Due Gov't, \$ *100* for

Valuation of horse, \$ *100*

Valuation of horse equipments, \$ *100*

Remarks: *Stop for 1  
Cross Cannon .02  
1 pr. scales .50*

Book mark: .....

*Sitter*

77

11 H. Art'y. U.S.C.T.

Alexander L Williams

2<sup>nd</sup> Sgt., Co. G, 11 Reg't U. S. Col'd H. Art'y.

Appears on

Company Muster Roll

for May & June, 1865.

Present or absent Present

Stoppage, \$ 100 for

Due Gov't, \$ 100 for

Valuation of horse, \$ 100

Valuation of horse equipments, \$ 100

Remarks: Stop for Morsgelo Bar \$1.70

Book mark:

Lammes



*N* | 11 H. Art'y. | **U.S.C.T.**

*Alexander J Williams*  
*2nd Lt* Co. G, 11 Reg't U. S. Col'd H. Art'y.

Appears on

**Company Muster Roll**

for *dated Aug 31*, 186*5*.

Present or absent.....

Stoppage, \$.....100 for.....

Due Gov't, \$.....100 for.....

Valuation of horse, \$.....100

Valuation of horse equipments, \$.....100

Remarks: *Disch'd for disability*  
*July 10/65 by order Maj Genl*  
*Canby. Spt of La & Leg*  
*Final bills + dischg furnished*

Book mark:.....

*L. Lawrence*

Copyist.

*N* | 11 H. Art'y. | U.S.C.T.

*Alexander J Williams*  
2nd Lt., Co. *G*, 11 Reg't U. S. Col'd H. Art'y.

Appears on Co. Muster-out Roll, dated  
*New Orleans La. Oct 2*, 1865.

Muster-out to date \_\_\_\_\_, 186 .

Last paid to *Jan 28*, 1865.

Clothing account:

Last settled \_\_\_\_\_, 186 ; drawn since \$ \_\_\_\_\_ 100

Due soldier \$ \_\_\_\_\_ 100; due U. S. \$ \_\_\_\_\_ 100

Am't for cloth'g in kind or money adv'd \$ \_\_\_\_\_ 100

Due U. S. for arms, equipments, &c., \$ \_\_\_\_\_ 100

Bounty paid \$ \_\_\_\_\_ 100; due \$ \_\_\_\_\_ 100

Remarks: *Joined at Org; Organ*  
*was Pat. Evr 10/63 bridged*  
*at Donaldville La July 20/65*  
*as Surg. sent 7 Dis. Honor*  
*units given*

Book mark: *Y161 Pg 44, 73*

*268-125*

*Lawrence*

Williams, Alex<sup>r</sup> J

J, Co., 11 Reg't U.S.C.A.

3 Enclosures.

Bed Cards .....	Final Statements /
Burial Records .....	Furloughs or L. of A .....
Certs. of Dis. for Discharge /	Med. Certificates .....
C. M. Charges .....	Med. Des. Lists .....
Descriptive Lists .....	Orders .....
Discharge Certificates .....	Pris. of War Record .....
Enlistment Papers .....	Resignations .....

Other papers relating to—

Admission to Hosp'l .....	Furlough or L. of A .....
Casualty Sheet .....	Med. Examination .....
Confinement .....	Misc. Information .....
Contracts .....	Pay or Clothing .....
Death or Effects .....	Personal Reports .....
Desertion .....	Rank .....
Discharge from Hosp'l .....	Transfer to Hosp'l .....
Discharge from Service .....	Transfer to V. R. C. .....
Duty .....	Transportation .....



DECLARATION OF RECRUIT.

I, *Alexander Williams* desiring to VOLUNTEER as a Soldier in the ARMY OF THE UNITED STATES, for the term of *three years* do declare that I am *27* years and months of age; that I have never been discharged from the United States service on account of disability or by sentence of a court martial, or by order, before the expiration of a term of enlistment; and I know of no impediment to my serving honestly and faithfully as a soldier for

Given at *Bowdoin*  
The *7* day of *Oct* 18*63*  
Witness: *J. H. [unclear]* *Alexander Williams*



Discharged

Regt of

enlistment; last served in Company (

By *J. H. [unclear]*  
*14* Regiment of *Artillery*

*Oct 7*  
18*63*

Volunteered at *Bowdoin*

*Alexander Williams*

No. *92*

*11000000*

CONSENT IN CASE OF MINOR.

I, \_\_\_\_\_ of \_\_\_\_\_ is \_\_\_\_\_ years of age; and I do hereby freely give my CONSENT to his volunteering as a SOLDIER in the ARMY OF THE UNITED STATES for the period of \_\_\_\_\_

Given at \_\_\_\_\_  
The \_\_\_\_\_ day of \_\_\_\_\_  
Witness: \_\_\_\_\_

Do CERTIFY that I am the \_\_\_\_\_; that the said \_\_\_\_\_

# VOLUNTEER ENLISTMENT.

State of *Rhode Island* Town of *Providence*  
I, *Alexander Williams* born in *Cosmopolitan*  
in the State of *Rhode Island* aged *27* years, and by occupation  
a *Business* DO HEREBY ACKNOWLEDGE to have volunteered this *7<sup>th</sup>*  
day of *Oct* 18 *63* to serve as a SOLDIER in the ARMY OF THE UNITED STATES  
OF AMERICA, for the period of *three years*, unless sooner discharged by proper authority:  
Do also agree to accept such bounty, pay, rations and clothing, as are, or may be, established, by law for  
volunteers. And I, *Alexander Williams* do solemnly swear, that I will bear  
true faith and allegiance to the *United States of America*, and that I will serve them honestly and faith-  
fully against all their enemies or opposers whomsoever; and that I will observe and obey the orders of the  
President of the United States, and the orders of the officers appointed over me, according to the Rules  
and Articles of War.

Sworn and Subscribed to, at *Providence*

this *7<sup>th</sup>* day of *Oct* 18 *63*

BEFORE *S. P. Lamson*  
*Major R. I. A.*

I CERTIFY, ON HONOR, That I have carefully examined the above-named Volunteer, agreeable to the General Regulations of  
the Army, and that, in my opinion, he is free from all bodily defects and mental infirmity, which would, in any way, disqualify him  
from performing the duties of a soldier.

*John G. Gardner M.D.*

EXAMINING SURGEON.

I CERTIFY, ON HONOR, That I have minutely inspected the Volunteer, *Alexander Williams*  
previously to his enlistment, and that he was entirely sober when enlisted; that to the best of my judgment and belief, he is of  
lawful age; and that, in accepting him as duly qualified to perform the duties of an able-bodied soldier, I have strictly observed the  
Regulations which govern the recruiting service. This soldier has *Brown* eyes *Black* hair,  
*Dark* complexion, is *5* feet, *5 2* inches high.

*J. B. Hensley*  
*Major 14<sup>th</sup> Regiment of R. I. A.* Volunteers,

RECRUITING OFFICER.



Headquarters, Department of the Gulf.

New Orleans, La., July 5<sup>th</sup> 1865.

To be discharged.

By order of Major General E. P. S. Canby:

*E. Howell*  
Captain and A. G.

ment of  
pound,  
man-  
ajury  
ly, or  
ajury  
larly  
acted  
y aid  
f the

When the facts are not known to the company commander, the certificate of any officer, or affidavit of other person having such knowledge, will be appended—as the surgeon in charge of a hospital, the officer commanding a detachment of recruits, &c., &c.

NOTE 2.

When a probable case for pension, special care must be taken to state the degree of disability—as  $\frac{1}{2}$ ,  $\frac{3}{4}$ , &c., &c.; to describe particularly the disability, wound, or disease; the extent to which it deprives him of the use of any limb or faculty, or affects his health, strength, activity, constitution, or capacity to labor or earn his subsistence. The surgeon will add, from his knowledge of the facts and circumstances, and from the evidence in the case, his professional opinion of the cause or origin of the disability. In the case of discharges by Medical Inspectors, the last paragraph will state that the "discharge was given by consent of the soldier, after a personal examination, and for disability, the nature, degree, and origin of which are correctly described in the within certificate."

Par. 1260 Regulations, Edit. 1861.

Medical officers, in giving certificates of disability, are to take particular care in all cases that have not been under their charge; and especially in epilepsy, convulsions, chronic rheumatism, derangement of the urinary organs, ophthalmia, ulcers, or any obscure disease liable to be feigned or purposely produced; and in no case shall such certificate be given until after sufficient time and examination to detect any attempt at deception.

DIRECTIONS.

This certificate will be made out in duplicate by the soldier's company commander, or other officer commanding the separate detachment to which he belongs and sent by him to the surgeon who has charge of the hospital where the soldier is sick. The surgeon will then fill out and sign the surgeon's certificate, and forward these papers to the regimental, detachment, or post commander, who will forward them, with his action endorsed thereon, through the proper channel, to his division commander; or, if the troops are not attached to a division, to his corps, department, or other commander or officer to whom the authority to discharge enlisted men may be specially delegated.

These certificates, after having received the action of the highest authority to which they are required to be sent, will be returned through the same channel to the regimental, post, or detachment commander, who will, if the discharge is authorized by the endorsement of the proper authority, sign the soldier's discharge, and the last certificate on this paper; see that the soldier is furnished with the proper final statements in duplicate, and forward BOTH of these certificates direct to the Adjutant General United States Army, at Washington, D. C.; they will not under any circumstances be given

ADJUTANT GENERAL'S OFFICE

July 26<sup>th</sup> 1865

Duplicate sent the Pension Office.

CERTIFICATE OF DISABILITY FOR DISCHARGE

IN THE CASE OF

*A. G. Williams*

*2nd Regt* Co. *9*

*Eleventh* Reg't of *U.S.C.A.*

*H. D. S. 2248*  
*H. D. S. Lafourche District*  
*Thibodaux La. June 26<sup>th</sup> 1865.*

Respectfully forwarded.

Approved  
*P. A. Cameron*  
Brig. Gen. Vol.  
Bouy Resol

Received (A. G. Office) \_\_\_\_\_, 1865

*Carson O. R. Evans*  
*Recd 26<sup>th</sup> June 29<sup>th</sup> 1865*

*Hodges 11th U.S.C.A. (Hy)*  
*and U.S. Forces Plaquemine La.*

*June 20<sup>th</sup> 1865*

Respectfully forwarded.

Approved  
*J. S. Phelps*

*Col 11th U.S.C.A. (Hy)*  
Commanding

*H. D. S. Lafourche Dist*  
*Thibodaux La June 26<sup>th</sup> 1865.*

Respectfully forwarded  
Approved

*A. J. DAVWE*  
*Surg. 75<sup>th</sup> In file I.*  
In Charge District

*Shipped June 29<sup>th</sup> 1865*  
*P. A. Cameron*  
*Med. Director*



ARMY OF THE UNITED STATES  
 CERTIFICATE  
 OF DISABILITY FOR DISCHARGE.



In Mr. Sg't. Alexander J. Williams of Captain Nelson  
 Company, (G) of the 67th Regiment of United States  
 Col. J. M. Henry was enlisted by J. C. Engler of  
 the 67th Regiment of at Providence R. I.  
 on the 7th day of October 1863, to serve three years; he was born  
 in in the State of Connecticut is twenty seven  
 years of age, 5 feet 5 1/2 inches high, Black complexion, Black eyes,  
 Black hair, and by occupation when enlisted a Carpenter. During the last two  
 months said soldier has been unfit for duty 60 days.\*

*This soldier has suffered for more than six months with rheumatism, and has not had the use of his arms for more than two months. The disease was contracted outside of his line of duty.*

STATION: Providence R. I.  
 DATE: June 4th 1865

J. B. Goffe  
 1st Lt. U.S.A. (Chy)  
 Commanding Company.

I CERTIFY, that I have carefully examined the said Alexander J. Williams of  
 Captain Nelson Company, and find him incapable of performing the duties of a soldier  
 because of Chronic Rheumatism which has involved and crippled the most of the joints of the upper and lower limbs to that extent as to render him totally unfit for the service. The disease was contracted before he was mustered into service. The degree of disability total.

George W. McCaskey  
 Surgeon  
 2d Batt. 11th U.S.C. Artillery

DISCHARGED, this 7th day of July 1865, at Providence R. I.

W. S. Sypher  
 Commanding the Reg't.

The soldier desires to be addressed at  
 Town \_\_\_\_\_ County \_\_\_\_\_ State \_\_\_\_\_

\* See Note 1 on the back of this.      \* See Note 2 on the back of this.



*Extract from Act of Congress.*

SEC. 12. *And be it further enacted,* That the fees of agents and attorneys for making out and causing to be executed the papers necessary to establish a claim for a pension, bounty, and other allowance before the Pension Office, under this act, shall not exceed the following rates: For making out and causing to be duly executed a declaration by the applicant, with the necessary affidavits, and forwarding the same to the Pension Office, with the requisite correspondence, ten dollars; which sum shall be received by such agent or attorney in full for all services in obtaining such pension, and shall not be demanded or received, in whole or in part, until such pension shall be obtained; and the sixth and seventh sections of an act entitled "An act to grant pensions," approved July [fourteenth,] eighteen hundred and sixty-two, are hereby repealed.

SEC. 13. *And be it further enacted,* That any agent or attorney who shall, directly or indirectly, demand or receive any greater compensation for his services under this act than is prescribed in the preceding section of this act, or who shall contract or agree to prosecute any claim for a pension, bounty, or other allowance under this act, on the condition that he shall receive a per centum upon any portion of the amount of such claim, or who shall wrongfully withhold from a pensioner or other claimant the whole or any part of the pension or claim allowed and due to such pensioner or claimant, shall be deemed guilty of a high misdemeanor, and, upon conviction thereof, shall, for every such offense, be fined not exceeding three hundred dollars, or imprisoned at hard labor not exceeding two years, or both, according to the circumstances and aggravations of the offense.

Approved July 4, 1834.

NOTE 10.—If any soldier is charged a higher fee than that allowed by the above act, he should report the fact and the name of the agent to the Adjutant General, in order that steps may be taken to have the same refunded.

FINAL STATEMENT

OF

*Sgt. A. T. Williams*  
*Co. 3*  
*16 Reg't of U. S. C. A. Co.*  
*Discharged*  
VOLUNTEERS.  
*(retained)*

NOTE 1.—Two of these certificates (or duplicates) are to be given to each Volunteer Soldier or drafted man who may be discharged without being mustered out. (Final Statements are never given to men mustered out of service.) That he may at once receive from the Paymaster the pay, &c., due him, and the captain or other COMMISSIONED officer commanding the company will certify to the act of the delivery of the duplicate certificates; with these certificates the Soldier is "entitled to" his discharge, and should also present his discharge to the Paymaster to have the payment endorsed on it. The discharge is to be given back to the Soldier by the Paymaster; the latter only retaining as his vouchers the duplicate certificates.

NOTE 2.—If the Soldier is entitled to pay for the use of his horse, the Company Commander will certify to that fact on the back of both these final statements, and also to the time he has pay due for having been so mounted on his own horse.

NOTE 3.—When a Soldier is furnished with final statements, his descriptive list, if he has one, should be taken up by the officer who gives the Soldier these statements, and endorsed with a statement to this effect by the officer. The endorsement should exhibit a full statement of the time for which the Soldier was allowed pay on his final statements, the clothing account, and all other charges against him or in his favor, so as to comprise a complete exhibit of his account. It will then be transmitted to the Company Commander of the Soldier, who will enter all the data necessary to a full understanding of the Soldier's account on the muster roll upon which the Soldier's discharge is reported. The descriptive list will then be destroyed. The object of this is, that the remaining portion of the Soldier's account may be settled upon the receipt of these muster rolls, and the Soldier receive any pay or allowances that may be due him at the time of his discharge, and which may not appear on his last final statements from the fact that his descriptive list is incomplete. These accounts for back pay, &c., are settled by the 2d Auditor of the Treasury Department.

NOTE 4.—Charges for loss or injury to ordnance, horse equipments, and other miscellaneous charges, should appear under the heading of "Other Stoppages."

NOTE 5.—Bounty paid by State authorities, and not by the United States, will not be entered on this statement.

NOTE 6.—Amounts due the Sutler and Laundress must be entered on the muster roll on which the discharge, death, desertion, &c., is reported, as well as on the final statement, otherwise the amount cannot be collected from the United States.

NOTE 7.—This blank will be used for deceased volunteers and drafted men, as well as for others.

NOTE 8.—Where a Soldier dies in Hospital or on detached service, his descriptive list, if he has one, should be sent with his final statements, in duplicate, to the Adjutant General, Washington, D. C.

NOTE 9.—If the soldier is a drafted man or substitute, the space for time, &c., of enrolled, should contain only the words "drafted" or "substitute," as the case may be. If the Soldier is a "VETERAN," (or "RECRUIT") the words as a veteran, (or recruit,) as the case may be, should be interlined after the words mustered into the service of the U. S. A statement of all the installments of Veteran or Recruit Bounty RECEIVED by the Soldier must be made on the back of each final statement.

1863-1871  
GEN'S



I certify, on honor, that Alexander J. Williams, a Pr. Sr. Sergt. of  
Captain Asa Pelegan Company ( 2 ) of the 11<sup>th</sup> Regiment of U. S. Col. (Vol)  
**VOLUNTEERS**, of the State of Rhode Island, born in \_\_\_\_\_, State  
of Connecticut, aged 27 years; 5 feet 5/2 inches high; Blk complexion,  
Blk eyes, Blk hair, and by occupation a Burnisher, who joined for service  
and was enrolled (see Note 9) on the 7<sup>th</sup> day of October, 1863, at Prov. R. I.  
by J. C. Engley, for the period of three years, and mustered into  
the service of the United States on the 4<sup>th</sup> day of November, 1863, at  
Prov. R. I., by Capt. May U.S.A.; and having served  
HONESTLY and FAITHFULLY with his Company to the present date, is now entitled to a  
**DISCHARGE** by reason of Disability. I incurred on my own certifying

Disability July 10, 1865, by order of Maj. Gen. E. R. S. Canby  
The said Alexander J. Williams was last paid by Paymaster  
Maj. Sandhouse, to include the 28<sup>th</sup> day of February, 1865, and  
has pay due him from that time to the present date; he is entitled to pay and subsistence for  
**TRAVELING** to place of enrollment, and whatever other allowances are authorized to volunteer  
soldiers, drafted men, or militia, so discharged. He has received from the United States **CLOTHING**  
amounting to 26 <sup>04</sup>/<sub>100</sub> dollars, since the 31<sup>st</sup> day of August,  
1864, when his clothing account was last settled. He has received from the United States  
\_\_\_\_\_ <sup>\_\_\_\_\_</sup>/<sub>100</sub> dollars advanced **BOUNTY**.

There is to be stopped from him, on account of the State of \_\_\_\_\_, or other  
authorities, for **CLOTHING, &c.**, received on entering service, \_\_\_\_\_ <sup>\_\_\_\_\_</sup>/<sub>100</sub> dollars; and  
for other stoppages, viz: 1 waist belt and photo. non. Com. off.  
74 \_\_\_\_\_  
\_\_\_\_\_ <sup>74</sup>/<sub>100</sub> dollars.

He has been furnished with **TRANSPORTATION** in kind from the place of his discharge to  
New Orleans La.; and he has been **SUBSISTED** for **TRAVELING** to his  
place of enrollment, up to the 20<sup>th</sup> of July, 1865.

He is indebted to \_\_\_\_\_, **SUTLER**, \_\_\_\_\_ <sup>\_\_\_\_\_</sup>/<sub>100</sub> dollars.  
He is indebted to \_\_\_\_\_, **LAUNDRESS**, \_\_\_\_\_ <sup>\_\_\_\_\_</sup>/<sub>100</sub> dollars.

Given in Duplicate, at Donaldsonville La., this 10 day  
of July, 1865.

A. B. Goffe  
1<sup>st</sup> Lieut. U.S.A. (Vol)  
Commanding Company.



2004

Williams Alfred.

Co. B., 11 U.S. Col'd H. Art'y.

Private. Private.

CARD NUMBERS.

1	6183953	26
2	6184097	27
3	6184241	28
4	6184381	29
5	6184579	30
6	6184652	31
7	6184779	32
8	6184903	33
9	6185017	34
10	6185-132	35
11	6185-243	36
12	6185-351	37
13	6185459	38
14	9124221	39
15	9124359	40
16		41
17		42
18		43
19		44
20		45
21		46
22		47
23		48
24		49
25		50

Book Mark:

See also

REP 363226.

\$ 137648 P. C. H. STON

John Oliver Esq

*W* | **11 H. Art'y. | U.S.C.T.**

*Alfred Williams*

....., Co. *B*, 11 Reg't U. S. Col'd H. Art'y.

Appears on

**Company Descriptive Book**

of the organization named above.

**DESCRIPTION.**

Age *25* years; height *5* feet *6* inches.

Complexion *Dk*

Eyes *Blk*; hair *Blk*

Where born *Mississippi*

Occupation *Laborer*

**ENLISTMENT.**

When *Aug 26*, 186*3*.

Where *Ind R I*

By whom *J C Engley*; term *3* y'rs.

Remarks: .....

.....

.....

.....

.....

.....

.....

.....

.....

.....

*James*



*W* | 11 H. Art'y. | **U.S.C.T.**

*Alfred Williams*

....., Co *B* ....., 11 Reg't U. S. Col'd H. Art'y.

Appears on

**Company Descriptive Book**

of the organization named above.

**DESCRIPTION.**

Age *25* years; height *5* feet *6* inches.

Complexion *Dk*

Eyes *Blk*; hair *Blk*

Where born *Mississippi*

Occupation *Laborer*

**ENLISTMENT.**

When *Aug 26*, 186 .

Where *Providence*

By whom *J. C. Gayley*; term *3* y'rs.

Remarks: .....

.....

.....

.....

.....

.....

.....

.....

.....

.....

.....

.....

.....

.....

.....

.....

.....

.....

.....

.....

.....

.....

.....

.....

.....

.....

*James*

*W* | 11 H. Art'y. | U.S.C.T.

*Alfred Williams*

*Pvt.*, Co *B*, 14 Reg't R. I. Col'd H. Art'y.\*

Age *25* years.

Appears on

**Company Muster-in Roll**

of the organization named above. Roll dated

*Providence R.I. Sept 14*, 1863.

Muster-in to date *Sept 14*, 1863.

Joined for duty and enrolled:

When *Aug 26*, 186 .

Where *Providence*

Period *3* years.

Valuation of horse, \$.....*100*

Valuation of horse equipments, \$.....*100*

Remarks:.....

.....

.....

\* This organization subsequently became Co *B*, 11 Reg't U. S. Colored Heavy Artillery.

Book mark:.....

.....

*J. Walker*

*W* | 11 H. Art'y. | U.S.C.T.

*Alfred Williams*  
*Prvt*, Co. B, 14 Reg't R. I. Col'd H. Art'y.\*

Appears on

**Company Muster Roll**

for *Sept 14 to Dec 31*, 1863.

Present or absent *Present*

Stoppage, \$..... $\overline{100}$  for .....

Due Gov't, \$..... $\overline{100}$  for .....

Valuation of horse, \$..... $\overline{100}$

Valuation of horse equipments, \$..... $\overline{100}$

Remarks:.....  
.....  
.....  
.....  
.....  
.....  
.....  
.....

\* This organization subsequently became Co. B, 11 Reg't U. S. Colored Heavy Artillery.

Book mark:.....

*J. Walker*

Copyist.



*W* | 11 H. Art'y. | U.S.C.T.

*Alfred Williams*  
*Priv*, Co. B, 14 Reg't R. I. Col'd H. Art'y.\*

Appears on

**Company Muster Roll**

for *Jan & Feb*, 186*4*.

Present or absent *Present*

Stoppage, \$.....100 for .....

Due Gov't, \$.....100 for .....

Valuation of horse, \$.....100

Valuation of horse equipments, \$.....100

Remarks:.....

.....  
.....  
.....  
.....  
.....

\*This organization subsequently became Co. B, 11 Reg't U. S. Colored Heavy Artillery.

Book mark:.....

*J. Walker*

*W* | **11 H. Art'y. | U.S.C.T.**

*Alfred Williams*  
*Pvt.*, Co. *B*, 8 Reg't U. S. Col'd H. Art'y.\*

Appears on

**Company Muster Roll**

for *March & April*, 1864.

Present or absent *Present*

Stoppage, \$ 100 for

Due Gov't, \$ 100 for

Valuation of horse, \$ 100

Valuation of horse equipments, \$ 100

Remarks:

† This organization subsequently became Co. *B*, 11 Reg't U. S. Colored Heavy Artillery.

Book mark:

*J. Walker*

Copyist.

*W* | 11 H. Art'y. | U.S.C.T.

*Alfred Williams*  
*Pvt*, Co *B*, 8 Reg't U. S. Col'd H. Art'y.\*

Appears on

**Company Muster Roll**

for *May & June*, 1864.

Present or absent *Present*

Stoppage, \$ 100 for

Due Gov't, \$ 100 for

Valuation of horse, \$ 100

Valuation of horse equipments, \$ 100

Remarks:

† This organization subsequently became Co *B*, 11 Reg't U. S. Colored Heavy Artillery.

Book mark:

*J. Walker*

Copyist.



*A* | 11 H. Art'y. | U.S.C.T.

*Alfred Williams*  
*Pri*, Co. B, 11 Reg't U. S. Col'd H. Art'y.

Appears on

**Company Muster Roll**  
for *July & Aug*, 1864.  
Present or absent *Present*

Stoppage, \$ 100 for

Due Gov't, \$ 100 for

Valuation of horse, \$ 100

Valuation of horse equipments, \$ 100

Remarks: *Free Apr 19/61*

Book mark: \_\_\_\_\_

*J. W. Moore*

*A* | **11 H. Art'y.** | **U.S.C.T.**

*Alfred Williams*

*Pri*, Co. B, 11 Reg't U. S. Col'd H. Art'y.

Appears on

**Company Muster Roll**

for *Sept & Oct*, 186*4*.

Present or absent *Present*

Stoppage, \$ *100* for

Due Gov't, \$ *100* for

Valuation of horse, \$ *100*

Valuation of horse equipments, \$ *100*

Remarks:

Book mark:

*E. M. Moore*

Copyist.

*11*

11 H. Art'y.

U.S.C.T.

*Alfred Williams*

*Pi*, Co. B, 11 Reg't U. S. Col'd H. Art'y.

Appears on

**Company Muster Roll**

for *Nov & Dec*, 1864.

Present or absent *Present*

Stoppage, \$ 100 for

Due Gov't, \$ 100 for

Valuation of horse, \$ 100

Valuation of horse equipments, \$ 100

Remarks:

Book mark:

*[Signature]*

Copyist.



*A*

**11 H. Art'y. | U.S.C.T.**

*Alfred Williams*

*Pr*, Co. B, 11 Reg't U. S. Col'd H. Art'y.

Appears on

**Company Muster Roll**

for *Jan & Feb*, 186*4*.

Present or absent *Present*

Stoppage, \$ *100* for

Due Gov't, \$ *100* for

Valuation of horse, \$ *100*

Valuation of horse equipments, \$ *100*

Remarks: \_\_\_\_\_

\_\_\_\_\_

\_\_\_\_\_

\_\_\_\_\_

\_\_\_\_\_

\_\_\_\_\_

\_\_\_\_\_

Book mark: \_\_\_\_\_

\_\_\_\_\_

*J. M. Moore*

Copyist.

*11* | **11 H. Art'y. | U.S.C.T.**

*Alfred Williams*

*Pvt*, Co. B, 11 Reg't U. S. Col'd H. Art'y.

Appears on

**Company Muster Roll**

for *May & Apr*, 186*4*.

Present or absent *Present*

Stoppage, \$ *100* for

Due Gov't, \$ *100* for

Valuation of horse, \$ *100*

Valuation of horse equipments, \$ *100*

Remarks:

Book mark:

*J. W. Moore*

Copyist.

*77* 11 H. Art'y. | U.S.C.T.

*Alfred Williams*  
*Pr*, Co. B, 11 Reg't U. S. Col'd H. Art'y.

Appears on

**Company Muster Roll**

for *May & June*, 1865.

Present or absent *Present*

Stoppage, \$ 100 for

Due Gov't, \$ 100 for

Valuation of horse, \$ 100

Valuation of horse equipments, \$ 100

Remarks:  
\_\_\_\_\_  
\_\_\_\_\_  
\_\_\_\_\_  
\_\_\_\_\_  
\_\_\_\_\_  
\_\_\_\_\_

Book mark: \_\_\_\_\_

*Williams* Copyist.



*11* 11 H. Art'y. | U.S.C.T.

*Alfred Williams*  
*Co. B, 11 Reg't U. S. Col'd H. Art'y.*

Appears on

**Company Muster Roll**

for *July & Aug*, 186*5*.

Present or absent *Present*

Stoppage, \$ 100 for

Due Gov't, \$ 100 for

Valuation of horse, \$ 100

Valuation of horse equipments, \$ 100

Remarks:  
-----  
-----  
-----  
-----  
-----  
-----  
-----  
-----

Book mark: -----

*Alfred Williams*

71 | **11 H. Art'y. | U.S.C.T.**

Alfred Williams

Pl., Co. B, 11 Reg't U. S. Col'd H. Art'y.

Appears on **Co. Muster-out Roll**, dated  
New Orleans La, Oct. 2, 1865.

Muster-out to date Oct. 2, 1865.

Last paid to Feb 28, 1865.

**Clothing account:**

Last settled....., 186 ; drawn since \$.....<sup>100</sup>

Due soldier \$ 8 <sup>90</sup>/<sub>100</sub>; due U. S. \$.....<sup>100</sup>

Am't for cloth'g in kind or money adv'd \$.....<sup>100</sup>

Due U. S. for arms, equipments, &c., \$ ca <sup>02</sup>/<sub>100</sub>

Bounty paid \$ None <sup>100</sup>; due \$ 100 <sup>00</sup>/<sub>100</sub>

Remarks: joined reg't arge  
at top of camp last

Book mark : .....

Hoyberger  
Copyist.

Williams, Alfred

P, Co., 11 Reg't U.S. Cavalry

Enclosures.

Bed Cards .....	Final Statements .....
Burial Records .....	Furloughs or L. of A. ....
Certs. of Dis. for Discharge .....	Med. Certificates .....
C. M. Charges .....	Med. Des. Lists .....
Descriptive Lists .....	Orders .....
Discharge Certificates .....	Pris. of War Record .....
Enlistment Papers .....	Resignations .....

Other papers relating to—

Admission to Hosp'l .....	Furlough or L. of A. ....
Casualty Sheet .....	Med. Examination .....
Confinement .....	Misc. Information .....
Contracts .....	Pay or Clothing .....
Death or Effects .....	Personal Reports .....
Desertion .....	Rank .....
Discharge from Hosp'l .....	Transfer to Hosp'l .....
Discharge from Service .....	Transfer to V. R. C. ....
Duty .....	Transportation .....



**DECLARATION OF RECRUIT.**

I, *Alfred Williams* desiring to VOLUNTEER as a Soldier in the ARMY OF THE UNITED STATES, for the term of *Three Years* do declare that I am *22* years and *00* months of age; that I have never been discharged from the United States service on account of disability or by sentence of a court martial, or by order, before the expiration of a term of enlistment; and I know of no impediment to my serving honestly and faithfully as a soldier for *Three Years*

Given at *Stout*  
 The *15* day of *Oct*, 18*63*  
 Witness: *Geo J. Minster* *Alfred Williams*

*11000000*  
*94*

Volunteered at *Bunkerland*  
*Co. 1st Regt*  
 186*3*

By *Alfred Williams*  
 Regiment of *14th*

enlistment; last served in Company ( )  
 Reg't of *14th*

Discharged *for*  
*11*  
*1871*

**CONSENT IN CASE OF MINOR.**

I, \_\_\_\_\_ Do CERTIFY that I am the \_\_\_\_\_ of \_\_\_\_\_ is \_\_\_\_\_ years of age; and I do hereby freely give my CONSENT to his volunteering as a SOLDIER in the ARMY OF THE UNITED STATES for the period of \_\_\_\_\_

Given at \_\_\_\_\_  
 The \_\_\_\_\_ day of \_\_\_\_\_  
 Witness \_\_\_\_\_



VOLUNTEER ENLISTMENT.



State of Rhode Island

Town of Cumberland

I, Alfred William, born in North Carolina aged 22 years, and by occupation a Farmer DO HEREBY ACKNOWLEDGE to have volunteered this

day of October 18 63 to serve as a SOLDIER in the ARMY OF THE UNITED STATES OF AMERICA, for the period of Three Years, unless sooner discharged by proper authority: Do also agree to accept such bounty, pay, rations and clothing, as are, or may be, established, by law for volunteers. And I, Alfred William do solemnly swear, that I will bear true faith and allegiance to the United States of America, and that I will serve them honestly and faithfully against all their enemies or opposers whomsoever; and that I will observe and obey the orders of the President of the United States, and the orders of the officers appointed over me, according to the Rules and Articles of War.

Sworn and Subscribed to, at Providence, R.I. this 1st day of Oct. 18 63

BEFORE S. P. [Signature] Alfred William

I CERTIFY, ON HONOR, that I have carefully examined the above-named Volunteer, agreeable to the General Regulations of the Army, and that, in my opinion, he is free from all bodily defects and mental infirmity, which would, in any way, disqualify him from performing the duties of a soldier.

[Signature] EXAMINING SURGEON.

I CERTIFY, ON HONOR, That I have minutely inspected the Volunteer, Alfred William, previously to his enlistment, and that he was entirely sober when enlisted; that to the best of my judgment and belief, he is of lawful age; and that, in accepting him as duly qualified to perform the duties of an able-bodied soldier, I have strictly observed the Regulations which govern the recruiting service. This soldier has Black eyes Black hair, Black complexion, is 5 ft, 7 in high.

14th Regiment of R.I. Volunteers,

[Signature] RECRUITING OFFICER.

2005

Williams Alfred  
Co E., 11 U.S. Col'd H. Art'y.

Private Private

CARD NUMBERS.

1	6189024	26
2	6189169	27
3	6189313	28
4	6189455	29
5	6189600	30
6	6189737	31
7	6189869	32
8	6189998	33
9	6190124	34
10	6190257	35
11	6190387	36
12	6190515	37
13	6190639	38
14	9124967	39
15		40
16		41
17		42
18		43
19		44
20		45
21		46
22		47
23		48
24		49
25		50

Book Mark:

See also



*W* | **11 H. Art'y. U.S.C.T.**

*Alfred Williams*

, Co. *C*, 11 Reg't U. S. Col'd H. Art'y.

Appears on  
**Company Descriptive Book**  
of the organization named above.

**DESCRIPTION.**

Age *22* years; height *5* feet *7* inches.

Complexion *Black.*

Eyes *Black*; hair *Blk.*

Where born *N. C.*

Occupation *Farmer*

**ENLISTMENT.**

When *Oct. 1*, 186 *3*.

Where *Prov., R. I.*

By whom *J. C. Engley*; term *3* y'rs.

Remarks:  
\_\_\_\_\_  
\_\_\_\_\_  
\_\_\_\_\_  
\_\_\_\_\_  
\_\_\_\_\_  
\_\_\_\_\_  
\_\_\_\_\_

*O. J. Markle,*

Copyist.

W | 11 H. Art'y. | U.S.C.T.

Alfred Williams

Co. E, 14 Reg't R. I. Col'd H. Art'y.\*

Age 22 years.

Appears on

**Company Muster-in Roll**

of the organization named above. Roll dated

Providence, R.I., Oct. 1, 1863.

Muster-in to date Oct. 3, 1863.

Joined for duty and enrolled:

When Oct. 1, 1863.

Where Prov., R.I.

Period 3 years.

Valuation of horse, \$ 100

Valuation of horse equipments, \$ 100

Remarks: Providence, R.I. 101st

\* This organization subsequently became Co. E, 11 Reg't U. S. Colored Heavy Artillery.

Book mark: \_\_\_\_\_

Chandler

W

11 H. Art'y. U.S.C.T.

Alfred Williams

Pvt., Co. E, 14 Reg't R. I. Col'd H. Art'y.\*

Appears on

Company Muster Roll

for Oct. 5 to Dec. 31, 1863.

Present or absent Present

Stoppage, \$ 100 for

Due Gov't, \$ 100 for

Valuation of horse, \$ 100

Valuation of horse equipments, \$ 100

Remarks:

\*This organization subsequently became Co. E, 11 Reg't U. S. Col'd Heavy Artillery.

Book mark:

Chandler

Copyist.



W

11 H. Art'y. U.S.C.T.

Alfred Williams

Pvt, Co. E, 14 Reg't R. I. Col'd H. Art'y.\*

Appears on

Company Muster Roll

for Jan. & Feb., 1864

Present or absent Present

Stoppage, \$ 100 for

Due Gov't, \$ 100 for

Valuation of horse, \$ 100

Valuation of horse equipments, \$ 100

Remarks: One Laurens \$ 75

\*This organization subsequently became Co. E, 11 Reg't U. S. Col'd Heavy Artillery.

Book mark:

Chandler

Copyst.

*W* | 11 H. Art'y. | U.S.C.T.

*Alfred Williams*

*Priv*, Co. E, 14 Reg't R. I. Col'd H. Art'y.\*

Appears on

**Company Muster Roll**

for *March & April*, 1864.

Present or absent *Present*

Stoppage, \$ *100* for

Due Gov't, \$ *100* for

Valuation of horse, \$ *100*

Valuation of horse equipments, \$ *100*

Remarks: *Due Laundress 75*

\*This organization subsequently became Co. E, 11 Reg't U. S. Col'd Heavy Artillery.

Book mark: \_\_\_\_\_

*Chandler*

*W* | **11 H. Art'y. U.S.C.T.**

*Alfred Williams*  
Art. Co. *E*, 8 Reg't U. S. Col'd H. Art'y.\*

Appears on

**Company Muster Roll**

for *May & June*, 186*4*

Present or absent *Present*

Stoppage, \$ 100 for

Due Gov't, \$ 100 for

Valuation of horse, \$ 100

Valuation of horse equipments, \$ 100

Remarks: *Due Landress 75*

† This organization subsequently became Co. *E*, 11 Reg't U. S. Colored Heavy Artillery.

Book mark: \_\_\_\_\_

*Chandler*  
Copyist.



*W* | 11 H. Art'y. | **U.S.C.T.**

*Alfred Williams*  
*W. F.*, Co. E, 11 Reg't U. S. Col'd H. Art'y.

Appears on

**Company Muster Roll**

for *Jul. 1st*, 186*7*.

Present or absent *Present*

Stoppage, \$ \_\_\_\_\_ 100 for \_\_\_\_\_

Due Gov't, \$ \_\_\_\_\_ 100 for \_\_\_\_\_

Valuation of horse, \$ \_\_\_\_\_ 100

Valuation of horse equipments, \$ \_\_\_\_\_ 100

Remarks: *See numbers 45*

Book mark: \_\_\_\_\_

*H. H. H. H. H.*  
Copyist.

11 | 11 H. Art'y. | U.S.C.T.

*Alfred Williams*  
*Pvt.*, Co. E, 11 Reg't U. S. Col'd H. Art'y.

Appears on

**Company Muster Roll**  
for *Sept. & Oct.*, 186*4*.

Present or absent *Present*

Stoppage, \$ 100 for

Due Gov't, \$ 100 for

Valuation of horse, \$ 100

Valuation of horse equipments, \$ 100

Remarks: *Free April 19 - 1861.*  
*See Summary 75-*

Book mark: \_\_\_\_\_

*H. H. H. H.*  
Copyist.

*W* | 11 H. Art'y. | U.S.C.T.

*Alfred Williams*  
*Sgt.*, Co. E, 11 Reg't U. S. Col'd H. Art'y.

Appears on

**Company Muster Roll**

for *Nov. Dec.*, 186*4*.

Present or absent *Present*

Stoppage, \$ *100* for

Due Gov't, \$ *100* for

Valuation of horse, \$ *100*

Valuation of horse equipments, \$ *100*

Remarks: *Free April 19-1861*  
*Due Cambridge 75*

Book mark: \_\_\_\_\_

*Hathaway*  
Copyist.



*W* | 11 H. Art'y. | **U.S.C.T.**

*Alfred Williams*

*Sgt.*, Co. E, 11 Reg't U. S. Col'd H. Art'y.

Appears on

**Company Muster Roll**

for *Jan. & Feb.*, 1865.

Present or absent *Present*

Stoppage, \$ 100 for

Due Gov't, \$ 100 for

Valuation of horse, \$ 100

Valuation of horse equipments, \$ 100

Remarks:  
\_\_\_\_\_  
\_\_\_\_\_  
\_\_\_\_\_  
\_\_\_\_\_  
\_\_\_\_\_

Book mark: \_\_\_\_\_

(858)

*Patraway*  
Copyist.

*W* | 11 H. Art'y. | U.S.C.T.

*Alfred Williams*

*Pvt.*, Co. E, 11 Reg't U. S. Col'd H. Art'y.

Appears on

**Company Muster Roll**

for *Wm. J. Pl.*, 1865.

Present or absent *Present*

Stoppage, \$ *49* for *Haversack*

Due Gov't, \$ *100* for

Valuation of horse, \$ *100*

Valuation of horse equipments, \$ *100*

Remarks:

Book mark:

*Put away*

*N* | 11 H. Art'y. | U.S.C.T.

*Alfred Williams*  
*Priv.*, Co. E, 11 Reg't U. S. Col'd H. Art'y.

Appears on

**Company Muster Roll**

for *May and June*, 1865.

Present or absent *Present*.

Stoppage, \$ 100 for

Due Gov't, \$ 100 for

Valuation of horse, \$ 100

Valuation of horse equipments, \$ 100

Remarks: *Stop for one haversack 49;*  
*1 cross cannon 02; one letter 01;*  
*2 figures 02; one feather 15.*

Book mark: \_\_\_\_\_

(858)

*J. B. James* Copyist.



*N* | 11 H. Art'y. | U.S.C.T.

*Alfred Williams*  
*Private*, Co. E, 11 Reg't U. S. Col'd H. Art'y.

Appears on

**Company Muster Roll**

for *July and August*, 1865.

Present or absent *Present*.

Stoppage, \$.....100 for .....

Due Gov't, \$.....100 for .....

Valuation of horse, \$.....100

Valuation of horse equipments, \$.....100

Remarks: .....

Book mark: .....

(358)

*J. B. Jones*

Copyist.

*W* | 11 H. Art'y. | U.S.C.T.

*Alfred Williams*

*Priv.*, Co. *E*, 11 Reg't U. S. Col'd H. Art'y.

Appears on Co. Muster-out Roll, dated

*New Orleans, La., Oct. 2, 1865.*

Muster-out to date

*Oct. 2, 1865.*

Last paid to

*Jan. 30, 1866.*

Clothing account:

Last settled....., 186 ; drawn since \$..... 100

Due soldier \$..... *11* <sup>*02*</sup>/<sub>100</sub>; due U. S. \$..... 100

Am't for cloth'g in kind or money adv'd \$..... 100

Due U. S. for arms, equipments, &c., \$..... 100

Bounty paid \$ ~~*none*~~ 100; due \$ *100* <sup>*00*</sup>/<sub>100</sub>

Remarks: *Joined at Org. Org<sup>n</sup>. Stop for  
me bed sack 2.25.*

Book mark : .....

(861)

*J. B. Jones*

Copyist.

2006

*Williams Amos*

Co. G., 11 U.S. Col'd H. Art'y.

*Private. Private.*

CARD NUMBERS.

1	6181375	26
2	6181413	27
3	6193836	28
4	6193965	29
5	6194087	30
6	6194214	31
7	9125286	32
8		33
9		34
10		35
11		36
12		37
13		38
14		39
15		40
16		41
17		42
18		43
19		44
20		45
21		46
22		47
23		48
24		49
25		50

Book Mark:

See also



*W* | 11 H. Art'y. | U. S. C. T.

*Amos Williams*

Recruit, Co. *G*, 11 Reg't U. S. Col'd H. Art'y.

Appears on

**Company Descriptive Book**

of the organization named above.

**DESCRIPTION.**

Age *24* years; height *5* feet *8* inches.

Complexion *Blk.*

Eyes *Blk.*; hair *Blk.*

Where born *Rhode Island.*

Occupation *Operator.*

**ENLISTMENT.**

When *March 13*, 186 *5*.

Where *Prov., R. I.*

By whom *A. B. Chadsey*; term *1* y'rs.

Remarks: *Joined April 14, 1865.*

*Received \$33.33 (bounty).*

*O. J. Markle*

Copyist.

*W*

11 H. Art'y. | U.S.C.T.

*Amos Williams*

Appears with rank of *Pvt* on

**Muster and Descriptive Roll of a Detachment of U. S. Vols. forwarded**

for the *11* Reg't *U.S.C.A. Art'y* Roll dated *Providence R.I. Mch 17, 1865.*

Where born *R.I.*

Age *24* y'rs; occupation *Operative*

When enlisted *Mch 13*, 1865.

Where enlisted *Prov. R.I.*

For what period enlisted *1* years.

Eyes *Blk*; hair *Blk*

Complexion *Blk.*; height *5* ft. *8* in.

When mustered in *Mch 13.*, 1865.

Where mustered in

Bounty paid \$ *100*; due \$ *100*

Where credited *Town South Kingston*  
*7th. Div. 2 Ang. Div R. I.*

Company to which assigned  
Remarks *Recruty entitled to bounty*

Book mark:

*W*  
Copyist.

*A*

11 H. Art'y. U.S.C.T.

*Amos Williams*

Appears with rank of *Pr* on

**Muster and Descriptive Roll of a Detachment of U. S. Vols. forwarded**

for the *11* Reg't *11th H. Art'y* Roll dated *North Haven Conn, Mar 27, 1865.*

Where born *Rhode Island*

Age *24* y'rs; occupation *Operative*

When enlisted *Mar 3*, 1865.

Where enlisted *Providence R.I.*

For what period enlisted *1* years.

Eyes *Blk*; hair *Blk*

Complexion *dark*; height *5* ft. *8* in.

When mustered in *Mar 3*, 1865.

Where mustered in *Providence*

Bounty paid \$ *63*<sup>*33*</sup>/<sub>*100*</sub>; due \$ *100*<sup>*00*</sup>/<sub>*100*</sub>

Where credited *S. Kingston R.I.*  
*2 Arty. Dist.*  
Company to which assigned

Remarks:

Book mark:

*Reid*



*M.*

11 H. Art'y. U.S.C.T.

*Amos Williams.*

*Priv.*, Co. G, 11 Reg't U. S. Col'd H. Art'y.

Appears on

**Company Muster Roll**

for *Mar. & Apr.*, 1865.

Present or absent *Present.*

Stoppage, \$ *100* for

Due Gov't, \$ *100* for

Valuation of horse, \$ *100*

Valuation of horse equipments, \$ *100*

Remarks: *Joined a re-  
cruit April 14, 1865*

Book mark: \_\_\_\_\_

*Sitter*

*W* | 11 H. Art'y. | **U.S.C.T.**

*Amos Williams*

*Plt.*, Co. G, 11 Reg't U. S. Col'd H. Art'y.

Appears on

**Company Muster Roll**

for *May & June*, 186 *S.*

Present or absent *Present*

Stoppage, \$ 100 for

Due Gov't, \$ 100 for

Valuation of horse, \$ 100

Valuation of horse equipments, \$ 100

Remarks: \_\_\_\_\_  
\_\_\_\_\_  
\_\_\_\_\_  
\_\_\_\_\_  
\_\_\_\_\_  
\_\_\_\_\_  
\_\_\_\_\_

Book mark: \_\_\_\_\_

*Lawrence*

*2*

11 H. Art'y. U.S.C.T.

*Amos Williams*

*Plt.*, Co. G, 11 Reg't U. S. Col'd H. Art'y.

Appears on

**Company Muster Roll**

for *dated Aug 31, 1865.*

Present or absent *Present*

Stoppage, \$ *100* for

Due Gov't, \$ *100* for

Valuation of horse, \$ *100*

Valuation of horse equipments, \$ *100*

Remarks: *Second allotment of bounty due*

Book mark:

*Lawrence*



21 | 11 H. Art'y. | U.S.C.T.

Amos Williams

Pr-, Co. B, 11 Reg't U. S. Col'd H. Art'y.

Appears on **Co. Muster-out Roll**, dated  
New Orleans, Oct. 2, 1865.

Muster-out to date Oct. 2, 1865.

Last paid to June 30, 1865.

**Clothing account:**

Last settled....., 186 ; drawn since \$.....<sup>100</sup>/<sub>100</sub>

Due soldier \$.....<sup>100</sup>/<sub>100</sub>; due U. S. \$ 19<sup>84</sup>/<sub>100</sub>

Am't for cloth'g in kind or money adv'd \$.....<sup>100</sup>/<sub>100</sub>

Due U. S. for arms, equipments, &c., \$ 8<sup>78</sup>/<sub>100</sub>

Bounty paid \$ 33<sup>33</sup>/<sub>100</sub>; due \$ 33<sup>33</sup>/<sub>100</sub>

Remarks: Joined on account  
of his former parents  
and 1/2 brother & Musketo  
shot

Book mark : .....

Laurence

Williams, Amos

11 Reg U.S.C. & A.

2 Enclosures.

Bed Cards	Final Statements
Burial Records	Furloughs or L. of A.
Certs. of Dis. for Discharge	Med. Certificates
C. M. Charges	Med. Des. Lists
Descriptive Lists	Orders
Discharge Certificates	Pris. of War Record
Enlistment Papers	Resignations

Other papers relating to—

Admission to Hosp'l	Furlough or L. of A.
Casualty Sheet	Med. Examination
Confinement	Misc. Information
Contracts	Pay or Clothing
Death or Effects	Personal Reports
Desertion	Rank
Discharge from Hosp'l	Transfer to Hosp'l
Discharge from Service	Transfer to V. R. C.
Duty	Transportation



DECLARATION OF RECRUIT.

I, Amos Williams, desiring to VOLUNTEER as a Soldier in the Army of the United States, for the term of ~~THREE~~ ONE YEARS, Do Declare, That I am 24 years and \_\_\_\_\_ months of age; that I have never been discharged from the United States service on account of disability or by sentence of a court martial, or by order before the expiration of a term of enlistment; and I know of no impediment to my serving honestly and faithfully as a soldier for one years.

GIVEN at Prudenville PA the 13 day of March 1865

Witness: C. J. Wheeler Amos Williams

NOTE 1.—This blank will be used for enlistments and re-enlistments—enlistment of veterans, &c., &c., in the volunteer service. They will be made out in duplicate in all cases—one to accompany the recruiting return of the superintendent (not the recruiting officer) to the Adjutant General, and one to accompany the accounts of the officer who pays bounty, &c. The Regiment and Company in which the soldier last served should be given on the back.  
NOTE 2.—An enlistment holds to service. A muster-in must, in all cases, precede payment of pay, bounty, pension, &c. A muster-in roll must, in all cases, be filed in the Adjutant General's Office as evidence of muster-in. The mustering officer, commissary, or assistant commissary of musters, as the case may be, will countersign both enlistments as having mustered the soldier into the service of the United States before either of them is given to the disbursing officer.

*Enrolled to the Army of South Virginia  
by order of Stony Creek P. O.*

Discharged \_\_\_\_\_, 18\_\_\_\_.  
Reg't of \_\_\_\_\_  
enlistment; last served in Company (\_\_\_\_\_)  
By Capt. C. B. Thacker  
6th Regt of U. S. Col. Artillery  
Volunteered at Prudenville PA  
March 13<sup>th</sup> 1865

No. 105  
Amos Williams

CONSENT IN CASE OF MINOR.

I, \_\_\_\_\_, Do CERTIFY, That I am the \_\_\_\_\_ of \_\_\_\_\_; that the said \_\_\_\_\_ is \_\_\_\_\_ years of age; and I do hereby freely give my CONSENT to his volunteering as a SOLDIER in the ARMY OF THE UNITED STATES for the period of THREE YEARS.

GIVEN at \_\_\_\_\_ the \_\_\_\_\_ day of \_\_\_\_\_

Witness: \_\_\_\_\_



VOLUNTEER ENLISTMENT.

STATE OF

*Rhode Island*



TOWN OF

*Providence*

I, *Amos Williams*, born in *RI*, in the State of *RI*, aged *24* years, and by occupation an *operator*, Do HEREBY ACKNOWLEDGE to have volunteered this *13<sup>th</sup>* day of *March*, 1865, to serve as a **Soldier** in the **Army of the United States of America**, for the period of ~~THREE~~ *ONE* YEARS, unless sooner discharged by proper authority: Do also agree to accept such bounty, pay, rations, and clothing, as are, or may be, established by law for volunteers. And I, *Amos Williams*, do solemnly swear, that I will bear true faith and allegiance to the **United States of America**, and that I will serve them honestly and faithfully against all their enemies or opposers whomsoever; and that I will observe and obey the orders of the President of the United States, and the orders of the officers appointed over me, according to the Rules and Articles of War.

Sworn and subscribed to, at *Providence RI* } *Amos Williams*  
this *13<sup>th</sup>* day of *March*, 1865, }  
BEFORE *Chas J. Wheeler*  
*Justice of the Peace*

I CERTIFY, ON HONOR, That I have carefully examined the above-named Volunteer, agreeably to the General Regulations of the Army, and that, in my opinion, he is free from all bodily defects and mental infirmity, which would in any way disqualify him from performing the duties of a soldier.

*F. H. Peckham*  
*242nd RI*  
EXAMINING SURGEON.

I CERTIFY, ON HONOR, That I have minutely inspected the Volunteer *Amos Williams*, previously to his enlistment, and that he was entirely sober when enlisted; that, to the best of my judgment and belief, he is of lawful age; and that, in accepting him as duly qualified to perform the duties of an able-bodied soldier, I have strictly observed the Regulations which govern the recruiting service. This soldier has *Black* eyes, *Black* hair, *Black* complexion, is *5* feet *8* inches high.

*A. S. Chadsey*  
*Capt. Prov. Mass*  
*2<sup>nd</sup> RI*  
Volunteers,  
RECRUITING OFFICER.

( A. G. O. No. 74 & 76. )

Mustered into the service of the United States, for ~~three~~ *one* year or during the war, from date of enlistment, in Company *RD* *1st* Regiment of *US Col Vols* Volunteers, on the *13<sup>th</sup>* day of *March*, 1865, at *Providence RI*  
*Recruit entitled to bounty*  
*A. S. Chadsey*  
*Capt. Prov. Mass*  
*2<sup>nd</sup> RI*



NOTE 1.—This blank will be used for both enlistments and re-enlistments—enlistment of veterans, &c., &c., in the volunteer service. They will be made out in duplicate in all cases—one to accompany the recruiting return of the superintendent (not the recruiting officer) to the Adjutant General, and one to accompany the accounts of the officer who pays bounty, &c. The Regiment and Company in which the soldier last served should be given on the back.

NOTE 2.—An enlistment holds to service. A muster-in must, in all cases, precede payment of pay, bounty, pension, &c. A muster-in roll must, in all cases, be filed in the Adjutant General's Office as evidence of muster-in. The mustering officer, commissary, or assistant commissary of musters, as the case may be, will countersign both enlistments as having mustered the soldier into the service of the United States before either of them is given to the disbursing officer.



*Enlisted to the term of South Hampton  
the 2nd Air 2d Company 2d Reg't.*

DECLARATION OF RECRUIT.

I, Amos Williams, desiring to VOLUNTEER as a Soldier in the Army of the United States, for the term of one ~~THREE~~ YEARS, Do Declare, That I am 24 years and \_\_\_\_\_ months of age; that I have never been discharged from the United States service on account of disability or by sentence of a court martial, or by order before the expiration of a term of enlistment; and I know of no impediment to my serving honestly and faithfully as a soldier for one ~~three~~ years.

GIVEN at Amidun N.D.  
the 13<sup>th</sup> day of March 1861

Witness: G. Muel Amos Williams

No. 237

Amos Williams  
Volunteered at Amidun N.D.

March 13, 1861

By Capt A. P. [unclear]  
Seventh Regiment of U.S. Artillery

enlistment; last served in Company ( )

Discharged \_\_\_\_\_, 1861

CONSENT IN CASE OF MINOR.

I, \_\_\_\_\_, DO CERTIFY, That I am the \_\_\_\_\_ of \_\_\_\_\_; that the said \_\_\_\_\_ is \_\_\_\_\_ years of age; and I do hereby freely give my CONSENT to his volunteering as a SOLDIER in the ARMY OF THE UNITED STATES for the period of THREE YEARS.

GIVEN at \_\_\_\_\_  
the \_\_\_\_\_ day of \_\_\_\_\_

Witness: \_\_\_\_\_

( A. G. O. No. 74 & 76. )



VOLUNTEER ENLISTMENT.

STATE OF

TOWN OF

*Rhode Island*



*Providence*

I, *Amos Williams*, born in \_\_\_\_\_, in the State of *RI*, aged *24* years, and by occupation a *operator*, Do HEREBY ACKNOWLEDGE to have volunteered this *13<sup>th</sup>* day of *March*, 186*5*, to serve as a ~~Soldier~~ *Private* in the Army of the United States of America, for the period of ~~THREE YEARS~~, unless sooner discharged by proper authority: Do also agree to accept such bounty, pay, rations, and clothing, as are, or may be, established by law for volunteers. And I, *Amos Williams*, do solemnly swear, that I will bear true faith and allegiance to the **United States of America**, and that I will serve them honestly and faithfully against all their enemies or opposers whomsoever; and that I will observe and obey the orders of the President of the United States, and the orders of the officers appointed over me, according to the Rules and Articles of War.

Sworn and subscribed to, at *Providence RI* } *Amos Williams*  
this *13<sup>th</sup>* day of *March*, 186*5* }  
BEFORE *Chas J. Chasey*  
*Recruiting Officer*

I CERTIFY, ON HONOR, That I have carefully examined the above-named Volunteer, agreeably to the General Regulations of the Army, and that, in my opinion, he is free from all bodily defects and mental infirmity, which would in any way disqualify him from performing the duties of a soldier.

*J. H. Peckham*  
*2d Lt RI*  
EXAMINING SURGEON.

I CERTIFY, ON HONOR, That I have minutely inspected the Volunteer *Amos Williams* previously to his enlistment, and that he was entirely sober when enlisted; that, to the best of my judgment and belief, he is of lawful age; and that, in accepting him as duly qualified to perform the duties of an able-bodied soldier, I have strictly observed the Regulations which govern the recruiting service. This soldier has *Black* eyes, *Black* hair, *Black* complexion, is *5* feet *8* inches high.

*Chas Chasey*  
*Capt Regt of Mas* Volunteers,  
*2d Lt RI* RECRUITING OFFICER.

(A. G. O. No. 74 & 76.)

Mustered into the service of the United States, for ~~three~~ *one* year or during the war, from date of enlistment, in Company *B6* of *Providence RI* Regiment of *US 6th Regt* Volunteers, on the *13<sup>th</sup>* day of *March*.  
*Amos Williams*  
*Chas Chasey*  
*2d Lt RI*



2007  
Williams Andrew

Co K., 11 U.S. Col'd H. Art'y.

Private. | Private.

CARD NUMBERS.

1	6197970	26
2	6198113	27
3	6198256	28
4	6198419	29
5	6198572	30
6	6198729	31
7	6198869	32
8	6199012	33
9	6199148	34
10	6199281	35
11	6199403	36
12	6199526	37
13	6199644	38
14	9125227	39
15		40
16		41
17		42
18		43
19		44
20		45
21		46
22		47
23		48
24		49
25		50

Book Mark:

V. 107. Q. 225. 46

See also

*W* | 11 H. Art'y. | U.S.C.T.

*Andrew Williams*

....., Co *K*, 11 Reg't U. S. Col'd H. Art'y.

Appears on

**Company Descriptive Book**

of the organization named above.

**DESCRIPTION.**

Age *20* years; height *5* feet *7* inches.

Complexion *DK*

Eyes *DK*; hair *Blk*

Where born *Delaware*

Occupation *Farmer*

**ENLISTMENT.**

When *Nov 26*, 186 .

Where *Civ R &*

By whom *J. C. Engly*; term *3* y'rs.

Remarks:

.....  
.....  
.....  
.....  
.....  
.....  
.....  
.....  
.....  
.....

*Griffith*

*W* | 11 H. Art'y. | U.S.C.T.

*Andrew Williams*

*Pt*, Co. *K*, 14 Reg't R. I. Col'd H. Art'y.\*

Age *20* years.

Appears on

**Company Muster-in Roll**

of the organization named above. Roll dated

*Sep. 20 Providence R.I. Dec 17*, 186*3*.

Muster-in to date *Dec 17*, 186*3*.

Joined for duty and enrolled:

When *Nov 26*, 186*3*.

Where *Providence R.I.*

Period *3* years.

Valuation of horse, \$.....*100*

Valuation of horse equipments, \$.....*100*

Remarks: .....

.....  
.....  
.....

\* This organization subsequently became Co. *K*, 11 Reg't U. S. Colored Heavy Artillery.

Book mark: .....

*J. H. Stewart*



*W* | **11 H. Art'y. | U.S.C.T.**

*Andrew Williams*

*Pt*, Co. K, 14 Reg't R. I. Col'd H. Art'y.\*

Appears on

**Company Muster Roll**

for *Dec 17 to Dec 31*, 186*3*.

Present or absent *Present*

Stoppage, \$.....*100* for .....

Due Gov't, \$.....*100* for .....

Valuation of horse, \$.....*100*

Valuation of horse equipments, \$.....*100*

Remarks:.....  
.....  
.....  
.....  
.....  
.....

\*This organization subsequently became Co. K, 11 Reg't U. S. Colored Heavy Artillery.

Book mark:.....

*J. Stewart*

*W* | **11 H. Art'y. | U.S.C.T.**

*Andrew Williams*

*Pt*, Co. K, 14 Reg't R. I. Col'd H. Art'y.\*

Appears on

**Company Muster Roll**  
for *Jan & Feb*, 1864.

Present or absent *Present*

Stoppage, \$.....100 for .....

Due Gov't, \$.....100 for .....

Valuation of horse, \$.....100

Valuation of horse equipments, \$.....100

Remarks:.....

\*This organization subsequently became Co. K, 11 Reg't U. S. Colored Heavy Artillery.

Book mark:.....

(358)

*W Stewart*

Copyist.

*W* | **11 H. Art'y.** | **U.S.C.T.**

*Andrew Williams*

*Pt*, Co. K, 14 Reg't R. I. Col'd H. Art'y.\*

Appears on

**Company Muster Roll**

for *Mch & Apr*, 1864.

Present or absent *Present*

Stoppage, \$ 100 for

Due Gov't, \$ 100 for

Valuation of horse, \$ 100

Valuation of horse equipments, \$ 100

Remarks: *Stop for wipes  
screw driver & gun  
slings \$ .59*

\*This organization subsequently became Co. K, 11 Reg't U. S. Colored Heavy Artillery.

Book mark: \_\_\_\_\_

*J. H. Stewart*



*W* | 11 H. Art'y. | **U.S.C.T.**

*Andrew Williams*  
*Prvt, Co. K*, 8 Reg't U. S. Col'd H. Art'y.\*

Appears on

**Company Muster Roll**

for *May & June*, 186*4*.

Present or absent

*Present.*

Stoppage, \$ 100 for

Due Gov't, \$ 100 for

Valuation of horse, \$ 100

Valuation of horse equipments, \$ 100

Remarks:

† This organization subsequently became Co *K*, 11 Reg't U. S. Colored Heavy Artillery.

Book mark:

*Stewart*

Copyist.

*W* | 11 H. Art'y. | U.S.C.T.

*Andrew Williams*

*Priv*, Co. K, 11 Reg't U. S. Col'd H. Art'y.

Appears on

**Company Muster Roll**

for *July & Aug*, 1864.

Present or absent *Present*

Stoppage, \$.....<sup>100</sup> for .....

Due Gov't, \$.....<sup>100</sup> for .....

Valuation of horse, \$.....<sup>100</sup>

Valuation of horse equipments, \$.....<sup>100</sup>

Remarks: *Free on 19 April 64  
\$6 per month due from  
enlistment to April  
30/64.*

Book marks.....

*Choward*

Copyist.

*W* 11 H. Art'y. U.S.C.T.

*Andrew Williams*  
Pr. Co. K, 11 Reg't U. S. Col'd H. Art'y.

Appears on

**Company Muster Roll**

for *Sept & Oct*, 186*4*.

Present or absent *Present*

Stoppage, \$.....100 for.....

Due Gov't, \$.....<sup>*03*</sup>/<sub>*100*</sub> for *C. & G. D.*

Valuation of horse, \$.....100

Valuation of horse equipments, \$.....100

Remarks:.....  
.....  
.....  
.....  
.....  
.....  
.....

Book mark:.....

*Steward*



*M* 11 H. Art'y. | **U.S.C.T.**

*Andrew Williams*

*Pvt.*, Co. K, 11 Reg't U. S. Col'd H. Art'y.

Appears on

**Company Muster Roll**

for *Nov 1864*, 186*4*.

Present or absent *Present*

Stoppage, \$ *100* for

Due Gov't, \$ *38* / *100* for *C & G. Q.*

Valuation of horse, \$ *100*

Valuation of horse equipments, \$ *100*

Remarks: \_\_\_\_\_

Book mark: \_\_\_\_\_

*Stewart*

*M* 11 H. Art'y. U.S.C.T.

*Andrew Williams*  
Pvt., Co. K, 11 Reg't U. S. Col'd H. Art'y.

Appears on

**Company Muster Roll**

for *Jan & Feb*, 1865.

Present or absent *Present*

Stoppage, \$ 100 for

Due Gov't, \$ 03 for *C & G. 2.*

Valuation of horse, \$ 100

Valuation of horse equipments, \$ 100

Remarks:

Book mark:

*Sturwald*  
Copyist.

*W* | 11 H. Art'y. | U.S.C.T.

*Andrew Williams*  
Pvt., Co. K, 11 Reg't U. S. Col'd H. Art'y.

Appears on

Company Muster Roll  
for *March & April* 1865.

Present or absent *Present*

Stoppage, \$ 100 for

Due Gov't, \$ 04 / 100 for *C & G. E.*

Valuation of horse, \$ 100

Valuation of horse equipments, \$ 100

Remarks: \_\_\_\_\_  
\_\_\_\_\_  
\_\_\_\_\_  
\_\_\_\_\_  
\_\_\_\_\_  
\_\_\_\_\_

Book mark: \_\_\_\_\_



*M* | 11 H. Art'y. | U.S.C.T.

*Andrew Williams*

*Prst*, Co. K, 11 Reg't U. S. Col'd H. Art'y.

Appears on

**Company Muster Roll**

for *May & June*, 1865.

Present or absent

*Present*

Stoppage, \$..... $\overline{100}$  for

Due Gov't, \$/..... $\frac{04}{100}$  for

*C & G E*

Valuation of horse, \$..... $\overline{100}$

Valuation of horse equipments, \$..... $\overline{100}$

Remarks:

Book mark:

*Grucher*

Copyist.

*A* | 11 H. Art'y. | U.S.C.T.

*Andrew Williams*

*Pvt*, Co. K, 11 Reg't U. S. Col'd H. Art'y.

Appears on

**Company Muster Roll**

for *July & Aug*, 1865.

Present or absent *Present*

Stoppage, \$ *100* for

Due Gov't, \$ *1* <sup>*04*</sup>/<sub>*100*</sub> for *C & L & E*

*lost and destroyed*

Valuation of horse, \$ *100*

Valuation of horse equipments, \$ *100*

Remarks:

Book mark:

*Spencer*

Copyist.

*N* | 11 H. Art'y. | U.S.C.T.

*Andrew Williams*

*Pot*, Co. *K*, 11 Reg't U. S. Col'd H. Art'y.

Appears on **Co. Muster-out Roll**, dated

*New Orleans, La, Oct. 2*, 1865.

Muster-out to date *Oct. 2*, 1865.

Last paid to *Feb. 27*, 1865.

Clothing account:

Last settled....., 186 ; drawn since \$.....<sup>100</sup>

Due soldier \$.....<sup>100</sup>; due U. S. \$ *22*.....<sup>62</sup>/<sub>100</sub>

Am't for cloth'g in kind or money adv'd \$.....<sup>100</sup>

Due U. S. for arms, equipments, &c., \$ *7*.....<sup>04</sup>/<sub>100</sub>

Bounty paid \$ *None* <sup>00</sup>.....<sup>100</sup>; due \$ *100*.....<sup>100</sup>

Remarks: *Joined at Orig. Regt.*

*Stop & Mangrove Bar, 2 Eagles lost.*

*1 Musket & Equipments retained.*

Book mark: *V 107. P. 225. 70.*

*Sprecher*



Williams, Andrew

P. Co., 11 Reg't U.S. Inf.

4 Enclosures.

Bed Cards	Final Statements
Burial Records	Furloughs or L. of A.
Certs. of Dis. for Discharge	Med. Certificates
C. M. Charges	Med. Des. Lists
Descriptive Lists	Orders
Discharge Certificates	Pris. of War Record
Enlistment Papers	Resignations

Other papers relating to—

Admission to Hosp'l	Furlough or L. of A.
Casualty Sheet	Med. Examination
Confinement	Misc. Information
Contracts	Pay or Clothing
Death or Effects	Personal Reports
Desertion	Rank
Discharge from Hosp'l	Transfer to Hosp'l
Discharge from Service	Transfer to V. R. C.
Duty	Transportation

DECLARATION OF RECRUIT.

I, Andrew Williams desiring to VOLUNTEER as a Soldier in the ARMY OF THE UNITED STATES, for the term of 3 years do declare that I am 20 years and 0 months of age; that I have never been discharged from the United States service on account of disability or by sentence of a court martial, or by order, before the expiration of a term of enlistment; and I know of no impediment to my serving honestly and faithfully as a soldier for 3 years

Given at Bowdoin  
The 26th day of Nov 1863

Witness:  
Ch. Mark

Andrew Williams  
mark

11200 extra

No. 96

Andrew Williams

Volunteered at Bowdoin

Nov 26th 1863

By Major G. C. Burdett

14th Regiment of Inf

enlistment; last served in Company ( )

Reg't of

Discharged 18



CONSENT IN CASE OF MINOR.

I, \_\_\_\_\_ Do CERTIFY that I am the \_\_\_\_\_ of \_\_\_\_\_; that the said \_\_\_\_\_ is \_\_\_\_\_ years of age; and I do hereby freely give my CONSENT to his volunteering as a SOLDIER in the ARMY OF THE UNITED STATES for the period of \_\_\_\_\_

Given at \_\_\_\_\_  
The \_\_\_\_\_ day of \_\_\_\_\_

Witness:



VOLUNTEER ENLISTMENT.



State of

Town of

Rhode Island Providence

I, Andrew Williams born in ... in the State of ... aged 20 years, and by occupation a ...

DO HEREBY ACKNOWLEDGE to have volunteered this 26th day of Nov 1863 to serve as a SOLDIER in the ARMY OF THE UNITED STATES OF AMERICA, for the period of 3 years, unless sooner discharged by proper authority: Do also agree to accept such bounty, pay, rations and clothing, as are, or may be, established, by law for volunteers. And I, Andrew Williams do solemnly swear, that I will bear true faith and allegiance to the United States of America, and that I will serve them honestly and faithfully against all their enemies or opposers whomsoever; and that I will observe and obey the orders of the President of the United States, and the orders of the officers appointed over me, according to the Rules and Articles of War.

Sworn and Subscribed to, at Providence R.I. this 26th day of Nov. 1863.

BEFORE Mr. John L. Noyes Public Notary

Andrew Williams Mark

I CERTIFY, ON HONOR, That I have carefully examined the above-named Volunteer, agreeable to the General Regulations of the Army, and that, in my opinion, he is free from all bodily defects and mental infirmity, which would, in any way, disqualify him from performing the duties of a soldier.

Johnson Gardner M.D.

EXAMINING SURGEON.

I CERTIFY, ON HONOR, That I have minutely inspected the Volunteer, Andrew Williams previously to his enlistment, and that he was entirely sober when enlisted; that to the best of my judgment and belief, he is of lawful age; and that, in accepting him as duly qualified to perform the duties of an able-bodied soldier, I have strictly observed the Regulations which govern the recruiting service. This soldier has Dark complexion, is 5 feet, Dark eyes Black hair inches high.

Major 14th Regiment of Prov. Artillery Volunteers,

RECRUITING OFFICER.



NOTE 1.—This blank will be used for both enlistments and re-enlistments—enlistment of veterans, &c., &c., in the volunteer service. They will be made out in duplicate in all cases—one to accompany the recruiting return of the superintendent (not the recruiting officer) to the Adjutant General, and one to accompany the accounts of the officer who pays bounty, &c. The Regiment and Company in which the soldier last served should be given on the back.

NOTE 2.—An enlistment holds to service. A muster-in must, in all cases, precede payment of pay, bounty, pension, &c. A muster-in roll must, in all cases, be filed in the Adjutant General's Office as evidence of muster-in. The mustering officer, commissary, or assistant commissary of musters, as the case may be, will countersign both enlistments as having mustered the soldier into the service of the United States before either of them is given to the disbursing officer.

DECLARATION OF RECRUIT.

I, Andrew J. Williams desiring to VOLUNTEER as a Soldier in the Army of the United States, for the term of THREE YEARS, Do Declare, That I am Twenty one years and two months of age; that I have never been discharged from the United States service on account of disability or by sentence of a court-martial, or by order before the expiration of a term of enlistment; and I know of no impediment to my serving honestly and faithfully as a soldier for three years.

GIVEN at Augusta Maine the fifteenth day of December 1863

Witness: North Boothby Andrew J. Williams  
Witness North Boothby

No. 13 W

Williams, Andrew J. (Colonel)

Volunteered at Augusta, Me.

Dec 15th 1863,

By Capt. J. D. Davis 1st Regt. Maine Artillery

for 14 Regiment of Maine Artillery

R. J. Wells

1st enlistment; last served in Company (—)

Reg't of \_\_\_\_\_

Discharged \_\_\_\_\_ 18—

NOV 18 1865, THIS PAPER WAS FORGOTTEN  
 FILED IN THE ENROLLMENT DIV. R. & P. O.

CONSENT IN CASE OF MINOR.

I, \_\_\_\_\_ Do CERTIFY, That I am the \_\_\_\_\_ of \_\_\_\_\_; that the said \_\_\_\_\_ is \_\_\_\_\_ years of age; and I do hereby freely give my CONSENT to his volunteering as a SOLDIER in the ARMY OF THE UNITED STATES for the period of THREE YEARS.

GIVEN at \_\_\_\_\_ the \_\_\_\_\_ day of \_\_\_\_\_

Witness: \_\_\_\_\_



Quota of Waterville  
VOLUNTEER ENLISTMENT.

STATE OF

Maine



TOWN OF

Augusta

I, *Andrew J. Williams* born in *Smithfield*  
in the State of *Maine* aged *twenty one* years,  
and by occupation a *Labourer* Do HEREBY ACKNOWLEDGE to have  
volunteered this *fifteenth* day of *December* 1863,  
to serve as a **Soldier** in the **Army of the United States of America**, for the  
period of **THREE YEARS**, unless sooner discharged by proper authority: Do also  
agree to accept such bounty, pay, rations, and clothing, as are, or may be, estab-  
lished by law for volunteers. And I, *Andrew J. Williams* do  
solemnly swear, that I will bear true faith and allegiance to the **United States  
of America**, and that I will serve them honestly and faithfully against all their  
enemies or opposers whomsoever; and that I will observe and obey the orders of  
the President of the United States, and the orders of the officers appointed over  
me, according to the Rules and Articles of War.

Sworn and subscribed to, at *Augusta Me.*  
this *seventeenth* day of *December* 1863,

BEFORE

*A. J. Williams*  
*Mark* Witness  
*Captain & Provost Marshal 3<sup>d</sup> District - of Maine*

I CERTIFY, ON HONOR, That I have carefully examined the above-named Volunteer, agreeably  
to the General Regulations of the Army, and that, in my opinion, he is free from all bodily defects and  
mental infirmity, which would in any way disqualify him from performing the duties of a soldier.

*A. J. Williams*  
EXAMINING SURGEON.

I CERTIFY, ON HONOR, That I have minutely inspected the Volunteer, *Andrew J. Williams*  
previously to his enlistment, and that he was entirely sober when enlisted; that, to the best of my  
judgment and belief, he is of lawful age; and that, in accepting him as duly qualified to perform the duties  
of an able-bodied soldier, I have strictly observed the Regulations which govern the recruiting service.  
This soldier has *Black* eyes, *Black* hair, *Black* complexion, is *five* feet  
*4* inches high.

*A. J. Williams*  
Regiment of \_\_\_\_\_ Volunteers,

RECRUITING OFFICER.

(A. G. O. No. 74 & 76.)

*Captain Provost Marshal  
3<sup>d</sup> District of Maine*

the \_\_\_\_\_ day of \_\_\_\_\_, 186 , at \_\_\_\_\_  
Mustered into the service of the United States, in Company \_\_\_\_\_, Regiment of \_\_\_\_\_ Volunteers, on

NOTE.—The Recruiting Officer will here enter the soldier's residence, and state whether \*married or single.

This soldier is a resident of *Smithfield* and is \* *Married*

*Noah Brantley*

Camp Wy. Augusta, Me.,  
Dec. 9<sup>th</sup>, 1863

Goodwin, Thos. H.,  
Capt. Comd'g.

Receipt for  
A. J. Williams

14 P. S. H. A. G. G.

May 1860. This receipt was formerly  
received by the [unclear] of [unclear]  
[unclear] [unclear] [unclear] [unclear] [unclear] [unclear]  
MAILED in the [unclear] DIVISION OF [unclear]



I certify that I have this day received  
at Camp J. B. Fry the following named  
recruits awaiting transportation to General  
Rendezvous:

No.	Name.
1	Andrew J. Williams for 14 <sup>th</sup> R. I. Heavy Artillery

One Man

Headquarters Refused  
Camp J. B. Fry  
Dec - 17<sup>th</sup> 1863.

Wm. Gardner  
Commanding Officer





[Form B.]

ROLL OF VOLUNTEERS ENLISTED IN THE

*Third*

DISTRICT, STATE OF

*Maine*

*Augusta*

*December 2<sup>nd</sup>*

, 1863.

NO.	NAME OF RECRUIT.	DESIGNATION.	REGIMENT SELECTED.	BY WHOM PRESENTED.	REMARKS.
✓ 1	<i>Williams, Andrew J. (Colored)</i>	<i>Raw Recruit</i>	<i>4<sup>th</sup> Maine Vols.</i>	<i>Noah Boothby</i>	

NOTE.—In the column headed "Designation," the word "veteran," or "new recruit," as the case may be, will be entered opposite the name of the recruit.

To

ACTING ASSISTANT PROVOST MARSHAL GENERAL.

*J. P. [Signature]*

CAPTAIN AND PROVOST MARSHAL

*3<sup>d</sup> District of Maine*



2008

Williams Andrew J

Co, 11 U.S. Col'd H. Art'y.

Private | O'Connell

CARD NUMBERS.

1	6181174	26
2	6181169	27
3		28
4		29
5		30
6		31
7		32
8		33
9		34
10		35
11		36
12		37
13		38
14		39
15		40
16		41
17		42
18		43
19		44
20		45
21		46
22		47
23		48
24		49
25		50

Book Mark:

See also

*W*

11 H. Art'y. | U.S.C.T.

*Andrew J. Williams*

Appears with rank of *Priv* on

**Muster and Descriptive Roll of a Detachment of U. S. Vols. forwarded**

*(14th Reg't U.S. Art'y)*  
for the *11* Reg't *U.S. Art'y* Roll dated

*August 21*, 1863.

Where born *Smithfield Me*

Age *21* y'rs; occupation *Laborer*

When enlisted *Dec 15*, 1863.

Where enlisted *August Me*

For what period enlisted *3* years.

Eyes *Blk*; hair *Blk*

Complexion *Blk*; height *5 ft. 10 in.*

When mustered in *Dec 17*, 1863.

Where mustered in

Bounty paid \$ *100*; due \$ *100*

Where credited *Smithfield Me*

Company to which assigned

Remarks: *Raw recruit*

*Not taken up on rolls of Regiment*

Book mark: *J. P. Hill. Co.*

*W*

*A*

11 H. Art'y.

U.S.C.T.

*Andrew J. Williams*

Appears with rank of *Priv* on

**Muster and Descriptive Roll of a Detachment of U. S. Vols. forwarded**

for the *11 Reg't (4 R. S. Gen & Artz) Md, Ct Artz* Roll dated

*August 21<sup>e</sup>, Dec 21, 1863.*

Where born *Smithfield Md*

Age *21* y'rs; occupation *Labourer*

When enlisted *Dec 15*, 1863.

Where enlisted *Augusta Md*

For what period enlisted *3* years.

Eyes *Blk*; hair *Blk*

Complexion *Blk*; height *5 ft 10* in.

When mustered in *Dec 17*, 1863.

Where mustered in

Bounty paid \$ *100*; due \$ *100*

Where credited *Fairfield Md 3<sup>d</sup> Dist.*

Company to which assigned

Remarks: *Raw recruit*

Book mark:

*Devo*



1126 S. O. H. C. A.

Williams, Andrew J.

14 Reg't P. V. H. C. A.

Enclosures.

Bed Cards	Final Statements
Burial Records	Furloughs or L. of A
Certs. of Dis. for Discharge	Med. Certificates
C. M. Charges	Med. Des. Lists
Descriptive Lists	Orders
Discharge Certificates	Pris. of War Record
Enlistment Papers	Resignations

Other papers relating to—

Admission to Hosp'l	Furlough or L. of A
Casualty Sheet	Med. Examination
Confinement	Misc. Information
Contracts	Pay or Clothing
Death or Effects	Personal Reports
Desertion	Rank
Discharge from Hosp'l	Transfer to Hosp'l
Discharge from Service	Transfer to V. R. C.
Duty	Transportation

NOTE 1.—This blank will be used for both enlistments and re-enlistments—enlistment of veterans, &c., &c., in the volunteer service. They will be made out in duplicate in all cases—one to accompany the recruiting return of the superintendent (not the recruiting officer) to the Adjutant General, and one to accompany the accounts of the officer who pays bounty, &c. The Regiment and Company in which the soldier last served should be given on the back.

NOTE 2.—An enlistment holds to service. A muster-in must, in all cases, precede payment of pay, bounty, pension, &c. A muster-in roll must, in all cases, be filed in the Adjutant General's Office as evidence of muster-in. The mustering officer, commissary, or assistant commissary of musters, as the case may be, will countersign both enlistments as having mustered the soldier into the service of the United States before either of them is given to the disbursing officer.

41293

DECLARATION OF RECRUIT.

I, Andrew J. Williams desiring to VOLUNTEER as a Soldier in the Army of the United States, for the term of THREE YEARS, Do Declare, That I am twenty one years and two months of age; that I have never been discharged from the United States service on account of disability or by sentence of a court-martial, or by order before the expiration of a term of enlistment; and I know of no impediment to my serving honestly and faithfully as a soldier for three years.

GIVEN at Augusta Maine the fifteenth day of Dec ~~15th~~ 1863

Witness:

North Boothby

Andrew J. Williams  
make

Witness North Boothby

No. 53

William Andrew J. Williams  
Volunteered at Augusta, Me.  
Dec 15th 1863.  
By Col. S. J. Davis, Provost Marshal  
10th Regiment of Heavy Artillery  
P. S. A.  
1st enlistment; last served in Company (—)  
Regt of  
Discharged 18—

CONSENT IN CASE OF MINOR.

I, \_\_\_\_\_ Do CERTIFY, That I am the \_\_\_\_\_ of \_\_\_\_\_; that the said \_\_\_\_\_ is \_\_\_\_\_ years of age; and I do hereby freely give my CONSENT to his volunteering as a SOLDIER in the ARMY OF THE UNITED STATES for the period of THREE YEARS.

GIVEN at \_\_\_\_\_ the \_\_\_\_\_ day of \_\_\_\_\_

Witness:



Quota of Waterville  
VOLUNTEER ENLISTMENT.

STATE OF

Maine



TOWN OF

Augusta

I, *Andrew J. Williams* <sup>(married)</sup> born in *Smithfield*  
in the State of *Maine* aged *twenty one* years,  
and by occupation a *Labourer* Do HEREBY ACKNOWLEDGE to have  
volunteered this *fifteenth* day of *December* 1863,  
to serve as a **Soldier** in the **Army of the United States of America**, for the  
period of **THREE YEARS**, unless sooner discharged by proper authority: Do also  
agree to accept such bounty, pay, rations, and clothing, as are, or may be, estab-  
lished by law for volunteers. And I, *Andrew J. Williams* do  
solemnly swear, that I will bear true faith and allegiance to the **United States  
of America**, and that I will serve them honestly and faithfully against all their  
enemies or opposers whomsoever; and that I will observe and obey the orders of  
the President of the United States, and the orders of the officers appointed over  
me, according to the Rules and Articles of War.

Sworn and subscribed to, at *Augusta Me.*

this *seventeenth* day of *December* 1863,

BEFORE

*A. J. Williams* } *Andrew J. Williams*  
*A. J. Williams* } *Mark Witness Noble Boothby*  
Captain & Provost Marshal 3<sup>d</sup> District of Maine

I CERTIFY, ON HONOR, That I have carefully examined the above-named Volunteer, agreeably  
to the General Regulations of the Army, and that, in my opinion, he is free from all bodily defects and  
mental infirmity, which would in any way disqualify him from performing the duties of a soldier.

*A. J. Williams*

EXAMINING SURGEON.

I CERTIFY, ON HONOR, That I have minutely inspected the Volunteer, *Andrew J. Williams*  
previously to his enlistment, and that he was entirely sober when enlisted; that, to the best of my  
judgment and belief, he is of lawful age; and that, in accepting him as duly qualified to perform the duties  
of an able-bodied soldier, I have strictly observed the Regulations which govern the recruiting service.  
This soldier has *Black* eyes, *Black* hair, *Black* complexion, is *five* feet  
*ten* inches high.

*A. J. Williams*

Regiment of \_\_\_\_\_ Volunteers,

(A. G. O. No. 74 & 76.)

*Captain Provost Marshal*  
*3<sup>d</sup> District of Maine*

RECRUITING OFFICER.

the \_\_\_\_\_ day of \_\_\_\_\_, 186 , at \_\_\_\_\_ Mustered into the service of the United States, in Company \_\_\_\_\_, Regiment of \_\_\_\_\_ Volunteers, on

Note.—The Recruiting Officer will here enter the soldier's residence, and state whether married or single.

This soldier is a resident of *Smithfield* and is \* *Married*



2009

Williams Benjamin

Co J., 11 U.S. Col'd H. Art'y.

Private Private.

CARD NUMBERS.

1	6196171	26
2	6196316	27
3	6196461	28
4	6196615	29
5	6196770	30
6	6196916	31
7	6197060	32
8	6197203	33
9	6197327	34
10	6197447	35
11	6197554	36
12	6197670	37
13	6197776	38
14	9125566	39
15		40
16		41
17		42
18		43
19		44
20		45
21		46
22		47
23		48
24		49
25		50

Book Mark:

See also

*A* | 11 H. Art'y. | U.S.C.T.

*Benjamin D Williams*

....., Co. *I*, 11 Reg't U. S. Col'd H. Art'y.

Appears on

**Company Descriptive Book**

of the organization named above.

**DESCRIPTION.**

Age *18* years; height *5* feet *4* inches.

Complexion *OK*

Eyes *OK*; hair *OK*

Where born *Deerfield N.Y.*

Occupation *Seaman*

**ENLISTMENT.**

When *Nov 14*, 186 .

Where *Prov R.I.*

By whom *P. H. Downing* term *3* y'rs.

Remarks: *Mustered out*

*Griffith*

Copyist.

*M* | 11 H. Art'y. | U.S.C.T.

*Benjamin Williams-*  
*Co. I*, 14 Reg't R. I. Col'd H. Art'y.\*

Age *18* years.

Appears on

**Company Muster-in Roll**

of the organization named above. Roll dated  
*Providence R.I. Nov 28*, 1863.

Muster-in to date *Nov 28*, 1863.

Joined for duty and enrolled:

When *Nov. 14*, 1863.

Where *Providence R.I.*

Period *3* years.

Valuation of horse, \$.....*100*

Valuation of horse equipments, \$.....*100*

Remarks: *2nd Dist R.I.*

\* This organization subsequently became Co. *C*, 11 Reg't U. S. Colored Heavy Artillery.

Book mark:.....

*C. A. Sawyer*



*W* | 11 H. Art'y. | U.S.C.T.

*Benjamin Williams*  
*Priv*, Co. I, 14 Reg't R. I. Col'd H. Art'y.\*

Appears on

**Company Muster Roll**

for *Nov 25 to Dec 31*, 1863.

Present or absent *Present*

Stoppage, \$.....100 for .....

Due Gov't, \$.....100 for .....

Valuation of horse, \$.....100

Valuation of horse equipments, \$.....100

Remarks:.....

\*This organization subsequently became Co. I, 11 Reg't U. S. Col'd Heavy Artillery.

Book mark:.....

(358)

*E. A. Harper*

Copyist.

*W*

11 H. Art'y.

U.S.C.T.

*Benjamin F Williams*

*Priv*, Co. I, 14 Reg't R. I. Col'd H. Art'y.\*

Appears on

**Company Muster Roll**

for *Jan & Feb*, 1864.

Present or absent *Present*

Stoppage, \$ 100 for

Due Gov't, \$ 100 for

Valuation of horse, \$ 100

Valuation of horse equipments, \$ 100

Remarks:

\*This organization subsequently became Co. I, 11 Reg't U. S. Col'd Heavy Artillery.

Book mark:

*A. A. Harper*

*W*

11 H. Art'y.

U.S.C.T.

*Benjamin Williams*

*Priv*, Co. I, 14 Reg't R. I. Col'd H. Art'y.\*

Appears on

**Company Muster Roll**

for *March April*, 1864.

Present or absent *Present*

Stoppage, \$ 100 for

Due Gov't, \$ 100 for

Valuation of horse, \$ 100

Valuation of horse equipments, \$ 100

Remarks:

\*This organization subsequently became Co. I, 11 Reg't U. S. Col'd Heavy Artillery.

Book mark:

*Expayzer*



*M*

11 H. Art'y. | U.S.C.T.

*Benjamin F. Williams -*  
*Co. D*, 8 Reg't U. S. Col'd H. Art'y.\*

Appears on

**Company Muster Roll**

for *May & June*, 1864.

Present or absent

*Present*

Stoppage, \$ 100 for

Due Gov't, \$ 100 for

Valuation of horse, \$ 100

Valuation of horse equipments, \$ 100

Remarks:

† This organization subsequently became Co. *D*, 11 Reg't U. S. Colored Heavy Artillery.

Book mark:

*A. J. Harper*

Copyist.

*aff* | 11 H. Art'y. | U. S. C. T.

*Benj. F. Williams*  
Private, Co. I, 11 Reg't U. S. Col'd H. Art'y.

Appears on

**Company Muster Roll**

for *July & Aug.*, 186*4*.

Present or absent *Present*

Stoppage, \$ 100 for

Due Gov't, \$ 49 for *Camp &*

*G. Equip.*

Valuation of horse, \$ 100

Valuation of horse equipments, \$ 100

Remarks: *\$6 p. m. Due from*  
*enlistment to April 30/60*  
*Free Apr. 19<sup>th</sup> 1861*

Book mark:

*(M. A. Michaels)*

*W* | 11 H. Art'y. | U. S. C. T.

*Benjamin F. Williams*  
Private, Co. I, 11 Reg't U. S. Col'd H. Art'y.

Appears on

**Company Muster Roll**

for *Sept & Oct*, 1864.

Present or absent. *Present*

Stoppage, \$ *100* for

Due Gov't, \$ *49* for *Camp Garrison*  
*Equipage*

Valuation of horse, \$ *100*

Valuation of horse equipments, \$ *100*

Remarks:

Book mark:

*M. A. Michaels*  
Copyist.



*W.* | 11 H. Art'y. | U. S. C. T.

*Benjamin F. Williams*  
Private, Co. I, 11 Reg't U. S. Col'd H. Art'y.

Appears on

Company Muster Roll

for *Nov & Dec.*, 1864.

Present or absent *Present*

Stoppage, \$ 100 for

Due Gov't, \$ 49 for *Camp Garrison*

*Equipage*

Valuation of horse, \$ 100

Valuation of horse equipments, \$ 100

Remarks:

Book mark:

*M. A. Michaels*  
Copyist.

*W*

**11 H. Art'y. | U. S. C. T.**

*Benjamin F. Williams*

*Private*, Co. I, 11 Reg't U. S. Col'd H. Art'y.

Appears on

**Company Muster Roll**

for *Jan'y & Febr.*, 186*5*.

Present or absent *Present*

Stoppage, \$ *100* for

Due Gov't, \$ *170/100* for *Camp & Garrison*

*Equipage* *170* *Ordnance* *32*

Valuation of horse, \$ *100*

Valuation of horse equipments, \$ *100*

Remarks:

-----  
-----  
-----  
-----  
-----  
-----  
-----  
-----

Book mark:

-----

*M. A. Michaels*

*A* | 11 H. Art'y. | U. S. C. T.

*Benjamin Williams*  
*Priv*, Co. I, 11 Reg't U. S. Col'd H. Art'y.

Appears on

Company Muster Roll

for *March & Apr*, 186*5*.

Present or absent *present*

Stoppage, \$ *32* for *ordnance*

*12 for C & G. E.*

Due Gov't, \$ *100* for

Valuation of horse, \$ *100*

Valuation of horse equipments, \$ *100*

Remarks:

Book mark:

*Woy*



*W* | 11 H. Art'y. | U. S. C. T.

*Benjamin F. Williams*  
*Pri.*, Co. I, 11 Reg't U. S. Col'd H. Art'y.

Appears on

Company Muster Roll

for *May & June*, 186*5*.  
*Present*

Present or absent

Stoppage, \$ 100 for

Due Gov't, \$ 100 for

Valuation of horse, \$ 100

Valuation of horse equipments, \$ 100

Remarks:

Book mark:

*Drumby*

*W* | 11 H. Art'y. | U. S. C. T.

*Benjamin F. Williams*

*Pr*....., Co. I, 11 Reg't U. S. Col'd H. Art'y.

Appears on

Company Muster Roll

for *July & Aug*....., 186 *5*

Present or absent *Present*

Stoppage, \$.....100 for .....

Due Gov't, \$.....100 for .....

Valuation of horse, \$.....100

Valuation of horse equipments, \$.....100

Remarks:.....

.....

.....

.....

.....

.....

.....

.....

Book mark:.....

.....

*Donnelly*

*W* | **11 H. Art'y. U.S.C.T.**

*Benjamin F. Williams*  
*Pvt I*, Co. *D*, 11 Reg't U. S. Col'd H. Art'y.

Appears on **Co. Muster-out Roll**, dated  
*Camp Parapet La Oct 2*, 1865.

Muster-out to date *Oct 2*, 1865.

Last paid to *Feb 28*, 1865.

**Clothing account:**

Last settled....., 186 ; drawn since \$..... 100

Due soldier \$..... 100; due U. S. \$..... 90  
100

Am't for cloth'g in kind or money adv'd \$..... 100

Due U. S. for arms, equipments, &c., \$..... 41  
100

Bounty paid \$ *none* 100; due \$ *100* 100

Remarks: *Joined at age 17. Lost*  
*1 screw driver, 1 tom-pick, 1 cart-*  
*ridge box plate, & 1 cartridge*  
*box belt plate*

Book mark: .....

*Somely*



Williams, Benj: Franklin

P, Co., 11 Reg't U.S.C.A

Enclosures.

Bed Cards .....	Final Statements .....
Burial Records .....	Furloughs or L. of A .....
Certs. of Dis. for Discharge .....	Med. Certificates .....
C. M. Charges .....	Med. Des. Lists .....
Descriptive Lists .....	Orders .....
Discharge Certificates .....	Pris. of War Record .....
Enlistment Papers .....	Resignations .....

Other papers relating to—

Admission to Hosp'l .....	Furlough or L. of A .....
Casualty Sheet .....	Med. Examination .....
Confinement .....	Misc. Information .....
Contracts .....	Pay or Clothing .....
Death or Effects .....	Personal Reports .....
Desertion .....	Rank .....
Discharge from Hosp'l .....	Transfer to Hosp'l .....
Discharge from Service .....	Transfer to V. R. C. .....
Duty .....	Transportation .....

DECLARATION OF RECRUIT.

I, Benj Franklin Williams desiring to VOLUNTEER as a Soldier in the ARMY OF THE UNITED STATES, for the term of three years months of age; that I have never been discharged from the United States service on account of disability or by sentence of a court martial, or by order, before the expiration of a term of enlistment; and I know of no impediment to my serving honestly and faithfully as a soldier for three years

Given at Providence R.I.  
The 14 day of Nov 1863

Witness:

J. W. Downing

Benj Franklin Williams  
mark

1120000000

Benj Franklin Williams

Volunteered at Providence R.I.

Nov 14 1863

By J. W. Downing  
14 Regiment of Prov. H. A. S.

enlistment; last served in Company ( )

Reg't of

Discharged

18



CONSENT IN CASE OF MINOR.

I, \_\_\_\_\_ Do CERTIFY that I am the \_\_\_\_\_  
of \_\_\_\_\_; that the said \_\_\_\_\_  
is \_\_\_\_\_ years of age; and I do hereby freely give  
any CONSENT to his volunteering as a SOLDIER in the ARMY OF THE UNITED STATES for the period of \_\_\_\_\_

Given at \_\_\_\_\_  
The \_\_\_\_\_ day of \_\_\_\_\_

Witness:

J. W. Downing



VOLUNTEER ENLISTMENT.

State of  
R.I.



Town of  
Providence  
Dorfield

I, Benj Franklin Williams born in Dorfield  
in the State of New York aged 18 years, and by occupation  
a Seaman  
DO HEREBY ACKNOWLEDGE to have volunteered this 14  
day of Nov 1863 to serve as a SOLDIER in the ARMY OF THE UNITED STATES

OF AMERICA, for the period of Three years, unless sooner discharged by proper authority:  
Do also agree to accept such bounty, pay, rations and clothing, as are, or may be, established, by law for  
volunteers. And I, Benj Franklin Williams do solemnly swear, that I will bear  
true faith and allegiance to the United States of America, and that I will serve them honestly and faith-  
fully against all their enemies or opposers whomsoever; and that I will observe and obey the orders of the  
President of the United States, and the orders of the officers appointed over me, according to the Rules  
and Articles of War.

Sworn and Subscribed to, at Providence Benj Franklin Williams  
this 14 day of Nov 1863 his  
BEFORE M. W. Corbridge mark

I CERTIFY, ON HONOR, That I have carefully examined the above-named Volunteer, agreeable to the General Regulations of  
the Army, and that, in my opinion, he is free from all bodily defects and mental infirmity, which would, in any way, disqualify him  
from performing the duties of a soldier.

Johnson Gardner M.D.

EXAMINING SURGEON.

I CERTIFY, ON HONOR, That I have minutely inspected the Volunteer, Benj Franklin Williams  
previously to his enlistment, and that he was entirely sober when enlisted; that to the best of my judgment and belief, he is of  
lawful age; and that, in accepting him as duly qualified to perform the duties of an able-bodied soldier, I have strictly observed the  
Regulations which govern the recruiting service. This soldier has dark eyes dark hair  
dark complexion. is 5 feet, 4 inches high.

14 Regiment of R. I. H. A Volunteers.

Peter W. Downing RECRUITING OFFICER.



2010

Williams Charles.

Co 20, 11 U.S. Col'd H. Art'y.

Private. Private.

CARD NUMBERS.

1	6187305	26
2	6187448	27
3	6187595	28
4	6187739	29
5	6187877	30
6	6188001	31
7	6188137	32
8	6188268	33
9	6188387	34
10	6188501	35
11	6188607	36
12	6188717	37
13	6188820	38
14	9124806	39
15	9124664	40
16		41
17		42
18		43
19		44
20		45
21		46
22		47
23		48
24		49
25		50

Book Mark:

See also

*W* | **11 H. Art'y. | U.S.C.T.**

*Charles Williams*

....., Co. *D*, 11 Reg't U. S. Col'd H. Art'y.

Appears on

**Company Descriptive Book**

of the organization named above.

**DESCRIPTION.**

Age *22* years; height *5* feet *3*/<sub>4</sub> inches.

Complexion *Blk.*

Eyes *Brown*; hair *Blk.*

Where born *Mobile, Ala.*

Occupation *Steward.*

**ENLISTMENT.**

When *Sept. 14*....., 186*3*.

Where *Prov.*

By whom *W. H. Helme*; term *3* y'rs.

Remarks: .....

.....  
.....  
.....  
.....  
.....  
.....  
.....  
.....  
.....  
.....

*O. J. Markle.*

*W* | **11 H. Art'y. U.S.C.T.**

*Charles Williams*

....., Co. *D*, 11 Reg't U. S. Col'd H. Art'y.

Appears on

**Company Descriptive Book**

of the organization named above.

**DESCRIPTION.**

Age *22* years; height *5* feet *3*<sup>*3*</sup>/<sub>*4*</sub> inches.

Complexion *Black.*

Eyes *Brown*; hair *Black*

Where born *Mobile, Ala.*

Occupation *Steward.*

**ENLISTMENT.**

When *Sep. 14*....., 186 *3*.

Where *Prov., R.I.*

By whom *W. H. Helme*; term *3* y'rs.

Remarks:

.....  
.....  
.....  
.....  
.....  
.....  
.....  
.....  
.....  
.....

*O. J. Markle*



*11* | 11 H. Art'y. | U.S.C.T.

*Charles Williams*  
Pot., Co. *D*, 14 Reg't R. I. Col'd H. Art'y.\*

Age *22* years.

Appears on

**Company Muster-in Roll**

of the organization named above. Roll dated

*Providence R.I., Sept 22, 1863.*

Muster-in to date *Sept. 22, 1863.*

Joined for duty and enrolled:

When *Sept. 14*, 186 .

Where *Prov. R. I.*

Period *3* years.

Valuation of horse, \$ *100*

Valuation of horse equipments, \$ *100*

Remarks: *Residence R.I.*

\* This organization subsequently became Co. *D*, 11 Reg't U. S. Colored Heavy Artillery.

Book mark: \_\_\_\_\_

*Lerrins*

*H* 11 H. Art'y. | **U.S.C.T.**

*Charles H. Williams*  
*Pvt.*, Co. D, 14 Reg't R. I. Col'd H. Art'y.\*

Appears on

**Company Muster Roll**  
for *Sept. 22 to Dec. 31*, 1863.

Present or absent *Present*

Stoppage, \$ 100 for

Due Gov't, \$ 100 for

Valuation of horse, \$ 100

Valuation of horse equipments, \$ 100

Remarks: *Stop for one Knapsack*  
*2.14*

\*This organization subsequently became Co. D, 11 Reg't U. S. Col'd Heavy Artillery.

Book mark: \_\_\_\_\_

*Lerring*

(358)

Copyist.

*H* | **11 H. Art'y. | U.S.C.T.**

*Charles Williams*  
-----  
*Pvt.*, Co. D, 14 Reg't R. I. Col'd H. Art'y.\*

Appears on

**Company Muster Roll**

for *Sept. 27/63 to Feb. 29, 1864.*

Present or absent *Present*

Stoppage, \$-----100 for -----

Due Gov't, \$-----100 for -----

Valuation of horse, \$-----100

Valuation of horse equipments, \$-----100

Remarks: *Knapsack \$2.14*

\*This organization subsequently became Co. D, 11 Reg't U. S. Col'd Heavy Artillery.

Book mark: -----

*Lerring*



*M* | **11 H. Art'y. U.S.C.T.**

*Charles Williams*  
*ser*, Co. *D*, 8 Reg't U. S. Col'd H. Art'y.\*

Appears on

**Company Muster Roll**

for *Mar & Apr*, 1864.

Present or absent *present*

Stoppage, \$ *100* for

Due Gov't, \$ *100* for

Valuation of horse, \$ *100*

Valuation of horse equipments, \$ *100*

Remarks: *Stop for*  
*knapsack \$ 2.14*

† This organization subsequently became Co. *D*, 11 Reg't U. S. Colored Heavy Artillery.

Book mark: \_\_\_\_\_

*W. L. Allen*

*M.*

**11 H. Art'y. U.S.C.T.**

*Charles Williams*

*priv.*, Co. *D*, 8 Reg't U. S. Col'd H. Art'y.\*

Appears on

**Company Muster Roll**

for *May & June*, 1864.

Present or absent *present*

Stoppage, \$ 100 for

Due Gov't, \$ 100 for

Valuation of horse, \$ 100

Valuation of horse equipments, \$ 100

Remarks: *Stop for  
knapsack 2.14*

\*This organization subsequently became Co. *D*, 11 Reg't U. S. Colored Heavy Artillery.

Book mark:

*Wm Allen*

*M* | 11 H. Art'y. | U.S.C.T.

*Charles Williams*  
*Out*, Co. D, 11 Reg't U. S. Col'd H. Art'y.

Appears on

**Company Muster Roll**

for *July Aug*, 186*4*

Present or absent *Present*

Stoppage, \$ *214* for *Ex Gr*  
100

Due Gov't, \$ 100 for

Valuation of horse, \$ 100

Valuation of horse equipments, \$ 100

Remarks: *free Apr 19/61*

Book mark:

*Proctor*



*M* | 11 H. Art'y. | U.S.C.T.

*Chas William*

*Pvt*, Co. D, 11 Reg't U. S. Col'd H. Art'y.

Appears on

**Company Muster Roll**

for *Sept + Oct*, 1864

Present or absent *Present*

Stoppage, \$ *100* for

Due Gov't, \$ *100* for

Valuation of horse, \$ *100*

Valuation of horse equipments, \$ *100*

Remarks: *Joined Co*

*Oct 18/64*

Book mark:

*Bradley*

*W* | 11 H. Art'y. | U.S.C.T.

*Charles Williams*  
*Priv.*, Co. D, 11 Reg't U. S. Col'd H. Art'y.

Appears on

**Company Muster Roll**

for *Nov. & Dec.*, 1864.

Present or absent *Present*

Stoppage, \$ 100 for

Due Gov't, \$ 100 for

Valuation of horse, \$ 100

Valuation of horse equipments, \$ 100

Remarks: \_\_\_\_\_  
\_\_\_\_\_  
\_\_\_\_\_  
\_\_\_\_\_  
\_\_\_\_\_  
\_\_\_\_\_

Book mark: \_\_\_\_\_

*Grogan*

*W* | 11 H. Art'y. | **U.S.C.T.**

*Charles Williams*  
*Priv.*, Co. D, 11 Reg't U. S. Col'd H. Art'y.

Appears on

**Company Muster Roll**

for *Jan. 5 Feb. 1865*, 1865.

Present or absent *Present*

Stoppage, \$ 100 for

Due Gov't, \$ 100 for

Valuation of horse, \$ 100

Valuation of horse equipments, \$ 100

Remarks:

Book mark:

*Grogan*



*W* | 11 H. Art'y. | U.S.C.T.

*Charles Williams*  
*Priv.*, Co. D, 11 Reg't U. S. Col'd H. Art'y.

Appears on

**Company Muster Roll**

for *March & April*, 1865.

Present or absent *Present*

Stoppage, \$.....100 for .....

Due Gov't, \$.....100 for .....

Valuation of horse, \$.....100

Valuation of horse equipments, \$.....100

Remarks: .....

.....  
.....  
.....  
.....  
.....  
.....  
.....  
.....

Book mark: .....

*Grogan*  
.....  
Copyist.

*W* | 11 H. Art'y. | U.S.C.T.

*Charles Williams,*  
*Privt.,* Co. D, 11 Reg't U. S. Col'd H. Art'y.

Appears on

**Company Muster Roll**

for *May & June*, 1865.

Present or absent *Present,*

Stoppage, \$ *45*/<sub>100</sub> for *ordnance*

Due Gov't, \$ *100* for

Valuation of horse, \$ *100*

Valuation of horse equipments, \$ *100*

Remarks:

Book mark:

*C. F. Thompson,*  
Copyist.

W | 11 H.q. | U.S.C.T.

Charles Williams  
Pvt., Co. D., 11 Reg't U. S. Col'd H.q.

Appears on

**Company Muster Roll**

for July & Aug., 1865.

Present or absent P Present.

Stoppage, \$ 45 / 100 for ordnance

Due Gov't, \$ 100 for

Valuation of horse, \$ 100

Valuation of horse equipments, \$ 100

Remarks:

Book mark:

(358)

C. G. Thompson.  
Copyist.



W | 11 H. Art'y. | **U.S.C.T.**

Charles Williams,  
Pvt., Co. D, 11 Reg't U. S. Col'd H. Art'y.

Appears on **Co. Muster-out Roll**, dated  
New Orleans, La., Oct. 2, 1865.

Muster-out to date Oct. 2, 1865.

Last paid to Feb. 28, 1865.

**Clothing account:**

Last settled....., 186 ; drawn since \$..... 100

Due soldier \$ 3/34 100; due U. S. \$..... 100

Am't for cloth'g in kind or money adv'd \$..... 100

Due U. S. for arms, equipments, &c., \$ 45 100

Bounty paid \$ none 100; due \$ 100 100

Remarks: joined at regt orgn.  
Stop for crew driver,  
Companion and Wifes lost  
Free Apr. 19/61

Book mark: 1865

C. F. Thompson.

Williams, Chas:

I, Co., 11 Reg't U.S.C.H.A.

Enclosures.

Bed Cards .....	Final Statements .....
Burial Records .....	Furloughs or L. of A. ....
Certs. of Dis. for Discharge .....	Med. Certificates .....
C. M. Charges .....	Med. Des. Lists .....
Descriptive Lists .....	Orders .....
Discharge Certificates .....	Pris. of War Record .....
Enlistment Papers .....	Resignations .....

Other papers relating to—

Admission to Hosp'l .....	Furlough or L. of A. ....
Casualty Sheet .....	Med. Examination .....
Confinement .....	Misc. Information .....
Contracts .....	Pay or Clothing .....
Death or Effects .....	Personal Reports .....
Desertion .....	Rank .....
Discharge from Hosp'l .....	Transfer to Hosp'l .....
Discharge from Service .....	Transfer to V. R. C. ....
Duty .....	Transportation .....

DECLARATION OF RECRUIT.

I, *Charles Williams* desiring to VOLUNTEER as a Soldier in the ARMY OF THE UNITED STATES, for the term of *three years* do declare that I am *22* years and *three years* months of age; that I have never been discharged from the United States service on account of disability or by sentence of a court martial, or by order, before the expiration of a term of enlistment; and I know of no impediment to my serving honestly and faithfully as a soldier for *three years*

Given at *Providence*  
The *14th* day of *Sept* 186*5*

Witness:

*W. H. Nelson*

*Charles Williams*

*11. W. S. - E. H. 24*

*Charles Williams*

Volunteered at *Providence R.I.*

*September 14th 1865*

By *W. H. Nelson*

*1st Lt. Regiment of M.A.S.*

enlistment; last served in Company ( )

Regt of

Discharged

18



CONSENT IN CASE OF MINOR.

I, \_\_\_\_\_ Do CERTIFY that I am the \_\_\_\_\_ of \_\_\_\_\_; that the said \_\_\_\_\_ is \_\_\_\_\_ years of age; and I do hereby freely give my CONSENT to his volunteering as a SOLDIER in the ARMY OF THE UNITED STATES for the period of \_\_\_\_\_

Given at \_\_\_\_\_  
The \_\_\_\_\_ day of \_\_\_\_\_

Witness:



# VOLUNTEER ENLISTMENT.

State of

Rhode Island



Town of

Providence

I, *Charles Williams*, born in *Mobile* in the State of *Alabama* aged *22* years, and by occupation a *Steward*

DO HEREBY ACKNOWLEDGE to have volunteered this *fourteenth* day of *September* 18 *63* to serve as a SOLDIER in the ARMY OF THE UNITED STATES OF AMERICA, for the period of *Three Years*, unless sooner discharged by proper authority: Do also agree to accept such bounty, pay, rations and clothing, as are, or may be, established, by law for volunteers. And I, *Charles Williams* do solemnly swear, that I will bear true faith and allegiance to the *United States of America*, and that I will serve them honestly and faithfully against all their enemies or opposers whomsoever; and that I will observe and obey the orders of the President of the United States, and the orders of the officers appointed over me, according to the Rules and Articles of War.

Sworn and Subscribed to, at *Providence*

this *14th* day of *Sept* 18 *63*.

BEFORE

*Thomas W. Smith*  
*Capt of the Regt*

*sub*  
*Charles Williams*  
*mark*

I CERTIFY, ON HONOR, That I have carefully examined the above-named Volunteer, agreeable to the General Regulations of the Army, and that, in my opinion, he is free from all bodily defects and mental infirmity, which would, in any way, disqualify him from performing the duties of a soldier.

*Johnson Gardner M.D.*

EXAMINING SURGEON.

I CERTIFY, ON HONOR, That I have minutely inspected the Volunteer, *Charles Williams* previously to his enlistment, and that he was entirely sober when enlisted; that to the best of my judgment and belief, he is of lawful age; and that, in accepting him as duly qualified to perform the duties of an able-bodied soldier, I have strictly observed the Regulations which govern the recruiting service. This soldier has *brown* eyes *black* hair

*fair* complexion, is *5* feet, *3 3/4* inches high.

*12th Colonel* Regiment of *H. Whiting* *R.I.* Volunteers.

*Wm. H. White* RECRUITING OFFICER.

2011

Williams Charles C.

Co A., 11 U.S. Col'd H. Art'y.

Private Private.

CARD NUMBERS.

1	6182280	26
2	6182420	27
3	6182567	28
4	6182707	29
5	6182845	30
6	6182976	31
7	6183103	32
8	6183225	33
9	6183333	34
10	6183443	35
11	6183548	36
12	6183655	37
13	6183761	38
14	9123909	39
15	9124263	40
16		41
17		42
18		43
19		44
20		45
21		46
22		47
23		48
24		49
25		50

Book Mark:

V. 135. P. 225. 72

See also



*W* | 11 H. Art'y. | U.S.C.T.

*Charles C Williams*

....., Co *A*, 11 Reg't U. S. Col'd H. Art'y.

Appears on

**Company Descriptive Book**

of the organization named above.

**DESCRIPTION.**

Age *19* years; height *5* feet *9* inches.

Complexion *African*

Eyes *Blk*; hair *Blk*

Where born *Pennsburg Pa*

Occupation *Seaman*

**ENLISTMENT.**

When *Aug 20*, 186*3*.

Where *Providence*

By whom *Thos. W. Foy*; term *3* y'rs.

Remarks:

*Janus*



W | 11 H. Art'y. | U.S.C.T.

Charles C. Williams

Co. A, 11 Reg't U. S. Col'd H. Art'y.

Appears on

**Company Descriptive Book**

of the organization named above.

**DESCRIPTION.**

Age 19 years; height 5 feet 9 inches.

Complexion African

Eyes Blue; hair Blue

Where born Genesburg Pa

Occupation Seaman

**ENLISTMENT.**

When Aug 20, 1863.

Where Providence

By whom Capt Jos Fry; term 3 y'rs.

Remarks:

Janus

*W* | 11 H. Art'y. | U.S.C.T.

*Charles C. Williams*

*Pvt.*, Co. *A*, 14 Reg't R. I. Col'd H. Art'y.\*

Age *19* years.

Appears on

**Company Muster-in Roll**

of the organization named above. Roll dated

*Camp Smith near Providence R. I., Aug 28, 1863.*

Muster-in to date

*Aug 28, 1863.*

Joined for duty and enrolled:

When *Aug 20*, 186*3*.

Where *Providence*

Period *3* years.

Valuation of horse, \$.....*100*

Valuation of horse equipments, \$.....*100*

Remarks: *1st District*

\* This organization subsequently became Co. *A*, 11 Reg't U. S. Colored Heavy Artillery.

Book mark:.....

*Prewitt*

*W* | 11 H. Art'y. | U.S.C.T.

*Charles C. Williams*  
*Prvt*, Co. A, 14 Reg't R. I. Col'd H. Art'y.\*

Appears on

**Company Muster Roll**

for *Aug 28* to *Dec 31*, 1863.

Present or absent *Present*

Stoppage, \$ 100 for

Due Gov't, \$ 100 for

Valuation of horse, \$ 100

Valuation of horse equipments, \$ 100

Remarks:

\*This organization subsequently became Co. A, 11 Reg't U. S. Colored Heavy Artillery.

Book mark:

*Prewitt*

Copyist.



*W* | 11 H. Art'y. | U.S.C.T.

*Charles E. Williams*  
Cpt., Co. A, 14 Reg't R. I. Col'd H. Art'y.\*

Appears on

**Company Muster Roll**

for *Jan & Feb*, 1864.

Present or absent *Present*

Stoppage, \$ *100* for

Due Gov't, \$ *100* for

Valuation of horse, \$ *100*

Valuation of horse equipments, \$ *100*

Remarks:

\*This organization subsequently became Co. A, 11 Reg't U. S. Colored Heavy Artillery.

Book mark:

*Prewitt*

Copyist.

*W* | 11 H. Art'y. | U.S.C.T.

*Charles C Williams*  
*Pvt*, Co. A, 14 Reg't R. I. Col'd H. Art'y.\*

Appears on

**Company Muster Roll**

for *March & April*, 1864.

Present or absent *Present*

Stoppage, \$ *100* for

Due Gov't, \$ *100* for

Valuation of horse, \$ *100*

Valuation of horse equipments, \$ *100*

Remarks:

\*This organization subsequently became Co. A, 11 Reg't U. S. Colored Heavy Artillery.

Book mark:

*Prewitt*

*W* | 11 H. Art'y. | U.S.C.T.

*Chas. C. Williams*  
Pvt., Co. *A*, 8 Reg't U. S. Col'd H. Art'y.\*

Appears on

**Company Muster Roll**

for *May & June*, 1864.

Present or absent *Present*

Stoppage, \$ 100 for

Due Gov't, \$ 100 for

Valuation of horse, \$ 100

Valuation of horse equipments, \$ 100

Remarks:

\*This organization subsequently became Co. *A*, 11 Reg't U. S. Colored Heavy Artillery.

Book mark:

*Prewitt*



*Ch.* | 11 H. Art'y. | U.S.C.T.

*Charles C. Williams*  
*Pr.*, Co. A, 11 Reg't U. S. Col'd H. Art'y.

Appears on

Company Muster Roll  
for *July & Aug.*, 186*4*.

Present or absent *Present*

Stoppage, \$ 100 for

Due Gov't, \$ 100 for

Valuation of horse, \$ 100

Valuation of horse equipments, \$ 100

Remarks: *Overd. Apr. 19/6;*

Book mark:

*C. C. Williams*  
Copied.

*Ok.*

**11 H. Art'y. U.S.C.T.**

*Charles B. Williams*

*Pl.*, Co. A, 11 Reg't U. S. Col'd H. Art'y.

Appears on

**Company Muster Roll**

for *Sept. & Oct.*, 186*4*.

Present or absent *Present*

Stoppage, \$ 100 for

Due Gov't, \$ 100 for

Valuation of horse, \$ 100

Valuation of horse equipments, \$ 100

Remarks:

-----  
-----  
-----  
-----  
-----  
-----

Book mark: -----

*[Signature]*  
-----  
Copyist.

*Op*

11 H. Art'y.

U.S.C.T.

*Charles B. Williams*

*Pl.*, Co. A, 11 Reg't U. S. Col'd H. Art'y.

Appears on

**Company Muster Roll**

for *Nov. 4* & *Dec.*, 1864.

Present or absent *Present*

Stoppage, \$ *2*/<sub>100</sub> for *C. & G. Co.*

Due Gov't, \$ *1*/<sub>100</sub> for

Valuation of horse, \$ *1*/<sub>100</sub>

Valuation of horse equipments, \$ *1*/<sub>100</sub>

Remarks:

Book mark:

*[Signature]*  
Copyist.



*11* | **11 H. Art'y. | U.S.C.T.**

*Charles B. Williams*  
....., Co. A, 11 Reg't U. S. Col'd H. Art'y.

Appears on  
**Company Muster Roll**  
for *Jan, & Feb.*....., 186*5*.

Present or absent *Present*.....

Stoppage, \$ *9*/<sub>100</sub> for *b. v. G. B.*.....

Due Gov't, \$.....<sub>100</sub> for .....

Valuation of horse, \$.....<sub>100</sub>

Valuation of horse equipments, \$.....<sub>100</sub>

Remarks:.....  
.....  
.....  
.....  
.....  
.....  
.....

Book mark:.....

.....  
*[Signature]*  
.....

*11* | **11 H. Art'y. | U.S.C.T.**

*Charles W. Williams*  
*B.*, Co. A, 11 Reg't U. S. Col'd H. Art'y.

Appears on

**Company Muster Roll**  
for *Jan, & Feb.*, 186*5*.

Present or absent *Present*

Stoppage, \$ *9*/<sub>100</sub> for *b. & G. B.*

Due Gov't, \$ *100* for

Valuation of horse, \$ *100*

Valuation of horse equipments, \$ *100*

Remarks:  
-----  
-----  
-----  
-----  
-----  
-----  
-----  
-----

Book mark: -----

*[Signature]*  
-----  
-----

*Dr.* | **11 H. Art'y. U.S.C.T.**

*Robert C. Williams*

*Pl.*, Co. A, 11 Reg't U. S. Col'd H. Art'y.

Appears on

**Company Muster Roll**

for *Mar. & Apr.*, 1865.

Present or absent *Present*

Stoppage, \$ *2.00* for *h. & G. C.*

Due Gov't, \$ *1.00* for

Valuation of horse, \$ *1.00*

Valuation of horse equipments, \$ *1.00*

Remarks:

Book mark:

*[Signature]*  
Copyist.



*Dr.* | 11 H. Art'y. | U.S.C.T.

*Charles C. Williams,*  
*Sir.*, Co. A, 11 Reg't U. S. Col'd H. Art'y.

Appears on

**Company Muster Roll**

for *May<sup>4<sup>th</sup></sup> June*, 1865.

Present or absent *Present.*

Stoppage, \$ 100 for

Due Gov't, \$ 100 for

Valuation of horse, \$ 100

Valuation of horse equipments, \$ 100

Remarks: \_\_\_\_\_  
\_\_\_\_\_  
\_\_\_\_\_  
\_\_\_\_\_  
\_\_\_\_\_  
\_\_\_\_\_

Book mark: \_\_\_\_\_

*R. D. Grainger*

*W.* 11 H. Art'y. **U.S.C.T.**

*Charles C. Williams*

*3rd*, Co. A, 11 Reg't U. S. C&Gd H. Art'y.

Appears on

**Company Muster Roll**

for *July to August* 1865.

Present or absent *Present*

Stoppage, \$ *100* for

Due Gov't, \$ *100* for

Valuation of horse, \$ *100*

Valuation of horse equipments, \$ *100*

Remarks:

Book mark:

*M. B. Sawyer*

*W* | 11 H. Art'y. | U.S.C.T.

*Charles C. Williams,*  
*Priv.,* Co. *A*, 11 Reg't U. S. Col'd H. Art'y.

Appears on **Co. Muster-out Roll**, dated

*New Orleans, La., Oct. 2,* 1865.

Muster-out to date *Oct. 2,* 1865.

Last paid to *Feb. 28,* 1865.

Clothing account:

Last settled....., 186 ; drawn since \$..... 100

Due soldier \$ *3.<sup>07</sup>*/<sub>100</sub>; due U. S. \$..... 100

Am't for cloth'g in kind or money adv'd \$..... 100

Due U. S. for arms, equipments, &c., \$ *6.<sup>00</sup>*/<sub>100</sub>

Bounty paid \$..... 100; due \$ *100.<sup>00</sup>*/<sub>100</sub>

Remarks: *Joined Orpl. Cogn.*

*Stopped for 1 Month (and)*  
*Account retained.*

Book mark: *V. 135 P. 225. 72.*



Williams, Chas. C.

I, Co., 11 Reg't U.S.C.H.A.

**Enclosures.**

Bed Cards .....	Final Statements .....
Burial Records .....	Furloughs or L. of A. ....
Certs. of Dis. for Discharge .....	Med. Certificates .....
C. M. Charges .....	Med. Des. Lists .....
Descriptive Lists .....	Orders .....
Discharge Certificates .....	Pris. of War Record .....
Enlistment Papers .....	Resignations .....

**Other papers relating to—**

Admission to Hosp'l .....	Furlough or L. of A. ....
Casualty Sheet .....	Med. Examination .....
Confinement .....	Misc. Information .....
Contracts .....	Pay or Clothing .....
Death or Effects .....	Personal Reports .....
Desertion .....	Rank .....
Discharge from Hosp'l .....	Transfer to Hosp'l .....
Discharge from Service .....	Transfer to V. R. C. ....
Duty .....	Transportation .....

DECLARATION OF RECRUIT.

I, *Charles C Williams* desiring to VOLUNTEER as a Soldier in the ARMY OF THE UNITED STATES, for the term of *three years*, do declare that I am *nineteen* years and months of age; that I have never been discharged from the United States service on account of disability or by sentence of a court martial, or by order, before the expiration of a term of enlistment; and I know of no impediment to my serving honestly and faithfully as a soldier for *the First Colored Company Heavy Artillery*

Given at *Providence*  
The *twentieth* day of

18*65*.

Witness:

*Julius P Hamblin*

*Charles C Williams*

*11 N. 2 St. A*  
No. *999*  
*Charles C Williams*  
Volunteered at *Providence R.I.*  
*Virginia Sept 1863.*  
By *Charles C Williams*  
Regiment of



Discharged .....  
Reg't of .....  
enlistment; last served in Company ( )

CONSENT IN CASE OF MINOR.

I, \_\_\_\_\_ Do CERTIFY that I am the \_\_\_\_\_  
of \_\_\_\_\_ ; that the said \_\_\_\_\_  
is \_\_\_\_\_ years of age; and I do hereby freely give  
my CONSENT to his volunteering as a SOLDIER in the ARMY OF THE UNITED STATES for the period of \_\_\_\_\_

Given at \_\_\_\_\_  
The \_\_\_\_\_ day of \_\_\_\_\_

Witness:



VOLUNTEER ENLISTMENT.

State of  
Rhode Island



Town of  
Providence

I, *Charles C Williams* born in *Pennsbury*  
in the State of *Pennsylvania* aged *Nineteen* years, and by occupation  
a *Seaman* DO HEREBY ACKNOWLEDGE to have volunteered this *twentieth*  
day of *August* 18*63*, to serve as a SOLDIER in the ARMY OF THE UNITED STATES  
of AMERICA, for the period of *Three years*, unless sooner discharged by proper authority:  
Do also agree to accept such bounty, pay, rations and clothing, as are, or may be, established by law for  
volunteers. And I, *Charles C Williams* do solemnly swear, that I will bear  
true faith and allegiance to the *United States of America*, and that I will serve them honestly and faith-  
fully against all their enemies or opposers whomsoever; and that I will observe and obey the orders of  
the President of the United States, and the orders of the officers appointed over me, according to the  
Rules and Articles of War.

Sworn and subscribed to, at *Providence*  
this *twentieth* day of *August* 18*63*.  
BEFORE *Geo. Palmer*  
*Justice of the Peace*

*Charles C Williams*

I CERTIFY, ON HONOR, That I have carefully examined the above-named Volunteer, agreeably to the General Regulations  
of the Army, and that, in my opinion, he is free from all bodily defects and mental infirmity, which would, in any way, disqualify  
him from performing the duties of a soldier.

*John W. Gardner*

EXAMINING SURGEON.

I CERTIFY, ON HONOR, That I have minutely inspected the Volunteer,  
previously to his enlistment, and that he was entirely sober when enlisted; that, to the best of my judgment and belief, he is  
of lawful age; and that, in accepting him as duly qualified to perform the duties of an able-bodied soldier, I have strictly observed  
the Regulations which govern the recruiting service. This soldier has *Black* eyes, *Black* hair,  
*African* complexion, is *five* feet, *Nine 1/2* inches high.

*Charles H Williams*

*Capt J. W. My*  
*First Colonel Company Heavy Artillery*  
*Regiment of Rhode Island Volunteers,*

RECRUITING OFFICER.



2012

Williams Charles H.

Co. G., 11 U.S. Col'd H. Art'y.

Private Private

CARD NUMBERS.

1	6192610	26
2	6192617	27
3	6192763	28
4	6192909	29
5	6193049	30
6	6193190	31
7	6193326	32
8	6193456	33
9	6193584	34
10	6193711	35
11	6193843	36
12	6194088	37
13	6194213	38
14	9125280	39
15		40
16		41
17		42
18		43
19		44
20		45
21		46
22		47
23		48
24		49
25		50

Book Mark:

See also

*N* | 11 H. Art'y. | U. S. C. T.

*Charles H. Williams*

....., Co. *9*, 11 Reg't U. S. Col'd H. Art'y.

Appears on

**Company Descriptive Book**

of the organization named above.

**DESCRIPTION.**

Age *21* years; height *5* feet *1* inches.

Complexion *Dark*.

Eyes *Dark*; hair *Dark*.

Where born *Arbans, New York*.

Occupation *Barber*.

**ENLISTMENT.**

When *Oct. 26*, 186 *3*.

Where *Prov., R. I.*

By whom *J. C. Engley*; term *3* y'rs.

Remarks: .....

.....

.....

.....

.....

.....

.....

.....

.....

.....

.....

.....

.....

.....

.....

.....

.....

.....

.....

.....

.....

.....

.....

.....

.....

*O. J. Markle*

W, | 11 H. Art'y. | U.S.C.T.

Charles H. Williams  
Priv, Co. G, 14 Reg't R. I. Col'd H. Art'y.\*

Age 21 years.

Appears on

**Company Muster-in Roll**

of the organization named above. Roll dated  
Providence, R. I., Nov. 4, 1863.

Muster-in to date Nov. 4, 1863.

Joined for duty and enrolled:

When Oct. 26, 1863.

Where Prov R. I.

Period 3 years.

Valuation of horse, \$ 100

Valuation of horse equipments, \$ 100

Remarks:

\* This organization subsequently became Co. G, 11 Reg't U. S. Colored Heavy Artillery.

Book mark:

Ramsey  
Copyist.



W. | 11 H. Art'y. | U.S.C.T.

Charles H. Williams  
1st Sgt., Co. G, 14 Reg't R. I. Col'd H. Art'y.\*

Appears on

**Company Muster Roll**

for Nov 4 to Dec. 31, 1863.

Present or absent Present

Stoppage, \$ 100 for

Due Gov't, \$ 100 for

Valuation of horse, \$ 100

Valuation of horse equipments, \$ 100

Remarks Promoted from Pvt.  
Nov. 10/63.

\* This organization subsequently became Co. G, 11 Reg't U. S. Colored Heavy Artillery.

Book mark:

Ramsey  
Copyist.

W. | 11 H. Art'y. | U.S.C.T.

Charles H. Williams  
1<sup>st</sup> Sgt, Co. G, 14 Reg't R. I. Col'd H. Art'y.\*

Appears on

**Company Muster Roll**

for Jan & Feb, 1864.

Present or absent Present.

Stoppage, \$ 100 for

Due Gov't, \$ 100 for

Valuation of horse, \$ 100

Valuation of horse equipments, \$ 100

Remarks: App'd 1<sup>st</sup> Sgt, Nov. 10/63.

\* This organization subsequently became Co. G, 11 Reg't U. S. Colored Heavy Artillery.

Book mark:

Ramsey

W. | 11 H. Art'y. | U.S.C.T.

Charles H. Williams  
1<sup>st</sup> Sergt, Co. G, 14 Reg't R. I. Col'd H. Art'y.\*

Appears on

**Company Muster Roll**

for Mar & Apr, 1864.

Present or absent Present

Stoppage, \$ 100 for

Due Gov't, \$ 100 for

Valuation of horse, \$ 100

Valuation of horse equipments, \$ 100

Remarks: App'td 1<sup>st</sup> Sergt., Nov. 10/63.

In arrest since April 29/64.

\* This organization subsequently became Co. G, 11 Reg't U. S. Colored Heavy Artillery.

Book mark: \_\_\_\_\_

Ramsey  
Copyist.



W.

11 H. Art'y. U.S.C.T.

Charles H. Williams  
1<sup>st</sup> Sgt. Co. G, 8 Reg't U. S. Col'd H. Art'y.\*

Appears on

Company Muster Roll

for May & June, 1864.

Present or absent Present.

Stoppage, \$ 100 for

Due Gov't, \$ 100 for

Valuation of horse, \$ 100

Valuation of horse equipments, \$ 100

Remarks: Appointed 1<sup>st</sup> Sgt.  
Nov. 10/63.

† This organization subsequently became Co. G, 11 Reg't U. S. Colored Heavy Artillery.

Book mark:

Ramsey  
Copyst.

*0/1* | **11 H. Art'y. U.S.C.T.**

*Charles H. Williams*

*1<sup>st</sup> Serg't*, Co. G, 11 Reg't U. S. Col'd H. Art'y.

Appears on

**Company Muster Roll**

for *July & Aug.*, 1864.

Present or absent *Present*

Stoppage, \$ *100* for

Due Gov't, \$ *100* for

Valuation of horse, \$ *100*

Valuation of horse equipments, \$ *100*

Remarks: *Appointed 1<sup>st</sup> Serg't  
Nov. 10, 1863.*

Book mark: \_\_\_\_\_

*Sitter*

*M.* | **11 H. Art'y. U.S.C.T.**

*Charles H. Williams.*  
*1<sup>st</sup> Serg't*, Co. G, 11 Reg't U. S. Col'd H. Art'y.

Appears on

**Company Muster Roll**

for *Sept. & Oct.*, 1864.

Present or absent *Present.*

Stoppage, \$ 100 for

Due Gov't, \$ 100 for

Valuation of horse, \$ 100

Valuation of horse equipments, \$ 100

Remarks: *Free Apr. 19 '61.*  
*App't'd 1<sup>st</sup> Serg't Nov.*  
*10, 1863.*

Book mark: \_\_\_\_\_

*Sitter*



*77*

**11 H. Art'y. U.S.C.T.**

*Charles H. Williams.*

*1<sup>st</sup> Serg't, Co. G, 11 Reg't U. S. Col'd H. Art'y.*

Appears on

**Company Muster Roll**

for *Nov. & Dec.*, 1864.

Present or absent *Present.*

Stoppage, \$ *100* for

Due Gov't, \$ *100* for

Valuation of horse, \$ *100*

Valuation of horse equipments, \$ *100*

Remarks: *Appointed Nov. 10, 1863.*

Book mark:

*Sitter.*

*M.*

**11 H. Art'y. U.S.C.T.**

*Charles H. Williams.*

*1<sup>st</sup> Serg't*, Co. G, 11 Reg't U. S. Col'd H. Art'y.

Appears on

**Company Muster Roll**

for *Jan. & Feb.*, 1865.

Present or absent *Present*

Stoppage, \$ *100* for

Due Gov't, \$ *100* for

Valuation of horse, \$ *100*

Valuation of horse equipments, \$ *100*

Remarks:

Book mark:

*Sitter.*

*M.*

11 H. Art'y. U.S.C.T.

*Charles H. Williams*

*1st Sert*, Co. G, 11 Reg't U. S. Col'd H. Art'y.

Appears on

**Company Muster Roll**

for *Mar. & Apr.*, 1863.

Present or absent *Present*

Stoppage, \$ *100* for

Due Gov't, \$ *100* for

Valuation of horse, \$ *100*

Valuation of horse equipments, \$ *100*

Remarks:

-----  
-----  
-----  
-----  
-----  
-----  
-----  
-----

Book mark: -----

*Sitter*



77 | 11 H. Art'y. | U.S.C.T.

Charles N Williams

1 Sgt., Co. G, 11 Reg't U. S. Col'd H. Art'y.

Appears on

**Company Muster Roll**

for May & June, 1865.

Present or absent Present

Stoppage, \$ 100 for

Due Gov't, \$ 100 for

Valuation of horse, \$ 100

Valuation of horse equipments, \$ 100

Remarks: Stop for Mosquitoes Bar  
# 1170

Book mark: \_\_\_\_\_

Lawrence

*W* | 11 H. Art'y. | **U.S.C.T.**

*Charles W Williams*

*Plt.*, Co. G, 11 Reg't U. S. Col'd H. Art'y.

Appears on

**Company Muster Roll**

for *dated Aug 31*, 186*5*:

Present or absent *Present*

Stoppage, \$ *100* for

Due Gov't, \$ *100* for

Valuation of horse, \$ *100*

Valuation of horse equipments, \$ *100*

Remarks: *Reduced from 1st Lt. to the Rank of July 17/65 by order of J. W. S. p. l. v.*

Book mark: \_\_\_\_\_

*Lawrence*

*N* | 11 H. Art'y. | **U.S.C.T.**

*Charles W Williams*

*Priv*, Co. *B*, 11 Reg't U. S. Col'd H. Art'y.

Appears on **Co. Muster-out Roll**, dated *New Orleans La Oct 2*, 1865.

Muster-out to date *Oct 2*, 1865.

Last paid to *June 30*, 1865.

**Clothing account:**

Last settled....., 186 ; drawn since \$.....<sup>100</sup>

Due soldier \$ *6*<sup>*50*</sup>/<sub>100</sub>; due U. S. \$.....<sup>100</sup>

Am't for cloth'g in kind or money adv'd \$.....<sup>100</sup>

Due U. S. for arms, equipments, &c., \$ *9*<sup>*10*</sup>/<sub>100</sub>

Bounty paid \$.....<sup>100</sup>; due \$ *157*<sup>*100*</sup>

Remarks: *Wounded at Camp Oregon  
Nov Oct to Nov 10, 63 1 Lt. A.  
to July 17/65 - stop for Amulet  
& acc'dts retained 1 Blk  
1 Pr seals*

Book mark : .....

*Lawrence*



William, Chas: H

D, Co., 11 Reg't U.S.C.A.

Enclosures.

Bed Cards .....	Final Statements .....
Burial Records .....	Furloughs or L. of A. ....
Certs. of Dis. for Discharge .....	Med. Certificates .....
C. M. Charges .....	Med. Des. Lists .....
Descriptive Lists .....	Orders / .....
Discharge Certificates .....	Pris. of War Record .....
Enlistment Papers .....	Resignations .....

Other papers relating to—

Admission to Hosp'l .....	Furlough or L. of A. / .....
Casualty Sheet .....	Med. Examination .....
Confinement / .....	Misc. Information / .....
Contracts .....	Pay or Clothing .....
Death or Effects .....	Personal Reports .....
Desertion .....	Rank .....
Discharge from Hosp'l .....	Transfer to Hosp'l .....
Discharge from Service .....	Transfer to V. R. C. ....
Duty .....	Transportation .....

DECLARATION OF RECRUIT.

I, *Charles W. Williams* desiring to VOLUNTEER as a Soldier in the ARMY OF THE UNITED STATES, for the term of *three years* do declare that I am *21* years and *3* months of age; that I have never been discharged from the United States service on account of disability or by sentence of a court martial, or by order, before the expiration of a term of enlistment; and I know of no impediment to my serving honestly and faithfully as a soldier for *three years*

Given at *Lowell* The *26th* day of *October* 18*63*

Witness: *R. L. Sean*

*Charles W. Williams*

*11 M D C R A*  
*100*

Volunteered at *Lowell, Vt.*  
*October 26th 1863*

By *Charles W. Williams*

*14th* Regiment of *Mass.*

enlistment; last served in Company (

Reg't of

Discharged



CONSENT IN CASE OF MINOR.

I, \_\_\_\_\_ of \_\_\_\_\_ is \_\_\_\_\_ years of age; and I do hereby freely give my CONSENT to his volunteering as a SOLDIER in the ARMY OF THE UNITED STATES for the period of \_\_\_\_\_

Given at \_\_\_\_\_ The \_\_\_\_\_ day of \_\_\_\_\_

Witness



# VOLUNTEER ENLISTMENT.



State of

*Rhode Island*

Town of

*Providence*

I, *Charles H. Williams* born in *Auburn*  
in the State of *New York* aged *21* years, and by occupation  
a *Barber* DO HEREBY ACKNOWLEDGE to have volunteered this *26th*  
day of *October* 18 *63* to serve as a SOLDIER in the ARMY OF THE UNITED STATES

OF AMERICA, for the period of *three years*, unless sooner discharged by proper authority:  
Do also agree to accept such bounty, pay, rations and clothing, as are, or may be, established, by law for  
volunteers. And I, *Charles H. Williams* do solemnly swear, that I will bear  
true faith and allegiance to the *United States of America*, and that I will serve them honestly and faith-  
fully against all their enemies or opposers whomsoever; and that I will observe and obey the orders of the  
President of the United States, and the orders of the officers appointed over me, according to the Rules  
and Articles of War.

Sworn and Subscribed to, at *Providence*  
this *26th* day of *October* 18 *63*  
BEFORE *Justices of the Peace* *Charles H. Williams*  
*mi*  
*mak*

I CERTIFY, ON HONOR, That I have carefully examined the above-named Volunteer, agreeable to the General Regulations of  
the Army, and that, in my opinion, he is free from all bodily defects and mental infirmity, which would, in any way, disqualify him  
from performing the duties of a soldier.

*Chisson Gardner*

EXAMINING SURGEON.

I CERTIFY, ON HONOR, That I have minutely inspected the Volunteer, *Charles H. Williams*  
previously to his enlistment, and that he was entirely sober when enlisted; that to the best of my judgment and belief, he is of  
lawful age; and that, in accepting him as duly qualified to perform the duties of an able-bodied soldier, I have strictly observed the  
Regulations which govern the recruiting service. This soldier has *dark* complexion, is *five* feet, *11* inches high. *dark* eyes *dark* hair.

*J. C. Engley Major*  
*14th* Regiment of *Volunteers,*

RECRUITING OFFICER.



Received from the  
you on the 1st 1865

William, Ohio, etc.

Requests a furlough  
for (7) seven days to  
visit Ohio & family.

29 Approved & respectfully forward  
There is only one absent  
in furlough from Co. E.  
at the present time

Wm. H. Johnson  
1st Lt. Company No. 2  
11th Regt. I. C. (Regt)

Health Inspector & Surg 11th U.S. Regt  
Regiment. San Juan, 15. 1865

Approved

To go as soon as Sergt Kelley  
and Sergt Mills return.

1865  
S.B.  
No. 13

By order of Maj  
H. G. Skobee  
Col. R. B. Banta  
J. M. D. D. D.  
2nd Div. 9th Corps

Recd from G

Camp Star, Plaquemine La.  
Jan. 14<sup>th</sup> 1865.

1<sup>st</sup> Lieut. G. H. Dancy,

(Capt. 2<sup>nd</sup> Regt. 11<sup>th</sup> Ala. S. L. Co. (Regt))

Sir - I have the honor to receive  
a gratings for (7) seven days to visit your children.

Very respectfully

Your obed<sup>t</sup> serv<sup>t</sup>

G. H. Williams

1<sup>st</sup> Lieut. 10<sup>th</sup> Ala. S. L. Co. (Regt)

202

Donaldsonville La.

July 17<sup>th</sup> 1865.

Yorkhill

Robt. S. 1<sup>st</sup> Lt. & Acty. Pro. Maj.

Reports the case of 1<sup>st</sup> Lieut.

Charles Williams of Co. G 11<sup>th</sup> U.S.

B. Art. (Heavy)

Her. Mrs.

U.S. Forces Donaldsonville

July 17<sup>th</sup> 1865

Respectfully  
referred to Maj  
R. J. Shan 1<sup>st</sup>  
Regt U.S. C. art.  
(1<sup>st</sup>) for his in-  
formation.

By order of  
Col. J. S. Synner  
Comd'g Troop  
H. W. Wittington  
1<sup>st</sup> Lt. 11<sup>th</sup> U.S. C. art.

Recd. July 17<sup>th</sup> 1865

Recd. 11. 16. 2. July 17<sup>th</sup> 1865



Office Provost Marshal,

PARISH OF ASCENSION.

Donaldsonville, La. July 17<sup>th</sup> 1865.

1<sup>st</sup> Lieut. J. C. Whiting:

I have the honor to report to you that 1<sup>st</sup> Sergt. Chas. Williams of Co. G. 11<sup>th</sup> U. S. C. Regt. (Heavy) has been in town here creating a disturbance in the Hotel. I had him report to this office and then ordered him to report to the commander of his company "Under Arrest". He tore his neck-tie apart, threw his coat down in the office and rushed out saying he would have revenge on the "d- n Dutch son of a bitch" that reported him. I then sent my whole guard after him with instructions to arrest him and take him to camp. I write while in the bar-room he made himself very familiar with Lieut-col. Wood by leaning on his shoulder. I write you the above for <sup>your</sup> information and trusting my actions will meet with your approval.

1<sup>st</sup> Lieut. J. C. Whiting  
Adj't M<sup>o</sup> U. S. C. R. (Regt)

I remain most respectfully  
your obed<sup>t</sup> servant

Wm. S. Galt  
1<sup>st</sup> Lt & Adj't Pro. Mar.

W. L. 11<sup>th</sup> Regt  
Donaldsonville La  
July 17<sup>th</sup> 1865,

---

General Order No. 23,

---

Reducing 1<sup>st</sup> Supt. Co, E,

---

W. L. 11<sup>th</sup> Regt  
July 21<sup>st</sup> 1865,



Hd-Qrs, Eleventh Reg't, U. S. C. A. (Hy.)

Donaldsonville, La. July 17. 1865.

General Orders.

No 23.

First Sergeant Charles A. Williams  
Co. G. 11 Reg U. S. C. A. (Hy). Is hereby reduced to the  
ranks. For intoxication and disorderly conduct  
His stripes will be cut from his arms  
in the presence of his Regiment on Dress Parade.

By order of  
Col J. W. Saylor  
Commanding Regt  
J. P. Manning  
1st Lieut. 11th Reg U. S. C. A. (Hy).  
Adjutant.



Mr. Ellensbrook,

(Charles H. Williams)

C. Co. 11 W.S. Art'y Regt

2

Adjutant General's Office,

COLORED TROOPS BRANCH,

July 31<sup>st</sup>, 1875.

Mr. Ellsbeck Vol. C. T., 187

Wanted in the case of Charles H. Williams, Co. "C",  
11<sup>th</sup> Reg't U.S.C.T.

Information in regard to arrest and if tried  
for March and April for Reports since Present "In"  
arrest since April 29, 1864

Respectfully,

L. A. Woodward  
Chief Clerk.  
J. H. Patton

Adjutant General's Office,

Div of ...  
1875

Vol. C. T., 187

Reply in case of ... 1<sup>st</sup> Sgt Co. G,  
11<sup>th</sup> Reg't U.S.C.T.

Summary Report of Co. G and other records of the Co and  
Regt in file request are report of his arrest April 24/64,  
near evidence of a trial in 1864.

Summary Reports date of July 15/65 report: "1<sup>st</sup> Sgt  
Charles H. Williams in confinement by order of Major  
A. S. Shaw" July 25 report: "1<sup>st</sup> Sgt C. H. Williams  
this date by Col. Dypher." Report information.

"Order 11<sup>th</sup> U.S.C.T. Reg't, Donaldsonville, La., July 17<sup>th</sup>, 1865,  
Order No. 23: "1<sup>st</sup> Sgt Charles H. Williams, Co. G, 11<sup>th</sup> Reg't U.S.C.  
Art. H. is hereby reduced to the ranks for intoxication and disorderly  
conduct. He stripes with ... out from our arms in the presence of  
his regiment on Dress Parade." by order Col. J. H. Dypher  
Comdg Regt.

C.A.3.



*Williams Ebenezer.*

Co *D.*, **11 U.S. Col'd H. Art'y.**

*Private. Private.*

CARD NUMBERS.

1	6187312	26
2	6187457	27
3	6187598	28
4	6187742	29
5	6187880	30
6	6188004	31
7	6188140	32
8	6188271	33
9	6188390	34
10	6188504	35
11	6188610	36
12	6188720	37
13	6188823	38
14	9124813	39
15	9121671	40
16		41
17		42
18		43
19		44
20		45
21		46
22		47
23		48
24		49
25		50

Book Mark: \_\_\_\_\_

See also \_\_\_\_\_



213 74478 P. O. Box  
A-305-7606, P.O. Box

SS. Mel Bur. 8/10/26

John Miller Esq

*W* | **11 H. Art'y. U.S.C.T.**

*Ebenezer Williams*

....., Co. *D*, 11 Reg't U. S. Col'd H. Art'y.

Appears on

**Company Descriptive Book**

of the organization named above.

**DESCRIPTION.\***

Age *20* years; height *5* feet *6 1/2* inches.

Complexion *Whit.*

Eyes *Brown*; hair *Blk.*

Where born *Long Island, N.Y.*

Occupation .....

**ENLISTMENT.**

When *Sept. 16*, 186*3*.

Where *Prov.*

By whom *Maj. Engley*; term *3* y'rs.

Remarks: *\*Promoted to be Corporal.*

*\*No further description given.*  
*\*A list is in the Descriptive Book.*

*O. J. Markle*

*W* | 11 H. Art'y. | **U.S.C.T.**

*Ebenezer Williams*

....., Co. *D*., 11 Reg't U. S. Col'd H. Art'y.

Appears on

**Company Descriptive Book**

of the organization named above.

**DESCRIPTION.**

Age *20* years; height *5* feet *6 1/2* inches.

Complexion *Mulatto.*

Eyes *Brown*; hair *Black.*

Where born *Long Island, N.Y.*

Occupation .....

**ENLISTMENT.**

When *Sep. 16*....., 186 *3*.

Where *Prov. R.I.*

By whom *J. C. Engley*; term *3* y'rs.

Remarks: .....

*x No further description given*

*O. J. Markle,*



174 | 11 H. Art'y. | U.S.C.T.

*Ebner Williams*  
Pvt., Co. *D*, 14 Reg't R. I. Col'd H. Art'y.\*

Age *20* years.

Appears on

**Company Muster-in Roll**

of the organization named above. Roll dated

*Providence R. I., Sept. 22, 1863.*

Muster-in to date

*Sept. 22, 1863.*

Joined for duty and enrolled:

When *Sept. 6*, 186 .

Where *Prov. R. I.*

Period *3* years.

Valuation of horse, \$.....*100*

Valuation of horse equipments, \$.....*100*

Remarks: *Residence N.Y.*

\* This organization subsequently became Co. *D*, 11 Reg't U. S. Colored Heavy Artillery.

Book mark: .....

*Loring*

*W* | **11 H. Art'y. | U.S.C.T.**

*Ebenezzer Williams*  
*Pvt.*, Co. D, 14 Reg't R. I. Col'd H. Art'y.\*

Appears on

**Company Muster Roll**

for *Sept. 22 to Dec. 31*, 1863.

Present or absent *Present*

Stoppage, \$ *100* for

Due Gov't, \$ *100* for

Valuation of horse, \$ *100*

Valuation of horse equipments, \$ *100*

Remarks: \_\_\_\_\_  
\_\_\_\_\_  
\_\_\_\_\_  
\_\_\_\_\_  
\_\_\_\_\_  
\_\_\_\_\_

\*This organization subsequently became Co. D, 11 Reg't U. S. Col'd Heavy Artillery.

Book mark: \_\_\_\_\_

(358) *Lerrin* Copyist.

*H* | 11 H. Art'y. | U.S.C.T.

*Elmer Williams*  
*Pvt.*, Co. D, 14 Reg't R. I. Col'd H. Art'y.\*

Appears on

**Company Muster Roll**

for *Sept. 22/63 to Feb. 29, 1864.*

Present or absent *Present*

Stoppage, \$ *100* for

Due Gov't, \$ *100* for

Valuation of horse, \$ *100*

Valuation of horse equipments, \$ *100*

Remarks:

\*This organization subsequently became Co. D, 11 Reg't U. S. Col'd Heavy Artillery.

Book mark:

*Loring*



*M.* | **11 H. Art'y. | U.S.C.T.**

*Eleazer Williams*

*ser.*, Co. *D.*, 8 Reg't U. S. Col'd H. Art'y.\*

Appears on

**Company Muster Roll**

for *Mar + Apr*, 1864.

Present or absent *present*

Stoppage, \$ *100* for

Due Gov't, \$ *100* for

Valuation of horse, \$ *100*

Valuation of horse equipments, \$ *100*

Remarks:  
.....  
.....  
.....  
.....  
.....  
.....  
.....  
.....

† This organization subsequently became Co. *D.*, 11 Reg't U. S. Colored Heavy Artillery.

Book mark: .....

*Am Allen*

*N.* | **11 H. Art'y. | U.S.C.T.**

*Benjamin Williams*  
*priv.*, Co. *D*, 8 Reg't U. S. Col'd H. Art'y.\*

Appears on

**Company Muster Roll**

for *May + June*, 18*64*.

Present or absent *present*

Stoppage, \$ *100* for

Due Gov't, \$ *100* for

Valuation of horse, \$ *100*

Valuation of horse equipments, \$ *100*

Remarks:

.....  
.....  
.....  
.....  
.....

\* This organization subsequently became Co. *D*, 11 Reg't U. S. Colored Heavy Artillery.

Book mark: .....

*Am. Allen*

W | 11 H. Art'y. | U.S.C.T.

Ebenzer Williams

Pvt, Co. D, 11 Reg't U. S. Col'd H. Art'y.

Appears on

Company Muster Roll

for July Aug, 1864

Present or absent Present

Stoppage, \$ 100 for

Due Gov't, \$ 100 for

Valuation of horse, \$ 100

Valuation of horse equipments, \$ 100

Remarks: Free Apr 19/61

Book mark:

Biddle



*U* | 11 H. Art'y. | U.S.C.T.

*Ebenezer Williams*

*Priv*, Co. D, 11 Reg't U. S. Col'd H. Art'y.

Appears on

**Company Muster Roll**

for *Sept Oct*, 186 *4*

Present or absent *Present*

Stoppage, \$ *100* for

Due Gov't, \$ *100* for

Valuation of horse, \$ *100*

Valuation of horse equipments, \$ *100*

Remarks:

Book mark:

*Prindle*

*W* | 11 H. Art'y. | U.S.C.T.

*Ebenezer Williams*  
*Priv.*, Co. D, 11 Reg't U. S. Col'd H. Art'y.

Appears on

**Company Muster Roll**

for *Nov. & Dec.*, 1864.

Present or absent

*Present*

Stoppage, \$ 100 for

Due Gov't, \$ 100 for

Valuation of horse, \$ 100

Valuation of horse equipments, \$ 100

Remarks:

Book mark:

*Grogan*

*W* | 11 H. Art'y. | U.S.C.T.

*Ebenezer Williams*  
*Priv.*, Co. D, 11 Reg't U. S. Col'd H. Art'y.

Appears on

**Company Muster Roll**

for *Jan. & Feb.*, 186*5*.

Present or absent *Present*

Stoppage, \$.....100 for .....

Due Gov't, \$.....100 for .....

Valuation of horse, \$.....100

Valuation of horse equipments, \$.....100

Remarks: .....

Book mark: .....

*Grogan*

Copyist.



*W* | 11 H. Art'y. | U.S.C.T.

*Ebenezer Williams*  
*Priv.*, Co. D, 11 Reg't U. S. Col'd H. Art'y.

Appears on

**Company Muster Roll**

for *March + April*, 1865.

Present or absent *Present*

Stoppage, \$ 100 for

Due Gov't, \$ 100 for

Valuation of horse, \$ 100

Valuation of horse equipments, \$ 100

Remarks: \_\_\_\_\_  
\_\_\_\_\_  
\_\_\_\_\_  
\_\_\_\_\_  
\_\_\_\_\_  
\_\_\_\_\_  
\_\_\_\_\_

Book mark: \_\_\_\_\_

*Grogan*  
Copyist.

*W* | 11 H. Art'y. | U.S.C.T.

*Ebenezer Williams,*  
Pvt., Co. D, 11 Reg't U. S. Col'd H. Art'y.

Appears on

**Company Muster Roll**

for *May & June*, 1865.

Present or absent *Present*

Stoppage, \$ *22* / *100* for *ordnance*

Due Gov't, \$ *100* for

Valuation of horse, \$ *100*

Valuation of horse equipments, \$ *100*

Remarks:

Book mark:

*C. F. Thompson,*  
Copyist.

W | H.A. | **U.S.C.T.**

Ebenezer Williams  
Privt, Co. D, 11 Reg't U. S. Col'd H.A.

Appears on

**Company Muster Roll**

for July & Aug., 1865.

Present or absent Present.

Stoppage, \$ 22 / 100 for ordnance

Due Gov't, \$ 100 for

Valuation of horse, \$ 100

Valuation of horse equipments, \$ 100

Remarks:

Book mark:

C. F. Thompson.  
Copyist.



W | 11 H. Art'y. | **U.S.C.T.**

Ebenezer Williams  
Privt., Co. D, 11 Reg't U. S. Col'd H. Art'y.

Appears on **Co. Muster-out Roll**, dated

New Orleans, La, Oct. 2, 1865.

Muster-out to date

Oct. 2, 1865.

Last paid to

Feb. 28, 1865.

**Clothing account:**

Last settled....., 186 ; drawn since \$.....<sup>100</sup>

Due soldier \$ 5<sup>93</sup>/<sub>100</sub>; due U. S. \$.....<sup>100</sup>

Am't for cloth'g in kind or money adv'd \$.....<sup>100</sup>

Due U. S. for arms, equipments, &c., \$.....<sup>78</sup>/<sub>100</sub>

Bounty paid \$ none <sup>100</sup>; due \$ 100 <sup>100</sup>

Remarks: Joined at or gl. or gu.  
Stop Munket & acct. ret'd. Co.  
Tompson, Wiper and four  
great Coat Straps lost.  
Free Apr. 19/61

Book mark: .....

C. F. Thompson.  
Copyist.

Williams, Ebenezer

P., Co.

11 Reg't U.S.C.A.

Enclosures.

Bed Cards .....	Final Statements .....
Burial Records .....	Furloughs or L. of A. ....
Certs. of Dis. for Discharge .....	Med. Certificates .....
C. M. Charges .....	Med. Des. Lists .....
Descriptive Lists .....	Orders .....
Discharge Certificates .....	Pris. of War Record .....
Enlistment Papers .....	Resignations .....

Other papers relating to—

Admission to Hosp'l .....	Furlough or L. of A. ....
Casualty Sheet .....	Med. Examination .....
Confinement .....	Misc. Information .....
Contracts .....	Pay or Clothing .....
Death or Effects .....	Personal Reports .....
Desertion .....	Rank .....
Discharge from Hosp'l .....	Transfer to Hosp'l .....
Discharge from Service .....	Transfer to V. R. C. ....
Duty .....	Transportation .....

DECLARATION OF RECRUIT.

I, *Ebenezer Williams*, desiring to VOLUNTEER as a Soldier in the ARMY OF THE UNITED STATES, for the term of *Three Years*, do declare that I am *Twenty* years and            months of age; that I have never been discharged from the United States service on account of disability or by sentence of a court martial, or by order, before the expiration of a term of enlistment; and I know of no impediment to my serving honestly and faithfully as a soldier for *Three Years*

Given at *Prov. R.I.*  
The *16* day of *Sept.* 18 *63*

Witness:

*Joseph Williams Jr* *Ebenezer Williams*

Discharged

Reg't of

enlistment; last served in Company ( )



18

No. *1124874*  
*Ebenezer Williams*  
Volunteered at *Providence R.I.*  
*Sept. 16 1863*  
By *J. Williams*  
Regiment of *1st Regt. A.C.*

CONSENT IN CASE OF MINOR.

I, \_\_\_\_\_ of \_\_\_\_\_ is \_\_\_\_\_ years of age; and I do hereby  give my CONSENT to his volunteering as a SOLDIER in the ARMY OF THE UNITED STATES for the period of \_\_\_\_\_

Given at \_\_\_\_\_  
The \_\_\_\_\_ day of \_\_\_\_\_

Witness:



# VOLUNTEER ENLISTMENT.

State of  
*Rhode Island*



Town of  
*Providence*

I, *Ebenezer Williams* born in *Long Island*  
in the State of *New York* aged *Twenty* years, and by occupation  
a *Farmer*

DO HEREBY ACKNOWLEDGE to have volunteered this *Sixteenth*  
day of *September* 18*63*, to serve as a SOLDIER in the ARMY OF THE UNITED STATES  
of AMERICA, for the period of *Three Years*, unless sooner discharged by proper authority:

Do also agree to accept such bounty, pay, rations and clothing, as are, or may be, established by law for  
volunteers. And I, *Ebenezer Williams* do solemnly swear, that I will bear  
true faith and allegiance to the *United States of America*, and that I will serve them honestly and faith-  
fully against all their enemies or opposers whomsoever; and that I will observe and obey the orders of  
the President of the United States, and the orders of the officers appointed over me, according to the  
Rules and Articles of War.

Sworn and subscribed to, at *Trov R.D.*  
this *17th* day of *Sept.* 18*63*

*Ebenezer Williams*

BEFORE *Wm. R. Neal*  
*Capt 7th Regt R.I. Vols*

I CERTIFY, ON HONOR, That I have carefully examined the above-named Volunteer, agreeably to the General Regulations  
of the Army, and that, in my opinion, he is free from all bodily defects and mental infirmity, which would, in any way, disqualify  
him from performing the duties of a soldier.

*B. Carpenter* EXAMINING SURGEON.

I CERTIFY, ON HONOR, That I have minutely inspected the Volunteer, *Ebenezer Williams*  
previously to his enlistment, and that he was entirely sober when enlisted; that, to the best of my judgment and belief, he is  
of lawful age; and that, in accepting him as duly qualified to perform the duties of an able-bodied soldier, I have strictly observed  
the Regulations which govern the recruiting service. This soldier has *Brown* eyes, *Blue* hair,  
*Russet* complexion, is *five* feet, *2 1/2* inches high.

*155th* *Civil* Regiment of *R.I. Vols.* Volunteers,

RECRUITING OFFICER.

2014

*Williams Edward.*

**Co A., 11 U.S. Col'd H. Art'y.**

*Private.* | *Private*

CARD NUMBERS.

1	6182279	26
2	6182419	27
3	6182566	28
4	6182706	29
5	6182843	30
6	6182994	31
7	6183821	32
8	9124070	33
9	9123913	34
10		35
11		36
12		37
13		38
14		39
15		40
16		41
17		42
18		43
19		44
20		45
21		46
22		47
23		48
24		49
25		50

Book Mark:

See also



*W* | 11 H. Art'y. | U.S.C.T.

*Edward Williams*

....., Co. *A*, 11 Reg't U. S. Col'd H. Art'y.

Appears on

**Company Descriptive Book**

of the organization named above.

**DESCRIPTION.**

Age *25* years; height *5* feet *7* inches.

Complexion *Dark*

Eyes *Dark*; hair *Dark*

Where born *New York N.Y.*

Occupation *Laborer*

**ENLISTMENT.**

When *Aug 18*, 1863.

Where *Providence*

By whom *W. Crabtree*; term *3* y'rs.

Remarks: *Died at Fort  
Jackson Aug. 26/64  
Inventory & final  
statements recd.  
Aug 27/64*

*James*



*Ed* | **11 H. Art'y. | U.S.C.T.**

*Edward Williams*

....., Co. *A*, 11 Reg't U. S. Col'd H. Art'y.

Appears on

**Company Descriptive Book**

of the organization named above.

**DESCRIPTION.**

Age *25* years; height *5* feet *7* inches.

Complexion *Dark*

Eyes *Dark*; hair *Dark*

Where born *New York N.Y.*

Occupation *Laborer*

**ENLISTMENT.**

When *Aug 18*, 186*3*.

Where *Providence*

By whom *L. Graham*; term *3* y'rs.

Remarks: *Dead at Fort Jackson La Aug 26/64 Inventory & final statement rec'd Aug 27/64*

*James*

*W* | 11 H. Art'y. | U.S.C.T.

*Edward Williams*  
Pvt., Co. *A*, 14 Reg't R. I. Col'd H. Art'y.\*

Age *25* years.

Appears on

**Company Muster-in Roll**

of the organization named above. Roll dated  
*Camp Smith near Providence R.I., Aug 28, 1863.*

Muster-in to date *Aug 28, 1863.*

Joined for duty and enrolled:

When *Aug 18*, 186*3*.

Where *Providence*

Period *3* years.

Valuation of horse, \$.....*100*

Valuation of horse equipments, \$.....*100*

Remarks: *1st District*

\* This organization subsequently became Co. *A*, 11 Reg't U. S. Colored Heavy Artillery.

Book mark:.....

*Prewitt*

*W* | **11 H. Art'y.** | **U.S.C.T.**

*Edward Williams*  
*Pvt.*, Co. A, 14 Reg't R. I. Col'd H. Art'y.\*

Appears on

**Company Muster Roll**

for *Aug 28* to *Dec 31*, 1863.

Present or absent *Present*

Stoppage, \$ 100 for

Due Gov't, \$ 100 for

Valuation of horse, \$ 100

Valuation of horse equipments, \$ 100

Remarks:

-----  
-----  
-----  
-----  
-----  
-----  
-----  
-----

\* This organization subsequently became Co. A, 11 Reg't U. S. Colored Heavy Artillery.

Book mark: -----  
-----

*Prewitt*  
Copyist.



*W* | 11 H. Art'y. | U.S.C.T.

*Edward Williams*  
*Pvt.*, Co. A, 14 Reg't R. I. Col'd H. Art'y.\*

Appears on

**Company Muster Roll**

for *Jan & Feb*, 1864.

Present or absent *Present*

Stoppage, \$ *100* for

Due Gov't, \$ *100* for

Valuation of horse, \$ *100*

Valuation of horse equipments, \$ *100*

Remarks:

\* This organization subsequently became Co. A, 11 Reg't U. S. Colored Heavy Artillery.

Book mark:

*Prewitt*

*W* | **11 H. Art'y. | U.S.C.T.**

*Edward Williams*  
*Pvt.*, Co. A, 14 Reg't R. I. Col'd H. Art'y.\*

Appears on

**Company Muster Roll**

for *March & April*, 1864.

Present or absent *Present*

Stoppage, \$ 100 for

Due Gov't, \$ 100 for

Valuation of horse, \$ 100

Valuation of horse equipments, \$ 100

Remarks:

\* This organization subsequently became Co. A, 11 Reg't U. S. Colored Heavy Artillery.

Book mark:

*Prewitt*  
Copyst.

*W* | **11 H. Art'y. | U.S.C.T.**

*Edward Williams*  
-----  
*Art*, Co. *A*, 8 Reg't U. S. Col'd H. Art'y.\*

Appears on

**Company Muster Roll**

for *May & June*, 1864.

Present or absent *Present*

Stoppage, \$ 100 for

Due Gov't, \$ 100 for

Valuation of horse, \$ 100

Valuation of horse equipments, \$ 100

Remarks: -----  
-----  
-----  
-----  
-----  
-----  
-----  
-----  
-----  
-----

\*This organization subsequently became Co. *A*, 11 Reg't U. S. Colored Heavy Artillery.

Book mark: -----  
-----

*Prewitt*



*W.*

11 H. Art'y. U.S.C.T.

*Edward Williams*

*W.*, Co. A, 11 Reg't U. S. Col'd H. Art'y.

Appears on

Company Muster Roll

for *July & Aug.*, 1864.

Present or absent

Stoppage, \$ 100 for

Due Gov't, \$ 100 for

Valuation of horse, \$ 100

Valuation of horse equipments, \$ 100

Remarks:

*Deceased  
Died Fort Jackson La.  
Aug. 26. 1864*

*Inventory and Final State-  
ments and Aug. 26. 1864*

Book mark:

*B. H. H.*

*W.* | 11 H. Art'y. | U.S.C.T.

*Edward Williams,*  
*Priv., Co. A., 11 Reg't U. S. Col'd H. Art'y.*

Appears on **Co. Muster-out Roll**, dated  
*New Orleans, La., Oct. 2, 1865.*

Muster-out to date \_\_\_\_\_, 186 .

Last paid to \_\_\_\_\_, 186 .

**Clothing account:**

Last settled \_\_\_\_\_, 186 ; drawn since \$ \_\_\_\_\_ 100

Due soldier \$ \_\_\_\_\_ 100; due U. S. \$ \_\_\_\_\_ 100

Am't for cloth'g in kind or money adv'd \$ \_\_\_\_\_ 100

Due U. S. for arms, equipments, &c., \$ \_\_\_\_\_ 100

Bounty paid \$ \_\_\_\_\_ 100; due \$ \_\_\_\_\_ 100

Remarks: *Joined Regt. Co. G. 26/64.*  
*Died Ft. Jackson, La., Aug.*  
*26/64. Insty. and Final Sett's*  
*ren'd Aug. 26/64.*

Book mark: \_\_\_\_\_

*R. D. Granger*

Williams, Edward

P, Co. A, 11 Reg U.S.C.H.A.

4 Enclosures.

Bed Cards	Descriptive Lists
Burial Records	Final Statements 2
Certs. of Dis. for Discharge	Furloughs
C. M. Charges	Med. Des. Lists
Med. Certificates	Orders

Other papers relating to—

Admission to Hosp'l	Furlough
Casualty Sheet (Officer's)	Med. Examination
Confinement	Misc. Information
Contracts	Pay or Clothing
Death or Effects 2	Personal Reports
Desertions	Rank
Discharge from Hosp'l	Transfer to Hosp'l
Discharge from Service	Transfer to V. R. C.
Duty	Transportation



ARTICLES OF WAR.

ART. 95. When any non-commissioned officer or soldier shall die, or be killed in the service of the United States, the then commanding officer of the troop or company shall, in the presence of two other commissioned officers, take an account of what effects he died possessed of, above his arms and accoutrements, and transmit the same to the office of the Department of War, which said effects are to be accounted for, and paid to the representatives of such deceased non-commissioned officer or soldier. And in case any of the officers, so authorized to take care of the effects of deceased officers and soldiers, should, before they have accounted to their representatives for the same, have occasion to leave the regiment or post, by preferment or otherwise, they shall, before they be permitted to quit the same, deposit in the hands of the commanding officer, or of the assistant military agent, all the effects of such deceased non-commissioned officers and soldiers, in order that the same may be secured for, and paid to, their respective representatives.

ARMY REGULATIONS—EDITION OF 1861.

DECEASED SOLDIERS.

Par. 152. Inventories of the effects of deceased non-commissioned officers and soldiers, required by the 95th Article of War, will be forwarded to the Adjutant General, by the commander of the company to which the deceased belonged, and a duplicate of the same to the colonel of the regiment. Final statements of pay, clothing, &c., will be sent with the inventories. When a soldier dies at a post or station absent from his company, it will be the duty of his immediate commander to furnish the required inventory, and, at the same time, to forward to the commanding officer of the company to which the soldier belonged, a report of his death, specifying the date, place, and cause; to what time he was last paid, and the money or other effects in his possession at the time of his decease; which report will be noted on the next muster roll of the company to which the man belonged. Each inventory will be endorsed, "Inventory of the effects of \_\_\_\_\_, late of company (—) \_\_\_\_\_ regiment of \_\_\_\_\_, who died at \_\_\_\_\_, the \_\_\_\_\_ day of \_\_\_\_\_, 186—." If a legal representative receive the effects, it will be stated in the report. If the soldier leave no effects, the fact will be reported.

Par. 153. Should the effects of a deceased non-commissioned officer or soldier not be administered upon within a short period after his decease, they shall be disposed of by a Council of Administration, under the authority of the commanding officer of the post, and the proceeds deposited with the Paymaster, to the credit of the United States, until they shall be claimed by the legal representatives of the deceased.

Par. 154. In all such cases of sales by the Council of Administration, a statement in detail, or account of the proceeds, duly certified by the Council and commanding officer, accompanied by the Paymaster's receipt for the proceeds, will be forwarded by the commanding officer to the Adjutant General. The statement will be endorsed, "Report of the proceeds of the effects of \_\_\_\_\_, late of company (—) \_\_\_\_\_ regiment of \_\_\_\_\_, who died at \_\_\_\_\_, the \_\_\_\_\_ day of \_\_\_\_\_, 186—."

NOTE 1.—The effects in all cases, when called for, should be turned over to the legal representative, without further authority from the Adjutant General. When the effects are turned over to the relatives of the deceased before these inventories are sent to the Adjutant General, their receipts therefor should be attached to the inventories. In all other cases, one copy will be sent with a letter of transmittal direct to the Adjutant General, and a duplicate retained by the officer.

NOTE 2.—Particular care should be taken to take receipts in duplicate from the Paymaster for any funds turned over to him; one copy should be sent direct to the Adjutant General and one retained by the officer.

INVENTORY OF THE EFFECTS

OF

Edward Williams

Late of Company A

8<sup>th</sup> Reg't of U S C A 36

Volunteers, who died at Fort Jackson

on the 20<sup>th</sup> day of August 1864.

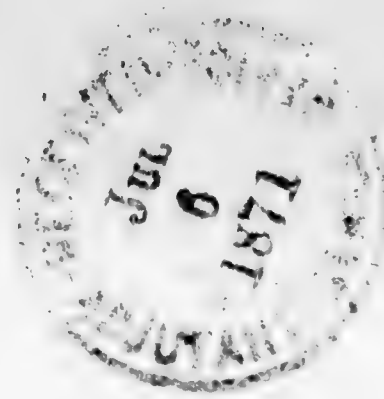

Inventory of the effects of Edward Williams late  
a Private of Captain Thos W. May Company A of  
the 8<sup>th</sup> Regiment of U.S.C.A. Heavy Volunteers, who was enrolled as  
a Private at Providence in the State of Rhode Island on  
the 18 day of August 1863, and mustered into the service of the United  
States as a Private on the 28<sup>th</sup> day of August 1863, at Providence  
in Company A, 14<sup>th</sup> Regiment of R.I. Heavy Volunteers, to serve three  
years or during the war; he was born in New York in the State  
of New York; he was 25 years of age, 5 feet 7 inches  
high, Dark complexion, Dark eyes, Dark hair, and by occupation, when enrolled,  
a Labourer; he died in Regt Hospital, at  
Fort Jackson on the 26<sup>th</sup> day of August 1864, by  
reason of Death Caused by Typho Malaria Fever,

INVENTORY.					
ARTICLES.	No.	ARTICLES.	No.	ARTICLES.	No.
Hats.....		Pairs trousers.....		Knapsacks.....	
Caps.....		Pairs flannel drawers.....			
Forage caps.....		Pairs cotton drawers.....			
Great coats.....		Flannel shirts.....			
Uniform coats.....		Cotton shirts.....			
Uniform jackets.....		Pairs boots.....			
Flannel sack coats.....		Pairs shoes.....			
Blouses.....		Pairs socks.....			
Stable frocks.....		Blankets.....		MONEY.	
Fatigue overalls.....		Haversacks.....		Specie.....	\$
				Notes.....	\$

I CERTIFY, ON HONOR, that the above inventory comprises all the effects of  
Edward Williams, deceased, and that the effects are in the hands  
of \_\_\_\_\_ at \_\_\_\_\_  
\_\_\_\_\_ to be disposed of by a Council of Administration.

(DUPLICATES.)

STATION: Fort Jackson La

DATE: August 27 1864

[A. G. O. No. 104.]

Thos W. May  
Capt U.S.C.A. & H  
Commanding the Company.



✓ FINAL STATEMENT

OF

*Edward William*

*8<sup>th</sup>* Reg't of U.S.C.A.H.  
*1126 S.*

**VOLUNTEERS.**

*Rec'd Aug 25 1864*

NOTE 1.—Two of these certificates (or duplicates) are to be given to each Volunteer Soldier or drafted man who may be discharged previously to the discharge of his company, that he may at once receive from the Paymaster the pay, &c., due him, and the captain or other COMMISSIONED officer commanding the company will certify to the act of the delivery of the duplicate certificates; on these certificates the Soldier is "entitled to" his discharge, and should also present his discharge to the Paymaster to have the payment endorsed on it. The discharge is to be given back to the Soldier by the Paymaster; the latter only retaining as his voucher the duplicate certificates.

NOTE 2.—If the Soldier is entitled to pay for the use of his horse, the Company Commander will certify to that fact on the back of both these final statements, and also to the time he has pay due for having been so mounted on his own horse.

NOTE 3.—When a Soldier is furnished with final statements, his descriptive list, if he has one, should be taken up by the officer who gives the Soldier these statements, and endorsed with a statement to this effect by the officer. This endorsement should exhibit a full statement of the time for which the Soldier was allowed pay on his final statements, the clothing account, and all other charges against him or in his favor, so as to comprise a complete exhibit of his account. It will then be transmitted to the company commander of the Soldier, who will enter all the data necessary to a full understanding of the Soldier's account on the muster roll upon which the Soldier's discharge is reported. The descriptive list will then be destroyed. The object of this is, that the remaining portion of the Soldier's account may be settled upon the receipt of these muster rolls, and the Soldier receive any pay or allowances that may be due him at the time of his discharge, and which may not appear on his final statements from the fact that his descriptive list is incomplete. These accounts for back pay, &c., are settled by the 2d Auditor of the Treasury Department.

NOTE 4.—Charges for loss or injury to ordnance, horse equipments, and other miscellaneous charges, should appear under the heading of "Other Stoppages."

NOTE 5.—Bounty paid by State authorities, and not by the United States, will not be entered on this statement.

NOTE 6.—Amounts due the Sutler and Laundress must be entered on the muster roll on which the discharge, death, desertion, &c., is reported, as well as on the final statement, otherwise the amount cannot be collected from the United States.

NOTE 7.—This blank will be used for deceased volunteers and drafted men, as well as for others.

NOTE 8.—Where a Soldier dies in Hospital or on detached service, his descriptive list, if he has one, should be sent with his final statements, in duplicate, to the Second Auditor, Washington, D. C.

ADJUTANT GENERAL'S OFFICE.

*Sept 13<sup>th</sup> 1864*

Duplicate with Inventory sent 2d Auditor.





I certify, on honor, that Edward Williams a Private of  
Captain Chas W Gray Company (10) of the 8<sup>th</sup> Regiment of U.S.C.A. Heavy  
**VOLUNTEERS**, of the State of Rhode Island, born in New York, State  
of New York, aged 25 years; 5 feet 7 inches high; Dark complexion,  
Dark eyes, Dark hair, and by occupation a Laborer, having joined the company on  
its original organization at Providence, and enrolled in it at the muster into  
the service of the United States at Providence R.I., on the Twenty Eight day  
of August, 1863, (~~or was mustered in service as a recruit, by~~ Capt. S. Gray  
1<sup>st</sup> U.S. Art., at \_\_\_\_\_, on the \_\_\_\_\_ day of \_\_\_\_\_,  
1863, or was drafted and mustered into the service of the United States from the \_\_\_\_\_  
Enrollment District of the State of \_\_\_\_\_, at \_\_\_\_\_,

on the \_\_\_\_\_ day of \_\_\_\_\_, 1863) to serve in the Regiment, for  
the term of Three Years: and having served **HONESTLY** and  
**FAITHFULLY** with his Company in 8<sup>th</sup> U.S.C.A. Heavy, to the present date, is now  
entitled to a **DISCHARGE** by reason of Death Caused by Typhoid  
Malaria Fever (Aced Aug 25<sup>th</sup> 1864 20th Regiment)

The said Edward Williams never was last paid by Paymaster  
\_\_\_\_\_ to include the \_\_\_\_\_ day of \_\_\_\_\_, 1863, and has  
pay due him from that time to the present date; he is entitled to pay and subsistence for  
**TRAVELING** to place of enrollment, and whatever other allowances are authorized to volunteer  
soldiers, drafted men, or militia, so discharged. He has received from the United States **CLOTHING**  
amounting to Seventy Five  $\frac{84}{100}$  dollars, since the 18 day of August,  
1863, when his clothing account was last settled. He has received from the United States  
 $\frac{100}{100}$  dollars advanced **BOUNTY**.

There is to be stopped from him, on account of the State of \_\_\_\_\_, or other  
authorities, for **CLOTHING**, &c., received on entering service, \_\_\_\_\_ dollars; and  
for other stoppages, viz: None \_\_\_\_\_ dollars.

He has been furnished with **TRANSPORTATION** in kind from the place of his discharge to  
\_\_\_\_\_ ; and he has been **SUBSISTED** for **TRAVELING** to his  
place of enrollment, up to the \_\_\_\_\_, 1863.

He is indebted to \_\_\_\_\_, **SUTLER**, \_\_\_\_\_ dollars.  
He is indebted to \_\_\_\_\_, **LAUNDRESS**, \_\_\_\_\_ dollars.

Given in Duplicate, at Fort Jackson, this 27<sup>th</sup> day  
of August, 1864.

Chas W Gray  
Capt. U.S.A.  
Commanding Company.

2015.

Williams Edward

Co. C., 11 U.S. Col'd H. Art'y.

Private. Private.

CARD NUMBERS.

1	6185642	26
2	6185788	27
3	6185930	28
4	6186073	29
5	6186205	30
6	6186334	31
7	6186458	32
8	6186570	33
9	6186683	34
10	6186794	35
11	6186905	36
12	6187017	37
13	6187127	38
14	4124513	39
15		40
16		41
17		42
18		43
19		44
20		45
21		46
22		47
23		48
24		49
25		50

Book Mark:

See also



*W* | **11 H. Art'y. | U.S.C.T.**

*Edward Williams*

....., Co. *C*, 11 Reg't U. S. Col'd H. Art'y.

Appears on

**Company Descriptive Book**

of the organization named above.

**DESCRIPTION.**

Age *20* years; height *5* feet *8* inches.

Complexion *DK mulatto*

Eyes *DK Hazel*; hair *Blk*

Where born *Brooklyn NY*

Occupation *Farmer*

**ENLISTMENT.**

When *Sept 1*, 186 *3*.

Where *Dr. R D*

By whom *My Sanford*; term *3* y'rs.

Remarks:

*James*

Copyist.



*N* | 11 H. Art'y. | U.S.C.T.

*Edward Williams*

*Priv, Co. C*, 14 Reg't R. I. Col'd H. Art'y.\*

Age *20* years.

Appears on

**Company Muster-in Roll**

of the organization named above. Roll dated

*Providence R.I., Sep 14*, 1863.

Muster-in to date *Sep 14*, 1863.

Joined for duty and enrolled:

When *Sept 1<sup>st</sup>*, 1863.

Where *Providence R.I.*

Period *3* years.

Valuation of horse, \$.....*100*

Valuation of horse equipments, \$.....*100*

Remarks:.....

\* This organization subsequently became Co. *C*, 11 Reg't U. S. Colored Heavy Artillery.

Book mark:.....

*Valentine*

*W* | 11 H. Art'y. | U.S.C.T.

*Edward Williams*

*Priv.*, Co. C, 14 Reg't R. I. Col'd H. Art'y.\*

Appears on

**Company Muster Roll**

for *Sept 14. to Dec 31*, 1863.

Present or absent *Present*

Stoppage, \$ *100* for

Due Gov't, \$ *100* for

Valuation of horse, \$ *100*

Valuation of horse equipments, \$ *100*

Remarks :

\*This organization subsequently became Co. C, 11 Reg't U. S. Colored Heavy Artillery.

Book mark :

*Valentine*

*N* | **11 H. Art'y. U.S.C.T.**

*Edward Williams*  
*Cuir*, Co. C, 14 Reg't R. I. Col'd H. Art'y.\*

Appears on

**Company Muster Roll**

for *Jan. & Feb.*, 1864.

Present or absent *Present*,

Stoppage, \$ *100* for

Due Gov't, \$ *100* for

Valuation of horse, \$ *100*

Valuation of horse equipments, \$ *100*

Remarks: \_\_\_\_\_  
\_\_\_\_\_  
\_\_\_\_\_  
\_\_\_\_\_  
\_\_\_\_\_

\*This organization subsequently became Co. C, 11 Reg't U. S. Colored Heavy Artillery.

Book mark: \_\_\_\_\_

*Valentine*



*N* | **11 H. Art'y. | U.S.C.T.**

*Edward Williams*  
*Priv*, Co. *C*, 8 Reg't U. S. Col'd H. Art'y.\*

Appears on

**Company Muster Roll**

for *March & Apr*, 186*H*.

Present or absent *Present*

Stoppage, \$ *100* for

Due Gov't, \$ *100* for

Valuation of horse, \$ *100*

Valuation of horse equipments, \$ *100*

Remarks:

\* This organization subsequently became Co. *C*, 11 Reg't U. S. Colored Heavy Artillery.

Book mark:

*Valentine*

*W* | **11 H. Art'y. | U.S.C.T.**

*Edward Williams*

*Priv*, Co. *C*, 8 Reg't U. S. Col'd H. Art'y.\*

Appears on

**Company Muster Roll**

for *May & June*, 186*4*.

Present or absent *Present*

Stoppage, \$ 100 for

Due Gov't, \$ 100 for

Valuation of horse, \$ 100

Valuation of horse equipments, \$ 100

Remarks:  
.....  
.....  
.....  
.....  
.....  
.....  
.....

† This organization subsequently became Co. *C*, 11 Reg't U. S. Colored Heavy Artillery.

Book mark: .....

*Valentine*

*A* | 11 H. Art'y. | U.S.C.T.

*Edward Williams*

*Cor.*, Co. C, 11 Reg't U. S. Col'd H. Art'y.

Appears on

**Company Muster Roll**

for *July & Aug*, 1864.

Present or absent. *Present*

Stoppage, \$ 100 for

Due Gov't, \$ 100 for

Valuation of horse, \$ 100

Valuation of horse equipments, \$ 100

Remarks: *True am 19, 61*

Book mark: \_\_\_\_\_

*Wm. J. ...*  
Coy. Sgt.



*A* | **11 H. Art'y. | U.S.C.T.**

*Edward Williams*

*Art*, Co. C, 11 Reg't U. S. Col'd H. Art'y.

Appears on

**Company Muster Roll**

for *Sept & Oct*, 186*4*

Present or absent *Present*

Stoppage, \$.....100 for .....

Due Gov't, \$.....100 for .....

Valuation of horse, \$.....100

Valuation of horse equipments, \$.....100

Remarks:.....  
.....  
.....  
.....  
.....  
.....  
.....  
.....

Book mark:.....

*Edward Williams*  
Copy

*H* | 11 H. Art'y. | U.S.C.T.

*Edwards Williams*

*Priv*, Co. C, 11 Reg't U. S. Col'd H. Art'y.

Appears on

**Company Muster Roll**

for *for Dec*, 186*4*.

Present or absent *Present*

Stoppage, \$ 100 for

Due Gov't, \$ 100 for

Valuation of horse, \$ 100

Valuation of horse equipments, \$ 100

Remarks: \_\_\_\_\_  
\_\_\_\_\_  
\_\_\_\_\_  
\_\_\_\_\_  
\_\_\_\_\_  
\_\_\_\_\_  
\_\_\_\_\_

Book mark: \_\_\_\_\_

*[Signature]*  
Copyist.

11 | 11 H. Art'y. | U.S.C.T.

*Edward Williams*

*Pr*, Co. C, 11 Reg't U. S. Col'd H. Art'y.

Appears on

**Company Muster Roll**

for *Jan 1st*, 1865.

Present or absent *Present*

Stoppage, \$ *100* for

Due Gov't, \$ *100* for

Valuation of horse, \$ *100*

Valuation of horse equipments, \$ *100*

Remarks:

Book mark:

*Edward Williams*  
Copyist.



*A* | 11 H. Art'y. | U.S.C.T.

*Edward Williams*

*Prvt*, Co. C, 11 Reg't U. S. Col'd H. Art'y.

Appears on

**Company Muster Roll**

for *March & Apr*, 186*4*.

Present or absent *Present*

Stoppage, \$ 100 for

Due Gov't, \$ 100 for

Valuation of horse, \$ 100

Valuation of horse equipments, \$ 100

Remarks:

Book mark:

*Amos* Copyist.

*M* | 11 H. Art'y. | U.S.C.T.

*Edward Williams*

*Pl*, Co. C, 11 Reg't U. S. Col'd H. Art'y.

Appears on

**Company Muster Roll**

for *May Am June*, 1865.

Present or absent

*Present*

Stoppage, \$.....100 for .....

Due Gov't, \$.....100 for .....

Valuation of horse, \$.....100

Valuation of horse equipments, \$.....100

Remarks:.....

.....  
.....  
.....  
.....  
.....  
.....  
.....  
.....  
.....

Book mark:.....

*Bliss*

*M* | 11 H. Art'y. | U.S.C.T.

*Edward Williams*

*PL*, Co. C, 11 Reg't U. S. Col'd H. Art'y.

Appears on

**Company Muster Roll**

for *July and Aug.*, 1865.

Present or absent *Present*

Stoppage, \$ *79* for *Conty. E*

Due Gov't, \$ *100* for

Valuation of horse, \$ *100*

Valuation of horse equipments, \$ *100*

Remarks: \_\_\_\_\_  
\_\_\_\_\_  
\_\_\_\_\_  
\_\_\_\_\_  
\_\_\_\_\_  
\_\_\_\_\_  
\_\_\_\_\_

Book mark: \_\_\_\_\_

*Bliss*  
Copyst.



*W* | 11 H. Art'y. | U.S.C.T.

*Edward Williamus*  
*Pr*, Co. *6*, 11 Reg't U. S. Col'd H. Art'y.

Appears on **Co. Muster-out Roll**, dated  
*New Orleans La, Oct. 2*, 1865.

Muster-out to date *Oct. 2*, 1865.

Last paid to *July 28*, 1865.

Clothing account:

Last settled....., 186 ; drawn since \$.....<sup>100</sup>

Due soldier \$.....<sup>100</sup>; due U. S. \$ *24*<sup>98</sup>/<sub>100</sub>

Am't for cloth'g in kind or money adv'd \$.....<sup>100</sup>

Due U. S. for arms, equipments, &c., \$.....<sup>100</sup>

Bounty paid \$.....<sup>100</sup>; due \$ *100*<sup>00</sup>/<sub>100</sub>

Remarks: *Joined Orgl. Argn.*  
*Stop for one mustet and*  
*acct's retained. Stop for*  
*6 and 4 Equifage articles*  
*unknown 79<sup>00</sup>*

Book mark : .....

*Bliss*

Copyist.

Williams, Edward

P, Co., 11 Reg't U.S.C.A.

**1 Enclosures.**

Bed Cards .....	Final Statements .....
Burial Records .....	Furloughs or L. of A. ....
Certs. of Dis. for Discharge .....	Med. Certificates .....
C. M. Charges .....	Med. Des. Lists .....
Descriptive Lists .....	Orders .....
Discharge Certificates .....	Pris. of War Record .....
Enlistment Papers .....	Resignations .....

Other papers relating to—

Admission to Hosp'l .....	Furlough or L. of A. ....
Casualty Sheet .....	Med. Examination .....
Confinement .....	Misc. Information .....
Contracts .....	Pay or Clothing .....
Death or Effects .....	Personal Reports .....
Desertion .....	Rank .....
Discharge from Hosp'l .....	Transfer to Hosp'l .....
Discharge from Service .....	Transfer to V. R. C. ....
Duty .....	Transportation .....

DECLARATION OF RECRUIT.

I, *Edward Williams*, desiring to VOLUNTEER as a Soldier in the ARMY OF THE UNITED STATES, for the term of *three years* do declare that I am *20* years and *1* months of age; that I have never been discharged from the United States service on account of disability or by sentence of a court martial, or by order, before the expiration of a term of enlistment; and I know of no impediment to my serving honestly and faithfully as a soldier for *3y*

Given at *Providence*  
The *12* day of *Sept.* 18 *63*

Witness:  
*Mr. H. H. White*

*hs*  
*Edward X Williams*  
*sub*

*11 204 001-2*  
No. *103*

*Edward Williams*

Volunteered at *Providence*

*Sept 11* 18*63*

By *Wm. J. Sampson*

Regiment of

enlistment; last served in Company (

Reg't of

Discharged 18



CONSENT IN CASE OF MINOR.

I, \_\_\_\_\_ of \_\_\_\_\_ is \_\_\_\_\_ years of age; and I do hereby freely give my CONSENT to his volunteering as a SOLDIER in the ARMY OF THE UNITED STATES for the period of \_\_\_\_\_

Given at \_\_\_\_\_  
The \_\_\_\_\_ day of \_\_\_\_\_

Witness:



# VOLUNTEER ENLISTMENT.

State of  
*Rhode Island*



Town of  
*Providence*

I, *Edmond Williams*  
in the State of *New York*  
a *free*

born in *South Brooklyn*  
aged *20* years, and by occupation

DO HEREBY ACKNOWLEDGE to have volunteered this *1st*  
day of *September* 18*63* to serve as a SOLDIER in the ARMY OF THE UNITED STATES  
OF AMERICA, for the period of *three years*, unless sooner discharged by proper authority:  
Do also agree to accept such bounty, pay, rations and clothing, as are, or may be, established; by law for  
volunteers. And I, *Edmond Williams* do solemnly swear, that I will bear  
true faith and allegiance to the *United States of America*, and that I will serve them honestly and faith-  
fully against all their enemies or opposers whomsoever; and that I will observe and obey the orders of the  
President of the United States, and the orders of the officers appointed over me, according to the Rules  
and Articles of War.

Sworn and Subscribed to, at *Providence*  
this *1st* day of *Sept* 18*63*  
BEFORE *S. P. [Signature]*

*Edmond X Williams*  
*Smith*

I CERTIFY, ON HONOR, That I have carefully examined the above-named Volunteer, agreeable to the General Regulations of  
the Army, and that, in my opinion, he is free from all bodily defects and mental infirmity, which would, in any way, disqualify him  
from performing the duties of a soldier.

*J. H. [Signature]*

EXAMINING SURGEON.

I CERTIFY, ON HONOR, That I have minutely inspected the Volunteer, *Edmond Williams*  
previously to his enlistment, and that he was entirely sober when enlisted; that to the best of my judgment and belief, he is of  
lawful age; and that, in accepting him as duly qualified to perform the duties of an able-bodied soldier, I have strictly observed the  
Regulations which govern the recruiting service. This soldier has *dark hazel* eyes *black* hair,  
*dark ruddy* complexion, is *5* feet, *8* inches high.

*First Col. Battalion R. A.*  
*R. P.* Volunteers,

RECRUITING OFFICER.

2016

Williams Edward

Co I, 11 U.S. Col'd H. Art'y.

Private | Private.

CARD NUMBERS.

1	6196173	26
2	6196317	27
3	6196462	28
4	6196616	29
5	6196771	30
6	6196917	31
7	6197061	32
8	6197204	33
9	6197328	34
10	6197448	35
11	6197555	36
12	6197671	37
13	6197777	38
14	9125569	39
15		40
16		41
17		42
18		43
19		44
20		45
21		46
22		47
23		48
24		49
25		50

Book Mark:

See also



*W* | 11 H. Art'y. | U.S.C.T.

*Edward Williams*

....., Co. *D*, 11 Reg't U. S. Col'd H. Art'y.

Appears on

**Company Descriptive Book**

of the organization named above.

**DESCRIPTION.**

Age *24* years; height *5* feet *4* inches.

Complexion *Blk*

Eyes *Blk*; hair *Blk*

Where born *Bedford Co Va*

Occupation *Black smt*

**ENLISTMENT.**

When *Nov 16*, 186 .

Where *Prov R.I.*

By whom *J. E. Engly*; term *3* y'rs.

Remarks: *mustered out*

*Gifford*

Copyist.



*W* | 11 H. Art'y. | U.S.C.T.

*Edward Williams*

*Priv*, Co. *D*, 14 Reg't R. I. Col'd H. Art'y.\*

Age *24* years.

Appears on

**Company Muster-in Roll**

of the organization named above. Roll dated

*Providence R.I. Nov 28*, 1863.

Muster-in to date

*Nov 28*, 1863

Joined for duty and enrolled:

When *Nov. 16*, 1863

Where *Providence R.I.*

Period *3* years.

Valuation of horse, \$.....*100*

Valuation of horse equipments, \$.....*100*

Remarks: *2nd Dist. R.I.*

\* This organization subsequently became Co. *D*, 11 Reg't U. S. Colored Heavy Artillery.

Book mark:.....

*E. A. Harper*

*M* | 11 H. Art'y. | U.S.C.T.

*Edward Williams*  
*Priv*, Co. I, 14 Reg't R. I. Col'd H. Art'y.\*

Appears on

**Company Muster Roll**

for *Nov 28 to Dec 31*, 1863.

Present or absent

*Present*

Stoppage, \$.....<sup>100</sup> for .....

Due Gov't, \$.....<sup>100</sup> for .....

Valuation of horse, \$.....<sup>100</sup>

Valuation of horse equipments, \$.....<sup>100</sup>

Remarks: .....

\*This organization subsequently became Co. I, 11 Reg't U. S. Col'd Heavy Artillery.

Book mark: .....

*C. A. Harper*

*W*

11 H. Art'y.

U.S.C.T.

*Edward Williams*

*Rwi*, Co. I, 14 Reg't R. I. Col'd H. Art'y.\*

Appears on

**Company Muster Roll**

for *Jan & Feb*, 1864.

Present or absent *Present*

Stoppage, \$ 100 for

Due Gov't, \$ 100 for

Valuation of horse, \$ 100

Valuation of horse equipments, \$ 100

Remarks:

\*This organization subsequently became Co. I, 11 Reg't U. S. Col'd Heavy Artillery.

Book mark:

*A. A. Harper*



*M* | 11 H. Art'y. | U.S.C.T.

*Edward Williams*

*Priv*, Co. I, 14 Reg't R. I. Col'd H. Art'y.\*

Appears on

**Company Muster Roll**

for *March April*, 1864.

Present or absent

*Present*

Stoppage, \$ 100 for

Due Gov't, \$ 100 for

Valuation of horse, \$ 100

Valuation of horse equipments, \$ 100

Remarks:

\*This organization subsequently became Co. I, 11 Reg't U. S. Col'd Heavy Artillery.

Book mark:

*C. A. Harper*

*M* | 11 H. Art'y. | U.S.C.T.

*Edward Williams*  
Priv, Co. *D*, 8 Reg't U. S. Col'd H. Art'y.\*

Appears on

**Company Muster Roll**

for *May & June*, 1864.

Present or absent *Present*

Stoppage, \$  $\frac{49}{100}$  for *C & L O*

Due Gov't, \$  $\frac{100}{100}$  for

Valuation of horse, \$  $\frac{100}{100}$

Valuation of horse equipments, \$  $\frac{100}{100}$

Remarks:  
-----  
-----  
-----  
-----  
-----  
-----  
-----  
-----

† This organization subsequently became Co. *D*, 11 Reg't U. S. Colored Heavy Artillery.

Book mark: -----

*C. S. Harper*

*W* | 11 H. Art'y. | U. S. C. T.

*Edward Williams*  
*Private*, Co. I, 11 Reg't U. S. Col'd H. Art'y.

Appears on

**Company Muster Roll**

for *July & Aug.*, 1864.

Present or absent. *Present*

Stoppage, \$ *100* for

Due Gov't, \$ *98* for *Camp &*

*G. Equip.*

Valuation of horse, \$ *100*

Valuation of horse equipments, \$ *100*

Remarks: *\$6 pm due from*

*enlistment to April 30/64*

*Free Apr. 19<sup>th</sup> 1864*

Book mark: \_\_\_\_\_

*M. A. Michaels*



*W.* | **11 H. Art'y.** | **U. S. C. T.**

*Edward Williams*

*Private*, Co. I, 11 Reg't U. S. Col'd H. Art'y.

Appears on

**Company Muster Roll**

for *Sept & Oct.*, 186*4*.

Present or absent *Present*.

Stoppage, \$ 100 for

Due Gov't, \$ 98 for *Camp Garrison*

*Equipage*

Valuation of horse, \$ 100

Valuation of horse equipments, \$ 100

Remarks:

-----  
-----  
-----  
-----  
-----  
-----  
-----  
-----  
-----  
-----

Book mark:

*M. A. Michaels*  
Copyist.

*W* | 11 H. Art'y. | U. S. C. T.

*Edward Williams*  
Private, Co. I, 11 Reg't U. S. Col'd H. Art'y.

Appears on

Company Muster Roll  
for *Nov & Dec*, 1864.

Present or absent *Present*

Stoppage, \$ 100 for

Due Gov't, \$ 98 for *Camp &*

*Tarrison Equipage*

Valuation of horse, \$ 100

Valuation of horse equipments, \$ 100

Remarks:

Book mark:

(358)

*M. A. Michaels*  
Copyist.

*W* | 11 H. Art'y. | U. S. C. T.

*Edward Williams*  
Private, Co. I, 11 Reg't U. S. Col'd H. Art'y.

Appears on

Company Muster Roll

for *Jan'y & Febr*, 1865!

Present or absent *Present*

Stoppage, \$ 100 for

Due Gov't, \$ *3*<sup>*95*</sup>/<sub>*100*</sub> for *Camp Garrison*

*Equipage*

Valuation of horse, \$ 100

Valuation of horse equipments, \$ 100

Remarks:

Book mark:

*M. A. Michaels*  
Copyist.



*N* | 11 H. Art'y. | U. S. C. T.

*Edward Williams*

*Priv*, Co. I, 11 Reg't U. S. Col'd H. Art'y.

Appears on

**Company Muster Roll**

for *Mech Tapp*, 1865.

Present or absent *present*

Stoppage, \$ *397* / *100* for *QVE*

Due Gov't, \$ \_\_\_\_\_ / *100* for \_\_\_\_\_

Valuation of horse, \$ \_\_\_\_\_ / *100*

Valuation of horse equipments, \$ \_\_\_\_\_ / *100*

Remarks: \_\_\_\_\_

Book mark: \_\_\_\_\_

*Moy* Copyist.

*W* | 11 H. Art'y. | U. S. C. T.

*Edward Williams*

*Pri*, Co. I, 11 Reg't U. S. Col'd H. Art'y.

Appears on

Company Muster Roll

for *May & June*, 186

Present or absent

*Present*

Stoppage, \$ 100 for

Due Gov't, \$ 100 for

Valuation of horse, \$ 100

Valuation of horse equipments, \$ 100

Remarks:

Book mark:

*Dunnely*

*W* | 11 H. Art'y. | U. S. C. T.

*Edward Williams*

*On*....., Co. I, 11 Reg't U. S. Col'd H. Art'y.

Appears on

for *Company Muster Roll*  
*July & Aug*....., 186 *5*.

Present or absent *Present*

Stoppage, \$.....<sup>100</sup> for .....

Due Gov't, \$.....<sup>100</sup> for .....

Valuation of horse, \$.....<sup>100</sup>

Valuation of horse equipments, \$.....<sup>100</sup>

Remarks:.....  
.....  
.....  
.....  
.....  
.....  
.....  
.....  
.....

Book mark:.....

*Samuel*



W | 11 H. Art'y. | U.S.C.T.

Edward Williams

Priv, Co. I, 11 Reg't U. S. Col'd H. Art'y.

Appears on Co. Muster-out Roll, dated  
Camp Rapit La, Oct 2, 1865.

Muster-out to date Oct 2, 1865.

Last paid to Feb 26, 1865.

Clothing account:

Last settled....., 186 ; drawn since \$.....<sup>100</sup>

Due soldier \$.....<sup>100</sup>; due U. S. \$.....<sup>60</sup>/<sub>100</sub>

Am't for cloth'g in kind or money adv'd \$.....<sup>100</sup>

Due U. S. for arms, equipments, &c., \$.....<sup>25</sup>/<sub>100</sub>

Bounty paid \$.....<sup>100</sup>; due \$.....<sup>100</sup>/<sub>100</sub>

Remarks: *Joined at org org. 1  
Musket & set of accoutrements  
retained. Lost 1 screw driver  
& 1 tom-pion*

Book mark: *P. M. Y. Apr 16. 66*

*Samuelly*

Williams Edward

, Co. 11 Reg't USCT

1 Enclosures.

Bed Cards	Final Statements
Burial Records	Furloughs or L. of A.
Certs. of Dis. for Discharge	Med. Certificates
C. M. Charges	Med. Des. Lists
Descriptive Lists	Orders
Discharge Certificates	Pris. of War Record
Enlistment Papers	Resignations

Other papers relating to—

Admission to Hosp'l	Furlough or L. of A.
Casualty Sheet	Med. Examination
Confinement	Misc. Information
Contracts	Pay or Clothing
Death or Effects	Personal Reports
Desertion	Rank
Discharge from Hosp'l	Transfer to Hosp'l
Discharge from Service	Transfer to V. R. C.
Duty	Transportation

DECLARATION OF RECRUIT.

I, Edward Williams desiring to VOLUNTEER as a Soldier in the ARMY OF THE UNITED STATES, for the term of three years do declare that I am 24 years and months of age; that I have never been discharged from the United States service on account of disability or by sentence of a court martial, or by order, before the expiration of a term of enlistment; and I know of no impediment to my serving honestly and faithfully as a soldier for three years

Given at Prov R.I.  
The 16<sup>th</sup> day of Aug 1869

Witness:  
E. A. Walker

Edw Williams  
Mark

W. Walker  
No. 1094

Edward Williams

Volunteered at Providence R.I.

Nov 16<sup>th</sup> 1863

By May J. C. English  
Regiment of 14<sup>th</sup>

enlistment: last served in Company ( )

Reg't of

Discharged



18

CONSENT IN CASE OF MINOR.

I, \_\_\_\_\_ Do CERTIFY that I am the \_\_\_\_\_ of \_\_\_\_\_; that the said \_\_\_\_\_ is \_\_\_\_\_ years of age; and I do hereby freely give my CONSENT to his volunteering as a SOLDIER in the ARMY OF THE UNITED STATES for the period of \_\_\_\_\_

Given at \_\_\_\_\_  
The \_\_\_\_\_ day of \_\_\_\_\_

Witness:



VOLUNTEER ENLISTMENT.

State of Rhode Island



Town of Providence

I, Edward Milliam born in Bedford Co in the State of Va aged 24 years, and by occupation a Blacksmith DO HEREBY ACKNOWLEDGE to have volunteered this 16th day of Nov 1863 to serve as a SOLDIER in the ARMY OF THE UNITED STATES OF AMERICA, for the period of three years, unless sooner discharged by proper authority:

Do also agree to accept such bounty, pay, rations and clothing, as are, or may be, established, by law for volunteers. And I, Edward Milliam do solemnly swear, that I will bear true faith and allegiance to the United States of America, and that I will serve them honestly and faithfully against all their enemies or opposers whomsoever; and that I will observe and obey the orders of the President of the United States, and the orders of the officers appointed over me, according to the Rules and Articles of War.

Sworn and Subscribed to, at Providence R.I. this 16th day of Nov 1863. Edward + Milliam mark

BEFORE Me J. P. [Signature] Justice of the Peace

I CERTIFY, ON HONOR That I have carefully examined the above-named Volunteer, agreeable to the General Regulations of the Army, and that, in my opinion, he is free from all bodily defects and mental infirmity, which would, in any way, disqualify him from performing the duties of a soldier.

[Signature] EXAMINING SURGEON.

I CERTIFY, ON HONOR, That I have minutely inspected the Volunteer, Edward Milliam previously to his enlistment, and that he was entirely sober when enlisted; that to the best of my judgment and belief, he is of lawful age; and that, in accepting him as duly qualified to perform the duties of an able-bodied soldier, I have strictly observed the Regulations which govern the recruiting service. This soldier has Black eyes Black hair Black complexion, is 5 feet, 4 inches high.

14 Regiment of 99th ACA Volunteers,

RECRUITING OFFICER.

Williams Edward.

Co L., 11 U.S. Col'd H. Art'y.

Private. Private.

CARD NUMBERS.

1	6199828	26
2	6199976	27
3	6200136	28
4	6201309	29
5	9125588	30
6		31
7		32
8		33
9		34
10		35
11		36
12		37
13		38
14		39
15		40
16		41
17		42
18		43
19		44
20		45
21		46
22		47
23		48
24		49
25		50

Book Mark:

See also



Hadst 10-5-48 WGR

John Oxley Esq



*W* | 11 H. Art'y. | U.S.C.T.

*Edward Williams*

....., Co. *L*, 11 Reg't U. S. Col'd H. Art'y.

Appears on

**Company Descriptive Book**

of the organization named above.

**DESCRIPTION.**

Age *29* years; height *5* feet *6 1/2* inches.

Complexion *African*

Eyes *Blk*; hair *Blk*

Where born *Hardy Co Va*

Occupation *Farmer*

**ENLISTMENT.**

When *Dec 7*, 186*3*.

Where *Prov R.I.*

By whom *J. C. Longly*; term *3* y'rs.

Remarks: *Died in Reg't Hospital  
Dutch Island R.I. Mch 7, 1864*

*Inventory & Final Statements  
sent Mch 8, 1864*

*Giffith*

Copyist.

*N* | 11 H. Art'y. | U.S.C.T.

*Edward Williams*  
Sgt., Co. *L*, 14 Reg't R. I. Col'd H. Art'y.\*

Age *29* years.

Appears on

**Company Muster-in Roll**

of the organization named above. Roll dated

*Camp in Providence, R. I. Dec 31, 1863.*

Muster-in to date *Dec. 31, 1863.*

Joined for duty and enrolled:

When *Dec. 7, 1863.*

Where *Prov, R. I.*

Period *3* years.

Valuation of horse, \$ *100*

Valuation of horse equipments, \$ *100*

Remarks: *Residence*  
*1<sup>st</sup> Dist R. I.*

\* This organization subsequently became Co. *L*, 11 Reg't U. S. Colored Heavy Artillery.

Book mark:.....

*Maukey*

*W*

11 H. Art'y.

U.S.C.T.

*Edmund Williams*

*ser*, Co. L, 14 Reg't R. I. Col'd H. Art'y.\*

Appears on

**Company Muster Roll**

for *Jan & Feb*, 186 *7*.

Present or absent *Present*

Stoppage, \$.....*100* for .....

Due Gov't, \$.....*100* for .....

Valuation of horse, \$.....*100*

Valuation of horse equipments, \$.....*100*

Remarks: .....

\* This organization subsequently became Co. L, 11 Reg't U. S. Colored Heavy Artillery.

Book mark: .....

*B. A. Edwards*

Copyist.



*74* | **11 H. Art'y.** | **U.S.C.T.**

*Edward Williams*  
*Pvt*, Co. L, 14 Reg't R. I. Col'd H. Art'y.\*

Appears on

**Company Muster Roll**  
for *Mar & Apr.*, 186*4*.

Present or absent.....

Stoppage, \$.....100 for.....

Due Gov't, \$.....100 for.....

Valuation of horse, \$.....100

Valuation of horse equipments, \$.....100

Remarks: *Died at Dutch Is-*  
*land R. I. Mar 7/64 of*  
*Varicolas*

\* This organization subsequently became Co. L, 11 Reg't U. S. Colored Heavy Artillery.

Book mark: *No 4; 694, Evidence of*  
*service re furnished to Gov't of*

*Mauply*  
(358) Copyist.

W | 11 H. Art'y. | U.S.C.T.

Edward Williams

Priv., Co. L, 11 Reg't U. S. Col'd H. Art'y.

Appears on Co. Muster-out Roll, dated  
New Orleans La., Oct 2, 1865.

Muster-out to date \_\_\_\_\_, 186 .

Last paid to \_\_\_\_\_, 186 .

Clothing account:

Last settled \_\_\_\_\_, 186 ; drawn since \$ \_\_\_\_\_ 100

Due soldier \$ \_\_\_\_\_ 100; due U. S. \$ \_\_\_\_\_ 100

Am't for cloth'g in kind or money adv'd \$ \_\_\_\_\_ 100

Due U. S. for arms, equipments, &c., \$ \_\_\_\_\_ 100

Bounty paid \$ \_\_\_\_\_ 100; due \$ \_\_\_\_\_ 100

Remarks *Joined at Orgl Organ  
sided March 7/64 Dutch Island  
R.I. of Variolous, Inventory, P.S.  
sent March 18/64.*

Book mark: *47,694*

*Murphy*

11

Williams, Edward

, Co. D, 1st Reg't U.S.C.A.

7 Enclosures.

Bed Cards .....	Final Statements <b>4</b> .....
Burial Records .....	Furloughs or L. of A. ....
Certs. of Dis. for Discharge .....	Med. Certificates .....
C. M. Charges .....	Med. Des. Lists .....
Descriptive Lists .....	Orders .....
Discharge Certificates .....	Pris. of War Record .....
Enlistment Papers <b>1</b> .....	Resignations .....

Other papers relating to—

Admission to Hosp'l .....	Furlough or L. of A. ....
Casualty Sheet .....	Med. Examination .....
Confinement .....	Misc. Information .....
Contracts .....	Pay or Clothing .....
Death or Effects <b>2</b> .....	Personal Reports .....
Desertion .....	Rank .....
Discharge from Hosp'l .....	Transfer to Hosp'l .....
Discharge from Service .....	Transfer to V. R. C. ....
Duty .....	Transportation .....



MICROFILM PUBLICATION M 1832

COMPILED MILITARY SERVICE RECORDS  
OF VOLUNTEER UNION SOLDIERS WHO SERVED WITH  
THE UNITED STATES COLORED TROOPS (USCT)  
11TH REGIMENT OF HEAVY ARTILLERY

PERSONAL PAPERS' TARGET SHEET

PLEASE NOTE THE CHECKED INFORMATION ABOUT THE PERSONAL PAPERS IN  
THIS FILE:

- NO PERSONAL PAPERS WERE FOUND IN THIS FILE WHEN THE  
RECORDS WERE ARRANGED FOR MICROFILMING.
- 9 PERSONAL PAPER(S) FOUND IN THIS FILE WHEN THE RECORDS  
WERE ARRANGED FOR MICROFILMING.

DECLARATION OF RECRUIT.

I, *Edward Williams* desiring to VOLUNTEER as a Soldier in the ARMY OF THE UNITED STATES, for the term of *three years* do declare that I am *29* years and months of age; that I have never been discharged from the United States service on account of disability or by sentence of a court martial, or by order, before the expiration of a term of enlistment; and I know of no impediment to my serving honestly and faithfully as a soldier for *three years*

Given at *Providence Rhode Island*  
The *7th* day of *Dec* 18*63*

Witness:

*Edward Williams*  
*Mark*

Discharged

Regt of

enlistment; last served in Company ( )

By

*Wm J. Congdon*  
*14* Regiment of *Wm J. Congdon*

Volunteered at

*Dec 7th*

1863

*Edward Williams*

*1121 No 610*



CONSENT IN CASE OF MINOR.

I, \_\_\_\_\_ Do CERTIFY that I am the \_\_\_\_\_ of \_\_\_\_\_; that the said \_\_\_\_\_ is \_\_\_\_\_ years of age; and I do hereby freely give my CONSENT to his volunteering as a SOLDIER in the ARMY OF THE UNITED STATES for the period of \_\_\_\_\_

Given at \_\_\_\_\_  
The \_\_\_\_\_ day of \_\_\_\_\_

Witness:



ARTICLES OF WAR.

ART. 95. When any non-commissioned officer or soldier shall die, or be killed in the service of the United States, the then commanding officer of the troop or company shall, in the presence of two other commissioned officers, take an account of what effects he died possessed of, above his arms and accoutrements, and transmit the same to the office of the Department of War, which said effects are to be accounted for, and paid to the representatives of such deceased non-commissioned officer or soldier. And in case any of the officers, so authorized to take care of the effects of deceased officers and soldiers, should, before they have accounted to their representatives for the same, have occasion to leave the regiment or post, by preferment or otherwise, they shall, before they be permitted to quit the same, deposit in the hands of the commanding officer, or of the assistant military agent, all the effects of such deceased non-commissioned officers and soldiers, in order that the same may be secured for, and paid to, their respective representatives.

ARMY REGULATIONS—EDITION OF 1861.

DECEASED SOLDIERS.

Par. 152. Inventories of the effects of deceased non-commissioned officers and soldiers, required by the 95th Article of War, will be forwarded to the Adjutant General, by the commander of the company to which the deceased belonged, and a duplicate of the same to the colonel of the regiment. Final statements of pay, clothing, &c., will be sent with the inventories. When a soldier dies at a post or station absent from his company, it will be the duty of his immediate commander to furnish the required inventory, and, at the same time, to forward to the commanding officer of the company to which the soldier belonged, a report of his death, specifying the date, place, and cause; to what time he was last paid, and the money or other effects in his possession at the time of his decease; which report will be noted on the next muster roll of the company to which the man belonged. Each inventory will be endorsed, "Inventory of the effects of \_\_\_\_\_, late of company (—) \_\_\_\_\_ regiment of \_\_\_\_\_, who died at \_\_\_\_\_, the \_\_\_\_\_ day of \_\_\_\_\_, 186—." If a legal representative receive the effects, it will be stated in the report. If the soldier leave no effects, the fact will be reported.

Par. 153. Should the effects of a deceased non-commissioned officer or soldier not be administered upon within a short period after his decease, they shall be disposed of by a Council of Administration, under the authority of the commanding officer of the post, and the proceeds deposited with the Paymaster, to the credit of the United States, until they shall be claimed by the legal representatives of the deceased.

Par. 154. In all such cases of sales by the Council of Administration, a statement in detail, or account of the proceeds, duly certified by the Council and commanding officer, accompanied by the Paymaster's receipt for the proceeds, will be forwarded by the commanding officer to the Adjutant General. The statement will be endorsed, "Report of the proceeds of the effects of \_\_\_\_\_, late of company (—) \_\_\_\_\_ regiment of \_\_\_\_\_, who died at \_\_\_\_\_, the \_\_\_\_\_ day of \_\_\_\_\_, 186—."

NOTE 1.—The effects in all cases, when called for, should be turned over to the legal representative, without further authority from the Adjutant General. When the effects are turned over to the relatives of the deceased before these inventories are sent to the Adjutant General, their receipts therefor should be attached to the inventories. In all other cases, one copy will be sent with a letter of transmittal direct to the Adjutant General, and a duplicate retained by the officer.

NOTE 2.—Particular care should be taken to take receipts in duplicate from the Paymaster for any funds turned over to him; one copy should be sent direct to the Adjutant General and one retained by the officer.

INVENTORY OF THE EFFECTS

OF

*Edward McLeure*

Late of Company *L*

*185* Reg't of *U.S. M.A.*

Volunteers, who died at *Dutch Island*

on the *22* day of *March* 186—

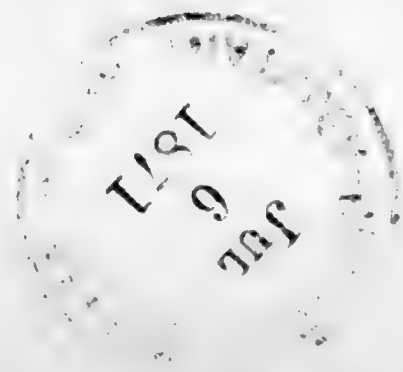



Inventory of the effects of Edward Williams late  
a Private of Captain G. A. Sparks Company E of  
the 14th Regiment of R. I. B. A. Volunteers, who was enrolled as  
a Private at Providence in the State of Rhode Island on  
the 7th day of December 1863, and mustered into the service of the United  
States as a Private on the 31st day of December 1863, at Providence  
in Company E, 14th Regiment of R. I. B. A. Volunteers, to serve 3  
years or during the war; he was born in Hardy Co. in the State  
of Virginia; he was 29 years of age, 6 feet 7 1/2 inches  
high, Afair complexion, dark eyes, dark hair, and by occupation, when enrolled,  
a Farmer; he died in Regt Hospital, at  
Dutch Island on the 7th day of March 1864, by  
reason of Varicels

INVENTORY.					
ARTICLES.	No.	ARTICLES.	No.	ARTICLES.	No.
Hats.....		Pairs trousers.....		Knapsacks.....	
Caps.....		Pairs flannel drawers.....			
Forage caps.....		Pairs cotton drawers.....			
Great coats.....		Flannel shirts.....			
Uniform coats.....		Cotton shirts.....			
Uniform jackets.....		Pairs boots.....			
Flannel sack coats.....		Pairs shoes.....			
Blouses.....		Pairs socks.....			
Stable frocks.....		Blankets.....			
Fatigue overalls.....		Haversacks.....			
				MONEY.	
				Specie.....	\$
				Notes.....	\$

I CERTIFY, ON HONOR, that the above inventory comprises all the effects of \_\_\_\_\_  
\_\_\_\_\_, deceased, and that the effects are in the hands  
of \_\_\_\_\_ at \_\_\_\_\_  
\_\_\_\_\_ to be disposed of by a Council of Administration.

(DUPLICATES.)

STATION: Dutch Island R.I.

DATE: March 7, 1864

G. A. Sparks  
Capt 14th R. I. B. A.  
Commanding the Company.

ARTICLES OF WAR.

ART. 95. When any non-commissioned officer or soldier shall die, or be killed in the service of the United States, the then commanding officer of the troop or company shall, in the presence of two other commissioned officers, take an account of what effects he died possessed of, above his arms and accoutrements, and transmit the same to the office of the Department of War, which said effects are to be accounted for, and paid to the representatives of such deceased non-commissioned officer or soldier. And in case any of the officers, so authorized to take care of the effects of deceased officers and soldiers, should, before they have accounted to their representatives for the same, have occasion to leave the regiment or post, by preferment or otherwise, they shall, before they be permitted to quit the same, deposit in the hands of the commanding officer, or of the assistant military agent, all the effects of such deceased non-commissioned officers and soldiers, in order that the same may be secured for, and paid to, their respective representatives.

ARMY REGULATIONS—EDITION OF 1863.

DECEASED SOLDIERS.

Par. 152. Inventories of the effects of deceased non-commissioned officers and soldiers, required by the 95th Article of War, will be forwarded to the Adjutant General, by the commander of the company to which the deceased belonged, and a duplicate of the same to the colonel of the regiment: Final statements of pay, clothing, &c., in duplicate, will be sent to the Adjutant General with one copy of the inventory. When a soldier dies at a post or station absent from his company, it will be the duty of his immediate commander to furnish the required inventory and final statements, and, at the same time, to forward to the commanding officer of the company to which the soldier belonged, a report of his death, specifying the date, place, and cause; to what time he was last paid, and the money or other effects in his possession at the time of his decease; which report will be noted on the next muster roll of the company to which the man belonged. Each inventory will be endorsed, "Inventory of the effects of \_\_\_\_\_, late of company (—) \_\_\_\_\_ regiment of \_\_\_\_\_, who died at \_\_\_\_\_, the \_\_\_\_\_ day of \_\_\_\_\_, 186—." If a legal representative receive the effects, it will be stated in the report. If the soldier leave no effects, the fact will be reported.

Par. 153. Should the effects of a deceased non-commissioned officer or soldier not be administered upon within a short period after his decease, they shall be disposed of by a Council of Administration, under the authority of the commanding officer of the post, and the proceeds deposited with the Paymaster, to the credit of the United States, until they shall be claimed by the legal representatives of the deceased.

Par. 154. In all such cases of sales by the Council of Administration, a statement in detail, or account of the proceeds, duly certified by the Council and commanding officer, accompanied by the Paymaster's receipt for the proceeds, will be forwarded by the commanding officer to the Adjutant General. The statement will be endorsed, "Report of the proceeds of the effects of \_\_\_\_\_, late of company (—) \_\_\_\_\_ regiment of \_\_\_\_\_, who died at \_\_\_\_\_, the \_\_\_\_\_ day of \_\_\_\_\_, 186—."

NOTE 1.—The effects in all cases, when called for, should be turned over to the legal representative, without further authority from the Adjutant General. When the effects are turned over to the relatives of the deceased before these inventories are sent to the Adjutant General, their receipts therefor should be attached to the inventories. In all other cases, one copy will be sent with a letter of transmittal direct to the Adjutant General, and a duplicate retained by the officer.

NOTE 2.—Particular care should be taken to take receipts in duplicate from the Paymaster for any funds turned over to him; one copy should be sent direct to the Adjutant General and one retained by the officer.

INVENTORY OF THE EFFECTS

OF

*Edward Williams*

Late of Company *L*

*14* Reg't of *R. I. H. Art*

Volunteers, who died at *Dutch Island*

on the *7* day of *March* 186*4*





Inventory of the effects of Edmund Williams late  
 a private of Captain Geo A Spink Company L of  
 the 14<sup>th</sup> Regiment of B V M A Volunteers, who was enrolled as  
 a private at Dutch Island in the State of Rhode Island on  
 the 7<sup>th</sup> day of December 1863, and mustered into the service of the United  
 States as a private on the 31<sup>st</sup> day of December 1863, at Dutch Island  
 in Company L, 14<sup>th</sup> Regiment of B V M A Volunteers, to serve 3  
 years or during the war; he was born in Hardy Co. in the State  
 of Virginia; he was 29 years of age, 5 feet 7/2 inches  
 high, African complexion, dark eyes, dark hair, and by occupation, when enrolled,  
 a farmer; he died in Regt Hospital, at  
Dutch Island on the 10<sup>th</sup> day of March 1864, by  
 reason of Varicolas

INVENTORY.					
ARTICLES.	No.	ARTICLES.	No.	ARTICLES.	No.
Hats.....		Pairs trousers.....		Knapsacks.....	
Caps.....		Pairs flannel drawers.....			
Forage Caps.....		Pairs cotton drawers.....			
Great coats.....		Flannel shirts.....			
Uniform coats.....		Cotton shirts.....			
Uniform jackets.....		Pairs boots.....			
Flannel sack coats.....		Pairs shoes.....			
Blouses.....		Pairs socks.....			
Sable frocks.....		Blankets.....			
Fatigue overalls.....		Haversacks.....			
				MONEY.	
				Specie.....	\$
				Notes.....	\$

I CERTIFY, ON HONOR, that the above inventory comprises all the effects of \_\_\_\_\_  
 \_\_\_\_\_ deceased, and that the effects are in the hands  
 of \_\_\_\_\_ at \_\_\_\_\_  
 \_\_\_\_\_ to be disposed of by a Council of Administration.

(DUPLICATES.)

STATION: Dutch Island RI

DATE: March 7 1864

[A. G. O. No. 104.]

George A Spink  
Captain  
 Commanding the Company.



ARTICLES OF WAR.

ART. 95. When any non-commissioned officer or soldier shall die, or be killed in the service of the United States, the then commanding officer of the troop or company shall, in the presence of two other commissioned officers, take an account of what effects he died possessed of, above his arms and accoutrements, and transmit the same to the office of the Department of War, which said effects are to be accounted for, and paid to the representatives of such deceased non-commissioned officer or soldier. And in case any of the officers, so authorized to take care of the effects of deceased officers and soldiers, should, before they have accounted to their representatives for the same, have occasion to leave the regiment or post, by preferment or otherwise, they shall, before they be permitted to quit the same, deposit in the hands of the commanding officer, or of the assistant military agent, all the effects of such deceased non-commissioned officers and soldiers, in order that the same may be secured for, and paid to, their respective representatives.

ARMY REGULATIONS—EDITION OF 1861.

DECEASED SOLDIERS.

Par. 152. Inventories of the effects of deceased non-commissioned officers and soldiers, required by the 95th Article of War, will be forwarded to the Adjutant General, by the commander of the company to which the deceased belonged, and a duplicate of the same to the colonel of the regiment. Final statements of pay, clothing, &c., will be sent with the inventories. When a soldier dies at a post or station absent from his company, it will be the duty of his immediate commander to furnish the required inventory, and, at the same time, to forward to the commanding officer of the company to which the soldier belonged, a report of his death, specifying the date, place, and cause; to what time he was last paid, and the money or other effects in his possession at the time of his decease; which report will be noted on the next muster-roll of the company to which the man belonged. Each inventory will be endorsed, "Inventory of the effects of \_\_\_\_\_, late of company (—) \_\_\_\_\_ regiment of \_\_\_\_\_, who died at \_\_\_\_\_, the \_\_\_\_\_ day of \_\_\_\_\_, 186—." If a legal representative receive the effects, it will be stated in the report. If the soldier leave no effects, the fact will be reported.

Par. 153. Should the effects of a deceased non-commissioned officer or soldier not be administered upon within a short period after his decease, they shall be disposed of by a Council of Administration, under the authority of the commanding officer of the post, and the proceeds deposited with the Paymaster, to the credit of the United States, until they shall be claimed by the legal representatives of the deceased.

Par. 154. In all such cases of sales by the Council of Administration, a statement in detail, or account of the proceeds, duly certified by the Council and commanding officer, accompanied by the Paymaster's receipt for the proceeds, will be forwarded by the commanding officer to the Adjutant General. The statement will be endorsed, "Report of the proceeds of the effects of \_\_\_\_\_, late of company (—) \_\_\_\_\_ regiment of \_\_\_\_\_, who died at \_\_\_\_\_, the \_\_\_\_\_ day of \_\_\_\_\_, 186—."

NOTE 1.—The effects in all cases, when called for, should be turned over to the legal representative, without further authority from the Adjutant General. When the effects are turned over to the relatives of the deceased before these inventories are sent to the Adjutant General, their receipts therefor should be attached to the inventories. In all other cases, one copy will be sent with a letter of transmittal direct to the Adjutant General, and a duplicate retained by the officer.

NOTE 2.—Particular care should be taken to take receipts in duplicate from the Paymaster for any funds turned over to him; one copy should be sent direct to the Adjutant General and one retained by the officer.

INVENTORY OF THE EFFECTS

OF

*Private Edward Williams*

Late of Company *L*

*14*" Reg't of *R I H Art'y*

Volunteers, who died at *Dutch Island*

*R I* on the *7*" day of *March* 186*4*.

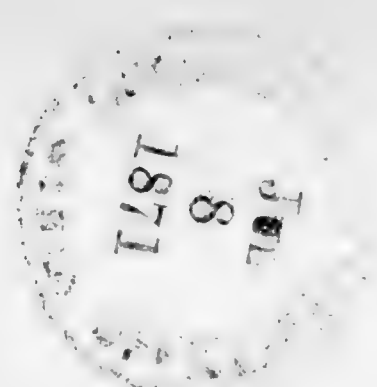

Inventory of the effects of Edward Williams late  
a Private of Captain G. A. Spink Company L of  
the 14<sup>th</sup> Regiment of R. I. Ho Arty Volunteers, who was enrolled as  
a Private at Providence in the State of Rhode Island on  
the 7 day of December 1863, and mustered into the service of the United  
States as a Private on the 13<sup>th</sup> day of December 1863, at Prov R.I.  
in Company L, 14<sup>th</sup> Regiment of R. I. Ho Arty Volunteers, to serve 3  
years or during the war; he was born in Hardy Co in the State  
of Virginia; he was 29 years of age, 5 feet 6 1/2 inches  
high, African complexion, Dark eyes, Dark hair, and by occupation, when enrolled,  
a Farmer; he died in Hospital at  
Camp Bailey Dutch Island on the 7 day of March 1864, by  
reason of Varicolas

INVENTORY.					
ARTICLES.	No.	ARTICLES.	No.	ARTICLES.	No.
Hats .....		Pairs trousers .....		Knapsacks .....	
Caps .....		Pairs flannel drawers .....			
Forage caps .....		Pairs cotton drawers .....			
Great coats .....		Flannel shirts .....			
Uniform coats .....		Cotton shirts .....			
Uniform jackets .....		Pairs boots .....			
Flannel sack coats .....		Pairs shoes .....			
Blouses .....		Pairs socks .....			
Stable frocks .....		Blankets .....			
Fatigue overalls .....		Haversacks .....			
				MONEY.	
				Specie .....	\$
				Notes .....	\$25.00

I CERTIFY, ON HONOR, that the above inventory comprises all the effects of Private  
Edward Williams, deceased, and that the effects are in the hands  
of Surgeon B. Carpenter at Camp Bailey Island  
Rhode Island to be disposed of by a Council of Administration.  
all his effects were interred with his body

(DUPLICATES.)

STATION Dutch Island R.I.

DATE: March 7<sup>th</sup> 1864

G. A. Spink Captain  
14<sup>th</sup> Regt R.I.  
Commanding the Company.



1  
102 1864

## FINAL STATEMENT

OF

Edward Williams

14<sup>th</sup> Reg't of R.I. A.

**VOLUNTEERS.**

---

NOTE 1.—Two of these certificates (or duplicates) are to be given to each volunteer soldier who may be discharged previously to the discharge of his company, that he may at once receive from the Paymaster the pay, &c., due him, and the captain or other officer commanding the company will certify to the act of the delivery of the duplicate certificates; on these certificates the Soldier is "entitled to" his *discharge*, and should also present his discharge to the Paymaster to have the payment endorsed on it. The discharge is to be given back to the Soldier by the Paymaster; the latter only retaining as his voucher the duplicate certificates.

NOTE 2.—If the Soldier is entitled to pay for the use of his horse, the Company Commander will certify to that fact, and also to the time he has pay due for having been so mounted on his own horse.

NOTE 3.—Amounts due the Sutler and Laundress must be entered on the Muster Roll of which the death, desertion, &c., is reported, as well as on the final statement, otherwise the amount cannot be collected from the United States.

NOTE 4.—This blank will be used for deceased volunteers as well as others.

---







A.C. Smith 5/1861  
Recd. for effect sent  
2 Auditor.  
B.

X Dupl. of ...  
✓

FINAL STATEMENT

OF

Edward Williams

14<sup>th</sup> Reg't of R.I. M. Arty  
11 U.S.

VOLUNTEERS.

Disd March 7<sup>th</sup> 1864

NOTE 1.—Two of these certificates (or duplicates) are to be given to each volunteer soldier who may be discharged previously to the discharge of his company, that he may at once receive from the Paymaster the pay, &c., due him, and the captain or other officer commanding the company will certify to the act of the delivery of the duplicate certificates; on these certificates the Soldier is "entitled to" his discharge, and should also present his discharge to the Paymaster to have the payment endorsed on it. The discharge is to be given back to the Soldier by the Paymaster; the latter only retaining as his voucher the duplicate certificates.

NOTE 2.—If the Soldier is entitled to pay for the use of his horse, the Company Commander will certify to that fact, and also to the time he has pay due for having been so mounted on his own horse.

NOTE 3.—Amounts due the Sutler and Laundress must be entered on the Muster Roll on which the death, desertion, &c., is reported, as well as on the final statement, otherwise the amount cannot be collected from the United States.

NOTE 4.—This blank will be used for deceased volunteers as well as others.

ADJUTANT GENERAL'S OFFICE

186

Duplicate with Inventory sent 2d Auditor.



I certify, on honor, that Edward Williams a Private of  
Captain G. A. Sprink Company (E) of the 14<sup>th</sup> Regiment of R. I. N. A.  
**VOLUNTEERS**, of the State of Rhode Island, born in Hasletts Co. State  
of Virginia, aged 29 years; 5 feet 6 1/2 inches high; Fair complexion,  
Dark eyes, Dark hair, and by occupation a Farmer, having joined the company on  
its original organization at Providence R. I., and enrolled in it at the muster into  
the service of the United States at Providence R. I., on the 12<sup>th</sup> day  
of December, 1863, (or was mustered in service as a recruit, by Capt. Sprink  
U. S. A., at Pro R. I., on the 12<sup>th</sup> day of December  
1863, to serve in the Regiment,) for the term of Three years  
and having served **HONESTLY** and **FAITHFULLY** with his Company in 14<sup>th</sup> Regt. R. I. N. A.  
to the present date, is now entitled to a **DISCHARGE** by reason of Death

(For date of death see Inventory - March 7<sup>th</sup> 1864)

The said Edward Williams was last paid by Paymaster  
Wesley Prout to include the \_\_\_\_\_ day of \_\_\_\_\_, 186  , and has  
pay due him from that time to the present date; he is entitled to pay and subsistence for  
**TRAVELING** to place of enrollment and whatever other allowances are authorized to volunteer  
soldiers, or militia, so discharged. He has received \_\_\_\_\_ 100 dollars,  
advanced by the United States on account of **CLOTHING**.

There is to be stopped from him, on account of the State of Rhode Island, or other  
authorities for **CLOTHING**, &c., received on entering service, \$ 36. 48 100 dollars; also,  
for expenses of **SUBSISTENCE** for **TRAVELING** from place of enrollment to the place of rendezvous,  
amounting to \_\_\_\_\_ 100 dollars: and on account of the United States for **EXTRA**  
**CLOTHING** received in kind from \_\_\_\_\_ and for other  
stoppages, viz:

\_\_\_\_\_ amounting to \_\_\_\_\_ 100 dollars;  
and he has been **SUBSISTED** for **TRAVELING** to his place of enrollment, up to the \_\_\_\_\_  
\_\_\_\_\_, 186  .

He is indebted to \_\_\_\_\_, **SUTLER**, \_\_\_\_\_ 100 dollars.  
He is indebted to \_\_\_\_\_, **LAUNDRESS**, \_\_\_\_\_ 100 dollars.

Given in Duplicate, at Providence R. I., this 8<sup>th</sup> day of March, 1864.

George A. Sprink Captain  
14<sup>th</sup> Regt. R. I. N. A.  
Commanding Company.



14  
3d 2m 1864  
FINAL STATEMENT

OF

Edmund Williams

8<sup>th</sup> Reg't of U.S.C.A. H.

VOLUNTEERS.

NOTE 1.—Two of these certificates (or duplicates) are to be given to each Volunteer Soldier or drafted man who may be discharged previously to the discharge of his company, that he may at once receive from the Paymaster the pay, &c., due him, and the captain or other COMMISSIONED officer commanding the company will certify to the act of the delivery of the duplicate certificates; on these certificates the Soldier is "entitled to" his discharge, and should also present his discharge to the Paymaster to have the payment endorsed on it. The discharge is to be given back to the Soldier by the Paymaster; the latter only retaining as his voucher the duplicate certificates.

NOTE 2.—If the Soldier is entitled to pay for the use of his horse, the Company Commander will certify to that fact on the back of both these final statements, and also to the time he has pay due for having been so mounted on his own horse.

NOTE 3.—When a Soldier is furnished with final statements, his descriptive list, if he has one, should be taken up by the officer who gives the Soldier these statements, and endorsed with a statement to this effect by the officer. This endorsement should exhibit a full statement of the time for which the Soldier was allowed pay on his final statements, the clothing account, and all other charges against him or in his favor, so as to comprise a complete exhibit of his account. It will then be transmitted to the company commander of the Soldier, who will enter all the data necessary to a full understanding of the Soldier's account on the muster roll upon which the Soldier's discharge is reported. The descriptive list will then be destroyed. The object of this is, that the remaining portion of the Soldier's account may be settled upon the receipt of these muster rolls, and the Soldier receive any pay or allowances that may be due him at the time of his discharge, and which may not appear on his final statements from the fact that his descriptive list is incomplete. These accounts for back pay, &c., are settled by the 2d Auditor of the Treasury Department.

NOTE 4.—Charges for loss or injury to ordnance, horse equipments, and other miscellaneous charges, should appear under the heading of "Other Stoppages."

NOTE 5.—Bounty paid by State authorities, and not by the United States, will not be entered on this statement.

NOTE 6.—Amounts due the Sutler and Laundress must be entered on the muster roll on which the discharge, death, desertion, &c., is reported, as well as on the final statement, otherwise the amount cannot be collected from the United States.

NOTE 7.—This blank will be used for deceased volunteers and drafted men, as well as for others.

NOTE 8.—Where a Soldier dies in Hospital or on detached service, his descriptive list, if he has one, should be sent with his final statements, in duplicate, to the Second Auditor, Washington, D. C.

1864

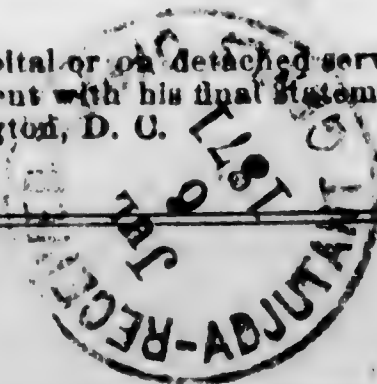

I certify, on honor, that Edward Williams a Private of  
 Captain Chas W. Fry Company (A) of the 8<sup>th</sup> Regiment of U. S. A. Heavy  
**VOLUNTEERS**, of the State of Rhode Island, born in New York, State  
 of New York, aged 25 years; 5 feet 7 inches high; Dark complexion,  
Dark eyes, Dark hair, and by occupation a Labourer, having joined the company on  
 its original organization at Providence, and enrolled in it at the muster into  
 the service of the United States at Providence, R. I., on the Twenty Eight day  
 of August, 1863, (or was mustered in service as a recruit, by Capt Silver  
1<sup>st</sup> U. S. Artz, at \_\_\_\_\_, on the \_\_\_\_\_ day of \_\_\_\_\_,  
 186\_\_\_\_, or was drafted and mustered into the service of the United States from the  
 Enrollment District of the State of \_\_\_\_\_, at \_\_\_\_\_,  
 on the \_\_\_\_\_ day of \_\_\_\_\_, 186\_\_\_\_) to serve in the Regiment, for  
 the term of Three Years; and having served HONESTLY and  
 FAITHFULLY with his Company in 8<sup>th</sup> U. S. A. Heavy to the present date, is now  
 entitled to a **DISCHARGE** by reason of Death caused by Typhoid Malaria  
Fever caused by.

The said Edward Williams <sup>never</sup> was ~~last~~ paid by Paymaster  
 \_\_\_\_\_ to include the \_\_\_\_\_ day of \_\_\_\_\_, 186\_\_\_\_, and has  
 pay due him from that time to the present date; he is entitled to pay and subsistence for  
**TRAVELING** to place of enrollment, and whatever other allowances are authorized to volunteer  
 soldiers, drafted men, or militia, so discharged. He has received from the United States **CLOTHING**  
 amounting to Seventy Five <sup>34</sup>/<sub>100</sub> dollars, since the 18<sup>th</sup> day of August,  
 1863, when his clothing account was last settled. He has received from the United States  
 \_\_\_\_\_ <sup>100</sup>/<sub>100</sub> dollars advanced **BOUNTY**.

There is to be stopped from him, on account of the State of \_\_\_\_\_ , or other  
 authorities, for **CLOTHING**, &c., received on entering service, \_\_\_\_\_  <sup>100</sup>/<sub>100</sub> dollars; and  
 for other stoppages, viz: No Effects   
 \_\_\_\_\_  \_\_\_\_\_ <sup>100</sup>/<sub>100</sub> dollars.

He has been furnished with **TRANSPORTATION** in kind from the place of his discharge to  
 \_\_\_\_\_; and he has been **SUBSISTED** for **TRAVELING** to his  
 place of enrollment, up to the \_\_\_\_\_ , 186\_\_\_\_.

He is indebted to \_\_\_\_\_ , **SUTLER**, \_\_\_\_\_ <sup>100</sup>/<sub>100</sub> dollars.  
 He is indebted to \_\_\_\_\_ , **LAUNDRESS**, \_\_\_\_\_ <sup>100</sup>/<sub>100</sub> dollars.

Given in Duplicate, at Fort Jackson, this 27<sup>th</sup> day  
 of August, 1864.

Chas W. Fry  
Capt. U. S. A. H.  
 \_\_\_\_\_  
 Commanding Company.



FINAL STATEMENT

OF

*Edward Williams*

*34* Reg't of *U.S. A.*

VOLUNTEERS.

NOTE 1.—Two of these certificates (or duplicates) are to be given to each volunteer soldier who may be discharged previously to the discharge of his company, that he may at once receive from the Paymaster the pay, &c., due him, and the captain or other officer commanding the company will certify to the act of the delivery of the duplicate certificates; on these certificates the Soldier is "entitled to" his *discharge*, and should also present his discharge to the Paymaster to have the payment endorsed on it. The discharge is to be given back to the Soldier by the Paymaster; the latter only retaining as his voucher the duplicate certificates.

NOTE 2.—If the Soldier is entitled to pay for the use of his horse, the Company Commander will certify to that fact, and also to the time he has pay due for having been so mounted on his own horse.

NOTE 3.—Amounts due the Sutler and Laundress must be entered on the Muster Roll on which the death, desertion, &c., is reported, as well as on the final statement, otherwise the amount cannot be collected from the United States.

NOTE 4.—This blank will be used for deceased volunteers as well as others.

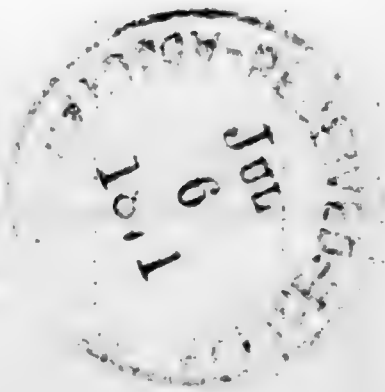

1864



I certify, on honor, that Edward Williams a Private of  
Captain E. A. Sparks Company (D) of the 14th Regiment of R. I. M. A.  
**VOLUNTEERS**, of the State of Rhode Island, born in Hurdy Co., State  
of Virginia, aged 39 years; 6 feet 7 1/2 inches high; Apr complexion,  
dark eyes, dark hair, and by occupation a Farmer, having joined the company on  
its original organization at Providence R.I., and enrolled in it at the muster into  
the service of the United States at Providence R.I., on the 7th day  
of December, 1863, (or was mustered in service as a recruit, by Capt. Wm  
Silvey, at Pro R.I., on the 31st day of December,  
1863, to serve in the Regiment,) for the term of Three Years;  
and having served **HONESTLY** and **FAITHFULLY** with his Company in 14th R. I. M. A.  
to the present date, is now entitled to a **DISCHARGE** by reason of Death  
He died at Regt Hospital, Dutch Island R.I.  
March 7th 1864.

The said Edward Williams was <sup>never</sup> last paid by Paymaster -  
to include the \_\_\_\_\_ day of \_\_\_\_\_, 186  , and has  
pay due him from that time to the present date; he is entitled to pay and subsistence for  
**TRAVELING** to place of enrollment and whatever other allowances are authorized to volunteer  
soldiers, or militia, so discharged. He has received Thirty Six <sup>98</sup>/<sub>100</sub> dollars,  
advanced by the United States on account of **CLOTHING**.

There is to be stopped from him, on account of the State of United States, or other  
authorities for **CLOTHING**, &c., received on entering service, Twenty <sup>48</sup>/<sub>100</sub> dollars; also,  
for expenses of **SUBSISTENCE** for **TRAVELING** from place of enrollment to the place of rendezvous,  
amounting to \_\_\_\_\_ <sup>100</sup>/<sub>100</sub> dollars: and on account of the United States for **EXTRA**  
**CLOTHING** received in kind from \_\_\_\_\_ and for other  
stoppages, viz:

\_\_\_\_\_ amounting to \_\_\_\_\_ <sup>100</sup>/<sub>100</sub> dollars;  
and he has been **SUBSISTED** for **TRAVELING** to his place of enrollment, up to the \_\_\_\_\_  
\_\_\_\_\_, 186  .

He is indebted to \_\_\_\_\_, **SUTLER**, \_\_\_\_\_ <sup>100</sup>/<sub>100</sub> dollars.  
He is indebted to \_\_\_\_\_, **LAUNDRESS**, \_\_\_\_\_ <sup>100</sup>/<sub>100</sub> dollars.

Given in Duplicate, at Dutch Island, this \_\_\_\_\_ day of \_\_\_\_\_, 186  .

E. A. Sparks  
Capt. W. R. G. King  
Commanding Company.

# FINAL STATEMENT

OF

*Priv. Edward Williams Co.*  
*14<sup>th</sup> Reg't of P. S. H. Art'y.*

## VOLUNTEERS.

NOTE 1.—Two of these certificates (or duplicates) are to be given to each Volunteer Soldier or drafted man who may be discharged previously to the discharge of his company, that he may at once receive from the Paymaster the pay, &c., due him, and the captain or other COMMISSIONED officer commanding the company will certify to the act of the delivery of the duplicate certificates; on these certificates the Soldier is "entitled to" his *discharge*, and should also present his discharge to the Paymaster to have the payment endorsed on it. The discharge is to be given back to the Soldier by the Paymaster; the latter only retaining as his voucher the duplicate certificates.

NOTE 2.—If the Soldier is entitled to pay for the use of his horse, the Company Commander will certify to that fact on the back of both these final statements, and also to the time he has pay due for having been so mounted on his own horse.

NOTE 3.—When a Soldier is furnished with final statements, his descriptive list, if he has one, should be taken up by the officer who gives the Soldier these statements, and endorsed with a statement to this effect by the officer. This endorsement should exhibit a full statement of the time for which the Soldier was allowed pay on his final statements, the clothing account, and all other charges against him or in his favor, so as to comprise a complete exhibit of his account. It will then be transmitted to the company commander of the Soldier, who will enter all the data necessary to a full understanding of the Soldier's account on the muster roll upon which the Soldier's discharge is reported. The descriptive list will then be destroyed. The object of this is, that the remaining portion of the Soldier's account may be settled upon the receipt of these muster rolls, and the Soldier receive any pay or allowances that may be due him at the time of his discharge, and which may not appear on his final statements from the fact that his descriptive list is incomplete. These accounts for back pay, &c., are settled by the 2d Auditor of the Treasury Department.

NOTE 4.—Charges for loss or injury to ordnance, horse equipments, and other miscellaneous charges, should appear under the heading of "Other Stoppages."

NOTE 5.—Bounty paid by State authorities, and not by the United States, will not be entered on this statement.

NOTE 6.—Amounts due the Sutler and Laundress must be entered on the muster roll on which the discharge, death, desertion, &c., is reported, as well as on the final statement, otherwise the amount cannot be collected from the United States.

NOTE 7.—This blank will be used for deceased volunteers and drafted men, as well as for others.

NOTE 8.—Where a Soldier dies in Hospital or detached service, his descriptive list, if he has one, should be sent with his final statements, in duplicate, to the Second Auditor, Washington, D. C.

1864



I certify, on honor, that Edward Williams, Private of  
Captain G. A. Spink's Company (2) of the 14<sup>th</sup> Regiment of B. I. H. Art'y  
**VOLUNTEERS**, of the State of Rhode Island, born in Hardy County, State  
of Virginia, aged 29 years; 6 feet 7<sup>1</sup>/<sub>2</sub> inches high; swarthy complexion,  
dark eyes, dark hair, and by occupation a Farmer, having joined the company on  
its original organization at Providence R. I., and enrolled in it at the muster into  
the service of the United States at Providence R. I., on the 7<sup>th</sup> day  
of December, 1863, (or was mustered in service as a ~~recruit~~, by Capt. Wm. Silvey  
U. S. A., at Providence R. I. on the 31<sup>st</sup> day of December,  
1863, or was drafted and mustered into the service of the United States from the \_\_\_\_\_  
Enrollment District of the State of \_\_\_\_\_, at \_\_\_\_\_,  
on the \_\_\_\_\_ day of \_\_\_\_\_, 1863 ) to serve in the Regiment, for  
the term of Three years: and having served **HONESTLY** and  
**FAITHFULLY** with his Company in \_\_\_\_\_ to the present date, is now  
entitled to a **DISCHARGE** by reason of Death, he died at Regt Hospital  
Quincy Island R. I. March 7<sup>th</sup> 1864.

The said Edward Williams <sup>never</sup> was ~~last~~ paid by Paymaster  
\_\_\_\_\_ to include the \_\_\_\_\_ day of \_\_\_\_\_, 1863, and has  
pay due him from that time to the present date; he is entitled to pay and subsistence for  
**TRAVELING** to place of enrollment, and whatever other allowances are authorized to volunteer  
soldiers, drafted men, or militia, so discharged. He has received from the United States **CLOTHING**  
amounting to Thirty six <sup>18</sup>/<sub>100</sub> dollars, since the \_\_\_\_\_ day of \_\_\_\_\_,  
1863, when his clothing account was last settled. He has received from the United States  
<sup>100</sup>/<sub>100</sub> dollars advanced **BOUNTY**.

There is to be stopped from him, on account of the State of U. S., or other  
authorities, for **CLOTHING**, &c., received on entering service, Twenty six <sup>48</sup>/<sub>100</sub> dollars; and  
for other stoppages, viz: \_\_\_\_\_

\_\_\_\_\_ <sup>100</sup>/<sub>100</sub> dollars.  
He has been furnished with **TRANSPORTATION** in kind from the place of his discharge to  
\_\_\_\_\_; and he has been **SUBSISTED** for **TRAVELING** to his  
place of enrollment, up to the \_\_\_\_\_, 1863.

He is indebted to \_\_\_\_\_, **SUTLER**, \_\_\_\_\_ <sup>100</sup>/<sub>100</sub> dollars.

He is indebted to \_\_\_\_\_, **LAUNDRESS**, \_\_\_\_\_ <sup>100</sup>/<sub>100</sub> dollars.

Given in Duplicate, at Quincy Island, this 7<sup>th</sup> day  
of March, 1864.

George Spink

Capt 14<sup>th</sup> R. I. A.

Artillery Commanding Company.



2018

*Williams French*

Co *D.*, 11 U.S. Col'd H. Art'y.

*Private* | *Private*

CARD NUMBERS.

1	6187306	26
2	6187449	27
3	6187596	28
4	6187740	29
5	6187878	30
6	6188002	31
7	6188138	32
8	6188269	33
9	6188388	34
10	6188502	35
11	6188608	36
12	6188718	37
13	6188821	38
14	9124665	39
15	9124807	40
16		41
17		42
18		43
19		44
20		45
21		46
22		47
23		48
24		49
25		50

Book Mark:

See also

*W* | 11 H. Art'y. | **U.S.C.T.**

*French Williams*

, Co. *D*, 11 Reg't U. S. Col'd H. Art'y.

Appears on

**Company Descriptive Book**

of the organization named above.

**DESCRIPTION.**

Age *22* years; height *5* feet *9* inches.

Complexion *Mul.*

Eyes *Hazel*; hair *Black*

Where born *Salem, Conn.*

Occupation *Laborer.*

**ENLISTMENT.**

When *Sep. 16*, 186*3*.

Where *Prov., R. I.*

By whom *W. Helme*; term *3* y'rs.

Remarks:

*O. J. Markle,*

Copyist.

*W* | **11 H. Art'y. U.S.C.T.**

*French Williams*

Co. *D*, 11 Reg't U. S. Col'd H. Art'y.

Appears on

**Company Descriptive Book**

of the organization named above.

**DESCRIPTION.**

Age *22* years; height *5* feet *9* inches.

Complexion *Wht.*

Eyes *Hazel*; hair *Blk.*

Where born *Jarem, Conn.*

Occupation *Subover.*

**ENLISTMENT.**

When *Sept. 16*, 186*3*.

Where *Prov.*

By whom *W. H. Helme*; term *3* y'rs.

Remarks:

-----  
-----  
-----  
-----  
-----  
-----  
-----  
-----  
-----  
-----

*O. J. Markle,*

Copyist.



*11* | 11 H. Art'y. | U.S.C.T.

*French Williams*

*Pvt.*, Co. *D*, 14 Reg't R. I. Col'd H. Art'y.\*

Age *22* years.

Appears on

**Company Muster-in Roll**

of the organization named above. Roll dated  
*Providence R.I. Sept. 22*, 1863.

Muster-in to date *Sept. 22*, 1863.

Joined for duty and enrolled:

When *Sept. 16*, 186 .

Where *Pro. R.I.*

Period *3* years.

Valuation of horse, \$.....100

Valuation of horse equipments, \$.....100

Remarks: *Residence R.I.*

\* This organization subsequently became Co. *D*, 11 Reg't U. S. Colored Heavy Artillery.

Book mark:.....

*Leering*

11 H. Arty. U.S.C.T.

*French William*

*Pvt.* Co. D. 14 Regt R. L. Col'd H. Arty.\*

Appears on

Company Muster Roll

for *Sept 22 - Dec 31, 1860.*

Present or absent *Present*

Stoppage \$ 100 00

Due Gov't \$ 100 00

Valuation of horse \$ 100

Valuation of horse equipments \$ 100

Remarks:

Book mark

*William*

*W* | 11 H. Art'y. | U.S.C.T.

*Grover Williams*

*Pvt.*, Co. D, 14 Reg't R. I. Col'd H. Art'y.\*

Appears on

**Company Muster Roll**

for *Sept. 27/63 to Feb. 29, 1864.*

Present or absent *Present*

Stoppage, \$ *100* for

Due Gov't, \$ *100* for

Valuation of horse, \$ *100*

Valuation of horse equipments, \$ *100*

Remarks: *Knapsack 1.85*  
*Saddlesack 49c*

\*This organization subsequently became Co. D, 11 Reg't U. S. Col'd Heavy Artillery.

Book mark: \_\_\_\_\_

*Loring*

(858)

Copyist.



*H* | **11 H. Art'y. | U.S.C.T.**

*French Williams*

*priv.*, Co. *D*, 8 Reg't U. S. Col'd H. Art'y.\*

Appears on

**Company Muster Roll**

for *Mar & Apr*, 186 *4*

Present or absent *present*

Stoppage, \$ *100* for

Due Gov't, \$ *100* for

Valuation of horse, \$ *100*

Valuation of horse equipments, \$ *100*

Remarks: *Stop for*  
*knapsack \$1.85*  
*Knapsack 49¢*

† This organization subsequently became Co. *D*, 11 Reg't U. S. Colored Heavy Artillery.

Book mark: \_\_\_\_\_

*Wm Allen*

*M.* | **11 H. Art'y. | U.S.C.T.**

*French Williams*  
Sgt., Co. *A*, 8 Reg't U. S. Col'd H. Art'y.\*

Appears on

**Company Muster Roll**

for *May & June*, 1864.

Present or absent *present*

Stoppage, \$ *100* for

Due Gov't, \$ *100* for

Valuation of horse, \$ *100*

Valuation of horse equipments, \$ *100*

Remarks: *Stop for  
Haversack 49 &*

\*This organization subsequently became Co. *A*, 11 Reg't U. S. Colored Heavy Artillery.

Book mark: \_\_\_\_\_

*W. L. Allen*

*M* | 11 H. Art'y. | **U.S.C.T.**

*French Williams*  
*Por*, Co. D, 11 Reg't U. S. Col'd H. Art'y.

Appears on

**Company Muster Roll**

for *July Aug*, 186*X*

Present or absent *Present*

Stoppage, \$ *2 34* for *Origs*

Due Gov't, \$ *100* for

Valuation of horse, \$ *100*

Valuation of horse equipments, \$ *100*

Remarks: *Free Apl 19/64*

Book mark:

*Prader*



*W* | 11 H. Art'y. | U.S.C.T.

*French William*  
*Pos*, Co. D, 11 Reg't U. S. Col'd H. Art'y.

Appears on

**Company Muster Roll**

for *Sept Oct*, 186 *4*

Present or absent *Present*

Stoppage, \$ *100* for

Due Gov't, \$ *100* for

Valuation of horse, \$ *100*

Valuation of horse equipments, \$ *100*

Remarks:

Book mark:

*Brad*

*W* | 11 H. Art'y. | U.S.C.T.

*French Williams*

*Priv.*, Co. D, 11 Reg't U. S. Col'd H. Art'y.

Appears on

**Company Muster Roll**

for *Nov. & Dec., 1864*

Present or absent *Present*

Stoppage, \$ 100 for

Due Gov't, \$ 100 for

Valuation of horse, \$ 100

Valuation of horse equipments, \$ 100

Remarks:

Book mark:

*Grogan*

*W* | 11 H. Art'y. | U.S.C.T.

*French Williams*  
*Priv.*, Co. D, 11 Reg't U. S. Col'd H. Art'y.

Appears on

**Company Muster Roll**

for *Jan. & Feb.*, 1865.

Present or absent *Present*

Stoppage, \$ 100 for

Due Gov't, \$ 100 for

Valuation of horse, \$ 100

Valuation of horse equipments, \$ 100

Remarks:

Book mark:

*Grogan*



*W* | 11 H. Art'y. | U.S.C.T.

*French Williams*  
*Pri*, Co. D, 11 Reg't U. S. Col'd H. Art'y.

Appears on

**Company Muster Roll**

for *March & April*, 186*5*.

Present or absent *Present*

Stoppage, \$ 100 for

Due Gov't, \$ 100 for

Valuation of horse, \$ 100

Valuation of horse equipments, \$ 100

Remarks:

Book mark:

*Grogan*

*W* | 11 H. Art'y. | U.S.C.T.

*French Williams*  
*Put*, Co. D, 11 Reg't U. S. Col'd H. Art'y.

Appears on

**Company Muster Roll**

for *May & June*, 1865.

Present or absent *Present*

Stoppage, \$ *1*<sup>*07*</sup>/<sub>100</sub> for *ordnance*  
*\$ .05 for C. & G. E.*

Due Gov't, \$ *1*<sup>*00*</sup>/<sub>100</sub> for

Valuation of horse, \$ *1*<sup>*00*</sup>/<sub>100</sub>

Valuation of horse equipments, \$ *1*<sup>*00*</sup>/<sub>100</sub>

Remarks:

Book mark:

*C. F. Thompson*  
Copyist.

W | // H. A. | U. S. C. T.

French Williams  
Priv. Co. D., // Reg't U. S. Col'd H. A.

Appears on

**Company Muster Roll**

for July & Aug., 1865.

Present or absent Present.

Stoppage, \$ 1<sup>07</sup>/<sub>100</sub> for ordnance

\$ .05 for C. & G. E.

Due Gov't, \$ 100 for

Valuation of horse, \$ 100

Valuation of horse equipments, \$ 100

Remarks: \_\_\_\_\_  
\_\_\_\_\_  
\_\_\_\_\_  
\_\_\_\_\_  
\_\_\_\_\_  
\_\_\_\_\_  
\_\_\_\_\_  
\_\_\_\_\_  
\_\_\_\_\_  
\_\_\_\_\_

Book mark: \_\_\_\_\_  
\_\_\_\_\_

C. F. Thompson.  
Copyist.



W | 11 H. Art'y. | U.S.C.T.

French Williams,  
Priv., Co. D, 11 Reg't U. S. Col'd H. Art'y.

Appears on **Co. Muster-out Roll**, dated  
New Orleans, La., Oct. 2, 1865.  
Muster-out to date Oct. 2, 1865.  
Last paid to Feb. 28 1865.

**Clothing account:**

Last settled....., 186 ; drawn since \$.....<sup>100</sup>

Due soldier \$.....<sup>100</sup>; due U. S. \$.....<sup>10</sup><sup>64</sup>/<sub>100</sub>

Am't for cloth'g in kind or money adv'd \$.....<sup>100</sup>

Due U. S. for arms, equipments, &c., \$.....<sup>21</sup>/<sub>100</sub>

Bounty paid \$.....<sup>now</sup> 100; due \$.....<sup>100</sup>/<sub>100</sub>

Remarks: Joined at orgl. orgn.

Stop musket & accs. ret'd.

6. Cart. box belt & plate,

Screw driver, Tompion

Wiper, 2 Cross Cannon

2 Letters, 6 Numbers & Eagle

Book mark: .....<sup>(over)</sup>

C. F. Thompson

JAN. 15

6188821

\*1891\*

*Free apr. 19/01*

Williams, Frank

P, Co., 11 Reg't USCA

Enclosures.

Bed Cards	Final Statements
Burial Records	Furloughs or L. of A
Certs. of Dis. for Discharge	Med. Certificates
C. M. Charges	Med. Des. Lists
Descriptive Lists	Orders
Discharge Certificates	Pris. of War Record
Enlistment Papers	Resignations

Other papers relating to—

Admission to Hosp'l	Furlough or L. of A
Casualty Sheet	Med. Examination
Confinement	Misc. Information
Contracts	Pay or Clothing
Death or Effects	Personal Reports
Desertion	Rank
Discharge from Hosp'l	Transfer to Hosp'l
Discharge from Service	Transfer to V. R. C.
Duty	Transportation



DECLARATION OF RECRUIT.

I, *French Williams* desiring to VOLUNTEER as a Soldier in the ARMY OF THE UNITED STATES, for the term of *three years* do declare that I am *22* years and *5* months of age; that I have never been discharged from the United States service on account of disability or by sentence of a court martial, or by order, before the expiration of a term of enlistment; and I know of no impediment to my serving honestly and faithfully as a soldier for *three years*

Given at *Portland*  
The *16<sup>th</sup>* day of *September* 18*63*

Witness:

*Wm H. [unclear]*

*French Williams*

*11 U.S.A. No. 1056*

*French Williams*

Volunteered at *Portland, Me.*

*September* 18*63*

By *[Signature]*

*1st [unclear] Regiment of [unclear]*

enlistment; last served in Company ( )

Reg't of

Discharged *Jul 11 1871* 18

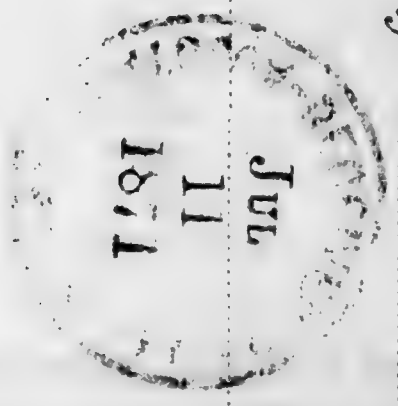

CONSENT IN CASE OF MINOR.

I, *[Signature]* of *[Signature]* Do CERTIFY that I am the *[Signature]*; that the said *[Signature]* years of age; and I do hereby freely give my CONSENT to his volunteering as a SOLDIER in the ARMY OF THE UNITED STATES for the period of *[Signature]*

Given at *[Signature]*  
The *[Signature]* day of *[Signature]*

Witness:

# VOLUNTEER ENLISTMENT.

State of



Town of

Rhode Island

Providence

I, French Williams

born in Salem

in the State of Connecticut  
a laborer

aged 22 years, and by occupation

DO HEREBY ACKNOWLEDGE to have volunteered this Sixteenth  
day of September 1863 to serve as a SOLDIER in the ARMY OF THE UNITED STATES  
OF AMERICA, for the period of three years, unless sooner discharged by proper authority:

Do also agree to accept such bounty, pay, rations and clothing, as are, or may be, established, by law for  
volunteers. And I, French Williams do solemnly swear, that I will bear  
true faith and allegiance to the United States of America, and that I will serve them honestly and faith-  
fully against all their enemies or opposers whomsoever; and that I will observe and obey the orders of the  
President of the United States, and the orders of the officers appointed over me, according to the Rules  
and Articles of War.

Sworn and Subscribed to, at Providence

this 16<sup>th</sup> day of September 1863.

BEFORE

*[Signature]*

*[Signature: French Williams]*

I CERTIFY, ON HONOR, That I have carefully examined the above-named Volunteer, agreeable to the General Regulations of  
the Army, and that, in my opinion, he is free from all bodily defects and mental infirmity, which would, in any way, disqualify him  
from performing the duties of a soldier.

*[Signature: M.B. Carpenter]* EXAMINING SURGEON.

I CERTIFY, ON HONOR, That I have minutely inspected the Volunteer, French Williams,  
previously to his enlistment, and that he was entirely sober when enlisted; that to the best of my judgment and belief, he is of  
lawful age; and that, in accepting him as duly qualified to perform the duties of an able-bodied soldier, I have strictly observed the  
Regulations which govern the recruiting service. This soldier has hazel eyes black hair

mulatto complexion, is 5 feet, 9 inch high.

*[Signature]* 1<sup>st</sup> Colonel Regiment of W. Williams R. I. Volunteers,  
Wm. H. Heber RECRUITING OFFICER.



Williams George.

Co I., 11 U.S. Col'd H. Art'y.

Private. Private.

CARD NUMBERS.

1	6196172	26
2	6196318	27
3	6196463	28
4	6196617	29
5	6196772	30
6	6196918	31
7	6197062	32
8	6197205	33
9	6197329	34
10	6197449	35
11	6197556	36
12	6197672	37
13	6197778	38
14	4125570	39
15		40
16		41
17		42
18		43
19		44
20		45
21		46
22		47
23		48
24		49
25		50

Book Mark:

See also



*W* | **11 H. Art'y. | U.S.C.T.**

*George Williams*

....., Co. *I*, 11 Reg't U. S. Col'd H. Art'y.

Appears on

**Company Descriptive Book**

of the organization named above.

**DESCRIPTION.**

Age *33* years; height *5* feet *5 1/2* inches.

Complexion *DK*

Eyes *DK*; hair *DK*

Where born *Germanstown Penn*

Occupation *Servant*

**ENLISTMENT.**

When *Nov 23*, 186 .

Where *Penn P. I.*

By whom *J. C. Engly*; term *3* y'rs.

Remarks: *Mustered out*

*Griffith*

*W* | 11 H. Art'y. | U.S.C.T.

*George Williams*

*Priv*, Co. *D*, 14 Reg't R. I. Col'd H. Art'y.\*

Age *33* years.

Appears on

**Company Muster-in Roll**

of the organization named above. Roll dated

*Providence R.I. Nov 28*, 1863.

Muster-in to date

*Nov 28*, 1863.

Joined for duty and enrolled:

When *Nov 23*, 1863

Where *Providence, R.I.*

Period *3* years.

Valuation of horse, \$.....*100*

Valuation of horse equipments, \$.....*100*

Remarks: *2nd Dist R.I.*

\* This organization subsequently became Co. *D*, 11 Reg't U. S. Colored Heavy Artillery.

Book mark:.....

*CA Harper*

*M* | 11 H. Art'y. | U.S.C.T.

*George Williams*  
*Priv*, Co. I, 14 Reg't R. I. Col'd H. Art'y.\*

Appears on

**Company Muster Roll**

for *Nov 28 to Dec 31*, 1863.

Present or absent *Present*

Stoppage, \$ 100 for

Due Gov't, \$ 100 for

Valuation of horse, \$ 100

Valuation of horse equipments, \$ 100

Remarks:

\*This organization subsequently became Co. I, 11 Reg't U. S. Col'd Heavy Artillery.

Book mark:

*C. A. Meyer*



*W*

11 H. Art'y.

U.S.C.T.

*George Williams*

*Priv*, Co. I, 14 Reg't R. I. Col'd H. Art'y.\*

Appears on

**Company Muster Roll**

for *Jan & Feb*, 1864.

Present or absent *Present*

Stoppage, \$ 100 for

Due Gov't, \$ 100 for

Valuation of horse, \$ 100

Valuation of horse equipments, \$ 100

Remarks:

\*This organization subsequently became Co. I, 11 Reg't U. S. Col'd Heavy Artillery.

Book mark:

*C. A. Harper*

*W* | 11 H. Art'y. | U.S.C.T.

*George Williams -*  
*Priv*, Co. I, 14 Reg't R. I. Col'd H. Art'y.\*

Appears on

**Company Muster Roll**

for *Mar & April*, 1864.

Present or absent *Present*

Stoppage, \$ 100 for

Due Gov't, \$ 100 for

Valuation of horse, \$ 100

Valuation of horse equipments, \$ 100

Remarks:

\*This organization subsequently became Co. I, 11 Reg't U. S. Col'd Heavy Artillery.

Book mark:

*C. A. Hayser*

*M* | 11 H. Art'y. | U.S.C.T.

*George Williams*  
*Priv*, Co. *I*, 8 Reg't U. S. Col'd H. Art'y.\*

Appears on

**Company Muster Roll**

for *May & June*, 186*4*.

Present or absent *Present*

Stoppage, \$ *100* for

Due Gov't, \$ *100* for

Valuation of horse, \$ *100*

Valuation of horse equipments, \$ *100*

Remarks: *Sick in Reg't  
Hospital*

† This organization subsequently became Co. *I*, 11 Reg't U. S. Colored Heavy Artillery.

Book mark:

*R. J. Harper*



*W* | 11 H. Art'y. | U. S. C. T.

*George Williams*

*Private*, Co. I, 11 Reg't U. S. Col'd H. Art'y.

Appears on

**Company Muster Roll**

for *July & Aug.*, 1864.

Present or absent *Present*

Stoppage, \$ *100* for

Due Gov't, \$ *100* for

Valuation of horse, \$ *100*

Valuation of horse equipments, \$ *100*

Remarks: *\$6 p.m. due from enlistment to April 30/64 Free Apr 19th 1861*

Book mark:

*M. A. Michaels*  
Copyist.

*W.* | **11 H. Art'y.** | **U. S. C. T.**

*George Williams*  
*Private*, Co. I, 11 Reg't U. S. Col'd H. Art'y.

Appears on

**Company Muster Roll**

for *Sept & Oct*, 1864.

Present or absent *Present*.

Stoppage, \$ 100 for

Due Gov't, \$ 100 for

Valuation of horse, \$ 100

Valuation of horse equipments, \$ 100

Remarks:

Book mark:

*M. A. Michaels*  
Copyist.

*W* | 11 H. Art'y. | U. S. C. T.

*George Williams*  
*Private*, Co. I, 11 Reg't U. S. Col'd H. Art'y.

Appears on

**Company Muster Roll**

for *Nov & Dec*, 1864.

Present or absent *Present*

Stoppage, \$ *100* for

Due Gov't, \$ *100* for

Valuation of horse, \$ *100*

Valuation of horse equipments, \$ *100*

Remarks: *D. D. Hospital Nurse*

Book mark: \_\_\_\_\_

*M. A. Michaels*



*W* | 11 H. Art'y. | U. S. C. T.

*George Williams*  
Private, Co. I, 11 Reg't U. S. Col'd H. Art'y.

Appears on

**Company Muster Roll**

for *Jan'y & Febr.*, 186*8*.

Present or absent *Present*.

Stoppage, \$ *100* for

Due Gov't, \$ *100* for

Valuation of horse, \$ *100*

Valuation of horse equipments, \$ *100*

Remarks:

Book mark:

*M. A. Michaels*  
Copyist.

*A* | 11 H. Art'y. | U. S. C. T.

*George Williams*  
*Priv*, Co. I, 11 Reg't U. S. Col'd H. Art'y.

Appears on

**Company Muster Roll**

for *March Apr*, 1863.

Present or absent *present*

Stoppage, \$ 100 for

Due Gov't, \$ 100 for

Valuation of horse, \$ 100

Valuation of horse equipments, \$ 100

Remarks:

Book mark:

*May*  
Copyist.

*W* | 11 H. Art'y. | U. S. C. T.

*George Williams*

*Pri*, Co. I, 11 Reg't U. S. Col'd H. Art'y.

Appears on

Company Muster Roll

for *May + June*, 186 *5*

Present or absent *Present*

Stoppage, \$ *100* for

Due Gov't, \$ *100* for

Valuation of horse, \$ *100*

Valuation of horse equipments, \$ *100*

Remarks:

Book mark:

*Donnelly*

(358) ✓

Copyist.



*W* | 11 H. Art'y. | U. S. C. T.

*George Williams*

*Pri*, Co. I, 11 Reg't U. S. Col'd H. Art'y.

Appears on

Company Muster Roll

for *July Aug*, 186 *5*.

Present or absent *Present*

Stoppage, \$ *100* for

Due Gov't, \$ *100* for

Valuation of horse, \$ *100*

Valuation of horse equipments, \$ *100*

Remarks:

Book mark:

*Samuel*

W | 11 H. Art'y. | U.S.C.T.

George Williams

Pri, Co. I, 11 Reg't U. S. Col'd H. Art'y.

Appears on Co. Muster-out Roll, dated  
Camp Rapet La Oct 2, 1865.

Muster-out to date Oct 2, 1865.

Last paid to Feb 28, 1865.

Clothing account:

Last settled....., 186 ; drawn since \$..... 100

Due soldier \$ 20 <sup>45</sup> / 100; due U. S. \$..... 100

Am't for cloth'g in kind or money adv'd \$..... 100

Due U. S. for arms, equipments, &c., \$ <sup>25</sup> / 100

" " " " " retained \$ 6  
Bounty paid \$ none / 100; due \$ 100 / 100

Remarks: joined at org org. 1  
Muster + set of accoutrements  
retained. Lost 1 screw driver +  
1 tom-pion

Book mark :

Donnelly

William Geo

Co, 1 Reg't U.S. H.A.

2 Enclosures

Bed Cards	Final Statements
Burial Records	Furloughs or L. of A
Certs. of Dis. for Discharge	Med. Certificates
C. M. Charges	Med. Des. Lists
Descriptive Lists	Orders
Discharge Certificates	Pris. of War Record
Enlistment Papers	Resignations

Other papers relating to—

Admission to Hosp'l	Furlough or L. of A
Casualty Sheet	Med. Examination
Confinement	Misc. Information <u>2</u>
Contracts	Pay or Clothing
Death or Effects	Personal Reports
Desertion	Rank
Discharge from Hosp'l	Transfer to Hosp'l
Discharge from Service	Transfer to V. R. C.
Duty	Transportation



Fort Stephens, Pass Manchac La  
May 24<sup>th</sup> 1864

Private George Williams of Company B  
7<sup>th</sup> U. S. Heavy Artillery (old), has leave  
to marry with Catherine Williams,  
residing in the Parish of Jefferson

J. B. Hauke

Captain Command<sup>g</sup> Comp<sup>y</sup> B  
7<sup>th</sup> U. S. H. Art. (old)

Marriage Certificate  
of Geo. Williams  
& Catherine Williams

May 25, 1864

Co B 9th U.S. Regt. A.M.

U.S. Army

# Marriage Certificate.

No. 3

The State of Louisiana.

Parish of Jefferson

I J. Furterman Provost Marshal  
of the Parish of Jefferson do  
hereby Certify that I have this Twenty fifth day of  
May A. D., One Thousand Eight Hundred and  
Sixty four in the Parish of Jefferson  
joined in the Bonds of Matrimony?

Geo Williams Co. B. 7<sup>th</sup> (ed. City Hall

Catherine Williams

In Testimony Whereof, I, the the undersigned, Provost  
Marshal for the Parish aforesaid have signed my name.

J. Furterman

Provost Marshal.



2020

Williams George L.

Co L., 11 U.S. Col'd H. Art'y.

Private. | Private.

CARD NUMBERS.

1	6199829	26
2	6199977	27
3	6200129	28
4	6200274	29
5	6200411	30
6	6200549	31
7	6200677	32
8	6200806	33
9	6200936	34
10	6201051	35
11	6201173	36
12	6201284	37
13	9125889	38
14		39
15		40
16		41
17		42
18		43
19		44
20		45
21		46
22		47
23		48
24		49
25		50

Book Mark:

See also

*W* | 11 H. Art'y. | U.S.C.T.

*George L Williams*

*L*, Co. *L*, 11 Reg't U. S. Col'd H. Art'y.

Appears on

**Company Descriptive Book**

of the organization named above.

**DESCRIPTION.**

Age *43* years; height *5* feet *7 1/2* inches.

Complexion *African*

Eyes *Blue*; hair *Black*

Where born *New York*

Occupation *Laborer*

**ENLISTMENT.**

When *Dec 14*, 186*3*.

Where *Prov A. I.*

By whom *P. M. Downing*; term *3* y'rs.

Remarks: *Mustered out Oct 2' 1865*

*Gifford*

Copyist.

*N* | 11 H. Art'y. | U.S.C.T.

*George L. Williams*  
Pvt, Co. *L*, 14 Reg't R. I. Col'd H. Art'y.\*

Age *42* years.

Appears on

**Company Muster-in Roll**

of the organization named above. Roll dated

*Camp in Providence R.I., Dec. 31, 1863.*

Muster-in to date

*Dec. 31, 1863.*

Joined for duty and enrolled:

When *Dec. 14*, 1863.

Where *Prov. R.I.*

Period *3* years.

Valuation of horse, \$ *100*

Valuation of horse equipments, \$ *100*

Remarks: *Residence*

*1<sup>st</sup> Dist R.I.*

\* This organization subsequently became Co. *L*, 11 Reg't U. S. Colored Heavy Artillery.

Book mark: \_\_\_\_\_

*Mauley*



*W* | **11 H. Art'y.** | **U.S.C.T.**

*George L Williams*  
*pr*, Co. L, 14 Reg't R. I. Col'd H. Art'y.\*

Appears on

**Company Muster Roll**

for *Jan 8<sup>th</sup> Feb*, 186*4*

Present or absent *Present*

Stoppage, \$.....100 for .....

Due Gov't, \$.....100 for .....

Valuation of horse, \$.....100

Valuation of horse equipments, \$.....100

Remarks: .....

\* This organization subsequently became Co. L, 11 Reg't U. S. Colored Heavy Artillery.

Book mark: .....

*B. D. Edwards*  
Copyist.

*W* | **11 H. Art'y. | U.S.C.T.**

*George L. Williams*  
*Private*, Co. L, 14 Reg't R. I. Col'd H. Art'y.\*

Appears on

**Company Muster Roll**  
for *Mar. & Apr.*, 186*4*.

Present or absent *Present*

Stoppage, \$ *100* for

Due Gov't, \$ *100* for

Valuation of horse, \$ *100*

Valuation of horse equipments, \$ *100*

Remarks:

*on daily duty  
as Co. Cook, Apr 18/64*

\* This organization subsequently became Co. L, 11 Reg't U. S. Colored Heavy Artillery.

Book mark:

*Manly*

*M* | **11 H. Art'y. | U.S.C.T.**

*George L. Williams*  
-----  
*Co. L*, 8 Reg't U. S. Col'd H. Art'y.\*

Appears on

**Company Muster Roll**

for *May & June*, 186*4*.

Present or absent *Present*

Stoppage, \$ 100 for

Due Gov't, \$ *0* 100 for *ordnance*

Valuation of horse, \$ 100

Valuation of horse equipments, \$ 100

Remarks: *on daily duty*  
*as Co. Cook*

† This organization subsequently became Co. *L*, 11 Reg't U. S. Colored Heavy Artillery.

Book mark: -----

(35H)

*Manning*

Copyist.



*W* | 11 H. Art'y. | U.S.C.T.

*George L. Williams*  
Pvt., Co. L, 11 Reg't U. S. Col'd H. Art'y.

Appears on

Company Muster Roll  
for *July & Aug*, 1864.

Present or absent *Present*

Stoppage, \$ *100* for

Due Gov't, \$ *30* / *100* for *ordnance*

Valuation of horse, \$ *100*

Valuation of horse equipments, \$ *100*

Remarks: *on daily duty*  
*as Co. Cook,*  
*\$6 per mo. back pay*  
*due from enlistment*  
*to Apr. 30/64*  
*Free on Apr 19/61*

Book mark:

*Mauley*  
Copyist.

W.

11 H. Art'y.

U.S.C.T.

George L. Williams.

Priv., Co. L, 11 Reg't U. S. Col'd H. Art'y.

Appears on

Company Muster Roll

for Sept & Oct, 1864

Present or absent present

Stoppage, \$ 42/100 for ordnance

Due Gov't, \$ 100 for

Valuation of horse, \$ 100

Valuation of horse equipments, \$ 100

Remarks: On daily duty as Company Cook.

\$6.00 per month back pay due from enlistment to April 30/64.

Free on April 19/61.

Book mark:

Baker,

Copyist.

W. | 11 H. Art'y. | U.S.C.T.

George L. Williams.

Priv., Co. L, 11 Reg't U. S. Col'd H. Art'y.

Appears on

**Company Muster Roll**

for Nov. & Dec., 1864

Present or absent present

Stoppage, \$ - <sup>42</sup> / 100 for ordnance.

Due Gov't, \$ 100 for

Valuation of horse, \$ 100

Valuation of horse equipments, \$ 100

Remarks: On daily duty as  
Company Cook.

Book mark:



W. | 11 H. Art'y. | U.S.C.T.

George L. Williams

Regt., Co. L, 11 Reg't U. S. Col'd H. Art'y.

Appears on

**Company Muster Roll**

for Jan & Feb., 1865.

Present or absent present.

Stoppage, \$ -  $\frac{22}{100}$  for ordnance.

Due Gov't, \$  $\frac{100}{100}$  for

Valuation of horse, \$  $\frac{100}{100}$

Valuation of horse equipments, \$  $\frac{100}{100}$

Remarks: On daily duty as  
Company Cook.

Book mark:

Baker

Copyist.

W. | 11 H. Art'y. | U.S.C.T.

George L. Williams.

Pvt., Co. L, 11 Reg't U. S. Col'd H. Art'y.

Appears on

Company Muster Roll

for March & April, 1865.

Present or absent present.

Stoppage, \$ -  $\frac{22}{100}$  for ordnance

Due Gov't, \$  $\frac{100}{100}$  for

Valuation of horse, \$  $\frac{100}{100}$

Valuation of horse equipments, \$  $\frac{100}{100}$

Remarks: On daily duty as Company Cook.

Book mark:

Baker,  
Copyist.

*W* | 11 H. Art'y. | U.S.C.T.

*George L Williams*  
*Pr*, Co. L, 11 Reg't U. S. Col'd H. Art'y.

Appears on

**Company Muster Roll**

for *May + June*, 1865.

Present or absent *Present*

Stoppage, \$ 100 for

Due Gov't, \$ 100 for

Valuation of horse, \$ 100

Valuation of horse equipments, \$ 100

Remarks: *on daily duty as  
Company Cook.*

Book mark: \_\_\_\_\_

*Murphy*



*W*

**11 H. Art'y. U.S.C.T.**

*George L. Williams*

*Pvt*, Co. L, 11 Reg't U. S. Col'd H. Art'y.

Appears on

**Company Muster Roll**

for *July & Aug*, 186*5*.

Present or absent *Present*

Stoppage, \$ *100* for

Due Gov't, \$ *100* for

Valuation of horse, \$ *100*

Valuation of horse equipments, \$ *100*

Remarks:

Book mark:

*Murphy*

Copyist.

*W* | 11 H. Art'y. | U.S.C.T.

*George L. Williams*

*Priv*, Co. L, 11 Reg't U. S. Col'd H. Art'y.

Appears on Co. Muster-out Roll, dated

*New Orleans La, Oct 2,* 1865.

Muster-out to date

*Oct 2,* 1865.

Last paid to

*Feb 28,* 1865.

Clothing account:

Last settled....., 186 ; drawn since \$.....<sup>100</sup>

Due soldier \$ *23*<sup>70</sup>.....<sup>100</sup>; due U. S. \$.....<sup>100</sup>

Am't for cloth'g in kind or money adv'd \$.....<sup>100</sup>

Due U. S. for arms, equipments, &c., \$.....<sup>100</sup>

Bounty paid \$.....<sup>100</sup>; due \$ *100*.....<sup>100</sup>

Remarks: *Joined at Regt. Regn*

*Stoppage for 1 musket &*

*accs retained \$6.00*

Book mark : .....

*Murphy*

Williams, Geo. L.

Co.

11 Reg't U.S.C.H.A.

Enclosures.

Bed Cards .....	Final Statements .....
Burial Records .....	Furloughs or L. of A .....
Certs. of Dis. for Discharge .....	Med. Certificates .....
C. M. Charges .....	Med. Des. Lists .....
Descriptive Lists .....	Orders .....
Discharge Certificates .....	Pris. of War Record .....
Enlistment Papers .....	Resignations .....

Other papers relating to—

Admission to Hosp'l .....	Furlough or L. of A .....
Casualty Sheet .....	Med. Examination .....
Confinement .....	Misc. Information .....
Contracts .....	Pay or Clothing .....
Death or Effects .....	Personal Reports .....
Desertion .....	Rank .....
Discharge from Hosp'l .....	Transfer to Hosp'l .....
Discharge from Service .....	Transfer to V. R. C. .....
Duty .....	Transportation .....



DECLARATION OF RECRUIT.

I, *George L. Williams* desiring to VOLUNTEER as a Soldier in the ARMY OF THE UNITED STATES, for the term of *3 years* do declare that I am *43* years and months of age; that I have never been discharged from the United States service on account of disability or by sentence of a court martial, or by order, before the expiration of a term of enlistment; and I know of no impediment to my serving honestly and faithfully as a soldier for *3 years*

Given at *Providence* The day of *Dec* 18 *68*.

Witness: *Went*

*George L. Williams*

*11 No 102*

Volunteered at *Providence* *George L. Williams*

*Dec 14* 1868

By *C. W. Johnson*

*14th Regiment of Infantry*

enlistment; last served in Company ( )

Reg't of

Discharged 18



CONSENT IN CASE OF MINOR.

I, \_\_\_\_\_ of \_\_\_\_\_ is \_\_\_\_\_ years of age; and I do hereby freely give my CONSENT to his volunteering as a SOLDIER in the ARMY OF THE UNITED STATES for the period of \_\_\_\_\_

Given at \_\_\_\_\_ The day of \_\_\_\_\_

Witness

# VOLUNTEER ENLISTMENT.

State of

*Rhode Island*



Town of

*Providence*

I, *George L. Williams*

born in

in the State of

*New York*

aged

*43*

years, and by occupation

a *Laborer*

day of

*Dec*

18 *63*

DO HEREBY ACKNOWLEDGE to have volunteered this *14th*

OF AMERICA, for the period of *3 Years*, unless sooner discharged by proper authority :

Do also agree to accept such bounty, pay, rations and clothing, as are, or may be, established, by law for volunteers. And I, *George L. Williams* do solemnly swear, that I will bear true faith and allegiance to the *United States of America*, and that I will serve them honestly and faithfully against all their enemies or opposers whomsoever ; and that I will observe and obey the orders of the President of the United States, and the orders of the officers appointed over me, according to the Rules and Articles of War.

Sworn and Subscribed to, at

*Providence*

this

*14th*

day of

*Dec*

18 *63*.

BEFORE

*Mr John L. Stoyes Publick*

*George L. Williams*

I CERTIFY, ON HONOR, That I have carefully examined the above-named Volunteer, agreeable to the General Regulations of the Army, and that, in my opinion, he is free from all bodily defects and mental infirmity, which would, in any way, disqualify him from performing the duties of a soldier.

*Johnson Gardner M.D.*

EXAMINING SURGEON.

I CERTIFY, ON HONOR, That I have minutely inspected the Volunteer

*George L. Williams*

previously to his enlistment, and that he was entirely sober when enlisted ; that to the best of my judgment and belief, he is of lawful age ; and that, in accepting him as duly qualified to perform the duties of an able bodied soldier, I have strictly observed the Regulations which govern the recruiting service. This soldier has

*African*

complexion, is

*five*

feet,

*7 1/2*

inches high.

eyes

*black*

hair

*Major 1st Regiment of N.Y. Arty*

Volunteers,

RECRUITING OFFICER.



Williams Henry.

Co B., 11 U.S. Col'd H. Art'y.

Private. Private.

CARD NUMBERS.

1	6183954	26
2	6184098	27
3	6184242	28
4	6184393	29
5	6185497	30
6	9124360	31
7	9124360	32
8		33
9		34
10		35
11		36
12		37
13		38
14		39
15		40
16		41
17		42
18		43
19		44
20		45
21		46
22		47
23		48
24		49
25		50

Book Mark

W. 173. 3573. W. 127. W  
10. 65. 74

See also



*W* | 11 H. Art'y. | **U.S.C.T.**

*Henry Williams*

Co. *B*, 11 Reg't U. S. Col'd H. Art'y.

Appears on

**Company Descriptive Book**

of the organization named above.

**DESCRIPTION.**

Age *38* years; height *5* feet *6½* inches.

Complexion *OA*

Eyes *Blk*; hair *Blk*

Where born *N. J.*

Occupation *Laborer*

**ENLISTMENT.**

When *Aug 19*, 1863.

Where *Prov. R. I.*

By whom *Maj. Sanford*; term *3* y'rs.

Remarks:  *Died of consumption*

*at Fort Esperanza Matagorda Island Texas,*

*April 18/64. Inventory*

*of effects & final statements rendered May*

*16/64*

*James*

Copyist.

U 11 H. Art'y. U.S.C.T.

Henry Williams  
Co. B, 11 Reg't U. S. Col'd H. Art'y.

Appears on

**Company Descriptive Book**

of the organization named above.

**DESCRIPTION.**

Age 38 years; height 5 feet 6 1/2 inches.

Complexion Dk

Eyes Blk; hair Blk

Where born N. J.

Occupation Laborer

**ENLISTMENT.**

When Aug 19, 186 .

Where Providence

By whom Quaford; term 3 y'rs.

Remarks: Died at Matayorda Island April 1864

Final statement & inventory of effects forwarded May 6. 64

James

*W* | 11 H. Art'y. | U.S.C.T.

*Henry Williams*  
*Pvt.*, Co. *B*, 14 Reg't R. I. Col'd H. Art'y.\*

Age *38* years.

Appears on

**Company Muster-in Roll**

of the organization named above. Roll dated

*Providence R.I., Sept 14, 1863.*

Muster-in to date *Sept 14 1863.*

Joined for duty and enrolled:

When *Aug. 19*, 186 .

Where *Providence*

Period *3* years.

Valuation of horse, \$.....100

Valuation of horse equipments, \$.....100

Remarks:.....

\* This organization subsequently became Co *B*, 11 Reg't U. S. Colored Heavy Artillery.

Book mark:.....

*J. Walker*



*100* **UNION MILITARY ASSOCIATION**

*Henry Williams*  
**COMPANY MASTER ROLL**

APPEARANCE

**COMPANY MASTER ROLL**

NO. *100* **1863**

PRESENT OR ABSENT *Present*

STOPPAGE \$ *100.00*

DUPLICATE \$ *100.00*

VALUATION OF HORSES \$ *100*

VALUATION OF HORSE EQUIPMENT \$ *100*

REMARKS:  
.....  
.....  
.....  
.....  
.....  
.....  
.....  
.....

\*In case of organization subsequent to receipt of this book it shall be the duty of the Association to report the same to the Adjutant General.

BOOK NO. *100*

*H. Williams*

7858

Copyright

100 100 HUMANITY U.S. COURT

Henry Williams  
P.O. BOX 1000 R.R. 1000 HUMANITY

Addressed to

Company Missouri RR 11

Date Jan 20 1894

Presented to Henry Williams

Number of 100

Value of 100

Value of 100

Value of 100

Remarks

Printed in compliance with subsequent act of Congress, A. S. 11, 12, 13, 14, 15, 16, 17, 18, 19, 20, 21, 22, 23, 24, 25, 26, 27, 28, 29, 30, 31, 32, 33, 34, 35, 36, 37, 38, 39, 40, 41, 42, 43, 44, 45, 46, 47, 48, 49, 50, 51, 52, 53, 54, 55, 56, 57, 58, 59, 60, 61, 62, 63, 64, 65, 66, 67, 68, 69, 70, 71, 72, 73, 74, 75, 76, 77, 78, 79, 80, 81, 82, 83, 84, 85, 86, 87, 88, 89, 90, 91, 92, 93, 94, 95, 96, 97, 98, 99, 100

BOOK & BILLS

*Henry Williams*

*W* | 11 H. Art'y. | U.S.C.T.

*Henry Williams*  
*P*, Co *B*, 8 Reg't U. S. Col'd H. Art'y.\*

Appears on

**Company Muster Roll**

for *Mk & Apl*, 1864.

Present or absent

Stoppage, \$ 100 for

Due Gov't, \$ 100 for

Valuation of horse, \$ 100

Valuation of horse equipments, \$ 100

Remarks: *Died at Matagorda Island Texas Apr. 18. 1864.*

† This organization subsequently became Co. *B*, 11 Reg't U. S. Colored Heavy Artillery.

Book mark:

*J. Walker*



*W* | 11 H. Art'y. | U.S.C.T.

*Henry Williams*

*Pl.*, Co. *B*, 11 Reg't U. S. Col'd H. Art'y.

Appears on **Co. Muster-out Roll**, dated  
*New Orleans La, Oct 2*, 1865.

Muster-out to date \_\_\_\_\_, 186 .

Last paid to \_\_\_\_\_, 186 .

**Clothing account:**

Last settled \_\_\_\_\_, 186 ; drawn since \$ \_\_\_\_\_ 100

Due soldier \$ \_\_\_\_\_ 100; due U. S. \$ \_\_\_\_\_ 100

Am't for cloth'g in kind or money adv'd \$ \_\_\_\_\_ 100

Due U. S. for arms, equipments, &c., \$ \_\_\_\_\_ 100

Bounty paid \$ \_\_\_\_\_ 100; due \$ \_\_\_\_\_ 100

Remarks: *Joined reg't reg'm  
Died at Matagorda I.  
Tex. Apr 18/64 Final  
Statements and In. of  
Eff. rendered*

Book mark: *V. 173. P. 35-73. W. 127  
U. S. C. T. 74*

*Foyberger*

*Williams, Henry*  
*B. B.*, *8<sup>th</sup> Reg't U. S. A.*

**4 Enclosures.**

Bed Cards .....	Final Statements <span style="float: right;"><i>2</i></span>
Burial Records .....	Furloughs or L. of A. ....
Certs. of Dis. for Discharge .....	Med. Certificates .....
C. M. Charges .....	Med. Des. Lists .....
Descriptive Lists .....	Orders .....
Discharge Certificates .....	Pris. of War Record .....
Enlistment Papers <span style="float: right;"><i>/</i></span> .....	Resignations .....

**Other papers relating to—**

Admission to Hosp'l .....	Furlough or L. of A. ....
Casualty Sheet .....	Med. Examination .....
Confinement .....	Misc. Information .....
Contracts .....	Pay or Clothing .....
Death or Effects <span style="float: right;"><i>1</i></span> .....	Personal Reports .....
Desertion .....	Rank .....
Discharge from Hosp'l .....	Transfer to Hosp'l .....
Discharge from Service .....	Transfer to V. R. C. ....
Duty .....	Transportation .....

DECLARATION OF RECRUIT.

I, *Henry Williams* desiring to VOLUNTEER as a Soldier in the ARMY OF THE UNITED STATES, for the term of *3 years*, do declare that I am *38* years and months of age; that I have never been discharged from the United States service on account of disability or by sentence of a court martial, or by order, before the expiration of a term of enlistment; and I know of no impediment to my serving honestly and faithfully as a soldier for *3 years*

Given at *Woodbury*  
The *19* day of *Aug* 18 *63*  
Witness: *J. B. [unclear]*  
*Henry Williams*  
*Recruit*



Discharged ..... 18

Reg't of .....  
enlistment; last served in Company ( )  
*11 WORTH*

By *Henry Williams*  
Volunteered at *Woodbury*  
*Aug 19 1863*  
Regiment of *Artillery*  
*109*

25

CONSENT IN CASE OF MINOR.

I, \_\_\_\_\_ Do CERTIFY that I am the \_\_\_\_\_ of \_\_\_\_\_; that the said \_\_\_\_\_ is \_\_\_\_\_ years of age; and I do hereby freely give my CONSENT to his volunteering as a SOLDIER in the ARMY OF THE UNITED STATES for the period of \_\_\_\_\_

Given at \_\_\_\_\_  
The \_\_\_\_\_ day of \_\_\_\_\_  
Witness: \_\_\_\_\_



# VOLUNTEER ENLISTMENT.

State of

*RI*



Town of

*Providence*

I, *Henry Williams* born in *New Jersey*  
in the State of \_\_\_\_\_ aged *28* years, and by occupation  
a *laborer*

DO HEREBY ACKNOWLEDGE to have volunteered this *19th*  
day of *Aug* 18*63*, to serve as a SOLDIER in the ARMY OF THE UNITED STATES  
of AMERICA, for the period of *3 yrs*, unless sooner discharged by proper authority:

Do also agree to accept such bounty, pay, rations and clothing, as are, or may be, established by law for  
volunteers. And I, *Henry Williams* do solemnly swear, that I will bear  
true faith and allegiance to the *United States of America*, and that I will serve them honestly and faith-  
fully against all their enemies or opposers whomsoever; and that I will observe and obey the orders of  
the President of the United States, and the orders of the officers appointed over me, according to the  
Rules and Articles of War.

Sworn and subscribed to, at

this *19th* day of *Aug* 18*63*

BEFORE

*Spencer*  
*Major 1st R.I. Ar.*  
I CERTIFY, ON HONOR, That I have carefully examined the above-named Volunteer, agreeably to the General Regulations  
of the Army, and that, in my opinion, he is free from all bodily defects and mental infirmity, which would, in any way, disqualify  
him from performing the duties of a soldier.

*John Gardner*  
*M.D.*

EXAMINING SURGEON.

I CERTIFY, ON HONOR, That I have minutely inspected the Volunteer, *Henry Williams*  
previously to his enlistment, and that he was entirely sober when enlisted; that, to the best of my judgment and belief, he is  
of lawful age; and that, in accepting him as duly qualified to perform the duties of an able-bodied soldier, I have strictly observed  
the Regulations which govern the recruiting service. This soldier has *Black* eyes, *Black* hair,  
*Dark* complexion, is *5* feet, *6 1/2* inches high.

Regiment of

*Spencer*  
*Major 1st R.I. Ar.*  
Volunteers,

RECRUITING OFFICER.

✓

FINAL STATEMENT

OF

Henry Williams

8th Reg't of U. S. H. Art'y. (Col'd)  
11th U.S.

VOLUNTEERS.

Rec'd April 18th 1864

NOTE 1.—Two of these certificates (or duplicates) are to be given to each Volunteer Soldier or drafted man who may be discharged previously to the discharge of his company, that he may at once receive from the Paymaster the pay, &c., due him, and the captain or other COMMISSIONED officer commanding the company will certify to the act of the delivery of the duplicate certificates; on these certificates the Soldier is "entitled to" his discharge, and should also present his discharge to the Paymaster to have the payment endorsed on it. The discharge is to be given back to the Soldier by the Paymaster; the latter only retaining as his voucher the duplicate certificates.

NOTE 2.—If the Soldier is entitled to pay for the use of his horse, the Company Commander will certify to that fact on the back of both these final statements, and also to the time he has pay due for having been so mounted on his own horse.

NOTE 3.—When a Soldier is furnished with final statements, his descriptive list, if he has one, should be taken up by the officer who gives the Soldier these statements, and endorsed with a statement to this effect by the officer. This endorsement should exhibit a full statement of the time for which the Soldier was allowed pay on his final statements, the clothing account, and all other charges against him or in his favor, so as to comprise a complete exhibit of his account. It will then be transmitted to the company commander of the Soldier, who will enter all the data necessary to a full understanding of the Soldier's account on the muster roll upon which the Soldier's discharge is reported. The descriptive list will then be destroyed. The object of this is, that the remaining portion of the Soldier's account may be settled upon the receipt of these muster rolls, and the Soldier receive any pay or allowances that may be due him at the time of his discharge, and which may not appear on his final statements from the fact that his descriptive list is incomplete. These accounts for back pay, &c., are settled by the 2d Auditor of the Treasury Department.

NOTE 4.—Charges for loss or injury to ordnance, horse equipments, and other miscellaneous charges, should appear under the heading of "Other Stoppages."

NOTE 5.—Bounty paid by State authorities, and not by the United States, will not be entered on this statement.

NOTE 6.—Amounts due the Sutler and Laundress must be entered on the muster roll on which the discharge, death, desertion, &c., is reported, as well as on the final statement, otherwise the amount cannot be collected from the United States.

NOTE 7.—This blank will be used for deceased volunteers and drafted men, as well as for others.

NOTE 8.—Where a Soldier dies in Hospital or on detached service, his descriptive list, if he has one, should be sent with his final statements, in duplicate, to the Second Auditor, Washington, D. C.

ADJUTANT GENERAL'S OFFICE.

Aug 13th 1864

Duplicate with Inventory sent 2d Auditor.



Quincy



I certify, on honor, that Henry Williams a Private of  
Captain Henry Simon's Company (B) of the 8<sup>th</sup> Regiment of U. S. Army (Col.)  
**VOLUNTEERS**, of the State of Rhode Island, born in \_\_\_\_\_, State  
of New Jersey, aged 38 years; 5 feet 6 inches high; Dark complexion.  
Black eyes, Black hair, and by occupation a Laborer, having joined the company on  
its original organization at Providence R. I., and enrolled in it at the muster into  
the service of the United States at Providence R. I., on the 14<sup>th</sup> day  
of September, 1863, (or was mustered in service as a recruit, by \_\_\_\_\_  
at \_\_\_\_\_, on the \_\_\_\_\_ day of \_\_\_\_\_,  
186  , or was drafted and mustered into the service of the United States from the \_\_\_\_\_  
Enrollment District of the State of \_\_\_\_\_, at \_\_\_\_\_,  
on the \_\_\_\_\_ day of \_\_\_\_\_, 186  .) to serve in the Regiment, for  
the term of Three Years: and having served **HONESTLY** and  
**FAITHFULLY** with his Company in said regiment to the present date, is now  
entitled to a **DISCHARGE** by reason of Death

(Died April 18<sup>th</sup> 1864)  
The said Henry Williams was ~~last~~ <sup>not</sup> paid by Paymaster  
since enlistment to include the 18<sup>th</sup> day of April, 1864, and has  
pay due him from that time to the present date; he is entitled to pay and subsistence for  
**TRAVELING** to place of enrollment, and whatever other allowances are authorized to volunteer  
soldiers, drafted men, or militia, so discharged. He has received from the United States **CLOTHING**  
amounting to Fifty three  $\frac{10}{100}$  dollars, since the 19<sup>th</sup> day of August,  
1863, when his clothing account was last settled. He has received from the United States  
    $\frac{  }{100}$  dollars advanced **BOUNTY**.

There is to be stopped from him, on account of the State of \_\_\_\_\_, or other  
authorities, for **CLOTHING**, &c, received on entering service. Eleven  $\frac{10}{100}$  dollars; and  
for other stoppages, viz: \_\_\_\_\_

\_\_\_\_\_  $\frac{  }{100}$  dollars.  
He has been furnished with **TRANSPORTATION** in kind from the place of his discharge to  
\_\_\_\_\_ ; and he has been **SUBSISTED** for **TRAVELING** to his  
place of enrollment, up to the \_\_\_\_\_, 186  .

He is indebted to \_\_\_\_\_, **SUTLER**, \_\_\_\_\_  $\frac{  }{100}$  dollars.

He is indebted to \_\_\_\_\_, **LAUNDRESS**, \_\_\_\_\_  $\frac{  }{100}$  dollars.

Given in Duplicate, at Matagorda Island, Texas, this 18<sup>th</sup> day  
of April, 1864.

Henry Simon  
Captain

Commanding Company



4  
2d Br. 1864

FINAL STATEMENT

OF

Henry Williams  
8th Reg't of U. S. H. Art'y (Col'd)

VOLUNTEERS.

---

NOTE 1.—Two of these certificates (or duplicates) are to be given to each volunteer soldier who may be discharged previously to the discharge of his company, that he may at once receive from the Paymaster the pay, &c., due him, and the captain or other officer commanding the company will certify to the act of the delivery of the duplicate certificates; on these certificates the Soldier is "entitled to" his discharge, and should also present his discharge to the Paymaster to have the payment endorsed on it. The discharge is to be given back to the Soldier by the Paymaster; the latter only retaining as his voucher the duplicate certificates.

NOTE 2.—If the Soldier is entitled to pay for the use of his horse, the Company Commander will certify to that fact, and also to the time he has pay due for having been so mounted on his own horse.

NOTE 3.—Amounts due the Sutler and Laundress must be entered on the Muster Roll on which the death, desertion, &c., is reported, as well as on the final statement, otherwise the amount cannot be collected from the United States.

NOTE 4.—This blank will be used for deceased volunteers as well as others.

---



I certify, on honor, that Henry Williams a Private of  
Captain Henry Simon's Company (B) of the 8<sup>th</sup> Regiment of U. S. Arty (Col)  
**VOLUNTEERS**, of the State of Rhode Island, born in \_\_\_\_\_, State  
of New Jersey, aged 38 years; 5 feet 6 inches high; Dark complexion,  
Black eyes, Black hair, and by occupation a Laborer, having joined the company on  
its original organization at Providence R. I., and enrolled in it at the muster into  
the service of the United States at Providence R. I., on the 14<sup>th</sup> day  
of September, 1863, (or was mustered in service as a recruit, by \_\_\_\_\_  
\_\_\_\_\_, at \_\_\_\_\_, on the \_\_\_\_\_ day of \_\_\_\_\_,  
186  , to serve in the Regiment,) for the term of Three Years;  
and having served **HONESTLY** and **FAITHFULLY** with his Company in 8<sup>th</sup> Regiment  
to the present date, is now entitled to a **DISCHARGE** by reason of Death

The said Henry Williams was ~~not~~ <sup>not</sup> paid by Paymaster  
since enlistment to include the 18<sup>th</sup> day of April, 1864, and has  
pay due him from that time to the present date; he is entitled to pay and subsistence for  
**TRAVELING** to place of enrollment and whatever other allowances are authorized to volunteer  
soldiers, or militia, so discharged. He has received Fifty three <sup>10</sup>/<sub>100</sub> dollars,  
advanced by the United States on account of **CLOTHING**.

There is to be stopped from him, on account of the State of \_\_\_\_\_, or other  
authorities for **CLOTHING**, &c., received on entering service, Eleven <sup>0</sup>/<sub>100</sub> dollars; also,  
for expenses of **SUBSISTENCE** for **TRAVELING** from place of enrollment to the place of rendezvous,  
amounting to \_\_\_\_\_ <sup>100</sup>/<sub>100</sub> dollars: and on account of the United States for **EXTRA**  
**CLOTHING** received in kind from \_\_\_\_\_ and for other  
stoppages, viz:

\_\_\_\_\_ amounting to \_\_\_\_\_ <sup>100</sup>/<sub>100</sub> dollars;  
and he has been **SUBSISTED** for **TRAVELING** to his place of enrollment, up to the \_\_\_\_\_  
\_\_\_\_\_, 186  .

He is indebted to \_\_\_\_\_, **SUTLER**, \_\_\_\_\_ <sup>100</sup>/<sub>100</sub> dollars.

He is indebted to \_\_\_\_\_, **LAUNDRESS**, \_\_\_\_\_ <sup>100</sup>/<sub>100</sub> dollars.

Given in Duplicate, at Matagorda Is., this 18<sup>th</sup> day of April, 1864.



Inventory  
of the effects of Private  
Henry Williams late  
of Company B. 8th Regt.  
of U. S. H. Arty. (Col'd.)  
who died at Matagorda  
Island Texas April 18, 1864

1864  
1864  
1864



Inventory of the Effects of Private Henry Williams  
late of Company B. 8<sup>th</sup> Regt. of U. S. H. Arty. (Col'd) who died  
at Matagorda Island, Texas, the 18<sup>th</sup> day of April, 1864.

Money \$1. 71  
one pr. Pants.  
one Cap  
two Blouses  
one Haversack  
one Over Coat  
one pr. Shoes  
three pr. Drawers.  
one Dress Coat.

two Shirts  
one Vest  
one Rubber Blanket  
one Wooden Blanket  
one Knapsack

I certify that the above is a correct inventory of the effects  
of Private Henry Williams Company B. 8<sup>th</sup> Regiment of  
U. S. H. Arty (Col'd) who died at Fort Esperanza the 18<sup>th</sup> day  
of April, 1864

Matagorda Island, Texas.  
April 18<sup>th</sup> 1864.

James  
Captain Co. B. 8<sup>th</sup> U. S. H. Arty (Col'd)

2022

*William Henry B.*

Co M., 11 U.S. Col'd H. Art'y.

*Private* | *Corporal.*

CARD NUMBERS.

1	6201478	26
2	6201506	27
3	6201662	28
4	6201822	29
5	6201981	30
6	6202130	31
7	6202283	32
8	6202413	33
9	6202533	34
10	6202648	35
11	6202760	36
12	6202863	37
13	9126036	38
14		39
15		40
16		41
17		42
18		43
19		44
20		45
21		46
22		47
23		48
24		49
25		50

Book Mark:-

See also



*H* | *11th Art'y* | **U.S.C.T.**

*Henry P. Williams*

*Co. M, 11th Reg't U.S. Col'd Art'y*

Appears on

**Company Descriptive Book**

of the organization named above.

**DESCRIPTION.**

Age *36* years; height *5* feet *5* inches.

Complexion *OK*

Eyes *OK*; hair *OK*

Where born *Pa*

Occupation *Engineer*

**ENLISTMENT.**

When *Dec 21*, 186*3*

Where *Prov R, D.*

By whom *J. B. Engly*; term *3* y'rs.

Remarks: *Mustered into U.S.*

*Service Jan 25, 1864*

*Mustered out*



211 | 11 H. Art'y. | **U.S.C.T.**

*Nenny B. Williams*  
Sgt., Co. *M*, 14 Reg't R. I. Col'd H. Art'y.\*

Age *36* years.

Appears on

**Company Muster-in Roll**

of the organization named above. Roll dated  
*Providence, R. I. Jan. 25*, 1864.

Muster-in to date *Jan. 25*, 1864.

Joined for duty and enrolled:

When *Dec. 21*, 1863.

Where *Prov., R. I.*

Period *3* years.

Valuation of horse, \$ *100*

Valuation of horse equipments, \$ *100*

Remarks: *2 district*

\* This organization subsequently became Co. *M*, 11 Reg't U. S. Colored Heavy Artillery.

Book mark: \_\_\_\_\_

*J. Allen*

*W* | 11 H. Art'y. | U.S.C.T.

*Henry B Williams*  
Corp, Co. M, 14 Reg't R. I. Col'd H. Art'y.\*

Appears on

**Company Muster Roll**

for *25-Jan to 29-Feb*, 1864.

Present or absent *Present*

Stoppage, \$ *100* for

Due Gov't, \$ *100* for

Valuation of horse, \$ *100*

Valuation of horse equipments, \$ *100*

Remarks: *Promoted to Corp*  
*Feb 17/64*

This organization subsequently became Co. M, 11 Reg't U. S. Colored Heavy Artillery.

Book mark:

*J Hudson*  
Copied.

*W*

11 H. Art'y. U.S.C.T.

*Henry B Williams*  
Cnp Co. M, 14 Reg't R. I. Col'd H. Art'y.\*

Appears on

**Company Muster Roll**

for *Mich + April*, 1864.

Present or absent *Present*

Stoppage, \$ 100 for

Due Gov't, \$ 100 for

Valuation of horse, \$ 100

Valuation of horse equipments, \$ 100

Remarks: *Corporal Feb 17/64*

This organization subsequently became Co. M, 11 Reg't U. S. Colored Heavy Artillery.

Book mark: \_\_\_\_\_

*J. Hudson*  
Coyt.



*M* | 11 H. Art'y. | U.S.C.T.

*Henry B. Williams*  
*Corl.*, Co. *M*, 8 Reg't U. S. Col'd H. Art'y.\*

Appears on

**Company Muster Roll**

for *May & June*, 1864.

Present or absent

*Present*

Stoppage, \$ 100 for

Due Gov't, \$ 100 for

Valuation of horse, \$ 100

Valuation of horse equipments, \$ 100

Remarks:

† This organization subsequently became Co. *M*, 11 Reg't U. S. Colored Heavy Artillery.

Book mark:

*T. A. B. C.*

*W*

11 H. Art'y.

U.S.C.T.

*Henry B. Williams*

*Corp.*, Co. M, 11 Reg't U. S. Col'd H. Art'y.

Appears on

**Company Muster Roll**

for *data Sep. 1*, 1864.

Present or absent *Present*

Stoppage, \$ *100* for

Due Gov't, \$ *100* for

Valuation of horse, \$ *100*

Valuation of horse equipments, \$ *100*

Remarks: *\$6 per m. due from  
enlistment to Sep. 30/64.  
Free on 19<sup>th</sup> Sep. 1861.*

Book mark:

*Pabler*

Copyist.

W | 11 H. Art'y. | **U.S.C.T.**

*Henry B. Williams*  
Coop, Co. M, 11 Reg't U. S. Col'd H. Art'y.

Appears on

**Company Muster Roll**

for *Sept & Oct*, 186*4*

Present or absent *Present*

Stoppage, \$.....100 for .....

Due Gov't, \$.....100 for .....

Valuation of horse, \$.....100

Valuation of horse equipments, \$.....100

Remarks:.....

Book mark:.....

*A. Hubber*  
Coptist.



W

11 H. Art'y.

U.S.C.T.

Henry B Williams  
Cap, Co. M, 11 Reg't U. S. Col'd H. Art'y.

Appears on

Company Muster Roll

for Nov & Dec, 1864.

Present or absent Present

Stoppage, \$ 100 for

Due Gov't, \$ 100 for

Valuation of horse, \$ 100

Valuation of horse equipments, \$ 100

Remarks:

Book mark:

A. Hubbell

Copyist.

717

11 H. Art'y. U.S.C.T.

*Henry B Williams*  
Corp, Co. M, 11 Reg't U. S. Col'd H. Art'y.

Appears on

**Company Muster Roll**

for *Jan to Feb*, 1865.

Present or absent *Present*

Stoppage, \$ 100 for

Due Gov't, \$ 100 for

Valuation of horse, \$ 100

Valuation of horse equipments, \$ 100

Remarks: *28<sup>o</sup> for Ordnance Stores*

Book mark:

*A. Hubbell*

71

11 H. Art'y.

U.S.C.T.

Henry B Williams  
Capt, Co. M, 11 Reg't U. S. Col'd H. Art'y.

Appears on

Company Muster Roll

for *March & April*, 1865.

Present or absent *Present.*

Stoppage, \$ *100* for

Due Gov't, \$ *100* for

Valuation of horse, \$ *100*

Valuation of horse equipments, \$ *100*

Remarks: *23¢ for Ordnance  
Stubs*

Book mark:

*A. Stubblee*



71

11 H. Art'y. U.S.C.T.

Henry B. Williams  
Capt., Co. M, 11 Reg't U. S. Col'd H. Art'y.

Appears on

Company Muster Roll

for May & June, 1865.

Present or absent Present

Stoppage, \$ 100 for

Due Gov't, \$ 2<sup>00</sup>/<sub>100</sub> for Gr & Equipage

Valuation of horse, \$ 100

Valuation of horse equipments, \$ 100

Remarks:

Book mark:

Fennett

Copyist.

11 H. Art'y. U.S.C.T.

*Henry B. Williams*  
Co. M, 11 Reg't U. S. Col'd H. Art'y.

Appears on

**Company Muster Roll**

for *July & Aug.*, 1865.

Present or absent *Present*

Stoppage, \$ 100 for

Due Gov't, \$ *2.00* 100 for *Co. G. Equipage*

Valuation of horse, \$ 100

Valuation of horse equipments, \$ 100

Remarks: \_\_\_\_\_  
\_\_\_\_\_  
\_\_\_\_\_  
\_\_\_\_\_  
\_\_\_\_\_  
\_\_\_\_\_  
\_\_\_\_\_

Book mark: \_\_\_\_\_

*Harrett*

Copyist.

71 | 11 H. Art'y. | **U.S.C.T.**

*Henry B. Williams*

*Capt*, Co. *M*, 11 Reg't U. S. Col'd H. Art'y.

Appears on **Co. Muster-out Roll**, dated  
*New Orleans La*, *Oct 2*, 1865.

Muster-out to date *Oct 2*, 1865.

Last paid to *Feb 28*, 1865.

**Clothing account:**

Last settled....., 186 ; drawn since \$.....<sup>100</sup>

Due soldier \$ *17* <sup>*40*</sup>/<sub>100</sub>; due U. S. \$.....<sup>100</sup>

Am't for cloth'g in kind or money adv'd \$.....<sup>100</sup>

Due U. S. for arms, equipments, &c., \$ *2* <sup>*00*</sup>/<sub>100</sub>

Bounty paid \$.....<sup>100</sup>; due \$ *100* <sup>*00*</sup>/<sub>100</sub>

Remarks: *joined at original organiza-*  
*tion. Private to Feb 17/64. Stop*  
*for one musket + accoutrements*  
*retained. / Musquito bar lost.*

Book mark : .....

*Forsyth*



Williams, Henry D

I, Co., 11 Reg't U.S.C. H.A.

Enclosures.

Bed Cards .....	Final Statements .....
Burial Records .....	Furloughs or L. of A .....
Certs. of Dis. for Discharge .....	Med. Certificates .....
C. M. Charges .....	Med. Des. Lists .....
Descriptive Lists .....	Orders .....
Discharge Certificates .....	Pris. of War Record .....
Enlistment Papers .....	Resignations .....

Other papers relating to—

Admission to Hosp'l .....	Furlough or L. of A .....
Casualty Sheet .....	Med. Examination .....
Confinement .....	Misc. Information .....
Contracts .....	Pay or Clothing .....
Death or Effects .....	Personal Reports .....
Desertion .....	Rank .....
Discharge from Hosp'l .....	Transfer to Hosp'l .....
Discharge from Service .....	Transfer to V. R. C. .....
Duty .....	Transportation .....

DECLARATION OF RECRUIT.

*Henry B Williams*  
THE UNITED STATES, for the term of

desiring to VOLUNTEER as a Soldier in the ARMY OF  
do declare that I am 36 years and

months of age; that I have never been discharged from the United States service on account of disability  
or by sentence of a court martial, or by order, before the expiration of a term of enlistment; and I know of no impediment to my  
serving honestly and faithfully as a soldier for 3 years

Given at *Providence*  
The 21<sup>st</sup> day of *Dec* 1863

Witness:

*S. Chase*

*Henry B. Williams*

Discharged



18

Reg't of

enlistment; last served in Company ( )

*By* *W. E. Engler*  
*14* Regiment of *Artillery*

*Dec 21<sup>st</sup> 1863*

Volunteered at

*Providence*

*Henry B Williams*

*N. H. O.*

*11 W. E. H. A.*

CONSENT IN CASE OF MINOR.

I,

of

is

years of age; and I do hereby freely give

my CONSENT to his volunteering as a SOLDIER in the ARMY OF THE UNITED STATES for the period of

Given at

The

day of

Witness:

*A*



VOLUNTEER ENLISTMENT.

State of Rhode Island



Town of Providence

I, Henry B. Williams, born in ... in the State of Pennsylvania aged 36 years, and by occupation an Engineer DO HEREBY ACKNOWLEDGE to have volunteered this 21<sup>st</sup> day of Dec 18 63 to serve as a SOLDIER in the ARMY OF THE UNITED STATES OF AMERICA, for the period of 3 years, unless sooner discharged by proper authority:

Do also agree to accept such bounty, pay, rations and clothing, as are, or may be, established, by law for volunteers. And I, Henry B Williams do solemnly swear, that I will bear true faith and allegiance to the United States of America, and that I will serve them honestly and faithfully against all their enemies or opposers whomsoever; and that I will observe and obey the orders of the President of the United States, and the orders of the officers appointed over me, according to the Rules and Articles of War.

Sworn and Subscribed to, at Providence this 21<sup>st</sup> day of Dec 18 63 Henry B. Williams BEFORE Mr John L. Arroy Public Notary

I CERTIFY, ON HONOR, That I have carefully examined the above-named Volunteer, agreeable to the General Regulations of the Army, and that, in my opinion, he is free from all bodily defects and mental infirmity, which would, in any way, disqualify him from performing the duties of a soldier.

John L. Arroy M.D. EXAMINING SURGEON.

I CERTIFY, ON HONOR, That I have minutely inspected the Volunteer, Henry B Williams previously to his enlistment, and that he was entirely sober when enlisted; that to the best of my judgment and belief, he is of lawful age; and that, in accepting him as duly qualified to perform the duties of an able-bodied soldier, I have strictly observed the Regulations which govern the recruiting service. This soldier has Dark eyes Dark hair complexion, is 5 feet, 5 inches high.

John B. ... Lt. Col. 14<sup>th</sup> Regiment of ... Volunteers.

RECRUITING OFFICER.



2023

*Williams Henry M.*

Co. A., 11 U.S. Col'd H. Art'y.

*Private. Artificer.*

CARD NUMBERS.

1	6194386	26
2	6194531	27
3	6194671	28
4	6194815	29
5	6194954	30
6	6195092	31
7	6195226	32
8	6195360	33
9	6195393	34
10	6195523	35
11	6195655	36
12	6195786	37
13	6195912	38
14	9125H25	39
15		40
16		41
17		42
18		43
19		44
20		45
21		46
22		47
23		48
24		49
25		50

Book Mark: 464.496

See also

#1930346 P.O. 244  
#2909523 And W.D.  
A4.1695005

John Miller Esq

*W* | **11 H. Art'y. | U.S.C.T.**

*Henry M. Williams*  
....., Co. *H*, 11 Reg't U. S. Col'd H. Art'y.

Appears on

**Company Descriptive Book**

of the organization named above.

**DESCRIPTION.**

Age *42* years; height *5* feet *2* inches.

Complexion *Blk*

Eyes *Blk*; hair *Blk*

Where born *Dover Del*

Occupation *Farmer*

**ENLISTMENT.**

When *Nov 2*, 186*3*.

Where *Prov. R.I.*

By whom *J.P. Engley*; term *3* y'rs.

Remarks: .....

.....  
.....  
.....  
.....  
.....  
.....  
.....  
.....  
.....  
.....

*W. J. Roe*



*W* | 11 H. Art'y. | U.S.C.T.

*Henry M. Williams*

*Priv*, Co. *D*, 14 Reg't R. I. Col'd H. Art'y.\*

Age *42* years.

Appears on

**Company Muster-in Roll**

of the organization named above. Roll dated

*Providence R.I., Nov 23, 1863.*

Muster-in to date

*Nov 23, 1863.*

Joined for duty and enrolled:

When *Nov. 2*, 1863.

Where *Providence R.I.*

Period *3* years.

Valuation of horse, \$ 100

Valuation of horse equipments, \$ 100

Remarks: *Residence Prov-*  
*idence R. I.*

\* This organization subsequently became Co. *H*, 11 Reg't U. S. Colored Heavy Artillery.

Book mark: \_\_\_\_\_

A. | 11 H. Art'y. | U.S.C.T.

Henry Williams  
Priv., Co. H, 14 Reg't R. I. Col'd H. Art'y.\*

Appears on

**Company Muster Roll**

for 23 Nov. to 31 Dec, 1863.

Present or absent Present

Stoppage, \$ 100 for

Due Gov't, \$ 100 for

Valuation of horse, \$ 100

Valuation of horse equipments, \$ 100

Remarks:

\*This organization subsequently became Co. H, 11 Reg't U. S. Colored Heavy Artillery.

Book mark:

Cerry

*A.* | 11 H. Art'y. | U.S.C.T.

*Henry M. Williams,*  
*Priv.,* Co. H, 14 Reg't R. I. Col'd H. Art'y.\*

Appears on

**Company Muster Roll**

for *Jan & Feb*, 1864.

Present or absent *Present*

Stoppage, \$.....100 for .....

Due Gov't, \$.....100 for .....

Valuation of horse, \$.....100

Valuation of horse equipments, \$.....100

Remarks:.....  
.....  
.....  
.....  
.....  
.....  
.....

\*This organization subsequently became Co. H, 11 Reg't U. S. Colored Heavy Artillery.

Book mark:.....

*Perry*

Copyist.



*N.* | 11 H. Art'y. | U.S.C.T.

*Henry M. Williams*

*Priv*, Co. H, 14 Reg't R. I. Col'd H. Art'y.\*

Appears on

**Company Muster Roll**

for *Mch & Apl.*, 1864.

Present or absent *Present*

Stoppage, \$ *100* for

Due Gov't, \$ *100* for

Valuation of horse, \$ *100*

Valuation of horse equipments, \$ *100*

Remarks: *On daily duty  
as artificer per  
Special Order No. 15*

\*This organization subsequently became Co. H, 11 U. S. Col'd H. Art'y

Book mark:

*Perry*

Copyist.

*W.*

**11 H. Art'y. | U.S.C.T.**

*Harry M. Williams*

*Co. H*, Co. *H*, 8 Reg't U. S. Col'd H. Art'y.\*

Appears on

**Company Muster Roll**

for *May & June*, 1864.

Present or absent *Present*

Stoppage, \$ 100 for

Due Gov't, \$ 100 for

Valuation of horse, \$ 100

Valuation of horse equipments, \$ 100

Remarks:

† This organization subsequently became Co. *H*, 11 Reg't U. S. Colored Heavy Artillery.

Book mark:

*Perry*

Copyist.

24

11 H. Art'y. U.S.C.T.

Henry M. Williams

Private, Co. H, 11 Reg't U. S. Col'd H. Art'y.

Appears on

Company Muster Roll

for July + Aug., 1864.

Present or absent Present

Stoppage, \$ 100 for

Due Gov't, \$ 100 for

Valuation of horse, \$ 100

Valuation of horse equipments, \$ 100

Remarks:

Book mark:

H. A. Tyler

Copyist.



*W*

**11 H. Art'y. U.S.C.T.**

*Henry M. Williams*  
*Private*, Co. H, 11 Reg't U. S. Col'd H. Art'y.

Appears on

**Company Muster Roll**

for *Dated Oct 31*, 186*4*.

Present or absent *Present*

Stoppage, \$ *100* for

Due Gov't, \$ *100* for

Valuation of horse, \$ *100*

Valuation of horse equipments, \$ *100*

Remarks: *Stop for Har-*  
*ersack 67 (new)*  
*Free Apr. 19, 1861.*

Book mark:

*W A Tyler*

*W* | 11 H. Art'y. | U.S.C.T.

*Henry M. Williams*  
Priv., Co. H, 11 Reg't U. S. Col'd H. Art'y.

Appears on

**Company Muster Roll**

for *Nov & Dec*, 1864.

Present or absent *Present*

Stoppage, \$ *100* for

Due Gov't, \$ *100* for

Valuation of horse, \$ *100*

Valuation of horse equipments, \$ *100*

Remarks: *Stop for one  
Haversack 67*

Book mark: \_\_\_\_\_

*W. Tyler*

Copyist.

*W* | 11 H. Art'y. | U.S.C.T.

*Henry M. Williams*  
Artificer, Co. H, 11 Reg't U. S. Col'd H. Art'y.

Appears on

**Company Muster Roll**

for *Jan + Feb*, 1865.

Present or absent *Present*

Stoppage, \$ *100* for

Due Gov't, \$ *100* for

Valuation of horse, \$ *100*

Valuation of horse equipments, \$ *100*

Remarks: *Stop for Haversack, 67*

Book mark:

*W. A. Tyler*

Copyist.



*W*

**11 H. Art'y. U.S.C.T.**

*Henry M. Williams*  
*Artificer*, Co. H, 11 Reg't U. S. Col'd H. Art'y.

Appears on

**Company Muster Roll**

for *March & Apr*, 1863.

Present or absent *Present*

Stoppage, \$ *100* for

Due Gov't, \$ *100* for

Valuation of horse, \$ *100*

Valuation of horse equipments, \$ *100*

Remarks:

Book mark:

*W. A. Sykes*

*M.*

**11 H. Art'y. U.S.C.T.**

*Henry M. Williams*  
Art'y., Co. H, 11 Reg't U. S. Col'd H. Art'y.

Appears on

**Company Muster Roll**

for *May and June*, 1865.

Present or absent *Present*

Stoppage, \$ 100 for

Due Gov't, \$ 100 for

Valuation of horse, \$ 100

Valuation of horse equipments, \$ 100

Remarks:

Book mark:

*Phillips*

Copyist.

*JK*

11 H. Art'y. U.S.C.T.

*Henry M. Williams*

Art., Co. H, 11 Reg't U. S. Col'd H. Art'y.

Appears on

**Company Muster Roll**

for *July and Aug.*, 186*6*.

Present or absent *Present*

Stoppage, \$ *100* for

Due Gov't, \$ *100* for

Valuation of horse, \$ *100*

Valuation of horse equipments, \$ *100*

Remarks: *Stop for haversack 95.*

Book mark:

*Chen*

Copyist.



*Ph.* | **11 H. Art'y. U.S.C.T.**

*Henry M Williams*  
Art. *Co. H.*, 11 Reg't U. S. Col'd H. Art'y.

Appears on **Co. Muster-out Roll**, dated  
*New Orleans La, Oct. 2*, 1863.  
Muster-out to date *Oct. 2*, 1863.  
Last paid to *June 30*, 1863.

**Clothing account:**

Last settled....., 186 ; drawn since \$.....<sup>100</sup>

Due soldier \$ *8*<sup>*47*</sup>/<sub>100</sub>; due U. S. \$.....<sup>100</sup>

Am't for cloth'g in kind or money adv'd \$.....<sup>100</sup>

Due U. S. for arms, equipments, &c., \$.....<sup>100</sup>

Bounty paid \$ *00*/<sub>100</sub>; due \$ *100*/<sub>100</sub>

Remarks: *joined at orig'l origin*

*Stop for Musket and*

*Acc'ts retained \$6*

*Stop for haversack and*

*canteen lost \$1.60*

Book mark: *464496*

*Phette*

Williams, Henry M.

D., Co., 11 Reg't U.S. A.

Enclosures.

Bed Cards .....	Final Statements .....
Burial Records .....	Furloughs or L. of A. ....
Certs. of Dis. for Discharge .....	Med. Certificates .....
C. M. Charges .....	Med. Des. Lists .....
Descriptive Lists .....	Orders .....
Discharge Certificates .....	Pris. of War Record .....
Enlistment Papers .....	Resignations .....

Other papers relating to—

Admission to Hosp'l .....	Furlough or L. of A. ....
Casualty Sheet .....	Med. Examination .....
Confinement .....	Misc. Information .....
Contracts .....	Pay or Clothing .....
Death or Effects .....	Personal Reports .....
Desertion .....	Rank .....
Discharge from Hosp'l .....	Transfer to Hosp'l .....
Discharge from Service .....	Transfer to V. R. C. ....
Duty .....	Transportation .....

DECLARATION OF RECRUIT.

I, *Henry M. Williams* desiring to VOLUNTEER as a Soldier in the ARMY OF THE UNITED STATES, for the term of *three years* do declare that I am *42* years and months of age; that I have never been discharged from the United States service on account of disability or by sentence of a court martial, or by order, before the expiration of a term of enlistment; and I know of no impediment to my serving honestly and faithfully as a soldier for *three years*

Given at *Lowell N.H.*  
The *second* day of *Nov*, 18*63*

Witness: *M. Adams* *Henry M. Williams*

No. *11 Moore*

Volunteered at *Lowell N.H.*  
*Henry M. Williams*

By *A. S. Sargent*  
*14th Regiment of Mass. Inf.*

enlistment; last served in Company ( )

Reg't of

Discharged

18

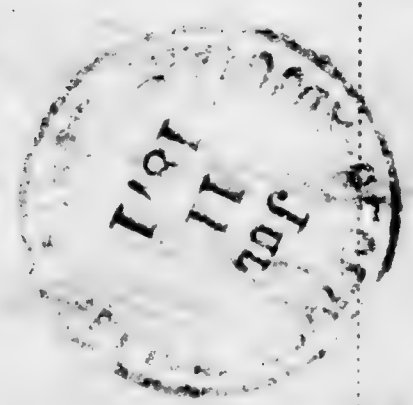

CONSENT IN CASE OF MINOR.

I, \_\_\_\_\_ of \_\_\_\_\_ is \_\_\_\_\_ years of age; and I do hereby freely give my CONSENT to his volunteering as a SOLDIER in the ARMY OF THE UNITED STATES for the period of \_\_\_\_\_

Given at \_\_\_\_\_  
The \_\_\_\_\_ day of \_\_\_\_\_  
Witness \_\_\_\_\_



VOLUNTEER ENLISTMENT.



State of

Rhode Island

Town of

Providence

I, Henry M. William

born in

Dover

in the State of

Delaware

aged 42

years, and by occupation

a farmer

DO HEREBY ACKNOWLEDGE to have volunteered this second

day of November 1863 to serve as a SOLDIER in the ARMY OF THE UNITED STATES

OF AMERICA, for the period of three years, unless sooner discharged by proper authority:

Do also agree to accept such bounty, pay, rations and clothing, as are, or may be, established, by law for

volunteers. And I, Henry M. William do solemnly swear, that I will bear

true faith and allegiance to the United States of America, and that I will serve them honestly and faith-

fully against all their enemies or opposers whomsoever; and that I will observe and obey the orders of the

President of the United States, and the orders of the officers appointed over me, according to the Rules

and Articles of War.

Sworn and Subscribed to, at

this

18

BEFORE

Handwritten signatures and text: "John D. Gardner" and "Henry M. William" in cursive, along with "Justice of the Peace" and "I took".

I CERTIFY, ON HONOR, That I have carefully examined the above-named Volunteer, agreeable to the General Regulations of the Army, and that, in my opinion, he is free from all bodily defects and mental infirmity, which would, in any way, disqualify him from performing the duties of a soldier.

Handwritten signature: John D. Gardner

EXAMINING SURGEON.

I CERTIFY, ON HONOR, That I have minutely inspected the Volunteer, Henry M. William previously to his enlistment, and that he was entirely sober when enlisted; that to the best of my judgment and belief, he is of lawful age; and that, in accepting him as duly qualified to perform the duties of an able-bodied soldier, I have strictly observed the Regulations which govern the recruiting service. This soldier has

dark complexion, is five feet, five inches high, black eyes, black hair.

14th Regiment of Heavy Artillery Volunteers,

RECRUITING OFFICER.

2024

Williams Isaac.

Co 10., 11 U.S. Col'd H. Art'y.

Private | Private.

CARD NUMBERS.

1	6187307	26
2	6187450	27
3	6187597	28
4	6187741	29
5	6187879	30
6	6188003	31
7	6188139	32
8	6188270	33
9	6188389	34
10	6188503	35
11	6188609	36
12	6188719	37
13	6188822	38
14	9174808	39
15	9174666	40
16		41
17		42
18		43
19		44
20		45
21		46
22		47
23		48
24		49
25		50

Book Mark:

See also



S 1172486 P O M M  
A. 2397166 P O R N

John Miller P O R N



*H* | 11 H. Art'y. | U.S.C.T.

*Isaac Williams*

....., Co. *D*, 11 Reg't U. S. Col'd H. Art'y.

Appears on

**Company Descriptive Book**

of the organization named above.

**DESCRIPTION.**

Age *23* years; height *5* feet *6* inches.

Complexion *Blk.*

Eyes *Blk.*; hair *Blk.*

Where born *Graves End, L. I.*

Occupation *Trimmer.*

**ENLISTMENT.**

When *Sept 12*, 186 *3*.

Where *Prov.*

By whom *J. G. Engley*; term *3* y'rs.

Remarks:

*O. J. Markle.*

Copyst.

*W* | **11 H. Art'y. | U.S.C.T.**

*Isaac Williams*

....., Co. *D*., 11 Reg't U. S. Col'd H. Art'y.

Appears on

**Company Descriptive Book**

of the organization named above.

**DESCRIPTION.**

Age *23* years; height *5* feet *6* inches.

Complexion *Black*.

Eyes *Black*; hair *Black*

Where born *Gouverneur, N.Y.*

Occupation *Farmer*.

**ENLISTMENT.**

When *Sep. 12*....., 186 *3*.

Where *Prov., R.I.*

By whom *J. C. Engley*; term *3* y'rs.

Remarks:

*O. J. Markle*

Copyist.

*W* | 11 H. Art'y. | U.S.C.T.

*Isaac Williams*

*Pvt.*, Co. *D*, 14 Reg't R. I. Col'd H. Art'y.\*

Age *23* years.

Appears on

**Company Muster-in Roll**

of the organization named above. Roll dated

*Providence R.I., Sept. 22, 1863.*

Muster-in to date *Sept. 22, 1863.*

**Joined for duty and enrolled:**

When *Sept. 12*, 186 .

Where *Prov. R. I.*

Period *3* years.

Valuation of horse, \$.....*100*

Valuation of horse equipments, \$.....*100*

Remarks: *Residence N.Y.*

\* This organization subsequently became Co. *D*, 11 Reg't U. S. Colored Heavy Artillery.

Book mark: .....

*Serring*



*W* | 11 H. Art'y. | U.S.C.T.

*Isaac Williams*

*Pvt.*, Co. D, 14 Reg't R. I. Col'd H. Art'y.\*

Appears on

**Company Muster Roll**

for *Sept. 22 to Dec. 31*, 1863.

Present or absent *Present*

Stoppage, \$ 100 for

Due Gov't, \$ 100 for

Valuation of horse, \$ 100

Valuation of horse equipments, \$ 100

Remarks:

\*This organization subsequently became Co. D, 11 Reg't U. S. Col'd Heavy Artillery.

Book mark:

*Loring*

*W* | **11 H. Art'y. | U.S.C.T.**

*Isaac Williams*

*Pvt.*, Co. D, 14 Reg't R. I. Col'd H. Art'y.\*

Appears on

**Company Muster Roll**

for *Sept. 22/63 to Feb. 29, 1864.*

Present or absent *Present*

Stoppage, \$.....100 for .....

Due Gov't, \$.....100 for .....

Valuation of horse, \$.....100

Valuation of horse equipments, \$.....100

Remarks:.....

\*This organization subsequently became Co. D, 11 Reg't U. S. Col'd Heavy Artillery.

Book mark : .....

*Levring*

(358)

Copyist.

*M* | **11 H. Art'y. | U.S.C.T.**

*Isaac Williams*

*Priv.*, Co. *D*, 8 Reg't U. S. Col'd H. Art'y.\*

Appears on

**Company Muster Roll**

for *Mar + Apr*, 1864.

Present or absent *present*

Stoppage, \$ *100* for

Due Gov't, \$ *100* for

Valuation of horse, \$ *100*

Valuation of horse equipments, \$ *100*

Remarks:

† This organization subsequently became Co. *D*, 11 Reg't U. S. Colored Heavy Artillery.

Book mark:

*Wm Allen*



*H* | **11 H. Art'y. | U.S.C.T.**

*Isaac Williams*  
*priv.*, Co. *D*, 8 Reg't U. S. Col'd H. Art'y.\*

Appears on

**Company Muster Roll**

for *May & June, 1864.*

Present or absent *Present*

Stoppage, \$ *100* for

Due Gov't, \$ *100* for

Valuation of horse, \$ *100*

Valuation of horse equipments, \$ *100*

Remarks:  
.....  
.....  
.....  
.....  
.....

\*This organization subsequently became Co. *D*, 11 Reg't U. S. Colored Heavy Artillery.

Book mark: .....

*Wm Allen*

*M* | 11 H. Art'y. | U.S.C.T.

*Isaac Williams*  
*Pot*, Co. D, 11 Reg't U. S. Col'd H. Art'y.

Appears on

**Company Muster Roll**

for *July 1861*, 186*1*.

Present or absent *Present*

Stoppage, \$ 100 for

Due Gov't, \$ 100 for

Valuation of horse, \$ 100

Valuation of horse equipments, \$ 100

Remarks: *Free Apr 19/61*

Book mark:

*Bruce*

*W* | 11 H. Art'y. | U.S.C.T.

*Isaac Williams*

*Priv*, Co. D, 11 Reg't U. S. Col'd H. Art'y.

Appears on

**Company Muster Roll**

for *Sept Oct*, 186 *X*

Present or absent *Present*

Stoppage, \$ 100 for

Due Gov't, \$ 100 for

Valuation of horse, \$ 100

Valuation of horse equipments, \$ 100

Remarks:

Book mark:

*Biddle*



*W* | 11 H. Art'y. | U.S.C.T.

*Isaac Williams*  
*Priv*, Co. D, 11 Reg't U. S. Col'd H. Art'y.

Appears on

**Company Muster Roll**

for *Nov. & Dec*, 1864

Present or absent *Present*

Stoppage, \$.....100 for .....

Due Gov't, \$.....100 for .....

Valuation of horse, \$.....100

Valuation of horse equipments, \$.....100

Remarks:.....

.....

.....

.....

.....

.....

.....

Book mark:.....

.....

.....

*Grogan*

*W* | 11 H. Art'y. | U.S.C.T.

*Isaac Williams*  
*Priv.*, Co. D, 11 Reg't U. S. Col'd H. Art'y.

Appears on

**Company Muster Roll**

for *Jan. & Feb.*, 1865.

Present or absent *Present*

Stoppage, \$.....100 for .....

Due Gov't, \$.....100 for .....

Valuation of horse, \$.....100

Valuation of horse equipments, \$.....100

Remarks:.....

.....  
.....  
.....  
.....  
.....  
.....  
.....  
.....

Book mark:.....

*Grogan*  
Copyist.

*W* | 11 H. Art'y. | U.S.C.T.

*Isaac Williams*  
*Priv.*, Co. D, 11 Reg't U. S. Col'd H. Art'y.

Appears on

**Company Muster Roll**

for *March & April*, 1865.

Present or absent *Present*

Stoppage, \$ 100 for

Due Gov't, \$ 100 for

Valuation of horse, \$ 100

Valuation of horse equipments, \$ 100

Remarks:

Book mark:

*Shogan*  
Copyist.



*W* | 11 H. Art'y. | U.S.C.T.

*Isaac Williams*

*Priv.*, Co. D, 11 Reg't U. S. Col'd H. Art'y.

Appears on

**Company Muster Roll**

for *May & June*, 186*5*.

Present or absent *Present*

Stoppage, \$  $\frac{25}{100}$  for *ordnance*  
*# .05 for C. & G. E.*

Due Gov't, \$  $\frac{100}{100}$  for

Valuation of horse, \$  $\frac{100}{100}$

Valuation of horse equipments, \$  $\frac{100}{100}$

Remarks:

Book mark:

*C. H. Thompson*

Copyist.

W | 11<sup>th</sup> Co. | U.S.C.T.

Isaac Williams  
Pvt., Co. D, 11<sup>th</sup> Reg't U. S. Col'd. 11<sup>th</sup> Co.,

Appears on

**Company Muster Roll**

for July & Aug., 1865.

Present or absent Present.

Stoppage, \$  $\frac{25}{100}$  for ordnance

\$.05 for C. & G. E.

Due Gov't, \$  $\frac{100}{100}$  for

Valuation of horse, \$  $\frac{100}{100}$

Valuation of horse equipments, \$  $\frac{100}{100}$

Remarks: \_\_\_\_\_  
\_\_\_\_\_  
\_\_\_\_\_  
\_\_\_\_\_  
\_\_\_\_\_  
\_\_\_\_\_  
\_\_\_\_\_  
\_\_\_\_\_  
\_\_\_\_\_

Book mark: \_\_\_\_\_  
\_\_\_\_\_

C. F. Thompson  
Copyist.

W | 11 H. Art'y. | U.S.C.T.

Isaac Williams,

Priv., Co. D, 11 Reg't U. S. Col'd H. Art'y.

Appears on Co. Muster-out Roll, dated  
New Orleans, La, Oct. 2, 1865.

Muster-out to date Oct. 2, 1865.

Last paid to Feb. 28, 1865.

Clothing account:

Last settled....., 186 ; drawn since \$..... 100

Due soldier \$ 2 74 100; due U. S. \$..... 100

Am't for cloth'g in kind or money adv'd \$..... 100

Due U. S. for arms, equipments, &c., \$..... 30 100

Bounty paid \$ 200 100; due \$ 100 100

Remarks: Joined at 0074. 0074.  
Stop musketry acct, ret'd, \$6.  
Knew driver, Tompion,  
Cross Cannon, Selter  
and 2 numbers lost.  
Free Apr. 19/6.

Book mark:

C. F. Thompson.  
Copyst.



Williams, Isaac

, Co. D, // Reg't M.C.H.

/ Inclosures.

Bed Cards .....	Final Statements .....
Burial Records .....	Furloughs or L. of A. ....
Certs. of Dis. for Discharge .....	Med. Certificates .....
C. M. Charges .....	Med. Des. Lists .....
Descriptive Lists .....	Orders .....
Discharge Certificates .....	Pris. of War Record .....
Enlistment Papers / .....	Resignations .....

Other papers relating to—

Admission to Hosp'l .....	Furlough or L. of A. ....
Casualty Sheet .....	Med. Examination .....
Confinement .....	Misc. Information .....
Contracts .....	Pay or Clothing .....
Death or Effects .....	Personal Reports .....
Desertion .....	Rank .....
Discharge from Hosp'l .....	Transfer to Hosp'l .....
Discharge from Service .....	Transfer to V. R. C. ....
Duty .....	Transportation .....

DECLARATION OF RECRUIT.

I, Isaac Williams, desiring to VOLUNTEER as a Soldier in the ARMY OF THE UNITED STATES, for the term of Three Years do declare that I am Twenty Three years and months of age; that I have never been discharged from the United States service on account of disability or by sentence of a court martial, or by order, before the expiration of a term of enlistment; and I know of no impediment to my serving honestly and faithfully as a soldier for Three Years

Given at River Rd  
The Amherst day of Sept 1863

Witness:

Robert Manning Jr Isaac Williams

Discharged

Reg't of

enlistment; last served in Company (



18

By

Isaac Williams

Regiment of

Volunteered at

River Rd

1863

No.

112

225

CONSENT IN CASE OF MINOR.

I, \_\_\_\_\_ Do CERTIFY that I am the \_\_\_\_\_ of \_\_\_\_\_ is \_\_\_\_\_ years of age; and I do hereby freely give my CONSENT to his volunteering as a SOLDIER in the ARMY OF THE UNITED STATES for the period of \_\_\_\_\_

Given at \_\_\_\_\_  
The \_\_\_\_\_ day of \_\_\_\_\_

Witness:



# VOLUNTEER ENLISTMENT.



State of *Rhode Island*

Town of *Providence*

I, *Isaac Williams* born in *Graves End*  
in the State of *New York* aged *Twenty three* years, and by occupation  
a *Carper*

DO HEREBY ACKNOWLEDGE to have volunteered this  
day of *September* 18 *63* to serve as a SOLDIER in the ARMY OF THE UNITED STATES  
OF AMERICA, for the period of *Three Months*, unless sooner discharged by proper authority:  
Do also agree to accept such bounty, pay, rations and clothing, as are, or may be, established, by law for  
volunteers. And I, *Isaac Williams* do solemnly swear, that I will bear  
true faith and allegiance to the *United States of America*, and that I will serve them honestly and faith-  
fully against all their enemies or opposers whomsoever; and that I will observe and obey the orders of the  
President of the United States, and the orders of the officers appointed over me, according to the Rules  
and Articles of War.

Sworn and Subscribed to, at *Providence*  
this *one* day of *Sept* 18 *63*  
BEFORE *S. J. [Signature]*

*Isaac Williams*  
*[Signature]*

I CERTIFY, ON HONOR, That I have carefully examined the above-named Volunteer, agreeable to the General Regulations of  
the Army, and that, in my opinion, he is free from all bodily defects and mental infirmity, which would, in any way, disqualify him  
from performing the duties of a soldier.

*B. Carpenter* EXAMINING SURGEON.  
*Isaac Williams*  
*[Signature]*

I CERTIFY, ON HONOR, That I have minutely inspected the Volunteer,  
previously to his enlistment, and that he was entirely sober when enlisted; that to the best of my judgment and belief, he is of  
lawful age; and that, in accepting him as duly qualified to perform the duties of an able-bodied soldier, I have strictly observed the  
Regulations which govern the recruiting service. This soldier has *Black* eyes *Black* hair,  
*Black* complexion, is *five* feet, *six* inches high.

Regiment of  
*S. D. Bugler*

Volunteers.  
RECRUITING OFFICER.



2025  
Williams Jacob.

Co. F., 11 U.S. Col'd H. Art'y.

Private | Private.

CARD NUMBERS.

1	6190814	26
2	6190960	27
3	6191106	28
4	6191247	29
5	6191392	30
6	6191529	31
7	6191660	32
8	6191789	33
9	6191911	34
10	6192044	35
11	6192170	36
12	6192308	37
13	6181968	38
14	6181958	39
15	6192469	40
16	9124114	41
17		42
18		43
19		44
20		45
21		46
22		47
23		48
24		49
25		50

Book Mark: \_\_\_\_\_

See also \_\_\_\_\_

W | 11 H. Art'y. | U.S.C.T.

Jacob Williams

, Co. F, 11 Reg't U. S. Col'd H. Art'y.

Appears on

**Company Descriptive Book**

of the organization named above.

**DESCRIPTION.**

Age 19 years; height 5 feet 6 inches.

Complexion K.

Eyes Brown; hair Brk.

Where born Vicksburg, Miss.

Occupation Laborer.

**ENLISTMENT.**

When Oct. 17, 1863.

Where Prov. R. I.

By whom J. C. Engley; term 3 y'rs.

Remarks: Deserted July 20, 1865 at

Gonardsonville, La. Has a full

face and figure, a clumsy

walk and speaks in a high

toned and peculiar voice. Up to

the time of desertion he conducted

himself very well in the

Company. Musket and Equipments,

Knapsack, Haversack and Canteen given.

O. J. Markle,

Copyist.

*It* | 11 H. Art'y. | U.S.C.T.

*Jacob Williams*  
*Pri*, Co *F*, 14 Reg't R. I. Col'd H. Art'y.\*

Age *28* years.

Appears on

**Company Muster-in Roll**

of the organization named above. Roll dated

*Providence R.I., Oct 20, 1863.*

Muster-in to date *Oct 20, 1863.*

Joined for duty and enrolled:

When *Oct 17*, 186 .

Where *Prov, R.I.*

Period *3* years.

Valuation of horse, \$ *100*

Valuation of horse equipments, \$ *100*

Remarks: \_\_\_\_\_

\_\_\_\_\_

\_\_\_\_\_

\_\_\_\_\_

\_\_\_\_\_

\_\_\_\_\_

\_\_\_\_\_

\_\_\_\_\_

\_\_\_\_\_

\_\_\_\_\_

\_\_\_\_\_

\_\_\_\_\_

\_\_\_\_\_

\_\_\_\_\_

\_\_\_\_\_

\_\_\_\_\_

\_\_\_\_\_

\_\_\_\_\_

\_\_\_\_\_

\_\_\_\_\_

\_\_\_\_\_

\_\_\_\_\_

\_\_\_\_\_

\* This organization subsequently became Co. *F*, 11 Reg't U. S. Colored Heavy Artillery.

Book mark: \_\_\_\_\_

*J. J. Neal*



*W* | 11 H. Art'y. | U.S.C.T.

*Jacob Williams*  
*Pr*, Co. F, 14 Reg't R. I. Col'd H. Art'y.\*

Appears on

**Company Muster Roll**

for *Oct 20 to Dec 31, 1863.*

Present or absent *Present*

Stoppage, \$ ..... 100 for .....

Due Gov't, \$ ..... 100 for .....

Valuation of horse, \$ ..... 100

Valuation of horse equipments, \$ ..... 100

Remarks: .....

\* This organization subsequently became Co. F, 11 Reg't U. S. Colored Heavy Artillery.

Book mark: .....

*A. M. O. L.*

*W* | 11 H. Art'y. | U.S.C.T.

*Jacob Williams*  
*Pr*, Co. F, 14 Reg't R. I. Col'd H. Art'y.\*

Appears on

**Company Muster Roll**

for *Jan & Feb*, 1864

Present or absent *Present*

Stoppage, \$.....100 for .....

Due Gov't, \$.....100 for .....

Valuation of horse, \$.....100

Valuation of horse equipments, \$.....100

Remarks:.....  
.....  
.....  
.....  
.....  
.....

\* This organization subsequently became Co. F, 11 Reg't U. S. Colored Heavy Artillery.

Book mark:.....

*L Neal*

*W* | 11 H. Art'y. | **U.S.C.T.**

*Jacob Wilhelmus*  
Cor, Co. F, 14 Reg't R. I. Col'd H. Art'y.\*

Appears on

**Company Muster Roll**

for *May + Apr*, 1864

Present or absent

*Present*

Stoppage, \$ 100 for

Due Gov't, \$ 100 for

Valuation of horse, \$ 100

Valuation of horse equipments, \$ 100

Remarks:

\* This organization subsequently became Co. F. 11 Reg't U. S. Colored Heavy Artillery.

Book mark:

*J. M. Col*



*It* | 11 H. Art'y. | U.S.C.T.

*Jacob Williams*  
*Priv*, Co. *4*, 8 Reg't U. S. Col'd H. Art'y.\*

Appears on

**Company Muster Roll**

for *May & June*, 18*64*.

Present or absent *Present*

Stoppage, \$ *100* for

Due Gov't, \$ *100* for

Valuation of horse, \$ *100*

Valuation of horse equipments, \$ *100*

Remarks: *Stop for one*  
*wiper upon*  
*Co. and screw-*  
*driver.*

† This organization subsequently became Co. *7*, 11 Reg't U. S. Colored Heavy Artillery.

Book mark: \_\_\_\_\_

*A. M. A.*

*W* | 11 H. Art'y. | U.S.C.T.

*Jacob Williams*  
*Art.*, Co. F, 11 Reg't U. S. Col'd H. Art'y.

Appears on

**Company Muster Roll**

for *July and Aug.*, 186*4*.

Present or absent *Present*.

Stoppage, \$ *100* for

Due Gov't, \$ *100* for

Valuation of horse, \$ *100*

Valuation of horse equipments, \$ *100*

Remarks: *Exp for C. B. Belt Plates 08*  
*wiper. 20 S. cone. 12 screw driver. 23*  
*haversack. 49, Free April 19/61.*

Book mark: .....

*Online.*

*W* | 11 H. Art'y. | U.S.C.T.

*Jacob Williams.*

*Priv.*, Co. F, 11 Reg't U. S. Col'd H. Art'y.

Appears on

**Company Muster Roll**

for *Sept. and Oct.*, 1864.

Present or absent *Present.*

Stoppage, \$ 100 for

Due Gov't, \$ 100 for

Valuation of horse, \$ 100

Valuation of horse equipments, \$ 100

Remarks: *Stop for C. Box Belt Plate .07*  
*wiper .20 S. cone .12 screwdriver .23*  
*haversack .49 pr. Shoulder scales .50*  
*Free April 19/61.*

Book mark : \_\_\_\_\_

*Online.*



*W* | 11 H. Art'y. | U.S.C.T.

*Jacob Williams.*  
*Prvt.*, Co. F, 11 Reg't U. S. Col'd H. Art'y.

Appears on

**Company Muster Roll**

for *Nov. and Dec.*, 1864.

Present or absent *Present.*

Stoppage, \$ *100* for

Due Gov't, \$ *100* for

Valuation of horse, \$ *100*

Valuation of horse equipments, \$ *100*

Remarks: *Stop for C. B. Belt Plate. 07*  
*wiper. 20 S. cone. 12 Screw-*  
*driver. 23 three hammers. 47*  
*for s. scales. 50, Free April 19/61.*

Book mark: \_\_\_\_\_

*Exline.*

*W* | 11 H. Art'y. | U.S.C.T.

*Jacob Williams.*

*Priv.*, Co. F, 11 Reg't U. S. Col'd H. Art'y.

Appears on

**Company Muster Roll**

for *Jan. and Feb.*, 1865.

Present or absent *Present.*

Stoppage, \$ *100* for

Due Gov't, \$ *100* for

Valuation of horse, \$ *100*

Valuation of horse equipments, \$ *100*

Remarks: *Stop for two harnesses. 98*  
*pr. scales. 50*

Book mark: \_\_\_\_\_

*Exhired.*

*W* | 11 H. Art'y. | U.S.C.T.

*Jacob Williams.*

*Priv.*, Co. F, 11 Reg't U. S. Col'd H. Art'y.

Appears on

**Company Muster Roll**

for *Mar. and Apr.*, 1865.

Present or absent *Present.*

Stoppage, \$ 100 for

Due Gov't, \$ 100 for

Valuation of horse, \$ 100

Valuation of horse equipments, \$ 100

Remarks: *Stop for priv. scales .50*  
*woolper. 20 haversacks .98*

Book mark: \_\_\_\_\_

*Offline.*



*M.*

11 H. Art'y. U.S.C.T.

*Jacob Williams*  
Co. F, 11 Reg't U. S. Col'd H. Art'y.

Appears on

Company Muster Roll

for *May & June*, 1865.

Present or absent *Present*.

Stoppage, \$ 100 for

Due Gov't, \$ 100 for

Valuation of horse, \$ 100

Valuation of horse equipments, \$ 100

Remarks: *Stop for wages*  
*20 etc.*

Book mark:

*Leid*  
Coyt.

*W.* | 11 H. Art'y. | U.S.C.T.

*Jacob Williams*  
*Boh.*, Co. F, 11 Reg't U. S. Col'd H. Art'y.

Appears on

**Company Muster Roll**

for *July & Aug.*, 1865.

Present or absent

Stoppage, \$ 100 for

Due Gov't, \$ 100 for

Valuation of horse, \$ 100

Valuation of horse equipments, \$ 100

Remarks: *Deserted at*  
*Donaldsonville, La.,*  
*Aug. 30.*  
*Staff for Ordnance*  
*\$ 23.32 for C. & G.*  
*Equipage \$ 4.70.*

Book mark:

*Leib*

*M. H. Artz* U.S.C.T.

*Jacob Williams*  
Pr. Co. *F*, 11 Reg't U. S. Col'd *H. Artz*

Appears on

**Descriptive List of Deserters**

dated *for July*, 186*5*.

Deserted:

When *July 20*, 186*5*.

Where *Donaldsonville, La.*

Arrested:

When \_\_\_\_\_, 186 .

Where \_\_\_\_\_

Remarks : \_\_\_\_\_  
\_\_\_\_\_  
\_\_\_\_\_  
\_\_\_\_\_  
\_\_\_\_\_

Book mark : \_\_\_\_\_

*M. O. Gilbert*

Copyist.



*N 11th H. Art'y.* **U.S.C.T.**

*Jacob Williams*  
*Pr., Co. F, 11 Reg't U. S. Col'd H. Art'y.*

Appears on

**Descriptive List of Deserters**

dated *July 31*, 186*5*.

Deserted:

When *July 20*, 186*5*.

Where *Donaldville, La.*

Arrested:

When \_\_\_\_\_, 186 .

Where \_\_\_\_\_

Remarks : \_\_\_\_\_

Book mark : \_\_\_\_\_

*N. O. Gilbert*

Copyist.

*M.* 11 H. Art'y. U.S.C.T.

*Jacob Williams*  
*Bt. Co. F.*, 11 Reg't U. S. Col'd H. Art'y.

Appears on **Co. Muster-out Roll**, dated  
*New Orleans, La. Oct 27*, 1865.

Muster-out to date ..... 1865 .

Last paid to *June 30*, 1865.

**Clothing account:**

Last settled ..... 1865 : drawn since \$ ..... 100

Due soldier \$ *16.27* / 100 : due U. S. \$ ..... 100

Am't for cloth'g in kind or money adv'd \$ ..... 100

Due U. S. for arms, equipments, &c., \$ *28.02* / 100

Bounty paid \$ *None* / 100 : due \$ *None* / 100

Remarks: *Joined at Orgin.*  
*Orgin. Deserted at New*  
*adsonville La. July*  
*20/65 - Stop for Muster,*  
*Effects complete, Knapsack,*  
*haversack & canteen lost.*

Book mark : .....

*J. Leib*  
Coryist.

Williams, Jacob

P., Co., 11 Reg't U.S. H.A.

3 Enclosures.

Bed Cards .....	Final Statements .....
Burial Records .....	Furloughs or L. of A. ....
Certs. of Dis. for Discharge .....	Med. Certificates .....
C. M. Charges .....	Med. Des. Lists .....
Descriptive Lists .....	Orders .....
Discharge Certificates .....	Pris. of War Record .....
Enlistment Papers .....	Resignations .....

Other papers relating to—

Admission to Hosp'l .....	Furlough or L. of A. ....
Casualty Sheet .....	Med. Examination .....
Confinement .....	Misc. Information 2 .....
Contracts .....	Pay or Clothing .....
Death or Effects .....	Personal Reports .....
Desertion .....	Rank .....
Discharge from Hosp'l .....	Transfer to Hosp'l .....
Discharge from Service .....	Transfer to V. R. C. ....
Duty .....	Transportation .....



DECLARATION OF RECRUIT.

I, *Jacob Williams* desiring to VOLUNTEER as a Soldier in the ARMY OF THE UNITED STATES, for the term of *3 years* do declare that I am *18* years and months of age; that I have never been discharged from the United States service on account of disability or by sentence of a court martial, or by order, before the expiration of a term of enlistment; and I know of no impediment to my serving honestly and faithfully as a soldier for

Given at *Bowdoin*  
The *17* day of *Oct* 18 *63* his  
Witness: *J. H. [unclear]* *Jacob Williams*  
*marks*



Discharged ..... 18  
Reg't of .....  
enlistment; last served in Company ( )

Volunteered at *Bowdoin*  
By *J. H. [unclear]* *1863*  
*14* Regiment of *Co. [unclear]*

*11 MORTON*  
No. *113*

CONSENT IN CASE OF MINOR.

I, \_\_\_\_\_ of \_\_\_\_\_ is \_\_\_\_\_ years of age; and I do hereby freely give my CONSENT to his volunteering as a SOLDIER in the ARMY OF THE UNITED STATES for the period of \_\_\_\_\_

Given at \_\_\_\_\_  
The \_\_\_\_\_ day of \_\_\_\_\_  
Witness: \_\_\_\_\_

VOLUNTEER ENLISTMENT.

State of Rhode Island



Town of Providence

I, Jacob Williams, born in Wickesburg, in the State of Ohio, aged 19 years, and by occupation a Carpenter, DO HEREBY ACKNOWLEDGE to have volunteered this 17 day of Oct 1863 to serve as a SOLDIER in the ARMY OF THE UNITED STATES OF AMERICA, for the period of 3 months, unless sooner discharged by proper authority:

Do also agree to accept such bounty, pay, rations and clothing, as are, or may be, established, by law for volunteers. And I, Jacob Williams do solemnly swear, that I will bear true faith and allegiance to the United States of America, and that I will serve them honestly and faithfully against all their enemies or opposers whomsoever; and that I will observe and obey the orders of the President of the United States, and the orders of the officers appointed over me, according to the Rules and Articles of War.

Sworn and Subscribed to, at Providence this 17 day of Oct 1863 BEFORE S.P. L... M... M...

his Jacob Williams mark

I CERTIFY, ON HONOR, That I have carefully examined the above-named Volunteer, agreeable to the General Regulations of the Army, and that, in my opinion, he is free from all bodily defects and mental infirmity, which would, in any way, disqualify him from performing the duties of a soldier.

Johnston Landrum M.D.

EXAMINING SURGEON.

I CERTIFY, ON HONOR, That I have minutely inspected the Volunteer, Jacob Williams, previously to his enlistment, and that he was entirely sober when enlisted; that to the best of my judgment and belief, he is of lawful age; and that, in accepting him as duly qualified to perform the duties of an able-bodied soldier, I have strictly observed the Regulations which govern the recruiting service. This soldier has Dark complexion, is 5 feet, 6 inches high, Brown eyes, Black hair.

John H. ... Regt 14 Regiment of A.C.V. Volunteers,

RECRUITING OFFICER.



Description of Private Jacob  
Williams Co "F" 11<sup>th</sup> U.S. Army  
who deserted at Donaldson  
ville La. July 20<sup>th</sup> 1865

Said Williams is 19 years of  
age. 5 feet, 6 inches in height.  
Dark complexion. Brown eyes.  
Black hair. He was born  
in Vicksburg Mississippi.  
and is by occupation a  
laborer. He was enlisted  
on the 17<sup>th</sup> of October, at  
Providence Rhode Island  
by J C Engley, for the  
period of three years -

He had just been paid  
in full to June 30<sup>th</sup> 1865.



Donaldsonville July 24/18

Reynolds Jas. A. Sicut

11<sup>th</sup> U.S. F.A. (7th)

Request arrest of  
Private Jacob  
Wickham of that regt

Donaldsonville La  
July 24. 1863

Lieut. H. D. Seavitt  
Provost Marshal Parish of Iberville  
Lieutenant

I have the honor to forward to you a description of Private Jacob Williams Co F 11th U.S. C. A. S. who deserted his company on the 20th inst. and is supposed to be at Plaquemine in this state. If you will use all means at your disposal for his apprehension and return to his company, you will greatly oblige his company commander.

W. A. Reynolds  
Lieut. 11th U.S. C. A. S.  
Comdg Co "F"



P.S.

Please to acknowledge the receipt of  
this communication and oblige

Yours very truly

J. A. Reynolds  
Lieut etc



2045

Williams James

Co. C., 11 U.S. Col'd H. Art'y

Private | Private

CARD NUMBERS.

1	6185637	26
2	6185783	27
3	6185929	28
4	6186072	29
5	6186204	30
6	6186333	31
7	6186454	32
8	6186569	33
9	6186682	34
10	6186793	35
11	6186904	36
12	6187016	37
13	6187126	38
14	9124512	39
15		40
16		41
17		42
18		43
19		44
20		45
21		46
22		47
23		48
24		49
25		50

Book Mark: @.N.27. @.24278

See also

S-784272 Poret  
8833022 - G.A.P.

P2745604 K. A. W. W. W.  
D. 3110789 P. A. R. U.

John Miller Co

*M* | **11 H. Art'y. | U.S.C.T.**

*James Williams*  
....., Co. *C*, 11 Reg't U. S. Col'd H. Art'y.

Appears on  
**Company Descriptive Book**  
of the organization named above.

**DESCRIPTION.**

Age *36* years; height *5* feet *9* inches.

Complexion *Dark*

Eyes *Dark*; hair *Dark*

Where born *Brooklyn N.Y.*

Occupation *Printer*

**ENLISTMENT.**

When *Aug 28*, 186*3*.

Where *Prov. R.I.*

By whom *Wm Sanford*; term *3* y'rs.

Remarks:  
.....  
.....  
.....  
.....  
.....  
.....  
.....  
.....  
.....  
.....

*James*



*M* | 11 H. Art'y. | U.S.C.T.

*James Williams*  
*Priv, Co. C*, 14 Reg't R. I. Col'd H. Art'y.\*

Age *36* years.

Appears on

**Company Muster-in Roll**

of the organization named above. Roll dated

*Providence R. I. Sep 14* 1863.

Muster-in to date *Sep 14*, 1863.

Joined for duty and enrolled:

When *Aug 28<sup>th</sup>*, 1863.

Where *Providence R. I.*

Period *3* years.

Valuation of horse, \$.....*100*

Valuation of horse equipments, \$.....*100*

Remarks: .....

\* This organization subsequently became Co. *C*, 11 Reg't U. S. Colored Heavy Artillery.

Book mark: .....

*Valentine*

*M* | 11 H. Art'y. | U.S.C.T.

*James Williams*  
Priv., Co. C, 14 Reg't R. I. Col'd H. Art'y.\*

Appears on

**Company Muster Roll**

for *Sept 14, to Dec 31, 1863*.

Present or absent *Present*.

Stoppage, \$ *100* for

Due Gov't, \$ *100* for

Valuation of horse, \$ *100*

Valuation of horse equipments, \$ *100*

Remarks :

\*This organization subsequently became Co. C, 11 Reg't U. S. Colored Heavy Artillery.

Book mark :

*Valentine*

*W* | 11 H. Art'y. | U.S.C.T.

*James Williams*  
*Priv.*, Co. C, 14 Reg't R. I. Col'd H. Art'y.\*

Appears on

**Company Muster Roll**

for *Jan & Feb.*, 186*4*.

Present or absent *Present*,

Stoppage, \$ *100* for

Due Gov't, \$ *100* for

Valuation of horse, \$ *100*

Valuation of horse equipments, \$ *100*

Remarks:

*Stop for Harness  
and Carten \$100*

\*This organization subsequently became Co. C, 11 Reg't U. S. Colored Heavy Artillery.

Book mark:

*Valentine*



*W* | **11 H. Art'y. | U.S.C.T.**

*James Williams*  
*Priv, Co. C., 8 Reg't U. S. Col'd H. Art'y.\**

Appears on

**Company Muster Roll**

for *March & April, 1864.*

Present or absent *Present.*

Stoppage, \$ *100* for

Due Gov't, \$ *100* for

Valuation of horse, \$ *100*

Valuation of horse equipments, \$ *100*

Remarks:

*Stop for C. & G. Equipage  
\$100*

\*This organization subsequently became Co. *C*, 11 Reg't U. S. Colored Heavy Artillery.

Book mark: \_\_\_\_\_

*Valentine*

*W* | **11 H. Art'y. | U.S.C.T.**

*James Williams*  
*Priv*, Co. *C*, 8 Reg't U. S. Col'd H. Art'y.\*

Appears on

**Company Muster Roll**

for *May & June*, 18*64*.

Present or absent *Present*.

Stoppage, \$ *100* for

Due Gov't, \$ *100* for

Valuation of horse, \$ *100*

Valuation of horse equipments, \$ *100*

Remarks:

*Stoppage for camp &  
Garrison Equipage \$100*

† This organization subsequently became Co. *C*, 11 Reg't U. S. Colored Heavy Artillery.

Book mark:

*Valentine*

*11* | **11 H. Art'y. U.S.C.T.**

*James Williams*  
*Priv*, Co. C, 11 Reg't U. S. Col'd H. Art'y.

Appears on

**Company Muster Roll**

for *July & Aug*, 186*1*.

Present or absent *Present*

Stoppage, \$ 100 for

Due Gov't, \$ 100 for

Valuation of horse, \$ 100

Valuation of horse equipments, \$ 100

Remarks *Stoppage for*  
*Co. G, E. \$1. free*  
*Apr 1961*

Book mark: \_\_\_\_\_

*Quinn*  
Copied.



*11* | **11 H. Art'y. | U.S.C.T.**

*James Williams*  
*Priv.*, Co. C, 11 Reg't U. S. Col'd H. Art'y.

Appears on

**Company Muster Roll**

for *Sept & Oct*, 186*4*

Present or absent *Present*

Stoppage, \$ *100* for

Due Gov't, \$ *100* for

Valuation of horse, \$ *100*

Valuation of horse equipments, \$ *100*

Remarks:  
\_\_\_\_\_  
\_\_\_\_\_  
\_\_\_\_\_  
\_\_\_\_\_  
\_\_\_\_\_  
\_\_\_\_\_

Book mark: \_\_\_\_\_

*Atwood*  
Coppist.

11 H. Art'y. U.S.C.T.

*James Williams*  
Co. C, 11 Reg't U. S. Col'd H. Art'y.

Appears on

**Company Muster Roll**

for *100 & 100*, 186 *4*

Present or absent *Present*

Stoppage, \$ *100* for

Due Gov't, \$ *100* for

Valuation of horse, \$ *100*

Valuation of horse equipments, \$ *100*

Remarks:  
-----  
-----  
-----  
-----  
-----  
-----  
-----  
-----

Book mark: -----

*Atwood*  
Copyist

11 H. Art'y. U.S.C.T.

*Amos Williams*

*Cor*, Co. C, 11 Reg't U. S. Col'd H. Art'y.

Appears on

**Company Muster Roll**

for *Jan & Feb*, 1867.

Present or absent *Present*

Stoppage, \$ 100 for

Due Gov't, \$ 100 for

Valuation of horse, \$ 100

Valuation of horse equipments, \$ 100

Remarks:

.....  
.....  
.....  
.....  
.....  
.....  
.....  
.....

Book mark: .....

*Amos Williams*



*H* | 11 H. Art'y. | **U.S.C.T.**

*James Williams*  
*Co. C*, Co. C, 11 Reg't U. S. Col'd H. Art'y.

Appears on

**Company Muster Roll**  
for *Men & ape*, 186*3*?

Present or absent *Present*

Stoppage, \$ *100* for

Due Gov't, \$ *100* for

Valuation of horse, \$ *100*

Valuation of horse equipments, \$ *100*

Remarks: \_\_\_\_\_  
\_\_\_\_\_  
\_\_\_\_\_  
\_\_\_\_\_  
\_\_\_\_\_  
\_\_\_\_\_  
\_\_\_\_\_

Book mark: \_\_\_\_\_

*James Williams*  
Copyist

*M* | 11 H. Art'y. | U.S.C.T.

*James Williams*  
*Pl*, Co. C, 11 Reg't U. S. Col'd H. Art'y.

Appears on

**Company Muster Roll**

for *May to June*, 1865.

Present or absent *Present*

Stoppage, \$ *100* for

Due Gov't, \$ *100* for

Valuation of horse, \$ *100*

Valuation of horse equipments, \$ *100*

Remarks: \_\_\_\_\_  
\_\_\_\_\_  
\_\_\_\_\_  
\_\_\_\_\_  
\_\_\_\_\_  
\_\_\_\_\_

Book mark: \_\_\_\_\_

*Bliss*  
Copyist.

*M* | 11 H. Art'y. | U.S.C.T.

*James Williams*  
*Pol*, Co. C, 11 Reg't U. S. Col'd H. Art'y.

Appears on

**Company Muster Roll**

for *July* <sup>*in*</sup> *Aug.*, 1865.

Present or absent. *Present*

Stoppage, \$ *00* <sup>*79*</sup> <sub>*100*</sub> for *Sam'l E.*

Due Gov't, \$ *00* <sup>*100*</sup> for

Valuation of horse, \$ *00* <sup>*100*</sup>

Valuation of horse equipments, \$ *00* <sup>*100*</sup>

Remarks: \_\_\_\_\_  
\_\_\_\_\_  
\_\_\_\_\_  
\_\_\_\_\_  
\_\_\_\_\_  
\_\_\_\_\_

Book mark: \_\_\_\_\_

*Bliss*  
Copyist.



*M* | 11 H. Art'y. | U.S.C.T.

*James Williams*  
*Pr*, Co. *C*, 11 Reg't U. S. Col'd H. Art'y.

Appears on Co. Muster-out Roll, dated  
*New Orleans La, Oct. 2*, 1865.

Muster-out to date *Oct. 2*, 1865.

Last paid to *July 28*, 1865.

Clothing account:

Last settled....., 186 ; drawn since \$..... 100

Due soldier \$ *20 43* / 100; due U. S. \$..... 100

Am't for cloth'g in kind or money adv'd \$..... 100

Due U. S. for arms, equipments, &c., \$..... 100

Bounty paid \$..... 100; due \$ *100 00* / 100

Remarks: *Joined Regt. Organ.*  
*Slip for one muster acct. retained. Slip for 6 and 1/2*  
*Equipage articles unknown*  
*79¢*

Book mark: *PV 27 P 24278*

*Bliss*

*M* | 11 H. Art'y. | U.S.C.T.

*James Williams*

*Pr*, Co. *C*, 11 Reg't U. S. Col'd H. Art'y.

Appears on Co. Muster-out Roll, dated  
*New Orleans La, Oct. 2, 1865.*

Muster-out to date *Oct. 2, 1865.*

Last paid to *July 28, 1865.*

Clothing account:

Last settled....., 186 ; drawn since \$.....<sup>100</sup>

Due soldier \$ *20*<sup>*43*</sup>/<sub>100</sub>; due U. S. \$.....<sup>100</sup>

Am't for cloth'g in kind or money adv'd \$.....<sup>100</sup>

Due U. S. for arms, equipments, &c., \$.....<sup>100</sup>

Bounty paid \$.....<sup>100</sup>; due \$ *100*<sup>*00*</sup>/<sub>100</sub>

Remarks: *Joined Regt. Organ.*

*Slip for one muster acct. retained.*

*Slip for <sup>C and G</sup>*

*Equipage articles unknown*

*79¢*

Book mark: *PV. 27 P. 24278*

*Bliss*

*Williams, Jas.*

*P.*, Co.

*11* Reg't *USCA*

**Enclosures.**

Bed Cards .....	Final Statements .....
Burial Records .....	Furloughs or L. of A .....
Certs. of Dis. for Discharge .....	Med. Certificates .....
C. M. Charges .....	Med. Des. Lists .....
Descriptive Lists .....	Orders .....
Discharge Certificates .....	Pris. of War Record .....
Enlistment Papers .....	Resignations .....

**Other papers relating to—**

Admission to Hosp'l .....	Furlough or L. of A .....
Casualty Sheet .....	Med. Examination .....
Confinement .....	Misc. Information .....
Contracts .....	Pay or Clothing .....
Death or Effects .....	Personal Reports .....
Desertion .....	Rank .....
Discharge from Hosp'l .....	Transfer to Hosp'l .....
Discharge from Service .....	Transfer to V. R. C. ....
Duty .....	Transportation .....



DECLARATION OF RECRUIT.

I, *James Williams* desiring to VOLUNTEER as a Soldier in the ARMY OF THE UNITED STATES, for the term of *Three years*, do declare that I am *36* years and months of age; that I have never been discharged from the United States service on account of disability or by sentence of a court martial, or by order, before the expiration of a term of enlistment; and I know of no impediment to my serving honestly and faithfully as a soldier for *Three years*

Given at *Providence*  
The *28th* day of *August* 18*63*.

Witness:

*Peter W. Downing*

*James Williams*

No. *174*

*James Williams*

Volunteered at *Providence*

*Aug 28/63*

By *Major Samuel P.*  
Regiment of

*11 MSCHA*

enlistment; last served in Company ( )

Reg't of

Discharged 18



CONSENT IN CASE OF MINOR.

I, \_\_\_\_\_ Do CERTIFY that I am the \_\_\_\_\_ of \_\_\_\_\_ is \_\_\_\_\_ years of age; and I do hereby freely give my CONSENT to his volunteering as a SOLDIER in the ARMY OF THE UNITED STATES for the period of \_\_\_\_\_

Given at \_\_\_\_\_  
The \_\_\_\_\_ day of \_\_\_\_\_

Witness:

VOLUNTEER ENLISTMENT.

State of Rhode Island



Town of Providence

I, James Williams born in New York in the State of New York aged 36 years, and by occupation a Carpenter

DO HEREBY ACKNOWLEDGE to have volunteered this 28th day of August 1863, to serve as a SOLDIER in the ARMY OF THE UNITED STATES of AMERICA, for the period of three years, unless sooner discharged by proper authority:

Do also agree to accept such bounty, pay, rations and clothing, as are, or may be, established by law for volunteers. And I, James Williams do solemnly swear, that I will bear true faith and allegiance to the United States of America, and that I will serve them honestly and faithfully against all their enemies or opposers whomsoever; and that I will observe and obey the orders of the President of the United States, and the orders of the officers appointed over me, according to the Rules and Articles of War.

Sworn and subscribed to, at Providence this 28th day of August 1863 BEFORE S. H. ... Major first R & L A ... James Williams

I CERTIFY, ON HONOR, That I have carefully examined the above-named Volunteer, agreeably to the General Regulations of the Army, and that, in my opinion, he is free from all bodily defects and mental infirmity, which would, in any way, disqualify him from performing the duties of a soldier.

Johnson Gardner M.D.

EXAMINING SURGEON.

I CERTIFY, ON HONOR, That I have minutely inspected the Volunteer, James Williams previously to his enlistment, and that he was entirely sober when enlisted; that, to the best of my judgment and belief, he is of lawful age; and that, in accepting him as duly qualified to perform the duties of an able-bodied soldier, I have strictly observed the Regulations which govern the recruiting service. This soldier has Dark complexion, is 5 feet, 9 inches high. Dark eyes, Dark hair.

Regiment of ... Volunteers,

RECRUITING OFFICER.



2027

Williams James.

Co. F., 11 U.S. Col'd H. Art'y.

Private

Private

CARD NUMBERS.

1	6190813	26
2	6190959	27
3	6191107	28
4	6191246	29
5	6191391	30
6	6191528	31
7	6181776	32
8	6191659	33
9	6191788	34
10	6191910	35
11	6192043	36
12	6192169	37
13	6192297	38
14	6192421	39
15	9125713	40
16	W-6-ROY-1867	41
17		42
18		43
19		44
20		45
21		46
22		47
23		48
24		49
25		50

Book Mark: W-6-ROY-1867

See also



Rep 423712  
S 1799739 - P.O. m m  
R. + P. 537387  
S 2909376 and 412  
A. S. 1623367

John Miller Esq

11 H. Art'y. U.S.C.T.

James Williams

Co. I, 11 Reg't U. S. Col'd H. Art'y.

Appears on

**Company Descriptive Book**

of the organization named above.

**DESCRIPTION.**

Age 19 years; height 6 feet inches.

Complexion *Washed*.

Eyes *Black*; hair *Blk*.

Where born *Columbus, Miss.*

Occupation *River Hand.*

**ENLISTMENT.**

When *Oct 15*, 1863.

Where *Proc. R. I.*

By whom *J. C. Engley*; term 3 y'rs.

Remarks: *Deserted Feb. 6, 1864. Returned Feb. 27, 1864. Reported as deserter on no rolls. Sentenced by Gen. Court Martial of Plaquemine, La. to work at hard labor for three months at Plaquemine. Sentence approved March 15, 1864.*

\* *Not in Descriptive Book.*

*O. J. Markle,*

*W* | 11 H. Art'y. | U.S.C.T.

*James Williams*  
*Priv*, Co. *F*, 14 Reg't R. I. Col'd H. Art'y.\*

Age *19* years.

Appears on

**Company Muster-in Roll**

of the organization named above. Roll dated  
*Providence R. I., Oct 20, 1863.*

Muster-in to date *Oct 20, 1867.*

Joined for duty and enrolled:

When *Oct 10*, 186 .

Where *Pro R. I.*

Period *3* years.

Valuation of horse, \$.....*100*

Valuation of horse equipments, \$.....*100*

Remarks:.....

\* This organization subsequently became Co. *F*, 11 Reg't U. S. Colored Heavy Artillery.

Book mark: *M-6-RCY-1867*

*Amal*



*W* | **11 H. Art'y. U.S.C.T.**

*James Williams*  
*Pri*, Co. F, 14 Reg't R. I. Col'd H. Art'y.\*

Appears on

**Company Muster Roll**

for *Oct 20 to Dec 31, 1863.*

Present or absent. *Present*

Stoppage, \$.....100 for .....

Due Gov't, \$.....100 for .....

Valuation of horse, \$.....100

Valuation of horse equipments, \$.....100

Remarks: .....

\* This organization subsequently became Co. F. 11 Reg't U. S. Colored Heavy Artillery.

Book mark: .....

*Wual*

*W* | 11 H. Art'y. | U.S.C.T.

*James Williams*  
*Pr*, Co. F, 14 Reg't R. I. Col'd H. Art'y.\*

Appears on

**Company Muster Roll**

for *Jan & Feb*, 1864

Present or absent *Present*

Stoppage, \$.....100 for .....

Due Gov't, \$.....100 for .....

Valuation of horse, \$.....100

Valuation of horse equipments, \$.....100

Remarks:.....  
.....  
.....  
.....  
.....  
.....  
.....  
.....

\* This organization subsequently became Co. E, 11 Reg't U. S. Colored Heavy Artillery.

Book mark: .....

*W. M. A.*

*W* | 11 H. Art'y. | U.S.C.T.

*James Williams*  
*Pri*, Co. F, 14 Reg't R. I. Col'd H. Art'y.\*

Appears on

**Company Muster Roll**

for *Mar & Apr*, 1864

Present or absent *Present*

Stoppage, \$ 100 for

Due Gov't, \$ 100 for

Valuation of horse, \$ 100

Valuation of horse equipments, \$ 100

Remarks: *Stop for one*  
*bayonet & scabbard*

\* This organization subsequently became Co. F, 11 Reg't U. S. Colored Heavy Artillery.

Book mark: \_\_\_\_\_

(358)

*A Neal*

Copyist.



*W* | **11 H. Art'y. | U.S.C.T.**

*James Williams*  
*Priv', Co. F,* 8 Reg't U. S. Col'd H. Art'y.\*

Appears on

**Company Muster Roll**

for *May & June*, 1864.

Present or absent *Present*

Stoppage, \$ 100 for

Due Gov't, \$ 100 for

Valuation of horse, \$ 100

Valuation of horse equipments, \$ 100

Remarks: *Stop for one*  
*bayonet scabbard,*  
*Wiper Spar cone*  
*and screw driver*

† This organization subsequently became Co. *F*, 11 Reg't U. S. Colored Heavy Artillery.

Book mark: \_\_\_\_\_

*A. Neal*

*M* 11 H. Art. U.S.C.T.

*James Williams*  
Prv., Co. *F*, 11 Reg't U. S. Col'd *H* Art.

Appears on

**Descriptive List of Deserters**

dated *July 13*, 1864.

Deserted:

When *Feb. 6*, 1864.

Where *New Orleans.*

Arrested:

When \_\_\_\_\_, 186 .

Where \_\_\_\_\_

Remarks: *Deserter has since been returned to his company.*

Book mark: \_\_\_\_\_

*N. O. Gilbert*

*W* | 11 H. Art'y. | U.S.C.T.

*James Williams.*  
-----  
*Prvt.*, Co. F, 11 Reg't U. S. Col'd H. Art'y.

Appears on

**Company Muster Roll**

for *July and Aug.*, 1864.

Present or absent *Present.*

Stoppage, \$-----100 for -----

Due Gov't, \$-----100 for -----

Valuation of horse, \$-----100

Valuation of horse equipments, \$-----100

Remarks: *Stip for bayonet 2.50*  
*ammun. 7; bayonet scabbard, 45*  
*wiper, 20 s. cone, 12 screw driver, 23*  
*Green April 12/61.*

Book mark: -----

*Gilmer.*



*W* | **11 H. Art'y. U.S.C.T.**

*James Williams.*  
*Pvt.*, Co. F, 11 Reg't U. S. Col'd H. Art'y.

Appears on

**Company Muster Roll**

for *Sept. and Oct.*, 1864.

Present or absent *Present.*

Stoppage, \$ 100 for

Due Gov't, \$ 100 for

Valuation of horse, \$ 100

Valuation of horse equipments, \$ 100

Remarks: *Stop for bayonet 2.50*  
*ramrod. 77 bayonet scabbard. 45*  
*wiper. 20 s. cone. 12 screwdriver. 23*  
*Free April 19/61.*

Book mark: \_\_\_\_\_

*Erline.*

*W* | 11 H. Art'y. | U.S.C.T.

*James Williams.*  
*Prvt.*, Co. F, 11 Reg't U. S. Col'd H. Art'y.

Appears on

**Company Muster Roll**

for *Nov. and Dec.*, 1864.

Present or absent *Present.*

Stoppage, \$ 100 for

Due Gov't, \$ 100 for

Valuation of horse, \$ 100

Valuation of horse equipments, \$ 100

Remarks: *Stop for bagonet 2.50*  
*ramrod. 77 bagnets scabbard. 45*  
*wiper. 20 3 cone. 12 screwdriver. 23*  
*two canteens. 82, For April 19/61.*

Book mark: \_\_\_\_\_

*E. L. Hine.*

*W* | 11 H. Art'y. | U.S.C.T.

*James Williams.*  
*Priv.*, Co. F, 11 Reg't U. S. Col'd H. Art'y.

Appears on

**Company Muster Roll**

for *Jan. and Feb.*, 1865.

Present or absent *Present.*

Stoppage, \$ *100* for

Due Gov't, \$ *100* for

Valuation of horse, \$ *100*

Valuation of horse equipments, \$ *100*

Remarks: *Stop for com to musket. 15*  
*two canteens. 82*

Book mark: \_\_\_\_\_

*Online.*



*W*

11 H. Art'y. U.S.C.T.

*James Williams*

*Priv.*, Co. F, 11 Reg't U. S. Col'd H. Art'y.

Appears on

**Company Muster Roll**

for *Mar. and Apr.*, 1865.

Present or absent *Present*

Stoppage, \$ *100* for

Due Gov't, \$ *100* for

Valuation of horse, \$ *100*

Valuation of horse equipments, \$ *100*

Remarks: *Stop for care to musket. 15*  
*stop \$10. per month of pay for*  
*three months per sentence of*  
*G. C. M. approved by Gen'l.*  
*Cameron March 15/65.*  
*Stop for canteens. 82*

Book mark: .....

*Exline*

*M* | 11 H. Art'y. | U.S.C.T.

*James Williams*  
Co. F, 11 Reg't U. S. Col'd H. Art'y.

Appears on

**Company Muster Roll**

for *May & June*, 1865.

Present or absent *Present*.

Stoppage, \$ 100 for

Due Gov't, \$ 100 for

Valuation of horse, \$ 100

Valuation of horse equipments, \$ 100

Remarks: *Stop \$10. per month of pay for three months per sentence of G. C. W. approved by Genl. Cameron March 15th.*

Book mark: \_\_\_\_\_

*M* | 11 H. Art'y. | U.S.C.T.

*James Williams*  
*Co. F*, Co. F, 11 Reg't U. S. Col'd H. Art'y.

Appears on

**Company Muster Roll**

for *July & Aug.*, 186*5*.  
Present or absent *Present.*

Stoppage, \$ 100 for

Due Gov't, \$ 100 for

Valuation of horse, \$ 100

Valuation of horse equipments, \$ 100

Remarks:

Book mark:

*Leib*  
Coryist.



*M.* | 11 H. Art'y. | U.S.C.T.

*James Williams*  
*Bvt. Co. F.*, 11 Reg't U. S. Col'd H. Art'y.

Appears on **Co. Muster-out Roll**, dated  
*New Orleans, La, Oct. 2*, 1865.

Muster-out to date *Oct. 2*, 1865.

Last paid to *June 30*, 1865.

**Clothing account:**

Last settled....., 186 ; drawn since \$..... 100

Due soldier \$ *5.06* / 100; due U. S. \$..... 100

Am't for cloth'g in kind or money adv'd \$..... 100

Due U. S. for arms, equipments, &c., \$ *6.00* / 100

Bounty paid \$ *None* / 100; due \$ *100.00* / 100

Remarks: *Joined at Orgueil*  
*Oran. + Stop. for muster*  
*Roll + acc'ts. Re-*  
*turned.*

Book mark *Discharge on file*

*Leib*

(361)

*(over)*

Copyist.

JAN. 15:

6192421

1891

*with N.C. Vol. 4, P. 67,  
167.*

W | 11<sup>th</sup> Regt. Art'y, U. S. C. S.

James Williams

, Co. F, 11<sup>th</sup> Reg't U. S. C. W. A.

**NOTATION.**

Book mark: W-6-R-6-S-1867.

**War Department,**

Adjutant General's Office,

Washington, Jan'y 10, 1867.

Discharge on file.

W. Allen



Williams, Jas.

S. Co. F.

11 Reg't U.S.C.H.A.

2 Enclosures.

Bed Cards .....	Final Statements .....
Burial Records .....	Furloughs or L. of A. ....
Certs. of Dis. for Discharge .....	Med. Certificates .....
C. M. Charges .....	Med. Des. Lists .....
Descriptive Lists .....	Orders .....
Discharge Certificates .....	Pris. of War Record .....
Enlistment Papers .....	Resignations .....

Other papers relating to—

Admission to Hosp'l .....	Furlough or L. of A. ....
Casualty Sheet .....	Med. Examination .....
Confinement .....	Misc. Information .....
Contracts .....	Pay or Clothing .....
Death or Effects .....	Personal Reports .....
Desertion .....	Rank .....
Discharge from Hosp'l .....	Transfer to Hosp'l .....
Discharge from Service .....	Transfer to V. R. C. ....
Duty .....	Transportation .....

DECLARATION OF RECRUIT.

I, *James Williams* desiring to VOLUNTEER as a Soldier in the ARMY OF THE UNITED STATES, for the term of *Three Years* do declare that I am *19* years and *10* months of age; that I have never been discharged from the United States service on account of disability or by sentence of a court martial, or by order, before the expiration of a term of enlistment; and I know of no impediment to my serving honestly and faithfully as a soldier for *Three Years*

Given at *Porter* The *10* day of *Dec* 18 *63*

Witness: *J. Williams* *James Williams*

*110524a*  
No. *115*

Volunteered at *Porter*  
*James Williams*

By *John H. ...*  
Regiment of *Porter*  
*1865*

enlistment; last served in Company ( )

Regt of

Discharged *18*

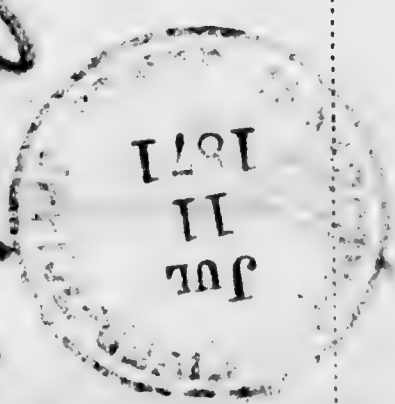

*11 Regt. U.O. & H.*  
*Ordn*

CONSENT IN CASE OF MINOR.

I, \_\_\_\_\_ of \_\_\_\_\_ is \_\_\_\_\_ years of age; and I do hereby freely give my CONSENT to his volunteering as a SOLDIER in the ARMY OF THE UNITED STATES for the period of \_\_\_\_\_

Given at \_\_\_\_\_ The \_\_\_\_\_ day of \_\_\_\_\_

Witness \_\_\_\_\_



# VOLUNTEER ENLISTMENT.



State of *Rhode Island*

Town of *Providence*  
*Columbus*

I, *James Williams* born in *Mississippi* aged *19* years, and by occupation a *River Hand* DO HEREBY ACKNOWLEDGE to have volunteered this *10* day of *Oct* 18 *63* to serve as a SOLDIER in the ARMY OF THE UNITED STATES OF AMERICA, for the period of *Three Months*, unless sooner discharged by proper authority:

Do also agree to accept such bounty, pay, rations and clothing, as are, or may be, established, by law for volunteers. And I, *James Williams* do solemnly swear, that I will bear true faith and allegiance to the *United States of America*, and that I will serve them honestly and faithfully against all their enemies or opposers whomsoever; and that I will observe and obey the orders of the President of the United States, and the orders of the officers appointed over me, according to the Rules and Articles of War.

Sworn and Subscribed to, at *Providence* this *10* day of *Oct* 18 *63*  
BEFORE *S. B. Crawford*

*James Williams*

I CERTIFY, ON HONOR, That I have carefully examined the above-named Volunteer, agreeable to the General Regulations of the Army, and that, in my opinion, he is free from all bodily defects and mental infirmity, which would, in any way, disqualify him from performing the duties of a soldier.

EXAMINING SURGEON.

I CERTIFY, ON HONOR, That I have minutely inspected the Volunteer *James Williams* previously to his enlistment, and that he was entirely sober when enlisted; that to the best of my judgment and belief, he is of lawful age; and that, in accepting him as duly qualified to perform the duties of an able-bodied soldier, I have strictly observed the Regulations which govern the recruiting service. This soldier has *Black* eyes *Dark* hair *Dark* complexion, is *5 1/2* feet, *5 1/2* inches high.

Regiment of

Volunteers.

*S. B. Crawford*

RECRUITING OFFICER.



Mr. Ellbrook

James Williams

Co. G. 11 U.S. 6th Inf. Regt.

✓

Adjutant General's Office,

COLORED TROOPS BRANCH,

June 25<sup>th</sup>, 1875

Mr. Ellerswood Vol.

C. T., 187

Wanted in case of

James Williams

, Co. "J",

11 Reg't

U.S. Col. 24<sup>th</sup> Reg't

Copy of G. O. No.

Mustered Roll for March and April 1865  
Department President with remarks: "Up \$10.00 per month  
of his pay for three months per Sentence of G. O. No. app'd.  
by Genl. Cameron March 15/65."

Respectfully,

R. A. Woodward  
Chief Clerk  
J. H. Patton

Adjutant General's Office,

Div. of Dict'd Commands

July 1<sup>st</sup>, 1875

Vol.

C. T., 187

Reply in case of

James Williams

, Co. "F",

11<sup>th</sup> Reg't U.S. Col. 24<sup>th</sup> Reg't

Headquarters Lafourche Dist. Philadelp., La. March 15/65  
General Orders, No. 39 - Part - Charge: "Riotous conduct  
to the prejudice of good order and Military discipline."  
Finding: - "Guilty". - Sentence: "To be confined at  
hard labor at such place as the Commanding General may  
direct for the period of (3) three months" with a ball  
weighing (32) thirty two pounds, attached to his left leg  
by a chain three (3) feet long, and to be deprived of  
(10) ten dollars of his monthly pay for and during said  
period of three (3) months."

(over)



Approved except that portion which decrees the prisoner  
to wear a ball and chain which is disapproved,  
Plaquemine, La. is designated as the place of  
Confinement. By Order of Brig Genl R. A. Cameron  
(sgd) B. B. Campbell  
Capt & A. U. Genl

Morning Reports Co. F. date of Dec<sup>r</sup>. 18/64 report: -

"Private J. Williams from duty to arrest waiting  
Court Martial." Date of June 16/65, they report: -

"Private James Williams from arrest to duty, by expiration  
C.A.S. of sentence of 3 months confinement."

Mr. Gilchrist

James Williams

Co. G. 11 U.S. 1st Inf. Regt.



6182282	26
6182422	27
6182568	28
6182709	29
6182977	30
6182846	31
6183104	32
6183226	33
6183334	34
6183444	35
6183549	36
6183656	37
6183762	38
6123908	39
6124062	40
16	41
17	42
18	43
19	44
20	45
21	46
22	47
23	48
24	49
25	50

Book Mark: V. 135 P. 224, 73.

See also

*11* | **11 H. Art'y. | U.S.C.T.**

*John Williams*  
....., Co. *A*, 11 Reg't U. S. Col'd H. Art'y.

Appears on

**Company Descriptive Book**

of the organization named above.

**DESCRIPTION.**

Age *34* years; height *5* feet *6* inches.

Complexion *Mulatto*

Eyes *Brown*; hair *Blk*

Where born *New Bedford Mass*

Occupation *Farmer*

**ENLISTMENT.**

When *Aug 11*, 186*3*.

Where *Providence*

By whom *M. Helmer*; term *3* y'rs.

Remarks: .....

.....  
.....  
.....  
.....  
.....  
.....  
.....  
.....  
.....  
.....

*Jawis*

We | 11 H. Art'y. | **U.S.C.T.**

John Williams

....., Co. A, 11 Reg't U. S. Col'd H. Art'y.

Appears on

**Company Descriptive Book**

of the organization named above.

**DESCRIPTION.**

Age 34 years; height 5 feet 6 inches.

Complexion Mulatto

Eyes brown; hair Blk

Where born New Bedford Mass

Occupation Farmer

**ENLISTMENT.**

When Aug 11, 1863.

Where Providence

By whom W H Helme; term 3 y'rs.

Remarks:

.....  
.....  
.....  
.....  
.....  
.....  
.....  
.....  
.....

James

Copyist.



*W* | 11 H. Art'y. | U.S.C.T.

*John Williams*  
-----  
*Privt*, Co. *A*, 14 Reg't R. I. Col'd H. Art'y.\*

Age *34* years.

Appears on

**Company Muster-in Roll**

of the organization named above. Roll dated  
*Camp Smith near*  
*Providence R.I., Aug 28, 1863.*

Muster-in to date

*Aug 28, 1863.*

Joined for duty and enrolled:

When *Aug 11*, 186*3*.

Where *Providence*

Period *3* years.

Valuation of horse, \$.....100

Valuation of horse equipments, \$.....100

Remarks: *1st District*

\* This organization subsequently became Co. *A*, 11 Reg't U. S. Colored Heavy Artillery.

Book mark:.....

*Prewitt*

*W* | **11 H. Art'y.** | **U.S.C.T.**

*John Williams*  
Prvt., Co. A, 14 Reg't R. I. Col'd H. Art'y.\*

Appears on

**Company Muster Roll**

for *Aug 28* to *Dec 31*, 186*3*.

Present or absent *Present*

Stoppage, \$ 100 for

Due Gov't, \$ 100 for

Valuation of horse, \$ 100

Valuation of horse equipments, \$ 100

Remarks:

\*This organization subsequently became Co. A, 11 Reg't U. S. Colored Heavy Artillery.

Book mark:

*Prewitt*

*W* | 11 H. Art'y. | U.S.C.T.

*John Williams*  
*Art*, Co. A, 14 Reg't R. I. Col'd H. Art'y.\*

Appears on

**Company Muster Roll**

for *Jan & Feb*, 1864.

Present or absent *Present*

Stoppage, \$ 100 for

Due Gov't, \$ 100 for

Valuation of horse, \$ 100

Valuation of horse equipments, \$ 100

Remarks:

\*This organization subsequently became Co. A, 11 Reg't U. S. Colored Heavy Artillery.

Book mark:

*Prewitt*



*W* | **11 H. Art'y.** | **U.S.C.T.**

*John Williams*  
*Prvt*, Co. A, 14 Reg't R. I. Col'd H. Art'y.\*

Appears on

**Company Muster Roll**

for *March & April*, 1864.

Present or absent *Present*

Stoppage, \$ 100 for

Due Gov't, \$ 100 for

Valuation of horse, \$ 100

Valuation of horse equipments, \$ 100

Remarks:

\*This organization subsequently became Co. A, 11 Reg't U. S. Colored Heavy Artillery.

Book mark:

*Prewitt*

*W* | **11 H. Art'y. | U.S.C.T.**

*John Williams*  
*Pvt*, Co. *A*, 8 Reg't U. S. Col'd H. Art'y.\*

Appears on

**Company Muster Roll**

for *May & June*, 1864.

Present or absent *Present*

Stoppage, \$ 100 for

Due Gov't, \$ 100 for

Valuation of horse, \$ 100

Valuation of horse equipments, \$ 100

Remarks:

\*This organization subsequently became Co. *A*, 11 Reg't U. S. Colored Heavy Artillery.

Book mark:

*Prewitt*

*W.*

11 H. Art'y. U.S.C.T.

*John Williams*

*Co. A, 11 Reg't U. S. Col'd H. Art'y.*

Appears on

**Company Muster Roll**

for *July & Aug.*, 186*4*.

Present or absent *Present*

Stoppage, \$ *100* for

Due Gov't, \$ *100* for

Valuation of horse, \$ *100*

Valuation of horse equipments, \$ *100*

Remarks: *Died April 19/61*

Book mark:

*B. A. G. H.*



*W.*

11 H. Art'y.

U.S.C.T.

*John Williams*

*Co. A, 11 Reg't U. S. Col'd H. Art'y.*

Appears on

**Company Muster Roll**

for *Sept. & Oct.*, 186*4*.

Present or absent *Present*

Stoppage, \$ 100 for

Due Gov't, \$ 100 for

Valuation of horse, \$ 100

Valuation of horse equipments, \$ 100

Remarks:

Book mark:

*[Signature]*  
Copyst.

*W.*

**11 H. Art'y. | U.S.C.T.**

*John Williams*

*W.*, Co. A, 11 Reg't U. S. Col'd H. Art'y.

Appears on

**Company Muster Roll**

for *Nov. & Dec.*, 186*4*.

Present or absent *Present*

Stoppage, \$ *3* <sup>*2*</sup>/<sub>*100*</sub> for *C & G. Co.*

Due Gov't, \$ *100* for

Valuation of horse, \$ *100*

Valuation of horse equipments, \$ *100*

Remarks:

Book mark:

*W. Williams*

*Ch.* | **11 H. Art'y. | U.S.C.T.**

*Wm. Williams*

*25*, Co. A, 11 Reg't U. S. Col'd H. Art'y.

Appears on

**Company Muster Roll**

for *Jan. 1, 1865*, 1865.

Present or absent *Present*

Stoppage, \$ *3* <sup>*00*</sup>/<sub>*100*</sub> for *W. & G.*

Due Gov't, \$ <sup>*00*</sup>/<sub>*100*</sub> for

Valuation of horse, \$ <sup>*00*</sup>/<sub>*100*</sub>

Valuation of horse equipments, \$ <sup>*00*</sup>/<sub>*100*</sub>

Remarks:

Book mark:

*D. F. [Signature]*



11 H. Art'y. U.S.C.T.

*John Williams*

Co. A, 11 Reg't U. S. Col'd H. Art'y.

Appears on

**Company Muster Roll**

for *Jan 1st*, 186*5*.

Present or absent *Present*

Stoppage, \$ *2.00* for *100*

Due Gov't, \$ *1.00* for *100*

Valuation of horse, \$ *100*

Valuation of horse equipments, \$ *100*

Remarks:

Book mark:

*[Signature]*

*No.* 11 H. Art'y. U.S.C.T.

*John Williams,*  
Priv., Co. A. 11 Reg't U. S. Cav'd H. Art'y.

Appears on

**Company Muster Roll**

for *May<sup>th</sup> June* 1865.

Present or absent *Present.*

Snuffage. \$ 100 for

Due Gov't \$ 100 for

Valuation of horse. \$ 100

Valuation of horse equipments. \$ 100

Remarks:

Book mark:

*R. D. Danner*

*W.* | 11 H. Art'y. | U.S.C.T.

*John Williams,*  
*Priv.*, Co. A, 11 Reg't U. S. Col'd H. Art'y.

Appears on

**Company Muster Roll**

for *July<sup>and</sup> August*, 1865.

Present or absent *Present.*

Stoppage, \$ 100 for

Due Gov't, \$ 100 for

Valuation of horse, \$ 100

Valuation of horse equipments, \$ 100

Remarks:

Book mark:

*R. S. Draumer*



*W* 11 H. Art'y. U.S.C.T.

*John Williams,*  
*Pvt., Co. A, 11 Reg't U. S. Col'd H. Art'y.*

Appears on **Co. Muster-out Roll**, dated  
*New Orleans La. Oct. 2, 1865.*  
Muster-out to date *Oct. 2, 1865.*  
Last paid to *Feb. 28, 1865.*

**Clothing account:**

Last settled....., 186 : drawn since \$..... 100  
Due soldier \$ *5.30* : due U. S. \$..... 100  
Am't for cloth'g in kind or money adv'd \$..... 100

Due U. S. for arms, equipments, &c.. \$ *6.50*  
Bounty paid \$..... 100: due \$ *100.00*

Remarks: *Joined Orgl. Orgnl.*  
*Stopped 1 Bedrock*  
*Stopped for 1 Muster*  
*Accounts retained.*

Book mark: *V. 135 P. 224. 73.*

Williams, John

P, Co. a, 11 Reg't U. S. C. H. A.

1 Enclosures.

Bed Cards	Descriptive Lists
Burial Records	Final Statements
Certs. of Dis. for Discharge	Furloughs
C. M. Charges	Med. Des. Lists
Med. Certificates	Orders

E. P. 1

Other papers relating to—

Admission to Hosp'l	Furlough
Casualty Sheet (Officer's)	Med. Examination
Confinement	Misc. Information
Contracts	Pay or Clothing
Death or Effects	Personal Reports
Desertions	Rank
Discharge from Hosp'l	Transfer to Hosp'l
Discharge from Service	Transfer to V. R. C.
Duty	Transportation

DECLARATION OF RECRUIT.

I, *John Williams* desiring to VOLUNTEER as a Soldier in the ARMY OF THE UNITED STATES, for the term of *three years* , do declare that I am *34* years and *five* months of age; that I have never been discharged from the United States service on account of disability or by sentence of a court martial, or by order, before the expiration of a term of enlistment; and I know of no impediment to my serving honestly and faithfully as a soldier for *the First Lt. Gen. Henry D. Miller*

Given at *Providence*  
The *eleventh* day of *August* 18*63*.

Witness: *Fred. B. Waugh.* *John Williams*

No. *116*

*John Williams*

Volunteered at *Providence*

*Regt. H. H. H. H.*

By

*11*  
Regiment of *Massetta*

enlistment; last served in Company ( )

Regt of

Discharged 18

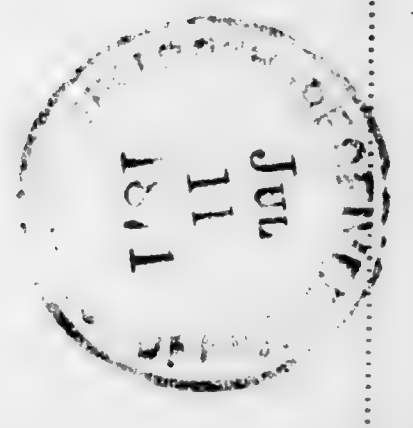

CONSENT IN CASE OF MINOR.

I, \_\_\_\_\_ Do CERTIFY that I am the \_\_\_\_\_ of \_\_\_\_\_ ; that the said \_\_\_\_\_ is \_\_\_\_\_ years of age; and I do hereby freely give my CONSENT to his volunteering as a SOLDIER in the ARMY OF THE UNITED STATES for the period of \_\_\_\_\_

Given at \_\_\_\_\_  
The \_\_\_\_\_ day of \_\_\_\_\_

Witness:



VOLUNTEER ENLISTMENT.

State of

Rhode Island



Town of

Providence  
East

I, John Williams

in the State of Massachusetts

born in

New Bedford

a farmer

aged

34

years, and by occupation

DO HEREBY ACKNOWLEDGE to have volunteered this eleventh day of August 1863, to serve as a SOLDIER in the ARMY OF THE UNITED STATES of AMERICA, for the period of three years, unless sooner discharged by proper authority:

Do also agree to accept such bounty, pay, rations and clothing, as are, or may be, established by law for volunteers. And I, John Williams do solemnly swear, that I will bear true faith and allegiance to the United States of America, and that I will serve them honestly and faithfully against all their enemies or opposers whomsoever; and that I will observe and obey the orders of the President of the United States, and the orders of the officers appointed over me, according to the Rules and Articles of War.

Sworn and subscribed to, at

this eleventh day of August 1863.

John Williams  
mark

BEFORE

Geo. Peabody  
Justice of the Peace

I CERTIFY, ON HONOR, That I have carefully examined the above-named Volunteer, agreeably to the General Regulations of the Army, and that, in my opinion, he is free from all bodily defects and mental infirmity, which would, in any way, disqualify him from performing the duties of a soldier.

Johnson Gardner  
M.D.

EXAMINING SURGEON.

I CERTIFY, ON HONOR, That I have minutely inspected the Volunteer, John Williams previously to his enlistment, and that he was entirely sober when enlisted; that, to the best of my judgment and belief, he is of lawful age; and that, in accepting him as duly qualified to perform the duties of an able-bodied soldier, I have strictly observed the Regulations which govern the recruiting service. This soldier has brown eyes, black hair, ruddy complexion, is 5 feet, 6 inches high.

First-located Company Heavy Artillery

Rhode Island Volunteers.

W. H. Nehme

RECRUITING OFFICER.

Williams John.

No. 11 U.S. Col'd H. Art'y.

Private.

Private.

CARD NUMBERS.

1	6183955	26
2	6184099	27
3	6184243	28
4	6184396	29
5	6185475	30
6	9124223	31
7	9124361	32
8		33
9		34
10		35
11		36
12		37
13		38
14		39
15		40
16		41
17		42
18		43
19		44
20		45
21		46
22		47
23		48
24		49
25		50

Book Mark:

See also



*W* | **11 H. Art'y. | U.S.C.T.**

*John Williams*  
....., Co *B*, 11 Reg't U. S. Col'd H. Art'y.

Appears on

**Company Descriptive Book**

of the organization named above.

**DESCRIPTION.**

Age *24* years; height *5* feet *7 1/4* inches.

Complexion *Dark*

Eyes *Brown*; hair *Blk*

Where born *New York N.Y.*

Occupation *Sailor*

**ENLISTMENT.**

When *Aug 19*, 1863.

Where *Prov. R. I.*

By whom *May Sanford*; term *3* y'rs.

Remarks: *Disch'd by reason  
of physical disability at  
Fort Gill Hope Prov.  
month from Providence  
R.I. Feb 25/64 by order  
of Senior Surg in charge*

*James*

Copyist.



W | 11 H. Art'y. | U.S.C.T.

*John Williams*

....., Co. *B*, 11 Reg't U. S. Col'd H. Art'y.

Appears on

**Company Descriptive Book**

of the organization named above.

**DESCRIPTION.**

Age *24* years; height *5* feet *7 1/4* inches.

Complexion *Dark*

Eyes *Brown*; hair *Blk*

Where born *New York N.Y.*

Occupation *Factor*

**ENLISTMENT.**

When *Aug 19*, 186 .

Where *Peruiana*

By whom *Must. J. Fred*, term *3* y'rs.

Remarks: *Disch'd at  
Lowell Hope Posts with  
R.I. - is ability -*

*James*

*W* | 11 H. Art'y. | U.S.C.T.

*John Williams*

*Co. B*, 14 Reg't R. I. Col'd H. Art'y.\*

Age *27* years.

Appears on

**Company Muster-in Roll**

of the organization named above. Roll dated

*Providence R. I., Sept 14, 1863.*

Muster-in to date *Sept 14, 1863.*

Joined for duty and enrolled:

When *Aug. 19*, 186 .

Where *Providence*

Period *3* years.

Valuation of horse, \$.....*100*

Valuation of horse equipments, \$.....*100*

Remarks: .....

.....

.....

.....

.....

.....

.....

.....

.....

.....

.....

.....

.....

.....

.....

.....

.....

.....

.....

.....

.....

.....

.....

.....

\* This organization subsequently became Co. *B*, 11 Reg't U. S. Colored Heavy Artillery.

Book mark: .....

.....

.....

.....

.....

.....

.....

.....

.....

.....

.....

.....

.....

.....

.....

.....

*J. Walker*

*W* | 11 H. Art'y. | U.S.C.T.

*John Williams*  
*Priv*, Co. B, 14 Reg't R. I. Col'd H. Art'y.\*

Appears on

**Company Muster Roll**

for *Sept 14 to Dec 31*, 1863.

Present or absent *X*

Stoppage, \$.....100 for

Due Gov't, \$.....100 for

Valuation of horse, \$.....100

Valuation of horse equipments, \$.....100

Remarks: *Absent Sick at Lovell General Hospital Portsmouth R.I.*

*X name written in column of Present and cancelled by line*

\*This organization subsequently became Co. B, 11 Reg't U. S. Colored Heavy Artillery.

Book mark: .....

*J. Walker*



*W* | 11 H. Art'y. | U.S.C.T.

*John Williams*  
*Priv.*, Co. B, 14 Reg't R. I. Col'd H. Art'y.\*

Appears on

**Company Muster Roll**

for *Jan & Feb*, 1864.

Present or absent *Absent*

Stoppage, \$ *100* for

Due Gov't, \$ *100* for

Valuation of horse, \$ *100*

Valuation of horse equipments, \$ *100*

Remarks: *Left at Lovell*  
*General Hospital, R.I.*  
*Dec. 1863.*

\*This organization subsequently became Co. B, 11 Reg't U. S. Colored Heavy Artillery.

Book mark:

*J. Walker*

*W* | 11 H. Art'y. | U.S.C.T.

*John Williams*

*Priv*, Co. *B*, 8 Reg't U. S. Col'd H. Art'y.\*

Appears on

**Company Muster Roll**

for *Mar & Apr*, 1864.

Present or absent

Stoppage, \$ 100 for

Due Gov't, \$ 100 for

Valuation of horse, \$ 100

Valuation of horse equipments, \$ 100

Remarks: *Discharged for disability at Lovell Hospital, R. I. Feb. 25. 1864.*

† This organization subsequently became Co. *B*, 11 Reg't U. S. Colored Heavy Artillery.

Book mark:

*J. Walker*

Copyist.

*W* | 11 H. Art'y. | U.S.C.T.

*John Williams*  
*Pvt.*, Co. *B*, 11 Reg't U. S. Col'd H. Art'y.

Appears on **Co. Muster-out Roll**, dated  
*New Orleans La., Oct 2, 1865.*

Muster-out to date ..... 186 .  
Last paid to ..... 186 .

**Clothing account:**

Last settled....., 186 ; drawn since \$.....<sup>100</sup>

Due soldier \$.....<sup>100</sup>; due U. S. \$.....<sup>100</sup>

Am't for cloth'g in kind or money adv'd \$.....<sup>100</sup>

Due U. S. for arms, equipments, &c., \$.....<sup>100</sup>

Bounty paid \$.....<sup>100</sup>; due \$.....<sup>100</sup>

Remarks: *joined aryl orgin*  
*Discharged at Prov. R. S.*  
*Feb. 25 /64 on Surg. Certificate*  
*of Disability*

Book mark: *C. S.*

(861) *Hoyberger* Copyist.



Williams, Jno.

D, Co. D,

1st Reg't U.S.C. H.A.

5 Enclosures.

Bed Cards .....	Final Statements .....
Burial Records .....	Furloughs or L. of A .....
Certs. of Dis. for Discharge / .....	Med. Certificates .....
C. M. Charges .....	Med. Des. Lists .....
Descriptive Lists .....	Orders .....
Discharge Certificates .....	Pris. of War Record .....
Enlistment Papers / .....	Resignations .....

Other papers relating to—

Admission to Hosp'l .....	Furlough or L. of A .....
Casualty Sheet / .....	Med. Examination .....
Confinement .....	Misc. Information .....
Contracts .....	Pay or Clothing .....
Death or Effects .....	Personal Reports .....
Desertion .....	Rank .....
Discharge from Hosp'l .....	Transfer to Hosp'l .....
Discharge from Service 2 .....	Transfer to V. R. C. .....
Duty .....	Transportation .....

DECLARATION OF RECRUIT.

I, John Wittgoye desiring to VOLUNTEER as a Soldier in the ARMY OF THE UNITED STATES, for the term of 3 months of age; that I have never been discharged from the United States service on account of disability or by sentence of a court martial, or by order, before the expiration of a term of enlistment; and I know of no impediment to my serving honestly and faithfully as a soldier for 3 years Princeton

Given at The 19th day of Aug 1863 John Williams

Witness: Amos P. Engley



Discharged ..... 18

Reg't of .....

enlistment; last served in Company ( )

By John Williams Regiment of 150th

Volunteered at Princeton

No. 1117

CONSENT IN CASE OF MINOR.

I, \_\_\_\_\_ of \_\_\_\_\_ is \_\_\_\_\_ years of age; and I do hereby freely give my CONSENT to his volunteering as a SOLDIER in the ARMY OF THE UNITED STATES for the period of \_\_\_\_\_

Given at The \_\_\_\_\_ day of \_\_\_\_\_

Witness: \_\_\_\_\_



# VOLUNTEER ENLISTMENT.

State of

R.I.



City of

Providence

I, John Williams born in NY in the State of NY aged 24 years, and by occupation

a Sailor DO HEREBY ACKNOWLEDGE to have volunteered this 15th day of Aug 1863, to serve as a SOLDIER in the ARMY OF THE UNITED STATES of AMERICA, for the period of 1 year, unless sooner discharged by proper authority:

Do also agree to accept such bounty, pay, rations and clothing, as are, or may be, established by law for volunteers. And I, John Williams do solemnly swear, that I will bear true faith and allegiance to the United States of America, and that I will serve them honestly and faithfully against all their enemies or opposers whomsoever; and that I will observe and obey the orders of the President of the United States, and the orders of the officers appointed over me, according to the Rules and Articles of War.

Sworn and subscribed to, at

this 15th day of Aug 1863

BEFORE

S. P. Sampson } John Williams  
Maj. 1st Regt.

I CERTIFY, ON HONOR, That I have carefully examined the above-named Volunteer, agreeably to the General Regulations of the Army, and that, in my opinion, he is free from all bodily defects and mental infirmity, which would, in any way, disqualify him from performing the duties of a soldier.

John Gardner  
M.D.

EXAMINING SURGEON.

I CERTIFY, ON HONOR, That I have minutely inspected the Volunteer, previously to his enlistment, and that he was entirely sober when enlisted; that, to the best of my judgment and belief, he is of lawful age; and that, in accepting him as duly qualified to perform the duties of an able-bodied soldier, I have strictly observed the Regulations which govern the recruiting service. This soldier has

Dark complexion, is 5 feet, 7 1/2 inches high. Dark eyes, Dark hair,

Regiment of

S. P. Sampson  
Maj. 1st Regt.  
Volunteers

RECRUITING OFFICER.



The company commander will here add a statement of all the facts known to him concerning the disease or wound, or cause of disability of the soldier; the time; place, manner, and all the circumstances under which the injury occurred, or disease originated or appeared; the duty, or service, or situation of the soldier at the time the injury was received or disease contracted, stating particularly whether the injury was received or the disease contracted in the line of his duty; and whatever other facts may aid a judgment as to the cause, immediate or remote, of the disability, and the circumstances attending it.

When the facts are not known to the company commander, the certificate of any officer, or affidavit of other person having such knowledge, will be appended—as the surgeon in charge of a hospital, the officer commanding a detachment of recruits, &c., &c.

NOTE 2.

When a probable case for pension, special care must be taken to state the degree of disability—as  $\frac{1}{2}$ ,  $\frac{3}{4}$ , &c., &c.; to describe particularly the disability, wound, or disease; the extent to which it deprives him of the use of any limb or faculty, or affects his health, strength, activity, constitution, or capacity to labor or earn his subsistence. The surgeon will add, from his knowledge of the facts and circumstances, and from the evidence in the case, his professional opinion of the cause or origin of the disability. In the case of discharges by Medical Inspectors, the last paragraph will state that the "discharge was given by consent of the soldier, after a personal examination, and for disability, the nature, degree, and origin of which are correctly described in the within certificate."

Par. 1260 Regulations, Edit. 1861.

Medical officers, in giving certificates of disability, are to take particular care in all cases that have not been under their charge; and especially in epilepsy, convulsions, chronic rheumatism, derangement of the urinary organs, ophthalmia, ulcers, or any obscure disease liable to be feined or purposely produced; and in no case shall such certificate be given until after sufficient time and examination to detect any attempt at deception.

DIRECTIONS.

This certificate will be made out in duplicate by the soldier's company commander, or other officer commanding the separate detachment to which he belongs and sent by him to the surgeon who has charge of the hospital where the soldier is sick. The surgeon will then fill out and sign the surgeon's certificate, and forward these papers to the regimental, detachment, or post commander, who will forward them, with his action endorsed thereon, through the proper channel, to his division commander; or, if the troops are not attached to a division, to his corps, department, or other commander or officer to whom the authority to discharge enlisted men may be specially delegated.

These certificates, after having received the action of the highest authority to which they are required to be sent, will be returned through the same channel to the regimental, post, or detachment commander, who will, if the discharge is authorized by the endorsement of the proper authority, sign the soldier's discharge, and the last certificate on this paper; see that the soldier is furnished with the proper final statements in duplicate, and forward BOTH of these certificates direct to the Adjutant General United States Army, at Washington, D. C.; they will not under any circumstances be given into the hands of the soldier.

CERTIFICATE OF DISABILITY FOR DISCHARGE

IN THE CASE OF

*18111 40*  
*N. 901 Ring Ave*  
 \_\_\_\_\_  
*John Williams*  
 a \_\_\_\_\_  
*Private* Co. *B*

\_\_\_\_\_ *14th* Reg't of *P. I. Vols*  
 11' *Adjutant General's Office,*

*Mar 10 1864*

*Duplicate sent the Pension Office*

APPROVED

*C. W. Brownell*

Surgeon, U. S. A.,

Medical Director Dep't of the East.

*Med. Dep't. of the East.*  
*New York City, Feb. 21st 1864.*

*To be discharged.*

*By comd. of Maj. Gen. Dix*

*Chas. Temple Dix*

*Maj. & A. D. C.*  
*A. A. A. G.*

Received (A. G. Office) \_\_\_\_\_, 186 .

*Ent on ORO of Cas*



ARMY OF THE UNITED STATES  
CERTIFICATE  
OF DISABILITY FOR DISCHARGE.



Private *John Williams* of *Lieut* *Phanuel E. Bishop's* Company, (*B*) of the *Fourteenth* *Infantry* Regiment of United States *Co. Art'y. P. I. Vols.* was enlisted by *Major Sanford* of the *Providence R. I.* Regiment of *Providence R. I.* at *Providence R. I.* on the *Nineteenth* day of *August* 1863, to serve *3* years; he was born in *New York* in the State of *New York* is *Twenty-four* years of age, *Five* feet *Seven 1/4* inches high, *Dark* complexion, *Brown* eyes, *Black* hair, and by occupation when enlisted a *Tailor*. During the last two months said soldier has been unfit for duty *Sixty* days.\* *Unfit for Invalid Corp.*

STATION: *Portsmouth Grove R. I.*  
DATE: *February 8th. 1864*

*W. C. Cornick*  
Ass. Surg. U. S. A.  
Commanding Company Hospital  
*Pro-tem.*

I CERTIFY, that I have carefully examined the said *John Williams* of *Lieut* *Phanuel E. Bishop's* Company, and find him incapable of performing the duties of a soldier because of *Phthisis pulmonalis - Disease contracted since enlistment - Has done no duty for four months - Will be able to earn a fair subsistence - Disability - one (1/8) third - Unfit for Invalid Corp.*

*W. C. Cornick*  
Ass. Surgeon. U. S. A.

DISCHARGED, this *Twenty-fifth* day of *February* 1864, at *Lowell General Hosp. U.S.A. Portsmouth Grove R. I.*

*W. C. Cornick*  
Ass. Surg. U.S.A.  
Commanding the Reg't. Hospital  
*Pro-tem.*

The soldier desires to be addressed at  
Town *New York City* County *New York* State *New York*

\* See Note 1 on the back of this. † See Note 2 on the back of this.

49

CASUALTY SHEET

No. ....

John Williams

Pari of Company B

14 Regiment of R. I. H. A

State Volunteers.

NATURE OF CASUALTY.

Discharged July 25/64.





CASUALTY SHEET.

Name: John Williams

Rank: Priv Company: B Regiment: 14

Arm: H. A. State: R. I.

Nature of Casualty: Discharge

CAUSE OF CASUALTY—(NAME OF DISEASE, &c.)

BY WHOM DISCHARGED.

DEGREE OF DISABILITY.

FROM WHAT SOURCE THIS INFORMATION WAS OBTAINED.

Roll of Service Books R. I. 1864.

BY WHOM CERTIFIED

M. J. Conrick  
A. S. USA

REMARKS.

DATE OF DISCHARGE, DEATH, &c.

Feb. 25. 1864.

PLACE OF DISCHARGE, DEATH, &c.

Portsmouth R. I.

W. Roger

Clerk.

222

11 a. S. C. N. C.

John Williams  
Discharged 25<sup>th</sup> Feb<sup>y</sup>  
1864 at Hospital  
Plymouth N. Y.

Rel. to Disch.

"Lovell"

U. S. A. General Hospital,

PORTSMOUTH GROVE, R. I.,

To the Commander of  
Co. [B] 14th Reg't  
of C. S. G. A.

February 26th 1864

Sir:

Private John Williams  
of Company [B] 14th Reg't C. S. G. A. has  
been an inmate of this Hospital since November 30th 1863.  
He left the Hospital on the 25th day of February 1864, having  
been discharged from the service by reason of Surgeon's certificate  
of disability sent to join his Regiment for duty.  
as a deserter.

He died on the \_\_\_\_\_ day of \_\_\_\_\_ 1863, of

He was mustered for pay on the \_\_\_\_\_

but was not paid

By order of Asst Surgeon Wm F. Hornick U.S.A. in charge  
Very Respectfully, pro tem.

Your obedient servant,

J. M. Merriam  
Asst Surgeon U.S.A.  
Ca. Off.



Notice of discharge  
of J. Williams

---

W. Barstow  
Asst. A. Surg.

May 16, 1861

W. J. G.

---

John Williams  
P. A.

Rel. to Surgeon.

HEAD-QUARTERS, DEPARTMENT OF THE EAST.

New York City, March 7 1864.

To

Commanding Officer,

Co. A

14<sup>15</sup> R. I. Arty (Col. 1st)

You are hereby notified that

Private  
John Williams

of your Company and Regiment has been discharged the service of the U. S., by reason of

Disability

at Portsmouth N. H. on the 21 day of July

1864, by orders from these Headquarters.

BY COMMAND OF MAJOR-GENERAL DIX.

Wilton Weston  
Assistant Adjutant General.  
Thro. Regl. Hd. Qrs.

2030  
Williams John.

Co K., 11 U.S. Col'd H. Art'y.

Private | Private

CARD NUMBERS.

1	6197971	26
2	6198114	27
3	6198257	28
4	6198420	29
5	6198573	30
6	6198730	31
7	6198870	32
8	6199013	33
9	6199149	34
10	6199282	35
11	6199527	36
12	6199645	37
13	9125728	38
14		39
15		40
16		41
17		42
18		43
19		44
20		45
21		46
22		47
23		48
24		49
25		50

Book Mark:

See also



81328685 P.O. in m  
81328392 P.O. off  
51332268 Draft

John Miller Esq

*W* | 11 H. Art'y. | U.S.C.T.

*John Williams*  
Co. *K*, 11 Reg't U. S. Col'd H. Art'y.

Appears on

**Company Descriptive Book**

of the organization named above.

**DESCRIPTION.**

Age *37* years; height *5* feet *8* inches.

Complexion *OK*

Eyes *Blk*; hair *Blk*

Where born *Maryland*

Occupation *Seaman*

**ENLISTMENT.**

When *Nov 30*, 186 .

Where *Prov R. I.*

By whom *J. C. Engly*; term *3* y'rs.

Remarks:

*Griffith*

*W* | 11 H. Art'y. | U.S.C.T.

*John Williams*

*Pt*, Co. *K* 14 Reg't R. I. Col'd H. Art'y.\*

Age *37* years.

Appears on

**Company Muster-in Roll**

of the organization named above. Roll dated

*Cp. nr. Providence R.I., Dec 17, 1863.*

Muster-in to date

*Dec 17, 1863.*

Joined for duty and enrolled:

When *Nov 30*, 1863.

Where *Providence R.I.*

Period *3* years.

Valuation of horse, \$ *100*

Valuation of horse equipments, \$ *100*

Remarks:

\* This organization subsequently became Co. *K*, 11 Reg't U. S. Colored Heavy Artillery.

Book mark:

*J. N. Stewart*

(356)

Copyist.



*W* | **11 H. Art'y. | U.S.C.T.**

*John Williams*  
*Pt*, Co. K, 14 Reg't R. I. Col'd H. Art'y.\*

Appears on

**Company Muster Roll**

for *Dec 17 to Dec 31*, 186*3*.

Present or absent *Present*

Stoppage, \$ 100 for

Due Gov't, \$ 100 for

Valuation of horse, \$ 100

Valuation of horse equipments, \$ 100

Remarks: \_\_\_\_\_  
\_\_\_\_\_  
\_\_\_\_\_  
\_\_\_\_\_  
\_\_\_\_\_

\*This organization subsequently became Co. K, 11 Reg't U. S. Colored Heavy Artillery.

Book mark: \_\_\_\_\_

*J. N. Stewart*  
(358) Copyist.

*M* | 11 H. Art'y. | U.S.C.T.

*John Williams*  
*Pt*, Co. K, 14 Reg't R. I. Col'd H. Art'y.\*

Appears on

Company Muster Roll  
for *Jan & Feb*, 1864.  
Present or absent *Present*

Stoppage, \$.....100 for .....

Due Gov't, \$.....100 for .....

Valuation of horse, \$.....100

Valuation of horse equipments, \$.....100

Remarks: .....

\*This organization subsequently became Co. K, 11 Reg't U. S. Colored Heavy Artillery.

Book mark: .....

*J. H. Stewart*  
(358) Copyist.

*W* | **11 H. Art'y.** | **U.S.C.T.**

*John Williams*  
*Pt*, Co. K, 14 Reg't R. I. Col'd H. Art'y.\*

Appears on

**Company Muster Roll**

for *Mch & Apr*, 1864.

Present or absent *Present*

Stoppage, \$ 100 for

Due Gov't, \$ 100 for

Valuation of horse, \$ 100

Valuation of horse equipments, \$ 100

Remarks:

\*This organization subsequently became Co. K, 11 Reg't U. S. Colored Heavy Artillery.

Book mark:

*J. Stewart*



*W* | **11 H. Art'y. | U.S.C.T.**

*John Williams*  
*Co. C*, 8 Reg't U. S. Col'd H. Art'y.\*

Appears on

**Company Muster Roll**

for *May & June*, 18*64*:

Present or absent *Present*

Stoppage, \$ 100 for

Due Gov't, \$ 100 for

Valuation of horse, \$ 100

Valuation of horse equipments, \$ 100

Remarks:  
.....  
.....  
.....  
.....  
.....  
.....

† This organization subsequently became *Co. C*, 11 Reg't U. S. Colored Heavy Artillery.

Book mark: .....

*Steward*

*W* | 11 H. Art'y. | U.S.C.T.

*John Williams*  
*Priv*, Co. K, 11 Reg't U. S. Col'd H. Art'y.

Appears on

**Company Muster Roll**

for *July & Aug*, 186*4*.

Present or absent *Present*

Stoppage, \$ 100 for

Due Gov't, \$ 100 for

Valuation of horse, \$ 100

Valuation of horse equipments, \$ 100

Remarks: *Free on 19 April 64*  
*\$ per month since*  
*from enlistment*  
*to April 30/64.*

Book mark:

*Chambers*

*W* 11 H. Art'y. U.S.C.T.

*John Williams*  
*Priv*, Co. K, 11 Reg't U. S. Col'd H. Art'y.

Appears on

**Company Muster Roll**

for *Sept & Oct*, 186*7*.

Present or absent *Present*.

Stoppage, \$ *100* for

Due Gov't, \$ *102* for *C. & G. Q.*

Valuation of horse, \$ *100*

Valuation of horse equipments, \$ *100*

Remarks:  
-----  
-----  
-----  
-----  
-----  
-----  
-----  
-----

Book mark: -----

*Steward*  
(358) Copyist.



*W* | 11 H. Art'y. | U.S.C.T.

*John Williams*  
*Prvt*, Co. K, 11 Reg't U. S. Col'd H. Art'y.

Appears on

**Company Muster Roll**

for *Nov 10*, 186*4*.

Present or absent *Present*

Stoppage, \$ 100 for

Due Gov't, \$ 100 for *C. & G. E.*

Valuation of horse, \$ 100

Valuation of horse equipments, \$ 100

Remarks:

Book mark:

*Stewart*

*W* | 11 H. Art'y. | U.S.C.T.

*John Williams*

*Pvt*, Co. K, 11 Reg't U. S. Col'd H. Art'y.

Appears on

**Company Muster Roll**

for *Jan & Feb*, 1865.

Present or absent *Present*

Stoppage, \$ 100 for

Due Gov't, \$ *1 02* / 100 for *C. & G. E.*

Valuation of horse, \$ 100

Valuation of horse equipments, \$ 100

Remarks: \_\_\_\_\_  
\_\_\_\_\_  
\_\_\_\_\_  
\_\_\_\_\_  
\_\_\_\_\_  
\_\_\_\_\_

Book mark: \_\_\_\_\_

*Steward*  
Copyist.

*A* | 11 H. Art'y. | U.S.C.T.

*John Williams*  
Pvt., Co. K, 11 Reg't U. S. Col'd H. Art'y.

Appears on

Company Muster Roll  
for *March & April, 1865*  
Present or absent *Present*

Stoppage, \$ \_\_\_\_\_ 100 for \_\_\_\_\_

Due Gov't, \$ \_\_\_\_\_ <sup>03</sup> 100 for *C.D.A.P.*

Valuation of horse, \$ \_\_\_\_\_ 100

Valuation of horse equipments, \$ \_\_\_\_\_ 100

Remarks: \_\_\_\_\_  
\_\_\_\_\_  
\_\_\_\_\_  
\_\_\_\_\_  
\_\_\_\_\_  
\_\_\_\_\_  
\_\_\_\_\_

Book mark: \_\_\_\_\_

*John Williams*  
Copyist.



*M* | 11 H. Art'y. | U.S.C.T.

*John Williams*  
*Pvt*, Co. K, 11 Reg't U. S. Col'd H. Art'y.

Appears on

**Company Muster Roll**

for *July & Aug*, 1865.

Present or absent *Present*

Stoppage, \$  $\frac{100}{100}$  for

Due Gov't, \$  $\frac{101}{100}$  for *C & G E*

*lost and destroyed*

Valuation of horse, \$  $\frac{100}{100}$

Valuation of horse equipments, \$  $\frac{100}{100}$

Remarks:

Book mark:

*Spucher*

*M* | 11 H. Art'y. | U.S.C.T.

*John Williams*

*Priv.*, Co. *K*, 11 Reg't U. S. Col'd H. Art'y.

Appears on **Co. Muster-out Roll**, dated

*New Orleans, La, Oct. 2*, 1865.

Muster-out to date

*Oct. 2*, 1865.

Last paid to

*Feb. 28*, 1865.

**Clothing account:**

Last settled....., 186 ; drawn since \$..... 100

Due soldier \$ *19* <sup>*76*</sup>/<sub>100</sub>; due U. S. \$..... 100

Am't for cloth'g in kind or money adv'd \$..... 100

Due U. S. for arms, equipments, &c., \$ <sup>*04*</sup>/<sub>100</sub>

Bounty paid \$ *None* 100; due \$ *100* <sup>*00*</sup>/<sub>100</sub>

Remarks: *Joined at Orig. Organ.*  
*Stop 2 Eagles lost.*

Book mark: .....

*Spencer*

*Williams, Inc.*  
P., Co., 11 Reg't *USCA A*

**Enclosures.**

Bed Cards .....	Final Statements .....
Burial Records .....	Furloughs or L. of A .....
Certs. of Dis. for Discharge .....	Med. Certificates .....
C. M. Charges .....	Med. Des. Lists .....
Descriptive Lists .....	Orders .....
Discharge Certificates .....	Pris. of War Record .....
Enlistment Papers .....	Resignations .....

**Other papers relating to—**

Admission to Hosp'l .....	Furlough or L. of A .....
Casualty Sheet .....	Med. Examination .....
Confinement .....	Misc. Information .....
Contracts .....	Pay or Clothing .....
Death or Effects .....	Personal Reports .....
Desertion .....	Rank .....
Discharge from Hosp'l .....	Transfer to Hosp'l .....
Discharge from Service .....	Transfer to V. R. C. .....
Duty .....	Transportation .....



DECLARATION OF RECRUIT.

I, *John Williams* desiring to VOLUNTEER as a Soldier in the ARMY OF THE UNITED STATES, for the term of *3 years* do declare that I am *27* years and *3* months of age; that I have never been discharged from the United States service on account of disability or by sentence of a court martial, or by order, before the expiration of a term of enlistment: and I know of no impediment to my serving honestly and faithfully as a soldier for *3 years*

Given at *Louisiana*  
The *20<sup>th</sup>* day of *Nov* 18 *63*

Witness:

*L. A. Newkirk*

*John Williams*  
*Mar*

No. *118*

*John Williams*  
Volunteered at *Louisiana*

*Nov 20<sup>th</sup>* 1863

By *May J. C. Sawyer*

*14<sup>th</sup>* Regiment of *Or* *City*

*1105504*

enlistment: last served in Company ( )

Reg't of

Discharged ..... 18



CONSENT IN CASE OF MINOR.

I, \_\_\_\_\_ Do CERTIFY that I am the \_\_\_\_\_ of \_\_\_\_\_; that the said \_\_\_\_\_ is \_\_\_\_\_ years of age; and I do hereby freely give my CONSENT to his volunteering as a SOLDIER in the ARMY OF THE UNITED STATES for the period of \_\_\_\_\_

Given at \_\_\_\_\_  
The \_\_\_\_\_ day of \_\_\_\_\_

Witness:

VOLUNTEER ENLISTMENT.

State of *Rhode Island* Town of *Providence*

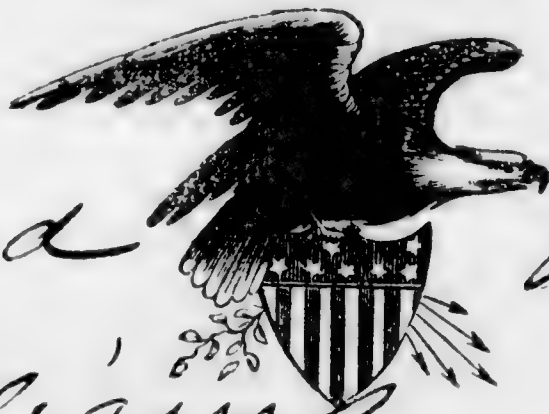

I, *John Williams* born in \_\_\_\_\_  
in the State of *Maryland* aged *27* years, and by occupation  
a *Chamman* DO HEREBY ACKNOWLEDGE to have volunteered this *30<sup>th</sup>*  
day of *Nov* 18*63* to serve as a SOLDIER in the ARMY OF THE UNITED STATES  
OF AMERICA, for the period of *3 years*, unless sooner discharged by proper authority:

Do also agree to accept such bounty, pay, rations and clothing, as are, or may be, established, by law for  
volunteers. And I, *John Williams* do solemnly swear, that I will bear  
true faith and allegiance to the *United States of America*, and that I will serve them honestly and faith-  
fully against all their enemies or opposers whomsoever; and that I will observe and obey the orders of the  
President of the United States, and the orders of the officers appointed over me, according to the Rules  
and Articles of War.

Sworn and Subscribed to, at *Providence*  
this *30<sup>th</sup>* day of *Nov* 18*63* *John Williams*  
BEFORE *Mr John LeRoy Pullen* *Mark*

I CERTIFY, ON HONOR, That I have carefully examined the above-named Volunteer, agreeable to the General Regulations of  
the Army, and that, in my opinion, he is free from all bodily defects and mental infirmity, which would, in any way, disqualify him  
from performing the duties of a soldier.

*Johnson Gardner M.D.*

EXAMINING SURGEON.

I CERTIFY, ON HONOR, That I have minutely inspected the Volunteer, *John Williams*  
previously to his enlistment, and that he was entirely sober when enlisted; that to the best of my judgment and belief, he is of  
lawful age; and that, in accepting him as duly qualified to perform the duties of an able-bodied soldier, I have strictly observed the  
Regulations which govern the recruiting service. This soldier has *Dark* eyes *Black* hair  
*Dark* complexion, is *5* feet, *8* inches high.

*May 14<sup>th</sup>* Regiment of *2d* *Arty* *Volunteers,*

RECRUITING OFFICER.

2031

*Williams John H.*

Co *K*, 11 U.S. Col'd H. Art'y.

*Private* | *Private*

CARD NUMBERS.

1	6197972	26
2	6173225	27
3	6108259	28
4	6172711	29
5	61715	30
6	613133	31
7	6108259	32
8	6108259	33
9	6108259	34
10	6108259	35
11	6108259	36
12	6108259	37
13	6108259	38
14	6108259	39
15	6108259	40
16	6108259	41
17	6108259	42
18	6108259	43
19	6108259	44
20	6108259	45
21	6108259	46
22	6108259	47
23	6108259	48
24	6108259	49
25	6108259	50

Book Mark:

See also



REP 334950.  
S. 1344250 Pomona

John Quinn Esq

*M* | **11 H. Art'y. | U.S.C.T.**

*John H. Williams*  
Co. *K*, 11 Reg't U. S. Col'd H. Art'y.

Appears on

**Company Descriptive Book**

of the organization named above.

**DESCRIPTION.**

Age *38* years; height *5* feet *5* inches.

Complexion

*DK*

Eyes

*DK*

; hair

*Blk*

Where born

*Delaware*

Occupation

*Farmer*

**ENLISTMENT.**

When

*Nov 30*

, 186

Where

*Prov R.I.*

By whom

*J. C. Engly*

; term

*3*

y'rs.

Remarks:

*Griffith*

Copist.

*M* | 11 H. Art'y. | **U.S.C.T.**

*John N. Williams*

*Bt*, Co. *K*, 14 Reg't R. I. Col'd H. Art'y.\*

Age *38* years.

Appears on

**Company Muster-in Roll**

of the organization named above. Roll dated  
*Sept. 17, Providence R.I. Dec 17, 1863.*

Muster-in to date *Dec 17, 1863.*

Joined for duty and enrolled:

When *Nov 30*, 186*3*.

Where *Providence*

Period *3* years.

Valuation of horse, \$.....*100*

Valuation of horse equipments, \$.....*100*

Remarks: .....

\* This organization subsequently became Co. *K*, 11 Reg't U. S. Colored Heavy Artillery.

Book mark: .....

*J. N. Stewart*

(356)

Copyist.



*W* | **11** H. Art'y. | **U.S.C.T.**

*John H. Williams*  
*Pl*, Co. K, 14 Reg't R. I. Col'd H. Art'y.\*

Appears on

**Company Muster Roll**

for *Dec 17 to Dec 31*, 186*3*

Present or absent *Present*

Stoppage, \$.....*100* for .....

Due Gov't, \$.....*100* for .....

Valuation of horse, \$.....*100*

Valuation of horse equipments, \$.....*100*

Remarks:.....  
.....  
.....  
.....  
.....  
.....

\*This organization subsequently became Co. K, 11 Reg't U. S. Colored Heavy Artillery.

Book mark:.....

*W Stewart*  
(358) *W Stewart* Copyist.

*N* | **11 H. Art'y. | U.S.C.T.**

*John N. Williams*  
*Pt*, Co. K, 14 Reg't R. I. Col'd H. Art'y.\*

Appears on

**Company Muster Roll**  
for *Jan & Feb*, 1864.  
Present or absent *Present*

Stoppage, \$.....100 for .....

Due Gov't, \$.....100 for .....

Valuation of horse, \$.....100

Valuation of horse equipments, \$.....100

Remarks:.....  
.....  
.....  
.....  
.....  
.....  
.....

\*This organization subsequently became Co. K, 11 Reg't U. S. Colored Heavy Artillery.

Book mark:.....

*J. Stewart*  
(358) Copyist.

*W* | **11 H. Art'y.** | **U.S.C.T.**

*John H. Williams*

*Pl*, Co. K, 14 Reg't R. I. Col'd H. Art'y.\*

Appears on

**Company Muster Roll**

for *March & April*, 1864.

Present or absent *Present*

Stoppage, \$ *100* for

Due Gov't, \$ *100* for

Valuation of horse, \$ *100*

Valuation of horse equipments, \$ *100*

Remarks:

-----  
-----  
-----  
-----  
-----  
-----  
-----

\*This organization subsequently became Co. K, 11 Reg't U. S. Colored Heavy Artillery.

Book mark: -----

*J. H. Stewart*



*W* | **11 H. Art'y. | U.S.C.T.**

*John H. Williams*  
*7th Co.*, 8 Reg't U. S. Col'd H. Art'y.\*

Appears on

**Company Muster Roll**

for *May June*, 1864.

Present or absent *Present*

Stoppage, \$ 100 for

Due Gov't, \$ 100 for

Valuation of horse, \$ 100

Valuation of horse equipments, \$ 100

Remarks:

† This organization subsequently became Co. *H*, 11 Reg't U. S. Colored Heavy Artillery.

Book mark:

*Steward*  
Copyist.

*M* | 11 H. Art'y. | **U.S.C.T.**

*John D. Williams*  
*Pvt.*, Co. K, 11 Reg't U. S. Col'd H. Art'y.

Appears on

**Company Muster Roll**

for *July 1867*, 1867.

Present or absent *Present*

Stoppage, \$ *100* for

Due Gov't, \$ *100* for

Valuation of horse, \$ *100*

Valuation of horse equipments, \$ *100*

Remarks: *Free on 1st April 67*  
*\$ per month due from*  
*Quarters to*  
*April 30/67.*

Book mark: \_\_\_\_\_

*W. W. W.*

*W* | 11 H. Art'y. | U.S.C.T.

*John H. Williams*  
*Prvt*, Co. K, 11 Reg't U. S. Col'd H. Art'y.

Appears on

**Company Muster Roll**

for *Sept 7 Oct*, 186*4*.

Present or absent *Present*.

Stoppage, \$ *100* for

Due Gov't, \$ *20* for *Ord*

Valuation of horse, \$ *100*

Valuation of horse equipments, \$ *100*

Remarks: *Due U.S. for C.T.*  
*G.O. 440*

Book mark: \_\_\_\_\_

*Steward*



*W* | 11 H. Art'y. | U.S.C.T.

*John G. Williams*  
Co. K, 11 Reg't U. S. Col'd H. Art'y.

Appears on

**Company Muster Roll**

for *Month of Dec*, 186*7*.

Present or absent *Present*.

Stoppage, \$ *100* for \_\_\_\_\_

Due Gov't, \$ *2*<sup>*100*</sup> for *Ordinance*

Valuation of horse, \$ *100*

Valuation of horse equipments, \$ *100*

Remarks: *Due US for  
C. & G. P. 144 etc.*

Book mark: \_\_\_\_\_

*E. Steward*

*W* | 11 H. Art'y. | U.S.C.T.

*John H. Williams*

*Prvt*, Co. K, 11 Reg't U. S. Col'd H. Art'y.

Appears on

**Company Muster Roll**

for *Jan & Feb*, 1865.

Present or absent *Present*

Stoppage, \$ *100* for

Due Gov't, \$ *21* for *Ordnance*

Valuation of horse, \$ *100*

Valuation of horse equipments, \$ *100*

Remarks: *Due to S for*  
*C. & G. 44 etc.*

Book mark: \_\_\_\_\_

*Chas. W. ...*

*W* 11 H. Art'y. U.S.C.T.

*James Williams*  
Pr., Co. K, 11 Reg't U. S. Col'd H. Art'y.

Appears on

Company Muster Roll  
for *March & April, 1865*  
Present or absent *Present*

Stoppage, \$ *100* for

Due Gov't, \$ *4* for *Balance*

Valuation of horse, \$ *100*

Valuation of horse equipments, \$ *100*

Remarks: *Due U.S. for*  
*C. & E. 48 cts.*

Book mark: \_\_\_\_\_

*W. A. L.*  
Copyist.



*M* | 11 H. Art'y. | U.S.C.T.

*John William*

*Pvt*, Co. K, 11 Reg't U. S. Col'd H. Art'y.

Appears on

**Company Muster Roll**

for *May & June*, 1865.

Present or absent *Present*

Stoppage, \$ 100 for

Due Gov't, \$ 01 / 100 for *C & G E*

Valuation of horse, \$ 100

Valuation of horse equipments, \$ 100

Remarks: \_\_\_\_\_  
\_\_\_\_\_  
\_\_\_\_\_  
\_\_\_\_\_  
\_\_\_\_\_  
\_\_\_\_\_  
\_\_\_\_\_

Book mark: \_\_\_\_\_  
\_\_\_\_\_

*Spracher*  
Copyist.

*M* | 11 H. Art'y. | U.S.C.T.

*John H. Williams*  
*Pvt*, Co. K, 11 Reg't U. S. Col'd H. Art'y.

Appears on

**Company Muster Roll**

for *May & June*, 186*5*.

Present or absent *Present*

Stoppage, \$ 100 for

Due Gov't, \$ 04 for *C & G E*

Valuation of horse, \$ 100

Valuation of horse equipments, \$ 100

Remarks:  
-----  
-----  
-----  
-----  
-----  
-----  
-----  
-----

Book mark: -----

*Spucher*  
Copyist.

*M* | 11 H. Art'y. | U.S.C.T.

*John H. Williams*  
*Pvt*, Co. K, 11 Reg't U. S. Col'd H. Art'y.

Appears on

**Company Muster Roll**

for *May & June*, 186*5*.

Present or absent *Present*

Stoppage, \$ 100 for

Due Gov't, \$ 04 / 100 for *C & G E*

Valuation of horse, \$ 100

Valuation of horse equipments, \$ 100

Remarks: \_\_\_\_\_  
\_\_\_\_\_  
\_\_\_\_\_  
\_\_\_\_\_  
\_\_\_\_\_  
\_\_\_\_\_

Book mark: \_\_\_\_\_

*Spucher*



*M* | **11 H. Art'y. U.S.C.T.**

*John H. Williams*  
*Priv*, Co. K, 11 Reg't U. S. Col'd H. Art'y.

Appears on

**Company Muster Roll**

for *July & Aug*, 1865.

Present or absent *Present*

Stoppage, \$ 100 for

Due Gov't, \$ 04 for *C & G E*

*lost and destroyed*

Valuation of horse, \$ 100

Valuation of horse equipments, \$ 100

Remarks:

Book mark:

*Sprecher*

Copyist.

*N* 11 H. Art'y. U.S.C.T.

*John H. Williams*  
*Priv*, Co. *K*, 11 Reg't U. S. Col'd H. Art'y.

Appears on **Co. Muster-out Roll**, dated  
*New Orleans, La, Oct. 2*, 1865.

Muster-out to date *Oct. 2*, 1865.

Last paid to *Feb. 28*, 1865.

Clothing account:

Last settled....., 186 ; drawn since \$..... 100

Due soldier \$..... 100; due U. S. \$ *26* <sup>*88*</sup> 100

Am't for cloth'g in kind or money adv'd \$..... 100

Due U. S. for arms, equipments, &c., \$ *7* <sup>*00*</sup> 100

Bounty paid \$ *None* 100: due \$ *100* <sup>*00*</sup> 100

Remarks: *Joined at Orig. Organ*  
*Ship & Mosquito bar lost.*  
*1 Musket & Equipments retained*

Book mark: .....

*Spreeker*

Williams, Jno. H.

S., Co., 11 Reg't U.S.C.A.

Enclosures.

Bed Cards	Final Statements
Burial Records	Furloughs or L. of A.
Certs. of Dis. for Discharge	Med. Certificates
C. M. Charges	Med. Des. Lists
Descriptive Lists	Orders
Discharge Certificates	Pris. of War Record
Enlistment Papers	Resignations

Other papers relating to—

Admission to Hosp'l	Furlough or L. of A.
Casualty Sheet	Med. Examination
Confinement	Misc. Information
Contracts	Pay or Clothing
Death or Effects	Personal Reports
Desertion	Rank
Discharge from Hosp'l	Transfer to Hosp'l
Discharge from Service	Transfer to V. R. C.
Duty	Transportation



DECLARATION OF RECRUIT.

I, *John A. Williams* desiring to VOLUNTEER as a Soldier in the ARMY OF THE UNITED STATES, for the term of *3 year* do declare that I am *38* years and months of age; that I have never been discharged from the United States service on account of disability or by sentence of a court martial, or by order, before the expiration of a term of enlistment; and I know of no impediment to my serving honestly and faithfully as a soldier for *3 year*

Given at *Providence*  
The *30<sup>th</sup>* day of *Nov* 18*63*

Witness: *E. A. Walker*

*John A. Williams*  
*Major*

No. *1117*  
*John A. Williams*  
Volunteered at *Providence*  
*Nov 30<sup>th</sup>* 18*63*  
By *Major J. C. Bayley*  
*14<sup>th</sup>* Regiment of *City* *Artillery*  
*111550343*  
enlistment: last served in Company ( )  
Rec'd of  
Discharged *18*

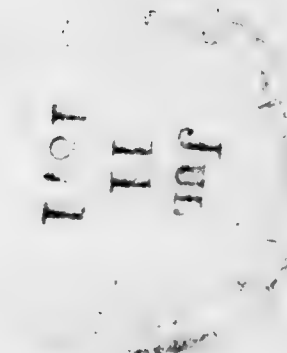

CONSENT IN-CASE OF MINOR.

I, \_\_\_\_\_ of \_\_\_\_\_ is \_\_\_\_\_ years of age; and I do hereby freely give my CONSENT to his volunteering as a SOLDIER in the ARMY OF THE UNITED STATES for the period of \_\_\_\_\_

Given at \_\_\_\_\_  
The \_\_\_\_\_ day of \_\_\_\_\_

Witness: \_\_\_\_\_

VOLUNTEER ENLISTMENT.

State of  
Rhode Island



Town of  
Providence

I, *John A. Williams* born in \_\_\_\_\_  
in the State of *Delaware* aged *28* years, and by occupation  
a *Framer* DO HEREBY ACKNOWLEDGE to have volunteered this *30<sup>th</sup>*  
day of *Nov* 18*63* to serve as a SOLDIER in the ARMY OF THE UNITED STATES  
OF AMERICA, for the period of *3 years*, unless sooner discharged by proper authority:

Do also agree to accept such bounty, pay, rations and clothing, as are, or may be, established, by law for  
volunteers. And I, *John A. Williams* do solemnly swear, that I will bear  
true faith and allegiance to the *United States of America*, and that I will serve them honestly and faith-  
fully against all their enemies or opposers whomsoever; and that I will observe and obey the orders of the  
President of the United States, and the orders of the officers appointed over me, according to the Rules  
and Articles of War.

Sworn and Subscribed to, at *Providence*  
this *30<sup>th</sup>* day of *Nov* 18*63*  
BEFORE *Mr John Le Royer Public Notary*

*John A. Williams*  
*Made*

I CERTIFY, ON HONOR, That I have carefully examined the above-named Volunteer, agreeable to the General Regulations of  
the Army, and that, in my opinion, he is free from all bodily defects and mental infirmity, which would, in any way, disqualify him  
from performing the duties of a soldier.

*Johnson Gardner M.D.*

EXAMINING SURGEON.

I CERTIFY, ON HONOR, That I have minutely inspected the Volunteer, *John A. Williams*  
previously to his enlistment, and that he was entirely sober when enlisted; that to the best of my judgment and belief, he is of  
lawful age; and that, in accepting him as duly qualified to perform the duties of an able-bodied soldier, I have strictly observed the  
Regulations which govern the recruiting service. This soldier has *Dark* eyes *Black* hair  
*Dark* complexion, is *5* feet, *5* inches high.

*May 14<sup>th</sup>* Regiment of *City Art* Volunteers.

RECRUITING OFFICER.



2032

Williams Jonas.

Co E., 11 U.S. Col'd H. Art'y.

Private Private

CARD NUMBERS.

1	6189023	26
2	6189170	27
3	6189314	28
4	6189456	29
5	6189602	30
6	6189738	31
7	6189870	32
8	6189999	33
9	6190125	34
10	6190258	35
11	6190388	36
12	6190516	37
13	6190640	38
14		39
15	R.P. 466,023	40
16		41
17		42
18		43
19		44
20		45
21		46
22		47
23		48
24		49
25		50

Book Mark:

R.P. 466,023.

See also



PP466073

John Oliver Cox

11 H. Art'y. U.S.C.T.

*James H. ...*

Co. C, 11 Reg't U. S. Col'd H. Art'y.

Appears on

**Company Descriptive Book**

of the organization named above.

**DESCRIPTION.**

Age ... years; height ... feet ... inches.

Complexion ... A.

Eyes ... A.; hair ... A.

Where born ... A., ...

Occupation ...

**ENLISTMENT.**

When ... Sept. 24, 1863.

Where ...

By whom ...; term ... y'rs.

Remarks:

*O. J. Markle,*

Copyist.

*W* | 11 H. Art'y. | U.S.C.T.

*Jonas Williams*  
Pvt., Co. *E*, 14 Reg't R. I. Col'd H. Art'y.\*

Age *25* years.

Appears on

**Company Muster-in Roll**

of the organization named above. Roll dated

*Providence, R. I., Oct. 5, 1863.*

Muster-in to date *Oct. 5, 1863.*

Joined for duty and enrolled:

When *Sept. 24, 1863.*

Where *Prov., R. I.*

Period *3* years.

Valuation of horse, \$ *100*

Valuation of horse equipments, \$ *100*

Remarks: *Newark, N. J.*

\* This organization subsequently became Co. *E*, 11 Reg't U. S. Colored Heavy Artillery.

Book mark: *W. H. 46623*

*Chandler*



*7* | **11 H. Art'y. U.S.C.T.**

*Jonas Williams*  
*Pr*, Co. E, 14 Reg't R. I. Col'd H. Art'y.\*

Appears on

**Company Muster Roll**

for *Oct. 5 to Dec. 31*, 1863.

Present or absent *Present*

Stoppage, \$ 100 for

Due Gov't, \$ 100 for

Valuation of horse, \$ 100

Valuation of horse equipments, \$ 100

Remarks: \_\_\_\_\_  
\_\_\_\_\_  
\_\_\_\_\_  
\_\_\_\_\_  
\_\_\_\_\_

\*This organization subsequently became Co. E, 11 Reg't U. S. Col'd Heavy Artillery.

Book mark: \_\_\_\_\_

*Shawler*

94

11 H. Art'y. U.S.C.T.

*Jonas Williams*  
Pr., Co. E, 14 Reg't R. I. Col'd H. Art'y.\*

Appears on

**Company Muster Roll**

for *Jan. & Feb.*, 1864.

Present or absent *Present*

Stoppage, \$ 100 for

Due Gov't, \$ 100 for

Valuation of horse, \$ 100

Valuation of horse equipments, \$ 100

Remarks: *Due Laundry \$ .75*

\*This organization subsequently became Co. E, 11 Reg't U. S. Col'd Heavy Artillery.

Book mark: \_\_\_\_\_

*Chandler*

Copyist.

W

11 H. Art'y.

U.S.C.T.

*Jonas Williams*  
Pvt, Co. E, 14 Reg't R. I. Col'd H. Art'y.\*

Appears on

**Company Muster Roll**

for *March & April*, 1864.

Present or absent *Present*

Stoppage, \$ 100 for

Due Gov't, \$ 100 for

Valuation of horse, \$ 100

Valuation of horse equipments, \$ 100

Remarks: *See Laurence 75*

\*This organization subsequently became Co. E, 11 Reg't U. S. Col'd Heavy Artillery.

Book mark: \_\_\_\_\_

*Chandler*  
Copyist.



*W*

**11 H. Art'y. U.S.C.T.**

*Jonas Williams*

*Priv. Co. E*, 8 Reg't U. S. Col'd H. Art'y.\*

Appears on

**Company Muster Roll**

for *May & June*, 1864.

Present or absent *Present*

Stoppage, \$ 100 for

Due Gov't, \$ 100 for

Valuation of horse, \$ 100

Valuation of horse equipments, \$ 100

Remarks: *See Laundry 75-*

\* This organization subsequently became Co. *E*, 11 Reg't U. S. Colored Heavy Artillery.

Book mark: \_\_\_\_\_

*Chandler*

Copyist.

11 H. Art'y. U.S.C.T.

*James H. ...*

*...*, Co. E, 11 Reg't U. S. Col'd H. Art'y.

Appears on

**Company Muster Roll**

for *...*, 186*...*

Present or absent *Present*

Stoppage, \$ 100 for

Due Gov't, \$ 100 for

Valuation of horse, \$ 100

Valuation of horse equipments, \$ 100

Remarks: *See number 5*

Book mark: \_\_\_\_\_

*H. H. ...*

11 H. Art'y. U.S.C.T.

*James J. ...*  
Co. E, 11 Reg't U. S. Col'd H. Art'y.

Appears on

**Company Muster Roll**

for *Sept 1862*, 1862.

Present or absent *present*

Stoppage, \$ 100 for

Due Gov't, \$ 100 for

Valuation of horse, \$ 100

Valuation of horse equipments, \$ 100

Remarks: *From ...*  
*...*

Book mark:



*W* | **11 H. Art'y. U.S.C.T.**

*Joseph Williams*  
*Private*, Co. E, 11 Reg't U. S. Col'd H. Art'y.

Appears on

**Company Muster Roll**

for *Nov. 1864*, 186*4*.

Present or absent *Present*

Stoppage, \$ *100* for

Due Gov't, \$ *100* for

Valuation of horse, \$ *100*

Valuation of horse equipments, \$ *100*

Remarks: *Discharged 17th Nov.*  
*Due 100*

Book mark: \_\_\_\_\_

*Joseph Williams*  
Copyist.

11 H. Art'y. **U.S.C.T.**

*James Williams*  
Sgt., Co. E, 11 Reg't U. S. Col'd H. Art'y.

Appears on

**Company Muster Roll**

for *Jan. 5. Feb.*, 1865.

Present or absent *Present*

Stoppage, \$ \_\_\_\_\_ 100 for \_\_\_\_\_

Due Gov't, \$ \_\_\_\_\_ 100 for \_\_\_\_\_

Valuation of horse, \$ \_\_\_\_\_ 100

Valuation of horse equipments, \$ \_\_\_\_\_ 100

Remarks: \_\_\_\_\_  
\_\_\_\_\_  
\_\_\_\_\_  
\_\_\_\_\_  
\_\_\_\_\_

Book mark: \_\_\_\_\_

*J. Williams*  
Copyist.

11 H. Art'y. U.S.C.T.

*John Williams*

*(Det.)*, Co. E, 11 Reg't U. S. Col'd H. Art'y.

Appears on

**Company Muster Roll**

for *Mar. 1st*, 1865.

Present or absent *Present*

Stoppage, \$ *1* <sup>*2*</sup> *100* for *Lawrence*  
*Carriage*

Due Gov't, \$ *100* for

Valuation of horse, \$ *100*

Valuation of horse equipments, \$ *100*

Remarks:

Book mark:

*John Williams*



*M* | 11 H. Art'y. | U.S.C.T.

*Jonas Williams*

*Pri.*, Co. E, 11 Reg't U. S. Col'd H. Art'y.

Appears on

**Company Muster Roll**

for *May and June*, 1865.

Present or absent *Present*

Stoppage, \$ 100 for

Due Gov't, \$ 100 for

Valuation of horse, \$ 100

Valuation of horse equipments, \$ 100

Remarks:

Book mark:

(358)

*J. B. James* Copyist.

11 | **11 H. Art'y. U.S.C.T.**

*James Williams*  
*Priv.*, Co. E, 11 Reg't U. S. Col'd H. Art'y.

Appears on

**Company Muster Roll**

for *July and August*, 1865.

Present or absent *Present*

Stoppage, \$ 100 for

Due Gov't, \$ 100 for

Valuation of horse, \$ 100

Valuation of horse equipments, \$ 100

Remarks:

Book mark:

(358)

*J. B. James* Copyist.

11 | 11 H. Art'y. | U.S.C.T.

Jonas Williams  
Co. E, 11 Reg't U. S. Col'd H. Art'y.

Appears on **Co. Muster-out Roll**, dated  
New Orleans, La., Oct. 2, 1865.  
Muster-out to date Oct. 2, 1865.  
Last paid to June 30, 1865.

**Clothing account:**

Last settled....., 1865 ; drawn since \$..... 100  
Due soldier \$..... 8<sup>65</sup>/<sub>100</sub>; due U. S. \$..... 100  
Am't for cloth'g in kind or money adv'd \$..... 100

Due U. S. for arms, equipments, &c., \$..... 100  
Bounty paid \$ none 100; due \$ 100 00/<sub>100</sub>

Remarks: Joined at Org<sup>s</sup> Org<sup>n</sup>. Step for  
one month but 9 ads returned 600; one  
Nov. bar 170.

Book mark: 1579, P.M.S. May 24/66.

(861) J. B. Jones Copyist.



W. 11 H. d. M. S. C. T.

Jonas Williams  
Co. E, 11. Reg't M. S. C. H. d.

**NOTATION.**

Book mark: R. + P. 466,023,

**Record and Pension Office,**

WAR DEPARTMENT,

Washington,

June 16 . 1897.

Discharge certificate  
on file.

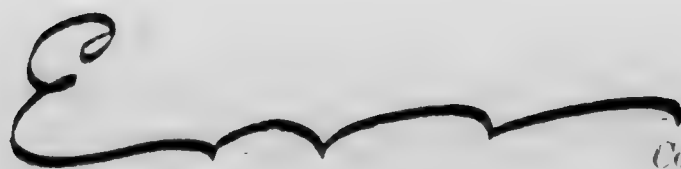

Compt.

*John Williams*  
*Co. 11 Reg't 145th*  
**Discharge**

on file with papers bearing following

Book Mark : *OSP 466023.*

**For Special File.**





**DECLARATION OF RECRUIT.**

I, Jonas Williams desiring to VOLUNTEER as a Soldier in the ARMY OF THE UNITED STATES, for the term of Three Years do declare that I am Twenty five years and \_\_\_\_\_ months of age; that I have never been discharged from the United States service on account of disability or by sentence of a court martial, or by order, before the expiration of a term of enlistment; and I know of no impediment to my serving honestly and faithfully as a soldier for Three Years

Given at Pro R D  
The 24<sup>th</sup> day of Sept

1868  
Jonas Williams  
mark

Witness:  
Sgt May F. M. Hill

Discharged \_\_\_\_\_ 1868

Regt of \_\_\_\_\_

enlistment; last served in Company ( \_\_\_\_\_ )

Volunteered at Providence R.I.  
Jonas Williams  
By A. G. Buckley Chap.  
4<sup>th</sup> Regiment of Artillery  
Sept 24<sup>th</sup> 1868

No. 1200

**CONSENT IN CASE OF MINOR.**

I, \_\_\_\_\_ of \_\_\_\_\_ is \_\_\_\_\_ years of age; and I do hereby freely give my CONSENT to his volunteering as a SOLDIER in the ARMY OF THE UNITED STATES for the period of \_\_\_\_\_

Given at \_\_\_\_\_  
The \_\_\_\_\_ day of \_\_\_\_\_

Witness

VOLUNTEER ENLISTMENT.



State of Rhode Island

Town of Providence

I, *Jonas Williams*  
in the State of *New Jersey*  
a *Sergeant*

born in *Newark*  
aged *Twenty five* years, and by occupation

DO HEREBY ACKNOWLEDGE to have volunteered this *Twenty fourth*  
day of *September* 18 *63* to serve as a SOLDIER in the ARMY OF THE UNITED STATES  
OF AMERICA, for the period of *Three Years*, unless sooner discharged by proper authority:  
Do also agree to accept such bounty, pay, rations and clothing, as are, or may be, established, by law for  
volunteers. And I, *Jonas Williams* do solemnly swear, that I will bear  
true faith and allegiance to the *United States of America*, and that I will serve them honestly and faith-  
fully against all their enemies or opposers whomsoever; and that I will observe and obey the orders of the  
President of the United States, and the orders of the officers appointed over me, according to the Rules  
and Articles of War.

Sworn and Subscribed to, at *Providence R.I.*  
this *24th* day of *Sept.* 18 *63*  
BEFORE *Wm. H. ...*  
*Jonas Williams*

I CERTIFY, ON HONOR, That I have carefully examined the above-named Volunteer, agreeable to the General Regulations of  
the Army, and that, in my opinion, he is free from all bodily defects and mental infirmity, which would, in any way, disqualify him  
from performing the duties of a soldier.

*B. Carpenter* EXAMINING SURGEON.  
*Jonas Williams*

I CERTIFY, ON HONOR, That I have minutely inspected the Volunteer,  
previously to his enlistment, and that he was entirely sober when enlisted, that to the best of my judgment and belief, he is of  
lawful age; and that, in accepting him as duly qualified to perform the duties of an able-bodied soldier, I have strictly observed the  
Regulations which govern the recruiting service. This soldier has *Black* eyes *Black* hair  
*Black* complexion, is *fair* feet, *3 1/2* inches high.

*14th* Regiment of *R.I. Vols.* Volunteers.

*J. H. ...* RECRUITING OFFICER.

2033

*William Levi*

Co *I*, **11 U.S. Col'd H. Art'y.**

*Private*

*Private*

CARD NUMBERS.

1	6190815	26
2	6190961	27
3	6191108	28
4	6191248	29
5	6191333	30
6	6191530	31
7	6191661	32
8	6191790	33
9	6191912	34
10	6192045	35
11	6192171	36
12	6192298	37
13	6192420	38
14	6192545	39
15		40
16		41
17		42
18		43
19		44
20		45
21		46
22		47
23		48
24		49
25		50

Book Mark:

*W. 980. 79. 69.*

See also



D. 153541-PO M M  
R. & P. 570063

S. 15-2332  
RTP 33333

S. 1617708 Auth 117

S. 1627829. and 713

S. 2138671 P.O. R. - P. 154

John Miller Esq

*A* **11** II. Art'y. **U.S.C.T.**

*John W. ...*

... Co. *7*, 11 Reg't U. S. Col'd II. Art'y.

Appears on

**Company Descriptive Book**

of the organization named above.

**DESCRIPTION.**

Age *21* years; height *5* feet *3* inches.

Complexion *W.*

Eyes *W.*; hair *W.*

Where born *W. Va., N.Y.*

Occupation *...*

**ENLISTMENT.**

When *Aug 10*, 186*7*.

Where *...*

By whom *...*; term *3* y'rs.

Remarks:

*C. Markle,*

*97* 11 H. Art'y. U.S.C.T.  
*Levi Williams*  
Co. *F*, 14 Reg't R. I. Col'd H. Art'y.\*  
Age *21* years.  
Appears on

**Company Muster-in Roll**

of the organization named above. Roll dated  
*Providence R.I. Oct 20* 1863.  
Muster-in to date *Oct 20* 1863.

Joined for duty and enrolled:  
When *Oct* \_\_\_\_\_, 186\_\_\_\_.  
Where *Providence R.I.*  
Period *3* years.

Valuation of horse, \$ \_\_\_\_\_ 100  
Valuation of horse equipments, \$ \_\_\_\_\_ 100

Remarks: \_\_\_\_\_  
\_\_\_\_\_  
\_\_\_\_\_

\* This organization subsequently became Co. *F*, 11 Reg't U. S. Colored Heavy Artillery.

Book mark: \_\_\_\_\_

*Maal*



11 H. Art'y. U.S.A.F.

*Levi Williams*  
Co. F. 11 Reg't R. I. Col'd H. Art'y.\*

Appears on

**Company Muster Roll**

for *Sept 20 to Dec 31, 1863.*

Present or absent *Present*

Stoppage, \$ 100 for

Due Gov't, \$ 100 for

Valuation of horse, \$ 100

Valuation of horse equipments, \$ 100

Remarks:

\* This organization subsequently became Co. F. 11 Reg't U. S. Colored Heavy Artillery.

Book mark:

*Meal*

*71* 11 H. Arty. U.S.C.T.

*Levi Williams*  
Co. F, 11 Reg't R. I. Co'd H. Art'y.\*

Appears on

**Company Muster Roll**

for *Jan & Feb*, 1864

Present or absent *Present*

Stoppage, \$ 100 for

Due Gov't, \$ 100 for

Valuation of horse, \$ 100

Valuation of horse equipments, \$ 100

Remarks:

\*This organization subsequently became Co. F, 11 Reg't U. S. Colored Heavy Artillery.

Book mark:

*A Neal*

*W* 11 H. Art'y. U.S.C.T.

*Levi Williams*

*Pr.* Co. F, 14 Reg't R. I. Col'd H. Art'y.\*

Appears on

**Company Muster Roll**

for *May + Apr*, 1864

Present or absent *Present*

Stoppage, \$ 100 for

Due Gov't, \$ 100 for

Valuation of horse, \$ 100

Valuation of horse equipments, \$ 100

Remarks: \_\_\_\_\_

\_\_\_\_\_

\_\_\_\_\_

\_\_\_\_\_

\_\_\_\_\_

\_\_\_\_\_

\* This organization subsequently became Co. F, 11 Reg't U. S. Colored Heavy Artillery.

Book mark: \_\_\_\_\_

*L Neal*



*W* 11 H. Art'y. **U.S.C.T.**

*Levi Williams*  
Co. *F*, 8 Reg't U. S. Col'd H. Art'y.\*

Appears on

**Company Muster Roll**

for *May + June*, 1864.

Present or absent

*Present*

Stoppage, \$ 100 for

Due Gov't, \$ 100 for

Valuation of horse, \$ 100

Valuation of horse equipments, \$ 100

Remarks *Stop for one  
wheeled and screw  
drivers, also one  
gun skin.*

\* This organization subsequently became Co. *F*, 11 Reg't U. S. Colored Heavy Artillery.

Book mark:

*S. T. Neal*  
Copyist.

11 H. Art'y. **U.S.C.T.**

*John Smith*  
*Private*, Co. F, 11 Reg't U. S. Col'd H. Art'y.

Appears on

**Company Muster Roll**

for *July 1st 1864*, 1864.

Present or absent *Present*

Stoppage, \$ 100 for

Due Gov't, \$ 100 for

Valuation of horse, \$ 100

Valuation of horse equipments, \$ 100

Remarks: *Sept 25*  
*W. 20 23 pr.*  
*250 250 contentment have*  
*such 44, Dec 19 61.*

Book mark:

*John Smith*

U. S. GOVERNMENT

Office

Company Muster Roll

[Faint, illegible text, likely a list or table of names and details]

Page

35

1865



11 H. 1877. U.S.C.T.

*Dea. Hill*  
P.O. [unclear] U.S.C. [unclear]

Approved

Company Muster Roll

*Company Muster Roll*

*Company Muster Roll*

*Company Muster Roll*

*Company Muster Roll*

*Company Muster Roll*

*Company Muster Roll*

*Company Muster Roll*  
*Company Muster Roll*  
*Company Muster Roll*  
*Company Muster Roll*

By [unclear]

*[Signature]*

*N* 11 II. Art'y. **U.S.C.T.**

*Levi Williams*  
*Pvt.*, Co. F, 11 Reg't U. S. Col'd II. Art'y.

Appears on

**Company Muster Roll**

for *Jan. and Feb.*, 1865.

Present or absent *Present.*

Stoppage, \$ 100 for

Due Gov't, \$ 100 for

Valuation of horse, \$ 100

Valuation of horse equipments, \$ 100

Remarks: *Stop for equipm. 20  
two knapsacks .98 two  
canteens .82*

Book mark:

*Expire.*

*W* | **11 H. Art'y. U.S.C.T.**

*Levi Williams*

*Prvt.*, Co. F, 11 Reg't U. S. Col'd H. Art'y.

Appears on

**Company Muster Roll**

for *Mar. and Apr.*, 1865.

Present or absent *Present.*

Stoppage, \$ 100 for

Due Gov't, \$ 100 for

Valuation of horse, \$ 100

Valuation of horse equipments, \$ 100

Remarks: *Stop for rippers. 40*  
*haversacks. 98. canteens. 82*

Book mark: \_\_\_\_\_

*Exline.*



*11*

**11 H. Art'y. U.S.C.T.**

*Levi Williams*  
*Sgt.*, Co. F, 11 Reg't U. S. Col'd H. Art'y.

Appears on

**Company Muster Roll**

for *May & June, 1865.*

Present or absent *Present.*

Stoppage, \$ *100* for

Due Gov't, \$ *100* for

Valuation of horse, \$ *100*

Valuation of horse equipments, \$ *100*

Remarks: *Stop for wages  
20 cts. Mos. Bank 170*

Book mark: \_\_\_\_\_

*Levi*  
Copied.

*W* **11** II. Art'y. **U.S.C.T.**  
*Levi Williams*  
*Prvt*, Co. F, 11 Reg't U. S. Col'd II. Art'y.

Appears on

**Company Muster Roll**

for *July & Aug.*, 1865.

Present or absent *Present*

Stoppage, \$ 100 for

Due Gov't, \$ 100 for

Valuation of horse, \$ 100

Valuation of horse equipments, \$ 100

Remarks: .....

Book mark: .....

*Leib*  
Coyt.

*N.* 11 H. Art'y. U.S.C.T.

*Levi Williams*  
Sgt., Co. *F.*, 11 Reg't U. S. Col'd H. Art'y.

Appears on Co. Muster-out Roll, dated  
*New Orleans, La. Oct. 2, 1865.*  
Muster-out to date *Oct. 2, 1865.*  
Last paid to *June 30, 1865.*

Clothing account:

Last settled....., 186 ; drawn since 100

Due soldier \$ 100; due U. S. \$ *20, 23* / 100

Am't for cloth'g in kind or money adv'd \$ 100

Due U. S. for arms, equipments, &c., \$ *8.65* / 100

Bounty paid \$ *None* 100; due \$ *100.00* / 100

Remarks: *Joined at Orquid  
Ordn. Stop. for musket  
& acc'ts. retained for  
two weeks. Bed sack  
lost. - Discharge given  
Oct. /65 with view to  
Book mark: *v. 98 p. 79.69**

(361) *Leib*  
*Copyist.*



JAN. 15

6192420

1891

payment without re-  
turning to the State,

Williams, Levi

7

Reg't U.S.C.A.

2

Enclosures.

Bed Cards .....	Final Statements .....
Burial Records .....	Furloughs or L. of A .....
Certs. of Dis. for Discharge .....	Med. Certificates .....
C. M. Charges .....	Med. Des. Lists .....
Descriptive Lists .....	Orders .....
Discharge Certificates .....	Pris. of War Record .....
Enlistment Papers .....	Resignations .....

Other papers relating to—

Admission to Hosp'l .....	Furlough or L. of A .....
Casualty Sheet .....	Med. Examination .....
Confinement .....	Misc. Information .....
Contracts .....	Pay or Clothing .....
Death or Effects .....	Personal Reports .....
Desertion .....	Rank .....
Discharge from Hosp'l .....	Transfer to Hosp'l .....
Discharge from Service .....	Transfer to V. R. C. .....
Duty .....	Transportation .....

**DECLARATION OF RECRUIT.**

I, *Levi Williams* desiring to VOLUNTEER as a Soldier in the ARMY OF THE UNITED STATES, for the term of *Three Years* do declare that I am *21* years and months of age; that I have never been discharged from the United States service on account of disability or by sentence of a court martial, or by order, before the expiration of a term of enlistment; and I know of no impediment to my serving honestly and faithfully as a soldier for *Three Years*

Given at *Prov R. I.*  
 The *10* day of *Dec.* 18 *63*

Witness:  
*J. H. Williams*

*Levi Williams*

Discharged: \_\_\_\_\_ 18

enlistment: last served in Company ( \_\_\_\_\_ )  
 Reg't of \_\_\_\_\_

Volunteered at *Prov R. I.*  
*Levi Williams*  
*Co. 19 - 1863*  
 By *J. H. Williams*  
 Regiment *1st Regt*

**CONSENT IN CASE OF MINOR.**

I, \_\_\_\_\_ Do CERTIFY that I am the \_\_\_\_\_ of \_\_\_\_\_; that the said \_\_\_\_\_ is \_\_\_\_\_ years of age; and I do hereby freely give my CONSENT to his volunteering as a SOLDIER in the ARMY OF THE UNITED STATES for the period of \_\_\_\_\_

Given at \_\_\_\_\_  
 The \_\_\_\_\_ day of \_\_\_\_\_  
 Witness \_\_\_\_\_



VOLUNTEER ENLISTMENT.



State of *Pennsylvania*

Town of *Providence*

I, *Levi Williams*

born in *New York*

in the State of *New York*

aged *21* years, and by occupation a *Boatsman*

DO HEREBY ACKNOWLEDGE to have volunteered this *10th* day of *October* 18*63* to serve as a SOLDIER in the ARMY OF THE UNITED STATES OF AMERICA, for the period of *Three Months*, unless sooner discharged by proper authority:

Do also agree to accept such bounty, pay, rations and clothing, as are, or may be, established, by law for volunteers. And I, *Levi Williams* do solemnly swear, that I will bear true faith and allegiance to the *United States of America*, and that I will serve them honestly and faithfully against all their enemies or opposers whomsoever; and that I will observe and obey the orders of the President of the United States, and the orders of the officers appointed over me, according to the Rules and Articles of War.

Sworn and Subscribed to, at *Providence* this *10th* day of *Oct.* 18*63*

*Levi Williams*

BEFORE *S. P. Lincoln*  
*Wm. D. A.*

I CERTIFY, ON HONOR, That I have carefully examined the above-named Volunteer, agreeable to the General Regulations of the Army, and that, in my opinion, he is free from all bodily defects and mental infirmity, which would, in any way, disqualify him from performing the duties of a soldier.

*John S. Gardner*

EXAMINING SURGEON.

I CERTIFY, ON HONOR, That I have minutely inspected the Volunteer, *Levi Williams* previously to his enlistment, and that he was entirely sober when enlisted; that to the best of my judgment and belief, he is of lawful age; and that, in accepting him as duly qualified to perform the duties of an able-bodied soldier, I have strictly observed the Regulations which govern the recruiting service. This soldier has *Dark* complexion, is *five* feet, *five* inches high. *Dark* eyes *Dark* hair.

Regiment of \_\_\_\_\_ Volunteers.

RECRUITING OFFICER.

1865  
Pleaguemur La, May 26<sup>th</sup> 1865

William Levi Price Jr  
Major & Captain

Applies for a furlough of  
15 days to visit New  
Orleans La.

11th U.S.C. Artillery  
Pleaguemur La May 26, 65

Respectfully forwarded

Approved

*W. H. Mear*

Major 11th U.S.C. Artillery  
Company B

Plaquemine, La.,

May 26<sup>th</sup> 1865

1<sup>st</sup> Lieut. Henry Barney  
Past Adj.

Sir,

I have the honor  
to apply for a furlough of five (5) days for the  
purpose of visiting New Orleans

I have the honor to be

Very Respectfully

Your Obedt Servant

Levi Williams

Private 1<sup>st</sup> Regt. U.S.C. & G.

Ordery 4<sup>th</sup> Batt. 4<sup>th</sup> Regt.



2034

Williams Michael  
Co B, 11 U.S. Col'd H. Art'y.

Private

Private

CARD NUMBERS.

1	26
2	27
3	28
4	29
5	30
6	31
7	32
8	33
9	34
10	35
11	36
12	37
13	38
14	39
15	40
16	41
17	42
18	43
19	44
20	45
21	46
22	47
23	48
24	49
25	50

Book Mark: 115,5-50 H.A.A.

See also

W | 11 H. Art'y. | U.S.C.T.

Michael Williams

Co. B, 11 Reg't U. S. Col'd H. Art'y.

Appears on

**Company Descriptive Book**

of the organization named above.

**DESCRIPTION.**

Age 29 years; height 5 feet 6 inches.

Complexion *Dark*

Eyes *Blk*; hair *Blk*

Where born *Brooklyn N.Y.*

Occupation *Labour*

**ENLISTMENT.**

When *Aug 21*, 186 .

Where *Providence*

By whom *Gratner*; term 3 y'rs.

Remarks: *Died at Fort Jackson  
on La Aug 31. 64 of  
Typhoid malarial fever.  
Funeral services at  
Sept 1. 64*

*Jones*

*A* 11 H. Art'y. U.S.C.T.

*Michael Williams*

, Co. *B*, 11 Reg't U. S. Col'd H. Art'y.

Appears on

**Company Descriptive Book**

of the organization named above.

**DESCRIPTION.**

Age *29* years; height *5* feet *6* inches.

Complexion *Fair*

Eyes *BLU*; hair *BLK*

Where born *Brooklyn N.Y.*

Occupation *Laborer*

**ENLISTMENT.**

When *Aug. 2*, 1863.

Where *Brooklyn N.Y.*

By whom *A. Grabner*; term *5* y'rs.

Remarks: *Discharged at Fort Jackson  
La. by Capt. M. Williams  
June 11, 1864. In  
company of Capt. Williams  
final statement to  
General Sibley 1. 64.*

*James*



*W* 11 H. Art'y. U.S.C.T.

*Michael Williams*  
*Capt*, Co *B*, 14 Reg't R. I. Col'd H. Art'y.

Age \_\_\_\_\_ years.

Appears on \_\_\_\_\_

**Company Muster-in Roll**

of the organization named above. Roll dated

*Providence R.I. Sept. 4, 186*

Muster-in to date *Sept. 4, 186*

Joined for duty and enrolled:

When *Aug. 26* ..... 186

Where *Providence* .....

Period .. years.

Valuation of horse, \$ \_\_\_\_\_ 100

Valuation of horse equipments, \$ \_\_\_\_\_ 100

Remarks: \_\_\_\_\_

This organization subsequently became Co. *B*, 11 Reg't U. S. Colored Heavy Artillery.

Book mark: .....

*J. Walker*

*W* 11 H. Art'y. **U.S.C.T.**

*Michael Williams*

Co. B, 11 Reg't R. I. Col'd H. Art'y.\*

Appears on

**Company Muster Roll**

for *Sept 12 to Dec 31*, 1863.

Present or absent *Present*

Stoppage, \$ 100 for

Due Gov't, \$ 100 for

Valuation of horse, \$ 100

Valuation of horse equipments, \$ 100

Remarks:

\*This organization subsequently became Co. B, 11 Reg't U. S. Colored Heavy Artillery.

Book mark:





*W* | **11 H. Art'y. | U.S.C.T.**

*Michael Williams*  
*Pvt*, Co. *A*, 8 Reg't U. S. Col'd H. Art'y.\*

Appears on

**Company Muster Roll**

for *Mch & Apr*, 18*64*.

Present or absent *Present*

Stoppage, \$ *100* for

Due Gov't, \$ *100* for

Valuation of horse, \$ *100*

Valuation of horse equipments, \$ *100*

Remarks:

\* This organization subsequently became Co. *B*, 11 Reg't U. S. Colored Heavy Artillery.

Book mark:

*J. Walker*  
Copyist.

*W* | 11 H. Art'y. | **U.S.C.T.**

*Michael Williams*  
*Capt*, Co. *B*, 8 Reg't U. S. Col'd H. Art'y.\*

Appears on

**Company Muster Roll**

for *May & June*, 1864.

Present or absent

*Present*

Stoppage, \$ ..... 100 for .....

Due Gov't, \$ ..... 100 for .....

Valuation of horse, \$ ..... 100

Valuation of horse equipments, \$ ..... 100

Remarks: .....

\* This organization subsequently became Co. *B*, 11 Reg't U. S. Colored Heavy Artillery.

Book mark: .....

*J. Walpe*

*A* 11 II. Art'y. U.S.C.T.

*William H. Moore*  
*Co.*, Co. B, 11 Reg't U. S. Col'd II. Art'y.

Appears on

**Company Muster Roll**

for *July & Aug*, 1864:

Present or absent *Present*

Stoppage, \$ 100 for

Due Gov't, \$ 100 for

Valuation of horse, \$ 100

Valuation of horse equipments, \$ 100

Remarks: *Spec for 19/61*

Book mark: \_\_\_\_\_

*W. H. Moore*



U. S. ARMY U. S. CAVALRY.

Michael Williams

Co. B. 11 Reg't U. S. Cav'd H. Arty.

Company

Company Muster Roll

Co. B. & Co. 1864

Present or absent

Supplies \$ 100 for

Due Gov't. \$ 100 for

Valuation of horse, \$ 100

Valuation of horse equipments, \$ 100

Remarks: Died at Fort Jackson La. Aug 21st of Typhoid fever. Inventory of effects & final discharge

Book mark: 115550 Mar 5/66

E. A. Moore

6758

Copist.

11 H. Art'y. U.S.C.T.

*Michael*

Co. *A*, 11 Reg't U. S. Col'd H. Art'y.

Appears on Co. Muster-out Roll, dated

*1861*, 186

Muster-out to date 186

Last paid to 186

Clothing account:

Last settled....., 186 ; drawn since \$.....100

Due soldier \$.....100; due U. S. \$.....100

Am't for cloth'g in kind or money adv'd \$.....100

Due U. S. for arms, equipments, &c., \$.....100

Bounty paid \$.....100; due \$.....100

Remarks: *1861 - 1862*

*1863 - 1864*

*1865 - 1866*

*1867 - 1868*

*1869 - 1870*

Book mark: *1861*

William, Michl

P, Co. B, 11 Reg't U.S.A.A.

4 Enclosures.

Bed Cards	Final Statements 2
Burial Records	Furloughs or L. of A.
Certs. of Dis. for Discharge	Med. Certificates
C. M. Charges	Med. Des. Lists
Descriptive Lists	Orders
Discharge Certificates	Pris. of War Record
Enlistment Papers	Resignations

Other papers relating to—

Admission to Hosp'l	Furlough or L. of A.
Casualty Sheet	Med. Examination
Confinement	Misc. Information
Contracts	Pay or Clothing
Death or Effects /	Personal Reports
Desertion	Rank
Discharge from Hosp'l	Transfer to Hosp'l
Discharge from Service	Transfer to V. R. C.
Duty	Transportation



DECLARATION OF RECRUIT.

I, *Michael Williams* desiring to VOLUNTEER as a Soldier in the ARMY OF THE UNITED STATES, for the term of *3 yr*, do declare that I am *29* years and \_\_\_\_\_ months of age; that I have never been discharged from the United States service on account of disability or by sentence of a court martial, or by order, before the expiration of a term of enlistment; and I know of no impediment to my serving honestly and faithfully as a soldier for *3 yr*

Given at *Portland* *Michael Williams*  
The *21<sup>st</sup>* day of *July* 18 *63*  
Witness: *R. J. Gagnier*

No. *1522*

*Michael Williams*

Volunteered at *Portland*

*Aug 21<sup>st</sup> 1863*

By *Major Sanford*

Regiment *11<sup>th</sup> Maine*

enlistment; last served in Company ( )

Reg't of

Discharged

18

*33*

CONSENT IN CASE OF MINOR.

I, \_\_\_\_\_ Do CERTIFY that I am the \_\_\_\_\_ of \_\_\_\_\_; that the said \_\_\_\_\_ is \_\_\_\_\_ years of age; and I do hereby freely give my CONSENT to his volunteering as a SOLDIER in the ARMY OF THE UNITED STATES for the period of \_\_\_\_\_

Given at \_\_\_\_\_  
The \_\_\_\_\_ day of \_\_\_\_\_

Witness:

VOLUNTEER ENLISTMENT.



State of *RI*

Town of *Groton*

I, *Michael Williams* born in *Brookline*  
in the State of *N.Y.* aged *29* years, and by occupation  
a *Lawyer* DO HEREBY ACKNOWLEDGE to have volunteered this *21<sup>st</sup>*  
day of *Aug* 18 *62*, to serve as a SOLDIER in the ARMY OF THE UNITED STATES  
of AMERICA, for the period of *One*, unless sooner discharged by proper authority:

Do also agree to accept such bounty, pay, rations and clothing, as are, or may be, established by law for  
volunteers. And I, *Michael Williams*, do solemnly swear, that I will bear  
true faith and allegiance to the *United States of America*, and that I will serve them honestly and faith-  
fully against all their enemies or opposers whomsoever: and that I will observe and obey the orders of  
the President of the United States, and the orders of the officers appointed over me, according to the  
Rules and Articles of War.

Sworn and subscribed to, at *Rhode*  
this *21<sup>st</sup>* day of *Aug* 18 *62*  
BEFORE *Wm. H. ...*

*Michael Williams*

I CERTIFY, ON HONOR, That I have carefully examined the above-named Volunteer, agreeably to the General Regulations  
of the Army, and that, in my opinion, he is free from all bodily defects and mental infirmity, which would, in any way, disqualify  
him from performing the duties of a soldier.

*Johnson Jones*  
EXAMINING SURGEON.

I CERTIFY, ON HONOR, That I have minutely inspected the Volunteer, *Michael Williams*  
previously to his enlistment, and that he was entirely sober when enlisted: that, to the best of my judgment and belief, he is  
of lawful age: and that, in accepting him as duly qualified to perform the duties of an able-bodied soldier, I have strictly observed  
the Regulations which govern the recruiting service. This soldier has *dark* eyes, *dark* hair.

*dark* complexion, is *5'* feet, *4* inches high.

*R. J. ...*

*Lt* Regiment of

Volunteers,

RECRUITING OFFICER.

V

FINAL STATEMENT

Michael Williams

11<sup>th</sup> Regt of U. S. A. Arty

VOLUNTEERS.

*[Signature]*

NOTE 1.—Two of these certificates are duplicate copies to the Adjutant General's Office and one to the 2d Auditor. The original copy is to be retained by the Soldier or his representative, and the duplicate copy is to be retained by the Adjutant General's Office. The duplicate copy is to be retained by the Adjutant General's Office. The duplicate copy is to be retained by the Adjutant General's Office.

NOTE 2.—If the Soldier is entitled to pay for the year of his term of Company, he should be so notified on the back of this statement, and the amount of his pay due for that year should be entered on his own list.

NOTE 3.—When a Soldier is furnished with his statement, his receipt therefor should be secured and retained by the Adjutant General's Office. The receipt should be retained by the Adjutant General's Office. The receipt should be retained by the Adjutant General's Office.

NOTE 4.—When a Soldier is entitled to pay for the year of his term of Company, he should be so notified on the back of this statement, and the amount of his pay due for that year should be entered on his own list.

NOTE 5.—Bounty paid by State authorities, and not by the United States, was not entered on this statement.

NOTE 6.—Accounts from the State and Territory should be retained by the Adjutant General's Office, and the duplicate copy is to be retained by the Adjutant General's Office.

NOTE 7.—This blank will be used for diseases, wounds, and other men, as well as for others.

NOTE 8.—When a Soldier dies in Hospital or on detached service his descriptive list, if he has one, should be sent with his final statement, as duplicate, to the Second Auditor, Washington, D. C.

ADJUTANT GENERAL'S OFFICE  
*Sept 13<sup>th</sup> 1864*  
Duplicate with Inventory sent 2d Auditor.

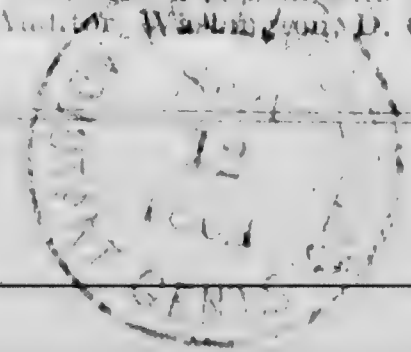



I certify, on honor, that Michael Williams a Private of  
 Captain Henry Simon's Company (B) of the 11<sup>th</sup> Regiment of U. S. Army  
**VOLUNTEERS**, of the State of Rhode Island, born in Providence, State  
 of Rhode Island, aged 29 years; 5 feet 4 inches high; Dark complexion,  
Blue eyes, Black hair, and by occupation a laborer, having joined the company on  
 its original organization at Providence R. I., and enrolled in it at the muster into  
 the service of the United States at Providence R. I., on the 14<sup>th</sup> day  
 of September, 1863, (or was mustered in service as a recruit, by  
 \_\_\_\_\_, at \_\_\_\_\_, on the \_\_\_\_\_ day of \_\_\_\_\_,  
 186\_\_\_\_, or was drafted and mustered into the service of the United States from the  
 Enrollment District of the State of \_\_\_\_\_, at \_\_\_\_\_,  
 on the \_\_\_\_\_ day of \_\_\_\_\_, 186\_\_\_\_) to serve in the Regiment, for  
 the term of Three Years; and having served HONESTLY and  
 FAITHFULLY with his Company in said regiment to the present date, is now  
 entitled to a **DISCHARGE** by reason of Death

The said Michael Williams was ~~not~~ paid by Paymaster  
since enlistment to include the 31<sup>st</sup> day of August, 1864, and has  
 pay due him from that time to the present date; he is entitled to pay and subsistence for  
 TRAVELING to place of enrollment, and whatever other allowances are authorized to volunteer  
 soldiers, drafted men, or militia, so discharged. He has received from the United States **CLOTHING**  
 amounting to 60  $\frac{00}{100}$  dollars, since the 21<sup>st</sup> day of August,  
 1863, when his clothing account was last settled. He has received from the United States  
 \_\_\_\_\_ dollars advanced **BOATRY**.

There is to be received from him, on account of the State of \_\_\_\_\_, or other  
 authorities, for **ENCOURAGEMENT**, &c., received on entering service, \_\_\_\_\_ dollars; and  
 for other stoppages, viz:

He has been furnished with **TRANSPORTATION** in kind from the place of his discharge to  
 \_\_\_\_\_; and he has been **SUBSISTED** for **TRAVELING** to his  
 place of enrollment, up to the \_\_\_\_\_.

He is indebted to \_\_\_\_\_, **SUITER**, \_\_\_\_\_ dollars.  
 He is indebted to \_\_\_\_\_, **LAUNDRESS**, One \_\_\_\_\_ dollars.

Given in Duplicate, at Fort Johnson, La., this 10<sup>th</sup> day  
 of September, 1864.

Henry Simon  
 \_\_\_\_\_  
 Commanding Company.

# FINAL STATEMENT

OF

*Michael Hilliard*  
*1st Regt U.S. Cavalry*

## VOLUNTEERS.

**NOTE 1.**—*Three duplicate certificates of discharge* are to be given to each Volunteer Soldier or Soldier who is to be discharged previously to the discharge of his company. One certificate is to be received from the Paymaster (the Paymaster's receipt is to be attached to the original certificate) and another COMMISSIONED officer or other authorized officer is to give the other two to the net of the delivery of the duplicate certificates. The certificate which the Soldier is "entitled to" his discharge, with his pay, is to be given to the Paymaster to have the payment made. The discharge is to be given back to the Soldier by the Paymaster, the latter retaining as his voucher the duplicate certificates.

**NOTE 2.**—If the Soldier is entitled to pay for the use of his horse, the Company Commander or other officer is to put on the back of both these final statements, and also on the back of his pay due for having been so mounted on his own horse.

**NOTE 3.**—When a Soldier is furnished with final statements, his descriptive list, if he has one, should be taken up by the officer who gives the Soldier these statements, and he should write a statement to this effect by the officer. This statement should be attached to the final statement of the time for which the Soldier is to receive his final statements, the clothing account, and the receipt for the clothing, in his favor, so as to comprise a complete statement of his account. This statement is to be sent to the company commander, who should forward all the data necessary to a full and complete report of the Soldier's account on the muster roll upon which the Soldier's discharge is reported. The descriptive list will then be destroyed. The receipt of this is, that the remaining portion of the Soldier's account may be settled upon the receipt of the muster rolls, and the Soldier receive his pay or allowances that may be due him at the time of his discharge, and which may not appear on his final statements from the fact that his descriptive list is incomplete. These accounts for back pay, &c., are settled by the 2d Auditor of the Treasury Department.

**NOTE 4.**—Charges for loss or injury to ordnance, horse equipments, and other miscellaneous charges, should appear under the heading of "Other Stoppages."

**NOTE 5.**—Bounty paid by State authorities, and not by the United States, will not be entered on this statement.

**NOTE 6.**—Amounts due the Suter and Landress must be entered on the muster roll on which the discharge, death, desertion, &c., is reported, as well as on the final statement, otherwise the amount cannot be collected from the United States.

**NOTE 7.**—This blank will be used for deceased volunteers and drafted men, as well as for others.

**NOTE 8.**—Where a Soldier dies in Hospital or on detached service, his descriptive list, if he has one, should be sent with his final statements in duplicate, to the Second Auditor, Washington, D. C.

I certify, on honor, that Michael Williams a private of  
 Captain Wm. S. ... Company (B) of the 11th Regiment of U. S. V. City  
 VOLUNTEERS, of the State of Mass. State, born in Providence, State  
 of Mass. State, aged 29 years; 5 feet 4 inches high; Dark complexion,  
Dark eyes, Dark hair, and by occupation a laborer, having joined the company on  
 its original organization at Providence R. I., and enrolled in it at the muster into  
 the service of the United States at Providence R. I., on the 11th day  
 of September, 1863, (or was mustered in service as a recruit, by Drum Grubner  
at Providence R. I. on the Twenty first day of August,  
 1864, or was drafted and mustered into the service of the United States from the  
 Enrollment District of the State of Mass.,  
 on the ... day of ..., 186...) to serve in the Regiment, for  
 the term of Three Years; and having served HONESTLY and  
 FAITHFULLY with his Company in said regiment to the present date, is now  
 entitled to a **DISCHARGE** by reason of Death

The said Michael Williams was ~~not~~ paid by Paymaster  
since enlistment to include the 31st day of August, 1864, and has  
 pay due him from that time to the present date; he is entitled to pay and subsistence for  
 TRAVELING to place of enrollment, and whatever other allowances are authorized to volunteer  
 soldiers, drafted men, or militia, so discharged. He has received from the United States ~~clothing~~  
 amounting to 60 dollars, since the 21st day of August,  
 1863, when his clothing account was last settled. He has received from the United States  
... dollars advanced BOUNTY.

There is to be stopped from him, on account of the State of ..., or other  
 authorities, for ~~clothing~~, &c., received on entering service, ... dollars; and  
 for other stoppages, viz:

He has been furnished with TRANSPORTATION in kind from the place of his discharge to  
...; and he has been SUBSISTED for TRAVELING to his  
 place of enrollment, up to the ...

He is indebted to ... CUTLER, ... dollars.

He is indebted to ... LAUNDRESS, ... dollars.

Given in Duplicate, at Fort Providence, La., this 11th day  
 of September, 1864.

Henry ...  
...  
 Commanding Company.



## ARTICLES OF WAR.

ART. 95. When any non-commissioned officer or soldier shall die, or be killed in the service of the United States, the then commanding officer of the troop or company shall, in the presence of two other commissioned officers, take an account of what effects he died possessed of, above his arms and accoutrements, and transmit the same to the office of the Department of War, which said effects are to be accounted for, and paid to the representatives of such deceased non-commissioned officer or soldier. And in case any of the officers, so authorized to take care of the effects of deceased officers and soldiers, should, before they have accounted to their representatives for the same, have occasion to leave the regiment or post, by preferment or otherwise, they shall, before they be permitted to quit the same, deposit in the hands of the commanding officer, or of the assistant military agent, all the effects of such deceased non-commissioned officers and soldiers, in order that the same may be secured for, and paid to, their respective representatives.

## ARMY REGULATIONS—EDITION OF 1861.

## DECEASED SOLDIERS.

Par. 152. Inventories of the effects of deceased non-commissioned officers and soldiers, required by the 95th Article of War, will be forwarded to the Adjutant General, by the commander of the company to which the deceased belonged, and a duplicate of the same to the colonel of the regiment. Final statements of pay, clothing, &c., will be sent with the inventories. When a soldier dies at a post or station absent from his company, it will be the duty of his immediate commander to furnish the required inventory, and, at the same time, to forward to the commanding officer of the company to which the soldier belonged, a report of his death, specifying the date, place, and cause; to what time he was last paid, and the money or other effects in his possession at the time of his decease; which report will be noted on the next muster roll of the company to which the man belonged. Each inventory will be endorsed, "Inventory of the effects of \_\_\_\_\_, late of company (—) \_\_\_\_\_ regiment of \_\_\_\_\_, who died at \_\_\_\_\_, the \_\_\_\_\_ day of \_\_\_\_\_, 186—." If a legal representative receive the effects, it will be stated in the report. If the soldier leave no effects, the fact will be reported.

Par. 153. Should the effects of a deceased non-commissioned officer or soldier not be administered upon within a short period after his decease, they shall be disposed of by a Council of Administration, under the authority of the commanding officer of the post, and the proceeds deposited with the Paymaster, to the credit of the United States, until they shall be claimed by the legal representatives of the deceased.

Par. 154. In all such cases of sales by the Council of Administration, a statement in detail, or account of the proceeds, duly certified by the Council and commanding officer, accompanied by the Paymaster's receipt for the proceeds, will be forwarded by the commanding officer to the Adjutant General. The statement will be endorsed, "Report of the proceeds of the effects of \_\_\_\_\_, late of company (—) \_\_\_\_\_ regiment of \_\_\_\_\_, who died at \_\_\_\_\_, the \_\_\_\_\_ day of \_\_\_\_\_, 186—."

NOTE 1.—The effects in all cases, when called for, should be turned over to the legal representative, without further authority from the Adjutant General. When the effects are turned over to the relatives of the deceased before these inventories are sent to the Adjutant General, their receipts therefor should be attached to the inventories. In all other cases, one copy will be sent with a letter of transmittal direct to the Adjutant General, and a duplicate retained by the officer.

NOTE 2.—Particular care should be taken to take receipts in duplicate from the Paymaster for any funds turned over to him; one copy should be sent direct to the Adjutant General and one retained by the officer.

## INVENTORY OF THE EFFECTS

OF

*Michael Williams*Late of Company *B**11<sup>th</sup>* Reg't of *U. S. A. Arty*Volunteers, who died at *Fort Jackson*on the *31<sup>st</sup>* day of *August* 1864.

Inventory of the effects of Michael Williams late  
 a private of Captain Henry Simpson Company B of  
 the 14<sup>th</sup> Regiment of U. S. Vols. Volunteers, who was enrolled as  
 a private at Providence in the State of Rhode Island on  
 the 21<sup>st</sup> day of August 1863, and mustered into the service of the United  
 States as a private on the 1<sup>st</sup> day of September 1863, at Providence  
 in Company B, 14<sup>th</sup> Regiment of U. S. Vols. Volunteers, to serve 3  
 years or during the war; he was born in Brooklyne in the State  
 of New York; he was 24 years of age, 5 feet 4 inches  
 high, dark complexion, dark eyes, dark hair, and by occupation, when enrolled,  
 a laborer; he died in Hospital, at  
Fort Jackson La on the 31<sup>st</sup> day of August 1864, by  
 reason of Gonorrhoic Venereal Fever.

INVENTORY.					
ARTICLES.	No.	ARTICLES.	No.	ARTICLES.	No.
Hats.....		Pairs trousers.....		Knapsacks.....	
Caps.....		Pairs flannel drawers.....		<u>Blanket, wool</u>	<u>1</u>
Forage caps.....		Pairs cotton drawers.....			
Great coats.....	<u>1</u>	Flannel shirts.....			
Uniform coats.....	<u>1</u>	Cotton shirts.....			
Uniform jackets.....		Pairs boots.....			
Flannel sack coats.....		Pairs shoes.....			
Blouses.....		Pairs socks.....			
Stable frocks.....		Blankets.....	<u>1</u>	MONEY.	
Fatigue overalls.....		Haversacks.....		Specie.....	\$
				Notes.....	\$

I CERTIFY, ON HONOR, that the above inventory comprises all the effects of private  
Michael Williams deceased, and that the effects are in the hands  
 of Mr. Capt. H. S. Jones at Fort Jackson  
Louisiana to be disposed of by a Council of Administration.

( DUPLICATES. )

STATION: Fort Jackson La

DATE: Sept. 1<sup>st</sup> 1864

Henry Simpson  
Captain  
 Commanding the Company.

2035

Williams Philip  
Co. G, 11 U.S. Col'd H. Art'y.

*Private*

*Musicalian*

CARD NUMBERS.

	26
	27
	28
	29
	30
	31
	32
	33
	34
10	35
11	36
12	37
13	38
14	39
15	40
16	41
17	42
18	43
19	44
20	45
21	46
22	47
23	48
24	49
25	50

Book Mark:

See also



583021-5011  
3 1743579 LMR

John Miller Co

000820



*W* | **11 H. Art'y. U.S.C.T.**

*Phillip Williams*  
*Priv*, Co. *E*, 14 Reg't R. I. Col'd H. Art'y.\*

Age *22* years.

Appears on

**Company Muster-in Roll**

of the organization named above. Roll dated

*Providence, R.I., Oct. 5, 1863.*

Muster-in to date

*Oct. 5, 1863.*

Joined for duty and enrolled:

When

*Oct. 3, 1863.*

Where

*Prov., R.I.*

Period

*3* years.

Valuation of horse, \$

100

Valuation of horse equipments, \$

100

Remarks:

*Providence, R.I. 1863*

\* This organization subsequently became Co. \_\_\_\_\_, 11 Reg't U. S. Colored Heavy Artillery.

Book mark: \_\_\_\_\_

*Chandler*



*W* 11 H. Art'y. U.S.C.T.

*Philip Williams*  
Co. E, 11 Reg't R. I. Col'd H. Art'y.\*

Appears on

**Company Muster Roll**

for *Oct 5 to Dec 31*, 1863.

Present or absent *Present*

Stoppage, \$ 100 for

Due Gov't, \$ 100 for

Valuation of horse, \$ 100

Valuation of horse equipments, \$ 100

Remarks:

\*This organization subsequently became Co. E, 11 Reg't U. S. Col'd Heavy Artillery.

Book mark:

*Chandler*

*H* 11 H. Art'y. U.S.C.T.

*Philip Williams*  
Priv., Co. E, 14 Reg't R. I. Col'd H. Art'y.\*

Appears on

**Company Muster Roll**

for *Jan. & Feb.*, 186*4*.

Present or absent *Present*

Stoppage, \$ 100 for

Due Gov't, \$ 100 for

Valuation of horse, \$ 100

Valuation of horse equipments, \$ 100

Remarks: *Due Laundry \$ .75*

\*This organization subsequently became Co. E, 11 Reg't U. S. Col'd Heavy Artillery.

Book mark: \_\_\_\_\_

*Chandler*

*7* 11 H. Art'y. U.S.C.T.

*Philip Williams.*  
*Pr.*, Co. E, 14 Reg't R. I. Col'd H. Art'y.\*

Appears on

**Company Muster Roll**

for *March & April*, 1864

Present or absent *Present*

Stoppage, \$ *100* for

Due Gov't, \$ *100* for

Valuation of horse, \$ *100*

Valuation of horse equipments, \$ *100*

Remarks: *See Laundry 75-*

\*This organization subsequently became Co. E, 11 Reg't U. S. Col'd Heavy Artillery.

Book mark: \_\_\_\_\_

*W. H. Allen*  
Copyst.



W

11 H. Art'y. U.S.C.T.

Philip Williams  
Priv. Co. E, 8 Reg't U. S. Col'd H. Art'y.\*

Appears on

Company Muster Roll

for May June 1864  
Present or absent Present

Stoppage, \$ 100 for

Due Gov't, \$ 100 for

Valuation of horse, \$ 100

Valuation of horse equipments, \$ 100

Remarks: Due Laurence 75

\*This organization subsequently became Co. E, 11 Reg't U. S. Colored Heavy Artillery.

Book mark:

L. Chandler  
Copyst.

11 H. Art'y. U.S.C.T.

*John J. Williams*

Co. E, 11 Reg't U. S. Col'd H. Art'y.

Appears on

Company Muster Roll

for *John J. Williams*, 186*2*.

Present or absent *Present*

Stoppage, \$ 100 for

Due Gov't, \$ 100 for

Valuation of horse \$ 100

Valuation of horse equipments, \$ 100

Remarks: *See Muster Roll*

Book mark: \_\_\_\_\_

*John J. Williams*

(358)

Company

**11 II. Art'y. U.S.C.T.**

*George W. ...*

..., Co. E, 11 Reg't U. S. Col'd II. Art'y.

Appears on

**Company Muster Roll**

for *Sept 1862*, 186*2*.

Present or absent *Present*

Stoppage, \$ ... 100 for

Due Gov't, \$ ... 100 for

Valuation of horse, \$ ... 100

Valuation of horse equipments, \$ ... 100

Remarks: *From ...*

Book mark : .....

*George W. ...*  
Copyst.



11 H. Art'y. U.S.C.T.

*George A. ...*

Co. E, 11 Reg't U. S. Col'd H. Art'y.

Appears on

Company Muster Roll

for *George A. ...*, 186*x*.

Present or absent *A*

Stoppage, \$ 100 for

Due Gov't, \$ 100 for

Valuation of horse, \$ 100

Valuation of horse equipments, \$ 100

Remarks: *From Muster Roll  
of ...*

Book mark: \_\_\_\_\_

(358)

*George A. ...*  
Copist.

✓ 11 H. Art'y. U.S.C.T.

*William H. Miller*

*W. H. Miller*, Co. E, 11 Reg't U. S. Col'd H. Art'y.

Appears on

*W. H. Miller*  
**Company Muster Roll**  
for *W. H. Miller*, 186*2*.

Present or absent *Present*

Stoppage, \$ 100 for

Due Gov't, \$ 100 for

Valuation of horse, \$ 100

Valuation of horse equipments, \$ 100

Remarks:

Book mark:

*W. H. Miller*  
*W. H. Miller*  
*W. H. Miller*  
Copyist.

11 H. Art'y. U.S.C.T.

*John W. ...*  
*...*  
Co. E, 11 Reg't U. S. Col'd H. Art'y.

Appears on

**Company Muster Roll**

for *Field of ...*, 1862.

Present or absent *Present*

Stoppage, \$ 100 for *...*

Due Gov't, \$ 100 for *...*

Valuation of horse, \$ 100

Valuation of horse equipments, \$ 100

Remarks:

Book mark:

*...*  
Copyist.



21 11 H. Art'y. U.S.C.T.

*Philip Williams*  
musician, Co. E, 11 Reg't U. S. Col'd H. Art'y.

Appears on

**Company Muster Roll**

for *May and June*, 1865.

Present or absent *Present*

Stoppage, \$ 100 for

Due Gov't, \$ 100 for

Valuation of horse, \$ 100

Valuation of horse equipments, \$ 100

Remarks: *Stoppage and dues \$5;  
no harnessack 67.*

Book mark:

(358) *J. B. James* Copyist.

*W* 11 H. Art'y. U.S.C.T.

*Philip Williams*

*Musicians*, Co. E, 11 Reg't U. S. Col'd H. Art'y.

Appears on

**Company Muster Roll**

for *July and August*, 186*5*.

Present or absent *Present*

Stoppage, \$ 100 for

Due Gov't, \$ 100 for

Valuation of horse, \$ 100

Valuation of horse equipments, \$ 100

Remarks: *Stop for one pair scales .70;*  
*one eagle .02; one letter .01, Two*  
*numbers .02; one cross .02.*

Book mark:

(358)

*J. B. Jones* Copist.

*N* 11 H. Art'y. **U.S.C.T.**

*Philip Williams*

*Musicians*, Co. *C*, 11 Reg't U. S. Col'd H. Art'y.

Appears on **Co. Muster-out Roll**, dated

*New Orleans, La.*, *Oct. 2*, 1865.

Muster-out to date *Oct. 2*, 1865.

Last paid to *June 30* 1865.

Clothing account:

Last settled \_\_\_\_\_, 186 : drawn since \$ 100

Due soldier \$ *2* <sup>*3*</sup> 100; due U. S. \$ 100

Am't for cloth'g in kind or money adv'd \$ 100

Due U. S. for arms, equipments, &c., \$ 100

Bounty paid \$ *none* 100; due \$ *100* <sup>*00*</sup> 100

Remarks: *He had been in the service of the U. S. Army for some time and was discharged on account of disability. He was discharged on the 2nd of October, 1865, at New Orleans, La. He was discharged on account of disability and was discharged on the 2nd of October, 1865, at New Orleans, La.*

Book mark: \_\_\_\_\_

(361) *J. B. James* Copyst.



*Williams, Philip*

*A*, Co., *11* Reg't *20th* *Inf*

**Enclosures.**

Bed Cards	Final Statements
Burial Records	Furloughs or L. of A
Certs. of Dis. for Discharge	Med. Certificates
C. M. Charges	Med. Des. Lists
Descriptive Lists	Orders
Discharge Certificates	Pris. of War Record
Enlistment Papers	Resignations

Other papers relating to—

Admission to Hosp'l	Furlough or L. of A
Casualty Sheet	Med. Examination
Confinement	Misc. Information
Contracts	Pay or Clothing
Death or Effects	Personal Reports
Desertion	Rank
Discharge from Hosp'l	Transfer to Hosp'l
Discharge from Service	Transfer to V. R. C.
Duty	Transportation

DECLARATION OF RECRUIT.

I, *John Hill*, desiring to VOLUNTEER as a Soldier in the ARMY OF THE UNITED STATES, for the term of *three years* do declare that I am *22* years and *3* months of age; that I have never been discharged from the United States service on account of disability or by sentence of a court martial, or by order, before the expiration of a term of enlistment; and I know of no impediment to my serving honestly and faithfully as a soldier for *three years*

Given at *London* The *10th* day of *April* 1863

Witness

*Joseph M. ...*

*Philip Williams*

Discharged

Rec'd of

enlistment; had served in Company ( )

*1st Regiment ...*

Volunteered at

*...*

CONSENT IN CASE OF MINOR.

I, *...* Do CERTIFY that I am the *...* of *...* that the said *...* is *...* years of age; and I do hereby freely give my consent to his volunteering as a SOLDIER in the ARMY OF THE UNITED STATES for the period of *...*

Given at *...* The *...* day of *...*

Witness

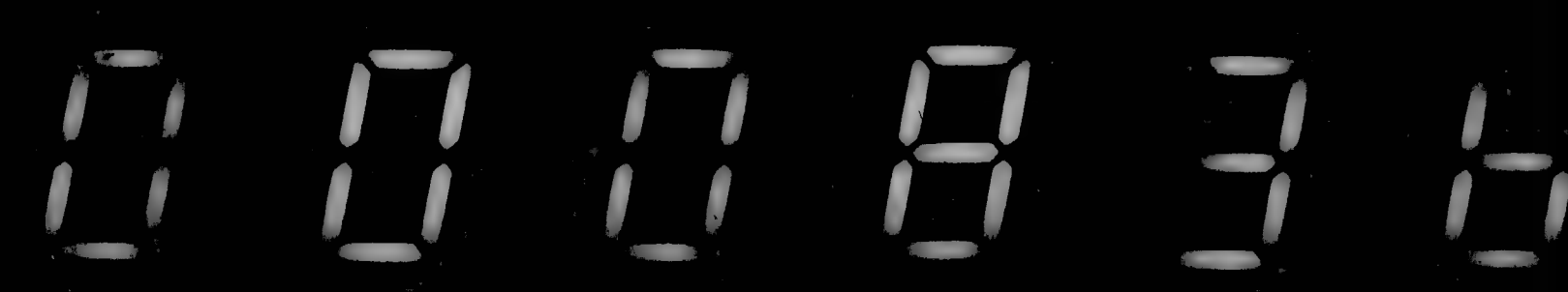





Donaldsonville La  
August 20-1865

Williamus Philip. Hiscian  
Co. "E." 11th Regt. (S.)

Requests a furlough for  
15 or 20 days with  
-mission to visit  
New Orleans La

Ad. Co. E. 11th Regt. (S.)  
Donaldsonville La  
August 21-1865

Respectfully forwarded  
Approved

Wm. G. Cheney  
1st Lt. Co. E. 11th Regt. (S.)

Commanding Officer

Approved  
J. H. [unclear]

Disapproved  
J. H. [unclear]

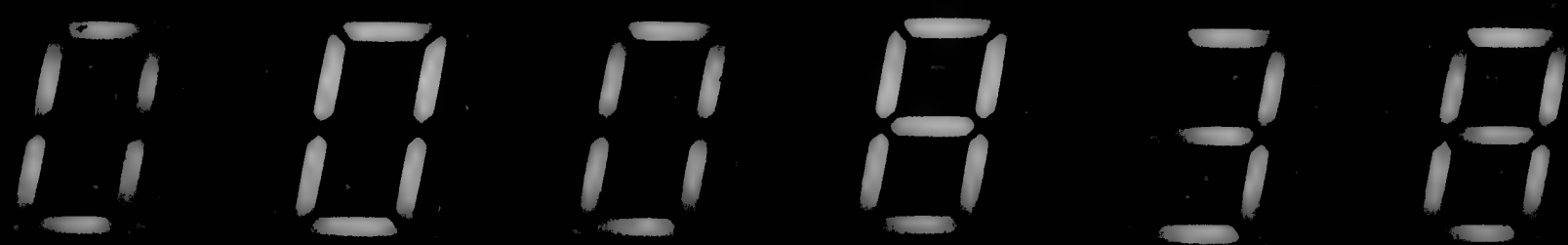

Waldenville Louisiana

August 25th 1855

1<sup>st</sup> Lieut J. C. Matthews, 2<sup>d</sup>  
10<sup>th</sup> Regt, 1<sup>st</sup> Div

Sir

I have the honor  
to respectfully request a passport  
to give leave with permission to  
visit New Orleans La

Very Respectfully

Wm. C. Matthews

Major, 10<sup>th</sup> Regt, 1<sup>st</sup> Div

000839

2030

Williams Richard  
Co <sup>25</sup>, 11 U.S. Col'd H. Art'y.

*Private*

*Private*

CARD NUMBERS.

1	26
2	27
3	28
4	29
5	30
6	31
7	32
8	33
9	34
10	35
11	36
12	37
13	38
14	39
15	40
16	41
17	42
18	43
19	44
20	45
21	46
22	47
23	48
24	49
25	50

Book Mark

See also



1850

1850  
1850  
1850

1850

11

1750

James M. Smith

1750

1750

1750

1750

1750

*Co* 11 H. Art'y. U.S.C.T.

*Richard Williams*

*Co*, Co. *...*, 14 Reg't R. I. Col'd H. Art'y.\*

Age *...* years.

Appears on

**Company Muster-in Roll**

of the organization named above. Roll dated

*Providence (Sept. 14)*, 186*...*

Muster-in to date *Sept. 14*, 186*...*

Joined for duty and enrolled:

When *Aug. 17* ..... 186*...*

Where *Providence* .....

Period *...* years.

Valuation of horse, \$ *...* 100

Valuation of horse equipments, \$ *...* 100

Remarks:

This organization subsequently became Co *B*, 11 Reg't U. S. Colored Heavy Artillery.

Book mark: .....

*...*



U.S. Army, 1914-1918

Richard W. ...

Appointed

Company Music Roll

Reports Due 3 1914

Presented 10

Approved 1000

Discharged 1000

Validation of hours 100

Validation of hours equipment 100

Remarks:

...

...

*W* | **11 H. Art'y. U.S.C.T.**

*Richard Williams*  
*Capt*, Co. B, 11 Reg't R. I. Co'd H. Art'y.\*

Appears on

**Company Muster Roll**

for *Jan - Feb*, 1864.

Present or absent

Stoppage, \$ 100 for

Due Gov't, \$ 100 for

Valuation of horse, \$ 100

Valuation of horse equipments, \$ 100

Remarks:

\*This organization subsequently became Co. B, 11 Reg't U. S. Col'd Heavy Artillery.

Book mark:

*W* 11 H. Art'y. U.S.C.T.

*Richard Williams*

*Co.*, 8 Reg't U. S. Col'd H. Art'y.\*

Appears on

**Company Muster Roll**

for *March & April* 1864

Present or absent *Present*

Stoppage, \$ 100 for

Due Gov't, \$ 100 for

Valuation of horse, \$ 100

Valuation of horse equipments, \$ 100

Remarks.

This organization subsequently became Co. *B*, 11 Reg't U. S. Colored Heavy Artillery.

Book mark:

(158)

*Richard Williams*  
Coptst.



*W* 11 H. Art'y. U.S.C.T.

*Richard Williams*

*Co.*, Co., 8 Reg't U. S. Col'd H. Art'y.\*

Appears on

**Company Muster Roll**

for *May & June*, 186

Present or absent *P*

Stoppage, \$ 100 for

Due Gov't, \$ 100 for

Valuation of horse, \$ 100

Valuation of horse equipments, \$ 100

Remarks:

\*This organization subsequently became Co. 11 Reg't U.S. Colored Heavy Artillery.

Book mark:

*Richard Williams*  
Capt.

11 H. Art'y. U.S.A.

*[Faint handwritten text]*  
Co. B. 11 Reg't U. S. Cold H. Art'y.

Appears on

**Company Muster Roll**

for *[handwritten]* 186*[handwritten]*

Present or absent *[handwritten]*

Stoppage, \$ 100 for

Due Gov't, \$ 100 for

Valuation of horse, \$ 100

Valuation of horse equipments, \$ 100

Remarks: *[handwritten notes]*

Book mark: \_\_\_\_\_

(178)

Copist.

17

William H. Moore  
17

Sept 7 1861

Wm H. Moore  
Sept 17 1861  
Final statement rendered

Wm H. Moore

Wm H. Moore



U. S. ARMY. U. S. C. A.

Co. U. S. Army U. S. C. A. Art'y.

Approved by Co. Muster-out Roll, dated

\_\_\_\_\_ 186

Muster-out to date \_\_\_\_\_ 186

Last paid to \_\_\_\_\_ 186

Clothing account:

Last settled \_\_\_\_\_ 100

Pre-allowance \_\_\_\_\_ 100

Additional clothing money advanced \_\_\_\_\_ 100

Do. V. Settlement \_\_\_\_\_ 100

Do. V. Settlement \_\_\_\_\_ 100

Do. V. Settlement \_\_\_\_\_ 100

Do. V. Settlement \_\_\_\_\_

(10) \_\_\_\_\_

*William, P. C.*

*S*, Co.

*11* Reg't *26th* *Inf*

**12 Enclosures.**

Bed Cards	Final Statements <i>3</i>
Burial Records	Furloughs or L. of A
Certs. of Dis. for Discharge	Med. Certificates
C. M. Charges	Med. Des. Lists
Descriptive Lists	Orders
Discharge Certificates	Pris. of War Record
Enlistment Papers	Resignations

Other papers relating to—

Admission to Hosp'l	Furlough or L. of A
Casualty Sheet <i>2</i>	Med. Examination
Confinement	Misc. Information <i>3</i>
Contracts	Pay or Clothing
Death or Effects <i>2</i>	Personal Reports
Desertion	Rank
Discharge from Hosp'l	Transfer to Hosp'l
Discharge from Service	Transfer to V. R. C.
Duty	Transportation

MICROFILM PUBLICATION M 1832

COMPILED MILITARY SERVICE RECORDS  
OF VOLUNTEER UNION SOLDIERS WHO SERVED WITH  
THE UNITED STATES COLORED TROOPS (USCT)  
11TH REGIMENT OF HEAVY ARTILLERY

PERSONAL PAPERS' TARGET SHEET

PLEASE NOTE THE CHECKED INFORMATION ABOUT THE PERSONAL PAPERS IN  
THIS FILE:

- NO PERSONAL PAPERS WERE FOUND IN THIS FILE WHEN THE  
RECORDS WERE ARRANGED FOR MICROFILMING.
- 1 PERSONAL PAPER(S) FOUND IN THIS FILE WHEN THE RECORDS  
WERE ARRANGED FOR MICROFILMING.

000852



DECLARATION OF RECRUIT.

I, Richard Wilson desiring to VOLUNTEER as a Soldier in the ARMY OF THE UNITED STATES, for the term of 3 years and 0 months of age; that I have never been discharged from the United States service on account of disability or by sentence of a court martial, or by order, before the expiration of a term of enlistment; and I know of no impediment to my serving honestly and faithfully as a soldier for 3 years

Given at Orford The 19th day of Aug 18 69

Witness:

Amos D. Smith

Richard Wilson  
Mark

Discharged

Regt of

enlistment; last served in Company ( )

18

Regiment of

By

Richard Wilson

Volunteered at

Orford

Richard Wilson

CONSENT IN CASE OF MINOR.

I, \_\_\_\_\_ Do CERTIFY that I am the \_\_\_\_\_ of \_\_\_\_\_; that the said \_\_\_\_\_ is \_\_\_\_\_ years of age; and I do hereby freely give my CONSENT to his volunteering as a SOLDIER in the ARMY OF THE UNITED STATES for the period of \_\_\_\_\_

Given at \_\_\_\_\_ The \_\_\_\_\_ day of \_\_\_\_\_

Witness

000053

VOLUNTEER ENLISTMENT.

State of

*W.D.*



County of

*Providence*

I, *Richard William*, born in *Calif*  
in the State of *Calif* aged *36* years, and by occupation  
a *Cook*  
day of *Aug* 18 *69*, DO HEREBY ACKNOWLEDGE to have volunteered this *19th*  
of AMERICA, for the period of *3 yrs*, unless sooner discharged by proper authority:

Do also agree to accept such bounty, pay, rations and clothing, as are, or may be, established by law for  
volunteers. And I, *Richard William* do solemnly swear, that I will bear  
true faith and allegiance to the *United States of America*, and that I will serve them honestly and faith-  
fully against all their enemies or opposers whomsoever: and that I will observe and obey the orders of  
the President of the United States, and the orders of the officers appointed over me, according to the  
Rules and Articles of War.

Sworn and subscribed to, at

this *19th* day of *Aug* 18 *69*

BEFORE

*S.P. Lawrence*

I CERTIFY, ON HONOR, That I have carefully examined the above named Volunteer, agreeably to the General Regulations  
of the Army, and that, in my opinion, he is free from all bodily defects and mental infirmity, which would, in any way, disqualify  
him from performing the duties of a soldier.

*Richard W. Lawrence*

EXAMINING SURGEON

I CERTIFY, ON HONOR, That I have minutely inspected the Volunteer,  
previously to his enlistment, and that he was entirely sober when enlisted; that, to the best of my judgment and belief, he is  
of lawful age; and that, in accepting him as duly qualified to perform the duties of an able-bodied soldier, I have strictly observed  
the Regulations which govern the recruiting service. This soldier has

*Dark* complexion, is *5* feet, *Dark* eyes, *Dark* hair,  
*Dark* inches high

Regiment of

*S.P. Lawrence*  
*Volunteers,*

RECRUITING OFFICER.

Duplicate

11/14/14

## FINAL STATEMENT

OF

Wm. J. Williams

S<sup>th</sup> Regt of U. S. Col. C. C. C.

### VOLUNTEERS.

NOTE 1.—Two of these certificates (or duplicates) are to be given to each Volunteer Soldier or drafted man who may be discharged previously to the discharge of his company, that he may at once receive from the Paymaster the pay, &c., due him, and the captain or other COMMISSIONED officer commanding the company will certify to the act of the delivery of the duplicate certificates; on these certificates the Soldier is "entitled to" his *discharge*, and should also present his discharge to the Paymaster to have the payment endorsed on it. The discharge is to be given back to the Soldier by the Paymaster; the latter only retaining as his voucher the duplicate certificates.

NOTE 2.—If the Soldier is entitled to pay for the use of his horse, the Company Commander will certify to that fact on the back of both these final statements, and also to the time he has pay due for having been so mounted on his own horse.

NOTE 3.—When a Soldier is furnished with final statements, his descriptive list, if he has one, should be taken up by the officer who gives the Soldier these statements, and endorsed with a statement to this effect by the officer. This endorsement should exhibit a full statement of the time for which the Soldier was allowed pay on his final statements, the clothing account, and all other charges against him or in his favor, so as to comprise a complete exhibit of his account. It will then be transmitted to the company commander of the Soldier, who will enter all the data necessary to a full understanding of the Soldier's account on the muster roll upon which the Soldier's discharge is reported. The descriptive list will then be destroyed. The object of this is, that the remaining portion of the Soldier's account may be settled upon the receipt of these muster rolls, and the Soldier receive any pay or allowances that may be due him at the time of his discharge, and which may not appear on his final statements from the fact that his descriptive list is incomplete. These accounts for back pay, &c., are settled by the 2d Auditor of the Treasury Department.

NOTE 4.—Charges for loss or injury to ordnance, horse equipments, and other miscellaneous charges, should appear under the heading of "Other Stoppages."

NOTE 5.—Bounty paid by State authorities, and not by the United States, will not be entered on this statement.

NOTE 6.—Amounts due the Sutler and Laundress must be entered on the muster roll on which the discharge, death, desertion, &c., is reported, as well as on the final statement, otherwise the amount cannot be collected from the United States.

NOTE 7.—This blank will be used for deceased volunteers and drafted men, as well as for others.

NOTE 8.—Where a Soldier dies in Hospital or on detached service, his descriptive list, if he has one, should be sent with his final statements, in duplicate, to the Second Auditor, Washington, D. C.



I certify, on honor, that Richard Williams a Private of  
 Captain Henry Simon Company (B) of the 8th Regiment of U.S.C.A.  
**VOLUNTEERS**, of the State of New York, born in New York, State  
 of New York, aged 36 years; 5 feet 7 inches high; Dark complexion.  
Brown eyes, Black hair, and by occupation a Cook, having joined the company on  
 its original organization at Providence R.I., and enrolled in it at the muster into  
 the service of the United States at Providence R.I., on the nineteenth day  
 of August, 1862, (or was mustered in service as a recruit, by  
Providence R.I., at Providence R.I., on the \_\_\_\_\_ day of \_\_\_\_\_,  
 1862, or was drafted and mustered into the service of the United States from the  
 Enrollment District of the State of \_\_\_\_\_, at \_\_\_\_\_,  
 on the \_\_\_\_\_ day of \_\_\_\_\_, 1862.) to serve in the Regiment, for  
 the term of Three years: and having served **HONESTLY** and  
**FAITHFULLY** with his Company in Depart. of the Gulf to the present date, is now  
 entitled to a **DISCHARGE** by reason of Death from Diarrhoea Chronic  
at New Orleans La. September 17th 1864

The said Richard Williams was ~~last~~<sup>never</sup> paid by Paymaster  
\_\_\_\_\_ to include the \_\_\_\_\_ day of \_\_\_\_\_, 1862, and has  
 pay due him from that time to the present date; he is entitled to pay and subsistence for  
**TRAVELING** to place of enrollment, and whatever other allowances are authorized to volunteer  
 soldiers, drafted men, or militia, so discharged. He has received from the United States **CLOTHING**  
 amounting to Fifty seven  $\frac{12}{100}$  dollars, since the \_\_\_\_\_ day of Enrollment,  
 1862, when his clothing account was last settled. He has received from the United States  
220  $\frac{0}{100}$  dollars advanced **BOUNTY**.

There is to be stopped from him, on account of the State of \_\_\_\_\_, or other  
 authorities, for **CLOTHING**, &c., received on entering service,  $\frac{0}{100}$  dollars; and  
 for other stoppages, viz: \_\_\_\_\_

\_\_\_\_\_  $\frac{0}{100}$  dollars.  
 He has been furnished with **TRANSPORTATION** in kind from the place of his discharge to  
\_\_\_\_\_; and he has been **SUBSISTED** for **TRAVELING** to his  
 place of enrollment, up to the \_\_\_\_\_, 1862.

He is indebted to \_\_\_\_\_, **SUTLER**,  $\frac{0}{100}$  dollars.

He is indebted to \_\_\_\_\_, **LAUNDRESS**,  $\frac{0}{100}$  dollars.

Given in Duplicate, at New Orleans La, this 17th day  
 of September, 1864.

Richard Williams  
 Commanding Company  
 Corps of Artillery Genl Hospital

# FINAL STATEMENT

OF

*Richard Williams*

*11<sup>th</sup> Regt of U. S. C.*

## VOLUNTEERS.

NOTE 1.—Two of these certificates (or duplicates) are to be given to each Volunteer Soldier or draught man who may be discharged previously to the discharge of his company, that he may at once receive from the Paymaster the pay & emoluments, and the captain or other commissioned officer commanding the company will certify to the act of the delivery of the duplicate certificates; on these certificates the Soldier is "entitled to" his discharge, and should also present his discharge to the Paymaster to have the payment endorsed on it. The discharge is to be given back to the Soldier by the Paymaster; the latter only retaining as his voucher the duplicate certificates.

NOTE 2.—If the Soldier is entitled to pay for the use of his horse, the Company Commander will certify to that fact on the back of both these final statements, and also to the time he has pay due for having been so mounted on his own horse.

NOTE 3.—When a Soldier is furnished with final statements, his descriptive list, if he has one, should be taken up by the officer who gives the Soldier these statements, and enclosed with a receipt to this effect by the officer. This descriptive list, and the final statement of the time for which the Soldier was engaged, and the final statements, the duplicate account, and a certificate of discharge, should also be sent to the company commander of the Soldier, who will enter on the data necessary for a full understanding of the Soldier's conduct on the muster roll, which the Soldier's discharge is a receipt for. The descriptive list will then be destroyed. The object of this is, that the remaining portion of the Soldier's account may be settled up on the muster roll, and the Soldier receive any pay or allowances due to him, which he is entitled to, and which he may not have received in his final statements. It is the fact that final statements are not a receipt for the account for back pay &c. are settled by the 2d Auditor of the Treasury Department.

NOTE 4.—Clothes and baggage, and other personal effects, and other miscellaneous earnings, should appear under the heading of "Other Supplies."

NOTE 5.—Money paid by State authorities, and not by the United States, will not be entered on this statement.

NOTE 6.—Accounts due the Soldier and his family must be entered on the muster roll on which his discharge is made, and on the account as well as on the final statement. The amount cannot be collected from the United States.

NOTE 7.—This blank will be used for deceased Volunteers and drafted men, as well as for others.

NOTE 8.—Where a Soldier dies in Hospital or in detached service, his descriptive list, if he has one, should be sent with his final statements in duplicate, to the Second Auditor, Washington, D. C.

I certify, on honor, that *Richard Williams* a private of  
 Captain *Bury Slocum's* Company (B) of the *11<sup>th</sup>* Regiment of *U. S. C. (N.Y.)*  
 VOLUNTEERS of the State of *Rhode Island*, born in \_\_\_\_\_ State  
 of *New York*, aged *36* years; *5* feet *7* inches high; *dark* complexion,  
*brunette* hair, and by occupation a *Cook*, having joined the company on  
 its original organization at *Providence R.I.*, and enrolled in it at the muster into  
 the service of the United States at *Providence R.I.* on the *14<sup>th</sup>* day  
 of *September*, 1863, or was mustered in service as a recruit by  
 \_\_\_\_\_ at \_\_\_\_\_ on the \_\_\_\_\_ day of \_\_\_\_\_  
 186\_\_\_\_, or was drafted and mustered into the service of the United States from the  
 Enrollment List of the State of \_\_\_\_\_, \_\_\_\_\_,  
 on the \_\_\_\_\_ day of \_\_\_\_\_, 186\_\_\_\_, to serve in the Regiment, for  
 the term of *Three Years*; and having served HONESTLY and  
 FAITHFULLY with his Company in *Said Regiment* to the present date, is now  
 entitled to a **DISCHARGE** by reason of *Death*.

The said *Richard Williams* was ~~not~~<sup>not</sup> paid by Paymaster  
*Samuel Stewart* to include the *17<sup>th</sup>* day of *September*, 1864, and has  
 pay due him from that time to the present date; he is entitled to pay and subsistence for  
 TRAVELING to place of enrollment, and whatever other allowances are authorized to a first or  
 soldier, drafted man, or militia, to district. He has received from the United States Government  
 amounting to *Fifty seven* <sup>*12<sup>1</sup>/<sub>2</sub>*</sup> dollars, since the *19<sup>th</sup>* day of *August*,  
 1863, when his draft amount was first settled. He has received from the United States  
 \_\_\_\_\_ dollars of arrears.

There is to be paid from him, on account of the State of \_\_\_\_\_, or other  
 authority, for **EXERCISES**, &c., received on entering service, \_\_\_\_\_ dollar; and  
 for other stoppages, viz:

\_\_\_\_\_ dollars.  
 He has been furnished with TRANSPORTATION to and from the place of his discharge to  
 \_\_\_\_\_; and he has been SUBSISTED for TRAVELING to his  
 place of enrollment, on the \_\_\_\_\_ day of \_\_\_\_\_, 186\_\_\_\_.

He is indebted to \_\_\_\_\_ for \_\_\_\_\_ dollars.  
 He is indebted to \_\_\_\_\_ for \_\_\_\_\_ dollars.

Given in Duplicate, at *New Providence, R.I.*, this *22<sup>nd</sup>* day  
 of *September*, 1864.

*Richard Williams*  
*Private U. S. C. (N.Y.)*  
 Commanding Company.



*M. C.*

FINAL STATEMENT

OF

*Wm. M. Williams*

*S. Reg't of U. S. C. A. U. S. A.*  
*No. 1, 5.*

**VOLUNTEERS.**

NOTE 1.—Two of these certificates (or duplicates) are to be given to each Volunteer Soldier or drafted man who may be discharged previously to the discharge of his company, that he may at once receive from the Paymaster the pay, &c., due him, and the captain or other COMMISSIONED officer commanding the company will certify to the act of the delivery of the duplicate certificates; on these certificates the Soldier is "entitled to" his discharge, and should also present his discharge to the Paymaster to have the payment endorsed on it. The discharge is to be given back to the Soldier by the Paymaster; the latter only retaining as his voucher the duplicate certificates.

NOTE 2.—If the Soldier is entitled to pay for the use of his horse, the Company Commander will certify to that fact on the back of both these final statements, and also to the time he has pay due for having been so mounted on his own horse.

NOTE 3.—When a Soldier is furnished with final statements, his descriptive list, if he has one, should be taken up by the officer who gives the Soldier these statements, and endorsed with a statement to this effect by the officer. This endorsement should exhibit a full statement of the time for which the Soldier was allowed pay on his final statements, the clothing account, and all other charges against him or in his favor, so as to comprise a complete exhibit of his account. It will then be transmitted to the company commander of the Soldier, who will enter all the data necessary to a full understanding of the Soldier's account on the muster roll upon which the Soldier's discharge is reported. The descriptive list will then be destroyed. The object of this is, that the remaining portion of the Soldier's account may be settled upon the receipt of these muster rolls, and the Soldier receive any pay or allowances that may be due him at the time of his discharge, and which may not appear on his final statements from the fact that his descriptive list is incomplete. These accounts for back pay, &c., are settled by the 2d Auditor of the Treasury Department.

NOTE 4.—Charges for loss or injury to ordnance, horse equipments, and other miscellaneous charges, should appear under the heading of "Other Stoppages."

NOTE 5.—Bounty paid by State authorities, and not by the United States, will not be entered on this statement.

NOTE 6.—Amounts due the Sutler and Laundress must be entered on the muster roll on which the discharge, death, desertion, &c., is reported, as well as on the final statement, otherwise the amount cannot be collected from the United States.

NOTE 7.—This blank will be used for deceased volunteers and drafted men, as well as for others.

NOTE 8.—Where a Soldier dies in Hospital or on detached service, his descriptive list, if he has one, should be sent with his final statements, in duplicate, to the Second Auditor, Washington, D. C.

ADMINISTRATIVE OFFICE

*Call 1864*

Duplicate with Inventory sent 2d Auditor.

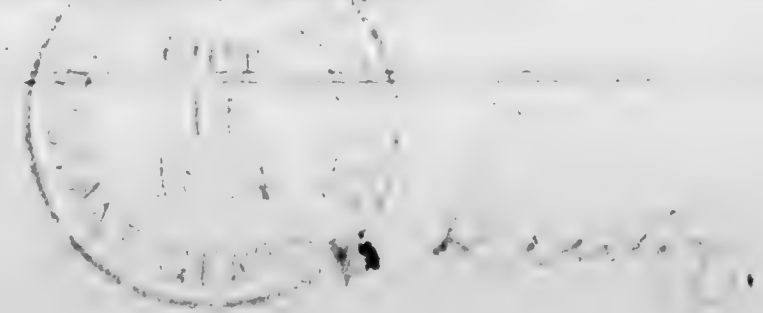

I certify, on honor, that Richard Williams a Private of  
 Captain Henry H. ... Company (2) of the 5 Regiment of U.S.C. ...  
**VOLUNTEERS**, of the State of ..., born in ..., State  
 of New York, aged 20 years; 5 feet 7 inches high; Dark complexion,  
Brown eyes, Black hair, and by occupation a ..., having joined the company on  
 its original organization at ..., and enrolled in it at the muster into  
 the service of the United States at Providence R.I., on the ... day  
 of August, 1862, (or was mustered in service as a recruit, by ...  
..., at ..., on the ... day of ...,  
 186..., or was drafted and mustered into the service of the United States from the ...  
 Enrollment District of the State of ..., at ...,  
 on the ... day of ..., 186...) to serve in the Regiment, for  
 the term of Three years: and having served **HONESTLY** and  
**FAITHFULLY** with his Company in ... to the present date, is now

entitled to a **DISCHARGE** by reason of Discharge from Disease Service  
at New Orleans, La. September 10<sup>th</sup> 1864

The said Richard Williams was ~~not~~ paid by Paymaster  
... to include the ... day of ..., 186..., and has  
 pay due him from that time to the present date; he is entitled to pay and subsistence for  
**TRAVELING** to place of enrollment, and whatever other allowances are authorized to volunteer  
 soldiers, drafted men, or militia, so discharged. He has received from the United States **CLOTHING**  
 amounting to Fifty Seven  $\frac{12}{100}$  dollars, since the ... day of ...,  
 186..., when his clothing account was last settled. He has received from the United States  
...  $\frac{100}{100}$  dollars advanced **BOUNTY**.

There is to be stopped from him, on account of the State of ..., or other  
 authorities, for **CLOTHING**, &c., received on entering service, ...  $\frac{100}{100}$  dollars; and  
 for other stoppages, viz:

...  $\frac{100}{100}$  dollars.

He has been furnished with **TRANSPORTATION** in kind from the place of his discharge to  
...; and he has been **SUBSISTED** for **TRAVELING** to his  
 place of enrollment, up to the ..., 186....

He is indebted to ..., **SUTLER**, ...  $\frac{100}{100}$  dollars.  
 He is indebted to ..., **LAUNDRESS**, ...  $\frac{100}{100}$  dollars.

Given in Duplicate, at New Orleans La, this 11<sup>th</sup> day  
 of September, 1864.

H. E. Payette  
Paymaster in Charge  
 Commanding Company  
 Corps d'Artillerie de la Marine

CASUALTY SHEET

No. *100*  
*William H. Williams*

*Private* of Company *D*

*5th* Regiment of *Mass. A. S. Cavalry*

State Volunteers.

NATURE OF CASUALTY.

.....



CASUALTY SHEET.

Name: *P. J. Williams*  
Rank: *Sergeant* Company: *E* Regiment: *5th*  
Arm: *U. S. Army* State: *Ill.*  
Nature of Casualty: *Death*

CAUSE OF CASUALTY—(NAME OF DISEASE, &c.)

*Chronic Sinusitis*

DEGREE OF DISABILITY.

BY WHOM CERTIFIED.

DATE OF DISCHARGE, DEATH, &c.

*Sept. 17, 1918*

PLACE OF DISCHARGE, DEATH, &c.

*The Camp at*

*W. D. C. Wash. D. C.*

BY WHOM DISCHARGED.

FROM WHAT SOURCE THIS INFORMATION WAS OBTAINED.

*Sur. of 2d Regt.*

REMARKS.

*Sur. of 2d Regt. sent to  
2nd. Camp at*

Clerk.

000862

CASUALTY SHEET

No. \_\_\_\_\_

*John H. ...*

\_\_\_\_\_ of Company \_\_\_\_\_

\_\_\_\_\_ Regiment of \_\_\_\_\_

*State Volunteers.*

---

---

NATURE OF CASUALTY.

CASUALTY SHEET.

Name: *J. M. [unclear]*  
Rank: *[unclear]* Company: *[unclear]* Regiment: *[unclear]*  
Arm: *[unclear]* State: *[unclear]*  
Nature of Casualty: *[unclear]*

CAUSE OF CASUALTY—(NAME OF DISEASE, &c.)

BY WHOM DISCHARGED.

FROM WHAT SOURCE THIS INFORMATION WAS  
OBTAINED.

DEGREE OF DISABILITY.

BY WHOM CERTIFIED.

REMARKS.

DATE OF DISCHARGE, DEATH, &c.

PLACE OF DISCHARGE, DEATH, &c.

Clerk.

(170)

000864



INVENTORY OF THE EFFECTS

Richard Williams

Lat. of Company B

11<sup>th</sup> Regt of 21<sup>st</sup> Co. (Hq)

Company, mounted at Fort Mifflin, Pa.

on the 17<sup>th</sup> of September 1804.

000865



*Receipt*

INVENTORY OF THE EFFECTS

of  
*Genl. George S. ...*

*Army Company*

Reg't of *M.C. H. ...*

*Volunteers, attached to ...*

at *the* day of *...* 18*...*

*George S. ...*

*...*

*[Faint, illegible text]*

DIRECTIONS.

*[Faint, illegible text]*

*not used*

000867



Richard Williams  
Henry James  
New York  
Sept 1864

Henry James  
Sept 1864

Commanding the Company

000868

UNITED STATES

ARMY

000869

RECORD OF DEATH AND INTERMENT.

Name and number of person interred.

*John Williams*

Number and locality of the grave.

Hospital number of the deceased.

*4121*

Regiment, Rank, and Company.

*2nd Regt. 11th Inf. 1st Div. 4th*

Residence before enlistment.

Conjugal condition (ated if married).

the residence of the widow.

Cause of death.

*Smallpox*

Age of the deceased.

Nativity.

References and Remarks.

Date of death and burial.

*July 1st 1864*

156

(A duplicate of this Record has been forwarded to the Sexton, and the other remains in this Hospital)

To

SIR,

It becomes my duty to inform you that the person above described died at this Hospital as herein stated; and that it is desired his remains should be interred with the usual military honors.

Respectfully,

*Surgeon U. S. Army*

MILITARY HOSPITAL

*Washington D.C.*

This copy of the record is to be kept in the office of the Surgeon, and the original is to be sent to the number of the grave to which the remains are interred. The State authorities are notified.

000870



Surgeon General's Office,

Record and Pension Bureau.

....., 186 ..

Respectfully referred to the Medical  
Director, Department of .....

These papers to be returned with  
report.

By Order of the Surgeon General:

*J. Woodward*

Headquarters, Department of the Gulf,

Medical Director's Office,

New Orleans, La.,

186 ..

Respectfully referred to the  
Surgeon General,  
Washington, D. C., with  
reference to the report of  
the Surgeon General,  
New Orleans, La.,



*W. S. Taylor*

Brevet Colonel and Surgeon, U. S. A., Medical Director.

000871

FORM 1.—FINAL

I CERTIFY, ON HONOR, that John Smith, a Private of Captain [Name] Volunteers, of the State of Pennsylvania, born in Pittsburgh, Pa., complexion, blue eyes, dark hair, and by occupation a Farmer, he and enrolled in it at the muster into the service of the United States as a recruit by [Name], at [Location], on the [Date] day of [Month] States from the [Location] Enrollment District of the State of [State], at for the term of Three Years, and having served honestly and faithfully entitled to a DISCHARGE by reason of death. Died in Regimental Hospital [Location].

The said John Smith was last paid by Paymaster Major [Name] from that time to the present date. He is entitled to pay and such allowances are authorized to volunteer soldiers, drafted men, or [Name] clothing amounting to 20 [Amount] dollars, since the 31st day of December received from the United States 25 [Amount] dollars advanced bounty.

There is to be stopped from him on account of the State of [State] service, nothing, [Amount] dollars; and for other stoppages, viz: nothing from the place of his discharge to [Location]; and he has not been substituted.

He is indebted to [Name], Sutler, [Amount] dollars.

He is indebted to [Name], Laundress, [Amount] dollars.

GIVEN, IN DUPLICATE, at Fort Brown, Texas, this 31st day of [Month] 186[Year].

FOR

INVENTORY of the effects of John Smith, late a Private of Captain [Name] Volunteers, who was enrolled as a Private at Pittsburgh, Pa., into the service of the United States as a Private on the 1st of [Month] Pennsylvania Volunteers, to serve three years or during the life of [Name], he was 21 years of age, 5 feet 10 inches high, light complexion, Farmer. He died in Regimental Hospital, at Fort Brown, Texas, [Date].

INVENTORY

ARTICLES.	No.	ARTICLES.
Hats.....		Pairs gloves.....
Coats.....		Pairs gaiters.....
Blankets.....		Pairs cotton drawers.....
Shirts.....		Pairs shirts.....
Shoes.....		Cotton shirts.....
Trunks.....		Pairs trousers.....
Books.....		Pairs shoes.....
Tools.....		Pairs socks.....
Other effects.....		Buttons.....
		Buttons.....

I CERTIFY, ON HONOR, that the above is a true and correct copy of the effects of the said John Smith, late a Private of Captain [Name] Volunteers, who was enrolled as a Private at Pittsburgh, Pa., into the service of the United States as a Private on the 1st of [Month] Pennsylvania Volunteers, to serve three years or during the life of [Name], he was 21 years of age, 5 feet 10 inches high, light complexion, Farmer. He died in Regimental Hospital, at Fort Brown, Texas, [Date].

Given at [Location], this 31st day of [Month] 186[Year].

[Signature]

Form 2.—HEIR'S RECEIPT

I, [Name], of the County of [County], State of [State], do hereby certify that I am the [Relationship] of the said [Name], late a Private of Captain [Name] Volunteers, who was enrolled as a Private at Pittsburgh, Pa., into the service of the United States as a Private on the 1st of [Month] Pennsylvania Volunteers, to serve three years or during the life of [Name], he was 21 years of age, 5 feet 10 inches high, light complexion, Farmer. He died in Regimental Hospital, at Fort Brown, Texas, [Date].

Form 3.—PAYMASTER'S RECEIPT

I, [Name], Paymaster of the [Regiment], do hereby certify that I have paid to the said [Name], late a Private of Captain [Name] Volunteers, who was enrolled as a Private at Pittsburgh, Pa., into the service of the United States as a Private on the 1st of [Month] Pennsylvania Volunteers, to serve three years or during the life of [Name], he was 21 years of age, 5 feet 10 inches high, light complexion, Farmer. He died in Regimental Hospital, at Fort Brown, Texas, [Date].

# MODEL FOR SET OF PAPERS FOR A DECEASED SOLDIER.

## FORM 1.—FINAL STATEMENT.

Statement of Captain J. Brown's Company, (A.) of the 1st Regiment of Pennsylvania Volunteers, State of Pennsylvania, aged 21 years, 5 feet 10 inches high, light complexion, blue eyes, dark hair, and by occupation, when enrolled, a Farmer, having joined the Company on its original organization at Pittsburg, Pa., on the 1st day of July, 1861, or was mustered into the service of the United States at Pittsburg, on the 1st day of July, 1861, or was drafted and mustered into the service of the United States at Pittsburg, on the 1st day of July, 1861, to serve in the Regiment of Pennsylvania Volunteers, and faithfully with his Company in the field to the present date, is now in a Regimental Hospital, Fort Brown, Texas, December 31, 1863, of typhoid fever, and was discharged on the 31st day of October, 1863, and has pay due him for pay and subsistence for *traveling* to place of enrollment, and whatever other duties performed, or militia, so discharged. He has received from the United States day of December, 1862, when his clothing account was last settled. He has received *bounty* of \$100.00, or other authorities, for *clothing*, &c., received on entering the State of Pennsylvania, viz: nothing, \$0.00 dollars. He has been furnished with no *transportation* in kind not been *subsisted* for *traveling* to his place of enrollment up to the 31st day of December, 1863, \$0.00 dollars.

JAMES BROWN,  
Captain Co. A, 1st Penn. Vols.,  
Commanding Company.

## FORM 2.

Statement of Captain J. Brown's Company, (A.) of the 1st Regiment of Pennsylvania Volunteers, State of Pennsylvania, on the 1st day of July, 1861, and mustered into the service of the United States at Pittsburg, Pa., on the 1st day of July, 1861, or was drafted and mustered into the service of the United States at Pittsburg, on the 1st day of July, 1861, to serve in the Regiment of Pennsylvania Volunteers, and faithfully with his Company in the field to the present date, is now in a Regimental Hospital, Fort Brown, Texas, on the 31st day of December, 1863, of typhoid fever.

## INVENTORY.

ARTICLES.	No.	ARTICLES.	No.
Knapsacks	1	Shirts	2
Woolen shirts	1	Necks	2
Blankets	1		
Coats	1		
Shirts	1		
Necks	1		
Shoes	1		
Stockings	1		
Trunk	1		
Valise	1		
Bedroll	1		
Blanket	1		
Coat	1		
Shirts	1		
Necks	1		
Shoes	1		
Stockings	1		
Trunk	1		
Valise	1		
Bedroll	1		
Blanket	1		
Coat	1		
Shirts	1		
Necks	1		
Shoes	1		
Stockings	1		
Trunk	1		
Valise	1		
Bedroll	1		
Blanket	1		
Coat	1		
Shirts	1		
Necks	1		
Shoes	1		
Stockings	1		
Trunk	1		
Valise	1		
Bedroll	1		
Blanket	1		
Coat	1		
Shirts	1		
Necks	1		
Shoes	1		
Stockings	1		
Trunk	1		
Valise	1		
Bedroll	1		
Blanket	1		
Coat	1		
Shirts	1		
Necks	1		
Shoes	1		
Stockings	1		
Trunk	1		
Valise	1		
Bedroll	1		
Blanket	1		
Coat	1		
Shirts	1		
Necks	1		
Shoes	1		
Stockings	1		
Trunk	1		
Valise	1		
Bedroll	1		
Blanket	1		
Coat	1		
Shirts	1		
Necks	1		
Shoes	1		
Stockings	1		
Trunk	1		
Valise	1		
Bedroll	1		
Blanket	1		
Coat	1		
Shirts	1		
Necks	1		
Shoes	1		
Stockings	1		
Trunk	1		
Valise	1		
Bedroll	1		
Blanket	1		
Coat	1		
Shirts	1		
Necks	1		
Shoes	1		
Stockings	1		
Trunk	1		
Valise	1		
Bedroll	1		
Blanket	1		
Coat	1		
Shirts	1		
Necks	1		
Shoes	1		
Stockings	1		
Trunk	1		
Valise	1		
Bedroll	1		
Blanket	1		
Coat	1		
Shirts	1		
Necks	1		
Shoes	1		
Stockings	1		
Trunk	1		
Valise	1		
Bedroll	1		
Blanket	1		
Coat	1		
Shirts	1		
Necks	1		
Shoes	1		
Stockings	1		
Trunk	1		
Valise	1		
Bedroll	1		
Blanket	1		
Coat	1		
Shirts	1		
Necks	1		
Shoes	1		
Stockings	1		
Trunk	1		
Valise	1		
Bedroll	1		
Blanket	1		
Coat	1		
Shirts	1		
Necks	1		
Shoes	1		
Stockings	1		
Trunk	1		
Valise	1		
Bedroll	1		
Blanket	1		
Coat	1		
Shirts	1		
Necks	1		
Shoes	1		
Stockings	1		
Trunk	1		
Valise	1		
Bedroll	1		
Blanket	1		
Coat	1		
Shirts	1		
Necks	1		
Shoes	1		
Stockings	1		
Trunk	1		
Valise	1		
Bedroll	1		
Blanket	1		
Coat	1		
Shirts	1		
Necks	1		
Shoes	1		
Stockings	1		
Trunk	1		
Valise	1		
Bedroll	1		
Blanket	1		
Coat	1		
Shirts	1		
Necks	1		
Shoes	1		
Stockings	1		
Trunk	1		
Valise	1		
Bedroll	1		
Blanket	1		
Coat	1		
Shirts	1		
Necks	1		
Shoes	1		
Stockings	1		
Trunk	1		
Valise	1		
Bedroll	1		
Blanket	1		
Coat	1		
Shirts	1		
Necks	1		
Shoes	1		
Stockings	1		
Trunk	1		
Valise	1		
Bedroll	1		
Blanket	1		
Coat	1		
Shirts	1		
Necks	1		
Shoes	1		
Stockings	1		
Trunk	1		
Valise	1		
Bedroll	1		
Blanket	1		
Coat	1		
Shirts	1		
Necks	1		
Shoes	1		
Stockings	1		
Trunk	1		
Valise	1		
Bedroll	1		
Blanket	1		
Coat	1		
Shirts	1		
Necks	1		
Shoes	1		
Stockings	1		
Trunk	1		
Valise	1		
Bedroll	1		
Blanket	1		
Coat	1		
Shirts	1		
Necks	1		
Shoes	1		
Stockings	1		
Trunk	1		
Valise	1		
Bedroll	1		
Blanket	1		
Coat	1		
Shirts	1		
Necks	1		
Shoes	1		
Stockings	1		
Trunk	1		
Valise	1		
Bedroll	1		
Blanket	1		
Coat	1		
Shirts	1		
Necks	1		
Shoes	1		
Stockings	1		
Trunk	1		
Valise	1		
Bedroll	1		
Blanket	1		
Coat	1		
Shirts	1		
Necks	1		
Shoes	1		
Stockings	1		
Trunk	1		
Valise	1		
Bedroll	1		
Blanket	1		
Coat	1		
Shirts	1		
Necks	1		
Shoes	1		
Stockings	1		
Trunk	1		
Valise	1		
Bedroll	1		
Blanket	1		
Coat	1		
Shirts	1		
Necks	1		
Shoes	1		
Stockings	1		
Trunk	1		
Valise	1		
Bedroll	1		
Blanket	1		
Coat	1		
Shirts	1		
Necks	1		
Shoes	1		
Stockings	1		
Trunk	1		
Valise	1		
Bedroll	1		
Blanket	1		
Coat	1		
Shirts	1		
Necks	1		
Shoes	1		
Stockings	1		
Trunk	1		
Valise	1		
Bedroll	1		
Blanket	1		
Coat	1		
Shirts	1		
Necks	1		
Shoes	1		
Stockings	1		
Trunk	1		
Valise	1		
Bedroll	1		
Blanket	1		
Coat	1		
Shirts	1		
Necks	1		
Shoes	1		
Stockings	1		
Trunk	1		
Valise	1		
Bedroll	1		
Blanket	1		
Coat	1		
Shirts	1		
Necks	1		
Shoes	1		
Stockings	1		
Trunk	1		
Valise	1		
Bedroll	1		
Blanket	1		
Coat	1		
Shirts	1		
Necks	1		
Shoes	1		
Stockings	1		
Trunk	1		
Valise	1		
Bedroll	1		
Blanket	1		
Coat	1		
Shirts	1		
Necks	1		
Shoes	1		
Stockings	1		
Trunk	1		
Valise	1		
Bedroll	1		
Blanket	1		
Coat	1		
Shirts	1		
Necks	1		
Shoes	1		
Stockings	1		
Trunk	1		
Valise	1		
Bedroll	1		
Blanket	1		
Coat	1		
Shirts	1		
Necks	1		
Shoes	1		
Stockings	1		
Trunk	1		
Valise	1		
Bedroll	1		
Blanket	1		
Coat	1		
Shirts	1		
Necks	1		



*[Faint, illegible text, possibly bleed-through from the reverse side of the page]*

RECEIVED ASSISTANT GENERALS  
OFFICE.  
JAN  
12  
1867

*[Small, faint handwritten or stamped mark]*

Headquarters, Department of the Gulf,  
Medical Director's Office,  
New Orleans, La., *Jan 22, 1861,*

*Respectfully returned to the  
Surgeon General U.S.A.  
Washington D.C. with  
reference made, serial  
of Surgeon in Charge,  
Beauregard Gen. Hospital*

*[Signature]*  
Brevet Colonel and Surgeon, U. S. A., Medical Director.

Headquarters, Department of the Gulf,  
Medical Director's Office,  
New Orleans, La., *Jan 22, 1861,*

*Respectfully returned to the  
Surgeon General U.S.A.  
Washington D.C. with  
reference made, serial  
of Surgeon in Charge,  
Beauregard Gen. Hospital*

*[Signature]*  
Brevet Colonel and Surgeon, U. S. A., Medical Director.

Surgeon General's Office,  
Record and Pension Bureau,  
....., 186 ..

Respectfully referred to the Medical  
Director, Department of ..

These papers to be returned with  
report.

BY ORDER OF THE SURGEON GENERAL:  
*[Signature]*  
Brevet Major and Assistant Surgeon, U. S. A.

000874

---

Respectfully returned. There are  
no records of the late Corp. S. A. H. P.  
since the late of his death  
of the late William S. J. Co. but his  
company of letters is not in the  
records of the office.

*[Faint signature]*  
\_\_\_\_\_  
\_\_\_\_\_  
\_\_\_\_\_  
\_\_\_\_\_

---



567

000075



WAR DEPARTMENT,

ADJUTANT GENERAL'S OFFICE,

WASHINGTON, *Oct 27*, 186*6*.

SIR:

Final Statements in the cases of deceased soldiers are required to be sent to the Adjutant General's Office in duplicate, with one copy of the Inventory of Effects. The Descriptive List should also be sent to this Office in cases where the soldier was absent from his Company at the time of his death. Where there were no effects, it should be so stated on a blank Inventory, properly signed.

Certificates of Disability should be sent in duplicate. Special care should be taken that the date of discharge and signature of the discharging officer should be affixed.

*136* of the Final Statement *Inventory*, has been received in the case of *Richard Williams*, of Co. *1st*, Regiment of *1st* Volunteers, whose papers were forwarded to this Office. You will please forward the missing papers without delay.

I have the honor to be, sir,

Very respectfully,

Your obedient servant,

*Recd Sept 1 1866*  
*B. C. O'Connell*

*[Signature]*

Assistant Adjutant General.  
(110)

COMMANDING OFFICER

*[Faint handwritten notes]*

00000000





2037

*Williams Samuel*  
Co *H*, 11 U.S. Col'd H. Art'y.

*Private* | *Private*

CARD NUMBERS.

1	26
2	27
3	28
4	29
5	30
6	31
7	32
8	33
9	34
10	35
11	36
12	37
13	38
14	39
15	40
16	41
17	42
18	43
19	44
20	45
21	46
22	47
23	48
24	49
25	50

Book Marks

See also



11th Artillery, U.S.C.T.

James C. McLean

Co. H, 11th Reg't U.S. Col'd Artillery

Appears on

**Company Descriptive Book**

of the organization named above.

**DESCRIPTION.**

Age 23 years; height 5 feet 4 inches.

Complexion Fair

Eyes Blue; hair Black

Where born St. Louis, Mo.

Occupation Sailor

**ENLISTMENT.**

When Feb 25, 1865

Where Prov. R. I.

By whom Wm. Karulis; term 1 y'rs.

Remarks: Recruit received at Haguenau, Pa. April 1865

W. J. P.

*24* 11 H. Art'y. U.S.C.T.

*Samuel Williams*

Appears with rank of *Private* on

Muster and Descriptive Roll of a Detachment of U. S. Vols. forwarded

for the 11 Reg't *U.S. Art'y* Roll dated

*Providence R.I. March 3, 1860.*

Where born *St. Albans, Vt.*

Age *23* y'rs; occupation *Carver*

When enlisted *Feb 20*, 1860.

Where enlisted *Providence R.I.*

For what period enlisted *4* years.

Eyes *Blk*; hair *Blk*

Complexion *dark*; height *5 ft. 4 in.*

When mustered in *Feb 20*, 1860.

Where mustered in *Pro. R.I.*

Bounty paid \$ *35*<sup>*13*</sup>/<sub>100</sub>; due \$ *26*<sup>*23*</sup>/<sub>100</sub>

Where credited *State R.I. at large*

Company to which assigned

Remarks *Permit entitled to bounty*

Book mark:

*W. W.*

Copyist.

11 II. Art'y. U.S.C.T.

*Samuel Williams*

Appears with rank of *Private* on

**Muster and Descriptive Roll of a Detachment of U. S. Vols. forwarded**

for the *11* Reg't *W. S. Hall* Roll dated *Nov 27*, 1865.

Where born *St. Joseph Mo. Mo.*

Age *23* y'rs; occupation *carver*

When enlisted *Feb 25*, 1865.

Where enlisted *Providence R.I.*

For what period enlisted *3* years.

Eyes *blk*; hair *blk*

Complexion *dark*; height *5 ft. 4* in.

When mustered in *Feb 25*, 1865.

Where mustered in *Providence R.I.*

Bounty paid \$ *100* 100; due \$ *100* 100

Where credited *St. J. S. at Forge*

Company to which assigned \_\_\_\_\_

Remarks: \_\_\_\_\_

Book mark: \_\_\_\_\_

*W. W.*



*W* 11 H. Art'y. U.S.C.T.

*Samuel Williams*  
*Co. H, 11 Reg't U. S. Col'd H. Art'y.*

Appears on

**Company Muster Roll**

for *March Apr*, 1865.

Present or absent *Present*

Stoppage, \$ *100* for

Due Gov't, \$ *100* for

Valuation of horse, \$ *100*

Valuation of horse equipments, \$ *100*

Remarks: *joined as a*  
*sergeant April 1865*  
*been paid \$3.75*

Book mark:

*W*

**11 H. Art'y. U.S.C.T.**

*Samuel Williams*

*Plt*, Co. H, 11 Reg't U. S. Col'd H. Art'y.

Appears on

**Company Muster Roll**

for *May and June*, 1865.

Present or absent *Present*

Stoppage, \$ *100* for

Due Gov't, \$ *100* for

Valuation of horse, \$ *100*

Valuation of horse equipments, \$ *100*

Remarks: *Joined as recruit*

*April 4<sup>th</sup> 1865,*

*Bounty \$33 1/2 screw driver*

*& wiper 43, Haversack 67*

Book mark: \_\_\_\_\_

*Rhodes*

*M*

11 H. Art'y. U.S.C.T.

Samuel Williams  
Pat., Co. H, 11 Reg't U. S. Cold H. Art'y.

Appears on

Company Muster Roll

for July and Aug., 1860.

Present or absent Present

Stoppage, \$ 100 for

Due Gov't, \$ 100 for

Valuation of horse, \$ 100

Valuation of horse equipments, \$ 100

Remarks: Due 2<sup>d</sup> Installment U.S. Bounty \$33.33 1/3

Book mark:

*Phillips*



*M.* **11 H. Art'y. U.S.C.T.**

*Samuel Williams*

*Pvt.*, Co. *H.*, 11 Reg't U. S. Col'd H. Art'y.

Appears on **Co. Muster-out Roll**, dated  
*New Orleans La., Oct. 2, 1865.*

Muster-out to date *Oct. 2, 1865.*

Last paid to *June 30, 1865.*

**Clothing account:**

Last settled ..... , 1865 ; drawn since \$ 100

Due soldier \$ 100; due U. S. \$ *30* <sup>*86*</sup> 100

Am't for cloth'g in kind or money adv'd \$ 100

Due U. S. for arms, equipments, &c., \$ 100

Bounty paid \$ *33* <sup>*33 1/3*</sup> 100; due \$ *33* <sup>*33 1/3*</sup> 100

Remarks: *Joined a Recruit*  
*Stop for Muster and*  
*Accts retained 1/6.*

Book mark : .....

*White*

Williams, Samuel

11 Reg't

U.S. C. N. A.

**Enclosures.**

Bed Cards	Final Statements
Burial Records	Furloughs or L. of A.
Certs. of Dis. for Discharge	Med. Certificates
C. M. Charges	Med. Des. Lists
Descriptive Lists	Orders
Discharge Certificates	Pris. of War Record
Enlistment Papers	Resignations

Other papers relating to—

Admission to Hosp'l	Furlough or L. of A.
Casualty Sheet	Med. Examination
Confinement	Misc. Information
Contracts	Pay or Clothing
Death or Effects	Personal Reports
Desertion	Rank
Discharge from Hosp'l	Transfer to Hosp'l
Discharge from Service	Transfer to V. R. C.
Duty	Transportation

NOTE 1.—This blank will be used for both enlistments and re-enlistments—enlistment of veterans, &c., &c., in the volunteer service. They will be made out in duplicate in all cases—one to accompany the recruiting return of the superintendent (not the recruiting officer) to the Adjutant General, and one to accompany the accounts of the officer who pays bounty, &c. The Regiment and Company in which the soldier last served should be given on the back.

NOTE 2.—An enlistment holds to service. A muster-in must, in all cases, precede payment of pay, bounty, pension, &c. A muster-in roll must, in all cases, be filed in the Adjutant General's Office as evidence of muster-in. The mustering officer, commissary, or assistant commissary of musters, as the case may be, will countersign both enlistments as having mustered the soldier into the service of the United States before either of them is given to the disbursing officer.

DECLARATION OF RECRUIT.

I, Samuel Williams, desiring to VOLUNTEER as a Soldier in the Army of the United States, for the term of one YEARS, Do Declare, That I am Twenty Three years and \_\_\_\_\_ months of age; that I have never been discharged from the United States service on account of disability or by sentence of a court martial, or by order before the expiration of a term of enlistment; and I know of no impediment to my serving honestly and faithfully as a soldier for one years.

GIVEN at Providence R.I. the 25 day of February 1865

Witness:

C. Bell Samuel Williams  
*Witness to his name*  
C. Bell

No. 1020

Samuel Williams  
 Volunteered at Providence R.I.

February 25, 1865.

By Capt. Wm. H. ...  
11th Regiment of Infantry

enlistment; last served in Company ( )

Reg't of \_\_\_\_\_

Discharged \_\_\_\_\_, 18 \_\_\_\_\_

CONSENT IN CASE OF MINOR.

I, \_\_\_\_\_, Do CERTIFY, That I am \_\_\_\_\_; that the \_\_\_\_\_ of \_\_\_\_\_ is \_\_\_\_\_ years of age; and I do hereby freely give my CONSENT to his volunteering as a SOLDIER in the ARMY OF THE UNITED STATES for the period of THREE YEARS.

GIVEN at \_\_\_\_\_ the \_\_\_\_\_ day of \_\_\_\_\_

Witness:



VOLUNTEER ENLISTMENT.

STATE OF

TOWN OF

Rhode Island

State at large



I, Samuel Williams, born in Saint Croix, Me. in the State of \_\_\_\_\_, aged twenty three years, and by occupation a Sailor, Do HEREBY ACKNOWLEDGE to have volunteered this Twenty fifth day of February, 1865, to serve as a **Soldier** in the **Army of the United States of America**, for the period of ~~TWO~~ **YEARS**, unless sooner discharged by proper authority: Do also agree to accept such bounty, pay, rations, and clothing, as are, or may be, established by law for volunteers. And I, Samuel Williams, do solemnly swear, that I will bear true faith and allegiance to the **United States of America**, and that I will serve them honestly and faithfully against all their enemies or opposers whomsoever; and that I will observe and obey the orders of the President of the United States, and the orders of the officers appointed over me, according to the Rules and Articles of War.

Sworn and subscribed to, at Providence, R.I. this 25 day of February, 1865.  
 BEFORE W. C. Hamilton  
 Capt. 1st Dist. Regt.

Samuel Williams  
 Volunteer

I CERTIFY, ON HONOR, That I have carefully examined the above-named Volunteer, agreeably to the General Regulations of the Army, and that, in my opinion, he is free from all bodily defects and mental infirmity, which would in any way disqualify him from performing the duties of a soldier.

W. C. Hamilton  
 Capt. 1st Dist. Regt.  
 EXAMINING SERGEON.

I CERTIFY, ON HONOR, That I have minutely inspected the Volunteer Samuel Williams previously to his enlistment, and that he was entirely sober when enlisted; that, to the best of my judgment and belief, he is of lawful age; and that, in accepting him as duly qualified to perform the duties of an able-bodied soldier, I have strictly observed the Regulations which govern the recruiting service. This soldier has Black eyes, Black hair, Dark complexion, is five feet four inches high

W. C. Hamilton  
 Capt. 1st Dist. Regt.  
 RECRUITING OFFICER.

Mustered into the service of the United States, for three years or during the war, from date of enlistment, in Company Fourth Regiment of Light Artillery Volunteers, on the 25 day of February, 1865, at Providence, R.I.

W. C. Hamilton  
 Capt. 1st Dist. Regt.  
 Recruiting Officer

NOTE 1.—This blank will be used for both enlistments and re-enlistments—enlistment of veterans, &c., &c., in the volunteer service. They will be made out in duplicate in all cases—one to accompany the recruiting return of the superintendent (not the recruiting officer) to the Adjutant General, and one to accompany the accounts of the officer who pays bounty, &c. The Regiment and Company in which the soldier last served should be given on the back.

NOTE 2.—An enlistment holds to service. A muster-in must, in all cases, precede payment of pay, bounty, pension, &c. A muster-in roll must, in all cases, be filed in the Adjutant General's Office as evidence of muster-in. The mustering officer, commissary, or assistant commissary of musters, as the case may be, will countersign both enlistments as having mustered the soldier into the service of the United States before either of them is given to the disbursing officer.

DECLARATION OF RECRUIT.

I, *Samuel Williams*, desiring to VOLUNTEER as a Soldier in the Army of the United States, for the term of ~~three~~ YEARS, Do Declare, That I am *Twenty three* years and \_\_\_\_\_ months of age; that I have never been discharged from the United States service on account of disability or by sentence of a court martial, or by order before the expiration of a term of enlistment; and I know of no impediment to my serving honestly and faithfully as a soldier for ~~one~~ years.

GIVEN at *Providence R.I.* the *25<sup>th</sup>* day of *February 1865*

Witness:

*C. K. [Signature]*

*Samuel Williams*  
*mark witness to his mark*  
*C. K. [Signature]*

No. *266*

*Samuel Williams*

Volunteered at *Providence R.I.*

*February 25<sup>th</sup>, 1865*

By *Capt. [Signature]*

*11<sup>th</sup> Regiment of [Signature]*

enlistment; last served in Company ( )

Reg't of \_\_\_\_\_

Discharged \_\_\_\_\_, 18 \_\_\_\_\_

1865  
 18  
 1868

CONSENT IN CASE OF MINOR.

I, \_\_\_\_\_, Do CERTIFY, That I am \_\_\_\_\_; that the \_\_\_\_\_ of \_\_\_\_\_; that the \_\_\_\_\_ is \_\_\_\_\_ years of age; and I do hereby freely give my CONSENT to his volunteering as a SOLDIER in the ARMY OF THE UNITED STATES for the period of THREE YEARS.

GIVEN at \_\_\_\_\_ the \_\_\_\_\_ day of \_\_\_\_\_

Witness:



VOLUNTEER ENLISTMENT.

STATE OF

TOWN OF

*Rhode Island*



*State at large*

I, *Samuel Williams*, born in *Saint Croix N.C.* in the State of \_\_\_\_\_, aged *Twenty three* years, and by occupation a *Sailor*, DO HEREBY ACKNOWLEDGE to have volunteered this *Twenty fifth* day of *February*, 1865, to serve as a **Soldier** in the **Army of the United States of America**, for the period of ~~TWO~~ **YEARS**, unless sooner discharged by proper authority: Do also agree to accept such bounty, pay, rations, and clothing, as are, or may be, established by law for volunteers. And I, *Samuel Williams*, do solemnly swear, that I will bear true faith and allegiance to the **United States of America**, and that I will serve them honestly and faithfully against all their enemies or opposers whomsoever; and that I will observe and obey the orders of the President of the United States, and the orders of the officers appointed over me, according to the Rules and Articles of War.

Sworn and subscribed to, at *Providence R.I.* }  
this *25<sup>th</sup>* day of *February*, 1865, } *Samuel Williams*  
BEFORE: *W. S. Hamilton* }  
*Capt. & Com. 1<sup>st</sup> Dist R.I.* } *Witness to his mark*

I CERTIFY, ON HONOR, That I have carefully examined the above-named Volunteer, agreeably to the General Regulations of the Army, and that, in my opinion, he is free from all bodily defects and mental infirmity, which would in any way disqualify him from performing the duties of a soldier.

*W. S. Hamilton*  
*Sup. 1<sup>st</sup> Dist R.I.*  
EXAMINING SERGEON.

I CERTIFY, ON HONOR, That I have minutely inspected the Volunteer *Samuel Williams* previously to his enlistment, and that he was entirely sober when enlisted; that, to the best of my judgment and belief, he is of lawful age; and that, in accepting him as duly qualified to perform the duties of an able-bodied soldier, I have strictly observed the Regulations which govern the recruiting service. This soldier has *Black* eyes, *Black* hair, *Dark* complexion, is *five* feet *four* inches high

*W. S. Hamilton*  
*Capt. & Com. 1<sup>st</sup> Dist R.I.*  
RECRUITING OFFICER.

(A. G. O. No. 71 & 76.)

Mustered into the service of the United States, for ~~two~~ years or during the war, from date of enlistment, in Company *B*, *4<sup>th</sup> Regt. of M<sup>ch</sup> Artillery*, Volunteers, on the *25<sup>th</sup>* day of *February*, 1865, at *Providence R.I.*

*W. S. Hamilton*  
*Capt. & Com. 1<sup>st</sup> Dist R.I.*  
Mustered Officer



2038

*Williams Theodore*

Co *L*, **11 U.S. Col'd H. Art'y.**

*Private*

*Private*

CARD NUMBERS.

1	26
2	27
3	28
4	29
5	30
6	31
7	32
8	33
9	34
10	35
11	36
12	37
13	38
14	39
15	40
16	41
17	42
18	43
19	44
20	45
21	46
22	47
23	48
24	49
25	50

Book Mark: \_\_\_\_\_

See also \_\_\_\_\_

*N* | 11 H. Art'y. | U.S.C.T.

*Theodore Williams*

....., Co. *2*, 11 Reg't U. S. Col'd H. Art'y.

Appears on

**Company Descriptive Book**

of the organization named above.

**DESCRIPTION.**

Age *19* years; height *5* feet *6* inches.

Complexion *Mulatto*

Eyes *Blue*; hair *Red*

Where born *Cumberland Co Penn*

Occupation *Barber*

**ENLISTMENT.**

When *Dec 11*, 186*3*.

Where *Prov R. I.*

By whom *J. B. Ewing*; term *3* y'rs.

Remarks: *Mustered out Oct 2' 1865*

*Guffey*

24 | 11 H. Art'y. | U.S.C.T.

Theodore Williams  
Det., Co. L, 14 Reg't R. I. Col'd H. Art'y.\*

Age 19 years.

Appears on

**Company Muster-in Roll**

of the organization named above. Roll dated

Camp M. P. in R. I., Dec 3, 1863.

Muster-in to date Dec. 3, 1863.

Joined for duty and enrolled:

When Dec 11, 1863.

Where Det., R.I.

Period 3 years.

Valuation of horse, \$ 100

Valuation of horse equipments, \$ 100

Remarks: Residence  
1 mile, R.I.

\* This organization subsequently became Co. L, 11 Reg't U. S. Colored Heavy Artillery.

Book mark: \_\_\_\_\_

Theodore Williams



*W* | **11 H. Art'y. U.S.C.T.**

*Theodore Williams*  
*priv*, Co. L, 14 Reg't R. I. Col'd H. Art'y.\*

Appears on

**Company Muster Roll**

for *Jan & Feb*, 186 *4*

Present or absent *Present*

Stoppage, \$ *100* for

Due Gov't, \$ *100* for

Valuation of horse, \$ *100*

Valuation of horse equipments, \$ *100*

Remarks:

\* This organization subsequently became Co. L, 11 Reg't U. S. Colored Heavy Artillery.

Book mark:

*B. D. Edwards*  
Copyist.

*11* **11 H. Art'y. U.S.C.T.**

*Wm. J. ...*  
*...*, Co. L, 14 Reg't R. I. Col'd H. Art'y.\*

Appears on

**Company Muster Roll**

for *March 1864*, 186*4*.

Present or absent *Present*

Stoppage, \$ *100* for

Due Gov't, \$ *100* for

Valuation of horse, \$ *100*

Valuation of horse equipments, \$ *100*

Remarks:

\* This organization subsequently became Co. L, 11 Reg't U. S. Colored Heavy Artillery.

Book mark :

*J. Mandy*

*W* | **11 H. Art'y. U.S.C.T.**

*Shadrach Williams*  
\_\_\_\_\_, Co. *L*, 8 Reg't U. S. Col'd H. Art'y.\*

Appears on

**Company Muster Roll**

for *May & June*, 186*4*.

Present or absent *Present*

Stoppage, \$ \_\_\_\_\_ 100 for \_\_\_\_\_

Due Gov't, \$ *2* 100 for *\_\_\_\_\_*

Valuation of horse, \$ \_\_\_\_\_ 100

Valuation of horse equipments, \$ \_\_\_\_\_ 100

Remarks:

\*This organization subsequently became Co. *L*, 11 Reg't U. S. Colored Heavy Artillery.

Book mark: \_\_\_\_\_

*W. H. [unclear]*



24 11 H. Art'y. U.S.C.T.

Thaddeus W. Williams  
Sgt., Co. L, 11 Reg't U.S. Cold H. Art'y.

Appears on

Company Muster Roll

for July 1st Aug, 1864.

Present or absent Present

Stoppage, \$ 100 for

Due Gov't, \$ 30 100 for

Valuation of horse, \$ 100

Valuation of horse equipments, \$ 100

Remarks: \$6 per ms, paid  
pay due from enlist-  
ment to Apr 30/64  
Paid on Apr 19/64

Book mark:

W. M. M. M.

(358)

Copist.

W. 11 H. Art'y. U.S.C.T.

Theodore Williams.

Dr. , Co. L, 11 Reg't U. S. Col'd H. Art'y.

Appears on

**Company Muster Roll**

for Sept. & Oct., 1864.

Present or absent present.

Stoppage, \$ 20 for ordnance

Due Gov't, \$ 100 for

Valuation of horse, \$ 100

Valuation of horse equipments, \$ 100

Remarks: \$6.00 per month back  
pay due from enlistment  
to April 30/64.  
Free on April 19/61.

Book mark: \_\_\_\_\_

*A.* 11 H. Art'y. U.S.C.T.

*Theodore Williams.*

*Regt.*, Co. L, 11 Reg't U.S. Cav'd H. Art'y.

Appears on

**Company Muster Roll**

for *Nov. & Dec.*, 1864

Present or absent *present.*

Stoppage, \$ - <sup>20</sup> 100 for *...*

Due Gov't, \$ 100 for *...*

Valuation of horse, \$ 100

Valuation of horse equipments, \$ 100

Remarks: *.....*

Book mark: *.....*

*Faker*  
Copyist.



*Pl.*

**11 H. Art'y. U.S.C.T.**

*Theodore Williams.*

*Pl.*, Co. L, 11 Reg't U. S. Col'd H. Art'y.

Appears on

**Company Muster Roll**

for *Jan & Feb.*, 1865.

Present or absent *Present.*

Stoppage, \$ 100 for

Due Gov't, \$ 100 for

Valuation of horse, \$ 100

Valuation of horse equipments, \$ 100

Remarks:

Book mark:

W. 11 H. Art'y. U.S.C.T.

Theodore Williams.

Pl., Co. L, 11 Reg't U. S. Col'd H. Art'y.

Appears on

Company Muster Roll

for March & April, 1865.

Present or absent present.

Stoppage, \$ 100 for

Due Gov't, \$ 100 for

Valuation of horse, \$ 100

Valuation of horse equipments, \$ 100

Remarks:

Book mark:

Gaper  
Copist.

*W*

**11 H. Art'y. U.S.C.T.**

*Theodore Williams*  
Priv, Co. L. H. Reg't U.S.C. 11 H. Art'y.

Appears on

**Company Muster Roll**

for *May & June*, 186*3*.

Present or absent *Present*

Stoppage, \$ 100 for

Due Gov't, \$ 100 for

Valuation of horse, \$ 100

Valuation of horse equipments, \$ 100

Remarks:

Book mark: .....

(358)

*Murphy*  
Copyst.



11th U.S.C.T.

Appearance

Company Muster Roll

1862

1863

1864

1865

1866

1867

1868

1869

11 H. Art'y. U.S.C.T.

*Theodore Williams*

*Prvt*, Co. L, 11 Reg't U. S. Col'd H. Art'y.

Appears on Co. Muster-out Roll, dated

*New Orleans La Oct*, 186<sup>4</sup>.

Muster-out to date *Oct*, 186<sup>4</sup>.

Last paid to *Feb 1864*, 186<sup>4</sup>.

Clothing account:

Last settled... 186...; drawn since \$... 100

Due soldier \$... 100; due U. S. \$ *6*<sup>10</sup> 100

Am't for cloth'g in kind or money adv'd \$... 100

Due U. S. for arms, equipments, &c., \$... 100

Bounty paid \$... 100; due \$ *10* 100

Remarks: *joined at Dept Camp  
Noth page for...  
acc. retained 700*

Book mark:

*William S. Tucker*

*I*, Co.

*11* Reg't *U. S. A.*

**Enclosures.**

Bed Cards	Final Statements
Burial Records	Furloughs or L. of A
Certs. of Dis. for Discharge	Med. Certificates
C. M. Charges	Med. Des. Lists
Descriptive Lists	Orders
Discharge Certificates	Pris. of War Record
Enlistment Papers	Resignations

Other papers relating to—

Admission to Hosp'l	Furlough or L. of A
Casualty Sheet	Med. Examination
Confinement	Misc. Information
Contracts	Pay or Clothing
Death or Effects	Personal Reports
Desertion	Rank
Discharge from Hosp'l	Transfer to Hosp'l
Discharge from Service	Transfer to V. R. C.
Duty	Transportation



DECLARATION OF RECRUIT.

I, *George J. ...* do hereby declare that I am *19* years and *11* months of age; that I have never been declared insane in the United States, nor have I been disabled or by sentence of a court martial, or by other law, from the expiration of a term of enlistment; and I do hereby declare that I will serve honestly and faithfully as a soldier for *one year*

Given at *Long Point*  
The *11* day of *June* 186*2*

Witness:

*George J. ...*

Discharged

18

Regt of

enlistment; last served in Company ( )

By: *George J. ...*  
*11th U.S. E.H.A.*  
*Regiment of U.S. Artillery*

Volunteered at

*Long Point*

1862

*George J. ...*

No.

CONSENT IN CASE OF MINOR.

I, \_\_\_\_\_ of \_\_\_\_\_ is \_\_\_\_\_ years of age, and I do hereby give my consent to his volunteering as a SOLDIER in the ARMY of the UNITED STATES for the period of \_\_\_\_\_

Given at \_\_\_\_\_  
The \_\_\_\_\_ day of \_\_\_\_\_

Witness:



VOLUNTEER ENLISTMENT.

State of

*Mass.*



Town of

*North Andover*

I, *Theodore Williams*

born in

in the State of *Mass.*

aged

*19*

years, and by occupation

a *laborer*

DO HEREBY ACKNOWLEDGE to have volunteered this *11<sup>th</sup>*

day of *Dec*

*1869*

to serve as a SOLDIER in the ARMY OF THE UNITED STATES

OF AMERICA, for the period of *three years*, unless sooner discharged by proper authority:

Do also agree to accept such bounty, pay, rations and clothing, as are, or may be, established, by law for volunteers. And I, *Theodore Williams*

do solemnly swear, that I will bear

true faith and allegiance to the *United States of America*, and that I will serve them honestly and faith-

fully against all their enemies or opposers whomsoever; and that I will observe and obey the orders of the

President of the United States, and the orders of the officers appointed over me, according to the Rules

and Articles of War.

Sworn and Subscribed to, at

*North Andover*

this

*11<sup>th</sup>*

day of

*Dec*

18*69*

*Theodore Williams*  
mark

BEFORE

*Me. J. L. ...*

I CERTIFY, ON HONOR, That I have carefully examined the above-named Volunteer, agreeable to the General Regulations of the Army, and that, in my opinion, he is free from all bodily defects and mental infirmity, which would, in any way, disqualify him from performing the duties of a soldier.

*Johnson Gardner M.D.*

EXAMINING SURGEON

I CERTIFY, ON HONOR, That I have minutely inspected the Volunteer, *Theodore Williams* previously to his enlistment, and that he was entirely sober when enlisted; that to the best of my judgment and belief, he is of lawful age; and that, in accepting him as duly qualified to perform the duties of an able-bodied soldier, I have strictly observed the Regulations which govern the recruiting service. This soldier has

*Mature*

complexion is

*fair*

feet

*6*

inches high

eyes

*blue*

hair

*11<sup>th</sup> Dec*

Regiment of

*Vol. Infy*

Volunteers,

RECRUITING OFFICER.

2039

Williams, Thomas C.  
Co. *B*, 11 U.S. Col'd H. Art'y.

*Private*

*Private*

CARD NUMBERS.

1	26
2	27
3	28
4	29
5	30
6	31
7	32
8	33
9	34
10	35
11	36
12	37
13	38
14	39
15	40
16	41
17	42
18	43
19	44
20	45
21	46
22	47
23	48
24	49
25	50

Book Mark:

See also



*J.* | **11 H. Art'y. U.S.C.T.**

*Thomas A. Williams*  
Co. *F*, 11 Reg't U. S. Col'd H. Art'y.

Appears on  
**Company Descriptive Book**  
of the organization named above.

**DESCRIPTION.**

Age *6* years; height *5* feet *6* inches.

Complexion *h.*

Eyes *h.*; hair *h.*

Where born *St. Louis, Mo.*

Occupation *...*

**ENLISTMENT.**

When *Jan. 16*, 186*7*.

Where *St. Louis, Mo.*

By whom *W. C. ...*; term *5* y'rs.

Remarks: *...*

*W. C. ...*  
Copyist.

*24* | **11 H. Art'y. U.S.C.T.**

*Thomas E. Williams*  
*Priv*, Co. *F*, 14 Reg't R. I. Col'd H. Art'y.\*

Age *20* years.

Appears on

**Company Muster-in Roll**

of the organization named above. Roll dated  
*Providence R.I., Oct 20, 1863.*

Muster-in to date *Oct 20, 1863.*

Joined for duty and enrolled:

When *Oct 16*, 186 .

Where *Prov R.I.*

Period *3* years.

Valuation of horse, \$ 100

Valuation of horse equipments, \$ 100

Remarks: \_\_\_\_\_

\* This organization subsequently became Co. *F*, 11 Reg't U. S. Colored Heavy Artillery.

Book mark: \_\_\_\_\_

*J. Neal*

*W*

**11 H. Art'y. U.S.C.T.**

*Thomas E. Williamson*  
Sgt., Co. F, 14 Reg't R. I. Col'd H. Art'y.\*

Appears on

**Company Muster Roll**

for *Oct 20 to Dec 31*, 186*3*.

Present or absent *Present*

Stoppage, \$ 100 for

Due Gov't, \$ 100 for

Valuation of horse, \$ 100

Valuation of horse equipments, \$ 100

Remarks:

\* This organization subsequently became Co. F, 11 Reg't U. S. Colored Heavy Artillery.

Book mark:

*Muel*



*A* 11 H. Art'y. U.S.C.T.

Thomas E. D. Williams  
Pri, Co. F, 14 Reg't R. I. Col'd H. Art'y.\*

Appears on

**Company Muster Roll**

for *Jan & Feb*, 1864

Present or absent *Present*

Stoppage, \$ *100* for

Due Gov't, \$ *100* for

Valuation of horse, \$ *100*

Valuation of horse equipments, \$ *100*

Remarks *Stop for one*

*set of Equipments*

*Complete*

\* This organization subsequently became Co. F, 11 Reg't U. S. Colored Heavy Artillery.

Book mark: \_\_\_\_\_

*M. Neal*

*21* 11 H. Art'y. U.S.C.T.

*Thomas E. O. Williams*  
Pvt, Co. F, 14 Reg't R. I. Col'd H. Art'y.\*

Appears on

**Company Muster Roll**

for *May & Apr*, 1864

Present or absent *Present*

Stoppage, \$ 100 for

Due Gov't, \$ 100 for

Valuation of horse, \$ 100

Valuation of horse equipments, \$ 100

Remarks *Stop for one set of Equipments*  
*Could be done,*

\* This organization subsequently became Co. F, 11 Reg't U. S. Colored Heavy Artillery.

Book mark: \_\_\_\_\_

*J. Neal*

*W* | 11 H. Art'y. U.S.C.T.

*Thomas E. D. Williams*  
Co. *F*, 8 Reg't U. S. Col'd H. Art'y.\*

Appears on

Company Muster Roll

for *May & June*, 1864.

Present or absent

*Present*

Stoppage, \$ 100 for

Due Gov't, \$ 100 for

Valuation of horse, \$ 00

Valuation of horse equipments, \$ 100

Remarks: *Stop for one set of equipments to Company also outfit per spare cone and screw driver.*

\* This organization subsequently became Co. *F*, 11 Reg't U. S. Colored Heavy Artillery.

Book mark:

*A. Neal*

(opust.)



*N.* **11** II. Art'y. **U.S.C.T.**

*Wm. H. D. ...*  
*...*, Co. F, 11 Reg't U. S. Col'd II. Art'y.

Appears on

**Company Muster Roll**

for *...*, 186*...*

Present or absent *...*

Stoppage, \$ *...* 100 for *...*

Due Gov't, \$ *...* 100 for *...*

Valuation of horse, \$ *...* 100

Valuation of horse equipments, \$ *...* 100

Remarks: *...*  
*...*  
*...*  
*...*

Book mark: *...*

*...*

*N* 11 H. Art'y. U.S.C.T.

*Thomas E. H. ...*  
*Pr.*, Co. F, 11 Reg't U. S. Col'd H. Art'y.

Appears on

**Company Muster Roll**

for *September 1864*, 1864.

Present or absent *Present*

Stoppage, \$ 100 for

Due Gov't, \$ 100 for

Valuation of horse, \$ 100

Valuation of horse equipments, \$ 100

Remarks: *Ship per set of equipments*  
*Complete 2.30 iron. 20 screw*  
*screw driver. 22 pr. Shovel*  
*Scales. 50, mass. eq. 25.*  
*Price April 19 64.*

Book mark: \_\_\_\_\_

*Price*

*W* 11 H. Art'y. U.S.C.T.

*Thomas E. S. Williams*

*Sgt.*, Co. F, 11 Reg't U. S. Col'd H. Art'y.

Appears on

**Company Muster Roll**

for *Nov. and Dec.*, 1864.

Present or absent *Present.*

Stoppage, \$ 100 for

Due Gov't, \$ 100 for

Valuation of horse, \$ 100

Valuation of horse equipments, \$ 100

Remarks: *Stoppage set of equipments:  
complete 3.30, two whippers 40  
scoons 12 screw driver 2.3 gun  
string 25 pr. s. scales 50  
two haversacks 98 two canteen  
tins 82, Done April 19/64.*

Book mark: \_\_\_\_\_

*Done*



11 B. 1861. U.S.C.T.

*Company Muster Roll*  
*1st Regt. U.S. Artillery*

Approved

Company Muster Roll

*1st Regt. U.S. Artillery*

*1861*

*1st Regt. U.S. Artillery*

*1861*

*1st Regt. U.S. Artillery*

*1861*

*1st Regt. U.S. Artillery*

*1861*

*1st Regt. U.S. Artillery*

*1861*

*1st Regt. U.S. Artillery*

*1861*

*1st Regt. U.S. Artillery*

*1861*

*1st Regt. U.S. Artillery*

*1861*

*1st Regt. U.S. Artillery*

*1861*

*1st Regt. U.S. Artillery*

*1861*

*1st Regt. U.S. Artillery*

*1861*

*1st Regt. U.S. Artillery*

U. S. ARMY

*Company Muster Roll*

APPROVED

Company Muster Roll

*1st* *March 1865*

*Company*

*1000*

*1000*

*1000*

*1000*

1000

11

11 H. Art's. U.S.C.T.

Thomas C. Williams

2<sup>d</sup> Lt. Col. F. H. R. U.S.C. & H. Art.

Appears on

Company Muster Roll

for May & June 1865

Present Present

Supplies 1000

Dr. Credits 1000

Value of property \$

Value of property \$

Remains Tol. for stock  
of grain \$200, for S.  
Cakes 50 - Tol. for  
wiper 20c, for  
river 23cts, for  
\$170, Canteen 65cts,

Book mark:.....

*W. C. Williams*  
a/cib



*W.* 11 H. Art'y. **U.S.C.T.**

*Thomas E. Williams*  
*Priv.*, Co. F, 11 Reg't U. S. Col'd H. Art'y.

Appears on

**Company Muster Roll**

for *July & Aug*, 1865.

Present or absent

*Present*

Stoppage, \$ 100 for

Due Gov't, \$ 100 for

Valuation of horse, \$ 100

Valuation of horse equipments, \$ 100

Remarks:

*Prov. for Ordnance  
1.12. for C. & G. Equip-  
age 1.35*

Book mark:

*Leib*  
Copyst.

*N.* 11 H. Art'y. U.S.C.T.

*Thomas E. Williams*  
*Prvt., Co. F., 11 Reg't U. S. Col'd H. Art'y.*

Appears on Co. Muster-out Roll, dated

*New Orleans, La. Oct. 2, 1865.*

Muster-out to date *Oct. 2, 1865.*

Last paid to *June 30, 1865.*

Clothing account:

Last settled \_\_\_\_\_, 1865; drawn since \$ 100

Due soldier \$ 100; due U. S. \$ *16.75* 100

Am't for cloth'g in kind or money adv'd \$ 100

Due U. S. for arms, equipments, &c., \$ *8.92* 100

Bounty paid *None* 100; due \$ *100.00* 100

Remarks:

*Joined at Oran.  
Oran. Stop for mus-  
ket & acc'ts. retained  
for cap box, bagonet  
scabbard, canton, two  
pr. G. Seales lost*

Book mark: *2924, Aug. Apr. 10/66*

*Leib*  
Copyist.

2040

Williams, Wilson

Co *M*, 11 U.S. Col'd H. Art'y.

*Private*      *Private*

CARD NUMBERS.

1		26
2		27
3		28
4		29
5		30
6		31
7		32
8		33
9		34
10		35
11		36
12		37
13		38
14		39
15		40
16		41
17		42
18		43
19		44
20		45
21		46
22		47
23		48
24		49
25		50

Book Mark: 2841-1880

See also



U.S.C.M.

*Handwritten text, possibly a name or title, mostly illegible.*

Company Descriptive Book

DESCRIPTION

*Handwritten entries under the 'DESCRIPTION' section, including names and dates.*

ENLISTMENT

*Handwritten entries under the 'ENLISTMENT' section, including names and dates.*

*Handwritten signature or name at the bottom of the page.*

*211* | **11 H. Art'y. U.S.C.T.**

*Wilson Williams*  
*Co. M, 14 Reg't R. I. Col'd H. Art'y.\**

Age *19* years.

Appears on

**Company Muster-in Roll**

of the organization named above. Roll dated

*Providence, R. I., Jan. 28, 1864.*

Muster-in to date *Jan. 28, 1864.*

Joined for duty and enrolled:

When *Nov. 18*, 186*3*.

Where *Providence, R. I.*

Period *3* years.

Valuation of horse, \$ 100

Valuation of horse equipments, \$ 100

Remarks: *1 Dist. Dist.*

\* This organization subsequently became Co. *M*, 11 Reg't U. S. Colored Heavy Artillery.

Book mark: \_\_\_\_\_

*M* 11 H. Art'y. U.S.C.T.

*Milburn Williams*  
*Pr*, Co. M, 14 Reg't R. I. Col'd H. Art'y.\*

Appears on

**Company Muster Roll**

for *25 Jan to 29 Feb*, 186*4*.

Present of absent *Present*

Stoppage, \$.....100 for.....

Due Gov't, \$.....100 for.....

Valuation of horse, \$.....100

Valuation of horse equipments, \$.....100

Remarks:.....

This organization subsequently became Co. M, 11 Reg't U. S. Colored Heavy Artillery.

Book mark:.....

*J. H. Anderson*  
Copyst.



*M* 11 H. Art'y. U.S.C.T.

*Wilson Williams*  
*Pat*, Co. M, 14 Reg't R. I. Col'd H. Art'y.\*

Appears on

**Company Muster Roll**

for *March + April*, 1864.

Present or absent *Present*

Stoppage, \$.....100 for .....

Due Gov't, \$.....100 for .....

Valuation of horse, \$.....100

Valuation of horse equipments, \$.....100

Remarks: *One daily duty*  
*as Company Cook*

This organization subsequently became Co. M, 11 Reg't U. S. Colored Heavy Artillery.

Book mark: .....

*J. Anderson*  
Copyist.

211 | 11 H. Art'y. | **U.S.C.T.**

*Wilson Williams*  
*Co. 211, 8 Reg't U. S. Col'd H. Art'y.\**

Appears on

**Company Muster Roll**

for *May & June*, 1864.

Present or absent *Present*

Stoppage, \$ 100 for

Due Gov't, \$ 100 for

Valuation of horse, \$ 100

Valuation of horse equipments, \$ 100

Remarks: *See entry*

\* This organization subsequently became Co. 211, 11 Reg't U. S. Colored Heavy Artillery.

Book mark:

211 11 H. Art'y. U.S.C.T.

William Williams  
Sgt., Co. M, 11 Reg't U. S. Col'd H. Art'y.

Appears on

**Company Muster Roll**

for dated Sept. 1, 1864.

Present or absent Present

Stoppage, \$ 100 for

Due Gov't, \$ 100 for

Valuation of horse, \$ 100

Valuation of horse equipments, \$ 100

Remarks: \$ 6 for m. & c. from  
muster roll to Sept. 30/64.  
Free on 14/10/64.

Book mark: \_\_\_\_\_

W. Williams  
Copyist.



711 H. Art'y. U.S.C.T.

Wilson Williams  
Pvt., Co. M, 11 Reg't U. S. Col'd H. Art'y.

Appears on

**Company Muster Roll**

for Sept 1st to Oct 1st, 1864.

Present or absent Present

Stoppage, \$ 100 for

Due Gov't, \$ 100 for

Valuation of horse, \$ 100

Valuation of horse equipments, \$ 100

Remarks:

Book mark:

A. Hubbell

Y. S. ...  
... ..

... ..

... ..  
... ..  
... ..  
... ..  
... ..  
... ..  
... ..  
... ..  
... ..  
... ..

... ..

... ..

710  
11 H. Art'y. **U.S.C.T.**

*Wilson Williams*  
Co. M, 11 Reg't U. S. Col'd H. Art'y.

Appears on

**Company Muster Roll**

for *Jan & Feb*, 1865<sup>a</sup>.

Present or absent *Present*

Stoppage, \$ 100 for

Due Gov't, \$ 100 for

Valuation of horse, \$ 100

Valuation of horse equipments, \$ 100

Remarks: \_\_\_\_\_  
\_\_\_\_\_  
\_\_\_\_\_  
\_\_\_\_\_  
\_\_\_\_\_  
\_\_\_\_\_

Book mark: \_\_\_\_\_

*A. Hubbard*

Copyist.



71- 11. Hally **U.S.C.T**  
Wilson Williams  
Capt. Co. M, 11 Reg't U. S. Col'd *lt col*

Appears on

**Company Muster Roll**

for *March 24*, 1865:

Present or absent *Present*

Stoppage, \$ *100* for

Due Gov't, \$ *100* for

Valuation of horse, \$ *100*

Valuation of horse equipments, \$ *100*

Remarks: \_\_\_\_\_

Book mark: \_\_\_\_\_

*J. H. Bell*  
Copyist.

74

11 H. Art'y. U.S.C.T.

*Wissen Williams*

*Private*, Co. M, 11 Reg't U. S. Col'd H. Art'y.

Appears on

**Company Muster Roll**

for *May 1 June*, 1865.

Present or absent *Present*

Stoppage, \$ *100* for

Due Gov't, \$ *200* for *C & V. Comhaz*

Valuation of horse, \$ *100*

Valuation of horse equipments, \$ *100*

Remarks:

Book mark:

*James H*

7. 11 H. Art'y. U.S.C.T.

William Williams  
Capt., Co. M, 11 Reg't U. S. Col'd H. Art'y.

Appears on

**Company Muster Roll**

for July & Aug, 1865.

Present or absent Present

Stoppage, \$ 100 for

Due Gov't, \$ 200 for W. G. ...

Valuation of horse, \$ 100

Valuation of horse equipments, \$ 100

Remarks:

Book mark:

F. ...  
Copyist.



11 H. Art'y. U.S.C.T.

*William Williams*  
Priv., Co. M, 11 Reg't U. S. Col'd H. Art'y.

Appears on Co. Muster-out Roll, dated  
*New Orleans La, Oct 2, 1865.*

Muster-out to date *Oct 2, 1865.*  
Last paid to *Feb 28, 1865.*

Clothing account:

Last settled....., 186 ; drawn since \$..... 100

Due soldier \$..... 100; due U. S. \$.....  $\frac{15-82}{100}$

Am't for cloth'g in kind or money adv'd \$..... 100

Due U. S. for arms, equipments, &c., \$.....  $\frac{2-00}{100}$

Bounty paid \$..... 100; due \$.....  $\frac{0-12}{100}$

Remarks: *incl. original organiza-*  
*tion. Disb. No. 100. Bar-*  
*ret. Disb. No. 100. & 100. &*  
*accounts retained.*

Book mark: *2871-1880*

*George H.*

*Williams, Wilson*

*P*, Co., *11* Reg't *21st* C *Inf*

**Enclosures.**

Bed Cards .....	Final Statements .....
Burial Records .....	Furloughs or L. of A .....
Certs. of Dis. for Discharge .....	Med. Certificates .....
C. M. Charges .....	Med. Dcs. Lists .....
Descriptive Lists .....	Orders .....
Discharge Certificates .....	Pris. of War Record .....
Enlistment Papers .....	Resignations .....

**Other papers relating to—**

Admission to Hosp'l .....	Furlough or L. of A .....
Casualty Sheet .....	Med. Examination .....
Confinement .....	Misc. Information .....
Contracts .....	Pay or Clothing .....
Death or Effects .....	Personal Reports .....
Desertion .....	Rank .....
Discharge from Hosp'l .....	Transfer to Hosp'l .....
Discharge from Service .....	Transfer to V. R. C. .....
Duty .....	Transportation .....

DECLARATION OF RECRUIT.

I, *Wilson Williams* desiring to VOLUNTEER as a Soldier in the ARMY OF THE UNITED STATES, for the term of *Three years* do declare that I am *19* years and months of age; that I have never been discharged from the United States service on account of disability or by sentence of a court martial, or by order, before the expiration of a term of enlistment; and I know of no impediment to my serving honestly and faithfully as a soldier for *Three years*

Given at *Providence*  
The *18* day of *Nov* 1863

Witness:  
*W. Adams*

*1100. 8. Co. N. C.*

No. *1000*

*Wilson Williams*

Volunteered at *Providence R.I.*

*Nov 18 1863*

By *Major Company*  
*14 Regiment of*

enlistment: last served in Company ( )

Reg't of

Discharged

*13*

CONSENT IN CASE OF MINOR.

I, \_\_\_\_\_ Do CERTIFY that I am the \_\_\_\_\_ of \_\_\_\_\_; that the said \_\_\_\_\_ is \_\_\_\_\_ years of age; and I do hereby freely give my consent to his volunteering as a SOLDIER in the ARMY OF THE UNITED STATES for the period of \_\_\_\_\_

Given at \_\_\_\_\_  
The \_\_\_\_\_ day of \_\_\_\_\_

Witness:



VOLUNTEER ENLISTMENT.

State of Rhode Island



Town of Providence

I, Wilson Williams born in Fredricksburg in the State of Virginia aged 19 years, and by occupation a farmer DO HEREBY ACKNOWLEDGE to have volunteered this 18 day of Nov 1863 to serve as a SOLDIER in the ARMY OF THE UNITED STATES OF AMERICA, for the period of three years, unless sooner discharged by proper authority:

Do also agree to accept such bounty, pay, rations and clothing, as are, or may be, established, by law for volunteers. And I, Wilson Williams do solemnly swear, that I will bear true faith and allegiance to the United States of America, and that I will serve them honestly and faithfully against all their enemies or opposers whomsoever; and that I will observe and obey the orders of the President of the United States, and the orders of the officers appointed over me, according to the Rules and Articles of War.

Sworn and Subscribed to, at Pawtucket this 18th day of Nov 1863.

BEFORE

I CERTIFY, on Honor, That I have carefully examined the above-named Volunteer, agreeable to the General Regulations of the Army, and that, in my opinion, he is free from all bodily defects and mental infirmity, which would, in any way, disqualify him from performing the duties of a soldier.

Johnston Gardner M.D.

EXAMINING SURGEON.

I CERTIFY, on Honor, That I have minutely inspected the Volunteer, previously to his enlistment, and that he was entirely sober when enlisted; that to the best of my judgment and belief, he is of lawful age; and that, in accepting him as duly qualified to perform the duties of an able-bodied soldier, I have strictly observed the Regulations which govern the recruiting service. This soldier has

African complexion, is 35 ft. 9 Black eyes Black hair

14 Regiment of R.I. H.A. Volunteers.

RECRUITING OFFICER.

204

Williamson Abraham H.

Co D, 11 U.S. Col'd H. Art'y.

Private

Private

CARD NUMBERS.

1	6187315	26
2	6187456	27
3	6187604	28
4	6187748	29
5	6187856	30
6	6188010	31
7	6188145	32
8	6188273	33
9	6188390	34
10	6188507	35
11	6188633	36
12	6188760	37
13	6188887	38
14		39
15		40
16		41
17		42
18		43
19		44
20		45
21		46
22		47
23		48
24		49
25		50

Book mark:

N. 154 P. 234. 73. +  
N. 102. N. 106. 73.

See also

*11* | **11 H. Art'y. U.S.C.T.**

*Abraham V. Williamson*  
....., Co. *E*, 11 Reg't U. S. Col'd H. Art'y.

Appears on  
**Company Descriptive Book**  
of the organization named above.

**DESCRIPTION.**

Age *22* years; height *5* feet *6* inches.

Complexion *swk.*

Eyes *swk.*; hair *swk.*

Where born *Ch. Williams, Va.*

Occupation

**ENLISTMENT.**

When *1 p.m. 50*, 186 .

Where *.....*

By whom *William V. ...*; term *5* y'rs.

Remarks:

*A. M. ...*  
Copist.



*11* 11 H. Art'y. U.S.C.T.

*Amos W. ...*

..., Co. ..., 11 Reg't U. S. Col'd H. Art'y.

Appears on  
**Company Descriptive Book**  
of the organization named above.

**DESCRIPTION.**

Age *21* years; height *5* feet *7* inches.

Complexion *dark*.

Eyes *dark*; hair *dark*.

Where born *Colorado*.

Occupation

**ENLISTMENT.**

When *July*, 186*5*.

Where *N. X.*

By whom *A. W. ...*; term *1* y'rs.

Remarks:

*A. J. Markler*  
Coptist.



THE HISTORY OF THE

... ..

CHAPTER I

... ..

... ..

... ..



11 H. Art'y. U.S.C.T.

Abraham Williamson  
Pot., Co. D, 14 Reg't R. I. Col'd H. Art'y.\*

Appears on

Company Muster Roll

for Sept. 22/63 to Feb. 29, 1864.

Present or absent

Stoppage, \$ 100 for

Due Gov't, \$ 100 for

Valuation of horse, \$ 100

Valuation of horse equipments, \$ 100

Remarks: *Provision Store*  
*\$1.29*

\*This organization subsequently became Co. D, 11 Reg't U. S. Col'd Heavy Artillery.

Book mark:

*Loring*

**11 H. Art'y. U.S.C.T.**

*William H. ...*

*Co. +*, 8 Reg't U. S. Col'd H. Art'y.\*

Appears on

**Company Muster Roll**

for *...*, 186*4*.

Present or absent *Present*

Stoppage, \$ *100* for

Due Gov't, \$ *100* for

Valuation of horse, \$ *100*

Valuation of horse equipments, \$ *100*

Remarks: *...*

\*This organization subsequently became Co. *...*, 11 Reg't U. S. Colored Heavy Artillery.

Book mark:

*...*

*M.* | **11 H. Art'y. | U.S.C.T.**

*Abraham Lincoln*  
*No. 1*, Co. *D*, 8 Reg't U. S. Col'd H. Art'y.\*

Appears on

**Company Muster Roll**

for *May & June*, 1864.

Present or absent *Present*

Stoppage, \$ ..... 100 for .....

Due Gov't, \$ ..... 100 for .....

Valuation of horse, \$ ..... 100

Valuation of horse equipments, \$ ..... 100

Remarks: .....

\*This organization subsequently became Co. *D*, 11 Reg't U. S. Colored Heavy Artillery.

Book mark: .....

*M. A. Allen*



*W* | 11 H. Art'y. | **U.S.C.T.**

*Abraham Williamson*  
*For*, Co. D, 11 Reg't U. S. Col'd H. Art'y.

Appears on

**Company Muster Roll**

for *July Aug*, 186*4*

Present or absent *Present*

Stoppage, \$ *2<sup>58</sup>*  $\frac{100}{100}$  for *Ord Stems*  
*& 49/100 for Cr Gr*

Due Gov't, \$  $\frac{100}{100}$  for

Valuation of horse, \$  $\frac{100}{100}$

Valuation of horse equipments, \$  $\frac{100}{100}$

Remarks: *Free apt 19/61*

Book mark:

*Biddle*

*W* | **11 H. Art'y. U.S.C.T.**

*Abraham Williams*  
*Pat*, Co. D, 11 Reg't U. S. Col'd H. Art'y.

Appears on

**Company Muster Roll**

for *Sept & Oct*, 186*4*

Present or absent *Present*

Stoppage, \$ *100* for

Due Gov't, \$ *100* for

Valuation of horse, \$ *100*

Valuation of horse equipments, \$ *100*

Remarks:

Book mark:

*Bridges*

22 | 11 H. Art'y. | U.S.C.T.

Abraham Williams  
Priv., Co. D, 11 Reg't U. S. Col'd H. Art'y.

Appears on

**Company Muster Roll**

for Nov. & Dec., 1864.

Present or absent Present

Stoppage, \$ 100 for

Due Gov't, \$ 100 for

Valuation of horse, \$ 100

Valuation of horse equipments, \$ 100

Remarks:

Book mark:

Progan



*W* 11 II. Art'y. **U.S.C.T.**

*Abraham H. Williamson*  
*Priv.*, Co. D, 11 Reg't U. S. Col'd II. Art'y.

Appears on

**Company Muster Roll**

for *Jan. to Feb.*, 1865.

Present or absent *Present*

Stoppage, \$ 100 for

Due Gov't, \$ 100 for

Valuation of horse, \$ 100

Valuation of horse equipments, \$ 100

Remarks:

Book mark:

*Grogan*

*W*

11 H. Art'y. U.S.C.T.

*Abraham H. Williamson*

*Priv.*, Co. D, 11 Reg't U. S. Col'd H. Art'y.

Appears on

**Company Muster Roll**

for *Mich & April*, 1865.

Present or absent *Present*

Stoppage, \$ ..... 100 for .....

Due Gov't, \$ ..... 100 for .....

Valuation of horse, \$ ..... 100

Valuation of horse equipments, \$ ..... 100

Remarks: .....

Book mark: .....

*Ernest*

*W* 11 II. Art'y. U.S.C.T.

*Abraham Williamson*  
*Privt*, Co. D, 11 Reg't U. S. Col'd II. Art'y.

Appears on

**Company Muster Roll**

for *May & June*, 1865.

Present or absent *Present*

Stoppage, \$ *45* for *ordnance*,  
100

Due Gov't, \$ 100 for

Valuation of horse, \$ 100

Valuation of horse equipments, \$ 100

Remarks:

Book mark:

*C. F. Thompson*  
Copyist.



W | 11 Co. | **U.S.C.T.**

Abraham W. Williamson  
Privt., Co. D, 11 Reg't U. S. Col'd Co. A,

Appears on

**Company Muster Roll**

for July & Aug., 1865.

Present or absent Present.

Stoppage, \$ 45 for ordnance

Due Gov't, \$ 100 for

Valuation of horse, \$ 100

Valuation of horse equipments, \$ 100

Remarks:

Book mark:

C. F. Thompson.

Copyist.

*W* 11 H. Art'y. U.S.C.T.

Abraham Williamson.  
Priv., Co. D, 11 Reg't U. S. Col'd H. Art'y.

Appears on Co. Muster-out Roll, dated  
*New Orleans, La., Oct. 2, 1865.*

Muster-out to date *Oct. 2, 1865.*

Last paid to *Feb. 28, 1865.*

Clothing account:

Last settled....., 186 ; drawn since \$ 100

Due soldier \$ 100; due U. S. \$ *12* <sup>48</sup> 100

Am't for cloth'g in kind or money adv'd \$ 100

Due U. S. for arms, equipments, &c., \$ <sup>55</sup> 100

Bounty paid \$ *now* 100: due \$ *100* 100

Remarks: *Joined at org. org. #*  
*Stop musket & accs, etc. 6.*  
*Screw driver, Tompion, Wiper*  
*2 Letters, Cross Cannon,*  
*2 Sacks and 2 Numbers*  
*lost. Free Apr. 19/61*

Book mark: *V. 154, P. 234, 73* (over)

*C. H. Thompson*

JAN. 15

6188825

#1891#

*W. 102. V. 10. C. 7. 73*

*P. V. 32. P. 53. 75*



*Williamson, Abraham W*  
*P*, Co., *11* Reg't *U.S.C.A.*

**Enclosures.**

Bed Cards .....	Final Statements .....
Burial Records .....	Furloughs or L. of A .....
Certs. of Dis. for Discharge .....	Med. Certificates .....
C. M. Charges .....	Med. Des. Lists .....
Descriptive Lists .....	Orders .....
Discharge Certificates .....	Pris. of War Record .....
Enlistment Papers .....	Resignations .....

**Other papers relating to—**

Admission to Hosp'l .....	Furlough or L. of A .....
Casualty Sheet .....	Med. Examination .....
Confinement .....	Misc. Information .....
Contracts .....	Pay or Clothing .....
Death or Effects .....	Personal Reports .....
Desertion .....	Rank .....
Discharge from Hosp'l .....	Transfer to Hosp'l .....
Discharge from Service .....	Transfer to V. R. C. .....
Duty .....	Transportation .....

DECLARATION OF RECRUIT.

I, *Alvahum W. Williamson* desiring to VOLUNTEER as a Soldier in the ARMY OF THE UNITED STATES, for the term of *three years* do declare that I am *Twenty three* years and months of age; that I have never been discharged from the United States service on account of disability or by sentence of a court martial, or by order, before the expiration of a term of enlistment; and I know of no impediment to my serving honestly and faithfully as a soldier for *three years*

Given at *Proctor* The *10* day of *Sept* 18*63*

Witness: *Res. L. J. Minton Jr*

*Alvahum W. Williamson* of his *William* *Williamson*

Discharged *18*

Ref't of *11 on 8.6.1863*

enlistment; last served in Company ( *100th Regt of I. I. C. H. A.* )

By *J. G. B. King* *Sept 20th 1863*

Volunteered at *Providence, R.I.*

*Alvahum W. Williamson*

CONSENT IN CASE OF MINOR.

I, \_\_\_\_\_ of \_\_\_\_\_ Do CERTIFY that I am the \_\_\_\_\_; that the said \_\_\_\_\_ is \_\_\_\_\_ years of age; and I do hereby freely give my CONSENT to his volunteering as a SOLDIER in the ARMY OF THE UNITED STATES for the period of \_\_\_\_\_

Given at \_\_\_\_\_ The \_\_\_\_\_ day of \_\_\_\_\_

Witness

VOLUNTEER ENLISTMENT.



State of *Rhode Island* Town of *Providence*

I, *Abraham W. Williamson* born in *Camden Co*  
in the State of *New Jersey* aged *Twenty three* years, and by occupation  
a *Merchant* DO HEREBY ACKNOWLEDGE to have volunteered this  
day of *September* 1863 to serve as a SOLDIER in the ARMY OF THE UNITED STATES  
OF AMERICA, for the period of *Three Years*, unless sooner discharged by proper authority:

Do also agree to accept such bounty, pay, rations and clothing, as are, or may be, established, by law for  
volunteers. And I, *Abraham W. Williamson* do solemnly swear, that I will bear  
true faith and allegiance to the *United States of America*, and that I will serve them honestly and faith-  
fully against all their enemies or opposers whomsoever; and that I will observe and obey the orders of the  
President of the United States, and the orders of the officers appointed over me, according to the Rules  
and Articles of War.

Sworn and Subscribed to, at *Prov R I*  
this *2* day of *Sept* 1863  
BEFORE *S. P. Sawyer*

*Abraham W. Williamson*  
mark

I CERTIFY, ON HONOR, That I have carefully examined the above-named Volunteer, agreeable to the General Regulations of  
the Army, and that, in my opinion, he is free from all bodily defects and mental infirmity, which would, in any way, disqualify him  
from performing the duties of a soldier.

*W. B. ...*

EXAMINING SURGEON.

I CERTIFY, ON HONOR, That I have minutely inspected the Volunteer, *Abraham W. Williamson*  
previously to his enlistment, and that he was entirely sober when enlisted; that to the best of my judgment and belief, he is of  
lawful age; and that, in accepting him as duly qualified to perform the duties of an able-bodied soldier, I have strictly observed the  
Regulations which govern the recruiting service. This soldier has *Black* eyes *Black* hair  
*Black* complexion, is *five* feet, *eight* inches high.

*14<sup>th</sup> Regiment of R. I. A. C.*

Volunteers.

RECRUITING OFFICER.



2042

*Williamson Alexander*

Co — , **11 U.S. Col'd H. Art'y**

*Annals*

*Private*

CARD NUMBERS.

1	6181450	26
2	6181644	27
3		28
4		29
5		30
6		31
7		32
8		33
9		34
10		35
11		36
12		37
13		38
14		39
15		40
16		41
17		42
18		43
19		44
20		45
21		46
22		47
23		48
24		49
25		50

Book Mark: \_\_\_\_\_

See also \_\_\_\_\_

D 182725503  
m. 8 363586  
J. 2705586 P 5277  
J. 2742333 P 5277

John Miller Co

000961

W. H. City U.S.C.T.

Abner Williamson

Bid., Co., 11 Reg't U. S. Col'd H. City

Appears on an

**Individual Muster-out Roll**

of the organization named above. Roll dated

Amira, 14, May 9, 1865.

Muster-out to date May 9, 1865.

Last paid to 186 .  
One day from enlistment

**Clothing account:**

Last settled . . . 186 . ; drawn since \$ . . . 100

Due soldier \$ . . . 100; due U. S. \$ 27 <sup>18</sup>/<sub>100</sub>

Am't for cloth'g in kind or money adv'd \$ 62 <sup>50</sup>/<sub>100</sub>

Due U. S. for arms, equipments, &c. \$ . . . 100

Bounty paid \$ 100 <sup>00</sup>/<sub>100</sub> due \$ . . . 100

Remarks: Discharged by special  
order of the Secy of War dated  
April 30 1865. This man never  
joined his regiment. Amount  
of bounty was not disbursed by  
War Dept. Add. 200 of his amount  
(over)

Book mark

(348) J. D. Jones Copyist.



*H*

11 H. Art'y. U.S.C.T.

*William Williamson*

Appears with rank of *1st Lt* on

**Muster and Descriptive Roll of a Detachment of U. S. Vols. forwarded**

for the *11* Reg't *H. Art'y.* Roll dated

*Cincinnati, May 27 1864.*

Where born *Phila. Pa.*

Age *20* yrs; occupation *Laborer*

When enlisted *Aug 26*, 186 *4*

Where enlisted *Staten N.Y.*

For what period enlisted *5* years.

Eyes *blk*; hair *blk*

Complexion *blk*; height *5* ft. *5* in.

When mustered in *Aug 26*, 186 *4*

Where mustered in *Staten N.Y.*

Bounty paid \$ *100* 100; due \$ *200* 100

Where credited *Staten 21 Cong.*

*Dist.*  
Company to which assigned

Remarks: *This man never*

*joined his Regt. Mustered*  
*out of the Service of the*

Book mark: *one*

*William Williamson*

1000

1000

1000

1000

1000

1000

1000

1871

6181450

1871

*Handwritten text, possibly a signature or name, appearing as a faint scribble.*



Williamson, Wm.

Sold, Co. 11 U.S.C.H.A. Reg't

3 Enclosures.

Bed Cards	Descriptive Lists
Burial Records	Final Statements
Certs. of Dis. for Discharge	Furloughs
C. M. Charges	Med. Des. Lists
Med. Certificates	Orders

Cent. ppw

2

Other papers relating to—

Admission to Hosp'l	Furlough
Casualty Sheet (Officer's)	Med. Examination
Confinement	Misc. Information
Contracts	Pay or Clothing
Death or Effects	Personal Reports
Desertions	Rank
Discharge from Hosp'l	Transfer to Hosp'l
Discharge from Service	Transfer to V. R. C.
Duty	Transportation

NOTE 1.—This blank will be used for both enlistments and re-enlistments—enlistment of veterans, &c., &c., in the volunteer service. They will be made out in duplicate in all cases—one to accompany the recruiting return of the superintendent (not the recruiting officer) to the Adjutant General, and one to accompany the accounts of the officer who pays bounty, &c. The Regiment and Company in which the soldier last served should be given on the back.

NOTE 2.—An enlistment holds to service. A muster-in must, in all cases, precede payment of pay, bounty, pension, &c. A muster-in roll must, in all cases, be filed in the Adjutant General's Office as evidence of muster-in. The mustering officer, commissary, or assistant commissary of musters, as the case may be, will countersign both enlistments as having mustered the soldier into the service of the United States before either of them is given to the disbursing officer.

DECLARATION OF RECRUIT.

I, Herbert Williamson desiring to VOLUNTEER as a Soldier in the Army of the United States, for the term of THREE YEARS. Do Declare, That I am 21 years and \_\_\_\_\_ months of age; that I have never been discharged from the United States service on account of disability or by sentence of a court martial, or by order before the expiration of a term of enlistment; and I know of no impediment to my serving honestly and faithfully as a soldier for three years.

GIVEN at Albion the 26<sup>th</sup> day of August 1862

Witness: William Lewis

Herbert Williamson  
must

Discharged \_\_\_\_\_ 18 \_\_\_\_\_  
enlistment: last served in Company ( )  
Reg't of \_\_\_\_\_

Volunteered at Albion, N.Y.  
By William Lewis 1862  
Regiment of N.Y. 8 Vols.

No. 107 / 19

CONSENT IN CASE OF MINOR.

I, \_\_\_\_\_ Do CERTIFY, That I am the \_\_\_\_\_ of \_\_\_\_\_; that the said \_\_\_\_\_ is \_\_\_\_\_ years of age; and I do hereby freely give my CONSENT to his volunteering as a SOLDIER in the ARMY OF THE UNITED STATES for the period of THREE YEARS.

GIVEN at \_\_\_\_\_ the \_\_\_\_\_ day of \_\_\_\_\_

Witness: \_\_\_\_\_

VOLUNTEER ENLISTMENT.

STATE OF

TOWN OF

*New York*

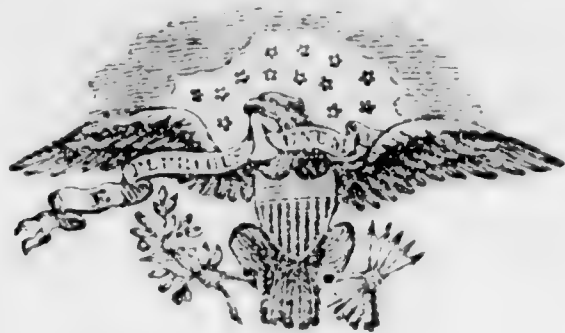

*Staten*

I, *Alexander Williamson* born in *Philadelphia*  
in the State of *Penn* aged *30* years,  
and by occupation a *carver* Do HEREBY ACKNOWLEDGE to have  
volunteered this *26* day of *August* 186*4*  
to serve as a **Soldier** in the **Army of the United States of America**, for  
the period of **THREE YEARS**, unless sooner discharged by proper authority:  
Do also agree to accept such bounty, pay, rations, and clothing, as are, or may be,  
established by law for volunteers. And I, *Alexander Williamson* do  
solemnly swear, that I will bear true faith and allegiance to the **United States  
of America**, and that I will serve them honestly and faithfully against all  
their enemies or opposers whomsoever; and that I will observe and obey the  
orders of the President of the United States, and the orders of the officers  
appointed over me, according to the Rules and Articles of War.

Sworn and subscribed to, at *Utica*  
this *24* day of *August* 186*4* *Alexander Williamson*  
BEFORE *Mellicam Lewis* *Mark*

I CERTIFY, ON HONOR, That I have carefully examined the above-named Volunteer, agreeably  
to the General Regulations of the Army, and that, in my opinion, he is free from all bodily defects and  
mental infirmity, which would in any way disqualify him from performing the duties of a soldier.

*W. A. Baird*  
Surgeon of the Board  
EXAMINING SURGEON.

I CERTIFY, ON HONOR, That I have minutely inspected the Volunteer, *Alexander Williamson*  
previously to his enlistment, and that he was entirely sober when enlisted; that, to the best of my  
judgment and belief, he is of lawful age; and that, in accepting him as duly qualified to perform the  
duties of an able-bodied soldier, I have strictly observed the Regulations which govern the recruiting  
service. This soldier has *Blue* eyes, *Black* hair, *Black* complexion, is *5*  
feet *6* inches high.

*Mellicam Lewis*  
*Colored 7th U.S. Regt of N.Y. Vol.*  
RECRUITING OFFICER.

(A. G. O. No. 71 & 76.)

Enlisted to U.S. Bounty

Mustered into the service of the United States, for three years or during the war, from date of enlistment, in Company  
*Colored* Regiment of *N.Y.* Volunteers, on the *26* day of *August* 1864 at *Utica* for *238* soldiers

*W. A. Baird*  
*Surgeon of the Board*  
*Examining Surgeon*



NOTE 1.—This blank will be used for both enlistments and re-enlistments—enlistment of veterans, &c., &c., in the volunteer service. They will be made out in duplicate in all cases—one to accompany the recruiting return of the superintendent (not the recruiting officer) to the Adjutant General, and one to accompany the accounts of the officer who pays bounty, &c. The Regiment and Company in which the soldier last served should be given on the back.

NOTE 2.—An enlistment holds to service. A muster-in must, in all cases, precede payment of pay, bounty, pension, &c. A muster-in roll must, in all cases, be filed in the Adjutant General's Office as evidence of muster-in. The mustering officer, commissary, or assistant commissary of musters, as the case may be, will countersign both enlistments as having mustered the soldier into the service of the United States before either of them is given to the disbursing officer.

DECLARATION OF RECRUIT.

I, Alexander Williamson desiring to VOLUNTEER as a Soldier in the Army of the United States, for the term of THREE YEARS. Do Declare, That I am 24 years and \_\_\_\_\_ months of age; that I have never been discharged from the United States service on account of disability or by sentence of a court martial, or by order before the expiration of a term of enlistment; and I know of no impediment to my serving honestly and faithfully as a soldier for three years.

GIVEN at Office the 24 day of August 1864

Witness: William Lewis Alexander Williamson

Addressed to 11 Regt R. I. Minors  
Capt. H. Brooks's Regiment to re-enlistment  
from A. G. O. Washington D. C. March 15/65

Discharged \_\_\_\_\_ 18 \_\_\_\_\_

Regt of \_\_\_\_\_

enlistment: last served in Company ( )

Volunteered at Shelburne  
24 August 1864  
By William Lewis  
Regiment of 11th Regt R. I. Minors  
Capt. H. Brooks M. G. Col.

Alexander Williamson  
No. \_\_\_\_\_

CONSENT IN CASE OF MINOR.

I, \_\_\_\_\_ Do CERTIFY, That I am \_\_\_\_\_; that the \_\_\_\_\_ of \_\_\_\_\_ is \_\_\_\_\_ years of age; and I do hereby freely give my CONSENT to his volunteering as a SOLDIER in the ARMY OF THE UNITED STATES for the period of THREE YEARS.

GIVEN at \_\_\_\_\_ the \_\_\_\_\_ day of \_\_\_\_\_

Witness: \_\_\_\_\_

VOLUNTEER ENLISTMENT.

STATE OF

TOWN OF

*Ill. Ill.*

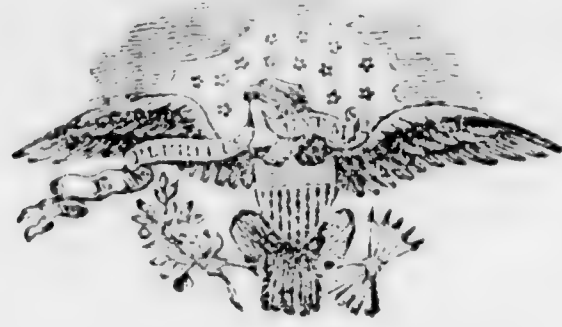

*St. Louis*

I, *Alexander Williams* born in *Ill. Ill.*

in the State of *Ill. Ill.* aged *20* years,

and by occupation a *Labourer* Do HEREBY ACKNOWLEDGE to have

volunteered this *27* day of *August* 186*4*,

to serve as a **Soldier** in the **Army of the United States of America**, for

the period of **THREE YEARS**, unless sooner discharged by proper authority:

Do also agree to accept such bounty, pay, rations, and clothing, as are, or may be,

established by law for volunteers. And I, *Alexander Williams* do

solemnly swear, that I will bear true faith and allegiance to the **United States**

**of America**, and that I will serve them honestly and faithfully against all

their enemies or opposers whomsoever; and that I will observe and obey the

orders of the President of the United States, and the orders of the officers

appointed over me, according to the Rules and Articles of War.

Sworn and subscribed to, at *St. Louis* this *26<sup>th</sup>* day of *August* 186*4* BEFORE *William Lewis* *Alexander Williams*

I CERTIFY, ON HONOR, That I have carefully examined the above-named Volunteer, agreeably to the General Regulations of the Army, and that, in my opinion, he is free from all bodily defects and mental infirmity, which would in any way disqualify him from performing the duties of a soldier.

*W. A. Babcock*  
Surgeon of the Board  
EXAMINING SURGEON.

I CERTIFY, ON HONOR, That I have minutely inspected the Volunteer *A. Williams* previously to his enlistment, and that he was entirely sober when enlisted; that, to the best of my judgment and belief, he is of lawful age; and that, in accepting him as duly qualified to perform the duties of an able-bodied soldier, I have strictly observed the Regulations which govern the recruiting service. This soldier has *Black eyes*, *Black hair*, *Black* complexion, is *5* feet *5* inches high.

*William Lewis*  
*Colored* *7th* Regiment of *Ill. Ill.* Volunteers.  
RECRUITING OFFICER.

(A. G. O. No. 71 & 76.)

*Entitled to the U. S. Bounty*

Mustered into the service of the United States, for three years or during the war, from date of enlistment, in Company *B*, Regiment of *Ill. Ill.* Volunteers, on the *26* day of *August*, 186*4*, at *St. Louis*

*J. P. Richardson*  
1st and 2nd Mo. Dragoon  
Mustering Officer



a-a-131 Dept Miss 1865  
resurrection March 4 1865

Head Quarters, Department of the Gulf,  
New Orleans, Louisiana.  
Respectfully transmitted.  
By Command of Major General Sherman:  
J. H. A. Assistant Adjutant General.

1169  
HEADQUARTERS, SOUTHERN DIV. LOUISIANA,  
New Orleans, April 17 1865.  
Respectfully transmitted.  
By Command of Major General Sherman:  
J. H. A. Assistant Adjutant General.

Adjutant General's Office  
4 Bay Road  
New Orleans

M. J. Shea

Approved  
A. 230. 24. 1865  
Head Quarters,  
Dept. of the Gulf  
New Orleans, April 16 1865  
Respectfully referred to  
the Command of the 11th U.S.  
Sold. Artillery, New Orleans.  
By Command of  
Major General Sherman:  
J. H. A.  
Assistant Adjutant General.  
Res Hd Qrs 24 April 1865

Received at Dept. of the Gulf  
New Orleans at Dept. of the Gulf  
J. H. A. assigned to the 11th U.S.  
Artillery.



War Department,

ADJUTANT GENERAL'S OFFICE,

Washington, *Apr 11 1865.*

*(Faint handwritten text, possibly a name and address)*

*(Faint handwritten text, possibly a letter body)*

*(Faint handwritten text, possibly a signature or closing)*

*(Faint handwritten text, possibly a name)*

*(Faint handwritten text, possibly a name)*

000972

2043

Williamson David H.  
Co. *L*, 11 U.S. Col'd H. Art'y.

*Private*

*Private*

CARD NUMBERS.

1	6 2 9 8 5 3 5	26
2	6 2 9 8 5 5 4	27
3	6 2 0 0 0 0	28
4	6 2 0 0 0 2	29
5	6 2 0 0 3 1	30
6	6 2 0 0 4 2	31
7	6 2 0 0 2 0	32
8	6 2 0 0 3 7 2	33
9	6 2 0 0 7 2 0	34
10	6 2 0 0 8 7 0	35
11	6 2 0 0 9 2 2	36
12	6 2 0 0 0 8 8	37
13		38
14		39
15		40
16		41
17		42
18		43
19		44
20		45
21		46
22		47
23		48
24		49
25		50

Book Mark:

See also

*M* 11 H. Art'y. U.S.C.T.

*David D Williamson*

, Co. , 11 Reg't U. S. Col'd H. Art'y.

Appears on

**Company Descriptive Book**

of the organization named above.

**DESCRIPTION.**

Age *19* years; height *5* feet *8½* inches.

Complexion *Mulatto*

Eyes *Blue*; hair *Light*

Where born *Zanesville Ohio*

Occupation *Magician*

**ENLISTMENT.**

When *Dec 21*, 186*3*.

Where *Providence*

By whom *J. B. Eughy*; term *3* y'rs.

Remarks: *Appointed Corporal  
Dec 31, 1863 by order of Lt Col  
Nelson Viall Comdr Regt  
Mustered out Dec 2, 1865*

*J. B. Eughy*

Copist.



*M.* | **11 H. Art'y. U.S.C.T.**

*David S. Williamson*  
*Priv.*, Co. *L*, 14 Reg't R. I. Col'd H. Art'y.\*

Age *19* years.

Appears on

**Company Muster-in Roll**

of the organization named above. Roll dated

*Sept. 11, 1863*, 1863.

Muster-in to date *Sept. 21, 1863*.

Joined for duty and enrolled:

When *Sept. 21*, 1863.

Where *Prov. N.Y.*

Period *5* years.

Valuation of horse, \$ 100

Valuation of horse equipments, \$ 100

Remarks: *See above*  
*Prov. N.Y.*

\* This organization subsequently became Co. *L*, 11 Reg't U. S. Colored Heavy Artillery.

Book mark: \_\_\_\_\_

*W. M. M.*

*M*

**11 H. Art'y. U.S.C.T.**

*David M. Williamson*  
*Corpl*, Co. L, 14 Reg't R. I. Col'd H. Art'y.\*

Appears on

**Company Muster Roll**

for *Jan & Feb*, 1864.

Present or absent *Present*

Stoppage, \$ *100* for

Due Gov't, \$ *100* for

Valuation of horse, \$ *100*

Valuation of horse equipments, \$ *100*

Remarks: *Appointed Corpl*  
*Nov 31 - 1863 by order of*  
*M. Col. Nelson Dill*

\* This organization subsequently became Co. L, 11 Reg't U. S. Colored Heavy Artillery.

Book mark :

*J. B. Edwards*  
Copyist.

*H.* | **11 H. Art'y. U.S.C.T.**

*David S. Williamson*  
*Capt*, Co. L, 14 Reg't R. I. Col'd H. Art'y.\*

Appears on

**Company Muster Roll**

for *Mar, & Apr*, 186*4*.

Present or absent *Present*

Stoppage, \$ *100* for

Due Gov't, \$ *100* for

Valuation of horse, \$ *100*

Valuation of horse equipments, \$ *100*

Remarks: *Approved Capt*  
*Lieut. Col. by order of*  
*Lt. Col. Nelson Hall*

\* This organization subsequently became Co. L, 11 Reg't U. S. Colored Heavy Artillery.

Book mark :

*W. Manning*



*W*

**11 H. Art'y. U.S.C.T.**

*David M. Williamson*  
Capt, Co. *L*, 8 Reg't U. S. Col'd H. Art'y.\*

Appears on

**Company Muster Roll**

for *May & June*, 186*4*

Present or absent *Present*

Stoppage, \$ ..... 100 for .....

Due Gov't, \$ ..... 100 for .....

Valuation of horse, \$ ..... 100

Valuation of horse equipments, \$ ..... 100

Remarks: *On daily duty at  
Post Hd Qrs*

\*This organization subsequently became Co. *L*, 11 Reg't U. S. Colored Heavy Artillery.

Book mark: .....

*D. G. Edwards*  
Coyust.

*21* 11 H. Art'y. U.S.C.T.

*David S. Williamson*  
Coop, Co. L, 11 Reg't U. S. Col'd H. Art'y.

Appears on

**Company Muster Roll**

for *July & Aug*, 186*4*.

Present or absent *Present*

Stoppage, \$..... 100 for .....

Due Gov't, \$..... 100 for .....

Valuation of horse, \$..... 100

Valuation of horse equipments, \$..... 100

Remarks: *C. Spec. with horse  
pay due to a certain date  
to Apr. 30, 186*4*  
Free Apr. 19, 186*1**

Book mark: .....

*Maerby*

U.

11 H. Art'y. U.S.C.T.

David W. Williamson  
Corpl., Co. L, 11 Reg't U. S. Col'd H. Art'y.

Appears on

Company Muster Roll

for Sept. & Oct., 1864.

Present or absent present.

Stoppage, \$ 100 for

Due Gov't, \$ 100 for

Valuation of horse, \$ 100

Valuation of horse equipments, \$ 100

Remarks: Appointed by  
order of Lt. Col. Viall,  
Dec. 31/63.

\$6.00 per month back pay  
due from enlistment to  
April 30/64.

Free on April 19/61.

Book mark:

Baker  
Copyist.



W. 11 H. Art'y. U.S.C.T.

David D. Williamson.

Corpl., Co. L, 11 Reg't U.S. Col'd H. Art'y.

Appears on

Company Muster Roll

for Nov. & Dec., 1864

Present or absent present.

Stoppage, \$ - 45/100 for *ordnance*

Due Gov't, \$ 100 for

Valuation of horse, \$ 100

Valuation of horse equipments, \$ 100

Remarks: *Appointed Corporal by order of Lt. Col. Viall, Dec. 31/63.*

Book mark:

*Baker*  
Copyist.

*W.* 11 H. Art'y. **U.S.C.T.**

*David D. Williamson.*  
*Sgt.*, Co. L, 11 Reg't U. S. Col'd H. Art'y.

Appears on

**Company Muster Roll**

for *Jan & Feb.*, 1865.

Present or absent *present.*

Stoppage, \$ *-* <sup>*45*</sup> 100 for *insurance*

Due Gov't, \$ 100 for

Valuation of horse, \$ 100

Valuation of horse equipments, \$ 100

Remarks: \_\_\_\_\_  
\_\_\_\_\_  
\_\_\_\_\_  
\_\_\_\_\_  
\_\_\_\_\_  
\_\_\_\_\_  
\_\_\_\_\_

Book mark: \_\_\_\_\_

*Faker,*  
Copyist.

*W.* 11 H. Art'y. U.S.C.T.

*David W. Williamson.*  
Corpl, Co. L, 11 Reg't U. S. Col'd II. Art'y.

Appears on

**Company Muster Roll**

for *March & April*, 1867.

Present or absent *present.*

Stoppage, \$ *—* <sup>45</sup>/<sub>100</sub> for *ordnance*

Due Gov't, \$ *—* 100 for *—*

Valuation of horse, \$ *—* 100

Valuation of horse equipments, \$ *—* 100

Remarks: *—*

Book mark: *—*

*Faker,*  
Copyist.



*W* 11 H. Art'y. **U.S.C.T.**

*David D. Williamson*

*Capt.*, Co. L, 11 Reg't U. S. Col'd H. Art'y.

Appears on

**Company Muster Roll**

for *May & June*, 1865.

Present or absent *Present*

Stoppage, \$ *100* for

Due Gov't, \$ *100* for

Valuation of horse, \$ *100*

Valuation of horse equipments, \$ *100*

Remarks:

Book mark:

*Murphy*

*W* 11 H. Art'y. U.S.C.T.

*David H. Williamson*

*Capt.*, Co. L, 11 Reg't U. S. Col'd H. Art'y.

Appears on

**Company Muster Roll**

for *July & Aug*, 1865.

Present or absent: *Present*

Stoppage, \$.....100 for .....

Due Gov't, \$.....100 for .....

Valuation of horse, \$.....100

Valuation of horse equipments, \$.....100

Remarks: .....

Book mark: .....

*Murphy*

11 H. Art'y. U.S.C.T.

David Williamson  
Capt., Co. L, 11 Reg't U. S. Col'd H. Art'y.

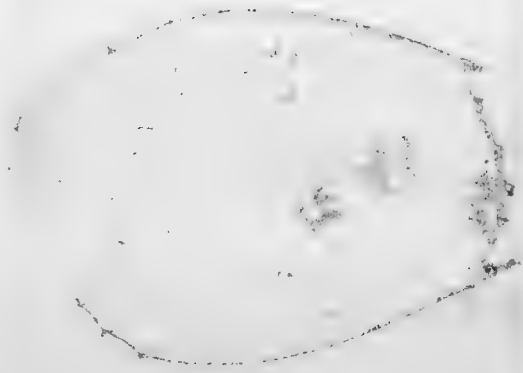

Appears on Co. Muster-out Roll, dated

November 1st, 1861

Muster-out to date Oct, 1861

Last paid to Feb 15, 1862

Clothing account:

Last settled, 1861; drawn since \$ 100

Due soldier \$ 100; due U. S. \$ 20 100

Am't for cloth'g in kind or money adv'd \$ 100

Due U. S. for arms, equipments, &c., \$ 100

Bounty paid \$ 100; due \$ 100 100

Remarks: Joined at regt organ.  
Credite to Acc. 1/65 Stoppage  
expenses & acct's claimed  
\$ 6.00

Book mark:

Murphy



*Williamson, David L.*  
*I*, Co., *11* Reg't *U.S.C.A.*

**Enclosures.**

Bed Cards .....	Final Statements .....
Burial Records .....	Furloughs or L. of A. ....
Certs. of Dis. for Discharge .....	Med. Certificates .....
C. M. Charges .....	Med. Des. Lists .....
Descriptive Lists .....	Orders .....
Discharge Certificates .....	Pris. of War Record .....
Enlistment Papers .....	Resignations .....

**Other papers relating to—**

Admission to Hosp'l .....	Furlough or L. of A. ....
Casualty Sheet .....	Med. Examination .....
Confinement .....	Misc. Information .....
Contracts .....	Pay or Clothing .....
Death or Effects .....	Personal Reports .....
Desertion .....	Rank .....
Discharge from Hosp'l .....	Transfer to Hosp'l .....
Discharge from Service .....	Transfer to V. R. C. ....
Duty .....	Transportation .....

DECLARATION OF RECRUIT.

*David G. Williamson*  
THE UNITED STATES, for the term of *years*  
months of age; that I have never been discharged from the United States service on account of disability  
by sentence of a court martial, or by order, before the expiration of a term of enlistment; and I know of no impediment to my  
serving honestly and faithfully as a soldier for *years*

Given at

The

*Providence*  
*21* day of *July* 186*5*

Witness:

*Witness*

*David G. Williamson*

Discharged

Regt of

enlistment: last served in Company

*11 Co. 8. E. N. D.*

*14 Regiment of Artillery*

*By: William H. England*

*Dec 21 1865*

Enlistment at *Providence*

*David G. Williamson*

No. *150*

CONSENT IN CASE OF MINOR.

Do CERTIFY that I am the

that the said

years of age; and I do hereby freely give

CONSENT to his volunteering as a Soldier in the ARMY OF THE UNITED STATES for the period of

Given at

The

day of

Witness:

VOLUNTEER ENLISTMENT.



State of

Town of

I, *David S. Williamson*

born in *France*

in the State of *Ohio*

aged *19*

years, and by occupation

a *Wagoner*

DO HEREBY ACKNOWLEDGE to have volunteered this *1st*

day of *Dec*

*1862*

to serve as a SOLDIER in the ARMY OF THE UNITED STATES

OF AMERICA, for the period of *3 years*

, unless sooner discharged by proper authority:

Do also agree to accept such bounty, pay, rations and clothing, as are, or may be, established, by law for

volunteers. And I, *David S. Williamson*

do solemnly swear, that I will bear true faith and allegiance to the *United States of America*, and that I will serve them honestly and faithfully

against all their enemies or opposers whomsoever; and that I will observe and obey the orders of the

President of the United States, and the orders of the officers appointed over me, according to the Rules

and Articles of War.

Sworn and Subscribed to, at *Proctor*

this *1st* day of *Dec* *1862*

BEFORE *Johnston Gardner*

I CERTIFY, ON HONOR, That I have carefully examined the above-named Volunteer, agreeable to the General Regulations of the Army, and that, in my opinion, he is free from all bodily defects and mental infirmity, which would, in any way, disqualify him from performing the duties of a soldier.

*Johnston Gardner*

EXAMINING SERGEON.

I CERTIFY, ON HONOR, That I have minutely inspected the Volunteer, *David S. Williamson* previously to his enlistment, and that he was entirely sober when enlisted; that to the best of my judgment and belief, he is of lawful age; and that, in accepting him as duly qualified to perform the duties of an able-bodied soldier, I have strictly observed the Regulations which govern the recruiting service. This soldier has

complexion, is *5* feet, *6* inches high.

*Johnston Gardner*

Regiment of *Artillery*

Volunteers.

RECRUITING OFFICER.



2044

*Williamson Thomas*  
**Co *D*, 11 U.S. Col'd H. Art'y.**

*Private*

*Private*

CARD NUMBERS.

1	<i>6750817</i>	26	
2	<i>6750818</i>	27	
3	<i>6750819</i>	28	
4	<i>6750820</i>	29	
5	<i>6750821</i>	30	
6		31	
7		32	
8		33	
9		34	
10		35	
11		36	
12		37	
13		38	
14		39	
15		40	
16		41	
17		42	
18		43	
19		44	
20		45	
21		46	
22		47	
23		48	
24		49	
25		50	

Book Mark:

*72*

*Q. 10 @ .166 79. 1138. P. 107*

See also

11 H. Art'y. U.S.C.T.

*James H. ...*  
Co. *F*, 11 Reg't U. S. Col'd H. Art'y.

Appears on

**Company Descriptive Book**

of the organization named above.

**DESCRIPTION.**

Age *27* years; height *5* feet *7* inches.

Complexion *fair*

Eyes *blue*; hair *brn*

Where born *Massachusetts*

Occupation *Farmer*

**ENLISTMENT.**

When *Oct 10*, 186*5*.

Where *Massachusetts*

By whom *W. ...*; term *5* y'rs.

Remarks: *Discharged ...*  
*at ... Co. ... 1866*  
*of ...*  
*... Co. ... 1866*  
*... death ...*  
*April 9, 1866.*

*C. ...*  
Copyist.

72 | **11 H. Art'y. U.S.C.T.**

Thomas Williamson  
Co. F, Co. F, 14 Reg't R. I. Col'd H. Art'y.\*

Age 17 years.

Appears on

**Company Muster-in Roll**

of the organization named above. Roll dated

Providence R.I. Oct 20, 1863.

Muster-in to date

Oct 20, 1863.

Joined for duty and enrolled:

When Oct 16, 1863.

Where Providence R.I.

Period 3 years.

Valuation of horse, \$ 100

Valuation of horse equipments, \$ 100

Remarks:

\* This organization subsequently became Co. F 11 Reg't U. S. Colored Heavy Artillery.

Book mark: \_\_\_\_\_

J. Neal



*H* 11 H. Art'y. U.S.C.T.

*Thomas Williamson*  
Sgt., Co. F, 14 Reg't R. I. Col'd H. Art'y.\*

Appears on

**Company Muster Roll**

for *Oct 22 to Dec 31, 1863*

Present or absent *Present*

Stoppage, \$ 100 for

Due Gov't, \$ 100 for

Valuation of horse, \$ 100

Valuation of horse equipments, \$ 100

Remarks:

\* This organization subsequently became Co. F, 11 Reg't U. S. Colored Heavy Artillery.

Book mark:

*A Neal*

*A* 11 H. Art'y. U.S.C.T.

*Thomas Williamson*  
Co. F, 14 Reg't R. I. Col'd H. Art'y.\*

Appears on

Company Muster Roll  
for *Jan + Feb*, 1864  
Present or absent *Present*  
Stoppage, \$ 100 for

Due Gov't, \$ 100 for

Valuation of horse, \$ 100

Valuation of horse equipments, \$ 100

Remarks:

\* This organization subsequently became Co. F, 11 Reg't U. S. Colored Heavy Artillery.

Book mark:

*A Trial*  
(358) Copyist.

*21* 11 H. Art'y. U.S.C.T.

*Thomas Williamson*  
Pri, Co. F, 14 Reg't R. I. Col'd H. Art'y.\*

Appears on

**Company Muster Roll**

for *Mar & Apr*, 1864.

Present or absent.....

Stoppage, \$.....100 for.....

Due Gov't, \$.....100 for.....

Valuation of horse, \$.....100

Valuation of horse equipments, \$.....100

Remarks: *Died April 2,*  
*1864 at New Orleans,*  
*La, of phthisis.*

\* This organization subsequently became Co. F. 11 Reg't U. S. Colored Heavy Artillery.

Book mark *P. O. P. 166, 64,*

*W. Neal*



*M.* 11 H. Art'y. U.S.C.T.

*Thomas Williamson*  
Bt., Co. *F*, 11 Reg't U. S. Col'd H. Art'y.

Appears on Co. Muster-out Roll, dated  
*New Orleans La. Oct. 2, 1865.*

Muster-out to date \_\_\_\_\_, 186\_\_\_\_  
Last paid to *Pay due from Enrollment.* 186\_\_\_\_

Clothing account:

Last settled \_\_\_\_\_, 186\_\_\_\_; drawn since \$ 100

Due soldier \$ 100; due U. S. \$ 100

Am't for cloth'g in kind or money adv'd \$ 100

Due U. S. for arms, equipments, &c., \$ 100

Bounty paid \$ 100; due \$ 100

Remarks: *Joined at Orgnl.  
Orgn. Died in Gen. Hos-  
pital at New Orleans  
La. Apr. 2, 64 of Phthisis  
Mr. & H. Stat. given.*

Book mark *P.V. 10 P/66. 79V/38P/07 72*

*Leib*  
Coryist.

Williamson Thomas

, Co.

Reg't

U. S. C. I.

**Enclosures.**

Bed Cards	Final Statements
Burial Records	Furloughs or L. of A.
Certs. of Dis. for Discharge	Med. Certificates
C. M. Charges	Med. Des. Lists
Descriptive Lists	Orders
Discharge Certificates	Pris. of War Record
Enlistment Papers	Resignations

Other papers relating to—

Admission to Hosp'l	Furlough or L. of A.
Casualty Sheet	Med. Examination
Confinement	Misc. Information
Contracts	Pay or Clothing
Death or Effects	Personal Reports
Desertion	Rank
Discharge from Hosp'l	Transfer to Hosp'l
Discharge from Service	Transfer to V. R. C.
Duty	Transportation

*W. H. ...*

*... Co.*

U. S. C. H. A.  
Regt.

**Enclosures.**

- |                              |                    |
|------------------------------|--------------------|
| Bed Cards                    | Descriptive Lists  |
| Burial Records /             | Final Statements ✓ |
| Certs. of Dis. for Discharge | Furloughs          |
| C. M. Charges                | Med. Des. Lists    |
| Med. Certificates            | Orders             |

Other papers relating to—

- |                            |                      |
|----------------------------|----------------------|
| Admission to Hosp'l        | Furlough             |
| Casualty Sheet (Officer's) | Med. Examination     |
| Confinement                | Misc. Information    |
| Contracts                  | Pay or Clothing      |
| Death or Effects ✓         | Personal Reports     |
| Descriptions               | Rank                 |
| Discharge from Hosp'l      | Transfer to Hosp'l   |
| Discharge from Service     | Transfer to V. R. C. |
| Duty                       | Transportation       |



MICROFILM PUBLICATION M 1832

COMPILED MILITARY SERVICE RECORDS  
OF VOLUNTEER UNION SOLDIERS WHO SERVED WITH  
THE UNITED STATES COLORED TROOPS (USCT)  
11TH REGIMENT OF HEAVY ARTILLERY

PERSONAL PAPERS' TARGET SHEET

PLEASE NOTE THE CHECKED INFORMATION ABOUT THE PERSONAL PAPERS IN  
THIS FILE:

- NO PERSONAL PAPERS WERE FOUND IN THIS FILE WHEN THE  
RECORDS WERE ARRANGED FOR MICROFILMING.
- 7 PERSONAL PAPER(S) FOUND IN THIS FILE WHEN THE RECORDS  
WERE ARRANGED FOR MICROFILMING.

DECLARATION OF RECRUIT.

I, *Private William Sum* desiring to VOLUNTEER as a Soldier in the ARMY OF THE UNITED STATES, for the term of *Three Years* do declare that I am *19* years and *16* months of age; that I have never been discharged from the United States service on account of disability or by sentence of a court martial, or by order, before the expiration of a term of enlistment; and I know of no impediment to my serving honestly and faithfully as a soldier for *Three Years*

Given at *River Rd*  
The *16* day of *Nov*

Witness:  
*J. M. ...*

*Private William Sum*

Discharged

Reg't of

enlistment; last served in Company ( )

By

Volunteered at

*James Williamson*  
No. *1*

*Oct 15 - 1863*

Regiment of

CONSENT IN CASE OF MINOR.

I, \_\_\_\_\_ of \_\_\_\_\_ is \_\_\_\_\_ years of age; and I do hereby freely give my CONSENT to his volunteering as a SOLDIER in the ARMY OF THE UNITED STATES for the period of \_\_\_\_\_

Given at \_\_\_\_\_  
The \_\_\_\_\_ day of \_\_\_\_\_

Witness:

Do CERTIFY that I am the \_\_\_\_\_; that the said \_\_\_\_\_

VOLUNTEER ENLISTMENT.



State of *Rhode Island* Town of *Providence*  
I, *Geo Williamson* born in *Somerset Co*

in the State of *N. J.* aged *19* years, and by occupation  
a *Farmer* DO HEREBY ACKNOWLEDGE to have volunteered this *16<sup>th</sup>*  
day of *October* 18*63* to serve as a SOLDIER in the ARMY OF THE UNITED STATES  
OF AMERICA, for the period of *Three Years*, unless sooner discharged by proper authority:

Do also agree to accept such bounty, pay, rations and clothing, as are, or may be, established, by law for  
volunteers. And I, *Geo Williamson* do solemnly swear, that I will bear  
true faith and allegiance to the *United States of America*, and that I will serve them honestly and faith-  
fully against all their enemies or opposers whomsoever; and that I will observe and obey the orders of the  
President of the United States, and the orders of the officers appointed over me, according to the Rules  
and Articles of War.

Sworn and Subscribed to at *Providence*  
this *16<sup>th</sup>* day of *Oct* 18*63* Before *J. P. Linsford* *Geo Williamson*  
*J. P. Linsford* *Quart*

I CERTIFY, on Honor, That I have carefully examined the above-named Volunteer, agreeable to the General Regulations of  
the Army, and that, in my opinion, he is free from all bodily defects and mental infirmity, which would, in any way, disqualify him  
from performing the duties of a soldier.

*John W. Merrill*

EXAMINING SURGEON.

I CERTIFY, ON HONOR, That I have minutely inspected the Volunteer, *Geo Williamson*  
previously to his enlistment, and that he was entirely sober when enlisted; that to the best of my judgment and belief, he is of  
lawful age; and that, in accepting him as duly qualified to perform the duties of an able-bodied soldier, I have strictly observed the  
Regulations which govern the recruiting service. This soldier has *Brown* eyes *Dark* hair  
*Brown* complexion, is *five* feet *seven* inches high.

Regiment of

Volunteers.

RECRUITING OFFICER.



## ARTICLES OF WAR.

ART. 95. When any non-commissioned officer or soldier shall die, or be killed in the service of the United States, the then commanding officer of the troop or company shall, in the presence of two other commissioned officers, take an account of what effects he died possessed of, above his arms and accoutrements, and transmit the same to the office of the Department of War, which said effects are to be accounted for, and paid to the representatives of such deceased non-commissioned officer or soldier. And in case any of the officers, so authorized to take care of the effects of deceased officers and soldiers, should, before they have accounted to their representatives for the same, have occasion to leave the regiment or post, by preferment or otherwise, they shall, before they be permitted to quit the same, deposit in the hands of the commanding officer, or of the assistant military agent, all the effects of such deceased non-commissioned officers and soldiers, in order that the same may be secured for, and paid to, their respective representatives.

## ARMY REGULATIONS—EDITION OF 1861.

## DECEASED SOLDIERS.

Par. 152. Inventories of the effects of deceased non-commissioned officers and soldiers, required by the 95th Article of War, will be forwarded to the Adjutant General, by the commander of the company to which the deceased belonged, and a duplicate of the same to the colonel of the regiment. Final statements of pay, clothing, &c., will be sent with the inventories. When a soldier dies at a post or station absent from his company, it will be the duty of his immediate commander to furnish the required inventory, and, at the same time, to forward to the commanding officer of the company to which the soldier belonged, a report of his death, specifying the date, place, and cause; to what time he was last paid, and the money or other effects in his possession at the time of his decease; which report will be noted on the next muster roll of the company to which the man belonged. Each inventory will be endorsed, "Inventory of the effects of \_\_\_\_\_, late of company (—) \_\_\_\_\_ regiment of \_\_\_\_\_, who died at \_\_\_\_\_, the \_\_\_\_\_ day of \_\_\_\_\_, 186—." If a legal representative receive the effects, it will be stated in the report. If the soldier leave no effects, the fact will be reported.

Par. 153. Should the effects of a deceased non-commissioned officer or soldier not be administered upon within a short period after his decease, they shall be disposed of by a Council of Administration, under the authority of the commanding officer of the post, and the proceeds deposited with the Paymaster, to the credit of the United States, until they shall be claimed by the legal representatives of the deceased.

Par. 154. In all such cases of sales by the Council of Administration, a statement in detail, or account of the proceeds, duly certified by the Council and commanding officer, accompanied by the Paymaster's receipt for the proceeds, will be forwarded by the commanding officer to the Adjutant General. The statement will be endorsed, "Report of the proceeds of the effects of \_\_\_\_\_, late of company (—) \_\_\_\_\_ regiment of \_\_\_\_\_, who died at \_\_\_\_\_, the \_\_\_\_\_ day of \_\_\_\_\_, 186—."

NOTE 1.—The effects in all cases, when called for, should be turned over to the legal representative, without further authority from the Adjutant General. When the effects are turned over to the relatives of the deceased before these inventories are sent to the Adjutant General, their receipts therefor should be attached to the inventories. In all other cases, one copy will be sent with a letter of transmittal direct to the Adjutant General, and a duplicate retained by the officer.

NOTE 2.—Particular care should be taken to take receipts in duplicate from the Paymaster for any funds turned over to him; one copy should be sent direct to the Adjutant General and one retained by the officer.

## INVENTORY OF THE EFFECTS

OF

*Thomas G. Haines*

Late of Company *11<sup>th</sup>*

*11<sup>th</sup>* Reg't of *1<sup>st</sup> Heavy Artillery*

Volunteers, who died at *W. Salinas*

on the *2<sup>nd</sup>* day of *Sept* 186*4*.

Inventory of the effects of Thomas Williamson late  
 a private of Captain John H. Baggott's Company 1<sup>st</sup> of  
 the 14<sup>th</sup> Regiment of 1<sup>st</sup> Maine Artillery (Vol.) Volunteers, who was enrolled as  
 a private at Andover in the State of Maine on  
 the 16<sup>th</sup> day of October 1861, and mustered into the service of the United  
 States as a private on the 20<sup>th</sup> day of October 1861, at Andover  
 in Company F, 14<sup>th</sup> Regiment of 1<sup>st</sup> Maine Artillery Volunteers, to serve  
 years or during the war; he was born in Cornwall Co. in the State  
 of New Hampshire; he was 19 years of age, 5 feet 7 inches  
 high, swarthy complexion, blue eyes, brn hair, and by occupation, when enrolled,  
 a farmer; he died in Andover at 12  
New Orleans La. on the 2<sup>nd</sup> day of April 1864, by  
 reason of Cholera

INVENTORY.					
ARTICLES.	No.	ARTICLES.	No.	ARTICLES.	No.
Hats.....		Pairs trousers.....	/	Knapsacks.....	
Caps.....		Pairs flannel drawers.....			
Forage caps.....		Pairs cotton drawers.....			
Great coats.....	/	Flannel shirts.....			
Uniform coats.....	/	Cotton shirts.....			
Uniform jackets.....		Pairs boots.....	/		
Flannel sack coats.....		Pairs shoes.....			
Blouses.....		Pairs socks.....			
Stable frocks.....		Blankets.....			
Fatigue overalls.....		Haversacks.....			
				MONEY.	
				Specie.....	\$
				Notes.....	\$

I CERTIFY, ON HONOR, that the above inventory comprises all the effects of private  
Thomas Williamson, deceased, and that the effects are in the hands  
 of John H. Baggott at U. S. General Hospital  
Andover to be disposed of by a Council of Administration.

(DUPLICATES.)

STATION: Andover

DATE: April 1864

John H. Baggott  
1<sup>st</sup> Maine Artillery  
 Commanding the Company.

FINAL STATEMENT

OF

Thomas Mathiasson

14th Reg't of R. I. H. Art'y

VOLUNTEERS.

NOTE 1.—Two of these certificates (or duplicates) are to be given to each volunteer soldier who may be discharged previously to the discharge of his company, that he may at once receive from the Paymaster the pay, &c. due him, and the captain or other officer commanding the company will certify to the act of the delivery of the duplicate certificates; on these certificates the Soldier is "entitled to" his discharge, and should also present his discharge to the Paymaster to have the payment endorsed on it. The discharge is to be given back to the Soldier by the Paymaster; the latter only retaining as his voucher the duplicate certificates.

NOTE 2.—If the Soldier is entitled to pay for the use of his horse, the Company Commander will certify to that fact, and also to the time he has pay due for having been so mounted on his own horse.

NOTE 3.—Amounts due the Sutler and Laundress must be entered on the Muster Roll on which the death, desertion, &c., is reported, as well as on the final statement, otherwise the amount cannot be collected from the United States.

NOTE 4.—This blank will be used for deceased volunteers as well as others.

RECEIVED OFFICE  
May 9<sup>th</sup> 1841  
Duplicate with Inventory sent 2d Auditor.



I certify, on honor, that Thomas Williamson a private of  
 Captain Charles S. Long Company (I.) of the 44th Regiment of Heavy Artillery  
**VOLUNTEERS**, of the State of Rhode Island, born in 1838 State  
 of New Jersey, aged 26 years; 5 feet 7 inches high; tan complexion,  
blue eyes, black hair, and by occupation a carpenter, having joined the company on  
 its original organization at Providence R.I., and enrolled in it at the muster into  
 the service of the United States at Providence R.I., on the fourteenth day  
 of October, 1863; ~~or~~ was mustered in service as a recruit, by John W. Smith  
Major 1st Regt. A. at Providence, on the 16th day of October  
 1863, to serve in the Regiment for the term of three years  
 and having served **HONESTLY** and **FAITHFULLY** with his Company in the field  
 to the present date, is now entitled to a **DISCHARGE** by reason of death caused  
by phthisis

The said Thomas Williamson ~~has not been paid~~ was last paid by Paymaster  
since enrolled to include the day of 186, and has  
 pay due him from that time to the present date; he is entitled to pay and subsistence for  
**TRAVELING** to place of enrollment and whatever other allowances are authorized to volunteer  
 soldiers, or militia, so discharged. He has received Twenty Seven  $\frac{8}{100}$  dollars,  
 advanced by the United States on account of **CLOTHING**.

There is to be stopped from him, on account of the State of \_\_\_\_\_, or other  
 authorities for **CLOTHING**, &c., received on entering service, \_\_\_\_\_ dollars; also,  
 for expenses of **SUBSISTENCE** for **TRAVELING** from place of enrollment to the place of rendezvous,  
 amounting to \_\_\_\_\_ dollars: and on account of the United States for **EXTRA**  
**CLOTHING** received in kind from \_\_\_\_\_ and for other  
 stoppages, viz:

one knapsack haversack and canteen  
 \_\_\_\_\_ amounting to \_\_\_\_\_ dollars;  
 and he has been **SUBSISTED** for **TRAVELING** to his place of enrollment, up to the \_\_\_\_\_  
 \_\_\_\_\_ 186 .

He is indebted to \_\_\_\_\_ **SUTLER**, \_\_\_\_\_ dollars.

He is indebted to \_\_\_\_\_ **LAUNDRESS**, \_\_\_\_\_ dollars.

Given in Duplicate, at San Francisco this 9th day of April, 1864 .

Charles S. Long  
Capt 44th Regt A.  
 Commanding Company.

# FINAL STATEMENT

OF

Thomas Williamson

4th Reg't of R. I. N. A. M.

## VOLUNTEERS.

---

NOTE 1.—Two of these certificates (or duplicates) are to be given to each volunteer soldier who may be discharged previously to the discharge of his company, that he may at once receive from the Paymaster the pay, &c., due him, and the captain or other officer commanding the company will certify to the act of the delivery of the duplicate certificates; on these certificates the Soldier is "entitled to" his *discharge*, and should also present his discharge to the Paymaster to have the payment endorsed on it. The discharge is to be given back to the Soldier by the Paymaster; the latter only retaining as his voucher the duplicate certificates.

NOTE 2.—If the Soldier is entitled to pay for the use of his horse, the Company Commander will certify to that fact, and also to the time he has pay due for having been so mounted on his own horse.

NOTE 3.—Amounts due the Sutler and Laundress must be entered on the Muster Roll on which the death, desertion, &c., is reported, as well as on the final statement, otherwise the amount cannot be collected from the United States.

NOTE 4.—This blank will be used for deceased volunteers as well as others.

---

17th  
&  
1871

I certify, on honor, that Thomas Williamson a Private of  
 Captain Wm. M. ... Company (1st) of the 14th Regiment of Illinois  
**VOLUNTEERS**, of the State of Ohio, born in Lawrence, State  
 of Ohio, aged 19 years; 5 feet 7 inches high; dark complexion,  
blue eyes, black hair, and by occupation a farmer, having joined the company on  
 its original organization at Lawrence, O., and enrolled in it at the muster into  
 the service of the United States at Lawrence, O., on the 10th day  
 of October, 1863; he was mustered in service as a recruit, by J. H. ...  
Sept 14th 1863, at Lawrence, O., on the 16th day of October  
 1863, to serve in the Regiment for the term of three years;  
 and having served **HONESTLY** and **FAITHFULLY** with his Company in the field  
 to the present date, is now entitled to a **DISCHARGE** by reason of death caused  
by illness.

The said Thomas Williamson has not been paid was last paid by Paymaster  
since enrolled to include the ... day of ... 186..., and has  
 pay due him from that time to the present date; he is entitled to pay and subsistence for  
**TRAVELING** to place of enrollment and whatever other allowances are authorized to volunteer  
 soldiers, or militia, so discharged. He has received Fifty Seven  $\frac{8}{100}$  dollars,  
 advanced by the United States on account of **CLOTHING**.

There is to be stopped from him, on account of the State of ..., or other  
 authorities for **CLOTHING**, &c., received on entering service, ... dollars; also,  
 for expenses of **SUBSISTENCE** for **TRAVELING** from place of enrollment to the place of rendezvous,  
 amounting to ... dollars: and on account of the United States for **EXTRA**  
**CLOTHING** received in kind from ... and for other  
 stoppages, viz:

... amounting to ... dollars;  
 and he has been **SUBSISTED** for **TRAVELING** to his place of enrollment, up to the ...  
..., 186....

He is indebted to ... **SUTLER**, ... dollars.  
 He is indebted to ... **LAUNDRESS**, ... dollars.

Given in Duplicate, at Camp Law, this 14th day of April, 1864.

Charles J. ...  
Capt. W. G. ...  
 Commanding Company.



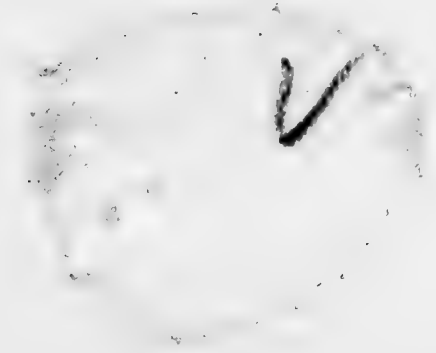

FINAL STATEMENT

OF

*Thomas H. ...*

*14th Reg't of U.S. Heavy Art.*

*11th B.*

**VOLUNTEERS.**

NOTE 1.—Two of these certificates (or duplicates) are to be given to each Volunteer Soldier or drafted man who may be discharged previously to the discharge of his company, that he may at once receive from the Paymaster the pay, &c., due him, and the captain or other COMMISSIONED officer commanding the company will certify to the act of the delivery of the duplicate certificates; on these certificates the Soldier is "entitled to" his discharge, and should also present his discharge to the Paymaster to have the payment endorsed on it. The discharge is to be given back to the Soldier by the Paymaster; the latter only retaining as his voucher the duplicate certificates.

NOTE 2.—If the Soldier is entitled to pay for the use of his horse, the Company Commander will certify to that fact on the back of both these final statements, and also to the time he has pay due for having been so mounted on his own horse.

NOTE 3.—When a Soldier is furnished with final statements, his descriptive list, if he has one, should be taken up by the officer who gives the Soldier these statements, and endorsed with a statement to this effect by the officer. This endorsement should exhibit a full statement of the time for which the Soldier was allowed pay on his final statements, the clothing account, and all other charges against him or in his favor, so as to comprise a complete exhibit of his account. It will then be transmitted to the company commander of the Soldier, who will enter all the data necessary to a full understanding of the Soldier's account on the muster roll upon which the Soldier's discharge is reported. The descriptive list will then be destroyed. The object of this is, that the remaining portion of the Soldier's account may be settled upon the receipt of these muster rolls, and the Soldier receive any pay or allowances that may be due him at the time of his discharge, and which may not appear on his final statements from the fact that his descriptive list is incomplete. These accounts for back pay, &c., are settled by the 2d Auditor of the Treasury Department.

NOTE 4.—Charges for loss or injury to ordnance, horse equipments, and other miscellaneous charges, should appear under the heading of "Other Stoppages."

NOTE 5.—Bounty paid by State authorities, and not by the United States, will not be entered on this statement.

NOTE 6.—Amounts due the Sutler and Laundress must be entered on the muster roll on which the discharge, death, desertion, &c., is reported, as well as on the final statement, otherwise the amount cannot be collected from the United States.

NOTE 7.—This blank will be used for deceased volunteers and drafted men, as well as for others.

NOTE 8.—Where a Soldier dies in Hospital or on detached service, his descriptive list, if he has one, should be sent with his final statements, in duplicate, to the Second Auditor, Washington, D. C.

ADJUTANT GENERAL'S OFFICE.  
*Co 13<sup>th</sup> 1864*  
Duplicate with Inventory sent 2d Auditor.

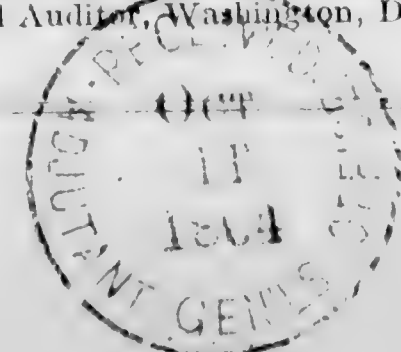

I certify, on honor, that Thomas McDermott a private of  
 Captain G. C. Leary's Company (F) of the 14th Regiment of Illinois Volunteers, of the State of Rhode Island, born in Amherst Co., State  
 of New Jersey, aged 17 years; 5 feet 7 inches high; brown complexion,  
brown eyes, dark hair, and by occupation a carpenter, having joined the company on  
 its original organization at Providence R.I., and enrolled in it at the muster into  
 the service of the United States at Providence R.I., on the twentieth day  
 of October, 1863, (or was mustered in service as a recruit, by  
 \_\_\_\_\_, at \_\_\_\_\_, on the \_\_\_\_\_ day of \_\_\_\_\_,  
 186 , or was drafted and mustered into the service of the United States from the \_\_\_\_\_  
 Enrollment District of the State of \_\_\_\_\_, at \_\_\_\_\_,  
 on the \_\_\_\_\_ day of \_\_\_\_\_, 186 ), to serve in the Regiment, for  
 the term of three years: and having served **HONESTLY** and  
**FAITHFULLY** with his Company in the field to the present date, is now  
 entitled to a **DISCHARGE** by reason of Death, Died in General Hospital  
at New Orleans, April 2nd 1864 of Malaria

The said Thomas McDermott has not been paid was last paid by Paymaster  
since enrolled on the to include the sixteenth day of October, 1863, and has  
 pay due him from that time to the present date; he is entitled to pay and subsistence for  
**TRAVELING** to place of enrollment, and whatever other allowances are authorized to volunteer  
 soldiers, drafted men, or militia, so discharged. He has received from the United States **CLOTHING**  
 amounting to Fifty Seven (\$57) <sup>08</sup>/<sub>100</sub> dollars, since the sixteenth day of October,  
 1863, when his clothing account was last settled. He has received from the United States  
\_\_\_\_\_ <sup>100</sup>/<sub>100</sub> dollars advanced **BOUNTY**.

There is to be stopped from him, on account of the State of \_\_\_\_\_, or other  
 authorities, for **CLOTHING**, &c., received on entering service, \_\_\_\_\_ <sup>100</sup>/<sub>100</sub> dollars; and  
 for other stoppages, viz: \_\_\_\_\_

\_\_\_\_\_ <sup>100</sup>/<sub>100</sub> dollars.  
 He has been furnished with **TRANSPORTATION** in kind from the place of his discharge to  
 \_\_\_\_\_; and he has been **SUBSISTED** for **TRAVELING** to his  
 place of enrollment, up to the \_\_\_\_\_, 186 .

He is indebted to \_\_\_\_\_, **SUTLER**, \_\_\_\_\_ <sup>100</sup>/<sub>100</sub> dollars.

He is indebted to \_\_\_\_\_, **LAUNDRESS**, \_\_\_\_\_ <sup>100</sup>/<sub>100</sub> dollars.

Given in Duplicate, at camp near New Orleans La, this 10th day  
 of April, 1864.

Charles G. Leary Capt. Co. F  
14th Reg. of Ill. Vols.  
 Commanding Company





I certify, on honor, that Thomas H. [unclear] a [unclear] of  
 Captain [unclear] Company ([unclear]) of the 14th Regiment of [unclear]  
**VOLUNTEERS**, of the State of [unclear], born in [unclear], State  
 of [unclear], aged [unclear] years; [unclear] feet [unclear] inches high; [unclear] complexion,  
[unclear] eyes, [unclear] hair, and by occupation a [unclear], having joined the company on  
 its original organization at [unclear], and enrolled in it at the muster into  
 the service of the United States at [unclear] on the [unclear] day  
 of [unclear], 186[unclear], (or was mustered in service as a recruit, by [unclear]  
[unclear], at [unclear], on the [unclear] day of [unclear],  
 186[unclear], or was drafted and mustered into the service of the United States from the [unclear]  
 Enrollment District of the State of [unclear], at [unclear],  
 on the [unclear] day of [unclear], 186[unclear]) to serve in the Regiment, for  
 the term of three years: and having served **HONESTLY** and  
**FAITHFULLY** with his Company in the field to the present date, is now  
 entitled to a **DISCHARGE** by reason of [unclear]

The said [unclear] was last paid by Paymaster [unclear]  
[unclear] to include the [unclear] day of [unclear], 186[unclear], and has  
 pay due him from that time to the present date; he is entitled to pay and subsistence for  
**TRAVELING** to place of enrollment, and whatever other allowances are authorized to volunteer  
 soldiers, drafted men, or militia, so discharged. He has received from the United States **CLOTHING**  
 amounting to [unclear] dollars, since the [unclear] day of [unclear],  
 186[unclear], when his clothing account was last settled. He has received from the United States  
[unclear] dollars advanced **BOUNTY**.

There is to be stopped from him, on account of the State of [unclear], or other  
 authorities, for **CLOTHING**, &c., received on entering service, [unclear] dollars; and  
 for other stoppages, viz: [unclear]

[unclear] dollars.  
 He has been furnished with **TRANSPORTATION** in kind from the place of his discharge to  
[unclear]; and he has been **SUBSISTED** for **TRAVELING** to his  
 place of enrollment, up to the [unclear], 186[unclear].

He is indebted to [unclear], **SUTLER**, [unclear] dollars.

He is indebted to [unclear], **LAUNDRESS**, [unclear] dollars.

Given in Duplicate, at [unclear], this [unclear] day  
 of [unclear], 186[unclear].

[Signature]  
[Signature]

Commanding Company.

COPY OF RECORD

FOR THE

ADJUTANT GENERAL, U. S. ARMY.

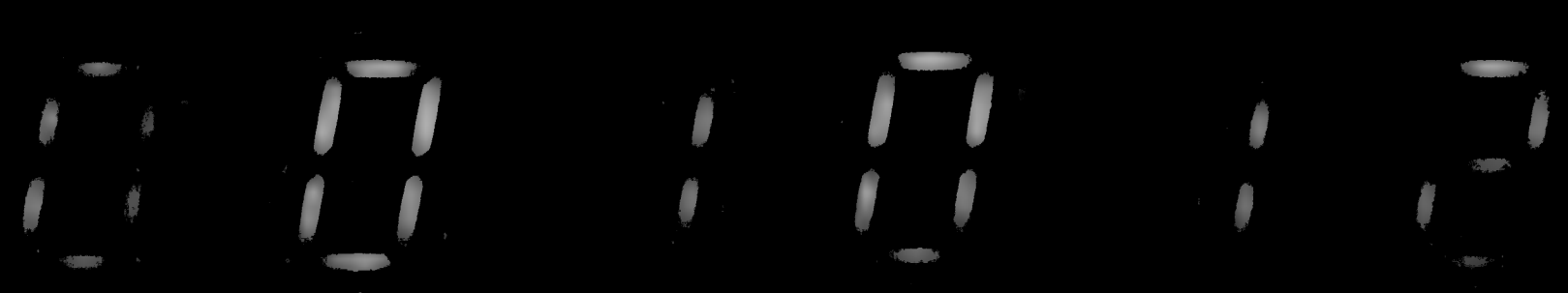

RECORD OF DEATH AND INTERMENT.

Name and number of person interred,

*Thomas Williams*

Number and locality of the Grave, - -

Hospital number of the deceased, - -

*465*

Regiment, rank, and company, - -

*14<sup>th</sup> R. I. Heavy art. - Priv. - J.*

Residence before enlistment, - - - -

Conjugal condition, (and if married, )  
the residence of the widow, )

Cause of death, - - - - - )

*Phthisis*

Age of the deceased, - - - - -

*24 years*

Nativity, - - - - -

References and remarks, - - - - )

Date of death and burial, - - - -

*April 2<sup>d</sup> 64*

( A duplicate of this Record has been forwarded to the Sexton, and another remains at this Hospital. )

To \_\_\_\_\_

SIR :

It becomes my duty to inform you that the person above described died at this Hospital as herein stated ; and that it is desired his remains should be interred with the usual military honors.

Respectfully,

*J. E. Piquette*

Surgeon U. S. Army.

*and*  
MILITARY HOSPITAL, \_\_\_\_\_

This copy of Record is to be transmitted to the Adjutant General at Washington immediately after the place of burial and the number of the grave have been ascertained and registered. The above notification is to remain attached.



2045

*Williamson William C.*

**Co *A*, 11 U.S. Col'd H. Art'y.**

*Private*

*Private*

CARD NUMBERS.

1	6190818	26
2	6190464	27
3	6191111	28
4	6191250	29
5	6191395	30
6	6191532	31
7	6191670	32
8	92446	33
9		34
10		35
11		36
12		37
13		38
14		39
15	1	40
16		41
17		42
18		43
19		44
20		45
21		46
22		47
23		48
24		49
25		50

Book Mark:

See also

*W.* | **11 H. Art'y. U.S.C.T.**

*William E. Williamson*  
....., Co. *F*, 11 Reg't U. S. Col'd H. Art'y.

Appears on

**Company Descriptive Book**

of the organization named above.

**DESCRIPTION.**

Age *17* years; height *5* feet *3* inches.

Complexion *Light Muscato.*

Eyes *Green*; hair *Dark*.

Where born *Barneset Co., N.J.*

Occupation *Furrier.*

**ENLISTMENT.**

When *Nov. 16*, 186*3*.

Where *Paris, N.J.*

By whom *J. O. Engle*; term *3* y'rs.

Remarks: *Discharged Sept. 1, 1864*  
*at Camp Stuart, Department of the*  
*South. Received Certificate of disa-*  
*bility under of War. Genl.*  
*Hobson. Discharge and final*  
*Statements given.*

*C. J. Marble,*

Copyist.

*W* | 11<sup>th</sup> H. Art'y. | U.S.C.T.

*William E. Williamson*

*Private*, Co. *F*, 14 Reg't R. I. Col'd H. Art'y.\*

Age *18* years.

Appears on

**Company Muster-in Roll**

of the organization named above. Roll dated

*Providence R.I., Oct 20, 1863.*

Muster-in to date

*Oct 20, 1863.*

Joined for duty and enrolled:

When

*Oct 16, 1863.*

Where

*Providence, R.I.*

Period

*3* years.

Valuation of horse, \$ 100

Valuation of horse equipments, \$ 100

Remarks:

\* This organization subsequently became Co. *F*, 11 Reg't U. S. Colored Heavy Artillery.

Book mark:

*S. Neal*



*W* 11 H. Art'y. U.S.C.T.

*William E. Williamson*  
*Priv*, Co. F, 14 Reg't R. I. Col'd H. Art'y.\*

Appears on

**Company Muster Roll**

for *Oct 20 to Dec 31*, 186*7*.

Present or absent *Present*

Stoppage, \$.....*100* for .....

Due Gov't, \$.....*100* for .....

Valuation of horse, \$.....*100*

Valuation of horse equipments, \$.....*100*

Remarks: .....

\* This organization subsequently became Co. F, 11 Reg't U. S. Colored Heavy Artillery.

Book mark: .....

*A Neal*

27

11 H. Art'y. U.S.C.T.

William E. Williamson  
Co. F, 14 Reg't R. I. Col'd H. Art'y.\*

Appears on

**Company Muster Roll**

for Jan 1st, 1864

Present or absent Present

Stoppage, \$ 100 for

Due Gov't, \$ 100 for

Valuation of horse, \$ 100

Valuation of horse equipments, \$ 100

Remarks:

\* This organization subsequently became Co. F. 11 Reg't U. S. Colored Heavy Artillery.

Book mark:

H. Neal

*11* 11 H. Art'y. **U.S.C.T.**

*William E. Williamson*  
*Pr*, Co. F, 14 Reg't R. I. Col'd H. Art'y.\*

Appears on

**Company Muster Roll**

for *7 Nov + Apr*, 1864.

Present or absent *Present*

Stoppage, \$ 100 for

Due Gov't, \$ 100 for

Valuation of horse, \$ 100

Valuation of horse equipments, \$ 100

Remarks:

\* This organization subsequently became Co. F, 11 Reg't U. S. Colored Heavy Artillery.

Book mark:

*A Neal*  
Copyist.



*W* | 11 H. Art'y. | **U.S.C.T.**

*William E Williamson*  
*Co. F*, Co. *F*, 8 Reg't U. S. Col'd H. Art'y.\*

Appears on

**Company Muster Roll**

for *May + June*, 1864

Present or absent *Present*

Stoppage, \$ 100 for

Due Gov't, \$ 100 for

Valuation of horse, \$ 100

Valuation of horse equipments, \$ 100

Remarks: *Stop for one*  
*week and crew*  
*driver*

† This organization subsequently became Co. *F*, 11 Reg't U. S. Colored Heavy Artillery.

Book mark:

*A Neal*

) | **11 H. Art'y. U.S.C.T.**

*William E. Williams*  
*Pvt.*, Co. F, 11 Reg't U. S. Col'd H. Art'y.

Appears on

**Company Muster Roll**

for *July and Aug.*, 1864.

Present or absent *Present.*

Stoppage, \$ 100 for

Due Gov't, \$ 100 for

Valuation of horse, \$ 100

Valuation of horse equipments, \$ 100

Remarks: *Stop for repairs. 20*  
*Screwdriver. 23, Spec April 17/66.*

Book mark: \_\_\_\_\_

*Ernie*

*W* | 11 H. Art'y. | U.S.C.T.

*William E. Williamson.*

*Prvt.*, Co. F, 11 Reg't U. S. Col'd H. Art'y.

Appears on

**Company Muster Roll**

for *Sept. and Oct.*, 1864.

Present or absent

Stoppage, \$ 100 for

Due Gov't, \$ 100 for

Valuation of horse, \$ 100

Valuation of horse equipments, \$ 100

Remarks: *Discharged Sept. 27/64  
at Piquerrine La. order of Genl.  
Harrison. Discharge & F. Statements  
given. Stop for two wipes. 40  
two screws given. 46 one com-  
pion. 02 two haversacks. 78  
two canteens. 82 one pr. Shoulder  
scales & ties. 50, Free April 19/61.*

Book mark:

*Outline.*



W.

11 H. Art'y. U.S.C.T.

William E. Williamson  
Bk., Co. F., 11 Reg't U. S. Col'd H. Art'y.

Appears on Co. Muster-out Roll, dated

New Orleans, La. Oct. 7, 1865.

Muster-out to date \_\_\_\_\_, 186 .

Last paid to Pay due from Enrollment, 186 .

Clothing account:

Last settled \_\_\_\_\_, 186 ; drawn since \$ \_\_\_\_\_ 100

Due soldier \$ \_\_\_\_\_ 100; due U. S. \$ \_\_\_\_\_ 100

Am't for cloth'g in kind or money adv'd \$ \_\_\_\_\_ 100

Due U. S. for arms, equipments, &c., \$ \_\_\_\_\_ 100

Bounty paid \$ \_\_\_\_\_ 100; due \$ \_\_\_\_\_ 100

Remarks: Joined at Orgnl.

Orgnl. Discharged at  
Flaguemin La. Sept. 29  
64, on Surg. Cer. of  
Disability. Order of Genl.  
Harrow, Mich. St. Stat. given.

Book mark: \_\_\_\_\_

Leib  
Copyist.

Williamson, M<sup>rs</sup> E

I, Co., 11 Reg't U.S.C.A.

**3 Enclosures.**

Bed Cards	Final Statements /
Burial Records	Furloughs or L. of A
Certs. of Dis. for Discharge /	Med. Certificates
C. M. Charges	Med. Des. Lists
Descriptive Lists	Orders
Discharge Certificates	Pris. of War Record
Enlistment Papers /	Resignations

Other papers relating to—

Admission to Hosp'l	Furlough or L. of A
Casualty Sheet	Med. Examination
Confinement	Misc. Information
Contracts	Pay or Clothing
Death or Effects	Personal Reports
Desertion	Rank
Discharge from Hosp'l	Transfer to Hosp'l
Discharge from Service	Transfer to V. R. C.
Duty	Transportation

DECLARATION OF RECRUIT.

I, *William C. Williams* desiring to VOLUNTEER as a Soldier in the ARMY OF THE UNITED STATES, for the term of *Three Years* do declare that I am *18* years and months of age; that I have never been discharged from the United States service on account of disability or by sentence of a court martial, or by order, before the expiration of a term of enlistment; and I know of no impediment to my serving honestly and faithfully as a soldier for *Three Years*

Given at *Fort R.D.*  
The *16* day of *Oct* 18 *63*

Witness:

*James J. [Signature]*

*William C. Williams*  
*Recruit*

Discharged at

18

Regt of

enlistment; last served in Company ( )

Regiment of

By

*[Signature]*

Volunteered at

*Fort R.D.*  
18 *63*

No.

*132*

*William C. Williams*  
*Recruit*

CONSENT IN CASE OF MINOR.

I, \_\_\_\_\_ of \_\_\_\_\_ Do CERTIFY that I am the \_\_\_\_\_ years of age; and I do hereby freely give my CONSENT to his volunteering as a SOLDIER in the ARMY OF THE UNITED STATES for the period of \_\_\_\_\_

Given at \_\_\_\_\_  
The \_\_\_\_\_ day of \_\_\_\_\_

Witness:



VOLUNTEER ENLISTMENT.



State of *Rhode Island* Town of *Providence*  
I, *William E. Williamson* born in *Somerset*

in the State of *R.I.* aged *18* years, and by occupation a *Farmer*

DO HEREBY ACKNOWLEDGE to have volunteered this *16* day of *October* 18 *63* to serve as a SOLDIER in the ARMY OF THE UNITED STATES OF AMERICA, for the period of *Three Months*, unless sooner discharged by proper authority:

Do also agree to accept such bounty, pay, rations and clothing, as are, or may be, established, by law for volunteers. And I, *William E. Williamson* do solemnly swear, that I will bear true faith and allegiance to the *United States of America*, and that I will serve them honestly and faithfully against all their enemies or opposers whomsoever; and that I will observe and obey the orders of the President of the United States, and the orders of the officers appointed over me, according to the Rules and Articles of War.

Sworn and Subscribed to, at *Prov R.I.* this *16* day of *Oct* 18 *63*

BEFORE *John W. ...* *William E. Williamson*

I CERTIFY, ON HONOR, That I have carefully examined the above-named Volunteer, agreeable to the General Regulations of the Army, and that, in my opinion, he is free from all bodily defects and mental infirmity, which would, in any way, disqualify him from performing the duties of a soldier.

*John W. ...*

EXAMINING SURGEON.

I CERTIFY, ON HONOR, That I have minutely inspected the Volunteer, *Wm E Williamson*

previously to his enlistment, and that he was entirely sober when enlisted; that to the best of my judgment and belief, he is of lawful age; and that, in accepting him as duly qualified to perform the duties of an able-bodied soldier, I have strictly observed the Regulations which govern the recruiting service. This soldier has

*Deciduous* complexion, is *five* feet, *five* inches high. *Brown* eyes *Black* hair

*John W. ...*  
*Regt 14* Regiment of *R.I.* Volunteers.

RECRUITING OFFICER.



NOTE 1.

The company commander will here add a statement of all the facts known to him concerning the disease or wound, or cause of disability of the soldier; the time, place, manner, and all the circumstances under which the injury occurred, or disease originated or appeared; the duty, or service, or situation of the soldier at the time the injury was received or disease contracted, stating particularly whether the injury was received or the disease contracted in the line of his duty; and whatever other facts may aid a judgment as to the cause, immediate or remote, of the disability, and the circumstances attending it.

When the facts are not known to the company commander, the certificate of any officer, or affidavit of other person having such knowledge, will be appended—as the surgeon in charge of a hospital, the officer commanding a detachment of recruits, &c., &c.

NOTE 2.

When a probable case for pension, special care must be taken to state the degree of disability—as 1, 2, 3, &c., &c.; to describe particularly the disability, wound, or disease; the extent to which it deprives him of the use of any limb or faculty, or affects his health, strength, activity, constitution, or capacity to labor or earn his subsistence. The surgeon will add, from his knowledge of the facts and circumstances, and from the evidence in the case, his professional opinion of the cause or origin of the disability. In the case of discharges by Medical Inspectors, the last paragraph will state that the "discharge was given by consent of the soldier, after a personal examination, and for disability, the nature, degree, and origin of which are correctly described in the within certificate."

Par. 1260 Regulations, Edit. 1861.

Medical officers, in giving certificates of disability, are to take particular care in all cases that have not been under their charge; and especially in epilepsy, convulsions, chronic rheumatism, derangement of the urinary organs, ophthalmia, ulcers, or any obscure disease liable to be feigned or purposely produced; and in no case shall such certificate be given until after sufficient time and examination to detect any attempt at deception.

DIRECTIONS.

This certificate will be made out in duplicate by the soldier's company commander, or other officer commanding the separate detachment to which he belongs, and sent by him to the surgeon who has charge of the hospital where the soldier is sick. The surgeon will then fill out and sign the surgeon's certificate, and forward these papers to the regimental, detachment, or post commander, who will forward them, with his action endorsed thereon, through the proper channel, to his division commander; or, if the troops are not attached to a division, to his corps, department, or other commander or officer to whom the authority to discharge enlisted men may be specially delegated.

These certificates, after having received the action of the highest authority to which they are required to be sent, will be returned through the same channel to the regimental, post, or detachment commander, who will, if the discharge is authorized by the endorsement of the proper authority, sign the soldier's discharge, and the last certificate on this paper; see that the soldier is furnished with the proper final statements in duplicate, and forward BOTH of these certificates direct to the Adjutant General United States Army, at Washington, D. C.; they will not, under any circumstances, be given into the hands of the soldier.

ADJUTANT GENERAL'S OFFICE

Oct 21 1864

Application sent the Pension Office.

CERTIFICATE OF DISABILITY FOR DISCHARGE

IN THE CASE OF

William E. Williamson

a private of Co. F

Eighth Regt of U. S. Art. H. U. S. Col. (Inf.) (404)

Hd. Qu. U. S. Forces. Plaquemine, La. Sept 13. 1864

Respectfully forwarded & Approved!

W. S. Sipher

Col. of the Regt U.S. C. A. (Heavy) Comd'g Post

Hd Qu. Dist Baton Rouge Surgeon's Office September 17 1864

Approved W. S. Sipher

1974 vol City Dist

Received (A. G. Office)



1864

Ent on & of Cas

Hd. Qu. District Baton Rouge Baton Rouge La. Sept 19 1864

Approved & Respectfully Forwarded

W. P. Benton

517

Brig Gen. Winch

Hd. Qu. of Baton Rouge & P. Hudson Baton Rouge Sept 22 1864

Almond. F. Hurmston 37th U.S. Inftry Surgeon in Chief of Dist.

Hd. Qu. Dist of RR & P. Baton Rouge La Sept 22. 64

To be discharged.

By command of Maj. Genl. Heron William H. Clapp Capt. & Co. A. S.



ARMY OF THE UNITED STATES.  
CERTIFICATE  
OF DISABILITY FOR DISCHARGE.



Private William E. Williamson, of Captain Charles C. Craigie's Company, (F) of the Eighth Regiment of United States Heavy Artillery was enlisted by J. C. Emery recruiting agent of the Eighth Regiment of U.S. Heavy Artillery at Providence, R.I. on the sixteenth day of October, 1864, to serve three years; he was born in Somerset Co in the State of New Jersey, is eighteen years of age, five feet five inches high, light mulatto complexion, brown eyes, black hair, and by occupation when enlisted a farmer. During the last two months said soldier has been unfit for duty 60 days.\* Said Williamson prior to his enlistment was troubled by pain in the side, but passed the surgeon's examination after a second trial. In February 1864 he was sick with the measles and has since been quite disabled from performing soldier's duty, being troubled with pain in the breast and side, raising phlegm, &c.

STATION: Plaquemine La.  
DATE: July 26th 1864

Charles C. Craigie Capt. Co. F  
8th U.S. Heavy Artillery  
Commanding Company.

I CERTIFY, that I have carefully examined the said William E. Williamson of Captain Charles C. Craigie's Company, and find him incapable of performing the duties of a soldier because of inflammation of the lungs and pleura. Said Williamson had in January last the measles and took cold since that time he has not been able to perform the duties of a soldier, and in my opinion will not be during the remainder of his term of enlistment. He is not fit for the Veteran Reserve Corps. The degree of disability 1/2

Horace McCreary  
Surgeon.  
2nd Batt 8th U.S. Heavy Artillery

DISCHARGED, this twenty-ninth day of September, 1864, at Plaquemine Louisiana.

Richard G. Shaw  
Maj. 11th Regt. U.S.A. (late 2nd)  
Commanding the 2nd Batt.

The Soldier desires to be addressed at  
Town Blombert County Somerset State New Jersey.

\* See Note 1 on the back of this. † See Note 2 on the back of this.  
[ A. G. O. No. 100 & 101—First. ] [ DUPLICATES. ]



8

## FINAL STATEMENT

OF

*William E. Williamson*

*11th Reg't of U. S. C. Art'y*

### VOLUNTEERS.

NOTE 1.—Two of these certificates (or duplicates) are to be given to each Volunteer Soldier or drafted man who may be discharged previously to the discharge of his company, that he may at once receive from the Paymaster the pay, &c., due him, and the captain or other COMMISSIONED officer commanding the company will certify to the act of the delivery of the duplicate certificates; on these certificates the Soldier is "entitled to" his discharge, and should also present his discharge to the Paymaster to have the payment endorsed on it. The discharge is to be given back to the Soldier by the Paymaster; the latter only retaining as his voucher the duplicate certificates.

NOTE 2.—If the Soldier is entitled to pay for the use of his horse, the Company Commander will certify to that fact on the back of both these final statements, and also to the time he has pay due for having been so mounted on his own horse.

NOTE 3.—When a Soldier is furnished with final statements, his descriptive list, if he has one, should be taken up by the officer who gives the Soldier these statements, and endorsed with a statement to this effect by the officer. This endorsement should exhibit a full statement of the time for which the Soldier was allowed pay on his final statements, the clothing account, and all other charges against him or in his favor, so as to comprise a complete exhibit of his account. It will then be transmitted to the company commander of the Soldier, who will enter all the data necessary to a full understanding of the Soldier's account on the muster roll upon which the Soldier's discharge is reported. The descriptive list will then be destroyed. The object of this is, that the remaining portion of the Soldier's account may be settled upon the receipt of these muster rolls, and the Soldier receive any pay or allowances that may be due him at the time of his discharge, and which may not appear on his final statements from the fact that his descriptive list is incomplete. These accounts for back pay, &c., are settled by the 2d Auditor of the Treasury Department.

NOTE 4.—Charges for loss or injury to ordnance, horse equipments, and other miscellaneous charges, should appear under the heading of "Other Stoppages."

NOTE 5.—Bounty paid by State authorities, and not by the United States, will not be entered on this statement.

NOTE 6.—Amounts due the Sutler and Laundress must be entered on the muster roll on which the discharge, death, desertion, &c., is reported, as well as on the final statement, otherwise the amount cannot be collected from the United States.

NOTE 7.—This blank will be used for deceased volunteers and drafted men, as well as for others.

NOTE 8.—Where a Soldier dies in Hospital or on detached service, his descriptive list, if he has one, should be sent with his final statements, in duplicate, to the Second Auditor, Washington, D. C.

NOV 11 1864

1864

I certify, on honor, that William E. Williamson a Private of  
Captain Charles C. Craig's Company (F) of the 11th Regiment of U. S. Army  
**VOLUNTEERS**, of the State of Rhode Island, born in Somerset Co, State  
of New Jersey, aged 18 years; 5 feet 5 inches high; A. Mulatto complexion,  
brown eyes, black hair, and by occupation a farmer, having joined the company on  
its original organization at Providence R. I., and enrolled in it at the muster into  
the service of the United States at Providence R. I., on the twentieth day  
of October, 1863, (or was mustered in service as a recruit, by \_\_\_\_\_  
\_\_\_\_\_, at \_\_\_\_\_, on the \_\_\_\_\_ day of \_\_\_\_\_,  
186\_\_\_\_, or was drafted and mustered into the service of the United States from the \_\_\_\_\_  
Enrollment District of the State of \_\_\_\_\_, at \_\_\_\_\_,  
on the \_\_\_\_\_ day of \_\_\_\_\_, 186\_\_\_\_,) to serve in the Regiment, for  
the term of three years: and having served **HONESTLY** and  
**FAITHFULLY** with his Company in the field to the present date, is now  
entitled to a **DISCHARGE** by reason of surgeon's certificate of  
disability.

The said William E. Williamson has not been paid  
since enlistment on the 16th day of October, 1863, and has  
pay due him from that time to the present date; he is entitled to pay and subsistence for  
**TRAVELING** to place of enrollment, and whatever other allowances are authorized to volunteer  
soldiers, drafted men, or militia, so discharged. He has received from the United States **CLOTHING**  
amounting to sixty nine  $\frac{7}{100}$  dollars, since the 16th day of October,  
1863, when his clothing account was last settled. He has received from the United States  
\_\_\_\_\_  $\frac{100}{100}$  dollars advanced **BOUNTY**.

There is to be stopped from him, on account of the State of \_\_\_\_\_, or other  
authorities, for **CLOTHING**, &c., received on entering service, \_\_\_\_\_  $\frac{100}{100}$  dollars; and  
for other stoppages, viz: two uniforms two sword drivers two barrels  
sacks two canteens for shoulder scales & stampion  
\_\_\_\_\_  $\frac{100}{100}$  dollars.

He has been furnished with **TRANSPORTATION** in kind from the place of his discharge to  
\_\_\_\_\_; and he has been **SUBSISTED** for **TRAVELING** to his  
place of enrollment, up to the \_\_\_\_\_, 186\_\_\_\_.

He is indebted to Wm Chase, **SUTLER**, fourty three  $\frac{100}{100}$  dollars.

He is indebted to \_\_\_\_\_, **LAUNDRESS**, \_\_\_\_\_  $\frac{100}{100}$  dollars.

Given in Duplicate, at Camp New Aquemine, this 29th day  
of September, 1864.



2046

Williamson William H.

Co L, 11 U.S. Col'd H. Art'y.

Private

Private

CARD NUMBERS.

1	6199836	26
2	6199982	27
3	6200134	28
4	6200276	29
5	6200413	30
6	6200551	31
7	6200679	32
8	6200808	33
9	6200938	34
10	6201053	35
11	6201175	36
12	6201286	37
13		38
14		39
15		40
16		41
17		42
18		43
19		44
20		45
21		46
22		47
23		48
24		49
25		50

Book Mark:

See also



*W* | 11 H. Art'y. | **U.S.C.T.**

*William H. Williamson*

....., Co. *L*., 11 Reg't U. S. Col'd H. Art'y.

Appears on

**Company Descriptive Book**

of the organization named above.

**DESCRIPTION.**

Age *20* years; height *5* feet *5* inches.

Complexion *DK*

Eyes *Brn*; hair *Blk*

Where born *Fallington Penn*

Occupation *Labourer*

**ENLISTMENT.**

When *Dec 19*, 186*3*.

Where *Prov R, I.*

By whom *J. Coughy*; term *3* y'rs.

Remarks: *Mustered Out Oct 2' 1865*

*Gifford*

Copyist.

21 | 11 H. Art'y. | U.S.C.T.

William H Williamson  
Priv, Co. L, 14 Reg't R. I. Col'd H. Art'y.\*

Age 20 years.

Appears on

**Company Muster-in Roll**

of the organization named above. Roll dated

Camp in Providence R.I Dec 31, 1863.

Muster-in to date Dec. 31, 1863.

Joined for duty and enrolled:

When Dec 19, 1863.

Where Prov. R.I.

Period 3 years.

Valuation of horse, \$ 100

Valuation of horse equipments, \$ 100

Remarks: Residence  
1<sup>st</sup> Dist. R.I.

\* This organization subsequently became Co. L, 11 Reg't U. S. Colored Heavy Artillery.

Book mark: \_\_\_\_\_

Manley

*W*

11 H. Art'y.

U.S.C.T.

*William H. Williamson*

*for*, Co. L, 14 Reg't R. I. Col'd H. Art'y.\*

Appears on

**Company Muster Roll**

for *Jan 8<sup>th</sup> Feb*, 1864.

Present or absent *Present*

Stoppage, \$ *100* for

Due Gov't, \$ *100* for

Valuation of horse, \$ *100*

Valuation of horse equipments, \$ *100*

Remarks:

\* This organization subsequently became Co. L, 11 Reg't U. S. Colored Heavy Artillery.

Book mark:

*A. P. Edwards*  
Copyist.



*W* | 11 H. Art'y. | U.S.C.T.

*William A. Williamson*  
*Plt*, Co. L, 14 Reg't R. I. Col'd H. Art'y.\*

Appears on

**Company Muster Roll**

for *Mar & Apr*, 1864.

Present or absent *Present*

Stoppage, \$.....100 for .....

Due Gov't, \$.....100 for .....

Valuation of horse, \$.....100

Valuation of horse equipments, \$.....100

Remarks: .....

\* This organization subsequently became Co. L, 11 Reg't U. S. Colored Heavy Artillery.

Book mark: .....

*W. H. Key*

Copyist.

*W* | 11 H. Art'y. | **U.S.C.T.**

*William H. Williamson*  
Pvt, Co. *L*, 8 Reg't U. S. Col'd H. Art'y.\*

Appears on

**Company Muster Roll**

for *May & June*, 186*4*.

Present or absent

Stoppage, \$ 100 for

Due Gov't, \$ 20 <sup>100</sup> for *advance*

Valuation of horse, \$ 100

Valuation of horse equipments, \$ 100

Remarks:

† This organization subsequently became Co. \_\_\_\_\_, 11 Reg't U. S. Colored Heavy Artillery.

Book mark:

*Mausky*

*24* | 11 H. Art'y. | U.S.C.T.

*William Williamson*

*Pvt*, Co. L, 11 Reg't U. S. Col'd H. Art'y.

Appears on

**Company Muster Roll**

for *July & Aug*, 186*4*

Present or absent *Present*

Stoppage, \$ *100* for

Due Gov't, \$ *20* for *ordnance*

Valuation of horse, \$ *100*

Valuation of horse equipments, \$ *100*

Remarks: *\$6 per mo. back pay  
due from enlistment  
to Apr. 30/64  
from on Apr. 19/61*

Book mark:

*Maerky*



W. | 11 H. Art'y. | U.S.C.T.

William H. Williamson.

Priv., Co. L, 11 Reg't U. S. Col'd H. Art'y.

Appears on

**Company Muster Roll**

for Sept & Oct, 1864

Present or absent present.

Stoppage, \$ 45/100 for ordnance

Due Gov't, \$ 100 for \_\_\_\_\_

Valuation of horse, \$ 100

Valuation of horse equipments, \$ 100

Remarks: \$6.00 per month back  
pay due from enlistment  
to April 30/64  
Free on April 19/61.

Book mark: \_\_\_\_\_

Baker  
Copyist.

W.

11 H. Art'y.

U.S.C.T.

William H. Williamson.

Pvt., Co. L, 11 Reg't U. S. Col'd H. Art'y.

Appears on

Company Muster Roll

for Nov. & Dec., 1864.

Present or absent present.

Stoppage, \$ -  $\frac{45}{100}$  for ordnance.

Due Gov't, \$ 100 for

Valuation of horse, \$ 100

Valuation of horse equipments, \$ 100

Remarks:

Book mark:

Baker,  
Copyist.

W.

11 H. Art'y.

U.S.C.T.

William A. Williamson.

Pvt., Co. L, 11 Reg't U. S. Col'd H. Art'y.

Appears on

Company Muster Roll

for Jan & Feb., 1865.

Present or absent present

Stoppage, \$ -  $\frac{25}{100}$  for ordnance.

Due Gov't, \$ 100 for

Valuation of horse, \$ 100

Valuation of horse equipments, \$ 100

Remarks:

Book mark:

Baker  
Copyist.



W.

11 H. Art'y. U.S.C.T.

William H. Williamson.

Pl., Co. L, 11 Reg't U. S. Col'd H. Art'y.

Appears on

Company Muster Roll

for March & April, 1860.

Present or absent present.

Stoppage, \$ -  $\frac{25}{100}$  for ordnance.

Due Gov't, \$ 100 for

Valuation of horse, \$ 100

Valuation of horse equipments, \$ 100

Remarks:

Book mark:

Baker.

Copyist.

*W* 11 H. Art'y. **U.S.C.T.**

*William H. Williamson*  
*Pvt*, Co. L, 11 Reg't U. S. Col'd H. Art'y.

Appears on

**Company Muster Roll**

for *May & June*, 1865.

Present or absent *Present*

Stoppage, \$.....100 for .....

Due Gov't, \$.....100 for .....

Valuation of horse, \$.....100

Valuation of horse equipments, \$.....100

Remarks: .....

Book mark: .....

*Murphy*

*W* | 11 H. Art'y. U.S.C.T.

*William H. Williamson*  
*Pvt*, Co. L, 11 Reg't U. S. Col'd H. Art'y.

Appears on

**Company Muster Roll**

for *July & Aug.*, 1865.

Present or absent *Present*

Stoppage, \$ *100* for

Due Gov't, \$ *100* for

Valuation of horse, \$ *100*

Valuation of horse equipments, \$ *100*

Remarks: *on special in Post Baker,*  
*at Carrollton, La., by sp. C*  
*55 dated Hd Qrs U.S. Forces*  
*Camp Parapet, La. July 23/65.*

Book mark: \_\_\_\_\_

*Murphy*



*W* | **11 H. Art'y. U.S.C.T.**

*William H. Williamson*

*Prvt*, Co. L, 11 Reg't U. S. Col'd H. Art'y.

Appears on **Co. Muster-out Roll**, dated  
*New Orleans La. Oct 2*, 1865.

Muster-out to date *Oct 2*, 1865.

Last paid to *Feb 28*, 1865.

**Clothing account:**

Last settled \_\_\_\_\_, 186 ; drawn since \$ \_\_\_\_\_ 100

Due soldier \$ *12* <sup>*46*</sup> 100; due U. S. \$ \_\_\_\_\_ 100

Am't for cloth'g in kind or money adv'd \$ \_\_\_\_\_ 100

Due U. S. for arms, equipments, &c., \$ \_\_\_\_\_ 100

Bounty paid \$ \_\_\_\_\_ 100; due \$ *100* 100

Remarks: *Joined at Orgl. Organiz.*  
*Stoppage for 1 Month &*  
*acc'ts retained \$ 6.00*

Book mark: \_\_\_\_\_

*Murphy*

Williamson, Wm J

S., Co., 11 Reg't W.C.A.A

**Enclosures.**

Bed Cards .....	Final Statements .....
Burial Records .....	Furloughs or L. of A .....
Certs. of Dis. for Discharge .....	Med. Certificates .....
C. M. Charges .....	Med. Des. Lists .....
Descriptive Lists .....	Orders .....
Discharge Certificates .....	Pris. of War Record .....
Enlistment Papers .....	Resignations .....

**Other papers relating to—**

Admission to Hosp'l .....	Furlough or L. of A .....
Casualty Sheet .....	Med. Examination .....
Confinement .....	Misc. Information .....
Contracts .....	Pay or Clothing .....
Death or Effects .....	Personal Reports .....
Desertion .....	Rank .....
Discharge from Hosp'l .....	Transfer to Hosp'l .....
Discharge from Service .....	Transfer to V. R. C. .....
Duty .....	Transportation .....

DECLARATION OF RECRUIT.

I, *William H. Williamson* desiring to VOLUNTEER as a Soldier in the ARMY OF THE UNITED STATES, for the term of *3 years* do declare that I am *20* years and months of age; that I have never been discharged from the United States service on account of disability or by sentence of a court martial, or by order, before the expiration of a term of enlistment; and I know of no impediment to my serving honestly and faithfully as a soldier for

Given at *Rowdeme* *William H. Williamson*  
The *15* day of *Dec* 18 *63* *mark*

Witness:

*J. B. Engley*

No. *133*

*William H. Williamson*  
Volunteered at *Rowdeme*

*Dec 15* 18*63*

By *J. B. Engley*  
*1st Regiment of Heavy*  
*Artillery*

enlistment: last served in Company ( )

Reg't of

Discharged

*Dec 11 1863*

18

CONSENT IN CASE OF MINOR.

I, \_\_\_\_\_ Do CERTIFY that I am the \_\_\_\_\_ of \_\_\_\_\_; that the said \_\_\_\_\_ is \_\_\_\_\_ years of age; and I do hereby freely give my CONSENT to his volunteering as a SOLDIER in the ARMY OF THE UNITED STATES for the period of \_\_\_\_\_

Given at \_\_\_\_\_  
The \_\_\_\_\_ day of \_\_\_\_\_

Witness:



VOLUNTEER ENLISTMENT.

State of  
Rhode Island



Town of  
Providence

I, *William H. Williamson* born in \_\_\_\_\_  
in the State of *Pennsylvania* aged *20* years, and by occupation  
a *Labourer* DO HEREBY ACKNOWLEDGE to have volunteered this *19<sup>th</sup>*  
day of *Dec* 18 *63* to serve as a SOLDIER in the ARMY OF THE UNITED STATES  
OF AMERICA, for the period of *3 Years*, unless sooner discharged by proper authority:  
Do also agree to accept such bounty, pay, rations and clothing, as are, or may be, established, by law for  
volunteers. And I, *William H. Williamson* do solemnly swear, that I will bear  
true faith and allegiance to the *United States of America*, and that I will serve them honestly and faith-  
fully against all their enemies or opposers whomsoever; and that I will observe and obey the orders of the  
President of the United States, and the orders of the officers appointed over me, according to the Rules  
and Articles of War.

Sworn and Subscribed to, at *Providence*

this *19<sup>th</sup>* day of *Dec* 18 *63*.

BEFORE

*Mr John LeMay Public Notary*

*his*  
*William H. Williamson*  
*mark*

I CERTIFY, ON HONOR, That I have carefully examined the above-named Volunteer, agreeable to the General Regulations of  
the Army, and that, in my opinion, he is free from all bodily defects and mental infirmity, which would, in any way, disqualify him  
from performing the duties of a soldier.

*Johnson Gardner M.D.*

EXAMINING SURGEON.

I CERTIFY, ON HONOR, That I have minutely inspected the Volunteer, *William H. Williamson*  
previously to his enlistment, and that he was entirely sober when enlisted; that to the best of my judgment and belief, he is of  
lawful age; and that, in accepting him as duly qualified to perform the duties of an able-bodied soldier, I have strictly observed the  
Regulations which govern the recruiting service. This soldier has *Brown* eyes *Blk* hair  
*Dark* complexion, is *5* feet, *5* inches high.

*J. B. Bradley*  
*Adj. 14<sup>th</sup> Regiment of N. H. V.*

Volunteers.

RECRUITING OFFICER.

2047

*Wilmer John W.*  
**Co K, 11 U.S. Col'd H. Art'y.**

*Private*

*Private*

CARD NUMBERS.

1	6197928	26
2	6198721	27
3	6198264	28
4	6198427	29
5	6198580	30
6	6198737	31
7	6198877	32
8	6199020	33
9	6199156	34
10	6199289	35
11	6199411	36
12	6199534	37
13	6199652	38
14	6125735	39
15		40
16		41
17		42
18		43
19		44
20		45
21		46
22		47
23		48
24		49
25		50

Book Mark:

See also

Ay. 1440711  
\$ 2788635 - P.O. m m

John Miller & Co



*W* | **11 H. Art'y. | U.S.C.T.**

*John W. Wilmer*  
....., Co. *K*, 11 Reg't U. S. Col'd H. Art'y.

Appears on

**Company Descriptive Book**

of the organization named above.

**DESCRIPTION.**

Age *26* years; height *5* feet *5 1/2* inches.

Complexion *DK*

Eyes *DK*; hair *Blk*

Where born *New Jersey*

Occupation *Farmer*

**ENLISTMENT.**

When *Nov 26*, 186 .

Where *Prov A. I.*

By whom *J. E. Engly*; term *3* y'rs.

Remarks:

*Griffith*

Copyst.

*W* | 11 H. Art'y. | U.S.C.T.

*John W. Wilmer*

*Pt*, Co. *K*, 14 Reg't R. I. Col'd H. Art'y.\*

Age *26* years.

Appears on

**Company Muster-in Roll**

of the organization named above. Roll dated

*Cp nr. Providence R.I. Dec 17, 1863.*

Muster-in to date *Dec 17, 1863.*

Joined for duty and enrolled:

When *Nov 26*, 186*3*.

Where *Providence R.I.*

Period *3* years.

Valuation of horse, \$.....*100*

Valuation of horse equipments, \$.....*100*

Remarks:.....

\* This organization subsequently became Co. *K*, 11 Reg't U. S. Colored Heavy Artillery.

Book mark:.....

*J. H. Stewart*

*W* | **11 H. Art'y.** | **U.S.C.T.**

*John W. Wilmer*  
*Pt*, Co. K, 14 Reg't R. I. Col'd H. Art'y.\*

Appears on

**Company Muster Roll**

for *Dec 17<sup>th</sup> Dec 31*, 1863.

Present or absent *Present*

Stoppage, \$.....100 for .....

Due Gov't, \$.....100 for .....

Valuation of horse, \$.....100

Valuation of horse equipments, \$.....100

Remarks:.....

\*This organization subsequently became Co. K, 11 Reg't U. S. Colored Heavy Artillery.

Book mark:.....

*J. Stewart*



*W* | **11 H. Art'y.** | **U.S.C.T.**

*John W. Wilmer*  
Pt., Co. K, 14 Reg't R. I. Col'd H. Art'y.\*

Appears on

**Company Muster Roll**

for *Jan & Feb*, 1864.

Present or absent *Present*

Stoppage, \$ 100 for

Due Gov't, \$ 100 for

Valuation of horse, \$ 100

Valuation of horse equipments, \$ 100

Remarks:

\*This organization subsequently became Co. K, 11 Reg't U. S. Colored Heavy Artillery.

Book mark:

*J. H. Stewart*

*W* | **11 H. Art'y.** | **U.S.C.T.**

*John H. Milmer*  
*Pt*, Co. K, 14 Reg't R. I. Col'd H. Art'y.\*

Appears on

**Company Muster Roll**

for *March & April*, 1864.

Present or absent *Present*

Stoppage, \$.....100 for .....

Due Gov't, \$.....100 for .....

Valuation of horse, \$.....100

Valuation of horse equipments, \$.....100

Remarks: *Stop for wife*  
*\$ . 2 0*

\*This organization subsequently became Co. K, 11 Reg't U. S. Colored Heavy Artillery.

Book mark : .....

*J. H. Stewart*  
Copyist.

*W* | 11 H. Art'y. | **U.S.C.T.**

*John W. Wilmer*  
*Co. C*, 8 Reg't U. S. Col'd H. Art'y.\*

Appears on

**Company Muster Roll**

for *May June*, 1864.

Present or absent

*Present*

Stoppage, \$ 100 for

Due Gov't, \$ 100 for

Valuation of horse, \$ 100

Valuation of horse equipments, \$ 100

Remarks:

† This organization subsequently became *Co. C* 11 Reg't U. S. Colored Heavy Artillery.

Book mark:

*Steward*

Copyist.



*W* 11 H. Art'y. U.S.C.T.

*John W. Wilmer*  
Co. K, 11 Reg't U. S. Col'd H. Art'y.

Appears on

**Company Muster Roll**

for *July & Aug*, 186*4*.

Present or absent *Present*

Stoppage, \$ 100 for

Due Gov't, \$ 100 for

Valuation of horse, \$ 100

Valuation of horse equipments, \$ 100

Remarks: *Free on 19 Apr/61  
\$6 per month due from  
enlistment to  
April 30/64.*

Book mark: \_\_\_\_\_

*Stewart*

*W* | 11 H. Art'y. | U.S.C.T.

*John W. Wilmar*  
Co. K, 11 Reg't U. S. Col'd H. Art'y.

Appears on

**Company Muster Roll**

for *Sept & Oct*, 186*4*.

Present or absent *Present*

Stoppage, \$ 100 for

Due Gov't, \$ 63 for *2nd*

Valuation of horse, \$ 100

Valuation of horse equipments, \$ 100

Remarks: *Due U.S. for*  
*C. & G. 998*

Book mark: \_\_\_\_\_

*Steward*

Copyist.

*A* | 11 H. Art'y. | U.S.C.T.

*John W. Wilmer*  
Prvt, Co. K, 11 Reg't U. S. Col'd H. Art'y.

Appears on

Company Muster Roll  
for *Nov 20*, 186*4*.

Present or absent *Present*

Stoppage, \$ 100 for

Due Gov't, \$ 44 for *Ordinance*

Valuation of horse, \$ 100

Valuation of horse equipments, \$ 100

Remarks: *Due U.S. for*  
*A. & G. 99 etc.*

Book mark: \_\_\_\_\_

*Steward*



*M* 11 H. Art'y. | **U.S.C.T.**

*John W. Milmer*  
*Prs.*, Co. K, 11 Reg't U. S. Col'd H. Art'y.

Appears on

**Company Muster Roll**

for *Jan't Feb*, 1865.

Present or absent *Present.*

Stoppage, \$ 100 for

Due Gov't, \$ 44 for *Ordnance.*

Valuation of horse, \$ 100

Valuation of horse equipments, \$ 100

Remarks: *Due US for*  
*C & G 2 99 etc.*

Book mark:

*Chas. Ward*

*W* | 11 H. Art'y. | U.S.C.T.

*John W Wilmer*  
Co. K, 11 Reg't U. S. Col'd H. Art'y.

Appears on

Company Muster Roll  
for *March & April*, 1865

Present or absent *Present*

Stoppage, \$ \_\_\_\_\_ 100 for \_\_\_\_\_

Due Gov't, \$ \_\_\_\_\_ 100 for *Advance*

Valuation of horse, \$ \_\_\_\_\_ 100

Valuation of horse equipments, \$ \_\_\_\_\_ 100

Remarks: *Due G.S. for  
C. & G. \$1.00*

Book mark: \_\_\_\_\_

*John W Wilmer*

*M* | 11 H. Art'y. | U.S.C.T.

*John H. Wilmer*  
*Pvt*, Co. K, 11 Reg't U. S. Col'd H. Art'y.

Appears on

**Company Muster Roll**

for *May & June*, 1865.

Present or absent *Present*

Stoppage, \$ 100 for

Due Gov't, \$ 01 for *C & L E*

Valuation of horse, \$ 100

Valuation of horse equipments, \$ 100

Remarks:

-----  
-----  
-----  
-----  
-----  
-----  
-----  
-----

Book mark:

-----

*Sprucker*  
(358) Copyist.



*M* | 11 H. Art'y. | U.S.C.T.

*John H. Wilmer*  
*Pvt*, Co. K, 11 Reg't U. S. Col'd H. Art'y.

Appears on

**Company Muster Roll**

for *July & Aug*, 186*5*.

Present or absent *Present*

Stoppage, \$ *100* for

Due Gov't, \$ *01* for *C & U E*

*lost and destroyed*

Valuation of horse, \$ *100*

Valuation of horse equipments, \$ *100*

Remarks:

Book mark:

*Spencer*  
Copyist.

*M* | 11 H. Art'y. | U.S.C.T.

*John H. Wilmer*

*Priv*, Co. *K*, 11 Reg't U. S. Col'd H. Art'y.

Appears on Co. Muster-out Roll, dated

*New Orleans, La*, *Oct. 2*, 1865.

Muster-out to date *Oct. 2*, 1865.

Last paid to *Feb. 28*, 1865.

Clothing account:

Last settled....., 186 ; drawn since \$..... 100

Due soldier \$ *16* <sup>*55*</sup>/<sub>100</sub>; due U. S. \$..... 100

Am't for cloth'g in kind or money adv'd \$..... 100

Due U. S. for arms, equipments, &c., \$ *6* <sup>*01*</sup>/<sub>100</sub>

Bounty paid \$ *None* <sup>*00*</sup>/<sub>100</sub>; due \$ *100* <sup>*00*</sup>/<sub>100</sub>

Remarks: *Joined at Orig. Organ.*

*Plat 1 letter "K" lost. 1 musket  
& Equipments retained.*

Book mark : .....

*Spicer*

Wilmer, Inc: W

P, Co., 11 Reg't U.S.C.H.A

Enclosures.

Bed Cards .....	Final Statements .....
Burial Records .....	Furloughs or L. of A .....
Certs. of Dis. for Discharge .....	Med. Certificates .....
C. M. Charges .....	Med. Des. Lists .....
Descriptive Lists .....	Orders .....
Discharge Certificates .....	Pris. of War Record .....
Enlistment Papers .....	Resignations .....

Other papers relating to—

Admission to Hosp'l .....	Furlough or L. of A .....
Casualty Sheet .....	Med. Examination .....
Confinement .....	Misc. Information .....
Contracts .....	Pay or Clothing .....
Death or Effects .....	Personal Reports .....
Desertion .....	Rank .....
Discharge from Hosp'l .....	Transfer to Hosp'l .....
Discharge from Service .....	Transfer to V. R. C. .....
Duty .....	Transportation .....



DECLARATION OF RECRUIT.

I, John M. Miller desiring to VOLUNTEER as a Soldier in the ARMY OF THE UNITED STATES, for the term of 3 year do declare that I am 26 years and 3 months of age; that I have never been discharged from the United States service on account of disability or by sentence of a court martial, or by order, before the expiration of a term of enlistment; and I know of no impediment to my serving honestly and faithfully as a soldier for 3 year

Given at Providence  
The 26<sup>th</sup> day of Nov 1863,

Witness:  
C. A. Walker

John M. Miller  
mark

Discharged

Reg't of

11<sup>th</sup>  
1871  
118

enlistment; last served in Company ( )

By Major G. C. Sawyer  
14<sup>th</sup> Regiment of Artillery  
11<sup>th</sup> Mass

Volunteered at

Providence  
Nov 26<sup>th</sup> 1863,

John M. Miller

No.

134  
Miller

CONSENT IN CASE OF MINOR.

I, \_\_\_\_\_ of \_\_\_\_\_ is \_\_\_\_\_ years of age; and I do hereby freely give my CONSENT to his volunteering as a SOLDIER in the ARMY OF THE UNITED STATES for the period of \_\_\_\_\_

Given at \_\_\_\_\_  
The \_\_\_\_\_ day of \_\_\_\_\_

Witness:

Do CERTIFY that I am the \_\_\_\_\_; that the said \_\_\_\_\_

VOLUNTEER ENLISTMENT.



State of Rhode Island

Town of Providence

I, John M. Milner born in Providence aged 26 years, and by occupation a Farmer

DO HEREBY ACKNOWLEDGE to have volunteered this 26th day of Nov 1863 to serve as a SOLDIER in the ARMY OF THE UNITED STATES OF AMERICA, for the period of three years, unless sooner discharged by proper authority: Do also agree to accept such bounty, pay, rations and clothing, as are, or may be, established, by law for volunteers. And I, John M. Milner do solemnly swear, that I will bear true faith and allegiance to the United States of America, and that I will serve them honestly and faithfully against all their enemies or opposers whomsoever; and that I will observe and obey the orders of the President of the United States, and the orders of the officers appointed over me, according to the Rules and Articles of War.

Sworn and Subscribed to, at Providence this 26th day of Nov 1863 John M. Milner Major

BEFORE John E. Noyes Public Notary

I CERTIFY, ON HONOR, That I have carefully examined the above-named Volunteer, agreeable to the General Regulations of the Army, and that, in my opinion, he is free from all bodily defects and mental infirmity, which would, in any way, disqualify him from performing the duties of a soldier.

Johnson Gardner M.D.

EXAMINING SURGEON.

I CERTIFY, ON HONOR, That I have minutely inspected the Volunteer, John M. Milner previously to his enlistment, and that he was entirely sober when enlisted; that to the best of my judgment and belief, he is of lawful age; and that, in accepting him as duly qualified to perform the duties of an able-bodied soldier, I have strictly observed the Regulations which govern the recruiting service. This soldier has Dark complexion, is 5 feet, 5 1/2 inches high. Dark eyes Black hair

Major 14th Regiment of Ry Artg Volunteers.

RECRUITING OFFICER.



2048

Wilmore Isaac

Co *A*, 11 U.S. Col'd H. Art'y.

Private | Private

CARD NUMBERS.

1	6190819	26
2	6190965	27
3	6190997	28
4	6191257	29
5	6191396	30
6	6191533	31
7	6191663	32
8	6191792	33
9	6191914	34
10	6192047	35
11	6192133	36
12	6192300	37
13	6192423	38
14	6125119	39
15		40
16		41
17		42
18		43
19		44
20		45
21		46
22		47
23		48
24		49
25		50

Book Mark:

2924 W. 211 P. 235.

See also



*11* | **11 H. Art'y. U.S.C.T.**

*Samuel Winmore*  
Co. *F*, 11 Reg't U. S. Col'd H. Art'y.

Appears on

**Company Descriptive Book**

of the organization named above.

**DESCRIPTION.**

Age *32* years; height *5* feet *4* inches.

Complexion *African*

Eyes *Blk.*; hair *Blk.*

Where born *Wilmington, Md.*

Occupation *Turner*

**ENLISTMENT.**

When *Oct. 16*, 186*3*.

Where *Prov., R.I.*

By whom *James S. Jefferson*, term *3* y'rs.

Remarks:

*Enlist in Descriptive Bk.*

*O. J. Markle,*

24 | 11 H. Art'y. | U.S.C.T.

Isaac Kilmore

Prov., Co. F, 14 Reg't R. I. Col'd H. Art'y.\*

Age 32 years.

Appears on

**Company Muster-in Roll**

of the organization named above. Roll dated

Providence R.I., Oct 20 1863.

Muster-in to date

Oct 20 1863.

Joined for duty and enrolled:

When Oct 16 186 .

Where Providence R.I.

Period 3 years.

Valuation of horse, \$ 100

Valuation of horse equipments, \$ 100

Remarks:

\* This organization subsequently became Co. F, 11 Reg't U. S. Colored Heavy Artillery.

Book mark:

A. M. O. L.

*It* | 11 H. Art'y. | U.S.C.T.

*Isaac Kilmore*

*Pr*, Co. F, 14 Reg't R. I. Col'd H. Art'y.\*

Appears on

**Company Muster Roll**

for *Oct 20 to Dec 31*, 1863.

Present or absent *Present*

Stoppage, \$.....100 for .....

Due Gov't, \$.....100 for .....

Valuation of horse, \$.....100

Valuation of horse equipments, \$.....100

Remarks: .....

\* This organization subsequently became Co. F, 11 Reg't U. S. Colored Heavy Artillery.

Book mark: .....

*J. Neal*



*W*

**11 H. Art'y. U.S.C.T.**

*Isaac Kilmon*

*Wagon*, Co. F, 14 Reg't R. I. Col'd H. Art'y.\*

Appears on

**Company Muster Roll**

for *Jan & Feb*, 1864.

Present or absent *Present*

Stoppage, \$ 100 for

Due Gov't, \$ 100 for

Valuation of horse, \$ 100

Valuation of horse equipments, \$ 100

Remarks:

\* This organization subsequently became Co. F, 11 Reg't U. S. Colored Heavy Artillery.

Book mark:

*LMoal*

*W* | 11 H. Art'y. | U.S.C.T.

*Isaac Kilmon*

*Pri*, Co. F, 14 Reg't R. I. Col'd H. Art'y.\*

Appears on

**Company Muster Roll**

for *May 1864*, 1864

Present or absent *Present*

Stoppage, \$ 100 for

Due Gov't, \$ 100 for

Valuation of horse, \$ 100

Valuation of horse equipments, \$ 100

Remarks:

\* This organization subsequently became Co. F. 11 Reg't U. S. Colored Heavy Artillery.

Book mark:

*A. Neal*  
Copyist.

*W* | 11 H. Art'y. | U.S.C.T.

*Isaac Wilmore*  
*Pr*, Co. *F*, 8 Reg't U. S. Col'd H. Art'y.\*

Appears on

Company Muster Roll

for *May & June*, 1864.

Present or absent

*Present*

Stoppage, \$ 100 for

Due Gov't, \$ 100 for

Valuation of horse, \$ 100

Valuation of horse equipments, \$ 100

Remarks

*Stop for one  
wiper and screw  
driver.*

† This organization subsequently became Co. *F*, 11 Reg't U. S. Colored Heavy Artillery.

Book mark:

*W. real*



*W* | 11 H. Art'y. | U.S.C.T.

*Isaac Wilmore.*

*Priv.*, Co. F, 11 Reg't U. S. Col'd H. Art'y.

Appears on

**Company Muster Roll**

for *July and Aug.*, 1864.

Present or absent *Present.*

Stoppage, \$ 100 for

Due Gov't, \$ 100 for

Valuation of horse, \$ 100

Valuation of horse equipments, \$ 100

Remarks: *Stop for wiper. 20*  
*Screw driver. 23, Free April 19/61.*

Book mark: \_\_\_\_\_

*Edwards*

*W* | 11 H. Art'y. | U.S.C.T.

*Isaac Wilmore.*

*Priv.*, Co. F, 11 Reg't U. S. Col'd H. Art'y.

Appears on

**Company Muster Roll**

for *Sept. and Oct.*, 1864.

Present or absent *Present.*

Stoppage, \$ *100* for

Due Gov't, \$ *100* for

Valuation of horse, \$ *100*

Valuation of horse equipments, \$ *100*

Remarks: *Stop for wiper. 20*  
*Screwdriver. 23, Free April 19/61.*

Book mark: \_\_\_\_\_

*Eoline.*

*N* | 11 H. Art'y. | U.S.C.T.

*Isaac Wilmore,*  
*Priv.*, Co. F, 11 Reg't U. S. Col'd H. Art'y.

Appears on

**Company Muster Roll**

for *Nov. and Dec.*, 1864.

Present or absent *Present.*

Stoppage, \$ *100* for

Due Gov't, \$ *100* for

Valuation of horse, \$ *100*

Valuation of horse equipments, \$ *100*

Remarks: *Stop for repairs. 20*  
*Screwdriver. 23 canteen. 41*  
*Free April 19/61.*

Book mark: \_\_\_\_\_

*Online.*



*W* | **11 H. Art'y. | U.S.C.T.**

*Isaac Wilmore.*

*Pvt.*, Co. F, 11 Reg't U. S. Col'd H. Art'y.

Appears on

**Company Muster Roll**

for *Jan. and Feb.*, 1865.

Present or absent *Present.*

Stoppage, \$ *100* for

Due Gov't, \$ *100* for

Valuation of horse, \$ *100*

Valuation of horse equipments, \$ *100*

Remarks: *Stop for canteen. 41*

Book mark: \_\_\_\_\_

*Exline.*

*N* | 11 H. Art'y. | U.S.C.T.

*Isaac Milmore,*

*Pvt.*, Co. F, 11 Reg't U. S. Col'd H. Art'y.

Appears on

**Company Muster Roll**

for *Mar. and Apr.*, 1865.

Present or absent *Present.*

Stoppage, \$ 100 for

Due Gov't, \$ 100 for

Valuation of horse, \$ 100

Valuation of horse equipments, \$ 100

Remarks: *Stop for canteen. 41*

Book mark: \_\_\_\_\_

*Exline.*

*M* | 11 H. Art'y. | U.S.C.T.

*Isaac Wilmore*  
*Sgt.*, Co. F, 11 Reg't U. S. Col'd H. Art'y.

Appears on

**Company Muster Roll**

for *May & June*, 1865.

Present or absent *Present*.

Stoppage, \$ 100 for

Due Gov't, \$ 100 for

Valuation of horse, \$ 100

Valuation of horse equipments, \$ 100

Remarks:

Book mark:



*M* | 11 H. Art'y. | U.S.C.T.

*Isaac Melmore*  
*Priv.*, Co. F, 11 Reg't U. S. Col'd H. Art'y.

Appears on

**Company Muster Roll**

for *July & Aug.*, 1865.

Present or absent  *Present.*

Stoppage, \$.....100 for .....

Due Gov't, \$.....100 for .....

Valuation of horse, \$.....100

Valuation of horse equipments, \$.....100

Remarks: .....

.....

.....

.....

.....

.....

.....

Book mark: .....

.....

*Leis*  
Copyst.

*L.* U. S. ARMY. U. S. C. T.

*Isaac Belmont*  
Private, 7th Regt U. S. Cal'd H. Arty.

Appears on Co. Muster-out Roll. Dated  
*New Orleans La. Oct 2 1865*  
Muster-out date *Oct 2 1865*  
Last paid *June 30 1865*

Clothing account:  
CASH PAID FOR ..... 1.50 ..... 1.50  
Dues for ..... 1.00 ..... 1.00  
ALL PAID FOR ..... 2.50 ..... 2.50

The U. S. Army ..... 6.00  
..... 1.00

REMARKS: *Joined at Orgin.  
Died Stop for mustlet  
Articles retained.*

BOOK MARK: *2724 5th Regt 73d*

*L. Belmont*  
Comd.

Millmore, Isaac

I, Co., 11 Reg't U.S.C.A.

Enclosures.

Bed Cards	Final Statements
Burial Records	Furloughs or L. of A.
Certs. of Dis. for Discharge	Med. Certificates
C. M. Charges	Med. Des. Lists
Descriptive Lists	Orders
Discharge Certificates	Pris. of War Record
Enlistment Papers	Resignations

Other papers relating to—

Admission to Hosp'l	Furlough or L. of A.
Casualty Sheet	Med. Examination
Confinement	Misc. Information
Contracts	Pay or Clothing
Death or Effects	Personal Reports
Desertion	Rank
Discharge from Hosp'l	Transfer to Hosp'l
Discharge from Service	Transfer to V. R. C.
Duty	Transportation



DECLARATION OF RECRUIT.

I, *Isaac Willmore* desiring to VOLUNTEER as a Soldier in the ARMY OF THE UNITED STATES, for the term of *Three years* do declare that I am *32* years and *—* months of age; that I have never been discharged from the United States service on account of disability or by sentence of a court martial, or by order, before the expiration of a term of enlistment; and I know of no impediment to my serving honestly and faithfully as a soldier for *Three years.*

Given at *Prov RD*  
The *16* day of *Dec* 18*63*

Witness:

*James Jefferson*

*his mark*  
*Isaac Willmore*

Discharged

18

Regt of

enlistment; last served in Company

By *James Jefferson*  
*1st Lt*  
*11th Regt of Ala.*

Volunteered at

*Providence RI*

No.

*134*

CONSENT IN CASE OF MINOR.

I, \_\_\_\_\_ Do CERTIFY that I am the \_\_\_\_\_ of \_\_\_\_\_; that the said \_\_\_\_\_ is \_\_\_\_\_ years of age; and I do hereby freely give my CONSENT to his volunteering as a SOLDIER in the ARMY OF THE UNITED STATES for the period of \_\_\_\_\_

Given at \_\_\_\_\_  
The \_\_\_\_\_ day of \_\_\_\_\_

Witness:



VOLUNTEER ENLISTMENT.

State of Rhode Island

Town of Providence



I, Isaac Millmore, born in Baltimore, aged 32 years, and by occupation a Tanner, DO HEREBY ACKNOWLEDGE to have volunteered this 23 day of Oct. 1863 to serve as a SOLDIER in the ARMY OF THE UNITED STATES OF AMERICA, for the period of Three years, unless sooner discharged by proper authority:

Do also agree to accept such bounty, pay, rations and clothing, as are, or may be, established, by law for volunteers. And I, Isaac Millmore do solemnly swear, that I will bear true faith and allegiance to the United States of America, and that I will serve them honestly and faithfully against all their enemies or opposers whomsoever; and that I will observe and obey the orders of the President of the United States, and the orders of the officers appointed over me, according to the Rules and Articles of War.

Sworn and Subscribed to, at

this 23 day of Oct. 1863

BEFORE

I CERTIFY, on HONOR, that I have carefully examined the above-named Volunteer, agreeable to the General Regulations of the Army, and that, in my opinion, he is free from all bodily defects and mental infirmity, which would, in any way, disqualify him from performing the duties of a soldier.

Johnson forwarded H.C.

EXAMINING SURGEON.

Isaac Millmore

I CERTIFY, ON HONOR, That I have minutely inspected the Volunteer, previously to his enlistment, and that he was entirely sober when enlisted; that to the best of my judgment and belief, he is of lawful age; and that, in accepting him as duly qualified to perform the duties of an able-bodied soldier, I have strictly observed the Regulations which govern the recruiting service. This soldier has

African complexion, is 5 feet, 4 inches high. Black eyes Black hair

17th Regiment of H.A.

Volunteers,

RECRUITING OFFICER.



2049

*Wilson Aaron*

**Co B, 11 U.S. Col'd H. Art'y.**

*Private*

*Private*

CARD NUMBERS.

1	6183957	26
2	6184101	27
3	6184245	28
4	6184383	29
5	6184521	30
6	6184654	31
7	6184780	32
8	6184902	33
9	6185018	34
10	6185133	35
11	6185244	36
12	6185352	37
13	6185460	38
14	91711363	39
15	9174776	40
16		41
17		42
18		43
19		44
20		45
21		46
22		47
23		48
24		49
25		50

Book Mark:

See also



D. 95-1816 P.O. 222

Q.M. + H. Stone 4-17-37 C.M.H.

John Miller C.H.

*U* | 11 H. Art'y. | **U.S.C.T.**

*Aaron Wilson*

....., Co. *B*, 11 Reg't U. S. Col'd H. Art'y.

Appears on

**Company Descriptive Book**

of the organization named above.

**DESCRIPTION.**

Age *40* years; height *5* feet *4* inches.

Complexion *Dark*

Eyes *Brown*; hair *Blk*

Where born *N Y*

Occupation *Cook*

**ENLISTMENT.**

When *Aug 19*, 186 .

Where *Providence*

By whom *My Sanford*; term *3* y'rs.

Remarks:

*James*

Copyist.

*W* | **11 H. Art'y. | U.S.C.T.**

*Aaron Wilson*

....., Co. *B*, 11 Reg't U. S. Col'd H. Art'y.

Appears on

**Company Descriptive Book**

of the organization named above.

**DESCRIPTION.**

Age *40* years; height *5* feet *4* inches.

Complexion *Dark*

Eyes *Blk*; hair *Blk*

Where born *N. Y.*

Occupation *Cook*

**ENLISTMENT.**

When *Aug 19*, 186*3*.

Where *Prov R I*

By whom *Myself*; term *3* y'rs.

Remarks:

.....  
.....  
.....  
.....  
.....  
.....  
.....  
.....  
.....

*James*



*W* | 11 H. Art'y. | U.S.C.T.

*Aaron Wilson*

*Pvt*, Co. *B*, 14 Reg't R. I. Col'd H. Art'y.\*

Age *40* years.

Appears on

**Company Muster-in Roll**

of the organization named above. Roll dated

*Providence R. I., Sept 14, 1863.*

Muster-in to date *Sept 14, 1863.*

Joined for duty and enrolled:

When *Aug. 19*....., 186 .

Where *Providence*.....

Period *3* years.

Valuation of horse, \$.....100

Valuation of horse equipments, \$.....100

Remarks:.....  
.....  
.....  
.....

\* This organization subsequently became Co. *B*, 11 Reg't U. S. Colored Heavy Artillery.

Book mark:.....  
.....

*J. Walker*

*W* | 11 H. Art'y. | U.S.C.T.

*Aaron Wilson*  
*Pvt.*, Co. B, 14 Reg't R. I. Col'd H. Art'y.\*

Appears on

**Company Muster Roll**

for *Sept 14 to Dec 31*, 1863.

Present or absent *Present*

Stoppage, \$.....100 for .....

Due Gov't, \$.....100 for .....

Valuation of horse, \$.....100

Valuation of horse equipments, \$.....100

Remarks: .....

.....  
.....  
.....  
.....  
.....  
.....  
.....  
.....

\*This organization subsequently became Co. B, 11 Reg't U. S. Colored Heavy Artillery.

Book mark: .....

.....

*J. Walker*  
Copyist.

*W* | 11 H. Art'y. | U.S.C.T.

*Aaron Wilson*

*Pvt.*, Co. B, 14 Reg't R. I. Col'd H. Art'y.\*

Appears on

**Company Muster Roll**

for *Jan & Feb*, 1864.

Present or absent *Present*

Stoppage, \$ *100* for

Due Gov't, \$ *100* for

Valuation of horse, \$ *100*

Valuation of horse equipments, \$ *100*

Remarks: \_\_\_\_\_  
\_\_\_\_\_  
\_\_\_\_\_  
\_\_\_\_\_  
\_\_\_\_\_

\*This organization subsequently became Co. B, 11 Reg't U. S. Colored Heavy Artillery.

Book mark: \_\_\_\_\_

*J. W. [unclear]*



*W* | 11 H. Art'y. | U.S.C.T.

*Aaron Wilson*  
*Priv*, Co. *B*, 8 Reg't U. S. Col'd H. Art'y.\*

Appears on

**Company Muster Roll**

for *Mch & Apl*, 1864.

Present or absent *Present*

Stoppage, \$ 100 for

Due Gov't, \$ 100 for

Valuation of horse, \$ 100

Valuation of horse equipments, \$ 100

Remarks:

† This organization subsequently became Co. *B*, 11 Reg't U. S. Colored Heavy Artillery.

Book mark:

*J. Walker*

*W* | 11 H. Art'y. | U.S.C.T.

*Aaron Wilson*

*Pvt*, Co *B*, 8 Reg't U. S. Col'd H. Art'y.\*

Appears on

**Company Muster Roll**

for *May & June*, 1864.

Present or absent *Present*

Stoppage, \$ *100* for

Due Gov't, \$ *100* for

Valuation of horse, \$ *100*

Valuation of horse equipments, \$ *100*

Remarks:

† This organization subsequently became Co. *B*, 11 Reg't U. S. Colored Heavy Artillery.

Book mark:

*J. Walker*

*H* | 11 H. Art'y. | U.S.C.T.

*Aaron Wilson*  
*Pri*, Co. B, 11 Reg't U. S. Col'd H. Art'y.

Appears on

**Company Muster Roll**  
for *July & Aug*, 1864.  
Present or absent *Present*

Stoppage, \$ 100 for

Due Gov't, \$ 100 for

Valuation of horse, \$ 100

Valuation of horse equipments, \$ 100

Remarks: *Free Apr 19/61*

Book mark: \_\_\_\_\_

*J. M. Moore*



11 | 11 H. Art'y. | U.S.C.T.

Aaron Wilson

Pi, Co. B, 11 Reg't U. S. Col'd H. Art'y.

Appears on

**Company Muster Roll**

for Sept & Oct, 1864.

Present or absent Present

Stoppage, \$ 100 for

Due Gov't, \$ 100 for

Valuation of horse, \$ 100

Valuation of horse equipments, \$ 100

Remarks:

Book mark:

J. M. Moore

*11*

11 H. Art'y.

U.S.C.T.

*Harold Wilson*

*Pvt.*, Co. B, 11 Reg't U. S. Col'd H. Art'y.

Appears on

**Company Muster Roll**

for *Nov 20*, 186 *4*

Present or absent *Present*

Stoppage, \$ *100* for

Due Gov't, \$ *100* for

Valuation of horse, \$ *100*

Valuation of horse equipments, \$ *100*

Remarks:

Book mark:

*J. Moore*

*A*

11 H. Art'y.

U.S.C.T.

*Harow Wilson*

*Pi*, Co. B, 11 Reg't U. S. Col'd H. Art'y.

Appears on

**Company Muster Roll**

for *Jan & Feb*, 186*J.*

Present or absent *Present*

Stoppage, \$ 100 for

Due Gov't, \$ 100 for

Valuation of horse, \$ 100

Valuation of horse equipments, \$ 100

Remarks:

Book mark:

*J. W. Moore*



*H* | 11 H. Art'y. | U.S.C.T.

*Aaron Wilson*

*Pi*, Co. B, 11 Reg't U. S. Col'd H. Art'y.

Appears on

**Company Muster Roll**

for *Mar & Apr*, 186*1*.

Present or absent

*Present*

Stoppage, \$ 100 for

Due Gov't, \$ 100 for

Valuation of horse, \$ 100

Valuation of horse equipments, \$ 100

Remarks:

Book mark:

*J. M. Moore*

*W* | 11 H. Art'y. | U.S.C.T.

*Amos Wilson*

*Pl.*, Co. B, 11 Reg't U. S. Col'd H. Art'y.

Appears on

**Company Muster Roll**

for *May & June*, 186*5*.

Present or absent *Present*

Stoppage, \$ 100 for

Due Gov't, \$ 100 for

Valuation of horse, \$ 100

Valuation of horse equipments, \$ 100

Remarks:

Book mark:

7 | 11 H. Art'y. | U.S.C.T.

*Amos Wilson*

*1st Lt.*, Co. B, 11 Reg't U. S. Col'd H. Art'y.

Appears on

**Company Muster Roll**

for *July & Aug.*, 186*5*.

Present or absent *Present*

Stoppage, \$ 100 for

Due Gov't, \$ 100 for

Valuation of horse, \$ 100

Valuation of horse equipments, \$ 100

Remarks:

-----  
-----  
-----  
-----  
-----  
-----  
-----  
-----

Book mark: -----

*Amos Wilson*



*11* H. Art'y. **U.S.C.T.**

*John Wilson*

*Co. B*, 11 Reg't U. S. Col'd H. Art'y.

Appears on **Co. Muster-out Roll**, dated

*Jan 1st* 186 *7*

Muster-out to date *Jan 1st* 186 *7*

Last paid to *Jan 1st* 186 *7*

**Clothing account:**

Last settled..... 186 : drawn since \$..... 100

Due soldier \$..... 100 : due U. S. \$..... 100

Am't for clothing in kind or money adv'd \$..... 100

Due U. S. for arms, equipments, &c., \$..... 100

Bounty paid \$..... 100 : due \$..... 100

Remarks: *Discharged*

*John Wilson*

Book mark: .....

Wilson, Aaron

P, Co., 11 Reg't U.S.C. H.A.

Enclosures.

Bed Cards .....	Final Statements .....
Burial Records .....	Furloughs or L. of A. ....
Certs. of Dis. for Discharge .....	Med. Certificates .....
C. M. Charges .....	Med. Des. Lists .....
Descriptive Lists .....	Orders .....
Discharge Certificates .....	Pris. of War Record .....
Enlistment Papers .....	Resignations .....

Other papers relating to—

Admission to Hosp'l .....	Furlough or L. of A. ....
Casualty Sheet .....	Med. Examination .....
Confinement .....	Misc. Information .....
Contracts .....	Pay or Clothing .....
Death or Effects .....	Personal Reports .....
Desertion .....	Rank .....
Discharge from Hosp'l .....	Transfer to Hosp'l .....
Discharge from Service .....	Transfer to V. R. C. ....
Duty .....	Transportation .....

DECLARATION OF RECRUIT.

I, *Carson Wilson* desiring to VOLUNTEER as a Soldier in the ARMY OF THE UNITED STATES, for the term of *3 years* do declare that I am *40* years and months of age; that I have never been discharged from the United States service on account of disability or by sentence of a court martial, or by order, before the expiration of a term of enlistment; and I know of no impediment to my serving honestly and faithfully as a soldier for *3 years*

Given at *Providence*  
The *19th* day of *Aug* 18 *63*  
Witness: *J. B. Ingby*  
*Carson Wilson*  
*Providence*



Discharged ..... 18

Regt of .....  
enlistment; last served in Company ( )

Volunteered at *Providence*  
*Aug 19 - 1863*  
By *Wm J. Sampford*  
Regiment of

No. *110000004100*  
*1863*

CONSENT IN CASE OF MINOR.

I, \_\_\_\_\_ of \_\_\_\_\_ is \_\_\_\_\_ years of age; and I do hereby freely give my CONSENT to his volunteering as a SOLDIER in the ARMY OF THE UNITED STATES for the period of \_\_\_\_\_

Given at \_\_\_\_\_  
The \_\_\_\_\_ day of \_\_\_\_\_  
Witness: \_\_\_\_\_



# VOLUNTEER ENLISTMENT.

State of

*R.I.*



Town of

*Providence*

I, *Osborn Wilson* born in *Yosh State*  
in the State of *R.I.* aged *40* years, and by occupation  
a

DO HEREBY ACKNOWLEDGE to have volunteered this *19th*  
day of *Aug* 18*69*, to serve as a SOLDIER in the ARMY OF THE UNITED STATES  
of AMERICA, for the period of *3 years*, unless sooner discharged by proper authority:

Do also agree to accept such bounty, pay, rations and clothing, as are, or may be, established by law for  
volunteers. And I, *Osborn Wilson* do solemnly swear, that I will bear  
true faith and allegiance to the *United States of America*, and that I will serve them honestly and faith-  
fully against all their enemies or opposers whomsoever; and that I will observe and obey the orders of  
the President of the United States, and the orders of the officers appointed over me, according to the  
Rules and Articles of War.

Sworn and subscribed to, at

this *19th* day of *Aug 18 69*

BEFORE

*Providence*  
*Osborn Wilson*  
*Mark*

I CERTIFY, ON HONOR, That I have carefully examined the above-named Volunteer, agreeably to the General Regulations  
of the Army, and that, in my opinion, he is free from all bodily defects and mental infirmity, which would, in any way, disqualify  
him from performing the duties of a soldier.

*John S. ...*

EXAMINING SURGEON.

I CERTIFY, ON HONOR, That I have minutely inspected the Volunteer, *Osborn Wilson*  
previously to his enlistment, and that he was entirely sober when enlisted; that, to the best of my judgment and belief, he is  
of lawful age; and that, in accepting him as duly qualified to perform the duties of an able-bodied soldier, I have strictly observed  
the Regulations which govern the recruiting service. This soldier has *Black* eyes, *Black* hair,  
*Dark* complexion, is *5* feet, *4* inches high.

*S. L. ...*  
*Maj. ...*  
Volunteers.

Regiment of

RECRUITING OFFICER.

2050

Wilson Andrew D.  
Co C, 11 U.S. Col'd H. Art'y.

Private | Private

CARD NUMBERS.

1	6185634	26
2	6185779	27
3	6185928	28
4	6186071	29
5	6186214	30
6	6187166	31
7	9124510	32
8		33
9		34
10		35
11		36
12		37
13		38
14		39
15		40
16		41
17		42
18		43
19		44
20		45
21		46
22		47
23		48
24		49
25		50

Book Mark:

See also



*W* | 11 H. Art'y. | **U.S.C.T.**

*Andrew J Wilson*

....., Co. *C*, 11 Reg't U. S. Col'd H. Art'y.

Appears on

**Company Descriptive Book**

of the organization named above.

**DESCRIPTION.**

Age *18* years; height *5* feet *7* inches.

Complexion *DM*

Eyes *DM*; hair *DM*

Where born *Ny Ny.*

Occupation *Writer*

**ENLISTMENT.**

When *Aug 27*, 186*3*.

Where *Prov. R I*

By whom *May Sanford*; term *3* y'rs.

Remarks: *Dead at corps Depo*

*Gen Hosp N. Orleans*

*La. June 7/64 Diarrhoea*

*acute sent final state-*

*ment Oct 7. 64.*

*C. S. G. E. 4. 20*

*James*



*W* | 11 H. Art'y. | U.S.C.T.

*Andrew D. Wilson*

*Priv., Co. C, 14 Reg't R. I. Col'd H. Art'y.\**

Age *18* years.

Appears on

**Company Muster-in Roll**

of the organization named above. Roll dated

*Providence R. I. Sep 14, 1863.*

Muster-in to date

*Sep 14, 1863.*

Joined for duty and enrolled:

When *Aug 24<sup>th</sup>*, 1863.

Where *Providence R. I.*

Period *3* years.

Valuation of horse, \$.....*100*

Valuation of horse equipments, \$.....*100*

Remarks:.....

\* This organization subsequently became Co. *C*, 11 Reg't U. S. Colored Heavy Artillery.

Book mark:.....

*Valentine*

*N* | 11 H. Art'y. | U.S.C.T.

*Andrew D. Wilson*

*Priv.*, Co. C, 14 Reg't R. I. Col'd H. Art'y.\*

Appears on

**Company Muster Roll**

for *Sept 14. to Dec 31, 1863*.

Present or absent *Present*,

Stoppage, \$ *100* for

Due Gov't, \$ *100* for

Valuation of horse, \$ *100*

Valuation of horse equipments, \$ *100*

Remarks: \_\_\_\_\_

\*This organization subsequently became Co. C, 11 Reg't U. S. Colored Heavy Artillery.

Book mark: \_\_\_\_\_

*Valentine*

*W* | 11 H. Art'y. | U.S.C.T.

*Andrew D. Wilson*

*Priv.*, Co. C, 14 Reg't R. I. Col'd H. Art'y.\*

Appears on

**Company Muster Roll**

for *Jan. & Feb.*, 186*H.*

Present or absent *Present*

Stoppage, \$ *100* for

Due Gov't, \$ *100* for

Valuation of horse, \$ *100*

Valuation of horse equipments, \$ *100*

Remarks :

\*This organization subsequently became Co. C, 11 Reg't U. S. Colored Heavy Artillery.

Book mark :

*Valentine*



*M* | **11 H. Art'y. | U.S.C.T.**

*Andrew Wilson*  
Priv. Co. *6*, 8 Reg't U. S. Col'd H. Art'y.\*

Appears on

**Company Muster Roll**

for *March & Apr*, 1864.

Present or absent *Present*

Stoppage, \$ *100* for

Due Gov't, \$ *100* for

Valuation of horse, \$ *100*

Valuation of horse equipments, \$ *100*

Remarks:

*Stop for C. & G. Equipage  
\$320*

\*This organization subsequently became Co. *6*, 11 Reg't U. S. Colored Heavy Artillery.

Book mark:

*Valentine*

*M* | 11 H. Art'y. | U.S.C.T.

*Andrew W. Wilson*  
Priv, Co. *C*, 8 Reg't U. S. Col'd H. Art'y.\*

Appears on

**Company Muster Roll**

for *May & June*, 1864.

Present or absent

Stoppage, \$ 100 for

Due Gov't, \$ 100 for

Valuation of horse, \$ 100

Valuation of horse equipments, \$ 100

Remarks: *Died at New Orleans Genl Hospital June 7<sup>th</sup> 1864. Stoppage for C. & G. Equipage \$420*

† This organization subsequently became Co. *C*, 11 Reg't U. S. Colored Heavy Artillery.

Book mark:

*Valentine*

*M-* | 11 H. Art'y. | U.S.C.T.

*Andrew D. Wilson*

*Pvt.*, Co. *C*, 11 Reg't U. S. Col'd H. Art'y.

Appears on **Co. Muster-out Roll**, dated  
*New Orleans La, Oct. 2*, 186*5*.

Muster-out to date \_\_\_\_\_, 186 .

Last paid to \_\_\_\_\_, 186 .

**Clothing account:**

Last settled \_\_\_\_\_, 186 ; drawn since \$ \_\_\_\_\_ <sup>100</sup>

Due soldier \$ \_\_\_\_\_ <sup>100</sup>; due U. S. \$ \_\_\_\_\_ <sup>100</sup>

Am't for cloth'g in kind or money adv'd \$ \_\_\_\_\_ <sup>100</sup>

Due U. S. for arms, equipments, &c., \$ \_\_\_\_\_ <sup>100</sup>

Bounty paid \$ \_\_\_\_\_ <sup>100</sup>; due \$ \_\_\_\_\_ <sup>100</sup>

Remarks: *Joined Argl. Argn.*  
*Died at G D A Hospit.*  
*N. O. La. June 7/64*  
*Invy. & Final Must. sent*

Book mark : \_\_\_\_\_

*Bliss*



Wilson, Andrew

D, Co. C,

11 Reg't U.S.C.H.A.

5 Enclosures.

Bed Cards

Burial Records

Certs. of Dis. for Discharge

C. M. Charges

Descriptive Lists

Discharge Certificates

Enlistment Papers

Final Statements

2

Furloughs or L. of A.

Med. Certificates

Med. Des. Lists

Orders

Pris. of War Record

Resignations

Other papers relating to—

Admission to Hosp'l

Casualty Sheet

Confinement

Contracts

Death or Effects

Desertion

Discharge from Hosp'l

Discharge from Service

Duty

Furlough or L. of A.

Med. Examination

Misc. Information

Pay or Clothing

Personal Reports

Rank

Transfer to Hosp'l

Transfer to V. R. C.

Transportation

DECLARATION OF RECRUIT.

I, *Andrew Wilson* desiring to VOLUNTEER as a Soldier in the ARMY OF THE UNITED STATES, for the term of *3 years*, do declare that I am *18* years and *3* months of age; that I have never been discharged from the United States service on account of disability or by sentence of a court martial, or by order, before the expiration of a term of enlistment; and I know of no impediment to my serving honestly and faithfully as a soldier for *3 years*

Given at *Providence*  
The *27th* day of *Aug* 18*63*

Witness:

*Wm Brown*

*Andrew Wilson*

*11*  
No. *1159*

*Andrew Wilson*

Volunteered at *Providence*

*Aug 1863*

By *Wm Sampson*

Regiment of

enlistment; last served in Company ( )

Regt of

Discharged 18



CONSENT IN CASE OF MINOR.

I, \_\_\_\_\_ of \_\_\_\_\_ is \_\_\_\_\_ years of age; and I do hereby freely give my consent to his volunteering as a SOLDIER in the ARMY OF THE UNITED STATES for the period of \_\_\_\_\_

Do CERTIFY that I am the \_\_\_\_\_; that the said

Given at \_\_\_\_\_ day of \_\_\_\_\_  
The \_\_\_\_\_

Witness:



# VOLUNTEER ENLISTMENT.

State of

*R 9*



Town of

*Providence*

I, *Andrew Wilson* — born in *N 9*  
in the State of *N 9* aged *18* years, and by occupation

a *Writer*  
day of *Aug* DO HEREBY ACKNOWLEDGE to have volunteered this *27<sup>th</sup>*  
*18 69*, to serve as a SOLDIER in the ARMY OF THE UNITED STATES  
of AMERICA, for the period of *3 yrs*, unless sooner discharged by proper authority:

Do also agree to accept such bounty, pay, rations and clothing, as are, or may be, established by law for  
volunteers. And I, *Andrew Wilson* do solemnly swear, that I will bear  
true faith and allegiance to the *United States of America*, and that I will serve them honestly and faith-  
fully against all their enemies or opposers whomsoever; and that I will observe and obey the orders of  
the President of the United States, and the orders of the officers appointed over me, according to the  
Rules and Articles of War.

Sworn and subscribed to, at *Providence*  
this *27<sup>th</sup>* day of *Aug* 18 *69* } *Andrew Wilson*  
BEFORE *S. Laupacis*

I CERTIFY, ON HONOR, that I have carefully examined the above-named Volunteer, agreeably to the General Regulations  
of the Army, and that, in my opinion, he is free from all bodily defects and mental infirmity, which would, in any way, disqualify  
him from performing the duties of a soldier.

*John Gardner*

EXAMINING SURGEON.

I CERTIFY, ON HONOR, That I have minutely inspected the Volunteer, *Andrew Wilson*  
previously to his enlistment, and that he was entirely sober when enlisted; that, to the best of my judgment and belief, he is  
of lawful age; and that, in accepting him as duly qualified to perform the duties of an able-bodied soldier, I have strictly observed  
the Regulations which govern the recruiting service. This soldier has  
*Dark* complexion, is *5* feet, *7* inches high. *Dark* eyes, *Dark* hair.

Regiment of

Volunteers,

RECRUITING OFFICER.



CASUALTY SHEET

No. \_\_\_\_\_

*Andrew D. Wilson*

*Priv* of Company *C*

*4<sup>th</sup>* Regiment of *A. I. C. Art.*

*State Volunteers.*

NATURE OF CASUALTY.

*Died, June 7, 1864*

CASUALTY SHEET.

Name: *Andrew D. Wilson*  
Rank: *Priv* Company: *C* Regiment: *4<sup>th</sup>*  
Arm: *R. I. O. Art* State: \_\_\_\_\_  
Nature of Casualty: *Death*

CAUSE OF CASUALTY—(NAME OF DISEASE, &c.)

BY WHOM DISCHARGED.

FROM WHAT SOURCE THIS INFORMATION WAS OBTAINED.

DEGREE OF DISABILITY.

BY WHOM CERTIFIED.

REMARKS.

DATE OF DISCHARGE, DEATH, &c.

PLACE OF DISCHARGE, DEATH, &c.

*Roll of Honor  
Louisiana Pg. 136*

*J. O.*

Clerk.

(170)

*Buried New Orleans La*

ARTICLES OF WAR.

ART. 95. When any non-commissioned officer or soldier shall die, or be killed in the service of the United States, the then commanding officer of the troop or company shall, in the presence of two other commissioned officers, take an account of what effects he died possessed of, above his arms and accoutrements, and transmit the same to the office of the Department of War, which said effects are to be accounted for, and paid to the representatives of such deceased non-commissioned officer or soldier. And in case any of the officers, so authorized to take care of the effects of deceased officers and soldiers, should, before they have accounted to their representatives for the same, have occasion to leave the regiment or post, by preferment or otherwise, they shall, before they be permitted to quit the same, deposit in the hands of the commanding officer, or of the assistant military agent, all the effects of such deceased non-commissioned officers and soldiers, in order that the same may be secured for, and paid to, their respective representatives.

ARMY REGULATIONS—EDITION OF 1861.

DECEASED SOLDIERS.

Par. 152. Inventories of the effects of deceased non-commissioned officers and soldiers, required by the 95th Article of War, will be forwarded to the Adjutant General, by the commander of the company to which the deceased belonged, and a duplicate of the same to the colonel of the regiment. Final statements of pay, clothing, &c., will be sent with the inventories. When a soldier dies at a post or station absent from his company, it will be the duty of his immediate commander to furnish the required inventory, and, at the same time, to forward to the commanding officer of the company to which the soldier belonged, a report of his death, specifying the date, place, and cause; to what time he was last paid, and the money or other effects in his possession at the time of his decease; which report will be noted on the next muster roll of the company to which the man belonged. Each inventory will be endorsed, "Inventory of the effects of \_\_\_\_\_, late of company (—) \_\_\_\_\_ regiment of \_\_\_\_\_, who died at \_\_\_\_\_, the \_\_\_\_\_ day of \_\_\_\_\_, 186—." If a legal representative receive the effects, it will be stated in the report. If the soldier leave no effects, the fact will be reported.

Par. 153. Should the effects of a deceased non-commissioned officer or soldier not be administered upon within a short period after his decease, they shall be disposed of by a Council of Administration, under the authority of the commanding officer of the post, and the proceeds deposited with the Paymaster, to the credit of the United States, until they shall be claimed by the legal representatives of the deceased.

Par. 154. In all such cases of sales by the Council of Administration, a statement in detail, or account of the proceeds, duly certified by the Council and commanding officer, accompanied by the Paymaster's receipt for the proceeds, will be forwarded by the commanding officer to the Adjutant General. The statement will be endorsed, "Report of the proceeds of the effects of \_\_\_\_\_, late of company (—) \_\_\_\_\_ regiment of \_\_\_\_\_, who died at \_\_\_\_\_, the \_\_\_\_\_ day of \_\_\_\_\_, 186—."

NOTE 1.—The effects in all cases, when called for, should be turned over to the legal representative, without further authority from the Adjutant General. When the effects are turned over to the relatives of the deceased before these inventories are sent to the Adjutant General, their receipts therefor should be attached to the inventories. In all other cases, one copy will be sent with a letter of transmittal direct to the Adjutant General, and a duplicate retained by the officer.

NOTE 2.—Particular care should be taken to take receipts in duplicate from the Paymaster for any funds turned over to him; one copy should be sent direct to the Adjutant General and one retained by the officer.

*Subscribed & sworn to*  
*Should no descriptive list*  
INVENTORY OF THE EFFECTS

OF  
*P. Andrew Wilson*  
Paymaster

Late of Company *C*  
*14<sup>th</sup> Reg't of Heavy Arty*

Volunteers, who died at *Camp of Gen. Paul*  
on the *7<sup>th</sup>* day of *June* 186*4*

*11<sup>th</sup> U.S.C.*



Inventory of the effects of Andrew D. Wilson late  
 a Private of Captain \_\_\_\_\_ Company C of  
 the 14<sup>th</sup> Regiment of Rhode Island Heavy Arty Co Volunteers, who was enrolled as  
 a \_\_\_\_\_ at \_\_\_\_\_ in the State of \_\_\_\_\_ on  
 the \_\_\_\_\_ day of \_\_\_\_\_ 186 , and mustered into the service of the United  
 States as a \_\_\_\_\_ on the \_\_\_\_\_ day of \_\_\_\_\_ 186 , at \_\_\_\_\_  
 in Company \_\_\_\_\_, \_\_\_\_\_ Regiment of \_\_\_\_\_ Volunteers, to serve \_\_\_\_\_  
 years or during the war; he was born in \_\_\_\_\_ in the State  
 of \_\_\_\_\_; he was \_\_\_\_\_ years of age, \_\_\_\_\_ feet \_\_\_\_\_ inches  
 high, \_\_\_\_\_ complexion, \_\_\_\_\_ eyes, \_\_\_\_\_ hair, and by occupation, when enrolled,  
 a \_\_\_\_\_; he died in Camps of Mobile Gen Hospital, at  
New Orleans Louisiana on the 7<sup>th</sup> day of June 1864, by  
 reason of Dysentery

INVENTORY.					
ARTICLES.	No.	ARTICLES.	No.	ARTICLES.	No.
Hats.....	/	Pairs trousers.....	/	<div style="display: flex; justify-content: space-between;"> <div style="writing-mode: vertical-rl; transform: rotate(180deg);">MONEY.</div> <div>           Knapsacks.....            /         </div> </div>	
Caps.....	/	Pairs flannel drawers.....	/		
Forage caps.....	/	Pairs cotton drawers.....	/		
Great coats.....	/	Flannel shirts.....	/		
Uniform coats.....	/	Cotton shirts.....	/		
Uniform jackets.....	/	Pairs boots.....	/		
Flannel sack coats.....	/	Pairs shoes.....	/		
Blouses.....	/	Pairs socks.....	/		
Stable frocks.....	/	Blankets.....	/		
Fatigue overalls.....	/	Haversacks.....	/		
				Specie.....	\$
				Notes.....	\$

I CERTIFY, ON HONOR, that the above inventory comprises all the effects of Private  
Andrew D. Wilson, deceased, and that the effects are in the hands  
 of Surgeon in Charge at Camps of Mobile Gen Hospital  
New Orleans Louisiana to be disposed of by a Council of Administration.

( DUPLICATES. )

STATION: New Orleans La

DATE: 7<sup>th</sup> June 1864

Surgeon R. H. West 1<sup>st</sup> Infantry Colonel  
 Commanding the Company.  
In Charge of Camp of Mobile Gen Hospital

FINAL STATEMENT

OF

*Andrew J. Wilson*  
11<sup>th</sup> Reg't of U. S. Col. Art'y Regt

VOLUNTEERS.

*Since June 7<sup>th</sup> 1864*

NOTE 1.—Two of these certificates (or duplicates) are to be given to each Volunteer Soldier or drafted man who may be discharged previously to the discharge of his company, that he may at once receive from the Paymaster the pay, &c., due him, and the captain or other COMMISSIONED officer commanding the company will certify to the act of the delivery of the duplicate certificates; on these certificates the Soldier is "entitled to" his discharge, and should also present his discharge to the Paymaster to have the payment endorsed on it. The discharge is to be given back to the Soldier by the Paymaster; the latter only retaining as his voucher the duplicate certificates.

NOTE 2.—If the Soldier is entitled to pay for the use of his horse, the Company Commander will certify to that fact on the back of both these final statements, and also to the time he has pay due for having been so mounted on his own horse.

NOTE 3.—When a Soldier is furnished with final statements, his descriptive list, if he has one, should be taken up by the officer who gives the Soldier these statements, and endorsed with a statement to this effect by the officer. This endorsement should exhibit a full statement of the time for which the Soldier was allowed pay on his final statements, the clothing account, and all other charges against him or in his favor, so as to comprise a complete exhibit of his account. It will then be transmitted to the Company Commander of the Soldier, who will enter all the data necessary to a full understanding of the Soldier's account on the muster roll upon which the Soldier's discharge is reported. The descriptive list will then be destroyed. The object of this is, that the remaining portion of the Soldier's account may be settled upon the receipt of these muster rolls, and the Soldier receive any pay or allowances that may be due him at the time of his discharge, and which may not appear on his final statements from the fact that his descriptive list is incomplete. These accounts for back pay, &c., are settled by the 2d Auditor of the Treasury Department.

NOTE 4.—Charges for loss or injury to ordnance, horse equipments, and other miscellaneous charges, should appear under the heading of "Other Stoppages."

NOTE 5.—Bounty paid by State authorities, and not by the United States, will not be entered on this statement.

NOTE 6.—Amounts due the Sutler and Laundress must be entered on the muster roll on which the discharge, death, desertion, &c., is reported, as well as on the final statement, otherwise the amount cannot be collected from the United States.

NOTE 7.—This blank will be used for deceased volunteers and drafted men, as well as for others.

NOTE 8.—Where a Soldier dies in Hospital or on detached service, his descriptive list, if he has one, should be sent with his final statements, in duplicate, to the Adjutant General, Washington, D. C.

ADJUTANT GENERAL'S OFFICE.  
*Oct 25<sup>th</sup> 1864*  
Duplicate with Inventory sent 2d Auditor.

OCT 21 1864  
ADJUTANT GEN'L'S OFFICE  
*Leub B.*



I certify, on honor, that Andrew O. Wilson a Private of  
Captain George Bucklin Company (C...) of the 11<sup>th</sup> Regiment of U.S. Col. A.  
**VOLUNTEERS**, of the State of Rhode Island, born in New York, State  
of New York, aged 18 years; 5 feet 7 inches high; Dark complexion,  
Dark eyes, Dark hair, and by occupation a Writer, having joined the company on  
its original organization at Providence R.I., and enrolled in it at the muster into  
the service of the United States at Providence R.I., on the Fifteenth day  
of September, 1863, (or was mustered in service as a recruit, by Major Sanford  
Providence R.I., on the Twenty-seventh day of August,  
1863, or was drafted and mustered into the service of the United States from the  
Enrollment District of the State of \_\_\_\_\_, at \_\_\_\_\_,

on the \_\_\_\_\_ day of \_\_\_\_\_, 1863,) to serve in the Regiment, for  
the term of Three Years: and having served **HONESTLY** and  
**FAITHFULLY** with his Company in The Field to the present date, is now  
entitled to a **DISCHARGE** by reason of Death He was free from the 1<sup>st</sup> April 1864  
Died at Corps de Siqure Hospital New Orleans La June 7<sup>th</sup> 1864

The said Andrew O. Wilson was last paid by Paymaster  
\_\_\_\_\_ to include the 27<sup>th</sup> day of August, 1863, and has  
pay due him from that time to the present date; he is entitled to pay and subsistence for  
**TRAVELING** to place of enrollment, and whatever other allowances are authorized to volunteer  
soldiers, drafted men, or militia, so discharged. He has received from the United States **CLOTHING**  
amounting to Twenty eight 100 dollars, since the 27<sup>th</sup> day of August 1863,  
1863, when his clothing account was last settled. He has received from the United States  
100 dollars advanced **BOUNTY**.

There is to be stopped from him, on account of the State of Rhode Island or other  
authorities, for **CLOTHING**, &c., received on entering service, Thirty six 100 dollars; and  
for other stoppages, viz: Camp Garrison Equipage 40 2/10 dollars  
\_\_\_\_\_ dollars.

He has been furnished with **TRANSPORTATION** in kind from the place of his discharge to  
\_\_\_\_\_ ; and he has been **SUBSISTED** for **TRAVELING** to his  
place of enrollment, up to the \_\_\_\_\_, 1863.

He is indebted to \_\_\_\_\_, **SUTLER**, \_\_\_\_\_ dollars.

He is indebted to \_\_\_\_\_, **LAUNDRESS**, \_\_\_\_\_ dollars.

Given in Duplicate, at Fort Jackson La, this 7<sup>th</sup> day  
of October, 1864

George Bucklin  
Capt 11<sup>th</sup> U.S. Col. A.  
Commanding Company.



10

2<sup>d</sup> 2<sup>r</sup>. 1864

## FINAL STATEMENT

OF

*Andrew O. Wilson*

*11<sup>th</sup>* Reg't of *Col Artz* *Reg*

**VOLUNTEERS.**

NOTE 1.—Two of these certificates (or duplicates) are to be given to each Volunteer Soldier or drafted man who may be discharged previously to the discharge of his company, that he may at once receive from the Paymaster the pay, &c., due him, and the captain or other COMMISSIONED officer commanding the company will certify to the act of the delivery of the duplicate certificates; on these certificates the Soldier is "entitled to" his discharge, and should also present his discharge to the Paymaster to have the payment endorsed on it. The discharge is to be given back to the Soldier by the Paymaster; the latter only retaining as his voucher the duplicate certificates.

NOTE 2.—If the Soldier is entitled to pay for the use of his horse, the Company Commander will certify to that fact on the back of both these final statements, and also to the time he has pay due for having been so mounted on his own horse.

NOTE 3.—When a Soldier is furnished with final statements, his descriptive list, if he has one, should be taken up by the officer who gives the Soldier these statements, and endorsed with a statement to this effect by the officer. This endorsement should exhibit a full statement of the time for which the Soldier was allowed pay on his final statements, the clothing account, and all other charges against him or in his favor, so as to comprise a complete exhibit of his account. It will then be transmitted to the Company Commander of the Soldier, who will enter all the data necessary to a full understanding of the Soldier's account on the muster roll upon which the Soldier's discharge is reported. The descriptive list will then be destroyed. The object of this is, that the remaining portion of the Soldier's account may be settled upon the receipt of these muster rolls, and the Soldier receive any pay or allowances that may be due him at the time of his discharge, and which may not appear on his final statements from the fact that his descriptive list is incomplete. These accounts for back pay, &c., are settled by the 2d Auditor of the Treasury Department.

NOTE 4.—Charges for loss or injury to ordnance, horse equipments, and other miscellaneous charges, should appear under the heading of "Other Stoppages."

NOTE 5.—Bounty paid by State authorities, and not by the United States, will not be entered on this statement.

NOTE 6.—Amounts due the Sutler and Laundress must be entered on the muster roll on which the discharge, death, desertion, &c., is reported, as well as on the final statement, otherwise the amount cannot be collected from the United States.

NOTE 7.—This blank will be used for deceased volunteers and drafted men, as well as for others.

NOTE 8.—Where a Soldier dies in Hospital or on detached service, his descriptive list, if he has one, should be sent, with his final statements, in duplicate, to the Adjutant General, Washington, D. C.

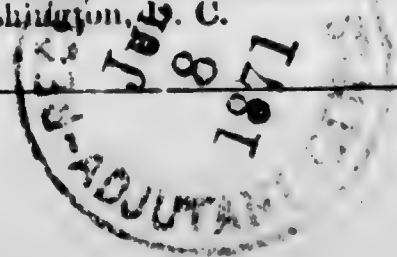

I certify, on honor, that Andrew O Wilson a Private of  
 Captain George Bucklin Company (C.) of the 11<sup>th</sup> Regiment of U.S. Col. A. H.  
**VOLUNTEERS**, of the State of Rhode Island, born in New York, State  
 of New York, aged 18 years; 5 feet 7 inches high; Dark complexion,  
Dark eyes, Dark hair, and by occupation a Writer, having joined the company on  
 its original organization at Providence R.I., and enrolled in it at the muster into  
 the service of the United States at Providence R.I., on the fourteenth day  
 of September, 1863, (or was mustered in service as a recruit, by Major Sanford  
 at Pro-R.I., on the Twenty seventh day of August,  
 1863, or was drafted and mustered into the service of the United States from the  
 Enrollment District of the State of \_\_\_\_\_, at \_\_\_\_\_,  
 on the \_\_\_\_\_ day of \_\_\_\_\_, 186 ) to serve in the Regiment, for  
 the term of Three Years: and having served **HONESTLY** and  
**FAITHFULLY** with his Company in The field to the present date, is now  
 entitled to a **DISCHARGE** by reason of Death free on the 19<sup>th</sup> April 1864  
Did at Camp Deliquie Hospital New Orleans La June 5<sup>th</sup> 1864  
 The said Andrew O Wilson was last paid by Paymaster  
 \_\_\_\_\_ to include the 27<sup>th</sup> day of August, 1863, and has  
 pay due him from that time to the present date; he is entitled to pay and subsistence for  
**TRAVELING** to place of enrollment, and whatever other allowances are authorized to volunteer  
 soldiers, drafted men, or militia, so discharged. He has received from the United States **CLOTHING**  
 amounting to Twenty eight 100 dollars, since the 27<sup>th</sup> day of August,  
 1863, when his clothing account was last settled. He has received from the United States  
 \_\_\_\_\_ 100 dollars advanced **BOUNTY**.

There is to be stopped from him, on account of the State of Rhode Island or other  
 authorities, for **CLOTHING**, &c., received on entering service, Thirty six 100 dollars; and  
 for other stoppages, viz: Camp & Garrison Equipage 4 20/100 dollars  
 \_\_\_\_\_  
 \_\_\_\_\_ 100 dollars.

He has been furnished with **TRANSPORTATION** in kind from the place of his discharge to  
 \_\_\_\_\_; and he has been **SUBSISTED** for **TRAVELING** to his  
 place of enrollment, up to the \_\_\_\_\_, 186 .

He is indebted to \_\_\_\_\_, **SUTLER**, \_\_\_\_\_ 100 dollars.

He is indebted to \_\_\_\_\_, **LAUNDRESS**, \_\_\_\_\_ 100 dollars.

Given in Duplicate, at Fort Jackson La, this 7<sup>th</sup> day  
 of October, 1864

No Effects  
George Bucklin

Capt 11<sup>th</sup> U.S. Col. A. H.  
 \_\_\_\_\_  
 Commanding Company.



205.1

Wilson Frank

Co L, 11 U.S. Col'd H. Art'y.

Private

Private

CARD NUMBERS.

1	6199826	26
2	6199974	27
3	6200127	28
4	6200277	29
5	6200417	30
6	6200552	31
7	6200680	32
8	6200809	33
9	6200939	34
10	6201054	35
11	6201176	36
12	6201287	37
13	9175843	38
14		39
15		40
16		41
17		42
18		43
19		44
20		45
21		46
22		47
23		48
24		49
25		50

Book Mark:

See also



*W* | 11 H. Art'y. | U.S.C.T.

*Frank Wilson*

....., Co. *L*., 11 Reg't U. S. Col'd H. Art'y.

Appears on

**Company Descriptive Book**

of the organization named above.

**DESCRIPTION.**

Age *28* years; height *5* feet *7 1/2* inches.

Complexion *Brown*

Eyes *DK*; hair

Where born *St Louis Mo.*

Occupation *Laborer*

**ENLISTMENT.**

When *Dec 7*, 186*3*

Where *Prov R.I.*

By whom *W Downing*, term *3* y'rs.

Remarks: *Mustered out Oct 2' 1865*

*Griffith*

24 | 11 H. Art'y. | U.S.C.T.

Frank Wilson

Priv., Co. L, 14 Reg't R. I. Col'd H. Art'y.\*

Age 28 years.

Appears on

**Company Muster-in Roll**

of the organization named above. Roll dated

Camp nr. Providence, R. I. Dec 31, 1863.

Muster-in to date Dec 31, 1863.

Joined for duty and enrolled:

When Dec 7, 1863.

Where Prov. R. I.

Period 3 years.

Valuation of horse, \$ 100

Valuation of horse equipments, \$ 100

Remarks: Residence  
1<sup>st</sup> Dist, R. I.

\* This organization subsequently became Co. L, 11 Reg't U. S. Colored Heavy Artillery.

Book mark:

Maukey

*W* | 11 H. Art'y. | U.S.C.T.

*Frank Wilson*  
*Jan*, Co. L, 14 Reg't R. I. Col'd H. Art'y.\*

Appears on

**Company Muster Roll**

for *Jan & Feb*, 186 *4*

Present or absent *Present*

Stoppage, \$ 100 for

Due Gov't, \$ 100 for

Valuation of horse, \$ 100

Valuation of horse equipments, \$ 100

Remarks:

\* This organization subsequently became Co. L, 11 Reg't U. S. Colored Heavy Artillery.

Book mark:

*B. B. Edwards*  
(355) Copyist.



*W* | **11 H. Art'y.** | **U.S.C.T.**

*Frank Wilson*

*Plt*, Co. L, 14 Reg't R. I. Col'd H. Art'y.\*

Appears on

**Company Muster Roll**

for *Mar, & Apr*, 1864.

Present or absent *Present*

Stoppage, \$.....100 for .....

Due Gov't, \$.....100 for .....

Valuation of horse, \$.....100

Valuation of horse equipments, \$.....100

Remarks: .....

.....  
.....  
.....  
.....  
.....

\* This organization subsequently became Co. L, 11 Reg't U. S. Colored Heavy Artillery.

Book mark : .....

*Mankey*

*W* | **11 H. Art'y. | U.S.C.T.**

*Frank Wilson*

*Priv*, Co. *L*, 8 Reg't U. S. Col'd H. Art'y.\*

Appears on

**Company Muster Roll**

for *May & June*, 186*4*.

Present or absent *Present*

Stoppage, \$ 100 for

Due Gov't, \$ 100 for

Valuation of horse, \$ 100

Valuation of horse equipments, \$ 100

Remarks:

† This organization subsequently became Co. *L*, 11 Reg't U. S. Colored Heavy Artillery.

Book mark:

*Mauply*

Copyist.

*W*

11 H. Art'y. U.S.C.T.

*Frank Wilson*  
*Priv*, Co. L, 11 Reg't U. S. Col'd H. Art'y.

Appears on

Company Muster Roll

for *July & Aug*, 186*4*.

Present or absent *Present*

Stoppage, \$ *100* for

Due Gov't, \$ *100* for

Valuation of horse, \$ *100*

Valuation of horse equipments, \$ *100*

Remarks: *6 per mo. back pay due from enlistment to Apr. 30/64 from Apr. 19-61*

Book mark:

*W. H. K. C.*



W.

11 H. Art'y.

U.S.C.T.

Frank Wilson.

Pvt., Co. L, 11 Reg't U. S. Col'd H. Art'y.

Appears on

**Company Muster Roll**

for Sept & Oct, 1864.

Present or absent present.

Stoppage, \$  $\frac{22}{100}$  for ordnance

Due Gov't, \$  $\frac{100}{100}$  for

Valuation of horse, \$  $\frac{100}{100}$

Valuation of horse equipments, \$  $\frac{100}{100}$

Remarks: \$6.00 per month back pay due from enlistment to April 30/64. Free on April 19/61.

Book mark:

Baker,  
Copyist.

W.

11 H. Art'y.

U.S.C.T.

Frank Wilson.

Pvt., Co. L, 11 Reg't U. S. Col'd H. Art'y.

Appears on

**Company Muster Roll**

for Nov. & Dec., 1864

Present or absent present.

Stoppage, \$ 100 for

Due Gov't, \$ 100 for

Valuation of horse, \$ 100

Valuation of horse equipments, \$ 100

Remarks:

Book mark:

Baker  
Copyist.

W.

11 H. Art'y. U.S.C.T.

Frank Wilson.

Plk., Co. L, 11 Reg't U. S. Col'd H. Art'y.

Appears on

Company Muster Roll

for Nov. & Dec., 1864

Present or absent present.

Stoppage, \$ 100 for

Due Gov't, \$ 100 for

Valuation of horse, \$ 100

Valuation of horse equipments, \$ 100

Remarks:

Book mark:

Baker, Copyist.



W. | 11 H. Art'y. | U.S.C.T.

Frank Wilson.

Prvt., Co. L, 11 Reg't U. S. Col'd H. Art'y.

Appears on

**Company Muster Roll**

for Jan. & Feb., 1865.

Present or absent. present.

Stoppage, \$ 100 for

Due Gov't, \$ 100 for

Valuation of horse, \$ 100

Valuation of horse equipments, \$ 100

Remarks:

Book mark:

Baker

*W.* | 11 H. Art'y. | U.S.C.T.

*Frank Wilson.*

*Priv.*, Co. L, 11 Reg't U. S. Col'd H. Art'y.

Appears on

**Company Muster Roll**

for *March & April*, 1865.

Present or absent *present.*

Stoppage, \$ *100* for

Due Gov't, \$ *100* for

Valuation of horse, \$ *100*

Valuation of horse equipments, \$ *100*

Remarks:

Book mark:

*Baker*

Copyist.

*W* | 11 H. Art'y. | U.S.C.T.

*Frank Wilson*

*Priv*, Co. L, 11 Reg't U. S. Col'd H. Art'y.

Appears on

**Company Muster Roll**

for *May & June*, 1865.

Present or absent *Present*

Stoppage, \$.....<sup>100</sup> for .....

Due Gov't, \$.....<sup>100</sup> for .....

Valuation of horse, \$.....<sup>100</sup>

Valuation of horse equipments, \$.....<sup>100</sup>

Remarks: .....

Book mark: .....

(358)

*Murphy*

Copyist.



*W*

11 H. Art'y.

U.S.C.T.

*Frank Wilson*

*Priv*, Co. L, 11 Reg't U. S. Col'd H. Art'y.

Appears on

**Company Muster Roll**

for *May & June*, 1865.

Present or absent *Present*

Stoppage, \$ 100 for

Due Gov't, \$ 100 for

Valuation of horse, \$ 100

Valuation of horse equipments, \$ 100

Remarks:

Book mark:

*Murphy*

W

11 H. Art'y.

U.S.C.T.

Frank Wilson

Pvt., Co. L, 11 Reg't U. S. Col'd H. Art'y.

Appears on

Company Muster Roll

for July & Aug., 1865.

Present or absent Present

Stoppage, \$ 100 for

Due Gov't, \$ 100 for

Valuation of horse, \$ 100

Valuation of horse equipments, \$ 100

Remarks: on daily duty as  
Company cook.

Book mark:

Murphy

*W* | **11 H. Art'y.** | **U.S.C.T.**

*Frank Wilson*  
*Pvt*, Co. L, 11 Reg't U. S. Col'd H. Art'y.

Appears on **Co. Muster-out Roll**, dated  
*New Orleans La, Oct 2*, 1865.

Muster-out to date *Oct 2*, 1865.

Last paid to *Feb 28*, 1865.

**Clothing account:**

Last settled....., 186 ; drawn since \$..... 100

Due soldier \$ *4 78* 100; due U. S. \$..... 100

Am't for cloth'g in kind or money adv'd \$..... 100

Due U. S. for arms, equipments, &c., \$..... 100

Bounty paid \$..... 100; due \$ *100* 100

Remarks: *Joined at Orlg. Organ*  
*Stoppage for 1 musket*  
*acct retained, \$6.00*

Book mark : .....

(361)

*Murphy* (copyist.)



Wilson, Frank

I, Co., 11 Reg't 21st C. I. A.

Enclosures.

Bed Cards .....	Final Statements .....
Burial Records .....	Furloughs or L. of A. ....
Certs. of Dis. for Discharge .....	Med. Certificates .....
C. M. Charges .....	Med. Des. Lists .....
Descriptive Lists .....	Orders .....
Discharge Certificates .....	Pris. of War Record .....
Enlistment Papers .....	Resignations .....

Other papers relating to—

Admission to Hosp'l .....	Furlough or L. of A. ....
Casualty Sheet .....	Med. Examination .....
Confinement .....	Misc. Information .....
Contracts .....	Pay or Clothing .....
Death or Effects .....	Personal Reports .....
Desertion .....	Rank .....
Discharge from Hosp'l .....	Transfer to Hosp'l .....
Discharge from Service .....	Transfer to V. R. C. ....
Duty .....	Transportation .....

DECLARATION OF RECRUIT.

I, *Frank Wilson* desiring to VOLUNTEER as a Soldier in the ARMY OF THE UNITED STATES, for the term of *Three years* do declare that I am *28* years and *0* months of age; that I have never been discharged from the United States service on account of disability or by sentence of a court martial, or by order, before the expiration of a term of enlistment; and I know of no impediment to my serving honestly and faithfully as a soldier for *the term*

Given at *Shore Rd.*  
The *7* day of *July* 18*67*

Witness:

*Frank Wilson*

*W. Harold A. Co.*

No. *138*

*Frank Wilson*

Volunteered at *Providence R.I.*

186*7*

By *W. H. A. Co.*

*14* Regiment of *55th* Mass. Inf.

Enlistment; last served in Company ( )

Reg't of

Discharged

18

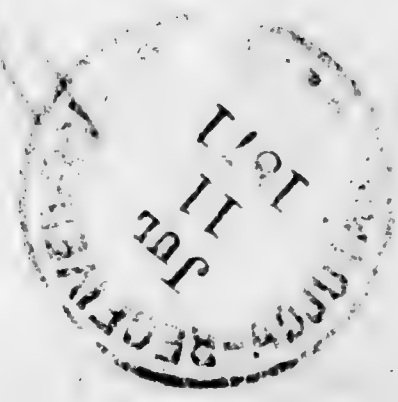

CONSENT IN CASE OF MINOR.

I, \_\_\_\_\_ Do CERTIFY that I am the \_\_\_\_\_ of \_\_\_\_\_; that the said \_\_\_\_\_ is \_\_\_\_\_ years of age; and I do hereby freely give my CONSENT to his volunteering as a SOLDIER in the ARMY OF THE UNITED STATES for the period of \_\_\_\_\_

Given at \_\_\_\_\_  
The \_\_\_\_\_ day of \_\_\_\_\_

Witness:



VOLUNTEER ENLISTMENT.



State of

Town of

I, Frank Wilson

in the State of Missouri a Laborer

born in

St. Louis

aged

28

years, and by occupation

DO HEREBY ACKNOWLEDGE to have volunteered this 7 day of Dec 1863 to serve as a SOLDIER in the ARMY OF THE UNITED STATES OF AMERICA, for the period of three years, unless sooner discharged by proper authority: Do also agree to accept such bounty, pay, rations and clothing, as are, or may be, established, by law for volunteers. And I, Frank Wilson do solemnly swear, that I will bear true faith and allegiance to the United States of America, and that I will serve them honestly and faithfully against all their enemies or opposers whomsoever; and that I will observe and obey the orders of the President of the United States, and the orders of the officers appointed over me, according to the Rules and Articles of War.

Sworn and Subscribed to, at

this

day of

1863

BEFORE

me J. M. Addema Justice of the Peace

Frank Wilson

I CERTIFY, ON HONOR, That I have carefully examined the above-named Volunteer, agreeable to the General Regulations of the Army, and that, in my opinion, he is free from all bodily defects and mental infirmity, which would, in any way, disqualify him from performing the duties of a soldier.

Johnston Gardner M.D.

EXAMINING SURGEON.

I CERTIFY, ON HONOR, That I have minutely inspected the Volunteer, Frank Wilson previously to his enlistment, and that he was entirely sober when enlisted; that to the best of my judgment and belief, he is of lawful age; and that, in accepting him as duly qualified to perform the duties of an able-bodied soldier, I have strictly observed the Regulations which govern the recruiting service. This soldier has dark eyes dark hair

brown complexion, is 5 feet, 7 1/2 inches high.

14 Regiment of R. I. H. I. Volunteers.

W. M. ... RECRUITING OFFICER.



L. W. Kemp H.

Wilson George

Co B, 11 U.S. Col'd H. Art'y.

Private

Private

CARD NUMBERS.

1	6183958	26
2	6184102	27
3	6184246	28
4	6184384	29
5	6184522	30
6	6184554	31
7	6184683	32
8	6184905	33
9	6185020	34
10	6185134	35
11	6185245	36
12	6185353	37
13	6185461	38
14	9173 21267	39
15	9174 3671	40
16		41
17		42
18		43
19		44
20		45
21		46
22		47
23		48
24		49
25		50

Book Mark:

See also

P. O. M. & S. M. 18/14/30 B. H.

John Miller Esq

*W* | 11 H. Art'y. | **U.S.C.T.**

*George H Wilson*  
Co. *B*, 11 Reg't U. S. Col'd H. Art'y.

Appears on  
**Company Descriptive Book**  
of the organization named above.

**DESCRIPTION.**

Age *19* years; height *5* feet *3 1/2* inches.

Complexion *Dark*

Eyes *Blk*; hair *Blk*

Where born *New York*

Occupation *Labour*

**ENLISTMENT.**

When *Aug 21*, 1863.

Where *Prov. R D*

By whom *St Greiner*; term *3* y'rs.

Remarks: *Dismissed with  
Aug 1. 64. Reduced to  
rank for neglect of  
duty Nov 20/64*

*James*

Copyist.



W | 11 H. Art'y. | U.S.C.T.

George H. Wilson

Co. B, 11 Reg't U. S. Col'd H. Art'y.

Appears on

**Company Descriptive Book**

of the organization named above.

**DESCRIPTION.**

Age 19 years; height 5 feet 3 1/2 inches.

Complexion *Dark*

Eyes *Brown*; hair *Blk*

Where born *N Y*

Occupation *Laborer*

**ENLISTMENT.**

When *Aug 21*, 186 .

Where *Providence*

By whom *F A Gubner*, term *3* y'rs.

Remarks:

*Jones*

*W.* | 11 H. Art'y. | U.S.C.T.

*George Wilson*  
*Priv.*, Co *B*, 14 Reg't R. I. Col'd H. Art'y.\*

Age *17* years.

Appears on

**Company Muster-in Roll**

of the organization named above. Roll dated  
*Providence R. I. Sept 14*, 1863.

Muster-in to date *Sept 14*, 1863.

Joined for duty and enrolled:

When *Aug 21*, 186 .

Where *Providence*

Period *3* years.

Valuation of horse, \$.....*100*

Valuation of horse equipments, \$.....*100*

Remarks :.....

\* This organization subsequently became Co *B*, 11 Reg't U. S. Colored Heavy Artillery.

Book mark :.....

*J. Walker*

(356)

Copyist.

*W* | 11 H. Art'y. | U.S.C.T.

*Geo. H. Wilson*  
*Pvt*, Co. B, 14 Reg't R. I. Col'd H. Art'y.\*

Appears on

**Company Muster Roll**

for *Sept 14 to Dec 31*, 1863.

Present or absent *Present*

Stoppage, \$.....100 for .....

Due Gov't, \$.....100 for .....

Valuation of horse, \$.....100

Valuation of horse equipments, \$.....100

Remarks: .....

\*This organization subsequently became Co. B, 11 Reg't U. S. Colored Heavy Artillery.

Book mark: .....

*J. Walker*



W | 11 H. Art'y. | **U.S.C.T.**

*George H. Wilson*  
*Plt*, Co. B, 14 Reg't R. I. Col'd H. Art'y.\*

Appears on

**Company Muster Roll**

for *Jan & Feb*, 1864.

Present or absent *Present*

Stoppage, \$ 100 for

Due Gov't, \$ 100 for

Valuation of horse, \$ 100

Valuation of horse equipments, \$ 100

Remarks:

\* This organization subsequently became Co. B, 11 Reg't U. S. Colored Heavy Artillery.

Book mark:

*J. Walker*  
Copyist.

W | 11 H. Art'y. | U.S.C.T.

George H. Wilson  
Priv., Co B, 8 Reg't U. S. Col'd H. Art'y.\*

Appears on

**Company Muster Roll**

for March-April, 1864.

Present or absent Present

Stoppage, \$ 100 for

Due Gov't, \$ 100 for

Valuation of horse, \$ 100

Valuation of horse equipments, \$ 100

Remarks:

† This organization subsequently became Co B, 11 Reg't U. S. Colored Heavy Artillery.

Book mark:

J. Walker  
Copyist.

*W* | 11 H. Art'y. | U.S.C.T.

*George H. Wilson*  
*Pvt.*, Co. *B*, 8 Reg't U. S. Col'd H. Art'y.\*

Appears on

**Company Muster Roll**

for *May & June*, 1864.

Present or absent *Present*

Stoppage, \$ 100 for

Due Gov't, \$ 100 for

Valuation of horse, \$ 100

Valuation of horse equipments, \$ 100

Remarks:

† This organization subsequently became Co. *B*, 11 Reg't U. S. Colored Heavy Artillery.

Book mark:

*J. Walker*



*A*

11 H. Art'y.

U.S.C.T.

*George H Wilson*

*Capt*, Co. B, 11 Reg't U. S. Col'd H. Art'y.

Appears on

**Company Muster Roll**

for *July & Aug*, 1864.

Present or absent

*Present*

Stoppage, \$ 100 for

Due Gov't, \$ 100 for

Valuation of horse, \$ 100

Valuation of horse equipments, \$ 100

Remarks:

*Promoted to be  
Capt Aug 1/64  
Spec Apr 19/61*

Book mark:

*J. Moore*

*H* | 11 H. Art'y. | U.S.C.T.

*George H. Wilson*  
Copt., Co. B, 11 Reg't U. S. Col'd H. Art'y.

Appears on

**Company Muster Roll**

for *Sept & Oct*, 1864.

Present or absent *Present*

Stoppage, \$ 100 for

Due Gov't, \$ 100 for

Valuation of horse, \$ 100

Valuation of horse equipments, \$ 100

Remarks:

Book mark:

*E. M. ...*

*11*

11 H. Art'y.

U.S.C.T.

*George H Hilton*

*Pi*, Co. B, 11 Reg't U. S. Col'd H. Art'y.

Appears on

**Company Muster Roll**

for *Nov + Dec*, 1864.

Present or absent *Present*

Stoppage, \$ *100* for

Due Gov't, \$ *100* for

Valuation of horse, \$ *100*

Valuation of horse equipments, \$ *100*

Remarks:

Book mark:

*OW Moore*



*A*

11 H. Art'y.

U.S.C.T.

*George H. Wilson*

*Co.*, Co. B, 11 Reg't U. S. Col'd H. Art'y.

Appears on

**Company Muster Roll**

for *Jan & Feb*, 186*J.*

Present or absent *Present*

Stoppage, \$ 100 for

Due Gov't, \$ 100 for

Valuation of horse, \$ 100

Valuation of horse equipments, \$ 100

Remarks:

Book mark:

*J. W. Moore*

Copyist.

*H*

11 H. Art'y.

U.S.C.T.

*George H. Wilson*

*Pri*, Co. B, 11 Reg't U. S. Col'd H. Art'y.

Appears on

**Company Muster Roll**

for *Jan & Feb*, 186 *J*.

Present or absent *Present*

Stoppage, \$ *100* for

Due Gov't, \$ *100* for

Valuation of horse, \$ *100*

Valuation of horse equipments, \$ *100*

Remarks:

-----  
-----  
-----  
-----  
-----  
-----  
-----  
-----

Book mark: -----

*J. W. Moore*  
Copyist.

*A*

11 H. Art'y.

U.S.C.T.

*George H Gilson*

*Gil*, Co. B, 11 Reg't U. S. Col'd H. Art'y.

Appears on

**Company Muster Roll**

for *Jan & Apr*, 186 J.

Present or absent

*Present*

Stoppage, \$ 100 for

Due Gov't, \$ 100 for

Valuation of horse, \$ 100

Valuation of horse equipments, \$ 100

Remarks:

Book mark:

*J. W. Moore*  
Copyist.



*4* | 11 H. Art'y. | U.S.C.T.

*George H. Wilson*  
Co. B, 11 Reg't U. S. Col'd H. Art'y.

Appears on

**Company Muster Roll**

for *May June*, 186*5*.

Present or absent *Present*

Stoppage, \$ 100 for

Due Gov't, \$ 100 for

Valuation of horse, \$ 100

Valuation of horse equipments, \$ 100

Remarks:  
\_\_\_\_\_  
\_\_\_\_\_  
\_\_\_\_\_  
\_\_\_\_\_  
\_\_\_\_\_  
\_\_\_\_\_  
\_\_\_\_\_

Book mark: \_\_\_\_\_  
\_\_\_\_\_

*W* | **11** H. Art'y. | **U.S.C.T.**

*Geo. H. Willson*

*Plt.*, Co. B, 11 Reg't U. S. Col'd H. Art'y.

Appears on

**Company Muster Roll**

for *July & Aug.*, 186*5*.

Present or absent *Present*

Stoppage, \$ *100* for

Due Gov't, \$ *100* for

Valuation of horse, \$ *100*

Valuation of horse equipments, \$ *100*

Remarks:

-----  
-----  
-----  
-----  
-----  
-----  
-----  
-----

Book mark: -----

-----

(358) *Speinger* Copyist.

*W* | 11 H. Art'y. | U.S.C.T.

*George H. Wilson*  
Pvt., Co. B, 11 Reg't U. S. Col'd H. Art'y.

Appears on Co. Muster-out Roll, dated  
*New Orleans La, Oct. 2, 1865.*

Muster-out to date *Oct. 2, 1865.*

Last paid to *Feb. 28, 1865.*

Clothing account:

Last settled....., 186 ; drawn since \$.....<sup>100</sup>

Due soldier \$.....<sup>100</sup>; due U. S. \$.....<sup>05</sup>/<sub>100</sub>

Am't for cloth'g in kind or money adv'd \$.....<sup>100</sup>

Due U. S. for arms, equipments, &c., \$.....<sup>6. 03</sup>/<sub>100</sub>

Bounty paid \$.....<sup>None</sup>/<sub>100</sub>; due \$.....<sup>100</sup>/<sub>100</sub>

Remarks: *joined org'd org'n. Was  
Pvt. from enrolment to Aug. 1/64  
Prom'd to Nov 20/64, S. Corp.  
Musket and acc'ts ret'd.  
Stop 3 members lost.*

Book mark: *3470. 1880*



2053

*Wilson George E.*

**Co A, 11 U.S. Col'd H. Art'y.**

*Corporal Private*

CARD NUMBERS.

1	6182157	26
2	6182301	27
3	6182440	28
4	6182710	29
5	6182848	30
6	6182979	31
7	6183106	32
8	6183228	33
9	6183336	34
10	6183446	35
11	6183551	36
12	6183658	37
13	6183764	38
14	9123911	39
15	9124067	40
16		41
17		42
18		43
19		44
20		45
21		46
22		47
23		48
24		49
25		50

Book Mark:

See also

*W* | 11 H. Art'y. | **U.S.C.T.**

*George E. Wilson*

*A*, Co. *A*, 11 Reg't U. S. Col'd H. Art'y.

Appears on

**Company Descriptive Book**

of the organization named above.

**DESCRIPTION.**

Age *32* years; height *5* feet *9* inches.

Complexion *Dark*

Eyes *Dark*; hair *Dark*

Where born *Buffalo N.Y.*

Occupation *Laborer*

**ENLISTMENT.**

When *May 15*, 186 *3*.

Where *Providence*

By whom *J. Galbraith*; term *3* y'rs.

Remarks: *appointed Aug 4*  
*Jan. 1. 64. sentenced*  
*to one yr hd labor Fortugas*  
*Fla. all pay stopped*  
*G. C. M. G. O. No 26. April*  
*3. 64. Descriptive list*  
*sent. Returned to duty*  
*April 28. 65*

*J. Galbraith*

11 H. Art'y. U.S.C.T.

George O Wilson  
Co. A, 11 Reg't U. S. Col'd H. Art'y.

Appears on  
**Company Descriptive Book**  
of the organization named above.

**DESCRIPTION.**

Age 32 years; height 5 feet 9 inches.

Complexion *Dark*

Eyes *Dark*; hair *Dark*

Where born *Buffalo N.Y.*

Occupation *Laborer*

**ENLISTMENT.**

When *Aug 15*, 1863.

Where *Providence*

By whom *Lt Granger*; term *3* y'rs.

Remarks: *affronted Serg X  
Jan 1/64. Sentenced  
to Fort Mifflin 1 yr. Hd labor  
all pay stopped. G.O. no  
26. apr 3/64. Description  
list sent*

*James*



*W* | 11 H. Art'y. | U.S.C.T.

*George E. Wilson*  
*Comp C, Co. A*, 14 Reg't R. I. Col'd H. Art'y.\*

Age *32* years.

Appears on

**Company Muster-in Roll**

of the organization named above. Roll dated  
*Camp Smith near*  
*Providence R.I.*, *Aug 28*, 186*3*.

Muster-in to date *Aug 28*, 186*3*.

Joined for duty and enrolled:

When *Aug 15*, 186*3*.

Where *Providence*

Period *3* years.

Valuation of horse, \$.....*100*

Valuation of horse equipments, \$.....*100*

Remarks:  
*1st District*

\* This organization subsequently became Co. *A*, 11 Reg't U. S. Colored Heavy Artillery.

Book mark:.....

*Prewitt*

*W* | **11 H. Art'y. | U.S.C.T.**

*George E. Wilson*  
*Serpl.* Co. A, 14 Reg't R. I. Col'd H. Art'y.\*

Appears on

**Company Muster Roll**

for *Aug 28* to *Dec 31, 1863*.

Present or absent *Present*

Stoppage, \$ *100* for

Due Gov't, \$ *100* for

Valuation of horse, \$ *100*

Valuation of horse equipments, \$ *100*

Remarks: *Appointed serpl.*  
*Aug. 28, 1863*

\*This organization subsequently became Co. A, 11 Reg't U. S. Colored Heavy Artillery.

Book mark: \_\_\_\_\_

*Plewitt*  
Copyist.

*W* | 11 H. Art'y. | U.S.C.T.

*George E. Wilson*  
Serg't, Co. A, 14 Reg't R. I. Col'd H. Art'y.\*

Appears on

**Company Muster Roll**

for *Jan & Feb*, 1864.

Present or absent *Present*

Stoppage, \$ *100* for

Due Gov't, \$ *100* for

Valuation of horse, \$ *100*

Valuation of horse equipments, \$ *100*

Remarks: *Promoted to be Serg't.*  
*Jan. 1, 1864*

\*This organization subsequently became Co. A, 11 Reg't U. S. Colored Heavy Artillery.

Book mark: \_\_\_\_\_

*Prewitt*  
Copyst.



*W* | 11 H. Art'y. | U.S.C.T.

*George E. Wilson*  
Pvt., Co. A, 14 Reg't R. I. Col'd H. Art'y.\*

Appears on

**Company Muster Roll**

for *Mich & Apl*, 1864.

Present or absent *Absent*

Stoppage, \$ *100* for

Due Gov't, \$ *100* for

Valuation of horse, \$ *100*

Valuation of horse equipments, \$ *100*

Remarks: *Sent to Fort Jefferson  
Ma. Apl. 3<sup>d</sup> 1 yr Ad Labor  
All pay stopped. G.O. 26*

\* This organization subsequently became Co. A, 11 Reg't U. S. Colored Heavy Artillery.

Book mark: \_\_\_\_\_

*Prewitt*  
Copyist.

*W* | **11 H. Art'y. | U.S.C.T.**

*George E. Wilson*  
Pvt, Co *A*, 8 Reg't U. S. Col'd H. Art'y.\*

Appears on

**Company Muster Roll**

for *May & June*, 1864.

Present or absent *absent*

Stoppage, \$ *100* for

Due Gov't, \$ *100* for

Valuation of horse, \$ *100*

Valuation of horse equipments, \$ *100*

Remarks: *Reduced to Rank*  
*1 yr. pay stopped. G.O. No 26*  
*Cpl. 3. 1864*  
*Fort Jefferson Fla.*

\*This organization subsequently became Co. *A*, 11 Reg't U. S. Colored Heavy Artillery.

Book mark: \_\_\_\_\_

*Prewitt*

W.

11 H. Art'y. U.S.C.T.

George C. Nelson  
R., Co. A, 11 Reg't U. S. Col'd H. Art'y.

Appears on

Company Muster Roll

for July & Aug., 1864

Present or absent

Stoppage, \$ 100 for

Due Gov't, \$ 100 for

Valuation of horse, \$ 100

Valuation of horse equipments, \$ 100

Remarks: 1 Yr pay stopped G. C.  
No 26 April 3rd of Hd. Qrs. 13  
A.C. at Portuguese  
Ordered April 19/64

Name written in "Present" Col  
unn. & cancelled by order

Book mark:

*[Signature]*  
Copyist.



*W.* | **11 H. Art'y.** | **U.S.C.T.**

*George C. Wilson*

*W.*, Co. A, 11 Reg't U. S. Col'd H. Art'y.

Appears on

**Company Muster Roll**

for *Sept. & Oct.*, 1864.

Present or absent *Absent*

Stoppage, \$ *100* for

Due Gov't, \$ *100* for

Valuation of horse, \$ *100*

Valuation of horse equipments, \$ *100*

Remarks: *One yr pay stopped  
Hard Labor Portugal Fla  
G. C. M. G. O. No. 26 Hd. Qrs. 3'  
A. D. April 3<sup>d</sup> 1864*

Book mark:

*B. Wilson*  
Copied.

*W.* | **11 H. Art'y.** | **U.S.C.T.**

*George B. Wilson*  
*Pr.*, Co. A, 11 Reg't U. S. Col'd H. Art'y.

Appears on

**Company Muster Roll**

for *Nov. & Dec.*, 1864.

Present or absent *Absent*

Stoppage, \$ 100 for

Due Gov't, \$ 100 for

Valuation of horse, \$ 100

Valuation of horse equipments, \$ 100

Remarks: *1 Yr. Hard labor Tortu-  
gas Fla. Loss of all pay.  
G. C. M. G. O. No. 16 Hd. Qrs.  
13<sup>th</sup> A. C. April 3<sup>rd</sup> 1864*

Book mark: \_\_\_\_\_

*R. A. [Signature]*

*C.P.* | 11 H. Art'y. | U.S.C.T.

*George B. Wilson*  
\_\_\_\_\_  
*Co. A, 11 Reg't U. S. Col'd H. Art'y.*

Appears on

**Company Muster Roll**  
for *Jan. 7 Dec.*, 186*5*.

Present or absent *Absent*

Stoppage, \$ \_\_\_\_\_ *100* for \_\_\_\_\_

Due Gov't, \$ \_\_\_\_\_ *100* for \_\_\_\_\_

Valuation of horse, \$ \_\_\_\_\_ *100*

Valuation of horse equipments, \$ \_\_\_\_\_ *100*

Remarks: *1 yr pay stopped*  
*S. C. M. C. Co. No. 26 No. 10.*  
*1300. (April 3<sup>rd</sup> 1864) Del.*  
*Letter of Induzes*

Book mark: \_\_\_\_\_

\_\_\_\_\_  
*[Signature]*  
\_\_\_\_\_  
Copyist.



*W.* | **11 H. Art'y. | U.S.C.T.**

*George O. Wilson*  
*W.*, Co. A, 11 Reg't U. S. Col'd H. Art'y.

Appears on

**Company Muster Roll**

for *Mar. & Apr.*, 1865.

Present or absent *Present*

Stoppage, \$ *50* / *100* for *Advance*

Due Gov't, \$ *100* for

Valuation of horse, \$ *100*

Valuation of horse equipments, \$ *100*

Remarks: *1 Yrs pay stopperd*  
*G. O. No. 26. Hd. Qrs.*  
*13 A.S. April 8/64*  
*Discharged from confinement at*  
*Fortugas.*

Book mark:

*R. H. [Signature]*  
Copyright.

*W.* | 11 H. Art'y. | U.S.C.T.

*George E. Wilson,*  
*Spriv.,* Co. A, 11 Reg't U. S. Col'd H. Art'y.

Appears on

**Company Muster Roll**

for *May<sup>4<sup>th</sup></sup> June*, 1865.

Present or absent *Present.*

Stoppage, \$.....100 for .....

Due Gov't, \$.....100 for .....

Valuation of horse, \$.....100

Valuation of horse equipments, \$.....100

Remarks: *1 Yrs. pay stopped  
by C. M. G. C. No. 26. Hd. Qrs.  
13 A. C. April 3/64.  
Stopped for ordnance  
\$5.50.*

Book mark: .....

*M. J. ...*

*W.* | 11 H. Art'y. | U.S.C.T.

*George E. Wilson,*  
Priv., Co. A, 11 Reg't U. S. Col'd H. Art'y.

Appears on

**Company Muster Roll**

for *July<sup>th</sup> August*, 1865.

Present or absent *Present.*

Stoppage, \$ *5.*<sup>50</sup>/<sub>100</sub> for *advance.*

Due Gov't, \$ *100* for

Valuation of horse, \$ *100*

Valuation of horse equipments, \$ *100*

Remarks: *One year's pay stopped.*  
*G. C. M. I. C. No. 26 Sta. Ar.*  
*13 A. C. April 3, 1864.*

Book mark:

*R. S. Grauer*



*W.* | 11 H. Art'y. | **U.S.C.T.**

*George E. Wilson,*  
Priv., Co. *A*, 11 Reg't U. S. Col'd H. Art'y.

Appears on **Co. Muster-out Roll**, dated  
*New Orleans, La., Oct. 2, 1865.*

Muster-out to date *Oct. 2, 1865.*

Last paid to *Has never been paid* 186

**Clothing account:**

Last settled....., 186 ; drawn since \$.....<sup>100</sup>

Due soldier \$ *8. <sup>09</sup> / 100*; due U. S. \$.....<sup>100</sup>

Am't for cloth'g in kind or money adv'd \$.....<sup>100</sup>

Due U. S. for arms, equipments, &c., \$ *6. <sup>00</sup> / 100*

Bounty paid \$.....<sup>100</sup>; due \$ *100. <sup>00</sup> / 100*

Remarks: *Joined Regt. Organ.*

*Free April 19/64.*

*One M. Pay stopped G. C.*

*M. G. C. No. 26 Sta. No. 13A.*

*C. April 3/64. Ensign. to Jan'y 64.*  
*(over)*

Book mark :

*R. D. Brewer*  
Copyist.

JAN. 14

6183764

61891A

Sergt. to April 3/64.  
Stopped 1 new Com. Off.  
Sword.

Stopped for 1 Mm. Let  
and accounts retained.

Wilson, Geo. E.

P., Co., 11 Reg't U.S. C. H. A.

3 Enclosures.

Bed Cards .....	Final Statements .....
Burial Records .....	Furloughs or L. of A. ....
Certs. of Dis. for Discharge .....	Med. Certificates .....
C. M. Charges / .....	Med. Des. Lists .....
Descriptive Lists .....	Orders .....
Discharge Certificates .....	Pris. of War Record .....
Enlistment Papers / .....	Resignations .....

Other papers relating to—

Admission to Hosp'l .....	Furlough or L. of A. ....
Casualty Sheet .....	Med. Examination .....
Confinement .....	Misc. Information / .....
Contracts .....	Pay or Clothing .....
Death or Effects .....	Personal Reports .....
Desertion .....	Rank .....
Discharge from Hosp'l .....	Transfer to Hosp'l .....
Discharge from Service .....	Transfer to V. R. C. ....
Duty .....	Transportation .....



DECLARATION OF RECRUIT.

I, *George E. Wilson* desiring to VOLUNTEER as a Soldier in the ARMY OF THE UNITED STATES, for the term of *32* months of age; that I have never been discharged from the United States service on account of disability or by sentence of a court martial, or by order, before the expiration of a term of enlistment; and I know of no impediment to my serving honestly and faithfully as a soldier for *3 years*

Given at The *15* day of *Aug* 18 *63* *George E. Wilson*

Witness: *R. Grabner*

*1160440*

No. *1334*

*George E. Wilson*

Volunteered at *Princeton*

*August 15th 1863*

By

Regiment of

enlistment; last served in Company ( )

Regt of

Discharged

18

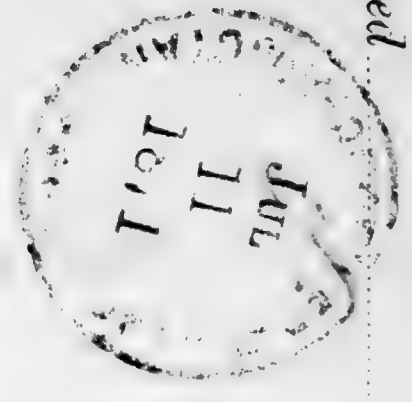

CONSENT IN CASE OF MINOR.

I, \_\_\_\_\_ Do CERTIFY that I am the \_\_\_\_\_ of \_\_\_\_\_; that the said \_\_\_\_\_ is \_\_\_\_\_ years of age; and I do hereby freely give my CONSENT to his volunteering as a SOLDIER in the ARMY OF THE UNITED STATES for the period of \_\_\_\_\_

Given at The \_\_\_\_\_ day of \_\_\_\_\_

Witness:

VOLUNTEER ENLISTMENT.

State of

R.I.



Town of

Providence

I, George E Wilson born in Buffalo in the State of N.Y. aged 38 years, and by occupation a Laborer

DO HEREBY ACKNOWLEDGE to have volunteered this 15th day of Aug 1863, to serve as a SOLDIER in the ARMY OF THE UNITED STATES of AMERICA, for the period of 3 years, unless sooner discharged by proper authority: Do also agree to accept such bounty, pay, rations and clothing, as are, or may be, established by law for volunteers. And I, George E Wilson do solemnly swear, that I will bear true faith and allegiance to the United States of America, and that I will serve them honestly and faithfully against all their enemies or opposers whomsoever; and that I will observe and obey the orders of the President of the United States, and the orders of the officers appointed over me, according to the Rules and Articles of War.

Sworn and subscribed to, at Providence George E Wilson this 15th day of Aug 1863

BEFORE S. P. Smith Mayor

I CERTIFY, ON HONOR, That I have carefully examined the above-named Volunteer, agreeably to the General Regulations of the Army, and that, in my opinion, he is free from all bodily defects and mental infirmity, which would, in any way, disqualify him from performing the duties of a soldier.

Johnson Gardner M.D. EXAMINING SURGEON.

I CERTIFY, ON HONOR, That I have minutely inspected the Volunteer, George E Wilson previously to his enlistment, and that he was entirely sober when enlisted; that, to the best of my judgment and belief, he is of lawful age; and that, in accepting him as duly qualified to perform the duties of an able-bodied soldier, I have strictly observed the Regulations which govern the recruiting service. This soldier has dark complexion, is 5 feet 9 inches high, dark eyes, dark hair.

Regiment of Volunteers, R.I. Guards Lieut RECRUITING OFFICER.

Summoning witness writs C. M.  
A. Y. Macdonald  
de - Judge Advocate

11 W. S. G. H. A.



Matagorda Island Texas  
March 22<sup>nd</sup> 1864

Comdr Officer

14<sup>th</sup> Rhode Island Heavy Artillery

Serg. George E Wilson Co. A - Prisoner  
Capt Thomas W. Fry  
1<sup>st</sup> Lieut. Charles H Chase  
1<sup>st</sup> Lieut & Adj't. Gept Brown  
2<sup>nd</sup> Lieut. Charles J Gay  
1<sup>st</sup> Sergt. Moses. F Brown Co. A

All of your Regiment are ordered  
to appear before a General Court Martial of  
Provisional Brigade to morrow morning at  
10. O'clock

Lieut A J W Donnell  
Judge Advocate

2. 11. 18

My Dear Sir

Yours very truly  
J. J.

Adjutant General's Office,

COLORED TROOPS BRANCH,

January 15<sup>th</sup>, 1875

Vol. C. T., 187

Wanted in case of *George E. Wilson*, Co. *A*,  
11<sup>th</sup> Reg't U. S. C. T.

*Copy of report made by*  
*Major J. H. ...*  
*reports him absent about 1 year to Fort Jefferson Fla April 30*  
*one year to Lake all pay stopped &c.*

Respectfully,

*H. A. Woodward*  
Chief Clerk  
*Per JH*

Adjutant General's Office,

Division of Records and Plans.

January 15<sup>th</sup>, 1875.

Vol. C. T., 187

Reply in case of *George E. Wilson*, Co. *A*,  
11<sup>th</sup> Reg't U. S. C. T.

*G.O. no 24* *Holders 1<sup>st</sup> Div 13<sup>th</sup> A.C. March 30. 1864.*  
*Regt* *Geo. E. Wilson* *Co "A" 14<sup>th</sup> "R.D. 1<sup>st</sup> Div* - Charge -  
*Conduct prejudicial to good order and military discipline -*  
*Findings - Guilty - Sentence - " x x x x to be reduced to the ranks*  
*and to be placed at confinement at Fort Jefferson, Fla., or such*  
*other place or places as may be designated by the proper authority*  
*for the period of one year, and forfeit all pay proper that may*  
*become due him during that time - Approved -*  
*Name born on records of Fort Jefferson - Released March 23, 1865 -*  
*Expiration of sentence -*

*J. H.*



LOST

Wilson George H.

Co E, 11 U.S. Col'd H. Art'y.

Private

Private

CARD NUMBERS.

1	6189021	26
2	6189172	27
3	6189316	28
4	6189458	29
5	6189603	30
6	6189740	31
7	6189872	32
8	6190001	33
9	6190127	34
10	6190260	35
11	6190389	36
12	6190517	37
13	6190641	38
14	912496H	39
15		40
16		41
17		42
18		43
19		44
20		45
21		46
22		47
23		48
24		49
25		50

Book Mark:

See also

P.O. M & M 1648234

8/22/29 a.

P.O. Peter

10/15/29 a.

all 750 10-15-29 a.

Ref. prior sent to P.O.

1648234 - 10/13/30 a.

John Miller P<sup>th</sup>

*11* | **11 H. Art'y. | U.S.C.T.**

*George H. Wilson*

*C*, Co. *C*, 11 Reg't U. S. Col'd H. Art'y.

Appears on

**Company Descriptive Book**

of the organization named above.

**DESCRIPTION.**

Age *33* years; height *5* feet *6 1/2* inches.

Complexion *Light*

Eyes *Black*; hair *Black*.

Where born *Baltimore, Md.*

Occupation *Laborer.*

**ENLISTMENT.**

When *Oct. 2*, 186*3*.

Where *Prov. R. I.*

By whom *L. B. Briggs*; term *3* y'rs.

Remarks:

*O. J. Markle,*



*W* | **11 H. Art'y. | U.S.C.T.**

*George H. Wilson*

*Pvt*, Co. *E*, 14 Reg't R. I. Col'd H. Art'y.\*

Age *33* years.

Appears on

**Company Muster-in Roll**

of the organization named above. Roll dated

*Providence, R. I., Oct. 5, 1863.*

Muster-in to date *Oct. 5, 1863.*

Joined for duty and enrolled:

When *Oct. 2, 1863.*

Where *Prov., R. I.*

Period *3* years.

Valuation of horse, \$ *100*

Valuation of horse equipments, \$ *100*

Remarks: *Providence, R. I. 101st*

\* This organization subsequently became Co. *E*, 11 Reg't U. S. Colored Heavy Artillery.

Book mark: \_\_\_\_\_

*Chandler*

W

11 H. Art'y. U.S.C.T.

George H. Wilson  
Priv., Co. E, 14 Reg't R. I. Col'd H. Art'y.\*

Appears on

Company Muster Roll

for Oct. 5 to Dec. 31, 1863.

Present or absent Present

Stoppage, \$ 100 for

Due Gov't, \$ 100 for

Valuation of horse, \$ 100

Valuation of horse equipments, \$ 100

Remarks:

\*This organization subsequently became Co. E, 11 Reg't U. S. Col'd Heavy Artillery.

Book mark:

Chandler

Copyist.

*W* | 11 H. Art'y. | U.S.C.T.

*George H. Wilson*  
*Priv*, Co. E, 14 Reg't R. I. Col'd H. Art'y.\*

Appears on

**Company Muster Roll**

for *Jan. & Feb.*, 186*4*.

Present or absent *Present*

Stoppage, \$ *100* for

Due Gov't, \$ *100* for

Valuation of horse, \$ *100*

Valuation of horse equipments, \$ *100*

Remarks: *Due Laurens \$ .75*

\*This organization subsequently became Co. E, 11 Reg't U. S. Col'd Heavy Artillery.

Book mark: \_\_\_\_\_

*Chandler*  
Copyist.



*W* | 11 H. Art'y. | U.S.C.T.

*George L. Wilson*  
*Priv*, Co. E, 14 Reg't R. I. Col'd H. Art'y.\*

Appears on

**Company Muster Roll**

for *March & April*, 1864.

Present or absent *Present*

Stoppage, \$ *100* for

Due Gov't, \$ *100* for

Valuation of horse, \$ *100*

Valuation of horse equipments, \$ *100*

Remarks: *Due Laundry 75-*

\*This organization subsequently became Co. E, 11 Reg't U. S. Col'd Heavy Artillery.

Book mark: \_\_\_\_\_

*Chandler*

*N*

**11 H. Art'y. U.S.C.T.**

*George H. Wilson*  
*Por E*, Co. *E*, 8 Reg't U. S. Col'd H. Art'y.\*

Appears on

**Company Muster Roll**

for *May & June*, 186*4*.

Present or absent *Present*

Stoppage, \$ *100* for

Due Gov't, \$ *100* for

Valuation of horse, \$ *100*

Valuation of horse equipments, \$ *100*

Remarks: *Due Laundry 75*

† This organization subsequently became Co. *E*, 11 Reg't U. S. Colored Heavy Artillery.

Book mark: \_\_\_\_\_

*Chandler*

Copyist.

21 | 11 H. Art'y. | U.S.C.T.

*George Wilson*  
*Pvt.*, Co. E, 11 Reg't U. S. Col'd H. Art'y.

Appears on

**Company Muster Roll**  
for *Jul. Aug.* 186*x*.

Present or absent *Present*

Stoppage, \$ 100 for

Due Gov't, \$ 100 for

Valuation of horse, \$ 100

Valuation of horse equipments, \$ 100

Remarks: *See number 75*

Book mark:

*W. H. Sawyer*  
Copyist.



11 H. Art'y. U.S.C.T.

*George H. Wilson*

*Private*, Co. E, 11 Reg't U. S. Col'd H. Art'y.

Appears on

**Company Muster Roll**

for *Sept. & Oct.*, 186*4*.

Present or absent *Present*

Stoppage, \$ 100 for

Due Gov't, \$ 100 for

Valuation of horse, \$ 100

Valuation of horse equipments, \$ 100

Remarks: *Present Sept 19-1864  
Detached for duty at Post  
St. Mrs. per spec. order #15  
March 31, 1864*

Book mark:

*Watson*

*M* | 11 H. Art'y. | U.S.C.T.

*George A. Wilson*  
*Plt.*, Co. E, 11 Reg't U. S. Col'd H. Art'y.

Appears on

**Company Muster Roll**

for *Nov. Dec.*, 186*4*.

Present or absent *Present*

Stoppage, \$ 100 for

Due Gov't, \$ 100 for

Valuation of horse, \$ 100

Valuation of horse equipments, \$ 100

Remarks: *Free April 9-1864*  
*Due Campers 75-*  
*Detached for duty at*  
*Post & M. pr. 310.*  
*nos. 18 - 11. 31, 1864*

Book mark:

*[Signature]*

11 H. Art'y. U.S.C.T.

*George H. Wilson*  
Co. E, 11 Reg't U. S. Col'd H. Art'y.

Appears on

**Company Muster Roll**  
for *Jan & Feb.*, 1865.

Present or absent *Present*

Stoppage, \$ 100 for

Due Gov't, \$ 100 for

Valuation of horse, \$ 100

Valuation of horse equipments, \$ 100

Remarks:  
\_\_\_\_\_  
\_\_\_\_\_  
\_\_\_\_\_  
\_\_\_\_\_  
\_\_\_\_\_  
\_\_\_\_\_

Book mark: \_\_\_\_\_

*W. H. Murray*  
(358) Copyist.



26 | 11 H. Art'y. | U.S.C.T.

*George H. Wilson*

*Pvt.*, Co. E, 11 Reg't U. S. Col'd H. Art'y.

Appears on

**Company Muster Roll**

for *Mar. 1st*, 1865.

Present or absent *Present*

Stoppage, \$ 100 for

Due Gov't, \$ 100 for

Valuation of horse, \$ 100

Valuation of horse equipments, \$ 100

Remarks:  
-----  
-----  
-----  
-----  
-----  
-----  
-----  
-----

Book mark: -----

*Garaway*  
Copyist.

24

11 H. Art'y. U.S.C.T.

George H. Wilson

Priv., Co. E, 11 Reg't U. S. Col'd H. Art'y.

Appears on

Company Muster Roll

for May and June, 1865.

Present or absent Present

Stoppage, \$ 100 for

Due Gov't, \$ 100 for

Valuation of horse, \$ 100

Valuation of horse equipments, \$ 100

Remarks:

Book mark:

(358)

J. B. Jones Copyist.

*N* | 11 H. Art'y. | **U.S.C.T.**

*George H. Wilson*  
*Prin*, Co. E, 11 Reg't U. S. Col'd H. Art'y.

Appears on

**Company Muster Roll**

for *July and August*, 1865.

Present or absent *Present*.

Stoppage, \$.....100 for .....

Due Gov't, \$.....100 for .....

Valuation of horse, \$.....100

Valuation of horse equipments, \$.....100

Remarks: .....

Book mark: .....

*J. B. Jones*  
Copyist.



*W* | 11 H. Art'y. | U.S.C.T.

*George H. Wilson*

*Priv., Co. E*, 11 Reg't U. S. Col'd H. Art'y.

Appears on **Co. Muster-out Roll**, dated

*New Orleans, La.*, *Oct. 2*, 1865.

Muster-out to date *Oct. 2*, 1865.

Last paid to *June 30*, 1865.

**Clothing account:**

Last settled....., 186 ; drawn since \$..... 100

Due soldier \$ *43<sup>07</sup>*/<sub>100</sub>; due U. S. \$..... 100

Am't for cloth'g in kind or money adv'd \$..... 100

Due U. S. for arms, equipments, &c., \$..... 100

Bounty paid \$ *none*/<sub>100</sub>; due \$ *100*/<sub>100</sub>

Remarks: *Joined at Capt. Oyster*

Book mark : .....

*J. B. Jones*

Wilson, Geo. H.

P, Co., 11 Reg't M C H A

2 Enclosures.

Bed Cards .....	Final Statements .....
Burial Records .....	Furloughs or L. of A .....
Certs. of Dis. for Discharge .....	Med. Certificates .....
C. M. Charges .....	Med. Des. Lists .....
Descriptive Lists .....	Orders .....
Discharge Certificates .....	Pris. of War Record .....
Enlistment Papers .....	Resignations .....

Other papers relating to—

Admission to Hosp'l .....	Furlough or L. of A .....
Casualty Sheet .....	Med. Examination .....
Confinement .....	Misc. Information .....
Contracts .....	Pay or Clothing .....
Death or Effects .....	Personal Reports .....
Desertion .....	Rank .....
Discharge from Hosp'l .....	Transfer to Hosp'l .....
Discharge from Service .....	Transfer to V. R. C. .....
Duty .....	Transportation .....

DECLARATION OF RECRUIT.

I, *George W. Wilson* desiring to VOLUNTEER as a Soldier in the ARMY OF THE UNITED STATES, for the term of *Three years* do declare that I am *Thirty Three* years and months of age; that I have never been discharged from the United States service on account of disability or by sentence of a court martial, or by order, before the expiration of a term of enlistment; and I know of no impediment to my serving honestly and faithfully as a soldier for *Three years*

Given at *Providence R. I.*  
The *second* day of *October* 1863

Witness: *Edwin Downe* *George W. Wilson*

*11 Bond 400  
141*

*George W. Wilson*  
Volunteered at *Providence R. I.*

*October 2<sup>nd</sup>* 1863

By *Charles B. Briggs*

*Capt. 14<sup>th</sup> Regiment of N. I. Cav. (Colo.)*

enlistment; last served in Company ( )

Reg't of

Discharged 18



CONSENT IN CASE OF MINOR.

I, \_\_\_\_\_ of \_\_\_\_\_ is \_\_\_\_\_ years of age; and I do hereby freely give my CONSENT to his volunteering as a SOLDIER in the ARMY OF THE UNITED STATES for the period of \_\_\_\_\_

Given at \_\_\_\_\_  
The \_\_\_\_\_ day of \_\_\_\_\_  
Witness \_\_\_\_\_



# VOLUNTEER ENLISTMENT.

State of  
*Rhode Island*



Town of  
*Providence*

I, *George W. Wilson* born in *Baltimore*  
in the State of *Maryland* aged *Thirty Three* years, and by occupation  
a *Labourer* DO HEREBY ACKNOWLEDGE to have volunteered this *second*  
day of *October* 18 *63* to serve as a SOLDIER in the ARMY OF THE UNITED STATES  
OF AMERICA, for the period of *Three years*, unless sooner discharged by proper authority:  
Do also agree to accept such bounty, pay, rations and clothing, as are, or may be, established, by law for  
volunteers. And I, *George W. Wilson* do solemnly swear, that I will bear  
true faith and allegiance to the *United States of America*, and that I will serve them honestly and faith-  
fully against all their enemies or opposers whomsoever; and that I will observe and obey the orders of the  
President of the United States, and the orders of the officers appointed over me, according to the Rules  
and Articles of War.

Sworn and Subscribed to, at *Prov. R. I.*  
this *second* day of *Oct* 18 *63* } *George W. Wilson*  
BEFORE *Thomas Greene*  
*Justice of the Peace*

I CERTIFY, ON HONOR, That I have carefully examined the above-named Volunteer, agreeable to the General Regulations of  
the Army, and that, in my opinion, he is free from all bodily defects and mental infirmity, which would, in any way, disqualify him  
from performing the duties of a soldier.

*Johnson Gardner M.D.*

EXAMINING SURGEON.

I CERTIFY, ON HONOR, That I have minutely inspected the Volunteer, *Geo. W. Wilson*  
previously to his enlistment, and that he was entirely sober when enlisted; that to the best of my judgment and belief, he is of  
lawful age; and that, in accepting him as duly qualified to perform the duties of an able-bodied soldier, I have strictly observed the  
Regulations which govern the recruiting service. This soldier has *Black* eyes *Black* hair  
*Light* complexion, is *five* feet, *six* *7/8* inches high.

*14<sup>th</sup>* Regiment of *Re I. W. Art.* - Volunteers,  
*Chas. B. Briggs*  
RECRUITING OFFICER.

DECLARATION OF RECRUIT.

I, *George Wilson* desiring to VOLUNTEER as a Soldier in the ARMY OF THE UNITED STATES, for the term of *3* years and *19* months of age; that I have never been discharged from the United States service on account of disability or by sentence of a court martial, or by order, before the expiration of a term of enlistment; and I know of no impediment to my serving honestly and faithfully as a soldier for *3* years *George H Wilson*

Given at *S. D. P. D. C.*  
The *21<sup>st</sup>* day of *Aug* 18*68*

Witness:  
*R. P. ...*

*11 ... H A*

No. *1400*

*George H Wilson*

Volunteered at *Providence*

*Aug 21<sup>st</sup> 1868*

By *Chas J Lambard*

Regiment of

enlistment; last served in Company ( )

Reg't of

Discharged 18



CONSENT IN CASE OF MINOR.

I, \_\_\_\_\_ of \_\_\_\_\_ is \_\_\_\_\_ years of age; and I do hereby freely give my consent to his volunteering as a SOLDIER in the ARMY OF THE UNITED STATES for the period of \_\_\_\_\_

Given at \_\_\_\_\_  
The \_\_\_\_\_ day of \_\_\_\_\_

Witness:



VOLUNTEER ENLISTMENT.

State of

*RJ*



Town of

*Ward*

I, *George Wilson* born in *New York*  
in the State of *N.Y.* aged *19* years, and by occupation

a *Laborer* DO HEREBY ACKNOWLEDGE to have volunteered this *21<sup>st</sup>*  
day of *Aug* 18 *60*, to serve as a SOLDIER in the ARMY OF THE UNITED STATES  
of AMERICA, for the period of *9 mo*, unless sooner discharged by proper authority:

Do also agree to accept such bounty, pay, rations and clothing, as are, or may be, established by law for  
volunteers. And I, *George Wilson* do solemnly swear, that I will bear  
true faith and allegiance to the *United States of America*, and that I will serve them honestly and faith-  
fully against all their enemies or opposers whomsoever; and that I will observe and obey the orders of  
the President of the United States, and the orders of the officers appointed over me, according to the  
Rules and Articles of War.

Sworn and subscribed to, at

this *21* day of *Aug* 18 *60*

BEFORE

*George W. Wilson*  
*My WA RA 1st*

I CERTIFY, ON HONOR, That I have carefully examined the above-named Volunteer, agreeably to the General Regulations  
of the Army, and that, in my opinion, he is free from all bodily defects and mental infirmity, which would, in any way, disqualify  
him from performing the duties of a soldier.

*John Andrew*

EXAMINING SURGEON.

I CERTIFY, ON HONOR, That I have minutely inspected the Volunteer,  
previously to his enlistment, and that he was entirely sober when enlisted; that, to the best of my judgment and belief, he is  
of lawful age; and that, in accepting him as duly qualified to perform the duties of an able-bodied soldier, I have strictly observed  
the Regulations which govern the recruiting service. This soldier has

*dark* complexion, is *5* feet, *3 1/2* inches high. *dark* eyes, *dark* hair.

*George Wilson*

*LA* Regiment of

*P. A. Graham*

Volunteers,

RECRUITING OFFICER.



Wilson Harvey

Co *M*, 11 U.S. Col'd H. Art'y.

Private

Private

CARD NUMBERS.

1	6201481	26
2	6201632	27
3	6201787	28
4	6201945	29
5	6202096	30
6	6202233	31
7	6202381	32
8	6202503	33
9	6202623	34
10	6202729	35
11	6202842	36
12	6202944	37
13	9126038	38
14		39
15		40
16		41
17		42
18		43
19		44
20		45
21		46
22		47
23		48
24		49
25		50

Book Mark:

See also

W | 11 Harty | U.S.C.T.

Harvey Wilson  
....., Co M, 11 Reg't U.S. Col'd Harty

Appears on  
**Company Descriptive Book**

of the organization named above.

**DESCRIPTION.**

Age 36 years; height 5 feet 10 inches.

Complexion Brn

Eyes DK; hair DK

Where born Ohio

Occupation Boatman

**ENLISTMENT.**

When Jan 1, 1864

Where Prov R. I.

By whom J. W. Engly; term 3 y'rs.

Remarks: Mustered into U.S.  
Service Jan 25, 1864  
Mustered out

Griffith

M | 11 H. Art'y. | **U.S.C.T.**

*Harvey Wilson*

*Priv.*, Co. *M*, 14 Reg't R. I. Col'd H. Art'y.\*

Age *36* years.

Appears on

**Company Muster-in Roll**

of the organization named above. Roll dated

*Providence, R.I. Jan. 25, 1864.*

Muster-in to date *Jan. 25, 1864.*

Joined for duty and enrolled:

When *Jan'y 1, 1864.*

Where *Provd., R.I.*

Period *3* years.

Valuation of horse, \$ *100*

Valuation of horse equipments, \$ *100*

Remarks: *2 district*

\* This organization subsequently became Co. *M*, 11 Reg't U. S. Colored Heavy Artillery.

Book mark: *100*

*J. Miller*



*W*

**11 H. Art'y. U.S.C.T.**

*Harvey Wilson*

*Pos*, Co. M, 14 Reg't R. I. Col'd H. Art'y.\*

Appears on

**Company Muster Roll**

for *25-Jan to 29-Feb*, 1864.

Present or absent *Present*

Stoppage, \$ *100* for

Due Gov't, \$ *100* for

Valuation of horse, \$ *100*

Valuation of horse equipments, \$ *100*

Remarks:

This organization subsequently became Co. M, 11 Reg't U. S. Colored Heavy Artillery.

Book mark:

(358)

*J. Underwood*  
Copied.

*W* | 11 H. Art'y. | U.S.C.T.

*Harvey Wilson*  
*Pvt*, Co. M, 14 Reg't R. I. Col'd H. Art'y.\*

Appears on

**Company Muster Roll**

for *Mich & apl*, 1864.

Present or absent *Present*

Stoppage, \$.....100 for .....

Due Gov't, \$.....100 for .....

Valuation of horse, \$.....100

Valuation of horse equipments, \$.....100

Remarks:.....  
.....  
.....  
.....  
.....  
.....  
.....  
.....

This organization subsequently became Co. M, 11 Reg't U. S. Colored Heavy Artillery.

Book mark:.....

*J. Henderson*  
(358) Copied.

211 | **11 H. Art'y. | U.S.C.T.**

Harvey Wilson  
Co. M, 8 Reg't U. S. Col'd H. Art'y.\*

Appears on

**Company Muster Roll**

for May & June, 1864.

Present or absent Present

Stoppage, \$ 100 for

Due Gov't, \$ 100 for

Valuation of horse, \$ 100

Valuation of horse equipments, \$ 100

Remarks:

† This organization subsequently became Co. M, 11 Reg't U. S. Colored Heavy Artillery.

Book mark:

Fabler



W

11 H. Art'y.

U.S.C.T.

*Harvey Wilson*

*Priv.*, Co. M, 11 Reg't U. S. Col'd H. Art'y.

Appears on

**Company Muster Roll**

for *date Sept. 1*, 186*4*.

Present or absent *Present*

Stoppage, \$ *100* for

Due Gov't, \$ *100* for

Valuation of horse, \$ *100*

Valuation of horse equipments, \$ *100*

Remarks: *\$6 per m. due from enlistment to April 30/64. Free on 19 April 1864.*

Book mark:

*Tabler*

71

11 H. Art'y.

U.S.C.T.

Harvey Wilson  
Co. M, 11 Reg't U. S. Col'd H. Art'y.

Appears on

Company Muster Roll

for Sept & Oct., 1864.

Present or absent Present.

Stoppage, \$ 100 for

Due Gov't, \$ 100 for

Valuation of horse, \$ 100

Valuation of horse equipments, \$ 100

Remarks:

Book mark:

A. Hubblell

Copyist.

71 | 11 H. Art'y. | U.S.C.T.

*Harvey Wilson*

*Co.*, Co. M, 11 Reg't U. S. Col'd H. Art'y.

Appears on

**Company Muster Roll**

for *Nov & Dec*....., 1864

Present or absent *Present.*

Stoppage, \$.....100 for .....

Due Gov't, \$.....100 for .....

Valuation of horse, \$.....100

Valuation of horse equipments, \$.....100

Remarks:.....

Book mark:.....

*A. Hubbell*

*Quisist.*



71

11 H. Art'y.

U.S.C.T.

Harvey Wilson

Wat., Co. M, 11 Reg't U. S. Col'd H. Art'y.

Appears on

Company Muster Roll

for Jan to Feb, 1865.

Present or absent Present.

Stoppage, \$ 100 for

Due Gov't, \$ 100 for

Valuation of horse, \$ 100

Valuation of horse equipments, \$ 100

Remarks: 22¢ for Ordnance  
Stubs

Book mark:

A. Hubbell

Copyist.

75 | 11. H. art | **U. S. C. T**

Harvey Wilson

Pvt., Com. Co., 11 Reg't U. S. Col'd H. art

Appears on

**Company Muster Roll**

for *Mich + apcl*, 1865.

Present or absent *Present.*

Stoppage, \$ 100 for

Due Gov't, \$ 100 for

Valuation of horse, \$ 100

Valuation of horse equipments, \$ 100

Remarks: *22¢ for Ordnance  
Stores*

Book mark:

*A. Hubbell*

11 H. Art'y. U.S.C.T.

*James Wilson*  
Priv., Co. M, 11 Reg't U. S. Col'd H. Art'y.

Appears on

**Company Muster Roll**

for *May & June*, 1865.

Present or absent *Present*

Stoppage, \$ 100 for

Due Gov't, \$  $\frac{23}{100}$  for *Ordinance Store*

" "  $\frac{200}{100}$  *for Equipage*

Valuation of horse, \$ 100

Valuation of horse equipments, \$ 100

Remarks:

Book mark:

*James Wilson*



71

11 H. Art'y. U.S.C.T.

Harvey Wilson

Priv., Co. M, 11 Reg't U. S. Col'd H. Art'y.

Appears on

Company Muster Roll

for July 1 - Aug, 1865.

Present or absent Present

Stoppage, \$ 100 for

Due Gov't, \$ 23/100 for Advance Store

200/100 " G. Equipage

Valuation of horse, \$ 100

Valuation of horse equipments, \$ 100

Remarks:

Book mark:

Forrest

Copyist.

7. | **11** H. Art'y. | **U.S.C.T.**

Harvey Wilson  
Priv., Co. M, 11 Reg't U. S. Col'd H. Art'y.

Appears on **Co. Muster-out Roll**, dated  
New Orleans La., Oct 2, 1865.

Muster-out to date Oct 2, 1865.

Last paid to Feb 28, 1865.

**Clothing account:**

Last settled....., 186 ; drawn since \$..... 100

Due soldier \$..... 100; due U. S. \$..... 2 <sup>95</sup>/<sub>100</sub>

Am't for cloth'g in kind or money adv'd \$..... 100

Due U. S. for arms, equipments, &c., \$..... 2 <sup>25</sup>/<sub>100</sub>

Bounty paid \$..... 100; due \$300 <sup>00</sup>/<sub>100</sub>

Remarks: joined at original organiza-  
tion. Stop for one month  
accoutrements retained.  
1 Mosquito Bar (1) Screw driver  
lost.

Book mark: .....

Ferrett

Wilson, Harvey

P., Co.

11 Reg't U.S.C. H.A.

Enclosures.

Bed Cards .....	Final Statements .....
Burial Records .....	Furloughs or L. of A. ....
Certs. of Dis. for Discharge .....	Med. Certificates .....
C. M. Charges .....	Med. Des. Lists .....
Descriptive Lists .....	Orders .....
Discharge Certificates .....	Pris. of War Record .....
Enlistment Papers .....	Resignations .....

Other papers relating to—

Admission to Hosp'l .....	Furlough or L. of A. ....
Casualty Sheet .....	Med. Examination .....
Confinement .....	Misc. Information .....
Contracts .....	Pay or Clothing .....
Death or Effects .....	Personal Reports .....
Desertion .....	Rank .....
Discharge from Hosp'l .....	Transfer to Hosp'l .....
Discharge from Service .....	Transfer to V. R. C. ....
Duty .....	Transportation .....



DECLARATION OF RECRUIT.

I, *Harvey Wilson* desiring to VOLUNTEER as a Soldier in the ARMY OF THE UNITED STATES, for the term of *3 years* do declare that I am *36* years and months of age; that I have never been discharged from the United States service on account of disability or by sentence of a court martial, or by order, before the expiration of a term of enlistment; and I know of no impediment to my serving honestly and faithfully as a soldier for *3 years*

Given at *Providence* The *1<sup>st</sup>* day of *June* 18*64*  
Witness: *Alban* *Harvey + Wilson*  
*man*

Discharged *Jan 11 1861*  
Rejt of *18*  
enlistment; last served in Company (

*116-2412*  
*116-2412*  
Volunteered at *Providence*  
*Harvey Wilson*  
*January 1<sup>st</sup> 1864*  
By *Wm. H. Bergeley*  
*1<sup>st</sup> Regt. of Heavy Arty*

CONSENT IN CASE OF MINOR.

I, \_\_\_\_\_ Do CERTIFY that I am the \_\_\_\_\_ of \_\_\_\_\_; that the said \_\_\_\_\_ is \_\_\_\_\_ years of age; and I do hereby freely give my CONSENT to his volunteering as a SOLDIER in the ARMY OF THE UNITED STATES for the period of \_\_\_\_\_

Given at \_\_\_\_\_ The \_\_\_\_\_ day of \_\_\_\_\_  
Witness \_\_\_\_\_

VOLUNTEER ENLISTMENT.



State of *Rhode Island* Town of *Providence*

I, *Harvey Wilson* born in \_\_\_\_\_  
in the State of *Ohio* aged *36* years, and by occupation  
a *Boatman*

DO HEREBY ACKNOWLEDGE to have volunteered this *1<sup>st</sup>*  
day of *June* 18 *64* to serve as a SOLDIER in the ARMY OF THE UNITED STATES  
OF AMERICA, for the period of *3 years*, unless sooner discharged by proper authority:

Do also agree to accept such bounty, pay, rations and clothing, as are, or may be, established, by law for  
volunteers. And I, *Harvey Wilson* do solemnly swear, that I will bear  
true faith and allegiance to the *United States of America*, and that I will serve them honestly and faith-  
fully against all their enemies or opposers whomsoever; and that I will observe and obey the orders of the  
President of the United States, and the orders of the officers appointed over me, according to the Rules  
and Articles of War.

Sworn and Subscribed to, at *Providence*  
this *1<sup>st</sup>* day of *June* 18 *64* *Harvey Wilson*  
BEFORE *Mr John L. Boyer Public Notary* *his*  
*mark*

I CERTIFY, ON HONOR, That I have carefully examined the above-named Volunteer, agreeable to the General Regulations of  
the Army, and that, in my opinion, he is free from all bodily defects and mental infirmity, which would, in any way, disqualify him  
from performing the duties of a soldier.

*Johnson Gardner M.D.*

EXAMINING SURGEON.

I CERTIFY, ON HONOR, That I have minutely inspected the Volunteer, *Harvey Wilson*  
previously to his enlistment, and that he was entirely sober when enlisted; that to the best of my judgment and belief, he is of  
lawful age; and that, in accepting him as duly qualified to perform the duties of an able-bodied soldier, I have strictly observed the  
Regulations which govern the recruiting service. This soldier has *Dark* eyes *Dark* hair,  
*Dark* complexion, is *5* feet, *10* inches high.

*Harvey Wilson*  
*Wilson*

*Co of 14* Regiment of *H Art'y* Volunteers,

RECRUITING OFFICER.



Wilson Jeremiah

Co E, 11 U.S. Col'd H. Art'y.

Private

Private

CARD NUMBERS.

1	6189022	26
2	6189173	27
3	6189317	28
4	6189459	29
5	6189604	30
6	6189741	31
7	6189873	32
8	6190002	33
9	6190128	34
10	6190261	35
11	6190390	36
12	6190518	37
13	6190642	38
14	9124970	39
15		40
16		41
17		42
18		43
19		44
20		45
21		46
22		47
23		48
24		49
25		50

Book Mark:

See also



Rep 468007

Q 1742524 P.O. 24 + 24

A.M. 1596302

John O'Neil Esq

*W* | 11 H. Art'y. | U.S.C.T.

*Jeremiah Wilson*

, Co. *E*, 11 Reg't U. S. Col'd H. Art'y.

Appears on

**Company Descriptive Book**

of the organization named above.

**DESCRIPTION.**

Age *27* years; height *5* feet *3* inches.

Complexion *Dark*

Eyes *Dark*; hair *Dark*

Where born *Phila, Pa.*

Occupation *Laborer*

**ENLISTMENT.**

When *Sept. 23*, 186*3*.

Where *Pros. R. L.*

By whom *J. C. Engley*, term *3* y'rs.

Remarks:

*\* As it is on Descriptive Book.*

*O. J. Markle,*

Copyist.

*W* | **11 H. Art'y.** | **U.S.C.T.**

*Jeremiah Wilson*  
-----  
*Priv.*, Co. *E*, 14 Reg't R. I. Col'd H. Art'y.\*

Age *27* years.

Appears on

**Company Muster-in Roll**

of the organization named above. Roll dated

*Providence, R.I., Oct. 5*, 186*3*.

Muster-in to date *Oct. 5*, 186*3*.

Joined for duty and enrolled:

When *Sept. 22*, 186*3*.

Where *Prov., R.I.*

Period *3* years.

Valuation of horse, \$.....*100*

Valuation of horse equipments, \$.....*100*

Remarks: *Philadelphia, Pa.*

\* This organization subsequently became Co. *E*, 11 Reg't U. S. Colored Heavy Artillery.

Book mark:.....

*Chandler*



W

11 H. Art'y.

U.S.C.T.

Jeremiah Wilson  
Pvt, Co. E, 14 Reg't R. I. Col'd H. Art'y.\*

Appears on

**Company Muster Roll**

for Oct. 5 to Dec. 31, 1863.

Present or absent Present

Stoppage, \$ 100 for

Due Gov't, \$ 100 for

Valuation of horse, \$ 100

Valuation of horse equipments, \$ 100

Remarks:

\*This organization subsequently became Co. E, 11 Reg't U. S. Col'd Heavy Artillery.

Book mark:

Chandler

Copyist.

*W*

**11 H. Art'y. U.S.C.T.**

*Jeremiah Wilson*  
*Pvt.*, Co. E, 14 Reg't R. I. Col'd H. Art'y.\*

Appears on

**Company Muster Roll**

for *Jan. & Feb.*, 186*H.*

Present or absent *Present*

Stoppage, \$ *100* for

Due Gov't, \$ *100* for

Valuation of horse, \$ *100*

Valuation of horse equipments, \$ *100*

Remarks: *Due Laundry \$ .75-*

\*This organization subsequently became Co. E, 11 Reg't U. S. Col'd Heavy Artillery.

Book mark: \_\_\_\_\_

*Chauncey*  
Copyist.

*W* | **11 H. Art'y. | U.S.C.T.**

*Jeremiah Wilson*  
*Pvt.*, Co. E, 14 Reg't R. I. Col'd H. Art'y.\*

Appears on

**Company Muster Roll**

for *March & April*, 186*7*.

Present or absent *Present*

Stoppage, \$ *100* for

Due Gov't, \$ *100* for

Valuation of horse, \$ *100*

Valuation of horse equipments, \$ *100*

Remarks: *Due Laundry .75-*

\*This organization subsequently became Co. E, 11 Reg't U. S. Col'd Heavy Artillery.

Book mark: \_\_\_\_\_

*Chandler*



*W* | **11 H. Art'y. U.S.C.T.**

*Jeremiah Wilson*  
*Pvt.*, Co. *E*, 8 Reg't U. S. Col'd H. Art'y.\*

Appears on

**Company Muster Roll**

for *May & June*, 186*4*.

Present or absent *Present*

Stoppage, \$ *100* for

Due Gov't, \$ *100* for

Valuation of horse, \$ *100*

Valuation of horse equipments, \$ *100*

Remarks: *Due Laundry 75*

† This organization subsequently became Co. *E*, 11 Reg't U. S. Colored Heavy Artillery.

Book mark: \_\_\_\_\_

*Chandler*

*21* | 11 H. Art'y. | U.S.C.T.

*Jeremiah Wilson*  
*Pvt.*, Co. E, 11 Reg't U. S. Col'd H. Art'y.

Appears on

**Company Muster Roll**  
for *Jul. Aug.*, 186*4*.

Present or absent *Present*

Stoppage, \$ 100 for

Due Gov't, \$ 100 for

Valuation of horse, \$ 100

Valuation of horse equipments, \$ 100

Remarks: *Due lumber 75-*

Book mark: \_\_\_\_\_

*Saturday*  
Copyist.

11 H. Art'y. U.S.C.T.

*Jeremiah Wilson*  
*Plt.*

Co. E, 11 Reg't U. S. Col'd H. Art'y.

Appears on

**Company Muster Roll**

for *Sept. & Oct.*, 1864.

Present or absent *Present*

Stoppage, \$ 100 for

Due Gov't, \$ 100 for

Valuation of horse, \$ 100

Valuation of horse equipments, \$ 100

Remarks: *Free April 19 - 20 / 64*  
*Due Laundry 75*

Book mark:

*J. L. Faraway*



26 | 11 H. Art'y. | U.S.C.T.

*Jeremiah Wilson*  
*Pvt.*, Co. E, 11 Reg't U. S. Col'd H. Art'y.

Appears on

**Company Muster Roll**

for *Nov. Dec.*, 186*4*.

Present or absent *Present*

Stoppage, \$ *100* for

Due Gov't, \$ *100* for

Valuation of horse, \$ *100*

Valuation of horse equipments, \$ *100*

Remarks: *Free April 19 - 1864*  
*Due amount \$ 75*

Book mark:

*H. Stearns*

11 | 11 H. Art'y. | U.S.C.T.

*Jeremiah Wilson*  
*Det.*, Co. E, 11 Reg't U. S. Col'd H. Art'y.

Appears on

**Company Muster Roll**

for *Jan. & Feb.*, 1865.

Present or absent *Present*

Stoppage, \$ *43* for *ordnance*

*Screw driver 23 - Wiper 20*

Due Gov't, \$ *70* for *Quartermaster*

*Canteens*

Valuation of horse, \$ 100

Valuation of horse equipments, \$ 100

Remarks: \_\_\_\_\_  
\_\_\_\_\_  
\_\_\_\_\_  
\_\_\_\_\_  
\_\_\_\_\_  
\_\_\_\_\_

Book mark: \_\_\_\_\_

*Hathaway*  
(358) *Hathaway* Copyist.

21 | 11 H. Art'y. | U.S.C.T.

*Jeremiah Wilson*  
*Pvt.*, Co. E, 11 Reg't U. S. Col'd H. Art'y.

Appears on

**Company Muster Roll**

for *Wm. L. A. M.*, 1865.

Present or absent *Present*

Stoppage, \$ *43* for *Screwdriver*

*23: wiper 20*

Due Gov't, \$ *82* for *Canteen*

Valuation of horse, \$ 100

Valuation of horse equipments, \$ 100

Remarks: \_\_\_\_\_

Book mark: \_\_\_\_\_

*Hattaway*



*N*

**11 H. Art'y. U.S.C.T.**

*Jeremiah Wilson*  
*Priv.*, Co. E, 11 Reg't U. S. Col'd H. Art'y.

Appears on

**Company Muster Roll**

for *May and June*, 1865

Present or absent *Present.*

Stoppage, \$ 100 for

Due Gov't, \$ 100 for

Valuation of horse, \$ 100

Valuation of horse equipments, \$ 100

Remarks: *Stop for one centure 65.*

Book mark:

(358)

*J. B. Jones* Copyist.

*W* | 11 H. Art'y. | U.S.C.T.

*Jeremiah Wilson*  
*Priv.*, Co. E, 11 Reg't U. S. Col'd H. Art'y.

Appears on

**Company Muster Roll**

for *July and August*, 1865.

Present or absent *Present*

Stoppage, \$ 100 for

Due Gov't, \$ 100 for

Valuation of horse, \$ 100

Valuation of horse equipments, \$ 100

Remarks: *Stop for me letter 01; 2 eagles 04; 2 numbers 02.*

Book mark: \_\_\_\_\_

(358)

*J. B. Jones*

Copyist.

*N* | 11 H. Art'y. | U.S.C.T.

*Jeremiah Wilson*  
Priv., Co. *E*, 11 Reg't U. S. Col'd H. Art'y.

Appears on Co. Muster-out Roll, dated  
*New Orleans, La., Oct. 2,* 1865.

Muster-out to date *Oct. 2,* 1865.

Last paid to *June 30,* 1865.

Clothing account:

Last settled....., 186 ; drawn since \$.....<sup>100</sup>

Due soldier \$.....<sup>100</sup>; due U. S. \$ *24*<sup>30</sup>/<sub>100</sub>

Am't for cloth'g in kind or money adv'd \$.....<sup>100</sup>

Due U. S. for arms, equipments, &c., \$.....<sup>100</sup>

Bounty paid \$ *None* <sup>100</sup>; due \$ *100*<sup>00</sup>/<sub>100</sub>

Remarks: *Joined at Capt. Org. Stop*  
*for one musket & acc't retained 6.00;*  
*one haversack 2.20; one Mos. bar 1.70; two*  
*knives .04; one letter .01; 2 A's .02.*

Book mark: .....

(361)

*J. B. Jones*

Copyist.



Wilson, Jered

S, Co.

11 Reg't USCA A

2 Enclosures.

Bed Cards .....	Final Statements .....
Burial Records .....	Furloughs or L. of A .....
Certs. of Dis. for Discharge .....	Med. Certificates .....
C. M. Charges .....	Med. Des. Lists .....
Descriptive Lists .....	Orders .....
Discharge Certificates .....	Pris. of War Record .....
Enlistment Papers .....	Resignations .....

Other papers relating to—

Admission to Hosp'l .....	Furlough or L. of A .....
Casualty Sheet .....	Med. Examination .....
Confinement .....	Misc. Information / .....
Contracts .....	Pay or Clothing .....
Death or Effects .....	Personal Reports .....
Desertion .....	Rank .....
Discharge from Hosp'l .....	Transfer to Hosp'l .....
Discharge from Service .....	Transfer to V. R. C. .....
Duty .....	Transportation .....

DECLARATION OF RECRUIT.

I, John Nelson Byrum desiring to VOLUNTEER as a Soldier in the ARMY OF THE UNITED STATES, for the term of 27 months of age; that I have never been discharged from the United States service on account of disability or by sentence of a court martial, or by order, before the expiration of a term of enlistment; and I know of no impediment to my serving honestly and faithfully as a soldier for

Given at Providence The 22nd day of Sept 1863 John Nelson his mark

Witness: A. D. Emery

Discharged 11 1871 Reg't of 11 1863

enlistment; last served in Company ( )

Volunteered at Providence John Nelson 11 1863 11 1871 11 1863 11 1871

No. 143 11 1863

CONSENT IN CASE OF MINOR.

I, \_\_\_\_\_ Do CERTIFY that I am the \_\_\_\_\_ of \_\_\_\_\_ is \_\_\_\_\_ years of age; and I do hereby freely give my CONSENT to his volunteering as a SOLDIER in the ARMY OF THE UNITED STATES for the period of \_\_\_\_\_

Given at \_\_\_\_\_ The \_\_\_\_\_ day of \_\_\_\_\_ Witness \_\_\_\_\_



VOLUNTEER ENLISTMENT.



State of

City of

*R.I.*  
*Providence*  
*Philadelphia*

I *William Wilson* born in *Penn* aged *27* years, and by occupation a *Bookbinder*

DO HEREBY ACKNOWLEDGE to have volunteered this *22<sup>nd</sup>* day of *Sept* 18 *62* to serve as a SOLDIER in the ARMY OF THE UNITED STATES OF AMERICA, for the period of *3 years* unless sooner discharged by proper authority:

Do also agree to accept such bounty, pay, rations and clothing, as are, or may be, established, by law for volunteers. And I, *W. Wilson* do solemnly swear, that I will bear true faith and allegiance to the *United States of America*, and that I will serve them honestly and faithfully against all their enemies or opposers whomsoever; and that I will observe and obey the orders of the President of the United States, and the orders of the officers appointed over me, according to the Rules and Articles of War.

Sworn and Subscribed to, at

this *22<sup>nd</sup>* day of *Sept* 18 *62*

BEFORE

*Providence*  
*W. Wilson*  
*S. P. [Signature]*  
*Major 1st R.I. [Signature]*

I CERTIFY, ON HONOR, that I have carefully examined the above-named Volunteer, agreeable to the General Regulations of the Army, and that, in my opinion, he is free from all bodily defects and mental infirmity, which would, in any way, disqualify him from performing the duties of a soldier.

*W. Carpenter* EXAMINING SURGEON.

I CERTIFY, ON HONOR, That I have minutely inspected the Volunteer, *W. Wilson* previously to his enlistment, and that he was entirely sober when enlisted; that to the best of my judgment and belief, he is of lawful age; and that, in accepting him as duly qualified to perform the duties of an able-bodied soldier, I have strictly observed the Regulations which govern the recruiting service. This soldier has *dark* eyes *dark* hair

*dark* complexion, is *6* feet, *2* inches high.

*14<sup>th</sup>* Regiment of *R.I. H.A.* Volunteers,

RECRUITING OFFICER.



Donaldsonville La

Aug 3<sup>rd</sup> 1865

Miss J. S. Parrot  
Co. E. 11<sup>th</sup> U.S. Cal Reg

Applies for Indulgence  
of five days.

Head-Quarters Co. E. 11<sup>th</sup> U.S. Cal Reg  
Donaldsonville, La

Aug 3<sup>rd</sup> 1865

Respectfully forwarded,  
Approved,

Wm. H. Clemens  
1<sup>st</sup> Lt 11<sup>th</sup> U.S. Cal Reg  
Company Bump

Head-Quarters 11<sup>th</sup> U.S. Cal Reg  
Donaldsonville La Aug 4<sup>th</sup> 65

Respectfully forwarded  
Approved  
J. G. Shaw  
Major 11<sup>th</sup> U.S. Cal Reg  
Company Bump

Recd Aug 4, 1865

From Butler,  
Donaldsonville, La.,  
August 8<sup>th</sup> 1865

1<sup>st</sup> Lieut. J. C. Whiting, Jr.  
Past Adjutant,  
Lieutenant,

I have the honor to apply for a furlough of five days for the purpose of visiting New Orleans, as I have an aunt there who is very sick and not expected to live.

Very Respectfully

Yours Servant  
Jeremiah S. Wilson  
Priv. Co. C. 11th U.S. C.A. (Reg.)

Furlough granted from Aug 6<sup>th</sup> to Aug 11<sup>th</sup> 1865

2057

*Wilson Jesse H.*

**Co H, 11 U.S. Col'd H. Art'y.**

*Private*

*Private*

**CARD NUMBERS.**

1	6194387	26
2	6194532	27
3	6194672	28
4	6194816	29
5	6194955	30
6	6195093	31
7	6195227	32
8	6195361	33
9	6195489	34
10	6195623	35
11	6195751	36
12	6195877	37
13	6196004	38
14	9125426	39
15		40
16		41
17		42
18		43
19		44
20		45
21		46
22		47
23		48
24		49
25		50

Book Mark: \_\_\_\_\_

See also \_\_\_\_\_



*W* | **11 H. Art'y. | U.S.C.T.**

*Jesse W. Wilson*

....., Co. *H*, 11 Reg't U. S. Col'd H. Art'y.

Appears on

**Company Descriptive Book**

of the organization named above.

**DESCRIPTION.**

Age *19* years; height *5* feet *10* inches.

Complexion *Blk*

Eyes *Blk*; hair *Blk*

Where born *Mayville, Ky*

Occupation *Farmer*

**ENLISTMENT.**

When *Nov 5*, 186*3*.

Where *Prov. R. I.*

By whom *J. C. Engley*; term *3* y'rs.

Remarks:.....

.....  
.....  
.....  
.....  
.....  
.....  
.....  
.....  
.....  
.....

*W J Roe*

*N.* | **11 H. Art'y.** | **U.S.C.T.**

*James W. Wilson*

*Priv.*, Co. *H.*, 14 Reg't R. I. Col'd H. Art'y.\*

Age *9* years.

Appears on

**Company Muster-in Roll**

of the organization named above. Roll dated

*Providence R.I., Nov 23*, 1863.

Muster-in to date

*Nov. 23*, 1863.

Joined for duty and enrolled:

When *Nov. 5*, 1863.

Where *Providence R.I.*

Period *3* years.

Valuation of horse, \$ *100*

Valuation of horse equipments, \$ *100*

Remarks: *Residence Providence R.I.*

\* This organization subsequently became Co. *A.*, 11 Reg't U. S. Colored Heavy Artillery.

Book mark: \_\_\_\_\_

*Perry*

N. | **11 H. Art'y.** | **U.S.C.T.**

Jesse N. Wilson  
Co., Co. H, 14 Reg't R. I. Col'd H. Art'y.\*

Appears on

**Company Muster Roll**

for 23 Nov. to 31 Dec., 1863.

Present or absent. Present

Stoppage, \$.....100 for .....

Due Gov't, \$.....100 for .....

Valuation of horse, \$.....100

Valuation of horse equipments, \$.....100

Remarks:.....

\*This organization subsequently became Co. H, 11 Reg't U. S. Colored Heavy Artillery.

Book mark:.....

Perry

Copyist.



*A.* | **11 H. Art'y. U.S.C.T.**

*Jesse W. Wilson*  
*Prv*, Co. H, 14 Reg't R. I. Col'd H. Art'y.\*

Appears on

**Company Muster Roll**

for *Jan & Feb*, 1864.

Present or absent *Present*

Stoppage, \$ *100* for

Due Gov't, \$ *100* for

Valuation of horse, \$ *100*

Valuation of horse equipments, \$ *100*

Remarks: *Due U. S. for one set of equipments complete*

\*This organization subsequently became Co. II, 11 Reg't U. S. Colored Heavy Artillery.

Book mark: \_\_\_\_\_

*Cerry*

*W.* | **11** H. Art'y. | **U.S.C.T.**

*Jesse W. Wilson,*  
*Pvt.*, Co. H, 14 Reg't R. I. Col'd H. Art'y.\*

Appears on

**Company Muster Roll**

for *Mch. & Apl.*, 1864.

Present or absent *Present*

Stoppage, \$.....100 for .....

Due Gov't, \$.....100 for .....

Valuation of horse, \$.....100

Valuation of horse equipments, \$.....100

Remarks: *Stop for one*  
*set of equipments*  
*Complete*

\*This organization subsequently became Co. H, 11 U. S. Col'd H. Art'y

Book mark: .....

*Perry*

*N.* | **11 H. Art'y. | U.S.C.T.**

*Jesse N. Wilson*  
Cmn, Co. *H*, 8 Reg't U. S. Col'd H. Art'y.\*

Appears on

**Company Muster Roll**

for *May & June*, 1864.

Present or absent *Present*

Stoppage, \$ *100* for

Due Gov't, \$ *100* for

Valuation of horse, \$ *100*

Valuation of horse equipments, \$ *100*

Remarks: *Stop for one set of equipments complete. one gun sling*

† This organization subsequently became Co. *H*, 11 Reg't U. S. Colored Heavy Artillery.

Book mark: \_\_\_\_\_

*Perry*



W

11 H. Art'y. U.S.C.T.

Jesse W. Wilson  
Private, Co. H, 11 Reg't U. S. Col'd H. Art'y.

Appears on

Company Muster Roll

for July & Aug., 1864.

Present or absent Present

Stoppage, \$ 100 for

Due Gov't, \$ 100 for

Valuation of horse, \$ 100

Valuation of horse equipments, \$ 100

Remarks: Stop for one  
set of Equipments  
Complete \$ 3.25  
Junsling 25 mosquito  
Box 1.00 Canvas 4.1  
Shoulder scales 50

Book mark:

W A Tyler

*W* 11 H. Art'y. U.S.C.T.

*Jesse W. Wilson*  
Private, Co. H, 11 Reg't U. S. Col'd H. Art'y.

Appears on

**Company Muster Roll**

for *Date of Oct 31*, 1864.

Present or absent *Present*

Stoppage, \$ *100* for

Due Gov't, \$ *100* for

Valuation of horse, \$ *100*

Valuation of horse equipments, \$ *100*

Remarks: *Stop for rest*  
*equipments complete*  
*#3. 2 5 gun sling. 2 5*  
*mosquito bar 1.00*  
*Canteen 41 seals 50*  
*Haversack 67 (new)*  
*Free Apr. 19, 1861*

Book mark:

*W A Tyler*

W

11 H. Art'y.

U.S.C.T.

Jesse W. Wilson

Priv't, Co. H, 11 Reg't U. S. Col'd H. Art'y.

Appears on

Company Muster Roll

for Nov & Dec, 1864.

Present or absent Present

Stoppage, \$ 100 for

Due Gov't, \$ 100 for

Valuation of horse, \$ 100

Valuation of horse equipments, \$ 100

Remarks: Stop for one set of equipments complete 3.25 gun sling .25 mosquito bar 1.00, Shoulder scales, Canvas T Flaversack 1.50

Book mark:

W. A. Tyler



*W* | 11 H. Art'y. | U.S.C.T.

*Jesse W. Wilson*  
Co. H, 11 Reg't U. S. Col'd H. Art'y.

Appears on

**Company Muster Roll**

for *Jan & Feb*, 1865.

Present or absent *Present*

Stoppage, \$ *100* for

Due Gov't, \$ *100* for

Valuation of horse, \$ *100*

Valuation of horse equipments, \$ *100*

Remarks: *I stop for Haver -  
week . 67*

Book mark:

*W. A. Tyler*

*W* | 11 H. Art'y. | U.S.C.T.

*Jesse W. Wilson*  
Priv't, Co. H, 11 Reg't U. S. Col'd H. Art'y.

Appears on

**Company Muster Roll**

for *March & Apr.*, 1865.

Present or absent *Present*

Stoppage, \$ *100* for

Due Gov't, \$ *100* for

Valuation of horse, \$ *100*

Valuation of horse equipments, \$ *100*

Remarks: *Stop for wiper*  
*120*

Book mark: *5-25*

*W. A. Tyler*

*M.*

11 H. Art'y. U.S.C.T.

*Jesse W. Wilson*

*Plt.*, Co. H, 11 Reg't U. S. Col'd H. Art'y.

Appears on

**Company Muster Roll**

for *Maryanne Jane*, 1865.

Present or absent *Present*

Stoppage, \$ *100* for

Due Gov't, \$ *100* for

Valuation of horse, \$ *100*

Valuation of horse equipments, \$ *100*

Remarks: *Stop for wiper 20*  
*Rear right RR. Musket 93*  
*Mosquito bar 100*

Book mark:

*Plt.*

Copyist.



*JK*

11 H. Art'y. U.S.C.T.

*Jesse M. Nelson*

*Priv*, Co. H, 11 Reg't U. S. Col'd H. Art'y.

Appears on

**Company Muster Roll**

for *July and Aug*, 1865.

Present or absent *Present*

Stoppage, \$ 100 for

Due Gov't, \$ 100 for

Valuation of horse, \$ 100

Valuation of horse equipments, \$ 100

Remarks:  
.....  
.....  
.....  
.....  
.....  
.....  
.....  
.....  
.....  
.....

Book mark: .....

*Phell*

*W.* | **11 H. Art'y.** | **U.S.C.T.**

*Jesse W. Wilson*

*Pvt.*, Co. *H.*, 11 Reg't U. S. Col'd H. Art'y.

Appears on **Co. Muster-out Roll**, dated

*New Orleans La.*, *Oct. 2*, 1865.

Muster-out to date *Oct. 2*, 1865.

Last paid to *June 30*, 1865.

**Clothing account:**

Last settled....., 186 ; drawn since \$..... 100

Due soldier \$..... 100; due U. S. \$ *17* <sup>06</sup>/<sub>100</sub>

Am't for cloth'g in kind or money adv'd \$..... 100

Due U. S. for arms, equipments, &c., \$..... 100

Bounty paid \$ *00* 100; due \$ *100* 100

Remarks: *joined at origl org<sup>n</sup>*  
*Stop for Muster and*  
*Accts retained \$6.*

Book mark: *6145 P.M.H. June 20, 66*

*P.M.H. - 7.442 H.B.U. July 13/66*

*244,306*

(861)

*Rhett*

Copyist.

Wilson, Jesse W

P. Co. *H*, 11 Reg't *USC HA*

*2* Enclosures.

Bed Cards .....	Final Statements .....
Burial Records .....	Furloughs or L. of A. ....
Certs. of Dis. for Discharge .....	Med. Certificates .....
C. M. Charges .....	Med. Des. Lists .....
Descriptive Lists .....	Orders .....
Discharge Certificates .....	Pris. of War Record .....
Enlistment Papers .....	Resignations .....

Other papers relating to—

Admission to Hosp'l .....	Furlough or L. of A. ....
Casualty Sheet .....	Med. Examination .....
Confinement <i>/</i> .....	Misc. Information .....
Contracts .....	Pay or Clothing .....
Death or Effects .....	Personal Reports .....
Desertion .....	Rank .....
Discharge from Hosp'l .....	Transfer to Hosp'l .....
Discharge from Service .....	Transfer to V. R. C. ....
Duty .....	Transportation .....



DECLARATION OF RECRUIT.

I, *Jesse W. Wilson* desiring to VOLUNTEER as a Soldier in the ARMY OF THE UNITED STATES, for the term of *3 Years* do declare that I am *21* years and months of age; that I have never been discharged from the United States service on account of disability or by sentence of a court martial, or by order, before the expiration of a term of enlistment; and I know of no impediment to my serving honestly and faithfully as a soldier for *3 Years*

Given at *Providence*  
The *5<sup>th</sup>* day of *November* 18*63*

Witness:  
*Mr. Hayes*

*Jesse Wilson*

*11*  
No. *4474*

Volunteered at *Providence*  
*Jesse W. Wilson*

*November 5<sup>th</sup>* 1863

By *Wm. J. & Engley*  
*14<sup>th</sup>* Regiment of *Artillery*

enlistment; last served in Company ( )

Regt of

Discharged *1863*



CONSENT IN CASE OF MINOR.

I, \_\_\_\_\_ Do CERTIFY that I am the \_\_\_\_\_ of \_\_\_\_\_; that the said \_\_\_\_\_ is \_\_\_\_\_ years of age; and I do hereby freely give my CONSENT to his volunteering as a SOLDIER in the ARMY OF THE UNITED STATES for the period of \_\_\_\_\_

Given at \_\_\_\_\_  
The \_\_\_\_\_ day of \_\_\_\_\_

Witness

# VOLUNTEER ENLISTMENT.

State of *Rhode Island* Town of *Providence*



I, *Jesse W. Wilson* born in *Maysville*  
in the State of *Kentucky* aged *21* years, and by occupation  
a *farmer*

DO HEREBY ACKNOWLEDGE to have volunteered this *5<sup>th</sup>*  
day of *November* 18 *63* to serve as a SOLDIER in the ARMY OF THE UNITED STATES  
OF AMERICA, for the period of *3 Years*, unless sooner discharged by proper authority:

Do also agree to accept such bounty, pay, rations and clothing, as are, or may be, established, by law for  
volunteers. And I, *Jesse W. Wilson* do solemnly swear, that I will bear  
true faith and allegiance to the *United States of America*, and that I will serve them honestly and faith-  
fully against all their enemies or opposers whomsoever; and that I will observe and obey the orders of the  
President of the United States, and the orders of the officers appointed over me, according to the Rules  
and Articles of War.

Sworn and Subscribed to, at *Providence*  
this *5<sup>th</sup>* day of *November* 18 *63*.

BEFORE *Jesse W. Wilson*  
*Justice of the Peace*  
I CERTIFY, ON HONOR, That I have carefully examined the above-named Volunteer, agreeable to the General Regulations of  
the Army, and that, in my opinion, he is free from all bodily defects and mental infirmity, which would, in any way, disqualify him  
from performing the duties of a soldier.

*Johnson Gardner*  
EXAMINING SURGEON.

I CERTIFY, ON HONOR, That I have minutely inspected the Volunteer,  
previously to his enlistment, and that he was entirely sober when enlisted; that to the best of my judgment and belief, he is of  
lawful age; and that, in accepting him as duly qualified to perform the duties of an able-bodied soldier, I have strictly observed the  
Regulations which govern the recruiting service. This soldier has  
*dark* complexion, is *five* feet, *10*  
*dark* eyes *dark* hair  
inches high.

Regiment of

Volunteers,

RECRUITING OFFICER.



Head Quarters 2<sup>d</sup> Regt 11<sup>th</sup> U.S. Col  
Pennsylvania Sa May 16<sup>th</sup> 1865

Sypher M. Hall Col 11<sup>th</sup> U.S. Col  
by Barny C. M. A. Adj.

Notifys comd of apper 2<sup>d</sup> Regt  
to comd to be read the exsting  
Bertacion order in relation  
to gambling and arld the  
release from arrest Pris  
Messrs Mellson of Co. H.  
and then hereafter any vio-  
lation of the orders refered  
to will be severely punished

Recd May 18<sup>th</sup> 1865



Hd-Qrs, Eleventh Reg't. U. S. C. A. (Inf.)  
Flagmont, La., May 18, 1865.

Major Richard G. Shan  
Comdg 2<sup>d</sup> Batt. 17<sup>th</sup> U. S. C. A. (Inf)  
Major-

You will cause  
the existing Battalion order or orders in  
relation to gambling to be read to your  
command at the next Dress Parade after  
the receipt of this order.

You will release Priv. Jesse Wilson  
Co. "H" your Battalion, from arrest, and here-  
after any violation of the orders referred  
to, you will severely punish

By order of Col. J. H. Lypher  
Comdg Regiment.

A. Henry Jarney  
1<sup>st</sup> Lt. 17<sup>th</sup> U. S. C. A. (Inf)  
Act. Adjutant

2000  
Wilson John H.  
Co *F*, 11 U.S. Col'd H. Art'y.

Private | Musician

CARD NUMBERS.

1	6190698	26
2	6190844	27
3	6191112	28
4	6191252	29
5	6191289	30
6	6191432	31
7	6191570	32
8	6191700	33
9	6191824	34
10	6191947	35
11	6192081	36
12	6192211	37
13	6192334	38
14	9174998	39
15		40
16		41
17		42
18		43
19		44
20		45
21		46
22		47
23		48
24		49
25		50

Book Mark:

See also

*A* | 11 H. Art'y. | U.S.C.T.

*John H. Wilson*  
Co. *F*, 11 Reg't U. S. Col'd H. Art'y.

Appears on  
**Company Descriptive Book**  
of the organization named above.

**DESCRIPTION.**

Age *20* years; height *5* feet *4* inches.

Complexion *Fl.*

Eyes *Dark*; hair *Bl.*

Where born *New York, N.Y.*

Occupation *Writer.*

**ENLISTMENT.**

When *Apr. 8*, 186 *3*.

Where *Prov., R.I.*

By whom *J. C. Engley*; term *3* y'rs.

Remarks: *Appointed musician  
from enlistment.*

*O. J. Markle.*  
Copist.



*W* | 11 H. Art'y. | U.S.C.T.

*John H. Wilson*  
Pri., Co. *F*, 14 Reg't R. I. Col'd H. Art'y.\*

Age *20* years.

Appears on

**Company Muster-in Roll**

of the organization named above. Roll dated

*Providence R.I. Oct 20*, 1863.

Muster-in to date

*Oct 20*, 1863.

Joined for duty and enrolled:

When *Oct 8*, 186 .

Where *Providence, R.I.*

Period *3* years.

Valuation of horse, \$.....*100*

Valuation of horse equipments, \$.....*100*

Remarks:

\* This organization subsequently became Co. *F*, 11 Reg't U. S. Colored Heavy Artillery.

Book mark:

*J. Neal*

*W*

11 H. Art'y. U.S.C.T.

*John H. Wilson*

*Mus* Co. F, 14 Reg't R. I. Col'd H. Art'y.\*

Appears on

**Company Muster Roll**

for *Oct 20 to Dec 31*, 1863.

Present or absent *Present*

Stoppage, \$ 100 for

Due Gov't, \$ 100 for

Valuation of horse, \$ 100

Valuation of horse equipments, \$ 100

Remarks:

\* This organization subsequently became Co. F, 11 Reg't U. S. Colored Heavy Artillery.

Book mark:

*S. Neal*

*W* | 11 H. Art'y. | U.S.C.T.

*John H. Wilson*  
Cai, Co. F, 14 Reg't R. I. Col'd H. Art'y.\*

Appears on

**Company Muster Roll**

for *Jan 1st Feb*, 186*4*

Present or absent *Present*

Stoppage, \$.....*100* for .....

Due Gov't, \$.....*100* for .....

Valuation of horse, \$.....*100*

Valuation of horse equipments, \$.....*100*

Remarks: *Stop for own  
Musical's sword  
and belt.*

\* This organization subsequently became Co. F, 11 Reg't U. S. Colored Heavy Artillery.

Book mark: .....

*J. Neal*



*W* | **11 H. Art'y.** | **U.S.C.T.**

*John A. Wilson*  
*Qui*, Co. F, 14 Reg't R. I. Col'd H. Art'y.\*

Appears on

**Company Muster Roll**

for *Mar & Apr*, 1864

Present or absent *Present*

Stoppage, \$.....100 for .....

Due Gov't, \$.....100 for .....

Valuation of horse, \$.....100

Valuation of horse equipments, \$.....100

Remarks *Stop for one*  
*Musicians' Sword*  
*and belt.*

\* This organization subsequently became Co. F. 11 Reg't U. S. Colored Heavy Artillery.

Book mark: .....

*A Neal*

*11* | 11 H. Art'y. | U.S.C.T.

*John D. Wilson*  
Mus, Co. *A*, 8 Reg't U. S. Col'd H. Art'y.\*

Appears on

**Company Muster Roll**

for *May & June*, 1864

Present or absent *Present*

Stoppage, \$ 100 for

Due Gov't, \$ 100 for

Valuation of horse, \$ 100

Valuation of horse equipments, \$ 100

Remarks *Stop for our*  
*Musicians sword*  
*and belt.*

† This organization subsequently became Co. *A*, 11 Reg't U. S. Colored Heavy Artillery.

Book mark: \_\_\_\_\_

*J. D. Wilson*

*M* | 11 H. Art'y. | U.S.C.T.

*John H. Wilson.*

*Musician*, Co. F, 11 Reg't U. S. Col'd H. Art'y.

Appears on

**Company Muster Roll**

for *July and Aug.*, 1864.

Present or absent *Present.*

Stoppage, \$ *100* for

Due Gov't, \$ *100* for

Valuation of horse, \$ *100*

Valuation of horse equipments, \$ *100*

Remarks: *Stop for sword belt*  
*.69, plates .08, sword 4.00 and*  
*canteen .41 Free April 19/61.*

Book mark: .....

*Online.*



*N* | 11 H. Art'y. | U.S.C.T.

*John H. Wilson.*  
*Musician*, Co. F, 11 Reg't U. S. Col'd H. Art'y.

Appears on

**Company Muster Roll**

for *Sept. and Oct.*, 1864.

Present or absent *Present.*

Stoppage, \$ 100 for

Due Gov't, \$ 100 for

Valuation of horse, \$ 100

Valuation of horse equipments, \$ 100

Remarks: *Stop for Musician's sword*  
*4.00 sword belt .55 plate .07 canton #*  
*Free April 19/61.*

Book mark: \_\_\_\_\_

*Online*

*W* | **11** H. Art'y. | **U.S.C.T.**

*John H. Wilson.*  
*Musician,* Co. F, 11 Reg't U. S. Col'd H. Art'y.

Appears on

**Company Muster Roll**

for *Nov. and Dec.*, 1864.

Present or absent *Present.*

Stoppage, \$ *100* for

Due Gov't, \$ *100* for

Valuation of horse, \$ *100*

Valuation of horse equipments, \$ *100*

Remarks: *Stop for musician's*  
*Sword 4.00 sword belt. 55*  
*plate. 07 two canteens. 82*  
*Free April 19/61.*

Book mark: \_\_\_\_\_

*Online.*

*W* | 11 H. Art'y. | U.S.C.T.

*John H. Wilson.*  
*Musician* Co. F, 11 Reg't U. S. Col'd H. Art'y.

Appears on

**Company Muster Roll**

for *Jan. and Feb.*, 1865.

Present or absent *Present.*

Stoppage, \$ 100 for

Due Gov't, \$ 100 for

Valuation of horse, \$ 100

Valuation of horse equipments, \$ 100

Remarks: *Stop for canteen. 41*

Book mark: \_\_\_\_\_

*Exline.*



*W* | 11 H. Art'y. | **U.S.C.T.**

*John H. Wilson.*  
*Musician*, Co. F, 11 Reg't U. S. Col'd H. Art'y.

Appears on

**Company Muster Roll**

for *Mar. and Apr.*, 1865.

Present or absent *Present.*

Stoppage, \$ 100 for

Due Gov't, \$ 100 for

Valuation of horse, \$ 100

Valuation of horse equipments, \$ 100

Remarks: *Stop for canteen. 41*

Book mark:

*Online.*

*N.* | 11 H. Art'y. | U.S.C.T.

*John H. Wilson*  
*Musician* Co. F, 11 Reg't U. S. Col'd H. Art'y.

Appears on

**Company Muster Roll**

for *May & June*, 1865.

Present or absent *Present*

Stoppage, \$ 100 for

Due Gov't, \$ 100 for

Valuation of horse, \$ 100

Valuation of horse equipments, \$ 100

Remarks: *Stop. for Haver-*  
*sack .95*

Book mark: 1.

*Leib*  
Copyst.

*W.* | 11 H. Art'y. | U.S.C.T.

*John H. Wilson*  
Musician Co. F, 11 Reg't U. S. Col'd H. Art'y.

Appears on

**Company Muster Roll**

for *July & Aug.*, 1865.

Present or absent: *Present.*

Stoppage, \$ *100* for

Due Gov't, \$ *100* for

Valuation of horse, \$ *100*

Valuation of horse equipments, \$ *100*

Remarks: *Stop for C & Y  
Equipage 1.00*

Book mark: \_\_\_\_\_

*Leib*  
Copyst.



W. | 11 H. Art'y. | U.S.C.T.

*John H. Wilson*  
Musician Co. F, 11 Reg't U. S. Col'd H. Art'y.

Appears on Co. Muster-out Roll, dated  
*New Orleans, La. Oct 2* 1865.

Muster-out to date *Oct. 2*, 1865.

Last paid to *June 30* 1865.

Clothing account:

Last settled....., 186 ; drawn since \$..... 100

Due soldier \$ *4.42* / 100; due U. S. \$..... 100

Am't for cloth'g in kind or money adv'd \$..... 100

Due U. S. for arms, equipments, &c., \$ *9.93* / 100

Bounty paid \$ *none* / 100; due \$ *100.00* / 100

Remarks: *Joined at Orgin,*  
*Orgin. Stop. for Havers*  
*back, Car team, drum*  
*Complete, drum head*  
*latter, drum sling,*  
*drum stick carriage,*

Book mark:.....

(361)

*(over)*

*Leib*  
Copied

JAN. 15

6192354

018910

*Two drum cords, one  
left drum squares lost.*

Wilson, Jas. H.

, Co. F, 11 Reg't U.S.C.H.A.

3 Enclosures.

Bed Cards .....	Final Statements .....
Burial Records .....	Furloughs or L. of A. ....
Certs. of Dis. for Discharge .....	Med. Certificates .....
C. M. Charges .....	Med. Des. Lists .....
Descriptive Lists .....	Orders .....
Discharge Certificates .....	Pris. of War Record .....
Enlistment Papers .....	Resignations .....

Other papers relating to—

Admission to Hosp'l .....	Furlough or L. of A. 2 .....
Casualty Sheet .....	Med. Examination .....
Confinement .....	Misc. Information / .....
Contracts .....	Pay or Clothing .....
Death or Effects .....	Personal Reports .....
Desertion .....	Rank .....
Discharge from Hosp'l .....	Transfer to Hosp'l .....
Discharge from Service .....	Transfer to V. R. C. ....
Duty .....	Transportation .....



**DECLARATION OF RECRUIT.**

I, John A. Wilson desiring to VOLUNTEER as a Soldier in the ARMY OF THE UNITED STATES, for the term of Three Years do declare that I am 20 years and          months of age; that I have never been discharged from the United States service on account of disability or by sentence of a court martial, or by order, before the expiration of a term of enlistment; and I know of no impediment to my serving honestly and faithfully as a soldier for Three Years

Given at Port Jervis the 25 day of Oct 1863

Witness: J. M. [unclear]

116004 H 45-  
No. Wilson

Volunteered at Port Jervis Oct. 18 1863

Regiment of         

enlistment; last served in Company (          )

Reg't of         

Discharged          18        

JUL 11 1863

**CONSENT IN CASE OF MINOR.**

I,          of          Do CERTIFY that I am the          years of age; and I do hereby freely give my CONSENT to his volunteering as a SOLDIER in the ARMY OF THE UNITED STATES for the period of         

Given at          The          day of         

Witness:

VOLUNTEER ENLISTMENT.

State of Rhode Island



Town of Providence

I, John H. Wilson born in N. York aged 20 years, and by occupation a ~~Printer~~ DO HEREBY ACKNOWLEDGE to have volunteered this 8 day of October 18 63 to serve as a SOLDIER in the ARMY OF THE UNITED STATES

OF AMERICA, for the period of ~~thirteen~~ months, unless sooner discharged by proper authority: Do also agree to accept such bounty, pay, rations and clothing, as are, or may be, established, by law for volunteers. And I, John H. Wilson do solemnly swear, that I will bear true faith and allegiance to the United States of America, and that I will serve them honestly and faithfully against all their enemies or opposers whomsoever; and that I will observe and obey the orders of the President of the United States, and the orders of the officers appointed over me, according to the Rules and Articles of War.

Sworn and Subscribed to, at Providence this 8 day of Oct 18 63 BEFORE J. H. Wilson

I CERTIFY, ON HONOR, That I have carefully examined the above-named Volunteer, agreeable to the General Regulations of the Army, and that, in my opinion, he is free from all bodily defects and mental infirmity, which would, in any way, disqualify him from performing the duties of a soldier.

John H. Wilson M.D.

EXAMINING SURGEON.

I CERTIFY, ON HONOR, That I have minutely inspected the Volunteer, John H. Wilson, previously to his enlistment, and that he was entirely sober when enlisted, that to the best of my judgment and belief, he is of lawful age; and that, in accepting him as duly qualified to perform the duties of an able-bodied soldier, I have strictly observed the Regulations which govern the recruiting service. This soldier has dark eyes, dark hair, dark complexion, is five feet, four inches high.

Regiment of

Volunteers,

RECRUITING OFFICER.



1913  
306 Donaldsonville La. 1865  
63  
July 7, 1865 1865-

Wilson, John H. Drummer  
11th U. S. Col'd Infy

Makes application for  
a furlough of (5) five  
days for the purpose  
of visiting New Orleans.

Adjut. Gen. Barr 17th U.S. Cav  
July 8, 1865.

Respectfully Demanded  
Approved.

R. G. Shaw

Major 17th U.S. Cav  
Comd'g Barr

Recd. at Barr July 8, 1865



Donaldsonville Louisiana  
July 7. 1865

1st Lieut J. C. Whiting Jr  
Post Adj't. Donaldsonville La.  
Lieutenant

I have the honor to apply for a furlough of (5) five days. For the purpose of visiting the city of New Orleans. I have not received a furlough since I enlisted.

I have the honor to be, Lieutenant  
Very Respectfully  
Your Obedient Servant  
John H. Wilson  
Drummer, 11<sup>th</sup> U. S. C. A. (Hqs)

Mr Ellersbrook

John E. Wilson

Co. F. 11<sup>th</sup> S. C. Artillery  
J. I.



Adjutant General's Office,

COLORED TROOPS BRANCH,

June 21<sup>st</sup>, 1875

Mr. Ellert Vol. C. T., 187  
Wanted in the case of John H. Wilson, Co. I,  
11<sup>th</sup> Reg't U.S.C. Artillery

Information in regard to absence when returned <sup>and</sup> if tried  
Regimental Return for Nov 1863 reports him "Absent  
without leave since Nov 24/63"

Respectfully,

W. A. Woodward  
Chief Clerk.  
J. W.

Adjutant General's Office,

Div. of Disc'd. Comm.

July 2<sup>nd</sup>, 1875

Vol. C. T., 187  
Reply in case of John H. Wilson, Co. F,  
11<sup>th</sup> Reg't U.S.C. Art. (ty)

Co. Morning Reports, 2<sup>nd</sup> Cons. M. Reports, on file,  
furnish no evidence of this man being absent without  
leave from Nov 7/64 to August 7/65.

Morning Report of Co. F dated November 25/63 reports:  
"J. H. Wilson absent with leave." Date of Nov 29/63: - J. H. Wilson  
absent without leave." Date of Dec 1/63: - "John H. Wilson  
returned."

Co 2<sup>nd</sup> Reg't Records on file furnish no evidence of a  
trial in this case or of the removal of the charge by S. Order.

C. I. S.



*Wilson Landon*

Co *H*, **11 U.S. Col'd H. Art'y.**

*Private*

*Private*

CARD NUMBERS.

1	6194389	26
2	6194534	27
3	6194674	28
4	6194818	29
5	6194957	30
6	6195095	31
7	6195229	32
8	6195363	33
9	6195491	34
10	6195625	35
11	6195753	36
12	6195879	37
13	6196006	38
14	9125427	39
15		40
16		41
17		42
18		43
19		44
20		45
21		46
22		47
23		48
24		49
25		50

Book Mark: \_\_\_\_\_

See also \_\_\_\_\_

W | 11 H. Art'y. | U.S.C.T.

Lamden Wilson

....., Co. 26, 11 Reg't U. S. Col'd H. Art'y.

Appears on

**Company Descriptive Book**

of the organization named above.

**DESCRIPTION.**

Age 28 years; height 5 feet 8 inches.

Complexion *Blk*

Eyes *Blk*; hair *Blk*

Where born *Indianapolis, Ind*

Occupation *Barber*

**ENLISTMENT.**

When *Nov 5*, 186 *7*

Where *Prov. R I*

By whom *J. Engler*; term *3* y'rs.

Remarks: .....

.....  
.....  
.....  
.....  
.....  
.....  
.....  
.....  
.....  
.....

*W. J. Rose*

*N.* | 11 H. Art'y. | U.S.C.T.

*Landon Wilson*

*Pro*, Co. *H*, 14 Reg't R. I. Col'd H. Art'y.\*

Age <sup>x</sup> \_\_\_\_\_ years.

Appears on

**Company Muster-in Roll**

of the organization named above. Roll dated

*Providence R.I., Nov 23, 1863.*

Muster-in to date *Nov 23, 1863.*

Joined for duty and enrolled:

When *Nov 5*, 1863.

Where *Providence R.I.*

Period *3* years.

Valuation of horse, \$ \_\_\_\_\_ 100

Valuation of horse equipments, \$ \_\_\_\_\_ 100

Remarks: *Residence Providence R.I.*

*\*Roll torn*

\* This organization subsequently became Co. *H*, 11 Reg't U. S. Colored Heavy Artillery.

Book mark: \_\_\_\_\_



*A.* | **11 H. Art'y.** | **U.S.C.T.**

*Leander Willson*

*Pvt.*, Co. H, 14 Reg't R. I. Col'd H. Art'y.\*

Appears on

**Company Muster Roll**

for *23 Nov. to 31 Dec*, 1863.

Present or absent *Present*

Stoppage, \$.....100 for .....

Due Gov't, \$.....100 for .....

Valuation of horse, \$.....100

Valuation of horse equipments, \$.....100

Remarks:.....

.....

.....

.....

.....

.....

.....

\*This organization subsequently became Co. H, 11 Reg't U. S. Colored Heavy Artillery.

Book mark:.....

.....

*Perry*

*W* | **11 H. Art'y. U.S.C.T.**

*Lander Wilson*  
*Co. H*, Co. H, 14 Reg't R. I. Col'd H. Art'y.\*

Appears on

**Company Muster Roll**

for *Jan & Feb*....., 186 *4*.

Present or absent *Present*.....

Stoppage, \$.....<sup>100</sup> for .....

Due Gov't, \$.....<sup>100</sup> for .....

Valuation of horse, \$.....<sup>100</sup>

Valuation of horse equipments, \$.....<sup>100</sup>

Remarks:.....  
.....  
.....  
.....  
.....  
.....

\*This organization subsequently became Co. H, 11 Reg't U. S. Colored Heavy Artillery.

Book mark:.....

*Perry*

*A.* | 11 H. Art'y. | U.S.C.T.

*Lander Wilson*

*Priv*, Co. H, 14 Reg't R. I. Col'd H. Art'y.\*

Appears on

**Company Muster Roll**

for *March & April*, 1864.

Present or absent *Present*

Stoppage, \$.....100 for .....

Due Gov't, \$.....100 for .....

Valuation of horse, \$.....100

Valuation of horse equipments, \$.....100

Remarks: .....

\*This organization subsequently became Co. H, 11 U. S. Col'd H. Art'y

Book mark: .....

*Perry*

Copyist.



*N*

**11 H. Art'y. | U.S.C.T.**

*Samden Wilson*

*Priv*, Co. *H*, 8 Reg't U. S. Col'd H. Art'y.\*

Appears on

**Company Muster Roll**

for *May & June*, 186*4*.

Present or absent *Present*

Stoppage, \$ *100* for

Due Gov't, \$ *100* for

Valuation of horse, \$ *100*

Valuation of horse equipments, \$ *100*

Remarks: *Stop for one canteen & haversack*

† This organization subsequently became Co. *H* 11 Reg't U. S. Colored Heavy Artillery.

Book mark: \_\_\_\_\_

*Perry*

*W* | **11 H. Art'y. U.S.C.T.**

*Lamdon Wilson*  
*Private*, Co. H, 11 Reg't U. S. Col'd H. Art'y.

Appears on

**Company Muster Roll**

for *July + Aug*, 1864.

Present or absent *Present*

Stoppage, \$ *100* for

Due Gov't, \$ *100* for

Valuation of horse, \$ *100*

Valuation of horse equipments, \$ *100*

Remarks: *Stop for canteen*  
*41 Haversack 48*  
*2 G. Coat straps 10*

Book mark:

*W A Tyler*

*W* | 11 H. Art'y. | U.S.C.T.

*Lamden Wilson*

*Private*, Co. H, 11 Reg't U. S. Col'd H. Art'y.

Appears on

**Company Muster Roll**

for *Dated Oct 31*, 186*4*.

Present or absent *Present*

Stoppage, \$ *100* for

Due Gov't, \$ *100* for

Valuation of horse, \$ *100*

Valuation of horse equipments, \$ *100*

Remarks: *Stop for Canten*  
*+ Haversack 89.*  
*2 ls. coat straps 10*  
*Free Apr. 19, 1861.*

Book mark:

*W A Tyler*



*W* | 11 H. Art'y. | U.S.C.T.

*Landon Wilson*  
*Priv't*, Co. H, 11 Reg't U. S. Col'd H. Art'y.

Appears on

**Company Muster Roll**

for *Nov & Dec*, 186 <sup>4</sup>/<sub>5</sub>

Present or absent *Present*

Stoppage, \$ 100 for

Due Gov't, \$ 100 for

Valuation of horse, \$ 100

Valuation of horse equipments, \$ 100

Remarks: *Stop for gun -*  
*sling 25, 2 G. Coat*  
*straps, 10 wiper 20*  
*1 Canteen + 2 Haversacks*  
*1.56*

Book mark:

*W A Tyler*

*M* 11 H. Art'y. U.S.C.T.

*Lamden Wilson*  
*Priv't*, Co. H, 11 Reg't U. S. Col'd H. Art'y.

Appears on

**Company Muster Roll**

for *Jan & Feb*, 1865.

Present or absent *Present*

Stoppage, \$ *100* for

Due Gov't, \$ *100* for

Valuation of horse, \$ *100*

Valuation of horse equipments, \$ *100*

Remarks: *Stop for wiper*  
*L. O. Haversack, 67*

Book mark:

*W. A. Tyler*

*W*

11 H. Art'y. U.S.C.T.

*Landon Wilson*

*Priv't*, Co. H, 11 Reg't U. S. Col'd H. Art'y.

Appears on

**Company Muster Roll**

for *March & Apr*, 1863.

Present or absent *Present*

Stoppage, \$ *100* for

Due Gov't, \$ *100* for

Valuation of horse, \$ *100*

Valuation of horse equipments, \$ *100*

Remarks:

-----  
-----  
-----  
-----  
-----  
-----  
-----  
-----  
-----  
-----

Book mark: -----

*W. A. Tyler*



*W*

11 H. Art'y. U.S.C.T.

*Lambdon Wilson*

*Pvt.*, Co. H, 11 Reg't U. S. Col'd H. Art'y.

Appears on

**Company Muster Roll**

for *May 10 June*, 186*8*.

Present or absent *Present*

Stoppage, \$ *100* for

Due Gov't, \$ *100* for

Valuation of horse, \$ *100*

Valuation of horse equipments, \$ *100*

Remarks: *Stop for ram -  
rod 75*

Book mark:

*Phelan*

*St.* | **11 H. Art'y. U.S.C.T.**

*Lamden Wilson*

*Pr.*, Co. H, 11 Reg't U. S. Col'd H. Art'y.

Appears on

**Company Muster Roll**

for *July and Aug*, 186*8*.

Present or absent *Present*

Stoppage, \$ 100 for

Due Gov't, \$ 100 for

Valuation of horse, \$ 100

Valuation of horse equipments, \$ 100

Remarks:

Book mark:

*Phillips*

*H* | 11 H. Art'y. | U.S.C.T.

*Lamden Wilson*

*Pvt.*, Co. *H.*; 11 Reg't U. S. Col'd H. Art'y.

Appears on **Co. Muster-out Roll**, dated

*New Orleans La., Oct. 2, 1865.*

Muster-out to date

*Oct. 2, 1865.*

Last paid to

*June 30, 1865.*

**Clothing account:**

Last settled....., 186 ; drawn since \$..... 100

Due soldier \$..... 100; due U. S. \$ *42* <sup>*96*</sup>/<sub>100</sub>

Am't for cloth'g in kind or money adv'd \$..... 100

Due U. S. for arms, equipments, &c., \$..... 100

Bounty paid \$ *00* 100; due \$ *100* 100

Remarks: *joined at orig'l org<sup>n</sup>*  
*stop for wipes and com-*  
*pion took 22 cts.*

Book mark : .....

*Phets*



Wilson, Landen

P, Co., 11 Reg't USC H. A.

2 Enclosures.

Bed Cards .....	Final Statements .....
Burial Records .....	Furloughs or L. of A. ....
Certs. of Dis. for Discharge .....	Med. Certificates .....
C. M. Charges .....	Med. Des. Lists .....
Descriptive Lists .....	Orders .....
Discharge Certificates .....	Pris. of War Record .....
Enlistment Papers .....	Resignations .....

Other papers relating to—

Admission to Hosp'l .....	Furlough or L. of A. ....
Casualty Sheet .....	Med. Examination .....
Confinement / .....	Misc. Information .....
Contracts .....	Pay or Clothing .....
Death or Effects .....	Personal Reports .....
Desertion .....	Rank .....
Discharge from Hosp'l .....	Transfer to Hosp'l .....
Discharge from Service .....	Transfer to V. R. C. ....
Duty .....	Transportation .....

DECLARATION OF RECRUIT.

I, *Lamden Wilson* desiring to VOLUNTEER as a Soldier in the ARMY OF THE UNITED STATES, for the term of *3 years* do declare that I am *28* years and \_\_\_\_\_ months of age; that I have never been discharged from the United States service on account of disability or by sentence of a court martial, or by order, before the expiration of a term of enlistment; and I know of no impediment to my serving honestly and faithfully as a soldier for *3 years*

Given at *Providence* *Lamden Wilson*  
The *5<sup>th</sup>* day of *November* 18 *63* *his* *mark*

Witness: *J.W. Hayes*

*11*  
*11*  
No. *1410*

Volunteered at *Providence*  
*Lamden Wilson*

*November 5<sup>th</sup>*  
1863,

By *J. B. Conroy Major*  
*14<sup>th</sup>* Regiment of *N. H. Art.*

enlistment; last served in Company ( )

Reg't of

Discharged

18

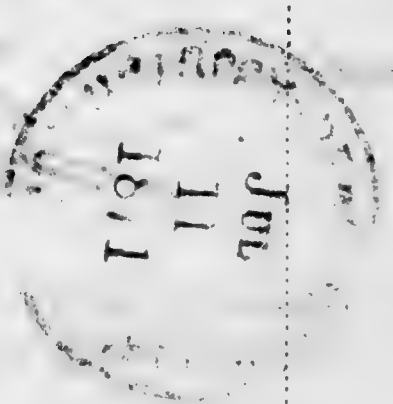

CONSENT IN CASE OF MINOR.

I, \_\_\_\_\_ of \_\_\_\_\_ is \_\_\_\_\_ years of age; and I do hereby freely give my CONSENT to his volunteering as a SOLDIER in the ARMY OF THE UNITED STATES for the period of \_\_\_\_\_

Given at \_\_\_\_\_  
The \_\_\_\_\_ day of \_\_\_\_\_

Witness



# VOLUNTEER ENLISTMENT.

State of  
*Rhode Island*



Town of  
*Providence*

I, *Lamden Wilson* born in *Indianapolis*  
in the State of *Indiana* aged *28* years, and by occupation  
a *Barber* DO HEREBY ACKNOWLEDGE to have volunteered this *3<sup>rd</sup>*  
day of *November* 18 *63* to serve as a SOLDIER in the ARMY OF THE UNITED STATES

OF AMERICA, for the period of *Three Years*, unless sooner discharged by proper authority :  
Do also agree to accept such bounty, pay, rations and clothing, as are, or may be, established, by law for  
volunteers. And I, *Lamden Wilson* do solemnly swear, that I will bear  
true faith and allegiance to the *United States of America*, and that I will serve them honestly and faith-  
fully against all their enemies or opposers whomsoever ; and that I will observe and obey the orders of the  
President of the United States, and the orders of the officers appointed over me, according to the Rules  
and Articles of War.

Sworn and Subscribed to, at *Providence*  
this *5<sup>th</sup>* day of *November* 18 *63* } *Lamden Wilson*  
BEFORE *J. A. Johnson* }  
*Agent of the Peace*

I CERTIFY, ON HONOR, That I have carefully examined the above-named Volunteer, agreeable to the General Regulations of  
the Army, and that, in my opinion, he is free from all bodily defects and mental infirmity, which would, in any way, disqualify him  
from performing the duties of a soldier.

*Johnson J. A.*  
EXAMINING SURGEON.

I CERTIFY, ON HONOR, That I have minutely inspected the Volunteer, *Lamden Wilson*  
previously to his enlistment, and that he was entirely sober when enlisted ; that to the best of my judgment and belief, he is of  
lawful age ; and that, in accepting him as duly qualified to perform the duties of an able-bodied soldier, I have strictly observed the  
Regulations which govern the recruiting service. This soldier has  
*dark* complexion, is *5* feet, *8* inches high, *dark* eyes *dark* hair

Regiment of \_\_\_\_\_ Volunteers,

RECRUITING OFFICER.



Office of Prov. Mur-  
Par. of Ascension  
Donald Somville La  
236 Aug 6, 1865  
76

Adeliman J. M.  
Capt R. M.

Makes statement  
in regard to  
drunkenness  
and abusive  
language of  
Pir Leonard  
Wilson, Co H,  
11<sup>th</sup> U.S.C.A. (1865)  
while on a pass  
in Donaldsonville

8B  
24  
Prov. U.S. Forces  
Donaldsonville La  
Aug 6, 1865

Respectfully referred  
to Maj. R. G. Shan  
H. U.S.C.A. (1865) County  
Aug 6, 1865

2<sup>nd</sup> Bat. who will  
act in this case.  
Hereafter passes  
will be recorded  
at the Hd. Qrs.  
of the 2<sup>nd</sup> Bat. and  
when men on  
passes do not  
return in time  
a guard will  
be sent to arrest  
them, and all  
such offenders  
parties will be  
promptly dealt  
with. Garrison  
with men  
mentioned should  
have returned  
at 3. P. on yes-  
terday  
By order of  
Colt W. Lyman  
Camp Post  
Adjutant  
Recd. B. H. [unclear] [unclear]

Office of Post Marshal  
Parish of Ascension  
Donaldsonville, La. Aug 6<sup>th</sup> 1865.

1<sup>st</sup> Lt. J. C. Whiting Jr.  
Post Adjutant.

A private of Co. H. 11<sup>th</sup> U.S. Cavalry  
(Laander Wilson) was arrested about 10<sup>1/2</sup> o'clock  
P.M. yesterday by my guard and this morning  
was sent to camp, under guard. I am informed  
that he was very much intoxicated and very  
abusive to Mr Emile Colin and other citizens.  
I mention this in order that means may be taken  
to prevent him and others like him from receiv-  
ing passes, and then abusing the privilege thus  
granted them.

Very Respectfully  
Your Obedt servant

M. Addeman  
Capt. 11<sup>th</sup> U.S. C. A. Regt  
& Acty Post Mar.



2000  
Wilson Samuel.

Co B, 11 U.S. Col'd H. Art'y.

Private

Private

CARD NUMBERS.

1	6183959	26
2	6184103	27
3	6184247	28
4	6184385	29
5	6184523	30
6	6184661	31
7	6185498	32
8	9124228	33
9	9124365	34
10		35
11		36
12		37
13		38
14		39
15		40
16		41
17		42
18		43
19		44
20		45
21		46
22		47
23		48
24		49
25		50

Book Mark: 93,347. + 94,347. H.B.M.

See also



W | 11 H. Art'y. | U.S.C.T.

Samuel H. Wilson

Co. B, 11 Reg't U. S. Col'd H. Art'y.

Appears on  
Company Descriptive Book

of the organization named above.

Age 33 years; height 5 feet 3 1/2 inches.

Complexion Dk

Eyes Brown; hair Blk

Where born N Haven Conn

Occupation Waiter

ENLISTMENT.

When Aug 22, 1864

Where Providence

By whom J C Engley; term 3 y'rs.

Remarks: Died at Fort Jackson La of Typhoid Malarial fever Aug 8/64. Final statements & inventory of effects forwarded Aug 9/64

Jams

*W* | 11 H. Art'y. | U.S.C.T.

*Samuel Wilson*

....., Co *B*, 11 Reg't U. S. Col'd H. Art'y.

Appears on

**Company Descriptive Book**

of the organization named above.

**DESCRIPTION.**

Age *33* years; height *5* feet *5 1/2* inches.

Complexion *Dark*

Eyes *Blk*; hair *Blk*

Where born *New Haven Conn*

Occupation *Waiter*

**ENLISTMENT.**

When *Aug 27*, 1863.

Where *Prov R* *(D)*

By whom *J.C. Easley*; term *3* y'rs.

Remarks: *Died at Fort Jackson  
& a of Typho malarial  
fever Aug 8. 64. In-  
ventory of effects &  
final statements  
rendered Aug 9. 64*

*James*

*W* | 11 H. Art'y. | U.S.C.T.

*Samuel Wilson*

*Art. Co. B*, 14 Reg't R. I. Col'd H. Art'y.\*

Age *33* years.

Appears on

**Company Muster-in Roll**

of the organization named above. Roll dated

*Providence R.I. Sept 14*, 1863.

Muster-in to date *Sept 14*, 1863.

Joined for duty and enrolled:

When *Aug 22*, 186 .

Where *Providence*

Period *3* years.

Valuation of horse, \$ *100*

Valuation of horse equipments, \$ *100*

Remarks: \_\_\_\_\_

\* This organization subsequently became Co. *B*, 11 Reg't U. S. Colored Heavy Artillery.

Book mark: \_\_\_\_\_

*J. Walker*



*W* | 11 H. Art'y. | U.S.C.T.

*Samuel Wilson*  
*Priv*, Co. B, 14 Reg't R. I. Col'd H. Art'y.\*

Appears on

**Company Muster Roll**

for *Sept 14 to Dec 31*, 1863

Present or absent *Present*

Stoppage, \$.....100 for .....

Due Gov't, \$.....100 for .....

Valuation of horse, \$.....100

Valuation of horse equipments, \$.....100

Remarks:.....

.....  
.....  
.....  
.....  
.....

\*This organization subsequently became Co. B, 11 Reg't U. S. Colored Heavy Artillery.

Book mark:.....

.....

(358) *J. Walker* Copyist.

*W* | 11 H. Art'y. | U.S.C.T.

*Samuel Wilson*  
*Pvt.*, Co. B, 14 Reg't R. I. Col'd H. Art'y.\*

Appears on

**Company Muster Roll**

for *Jan & Feb*, 1864.

Present or absent *Present*

Stoppage, \$ *100* for

Due Gov't, \$ *100* for

Valuation of horse, \$ *100*

Valuation of horse equipments, \$ *100*

Remarks:

\*This organization subsequently became Co. B, 11 Reg't U. S. Colored Heavy Artillery.

Book mark:

*J. Walker*

*W* | 11 H. Art'y. | U.S.C.T.

*Samuel Wilson*  
*Pvt*, Co *B*, 8 Reg't U. S. Col'd H. Art'y.\*

Appears on

**Company Muster Roll**

for *March & April*, 1864.

Present or absent *Present*

Stoppage, \$ 100 for

Due Gov't, \$ 100 for

Valuation of horse, \$ 100

Valuation of horse equipments, \$ 100

Remarks:  
-----  
-----  
-----  
-----  
-----  
-----  
-----  
-----

† This organization subsequently became Co *B*, 11 Reg't U. S. Colored Heavy Artillery.

Book mark: -----  
-----

*J. Walker*



*W* | 11 H. Art'y. | U.S.C.T.

*Samuel Wilson*  
Pvt., Co. *B*, 8 Reg't U. S. Col'd H. Art'y.\*

Appears on

**Company Muster Roll**

for *May & June*, 1864.

Present or absent *Present*

Stoppage, \$ 100 for

Due Gov't, \$ 100 for

Valuation of horse, \$ 100

Valuation of horse equipments, \$ 100

Remarks:

† This organization subsequently became Co. *B*, 11 Reg't U. S. Colored Heavy Artillery.

Book mark:

*J. Walker*

*H* | 11 H. Art'y. | U.S.C.T.

*Samuel Wilson*  
*Pri*, Co. B, 11 Reg't U. S. Col'd H. Art'y.

Appears on

**Company Muster Roll**

for *July & Aug*, 1864.

Present or absent

Stoppage, \$ 100 for

Due Gov't, \$ 100 for

Valuation of horse, \$ 100

Valuation of horse equipments, \$ 100

Remarks: *Stop for Ordnance 43 cb*  
*Died at Fort Jackson*  
*Aug 8/64*

Book mark: *90 347*

*J. H. Moore*

*71-* | 11 H. Art'y. | U.S.C.T.

*Samuel Wilson*

*Pl.*, Co. *B*, 11 Reg't U. S. Col'd H. Art'y.

Appears on **Co. Muster-out Roll**, dated  
*New Orleans La, Oct. 2*, 1865.

Muster-out to date \_\_\_\_\_, 186 .

Last paid to \_\_\_\_\_, 186 .

**Clothing account:**

Last settled \_\_\_\_\_, 186 ; drawn since \$ \_\_\_\_\_ 100

Due soldier \$ \_\_\_\_\_ 100; due U. S. \$ \_\_\_\_\_ 100

Am't for cloth'g in kind or money adv'd \$ \_\_\_\_\_ 100

Due U. S. for arms, equipments, &c., \$ \_\_\_\_\_ 100

Bounty paid \$ \_\_\_\_\_ 100; due \$ \_\_\_\_\_ 100

Remarks: *joined org'l org'l*

*Died at Fort Jackson  
La. Aug. 8/64 Final  
Statements and P. of Eff  
rendered*

Book mark: *94.347 H.B.V.*



Wilson, Saml H

P., Co., - 11 Reg't USC A.A.

4 ~~3~~ Enclosures.

Bed Cards .....	Final Statements <b>2</b> .....
Burial Records .....	Furloughs or L. of A .....
Certs. of Dis. for Discharge .....	Med. Certificates .....
C. M. Charges .....	Med. Des. Lists .....
Descriptive Lists .....	Orders .....
Discharge Certificates .....	Pris. of War Record .....
Enlistment Papers .....	Resignations .....

Other papers relating to—

Admission to Hosp'l .....	Furlough or L. of A .....
Casualty Sheet .....	Med. Examination .....
Confinement .....	Misc. Information .....
Contracts .....	Pay or Clothing .....
Death or Effects <b>/</b> .....	Personal Reports .....
Desertion .....	Rank .....
Discharge from Hosp'l .....	Transfer to Hosp'l .....
Discharge from Service .....	Transfer to V. R. C. .....
Duty .....	Transportation .....

DECLARATION OF RECRUIT.

I, *Samuel Wilson* desiring to VOLUNTEER as a Soldier in the ARMY OF THE UNITED STATES, for the term of *3 years*, do declare that I am *23* years and months of age; that I have never been discharged from the United States service on account of disability or by sentence of a court martial, or by order, before the expiration of a term of enlistment; and I know of no impediment to my serving honestly and faithfully as a soldier for *3 years*

*J. H. Wilson*

Given at *Providence*  
The *22* day of *Aug* 18 *60*.

Witness:  
*J. H. Wilson*

No. *147*

*Samuel Wilson*

Volunteered at *Providence*

*Aug 22nd 1860*

By *Wm. D. Sanford*

Regiment of

*11th Mass. Cav.*

enlistment; last served in Company ( )

Reg't of

Discharged 18



CONSENT IN CASE OF MINOR.

I, \_\_\_\_\_ of \_\_\_\_\_ is \_\_\_\_\_ years of age; and I do hereby freely give my consent to his volunteering as a SOLDIER in the ARMY OF THE UNITED STATES for the period of \_\_\_\_\_

Given at \_\_\_\_\_  
The \_\_\_\_\_ day of \_\_\_\_\_

Witness:



# VOLUNTEER ENLISTMENT.



State of *R.I.*

Town of *Providence*

I, *Samuel Wilson* born in *New Haven*  
in the State of *Conn* aged *23* years, and by occupation  
a *Carriage* DO HEREBY ACKNOWLEDGE to have volunteered this *22<sup>d</sup>*

day of *Aug* 18 *60*, to serve as a SOLDIER in the ARMY OF THE UNITED STATES  
of AMERICA, for the period of *3 year*, unless sooner discharged by proper authority:  
Do also agree to accept such bounty, pay, rations and clothing, as are, or may be, established by law for  
volunteers. And I, *Samuel Wilson* do solemnly swear, that I will bear  
true faith and allegiance to the *United States of America*, and that I will serve them honestly and faith-  
fully against all their enemies or opposers whomsoever; and that I will observe and obey the orders of  
the President of the United States, and the orders of the officers appointed over me, according to the  
Rules and Articles of War.

Sworn and subscribed to, at *Providence*  
this *22<sup>d</sup>* day of *Aug* 18 *60*.  
BEFORE *S. P. Lauford*

*Samuel Wilson*

I CERTIFY, ON HONOR, That I have carefully examined the above-named Volunteer, agreeably to the General Regulations  
of the Army, and that, in my opinion, he is free from all bodily defects and mental infirmity, which would, in any way, disqualify  
him from performing the duties of a soldier.

*Johnson Gardner*  
M.D.  
EXAMINING SURGEON.

I CERTIFY, ON HONOR, That I have minutely inspected the Volunteer, *Samuel Wilson*  
previously to his enlistment, and that he was entirely sober when enlisted; that, to the best of my judgment and belief, he is  
of lawful age; and that, in accepting him as duly qualified to perform the duties of an able-bodied soldier, I have strictly observed  
the Regulations which govern the recruiting service. This soldier has *dark* eyes, *dark* hair,  
*dark* complexion, is *5* feet, *5 2* inches high.

Regiment of \_\_\_\_\_ Volunteers,

*J. H. Angley* *Aug 12 1860*  
RECRUITING OFFICER.



28 —  
3<sup>rd</sup> 2<sup>nd</sup> 1864 —

FINAL STATEMENT

OF

Samuel Wilson

8<sup>th</sup> Reg't of U. S. H. Arty.

VOLUNTEERS.

NOTE 1.—Two of these certificates (or duplicates) are to be given to each volunteer soldier who may be discharged previously to the discharge of his company, that he may at once receive from the Paymaster the pay, &c., due him, and the captain or other officer commanding the company will certify to the act of the delivery of the duplicate certificates; on these certificates the Soldier is "entitled to" his discharge, and should also present his discharge to the Paymaster to have the payment endorsed on it. The discharge is to be given back to the Soldier by the Paymaster; the latter only retaining as his voucher the duplicate certificates.

NOTE 2.—If the Soldier is entitled to pay for the use of his horse, the Company Commander will certify to that fact, and also to the time he has pay due for having been so mounted on his own horse.

NOTE 3.—Amounts due the Sutler and Laundress must be entered on the Muster Roll on which the death, desertion, &c., is reported, as well as on the final statement, otherwise the amount cannot be collected from the United States.

NOTE 4.—This blank will be used for deceased volunteers as well as others.



1864

I certify, on honor, that Samuel Wilson a Private of  
Captain H. Simon Company (B) of the 8<sup>th</sup> Regiment of U. S. A. Artg-  
**VOLUNTEERS**, of the State of Rhode Island, born in New Haven, State  
of Connecticut, aged 33 years; 5 feet 5 $\frac{1}{2}$  inches high; dark complexion,  
Brown eyes, black hair, and by occupation a Writer, having joined the company on  
its original organization at Providence R. I., and enrolled in it at the muster into  
the service of the United States at Providence R. I., on the 14<sup>th</sup> day  
of September, 1863, (or was mustered in service as a recruit, by \_\_\_\_\_  
\_\_\_\_\_, at \_\_\_\_\_, on the \_\_\_\_\_ day of \_\_\_\_\_,  
186 , to serve in the Regiment,) for the term of Three Years;  
and having served **HONESTLY** and **FAITHFULLY** with his Company in said Regiment  
to the present date, is now entitled to a **DISCHARGE** by reason of Death

The said Samuel Wilson was ~~last~~<sup>not</sup> paid by Paymaster  
since Enlistment to include the 7<sup>th</sup> day of August, 1864, and has  
pay due him from that time to the present date; he is entitled to pay and subsistence for  
**TRAVELING** to place of enrollment and whatever other allowances are authorized to volunteer  
soldiers, or militia, so discharged. He has received Forty seven  $\frac{77}{100}$  dollars,  
advanced by the United States on account of **CLOTHING**.

There is to be stopped from him, on account of the State of \_\_\_\_\_, or other  
authorities for **CLOTHING**, &c., received on entering service, \_\_\_\_\_  $\frac{100}{100}$  dollars; also,  
for expenses of **SUBSISTENCE** for **TRAVELING** from place of enrollment to the place of rendezvous,  
amounting to \_\_\_\_\_  $\frac{100}{100}$  dollars: and on account of the United States for **EXTRA**  
**CLOTHING** received in kind from Capt Henry Simon and for other  
stoppages, viz: Screw driver, 25 Wiper, 20  
\_\_\_\_\_ amounting to Six  $\frac{20}{100}$  dollars;  
and he has been **SUBSISTED** for **TRAVELING** to his place of enrollment, up to the \_\_\_\_\_  
\_\_\_\_\_, 186 .

He is indebted to \_\_\_\_\_, **SUTLER**, \_\_\_\_\_  $\frac{100}{100}$  dollars.

He is indebted to Mrs. Turner & Co, **LAUNDRESS**, one  $\frac{100}{100}$  dollars.

Given in Duplicate, at Fort Jackson, this 8<sup>th</sup> day of August, 1864.

La-  
Henry Simon  
Captain  
Commanding Company.





FINAL STATEMENT

OF

*James Wilson*

*8th* Reg't of *U. S. H. Arty.*  
*11 U.S.*

VOLUNTEERS.

*Dischd Aug 8<sup>th</sup> 1864*

NOTE 1.—Two of these certificates (or duplicates) are to be given to each volunteer soldier who may be discharged previously to the discharge of his company, that he may at once receive from the Paymaster the pay, &c., due him, and the captain or other officer commanding the company will certify to the act of the delivery of the duplicate certificates; on these certificates the Soldier is "entitled to" his discharge, and should also present his discharge to the Paymaster to have the payment endorsed on it. The discharge is to be given back to the Soldier by the Paymaster; the latter only retaining as his voucher the duplicate certificates.

NOTE 2.—If the Soldier is entitled to pay for the use of his horse, the Company Commander will certify to that fact, and also to the time he has pay due for having been so mounted on his own horse.

NOTE 3.—Amounts due the Sutler and Laundress must be entered on the Muster Roll on which the death, desertion, &c., is reported, as well as on the final statement, otherwise the amount cannot be collected from the United States.

NOTE 4.—This blank will be used for deceased volunteers as well as others.

ADJUTANT GENERAL'S OFFICE.  
*Aug 24<sup>th</sup> 1864*  
Duplicate with Inventory sent 2d Auditor.



*James B.*



I certify, on honor, that Samuel Wilson a private of  
 Captain H. Simons Company (B) of the 8<sup>th</sup> Regiment of U. S. Militia  
**VOLUNTEERS**, of the State of Rhode Island, born in New Haven, State  
 of Connecticut, aged 33 years; 5 feet 5 1/2 inches high; dark complexion,  
brown eyes, black hair, and by occupation a Writer, having joined the company on  
 its original organization at Providence R. I., and enrolled in it at the muster into  
 the service of the United States at Providence R. I., on the 25<sup>th</sup> day  
 of September 1863, (or was mustered in service as a recruit, by \_\_\_\_\_  
 \_\_\_\_\_, at \_\_\_\_\_, on the \_\_\_\_\_ day of \_\_\_\_\_,  
 186 , to serve in the Regiment,) for the term of Three Years;  
 and having served **HONESTLY** and **FAITHFULLY** with his Company in said Regiment  
 to the present date, is now entitled to a **DISCHARGE** by reason of Death  
(Died Aug. 8<sup>th</sup> 1864 see index 102)

The said Samuel Wilson was ~~last~~ <sup>not</sup> paid by Paymaster  
since enlistment to include the 7<sup>th</sup> day of August, 1864, and has  
 pay due him from that time to the present date; he is entitled to pay and subsistence for  
**TRAVELING** to place of enrollment and whatever other allowances are authorized to volunteer  
 soldiers, or militia, so discharged. He has received Forty seven  $\frac{77}{100}$  dollars,  
 advanced by the United States on account of **CLOTHING**.

There is to be stopped from him, on account of the State of \_\_\_\_\_, or other  
 authorities for **CLOTHING**, &c., received on entering service, \_\_\_\_\_  $\frac{100}{100}$  dollars; also,  
 for expenses of **SUBSISTENCE** for **TRAVELING** from place of enrollment to the place of rendezvous,  
 amounting to \_\_\_\_\_  $\frac{100}{100}$  dollars: and on account of the United States for **EXTRA**  
**CLOTHING** received in kind from Capt. Henry Simons and for other  
 stoppages, viz: Green driver .25  
Wiper 20 amounting to six  $\frac{20}{100}$  dollars;  
 and he has been **SUBSISTED** for **TRAVELING** to his place of enrollment, up to the \_\_\_\_\_  
 \_\_\_\_\_, 186 .

He is indebted to \_\_\_\_\_, **SUTLER**, \_\_\_\_\_  $\frac{100}{100}$  dollars.  
 He is indebted to Mrs. Sarah S. Gay, **LAUNDRESS**, one  $\frac{7}{100}$  dollars.

Given in Duplicate, at Fort Jackson, this 8<sup>th</sup> day of August, 1864.

Henry Simons  
Captain  
 Commanding Company.



## ARTICLES OF WAR.

ART. 95. When any non-commissioned officer or soldier shall die, or be killed in the service of the United States, the then commanding officer of the troop or company shall, in the presence of two other commissioned officers, take an account of what effects he died possessed of, above his arms and accoutrements, and transmit the same to the office of the Department of War, which said effects are to be accounted for, and paid to the representatives of such deceased non-commissioned officer or soldier. And in case any of the officers, so authorized to take care of the effects of deceased officers and soldiers, should, before they have accounted to their representatives for the same, have occasion to leave the regiment or post, by preferment or otherwise, they shall, before they be permitted to quit the same, deposit in the hands of the commanding officer, or of the assistant military agent, all the effects of such deceased non-commissioned officers and soldiers, in order that the same may be secured for, and paid to, their respective representatives.

## ARMY REGULATIONS—EDITION OF 1861.

## DECEASED SOLDIERS.

Par. 152. Inventories of the effects of deceased non-commissioned officers and soldiers, required by the 95th Article of War, will be forwarded to the Adjutant General, by the commander of the company to which the deceased belonged, and a duplicate of the same to the colonel of the regiment. Final statements of pay, clothing, &c., will be sent with the inventories. When a soldier dies at a post or station absent from his company, it will be the duty of his immediate commander to furnish the required inventory, and, at the same time, to forward to the commanding officer of the company to which the soldier belonged, a report of his death, specifying the date, place, and cause; to what time he was last paid, and the money or other effects in his possession at the time of his decease; which report will be noted on the next muster roll of the company to which the man belonged. Each inventory will be endorsed, "Inventory of the effects of \_\_\_\_\_, late of company (—) \_\_\_\_\_ regiment of \_\_\_\_\_, who died at \_\_\_\_\_, the \_\_\_\_\_ day of \_\_\_\_\_, 186—." If a legal representative receive the effects, it will be stated in the report. If the soldier leave no effects, the fact will be reported.

Par. 153. Should the effects of a deceased non-commissioned officer or soldier not be administered upon within a short period after his decease, they shall be disposed of by a Council of Administration, under the authority of the commanding officer of the post, and the proceeds deposited with the Paymaster, to the credit of the United States, until they shall be claimed by the legal representatives of the deceased.

Par. 154. In all such cases of sales by the Council of Administration, a statement in detail, or account of the proceeds, duly certified by the Council and commanding officer, accompanied by the Paymaster's receipt for the proceeds, will be forwarded by the commanding officer to the Adjutant General. The statement will be endorsed, "Report of the proceeds of the effects of \_\_\_\_\_, late of company (—) \_\_\_\_\_ regiment of \_\_\_\_\_, who died at \_\_\_\_\_, the \_\_\_\_\_ day of \_\_\_\_\_, 186—."

NOTE 1.—The effects in all cases, when called for, should be turned over to the legal representative, without further authority from the Adjutant General. When the effects are turned over to the relatives of the deceased before these inventories are sent to the Adjutant General, their receipts therefor should be attached to the inventories. In all other cases, one copy will be sent with a letter of transmittal direct to the Adjutant General, and a duplicate retained by the officer.

NOTE 2.—Particular care should be taken to take receipts in duplicate from the Paymaster for any funds turned over to him; one copy should be sent direct to the Adjutant General and one retained by the officer.

## INVENTORY OF THE EFFECTS

OF

Samuel Wilson

Late of Company B-

8<sup>th</sup> Reg't of U. S. H. Art'y (Co. A)

Volunteers, who died at Fort Jackson La.

on the 8<sup>th</sup> day of August 1864.

Inventory of the effects of Samuel Wilson late  
 a Private of Captain Henry Simon Company B of  
 the 8<sup>th</sup> Regiment of U. S. A. Art. Volunteers, who was enrolled as  
 a private at Providence in the State of Rhode Island on  
 the 22<sup>nd</sup> day of August 1863, and mustered into the service of the United  
 States as a private on the 14 day of September 1863, at Providence  
 in Company B, 14<sup>th</sup> Regiment of R. I. A. Art. Volunteers, to serve 3  
 years or during the war; he was born in New Haven in the State  
 of Connecticut; he was 33 years of age, 5 feet 5 1/2 inches  
 high, dark complexion, brown eyes, black hair, and by occupation, when enrolled,  
 a Writer; he died in Hospital, at  
Fort Jackson, La. on the 8<sup>th</sup> day of August 1864, by  
 reason of Typhoid Malarial Fever.

INVENTORY.					
ARTICLES.	No.	ARTICLES.	No.	ARTICLES.	No.
Hats.....		Pairs trousers.....	1	Knapsacks.....	
Caps.....		Pairs flannel drawers.....			
Forage caps.....	1	Pairs cotton drawers.....	3		
Great coats.....	1	Flannel shirts.....	1		
Uniform coats.....	1	Cotton shirts.....			
Uniform jackets.....		Pairs boots.....			
Flannel sack coats.....		Pairs shoes.....			
Blouses.....	1	Pairs socks.....			
Stable frocks.....		Blankets.....			
Fatigue overalls.....		Haversacks.....			
				MONEY.	
				Specie.....	\$
				Notes.....	\$

I CERTIFY, ON HONOR, that the above inventory comprises all the effects of private  
Samuel Wilson, deceased, and that the effects are in the hands  
 of L. M. Sgt. Wm. H. Jones at Fort Jackson La.  
 to be disposed of by a Council of Administration.

(DUPLICATES.)

STATION: Fort Jackson La.

DATE: August 8<sup>th</sup> 1864.

[A. G. O. No. 104.]

Henry Simon  
Captain  
 Commanding the Company.



# MICROCOPY

1 8 1 8

ROLL

2 1 5

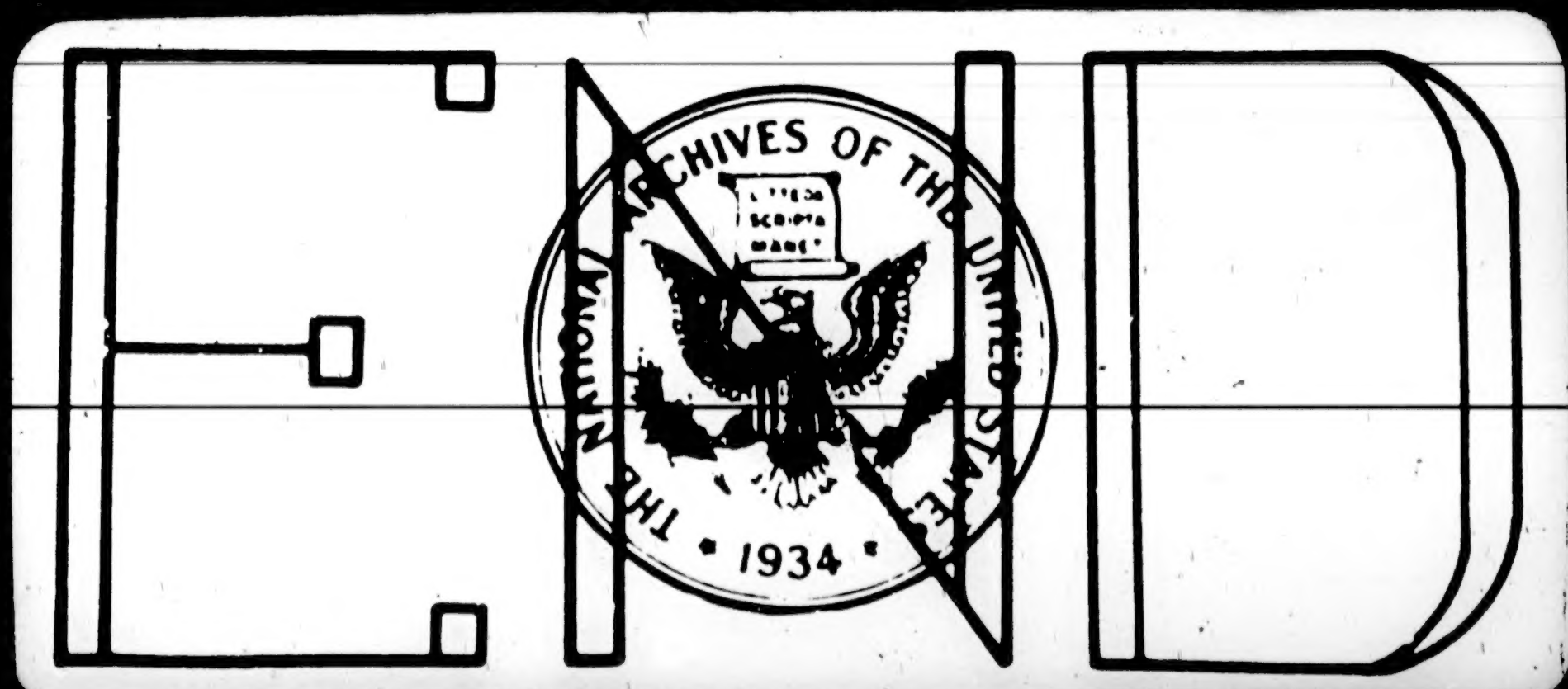

# IMAGE EVALUATION TEST TARGET (QA-3)

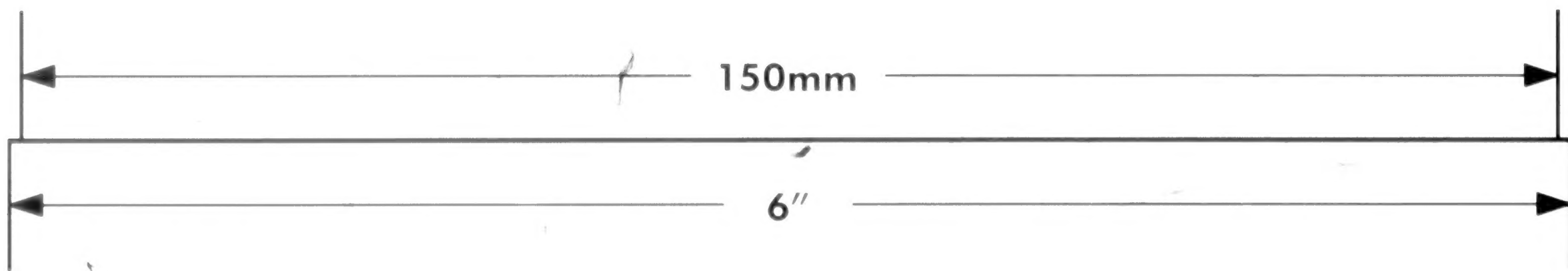
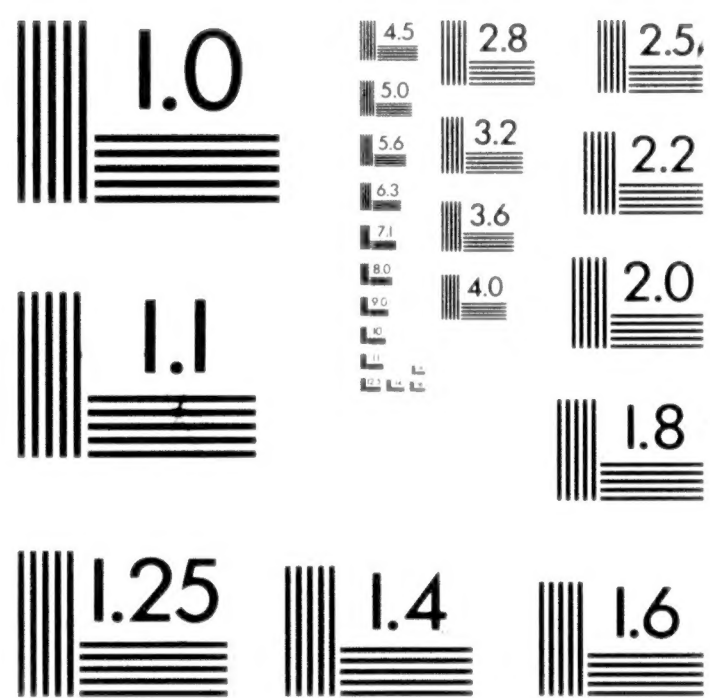
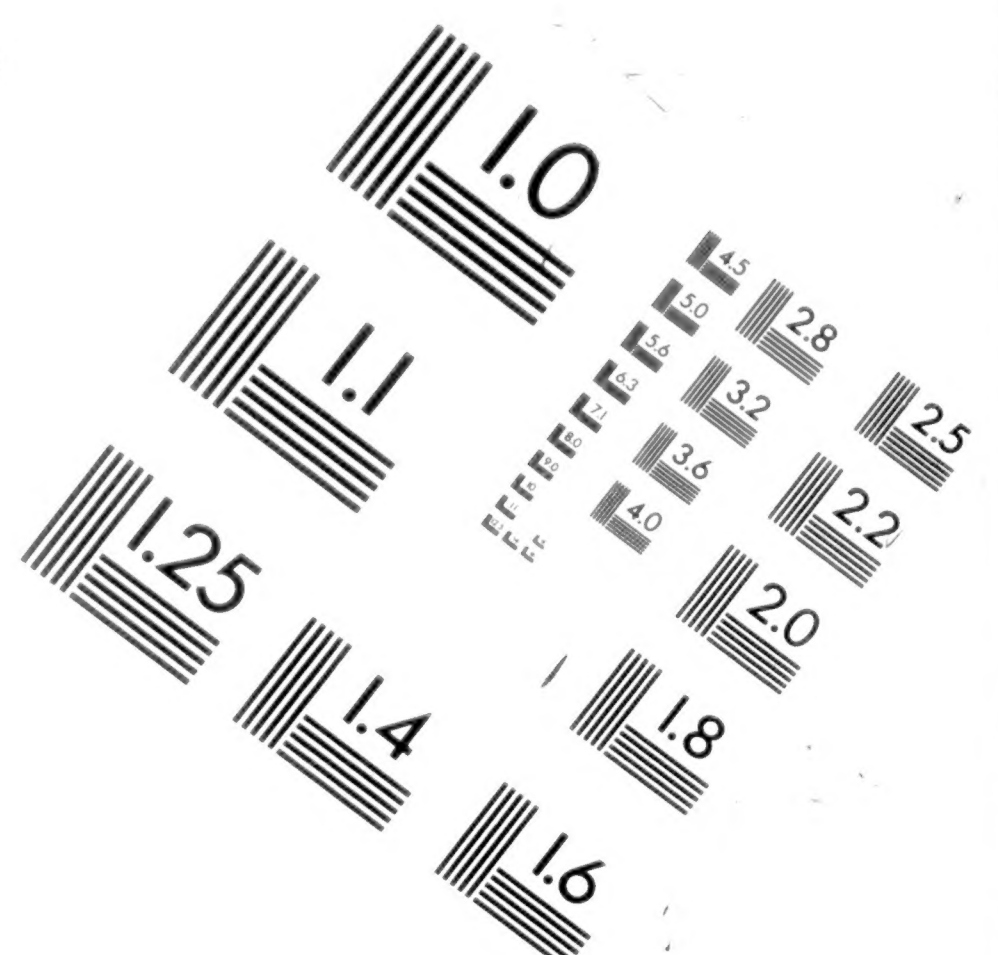
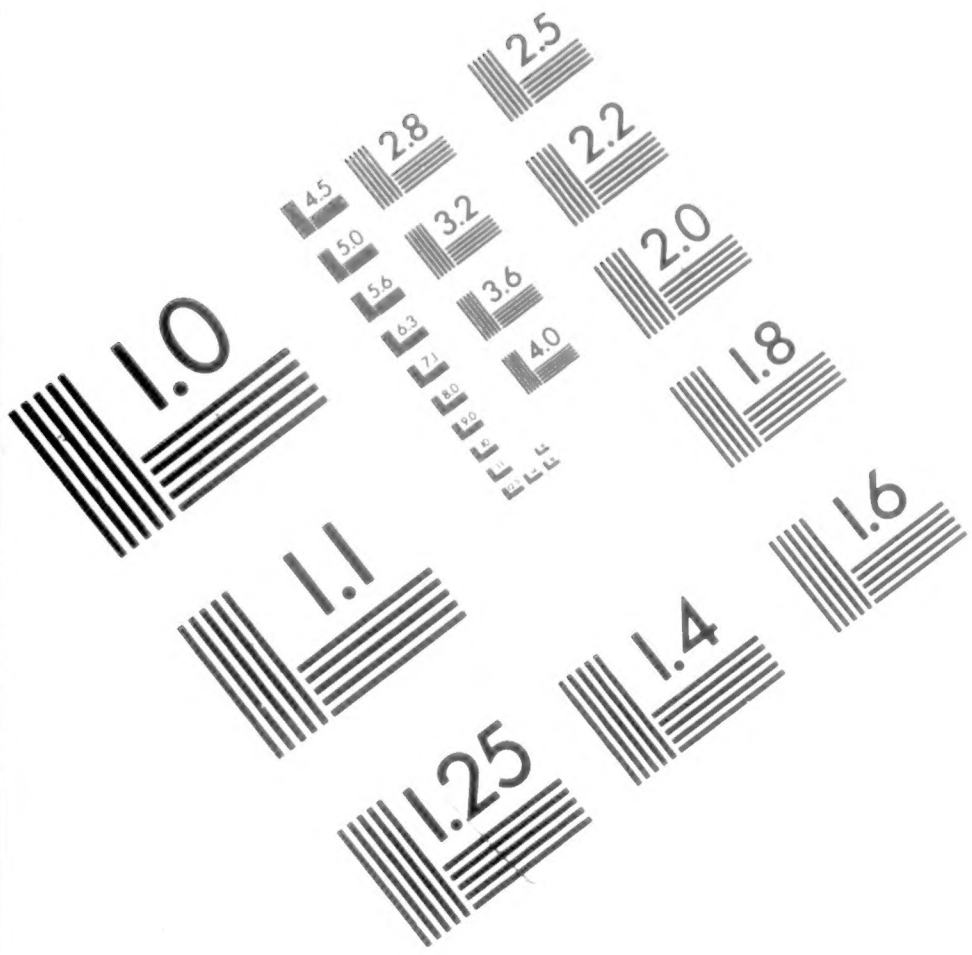

**APPLIED IMAGE, Inc**  
 1653 East Main Street  
 Rochester, NY 14609 USA  
 Phone: 716/482-0300  
 Fax: 716/288-5989

© 1993, Applied Image, Inc., All Rights Reserved

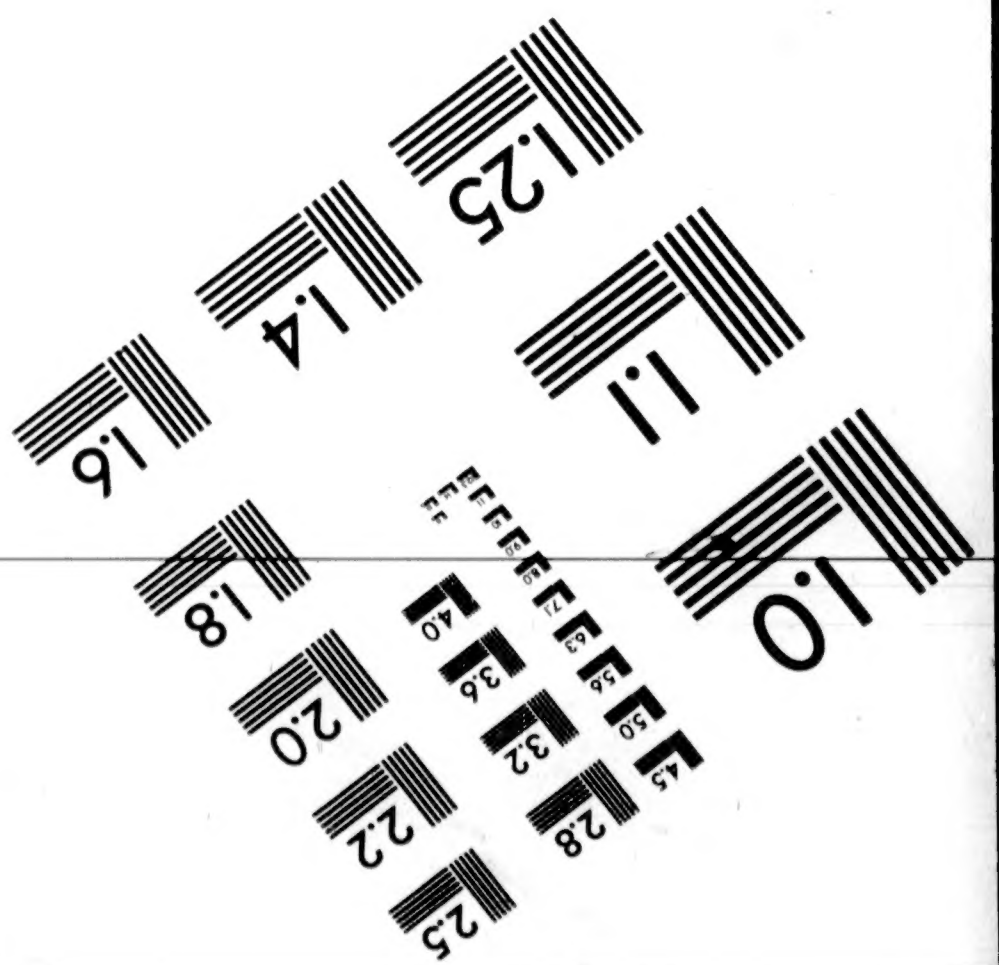
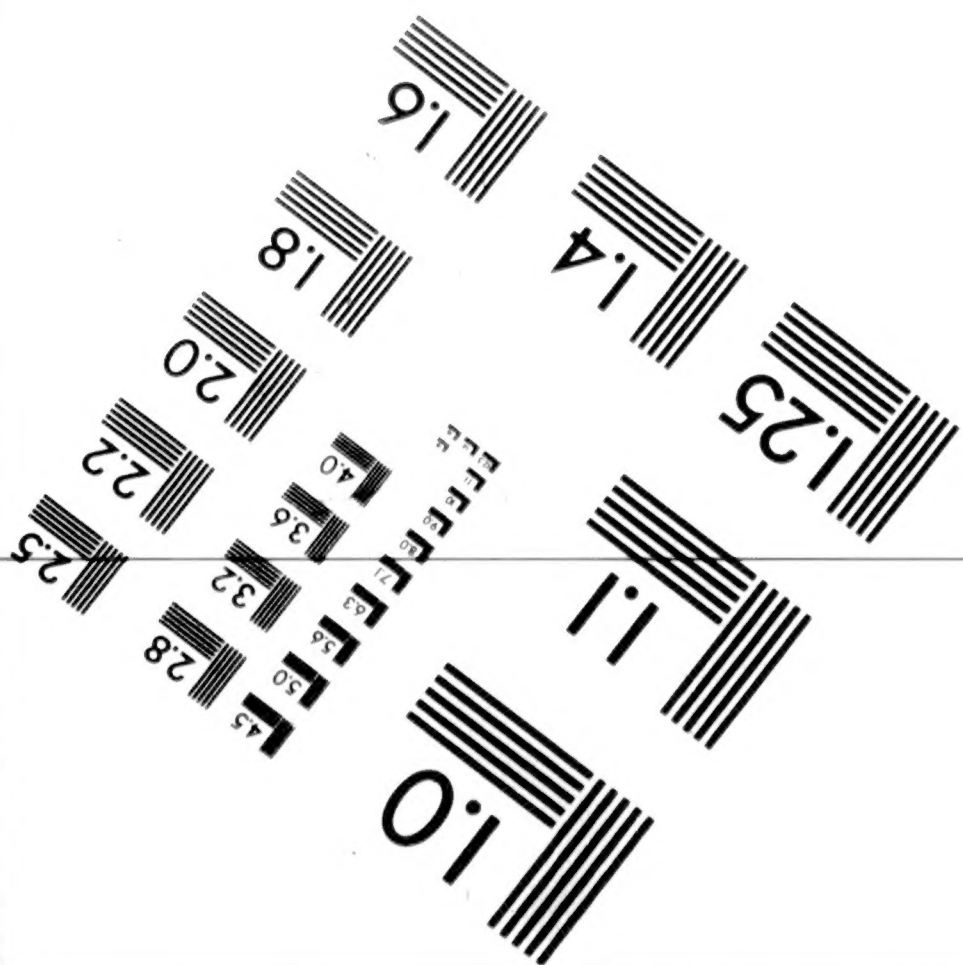

**THE END**

**PLEASE**

**REWIND**



