

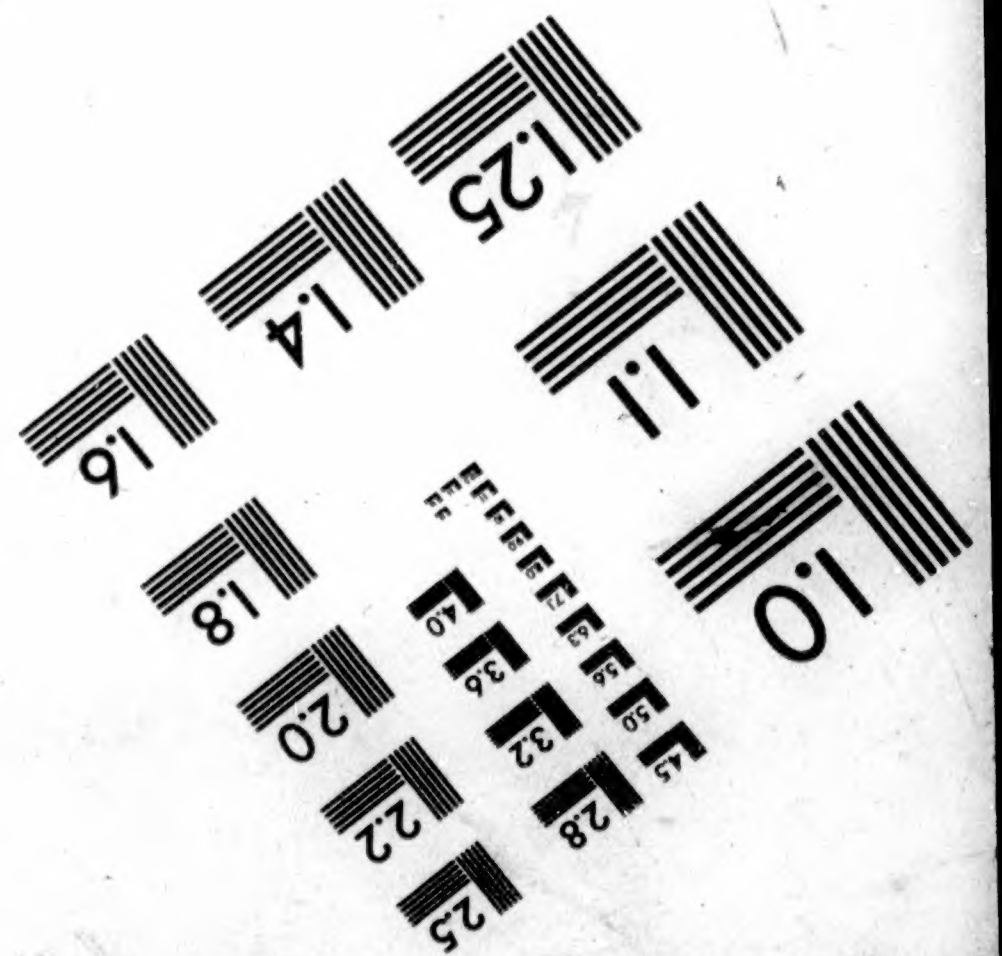

NATIONAL  
ARCHIVES  
MICROFILM  
PUBLICATIONS

# IMAGE EVALUATION TEST TARGET (QA-3)

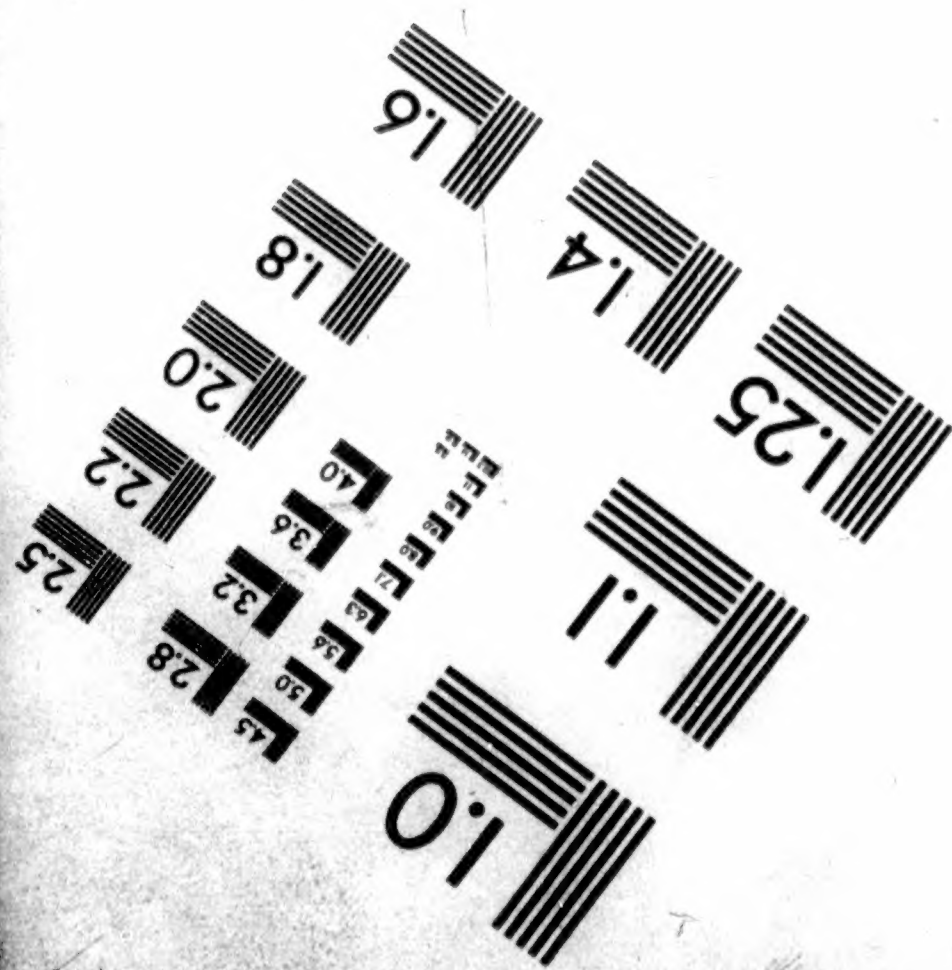
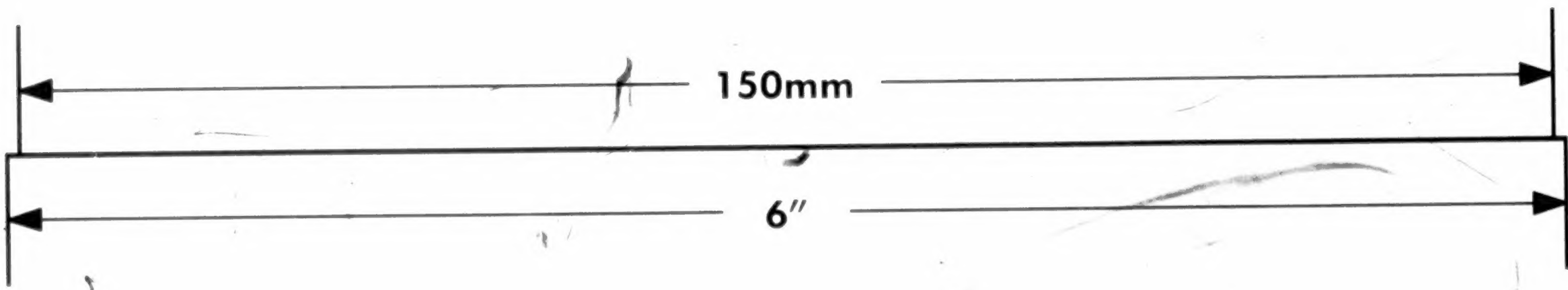
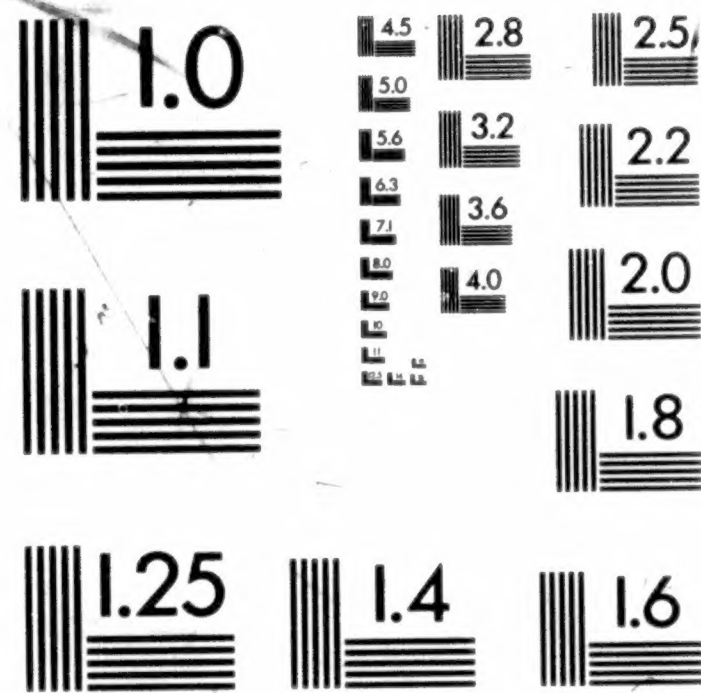
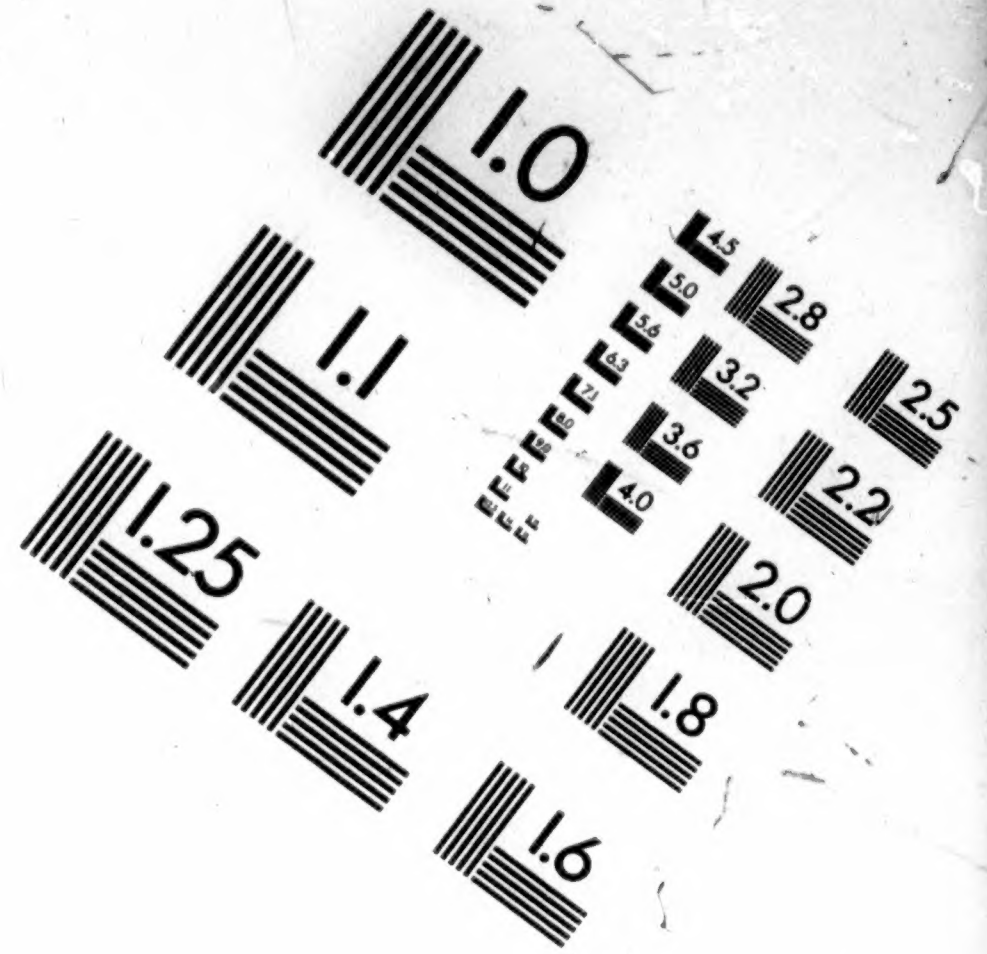
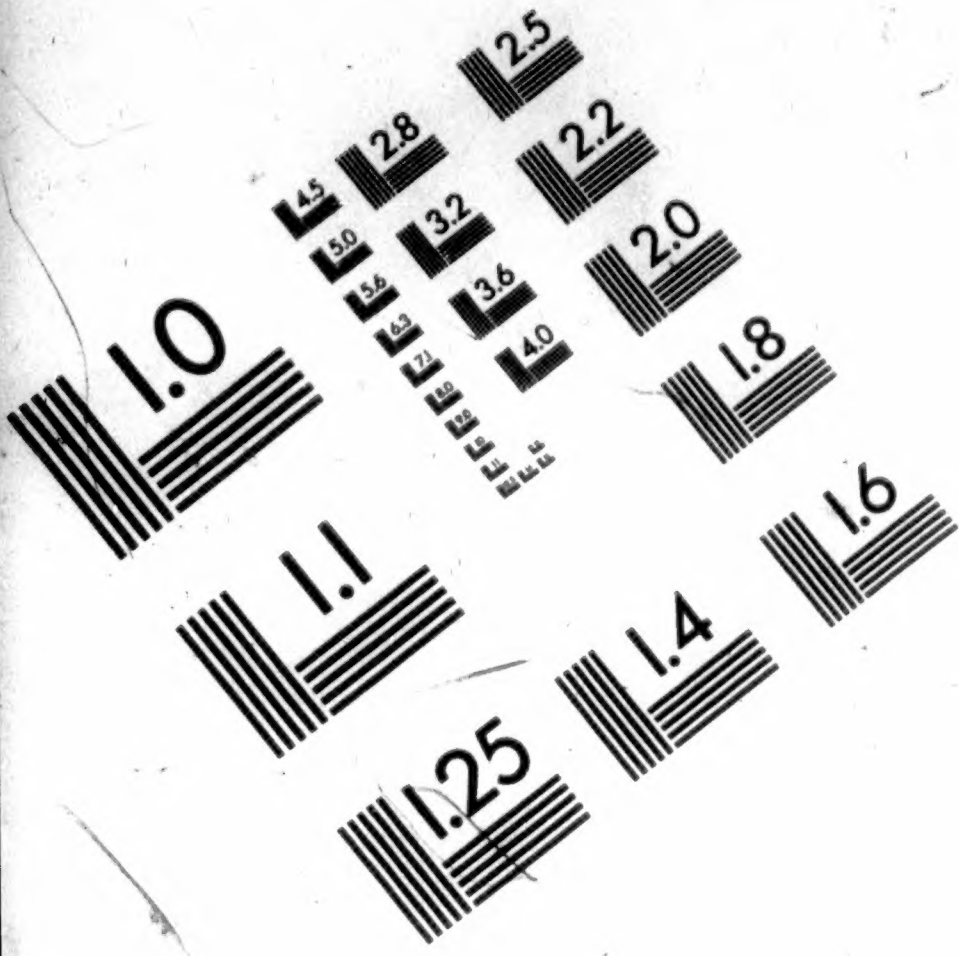

APPLIED IMAGE, Inc  
1653 East Main Street  
Rochester, NY 14609 USA  
Phone: 716/482-0300  
Fax: 716/288-5989

© 1993, Applied Image, Inc., All Rights Reserved

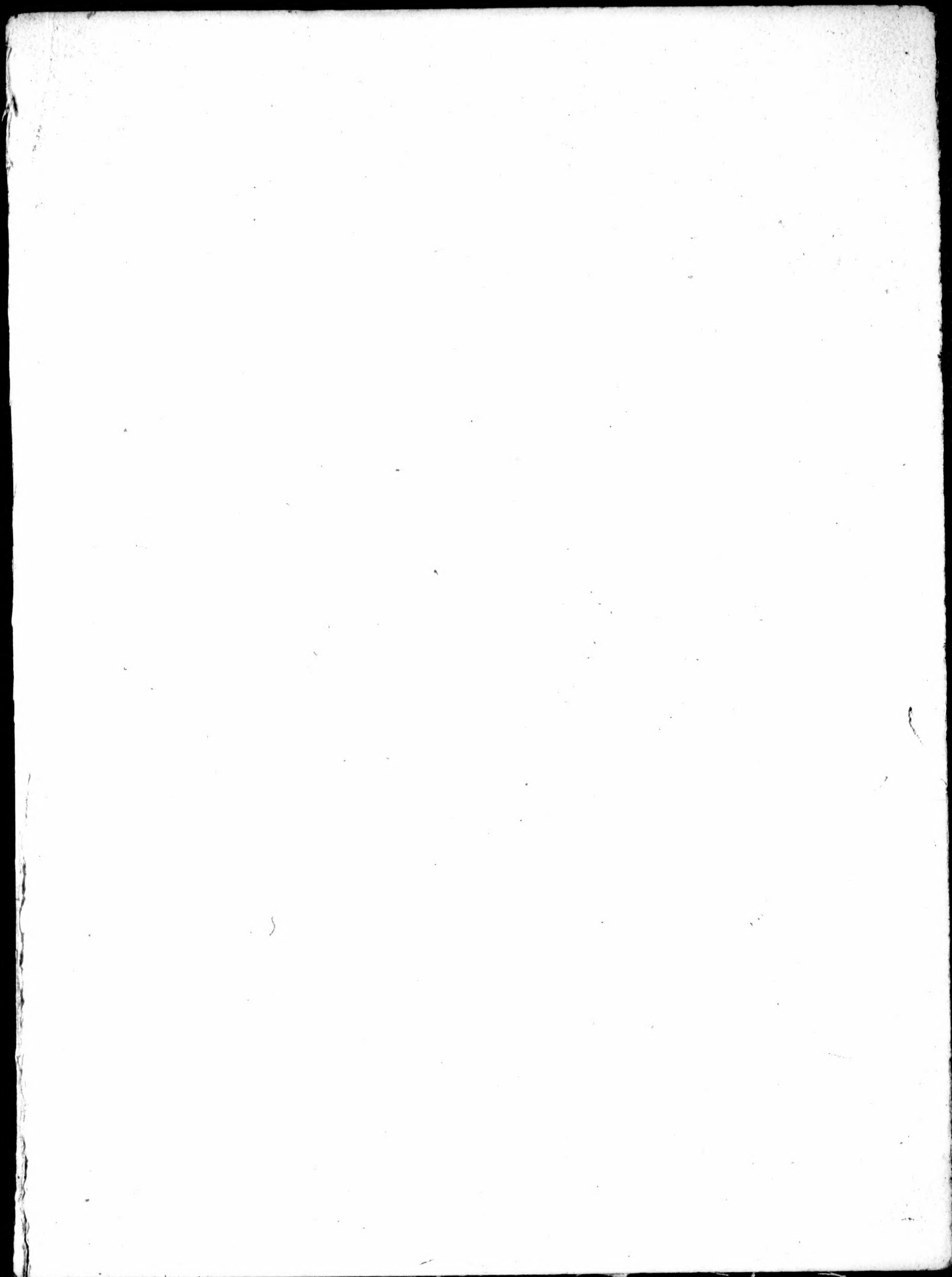

National Archives at College Park



8601 Adelphi Road College Park MD 20740-6001

Rebecca Sullivan Z2

OPERATOR

CAMERA

December 3, 1998 10

DATE FILMED

REDUCTION RATIO

~~24161~~-0576-014-02

FILM EMULSION NUMBER

M-1818

297

PROJECT NUMBER

ROLL NUMBER

**MICROCOPY**

**1 8 1 8**

**ROLL**

**2 9 7**

M1818

COMPILED MILITARY SERVICE RECORDS OF  
VOLUNTEER UNION SOLDIERS WHO SERVED WITH THE  
UNITED STATES COLORED TROOPS:  
Artillery Organizations

Introduction by Budge Weidman, Project Manager

Records prepared for microfilming by members of  
the Civil War Conservation Corps

Pat Alfredson	Sue Goward*	Mary Poggioli
Phyllis Altrogge	Bert Greenstein	Peggy Pratt
Kenneth Ashton	Anne Greenwood	Ray Puzio
Sue Barnard*	Jim Harris	Sylvia Scott
Dee Benson	Walter Hayden	Lynn Shearouse
Ann N. Brown	Mary Hayden	Mary Stack-Dunne
Robert Budway	Pat Ikonen	Ben Stearns
Randy Caldwell	Dick Ives	Bill Stormer*
MaryAnn Castellana*	Sarah Jaffe	Pat Sullivan
Mary Lou Cole	Barbara Kemp	Gorman Tidball*
Giovanni Croce	Bev Manypenny	Cathy Tinston
B.H. Custer	Frank Masterson	John Toole
Bob Denney	Joe Mazur	Maryellen Toole
Richard Dow	Kathleen McCarthy	Milt Weatherhead
Earl Dunn	Sarah McDougall	Russ Weidman
Yvette Fallin	Catherine McManus	C. Lois Young
Maria Flesher	Ben Miles	Robert Young
Naomi Glass	Dave Murray	

Team leaders are indicated by the asterisk.

National Archives and Records Administration  
Washington, DC  
1998

## INTRODUCTION

On the 299 rolls of this microfilm publication, M1818, are reproduced the compiled military service records of volunteer Union soldiers belonging to the artillery units organized for service with the United States Colored Troops (USCT). The USCT included 7 numbered cavalry regiments; 13 numbered artillery regiments plus one independent battery; 144 numbered infantry regiments; plus Brigade Bands Nos. 1 & 2 (Corps d'Afrique and US Colored Troops); Powell's Regiment Colored Infantry; Southard's Company Colored Infantry; Quartermaster Detachment; Pioneer Corps, 1st Division, 16th Army Corps; Unassigned Company A Colored Infantry; and Unassigned USCT. There are also miscellaneous service cards arranged alphabetically by surname at the end of the unit records. The records reproduced are part of the Records of the Adjutant General's Office, 1780's-1917, Record Group (RG) 94.

## Background

## United States Colored Troops

Since the time of the American Revolution, African Americans have volunteered to serve their country in time of war. The Civil War was no exception. Official sanction was the difficulty. In the fall of 1862 there were four Union regiments of African Americans raised in New Orleans, LA: the 1st, 2d, and 3d Louisiana Native Guard, and the 1st Louisiana Heavy Artillery (African Descent). The 1st South Carolina Infantry (African Descent) was not officially organized until January 1863; however, three companies of the regiment were on coastal expeditions as early as November 1862. Similarly, the 1st Kansas Colored Infantry was not mustered into Federal service until January 1863, even though the regiment had already participated in the action at Island Mound, MO, on October 27, 1862. These early unofficial regiments received little Federal support, but they showed the strength of the African American soldier's desire to fight for freedom.

The first official authorization to employ African Americans in Federal service was the Second Confiscation and Militia Act of July 17, 1862. This act allowed President Abraham Lincoln to receive into the military or naval service persons of African descent and gave him permission to use them for any purpose "he may judge best for the public welfare." However, the President did not authorize use of African Americans in combat until issuance of the Emancipation Proclamation on January 1, 1863.

In late January 1863, Governor John Andrew of Massachusetts received permission to raise a regiment of African American soldiers. The pace of organizing additional regiments was very slow. In March Secretary of War Edwin M. Stanton sent Gen. Lorenzo Thomas to the lower Mississippi Valley to recruit free and contraband African Americans. Thomas was given broad authority. He was to explain the administration's policy regarding African American soldiers and recruit



volunteers to raise and command them. Stanton wanted all officers of such units to be white, but that policy was softened to allow African American surgeons and chaplains. By the end of the war, in addition to the chaplains and surgeons, there were some 87 African American officers. Thomas's endeavor was very successful, and on May 22, 1863, the Bureau of Colored Troops was established to coordinate and organize regiments from all parts of the country. Created under War Department General Order No. 143, the bureau was responsible for handling "all matters relating to the organization of Colored Troops." The bureau was directly under the Adjutant General's Office and its procedures and rules were specific and strict. All African American regiments were now to be designated United States Colored Troops (USCT). At this time there were some African American regiments with state names and a few regiments in the Department of the Gulf designated as Corps d'Afrique. All these were ultimately assimilated into the USCT, even though some of the regiments, such as the 5th Massachusetts, retained their state designations.

To facilitate recruiting in the states of Maryland, Missouri, Tennessee, and eventually Kentucky, the War Department issued General Order No. 329 on October 3, 1863. Section 6 of the order stated that if any citizen should offer his or her slave for enlistment into the military service, that person would, "if such slave be accepted, receive from the recruiting officer a certificate thereof, and become entitled to compensation for the service or labor of said slave, not exceeding the sum of three hundred dollars, upon filing a valid deed of manumission and of release, and making satisfactory proof of title." For this reason, some records of manumission are contained in the compiled service records reproduced in this publication.

The USCT fought in 39 major engagements and over 400 lesser ones. Sixteen African American soldiers received Medals of Honor. As it was in other units, the death toll from disease was very high in the USCT. Deaths from disease and battle totaled 37,000. The last regiment of the USCT was mustered out of Federal service in December 1867.

Important sources for information about African American units in the Civil War are the War Department's *The War of the Rebellion: A Compilation of the Official Records of the Union and Confederate Armies* (Washington, DC: 1880-1901; reprinted Harrisburg, 1971 and 1985) and the Navy Department's *The War of the Rebellion; A Compilation of the Official Records of the Union and Confederate Navies* (Washington, DC: 1874-1922; reprinted Harrisburg, 1971 and 1985). These multivolume works contain reports of operations and other official correspondence.

#### U. S. Colored Heavy Artillery

**1st Heavy Artillery:** This regiment was organized at Knoxville, TN, between February and November 1864. It served in Knoxville, eastern Tennessee, western Virginia, northern Alabama, and western North Carolina. It was mustered out on March 31, 1866.

**2d Heavy Artillery:** This regiment was changed from the 2d Heavy Artillery to the 3d Heavy Artillery on April 26, 1864, and the compiled military service records appear there.

**3d Heavy Artillery:** Organized as the 1st Tennessee Heavy Artillery (African descent) at Memphis and Fort Pickering, TN, from June 5 to December 22, 1863, this regiment's designation was changed to the 3d United States Colored Heavy Artillery in April 1864. It served garrison duty at Fort Pickering and in defense of Memphis, TN. The unit mustered out on April 30, 1866.

**4th Heavy Artillery:** This unit was organized as the 2d Regiment Tennessee Heavy Artillery (African descent) from June 1863 until April 1864. It became the 4th United States Colored Heavy Artillery in April 1864. It served at Fort Halleck; Columbus, KY; and Union City, TN. The regiment had duty near Fort Donelson, TN, and moved to Pine Bluff, AR, where it was mustered out on February 25, 1866.

**5th Heavy Artillery:** This regiment was organized at Vicksburg, MS, between August 1863 and January 1864, as the 9th Louisiana Volunteers (African descent). Its designation was changed to the 5th Heavy Artillery in April 1864. The unit served garrison duty at Vicksburg, MS, and was mustered out on May 20, 1866.

**6th Heavy Artillery:** This regiment was organized as the 2d Mississippi Heavy Artillery (African descent) at Natchez, MS, from September 1863 to January 1864. It was changed to the 6th United States Colored Heavy Artillery on April 26, 1864. The unit served at Natchez, Mississippi, and Vidalia, LA. It was mustered out on May 18, 1866.

**7th Heavy Artillery:** The 7th Heavy Artillery was designated the 11th United States Colored Infantry (New) on January 23, 1865, and the compiled military service records appear there.

**8th Heavy Artillery:** This regiment was organized at Paducah, KY, from April to October 1864. It served garrison duty at Paducah and was mustered out on February 10, 1866.

**9th Heavy Artillery:** This regiment consisted of four companies and was organized at Clarksville and Nashville, TN, during October 1864. It was mustered out on May 5, 1865.

**10th Heavy Artillery:** Organization of this regiment at New Orleans, LA, began in November 1862. First designated the 1st Louisiana Heavy Artillery (African descent) in November 1863, it became the 1st Regiment Corps d'Afrique. In May 1864 the unit became the 10th United States Colored Heavy Artillery. The regiment was on garrison duty at New Orleans during its entire service. It served longer than any other USCT regiment, mustering out on February 22, 1867.

**11th Heavy Artillery:** This regiment was organized at Providence, RI, from August 1863 through January 1864, as the 14th Rhode Island Colored Heavy Artillery. In May 1864 it became the 11th United States Colored Heavy Artillery. The unit served garrison duty at New Orleans, LA, and was mustered out on October 2, 1865.

**12th Heavy Artillery:** This regiment was organized at Camp Nelson, KY, from July 1864 through July 1865. It served garrison duty at Camp Nelson, Bowling Green, and other points in the District of Kentucky. It was mustered out on April 24, 1866.

**13th Heavy Artillery:** This regiment was organized at Camp Nelson, KY, in June 1865, where it served garrison duty. It also served at Smithland and Lexington, KY. It was mustered out on November 18, 1865.

**14th Heavy Artillery:** This regiment was organized at New Bern and Morehead City, NC, from March 1864 to April 1865, as the 1st North Carolina Colored Heavy Artillery. It became the 14th United States Colored Heavy Artillery in March 1865. The unit served garrison duty at New Bern, NC, and was mustered out on December 11, 1865.

#### U. S. Colored Light Artillery

The 1st Regiment Light Artillery was recruited and organized under Maj. Gen. Benjamin F. Butler in December 1863. In February 1864 it was changed to Battery B of the 2d Light Artillery.

The 2d Regiment Light Artillery consisted of nine batteries, A through I, that were independently organized and deployed.

Battery A was organized at Nashville, TN, in April 1864. The battery served garrison duty at Nashville and participated in the Battle of Nashville December 15-16, 1864. It was mustered out January 13, 1866.

Battery B was organized at Fort Monroe, VA, in January and February 1864. It operated in Virginia and participated in the siege against Petersburg and Richmond. The battery was ordered to Texas in May 1865, and mustered out March 17, 1866.

Battery C was organized at Hebron's Plantation, MS, in November 1863, as the 1st Battery Louisiana Light Artillery (African descent). It was designated Battery C in April 1864. The battery had garrison duty at Goodrich Landing, Vicksburg, and Milliken's Bend. It was mustered out December 28, 1865.

Battery D was organized at Black River Bridge, MS, in December 1863, as the 2d Battery Louisiana Light Artillery (African descent). It was designated Battery D in April 1864. The battery had garrison duty at Goodrich Landing and Vicksburg, MS, and was mustered out on December 28, 1865.

Battery E was organized at Helena, AR, in December 1863, as the 3d Battery Louisiana Light Artillery (African descent). It was designated Battery E in April 1864. The battery had garrison duty at Helena, AR, and was mustered out on September 26, 1865.

Battery F was organized at Memphis, TN, in November 1863, as the Memphis Light Battery. It was designated Battery F in April 1864. The battery had garrison duty at Memphis, TN, until April 1865, when it moved to Bridgeport, AL. It was mustered out on December 28, 1865.

Battery G was organized at Hilton Head, SC, in May 1864 and had garrison duty at Hilton Head for its entire term. The battery was mustered out on August 12, 1865.

Battery H was organized at Pine Bluff, AR, in June 1864, as the 1st Arkansas Colored Battery. It was designated as Battery H in December 1864. The battery had garrison duty at Pine Bluff the entire term and was mustered out on September 14, 1865.

Battery I was organized at Memphis, TN, in April 1864. The battery had garrison duty at Memphis, TN, and operations in Mississippi. It was mustered out on January 10, 1866.

Independent Battery was organized at Leavenworth, KS, in December 1864. It had duty at Fort Leavenworth until it was mustered out on July 22, 1865.

#### Records Description

Compiled service records consist of a jacket-envelope for each soldier, labeled with his name, rank, unit, and card numbers. The compilation of service records of Union soldiers began in 1890 under the direction of Col. Fred C. Ainsworth, head of the Record and Pension Office of the Adjutant General's Office, Department of War. Information from muster rolls, regimental returns, descriptive books, and other records was copied verbatim onto cards. A separate card was prepared each time an individual name appeared on a document. These cards were numbered on the back, and these numbers were entered onto the outside jacket containing the cards. The carded information was verified by a separated operation of comparison; great care was taken to ensure that the cards were accurate.

A typical jacket contains card abstracts of entries found in original records relating to the soldier and original documents relating solely to that soldier. Examples of the latter include enlistment papers, substitute certificates, casualty sheets, death reports, prisoner-of-war memorandums, and correspondence. Unique to the records of the USCT are deeds of manumission, oaths of allegiance, proof of ownership, certificates of monetary award, and bills of sale. These items appear most frequently in units recruited in the border states of Kentucky, Missouri, and Maryland. These states remained in the Union but were slave states. Jackets and

cards include a section labeled "bookmark" which was reserved for cross-references to other records relating to the individual or his unit. The service records are arranged by arm of service, thereunder numerically by regiment or independent battalion or company, and thereunder alphabetically by name of the soldier. Records for officers are interfiled alphabetically by name with the records of enlisted men. If an individual served in more than one unit, which was typical for USCT officers, there will be a separate service record for each unit in which he served.

The unjacketed miscellaneous cards were accumulated by the War Department with the expectation that they would be incorporated in individual compiled service records. However, the expectation was never fulfilled, because either insufficient or contradictory information made it impossible to associate the cards or papers with a particular soldier's service records.

#### Related Records

Among the records of the Adjutant General's Office in the National Archives are many of the original records that were abstracted or "carded" by the Record and Pension Office. These include the individual unit's muster rolls, returns and descriptive books. Other series in RG 94 that contain information relating to volunteer Union soldiers who served with the USCT include carded records relating to Union staff officers, carded medical records of volunteer Union soldiers, unbound and bound regimental records and "record of events" cards. The regimental records of the 54th Massachusetts Infantry (Colored) have been reproduced as Microfilm Publication M1659, *Records of the Fifty-fourth Massachusetts Infantry Regiment (Colored), 1863-1865*.

The "record of events" cards include information copied from the unit's muster rolls and returns. They show the stations of the field and staff and those of the various companies of the regiment at the time the muster roll or return was prepared and sometimes mention battles, skirmishes, or other activities in which the regiment participated. The cards have been reproduced as Microfilm Publication M594, *Compiled Records Showing Service of Military Units in Volunteer Union Organizations*.

Record Group 94 also includes a card index for the USCT, reproduced as Microfilm Publication M589, *Index to Compiled Military Service Records of Volunteer Union Soldiers Who Served with U.S. Colored Troops*, which may be used to locate the regiment of USCT personnel. An index card gives the name of the soldier and his rank, as well as the unit in which he served; sometimes there is a cross-reference to his service in other units or organizations. The National Archives is continually producing microfilm publications of volunteer Union compiled military service records. A complete listing of finished publications can be found in the National Archives *Microfilm Resources for Research: A Comprehensive Catalog* which is available online at <http://www.nara.gov>.

The Records of the Colored Troops Division, within RG 94, include division correspondence and records relating to recruiting, the appointment of officers, and the slave or free status of individuals; and a compilation of historical extracts and official papers concerning the military service of African Americans from the colonial period through the Civil War entitled *The Negro in the Military Service of the United States 1639-1886*. This compilation is reproduced as Microfilm Publication M858. The Records of the Bounty and Claims Division, also in RG 94, include correspondence of the division and records relating to bounties and claims paid to loyal owners of slaves by the Slave Claims Commissions of Delaware, Kentucky, Maryland, Missouri, Tennessee, and West Virginia.

If an application for a pension was made, the pension application case file may be among the Records of the Veterans Administration (RG 15). Indexes to the pension applications have been reproduced as Microfilm Publication T288, *General Index to Pension Files, 1861-1934*, and T289, *Organizational Index to Pension Files of Veterans Who Served Between 1861 and 1900*.

If a soldier or officer was tried before a general court-martial or if an individual or his unit was the subject of a court of inquiry or military commission, transcripts of the proceedings may be among the Records of the Office of the Judge Advocate General (Army) (RG 153). The registers to the proceedings have been reproduced as Microfilm Publication M1105, *Registers of the Records of the Proceedings of the U.S. Army General Courts-Martial, 1809-1890*.

Other record groups having information pertaining to the USCT include Records of the Bureau of Refugees, Freedmen, and Abandoned Lands (RG 105); Records of the Provost Marshal General's Bureau (Civil War) (RG 110); Records of the Accounting Officers of the Department of the Treasury (RG 217); and Records of U.S. Army Continental Commands, 1821-1920 (RG 393).

Roll list

Roll      Description

1st United States Colored Heavy Artillery

- |    |   |
|----|---|
| 1  | Ackerson, David - Baker, Barney         |
| 2  | Baker, George - Bogle, Harry            |
| 3  | Bolden, Joseph - Brown, Edwin G.        |
| 4  | Brown, George - Carmack, Bachus         |
| 5  | Carmack, Gilbert - Cleveland, Loudon    |
| 6  | Clevenger, Charles - Cune, John C.      |
| 7  | Curd, George - Eblin, Richard           |
| 8  | Eckles, Silas - Furbush, Lewis          |
| 9  | Gaines, George - Greenleaf, Andrew      |
| 10 | Greenleaf, Julius - Hart, Benjamin      |
| 11 | Hartman, Henry - Hoff, David            |
| 12 | Holland, John - Jackson, Thomas J.      |
| 13 | Jackson, Washington - Jones, James      |
| 14 | Jones, John - Ledgewood, Clayborne      |
| 15 | Lee, Elhanon - Martin, Robert           |
| 16 | Mason, Henry - McKenney, Elijah         |
| 17 | McKinney, Lewis - Montcastle, Stewart   |
| 18 | Montgomery, Alfred - Owens, Benjamin    |
| 19 | Owens, Granville - Ragan, Nelson        |
| 20 | Ragan, Rome - Russell, Orlando A.       |
| 21 | Russell, Perry - Smith, Archie          |
| 22 | Smith, Bart - Suddles, Robert           |
| 23 | Summers, Joseph D. - Turner, Charles    |
| 24 | Turner, Henry - Weir, Richard           |
| 25 | Weir, Robert - Willis, Albert           |
| 26 | Willis, Beverly S. - Zimmerman, William |

3d United States Colored Heavy Artillery

- |    |  |
|----|--|
| 27 | Abel, William - Armour, Lewis          |
| 28 | Armstaed, William - Beaufort, Thomas   |
| 29 | Beaumont, Henry - Bowler, Lafayette P. |
| 30 | Bowman, Fleming - Brummer, John E.     |
| 31 | Bryan, Solon - Carter, William         |
| 32 | Cartman, John - Cook, Isham            |
| 33 | Cook, John - Davis, Doctor             |
| 34 | Davis, George - Easen, Samuel          |
| 35 | Easley, Wesley - Flinn, Clay           |
| 36 | Flint, James - Gilbreth, Eli           |

NATIONAL ARCHIVES MICROFILM PUBLICATIONS

Roll	Description
37	Gilbreth, Guy - Griffin, Samuel
38	Griffin, William - Harrison, James
39	Harrison, James C. - Hicks, Smith
40	Higginbottom, Nimrod - Hunt, Rubin
41	Hunt, William - Johnson, Charles
42	Johnson, Crawford - Jones, Isaac
43	Jones, Isam - Knight, Warren
44	Knox, Overton - Mabin, Baker
45	Mabin, James - McDonald, Manuel
46	McDonald, Ruben - Mills, Robert
47	Milroy, John - Nealy, Henry
48	Ned, Lewis - Patterson, Pembroke J. (Perin J.)
49	Patton, Richmond - Powers, William
50	Prewitt, Greene - Roberts, Lewis
51	Robinette, Henry - Scott, Edmond
52	Scott, Elijah - Smith, Peter
53	Smith, Randall - Tapscott, Julius
54	Tarwater, Jesse - Todd, William
55	Todd, Willis - Wallace, Robert
56	Wallace, Sandford - Wells, Duncan
57	Wells, Joseph - Williams, Guyo
58	Williams, George - Wolbrecht, Adolf
59	Wood, Charles - Young, William H.

4th United States Colored Heavy Artillery

60	Abbott, John - Barnes, Samuel
61	Barnes, Thomas - Britt, Jackson
62	Britten, Charles - Clark, Mitchell
63	Clay, Henry - Daniel, Richard
64	Daniels, William - Dyson, Jack
65	Dyson, Paul - Gardner, Riley
66	Gardner, Washington - Hall, Henry
67	Hall, Jack - Horton, Mack
68	Horton, William - Jones, Levi
69	Jones, Louis - Lewis, Stephen
70	Lewis, Thomas - McMurray, Anderson (John)
71	McMurray, George - Need, Benjamin
72	Nelson, John - Prior, Alfred
73	Prior, Gabriel - Rutland, Isaac
74	Ruttkay, Albert - Smith, Louis
75	Smith, Samuel - Turner, Frank
76	Turner, James - White, Henry
77	White, Raven - Youngs, William



NATIONAL ARCHIVES MICROFILM PUBLICATIONS

Roll Description

5th United States Colored Heavy Artillery

78 Abbott, Richard - Armstrong, William  
 79 Arrindale, John B. - Bentley, Francis A.  
 80 Bentley, Isam - Brooks, Lawyer  
 81 Brooks, Robert - Cabin, Henry  
 82 Cabin, Shadrick - Coleman, Nathan  
 83 Coleman, William - Davidson, Ellis  
 84 Davis, Alfred - Dodd, Taylor  
 85 Dodds, Peter - Feltis, Jackson  
 86 Felton, Martin - Gilford, Charles  
 87 Gillespie, Gilbert - Hagan, Alex  
 88 Hagans, Joseph - Hayes, John S.  
 89 Haythorn, Henry - Hood, John  
 90 Hooker, William - James, Warren  
 91 January, Nathan - Johnson, Wiley  
 92 Johnson, William - Kindley, Edward  
 93 King, Elijah - Lewis, Ely J.  
 94 Lewis, George W. - Manitoie, Samuel  
 95 Manly, Elisha - McNeil, William  
 96 McQuilley, Clayton - Mosley, Jacob  
 97 Moss, Alfred - Parker, James  
 98 Parker, John H. - Powell, Monroe  
 99 Power, Henry - Roach, Watt  
 100 Robb, Benjamin - Shaw, Barrow  
 101 Shaw, James - Smith, Robert  
 102 Smith, Samuel - Tate, John  
 103 Taylor, Anderson - Trueman, Henry  
 104 Truman, Nelson - Ward, George  
 105 Ward, Jacob - West, Moses  
 106 Westbrook, Ellick - Williams, John B.  
 107 Williams, Jordan - Wood, Theodore  
 108 Woodam, Henry - Young, William  
 Miscellaneous Service Cards  
 Allen, Geo. - Young, L.

6th United States Colored Heavy Artillery

109 Aaron, William - Barton, Granderson  
 110 Baseman, Jerry - Bracton, John  
 111 Bradford, Henry - Bush, Wilson  
 112 Bustis, Mondey - Clay, Henry  
 113 Clay, William - Davenport, William  
 114 Davenport, Wilson - Dunbar, Newton

NATIONAL ARCHIVES MICROFILM PUBLICATIONS

Roll	Description
115	Dunbow, Hannibal - Fox, William
116	Francis, James - Green, George
117	Green, James - Harris, Hiram
118	Harris, John - Hopper, Anthony
119	Hopper, Handy - James, Joseph
120	Jasper, Samuel - Jones, John
121	Jones, Jonas - Leavitt, Charles B.
122	Lee, David - McBride, Samuel
123	McCabe, Alexander H. - Moore, Joseph
124	Moore, Manual - Owens, Willis
125	Page, Benjamin - Reece, Edward
126	Reese, William - Samuel, William
127	Sanders, Archibald - Smart, Robert
128	Smith, Aaron - Suzette, Armstead
129	Swanson, Jack - Trotter, George
130	Troyman, George - Waters, Robert
131	Waters, Wesley - Williams, Bedney
132	Williams, Benjamin - Wilson, George
133	Wilson, Guy - Young, Wesley
	Miscellaneous Service Cards
	Adams, Winder - Williams, John
	 8th United States Colored Heavy Artillery
134	Abanather, Paten - Beasley, George W.
135	Beasley, Washington - Boyd, Isaac
136	Boyd, Paine - Burrill, George
137	Burris, Abram - Cofield, Henry
138	Cofield, Isaac - Davis, George
139	Davis, Jerry - Edwards, Frank
140	Edwards, Gus - Ginigan, Thomas
141	Givens, George - Hampton, Phillip
142	Hancock, James - Hodge, Cotney
143	Hodge, Gaines - Johnson, Charles
144	Johnson, Clinton - Lee, Wash
145	Leeper, Thomas - Maxwell, Henry
146	Maxwell, Samuel - Moore, Amos
147	Moore, David - Pearson, Alexander
148	Pearson, Charley - Rice, Pleasant
149	Rice, Taylor - Sherrer, Elick
150	Shirles, James - Talbot, Henry
151	Talley, William - Turner, Robert
152	Tyler, Jerry - Williams, John
153	Williams, Sam - Young, William

NATIONAL ARCHIVES MICROFILM PUBLICATIONS

Roll Description

9th United States Colored Heavy Artillery

- 154 Ailer, John - Coleman, Miles
- 155 Collins, Moses A. - Grosskopff, Edward
- 156 Grubb, Andrew - Landon, Harry
- 157 Lanier, Jesse - Payne, George
- 158 Payne, James - Tory, Madison
- 159 Toryand, Emanuel - Young, George

10th United States Colored Heavy Artillery

- 160 Aaron, Benjamin - Auguste, Daniel
- 161 Augustus, Edward - Benson, George
- 162 Bentley, William H. - Brooks, Walker
- 163 Brooks, Washington - Camel, Paul
- 164 Cameron, Henry - Coleman, James
- 165 Coleman, John - Deale, Joseph
- 166 Deale, Thomas - Ellis, Robert
- 167 Ellis, Silas - Frederick, Joseph
- 168 Freeland, Martin A. - Grandison, Alfred
- 169 Grant, Moses - Harrison, Logan
- 170 Harrison, Thomas - Hoyt, Joseph
- 171 Hubbard, Henry - Jenkins, Solomon
- 172 Jennings, Caleb - Jozen, Jules
- 173 Julia, Nora - Libscomb, George
- 174 Lightfoot, Columbus - Maryday, John
- 175 Masdael, Noel - Misker, Robert
- 176 Mitchel, Alexander - Oldham, George B.
- 177 Oliver, Emile - Purnell, John
- 178 Putnam, Winthrop D. - Robinson, Henry
- 179 Robinson, Isaac - Simmons, Owen
- 180 Simms, Amos - Spencer, John
- 181 Spriggs, Thomas - Thornton, John
- 182 Thurston, Charles - Warner, Dudley
- 183 Warner, George E. - Wesley, John
- 184 West, Alexander - Willis, Stephen
- 185 Willson, George - Zozey, Jules
- Miscellaneous Service Cards
  - Cann, Mercer - Grayson, John W.
- 186 Miscellaneous Service Cards
  - Green, Andrew P. - Rygaard, Soren
- 187 Miscellaneous Service Cards
  - Sabatier, Peter - Zevenette, Paul

NATIONAL ARCHIVES MICROFILM PUBLICATIONS

Roll Description

11th United States Colored Heavy Artillery

- 188 Abbott, George M. - Bailey, James A.
- 189 Baird, Sylvester - Boardley, James
- 190 Boardley, John W. - Brown, Nathan
- 191 Brown, Samuel - Carter, William H.
- 192 Cartright, George W. - Commings, Hugh S.
- 193 Comstock, Joseph J. - Davis, Lyman
- 194 Davis, Stephen - Dubois, James
- 195 Duesenbury, Lewis - Fletcher, Roderick S.
- 196 Fletcher, Samuel - Garrison, John
- 197 Gaskell, George L. - Groff, Joseph
- 198 Guard, Andrew - Hector, William H.
- 199 Heelms, Harkness - Howard, Richard
- 200 Howard, Thomas - Jackson, Lewis
- 201 Jackson, Norton - Johnson, Joseph W.
- 202 Johnson, Nathan - King, Cornelius
- 203 King, George - Loucks, John A.
- 204 Low, Charles H. - Miller, Benjamin
- 205 Miller, Floyd N. - Nicholas, Samuel
- 206 Nichols, Alfred - Pierce, George W.
- 207 Pierce, John B. - Reed, Washington
- 208 Reese, Edward - Sampson, William H.
- 209 Sanders, Edward - Skanks, James S.
- 210 Skanks, Thomas C. - Sommerset, Levi
- 211 Southwick, Henry K. - Taylor, Alfred M.
- 212 Taylor, Charles - Townsend, John
- 213 Tracy, John - Warren, John
- 214 Washington, George - Whiting, Joseph C., Jr.
- 215 Wigden, Cyrus B. - Wilson, Samuel
- 216 Wilson, William - Young, Francis
- Miscellaneous Service Cards
  - Abbot, George W. - Dyer, William S.
- 217 Miscellaneous Service Cards
  - Earl, Peter - Young, William H.

12th United States Colored Heavy Artillery

- 218 Abbott, John - Barbee, Squire
- 219 Barber, Sherwood - Boller, Jerry
- 220 Bolor, Collins - Bryant, Frederick
- 221 Bryant, Henry - Bush, Reason
- 222 Butler, Aaron - Clark, Richard
- 223 Clark, Samuel - Criffield, Lewis

NATIONAL ARCHIVES MICROFILM PUBLICATIONS

Roll	Description
224	Christopher, James - Dock, Calvin E.
225	Dodge, Henry - Farnesley, Jack
226	Farrus, Ephraim - Gaves, David
227	Gentry, George - Haggin, George
228	Haggin, Samuel - Hawkins, Robert
229	Hawkins, Thomas - Hode, Adam
230	Hodge, Charles - Jackson, Andrew
231	Jackson, Augustus - Jopee, Joseph
232	Juda, Enoch - Lewis, Windsor
233	Lidick, Randall - Maton, Levi
234	Matthews, Charles W. - Mitchell, John
235	Mitchell, Monroe - Nelson, Joseph
236	Nesbin, William - Porter, Daniel
237	Porter, William R. - Richason, Shelly
238	Richie, George - Scott, Smith
239	Scott, Stephen - Smith, Leroy
240	Smith, Lyman - Taylor, Charles
241	Taylor, Cornelius - Turner, David
242	Turner, George - Warren, James
243	Washington, Anthony - Williams, Berry
244	Williams, Charles - Woodson, David
245	Woodson, Egbert - Young, Thomas
	Miscellaneous Service Cards
	Baughman, John - Heel, Rubin
246	Miscellaneous Service Cards
	Helm, Harry - Young, Stephen
<b>13th United States Colored Heavy Artillery</b>	
247	Abbott, Josiah - Bell, Augustine
248	Bell, Charles - Brown, Jesse
249	Brown, Lindsay - Connor, Cyrus
250	Connor, Isaac - Dyre, George
251	Early, Edward - Ginn, Samuel
252	Ginnis, Sidney Clay - Heath, Henry
253	Heath, Lewis - Jarrett, Charles
254	Jay, Johnson - Lee, William
255	Lender, Richard - McKinney, Cass
256	McKinney, Henry Clay - Owens, Robert
257	Owens, Smith - Randolph, Loyd
258	Rankins, Archibald - Scott, Jerry
259	Scott, John - Sugg, Edmond
260	Suiter, Jacob A. - Waddie, Harry
261	Waddy, Peter - Willett, Price

NATIONAL ARCHIVES MICROFILM PUBLICATIONS

Roll	Description
262	Willett, Robert - Young, William
263	Miscellaneous Service Cards Abbott, Josiah - Yumber, Anthony

14th United States Colored Heavy Artillery

264	Acot, Isaac - Becton, Henry
265	Becton, Moses - Burke, George W.
266	Burke, William A. - Davis, Toney
267	Dean, Thomas - Fullford, William
268	Fulton, James - Hardy, William
269	Harget, Israel - Hovey, William
270	Howard, Calvin - Kensley, Silas
271	Kent, Henry - McKeever, Simon
272	McMichael, Joseph - Noble, William
273	Nobles, Charles - Randall, Evans
274	Randall, Willey - Shark, Bryant
275	Sheckelford, Daniel - Smith, Samuel
276	Smith, Sterling - Thompson, John Henry
277	Thompson, Mark - Weeks, Ezekiel
278	Weidman, Albert - Wilson, Payton
279	Wilson, Richard - Young, William
	Miscellaneous Service Cards Acott, Isaac - Young, William

2d Regiment United States Colored Light Artillery

280	Able, John - Bernard, Albert
281	Berry, Henry - Brown, Sang
282	Brown, Thomas - Clark, William
283	Clay, Henry - Disen, Henry
284	Disen, Watkins - Francis, Henry
285	Franklin, Albert - Haines, Roe
286	Haines, Thomas - Hunt, Thomas
287	Hunter, Alexander M. - Kennedy, Abram
288	Kennel, George - March, George
289	Marcy, Anthony - Mobbs, Daniel
290	Moffet, John - Pattiller, Alfred
291	Pattiller, Patrick - Richardson, Jacob
292	Ridgeway, Anthony - Smith, Louis B.
293	Smith, Minus - Tucker, Alfred

NATIONAL ARCHIVES MICROFILM PUBLICATIONS

Roll	Description
294	Tucker, Sandy - Williams, Calvin
295	Williams, Charles - Zinum, John
296	Miscellaneous Service Cards Abraham, Francis - Young, Ruben
Independent Battery, United States Colored Light Artillery	
297	Alexander, John - Hancock, George W.
298	Hanson, Noah C. - Scott, Andrew
299	Scott, Reynolds - Yeager, John Miscellaneous Service Cards Douglass, H. Ford - Minor, P.M.

NATIONAL ARCHIVES MICROFILM PUBLICATIONS

Microfilm Publication M1818

COMPILED MILITARY SERVICE RECORDS OF VOLUNTEER UNION  
SOLDIERS WHO SERVED WITH THE UNITED STATES COLORED  
TROOPS: Artillery Organizations

Roll 297

Independent Battery, United States Colored Light Artillery

Alexander, John - Hancock, George W.



*Private Private*

CARD NUMBERS.

233723-	26
233877	27
234051	28
6234189	29
6234357	30
6234520	31
9132906	32

33  
34  
35  
36  
37  
38  
39  
40  
41  
42  
43  
44  
45  
46  
47  
48  
49  
50

Book Mark: *B. 179 Mo X + 3085. 1878.*

also

Q + P 392344  
S 1060832 Po M + W  
A 1810669 Po M + W

W Spence  
9

A | Indpt. Batt'y. | U.S.C.T.

John Alexander

Indpt. Batt'y, U. S. Col'd L. Art'y.

Appears on

Battery Descriptive Book

of the organization named above.

DESCRIPTION.

Age 29 years; height 5 feet 9 1/2 inches.

Complexion Black

Eyes Black; hair Black

Where born Mason Co. Ky.

Occupation Laborer

ENLISTMENT.

When July 22, 1864

Where Harrodsburg & Co.

By whom Sgt Mathews; term 3 y'rs.

Remarks:

Holbrook

(383g)

Copyist.

A | Indpt. Battery. | U.S.C.T.

John Alexander  
Pat, Indpt. Battery, U. S. Col'd L. Art'y.

Appears on

**Battery Muster-in and Descriptive Roll**

of the organization named above. Roll dated

Leavenworth Mo Dec 23, 1864.

Where born Mason Co. Ky

Age 29 y'rs; occupation Laborer

When enlisted July 22, 1864.

Where enlisted Leavenworth Mo

For what period enlisted 3 years.

Eyes Blue; hair Blue

Complexion Blue; height 5 ft 4 1/2 in.

When mustered in July 23, 1864.

Where mustered in Leavenworth Mo

Bounty paid \$ 100<sup>00</sup>/<sub>100</sub>; due \$ 200<sup>00</sup>/<sub>100</sub>

Where credited

Battery to which assigned

Remarks: Co. M. Dist Co.  
7th S.D. Garrard  
Leavenworth Kansas

Book mark: \* B-179 mo. K  
\* Company

(856g) J. H. Hawley Copyist.

A | Indpt. Battery. | **U.S.C.T.**

*John Alexander*

*Govt*, Indpt. Battery, U. S. Col'd L. Art'y.

Appears on

**Battery Muster Roll**

for *Enlistment to Dec 31, 1864*

Present or absent *Present*

Stoppage, \$ 100 for

Due Gov't, \$ 100 for

Valuation of horse, \$ 100

Valuation of horse equipments, \$ 100

Remarks:

Book mark:

*J. A. Schuyler*

(358)

Copyist.

A | Indpt. Battery. | U.S.C.T.

John Alexander  
Post, Indpt. Battery, U. S. Col'd L. Art'y.

Appears on

**Battery Muster Roll**

for *July / Feb*, 186<sup>5</sup>.

Present or absent *Present*

Stoppage, \$ 100 for

Due Gov't, \$ 100 for

Valuation of horse, \$ 100

Valuation of horse equipments, \$ 100

Remarks:

Book mark:

*J. H. Schreyer*  
(358) Copyist.

*26 Jan 2*

JAN. 17

6234051

01891\*

*A* | Indpt. Battery. | **U.S.C.T.**

*John Alexander,*  
*Pr*, Indpt. Battery, U. S. Col'd L. Art'y.

Appears on

**Battery Muster Roll**

for *Mar + Apl*, 1865.

Present or absent *Present*,

Stoppage, \$ 100 for

Due Gov't, \$ 100 for

Valuation of horse, \$ 100

Valuation of horse equipments, \$ 100

Remarks:

Book mark:

*Prater*



*A* | Indpt. Battery. | **U.S.C.T.**

*John Alexander,*  
*Pr*, Indpt. Battery, U. S. Col'd L. Art'y.

Appears on

**Battery Muster Roll**

for *May & June*, 186*5*.

Present or absent *Present,*

Stoppage, \$ 100 for

Due Gov't, \$ 100 for

Valuation of horse, \$ 100

Valuation of horse equipments, \$ 100

Remarks:

Book mark:

*Parter*

(358)

Copyist.

*A* | Indpt. Battery. | **U.S.C.T.**

*John Alexander*

*A*, Indpt. Battery U. S. Col'd Light Art'y.

Appears on **Batt'y Muster-out Roll**, dated *W. Leavenworth, Ms., July 22, 1865.*

Muster-out to date *July 22, 1865.*

Last paid to *Dec, 31, 1864.*

Clothing account:

Last settled....., 186 ; drawn since \$ *43*<sup>54</sup>/<sub>100</sub>,

Due soldier \$.....<sub>100</sub>; due U. S. \$.....<sub>100</sub>

Am't for cloth'g in kind or money adv'd \$.....<sub>100</sub>

Due U. S. for arms, equipments, &c., \$.....<sub>100</sub>

Bounty paid \$ *100* <sub>100</sub>; due \$ *none* <sub>100</sub>,

Remarks: *Due C. Fenlon, Sutter,*  
*\$10-*

Book mark: *B179, no. K, 3085, 1878.*

(361)

*Parter*  
Copyist.

*Alexander John*

Co. **Ind. Batt. U. S. C. A.** Reg't

*3*

**Enclosures.**

- |                                   |                        |
|-----------------------------------|------------------------|
| Bed Cards.....                    | Descriptive Lists..... |
| Burial Records.....               | Final Statements.....  |
| Certs. of Dis. for Discharge..... | Furloughs.....         |
| C. M. Charges.....                | Med. Des. Lists.....   |
| Med. Certificates.....            | Orders.....            |

*See page*

*2*

Other papers relating to—

- |                                 |                                  |
|---------------------------------|----------------------------------|
| Admission to Hosp'l.....        | Furlough.....                    |
| Casualty Sheet (Officer's)..... | Med. Examination.....            |
| Confinement.....                | Misc. Information <i>/</i> ..... |
| Contracts.....                  | Pay or Clothing.....             |
| Death or Effects.....           | Personal Reports.....            |
| Desertions.....                 | Rank.....                        |
| Discharge from Hosp'l.....      | Transfer to Hosp'l.....          |
| Discharge from Service.....     | Transfer to V. R. C.....         |
| Duty.....                       | Transportation.....              |

MICROFILM PUBLICATION M 1836

COMPILED MILITARY SERVICE RECORDS  
OF VOLUNTEER UNION SOLDIERS WHO SERVED WITH  
THE UNITED STATES COLORED TROOPS (USCT)  
INDEPENDENT BATTERY LIGHT ARTILLERY

PERSONAL PAPERS' TARGET SHEET

PLEASE NOTE THE CHECKED INFORMATION ABOUT THE PERSONAL PAPERS IN  
THIS FILE:

- NO PERSONAL PAPERS WERE FOUND IN THIS FILE WHEN THE  
RECORDS WERE ARRANGED FOR MICROFILMING.
- 4 PERSONAL PAPER(S) FOUND IN THIS FILE WHEN THE RECORDS  
WERE ARRANGED FOR MICROFILMING.

NOTE 1.—This blank will be used for both enlistments and re-enlistments—enlistment of veterans, &c., &c., in the volunteer service. They will be made out in duplicate in all cases—one to accompany the recruiting return of the superintendent (not the recruiting officer) to the Adjutant General, and one to accompany the accounts of the officer who pays bounty, &c. The Regiment and Company in which the soldier last served should be given on the back.

NOTE 2.—An enlistment holds to service. A muster-in must, in all cases, precede payment of pay, bounty, pension, &c. A muster-in roll must, in all cases, be filed in the Adjutant General's Office as evidence of muster-in. The mustering officer, commissary, or assistant commissary of musters, as the case may be, will countersign both enlistments as having mustered the soldier into the service of the United States before either of them is given to the disbursing officer.

DECLARATION OF RECRUIT.

I, John Alexander desiring to VOLUNTEER as a Soldier in the Army of the United States, for the term of THREE YEARS, Do Declare, That I am 29 years and 0 months of age; that I have never been discharged from the United States service on account of disability or by sentence of a court martial, or by order before the expiration of a term of enlistment; and I know of no impediment to my serving honestly and faithfully as a soldier for three years.

GIVEN at Leavenworth City State of Kansas the 22 day of July 1864

Witness: C. H. Langston John Alexander  
mark

..... enlistment; last served in Company ( )  
..... Reg't of .....  
Discharged ..... '18

John Alexander  
Volunteered at Leavenworth, Mo. by  
John Alexander 1864,  
By John S. Matthews of Leavenworth  
Recruiting Co. of 1st Ill Artillery



CONSENT IN CASE OF MINOR.

I, ..... DO CERTIFY, That I am the ..... of .....; that the said ..... is ..... years of age; and I do hereby freely give my CONSENT to his volunteering as a SOLDIER in the ARMY OF THE UNITED STATES for the period of THREE YEARS.

GIVEN at ..... the ..... day of .....

Witness: .....

VOLUNTEER ENLISTMENT.

STATE OF



TOWN OF

*Kansas*

*Leavenworth City*

I, *John Alexander* born in *Marion County*  
 in the State of *Kentucky* aged *29* years,  
 and by occupation a *Farmer* Do HEREBY ACKNOWLEDGE to have  
 volunteered this *22* day of *July* 1864,  
 to serve as a **Soldier** in the **Army of the United States of America**, for  
 the period of **THREE YEARS**, unless sooner discharged by proper authority:  
 Do also agree to accept such bounty, pay, rations, and clothing, as are, or may be,  
 established by law for volunteers. And I, *John Alexander* do  
 solemnly swear, that I will bear true faith and allegiance to the **United States**  
**of America**, and that I will serve them honestly and faithfully against all  
 their enemies or opposers whomsoever; and that I will observe and obey the  
 orders of the President of the United States, and the orders of the officers  
 appointed over me, according to the Rules and Articles of War.

Sworn and subscribed to, at *Leavenworth* his  
 this *22* day of *July* 1864, *John Alexander*  
 BEFORE *John X. Alexander*  
*Squad Recruiting Co No 2 W.S. Col Artillery* mark

I CERTIFY, ON HONOR, That I have carefully examined the above-named Volunteer, agreeably  
 to the General Regulations of the Army, and that, in my opinion, he is free from all bodily defects and  
 mental infirmity, which would in any way disqualify him from performing the duties of a soldier.

*Jiffie Sinko*  
 Surg Board of Enrollment  
*North Dist Kansas*  
 EXAMINING SURGEON.

I CERTIFY, ON HONOR, That I have minutely inspected the Volunteer, *John Alexander*  
 previously to his enlistment, and that he was entirely sober when enlisted; that, to the best of my  
 judgment and belief, he is of lawful age; and that, in accepting him as duly qualified to perform the  
 duties of an able-bodied soldier, I have strictly observed the Regulations which govern the recruiting  
 service. This soldier has *Black* eyes, *Black* hair, *Black* complexion, is *5*  
 feet *9 1/2* inches high.

*Squad Recruiting Co No 2 W.S. Col Artillery*  
 Regiment of *Volunteers*  
 RECRUITING OFFICER.

Mustered into the service of the United States, for three years or during the war, from date of enlistment, in Company .....  
 Regiment of ..... Volunteers, on the ..... day of ..... 1864, at .....

NOTE 1.—This blank will be used for both enlistments and re-enlistments—enlistment of veterans, &c., &c., in the volunteer service. They will be made out in duplicate in all cases—one to accompany the recruiting return of the superintendent (not the recruiting officer) to the Adjutant General, and one to accompany the accounts of the officer who pays bounty, &c. The Regiment and Company in which the soldier last served should be given on the back.

NOTE 2.—An enlistment holds to service. A muster-in must, in all cases, precede payment of pay, bounty, pension, &c. A muster-in roll must, in all cases, be filed in the Adjutant General's Office as evidence of muster-in. The mustering officer, commissary, or assistant commissary must, as the case may be, will countersign both enlistments as having mustered the soldier into the service of the United States before either of them is given to the disbursing officer.

2nd. Aud. Nov. 23d 1892

DECLARATION OF RECRUIT.

I, John Alexander desiring to VOLUNTEER as a Soldier in the Army of the United States, for the term of THREE YEARS Do Declare, That I am 29 years and 0 months of age; that I have never been discharged from the United States service on account of disability or by sentence of a court-martial, or by order before the expiration of a term of enlistment; and I know of no impediment to my serving honestly and faithfully as a soldier for three years.

GIVEN at Leavenworth City - State of Kansas the 22<sup>nd</sup> day of July 1864

Witness: W. A. Burdick John Alexander  
mark

No. 221

John Alexander  
Volunteered at Leavenworth City  
July 22  
1864

By Wm. H. ...  
Regiment of

enlistment; last served in Company ( )  
Reg't of  
Discharged ..... 18

CONSENT IN CASE OF MINOR.

I, ..... Do CERTIFY, That I am the ..... of .....; that the said ..... is ..... years of age; and I do hereby freely give my CONSENT to his volunteering as a SOLDIER in the ARMY OF THE UNITED STATES for the period of THREE YEARS.

GIVEN at ..... the ..... day of .....

Witness: .....

VOLUNTEER ENLISTMENT.

STATE OF

*Kansas*

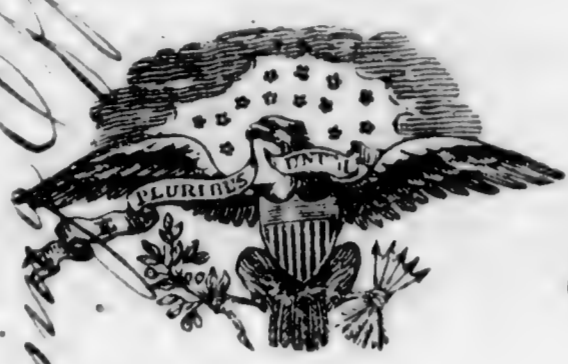

TOWN OF

*Leavenworth City*

*John Alexander* born in *Mason County*

in the State of *Kentucky* aged *29* years,

and by occupation a *Laborer* DO HEREBY ACKNOWLEDGE to have

volunteered this *22<sup>nd</sup>* day of *July* 1864

to serve as a **Soldier** in the **Army of the United States of America**, for the

period of **THREE YEARS** unless sooner discharged by proper authority: Do also

agree to accept such bounty, pay, rations, and clothing, as are, or may be, estab-

lished by law for volunteers. And I, *John Alexander* do

solemnly swear, that I will bear true faith and allegiance to the **United States**

**of America**, and that I will serve them honestly and faithfully against all their

enemies or opposers whomsoever; and that I will observe and obey the orders of

the President of the United States, and the orders of the officers appointed over

me, according to the Rules and Articles of War.

Witness my hand and subscribed to, at *Leavenworth City*

this *22<sup>nd</sup>* day of *July* 1864 *John Alexander*

BEFORE *G. D. Matthews* *2<sup>nd</sup> Lieut*

*Recruiting Co. K. 2<sup>nd</sup> U.S. Col. Cavalry*

I CERTIFY, ON HONOR, That I have carefully examined the above-named Volunteer, agreeably

to the General Regulations of the Army, and that, in my opinion, he is free from all bodily defects and

mental infirmity, which would in any way disqualify him from performing the duties of a soldier.

*Gifford Birks*  
*Surgeon Board of Enrollment*  
*North Dist. Kansas*  
EXAMINING SURGEON.

I CERTIFY, ON HONOR, That I have minutely inspected the Volunteer, *John Alexander*

previously to his enlistment, and that he was entirely sober when enlisted; that, to the best of my

judgment and belief, he is of lawful age; and that, in accepting him as duly qualified to perform the duties

of an able-bodied soldier, I have strictly observed the Regulations which govern the recruiting service.

This soldier has *Black* eyes, *Black* hair, *Black* complexion, is *5* feet

*9 1/2* inches high.

*G. D. Matthews* *2<sup>nd</sup> Lieut*

*Recruiting Co. K. 2<sup>nd</sup> U.S. Col. Cavalry*

Volunteers,  
RECRUITING OFFICER.

A. G. O. No. 74 & 75.

*This recruit has received One hundred dollars advance bounty from the bounty fund and is to be paid by me that I may be able to pay for his outfit from the bounty fund.*

*from date of company organization*  
the *23<sup>rd</sup>* day of *July* 1864 at *Leavenworth* *2<sup>nd</sup> U.S. Col. Cavalry* Regiment of *2<sup>nd</sup> U.S. Col. Cavalry* *Volunteers* on *Mustered into the service of the United States, in Company*



War Department,

ADJUTANT GENERAL'S OFFICE,

Washington, Feb. 12<sup>th</sup> 1867.

Respectfully returned to the  
 Commission for the State of  
 Missouri, with the informa-  
 tion that John Alexander  
 was enlisted at Leavenworth Kan.  
 July 22<sup>d</sup> 1864. and was  
 mustered in as Pvt in 1<sup>st</sup> Ind Regt  
 U. S. C. A. Feb. 28<sup>th</sup> 1864.

B. 179. mo.

A. B. Rowan

Asst. Adj't General.

W.B.

179 K  
**ENDORSEMENT.**

No. ~~757~~

APPLICATION OF

*John Bronaugh*

OF

*Clay County Mo*

For compensation for service of Slave

*John Alexander*

enlisted *July 22* 186*4*

in *Co. Independent Battery* Regiment,

U. S. Colored Troops. *Artillery*

Received *Jan'y 22* 186*7*

Compensation awarded

186

Dollars.

President Board of Claims.

P. O. Address of Applicant,

*J.C.*

**CERTIFICATE OF AWARD OF THE BOARD OF CLAIMS.**

OFFICE OF THE BOARD OF CLAIMS.

*For Slaves Enlisted or Drafted in the service of the United States.*

186

We hereby certify that \_\_\_\_\_ of \_\_\_\_\_  
county, State of \_\_\_\_\_ having proved, under oath \_\_\_\_\_ loyalty to the Constitution  
and Government of the United States, and established \_\_\_\_\_ title as to the ownership of \_\_\_\_\_  
\_\_\_\_\_ a slave \_\_\_\_\_ and mustered  
at \_\_\_\_\_ on the \_\_\_\_\_ day of \_\_\_\_\_ 186\_\_\_\_  
by \_\_\_\_\_ in the service of the United States, in the  
\_\_\_\_\_ regiment of Colored Troops, Co. \_\_\_\_\_ the sum of \_\_\_\_\_  
dollars has been awarded to \_\_\_\_\_ by this Board, subject to the approval of the Secretary of War, as a  
compensation for the said slave, under provisions of Section 24, Act approved February 24, 1864, and Section  
2, Act approved July 28, 1866.

\_\_\_\_\_  
President of the Board.

\_\_\_\_\_  
Member of the Board.

*R. Marsh*  
Member of the Board.

To \_\_\_\_\_

Chief of the Bureau for the Organization of Colored Troops,

WASHINGTON, D. C.



for the adjustment of such claims, before the Departments at Washington, D. C., where the same may become necessary. and elsewhere, and in his name, place and stead, for him and in his name to ask, demand, recover and receive such compensation as may be awarded as aforesaid, hereby giving and granting unto his said Attorney full power and authority to do and perform all and every act and thing whatsoever requisite and necessary to be done in and about the premises as full and to all intents and purposes the same as he might or could do were he personally present, hereby ratifying and confirming all his said Attorney or his substitutes by his appointment shall lawfully do or cause to be done by virtue hereof; and it is understood and agreed that this power of Attorney cannot be revoked by him without the consent of his Attorney herein appointed.

State of Missouri }  
County of Clay }

(5) John Brown



On this 24 day of November 1864, personally appeared me J. E. Lincoln a Notary in and for the county and State aforesaid John Brown the claimant above mentioned, and made oath to the foregoing statement by him subscribed, and he further acknowledge the signing and sealing of the foregoing Power of Attorney to be his own free binding act, for the purposes and objects therein contained and set forth: and at the same time also personally appeared the above named Martin J. Samuel and John Snagg and made oath to the truth of the statements by them respectively subscribed.

WITNESS, My hand and seal, upon the day and date first above written.

[SEAL]



(6) \_\_\_\_\_

INSTRUCTIONS.

- (1) State all the circumstances connected with obtaining title—when, where and how.
- (2) Signature of claimant.
- (3) Signatures of witnesses to ownership.
- (4) Signatures of witnesses to loyalty.
- (5) Signature of claimant.
- (6) Signature of Notary Public or Clerk of Court, authenticated by seal.

If title is by purchase, state date of bill of sale, and where recorded. When possible, file the bill of sale. If title is by inheritance, state when and from whom the slave was inherited, and where the will is recorded or the administrator was appointed. If claimant is a trustee, executor or administrator, he must show by the record, proof that he is such. Where the same party claims compensation for more than one slave, he must file a separate claim for each.

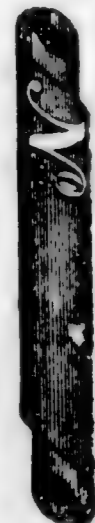

Affidavits of Ownership and Loyalty,  
and Power of Attorney,  
IN THE APPLICATION OF

John Brown

Clay County - Missouri

For Compensation for Service of Slave.

JAMES CRAIG,  
ST. JOSEPH, MO.,  
Attorney for Claimant.

1864

John Bronaugh claimant for  
 compensation under the Acts of Congress of February 24th, 1864, and July 28th, 1866, for  
John Alexander a slave, who was enlisted into the military service of the United  
 States, upon the 22<sup>nd</sup> day of July 1864, having been duly sworn  
 declares that at the date of the enlistment of said slave  
 as aforesaid, and as more fully set forth in his application, he was the lawful owner of said  
slave and obtained his title to him in the following manner; (1)

By purchase and delivery of the slave

(1) John Bronaugh  
Martius T. Samuel and John Gregg  
 having been duly sworn, declare that they are personally acquainted with  
John Bronaugh the claimant for compensation for his  
 slave John Alexander under the Acts of Congress of February 24th, 1864, and  
 July 28, 1866, and know that said slave at the date of his enlistment  
into the military service of the United States, and for a long time  
 previous thereto was the slave of said Bronaugh  
 They also declare that they have no interest in said claim.

Martius T. Samuel  
 (1) John Gregg  
Martius T. Samuel and John Gregg  
 having first been duly sworn, upon their oaths declare that they reside respectively in  
 county of Clay State of Missouri and the  
 county of Clay State of Missouri; that they are personally acquainted with  
John Bronaugh  
 claimant for compensation for his slave John Alexander under  
 the Acts of Congress of February 24, 1864, and July 28, 1866, and that they know that said claimant has firmly and  
 faithfully maintained his allegiance and adherence to the Government of the United States, by defending its cause  
 against the Government of the so-called Confederate States of America, in all suitable and practicable ways, and accord-  
 ing to his ability. They also swear that they have themselves maintained a like adherence and allegiance to the  
 Government of the United States, and that they have no interest in said claim.

Martius T. Samuel  
 (1) John Gregg  
 And the said John Bronaugh  
 claimant further declares that in consideration of valuable services rendered and to be rendered, he hath and  
 doth employ and constitute, as his Attorney, **JAMES CRAIG**, of Saint Joseph, Missouri, to prosecute his claim  
 for compensation which may be awarded to him as owner of said slave, by the Acts of Congress in that regard,  
 before the Board of Claims appointed for the State of Missouri

Company U.S. Col'd L. Art'y.

Private Sergeant

CARD NUMBERS.

6233540	26
6233726	27
6233878	28
6234033	29
6234171	30
6234482	31
6233713	32
6234639	33
9132907	34
	35
	36
	37
	38
	39
	40
	41
	42
	43
	44
	45
	46
	47
	48
	49
	50

Book Mark: EB. Vol 11. P 573.

See also |

A 1885 422 Po. m + 24  
Apo. 2715429 ap  
S.H. - 8/12/18 - W.H.L.

W.S. Spencer  
9

*A* | Indpt. Batt'y. | **U.S.C.T.**

*John Anderson*

....., Indpt. Batt'y, U. S. Col'd L. Art'y.

Appears on

**Battery Descriptive Book**

of the organization named above.

**DESCRIPTION.**

Age *22* years; height *5* feet *8* inches.

Complexion *Brown*

Eyes *Black*; hair *Black*

Where born *Cherokee Nation*

Occupation *Carrier*

**ENLISTMENT.**

When *Oct. 25*, 1864.

Where *Fort Scott Kas.*

By whom *Leut Matthews*; term *3* y'rs.

Remarks: .....

.....  
.....  
.....  
.....  
.....  
.....  
.....  
.....  
.....  
.....

*Shelbrook*



A | Indpt. Battery. | **U.S.C.T.**

*John Anderson*  
 Appears with rank of *Priv* on

**Muster and Descriptive Roll of a Detachment of U. S. Vols. forwarded**

for the Indpt. Batt'y, U. S. Col'd L. Arty. Roll dated

*Leavenworth, Kans, Nov. 29, 1864.*

Where born *Cherokee Nation*

Age *22* y'rs; occupation *Farmer*

When enlisted *Oct 25, 1864.*

Where enlisted *Ft. Scott, Ks*

For what period enlisted *3* years.

Eyes *Blk*; hair *Blk*

Complexion *Brown*; height *5 ft. 8 in.*

When mustered in *Nov. 29, 1864.*

Where mustered in *Leavenworth, Ks.*

Bounty paid \$ *100*; due \$ *100*

Where credited

Battery to which assigned

Remarks *Credited to Southern District Kansas, Fort Scott, Bourbon County Vol. Recruit and entitled to Bounty*

Book mark:

*E. L. Thornton*

A | Indpt. Battery. | U.S.C.T.

*John Anderson*  
*Sgt*, Indpt. Battery, U. S. Col'd L. Art'y.

Appears on

**Battery Muster-in and Descriptive Roll**

of the organization named above. Roll dated

*Levernworth Co, Dec 3*, 1864.

Where born *Cherokee Nation*

Age *24* y'rs; occupation *Farmer*

When enlisted *Oct 25*, 1864.

Where enlisted *Fort Scott Co*

For what period enlisted *3* years.

Eyes *Blk*; hair *Blk*

Complexion *Brn*; height *5 ft. 8 in.*

When mustered in *Nov 29*, 1864.

Where mustered in *Levernworth*

Bounty paid \$ *100<sup>00</sup>/<sub>100</sub>*; due \$ *200<sup>00</sup>/<sub>100</sub>*

Where credited

Battery to which assigned

Remarks: *C. I. Dist Co, Fort Scott Benton Co, Mo.*

Book mark :

*J. H. Scherley*  
 (356g) Copyist.

A | Indpt. Battery. | U.S.C.T.

*John Anderson*  
*Co't*, Indpt. Battery, U. S. Col'd L. Art'y.

Appears on

**Battery Muster Roll**

for *Quadrant to Dec 31*, 186 *4*.

Present or absent *Present*

Stoppage, \$ 100 for

Due Gov't, \$ 100 for

Valuation of horse, \$ 100

Valuation of horse equipments, \$ 100

Remarks:

Book mark:

*A. Schrod*  
(358) Copyist.

A | Indpt. Battery. | U.S.C.T.

John Anderson  
3rd duty, Sergeant, Indpt. Battery, U. S. Col'd L. Art'y.

Appears on

Battery Muster Roll

for *Jan & Feb*, 186<sup>5</sup>.

Present or absent *Present*

Stoppage, \$ 100 for

Due Gov't, \$ 100 for

\* Valuation of horse, \$ 100

Valuation of horse equipments, \$ 100

Remarks: *Appointed Sergeant  
Jan 1st/65 by Major  
P. H. Keunt Chf. Artillery  
Dept of Rom*

Book mark:

*J. Schreyer*  
(358) Copyist.

*A* | Indpt. Battery. | **U.S.C.T.**

*John Anderson*  
*Sgt*, Indpt. Battery, U. S. Col'd L. Art'y.

Appears on

**Battery Muster Roll**

for *Mar + Apr*, 1865.

Present or absent *Present*.

Stoppage, \$ *100* for

Due Gov't, \$ *100* for

Valuation of horse, \$ *100*

Valuation of horse equipments, \$ *100*

Remarks: *Apptd, Sergt, Jan,*  
*1/65*

Book mark: \_\_\_\_\_

*Porter*

(358)

Copyist.

*A* | Indpt. Battery. | **U.S.C.T.**

*John Anderson,*  
*Sergeant*, Indpt. Battery, U. S. Col'd L. Art'y.

Appears on

**Battery Muster Roll**

for *May + June*, 1865.

Present or absent.....

Stoppage, \$ 100 for.....

Due Gov't, \$ 100 for.....

Valuation of horse, \$ 100

Valuation of horse equipments, \$ 100

Remarks: *Discharged from*  
*Hospital by G.O. No. 77,*  
*War Dept. April 28/65,*

Book mark: *Discharged*  
*over*

*Parler*

JAN. 17

6234482

\*1891\*

May 29/65, C. B. F. H.  
P. 513.

A | *Indpt Batty* | U.S.C.T.

*John Anderson*

*Sergt, Co. Indpt Batty* Reg't U. S. Col'd *St Arty*

Appears on a

**Detachment Muster-out Roll**

of the organization named above. Roll dated

*At Leavenworth Kas*, *May 29*, 1865.

Muster-out to date *May 29*, 1865.

Last paid to *Dec 31*, 1864

**Clothing account:**

Last settled *Nov 1864*, 186 ; drawn since \$ 100

Due soldier \$ 100; due U. S. \$ 100

Am't for cloth'g in kind or money adv'd \$ *70* <sup>*54*</sup>/<sub>100</sub>

Due U. S. for arms, equipments, &c., \$ 100

Bounty paid \$ *100* 100 due \$ 100

Remarks: *Forwarded from Hospital at Ft Leavenworth Kas and mustered out in accordance with Telegraphic order A G O War Dept May 3<sup>rd</sup> 1865*

Book mark:

*G W Hendrick*



*A* | Indpt. Battery. | **U.S.C.T.**

*John Anderson*

*Pr*....., Indpt. Battery U. S. Col'd Light Art'y.

Appears on **Batt'y Muster-out Roll**, dated

*St. Lawrence, Mo., July 22, 1865.*

Muster-out to date ..... 186 .

Last paid to *Dec 31*....., 1864.

**Clothing account:**

Last settled....., 186 ; drawn since \$ *70* <sup>*34*</sup>/<sub>*100*</sub>,

Due soldier \$.....<sup>100</sup>; due U. S. \$.....<sup>100</sup>

Am't for cloth'g in kind or money adv'd \$.....<sup>100</sup>

Due U. S. for arms, equipments, &c., \$.....<sup>100</sup>

Bounty paid \$.....<sup>100</sup>; due \$.....<sup>100</sup>

Remarks: *Discharged from Hospital on surgeons Cert. of Disability, Apl. 25/65.*

Book mark: *Discharged May 29/65, over*

*Printed*

JAN. 17

6234639

★1891★

*E. B. F. H. P. 513.*

*Anderson John*

, Co. *Qua. Batt* Reg't *W.S.C. A*

*2* Enclosures.

Bed Cards .....	Final Statements .....
Burial Records .....	Furloughs or L. of A .....
Certs. of Dis. for Discharge .....	Med. Certificates .....
C. M. Charges .....	Med. Des. Lists .....
Descriptive Lists .....	Orders .....
Discharge Certificates .....	Pris. of War Record .....
Enlistment Papers <i>2</i> .....	Resignations .....

Other papers relating to—

Admission to Hosp'l .....	Furlough or L. of A .....
Casualty Sheet .....	Med. Examination .....
Confinement .....	Misc. Information .....
Contracts .....	Pay or Clothing .....
Death or Effects .....	Personal Reports .....
Desertion .....	Rank .....
Discharge from Hosp'l .....	Transfer to Hosp'l .....
Discharge from Service .....	Transfer to V. R. C. .....
Duty .....	Transportation .....

NOTE 1.—This blank will be used for both enlistments and re-enlistments—enlistment of veterans, &c., &c., in the volunteer service. They will be made out in duplicate in all cases—one to accompany the recruiting return of the superintendent (not the recruiting officer) to the Adjutant General, and one to accompany the accounts of the officer who pays bounty, &c. The Regiment and Company in which the soldier last served should be given on the back.

NOTE 2.—An enlistment holds to service. A muster-in must, in all cases, precede payment of pay, bounty, pension, &c. A muster-in roll must, in all cases, be filed in the Adjutant General's Office as evidence of muster-in. The mustering officer, commissary, or assistant commissary of musters, as the case may be, will countersign both enlistments as having mustered the soldier into the service of the United States before either of them is given to the disbursing officer.

2nd. Aud. Nov. 23d 1892

DECLARATION OF RECRUIT.

I, John Anderson desiring to VOLUNTEER as a Soldier in the Army of the United States, for the term of THREE YEARS, Do Declare, That I am Twenty Two years and \_\_\_\_\_ months of age; that I have never been discharged from the United States service on account of disability or by sentence of a court martial, or by order before the expiration of a term of enlistment; and I know of no impediment to my serving honestly and faithfully as a soldier for three years.

GIVEN at Fort Scott, Kansas the 25th day of October 1864

Witness:

Noah C. Hanson John Anderson  
mark

No. 2

John Anderson

Volunteered at Fort Scott

This is 18th day October 64,

By Wm. Matthews Secy. Rec. Office

And B. H. Hays of 1st. Col. Artillery

\_\_\_\_\_ enlistment; last served in Company ( )

Reg't of \_\_\_\_\_

Discharged \_\_\_\_\_ 18 .

CONSENT IN CASE OF MINOR.

I, \_\_\_\_\_ Do CERTIFY, That I am the \_\_\_\_\_ of \_\_\_\_\_; that the said \_\_\_\_\_ is \_\_\_\_\_ years of age; and I do hereby freely give my CONSENT to his volunteering as a SOLDIER in the ARMY OF THE UNITED STATES for the period of THREE YEARS.

GIVEN at \_\_\_\_\_ the \_\_\_\_\_ day of \_\_\_\_\_

Witness: \_\_\_\_\_

VOLUNTEER ENLISTMENT.

STATE OF



TOWN OF

York Scott.

I, John Anderson born in Cherokee Georgia

aged Twenty 2 1/2 years, and by occupation a Farmer

Do HEREBY ACKNOWLEDGE to have volunteered this Twenty fifth day of October 1864

to serve as a Soldier in the Army of the United States of America, for the period of THREE YEARS, unless sooner discharged by proper authority:

Do also agree to accept such bounty, pay, rations, and clothing, as are, or may be, established by law for volunteers.

And I, John Anderson do solemnly swear, that I will bear true faith and allegiance to the United States of America, and that I will serve them honestly and faithfully against all their enemies or opposers whomsoever; and that I will observe and obey the orders of the President of the United States, and the orders of the officers appointed over me, according to the Rules and Articles of War.

Sworn and subscribed to, at York Scott this 25th day of October 1864

BEFORE Wm S Matthews 2d Lt & Recruiting Officer 2d Bally U S Cavd Artillery

I CERTIFY, ON HONOR, That I have carefully examined the above-named Volunteer, agreeably to the General Regulations of the Army, and that, in my opinion, he is free from all bodily defects and mental infirmity, which would in any way disqualify him from performing the duties of a soldier.

Tiffine Birks Surgeon Board of Enlistment Examining Surgeon

I CERTIFY, ON HONOR, That I have minutely inspected the Volunteer, John Anderson previously to his enlistment, and that he was entirely sober when enlisted; that, to the best of my judgment and belief, he is of lawful age; and that, in accepting him as duly qualified to perform the duties of an able-bodied soldier, I have strictly observed the Regulations which govern the recruiting service.

This soldier has Black eyes, Black hair, Brown complexion, is five feet 8 1/2 inches high.

Wm S Matthews 2d Lt & Recruiting Officer 2d Bally U S Cavd Artillery

Volunteers, RECRUITING OFFICER.

(A. G. O. No. 74 & 78.)

Mustered into the service of the United States, for three years or during the war, from date of enlistment, in Company 1st Bally U S Cavd Regiment of Artillery, on the 27th day of November 1864 at Columbus Ga

Vertical handwritten notes on the left margin: 'The recruit has received one hundred dollars advance bounty from the Bounty fund...'

Vertical handwritten notes on the right margin: 'John Anderson', 'Tiffine Birks', 'Wm S Matthews'.

NOTE 1.—This blank will be used for both enlistments and re-enlistments—enlistment of veterans, &c., &c., in the volunteer service. They will be made out in duplicate in all cases—one to accompany the recruiting return of the superintendent (not the recruiting officer) to the Adjutant General, and one to accompany the accounts of the officer who pays bounty, &c. The Regiment and Company in which the soldier last served should be given on the back.

NOTE 2.—An enlistment holds to service. A muster-in must, in all cases, precede payment of pay, bounty, pension, &c. A muster-in roll must, in all cases, be filed in the Adjutant General's Office as evidence of muster-in. The mustering officer, commissary, or assistant commissary of musters, as the case may be, will countersign both enlistments as having mustered the soldier into the service of the United States before either of them is given to the disbursing officer.

DECLARATION OF RECRUIT.

*John Anderson* desiring to VOLUNTEER as a Soldier in the Army of the United States, for the term of THREE YEARS, Do Declare, That I am *Twenty two* years and \_\_\_\_\_ months of age; that I have never been discharged from the United States service on account of disability or by sentence of a court martial, or by order before the expiration of a term of enlistment; and I know of no impediment to my serving honestly and faithfully as a soldier for three years.

GIVEN at *Fort Scott Kansas,* the *25<sup>th</sup>* day of *October, 1864.*

Witness:

*Noah C. Hanson* *John Anderson*  
*mark*

\_\_\_\_\_ enlistment; last served in Company ( )  
\_\_\_\_\_ Reg't of \_\_\_\_\_  
Discharged \_\_\_\_\_ 18 \_\_\_\_\_

*John Anderson*  
Volunteered at *Fort Scott,*  
*April 18<sup>th</sup> day October 1864,*  
By *Wm D. Matthews* 2nd Lt Recruit  
*1st Regt Artillery*

No. \_\_\_\_\_  
*7*

CONSENT IN CASE OF MINOR.

I, \_\_\_\_\_ Do CERTIFY, That I am the \_\_\_\_\_ of \_\_\_\_\_; that the said \_\_\_\_\_ is \_\_\_\_\_ years of age; and I do hereby freely give my CONSENT to his volunteering as a SOLDIER in the ARMY OF THE UNITED STATES for the period of THREE YEARS.

GIVEN at \_\_\_\_\_ the \_\_\_\_\_ day of \_\_\_\_\_

Witness: \_\_\_\_\_

VOLUNTEER ENLISTMENT.

STATE OF

TOWN OF

*Kansas*



*Fort Scott*

I, *John Anderson* born in *Cherokee*  
~~in the State of~~ *Nation* aged *Twenty two* years,  
 and by occupation a *Farmer* DO HEREBY ACKNOWLEDGE to have  
 volunteered this *Twenty fifth* day of *October* 1864  
 to serve as a **Soldier** in the **Army of the United States of America**, for  
 the period of **THREE YEARS**, unless sooner discharged by proper authority:  
 Do also agree to accept such bounty, pay, rations, and clothing, as are, or may be,  
 established by law for volunteers. And I *John Anderson* do  
 solemnly swear, that I will bear true faith and allegiance to the **United States**  
**of America**, and that I will serve them honestly and faithfully against all  
 their enemies or opposers whomsoever; and that I will observe and obey the  
 orders of the President of the United States, and the orders of the officers  
 appointed over me, according to the Rules and Articles of War.

Sworn and subscribed to, at *Fort Scott*  
 this *25<sup>th</sup>* day of *October* 1864  
 BEFORE *Wm D Matthews*  
*2nd Lt. Recruiting officer of Ind. Bat. U.S. Artillery*

I CERTIFY, ON HONOR, That I have carefully examined the above-named Volunteer, agreeably  
 to the General Regulations of the Army, and that, in my opinion, he is free from all bodily defects and  
 mental infirmity, which would in any way disqualify him from performing the duties of a soldier.

*Lizzie Binkis*  
*Surgeon Bd of Examiners*  
*Arthur D. Camp* EXAMINING SURGEON.

I CERTIFY, ON HONOR, That I have minutely inspected the Volunteer, *John Anderson*  
 previously to his enlistment, and that he was entirely sober when enlisted; that, to the best of my  
 judgment and belief, he is of lawful age; and that, in accepting him as duly qualified to perform the  
 duties of an able-bodied soldier, I have strictly observed the Regulations which govern the recruiting  
 service. This soldier has *Black* eyes, *Black* hair, *Brown* complexion, is *five*  
 feet *eight* inches high.

*Wm D Matthews*  
*2nd Lt Ind. Battery U.S. Artillery (col)*  
 Regiment of *Volunteers*  
 RECRUITING OFFICER.

(A. G. O. No. 74 & 76.)

Mustered into the service of the United States, for three years or during the war, from date of enlistment, in *Company* *the 1st*  
*Batt. U.S. Cav. Regiment of Cavalry* *Volunteers*, on the *24* day of *August* 1864 at *Fort Scott*  
*John Anderson*  
*John Anderson*  
*John Anderson*

W. D. Duff's U.S. Col'd L. Arty

*Private Private*

CARD NUMBERS.

6233607	26
6233741	27
6233890	28
6234054	29
6234191	30
6234359	31
6234522	32
9132921	33
	34
	35
	36
	37
	38
	39
	40
	41
	42
	43
	44
	45
	46
	47
	48
	49
	50

Book Mark:

See also



*D* | Indpt. Batt'y. | **U.S.C.T.**

*George Bailey*

....., Indpt. Batt'y, U. S. Col'd L. Art'y.

Appears on

**Battery Descriptive Book**

of the organization named above.

**DESCRIPTION.**

Age *20* years; height *5* feet *7* inches.

Complexion *Black*

Eyes *Black*; hair *Black*

Where born *Platte Mission*

Occupation *Labourer*

**ENLISTMENT.**

When *Dec. 4*, 186 *4*.

Where *Dr. Fort Worth Tex.*

By whom *S. Matthews*; term *3* y'rs.

Remarks: .....

.....

.....

.....

.....

.....

.....

.....

.....

.....

.....

(383g)

*Ballou*

Copyist.

B | Indpt. Battery. | **U.S.C.T.**

George Bailey

Appears with rank of Priv on

**Muster and Descriptive Roll of a Detachment of U. S. Vols. forwarded**

for the Indpt. Batt'y, U. S. Col'd L. Arty. Roll dated

Leavenworth, Kans., Dec 5, 1864.

Where born Platte Co., Missouri

Age 20 y'rs; occupation Labourer

When enlisted Dec. 4, 1864.

Where enlisted Leavenworth

For what period enlisted 3 years.

Eyes Blk; hair Blk

Complexion Blk; height 5 ft. 7 in.

When mustered in Dec. 5, 1864.

Where mustered in Leavenworth, Ks.

Bounty paid \$ 100; due \$ 100

Where credited

Battery to which assigned

Remarks: Credited to Northern District Kansas 20th Sub. Dist. 2<sup>d</sup> Ward. Leavenworth City. Leavenworth County. Vol over

Book mark:

E. L. Thariton

JAN. 17

6233608

★1891★

recruit to entitled to  
bounty.

*D* | Indpt. Battery. | **U.S.C.T.**

*George Daily*  
 *Pvt*, Indpt. Battery, U. S. Col'd L. Art'y.

Appears on

**Battery Muster-in and Descriptive Roll**

of the organization named above. Roll dated

*Leavenworth Co. Dec 23*, 1864.

Where born *Platt Co. Mo.*

Age *20* y'rs; occupation *Laborer*

When enlisted *Dec 4*, 1864.

Where enlisted *Fort Leavenworth*

For what period enlisted *3* years.

Eyes *Blue*; hair *Blue*

Complexion *Blue*; height *5* ft. *7* in.

When mustered in *Dec 5*, 1864.

Where mustered in *Leavenworth*

Bounty paid \$ *100*<sup>*00*</sup>/<sub>*100*</sub>; due \$ *200*<sup>*00*</sup>/<sub>*100*</sub>

Where credited

Battery to which assigned

Remarks: *Co. H. Dist Co*  
*20th I.D. 20th ward*  
*Leavenworth Co*

Book mark: *6100 Mo. H.*

*J. Schindler*  
(856g) Copyist.

B | Indpt. Battery. | U.S.C.T.

George Parley

Pat, Indpt. Battery, U. S. Col'd L. Art'y.

Appears on

Battery Muster Roll

for Enlistment to Dec 31, 1864.

Present or absent Present

Stoppage, \$ 100 for

Due Gov't, \$ 100 for

Valuation of horse, \$ 100

Valuation of horse equipments, \$ 100

Remarks:

Book mark:

J. Schroy

(358)

Copyist.

19

Indpt. Battery.

U.S.C.T.

George Bailey

Pot

, Indpt. Battery, U. S. Col'd L. Art'y.

Appears on

**Battery Muster Roll**

for

July & Feb

, 186

5

Present or absent

Present

Stoppage, \$

100 for

Due Gov't, \$

100 for

Valuation of horse, \$

100

Valuation of horse equipments, \$

100

Remarks:

Book mark:

(358)

J. H. Shorley

Copyist.

*B*

Indpt. Battery.

U.S.C.T.

*George Bailey*

*On*, Indpt. Battery, U. S. Col'd L. Art'y.

Appears on

**Battery Muster Roll**

for *Mar, & Apr*, 186*5*.

Present or absent *Present*

Stoppage, \$ *100* for

Due Gov't, \$ *100* for

Valuation of horse, \$ *100*

Valuation of horse equipments, \$ *100*

Remarks:

Book mark:

*Enter*

*B* | Indpt. Battery. | **U.S.C.T.**

*George Bailey*, -----

*B*, Indpt. Battery, U.S. Col'd L. Art'y.

Appears on

**Battery Muster Roll**

for *May & June*, 1865.

Present or absent *Present*

Stoppage, \$-----<sup>100</sup> for -----

Due Gov't, \$-----<sup>100</sup> for -----

Valuation of horse, \$-----<sup>100</sup>

Valuation of horse equipments, \$-----<sup>100</sup>

Remarks: -----  
-----  
-----  
-----  
-----  
-----  
-----

Book mark: -----

*Paster*

Copyist.



*P* | Indpt. Battery. | **U.S.C.T.**

*George Bailey,*  
*Co*, Indpt. Battery U. S. Col'd Light Art'y.

Appears on **Batt'y Muster-out Roll**, dated  
*W. Lawrence, Mo., July 22, 1865.*

Muster-out to date *July 22, 1865.*

Last paid to *Dec, 31, 1864.*

**Clothing account:**

Last settled....., 186 ; drawn since \$ *56* <sup>*19*</sup>/<sub>*100*</sub>,

Due soldier \$.....<sup>*100*</sup>/<sub>*100*</sub>; due U. S. \$.....<sup>*100*</sup>/<sub>*100*</sub>

Am't for cloth'g in kind or money adv'd \$.....<sup>*100*</sup>/<sub>*100*</sub>

Due U. S. for arms, equipments, &c., \$.....<sup>*100*</sup>/<sub>*100*</sub>

Bounty paid \$ *100* <sup>*100*</sup>/<sub>*100*</sub>; due \$ *none* <sup>*100*</sup>/<sub>*100*</sub>,

Remarks:.....  
.....  
.....  
.....  
.....  
.....  
.....  
.....

Book mark: *C, 100, Mo., K.*

*Paster*

*Bailey George*

, Co. *Inf. Batt. Reg't U.S.C.A.*

*3* Enclosures.

Bed Cards .....	Final Statements .....
Burial Records .....	Furloughs or L. of A. ....
Certs. of Dis. for Discharge .....	Med. Certificates .....
C. M. Charges .....	Med. Des. Lists .....
Descriptive Lists .....	Orders .....
Discharge Certificates .....	Pris. of War Record .....
Enlistment Papers <i>2</i> .....	Resignations .....

Other papers relating to—

Admission to Hosp'l .....	Furlough or L. of A. ....
Casualty Sheet .....	Med. Examination .....
Confinement .....	Misc. Information <i>/</i> .....
Contracts .....	Pay or Clothing .....
Death or Effects .....	Personal Reports .....
Desertion .....	Rank .....
Discharge from Hosp'l .....	Transfer to Hosp'l .....
Discharge from Service .....	Transfer to V. R. C. ....
Duty .....	Transportation .....

MICROFILM PUBLICATION M 1836

COMPILED MILITARY SERVICE RECORDS  
OF VOLUNTEER UNION SOLDIERS WHO SERVED WITH  
THE UNITED STATES COLORED TROOPS (USCT)  
INDEPENDENT BATTERY LIGHT ARTILLERY

PERSONAL PAPERS' TARGET SHEET

PLEASE NOTE THE CHECKED INFORMATION ABOUT THE PERSONAL PAPERS IN  
THIS FILE:

- NO PERSONAL PAPERS WERE FOUND IN THIS FILE WHEN THE  
RECORDS WERE ARRANGED FOR MICROFILMING.
- 4 PERSONAL PAPER(S) FOUND IN THIS FILE WHEN THE RECORDS  
WERE ARRANGED FOR MICROFILMING.

War Department,

ADJUTANT GENERAL'S OFFICE,

Washington, Jan 30<sup>th</sup> 1867.

Respectfully returned to the  
Commission for the State of  
Massachusetts, with the informa-  
tion that George Bowler  
was enlisted at Fort Leavenworth, Mo.  
December 1<sup>st</sup> 1864, and was  
mustered in as Pvt. in 2<sup>nd</sup> Regt.  
U. S. Co. 1<sup>st</sup> Artillery Dec. 5. 1864.

C. 100. pro.

A. B. Moore

Asst. Adj't General.

A. B.

**ENDORSEMENT.**

CERTIFICATE OF AWARD OF THE BOARD OF CLAIMS.

OFFICE OF THE BOARD OF CLAIMS,

For Slaves Enlisted or Drafted in the Service of the United States.

No. *100* *K*

APPLICATION OF

*Elizabeth A Cain*

OF

*Platts Co Mo*

for compensation for service of  
slave *George Bailey*  
enlisted *Dec 4* 1864,

in *Ind Battery light* *artillery* *Regiment,*

U. S. Colored Troops.

Received *Jan 14* 1867,

Compensation awarded,  
\_\_\_\_\_ 186 \_\_\_\_\_  
Dollars.

President Board of Claims.

P. O. Address of Applicant.

*Chipman Hosmer Esq*  
*Washington*  
*Dc*  
*atys*

\_\_\_\_\_ 186

We hereby certify that \_\_\_\_\_ of \_\_\_\_\_  
county, State of \_\_\_\_\_, having proved, under oath \_\_\_\_\_ loyalty to the Con-  
stitution and Government of the United States, and established \_\_\_\_\_ title as to the ownership of  
\_\_\_\_\_ a slave \_\_\_\_\_ and mustered  
at \_\_\_\_\_ on the \_\_\_\_\_ day of \_\_\_\_\_ 186 \_\_\_\_\_,  
by \_\_\_\_\_ in the service of the United States, in the  
\_\_\_\_\_ regiment of Colored Troops, Co. \_\_\_\_\_ the sum of \_\_\_\_\_  
dollars has been awarded to \_\_\_\_\_ by this Board, subject to the approval of the Secretary of War, as  
a compensation for the said slave, under provisions of Section 24, Act approved February 24, 1864, and  
Section 2, Act approved July 28, 1866.

\_\_\_\_\_ President of the Board.

\_\_\_\_\_ Member of the Board.

*[Signature]* Member of the Board.

To \_\_\_\_\_  
Chief of the Bureau for the  
Organization of Colored Troops, Washington, D. C.

(Form A.)

CLAIM FOR COMPENSATION FOR ENLISTED SLAVE.

No. I, Elizabeth Cain, a loyal citizen, and a resident of Missouri County of Platte State of Missouri hereby claim compensation, under the provisions of

Section 24 Act approved February 24, 1864, and Section 2, Act approved July 28, 1866, for my slave George Bailey enlisted December 1st 1864, at Lawrenceville, Mo. by Lieut. Miner in the 2nd Batty, Regiment U. S. Colored Troops, Light Co.

; certificate of which enlistment, and a descriptive list, as required, accompanying this application. I never received any certificate

In proof of my loyalty to the Constitution and Government of the United States, I present the accompanying oath, which I have taken, signed and acknowledged; to be filed with this application, in accordance with requirement of General Order, No. 329, 1863, War Department, Adjutant General's Office.

E. A. Cain

December 1st 1866.

OATH OF ALLEGIANCE.

I, Elizabeth Cain the owner and claimant, do solemnly swear that the foregoing claim is a just and true claim due to me as master and owner of the said slave, and that the facts alleged in said claim in respect to the enlistment of said slave into the military service of the United States are true. And I do further swear that I have never joined, or been concerned in any insurrection or rebellion; that I have never borne arms against the United States; that I have never given any aid, countenance, counsel or encouragement to any person or persons engaged, or whom I had reason to believe were about to engage, in insurrection, rebellion or armed hostility against the United States: that I have neither sought, nor accepted, nor attempted to exercise the functions of any office, civil or military, nor to perform any service whatever under any authority, or pretended authority, in hostility to the United States; that I have not yielded a voluntary support to any insurrection, rebellion or pretended government, authority, power or constitution within the United States, hostile thereto. And I do further swear that, to the best of my knowledge and ability, I have supported and defended, and will continue to support and defend, the United States, against all enemies, foreign and domestic, and that I have supported, defended and obeyed, and will continue to support, defend and obey, the Constitution and laws of the United States, that I will bear true faith and allegiance to the same; and that I take this oath freely, without any mental reservation or purpose of evasion. So help me God.

E. A. Cain

Sworn to and subscribed before me, at office in Platte Co. Mo. with the seal thereof, offered this 1st day of December 1866.

Geo. H. Hall Clerk Platte County Circuit Court

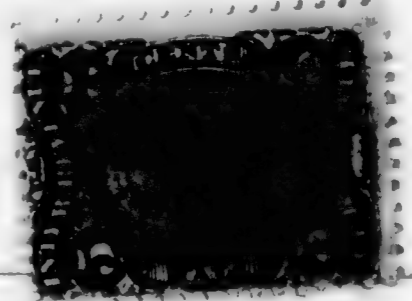

Affidavits of disinterested loyal parties will be required to prove the active loyalty of the claimant during the war.

for the adjustment of such claims, before the Departments at Washington, D. C., where the same may become necessary, and elsewhere, and in *her* name, place and stead, for *her* and in *her* name to ask, demand, recover and receive such compensation as may be awarded as aforesaid, hereby giving and granting unto *her* said Attorneys full power and authority to do and perform all and every act and thing whatsoever requisite and necessary to be done in and about the premises as full and to all intents and purposes the same as *she* might or could do were *she* personally present, hereby ratifying and confirming all *her* said Attorneys or their substitutes by their appointment shall lawfully do or cause to be done by virtue hereof; and it is understood and agreed that this Power of Attorney cannot be revoked by *her* without the consent of *her* Attorneys herein appointed.

(5) *E. A. Cain*

STATE OF *Missouri*  
County of *Platte* } ss.

On this *1st* day of *Dec* 186*6*, personally appeared before me *Geo. W. Beet* a *Justice Court* in and for the county and State aforesaid *Elizabeth W. Cain* the claimant above mentioned, and made oath to the foregoing statement by *her* subscribed, and *she* further acknowledged the signing and sealing of the foregoing Power of Attorney to be his own free binding act, for the purposes and objects therein contained and set forth; and at the same time also personally appeared the above named *Dollie Todd* and *Henry D. Park* and *H. H. Field* and *S. P. Remington* and made oath to the truth of the statements by them respectively subscribed.

Witness my hand and seal, upon the day and date first above written. *at office in Platte County Missouri Geo. W. Beet Clerk*  
(6) *Platte County Circuit Court*

[SEAL.]

INSTRUCTIONS.

- (1) State all the circumstances connected with obtaining title—when, where and how.
- (2) Signature of claimant.
- (3) Signatures of witnesses to ownership.
- (4) Signatures of witnesses to loyalty.
- (5) Signature of claimant.
- (6) Signature of Notary Public or Clerk of Court, authenticated by seal.

If title is by purchase, state date of bill of sale, and where recorded. When possible, file the bill of sale. If title is by inheritance, state when and from whom the slave was inherited, and where the will is recorded or the administrator was appointed. If claimant is a trustee, executor or administrator, he must show by the record proof that he is such. Where the same party claims compensation for more than one slave, he must file a separate claim for each.

No. *100 15*

Affidavits of Ownership and Loyalty, and Power of Attorney, in the Application of

*Elizabeth W. Cain*

For Compensation for Service of Slave.

*and H. H. Field*

CHITMAN HOSEMER & CO.  
Notaries Public, D. C.

*Elizabeth A. Cain* claimant for compensation under the Acts of Congress of February 24th, 1864, and July 28th, 1866, for *George Bailey* a slave, who was *enlisted* into the military service of the United States upon the *fourth* day of *December* 1864, having been duly sworn declares that at the date of the *enlistment* of said *George Bailey* as aforesaid, and as more fully set forth in *her* application, *she was* the lawful owner of said *George Bailey* and obtained *her* title to him in the following manner: (1)  
*She inherited said George Bailey, and owned him for at least twenty years.*

(2) *E. A. Cain*  
*Dollie Todd* a resident of *Platte* County, State of *Missouri* and *Henry D. Park* a resident of *Platte* County, State of *Missouri* having been duly sworn, declare that they are personally acquainted with *Elizabeth A. Cain* the claimant for compensation for *her* slave *George Bailey* under the Acts of Congress of February 24th, 1864, and July 28, 1866, and know that said *George Bailey* at the date of his *enlistment* into the military service of the United States, and for *15* years previous thereto was the slave of said *Elizabeth A. Cain*.  
 They also declare that they have no interest in said claim.

(3) *Dollie Todd*  
*Wm H. Field* a resident of *Platte* County, State of *Missouri* and *S. P. Remington* a resident of *Platte* County, State of *Missouri* having first been duly sworn, upon their oaths declare that they reside respectively in county of *Platte* State of *Missouri* and county of *Platte* State of *Missouri*; that they are personally acquainted with *Elizabeth A. Cain* claimant for compensation for *her* slave *George Bailey* under the Acts of Congress of February 24, 1864, and July 28, 1866, and that they know that said claimant has firmly and faithfully maintained *her* allegiance and adherence to the Government of the United States, by defending its cause against the Government of the so-called Confederate States of America, in all suitable and practicable ways, and according to *her* ability; they also swear that they have themselves maintained a like adherence and allegiance to the Government of the United States, and that they have no interest in said claim.

(4) *Wm H. Field*  
*S. P. Remington*  
 And the said *Elizabeth A. Cain* claimant further declares that in consideration of valuable services rendered and to be rendered, *she* hath and doth employ and constitute, as *her* Attorneys, **CHIPMAN, HOSMER & CO.,** Washington, D. C., to prosecute *her* claim for compensation which may be awarded to *her* as owner of said slave, by the Acts of Congress in that regard, before the Board of Claims appointed for the State of *Missouri*.



DECLARATION OF RECRUIT.

I, George Bailey desiring to VOLUNTEER as a Soldier in the Army of the United States, for the term of THREE YEARS, Do Declare, That I am (20) Twenty years and \_\_\_\_\_ months of age; that I have never been discharged from the United States service on account of disability or by sentence of a court martial, or by order before the expiration of a term of enlistment; and I know of no impediment to my serving honestly and faithfully as a soldier for three years.

GIVEN at Fort Leavenworth State of Kansas the fourth day of December 1864

Witness:

Southey Hanson

George X Bailey

NOTE 1.—This blank will be used for both enlistments and re-enlistments of veterans, &c. &c., in the volunteer service. They will be made out in duplicate in all cases—one to accompany the recruiting return of the superintendent (not the recruiting officer) to the Adjutant General, and one to accompany the accounts of the officer who pays bounty, &c. The Regiment and Company in which the soldier last served should be given on the back.

NOTE 2.—An enlistment holds to service. A muster-in must, in all cases, precede payment of pay, bounty, pension, &c. A muster-in roll must, in all cases, be filed in the Adjutant General's Office as evidence of muster-in. The mustering officer, commissary, or assistant commissary of musters, as the case may be, will countersign both enlistments as having mustered the soldier into the service of the United States before either of them is given to the disbursing officer.

Rec'd from 2nd. Aud. Nov. 23rd 1892

Discharged ..... 18  
Reg't of .....  
enlistment; last served in Company ( )

No. 17  
George Bailey  
Volunteered at Fort Leavenworth  
fourth December 1864  
By W. R. Matthews 2d Lieut  
Indep. Regt. Battery 1st U.S. Artillery

CONSENT IN CASE OF MINOR.

I, \_\_\_\_\_ Do CERTIFY, That I am \_\_\_\_\_ the \_\_\_\_\_ of \_\_\_\_\_; that the said \_\_\_\_\_ is \_\_\_\_\_ years of age; and I do hereby freely give my CONSENT to his volunteering as a SOLDIER in the ARMY OF THE UNITED STATES for the period of THREE YEARS.

GIVEN at \_\_\_\_\_ the \_\_\_\_\_ day of \_\_\_\_\_

Witness: \_\_\_\_\_

VOLUNTEER ENLISTMENT.

STATE OF

TOWN OF



*Kansas*

*Fort Leavenworth*

I, *George Bailey* born in *Platte County*  
 in the State of *Missouri* aged *20* years,  
 and by occupation a *laborer* Do HEREBY ACKNOWLEDGE to have  
 volunteered this *Fourth (4<sup>th</sup>)* day of *December* 1864,  
 to serve as a **Soldier** in the **Army of the United States of America**, for  
 the period of **THREE YEARS**, unless sooner discharged by proper authority:  
 Do also agree to accept such bounty, pay, rations, and clothing, as are, or may be,  
 established by law for volunteers. And I, *George Bailey* do  
 solemnly swear, that I will bear true faith and allegiance to the **United States**  
**of America**, and that I will serve them honestly and faithfully against all  
 their enemies or opposers whomsoever; and that I will observe and obey the  
 orders of the President of the United States, and the orders of the officers  
 appointed over me, according to the Rules and Articles of War.

Sworn and subscribed to, at *Fort Leavenworth*  
 this *Fourth* day of *December* 1864,  
 BEFORE *Wm D Matthews 2<sup>d</sup> Lt*

*George A Bailey*  
 his mark

*Recruiting 2<sup>d</sup> Battery U S Col Artillery*

I CERTIFY, ON HONOR, That I have carefully examined the above-named Volunteer, agreeably  
 to the General Regulations of the Army, and that, in my opinion, he is free from all bodily defects and  
 mental infirmity, which would in any way disqualify him from performing the duties of a soldier.

*Jesse Sinks*  
 Surg Board of Enrollment  
*North Dist Kansas*  
 EXAMINING SURGEON.

I CERTIFY, ON HONOR, That I have minutely inspected the Volunteer, *Geo Bailey*  
 previously to his enlistment, and that he was entirely sober when enlisted; that, to the best of my  
 judgment and belief, he is of lawful age; and that, in accepting him as duly qualified to perform the  
 duties of an able-bodied soldier, I have strictly observed the Regulations which govern the recruiting  
 service. This soldier has *black* eyes, *black* hair, *black* complexion, is *5*  
 feet *7* inches high.

*Wm D Matthews 2<sup>d</sup> Lt Recruiting*  
*2<sup>d</sup> Battery U S Artillery*  
 RECRUITING OFFICER.

(A. G. O. No. 74 & 76.)

Mustered into the service of the United States, for three years or during the war, from date of enlistment, in *Company* *Double*  
*Bally US Col & Regiment of Arty Light* Volunteers, on the *5<sup>th</sup>* day of *December*, 1864 at *Leavenworth KS*

The undersigned has examined the above named volunteer and finds him to be a free white male citizen of the United States of the age of 20 years and over and is qualified for the service of the United States Army.

NOTE 1.—This blank will be used for both enlistments and re-enlistments—enlistment of veterans, &c., &c., in the volunteer service. They will be made out in duplicate in all cases—one to accompany the recruiting return of the superintendent (not the recruiting officer) to the Adjutant General, and one to accompany the accounts of the officer who pays bounty, &c. The Regiment and Company in which the soldier last served should be given on the back.

NOTE 2.—An enlistment holds to service. A muster-in must, in all cases, precede payment of pay, bounty, pension, &c. A muster-in roll must, in all cases, be filed in the Adjutant General's Office as evidence of muster-in. The mustering officer, commissary, or assistant commissary of musters, as the case may be, will countersign both enlistments as having mustered the soldier into the service of the United States before either of them is given to the disbursing officer.

DECLARATION OF RECRUIT.

I, George Bailey desiring to VOLUNTEER as a Soldier in the Army of the United States, for the term of THREE YEARS, Do Declare, That I am 20 years and Twenty months of age; that I have never been discharged from the United States service on account of disability or by sentence of a court martial, or by order before the expiration of a term of enlistment; and I know of no impediment to my serving honestly and faithfully as a soldier for three years.

GIVEN at Fort Leavenworth State of Kansas the Fourth day of December 1864

Witness: Yours O. Henderson George Bailey  
Major

No. ....

George Bailey

Volunteered at Fort Leavenworth

Fourth December 1864

By W. D. Matthews Captain

Adjut. Regt. U.S. Col. Artillery

enlistment; last served in Company ( )

1st 1st Regt. of Artillery Col. Artillery

Discharged ..... 18 ..

CONSENT IN CASE OF MINOR.

I, ..... Do CERTIFY, That I am the ..... of .....; that the said ..... is ..... years of age; and I do hereby freely give my CONSENT to his volunteering as a SOLDIER in the ARMY OF THE UNITED STATES for the period of THREE YEARS.

GIVEN at ..... the ..... day of .....

Witness: .....

(A. G. O. No. 74 & 76.)

2

2035, 2d Ward

VOLUNTEER ENLISTMENT.

STATE OF



TOWN OF

Kansas

Fort Leavenworth

I, George Bailey born in Platte County  
 in the State of Missouri aged 20 years,  
 and by occupation a Labourer DO HEREBY ACKNOWLEDGE to have  
 volunteered this 4th day of December 1864,  
 to serve as a **Soldier** in the **Army of the United States of America**, for  
 the period of **THREE YEARS**, unless sooner discharged by proper authority:  
 Do also agree to accept such bounty, pay, rations, and clothing, as are, or may be,  
 established by law for volunteers. And I, George Bailey do  
 solemnly swear, that I will bear true faith and allegiance to the **United States**  
**of America**, and that I will serve them honestly and faithfully against all  
 their enemies or opposers whomsoever; and that I will observe and obey the  
 orders of the President of the United States, and the orders of the officers  
 appointed over me, according to the Rules and Articles of War.

Sworn and subscribed to, at Fort Leavenworth } George Bailey  
 this 4th day of December 1864. }  
 BEFORE Wm D Matthews }  
 Recruiting 2nd Battery U.S. Col Artillery

I CERTIFY, ON HONOR, That I have carefully examined the above-named Volunteer, agreeably  
 to the General Regulations of the Army, and that, in my opinion, he is free from all bodily defects and  
 mental infirmity, which would in any way disqualify him from performing the duties of a soldier.

Wm D Matthews  
 Surg Board of Enrollment  
North Dist Kansas  
 EXAMINING SURGEON.

I CERTIFY, ON HONOR, That I have minutely inspected the Volunteer, George Bailey  
 previously to his enlistment, and that he was entirely sober when enlisted; that, to the best of my  
 judgment and belief, he is of lawful age; and that, in accepting him as duly qualified to perform the  
 duties of an able-bodied soldier, I have strictly observed the Regulations which govern the recruiting  
 service. This soldier has black eyes, black hair, black complexion, is 5  
 feet 4 inches high.

Wm D Matthews Recruiting  
2nd Battery U.S. Col Artillery  
 RECRUITING OFFICER.

(A. G. O. No. 74 & 76.)

Mustered into the service of the United States, for three years or during the war, from date of enlistment, in Company 1st  
Battalion, 1864, at Leavenworth  
2nd Battery U.S. Col Artillery

Wm D Matthews  
2nd Battery U.S. Col Artillery

Wm D Matthews

*Private* *Private*

W. Datt'y U.S. Col'd L. Art'y

CARD NUMBERS.

6233609	26
6233742	27
6233891	28
6234055	29
6234192	30
6234360	31
6234523	32
9132923	33
	34
	35
	36
	37
	38
	39
	40
	41
	42
	43
	44
	45
	46
	47
	48
	49
	50

Book Mark: \_\_\_\_\_

See also \_\_\_\_\_

S. 2863838 Pomil

M. Spencer  
y

*D* | Indpt. Batt'y. | U.S.C.T.

*Benjamin Baker*

....., Indpt. Batt'y, U. S. Col'd L. Art'y.

Appears on

**Battery Descriptive Book**

of the organization named above.

**DESCRIPTION.**

Age *18* years; height *5* feet *5* inches.

Complexion *Mulatto*

Eyes *Brown*; hair *Black*

Where born *Fayette Missouri*

Occupation *Laborer*

**ENLISTMENT.**

When *Dec.* *4*, 186 *4*

Where *Ft. Dear "K"*

By whom *A. Mathews*; term *3* y'rs.

Remarks:

.....  
.....  
.....  
.....  
.....  
.....  
.....

*Shelbrook*

B | Indpt. Battery. | **U.S.C.T.**

*Benjamin Baker*

Appears with rank of *Priv* on

**Muster and Descriptive Roll of a Detachment of U. S. Vols. forwarded**

for the Indpt. Batt'y, U. S. Col'd L. Arty. Roll dated

*Leavenworth, Ke, Dec. 5, 1864.*

Where born *Lafayette Co., Missouri*

Age *18* y'rs; occupation *Labourer*

When enlisted *Dec. 4, 1864.*

Where enlisted *St. Leavenworth*

For what period enlisted *3* years.

Eyes *Bro*; hair *Blk*

Complexion *Mulatto*; height *5* ft. *5* in.

When mustered in *Dec. 5, 1864.*

Where mustered in *Leavenworth, Ke*

Bounty paid \$ *100*; due \$ *100*

Where credited \_\_\_\_\_

Battery to which assigned \_\_\_\_\_

Remarks: *Credited to Northern District*

*3rd Ward Leavenworth City, Leavenworth County, Vol. Recruit*

*over*

Book mark: \_\_\_\_\_

\_\_\_\_\_

*E. L. Thomson*



JAN. 17

6233609

1891\*

*referred to County*

79

Indpt. Battery.

U.S.C.T.

Benjamin Zaker

Post

Indpt. Battery, U. S. Col'd L. Art'y.

Appears on

**Battery Muster-in and Descriptive Roll**

of the organization named above. Roll dated

Lovernworth Mo. Dec 23, 1864.

Where born Lafayette Co. Mo

Age 18 y'rs; occupation Laborer

When enlisted Dec 4, 1864.

Where enlisted Fort Lovernworth Mo

For what period enlisted 3 years.

Eyes Bro; hair Y Blk

Complexion Mulatto; height 5 ft. 5 in.

When mustered in Dec 5, 1864.

Where mustered in Lovernworth

Bounty paid \$ 100; due \$ 300 <sup>00</sup>/<sub>100</sub>

Where credited

Battery to which assigned

Remarks: Co. M. Dist No.

21st SD. 3rd Ward

Lovernworth Mo.

Book mark :

J. W. Scherley

(8569)

Copyist.

73

Indpt. Battery.

U.S.C.T.

*Benjamin Baker*

*Post*, Indpt. Battery, U. S. Col'd L. Art'y.

Appears on

**Battery Muster Roll**

for *Enlistment to Dec 31, 1864.*

Present or absent *Present*

Stoppage, \$ 100 for

Due Gov't, \$ 100 for

Valuation of horse, \$ 100

Valuation of horse equipments, \$ 100

Remarks:

Book mark:

(358)

*J. H. Schrey*

Copyist.

13

Indpt. Battery. | U.S.C.T.

Benjamin Baker

Pvt., Indpt. Battery, U. S. Col'd L. Art'y.

Appears on

Battery Muster Roll

for *Jan, Feb*, 1865

Present or absent *Present*

Stoppage, \$ 100 for

Due Gov't, \$ 100 for

Valuation of horse, \$ 100

Valuation of horse equipments, \$ 100

Remarks:

Book mark:

*J. Schuster*  
(358) Copyist.

*B* | Indpt. Battery. | **U.S.C.T.**

*Benjamin Parker,*  
*B*, Indpt. Battery, U. S. Col'd L. Art'y.

Appears on

**Battery Muster Roll**

for *Mar, & Apr,* 186 *5.*

Present or absent *Present,*

Stoppage, \$ *100* for

Due Gov't, \$ *100* for

Valuation of horse, \$ *100*

Valuation of horse equipments, \$ *100*

Remarks:

Book mark:

*Parker*

(358)

Copyist.

*B* | Indpt. Battery. | **U.S.C.T.**

*Benjamin Baker,*  
*B*, Indpt. Battery, U. S. Col'd L. Art'y.

Appears on

**Battery Muster Roll**

for *May - June*, 186*5*.

Present or absent *Present,*

Stoppage, \$ 100 for

Due Gov't, \$ 100 for

Valuation of horse, \$ 100

Valuation of horse equipments, \$ 100

Remarks:

Book mark:

*Baker*

*B* | Indpt. Battery. | **U.S.C.T.**

*Benjamin Baker,*

*B*, Indpt. Battery U. S. Col'd Light Art'y.

Appears on **Batt'y Muster-out Roll**, dated

*W. Secumouth, Kas, July 27, 1865.*

Muster-out to date *July 22,* 1865.

Last paid to *Dec. 31,* 1864.

Clothing account:

Last settled....., 186 ; drawn since \$ ~~44~~ <sup>84</sup> 100,

Due soldier \$..... 100; due U. S. \$..... 100

Am't for cloth'g in kind or money adv'd \$..... 100

Due U. S. for arms, equipments, &c., \$..... 100

Bounty paid \$ *None* 100; due \$ *100* 100,

Remarks:.....

.....  
.....  
.....  
.....  
.....  
.....

Book mark:.....

*Parter*

*Baker Benjamin*

Co. *1st. Batt. U.S.C.A.* Reg't

*2* Enclosures.

Bed Cards .....	Final Statements .....
Burial Records .....	Furloughs or L. of A. ....
Certs. of Dis. for Discharge .....	Med. Certificates .....
C. M. Charges .....	Med. Des. Lists .....
Descriptive Lists .....	Orders .....
Discharge Certificates .....	Pris. of War Record .....
Enlistment Papers .....	Resignations .....

Other papers relating to—

Admission to Hosp'l .....	Furlough or L. of A. ....
Casualty Sheet .....	Med. Examination .....
Confinement .....	Misc. Information .....
Contracts .....	Pay or Clothing .....
Death or Effects .....	Personal Reports .....
Desertion .....	Rank .....
Discharge from Hosp'l .....	Transfer to Hosp'l .....
Discharge from Service .....	Transfer to V. R. C. ....
Duty .....	Transportation .....



DECLARATION OF RECRUIT.

NOTE 1.—This blank will be used for both enlistments and re-enlistments—enlistment of veterans, &c., &c., in the volunteer service. They will be made out in duplicate in all cases—one to accompany the recruiting return of the superintendent (not the recruiting officer) to the Adjutant General, and one to accompany the accounts of the officer who pays bounty, &c. The Regiment and Company in which the soldier last served should be given on the back.  
NOTE 2.—An enlistment holds to service. A muster-in must, in all cases, precede payment of pay, bounty, pension, &c. A muster-in roll must, in all cases, be filed in the Adjutant General's Office as evidence of muster-in. The mustering officer, commissary, or assistant commissary of musters, as the case may be, will countersign both enlistments as having mustered the soldier into the service of the United States before either of them is given to the disbursing officer.

I, Benjamin Baker desiring to VOLUNTEER as a Soldier in the Army of the United States, for the term of THREE YEARS, Do Declare, That I am 18 Eighteen years and \_\_\_\_\_ months of age; that I have never been discharged from the United States service on account of disability or by sentence of a court martial, or by order before the expiration of a term of enlistment; and I know of no impediment to my serving honestly and faithfully as a soldier for three years.

GIVEN at Fort Leavenworth State of Kansas the Fourth day of December 1864

Witness: Benjamin Wilson Benjamin Baker

No. 12  
Benjamin Baker  
Volunteered at Fort Leavenworth  
Fourth December 1864  
By Wm E Matthews Quartermaster  
Adj't M & C's Artillery  
..... enlistment; last served in Company ( )  
Reg't of .....  
Discharged ..... 18 ..

CONSENT IN CASE OF MINOR.

I, ..... Do CERTIFY, That I am the ..... of .....; that the said ..... is ..... years of age; and I do hereby freely give my CONSENT to his volunteering as a SOLDIER in the ARMY OF THE UNITED STATES for the period of THREE YEARS.

GIVEN at ..... the ..... day of .....

Witness: .....

21<sup>st</sup> S. 3<sup>rd</sup> Ward

VOLUNTEER ENLISTMENT.

STATE OF



TOWN OF

Kansas

Fort Leavenworth

I, Benjamin Baker born in La Fayette County  
 in the State of Missouri aged 18 years,  
 and by occupation a Laborer Do HEREBY ACKNOWLEDGE to have  
 volunteered this 4<sup>th</sup> day of December 1864,  
 to serve as a Soldier in the Army of the United States of America, for  
 the period of THREE YEARS, unless sooner discharged by proper authority:  
 Do also agree to accept such bounty, pay, rations, and clothing, as are, or may be,  
 established by law for volunteers. And I, Benjamin Baker do  
 solemnly swear, that I will bear true faith and allegiance to the United States  
 of America, and that I will serve them honestly and faithfully against all  
 their enemies or opposers whomsoever; and that I will observe and obey the  
 orders of the President of the United States, and the orders of the officers  
 appointed over me, according to the Rules and Articles of War.

Sworn and subscribed to, at Fort Leavenworth  
 this 4<sup>th</sup> day of December 1864, Benjamin Baker  
 BEFORE Wm D Matthews 2<sup>nd</sup> Lt Recruiting Officer  
 1<sup>st</sup> Battery U.S. Col Artillery Light

I CERTIFY, ON HONOR, That I have carefully examined the above-named Volunteer, agreeably  
 to the General Regulations of the Army, and that, in my opinion, he is free from all bodily defects and  
 mental infirmity, which would in any way disqualify him from performing the duties of a soldier.

Tiffin Sinks  
 Surg Board of Enrollment  
 North Dist Kansas  
 EXAMINING SURGEON.

I CERTIFY, ON HONOR, That I have minutely inspected the Volunteer, Benjamin Baker  
 previously to his enlistment, and that he was entirely sober when enlisted; that, to the best of my  
 judgment and belief, he is of lawful age; and that, in accepting him as duly qualified to perform the  
 duties of an able-bodied soldier, I have strictly observed the Regulations which govern the recruiting  
 service. This soldier has brown eyes, black hair, yellow complexion, is 5  
 feet 5 inches high.

Wm D Matthews 2<sup>nd</sup> Lt Recruiting  
 1<sup>st</sup> Battery U.S. Col Artillery  
 RECRUITING OFFICER.

Mustered into the service of the United States, for three years or during the war, from date of enlistment, in ~~Company~~ **Company** ~~Light~~ **Light** ~~Vol~~ **Vol** on the **4<sup>th</sup>** day of **December**, 1864, at **Leavenworth** ~~Mo~~ **Kans**  
 Battery U.S. Col Artillery Light Vol on the 4<sup>th</sup> day of December, 1864, at Leavenworth Kans  
 Tiffin Sinks  
 Surg Board of Enrollment  
 North Dist Kansas  
 Wm D Matthews 2<sup>nd</sup> Lt Recruiting  
 1<sup>st</sup> Battery U.S. Col Artillery  
 RECRUITING OFFICER.

NOTE 1.—This blank will be used for both enlistments and re-enlistments—enlistment of veterans, &c., &c., in the volunteer service. They will be made out in duplicate in all cases—one to accompany the recruiting return of the superintendent (not the recruiting officer) to the Adjutant General, and one to accompany the accounts of the officer who pays bounty, &c. The Regiment and Company in which the soldier last served should be given on the back.

NOTE 2.—An enlistment holds to service. A muster-in must, in all cases, precede payment of pay, bounty, pension, &c. A muster-in roll must, in all cases, be filed in the Adjutant General's Office as evidence of muster-in. The mustering officer, commissary, or assistant commissary of musters, as the case may be, will countersign both enlistments as having mustered the soldier into the service of the United States before either of them is given to the disbursing officer.

DECLARATION OF RECRUIT.

I, Benjamin Baker desiring to VOLUNTEER as a Soldier in the Army of the United States, for the term of THREE YEARS, Do Declare, That I am (18) Eighteen years and \_\_\_\_\_ months of age; that I have never been discharged from the United States service on account of disability or by sentence of a court martial, or by order before the expiration of a term of enlistment; and I know of no impediment to my serving honestly and faithfully as a soldier for three years.

GIVEN at Fort Leavenworth State of Kansas the Fourth day of December 1864

Witness:

Benjamin Wilson Benjamin Baker  
*his mark*

No. ....

Benjamin Baker  
 Volunteered at Fort Leavenworth  
Fourth December 1864,  
 By W. S. Matthews & Rank  
Adjutant Regiment 11th Infantry

..... enlistment; last served in Company ( )  
W. S. Matthews Regt of Colored Artillery  
 Discharged ..... 18 .....

CONSENT IN CASE OF MINOR.

I, ..... Do CERTIFY, That I am .....; that the ..... of .....; that the ..... is ..... years of age; and I do hereby freely give my CONSENT to his volunteering as a SOLDIER in the ARMY OF THE UNITED STATES for the period of THREE YEARS.

GIVEN at ..... the ..... day of .....

Witness:

VOLUNTEER ENLISTMENT.

STATE OF

TOWN OF

*Kansas*



*Fort Leavenworth*

I, *Benjamin Baker* born in *La Fayette County*  
 in the State of *Missouri* aged *(18) Eighteen* years,  
 and by occupation a *Laborer* DO HEREBY ACKNOWLEDGE to have  
 volunteered this *4th* *Fourth* day of *December* 1864,  
 to serve as a **Soldier** in the **Army of the United States of America**, for  
 the period of **THREE YEARS**, unless sooner discharged by proper authority:  
 Do also agree to accept such bounty, pay, rations, and clothing, as are, or may be,  
 established by law for volunteers. And I, *Benjamin Baker* do  
 solemnly swear, that I will bear true faith and allegiance to the **United States**  
**of America**, and that I will serve them honestly and faithfully against all  
 their enemies or opposers whomsoever; and that I will observe and obey the  
 orders of the President of the United States, and the orders of the officers  
 appointed over me, according to the Rules and Articles of War.

Sworn and subscribed to, at *Fort Leavenworth*  
 this *4th* day of *December* 1864, *Benjamin Baker*  
 BEFORE *Wm D Matthews 2nd Lt* *mark*

*Recruiting 2nd Battery U.S. Col Artillery Light*

I CERTIFY, ON HONOR, That I have carefully examined the above-named Volunteer, agreeably  
 to the General Regulations of the Army, and that, in my opinion, he is free from all bodily defects and  
 mental infirmity, which would in any way disqualify him from performing the duties of a soldier.

*Tiffin Sinks*  
*Surg Board of Enrollment*  
*North Dist Kansas*  
 EXAMINING SURGEON.

I CERTIFY, ON HONOR, That I have minutely inspected the Volunteer, *Benjamin Baker*  
 previously to his enlistment, and that he was entirely sober when enlisted; that, to the best of my  
 judgment and belief, he is of lawful age; and that, in accepting him as duly qualified to perform the  
 duties of an able-bodied soldier, I have strictly observed the Regulations which govern the recruiting  
 service. This soldier has *blue* eyes, *black* hair, *medium* complexion, is *5-*  
 feet *5* inches high.

*Wm D Matthews 2nd Lt*  
*Recruiting 2nd Battery U.S. Col Artillery*  
 RECRUITING OFFICER.

(A. G. O. No. 74 & 76.)

Mustered into the service of the United States, for three years or during the war, from date of enlistment, in *Company* *1st*  
*Battalion* *1st* *Regiment of* *Artillery Light* *Volunteers*, on the *5th* day of *November*, 1864, at *Leavenworth Kan*  
*Benjamin Baker*  
*Capt 2nd Artillery Light*  
*Wm D Matthews 2nd Lt*  
*Recruiting 2nd Battery U.S. Col Artillery*

Batt'y U.S. Col'd L. Art'y

Private Private

CARD NUMBERS.

6233729	26
6233841	27
623405-2	28
6234326	29
6234641	30
9132910	31
	32
	33
	34
	35
	36
	37
	38
	39
	40
	41
	42
	43
	44
	45
	46
	47
	48
	49
	50

Book Mark:

See also:

*J* | Indpt. Batt'y. | **U.S.C.T.**

*James Bayson*

....., Indpt. Batt'y, U. S. Col'd L. Art'y.

Appears on

**Battery Descriptive Book**

of the organization named above.

**DESCRIPTION.**

Age *40* years; height *5* feet *5* inches.

Complexion *Black*

Eyes *Black*; hair *Black*

Where born *Mason Co. Ky*

Occupation *Farmer*

**ENLISTMENT.**

When *July 20*, 186*4*.

Where *Leav. Pls*

By whom *A. Matthews*; term *3* y'rs.

Remarks: .....

.....  
.....  
.....  
.....  
.....  
.....  
.....  
.....  
.....  
.....

*Shelton*

(383g)

Copyist.

B

Indpt. Battery. U.S.C.T.

James B. Mion  
Pot, Indpt. Battery, U. S. Col'd L. Art'y.

Appears on

Battery Muster-in and Descriptive Roll  
of the organization named above. Roll dated  
Leavenworth Mo Dec 23, 1864.

Where born Mason Co, Ky

Age 40 y'rs; occupation Farmer

When enlisted July 20, 1864.

Where enlisted Leavenworth Mo

For what period enlisted 3 years.

Eyes Blue; hair Blue

Complexion Brown; height 5 ft. 5 in.

When mustered in July 22, 1864.

Where mustered in Leavenworth

Bounty paid \$100<sup>00</sup>/<sub>100</sub>; due \$200<sup>00</sup>/<sub>100</sub>

Where credited

Battery to which assigned

Remarks: C. M. Dist Co,  
22d S. D. # 1 Ward  
Leavenworth Mo

Book mark :

J. Schrey  
(856g) Copyist.

73

Indpt. Battery.

U.S.C.T.

James Banyon  
Pot

, Indpt. Battery, U. S. Col'd L. Art'y.

Appears on

**Battery Muster Roll**

for *Admission to Dec 31, 1864*

Present or absent *Present*

Stoppage, \$ 100 for

Due Gov't, \$ 100 for

Valuation of horse, \$ 100

Valuation of horse equipments, \$ 100

Remarks:

Book mark:

(358)

*J. H. Schrey*

Copyist.



79

Indpt. Battery.

U.S.C.T.

James Banyon  
Pot

, Indpt. Battery, U. S. Col'd L. Art'y.

Appears on

**Battery Muster Roll**

for

Jan Feb

, 1865

Present or absent

Present

Stoppage, \$

100 for

Due Gov't, \$

100 for

Valuation of horse, \$

100

Valuation of horse equipments, \$

100

Remarks:

Book mark:

J. Scherby

(358)

Copyist.

*B* | Indpt. Battery. | **U.S.C.T.**

*James Bayan,*  
*Pr*, Indpt. Battery, U. S. Col'd L. Art'y.

Appears on

**Battery Muster Roll**

for *Mar & Apr*, 1865.

Present or absent

Stoppage, \$ 100 for

Due Gov't, \$ 100 for

Valuation of horse, \$ 100

Valuation of horse equipments, \$ 100

Remarks: *Discharged on  
Surgeons Certificate of  
Disability Apr. 21/65.*

Book mark:

*Porter*

(358)

Copyist.

*J* | Indpt. Battery. | **U.S.C.T.**

*James Pinyan,*  
*A*, Indpt. Battery U. S. Col'd Light Art'y.

Appears on **Batt'y Muster-out Roll**, dated  
*St. Lawrence, Mo., July 22, 1865.*

Muster-out to date \_\_\_\_\_, 186 .

Last paid to \_\_\_\_\_, 186 .

**Clothing account:**

Last settled \_\_\_\_\_, 186 ; drawn since \$ <sup>x</sup> *74* / *100*

Due soldier \$ \_\_\_\_\_ *100*; due U. S. \$ \_\_\_\_\_ *100*

Am't for cloth'g in kind or money adv'd \$ \_\_\_\_\_ *100*

Due U. S. for arms, equipments, &c., \$ \_\_\_\_\_ *100*

Bounty paid \$ \_\_\_\_\_ *100*; due \$ \_\_\_\_\_ *100*

Remarks: *Discharged on*  
*Surgeon's Cert. of Disabl.*  
*Apr. 21/65.*

Book mark: *P. 162, Mo. K., CD,*  
*& Company*

*Porter*

*Bunions James*

....., Co. *Luc. Bato* Reg't *W.S.C.S.*

*B/* Enclosures.

Bed Cards .....	Final Statements .....
Burial Records .....	Furloughs or L. of A. ....
Certs. of Dis. for Discharge/ .....	Med. Certificates .....
C. M. Charges .....	Med. Des. Lists .....
Descriptive Lists .....	Orders .....
Discharge Certificates .....	Pris. of War Record .....
Enlistment Papers ..... <i>3</i>	Resignations .....

Other papers relating to—

Admission to Hosp'l .....	Furlough or L. of A. ....
Casualty Sheet .....	Med. Examination .....
Confinement .....	Misc. Information .....
Contracts .....	Pay or Clothing .....
Death or Effects .....	Personal Reports .....
Desertion .....	Rank .....
Discharge from Hosp'l .....	Transfer to Hosp'l .....
Discharge from Service .....	Transfer to V. R. C. ....
Duty .....	Transportation .....
.....	.....

MICROFILM PUBLICATION M 1836

COMPILED MILITARY SERVICE RECORDS  
OF VOLUNTEER UNION SOLDIERS WHO SERVED WITH  
THE UNITED STATES COLORED TROOPS (USCT)  
INDEPENDENT BATTERY LIGHT ARTILLERY

PERSONAL PAPERS' TARGET SHEET

PLEASE NOTE THE CHECKED INFORMATION ABOUT THE PERSONAL PAPERS IN  
THIS FILE:

- NO PERSONAL PAPERS WERE FOUND IN THIS FILE WHEN THE  
RECORDS WERE ARRANGED FOR MICROFILMING.
- 6 PERSONAL PAPER(S) FOUND IN THIS FILE WHEN THE RECORDS  
WERE ARRANGED FOR MICROFILMING.

DECLARATION OF RECRUIT.

I, James Bunion desiring to VOLUNTEER as a Soldier in the Army of the United States, for the term of THREE YEARS Do Declare, That I am 40 years and 0 months of age; that I have never been discharged from the United States service on account of disability or by sentence of a court martial, or by order before the expiration of a term of enlistment; and I know of no impediment to my serving honestly and faithfully as a soldier for three years.

GIVEN at Leavenworth City - State of Kansas the 20 day of July 1864

Witness:

W. A. Burnham

James Bunion his mark

NOTE 1.—This blank will be used for both enlistments and re-enlistments—enlistment of veterans, &c., &c., in the volunteer service. They will be made out in duplicate in all cases—one to accompany the recruiting return of the superintendent (not the recruiting officer) to the Adjutant General, and one to accompany the accounts of the officer who pays bounty, &c. The Regiment and Company in which the soldier last served should be given on the back.

NOTE 2.—An enlistment holds no service. A muster-in must, in all cases, precede payment of pay, bounty, pension, &c. A muster-in roll must, in all cases, be filed in the Adjutant General's Office as evidence of muster-in. The mustering officer, commissary, or assistant commissary of musters, as the case may be, will countersign both enlistments as having mustered the soldier into the service of the United States before either of them is given to the disbursing officer.

No. 14

James Bunion  
Volunteered at Leavenworth City

July 20 1864

By Wm. D. Matthews

2nd Iowa Regiment, 25th U.S. Infantry

Company 1st Battalion

enlistment; last served in Company ( )

Reg't of \_\_\_\_\_

Discharged \_\_\_\_\_ 1864

CONSENT IN CASE OF MINOR.

I, \_\_\_\_\_ Do CERTIFY, That I am the \_\_\_\_\_ of \_\_\_\_\_; that the said \_\_\_\_\_ is \_\_\_\_\_ years of age; and I do hereby freely give my CONSENT to his volunteering as a SOLDIER in the ARMY OF THE UNITED STATES for the period of THREE YEARS.

GIVEN at \_\_\_\_\_ the \_\_\_\_\_ day of \_\_\_\_\_

Witness:

VOLUNTEER ENLISTMENT.

STATE OF

TOWN OF

*Kansas*



*Leavenworth City*

I, *John Banion* born in *Mason County*  
 in the State of *Kentucky* aged *40* years,  
 and by occupation a *Furner* Do HEREBY ACKNOWLEDGE to have  
 volunteered this *21<sup>st</sup>* day of *July* 186*4*  
 to serve as a **Soldier** in the **Army of the United States of America**, for  
 the period of **THREE YEARS**, unless sooner discharged by proper authority:  
 Do also agree to accept such bounty, pay, rations, and clothing, as are, or may be,  
 established by law for volunteers. And I, \_\_\_\_\_ do  
 solemnly swear, that I will bear true faith and allegiance to the **United States**  
**of America**, and that I will serve them honestly and faithfully against all  
 their enemies or opposers whomsoever; and that I will observe and obey the  
 orders of the President of the United States, and the orders of the officers  
 appointed over me, according to the Rules and Articles of War.

Sworn and subscribed to, at *Leavenworth City* } *his*  
 this *20* day of *July* 186*4* } *John Banion*  
 BEFORE *Wm. D. Matthews 2<sup>nd</sup>* } *mark*  
*Lieut Recruiting Co, K 2<sup>nd</sup> U.S. Col<sup>d</sup> Artillery*

I CERTIFY, ON HONOR, That I have carefully examined the above-named Volunteer, agreeably to the General Regulations of the Army, and that, in my opinion, he is free from all bodily defects and mental infirmity, which would in any way disqualify him from performing the duties of a soldier.

*Wm. D. Matthews*  
*Sur Board of Enrollment*  
*North<sup>th</sup> Dist<sup>ct</sup> Kansas*  
 EXAMINING SURGEON.

I CERTIFY, ON HONOR, That I have minutely inspected the Volunteer, \_\_\_\_\_ previously to his enlistment, and that he was entirely sober when enlisted; that, to the best of my judgment and belief, he is of lawful age; and that, in accepting him as duly qualified to perform the duties of an able-bodied soldier, I have strictly observed the Regulations which govern the recruiting service. This soldier has *Black* eyes, *Black* hair, *Black* complexion, is *5* feet *5* inches high.

*Wm. D. Matthews 2<sup>nd</sup>*  
*Recruiting Co, K, 2<sup>nd</sup> U.S. Col<sup>d</sup> Artillery*  
 Regiment of \_\_\_\_\_ Volunteers,  
 RECRUITING OFFICER.

Mustered into the service of the United States, for three years or during the war, from date of enlistment, in Company \_\_\_\_\_  
 Regiment of \_\_\_\_\_ Volunteers, on the \_\_\_\_\_ day of \_\_\_\_\_, 186*4*, at \_\_\_\_\_

DECLARATION OF RECRUIT.

I, James Bunion desiring to VOLUNTEER as a Soldier in the Army of the United States, for the term of THREE YEARS Do Declare, That I am 40 years and 10 months of age; that I have never been discharged from the United States service on account of disability or by sentence of a court martial, or by order before the expiration of a term of enlistment, and I know of no impediment to my serving honestly and faithfully as a soldier for three years.

GIVEN at Leavenworth City - State of Kansas the 20 day of July 1864

Witness: W.A. Burnham James Bunion his mark

NOTE 1.—This blank will be used for both enlistments and re-enlistments—enlistment of veterans, &c., &c., in the volunteer service. They will be made out in duplicate in all cases—one to accompany the recruiting return of the superintendent (not the recruiting officer) to the Adjutant General, and one to accompany the accounts of the officer who pays bounty, &c. The Regiment and Company in which the soldier last served should be given on the back.  
NOTE 2.—An enlistment holds to service. A muster-in must, in all cases, precede payment of pay, bounty, pension, &c. A muster-in roll must, in all cases, be filed in the Adjutant General's Office as evidence of muster-in. The mustering officer, commissary, or assistant commissary of musters, as the case may be, will countersign both enlistments as having mustered the soldier into the service of the United States before either of them is given to the disbursing officer.

Discharged \_\_\_\_\_ 18 \_\_\_\_  
enlistment; last served in Company ( )  
Reg't of \_\_\_\_\_

James Bunion  
Volunteered at Leavenworth City -  
July 21 1864,  
By Lieut. W.D. Matthews 2nd Lieut  
Recruiting Co. H, 20th U.S. Col. Inf.  
Regiment of \_\_\_\_\_

No. 14

CONSENT IN CASE OF MINOR.

I, \_\_\_\_\_ Do CERTIFY, That I am the \_\_\_\_\_ of \_\_\_\_\_; that the said \_\_\_\_\_ is \_\_\_\_\_ years of age; and I do hereby freely give my CONSENT to his volunteering as a SOLDIER in the ARMY OF THE UNITED STATES for the period of THREE YEARS.

GIVEN at \_\_\_\_\_ the \_\_\_\_\_ day of \_\_\_\_\_

Witness: \_\_\_\_\_

(A. G. O. No. 74 & 75.)



VOLUNTEER ENLISTMENT.

STATE OF

TOWN OF

Kansas



Leavenworth City

I, James Bunion born in Mason County  
 in the State of Kentucky aged 40 years,  
 and by occupation a Farmer Do HEREBY ACKNOWLEDGE to have  
 volunteered this 20 day of July 1864  
 to serve as a **Soldier** in the **Army of the United States of America**, for  
 the period of **THREE YEARS**, unless sooner discharged by proper authority:  
 Do also agree to accept such bounty, pay, rations, and clothing, as are, or may be,  
 established by law for volunteers. And I, James Bunion do  
 solemnly swear, that I will bear true faith and allegiance to the **United States**  
**of America**, and that I will serve them honestly and faithfully against all  
 their enemies or opposers whomsoever; and that I will observe and obey the  
 orders of the President of the United States, and the orders of the officers  
 appointed over me, according to the Rules and Articles of War.

Sworn and subscribed to, at Leavenworth } his  
 this 20 day of July 1864 } James Bunion  
 BEFORE Wm. D. Matthews 2<sup>nd</sup> } mark  
Lieut, Recruiting Co, K, 2<sup>nd</sup> U.S. Col Artillery

I CERTIFY, ON HONOR, That I have carefully examined the above-named Volunteer, agreeably  
 to the General Regulations of the Army, and that, in my opinion, he is free from all bodily defects and  
 mental infirmity, which would in any way disqualify him from performing the duties of a soldier.

Tiffin Sinko  
Surg Board of Enrollment  
North Dist. Kansas  
 EXAMINING SURGEON.

I CERTIFY, ON HONOR, That I have minutely inspected the Volunteer,  
 previously to his enlistment, and that he was entirely sober when enlisted; that, to the best of my  
 judgment and belief, he is of lawful age; and that, in accepting him as duly qualified to perform the  
 duties of an able-bodied soldier, I have strictly observed the Regulations which govern the recruiting  
 service. This soldier has Black eyes, Black hair, Black complexion, is 5  
 feet 5 inches high.

Wm. D. Matthews 2<sup>nd</sup> Lieut  
Recruiting Co, K, 2<sup>nd</sup> U.S. Col Artillery  
 Regiment of Volunteers,  
 RECRUITING OFFICER.

Mustered into the service of the United States, for three years or during the war, from date of enlistment, in Company         
 Regiment of        Volunteers, on the 20 day of July, 1864, at Leavenworth, Kansas

DECLARATION OF RECRUIT.

x, James Bunion desiring to VOLUNTEER as a Soldier in the Army of the United States, for the term of THREE YEARS Do Declare, That I am 40 years and 0 months of age; that I have never been discharged from the United States service on account of disability or by sentence of a court martial, or by order before the expiration of a term of enlistment; and I know of no impediment to my serving honestly and faithfully as a soldier for three years.

GIVEN at Leavenworth Co - State Kansas the 20 day of July 1864

Witness:

W. H. Bunker James Bunion  
mark

NOTE 1.—This blank will be used for both enlistments and re-enlistments—enlistment of veterans, &c., &c., in the volunteer service. They will be made out in duplicate in all cases—one to accompany the recruiting return of the superintendent (not the recruiting officer) to the Adjutant General, and one to accompany the accounts of the officer who pays bounty, &c. The Regiment and Company in which the soldier last served should be given on the back.

NOTE 2.—An enlistment holds to service. A muster-in must, in all cases, precede payment of pay, bounty, pension, &c. A muster-in roll must, in all cases, be filed in the Adjutant General's Office as evidence of muster-in. The mustering officer, commissary, or assistant commissary of musters, as the case may be, will countersign both enlistments as having mustered the soldier into the service of the United States before either of them is given to the disbursing officer.

Aud. Nov. 23d 1892

Discharged \_\_\_\_\_ 18 .

Reg't of \_\_\_\_\_

Enlistment; last served in Company ( )

By Wm. D. Matthews 2nd Lieut  
Recruiting Co. K. 2nd U.S. Cavalry  
Regiment of \_\_\_\_\_

Volunteered at Leavenworth Co -  
July 20 1864,  
James Bunion

No. 422

CONSENT IN CASE OF MINOR.

I, \_\_\_\_\_ Do CERTIFY, That I am the \_\_\_\_\_ of \_\_\_\_\_; that the said \_\_\_\_\_ is \_\_\_\_\_ years of age; and I do hereby freely give my CONSENT to his volunteering as a SOLDIER in the ARMY OF THE UNITED STATES for the period of THREE YEARS.

GIVEN at \_\_\_\_\_ the \_\_\_\_\_ day of \_\_\_\_\_

Witness: \_\_\_\_\_

VOLUNTEER ENLISTMENT.

STATE OF

*Kansas*



TOWN OF

*Leavenworth City*

I, *James Bunion* born in *Mason County*  
 in the State of *Kentucky* aged *40* years,  
 and by occupation a *Farmer* DO HEREBY ACKNOWLEDGE to have  
 volunteered this *20* day of *July* 186*4*  
 to serve as a **Soldier** in the Army of the United States of America, for  
 the period of **THREE YEARS**, unless sooner discharged by proper authority:  
 Do also agree to accept such bounty, pay, rations, and clothing, as are, or may be,  
 established by law for volunteers. And I, *James Bunion* do  
 solemnly swear, that I will bear true faith and allegiance to the **United States**  
**of America**, and that I will serve them honestly and faithfully against all  
 their enemies or opposers whomsoever; and that I will observe and obey the  
 orders of the President of the United States, and the orders of the officers  
 appointed over me, according to the Rules and Articles of War.

Sworn and subscribed to, at *Leavenworth City*  
 this *20* day of *July* 186*4* *James Bunion*  
 BEFORE *Wm D Matthews* *2nd Lieut*  
*Lieut - Recruiting Co. K. 2nd U.S. Col'd Artillery*

I CERTIFY, ON HONOR, That I have carefully examined the above-named Volunteer, agreeably  
 to the General Regulations of the Army, and that, in my opinion, he is free from all bodily defects and  
 mental infirmity, which would in any way disqualify him from performing the duties of a soldier.

*Tiffin Brinton*  
 Surg Board of Enrollment  
*North Dist Kansas*  
 EXAMINING SURGEON.

I CERTIFY, ON HONOR, That I have minutely inspected the Volunteer, \_\_\_\_\_  
 previously to his enlistment, and that he was entirely sober when enlisted; that, to the best of my  
 judgment and belief, he is of lawful age; and that, in accepting him as duly qualified to perform the  
 duties of an able-bodied soldier, I have strictly observed the Regulations which govern the recruiting  
 service. This soldier has *Blue* eyes, *Blue* hair, *Blue* complexion, is *5*  
 feet *5* inches high.

*Wm D Matthews* *2nd Lieut*  
*Recruiting Co. K. 2nd U.S. Col'd Artillery*  
 \_\_\_\_\_  
 Regiment of \_\_\_\_\_ Volunteers,  
 RECRUITING OFFICER.

(A. G. O. No. 74 & 76.)

*This recruit has received one hundred dollars advance bounty from the County fund, authorized by Act of Congress, approved March 3rd 1862, and Circular No 24, from the Provost Marshal General, dated March 15th 1862.*

Mustered into the service of the United States, for three years or during the war, from date of enlistment, in Company \_\_\_\_\_, Regiment of *1st* *Volunteers*, on the *22* day of *July*, 186*4*, at *Leavenworth*

*Company Quartermaster*  
*1st* *Volunteers*  
*Leavenworth*

NOTE 1.

The company commander will here add a statement of all the facts known to him concerning the disease or wound, or cause of disability of the soldier; the time, place, manner, and all the circumstances under which the injury occurred, or disease originated or appeared; the duty, or service, or situation of the soldier at the time the injury was received or disease contracted, stating particularly whether the injury was received or the disease contracted in the line of his duty; and whatever other facts may aid a judgment as to the cause, immediate or remote, of the disability, and the circumstances attending it.

When the facts are not known to the company commander, the certificate of any officer, or affidavit of other person having such knowledge, will be appended—as the surgeon in charge of a hospital, the officer commanding a detachment of recruits, &c., &c.

NOTE 2.

When a probable case for pension, special care must be taken to state the degree of disability—as 1/2, 3/4, &c., &c.; to describe particularly the disability, wound, or disease; the extent of which it deprives him of the use of any limb or faculty, or affects his health, strength, activity, constitution, or capacity to labor or earn his subsistence. The surgeon will add, from his knowledge of the facts and circumstances, and from the evidence in the case, his professional opinion of the cause or origin of the disability. In the case of discharges by Medical Inspectors, the last paragraph will state that the "discharge was given by consent of the soldier, after a personal examination, and for disability, the nature, degree, and origin of which are correctly described in the within certificate."

Par. 1260 Regulations, Edit. 1861.

Medical officers, in giving certificates of disability, are to take particular care in all cases that have not been under their charge; and especially in epilepsy, convulsions, chronic rheumatism, derangement of the urinary organs, ophthalmia, ulcers, or any obscure disease liable to be feigned or purposely produced; and in no case shall such certificate be given until after sufficient time and examination to detect any attempt at deception.

DIRECTIONS.

This certificate will be made out in duplicate by the soldier's company commander, or other officer commanding the separate detachment to which he belongs, and sent by him to the surgeon who has charge of the hospital where the soldier is sick. The surgeon will then fill out and sign the surgeon's certificate, and forward these papers to the regimental, detachment, or post commander, who will forward them, with his action endorsed thereon, through the proper channel, to his division commander; or, if the troops are not attached to a division, to his corps, department, or other commander or officer to whom the authority to discharge enlisted men may be specially delegated.

These certificates, after having received the action of the highest authority to which they are required to be sent, will be returned through the same channel to the regimental, post, or detachment commander, who will, if the discharge is authorized by the endorsement of the proper authority, sign the soldier's discharge, and the last certificate on this paper; see that the soldier is furnished with the proper final statements in duplicate, and forward both of these certificates direct to the Adjutant General United States Army, at Washington, D. C.; they will not, under any circumstances, be given to the soldier.

ADJUTANT GENERAL'S OFFICE  
May 15<sup>th</sup> 1865  
Duplicate sent to Pension Office.

CERTIFICATE OF DISABILITY FOR DISCHARGE  
IN THE CASE OF

B. 199, Headquarters - Dec 1863  
up  
1875  
James Banyan  
Private Independent Battery  
No 1 Reg't of Colored Art  
APPROVED

Genl. Rausch

SURGEON U.S.A  
MEDICAL DIRECTOR

Headqrs Dept of the Missouri  
St Louis Mo April 17<sup>th</sup> 1865  
To be Discharged

By order of  
Maj Genl Dodge  
R. Brown  
Capt Adjt Genl

Received (A. G. Office) 186  
Headqrs Dept of the Missouri  
St Louis Mo April 17<sup>th</sup> 1865  
Cut on O.R. of Cars  
A.B.

ARMY OF THE UNITED STATES. CERTIFICATE OF DISABILITY FOR DISCHARGE.



Approved  
B. Davis  
Surgeon  
Medical Director U.S.

Private James Banyan, of Captain H. Ford Douglas Independent Battery, U.S. Colored Artillery Regiment of the United States who was enlisted by Lieut. William B. Matthews of the 1st Regt. of the Independent Battery at Leavenworth on the twentieth day of July, 1864, to serve three years; he was born in Mason County, in the State of Kentucky, is forty years of age, five feet three inches high, black complexion, black eyes, black hair, and by occupation when enlisted a farmer. During the last two months said soldier has been unfit for duty most days. He is constantly troubled with Rheumatism and pain in the breast, which has disqualified him for performing his duty ever since he has been a member of the Battery now three months.

STATION: Fort Leavenworth  
DATE: April 8th 1865

H. Ford Douglas  
Captain  
Commanding Company.

I CERTIFY, that I have carefully examined the said James Banyan of Captain H. Ford Douglas Company, and find him incapable of performing the duties of a soldier because of Chronic Pericarditis, Result of Rheumatism. In my opinion the Disability existed prior to enlistment. He is unfit for Service in Artillery Corps.

Wm. H. Fenn  
Surgeon  
In Ch. Fort Leavenworth

DISCHARGED, this 21st day of April, 1865, at Fort Leavenworth

W. Davis Col  
Commanding the Regt. Art

The Soldier desires to be addressed at  
Town Leavenworth County Leavenworth State Kansas

\* See Note 1 on the back of this. † See Note 2 on the back of this.

War Department,  
 ADJUTANT GENERAL'S OFFICE,

Washington, Jan. 30<sup>th</sup> 1867.

Respectfully returned to the  
 Commission for the State of  
 Missouri, with the informa-  
 tion that James Banyan  
 was enlisted at Leavenworth, Kans  
 July 20<sup>th</sup> 1864, and was  
 mustered in as Pvt. in 2nd Batt'y  
 U. S. C. Lt. Col. July 23<sup>rd</sup> 1864.

P. 169. Mo.

A. J. Russell

J.B.

Asst. Adj. Gen.

~~783~~ 162 10  
**ENDORSEMENT.**

No. ~~1827~~ ~~1797~~

APPLICATION OF

*John D. Pepper*  
*Platte Co*

for compensation for service of  
slave *James Banyan*  
enlisted *March 1st* 1865,  
in *Co. 1st Batty US Regiment,*  
*col Light Art.*  
U. S. Colored Troops.

Received *July 24* 186 )

Compensation awarded,  
186 ,

Dollars.

President Board of Claims.

P. O. Address of Applicant.

*Chipman, Mosmer & Co*  
*Attys*  
*Washington*  
*D. C.*

**CERTIFICATE OF AWARD OF THE BOARD OF CLAIMS.**

OFFICE OF THE BOARD OF CLAIMS,

For Slaves Enlisted or Drafted in the Service of the United States.

186

We hereby certify that \_\_\_\_\_ of \_\_\_\_\_  
county, State of \_\_\_\_\_, having proved, under oath \_\_\_\_\_ loyalty to the Con-  
stitution and Government of the United States, and established \_\_\_\_\_ title as to the ownership of  
\_\_\_\_\_ a slave \_\_\_\_\_ and mustered  
at \_\_\_\_\_ on the \_\_\_\_\_ day of \_\_\_\_\_ 186\_\_\_\_,  
by \_\_\_\_\_ in the service of the United States, in the  
\_\_\_\_\_ regiment of Colored Troops, Co. \_\_\_\_\_ the sum of \_\_\_\_\_  
dollars has been awarded to \_\_\_\_\_ by this Board, subject to the approval of the Secretary of War, as  
a compensation for the said slave, under provisions of Section 24, Act approved February 24, 1864, and  
Section 2, Act approved July 28, 1866.

\_\_\_\_\_  
President of the Board.

\_\_\_\_\_  
Member of the Board.

*R. March*  
Member of the Board.

To \_\_\_\_\_

Chief of the Bureau for the  
Organization of Colored Troops, Washington, D. C.

CLAIM FOR COMPENSATION FOR ENLISTED SLAVE.

No. *John D Pepper*, a loyal citizen, and a resident  
 of *Marshall* County of *Platte* State of  
*Kansas* hereby claim compensation, under the provisions of  
 Section 24, Act approved February 24, 1864, and Section 2, Act approved July 28, 1866, for my slave  
*James Sanjan* enlisted *1<sup>st</sup> March*  
 1865, at *Leavenworth Kan* by *Serjeant Miner*  
 in the *U S Cold Art (Light and Batt)* Regiment U. S. Colored Troops,  
 Co. \_\_\_\_\_; certificate of which enlistment, and a descriptive list, as required, accompanying this  
 application.

In proof of my loyalty to the Constitution and Government of the United States, I present the accompanying  
 oath, which I have taken, signed and acknowledged; to be filed with this application, in accordance with require-  
 ment of General Order, No. 329, 1863, War Department, Adjutant General's Office.

*J. D. Pepper*

*December 1<sup>st</sup>* 1866

*John D Pepper* OATH OF ALLEGIANCE.

I, *John D Pepper* the owner and claimant, do solemnly swear that the foregoing  
 claim is a just and true claim due to me as master and owner of the said slave, and that the facts alleged in  
 said claim in respect to *enlistment* of said slave into the military service of the United  
 States are true. And I do further swear that I have never joined, or been concerned in any insurrection or  
 rebellion; that I have never borne arms against the United States; that I have never given any aid, countenance,  
 counsel or encouragement to any person or persons engaged, or whom I had reason to believe were about to  
 engage, in insurrection, rebellion or armed hostility against the United States: that I have neither sought, nor  
 accepted, nor attempted to exercise the functions of any office, civil or military, nor to perform any service  
 whatever under any authority, or pretended authority, in hostility to the United States; that I have not  
 yielded a voluntary support to any insurrection, rebellion or pretended government, authority, power or consti-  
 tution within the United States, hostile thereto. And I do further swear that, to the best of my knowledge and  
 ability, I have supported and defended, and will continue to support and defend, the United States, against all  
 enemies, foreign and domestic, and that I have supported, defended and obeyed, and will continue to support,  
 defend and obey, the Constitution and laws of the United States, that I will bear true faith and allegiance to the  
 same; and that I take this oath freely, without any mental reservation or purpose of evasion. So help me God.

*J. D. Pepper*

Sworn to and subscribed before me, at *Wesley Mo*  
 this *1<sup>st</sup>* day of *December* 1866.

*James J. Hitt*  
 Notary Public

Affidavits of disinterested loyal parties will be required to prove the active loyalty of the claimant during the war.





for the adjustment of such claims, before the Departments at Washington, D. C., where the same may become necessary, and elsewhere, and in his name, place and stead, for him and in his name to ask, demand, recover and receive such compensation as may be awarded as aforesaid, hereby giving and granting unto his said Attorneys full power and authority to do and perform all and every act and thing whatsoever requisite and necessary to be done in and about the premises as full and to all intents and purposes the same as he might or could do were he personally present, hereby ratifying and confirming all his said Attorneys or their substitutes by their appointment shall lawfully do or cause to be done by virtue hereof; and it is understood and agreed that this Power of Attorney cannot be revoked by him without the consent of his Attorneys herein appointed.

(5) J. D. Pepper

STATE OF Missouri } ss.  
 County of Platte

On this 1st day of December 1866, personally appeared before me James J. Stitt a Notary Public in and for the county and State aforesaid J. D. Pepper the claimant above mentioned, and made oath to the foregoing statement by him subscribed, and he further acknowledge the signing and sealing of the foregoing Power of Attorney to be his own free binding act, for the purposes and objects therein contained and set forth; and at the same time also personally appeared the above named James H. Goiffith and James A. Miller Benjamin Bonifant and James H. Steele and made oath to the truth of the statements by them respectively subscribed.

Witness my hand and seal, upon the day and date first above written.

[SEAL.]

(6) James J. Stitt  
Notary Public

INSTRUCTIONS.

- (1) State all the circumstances connected with obtaining title—when, where and how.
- (2) Signature of claimant.
- (3) Signatures of witnesses to ownership.
- (4) Signatures of witnesses to loyalty.
- (5) Signature of claimant.
- (6) Signature of Notary Public or Clerk of Court, authenticated by seal.

If title is by purchase, state date of bill of sale, and where recorded. When possible, file the bill of sale. If title is by inheritance, state when and from whom the slave was inherited, and where the will is recorded or the administrator was appointed.  
 If claimant is a trustee, executor or administrator, he must show by the record proof that he is such.  
 Where the same party claims compensation for more than one slave, he must file a separate claim for each.



For Compensation for Service of Slave.

Affidavits of Ownership and Loyalty, and Power of Attorney, in the Application of

John P. Johnson

No. 162

CHIPMAN, HOSMER & CO.,  
 WASHINGTON, D. C.,  
 Attorneys for Claimant.

*John D. Pepper* claimant for compensation under the Acts of Congress of February 24th, 1864, and July 28th, 1866, for *James Banyan* a slave, who was *enlisted* into the military service of the United States upon the *First* day of *March* 186*5*, having been duly sworn declares that at the date of the *enlistment* of said *James Banyan* as aforesaid, and as more fully set forth in *his* application, *he was* the lawful owner of said *James Banyan* and obtained *his* title to him in the following manner: (1)  
*By purchase from the Administrator of the estate of Nott, Duwall at Platte City Mo in the year 1843, at public sale*

(2) *J. D. Pepper*  
*James H. Griffith* a resident of *Platte* County, State of *Missouri* and *James A. Miller* a resident of *Platte* County, State of *Missouri* having been duly sworn, declare that they are personally acquainted with *John D. Pepper* the claimant for compensation for *his* slave *James Banyan* under the Acts of Congress of February 24th, 1864, and July 28, 1866, and know that said *James Banyan* at the date of his *enlistment* into the military service of the United States, and for *ten years* previous thereto was the slave of said *John D. Pepper*. They also declare that they have no interest in said claim.

(3) *James H. Griffith*  
*Benj Bonifant* a resident of *Platte* County, State of *Missouri* and *J. W. Steele* a resident of *Platte* County, State of *Missouri* having first been duly sworn, upon their oaths declare that they reside respectively in county of *Platte* State of *Missouri* and county of *Platte* State of *Missouri*; that they are personally acquainted with *John D. Pepper* claimant for compensation for *his* slave *James Banyan* under the Acts of Congress of February 24, 1864, and July 28, 1866, and that they know that said claimant has firmly and faithfully maintained *his* allegiance and adherence to the Government of the United States, by defending its cause against the Government of the so-called Confederate States of America, in all suitable and practicable ways, and according to *his* ability; they also swear that they have themselves maintained a like adherence and allegiance to the Government of the United States, and that they have no interest in said claim.

And the said *John D. Pepper* claimant further declares that in consideration of valuable services rendered and to be rendered, *him* hath and doth employ and constitute, as *his* Attorneys, **CHIPMAN, HOSMER & CO.**, Washington, D. C., to prosecute *his* claim for compensation which may be awarded to *him* as owner of said slave, by the Acts of Congress in that regard, before the Board of Claims appointed for the State of *Missouri*

~~162~~

162 10

*[Faint, illegible text or markings]*

STATE OF MISSOURI, } SS.  
 COUNTY OF PLATTE,

I, Geo W Belt, Clerk of the Circuit Court and Ex-Officio Recorder for said Court, do hereby certify that **James J. Hitt**, is and was on the 1<sup>st</sup> day of Dec A. D. 1866 an acting Notary Public within and for said County, duly qualified and commissioned, and all of his acts as such are entitled to full faith and credit.

In testimony whereof I, Geo W Belt Clerk, as aforesaid, have hereunto set my hand and affixed the seal of said Court at office, this 3<sup>rd</sup> day of Dec A. D. 1866  
Geo W Belt, Clerk.

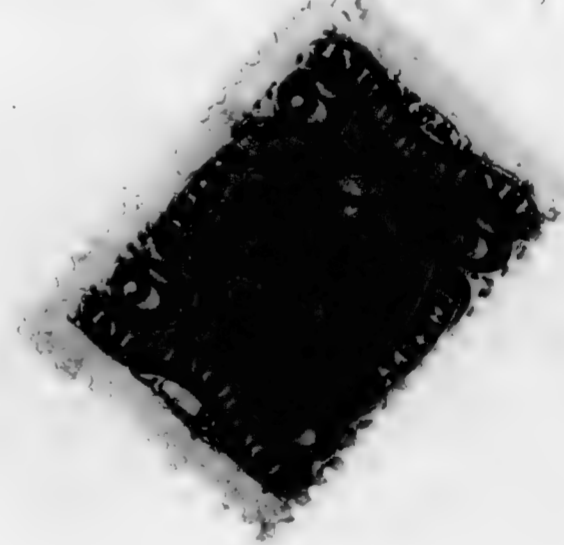

1st Lt. U.S. Col' of Art'y

Private Private

CARD NUMBERS.

623357f	26
623373f	27
6233887	28
6234053	29
6234190	30
623435f	31
6234521	32
9132919	33
	34
	35
	36
	37
	38
	39
	40
	41
	42
	43
	44
	45
	46
	47
	48
	49
	50

Book Mark:

See also

*D*

Indpt. Batt'y.

U.S.C.T.

*Frank Barber*

....., Indpt. Batt'y, U. S. Col'd L. Art'y.

Appears on

**Battery Descriptive Book**

of the organization named above.

**DESCRIPTION.**

Age *20* years; height *5* feet *3* inches.

Complexion *Black*

Eyes *Black*; hair *Black*

Where born *Jackson Mississipi*

Occupation *Farmen*

**ENLISTMENT.**

When *Dec. 7*, 186 *4*

Where *For the 1st S's*

By whom *A Minor*; term *3* y'rs.

Remarks: .....

.....  
 .....  
 .....  
 .....  
 .....  
 .....  
 .....

*Healbrov*

(383g)

Copyist.

*B* | Indpt. Battery. | **U.S.C.T.**

*Frank Barber*

Appears with rank of *Priv* on

**Muster and Descriptive Roll of a Detachment of U. S. Vols. forwarded**

for the Indpt. Batt'y, U. S. Col'd L. Arty. Roll dated

*Lavenworth City, Kans. Oct 8, 1864.*

Where born *Jackson Co., Missouri*

Age *20* y'rs; occupation *Farmer*

When enlisted *Oct 7*, 1864.

Where enlisted *Lav. City, Kans*

For what period enlisted *3* years.

Eyes *Black*; hair *Black*

Complexion *Black*; height *5* ft. *3* in.

When mustered in *Oct 8*, 1864.

Where mustered in *Lav. City, K*

Bounty paid \$ *100*; due \$ *100*

Where credited

Battery to which assigned

Remarks: *Redited to South<sup>n</sup> Dist. of Kansas, 31st Pub. District Lawrence Tp. Douglas Co. Volunteer Recruit entitled to Bounty*

Book mark:

*E. L. Thorton*

B

Indpt. Battery.

U.S.C.T.

Frank Barber

Pat, Indpt. Battery, U. S. Col'd L. Art'y.

Appears on

Battery Muster-in and Descriptive Roll

of the organization named above. Roll dated

Leavenworth Mo, Dec 27, 1864.

Where born Jackson Co. Mo

Age 20 yrs; occupation Farmer

When enlisted Dec 7, 1864.

Where enlisted Leavenworth Mo

For what period enlisted 3 years.

Eyes Blue; hair Blue

Complexion Blue; height 5-3 in.

When mustered in Dec 8, 1864.

Where mustered in Leavenworth

Bounty paid \$100<sup>00</sup>/<sub>100</sub>; due \$200<sup>00</sup>/<sub>100</sub>

Where credited

Battery to which assigned

Remarks: A. I. dist Co  
31st I. S. Lawrence Sp.  
Douglas Co.

Book mark :

J. H. [Signature]

(856g)

Copyist.



B | Indpt. Battery. | U.S.C.T.

Frank Barber<sup>x</sup>

Pos, Indpt. Battery, U. S. Col'd L. Art'y.

Appears on

**Battery Muster Roll**

for Mustering to Dec 31, 1864

Present or absent Present

Stoppage, \$ 100 for

Due Gov't, \$ 100 for

Valuation of horse, \$ 100

Valuation of horse equipments, \$ 100

Remarks:

\*Borne as Barker in Col.  
of names of men present.  
Comp.

Book mark:

*J. H. Schorley*

(358)

Copyist.

*B* | Indpt. Battery. | **U.S.C.T.**

*Frank Barber*  
*Pot*, Indpt. Battery, U. S. Col'd L. Art'y.

Appears on

**Battery Muster Roll**  
for *May & Feb*, 186<sup>*5*</sup>.

Present or absent *Present*

Stoppage, \$ 100 for

Due Gov't, \$ 100 for

Valuation of horse, \$ 100

Valuation of horse equipments, \$ 100

Remarks:  
.....  
.....  
.....  
.....  
.....  
.....  
.....

Book mark: .....

*J. S. Schooley*  
(358) Copyist.

*B* | Indpt. Battery. | **U.S.C.T.**

*Frank Barber,*  
*Pr*, Indpt. Battery, U. S. Col'd L. Art'y.

Appears on

**Battery Muster Roll**

for *Mar, Apl.*, 186 *5*.

Present or absent *Present.*

Stoppage, \$ 100 for

Due Gov't, \$ 100 for

Valuation of horse, \$ 100

Valuation of horse equipments, \$ 100

Remarks:  
\_\_\_\_\_  
\_\_\_\_\_  
\_\_\_\_\_  
\_\_\_\_\_  
\_\_\_\_\_  
\_\_\_\_\_

Book mark: \_\_\_\_\_

*Parter*

*B* | Indpt. Battery. | **U.S.C.T.**

*Frank Barber,*

*Pr*, Indpt. Battery, U. S. Col'd L. Art'y.

Appears on

**Battery Muster Roll**

for *May + June*, 186 *5*

Present or absent *Present,*

Stoppage, \$ *100* for

Due Gov't, \$ *100* for

Valuation of horse, \$ *100*

Valuation of horse equipments, \$ *100*

Remarks:

-----  
-----  
-----  
-----  
-----  
-----  
-----  
-----  
-----  
-----

Book mark: -----

*Barber*  
-----  
Copyist.

*B*

Indpt. Battery.

U.S.C.T.

*Frank Barber*

*A*, Indpt. Battery U. S. Col'd Light Art'y.

Appears on **Batt'y Muster-out Roll**, dated

*At Leavenworth, Mo., July 22, 1865.*

Muster-out to date *July 22, 1865.*

Last paid to *Dec. 31, 1864.*

Clothing account:

Last settled....., 186 ; drawn since \$ *27*<sup>*27*</sup>/<sub>100</sub>,

Due soldier \$.....<sub>100</sub>; due U. S. \$.....<sub>100</sub>

Am't for cloth'g in kind or money adv'd \$.....<sub>100</sub>

Due U. S. for arms, equipments, &c., \$.....<sub>100</sub>

Bounty paid \$ *100* <sub>100</sub>; due \$ *None* <sub>100</sub>,

Remarks:.....

.....  
.....  
.....  
.....  
.....  
.....

Book mark:.....

*Barber*

(361)

Copyist.

*Barber Frank*

, Co. *1st Batt. Regt. U.S.C.A.*

*2* Enclosures.

Bed Cards .....	Final Statements .....
Burial Records .....	Furloughs or L. of A. ....
Certs. of Dis. for Discharge .....	Med. Certificates .....
C. M. Charges .....	Med. Des. Lists .....
Descriptive Lists .....	Orders .....
Discharge Certificates .....	Pris. of War Record .....
Enlistment Papers <i>2</i> .....	Resignations .....

Other papers relating to—

Admission to Hosp'l .....	Furlough or L. of A. ....
Casualty Sheet .....	Med. Examination .....
Confinement .....	Misc. Information .....
Contracts .....	Pay or Clothing .....
Death or Effects .....	Personal Reports .....
Desertion .....	Rank .....
Discharge from Hosp'l .....	Transfer to Hosp'l .....
Discharge from Service .....	Transfer to V. R. C. ....
Duty .....	Transportation .....

NOTE 1.—This blank will be used for both enlistments and re-enlistments—enlistment of veterans, &c., &c., in the volunteer service. They will be made out in duplicate in all cases—ono to accompany the recruiting return of the superintendent (not the recruiting officer) to the Adjutant General, and one to accompany the accounts of the officer who pays bounty, &c. The Regiment and Company in which the soldier last served should be given on the back.

NOTE 2.—An enlistment holds to service. A muster-in must, in all cases, precede payment of pay, bounty, pension, &c. A muster-in roll must, in all cases, be filed in the Adjutant General's Office as evidence of muster-in. The mustering officer, commissary, or assistant commissary of musters, as the case may be, will countersign both enlistments as having mustered the soldier into the service of the United States before either of them is given to the disbursing officer.

DECLARATION OF RECRUIT.

I, Frank Barber desiring to VOLUNTEER as a Soldier in the Army of the United States, for the term of THREE YEARS, Do Declare, That I am Twenty 20 years and \_\_\_\_\_ months of age; that I have never been discharged from the United States service on account of disability or by sentence of a court martial, or by order before the expiration of a term of enlistment; and I know of no impediment to my serving honestly and faithfully as a soldier for three years.

GIVEN at Leavenworth State of Kansas the 7th day of October 1864

Witness:

Ben Wilson

Frank Barber  
mark

No. \_\_\_\_\_

12

enlistment; last served in Company ( )  
Reg't of \_\_\_\_\_  
Discharged \_\_\_\_\_ 18 \_\_\_\_\_

Frank Barber  
Volunteered at Leavenworth  
October 7th 1864  
By S. A. Morrison 2<sup>d</sup> Lieut  
Ind't 12<sup>th</sup> Reg't of Ill's 10<sup>th</sup> Cavalry

CONSENT IN CASE OF MINOR.

I, \_\_\_\_\_ Do CERTIFY, That I am the \_\_\_\_\_ of \_\_\_\_\_; that the said \_\_\_\_\_ is \_\_\_\_\_ years of age; and I do hereby freely give my CONSENT to his volunteering as a SOLDIER in the ARMY OF THE UNITED STATES for the period of THREE YEARS.

GIVEN at \_\_\_\_\_ the \_\_\_\_\_ day of \_\_\_\_\_

Witness:

VOLUNTEER ENLISTMENT.

STATE OF

TOWN OF

*Kansas*



*Leavenworth*

I, *Frank Barber* born in *Jackson County*  
 in the State of *Missouri* aged *20* years,  
 and by occupation a *Farmer* Do HEREBY ACKNOWLEDGE to have  
 volunteered this *Seventh (7<sup>th</sup>)* day of *October* 1864,  
 to serve as a **Soldier** in the **Army of the United States of America**, for  
 the period of **THREE YEARS**, unless sooner discharged by proper authority:  
 Do also agree to accept such bounty, pay, rations, and clothing, as are, or may be,  
 established by law for volunteers. And I, *Frank Barber* do  
 solemnly swear, that I will bear true faith and allegiance to the **United States**  
**of America**, and that I will serve them honestly and faithfully against all  
 their enemies or opposers whomsoever; and that I will observe and obey the  
 orders of the President of the United States, and the orders of the officers  
 appointed over me, according to the Rules and Articles of War.

Sworn and subscribed to, at *Leavenworth*  
 this *7<sup>th</sup>* day of *October* 1864, } *Frank Barber*  
 BEFORE *P. H. Minor 2<sup>d</sup> Lieut* } *his*  
*Recruiting Inlt Battery U.S. 6<sup>th</sup> Artillery* } *mark*

I CERTIFY, ON HONOR, That I have carefully examined the above-named Volunteer, agreeably  
 to the General Regulations of the Army, and that, in my opinion, he is free from all bodily defects and  
 mental infirmity, which would in any way disqualify him from performing the duties of a soldier.

*Jiffine Links*  
*Surg Board of Cavalry*  
*North Dist Kan*  
 EXAMINING SURGEON.

I CERTIFY, ON HONOR, That I have minutely inspected the Volunteer, *Frank Barber*  
 previously to his enlistment, and that he was entirely sober when enlisted; that, to the best of my  
 judgment and belief, he is of lawful age; and that, in accepting him as duly qualified to perform the  
 duties of an able-bodied soldier, I have strictly observed the Regulations which govern the recruiting  
 service. This soldier has *black* eyes, *black* hair, *black* complexion, is *5-*  
 feet *3* inches high.

*P. H. Minor 2<sup>d</sup> Lieut*  
*Inlt Battery U.S. 6<sup>th</sup> Artillery*  
 RECRUITING OFFICER.

Mustered into the service of the United States, for three years or during the war, from date of enlistment, in ~~Company~~ *Shelburne*  
*Battery U.S. Regiment of Cavalry (1<sup>st</sup>) Volunteers*, on the *8<sup>th</sup>* day of *October*, 1864, at *Leavenworth, Kansas*.

*John A. Minor*  
*Capt. & Recr. Marshal*  
*North Dist. of Kansas*



NOTE 1.—This blank will be used for both enlistments and re-enlistments—enlistment of veterans, &c., &c., in the volunteer service. They will be made out in duplicate in all cases—one to accompany the recruiting return on the superintendent (not the recruiting officer) to the Adjutant General, and one to accompany the accounts of the officer who pays bounty, &c. The Regiment and Company in which the soldier last served should be given on the back.

NOTE 2.—An enlistment holds to the expiration of the term of enlistment. A muster-in must, in all cases, precede payment of pay, bounty, pension, &c. A muster-in roll must, in all cases, be filed in the Adjutant General's Office as evidence of muster-in. The mustering officer, commissary, or assistant commissary of musters, as the case may be, will countersign both enlistments as having mustered the soldier into the service of the United States before either of them is given to the disbursing officer.

2nd. Aud. Nov. 23d 1892

DECLARATION OF RECRUIT.

I, Frank Barber desiring to VOLUNTEER as a Soldier in the Army of the United States, for the term of THREE YEARS, Do Declare, That I am Twenty 20 years and \_\_\_\_\_ months of age; that I have never been discharged from the United States service on account of disability or by sentence of a court martial, or by order before the expiration of a term of enlistment; and I know of no impediment to my serving honestly and faithfully as a soldier for three years.

GIVEN at Leavenworth State of Kansas the Seventh (7th) day of October 1864

Witness: Geny Wilson Frank Barber  
mark

No. 7  
Frank Barber  
Volunteered at Leavenworth  
October Seventh 1864  
By P. J. Minor 1st Lieut  
1st Regt Artillery

Discharged ..... 18 .  
Reg't of .....  
enlistment; last served in Company ( )

CONSENT IN CASE OF MINOR.

I, \_\_\_\_\_ Do CERTIFY, That I am the \_\_\_\_\_ of \_\_\_\_\_; that the said \_\_\_\_\_ is \_\_\_\_\_ years of age; and I do hereby freely give my CONSENT to his volunteering as a SOLDIER in the ARMY OF THE UNITED STATES for the period of THREE YEARS.

GIVEN at \_\_\_\_\_ the \_\_\_\_\_ day of \_\_\_\_\_

Witness: \_\_\_\_\_

VOLUNTEER ENLISTMENT.

STATE OF



TOWN OF

*Missouri*

*Leavenworth*

I, *Frank Barber* born in *Jackson County*  
 in the State of *Missouri* aged *20* years,  
 and by occupation a *Farmer* Do HEREBY ACKNOWLEDGE to have  
 volunteered this *Seventh (7th)* day of *October* 1864,  
 to serve as a **Soldier** in the **Army of the United States of America**, for  
 the period of **THREE YEARS**, unless sooner discharged by proper authority:  
 Do also agree to accept such bounty, pay, rations, and clothing, as are, or may be,  
 established by law for volunteers. And I, *Frank Barber* do  
 solemnly swear, that I will bear true faith and allegiance to the **United States**  
**of America**, and that I will serve them honestly and faithfully against all  
 their enemies or opposers whomsoever; and that I will observe and obey the  
 orders of the President of the United States, and the orders of the officers  
 appointed over me, according to the Rules and Articles of War.

Sworn and subscribed to, at *Leavenworth*  
 this *Seventh* day of *October* 1864, } *Frank Barber*  
 BEFORE *P. A. Minor 2<sup>d</sup> Lieut* } *his*  
*Recruiting Invt Battery U.S. Cold Artillery* } *mark*

I CERTIFY, ON HONOR, That I have carefully examined the above-named Volunteer, agreeably  
 to the General Regulations of the Army, and that, in my opinion, he is free from all bodily defects and  
 mental infirmity, which would in any way disqualify him from performing the duties of a soldier.

*Jeffrey Sinks*  
*Surg Board of Enrolled*  
*North Dist Kansas*  
 EXAMINING SURGEON.

I CERTIFY, ON HONOR, That I have minutely inspected the Volunteer, *Frank Barber*  
 previously to his enlistment, and that he was entirely sober when enlisted; that, to the best of my  
 judgment and belief, he is of lawful age; and that, in accepting him as duly qualified to perform the  
 duties of an able-bodied soldier, I have strictly observed the Regulations which govern the recruiting  
 service. This soldier has *black* eyes, *black* hair, *black* complexion, is *5*  
 feet *3* inches high.

*P. A. Minor 2<sup>d</sup> Lieut*  
*Independent Battery U.S. Cold Artillery*  
 RECRUITING OFFICER.

(A. G. O. No. 74 & 76.)

*Battery U.S. Recruit of Cold Artillery (A. 1)*  
 Mustered into the service of the United States, for three years or during the war, from date of enlistment, in *Company Jackson*  
 on the *8<sup>th</sup>* day of *October*, 1864, at *Leavenworth Missouri*  
*J. W. A. Brown*  
*Capt. & Provost Marshal*  
*North Dist. of Kansas*

*Frank Barber is a farmer from the County of Jackson Missouri and was born July 11, 1844, and was 20 years of age on the 7th day of October 1864.*

Adpt. Batt'y U.S. Col'd L. Art'y.

Private Private

CARD NUMBERS.

1	6233636	26
2	6234056	27
3	6234190	28
4	6234361	29
5	6234524	30
6	9133094	31
7		32
8		33
9		34
10		35
11		36
12		37
13		38
14		39
15		40
16		41
17		42
18		43
19		44
20		45
21		46
22		47
23		48
24		49
25		50

Book Mark:

See also

*D* | Indpt. Batt'y. | **U.S.C.T.**

*George Bates*

....., Indpt. Batt'y, U. S. Col'd L. Art'y.

Appears on  
**Battery Descriptive Book**  
of the organization named above.

**DESCRIPTION.**

Age *18* years; height *5* feet *7* inches.

Complexion *Mulatto*

Eyes *Black*; hair *Black*

Where born *Chautauq Co. N.Y.*

Occupation *Laborer*

**ENLISTMENT.**

When *Jan 23*, 186*5*.

Where *Near 10th Regt*

By whom *A. M. ...*; term *3* y'rs.

Remarks:  
.....  
.....  
.....  
.....  
.....  
.....  
.....  
.....  
.....  
.....

*Hochstetler*

*B* | Indpt. Battery. | **U.S.C.T.**

*George Bates*

Appears with rank of *Priv* on

**Muster and Descriptive Roll of a Detachment of U. S. Vols. forwarded**

for the Indpt. Batt'y, U. S. Col'd L. Arty. Roll dated

*Leavenworth Kas*, Jan. 24, 1865.

Where born *Chariton Co. Missouri*

Age *18* y'rs; occupation *Labaret*

When enlisted d. *Jan. 23*, 1865.

Where enlisted *Leavenworth, Kas*

For what period enlisted *3* years.

Eyes *Black*; hair *Black*

Complexion *Mulatto*; height *5* ft. *7* in.

When mustered in *Jan. 24*, 1865.

Where mustered in *Leavenworth*

Bounty paid \$ *000* <sup>100</sup>; due \$ *300* <sup>100</sup>

Where credited

Battery to which assigned

Remarks: *Credited to Northern Dist  
Kas. 19<sup>th</sup> Sub. Dist. 1st Ward  
Leavenworth City, Val. Recruit  
entitled to bounty.*

Book mark:

*E. L. Thomsen*

79 | Indpt. Battery. | U.S.C.T.

George Bates

Pvt, Indpt. Battery, U. S. Col'd L. Art'y.

Appears on

**Battery Muster Roll**

for *Jan & Feb*, 186<sup>5</sup>.

Present or absent *Present*

Stoppage, \$ 100 for

Due Gov't, \$ 100 for

Valuation of horse, \$ 100

Valuation of horse equipments, \$ ~~100~~

Remarks: *Bounty due 100*

Book mark: \_\_\_\_\_

(358) *J. Schoder* Copyist.

*B* | Indpt. Battery. | **U.S.C.T.**

*George Bates,*  
*M*, Indpt. Battery, U. S. Col'd L. Art'y.

Appears on

**Battery Muster Roll**

for *Mar, & Apr,*, 186 *5*.

Present or absent *Present,*

Stoppage, \$ *100* for

Due Gov't, \$ *100* for

Valuation of horse, \$ *100*

Valuation of horse equipments, \$ *100*

Remarks: *Bounty due \$100.00,*

Book mark: \_\_\_\_\_

*Bates*

*P*

Indpt. Battery.

U.S.C.T.

*George Bates,*

*P*, Indpt. Battery, U. S. Col'd L. Art'y.

Appears on

**Battery Muster Roll**

for *May & June*, 186*5*.

Present or absent *Present,*

Stoppage, \$ 100 for

Due Gov't, \$ 100 for

Valuation of horse, \$ 100

Valuation of horse equipments, \$ 100

Remarks: *County due, \$100-*

Book mark:

*Bates,*

(358)

Copyist.



*A* | Indpt. Battery. | **U.S.C.T.**

*George Bates,*

*M*, Indpt. Battery U. S. Col'd Light Art'y.

Appears on **Batt'y Muster-out Roll**, dated  
*Ft. Leavenworth, Mo, July 22, 1865.*

Muster-out to date *July 22*, 1865.

Last paid to *(Pay due from enlistment)* 1865.

**Clothing account:**

Last settled....., 1865 ; drawn since \$*62*<sup>66</sup>/<sub>100</sub>

Due soldier \$.....<sup>100</sup>; due U. S. \$.....<sup>100</sup>

Am't for cloth'g in kind or money adv'd \$.....<sup>100</sup>

Due U. S. for arms, equipments, &c., \$.....<sup>100</sup>

Bounty paid \$ *None*<sup>100</sup>; due \$*100*<sup>100</sup>

Remarks:.....

.....  
.....  
.....  
.....  
.....  
.....

Book mark :.....

.....  
*Bates*  
Copyist.

*Bates George*

, Co. *Lud. Batt* Reg't *U.S.C. A*

**3 Enclosures.**

Bed Cards .....	Final Statements .....
Burial Records .....	Furloughs or L. of A .....
Certs. of Dis. for Discharge .....	Med. Certificates .....
C. M. Charges .....	Med. Des. Lists .....
Descriptive Lists .....	Orders .....
Discharge Certificates .....	Pris. of War Record .....
Enlistment Papers ..... <i>2</i>	Resignations .....

**Other papers relating to—**

Admission to Hosp'l .....	Furlough or L. of A .....
Casualty Sheet .....	Med. Examination .....
Confinement .....	Misc. Information .....
Contracts .....	Pay or Clothing .....
Death or Effects .....	Personal Reports .....
Desertion .....	Rank .....
Discharge from Hosp'l .....	Transfer to Hosp'l .....
Discharge from Service .....	Transfer to V. R. C. ....
Duty ..... <i>/</i>	Transportation .....

MICROFILM PUBLICATION M 1836

COMPILED MILITARY SERVICE RECORDS  
OF VOLUNTEER UNION SOLDIERS WHO SERVED WITH  
THE UNITED STATES COLORED TROOPS (USCT)  
INDEPENDENT BATTERY LIGHT ARTILLERY

PERSONAL PAPERS' TARGET SHEET

PLEASE NOTE THE CHECKED INFORMATION ABOUT THE PERSONAL PAPERS IN  
THIS FILE:

NO PERSONAL PAPERS WERE FOUND IN THIS FILE WHEN THE  
RECORDS WERE ARRANGED FOR MICROFILMING.

3 PERSONAL PAPER(S) FOUND IN THIS FILE WHEN THE RECORDS  
WERE ARRANGED FOR MICROFILMING.

DECLARATION OF RECRUIT.

NOTE 1.—This blank will be used for both enlistments and re-enlistments—enlistment of veterans, &c., &c., in the volunteer service. They will be made out in duplicate in all cases—one to accompany the recruiting return of the superintendent (not the recruiting officer) to the Adjutant General, and one to accompany the accounts of the officer who pays bounty, &c. The Regiment and Company in which the soldier last served should be given on the back.  
NOTE 2.—An enlistment holds to service. A muster-in must, in all cases, precede payment of pay, bounty, pension, &c. A muster-in roll must, in all cases, be filed in the Adjutant General's Office as evidence of muster-in. The mustering officer, commissary, or assistant commissary of musters, as the case may be, will countersign both enlistments as having mustered the soldier into the service of the United States before either of them is given to the disbursing officer.

I, George Bates, desiring to VOLUNTEER as a Soldier in the Army of the United States, for the term of THREE YEARS, Do Declare, That I am Eighteen years and \_\_\_\_\_ months of age; that I have never been discharged from the United States service on account of disability or by sentence of a court martial, or by order before the expiration of a term of enlistment; and I know of no impediment to my serving honestly and faithfully as a soldier for three years.

GIVEN at Lawrenceville State of Kansas the 23rd day of January, 1863.

Witness: John Wesley Scott

George Bates mark

Discharged \_\_\_\_\_, 18 \_\_\_\_\_

Reg't of \_\_\_\_\_

enlistment; last served in Company ( ) \_\_\_\_\_

No. 627  
Volunteered at Lawrenceville  
23rd January, 1863  
By Regt of Kansas 5th  
John Wesley Scott

CONSENT IN CASE OF MINOR.

I, \_\_\_\_\_, Do CERTIFY, That I am \_\_\_\_\_; that the \_\_\_\_\_ of \_\_\_\_\_; that the \_\_\_\_\_ is \_\_\_\_\_ years of age; and I do hereby freely give my CONSENT to his volunteering as a SOLDIER in the ARMY OF THE UNITED STATES for the period of THREE YEARS.

GIVEN at \_\_\_\_\_ the \_\_\_\_\_ day of \_\_\_\_\_

Witness: \_\_\_\_\_

*Credited to Northern Dist Kas 19<sup>th</sup> Dist 1<sup>st</sup> Ward Leavenworth City*

VOLUNTEER ENLISTMENT.

STATE OF

*Kansas*



TOWN OF

*Leavenworth*

I, *George Bates*, born in *Chariton County* in the State of *Missouri*, aged *Eighteen* years, and by occupation a *Laborer*, DO HEREBY ACKNOWLEDGE to have volunteered this *Twenty Third 23<sup>rd</sup>* day of *January*, 1865, to serve as a **Soldier** in the **Army of the United States of America**, for the period of **THREE YEARS**, unless sooner discharged by proper authority: Do also agree to accept such bounty, pay, rations, and clothing, as are, or may be, established by law for volunteers. And I, *George Bates*, do solemnly swear, that I will bear true faith and allegiance to the **United States of America**, and that I will serve them honestly and faithfully against all their enemies or opposers whomsoever; and that I will observe and obey the orders of the President of the United States, and the orders of the officers appointed over me, according to the Rules and Articles of War.

Sworn and subscribed to, at *Leavenworth* this *23<sup>rd</sup>* day of *January*, 1865, BEFORE *P. B. Minor 2<sup>nd</sup> Lieut Recruiting* *Indy Battery U.S. Colored Artillery* *George Bates* his *mass*

I CERTIFY, ON HONOR, That I have carefully examined the above-named Volunteer, agreeably to the General Regulations of the Army, and that, in my opinion, he is free from all bodily defects and mental infirmity, which would in any way disqualify him from performing the duties of a soldier.

*Tiffin Sinks*  
Surg Board of Qualifiers  
*North's Dis Kansas*  
EXAMINING SURGEON.

I CERTIFY, ON HONOR, That I have minutely inspected the Volunteer *George Bates* previously to his enlistment, and that he was entirely sober when enlisted; that, to the best of my judgment and belief, he is of lawful age; and that, in accepting him as duly qualified to perform the duties of an able-bodied soldier, I have strictly observed the Regulations which govern the recruiting service. This soldier has *Black* eyes, *black* hair, *Widow's* complexion, is *5-* feet *4* inches high.

*P. B. Minor 2<sup>nd</sup> Lieut*  
*Indy Battery U.S. Colored Artillery*  
RECRUITING OFFICER.

(A. G. O. No. 74 & 76.)

*Mustered into the service of the United States, for three years or during the war, from date of enlistment, in*  
*Battery Regiment of U.S. Col. Artillery* Volunteers, on the *23<sup>rd</sup>* day of *January*, 1865, at *Leavenworth Kas*  
*John W. McMahon*  
*John W. McMahon*  
*John W. McMahon*

NOTE 1.—This blank will be used for both enlistments and re-enlistments—enlistment of veterans, &c., &c., in the volunteer service. They will be made out in duplicate in all cases—one to accompany the recruiting return of the superintendent (not the recruiting officer) to the Adjutant General, and one to accompany the accounts of the officer who pays bounty, &c. The Regiment and Company in which the soldier last served should be given on the back.

NOTE 2.—An enlistment holds to service. A muster-in must, in all cases, precede payment of pay, bounty, pension, &c. A muster-in roll must, in all cases, be filed in the Adjutant General's Office as evidence of muster-in. The mustering officer, commissary, or assistant commissary of musters, as the case may be, will countersign both enlistments as having mustered the soldier into the service of the United States before either of them is given to the disbursing officer.

DECLARATION OF RECRUIT.

I, George Bates, desiring to VOLUNTEER as a Soldier in the Army of the United States, for the term of THREE YEARS, Do Declare, That I am Eighteen years and \_\_\_\_\_ months of age; that I have never been discharged from the United States service on account of disability or by sentence of a court martial, or by order before the expiration of a term of enlistment; and I know of no impediment to my serving honestly and faithfully as a soldier for three years.

GIVEN at Leavenworth State of Kansas the 23<sup>rd</sup> day of January 1865

Witness: John Wesley Scott

George Bates  
his mark

No. \_\_\_\_\_

George Bates  
Volunteered at Leavenworth

23<sup>rd</sup> January, 1865

By John Wesley Scott

Adjutant General's Office

\_\_\_\_\_ enlistment; last served in Company ( )

\_\_\_\_\_ Reg't of \_\_\_\_\_

Discharged \_\_\_\_\_, 18 \_\_\_\_\_

20

CONSENT IN CASE OF MINOR.

I, \_\_\_\_\_, Do CERTIFY, That I am \_\_\_\_\_; that the \_\_\_\_\_ of \_\_\_\_\_; that the \_\_\_\_\_ is \_\_\_\_\_ years of age; and I do hereby freely give my CONSENT to his volunteering as a SOLDIER in the ARMY OF THE UNITED STATES for the period of THREE YEARS.

GIVEN at \_\_\_\_\_ the \_\_\_\_\_ day of \_\_\_\_\_

Witness: \_\_\_\_\_

One filed to Norman ... 19<sup>th</sup> Sub Dist.

VOLUNTEER ENLISTMENT.

STATE OF

TOWN OF

Kansas



Lavenworth

I, George Bates, born in Charleston Mo in the State of Missouri, aged fifteen years, and by occupation a Laborer, Do HEREBY ACKNOWLEDGE to have volunteered this twenty third 23<sup>rd</sup> day of January, 1863, to serve as a Soldier in the Army of the United States of America, for the period of THREE YEARS, unless sooner discharged by proper authority: Do also agree to accept such bounty, pay, rations, and clothing, as are, or may be, established by law for volunteers. And I, George S. Wicks, do solemnly swear, that I will bear true faith and allegiance to the United States of America, and that I will serve them honestly and faithfully against all their enemies or opposers whomsoever; and that I will observe and obey the orders of the President of the United States, and the orders of the officers appointed over me, according to the Rules and Articles of War.

Sworn and subscribed to, at Lavenworth this 23<sup>rd</sup> day of January, 1863, BEFORE D. H. Minon 2<sup>nd</sup> Lieut Indpt Bty U.S. Colonel Artillery

I CERTIFY, ON HONOR, That I have carefully examined the above-named Volunteer, agreeably to the General Regulations of the Army, and that, in my opinion, he is free from all bodily defects and mental infirmity, which would in any way disqualify him from performing the duties of a soldier.

W. J. Binkes Surg Board of Enrollment North Dist Kansas EXAMINING SURGEON.

I CERTIFY, ON HONOR, That I have minutely inspected the Volunteer George Bates previously to his enlistment, and that he was entirely sober when enlisted; that, to the best of my judgment and belief, he is of lawful age; and that, in accepting him as duly qualified to perform the duties of an able-bodied soldier, I have strictly observed the Regulations which govern the recruiting service. This soldier has Black eyes, Black hair, Mulatto complexion, is 5 feet 7 inches high.

D. H. Minon 2<sup>nd</sup> Lieut Indpt Bty U.S. Colonel Artillery RECRUITING OFFICER.

(A. G. O. No. 74 & 76.)

Mustered into the service of the United States, for three years or during the war, from date of enlistment, in Company ... of 10<sup>th</sup> Regt of Artillery Volunteers, on the 24<sup>th</sup> day of January, 1863, at Lavenworth, Kansas.

Handwritten signatures and notes on the right side of the document.

Geo Bates  
 1<sup>st</sup> Dnp. Cal  
 Batthy S. A.

Military Prison  
 To the Secretary of the  
 May 29 1865

When named man  
 released this day

Joseph Sumner  
 In charge of Prison



No. 1000 Post Fort Leavenworth  
 May 29<sup>th</sup> 1865

Lieutenant,

You will please to release from  
 arrest Roman-George Bates 1<sup>st</sup> Indpt.  
 Col<sup>l</sup> Batty and order him to report  
 to his command for duty.

By order of  
 Lt. Col. Hermann  
 J. Dodge  
 The Post adj<sup>t</sup>

A. Bennett  
 In Charge of Prison

Company U.S. Col'd L. Art'y

*Private* | *Private*

CARD NUMBERS.

1 6 2 3 3 7 3 0  
 2 6 2 3 3 8 1 2  
 3 6 2 3 4 1 5 9  
 4 6 2 3 4 6 7 1  
 5 9 1 3 2 9 1 1

26  
 27  
 28  
 29  
 30  
 31  
 32  
 33  
 34  
 35  
 36  
 37  
 38  
 39  
 40  
 41  
 42  
 43  
 44  
 45  
 46  
 47  
 48  
 49  
 50

Book Mark: \_\_\_\_\_

See also \_\_\_\_\_

NS-1128/36

June

W. Spencer  
g

*B*

Indpt. Batt'y. | **U.S.C.T.**

*Robert A. Beale*

....., Indpt. Batt'y, U. S. Col'd L. Art'y.

Appears on

**Battery Descriptive Book**  
of the organization named above.

**DESCRIPTION.**

Age *18* years; height *5* feet *11* inches.

Complexion *Black*

Eyes *Black*; hair *Black*

Where born *Buchanan Co. Missouri*

Occupation *Laborer*

**ENLISTMENT.**

When *July 23*, 186 *4*.

Where *Arvumoth - Ala*

By whom *Lieut Matthews*; term *3* y'rs.

Remarks: .....

.....  
.....  
.....  
.....  
.....  
.....  
.....  
.....

*Boalson*

*B* | Indpt. Battery. | **U.S.C.T.**

*Robert A. Bell*

*Fat*, Indpt. Battery, U. S. Col'd L. Art'y.

Appears on

**Battery Muster-in and Descriptive Roll**

of the organization named above. Roll dated

*Leavenworth Co Indpt, 1864*

Where born *Buchanan Co, Mo.*

Age *18* y'rs; occupation *Librarian*

When enlisted *July 23*, 1864

Where enlisted *Leavenworth Co*

For what period enlisted *3* years.

Eyes *Blu*; hair *Blk*

Complexion *Blu*; height *5* ft. *11* in.

When mustered in *July 26*, 1864

Where mustered in *Leavenworth*

Bounty paid \$ *100*<sup>*00*</sup>/<sub>*100*</sub>; due \$ *200*<sup>*00*</sup>/<sub>*100*</sub>

Where credited

Battery to which assigned

Remarks: *A. N. Dist 20<sup>th</sup> I.D.  
2<sup>nd</sup> Ward Leavenworth Kans.*

Book mark :

*J. H. Anderson*

(856g)

Copyist.

B

Indpt. Battery.

U.S.C.T.

Robert A. Belle

Fox, Indpt. Battery, U. S. Col'd L. Art'y.

Appears on

Battery Muster Roll

for List must to Dec 31, 1864.

Present or absent Absent

Stoppage, \$ 100 for

Due Gov't, \$ 100 for

Valuation of horse, \$ 100

Valuation of horse equipments, \$ 100

Remarks: Absent without leave

Book mark:

J. A. Schuler

(358)

Copyist.

B

Indpt. Battery. | **U.S.C.T.**

Robert A. Bell

Indpt. Battery, U. S. Col'd L. Art'y.

Appears on

**Battery Muster Roll**

for *Jan & Feb*, 186*5*.

Present or absent

Stoppage, \$ 100 for

Due Gov't, \$ 100 for

Valuation of horse, \$ 100

Valuation of horse equipments, \$ 100

Remarks: *Died in General Hospital at Fort Leavenworth Feb 22<sup>d</sup> 1865 of Pneumonia*

Book mark:

*J. Schindler*

(358)

Copyist.

*B* | Indpt. Battery. | **U.S.C.T.**

*Robert A. Bell,*

*B*, Indpt. Battery U. S. Col'd Light Art'y.

Appears on **Batt'y Muster-out Roll**, dated  
*Ft. Leavenworth, Ks, July 22, 1865.*

Muster-out to date \_\_\_\_\_, 186 .

Last paid to *Pay due from enlistment*, 186 .

**Clothing account:**

Last settled \_\_\_\_\_, 186 ; drawn since \$ *60* <sup>*76*</sup>/<sub>*100*</sub>,

Due soldier \$ \_\_\_\_\_ <sup>*100*</sup>/<sub>*100*</sub>; due U. S. \$ \_\_\_\_\_ <sup>*100*</sup>/<sub>*100*</sub>

Am't for cloth'g in kind or money adv'd \$ \_\_\_\_\_ <sup>*100*</sup>/<sub>*100*</sub>

Due U. S. for arms, equipments, &c., \$ \_\_\_\_\_ <sup>*100*</sup>/<sub>*100*</sub>

Bounty paid \$ *100* <sup>*100*</sup>/<sub>*100*</sub>; due \$ *none* <sup>*100*</sup>/<sub>*100*</sub>,

Remarks: *Lied in G. Hospital,*  
*Ft. Leavenworth, Ks., Feby,*  
*22/65.*

Book mark : \_\_\_\_\_

*Porter*



Bell Robert A.

, Co. *1st. Batt Reg't W.S.C.A*

*43* Enclosures.

Bed Cards .....	Final Statements <i>/</i> .....
Burial Records .....	Furloughs or L. of A. ....
Certs. of Dis. for Discharge .....	Med. Certificates .....
C. M. Charges .....	Med. Des. Lists .....
Descriptive Lists .....	Orders .....
Discharge Certificates .....	Pris. of War Record .....
Enlistment Papers <i>2</i> .....	Resignations .....

Other papers relating to—

Admission to Hosp'l .....	Furlough or L. of A. ....
Casualty Sheet .....	Med. Examination .....
Confinement .....	Misc. Information .....
Contracts .....	Pay or Clothing .....
Death or Effects <i>/</i> .....	Personal Reports .....
Desertion .....	Rank .....
Discharge from Hosp'l .....	Transfer to Hosp'l .....
Discharge from Service .....	Transfer to V. R. C. ....
Duty .....	Transportation .....

NOTE 1.—This blank will be used for both enlistments and re-enlistments—enlistment of veterans, &c., &c., in the volunteer service. They will be made out in duplicate in all cases—one to accompany the recruiting return of the superintendent (not the recruiting officer) to the Adjutant General, and one to accompany the accounts of the officer who pays bounty, &c. The Regiment and Company in which the soldier last served should be given on the back.

NOTE 2.—An enlistment holds to service. A muster-in must, in all cases, precede payment of pay, bounty, pension, &c. A muster-in roll must, in all cases, be filed in the Adjutant General's Office as evidence of muster-in. The mustering officer, commissary, or assistant commissary of musters, as the case may be, will countersign both enlistments as having mustered the soldier into the service of the United States before either of them is given to the disbursing officer.

NOV. 23 1892

DECLARATION OF RECRUIT.

I, Robert A Bell desiring to VOLUNTEER as a Soldier in the Army of the United States, for the term of THREE YEARS Do Declare, That I am Eighteen years ~~old~~ months of age; that I have never been discharged from the United States service on account of disability or by sentence of a court-martial, or by order before the expiration of a term of enlistment; and I know of no impediment to my serving honestly and faithfully as a soldier for three years.

GIVEN at Leavenworth City State of Kansas the 23 day of July 1864

Witness: W A Burnham Robert A Bell

No. 105

Robert A Bell

Volunteered at Leavenworth City

Class 23 1864

By W D. Powell 2nd Lieut 2nd Regt U. S. Cavalry

enlistment; last served in Company ( )

Reg't of

Discharged 18

CONSENT IN CASE OF MINOR.

I, \_\_\_\_\_ Do CERTIFY, That I am \_\_\_\_\_; that the \_\_\_\_\_ of \_\_\_\_\_; that the \_\_\_\_\_ is \_\_\_\_\_ years of age; and I do hereby freely give my CONSENT to his volunteering as a SOLDIER in the ARMY OF THE UNITED STATES for the period of THREE YEARS.

GIVEN at \_\_\_\_\_ the \_\_\_\_\_ day of \_\_\_\_\_

Witness: \_\_\_\_\_

VOLUNTEER ENLISTMENT.

STATE OF

*Kansas*

TOWN OF

*Levernort City*



I, *Robt A Bell* born in *Buchanan Co.*  
 in the State of *Missouri* aged *eighteen* years,  
 and by occupation a *Laborer* Do HEREBY ACKNOWLEDGE to have  
 volunteered this *23* day of *July* 1864,  
 to serve as a **Soldier** in the **Army of the United States of America**, for the  
 period of **THREE YEARS** unless sooner discharged by proper authority: Do also  
 agree to accept such bounty, pay, rations, and clothing, as are or may be, estab-  
 lished by law for volunteers. And I, *Robt A Bell* do  
 solemnly swear, that I will bear true faith and allegiance to the **United States**  
**of America**, and that I will serve them honestly and faithfully against all their  
 enemies or opposers whomsoever; and that I will observe and obey the orders of  
 the President of the United States, and the orders of the officers appointed over  
 me, according to the Rules and Articles of War.

Sworn and subscribed to, at *Levernort City*  
 this *23* day of *July* 1864,  
 BEFORE *Wm D Matthews 2nd Lieut*

*Robt A Bell*  
 his  
 mark

I CERTIFY, ON HONOR, That I have carefully examined the above-named Volunteer, agreeably  
 to the General Regulations of the Army, and that, in my opinion, he is free from all bodily defects and  
 mental infirmity, which would in any way disqualify him from performing the duties of a soldier.

*Tiffin Banks*  
 Surg Board of Enrollement  
*North Dist Kansas*  
 EXAMINING SURGEON.

I CERTIFY, ON HONOR, That I have minutely inspected the Volunteer, *Robt A Bell*  
 previously to his enlistment, and that he was entirely sober when enlisted; that, to the best of my  
 judgment and belief, he is of lawful age; and that, in accepting him as duly qualified to perform the duties  
 of an able bodied soldier, I have strictly observed the Regulations which govern the recruiting service.  
 This soldier has *Black* eyes, *Black* hair, *Black* complexion, is *5-* feet  
*11* inches high.

*Wm D Matthews 2nd Lieut*  
*Recruiting Co. 16. 2nd U.S. Col of Artillery*  
 Regiment of *Volunteers*,  
 RECRUITING OFFICER.

(A. G. O. No. 74 & 75.)

*This recruit has received one hundred dollars advance bounty from the bounty fund  
 authorized by Act of Congress approved July 13th 1864. The receipt of the  
 the Provost Marshal General*

Mustered into the service of the United States, in **Company** *Company*  
 the *26* day of *July* 1864, at *Levernort City Kansas*  
*Robt A Bell*  
 Regiment of *Volunteers*  
 on *from state of*

NOTE 1.—This blank will be used for both enlistments and re-enlistments—enlistment of veterans, &c., &c., in the volunteer service. They will be made out in duplicate in all cases—one to accompany the recruiting return of the superintendent (not the recruiting officer) to the Adjutant General, and one to accompany the accounts of the officer who pays bounty, &c. The Regiment and Company in which the soldier last served should be given on the back.

NOTE 2.—An enlistment holds to service. A muster-in must, in all cases, precede payment of pay, bounty, pension, &c. A muster-in roll must, in all cases, be filed in the Adjutant General's Office as evidence of muster-in. The mustering officer, commissary, or assistant commissary of musters, as the case may be, will countersign both enlistments as having mustered the soldier into the service of the United States before either of them is given to the disbursing officer.

DECLARATION OF RECRUIT.

I, Robt A. Bell desiring to VOLUNTEER as a Soldier in the Army of the United States, for the term of THREE YEARS Do Declare, That I am Eighteen years ~~months~~ of age; that I have never been discharged from the United States service on account of disability or by sentence of a court-martial, or by order before the expiration of a term of enlistment; and I know of no impediment to my serving honestly and faithfully as a soldier for three years.

GIVEN at Government City State of Kansas the 23 day of July 1864

Witness: W.A. Bunker Robt A. Bell  
mark

No. 26 33512

Robt A. Bell

Volunteered at Government City

July 23 1864,

By Wm D Matthews 2nd Lieut  
Regiment of Cavalry U.S. Extra Artillery

Company 2nd

enlistment; last served in Company ( )

Reg't of

Discharged 18

CONSENT IN CASE OF MINOR.

I, \_\_\_\_\_ Do CERTIFY, That I am \_\_\_\_\_; that the \_\_\_\_\_ of \_\_\_\_\_; that the \_\_\_\_\_ is \_\_\_\_\_ years of age; and I do hereby freely give my CONSENT to his volunteering as a SOLDIER in the ARMY OF THE UNITED STATES for the period of THREE YEARS.

GIVEN at \_\_\_\_\_ the \_\_\_\_\_ day of \_\_\_\_\_

Witness: \_\_\_\_\_

VOLUNTEER ENLISTMENT.

STATE OF

*Kansas*



TOWN OF

*Leavenworth City*

I, *Robt A Bell* born in *Buchanan Co*

in the State of *Missouri* aged *eighteen* years,

and by occupation a *Laborer* Do HEREBY ACKNOWLEDGE to have

volunteered this *23* day of *July* 1864.

to serve as a **Soldier** in the **Army of the United States of America**, for the period of **THREE YEARS** unless sooner discharged by proper authority: Do also

agree to accept such bounty, pay, rations, and clothing, as are, or may be, established by law for volunteers. And I, *Robt A Bell* do

solemnly swear, that I will bear true faith and allegiance to the **United States of America**, and that I will serve them honestly and faithfully against all their

enemies or opposers whomsoever; and that I will observe and obey the orders of the President of the United States, and the orders of the officers appointed over

me, according to the Rules and Articles of War.

Sworn and subscribed to, at *Leavenworth City* *Robt A Bell* his

this *23<sup>rd</sup>* day of *July* 1864

BEFORE *Wm D Matthews* and *Quint - Recruiting Co 26<sup>th</sup> Wis. Col Artillery* mark

I CERTIFY, ON HONOR, That I have carefully examined the above-named Volunteer, agreeably to the General Regulations of the Army, and that, in my opinion, he is free from all bodily defects and mental infirmity, which would in any way disqualify him from performing the duties of a soldier.

*Viggin Sinks*  
*Surg Board of Enrollment*  
*North Dist Kansas*

EXAMINING SURGEON.

I CERTIFY, ON HONOR, That I have minutely inspected the Volunteer, *Robt A Bell* previously to his enlistment, and that he was entirely sober when enlisted; that, to the best of my judgment and belief, he is of lawful age; and that, in accepting him as duly qualified to perform the duties of an able-bodied soldier, I have strictly observed the Regulations which govern the recruiting service.

This soldier has *Black* eyes, *Black* hair, *Black* complexion, is *5* feet

*11* inches high.

*Wm D Matthews* and *Quint - Recruiting Co 26<sup>th</sup> Wis. Col Artillery*  
Regiment of *Volunteers*,  
Volunteers,

RECRUITING OFFICER.

the *23<sup>rd</sup>* day of *July* 1864 at *Leavenworth City*

Mustered into the service of the United States, in Company *11<sup>th</sup>*

Regiment of *Volunteers*, on

*Capt. A. L. ... 1865*  
*Adjutant General's Office*

**FINAL STATEMENT**

OF

*Co. Robert A. Bell*  
*Sed. Reg. Patty W. Bell (St.)*

**VOLUNTEERS.**

*Disch. April 22 1865*

*A. L.*  
*Co. Command receipt to Serg*  
*for Effects sent 2 Aug.*  
*777*

NOTE 1.—Two of these certificates (or duplicates) are to be given to each Volunteer Soldier or drafted man who may be discharged previously to the discharge of his company, that he may at once receive from the Paymaster the pay, &c., due him, and the captain or other COMMISSIONED officer commanding the company will certify to the act of the delivery of the duplicate certificates; on these certificates the Soldier is "entitled to" his discharge, and should also present his discharge to the Paymaster to have the payment endorsed on it. The discharge is to be given back to the Soldier by the Paymaster; the latter only retaining as his voucher the duplicate certificates.

NOTE 2.—If the Soldier is entitled to pay for the use of his horse, the Company Commander will certify to that fact on the back of both these final statements, and also to the time he has paid due for having been so mounted on his own horse.

NOTE 3.—When a Soldier is furnished with final statements, his descriptive list, if he has one, should be taken up by the officer who gives the Soldier these statements, and endorsed with a statement to this effect by the officer. This endorsement should exhibit a full statement of the time for which the Soldier was allowed pay on his final statements, the clothing account, and all other charges against him or in his favor, so as to comprise a complete exhibit of his account. It will then be transmitted to the company commander of the Soldier, who will enter all the data necessary to a full understanding of the Soldier's account on the muster roll upon which the Soldier's discharge is reported. The descriptive list will then be destroyed. The object of this is, that the remaining portion of the Soldier's account may be settled upon the receipt of these muster rolls, and the Soldier receive any pay or allowances that may be due him at the time of his discharge, and which may not appear on his final statements from the fact that his descriptive list is incomplete. These accounts for back pay, &c., are settled by the 2d Auditor of the Treasury Department.

NOTE 4.—Charges for loss or injury to ordnance, horse equipments, and other miscellaneous charges, should appear under the heading of "Other Stoppages."

NOTE 5.—Bounty paid by State authorities, and not by the United States, will not be entered on this statement.

NOTE 6.—Amounts due the Sutler and Laundress must be entered on the muster roll on which the discharge, death, desertion, &c., is reported, as well as on the final statement, otherwise the amount cannot be collected from the United States.

NOTE 7.—This blank will be used for deceased volunteers and drafted men, as well as for others.

NOTE 8.—Where a Soldier dies in Hospital or on detached service, his descriptive list, if he has one, should be sent with his final statements, in duplicate, to the Adjutant General, Washington, D. C.

**ADJUTANT GENERAL'S OFFICE**

*March 7 1865*

Duplicate with Inventory sent 2d Auditor.



I certify, on honor, that Robert A. Bell a Private of  
 Captain H. Ford Douglas Company ( ) of the Indep<sup>d</sup> Batty W.S. Col. Artillery (Light)  
**VOLUNTEERS**, of the State of Missouri, born in Buchanan County, State  
 of Missouri, aged 18 years; 5 feet 11 inches high; Black complexion,  
Black eyes, Black hair, and by occupation a Laborer having joined the company on  
 its original organization at Leavenworth City Kansas and enrolled in it at the muster into  
 the service of the United States at Leavenworth Kansas, on the 26<sup>th</sup> day  
 of July, 1864, (or was mustered in service as a recruit, by \_\_\_\_\_  
 \_\_\_\_\_, at \_\_\_\_\_, on the \_\_\_\_\_ day of \_\_\_\_\_,  
 186 , or was drafted and mustered into the service of the United States from the \_\_\_\_\_  
 Enrollment District of the State of \_\_\_\_\_, at \_\_\_\_\_, \_\_\_\_\_,  
 on the \_\_\_\_\_ day of \_\_\_\_\_, 186 ,) to serve in the Batty Regiment, for  
 the term of Three years : and having served **HONESTLY** and  
**FAITHFULLY** with his Company in Kansas to the present date, is now  
 entitled to a **DISCHARGE** by reason of Died in General Hospital Fort  
Leavenworth Kansas February 22<sup>d</sup> 1865. of Pneumonia

The said Robert A. Bell has pay due him was last paid by Paymaster  
 \_\_\_\_\_ to include the \_\_\_\_\_ day of \_\_\_\_\_, 186 , and has  
 pay due him from that time to the present date; he is entitled to pay and subsistence for  
**TRAVELING** to place of enrollment, and whatever other allowances are authorized to volunteer  
 soldiers, drafted men, or militia, so discharged. He has received from the United States **CLOTHING**  
 amounting to \$ 60 76/<sub>100</sub> dollars, since the date 24<sup>th</sup> of Enlistment  
 186 , when his clothing account was last settled. He has received from the United States  
\$ 100 00/<sub>100</sub> dollars advanced **BOUNTY**.

~~There is to be stopped from him, on account of the State of \_\_\_\_\_, or other  
 authorities, for **CLOTHING**, &c., received on entering service, \_\_\_\_\_ 100 dollars; and  
 for other stoppages, viz: \_\_\_\_\_~~

\_\_\_\_\_ 100 dollars.  
 He has been furnished with **TRANSPORTATION** in kind from the place of his discharge to  
 \_\_\_\_\_; and he has been **SUBSISTED** for **TRAVELING** to his  
 place of enrollment, up to the \_\_\_\_\_, 186 .

He is indebted to \_\_\_\_\_, **SUTLER**, \_\_\_\_\_ 100 dollars.  
 He is indebted to \_\_\_\_\_, **LAUNDRESS**, \_\_\_\_\_ 100 dollars.

Given in Duplicate, at Fort Leavenworth Kansas, this 26<sup>th</sup> day  
 of February, 1865.

Capt H. Ford Douglas  
 Commanding Company Battery

INVENTORY OF THE EFFECTS

OF

ARTICLES OF WAR.

ART. 95. When any non-commissioned officer or soldier shall die, or be killed in the service of the United States, the then commanding officer of the troop or company shall, in the presence of two other commissioned officers, take an account of what effects he died possessed of, above his arms and accoutrements, and transmit the same to the office of the Department of War, which said effects are to be accounted for, and paid to the representatives of such deceased non-commissioned officer or soldier. And in case any of the officers, so authorized to take care of the effects of deceased officers and soldiers, should, before they have accounted to their representatives for the same, have occasion to leave the regiment or post, by preferment or otherwise, they shall, before they be permitted to quit the same, deposit in the hands of the commanding officer, or of the assistant military agent, all the effects of such deceased non-commissioned officers and soldiers, in order that the same may be secured for, and paid to, their respective representatives.

ARMY REGULATIONS—EDITION OF 1863.

DECEASED SOLDIERS.

Par. 152. Inventories of the effects of deceased non-commissioned officers and soldiers, required by the 95th Article of War, will be forwarded to the Adjutant General, by the commander of the company to which the deceased belonged, and a duplicate of the same to the colonel of the regiment. Final statements of pay, clothing, &c., in duplicate, will be sent to the Adjutant General with one copy of the inventory. When a soldier dies at a post or station absent from his company, it will be the duty of his immediate commander to furnish the required inventory and final statements, and, at the same time, to forward to the commanding officer of the company to which the soldier belonged, a report of his death, specifying the date, place, and cause; to what time he was last paid, and the money or other effects in his possession at the time of his decease; which report will be noted on the next muster roll of the company to which the man belonged. Each inventory will be endorsed, "Inventory of the effects of \_\_\_\_\_, late of company (—) \_\_\_\_\_ regiment of \_\_\_\_\_, who died at \_\_\_\_\_, the \_\_\_\_\_ day of \_\_\_\_\_, 186—." If a legal representative receive the effects, it will be stated in the report. If the soldier leave no effects, the fact will be reported.

Par. 153. Should the effects of a deceased non-commissioned officer or soldier not be administered upon within a short period after his decease, they shall be disposed of by a Council of Administration, under the authority of the commanding officer of the post, and the proceeds deposited with the Paymaster, to the credit of the United States, until they shall be claimed by the legal representatives of the deceased.

Par. 154. In all such cases of sales by the Council of Administration, a statement in detail, or account of the proceeds, duly certified by the Council and commanding officer, accompanied by the Paymaster's receipt for the proceeds, will be forwarded by the commanding officer to the Adjutant General. The statement will be endorsed, "Report of the proceeds of the effects of \_\_\_\_\_, late of company (—) \_\_\_\_\_ regiment of \_\_\_\_\_, who died at \_\_\_\_\_, the \_\_\_\_\_ day of \_\_\_\_\_, 186—."

NOTE 1.—The effects in all cases, when called for, should be turned over to the legal representative, without further authority from the Adjutant General. When the effects are turned over to the relatives of the deceased before these inventories are sent to the Adjutant General, their receipts therefor should be attached to the inventories. In all other cases, one copy will be sent with a letter of transmittal direct to the Adjutant General, and a duplicate retained by the officer.

NOTE 2.—Particular care should be taken to take receipts in duplicate from the Paymaster for any funds turned over to him; one copy should be sent direct to the Adjutant General and one retained by the officer.

Late of Company \_\_\_\_\_

Reg't of \_\_\_\_\_

Volunteers, who died at \_\_\_\_\_

on the \_\_\_\_\_ day of \_\_\_\_\_ 186 .





Inventory of the effects of Robert A. Bell late  
a Private of Captain Wm Ford Douglas Company Independent of Artillery  
the Battery Regiment of U.S. Col. Artillery (Light) Volunteers, who was enrolled as  
a Private at Leavenworth City in the State of Kansas on  
the 26<sup>th</sup> day of July 1864, and mustered into the service of the United  
States as a Private on the 26<sup>th</sup> day of July 1864, at Leavenworth City  
in Company Independent Battery of U.S. Col. Artillery Volunteers, to serve Three  
years or during the war; he was born in Buchanan County in the State  
of Missouri; he was 18 years of age, 5 feet 11 inches  
high, Black complexion, black eyes, black hair, and by occupation, when enrolled,  
a Subsister; he died in General Hospital, at  
Leavenworth Kansas on the 22<sup>nd</sup> day of February 1865, by  
reason of Dysentery

INVENTORY.					
ARTICLES.	No.	ARTICLES.	No.	ARTICLES.	No.
Hats.....	1	Pairs trowsers.....		Knapsacks.....	
Caps.....		Pairs flannel drawers.....			
Forage caps.....		Pairs cotton drawers.....			
Great coats.....	1	Flannel shirts.....			
Uniform coats.....		Cotton shirts.....			
Uniform jackets.....	1	Pairs boots.....	1		
Flannel sack coats.....		Pairs shoes.....			
Blouses.....		Pairs socks.....			
Stable frocks.....		Blankets.....			
Fatigue overalls.....		Haversacks.....			
				MONEY.	
				Specie.....	\$
				Notes.....	\$

I CERTIFY, ON HONOR, that the above inventory comprises all the effects of Private  
Robert A. Bell, deceased, and that the effects are in the hands  
of Capt. Wm Ford Douglas at Fort Leavenworth Kansas  
to be disposed of by a Council of Administration.

( DUPLICATES. )

STATION: Fort Leavenworth  
DATE: February 24<sup>th</sup> 1865

Capt. Wm Ford Douglas  
Commanding the Company Battery

Copt. Batt'y U.S. Col'd L. Art'y.

Private Private

CARD NUMBERS.

1	6233624	26
2	6233744	27
3	6233893	28
4	6234057	29
5	6234194	30
6	6234362	31
7	6234525	32
8	9132925	33
9		34
10		35
11		36
12		37
13		38
14		39
15		40
16		41
17		42
18		43
19		44
20		45
21		46
22		47
23		48
24		49
25		50

Book Mark:

See also

*D*

Indpt. Batt'y. | **U.S.C.T.**

*William Bell*

....., Indpt. Batt'y, U. S. Col'd L. Art'y.

Appears on

**Battery Descriptive Book**

of the organization named above.

**DESCRIPTION.**

Age *20* years; height *5* feet *5* inches.

Complexion *Black*

Eyes *Black*; hair *Black*

Where born *Platte Missouri*

Occupation *Laborer*

**ENLISTMENT.**

When *Dec. 12*, 186*4*

Where *Ft. Rauh Mo.*

By whom *G. Malheur*; term *3* y'rs.

Remarks: .....

.....

.....

.....

.....

.....

.....

.....

.....

*Holbrook*

*B* | Indpt. Battery. | **U.S.C.T.**

*William Belt*

Appears with rank of *Priv* on

**Muster and Descriptive Roll of a Detachment of U. S. Vols. forwarded**

for the Indpt. Batt'y, U. S. Col'd L. Arty. Roll dated

*Leavenworth, Kans., Dec. 12, 1864.*

Where born *Platte Co. Missouri.*

Age *20* y'rs; occupation *Laborer*

When enlisted *Dec 12*, 1864.

Where enlisted *Leavenworth, Kans.*

For what period enlisted *3* years.

Eyes *Black*; hair *Black*

Complexion *Black*; height *5* ft. *5* in.

When mustered in *Dec 12*, 1864.

Where mustered in *Leavenworth, Ks.*

Bounty paid \$ *100*; due \$ *100*

Where credited

Battery to which assigned

Remarks: *Credited to North<sup>n</sup>*

*Dist. Kansas, 19 Sub-District,*

*1<sup>st</sup> Ward, Leavenworth City,*

*vol. Recruit & entitled to Bounty*

Book mark:

*E. L. Thaw*

B

Indpt. Battery. U.S.C.T.

William Bell

Indpt. Battery, U. S. Col'd L. Art'y.

Appears on

**Battery Muster-in and Descriptive Roll**

of the organization named above. Roll dated

Leavenworth Co, Dec 23, 1864.

Where born Platt Co, Mo,

Age 20 y'rs; occupation Laborer

When enlisted Dec 12, 1864.

Where enlisted Fort Leavenworth Co

For what period enlisted 3 years.

Eyes Blu; hair Blu

Complexion Blu; height 5 ft. 5 in.

When mustered in Dec 12, 1864.

Where mustered in Leavenworth

Bounty paid \$100<sup>00</sup>/<sub>100</sub>; due \$200<sup>00</sup>/<sub>100</sub>

Where credited

Battery to which assigned

Remarks: A. N. Dist Co  
19<sup>th</sup> S. D. 1<sup>st</sup> Ward  
Leavenworth Co.

Book mark: 28 S. D. Kans

J. H. Schorley  
(856g) Copyist.

19

Indpt. Battery. | U.S.C.T.

William Belt

Pat, Indpt. Battery, U. S. Col'd L. Art'y.

Appears on

**Battery Muster Roll**

for *Artist must to Dec 31*, 1864

Present or absent *Present*

Stoppage, \$ 100 for

Due Gov't, \$ 100 for

Valuation of horse, \$ 100

Valuation of horse equipments, \$ 100

Remarks:

Book mark:

*J. H. Scherby*  
(358) Copyist.

B | Indpt. Battery. | U.S.C.T.

Wm C. Belt

Priv, Indpt. Battery, U. S. Col'd L. Art'y.

Appears on

Battery Muster Roll

for Jan & Feb, 1865

Present or absent Present

Stoppage, \$ 100 for

Due Gov't, \$ 100 for

Valuation of horse, \$ 100

Valuation of horse equipments, \$ 100

Remarks:

Book mark:

J. H. Schorley

(358)

Copyist.

*B*

Indpt. Battery.

U.S.C.T.

*William C. Belt,*

*In*, Indpt. Battery, U. S. Col'd L. Art'y.

Appears on

**Battery Muster Roll**

for *Man, & Apl.*, 186 *5*.

Present or absent *Present*

Stoppage, \$ 100 for

Due Gov't, \$ 100 for

Valuation of horse, \$ 100

Valuation of horse equipments, \$ 100

Remarks:

Book mark:

*Baxter*

(358)

Copyist.



*B* | Indpt. Battery. | **U.S.C.T.**

*William Bell,*

*On*, Indpt. Battery, U. S. Col'd L. Art'y.

Appears on

**Battery Muster Roll**

for *May & June*, 186*5*.

Present or absent *Present,*

Stoppage, \$ 100 for

Due Gov't, \$ 100 for

Valuation of horse, \$ 100

Valuation of horse equipments, \$ 100

Remarks:

Book mark:

*Porter*

Copyist.

*S* | Indpt. Battery. | **U.S.C.T.**

*William Bell,*

*W*, Indpt. Battery U. S. Col'd Light Art'y.

Appears on **Batt'y Muster-out Roll**, dated

*M. Leavenworth, Mo., July 22, 1865.*

Muster-out to date *July 22, 1865.*

Last paid to *Pay due from enlistment, 186*

**Clothing account:**

Last settled....., 186 ; drawn since ~~\$51~~ <sup>59</sup> 100,

Due soldier \$.....100; due U. S. \$.....100

Am't for cloth'g in kind or money adv'd \$.....100

Due U. S. for arms, equipments, &c., \$.....100

Bounty paid \$ *100* 100; due \$ *None* 100,

Remarks:.....

Book mark: *28 St. Kansas.*

(361)

*Printed*  
Copyist.

*Bell, William*

, Co. *Inf Batt* Reg't *U.S.C. A*

*3* Enclosures.

Bed Cards .....	Final Statements .....
Burial Records .....	Furloughs or L. of A .....
Certs. of Dis. for Discharge .....	Med. Certificates .....
C. M. Charges .....	Med. Des. Lists .....
Descriptive Lists .....	Orders .....
Discharge Certificates .....	Pris. of War Record .....
Enlistment Papers .....	Resignations .....

Other papers relating to—

Admission to Hosp'l .....	Furlough or L. of A .....
Casualty Sheet .....	Med. Examination .....
Confinement .....	Misc. Information / .....
Contracts .....	Pay or Clothing .....
Death or Effects .....	Personal Reports .....
Desertion .....	Rank .....
Discharge from Hosp'l .....	Transfer to Hosp'l .....
Discharge from Service .....	Transfer to V. R. C. .....
Duty .....	Transportation .....

MICROFILM PUBLICATION M 1836

COMPILED MILITARY SERVICE RECORDS  
OF VOLUNTEER UNION SOLDIERS WHO SERVED WITH  
THE UNITED STATES COLORED TROOPS (USCT)  
INDEPENDENT BATTERY LIGHT ARTILLERY

PERSONAL PAPERS' TARGET SHEET

PLEASE NOTE THE CHECKED INFORMATION ABOUT THE PERSONAL PAPERS IN  
THIS FILE:

- NO PERSONAL PAPERS WERE FOUND IN THIS FILE WHEN THE  
RECORDS WERE ARRANGED FOR MICROFILMING.
- 5 PERSONAL PAPER(S) FOUND IN THIS FILE WHEN THE RECORDS  
WERE ARRANGED FOR MICROFILMING.

NOTE 1.—This blank will be used for both enlistments and re-enlistments—enlistment of veterans, &c., &c., in the volunteer service. They will be made out in duplicate in all cases—one to accompany the recruiting return of the superintendent (not the recruiting officer) to the Adjutant General, and one to accompany the accounts of the officer who pays bounty, &c. The Regiment and Company in which the soldier last served should be given on the back.

NOTE 2.—An enlistment holds to service. A muster-in must, in all cases, precede payment of pay, bounty, pension, &c. A muster-in roll must, in all cases, be filed in the Adjutant General's Office as evidence of muster. The mustering officer, commissary, or assistant commissary of musters, as the case may be, will countersign both enlistments as having mustered the soldier into the service of the United States before either of them is given by the disbursing officer.

From 2nd. Aud. Nov. 23d 1892

DECLARATION OF RECRUIT.

I, William Bert desiring to VOLUNTEER as a Soldier in the Army of the United States, for the term of THREE YEARS, Do Declare, That I am Twenty 20 years and \_\_\_\_\_ months of age; that I have never been discharged from the United States service on account of disability or by sentence of a court martial, or by order before the expiration of a term of enlistment; and I know of no impediment to my serving honestly and faithfully as a soldier for three years.

GIVEN at Lawrenceville Ga the 12 day of December 1861

Witness:

[Signature] [Signature]

No. 12

\_\_\_\_\_ enlistment; last served in Company ( )  
\_\_\_\_\_ Reg't of \_\_\_\_\_  
Discharged \_\_\_\_\_ 18 \_\_\_\_\_

Volunteered at Lawrenceville Ga  
12th Regt of Decatur 1861  
By Wm K. Matthews  
Adjutant of Regt. May 11, 1862  
William Bert

CONSENT IN CASE OF MINOR.

I, \_\_\_\_\_ Do CERTIFY, That I am the \_\_\_\_\_ of \_\_\_\_\_; that the said \_\_\_\_\_ is \_\_\_\_\_ years of age; and I do hereby freely give my CONSENT to his volunteering as a SOLDIER in the ARMY OF THE UNITED STATES for the period of THREE YEARS.

GIVEN at \_\_\_\_\_ the \_\_\_\_\_ day of \_\_\_\_\_

Witness:

VOLUNTEER ENLISTMENT.

STATE OF



TOWN OF

Leavenworth

I, William D. Mathew born in West County  
 in the State of Missouri aged twenty 20 years,  
 and by occupation a Recruiter DO HEREBY ACKNOWLEDGE to have  
 volunteered this twelfth day of December 1864.  
 to serve as a **Soldier** in the **Army of the United States of America**, for  
 the period of **THREE YEARS**, unless sooner discharged by proper authority:  
 Do also agree to accept such bounty, pay, rations, and clothing, as are, or may be,  
 established by law for volunteers. And I, William D. Mathew do  
 solemnly swear, that I will bear true faith and allegiance to the **United States**  
**of America**, and that I will serve them honestly and faithfully against all  
 their enemies or opposers whomsoever; and that I will observe and obey the  
 orders of the President of the United States, and the orders of the officers  
 appointed over me, according to the Rules and Articles of War.

Sworn and subscribed to, at Leavenworth his first  
 this twelfth day of December 1864  
 BEFORE William D. Mathew, Recruter  
Recruiting Soldier West Artillery

CERTIFY, ON HONOR, That I have carefully examined the above-named Volunteer, agreeably  
 to the General Regulations of the Army, and that, in my opinion, he is free from all bodily defects and  
 mental infirmity, which would in any way disqualify him from performing the duties of a soldier.

Jesse Sims  
 Surg. Genl. of Enrollment  
 North Dist Kansas  
 EXAMINING SURGEON.

CERTIFY, ON HONOR, That I have minutely inspected the Volunteer, William D. Mathew  
 previously to his enlistment, and that he was entirely sober when enlisted; that, to the best of my  
 judgment and belief, he is of lawful age; and that, in accepting him as duly qualified to perform the  
 duties of an able-bodied soldier, I have strictly observed the Regulations which govern the recruiting  
 service. This soldier has black eyes, black hair, black complexion, is 5  
 feet 7 inches high.

William D. Mathew, Recruter  
Recruiting Soldier West Artillery  
 Regiment of Battery A. S. Volunteers,  
 RECRUITING OFFICER.

(A. G. O. No. 74 & 76.)

Battery A. S. Artillery  
 Mustered into the service of the United States, for three years or during the war, from date of enlistment, in Independent  
 of Artillery Regt. on the 12 day of December, 1864, at Leavenworth, Kansas

*This warrant has a reward of one hundred dollars advance bounty from the County fund, authorized by an Act of Congress approved July 4, 1864, and General Order No. 2, from the Provost Marshal General, dated August 19, 1864.*

DECLARATION OF RECRUIT.

I, William Belt desiring to VOLUNTEER as a Soldier in the Army of the United States, for the term of THREE YEARS, Do Declare, That I am Twenty 20 years and \_\_\_\_\_ months of age; that I have never been discharged from the United States service on account of disability or by sentence of a court martial, or by order before the expiration of a term of enlistment; and I know of no impediment to my serving honestly and faithfully as a soldier for three years.

GIVEN at Leavenworth City, Kansas the 12 day of December 1874

Witness:

[Signature] William Belt

NOTE 1.—This blank will be used for both enlistments and re-enlistments—enlistment of veterans, &c., &c., in the volunteer service. They will be made out in duplicate in all cases—one to accompany the recruiting return of the superintendent (not the recruiting officer) to the Adjutant General, and one to accompany the accounts of the officer who pays bounty, &c. The Regiment and Company in which the soldier last served should be given on the back.  
NOTE 2.—An enlistment holds to service. A muster-in must, in all cases, precede payment of pay, bounty, pension, &c. A muster-in roll must, in all cases, be filed in the Adjutant General's Office as evidence of muster-in. The mustering officer, commissary, or assistant commissary of musters, as the case may be, will countersign both enlistments as having mustered the soldier into the service of the United States before either of them is given to the disbursing officer.

No. ....

6

William Belt  
Volunteered at Leavenworth  
the 12th day of Dec 1874,  
By [Signature]  
[Signature]  
\_\_\_\_\_ enlistment; last served in Company ( )  
And Walter Regt of A. S. C. 1st Regt  
Discharged \_\_\_\_\_ 18 .

CONSENT IN CASE OF MINOR.

I, \_\_\_\_\_ Do CERTIFY, That I am the \_\_\_\_\_ of \_\_\_\_\_; that the said \_\_\_\_\_ is \_\_\_\_\_ years of age; and I do hereby freely give my CONSENT to his volunteering as a SOLDIER in the ARMY OF THE UNITED STATES for the period of THREE YEARS.

GIVEN at \_\_\_\_\_ the \_\_\_\_\_ day of \_\_\_\_\_

Witness:

1<sup>st</sup> Ward

VOLUNTEER ENLISTMENT.

STATE OF

*Kansas*



TOWN OF

*Leavenworth*

I, *William Belt* born in *Wet County*  
 in the State of *Missouri* aged *Twenty 20* years,  
 and by occupation a *Labourer* Do HEREBY ACKNOWLEDGE to have  
 volunteered this *twelfth 12* day of *December* 186*4*  
 to serve as a **Soldier** in the **Army of the United States of America**, for  
 the period of **THREE YEARS**, unless sooner discharged by proper authority:  
 Do also agree to accept such bounty, pay, rations, and clothing, as are, or may be,  
 established by law for volunteers. And I, *William Belt* do  
 solemnly swear, that I will bear true faith and allegiance to the **United States**  
**of America**, and that I will serve them honestly and faithfully against all  
 their enemies or opposers whomsoever; and that I will observe and obey the  
 orders of the President of the United States, and the orders of the officers  
 appointed over me, according to the Rules and Articles of War.

Sworn and subscribed to, at *Leavenworth*  
 this *12* day of *Dec* 186*4* } *William Belt*  
 BEFORE *William D. Matthews* }  
*Recruiting Indus Cold Light Artillery*

I CERTIFY, ON HONOR, That I have carefully examined the above-named Volunteer, agreeably  
 to the General Regulations of the Army, and that, in my opinion, he is free from all bodily defects and  
 mental infirmity, which would in any way disqualify him from performing the duties of a soldier.

*Lizzie Sinks*  
*Sur Board of Enrolment*  
*North Dist Kansas*  
 EXAMINING SURGEON.

I CERTIFY, ON HONOR, That I have minutely inspected the Volunteer, *William Belt*  
 previously to his enlistment, and that he was entirely sober when enlisted; that, to the best of my  
 judgment and belief, he is of lawful age; and that, in accepting him as duly qualified to perform the  
 duties of an able-bodied soldier, I have strictly observed the Regulations which govern the recruiting  
 service. This soldier has *black* eyes, *black* hair, *black* complexion, is *55*  
 feet *5* inches high.

*William D. Matthews*  
*Recruiting Indus Cold Light Artillery*  
 Regiment of *Battery* Volunteers,  
 RECRUITING OFFICER.

*Belt* Mustered into the service of the United States, for three years or during the war, from date of enlistment, in *Leavenworth*  
*Regiment of Cold Light Artillery*, on the *12* day of *December*, 1864, at *Leavenworth Kansas*  
*William D. Matthews*  
*Recruiting Indus Cold Light Artillery*  
*Leavenworth Kansas*



28 K

**ENDORSEMENT.**

No. 678

APPLICATION OF

Mary A Hollingsworth

OF

Platte Co

for compensation for service of

slave William Belt

enlisted December 12 1864,

in Co. Indep. Batt. Regiment,

U. S. Colored Troops.

Received Dec 20 1866,

Compensation awarded,

..... 186 ,

..... Dollars.

President Board of Claims.

P. C. Address of Applicant.

Chapman Hosmer Reo

Washington

D.C.

Atty

War Department,  
 ADJUTANT GENERAL'S OFFICE,  
 Washington, Dec 30 1866 .

Respectfully returned to the  
 Commission for the State of  
 Missouri, with the informa-  
 tion that William Belt  
 was enlisted at Leavenworth Kans  
December 12, 1864, and was  
 mustered in as private in Independent  
Battery Light Art., Dec 12, 1864,  
Mo 28

A. J. Rainey

1866 compensation for the said slave, under provisions of Section 24, Act approved February 24, 1864, and Section 2, Act approved July 28, 1866.

AWARD OF THE BOARD OF CLAIMS.  
 OFFICE OF THE BOARD OF CLAIMS,  
 r Drafted in the Service of the United States.

..... 186

of .....

....., having proved, under oath ..... loyalty to the Con-  
 d States, and established ..... title as to the ownership of  
 a slave ..... and mustered  
 ..... day of ..... 186 .....

..... in the service of the United States, in the  
 red Troops, Co. .... the sum of .....

..... this Board, subject to the approval of the Secretary of War, as

..... President of the Board.

..... Member of the Board.

R. H. ... Member of the Board.

To .....

Chief of the Bureau for the  
 Organization of Colored Troops, Washington, D. C.

(Form A.)

CLAIM FOR COMPENSATION FOR ENLISTED SLAVE.

No. \_\_\_\_\_  
 I, Mary A Hollingsworth, a loyal citizen, and a resident  
 of Missouri County of Platte State of  
Missouri hereby claim compensation, under the provisions of  
 Section 24, Act approved February 24, 1864, and Section 2, Act approved July 28, 1866, for my slave  
Miliamy Belt enlisted December 12<sup>th</sup>  
 1864, at Leavenworth Kansas by Lieut Matthews  
 in the Indpt Battery Regiment U. S. Colored Troops,  
Light; certificate of which enlistment, and a descriptive list, as required, accompanying this  
 application. claimant red none

In proof of my loyalty to the Constitution and Government of the United States, I present the accompanying oath, which I have taken, signed and acknowledged; to be filed with this application, in accordance with requirement of General Order, No. 329, 1863, War Department, Adjutant General's Office.

Mary A Hollingsworth  
November 1866

OATH OF ALLEGIANCE.

I, Mary A Hollingsworth the owner and claimant, do solemnly swear that the foregoing claim is a just and true claim due to me as master and owner of the said slave, and that the facts alleged in said claim in respect to the enlistment of said slave into the military service of the United States are true. And I do further swear that I have never joined, or been concerned in any insurrection or rebellion; ~~that I have never borne arms~~ against the United States; that I have never given any aid, countenance, counsel or encouragement to any person or persons engaged, or whom I had reason to believe were about to engage, in insurrection, rebellion or armed hostility against the United States: that I have neither sought, nor accepted, nor attempted to exercise the functions of any office, civil or military, nor to perform any service whatever under any authority, or pretended authority, in hostility to the United States; that I have not yielded a voluntary support to any insurrection, rebellion or pretended government, authority, power or constitution within the United States, hostile thereto. And I do further swear that, to the best of my knowledge and ability, I have supported and defended, and will continue to support and defend, the United States, against all enemies, foreign and domestic, and that I have supported, defended and obeyed, and will continue to support, defend and obey, the Constitution and laws of the United States, that I will bear true faith and allegiance to the same; and that I take this oath freely, without any mental reservation or purpose of evasion. So help me God.

Mary A Hollingsworth

Sworn to and subscribed before me, at office in Platte City Mo  
with the seal thereof affixed  
 this 22 day of November 1866.

Orville Belt Clerk  
Platte County Circuit Court



Affidavits of disinterested loyal parties will be required to prove the active loyalty of the claimant during the war.

for the adjustment of such claims, before the Departments at Washington, D. C., where the same may become necessary, and elsewhere, and in her name, place and stead, for her and in her name to ask, demand, recover and receive such compensation as may be awarded as aforesaid, hereby giving and granting unto her said Attorneys full power and authority to do and perform all and every act and thing whatsoever requisite and necessary to be done in and about the premises as full and to all intents and purposes the same as she might or could do were she personally present, hereby ratifying and confirming all her said Attorneys or their substitutes by their appointment shall lawfully do or cause to be done by virtue hereof; and it is understood and agreed that this Power of Attorney cannot be revoked by her without the consent of her Attorneys herein appointed.

(\*) Mary A. Hollingsworth

STATE OF Missouri } as.  
County of Platte

On this 22 day of November, 1866, personally appeared before me Geo. H. Best a Clerk in and for the county and State aforesaid Mary A. Hollingsworth the claimant above mentioned, and made oath to the foregoing statement by her subscribed, and she further acknowledge the signing and sealing of the foregoing Power of Attorney to be his own free binding act, for the purposes and objects therein contained and set forth; and at the same time also personally appeared the above named Wm. D. Bond and Oriniah Perry and A. Speare and W. D. McClung and made oath to the truth of the statements by them respectively subscribed.

Witness my hand and seal, upon the day and date first above written. at office in Platte City Missouri  
(\*) Geo. H. Best  
Platte County Circuit Court

[SEAL.]

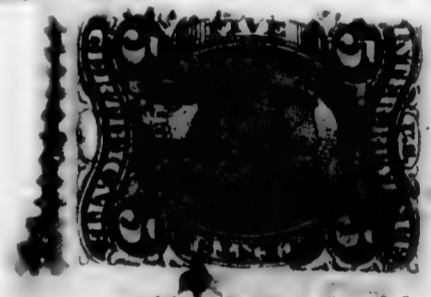

INSTRUCTIONS.

- (1) State all the circumstances connected with obtaining title—when, where and how.
- (2) Signature of claimant.
- (3) Signatures of witnesses to ownership.
- (4) Signatures of witnesses to loyalty.
- (5) Signature of claimant.
- (6) Signature of Notary Public or Clerk of Court, authenticated by seal.

If title is by purchase, state date of bill of sale, and where recorded. When possible, file the bill of sale. If title is by inheritance, state when and from whom the slave was inherited, and where the will is recorded or the administrator was appointed. If claimant is a trustee, executor or administrator, he must show by the record proof that he is such. Where the same party claims compensation for more than one slave, he must file a separate claim for each.

No. 28

Affidavits of Ownership and Loyalty, and Power of Attorney, in the Application of

Mary A. Hollingsworth

For Compensation for Service of Slave.

done up

CHIPMAN, HOSMER & CO.,  
WASHINGTON, D. C.,  
Attorneys for Claimant.

[FORM B.]

*Mary A Hollingsworth* claimant for compensation under the Acts of Congress of February 24th, 1864, and July 28th, 1866, for *William Belt* a slave, who was enlisted into the military service of the United States upon the *twelfth* day of *December* 1864, having been duly sworn declares that at the date of the enlistment of said *William Belt* as aforesaid, and as more fully set forth in *her* application, *she was* the lawful owner of said *William Belt* and obtained *her* title to him in the following manner: (1) *the said William Belt was the property of her husband, Benjamin F. Hollingsworth dec'd, and at his death, viz, on the 25th day of February, 1860, the said William Belt became the property of said Mary A Hollingsworth, the claimant*

(2) *Mary A Hollingsworth*  
*Wm D Bounel* a resident of *Platte* County, State of *Mo* and *Jeremiah Peery* a resident of *Platte* County, State of *Mo*  
 having been duly sworn, declare that they are personally acquainted with *Mary A Hollingsworth* the claimant for compensation for *her* slave *William Belt* under the Acts of Congress of February 24th, 1864, and July 28, 1866, and know that said *William Belt* at the date of his enlistment into the military service of the United States, and for *four years* previous thereto was the slave of said *Mary A Hollingsworth*. They also declare that they have no interest in said claim.

*Wm D Bounel*  
 (3) *Jeremiah Peery*  
*S. H. Spears* a resident of *Platte* County, State of *Missouri* and *W. J. Wellenough* a resident of *Platte* County, State of *Mo*

having first been duly sworn, upon their oaths declare that they reside respectively in \_\_\_\_\_ county of \_\_\_\_\_ State of \_\_\_\_\_ and \_\_\_\_\_ county of \_\_\_\_\_ State of \_\_\_\_\_; that they are personally acquainted with *Mary A Hollingsworth* claimant for compensation for *her* slave *William Belt* under the Acts of Congress of February 24, 1864, and July 28, 1866, and that they know that said claimant has firmly and faithfully maintained *her* allegiance and adherence to the Government of the United States, by defending its cause against the Government of the so-called Confederate States of America, in all suitable and practicable ways, and according to *her* ability; they also swear that they have themselves maintained a like adherence and allegiance to the Government of the United States, and that they have no interest in said claim.

*S. H. Spears*  
 (4) *W. J. Wellenough*  
 And the said *Mary A Hollingsworth* she hath claimant further declares that in consideration of valuable services rendered and to be rendered, and doth employ and constitute, as *her* Attorneys, **CHIPMAN, HOSMER & CO.,** Washington, D. C., to prosecute *her* claim for compensation which may be awarded to *her* as owner of said slave, by the Acts of Congress in that regard, before the Board of Claims appointed for the State of *Missouri*

Batt'y U.S. Col'd L. Art'y

Private Private

CARD NUMBERS.

1	6233675	26
2	6234195	27
3	6234362	28
4	6234526	29
5	9133063	30
6		31
7		32
8		33
9		34
10		35
11		36
12		37
13		38
14		39
15		40
16		41
17		42
18		43
19		44
20		45
21		46
22		47
23		48
24		49
25		50

Book Mark:

See also

OSP 576838

P 25-25717 P.O. aff

P 2537069 P.O. aff

P. 2551640 P.O. Ret.

W. Spencer  
by

*D* | Indpt. Batt'y. | **U.S.C.T.**

*Dennis Black*

....., Indpt. Batt'y, U. S. Col'd L. Art'y.

Appears on

**Battery Descriptive Book**

of the organization named above.

**DESCRIPTION.**

Age *18* years; height *5* feet *4* inches.

Complexion *Brown*

Eyes *Brown*; hair *Brown*

Where born *Clay Co. Mo.*

Occupation *Laborer*

**ENLISTMENT.**

When *Feb 28*, 186 *5*.

Where *Farrumouth K's.*

By whom *D. Minor*; term *3* y'rs.

Remarks: .....

.....

.....

.....

.....

.....

.....

.....

.....

.....

(383g)

*Black*

Copyist.

*B* | Indpt. Battery. | **U.S.C.T.**

*Dennis Black*

Appears with rank of *Priv* on

**Muster and Descriptive Roll of a Detachment of U. S. Vols. forwarded**

for the Indpt. Batt'y, U. S. Col'd L. Arty. Roll dated

*Leavenworth, Kan Feb 28, 1865.*

Where born *Clay Co. Missouri*

Age *18* y'rs; occupation *Labourer*

When enlisted *Feb. 28*, 1865.

Where enlisted *Leavenworth, Kan*

For what period enlisted *3* years.

Eyes *brn*; hair *brn*

Complexion *brn*; height *5 ft. 4 in.*

When mustered in *Feb 28*, 1865.

Where mustered in *Leavorth, Kans*

Bounty paid \$ *100 100*; due \$ *200 100*

Where credited.....

Battery to which assigned.....

Remarks: *Credited to North dist. Kan  
25<sup>th</sup> Sub. dist. 4<sup>th</sup> Ward, Leaven-  
worth City, Mo. Recruit &  
entitled to bounty*

Book mark:.....

*E. Thawnton*



*B*

Indpt. Battery. | **U.S.C.T.**

*Dennis Black,*

*Co*, Indpt. Battery, U. S. Col'd L. Art'y.

Appears on

**Battery Muster Roll**

for *Mar, & Apr.*, 1865.

Present or absent *Present,*

Stoppage, \$ 100 for

Due Gov't, \$ 100 for

Valuation of horse, \$ 100

Valuation of horse equipments, \$ 100

Remarks:

Book mark:

*Butler*

(358)

Copyist.

B Ind't Battery Co 867

Alvin Black

1st Co. Ind't Battery Reg't 2507

Appears on

Battery Muster Roll

for May & June, 1865.

Present or absent Present

Stoppage, \$ 100 for

Due Gov't, \$ 100 for

Valuation of horse, \$ 100

Valuation of horse equipments, \$ 100

Remarks :

Book mark :

(358)

W. J. Spencer

Copyist

*A* | Indpt. Battery. | **U.S.C.T.**

*Denis Black,*

*A*, Indpt. Battery U. S. Col'd Light Art'y.

Appears on **Batt'y Muster-out Roll**, dated

*M. Lavenworth, Va., July 27, 1865.*

Muster-out to date

*July 22, 1865.*

Last paid to *(Pay due from Enlistment)* 186

Clothing account:

Last settled \_\_\_\_\_, 186 ; drawn since \$ *63*<sup>55</sup>/<sub>100</sub>,

Due soldier \$ \_\_\_\_\_<sub>100</sub>; due U. S. \$ \_\_\_\_\_<sub>100</sub>

Am't for cloth'g in kind or money adv'd \$ \_\_\_\_\_<sub>100</sub>

Due U. S. for arms, equipments, &c., \$ \_\_\_\_\_<sub>100</sub>

Bounty paid \$ *100* <sub>100</sub>; due \$ *none* <sub>100</sub>,

Remarks: *Due E. Fenlon, Sutter,*

*\$ 300,*

Book mark : \_\_\_\_\_

*Poster*

Copyist.

*Black Dennis*

, Co. *Ind. Batt* Reg't *U.S.C.A.*

*2* Enclosures.

Bed Cards .....	Final Statements .....
Burial Records .....	Furloughs or L. of A. ....
Certs. of Dis. for Discharge .....	Med. Certificates .....
C. M. Charges .....	Med. Des. Lists .....
Descriptive Lists .....	Orders .....
Discharge Certificates .....	Pris. of War Record .....
Enlistment Papers <i>2</i> .....	Resignations .....

Other papers relating to—

Admission to Hosp'l .....	Furlough or L. of A. ....
Casualty Sheet .....	Med. Examination .....
Confinement .....	Misc. Information .....
Contracts .....	Pay or Clothing .....
Death or Effects .....	Personal Reports .....
Desertion .....	Rank .....
Discharge from Hosp'l .....	Transfer to Hosp'l .....
Discharge from Service .....	Transfer to V. R. C. ....
Duty .....	Transportation .....

DECLARATION OF RECRUIT.

I, Dennis Black, desiring to VOLUNTEER as a Soldier in the Army of the United States, for the term of THREE YEARS, Do Declare, That I am Eighteen (18) years and \_\_\_\_\_ months of age; that I have never been discharged from the United States service on account of disability or by sentence of a court martial, or by order before the expiration of a term of enlistment; and I know of no impediment to my serving honestly and faithfully as a soldier for three years.

GIVEN at Leavenworth City, Kansas the 28 day of February 1865.

Witness: Thomas Barrigg Dennis Black  
mak

NOTE 1.—This blank will be used for both enlistments and re-enlistments—enlistment of veterans, &c., &c., in the volunteer service. They will be made out in duplicate in all cases—one to accompany the recruiting return of the superintendent (not the recruiting officer) to the Adjutant General, and one to accompany the accounts of the officer who pays bounty, &c. The Regiment and Company in which the soldier last served should be given on the back  
NOTE 2.—An enlistment holds to service. A muster-in must, in all cases, precede payment of pay, bounty, pension, &c. A muster-in roll must, in all cases, be filed in the Adjutant General's Office as evidence of muster-in. The mustering officer, commissary, or assistant commissary of musters, as the case may be, will countersign both enlistments as having mustered the soldier into the service of the United States before either of them is given to the disbursing officer.

Rec'd from 2nd. Aud. Nov. 23d 1892

Discharged \_\_\_\_\_, 18 \_\_\_\_\_

Reg't of \_\_\_\_\_

enlistment: last served in Company ( ) \_\_\_\_\_

Volunteered at Leavenworth, Kansas  
Dennis Black No. 8  
February 28, 1865  
By Wm. S. Barrigg Major  
for Dr. Barrigg Captain  
W. S. Barrigg Major

CONSENT IN CASE OF MINOR.

I, \_\_\_\_\_, Do CERTIFY, That I am \_\_\_\_\_ of \_\_\_\_\_; that the said \_\_\_\_\_ is \_\_\_\_\_ years of age; and I do hereby freely give my CONSENT to his volunteering as a SOLDIER in the ARMY OF THE UNITED STATES for the period of THREE YEARS.

GIVEN at \_\_\_\_\_ the \_\_\_\_\_ day of \_\_\_\_\_

Witness: \_\_\_\_\_

Constituted to North Dist Kas 22<sup>d</sup> Sub Dist 4<sup>th</sup> Ward Leavenworth City

*Three hundred dollars advance bounty of the three hundred dollars bounty authorized by an act of Congress approved July 4<sup>th</sup> 1864 and hereafter to be paid to the recruit on his arrival at the place of enlistment. The said advance bounty shall be paid to the recruit on his arrival at the place of enlistment.*

**VOLUNTEER ENLISTMENT.**

STATE OF



TOWN OF

*Missouri*

*Leavenworth*

I, Dennis Black, born in Clay Co. in the State of Missouri, aged 18 years, and by occupation a Laborer, DO HEREBY ACKNOWLEDGE to have volunteered this Twenty eighth (28) day of February, 1865, to serve as a **Soldier** in the **Army of the United States of America**, for the period of **THREE YEARS**, unless sooner discharged by proper authority: Do also agree to accept such bounty, pay, rations, and clothing, as are, or may be, established by law for volunteers. And I, Dennis Black, do solemnly swear, that I will bear true faith and allegiance to the **United States of America**, and that I will serve them honestly and faithfully against all their enemies or opposers whomsoever; and that I will observe and obey the orders of the President of the United States, and the orders of the officers appointed over me, according to the Rules and Articles of War.

Sworn and subscribed to, at Leavenworth this 28 day of February, 1865, BEFORE P. H. Minor 2<sup>d</sup> Lieut } Dennis Black his mark  
Ind. Baty U.S. 6<sup>th</sup> Artillery

I CERTIFY, ON HONOR, That I have carefully examined the above-named Volunteer, agreeably to the General Regulations of the Army, and that, in my opinion, he is free from all bodily defects and mental infirmity, which would in any way disqualify him from performing the duties of a soldier.

W. J. Sinks  
Surgeon of Enrollment with Dist Kas  
EXAMINING SURGEON.

I CERTIFY, ON HONOR, That I have minutely inspected the Volunteer Dennis Black previously to his enlistment, and that he was entirely sober when enlisted; that, to the best of my judgment and belief, he is of lawful age; and that, in accepting him as duly qualified to perform the duties of an able-bodied soldier, I have strictly observed the Regulations which govern the recruiting service. This soldier has Brown eyes, Brown hair, Brown complexion, is 5' inches high.

P. H. Minor 2<sup>d</sup> Lieut  
Ind. Baty U.S. 6<sup>th</sup> Artillery (Eight)  
RECRUITING OFFICER.

(A. G. O. No. 74 & 76.)

U.S. Calmwell

*J. H. H.*

Mustered into the service of the United States, for three years or during the war, from date of enlistment, in February 1865, at Leavenworth Kas

North Dist Kansas

*Independent Battery*

NOTE 1.—This blank will be used for both enlistments and re-enlistments—enlistment of veterans, &c., &c., in the volunteer service. They will be made out in duplicate in all cases—one to accompany the recruiting return of the superintendent (not the recruiting officer) to the Adjutant General, and one to accompany the accounts of the officer who pays bounty, &c. The Regiment and Company in which the soldier last served should be given on the back

NOTE 2.—An enlistment holds to service. A muster-in must, in all cases, precede payment of pay, bounty, pension, &c. A muster-in roll must, in all cases, be filed in the Adjutant General's Office as evidence of muster-in. The mustering officer, commissary, or assistant commissary of musters, as the case may be, will countersign both enlistments as having mustered the soldier into the service of the United States before either of them is given to the disbursing officer.

DECLARATION OF RECRUIT.

I, Dennis Black, desiring to VOLUNTEER as a Soldier in the Army of the United States, for the term of THREE YEARS, Do Declare, That I am Eighteen (18) years and \_\_\_\_\_ months of age; that I have never been discharged from the United States service on account of disability or by sentence of a court martial, or by order before the expiration of a term of enlistment; and I know of no impediment to my serving honestly and faithfully as a soldier for three years.

GIVEN at Leavenworth City Kansas the 28 day of February 1865

Witness: Thomas Barrig Dennis Black  
mark

Discharged \_\_\_\_\_, 18 \_\_\_\_\_

Reg't of \_\_\_\_\_

enlistment: last served in Company ( ) \_\_\_\_\_

for Capt. Babby  
for Sgt. M. S. Lee

Volunteered at Leavenworth February 28, 1865  
Dennis Black

for Capt. Babby  
for Sgt. M. S. Lee

CONSENT IN CASE OF MINOR.

I, \_\_\_\_\_, Do CERTIFY, That I am \_\_\_\_\_; that the \_\_\_\_\_ of \_\_\_\_\_; that the \_\_\_\_\_ is \_\_\_\_\_ years of age; and I do hereby freely give my CONSENT to his volunteering as a SOLDIER in the ARMY OF THE UNITED STATES for the period of THREE YEARS.

GIVEN at \_\_\_\_\_ the \_\_\_\_\_ day of \_\_\_\_\_

Witness: \_\_\_\_\_

(A. G. O. No. 74 & 76.)

Enrolled to north Dist No 22<sup>d</sup> Sub Dist 4<sup>th</sup> Ward Leavenworth City  
M. W. W. W.

VOLUNTEER ENLISTMENT.

STATE OF

TOWN OF

Kansas



Leavenworth

I, Dennis Black, born in May, Mo  
in the State of Missouri, aged 18 1/2 years,  
and by occupation a Laborer, Do HEREBY ACKNOWLEDGE to have  
volunteered this Twenty Eighth (28) day of February, 1865  
to serve as a **Soldier** in the **Army of the United States of America**, for  
the period of **THREE YEARS**, unless sooner discharged by proper authority:  
Do also agree to accept such bounty, pay, rations, and clothing, as are, or may be,  
established by law for volunteers. And I, Dennis Black, do  
solemnly swear, that I will bear true faith and allegiance to the **United States  
of America**, and that I will serve them honestly and faithfully against all  
their enemies or opposers whomsoever; and that I will observe and obey the  
orders of the President of the United States, and the orders of the officers  
appointed over me, according to the Rules and Articles of War.

Sworn and subscribed to, at Leavenworth  
this 28 day of February, 1865, } Dennis Black  
BEFORE P. H. Minor 2<sup>d</sup> Lieut } mark  
Ind. Baty. U.S. Artillery

I CERTIFY, ON HONOR, That I have carefully examined the above-named Volunteer, agreeably  
to the General Regulations of the Army, and that, in my opinion, he is free from all bodily defects and  
mental infirmity, which would in any way disqualify him from performing the duties of a soldier.

J. J. W. W.  
Surg. Board of Enrollment. North Dist No  
EXAMINING SURGEON.

I CERTIFY, ON HONOR, That I have minutely inspected the Volunteer Dennis Black  
previously to his enlistment, and that he was entirely sober when enlisted; that, to the best of my  
judgment and belief, he is of lawful age; and that, in accepting him as duly qualified to perform the  
duties of an able-bodied soldier, I have strictly observed the Regulations which govern the recruiting  
service. This soldier has Brown eyes, Brown hair, Brown complexion, is 5  
feet 4 inches high.

P. H. Minor 2<sup>d</sup> Lieut  
Ind. Baty U.S. Artillery (Eight)  
REGUITING OFFICER.

(A. G. O. No. 74 & 76.)

Registered into the service of the United States, for three years or during the war, from date of enlistment, in Leavenworth on the 28<sup>th</sup> day of February 1865 at Leavenworth  
North Dist Kansas  
J. J. W. W.  
Wm. S. W. W.  
Wm. S. W. W.



*James*  
 Capt. Datt'y U.S. Col'd L. Art'y.

*Private Corporal*

CARD NUMBERS.

1	6233733	26
2	6233844	27
3	6234058	28
4	6234184	29
5	6234351	30
6	6234515	31
7	9132914	32
8		33
9		34
10		35
11		36
12		37
13		38
14		39
15		40
16		41
17		42
18		43
19		44
20		45
21		46
22		47
23		48
24		49
25		50

Book Mark:

See also

61097821 P.O. *sum*

*W. Spencer*  
*y*

*S* | Indpt. Batt'y. | **U.S.C.T.**

*Jack Boston*

....., Indpt. Batt'y, U. S. Col'd L. Art'y.

Appears on

**Battery Descriptive Book**

of the organization named above.

**DESCRIPTION.**

Age *24* years; height *5* feet *7* inches.

Complexion *Black*

Eyes *Black*; hair *Black*

Where born *Cole Mission*

Occupation *Farmer*

**ENLISTMENT.**

When *July 25*, 186 *4*.

Where *Myardotte Is*

By whom *Lt. Munir*; term *3* y'rs.

Remarks: .....

.....  
.....  
.....  
.....  
.....  
.....  
.....

*Holbrook*

*B* | Indpt. Battery. | **U.S.C.T.**

*John Bolton*  
*Box*, Indpt. Battery, U. S. Col'd L. Art'y.

Appears on

**Battery Muster-in and Descriptive Roll**

of the organization named above. Roll dated

*Leavenworth Co Dec 23*, 186 *4*.

Where born *Cole ks. Mo.*

Age *24* y'rs; occupation *Farmer*

When enlisted *July 23*, 186 *4*.

Where enlisted *Wyandotte Co*

For what period enlisted *3* years.

Eyes *Blu*; hair *Blu*

Complexion *Blu*; height *5* ft. *7* in.

When mustered in *July 28*, 186 *4*.

Where mustered in *Leavenworth*

Bounty paid \$ *100*<sup>*00*</sup>/<sub>*100*</sub>; due \$ *200*<sup>*00*</sup>/<sub>*100*</sub>

Where credited

Battery to which assigned

Remarks: *in M. Dist Co,*  
*19th S.D. 1st Ward*  
*Leavenworth Co.*

Book mark :

*H. Schooley*  
(856a) Copyist.

B. | Indpt. Battery. | U.S.C.T.

Jack Bolton  
Pat, Indpt. Battery, U. S. Col'd L. Art'y.

Appears on

**Battery Muster Roll**

for *Enlistment to Dec 31, 1864.*

Present or absent *Present*

Stoppage, \$ 100 for

Due Gov't, \$ 100 for

Valuation of horse, \$ 100

Valuation of horse equipments, \$ 100

Remarks:

Book mark:

*J. Schuster*  
(358) Copyist.

73

Indpt. Battery.

U.S.C.T.

Jack Bolton  
Pat

, Indpt. Battery, U. S. Col'd L. Art'y.

Appears on

**Battery Muster Roll**

for *Jan Feb*, 186<sup>5</sup>.

Present or absent *Present*

Stoppage, \$ \_\_\_\_\_ 100 for \_\_\_\_\_

Due Gov't, \$ \_\_\_\_\_ 100 for \_\_\_\_\_

Valuation of horse, \$ \_\_\_\_\_ 100

Valuation of horse equipments, \$ \_\_\_\_\_ 100

Remarks: \_\_\_\_\_

Book mark: \_\_\_\_\_

(358)

*J. S. Ashley*

Copyist.

*S* | Indpt. Battery. | **U.S.C.T.**

*Jack Boulton,*  
*Corpl*, Indpt. Battery, U. S. Col'd L. Art'y.

Appears on

**Battery Muster Roll**

for *Mar & Apl*, 1865.

Present or absent *Present*.

Stoppage, \$ *100* for

Due Gov't, \$ *100* for

Valuation of horse, \$ *100*

Valuation of horse equipments, \$ *100*

Remarks: *Pay due as private*  
*from Dec. 31/64, to Apl,*  
*19/65.*

Book mark:

*Parter*  
Copyist.

*B* | Indpt. Battery. | **U.S.C.T.**

*Luc Bolton,*

*Capt.*, Indpt. Battery, U. S. Col'd L. Art'y.

Appears on

**Battery Muster Roll**

for *May & June*, 1865.

Present or absent *Present,*

Stoppage, \$ 100 for

Due Gov't, \$ 100 for

Valuation of horse, \$ 100

Valuation of horse equipments, \$ 100

Remarks: *Pay due Capt. apl,*  
*19/65,*

Book mark:

*Porter*

(358)

Copyist.



*P* | Indpt. Battery. | **U.S.C.T.**

*Jack Boulton*

*Corpl.*, Indpt. Battery U. S. Col'd Light Art'y.

Appears on **Batt'y Muster-out Roll**, dated  
*St. Lawrence, Me., July 21, 1865.*

Muster-out to date *July 27*, 1865.

Last paid to *Dec. 31*, 1864.

Clothing account:

Last settled....., 186 ; drawn since \$ *71* <sup>53</sup>/<sub>100</sub>,

Due soldier \$ 100; due U. S. \$ 100

Am't for cloth'g in kind or money adv'd \$ 100

Due U. S. for arms, equipments, &c., \$ 100

Bounty paid \$ *100* 100; due \$ *none* 100,

Remarks: *Arr. from enlistment to  
Apr. 19/65; then corpl.*

.....  
.....  
.....  
.....

Book mark: .....

.....  
.....  
*Center*  
Copyist.

*Boltos Jack*

, Co. *2nd Batt* Reg't *W. I. C. A*

**2 Enclosures.**

Bed Cards .....	Final Statements .....
Burial Records .....	Furloughs or L. of A .....
Certs. of Dis. for Discharge .....	Med. Certificates .....
C. M. Charges .....	Med. Des. Lists .....
Descriptive Lists .....	Orders .....
Discharge Certificates .....	Pris. of War Record .....
Enlistment Papers <b>2</b> .....	Resignations .....

**Other papers relating to—**

Admission to Hosp'l .....	Furlough or L. of A .....
Casualty Sheet .....	Med. Examination .....
Confinement .....	Misc. Information .....
Contracts .....	Pay or Clothing .....
Death or Effects .....	Personal Reports .....
Desertion .....	Rank .....
Discharge from Hosp'l .....	Transfer to Hosp'l .....
Discharge from Service .....	Transfer to V. R. C. .....
Duty .....	Transportation .....

NOTE 1.—This blank will be used for both enlistments and re-enlistments—enlistment of veterans, &c., &c., in the volunteer service. They will be made out in duplicate in all cases—one to accompany the recruiting return of the superintendent (not the recruiting officer) to the Adjutant General, and one to accompany the accounts of the officer who pays bounty, &c. The Regiment and Company in which the soldier last served should be given on the back.  
NOTE 2.—An enlistment holds to service. A muster-in must, in all cases, precede payment of pay, bounty, pension, &c. A muster-in roll must, in all cases, be filed in the Adjutant General's Office as evidence of muster-in. The mustering officer, commissary, or assistant commissary of musters, as the case may be, will countersign both enlistments as having mustered the soldier into the service of the United States before either of them is given to the disbursing officer.

DECLARATION OF RECRUIT.

I, Jack Bolton desiring to VOLUNTEER as a Soldier in the Army of the United States, for the term of THREE YEARS Do Declare, That I am 24 years and \_\_\_\_\_ months of age; that I have never been discharged from the United States service on account of disability or by sentence of a court-martial, or by order before the expiration of a term of enlistment; and I know of no impediment to my serving honestly and faithfully as a soldier for three years.

GIVEN at Wyanadette State of Kansas the 25 day of July 1864

Witness: Henry Copeland Jack Bolton  
male

No. 43

Jack Bolton  
Volunteered at Wyanadette  
July 23 1864,  
By H. A. Minner 2nd Lieut  
1st Regiment of Kansas Soldiers  
Wyanadette, Kansas  
enlistment; last served in Company ( )  
Reg't of \_\_\_\_\_  
Discharged \_\_\_\_\_ 18 .

CONSENT IN CASE OF MINOR.

I, \_\_\_\_\_ Do CERTIFY, That I am the \_\_\_\_\_ of \_\_\_\_\_; that the said \_\_\_\_\_ is \_\_\_\_\_ years of age; and I do hereby freely give my CONSENT to his volunteering as a SOLDIER in the ARMY OF THE UNITED STATES for the period of THREE YEARS.

GIVEN at \_\_\_\_\_ the \_\_\_\_\_ day of \_\_\_\_\_

Witness: \_\_\_\_\_

VOLUNTEER ENLISTMENT.

STATE OF

*Kansas*



TOWN OF

*Wyandotte County*

I, *Jack Bolton*

born in *Leda County*

in the State of *Missouri* aged *24* years,  
and by occupation a *Farmer* DO HEREBY ACKNOWLEDGE to have

volunteered this *25* day of *July* 1864,

to serve as a **Soldier** in the **Army of the United States of America**, for the period of **THREE YEARS** unless sooner discharged by proper authority: Do also

agree to accept such bounty, pay, rations, and clothing, as are, or may be, established by law for volunteers. And I, *Jack Bolton* do

solemnly swear, that I will bear true faith and allegiance to the **United States of America**, and that I will serve them honestly and faithfully against all their

enemies or opposers whomsoever; and that I will observe and obey the orders of the President of the United States, and the orders of the officers appointed over

me, according to the Rules and Articles of War.

Sworn and subscribed to, at *Wyandotte*  
this *25* day of *July* 1864,

BEFORE *P. H. Minor 2<sup>d</sup> Lieut.* } *Jack Bolton*  
*Recruiting officer* } *his*  
*mark*

I CERTIFY, ON HONOR, That I have carefully examined the above-named Volunteer, agreeably to the General Regulations of the Army, and that, in my opinion, he is free from all bodily defects and mental infirmity, which would in any way disqualify him from performing the duties of a soldier.

*Tiffin Sinks*  
*Surg. Genl. of Enrollment*  
*North Dist Kansas*  
EXAMINING SURGEON.

I CERTIFY, ON HONOR, That I have minutely inspected the Volunteer, *Jack Bolton* previously to his enlistment, and that he was entirely sober when enlisted; that, to the best of my judgment and belief, he is of lawful age; and that, in accepting him as duly qualified to perform the duties of an able-bodied soldier, I have strictly observed the Regulations which govern the recruiting service.

This soldier has *black* eyes, *black* hair, *black* complexion, is *5* feet *7* inches high.

*P. H. Minor 2<sup>d</sup> Lieut.*  
*1<sup>st</sup> Regiment of Battery* Volunteers,  
RECRUITING OFFICER.

(A. G. O. No. 74 & 75.)

the *25* day of *July* 1864, at *Wyandotte* *11/1* Regiment of *11/1* Volunteers, on

DECLARATION OF RECRUIT.

NOTE 1.—This blank will be used for both enlistments and re-enlistments—enlistment of veterans, &c., &c., in the volunteer service. They will be made out in duplicate in all cases—one to accompany the recruiting return of the superintendent (not the recruiting officer) to the Adjutant General, and one to accompany the accounts of the officer who pays bounty, &c. The Regiment and Company in which the soldier last served should be given on the back.  
NOTE 2.—An enlistment holds to service. A muster-in must, in all cases, precede payment of pay, bounty, pension, &c. A muster-in roll must, in all cases, be filed in the Adjutant General's Office as evidence of muster-in. The mustering officer, commissary, or assistant commissary of musters, as the case may be, will countersign both enlistments as having mustered the soldier into the service of the United States before either of them is given to the disbursing officer.

Rec'd from 2nd. App. Nov. 23rd 1892

I, Jack Bolton desiring to VOLUNTEER as a Soldier in the Army of the United States, for the term of THREE YEARS Do Declare, That I am 24 years and \_\_\_\_\_ months of age; that I have never been discharged from the United States service on account of disability or by sentence of a court-martial, or by order before the expiration of a term of enlistment; and I know of no impediment to my serving honestly and faithfully as a soldier for three years.

GIVEN at Wyandotte State of Kansas the 23rd day of July 1894

Witness: W.A. Buchanan Louis Sanford mark

enlistment; last served in Company ( )  
Reg't of \_\_\_\_\_  
Discharged \_\_\_\_\_ 18 \_\_\_\_\_

By W.P. Johnson 1st Lieut  
1st 32 Regiment of Cavalry  
Volunteered at Wyandotte  
July 23rd 1894  
Jack Bolton

No. 75-9  
11016

CONSENT IN CASE OF MINOR.

I, \_\_\_\_\_ Do CERTIFY, That I am the \_\_\_\_\_ of \_\_\_\_\_; that the said \_\_\_\_\_ is \_\_\_\_\_ years of age; and I do hereby freely give my CONSENT to his volunteering as a SOLDIER in the ARMY OF THE UNITED STATES for the period of THREE YEARS.

GIVEN at \_\_\_\_\_ the \_\_\_\_\_ day of \_\_\_\_\_

Witness: \_\_\_\_\_

VOLUNTEER ENLISTMENT.

STATE OF

Kansas

TOWN OF

Wyanadette



I, Jack Bolton

born in Lebe County

in the State of Missouri aged 24 years,

and by occupation a Farmer. Do HEREBY ACKNOWLEDGE to have

volunteered this 25 day of July 1864,

to serve as a **Soldier** in the **Army of the United States of America**, for the

period of **THREE YEARS** unless sooner discharged by proper authority: Do also

agree to accept such bounty, pay, rations, and clothing, as are, or may be, estab-

lished by law for volunteers. And I, Jack Bolton do

solemnly swear, that I will bear true faith and allegiance to the **United States**

**of America**, and that I will serve them honestly and faithfully against all their

enemies or opposers whomsoever; and that I will observe and obey the orders of

the President of the United States, and the orders of the officers appointed over

me, according to the Rules and Articles of War.

Sworn and subscribed to, at Wyanadette

this 25 day of July 1864 } Jack Bolton

BEFORE P. H. Minor 2nd Lieut } Recruiting 1st Co Col Artillery

**I CERTIFY, ON HONOR**, That I have carefully examined the above-named Volunteer, agreeably

to the General Regulations of the Army, and that, in my opinion, he is free from all bodily defects and

mental infirmity, which would in any way disqualify him from performing the duties of a soldier.

Jiffie Sinks  
Surf Board of Enrollment  
North Dist Kansas  
EXAMINING SURGEON.

**I CERTIFY, ON HONOR**, That I have minutely inspected the Volunteer, Jack Bolton

previously to his enlistment, and that he was entirely sober when enlisted; that, to the best of my

judgment and belief, he is of lawful age; and that, in accepting him as duly qualified to perform the duties

of an able bodied soldier, I have strictly observed the Regulations which govern the recruiting service.

This soldier has black eyes, black hair, black complexion, is 5 feet

inches high.

P. H. Minor 2nd Lieut  
1st Regiment of Col Artillery Volunteers,  
RECRUITING OFFICER.

A. G. O. No. 74 & 75.

*The recruit has received one hundred dollars bounty from the Bounty funds authorized by Act of Congress of 1862 and Circular No 27 from the Provost Marshal General, U.S. Army, Washington, D.C. 1864.*

*Company of 1st Regt of Artillery  
Mustered into the service of the United States, in Company  
the 25th day of July 1864, at Wyanadette, Kansas  
Recruiting 1st Co Col Artillery  
Volunteers, on*

*W. H. Warren*

**Capt. Batt'y U.S. Col'd L. Art'y**

*Private Corporal*

**CARD NUMBERS.**

1	6233676	26
2	6234173	27
3	6234350	28
4	62345-13	29
5	9133064	30
6		31
7		32
8		33
9		34
10		35
11		36
12		37
13		38
14		39
15		40
16		41
17		42
18		43
19		44
20		45
21		46
22		47
23		48
24		49
25		50

**Book Mark:** \_\_\_\_\_

**See also** \_\_\_\_\_

8875782 *Penn*

*W. S. Penn*  
2





Indpt. Batt'y. | **U.S.C.T.**

*Warren Books*

....., Indpt. Batt'y, U. S. Col'd L. Art'y.

Appears on

**Battery Descriptive Book**

of the organization named above.

**DESCRIPTION.**

Age *37* years; height *6* feet *3* inches.

Complexion *Brown*

Eyes *Brown*; hair *Dark*

Where born *Warren Co. Ky.*

Occupation *Farmer*

**ENLISTMENT.**

When *Feb. 28*, 186 *5*.

Where *Fearnot's Co.*

By whom *Lt. Minor*; term *3* y'rs.

Remarks: *Promoted to Corp*  
*disd apl 19 - 65*

*Shoobrook*

*B* | Indpt. Battery. | **U.S.C.T.**

*Warren Booth*

Appears with rank of *Priv* on

**Muster and Descriptive Roll of a Detachment of U. S. Vols. forwarded**

for the Indpt. Batt'y, U. S. Col'd L. Arty. Roll dated

*Leavenworth, Kas, Feb 28, 1865.*

Where born *Warren Co. Ken.*

Age *37* y'rs; occupation *Farmer*

When enlisted *Feb 28*, 1865.

Where enlisted *Leavenworth, Kas.*

For what period enlisted *3* years.

Eyes *brn*; hair *dark*

Complexion *brn*; height *6 ft. 3 in.*

When mustered in *Feb. 28*, 1865.

Where mustered in *Leavworth, Kas.*

Bounty paid \$ *100.00*; due \$ *200.00*

Where credited.....

Battery to which assigned.....

Remarks: *Credited to North. Dist, Co.*

*25<sup>th</sup> Sub dist, 4<sup>th</sup> Ward, Leaven-*

*worth Arty, Vol. recruit &*

*entitled to bounty*

Book mark:.....

*E. L. Tharnton*

*B* | Indpt. Battery. | **U.S.C.T.**

*Warren D. Root,*  
*Cape*, Indpt. Battery, U. S. Col'd L. Art'y.

Appears on

**Battery Muster Roll**

for *Mar, & apr,*, 1865.

Present or absent *Present*

Stoppage, \$ *100* for

Due Gov't, \$ *100* for

Valuation of horse, \$ *100*

Valuation of horse equipments, \$ *100*

Remarks: *Bounty due \$100.00*  
*Pay due as private from*  
*Feb, 28/65, to apr, 19/65,*

Book mark: \_\_\_\_\_

*Porter*

*B* | Indpt. Battery. | **U.S.C.T.**

*Warren Boots,*

*Capt.*, Indpt. Battery, U. S. Col'd L. Art'y.

Appears on

**Battery Muster Roll**

for *May - June*, 1865.

Present or absent *Present,*

Stoppage, \$ *100* for

Due Gov't, \$ *100* for

Valuation of horse, \$ *100*

Valuation of horse equipments, \$ *100*

Remarks: *Bounty due \$100-  
Pay due Capt. April 19/65,*

Book mark: \_\_\_\_\_

*Parter*

(358)

Copyist.

*D* | Indpt. Battery. | **U.S.C.T.**

*Warren Boats,*

*Corpl.*, Indpt. Battery U. S. Col'd Light Art'y.

Appears on **Batt'y Muster-out Roll**, dated

*Mt. Scavenworth Ms. July 22, 1865,*

Muster-out to date *July 22,* 1865.

Last paid to *(Pay due from enlist.)* 1865.

Clothing account:

Last settled....., 1865 ; drawn since \$ *67* <sup>*23*</sup>/<sub>100</sub>,

Due soldier \$.....<sup>100</sup>; due U. S. \$.....<sup>100</sup>

Am't for cloth'g in kind or money adv'd \$.....<sup>100</sup>

Due U. S. for arms, equipments, &c., \$.....<sup>100</sup>

Bounty paid \$ *None* <sup>100</sup>; due \$ *100* <sup>100</sup>,

Remarks: *Prio. from enlistment to Apr. 19/65, then Corpl.*

Book mark : .....

*Parter*

Copyist.

*Boots Marrow*

, Co. *Ind Batt* Reg't *W. I. C. A.*

**2 Enclosures.**

Bed Cards .....	Final Statements .....
Burial Records .....	Furloughs or L. of A .....
Certs. of Dis. for Discharge .....	Med. Certificates .....
C. M. Charges .....	Med. Des. Lists .....
Descriptive Lists .....	Orders .....
Discharge Certificates .....	Pris. of War Record .....
Enlistment Papers <b>2</b> .....	Resignations .....

Other papers relating to—

Admission to Hosp'l .....	Furlough or L. of A .....
Casualty Sheet .....	Med. Examination .....
Confinement .....	Misc. Information .....
Contracts .....	Pay or Clothing .....
Death or Effects .....	Personal Reports .....
Desertion .....	Rank .....
Discharge from Hosp'l .....	Transfer to Hosp'l .....
Discharge from Service .....	Transfer to V. R. C. .....
Duty .....	Transportation .....

NOTE 1.—This blank will be used for both enlistments and re-enlistments—enlistment of veterans, &c., &c., in the volunteer service. They will be made out in duplicate in all cases—one to accompany the recruiting return of the superintendent (not the recruiting officer) to the Adjutant General, and one to accompany the accounts of the officer who pays bounty, &c. The Regiment and Company in which the soldier last served should be given on the back

NOTE 2.—An enlistment holds to service. A muster-in must, in all cases, precede payment of pay, bounty, pension, &c. A muster-in roll must, in all cases, be filed in the Adjutant General's Office as evidence of muster-in. The mustering officer, commissary, or assistant commissary of musters, as the case may be, will countersign both enlistments as having mustered the soldier into the service of the United States before either of them is given to the disbursing officer.

DECLARATION OF RECRUIT.

I, Warren Boots, desiring to VOLUNTEER as a Soldier in the Army of the United States, for the term of THREE YEARS, Do Declare, That I am (37) years and — months of age; that I have never been discharged from the United States service on account of disability or by sentence of a court martial, or by order before the expiration of a term of enlistment; and I know of no impediment to my serving honestly and faithfully as a soldier for three years.

GIVEN at Leavenworth Kansas the 28 day of February 1865

Witness: Thomas Plummer

Warren Boots  
man

Co. 13 Battery  
Regt 7

No. ....

Volunteered at Leavenworth Kas

February 28, 1865

By 2d Lt. G. J. Plummer

Adj. Gen. Regt. 7, 13th Army

enlistment; last served in Company ( )

Reg't of

Discharged ..... 18

CONSENT IN CASE OF MINOR.

I, ....., Do CERTIFY, That I am the ..... of .....; that the said ..... is ..... years of age; and I do hereby freely give my CONSENT to his volunteering as a SOLDIER in the ARMY OF THE UNITED STATES for the period of THREE YEARS.

GIVEN at ..... the ..... day of .....

Witness:

VOLUNTEER ENLISTMENT.

STATE OF

TOWN OF

*Kansas*



*Leavenworth*

I, *Warren Boots*, born in *Warren Co*  
 in the State of *Kentucky*, aged *thirty seven* years,  
 and by occupation a *Farmer*, Do HEREBY ACKNOWLEDGE to have  
 volunteered this *twenty eighth* day of *February*, 1865,  
 to serve as a **Soldier** in the **Army of the United States of America**, for  
 the period of **THREE YEARS**, unless sooner discharged by proper authority:  
 Do also agree to accept such bounty, pay, rations, and clothing, as are, or may be,  
 established by law for volunteers. And I, *Warren Boots*, do  
 solemnly swear, that I will bear true faith and allegiance to the **United States**  
**of America**, and that I will serve them honestly and faithfully against all  
 their enemies or opposers whomsoever; and that I will observe and obey the  
 orders of the President of the United States, and the orders of the officers  
 appointed over me, according to the Rules and Articles of War.

Sworn and subscribed to, at *Leavenworth* his  
 this *28th* day of *July*, 1865, *Warren Boots*  
 BEFORE *P. H. Minor 2nd Lieut* *ma*  
*Ind. Baty. U.S. Col 4th Arty (Light)*

I CERTIFY, ON HONOR, That I have carefully examined the above-named Volunteer, agreeably  
 to the General Regulations of the Army, and that, in my opinion, he is free from all bodily defects and  
 mental infirmity, which would in any way disqualify him from performing the duties of a soldier.

*W. G. Smith*  
*Surgeon Board of Enrollment 4th Dist. Kas*  
 EXAMINING SURGEON.

I CERTIFY, ON HONOR, That I have minutely inspected the Volunteer *Warren Boots*  
 previously to his enlistment, and that he was entirely sober when enlisted; that, to the best of my  
 judgment and belief, he is of lawful age; and that, in accepting him as duly qualified to perform the  
 duties of an able-bodied soldier, I have strictly observed the Regulations which govern the recruiting  
 service. This soldier has *brown* eyes, *dark* hair, *brown* complexion, is *Six*  
 feet *three* inches high.

*P. H. Minor 2nd Lieut*  
*Ind. Baty U.S. Col 4th Arty (Light)*  
 Recruit of *Volunteers*

( A. G. O. No. 74 & 76. )

RECRUITING OFFICER.

Mustered into the service of the United States, for three years or during the war, from date of enlistment, in  
 the *9th* Regiment of *Indiana* (Light) Volunteers, on the *28* day of *February*, 1865, at *Leavenworth Kas*  
*Warren Boots*  
*Ind. Baty U.S. Col 4th Arty (Light)*  
*Ind. Dist. Kas*  
*Ind. Dist. Kas*



DECLARATION OF RECRUIT.

I, Warren Boott, desiring to VOLUNTEER as a Soldier in the Army of the United States, for the term of THREE YEARS, Do Declare, That I am (37) years and \_\_\_\_\_ months of age; that I have never been discharged from the United States service on account of disability or by sentence of a court martial, or by order before the expiration of a term of enlistment; and I know of no impediment to my serving honestly and faithfully as a soldier for three years.

GIVEN at Leavenworth Kansas the 28 day of February

Witness: Thomas Ploman Warren Boott  
mark

No. 8

Warren Boott

Volunteered at

Leavenworth Mo. Mo  
February 28 1865

By W. G. Sp. of Minn

W. G. Sp. of Minn  
W. G. Sp. of Minn

enlistment; last served in Company ( )

Reg't of

Discharged

18

CONSENT IN CASE OF MINOR.

I, \_\_\_\_\_, Do CERTIFY, That I am \_\_\_\_\_; that the \_\_\_\_\_ of \_\_\_\_\_; that the said \_\_\_\_\_ is \_\_\_\_\_ years of age; and I do hereby freely give my CONSENT to his volunteering as a SOLDIER in the ARMY OF THE UNITED STATES for the period of THREE YEARS.

GIVEN at \_\_\_\_\_ the \_\_\_\_\_ day of \_\_\_\_\_

Witness: \_\_\_\_\_

NOTE 1.—This blank will be used for both enlistments and re-enlistments—enlistment of veterans, &c., &c., in the volunteer service. They will be made out in duplicate in all cases—one to accompany the recruiting return of the superintendent (not the recruiting officer) to the Adjutant General, and one to accompany the accounts of the officer who pays bounty, &c. The Regiment and Company in which the soldier last served should be given on the back  
NOTE 2.—An enlistment holds to service. A muster-in must, in all cases, precede payment of pay, bounty, pension, &c. A muster-in roll must, in all cases, be filed in the Adjutant General's Office as evidence of muster-in. The mustering officer, commissary, or assistant commissary of musters, as the case may be, will countersign both enlistments as having mustered the soldier into the service of the United States before either of them is given to the disbursing officer.

Rec'd from 2nd. Aud. Nov. 23d 1892

Assigned to North Dist. Kas 2<sup>nd</sup> Sub Dist. 4 Ward Leavenworth City  
 N. Kas

This recruit has received One hundred dollars advance bounty of the three hundred  
 dollars bounty authorized by an Act of Congress approved July 4 1864 and Enclosed  
 by former Capt. P. H. Minor 2<sup>nd</sup> Lieut.

STATE OF Kansas TOWN OF Leavenworth



I, Warren Boots, born in Marion  
 in the State of Kentucky, aged thirty seven years,  
 and by occupation a Farmer, Do HEREBY ACKNOWLEDGE to have  
 volunteered this twenty eighth day of February, 1865,  
 to serve as a Soldier in the Army of the United States of America, for  
 the period of THREE YEARS, unless sooner discharged by proper authority:  
 Do also agree to accept such bounty, pay, rations, and clothing, as are, or may be,  
 established by law for volunteers. And I, Warren Boots, do  
 solemnly swear, that I will bear true faith and allegiance to the United States  
of America, and that I will serve them honestly and faithfully against all  
 their enemies or opposers whomsoever; and that I will observe and obey the  
 orders of the President of the United States, and the orders of the officers  
 appointed over me, according to the Rules and Articles of War.

Sworn and subscribed to, at Leavenworth } Warren Boots his  
 this 28th day of February, 1865, } mark.  
 BEFORE P. H. Minor 2<sup>nd</sup> Lieut.  
Ind. Baty, U.S. 1st Artillery

I CERTIFY, ON HONOR, That I have carefully examined the above-named Volunteer, agreeably  
 to the General Regulations of the Army, and that, in my opinion, he is free from all bodily defects and  
 mental infirmity, which would in any way disqualify him from performing the duties of a soldier.

V. G. S. Bunker  
 Surg. Board of Enrollment North Dist. Kas.  
 EXAMINING SURGEON.

I CERTIFY, ON HONOR, That I have minutely inspected the Volunteer Warren Boots  
 previously to his enlistment, and that he was entirely sober when enlisted; that, to the best of my  
 judgment and belief, he is of lawful age; and that, in accepting him as duly qualified to perform the  
 duties of an able-bodied soldier, I have strictly observed the Regulations which govern the recruiting  
 service. This soldier has brown eyes, dark hair, Brown complexion, is Six  
three inches high.

P. H. Minor 2<sup>nd</sup> Lieut.  
Ind. Baty U.S. 1st Artillery (right)  
 RECRUITING OFFICER.

(G. O. No. 74 & 76.)

Mustered into the service of the United States, for three years or during the war, from date of enlistment, in  
106<sup>th</sup> Regt., Regiment of Wis. Light Volunteers, on the 21<sup>st</sup> day of February, 1865, at Leavenworth, Kas.  
John C. Ashman  
Capt. Co. 106th Regt. Wis. Light  
Shelby B. Babler  
Leavenworth, Kas.

*Britton George*

ndpt. Batt'y U.S. Col'd L. Art'y

*Private*

CARD NUMBERS.

1	6233735	26
2	623385	27
3	9132916	28
4		29
5		30
6		31
7		32
8		33
9		34
10		35
11		36
12		37
13		38
14		39
15		40
16		41
17		42
18		43
19		44
20		45
21		46
22		47
23		48
24		49
25		50

Book Mark:

See also

*J* | Indpt. Batt'y. | **U.S.C.T.**

*George Brillan*

....., Indpt. Batt'y, U. S. Col'd L. Art'y.

Appears on

**Battery Descriptive Book**

of the organization named above.

**DESCRIPTION.**

Age *19* years; height *5* feet *5* inches.

Complexion *Brown*

Eyes *Black*; hair *Black*

Where born *Brownville Tenn*

Occupation *Laborer*

**ENLISTMENT.**

When *Aug 6*, 186 *4*.

Where *Pennock Ala.*

By whom *A. Matthews*; term *3* y'rs.

Remarks: .....  
.....  
.....  
.....  
.....  
.....  
.....  
.....  
.....

*Shelburne*

NRRH 206  
B | Indpt. Battery. | **U.S.C.T.**

George Britton

Pvt, Indpt. Battery, U. S. Col'd L. Art'y.

Appears on

**Battery Muster-in and Descriptive Roll**

of the organization named above. Roll dated

Leavenworth Mo. Dec 23, 1864.

Where born Brownsville Tenn.

Age 19 y'rs; occupation Laborer

When enlisted Aug 6, 1864.

Where enlisted Leavenworth Mo.

For what period enlisted 3 years.

Eyes Blue; hair Blue

Complexion Bro; height 5 ft. 5 in.

When mustered in Aug 9, 1864.

Where mustered in Leavenworth

Bounty paid \$ 100; due \$ 300 <sup>00</sup>/<sub>100</sub>

Where credited

Battery to which assigned

Remarks: On N Diet No  
21<sup>st</sup> Co. 3<sup>rd</sup> Ward  
Leavenworth Mo.

Book mark ;

J. H. Ashley  
(856g) Copyist.

73

Indpt. Battery.

U.S.C.T.

George Brittan

Pat, Indpt. Battery, U. S. Col'd L. Art'y.

Appears on

Battery Muster Roll

for List must to Dec 31, 186 1/2

Present or absent. Absent

Stoppage, \$ 100 for

Due Gov't, \$ 100 for

Valuation of horse, \$ 100

Valuation of horse equipments, \$ 100

Remarks: Absent without leave

no born on Dec Rolls of Batty

Book mark:

J. S. [Signature]

(358)

Copyist.

*Britton George*

, Co. *1<sup>st</sup> Sea Batt* Reg't *U. S. C. A.*

*2* **Enclosures.**

Bed Cards .....	Final Statements .....
Burial Records .....	Furloughs or L. of A .....
Certs. of Dis. for Discharge .....	Med. Certificates .....
C. M. Charges .....	Med. Des. Lists .....
Descriptive Lists .....	Orders .....
Discharge Certificates .....	Pris. of War Record .....
Enlistment Papers .....	Resignations .....

**Other papers relating to—**

Admission to Hosp'l .....	Furlough or L. of A .....
Casualty Sheet .....	Med. Examination .....
Confinement .....	Misc. Information .....
Contracts .....	Pay or Clothing .....
Death or Effects .....	Personal Reports .....
Desertion .....	Rank .....
Discharge from Hosp'l .....	Transfer to Hosp'l .....
Discharge from Service .....	Transfer to V. R. C. .....
Duty .....	Transportation .....

NOTE 1.—This blank will be used for both enlistments and re-enlistments—enlistment of veterans, &c., &c., in the volunteer service. They will be made out in duplicate in all cases—one to accompany the recruiting return of the superintendent (not the recruiting officer) to the Adjutant General, and one to accompany the accounts of the officer who pays bounty, &c. The Regiment and Company in which the soldier last served should be given on the back.

NOTE 2.—An enlistment holds to service. A muster-in must, in all cases, precede payment of pay, bounty, pension, &c. A muster-in roll must, in all cases, be filed in the Adjutant General's Office as evidence of muster-in. The mustering officer, commissary, or assistant commissary of musters, as the case may be, will countersign both enlistments as having mustered the soldier into the service of the United States before either of them is given to the disbursing officer.

DECLARATION OF RECRUIT.

I, George Brittan desiring to VOLUNTEER as a Soldier in the Army of the United States, for the term of THREE YEARS, Do Declare, That I am 21 years and 0 months of age; that I have never been discharged from the United States service on account of disability or by sentence of a court martial, or by order before the expiration of a term of enlistment; and I know of no impediment to my serving honestly and faithfully as a soldier for three years.

GIVEN at Leavenworth City - State of Kansas the 21<sup>st</sup> day of August 1864

Witness:

W. A. Beersham

George Brittan  
mark

Discharged ..... 18 ..

Reg't of ..

enlistment; last served in Company ( )

By Wm. A. Beersham Adjutant  
1st Regt. U.S. Col. Sig. Artillery

Volunteered at Leavenworth City  
August 6 1864

George Brittan

No. 372

CONSENT IN CASE OF MINOR.

I, .. Do CERTIFY, That I am the .. of ..; that the said .. is .. years of age; and I do hereby freely give my CONSENT to his volunteering as a SOLDIER in the ARMY OF THE UNITED STATES for the period of THREE YEARS.

GIVEN at ..... the ..... day of ..

Witness: ..



51,33

VOLUNTEER ENLISTMENT.

STATE OF

TOWN OF

*Kansas*

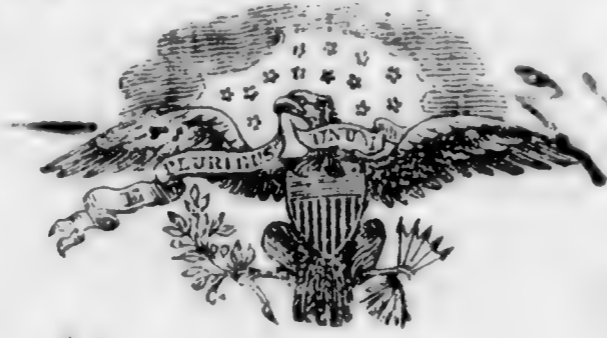

*Leavenworth City*

I, *George Brittan* born in *Brownsville*  
 in the State of *Pennsylvania* aged *19* years,  
 and by occupation a *Laborer* Do HEREBY ACKNOWLEDGE to have  
 volunteered this *Sixth* day of *August* 1864,  
 to serve as a **Soldier** in the **Army of the United States of America**, for  
 the period of **THREE YEARS**, unless sooner discharged by proper authority:  
 Do also agree to accept such bounty, pay, rations, and clothing, as are, or may be,  
 established by law for volunteers. And I, *George Brittan* do  
 solemnly swear, that I will bear true faith and allegiance to the **United States**  
**of America**, and that I will serve them honestly and faithfully against all  
 their enemies or opposers whomsoever; and that I will observe and obey the  
 orders of the President of the United States, and the orders of the officers  
 appointed over me, according to the Rules and Articles of War.

Sworn and subscribed to, at *Leavenworth City* *George Brittan* his  
 this *Sixth* day of *August* 1864, *mark*  
 BEFORE *Wm D Matthews 2nd Lieut*  
*Recruiting 1st Ind. U.S. Col. Light Artillery*

I CERTIFY, ON HONOR, That I have carefully examined the above-named Volunteer, agreeably  
 to the General Regulations of the Army, and that, in my opinion, he is free from all bodily defects and  
 mental infirmity, which would in any way disqualify him from performing the duties of a soldier.

*Viggin Sinks*  
*Sur Board of Enrollment*  
*North Dist Kansas*  
 EXAMINING SURGEON.

I CERTIFY, ON HONOR, That I have minutely inspected the Volunteer, *George Brittan*  
 previously to his enlistment, and that he was entirely sober when enlisted; that, to the best of my  
 judgment and belief, he is of lawful age; and that, in accepting him as duly qualified to perform the  
 duties of an able-bodied soldier, I have strictly observed the Regulations which govern the recruiting  
 service. This soldier has *Black* eyes, *Black* hair, *Brown* complexion, is  
 feet ..... inches high.

*Wm D Matthews 2nd Lieut*  
*Recruiting 1st Ind. U.S. Col. Light Artillery*  
 Regiment of ..... Volunteers,  
 RECRUITING OFFICER.

Mustered into the service of the United States, for three years or during the war, from date of enlistment, in Company .....  
 Regiment of ..... Volunteers, on the ..... day of ..... 186 , at .....

They will be made out in duplicate... Do not make out in duplicate... They will be made out in duplicate... and one to accompany the accounts of the officer... in which the soldier last served should be given on the back... An enlistment holds to service... General's Office as evidence of muster-in... mustered the soldier into the

DECLARATION OF RECRUIT.

I, George Britton desiring to VOLUNTEER as a Soldier in the Army of the United States, for the term of THREE YEARS, Do Declare, That I am 19 years 0 months of age; that I have never been discharged from the United States service on account of disability or by sentence of a court martial, or by order before the expiration of a term of enlistment; and I know of no impediment to my serving honestly and faithfully as a soldier for three years.

GIVEN at Leavenworth City State Kansas the sixth day of August 1864

Witness:

W. B. [unclear] George Britton

No. 52

George Britton

Volunteered at Leavenworth K.S.

August 6 1864,

By Wm. D. Matthews

Recruit - 15<sup>th</sup> Regt. U.S. Cavalry

enlistment; last served in Company ( )

Reg't of

Discharged 18

CONSENT IN CASE OF MINOR.

Do CERTIFY, That I am \_\_\_\_\_; that the \_\_\_\_\_; that the \_\_\_\_\_ years of age; and I do hereby freely give my CONSENT to his volunteering as a SOLDIER in the ARMY OF THE UNITED STATES for the term of THREE YEARS.

GIVEN at \_\_\_\_\_ day of \_\_\_\_\_

VOLUNTEER ENLISTMENT.

STATE OF

TOWN OF

Kansas



Leavenworth City

I, George Brittan born in Brownsville  
in the State of Pennsylvania aged 19 years,  
and by occupation a Labourer DO SOLEMNLY ACKNOWLEDGE to have  
volunteered this sixth day of August 1864,

to serve as a **Soldier** in the **Army of the United States of America**, for  
the period of **THREE YEARS**, unless sooner discharged by proper authority:  
Do also agree to accept such bounty, pay, rations, and clothing, as are, or may be,  
established by law for volunteers. And I, George Brittan do  
solemnly swear, that I will bear true faith and allegiance to the **United States**  
**of America**, and that I will serve them honestly and faithfully against all  
their enemies or opposers whomsoever; and that I will observe and obey the  
orders of the President of the United States, and the orders of the officers  
appointed over me, according to the Rules and Articles of War.

Sworn and subscribed to, at

this sixth day of August 1864,

BEFORE

Wm D Matthews 2nd Lieut mark  
Recruiting 1st Ind. U.S. Col. Light Artillery

I CERTIFY, ON HONOR, That I have carefully examined the above-named Volunteer, agreeably  
to the General Regulations of the Army, and that, in my opinion, he is free from all bodily defects and  
mental infirmity, which would in any way disqualify him from performing the duties of a soldier.

Jiffie Dinko  
Surg Board of Enrollment  
North Dist Kansas  
EXAMINING SURGEON.

George Brittan  
Brittan

I CERTIFY, ON HONOR, That I have minutely inspected the Volunteer,  
previously to his enlistment, and that he was entirely sober when enlisted; that, to the best of my  
judgment and belief, he is of lawful age; and that, in accepting him as duly qualified to perform the  
duties of an able-bodied soldier, I have strictly observed the Regulations which govern the recruiting  
service. This soldier has Black eyes, Black hair, Brown complexion, is 5  
feet 5 inches high.

Wm D Matthews 2nd Lieut  
Recruiting 1st Ind. U.S. Col. Light Artillery  
Regiment of Volunteers,

RECRUITING OFFICER.

Mustered into the service of the United States, for three years or during the war, from date of enlistment, in Company  
1st Ind. U.S. Col. Light Artillery  
Leavenworth City  
August 1864  
at Leavenworth City  
Volunteers on the sixth day of August, 1864, at Leavenworth City  
George Brittan  
Leavenworth City

*Frank Henry*

Adpt. Batt'y U.S. Col'd L. Art'y

*Private Private*

CARD NUMBERS.

1	6233644	26
2	6234059	27
3	6234197	28
4	6234363	29
5	6234527	30
6	9133095	31
7		32
8		33
9		34
10		35
11		36
12		37
13		38
14		39
15		40
16		41
17		42
18		43
19		44
20		45
21		46
22		47
23		48
24		49
25		50

Book Mark: \_\_\_\_\_

See also \_\_\_\_\_

A621352 0.090

51278153 00mm

01230347 and 018

00903394 3/4 R113  
13

M. S. Penner  
4

B

Indpt. Batt'y.

U.S.C.T.

Henry Brooks

, Indpt. Batt'y, U. S. Col'd L. Art'y.

Appears on

**Battery Descriptive Book**

of the organization named above.

**DESCRIPTION.**

Age 17 years; height 5 feet  inches.

Complexion Black

Eyes Black; hair Black

Where born Blatt Co. Mo.

Occupation Farmer

**ENLISTMENT.**

When Jan. 16, 1865.

Where Laverne Kans

By whom Capt. J. J. [unclear], term 3 y'rs.

Remarks:  
-----  
-----  
-----  
-----  
-----  
-----  
-----  
-----  
-----  
-----

Healbrook

*B* | Indpt. Battery. | **U.S.C.T.**

*Henry Brooks*

Appears with rank of *Priv* on

**Muster and Descriptive Roll of a Detachment of U. S. Vols. forwarded**

for the Indpt. Batt'y, U. S. Col'd L. Arty. Roll dated

*Leavenworth, Kas, Jan. 17, 1865.*

Where born *Platte Co. Missouri*

Age *17* y'rs; occupation *Farmer*

When enlisted *Jan. 16*, 1865.

Where enlisted *Leavenworth, Kas*

For what period enlisted *3* years.

Eyes *Black*; hair *Black*

Complexion *Black*; height *5* ft. *—* in.

When mustered in *Jan. 17*, 1865.

Where mustered in *Leavworth, Kas.*

Bounty paid \$ *000* <sup>100</sup>; due \$ *300* <sup>100</sup>

Where credited

Battery to which assigned

Remarks: *Credited to South<sup>m</sup> Dist<sup>s</sup>  
Kas. 31 Sub. Dist. Lawrence  
Douglas Co. Volunteer Recruit  
& entitled to Bounty.*

Book mark:

*E. Thacker*

(339)

Copyist.

73

Indpt. Battery.

U.S.C.T.

Henry Brooks

Pat, Indpt. Battery, U. S. Col'd L. Art'y.

Appears on

Battery Muster Roll

for Jan & Feb, 1865

Present or absent Present

Stoppage, \$ 100 for

Due Gov't, \$ 100 for

Valuation of horse, \$ 100

Valuation of horse equipments, \$ 100

Remarks:

Book mark:

(358) J. Schroder Copyist.



*B* | Indpt. Battery. | **U.S.C.T.**

*Henry Brooks,*  
*H*, Indpt. Battery, U. S. Col'd L. Art'y.

Appears on

**Battery Muster Roll**

for *Mar, & Apl,* 1865.

Present or absent *Present,*

Stoppage, \$ 100 for

Due Gov't, \$ 100 for

Valuation of horse, \$ 100

Valuation of horse equipments, \$ 100

Remarks: *Penalty due, \$100.00,*

Book mark: \_\_\_\_\_

*Porter*

(358)

Copyist.

*B* | Indpt. Battery. | **U.S.C.T.**

*Henry Brooks,*  
*A*, Indpt. Battery, U. S. Col'd L. Art'y.

Appears on

**Battery Muster Roll**

for *May & June*, 1865.

Present or absent *Present,*

Stoppage, \$ *100* for

Due Gov't, \$ *100* for

Valuation of horse, \$ *100*

Valuation of horse equipments, \$ *100*

Remarks: *County due \$100-*

Book mark: \_\_\_\_\_

*Porter*

(358)

Copyist.

*P*

Indpt. Battery. **U.S.C.T.**

*Henry Brooks,*

*H*, Indpt. Battery U. S. Col'd Light Art'y.

Appears on **Batt'y Muster-out Roll**, dated

*Pr. Leavenworth, Kas., July 22, 1865.*

Muster-out to date *July 22, 1865.*

Last paid to *Pay due from enlistment 186*

Clothing account:

Last settled....., 186 ; drawn since \$ *67* <sup>*94*</sup>/<sub>100</sub>,

Due soldier \$.....<sub>100</sub>; due U. S. \$.....<sub>100</sub>

Am't for cloth'g in kind or money adv'd \$.....<sub>100</sub>

Due U. S. for arms, equipments, &c., \$.....<sub>100</sub>

Bounty paid \$ *None* <sub>100</sub>; due \$ *None* <sub>100</sub>

Remarks: *Due E. Taylor, Suptes,*  
*\$10-*

Book mark :.....

*Porter*

(361)

Copyist.

*Brooks Henry*

, Co. *Inf. Batt* Reg't *W. S. C. I.*

*2* Enclosures.

Bed Cards .....	Final Statements .....
Burial Records .....	Furloughs or L. of A .....
Certs. of Dis. for Discharge .....	Med. Certificates .....
C. M. Charges .....	Med. Des. Lists .....
Descriptive Lists .....	Orders .....
Discharge Certificates .....	Pris. of War Record .....
Enlistment Papers <i>2</i> .....	Resignations .....

Other papers relating to—

Admission to Hosp'l .....	Furlough or L. of A .....
Casualty Sheet .....	Med. Examination .....
Confinement .....	Misc. Information .....
Contracts .....	Pay or Clothing .....
Death or Effects .....	Personal Reports .....
Desertion .....	Rank .....
Discharge from Hosp'l .....	Transfer to Hosp'l .....
Discharge from Service .....	Transfer to V. R. C. .....
Duty .....	Transportation .....
.....	.....

NOTE 1.—This blank will be used for both enlistments and re-enlistments—enlistment of veterans, &c., &c., in the volunteer service. They will be made out in duplicate in all cases—one to accompany the recruiting return of the superintendent (not the recruiting officer) to the Adjutant General, and one to accompany the accounts of the officer who pays bounty, &c. The Regiment and Company in which the soldier last served should be given on the back

NOTE 2.—An enlistment holds to service. A muster-in must, in all cases, precede payment of pay, bounty, pension, &c. A muster-in roll must, in all cases, be filed in the Adjutant General's Office as evidence of muster-in. The mustering officer, commissary, or assistant commissary of musters, as the case may be, will countersign both enlistments as having mustered the soldier into the service of the United States before either of them is given to the disbursing officer.

DECLARATION OF RECRUIT.

I, Henry Brooks, desiring to VOLUNTEER as a Soldier in the Army of the United States, for the term of THREE YEARS, Do Declare, That I am Seventeen years and \_\_\_\_\_ months of age; that I have never been discharged from the United States service on account of disability or by sentence of a court martial, or by order before the expiration of a term of enlistment; and I know of no impediment to my serving honestly and faithfully as a soldier for three years.

GIVEN at Leavenworth City the 16<sup>th</sup> day of January

Witness:

W. A. Burnham Henry Brooks  
Leavenworth

Discharged \_\_\_\_\_, 18\_\_

Reg't of \_\_\_\_\_

enlistment; last served in Company ( ) \_\_\_\_\_

No. \_\_\_\_\_  
Henry Brooks  
Volunteered at Leavenworth  
January 16 1865  
By W. A. Burnham  
Adj. Gen. Regiment of US Cavalry (10<sup>th</sup>)

CONSENT IN CASE OF MINOR.

I, W. A. Burnham, Do CERTIFY, That I am the Guardian of Henry Brooks; that the said Henry Brooks is Seventeen years of age; and I do hereby freely give my CONSENT to his volunteering as a SOLDIER in the ARMY OF THE UNITED STATES for the period of THREE YEARS.

GIVEN at Leavenworth City the 15<sup>th</sup> day of January 1865

Witness:

W. A. Burnham  
E. N. Olney

Credited to Louche via Kan 31st Sub Dist Lawrence Mo. as led

VOLUNTEER ENLISTMENT.

STATE OF

TOWN OF

Kansas



Lawrence

I, Henry Brooks, born in Platte Co. in the State of Missouri, aged Seventeen years, and by occupation a Farmer, Do HEREBY ACKNOWLEDGE to have volunteered this Fifteenth day of January, 1865, to serve as a Soldier in the Army of the United States of America, for the period of THREE YEARS, unless sooner discharged by proper authority: Do also agree to accept such bounty, pay, rations, and clothing, as are, or may be, established by law for volunteers. And I, Henry Brooks, do solemnly swear, that I will bear true faith and allegiance to the United States of America, and that I will serve them honestly and faithfully against all their enemies or opposers whomsoever; and that I will observe and obey the orders of the President of the United States, and the orders of the officers appointed over me, according to the Rules and Articles of War.

Sworn and subscribed to, at Lawrence this 16th day of Jan, 1865, before Lieut H Ford Douglass Recruiting 1st Ind W.S. Cold Battery Light

I CERTIFY, ON HONOR, That I have carefully examined the above-named Volunteer, agreeably to the General Regulations of the Army, and that, in my opinion, he is free from all bodily defects and mental infirmity, which would in any way disqualify him from performing the duties of a soldier.

Effie Dicks Surgeon of Engellines 5th North Dist Kansas EXAMINING SURGEON.

I CERTIFY, ON HONOR, That I have minutely inspected the Volunteer Henry Brooks previously to his enlistment, and that he was entirely sober when enlisted; that, to the best of my judgment and belief, he is of lawful age; and that, in accepting him as duly qualified to perform the duties of an able-bodied soldier, I have strictly observed the Regulations which govern the recruiting service. This soldier has blue eyes, black hair, black complexion, is five feet inches high.

Lieut H Ford Douglass 1st Ind Battery U.S. Col. Artillery RECRUITING OFFICER.

(A. G. O. No. 71 & 76.)

Mustered into the service of the United States. for three years or during the war from date of enlistment, in Company G 1st Ind Battery U.S. Col. Artillery, 1st Regt. of Heavy Artillery, Missouri, on the 17th day of January, 1865, at Lawrence, Kansas.

DECLARATION OF RECRUIT.

I, Henry Brooks, desiring to VOLUNTEER as a Soldier in the Army of the United States, for the term of THREE YEARS, Do Declare, That I am Seventeen years and \_\_\_\_\_ months of age; that I have never been discharged from the United States service on account of disability or by sentence of a court martial, or by order before the expiration of a term of enlistment; and I know of no impediment to my serving honestly and faithfully as a soldier for three years.

GIVEN at Seavenworth City the 16<sup>th</sup> day of January 1865

Witness: W. H. Burnham Henry Brooks mark

NOTE 1.—This blank will be used for both enlistments and re-enlistments—enlistment of veterans, &c., &c., in the volunteer service. They will be made out in duplicate in all cases—one to accompany the recruiting return of the superintendent (not the recruiting officer) to the Adjutant General, and one to accompany the accounts of the officer who pays bounty, &c. The Regiment and Company in which the soldier last served should be given on the back  
NOTE 2.—An enlistment holds to service. A muster-in must, in all cases, precede payment of pay, bounty, pension, &c. A muster-in roll must, in all cases, be filed in the Adjutant General's Office as evidence of muster-in. The mustering officer, commissary, or assistant commissary of musters, as the case may be, will countersign both enlistments as having mustered the soldier into the service of the United States before either of them is given to the disbursing officer.

Discharged ..... 18  
.....  
.....  
.....  
enlistment; last served in Company ( )  
Reg't of .....

Volunteered at Seavenworth Va  
January 16, 1865  
by St. H. Ford surgeon  
1<sup>st</sup> Regt of W. S. Col at R. 17

No. 15

CONSENT IN CASE OF MINOR.

I, W. H. Burnham, Do CERTIFY That I am the Guardian of Henry Brooks; that the said Henry Brooks is seventeen years of age; and I do hereby freely give my CONSENT to his volunteering as a SOLDIER in the ARMY OF THE UNITED STATES for the period of THREE YEARS.

GIVEN at Seavenworth City the 16<sup>th</sup> day of January 1865

Witness: W. H. Burnham

*Credited to ~~State~~ sub Kas 31<sup>st</sup> but out Louisiana single less county  
Southern*

*Sumner*

VOLUNTEER ENLISTMENT.

STATE OF

TOWN OF

*Kansas*



*Leavenworth*

I, *Henry Brooks*, born in *Platte Co*  
in the State of *Missouri*, aged *Seventeen* years,  
and by occupation a *farmer*, Do HEREBY ACKNOWLEDGE to have  
volunteered this *Sixteenth* day of *January*, 1865,  
to serve as a **Soldier** in the **Army of the United States of America**, for  
the period of **THREE YEARS**, unless sooner discharged by proper authority:  
Do also agree to accept such bounty, pay, rations, and clothing, as are, or may be,  
established by law for volunteers. And I, *Henry Brooks*, do  
solemnly swear, that I will bear true faith and allegiance to the **United States  
of America**, and that I will serve them honestly and faithfully against all  
their enemies or opposers whomsoever; and that I will observe and obey the  
orders of the President of the United States, and the orders of the officers  
appointed over me, according to the Rules and Articles of War.

Sworn and subscribed to, at *Leavenworth*  
this *16<sup>th</sup>* day of *Jan*, 1865,  
BEFORE *Lieut H Ford* *and* *W.S. Cold* *Battery* *(Sig Bty)*

I CERTIFY, ON HONOR, That I have carefully examined the above-named Volunteer, agreeably  
to the General Regulations of the Army, and that, in my opinion, he is free from all bodily defects and  
mental infirmity, which would in any way disqualify him from performing the duties of a soldier.

*Tiffin Links*  
*Sur Board of Enrollment*  
*Leavenworth Kansas*  
EXAMINING SURGEON.

I CERTIFY, ON HONOR, That I have ~~minutely~~ inspected the Volunteer *Henry Brooks*  
previously to his enlistment, and that he was entirely sober when enlisted; that, to the best of my  
judgment and belief, he is of lawful age; and that, in accepting him as duly qualified to perform the  
duties of an able-bodied soldier, I have strictly observed the Regulations which govern the recruiting  
service. This soldier has *black* eyes, *black* hair, *black* complexion, is *five*  
feet \_\_\_\_\_ inches high.

*Lieut H Ford Douglas*  
*and Battery and Col. Potilly*  
RECRUITING OFFICER.

*Battery* *Regiment of* *W. S. Cold* *Battery* *(Sig Bty)* *Volunteers*, on the *17<sup>th</sup>* day of *January*, 1865, at *Leavenworth Kansas*,  
in *Company* *and* *Leavenworth*

*John W. Johnson*  
*Captain* *Harold* *Muskel*  
*Leavenworth Kansas*



*Wynn, Alfred*

Apt. Batt'y U.S. Col'd L. Art'y

*Private*

*Private*

CARD NUMBERS.

1	6233736	26
2	6233556	27
3	9132917	28
4		29
5		30
6		31
7		32
8		33
9		34
10		35
11		36
12		37
13		38
14		39
15		40
16		41
17		42
18		43
19		44
20		45
21		46
22		47
23		48
24		49
25		50

Book Mark:

See also

*B*

Indpt. Batt'y. | **U.S.C.T.**

*Alford Brown*

....., Indpt. Batt'y, U. S. Col'd L. Art'y.

Appears on

**Battery Descriptive Book**

of the organization named above.

**DESCRIPTION.**

Age *48* years; height *5* feet *6* inches.

Complexion *Black*

Eyes *Black*; hair *Gray*

Where born *Wmays Penn.*

Occupation *Laborer*

**ENLISTMENT.**

When *Aug. 15*, 1864.

Where *Strawmouth - A's.*

By whom *A. M. Perkins*; term *3* y'rs.

Remarks:

.....  
 .....  
 .....  
 .....  
 .....  
 .....  
 .....  
 .....

*Scobrook*

19

Indpt. Battery. U.S.C.T.

Alfred Brown

Pat, Indpt. Battery, U. S. Col'd L. Art'y.

Appears on

**Battery Muster-in and Descriptive Roll**

of the organization named above. Roll dated

Leavenworth Mo Dec 28, 1864

Where born Murray Co, Tenn

Age 48 y'rs; occupation Laborer

When enlisted Aug 15, 1864

Where enlisted Leavenworth Mo

For what period enlisted 3 years.

Eyes Blue; hair Grey

Complexion Blue; height 5 ft. 6 in.

When mustered in Aug 18, 1864.

Where mustered in Leavenworth

Bounty paid \$ 100; due \$ 300 <sup>00</sup>/<sub>100</sub>

Where credited

Battery to which assigned

Remarks: Or N. dist No  
74-SS, 4<sup>th</sup> Ward  
Leavenworth Mo.

Book mark ;

(856g) *J. Schuster* Copyist.

93 | Indpt. Battery. | **U.S.C.T.**

*Alford Brown*

*93*, Indpt. Battery, U. S. Col'd L. Art'y.

Appears on

**Battery Muster Roll**

for *July's Muster to Dec 31*, 1864.

Present or absent *Absent*

Stoppage, \$ 100 for

Due Gov't, \$ 100 for

Valuation of horse, \$ 100

Valuation of horse equipments, \$ 100

Remarks: *Absent without  
leave*

*Not on the Rolls of Batty*

Book mark:

*J. Scherley*

(358)

Copyist.

*Brown Alfred*

, Co. *Ind. Batt* Reg't *W. I. C. S.*

*2* Enclosures.

Bed Cards .....	Final Statements .....
Burial Records .....	Furloughs or L. of A. ....
Certs. of Dis. for Discharge .....	Med. Certificates .....
C. M. Charges .....	Med. Des. Lists .....
Descriptive Lists .....	Orders .....
Discharge Certificates .....	Pris. of War Record .....
Enlistment Papers <i>2</i> .....	Resignations .....

Other papers relating to—

Admission to Hosp'l .....	Furlough or L. of A. ....
Casualty Sheet .....	Med. Examination .....
Confinement .....	Misc. Information .....
Contracts .....	Pay or Clothing .....
Death or Effects .....	Personal Reports .....
Desertion .....	Rank .....
Discharge from Hosp'l .....	Transfer to Hosp'l .....
Discharge from Service .....	Transfer to V. R. C. ....
Duty .....	Transportation .....

MICROFILM PUBLICATION M 1836

COMPILED MILITARY SERVICE RECORDS  
OF VOLUNTEER UNION SOLDIERS WHO SERVED WITH  
THE UNITED STATES COLORED TROOPS (USCT)  
INDEPENDENT BATTERY LIGHT ARTILLERY

PERSONAL PAPERS' TARGET SHEET

PLEASE NOTE THE CHECKED INFORMATION ABOUT THE PERSONAL PAPERS IN  
THIS FILE:

- NO PERSONAL PAPERS WERE FOUND IN THIS FILE WHEN THE  
RECORDS WERE ARRANGED FOR MICROFILMING.
- 3 PERSONAL PAPER(S) FOUND IN THIS FILE WHEN THE RECORDS  
WERE ARRANGED FOR MICROFILMING.

NOTE 1.—This blank will be used for both enlistments and re-enlistments—enlistment of veterans, &c., &c., in the volunteer service. They will be made out in duplicate in all cases—one to accompany the recruiting return of the superintendent (not the recruiting officer) to the Adjutant General, and one to accompany the accounts of the officer who pays bounty, &c. The Regiment and Company in which the soldier last served should be given on the back.

NOTE 2.—An enlistment holds to service. A muster-in must, in all cases, precede payment of pay, bounty, pension, &c. A muster-in roll must, in all cases, be filed in the Adjutant General's Office as evidence of muster-in. The mustering officer, commissary, or assistant commissary of musters, as the case may be, will countersign both enlistments as having mustered the soldier into the service of the United States before either of them is given to the disbursing officer.

DECLARATION OF RECRUIT.

I, Alfred Brown desiring to VOLUNTEER as a Soldier in the Army of the United States, for the term of THREE YEARS Do Declare, That I am 40 years and \_\_\_\_\_ months of age; that I have never been discharged from the United States service on account of disability or by sentence of a court-martial, or by order before the expiration of a term of enlistment; and I know of no impediment to my serving honestly and faithfully as a soldier for three years.

GIVEN at Seawenworth State of Kansas the 13<sup>th</sup> day of August 1864

Witness: W. H. Bushman Alfred <sup>his</sup> Brown  
witness

No. 78

Alfred Brown  
Volunteered at Seawenworth

August 13<sup>th</sup> 1864

By W. H. Bushman Adjutant

1<sup>st</sup> U. S. Regiment of Artillery

enlistment; last served in Company ( )

Reg't of \_\_\_\_\_

Discharged \_\_\_\_\_ 18 \_\_\_\_\_

CONSENT IN CASE OF MINOR.

I, \_\_\_\_\_ Do CERTIFY, That I am \_\_\_\_\_; that the \_\_\_\_\_ of \_\_\_\_\_; that the said \_\_\_\_\_ is \_\_\_\_\_ years of age; and I do hereby freely give my CONSENT to his volunteering as a SOLDIER in the ARMY OF THE UNITED STATES for the period of THREE YEARS.

GIVEN at \_\_\_\_\_ the \_\_\_\_\_ day of \_\_\_\_\_

Witness: \_\_\_\_\_

35-36

VOLUNTEER ENLISTMENT.

STATE OF

*Kansas*



TOWN OF

*Leavenworth*

I, *Alfred Brown* born in *Murray Co*  
in the State of *Missouri* aged *40* years,

and by occupation a *Laborer*. Do HEREBY ACKNOWLEDGE to have  
volunteered this *15<sup>th</sup>* day of *August* 1864,

to serve as a **Soldier** in the **Army of the United States of America**, for the  
period of **THREE YEARS** unless sooner discharged by proper authority: Do also  
agree to accept such bounty, pay, rations, and clothing, as are, or may be, estab-  
lished by law for volunteers. And I, *Alfred Brown* do  
solemnly swear, that I will bear true faith and allegiance to the **United States  
of America**, and that I will serve them honestly and faithfully against all their  
enemies or opposers whomsoever; and that I will observe and obey the orders of  
the President of the United States, and the orders of the officers appointed over  
me, according to the Rules and Articles of War.

Sworn and subscribed to, at *Leavenworth*

this *15<sup>th</sup>* day of *August* 1864,

BEFORE

*Wm D Matthews 2<sup>d</sup> Lieut*  
*Recruiting 1<sup>st</sup> U.S. Col Battery*

*Alfred Brown*  
*his mark*

I CERTIFY, ON HONOR, That I have carefully examined the above-named Volunteer, agreeably  
to the General Regulations of the Army, and that, in my opinion, he is free from all bodily defects and  
mental infirmity, which would in any way disqualify him from performing the duties of a soldier.

*Jiffie Sims*  
*Duty Board enrollment*  
*North D. of Kansas*

EXAMINING SURGEON.

I CERTIFY, ON HONOR, That I have minutely inspected the Volunteer, *Alfred Brown*  
previously to his enlistment, and that he was entirely sober when enlisted; that, to the best of my  
judgment and belief, he is of lawful age; and that, in accepting him as duly qualified to perform the duties  
of an able-bodied soldier, I have strictly observed the Regulations which govern the recruiting service.  
This soldier has *black* eyes, *gray* hair, *black* complexion, is *5<sup>ft</sup>* feet  
*6* inches high.

*Wm D Matthews 2<sup>d</sup> Lieut*  
*1<sup>st</sup> U.S. Col Battery*

Volunteers,  
RECRUITING OFFICER.

the ..... day of ..... 186 , at .....  
Mustered into the service of the United States, in Company .....  
Regiment of .....  
Volunteers, on



**NOTE 1.**—This blank will be used for both enlistments and re-enlistments—enlistment of veterans, &c., &c., in the volunteer service. They will be made out in duplicate in all cases—one to accompany the recruiting return of the superintendent (not the recruiting officer) to the Adjutant General, and one to accompany the accounts of the officer who pays bounty, &c. The Regiment and Company in which the soldier last served should be given on the back.

**NOTE 2.**—An enlistment holds to service. A muster-in must, in all cases, precede payment of pay, bounty, pension, &c. A muster-in roll must, in all cases, be filed in the Adjutant General's Office as evidence of muster-in. The mustering officer, commissary, or assistant commissary of musters, as the case may be, will countersign both enlistments as having mustered the soldier into the service of the United States before either of them is given to the disbursing officer.

DECLARATION OF RECRUIT.

I, Alfred Brown desiring to VOLUNTEER as a Soldier in the Army of the United States, for the term of THREE YEARS Do Declare, That I am 48 years and \_\_\_\_\_ months of age; that I have never been discharged from the United States service on account of disability or by sentence of a court-martial, or by order before the expiration of a term of enlistment; and I know of no impediment to my serving honestly and faithfully as a soldier for three years.

GIVEN at Leavenworth State of Kansas the 15 day of August 1864

Witness: M. H. Dunham Alfred Brown

No. 6812

Alfred Brown  
 Volunteered at Leavenworth  
August 15 1864,  
 By M. H. Dunham Adjutant  
1st Regiment of Battery

..... enlistment; last served in Company ( )  
 ..... Reg't of .....  
 Discharged ..... 18 ..

CONSENT IN CASE OF MINOR.

I, \_\_\_\_\_ Do CERTIFY, That I am \_\_\_\_\_ the \_\_\_\_\_ of \_\_\_\_\_; that the said \_\_\_\_\_ is \_\_\_\_\_ years of age; and I do hereby freely give my CONSENT to his volunteering as a SOLDIER in the ARMY OF THE UNITED STATES for the period of THREE YEARS.

GIVEN at \_\_\_\_\_ the \_\_\_\_\_ day of \_\_\_\_\_

Witness: \_\_\_\_\_

3536

### VOLUNTEER ENLISTMENT.

STATE OF

Kansas



TOWN OF

Leavenworth

I, Alfred Brown born in Maine  
in the State of Maine aged 48 years,  
and by occupation a Laborer DO HEREBY ACKNOWLEDGE to have  
volunteered this 15<sup>th</sup> day of August 1864,

to serve as a **Soldier** in the **Army of the United States of America**, for the  
period of **THREE YEARS** unless sooner discharged by proper authority: Do also  
agree to accept such bounty, pay, rations, and clothing, as are, or may be, estab-  
lished by law for volunteers. And I, Alfred Brown do  
solemnly swear, that I will bear true faith and allegiance to the **United States  
of America**, and that I will serve them honestly and faithfully against all their  
enemies or opposers whomsoever; and that I will observe and obey the orders of  
the President of the United States, and the orders of the officers appointed over  
me, according to the Rules and Articles of War.

Sworn and subscribed to, at Leavenworth

this 15<sup>th</sup> day of August 1864

BEFORE Wm J Matthews 2<sup>d</sup> Lieut

Recruiting 1<sup>st</sup> U.S. Col Battery

Alfred Brown  
with

I CERTIFY, ON HONOR, That I have carefully examined the above-named Volunteer, agreeably  
to the General Regulations of the Army, and that, in my opinion, he is free from all bodily defects and  
mental infirmity, which would in any way disqualify him from performing the duties of a soldier.

Jefferson Simka  
Judge Board enrollment  
North 2<sup>d</sup> Kansas

EXAMINING SURGEON.

I CERTIFY, ON HONOR, That I have minutely inspected the Volunteer, Alfred Brown  
previously to his enlistment, and that he was entirely sober when enlisted; that, to the best of my  
judgment and belief, he is of lawful age; and that, in accepting him as duly qualified to perform the duties  
of an able-bodied soldier, I have strictly observed the Regulations which govern the recruiting service.

This soldier has black eyes, grey hair, black complexion, is 5<sup>ft</sup> feet  
6 inches high.

Wm J Matthews 2<sup>d</sup> Lieut

1<sup>st</sup> U.S. Col Battery Volunteers,

RECRUITING OFFICER.

the ..... day of ..... 1864, at .....  
Mustered into the service of the United States, in Company .....  
Regiment of .....  
Volunteers, on

D. 66. O. P. M. G. Vol. 37. 1865

H. Seaman with Apr 29/65

Douglas H. Ford

Capt J. P. Batty

Act's release of Sgt  
Brown of Indpt Col'd  
Batty -

Enclosure -

Rec'd O. P. M. G. Vol. 37. Apr 26/65

H. J. Des Andres Battery  
 Ft Leavenworth April 24/63.

Major - I have the honor to represent  
 that to hold Serjt Brown a member of this  
 Battery in Prison is manifestly unjust.  
 Enclosed is the Proceeding of his trial  
 and argument by Court Martineer.  
 I would most respectfully ask  
 that he be released.

Very Respectfully  
 Yours  
 H. J. Des Andres  
 Capt Comd'g Battery

Art. Batt'y U.S. Col'd L. Art'y.

Private Private

CARD NUMBERS.

1	6233732	26
2	6234023	27
3	6234062	28
4	6234200	29
5	6234367	30
6	6234530	31
7	9132913	32
8		33
9		34
10		35
11		36
12		37
13		38
14		39
15		40
16		41
17		42
18		43
19		44
20		45
21		46
22		47
23		48
24		49
25		50

Book Mark:

See also

*P* | Indpt. Batt'y. | **U.S.C.T.**

*Henry Brown*

....., Indpt. Batt'y, U. S. Col'd L. Art'y.

Appears on

**Battery Descriptive Book**

of the organization named above.

**DESCRIPTION.**

Age *18* years; height *5* feet *5* inches.

Complexion *Dark*

Eyes *Brown*; hair *Black*

Where born *Cook's Ill.*

Occupation  *cigar maker*

**ENLISTMENT.**

When *July 25*, 186 *4*

Where *Myardotte Ill*

By whom *L Minor*; term *3* y'rs.

Remarks: .....

.....

.....

.....

.....

.....

.....

.....

.....

.....

.....

.....

.....

.....

.....

.....

*Shelton*

B

Indpt. Battery.

U.S.C.T.

Henry Brown

Pat, Indpt. Battery, U. S. Col'd L. Art'y.

Appears on

**Battery Muster-in and Descriptive Roll**

of the organization named above. Roll dated

Leavenworth Mo Dec 28, 1864.

Where born Toledo Ind

Age 18 y'rs; occupation cigar maker

When enlisted July 25, 1864

Where enlisted My mother's Co

For what period enlisted 3 years.

Eyes Brn; hair Blk

Complexion Dark; height 5 ft. 5 in.

When mustered in July 28, 1864

Where mustered in Leavenworth

Bounty paid \$ 100; due \$ 300 <sup>00</sup>/<sub>100</sub>

Where credited

Battery to which assigned

Remarks:

Deserted Aug 26<sup>th</sup> / 64

Book mark :

*[Signature]*

(856g)

Copyist.

B | Indpt. Battery. | U.S.C.T.

Henry Brown

Pax, Indpt. Battery, U. S. Col'd L. Art'y.

Appears on

**Battery Muster Roll**

for *Enlistment to Dec 31, 1864*

Present or absent

Stoppage, \$ 100 for

Due Gov't, \$ 100 for

Valuation of horse, \$ 100

Valuation of horse equipments, \$ 100

Remarks: *Deserted from  
Post Leavenworth Mo,  
Oct. 25<sup>th</sup> 1864*

Book mark:

*J. A. Ashley*

(358)

Copyist.



*B*

Indpt. Battery. | **U.S.C.T.**

*Henry Brown*

*Pot*, Indpt. Battery, U. S. Col'd L. Art'y.

Appears on

**Battery Muster Roll**

for *Jan'y 7 Feb*, 186<sup>5</sup>.

Present or absent *Present*

Stoppage, \$ 100 for

Due Gov't, \$ 100 for

Valuation of horse, \$ 100

Valuation of horse equipments, \$ 100

Remarks: *In arrest*

Book mark:

*J. S. Shoolby*

(358)

Copyist.

*B* | Indpt. Battery. | **U.S.C.T.**

*Henry Brown*

*B*, Indpt. Battery, U. S. Col'd L. Art'y.

Appears on

**Battery Muster Roll**

for *Mar & Apr*, 1865.

Present or absent *Present*

Stoppage, \$ *100* for

Due Gov't, \$ *100* for

Valuation of horse, \$ *100*

Valuation of horse equipments, \$ *100*

Remarks: *County due \$100.00,*

Book mark:

*Parter*

*B* | Indpt. Battery. | **U.S.C.T.**

*Henry Brown*

*B*, Indpt. Battery, U. S. Col'd L. Art'y.

Appears on

**Battery Muster Roll**

for *May & June*, 186*5*.

Present or absent *Present*

Stoppage, \$ 100 for

Due Gov't, \$ 100 for

Valuation of horse, \$ 100

Valuation of horse equipments, \$ 100

Remarks: *County due \$100.*

Book mark:

*Porter*

(358)

Copyist.

*P* | Indpt. Battery. | **U.S.C.T.**

*Nenny Brown,*

*P*, Indpt. Battery U. S. Col'd Light Art'y.

Appears on **Batt'y Muster-out Roll**, dated  
*W. Leavenworth, Ms, July 22, 1865.*

Muster-out to date *July 22*, 1865.

Last paid to *(Pay due from enlistment)* 186

Clothing account:

Last settled....., 186 ; drawn since \$ *86*<sup>*48*</sup>/<sub>100</sub>,

Due soldier \$.....<sub>100</sub>; due U. S. \$.....<sub>100</sub>

Am't for cloth'g in kind or money adv'd \$.....<sub>100</sub>

Due U. S. for arms, equipments, &c., \$.....<sub>100</sub>

Bounty paid \$ *None*<sub>100</sub>; due \$ *100*<sub>100</sub>,

Remarks: *Due E. Fenlon, Sutter,*

~~*\$10-*~~

Book mark :.....

*Porter*

Copyist.

Brown Henry

, Co. 1st Batt Reg't U.S.C.A

3

**Enclosures.**

Bed Cards .....	Final Statements .....
Burial Records .....	Furloughs or L. of A .....
Certs. of Dis. for Discharge .....	Med. Certificates .....
C. M. Charges .....	Med. Des. Lists .....
Descriptive Lists .....	Orders .....
Discharge Certificates .....	Pris. of War Record .....
Enlistment Papers ..... 2	Resignations .....

**Other papers relating to—**

Admission to Hosp'l .....	Furlough or L. of A .....
Casualty Sheet .....	Med. Examination .....
Confinement .....	Misc. Information / .....
Contracts .....	Pay or Clothing .....
Death or Effects .....	Personal Reports .....
Desertion .....	Rank .....
Discharge from Hosp'l .....	Transfer to Hosp'l .....
Discharge from Service .....	Transfer to V. R. C. .....
Duty .....	Transportation .....

NOTE 1.—This blank will be used for both enlistments and re-enlistments—enlistment of veterans, &c., &c., in the volunteer service. They will be made out in duplicate in all cases—one to accompany the recruiting return of the superintendent (not the recruiting officer) to the Adjutant General, and one to accompany the accounts of the officer who pays bounty, &c. The Regiment and Company in which the soldier last served should be given on the back.

NOTE 2.—An enlistment holds to service. A muster-in must, in all cases, precede payment of pay, bounty, pension, &c. A muster-in roll must, in all cases, be filed in the Adjutant General's Office as evidence of muster-in. The mustering officer, commissary, or assistant commissary of musters, as the case may be, will countersign both enlistments as having mustered the soldier into the service of the United States before either of them is given to the disbursing officer.

DECLARATION OF RECRUIT.

I, Henry Brown desiring to VOLUNTEER as a Soldier in the Army of the United States, for the term of THREE YEARS, Do Declare, That I am 18 years and \_\_\_\_\_ months of age; that I have never been discharged from the United States service on account of disability or by sentence of a court martial, or by order before the expiration of a term of enlistment; and I know of no impediment to my serving honestly and faithfully as a soldier for three years.

GIVEN at Wyandotte State of Kansas the 25-1 day of July 1864

Witness:

Jas Wilkerson

Henry Brown

No. 43

Volunteered at Wyandotte

July 1864

By P. A. Minor 2nd Lt  
1st R. Regiment of Artillery

enlistment; last served in Company ( )

Reg't of \_\_\_\_\_

Discharged \_\_\_\_\_ 18 .

CONSENT IN CASE OF MINOR.

I, \_\_\_\_\_ Do CERTIFY, That I am the \_\_\_\_\_ of \_\_\_\_\_; that the said \_\_\_\_\_ is \_\_\_\_\_ years of age; and I do hereby freely give my CONSENT to his volunteering as a SOLDIER in the ARMY OF THE UNITED STATES for the period of THREE YEARS.

GIVEN at \_\_\_\_\_

the \_\_\_\_\_ day of \_\_\_\_\_

Witness: \_\_\_\_\_

VOLUNTEER ENLISTMENT.

STATE OF



TOWN OF

Kansas

Wyandotte

I, Henry Brown born in Cook County  
in the State of Illinois aged 15 years,  
and by occupation a Cigar Maker Do HEREBY ACKNOWLEDGE to have  
volunteered this 25 day of July 1864,  
to serve as a **Soldier** in the **Army of the United States of America**, for  
the period of **THREE YEARS**, unless sooner discharged by proper authority:  
Do also agree to accept such bounty, pay, rations, and clothing, as are, or may be,  
established by law for volunteers. And I, Henry Brown do  
solemnly swear, that I will bear true faith and allegiance to the **United States**  
**of America**, and that I will serve them honestly and faithfully against all  
their enemies or opposers whomsoever; and that I will observe and obey the  
orders of the President of the United States, and the orders of the officers  
appointed over me, according to the Rules and Articles of War.

Sworn and subscribed to, at Wyandotte  
this 25<sup>th</sup> day of July 1864, } Henry Brown  
BEFORE P. O. Minor }

I CERTIFY, ON HONOR, That I have carefully examined the above-named Volunteer, agreeably  
to the General Regulations of the Army, and that, in my opinion, he is free from all bodily defects and  
mental infirmity, which would in any way disqualify him from performing the duties of a soldier.

Tiffin Sicks  
Subj Board of Enrollment  
North-West Kansas  
EXAMINING SURGEON.

I CERTIFY, ON HONOR, That I have minutely inspected the Volunteer, .....  
previously to his enlistment, and that he was entirely sober when enlisted; that, to the best of my  
judgment and belief, he is of lawful age; and that, in accepting him as duly qualified to perform the  
duties of an able-bodied soldier, I have strictly observed the Regulations which govern the recruiting  
service. This soldier has Brown eyes, Black hair, Dark complexion, is 5-  
5 feet 5- inches high.

P. O. Minor  
2<sup>nd</sup> Lieut Regiment of 1<sup>st</sup> K. C. Battery  
Volunteers,  
RECRUITING OFFICER.

Mustered into the service of the United States, for three years or during the war, from date of enlistment, in Company 10th,  
 Regiment of 1<sup>st</sup> Kansas Volunteers, on the 25<sup>th</sup> day of July, 1864, at Wyandotte, Kas.  
Wm. H. ...  
...

NOTE 1.—This blank will be used for both enlistments and re-enlistments—enlistment of veterans, &c., &c., in the volunteer service. They will be made out in duplicate in all cases—one to accompany the recruiting return of the superintendent (not the recruiting officer) to the Adjutant General, and one to accompany the accounts of the officer who pays bounty, &c. The Regiment and Company in which the soldier last served should be given on the back.

NOTE 2.—An enlistment holds to service. A muster-in must, in all cases, precede payment of pay, bounty, pension, &c. A muster-in roll must, in all cases, be filed in the Adjutant General's Office as evidence of muster-in. The mustering officer, commissary, or assistant commissary of musters, as the case may be, will countersign both enlistments as having mustered the soldier into the service of the United States before either of them is given to the disbursing officer.

DECLARATION OF RECRUIT.

I, Henry Brown desiring to VOLUNTEER as a Soldier in the Army of the United States, for the term of THREE YEARS, Do Declare, That I am 18 years and 4 months of age; that I have never been discharged from the United States service on account of disability or by sentence of a court martial, or by order before the expiration of a term of enlistment; and I know of no impediment to my serving honestly and faithfully as a soldier for three years.

GIVEN at Wyanemont the 25 day of July 1864

Witness: James Wilkinson H. Brown

Discharged ..... 18 ..  
 ..... Regiment of .....  
 ..... enlistment; last served in Company ( )

Henry Brown  
 Volunteered at Wyanemont  
July 25th 1864,  
 By John H. Minor  
 1<sup>st</sup> Regiment of W. B. Battery

31235  
 No. 43

CONSENT IN CASE OF MINOR.

I, ..... Do CERTIFY, That I am the ..... of .....; that the said ..... is ..... years of age; and I do hereby freely give my CONSENT to his volunteering as a SOLDIER in the ARMY OF THE UNITED STATES for the period of THREE YEARS.

GIVEN at ..... the ..... day of .....

Witness: .....



VOLUNTEER ENLISTMENT.

STATE OF

*Kansas*



TOWN OF

*Wyandott*

I, *Henry Brown*

born in *Cook County*

in the State of *Illinois* aged *18* years,

and by occupation a *Cigar Maker* Do HEREBY ACKNOWLEDGE to have

volunteered this *25* day of *July* 186*4*

to serve as a **Soldier** in the **Army of the United States of America**, for the period of **THREE YEARS**, unless sooner discharged by proper authority:

Do also agree to accept such bounty, pay, rations, and clothing, as are, or may be, established by law for volunteers. And I, *Henry Brown* do

solemnly swear, that I will bear true faith and allegiance to the **United States of America**, and that I will serve them honestly and faithfully against all

their enemies or opposers whomsoever; and that I will observe and obey the orders of the President of the United States, and the orders of the officers

appointed over me, according to the Rules and Articles of War.

Sworn and subscribed to, at *Wyandott* } *Je Brown*

this *25* day of *July* 186*4*

BEFORE *P. H. Minor*

I CERTIFY, ON HONOR, That I have carefully examined the above-named Volunteer, agreeably to the General Regulations of the Army, and that, in my opinion, he is free from all bodily defects and mental infirmity, which would in any way disqualify him from performing the duties of a soldier.

*Tiffin Sikes*  
Adj. Genl. of Enrollment  
North Dist. Kansas  
EXAMINING SURGEON.

I CERTIFY, ON HONOR, That I have minutely inspected the Volunteer, ..... previously to his enlistment, and that he was entirely sober when enlisted; that, to the best of my judgment and belief, he is of lawful age; and that, in accepting him as duly qualified to perform the duties of an able-bodied soldier, I have strictly observed the Regulations which govern the recruiting service. This soldier has *Brown* eyes, *Black* hair, *Dark* complexion, is *5'* feet *5"* inches high.

*P. H. Minor*  
*2nd Lieut. of N. C. Battery*  
Regiment of *N. C. Battery* Volunteers  
RECRUITING OFFICER.

(A. G. O. No. 74 & 76.)

Mustered into the service of the United States, for three years or during the war, from date of enlistment, in Company .....  
Regiment of .....  
Volunteers, on the ..... day of ..... 186 , at .....

at or near Hyandatt, Kansas. " Plea -  
Not guilty. - Finding Not guilty, and the  
Court does therefore acquit him,  
Finding and acquittal confirmed.

" " " " " "  
By command of " "  
Maj. Genl. Dodge.

Dec. 16<sup>th</sup> 75. B.

Kangas  
July

For [unclear]

Adjutant General's Office,

COLORED TROOPS BRANCH,

December 13, 1875

Mr. Clerk Vol. C. T., 187

Wanted in the case of Henry Brown, 1st Bn. Co. 1st  
US ~~Regt~~ Col. Co. St. information as to name of  
M. R. person to be reported as deserter  
from St. Louis to K. S. Oct 25 '64  
M. R. person Feb 1865 - Present in arrest  
M. R. man 7 Apr 1865 Present for duty

Respectfully,

W. A. Woodward,  
P. J. Chief Clerk

Adjutant General's Office,

, 187

Vol. C. T., 187

Reply in case of Henry Brown, Co.  
Independent Batty. U. S. C. Art. St.

Records of Batty incomplete and furnish  
no information.

Head Quarters Dept. of the Missouri, St. Louis Mo. April 11 1865  
G. O. No. 97. " " " 1st Henry Brown  
Sergt. Ind. Batty U. S. Art. Charge Deserter.  
Specification. " " did absent himself  
from, without leave, and desert said service on or  
about the 15th day November, 1864 and remain absent  
till arrested, on or about Jan. 10 1865. This

*J. M. ...*  
 Wm. B. Burt's U.S. Col'd L. Art'y

*Private Private*

CARD NUMBERS.

6 2 3 3 5 2 1	26
6 2 3 3 7 4 5	27
6 2 3 3 8 9 4	28
6 2 3 4 0 6 0	29
6 2 3 4 1 9 6	30
6 2 3 4 3 6 4	31
6 2 3 3 7 1 5	32
6 2 3 4 6 4 0	33
9 1 3 7 9 2 6	34
	35
	36
	37
	38
	39
	40
	41
	42
	43
	44
	45
	46
	47
	48
	49
	50

Book Mark:

See also

J | Indpt. Batt'y. | U.S.C.T.

Matthew Brown

....., Indpt. Batt'y, U. S. Col'd L. Art'y.

Appears on

**Battery Descriptive Book**

of the organization named above.

**DESCRIPTION.**

Age 28 years; height 5 feet 9 inches.

Complexion Black

Eyes Black; hair Black

Where born Jefferson Ga.

Occupation Farmer

**ENLISTMENT.**

When Oct. 27, 1864

Where Ft Scott Ala.

By whom Lt. Mathews; term 3 y'rs.

Remarks:

.....  
.....  
.....  
.....  
.....  
.....

Robertson

NRRH 255  
B | Indpt. Battery. | U.S.C.T.

Matthew Brown

Pvt, Indpt. Battery, U. S. Col'd L. Art'y.

Appears on

**Battery Muster-in and Descriptive Roll**

of the organization named above. Roll dated

Sevenmont Mo Dec<sup>25</sup>, 1864.

Where born Jefferson Co, Va,

Age 28 y'rs; occupation Farmer

When enlisted Oct 29, 1864.

Where enlisted Fort Scott Mo,

For what period enlisted 3 years.

Eyes Blu; hair Blu

Complexion Blu; height 5 ft. 9 in.

When mustered in Nov 29, 1864.

Where mustered in Sevenmont

Bounty paid \$100<sup>00</sup>/<sub>100</sub>; due \$200<sup>00</sup>/<sub>100</sub>

Where credited

Battery to which assigned

Remarks: On S. Dist Mo  
Fort Scott Burton Co Mo

Book mark:

(356g)

Copyist.

*B* | Indpt. Battery. | **U.S.C.T.**

*Mathew Bram*

Appears with rank of *Priv* on

**Muster and Descriptive Roll of a Detachment of U. S. Vols. forwarded**

for the Indpt. Batt'y, U. S. Col'd L. Arty. Roll dated

*Leavenworth, Kans., Nov. 29, 1864.*

Where born *Jefferson Co., Virginia*

Age *28* y'rs; occupation *Farmer*

When enlisted *Oct 27, 1864.*

Where enlisted *W. Scott, Mo*

For what period enlisted *3* years.

Eyes *Blk*; hair *Blk*

Complexion *Blk*; height *5 ft. 9 in.*

When mustered in *Nov 29, 1864.*

Where mustered in *Leavenworth, Kans.*

Bounty paid \$ *100*; due \$ *100*

Where credited

Battery to which assigned

Remarks: *Credited to Southern Dist Kansas. W. Scott, Bourbon Co. Vol. Recruit & entitled to Bounty.*

Book mark:

*E. L. Stanton*

43

Indpt. Battery. | U.S.C.T.

Matthew Brown

Pvt

, Indpt. Battery, U. S. Col'd L. Art'y.

Appears on

**Battery Muster Roll**

for *Enlistment to Dec 31, 1864*

Present or absent *Present*

Stoppage, \$ 100 for

Due Gov't, \$ 100 for

Valuation of horse, \$ 100

Valuation of horse equipments, \$ 100

Remarks:

Book mark:

*J. H. Schroy*

(358)

Copyist.



78

Indpt. Battery.

U.S.C.T.

Matthew Brown

Pvt, Indpt. Battery, U. S. Col'd L. Art'y.

Appears on

Battery Muster Roll

for Jan & Feb, 1865

Present or absent Present

Stoppage, \$ 100 for

Due Gov't, \$ 100 for

Valuation of horse, \$ 100

Valuation of horse equipments, \$ 100

Remarks:

Book mark:

(358) J. H. Scholly Copyist.

*B* | Indpt. Battery. | **U.S.C.T.**

*Mathew Brown,*

*Pr*, Indpt. Battery, U. S. Col'd L. Art'y.

Appears on

**Battery Muster Roll**

for *Jan + Apl*, 1865.

Present or absent *Present*

Stoppage, \$ 100 for

Due Gov't, \$ 100 for

Valuation of horse, \$ 100

Valuation of horse equipments, \$ 100

Remarks:  
\_\_\_\_\_  
\_\_\_\_\_  
\_\_\_\_\_  
\_\_\_\_\_  
\_\_\_\_\_  
\_\_\_\_\_  
\_\_\_\_\_  
\_\_\_\_\_

Book mark: \_\_\_\_\_

\_\_\_\_\_  
*Prater*  
\_\_\_\_\_  
(358) Copyist.

*B* | Indpt. Battery. | **U.S.C.T.**

*Mathew Brown,*

*M*, Indpt. Battery, U. S. Col'd L. Art'y.

Appears on

**Battery Muster Roll**

for *May & June*, 1865.

Present or absent *Present,*

Stoppage, \$ *100* for

Due Gov't, \$ *100* for

Valuation of horse, \$ *100*

Valuation of horse equipments, \$ *100*

Remarks:

Book mark:

*Poster*

*B* *Indpt Battery* **U.S.C.T.**  
 \_\_\_\_\_  
*Matthew Brown*  
 \_\_\_\_\_  
*Priv, Co. Indpt Battery Reg't U. S. Col'd* *St Arty*  
 \_\_\_\_\_

Appears on a

**Detachment Muster-out Roll**

of the organization named above. Roll dated

*At Leavenworth Kans. July 3*, 1865.  
 \_\_\_\_\_

Muster-out to date *July 3*, 1865.  
 \_\_\_\_\_

Last paid to *Paid due from enlistment*, 186  
 \_\_\_\_\_

**Clothing account:**

Last settled *never*, 186 ; drawn since \$ 100

Due soldier \$ 100; due U. S. \$ 100

Am't for cloth'g in kind or money adv'd \$ *63 <sup>49</sup>/<sub>100</sub>*

Due U. S. for arms, equipments, &c., \$ 100

Bounty paid \$ 100 due \$ *300* 100

Remarks: *Forwarded from* *h*  
*Hospital Fort Leavenworth Kansas*  
*and mustered out in accordance*  
*with Genl Order No 77 War*  
*Dept 1865*

Book mark: \_\_\_\_\_

*G W Deadrick*  
 \_\_\_\_\_

*B* | Indpt. Battery. | **U.S.C.T.**

*Mathew Brown,*

*M*, Indpt. Battery U. S. Col'd Light Art'y.

Appears on **Batt'y Muster-out Roll**, dated  
*St. Lawrence Co., N.Y., July 27, 1865.*

Muster-out to date ..... 186 .

Last paid to ..... 186 .

Clothing account:

Last settled....., 186 ; drawn since \$ *63*<sup>*49*</sup>/<sub>100</sub>

Due soldier \$ .....<sup>100</sup>; due U. S. \$ .....<sup>100</sup>

Am't for cloth'g in kind or money adv'd \$ .....<sup>100</sup>

Due U. S. for arms, equipments, &c., \$ .....<sup>100</sup>

Bounty paid \$ .....<sup>100</sup>; due \$ .....<sup>100</sup>

Remarks: *Discharged from  
hospital by G.O. no. 77,  
New Dept 1865, July 3/65,*

Book mark : .....

*P. Carter*  
Copyist.

*Brown Marked*

, Co. *Lud Bath* Reg't *U. S. C. A.*

*2* Enclosures.

Bed Cards .....	Final Statements .....
Burial Records .....	Furloughs or L. of A. ....
Certs. of Dis. for Discharge .....	Med. Certificates .....
C. M. Charges .....	Med. Des. Lists .....
Descriptive Lists .....	Orders .....
Discharge Certificates .....	Pris. of War Record .....
Enlistment Papers <i>2</i> .....	Resignations .....

Other papers relating to—

Admission to Hosp'l .....	Furlough or L. of A. ....
Casualty Sheet .....	Med. Examination .....
Confinement .....	Misc. Information .....
Contracts .....	Pay or Clothing .....
Death or Effects .....	Personal Reports .....
Desertion .....	Rank .....
Discharge from Hosp'l .....	Transfer to Hosp'l .....
Discharge from Service .....	Transfer to V. R. C. ....
Duty .....	Transportation .....

NOTE 1.—This blank will be used for both enlistments and re-enlistments—enlistment of veterans, &c., &c., in the volunteer service. They will be made out in duplicate in all cases—one to accompany the recruiting return of the superintendent (not the recruiting officer) to the Adjutant General, and one to accompany the accounts of the officer who pays bounty, &c. The Regiment and Company in which the soldier last served should be given on the back.

NOTE 2.—An enlistment holds to service. A muster-in must, in all cases, precede payment of pay, bounty, pension, &c. A muster-in roll must, in all cases, be filed in the Adjutant General's Office as evidence of muster-in. The mustering officer, commissary, or assistant commissary of musters, as the case may be, will countersign both enlistments as having mustered the soldier into the service of the United States before either of them is given to the disbursing officer.

DECLARATION OF RECRUIT.

I, Mathew Brown desiring to VOLUNTEER as a Soldier in the Army of the United States, for the term of THREE YEARS, Do Declare, That I am Twenty seven 27th years and 27th months of age; that I have never been discharged from the United States service on account of disability or by sentence of a court martial, or by order before the expiration of a term of enlistment; and I know of no impediment to my serving honestly and faithfully as a soldier for three years.

GIVEN at Fort Scott Kansas the 27th day of October 1864

Witness: Leah Hanson Mathew Brown mark

No. ....

Mathew Brown

Volunteered at Fort Scott Kansas

27th of October 1864

By Wm B. Matthews 2nd Lt

Rec't India Battery 1st Col 1st Div

\_\_\_\_\_ enlistment; last served in Company ( )

\_\_\_\_\_ Reg't of \_\_\_\_\_

Discharged \_\_\_\_\_ 18 .

CONSENT IN CASE OF MINOR.

I, \_\_\_\_\_ Do CERTIFY, That I am the \_\_\_\_\_ of \_\_\_\_\_; that the said \_\_\_\_\_ is \_\_\_\_\_ years of age; and I do hereby freely give my CONSENT to his volunteering as a SOLDIER in the ARMY OF THE UNITED STATES for the period of THREE YEARS.

GIVEN at \_\_\_\_\_ the \_\_\_\_\_ day of \_\_\_\_\_

Witness: \_\_\_\_\_

31

VOLUNTEER ENLISTMENT.

STATE OF

TOWN OF

Kansas



Fort Scott.

I, Matthew Brown born in Jefferson Co Va in the State of Virginia aged Twenty Eight years, and by occupation a Farmer Do HEREBY ACKNOWLEDGE to have volunteered this Twenty Seventh day of October 1864 to serve as a Soldier in the Army of the United States of America, for the period of THREE YEARS, unless sooner discharged by proper authority: Do also agree to accept such bounty, pay, rations, and clothing, as are, or may be, established by law for volunteers. And I Matthew Brown do solemnly swear, that I will bear true faith and allegiance to the United States of America, and that I will serve them honestly and faithfully against all their enemies or opposers whomsoever; and that I will observe and obey the orders of the President of the United States, and the orders of the officers appointed over me, according to the Rules and Articles of War.

Sworn and subscribed to, at

Fort Scott

Matthew Brown his

this 27th day of

October 1864

BEFORE

Cyrus D. Matthews

Major independent Bat., U.S. Col's artillery

Recruiting officer of the

I CERTIFY, ON HONOR, That I have carefully examined the above-named Volunteer, agreeably to the General Regulations of the Army, and that, in my opinion, he is free from all bodily defects and mental infirmity, which would in any way disqualify him from performing the duties of a soldier.

Tiffin Sinks  
Surgeon Bde of Engineers  
United States Army EXAMINING SURGEON.

I CERTIFY, ON HONOR, That I have minutely inspected the Volunteer, Matthew Brown previously to his enlistment, and that he was entirely sober when enlisted; that, to the best of my judgment and belief, he is of lawful age; and that, in accepting him as duly qualified to perform the duties of an able-bodied soldier, I have strictly observed the Regulations which govern the recruiting service. This soldier has black eyes, black hair, black complexion, is five feet seven inches high.

Cyrus D. Matthews 2d Lieut of  
Ind pr Bary U S Cav & Arty Lieut  
Volunteers

RECRUITING OFFICER.

Mustered into the service of the United States, for three years or during the war, from date of enlistment, in Company G 1st Regiment of Volunteers, on the 27 day of October, 1864 at Fort Scott

John A. [unclear]  
[unclear]  
[unclear]



NOTE 1.—This blank will be used for both enlistments and re-enlistments—enlistment of veterans, &c., &c., in the volunteer service. They will be made out in duplicate in all cases—one to accompany the recruiting return of the superintendent (not the recruiting officer) to the Adjutant General, and one to accompany the accounts of the officer who pays bounty, &c. The Regiment and Company in which the soldier last served should be given on the back.

NOTE 2.—An enlistment holds to service. A muster-in must, in all cases, precede payment of pay, bounty, pension, &c. A muster-in roll must, in all cases, be filed in the Adjutant General's Office as evidence of muster-in. The mustering officer, commissary, or assistant commissary of musters, as the case may be, will countersign both enlistments as having mustered the soldier into the service of the United States before either of them is given to the disbursing officer.

DECLARATION OF RECRUIT.

I, Mathew Brown desiring to VOLUNTEER as a Soldier in the Army of the United States, for the term of THREE YEARS, Do Declare, That I am Twenty Eight years and \_\_\_\_\_ months of age; that I have never been discharged from the United States service on account of disability or by sentence of a court martial, or by order before the expiration of a term of enlistment; and I know of no impediment to my serving honestly and faithfully as a soldier for three years.

GIVEN at Fort Scott, Kansas the 29th day of October 1864.

Witness:

Noah L. Hanson Mathew Brown  
mark

No. 181

Mathew Brown  
Volunteered at Fort Scott Kansas.  
This 29th day of October 1864.  
By Wm. D. Mathews 1st Regt  
Ind. Battery U.S. Col. Artillery

\_\_\_\_\_ enlistment; last served in Company ( )  
\_\_\_\_\_ Regt of \_\_\_\_\_  
Discharged \_\_\_\_\_ 18 \_\_\_\_

Rec'd from 2nd. Aud. Nov. 23d 1892

CONSENT IN CASE OF MINOR.

I, \_\_\_\_\_ Do CERTIFY, That I am \_\_\_\_\_; that the \_\_\_\_\_ of \_\_\_\_\_; that the \_\_\_\_\_ is \_\_\_\_\_ years of age; and I do hereby freely give my CONSENT to his volunteering as a SOLDIER in the ARMY OF THE UNITED STATES for the period of THREE YEARS.

GIVEN at \_\_\_\_\_ the \_\_\_\_\_ day of \_\_\_\_\_

Witness: \_\_\_\_\_

VOLUNTEER ENLISTMENT.

STATE OF

Kansas



TOWN OF

Fort Scott.

I, Matthew Brown born in Jefferson County

in the State of Virginia aged Twenty Eight years,

and by occupation a Farmer Do HEREBY ACKNOWLEDGE to have

volunteered this 27th day of October 1864

to serve as a Soldier in the Army of the United States of America, for

the period of THREE YEARS, unless sooner discharged by proper authority:

Do also agree to accept such bounty, pay, rations, and clothing, as are, or may be,

established by law for volunteers. And I, Matthew Brown do

solemnly swear, that I will bear true faith and allegiance to the United States

of America, and that I will serve them honestly and faithfully against all

their enemies or opposers whomsoever; and that I will observe and obey the

orders of the President of the United States, and the orders of the officers

appointed over me, according to the Rules and Articles of War.

Sworn and subscribed to, at Fort Scott, his

this 27th day of October 1864 Matthew Brown,

BEFORE Wm D Matthews mark

Recruiting officer of Ind. Bat. U.S. 6th Artillery

I CERTIFY, ON HONOR, That I have carefully examined the above-named Volunteer, agreeably

to the General Regulations of the Army, and that, in my opinion, he is free from all bodily defects and

mental infirmity, which would in any way disqualify him from performing the duties of a soldier.

Tiffin Sinks  
Surgeon Bd of Examiners  
Examining Surgeon.

I CERTIFY, ON HONOR, That I have minutely inspected the Volunteer, Matthew Brown

previously to his enlistment, and that he was entirely sober when enlisted; that, to the best of my

judgment and belief, he is of lawful age; and that, in accepting him as duly qualified to perform the

duties of an able-bodied soldier, I have strictly observed the Regulations which govern the recruiting

service. This soldier has black eyes, black hair, black complexion, is Five

feet None inches high.

Wm D Matthews  
Capt U.S. Artillery  
Recruiting Officer.

Mustered into the service of the United States, for three years or during the war, from date of enlistment, in Company the 1st  
Regiment of Volunteers, on the 27th day of October, 1864 at Fort Scott, Kansas  
John D. Matthews  
Surgeon

This record has been made in hundred dollar column, bounty from the bounty fund, author-  
ized by an Act of Congress, approved March 3, 1879, and is subject to the provisions of the Act  
approved March 3, 1879, and is subject to the provisions of the Act approved March 3, 1879.

(A. G. O. No. 74 & 76.)

*John Sawney*

Adpt. Batt'y U.S. Col'd L. Art'y.

*Private Private*

CARD NUMBERS.

1	6233690	26
2	6237198	27
3	6234365	28
4	6234528	29
5	9133062	30
6		31
7		32
8		33
9		34
10		35
11		36
12		37
13		38
14		39
15		40
16		41
17		42
18		43
19		44
20		45
21		46
22		47
23		48
24		49
25		50

Book Mark:

See also

P | Indpt. Batt'y. | **U.S.C.T.**

*Sarvey Brown*

....., Indpt. Batt'y, U. S. Col'd L. Art'y.

Appears on

**Battery Descriptive Book**

of the organization named above.

**DESCRIPTION.**

Age *49* years; height *5* feet *7* inches.

Complexion *Black*

Eyes *Black*; hair *Black*

Where born *Virginia*

Occupation *Laborer*

**ENLISTMENT.**

When *March 1*, 1865.

Where *Hammond*

By whom *D. Muir*; term *3* y'rs.

Remarks: .....

.....  
.....  
.....  
.....  
.....  
.....  
.....  
.....  
.....

(383g)

*Boalhook*

Copyist.

B | Indpt. Battery. | U.S.C.T.

Sawney Brown

Appears with rank of *Priv* on**Muster and Descriptive Roll of a Detachment of U. S. Vols. forwarded**

for the Indpt. Batt'y, U. S. Col'd L. Arty. Roll dated

*Leavenworth, Kas, Mch 1, 1865.*Where born *Virginia*Age *49* y'rs; occupation *Labourer*When enlist'd *Mch 1, 1865.*Where enlisted *Leavth, Kas*For what period enlisted *3* years.Eyes *black*; hair *black*Complexion *black*; height *5* ft. *7* in.When mustered in *Mch 1, 1865.*Where mustered in *Leavth, Kas*Bounty paid \$ *100* <sup>100</sup>; due \$ *200* <sup>100</sup>

Where credited

Battery to which assigned

Remarks: *Credited to Northern Dist  
Kans. 2<sup>d</sup> Sub. Dist 4<sup>th</sup> Ward.  
Leavenworth City. Vol. Recruit  
& entitled to bounty*

Book mark:

*E. L. Thomsen*

*B* | Indpt. Battery. | **U.S.C.T.**

*Sawney Brown,*  
*M*, Indpt. Battery, U. S. Col'd L. Art'y.

Appears on

**Battery Muster Roll**

for *Mar, & apr,*, 186 *5*.

Present or absent *Present,*

Stoppage, \$ 100 for

Due Gov't, \$ 100 for

Valuation of horse, \$ 100

Valuation of horse equipments, \$ 100

Remarks:

Book mark:

*Porter*

(358)

Copyist.

*B* | Indpt. Battery. | **U.S.C.T.**

*Journey Brown,*  
*Pr*, Indpt. Battery, U. S. Col'd L. Art'y.

Appears on

**Battery Muster Roll**

for *May & June*, 1865.

Present or absent *Present,*

Stoppage, \$ 100 for

Due Gov't, \$ 100 for

Valuation of horse, \$ 100

Valuation of horse equipments, \$ 100

Remarks:  
\_\_\_\_\_  
\_\_\_\_\_  
\_\_\_\_\_  
\_\_\_\_\_  
\_\_\_\_\_  
\_\_\_\_\_

Book mark: \_\_\_\_\_

*Partes*

P | Indpt. Battery. | **U.S.C.T.**

*Jawney Brown,*

*P*, Indpt. Battery U. S. Col'd Light Art'y.

Appears on **Batt'y Muster-out Roll**, dated

*W. Seavernth, Ns., July 27, 1865.*

Muster-out to date *July 27, 1865.*

Last paid to *Pay due from enlistment, 1865.*

Clothing account:

Last settled....., 186 ; drawn since \$ *59*<sup>73</sup>/<sub>100</sub>,

Due soldier \$.....<sup>100</sup>; due U. S. \$.....<sup>100</sup>

Am't for cloth'g in kind or money adv'd \$.....<sup>100</sup>

Due U. S. for arms, equipments, &c., \$.....<sup>100</sup>

Bounty paid \$ *100* <sup>100</sup>; due \$ *None* <sup>100</sup>,

Remarks:.....  
.....  
.....  
.....  
.....

Book mark : *2552, 1883,*

*Porter*



*Brown Sawney*

, Co. *Ind Batt* Reg't *U.S.C. A*

*2* Enclosures.

Bed Cards .....	Final Statements .....
Burial Records .....	Furloughs or L. of A .....
Certs. of Dis. for Discharge .....	Med. Certificates .....
C. M. Charges .....	Med. Des. Lists .....
Descriptive Lists .....	Orders .....
Discharge Certificates .....	Pris. of War Record .....
Enlistment Papers .....	Resignations .....

Other papers relating to—

Admission to Hosp'l .....	Furlough or L. of A .....
Casualty Sheet .....	Med. Examination .....
Confinement .....	Misc. Information .....
Contracts .....	Pay or Clothing .....
Death or Effects .....	Personal Reports .....
Desertion .....	Rank .....
Discharge from Hosp'l .....	Transfer to Hosp'l .....
Discharge from Service .....	Transfer to V. R. C. .....
Duty .....	Transportation .....

DECLARATION OF RECRUIT.

I, Sauney Brown, desiring to VOLUNTEER as a Soldier in the Army of the United States, for the term of THREE YEARS. Do Declare, That I am Forty nine (49) years and          months of age; that I have never been discharged from the United States service on account of disability or by sentence of a court martial, or by order before the expiration of a term of enlistment; and I know of no impediment to my serving honestly and faithfully as a soldier for three years.

GIVEN at Leavenworth City, Kansas the 1st day of March 1865.

Witness: Titimus Pemberton Sauney<sup>his</sup> Brown  
mark

NOTE 1.—This blank will be used for both enlistments and re-enlistments—enlistment of veterans, &c., &c., in the volunteer service. They will be made out in duplicate in all cases—one to accompany the recruiting return of the superintendent (not the recruiting officer) to the Adjutant General, and one to accompany the accounts of the officer who pays bounty, &c. The Regiment and Company in which the soldier last served should be given on the back.

NOTE 2.—An enlistment holds to service. A muster-in must, in all cases, precede payment of pay, bounty, pension, &c. A muster-in roll must, in all cases, be filed in the Adjutant General's Office as evidence of muster-in. The mustering officer, commissary, or assistant commissary of musters, as the case may be, will countersign both enlistments as having mustered the soldier into the service of the United States before either of them is given to the disbursing officer.

Discharged          18           
Reg't of           
enlistment; last served in Company (          )

Volunteered at Leavenworth Kas  
March 1st 1865  
By Capt. J. M. McWhorter, Prov. Master  
U.S. Colored Reg't 5th  
Adj't Bakers Regiment of Artillery, 1st  
No.           
No.           
34  
3-  
and upon bond 13th April

CONSENT IN CASE OF MINOR.

I,         , Do CERTIFY, That I am the          of         ; that the said          is          years of age; and I do hereby freely give my CONSENT to his volunteering as a SOLDIER in the ARMY OF THE UNITED STATES for the period of THREE YEARS.

GIVEN at          the          day of         .

Witness:

*Created to Northern Dist. Kansas. 22<sup>nd</sup> Sub Dist 4<sup>th</sup> Ward Leavenworth Co etc*

VOLUNTEER ENLISTMENT.

STATE OF

TOWN OF

*Kansas*



*Leavenworth*

I, *Samney Brown*, born *in* \_\_\_\_\_  
in the State of *Virginia*, aged *49* years,  
and by occupation a *Laborer*. Do HEREBY ACKNOWLEDGE to have  
volunteered this *First (1<sup>st</sup>)* day of *March*, 1865;  
to serve as a **Soldier** in the **Army of the United States of America**, for  
the period of **THREE YEARS**, unless sooner discharged by proper authority:  
Do also agree to accept such bounty, pay, rations, and clothing, as are, or may be,  
established by law for volunteers. And I, *Samney Brown*, do  
solemnly swear, that I will bear true faith and allegiance to the **United States  
of America**, and that I will serve them honestly and faithfully against all  
their enemies or opposers whomsoever; and that I will observe and obey the  
orders of the President of the United States, and the orders of the officers  
appointed over me, according to the Rules and Articles of War.

Sworn and subscribed to, at *Leavenworth*  
this *1<sup>st</sup>* day of *March*, 1865, } *Samney Brown*  
BEFORE *P. H. Minor 2<sup>nd</sup> Lieut* } *mark*  
*Ind. Baty. U.S. Col & Artillery*

I CERTIFY, ON HONOR, That I have carefully examined the above-named Volunteer, agreeably  
to the General Regulations of the Army, and that, in my opinion, he is free from all bodily defects and  
mental infirmity, which would in any way disqualify him from performing the duties of a soldier.

*Tiffin Ficks*  
*Surgeon Board of Enrollment*  
*Northern Dist Kansas*  
EXAMINING SURGEON.

I CERTIFY, ON HONOR, That I have minutely inspected the Volunteer *Samney Brown*  
previously to his enlistment, and that he was entirely sober when enlisted; that, to the best of my  
judgment and belief, he is of lawful age; and that, in accepting him as duly qualified to perform the  
duties of an able-bodied soldier, I have strictly observed the Regulations which govern the recruiting  
service. This soldier has *Black* eyes, *Black* hair, *Black* complexion, is \_\_\_\_\_  
feet \_\_\_\_\_ inches high.

*P. H. Minor 2<sup>nd</sup> Lieut*  
*Ind. Baty. U.S. Col & Artillery (5<sup>th</sup>)*  
RECRUITING OFFICER.

*U.S. Colonel*  
*Phillips*  
*Regiment of*

Mustered into the service of the United States, for three years or during the war, from date of enlistment, in \_\_\_\_\_

*Lighth*  
Volunteers, on the \_\_\_\_\_ day of \_\_\_\_\_

*March*, 1865, at \_\_\_\_\_

*Leavenworth*

*Wm. H. Minor*  
*Major*  
*Artillery*

*Leavenworth*

DECLARATION OF RECRUIT.

I, Sammy Brown, desiring to VOLUNTEER as a Soldier in the Army of the United States, for the term of THREE YEARS, Do Declare, That I am Forty nine (49) years and — months of age; that I have never been discharged from the United States service on account of disability or by sentence of a court martial, or by order before the expiration of a term of enlistment; and I know of no impediment to my serving honestly and faithfully as a soldier for three years.

GIVEN at Leavenworth City Kansas the 1st day of March 1865

Witness: Sammy Brown mark

Linus Pemberton

NOTE 1.—This blank will be used for both enlistments and re-enlistments—enlistment of veterans, &c., &c., in the volunteer service. They will be made out in duplicate in all cases—one to accompany the recruiting return of the superintendent (not the recruiting officer) to the Adjutant General, and one to accompany the accounts of the officer who pays bounty, &c. The Regiment and Company in which the soldier last served should be given on the back.  
NOTE 2.—An enlistment holds to service. A muster-in must, in all cases, precede payment of pay, bounty, pension, &c. A muster-in roll must, in all cases, be filed in the Adjutant General's Office as evidence of muster-in. The mustering officer, commissary, or assistant commissary of musters, as the case may be, will countersign both enlistments as having mustered the soldier into the service of the United States before either of them is given to the disbursing officer.

Rec'd from 2nd. Aud. Nov. 23d 1892

Discharged..... 18  
Reg't of .....  
enlistment; last served in Company ( )

No. 8  
Sammy Brown  
Volunteered at Leavenworth Kas.  
March 1st, 1865.  
By Capt. A. M. Johnson Co. 1st  
U.S. Cavalry 1st  
Regiment Voluntary Light

CONSENT IN CASE OF MINOR.

I, \_\_\_\_\_, Do CERTIFY, That I am \_\_\_\_\_; that the \_\_\_\_\_ of \_\_\_\_\_ years of age; and I do hereby freely give my CONSENT to his volunteering as a SOLDIER in the ARMY OF THE UNITED STATES for the period of THREE YEARS.

GIVEN at \_\_\_\_\_ the \_\_\_\_\_ day of \_\_\_\_\_

Witness: \_\_\_\_\_

(A. G. O. No. 74 & 76.)

*Credited to Northern Dist Kansas 22<sup>d</sup> Sub Dist 4<sup>th</sup> Merit Leavenworth City  
HI 11111*

*This recruit has received one hundred dollars advance bounty of the three hundred dollars authorized by an Act of Congress July 4<sup>th</sup> 1864 and ordered to be paid to the recruit by the Quartermaster's Office*

VOLUNTEER ENLISTMENT.

STATE OF

*Kansas*

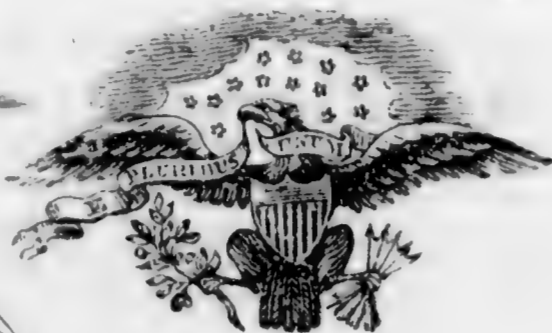

TOWN OF

*Leavenworth*

I, *Sweeney Brown*, born in \_\_\_\_\_  
 in the State of *Virginia*, aged *49* years,  
 and by occupation a *Laborer*, DO HEREBY ACKNOWLEDGE to have  
 volunteered this *Ten (10<sup>th</sup>)* day of *March*, 1865,  
 to serve as a *Soldier* in the Army of the United States of America, for  
 the period of *THREE YEARS*, unless sooner discharged by proper authority:  
 Do also agree to accept such bounty, pay, rations, and clothing, as are, or may be,  
 established by law for volunteers. And I, *Sweeney Brown*, do  
 solemnly swear, that I will bear true faith and allegiance to the **United States  
 of America**, and that I will serve them honestly and faithfully against all  
 their enemies or opposers whomsoever; and that I will observe and obey the  
 orders of the President of the United States, and the orders of the officers  
 appointed over me, according to the Rules and Articles of War.

Sworn and subscribed to, at *Leavenworth*  
 this *10<sup>th</sup>* day of *March*, 1865, } *Sweeney Brown*  
 BEFORE *P. W. Minor 2<sup>d</sup> Lieut* } *his*  
*End. Bats. U. S. Col Artillery* } *mark*

I CERTIFY, ON HONOR, That I have carefully examined the above-named Volunteer, agreeably  
 to the General Regulations of the Army, and that, in my opinion, he is free from all bodily defects and  
 mental infirmity, which would in any way disqualify him from performing the duties of a soldier.

*T. J. Dicks*  
*Surgeon Board of Enrolment*  
*Northern Dist Kansas*  
 EXAMINING SURGEON.

I CERTIFY, ON HONOR, That I have minutely inspected the Volunteer *Sweeney Brown*  
 previously to his enlistment, and that he was entirely sober when enlisted; that, to the best of my  
 judgment and belief, he is of lawful age; and that, in accepting him as duly qualified to perform the  
 duties of an able-bodied soldier, I have strictly observed the Regulations which govern the recruiting  
 service. This soldier has *Black* eyes, *Black* hair, *Black* complexion, is \_\_\_\_\_  
 feet \_\_\_\_\_ inches high.

*P. W. Minor 2<sup>d</sup> Lieut*  
*End. Bats. U. S. Col Artillery (Signed)*  
 RECRUITING OFFICER.

(A. G. O. No. 74 & 76.)

*U. S. Col Artillery*  
 Mustered into the service of the United States, for three years or during the war, from date of enlistment, in Company \_\_\_\_\_  
*Light* Volunteers, on the \_\_\_\_\_ day of *March*, 1865; at *Leavenworth Mo*

*Wm. Thomas Dicks*  
*Major*  
*1<sup>st</sup> Btry*

*William J. Brown*  
 Capt. Batt'y U.S. Col'd L. Art'y

*Private* | *Private*

CARD NUMBERS.

1	6233737	26
2	6234019	27
3	6234680	28
4	9132918	29
5		30
6		31
7		32
8		33
9		34
10		35
11		36
12		37
13		38
14		39
15		40
16		41
17		42
18		43
19		44
20		45
21		46
22		47
23		48
24		49
25		50

Book Mark: *EB Y11-P.454 + 127.109,*

See also

Hds. Ref. 26 Dep. 46 Game

W. S. Ferris  
3

*J* | Indpt. Batt'y. | **U.S.C.T.**

*Thomas Bryant*

....., Indpt. Batt'y, U. S. Col'd L. Art'y.

Appears on

**Battery Descriptive Book**

of the organization named above.

**DESCRIPTION.**

Age *28* years; height *5* feet *6* inches.

Complexion *Brown*

Eyes *Black*; hair *Black*

Where born *Clay Mission*

Occupation *Farmer*

**ENLISTMENT.**

When *Aug. 14*, 186*4*.

Where *Myardotte Ala*

By whom *Lt Mann*; term *3* y'rs.

Remarks:

.....  
.....  
.....  
.....  
.....  
.....  
.....  
.....  
.....  
.....

*Shelbrook*



B

Indpt. Battery. U.S.C.T.

Thomas Bryant

Pat, Indpt. Battery, U. S. Col'd L. Art'y.

Appears on

Battery Muster-in and Descriptive Roll

of the organization named above. Roll dated

Leavenworth Mo, Dec 28, 1864

Where born Clay Co. Mo.

Age 20 y'rs; occupation Farmer

When enlisted Aug 14, 1864

Where enlisted Wyandotte Mo.

For what period enlisted 3 years.

Eyes Blue; hair Blue

Complexion Bro; height 5 ft. 6 in.

When mustered in Aug 18, 1864

Where mustered in Leavenworth

Bounty paid \$ 100; due \$ 300 00/100

Where credited

Battery to which assigned

Remarks: Died Oct. 20/64

Book mark: X Comparer

J. Schooley

(856g)

Copyist.

19 | Indpt. Battery. | **U.S.C.T.**

Thomas Bryant  
Pat, Indpt. Battery, U. S. Col'd L. Art'y.

Appears on

**Battery Muster Roll**

for *Enlistment to Dec 31*, 1864.

Present or absent

Stoppage, \$ 100 for

Due Gov't, \$ 100 for

Valuation of horse, \$ 100

Valuation of horse equipments, \$ 100

Remarks: *Died in Hospital  
at Fort Leavenworth Mo,  
Oct. 31<sup>st</sup> 1864, from  
Effects of Typhoid Fever*

Book mark: *127.109*

(358) *J. S. [Signature]* Copyist.

*B* | Indpt. Battery. | **U.S.C.T.**

*Thomas Bryant,*

....., Indpt. Battery U. S. Col'd Light Art'y.

Appears on **Batt'y Muster-out Roll**, dated

*Ft. Leavenworth, Kas, July 22, 1865.*

Muster-out to date ....., 186 .

Last paid to ....., 186 .

**Clothing account:**

Last settled....., 186 ; drawn since \$..... 100

Due soldier \$..... 100; due U. S. \$..... 100

Am't for cloth'g in kind or money adv'd \$..... 100

Due U. S. for arms, equipments, &c., \$..... 100

Bounty paid \$..... 100; due \$..... 100

Remarks:.....

Book mark : *Rec'd Oct. 31/64. G.R. 11, 500*

(361)

*Porter*  
.....  
Copyist.

JAN. 17

6234680

018910

*P. 456, v. 127, 109, HB, 7*

*Boyant Thomas*

, Co. *Ind. Batt* Reg't *W. I. C. A*

*2* **Enclosures.**

Bed Cards .....	Final Statements .....
Burial Records .....	Furloughs or L. of A. ....
Certs. of Dis. for Discharge .....	Med. Certificates .....
C. M. Charges .....	Med. Des. Lists .....
Descriptive Lists .....	Orders .....
Discharge Certificates .....	Pris. of War Record .....
Enlistment Papers <i>2</i> .....	Resignations .....

Other papers relating to—

Admission to Hosp'l .....	Furlough or L. of A. ....
Casualty Sheet .....	Med. Examination .....
Confinement .....	Misc. Information .....
Contracts .....	Pay or Clothing .....
Death or Effects .....	Personal Reports .....
Desertion .....	Rank .....
Discharge from Hosp'l .....	Transfer to Hosp'l .....
Discharge from Service .....	Transfer to V. R. C. ....
Duty .....	Transportation .....

DECLARATION OF RECRUIT.

I, Thomas Bryant desiring to VOLUNTEER as a Soldier in the Army of the United States, for the term of THREE YEARS, Do Declare, That I am 20 years and \_\_\_\_\_ months of age; that I have never been discharged from the United States service on account of disability or by sentence of a court martial, or by order before the expiration of a term of enlistment; and I know of no impediment to my serving honestly and faithfully as a soldier for three years.

GIVEN at Wyandott State of Kansas the 14<sup>th</sup> day of August 1864

Witness:

W. H. Bussard Thomas X Bryant

NOTE 1.—This blank will be used for both enlistments and re-enlistments—enlistment of veterans, &c., &c. in the volunteer service. They will be made out in duplicate in all cases—one to accompany the recruiting return of the superintendent (not the recruiting officer) to the Adjutant General, and one to accompany the accounts of the officer who pays bounty, &c. The Regiment and Company in which the soldier last served should be given on the back.

NOTE 2.—An enlistment holds to service. A muster-in must, in all cases, precede payment of pay, bounty, pension, &c. A muster-in roll must, in all cases, be filed in the Adjutant General's Office as evidence of muster-in. The mustering officer, commissary, or assistant commissary of musters, as the case may be, will countersign both enlistments as having mustered the soldier into the service of the United States before either of them is given to the disbursing officer.

No. 74

Thomas Bryant  
Volunteered at Wyandott  
August 14<sup>th</sup> 1864  
By W. H. Minor 2<sup>d</sup> Lieut  
1<sup>st</sup> Regt of 1<sup>st</sup> Battery

enlistment; last served in Company ( )  
Regt of \_\_\_\_\_  
Discharged \_\_\_\_\_ 18 \_\_\_\_\_

CONSENT IN CASE OF MINOR.

I, \_\_\_\_\_ Do CERTIFY, That I am \_\_\_\_\_; that the \_\_\_\_\_ of \_\_\_\_\_; that the \_\_\_\_\_ is \_\_\_\_\_ years of age; and I do hereby freely give my CONSENT to his volunteering as a SOLDIER in the ARMY OF THE UNITED STATES for the period of THREE YEARS.

GIVEN at \_\_\_\_\_ the \_\_\_\_\_ day of \_\_\_\_\_

Witness:

3 3/2 34-

VOLUNTEER ENLISTMENT.

STATE OF

*Kansas.*



TOWN OF

*Hyandott*

I, *Thomas Bryant* born in *Clay Co*  
 in the State of *Missouri* aged *20* years,  
 and by occupation a *Farmer* Do HEREBY ACKNOWLEDGE to have  
 volunteered this *14<sup>th</sup>* day of *August* 186 *4*  
 to serve as a **Soldier** in the **Army of the United States of America**, for  
 the period of **THREE YEARS**, unless sooner discharged by proper authority:  
 Do also agree to accept such bounty, pay, rations, and clothing, as are, or may be,  
 established by law for volunteers. And I, *Thomas Bryant* do  
 solemnly swear, that I will bear true faith and allegiance to the **United States**  
**of America**, and that I will serve them honestly and faithfully against all  
 their enemies or opposers whomsoever; and that I will observe and obey the  
 orders of the President of the United States, and the orders of the officers  
 appointed over me, according to the Rules and Articles of War.

Sworn and subscribed to, at *Hyandott*  
 this *14<sup>th</sup>* day of *August* 186 *4*. *Thomas Bryant*  
 BEFORE *P. H. Minor 2<sup>nd</sup> Lieut* *his*  
*Recruiting 1<sup>st</sup> U.S. Col Battery* *mark*

I CERTIFY, ON HONOR, That I have carefully examined the above-named Volunteer, agreeably  
 to the General Regulations of the Army, and that, in my opinion, he is free from all bodily defects and  
 mental infirmity, which would in any way disqualify him from performing the duties of a soldier.

*Giffen Sinks*  
*Surg Board Enrollment*  
*North Dist Kansas*  
 EXAMINING SURGEON.

I CERTIFY, ON HONOR, That I have minutely inspected the Volunteer, *Thomas Bryant*  
 previously to his enlistment, and that he was entirely sober when enlisted; that, to the best of my  
 judgment and belief, he is of lawful age; and that, in accepting him as duly qualified to perform the  
 duties of an able-bodied soldier, I have strictly observed the Regulations which govern the recruiting  
 service. This soldier has *black* eyes, *black* hair, *black* complexion, is *5-*  
 feet *6* inches high.

*P. H. Minor 2<sup>nd</sup> Lieut*  
*1<sup>st</sup> U.S. Col Battery* Volunteers,  
 RECRUITING OFFICER.

Mustered into the service of the United States, for three years or during the war, from date of enlistment, in Company .....  
 Regiment of ..... Volunteers, on the ..... day of ..... 186 , at .....

DECLARATION OF RECRUIT.

I, Thomas Bryant desiring to VOLUNTEER as a Soldier in the Army of the United States, for the term of THREE YEARS, Do Declare, That I am 20 years and \_\_\_\_\_ months of age; that I have never been discharged from the United States service on account of disability or by sentence of a court martial, or by order before the expiration of a term of enlistment; and I know of no impediment to my serving honestly and faithfully as a soldier for three years.

GIVEN at Wyandott State of Kansas the 14<sup>th</sup> day of August 1864

Witness: W. A. Burhan Thomas Bryant  
his mark

NOTE 1.—This blank will be used for both enlistments and re-enlistments—enlistment of veterans, &c., &c., in the volunteer service. They will be made out in duplicate in all cases—one to accompany the recruiting return of the superintendent (not the recruiting officer) to the Adjutant General, and one to accompany the accounts of the officer who pays bounty, &c. The Regiment and Company in which the soldier last served should be given on the back.  
NOTE 2.—An enlistment holds to service. A muster-in must, in all cases, precede payment of pay, bounty, pension, &c. A muster-in roll must, in all cases, be filed in the Adjutant General's Office as evidence of muster-in. The mustering officer, commissary, or assistant commissary of musters, as the case may be, will countersign both enlistments as having mustered the soldier into the service of the United States before either of them is given to the disbursing officer.

No. 15  
Thomas Bryant  
Volunteered at Wyandott  
August 14<sup>th</sup> 1864  
By P. H. Minor 2<sup>nd</sup> Lieut  
1<sup>st</sup> Regiment of Battery  
..... enlistment; last served in Company (.....)  
..... Reg't of .....  
Discharged ..... 18 .....

CONSENT IN CASE OF MINOR.

I, ..... Do CERTIFY, That I am the ..... of .....; that the said ..... is ..... years of age; and I do hereby freely give my CONSENT to his volunteering as a SOLDIER in the ARMY OF THE UNITED STATES for the period of THREE YEARS.

GIVEN at ..... the ..... day of .....

Witness: .....



382 35-

VOLUNTEER ENLISTMENT.

STATE OF

Kansas



TOWN OF

Wyandotte

I, Thomas Bryant born in Clay Co  
in the State of Missouri aged 20 years,  
and by occupation a Farmer Do HEREBY ACKNOWLEDGE to have  
volunteered this 14<sup>th</sup> day of August, 1864,  
to serve as a **Soldier** in the **Army of the United States of America**, for  
the period of **THREE YEARS**, unless sooner discharged by proper authority:  
Do also agree to accept such bounty, pay, rations, and clothing, as are, or may be,  
established by law for volunteers. And I, Thomas Bryant do  
solemnly swear, that I will bear true faith and allegiance to the **United States**  
**of America**, and that I will serve them honestly and faithfully against all  
their enemies or opposers whomsoever; and that I will observe and obey the  
orders of the President of the United States, and the orders of the officers  
appointed over me, according to the Rules and Articles of War.

Sworn and subscribed to, at Wyandotte  
this 14<sup>th</sup> day of August 1864. Thomas Bryant his  
BEFORE J. G. Minor 2<sup>d</sup> Lieut mark  
Recruiting 1<sup>st</sup> U S Col Battery

I CERTIFY, ON HONOR, That I have carefully examined the above-named Volunteer, agreeably to the General Regulations of the Army, and that, in my opinion, he is free from all bodily defects and mental infirmity, which would in any way disqualify him from performing the duties of a soldier.

Jiffie Sinks  
Surgeon General  
North Dist Kansas

EXAMINING SURGEON.

I CERTIFY, ON HONOR, That I have minutely inspected the Volunteer, Thomas Bryant  
previously to his enlistment, and that he was entirely sober when enlisted; that, to the best of my  
judgment and belief, he is of lawful age; and that, in accepting him as duly qualified to perform the  
duties of an able-bodied soldier, I have strictly observed the Regulations which govern the recruiting  
service. This soldier has black eyes, black hair, brown complexion, is 5'  
6 inches high.

J. G. Minor 2<sup>d</sup> Lieut  
1<sup>st</sup> U S Col Battery Volunteers,  
RECRUITING OFFICER.

Mustered into the service of the United States, for three years or during the war, from date of enlistment, in Company ...  
... Regiment of ... Volunteers, on the ... day of ..., 1864, at ...

Bryant, Thomas.

O., Co. 1st, Batty Reg't M.C.A.

2 Enclosures.

Bed Cards	2	Descriptive Lists
Burial Records	2	Final Statements 1
Certs. of Dis. for Discharge		Furloughs
C. M. Charges		Med. Des. Lists
Med. Certificates		Orders

Other papers relating to—

Admission to Hosp'l	Furlough
Casualty Sheet (Officer's)	Med. Examination
Confinement	Misc. Information
Contracts	Pay or Clothing
Death or Effects 2	Personal Reports
Desertions	Rank
Discharge from Hosp'l	Transfer to Hosp'l
Discharge from Service	Transfer to V. R. C.
Duty	Transportation

MICROFILM PUBLICATION M1836

COMPILED MILITARY SERVICE RECORDS  
OF VOLUNTEER UNION SOLDIERS WHO SERVED WITH  
THE UNITED STATES COLORED TROOPS (USCT)  
INDEPENDENT BATTERY LIGHT ARTILLERY

PERSONAL PAPERS' TARGET SHEET

PLEASE NOTE THE CHECKED INFORMATION ABOUT THE PERSONAL PAPERS IN  
THIS FILE:

- NO PERSONAL PAPERS WERE FOUND IN THIS FILE WHEN THE  
RECORDS WERE ARRANGED FOR MICROFILMING.
- 5 PERSONAL PAPER(S) FOUND IN THIS FILE WHEN THE RECORDS  
WERE ARRANGED FOR MICROFILMING.

Thomas Bryant  
Priv. 2nd Battery. Col<sup>d</sup> U.S.A.  
Oct. 31. 64.  
P. 32. Fort Leavenworth, Kans.

HOSPITAL RECORD,

SUBJECT TO THE

ORDER OF THE SURGEON GENERAL

UNITED STATES ARMY.

No. 1.

RECORD OF DEATH AND INTERMENT.

Name and number of person interred.	<i>Thomas Bryant</i>	
Number and locality of the grave . .		
Hospital number of the deceased . .	<i>226</i>	
Regiment, rank, and company . . . .	<i>Priv. 2nd. Bat. U. S. Col. art.</i>	
Residence before enlistment . . . . .		
Conjugal condition, (and if married, ) the residence of the widow) . . . . }		
Cause of death . . . . .	<i>Acute dysentery.</i>	
Age of the deceased . . . . .		
Nativity . . . . .		
References and remarks . . . . .	<i>Company present</i>	
Date of death and burial . . . . .	<i>Died &amp; buried 31<sup>st</sup> Oct.</i>	<i>1864.</i>

Duplicates sent to the Adjutant General of the United States Army, and to the Sexton of the  
 \_\_\_\_\_ Cemetery.

Memoranda: *1 pr pants, 1 over coat, 1 blouse, 1 jacket,  
 1 hat, 1 pr boots,*

INVENTORY OF THE EFFECTS

of *Thomas Bryant*

late of Company (-----), -----

Regiment of ----- who died

at *Post Hospital, Fort Leavenworth, Kas*

the *31<sup>st</sup>* day of *October* 186*6*

*2nd Batt, U. S. A. (St)*

*msk*



ARMY OF THE UNITED STATES



INVENTORY OF EFFECTS OF DECEASED SOLDIERS.

Captain Thomas Bryant late of Rafferty's Company of the Battery... died in Post Hospital at Fort Leavenworth, Kas. the 31st day of Oct 1864. Cause of death acute Dysentery

INVENTORY.

Table with columns for articles (Hat, Cap, Forage Cap, Great Coat, Uniform Coat, Uniform Jacket, Flannel Sack Coat, Stable Frock, Fatigue Overall, pr. Trowsers, pr. Flannel Drawers, pr. Cotton Drawers, Flannel Shirts, Cotton Shirts, pr. Boots, pr. Shoes, pr. Socks, Blanket) and rows for No., Specie, Bank Notes.

I CERTIFY, on honor, that the above named articles were all the effects of Priv. Tho. Bryant deceased, and are in store at Post Hospital, Ft. Leavenworth, Kas. to be disposed of by a Council of Administration.

Fort Leavenworth Nov 1 1864

Signature of Council of Administration

NOTE 1.—The Inventories of the Effects of Deceased Enlisted Men, required by the 95th Article of War, will be forwarded, as soon as practicable, by the Company, or other Commander, to the Adjutant General of the Army, Washington, D. C., and to the Headquarters of the Regiment or Corps to which the Soldier belonged at the time of decease. (See Article XVII of Regulations.) NOTE 2.—With the Inventory of Effects, there will be forwarded to the Adjutant General of the Army, Washington, D. C. duplicate Final Statements of the Deceased Soldier's Accounts with the United States.

COPY OF RECORD

FOR THE

ADJUTANT GENERAL, U. S. ARMY





No. 2.

RECORD OF DEATH AND INTERMENT.

Name and number of person interred.	<i>Thomas Bryant</i>
Number and locality of the grave . . .	
Hospital number of the deceased . . .	<i>226</i>
Regiment, rank, and company . . . . .	<i>Priv. W. S. Co. 1st Art.</i>
Residence before enlistment . . . . .	
Conjugal condition, (and if married, ) the residence of the widow) . . . . .	
Cause of death . . . . .	<i>Acute Dysentery</i>
Age of the deceased . . . . .	
Nativity . . . . .	
References and remarks . . . . .	<i>Company present</i>
Date of death and burial . . . . .	<i>Died &amp; buried 31<sup>st</sup> Oct. 1864</i>

[A duplicate of this Record has been forwarded to the Sexton, and another remains at this Hospital.]

To *Adj. Gen. W. S. A.*

It becomes my duty to inform you that the person above described died at this Hospital as herein stated; and that it is desired his remains should be interred with the usual military honors.

Respectfully,

*Am. J. P. . . . .*  
*a. a., Surgeon U. S. Army.*  
*in charge Post Hos.*

MILITARY HOSPITAL, *Ft. Leavenworth*  
*Kas.*

This copy of Record is to be transmitted to the Adjutant General at Washington immediately after the place of burial and the number of the grave have been ascertained and registered. The above notification is to remain attached.

ARTICLES OF WAR.

ART. 95. When any non-commissioned officer or soldier shall die, or be killed in the service of the United States, the then commanding officer of the troop or company shall, in the presence of two other commissioned officers, take an account of what effects he died possessed of, above his arms and accoutrements, and transmit the same to the office of the Department of War, which said effects are to be accounted for, and paid to the representatives of such deceased non-commissioned officer or soldier. And in case any of the officers, so authorized to take care of the effects of deceased officers and soldiers, should, before they have accounted to their representatives for the same, have occasion to leave the regiment or post, by preferment or otherwise, they shall, before they be permitted to quit the same, deposit in the hands of the commanding officer, or of the assistant military agent, all the effects of such deceased non-commissioned officers and soldiers, in order that the same may be secured for, and paid to, their respective representatives.

ARMY REGULATIONS—EDITION OF 1863.

DECEASED SOLDIERS.

Par. 152. Inventories of the effects of deceased non-commissioned officers and soldiers, required by the 95th Article of War, will be forwarded to the Adjutant General, by the commander of the company to which the deceased belonged, and a duplicate of the same to the colonel of the regiment. Final statements of pay, clothing, &c., in duplicate, will be sent to the Adjutant General with one copy of the inventory. When a soldier dies at a post or station absent from his company, it will be the duty of his immediate commander to furnish the required inventory and final statements, and, at the same time, to forward to the commanding officer of the company to which the soldier belonged, a report of his death, specifying the date, place, and cause; to what time he was last paid, and the money or other effects in his possession at the time of his decease; which report will be noted on the next muster roll of the company to which the man belonged. Each inventory will be endorsed, "Inventory of the effects of \_\_\_\_\_, late of company (—) \_\_\_\_\_ regiment of \_\_\_\_\_, who died at \_\_\_\_\_, the \_\_\_\_\_ day of \_\_\_\_\_, 186—." If a legal representative receive the effects, it will be stated in the report. If the soldier leave no effects, the fact will be reported.

Par. 153. Should the effects of a deceased non-commissioned officer or soldier not be administered upon within a short period after his decease, they shall be disposed of by a Council of Administration, under the authority of the commanding officer of the post, and the proceeds deposited with the Paymaster, to the credit of the United States, until they shall be claimed by the legal representatives of the deceased.

Par. 154. In all such cases of sales by the Council of Administration, a statement in detail, or account of the proceeds, duly certified by the Council and commanding officer, accompanied by the Paymaster's receipt for the proceeds, will be forwarded by the commanding officer to the Adjutant General. The statement will be endorsed, "Report of the proceeds of the effects of \_\_\_\_\_, late of company (—) \_\_\_\_\_ regiment of \_\_\_\_\_, who died at \_\_\_\_\_, the \_\_\_\_\_ day of \_\_\_\_\_, 186—."

NOTE 1.—The effects in all cases, when called for, should be turned over to the legal representative, without further authority from the Adjutant General. When the effects are turned over to the relatives of the deceased before these inventories are sent to the Adjutant General, their receipts therefor should be attached to the inventories. In all other cases, one copy will be sent with a letter of transmittal direct to the Adjutant General, and a duplicate retained by the officer.

NOTE 2.—Particular care should be taken to take receipts in duplicate from the Paymaster for any funds turned over to him; one copy should be sent direct to the Adjutant General and one retained by the officer.

INVENTORY OF THE EFFECTS

OF

.....  
*Late of Company* .....

.....  
*Reg't of* .....

*Volunteers, who died at* .....

*on the* ..... *day of* ..... 186 .

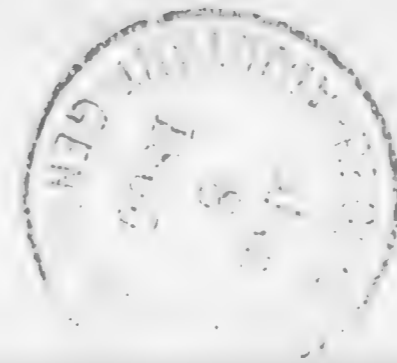

**Inventory** of the effects of Thomas Bryant late  
a Pirate of Captain W. Ford Douglas Company Independent  
the Battery Regiment of U.S. Colored Artillery (Light) Volunteers, who was enrolled as  
a Pirate at Mandotte, Kansas in the State of \_\_\_\_\_ on  
the 14<sup>th</sup> day of August 1864, and mustered into the service of the United  
States as a Pirate on the 18<sup>th</sup> day of August 1864, at Leavenworth  
in Company Independent Regiment of U.S. Col. Artillery (L) Volunteers, to serve Three  
years or during the war; he was born in Clay County in the State  
of Missouri; he was 21 years of age, 5 feet 6 inches  
high, Black complexion, Black eyes, Black hair, and by occupation, when enrolled,  
a Farmer; he died in Post Hospital, at  
Fort Leavenworth, Kan on the 31<sup>st</sup> day of October 1864, by  
reason of Ephoril Fever

INVENTORY.					
ARTICLES.	No.	ARTICLES.	No.	ARTICLES.	No.
Hats.....	<u>One</u>	Pairs trousers.....		Knapsacks.....	
Caps.....		Pairs flannel drawers.....			
Forage caps.....		Pairs cotton drawers.....			
Great coats.....	<u>One</u>	Flannel shirts.....			
Uniform coats.....		Cotton shirts.....			
Uniform jackets.....	<u>One</u>	Pairs boots.....			
Flannel sack coats.....		Pairs shoes.....	<u>One</u>		
Blouses.....	<u>One</u>	Pairs socks.....			
Stable frocks.....		Blankets.....			
Fatigue overalls.....		Haversacks.....			
				MONEY.	
					Specie.....
				Notes.....	\$

I CERTIFY, ON HONOR, that the above inventory comprises all the effects of Pirate  
Thomas Bryant, deceased, and that the effects are in the hands  
of Surgeon in Charge of Post Hospital at Fort Leavenworth, Kansas  
to be disposed of by a Council of Administration.

( DUPLICATES. )

Captain W. Ford Douglas

STATION: Fort Leavenworth

Commanding the Company.

DATE: December 28<sup>th</sup> 1864

[OFFICE ENDORSEMENT.]

V

War Department,

ADJUTANT GENERAL'S OFFICE,

Sept 19, 1875.

The death of *Wm. J. Brown* of *Co. B, Battery* Reg't U. S. Colored *Art. Bn.*, is reported as follows:

- On Company Muster Roll. *From August 1864, Oct 31, 1864*
- Company Muster-out Roll. *Name not known*, 186-
- Company Descriptive Book. ...., 186
- Company Morning Reports. ...., 186
- Soldier's Final Statement. *October 31*, 1864
- Soldier's Record of Death and Interment. *October 31*, 1864
- Soldier's Inventory of Effects. *October 31*, 1864
- Soldier's Certificate of Disability for Discharge. ...., 166
- Soldier's Individual Muster out Roll. ...., 186
- Regimental Return. *For October, 1864, Not on file*, 186
- Regimental Quarterly Returns. *Name on file*, 186
- Regimental Descriptive Book. ...., 186

By Surgeon General. ...., 186  
(*Oct 31*), 1864 is held to be the correct date, and the Company Muster-out Roll will be amended accordingly.

*Thomas M. Stewart*  
Assistant Adjutant General.  
*CPB 11*  
*Nov 456 of Oct 23 1875.*

FINAL STATEMENT

OF

*Thomas Bryant*  
*Independent Battery U.S. Cavalry*  
*Artillery*

**VOLUNTEERS.**

*Recd Oct 31 1865*

NOTE 1.—Two of these certificates (or duplicates) are to be given to each Volunteer Soldier or drafted man who may be discharged previously to the discharge of his company, that he may at once receive from the Paymaster the pay, &c., due him, and the captain or other COMMISSIONED officer commanding the company will certify to the act of the delivery of the duplicate certificates; on these certificates the Soldier is "entitled to" his discharge, and should also present his discharge to the Paymaster to have the payment endorsed on it. The discharge is to be given back to the Soldier by the Paymaster; the latter only retaining as his voucher the duplicate certificates.

NOTE 2.—If the Soldier is entitled to pay for the use of his horse, the Company Commander will certify to that fact on the back of both these final statements, and also to the time he has pay due for having been so mounted on his own horse.

NOTE 3.—When a Soldier is furnished with final statements, his descriptive list, if he has one, should be taken up by the officer who gives the Soldier these statements, and endorsed with a statement to this effect by the officer. This endorsement should exhibit a full statement of the time for which the Soldier was allowed pay on his final statements, the clothing account, and all other charges against him or in his favor, so as to comprise a complete exhibit of his account. It will then be transmitted to the company commander of the Soldier, who will enter all the data necessary to a full understanding of the Soldier's account on the muster roll upon which the Soldier's discharge is reported. The descriptive list will then be destroyed. The object of this is, that the remaining portion of the Soldier's account may be settled upon the receipt of these muster rolls. If the Soldier receive any pay or allowances that may be due him at the time of his discharge, and which may not appear on his final statements from the fact that his descriptive list is incomplete. These accounts for back pay, &c., are settled by the 2d Auditor of the Treasury Department.

NOTE 4.—Charges for loss or injury to ordnance, horse equipments, and other miscellaneous charges, should appear under the heading of "Other Stoppages."

NOTE 5.—Bounty paid by State authorities, and not by the United States, will not be entered on this statement.

NOTE 6.—Amounts due the Sawyer and Laundress must be entered on the muster roll on which the discharge, death, desertion, &c., is reported, as well as on the final statement, otherwise the amount cannot be collected from the United States.

NOTE 7.—This blank will be used for deceased volunteers and drafted men, as well as for others.

NOTE 8.—Where a Soldier dies in Hospital or on detached service, his descriptive list, if he has one, should be sent with his final statements, in duplicate, to the Adjutant General, Washington, D. C.

ADJUTANT GENERAL'S OFFICE.

*March 8 1865*

Duplicate with Inventory sent 2d Auditor.

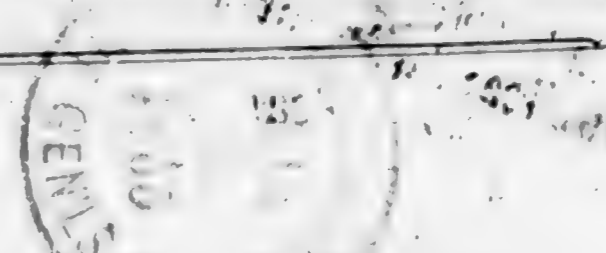

I certify, on honor, that Thomas Bryant a Private of  
 Captain Wm Ford Douglas Company ( ) of the 10th Regiment of U.S. Col. Artillery  
~~VOLUNTEERS~~, of the State of \_\_\_\_\_, born in Clay County, State  
 of Missouri, aged 20 years; 5 feet 6 inches high; Black complexion,  
Black eyes, Black hair, and by occupation a Farmer, having joined the company on  
 its original organization at Independence Mo. Aug 14th 1861, and enrolled in it at the muster into  
 the service of the United States at Leavenworth Kansas, on the 11th day  
 of August, 1861, (~~or was mustered in service as a recruit, by \_\_\_\_\_~~  
~~\_\_\_\_\_ at \_\_\_\_\_ on the \_\_\_\_\_ day of \_\_\_\_\_,~~  
~~186~~ , or was drafted and mustered into the service of the United States from the  
 Enrollment District of the State of \_\_\_\_\_, at \_\_\_\_\_,  
 on the \_\_\_\_\_ day of \_\_\_\_\_, 1861 ) to serve in the 10th Regiment, for

the term of Three years: and having served HONESTLY and  
 FAITHFULLY with his Company in Kansas to the present date, is now  
 entitled to a **DISCHARGE** by reason of Died in Post Hospital at Fort Leavenworth  
Kansas October 21st 1864 of Typhoid Fever

The said Tom Thomas Bryant has paid ~~from date of enlistment~~ was last paid by Paymaster  
 \_\_\_\_\_ to include the \_\_\_\_\_ day of \_\_\_\_\_, 1861, and has  
 pay due him from that time to the present date; he is entitled to pay and subsistence for  
 TRAVELING to place of enrollment, and whatever other allowances are authorized to volunteer  
 soldiers, drafted men, or militia, so discharged. He has received from the United States **CLOTHING**  
 amounting to \$51 69 dollars, since the date day of Enlistment,  
 1861, when his clothing account was last settled. He has received from the United States  
122 100 dollars advanced **BOUNTY**.

~~There is to be stopped from him, on account of the State of \_\_\_\_\_, or other  
 authorities, for CLOTHING, &c, received on entering service, \_\_\_\_\_ dollars; and  
 for other stoppages, viz: \_\_\_\_\_~~

\_\_\_\_\_ dollars.  
 He has been furnished with TRANSPORTATION in kind from the place of his discharge to  
 \_\_\_\_\_; and he has been SUBSISTED for TRAVELING to his  
 place of enrollment, up to the \_\_\_\_\_, 1861.

~~He is indebted to \_\_\_\_\_, BUTLER, \_\_\_\_\_ dollars.  
 He is indebted to \_\_\_\_\_, LAUNDRESS, \_\_\_\_\_ dollars.~~

Given in Duplicate, at Fort Leavenworth Kansas, this 21st day  
 of December, 1864.

Captain Wm Ford Douglas  
gnd reg Battery U.S. colored artiller  
 \_\_\_\_\_  
 Commanding Company

*James Smith*

1st. Batt'y U.S. Cold L. Art'y

*Private Private*

CARD NUMBERS.

6233633	26
6238740	27
6233889	28
6234063	29
6234201	30
6234368	31
6234531	32
9132977	33
	34
	35
	36
	37
	38
	39
	40
	41
	42
	43
	44
	45
	46
	47
	48
	49
	50

Book Mark:

See also

*D*

Indpt. Batt'y. | **U.S.C.T.**

*Munth Buckner*

....., Indpt. Batt'y, U. S. Col'd L. Art'y.

Appears on

**Battery Descriptive Book**

of the organization named above.

**DESCRIPTION.**

Age *21* years; height *5* feet *7 1/2* inches.

Complexion *Black*

Eyes *Black*; hair *Black*

Where born *Randolph Missouri*

Occupation *Tobaccoist*

**ENLISTMENT.**

When *Dec 15*, 186 *4*

Where .....

By whom *A. Munis*; term *3* y'rs.

Remarks: .....

.....  
.....  
.....  
.....  
.....  
.....  
.....  
.....  
.....  
.....

*Halbrook*

(383g)

Copist.



3 | Indpt. Battery. | U.S.C.T.

*Merritt Buckner*

Appears with rank of *Priv* on

**Muster and Descriptive Roll of a Detachment of U. S. Vols. forwarded**

for the Indpt. Batt'y, U. S. Col'd L. Arty. Roll dated

*Leavenworth, Mo., Dec. 17, 1864.*

Where born *Randolph Co., Missouri*

Age *21* y'rs; occupation *Tobacconist*

When enlisted *Dec., 15, 1864.*

Where enlisted *Leavenworth, Kans.*

For what period enlisted *3* years.

Eyes *Black*; hair *Black*

Complexion *Black*; height *5 ft. 7 1/2 in.*

When mustered in *Dec. 17, 1864.*

Where mustered in *Leavenworth, Mo.*

Bounty paid \$ *100*; due \$ *100*

Where credited

Battery to which assigned

Remarks: *Credited to North Dist.*

*Kans. 28 Sub. Dist. Wyandotte*

*City Co. Vol. recruit &*

*entitled to Bounty.*

Book mark:

*E. L. Thornton*

B

Indpt. Battery. U.S.C.T.

Marritt Buckner

Pat, Indpt. Battery, U. S. Col'd L. Art'y.

Appears on

Battery Muster-in and Descriptive Roll

of the organization named above. Roll dated

Leavenworth Mo Dec 23, 1864.

Where born Randolph Co. Mo.

Age 21 y'rs; occupation Tobaccoist

When enlisted Dec 15, 1864.

Where enlisted Leavenworth Mo

For what period enlisted 3 years.

Eyes Blue; hair Blue

Complexion Blue; height 5 ft 7 1/2 in.

When mustered in Dec 17, 1864.

Where mustered in Leavenworth

Bounty paid \$100 00/100; due \$200 00/100

Where credited

Battery to which assigned

Remarks: Or N. Dist Mo  
28th S.D. Wyandotte City  
Mo

Book mark;

(856g)

J. H. [Signature]

Copyist.

B | Indpt. Battery. | U.S.C.T.

Merritt Quaker

Pat, Indpt. Battery, U. S. Col'd L. Art'y.

Appears on

Battery Muster Roll

for Enrollment to Dec 31, 1864.

Present or absent Absent

Stoppage, \$ 100 for

Due Gov't, \$ 100 for

Valuation of horse, \$ 100

Valuation of horse equipments, \$ 100

Remarks: Absent without leave

Book mark:

(358) W. Schrey Copyist.

79

Indpt. Battery. | **U.S.C.T.**

Merritt Buckner

Det., Indpt. Battery, U. S. Col'd L. Art'y.

Appears on

**Battery Muster Roll**

for *Jan'y Feb*, 186<sup>5</sup>.

Present or absent *Present*

Stoppage, \$ 100 for

Due Gov't, \$ 100 for

Valuation of horse, \$ 100

Valuation of horse equipments, \$ 100

Remarks:

Book mark:

*W. Schorly*  
(358) Copyist.

*B* | Indpt. Battery. | **U.S.C.T.**

*Merritt Buckner,*

*B*, Indpt. Battery, U. S. Col'd L. Art'y.

Appears on

**Battery Muster Roll**

for *Mar, & Apr.*, 1865.

Present or absent *Present.*

Stoppage, \$ 100 for

Due Gov't, \$ 100 for

Valuation of horse, \$ 100

Valuation of horse equipments, \$ 100

Remarks:

Book mark:

*Porter*

*B*

Indpt. Battery. | **U.S.C.T.**

*Merritt Beckner,*  
*Pr*, Indpt. Battery, U. S. Col'd L. Art'y.

Appears on

**Battery Muster Roll**

for *May - June*, 186*5*.

Present or absent *Present*

Stoppage, \$ 100 for

Due Gov't, \$ 100 for

Valuation of horse, \$ 100

Valuation of horse equipments, \$ 100

Remarks:

Book mark: *...*

*Butler*

(358)

Copyist.

*S*

Indpt. Battery. | **U.S.C.T.**

*Merritt Pucknes,*

*R*, Indpt. Battery U. S. Col'd Light Art'y.

Appears on **Batt'y Muster-out Roll**, dated

*St. Leonards, N.S., July 22, 1865.*

Muster-out to date *July 22, 1865.*

Last paid to *Pay due from Enlistment 186*

Clothing account:

Last settled....., 186 ; drawn since \$ *62<sup>99</sup>*/<sub>100</sub>,

Due soldier \$ *100*/<sub>100</sub>; due U. S. \$ *100*/<sub>100</sub>

Am't for cloth'g in kind or money adv'd \$ *100*/<sub>100</sub>

Due U. S. for arms, equipments, &c., \$ *100*/<sub>100</sub>

Bounty paid \$ *100*/<sub>100</sub>; due \$ *None*/<sub>100</sub>,

Remarks:.....  
.....  
.....  
.....  
.....  
.....  
.....  
.....

Book mark: *V. 66, P. 260, 73,*

*Porter*

(361)

Copyist.

*Buckner Merritt*

, Co. *1st Batt* Reg't *W. S. G. I.*

Enclosures.

Bed Cards .....	Final Statements .....
Burial Records .....	Furloughs or L. of A. ....
Certs. of Dis. for Discharge .....	Med. Certificates .....
C. M. Charges .....	Med. Des. Lists .....
Descriptive Lists .....	Orders .....
Discharge Certificates .....	Pris. of War Record .....
Enlistment Papers .....	Resignations .....

Other papers relating to—

Admission to Hosp'l .....	Furlough or L. of A. ....
Casualty Sheet .....	Med. Examination .....
Confinement .....	Misc. Information .....
Contracts .....	Pay or Clothing .....
Death or Effects .....	Personal Reports .....
Desertion .....	Rank .....
Discharge from Hosp'l .....	Transfer to Hosp'l .....
Discharge from Service .....	Transfer to V. R. C. ....
Duty .....	Transportation .....



NOTE 1.—This blank will be used for both enlistments and re-enlistments—enlistment of veterans, &c., &c., in the volunteer service. They will be made out in duplicate in all cases—one to accompany the recruiting return of the superintendent (not the recruiting officer) to the Adjutant General, and one to accompany the accounts of the officer who pays bounty, &c. The Regiment and Company in which the soldier last served should be given on the back.

NOTE 2.—An enlistment holds to service. A muster-in must, in all cases, precede payment of pay, bounty, pension, &c. A muster-in roll must, in all cases, be filed in the Adjutant General's Office as evidence of muster-in. The mustering officer, commissary, or assistant commissary of musters, as the case may be, will countersign both enlistments as having mustered the soldier into the service of the United States before either of them is given to the disbursing officer.

DECLARATION OF RECRUIT.

I, Meritt Buckner desiring to VOLUNTEER as a Soldier in the Army of the United States, for the term of THREE YEARS, Do Declare, That I am Twenty one years and \_\_\_\_\_ months of age; that I have never been discharged from the United States service on account of disability or by sentence of a court martial, or by order before the expiration of a term of enlistment; and I know of no impediment to my serving honestly and faithfully as a soldier for three years.

GIVEN at Leavenworth State Kansas the 15 day of December 1864

Witness: John W. C. Hanson Meritt <sup>his</sup> Buckner  
man

No. ....

Meritt Buckner

Volunteered at Leavenworth

15<sup>th</sup> December 1864

By P. H. Minor 2<sup>d</sup> Lieut

Regiment of \_\_\_\_\_

\_\_\_\_\_ enlistment; last served in Company ( )

John W. C. Hanson

Discharged \_\_\_\_\_ 18 \_\_\_\_\_

CONSENT IN CASE OF MINOR.

I, \_\_\_\_\_ Do CERTIFY, That I am the \_\_\_\_\_ of \_\_\_\_\_; that the said \_\_\_\_\_ is \_\_\_\_\_ years of age; and I do hereby freely give my CONSENT to his volunteering as a SOLDIER in the ARMY OF THE UNITED STATES for the period of THREE YEARS.

GIVEN at \_\_\_\_\_ the \_\_\_\_\_ day of \_\_\_\_\_

Witness: \_\_\_\_\_

3

VOLUNTEER ENLISTMENT.

STATE OF

TOWN OF

Kansas



Leavenworth

I, Meritt Buckner born in Randolph Co  
 in the State of Milford aged Twenty one years,  
 and by occupation a Tobaccoist. Do HEREBY ACKNOWLEDGE to have  
 volunteered this 15<sup>th</sup> Fifteenth day of December 1864,  
 to serve as a **Soldier** in the **Army of the United States of America**, for  
 the period of **THREE YEARS**, unless sooner discharged by proper authority:  
 Do also agree to accept such bounty, pay, rations, and clothing, as are, or may be,  
 established by law for volunteers. And I, Meritt Buckner do  
 solemnly swear, that I will bear true faith and allegiance to the **United States  
 of America**, and that I will serve them honestly and faithfully against all  
 their enemies or opposers whomsoever; and that I will observe and obey the  
 orders of the President of the United States, and the orders of the officers  
 appointed over me, according to the Rules and Articles of War.

Sworn and subscribed to, at Leavenworth  
 this 15<sup>th</sup> day of December 1864, } Meritt's Buckner  
 BEFORE P. H. Minor 2<sup>d</sup> Lieut } Mark  
Indpt Battery U.S. Colored Artillery

I CERTIFY, ON HONOR, That I have carefully examined the above-named Volunteer, agreeably  
 to the General Regulations of the Army, and that, in my opinion, he is free from all bodily defects and  
 mental infirmity, which would in any way disqualify him from performing the duties of a soldier.

Tiffin Links  
Surg Board of Enrollments  
for the Dist Kansas  
 EXAMINING SURGEON.

I CERTIFY, ON HONOR, That I have minutely inspected the Volunteer, Meritt Buckner  
 previously to his enlistment, and that he was entirely sober when enlisted; that, to the best of my  
 judgment and belief, he is of lawful age; and that, in accepting him as duly qualified to perform the  
 duties of an able-bodied soldier, I have strictly observed the Regulations which govern the recruiting  
 service. This soldier has black eyes, black hair, black complexion, is 5-  
 feet 7 1/2 inches high.

P. H. Minor 2<sup>d</sup> Lieut  
Indpt Battery U.S. Col. Artillery  
 RECRUITING OFFICER.

Mustered into the service of the United States, for three years or during the war, from date of enlistment, in Company Independent  
Battery U.S. Regiment of Artillery on the 17<sup>th</sup> day of December, 1864, at Leavenworth, Kansas  
James H. Brown  
Capt. & Quartermaster  
of the Dist. Kansas

DECLARATION OF RECRUIT.

*Meritt Buckner* desiring

to VOLUNTEER as a Soldier in the Army of the United States, for the term of THREE YEARS, Do Declare, That I am *Twenty one* years and \_\_\_\_\_ months of age; that I have never been discharged from the United States service on account of disability or by sentence of a court martial, or by order before the expiration of a term of enlistment; and I know of no impediment to my serving honestly and faithfully as a soldier for three years.

GIVEN at *Leavenworth State Kansas* the *13<sup>th</sup>* day of *December 1864*

Witness:

*Noah C. Hanson*

*Meritt Buckner*  
mark

NOTE 1.—This blank will be used for both enlistments and re-enlistments—enlistment of veterans, &c., &c., in the volunteer service. They will be made out in duplicate in all cases—one to accompany the recruiting return of the superintendent (not the recruiting officer) to the Adjutant General, and one to accompany the accounts of the officer who pays bounty, &c. The Regiment and Company in which the soldier last served should be given on the back.  
NOTE 2.—An enlistment holds to service. A muster-in must, in all cases, precede payment of pay, bounty, pension, &c. A muster-in roll must, in all cases, be filed in the Adjutant General's Office as evidence of muster-in. The mustering officer, commissary, or assistant commissary of musters, as the case may be, will countersign both enlistments as having mustered the soldier into the service of the United States before either of them is given to the disbursing officer.

Rec'd from 2nd. Aud. Nov. 23<sup>d</sup> 1862

No. *96*

*Meritt Buckner*

Volunteered at *Leavenworth*

*13<sup>th</sup> December 1864*

By *W. H. Mearns 2d Lieut*

*Inspector Adjutant U.S. Vol. Artillery*

\_\_\_\_\_ enlistment; last served in Company ( )

\_\_\_\_\_ Reg't of \_\_\_\_\_

Discharged \_\_\_\_\_ 18 .

CONSENT IN CASE OF MINOR.

I, \_\_\_\_\_ Do CERTIFY, That I am the \_\_\_\_\_ of \_\_\_\_\_; that the said \_\_\_\_\_ is \_\_\_\_\_ years of age; and I do hereby freely give my CONSENT to his volunteering as a SOLDIER in the ARMY OF THE UNITED STATES for the period of THREE YEARS.

GIVEN at \_\_\_\_\_ the \_\_\_\_\_ day of \_\_\_\_\_

Witness: \_\_\_\_\_

*28<sup>th</sup> Sub Dist Wagonville*  
*This recruit has received a 100 dollar advance bounty from the bounty fund authorized by Congress July 17<sup>th</sup> 1862 and from the State of Kansas as provided by the Act of Congress July 17<sup>th</sup> 1862. He has also received 100 dollars from the bounty fund of the State of Kansas.*

VOLUNTEER ENLISTMENT.

STATE OF



TOWN OF

*Leavenworth*

I, *Meritt* *Buckner* born in *Round Bay*  
in the State of *Missouri* aged *Twenty One* years,  
and by occupation a *Tobaccoist* Do HEREBY ACKNOWLEDGE to have  
volunteered this *fifteenth* day of *December* 186*4*,  
to serve as a *Soldier* in the *Army of the United States of America*, for  
the period of *THREE YEARS*, unless sooner discharged by proper authority:  
Do also agree to accept such bounty, pay, rations, and clothing, as are, or may be,  
established by law for volunteers. And I, *Meritt* *Buckner* do  
solemnly swear, that I will bear true faith and allegiance to the *United States*  
*of America*, and that I will serve them honestly and faithfully against all  
their enemies or opposers whomsoever; and that I will observe and obey the  
orders of the President of the United States, and the orders of the officers  
appointed over me, according to the Rules and Articles of War.

Sworn and subscribed to, at *Leavenworth*  
this *15<sup>th</sup>* day of *December* 186*4*,  
BEFORE *P. H. Minor 2<sup>d</sup> Lieut*  
*Indpt Battery US Col Artillery* } *Meritt* *Buckner*  
mark

I CERTIFY, ON HONOR, That I have carefully examined the above-named Volunteer, agreeably  
to the General Regulations of the Army, and that, in my opinion, he is free from all bodily defects and  
mental infirmity, which would in any way disqualify him from performing the duties of a soldier.

*Tiffin Sikes*  
*Surg Board of Enrollment*  
*North Dist Kansas*  
EXAMINING SURGEON.

I CERTIFY, ON HONOR, That I have minutely inspected the Volunteer, *Meritt* *Buckner*  
previously to his enlistment, and that he was entirely sober when enlisted; that, to the best of my  
judgment and belief, he is of lawful age; and that, in accepting him as duly qualified to perform the  
duties of an able-bodied soldier, I have strictly observed the Regulations which govern the recruiting  
service. This soldier has *black* eyes, *black* hair, *black* complexion, is *5*  
feet *12* inches high.

*P. H. Minor 2<sup>d</sup> Lieut*  
*Indpt Battery US Col Artillery*  
RECRUITING OFFICER.

*Battery No. 28*  
*Regiment of Col Artillery*  
Mustered into the service of the United States, for three years or during the war, from date of enlistment, in *Company*  
on the *17* day of *December*, 186*4* at *Leavenworth Kansas*  
*Sept 1864*  
*Wm. O. Brown*  
*Colt's Regt - Kansas*  
*Wm. O. Brown*

*[Faded handwritten name]*  
 Capt. Batt'y U.S. Col'd L. Art'y.

*Private* | *Private*

CARD NUMBERS.

1	6233734	26
2	6234022	27
3	6234064	28
4	6234202	29
5	6234369	30
6	6234533	31
7	9137915	32
8		33
9		34
10		35
11		36
12		37
13		38
14		39
15		40
16		41
17		42
18		43
19		44
20		45
21		46
22		47
23		48
24		49
25		50

Book Mark:

See also

8777871 - Po 90 std.  
5-966928 " m.w.  
S. 1032406 - P.O. aff  
D. 1228368 P.O. aff

*M. Spencer*  
3

*D* | Indpt. Batt'y. | **U.S.C.T.**

*Ferris Buford*

....., Indpt. Batt'y, U. S. Col'd L. Art'y.

Appears on

**Battery Descriptive Book**

of the organization named above.

**DESCRIPTION.**

Age *44* years; height *5* feet *1* inches.

Complexion *Black*

Eyes *Black*; hair *Black*

Where born *Jasamin Ky.*

Occupation *Farmer*

**ENLISTMENT.**

When *July 25*....., 186 *4*

Where *Myaudotte Ms.*

By whom *S. Minor*.....; term *3* y'rs.

Remarks: .....

.....

.....

.....

.....

.....

.....

.....

.....

(383g)

*Hoelbrock*

Copyist.

13

Indpt. Battery.

U.S.C.T.

Lewis Buford

Pet

Indpt. Battery, U. S. Col'd L. Art'y.

Appears on

**Battery Muster-in and Descriptive Roll**

of the organization named above. Roll dated

Leavenworth Mo Dec 28, 1864.

Where born Jessamine Co Ky.

Age 44 y'rs; occupation Farmer

When enlisted July 25, 1864.

Where enlisted Wyandotte Mo

For what period enlisted 3 years.

Eyes Blue; hair Black

Complexion Blue; height 5 ft. 1 in.

When mustered in July 28, 1864.

Where mustered in Leavenworth

Bounty paid \$ 100; due \$ 300<sup>00</sup>/<sub>100</sub>

Where credited

Battery to which assigned

Remarks: C. N. Dist Co

Co. A. D. 2<sup>d</sup> Ward

Leavenworth Mo.

Book mark:

(856g)

Copied.



*B*

Indpt. Battery.

U.S.C.T.

*Lewis Buford*

*Pat*

, Indpt. Battery, U. S. Col'd L. Art'y.

Appears on

**Battery Muster Roll**

for *Lewis Buford to Dec 31*, 1864.

Present or absent

Stoppage, \$ 100 for

Due Gov't, \$ 100 for

Valuation of horse, \$ 100

Valuation of horse equipments, \$ 100

Remarks: *Deserted from  
Fort Leavenworth Kan.  
Oct 22<sup>d</sup> 1864*

Book mark:

*J. H. Schrey*

(358)

Copyist.

79

Indpt. Battery. | U.S.C.T.

Lewis Buford

Dot

, Indpt. Battery, U. S. Col'd L. Art'y.

Appears on

**Battery Muster Roll**

for *Samy T. Fet*, 186 *5*

Present or absent *Present*

Stoppage, \$ 100 for

Due Gov't, \$ 100 for

Valuation of horse, \$ 100

Valuation of horse equipments, \$ 100

Remarks: *In arrest*

Book mark:

*J. Schooley*  
(358) Copyist.

*B* | Indpt. Battery. | **U.S.C.T.**

*Lewis Buford,*  
*M*, Indpt. Battery, U. S. Col'd L. Art'y.

Appears on

**Battery Muster Roll**

for *May & Apl,*, 1865.

Present or absent *Present,*

Stoppage, \$ *100* for

Due Gov't, \$ *100* for

Valuation of horse, \$ *100*

Valuation of horse equipments, \$ *100*

Remarks: *County due, \$100.00,*

Book mark: \_\_\_\_\_

*Parter*

(358)

Copyist.

*[Handwritten mark]*

*B* | Indpt. Battery. | **U.S.C.T.**

*Lewis Bufford*

*Pr*, Indpt. Battery, U. S. Col'd L. Art'y.

Appears on

**Battery Muster Roll**

for *May - June*, 186*5*.

Present or absent *Present*

Stoppage, \$ 100 for

Due Gov't, \$ 100 for

Valuation of horse, \$ 100

Valuation of horse equipments, \$ 100

Remarks:

Book mark:

*Darter*

*B*

Indpt. Battery.

U.S.C.T.

*Lewis Bufford*

*B*, Indpt. Battery U. S. Col'd Light Art'y.

Appears on **Batt'y Muster-out Roll**, dated

*W. Seavernth, Mo, July 23* 1865.

Muster-out to date *July 22*, 1865.

Last paid to *Dec. 31*, 1864.

Clothing account:

Last settled....., 186 ; drawn since \$ *75* <sup>*06*</sup>/<sub>100</sub>,

Due soldier \$ .....<sup>100</sup>; due U. S. \$ .....<sup>100</sup>

Am't for cloth'g in kind or money adv'd \$ .....<sup>100</sup>

Due U. S. for arms, equipments, &c., \$ .....<sup>100</sup>

Bounty paid \$ *none* <sup>100</sup>; due \$ *100* <sup>100</sup>,

Remarks:.....

Book mark:.....

*Butler*

(361)

Copyist.

*Burford Louis*

, Co. *1st Batt* Regt *W.S. C.A*

*4* Enclosures.

Bed Cards .....	Final Statements .....
Burial Records .....	Furloughs or L. of A .....
Certs. of Dis. for Discharge .....	Med. Certificates .....
C. M. Charges ..... /	Med. Des. Lists .....
Descriptive Lists .....	Orders .....
Discharge Certificates .....	Pris. of War Record .....
Enlistment Papers ..... 2	Resignations .....

Other papers relating to—

Admission to Hosp'l .....	Furlough or L. of A .....
Casualty Sheet .....	Med. Examination .....
Confinement .....	Misc. Information .....
Contracts .....	Pay or Clothing .....
Death or Effects .....	Personal Reports .....
Desertion .....	Rank .....
Discharge from Hosp'l .....	Transfer to Hosp'l .....
Discharge from Service .....	Transfer to V. R. C. ....
Duty ..... /	Transportation .....

NOTE 1.—This blank will be used for both enlistments and re-enlistments—enlistment of veterans, &c., &c., in the volunteer service. They will be made out in duplicate in all cases—one to accompany the recruiting return of the superintendent (not the recruiting officer) to the Adjutant General, and one to accompany the accounts of the officer who pays bounty, &c. The Regiment and Company in which the soldier last served should be given on the back.

NOTE 2.—An enlistment holds to service. A muster-in must, in all cases, precede payment of pay, bounty, pension, &c. A muster-in roll must, in all cases, be filed in the Adjutant General's Office as evidence of muster-in. The mustering officer, commissary, or assistant commissary of musters, as the case may be, will countersign both enlistments as having mustered the soldier into the service of the United States before either of them is given to the disbursing officer.

DECLARATION OF RECRUIT.

I, Louis Buford desiring to VOLUNTEER as a Soldier in the Army of the United States, for the term of THREE YEARS Do Declare, That I am 42 years and \_\_\_\_\_ months of age; that I have never been discharged from the United States service on account of disability or by sentence of a court-martial, or by order before the expiration of a term of enlistment; and I know of no impediment to my serving honestly and faithfully as a soldier for three years.

GIVEN at Wyanadette State of Kansas the 25 day of July 1864

Witness: Henry Copeland Louis Buford mark

No. 42

Louis Buford  
Volunteered at Wyanadette  
July 25 1864

By Wm. M. Minor 2nd Lieut.

1st 2d Regiment of Artillery

Wyanadette, Kansas

enlistment; last served in Company ( )

Reg't of \_\_\_\_\_

Discharged \_\_\_\_\_ 18 \_\_\_\_\_

CONSENT IN CASE OF MINOR.

I, \_\_\_\_\_ Do CERTIFY, That I am the \_\_\_\_\_ of \_\_\_\_\_; that the said \_\_\_\_\_ is \_\_\_\_\_ years of age; and I do hereby freely give my CONSENT to his volunteering as a SOLDIER in the ARMY OF THE UNITED STATES for the period of THREE YEARS.

GIVEN at \_\_\_\_\_ the \_\_\_\_\_ day of \_\_\_\_\_

Witness: \_\_\_\_\_

VOLUNTEER ENLISTMENT.

STATE OF

*Kansas*

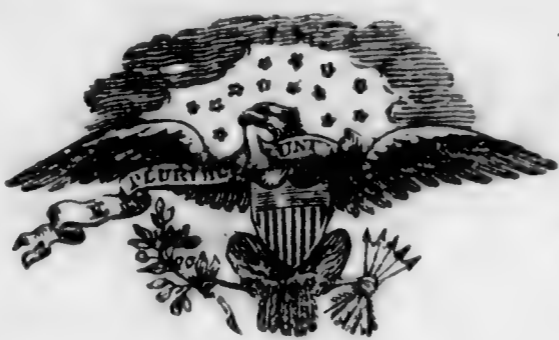

TOWN OF

*Wyandotte Co*

I, *Louis Buford*

born in *Pepin Co*

in the State of *Kentucky* aged *44* years,

and by occupation a *Farmer*. Do HEREBY ACKNOWLEDGE to have

volunteered this *25* day of *July* 1864,

to serve as a **Soldier** in the **Army of the United States of America**, for the period of **THREE YEARS** unless sooner discharged by proper authority: Do also

agree to accept such bounty, pay, rations, and clothing, as are, or may be, established by law for volunteers. And I, *Louis Buford* do

solemnly swear, that I will bear true faith and allegiance to the **United States of America**, and that I will serve them honestly and faithfully against all their

enemies or opposers whomsoever; and that I will observe and obey the orders of the President of the United States, and the orders of the officers appointed over

me, according to the Rules and Articles of War.

Sworn and subscribed to, at *Wyandotte*

this *25* day of *July* 1864

BEFORE

*P. H. Minor 2<sup>d</sup> Lieut*  
*Recruiting 1<sup>st</sup> Regt. C. Artillery*

*Louis X. Buford*  
*made*

I CERTIFY, ON HONOR, That I have carefully examined the above-named Volunteer, agreeably to the General Regulations of the Army, and that, in my opinion, he is free from all bodily defects and mental infirmity, which would in any way disqualify him from performing the duties of a soldier.

*Viffin Binks*  
*Surgeon of Enrollments*  
*North Dist. Kansas*

EXAMINING SURGEON.

I CERTIFY, ON HONOR, That I have minutely inspected the Volunteer, *Louis Buford* previously to his enlistment, and that he was entirely sober when enlisted; that, to the best of my judgment and belief, he is of lawful age; and that, in accepting him as duly qualified to perform the duties of an able-bodied soldier, I have strictly observed the Regulations which govern the recruiting service.

This soldier has *black* eyes, *black* hair, *black* complexion, is *5* feet *1* inches high.

*P. H. Minor 2<sup>d</sup> Lieut*  
*1<sup>st</sup> Regt. C. Artillery*

RECRUITING OFFICER.

the ..... day of ..... 186 , at ..... Mustered into the service of the United States, in Company ..... Regiment of ..... Volunteers, on



NOTE 1.—This blank will be used for both enlistments and re-enlistments—enlistment of veterans, &c., &c., in the volunteer service. They will be made out in duplicate in all cases—one to accompany the recruiting return of the superintendent (not the recruiting officer) to the Adjutant General, and one to accompany the accounts of the officer who pays bounty, &c. The Regiment and Company in which the soldier last served should be given on the back.

NOTE 2.—An enlistment holds to service. A muster-in must, in all cases, precede payment of pay, bounty, pension, &c. A muster-in roll must, in all cases, be filed in the Adjutant General's Office as evidence of muster-in. The mustering officer, commissary, or assistant commissary of musters, as the case may be, will countersign both enlistments as having mustered the soldier into the service of the United States before either of them is given to the disbursing officer.

DECLARATION OF RECRUIT.

I, Louis Buford desiring to VOLUNTEER as a Soldier in the Army of the United States, for the term of THREE YEARS, Do Declare, That I am 44 years and \_\_\_\_\_ months of age; that I have never been discharged from the United States service on account of disability or by sentence of a court-martial, or by order before the expiration of a term of enlistment; and I know of no impediment to my serving honestly and faithfully as a soldier for three years.

GIVEN at Maryandotte the 25<sup>th</sup> day of July 1864

Witness: W. A. Burnham Louis Buford  
made

No. 42

Louis Buford

Volunteered at Maryandotte

July 25<sup>th</sup> 1864

By P. A. Minor 2<sup>nd</sup> Lieut

1<sup>st</sup> Regiment of Artillery

enlistment, last served in Company ( )

Reg't of \_\_\_\_\_

Discharged \_\_\_\_\_ 18 .

CONSENT IN CASE OF MINOR.

I, \_\_\_\_\_ Do CERTIFY, That I am the \_\_\_\_\_ of \_\_\_\_\_; that the said \_\_\_\_\_ is \_\_\_\_\_ years of age; and I do hereby freely give my CONSENT to his volunteering as a SOLDIER in the ARMY OF THE UNITED STATES for the period of THREE YEARS.

GIVEN at \_\_\_\_\_ the \_\_\_\_\_ day of \_\_\_\_\_

Witness: \_\_\_\_\_

VOLUNTEER ENLISTMENT.

STATE OF

Kansas



TOWN OF

Wyandotte Co

I, Louis Bonford

born in Jefferson Co

in the State of Kentucky aged 24 years,

and by occupation a Farmer. Do HEREBY ACKNOWLEDGE to have

volunteered this 25 day of July 1864,

to serve as a Soldier in the Army of the United States of America, for the

period of THREE YEARS, unless sooner discharged by proper authority: Do also

agree to accept such bounty, pay, rations, and clothing, as are, or may be, estab-

lished by law for volunteers. And I, Louis Bonford do

solemnly swear, that I will bear true faith and allegiance to the United States

of America, and that I will serve them honestly and faithfully against all their

enemies or opposers whomsoever; and that I will observe and obey the orders of

the President of the United States, and the orders of the officers appointed over

me, according to the Rules and Articles of War.

Sworn and subscribed to, at Wyandotte

this 25 day of July 1864 } Louis Bonford

BEFORE P. H. Minor 2nd Lieut } made

Recruiting 1st Lt Colrd Artletty

I CERTIFY, ON HONOR, That I have carefully examined the above-named Volunteer, agreeably

to the General Regulations of the Army, and that, in my opinion, he is free from all bodily defects and

mental infirmity, which would in any way disqualify him from performing the duties of a soldier.

Jiffie Sinks  
Surgeon Board of Enrollment  
North Dist. Kansas  
EXAMINING SURGEON.

I CERTIFY, ON HONOR, That I have minutely inspected the Volunteer, Louis Bonford

previously to his enlistment, and that he was entirely sober when enlisted; that, to the best of my

judgment and belief, he is of lawful age; and that, in accepting him as duly qualified to perform the duties

of an able-bodied soldier, I have strictly observed the Regulations which govern the recruiting service.

This soldier has black eyes, black hair, black complexion, is 5 feet

1 inches high.

P. H. Minor 2nd Lieut  
1st Lt Colrd Artletty Volunteers,  
RECRUITING OFFICER.

the 25th day of July 1864 at Wyandotte Co Kansas  
from state of Kentucky  
Mustered into the service of the United States, in Company  
Regiment of  
Volunteers, on

Order Releasing  
Lewis Buford  
Ind Cold & Botley  
March 23<sup>rd</sup> 1865

Headquarters, Department of <sup>Mo</sup> Kansas,  
OFFICE OF PROVOST MARSHAL GENERAL.

Fort Leavenworth, March 23 1865.

S. Bennett:

Will please release from  
Lewis Buford Capt Bty  
Co'd. Arty. per arrest

Rec'd  
M. H. V. V. V.  
10/1 - A.

Rel by Order Maj' Genl Candy

Headquarters, Dept of the Army,  
St. Leavenworth, Mich 19th, 1865.

The within case will  
be tried by the S. D. Ct. in-  
ferred by S. D. No. 74, S. D., from  
these headquarters.

By Order of  
Maj. Gen. Dodge

*Lucey Eaton*  
Maj. & Judge Advocate

Court Martial Rooms  
St Leavenworth Mich 22<sup>nd</sup>

Respectfully returned to  
the Judge Advocate of the  
Department with the infor-  
mation that as far as I can  
learn from the officers of the  
Battery, there can be no evi-  
dence whatever brought against  
this man, and would therefore  
recommend the withdrawal of the  
charges

Respectfully A. C. Ellis.

*W. H. J. A.*  
Resid. of A. C. D. of Army, Mich 19th, 1865

<sup>360</sup>  
Judge Advocate Office,  
St. Leavenworth, March 23, 1865.

Respectfully referred to  
Major Heath, Asst S. D. S., with  
recommendation that the within  
named <sup>Admiral</sup> be released.

*J. A. McE...*  
Major and Judge Advocate

Release

H.

Released and  
ordered to Report  
to Co Commander

*J. J. B...*

Lewis Buford  
Ind Battery  
No. Col. Light  
Arty

Charges against  
 Lewis Buford, private Independent  
 Battery U.S. Colored Light Artillery.

Charge  
 Desertion.

Specification

In this that he Lewis Buford  
 private of Independent Battery U.S.  
 Colored Light Artillery, a duly enlist-  
 ed Soldier, in the service of the United  
 States did without leave absent him-  
 self from and desert said service  
 on or about the 28<sup>th</sup> day of October 1864,  
 and remain absent until arrested on  
 or about the 10<sup>th</sup> day of January 1865

This in the States of Kansas and  
 Missouri

James H. Burnett  
 1<sup>st</sup> Lieut In Charge of Troop

Witness  
 H. Ford Douglas, Capt In Charge Battery U.S. Light Art.  
 Wm S Matthews, 1<sup>st</sup> Lieut " " " " " "

*Surgeon Frederick*

Adpt. Batt'y U.S. Col'd L. Art'y

*Private*

*Private*

CARD NUMBERS.

1	6233727	26
2	6233879	27
3	9132908	28
4		29
5		30
6		31
7		32
8		33
9		34
10		35
11		36
12		37
13		38
14		39
15		40
16		41
17		42
18		43
19		44
20		45
21		46
22		47
23		48
24		49
25		50

Book Mark:

See also

*D* | Indpt. Batt'y. | **U.S.C.T.**

*Frederick Burgess*

....., Indpt. Batt'y, U. S. Col'd L. Art'y.

Appears on

**Battery Descriptive Book**

of the organization named above.

**DESCRIPTION.**

Age *21* years; height *5 feet 8 1/2* inches.

Complexion *Black*

Eyes *Dark*; hair *Black*

Where born *Maehula Tenn*

Occupation *Laborer*

**ENLISTMENT.**

When *July 12*, 1864

Where *Avenworth Ga*

By whom *A. Mathers*; term *3* y'rs.

Remarks: .....

.....  
.....  
.....  
.....  
.....  
.....  
.....  
.....

*Shelton*



B | Indpt. Battery. | U.S.C.T.

*Frederick Burgess*

*Pat*, Indpt. Battery, U. S. Col'd L. Art'y.

Appears on

**Battery Muster-in and Descriptive Roll**

of the organization named above. Roll dated

*Leavenworth Mo Dec 23*, 1864.

Where born *Nashville Tenn.*

Age *25* y'rs; occupation *Laborer*

When enlisted *July 12*, 1864.

Where enlisted *Leavenworth Mo*

For what period enlisted *3* years.

Eyes *dk*; hair *dk*

Complexion *Brn*; height *5* ft. *8 1/2* in.

When mustered in *July 16*, 1864.

Where mustered in *Leavenworth*

Bounty paid \$ *100*; due \$ *100 00/100*

Where credited

Battery to which assigned

Remarks: *C. M. Dist Co.*  
*Sgt J. D. Zarnad*  
*Leavenworth Mo*

Book mark :

(356g) *J. H. Chesley* Copyist.

*B* | Indpt. Battery. | **U.S.C.T.**

*Fredrick Burgess*

*Pvt*, Indpt. Battery, U. S. Col'd L. Art'y.

Appears on

**Battery Muster Roll**

for *Enlistment to Dec 31*, 186 *4*.

Present or absent *Present*

Stoppage, \$ *100* for

Due Gov't, \$ *100* for

Valuation of horse, \$ *100*

Valuation of horse equipments, \$ *100*

Remarks:

*at home on Dec. Roll of Batt'y*

Book mark:

*J. H. Schuch*  
(358) Copyist.

Burgess Frederick  
 P, Co. 1st Bn. 1st Regt. U.S.C.L.A.  
 2 Enclosures.

Bed Cards .....	Final Statements .....
Burial Records .....	Furloughs or L. of A .....
Certs. of Dis. for Discharge .....	Med. Certificates .....
C. M. Charges .....	Med. Des. Lists .....
Descriptive Lists .....	Orders .....
Discharge Certificates .....	Pris. of War Record .....
Enlistment Papers / .....	Resignations .....

Other papers relating to—

Admission to Hosp'l .....	Furlough or L. of A .....
Casualty Sheet .....	Med. Examination .....
Confinement .....	Misc. Information / .....
Contracts .....	Pay or Clothing .....
Death or Effects .....	Personal Reports .....
Desertion .....	Rank .....
Discharge from Hosp'l .....	Transfer to Hosp'l .....
Discharge from Service .....	Transfer to V. R. C. .....
Duty .....	Transportation .....

DECLARATION OF RECRUIT.

NOTE 1.—This blank will be used for both enlistments and re-enlistments—enlistment of veterans, &c., &c., in the volunteer service. They will be made out in duplicate in all cases—one to accompany the recruiting return of the superintendent (not the recruiting officer) to the Adjutant General, and one to accompany the accounts of the officer who pays bounty, &c. The Regiment and Company in which the soldier last served should be given on the back.

NOTE 2.—An enlistment holds to service. A muster-in must, in all cases, precede payment of pay, bounty, pension, &c. A muster-in roll must, in all cases, be filed in the Adjutant General's Office as evidence of muster-in. The mustering officer, commissary, or assistant commissary of musters, as the case may be, will countersign both enlistments as having mustered the soldier into the service of the United States before either of them is given to the disbursing officer.

I, Fredrick Bergelf desiring to VOLUNTEER as a Soldier in the Army of the United States, for the term of THREE YEARS, Do Declare, That I am 25 years and 2 1/2 months of age; that I have never been discharged from the United States service on account of disability or by sentence of a court martial, or by order before the expiration of a term of enlistment; and I know of no impediment to my serving honestly and faithfully as a soldier for three years.

GIVEN at Leavenworth Mo the 12<sup>th</sup> day of July 1864

Witness:

C. H. Langston

Fredrick Bergelf  
mark

Discharged 18

enlistment; last served in Company ( )  
Reg't of

12<sup>th</sup> Regiment of Cavalry  
for Colonel's Battery

By John J. ...

Volunteered at Leavenworth Mo 12<sup>th</sup> 1864

Fredrick Bergelf

No. 3  
4  
1864

CONSENT IN CASE OF MINOR.

I, \_\_\_\_\_ Do CERTIFY, That I am \_\_\_\_\_; that the \_\_\_\_\_ of \_\_\_\_\_; that the said \_\_\_\_\_ is \_\_\_\_\_ years of age; and I do hereby freely give my CONSENT to his volunteering as a SOLDIER in the ARMY OF THE UNITED STATES for the period of THREE YEARS.

GIVEN at \_\_\_\_\_ the \_\_\_\_\_ day of \_\_\_\_\_

Witness:

VOLUNTEER ENLISTMENT.

STATE OF



TOWN OF

I, *Fredrick Burgess* born in *Nashville*  
 in the State of *Tennessee* aged *25* years,  
 and by occupation a *Labourer* Do HEREBY ACKNOWLEDGE to have  
 volunteered this *twelfth* day of *July* 1864,  
 to serve as a **Soldier** in the **Army of the United States of America**, for  
 the period of **THREE YEARS**, unless sooner discharged by proper authority:  
 Do also agree to accept such bounty, pay, rations, and clothing, as are, or may be,  
 established by law for volunteers. And I, *Fredrick Burgess* do  
 solemnly swear, that I will bear true faith and allegiance to the **United States  
 of America**, and that I will serve them honestly and faithfully against all  
 their enemies or opposers whomsoever; and that I will observe and obey the  
 orders of the President of the United States, and the orders of the officers  
 appointed over me, according to the Rules and Articles of War.

Sworn and subscribed to, at *Gavemuth* on  
 this *12<sup>th</sup>* day of *July* 1864 } *Fredrick Burgess*  
 BEFORE *R. J. Hinton* } *mark*  
*Capt 2<sup>d</sup> 16<sup>th</sup> Coe Vol.*

I CERTIFY, ON HONOR, That I have carefully examined the above-named Volunteer, agreeably  
 to the General Regulations of the Army, and that, in my opinion, he is free from all bodily defects and  
 mental infirmity, which would in any way disqualify him from performing the duties of a soldier.

*J. J. Binks*  
 Surg Board of Enrollment  
 North Dist Kansas  
 EXAMINING SURGEON.

I CERTIFY, ON HONOR, That I have minutely inspected the Volunteer, *Fredrick Burgess*,  
 previously to his enlistment, and that he was entirely sober when enlisted; that, to the best of my  
 judgment and belief, he is of lawful age; and that, in accepting him as duly qualified to perform the  
 duties of an able-bodied soldier, I have strictly observed the Regulations which govern the recruiting  
 service. This soldier has *dark* eyes, *black* hair, *black* complexion, is *5*  
 feet *5 1/2* inches high.

*Wm. D. Matthews*  
*25<sup>th</sup> Lieut 1<sup>st</sup> D.C.B. Volunteers,*  
 Regiment of  
 RECRUITING OFFICER.

(A. G. O. No. 74 & 76.)

Mustered into the service of the United States, for three years or during the war, from date of enlistment, in Company *1<sup>st</sup> 34<sup>th</sup>*  
*Regiment of 34<sup>th</sup> Me. Inf.*  
 Volunteers, on the *16<sup>th</sup>* day of *July*, 1864, at *Gavemuth, Tenn.*

✓  
Frederick Douglass  
Sindley & Bayly

Wheat & Rice

Adjutant General's Office,

COLORED TROOPS BRANCH,

November 15, 1875

Mr. Ellsworth Vol. C. T., 187

Wanted in the case of Frederick Burgess, Pvt., Co. Indpt. Batty, ~~Indpt~~ U.S. Col. (Indpt.) who appeared in signing the final disbandment of them, last found on the R. Road organization to Decr 31. 1864 as Present for duty.

Respectfully,

J. A. Woodward  
Chief Clerk.

In J. H. Hutton

Adjutant General's Office,

Division of Discontinued Commands.

Nov 19<sup>th</sup>, 1875

Vol. C. T., 187  
Reply in case of Frederick Burgess  
Indpt. Battery U.S.C.A. (La.)

Robt.

Batty & Co. 10th reports him deserted "Sept 4." 64 at "Fort Leavenworth. Kas" No further record -

Batty's Mory Rpts are not on file -

J. A. H.

*Wm*  
*Wesley, Wram*  
 Apt. Batt'y U.S. Col'd L. Art'y.

*Private*      *Private*

CARD NUMBERS.

1	6233610	36
2	6233743	37
3	6233892	38
4	6234065	39
5	6234203	40
6	6234370	41
7	6234532	42
8	9137924	43
9		44
10		45
11		46
12		47
13		48
14		49
15		50
16		
17		
18		
19		
20		
21		
22		
23		
24		
25		

Book Mark:

See also



*D* | Indpt. Batt'y. | **U.S.C.T.**

*Hiram Bailey*

....., Indpt. Batt'y, U. S. Col'd L. Art'y.

Appears on

**Battery Descriptive Book**

of the organization named above.

**DESCRIPTION.**

Age *39* years; height *5* feet *4* inches.

Complexion *Black*

Eyes *Black*; hair *Black*

Where born *Scott A. Antwerp*

Occupation *Labour*

**ENLISTMENT.**

When *Dec. 3*, 186 *4*

Where *St. Paul's A. Camp.*

By whom *A. Matthews*; term *3* y'rs.

Remarks: .....

.....

.....

.....

.....

.....

.....

.....

.....

*Healroot*

B

Indpt. Battery.

U.S.C.T.

Liam Bunley

Appears with rank of *Priv* on**Muster and Descriptive Roll of a Detachment of U. S. Vols. forwarded**

for the Indpt. Batt'y, U. S. Col'd L. Arty. Roll dated

Leavenworth, *Ks.*, Dec 5, 1864.Where born *Scott Co, Ken.*Age *39* y'rs; occupation *Labourer*When enlisted *Dec 3*, 1864.Where enlisted *St. Leavenworth*For what period enlisted *3* years.Eyes *Blk*; hair *Blk*Complexion *Blk*; height *5* ft. *4* in.When mustered in *Dec. 5*, 1864.Where mustered in *Leavenworth, Ks.*Bounty paid \$ *100*; due \$ *100*

Where credited

Battery to which assigned

Remarks: *Credited to Northern District Kansas, 19<sup>th</sup> Sub. Dist. 1st Ward. Government Reserve, Leavenworth City. Leav- over*

Book mark:

E. L. Hamilton

(339)

Copyist.

B

Indpt. Battery. U.S.C.T.

Kieran Parley

Co., Indpt. Battery, U. S. Col'd L. Art'y.

Appears on

Battery Muster-in and Descriptive Roll

of the organization named above. Roll dated

Leavenworth Mo Dec 23, 1864.

Where born Scott Co, Ky,

Age 39 y'rs; occupation Laborer

When enlisted Dec 3<sup>d</sup>, 1864.

Where enlisted Fort Leavenworth Mo.

For what period enlisted 3 years.

Eyes Blu; hair Blu

Complexion Blu; height 5 ft. 4 in.

When mustered in Dec 5, 1864.

Where mustered in Leavenworth

Bounty paid \$100<sup>00</sup>/<sub>100</sub>; due \$200<sup>00</sup>/<sub>100</sub>

Where credited

Battery to which assigned

Remarks. Co M. Dist No 19<sup>th</sup> I.D. 1st Ward Leavenworth Mo

Book mark :

J. H. Schoddy (8567) Copyist.

JAN. 17

6233610

\*1891\*

enworth County. Vol.  
Receipt & entitled to  
County.

49

Indpt. Battery.

U.S.C.T.

Hiram Parley

PA, Indpt. Battery, U. S. Col'd L. Art'y.

Appears on

Battery Muster Roll

for July's Muster to Dec 31, 1864.

Present or absent Present

Stoppage, \$ 100 for

Due Gov't, \$ 100 for

Valuation of horse, \$ 100

Valuation of horse equipments, \$ 100

Remarks:

Book mark:

J. Schudy

(358)

Copyist.

49

Indpt. Battery. | **U.S.C.T.**

*Miriam Purley*

*Pat*, Indpt. Battery, U. S. Col'd L. Art'y.

Appears on

**Battery Muster Roll**

for *Jan'y & Feb*, 186<sup>*6*</sup>.

Present or absent *Present*

Stoppage, \$ 100 for

Due Gov't, \$ 100 for

Valuation of horse, \$ 100

Valuation of horse equipments, \$ 100

Remarks:

Book mark:

*J. Schoder*  
(358) Copyist.

*B* | Indpt. Battery. | **U.S.C.T.**

*William Purley,*  
*Pr*, Indpt. Battery, U. S. Col'd L. Art'y.

Appears on

**Battery Muster Roll**

for *Mar, & Apl,*, 1865.

Present or absent *Present,*

Stoppage, \$ 100 for

Due Gov't, \$ 100 for

Valuation of horse, \$ 100

Valuation of horse equipments, \$ 100

Remarks:

Book mark:

*Porter*

*B* | Indpt. Battery. | **U.S.C.T.**

*Myron Purley,*  
*B*, Indpt. Battery, U. S. Col'd L. Art'y.

Appears on

**Battery Muster Roll**

for *May + June*, 186 *5*

Present or absent *Present*

Stoppage, \$ 100 for

Due Gov't, \$ 100 for

Valuation of horse, \$ 100

Valuation of horse equipments, \$ 100

Remarks:  
\_\_\_\_\_  
\_\_\_\_\_  
\_\_\_\_\_  
\_\_\_\_\_  
\_\_\_\_\_  
\_\_\_\_\_  
\_\_\_\_\_

Book mark: \_\_\_\_\_

*Parter,*

Copyist.



*P* | Indpt. Battery. | **U.S.C.T.**

*Nathan Burley*  
*N*, Indpt. Battery U. S. Col'd Light Art'y.

Appears on **Batt'y Muster-out Roll**, dated  
*St. Lawrence Co., N.Y., July 22*, 1865.  
 Muster-out to date *July 22*, 1865.  
 Last paid to *Dec. 31*, 1864.

**Clothing account:**

Last settled....., 186 ; drawn since \$ *30* <sup>*64*</sup>/<sub>100</sub>,

Due soldier \$ .....<sup>100</sup>; due U. S. \$ .....<sup>100</sup>

Am't for cloth'g in kind or money adv'd \$ .....<sup>100</sup>

Due U. S. for arms, equipments, &c., \$ .....<sup>100</sup>

Bounty paid \$ *100* <sup>100</sup>; due \$ *none* <sup>100</sup>,

Remarks:.....  
 .....  
 .....  
 .....  
 .....  
 .....

Book mark: *V, 219, P. 13, 75, 84, 61, 561.*

*Paster*

Burley Hiram

, Co. 1st Batt Reg't U. S. C. A

2 Enclosures.

Bed Cards .....	Final Statements .....
Burial Records .....	Furloughs or L. of A .....
Certs. of Dis. for Discharge .....	Med. Certificates .....
C. M. Charges .....	Med. Des. Lists .....
Descriptive Lists .....	Orders .....
Discharge Certificates .....	Pris. of War Record .....
Enlistment Papers ..... 2	Resignations .....

Other papers relating to—

Admission to Hosp'l .....	Furlough or L. of A .....
Casualty Sheet .....	Med. Examination .....
Confinement .....	Misc. Information .....
Contracts .....	Pay or Clothing .....
Death or Effects .....	Personal Reports .....
Desertion .....	Rank .....
Discharge from Hosp'l .....	Transfer to Hosp'l .....
Discharge from Service .....	Transfer to V. R. C. .....
Duty .....	Transportation .....

NOTE 1.—This blank will be used for both enlistments and re-enlistments—enlistment of veterans, &c., &c., in the volunteer service. They will be made out in duplicate in all cases—one to accompany the recruiting return of the superintendent (not the recruiting officer) to the Adjutant General, and one to accompany the accounts of the officer who pays bounty, &c. The Regiment and Company in which the soldier last served should be given on the back.

NOTE 2.—An enlistment holds to service. A muster-in must, in all cases, precede payment of pay, bounty, pension, &c. A muster-in roll must, in all cases, be filed in the Adjutant General's Office as evidence of muster-in. The mustering officer, commissary, or assistant commissary of musters, as the case may be, will countersign both enlistments as having mustered the soldier into the service of the United States before either of them is given to the disbursing officer.

DECLARATION OF RECRUIT.

I, Hiram Burley desiring to VOLUNTEER as a Soldier in the Army of the United States, for the term of THREE YEARS, Do Declare, That I am thirty-nine 39 years and \_\_\_\_\_ months of age; that I have never been discharged from the United States service on account of disability or by sentence of a court martial, or by order before the expiration of a term of enlistment; and I know of no impediment to my serving honestly and faithfully as a soldier for three years.

GIVEN at Fort Leavenworth State of Kansas the third day of December 1864

Witness: Benjamin Wilson Hiram Burley  
marks

No. ....

Hiram Burley  
Volunteered at Fort Leavenworth  
third December 1864,  
By Wm. S. Matthews Adj. Gen.  
Major George M. S. C. Whittow

..... enlistment; last served in Company ( )  
Adj. Bally Regt of W. D. Calhoun 1st Regt  
Discharged ..... 18 ..

CONSENT IN CASE OF MINOR.

I, ..... Do CERTIFY, That I am the ..... of .....; that the said ..... is ..... years of age; and I do hereby freely give my CONSENT to his volunteering as a SOLDIER in the ARMY OF THE UNITED STATES for the period of THREE YEARS.

GIVEN at ..... the ..... day of .....

Witness: .....

4

VOLUNTEER ENLISTMENT.

STATE OF

TOWN OF

Kansas



Fort Leavenworth

I, Hiram Buxley born in Scott County in the State of Kentucky aged 39 thirty nine years, and by occupation a Laborer Do HEREBY ACKNOWLEDGE to have volunteered this third (3rd) day of December 1864, to serve as a Soldier in the Army of the United States of America, for the period of THREE YEARS, unless sooner discharged by proper authority: Do also agree to accept such bounty, pay, rations, and clothing, as are, or may be, established by law for volunteers. And I, Hiram Buxley do solemnly swear, that I will bear true faith and allegiance to the United States of America, and that I will serve them honestly and faithfully against all their enemies or opposers whomsoever; and that I will observe and obey the orders of the President of the United States, and the orders of the officers appointed over me, according to the Rules and Articles of War.

Sworn and subscribed to, at Fort Leavenworth this third day of December 1864. BEFORE Wm D Matthews Lieut Recruiting officer Indpr Battery U.S. col artillery Hiram Buxley his mark

I CERTIFY, ON HONOR, That I have carefully examined the above-named Volunteer, agreeably to the General Regulations of the Army, and that, in my opinion, he is free from all bodily defects and mental infirmity, which would in any way disqualify him from performing the duties of a soldier.

Tiffin Binks Surg Board of Enrolled North Dist Kansas EXAMINING SURGEON.

I CERTIFY, ON HONOR, That I have minutely inspected the Volunteer, Hiram Buxley previously to his enlistment, and that he was entirely sober when enlisted; that, to the best of my judgment and belief, he is of lawful age; and that, in accepting him as duly qualified to perform the duties of an able-bodied soldier, I have strictly observed the Regulations which govern the recruiting service. This soldier has black eyes, black hair, black complexion, is 5 feet 4 inches high.

Wm D Matthews Lieut Indpr Battery U.S. col Artillery RECRUITING OFFICER.

Buxley U.S. Col Regiment Army Signal Volunteers on the 5th day of December 1864 at Leavenworth Kan

Vertical handwritten signatures and notes on the right side of the document.

DECLARATION OF RECRUIT.

I, Hiram Barkley desiring to VOLUNTEER as a Soldier in the Army of the United States, for the term of THREE YEARS, Do Declare, That I am thirty nine years and \_\_\_\_\_ months of age; that I have never been discharged from the United States service on account of disability or by sentence of a court martial, or by order before the expiration of a term of enlistment; and I know of no impediment to my serving honestly and faithfully as a soldier for three years.

GIVEN at Fort Leavenworth State of Kansas the third day of December 1864

Witness: Benjamin Wilson Hiram Barkley  
his

NOTE 1.—This blank will be used for both enlistments and re-enlistments—enlistment of veterans, &c. &c., in the volunteer service. They will be made out in duplicate in all cases—one to accompany the recruiting return of the appointing officer (not the recruiting officer) to the Adjutant General, and one to accompany the accounts of the officer who pays bounty, &c. The Regiment and Company in which the soldier last served should be given on the back.  
NOTE 2.—An enlistment holds to service. A muster-in must, in all cases, precede payment of pay, bounty, pension, &c. A muster-in roll must, in all cases, be filed in the Adjutant General's Office as evidence of muster-in. The mustering officer, commissary, or assistant commissary of musters, as the case may be, will countersign both enlistments as having mustered the soldier into the service of the United States before either of them is given to the disbursing officer.

Rec'd from 2nd. Aud. Nov. 23d 1892

enlistment; last served in Company ( )  
Reg't of \_\_\_\_\_  
Discharged \_\_\_\_\_ 18 .

No. 110  
Hiram Barkley  
Volunteered at Fort Leavenworth  
third December 1864  
By W. D. Matthews 2d Lieut  
Regt. 1st Artillery

CONSENT IN CASE OF MINOR.

I, \_\_\_\_\_ DO CERTIFY, That I am the \_\_\_\_\_ of \_\_\_\_\_; that the said \_\_\_\_\_ is \_\_\_\_\_ years of age; and I do hereby freely give my CONSENT to his volunteering as a SOLDIER in the ARMY OF THE UNITED STATES for the period of THREE YEARS.

GIVEN at \_\_\_\_\_ the \_\_\_\_\_ day of \_\_\_\_\_

Witness: \_\_\_\_\_

1st war (1861-1865)

VOLUNTEER ENLISTMENT.

STATE OF



TOWN OF

Fort Leavenworth

I, Hiram Burley born in Scott County  
 in the State of Kentucky aged 39 Thirty nine years,  
 and by occupation a Laborer Do HEREBY ACKNOWLEDGE to have  
 volunteered this Third (3<sup>rd</sup>) day of December 1864,  
 to serve as a Soldier in the Army of the United States of America, for  
 the period of THREE YEARS, unless sooner discharged by proper authority:  
 Do also agree to accept such bounty, pay, rations, and clothing, as are, or may be,  
 established by law for volunteers. And I, Hiram Burley do  
 solemnly swear, that I will bear true faith and allegiance to the United States  
of America, and that I will serve them honestly and faithfully against all  
 their enemies or opposers whomsoever; and that I will observe and obey the  
 orders of the President of the United States, and the orders of the officers  
 appointed over me, according to the Rules and Articles of War.

Sworn and subscribed to, at Fort Leavenworth  
 this Third day of December 1864, Hiram Burley  
 BEFORE Wm D Matthews Lieut  
Recruiting Officer Indpt Btry Col Artillery

I CERTIFY, ON HONOR, That I have carefully examined the above-named Volunteer, agreeably  
 to the General Regulations of the Army, and that, in my opinion, he is free from all bodily defects and  
 mental infirmity, which would in any way disqualify him from performing the duties of a soldier.

Jeffie Sinks  
Surg Board of Enrollment  
North Dist Kansas  
 EXAMINING SURGEON.

I CERTIFY, ON HONOR, That I have minutely inspected the Volunteer, Hiram Burley  
 previously to his enlistment, and that he was entirely sober when enlisted; that, to the best of my  
 judgment and belief, he is of lawful age; and that, in accepting him as duly qualified to perform the  
 duties of an able-bodied soldier, I have strictly observed the Regulations which govern the recruiting  
 service. This soldier has black eyes, black hair, black complexion, is 5  
 feet 4 inches high.

Wm D Matthews Lieut  
Indpt Btry U.S. Col Artillery  
 RECRUITING OFFICER.

Mustered into the service of the United States, for three years or during the war, from date of enlistment, in Company  
Burley U.S. Col Regiment of Artillery Sgt Volunteers, on the 5<sup>th</sup> day of December, 1864 at Leavenworth  
Indpt Btry U.S. Col Artillery

Wm D Matthews  
Capt & Rec. Marshal  
Indpt Btry U.S. Col Artillery

(A. G. O. No. 74 & 76.)

*Wesley Patton*

**1st Batt'y U.S. Col'd L. Art'y**

*Private*

*Private*

**CARD NUMBERS.**

1	6233728	26
2	6233880	27
3	6234066	28
4	6234205	29
5	6234371	30
6	6234533	31
7	9132909	32
8		33
9		34
10		35
11		36
12		37
13		38
14		39
15		40
16		41
17		42
18		43
19		44
20		45
21		46
22		47
23		48
24		49
25		50

Book Mark:

See also

*B* | Indpt. Batt'y. | **U.S.C.T.**

*Patton Burley*

....., Indpt. Batt'y, U. S. Col'd L. Art'y.

Appears on

**Battery Descriptive Book**

of the organization named above.

**DESCRIPTION.**

Age *33* years; height *5* feet *4* inches.

Complexion *Black*

Eyes *Black*; hair *Black*

Where born *Virginia*

Occupation *Farmer*

**ENLISTMENT.**

When *July 14*, 186 *4*.

Where *Ferrumouth Mo*

By whom *A. Matthews*; term *3* y'rs.

Remarks: .....

.....

.....

.....

.....

.....

.....

.....

.....

*Halbrook*



B

Indpt. Battery.

U.S.C.T.

Patton Purley

Pat, Indpt. Battery, U. S. Col'd L. Art'y.

Appears on

**Battery Muster-in and Descriptive Roll**

of the organization named above. Roll dated

Leavenworth Mo Dec 29, 1864.

Where born Va

Age 33 y'rs; occupation Farmer

When enlisted July 14, 1864.

Where enlisted Leavenworth Mo

For what period enlisted 3 years.

Eyes Blue; hair Blue

Complexion Bru; height 5 ft. 4 in.

When mustered in July 16, 1864.

Where mustered in Leavenworth

Bounty paid \$ 25<sup>00</sup>/<sub>100</sub>; due \$ 75<sup>00</sup>/<sub>100</sub>

Where credited

Battery to which assigned

Remarks: W. M. Dist Co  
2nd SD. 4th Ward  
Leavenworth Mo.

Book mark :

(356g) J. H. Scherley Copyist.

*B* | Indpt. Battery. | **U.S.C.T.**

*Patton Burley*

*Pat*, Indpt. Battery, U. S. Col'd L. Art'y.

Appears on

**Battery Muster Roll**

for *Enlistment to Dec 31*, 186 *✓*

Present or absent *Present*

Stoppage, \$ *100* for

Due Gov't, \$ *100* for

Valuation of horse, \$ *100*

Valuation of horse equipments, \$ *100*

Remarks:

Book mark:

*J. A. Schudy*  
(358) Copyist.

*D*

Indpt. Battery. | **U.S.C.T.**

*Patton Burley*

*Priv*, Indpt. Battery, U. S. Col'd L. Art'y.

Appears on

**Battery Muster Roll**

for *Jany Feb*, 186<sup>5</sup>

Present or absent *Present*

Stoppage, \$ \_\_\_\_\_ <sup>100</sup> for \_\_\_\_\_

Due Gov't, \$ \_\_\_\_\_ <sup>100</sup> for \_\_\_\_\_

Valuation of horse, \$ \_\_\_\_\_ <sup>100</sup>

Valuation of horse equipments, \$ \_\_\_\_\_ <sup>100</sup>

Remarks: \_\_\_\_\_  
\_\_\_\_\_  
\_\_\_\_\_  
\_\_\_\_\_  
\_\_\_\_\_  
\_\_\_\_\_  
\_\_\_\_\_

Book mark: \_\_\_\_\_

*J. H. Schudy*

(358)

Copyist.

*S* | Indpt. Battery. | **U.S.C.T.**

*Patton Burley,*  
*M*, Indpt. Battery, U.S. Col'd L. Art'y.

Appears on

**Battery Muster Roll**

for *May & Apr*, 1865.

Present or absent *Present*

Stoppage, \$ 100 for

Due Gov't, \$ 100 for

Valuation of horse, \$ 100

Valuation of horse equipments, \$ 100

Remarks:

Book mark:

*Parter*

*B* | Indpt. Battery. | **U.S.C.T.**

*Patton Purley,*

*Pr*, Indpt. Battery, U.S. Col'd L. Art'y.

Appears on

**Battery Muster Roll**

for *May & June*, 1865.

Present or absent *Present,*

Stoppage, \$ 100 for

Due Gov't, \$ 100 for

Valuation of horse, \$ 100

Valuation of horse equipments, \$ 100

Remarks:

Book mark: *Patton Purley*

*Patton*

B | *Dr. Duty* U.S.C.T.

*Patton Purley*  
*Co. Ind. Reg't* U. S. Col'd *Arly*

Appears on **Co. Muster-out Roll**, dated  
*At Leavenworth Mo July 22*, 1865.

Muster-out to date *July 22*, 1865.

Last paid to *Dec 31*, 1864.

Clothing account:

Last settled....., 186 ; drawn since \$ *43*<sup>*19*</sup>/<sub>100</sub>

Due soldier \$.....<sub>100</sub>; due U. S. \$.....<sub>100</sub>

Am't for cloth'g in kind or money adv'd \$.....<sub>100</sub>

Due U. S. for arms, equipments, &c., \$.....<sub>100</sub>

Bounty paid \$ *25*<sub>100</sub>; due \$ *25*<sub>100</sub>

Remarks:.....

.....

.....

.....

.....

Book mark:.....

.....

.....

.....

.....

.....

.....

.....

.....

.....

.....

.....

.....

.....

.....

.....

.....

(361)

*W. Spencer*

*4* Copyist.

*Burley Patton*

, Co. *1st Batt* Reg't *W.S.C. A*

**3** Enclosures.

Bed Cards .....	Final Statements .....
Burial Records .....	Furloughs or L. of A .....
Certs. of Dis. for Discharge .....	Med. Certificates .....
C. M. Charges .....	Med. Des. Lists .....
Descriptive Lists .....	Orders .....
Discharge Certificates .....	Pris. of War Record .....
Enlistment Papers <b>3</b> .....	Resignations .....

Other papers relating to—

Admission to Hosp'l .....	Furlough or L. of A .....
Casualty Sheet .....	Med. Examination .....
Confinement .....	Misc. Information .....
Contracts .....	Pay or Clothing .....
Death or Effects .....	Personal Reports .....
Desertion .....	Rank .....
Discharge from Hosp'l .....	Transfer to Hosp'l .....
Discharge from Service .....	Transfer to V. R. C. .....
Duty .....	Transportation .....

NOTE 1.—This blank will be used for both enlistments and re-enlistments—enlistment of veterans, &c., &c., in the volunteer service. They will be made out in duplicate in all cases—one to accompany the recruiting return of the superintendent (not the recruiting officer) to the Adjutant General, and one to accompany the accounts of the officer who pays bounty, &c. The Regiment and Company in which the soldier last served should be given on the back.

NOTE 2.—An enlistment holds to service. A muster-in must, in all cases, precede payment of pay, bounty, pension, &c. A muster-in roll must, in all cases, be filed in the Adjutant General's Office as evidence of muster-in. The mustering officer, commissary, or assistant commissary of musters, as the case may be, will countersign both enlistments as having mustered the soldier into the service of the United States before either of them is given to the disbursing officer.

DECLARATION OF RECRUIT.

I, Patton Burley desiring to VOLUNTEER as a Soldier in the Army of the United States, for the term of THREE YEARS, Do Declare, That I am 33 years and \_\_\_\_\_ months of age; that I have never been discharged from the United States service on account of disability or by sentence of a court martial, or by order before the expiration of a term of enlistment; and, I know of no impediment to my serving honestly and faithfully as a soldier for three years.

GIVEN at Llavenworth State of Kansas the 14<sup>th</sup> day of July 1864.

Witness:

W. A. Burnham

Patton Burley <sup>his</sup> mark

No. 5

Patton Burley  
Volunteered at Llavenworth

July 14<sup>th</sup> 1864,

By A. D. Matthews

2<sup>d</sup> Lieutenant of 2<sup>d</sup> B. Battery

Regt. 1<sup>st</sup> Regt. 1<sup>st</sup> Cavalry

Enlistment; last served in Company ( )

Reg't of \_\_\_\_\_

Discharged \_\_\_\_\_ 18  

CONSENT IN CASE OF MINOR.

I, \_\_\_\_\_ Do CERTIFY, That I am \_\_\_\_\_; that the \_\_\_\_\_ of \_\_\_\_\_; that the said \_\_\_\_\_ is \_\_\_\_\_ years of age; and I do hereby freely give my CONSENT to his volunteering as a SOLDIER in the ARMY OF THE UNITED STATES for the period of THREE YEARS.

GIVEN at \_\_\_\_\_ the \_\_\_\_\_ day of \_\_\_\_\_

Witness: \_\_\_\_\_



VOLUNTEER ENLISTMENT.

STATE OF

TOWN OF

*Kansas*



*Leavenworth*

I, *Patton Burley* born in \_\_\_\_\_  
 in the State of *Virginia* aged *33* years,  
 and by occupation a *Farmer* Do HEREBY ACKNOWLEDGE to have  
 volunteered this *14<sup>th</sup>* day of *July* 1864,  
 to serve as a **Soldier** in the **Army of the United States of America**, for  
 the period of **THREE YEARS**, unless sooner discharged by proper authority:  
 Do also agree to accept such bounty, pay, rations, and clothing, as are, or may be,  
 established by law for volunteers. And I, *Patton Burley* do  
 solemnly swear, that I will bear true faith and allegiance to the **United States  
 of America**, and that I will serve them honestly and faithfully against all  
 their enemies or opposers whomsoever; and that I will observe and obey the  
 orders of the President of the United States, and the orders of the officers  
 appointed over me, according to the Rules and Articles of War.

Sworn and subscribed to, at *Leavenworth*  
 this *14<sup>th</sup>* day of *July* 1864, } *Patton<sup>his</sup> Burley*  
 BEFORE *Wm. D. Matthews* } *marks*  
*2<sup>nd</sup> Lieut Recruiting*

I CERTIFY, ON HONOR, That I have carefully examined the above-named Volunteer, agreeably  
 to the General Regulations of the Army, and that, in my opinion, he is free from all bodily defects and  
 mental infirmity, which would in any way disqualify him from performing the duties of a soldier.

*Jeffie Links*  
*Surgeon Board of Enrollment*  
*North-West Kansas*  
 EXAMINING SURGEON.

I CERTIFY, ON HONOR, That I have minutely inspected the Volunteer, *Patton Burley*  
 previously to his enlistment, and that he was entirely sober when enlisted; that, to the best of my  
 judgment and belief, he is of lawful age; and that, in accepting him as duly qualified to perform the  
 duties of an able-bodied soldier, I have strictly observed the Regulations which govern the recruiting  
 service. This soldier has *black* eyes, *black* hair, *black* complexion, is *5*  
 feet *4* inches high.

*Wm. D. Matthews*  
*2<sup>nd</sup> Lieut / 1<sup>st</sup> X. C. Baty* Volunteers,  
 RECRUITING OFFICER.

Mustered into the service of the United States, for three years or during the war, from date of enlistment, in Company \_\_\_\_\_  
 Regiment of \_\_\_\_\_ Volunteers, on the \_\_\_\_\_ day of \_\_\_\_\_, 186 , at \_\_\_\_\_

NOTE 1.—This blank will be used for both enlistments and re-enlistments—enlistment of veterans, &c., &c., in the volunteer service. They will be made out in duplicate in all cases—one to accompany the recruiting return of the superintendent (not the recruiting officer) to the Adjutant General, and one to accompany the accounts of the officer who pays bounty, &c. The Regiment and Company in which the soldier last served should be given on the back.

NOTE 2.—An enlistment holds to service. A muster-in must, in all cases, precede payment of pay, bounty, pension, &c. A muster-in roll must, in all cases, be filed in the Adjutant General's Office as evidence of muster-in. The mustering officer, commissary, or assistant commissary of musters, as the case may be, will countersign both enlistments as having mustered the soldier into the service of the United States before either of them is given to the disbursing officer.

DECLARATION OF RECRUIT.

I, Patton Bourley desiring to VOLUNTEER as a Soldier in the Army of the United States, for the term of THREE YEARS, Do Declare, That I am 33 years and \_\_\_\_\_ months of age; that I have never been discharged from the United States service on account of disability or by sentence of a court martial, or by order before the expiration of a term of enlistment; and I know of no impediment to my serving honestly and faithfully as a soldier for three years.

GIVEN at Leavenworth State of Kansas the 14 day of July 1864

Witness:

W. H. Burman Patton Bourley  
*no mark*

No. 51

Patton Bourley

Volunteered at Leavenworth

July 14<sup>th</sup> 1864,

By M. P. Matthews

1st Lt. Co. Battery

enlistment; last served in Company ( )

Reg't of \_\_\_\_\_

Discharged \_\_\_\_\_ 1864

G. I. Crawford

CONSENT IN CASE OF MINOR.

I, \_\_\_\_\_ Do CERTIFY, That I am the \_\_\_\_\_ of \_\_\_\_\_; that the said \_\_\_\_\_ is \_\_\_\_\_ years of age; and I do hereby freely give my CONSENT to his volunteering as a SOLDIER in the ARMY OF THE UNITED STATES for the period of THREE YEARS.

GIVEN at \_\_\_\_\_ the \_\_\_\_\_ day of \_\_\_\_\_

Witness:

VOLUNTEER ENLISTMENT.

STATE OF

*Kansas*



TOWN OF

*Lavenworth*

I, *Patton Burley* born in \_\_\_\_\_  
 in the State of *Virginia* aged *33* years,  
 and by occupation a *Farmer* DO HEREBY ACKNOWLEDGE to have  
 volunteered this *14<sup>th</sup>* day of *July* 186*4*  
 to serve as a **Soldier** in the **Army of the United States of America**, for  
 the period of **THREE YEARS**, unless sooner discharged by proper authority:  
 Do also agree to accept such bounty, pay, rations, and clothing, as are, or may be,  
 established by law for volunteers. And I, *Patton Burley* do  
 solemnly swear, that I will bear true faith and allegiance to the **United States  
 of America**, and that I will serve them honestly and faithfully against all  
 their enemies or opposers whomsoever; and that I will observe and obey the  
 orders of the President of the United States, and the orders of the officers  
 appointed over me, according to the Rules and Articles of War.

Sworn and subscribed to, at *Lavenworth*  
 this *14<sup>th</sup>* day of *July* 186*4* } *Patton Burley*  
 BEFORE *Wm. O. Matthews* } *mark*  
*2<sup>nd</sup> Lieut Recruiting*

I CERTIFY, ON HONOR, That I have carefully examined the above-named Volunteer, agreeably  
 to the General Regulations of the Army, and that, in my opinion, he is free from all bodily defects and  
 mental infirmity, which would in any way disqualify him from performing the duties of a soldier.

*Liffie Links*  
*Sur Board of Enrollment*  
*North Dist Kansas*  
 EXAMINING SURGEON.

I CERTIFY, ON HONOR, That I have minutely inspected the Volunteer, *Patton Burley*  
 previously to his enlistment, and that he was entirely sober when enlisted; that, to the best of my  
 judgment and belief, he is of lawful age; and that, in accepting him as duly qualified to perform the  
 duties of an able-bodied soldier, I have strictly observed the Regulations which govern the recruiting  
 service. This soldier has *black* eyes, *black* hair, *black* complexion, is *5-*  
 feet *4* inches high.

*Wm. O. Matthews*  
*2<sup>nd</sup> Lieut of 1<sup>st</sup> K. C. Bat* Volunteers,  
 RECRUITING OFFICER.

(A. G. O. No. 74 & 76.)

Mustered into the service of the United States, for three years or during the war, from date of enlistment, in Company *C*  
 Regiment of *1<sup>st</sup> K. C. Bat* Volunteers, on the *16* day of *July*, 186*4*, at *Lavenworth*

NOTE 1.—This blank will be used for both enlistments and re-enlistments—enlistment of veterans, &c., &c., in the volunteer service. They will be made out in duplicate in all cases—one to accompany the recruiting return of the superintendent (not the recruiting officer) to the Adjutant General, and one to accompany the accounts of the officer who pays bounty, &c. The Regiment and Company in which the soldier last served should be given on the back.

NOTE 2.—An enlistment holds to service. A muster-in must, in all cases, precede payment of pay, bounty, pension, &c. A muster-in roll must, in all cases, be filed in the Adjutant General's Office as evidence of muster-in. The mustering officer, commissary, or assistant commissary of musters, as the case may be, will countersign both enlistments as having mustered the soldier into the service of the United States before either of them is given to the disbursing officer.

REC'D from 2nd. Aud. Nov. 23d 1892

DECLARATION OF RECRUIT.

I, Patton Barley desiring to VOLUNTEER as a Soldier in the Army of the United States, for the term of THREE YEARS, Do Declare, That I am 33 years and \_\_\_\_\_ months of age; that I have never been discharged from the United States service on account of disability or by sentence of a court martial, or by order before the expiration of a term of enlistment; and I know of no impediment to my serving honestly and faithfully as a soldier for three years.

GIVEN at Leavenworth State of Kansas. the 14<sup>th</sup> day of July 1864.

Witness:

W.A. Burnham

Patton Barley his mark

Discharged ..... 18 ..

Reg't of ..

Enlistment; last served in Company ( )

By W.D. Matthews  
14 1864,  
 2<sup>d</sup> Regiment of K. O. Battery

Volunteered at Leavenworth  
Patton Barley

No. 237

CONSENT IN CASE OF MINOR.

I, \_\_\_\_\_ Do CERTIFY, That I am the \_\_\_\_\_ of \_\_\_\_\_; that the said \_\_\_\_\_ is \_\_\_\_\_ years of age; and I do hereby freely give my CONSENT to his volunteering as a SOLDIER in the ARMY OF THE UNITED STATES for the period of THREE YEARS.

GIVEN at .....

the ..... day of .....

Witness: .....

VOLUNTEER ENLISTMENT.

STATE OF

*Kansas*



TOWN OF

*Lavenworth*

I, *Salton Burley* born in \_\_\_\_\_

in the State of *Virginia* aged *33* years,

and by occupation a *Farmer* Do HEREBY ACKNOWLEDGE to have

volunteered this *14<sup>th</sup>* day of *July* 1864,

to serve as a **Soldier** in the **Army of the United States of America**, for the period of **THREE YEARS**, unless sooner discharged by proper authority:

Do also agree to accept such bounty, pay, rations, and clothing, as are, or may be, established by law for volunteers. And I, *Salton Burley* do

solemnly swear, that I will bear true faith and allegiance to the **United States of America**, and that I will serve them honestly and faithfully against all

their enemies or opposers whomsoever; and that I will observe and obey the orders of the President of the United States, and the orders of the officers

appointed over me, according to the Rules and Articles of War.

Sworn and subscribed to, at *Lavenworth*

this *14<sup>th</sup>* day of *July* 1864, } *Salton X Burley*  
his mark

BEFORE *Wm. D. Matthews* }  
*2<sup>d</sup> Lieut Recruiting*

I CERTIFY, ON HONOR, That I have carefully examined the above-named Volunteer, agreeably to the General Regulations of the Army, and that, in my opinion, he is free from all bodily defects and mental infirmity, which would in any way disqualify him from performing the duties of a soldier.

*Jeffie Sinko*  
Subj Board of Enrollment  
North Dist Kansas  
EXAMINING SURGEON.

I CERTIFY, ON HONOR, That I have minutely inspected the Volunteer, *Salton Burley* previous to his enlistment, and that he was entirely sober when enlisted; that, to the best of my judgment and belief, he is of lawful age; and that, in accepting him as duly qualified to perform the duties of an able-bodied soldier, I have strictly observed the Regulations which govern the recruiting service. This soldier has *black* eyes, *black* hair, *black* complexion, is *5*

feet \_\_\_\_\_ inches high.

*Wm. D. Matthews*  
*2<sup>d</sup> Lieut of 1<sup>st</sup> K. C. Baty Volunteers,*  
RECRUITING OFFICER.

(A. G. O. No. 74 & 76.)

*It must be said that the bounty of the one hundred dollars is not to be paid until the soldier has been mustered into the service of the United States...*

Mustered into the service of the United States, for three years or during the war, from date of enlistment, in Company *1<sup>st</sup> Kansas* *1<sup>st</sup> Kansas* Regiment of *Volunteers*, on the *14<sup>th</sup>* day of *July*, 1864, at *Lavenworth* *Kansas*

*Russell, Fenton*

adpt. Batt'y U.S. Col'd L. Art'y

*Private* | *Private*

CARD NUMBERS.

1	6233626	26
2	6233739	27
3	6233888	28
4	6234061	29
5	6234199	30
6	6234366	31
7	6234529	32
8	9132920	33
9		34
10		35
11		36
12		37
13		38
14		39
15		40
16		41
17		42
18		43
19		44
20		45
21		46
22		47
23		48
24		49
25		50

Book Mark:

See also

*J* | Indpt. Batt'y. | **U.S.C.T.**

*Leuton Burrell*

....., Indpt. Batt'y, U. S. Col'd L. Art'y.

Appears on

**Battery Descriptive Book**

of the organization named above.

**DESCRIPTION.**

Age *23* years; height *5* feet *9* inches.

Complexion *Black*

Eyes *Black*; hair *Black*

Where born *Virginia*

Occupation *Laborer*

**ENLISTMENT.**

When *Dec. 12*, 186 *4*

Where .....

By whom *L. Mathews*; term *3* y'rs.

Remarks: .....

.....

.....

.....

.....

.....

.....

.....

*Shalbrook*

*B* | Indpt. Battery. | **U.S.C.T.**

*Fenton Burrell*

Appears with rank of *Priv* on

**Muster and Descriptive Roll of a Detachment of U. S. Vols. forwarded**

for the Indpt. Batt'y, U. S. Col'd L. Arty. Roll dated

*Leavenworth, Mo, Dec. 13, 1864.*

Where born *Virginia*

Age *23* y'rs; occupation *Laborer*

When enlisted *Dec. 12, 1864.*

Where enlisted *Leavenworth, Mo*

For what period enlisted *3* years.

Eyes *Black*; hair *Black*

Complexion *Black*; height *5 ft. 9 in.*

When mustered in *Dec 13, 1864.*

Where mustered in *Leavenworth, Mo.*

Bounty paid \$ *100*; due \$ *100*

Where credited

Battery to which assigned

Remarks: *Credited to North<sup>m</sup> Dist. Kansas, 20<sup>th</sup> Subdistrict, 2<sup>nd</sup> Ward, Leavenworth City, Vol. Recruit 1 entitled to Bounty.*

Book mark:

*E. L. Tharnton*



NARA 378  
B | Indpt. Battery. | U.S.C.T.

Anton Durrell

Pvt, Indpt. Battery, U. S. Col'd L. Art'y.

Appears on

**Battery Muster-in and Descriptive Roll**

of the organization named above. Roll dated

Sevenworth Ks, Dec 23, 1864.

Where born

Va

Age

23 y'rs; occupation

Labourer

When enlisted

Dec 12, 1864.

Where enlisted

Sevenworth Ks

For what period enlisted

3 years.

Eyes

Blue; hair

Blue

Complexion

Dark; height

5 ft. 9 in.

When mustered in

Dec 13, 1864.

Where mustered in

Sevenworth

Bounty paid

\$100<sup>00</sup>/<sub>100</sub>; due

\$200<sup>00</sup>/<sub>100</sub>

Where credited

Battery to which assigned

Remarks:

on M. Dist Ks,

Co. I. D. 2<sup>nd</sup> Ward

Sevenworth Ks.

Book mark:

(8567)

Copyist.

*B* | Indpt. Battery. | **U.S.C.T.**

*Anton Burrell*

*Post*, Indpt. Battery, U. S. Col'd L. Art'y.

Appears on

**Battery Muster Roll**

for *Enlistment to Dec 31*, 186*4*.

Present or absent *Present*

Stoppage, \$ 100 for

Due Gov't, \$ 100 for

Valuation of horse, \$ 100

Valuation of horse equipments, \$ 100

Remarks:

Book mark:

*J. Schively*

(358)

Copyist.

73

Indpt. Battery. | U.S.C.T.

Gerton Burrell

Co't, Indpt. Battery, U. S. Col'd L. Art'y.

Appears on

**Battery Muster Roll**

for *Jan & Feb*, 186<sup>5</sup>.

Present or absent *Present*

Stoppage, \$ 100 for

Due Gov't, \$ 100 for

Valuation of horse, \$ 100

Valuation of horse equipments, \$ 100

Remarks:

Book mark:

*J. H. Schooley*

(358)

Copyist.

*B* | Indpt. Battery. | **U.S.C.T.**

*Anton Burrell,*

*A*, Indpt. Battery, U. S. Col'd L. Art'y.

Appears on

**Battery Muster Roll**

for *Mar & Apr*, 1865.

Present or absent *Present*

Stoppage, \$ 100 for

Due Gov't, \$ 100 for

Valuation of horse, \$ 100

Valuation of horse equipments, \$ 100

Remarks:

Book mark: *...*

*Butler*

*B* | Indpt. Battery. | **U.S.C.T.**

*Fenton Burrell,*

*Pvt.*, Indpt. Battery, U. S. Col'd L. Art'y.

Appears on

**Battery Muster Roll**

for *May & June*, 186*5*.

Present or absent *Present,*

Stoppage, \$ 100 for

Due Gov't, \$ 100 for

Valuation of horse, \$ 100

Valuation of horse equipments, \$ 100

Remarks:

Book mark: *358*

*Parter*  
Copyist.

*A*

Indpt. Battery.

U.S.C.T.

*Anton Surrall*

*A*, Indpt. Battery U. S. Col'd Light Art'y.

Appears on **Batt'y Muster-out Roll**, dated

*M. Leavenworth, Kas., July 22, 1865.*

Muster-out to date *July 22, 1865.*

Last paid to *Dec. 31, 1864.*

Clothing account:

Last settled....., 186 ; drawn since \$ *63<sup>06</sup>*/<sub>100</sub>,

Due soldier \$.....<sub>100</sub>; due U. S. \$.....<sub>100</sub>

Am't for cloth'g in kind or money adv'd \$.....<sub>100</sub>

Due U. S. for arms, equipments, &c., \$.....<sub>100</sub>

Bounty paid \$ *100*/<sub>100</sub>; due \$ *None*/<sub>100</sub>,

Remarks:.....

.....  
 .....  
 .....  
 .....  
 .....  
 .....

Book mark:.....

*Patten*

*Burnell Fenton*

, Co. *1st* *Batt* *U.S. C. A.*  
*Reg't*

**2 Enclosures.**

Bed Cards .....	Final Statements .....
Burial Records .....	Furloughs or L. of A .....
Certs. of Dis. for Discharge .....	Med. Certificates .....
C. M. Charges .....	Med. Des. Lists .....
Descriptive Lists .....	Orders .....
Discharge Certificates .....	Pris. of War Record .....
Enlistment Papers .....	Resignations .....

Other papers relating to—

Admission to Hosp'l .....	Furlough or L. of A .....
Casualty Sheet .....	Med. Examination .....
Confinement .....	Misc. Information .....
Contracts .....	Pay or Clothing .....
Death or Effects .....	Personal Reports .....
Desertion .....	Rank .....
Discharge from Hosp'l .....	Transfer to Hosp'l .....
Discharge from Service .....	Transfer to V. R. C. .....
Duty .....	Transportation .....

NOTE 1.—This blank will be used for both enlistments and re-enlistments—enlistment of veterans, &c., &c., in the volunteer service. They will be made out in duplicate in all cases—one to accompany the recruiting return of the superintendent (not the recruiting officer) to the Adjutant General, and one to accompany the accounts of the officer who pays bounty, &c. The Regiment and Company in which the soldier last served should be given on the back.

NOTE 2.—An enlistment holds to service. A muster-in must, in all cases, precede payment of pay, bounty, pension, &c. A muster-in roll must, in all cases, be filed in the Adjutant General's Office as evidence of muster-in. The mustering officer, commissary, or assistant commissary of musters, as the case may be, will countersign both enlistments as having mustered the soldier into the service of the United States before either of them is ~~used~~ <sup>used</sup> by the disbursing officer.

2100. Aud. Nov. 23d 1892

DECLARATION OF RECRUIT.

*Henton Burrell* desiring to VOLUNTEER as a Soldier in the Army of the United States, for the term of THREE YEARS, Do Declare, That I am *23 Twenty Three* years and \_\_\_\_\_ months of age; that I have never been discharged from the United States service on account of disability or by sentence of a court martial, or by order before the expiration of a term of enlistment; and I know of no impediment to my serving honestly and faithfully as a soldier for three years.

GIVEN at *Leavenworth State of Kansas* the *12<sup>th</sup>* day of *December 1864*

Witness: *Benjamin Wilson* *Henton Burrell*

No. *8*

*Henton Burrell*

Volunteered at *Leavenworth*

*12<sup>th</sup> December 1864*

By *William D Matthews*

*Adj't Reg't 91<sup>st</sup> Reg't Artillery*

*High*

\_\_\_\_\_ enlistment; last served in Company ( )

\_\_\_\_\_ Reg't of \_\_\_\_\_

Discharged \_\_\_\_\_ 18 .

CONSENT IN CASE OF MINOR.

I, \_\_\_\_\_ Do CERTIFY, That I am the \_\_\_\_\_ of \_\_\_\_\_; that the said \_\_\_\_\_ is \_\_\_\_\_ years of age; and I do hereby freely give my CONSENT to his volunteering as a SOLDIER in the ARMY OF THE UNITED STATES for the period of THREE YEARS.

GIVEN at \_\_\_\_\_ the \_\_\_\_\_ day of \_\_\_\_\_

Witness: \_\_\_\_\_



VOLUNTEER ENLISTMENT.

STATE OF



TOWN OF

*Kansas*

*Leavenworth*

I, *Horton Burrell* born in \_\_\_\_\_  
 in the State of *Virginia* aged *23 twenty three* years,  
 and by occupation a *Laborer* Do HEREBY ACKNOWLEDGE to have  
 volunteered this *12<sup>th</sup> twelfth* day of *December* 1864,  
 to serve as a **Soldier** in the **Army of the United States of America**, for  
 the period of **THREE YEARS**, unless sooner discharged by proper authority:  
 Do also agree to accept such bounty, pay, rations, and clothing, as are, or may be,  
 established by law for volunteers. And I, *Horton Burrell* do  
 solemnly swear, that I will bear true faith and allegiance to the **United States  
 of America**, and that I will serve them honestly and faithfully against all  
 their enemies or opposers whomsoever; and that I will observe and obey the  
 orders of the President of the United States, and the orders of the officers  
 appointed over me, according to the Rules and Articles of War.

Sworn and subscribed to, at *Leavenworth*  
 this *12<sup>th</sup> twelfth* day of *December* 1864, by *Horton Burrell*  
 BEFORE *William O. Matthews and Lieut*  
*Recruiting and US Col & Lieut Artillery*

I CERTIFY, ON HONOR, That I have carefully examined the above-named Volunteer, agreeably  
 to the General Regulations of the Army, and that, in my opinion, he is free from all bodily defects and  
 mental infirmity, which would in any way disqualify him from performing the duties of a soldier.

*Tiffin Dicks*  
 Surg Board of Enrollment  
 "North" Dist Kansas  
 EXAMINING SURGEON.

I CERTIFY, ON HONOR, That I have minutely inspected the Volunteer, *Horton Burrell*  
 previously to his enlistment, and that he was entirely sober when enlisted; that, to the best of my  
 judgment and belief, he is of lawful age; and that, in accepting him as duly qualified to perform the  
 duties of an able-bodied soldier, I have strictly observed the Regulations which govern the recruiting  
 service. This soldier has *Black* eyes, *Black* hair, *Black* complexion, is *5*  
 feet \_\_\_\_\_ inches high.

*William O. Matthews and Lieut*  
*Recruiting and US Col & Lieut Artillery*  
 \_\_\_\_\_ Regiment of \_\_\_\_\_ Volunteers,  
 RECRUITING OFFICER.

(A. G. O. No. 74 & 76.)

*This recruit has received the bounty advance bounty from the Bounty Fund,  
 authorized by Act of Congress, approved May 20, 1864, and Executive Order, from the  
 Provost Marshal, dated \_\_\_\_\_*

Mustered into the service of the United States, for three years or during the war, from date of enlistment, in ~~\_\_\_\_\_~~ *Independent*  
*13<sup>th</sup>* day of *December*, 1864, at *Leavenworth* *Kansas*  
*Regiment* *1st* *Volunteers*

*William O. Matthews*  
*Recruiting and US Col & Lieut Artillery*  
*Leavenworth*

NOTE 1.—This blank will be used for both enlistments and re-enlistments—enlistment of veterans, &c., &c., in the volunteer service. They will be made out in duplicate in all cases—one to accompany the recruiting return of the superintendent (not the recruiting officer) to the Adjutant General, and one to accompany the accounts of the officer who pays bounty, &c. The Regiment and Company in which the soldier last served should be given on the back.

NOTE 2.—An enlistment holds to service. A muster-in must, in all cases, precede payment of pay, bounty, pension, &c. A muster-in roll must, in all cases, be filed in the Adjutant General's Office as evidence of muster-in. The mustering officer, commissary, or assistant commissary of musters, as the case may be, will countersign both enlistments as having mustered the soldier into the service of the United States before either of them is given to the disbursing officer.

DECLARATION OF RECRUIT.

I, Fenton Burrell desiring to VOLUNTEER as a Soldier in the Army of the United States, for the term of THREE YEARS, Do Declare, That I am 23 Twenty three years and \_\_\_\_\_ months of age; that I have never been discharged from the United States service on account of disability or by sentence of a court martial, or by order before the expiration of a term of enlistment; and I know of no impediment to my serving honestly and faithfully as a soldier for three years.

GIVEN at Leavenworth State of Kansas the 12<sup>th</sup> day of December 1864

Witness: Benjamin Wilson Fenton Burrell  
Mark

No. \_\_\_\_\_

Fenton Burrell

Volunteered at Leavenworth

12<sup>th</sup> December 1864,

By W. H. Matthews

Capt. 1<sup>st</sup> Battery U.S. Col. Artillery

Legible

\_\_\_\_\_ enlistment; last served in Company ( )

1<sup>st</sup> Regt of U. S. Artillery

Discharged \_\_\_\_\_ 18 \_\_\_\_\_

CONSENT IN CASE OF MINOR.

I, \_\_\_\_\_ Do CERTIFY, That I am the \_\_\_\_\_ of \_\_\_\_\_; that the said \_\_\_\_\_ is \_\_\_\_\_ years of age; and I do hereby freely give my CONSENT to his volunteering as a SOLDIER in the ARMY OF THE UNITED STATES for the period of THREE YEARS.

GIVEN at \_\_\_\_\_ the \_\_\_\_\_ day of \_\_\_\_\_

Witness: \_\_\_\_\_

2. 7. 1864

VOLUNTEER ENLISTMENT.

STATE OF

*Kansas*



TOWN OF

*Leavenworth*

I, *Frenton Burrell* born in \_\_\_\_\_  
in the State of *Virginia* aged *twenty three* years,  
and by occupation a *Sawyer* Do HEREBY ACKNOWLEDGE to have  
volunteered this *twelfth* day of *December* 1864  
to serve as a **Soldier** in the **Army of the United States of America**, for  
the period of **THREE YEARS**, unless sooner discharged by proper authority:  
Do also agree to accept such bounty, pay, rations, and clothing, as are, or may be,  
established by law for volunteers. And I, *Frenton Burrell* do  
solemnly swear, that I will bear true faith and allegiance to the **United States  
of America**, and that I will serve them honestly and faithfully against all  
their enemies or opposers whomsoever; and that I will observe and obey the  
orders of the President of the United States, and the orders of the officers  
appointed over me, according to the Rules and Articles of War.

Sworn and subscribed to, at *Leavenworth* his  
this *12<sup>th</sup>* day of *December* 1864 *Frenton Burrell*  
BEFORE *William O Matthews* *Recruiting and U.S. Col'd light artiller*

I CERTIFY, ON HONOR, That I have carefully examined the above-named Volunteer, agreeably  
to the General Regulations of the Army, and that, in my opinion, he is free from all bodily defects and  
mental infirmity, which would in any way disqualify him from performing the duties of a soldier.

*Jiffie Sims*  
Surgeon Board of Enrollment  
*North Star Kansas*  
EXAMINING SURGEON.

I CERTIFY, ON HONOR, That I have minutely inspected the Volunteer *Frenton Burrell*  
previously to his enlistment, and that he was entirely sober when enlisted; that, to the best of my  
judgment and belief, he is of lawful age; and that, in accepting him as duly qualified to perform the  
duties of an able-bodied soldier, I have strictly observed the Regulations which govern the recruiting  
service. This soldier has *Black* eyes, *Black* hair, *Black* complexion, is \_\_\_\_\_  
feet *5* inches high.

*William O Matthews* *Recruiting and U.S. Col'd light artiller*  
Regiment of *Battery* Volunteers,  
RECRUITING OFFICER.

(A. G. O. No. 74 & 76.)

*Mustered into the service of the United States, for three years or during the war, from date of enlistment, in ~~Company~~ *Company* *Charles*  
Northern *1st* *Regiment* of *Col'd Art* (11<sup>th</sup>) ~~Volunteers~~ on the *12<sup>th</sup>* day of *December*, 1864, at *Leavenworth* *Kansas**

*Wm O Matthews*  
*Recruiting and U.S. Col'd light artiller*  
*11<sup>th</sup>*  
*Volunteers*

pt. Battery B. Col'd L. Art'y

Private Private

CARD NUMBERS.

6233731	26
6233883	27
6234668	28
9132912	29
B128-05-1875	30
	31
	32
	33
	34
	35
	36
	37
	38
	39
	40
	41
	42
	43
	44
	45
	46
	47
	48
	49
	50

Book Mark: EB. Vol 11. P456-8  
B.128-V.11-67-757

See also

*J*

Indpt. Batt'y. **U.S.C.T.**

*James Butler*

....., Indpt. Batt'y, U. S. Col'd L. Art'y.

Appears on

**Battery Descriptive Book**

of the organization named above.

**DESCRIPTION.**

Age *24* years; height *5* feet *11* inches.

Complexion *Black*

Eyes *dark*; hair *Black*

Where born *Lincoln Kentucky*

Occupation *Cook*

**ENLISTMENT.**

When *July 25*, 186 *4*

Where .....

By whom *S. Mathews*; term *3* y'rs.

Remarks: .....

.....  
 .....  
 .....  
 .....  
 .....  
 .....  
 .....  
 .....

*Robb*

*B*

Indpt. Battery. | **U.S.C.T.**

*James Butler*  
*Pat*

Indpt. Battery, U. S. Col'd L. Art'y.

Appears on

**Battery Muster-in and Descriptive Roll**

of the organization named above. Roll dated

*Leavenworth Mo Dec 23*, 1864.

Where born *Lincoln Co. Ky*

Age *24* y'rs; occupation *Cooper*

When enlisted *July 25*, 1864.

Where enlisted *Leavenworth Mo*

For what period enlisted *3* years.

Eyes *Blu*; hair *Blu*

Complexion *Bro*; height *5* ft. *11* in.

When mustered in *July 26*, 1864.

Where mustered in *Leavenworth*

Bounty paid \$ *100*; due \$ *300*<sup>*00*</sup>/<sub>*100*</sub>

Where credited

Battery to which assigned

Remarks: *Discharged Aug 10<sup>th</sup>*  
*1864*

Book mark:

*H. Scherley*  
(8566) Copyist.

B | Indpt. Battery: | **U.S.C.T.**

*James Butler*  
*Govt*, Indpt. Battery, U. S. Col'd L. Art'y.

Appears on

**Battery Muster Roll**

for *Enlistment to Dec 31*, 186 *4*.

Present or absent *Absent*

Stoppage, \$ *100* for

Due Gov't, \$ *100* for

Valuation of horse, \$ *100*

Valuation of horse equipments, \$ *100*

Remarks: *Absent without leave*

Book mark: *Deserted Aug 10/64*  
*over*

(358) *J. H. Schrey* Copyist.

JAN. 17

6233883

418914

S. B. V. 11. P. 456 &  
B. 128. V. 11. C. D. 75,



*B* | Indpt. Battery. | **U.S.C.T.**

*James Butler,*

*B*, Indpt. Battery U. S. Col'd Light Art'y.

Appears on **Batt'y Muster-out Roll**, dated

*Fort Leavenworth, Mo., July 22, 1865.*

Muster-out to date ..... 186 .

Last paid to ..... 186 .

**Clothing account:**

Last settled....., 186 ; drawn since \$..... 100

Due soldier \$..... 100; due U. S. \$..... 100

Am't for cloth'g in kind or money adv'd \$..... 100

Due U. S. for arms, equipments, &c., \$..... 100

Bounty paid \$..... 100; due \$..... 100

Remarks:.....

.....

.....

.....

.....

.....

.....

Book mark: *Deserted Aug. 10/64,*  
*over*

*Butler*

JAN. 17

6234668

\*1891\*

*E.N. 11, P. 456, v. B. 128,  
N. 11, C. 9, 75,*

*B Indpt. Batty's Co. U.S.C.S.*

*James Butler*

*, Co Indpt. Batty U.S.C.S.*

**NOTATION.**

*EB 11/456*

Book mark: *B-128: C.S-1875.*

**War Department,**

**Adjutant General's Office,**

*Washington, Sept. 15, 1875.*

*Deserted August 10. 1864.*

*M. Allen*

*Butter James*

....., Co. ...., *1st Batt* *Reg't* *W.S.C.A*

*2* **Enclosures.**

Bed Cards .....	Final Statements .....
Burial Records .....	Furloughs or L. of A .....
Certs. of Dis. for Discharge .....	Med. Certificates .....
C. M. Charges .....	Med. Des. Lists .....
Descriptive Lists .....	Orders .....
Discharge Certificates .....	Pris. of War Record .....
Enlistment Papers <i>2</i> .....	Resignations .....

**Other papers relating to—**

Admission to Hosp'l .....	Furlough or L. of A .....
Casualty Sheet .....	Med. Examination .....
Confinement .....	Misc. Information .....
Contracts .....	Pay or Clothing .....
Death or Effects .....	Personal Reports .....
Desertion .....	Rank .....
Discharge from Hosp'l .....	Transfer to Hosp'l .....
Discharge from Service .....	Transfer to V. R. C. .....
Duty .....	Transportation .....
.....	.....

NOTE 1.—This blank will be used for both enlistments and re-enlistments—enlistment of veterans, &c., &c., in the volunteer service. They will be made out in duplicate in all cases—one to accompany the recruiting return of the superintendent (not the recruiting officer) to the Adjutant General, and one to accompany the accounts of the officer who pays bounty, &c. The Regiment and Company in which the soldier last served should be given on the back.

NOTE 2.—An enlistment holds to service. A muster-in must, in all cases, precede payment of pay, bounty, pension, &c. A muster-in roll must, in all cases, be filed in the Adjutant General's Office as evidence of muster-in. The mustering officer, commissary, or assistant commissary of musters, as the case may be, will countersign both enlistments as having mustered the soldier into the service of the United States before either of them is given to the disbursing officer.

DECLARATION OF RECRUIT.

I, James Butler desiring to VOLUNTEER as a Soldier in the Army of the United States, for the term of THREE YEARS Do Declare, That I am 24 years and \_\_\_\_\_ months of age; that I have never been discharged from the United States service on account of disability or by sentence of a court-martial, or by order before the expiration of a term of enlistment; and I know of no impediment to my serving honestly and faithfully as a soldier for three years.

GIVEN at Leavenworth, Kansas the 25<sup>th</sup> day of July, 1864

Witness: R. J. Hinton James Butler  
Capt & A. J. C. U. S. C. V. mark

Discharged \_\_\_\_\_ 18 .  
Reg't of \_\_\_\_\_  
enlistment; last served in Company ( )

James Butler  
Volunteered at Leavenworth, Ks  
July 25<sup>th</sup> 1864  
By R. J. Hinton  
2<sup>d</sup> Light Artillery, U. S. C. V.  
Capt & A. J. C. U. S. C. V.  
No. 29 recruit

CONSENT IN CASE OF MINOR.

I, \_\_\_\_\_ Do CERTIFY, That I am the \_\_\_\_\_ of \_\_\_\_\_; that the said \_\_\_\_\_ is \_\_\_\_\_ years of age; and I do hereby freely give my CONSENT to his volunteering as a SOLDIER in the ARMY OF THE UNITED STATES for the period of THREE YEARS.

GIVEN at \_\_\_\_\_ the \_\_\_\_\_ day of \_\_\_\_\_

Witness: \_\_\_\_\_

VOLUNTEER ENLISTMENT.

STATE OF

*Kansas*



TOWN OF

*Lavenworth*

I, *James Butler*

born in *Lincoln Co*

in the State of *Kentucky* aged *24* years,

and by occupation a *Cook* Do HEREBY ACKNOWLEDGE to have

volunteered this *Twenty fifth* day of *July* 1864,

to serve as a **Soldier** in the **Army of the United States of America**, for the period of **THREE YEARS** unless sooner discharged by proper authority: Do also

agree to accept such bounty, pay, rations, and clothing, as are, or may be, established by law for volunteers. And I, *James Butler* do

solemnly swear, that I will bear true faith and allegiance to the **United States of America**, and that I will serve them honestly and faithfully against all their

enemies or opposers whomsoever; and that I will observe and obey the orders of the President of the United States, and the orders of the officers appointed over

me, according to the Rules and Articles of War.

Sworn and subscribed to, at *Lavenworth,* } *James Butler*  
this *25<sup>th</sup>* day of *July* 1864. } *mark*

BEFORE *Wm D Matthews*  
*2<sup>d</sup> Lt Recruiting Co B. 2<sup>d</sup> S. A. U. S. C. T.*

I CERTIFY, ON HONOR, That I have carefully examined the above-named Volunteer, agreeably to the General Regulations of the Army, and that, in my opinion, he is free from all bodily defects and mental infirmity, which would in any way disqualify him from performing the duties of a soldier.

*Jeffere Simko*  
*Sur Board of Enrolment*  
*North Dist Kansas*  
EXAMINING SURGEON.

I CERTIFY, ON HONOR, That I have minutely inspected the Volunteer, *James Butler* previously to his enlistment, and that he was entirely sober when enlisted; that, to the best of my judgment and belief, he is of lawful age; and that, in accepting him as duly qualified to perform the duties of an able-bodied soldier, I have strictly observed the Regulations which govern the recruiting service. This soldier has *dark* eyes, *black* hair, *black* complexion, is *five* feet *eleven* inches high.

*Wm D Matthews* *2<sup>d</sup> Lt Co "B"*  
*2<sup>d</sup> Regiment of Light Artillery U.S. Volunteers,*  
RECRUITING OFFICER.

(A. G. O. No. 74 & 75.)

Mustered into the service of the United States, in Company *Company of volunteers* the *25<sup>th</sup>* day of *July* 1864, at *Lavenworth* *James Butler* *2<sup>d</sup> S. A. U. S. C. T.* *2<sup>d</sup> Lt* *Recruiting Co B* *2<sup>d</sup> S. A. U. S. C. T.* *James Butler* *mark* *Wm D Matthews* *2<sup>d</sup> Lt Co "B"* *2<sup>d</sup> Regiment of Light Artillery U.S. Volunteers,* *Jeffere Simko* *Sur Board of Enrolment* *North Dist Kansas* *EXAMINING SURGEON.* *I CERTIFY, ON HONOR, That I have minutely inspected the Volunteer, James Butler previously to his enlistment, and that he was entirely sober when enlisted; that, to the best of my judgment and belief, he is of lawful age; and that, in accepting him as duly qualified to perform the duties of an able-bodied soldier, I have strictly observed the Regulations which govern the recruiting service. This soldier has dark eyes, black hair, black complexion, is five feet eleven inches high.* *Wm D Matthews* *2<sup>d</sup> Lt Co "B"* *2<sup>d</sup> Regiment of Light Artillery U.S. Volunteers,* *RECRUITING OFFICER.* *Jeffere Simko* *Sur Board of Enrolment* *North Dist Kansas* *EXAMINING SURGEON.*

DECLARATION OF RECRUIT.

I, James Butler desiring to VOLUNTEER as a Soldier in the Army of the United States, for the term of THREE YEARS Do Declare, That I am twenty-four years and months of age; that I have never been discharged from the United States service on account of disability or by sentence of a court-martial, or by order before the expiration of a term of enlistment; and I know of no impediment to my serving honestly and faithfully as a soldier for three years.

GIVEN at Leavenworth, Kansas, the 25th day of July, 1864

Witness: R. J. Hinton James Butler Capt and A. D. C. U.S. B.V. mark

NOTE 1.—This blank will be used for both enlistments and re-enlistments of veterans, &c., &c., in the volunteer service. They will be made out in duplicate in all cases—one to accompany the recruiting return of the superintendent (not the recruiting officer) to the Adjutant General, and one to accompany the accounts of the officer who pays bounty, &c. The Regiment and Company in which the soldier last served should be given on the back.

NOTE 2.—An enlistment holds to service. A muster-in must, in all cases, precede payment of pay, bounty, pension, &c. A muster-in roll must, in all cases, be filed in the Adjutant General's Office as evidence of muster-in. The mustering officer, commissary, or assistant commissary of musters, as the case may be, will countersign both enlistments as having mustered the soldier into the service of the United States before either of them is given to the disbursing officer.

enlistment; last served in Company ( ) Reg't of Discharged 18

James Butler Volunteered at Leavenworth, Ks July 25th 1864 By J. W. D. Matthews 2d Lt. Co. 1st Regt. U.S. Cav.

No. 29 3753

CONSENT IN CASE OF MINOR.

I, Do CERTIFY, That I am the of; that the said is years of age; and I do hereby freely give my CONSENT to his volunteering as a SOLDIER in the ARMY OF THE UNITED STATES for the period of THREE YEARS.

GIVEN at the day of

Witness:

VOLUNTEER ENLISTMENT.

STATE OF

TOWN OF

*Kentucky*



*Leavenworth*

I, *James Butler* born in *Lincoln Co*  
 in the State of *Kentucky* aged *24* years,  
 and by occupation a *Cook* Do HEREBY ACKNOWLEDGE to have  
 volunteered this *twenty-fifth* day of *July* 1864,  
 to serve as a **Soldier** in the **Army of the United States of America**, for the  
 period of **THREE YEARS** unless sooner discharged by proper authority: Do also  
 agree to accept such bounty, pay, rations, and clothing, as are, or may be, estab-  
 lished by law for volunteers. And I, *James Butler* do  
 solemnly swear, that I will bear true faith and allegiance to the **United States**  
**of America**, and that I will serve them honestly and faithfully against all their  
 enemies or opposers whomsoever; and that I will observe and obey the orders of  
 the President of the United States, and the orders of the officers appointed over  
 me, according to the Rules and Articles of War.

Sworn and subscribed to, at *Leavenworth*  
 this *25<sup>th</sup>* day of *July* 1864, } *James Butler*  
 BEFORE *Wm D Matthews* } *his*  
*2<sup>d</sup> Lt. Recruiting Co 16. 2<sup>d</sup> R. L. A. U.S. C.T.* } *mark*

I CERTIFY, ON HONOR, That I have carefully examined the above-named Volunteer, agreeably  
 to the General Regulations of the Army, and that, in my opinion, he is free from all bodily defects and  
 mental infirmity, which would in any way disqualify him from performing the duties of a soldier.

*Tiffin Sinks*  
*Sur Board of Enrollment*  
*North Dist Kansas*  
 EXAMINING SURGEON.

I CERTIFY, ON HONOR, That I have minutely inspected the Volunteer, *James Butler*  
 previously to his enlistment, and that he was entirely sober when enlisted; that, to the best of my  
 judgment and belief, he is of lawful age; and that, in accepting him as duly qualified to perform the duties  
 of an able-bodied soldier, I have strictly observed the Regulations which govern the recruiting service.  
 This soldier has *dark* eyes, *black* hair, *black* complexion, is *five* feet  
*eleven* inches high.

*Wm D Matthews* *2<sup>d</sup> Lt. Co 16*  
*2<sup>d</sup> Regiment of Light Artillery U.S.C. Volunteers,*  
 RECRUITING OFFICER.

Mustered into the service of the United States, in Company  
 the *26<sup>th</sup>* day of *July* 1864, at *Leavenworth*

*Adj. Gen. G. B. M. Smith*  
 Regiment of *2<sup>d</sup> R. L. A. U.S. C.T.*

Volunteers on



*Canada, Felix*

**1st. Batt'y U.S. Col'd L. Art'y.**

*Private Sergeant*

**CARD NUMBERS.**

1	623375-3	26
2	6233901	27
3	6234031	28
4	6234169	29
5	6234337	30
6	6234501	31
7	9132934	32
8		33
9		34
10		35
11		36
12		37
13		38
14		39
15		40
16		41
17		42
18		43
19		44
20		45
21		46
22		47
23		48
24		49
25		50

Book Mark: \_\_\_\_\_

See also \_\_\_\_\_

*C* | Indpt. Batt'y. | **U.S.C.T.**

*Felix Canada*

....., Indpt. Batt'y, U. S. Col'd L. Art'y.

Appears on

**Battery Descriptive Book**

of the organization named above.

**DESCRIPTION.**

Age *25* years; height *6* feet *1* inches.

Complexion *Brown*

Eyes *Black*; hair *fauzy*

Where born *Murray Tenn*

Occupation *Laborer*

**ENLISTMENT.**

When *Aug. 4*, 186 *4*.

Where *near the sea*

By whom *H Mathews*; term *3* y'rs.

Remarks: .....

.....  
 .....  
 .....  
 .....  
 .....  
 .....  
 .....

*Holbrook*

(383g)

Copyist.

6 | Indpt. Battery. | **U.S.C.T.**

*Felix Canada*

*Pvt*, Indpt. Battery, U. S. Col'd L. Art'y.

Appears on

**Battery Muster-in and Descriptive Roll**

of the organization named above. Roll dated

*Levernworth Co Dec 93*, 1864.

Where born *Murray Co Tenn*

Age *25* y'rs; occupation *Laborer*

When enlisted *Aug 4*, 1864.

Where enlisted *Levernworth Co.*

For what period enlisted *3* years.

Eyes *Blu*; hair *Sandy*

Complexion *Bro*; height *6 ft 1* in.

When mustered in *Aug 6*, 1864.

Where mustered in *Levernworth*

Bounty paid \$*100*<sup>00</sup>/<sub>100</sub>; due \$*200*<sup>00</sup>/<sub>100</sub>

Where credited \_\_\_\_\_

Battery to which assigned \_\_\_\_\_

Remarks: *C. N. Dist Co.  
24<sup>th</sup> ID. 4<sup>th</sup> Mass  
Levernworth Mass*

Book mark: \_\_\_\_\_

*H. Scholby*  
(356g) Copyist.

6 | Indpt. Battery. | U.S.C.T.

Felix Canada

Pvt, Indpt. Battery, U. S. Col'd L. Art'y.

Appears on

**Battery Muster Roll**

for *Enlistment to Dec 3/1864*

Present or absent *Present*

Stoppage, \$ \_\_\_\_\_ 100 for \_\_\_\_\_

Due Gov't, \$ \_\_\_\_\_ 100 for \_\_\_\_\_

Valuation of horse, \$ \_\_\_\_\_ 100

Valuation of horse equipments, \$ \_\_\_\_\_ 100

Remarks: \_\_\_\_\_  
\_\_\_\_\_  
\_\_\_\_\_  
\_\_\_\_\_  
\_\_\_\_\_  
\_\_\_\_\_

Book mark: \_\_\_\_\_

*W. Schrey*  
(358) Copyist.

6 | Indpt. Battery. | **U.S.C.T.**

*Felix Canada*

<sup>ret duty</sup>  
*Sergt*, Indpt. Battery, U. S. Col'd L. Art'y.

Appears on

**Battery Muster Roll**

for *Jan'y & Feb*, 186*5*.

Present or absent *Present*

Stoppage, \$ 100 for

Due Gov't, \$ 100 for

Valuation of horse, \$ 100

Valuation of horse equipments, \$ 100

Remarks: *Appointed Sergt  
Jan'y 1865 by Maj.  
P. G. Hunt Chief Clerk  
Dept of War.*

Book mark:

*J. S. [Signature]*  
(358) Copyist.

*O* | Indpt. Battery. | **U.S.C.T.**

*Felix Canada,*  
*Sergh.*, Indpt. Battery, U. S. Col'd L. Art'y.

Appears on

**Battery Muster Roll**

for *Mar + Apr,* 1865.

Present or absent *Present,*

Stoppage, \$ 100 for

Due Gov't, \$ 100 for

Valuation of horse, \$ 100

Valuation of horse equipments, \$ 100

Remarks: *App'd, Sergh, Jan,*  
*1/65.*

Book mark:

*Porter*

Copyist.

C | Indpt. Battery. | **U.S.C.T.**

*Felix Canada,*  
*Sergt,* Indpt. Battery, U. S. Col'd L. Art'y.

Appears on

**Battery Muster Roll**

for *May & June*, 186*5*.

Present or absent *Present,*

Stoppage, \$ 100 for

Due Gov't, \$ 100 for

Valuation of horse, \$ 100

Valuation of horse equipments, \$ 100

Remarks: *x Pay due as Privt,*  
*Aug 4/64, to Jan 1/65,*  
*as Sergt, from Jan 1/65,*

*x As shown by roll.*

Book mark:

*Butler*

C | Indpt. Battery. | U.S.C.T.

*Felix Canada*

*Sgt*, Indpt. Battery U. S. Col'd Light Art'y.

Appears on **Batt'y Muster-out Roll**, dated  
*W Leavenworth Co July 22, 1865.*

Muster-out to date *July 22, 1865.*

Last paid to *Dec 31*, 186 *4*.

Clothing account:

Last settled....., 186 ; drawn since \$ *67* <sup>*44*</sup>/<sub>100</sub>,

Due soldier \$.....<sup>100</sup>; due U. S. \$.....<sup>100</sup>

Am't for cloth'g in kind or money adv'd \$.....<sup>100</sup>

Due U. S. for arms, equipments, &c., \$.....<sup>100</sup>

Bounty paid \$ *100* <sup>100</sup>; due \$ *None* <sup>100</sup>,

Remarks: *Private from enlistment to Jan'y 1/65, then Sergeant.*

Book mark :.....

*Parter*



*Indpt Balty*

*Canada, Felix*

....., Co. ...., *2* Reg't. *1st CLA*

*2* Enclosures.

Bed Cards .....	Final Statements .....
Burial Records .....	Furloughs or L. of A .....
Certs. of Dis. for Discharge .....	Med. Certificates .....
C. M. Charges .....	Med. Des. Lists .....
Descriptive Lists .....	Orders .....
Discharge Certificates .....	Pris. of War Record .....
Enlistment Papers <i>2</i> .....	Resignations .....

Other papers relating to—

Admission to Hosp'l .....	Furlough or L. of A .....
Casualty Sheet .....	Med. Examination .....
Confinement .....	Misc. Information .....
Contracts .....	Pay or Clothing .....
Death or Effects .....	Personal Reports .....
Desertion .....	Rank .....
Discharge from Hosp'l .....	Transfer to Hosp'l .....
Discharge from Service .....	Transfer to V. R. C. .....
Duty .....	Transportation .....

NOTE 1.—This blank will be used for both enlistments and re-enlistments—enlistment of veterans, &c., &c., in the volunteer service. They will be made out in duplicate in all cases—one to accompany the recruiting return of the superintendent (not the recruiting officer) to the Adjutant General, and one to accompany the accounts of the officer who pays bounty, &c. The Regiment and Company in which the soldier last served should be given on the back.

NOTE 2.—An enlistment holds to service. A muster-in must, in all cases, precede payment of pay, bounty, pension, &c. A muster-in roll must, in all cases, be filed in the Adjutant General's Office as evidence of muster-in. The mustering officer, commissary, or assistant commissary of musters, as the case may be, will countersign both enlistments as having mustered the soldier into the service of the United States before either of them is given to the disbursing officer.

DECLARATION OF RECRUIT.

I, Yelvis Canada desiring to VOLUNTEER as a Soldier in the Army of the United States, for the term of THREE YEARS Do Declare, That I am 25 years and 0 months of age; that I have never been discharged from the United States service on account of disability or by sentence of a court-martial, or by order before the expiration of a term of enlistment; and I know of no impediment to my serving honestly and faithfully as a soldier for three years.

GIVEN at Leavenworth State of Kansas the 14th day of August 1864

Witness: John J. Penhaly Yelvis Canada  
muck

..... enlistment; last served in Company ( )  
Reg't of .....

Discharged ..... 18 .....

No. 48  
Yelvis Canada  
Volunteered at Leavenworth Mo  
14th Aug 1864  
By W. J. Wood  
Recruiting Officer

CONSENT IN CASE OF MINOR.

I, W. J. Wood Do CERTIFY, That I am the 14th of August that the said Yelvis Canada is 25 years of age; and I do hereby freely give my CONSENT to his volunteering as a SOLDIER in the ARMY OF THE UNITED STATES for the period of THREE YEARS.

GIVEN at Leavenworth the 14th day of August

Witness: W. J. Wood

VOLUNTEER ENLISTMENT.

STATE OF

*Kansas*



TOWN OF

*Seamouth*

I *Felix Canada* born in *Henry Co. Va.*  
in the State of *ennessee* aged *25* years,

and by occupation a *Laborer* Do HEREBY ACKNOWLEDGE to have  
volunteered this *4th* day of *August* 186*4*

to serve as a **Soldier** in the **Army of the United States of America**, for the  
period of **THREE YEARS** unless sooner discharged by proper authority: Do also  
agree to accept such bounty, pay, rations, and clothing, as are, or may be, estab-  
lished by law for volunteers. And I, *Felix Canada* do  
solemnly swear, that I will bear true faith and allegiance to the **United States  
of America**, and that I will serve them honestly and faithfully against all their  
enemies or opposers whomsoever; and that I will observe and obey the orders of  
the President of the United States, and the orders of the officers appointed over  
me, according to the Rules and Articles of War.

Sworn and subscribed to, at *Seamouth Va. his Canada*  
this *4th* day of *Augt* 186*4* *Felix Canada*  
BEFORE *Wm D Matthews* *Recruit* *mark*

*Recruiting Co 2d U.S. Colored Artillery*  
I CERTIFY, ON HONOR, That I have carefully examined the above-named Volunteer, agreeably  
to the General Regulations of the Army, and that, in my opinion, he is free from all bodily defects and  
mental infirmity, which would in any way disqualify him from performing the duties of a soldier.

*Tiffine Sims*  
*Surgeon Board of Enrollment*  
*North West Kansas*  
EXAMINING SURGEON.

I CERTIFY, ON HONOR, That I have minutely inspected the Volunteer, *Felix Canada*  
previously to his enlistment, and that he was entirely sober when enlisted; that, to the best of my  
judgment and belief, he is of lawful age; and that, in accepting him as duly qualified to perform the duties  
of an able-bodied soldier, I have strictly observed the Regulations which govern the recruiting service.  
This soldier has *Black* eyes, *Sandy* hair, *Brown* complexion, is *4* feet  
*1* inches high.

*Wm D Matthews* *Recruit*  
*Recruiting Co 2d U.S. Colored Artillery*  
RECRUITING OFFICER.

the *4th* day of *August*, 186*4*, at *Seamouth*

Regiment of *2d U.S. Colored Artillery* Volunteers, on

NOTE 1.—This blank will be used for both enlistments and re-enlistments—enlistment of veterans, &c., &c., in the volunteer service. They will be made out in duplicate in all cases—one to accompany the recruiting return of the superintendent (not the recruiting officer) to the Adjutant General, and one to accompany the accounts of the officer who pays bounty, &c. The Regiment and Company in which the soldier last served should be given on the back.

NOTE 2.—An enlistment holds to service. A muster-in must, in all cases, precede payment of pay, bounty, pension, &c. A muster-in roll must, in all cases, be filed in the Adjutant General's Office as evidence of muster-in. The mustering officer, commissary, or assistant commissary of musters, as the case may be, will countersign both enlistments as having mustered the soldier into the service of the United States before either of them is given to the disbursing officer.

DECLARATION OF RECRUIT.

I, Felix Canada desiring to VOLUNTEER as a Soldier in the Army of the United States, for the term of THREE YEARS Do Declare, That I am 25 years and — months of age; that I have never been discharged from the United States service on account of disability or by sentence of a court-martial, or by order before the expiration of a term of enlistment; and I know of no impediment to my serving honestly and faithfully as a soldier for three years.

GIVEN at Lavenworth State of Kansas the 4th day of August 1864

Witness: John J. Penhalg Felix Canada  
mark

Rec'd from 2nd. Aud. Nov. 23d 1892

enlistment; last served in Company ( — )  
 Reg't of —  
 Discharged — 18—

No. —  
Felix Canada  
 Volunteered at Lavenworth City  
this 4th August 1864  
 By John J. Penhalg  
Adjutant General

CONSENT IN CASE OF MINOR.

I, — Do CERTIFY, That I am the — of —; that the said — is — years of age; and I do hereby freely give my CONSENT to his volunteering as a SOLDIER in the ARMY OF THE UNITED STATES for the period of THREE YEARS.

GIVEN at — the — day of —

Witness: —

VOLUNTEER ENLISTMENT.

STATE OF

*Kansas*



TOWN OF

*Lavenworth*

I, *Felix Canada* born in *Murry Co. Tennessee*

aged *25* years,

and by occupation a *Laborer* Do HEREBY ACKNOWLEDGE to have

volunteered this *14th* day of *August* 186*4*

to serve as a **Soldier** in the **Army of the United States of America**, for the period of **THREE YEARS** unless sooner discharged by proper authority: Do also

agree to accept such bounty, pay, rations, and clothing, as are, or may be, established by law for volunteers. And I, *Felix Canada* do

solemnly swear, that I will bear true faith and allegiance to the **United States of America**, and that I will serve them honestly and faithfully against all their

enemies or opposers whomsoever; and that I will observe and obey the orders of the President of the United States, and the orders of the officers appointed over

me, according to the Rules and Articles of War.

Sworn and subscribed to, at

*Lavenworth* this *14th* day of *August* 186*4* *Felix Canada*

BEFORE *Wm D Matthews* *Lieut*

*Recruiting Co K. 2nd U.S. Col Artily*

I CERTIFY, ON HONOR, That I have carefully examined the above-named Volunteer, agreeably to the General Regulations of the Army, and that, in my opinion, he is free from all bodily defects and mental infirmity, which would in any way disqualify him from performing the duties of a soldier.

*Tiffin Sinks*  
*Surf Board of Enrollment*  
*North Star Kansas*  
EXAMINING SURGEON.

I CERTIFY, ON HONOR, That I have minutely inspected the Volunteer *Felix Canada* previously to his enlistment, and that he was entirely sober when enlisted; that, to the best of my judgment and belief, he is of lawful age; and that, in accepting him as duly qualified to perform the duties of an able bodied soldier, I have strictly observed the Regulations which govern the recruiting service.

The soldier has *Black* eyes, *Sandy* hair, *Brown* complexion, is *5* feet *0* inches high.

*Wm D Matthews* *Lieut*  
*Recruiting Co K. 2nd U.S. Col Artily*  
RECRUITING OFFICER.

(A. G. O. No. 74 & 75.)

*This recruit has received one hundred dollars advance bounty from the County fund, authorized by the Act of Congress approved July 13th 1864, Sec. 10, Act. No. 27 from the Prov. of Missouri. Wm D Matthews*

*Mustered into the service of the United States, in Company ... Regiment of ... Volunteers, on the ... day of ... 1864, at ...*

*Arthur George*

**Capt. Batt'y U.S. Col'd L. Art'y.**

*Private*

*Private*

**CARD NUMBERS.**

6234495	26
	27
	28
	29
	30
	31
	32
	33
	34
	35
	36
	37
	38
	39
	40
	41
	42
	43
	44
	45
	46
	47
	48
	49
	50

Book Mark: \_\_\_\_\_

See also \_\_\_\_\_

*C* | Indpt. Battery. | **U.S.C.T.**

*George Carthur,*  
*G*....., Indpt. Battery, U. S. Col'd L. Art'y.

Appears on

**Battery Muster Roll**

for *May & June*....., 1865.

Present or absent *Present,*.....

Stoppage, \$.....<sup>100</sup> for.....

Due Gov't, \$.....<sup>100</sup> for.....

Valuation of horse, \$.....<sup>100</sup>

Valuation of horse equipments, \$.....<sup>100</sup>

Remarks: *Attached,*.....

*Not home on other Rollo of Batt.*

Book mark:.....

*Porter*

(358)

Copyist.

*Easter Museum*

adpt. Batt'y U.S. Col'd L. Art'y.

*Private*

*Private*

CARD NUMBERS.

1	6233754	26
2	6233902	27
3	9132935	28
4		29
5		30
6		31
7		32
8		33
9		34
10		35
11		36
12		37
13		38
14		39
15		40
16		41
17		42
18		43
19		44
20		45
21		46
22		47
23		48
24		49
25		50

Book Mark: \_\_\_\_\_

See also \_\_\_\_\_



C | Indpt. Batt'y. | U.S.C.T.

*Memnon Carter*

....., Indpt. Batt'y, U. S. Col'd L. Art'y.

Appears on

**Battery Descriptive Book**

of the organization named above.

**DESCRIPTION.**

Age *22* years; height *5* feet *8* inches.

Complexion *Black*

Eyes *Black*, hair *Black*

Where born *Clay Mo.*

Occupation *Farmer*

**ENLISTMENT.**

When *Aug 4*, 186 *4*

Where *Wyandotte Mo.*

By whom *L. Minor*; term *3* y'rs.

Remarks: .....

*Holbrook*

*C*

Indpt. Battery. U.S.C.T.

*Merrin Caster*

*Pax*, Indpt. Battery, U. S. Col'd L. Art'y.

Appears on

**Battery Muster-in and Descriptive Roll**

of the organization named above. Roll dated

*Leavenworth Kas Dec 23*, 1864.

Where born *Clay Co Mo*

Age *22* yrs; occupation *Farmer*

When enlisted *July 14*, 1864.

Where enlisted *Wyandotte Kas*

For what period enlisted *3* years.

Eyes *Blue*; hair *Blue*

Complexion *Blue*; height *5 ft. 8 in.*

When mustered in *July 9*, 1864.

Where mustered in *Leavenworth*

Bounty paid \$ *100*; due \$ *300<sup>00</sup>/<sub>100</sub>*

Where credited

Battery to which assigned

Remarks: *at M Dist Kas  
of 7 & 8 D 4<sup>th</sup> Ward  
Leavenworth Kas*

Book mark ;

*J. Schoddy*

(8569)

Copyist.

6 | Indpt. Battery. | **U.S.C.T.**

*Merwin Carter*

*For*, Indpt. Battery, U. S. Col'd L. Art'y.

Appears on

**Battery Muster Roll**

for *Enlistment to Dec 31, 1864*

Present or absent *Absent*

Stoppage, \$ 100 for

Due Gov't, \$ 100 for

Valuation of horse, \$ 100

Valuation of horse equipments, \$ 100

Remarks: *Absent without leave*

*Not on Sub Rolls of Battery*

Book mark:

*J. H. Schuster*  
(358) Copyist.

*Carter Merriam*

, Co. *Ind Batt. U.S.C.A.*  
*Reg't*

*2* Enclosures.

Bed Cards .....	Final Statements .....
Burial Records .....	Furloughs or L. of A. ....
Certs. of Dis. for Discharge .....	Med. Certificates .....
C. M. Charges .....	Med. Des. Lists .....
Descriptive Lists .....	Orders .....
Discharge Certificates .....	Pris. of War Record .....
Enlistment Papers <i>2</i> .....	Resignations .....

Other papers relating to—

Admission to Hosp'l .....	Furlough or L. of A. ....
Casualty Sheet .....	Med. Examination .....
Confinement .....	Misc. Information .....
Contracts .....	Pay or Clothing .....
Death or Effects .....	Personal Reports .....
Desertion .....	Rank .....
Discharge from Hosp'l .....	Transfer to Hosp'l .....
Discharge from Service .....	Transfer to V. R. C. ....
Duty .....	Transportation .....

DECLARATION OF RECRUIT.

NOTE 1.—This blank will be used for both enlistments and re-enlistments—enlistment of veterans, &c., &c., in the volunteer service. They will be made out in duplicate in all cases—one to accompany the recruiting return of the superintendent (not the recruiting officer) to the Adjutant General, and one to accompany the accounts of the officer who pays bounty, &c. The Regiment and Company in which the soldier last served should be given on the back.  
NOTE 2.—An enlistment holds to service. A muster-in must, in all cases, precede payment of pay, bounty, pension, &c. A muster-in roll must, in all cases, be filed in the Adjutant General's Office as evidence of muster-in. The mustering officer, commissary, or assistant commissary of musters, as the case may be, will countersign both enlistments as having mustered the soldier into the service of the United States before either of them is given to the disbursing officer.

I, Merwin Leater desiring to VOLUNTEER as a Soldier in the Army of the United States, for the term of THREE YEARS, Do Declare, That I am 22 years and \_\_\_\_\_ months of age; that I have never been discharged from the United States service on account of disability or by sentence of a court martial, or by order before the expiration of a term of enlistment; and I know of no impediment to my serving honestly and faithfully as a soldier for three years.

GIVEN at Wendell State of Kansas the 4<sup>th</sup> day of August 1864

Witness: James Walker Merwin Leater  
mark

No. 753

Merwin Leater

Volunteered at Wendell

August 4<sup>th</sup> 1864

By Wm. J. Miller 2<sup>d</sup> Lieut

1<sup>st</sup> Regt. Kansas Cavalry

Wm. J. Miller

enlistment; last served in Company ( )

Reg't of

Discharged 18

X

CONSENT IN CASE OF MINOR.

I, \_\_\_\_\_ Do CERTIFY, That I am \_\_\_\_\_; that the \_\_\_\_\_ of \_\_\_\_\_; that the \_\_\_\_\_ is \_\_\_\_\_ years of age; and I do hereby freely give my CONSENT to his volunteering as a SOLDIER in the ARMY OF THE UNITED STATES for the period of THREE YEARS.

GIVEN at \_\_\_\_\_ the \_\_\_\_\_ day of \_\_\_\_\_

Witness: \_\_\_\_\_

VOLUNTEER ENLISTMENT.

STATE OF



TOWN OF

*Kansas*

*Myandett*

I, *Merwin Carter* born in *Clay Co*  
 in the State of *Missouri* aged *22* years,  
 and by occupation a *Farmer* Do HEREBY ACKNOWLEDGE to have  
 volunteered this *4<sup>th</sup>* day of *August* 1864,  
 to serve as a **Soldier** in the **Army of the United States of America**, for  
 the period of **THREE YEARS**, unless sooner discharged by proper authority:  
 Do also agree to accept such bounty, pay, rations, and clothing, as are, or may be,  
 established by law for volunteers. And I, *Merwin Carter* do  
 solemnly swear, that I will bear true faith and allegiance to the **United States**  
**of America**, and that I will serve them honestly and faithfully against all  
 their enemies or opposers whomsoever; and that I will observe and obey the  
 orders of the President of the United States, and the orders of the officers  
 appointed over me, according to the Rules and Articles of War.

Sworn and subscribed to, at *Myandett*  
 this *4<sup>th</sup>* day of *August* 1864 } *Merwin Carter*  
 BEFORE *P. H. Minor 2<sup>d</sup> Lieut* } *his*  
*Recruiting 1<sup>st</sup> Co 6<sup>th</sup> Cal Battery* } *mark*

I CERTIFY, ON HONOR, That I have carefully examined the above-named Volunteer, agreeably to the General Regulations of the Army, and that, in my opinion, he is free from all bodily defects and mental infirmity, which would in any way disqualify him from performing the duties of a soldier.

*Tiffin Sims*  
*Subj Board of Enrollment*  
*North West Dist Kansas*  
 EXAMINING SURGEON.

I CERTIFY, ON HONOR, That I have minutely inspected the Volunteer, *Merwin Carter* previously to his enlistment, and that he was entirely sober when enlisted; that, to the best of my judgment and belief, he is of lawful age; and that, in accepting him as duly qualified to perform the duties of an able-bodied soldier, I have strictly observed the Regulations which govern the recruiting service. This soldier has *black* eyes, *black* hair, *black* complexion, is *5<sup>ft</sup>* feet *8* inches high.

*P. H. Minor 2<sup>d</sup> Lieut*  
*1<sup>st</sup> Co 6<sup>th</sup> Cal Battery* Volunteers,  
 RECRUITING OFFICER.

Mustered into the service of the United States, for three years or during the war, from date of enlistment, in Company .....  
 Regiment of ..... Volunteers, on the *9* day of *August*, 1864, at *Myandett*

NOTE 1.—This blank will be used for both enlistments and re-enlistments—enlistment of veterans, &c., &c., in the volunteer service. They will be made out in duplicate in all cases—one to accompany the recruiting return of the superintendent (not the recruiting officer) to the Adjutant General, and one to accompany the accounts of the officer who pays bounty, &c. The Regiment and Company in which the soldier last served should be given on the back.

NOTE 2.—An enlistment holds to service. A muster-in must, in all cases, precede payment of pay, bounty, pension, &c. A muster-in roll must, in all cases, be filed in the Adjutant General's Office as evidence of muster-in. The mustering officer, commissary, or assistant commissary of musters, as the case may be, will countersign both enlistments as having mustered the soldier into the service of the United States before either of them is given to the disbursing officer.

### DECLARATION OF RECRUIT.

I, Merwin Carter desiring to VOLUNTEER as a Soldier in the Army of the United States, for the term of THREE YEARS, Do Declare, That I am 22 years and \_\_\_\_\_ months of age; that I have never been discharged from the United States service on account of disability or by sentence of a court martial, or by order before the expiration of a term of enlistment; and I know of no impediment to my serving honestly and faithfully as a soldier for three years.

GIVEN at Wyandott State of Kansas the 4<sup>th</sup> day of August 1864

Witness: James Wilson  
Merwin Carter  
military

No. M 353

Merwin Carter  
Volunteered at Wyandott

August 4 1864

By Sgt Merwin Carter

1st Regt of 13 Battery

enlistment; last served in Company ( )

Reg't of \_\_\_\_\_

Discharged \_\_\_\_\_ 18 \_\_\_\_

### CONSENT IN CASE OF MINOR.

I, \_\_\_\_\_ Do CERTIFY, That I am \_\_\_\_\_; that the \_\_\_\_\_ of \_\_\_\_\_; that the \_\_\_\_\_ is \_\_\_\_\_ years of age; and I do hereby freely give my CONSENT to his volunteering as a SOLDIER in the ARMY OF THE UNITED STATES for the period of THREE YEARS.

GIVEN at \_\_\_\_\_ the \_\_\_\_\_ day of \_\_\_\_\_

Witness: \_\_\_\_\_

(A. G. O. No. 74 & 76.)

VOLUNTEER ENLISTMENT.

STATE OF



TOWN OF

*Kansas*

*Wymond*

I, *Merwin Carter* born in *Clay Co.*  
 in the State of *Missouri* aged *22* years,  
 and by occupation a *Farmer* Do HEREBY ACKNOWLEDGE to have  
 volunteered this *4<sup>th</sup>* day of *August* 186*4*,  
 to serve as a **Soldier** in the **Army of the United States of America**, for  
 the period of **THREE YEARS**, unless sooner discharged by proper authority:  
 Do also agree to accept such bounty, pay, rations, and clothing, as are, or may be,  
 established by law for volunteers. And I, *Merwin Carter* do  
 solemnly swear, that I will bear true faith and allegiance to the **United States  
 of America**, and that I will serve them honestly and faithfully against all  
 their enemies or opposers whomsoever; and that I will observe and obey the  
 orders of the President of the United States, and the orders of the officers  
 appointed over me, according to the Rules and Articles of War.

Sworn and subscribed to, at *Wymond*  
 this *4<sup>th</sup>* day of *August* 186*4*, } *Merwin Carter*  
 BEFORE *P. B. Minor 2<sup>d</sup> Lieut* }  
*Recruiting 1<sup>st</sup> & 2<sup>d</sup> Battery*

I CERTIFY, ON HONOR, That I have carefully examined the above-named Volunteer, agreeably  
 to the General Regulations of the Army, and that, in my opinion, he is free from all bodily defects and  
 mental infirmity, which would in any way disqualify him from performing the duties of a soldier.

*Stiffen Binks*  
*Surg Board of Enrollment*  
*North Dixie Kansas*  
 EXAMINING SURGEON.

I CERTIFY, ON HONOR, That I have minutely inspected the Volunteer, *Merwin Carter*  
 previously to his enlistment, and that he was entirely sober when enlisted; that, to the best of my  
 judgment and belief, he is of lawful age; and that, in accepting him as duly qualified to perform the  
 duties of an able-bodied soldier, I have strictly observed the Regulations which govern the recruiting  
 service. This soldier has *black* eyes, *black* hair, *black* complexion, is *5-*  
 feet *8* inches high.

*P. B. Minor 2<sup>d</sup> Lieut*  
*1<sup>st</sup> & 2<sup>d</sup> Battery* Volunteers,  
 RECRUITING OFFICER.

(A. G. O. No. 74 & 76.)

Mustered into the service of the United States, for three years or during the war, from date of enlistment, in Company *1<sup>st</sup>*  
*21<sup>st</sup> Regt* Regiment of *Missouri* Volunteers, on the *4<sup>th</sup>* day of *August*, 186*4*, at *Wymond*, *Kansas*.  
*Merwin Carter*  
*21<sup>st</sup> Regt*  
*Missouri*  
*Volunteer*



*Person Thomas*

**1st. Batt'y U.S. Col'd L. Art'y.**

*Private Private*

**CARD NUMBERS.**

6233695	26
6234204	27
6234372	28
6234534	29
9133072	30
	31
	32
	33
	34
	35
	36
	37
	38
	39
	40
	41
	42
	43
	44
	45
	46
	47
	48
	49
	50

**Book Mark:**

**See also**

C | Indpt. Battery. | U.S.C.T.

Thomas Chiverson

Appears with rank of *Priv* on

**Muster and Descriptive Roll of a Detachment of U. S. Vols. forwarded**

for the Indpt. Batt'y, U. S. Col'd L. Arty. Roll dated

*Leavenworth, Kans, Mch 3, 1865.*

Where born *Missouri*

Age *18* y'rs; occupation *Farmer*

When enlisted d. *Mch 3, 1865.*

Where enlisted *Leavenworth, Kans*

For what period enlisted *1* years.

Eyes *black*; hair *black*

Complexion *black*; height *5 ft. 9 1/2 in.*

When mustered in *Mch 3, 1865.*

Where mustered in *Leavenworth, Kas.*

Bounty paid \$ *33*<sup>*33*</sup>/<sub>*100*</sub>; due \$ *66*<sup>*67*</sup>/<sub>*100*</sub>

Where credited

Battery to which assigned

Remarks: *Credited to North. Dist. Co. 23 sub. dist. Kickapoo Tp., Leavenworth County, Vol. recruit & entitled to bounty.*

Book mark:

*E. L. Shannon*

*C* | Indpt. Batt'y. | **U.S.C.T.**

*Thomas Chiverson*

....., Indpt. Batt'y, U. S. Col'd L. Art'y.

Appears on

**Battery Descriptive Book**

of the organization named above.

**DESCRIPTION.**

Age *18* years; height *5* feet *9 1/2* inches.

Complexion *Black*

Eyes *Black*; hair *Black*

Where born *(Missouri)*

Occupation *Farmer*

**ENLISTMENT.**

When *March 3*, 186*5*.

Where *Leavitt A's*

By whom *Capt McMahon*; term *1* y'rs.

Remarks: .....

.....  
 .....  
 .....  
 .....  
 .....  
 .....  
 .....  
 .....

*Holbrook*

*C* | Indpt. Battery. | **U.S.C.T.**

*Thomas Chiverson*

*Cn*, Indpt. Battery, U. S. Col'd L. Art'y.

Appears on

**Battery Muster Roll**

for *Mar & Apr*, 1865.

Present or absent *Present*

Stoppage, \$ 100 for

Due Gov't, \$ 100 for

Valuation of horse, \$ 100

Valuation of horse equipments, \$ 100

Remarks:

-----  
-----  
-----  
-----  
-----  
-----  
-----  
-----  
-----

Book mark: -----

*Porter*

*C*

Indpt. Battery.

U.S.C.T.

*Thomas Chiverson,*

*On*, Indpt. Battery, U. S. Col'd L. Art'y.

Appears on

**Battery Muster Roll**

for *May & June*, 1865.

Present or absent *Present,*

Stoppage, \$ 100 for

Due Gov't, \$ 100 for

Valuation of horse, \$ 100

Valuation of horse equipments, \$ 100

Remarks:

Book mark:

*Parter*

(358)

Copyist.

*C* | Indpt. Battery. | **U.S.C.T.**

*Thomas Cheverson,*

*C*, Indpt. Battery U. S. Col'd Light Art'y.

Appears on **Batt'y Muster-out Roll**, dated  
*St. Lawrence, Mo., July 22, 1865.*

Muster-out to date *July 22, 1865.*

Last paid to *(Pay due from enlistment)* 186 .

Clothing account:

Last settled....., 186 ; drawn since \$ *60* <sup>*50*</sup>/<sub>*100*</sub>,

Due soldier \$ *100*; due U. S. \$ *100*

Am't for cloth'g in kind or money adv'd \$ *100*

Due U. S. for arms, equipments, &c., \$ *100*

Bounty paid \$ *3.3* <sup>*33*</sup>/<sub>*100*</sub>; due \$ *None* <sup>*100*</sup>/<sub>*100*</sub>,

Remarks:.....  
.....  
.....  
.....  
.....  
.....

Book mark:.....

*Butler*

*Chievers Thomas*

....., Co. ...., *1st* <sup>Batt.</sup> <sub>Reg't</sub> *U.S.C.A*

*2* Enclosures.

Bed Cards .....	Final Statements .....
Burial Records .....	Furloughs or L. of A .....
Certs. of Dis. for Discharge .....	Med. Certificates .....
C. M. Charges .....	Med. Des. Lists .....
Descriptive Lists .....	Orders .....
Discharge Certificates .....	Pris. of War Record .....
Enlistment Papers .....	<i>2</i> Resignations .....

Other papers relating to—

Admission to Hosp'l .....	Furlough or L. of A .....
Casualty Sheet .....	Med. Examination .....
Confinement .....	Misc. Information .....
Contracts .....	Pay or Clothing .....
Death or Effects .....	Personal Reports .....
Desertion .....	Rank .....
Discharge from Hosp'l .....	Transfer to Hosp'l .....
Discharge from Service .....	Transfer to V. R. C. .....
Duty .....	Transportation .....
.....	.....

NOTE 1.—This blank will be used for both enlistments and re-enlistments—enlistment of veterans, &c., &c., in the volunteer service. They will be made out in duplicate in all cases—one to accompany the recruiting return of the superintendent (not the recruiting officer) to the Adjutant General, and one to accompany the accounts of the officer who pays bounty, &c. The Regiment and Company in which the soldier last served should be given on the back.

NOTE 2.—An enlistment holds to service. A muster-in must, in all cases, precede payment of pay, bounty, pension, &c. A muster-in roll must, in all cases, be filed in the Adjutant General's Office as evidence of muster-in. The mustering officer, commissary, or assistant commissary of musters, as the case may be, will countersign both enlistments as having mustered the soldier into the service of the United States before either of them is given to the disbursing officer.

DECLARATION OF RECRUIT.

I, Thomas Cheveron, desiring to VOLUNTEER as a Soldier in the Army of the United States, for the term of one ~~THREE YEARS~~, Do Declare, That I am Eighteen years and \_\_\_\_\_ months of age; that I have never been discharged from the United States service on account of disability or by sentence of a court martial, or by order before the expiration of a term of enlistment; and I know of no impediment to my serving honestly and faithfully as a soldier for three years.

GIVEN at Leavenworth Kansas the 3<sup>d</sup> day of March 1863

Witness:

Wm. Shoten Thomas Cheveron  
mark

Discharged \_\_\_\_\_, 18 \_\_\_\_\_

Reg't of \_\_\_\_\_

enlistment: last served in Company ( ) \_\_\_\_\_

Dr. J. H. A. M. of Denver  
Volunteered at Leavenworth, Kansas  
March 3, 1863  
1863  
1-52

CONSENT IN CASE OF MINOR.

I, \_\_\_\_\_, Do CERTIFY, That I am \_\_\_\_\_; that the \_\_\_\_\_ of \_\_\_\_\_ is \_\_\_\_\_ years of age; and I do hereby freely give my CONSENT to his volunteering as a SOLDIER in the ARMY OF THE UNITED STATES for the period of THREE YEARS.

GIVEN at \_\_\_\_\_ the \_\_\_\_\_ day of \_\_\_\_\_

Witness: \_\_\_\_\_



*Credited to Nathan Dick James Sub-Dist. Leavenworth County*

VOLUNTEER ENLISTMENT.

STATE OF

TOWN OF

*Kansas*



*Leavenworth*

I, *Thomas Chiverson*, born in \_\_\_\_\_  
in the State of *Missouri*, aged *Eighteen* years,  
and by occupation a *Farmer*, Do HEREBY ACKNOWLEDGE to have  
volunteered this *Third* day of *March*, 1865:

to serve as a **Soldier** in the **Army of the United States of America**, for  
the period of ~~THREE YEARS~~ *one*, unless sooner discharged by proper authority:  
Do also agree to accept such bounty, pay, rations, and clothing, as are, or may be,  
established by law for volunteers. And I, *Thomas Chiverson*, do  
solemnly swear, that I will bear true faith and allegiance to the **United States  
of America**, and that I will serve them honestly and faithfully against all  
their enemies or opposers whomsoever; and that I will observe and obey the  
orders of the President of the United States, and the orders of the officers  
appointed over me, according to the Rules and Articles of War.

Sworn and subscribed to, at *Leavenworth, Kan.*  
this *3rd* day of *March*, 1865, } *Thomas Chiverson*  
BEFORE *J. M. [Signature]* } *his*  
*& approved by me under articles* } *mark*

I CERTIFY, ON HONOR, That I have carefully examined the above-named Volunteer, agreeably  
to the General Regulations of the Army, and that, in my opinion, he is free from all bodily defects and  
mental infirmity, which would in any way disqualify him from performing the duties of a soldier.

*P. H. [Signature]*  
Adj. Board of Enrollment & Dist. [Signature]  
EXAMINING SURGEON.

I CERTIFY, ON HONOR, That I have minutely inspected the Volunteer *Thomas Chiverson*  
previously to his enlistment, and that he was entirely sober when enlisted; that, to the best of my  
judgment and belief, he is of lawful age; and that, in accepting him as duly qualified to perform the  
duties of an able-bodied soldier, I have strictly observed the Regulations which govern the recruiting  
service. This soldier has *Black* eyes, *Black* hair, *Black* complexion, is *Five*  
feet *Nine* inches high.

*J. M. [Signature]*  
Adj. & Secy. of [Signature] *Kansas* Volunteers,  
RECRUITING OFFICER.

(A. G. O. No. 74 & 76.)

*Mustered into the service of the United States, for ~~three~~ <sup>one</sup> years or during the war, from date of enlistment, in Company \_\_\_\_\_  
Regiment of *Artillery* Volunteers, on the *3rd* day of *March*, 1865, at *Leavenworth, Kan.**

*Wm. [Signature]*  
Capt. [Signature] 1st Regt. [Signature]

Rec'd from [unclear] 11/18/65

NOTE 1.—This blank will be used for both enlistments and re-enlistments—enlistment of veterans, &c., in the volunteer service. They will be made out in duplicate in all cases—one to accompany the recruiting return of the superintendent (not the recruiting officer) to the Adjutant General, and one to accompany the accounts of the officer who pays bounty, &c. The Regiment and Company in which the soldier last served will be given on the back.

NOTE 2.—An enlistment holds to service. A muster-in must, in all cases, precede payment of pay, bounty, pension, &c. A muster-in roll must, in all cases, be filed in the Adjutant General's Office as evidence of muster-in. The muster-in officer, commissary, or assistant commissary of musters, as the case may be, will countersign both enlistments as having mustered the soldier into the service of the United States before either of them is given to the disbursing officer.

DECLARATION OF RECRUIT.

I, Thomas Chiverson, desiring to VOLUNTEER as a Soldier in the Army of the United States, for the term of THREE YEARS, Do Declare, That I am eighteen years and \_\_\_\_\_ months of age; that I have never been discharged from the United States service on account of disability or by sentence of a court martial, or by order before the expiration of a term of enlistment; and I know of no impediment to my serving honestly and faithfully as a soldier for ~~three~~ years.

GIVEN at Leavenworth Kans the 3d day of March 1865

Witness: Wm. Holen Thomas Chiverson mark

Discharged \_\_\_\_\_ 18 \_\_\_\_\_  
Reg't of \_\_\_\_\_  
enlistment; last served in Company ( )

No. 27  
Thomas Chiverson  
Volunteered at Leavenworth Kansas  
March 3d 1865  
By Capt. G. M. of Gen. [unclear]  
5th Ill. Inf. Regt. of [unclear]

CONSENT IN CASE OF MINOR.

I, \_\_\_\_\_, Do CERTIFY, That I am the \_\_\_\_\_ of \_\_\_\_\_; that the said \_\_\_\_\_ is \_\_\_\_\_ years of age; and I do hereby freely give my CONSENT to his volunteering as a SOLDIER in the ARMY OF THE UNITED STATES for the period of THREE YEARS.

GIVEN at \_\_\_\_\_ the \_\_\_\_\_ day of \_\_\_\_\_

Witness: \_\_\_\_\_

Decided to Enlist. Dick James Co. Sub. Dist. Leavenworth County

VOLUNTEER ENLISTMENT.

STATE OF

Kansas

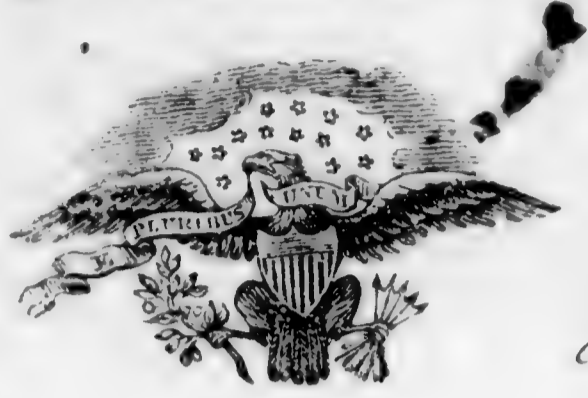

TOWN OF

Leavenworth

I, Thomas Chiverson, born in Missouri, aged Eighteen years, and by occupation a Farmer, Do HEREBY ACKNOWLEDGE to have volunteered this third day of March, 1865,

to serve as a Soldier in the Army of the United States of America, for the period of THREE YEARS, unless sooner discharged by proper authority: Do also agree to accept such bounty, pay, rations, and clothing, as are, or may be, established by law for volunteers. And I, Thomas Chiverson, do solemnly swear, that I will bear true faith and allegiance to the United States of America, and that I will serve them honestly and faithfully against all their enemies or opposers whomsoever; and that I will observe and obey the orders of the President of the United States, and the orders of the officers appointed over me, according to the Rules and Articles of War.

Sworn and subscribed to, at Leavenworth Kansas, this 3rd day of March, 1865, Thomas Chiverson

BEFORE Capt. J. M. ...

I CERTIFY, ON HONOR, That I have carefully examined the above-named Volunteer, agreeably to the General Regulations of the Army, and that, in my opinion, he is free from all bodily defects and mental infirmity, which would in any way disqualify him from performing the duties of a soldier.

Tiffin ... Board of Enrollment ... EXAMINING SURGEON.

I CERTIFY, ON HONOR, That I have minutely inspected the Volunteer previously to his enlistment, and that he was entirely sober when enlisted; that, to the best of my judgment and belief, he is of lawful age; and that, in accepting him as duly qualified to perform the duties of an able-bodied soldier, I have strictly observed the Regulations which govern the recruiting service. This soldier has Black eyes, Black hair, Black complexion, is five feet nine inches high.

Recruiting Officer signature

RECRUITING OFFICER.

Mustered into the service of the United States, for three years or during the war, from date of enlistment, in Company ...

Vertical handwritten notes on the left margin.

*George B.*  
Apt. Batt'y U.S. Col'd L. Art'y.

*Private Private*

CARD NUMBERS.

6233629	26
6233757	27
6233905	28
6234067	29
6234206	30
6234373	31
6234535	32
9137938	33
	34
	35
10	36
11	37
12	38
12	39
14	40
15	41
16	42
17	43
18	44
19	45
20	46
21	47
22	48
23	49
24	50
25	

Book Mark: \_\_\_\_\_

See also \_\_\_\_\_

*C* | Indpt. Batt'y. | **U.S.C.T.**

*George M Clark*

....., Indpt. Batt'y, U. S. Col'd L. Art'y.

Appears on

**Battery Descriptive Book**

of the organization named above.

**DESCRIPTION.**

Age *24* years; height *5* feet *7* inches.

Complexion *Black*

Eyes *Black*; hair *Black*

Where born *Lafayette Mo.*

Occupation *Tobacco*

**ENLISTMENT.**

When *Dec. 15*....., 186 *4*

Where *Seav<sup>th</sup> Sts.*

By whom *A Minor*.....; term *3* y'rs.

Remarks: .....

.....  
.....  
.....  
.....  
.....  
.....  
.....  
.....  
.....  
.....

*Stalbrook*

C

Indpt. Battery.

U.S.C.T.

George M. Clark

Appears with rank of *Priv* on**Muster and Descriptive Roll of a Detachment of U. S. Vols. forwarded**

for the Indpt. Batt'y, U. S. Col'd L. Arty. Roll dated

*Leavenworth, Ks*, Dec. 16, 1864.Where born *Lafayette Co., Missouri*Age *24* y'rs; occupation *Tobacconist*When enlisted *Dec. 15*, 1864.Where enlisted *Leavenworth, Ks*For what period enlisted *3* years.Eyes *Black*; hair *Black*Complexion *Black*; height *5* ft. *7* in.When mustered in *Dec. 16*, 1864.Where mustered in *Leavenworth, Ks*Bounty paid \$ *100*; due \$ *100*

Where credited

Battery to which assigned

Remarks: *Credited to North Dist.**Kans. 28<sup>th</sup> Sub dist. Wyandotte**city Co. Volunteer recruit &**enrolled to Bounty*

Book mark:

*E. L. Thorton*

(339)

Copyist.

6

Indpt. Battery. U.S.C.T.

George M. Calvert

Pvt., Indpt. Battery, U. S. Col'd L. Art'y.

Appears on

**Battery Muster-in and Descriptive Roll**

of the organization named above. Roll dated

Leavenworth Mo Dec 23, 1864.

Where born Lafayette Mo.

Age 24 y'rs; occupation Bricklayer

When enlisted Dec 15, 1864.

Where enlisted Leavenworth Mo

For what period enlisted 3 years.

Eyes Blue; hair Blue

Complexion Blue; height 5 ft. 7 in.

When mustered in Dec 16, 1864.

Where mustered in Leavenworth

Bounty paid \$100<sup>00</sup>/<sub>100</sub>; due \$200<sup>00</sup>/<sub>100</sub>

Where credited

Battery to which assigned

Remarks: G. M. Calvert Co  
28th S. D. Myandotte City  
Mo

Book mark :

(856g) *J. H. Shirley* Copyist.

*L* | Indpt. Battery. | **U.S.C.T.**

*George M. Clark*

*Private*, Indpt. Battery, U. S. Col'd L. Art'y.

Appears on

**Battery Muster Roll**

for *Enlistment to Dec 31*, 186 *4*

Present or absent *Present*

Stoppage, \$ *100* for

Due Gov't, \$ *100* for

Valuation of horse, \$ *100*

Valuation of horse equipments, \$ *100*

Remarks:

Book mark:

*J. H. Stanley*  
(358) Copyist.



6

Indpt. Battery.

U.S.C.T.

George M. Clark

Private

, Indpt. Battery, U. S. Col'd L. Art'y.

Appears on

**Battery Muster Roll**

for *Company F*, 186<sup>5</sup>.

Present or absent *Present*

Stoppage, \$ 100 for

Due Gov't, \$ 100 for

Valuation of horse, \$ 100

Valuation of horse equipments, \$ 100

Remarks:

Book mark:

*J. W. Schuler*

(358)

Copyist.

*C* | Indpt. Battery. | **U.S.C.T.**

*George W. Clark,*

*Pr*, Indpt. Battery, U. S. Col'd L. Art'y.

Appears on

**Battery Muster Roll**

for *May & Apr*, 186 *5*.

Present or absent *Present*

Stoppage, \$ 100 for

Due Gov't, \$ 100 for

Valuation of horse, \$ 100

Valuation of horse equipments, \$ 100

Remarks:

Book mark:

*Sutter*

*C*

Indpt. Battery.

U.S.C.T.

*George M. Clark*

*M*, Indpt. Battery, U. S. Col'd L. Art'y.

Appears on

**Battery Muster Roll**

for *May & June*, 186 *5*.

Present or absent *Present*,

Stoppage, \$            <sup>100</sup> for           

Due Gov't, \$            <sup>100</sup> for           

Valuation of horse, \$            <sup>100</sup>

Valuation of horse equipments, \$            <sup>100</sup>

Remarks:

-----  
-----  
-----  
-----  
-----  
-----  
-----  
-----  
-----  
-----

Book mark:

*Benton*

Copyist.

*C*

Indpt. Battery.

U.S.C.T.

*George M. Clark,*  
*Pr*, Indpt. Battery U. S. Col'd Light Art'y.

Appears on **Batt'y Muster-out Roll**, dated  
*W. Leavenworth, Mo., July 22, 1865.*

Muster-out to date *July 22, 1865.*

Last paid to *Dec. 31, 1864.*

Clothing account:

Last settled....., 186 ; drawn since \$ *66<sup>82</sup>* 100,

Due soldier \$ ..... 100; due U. S. \$ ..... 100

Am't for cloth'g in kind or money adv'd \$ ..... 100

Due U. S. for arms, equipments, &c., \$ ..... 100

Bounty paid \$ *100* 100; due \$ *None*, 100,

Remarks:.....  
.....  
.....  
.....  
.....  
.....

Book mark: *N. 166, P. 265, 73.*

*Parter*

Clark George M.

, Co. 1st Batt WSCA  
Regt

3 Enclosures.

Bed Cards .....	Final Statements .....
Burial Records .....	Furloughs or L. of A .....
Certs. of Dis. for Discharge .....	Med. Certificates .....
C. M. Charges .....	Med. Des. Lists .....
Descriptive Lists .....	Orders .....
Discharge Certificates .....	Pris. of War Record .....
Enlistment Papers ..... 3	Resignations .....

Other papers relating to—

Admission to Hosp'l .....	Furlough or L. of A .....
Casualty Sheet .....	Med. Examination .....
Confinement .....	Misc. Information .....
Contracts .....	Pay or Clothing .....
Death or Effects .....	Personal Reports .....
Desertion .....	Rank .....
Discharge from Hosp'l .....	Transfer to Hosp'l .....
Discharge from Service .....	Transfer to V. R. C. ....
Duty .....	Transportation .....

NOTE 1.—This blank will be used for both enlistments and re-enlistments—enlistment of veterans, &c., &c., in the volunteer service. They will be made out in duplicate in all cases—one to accompany the recruiting return of the superintendent (not the recruiting officer) to the Adjutant General, and one to accompany the accounts of the officer who pays bounty, &c. The Regiment and Company in which the soldier last served should be given on the back

NOTE 2.—An enlistment holds to service. A muster-in must, in all cases, precede payment of pay, bounty, pension, &c. A muster-in roll must, in all cases, be filed in the Adjutant General's Office as evidence of muster-in. The mustering officer, commissary, or assistant commissary of musters, as the case may be, will countersign both enlistments as having mustered the soldier into the service of the United States before either of them is given to the disbursing officer.

Rec'd from 2nd. Aud. Nov. 23d 1892

DECLARATION OF RECRUIT.

I, George M Clark, desiring to VOLUNTEER as a Soldier in the Army of the United States, for the term of THREE YEARS, Do Declare, That I am Twenty four years and \_\_\_\_\_ months of age; that I have never been discharged from the United States service on account of disability or by sentence of a court martial, or by order before the expiration of a term of enlistment; and I know of no impediment to my serving honestly and faithfully as a soldier for three years.

GIVEN at Leavenworth Kansas the 15<sup>th</sup> day of December 1864

Witness: Edward Gilliland Lt. Col. 15<sup>th</sup> K. V. C. George M Clark  
mark

No. 223  
George M. Clark  
Volunteered at Leavenworth Kansas  
December 15<sup>th</sup>, 1864,  
By A. P. H. Minor Capt. Quar.  
Regiment of \_\_\_\_\_  
enlistment; last served in Company ( ) \_\_\_\_\_  
Reg't of \_\_\_\_\_  
Discharged \_\_\_\_\_, 18 \_\_\_\_\_

CONSENT IN CASE OF MINOR.

I, \_\_\_\_\_, Do CERTIFY, That I am \_\_\_\_\_; that the \_\_\_\_\_ of \_\_\_\_\_; that the \_\_\_\_\_ is \_\_\_\_\_ years of age; and I do hereby freely give my CONSENT to his volunteering as a SOLDIER in the ARMY OF THE UNITED STATES for the period of THREE YEARS.

GIVEN at \_\_\_\_\_ the \_\_\_\_\_ day of \_\_\_\_\_

Witness: \_\_\_\_\_

(A. G. O. No. 74 & 76.)

VOLUNTEER ENLISTMENT.

STATE OF

TOWN OF



*George M. Clark*, born in *Safayette Co*  
 in the State of *Missouri*, aged *24* years,  
 and by occupation a *Tobacconist*. DO HEREBY ACKNOWLEDGE to have  
 volunteered this *15* day of *December*, 1864,  
 to serve as a **Soldier** in the **Army of the United States of America**, for  
 the period of **THREE YEARS**, unless sooner discharged by proper authority:  
 Do also agree to accept such bounty, pay, rations, and clothing, as are, or may be,  
 established by law for volunteers. And I, *George M. Clark*, do  
 solemnly swear, that I will bear true faith and allegiance to the **United States**  
**of America**, and that I will serve them honestly and faithfully against all  
 their enemies or opposers whomsoever; and that I will observe and obey the  
 orders of the President of the United States, and the orders of the officers  
 appointed over me, according to the Rules and Articles of War.

Sworn and subscribed to, at *Leavenworth*  
 this *15* day of *December*, 1864, } *George M. Clark*  
 BEFORE *P. H. Minor - Lieut* }  
*Recruiting Indpt Battery*

I CERTIFY, ON HONOR, That I have carefully examined the above-named Volunteer, agreeably  
 to the General Regulations of the Army, and that, in my opinion, he is free from all bodily defects and  
 mental infirmity, which would in any way disqualify him from performing the duties of a soldier.

*W. H. S. Sikes*  
*State Board of Enrollment*  
*Leavenworth, Kansas*  
 EXAMINING SURGEON.

I CERTIFY, ON HONOR, That I have minutely inspected the Volunteer *Geo. M. Clark*  
 previously to his enlistment, and that he was entirely sober when enlisted; that, to the best of my  
 judgment and belief, he is of lawful age; and that, in accepting him as duly qualified to perform the  
 duties of an able-bodied soldier, I have strictly observed the Regulations which govern the recruiting  
 service. This soldier has *black* eyes, *black* hair, *black* complexion, is *5*  
 feet *7* inches high.

*P. H. Minor - Lieut*  
*Indpt Battery U.S. Col. Artillery*  
 RECRUITING OFFICER.

(A. G. O. No. 74 & 76.)

Mustered into the service of the United States, for three years or during the war, from date of enlistment, in *Company* *Independent*  
*Battery U.S. Regiment of Artillery* Volunteers, on the *16* day of *December*, 1864, at *Leavenworth* *Kan*

This warrant has received one hundred dollars bounty from the Bounty Fund,  
 authorized by an Act of Congress, and Circular from the Provost  
 Marshal General, dated July 1, 1864.

DECLARATION OF RECRUIT.

I, George M Clark desiring to VOLUNTEER as a Soldier in the Army of the United States, for the term of THREE YEARS, Do declare, That I am 24 Twenty four years and \_\_\_\_\_ months of age; that I have never been discharged from the United States service on account of disability or by sentence of a court-martial, or by order before the expiration of a term of enlistment; and I know of no impediment to my serving honestly and faithfully as a soldier for three years.

GIVEN at Leavenworth State of Kansas  
The 15th day of December 1864

Witness: Col Gill Lieut 15th K O C George M Clark

No. \_\_\_\_\_

George M Clark

Volunteered at Leavenworth

15th December 1864,

By Pt Quinn J Lieut

Adjutant 1st Regt 15th K O C

G. M. Clark

enlistment; last served in Company ( )

1st Regt 15th K O C

Discharged \_\_\_\_\_ 18 .

Clark

6

CONSENT IN CASE OF MINOR.

I, \_\_\_\_\_ of \_\_\_\_\_ is \_\_\_\_\_ years of age; and I do hereby freely give my consent to his volunteering as a SOLDIER in the ARMY OF THE UNITED STATES for the period of THREE YEARS.

GIVEN at \_\_\_\_\_  
The \_\_\_\_\_ day of \_\_\_\_\_

Witness: \_\_\_\_\_



Mustered into the Service of the United States for three years ordering the war from date of enlistment in Independent Battery U.S. Artillery (Sigsbee) on the 16th day of December 1864 at Leavenworth Kansas.   
 Capt. J. C. Johnson   
 Capt. Harriet Marshall Cook - Dist. Kansas

**VOLUNTEER ENLISTMENT.**

STATE OF *Kansas*



TOWN OF *Leavenworth*

I, *George M Clark* in the State of *Missouri* and by occupation a *Tobaccoist* volunteered this *15<sup>th</sup> Fifteenth*

born in *Lafayette Co,* aged *24 Twenty four* years, Do HEREBY ACKNOWLEDGE to have day of *December 1864,*

to serve as a **Soldier** in the Army of the United States of America, for the period of **THREE YEARS**, unless sooner discharged by proper authority: Do also agree to accept such bounty, pay, rations, and clothing, as are, or may be, established by law for volunteers. And I, *George M Clark* do solemnly swear, that I will bear true faith and allegiance to the **United States of America**, and that I will serve them honestly and faithfully against all their enemies or opposers whomsoever; and that I will observe and obey the orders of the President of the United States, and the orders of the officers appointed over me, according to the Rules and Articles of War.

Sworn and subscribed to, at *Leavenworth* this *15<sup>th</sup>* day of *December 1864,*

BEFORE *P. H. Minor D. Sient* Recruiting Officer *Indep Battery U.S. Artillery*

*George M Clark* his name

I CERTIFY, ON HONOR, That I have carefully examined the above named Volunteer, agreeably to the General Regulations of the Army, and that in my opinion he is free from all bodily defects and mental infirmity, which would, in any way, disqualify him from performing the duties of a soldier.

*Jiffie Binks*  
Surgeon Board of Examiners  
*North Dist Kansas*  
EXAMINING SURGEON

I CERTIFY, ON HONOR, That I have minutely inspected the Volunteer, *Geo M. Clark* previously to his enlistment, and that he was entirely sober when enlisted; that, to the best of my judgment and belief, he is of lawful age; and that, in accepting him as duly qualified to perform the duties of an able-bodied soldier, I have strictly observed the Regulations which govern the recruiting service. This soldier has *black eyes, black hair, black* complexion, is *5* feet *7* inches high.

*P. H. Minor D. Sient*  
*Indep Battery U.S. Artillery*  
Regiment of *Volunteers,* RECRUITING OFFICER.

DECLARATION OF RECRUIT.

I, George M Clark desiring to VOLUNTEER as a Soldier in the Army of the United States, for the term of THREE YEARS, Do declare, That I am 24 Twenty four years and \_\_\_\_\_ months of age; that I have never been discharged from the United States service on account of disability or by sentence of a court-martial, or by order before the expiration of a term of enlistment; and I know of no impediment to my serving honestly and faithfully as a soldier for three years.

GIVEN at Leavenworth State of Kansas  
The 15<sup>th</sup> day of December 1864  
Witness: Edw. Hill Capt 15<sup>th</sup> K.C. George M Clark  
mark

\_\_\_\_\_ enlistment; last served in Company ( )  
And Major Regt of A. S. Artillery  
Discharged \_\_\_\_\_ 18 .

No. \_\_\_\_\_  
George M Clark  
Volunteered at Leavenworth  
15<sup>th</sup> December 1864,  
By P. A. Miner 2<sup>d</sup> Lieut  
And Lt of Artillery 1<sup>st</sup> 3<sup>rd</sup> Regt Artillery

CONSENT IN CASE OF MINOR.

I, \_\_\_\_\_ of \_\_\_\_\_ Do CERTIFY, That I am the \_\_\_\_\_ ; that the \_\_\_\_\_ years of age; and I said \_\_\_\_\_ is \_\_\_\_\_ years of age; and I do hereby freely give my CONSENT to his volunteering as a SOLDIER in the ARMY OF THE UNITED STATES for the period of THREE YEARS.

GIVEN at \_\_\_\_\_  
The \_\_\_\_\_ day of \_\_\_\_\_  
Witness: \_\_\_\_\_

Mustered into the service of the United States for three years or during the war from date of enlistment in Independent Battery U.S. Colored Artillery (Light) on the 16th day of December 1864 at Leavenworth Kansas.

George M. Clark  
Capt. Provost Marshal North District Kansas  
Manassas Va.

VOLUNTEER ENLISTMENT.

<sup>Foot sore</sup>  
STATE OF Kansas TOWN OF Leavenworth City



I, George M Clark born in Lafayette Co aged 24! Twenty four years, in the State of Missouri and by occupation a Tobacconist volunteered this 13<sup>th</sup> Fifteenth day of December 1864, to serve as a Soldier in the Army of the United States of America, for the period of THREE YEARS, unless sooner discharged by proper authority: Do also agree to accept such bounty, pay, rations, and clothing, as are, or may be, established by law for volunteers. And I, George M Clark do solemnly swear, that I will bear true faith and allegiance to the United States of America, and that I will serve them honestly and faithfully against all their enemies or opposers whomsoever; and that I will observe and obey the orders of the President of the United States, and the orders of the officers appointed over me, according to the Rules and Articles of War.

Sworn and subscribed to, at Leavenworth this 13<sup>th</sup> day of December 1864 } George M Clark

BEFORE P. H. Minor 2<sup>d</sup> Lieut }  
Indpt Battery U.S. Col Artillery

I CERTIFY, ON HONOR That I have carefully examined the above named Volunteer, agreeably to the General Regulations of the Army, and that in my opinion he is free from all bodily defects and mental infirmity, which would, in any way, disqualify him from performing the duties of a soldier.

W. J. Binks  
Surg Board of Enrollment  
North Dist Kansas  
EXAMINING SURGEON

I CERTIFY, ON HONOR, That I have minutely inspected the Volunteer, Geo M Clark previously to his enlistment, and that he was entirely sober when enlisted; that, to the best of my judgment and belief, he is of lawful age; and that, in accepting him as duly qualified to perform the duties of an able-bodied soldier, I have strictly observed the Regulations which govern the recruiting service. This soldier has black eyes black hair, black complexion, is 5 feet 4 inches high.

P. H. Minor 2<sup>d</sup> Lieut  
Regt of Batty U.S. Colored Artillery  
RECRUITING OFFICER.

*James Henry*  
 Capt. Batt'y U.S. Col'd L. Art'y.

*Private Private*

CARD NUMBERS.

1	623375-6
2	6233903
3	6234162
4	6234673
5	9132936
6	
7	
8	
9	
10	
11	
12	
13	
14	
15	
16	
17	
18	
19	
20	
21	
22	
23	
24	
25	

26
27
28
29
30
31
32
33
34
35
36
37
38
39
40
41
42
43
44
45
46
47
48
49
50

Book Mark:

See also

D.1194443 P.O. m m  
Hls. Ref - 21 March 46  
SAM,

M. Spencer  
4

*C* | Indpt. Batt'y. | **U.S.C.T.**

*James Clay*

....., Indpt. Batt'y, U. S. Col'd L. Art'y.

Appears on

**Battery Descriptive Book**

of the organization named above.

**DESCRIPTION.**

Age *29* years; height *5* feet *6* inches.

Complexion *Black*

Eyes *Black*; hair *Black*

Where born *N. Carolina*

Occupation *Laborer*

**ENLISTMENT.**

When *Aug. 10* —, 1864.

Where *Earth Co.*

By whom *S. Mathews*; term *3* y'rs.

Remarks: .....

.....

.....

.....

.....

.....

.....

.....

.....

*Healbrook*

*C*

Indpt. Battery. U.S.C.T.

*Henry Clay*

*Private*, Indpt. Battery, U. S. Col'd L. Art'y.

Appears on

**Battery Muster-in and Descriptive Roll**

of the organization named above. Roll dated

*Leavenworth Co Dec 23*, 1864.

Where born *N. C.*

Age *29* y'rs; occupation *Laborer*

When enlisted *May 10*, 1864.

Where enlisted *Leavenworth Co*

For what period enlisted *3* years.

Eyes *Blue*; hair *Blue*

Complexion *Blue*; height *5 ft. 6 in.*

When mustered in *May 18*, 1864.

Where mustered in *Leavenworth*

Bounty paid \$ *100<sup>00</sup>*/<sub>100</sub>; due \$ *20<sup>00</sup>*/<sub>100</sub>

Where credited

Battery to which assigned

Remarks: *Or N. Dist Co  
19<sup>th</sup> S.D. 1<sup>st</sup> Ward  
Leavenworth Co.*

Book mark :

*J. H. [Signature]*

(856g)

Copyist.

6 | Indpt. Battery. | **U.S.C.T.**

*Henry Clay*

*Pvt*, Indpt. Battery, U. S. Col'd L. Art'y.

Appears on

**Battery Muster Roll**

for *July's Muster to Dec 31*, 186 *x*

Present or absent *Present*

Stoppage, \$ 100 for

Due Gov't, \$ 100 for

Valuation of horse, \$ 100

Valuation of horse equipments, \$ 100

Remarks:

Book mark:

*J. H. Schrey*  
(358) Copyist.



6 | Indpt. Battery. | U.S.C.T.

Henry Clay

20<sup>th</sup>, Indpt. Battery, U. S. Col'd L. Art'y.

Appears on

**Battery Muster Roll**

for *Jan Feb*, 186<sup>5</sup>.

Present or absent

Stoppage, \$ 100 for

Due Gov't, \$ 100 for

Valuation of horse, \$ 100

Valuation of horse equipments, \$ 100

Remarks: *died in New  
Hospital at Fort  
Leavenworth Feb 20<sup>th</sup>  
1st of Pneumonia*

Book mark:

*J. S. ...*

(356)

Copyist.

*C* | Indpt. Battery. | **U.S.C.T.**

*Nancy Clay,*  
*N*, Indpt. Battery U. S. Col'd Light Art'y.

Appears on **Batt'y Muster-out Roll**, dated  
*Ft. Leavenworth, Kas, July 22, 1865.*

Muster-out to date \_\_\_\_\_, 186 .

Last paid to *(Pay due from enlistment, 186* .

Clothing account:

Last settled \_\_\_\_\_, 186 ; drawn since \$ *43* <sup>*76*</sup>/<sub>*100*</sub>

Due soldier \$ \_\_\_\_\_ <sup>*100*</sup>/<sub>*100*</sub>; due U. S. \$ \_\_\_\_\_ <sup>*100*</sup>/<sub>*100*</sub>

Am't for cloth'g in kind or money adv'd \$ \_\_\_\_\_ <sup>*100*</sup>/<sub>*100*</sub>

Due U. S. for arms, equipments, &c., \$ \_\_\_\_\_ <sup>*100*</sup>/<sub>*100*</sub>

Bounty paid \$ *100* <sup>*100*</sup>/<sub>*100*</sub>; due \$ *none* <sup>*100*</sup>/<sub>*100*</sub>,

Remarks: *Died in G. Hospital,*  
*Ft. Leavenworth, July 20/65,*

Book mark: *V. 191. P. 180. 74.*

(361)

*Barter*  
Copyist.

*Inapt Batty.*

*Clay Henry*

....., Co. ...., Reg't *105th*

*3*

Enclosures.

Bed Cards .....	Final Statements / .....
Burial Records .....	Furloughs or L. of A .....
Certs. of Dis. for Discharge .....	Med. Certificates .....
C. M. Charges .....	Med. Des. Lists .....
Descriptive Lists .....	Orders .....
Discharge Certificates .....	Pris. of War Record .....
Enlistment Papers <i>2</i> .....	Resignations .....

Other papers relating to—

Admission to Hosp'l .....	Furlough or L. of A .....
Casualty Sheet .....	Med. Examination .....
Confinement .....	Misc. Information .....
Contracts .....	Pay or Clothing .....
Death or Effects .....	Personal Reports .....
Desertion .....	Rank .....
Discharge from Hosp'l .....	Transfer to Hosp'l .....
Discharge from Service .....	Transfer to V. R. C. .....
Duty .....	Transportation .....

NOTE 1.—This blank will be used for both enlistments and re-enlistments—enlistment of veterans, &c., &c., in the volunteer service. They will be made out in duplicate in all cases—one to accompany the recruiting return of the superintendent (not the recruiting officer) to the Adjutant General, and one to accompany the accounts of the officer who pays bounty, &c. The Regiment and Company in which the soldier last served should be given on the back.

NOTE 2.—An enlistment holds to service. A muster-in must, in all cases, precede payment of pay, bounty, pension, &c. A muster-in roll must, in all cases, be filed in the Adjutant General's Office as evidence of muster-in. The mustering officer, commissary, or assistant commissary of musters, as the case may be, will countersign both enlistments as having mustered the soldier into the service of the United States before either of them is given to the disbursing officer.

DECLARATION OF RECRUIT.

I, Henry Clay desiring to VOLUNTEER as a Soldier in the Army of the United States, for the term of THREE YEARS Do Declare, That I am 25 years ~~old~~ of age, that I have never been discharged from the United States service on account of disability or by sentence of a court-martial, or by order before the expiration of a term of enlistment; and I know of no impediment to my serving honestly and faithfully as a soldier for three years.

GIVEN at Lawrence in the State of Kansas the 13 day of August 1864

Witness: W. A. Burnham Henry Clay

No. 622

Henry Clay  
Volunteered at Lawrence, Mo.  
13-12 1864,  
By W. A. Burnham 2d Lieut.  
1st U. S. Regiment of Col. Artillery  
.....  
enlistment; last served in Company ( )  
.....  
Reg't of .....  
Discharged ..... 18 ..

CONSENT IN CASE OF MINOR.

I, ..... Do CERTIFY, That I am the ..... of .....; that the said ..... is ..... years of age; and I do hereby freely give my CONSENT to his volunteering as a SOLDIER in the ARMY OF THE UNITED STATES for the period of THREE YEARS.

GIVEN at ..... the ..... day of .....

Witness: .....

3334  
VOLUNTEER ENLISTMENT.

STATE OF

*Kansas*



TOWN OF

*Seventeenth*

I, *Henry Clay* born in \_\_\_\_\_

in the State of *North Carolina* aged *29* years,

and by occupation a *Laborer* Do HEREBY ACKNOWLEDGE to have

volunteered this *15* day of *August* 186*4*

to serve as a **Soldier** in the **Army of the United States of America**, for the

period of **THREE YEARS** unless sooner discharged by proper authority: Do also

agree to accept such bounty, pay, rations, and clothing, as are, or may be, estab-

lished by law for volunteers. And I, *Henry Clay* do

solemnly swear, that I will bear true faith and allegiance to the **United States**

**of America**, and that I will serve them honestly and faithfully against all their

enemies or opposers whomsoever; and that I will observe and obey the orders of

the President of the United States, and the orders of the officers appointed over

me, according to the Rules and Articles of War.

Sworn and subscribed to, at *Seventeenth*

this *15* day of *August* 186*4*,

BEFORE *Wm D Matthews 2nd Lieut*  
*Recruiting 1st Ind U.S. Col Artillery*

*Henry Clay*

I CERTIFY, ON HONOR, That I have carefully examined the above-named Volunteer, agreeably to the General Regulations of the Army, and that, in my opinion, he is free from all bodily defects and mental infirmity, which would in any way disqualify him from performing the duties of a soldier.

*Tiffin Binks*  
*Surgeon Board enrollment*  
*North Kansas*

EXAMINING SURGEON.

I CERTIFY, ON HONOR, That I have minutely inspected the Volunteer, *Henry Clay* previously to his enlistment, and that he was entirely sober when enlisted; that, to the best of my judgment and belief, he is of lawful age; and that, in accepting him as duly qualified to perform the duties of an able-bodied soldier, I have strictly observed the Regulations which govern the recruiting service.

This soldier has *Black* eyes, *Black* hair, *Black* complexion, is *5* feet

*6* inches high.

*Wm D Matthews 2nd*  
*Recruiting 1st Ind. Col Artillery*  
*Volunteers,*

RECRUITING OFFICER

the *15* day of *August* 186*4*, at \_\_\_\_\_ Regiment of \_\_\_\_\_ Volunteers, on

NOTE 1.—This blank will be used for both enlistments and re-enlistments—enlistment of veterans, &c., &c., in the volunteer service. They will be made out in duplicate in all cases—one to accompany the recruiting return of the superintendent (not the recruiting officer) to the Adjutant General, and one to accompany the accounts of the officer who pays bounty, &c. The Regiment and Company in which the soldier last served should be given on the back.

NOTE 2.—An enlistment holds to service. A muster-in must, in all cases, precede payment of pay, bounty, pension, &c. A muster-in roll must, in all cases, be filed in the Adjutant General's Office as evidence of muster-in. The mustering officer, commissary, or assistant commissary of musters, as the case may be, will countersign both enlistments as having mustered the soldier into the service of the United States before either of them is given to the disbursing officer.

DECLARATION OF RECRUIT.

I, Henry Clay desiring to VOLUNTEER as a Soldier in the Army of the United States, for the term of THREE YEARS Do Declare, That I am 29 years and months of age; that I have never been discharged from the United States service on account of disability or by sentence of a court-martial, or by order before the expiration of a term of enlistment; and I know of no impediment to my serving honestly and faithfully as a soldier for three years.

GIVEN at Lawrence in the State of Kansas the 15 day of August 1864

Witness: W. H. Burnham Henry Clay

Rec'd from 2nd. Aud. Nov. 23d 1892

Discharged ..... 18 ..  
 ..... enlistment; last served in Company ( )  
 ..... Reg't of .....

Henry Clay  
 Volunteered at Lawrence  
August 13 1864  
 By Wm. D. Newburn  
 Capt. 15th Regt. U. S. Artillery

No. 1000

CONSENT IN CASE OF MINOR.

I, ..... Do CERTIFY, That I am the ..... of .....; that the said ..... is ..... years of age; and I do hereby freely give my CONSENT to his volunteering as a SOLDIER in the ARMY OF THE UNITED STATES for the period of THREE YEARS.

GIVEN at ..... the ..... day of .....

Witness: .....

33 34

VOLUNTEER ENLISTMENT.

STATE OF

TOWN OF

*Kansas*

*Leavenworth*



I, *Henry Clay* born in

in the State of *North Carolina* aged *29* years,

and by occupation a *Soldier* Do HEREBY ACKNOWLEDGE to have

volunteered this *15* day of *August* 1864,

to serve as a **Soldier** in the **Army of the United States of America**, for the period of **THREE YEARS** unless sooner discharged by proper authority: Do also

agree to accept such bounty, pay, rations, and clothing, as are, or may be, established by law for volunteers. And I, *Henry Clay* do

solemnly swear, that I will bear true faith and allegiance to the **United States of America**, and that I will serve them honestly and faithfully against all their

enemies or opposers whomsoever; and that I will observe and obey the orders of the President of the United States, and the orders of the officers appointed over

me, according to the Rules and Articles of War.

sworn and subscribed to, at *Leavenworth*

this *15* day of *August* 1864,

BEFORE *Wm D Matthews 2nd Lieut*

*Recruiting 1st Ind. U.S. Col Artillery*

*Henry Clay*

I CERTIFY, ON HONOR, That I have carefully examined the above-named Volunteer, agreeably to the General Regulations of the Army, and that, in my opinion, he is free from all bodily defects and mental infirmity, which would in any way disqualify him from performing the duties of a soldier.

*Jiffie Sinks*  
*Surg Bond enrollment*  
*North Dist Kansas*

EXAMINING SURGEON.

I CERTIFY, ON HONOR, That I have minutely inspected the Volunteer, *Henry Clay* previously to his enlistment, and that he was entirely sober when enlisted; that, to the best of my judgment and belief, he is of lawful age; and that, in accepting him as duly qualified to perform the duties of an able-bodied soldier, I have strictly observed the Regulations which govern the recruiting service.

This soldier has *Black* eyes, *Black* hair, *Black* complexion, is *5* feet *5* inches high.

*Wm D Matthews 2nd Lieut*  
*Recruiting 1st Ind. U.S. Col Artillery*

RECRUITING OFFICER.

A. G. O. No. 74 & 75.

*This recruit has received one hundred dollars advance bounty from the County fund authorized by an Act of Congress approved July 4th 1864. Henry Clay No 24 from the Prov. Co. 4th Regt. 1st Ind. U.S. Col Artillery*

the *15* day of *August* 1864 at *Leavenworth Kansas*  
Mustered into the service of the United States, in Company *Company* Regiment of *2nd Ind. U.S. Col Artillery* Volunteers on *15th August 1864*

FINAL STATEMENT

OF

Private Henry Clay  
Adj. Gen. Regt of U.S. Artillery  
(Lieut.)  
VOLUNTEERS.  
April 20 1865

AGC  
Collected receipts for  
Exp. sent 2d Auditor  
M

NOTE 1.—Two of these certificates (or duplicates) are to be given to each Volunteer Soldier or drafted man who may be discharged previously to the discharge of his company, that he may at once receive from the Paymaster the pay, &c., due him, and the captain or other COMMISSIONED officer commanding the company will certify to the act of the delivery of the duplicate certificates; on these certificates the Soldier is "entitled to" his discharge, and should also present his discharge to the Paymaster to have the payment endorsed on it. The discharge is to be given back to the Soldier by the Paymaster; the latter only retaining as his voucher the duplicate certificates.

NOTE 2.—If the Soldier is entitled to pay for the use of his horse, the Company Commander will certify to that fact on the back of both these final statements, and also to the time he has pay due for having been so mounted on his own horse.

NOTE 3.—When a Soldier is furnished with final statements, his descriptive list, if he has one, should be taken up by the officer who gives the Soldier these statements, and endorsed with a statement to this effect by the officer. This endorsement should exhibit a full statement of the time for which the Soldier was allowed pay on his final statements, the clothing account, and all other charges against him or in his favor, so as to comprise a complete exhibit of his account. It will then be transmitted to the company commander of the Soldier, who will enter all the data necessary to a full understanding of the Soldier's account on the muster roll upon which the Soldier's discharge is reported. The descriptive list will then be destroyed. The object of this is, that the remaining portion of the Soldier's account may be settled upon the receipt of these muster rolls, and the Soldier receive any pay or allowances that may be due him at the time of his discharge, and which may not appear on his final statements from the fact that his descriptive list is incomplete. These accounts for back pay, &c., are settled by the 2d Auditor of the Treasury Department.

NOTE 4.—Charges for loss or injury to ordnance, horse equipments, and other miscellaneous charges, should appear under the heading of "Other Stoppages."

NOTE 5.—Bounty paid by State authorities, and not by the United States, will not be entered on this statement.

NOTE 6.—Amounts due the Sutler and Laundress must be entered on the muster roll on which the discharge, death, desertion, &c., is reported, as well as on the final statement, otherwise the amount cannot be collected from the United States.

NOTE 7.—This blank will be used for deceased volunteers and drafted men, as well as for others.

NOTE 8.—Where a Soldier dies in Hospital or on detached service, his descriptive list, if he has one, should be sent with his final statements, in duplicate, to the Adjutant General, Washington, D. C.

ADJUTANT GENERAL'S OFFICE  
May 18 1865  
Duplicate with Inventory sent 2d Auditor.

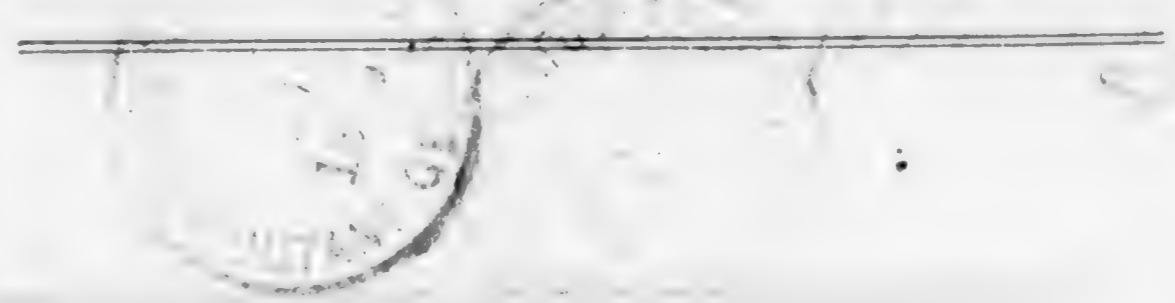



I certify, on honor, that Henry Clay a Private of  
 Captain H. F. Douglas Company ( ) of the Battery 1st Regiment of U.S. Colored Artillery (1st)  
**VOLUNTEERS**, of the State of Kansas, born in \_\_\_\_\_, State  
 of North Carolina, aged 25 years; 5 feet 6 inches high; Black complexion,  
Black eyes, Black hair, and by occupation a Laborer, having joined the company on  
 its original organization at Leavenworth, and enrolled in it at the muster into  
 the service of the United States at Leavenworth, on the Fifteenth (15<sup>th</sup>) day  
 of August, 1864, (or was mustered in service as a recruit, by \_\_\_\_\_  
 \_\_\_\_\_, at \_\_\_\_\_, on the \_\_\_\_\_ day of \_\_\_\_\_,  
 186 , or was drafted and mustered into the service of the United States from the \_\_\_\_\_  
 Enrollment District of the State of \_\_\_\_\_, at \_\_\_\_\_,  
 on the \_\_\_\_\_ day of \_\_\_\_\_, 186 ) to serve in the Battery 1st Regiment, for  
 the term of three (3) years unless sooner discharged: and having served HONESTLY and  
 FAITHFULLY with his Company in \_\_\_\_\_ to the present date, is now

entitled to a **DISCHARGE** by reason of Death caused by pneumonia  
at Post Hospital Fort Leavenworth February Twenty-fifth 1865

The said Henry Clay was last paid by Paymaster  
Major Smith to include the thirty-first (31<sup>st</sup>) day of December, 1864, and has  
 pay due him from that time to the present date; he is entitled to pay and subsistence for  
 TRAVELING to place of enrollment, and whatever other allowances are authorized to volunteer  
 soldiers, drafted men, or militia, so discharged. He has received from the United States **CLOTHING**  
 amounting to Forty three (43)  $\frac{76}{100}$  dollars, since the 18<sup>th</sup> day of August,  
 1864, when his clothing account was last settled. He has received from the United States  
one hundred (100)  $\frac{00}{100}$  dollars advanced **BOUNTY**.

There is to be stopped from him, on account of the State of \_\_\_\_\_, or other  
 authorities, for **CLOTHING**, &c, received on entering service, \_\_\_\_\_  $\frac{00}{100}$  dollars; and  
 for other stoppages, viz: \_\_\_\_\_

\_\_\_\_\_  $\frac{00}{100}$  dollars.  
 He has been furnished with TRANSPORTATION in kind from the place of his discharge to  
 \_\_\_\_\_; and he has been SUBSISTED for TRAVELING to his  
 place of enrollment, up to the \_\_\_\_\_, 186 .

He is indebted to \_\_\_\_\_, **SUTLER**, \_\_\_\_\_  $\frac{44}{100}$  dollars.  
 He is indebted to \_\_\_\_\_, **LAUNDRESS**, \_\_\_\_\_  $\frac{02}{100}$  dollars.

Given in Duplicate, at Fort Leavenworth Kansas, this 20<sup>th</sup> day  
 of February, 1865.

H. F. Douglas  
 Captain

Commanding Company

H. F. Douglas  
 Secy of War  
 Jan 20/65

*Robert Burns*

1st Lt. Batt'y U.S. Col'd L. Art'y

*Private Sergeant*  
CARD NUMBERS.

6233642	26
6234036	27
6234173	28
6234341	29
6234505	30
9133096	31
	32
	33
	34
	35
	36
	37
	38
	39
	40
	41
	42
	43
	44
	45
	46
	47
	48
	49
	50

Book Mark:

See also

A. 582 490 P.O. 90

R + P 656677

D. 2086731 *Person*

A 2393271 *Ally*

S-2403467 - *And. W.D.*

*Myfence*  
*7*

C | Indpt. Batt'y. | U.S.C.T.

Robert Clayburn

....., Indpt. Batt'y, U. S. Col'd L. Art'y.

Appears on

**Battery Descriptive Book**

of the organization named above.

**DESCRIPTION.**

Age 26 years; height 5 feet 8 inches.

Complexion Light

Eyes Blue; hair Black

Where born Mon Co. Ia.

Occupation Farmer

**ENLISTMENT.**

When Jan 16, 1865.

Where Quindan Kas

By whom Capt. Douglas; term 3 y'rs.

Remarks:

.....  
.....  
.....  
.....  
.....  
.....  
.....  
.....  
.....  
.....

Boelrovt

C | Indpt. Battery. | **U.S.C.T.**

Robert Clayburn

Appears with rank of *Priv* on

**Muster and Descriptive Roll of a Detachment of U. S. Vols. forwarded**

for the Indpt. Batt'y, U. S. Col'd L. Arty. Roll dated

*Leavenworth, Kas, Jan. 17 1865.*

Where born *Union Co, Louisiana*

Age *26* y'rs; occupation *Farmer*

When enlisted *Jan. 16*, 1865.

Where enlisted *Leavenworth, Kas*

For what period enlisted *3* years.

Eyes *Blue*; hair *Black*

Complexion *light*; height *5 ft. 8 in.*

When mustered in *Jan. 17*, 1865.

Where mustered in *Leavworth, Kas.*

Bounty paid \$ *000* <sup>100</sup>; due \$ *300* <sup>100</sup>

Where credited

Battery to which assigned

Remarks: *Transferred to North Dist*  
*Kav. 28<sup>th</sup> Sub. Dist Quindaro*  
*Township Wyandotte County*  
*Volunteer Recruit entitled to Bounty*

Book mark:

*E. L. Harman*

*C*

Indpt. Battery.

U.S.C.T.

*Robert Cloyburn*

*6th Regt  
Serg X*

, Indpt. Battery, U. S. Col'd L. Art'y.

Appears on

**Battery Muster Roll**

for *Jan'y & Feb*, 186*5*.

Present or absent *Present*

Stoppage, \$ 100 for

Due Gov't, \$ 100 for

Valuation of horse, \$ 100

Valuation of horse equipments, \$ 100

Remarks: *Appointed Sergt  
Jan'y 1865 by Maj.  
R. W. Hunt Chief Artillery  
Dept of War.*

Book mark:

*J. H. Schreyer*

(358)

Copyist.

*C* | Indpt. Battery. | **U.S.C.T.**

*Robert Clayburn,*  
*Sergt.*, Indpt. Battery, U. S. Col'd L. Art'y.

Appears on

**Battery Muster Roll**

for *Jan & Apl.*, 1865.

Present or absent *Present*

Stoppage, \$ *100* for

Due Gov't, \$ *100* for

Valuation of horse, \$ *100*

Valuation of horse equipments, \$ *100*

Remarks: *Pay due as private*  
*from Jan. 16/65, to Feb. 11/65,*  
*& as Sergt. from Feb. 11/65,*

Book mark:

*Paater*

(358)

Copyist.

*C*

Indpt. Battery.

U.S.C.T.

*Robert Clayburn,*

*Sergeant* Indpt. Battery, U. S. Col'd L. Art'y.

Appears on

**Battery Muster Roll**

for *May + June*, 1865.

Present or absent *Present,*

Stoppage, \$ *100* for

Due Gov't, \$ *100* for

Valuation of horse, \$ *100*

Valuation of horse equipments, \$ *100*

Remarks: *Pay due as Pilot,*  
*to Feb. 16/65, as sergeant,*  
*from Feb. 16/65,*

Book mark:

*Porter*

(358)

Copyist.



C | Indpt. Battery. | U.S.C.T.

*Robert Clayburn,*  
*Sgt.,* Indpt. Battery U. S. Col'd Light Art'y.

Appears on **Batt'y Muster-out Roll**, dated  
*W. Leavenworth, Ky July 22, 1865.*

Muster-out to date *July 22, 1865.*

Last paid to (*Pay due from enlistment*) 186 .

Clothing account:

Last settled....., 186 ; drawn since \$ *51* <sup>*49*</sup>/<sub>100</sub>

Due soldier \$.....<sup>100</sup>; due U. S. \$.....<sup>100</sup>

Am't for cloth'g in kind or money adv'd \$.....<sup>100</sup>

Due U. S. for arms, equipments, &c., \$.....<sup>100</sup>

Bounty paid \$ *None* <sup>100</sup>; due \$ *100* <sup>100</sup>.

Remarks: *Write from enlistment,*  
*to Jan'y, 1/65, then Sergt.,*

Book mark :.....

*Parten*

(361)

Copyist.

*Clayburn & Pollock*

Co. *Ind* Batt *W.S.C.A*  
Reg't

*2* Enclosures.

Bed Cards .....	Final Statements .....
Burial Records .....	Furloughs or L. of A. ....
Certs. of Dis. for Discharge .....	Med. Certificates .....
C. M. Charges .....	Med. Des. Lists .....
Descriptive Lists .....	Orders .....
Discharge Certificates .....	Pris. of War Record .....
Enlistment Papers <i>2</i> .....	Resignations .....

Other papers relating to—

Admission to Hosp'l .....	Furlough or L. of A. ....
Casualty Sheet .....	Med. Examination .....
Confinement .....	Misc. Information .....
Contracts .....	Pay or Clothing .....
Death or Effects .....	Personal Reports .....
Desertion .....	Rank .....
Discharge from Hosp'l .....	Transfer to Hosp'l .....
Discharge from Service .....	Transfer to V. R. C. ....
Duty .....	Transportation .....

NOTE 1.—This blank will be used for both enlistments and re-enlistments—enlistment of veterans, &c., &c., in the volunteer service. They will be made out in duplicate in all cases—one to accompany the recruiting return of the superintendent (not the recruiting officer) to the Adjutant General, and one to accompany the accounts of the officer who pays bounty, &c. The Regiment and Company in which the soldier last served should be given on the back.

NOTE 2.—An enlistment holds to service. A muster-in must, in all cases, precede payment of pay, bounty, pension, &c. A muster-in roll must, in all cases, be filed in the Adjutant General's Office as evidence of muster-in. The mustering officer, commissary, or assistant commissary of musters, as the case may be, will countersign both enlistments as having mustered the soldier into the service of the United States before either of them is given to the disbursing officer.

DECLARATION OF RECRUIT.

I, Robert Clayburn, desiring to VOLUNTEER as a Soldier in the Army of the United States, for the term of THREE YEARS, Do Declare, That I am Twenty Six years and \_\_\_\_\_ months of age; that I have never been discharged from the United States service on account of disability or by sentence of a court martial, or by order before the expiration of a term of enlistment; and I know of no impediment to my serving honestly and faithfully as a soldier for three years.

GIVEN at Seaman worth City the 16<sup>th</sup> day of January 1865

Witness: W. H. Bunker Robert Clayburn

Discharged \_\_\_\_\_, 18\_\_\_\_  
Reg't of \_\_\_\_\_  
enlistment; last served in Company ( ) \_\_\_\_\_

No. \_\_\_\_\_  
Robert Clayburn  
Volunteered at Seaman worth Va  
January 16, 1865  
Reg't of 1st Artillery  
1st Reg't of 1st Artillery  
of 1st Artillery

CONSENT IN CASE OF MINOR.

I, \_\_\_\_\_, Do CERTIFY, That I am \_\_\_\_\_; that the \_\_\_\_\_ of \_\_\_\_\_ is \_\_\_\_\_ years of age; and I do hereby freely give my CONSENT to his volunteering as a SOLDIER in the ARMY OF THE UNITED STATES for the period of THREE YEARS.

GIVEN at \_\_\_\_\_ the \_\_\_\_\_ day of \_\_\_\_\_

Witness: \_\_\_\_\_

Credited to Northern district Kansas 28<sup>th</sup> Dist 2nd Land Dist Township Drysdale County

VOLUNTEER ENLISTMENT.

STATE OF

TOWN OF

*Kansas*



*Seamanworth*

I, *Robert Clayburn*, born in *Missis Co -*  
in the State of *Louisiana*, aged *Twenty Six* years,  
and by occupation a *farmer*, Do HEREBY ACKNOWLEDGE to have  
volunteered this *Sixteenth* day of *January*, 1865,  
to serve as a **Soldier** in the **Army of the United States of America**, for  
the period of **THREE YEARS**, unless sooner discharged by proper authority:  
Do also agree to accept such bounty, pay, rations, and clothing, as are, or may be,  
established by law for volunteers. And I, *Robert Clayburn*, do  
solemnly swear, that I will bear true faith and allegiance to the **United States  
of America**, and that I will serve them honestly and faithfully against all  
their enemies or opposers whomsoever; and that I will observe and obey the  
orders of the President of the United States, and the orders of the officers  
appointed over me, according to the Rules and Articles of War.

Sworn and subscribed to, at *Seamanworth*  
• this *16<sup>th</sup>* day of *Jan*, 1865 } *Robert Clayburn*  
BEFORE *Sicut W Bond Douglas*  
*Recruiting for Battery*

I CERTIFY, ON HONOR, That I have carefully examined the above-named Volunteer, agreeably  
to the General Regulations of the Army, and that, in my opinion, he is free from all bodily defects and  
mental infirmity, which would in any way disqualify him from performing the duties of a soldier.

*Jiffie Sims*  
*Sur Board of Amollunns*  
*North Dist Kansas*  
EXAMINING SURGEON.

I CERTIFY, ON HONOR, That I have minutely inspected the Volunteer *Robert Clayburn*  
previously to his enlistment, and that he was entirely sober when enlisted; that, to the best of my  
judgment and belief, he is of lawful age; and that, in accepting him as duly qualified to perform the  
duties of an able-bodied soldier, I have strictly observed the Regulations which govern the recruiting  
service. This soldier has *Blue* eyes, *Black* hair, *Light* complexion, is *fine*  
feet *8* inches high.

*Sicut W Bond Douglas*  
*2nd Battery US Col Arty*  
Regiment of *Volunteers*,  
RECRUITING OFFICER.

(A. G. O. No. 74 & 75.)

*Battery* Mustered into the service of the United States, for three years or during the war, from date of enlistment, in *Company* *Seamanworth Kansas*  
*286th Cavalry* Volunteers, on the *17<sup>th</sup>* day of *January*, 1865, at *Seamanworth Kansas*

*James G. ...*  
*at Seamanworth*  
*North Dist Kansas*

NOTE 1.—This blank will be used for both enlistments and re-enlistments—enlistment of veterans, &c., &c., in the volunteer service. They will be made out in duplicate in all cases—one to accompany the recruiting return of the superintendent (not the recruiting officer) to the Adjutant General, and one to accompany the accounts of the officer who pays bounty, &c. The Regiment and Company in which the soldier last served should be given on the back.

NOTE 2.—An enlistment holds to service. A muster-in must, in all cases, precede payment of pay, bounty, pension, &c. A muster-in roll must, in all cases, be filed in the Adjutant General's Office as evidence of muster-in. The mustering officer, commissary, or assistant commissary of musters, as the case may be, will countersign both enlistments as having mustered the soldier into the service of the United States before either of them is given to the disbursing officer.

DECLARATION OF RECRUIT.

I, Robert Clayburn, desiring to VOLUNTEER as a Soldier in the Army of the United States, for the term of THREE YEARS, Do Declare, That I am Twenty Six years and 4 months of age; that I have never been discharged from the United States service on account of disability or by sentence of a court martial, or by order before the expiration of a term of enlistment; and I know of no impediment to my serving honestly and faithfully as a soldier for three years.

GIVEN at Seaman Worth City the 10<sup>th</sup> day of January 1865

Witness: W.A. Burrhead Robert Clayburn

Discharged 18

Reg't of

enlistment; last served in Company ( )

No. 16  
Robert Clayburn  
Volunteered Seaman Worth Va  
January 16. 1865  
By W.A. Burrhead  
Adj. Genl. Regt. of U.S. Volunteers

16

CONSENT IN CASE OF MINOR.

I, \_\_\_\_\_, Do CERTIFY, That I am the \_\_\_\_\_ of \_\_\_\_\_; that the said \_\_\_\_\_ is \_\_\_\_\_ years of age; and I do hereby freely give my CONSENT to his volunteering as a SOLDIER in the ARMY OF THE UNITED STATES for the period of THREE YEARS.

GIVEN at \_\_\_\_\_ the \_\_\_\_\_ day of \_\_\_\_\_

Witness: \_\_\_\_\_

*Specified to North District of Kansas at 28th Sub Dist Minidous Township Wyandotte County  
29th Sub Dist. No 5th Dist*

VOLUNTEER ENLISTMENT.

STATE OF

TOWN OF

*Kansas*



*Leavenworth*

I, *Robert Clayburn*, born in *Union Co -*  
in the State of *Louisiana*, aged *Twenty Six* years,  
and by occupation a *farmer*, Do HEREBY ACKNOWLEDGE to have  
volunteered this *Sixteenth* day of *January*, 1865,  
to serve as a **Soldier** in the **Army of the United States of America**, for  
the period of **THREE YEARS**, unless sooner discharged by proper authority:  
Do also agree to accept such bounty, pay, rations, and clothing, as are, or may be,  
established by law for volunteers. And I, *Robert Clayburn*, do  
solemnly swear, that I will bear true faith and allegiance to the **United States  
of America**, and that I will serve them honestly and faithfully against all  
their enemies or opposers whomsoever; and that I will observe and obey the  
orders of the President of the United States, and the orders of the officers  
appointed over me, according to the Rules and Articles of War.

Sworn and subscribed to, at *Leavenworth*  
this *16th* day of *Jan*, 1865, *Robert Clayburn*  
BEFORE *H. Ford Douglon*  
*Lieut + Recruiting Officer*

I CERTIFY, ON HONOR, That I have carefully examined the above-named Volunteer, agreeably  
to the General Regulations of the Army, and that, in my opinion, he is free from all bodily defects and  
mental infirmity, which would in any way disqualify him from performing the duties of a soldier.

*Lizzie Simko*  
*Surg Board of Enrollment*  
*North Dist Kansas*  
EXAMINING SURGEON.

I CERTIFY, ON HONOR, That I have minutely inspected the Volunteer *Robert Clayburn*  
previously to his enlistment, and that he was entirely sober when enlisted; that, to the best of my  
judgment and belief, he is of lawful age; and that, in accepting him as duly qualified to perform the  
duties of an able-bodied soldier, I have strictly observed the Regulations which govern the recruiting  
service. This soldier has *blue* eyes, *black* hair, *light* complexion, is *five*  
feet *8* inches high.

*Lieut H Ford Douglon*  
*2nd Batty us ca- arty*  
Volunteers,  
RECRUITING OFFICER.

(A. G. O. No. 74 & 76.)

Mustered into the service of the United States, for three years or during the war, from date of enlistment, in *Company*  
*Battery* Regiment of *1st Cavalry* Volunteers, on the *16th* day of *January*, 1865, at *Leavenworth Kansas*  
*John G. Gannon*  
*Company*  
*1st Cavalry*

*John G. Gannon*  
*Company*  
*1st Cavalry*

*James, John*

1st. Batt'y U.S. Col'd L. Art'y

*Private Private*

CARD NUMBERS.

6233750	26
6233899	27
6234072	28
6234211	29
6234378	30
6234540	31
9132931	32
	33
	34
	35
	36
	37
	38
	39
	40
	41
	42
	43
	44
	45
	46
	47
	48
	49
	50

Book Mark:

See also

S. 1010812 - Land. Per. Sec.  
\$1954290 P.O. M + M

W. S. Jensen  
7



*C* | Indpt. Batt'y. | **U.S.C.T.**

*John Cleaver*

....., Indpt. Batt'y, U. S. Col'd L. Art'y.

Appears on

**Battery Descriptive Book**

of the organization named above.

**DESCRIPTION.**

Age *18* years; height *5* feet *8* inches.

Complexion *dark*

Eyes *Black*; hair *Black*

Where born *Jackson Mo.*

Occupation *Gentleman*

**ENLISTMENT.**

When *July 25*, 186 *4*.

Where *Wyandotte Kas.*

By whom *S. Minor*; term *3* y'rs.

Remarks: .....

.....  
.....  
.....  
.....  
.....  
.....  
.....  
.....  
.....  
.....

*Loelbrook*

6

Indpt. Battery. U.S.C.T.

John Cleaver  
*Put*

Indpt. Battery, U. S. Col'd L. Art'y.

Appears on

**Battery Muster-in and Descriptive Roll**

of the organization named above. Roll dated

Severnworth No Dist 23, 1864.

Where born Jacksonles Mo.

Age 18 y'rs; occupation Gunterman

When enlisted July 25, 1864.

Where enlisted Myandote No

For what period enlisted 3 years.

Eyes Blue; hair Blue

Complexion Dark; height 5 ft. 8 in.

When mustered in July 28, 1864.

Where mustered in Severnworth

Bounty paid \$ 100<sup>00</sup>/<sub>100</sub>; due \$ 200<sup>00</sup>/<sub>100</sub>

Where credited

Battery to which assigned

Remarks: U.S. Dist No  
 28<sup>th</sup> Myandote No,

Book mark: K. 262, No. 76.

*J. J. [Signature]*

(856g)

Copyist.

6 | Indpt. Battery. | **U.S.C.T.**

John Cleaver  
Govt, Indpt. Battery, U. S. Col'd L. Art'y.

Appears on

**Battery Muster Roll**

for Enlistment to Dec 31, 1864.

Present or absent Present

Stoppage, \$ 100 for

Due Gov't, \$ 100 for

Valuation of horse, \$ 100

Valuation of horse equipments, \$ 100

Remarks:  
.....  
.....  
.....  
.....  
.....  
.....  
.....  
.....

Book mark: .....

W. H. Hardy  
(358) Copyist.

*C*

Indpt. Battery. | **U.S.C.T.**

*John Colver*  
*Pat*

Indpt. Battery, U. S. Col'd L. Art'y.

Appears on

**Battery Muster Roll**

for *Jan Feb*, 186<sup>*5*</sup>.

Present or absent *Present*

Stoppage, \$ 100 for

Due Gov't, \$ 100 for

Valuation of horse, \$ 100

Valuation of horse equipments, \$ 100

Remarks:

Book mark:

*J A Schooley*  
(358) Copyist.

*C* | Indpt. Battery. | **U.S.C.T.**

*John Cleaves*  
.....  
*C*....., Indpt. Battery, U. S. Col'd L. Art'y.

Appears on

**Battery Muster Roll**

for *Mar. & Apr.*....., 1865.

Present or absent *Present*.....

Stoppage, \$.....<sup>100</sup> for.....

Due Gov't, \$.....<sup>100</sup> for.....

Valuation of horse, \$.....<sup>100</sup>

Valuation of horse equipments, \$.....<sup>100</sup>

Remarks:.....  
.....  
.....  
.....  
.....  
.....  
.....  
.....  
.....

Book mark:.....

*Porter*  
.....

(358)

Copyist.

*C*

Indpt. Battery.

U.S.C.T.

*John Cleaves,*  
*Pr*, Indpt. Battery, U. S. Col'd L. Art'y.

Appears on

**Battery Muster Roll**

for *May & June*, 1865.

Present or absent *Present.*

Stoppage, \$ 100 for

Due Gov't, \$ 100 for

Valuation of horse, \$ 100

Valuation of horse equipments, \$ 100

Remarks:  
\_\_\_\_\_  
\_\_\_\_\_  
\_\_\_\_\_  
\_\_\_\_\_  
\_\_\_\_\_  
\_\_\_\_\_  
\_\_\_\_\_  
\_\_\_\_\_

Book mark: \_\_\_\_\_

*Parter*

Copyist.

*C* | Indpt. Battery. | **U.S.C.T.**

*John Cleaves,*  
*C*, Indpt. Battery U. S. Col'd Light Art'y.

Appears on **Batt'y Muster-out Roll**, dated  
*Mt. Vernon, Va., July 22,* 1865.

Muster-out to date *July 22,* 1865.

Last paid to *Decr 31,* 1864.

Clothing account:

Last settled....., 186 ; drawn since \$ *82*<sup>00</sup><sup>3</sup>,

Due soldier \$.....<sup>100</sup>; due U. S. \$.....<sup>100</sup>

Am't for cloth'g in kind or money adv'd \$.....<sup>100</sup>

Due U. S. for arms, equipments, &c., \$.....<sup>100</sup>

Bounty paid \$ *100* <sup>100</sup>; due \$ *none* <sup>100</sup>,

Remarks: *See E. P. Wilson, Sutter,*  
*\$10-*

Book mark: *K, 262, Mo. K.*

*Porter*

*Beaver, John*

*P*, Co. *Ind. Batt.*, U. S. C. A.  
Reg't

~~3~~ Enclosures.

Bed Cards.....	Descriptive Lists.....
Burial Records.....	Final Statements.....
Certs. of Dis. for Discharge.....	Furloughs.....
C. M. Charges.....	Med. Des. Lists.....
Med. Certificates.....	Orders.....

*Enlist.* *2*

Other papers relating to—

Admission to Hosp'l.....	Furlough.....
Casualty Sheet (Officer's).....	Med. Examination.....
Confinement.....	Misc. Information.....
Contracts.....	Pay or Clothing.....
Death or Effects.....	Personal Reports.....
Desertions.....	Rank.....
Discharge from Hosp'l.....	Transfer to Hosp'l.....
Discharge from Service.....	Transfer to V. R. C.....
Duty.....	Transportation.....



MICROFILM PUBLICATION M 1836

COMPILED MILITARY SERVICE RECORDS  
OF VOLUNTEER UNION SOLDIERS WHO SERVED WITH  
THE UNITED STATES COLORED TROOPS (USCT)  
INDEPENDENT BATTERY LIGHT ARTILLERY

PERSONAL PAPERS' TARGET SHEET

PLEASE NOTE THE CHECKED INFORMATION ABOUT THE PERSONAL PAPERS IN  
THIS FILE:

- NO PERSONAL PAPERS WERE FOUND IN THIS FILE WHEN THE  
RECORDS WERE ARRANGED FOR MICROFILMING.
- 6 PERSONAL PAPER(S) FOUND IN THIS FILE WHEN THE RECORDS  
WERE ARRANGED FOR MICROFILMING.

✓ 262 K

Inapt Betty La.  
Colo.

**NOTE 1.**—This blank will be used for both enlistments and re-enlistments—enlistment of veterans, &c., &c., in the volunteer service. They will be made out in duplicate in all cases—one to accompany the recruiting return of the superintendent (not the recruiting officer) to the Adjutant General, and one to accompany the accounts of the officer who pays bounty, &c. The Regiment and Company in which the soldier last served should be given on the back.

**NOTE 2.**—An enlistment holds to service. A muster-in must, in all cases, precede payment of pay, bounty, pension, &c. A muster-in roll must, in all cases, be filed in the Adjutant General's Office as evidence of muster-in. The mustering officer, commissary, or assistant commissary of musters, as the case may be, will countersign both enlistments as having mustered the soldier into the service of the United States before either of them is given to the disbursing officer.

Rec'd from 2nd. Aud. Nov. 23d 1892

**DECLARATION OF RECRUIT.**

I, John Cleaver desiring to VOLUNTEER as a Soldier in the Army of the United States, for the term of THREE YEARS Do Declare, That I am 16 years and \_\_\_\_\_ months of age; that I have never been discharged from the United States service on account of disability or by sentence of a court-martial, or by order before the expiration of a term of enlistment; and I know of no impediment to my serving honestly and faithfully as a soldier for three years.

GIVEN at Wyandotte State of Kansas the 25th day of July 1864

Witness: W.A. Burnham John Cleaver  
*made*

No. 4715

John Cleaver

Volunteered at Wyandotte

July 23 1864

By Sgt. J. G. Ginn

1st Regiment 3rd Army

enlistment; last served in Company ( )

Reg't of \_\_\_\_\_

Discharged \_\_\_\_\_ 18 \_\_\_\_\_

**CONSENT IN CASE OF MINOR.**

I, \_\_\_\_\_ Do CERTIFY, That I am the \_\_\_\_\_ of \_\_\_\_\_; that the said \_\_\_\_\_ is \_\_\_\_\_ years of age; and I do hereby freely give my CONSENT to his volunteering as a SOLDIER in the ARMY OF THE UNITED STATES for the period of THREE YEARS.

GIVEN at \_\_\_\_\_ the \_\_\_\_\_ day of \_\_\_\_\_

Witness: \_\_\_\_\_

VOLUNTEER ENLISTMENT.

STATE OF

TOWN OF

*Kansas*



*Wyanadotte*

I, *John Cleaver*

born in *Jackson Co*

in the State of *Missouri*

aged *18* years,

and by occupation a *Carpenter*

DO HEREBY ACKNOWLEDGE to have

volunteered this *twenty fifth* day of *July* 1864.

to serve as a **Soldier** in the **Army of the United States of America**, for the period of **THREE YEARS** unless sooner discharged by proper authority: Do also agree to accept such bounty, pay, rations, and clothing, as are, or may be, established by law for volunteers. And I, *John Cleaver* do solemnly swear, that I will bear true faith and allegiance to the **United States of America**, and that I will serve them honestly and faithfully against all their enemies or opposers whomsoever; and that I will observe and obey the orders of the President of the United States, and the orders of the officers appointed over me, according to the Rules and Articles of War.

Sworn and subscribed to, at *Wyanadotte*

this *25* day of *July* 1864.

BEFORE

*P. H. Minor*  
Recruiting Officer

*John Cleaver*  
made

I CERTIFY, ON HONOR, That I have carefully examined the above-named Volunteer, agreeably to the General Regulations of the Army, and that, in my opinion, he is free from all bodily defects and mental infirmity, which would in any way disqualify him from performing the duties of a soldier.

*Jeffie Sinks*  
Surgeon  
North Dist Kansas  
EXAMINING SURGEON.

I CERTIFY, ON HONOR, That I have minutely inspected the Volunteer *John Cleaver* previously to his enlistment, and that he was entirely sober when enlisted; that, to the best of my judgment and belief, he is of lawful age; and that, in accepting him as duly qualified to perform the duties of an able-bodied soldier, I have strictly observed the Regulations which govern the recruiting service. This soldier has *black* eyes, *black* hair, *dark* complexion, is *5* feet *8* inches high.

*P. H. Minor*  
*1st* *Regiment* *Battery* Volunteers,  
Recruiting Officer.

Mustered into the service of the United States, in *Company* the *25th* day of *July* 1864 at *Wyanadotte* from *State of Missouri*

Regiment of *1st*

Volunteers, on

*Handwritten notes on the left margin, including 'Recruiting Officer' and 'John Cleaver'.*

*Handwritten notes on the right margin, including 'Mustered into the service...' and 'John Cleaver'.*

NOTE 1.—This blank will be used for both enlistments and re-enlistments—enlistment of veterans, &c., in the volunteer service. They will be made out in duplicate in all cases—one to accompany the recruiting return of the superintendent (not the recruiting officer) to the Adjutant General, and one to accompany the accounts of the officer who pays bounty, &c. The Regiment and Company in which the soldier last served should be given on the back.

NOTE 2.—An enlistment holds to service. A muster-in must, in all cases, precede payment of pay, bounty, pension, &c. A muster-in roll must, in all cases, be filed in the Adjutant General's Office as evidence of muster-in. The mustering officer, commissary, or assistant commissary of musters, as the case may be, will countersign both enlistments as having mustered the soldier into the service of the United States before either of them is given to the disbursing officer.

DECLARATION OF RECRUIT.

I, John Cleaver desiring to VOLUNTEER as a Soldier in the Army of the United States, for the term of THREE YEARS Do Declare, That I am 18 years and \_\_\_\_\_ months of age; that I have never been discharged from the United States service on account of disability or by sentence of a court-martial, or by order before the expiration of a term of enlistment; and I know of no impediment to my serving honestly and faithfully as a soldier for three years.

GIVEN at Wyanadette State of D.C. the 25 day of July 1864

Witness: Henry Cooper John Cleaver  
*male*

No. 42

John Cleaver  
 Volunteered at Wyanadette  
25 1864,  
 By G. D. Minor 2nd Lieut.  
1st D. Regiment of Artillery  
Fort Barry U.S.A., D.C.  
 \_\_\_\_\_ enlistment; last served in Company ( )  
 \_\_\_\_\_ Reg't of \_\_\_\_\_  
 Discharged \_\_\_\_\_ 18 \_\_\_\_\_

CONSENT IN CASE OF MINOR.

I, \_\_\_\_\_ Do CERTIFY, That I am \_\_\_\_\_ the \_\_\_\_\_ of \_\_\_\_\_; that the said \_\_\_\_\_ is \_\_\_\_\_ years of age; and I do hereby freely give my CONSENT to his volunteering as a SOLDIER in the ARMY OF THE UNITED STATES for the period of THREE YEARS.

GIVEN at \_\_\_\_\_ the \_\_\_\_\_ day of \_\_\_\_\_

Witness: \_\_\_\_\_

VOLUNTEER ENLISTMENT.

STATE OF

*Kansas*



TOWN OF

*Wyandotte Co*

I, *John Cleaver*

born in *Jackson Co*

in the State of *Missouri* aged *18* years, and by occupation a

Do HEREBY ACKNOWLEDGE to have volunteered this *25* day of *July* 1864,

to serve as a **Soldier** in the **Army of the United States of America**, for the period of **THREE YEARS** unless sooner discharged by proper authority: Do also agree to accept such bounty, pay, rations, and clothing, as are, or may be, established by law for volunteers. And I, *John Cleaver* do solemnly swear, that I will bear true faith and allegiance to the **United States of America**, and that I will serve them honestly and faithfully against all their enemies or opposers whomsoever; and that I will observe and obey the orders of the President of the United States, and the orders of the officers appointed over me, according to the Rules and Articles of War.

Sworn and subscribed to, at *Wyandotte* this *25* day of *July* 1864 } *John Cleaver*  
BEFORE *P. H. Minor 2<sup>d</sup> Lieut* } *his*  
*Recruiting officer* } *mark*

I CERTIFY, ON HONOR, That I have carefully examined the above-named Volunteer, agreeably to the General Regulations of the Army, and that, in my opinion, he is free from all bodily defects and mental infirmity, which would in any way disqualify him from performing the duties of a soldier.

*Jeffie Sinks*  
*Surg. Genl of Enrollment*  
*North West Texas*  
EXAMINING SURGEON.

I CERTIFY, ON HONOR, That I have minutely inspected the Volunteer, previously to his enlistment, and that he was entirely sober when enlisted; that, to the best of my judgment and belief, he is of lawful age; and that, in accepting him as duly qualified to perform the duties of an able-bodied soldier, I have strictly observed the Regulations which govern the recruiting service. This soldier has *black* eyes, *black* hair, *Dark* complexion, is *5* feet *8* inches high.

*P. H. Minor 2<sup>d</sup> Lieut*  
*1<sup>st</sup> H. Col. Battery* Volunteers,  
RECRUITING OFFICER.

Mustered into the service of the United States, in Company ..... Regiment of ..... Volunteers, on the *28* day of *July* 1864 at .....

262 K

Affidavit of

John Kleber

or "Clearer"

Relating to the

Clearing of the

State of Mo }  
 County of Jackson }

Personally appeared before me a Notary public in and for the County of Jackson State of Missouri John Kleber colored late private in the Independent Battery of U.S. Col'd Light Artillery who being duly sworn & said that his name is John Kleber and not John Cleaver and that it was erroneously written "Cleaver" by the enrolling and mustering officers.

That he was born as he believes upon the premises of <sup>Fredrick</sup> John Kleber citizen of west port Missouri that his mother was the property of said ~~John~~ Fredrick Kleber and that he himself at the date of his enlistment as above was owned by said Fredrick Kleber the applicant for reimbursement for his said services as a soldier in the Independent Battery of U.S. Colored Light Artillery.

John Kleber

Attest  
 Notary Public  
 My Comm. expires

Sworn to and subscribed before me this 2<sup>d</sup> day of July 1864  
 E. M. Carson  
 Notary Public





State of Mo }  
County of Jackson }

Personally appeared before me a Notary public in and for the County of Jackson State of Missouri John Kleber colored late private in the Independent Battery of U.S. Col'd Light Artillery who being duly sworn & says that his name is John Kleber and not John Cleaver and that it was erroneously written "Cleaver" by the enrolling and mustering officers.

That he was born as he believes upon the premises of <sup>Fredrick</sup> ~~John~~ Kleber citizen of west port Missouri that his mother was the property of said ~~John~~ Fredrick Kleber and that he himself at the date of his enlistment as above was owned by said Fredrick Kleber the applicant for reimbursement for his said services as a soldier in the Independent Battery of U.S. Colored Light Artillery  
John Kleber

Attest

*[Signature]*

*[Signature]*

Sworn to and subscribed before me this 2<sup>d</sup> day of July 1864  
E. M. Carson  
Notary Public

for the adjustment of such claims, before the Departments at Washington, D. C., where the same may become necessary, and elsewhere, and in his name, place and stead, for him and in his name to ask, demand, recover and receive such compensation as may be awarded as aforesaid, hereby giving and granting unto his said Attorneys full power and authority to do and perform all and every act and thing whatsoever requisite and necessary to be done in and about the premises as full and to all intents and purposes the same as he might or could do were he personally present, hereby ratifying and confirming all his said Attorneys or their substitutes by their appointment shall lawfully do or cause to be done by virtue hereof; and it is understood and agreed that this Power of Attorney cannot be revoked by him without the consent of his Attorneys herein appointed.

(5) Frederick Kleber

STATE OF Missouri  
County of Hackberry

On this 20 day of January 1867, personally appeared before me E. Case, Jr. a Notary Public in and for the county and State aforesaid Frederick Kleber the claimant above mentioned, and made oath to the foregoing statement by him subscribed, and he further acknowledge the signing and sealing of the foregoing Power of Attorney to be his own free binding act, for the purposes and objects therein contained and set forth; and at the same time also personally appeared the above named Wm Sinschier and Christina Cater and Henry Sager and Julius Boeber and made oath to the truth of the statements by them respectively subscribed.

Witness my hand and seal, upon the day and date first above written.

(6) Ernest Case, Jr.  
Notary Public

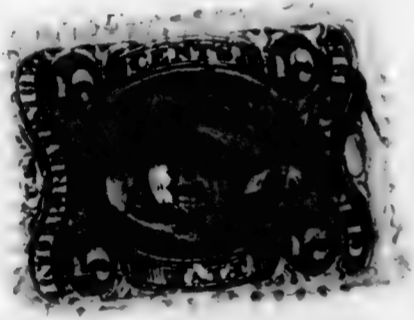

INSTRUCTIONS.

- (1) State all the circumstances connected with obtaining title—when, where and how.
  - (2) Signature of claimant.
  - (3) Signatures of witnesses to ownership.
  - (4) Signatures of witnesses to loyalty.
  - (5) Signature of claimant.
  - (6) Signature of Notary Public or Clerk of Court, authenticated by seal.
- If title is by purchase, state date of bill of sale, and where recorded. When possible, file the bill of sale. If title is by inheritance, state when and from whom the slave was inherited, and where the will is recorded or the administrator was appointed.  
If claimant is a trustee, executor or administrator, he must show by the record proof that he is such.  
Where the same party claims compensation for more than one slave, he must file a separate claim for each.

2  
CHIPMAN, HOSMER & CO.,  
WASHINGTON, D. C.,  
Attorneys for Claimant.

For Compensation for Service of Slave,  
John Keller  
Stearns

Affidavits of Ownership and Loyalty, and Power  
of Attorney, in the Application of  
Frederick Kleber

No. 262 B

[FORM B.]

Frederick Kleber claimant for compensation under the Acts of Congress of February 24th, 1864, and July 28th, 1866, for John Kleber a slave, who was enlisted into the military service of the United States upon the 20<sup>th</sup> day of July 1864, having been duly sworn declares that at the date of the enlistment of said John Kleber as aforesaid, and as more fully set forth in his application, he was the lawful owner of said John Kleber and obtained his title to him in the following manner: (1)

He was born on my place and his mother was my property, all his life previous to his enlistment and was my property, all of his life previous to his enlistment. His name is John Kleber & the name "Clearer" in the muster rolls of the Independent Battery, U.S. Col'd Light Artillery was written by the enrolling and mustering officer through mistake in the name of the name is given by me.

Wm Soudsheim a resident of Jackson County, State of Missouri and Christian Eckert a resident of Jackson County, State of Missouri having been duly sworn, declare that they are personally acquainted with Frederick Kleber the claimant for compensation for John Kleber slave under the Acts of Congress of February 24th, 1864, and July 28, 1866, and know that said John Kleber at the date of his enlistment into the military service of the United States, and for six years or more previous thereto was the slave of said Frederick Kleber. They also declare that they have no interest in said claim.

Wm Soudsheim  
(3) W C Eckert  
Henry Sager a resident of Jackson County, State of Missouri and Julius Becker a resident of Jackson County, State of Missouri

having first been duly sworn, upon their oaths declare that they reside respectively in Westport county of Jackson State of Mo and Westport county of Jackson State of Mo; that they are personally acquainted with Frederick Kleber claimant for compensation for his slave John Kleber under the Acts of Congress of February 24, 1864, and July 28, 1866, and that they know that said claimant has firmly and faithfully maintained his allegiance and adherence to the Government of the United States, by defending its cause against the Government of the so-called Confederate States of America, in all suitable and practicable ways, and according to his ability; they also swear that they have themselves maintained a like adherence and allegiance to the Government of the United States, and that they have no interest in said claim. and the slave described in the rolls of the Independent Battery, U.S. Colored Light Artillery as "Clearer" is the identical man described above as John Kleber.

(4) Henry Sager  
Julius Becker  
And the said Frederick Kleber claimant further declares that in consideration of valuable services rendered and to be rendered, he hath and doth employ and constitute, as his Attorneys, **CHIPMAN, HOSMER & CO.,** Washington, D. C., to prosecute his claim for compensation which may be awarded to him as owner of said slave, by the Acts of Congress in that regard, before the Board of Claims appointed for the State of Missouri

**ENDORSEMENT.**

*262 X*

No. ~~262 X~~ *262 X*

APPLICATION OF

*Frederic Webster*

OR

*Kammleley Mrs*

for compensation for service of

slave *John Chew*

enlisted *July 25<sup>th</sup>* 1864

in *2<sup>nd</sup> Bally's City Regiment,*

U. S. Colored Troops.

Received *Jan'y 30* 1867,

Compensation awarded, 186,

Dollars.

President Board of Claims.

P. O. Address of Applicant.

*Amos Hall 53<sup>rd</sup> Ave*

*Kammleley*

*John W. Stearns*  
*Amos Hall 53<sup>rd</sup> Ave*  
*Allyo*

War Department,  
ADJUTANT GENERAL'S OFFICE,  
Washington, *July 29* 1867.

Respectfully returned to the  
Commission for the State of  
Mass. care, with the informa-  
tion that John Webster  
was enlisted at *Worcester Mass*  
*July 25<sup>th</sup> 1864* and was  
mustered in as *Private 2<sup>nd</sup> Bally's*  
*U. S. Col. July 28 1864*

*A. J. R. Lawrence*

Asst. Adj't General.

Section 2, Act approved July 28, 1866.

AWARD OF THE BOARD OF CLAIMS.

OFFICE OF THE BOARD OF CLAIMS,

or Drafted in the Service of the United States.

186

having proved, under oath \_\_\_\_\_ loyalty to the Con-  
ed States, and established \_\_\_\_\_ title as to the ownership of  
a slave \_\_\_\_\_ and mustered  
\_\_\_\_\_ day of \_\_\_\_\_ 186

\_\_\_\_\_ in the service of the United States, in the  
\_\_\_\_\_ the sum of \_\_\_\_\_

\_\_\_\_\_ colored Troops, Co. \_\_\_\_\_  
by this Board, subject to the approval of the Secretary of War, as  
under provisions of Section 24, Act approved February 24, 1864, and

President of the Board.

Member of the Board.

Member of the Board.

Chief of the Bureau for the  
Organization of Colored Troops, Washington, D. C.

To \_\_\_\_\_

( Form A. )

CLAIM FOR COMPENSATION FOR ENLISTED SLAVE.

I, Frederick Kleber, a loyal citizen, and a resident of Westport County of Jackson State of Missouri

hereby claim compensation, under the provisions of Section 24, Act approved February 24, 1864, and Section 2, Act approved July 28, 1866, for my slave John Kleber enlisted as "John Cleaver" July 25<sup>th</sup> 1864, at Myrtle, Kansas by Light in the Independent Battery Regiment U. S. Colored Troops, Co. Light; certificate of which enlistment, and a descriptive list, as required, ~~accompanying this~~ application. I never received

In proof of my loyalty to the Constitution and Government of the United States, I present the accompanying oath, which I have taken, signed and acknowledged; to be filed with this application, in accordance with requirement of General Order, No. 329, 1863, War Department, Adjutant General's Office.

Frederick Kleber  
July 2<sup>d</sup> 26 1867

OATH OF ALLEGIANCE.

I, Frederick Kleber the owner and claimant, do solemnly swear that the foregoing claim is a just and true claim due to me as master and owner of the said slave, and that the facts alleged in said claim in respect to John Kleber of said slave into the military service of the United States are true. And I do further swear that I have never joined, or been concerned in any insurrection or rebellion, ~~that I have never borne arms~~ against the United States; that I have never given any aid, countenance, counsel or encouragement to any person or persons engaged, or whom I had reason to believe were about to engage, in insurrection, rebellion or armed hostility against the United States; that I have neither sought, nor accepted, nor attempted to exercise the functions of any office, civil or military, nor to perform any service whatever under any authority, or pretended authority, in hostility to the United States; that I have not yielded a voluntary support to any insurrection, rebellion or pretended government, authority, power or constitution within the United States, hostile thereto. And I do further swear that, to the best of my knowledge and ability, I have supported and defended, and will continue to support and defend, the United States, against all enemies, foreign and domestic, and that I have supported, defended and obeyed, and will continue to support, defend and obey, the Constitution and laws of the United States, that I will bear true faith and allegiance to the same; and that I take this oath freely, without any mental reservation or purpose of evasion. So help me God.

Frederick Kleber

Sworn to and subscribed before me, at Kansas City, Mo

this 2<sup>d</sup> day of July 1867

Ernie Conroy  
Notary Public

Affidavits of disinterested loyal parties will be required to prove the active loyalty of the claimant during the war.

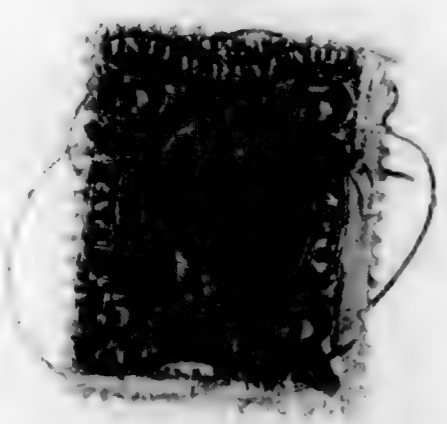

(Form A.)

CLAIM FOR COMPENSATION FOR ENLISTED SLAVE.

I, Frederick Kleber, a loyal citizen, and a resident of Westport County of Jackson State of Missouri

hereby claim compensation, under the provisions of Section 24, Act approved February 24, 1864, and Section 2, Act approved July 28, 1866, for my slave John Kleber enlisted as John enlisted Cleaver July 28<sup>th</sup> 1864, at Myaudalle Kansas by \_\_\_\_\_ in the Independent Battery Regiment U. S. Colored Troops, Co. \_\_\_\_\_; certificate of which enlistment, and a descriptive list, as required, ~~accompanying this~~ application. Never received

In proof of my loyalty to the Constitution and Government of the United States, I present the accompanying oath, which I have taken, signed and acknowledged; to be filed with this application, in accordance with requirement of General Order, No. 329, 1863, War Department, Adjutant General's Office.

July 2<sup>d</sup> 2d 1867. Frederick Kleber

OATH OF ALLEGIANCE.

I, Frederick Kleber the owner and claimant, do solemnly swear that the foregoing claim is a just and true claim due to me as master and owner of the said slave, and that the facts alleged in said claim in respect to the enlistment of said slave into the military service of the United States are true. And I do further swear that I have never joined, or been concerned in any insurrection or rebellion; ~~that I have never borne arms~~ against the United States; that I have never given any aid, countenance, counsel or encouragement to any person or persons engaged, or whom I had reason to believe were about to engage, in insurrection, rebellion or armed hostility against the United States; that I have neither sought, nor accepted, nor attempted to exercise the functions of any office, civil or military, nor to perform any service whatever under any authority, or pretended authority, in hostility to the United States; that I have not yielded a voluntary support to any insurrection, rebellion or pretended government, authority, power or constitution within the United States, hostile thereto. And I do further swear that, to the best of my knowledge and ability, I have supported and defended, and will continue to support and defend, the United States, against all enemies, foreign and domestic, and that I have supported, defended and obeyed, and will continue to support, defend and obey, the Constitution and laws of the United States, that I will bear true faith and allegiance to the same; and that I take this oath freely, without any mental reservation or purpose of evasion. So help me God.

Frederick Kleber  
Sworn to and subscribed before me, at Kansas City, Mo  
this 2d day of July 1867.  
Ernest Cassin  
Notary Public

Affidavits of disinterested loyal parties will be required to prove the active loyalty of the claimant during the war.

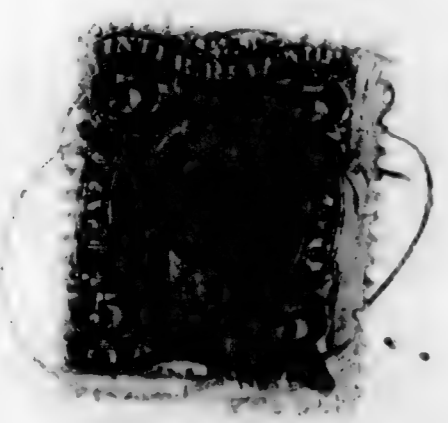

*and*  
pt. Batt'y U.S. Col'd L. Art'y

*Private Private*

CARD NUMBERS.

6 2 3 35 f 2	26
6 2 3 37 5 f	27
6 2 3 39 0 6	28
6 2 3 40 6 f	29
6 2 3 42 0 7	30
6 2 3 43 7 4	31
6 2 3 45 3 6	32
913 2939	33
	34
	35
	36
	37
	38
	39
	40
	41
	42
	43
	44
	45
	46
	47
	48
	49
	50

Book Mark:

See also

*C* | Indpt. Batt'y. | **U.S.C.T.**

*Samuel Coleman*

....., Indpt. Batt'y, U. S. Col'd L. Art'y.

Appears on

**Battery Descriptive Book**

of the organization named above.

**DESCRIPTION.**

Age *18* years; height *5* feet *6* inches.

Complexion *Black*

Eyes *Black*; hair *Black*

Where born *Choctaw Nation*

Occupation *Labourer*

**ENLISTMENT.**

When *Oct. 7*....., 1864.

Where *At Scott's Co*

By whom *S. Mathews* ; term *3* y'rs.

Remarks: .....

.....

.....

.....

.....

.....

.....

.....

.....

.....

.....

.....

.....

.....

.....

.....

.....

.....

.....

.....

.....

.....

.....

.....

.....

.....

.....

.....

.....

.....

.....

.....

.....

.....

*Holbrook*



C | Indpt. Battery. | **U.S.C.T.**

*Samuel Coalman*

Appears with rank of *Priv* on

**Muster and Descriptive Roll of a Detachment of U. S. Vols. forwarded**

for the Indpt. Batt'y, U. S. Col'd L. Arty. Roll dated

*Lavenworth, Kans, Nov. 29 1864.*

Where born *Choctaw Nation*

Age *18* y'rs; occupation *Laborer*

When enlisted *Oct 7, 1864.*

Where enlisted *W. Scott, Ks*

For what period enlisted *3* years.

Eyes *Blk*; hair *Blk*

Complexion *Blk*; height *5 ft. 6 in.*

When mustered in *Nov 29, 1864.*

Where mustered in *Lavenworth, Kans*

Bounty paid \$ *100*; due \$ *100*

Where credited

Battery to which assigned

Remarks: *Credited to Southern District Kansas, W. Scott, Bourbon Co. Vol Recruit & entitled to Bounty.*

Book mark:

*E. L. Tharmon*

6 | Indpt. Battery. | U.S.C.T.

Samuel Coleman

Pat, Indpt. Battery, U. S. Col'd L. Art'y.

Appears on

**Battery Muster-in and Descriptive Roll**

of the organization named above. Roll dated

Severmouth Co. Va. Dec 25 1864.

Where born Choctaw Nation

Age 18 y'rs; occupation Laborer

When enlisted Oct. 7, 1864.

Where enlisted Fort Scott Co

For what period enlisted 3 years.

Eyes Blue; hair Blue

Complexion Blue; height 5 ft. 6 in.

When mustered in Nov 29, 1864.

Where mustered in Severmouth

Bounty paid \$100 00/100; due \$200 00/100

Where credited

Battery to which assigned

Remarks: A. I. Dist Co.  
Fort Scott Bourbon Co  
Co.

Book mark:

J. S. [Signature]

(856g)

Copyist.

*C*

Indpt. Battery.

U.S.C.T.

*Samuel Coleman*

*Pvt*, Indpt. Battery, U. S. Col'd L. Art'y.

Appears on

**Battery Muster Roll**

for *Enlistment to Dec 31*, 186*4*.

Present or absent *Absent*

Stoppage, \$ 100 for

Due Gov't, \$ 100 for

Valuation of horse, \$ 100

Valuation of horse equipments, \$ 100

Remarks: *Sick in Hospital at Ft. Leavenworth Mo.*

Book mark:

*J. S. Sholey* Copyist.

6

Indpt. Battery. | **U.S.C.T.**

*Samuel Coleman*

*Pat*, Indpt. Battery, U. S. Col'd L. Art'y.

Appears on

**Battery Muster Roll**

for *Samuel Coleman*, 186<sup>5</sup>.

Present or absent *Present*

Stoppage, \$ 100 for

Due Gov't, \$ 100 for

Valuation of horse, \$ 100

Valuation of horse equipments, \$ 100

Remarks:

Book mark:

*J. H. Scherby*  
(358) Copyist.

*C* | Indpt. Battery. | **U.S.C.T.**

*Samuel Coleman,*

*S*....., Indpt. Battery, U. S. Col'd L. Art'y.

Appears on

**Battery Muster Roll**

for *May, 1865*, 186*5*.

Present or absent *Absent*

Stoppage, \$.....<sup>100</sup> for.....

Due Gov't, \$.....<sup>100</sup> for.....

Valuation of horse, \$.....<sup>100</sup>

Valuation of horse equipments, \$.....<sup>100</sup>

Remarks:.....

Book mark:.....

*Enter*

*C*

Indpt. Battery.

U.S.C.T.

*Samuel Coleman,*

*Pr*, Indpt. Battery, U. S. Col'd L. Art'y.

Appears on

**Battery Muster Roll**

for *May & June*, 1865.

Present or absent *Present,*

Stoppage, \$ 100 for

Due Gov't, \$ 100 for

Valuation of horse, \$ 100

Valuation of horse equipments, \$ 100

Remarks:

Book mark:

*Parter*

(358)

Copyist.

*C*

Indpt. Battery.

U.S.C.T.

*Samuel Coleman,*

*C*, Indpt. Battery U. S. Col'd Light Art'y.

Appears on **Batt'y Muster-out Roll**, dated

*M. Lawrenceworth Ky, July 22, 1865.*

Muster-out to date *July 22, 1865.*

Last paid to *Dec. 31, 1864.*

Clothing account:

Last settled....., 186 ; drawn since \$ *88*<sup>*11*</sup>/<sub>100</sub>

Due soldier \$.....<sub>100</sub>; due U. S. \$.....<sub>100</sub>

Am't for cloth'g in kind or money adv'd \$.....<sub>100</sub>

Due U. S. for arms, equipments, &c., \$.....<sub>100</sub>

Bounty paid \$ *100*<sub>100</sub>; due \$ *None*<sub>100</sub>,

Remarks:.....

.....  
.....  
.....  
.....  
.....  
.....  
.....

Book mark:.....

*Parter*

(861)

Copyist.

*Coleman Samuel*

....., Co. ...., ..... Reg't .....

*5* Enclosures.

Bed Cards .....	Final Statements .....
Burial Records .....	Furloughs or L. of A. ....
Certs. of Dis. for Discharge .....	Med. Certificates .....
C. M. Charges .....	Med. Des. Lists .....
Descriptive Lists .....	Orders .....
Discharge Certificates .....	Pris. of War Record .....
Enlistment Papers .....	Resignations .....

*2*

Other papers relating to—

Admission to Hosp'l .....	Furlough or L. of A. ....
Casualty Sheet .....	Med. Examination .....
Confinement .....	Misc. Information <i>3</i> .....
Contracts .....	Pay or Clothing .....
Death or Effects .....	Personal Reports .....
Desertion .....	Rank .....
Discharge from Hosp'l .....	Transfer to Hosp'l .....
Discharge from Service .....	Transfer to V. R. C. ....
Duty .....	Transportation .....

*3*



MICROFILM PUBLICATION M 1836

COMPILED MILITARY SERVICE RECORDS  
OF VOLUNTEER UNION SOLDIERS WHO SERVED WITH  
THE UNITED STATES COLORED TROOPS (USCT)  
INDEPENDENT BATTERY LIGHT ARTILLERY

PERSONAL PAPERS' TARGET SHEET

PLEASE NOTE THE CHECKED INFORMATION ABOUT THE PERSONAL PAPERS IN  
THIS FILE:

NO PERSONAL PAPERS WERE FOUND IN THIS FILE WHEN THE  
RECORDS WERE ARRANGED FOR MICROFILMING.

8 PERSONAL PAPER(S) FOUND IN THIS FILE WHEN THE RECORDS  
WERE ARRANGED FOR MICROFILMING.

NOTE 1.—This blank will be used for both enlistments and re-enlistments—enlistment of veterans, &c., &c., in the volunteer service. They will be made out in duplicate in all cases—one to accompany the recruiting return of the superintendent (not the recruiting officer) to the Adjutant General, and one to accompany the accounts of the officer who pays bounty, &c. The Regiment and Company in which the soldier last served should be given on the back.

NOTE 2.—An enlistment holds to service. A muster-in must, in all cases, precede payment of pay, bounty, pension, &c. A muster-in roll must, in all cases, be filed in the Adjutant General's Office as evidence of muster-in. The mustering officer, commissary, or assistant commissary of musters, as the case may be, will countersign both enlistments as having mustered the soldier into the service of the United States before either of them is given to the disbursing officer.

DECLARATION OF RECRUIT.

*Samuel Coleman*, ..... desiring to VOLUNTEER as a Soldier in the Army of the United States, for the term of THREE YEARS, Do Declare, That I am *Eighteen, 18<sup>th</sup>* years and ..... months of age; that I have never been discharged from the United States service on account of disability or by sentence of a court martial, or by order before the expiration of a term of enlistment; and I know of no impediment to my serving honestly and faithfully as a soldier for three years.

GIVEN at *Fort Scott Kansas,* the *7<sup>th</sup>* day of *October 1864.*

Witness:

*David L. Hanson,*

*Samuel Coleman*  
mark

No. ....

5

\_\_\_\_\_ enlistment; last served in Company ( )  
\_\_\_\_\_ Reg't of \_\_\_\_\_  
Discharged \_\_\_\_\_ 18 .

*Samuel Coleman*  
Volunteered at *Fort Scott, Kansas*  
*9<sup>th</sup> of May of 1864.*  
By *Henry M. Matthews 2nd Lt*  
*Adj. Col. Battery*  
*1st Regt. Cavalry*  
*1st Div. 1st Cavalry*

CONSENT IN CASE OF MINOR.

I, ..... Do CERTIFY, That I am the ..... of .....; that the said ..... is ..... years of age; and I do hereby freely give my CONSENT to his volunteering as a SOLDIER in the ARMY OF THE UNITED STATES for the period of THREE YEARS.

GIVEN at ..... the ..... day of .....

Witness:

VOLUNTEER ENLISTMENT.

STATE OF

*Kansas,*



TOWN OF

*Fort Scott*

I, *Samuel Coleman* born in *Chocktaw*  
in the State of *Nation* aged *Eighteen* years,  
and by occupation a *Labourer* Do HEREBY ACKNOWLEDGE to have  
volunteered this *Seventh* day of *October* 1864  
to serve as a **Soldier** in the **Army of the United States of America**, for  
the period of **THREE YEARS**, unless sooner discharged by proper authority:  
Do also agree to accept such bounty, pay, rations, and clothing, as are, or may be,  
established by law for volunteers. And I, *Samuel Coleman* do  
solemnly swear, that I will bear true faith and allegiance to the **United States  
of America**, and that I will serve them honestly and faithfully against all  
their enemies or opposers whomsoever; and that I will observe and obey the  
orders of the President of the United States, and the orders of the officers  
appointed over me, according to the Rules and Articles of War.

Sworn and subscribed to, at *Fort Scott*  
this *7th* day of *October* 1864  
BEFORE *Wm D Matthews*  
*Recruiting officer* and *Samuel Coleman*  
*mark* *2d Bat. U.S. Col.*

I CERTIFY, ON HONOR, That I have carefully examined the above-named Volunteer, agreeably  
to the General Regulations of the Army, and that, in my opinion, he is free from all bodily defects and  
mental infirmity, which would in any way disqualify him from performing the duties of a soldier.

*Tiffin Dinks*  
*Surg. & Bd. of Examiners*  
*Arch. W. Lee* EXAMINING SURGEON.

I CERTIFY, ON HONOR, That I have minutely inspected the Volunteer, *Samuel Coleman*  
previously to his enlistment, and that he was entirely sober when enlisted; that, to the best of my  
judgment and belief, he is of lawful age; and that, in accepting him as duly qualified to perform the  
duties of an able-bodied soldier, I have strictly observed the Regulations which govern the recruiting  
service. This soldier has *black* eyes, *black* hair, *black* complexion, is *five*  
feet *Six 1/4* inches high.

*Wm D Matthews*  
*2d Lt. 2d Regt. of U.S. Col. Army* RECRUITING OFFICER.

Mustered into the service of the United States, for three years or during the war, from date of enlistment, in *Company* *the 2d*  
*2d* *Regiment of U.S. Col. Army* *Volunteers* on the *27* day of *November*, 1864, at *Leavenworth* *Ks*  
*Samuel Coleman*  
*Private*  
*Arch. W. Lee*

DECLARATION OF RECRUIT.

NOTE.—This blank will be used for both enlistments and re-enlistments—enlistment of veterans, &c., &c., in the volunteer service. They will be made out in duplicate in all cases—one to accompany the recruiting return of the superintendent (not the recruiting officer) to the Adjutant General, and one to accompany the accounts of the officer who pays bounty, &c. The Regiment and Company in which the soldier last served should be given on the back.  
NOTE 2.—An enlistment holds to service. A muster-in must, in all cases, precede payment of pay, bounty, pension, &c. A muster-in roll must, in all cases, be filed in the Adjutant General's Office as evidence of muster-in. The mustering officer, commissary, or assistant commissary of musters, as the case may be, will countersign both enlistments as having mustered the soldier into the service of the United States before either of them is given to the disbursing officer.

\* Samuel Coleman desiring to VOLUNTEER as a Soldier in the Army of the United States, for the term of THREE YEARS, Do Declare, That I am Eighteen <sup>18<sup>th</sup></sup> years and \_\_\_\_\_ months of age; that I have never been discharged from the United States service on account of disability or by sentence of a court martial, or by order before the expiration of a term of enlistment; and I know of no impediment to my serving honestly and faithfully as a soldier for three years.

GIVEN at Fort Scott Kansas the 7<sup>th</sup> day of October 1864

Witness: Noah E. Hanson Samuel Coleman  
of the 1<sup>st</sup> and 2<sup>nd</sup> Battalions of the 1<sup>st</sup> and 2<sup>nd</sup> Battalions of the 1<sup>st</sup> and 2<sup>nd</sup> Battalions of the 1<sup>st</sup> and 2<sup>nd</sup> Battalions

No. 544

Samuel Coleman

Volunteered at Fort Scott, Kansas.

By Wm G. Matthews of the 1<sup>st</sup> and 2<sup>nd</sup> Battalions

Regiment of the 1<sup>st</sup> and 2<sup>nd</sup> Battalions

\_\_\_\_\_ enlistment; last served in Company ( )

\_\_\_\_\_ Reg't of \_\_\_\_\_

Discharged \_\_\_\_\_ 18 \_\_\_\_\_

Rec'd from 2nd. Aud. Nov. 23d 1892

CONSENT IN CASE OF MINOR.

I, \_\_\_\_\_ Do CERTIFY, That I am the \_\_\_\_\_ of \_\_\_\_\_; that the said \_\_\_\_\_ is \_\_\_\_\_ years of age; and I do hereby freely give my CONSENT to his volunteering as a SOLDIER in the ARMY OF THE UNITED STATES for the period of THREE YEARS.

GIVEN at \_\_\_\_\_ the \_\_\_\_\_ day of \_\_\_\_\_

Witness: \_\_\_\_\_

VOLUNTEER ENLISTMENT.

STATE OF

TOWN OF

*Wm. D. Coleman*  
Kansas



Fort Scott.

I, Samuel Coleman born in Chocktaw

in the State of Nation aged Eighteen<sup>18m</sup> years,

and by occupation a Labourer Do HEREBY ACKNOWLEDGE to have volunteered this Seventh 7th day of October 1864,

to serve as a **Soldier** in the **Army of the United States of America**, for the period of **THREE YEARS**, unless sooner discharged by proper authority:

Do also agree to accept such bounty, pay, rations, and clothing, as are, or may be, established by law for volunteers. And I, Samuel Coleman do

solemnly swear, that I will bear true faith and allegiance to the **United States of America**, and that I will serve them honestly and faithfully against all

their enemies or opposers whomsoever; and that I will observe and obey the orders of the President of the United States, and the orders of the officers

appointed over me, according to the Rules and Articles of War.

Sworn and subscribed to, at Fort Scott, his Samuel Coleman  
this 7th day of October 1864

BEFORE Wm. D. Matthews Recruiting officer of Ind. B. of U.S. Co. 2d

I CERTIFY, ON HONOR, That I have carefully examined the above-named Volunteer, agreeably to the General Regulations of the Army, and that, in my opinion, he is free from all bodily defects and mental infirmity, which would in any way disqualify him from performing the duties of a soldier.

Tiffin Bink  
Surg. Bd. of Enlistment  
Smith EXAMINING SURGEON.

I CERTIFY, ON HONOR, That I have minutely inspected the Volunteer, Samuel Coleman previously to his enlistment, and that he was entirely sober when enlisted; that, to the best of my judgment and belief, he is of lawful age; and that, in accepting him as duly qualified to perform the duties of an able-bodied soldier, I have strictly observed the Regulations which govern the recruiting service. This soldier has Black eyes, Black hair, Black complexion, is fine feet 5 1/2 inches high.

Wm. D. Matthews  
2d Lt. Ind. B. of U.S. Co. 2d Volunteers, 2d  
RECRUITING OFFICER.

(A. G. O. No. 74 & 76.)

*Mustered into the service of the United States, for three years or during the year, from date of enlistment, in Company*  
Batt. 11th Regt. of U.S. Col. Art. Volunteers, on the 27 day of November, 1864 at Leavenworth  
Chapman  
Smith  
Chapman

*This recruit has received one hundred dollars bounty from the County Fund  
authorizes Wm. D. Matthews to receive the same from the  
County Treasurer*

Ad Des Indpls  
 Both Ft-Lourence etc  
 May 30/65

Respectfully returned  
 With the information, that  
 I have no facts that will  
 warrant a trial. I suppose  
 from all I can learn that  
 it was purely accidental.  
 I would respect fully  
 with draw charges and  
 hope you will release  
 him.

Respectfully  
 Wm F. Douglas

Capt Comdr. Bally  
 Released  
 May 4 1965

Fort Leavenworth Kansas  
Office of Military Prison  
May 3, 1863

Captain

There has been transferred from the Post Guard House  
to the Pr. Mar. Generals Prison Private Samuel Colman of  
your Battery who was confined by the Officer of the day  
April 6<sup>th</sup> 1863 for shooting Private George Washington of the  
Battery. Will you please send me a list of the  
witnesses in the case and all the facts and  
circumstances that you can gather in the case  
if sufficient, ~~to present the~~ proper charges

Very Respectfully,

Your Obedient Servant

James M. Bennett

1st Lieut Co H 2<sup>d</sup> Colorado Cav Regt

In Charge of Military Prison

Wm Ford Douglass

Captain Comdg 1<sup>st</sup> Ind Artillery Battery

Order releasing  
Samuel Colman Ford Col. 2d Regt  
Released May, 4, 1863

---



Sergeant of Prison

Colman and Cold Battery

You will confine Samuel

James F. Bennett  
Lieut. in Charge of Prison  
Pr Lawrence

May 9<sup>th</sup>

Lieut Bennett,

Please confer Samuel  
Johnson, Private and Cold Battery U S Light  
Artillery for disobedience of order, he would be  
conferred about ten days

Wm Matthews  
Lieut. Artillery U S Army

Order Company  
Summit Colman Dept Col Bdr

Recd May 9 1866

Released

May 13 1866

Headquarters, Department of War  
Office of Provost Marshal General.  
Official Business.

Order Company  
Summit Colman Dept Col Bdr

Recd May 9 1863

Released

May 13 1863

Headquarters, Department of War  
Office of Provost Marshal General.  
Official Business.

*Shull, Jacob*

Co. Capt. Batt'y U.S. Col'd L. Art'y.

*Private Private*

CARD NUMBERS.

1	62335-83	26
2	6233755-	27
3	6233904	28
4	6234069	29
5	6234208	30
6	6234375-	31
7	62345-37	32
8	9132937	33
9		34
10		35
11		36
12		37
13		38
14		39
15		40
16		41
17		42
18		43
19		44
20		45
21		46
22		47
23		48
24		49
25		50

Book Mark:

See also

S785461 Jandy,  
S-1071485 " net  
S-1028499 - Q and.  
A 1686340 P.O. 7474  
RTP 564410  
Hst - 7-8-68 - MM

McSpencer  
7

*C*

Indpt. Batt'y.

**U.S.C.T.**

*Jack Calmel*

....., Indpt. Batt'y, U. S. Col'd L. Art'y.

Appears on

**Battery Descriptive Book**

of the organization named above.

**DESCRIPTION.**

Age *18* years; height *five* feet *4* inches.

Complexion *Black*

Eyes *Black*; hair *Black*

Where born *N. Carolina*

Occupation *Farmer*

**ENLISTMENT.**

When *Oct. 25*, 186 *4*

Where *Ft. Scott Ariz.*

By whom *A. Mulhens*; term *3* y'rs.

Remarks: .....

.....

.....

.....

.....

.....

*Sholbrook*

*C* | Indpt. Battery. | **U.S.C.T.**

*Jack Colwell*

Appears with rank of *Priv* on

**Muster and Descriptive Roll of a Detachment of U. S. Vols. forwarded**

for the Indpt. Batt'y, U. S. Col'd L. Arty. Roll dated

*Leavenworth, Kans, Nov. 29, 1864.*

Where born *North Carolina*

Age *18* y'rs; occupation *Farmer*

When enlisted *Oct 25, 1864.*

Where enlisted *W. Scott, Ks*

For what period enlisted *3* years.

Eyes *Blk*; hair *Blk*

Complexion *Blk*; height *5* ft. *4* in.

When mustered in *Nov. 29, 1864.*

Where mustered in *Leavenworth, Kans*

Bounty paid \$ *100*; due \$ *100*

Where credited

Battery to which assigned

Remarks: *Credited to Southern Dist, Kans. W. Scott, Bourbon Co. Vol. Recruit & entitled to Bounty.*

Book mark:

*E. L. Thurman*



6

Indpt. Battery.

U.S.C.T.

Zach Caldwell

Post

Indpt. Battery, U. S. Col'd L. Art'y.

Appears on

Battery Muster-in and Descriptive Roll

of the organization named above. Roll dated

Governments Dec 23, 1864.

Where born N.C.

Age 18 y'rs; occupation Farmer

When enlisted Oct 25, 1864.

Where enlisted Fort Scott Co

For what period enlisted 3 years.

Eyes Blue; hair Blue

Complexion Blue; height 5 ft. 4 in.

When mustered in Nov 29, 1864.

Where mustered in Government

Bounty paid \$100<sup>00</sup>/<sub>100</sub>; due \$200<sup>00</sup>/<sub>100</sub>

Where credited

Battery to which assigned

Remarks: Co. D. Dist Co. Fort Scott Bourdon Co. Co.

Book mark ;

(856g) [Signature] Copyist.

*C*

Indpt. Battery.

**U.S.C.T.**

*Jack Caldwell*  
*Pat*

, Indpt. Battery, U. S. Col'd L. Art'y.

Appears on

**Battery Muster Roll**

for *Enlistment to Dec 31*, 186*4*.

Present or absent *Present*

Stoppage, \$ 100 for

Due Gov't, \$ 100 for

Valuation of horse, \$ 100

Valuation of horse equipments, \$ 100

Remarks:

Book mark:

*J. Schooley*

(358)

Copyist.

*C*

Indpt. Battery.

U.S.C.T.

*Jack Colwell*  
*Pat*

, Indpt. Battery, U. S. Col'd L. Art'y.

Appears on

**Battery Muster Roll**

for

*Jan Feb*

, 186*5*

Present or absent

*Present*

Stoppage, \$

100 for

Due Gov't, \$

100 for

Valuation of horse, \$

100

Valuation of horse equipments, \$

100

Remarks:

Book mark:

(358)

*J. H. Scherley*

Copyist.

*C* | Indpt. Battery. | **U.S.C.T.**

*Jack Caldwell,*  
*Pr*, Indpt. Battery, U. S. Col'd L. Art'y.

Appears on

**Battery Muster Roll**

for *Mar & Apr*, 1865.

Present or absent *Present*

Stoppage, \$ 100 for

Due Gov't, \$ 100 for

Valuation of horse, \$ 100

Valuation of horse equipments, \$ 100

Remarks:  
-----  
-----  
-----  
-----  
-----  
-----  
-----  
-----  
-----

Book mark: -----

*Paute*

0 | Indpt. Battery. | **U.S.C.T.**

Jack Calwell  
Pr, Indpt. Battery, U. S. Col'd L. Art'y.

Appears on

**Battery Muster Roll**

for May & June, 1865.

Present or absent Present

Stoppage, \$ 100 for

Due Gov't, \$ 100 for

Valuation of horse, \$ 100

Valuation of horse equipments, \$ 100

Remarks:  
\_\_\_\_\_  
\_\_\_\_\_  
\_\_\_\_\_  
\_\_\_\_\_  
\_\_\_\_\_  
\_\_\_\_\_  
\_\_\_\_\_

Book mark: \_\_\_\_\_

\_\_\_\_\_  
Paster  
Copyist.

*C*

Indpt. Battery.

**U.S.C.T.**

*Zack Colwell,*  
*Pr*

, Indpt. Battery U. S. Col'd Light Art'y.

Appears on **Batt'y Muster-out Roll**, dated

*H. Leavenworth Co. July 27, 1865.*

Muster-out to date *July 29,* 1865.

Last paid to *Dec. 31,* 1864.

Clothing account:

Last settled....., 186 ; drawn since \$ *79*<sup>*35*</sup>/<sub>100</sub>,

Due soldier \$ 100; due U. S. \$ 100

Am't for cloth'g in kind or money adv'd \$ 100

Due U. S. for arms, equipments, &c., \$ 100

Bounty paid \$ *100* 100; due \$ *None* 100,

Remarks: .....

.....  
.....  
.....  
.....  
.....  
.....

Book mark : .....

*Porter*

Calwell Zack

, Co. , *Ind Batt. U.S.C.A*  
*Reg't*

**2 Enclosures.**

Bed Cards .....	Final Statements .....
Burial Records .....	Furloughs or L. of A .....
Certs. of Dis. for Discharge .....	Med. Certificates .....
C. M. Charges .....	Med. Des. Lists .....
Descriptive Lists .....	Orders .....
Discharge Certificates .....	Pris. of War Record .....
Enlistment Papers .....	Resignations .....

Other papers relating to—

Admission to Hosp'l .....	Furlough or L. of A .....
Casualty Sheet .....	Med. Examination .....
Confinement .....	Misc. Information .....
Contracts .....	Pay or Clothing .....
Death or Effects .....	Personal Reports .....
Desertion .....	Rank .....
Discharge from Hosp'l .....	Transfer to Hosp'l .....
Discharge from Service .....	Transfer to V. R. C. .....
Duty .....	Transportation .....

NOTE 1.—This blank will be used for both enlistments and re-enlistments—enlistment of veterans, &c., &c., in the volunteer service. They will be made out in duplicate in all cases—one to accompany the recruiting return of the superintendent (not the recruiting officer) to the Adjutant General, and one to accompany the accounts of the officer who pays bounty, &c. The Regiment and Company in which the soldier last served should be given on the back.

NOTE 2.—An enlistment holds to service. A muster-in must, in all cases, precede payment of pay, bounty, pension, &c. A muster-in roll must, in all cases, be filed in the Adjutant General's Office as evidence of muster-in. The mustering officer, commissary, or assistant commissary of musters, as the case may be, will countersign both enlistments as having mustered the soldier into the service of the United States before either of them is given to the disbursing officer.

### DECLARATION OF RECRUIT.

*Zach Calwell*, ..... desiring to VOLUNTEER as a Soldier in the Army of the United States, for the term of THREE YEARS, Do Declare, That I am *Eighteen* years and ..... months of age; that I have never been discharged from the United States service on account of disability or by sentence of a court martial, or by order before the expiration of a term of enlistment; and I know of no impediment to my serving honestly and faithfully as a soldier for three years.

GIVEN at *Fort Scott Kansas,* the *25<sup>th</sup>* day of *October*, 18*64*.

Witness:

*Noah C. Hanson,* *Zach Calwell*

No. *31*

*Zach Calwell,*  
Volunteered at *Fort Scott Kansas,*

*On the 25<sup>th</sup> day of October 1864,*  
*By Wm D. Matthews Capt I*  
*Regiment of Cavalry*  
*Resident of Fort Scott Kansas*

\_\_\_\_\_ enlistment; last served in Company ( )

\_\_\_\_\_ Reg't of \_\_\_\_\_

Discharged \_\_\_\_\_ 18 .

Rec'd from 2nd. Aud. Nov. 23d 1892

### CONSENT IN CASE OF MINOR.

I, ..... Do CERTIFY, That I am the ..... of .....; that the said ..... is ..... years of age; and I do hereby freely give my CONSENT to his volunteering as a SOLDIER in the ARMY OF THE UNITED STATES for the period of THREE YEARS.

GIVEN at ..... the ..... day of .....

Witness: \_\_\_\_\_



VOLUNTEER ENLISTMENT.

STATE OF

TOWN OF



*Franklin*

*Fort Scott.*

I, *Jack Calwell* born in \_\_\_\_\_  
in the State of *North Carolina* aged *Eighteen* 18<sup>th</sup> years,

and by occupation a *Farmer* Do HEREBY ACKNOWLEDGE to have  
volunteered this *Twenty fifth* day of *October* 1864

to serve as a **Soldier** in the **Army of the United States of America**, for  
the period of **THREE YEARS**, unless sooner discharged by proper authority:

Do also agree to accept such bounty, pay, rations, and clothing, as are, or may be,  
established by law for volunteers. And I, *Jack Calwell* do

solemnly swear, that I will bear true faith and allegiance to the **United States  
of America**, and that I will serve them honestly and faithfully against all  
their enemies or opposers whomsoever; and that I will observe and obey the  
orders of the President of the United States, and the orders of the officers  
appointed over me, according to the Rules and Articles of War.

Sworn and subscribed to, at *Fort Scott* } *Jack Calwell*  
this *25<sup>th</sup>* day of *October* 1864 }  
BEFORE *Wm S Matthews* }  
*Recruiting Officer of the 2<sup>d</sup> S. In. Bat. U.S. Col. Artillery*

I CERTIFY, ON HONOR, That I have carefully examined the above-named Volunteer, agreeably  
to the General Regulations of the Army, and that, in my opinion, he is free from all bodily defect and  
mental infirmity, which would in any way disqualify him from performing the duties of a soldier.

*Tiffin Binks*  
*Sing. Bd of Enrollment*  
*Armed. Dept Kansas* EXAMINING SURGEON.

I CERTIFY, ON HONOR, That I have minutely inspected the Volunteer, *Jack Calwell*  
previously to his enlistment, and that he was entirely sober when enlisted; that, to the best of my  
judgment and belief, he is of lawful age; and that, in accepting him as duly qualified to perform the  
duties of an able-bodied soldier, I have strictly observed the Regulations which govern the recruiting  
service. This soldier has *black* eyes, *black* hair, *black* complexion, is *five*  
feet *four* inches high.

*Wm S Matthews*  
*2<sup>d</sup> S. In. Bat. U.S. Col. Artillery* RECRUITING OFFICER.

(A. G. O. No. 74 & 76.)

*Batt: 118 Co. D. Regiment of Artillery, Light. Volunteers, on the 25<sup>th</sup> day of October 1864 at Fort Scott, Kansas.*

*This recruit has received the bounty from the bounty fund and has been issued a bounty certificate from the Provost Marshal's office.*

NOTE 1.—This blank will be used for both enlistments and re-enlistments—enlistment of veterans, &c., in the volunteer service. They will be made out in duplicate in all cases—one to accompany the recruiting return of the superintendent (not the recruiting officer) to the Adjutant General, and one to accompany the accounts of the officer who pays bounty, &c. The Regiment and Company in which the soldier last served should be given on the back.

NOTE 2.—An enlistment holds to service. A muster-in must, in all cases, precede payment of pay, bounty, pension, &c. A muster-in roll must, in all cases, be filed in the Adjutant General's Office as evidence of muster-in. The mustering officer, commissary, or assistant commissary of musters, as the case may be, will countersign both enlistments as having mustered the soldier into the service of the United States before either of them is given to the disbursing officer.

DECLARATION OF RECRUIT.

\* Jack Calwell ..... desiring to VOLUNTEER as a Soldier in the Army of the United States, for the term of THREE YEARS, Do Declare, That I am Eighteen years and ..... months of age; that I have never been discharged from the United States service on account of disability or by sentence of a court martial, or by order before the expiration of a term of enlistment; and I know of no impediment to my serving honestly and faithfully as a soldier for three years.

GIVEN at Fort Scott Kansas, the 25th day of October 1864

Witness: Frank L. Hanson Jamil Calwell  
*mark*

\_\_\_\_\_ enlistment; last served in Company ( )  
 \_\_\_\_\_ Reg't of \_\_\_\_\_  
 Discharged \_\_\_\_\_ 18 \_\_\_\_\_

Jack Calwell  
 Volunteered at Fort Scott Kansas  
this 25th day of October  
1864  
By Wm. S. Matthews 2d Sst  
Recruit 9nd Battery Col Drifters  
Regiment of

No. ....

10

CONSENT IN CASE OF MINOR.

I, ..... Do CERTIFY, That I am the ..... of .....; that the said ..... is ..... years of age; and I do hereby freely give my CONSENT to his volunteering as a SOLDIER in the ARMY OF THE UNITED STATES for the period of THREE YEARS.

GIVEN at ..... the ..... day of .....

Witness: .....

VOLUNTEER ENLISTMENT.

STATE OF Kansas



TOWN OF Fort Scott,

I, Zach Calwell, born in \_\_\_\_\_  
in the State of North Carolina aged Eighteen years,  
and by occupation a Farmer DO HEREBY ACKNOWLEDGE to have  
volunteered this Twenty fifth 25<sup>th</sup> day of October 1864  
to serve as a Soldier in the Army of the United States of America, for  
the period of THREE YEARS, unless sooner discharged by proper authority:  
Do also agree to accept such bounty, pay, rations, and clothing, as are, or may be,  
established by law for volunteers. And I, Zach Calwell do  
solemnly swear, that I will bear true faith and allegiance to the United States  
of America, and that I will serve them honestly and faithfully against all  
their enemies or opposers whomsoever; and that I will observe and obey the  
orders of the President of the United States, and the orders of the officers  
appointed over me, according to the Rules and Articles of War.

Sworn and subscribed to, at Fort Scott of his  
this Twenty fifth 25<sup>th</sup> day of October 1864 Zach Calwell  
BEFORE Wm D Mathews mark  
Recruiting officer of Ind. U.S. Col- Artillery

I CERTIFY, ON HONOR, That I have carefully examined the above-named Volunteer, agreeably  
to the General Regulations of the Army, and that, in my opinion, he is free from all bodily defects and  
mental infirmity, which would in any way disqualify him from performing the duties of a soldier.

Wm D Mathews  
Surg<sup>n</sup> B. of A. M. M. M. M.  
Wm D Mathews EXAMINING SURGEON.

I CERTIFY, ON HONOR, That I have minutely inspected the Volunteer, Zach Calwell  
previously to his enlistment, and that he was entirely sober when enlisted; that, to the best of my  
judgment and belief, he is of lawful age; and that, in accepting him as duly qualified to perform the  
duties of an able-bodied soldier, I have strictly observed the Regulations which govern the recruiting  
service. This soldier has black eyes, black hair, black complexion, is five  
feet four inches high.

Wm D Mathews, Jr.  
Super Barty Co U.S. Col- Artillery  
Recruiting Officer  
RECRUITING OFFICER.

(A. G. O. No. 74 & 76.)

Mustered into the service of the United States, for three years or during the war, from date of enlistment, in Company the 1<sup>st</sup>  
Regiment of Artillery on the 25<sup>th</sup> day of October 1864 at Fort Scott  
Wm D Mathews  
Super Barty Co U.S. Col- Artillery  
Recruiting Officer

*per Daniel*

**Capt. Batt'y U.S. Cold L. Art'y.**

*Private Private*

**CARD NUMBERS.**

6233757	26
6234024	27
6234379	28
6234541	29
9132932	30
	31
	32
	33
	34
	35
	36
	37
	38
	39
	40
	41
	42
	43
	44
	45
	46
	47
	48
	49
	50

Book Mark: *1656 - L.J. 83.*

See also

C | Indpt. Batt'y. | U.S.C.T.

Daniel Cooper

....., Indpt. Batt'y, U. S. Col'd L. Art'y.

Appears on

**Battery Descriptive Book**  
of the organization named above.

**DESCRIPTION.**

Age 22 years; height 5 feet 9 inches.

Complexion Black

Eyes Black; hair Black

Where born Logan City

Occupation Labourer

**ENLISTMENT.**

When July 27, 186 4

Where Pearl R's

By whom A. Mathews; term 3 y'rs.

Remarks: .....

.....  
.....  
.....  
.....  
.....  
.....  
.....  
.....

Hollbrook

*B*

Indpt. Battery. **U.S.C.T.**

*Daniel Cooper*

*Pat*

Indpt. Battery, U. S. Col'd L. Art'y.

Appears on

**Battery Muster-in and Descriptive Roll**

of the organization named above. Roll dated

*Leavenworth Mo Dec 29*, 1864.

Where born *Logan Co. Ky*

Age *22* y'rs; occupation *Laborer*

When enlisted *July 27*, 1864.

Where enlisted *Leavenworth Mo.*

For what period enlisted *3* years.

Eyes *Blu*; hair *Blu*

Complexion *Blu*; height *5* ft. *9* in.

When mustered in *July 29*, 1864.

Where mustered in *Leavenworth*

Bounty paid \$ *100*; due \$ *300*<sup>*00*</sup>/<sub>*100*</sub>

Where credited

Battery to which assigned

Remarks: *A. N. Dist Co. 21<sup>st</sup> So. 30<sup>th</sup> para Leavenworth Mo.*

Book mark: *43 I. O. Camp*

*J. H. Shirley*  
(856g) Copyist.

6 | Indpt. Battery. | **U.S.C.T.**

*Daniel Cooper*

*Co*, Indpt. Battery, U. S. Col'd L. Art'y.

Appears on

**Battery Muster Roll**

for *Enlistment to Dec 31, 1864*.

Present or absent \_\_\_\_\_

Stoppage, \$ \_\_\_\_\_ 100 for \_\_\_\_\_

Due Gov't, \$ \_\_\_\_\_ 100 for \_\_\_\_\_

Valuation of horse, \$ \_\_\_\_\_ 100

Valuation of horse equipments, \$ \_\_\_\_\_ 100

Remarks: *Deserted from  
Command at Carthage  
Mo. while in pursuit  
of the enemy Oct. 28th  
1864*

*Roll must of June/65 must on  
which name appears,*

Book mark: \_\_\_\_\_

*W. Schoddy*  
(358) Copyist.

*C* | Indpt. Battery. | **U.S.C.T.**

*Daniel Cooper,*  
*Pr*, Indpt. Battery, U. S. Col'd L. Art'y.

Appears on

**Battery Muster Roll**

for *May & June*, 186*5*.

Present or absent *Present.*

Stoppage, \$ 100 for

Due Gov't, \$ 100 for

Valuation of horse, \$ 100

Valuation of horse equipments, \$ 100

Remarks:

Book mark:

*Baxter*



C | Indpt. Battery. | **U.S.C.T.**

*Daniel Cooper,*

*R*, Indpt. Battery U. S. Col'd Light Art'y.

Appears on **Batt'y Muster-out Roll**, dated

*M. Leavenworth, Ky, July 22, 1865.*

Muster-out to date *July 22, 1865.*

Last paid to *Pay due from enlistment,* 186 .

Clothing account:

Last settled....., 186 ; drawn since \$ *72* <sup>16</sup>/<sub>100</sub>,

Due soldier \$.....<sup>100</sup>; due U. S. \$.....<sup>100</sup>

Am't for cloth'g in kind or money adv'd \$.....<sup>100</sup>

Due U. S. for arms, equipments, &c., \$.....<sup>100</sup>

Bounty paid \$ *None* <sup>100</sup>; due \$ *100* <sup>100</sup>,

Remarks:.....  
.....  
.....  
.....  
.....  
.....  
.....  
.....  
.....

Book mark : *1094, 1883, 1656, C/1/83,*  
*over*

(361)

*Porter*  
Copyist.

JAN. 17

6234541

☆1891☆

*43 S. C. Kans,*

*Cooper Daniel*

Co. \_\_\_\_\_, *1st* *Batt* *Reg't* *W.S.C.A*

*2* Enclosures.

Bed Cards .....	Final Statements .....
Burial Records .....	Furloughs or L. of A .....
Certs. of Dis. for Discharge .....	Med. Certificates .....
C. M. Charges .....	Med. Des. Lists .....
Descriptive Lists .....	Orders .....
Discharge Certificates .....	Pris. of War Record .....
Enlistment Papers .....	Resignations .....

Other papers relating to—

Admission to Hosp'l .....	Furlough or L. of A .....
Casualty Sheet .....	Med. Examination .....
Confinement .....	Misc. Information <i>1</i> .....
Contracts .....	Pay or Clothing .....
Death or Effects .....	Personal Reports .....
Desertion .....	Rank .....
Discharge from Hosp'l .....	Transfer to Hosp'l .....
Discharge from Service .....	Transfer to V. R. C. .....
Duty .....	Transportation .....

MICROFILM PUBLICATION M 1836

COMPILED MILITARY SERVICE RECORDS  
OF VOLUNTEER UNION SOLDIERS WHO SERVED WITH  
THE UNITED STATES COLORED TROOPS (USCT)  
INDEPENDENT BATTERY LIGHT ARTILLERY

PERSONAL PAPERS' TARGET SHEET

PLEASE NOTE THE CHECKED INFORMATION ABOUT THE PERSONAL PAPERS IN  
THIS FILE:

- NO PERSONAL PAPERS WERE FOUND IN THIS FILE WHEN THE  
RECORDS WERE ARRANGED FOR MICROFILMING.
- 6 PERSONAL PAPER(S) FOUND IN THIS FILE WHEN THE RECORDS  
WERE ARRANGED FOR MICROFILMING.

DECLARATION OF RECRUIT.

I, Daniel Cooper desiring to VOLUNTEER as a Soldier in the Army of the United States, for the term of THREE YEARS Do Declare, That I am 22 years and 0 months of age; that I have never been discharged from the United States service on account of disability or by sentence of a court-martial, or by order before the expiration of a term of enlistment; and I know of no impediment to my serving honestly and faithfully as a soldier for three years.

GIVEN at Leavenworth City - State of Kansas the 27<sup>th</sup> day of July, 1864

Witness: [Signature] Daniel Cooper mark

NOTE 1.—This blank will be used for both enlistments and re-enlistments—enlistment of veterans, &c., &c., in the vovservice. They will be made out in duplicate in all cases—one to accompany the recruiting return of the superintendent (not the recruiting officer) to the Adjutant General, to accompany the accounts of the officer who pays bounty, &c. The Regiment and Company in which the soldier last served should be given on the back.  
NOTE 2.—An enlistment holds to service. A muster-in must, in all cases, precede payment of pay, bounty, pension. A muster-in roll must, in all cases, be filed in the Adjutant General's Office as evidence of muster-in. The mustering officer, commissary, or assistant commissary of musters case may be, will countersign both enlistments as having mustered the soldier into the service of the United States before either of them is given to the disbursing officer.

..... enlistment; last served in Company ( )  
..... Reg't of .....  
Discharged ..... 18 ..

No. 3-27  
Daniel Cooper  
Volunteered at Leavenworth City  
July 27 1864  
By [Signature] Adjutant  
Leavenworth City, Kansas  
Adjutant of [Signature]

CONSENT IN CASE OF MINOR.

I, ..... Do CERTIFY, That I am the ..... of .....; that the said ..... is ..... years of age; and I do hereby freely give my CONSENT to his volunteering as a SOLDIER in the ARMY OF THE UNITED STATES for the period of THREE YEARS.

GIVEN at .....  
the ..... day of .....  
Witness: .....

VOLUNTEER ENLISTMENT.

STATE OF

*Kansas*



TOWN OF

*Leavenworth City*

I, *Daniel Cooper* born in *Soyan County*

in the State of *Kentucky* aged *22* years,

and by occupation a *Subvers* Do HEREBY ACKNOWLEDGE to have volunteered this *27<sup>th</sup>* day of *July* 186*4*,

to serve as a **Soldier** in the **Army of the United States of America**, for the period of **THREE YEARS** unless sooner discharged by proper authority: Do also agree to accept such bounty, pay, rations, and clothing, as are, or may be, established by law for volunteers. And I, *Daniel Cooper* do solemnly swear, that I will bear true faith and allegiance to the **United States of America**, and that I will serve them honestly and faithfully against all their enemies or opposers whomsoever; and that I will observe and obey the orders of the President of the United States, and the orders of the officers appointed over me, according to the Rules and Articles of War.

Sworn and subscribed to, at *Leavenworth City* this *27* day of *July* 186*4* *Daniel Cooper* his mark

BEFORE *Wm D Matthews 2<sup>nd</sup> Lieut* Recruiting Co, K 2<sup>nd</sup> U.S. Col<sup>d</sup> Artillery

I CERTIFY, ON HONOR, That I have carefully examined the above-named Volunteer, agreeably to the General Regulations of the Army, and that, in my opinion, he is free from all bodily defects and mental infirmity, which would in any way disqualify him from performing the duties of a soldier.

*Jiffine Sinks*  
Surgeon Board of Enrollment  
*North Dist Kansas*  
EXAMINING SURGEON.

I CERTIFY, ON HONOR, That I have minutely inspected the Volunteer, previously to his enlistment, and that he was entirely sober when enlisted; that, to the best of my judgment and belief, he is of lawful age; and that, in accepting him as duly qualified to perform the duties of an able-bodied soldier, I have strictly observed the Regulations which govern the recruiting service. This soldier has *Black* eyes, *Black* hair, *Black* complexion, is *5* feet *9* inches high.

*Wm D Matthews 2<sup>nd</sup> Lieut*  
Recruiting Co, K 2<sup>nd</sup> U.S. Col<sup>d</sup> Artillery  
Regiment of *Volunteers,*  
RECRUITING OFFICER.

(A. G. O. No. 74 & 75.)

the *27<sup>th</sup>* day of *July*, 186*4*, at *Leavenworth City*, *Kansas*.  
Mustered into the service of the United States, in Company *1st*, Regiment of *1st* *Volunteers*, on *July 27<sup>th</sup> 1864*

DECLARATION OF RECRUIT.

I, Daniel Cooper desiring to VOLUNTEER as a Soldier in the Army of the United States, for the term of THREE YEARS Do Declare, That I am 22 years and months of age; that I have never been discharged from the United States service on account of disability or by sentence of a court-martial, or by order before the expiration of a term of enlistment; and I know of no impediment to my serving honestly and faithfully as a soldier for three years.

GIVEN at Lawrence in the City - State of Kansas the 27 day of July 1864

Witness:

W. H. Pennington

Daniel Cooper mark

No. 33

Daniel Cooper Volunteered at Lawrence in the City -

June 27 1864

By Wm. D. Matthews 2nd Lieut Adj. Gen. U.S. Army

Accepted for Enlistment

enlistment; last served in Company ( )

Reg't of

Discharged 18

CONSENT IN CASE OF MINOR.

I, Do CERTIFY, That I am the of ; that the said is years of age; and I do hereby freely give my CONSENT to his volunteering as a SOLDIER in the ARMY OF THE UNITED STATES for the period of THREE YEARS.

GIVEN at

the day of

Witness:

NOTE 1.—This blank will be used for both enlistments and re-enlistments of veterans, &c., &c., in the volunteer service. They will be made out in duplicate in all cases—one to accompany the recruiting return of the superintendent (not the recruiting officer) to the Adjutant General, and one to accompany the accounts of the officer who pays bounty, &c. The Regiment and Company in which the soldier last served should be given on the back. NOTE 2.—An enlistment holds to service. A muster-in must, in all cases, precede payment of pay, bounty, pension, &c. A muster-in roll must, in all cases, be filed in the Adjutant General's Office as evidence of muster-in. The mustering officer, commissary, or assistant commissary of musters, as the case may be, will countersign both enlistments as having mustered the soldier into the service of the United States before either of them is given to the disbursing officer.

VOLUNTEER ENLISTMENT.

STATE OF

*Kansas*



TOWN OF

*Leavenworth City*

I, *Daniel Cooper* born in *Logan County*

in the State of *Kentucky* aged *22* years,

and by occupation a *Soldier* Do HEREBY ACKNOWLEDGE to have

volunteered this *27<sup>th</sup>* day of *July* 1864,

to serve as a **Soldier** in the **Army of the United States of America**, for the period of **THREE YEARS** unless sooner discharged by proper authority: Do also

agree to accept such bounty, pay, rations, and clothing, as are, or may be, established by law for volunteers. And I, *Daniel Cooper* do

solemnly swear, that I will bear true faith and allegiance to the **United States of America**, and that I will serve them honestly and faithfully against all their

enemies or opposers whomsoever; and that I will observe and obey the orders of the President of the United States, and the orders of the officers appointed over

me, according to the Rules and Articles of War.

Sworn and subscribed to, at *Leavenworth City* *Daniel Cooper* his  
this *27* day of *July* 1864 *mark*

BEFORE *Wm D Matthews 2nd Lieut -*  
*Recruiting Co. K. 2nd U.S. Col. Cavalry*

I CERTIFY, ON HONOR, That I have carefully examined the above-named Volunteer, agreeably to the General Regulations of the Army, and that, in my opinion, he is free from all bodily defects and mental infirmity, which would in any way disqualify him from performing the duties of a soldier.

*Gifford Sinks*  
*Surg Board of Enrollment*  
*North Dist. Kansas*  
EXAMINING SURGEON.

I CERTIFY, ON HONOR, That I have minutely inspected the Volunteer, *Daniel Cooper* previously to his enlistment, and that he was entirely sober when enlisted; that, to the best of my judgment and belief, he is of lawful age; and that, in accepting him as duly qualified to perform the duties of an able-bodied soldier, I have strictly observed the Regulations which govern the recruiting service. This soldier has *Black* eyes, *Black* hair *Black* complexion, is *5* feet *9* inches high.

*Wm D Matthews 2nd Lieut*  
*Recruiting Co. K. 2nd U.S. Col. Cavalry*  
Regiment of *Volunteers,*  
RECRUITING OFFICER.

(A. G. O. No. 74 & 75.)

the ..... day of ..... 186 , at .....  
Mustered into the service of the United States, in Company .....  
Regiment of .....  
Volunteers, on



NARA 554

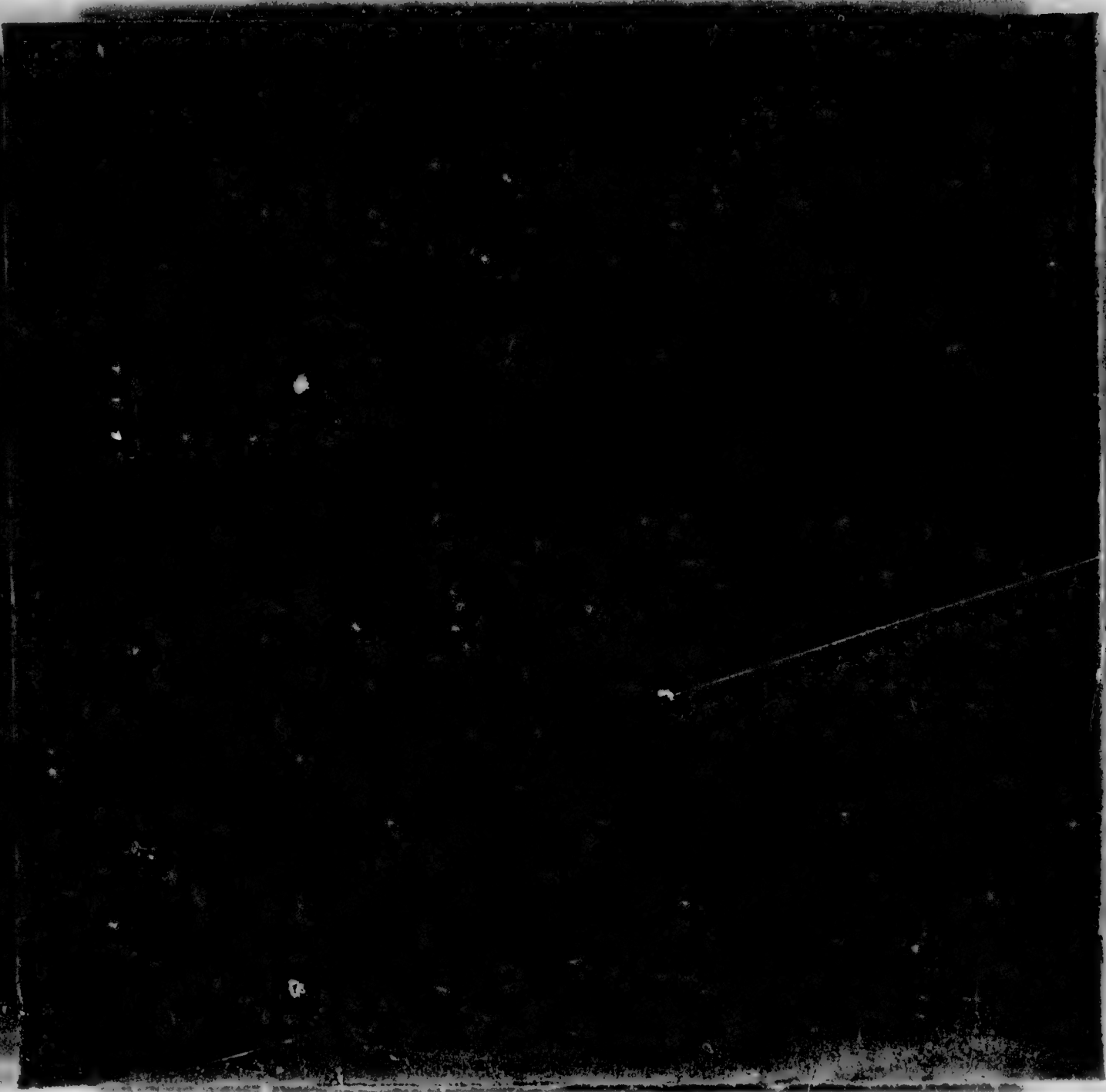

War Department,

ADJUTANT GENERAL'S OFFICE,

Washington, Dec. 30. 1866.

Respectfully returned to the  
Commission for the State of  
Missouri, with the informa-  
tion that Daniel Cooper  
was enlisted at Leavenworth, Kans  
July 27, 1864, and was  
mustered in as private in Independent  
Battery Lt. Art. July 29, 1864,  
6437

A. F. Reinwood

13413.

A. A. G.

~~#167~~ 43

**ENDORSEMENT.**

No. ~~603~~

APPLICATION OF

*Cornelius Cooper*  
OF  
*Platt Co. Kans.*

for compensation for service of  
slave *Daniel Cooper*  
enlisted *July 27* 186*4*

*Independent Battery* Regiment,  
in *Co.*  
U. S. Colored *Artillery* Troops.

Received *Dec 20* 1866,

Compensation awarded,  
186 ,  
Dollars.

President Board of Claims.

P. O. Address of Applicant.  
*Superior Hoseworks Co*  
*Washington D.C.*  
*Atty*

CERTIFICATE OF AWARD OF THE BOARD OF CLAIMS.

OFFICE OF THE BOARD OF CLAIMS,

For Slaves Enlisted or Drafted in the Service of the United States.

186

We hereby certify that \_\_\_\_\_ of \_\_\_\_\_  
county, State of \_\_\_\_\_, having proved, under oath \_\_\_\_\_ loyalty to the Con-  
stitution and Government of the United States, and established \_\_\_\_\_ title as to the ownership of  
\_\_\_\_\_ a slave \_\_\_\_\_ and mustered  
at \_\_\_\_\_ on the \_\_\_\_\_ day of \_\_\_\_\_ 186\_\_\_\_,  
by \_\_\_\_\_ in the service of the United States, in the  
\_\_\_\_\_ regiment of Colored Troops, Co. \_\_\_\_\_ the sum of \_\_\_\_\_  
dollars has been awarded to \_\_\_\_\_ by this Board, subject to the approval of the Secretary of War, as  
a compensation for the said slave, under provisions of Section 24, Act approved February 24, 1864, and  
Section 2, Act approved July 28, 1866.

\_\_\_\_\_  
President of the Board.

\_\_\_\_\_  
Member of the Board.

*R. M. ...*  
Member of the Board.

To \_\_\_\_\_  
Chief of the Bureau for the  
Organization of Colored Troops, Washington, D. C.

(Form A.)

CLAIM FOR COMPENSATION FOR ENLISTED SLAVE.

No. I, Cornelius Cooper, a loyal citizen, and a resident of Kansas County of Platte State of Kansas hereby claim compensation, under the provisions of

Section 24, Act approved February 24, 1864, and Section 2, Act approved July 28, 1866, for my slave Daniel Cooper enlisted July 27th 1864, at Leavenworth, Kas by Lieut Matthews in the Indpt Battery Regiment U. S. Colored Troops, Artillery Co. \_\_\_\_\_; certificate of which enlistment, and a descriptive list; as required, ~~accompanying this~~ application. Incumbent on above

In proof of my loyalty to the Constitution and Government of the United States, I present the accompanying oath, which I have taken, signed and acknowledged; to be filed with this application, in accordance with requirement of General Order, No. 329, 1863, War Department, Adjutant General's Office.

Cornelius Cooper  
October 31st 1866.

OATH OF ALLEGIANCE.

I, Cornelius Cooper the owner and claimant, do solemnly swear that the foregoing claim is a just and true claim due to me as master and owner of the said slave, and that the facts alleged in said claim in respect to the enlistment of said slave into the military service of the United States are true. And I do further swear that I have never joined, or been concerned in any insurrection or rebellion; that I have never borne arms against the United States; that I have never given any aid, countenance, counsel or encouragement to any person or persons engaged, or whom I had reason to believe were about to engage, in insurrection, rebellion or armed hostility against the United States; that I have neither sought, nor accepted, nor attempted to exercise the functions of any office, civil or military, nor to perform any service whatever under any authority, or pretended authority, in hostility to the United States; that I have not yielded a voluntary support to any insurrection, rebellion or pretended government, authority, power or constitution within the United States, hostile thereto. And I do further swear that, to the best of my knowledge and ability, I have supported and defended, and will continue to support and defend, the United States, against all enemies, foreign and domestic, and that I have supported, defended and obeyed, and will continue to support, defend and obey, the Constitution and laws of the United States, that I will bear true faith and allegiance to the same; and that I take this oath freely, without any mental reservation or purpose of evasion. So help me God.

Cornelius Cooper

Sworn to and subscribed before me, at Platte City Mo this 31st day of October 1866.

With the seal thereof affixed at office in Platte City Mo 920 11 13th Oct.

Platte County Circuit Court

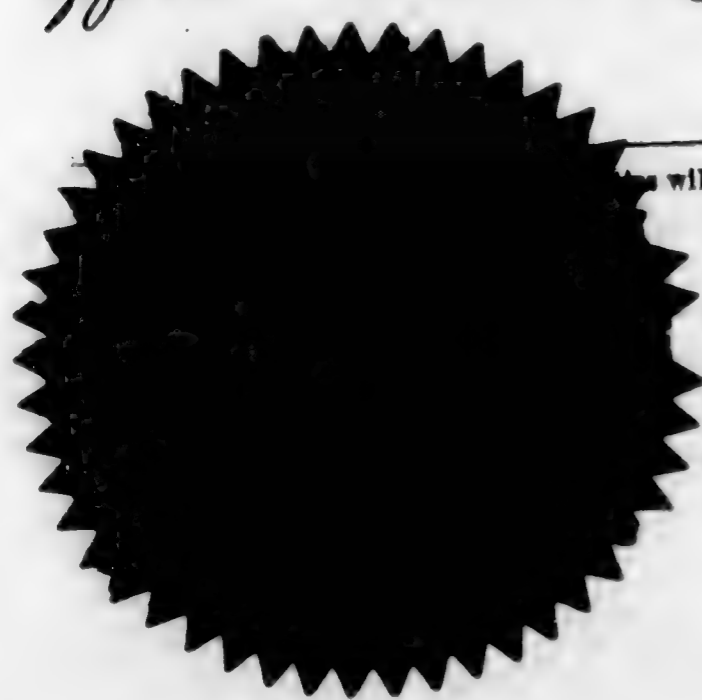

will be required to prove the active loyalty of the claimant during the war.

for the adjustment of such claims, before the Departments at Washington, D. C., where the same may become necessary, and elsewhere, and in *his* name, place and stead; for *him* and in *his* name to ask, demand, recover and receive such compensation as may be awarded as aforesaid, hereby giving and granting unto *his* said Attorneys full power and authority to do and perform all and every act and thing whatsoever requisite and necessary to be done in and about the premises as full and to all intents and purposes the same as *he* might or could do were *he* personally present, hereby ratifying and confirming all *his* said Attorneys or their substitutes by their appointment shall lawfully do or cause to be done by virtue hereof; and it is understood and agreed that this Power of Attorney cannot be revoked by *him* without the consent of *his* Attorneys herein appointed.

(5) *Cornelius Cooper*

STATE OF *Missouri* }  
 County of *Platte* } ss.

On this *31<sup>st</sup>* day of *October* 1866, personally appeared before me *George W. Belt* a *Clk of Cir. Court* in and for the county and State aforesaid *Cornelius Cooper* the claimant above mentioned, and made oath to the foregoing statement by *him* subscribed, and *he* further acknowledged the signing and sealing of the foregoing Power of Attorney to be his own free binding act, for the purposes and objects therein contained and set forth; and at the same time also personally appeared the above named *John M. Wilson* and *William Triplett* *George W. Crobarger* and *S. J. Remington* and made oath to the truth of the statements by them respectively subscribed.

Witness my hand and seal, upon the day and date first above written. *at office in Platte City, Mo*  
 (6) *George W. Belt Clerk*  
*Platte County Circuit Court*

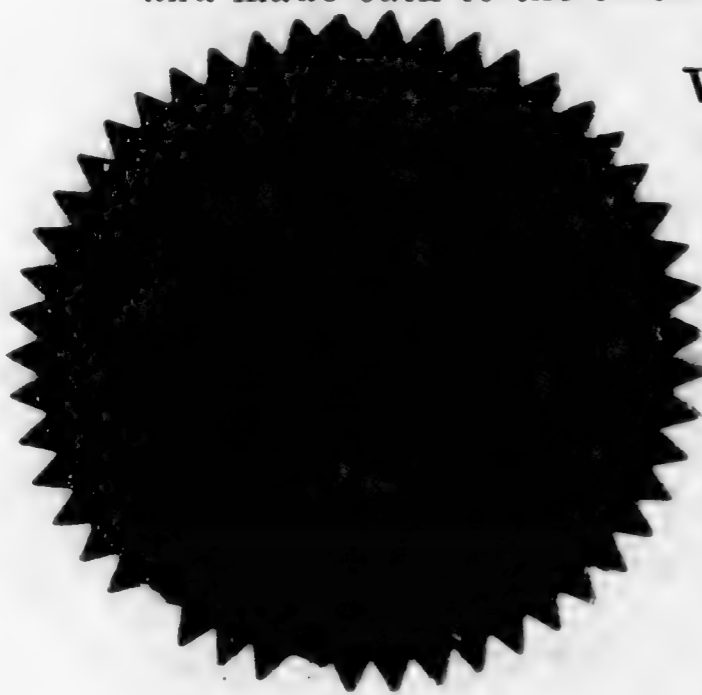

INSTRUCTIONS.

- (1) State all the circumstances connected with obtaining title—when, where and how.
  - (2) Signature of claimant.
  - (3) Signatures of witnesses to ownership.
  - (4) Signatures of witnesses to loyalty.
  - (5) Signature of claimant.
  - (6) Signature of Notary Public or Clerk of Court, authenticated by seal.
- If title is by *purchase*, state date of bill of sale, and where recorded. When possible, file the bill of sale. If title is by inheritance, state when and from whom the slave was inherited, and where the will is recorded or the administrator was appointed.  
 If claimant is a trustee, executor or administrator, he must show by the record proof that he is such.  
 Where the same party claims compensation for more than one slave, he must file a separate claim for each.

CHIPMAN, HOSMER & CO.,  
 WASHINGTON, D. C.,  
 Attorneys for Claimant.

For Compensation for Service of Slave.

*Cornelius Cooper*  
*Notary Public*

Affidavits of Ownership and Loyalty, and Power of Attorney, in the Application of

No. *113*

FORM B.

Cornelius Cooper claimant for compensation under the Acts of Congress of February 24th, 1864, and July 28th, 1866, for Daniel Cooper a slave, who was enlisted into the military service of the United States upon the 27th day of July 1864, having been duly sworn declares that at the date of the enlistment of said Daniel Cooper as aforesaid, and as more fully set forth in his application, he was the lawful owner of said Daniel Cooper and obtained his title to him in the following manner: (1)  
By Purchase from William Singleton as per Bill of Sale herewith submitted

(2) Cornelius Cooper  
John M. Wilson a resident of Platte County, State of Missouri and William Triplett a resident of Platte County, State of Missouri having been duly sworn, declare that they are personally acquainted with Cornelius Cooper the claimant for compensation for his slave Daniel Cooper under the Acts of Congress of February 24th, 1864, and July 28, 1866, and know that said Cornelius Cooper at the date of his enlistment into the military service of the United States, and for ten years previous thereto was the slave of said Cornelius Cooper. They also declare that they have no interest in said claim.

(3) John M. Wilson  
William Triplett  
George W. Crobarger a resident of Platte County, State of Missouri and J. J. Remington a resident of Platte County, State of Missouri having first been duly sworn, upon their oaths declare that they reside respectively in Platte county of Missouri and Platte county of Missouri; that they are personally acquainted with Cornelius Cooper claimant for compensation for his slave Daniel Cooper under the Acts of Congress of February 24, 1864, and July 28, 1866, and that they know that said claimant has firmly and faithfully maintained his allegiance and adherence to the Government of the United States, by defending its cause against the Government of the so-called Confederate States of America, in all suitable and practicable ways, and according to his ability; they also swear that they have themselves maintained a like adherence and allegiance to the Government of the United States, and that they have no interest in said claim.

(4) George W. Crobarger  
J. J. Remington  
 And the said Cornelius Cooper claimant further declares that in consideration of valuable services rendered and to be rendered, he hath and doth employ and constitute, as his Attorneys, **CHIPMAN, HOSMER & CO.**, Washington, D. C., to prosecute his claim for compensation which may be awarded to him as owner of said slave, by the Acts of Congress in that regard, before the Board of Claims appointed for the State of Missouri.

43 K

Bill of Sale

Know all Men by these presents that  
I William A Singleton of the County of Polk  
and State of Missouri for and in consideration  
of the sum of Six hundred dollars to me  
in hand paid by Cornelius Cooper the  
receipt where of is hereby acknowledge  
do by these presents bargain sell and deliver  
unto the Said Cornelius Cooper and his assigns  
a Negro Boy Slave for life called and  
known by the name of Daniel now of the  
age of ten years last August  
And the Said William A Singleton for himself  
his heirs and executors and Administrators  
do hereby covenant to and with the Said  
Cornelius Cooper his assigns that the  
Said Negro Boy Daniel is a slave for life  
and that he is perfectly sound both in  
body and mind  
In testimony whereof I have hereunto  
set my hand this 26<sup>th</sup> day of Feb 1853  
William A Singleton



*Spelman Henry C*  
Adpt. Batt'y U.S. Col'd L. Art'y.

*Private 1st Sergeant*  
CARD NUMBERS

<i>6233636</i>	26
<i>6233752</i>	27
<i>6233900</i>	28
<i>6234029</i>	29
<i>6234167</i>	30
<i>6234335</i>	31
<i>6234499</i>	32
<i>9132933</i>	33
	34
	35
	36
	37
	38
	39
	40
	41
	42
	43
	44
	45
	46
	47
	48
	49
	50

Book Mark: \_\_\_\_\_

See also \_\_\_\_\_

*S-1273016 - P.O. - m & m*

*Spelman*  
*H*

C | Indpt. Batt'y. | U.S.C.T.

Henry C Copeland

Indpt. Batt'y, U. S. Col'd L. Art'y.

Appears on

Battery Descriptive Book  
of the organization named above.

DESCRIPTION.

Age 24 years; height 5 feet 8 inches.

Complexion Mulatto

Eyes Black; hair Black

Where born North Carolina

Occupation Carpenter

ENLISTMENT.

When Dec. 20, 1864

Where North Carolina

By whom J. Matthews; term 3 y'rs.

Remarks:

[Empty lines for remarks]

Sholbrook

(383g)

Copyist.

C | Indpt. Battery. | U.S.C.T.

*Henry C. Copeland*

Appears with rank of *Priv* on

**Muster and Descriptive Roll of a Detachment of U. S. Vols. forwarded**

for the Indpt. Batt'y, U. S. Col'd L. Arty. Roll dated

*Leavenworth, Kas., Dec. 20, 1864.*

Where born *N. Carolina*

Age *24* y'rs; occupation *Carpenter*

When enlisted *Dec. 20*, 1864.

Where enlisted *Leavenworth, Kas.*

For what period enlisted *3* years.

Eyes *Black*; hair *Black*

Complexion *Muslate*; height *5* ft. *8* in.

When mustered in *Dec. 20*, 1864.

Where mustered in *Leavenworth, Kas.*

Bounty paid \$ *100*; due \$ *100*

Where credited

Battery to which assigned

Remarks: *Credited to North Dist. Kas. 19th Sub. Dist. 1st Ward, Leav. City Vol. recruit & entitled to bounty.*

Book mark:

*E. L. Thornton*

6 | Indpt. Battery. | U.S.C.T.

Henry E. Copeland

Pat, Indpt. Battery, U. S. Col'd L. Art'y.

Appears on

**Battery Muster-in and Descriptive Roll**

of the organization named above. Roll dated

Severnworth Co. Dec 23, 1864.

Where born N.C.

Age 24 y'rs; occupation Carpenter

When enlisted Dec 20, 1864.

Where enlisted Severnworth Co.

For what period enlisted 3 years.

Eyes Blu; hair Blu

Complexion Mulatto; height 5 ft. 8 in.

When mustered in Dec 20, 1864.

Where mustered in Severnworth Co.

Bounty paid \$100<sup>00</sup>/<sub>100</sub>; due \$200<sup>00</sup>/<sub>100</sub>

Where credited

Battery to which assigned

Remarks: A.M. dist No 194 So. 1st Ward Severnworth Co

Book mark:

J. H. [Signature] Copyist.

(856g)

6 | Indpt. Battery. | **U.S.C.T.**

Henry E. Copeland  
Pat, Indpt. Battery, U. S. Col'd L. Art'y.

Appears on

**Battery Muster Roll**

for Enlistment to Dec 31, 186 4

Present or absent Present

Stoppage, \$ 100 for

Due Gov't, \$ 100 for

Valuation of horse, \$ 100

Valuation of horse equipments, \$ 100

Remarks:

-----  
-----  
-----  
-----  
-----  
-----  
-----  
-----

Book mark: -----

J. H. Schrey  
(358) Copyist.

C | Indpt. Battery. | **U.S.C.T.**

*Henry C. Copeland*  
*1st Sgt*, Indpt. Battery, U. S. Col'd L. Art'y.

Appears on

**Battery Muster Roll**

for *Jan'y & Feb*, 186*5*.

Present or absent *Present*

Stoppage, \$ 100 for

Due Gov't, \$ 100 for

Valuation of horse, \$ 100

Valuation of horse equipments, \$ 100

Remarks: *Appointed 1st Sgt*  
*Jan'y 1st/65 by M. G.*  
*P. H. Keunt Chief Artily*  
*Dept of Kans.*

Book mark: \_\_\_\_\_

*J. S. [Signature]*  
(358) Copyist.

*Q*

Indpt. Battery.

U.S.C.T.

*Henry C. Copeland*  
*12 Sept*, Indpt. Battery, U. S. Col'd L. Art'y.

Appears on

**Battery Muster Roll**

for *Mar, & Apr,* 1865.

Present or absent *Present,*

Stoppage, \$ *100* for

Due Gov't, \$ *100* for

Valuation of horse, \$ *100*

Valuation of horse equipments, \$ *100*

Remarks: *Appointed to 12 Sept,*  
*since Jan, 1/65,*

Book mark:

*Parter*

(358)

Copyist.

*C*

Indpt. Battery.

U.S.C.T.

*Merrill E. Copeland*  
*1<sup>st</sup> Sgt*, Indpt. Battery, U. S. Col'd L. Art'y.

Appears on

**Battery Muster Roll**

for *May & June*, 186 *5*

Present or absent *Present*,

Stoppage, \$ *100* for

Due Gov't, \$ *100* for

Valuation of horse, \$ *100*

Valuation of horse equipments, \$ *100*

Remarks:

Book mark:

*Parter*

(358)

Copyist.



C | Indpt. Battery. | **U.S.C.T.**

*Henry C. Copeland,*  
*1<sup>st</sup> Sgt.*, Indpt. Battery U. S. Col'd Light Art'y.

Appears on **Batt'y Muster-out Roll**, dated

*at Leavenworth, Mo, July 22 1865.*

Muster-out to date *July 22*, 1865.

Last paid to *Dec 31*, 1864.

Clothing account:

Last settled *never*, 186 ; drawn since \$ *62* <sup>*69*</sup>/<sub>100</sub>

Due soldier \$ 100; due U. S. \$ 100

Am't for cloth'g in kind or money adv'd \$ 100

Due U. S. for arms, equipments, &c., \$ 100

Bounty paid \$ *100* 100; due \$ *None* 100

Remarks: *Private from enlistment to Jan'y 1/65, then 1<sup>st</sup> Sert.*

Book mark:

*Darter*

Copyist.

*Copeland Henry E*

, Co. \_\_\_\_\_,

*1st Batt*  
*Reg't U.S.C.A*

**3** Enclosures.

Bed Cards .....	Final Statements .....
Burial Records .....	Furloughs or L. of A .....
Certs. of Dis. for Discharge .....	Med. Certificates .....
C. M. Charges .....	Med. Des. Lists .....
Descriptive Lists .....	Orders .....
Discharge Certificates .....	Pris. of War Record .....
Enlistment Papers <b>3</b> .....	Resignations .....

Other papers relating to—

Admission to Hosp'l .....	Furlough or L. of A .....
Casualty Sheet .....	Med. Examination .....
Confinement .....	Misc. Information .....
Contracts .....	Pay or Clothing .....
Death or Effects .....	Personal Reports .....
Desertion .....	Rank .....
Discharge from Hosp'l .....	Transfer to Hosp'l .....
Discharge from Service .....	Transfer to V. R. C. .....
Duty .....	Transportation .....

DECLARATION OF RECRUIT.

I, Henry E Copeland, desiring to VOLUNTEER as a Soldier in the Army of the United States, for the term of THREE YEARS, Do Declare, That I am 24 years and \_\_\_\_\_ months of age; that I have never been discharged from the United States service on account of disability or by sentence of a court martial, or by order before the expiration of a term of enlistment; and I know of no impediment to my serving honestly and faithfully as a soldier for three years.

GIVEN at Severnuth City the 20 day of December 1864

Witness:

Edw. C. Clegg

Henry E Copeland

NOTE 1.—This blank will be used for both enlistments and re-enlistments—enlistment of veterans, &c., &c., in the volunteer service. They will be made out in duplicate in all cases—one to accompany the recruiting return of the superintendent (not the recruiting officer) to the Adjutant General, and one to accompany the accounts of the officer who pays bounty, &c. The Regiment and Company in which the soldier last served should be given on the back

NOTE 2.—An enlistment holds to service. A muster-in must, in all cases, precede payment of pay, bounty, pension, &c. A muster-in roll must, in all cases, be filed in the Adjutant General's Office as evidence of muster-in. The mustering officer, commissary, or assistant commissary of musters, as the case may be, will countersign both enlistments as having mustered the soldier into the service of the United States before either of them is given to the disbursing officer.

Rec'd from 2nd. Aud. Nov. 23d 1892

enlistment; last served in Company ( )  
Reg't of \_\_\_\_\_  
Discharged \_\_\_\_\_, 18 \_\_\_\_\_

No. 11  
Henry E. Copeland  
Volunteered at Severnuth  
This 20th day of Dec 1864  
By Wm. Matthews 103d  
Rec. Co. 1st Btry 11th  
Regiment of Artillery

CONSENT IN CASE OF MINOR.

I, \_\_\_\_\_, Do CERTIFY, That I am \_\_\_\_\_ of \_\_\_\_\_; that the said \_\_\_\_\_ is \_\_\_\_\_ years of age; and I do hereby freely give my CONSENT to his volunteering as a SOLDIER in the ARMY OF THE UNITED STATES for the period of THREE YEARS.

GIVEN at \_\_\_\_\_ the \_\_\_\_\_ day of \_\_\_\_\_

Witness:

credited to northern Dist Kansas. 1st Sub. Dist 1st Ward Leavenworth city

This warrant has received one hundred dollars bounty from the Bounty fund authorized by an Act of Congress approved July 14, 1864, and Circular No. 27 from the Provost Marshal General, dated July 9, 1864.

VOLUNTEER ENLISTMENT.

STATE OF



TOWN OF

Kansas

Leavenworth

I, Henry E. Copeland, born in \_\_\_\_\_, in the State of North Carolina, aged twentyfour years, and by occupation a Carpenter, Do HEREBY ACKNOWLEDGE to have volunteered this twentieth 20 day of December, 1864, to serve as a Soldier in the Army of the United States of America, for the period of THREE YEARS, unless sooner discharged by proper authority: Do also agree to accept such bounty, pay, rations, and clothing, as are, or may be, established by law for volunteers. And I Henry E. Copeland, do solemnly swear, that I will bear true faith and allegiance to the United States of America, and that I will serve them honestly and faithfully against all their enemies or opposers whomsoever; and that I will observe and obey the orders of the President of the United States, and the orders of the officers appointed over me, according to the Rules and Articles of War.

Sworn and subscribed to, at Leavenworth, Henry E. Copeland this 20th day of Dec, 1864, BEFORE Wm. S. Matthews 2nd Lt Recruiting officer

I CERTIFY, ON HONOR, That I have carefully examined the above-named Volunteer, agreeably to the General Regulations of the Army, and that, in my opinion, he is free from all bodily defects and mental infirmity, which would in any way disqualify him from performing the duties of a soldier.

Jiffie Sinks Surgeon of Enrollments "North" Dist Kansas EXAMINING SURGEON.

I CERTIFY, ON HONOR, That I have minutely inspected the Volunteer Henry E. Copeland previously to his enlistment, and that he was entirely sober when enlisted; that, to the best of my judgment and belief, he is of lawful age; and that, in accepting him as duly qualified to perform the duties of an able-bodied soldier, I have strictly observed the Regulations which govern the recruiting service. This soldier has Black eyes, Black hair, Mulatto complexion, is 5 feet 8 inches high.

Wm. S. Matthews 2nd Lt Recruiting officer

(A. G. O. No. 74 & 76.)

REGRETING OFFICER.

Mustered into the service of the United States, for three years or during the war from date of enlistment, in Company \_\_\_\_\_ of \_\_\_\_\_ Regiment of \_\_\_\_\_ Volunteers, on the 22 day of December, 1864, at Leavenworth Kansas

Wm. S. Matthews 2nd Lt

NOTE 1.—This blank will be used for both enlistments and re-enlistments—enlistment of veterans, &c., &c., in the volunteer service. They will be made out in duplicate in all cases—one to accompany the recruiting return of the superintendent (not the recruiting officer) to the Adjutant General, and one to accompany the accounts of the officer who pays bounty, &c. The Regiment and Company in which the soldier last served should be given on the back.

NOTE 2.—An enlistment holds to service. A muster-in must, in all cases, precede payment of pay, bounty, pension, &c. A muster-in roll must, in all cases, be filed in the Adjutant General's Office as evidence of muster-in. The mustering officer, commissary, or assistant commissary of musters, as the case may be, will countersign both enlistments as having mustered the soldier into the service of the United States before either of them is given to the disbursing officer.

DECLARATION OF RECRUIT.

I, Henry C Copeland, desiring to VOLUNTEER as a Soldier in the Army of the United States, for the term of THREE YEARS, Do Declare, That I am 24 1/2 years and \_\_\_\_\_ months of age; that I have never been discharged from the United States service on account of disability or by sentence of a court martial, or by order before the expiration of a term of enlistment; and I know of no impediment to my serving honestly and faithfully as a soldier for three years.

GIVEN at Leavenworth City the 20<sup>th</sup> day of December 1864

Witness:

E. W. Cloy

Henry C Copeland

No.

Henry C Copeland

Volunteered at Leavenworth

this 20<sup>th</sup> day of Dec 1864

By Amos Matthews 1st Lt  
and Recruiting Officer  
of 1st Battery 118<sup>th</sup> Artillery  
Regiment of

enlistment; last served in Company ( )

1st Battery Regt of 118<sup>th</sup> Artillery

Discharged \_\_\_\_\_, 18

22

CONSENT IN CASE OF MINOR.

I, \_\_\_\_\_, Do CERTIFY, That I am \_\_\_\_\_; that the \_\_\_\_\_ of \_\_\_\_\_; that the \_\_\_\_\_ is \_\_\_\_\_ years of age; and I do hereby freely give my CONSENT to his volunteering as a SOLDIER in the ARMY OF THE UNITED STATES for the period of THREE YEARS.

GIVEN at \_\_\_\_\_ the \_\_\_\_\_ day of \_\_\_\_\_

Witness:

credited to north Dist. Kansas. 19<sup>th</sup> Sub. Dist. 1<sup>st</sup> Ward ...  
19<sup>th</sup> Sub. Dist.

VOLUNTEER ENLISTMENT.

STATE OF

TOWN OF

*Kansas*



*Seavenworth*

I, *Henry E. Copeland* born in \_\_\_\_\_  
in the State of *North Carolina*, aged *Twenty four*<sup>24</sup> years,  
and by occupation a *Carpenter*. Do HEREBY ACKNOWLEDGE to have  
volunteered this *twentieth 20* day of *December*, 1864,  
to serve as a **Soldier** in the **Army of the United States of America**, for  
the period of **THREE YEARS**, unless sooner discharged by proper authority:  
Do also agree to accept such bounty, pay, rations, and clothing, as are, or may be,  
established by law for volunteers. And I, *Henry E. Copeland*, do  
solemnly swear, that I will bear true faith and allegiance to the **United States  
of America**, and that I will serve them honestly and faithfully against all  
their enemies or opposers whomsoever; and that I will observe and obey the  
orders of the President of the United States, and the orders of the officers  
appointed over me, according to the Rules and Articles of War.

Sworn and subscribed to, at *Seavenworth*  
this *20<sup>th</sup>* day of *Dec*, 1864, by *Henry E. Copeland*  
BEFORE *Wm. Matthews 2<sup>nd</sup> Lt*  
*Recruiting officer*

I CERTIFY, ON HONOR, That I have carefully examined the above-named Volunteer, agreeably  
to the General Regulations of the Army, and that, in my opinion, he is free from all bodily defects and  
mental infirmity, which would in any way disqualify him from performing the duties of a soldier.

*Jiffie Banks*  
*Surg Board of Cassville*  
*North Dist Kansas*  
EXAMINING SURGEON.

I CERTIFY, ON HONOR, That I have minutely inspected the Volunteer *Henry E. Copeland*  
previously to his enlistment, and that he was entirely sober when enlisted; that, to the best of my  
judgment and belief, he is of lawful age; and that, in accepting him as duly qualified to perform the  
duties of an able-bodied soldier, I have strictly observed the Regulations which govern the recruiting  
service. This soldier has *Black* eyes, *Black* hair, *White* complexion, is *5*  
feet *8* inches high.

*Wm. Matthews 2<sup>nd</sup> Lt*  
*Recruiting officer*  
Regiment of \_\_\_\_\_ Volunteers.  
RECRUITING OFFICER.

(A. G. O. No. 74 & 76.)

Mustered into the service of the United States for three years or during the war from date of enlistment, in *Company* *Smallwood*  
*Regiment of* *1<sup>st</sup> Regt Artillery* *Volunteers*, on the *20* day of *December*, 1864, at *Seavenworth Kas*

*Wm. Matthews*  
*North Dist Kansas*

NOTE 1.—This blank will be used for both enlistments and re-enlistments—enlistment of veterans, &c., &c., in the volunteer service. They will be made out in duplicate in all cases—one to accompany the recruiting return of the superintendent (not the recruiting officer) to the Adjutant General, and one to accompany the accounts of the officer who pays bounty, &c. The Regiment and Company in which the soldier last served should be given on the back.

NOTE 2.—An enlistment holds to service. A muster-in must, in all cases, precede payment of pay, bounty, pension, &c. A muster-in roll must, in all cases, be filed in the Adjutant General's Office as evidence of muster-in. The mustering officer, commissary, or assistant commissary of musters, as the case may be, will countersign both enlistments as having mustered the soldier into the service of the United States before either of them is given to the disbursing officer.

DECLARATION OF RECRUIT.

I, Henry E. Copeland, desiring to VOLUNTEER as a Soldier in the Army of the United States, for the term of THREE YEARS, Do Declare, That I am 24 twenty four years and \_\_\_\_\_ months of age; that I have never been discharged from the United States service on account of disability or by sentence of a court martial, or by order before the expiration of a term of enlistment; and I know of no impediment to my serving honestly and faithfully as a soldier for three years.

GIVEN at Lawrence, Kansas the 25<sup>th</sup> day of December 1864

Witness:

Henry E. Copeland

No. \_\_\_\_\_

Henry E. Copeland

Volunteered at Lawrence, Kansas

25<sup>th</sup> December 1864.

By Wm. D. Matthews Adj.

Recruit Regiment of Cavalry 1<sup>st</sup> Missouri

enlistment; last served in Company ( )

Reg't of \_\_\_\_\_

Discharged \_\_\_\_\_ 1864.

CONSENT IN CASE OF MINOR.

I, \_\_\_\_\_, Do CERTIFY, That I am \_\_\_\_\_; that the \_\_\_\_\_ of \_\_\_\_\_; that the \_\_\_\_\_ is \_\_\_\_\_ years of age; and I do hereby freely give my CONSENT to his volunteering as a SOLDIER in the ARMY OF THE UNITED STATES for the period of THREE YEARS.

GIVEN at \_\_\_\_\_ the \_\_\_\_\_ day of \_\_\_\_\_

Witness:

VOLUNTEER ENLISTMENT.

STATE OF



TOWN OF

I, Henry E Copeland, born in \_\_\_\_\_  
 in the State of W. Va. Carolina, aged 24 Twenty four years,  
 and by occupation a Carpenter, Do HEREBY ACKNOWLEDGE to have  
 volunteered this 20 Twentieth day of December, 1864,  
 to serve as a **Soldier** in the **Army of the United States of America**, for  
 the period of **THREE YEARS**, unless sooner discharged by proper authority:  
 Do also agree to accept such bounty, pay, rations, and clothing, as are, or may be,  
 established by law for volunteers. And I, Henry E Copeland, do  
 solemnly swear, that I will bear true faith and allegiance to the **United States**  
**of America**, and that I will serve them honestly and faithfully against all  
 their enemies or opposers whomsoever; and that I will observe and obey the  
 orders of the President of the United States, and the orders of the officers  
 appointed over me, according to the Rules and Articles of War.

Sworn and subscribed to, at Leavenworth  
 this 21<sup>st</sup> day of December 1864 } Henry E Copeland  
 BEFORE W D M Matthews Esq  
Recruiting Indpt Battery

I CERTIFY, ON HONOR, That I have carefully examined the above-named Volunteer, agreeably  
 to the General Regulations of the Army, and that, in my opinion, he is free from all bodily defects and  
 mental infirmity, which would in any way disqualify him from performing the duties of a soldier.

Tiffin Dierkes  
Sur Board of Enrollment  
North West Kansas  
 EXAMINING SURGEON.

I CERTIFY, ON HONOR, That I have minutely inspected the Volunteer Henry E Copeland  
 previously to his enlistment, and that he was entirely sober when enlisted; that, to the best of my  
 judgment and belief, he is of lawful age; and that, in accepting him as duly qualified to perform the  
 duties of an able-bodied soldier, I have strictly observed the Regulations which govern the recruiting  
 service. This soldier has Blue eyes, Dark hair, Melancholy complexion, is \_\_\_\_\_  
 feet \_\_\_\_\_ inches high.

Wm D Matthews Esq  
Indpt Recruit of U.S. led. Indpt Volunteers,  
 RECRUITING OFFICER.

(A. G. O. No. 71 & 76.)

Mustered into the service of the United States, for three years or during the war, from date of enlistment, in Company Indpt Recruit  
Regiment of Artillery Volunteers, on the 21<sup>st</sup> day of December, 1864, at Leavenworth Kansas  
W D M Matthews  
Recruiting Indpt Battery  
Wm D Matthews Esq  
Indpt Recruit of U.S. led. Indpt Volunteers



*[Faint handwritten text]*  
Capt. Batt'y U.S. Col'd L. Art'y.

*Private Private*

CARD NUMBERS.

6233748	26
6233897	27
6234161	28
6234672	29
9132929	30
0130-05-1873	31
	32
	33
	34
	35
	36
	37
	38
	39
	40
	41
	42
	43
	44
	45
	46
	47
	48
	49
	50

Book Mark: *EB. V. 10, 8546, 0130*  
*710-62-1873*

See also

241. (Rupl) 12 mch 46 JAWC

W. Spencer  
9

*C* | Indpt. Batt'y. | **U.S.C.T.**

*David Crathens*

....., Indpt. Batt'y, U. S. Col'd L. Art'y.

Appears on

**Battery Descriptive Book**

of the organization named above.

**DESCRIPTION.**

Age *19* years; height *5* feet *6* inches.

Complexion *Black*

Eyes *Black*; hair *Black*

Where born *Arkansas*

Occupation *Farmer*

**ENLISTMENT.**

When *July 20*, 186 *4*

Where *Fort A's.*

By whom *S. Matthews*; term *3* y'rs.

Remarks: .....

.....

.....

.....

.....

.....

.....

.....

.....

(383g)

*Stolbrook*  
Copyist.

6 | Indpt. Battery. | U.S.C.T.

David Craters

Pat, Indpt. Battery, U. S. Col'd L. Art'y.

Appears on

**Battery Muster-in and Descriptive Roll**

of the organization named above. Roll dated

Leavenworth Mo Dec 23, 1864.

Where born Ark.

Age 19 y'rs; occupation Farmer

When enlisted July 20, 1864.

Where enlisted Leavenworth Mo

For what period enlisted 3 years.

Eyes Br; hair Br

Complexion Br; height 5 ft. 6 in.

When mustered in July 22, 1864.

Where mustered in Leavenworth

Bounty paid \$100<sup>00</sup>/<sub>100</sub>; due \$200<sup>00</sup>/<sub>100</sub>

Where credited

Battery to which assigned

Remarks: On M Dist Co  
19th SD 1st Ward  
Leavenworth Mo.

Book mark:

J. Schuster  
(356g) Copyist.

C | Indpt. Battery. | U.S.C.T.

David Crothers

Pvt, Indpt. Battery, U. S. Col'd L. Art'y.

Appears on

**Battery Muster Roll**

for *Enlistment to Dec 31*, 1864.

Present or absent. *Absent*

Stoppage, \$ \_\_\_\_\_ <sup>100</sup> for \_\_\_\_\_

Due Gov't, \$ \_\_\_\_\_ <sup>100</sup> for \_\_\_\_\_

Valuation of horse, \$ \_\_\_\_\_ <sup>100</sup>

Valuation of horse equipments, \$ \_\_\_\_\_ <sup>100</sup>

Remarks: *Sick in Hospital at Fort Leavenworth Mo.*

Book mark: \_\_\_\_\_

*J. H. Schreyer*

(358)

Copyist.

6

Indpt. Battery. | U.S.C.T.

David Crothers

Prot, Indpt. Battery, U. S. Col'd L. Art'y.

Appears on

Battery Muster Roll

for Jimmy T. Feb, 1865

Present or absent

Stoppage, \$ 100 for

Due Gov't, \$ 100 for

Valuation of horse, \$ 100

Valuation of horse equipments, \$ 100

Remarks: Died in Genl Hospital at Fort Leavenworth Feb 24 1865 of pneumonia

Book mark: Died Jan 24/65 over

J. W. Stanley

(358)

Copyist.

JAN. 17

6234161

01891\*

E. B. V. 10. R. 546

*C*

Indpt. Battery.

U.S.C.T.

*David Caruthers,*

*A*, Indpt. Battery U. S. Col'd Light Art'y.

Appears on **Batt'y Muster-out Roll**, dated

*St. Leavenworth, Mo., July 22, 1865.*

Muster-out to date \_\_\_\_\_, 186 .

Last paid to *Pay due from enlistment* 186 .

Clothing account:

Last settled \_\_\_\_\_, 186 ; drawn since \$ *30* <sup>*76*</sup>/<sub>100</sub>,

Due soldier \$ \_\_\_\_\_ <sup>100</sup>; due U. S. \$ \_\_\_\_\_ <sup>100</sup>

Am't for cloth'g in kind or money adv'd \$ \_\_\_\_\_ <sup>100</sup>

Due U. S. for arms, equipments, &c., \$ \_\_\_\_\_ <sup>100</sup>

Bounty paid \$ *100* <sup>100</sup>; due \$ *None* <sup>100</sup>,

Remarks: *Died in G. Hospital,*  
*St. Leavenworth, Mo., July, 2/65,*

Book mark: *Died Jan'y. 24/65.*  
*over*

*Caruthers*

Copyist.



JAN. 17

6234672

01891\*

*CP, 10, P, 546, & 7, 173,  
P, 126, 73, + C, 130, 7, 10,  
C, 7, 173, + 288, 804,*

C 1 L.A. USCJ  
David Crothers  
Adjut. Gen. Regt. L.A.

**NOTATION.**

Book mark C-130-C.J. 73

**Record and Pension Office,**

**WAR DEPARTMENT.**

This book mark refers only to a report from the medical records, made by the Surgeon General to the Adjutant General, relative to the above-named man. As the medical records have since been carded, no transcript of this report is made hereon.

J. Ewers

(491)

Copyist.

*Cruthers, David*

, Co. ....

*2* Reg't *U.S. Arty.*

*4* Enclosures.

Bed Cards .....	Final Statements / .....
Burial Records / .....	Furloughs or L. of A. ....
Certs. of Dis. for Discharge .....	Med. Certificates .....
C. M. Charges .....	Med. Des. Lists .....
Descriptive Lists .....	Orders .....
Discharge Certificates .....	Pris. of War Record .....
Enlistment Papers <i>2</i> .....	Resignations .....

Other papers relating to—

Admission to Hosp'l .....	Furlough or L. of A. ....
Casualty Sheet .....	Med. Examination .....
Confinement .....	Misc. Information .....
Contracts .....	Pay or Clothing .....
Death or Effects .....	Personal Reports .....
Desertion .....	Rank .....
Discharge from Hosp'l .....	Transfer to Hosp'l .....
Discharge from Service .....	Transfer to V. R. C. ....
Duty .....	Transportation .....

MICROFILM PUBLICATION M 1836

COMPILED MILITARY SERVICE RECORDS  
OF VOLUNTEER UNION SOLDIERS WHO SERVED WITH  
THE UNITED STATES COLORED TROOPS (USCT)  
INDEPENDENT BATTERY LIGHT ARTILLERY

PERSONAL PAPERS' TARGET SHEET

PLEASE NOTE THE CHECKED INFORMATION ABOUT THE PERSONAL PAPERS IN  
THIS FILE:

- NO PERSONAL PAPERS WERE FOUND IN THIS FILE WHEN THE  
RECORDS WERE ARRANGED FOR MICROFILMING.
- 5 PERSONAL PAPER(S) FOUND IN THIS FILE WHEN THE RECORDS  
WERE ARRANGED FOR MICROFILMING.

NOTE 1.—This blank will be used for both enlistments and re-enlistments—enlistment of veterans, &c., &c., in the volunteer service. They will be made out in duplicate in all cases—one to accompany the recruiting return of the superintendent (not the recruiting officer) to the Adjutant General, and one to accompany the accounts of the officer who pays bounty, &c. The Regiment and Company in which the soldier last served should be given on the back.

NOTE 2.—An enlistment holds to service. A muster-in must, in all cases, precede payment of pay, bounty, pension, &c. A muster-in roll must, in all cases, be filed in the Adjutant General's Office as evidence of muster-in. The mustering officer, commissary, or assistant commissary of musters, as the case may be, will countersign both enlistments as having mustered the soldier into the service of the States before either of them is given to the disbursing officer.

DECLARATION OF RECRUIT.

I, David Cruthers desiring to VOLUNTEER as a Soldier in the Army of the United States, for the term of THREE YEARS Do Declare, That I am 19 years and      months of age; that I have never been discharged from the United States service on account of disability or by sentence of a court martial, or by order before the expiration of a term of enlistment; and I know of no impediment to my serving honestly and faithfully as a soldier for three years.

GIVEN at Leavenworth City State Kansas the 20 day of July 1864

Witness:

W. H. Birmingham

David Cruthers  
*his mark*

No. 1016

David Cruthers

Volunteered at Leavenworth KS

July 20<sup>th</sup> 1864,

By Wm D. Mumfrees Regt  
20<sup>th</sup> Regt. Mevmt. Co. 2<sup>d</sup> U.S. Cal & Artillery

enlistment; last served in Company ( )

Reg't of

Discharged 18

Rec'd from 2nd. Aud. Nov 23<sup>rd</sup> 1864

CONSENT IN CASE OF MINOR.

I, \_\_\_\_\_ Do CERTIFY, That I am \_\_\_\_\_; that the \_\_\_\_\_ of \_\_\_\_\_; that the \_\_\_\_\_ is \_\_\_\_\_ years of age; and I do hereby freely give my CONSENT to his volunteering as a SOLDIER in the ARMY OF THE UNITED STATES for the period of THREE YEARS.

GIVEN at \_\_\_\_\_ the \_\_\_\_\_ day of \_\_\_\_\_

Witness:

VOLUNTEER ENLISTMENT.

STATE OF

TOWN OF

*Kansas*

*Leavenworth City*



I, *David Cruthers* born in \_\_\_\_\_

in the State of *Arkansas* aged *19* years,

and by occupation a *Farmer* Do HEREBY ACKNOWLEDGE to have

volunteered this *20* day of *July* 1864,

to serve as a **Soldier** in the **Army of the United States of America**, for

the period of **THREE YEARS**, unless sooner discharged by proper authority:

Do also agree to accept such bounty, pay, rations, and clothing, as are, or may be, established by law for volunteers. And I, *David Cruthers* do

solemnly swear, that I will bear true faith and allegiance to the **United States**

of **America**, and that I will serve them honestly and faithfully against all

their enemies or opposers whomsoever; and that I will observe and obey the

orders of the President of the United States, and the orders of the officers

appointed over me, according to the Rules and Articles of War.

Sworn and subscribed to, at *Leavenworth City* this *20<sup>th</sup>* day of *July* 1864,

*David Cruthers*  
his  
mark

BEFORE *Wm. D. Matthews 2nd Lieut.*  
*Recruiting Co. R. 2nd U.S. Col. Artillery*

I CERTIFY, ON HONOR, That I have carefully examined the above-named Volunteer, agreeably to the General Regulations of the Army, and that, in my opinion, he is free from all bodily defects and mental infirmity, which would in any way disqualify him from performing the duties of a soldier.

*Jeffie Sinks*  
*Surg. Board of Enrollment*  
*North Dist. Kansas*  
EXAMINING SURGEON.

I CERTIFY, ON HONOR, That I have minutely inspected the Volunteer, *David Cruthers* previously to his enlistment, and that he was entirely sober when enlisted; that, to the best of my judgment and belief, he is of lawful age; and that, in accepting him as duly qualified to perform the duties of an able-bodied soldier, I have strictly observed the Regulations which govern the recruiting service. This soldier has *Black* eyes, *Black* hair, *Black* complexion, is *5* feet *6* inches high.

*Wm. D. Matthews 2nd Lieut.*  
*Recruiting Co. R. 2nd U.S. Col. Artillery*  
Volunteers,  
RECRUITING OFFICER.

(A. G. O. No. 74 & 75.)

Mustered into the service of the United States, for three years or during the war, from date of enlistment, in Company \_\_\_\_\_ Regiment of *2nd* *Volunteers*, on the *22* day of *July*, 1864, at *Leavenworth*

*Received by me from the County Clerk of Leavenworth, Kansas, for the above named volunteer, the sum of \$100.00, being the bounty and clothing money, on July 21st 1864.*

DECLARATION OF RECRUIT.

I, *David Cruthers* desiring  
VOLUNTEER as a Soldier in the Army of the United States, for the term of THREE YEARS

Do Declare, That I am *19* years of age; that I have never been discharged from the United States service on account of disability or by sentence of a court martial, or by order before the expiration of a term of enlistment; and I know of no impediment to my serving honestly and faithfully as a soldier for three years.

GIVEN at *Leavenworth, Kas.* the *20* day of *July* 18*64*

Witness: *W.H. Butcher* *David Cruthers* mark

A muster-in roll must, in all cases, be filed in the Adjutant General's Office. They will be made out by the Adjutant General, and he to accompany the recruit to the recruiting office. A muster-in roll must, in all cases, be filed in the Adjutant General's Office. They will be made out by the Adjutant General, and he to accompany the recruit to the recruiting office.

NOTE 1.—This blank will be used for both enlistments and re-enlistments—enlistment of veterans, &c., &c., in the volunteer service. They will be made out by the Adjutant General, and he to accompany the recruit to the recruiting office. A muster-in roll must, in all cases, be filed in the Adjutant General's Office. They will be made out by the Adjutant General, and he to accompany the recruit to the recruiting office.

Discharged \_\_\_\_\_ 18  
enlistment; last served in Company ( )  
Reg't of \_\_\_\_\_

No. *15*  
*David Cruthers*  
Volunteered at *Leavenworth, Kas.*  
*July 20* 18*64*  
By *Wm. D. McDowell* and  
*Levy Recruiting Co., 2nd U.S. Col.*

CONSENT IN CASE OF MINOR.

I, \_\_\_\_\_ Do CERTIFY, That I am  
the \_\_\_\_\_ of \_\_\_\_\_; that the  
said \_\_\_\_\_ is \_\_\_\_\_ years of age; and I  
do hereby freely give my CONSENT to his volunteering as a SOLDIER in the ARMY OF THE UNITED STATES for the period of THREE YEARS.

GIVEN at \_\_\_\_\_  
the \_\_\_\_\_ day of \_\_\_\_\_

Witness: \_\_\_\_\_

(A. G. O. No. 74 & 76.)

VOLUNTEER ENLISTMENT.

STATE OF

Kansas



TOWN OF

Leavenworth City

I, David Cruthers born in \_\_\_\_\_  
in the State of Arkansas aged 19 years,  
and by occupation a Furrier Do hereby acknowledge to have  
volunteered this 20 day of July 1864  
to serve as a **Soldier** in the **Army** of the **United States** of America, for  
the period of **THREE YEARS**, unless sooner discharged by proper authority:  
Do also agree to accept such bounty, pay, rations, and clothing, as are, or may be,  
established by law for volunteers. And I, David Cruthers do  
solemnly swear, that I will bear true faith and allegiance to the **United States**  
**of America**, and that I will serve them honestly and faithfully against all  
their enemies or opposers whomsoever; and that I will observe and obey the  
orders of the President of the United States, and the orders of the officers  
appointed over me, according to the Rules and Articles of War.

Sworn and subscribed to, at Leavenworth City his  
this 20 day of July 1864, David Cruthers  
BEFORE Wm. D. Matthews 2nd Lieut mark

Recruiting Co. K, 2nd U. S. Col. Artillery

I CERTIFY, ON HONOR, That I have carefully examined the above-named Volunteer, agreeably  
to the General Regulations of the Army, and that, in my opinion, he is free from all bodily defects and  
mental infirmity, which would in any way disqualify him from performing the duties of a soldier.

Tiffin Binks  
Surgeon Board of Enrollment  
North Dist. Kansas  
EXAMINING SURGEON.

I CERTIFY, ON HONOR, That I have minutely inspected the Volunteer, \_\_\_\_\_  
previously to his enlistment, and that he was entirely sober when enlisted; that, to the best of my  
judgment and belief, he is of lawful age; and that, in accepting him as duly qualified to perform the  
duties of an able-bodied soldier, I have strictly observed the Regulations which govern the recruiting  
service. This soldier has \_\_\_\_\_ eyes, \_\_\_\_\_ hair, \_\_\_\_\_ complexion, is \_\_\_\_\_  
feet \_\_\_\_\_ inches high.

Wm. D. Matthews 2nd Lieut  
Recruiting Co. K, 2nd U. S. Col. Artillery  
Regiment of \_\_\_\_\_ Volunteers,  
RECRUITING OFFICER.

(A. G. O. No. 74 & 75.)

Mustered into the service of the United States, for three years or during the war, from date of enlistment, in Company \_\_\_\_\_  
Regiment of \_\_\_\_\_ Volunteers, on the 22 day of July, 1864, at \_\_\_\_\_



David Crothers  
Priv. 2nd. Battery Col<sup>d</sup> U.S.A.  
Jan. 24. 65.  
D. H. Fort Leavenworth, Kans.

HOSPITAL RECORD,

SUBJECT TO THE

ORDER OF THE SURGEON GENERAL  
UNITED STATES ARMY.

No. 1.

RECORD OF DEATH AND INTERMENT.

Name and number of person interred.	<i>David Brothers</i>	
Number and locality of the grave . . .		
Hospital number of the deceased . . .		
Regiment, rank, and company . . . . .	<i>Priv. Independent Bat. W. J. Col. Art.</i>	
Residence before enlistment . . . . .		
Conjugal condition, (and if married, ) the residence of the widow) . . . . .		
Cause of death . . . . .	<i>Pneumonia.</i>	
Age of the deceased . . . . .		
Nativity . . . . .		
References and remarks . . . . .	<i>Command, on duty at the Post</i>	
Date of death and burial . . . . .	<i>January 24<sup>th</sup></i>	<i>1865.</i>

Duplicates sent to the Adjutant General of the United States Army, and to the Sexton of the Cemetery.

Memoranda:

*1 Over coat - 1 Blouse - 1 pr. Pants -  
1 pr. Boots -*

[OFFICE INDORSEMENT.]

War Department,

ADJUTANT GENERAL'S OFFICE,

December 12, 1873

The death of Peto David  
Crathus, Co. Cud, Bat. Lt Regt U. S.  
Colored Artillery, is reported as follows:—

On Company Muster Roll.

For *Jan<sup>y</sup> Feb<sup>y</sup>* 1865, *Feb<sup>y</sup> 2*, 1865.  
Company Muster-out Roll.

*February 2*, 1865,  
Company Descriptive Book.

....., 186

Company Morning Reports.

....., 186

Soldier's Final Statement.

*January 24*, 1865,  
Soldier's Record of Death and Interment.

....., 186

Soldier's Inventory of Effects.

....., 186

Soldier's Certificate of Disability for Discharge.

....., 186

Soldier's Individual Muster-out Roll.

....., 186

Regimental Return.

For ....., 186 , ....., 186

Regimental Quarterly Returns.

....., 186

Regimental Descriptive Book.

....., 186

By Surgeon General.

(C. 130. 10. 187), *January 24*, 1865,

*January 24*" , 1865, is held to be  
the correct date, and the Company Muster  
Roll will be amended accordingly.

*Thomas M. Sargent*

E. B. 524<sup>10</sup> See letter to <sup>Asst. Adj. Gen.</sup> Auditor  
dated *Jan<sup>y</sup> 10. 1874.*

FINAL STATEMENT

OF

*Private David Coulter*  
*Regt. 1st W. Cal. Artillery*

**VOLUNTEERS.**

*Quadrant No. 1115*

NOTE 1.—Two of these certificates (or duplicates) are to be given to each Volunteer Soldier or drafted man who may be discharged previously to the discharge of his company, that he may at once receive from the Paymaster the pay, &c., due him, and the captain or other COMMISSIONED officer commanding the company will certify to the act of the delivery of the duplicate certificates; on these certificates the Soldier is "entitled to" his discharge, and should also present his discharge to the Paymaster to have the payment endorsed on it. The discharge is to be given back to the Soldier by the Paymaster; the latter only retaining as his voucher the duplicate certificates.

NOTE 2.—If the Soldier is entitled to pay for the use of his horse, the Company Commander will certify to that fact on the back of both these final statements, and also to the time he has pay due for having been so mounted on his own horse.

NOTE 3.—When a Soldier is furnished with final statements, his descriptive list, if he has one, should be taken up by the officer who gives the Soldier these statements, and endorsed with a statement to this effect by the officer. This endorsement should exhibit a full statement of the time for which the Soldier was allowed pay on his final statements, the clothing account, and all other charges against him or in his favor, so as to comprise a complete exhibit of his account. It will then be transmitted to the company commander of the Soldier, who will enter all the data necessary to a full understanding of the Soldier's account on the muster roll upon which the Soldier's discharge is reported. The descriptive list will then be destroyed. The object of this is, that the remaining portion of the Soldier's account may be settled upon the receipt of these muster rolls, and the Soldier receive any pay or allowances that may be due him at the time of his discharge, and which may not appear on his final statements from the fact that his descriptive list is incomplete. These accounts for back pay, &c., are settled by the 2d Auditor of the Treasury Department.

NOTE 4.—Charges for loss or injury to ordnance, horse equipments, and other miscellaneous charges, should appear under the heading of "Other Stoppages."

NOTE 5.—Bounty paid by State authorities, and not by the United States, will not be entered on this statement.

NOTE 6.—Amounts due the Sutler and Laundress must be entered on the muster roll on which the discharge, death, desertion, &c., is reported, as well as on the final statement, otherwise the amount cannot be collected from the United States.

NOTE 7.—This blank will be used for deceased volunteers and drafted men, as well as for others.

NOTE 8.—Where a Soldier dies in Hospital or on detached service, his descriptive list, if he has one, should be sent with his final statements, in duplicate, to the Adjutant General, Washington, D. C.

ADJUTANT GENERAL'S OFFICE.  
*March 8<sup>th</sup> 1865.*  
 Duplicate with Inventory sent 2d Auditor.

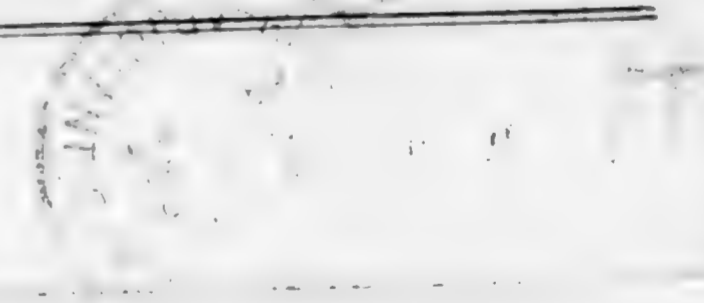

I certify, on honor, that David Brothers a Private of  
Captain Wm Douglas Company (      ) of the Independent <sup>Battery</sup> ~~Regiment~~ of W. S. Colored Artillery (Light)  
**VOLUNTEERS**, of the State of       , born in       , State  
of Arkansas, aged 19<sup>th</sup> years; 5 feet 6 inches high; Black complexion,  
Black eyes, Black hair, and by occupation a Farmer, having joined the company on  
its original organization at Leavenworth City, and enrolled in it at the muster into  
the service of the United States at Leavenworth City, on the 20<sup>th</sup> day  
of July, 1864, (~~or was mustered in service as a recruit, by~~  
, at , on the  day of ,

~~186~~, or was drafted and mustered into the service of the United States from the  
~~Enrollment District of the State of~~ , at   
on the  day of , 186 ) to serve in the Regiment, for

the term of Three Years: and having served **HONESTLY** and  
**FAITHFULLY** with his Company in Arkansas to the present date, is now  
entitled to a **DISCHARGE** by reason of Died in Post Hospital Fort Leavenworth  
Arkansas on the 24<sup>th</sup> day of January 1865 of Pneumonia

The said Private David Brothers has pay due from date of enlistment  
       to include the        day of       , 186   , and has  
pay due him from that time to the present date; he is entitled to pay and subsistence for  
**TRAVELING** to place of enrollment, and whatever other allowances are authorized to volunteer  
soldiers, drafted men, or militia, so discharged. He has received from the United States **CLOTHING**  
amounting to \$ 30. <sup>76</sup>/<sub>100</sub> dollars, since the date day of Enlistment,  
186   , when his clothing account was last settled. He has received from the United States  
\$ 1.00. <sup>40</sup>/<sub>100</sub> dollars advanced **BOUNTY**.

~~There is to be stopped from him, on account of the State of~~ , or other  
~~authorities, for CLOTHING, &c., received on entering service,~~  <sup>100</sup>/<sub>100</sub> dollars, and  
~~for other stoppages, viz:~~

<sup>100</sup>/<sub>100</sub> dollars.

He has been furnished with **TRANSPORTATION** in kind from the place of his discharge to  
; and he has been **SUBSISTED** for **TRAVELING** to his  
place of enrollment, up to the , 186   .

~~He is indebted to~~ , **SUTLER**,  <sup>100</sup>/<sub>100</sub> dollars.

~~He is indebted to~~ , **LAUNDRESS**,  <sup>100</sup>/<sub>100</sub> dollars.

Given in Duplicate, at Fort Leavenworth, this 16<sup>th</sup> day  
of February, 1865.

Capt Wm Douglas  
Commanding Company Battery

ARTICLES OF WAR.

ART. 95. When any non-commissioned officer or soldier shall die, or be killed in the service of the United States, the then commanding officer of the troop or company shall, in the presence of two other commissioned officers, take an account of what effects he died possessed of, above his arms and accoutrements, and transmit the same to the office of the Department of War, which said effects are to be accounted for, and paid to the representatives of such deceased non-commissioned officer or soldier. And in case any of the officers, so authorized to take care of the effects of deceased officers and soldiers, should, before they have accounted to their representatives for the same, have occasion to leave the regiment or post, by preferment or otherwise, they shall, before they be permitted to quit the same, deposit in the hands of the commanding officer, or of the assistant military agent, all the effects of such deceased non-commissioned officers and soldiers, in order that the same may be secured for, and paid to, their respective representatives.

ARMY REGULATIONS—EDITION OF 1863.

DECEASED SOLDIERS.

Par. 152. Inventories of the effects of deceased non-commissioned officers and soldiers, required by the 95th Article of War, will be forwarded to the Adjutant General, by the commander of the company to which the deceased belonged, and a duplicate of the same to the colonel of the regiment. Final statements of pay, clothing, &c., in duplicate, will be sent to the Adjutant General with one copy of the inventory. When a soldier dies at a post or station absent from his company, it will be the duty of his immediate commander to furnish the required inventory and final statements, and, at the same time, to forward to the commanding officer of the company to which the soldier belonged, a report of his death, specifying the date, place, and cause; to what time he was last paid, and the money or other effects in his possession at the time of his decease; which report will be noted on the next muster roll of the company to which the man belonged. Each inventory will be endorsed, "Inventory of the effects of \_\_\_\_\_, late of company (—) \_\_\_\_\_ regiment of \_\_\_\_\_, who died at \_\_\_\_\_, the \_\_\_\_\_ day of \_\_\_\_\_, 186—." If a legal representative receive the effects, it will be stated in the report. If the soldier leave no effects, the fact will be reported.

Par. 153. Should the effects of a deceased non-commissioned officer or soldier not be administered upon within a short period after his decease, they shall be disposed of by a Council of Administration, under the authority of the commanding officer of the post, and the proceeds deposited with the Paymaster, to the credit of the United States, until they shall be claimed by the legal representatives of the deceased.

Par. 154. In all such cases of sales by the Council of Administration, a statement in detail, or account of the proceeds, duly certified by the Council and commanding officer, accompanied by the Paymaster's receipt for the proceeds, will be forwarded by the commanding officer to the Adjutant General. The statement will be endorsed, "Report of the proceeds of the effects of \_\_\_\_\_, late of company (—) \_\_\_\_\_ regiment of \_\_\_\_\_, who died at \_\_\_\_\_, the \_\_\_\_\_ day of \_\_\_\_\_, 186—."

NOTE 1.—The effects in all cases, when called for, should be turned over to the legal representative, without further authority from the Adjutant General. When the effects are turned over to the relatives of the deceased before these inventories are sent to the Adjutant General, their receipts therefor should be attached to the inventories. In all other cases, one copy will be sent with a letter of transmittal direct to the Adjutant General, and a duplicate retained by the officer.

NOTE 2.—Particular care should be taken to take receipts in duplicate from the Paymaster for any funds turned over to him; one copy should be sent direct to the Adjutant General and one retained by the officer.

INVENTORY OF THE EFFECTS

OF

.....  
*Late of Company* .....

.....  
*Reg't of* .....

.....  
*Volunteers, who died at* .....

.....  
*on the* ..... *day of* ..... 186 .



Inventory of the effects of David Cuthbert late  
 a Private of Captain Wm Ford Douglas Company Independent  
 the Battery Regiment of U.S. Cav. Artillery (Light) Volunteers, who was enrolled as  
 a Private at Leavenworth City in the State of Kansas on  
 the 20th day of July 1864, and mustered into the service of the United  
 States as a private on the 20th day of July 1864, at Leavenworth City  
 in Company Independent Battery Regiment of U.S. Cav. Artillery (Light) Volunteers, to serve three  
 years or during the war; he was born in \_\_\_\_\_ in the State  
 of Arkansas; he was 19 years of age, 5 feet 0 inches  
 high, Dark complexion, Black eyes, black hair, and by occupation, when enrolled,  
 a Farmer; he died in Leavenworth Hospital, at  
Fort Leavenworth Kans on the 24th day of January 1865, by  
 reason of Pneumonia

INVENTORY.					
ARTICLES.	No.	ARTICLES.	No.	ARTICLES.	No.
Hats.....		Pairs trousers.....	1	Knapsacks.....	
Caps.....		Pairs flannel drawers.....			
Forage caps.....		Pairs cotton drawers.....			
Great coats.....	1	Flannel shirts.....			
Uniform coats.....		Cotton shirts.....			
Uniform jackets.....		Pairs boots.....	1		
Flannel sack coats.....		Pairs shoes.....			
Blouses.....	1	Pairs socks.....		MONEY.	
Stable frocks.....		Blankets.....		Specie.....	\$
Fatigue overalls.....		Haversacks.....		Notes.....	\$

I CERTIFY, ON HONOR, that the above inventory comprises all the effects of Private  
David Cuthbert, deceased, and that the effects are in the hands  
 of Capt Wm Ford Douglas at Fort Leavenworth Kansas  
 to be disposed of by a Council of Administration.

( DUPLICATES. )

Capt Wm Ford Douglas  
 Commanding the Company Battery

STATION: Fort Leavenworth

DATE: February 25th 1865

*David*

pt. Batt'y U.S. Col'd L. Art'y

*Private Private*

CARD NUMBERS.

6233749	26
6233898	27
6234070	28
6234209	29
6234376	30
6234538	31
9132930	32
	33
	34
	35
	36
	37
	38
	39
	40
	41
	42
	43
	44
	45
	46
	47
	48
	49
	50

Book Mark:

See also



RP 682326

W. Spencer  
SP

*C* | Indpt. Batt'y. | **U.S.C.T.**

*David Crockett*

....., Indpt. Batt'y, U. S. Col'd L. Art'y.

Appears on

**Battery Descriptive Book**  
of the organization named above.

**DESCRIPTION.**

Age *25* years; height *5* feet *6* inches.

Complexion *Black*

Eyes *Black*; hair *Black*

Where born *Christianity*

Occupation *Farmer*

**ENLISTMENT.**

When *July 23*, 1864

Where *San Antonio*

By whom *J Mathews*; term *3* y'rs.

Remarks: .....

.....  
.....  
.....  
.....  
.....  
.....  
.....  
.....  
.....  
.....

*Hollbrook*

6

Indpt. Battery.

U.S.C.T.

David Crocket

Pvt., Indpt. Battery, U. S. Col'd L. Art'y.

Appears on

**Battery Muster-in and Descriptive Roll**

of the organization named above. Roll dated

Leavenworth Mo Dec 23, 1864.

Where born Christian Co, Ky.

Age 25 y'rs; occupation Farmer

When enlisted July 23, 1864.

Where enlisted Leavenworth Mo

For what period enlisted 3 years.

Eyes Blue; hair Blue

Complexion Blue; height 5 ft. 6 in.

When mustered in July 23, 1864.

Where mustered in Leavenworth

Bounty paid \$100<sup>00</sup>/<sub>100</sub>; due \$200<sup>00</sup>/<sub>100</sub>

Where credited

Battery to which assigned

Remarks: A. N. Dist Co.

20th Co, 2d Ward

Leavenworth Mo

Book mark ;

J. J. Schisley  
(856g) Copyist.

6 | Indpt. Battery. | **U.S.C.T.**

David Crockett

Pvt, Indpt. Battery, U. S. Col'd L. Art'y.

Appears on

**Battery Muster Roll**

for Enlistment to Dec 31, 186 4

Present or absent Present

Stoppage, \$ 100 for

Due Gov't, \$ 100 for

Valuation of horse, \$ 100

Valuation of horse equipments, \$ 100

Remarks:  
\_\_\_\_\_  
\_\_\_\_\_  
\_\_\_\_\_  
\_\_\_\_\_  
\_\_\_\_\_  
\_\_\_\_\_

Book mark: \_\_\_\_\_

(358) J. W. Schrey Copyist.

6 | Indpt. Battery. | **U.S.C.T.**

David Crockett

Pvt, Indpt. Battery, U. S. Col'd L. Art'y.

Appears on

**Battery Muster Roll**

for Jan Feb, 1865

Present or absent Present

Stoppage, \$ 100 for

Due Gov't, \$ 100 for

Valuation of horse, \$ 100

Valuation of horse equipments, \$ 100

Remarks:

Book mark:

(358) [Signature] Copyist.

*C*

Indpt. Battery. | **U.S.C.T.**

*David Crocket,*

*A*, Indpt. Battery, U. S. Col'd L. Art'y.

Appears on

**Battery Muster Roll**

for *Man & wife,* 186 *5.*

Present or absent *Present.*

Stoppage, \$ 100 for

Due Gov't, \$ 100 for

Valuation of horse, \$ 100

Valuation of horse equipments, \$ 100

Remarks:  
\_\_\_\_\_  
\_\_\_\_\_  
\_\_\_\_\_  
\_\_\_\_\_  
\_\_\_\_\_  
\_\_\_\_\_  
\_\_\_\_\_

Book mark: \_\_\_\_\_

*Porter*

Copyist.

*C* | Indpt. Battery. | **U.S.C.T.**

*David Crocket,*

*C*, Indpt. Battery, U. S. Col'd L. Art'y.

Appears on

**Battery Muster Roll**

for *May & June*, 186 *5*

Present or absent *Present,*

Stoppage, \$ 100 for

Due Gov't, \$ 100 for

Valuation of horse, \$ 100

Valuation of horse equipments, \$ 100

Remarks:

Book mark:

*Poster*

Copyist.

*C* | Indpt. Battery. | **U.S.C.T.**

*David Crocket,*

*A*....., Indpt. Battery U. S. Col'd Light Art'y.

Appears on **Batt'y Muster-out Roll**, dated  
*M. Leavenworth, Ky, July 27, 1865.*

Muster-out to date *July 27, 1865.*

Last paid to *Dec. 31, 1864.*

**Clothing account:**

Last settled....., 186 ; drawn since \$ *70* <sup>*63*</sup>/<sub>*100*</sub>,

Due soldier \$ *100*/<sub>*100*</sub>; due U. S. \$ *100*/<sub>*100*</sub>

Am't for cloth'g in kind or money adv'd \$ *100*/<sub>*100*</sub>

Due U. S. for arms, equipments, &c., \$ *100*/<sub>*100*</sub>

Bounty paid \$ *100* <sub>*100*</sub>; due \$ *None* <sub>*100*</sub>,

Remarks:.....  
.....  
.....  
.....  
.....  
.....

Book mark:.....

*Parter*  
Copyist.



*Indpt Batty use sa*

*Crocket David*

\_\_\_\_\_, Co. \_\_\_\_\_, *2* Regt *U.S.C.A.*

*2* Enclosures.

Bed Cards .....	Final Statements .....
Burial Records .....	Furloughs or L. of A .....
Certs. of Dis. for Discharge .....	Med. Certificates .....
C. M. Charges .....	Med. Des. Lists .....
Descriptive Lists .....	Orders .....
Discharge Certificates .....	Pris. of War Record .....
Enlistment Papers <i>2</i> .....	Resignations .....

Other papers relating to—

Admission to Hosp'l .....	Furlough or L. of A. ....
Casualty Sheet .....	Med. Examination .....
Confinement .....	Misc. Information .....
Contracts .....	Pay or Clothing .....
Death or Effects .....	Personal Reports .....
Desertion .....	Rank .....
Discharge from Hosp'l .....	Transfer to Hosp'l .....
Discharge from Service .....	Transfer to V. R. C. ....
Duty .....	Transportation .....
.....	.....

DECLARATION OF RECRUIT.

I, David Crockett desiring to VOLUNTEER as a Soldier in the Army of the United States, for the term of THREE YEARS Do Declare, That I am 25 years and — months of age; that I have never been discharged from the United States service on account of disability or by sentence of a court-martial, or by order before the expiration of a term of enlistment; and I know of no impediment to my serving honestly and faithfully as a soldier for three years.

GIVEN at Leavenworth - State of Kansas the 23 day of July 1864

Witness: W. A. Bunch David Crockett

NOTE 1.—This blank will be used for both enlistments and re-enlistments—enlistment of veterans, &c., &c., in the volunteer service. They will be made out in duplicate in all cases—one to accompany the recruiting return of the superintendent (not the recruiting officer) to the Adjutant General, and one to accompany the accounts of the officer who pays bounty, &c. The Regiment and Company in which the soldier last served should be given on the back.  
NOTE 2.—An enlistment holds to service. A muster-in must, in all cases, precede payment of pay, bounty, pension, &c. A muster-in roll must, in all cases, be filed in the Adjutant General's Office as evidence of muster-in. The mustering officer, commissary, or assistant commissary of musters, as the case may be, will countersign both enlistments as having mustered the soldier into the service of the United States before either of them is given to the disbursing officer.

Rec'd from 2nd. Aud. Nov. 23d 1892

enlistment; last served in Company ( )  
Reg't of .....  
Discharged ..... 18 ..

No. 1000  
David Crockett  
Volunteered at Leavenworth Mo  
July 23 1864  
By Wm. D. Matthews 2nd Lt. 5th  
Regiment of U.S. Cavalry

CONSENT IN CASE OF MINOR.

I, ..... Do CERTIFY, That I am the ..... of .....; that the said ..... is ..... years of age; and I do hereby freely give my CONSENT to his volunteering as a SOLDIER in the ARMY OF THE UNITED STATES for the period of THREE YEARS.

GIVEN at ..... the ..... day of .....

Witness: .....

VOLUNTEER ENLISTMENT.

STATE OF

*Kansas*



TOWN OF

*Leavenworth City*

I, *David Crocket* born in *Christiana Co,*

in the State of *Kentucky* aged *25* years,

and by occupation a *Farmer* Do HEREBY ACKNOWLEDGE to have

volunteered this *twenty-third* day of *July* 1864,

to serve as a **Soldier** in the **Army of the United States of America**, for the period of **THREE YEARS** unless sooner discharged by proper authority: Do also

agree to accept such bounty, pay, rations, and clothing, as are, or may be, established by law for volunteers. And I, *David Crocket* do

solemnly swear, that I will bear true faith and allegiance to the **United States**

**of America**, and that I will serve them honestly and faithfully against all their

enemies or opposers whomsoever; and that I will observe and obey the orders of

the President of the United States, and the orders of the officers appointed over

me, according to the Rules and Articles of War.

Sworn and subscribed to, at *Leavenworth City* his

this *23<sup>rd</sup>* day of *July* 1864 *David Crocket*

BEFORE *Wm D Matthews* 2<sup>nd</sup> Lieut

*Recruiting Co. K, 2<sup>nd</sup> U.S. Col. Artillery*

I CERTIFY, ON HONOR, That I have carefully examined the above-named Volunteer, agreeably to the General Regulations of the Army, and that, in my opinion, he is free from all bodily defects and mental infirmity, which would in any way disqualify him from performing the duties of a soldier.

*Jiffin Sims*  
*Sub Surgeon of Cavalry*  
*North Kansas*

EXAMINING SURGEON.

I CERTIFY, ON HONOR, That I have minutely inspected the Volunteer, *David Crocket* previously to his enlistment, and that he was entirely sober when enlisted; that, to the best of my judgment and belief, he is of lawful age; and that, in accepting him as duly qualified to perform the duties of an able-bodied soldier, I have strictly observed the Regulations which govern the recruiting service.

This soldier has *Black* eyes, *Black* hair, *Black* complexion, is *5* feet *6* inches high.

*Wm D Matthews* 2<sup>nd</sup> Lieut  
*Recruiting Co. K, 2<sup>nd</sup> U.S. Col. Artillery*  
Regiment of *Volunteers*

RECRUITING OFFICER.

Mustered into the service of the United States, in Company *K* 2<sup>nd</sup> Regiment of *Volunteers*, on the *23<sup>rd</sup>* day of *July* 1864, at *Leavenworth Kansas* for *3 years* on duty *the 23<sup>rd</sup>* day of *July* 1864, at *Leavenworth Kansas*

*Original from the County of...*

NOTE 1.—This blank will be used for both enlistments and re-enlistments—enlistment of veterans, &c., &c., in the volunteer service. They will be made out in duplicate in all cases—one to accompany the recruiting return of the superintendent (not the recruiting officer) to the Adjutant General, and one to accompany the accounts of the officer who pays bounty, &c. The Regiment and Company in which the soldier last served should be given on the back.

NOTE 2.—An enlistment holds to service. A muster-in must, in all cases, precede payment of pay, bounty, pension, &c. A muster-in roll must, in all cases, be filed in the Adjutant General's Office as evidence of muster-in. The mustering officer, commissary, or assistant commissary of musters, as the case may be, will countersign both enlistments as having mustered the soldier into the service of the United States before either of them is given to the disbursing officer.

DECLARATION OF RECRUIT.

I *David Crockett* desiring

to VOLUNTEER as a Soldier in the Army of the United States, for the term of THREE YEARS

Do Declare, That I am *25* years and ~~months~~ of age; that I have never been discharged from the United States service on account of disability or by sentence of a court-martial, or by order before the expiration of a term of enlistment; and I know of no impediment to my serving honestly and faithfully as a soldier for three years.

GIVEN at *Leavenworth Kas* the *23* day of *July*

Witness: *W. H. Burnham* *David Crockett*

No. 21

*David Crockett*

Volunteered at *Leavenworth Kas*

*July 23 1864*

By *Wm. M. Jones* 2nd Lt.

*Leavenworth Kas*

enlistment; last served in Company ( )

Reg't of

Discharged 18

CONSENT IN CASE OF MINOR.

I, ..... Do CERTIFY, That I am the ..... of .....; that the said ..... is ..... years of age; and I do hereby freely give my CONSENT to his volunteering as a SOLDIER in the ARMY OF THE UNITED STATES for the period of THREE YEARS.

GIVEN at ..... the ..... day of .....

Witness: .....

(A. G. O. No. 74 & 75.)

VOLUNTEER ENLISTMENT.

STATE OF

*Kansas*



TOWN OF

*Leavenworth City*

I, *David Crocket* born in *Christian County*  
 in the State of *Kentucky* aged *25* years,  
 and by occupation a *Farmer* Do HEREBY ACKNOWLEDGE to have  
 volunteered this *23<sup>rd</sup>* day of *July* 1864  
 to serve as a **Soldier** in the **Army of the United States of America**, for the  
 period of **THREE YEARS** unless sooner discharged by proper authority: Do also  
 agree to accept such bounty, pay, rations, and clothing, as are, or may be, estab-  
 lished by law for volunteers. And I, *David Crocket* do  
 solemnly swear, that I will bear true faith and allegiance to the **United States**  
**of America**, and that I will serve them honestly and faithfully against all their  
 enemies or opposers whomsoever; and that I will observe and obey the orders of  
 the President of the United States, and the orders of the officers appointed over  
 me, according to the Rules and Articles of War.

Mustered into the service of the United States, in Company ..... Regiment of ..... Volunteers, on the *23* day of ..... 186*4* at .....

Sworn and subscribed to, at *Leavenworth City*  
 this *23<sup>rd</sup>* day of *July* 1864 by *David Crocket*  
 BEFORE *Wm D Matthews* 2<sup>d</sup> Lt and *Wm D Matthews* 2<sup>d</sup> Lt  
*Recruiting Co, 2<sup>d</sup> W.S. Col Artillery*

I CERTIFY, ON HONOR, That I have carefully examined the above-named Volunteer, agreeably to the General Regulations of the Army, and that, in my opinion, he is free from all bodily defects and mental infirmity, which would in any way disqualify him from performing the duties of a soldier.

*Jiffin Sims*  
*Sur Board of Enrolment*  
*North West Dist Kansas*  
 EXAMINING SURGEON.

I CERTIFY, ON HONOR, That I have minutely inspected the Volunteer, *David Crocket*  
 previously to his enlistment, and that he was entirely sober when enlisted; that, to the best of my  
 judgment and belief, he is of lawful age; and that, in accepting him as duly qualified to perform the duties  
 of an able-bodied soldier, I have strictly observed the Regulations which govern the recruiting service.  
 This soldier has *Black* eyes, *Black* hair, *Black* complexion, is *5* feet  
*0* inches high.

*Wm D Matthews* 2<sup>d</sup> Lt  
*Recruiting Co, 2<sup>d</sup> W.S. Col Artillery*  
 Regiment of ..... Volunteers,  
 RECRUITING OFFICER.

*Sumner, James*

**1st. Batt'y U.S. Col'd L. Art'y**

*Private Private*

**CARD NUMBERS.**

6233746	26
6233895	27
6234042	28
6.234212	29
6234380	30
62345-42	31
9132927	32
	33
	34
	35
	36
	37
	38
	39
	40
	41
	42
	43
	44
	45
	46
	47
	48
	49
	50

Book Mark:

See also

RFP 466693  
 Q. 1573922 *PO return*  
 RFP 733143  
 P 2311198 P.O. aff  
 A 2384457 P.O. aff  
 A 2396916 PO aff  
 Q. 3216799 *PO Ret.*

*W. J. Spencer*  
*3*

C | Indpt. Batt'y. | **U.S.C.T.**

*James Crump*

....., Indpt. Batt'y, U. S. Col'd L. Art'y.

Appears on

**Battery Descriptive Book**

of the organization named above.

**DESCRIPTION.**

Age *17* years; height *5* feet *6* inches.

Complexion *Yellow*

Eyes *Brown*; hair *Black*

Where born *Jackson (Ms.)*

Occupation *Soldier*

**ENLISTMENT.**

When *July 15*, 186*4*

Where *Seventh A Co*

By whom *Sgt Mathews*; term *3* y'rs.

Remarks: .....

.....  
.....  
.....  
.....  
.....  
.....  
.....  
.....

(383g)

*Shalbrook*

Copyist.



6 | Indpt. Battery. | U.S.C.T.

James Crump  
Pat

Indpt. Battery, U. S. Col'd L. Art'y.

Appears on

**Battery Muster-in and Descriptive Roll**

of the organization named above. Roll dated

Leavenworth Mo, Dec 23, 1864.

Where born Jackson Co Mo

Age 17 yrs; occupation Farmer

When enlisted July 15, 1864.

Where enlisted Leavenworth Mo

For what period enlisted 3 years.

Eyes Bro; hair Brn

Complexion Yellow; height 5 ft. 6 in.

When mustered in July 16, 1864.

Where mustered in Leavenworth

Bounty paid \$ 25<sup>00</sup>/<sub>100</sub>; due \$ 75<sup>00</sup>/<sub>100</sub>

Where credited

Battery to which assigned

Remarks: Cr in dist  
21st S.D. 3rd ward  
Leavenworth Mo

Book mark :

J. Schuster

(856g)

Copyist.

C | Indpt. Battery. | U.S.C.T.

James Crump  
Sgt., Indpt. Battery, U. S. Col'd L. Art'y.

Appears on

**Battery Muster Roll**

for *Enlistment to Dec 31, 1864.*

Present or absent *Present*

Stoppage, \$ 100 for

Due Gov't, \$ 100 for

Valuation of horse, \$ 100

Valuation of horse equipments, \$ 100

Remarks:

Book mark:

(358) *J. H. Schoddy* Copyist.

6

Indpt. Battery.

U.S.C.T.

James Crump  
Corp, Indpt. Battery, U. S. Col'd L. Art'y.

Appears on

**Battery Muster Roll**

for

Jan'y & Feb

186

5

Present or absent

Present

Stoppage, \$

100 for

Due Gov't, \$

100 for

Valuation of horse, \$

100

Valuation of horse equipments, \$

100

Remarks:

Appointed Corp'l  
Jan'y 1865 by Major  
P. H. Hunt Chf Artillery  
Dept of Kansas

Book mark:

(358)

J. S. Schuler

Copyist.

*C*

Indpt. Battery.

U.S.C.T.

*James Crump*  
*Pr*

, Indpt. Battery, U. S. Col'd L. Art'y.

Appears on

**Battery Muster Roll**

for *Mar & Apr*, 1865.

Present or absent *Present*

Stoppage, \$ 100 for

Due Gov't, \$ 100 for

Valuation of horse, \$ 100

Valuation of horse equipments, \$ 100

Remarks: *Say due as corpe,*  
*from Dec, 31/64, to Apr,*  
*19/65*

Book mark:

*Prater*

*C*

Indpt. Battery.

U.S.C.T.

*James Crump,*  
*Pr*, Indpt. Battery, U. S. Col'd L. Art'y.

Appears on

**Battery Muster Roll**

for *May & June*, 1865.

Present or absent *Present.*

Stoppage, \$ 100 for

Due Gov't, \$ 100 for

Valuation of horse, \$ 100

Valuation of horse equipments, \$ 100

Remarks:

Book mark:

*Porter*

(358)

Copyist.

*D* | Indpt. Battery. | **U.S.C.T.**

*James Crump,*

*A*, Indpt. Battery U. S. Col'd Light Art'y.

Appears on **Batt'y Muster-out Roll**, dated

*Mt. Vernon Va. July 22* 1865.

Muster-out to date *July 22*, 1865.

Last paid to *Dec. 31*, 1864.

Clothing account:

Last settled....., 186 ; drawn since \$ *81* <sup>*28*</sup>/<sub>100</sub>,

Due soldier \$.....<sup>100</sup>; due U. S. \$.....<sup>100</sup>

Am't for cloth'g in kind or money adv'd \$.....<sup>100</sup>

Due U. S. for arms, equipments, &c., \$.....<sup>100</sup>

Bounty paid \$ *25* <sup>100</sup>; due \$ *75* <sup>100</sup>,

Remarks: *Due E. Fenton, Sitter,*  
*\$5-*

Book mark: *V. 138, P. 156, 76.*

*Parter*

Copyist.

*Crump, James*

, Co. *Indpt. Battery U.S.C.L.A.*

**3** Enclosures.

Bed Cards .....	Final Statements .....
Burial Records .....	Furloughs or L. of A .....
Certs. of Dis. for Discharge .....	Med. Certificates .....
C. M. Charges .....	Med. Des. Lists .....
Descriptive Lists .....	Orders .....
Discharge Certificates .....	Pris. of War Record .....
Enlistment Papers .....	Resignations .....

Other papers relating to—

Admission to Hosp'l .....	Furlough or L. of A .....
Casualty Sheet .....	Med. Examination .....
Confinement .....	Misc. Information .....
Contracts .....	Pay or Clothing .....
Death or Effects .....	Personal Reports .....
Desertion .....	Rank .....
Discharge from Hosp'l .....	Transfer to Hosp'l .....
Discharge from Service .....	Transfer to V. R. C. .....
Duty .....	Transportation .....

DECLARATION OF RECRUIT.

I, James Crump desiring to VOLUNTEER as a Soldier in the Army of the United States, for the term of THREE YEARS, Do Declare, That I am 17 years and \_\_\_\_\_ months of age; that I have never been discharged from the United States service on account of disability or by sentence of a court martial, or by order before the expiration of a term of enlistment; and I know of no impediment to my serving honestly and faithfully as a soldier for three years.

GIVEN at Lecomworth State of Kansas the 15<sup>th</sup> day of July 1864

Witness:

M H Burnham

James Crump  
his mark

NOTE 1.—This blank will be used for both enlistments and re-enlistments—enlistment of veterans, &c., &c., in the volunteer service. They will be made out in duplicate in all cases—one to accompany the recruiting return of the superintendent (not the recruiting officer) to the Adjutant General, and one to accompany the accounts of the officer who pays bounty, &c. The Regiment and Company in which the soldier last served should be given on the back.

NOTE 2.—An enlistment holds to service. A muster-in must, in all cases, precede payment of pay, bounty, pension, &c. A muster-in roll must, in all cases, be filed in the Adjutant General's Office as evidence of muster-in. The mustering officer, commissary, or assistant commissary of musters, as the case may be, will countersign both enlistments as having mustered the soldier into the service of the United States before either of them is given to the disbursing officer.

No. 7

James Crump  
Volunteered at Lecomworth Kansas  
July 13<sup>th</sup> 1864,  
By Lieut Wm D Matthews  
2<sup>nd</sup> Soud Regiment of Cavalry S Co 1<sup>st</sup> Div  
..... enlistment; last served in Company ( )  
..... Reg't of .....  
Discharged ..... 18 ..

CONSENT IN CASE OF MINOR.

I, \_\_\_\_\_ Do CERTIFY, That I am the \_\_\_\_\_ of \_\_\_\_\_; that the said \_\_\_\_\_ is \_\_\_\_\_ years of age; and I do hereby freely give my CONSENT to his volunteering as a SOLDIER in the ARMY OF THE UNITED STATES for the period of THREE YEARS.

GIVEN at \_\_\_\_\_ the \_\_\_\_\_ day of \_\_\_\_\_

Witness:



VOLUNTEER ENLISTMENT.

STATE OF



TOWN OF

*Kansas*

*Leavenworth*

I, *James Crump* born in *Jackson County*  
 in the State of *Missouri* aged *21* years,  
 and by occupation a *Laborer* Do HEREBY ACKNOWLEDGE to have  
 volunteered this *15<sup>th</sup>* day of *July* 1864,  
 to serve as a **Soldier** in the **Army of the United States of America**, for  
 the period of **THREE YEARS**, unless sooner discharged by proper authority:  
 Do also agree to accept such bounty, pay, rations, and clothing, as are, or may be,  
 established by law for volunteers. And I, *James Crump* do  
 solemnly swear, that I will bear true faith and allegiance to the **United States**  
**of America**, and that I will serve them honestly and faithfully against all  
 their enemies or opposers whomsoever; and that I will observe and obey the  
 orders of the President of the United States, and the orders of the officers  
 appointed over me, according to the Rules and Articles of War.

Sworn and subscribed to, at *Leavenworth*  
 this *15<sup>th</sup>* day of *July* 1864, } *James Crump*  
 BEFORE *J. M. Matthews* } *his*  
*mark*

I CERTIFY, ON HONOR, That I have carefully examined the above-named Volunteer, agreeably  
 to the General Regulations of the Army, and that, in my opinion, he is free from all bodily defects and  
 mental infirmity, which would in any way disqualify him from performing the duties of a soldier.

*Tiffin Sinks*  
*Surgeon Board of Enrollment*  
*Porter's Dist. Kansas*  
 EXAMINING SURGEON.

I CERTIFY, ON HONOR, That I have minutely inspected the Volunteer,  
 previously to his enlistment, and that he was entirely sober when enlisted; that, to the best of my  
 judgment and belief, he is of lawful age; and that, in accepting him as duly qualified to perform the  
 duties of an able-bodied soldier, I have strictly observed the Regulations which govern the recruiting  
 service. This soldier has *brown* eyes, *black* hair, *yellow* complexion, is *5*  
 feet *6* inches high.

*J. M. Matthews*  
*2<sup>nd</sup> Lieut of Recruiting (Volunteer) Battery*  
 RECRUITING OFFICER.

Mustered into the service of the United States, for three years or during the war, from date of enlistment, in Company .....  
 Regiment of ..... Volunteers, on the ..... day of ..... 1864, at .....

DECLARATION OF RECRUIT.

I, James Cronp desiring to VOLUNTEER as a Soldier in the Army of the United States, for the term of THREE YEARS, Do Declare, That I am 17 years and \_\_\_\_\_ months of age; that I have never been discharged from the United States service on account of disability or by sentence of a court martial, or by order before the expiration of a term of enlistment; and I know of no impediment to my serving honestly and faithfully as a soldier for three years.

GIVEN at Leavenworth State of Kansas the 15<sup>th</sup> day of July 1864

Witness:

W. H. Burnham

James Cronp his mark

No. 9

James Cronp  
Volunteered at Leavenworth Kansas

July 15<sup>th</sup> 1864,

By Wm. D. Matthews

2<sup>nd</sup> Lieut Regiment of 2<sup>nd</sup> Div. 1<sup>st</sup> Artillery

enlistment; last served in Company ( )

Reg't of

Discharged 18

CONSENT IN CASE OF MINOR.

I, \_\_\_\_\_ DO CERTIFY, That I am the \_\_\_\_\_ of \_\_\_\_\_; that the said \_\_\_\_\_ is \_\_\_\_\_ years of age; and I do hereby freely give my CONSENT to his volunteering as a SOLDIER in the ARMY OF THE UNITED STATES for the period of THREE YEARS.

GIVEN at \_\_\_\_\_ the \_\_\_\_\_ day of \_\_\_\_\_

Witness:

NOTE 1.—This blank will be used for both enlistments and re-enlistments—enlistment of veterans, &c., &c., in the volunteer service. They will be made out in duplicate in all cases—one to accompany the recruiting return of the superintendent (not the recruiting officer) to the Adjutant General, and one to accompany the accounts of the officer who pays bounty, &c. The Regiment and Company in which the soldier last served should be given on the back.

NOTE 2.—An enlistment holds to service. A muster-in must, in all cases, precede payment of pay, bounty, pension, &c. A muster-in roll must, in all cases, be filed in the Adjutant General's Office as evidence of muster-in. The mustering officer, commissary, or assistant commissary of musters, as the case may be, will countersign both enlistments as having mustered the soldier into the service of the United States before either of them is given to the disbursing officer.

VOLUNTEER ENLISTMENT.

STATE OF

*Kansas*



TOWN OF

*Leavenworth*

I, *James Crump* born in *Jackson County*  
 in the State of *Missouri* aged *17* years,  
 and by occupation a *Laborer* DO HEREBY ACKNOWLEDGE to have  
 volunteered this *15<sup>th</sup>* day of *July* 1864,  
 to serve as a **Soldier** in the **Army of the United States of America**, for  
 the period of **THREE YEARS**, unless sooner discharged by proper authority:  
 Do also agree to accept such bounty, pay, rations, and clothing, as are, or may be,  
 established by law for volunteers. And I, *James Crump* do  
 solemnly swear, that I will bear true faith and allegiance to the **United States**  
**of America**, and that I will serve them honestly and faithfully against all  
 their enemies or opposers whomsoever; and that I will observe and obey the  
 orders of the President of the United States, and the orders of the officers  
 appointed over me, according to the Rules and Articles of War.

Sworn and subscribed to, at *Leavenworth*  
 this *15<sup>th</sup>* day of *July* 1864,  
 BEFORE *Wm L Matthews* } *James Crump*  
*2<sup>nd</sup> Lieut Recruiting* } *his*  
 } *mark*

I CERTIFY, ON HONOR, That I have carefully examined the above-named Volunteer, agreeably  
 to the General Regulations of the Army, and that, in my opinion, he is free from all bodily defects and  
 mental infirmity, which would in any way disqualify him from performing the duties of a soldier.

*Tiffin Sinks*  
*Sur Board of Enrollment*  
*North West Kansas*  
 EXAMINING SURGEON.

I CERTIFY, ON HONOR, That I have minutely inspected the Volunteer,  
 previously to his enlistment, and that he was entirely sober when enlisted; that, to the best of my  
 judgment and belief, he is of lawful age; and that, in accepting him as duly qualified to perform the  
 duties of an able-bodied soldier, I have strictly observed the Regulations which govern the recruiting  
 service. This soldier has *brown* eyes, *black* hair, *yellow* complexion, is *5*  
 feet *6* inches high.

*Wm L Matthews*  
*2<sup>nd</sup> Lieut Recruiting 1<sup>st</sup> K.C. Battery*  
 Regiment of *Volunteers*,  
 RECRUITING OFFICER.

Mustered into the service of the United States, for three years or during the war, from date of enlistment, in Company  
 Regiment of *1<sup>st</sup>* Volunteers, on the *16* day of *July*, 1864, at *Leavenworth*

NOTE 1.—This blank will be used for both enlistments and re-enlistments—enlistment of veterans, &c., &c., in the volunteer service. They will be made out in duplicate in all cases—one to accompany the recruiting return of the superintendent (not the recruiting officer) to the Adjutant General, and one to accompany the accounts of the officer who pays bounty, &c. The Regiment and Company in which the soldier last served should be given on the back.

NOTE 2.—An enlistment holds to service. A muster-in must, in all cases, precede payment of pay, bounty, pension, &c. A muster-in roll must, in all cases, be filed in the Adjutant General's Office as evidence of muster-in. The mustering officer, commissary, or assistant commissary of musters, as the case may be, will countersign both enlistments as having mustered the soldier into the service of the United States before either of them is given to the disbursing officer.

DECLARATION OF RECRUIT.

I, James Crump desiring to VOLUNTEER as a Soldier in the Army of the United States, for the term of THREE YEARS, Do Declare, That I am 17 years and \_\_\_\_\_ months of age; that I have never been discharged from the United States service on account of disability or by sentence of a court martial, or by order before the expiration of a term of enlistment; and I know of no impediment to my serving honestly and faithfully as a soldier for three years.

GIVEN at Leavenworth State of Kansas the 15 day of July 1864

Witness: W. A. Burnham James Crump his mark

Rec'd from Ind. Aud. Nov. 23d 1892

No. 147

James Crump

Entered at Leavenworth Kansas

July 15<sup>th</sup> 1864

By W. J. Patton

1st Regiment of W. J. Patton's

enlistment; last served in Company ( )

Reg't of \_\_\_\_\_

Discharged \_\_\_\_\_ 18 \_\_\_\_\_

CONSENT IN CASE OF MINOR.

I, \_\_\_\_\_ Do CERTIFY, That I am the \_\_\_\_\_ of \_\_\_\_\_; that the said \_\_\_\_\_ is \_\_\_\_\_ years of age; and I do hereby freely give my CONSENT to his volunteering as a SOLDIER in the ARMY OF THE UNITED STATES for the period of THREE YEARS.

GIVEN at \_\_\_\_\_ the \_\_\_\_\_ day of \_\_\_\_\_

Witness: \_\_\_\_\_

VOLUNTEER ENLISTMENT.

STATE OF



TOWN OF

Leavenworth

I, James Crump born in Jackson County

in the State of Missouri aged 17 years,  
and by occupation a Laborer Do HEREBY ACKNOWLEDGE to have  
volunteered this 15<sup>th</sup> day of July 1864,

to serve as a Soldier in the Army of the United States of America, for  
the period of THREE YEARS, unless sooner discharged by proper authority:  
Do also agree to accept such bounty, pay, rations, and clothing, as are, or may be,  
established by law for volunteers. And I, James Crump do  
solemnly swear, that I will bear true faith and allegiance to the United States  
of America, and that I will serve them honestly and faithfully against all  
their enemies or opposers whomsoever; and that I will observe and obey the  
orders of the President of the United States, and the orders of the officer  
appointed over me, according to the Rules and Articles of War.

Sworn and subscribed to, at Leavenworth  
this 15<sup>th</sup> day of July 1864, } James Crump  
BEFORE Wm D Matthews } his  
mark

2<sup>nd</sup> Lieut Recruiting  
I CERTIFY, ON HONOR, That I have carefully examined the above-named Volunteer, agreeably  
to the General Regulations of the Army, and that, in my opinion, he is free from all bodily defects and  
mental infirmity, which would in any way disqualify him from performing the duties of a soldier.

Tiffin Sinks  
Chief Board of Enrollment  
North Dist Kansas  
EXAMINING SURGEON.

I CERTIFY, ON HONOR, That I have minutely inspected the Volunteer, James Crump  
previously to his enlistment, and that he was entirely sober when enlisted; that to the best of my  
judgment and belief, he is of lawful age; and that, in accepting him as duly qualified to perform the  
duties of an able-bodied soldier, I have strictly observed the Regulations which govern the recruiting  
service. This soldier has brown eyes, black hair, yellow complexion, is 5  
feet 6 inches high.

Wm D Matthews  
2<sup>nd</sup> Regiment of Recruiting 1<sup>st</sup> Volunteers Battery  
RECRUITING OFFICER.

(G. O. No. 74 & 76.)

*This recruit has received twenty five dollars advance bounty of the Army hundred dollar bounty approved July 5, 1862.*

*Company D 5<sup>th</sup> Cavalry 1<sup>st</sup> Kansas*  
Mustered into the service of the United States, for three years or during the war, from date of enlistment in Leavenworth City  
15<sup>th</sup> July 1864 at Leavenworth City  
1<sup>st</sup> Kansas  
1<sup>st</sup> Kansas  
1<sup>st</sup> Kansas  
1<sup>st</sup> Kansas

*John*  
 Capt. Datt'y U.S. Col'd L. Art'y.

*Private Bugler*

CARD NUMBERS.

6 2 3 3 7 4 7	26
6 2 3 3 8 9 6	27
6 2 3 4 0 4 9	28
6 2 3 4 1 8 7	29
6 2 3 4 3 5 5	30
6 2 3 4 5 1 8	31
9 1 3 2 9 2 8	32
	33
	34
	35
	36
	37
	38
	39
	40
	41
	42
	43
	44
	45
	46
	47
	48
	49
	50

Book Mark:

See also

D 2684565 - PO Rtd  
SS Cor. Sec. (Copy) 11/2/32 OLB.

W. Spencer  
4

C

Indpt. Batt'y.

U.S.C.T.

*John Crump*

Indpt. Batt'y, U. S. Col'd L. Art'y.

Appears on

**Battery Descriptive Book**

of the organization named above.

**DESCRIPTION.**

Age *20* years; height *5* feet *7* inches.

Complexion *Brown*

Eyes *Brown*; hair *Black*

Where born *Jackson Mo.*

Occupation *Laborer*

**ENLISTMENT.**

When *July 10*, 186*4*.

Where *Ray Co Mo*

By whom *A Mathews*; term *3* y'rs.

Remarks:

.....  
 .....  
 .....  
 .....  
 .....  
 .....  
 .....

*Shelbrook*



6 | Indpt. Battery. | U.S.C.T.

*John Crump*  
*Pat*, Indpt. Battery, U. S. Col'd L. Art'y.

Appears on  
**Battery Muster-in and Descriptive Roll**  
of the organization named above. Roll dated  
*Leavenworth Mo Dec 20*, 186 *x*.

Where born *Jackson Co. Mo*

Age *21* yrs; occupation *Laborer*

When enlisted *July 15*, 186 *x*.

Where enlisted *Leavenworth Mo*

For what period enlisted *3* years.

Eyes *Brn*; hair *Blk*

Complexion *Brn*; height *5* ft. *7* in.

When mustered in *July 16*, 186 *x*.

Where mustered in *Leavenworth*

Bounty paid \$ *25*<sup>*00*</sup>/<sub>*100*</sub>; due \$ *75*<sup>*00*</sup>/<sub>*100*</sub>

Where credited

Battery to which assigned

Remarks: *Co. N. Dist No*  
*21st SO. 3rd Ward*  
*Leavenworth Mo.*

Book mark ;

*J. H. [Signature]*

(856g)

Copyist.

6 | Indpt. Battery. | **U.S.C.T.**

John Crump  
Pr, Indpt. Battery, U. S. Col'd L. Art'y.

Appears on

**Battery Muster Roll**

for Liberty must to Dec 31, 186 X.

Present or absent Present

Stoppage, \$ \_\_\_\_\_ 100 for \_\_\_\_\_

Due Gov't, \$ \_\_\_\_\_ 100 for \_\_\_\_\_

Valuation of horse, \$ \_\_\_\_\_ 100

Valuation of horse equipments, \$ \_\_\_\_\_ 100

Remarks: \_\_\_\_\_  
\_\_\_\_\_  
\_\_\_\_\_  
\_\_\_\_\_  
\_\_\_\_\_  
\_\_\_\_\_  
\_\_\_\_\_

Book mark: \_\_\_\_\_

(358) J. H. Scholz Copyist.

6 | Indpt. Battery. | **U.S.C.T.**

*John L. Rump*  
*Drum*

Indpt. Battery, U. S. Col'd L. Art'y.

Appears on

**Battery Muster Roll**

for *John L. Rump*, 1865.

Present or absent *Present*

Stoppage, \$ 100 for

Due Gov't, \$ 100 for

Valuation of horse, \$ 100

Valuation of horse equipments, \$ 100

Remarks:  
\_\_\_\_\_  
\_\_\_\_\_  
\_\_\_\_\_  
\_\_\_\_\_  
\_\_\_\_\_

Book mark: \_\_\_\_\_

*J. H. Rowley*  
(358) Copyist.

*C* | Indpt. Battery. | **U.S.C.T.**

*John Crump*  
*Engler*, Indpt. Battery, U. S. Col'd L. Art'y.

Appears on

**Battery Muster Roll**

for *Mar. & Apr.*, 1865.

Present or absent *Present*

Stoppage, \$ 100 for

Due Gov't, \$ 100 for

Valuation of horse, \$ 100

Valuation of horse equipments, \$ 100

Remarks:

Book mark:

*Enter*

*C* | Indpt. Battery. | **U.S.C.T.**

*John Crump,*  
*Angler,* Indpt. Battery, U. S. Col'd L. Art'y.

Appears on

**Battery Muster Roll**

for *May & June*, 186 *5*

Present or absent *Present,*

Stoppage, \$ 100 for

Due Gov't, \$ 100 for

Valuation of horse, \$ 100

Valuation of horse equipments, \$ 100

Remarks:  
-----  
-----  
-----  
-----  
-----  
-----  
-----  
-----  
-----  
-----

Book mark: *100*

*Butler*

*C* | Indpt. Battery. | **U.S.C.T.**

*John Crump,*  
*Drum*, Indpt. Battery U. S. Col'd Light Art'y.

Appears on **Batt'y Muster-out Roll**, dated  
*W. Leavenworth, Mo., July 27, 1865.*

Muster-out to date *July 27, 1865.*

Last paid to *Dec. 31, 1864.*

**Clothing account:**

Last settled....., 186 ; drawn since \$ *67* <sup>*06*</sup>/<sub>*100*</sub>,

Due soldier \$.....<sup>*100*</sup>/<sub>*100*</sub>; due U. S. \$.....<sup>*100*</sup>/<sub>*100*</sub>

Am't for cloth'g in kind or money adv'd \$.....<sup>*100*</sup>/<sub>*100*</sub>

Due U. S. for arms, equipments, &c., \$.....<sup>*100*</sup>/<sub>*100*</sub>

Bounty paid \$ *25* <sup>*100*</sup>/<sub>*100*</sub>; due \$ *75* <sup>*100*</sup>/<sub>*100*</sub>,

Remarks: *Drum from enlistment,*  
*from enrollment.*

.....  
.....  
.....  
.....

Book mark: *V. 138, P. 155, 76.*

*Porter*

*Crump, John*

*, Co. Indpt Batty Regt U. S. L. S. Arty.*

**3** Enclosures.

Bed Cards .....	Final Statements .....
Burial Records .....	Furloughs or L. of A .....
Certs. of Dis. for Discharge .....	Med. Certificates .....
C. M. Charges .....	Med. Des. Lists .....
Descriptive Lists .....	Orders .....
Discharge Certificates .....	Pris. of War Record .....
Enlistment Papers .....	Resignations .....

Other papers relating to—

Admission to Hosp'l .....	Furlough or L. of A .....
Casualty Sheet .....	Med. Examination .....
Confinement .....	Misc. Information .....
Contracts .....	Pay or Clothing .....
Death or Effects .....	Personal Reports .....
Desertion .....	Rank .....
Discharge from Hosp'l .....	Transfer to Hosp'l .....
Discharge from Service .....	Transfer to V. R. C. ....
Duty .....	Transportation .....

DECLARATION OF RECRUIT.

I, John Crump desiring to VOLUNTEER as a Soldier in the Army of the United States, for the term of THREE YEARS, Do Declare, That I am 20 1/2 years and \_\_\_\_\_ months of age; that I have never been discharged from the United States service on account of disability or by sentence of a court martial, or by order before the expiration of a term of enlistment; and I know of no impediment to my serving honestly and faithfully as a soldier for three years.

GIVEN at Leavenworth State of Kansas the 15 day of July 1864

Witness:

W.A. Burnham

John Crump  
mark

No. 6

John Crump

Volunteered at Leavenworth, Kansas

July 15<sup>th</sup> 1864

By Lieut. Wm. D. Matthews

2<sup>nd</sup> West Regiment of Cavalry U.S. Artillery

enlistment; last served in Company ( )

Reg't of \_\_\_\_\_

Discharged \_\_\_\_\_ 18 .

CONSENT IN CASE OF MINOR.

I, \_\_\_\_\_ Do CERTIFY, That I am the \_\_\_\_\_ of \_\_\_\_\_; that the said \_\_\_\_\_ is \_\_\_\_\_ years of age; and I do hereby freely give my CONSENT to his volunteering as a SOLDIER in the ARMY OF THE UNITED STATES for the period of THREE YEARS.

GIVEN at \_\_\_\_\_ the \_\_\_\_\_ day of \_\_\_\_\_

Witness:

NOTE 1.—This blank will be used for both enlistments and re-enlistments—enlistment of veterans, &c., &c., in the volunteer service. They will be made out in duplicate in all cases—one to accompany the recruiting return of the superintendent (not the recruiting officer) to the Adjutant General, and one to accompany the accounts of the officer who pays bounty, &c. The Regiment and Company in which the soldier last served should be given on the back.

NOTE 2.—An enlistment holds to service. A muster-in must, in all cases, precede payment of pay, bounty, pension, &c. A muster-in roll must, in all cases, be filed in the Adjutant General's Office as evidence of muster-in. The mustering officer, commissary, or assistant commissary of musters, as the case may be, will countersign both enlistments as having mustered the soldier into the service of the United States before either of them is given to the disbursing officer.



VOLUNTEER ENLISTMENT.

STATE OF



TOWN OF

*Kansas*

*Lavenworth*

I, *John Crump*, born in *Jackson County*  
in the State of *Missouri*, aged *20* years,  
and by occupation a *Laborer*. Do HEREBY ACKNOWLEDGE to have  
volunteered this *15<sup>th</sup>* day of *July*, 186*4*  
to serve as a **Soldier** in the **Army of the United States of America**, for  
the period of **THREE YEARS**, unless sooner discharged by proper authority:  
Do also agree to accept such bounty, pay, rations, and clothing, as are, or may be,  
established by law for volunteers. And I, *John Crump*, do  
solemnly swear, that I will bear true faith and allegiance to the **United States**  
**of America**, and that I will serve them honestly and faithfully against all  
their enemies or opposers whomsoever; and that I will observe and obey the  
orders of the President of the United States, and the orders of the officers  
appointed over me, according to the Rules and Articles of War.

Sworn and subscribed to, at *Lavenworth*  
this *15<sup>th</sup>* day of *July*, 186*4*  
BEFORE *Wm D. Matthews* } *John Crump*  
*22*

I CERTIFY, ON HONOR, That I have carefully examined the above-named Volunteer, agreeably  
to the General Regulations of the Army, and that, in my opinion, he is free from all bodily defects and  
mental infirmity, which would in any way disqualify him from performing the duties of a soldier.

*Jiffie Sink*  
*Sur. Board of Enrollment*  
*North West Dist. Kansas*  
EXAMINING SURGEON.

I CERTIFY, ON HONOR, That I have minutely inspected the Volunteer,  
previously to his enlistment, and that he was entirely sober when enlisted; that, to the best of my  
judgment and belief, he is of lawful age; and that, in accepting him as duly qualified to perform the  
duties of an able-bodied soldier, I have strictly observed the Regulations which govern the recruiting  
service. This soldier has *Brown* eyes, *Black* hair, *Brown* complexion, is *5*  
feet *7* inches high.

*Wm D Matthews*  
*2<sup>nd</sup> Regiment of Recruiting Volunteers* *K.C.B.*  
RECRUITING OFFICER.

Mustered into the service of the United States, for three years or during the war, from date of enlistment, in Company  
Regiment of ..... Volunteers, on the *16* day of *July*, 186*4*, at .....

NOTE 1.—This blank will be used for both enlistments and re-enlistments—enlistment of veterans, &c., &c., in the volunteer service. They will be made out in duplicate in all cases—one to accompany the recruiting return of the superintendent (not the recruiting officer) to the Adjutant General, and one to accompany the accounts of the officer who pays bounty, &c. The Regiment and Company in which the soldier last served should be given on the back.

NOTE 2.—An enlistment holds to service. A muster-in must, in all cases, precede payment of pay, bounty, pension, &c. A muster-in roll must, in all cases, be filed in the Adjutant General's Office as evidence of muster-in. The mustering officer, commissary, or assistant commissary of musters, as the case may be, will countersign both enlistments as having mustered the soldier into the service of the United States before either of them is given to the disbursing officer.

DECLARATION OF RECRUIT.

I, John Crump desiring to VOLUNTEER as a Soldier in the Army of the United States, for the term of THREE YEARS, Do Declare, That I am 20<sup>th</sup> years and \_\_\_\_\_ months of age; that I have never been discharged from the United States service on account of disability or by sentence of a court martial, or by order before the expiration of a term of enlistment; and I know of no impediment to my serving honestly and faithfully as a soldier for three years.

GIVEN at Leavenworth State of Kansas the 15<sup>th</sup> day of July 15<sup>th</sup> 1864

Witness:

W. H. Burnham John Crump  
*his mark*

No. 6

John Crump  
 Volunteered at Leavenworth

1864,

By W. S. Matthews

1st Lt. Regiment of Battery

..... enlistment; last served in Company ( )

..... Reg't of .....

Discharged ..... 18 .....

CONSENT IN CASE OF MINOR.

I, ..... Do CERTIFY, That I am the ..... of .....; that the said ..... is ..... years of age; and I do hereby freely give my CONSENT to his volunteering as a SOLDIER in the ARMY OF THE UNITED STATES for the period of THREE YEARS.

GIVEN at ..... the ..... day of .....

Witness:

VOLUNTEER ENLISTMENT.

STATE OF

TOWN OF

Kansas



Leavenworth

I, John Crump born in Jackson County  
 in the State of Virginia aged 26 years,  
 and by occupation a Laborer Do HEREBY ACKNOWLEDGE to have  
 volunteered this 15<sup>th</sup> day of July 1864  
 to serve as a **Soldier** in the **Army of the United States of America**, for  
 the period of **THREE YEARS**, unless sooner discharged by proper authority:  
 Do also agree to accept such bounty, pay, rations, and clothing, as are, or may be,  
 established by law for volunteers. And I, John Crump do  
 solemnly swear, that I will bear true faith and allegiance to the **United States**  
**of America**, and that I will serve them honestly and faithfully against all  
 their enemies or opposers whomsoever; and that I will observe and obey the  
 orders of the President of the United States, and the orders of the officers  
 appointed over me, according to the Rules and Articles of War.

Sworn and subscribed to, at Leavenworth  
 this 15<sup>th</sup> day of July 1864  
 BEFORE Wm D Matthews } John Crump  
 mark

I CERTIFY, ON HONOR, That I have carefully examined the above-named Volunteer, agreeably to the General Regulations of the Army, and that, in my opinion, he is free from all bodily defects and mental infirmity, which would in any way disqualify him from performing the duties of a soldier.

Tiffin Banks  
 Surg Board of Enrollment  
North Dist Kansas  
 EXAMINING SURGEON.

I CERTIFY, ON HONOR, That I have minutely inspected the Volunteer, .....  
 previously to his enlistment, and that he was entirely sober when enlisted; that, to the best of my  
 judgment and belief, he is of lawful age; and that, in accepting him as duly qualified to perform the  
 duties of an able-bodied soldier, I have strictly observed the Regulations which govern the recruiting  
 service. This soldier has brown eyes, black hair, Brown complexion, is 5  
 feet 7 inches high.

Wm D Matthews  
2d Lt Regiment of Recruiting Volunteers, Cold Spring  
 RECRUITING OFFICER.

(A. G. O. No. 74 & 76.)

Mustered into the service of the United States, for three years or during the war, from date of enlistment, in Company .....  
 Regiment of ..... Volunteers, on the ..... day of ..... 186 , at .....

DECLARATION OF RECRUIT.

I, John Crump desiring to VOLUNTEER as a Soldier in the Army of the United States, for the term of THREE YEARS, Do Declare, That I am 20 years and \_\_\_\_\_ months of age; that I have never been discharged from the United States service on account of disability or by sentence of a court martial, or by order before the expiration of a term of enlistment; and I know of no impediment to my serving honestly and faithfully as a soldier for three years.

GIVEN at Leavenworth State of Kansas the 15<sup>th</sup> day of July

Witness:

W. A. Burnham John Crump  
nash

NOTE 1.—This blank will be used for both enlistments and re-enlistments—enlistment of veterans, &c., &c., in the volunteer service. They will be made out in duplicate in all cases—one to accompany the recruiting return of the superintendent (not the recruiting officer) to the Adjutant General, and one to accompany the accounts of the officer who pays bounty, &c. The Regiment and Company in which the soldier last served should be given on the back.  
NOTE 2.—An enlistment holds to service. A muster-in must, in all cases, precede payment of pay, bounty, pension, &c. A muster-in roll must, in all cases, be filed in the Adjutant General's Office as evidence of muster-in. The mustering officer, commissary, or assistant commissary of musters, as the case may be, will countersign both enlistments as having mustered the soldier into the service of the United States before either of them is given to the disbursing officer.

Rec'd from 2nd. Aud. Nov. 23d 1892

enlistment; last served in Company ( )  
Reg't of \_\_\_\_\_  
Discharged \_\_\_\_\_ 18 \_\_\_\_\_

No. 105  
John Crump  
Volunteered at Leavenworth  
July 15<sup>th</sup> 1864,  
By W. A. Matthews  
2d Lieutenant of Recruiting  
Co. K to 15

CONSENT IN CASE OF MINOR.

I, \_\_\_\_\_ Do CERTIFY, That I am \_\_\_\_\_; that the \_\_\_\_\_ of \_\_\_\_\_; that the \_\_\_\_\_ years of age; and I do hereby freely give my CONSENT to his volunteering as a SOLDIER in the ARMY OF THE UNITED STATES for the period of THREE YEARS.

GIVEN at \_\_\_\_\_ the \_\_\_\_\_ day of \_\_\_\_\_

Witness:

[Signature]

*When recruit was issued Twenty five dollar advance bounty of the one hundred dollars bounty authorized by section of act approved July 5, 1862*

STATE OF Missouri

**VOLUNTEER ENLISTMENT.**



TOWN OF Leavenworth

I, John Crump born in Jackson County  
the State of Missouri aged 20 years,  
and by occupation a Laborer DO HEREBY ACKNOWLEDGE to have  
volunteered this 13<sup>th</sup> day of July 1864.

to serve as a **Soldier** in the **Army of the United States of America**, for  
the period of **THREE YEARS**, unless sooner discharged by proper authority:  
Do also agree to accept such bounty, pay, rations, and clothing, as are, or may be,  
established by law for volunteers. And I, John Crump do  
solemnly swear, that I will bear true faith and allegiance to the **United States  
of America**, and that I will serve them honestly and faithfully against all  
their enemies or opposers whomsoever; and that I will observe and obey the  
orders of the President of the United States, and the orders of the officers  
appointed over me, according to the Rules and Articles of War.

Sworn and subscribed to, at Leavenworth  
this 13<sup>th</sup> day of July 1864 } John Crump  
BEFORE Wm D Matthews } <sup>his</sup>  
2<sup>nd</sup> Lieut Recruiting officer } <sub>mark</sub>

I CERTIFY, ON HONOR, That I have carefully examined the above-named Volunteer, agreeably  
to the General Regulations of the Army, and that, in my opinion, he is free from all bodily defects and  
mental infirmity, which would in any way disqualify him from performing the duties of a soldier.

Jeffie Dinko  
Sur Board of Enrolled  
North West Kansas  
EXAMINING SURGEON.

I CERTIFY, ON HONOR, That I have minutely inspected the Volunteer,  
previously to his enlistment, and that he was entirely sober when enlisted; that, to the best of my  
judgment and belief, he is of lawful age; and that, in accepting him as duly qualified to perform the  
duties of an able-bodied soldier, I have strictly observed the Regulations which govern the recruiting  
service. This soldier has green eyes, black hair, brown complexion, is 5  
feet 7 inches high.

Wm D Matthews  
2<sup>nd</sup> Lieut Recruiting Volunteers,  
OFFICER.

G. O. No. 74 & 76.)

Mustered into the service of the United States, for three years or during the war, from date of enlistment, in Company 1st Kansas  
Volunteers, on the 10th day of July, 1864, at Leavenworth  
1st Lieut 3d Mo Art  
Adj. Quarters

*Wilmington, John*  
Capt. Batt'y U.S. Co'd L. Art'y.

*Private Private*

CARD NUMBERS.

62335-84	26
623375-9	27
623390-8	28
6234071	29
6234210	30
6234377	31
62345-39	32
9132940	33
	34
	35
	36
	37
	38
	39
	40
	41
	42
	43
	44
	45
	46
	47
	48
	49
	50

Book Mark: \_\_\_\_\_

See also \_\_\_\_\_

C | Indpt. Batt'y. | U.S.C.T.

John Cunningham

....., Indpt. Batt'y, U. S. Col'd L. Art'y.

Appears on

**Battery Descriptive Book**

of the organization named above.

**DESCRIPTION.**

Age 27 years; height 5 feet 7 1/2 inches.

Complexion Brown

Eyes Black; hair Black

Where born Lanruma Md.

Occupation Cook

**ENLISTMENT.**

When Nov. 9, 186 4

Where Ft Scott Ala.

By whom A Mathews; term 3 y'rs.

Remarks: .....

.....  
.....  
.....  
.....  
.....  
.....  
.....  
.....

Keelbrook

C | Indpt. Battery. | U.S.C.T.

*John Cunningham*  
Appears with rank of *Priv* on

**Muster and Descriptive Roll of a Detachment of U. S. Vols. forwarded**

for the Indpt. Batt'y, U. S. Col'd L. Arty. Roll dated

*Leavenworth, Kans, Nov. 29, 1864.*

Where born *Lawrence Co. Missis.*

Age *27* y'rs; occupation *Book*

When enlisted *Nov. 9*, 1864.

Where enlisted *St. Scott, Ks.*

For what period enlisted *3* years.

Eyes *Blue*; hair *Blue*

Complexion *Brown*; height *5* ft. *7* in.

When mustered in *Nov. 29*, 1864.

Where mustered in *Leavenworth, Ks.*

Bounty paid \$ *100*; due \$ *100*

Where credited

Battery to which assigned

Remarks: *Credited to Southern District, Kansas, St. Scott Bourbon Co. Vol. Recruit & entitled to Bounty*

Book mark:

*E. L. Thayer*



6

Indpt. Battery.

U.S.C.T.

*John Cunningham*  
*Pvt*, Indpt. Battery, U. S. Col'd L. Art'y.

Appears on

**Battery Muster-in and Descriptive Roll**

of the organization named above. Roll dated

*Lorenworth K, Dec 23, 1864.*

Where born *Laurie Co, Mo,*

Age *27* y'rs; occupation *book*

When enlisted *Nov 9, 1864.*

Where enlisted *Fort Scott Ks*

For what period enlisted *3* years.

Eyes *Blu*; hair *Blk*

Complexion *Bro*; height *5 ft. 7 1/2 in.*

When mustered in *Nov 24, 1864.*

Where mustered in *Lorenworth*

Bounty paid \$ *100*; due \$ *300 <sup>00</sup>/<sub>100</sub>*

Where credited

Battery to which assigned

Remarks: *C. S. dist K*  
*Fort Scott Bourke*  
*Ks.*

Book mark :

*J. S. Schley*  
(356g) Copyist.

6

Indpt. Battery.

U.S.C.T.

John Cunningham  
Pot, Indpt. Battery, U. S. Col'd L. Art'y.

Appears on

**Battery Muster Roll**

for *Return to Dec 31, 1864*

Present or absent *Present*

Stoppage, \$ 100 for

Due Gov't, \$ 100 for

Valuation of horse, \$ 100

Valuation of horse equipments, \$ 100

Remarks:

Book mark:

*J. H. Schooley*  
(358) Copyist.

C | Indpt. Battery. | **U.S.C.T.**

John Cunningham  
1st Lt, Indpt. Battery, U. S. Col'd L. Art'y.

Appears on

**Battery Muster Roll**

for Jan 1st, 1865.

Present or absent Present

Stoppage, \$ 100 for

Due Gov't, \$ 100 for

Valuation of horse, \$ 100

Valuation of horse equipments, \$ 100

Remarks:

.....  
.....  
.....  
.....  
.....  
.....  
.....  
.....

Book mark: .....

J. Schrey  
(358) Copyist.

*C* | Indpt. Battery. | **U.S.C.T.**

*John Cunningham*  
*Cn*....., Indpt. Battery, U. S. Col'd L. Art'y.

Appears on

**Battery Muster Roll**

for *Man, & Apl.*....., 186*5*.

Present or absent *Present,*.....

Stoppage, \$.....<sup>100</sup> for.....

Due Gov't, \$.....<sup>100</sup> for.....

Valuation of horse, \$.....<sup>100</sup>

Valuation of horse equipments, \$.....<sup>100</sup>

Remarks:.....  
.....  
.....  
.....  
.....  
.....  
.....  
.....

Book mark:.....

*Porter*

C | Indpt. Battery. | **U.S.C.T.**

*John Cunningham,*  
M, Indpt. Battery, U. S. Col'd L. Art'y.

Appears on

**Battery Muster Roll**

for May & June, 1865.

Present or absent Present

Stoppage, \$ 100 for

Due Gov't, \$ 100 for

Valuation of horse, \$ 100

Valuation of horse equipments, \$ 100

Remarks:  
\_\_\_\_\_  
\_\_\_\_\_  
\_\_\_\_\_  
\_\_\_\_\_  
\_\_\_\_\_  
\_\_\_\_\_

Book mark: \_\_\_\_\_

*Porter*  
\_\_\_\_\_

Copyist.

*C*

Indpt. Battery.

U.S.C.T.

*John Cunningham,*  
*Cm.*, Indpt. Battery U. S. Col'd Light Art'y.

Appears on **Batt'y Muster-out Roll**, dated

*M. Seaworth, Va., July 27* 1865.

Muster-out to date

*July 27*, 1865.

Last paid to

*Dec. 31*, 1864.

Clothing account:

Last settled....., 186 ; drawn since \$ *72*<sup>*31*</sup>/<sub>*100*</sub>,

Due soldier \$.....<sup>*100*</sup>; due U. S. \$.....<sup>*100*</sup>

Am't for cloth'g in kind or money adv'd \$.....<sup>*100*</sup>

Due U. S. for arms, equipments, &c., \$.....<sup>*100*</sup>

Bounty paid \$ *None* <sup>*100*</sup>; due \$ *100* <sup>*100*</sup>.

Remarks:.....

Book mark:.....

*Porter*  
Copyist.

Cunningham John

, Co. , *2nd Batt. W.C.S.*  
*Reg't*

*2* Enclosures.

Bed Cards .....	Final Statements .....
Burial Records .....	Furloughs or L. of A .....
Certs. of Dis. for Discharge .....	Med. Certificates .....
C. M. Charges .....	Med. Des. Lists .....
Descriptive Lists .....	Orders .....
Discharge Certificates .....	Pris. of War Record .....
Enlistment Papers .....	Resignations .....

Other papers relating to—

Admission to Hosp'l .....	Furlough or L. of A .....
Casualty Sheet .....	Med. Examination .....
Confinement .....	Misc. Information .....
Contracts .....	Pay or Clothing .....
Death or Effects .....	Personal Reports .....
Desertion .....	Rank .....
Discharge from Hosp'l .....	Transfer to Hosp'l .....
Discharge from Service .....	Transfer to V. R. C. .....
Duty .....	Transportation .....

NOTE 1.—This blank will be used for both enlistments and re-enlistments—enlistment of veterans, &c., &c., in the volunteer service. They will be made out in duplicate in all cases—one to accompany the recruiting return of the superintendent (not the recruiting officer) to the Adjutant General, and one to accompany the accounts of the officer who pays bounty, &c. The Regiment and Company in which the soldier last served should be given on the back.

NOTE 2.—An enlistment holds to service. A muster-in must, in all cases, precede payment of pay, bounty, pension, &c. A muster-in roll must, in all cases, be filed in the Adjutant General's Office as evidence of muster-in. The mustering officer, commissary, or assistant commissary of musters, as the case may be, will countersign both enlistments as having mustered the soldier into the service of the United States before either of them is given to the disbursing officer.

DECLARATION OF RECRUIT.

I, John Cunningham desiring to VOLUNTEER as a Soldier in the Army of the United States, for the term of THREE YEARS, Do Declare, That I am Twenty Seven years and \_\_\_\_\_ months of age; that I have never been discharged from the United States service on account of disability or by sentence of a court martial, or by order before the expiration of a term of enlistment; and I know of no impediment to my serving honestly and faithfully as a soldier for three years.

GIVEN at Fort Scott Kas the 9<sup>th</sup> day of November 1864

Witness: Noah C. Hanson John Cunningham  
Master

\_\_\_\_\_ enlistment; last served in Company ( )  
\_\_\_\_\_ Reg't of \_\_\_\_\_  
Discharged \_\_\_\_\_ 18 \_\_\_\_\_

No. \_\_\_\_\_  
John Cunningham  
Volunteered at Fort Scott Kas  
9<sup>th</sup> day of November 1864,  
By W. D. Matthews, 2<sup>d</sup> Lt. 2<sup>d</sup> Regiment  
9<sup>th</sup> Infantry, 11<sup>th</sup> Star Regt. 1<sup>st</sup> Div.

2

CONSENT IN CASE OF MINOR.

I, \_\_\_\_\_ Do CERTIFY, That I am \_\_\_\_\_ the \_\_\_\_\_ of \_\_\_\_\_; that the said \_\_\_\_\_ is \_\_\_\_\_ years of age; and I do hereby freely give my CONSENT to his volunteering as a SOLDIER in the ARMY OF THE UNITED STATES for the period of THREE YEARS.

GIVEN at \_\_\_\_\_ the \_\_\_\_\_ day of \_\_\_\_\_

Witness: \_\_\_\_\_



VOLUNTEER ENLISTMENT.

STATE OF

*Kansas*



TOWN OF

*Gen Scott*

I, *John Cunningham* born in *Lawrence County*  
 in the State of *Missouri* aged *Twenty Six* years,  
 and by occupation a *Cook* Do HEREBY ACKNOWLEDGE to have  
 volunteered this *Twelfth* day of *November* 186 *4*  
 to serve as a **Soldier** in the **Army of the United States of America**, for  
 the period of **THREE YEARS**, unless sooner discharged by proper authority:  
 Do also agree to accept such bounty, pay, rations, and clothing, as are, or may be,  
 established by law for volunteers. And I, *John Cunningham* do  
 solemnly swear, that I will bear true faith and allegiance to the **United States**  
**of America**, and that I will serve them honestly and faithfully against all  
 their enemies or opposers whomsoever; and that I will observe and obey the  
 orders of the President of the United States, and the orders of the officers  
 appointed over me, according to the Rules and Articles of War.

Sworn and subscribed to, at *Gen Scott Kas*  
 this *9th* day of *Nov* 186 *4*  
 BEFORE *Wm D Matthews* *John Cunningham*  
*mark*

*2d Lt & Recruiting In d Battery U S Cav*  
 I CERTIFY, ON HONOR, That I have carefully examined the above-named Volunteer, agreeably  
 to the General Regulations of the Army, and that, in my opinion, he is free from all bodily defects and  
 mental infirmity, which would in any way disqualify him from performing the duties of a soldier.

*Tiffin Binks*  
*Surgeon Bt of Cavalry*  
*North District Kas* EXAMINING SURGEON.

I CERTIFY, ON HONOR, That I have minutely inspected the Volunteer, *John Cunningham*  
 previously to his enlistment, and that he was entirely sober when enlisted; that, to the best of my  
 judgment and belief, he is of lawful age; and that, in accepting him as duly qualified to perform the  
 duties of an able-bodied soldier, I have strictly observed the Regulations which govern the recruiting  
 service. This soldier has *black* eyes, *black* hair, *Wm* complexion, is *five*  
 feet *seven* inches high.

*Wm D Matthews* *2d Lt & Recruiting*  
*In d Battery* Regiment of *U S Cav* Volunteers,  
 RECRUITING OFFICER.

Mustered into the service of the United States, for three years or during the war, from date of enlistment, in Company *the 1st*  
*Battery U S Cav* Regiment of *Army of the* Volunteers, on the *29* day of *November*, 186 *4* at *Lawrence Kas*  
*John Cunningham*  
*John Cunningham*  
*John Cunningham*

NOTE 1.—This blank will be used for both enlistments and re-enlistments—enlistment of veterans, &c., &c., in the volunteer service. They will be made out in duplicate in all cases—one to accompany the recruiting return of the superintendent (not the recruiting officer) to the Adjutant General, and one to accompany the accounts of the officer who pays bounty, &c. The Regiment and Company in which the soldier last served should be given on the back.

NOTE 2.—An enlistment holds to service. A muster-in must, in all cases, precede payment of pay, bounty, pension, &c. A muster-in roll must, in all cases, be filed in the Adjutant General's Office as evidence of muster-in. The mustering officer, commissary, or assistant commissary of musters, as the case may be, will countersign both enlistments as having mustered the soldier into the service of the United States before either of them is given to the disbursing officer.

DECLARATION OF RECRUIT.

*John Lounsbury* desiring to VOLUNTEER as a Soldier in the Army of the United States, for the term of THREE YEARS, Do Declare, That I am *27-11* years and \_\_\_\_\_ months of age; that I have never been discharged from the United States service on account of disability or by sentence of a court martial, or by order before the expiration of a term of enlistment; and I know of no impediment to my serving honestly and faithfully as a soldier for three years.

GIVEN at *Fort Scott Kansas* the *9* day of *Nov 1864*

Witness: *Wm J. Danvers*  
*Mark*

*John Lounsbury*  
*Mark*

No. *155*

*John Lounsbury*

Volunteered at *Fort Scott*

*this 9 day of Nov 1864*

By *Wm J. Matthews* Adjutant

*Recruiting Regiment*  
*1st Cavalry*

*Light*

enlistment; last served in Company ( )

Reg't of

Discharged

*18*

CONSENT IN CASE OF MINOR.

I, \_\_\_\_\_ Do CERTIFY, That I am the \_\_\_\_\_ of \_\_\_\_\_; that the said \_\_\_\_\_ is \_\_\_\_\_ years of age; and I do hereby freely give my CONSENT to his volunteering as a SOLDIER in the ARMY OF THE UNITED STATES for the period of THREE YEARS.

GIVEN at \_\_\_\_\_ the \_\_\_\_\_ day of \_\_\_\_\_

Witness: \_\_\_\_\_

71 Scott, Lawrence Co. Mo.

VOLUNTEER ENLISTMENT.

STATE OF



TOWN OF

Kansas

Front Scott

I, John Courinham born in Lawrence County  
 in the State of Missouri aged Twenty seven years,  
 and by occupation a Cook Do HEREBY ACKNOWLEDGE to have  
 volunteered this ninth day of Nov 1864  
 to serve as a **Soldier** in the **Army of the United States of America**, for  
 the period of **THREE YEARS**, unless sooner discharged by proper authority:  
 Do also agree to accept such bounty, pay, rations, and clothing, as are, or may be,  
 established by law for volunteers. And I John Courinham do  
 solemnly swear, that I will bear true faith and allegiance to the **United States**  
**of America**, and that I will serve them honestly and faithfully against all  
 their enemies or opposers whomsoever; and that I will observe and obey the  
 orders of the President of the United States, and the orders of the officers  
 appointed over me, according to the Rules and Articles of War.

Sworn and subscribed to, at Front Scott his  
 this 9th day of Nov 1864 John Courinham  
 BEFORE Wm Mathews 2nd Lt mark  
and Recruiting Sg Battery US Col Artillery

I CERTIFY, ON HONOR, That I have carefully examined the above-named Volunteer, agreeably  
 to the General Regulations of the Army, and that, in my opinion, he is free from all bodily defects and  
 mental infirmity, which would in any way disqualify him from performing the duties of a soldier.

Liffin Sims  
 Surg Board of Enrollment  
North Dist Kansas  
 EXAMINING SURGEON.

I CERTIFY, ON HONOR, That I have minutely inspected the Volunteer, John Courinham  
 previously to his enlistment, and that he was entirely sober when enlisted; that, to the best of my  
 judgment and belief, he is of lawful age; and that, in accepting him as duly qualified to perform the  
 duties of an able-bodied soldier, I have strictly observed the Regulations which govern the recruiting  
 service. This soldier has Black eyes, Black hair, Brown complexion, is  
 feet 7 1/2 inches high.

Wm Mathews 2nd Lt and Recruiting  
Sg Battery US Col Artillery  
 RECRUITING OFFICER.

Mustered into the service of the United States, for three years or during the war, from date of enlistment, in Company the 1st  
Regiment of Orly's Light Volunteers, on the 24 day of November 1864 at Lawrence  
Mo

*Cole Anderson*

Indpt. Batt'y U.S. Col'd L. Art'y.

*Private* | *Private*

CARD NUMBERS.

<i>6233763</i>	26
<i>6233911</i>	27
<i>9132944</i>	28
	29
	30
	31
	32
	33
	34
	35
	36
	37
	38
	39
	40
	41
	42
	43
	44
	45
	46
	47
	48
	49
	50

Book Mark:

See also

S. 775259 - Pond.

W. S. Spencer  
4

*DA* Indpt. Batt'y. | **U.S.C.T.**

*Anderson Dale*

....., Indpt. Batt'y, U. S. Col'd L. Art'y.

Appears on

**Battery Descriptive Book**

of the organization named above.

**DESCRIPTION.**

Age *31* years; height.....feet.....inches.

Complexion *Brown*

Eyes *Black*; hair *Black*

Where born *Clay Co. Mo.*

Occupation *Abover*

**ENLISTMENT.**

When *May 15*....., 1864.

Where *near the O's*

By whom *Lt Mathews*; term *3* y'rs.

Remarks: .....

.....  
 .....  
 .....  
 .....  
 .....  
 .....  
 .....

*Chalbrook*

D

Indpt. Battery. U.S.C.T.

Anderson Dale

Pvt., Indpt. Battery, U. S. Col'd L. Art'y.

Appears on

**Battery Muster-in and Descriptive Roll**

of the organization named above. Roll dated

Leavenworth Mo Dec 28, 1864.

Where born Gayles, Mo,

Age 21 y'rs; occupation Laborer

When enlisted Aug 15, 1864.

Where enlisted Leavenworth Mo.

For what period enlisted 3 years.

Eyes Blue; hair Blue

Complexion Brown; height 5 ft. 10 in.

When mustered in Aug 18, 1864.

Where mustered in Leavenworth

Bounty paid \$ 100; due \$ 300 <sup>00</sup>/<sub>100</sub>

Where credited

Battery to which assigned

Remarks: A. M. Dist Co  
19<sup>th</sup> I.D. 1<sup>st</sup> Para  
Leavenworth Mo.

Book mark:

J. H. Schrey

(856g)

Copyist.

D | Indpt. Battery. | U.S.C.T.

Anderson Dale

Pat, Indpt. Battery, U. S. Col'd L. Art'y.

Appears on

Battery Muster Roll

for Enlistment to Dec 31, 1864

Present or absent Absent

Stoppage, \$ 100 for

Due Gov't, \$ 100 for

Valuation of horse, \$ 100

Valuation of horse equipments, \$ 100

Remarks: Absent without leave

Now Sec. Rules of Battery

Book mark:

J. Schroy

(358)

Copyist.



*Paul Anderson*

....., Co. ...., *1st* Batt. *U.S.C.A.*  
*Reg't*

*2* **Enclosures.**

Bed Cards .....	Final Statements .....
Burial Records .....	Furloughs or L. of A. ....
Certs. of Dis. for Discharge .....	Med. Certificates .....
C. M. Charges .....	Med. Des. Lists .....
Descriptive Lists .....	Orders .....
Discharge Certificates .....	Pris. of War Record .....
Enlistment Papers .....	Resignations .....

**Other papers relating to—**

Admission to Hosp'l .....	Furlough or L. of A. ....
Casualty Sheet .....	Med. Examination .....
Confinement .....	Misc. Information .....
Contracts .....	Pay or Clothing .....
Death or Effects .....	Personal Reports .....
Desertion .....	Rank .....
Discharge from Hosp'l .....	Transfer to Hosp'l .....
Discharge from Service .....	Transfer to V. R. C. ....
Duty .....	Transportation .....

NOTE 1.—This blank will be used for both enlistments and re-enlistments of veterans, &c., &c., in the volunteer service. They will be made out in duplicate in all cases—one to accompany the recruiting return of the superintendent (not the recruiting officer) to the Adjutant General, and one to accompany the accounts of the officer who pays bounty, &c. The Regiment and Company in which the soldier last served should be given on the back.

NOTE 2.—An enlistment holds to service. A muster-in must, in all cases, precede payment of pay, bounty, pension, &c. A muster-in roll must, in all cases, be filed in the Adjutant General's Office as evidence of muster-in. The mustering officer, commissary, or assistant commissary of musters, as the case may be, will countersign both enlistments as having mustered the soldier into the service of the United States before either of them is given to the disbursing officer.

DECLARATION OF RECRUIT.

I, Andersen Sale desiring to VOLUNTEER as a Soldier in the Army of the United States, for the term of THREE YEARS Do Declare, That I am 31 years and \_\_\_\_\_ months of age; that I have never been discharged from the United States service on account of disability or by sentence of a court-martial, or by order before the expiration of a term of enlistment; and I know of no impediment to my serving honestly and faithfully as a soldier for three years.

GIVEN at Leavenworth State Prison the 15 day of August 1864

Witness:

A. Burnham

Andersen Sale  
mark

No. 89

.....  
enlistment; last served in Company ( )  
.....  
Reg't of .....  
.....  
Discharged ..... 18 .....

.....  
Volunteered at Leavenworth Prison  
.....  
August 15-16 1864,  
By A. O. Matthews  
Adjutant Regiment of A. J. Smith

CONSENT IN CASE OF MINOR.

I, ..... Do CERTIFY, That I am the ..... of .....; that the said ..... is ..... years of age; and I do hereby freely give my CONSENT to his volunteering as a SOLDIER in the ARMY OF THE UNITED STATES for the period of THREE YEARS.

GIVEN at ..... the ..... day of .....

Witness:

35 1/2 36 1/2

VOLUNTEER ENLISTMENT.

STATE OF

Kansas



TOWN OF

Leavenworth

I, Anderson Dale born in Clay Co

in the State of Missouri aged 31 years,

and by occupation a Laborer DO HEREBY ACKNOWLEDGE to have

volunteered this 15th day of August 1864,

to serve as a Soldier in the Army of the United States of America, for the period of THREE YEARS unless sooner discharged by proper authority: Do also

agree to accept such bounty, pay, rations, and clothing, as are, or may be, established by law for volunteers. And I,

do solemnly swear, that I will bear true faith and allegiance to the United States

of America, and that I will serve them honestly and faithfully against all their

enemies or opposers whomsoever; and that I will observe and obey the orders of

the President of the United States, and the orders of the officers appointed over

me, according to the Rules and Articles of War.

Sworn and subscribed to, at Leavenworth Anderson Dale his

this 15th day of August 1864,

BEFORE Wm D Matthews 2nd Lieut mark

I CERTIFY, ON HONOR, That I have carefully examined the above-named Volunteer, agreeably to the General Regulations of the Army, and that, in my opinion, he is free from all bodily defects and mental infirmity, which would in any way disqualify him from performing the duties of a soldier.

Jiffie Sinks Examining Surgeon

I CERTIFY, ON HONOR, That I have minutely inspected the Volunteer, Anderson Dale

previously to his enlistment, and that he was entirely sober when enlisted; that, to the best of my judgment and belief, he is of lawful age; and that, in accepting him as duly qualified to perform the duties of an able-bodied soldier, I have strictly observed the Regulations which govern the recruiting service.

This soldier has Black eyes, Black hair, Brown complexion, is 5 feet

10 inches high.

Wm D Matthews 2nd Lieut Recruiting Officer

RECRUITING OFFICER.

(A. G. O. No. 74 & 75.

the 15th day of August 1864, at Leavenworth, Kansas, Mustered into the service of the United States, in Company ... Regiment of ... Volunteers, on

DECLARATION OF RECRUIT.

NOTE 1.—This blank will be used for both enlistments and re-enlistments—enlistment of veterans, &c., &c., in the volunteer service. They will be made out in duplicate in all cases—one to accompany the recruiting return of the superintendent (not the recruiting officer) to the Adjutant General, and one to accompany the accounts of the officer who pays bounty, &c. The Regiment and Company in which the soldier last served should be given on the back.

NOTE 2.—An enlistment holds to service. A muster-in must, in all cases, precede payment of pay, bounty, pension, &c. A muster-in roll must, in all cases, be filed in the Adjutant General's Office as evidence of muster-in. The mustering officer, commissary, or assistant commissary of musters, as the case may be, will countersign both enlistments as having mustered the soldier into the service of the United States before either of them is given to the disbursing officer.

I, Anderson Dale desiring to VOLUNTEER as a Soldier in the Army of the United States, for the term of THREE YEARS Do Declare, That I am 31 years and \_\_\_\_\_ months of age; that I have never been discharged from the United States service on account of disability or by sentence of a court-martial, or by order before the expiration of a term of enlistment; and I know of no impediment to my serving honestly and faithfully as a soldier for three years.

GIVEN at Leavenworth State of Kansas the 15 day of August 1864

Witness: W. A. Bumphum Anderson's State  
mark

No. 69

Anderson Dale  
Volunteered at Leavenworth

August 13 1864.

By Wm. H. D. New Thos. J. ...  
Adj. Recr. U.S. Army

Regiment of 1st S. C. ...

enlistment; last served in Company ( )

Reg't of \_\_\_\_\_

Discharged \_\_\_\_\_ 18 \_\_\_\_\_

X

CONSENT IN CASE OF MINOR.

I, \_\_\_\_\_ Do CERTIFY, That I am \_\_\_\_\_; that the \_\_\_\_\_ of \_\_\_\_\_; that the said \_\_\_\_\_ is \_\_\_\_\_ years of age; and I do hereby freely give my CONSENT to his volunteering as a SOLDIER in the ARMY OF THE UNITED STATES for the period of THREE YEARS.

GIVEN at \_\_\_\_\_ the \_\_\_\_\_ day of \_\_\_\_\_

Witness: \_\_\_\_\_

VOLUNTEER ENLISTMENT.

STATE OF

*Kansas*



TOWN OF

*Leavenworth*

I, *Anderson Dale* born in *Leary Co*  
 in the State of *Missouri* aged *31* years,  
 and by occupation a *Laborer* Do HEREBY ACKNOWLEDGE to have  
 volunteered this *15* day of *August* 1864,  
 to serve as a **Soldier** in the **Army of the United States of America**, for the  
 period of **THREE YEARS** unless sooner discharged by proper authority: Do also  
 agree to accept such bounty, pay, rations, and clothing, as are, or may be, estab-  
 lished by law for volunteers. And I, do  
 solemnly swear, that I will bear true faith and allegiance to the **United States**  
**of America**, and that I will serve them honestly and faithfully against all their  
 enemies or opposers whomsoever; and that I will observe and obey the orders of  
 the President of the United States, and the orders of the officers appointed over  
 me, according to the Rules and Articles of War.

Sworn and subscribed to, at *Leavenworth Mo*  
 this *15* day of *August* 1864, *Anderson Dale* his  
 BEFORE *Wm D Matthews 2nd Lieut* *mark*  
*Recruiting 1st Ina U.S. Col Artillery*

I CERTIFY, ON HONOR, That I have carefully examined the above-named Volunteer, agreeably  
 to the General Regulations of the Army, and that, in my opinion, he is free from all bodily defects and  
 mental infirmity, which would in any way disqualify him from performing the duties of a soldier.

*Tiffin Binks*  
*Surgeon General*  
*West Dept Kansas*

EXAMINING SURGEON.

I CERTIFY, ON HONOR, That I have minutely inspected the Volunteer, *Anderson Dale*  
 previously to his enlistment, and that he was entirely sober when enlisted; that, to the best of my  
 judgment and belief, he is of lawful age; and that, in accepting him as duly qualified to perform the duties  
 of an able-bodied soldier, I have strictly observed the Regulations which govern the recruiting service.  
 This soldier has *Black* eyes, *Black* hair, *Brown* complexion, is *5* feet  
*4* inches high.

*Wm D Matthews 2nd Lieut*  
*Recruiting 1st Ina U.S. Col Artillery*  
 Regiment of *Volunteers,*

RECRUITING OFFICER.

the ..... day of ..... 186 , at .....  
 Mustered into the service of the United States, in Company .....  
 Regiment of .....  
 Volunteers, on

40

*Dance Michael*

ndpt. Batt'y U.S. Col'd L. Art'y

*Private*

*Private*

CARD NUMBERS.

*62.34.496*

- 26
- 27
- 28
- 29
- 30
- 31
- 32
- 33
- 34
- 35
- 36
- 37
- 38
- 39
- 40
- 41
- 42
- 43
- 44
- 45
- 46
- 47
- 48
- 49
- 50

Book Mark:

See also

D | Indpt. Battery. | **U.S.C.T.**

*Michael Dances,*  
*Pr*, Indpt. Battery, U. S. Col'd L. Art'y.

Appears on

**Battery Muster Roll**

for *May & June*, 186 *5*.

Present or absent *Present*

Stoppage, \$ 100 for

Due Gov't, \$ 100 for

Valuation of horse, \$ 100

Valuation of horse equipments, \$ 100

Remarks: *Attached,*

*not found on other Rolls of Btry*

Book mark:

*Parter*

*James J. Perry*

Adpt. Batt'y U.S. Col'd L. Art'y.

*Private Private*

CARD NUMBERS.

6 2 3 3 6 7 7	26
6 2 3 4 2 1 6	27
6 2 3 4 3 8 5	28
6 2 3 4 5 4 5	29
9 1 3 3 0 6 6	30
	31
	32
	33
	34
	35
	36
	37
	38
	39
	40
	41
	42
	43
	44
	45
	46
	47
	48
	49
	50

Book Mark:

See also



*D* | Indpt. Batt'y. | **U.S.C.T.**

*Jerry Daniel*

....., Indpt. Batt'y, U. S. Col'd L. Art'y.

Appears on

**Battery Descriptive Book**  
of the organization named above.

**DESCRIPTION.**

Age *19* years; height *5* feet *1* inches.

Complexion *Brown*

Eyes *Black*; hair *Black*

Where born *Benton Co. Mo.*

Occupation *Farmer*

**ENLISTMENT.**

When *Feb 28*, 186*5*.

Where *Franklin Co.*

By whom *D. Quinn*; term *3* y'rs.

Remarks: .....  
.....  
.....  
.....  
.....  
.....  
.....  
.....

*Holbrook*

NARA 676  
D | Indpt. Battery. | U.S.C.T.

*Jerry Daniel*  
Appears with rank of *Priv* on

**Muster and Descriptive Roll of a Detachment of U. S. Vols. forwarded**

for the Indpt. Batt'y, U. S. Col'd L. Arty. Roll dated

*Lavenworth, Ky, Feb. 28, 1865.*

Where born *Benton Co., Missouri*

Age *19* y'rs; occupation *Farmer*

When enlisted *Feb. 28*, 1865.

Where enlisted *Lavenworth, Kans*

For what period enlisted *3* years.

Eyes *black*; hair *black*

Complexion *brun*; height *5* ft. *1* in.

When mustered in *Feb 28*, 1865.

Where mustered in *Lavenworth, Kans*

Bounty paid \$ *100* <sup>100</sup>; due \$ *200* <sup>100</sup>

Where credited

Battery to which assigned

Remarks: *Credited to 1st Arty. Dist.,  
Co. 22 Sub. Dist. 4th Ward Lavenworth  
City, Vol. Recruit & entitled to bounty*

Book mark:

*E. L. Thornton*

(339)

Copyst.

*D.* | Indpt. Battery: | **U.S.C.T.**

*Jerry Daniel,*  
*On*, Indpt. Battery, U. S. Col'd L. Art'y.

Appears on

**Battery Muster Roll**

for *Mar, & Apr,* 1865.

Present or absent *Present,*

Stoppage, \$ 100 for

Due Gov't, \$ 100 for

Valuation of horse, \$ 100

Valuation of horse equipments, \$ 100

Remarks:  
\_\_\_\_\_  
\_\_\_\_\_  
\_\_\_\_\_  
\_\_\_\_\_  
\_\_\_\_\_  
\_\_\_\_\_  
\_\_\_\_\_

Book mark: \_\_\_\_\_

*Porter*

*D* | Indpt. Battery. | **U.S.C.T.**

*Jermy Daniel,*  
*On*, Indpt. Battery, U. S. Col'd L. Art'y.

Appears on

**Battery Muster Roll**

for *May & June*, 186*5*.

Present or absent *Present,*

Stoppage, \$ \_\_\_\_\_ <sup>100</sup> for \_\_\_\_\_

Due Gov't, \$ \_\_\_\_\_ <sup>100</sup> for \_\_\_\_\_

Valuation of horse, \$ \_\_\_\_\_ <sup>100</sup>

Valuation of horse equipments, \$ \_\_\_\_\_ <sup>100</sup>

Remarks: \_\_\_\_\_  
\_\_\_\_\_  
\_\_\_\_\_  
\_\_\_\_\_  
\_\_\_\_\_  
\_\_\_\_\_  
\_\_\_\_\_

Book mark: \_\_\_\_\_

(358)

*Enter*  
Copyist.

D | Indpt. Battery. | **U.S.C.T.**

*Gerry Daniel,*  
*G*, Indpt. Battery U. S. Col'd Light Art'y.

Appears on **Batt'y Muster-out Roll**, dated  
*Ft. Leavenworth, Mo., July 22, 1865.*

Muster-out to date *July 22, 1865.*

Last paid to *(Pay due from enlistment)* 186 .

Clothing account:

Last settled....., 186 ; drawn since \$ *50* <sup>*25*</sup>/<sub>100</sub>

Due soldier \$.....<sub>100</sub> ; due U. S. \$.....<sub>100</sub>

Am't for cloth'g in kind or money adv'd \$.....<sub>100</sub>

Due U. S. for arms, equipments, &c., \$.....<sub>100</sub>

Bounty paid \$ *100* <sub>100</sub> ; due \$ *None* <sub>100</sub>,

Remarks:.....  
.....  
.....  
.....  
.....  
.....

Book mark :.....

*J. Carter*  
Copyist.

*Daniel Perry*

....., Co. ...., *2nd* *Batt* *Reg't* *U.S.C.S.*

*2* **Enclosures.**

Bed Cards .....	Final Statements .....
Burial Records .....	Furloughs or L. of A. ....
Certs. of Dis. for Discharge .....	Med. Certificates .....
C. M. Charges .....	Med. Des. Lists .....
Descriptive Lists .....	Orders .....
Discharge Certificates .....	Pris. of War Record .....
Enlistment Papers .....	Resignations .....

**Other papers relating to—**

Admission to Hosp'l .....	Furlough or L. of A. ....
Casualty Sheet .....	Med. Examination .....
Confinement .....	Misc. Information .....
Contracts .....	Pay or Clothing .....
Death or Effects .....	Personal Reports .....
Desertion .....	Rank .....
Discharge from Hosp'l .....	Transfer to Hosp'l .....
Discharge from Service .....	Transfer to V. R. C. ....
Duty .....	Transportation .....

DECLARATION OF RECRUIT.

I, Jerry Daniel, desiring to VOLUNTEER as a Soldier in the Army of the United States, for the term of THREE YEARS, Do Declare, That I am nineteen (19) years and \_\_\_\_\_ months of age; that I have never been discharged from the United States service on account of disability or by sentence of a court martial, or by order before the expiration of a term of enlistment; and I know of no impediment to my serving honestly and faithfully as a soldier for three years.

GIVEN at Leavenworth City Kansas the 28 day of February 1865

Witness:

J. M. Scott

Jerry Daniel  
Private

NOTE 1.—This blank will be used for both enlistments and re-enlistments—enlistment of veterans, &c., &c., in the volunteer service. They will be made out in duplicate in all cases—one to accompany the recruiting return of the superintendent (not the recruiting officer) to the Adjutant General and one to accompany the accounts of the officer who pays bounty, &c. The Regiment and Company in which the soldier last served should be given on the back

NOTE 2.—An enlistment holds to service. A muster-in must, in all cases, precede payment of pay, bounty, pension, &c. A muster-in roll must, in all cases, be filed in the Adjutant General's Office as evidence of muster-in. The mustering officer, commissary, or assistant commissary of musters, as the case may be, will countersign both enlistments as having mustered the soldier into the service of the United States before either of them is given to the disbursing officer.

Rec'd from 2nd. Aud. Nov. 23d 1892

No. 8  
Jerry Daniel  
Volunteered at Leavenworth, Kas.  
February 28, 1865  
By Genl Paul G. A. Plummer  
2nd Regt. Cavalry, 1st Div., 1st Army  
enlistment; last served in Company ( )  
Reg't of \_\_\_\_\_  
Discharged \_\_\_\_\_, 18 \_\_\_\_\_

CONSENT IN CASE OF MINOR.

I, \_\_\_\_\_ Do CERTIFY, That I am \_\_\_\_\_; that the \_\_\_\_\_ of \_\_\_\_\_; that the said \_\_\_\_\_ is \_\_\_\_\_ years of age; and I do hereby freely give my CONSENT to his volunteering as a SOLDIER in the ARMY OF THE UNITED STATES for the period of THREE YEARS.

GIVEN at \_\_\_\_\_ the \_\_\_\_\_ day of \_\_\_\_\_

Witness:

*This recruit has received One hundred dollars advance bounty of the three hundred dollars bounty authorized by an Act of Congress approved July 18th and August 19th 1864.*

*Resided to North Dist Kas. 22<sup>nd</sup> Sub Dist 4<sup>th</sup> Ward Leavenworth City*

*P. H. Minor*  
*2<sup>d</sup> Lieut*  
*Ind Bat U.S. Artillery*

VOLUNTEER ENLISTMENT.

STATE OF

TOWN OF



*Kansas*

*Leavenworth*

I, *Jerry Daniel*, born in *Benton Co*  
in the State of *Missouri*, aged *19* years,  
and by occupation a *Fanner*, DO HEREBY ACKNOWLEDGE to have  
volunteered this *Twenty eight (28)* day of *February*, 1865,  
to serve as a **Soldier** in the **Army of the United States of America**, for  
the period of **THREE YEARS**, unless sooner discharged by proper authority:  
Do also agree to accept such bounty, pay, rations, and clothing, as are, or may be,  
established by law for volunteers. And I, *Jerry Daniel*, do  
solemnly swear, that I will bear true faith and allegiance to the **United States**  
**of America**, and that I will serve them honestly and faithfully against all  
their enemies or opposers whomsoever; and that I will observe and obey the  
orders of the President of the United States, and the orders of the officers  
appointed over me, according to the Rules and Articles of War.

Sworn and subscribed to, at *Leavenworth*  
this *28* day of *February*, 1865, } *Jerry Daniel*  
BEFORE *P. H. Minor 2<sup>d</sup> Lieut* } *his*  
*Ind Bat U.S. Artillery* } *mark*

I CERTIFY, ON HONOR, That I have carefully examined the above-named Volunteer, agreeably  
to the General Regulations of the Army, and that, in my opinion, he is free from all bodily defects and  
mental infirmity, which would in any way disqualify him from performing the duties of a soldier.

*W. H. Minor*  
*Surgeon*  
*Ind Bat U.S. Artillery*  
EXAMINING SURGEON.

I CERTIFY, ON HONOR, That I have minutely inspected the Volunteer *Jerry Daniel*  
previously to his enlistment, and that he was entirely sober when enlisted; that, to the best of my  
judgment and belief, he is of lawful age; and that, in accepting him as duly qualified to perform the  
duties of an able-bodied soldier, I have strictly observed the Regulations which govern the recruiting  
service. This soldier has *Black* eyes, *Black* hair, *Brown* complexion, is *5*  
feet *1* inch high.

*P. H. Minor 2<sup>d</sup> Lieut*  
*Ind Bat U.S. Artillery (Eight)*  
RECRUITING OFFICER.

(A. G. O. No. 74 & 76.)

Mustered into the service of the United States, for three years or during the war, from date of enlistment, in  
*Vol. 1<sup>st</sup> Regiment of Col. U.S. High Volunteers*, on the *28* day of *February*, 1865, at *Leavenworth Kas*  
*Wm. G. Ashmun*  
*Coapt. Major Wm. M. Post-Kee*  
*Snadley*  
*Robby*



NOTE 1.—This blank will be used for both enlistments and re-enlistments—enlistment of veterans, &c., &c., in the volunteer service. They will be made out in duplicate in all cases—one to accompany the recruiting return of the superintendent (not the recruiting officer) to the Adjutant General, and one to accompany the accounts of the officer who pays bounty, &c. The Regiment and Company in which the soldier last served should be given on the back.

NOTE 2.—An enlistment holds to service. A muster-in must, in all cases, precede payment of pay, bounty, pension, &c. A muster-in roll must, in all cases, be filed in the Adjutant General's Office as evidence of muster-in. The mustering officer, commissary, or assistant commissary of musters, as the case may be, will countersign both enlistments as having mustered the soldier into the service of the United States before either of them is given to the disbursing officer.

DECLARATION OF RECRUIT.

I, Larry Danel, desiring to VOLUNTEER as a Soldier in the Army of the United States, for the term of THREE YEARS, Do Declare, That I am nineteen (19) years and \_\_\_\_\_ months of age; that I have never been discharged from the United States service on account of disability or by sentence of a court martial, or by order before the expiration of a term of enlistment; and I know of no impediment to my serving honestly and faithfully as a soldier for three years.

GIVEN at Heavenworth city Kansas the 28 day of February 1903

Witness:

J. M. Scott

Larry Danel  
mark

Philip B. Bostrom Vol 2

Discharged \_\_\_\_\_ 18 \_\_\_\_\_

enlistment; last served in Company ( ) Reg't of \_\_\_\_\_

By Wm. L. G. G. Shiner  
Ensign, 1st Reg't, U.S. Army

Volunteered at Heavenworth, Kan. February 28, 1903

No. \_\_\_\_\_

CONSENT IN CASE OF MINOR.

I, \_\_\_\_\_, Do CERTIFY, That I am \_\_\_\_\_; that the \_\_\_\_\_ of \_\_\_\_\_ is \_\_\_\_\_ years of age; and I do hereby freely give my CONSENT to his volunteering as a SOLDIER in the ARMY OF THE UNITED STATES for the period of THREE YEARS.

GIVEN at \_\_\_\_\_ the \_\_\_\_\_ day of \_\_\_\_\_

Witness:

Inscribed to North Dist Kas 22<sup>d</sup> Sub Dist 4<sup>th</sup> Ward Leavenworth City

VOLUNTEER ENLISTMENT.

STATE OF

*Kansas*

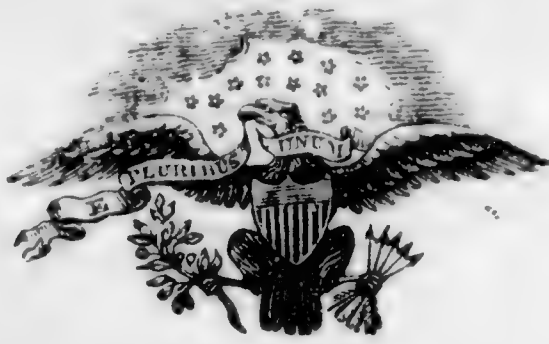

TOWN OF

*Leavenworth*

I, *Jerry Daniel*, born in *Benton Co*  
in the State of *Missouri*, aged *19* years,  
and by occupation a *Farmer*, Do HEREBY ACKNOWLEDGE to have  
volunteered this *Twenty eighth (28)* day of *February*, 1865,  
to serve as a **Soldier** in the **Army of the United States of America**, for  
the period of **THREE YEARS**, unless sooner discharged by proper authority:  
Do also agree to accept such bounty, pay, rations, and clothing, as are, or may be,  
established by law for volunteers. And I, *Jerry Daniel*, do  
solemnly swear, that I will bear true faith and allegiance to the **United States  
of America**, and that I will serve them honestly and faithfully against all  
their enemies or opposers whomsoever; and that I will observe and obey the  
orders of the President of the United States, and the orders of the officers  
appointed over me, according to the Rules and Articles of War.

Sworn and subscribed to, at *Leavenworth*  
this *28* day of *February*, 1865, } *Jerry Daniel*  
BEFORE *P. H. Minor 2<sup>d</sup> Lieut* } *mark*  
*Ind. Baty. U.S. Col<sup>d</sup> Artillery*

I CERTIFY, ON HONOR, That I have carefully examined the above-named Volunteer, agreeably  
to the General Regulations of the Army, and that, in my opinion, he is free from all bodily defects and  
mental infirmity, which would in any way disqualify him from performing the duties of a soldier.

*W. J. Wick*  
*Surg. Board of Enrollment North Dist. Kas*  
EXAMINING SURGEON.

I CERTIFY, ON HONOR, That I have minutely inspected the Volunteer *Jerry Daniel*  
previously to his enlistment, and that he was entirely sober when enlisted; that, to the best of my  
judgment and belief, he is of lawful age; and that, in accepting him as duly qualified to perform the  
duties of an able-bodied soldier, I have strictly observed the Regulations which govern the recruiting  
service. This soldier has *Black* eyes, *Black* hair, *Brown* complexion, is *5*  
feet *1* inches high.

*P. H. Minor 2<sup>d</sup> Lieut*  
*Ind. Baty U.S. Col<sup>d</sup> Art. (Light)*  
RECRUITING OFFICER.

(A. G. O. No. 74 & 76.)

Mustered into the service of the United States, for three years or during the war, from date of enlistment, in  
*Company* *Volunteers*, on the *28* day of *February*, 1865, at *Leavenworth Kas*

*W. J. Wick*  
*Capt. & Surg. Major, North Dist - Kas*

*Ind. Baty*

*James*  
Capt. Batt'y U.S. Col'd L. Art'y

*Private* | *Private*

CARD NUMBERS.

1	6 2 3 3 7 6 1	26
2	6 2 3 3 9 0 7	27
3	6 2 3 4 0 7 3	28
4	6 2 3 4 2 1 4	29
5	6 2 3 4 3 8 2	30
6	6 2 3 4 5 4 4	31
7	9 1 3 2 9 4 1	32
8		33
9		34
10		35
11		36
12		37
13		38
14		39
15		40
16		41
17		42
18		43
19		44
20		45
21		46
22		47
23		48
24		49
25		50

Book Mark: *1049-107 83.*

See also

S 904608 P.O. man

M. Spence  
4

*D* | Indpt. Batt'y. | **U.S.C.T.**

*James Davis*

....., Indpt. Batt'y, U. S. Col'd L. Art'y.

Appears on

**Battery Descriptive Book**

of the organization named above.

**DESCRIPTION.**

Age *18* years; height *5* feet *6* inches.

Complexion *Black*

Eyes *Black*; hair *Black*

Where born *Madison Co. Mo.*

Occupation *Slave*

**ENLISTMENT.**

When *July 18* ....., 186 *4*

Where *near north Mo.*

By whom *G Mathews* ; term *3* y'rs.

Remarks: .....

*Healbrook*

D

Indpt. Battery. U.S.C.T.

James Davis  
Pvt

Indpt. Battery, U. S. Col'd L. Art'y.

Appears on

**Battery Muster-in and Descriptive Roll**

of the organization named above. Roll dated

Leavenworth Mo Dec 23 1864

Where born Andrew Leo Mo.

Age 18 y'rs; occupation Laborer

When enlisted July 19, 1864

Where enlisted Leavenworth Mo.

For what period enlisted 3 years.

Eyes Blu; hair Blu

Complexion Bru; height 5 ft. 6 in.

When mustered in July 20, 1864

Where mustered in Leavenworth

Bounty paid \$ 25 00/100; due \$ 75 00/100

Where credited

Battery to which assigned

Remarks: A. N. Dist Co  
20" S. D. 2" rank  
Leavenworth Mo

Book mark :

(856g)

J. H. [Signature]

Copyst.

*D*

Indpt. Battery.

U.S.C.T.

*James Davis*  
*Pvt*

, Indpt. Battery, U. S. Col'd L. Art'y.

Appears on

**Battery Muster Roll**

for *Enlistment to D & B 1*, 186 *✓*

Present or absent. *Present*

Stoppage, \$ *100* for

Due Gov't, \$ *100* for

Valuation of horse, \$ *100*

Valuation of horse equipments, \$ *100*

Remarks:

Book mark:

*J. H. Ashley*

(368)

Copyist.

*D* | Indpt. Battery. | **U.S.C.T.**

*James Davis*  
*Co*, Indpt. Battery, U. S. Col'd L. Art'y.

Appears on

**Battery Muster Roll**

for *Jan Feb*, 186<sup>*5*</sup>.

Present or absent *Present*

Stoppage, \$ 100 for

Due Gov't, \$ 100 for

Valuation of horse, \$ 100

Valuation of horse equipments, \$ 100

Remarks: \_\_\_\_\_  
\_\_\_\_\_  
\_\_\_\_\_  
\_\_\_\_\_  
\_\_\_\_\_  
\_\_\_\_\_

Book mark: \_\_\_\_\_

*J. Schroder*  
(358) Copyist.



*D* | Indpt. Battery. | **U.S.C.T.**

*James Davis*  
*Co*, Indpt. Battery, U. S. Col'd L. Art'y.

Appears on

**Battery Muster Roll**

for *Mar, & Apr*, 1865.

Present or absent *Present*

Stoppage, \$ 100 for

Due Gov't, \$ 100 for

Valuation of horse, \$ 100

Valuation of horse equipments, \$ 100

Remarks:

Book mark:

*Parter*

*D* | Indpt. Battery. | **U.S.C.T.**

*James Davis*

*D*, Indpt. Battery, U. S. Col'd L. Art'y.

Appears on

**Battery Muster Roll**

for *May & June*, 186*5*.

Present or absent *Present*

Stoppage, \$ 100 for

Due Gov't, \$ 100 for

Valuation of horse, \$ 100

Valuation of horse equipments, \$ 100

Remarks:  
\_\_\_\_\_  
\_\_\_\_\_  
\_\_\_\_\_  
\_\_\_\_\_  
\_\_\_\_\_  
\_\_\_\_\_  
\_\_\_\_\_

Book mark: \_\_\_\_\_

*Butler*

Copyist.

*D* | Indpt. Battery. | **U.S.C.T.**

*James Davis,*  
*Dy,* Indpt. Battery U. S. Col'd Light Art'y.

Appears on **Batt'y Muster-out Roll**, dated

*M. Leavenworth, Ms. July 27* 1865.

Muster-out to date *July 22*, 1865.

Last paid to *Dec. 31*, 1864.

**Clothing account:**

Last settled....., 186 ; drawn since \$ *75*<sup>90</sup>/<sub>100</sub>,

Due soldier \$.....<sub>100</sub>; due U. S. \$.....<sub>100</sub>

Am't for cloth'g in kind or money adv'd \$.....<sub>100</sub>

Due U. S. for arms, equipments, &c., \$.....<sub>100</sub>

Bounty paid \$ *25*/<sub>100</sub>; due \$ *75*/<sub>100</sub>,

Remarks:.....

Book mark: *1649, C.F. 183,*

*Pantos*

*Indypt Patty*

*Davis, James*

*1st Lt. U.S.A.*  
 Co. *A*, Reg't *1st*

~~3~~ *3* Enclosures.

Bed Cards.....	Final Statements <i>#</i> .....
Burial Records <i>#</i> .....	Furloughs.....
Certs. of Dis. for Discharge.....	Med. Certificates.....
C. M. Charges.....	Med. Des. Lists.....
Descriptive Lists.....	Orders.....
Discharge Certificates.....	Pris. of War Record.....

*Exhibit* *3*

Other papers relating to—

Admission to Hosp'l.....	Furlough.....
Casualty Sheet.....	Med. Examination.....
Confinement.....	Misc. Information.....
Contracts.....	Pay or Clothing.....
Death or Effects <i>#</i> .....	Personal Reports.....
Desertions.....	Rank.....
Discharge from Hosp'l.....	Transfer to Hosp'l.....
Discharge from Service.....	Transfer to V. R. C.....
Duty.....	Transportation.....

DECLARATION OF RECRUIT.

NOTE 1.—This blank will be used for both enlistments and re-enlistments—enlistment of veterans, &c., &c., in the volunteer service. They will be made out in duplicate in all cases—one to accompany the recruiting return of the superintendent (not the recruiting officer) to the Adjutant General, and one to accompany the accounts of the officer who pays bounty, &c. The Regiment and Company in which the soldier last served should be given on the back.  
NOTE 2.—An enlistment holds to service. A muster-in must, in all cases, precede payment of pay, bounty, pension, &c. A muster-in roll must, in all cases, be filed in the Adjutant General's Office as evidence of muster-in. The mustering officer, commissary, or assistant commissary of muster as the case may be, will countersign both enlistments as having mustered the soldier into the service of the United States before either of them is given to the disbursing officer.

I, James Davis desiring to VOLUNTEER as a Soldier in the Army of the United States, for the term of THREE YEARS Do Declare, That I am 18 years and \_\_\_\_\_ months of age; that I have never been discharged from the United States service on account of disability or by sentence of a court martial, or by order before the expiration of a term of enlistment; and I know of no impediment to my serving honestly and faithfully as a soldier for three years.

GIVEN at Leavenworth State of Kansas the 18<sup>th</sup> day of July 1864

Witness: W.A. Burnham James W. Davis  
mark

No. 10

James Davis  
Volunteered at Leavenworth City  
July 18<sup>th</sup> 1864  
By Wm. S. Matthews Adjutant  
Recruiting Agent for the 1st Cal. Artillery  
Enlistment; last served in Company ( )  
Reg't of \_\_\_\_\_  
Discharged \_\_\_\_\_ 18 \_\_\_\_\_

CONSENT IN CASE OF MINOR.

I, \_\_\_\_\_ Do CERTIFY, That I am \_\_\_\_\_; that the \_\_\_\_\_ of \_\_\_\_\_; that the \_\_\_\_\_ is \_\_\_\_\_ years of age; and I do hereby freely give my CONSENT to his volunteering as a SOLDIER in the ARMY OF THE UNITED STATES for the period of THREE YEARS.

GIVEN at \_\_\_\_\_ the \_\_\_\_\_ day of \_\_\_\_\_

Witness: \_\_\_\_\_

(A. G. O. No. 74 & 76.)

VOLUNTEER ENLISTMENT.

STATE OF



TOWN OF

*Kansas*

*Lawrence City*

I, *James Davis* born in *Madison County*  
 in the State of *Missouri* aged *18* years,  
 and by occupation a *laborer* Do HEREBY ACKNOWLEDGE to have  
 volunteered this *10<sup>th</sup>* day of *July* 186*4*  
 to serve as a **Soldier** in the **Army of the United States of America**, for  
 the period of **THREE YEARS**, unless sooner discharged by proper authority:  
 Do also agree to accept such bounty, pay, rations, and clothing, as are, or may be,  
 established by law for volunteers. And I, *James Davis* do  
 solemnly swear, that I will bear true faith and allegiance to the **United States**  
**of America**, and that I will serve them honestly and faithfully against all  
 their enemies or opposers whomsoever; and that I will observe and obey the  
 orders of the President of the United States, and the orders of the officers  
 appointed over me, according to the Rules and Articles of War.

Sworn and subscribed to, at *Lawrence*  
 this *18<sup>th</sup>* day of *July* 186*4* } *James Davis*  
 BEFORE *Wm D Matthews* } *mark*

*2<sup>nd</sup> Lieut Recruiting Co. K 2<sup>nd</sup> US Col Artillery*  
 I CERTIFY, ON HONOR, That I have carefully examined the above-named Volunteer, agreeably  
 to the General Regulations of the Army, and that, in my opinion, he is free from all bodily defects and  
 mental infirmity, which would in any way disqualify him from performing the duties of a soldier.

*Tiffin Dink*  
*Surg Bagn of Enrollment*  
*North West Corner Kansas*  
 EXAMINING SURGEON.

I CERTIFY, ON HONOR, That I have minutely inspected the Volunteer, *James Davis*  
 previously to his enlistment, and that he was entirely sober when enlisted; that, to the best of my  
 judgment and belief, he is of lawful age; and that, in accepting him as duly qualified to perform the  
 duties of an able-bodied soldier, I have strictly observed the Regulations which govern the recruiting  
 service. This soldier has *Black* eyes, *Black* hair, *Black* complexion, is *5*  
 feet *6* inches high.

*Wm D Matthews 2<sup>nd</sup> Lieut*  
*Recruit Co. K, 2<sup>nd</sup> US Col Artillery*  
 Volunteers,  
 RECRUITING OFFICER.

Mustered into the service of the United States, for three years or during the war, from date of enlistment, in Company \_\_\_\_\_  
 Regiment of \_\_\_\_\_ Volunteers, on the \_\_\_\_\_ day of \_\_\_\_\_, 186*4*, at \_\_\_\_\_

DECLARATION OF RECRUIT.

I, James Davies desiring to VOLUNTEER as a Soldier in the Army of the United States, for the term of THREE YEARS Do Declare, That I am 18 years and \_\_\_\_\_ months of age; that I have never been discharged from the United States service on account of disability or by sentence of a court martial, or by order before the expiration of a term of enlistment; and I know of no impediment to my serving honestly and faithfully as a soldier for three years.

GIVEN at Leavenworth State of Kansas the 18<sup>th</sup> day of July 1864

Witness:

W. H. Burnham

James Davies his mark

No. 110

James Davies  
Volunteered at Leavenworth

July 18<sup>th</sup> 1864.

By Wm. D. Newberry  
Recruiting Co. H 2<sup>nd</sup> U.S. Cavalry

enlistment; last served in Company ( )

Reg't of \_\_\_\_\_

Discharged \_\_\_\_\_ 18 \_\_\_\_\_

CONSENT IN CASE OF MINOR.

I, \_\_\_\_\_ DO CERTIFY, That I am the \_\_\_\_\_ of \_\_\_\_\_; that the said \_\_\_\_\_ is \_\_\_\_\_ years of age; and I do hereby freely give my CONSENT to his volunteering as a SOLDIER in the ARMY OF THE UNITED STATES for the period of THREE YEARS.

GIVEN at \_\_\_\_\_ the \_\_\_\_\_ day of \_\_\_\_\_

Witness: \_\_\_\_\_

NOTE 1.—This blank will be used for both enlistments and re-enlistments—enlistment of veterans, &c., &c., in the volunteer service. They will be made out in duplicate in all cases—one to accompany the recruiting return of the superintendent (not the recruiting officer) to the Adjutant General, and one to accompany the accounts of the officer who pays bounty, &c. The Regiment and Company in which the soldier last served should be given on the back.

NOTE 2.—An enlistment holds to service. A muster-in must, in all cases, precede payment of pay, bounty, pension, &c. A muster-in roll must, in all cases, be filed in the Adjutant General's Office as evidence of muster-in. The mustering officer, commissary, or assistant commissary of musters, as the case may be, will countersign both enlistments as having mustered the soldier into the service of the United States before either of them is given to the disbursing officer.

VOLUNTEER ENLISTMENT.

STATE OF



TOWN OF

Kansas

Leavenworth City

I, James Davies born in Andrew County  
 in the State of Missouri aged 18 years,  
 and by occupation a Laborer DO HEREBY ACKNOWLEDGE to have  
 volunteered this 18<sup>th</sup> day of July 1864,  
 to serve as a **Soldier** in the **Army of the United States of America**, for  
 the period of **THREE YEARS**, unless sooner discharged by proper authority:  
 Do also agree to accept such bounty, pay, rations, and clothing, as are, or may be,  
 established by law for volunteers. And I, James Davies do  
 solemnly swear, that I will bear true faith and allegiance to the **United States**  
**of America**, and that I will serve them honestly and faithfully against all  
 their enemies or opposers whomsoever; and that I will observe and obey the  
 orders of the President of the United States, and the orders of the officers  
 appointed over me, according to the Rules and Articles of War.

Sworn and subscribed to, at Leavenworth City

this 18<sup>th</sup> day of July 1864

BEFORE Wm D Matthews 2<sup>nd</sup> Lt

Lieut, Recruiting Co, R. 2<sup>nd</sup> U.S. Col<sup>d</sup> Artillery

James Davies  
his  
mark

I CERTIFY, ON HONOR, That I have carefully examined the above-named Volunteer, agreeably to the General Regulations of the Army, and that, in my opinion, he is free from all bodily defects and mental infirmity, which would in any way disqualify him from performing the duties of a soldier.

Tiffin Sinks  
Sur Board of Enlistment  
North Dist Kansas  
EXAMINING SURGEON.

I CERTIFY, ON HONOR, That I have minutely inspected the Volunteer, previously to his enlistment, and that he was entirely sober when enlisted; that, to the best of my judgment and belief, he is of lawful age; and that, in accepting him as duly qualified to perform the duties of an able-bodied soldier, I have strictly observed the Regulations which govern the recruiting service. This soldier has Black eyes, Black hair, Black complexion, is 5 feet 6 inches high.

Wm D Matthews 2<sup>nd</sup> Lt  
Recruiting Co, R. 2<sup>nd</sup> U.S. Col<sup>d</sup> Artillery  
Regiment of Volunteers

RECRUITING OFFICER.

Mustered into the service of the United States, for three years or during the war, from date of enlistment, in Company \_\_\_\_\_  
 Regiment of \_\_\_\_\_ Volunteers, on the \_\_\_\_\_ day of \_\_\_\_\_, 1864, at \_\_\_\_\_



DECLARATION OF RECRUIT.

NOTE 1.—This blank will be used for both enlistments and re-enlistments—enlistment of veterans, &c., &c., in the volunteer service. They will be made out in duplicate in all cases—one to accompany the recruiting return of the superintendent (not the recruiting officer) to the Adjutant General, and one to accompany the accounts of the officer who pays bounty, &c. The Regiment and Company in which the soldier last served should be given on the back.  
NOTE 2.—An enlistment holds to service. A muster-in must, in all cases, precede payment of pay, bounty, pension, &c. A muster-in roll must, in all cases, be filed in the Adjutant General's Office as evidence of muster-in. The mustering officer, commissary, or assistant commissary of musters, as the case may be, will countersign both enlistments as having mustered the soldier into the service of the United States before either of them is given to the disbursing officer.

Rec'd from 2nd. Aud. Nov. 23d 1892

I, James Davis desiring to VOLUNTEER as a Soldier in the Army of the United States, for the term of THREE YEARS Do Declare, That I am 18 1/2 years and \_\_\_\_\_ months of age; that I have never been discharged from the United States service on account of disability or by sentence of a court martial, or by order before the expiration of a term of enlistment; and I know of no impediment to my serving honestly and faithfully as a soldier for three years.

GIVEN at Lawrenceville, State of Ga. the 18th day of July 1864

Witness:

W. A. Burnham James Davis's  
mark

No. 1122

James Davis

Volunteered at Lawrenceville, Ga.

July 18th 1864,

By Wm. D. Matthews recruit

Recruiting Agent for the 2nd U.S. Col. of Colored Soldiers

\_\_\_\_\_ enlistment; last served in Company ( )

Reg't of \_\_\_\_\_

Discharged \_\_\_\_\_ 18 \_\_\_\_\_

CONSENT IN CASE OF MINOR.

I, \_\_\_\_\_ DO CERTIFY, That I am the \_\_\_\_\_ of \_\_\_\_\_; that the said \_\_\_\_\_ is \_\_\_\_\_ years of age; and I do hereby freely give my CONSENT to his volunteering as a SOLDIER in the ARMY OF THE UNITED STATES for the period of THREE YEARS.

GIVEN at \_\_\_\_\_ the \_\_\_\_\_ day of \_\_\_\_\_

Witness: \_\_\_\_\_

VOLUNTEER ENLISTMENT.

STATE OF



TOWN OF

*Kansas*

*Lewenworth*

I, *James Davies* born in *Andrew County*  
 in the State of *Missouri* aged *18* years,  
 and by occupation a *Solar* Do HEREBY ACKNOWLEDGE to have  
 volunteered this *18<sup>th</sup>* day of *July* 1864  
 to serve as a **Soldier** in the **Army of the United States of America**, for  
 the period of **THREE YEARS**, unless sooner discharged by proper authority:  
 Do also agree to accept such bounty, pay, rations, and clothing, as are, or may be,  
 established by law for volunteers. And I, *James Davies* do  
 solemnly swear, that I will bear true faith and allegiance to the **United States**  
**of America**, and that I will serve them honestly and faithfully against all  
 their enemies or opposers whomsoever; and that I will observe and obey the  
 orders of the President of the United States, and the orders of the officers  
 appointed over me, according to the Rules and Articles of War.

Sworn and subscribed to, at *Lewenworth*  
 this *18<sup>th</sup>* day of *July* 1864 } *James Davies*  
 BEFORE *Wm D. Matthews* } *mark*

*1<sup>st</sup> Lieut Recruiting Co. K. 2<sup>nd</sup> Cal Artillery*  
 I CERTIFY, ON HONOR, That I have carefully examined the above-named Volunteer, agreeably  
 to the General Regulations of the Army, and that, in my opinion, he is free from all bodily defects and  
 mental infirmity, which would in any way disqualify him from performing the duties of a soldier.

*Jiffie Binkes*  
*Surg Board of Enrollment*  
*North West Dist Kansas*  
 EXAMINING SURGEON.

I CERTIFY, ON HONOR, That I have minutely inspected the Volunteer, *James Davies*  
 previously to his enlistment, and that he was entirely sober when enlisted; that, to the best of my  
 judgment and belief, he is of lawful age; and that, in accepting him as duly qualified to perform the  
 duties of an able-bodied soldier, I have strictly observed the Regulations which govern the recruiting  
 service. This soldier has *Black* eyes, *Black* hair, *Black* complexion, is *5*  
 feet *6* inches high.

*Wm D. Matthews 2<sup>nd</sup> Lieut*  
*Recruiting Co. K. 2<sup>nd</sup> Cal Artillery*  
 Volunteers,  
 RECRUITING OFFICER.

(A. G. O. No. 74 & 76.)

*This recruit has received Twenty five dollars advance bounty from the Bounty fund  
 authorized by the Act of Congress of July 1864*

*Mustered into the service of the United States, for three years or during the war, from date of enlistment, in Company [blank] 1<sup>st</sup> Kansas  
 Regiment of Infantry Volunteers, on the [blank] day of [blank] 1864, at Lewenworth City Kansas*

*Wm D. Matthews 2<sup>nd</sup> Lieut  
 Recruiting Co. K. 2<sup>nd</sup> Cal Artillery*

*David Newton*

Adpt. Batt'y U.S. Col'd L. Art'y.

*Private Private*

CARD NUMBERS.

6 2 3 3 6 9 1	26
6 2 3 4 7 1 5	27
6 2 3 4 3 8 3	28
6 2 3 3 7 1 6	29
6 2 3 4 6 4 2	30
9 1 3 3 0 6 5	31
	32
	33
	34
	35
	36
	37
	38
	39
	40
	41
	42
	43
	44
	45
	46
	47
	48
	49
	50

Book Mark:

See also

*D* Indpt. Batt'y. | **U.S.C.T.**

*Newton Davis*

....., Indpt. Batt'y, U. S. Col'd L. Art'y.

Appears on

**Battery Descriptive Book**

of the organization named above.

**DESCRIPTION.**

Age *48* years; height *5* feet *6* inches.

Complexion *Black*

Eyes *Black*; hair *Black*

Where born *Mason Co. Ky*

Occupation *Laborer*

**ENLISTMENT.**

When *March 1*, 186*5*.

Where *Fearnot AK's*

By whom *By Major*; term *3* y'rs.

Remarks: .....

.....

.....

.....

.....

.....

.....

.....

.....

*Shelton*

D | Indpt. Battery. | **U.S.C.T.**

*Newton Davis*

Appears with rank of *Priv* on

**Muster and Descriptive Roll of a Detachment of U. S. Vols. forwarded**

for the Indpt. Batt'y, U. S. Col'd L. Arty. Roll dated

*Leavenworth, Mo, Mch 1, 1865.*

Where born *Mason Co., Ken.*

Age *48* y'rs; occupation *Labourer*

When enlisted *Mch 1, 1865.*

Where enlisted *Leavth, Kans*

For what period enlisted *3* years.

Eyes *black*; hair *black*

Complexion *black*; height *5 ft. 6 in.*

When mustered in *Mch 1, 1865.*

Where mustered in *Leavth, Kans*

Bounty paid \$ *100* 100; due \$ *200* 100

Where credited

Battery to which assigned

Remarks: *Credited to 10th Dist. Kans. 2<sup>d</sup> Sub. Dist. 4<sup>th</sup> Ward. Leavenworth City. Vol. Recruit & entitled to bounty.*

Book mark:

*E. L. Hammon*

*D* | Indpt. Battery. | **U.S.C.T.**

*Newton Davis,*

*N*, Indpt. Battery, U. S. Col'd L. Art'y.

Appears on

**Battery Muster Roll**

for *Mar, & Apr,* 1865.

Present or absent *Present*

Stoppage, \$ 100 for

Due Gov't, \$ 100 for

Valuation of horse, \$ 100

Valuation of horse equipments, \$ 100

Remarks:

Book mark:

*Printer*

*D* | Indpt. Battery. | **U.S.C.T.**

*Newton Davis*

*D*, Indpt. Battery, U. S. Col'd L. Art'y.

Appears on

**Battery Muster Roll**

for *May & June*, 186 *5*

Present or absent *Present*

Stoppage, \$ 100 for

Due Gov't, \$ 100 for

Valuation of horse, \$ 100

Valuation of horse equipments, \$ 100

Remarks:

Book mark:

*Paster*

(358)

Copyist.

*A* *Wright* *Battly* U.S.C.T.

*Newton* *Davis*

*Priv*, Co. *Wright*, *Battly* Reg't U. S. Col'd *1st* *Party*

Appears on a

**Detachment Muster-out Roll**

of the organization named above. Roll dated

*Fort* *Leavenworth* *Kan* *July* *3*, 1865.

Muster-out to date *July* *3*, 1865.

Last paid to *Pay due from enlistment*, 186

**Clothing account:**

Last settled *new*, 186 ; drawn since \$ 100

Due soldier \$ 100; due U. S. \$ 100

Am't for cloth'g in kind or money adv'd \$ *34* <sup>*93*</sup>/<sub>100</sub>

Due U. S. for arms, equipments, &c., \$ 100

Bounty paid \$ *100* 100 due \$ *none* 100

Remarks: *Forwarded from Post Hospital Fort Leavenworth Kansas and mustered out in accordance with Genl Orders No 47 War Dept 1865*

Book mark:

*G W Hendrick*



D | Indpt. Battery. | **U.S.C.T.**

*Newton Davis,*

*N*....., Indpt. Battery U. S. Col'd Light Art'y.

Appears on **Batt'y Muster-out Roll**, dated

*W. Lawrence, Ke. July 22, 1865.*

Muster-out to date ..... 186 .

Last paid to ..... 186 .

**Clothing account:**

Last settled....., 186 ; drawn since \$ *54* <sup>*93*</sup>/<sub>100</sub>

Due soldier \$.....<sup>100</sup>; due U. S. \$.....<sup>100</sup>

Am't for cloth'g in kind or money adv'd \$.....<sup>100</sup>

Due U. S. for arms, equipments, &c., \$.....<sup>100</sup>

Bounty paid \$.....<sup>100</sup>; due \$.....<sup>100</sup>

Remarks: *Discharged from hospital by G.O. no. 74, War Dept, 1865. July 3/65,*

Book mark : .....

*Dutton*

*Davis Acosta*

, Co. *1st Batt* *Reg't* *U.S.C.A.*

Enclosures.

Bed Cards .....	Final Statements .....
Burial Records .....	Furloughs or L. of A. ....
Certs. of Dis. for Discharge .....	Med. Certificates .....
C. M. Charges .....	Med. Des. Lists .....
Descriptive Lists .....	Orders .....
Discharge Certificates .....	Pris. of War Record .....
Enlistment Papers .....	<input checked="" type="checkbox"/> Resignations .....

Other papers relating to—

Admission to Hosp'l .....	Furlough or L. of A. ....
Casualty Sheet .....	Med. Examination .....
Confinement .....	Misc. Information .....
Contracts .....	Pay or Clothing .....
Death or Effects .....	Personal Reports .....
Desertion .....	Rank .....
Discharge from Hosp'l .....	Transfer to Hosp'l .....
Discharge from Service .....	Transfer to V. R. C. ....
Duty .....	Transportation .....

DECLARATION OF RECRUIT.

I, Norton Davis, desiring

to VOLUNTEER as a Soldier in the Army of the United States, for the term of THREE YEARS,  
Do Declare, That I am Forty Eight (48) years and        months

of age; that I have never been discharged from the United States service on account of disability or  
by sentence of a court martial, or by order before the expiration of a term of enlistment; and I know of  
no impediment to my serving honestly and faithfully as a soldier for three years.

GIVEN at Leavenworth City, Kansas  
the 10<sup>th</sup> day of March 1865

Witness:

S. L. Cook

Norton Davis  
mark

NOTE 1.—This blank will be used for both enlistments and re-enlistments—enlistment of veterans, &c., &c., in the volunteer service. They will be made out in duplicate in all cases—one to accompany the recruiting return of the superintendent (not the recruiting officer) to the Adjutant General, and one to accompany the accounts of the officer who pays bounty, &c. The Regiment and Company in which the soldier last served should be given on the back.

NOTE 2.—An enlistment holds to service. A muster-in must, in all cases, precede payment of pay, bounty, pension, &c. A muster-in roll must, in all cases, be filed in the Adjutant General's Office as evidence of muster-in. The mustering officer, commissary, or assistant commissary of musters, as the case may be, will countersign both enlistments as having mustered the soldier into the service of the United States before either of them is given to the disbursing officer.

Joseph Anthony  
No. 9 Vol 210

Norton Davis

Volunteered at Leavenworth, Mo  
March 10<sup>th</sup>, 1865

By Joseph Anthony March 10<sup>th</sup>  
U.S. Colonel & 1<sup>st</sup> Regiment of Artillery, 1<sup>st</sup>

enlistment; last served in Company ( )

Reg't of

Discharged       , 18      

CONSENT IN CASE OF MINOR.

I,       , Do CERTIFY, That I am  
the        of       ; that the  
said        is        years of age; and I  
do hereby freely give my CONSENT to his volunteering as a SOLDIER in the ARMY OF THE UNITED  
STATES for the period of THREE YEARS.

GIVEN at         
the        day of       

Witness:

Credited to Northern Dist Kansas 22<sup>nd</sup> Sub-Dist 4<sup>th</sup> Ward Leavenworth City  
to whom

VOLUNTEER ENLISTMENT.

STATE OF

TOWN OF

*Kansas*

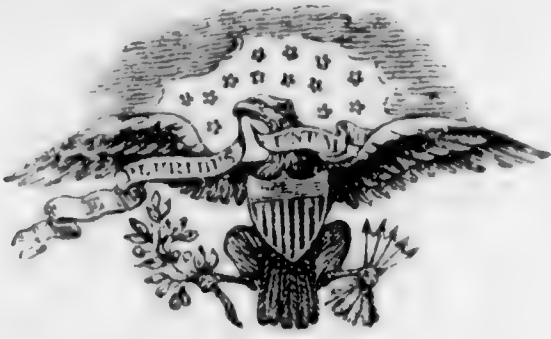

*Leavenworth*

I, *Newton Davis*, born in *Mason Co*  
in the State of *Kentucky*, aged *48* years,  
and by occupation a *Laborer*, Do HEREBY ACKNOWLEDGE to have  
volunteered this *First (1<sup>st</sup>)* day of *March*, 1865,  
to serve as a **Soldier** in the **Army of the United States of America**, for  
the period of **THREE YEARS**, unless sooner discharged by proper authority:  
Do also agree to accept such bounty, pay, rations, and clothing, as are, or may be,  
established by law for volunteers. And I, *Newton Davis*, do  
solemnly swear, that I will bear true faith and allegiance to the **United States  
of America**, and that I will serve them honestly and faithfully against all  
their enemies or opposers whomsoever; and that I will observe and obey the  
orders of the President of the United States, and the orders of the officers  
appointed over me, according to the Rules and Articles of War.

Sworn and subscribed to, at *Leavenworth*  
this *1<sup>st</sup>* day of *March*, 1865, } *Newton Davis*  
BEFORE *P. H. Minor 2<sup>nd</sup> Lieut* } *not*  
*Inf. Regt. U. S. Col. 4<sup>th</sup> Artillery*

I CERTIFY, ON HONOR, That I have carefully examined the above-named Volunteer, agreeably  
to the General Regulations of the Army, and that, in my opinion, he is free from all bodily defects and  
mental infirmity, which would in any way disqualify him from performing the duties of a soldier.

*Tiffin Weeks*  
*Surgeon & Surgeon General*  
*Northern Dist Kan*  
EXAMINING SURGEON.

I CERTIFY, ON HONOR, That I have minutely inspected the Volunteer *Newton Davis*  
previously to his enlistment, and that he was entirely sober when enlisted; that, to the best of my  
judgment and belief, he is of lawful age; and that, in accepting him as duly qualified to perform the  
duties of an able-bodied soldier, I have strictly observed the Regulations which govern the recruiting  
service. This soldier has *Black* eyes, *Black* hair, *Black* complexion, is *5*  
feet *6* inches high.

*P. H. Minor 2<sup>nd</sup> Lieut*  
*Inf. Regt. U. S. Col. 4<sup>th</sup> Artillery (Light)*  
RECRUITING OFFICER.

Mustered into the service of the United States, for three years or during the war, from date of enlistment, in *Company* *3<sup>rd</sup>* *Regiment* *Artillery* *1<sup>st</sup>* *day of* *March*, 1865, at *Leavenworth Kan*  
*2<sup>nd</sup> Sub-Dist 4<sup>th</sup> Ward*  
*Leavenworth Kan*  
*1865*

*Cap. H. B. Marshall*  
*Northern Dist Kan*

DECLARATION OF RECRUIT.

I, Newton Davis, desiring to VOLUNTEER as a Soldier in the Army of the United States, for the term of THREE YEARS, Do Declare, That I am Forty Eight (48) years, and — months of age; that I have never been discharged from the United States service on account of disability or by sentence of a court martial, or by order before the expiration of a term of enlistment; and I know of no impediment to my serving honestly and faithfully as a soldier for three years.

GIVEN at Leavenworth City Kansas the 10<sup>th</sup> day of March 1865

Witness:

Bob Cook

Newton his Davis mark

No. 8

Newton Davis

Volunteered at Leavenworth Mo

March 1st, 1865

By Capt. Wm. W. ...

1st U.S. Colored Regt. Artillery

enlistment; last served in Company ( )

Regt of

Discharged —, 18—

CONSENT IN CASE OF MINOR.

I, \_\_\_\_\_, Do CERTIFY, That I am \_\_\_\_\_; that the \_\_\_\_\_ of \_\_\_\_\_ is \_\_\_\_\_ years of age; and I do hereby freely give my CONSENT to his volunteering as a SOLDIER in the ARMY OF THE UNITED STATES for the period of THREE YEARS.

GIVEN at \_\_\_\_\_ the \_\_\_\_\_ day of \_\_\_\_\_

Witness:

(A. G. O. No. 74 & 76.)

NOTE 1.—This blank will be used for both enlistments and re-enlistments—enlistment of veterans, &c., &c., in the volunteer service. They will be made out in duplicate in all cases—one to accompany the recruiting return of the superintendent (not the recruiting officer) to the Adjutant General, and one to accompany the accounts of the officer who pays bounty, &c. The Regiment and Company in which the soldier last served should be given on the back.  
NOTE 2.—An enlistment holds to service. A muster-in must, in all cases, precede payment of pay, bounty, pension, &c. A muster-in roll must, in all cases, be filed in the Adjutant General's Office as evidence of muster-in. The mustering officer, commissary, or assistant commissary of musters, as the case may be, will countersign both enlistments as having mustered the soldier into the service of the United States before either of them is given to the disbursing officer.

Rec'd from 2nd. Aud. Nov. 23d 1892

*Rec'd to Northern Dist Kansas 22<sup>d</sup> Sub Dist 4<sup>th</sup> Ward Leavenworth City*  
*U.S. Colored Artillery Regiment No. 10<sup>th</sup>*  
*March 1865*  
*Volunteers, on the 1<sup>st</sup> day of March, 1865, at Leavenworth, Kas*  
*Company 1<sup>st</sup> Battery*  
*Rec'd to Northern Dist Kansas 22<sup>d</sup> Sub Dist 4<sup>th</sup> Ward Leavenworth City*  
*U.S. Colored Artillery Regiment No. 10<sup>th</sup>*  
*March 1865*  
*Volunteers, on the 1<sup>st</sup> day of March, 1865, at Leavenworth, Kas*  
*Company 1<sup>st</sup> Battery*

VOLUNTEER ENLISTMENT.

STATE OF

*Kansas*



TOWN OF

*Leavenworth*

I, *Newton Davis*, born in *Mason Co.*  
in the State of *Kentucky*, aged *45* years,  
and by occupation a *Laborer*, Do HEREBY ACKNOWLEDGE to have  
volunteered this *1<sup>st</sup> (1865)* day of *March*, 1865,  
to serve as a **Soldier** in the **Army of the United States of America**, for  
the period of **THREE YEARS**, unless sooner discharged by proper authority:  
Do also agree to accept such bounty, pay, rations, and clothing, as are, or may be,  
established by law for volunteers. And I, *Newton Davis*, do  
solemnly swear, that I will bear true faith and allegiance to the **United States  
of America**, and that I will serve them honestly and faithfully against all  
their enemies or opposers whomsoever; and that I will observe and obey the  
orders of the President of the United States, and the orders of the officers  
appointed over me, according to the Rules and Articles of War.

Sworn and subscribed to, at *Leavenworth*  
this *1<sup>st</sup>* day of *March*, 1865, } *Newton Davis*  
BEFORE *P.H. Minor 2<sup>nd</sup> Lieut.* } *mark*  
*Ind. Baty. U.S. Col<sup>d</sup> Artillery*

I CERTIFY, ON HONOR, That I have carefully examined the above-named Volunteer, agreeably  
to the General Regulations of the Army, and that, in my opinion, he is free from all bodily defects and  
mental infirmity, which would in any way disqualify him from performing the duties of a soldier.

*William B. Smith*  
*Surgeon Board of Enrollment*  
*Northern Dist Kansas*  
EXAMINING SURGEON.

I CERTIFY, ON HONOR, That I have minutely inspected the Volunteer *Newton Davis*  
previously to his enlistment, and that he was entirely sober when enlisted; that, to the best of my  
judgment and belief, he is of lawful age; and that, in accepting him as duly qualified to perform the  
duties of an able-bodied soldier, I have strictly observed the Regulations which govern the recruiting  
service. This soldier has *Black* eyes, *Black* hair, *Black* complexion, is  
sect *0* inches high.

*P.H. Minor 2<sup>nd</sup> Lieut*  
*Ind. Baty U.S. Col<sup>d</sup> Artillery (Right)*  
RECRUITING OFFICER.

(A. G. O. No. 74 & 76.)

*U.S. Colored Artillery Regiment No. 10<sup>th</sup>*  
Mustered into the service of the United States, for three years or during the war, from date of enlistment, in  
*Company 1<sup>st</sup> Battery*  
Volunteers, on the *1<sup>st</sup>* day of *March*, 1865, at *Leavenworth, Kas*  
*Company 1<sup>st</sup> Battery*

1st. Batt'y U.S. Col U.L. Arty

Private - Private

CARD NUMBERS.

6 2 3 3 6 3 0	26
6 2 3 3 7 6 0	27
6 2 3 3 9 0 9	28
6 2 3 4 0 7 4	29
6 2 3 4 2 1 3	30
6 2 3 4 3 8 1	31
6 2 3 4 5 4 3	32
9 1 3 2 9 4 2	33
	34
	35
	36
	37
	38
	39
	40
	41
	42
	43
	44
	45
	46
	47
	48
	49
	50

Book Mark:

See also

S. 2050422 P.O. m m  
S. 2242282 And W. L.  
A. 1924888  
A. 1958931

*N. Spencer*  
*g*



*D* | Indpt. Batt'y. | **U.S.C.T.**

*Tilford Davis*

....., Indpt. Batt'y, U. S. Col'd L. Art'y.

Appears on

**Battery Descriptive Book**

of the organization named above.

**DESCRIPTION.**

Age *37* years; height *5* feet *7* inches.

Complexion *Brown*

Eyes *Black*; hair *Black*

Where born *Madison Co. Ky*

Occupation *Farmer*

**ENLISTMENT.**

When *Dec. 15*, 1864.

Where *Wyandott Ks*

By whom *L Minor*; term *3* y'rs.

Remarks:

.....  
.....  
.....  
.....  
.....  
.....  
.....  
.....

*Sholbrook*

2 | Indpt. Battery. | **U.S.C.T.**

*Tilford Davis*

Appears with rank of *Priv* on

**Muster and Descriptive Roll of a Detachment of U. S. Vols. forwarded**

for the Indpt. Batt'y, U. S. Col'd L. Arty. Roll dated

*Lavenworth, Ks., Dec. 16, 1864.*

Where born *Madison Co. Kentucky*

Age *37* y'rs; occupation *Farmer*

When enlisted *Dec. 15, 1864.*

Where enlisted *Wyandotte, Ks*

For what period enlisted *3* years.

Eyes *Black*; hair *Black*

Complexion *Brown*; height *5* ft. *7* in.

When mustered in *Dec. 16, 1864.*

Where mustered in *Lavenworth, Ks.*

Bounty paid \$ *100*; due \$ *100*

Where credited

Battery to which assigned

Remarks: *Credited to North<sup>m</sup> Dist*

*Kans. 28 Subdist. Wyandotte*

*City Co. Volunteer recruit*

*entitled to bounty.*

Book mark:

*E. L. Harbison*

D

Indpt. Battery.

U.S.C.T.

Silford Davis

Pvt

, Indpt. Battery, U. S. Col'd L. Art'y.

Appears on

**Battery Muster-in and Descriptive Roll**

of the organization named above. Roll dated

Lewersworth Co. Dec 23, 1864.

Where born Madison Co. Ky

Age 37 y'rs; occupation Farmer

When enlisted Dec 15, 1864.

Where enlisted Wyandotte Co

For what period enlisted 3 years.

Eyes Blue; hair Blue

Complexion Bro; height 5 ft. 7 in.

When mustered in Dec 16, 1864.

Where mustered in Lewersworth

Bounty paid \$ 100 <sup>00</sup>/<sub>100</sub>; due \$ 200 <sup>00</sup>/<sub>100</sub>

Where credited

Battery to which assigned

Remarks: Co. M. Dist No.

28<sup>th</sup> I. L. Wyandotte Co

Book mark :

J. H. Schrey

(856g)

Copyist.

D | Indpt. Battery. | **U.S.C.T.**

*Telford Davis*

*Telf*, Indpt. Battery, U. S. Col'd L. Art'y.

Appears on

**Battery Muster Roll**

for *Enlistment to Dec 31*, 1864.

Present or absent *Absent*

Stoppage, \$ 100 for

Due Gov't, \$ 100 for

Valuation of horse, \$ 100

Valuation of horse equipments, \$ 100

Remarks: *Absent without leave at My middle Co. from Dec 25<sup>th</sup> 1864 to Jan 5<sup>th</sup> 1865*

Book mark:

(358)

*J. H. Schorley*

Copyist.

*D*

Indpt. Battery.

U.S.C.T.

*Tilford Davis*

*Pat*

, Indpt. Battery, U. S. Col'd L. Art'y.

Appears on

**Battery Muster Roll**

for

*July 1865*

1865

Present or absent

*Present*

Stoppage, \$

100 for

Due Gov't, \$

100 for

Valuation of horse, \$

100

Valuation of horse equipments, \$

100

Remarks:

Book mark:

*J. J. Schrey*

(358)

Copyist.

*D* | Indpt. Battery. | **U.S.C.T.**

*Silford Davis*

*Pr*, Indpt. Battery, U. S. Col'd L. Art'y.

Appears on

**Battery Muster Roll**

for *Mar, & Apr*, 1865.

Present or absent *Present*

Stoppage, \$ 100 for

Due Gov't, \$ 100 for

Valuation of horse, \$ 100

Valuation of horse equipments, \$ 100

Remarks:

Book mark:

*Butler*

D | Indpt. Battery. | **U.S.C.T.**

*Tilford Davis,*  
*D*, Indpt. Battery, U. S. Col'd L. Art'y.

Appears on

**Battery Muster Roll**

for *May & June*, 186*5*.

Present or absent *Present*.

Stoppage, \$ 100 for

Due Gov't, \$ 100 for

Valuation of horse, \$ 100

Valuation of horse equipments, \$ 100

Remarks:

Book mark:

*Parter*

(358)

Copyist.

*D*

Indpt. Battery.

**U.S.C.T.**

*Tilford Davis,*  
*A*, Indpt. Battery U. S. Col'd Light Art'y.

Appears on **Batt'y Muster-out Roll**, dated

*M. Seammouth, Ky, July 27* 1865.

Muster-out to date *July 22*, 1865.

Last paid to *Dec. 31*, 1864.

Clothing account:

Last settled....., 186 ; drawn since \$ *59<sup>01</sup>* <sup>100</sup>,

Due soldier \$ ..... <sup>100</sup>; due U. S. \$ ..... <sup>100</sup>

Am't for cloth'g in kind or money adv'd \$ ..... <sup>100</sup>

Due U. S. for arms, equipments, &c., \$ ..... <sup>100</sup>

Bounty paid \$ *100* <sup>100</sup>; due \$ *None* <sup>100</sup>,

Remarks:.....

.....  
.....  
.....  
.....  
.....  
.....  
.....

Book mark:.....

.....  
*Parter*  
Copyist.



*Davis Silford*

Co. *1st Batt* *Reg't* *U.S.C.A.*

**Enclosures.**

Bed Cards .....	Final Statements .....
Burial Records .....	Furloughs or L. of A. ....
Certs. of Dis. for Discharge .....	Med. Certificates .....
C. M. Charges .....	Med. Des. Lists .....
Descriptive Lists .....	Orders .....
Discharge Certificates .....	Pris. of War Record .....
Enlistment Papers .....	Resignations .....

Other papers relating to—

Admission to Hosp'l .....	Furlough or L. of A. ....
Casualty Sheet .....	Med. Examination .....
Confinement .....	Misc. Information .....
Contracts .....	Pay or Clothing .....
Death or Effects .....	Personal Reports .....
Desertion .....	Rank .....
Discharge from Hosp'l .....	Transfer to Hosp'l .....
Discharge from Service .....	Transfer to V. R. C. ....
Duty .....	Transportation .....

NOTE 1.—This blank will be used for both enlistments and re-enlistments—enlistment of veterans, &c., &c., in the volunteer service. They will be made out in duplicate in all cases—one to accompany the recruiting return of the superintendent (not the recruiting officer) to the Adjutant General, and one to accompany the accounts of the officer who pays bounty, &c. The Regiment and Company in which the soldier last served should be given on the back.

NOTE 2.—An enlistment holds to service. A muster-in must, in all cases, precede payment of pay, bounty, pension, &c. A muster-in roll must, in all cases, be filed in the Adjutant General's Office as evidence of muster-in. The mustering officer, commissary, or assistant commissary of musters, as the case may be, will countersign both enlistments as having mustered the soldier into the service of the United States before either of them is given to the disbursing officer.

Rec'd from 2nd. Aud. Nov. 23d 1892

DECLARATION OF RECRUIT.

I, Silford Davis, desiring to VOLUNTEER as a Soldier in the Army of the United States, for the term of THREE YEARS, Do Declare, That I am thirty seven years and \_\_\_\_\_ months of age; that I have never been discharged from the United States service on account of disability or by sentence of a court martial, or by order before the expiration of a term of enlistment; and I know of no impediment to my serving honestly and faithfully as a soldier for three years.

GIVEN at Wandell, Kansas the 15<sup>th</sup> day of December 1864

Witness: D. H. Minor Silford Davis  
mark

No. 14  
Silford Davis  
Volunteered at Wandell, Kansas  
15<sup>th</sup> December, 1864  
By Edward Gill Regt. Officer  
1<sup>st</sup> Cavalry Regiment of Kansas  
enlistment; last served in Company ( )  
Reg't of \_\_\_\_\_  
Discharged \_\_\_\_\_, 18\_\_\_\_  
2nd Lt. 1<sup>st</sup> Cavalry

CONSENT IN CASE OF MINOR.

I, \_\_\_\_\_, Do CERTIFY, That I am \_\_\_\_\_; that the \_\_\_\_\_ of \_\_\_\_\_ is \_\_\_\_\_ years of age; and I do hereby freely give my CONSENT to his volunteering as a SOLDIER in the ARMY OF THE UNITED STATES for the period of THREE YEARS.

GIVEN at \_\_\_\_\_ the \_\_\_\_\_ day of \_\_\_\_\_

Witness: \_\_\_\_\_

(A. G. O. No. 74 & 76.)

VOLUNTEER ENLISTMENT.

STATE OF



TOWN OF

I, Litford Davis, born in Madison Co  
 in the State of Kentucky, aged 37 thirty seven years,  
 and by occupation a Farmer. Do HEREBY ACKNOWLEDGE to have  
 volunteered this 15th fifteenth day of December, 1864,  
 to serve as a Soldier in the Army of the United States of America, for  
 the period of THREE YEARS, unless sooner discharged by proper authority:  
 Do also agree to accept such bounty, pay, rations, and clothing, as are, or may be,  
 established by law for volunteers. And I, Litford Davis, do  
 solemnly swear, that I will bear true faith and allegiance to the United States  
of America, and that I will serve them honestly and faithfully against all  
 their enemies or opposers whomsoever; and that I will observe and obey the  
 orders of the President of the United States, and the orders of the officers  
 appointed over me, according to the Rules and Articles of War.

Sworn and subscribed to, at Wyandotte  
 this 15th day of December, 1864.  
 BEFORE Edward Gill 2nd Lt 15th K.V.C. } Litford Davis

I CERTIFY, ON HONOR, That I have carefully examined the above-named Volunteer, agreeably  
 to the General Regulations of the Army, and that, in my opinion, he is free from all bodily defects and  
 mental infirmity, which would in any way disqualify him from performing the duties of a soldier.

W. H. Simpson  
 Surgeon Board of Consultants  
 Fort Leavenworth, Kansas  
 EXAMINING SURGEON.

I CERTIFY, ON HONOR, That I have minutely inspected the Volunteer Litford Davis  
 previously to his enlistment, and that he was entirely sober when enlisted; that, to the best of my  
 judgment and belief, he is of lawful age; and that, in accepting him as duly qualified to perform the  
 duties of an able-bodied soldier, I have strictly observed the Regulations which govern the recruiting  
 service. This soldier has black eyes, black hair, brun complexion, is 5  
 feet 4 inches high.

Edward Gill 2nd Lt 15th K.V.C.  
15th Regiment of Kan Cavalry Volunteers,  
 RECRUITING OFFICER.

(A. G. O. No. 74 & 76.)

Mustered into the service of the United States, for three years or during the war, from date of enlistment, in Company B 15th Regiment of Kan Cavalry Volunteers, on the 16 day of December, 1864, at Leavenworth Kansas

W. H. Simpson  
 Surgeon  
 Fort Leavenworth, Kansas

*The recruit has received one hundred dollars advance bounty from the Bounty fund, authorized by an Act of Congress approved July 11, 1861, and Circular No. 2, from the Provost Marshal General dated July 17, 1861.*

DECLARATION OF RECRUIT.

I, Dillard Davis desiring to VOLUNTEER as a Soldier in the Army of the United States, for the term of THREE YEARS, Do declare, That I am Thirty Seven years and \_\_\_\_\_ months of age; that I have never been discharged from the United States service on account of disability or by sentence of a court-martial, or by order before the expiration of a term of enlistment; and I know of no impediment to my serving honestly and faithfully as a soldier for three years.

GIVEN at Wyandotte State Kansas  
The 15<sup>th</sup> day of December 1864  
Dillard <sup>his</sup> Davis  
<sub>mark</sub>

Witness:  
P. A. Minor

No. \_\_\_\_\_

Dillard Davis

Volunteered at Wyandotte

14<sup>th</sup> December 1864

By Ed Will. Beck - 15<sup>th</sup> REGT

Regiment of \_\_\_\_\_

\_\_\_\_\_ enlistment; last served in Company ( )

And Ball's Regt of 21<sup>st</sup> Cal. Light

Discharged \_\_\_\_\_ 18 .

CONSENT IN CASE OF MINOR.

I, \_\_\_\_\_ of \_\_\_\_\_ Do CERTIFY, That I am the \_\_\_\_\_ ; that the \_\_\_\_\_ years of age; and I said \_\_\_\_\_ is \_\_\_\_\_ do hereby freely give my CONSENT to his volunteering as a SOLDIER in the ARMY OF THE UNITED STATES for the period of THREE YEARS.

GIVEN at \_\_\_\_\_  
The \_\_\_\_\_ day of \_\_\_\_\_

Witness:

Wandotte city

VOLUNTEER ENLISTMENT.

STATE OF

Kansas



TOWN OF

Wandotte

I, Silford Davis

in the State of Kentucky and by occupation a Farmer volunteered this Fourteenth

born in Madison Co aged Thirty seven years, DO HEREBY ACKNOWLEDGE to have day of December 1864

to serve as a Soldier in the Army of the United States of America, for the period of THREE YEARS, unless sooner discharged by proper authority: Do also agree to accept such bounty, pay, rations, and clothing, as are, or may be, established by law for volunteers. And I, Silford Davis do solemnly swear, that I will bear true faith and allegiance to the United States of America, and that I will serve them honestly and faithfully against all their enemies or opposers whomsoever; and that I will observe and obey the orders of the President of the United States, and the orders of the officers appointed over me, according to the Rules and Articles of War.

Sworn and subscribed to, at Wandotte Ky this 14th day of December 1864. BEFORE Lieut Giles 15th K.V.C.

Silford Davis his mark

I CERTIFY, ON HONOR, That I have carefully examined the above named Volunteer, agreeably to the General Regulations of the Army, and that in my opinion he is free from all bodily defects and mental infirmity, which would, in any way, disqualify him from performing the duties of a soldier.

Jiffie Sims Surg Board of Enrollment North Dist Kansas EXAMINING SURGEON

I CERTIFY, ON HONOR, That I have minutely inspected the Volunteer, Silford Davis previously to his enlistment, and that he was entirely sober when enlisted; that, to the best of my judgment and belief, he is of lawful age; and that, in accepting him as duly qualified to perform the duties of an able-bodied soldier, I have strictly observed the Regulations which govern the recruiting service. This soldier has Black eyes, Black hair, Brown complexion, is 5 feet 7 inches high.

Edward Gill 2d Lieut, 15th Regt of Kan Cavalry Volunteers, RECRUITING OFFICER

Mustered into the service of the United States for three years, or during the war, from date of enlistment in Independent Battery U.S. Colored Artillery (Light) on the 16th day of December 1864, at Lawrence, Mo., Kansas.

George W. ... Capt. ...

*James William J.*  
 Capt. Batt'y U.S. Col'd L. Art'y.

*Private Sergeant*  
 CARD NUMBERS.

6 2 3 3 5 8 5	26
6 2 3 3 7 6 4	27
6 2 3 3 9 1 2	28
6 2 3 4 0 3 9	29
6 2 3 4 1 7 7	30
6 2 3 4 3 3 9	31
6 2 3 4 5 0 3	32
9 1 3 2 9 4 5	33
	34
	35
	36
	37
	38
	39
	40
	41
	42
	43
	44
	45
	46
	47
	48
	49
	50

Mark: \_\_\_\_\_  
 \_\_\_\_\_

*DA* Indpt. Batt'y. | **U.S.C.T.**

*William F. Davis*

....., Indpt. Batt'y, U. S. Col'd L. Art'y.

Appears on

**Battery Descriptive Book**  
of the organization named above.

**DESCRIPTION.**

Age *25* years; height *5* feet *7 1/2* inches.

Complexion *Mulatto*

Eyes *Black*; hair *Black*

Where born *Douglas Co. Mo.*

Occupation *Waiter*

**ENLISTMENT.**

When *Oct. 3*, 186 *4*.

Where *Fort Scott Mo.*

By whom *St. Matthews*; term *3* y'rs.

Remarks: .....

*Shelbourn*

D

Indpt. Battery.

U.S.C.T.

*William F. Davies*Appears with rank of *Priv* on**Muster and Descriptive Roll of a Detachment of U. S. Vols. forwarded**

for the Indpt. Batt'y, U. S. Col'd L. Arty. Roll dated

*Leavenworth, Ks, Nov. 29, 1864.*Where born *Darphan Co., Kans.*Age *25* y'rs; occupation *Waiter*When enlisted *Oct 3, 1864.*Where enlisted *St. Louis, Ks*For what period enlisted *3* years.Eyes *Blk*; hair *Blk*Complexion *Mulatto*; height *5 ft. 7 in.*When mustered in *Nov. 29, 1864.*Where mustered in *Leavenworth, Ks.*Bounty paid \$ *100*; due \$ *100*

Where credited

Battery to which assigned

Remarks: *Credited to Southern**Dist., Kansas, W. Scott, Bomben**Co. Vol. Recruit & entitled to**Bounty.*

Book mark:

*E. L. Thornton*



*D* | Indpt. Battery. | **U.S.C.T.**

*Wm F Davis*

*Co*, Indpt. Battery, U. S. Col'd L. Art'y.

Appears on

**Battery Muster-in and Descriptive Roll**

of the organization named above. Roll dated

*Leavenworth Mo Dec 23*, 1864.

Where born *Donaphins Mo*

Age *25* y'rs; occupation *waiter*

When enlisted *Oct 3<sup>d</sup>*, 1864.

Where enlisted *Fort Scott Mo*

For what period enlisted *3* years.

Eyes *Blu*; hair *Blu*

Complexion *rudder*; height *5* ft. *7 1/2* in.

When mustered in *Nov 24*, 1864.

Where mustered in *Leavenworth*

Bounty paid \$ *100<sup>00</sup>* / *100*; due \$ *200<sup>00</sup>* / *100*

Where credited

Battery to which assigned

Remarks: *A. S. Dist Co  
Fort Scott Bourbon Co.  
Kans.*

Book mark:

*J. J. Schooley*

(356g)

Copyist.

D | Indpt. Battery. | U.S.C.T.

Wm J Davis

Pat, Indpt. Battery, U. S. Col'd L. Art'y.

Appears on

Battery Muster Roll

for Enlistment to Dec 31, 1864.

Present or absent Present

Stoppage, \$ 100 for

Due Gov't, \$ 100 for

Valuation of horse, \$ 100

Valuation of horse equipments, \$ 100

Remarks:

Book mark:

W Schrodley

(358)

Copyist.

*D* | Indpt. Battery. | **U.S.C.T.**

*William F Davis*  
-----  
*3<sup>rd</sup> Corp*, Indpt. Battery, U. S. Col'd L. Art'y.

Appears on

**Battery Muster Roll**

for *Jan'y & Feb*, 186*5*.

Present or absent. *Present*

Stoppage, \$-----*100* for-----

Due Gov't, \$-----*100* for-----

Valuation of horse, \$-----*100*

Valuation of horse equipments, \$-----*100*

Remarks: *Appointed Corp*  
*Jan'y 1865 by Maj.*  
*R. W. Hunt Chf Artillery*  
*Dept of Rand.*

Book mark:-----

-----  
*W Schoddy*  
-----  
(358) Copyist.

D

Indpt. Battery. | U.S.C.T.

*Willard J. Davis,*  
*Corpl.*, Indpt. Battery, U. S. Col'd L. Art'y.

Appears on

**Battery Muster Roll**

for *Mar, + Apl,* 1865.

Present or absent *Present,*

Stoppage, \$ 100 for

Due Gov't, \$ 100 for

Valuation of horse, \$ 100

Valuation of horse equipments, \$ 100

Remarks:  
\_\_\_\_\_  
\_\_\_\_\_  
\_\_\_\_\_  
\_\_\_\_\_  
\_\_\_\_\_  
\_\_\_\_\_

Book mark: \_\_\_\_\_

*Porter*

*L* | Indpt. Battery. | **U.S.C.T.**

*William F. Davis,*  
*Sgt*, Indpt. Battery, U. S. Col'd L. Art'y.

Appears on

**Battery Muster Roll**

for *May & June*, 1865.

Present or absent *Present*

Stoppage, \$ *100* for

Due Gov't, \$ *100* for

Valuation of horse, \$ *100*

Valuation of horse equipments, \$ *100*

Remarks: *Pay due as Corp.,*  
*from Dec, 31/64, to June*  
*1/65. Promoted Sgt, June*  
*1/65.*

Book mark: \_\_\_\_\_

*Parter*

(358)

Copyist.

D | Indpt. Battery. | **U.S.C.T.**

*William F. Davis,*

*Sgt.*, Indpt. Battery U. S. Col'd Light Art'y.

Appears on **Batt'y Muster-out Roll**, dated

*W. Seavernoth, No. July 22, 1865.*

Muster-out to date *July 22*, 1865.

Last paid to *Dec. 31*, 1864.

Clothing account:

Last settled....., 186 ; drawn since \$ *83* <sup>*51*</sup>/<sub>100</sub>,

Due soldier \$ <sup>100</sup>/<sub>100</sub>; due U. S. \$ <sup>100</sup>/<sub>100</sub>

Am't for cloth'g in kind or money adv'd \$ <sup>100</sup>/<sub>100</sub>

Due U. S. for arms, equipments, &c., \$ <sup>100</sup>/<sub>100</sub>

Bounty paid \$ <sup>100</sup>/<sub>100</sub>; due \$ *none* <sup>100</sup>/<sub>100</sub>

Remarks: *Private from enlistment to Jan'y, 1/65; then Corp'l, to June 1. Then Serg't. Due E. Fenton, Sutter, \$10-*

Book mark :.....

*Porter*

*Davis William F.*

, Co. *1st* *Batt* *U.S.C.A.*  
*Reg't*

**7** Enclosures.

Bed Cards .....	Final Statements .....
Burial Records .....	Furloughs or L. of A. ....
Certs. of Dis. for Discharge .....	Med. Certificates .....
C. M. Charges .....	Med. Des. Lists .....
Descriptive Lists .....	Orders .....
Discharge Certificates .....	Pris. of War Record .....
Enlistment Papers <b>2</b> .....	Resignations .....

Other papers relating to—

Admission to Hosp'l .....	Furlough or L. of A. ....
Casualty Sheet .....	Med. Examination .....
Confinement .....	Misc. Information .....
Contracts .....	Pay or Clothing .....
Death or Effects .....	Personal Reports .....
Desertion .....	Rank .....
Discharge from Hosp'l .....	Transfer to Hosp'l .....
Discharge from Service .....	Transfer to V. R. C. ....
Duty .....	Transportation .....

DECLARATION OF RECRUIT.

NOTE 1.—This blank will be used for both enlistments and re-enlistments—enlistment of veterans, &c., &c., in the volunteer service. They will be made out in duplicate in all cases—one to accompany the recruiting return of the superintendent (not the recruiting officer) to the Adjutant General, and one to accompany the accounts of the officer who pays bounty, &c. The Regiment and Company in which the soldier last served should be given on the back. NOTE 2.—An enlistment holds to service. A muster-in must, in all cases, precede payment of pay, bounty, pension, &c. A muster-in roll must, in all cases, be filed in the Adjutant General's Office as evidence of muster-in. The mustering officer, commissary, or assistant commissary of musters, as the case may be, will countersign both enlistments as having mustered the soldier into the service of the United States before either of them is given to the disbursing officer.

Rec'd from 2nd. Aud. Nov. 23d 1892

I, William J. Davis desiring to VOLUNTEER as a Soldier in the Army of the United States, for the term of THREE YEARS, Do Declare, That I am Twenty five years and \_\_\_\_\_ months of age; that I have never been discharged from the United States service on account of disability or by sentence of a court martial, or by order before the expiration of a term of enlistment; and I know of no impediment to my serving honestly and faithfully as a soldier for three years.

GIVEN at Fort Scott Kansas the 30 day of October 1864

Witness:

Noah C. Phanson,

Wm J Davis  
recr

No. 255

Wm J Davis

Volunteered at Fort Scott Ks

October 3d 1864,

By W J Phanson, 3rd Lt & Co. Sgt

1st Bn, Regiment of U.S. Cavalry, 5th

enlistment; last served in Company ( )

Reg't of \_\_\_\_\_

Discharged \_\_\_\_\_ 18 \_\_\_\_\_

CONSENT IN CASE OF MINOR.

I, \_\_\_\_\_ Do CERTIFY, That I am the \_\_\_\_\_ of \_\_\_\_\_; that the said \_\_\_\_\_ is \_\_\_\_\_ years of age; and I do hereby freely give my CONSENT to his volunteering as a SOLDIER in the ARMY OF THE UNITED STATES for the period of THREE YEARS.

GIVEN at \_\_\_\_\_ the \_\_\_\_\_ day of \_\_\_\_\_

Witness: \_\_\_\_\_



VOLUNTEER ENLISTMENT.

STATE OF

*Kansas*



TOWN OF

*Thor Scott*

I, *William J. Davies* born in *Dripping Co*  
in the State of *Kansas* aged *Twenty five* years,

and by occupation a *Writer* Do HEREBY ACKNOWLEDGE to have  
volunteered this *third* day of *October* 186*4*

to serve as a **Soldier** in the **Army of the United States of America**, for  
the period of **THREE YEARS**, unless sooner discharged by proper authority:  
Do also agree to accept such bounty, pay, rations, and clothing, as are, or may be,  
established by law for volunteers. And I, *William J. Davies* do  
solemnly swear, that I will bear true faith and allegiance to the **United States**  
**of America**, and that I will serve them honestly and faithfully against all  
their enemies or opposers whomsoever; and that I will observe and obey the  
orders of the President of the United States, and the orders of the officers  
appointed over me, according to the Rules and Articles of War.

Sworn and subscribed to, at *Thor Scott*  
this *3d* day of *October* 186*4*  
BEFORE *Wm. S. Matthew*

I CERTIFY, ON HONOR, That I have carefully examined the above-named Volunteer, agreeably  
to the General Regulations of the Army, and that, in my opinion, he is free from all bodily defects and  
mental infirmity, which would in any way disqualify him from performing the duties of a soldier.

*Tiffin Sinks*  
*Surg. Bd of Enrollment*  
*Sp. Dir. Dist Kansas* EXAMINING SURGEON.

I CERTIFY, ON HONOR, That I have minutely inspected the Volunteer, *William J. Davies*  
previously to his enlistment, and that he was entirely sober when enlisted; that, to the best of my  
judgment and belief, he is of lawful age; and that, in accepting him as duly qualified to perform the  
duties of an able-bodied soldier, I have strictly observed the Regulations which govern the recruiting  
service. This soldier has *Blue* eyes, *Light* hair, *Medulla* complexion, is *Five*  
feet *Seven 1/2* inches high.

*Wm. S. Matthew*  
*2d Lt. In 1st Batty Regiment of U.S. Cav. Army* Volunteers, *Light*  
RECRUITING OFFICER.

*200 dollars advance bounty from the County funds*  
*and circular No. 2 of form*  
*of the Adjutant General's Office*

Mustered into the service of the United States, for three years or during the war, from date of enlistment, in *Company*  
*of 1st* *Regiment of* *Artillery* *Light* *Volunteers*, on the *19* day of *November*, 186*4* at *Sumner*  
*Sp. Dir. Dist Kansas*  
*Sp. Dir. Dist Kansas*

NOTE 1.—This blank will be used for both enlistments and re-enlistments—enlistment of veterans, &c., &c., in the volunteer service. They will be made out in duplicate in all cases—one to accompany the recruiting return of the superintendent (not the recruiting officer) to the Adjutant General, and one to accompany the accounts of the officer who pays bounty, &c. The Regiment and Company in which the soldier last served should be given on the back.

NOTE 2.—An enlistment holds to service. A muster-in must, in all cases, precede payment of pay, bounty, pension, &c. A muster-in roll must, in all cases, be filed in the Adjutant General's Office as evidence of muster-in. The mustering officer, commissary, or assistant commissary of musters, as the case may be, will countersign both enlistments as having mustered the soldier into the service of the United States before either of them is given to the disbursing officer.

DECLARATION OF RECRUIT.

I, William J. Davis desiring to VOLUNTEER as a Soldier in the Army of the United States, for the term of THREE YEARS, Do Declare, That I am Twenty Five years and \_\_\_\_\_ months of age; that I have never been discharged from the United States service on account of disability or by sentence of a court martial, or by order before the expiration of a term of enlistment; and I know of no impediment to my serving honestly and faithfully as a soldier for three years.

GIVEN at Fort Scott - Kansas the 3d day of October 1864

Witness: Noah C. Hanson Wm. J. Daniels

No. \_\_\_\_\_

Wm. J. Davis

Volunteered at Fort Scott Kan.

October 3d 1864,

By Wm. J. Matthews, 2d Lt. & Recy.

1st Batta. Regiment of U. S. Cav. Army Light

\_\_\_\_\_ enlistment; last served in Company ( )

\_\_\_\_\_ Regt of \_\_\_\_\_

Discharged \_\_\_\_\_ 18 \_\_\_\_\_

15

CONSENT IN CASE OF MINOR.

I, \_\_\_\_\_ Do CERTIFY, That I am the \_\_\_\_\_ of \_\_\_\_\_; that the said \_\_\_\_\_ is \_\_\_\_\_ years of age; and I do hereby freely give my CONSENT to his volunteering as a SOLDIER in the ARMY OF THE UNITED STATES for the period of THREE YEARS.

GIVEN at \_\_\_\_\_ the \_\_\_\_\_ day of \_\_\_\_\_

Witness: \_\_\_\_\_

VOLUNTEER ENLISTMENT.

STATE OF

*Kansas*



TOWN OF

*Fort Scott*

I, *William J. Davies* born in *Doniphan Co*  
 in the State of *Kansas* aged *Twenty five* years,  
 and by occupation a *Waiter* Do HEREBY ACKNOWLEDGE to have  
 volunteered this *third* day of *October* 186*4*,  
 to serve as a **Soldier** in the **Army of the United States of America**, for  
 the period of **THREE YEARS**, unless sooner discharged by proper authority:  
 Do also agree to accept such bounty, pay, rations, and clothing, as are, or may be,  
 established by law for volunteers. And I, *William J. Davies* do  
 solemnly swear, that I will bear true faith and allegiance to the **United States**  
**of America**, and that I will serve them honestly and faithfully against all  
 their enemies or opposers whomsoever; and that I will observe and obey the  
 orders of the President of the United States, and the orders of the officers  
 appointed over me, according to the Rules and Articles of War.

Sworn and subscribed to, at *Fort Scott, Kas*  
 this *3d* day of *October* 186*4*,  
 BEFORE *Wm J. Matthews* } *Wm J. Davies*  
*notary*

*2d Lieut. Recruiting, 2d Regt, U.S. Cav. Army, Light*

I CERTIFY, ON HONOR, That I have carefully examined the above-named Volunteer, agreeably  
 to the General Regulations of the Army, and that, in my opinion, he is free from all bodily defects and  
 mental infirmity, which would in any way disqualify him from performing the duties of a soldier.

*Tiffin Sinks*  
*Surg. 3d of Cavalry*  
*Am. Cav. Regt. Kas* EXAMINING SURGEON.

I CERTIFY, ON HONOR, That I have minutely inspected the Volunteer, *William J. Davies*  
 previously to his enlistment, and that he was entirely sober when enlisted; that, to the best of my  
 judgment and belief, he is of lawful age; and that, in accepting him as duly-qualified to perform the  
 duties of an able-bodied soldier, I have strictly observed the Regulations which govern the recruiting  
 service. This soldier has *Blue* eyes, *Light* hair, *Rubato* complexion, is *five*  
 feet *seven* inches high.

*Wm J. Matthews*  
*2d Lieut. Recruiting, 2d Regt, U.S. Cav. Army, Light*  
 RECRUITING OFFICER.

Mustered into the service of the United States, for three years or during the war, from date of enlistment, in ~~Company~~ *Co. A*,  
*2d Regt, U.S. Cav. Army, Light* Regiment of *Orly Light* Volunteers, on the *29* day of *November*, 186*4* at *Fort Scott, Kas*  
*Wm J. Matthews*  
*notary*  
*Wm J. Davies*  
*notary*

*Jan. 1862*

Adpt. Batt'y U.S. Col'd L. Art'y.

*Private*      *Private*

CARD NUMBERS.

6 2 3 3 7 6 2	26
6 2 3 3 9 1 0	27
6 2 3 4 0 7 5	28
6 2 3 4 2 1 7	29
6 2 3 4 3 8 4	30
6 2 3 4 5 4 6	31
9 1 3 2 9 4 3	32
	33
	34
	35
	36
	37
	38
	39
	40
	41
	42
	43
	44
	45
	46
	47
	48
	49
	50

Book Mark: \_\_\_\_\_

See also \_\_\_\_\_

*D* | Indpt. Batt'y. | **U.S.C.T.**

*Tippacawo Dean*

....., Indpt. Batt'y, U. S. Col'd L. Art'y.

Appears on

**Battery Descriptive Book**

of the organization named above.

**DESCRIPTION.**

Age *21* years; height *5* feet *7* inches.

Complexion *Black*

Eyes *Black*; hair *Black*

Where born *Platte Co Mo.*

Occupation *Labourer*

**ENLISTMENT.**

When *July 27*, 186*4*.

Where *Bar north Pls.*

By whom *L. Minor*; term *3* y'rs.

Remarks:

.....  
 .....  
 .....  
 .....  
 .....  
 .....  
 .....  
 .....  
 .....

*Shalbrook*

*D*

Indpt. Battery. U.S.C.T.

*Appacone Dean*

*64*, Indpt. Battery, U. S. Col'd L. Art'y.

Appears on

**Battery Muster-in and Descriptive Roll**

of the organization named above. Roll dated

*Levernworth Co. D. C. S. B.*, 186 *4*.

Where born *Platte Co. Mo.*

Age *21* y'rs; occupation *Laborer*

When enlisted *July 27*, 186 *4*.

Where enlisted *Levernworth Co*

For what period enlisted *3* years.

Eyes *Blk*; hair *Blk*

Complexion *Brn*; height *5* ft. *7* in.

When mustered in *July 28*, 186 *4*.

Where mustered in *Levernworth Co*

Bounty paid \$ *100* <sup>*00*</sup>/<sub>*100*</sub>; due \$ *200* <sup>*00*</sup>/<sub>*100*</sub>

Where credited

Battery to which assigned

Remarks: *C. H. Dist Co*  
*20<sup>th</sup> I. S. 2<sup>nd</sup> Ward*  
*Levernworth Co*

Book mark ;

*J. H. Schley*

(856g)

Copyist.

D

Indpt. Battery.

U.S.C.T.

*Lippincott Dean*

*At*, Indpt. Battery, U. S. Col'd L. Art'y.

Appears on

**Battery Muster Roll**

for *February to Dec 31, 1864*

Present or absent *Present*

Stoppage, \$ 100 for

Due Gov't, \$ 100 for

Valuation of horse, \$ 100

Valuation of horse equipments, \$ 100

Remarks:

Book mark:

*J. H. Schreyer*

(358)

Copyist.

*D*

Indpt. Battery. | **U.S.C.T.**

*Tippencanoe Dean*  
*Gar*

, Indpt. Battery, U. S. Col'd L. Art'y.

Appears on

**Battery Muster Roll**

for *Jan & Feb*, 186<sup>5</sup>.

Present or absent *Present*

Stoppage, \$ 100 for

Due Gov't, \$ 100 for

Valuation of horse, \$ 100

Valuation of horse equipments, \$ 100

Remarks:  
.....  
.....  
.....  
.....  
.....  
.....  
.....

Book mark: .....

*J. Schrey*  
(358) Copyist.



*D*

Indpt. Battery.

**U.S.C.T.**

*Tijacum Dean,*

*R*, Indpt. Battery, U. S. Col'd L. Art'y.

Appears on

**Battery Muster Roll**

for *May & Apl*, 186 *5*.

Present or absent *Present*

Stoppage, \$ \_\_\_\_\_ <sup>100</sup> for \_\_\_\_\_

Due Gov't, \$ \_\_\_\_\_ <sup>100</sup> for \_\_\_\_\_

Valuation of horse, \$ \_\_\_\_\_ <sup>100</sup>

Valuation of horse equipments, \$ \_\_\_\_\_ <sup>100</sup>

Remarks: \_\_\_\_\_  
\_\_\_\_\_  
\_\_\_\_\_  
\_\_\_\_\_  
\_\_\_\_\_  
\_\_\_\_\_  
\_\_\_\_\_  
\_\_\_\_\_

Book mark: \_\_\_\_\_

*Porter*

Copyist.

D | Indpt. Battery. | **U.S.C.T.**

*Tipton Dean,*  
*D*, Indpt. Battery, U. S. Col'd L. Art'y.

Appears on

**Battery Muster Roll**

for *May & June*, 1865.

Present or absent *Present,*

Stoppage, \$ 100 for

Due Gov't, \$ 100 for

Valuation of horse, \$ 100

Valuation of horse equipments, \$ 100

Remarks:  
\_\_\_\_\_  
\_\_\_\_\_  
\_\_\_\_\_  
\_\_\_\_\_  
\_\_\_\_\_  
\_\_\_\_\_

Book mark: \_\_\_\_\_

*Porter*  
Copyist.

D | Indpt. Battery. | **U.S.C.T.**

*Tiptonno Dean,*

*D*, Indpt. Battery U. S. Col'd Light Art'y.

Appears on **Batt'y Muster-out Roll**, dated

*St. Lawrence Kas. July 22, 1865.*

Muster-out to date *July 22, 1865.*

Last paid to *Dec. 31, 1864.*

**Clothing account:**

Last settled....., 186 ; drawn since \$ *70*<sup>90</sup>/<sub>100</sub>,

Due soldier \$ 100; due U. S. \$ 100

Am't for cloth'g in kind or money adv'd \$ 100

Due U. S. for arms, equipments, &c., \$ 100

Bounty paid \$ *100*<sup>100</sup>/<sub>100</sub>; due \$ *None*<sup>100</sup>/<sub>100</sub>,

Remarks:.....

.....  
.....  
.....  
.....  
.....  
.....

Book mark:.....

*Partes*

Copyist.

Dear Tippenacor

....., Co. ...., Reg't *N & C. La*

*2* Enclosures.

Bed Cards .....	Final Statements .....
Burial Records .....	Furloughs or L. of A .....
Certs. of Dis. for Discharge .....	Med. Certificates .....
C. M. Charges .....	Med. Des. Lists .....
Descriptive Lists .....	Orders .....
Discharge Certificates .....	Pris. of War Record .....
Enlistment Papers .....	Resignations .....

Other papers relating to—

Admission to Hosp'l .....	Furlough or L. of A .....
Casualty Sheet .....	Med. Examination .....
Confinement .....	Misc. Information .....
Contracts .....	Pay or Clothing .....
Death or Effects .....	Personal Reports .....
Desertion .....	Rank .....
Discharge from Hosp'l .....	Transfer to Hosp'l .....
Discharge from Service .....	Transfer to V. R. C. .....
Duty .....	Transportation .....

Dear Tippenacos

....., Co. ...., Reg't N & C. La

2 Enclosures.

Bed Cards .....	Final Statements .....
Burial Records .....	Furloughs or L. of A .....
Certs. of Dis. for Discharge .....	Med. Certificates .....
C. M. Charges .....	Med. Des. Lists .....
Descriptive Lists .....	Orders .....
Discharge Certificates .....	Pris. of War Record .....
Enlistment Papers .....	Resignations .....

Other papers relating to—

Admission to Hosp'l .....	Furlough or L. of A .....
Casualty Sheet .....	Med. Examination .....
Confinement .....	Misc. Information .....
Contracts .....	Pay or Clothing .....
Death or Effects .....	Personal Reports .....
Desertion .....	Rank .....
Discharge from Hosp'l .....	Transfer to Hosp'l .....
Discharge from Service .....	Transfer to V. R. C. ....
Duty .....	Transportation .....

DECLARATION OF RECRUIT.

I, Peppercorne Deane desiring to VOLUNTEER as a Soldier in the Army of the United States, for the term of THREE YEARS Do Declare, That I am 21 years and            months of age; that I have never been discharged from the United States service on account of disability or by sentence of a court-martial, or by order before the expiration of a term of enlistment; and I know of no impediment to my serving honestly and faithfully as a soldier for three years.

GIVEN at Leavenworth City State of Kansas the 27<sup>th</sup> day of July 1864

Witness: W.A. Burdham Peppercorne Deane

NOTE 1.—This blank will be used for both enlistments and re-enlistments—enlistment of veterans, &c., &c., in the volunteer service. They will be made out in duplicate in all cases—one to accompany the recruiting return of the superintendent (not the recruiting officer) to the Adjutant General, and one to accompany the accounts of the officer who pays bounty, &c. The Regiment and Company in which the soldier last served should be given on the back.  
NOTE 2.—An enlistment holds to service. A muster-in must, in all cases, precede payment of pay, bounty, pension, &c. A muster-in roll must, in all cases, be filed in the Adjutant General's Office as evidence of muster-in. The mustering officer, commissary, or assistant commissary of musters, as the case may be, will countersign both enlistments as having mustered the soldier into the service of the United States before either of them is given to the disbursing officer.

Rec'd from 2nd. Aud. Nov. 23d 1892

enlistment; last served in Company ( )  
Reg't of             
Discharged            18           

Peppercorne Deane  
Volunteered at Leavenworth Mo  
July 27 1864  
By Wm D. Matthews Captain  
Company C. 11. 2 reg. 1st Div. 1st Army  
Regiment of           

No.           

CONSENT IN CASE OF MINOR.

I,            Do CERTIFY, That I am            years of age; and I do hereby freely give my CONSENT to his volunteering as a SOLDIER in the ARMY OF THE UNITED STATES for the period of THREE YEARS.

GIVEN at            the            day of           

Witness:

33,35-

VOLUNTEER ENLISTMENT.

STATE OF

Kansas



TOWN OF

Seventeenth Co

I, *Pippucanoe Dean* born in *Platte County*

in the State of *Missouri* aged *21* years,

and by occupation a *Soldier* Do HEREBY ACKNOWLEDGE to have

volunteered this *27* day of *July* 186*4*

to serve as a **Soldier** in the **Army of the United States of America**, for the period of **THREE YEARS** unless sooner discharged by proper authority: Do also agree to accept such bounty, pay, rations, and clothing, as are, or may be, established by law for volunteers.

And I, *Pippucanoe Dean* do solemnly swear, that I will bear true faith and allegiance to the **United States of America**, and that I will serve them honestly and faithfully against all their enemies or opposers whomsoever; and that I will observe and obey the orders of the President of the United States, and the orders of the officers appointed over me, according to the Rules and Articles of War.

Sworn and subscribed to, *Seventeenth Co* *Pippucanoe Dean*  
this *27* day of *July* 186*4* *his mark*

BEFORE *D. B. Minor* *2nd Lieut.*  
*Recruiting Co. K. 2nd U.S. Col. Artillery*

I CERTIFY, ON HONOR, That I have carefully examined the above-named Volunteer, agreeably to the General Regulations of the Army, and that, in my opinion, he is free from all bodily defects and mental infirmity, which would in any way disqualify him from performing the duties of a soldier.

*Jiffie Sinks*  
*Surg Board of Enrollment*  
*North West Dist Kansas*  
EXAMINING SURGEON.

I CERTIFY, ON HONOR, That I have minutely inspected the Volunteer *Pippucanoe Dean* previously to his enlistment, and that he was entirely sober when enlisted; that, to the best of my judgment and belief, he is of lawful age; and that, in accepting him as duly qualified to perform the duties of an able-bodied soldier, I have strictly observed the Regulations which govern the recruiting service. This soldier has *Black* eyes, *Black* hair, *Black* complexion, is *5* feet *10* inches high.

*D. B. Minor* *2nd Lieut.*  
*Recruiting Co. K. 2nd U.S. Col. Artillery*  
Volunteers,  
RECRUITING OFFICER.

(A. G. O. No. 74 & 75.)

*This recruit received one hundred dollars ad. from the County fund, under the act of the Legislature of Mo. 1862, from the County of Platte, Mo. 1864.*

Mustered into the service of the United States, in *Company* *Seventeenth Co* *2nd Regt. Kansas* *Volunteers*, on the *27th* day of *July* 186*4*, at *Seventeenth Co* *2nd Regt. Kansas*

NOTE 1.—This blank will be used for both enlistments and re-enlistments—enlistment of veterans, &c., &c., in the volunteer service. They will be made out in duplicate in all cases—one to accompany the recruiting return of the superintendent (not the recruiting officer) to the Adjutant General, and one to accompany the accounts of the officer who pays bounty, &c. The Regiment and Company in which the soldier last served should be given on the back.  
NOTE 2.—An enlistment holds to service. A muster-in must, in all cases, precede payment of pay, bounty, pension, &c. A muster-in roll must, in all cases, be filed in the Adjutant General's Office as evidence of muster-in. The mustering officer, commissary, or assistant commissary of musters, as the case may be, will countersign both enlistments as having mustered the soldier into the service of the United States before either of them is given to the disbursing officer.

DECLARATION OF RECRUIT.

I, J. Pippucanoe Dean desiring to VOLUNTEER as a Soldier in the Army of the United States, for the term of THREE YEARS Do Declare, That I am 21 years and — months of age; that I have never been discharged from the United States service on account of disability or by sentence of a court-martial, or by order before the expiration of a term of enlistment; and I know of no impediment to my serving honestly and faithfully as a soldier for three years.

GIVEN at Leavenworth City - State of Kansas the 27 day of July 1864

Witness: W. A. Burnham J. Pippucanoe Dean  
Chap

No. 24

Discharged ..... 18 ..  
..... Reg't of .....  
..... enlistment; last served in Company ( )

J. Pippucanoe Dean  
Volunteered at Leavenworth Mo  
July 27 1864.  
By Wm. D. Matthews & Wm. D. Matthews  
Commissary & Asst. Comm. U. S. Corp. & Cavalry  
Regiment of .....

CONSENT IN CASE OF MINOR.

I, ..... Do CERTIFY, That I am the ..... of .....; that the said ..... is ..... years of age; and I do hereby freely give my CONSENT to his volunteering as a SOLDIER in the ARMY OF THE UNITED STATES for the period of THREE YEARS.

GIVEN at ..... the ..... day of .....

Witness: .....



VOLUNTEER ENLISTMENT.

STATE OF

*Kansas*



TOWN OF

*Leavenworth City*

I, *Tippucanoe Dean*

born in

*Platte Co*

in the State of

*Missouri*

aged

*21*

years,

and by occupation a

*Laborer*

DO HEREBY ACKNOWLEDGE to have

volunteered this

*27*

day of

*July*

1864,

to serve as a **Soldier** in the **Army of the United States of America**, for the period of **THREE YEARS** unless sooner discharged by proper authority: Do also

agree to accept such bounty, pay, rations, and clothing, as are, or may be, established by law for volunteers. And I, *Tippucanoe Dean* do

solemnly swear, that I will bear true faith and allegiance to the **United States of America**, and that I will serve them honestly and faithfully against all their

enemies or opposers whomsoever; and that I will observe and obey the orders of the President of the United States, and the orders of the officers appointed over

me, according to the Rules and Articles of War.

Sworn and subscribed to, at

*Leavenworth City*

this

*27*

day of

*July*

1864,

BEFORE

*J. H. Minor*

*2nd Lieut. Recruiting Co. K. 2nd U.S. Col. Artillery*

*his*  
*Tippucanoe Dean*  
*mark*

I CERTIFY, ON HONOR, That I have carefully examined the above-named Volunteer, agreeably to the General Regulations of the Army, and that, in my opinion, he is free from all bodily defects and mental infirmity, which would in any way disqualify him from performing the duties of a soldier.

*Jiffie Sinks*  
*Surgeon Board of Enrollment*  
*North Star Kansas*  
EXAMINING SURGEON.

I CERTIFY, ON HONOR, That I have minutely inspected the Volunteer, *Tippucanoe Dean* previously to his enlistment, and that he was entirely sober when enlisted; that, to the best of my judgment and belief, he is of lawful age; and that, in accepting him as duly qualified to perform the duties of an able-bodied soldier, I have strictly observed the Regulations which govern the recruiting service.

This soldier has *Black* eyes, *Black* hair, *Black* complexion, is *5* feet *7* inches high.

*J. H. Minor*  
*2nd Lieut. Recruiting Co. K. 2nd U.S. Col. Artillery*  
Regiment of *Volunteers*

RECRUITING OFFICER.

the ..... day of ..... 186 , at ..... Mustered into the service of the United States, in Company ..... Regiment of ..... Volunteers, on

*Douglas Harrison*

Adpt. Batt'y U.S. Col'd L. Art'y.

*Private Private*

CARD NUMBERS.

6 2 3 3 6 6 4	26
6 2 3 4 2 1 9	27
6 2 3 4 3 8 6	28
6 2 3 4 5 4 8	29
9 1 3 3 0 6 0	30
9 1 3 3 0 6 8	31
	32
	33
	34
	35
	36
	37
	38
	39
	40
	41
	42
	43
	44
	45
	46
	47
	48
	49
	50

Book Mark:

See also

*D* | Indpt. Batt'y. | **U.S.C.T.**

*Harrison Douglas*

....., Indpt. Batt'y, U. S. Col'd L. Art'y.

Appears on

**Battery Descriptive Book**

of the organization named above.

**DESCRIPTION.**

Age *18* years; height *5* feet *4* inches.

Complexion *Yellow*

Eyes *Black*; hair *Black*

Where born *Missouri*

Occupation *Saddler*

**ENLISTMENT.**

When *Feb 25*, 186*5*.

Where *Franklin D.C.*

By whom *A. Miller*; term *3* y'rs.

Remarks: .....

*x Entry Cancelled*

*Hallbrook*

*L* | Indpt. Batt'y. | **U.S.C.T.**

*Harrison Douglas*

....., Indpt. Batt'y, U. S. Col'd L. Art'y.

Appears on

**Battery Descriptive Book**  
of the organization named above.

**DESCRIPTION.**

Age *18* years; height *5* feet *4* inches.

Complexion *Yellow*

Eyes *Black*; hair *Black*

Where born *Missouri*

Occupation *Saddler*

**ENLISTMENT.**

When *Feb 25*, 186*5*.

Where *Parish K's.*

By whom *D. Munn*; term *3* y'rs.

Remarks: .....

.....  
.....  
.....  
.....  
.....  
.....  
.....  
.....  
.....  
.....

*Shelbrook*

D | Indpt. Battery. | U.S.C.T.

*Harrison Douglass*

Appears with rank of *Priv* on

**Muster and Descriptive Roll of a Detachment of U. S. Vols. forwarded**

for the Indpt. Batt'y, U. S. Col'd L. Arty. Roll dated

*Leavenworth, Kas, Feb. 25, 1865.*

Where born *Missouri*

Age *18* y'rs; occupation *Saddler*

When enlisted *Feb 25*, 1865.

Where enlisted *Leavorth, Kas*

For what period enlisted *3* years.

Eyes *black*; hair *black*

Complexion *yellow*; height *5* ft. *4* in.

When mustered in *Feb 25*, 1865.

Where mustered in *Leavorth, Kas*

Bounty paid \$ *100* 100; due \$ *200* 100

Where credited

Battery to which assigned

Remarks: *Credited to Northern dist. Kas. 25 Sub. dist. 4" Ward Leavenworth City. Vol. Re-Enit & entitled to Bounty.*

Book mark:

*E. L. Tharnton*

D | Indpt. Battery. | U.S.C.T.

Harrison Douglas,  
Pr, Indpt. Battery, U. S. Col'd L. Art'y.

Appears on

**Battery Muster Roll**

for Mar & Apr, 1865.

Present or absent Present,

Stoppage, \$ 100 for

Due Gov't, \$ 100 for

Valuation of horse, \$ 100

Valuation of horse equipments, \$ 100

Remarks:

Book mark:

Porter

D | Indpt. Battery. | U.S.C.T.

*Harrison Douglas*

*Pr*, Indpt. Battery, U. S. Col'd L. Art'y.

Appears on

**Battery Muster Roll**

for *May & June*, 1865.

Present or absent *Present*,

Stoppage, \$ 100 for

Due Gov't, \$ 100 for

Valuation of horse, \$ 100

Valuation of horse equipments, \$ 100

Remarks:

Book mark:

*Porter*

(358)

Copyist.

*D* | Indpt. Battery. | **U.S.C.T.**

*Harrison Douglas,*

*H*, Indpt. Battery U. S. Col'd Light Art'y.

Appears on **Batt'y Muster-out Roll**, dated

*M. Sevinenth Co., July 22, 1865.*

Muster-out to date *July 22, 1865.*

Last paid to *Pay due from Enlistment* 186 .

Clothing account:

Last settled . . . . ., 186 ; drawn since \$ *67*<sup>*72*</sup>/<sub>100</sub>,

Due soldier \$ . . . . .<sup>100</sup>; due U. S. \$ . . . . .<sup>100</sup>

Am't for cloth'g in kind or money adv'd \$ . . . . .<sup>100</sup>

Due U. S. for arms, equipments, &c., \$ . . . . .<sup>100</sup>

Bounty paid \$ *100* <sup>100</sup>; due \$ *None* <sup>100</sup>,

Remarks: . . . . .  
. . . . .  
. . . . .  
. . . . .  
. . . . .  
. . . . .

Book mark: . . . . .

*Porter*

Copyist.



*Douglas Harrison*

, Co. *1st* *Batt.* *U.S.C.A.*  
*Reg't*

**Enclosures.**

Bed Cards .....	Final Statements .....
Burial Records .....	Furloughs or L. of A. ....
Certs. of Dis. for Discharge .....	Med. Certificates .....
C. M. Charges .....	Med. Des. Lists .....
Descriptive Lists .....	Orders .....
Discharge Certificates .....	Pris. of War Record .....
Enlistment Papers <i>7</i> .....	Resignations .....

Other papers relating to—

Admission to Hosp'l .....	Furlough or L. of A. ....
Casualty Sheet .....	Med. Examination .....
Confinement .....	Misc. Information .....
Contracts .....	Pay or Clothing .....
Death or Effects .....	Personal Reports .....
Desertion .....	Rank .....
Discharge from Hosp'l .....	Transfer to Hosp'l .....
Discharge from Service .....	Transfer to V. R. C. ....
Duty .....	Transportation .....
.....	.....

NOTE 1.—This blank will be used for both enlistments—enlistment of veterans, &c., &c., in the volunteer service. They will be made out in duplicate in all cases—one to accompany the recruiting return of the superintendent (recruiting officer) to the Adjutant General, and one to accompany the accounts of the officer who pays bounty, &c. The Regiment and Company in which the soldier last served should be written on the back

NOTE 2.—An enlistment holds to service. A muster-in must, in all cases, precede payment of pay, bounty, pension, &c. A muster-in roll must, in all cases, be filed in the Adjutant General's Office as evidence of muster-in. The mustering officer, commissary, or assistant commissary of musters, as the case may be, will countersign both enlistments as having mustered the soldier into the service of the United States before either of them is given to the disbursing officer.

DECLARATION OF RECRUIT.

I, Harrison Douglass, desiring to VOLUNTEER as a Soldier in the Army of the United States, for the term of THREE YEARS, Do Declare, That I am eighteen 18 years and \_\_\_\_\_ months of age; that I have never been discharged from the United States service on account of disability or by sentence of a court martial, or by order before the expiration of a term of enlistment; and I know of no impediment to my serving honestly and faithfully as a soldier for three years.

GIVEN at Leicesterworth Kans the 25 day of February 1865

Witness: D. L. Cook Harrison Douglass mark

Discharged \_\_\_\_\_, 18 \_\_\_\_\_

Reg't of \_\_\_\_\_

enlistment; last served in Company ( ) \_\_\_\_\_

No. 7  
Harrison Douglass  
Volunteered at Leicesterworth Kansas  
February 25, 1865  
By Robert M. Olsham  
Adjutant General's Office  
Leicesterworth Kansas

CONSENT IN CASE OF MINOR.

I, \_\_\_\_\_, Do CERTIFY, That I am \_\_\_\_\_; that the \_\_\_\_\_ of \_\_\_\_\_; that the said \_\_\_\_\_ is \_\_\_\_\_ years of age; and I do hereby freely give my CONSENT to his volunteering as a SOLDIER in the ARMY OF THE UNITED STATES for the period of THREE YEARS.

GIVEN at \_\_\_\_\_ the \_\_\_\_\_ day of \_\_\_\_\_

Witness: \_\_\_\_\_

*One permit has received One hundred dollars advance bounty of the three hundred dollars bounty authorized by an act of Congress approved July 4<sup>th</sup> 1864, and awarded to me by the Provost Marshal General dated July 10<sup>th</sup> 1864.*

*recruited to Northern Dist. Kansas. 22<sup>d</sup> Sub Dist 4<sup>th</sup> Ward Leavenworth City*

VOLUNTEER ENLISTMENT.

STATE OF



TOWN OF

*Kansas*

*Leavenworth*

I, *Harrison Douglass*, born in \_\_\_\_\_  
in the State of *Missouri*, aged *18* years,  
and by occupation a *Saddler*. Do HEREBY ACKNOWLEDGE to have  
volunteered this *Twenty-fifth (25)* day of *February*, 1865,  
to serve as a **Soldier** in the **Army of the United States of America**, for  
the period of **THREE YEARS**, unless sooner discharged by proper authority:  
Do also agree to accept such bounty, pay, rations, and clothing, as are, or may be,  
established by law for volunteers. And I, *Harrison Douglass*, do  
solemnly swear, that I will bear true faith and allegiance to the **United States  
of America**, and that I will serve them honestly and faithfully against all  
their enemies or opposers whomsoever; and that I will observe and obey the  
orders of the President of the United States, and the orders of the officers  
appointed over me, according to the Rules and Articles of War.

Sworn and subscribed to, at *Leavenworth*  
this *25* day of *February*, 1865, } *Harrison Douglass*  
BEFORE *P. H. Minor 2<sup>d</sup> Lieut* } *mark*  
*and Baty U.S. Col. & City Light*

I CERTIFY, ON HONOR, That I have carefully examined the above-named Volunteer, agreeably  
to the General Regulations of the Army, and that, in my opinion, he is free from all bodily defects and  
mental infirmity, which would in any way disqualify him from performing the duties of a soldier.

*Wiffie Binks*  
*Surgeon Genl of enrollment*  
*Northern Dist Kansas*  
EXAMINING SURGEON.

I CERTIFY, ON HONOR, That I have minutely inspected the Volunteer *Harrison Douglass*  
previously to his enlistment, and that he was entirely sober when enlisted; that, to the best of my  
judgment and belief, he is of lawful age; and that, in accepting him as duly qualified to perform the  
duties of an able-bodied soldier, I have strictly observed the Regulations which govern the recruiting  
service. This soldier has *Black* eyes, *Black* hair, *Yellow* complexion, is *5*  
feet *4* inches high.

*P. H. Minor 2<sup>d</sup> Lieut*  
*and Baty U.S. Col. & City Light*  
RECRUITING OFFICER.

(G. O. No. 74 & 76.)

*Volunteers, on the 25<sup>th</sup> day of February, 1865, at Leavenworth Mo*

*Independent B. & F. Co.*  
*Robert C. Johnson*  
*Robert C. Johnson*  
*Robert C. Johnson*

DECLARATION OF RECRUIT.

I, Harrison Douglas, desiring to VOLUNTEER as a Soldier in the Army of the United States, for the term of THREE YEARS, Do Declare, That I am eighteen (18) years and \_\_\_\_\_ months of age; that I have never been discharged from the United States service on account of disability or by sentence of a court martial, or by order before the expiration of a term of enlistment; and I know of no impediment to my serving honestly and faithfully as a soldier for three years.

GIVEN at Leavenworth City, Kansas the 25 day of February 1865

Witness: L. D. Cook Harrison Douglas mark

NOTE 1.—This blank will be used for both enlistments and re-enlistments—enlistment of veterans, &c., &c., in the volunteer service. They will be made out in duplicate in all cases—one to accompany the recruiting return of the superintendent (not the recruiting officer) to the Adjutant General, and one to accompany the accounts of the officer who pays bounty, &c. The Regiment and Company in which the soldier last served should be given on the back

NOTE 2.—An enlistment holds to service. A muster-in must, in all cases, precede payment of pay, bounty, pension, &c. A muster-in roll must, in all cases, be filed in the Adjutant General's Office as evidence of muster-in. The mustering officer, commissary, or assistant commissary of musters, as the case may be, will countersign both enlistments as having mustered the soldier into the service of the United States before either of them is given to the disbursing officer.

Company B Battery 3

No. Harrison Douglas

Volunteered at Leavenworth Kas

February 25<sup>th</sup> 1865

By Robert M. C. Abner for Adjutant General's Office U.S. Col. 1st Regt. 1865

enlistment; last served in Company ( )

Regt of

Discharged ..... 18

CONSENT IN CASE OF MINOR.

I, \_\_\_\_\_, Do CERTIFY, That I am \_\_\_\_\_; that the \_\_\_\_\_ of \_\_\_\_\_; that the \_\_\_\_\_ is \_\_\_\_\_ years of age; and I do hereby freely give my CONSENT to his volunteering as a SOLDIER in the ARMY OF THE UNITED STATES for the period of THREE YEARS.

GIVEN at \_\_\_\_\_ the \_\_\_\_\_ day of \_\_\_\_\_

Witness: \_\_\_\_\_

(A. G. O. No. 74 & 76.)

credited to Northern Dist. Kansas 22<sup>d</sup> Sub Dist. 4<sup>th</sup> Ward Leavenworth City 10

H. H. Wood

VOLUNTEER ENLISTMENT.

STATE OF

TOWN OF

Kansas



Leavenworth

I, Marrison Douglass, born in \_\_\_\_\_ in the State of Missouri, aged 18 years, and by occupation a Saddler, Do HEREBY ACKNOWLEDGE to have volunteered this Twenty fifth (25) day of February, 1865, to serve as a **Soldier** in the **Army of the United States of America**, for the period of **THREE YEARS**, unless sooner discharged by proper authority: Do also agree to accept such bounty, pay, rations, and clothing, as are, or may be, established by law for volunteers. And I, Marrison Douglass, do solemnly swear, that I will bear true faith and allegiance to the **United States of America**, and that I will serve them honestly and faithfully against all their enemies or opposers whomsoever; and that I will observe and obey the orders of the President of the United States, and the orders of the officers appointed over me, according to the Rules and Articles of War.

Sworn and subscribed to, at Leavenworth this 25 day of February, 1865, } Marrison Douglass his mark  
BEFORE P. H. Miller 2<sup>d</sup> Lieut  
And Battery U.S. Col. 4<sup>th</sup> Light

I CERTIFY, ON HONOR, That I have carefully examined the above-named Volunteer, agreeably to the General Regulations of the Army, and that, in my opinion, he is free from all bodily defects and mental infirmity, which would in any way disqualify him from performing the duties of a soldier.

Tiffie Binko  
Surgeon Genl of Enrollment  
Northern Dist Kansas  
EXAMINING SURGEON.

I CERTIFY, ON HONOR, That I have minutely inspected the Volunteer Marrison Douglass previously to his enlistment, and that he was entirely sober when enlisted; that, to the best of my judgment and belief, he is of lawful age; and that, in accepting him as duly qualified to perform the duties of an able-bodied soldier, I have strictly observed the Regulations which govern the recruiting service. This soldier has Black eyes, Black hair, yellow complexion, is 5 feet 4 inches high.

P. H. Miller 2<sup>d</sup> Lieut  
And Battery U.S. Col. 4<sup>th</sup> Light (Lieut)  
RECRUITING OFFICER.

(A. G. O. No. 74 & 76.)

U.S. Cavalry Battery - Light  
Mustered into the service of the United States, for three years or during the war, from date of enlistment, in ~~Company~~ Independent Battery  
Volunteers, on the 25<sup>th</sup> day of February, 1865, at Leavenworth

James Marshall  
Robert Thomas

*Mr. Captain*

CARD NUMBERS.

22
369
3874
4026
4166
4333
4497

- 26
- 27
- 28
- 29
- 30
- 31
- 32
- 33
- 34
- 35
- 36
- 37
- 38
- 39
- 40
- 41
- 42
- 43
- 44
- 45
- 46
- 47
- 48
- 49
- 50

S787538 P6 m + m det -

R + P 400 250 Rev

D-76-C.T.-1865

MS Spencer  
9

*D*

Indpt. Battery.

U.S.C.T.

*Hazekiah Ford Douglas*  
*Capt*, Indpt. Battery, U. S. Col'd L. Art'y.

Appears on

**Battery Muster-in and Descriptive Roll**

of the organization named above. Roll dated

*Lebanonworth Va, Dec 23, 1864*

Where born *Virginia*

Age *33* y'rs; occupation *Preacher*

When enlisted \_\_\_\_\_, 186 .

Where enlisted \_\_\_\_\_

For what period enlisted *3* years.

Eyes *Brn*; hair *Blk*

Complexion *Light*; height *5* ft. *11* in.

When mustered in \_\_\_\_\_, 186 .

Where mustered in \_\_\_\_\_

Bounty paid \$ *100*; due \$ *100*

Where credited \_\_\_\_\_

Battery to which assigned \_\_\_\_\_

Remarks: *Recommended by*  
*Major Genl Curtis*  
*Ordng Dept of War*  
*for appoint. as Captain*

Book mark ; \_\_\_\_\_

*J. H. Chesley*  
 (856g) Copyist.



*D* | *Indept Batty* | **U.S.C.T.**

*H. Ford Douglass*  
*Capt., Co. Indept Batty, 1st U. S. Col'd Artz.*

Age *34* years.

Appears on a

**Detachment Muster-in Roll**

of the organization named above. Roll dated

*Ft Leavenworth Ks., Feby 27, 1865.*

Muster-in to date *Feb-27, 1865.*

*Mustered into service*  
~~Joined for duty and enrolled:~~

When *Feby 27, 1865.*

Where *Ft Leavenworth Ks.*

Period *3* years.

Valuation of horse, \$ *100*

Valuation of horse equipments, \$ *100*

Remarks: *Mustered from Civil life by virtue of a Commission from Secy. of War Dated Washington D.C. Feby 16-1865. (over)*

Book mark :

*C. G. Smith*

JAN. 17

6233569

1891\*

Must be taken  
effect Feb. 27-1868.

Credited to - Kickapoo  
Leavenworth Co.

Kansas, No. of Enrollment,  
District - Northern.

D

Indpt. Battery.

U.S.C.T.

W. Ford Douglas

Capt, Indpt. Battery, U. S. Col'd L. Art'y.

Appears on

Battery Muster Roll

for List must to Dec 31, 1864

Present or absent Not stated (Sign Roll)

Stoppage, \$ 100 for

Due Gov't, \$ 100 for

Valuation of horse, \$ 100

Valuation of horse equipments, \$ 100

Remarks: Recommended by Maj Gen Curtis, Comd'g Dept of Kans. for appointment as Captain

Book mark:

J. J. Schuch

(358)

Copyist.

*D* | Indpt. Battery. | **U.S.C.T.**

*H. Ford Douglas*  
*Capt*, Indpt. Battery, U. S. Col'd L. Art'y.

Appears on

**Battery Muster Roll**

for *May & Feb*, 186<sup>5</sup>.

Present or absent *Not stated (Sigsbee Roll)*

Stoppage, \$ 100 for

Due Gov't, \$ 100 for

Valuation of horse, \$ 100

Valuation of horse equipments, \$ 100

Remarks: *On Commission dated Feb 16<sup>th</sup>, 1865. direct from the Sec. of War*

Book mark: \_\_\_\_\_

*J. H. Scherley*  
(358) Copyist.

D | Indpt. Battery. | U.S.C.T.

*N. Ford Douglas*

*Capt*, Indpt. Battery, U. S. Col'd L. Art'y.

Appears on

**Battery Muster Roll**

for *Mar + Apr*, 1865.

Present or absent *Present*.

Stoppage, \$ 100 for

Due Gov't, \$ 100 for

Valuation of horse, \$ 100

Valuation of horse equipments, \$ 100

Remarks: *Pay due from  
muster,*

Book mark: \_\_\_\_\_

*Patix*

D | Indpt. Battery. | U.S.C.T.

*A. Ford Douglas,*  
*Capt.,* Indpt. Battery, U. S. Col'd L. Art'y.

Appears on

**Battery Muster Roll**

for *May & June*, 1865.

Present or absent *Absent,*

Stoppage, \$ 100 for

Due Gov't, \$ 100 for

Valuation of horse, \$ 100

Valuation of horse equipments, \$ 100

Remarks: *An furlough since*  
*June 13/65, I.O. 200/46,*  
*Hd. Qrs, Dept, of Mo,*  
*June 13/65,*

Book mark: \_\_\_\_\_

*Parter*

D | Indpt. Battery. | **U.S.C.T.**

*A. Ford Douglas,*  
 Capt., Indpt. Battery U. S. Col'd Light Art'y.

Appears on **Batt'y Muster-out Roll**, dated  
*Ft Leavenworth, Kas, July 27 1865.*

Muster-out to date *July 27*, 1865.

Last paid to *May 31*, 1865.

Clothing account:

Last settled....., 186 ; drawn since \$..... 100

Due soldier \$..... 100; due U. S. \$..... 100

Am't for cloth'g in kind or money adv'd \$..... 100

Due U. S. for arms, equipments, &c., \$..... 100

Bounty paid \$..... 100; due \$..... 100

Remarks: *Not entitled to final settlement until he has satisfied the pay dept. of his non indebtedness to Government.*

Book mark: .....

(361)

*Paster*  
 Copyist.

Douglas, W. F.  
 Capt., Co. Inl. Batty, Regt. U.S.C.S.A.

2 Enclosures.

Bed Cards .....	Final Statements .....
Burial Records .....	Furloughs or L. of A. ....
Certs. of Dis. for Discharge .....	Med. Certificates .....
C. M. Charges .....	Med. Des. Lists .....
Descriptive Lists .....	Orders .....
Discharge Certificates .....	Pris. of War Record .....
Enlistment Papers .....	Resignations .....

Other papers relating to—

Admission to Hosp'l .....	Furlough or L. of A. /
Casualty Sheet .....	Med. Examination .....
Confinement .....	Misc. Information /
Contracts .....	Pay or Clothing .....
Death or Effects .....	Personal Reports .....
Desertion .....	Rank .....
Discharge from Hosp'l .....	Transfer to Hosp'l .....
Discharge from Service .....	Transfer to V. R. C. ....
Duty .....	Transportation .....



1671. P. 4. 13. 6. 76.  
"J" 55 Dist. Mo. Kans 1865  
to 441 of 40 E. Mc Tol 3 1565  
Fort Leavenworth Kas  
June 10<sup>th</sup> 65

Douglas Capt H. J.  
Comd. Battery  
Ind. Battery U.S. Cold St. Ariz.  
No  
Post Adjt.

Requests leave of absence  
for thirty (30) days to  
visit Chicago Ill.  
Been in service four years  
never had leave of absence  
St Matthews is serving with  
the Co

Head Quarters Post # Leavenworth  
June the 10<sup>th</sup> 65

Respectfully forwarded  
to Capt Ino Pratt aq.  
his most <sup>highly</sup> ~~highly~~  
approved. Capt Douglas's  
service <sup>will</sup> ~~can~~ be spared.  
Wm. H. Merrill  
Lieut. Quarters Post.

Ad Quarters North Co  
Post Leavenworth June 12<sup>th</sup> 65

Respy forwarded  
Wm. H. Merrill  
Adj. Genl

292

Recd Adjt. Quarters Post # Leavenworth June 12, 1865  
Wm. H. Merrill  
June 10<sup>th</sup> 1865

Fort Leavenworth June 10th 1865-

J. G. Dodge.  
 Lt Col Post Adjt

Sir

I have the honor to most respectfully  
 request of the General Commanding to grant me a leave of  
 absence for thirty  $\frac{30}{11}$  days

I wish to go to my home in Chicago Illinois to settle some  
 business that requires my attention I have been in the service  
 now going on four years either as a Private or an Officer  
 and have never had a furlough

Lieut William D. Northens is serving with the company to  
 which I belong and my services can easily be spared for  
 the period desired

I am very respectfully

Your Obedt Servant

Wm A. H. [Signature]  
 Capt Commanding Battery

Wm Ford Douglas

Collected  
No. Ford Douglas  
And Asst Comd of Batt

Nov. 1905. This paper was originally a part of a book of Stubs of Requisitions for Transportation. The book was formerly filed in the Archives Division, M. S. O. with the records of the Supt. Vol. Rec. Service of Mo.

I, Wm Ford Douglas, late Captain of Company And Asst Regiment of Batt Col & Vole do hereby depose and say

That I was commissioned as Captain and mustered into the service of the United States as such, on the 27th day of Feb, 1865, and was mustered out of said service on the 22d day of July, 1865, then holding the rank of Captain in the And Asst Regiment of Batt Col & Vole.

That I never served in any other organization than the above mentioned. That during my term of service I have, to the best of my ability, duly rendered complete and correct Returns of all Clothing, Carriage and Prison Equipage, Ordnance and Ordnance Stores, Commissary Stores, and all other Public Property for which I ever Received, or became in any manner responsible, whether said Government Property was captured from the enemy, duly Invoiced to me, or came informally into my possession: and that I am not in arrears or indebted to the United States on any account whatsoever.

Wm Ford Douglas

Wm M. M. M.  
Sworn and subscribed to before me this 1st day of November 1865 at Fort Leavenworth Mo. no Civil Magistrate being available at this Post.  
Captain 13th Missouri Cav.,  
And Asst. Com. of Masters.

This copy of this paper was formerly filed in the Archives of the Chief Muster Office, Missouri, in the Archives of the M. S. O.

1900. This page was originally a part of a book of records and for some reason the book was formerly in the archives Division, U. S. Army, at the headquarters of the War Department at Washington, D. C.

Headquarters, Dist. of Kansas,  
Office Asst. Com. of Musters,  
FORT LEAVENWORTH, Nov 1<sup>st</sup> 1865

As provided in Circular No. 33, War Department, A. G. O., dated July 13th, 1865, I certify on the within Affidavit of Wm Ford Douglass Captain, of the Indep<sup>t</sup> Regiment of Batt Cal A Volunteers, that he has made returns to the proper Heads of Departments of all public property for which he has become responsible since entering the service of the United States, and that he is not indebted to the United States on any account, and he is entitled to final payment without further evidence of non indebtedness.

*[Handwritten Signature]*

Captain 13th Missouri Cav.,  
Capt 2<sup>d</sup> U.S. Vols And Asst. Com. of Musters

*Walter Harvey*

**1st. Batt'y U.S. Col'd L. Art'y.**

*Private*      *Corporal*

**CARD NUMBERS.**

6 2 3 3 6 4 3	26
6 2 3 4 0 3 8	27
6 2 3 4 1 7 6	28
6 2 3 4 3 4 4	29
6 2 3 4 5 0 8	30
9 1 3 3 0 9 7	31
	32
	33
	34
	35
	36
	37
	38
	39
	40
	41
	42
	43
	44
	45
	46
	47
	48
	49
	50

Book Mark: \_\_\_\_\_

See also \_\_\_\_\_

S- 2001580 P.O. aff  
D. 2878057 P.O. Ret.

MS Spencer  
3

*22* Indpt. Batt'y. | **U.S.C.T.**

*Harvey Drake*

....., Indpt. Batt'y, U. S. Col'd L. Art'y.

Appears on

**Battery Descriptive Book**

of the organization named above.

**DESCRIPTION.**

Age *25* years; height *5* feet *11 1/2* inches.

Complexion *Yellow*

Eyes *Brown*, hair *Black*

Where born *Howard Co, Mo*

Occupation *Farmer*

**ENLISTMENT.**

When *Jan 16*, 186*5*.

Where *Quindaro Mo*

By whom *Capt Douglas*; term *5* y'rs.

Remarks:

.....  
 .....  
 .....  
 .....  
 .....  
 .....  
 .....

*Hollman*

D | Indpt. Battery. | **U.S.C.T.**

*Lawey Drake*

Appears with rank of *Priv* on

**Muster and Descriptive Roll of a Detachment of U. S. Vols. forwarded**

for the Indpt. Batt'y, U. S. Col'd L. Arty. Roll dated

*Leavenworth, Kas, Jan. 17, 1865.*

Where born *Kawana Co, Missouri*

Age *25* y'rs; occupation *Farmer*

When enlisted d. *Jan 16*, 1865.

Where enlisted *Leavenworth, Kas.*

For what period enlisted *3* years.

Eyes *Brown*; hair *Black*

Complexion *Yellow*; height *5 ft. 11 1/2 in.*

When mustered in *Jan. 17*, 1865.

Where mustered in *Leavworth, Kas*

Bounty paid \$ *0 00 100*; due \$ *30 0 100*

Where credited.....

Battery to which assigned.....

Remarks: *Credited to Northern Dist*  
*Kas. 28<sup>th</sup> Sub. Dist. Quindaro*  
*Township Wyandotte County.*  
*Volunteer Recruit entitled to bounty*

Book mark:.....

*E. L. Thosent*

(339)

Copyist.



D

Indpt. Battery. | U.S.C.T.

Harvey Drake  
2<sup>d</sup> Corp, Indpt. Battery, U. S. Col'd L. Art'y.

Appears on

**Battery Muster Roll**

for Jan'y 1<sup>st</sup> 1865, 1865.

Present or absent Present

Stoppage, \$ 100 for

Due Gov't, \$ 100 for

Valuation of horse, \$ 100

Valuation of horse equipments, \$ 100

Remarks: Appointed Corp  
Jan'y 1<sup>st</sup> 1865 by Maj  
R. H. Hunt Adj Adjt  
Dept of War.

Book mark: \_\_\_\_\_

A Schooley  
(358) Copyist.

*D* | Indpt. Battery. | **U.S.C.T.**

*Harvey Drake,*  
*Capt*, Indpt. Battery, U. S. Col'd L. Art'y.

Appears on

**Battery Muster Roll**

for *Man & apt.*, 186 *5*.

Present or absent *Present,*

Stoppage, \$ *100* for

Due Gov't, \$ *100* for

Valuation of horse, \$ *100*

Valuation of horse equipments, \$ *100*

Remarks: *Pay due as private*  
*from Jan'y, 16/65 to Feb. 1/65.*

Book mark: \_\_\_\_\_

*Porter*

(358)

Copyist.

*D*

Indpt. Battery.

U.S.C.T.

*Harvey Drake,*

*Corpl*, Indpt. Battery, U. S. Col'd L. Art'y.

Appears on

**Battery Muster Roll**

for *May & June*, 1865.

Present or absent *Present.*

Stoppage, \$ *100* for

Due Gov't, \$ *100* for

Valuation of horse, \$ *100*

Valuation of horse equipments, \$ *100*

Remarks: *Pay due Corpl,  
from Feb. 1/65.*

Book mark:

*Parter*  
Copyist.

D | Indpt. Battery. | **U.S.C.T.**

*Harvey Drake,*  
*Capt.*, Indpt. Battery U. S. Col'd Light Art'y.

Appears on **Batt'y Muster-out Roll**, dated  
*W. Leavenworth, Ky, July 22, 1865.*

Muster-out to date *July 22*, 1865.

Last paid to *Pay due from enlistment,* 1865.

**Clothing account:**

Last settled....., 186 ; drawn since \$ *45*<sup>39</sup> 100,

Due soldier \$..... 100; due U. S. \$..... 100

Am't for cloth'g in kind or money adv'd \$..... 100

Due U. S. for arms, equipments, &c., \$..... 100

Bounty paid \$ *None* 100; due \$ *100* 100,

Remarks: *Private from enlistment*  
*to Feby, 1865; then Capt.*

Book mark: *361, 1879.*

*Butler*

*Drake Harvey*

Co. *1st*, *Batt. U.S.C. A*  
*Reg't*

*2* Enclosures.

Bed Cards .....	Final Statements .....
Burial Records .....	Furloughs or L. of A. ....
Certs. of Dis. for Discharge .....	Med. Certificates .....
C. M. Charges .....	Med. Des. Lists .....
Descriptive Lists .....	Orders .....
Discharge Certificates .....	Pris. of War Record .....
Enlistment Papers .....	Resignations .....

Other papers relating to—

Admission to Hosp'l .....	Furlough or L. of A. ....
Casualty Sheet .....	Med. Examination .....
Confinement .....	Misc. Information .....
Contracts .....	Pay or Clothing .....
Death or Effects .....	Personal Reports .....
Desertion .....	Rank .....
Discharge from Hosp'l .....	Transfer to Hosp'l .....
Discharge from Service .....	Transfer to V. R. C. ....
Duty .....	Transportation .....

NOTE 1.—This blank will be used for both enlistments and re-enlistments—enlistment of veterans, &c., &c., in the volunteer service. They will be made out in duplicate in all cases—one to accompany the recruiting return of the superintendent (not the recruiting officer) to the Adjutant General, and one to accompany the accounts of the officer who pays bounty, &c. The Regiment and Company in which the soldier last served should be given on the back.

NOTE 2.—An enlistment holds to service. A muster-in must, in all cases, precede payment of pay, bounty, pension, &c. A muster-in roll must, in all cases, be filed in the Adjutant General's Office as evidence of muster-in. The mustering officer, commissary, or assistant commissary of musters, as the case may be, will countersign both enlistments as having mustered the soldier into the service of the United States before either of them is given to the disbursing officer.

DECLARATION OF RECRUIT.

I, Harvey Drake, desiring to VOLUNTEER as a Soldier in the Army of the United States, for the term of THREE YEARS, Do Declare, That I am Twenty five years and \_\_\_\_\_ months of age; that I have never been discharged from the United States service on account of disability or by sentence of a court martial, or by order before the expiration of a term of enlistment; and I know of no impediment to my serving honestly and faithfully as a soldier for three years.

GIVEN at Leavenworth the 10<sup>th</sup> day of January 1864

Witness: A. W. Kelly

No. \_\_\_\_\_  
Harvey Drake  
 Recruited at Leavenworth Kas  
January 16<sup>th</sup> 1864  
1864  
10<sup>th</sup> day of January 1864  
for Capt. Regt. of 18<sup>th</sup> Cal. Inf.

..... enlistment; last served in Company ( )  
 Regt of .....  
 Discharged ..... 18 .....

CONSENT IN CASE OF MINOR.

I, \_\_\_\_\_, Do CERTIFY, That I am \_\_\_\_\_; that the \_\_\_\_\_ of \_\_\_\_\_; that the said \_\_\_\_\_ is \_\_\_\_\_ years of age; and I do hereby freely give my CONSENT to his volunteering as a SOLDIER in the ARMY OF THE UNITED STATES for the period of THREE YEARS.

GIVEN at \_\_\_\_\_ the \_\_\_\_\_ day of \_\_\_\_\_

Witness: \_\_\_\_\_

(A. G. O. No. 74 & 76.)

*Credited to Northern Missouri Mass and 2<sup>nd</sup> Sub Dist Grand Jurisdiction Wyandotte County  
2<sup>nd</sup> Sub Dist Andy Butts.*

VOLUNTEER ENLISTMENT.

STATE OF



TOWN OF

*Kansas*

*Lawrence*

I, *Harvey Drake*, born in *Kanawha*  
in the State of *Missouri*, aged *Twenty five* years,  
and by occupation a *farmer*, Do HEREBY ACKNOWLEDGE to have  
volunteered this *Sixteenth* day of *January*, 1865,  
to serve as a **Soldier** in the **Army of the United States of America**, for  
the period of **THREE YEARS**, unless sooner discharged by proper authority:  
Do also agree to accept such bounty, pay, rations, and clothing, as are, or may be,  
established by law for volunteers. And I, *Harvey Drake*, do  
solemnly swear, that I will bear true faith and allegiance to the **United States  
of America**, and that I will serve them honestly and faithfully against all  
their enemies or opposers whomsoever; and that I will observe and obey the  
orders of the President of the United States, and the orders of the officers  
appointed over me, according to the Rules and Articles of War.

Sworn and subscribed to, at *Lawrence* } *Harvey Drake*  
this *16<sup>th</sup>* day of *Jan*, 1865 }  
BEFORE *Lieut W Ford Douglas*  
*Recruiting Officer*

I CERTIFY, ON HONOR, That I have carefully examined the above-named Volunteer, agreeably  
to the General Regulations of the Army, and that, in my opinion, he is free from all bodily defects and  
mental infirmity, which would in any way disqualify him from performing the duties of a soldier.

*Jiffie Binks*  
Surgeon Board of Enrollment  
*North Dist Kansas*  
EXAMINING SURGEON.

I CERTIFY, ON HONOR, That I have minutely inspected the Volunteer *Harvey Drake*  
previously to his enlistment, and that he was entirely sober when enlisted; that, to the best of my  
judgment and belief, he is of lawful age; and that, in accepting him as duly qualified to perform the  
duties of an able-bodied soldier, I have strictly observed the Regulations which govern the recruiting  
service. This soldier has *brown* eyes, *black* hair, *yellow* complexion, is *five*  
feet *11/2* inches high.

*Lieut W Ford Douglas*  
*2nd Battery US Col Artillery*  
Recruiting Officer.

(A. G. O. No. 71 & 76.)

*Battery* Mustered into the service of the United States for three years or during the war, from date of enlistment, in *Company*  
*Regiment of US Col Artillery* *Volunteers*, on the *17* day of *January*, 1865, at *Lawrence* *Kansas*  
*2nd Battery US Col Artillery*

*Arthur M. ...*  
*Northwest Missouri*

NOTE 1.—This blank will be used for both enlistments and re-enlistments—enlistment of veterans, &c., &c., in the volunteer service. They will be made out in duplicate in all cases—one to accompany the recruiting return of the superintendent (not the recruiting officer) to the Adjutant General, and one to accompany the accounts of the officer who pays bounty, &c. The Regiment and Company in which the soldier last served should be given on the back

NOTE 2.—An enlistment holds to service. A muster-in must, in all cases, precede payment of pay, bounty, pension, &c. A muster-in roll must, in all cases, be filed in the Adjutant General's Office as evidence of muster-in. The mustering officer, commissary, or assistant commissary of musters, as the case may be, will countersign both enlistments as having mustered the soldier into the service of the United States before either of them is given to the disbursing officer.

DECLARATION OF RECRUIT.

I, Harvey Drake, desiring to VOLUNTEER as a Soldier in the Army of the United States, for the term of THREE YEARS, Do Declare, That I am twenty five years and \_\_\_\_\_ months of age; that I have never been discharged from the United States service on account of disability or by sentence of a court martial, or by order before the expiration of a term of enlistment; and I know of no impediment to my serving honestly and faithfully as a soldier for three years.

GIVEN at Seaworth the 16 day of January 1865

Witness: B. N. O. Bluff

No. \_\_\_\_\_  
Harvey Drake  
 Volunteered at Seaworth Va  
January 16<sup>th</sup> 1865  
Biggs' 1<sup>st</sup> Battalion  
1<sup>st</sup> Regt of Cavalry  
1<sup>st</sup> Div of Cavalry

Discharged \_\_\_\_\_, 18\_\_\_\_  
 Regt of \_\_\_\_\_  
 enlistment; last served in Company ( )

CONSENT IN CASE OF MINOR.

I, \_\_\_\_\_ Do CERTIFY, That I am \_\_\_\_\_; that the \_\_\_\_\_ of \_\_\_\_\_; that the \_\_\_\_\_ is \_\_\_\_\_ years of age; and I do hereby freely give my CONSENT to his volunteering as a SOLDIER in the ARMY OF THE UNITED STATES for the period of THREE YEARS.

GIVEN at \_\_\_\_\_ the \_\_\_\_\_ day of \_\_\_\_\_

Witness: \_\_\_\_\_



*credited to Northern Dist. 28 "but dist name also recorded" my all done & done up.*

VOLUNTEER ENLISTMENT.

STATE OF

TOWN OF

*Kansas*



*Seamanworth*

I, *Harvey Drake*, born in *Howard Co*  
in the State of *Missouri*, aged *twenty five* years,  
and by occupation a *farmer*, Do HEREBY ACKNOWLEDGE to have  
volunteered this *Sixteenth* day of *January*, 1865  
to serve as a **Soldier** in the **Army of the United States of America**, for  
the period of **THREE YEARS**, unless sooner discharged by proper authority:  
Do also agree to accept such bounty, pay, rations, and clothing, as are, or may be,  
established by law for volunteers. And I, *Harvey Drake*, do  
solemnly swear, that I will bear true faith and allegiance to the **United States**  
**of America**, and that I will serve them honestly and faithfully against all  
their enemies or opposers whomsoever; and that I will observe and obey the  
orders of the President of the United States, and the orders of the officers  
appointed over me, according to the Rules and Articles of War.

Sworn and subscribed to, at *Seamanworth*  
this *16th* day of *Jan*, 1865 } *Harvey Drake*  
BEFORE *Sgt A. G. Douglas*  
*Recruiting for Battery*

I CERTIFY, ON HONOR, That I have carefully examined the above-named Volunteer, agreeably  
to the General Regulations of the Army, and that, in my opinion, he is free from all bodily defects and  
mental infirmity, which would in any way disqualify him from performing the duties of a soldier.

*Jiffie Bicks*  
*Surg Board of Quartermaster*  
*North Dist Kansas*  
EXAMINING SURGEON.

I CERTIFY, ON HONOR, That I have minutely inspected the Volunteer *Harvey Drake*  
previously to his enlistment, and that he was entirely sober when enlisted; that, to the best of my  
judgment and belief, he is of lawful age; and that, in accepting him as duly qualified to perform the  
duties of an able-bodied soldier, I have strictly observed the Regulations which govern the recruiting  
service. This soldier has *brown* eyes, *black* hair, *yellow* complexion, is *five*  
feet *11/2* inches high.

*Sgt A. G. Douglas*  
*Dud-Battery U S Col - Artillery*  
Recruiting Officer.

*Mustered into the service of the United States, for three years or during the War, from date of enlistment, in*  
*Regiment of Missouri Artillery* *(8th)* *Volunteers, on the 17th day of January, 1865, at Seamanworth Kansas*  
*for Private*  
*John Henry Drake*  
*Seamanworth Kansas*

Private Duffey U.S. Col'd L. Art'y.

Private Corporal

CARD NUMBERS.

6233645
6234076
6234186
6234353
6234516
9133098

26  
27  
28  
29  
30  
31  
32  
33  
34  
35  
36  
37  
38  
39  
40  
41  
42  
43  
44  
45  
46  
47  
48  
49  
50

Book Mark:

See also

S. 61699 & P. O. 90  
S. 1757175 P. O. M & M.

Abel 1374919

S. 2798574 And (copy)

Ent. in line to Susan W. Drake, Denver Colo. 7/12/34  
att.

Apples for C. & L. & visit to line

to be followed by L. Penn. in

Susan Drake Denver Col. 3/19/34

neg on med Record to Susan W. Drake

1525-E. 30th Ave - Denver, Colo -

10-5-38 - DEC

MS Spencer

u

D | Indpt. Batt'y. | **U.S.C.T.**

*Noah Drake*

....., Indpt. Batt'y, U. S. Col'd L. Art'y.

Appears on

**Battery Descriptive Book**

of the organization named above.

**DESCRIPTION.**

Age *18* years; height *5* feet *8* inches.

Complexion *Yellow*

Eyes *Grey*; hair *light*

Where born *Howard Co. Mo.*

Occupation *Farmer*

**ENLISTMENT.**

When *Jan 16*, 186 *5*.

Where *Quindaro Kas.*

By whom *Capt Douglas*, term *3* y'rs.

Remarks: .....

.....  
 .....  
 .....  
 .....  
 .....  
 .....  
 .....

*Blackrock*

(383g)

Copyist.

D | Indpt. Battery. | U.S.C.T.

Noah W. Drake

Appears with rank of *Priv* on**Muster and Descriptive Roll of a Detachment of U. S. Vols. forwarded**

for the Indpt. Batt'y, U. S. Col'd L. Arty. Roll dated

*Leavenworth, Mo. Jan. 17, 1865.*Where born *Howard Co., Missouri*Age *18* y'rs; occupation *Farmer*When enlisted d. *Jan. 16, 1865.*Where enlisted *Leavenworth, Mo.*For what period enlisted *3* years.Eyes *Grey*; hair *Light*Complexion *fellow*; height *5 ft. 8 in.*When mustered in *Jan. 17, 1865.*Where mustered in *Leavenworth, Mo.*Bounty paid \$ *100*; due \$ *30*

Where credited

Battery to which assigned

Remarks: *Credited to North Dist.**Kav. 28<sup>th</sup> Sub. Dist. Indiana**th. Myandotte Co. Vol. Recruit**& entitled to bounty.*

Book mark:

*E. Thorton*

D

Indpt. Battery.

U.S.C.T.

Noah Drake

Pot

, Indpt. Battery, U. S. Col'd L. Art'y.

Appears on

**Battery Muster Roll**

for *Jan & Feb*, 186<sup>5</sup>.

Present or absent *Present*

Stoppage, \$ 100 for

Due Gov't, \$ 100 for

Valuation of horse, \$ 100

Valuation of horse equipments, \$ 100

Remarks: *Bounty due 100.*

Book mark:

*J. Schodley*

(358)

Copyist.

D

Indpt. Battery.

U.S.C.T.

Noah Drake,  
Corpl., Indpt. Battery, U. S. Col'd L. Art'y.

Appears on

**Battery Muster Roll**

for *Man, & Apl,*, 1865.

Present or absent *Present,*

Stoppage, \$ *100* for

Due Gov't, \$ *100* for

Valuation of horse, \$ *100*

Valuation of horse equipments, \$ *100*

Remarks: *County due \$100.00,  
Pay due as private from  
Jan'y, 16/65, to Apl, 19/65,*

Book mark:

*Parter*

D | Indpt. Battery. | **U.S.C.T.**

*North Drake,*

*Corpl*, Indpt. Battery, U. S. Col'd L. Art'y.

Appears on

**Battery Muster Roll**

for *May & June*, 1865.

Present or absent *Present*

Stoppage, \$ 100 for

Due Gov't, \$ 100 for

Valuation of horse, \$ 100

Valuation of horse equipments, \$ 100

Remarks: *Comnty due \$100-,  
Pay due Corpl, Apl, 19/65,*

Book mark: *...*

*Parter*



D | Indpt. Battery. | **U.S.C.T.**

*Noah Drake,*

*Corpl.*, Indpt. Battery U. S. Col'd Light Art'y.

Appears on **Batt'y Muster-out Roll**, dated  
*Th. Seavernworth's, July 22, 1865.*

Muster-out to date *July 22*, 1865.

Last paid to *Pay due from enlist.,* 1865.

Clothing account:

Last settled....., 186 ; drawn since \$ *48* <sup>79</sup>/<sub>100</sub>,

Due soldier \$ <sup>100</sup>/<sub>100</sub>; due U. S. \$ <sup>100</sup>/<sub>100</sub>

Am't for cloth'g in kind or money adv'd \$ <sup>100</sup>/<sub>100</sub>

Due U. S. for arms, equipments, &c., \$ <sup>100</sup>/<sub>100</sub>

Bounty paid \$ *none* <sup>100</sup>/<sub>100</sub>; due \$ *100* <sup>100</sup>/<sub>100</sub>,

Remarks: *Priv. from enlistment  
to Apr. 19/65, then Corpl.*

Book mark : .....

*Patten*  
Copyist.

*Drake Noah W.*

, Co. *1st Batt* *Reg't* *U.S. C.A.*

*2* **Enclosures.**

Bed Cards .....	Final Statements .....
Burial Records .....	Furloughs or L. of A. ....
Certs. of Dis. for Discharge .....	Med. Certificates .....
C. M. Charges .....	Med. Des. Lists .....
Descriptive Lists .....	Orders .....
Discharge Certificates .....	Pris. of War Record .....
Enlistment Papers .....	Resignations .....

**Other papers relating to—**

Admission to Hosp'l .....	Furlough or L. of A. ....
Casualty Sheet .....	Med. Examination .....
Confinement .....	Misc. Information .....
Contracts .....	Pay or Clothing .....
Death or Effects .....	Personal Reports .....
Desertion .....	Rank .....
Discharge from Hosp'l .....	Transfer to Hosp'l .....
Discharge from Service .....	Transfer to V. R. C. ....
Duty .....	Transportation .....

MICROFILM PUBLICATION M1836

COMPILED MILITARY SERVICE RECORDS  
OF VOLUNTEER UNION SOLDIERS WHO SERVED WITH  
THE UNITED STATES COLORED TROOPS (USCT)  
INDEPENDENT BATTERY LIGHT ARTILLERY

PERSONAL PAPERS' TARGET SHEET

PLEASE NOTE THE CHECKED INFORMATION ABOUT THE PERSONAL PAPERS IN  
THIS FILE:

NO PERSONAL PAPERS WERE FOUND IN THIS FILE WHEN THE  
RECORDS WERE ARRANGED FOR MICROFILMING.

3 PERSONAL PAPER(S) FOUND IN THIS FILE WHEN THE RECORDS  
WERE ARRANGED FOR MICROFILMING.

DECLARATION OF RECRUIT.

I, Spah W Drake, desiring to VOLUNTEER as a Soldier in the Army of the United States, for the term of THREE YEARS, Do Declare, That I am eighteen years and \_\_\_\_\_ months of age; that I have never been discharged from the United States service on account of disability or by sentence of a court martial, or by order before the expiration of a term of enlistment; and I know of no impediment to my serving honestly and faithfully as a soldier for three years.

GIVEN at Leavenworth City the 16th day of January

Witness: W. H. Burnham Spah W Drake

NOTE 1.—This blank will be used for both enlistments and re-enlistments—enlistment of veterans, &c., &c., in the volunteer service. They will be made out in duplicate in all cases—one to accompany the recruiting return of the superintendent (not the recruiting officer) to the Adjutant General, and one to accompany the accounts of the officer who pays bounty, &c. The Regiment and Company in which the soldier last served should be given on the back  
NOTE 2.—An enlistment holds to service. A muster-in must, in all cases, precede payment of pay, bounty, pension, &c. A muster-in roll must, in all cases, be filed in the Adjutant General's Office as evidence of muster-in. The mustering officer, commissary, or assistant commissary of musters, as the case may be, will countersign both enlistments as having mustered the soldier into the service of the United States before either of them is given to the disbursing officer.

Discharged \_\_\_\_\_, 18\_\_\_\_  
Reg't of \_\_\_\_\_  
enlistment; last served in Company ( )

No. \_\_\_\_\_  
Spah W Drake  
Volunteered at Leavenworth Mo  
January 16 1865  
By W. H. Burnham  
Adjutant  
Regiment of U.S. Cavalry (1st)

CONSENT IN CASE OF MINOR.

I, \_\_\_\_\_, Do CERTIFY, That I am \_\_\_\_\_; that the \_\_\_\_\_ of \_\_\_\_\_; that the \_\_\_\_\_ is \_\_\_\_\_ years of age; and I do hereby freely give my CONSENT to his volunteering as a SOLDIER in the ARMY OF THE UNITED STATES for the period of THREE YEARS.

GIVEN at \_\_\_\_\_ the \_\_\_\_\_ day of \_\_\_\_\_

Witness: \_\_\_\_\_

credited to Northrup's Kas 28th but will surrender if my auditors see

9

VOLUNTEER ENLISTMENT.

STATE OF

*Kansas*



TOWN OF

*Lawrence*

I, *Noah W Drake*, born in *Howard County* in the State of *Missouri*, aged *fifteen* years, and by occupation a *farmer*, Do HEREBY ACKNOWLEDGE to have volunteered this *Sixteenth* day of *January*, 1865, to serve as a **Soldier** in the **Army of the United States of America**, for the period of **THREE YEARS**, unless sooner discharged by proper authority: Do also agree to accept such bounty, pay, rations, and clothing, as are, or may be, established by law for volunteers. And I, *Noah W Drake*, do solemnly swear, that I will bear true faith and allegiance to the **United States of America**, and that I will serve them honestly and faithfully against all their enemies or opposers whomsoever; and that I will observe and obey the orders of the President of the United States, and the orders of the officers appointed over me, according to the Rules and Articles of War.

Sworn and subscribed to, at *Lawrence* this *16th* day of *Jan*, 1865, *Noah W Drake* BEFORE *Lieut H Ford Douglas* *1st Ind U.S. Col - Art - Light*

I CERTIFY, ON HONOR, That I have carefully examined the above-named Volunteer, agreeably to the General Regulations of the Army, and that, in my opinion, he is free from all bodily defects and mental infirmity, which would in any way disqualify him from performing the duties of a soldier.

*Tiffin Binks*  
Surgeon Board of Inspectors  
West Dist Kansas  
EXAMINING SURGEON.

I CERTIFY, ON HONOR, That I have minutely inspected the Volunteer *Noah W Drake* previously to his enlistment, and that he was entirely sober when enlisted; that, to the best of my judgment and belief, he is of lawful age; and that, in accepting him as duly qualified to perform the duties of an able-bodied soldier, I have strictly observed the Regulations which govern the recruiting service. This soldier has *grey* eyes, *light* hair, *yellow* complexion, is *fine* feet *8* inches high.

*Lieut H Ford Douglas*  
1st Ind - Art - Light  
Regiment of *Volunteers*,  
RECRUITING OFFICER.

(A. G. O. No. 74 & 76.)

Mustered into the service of the United States, for three years or during the war, from date of enlistment, in *Company* *Detachment* *Battalion* *Regiment of U.S. Cavalry Light* Volunteers, on the *17th* day of *January*, 1865, at *Lawrence* *Kans*

DECLARATION OF RECRUIT.

I, Noah W Drake, desiring to VOLUNTEER as a Soldier in the Army of the United States, for the term of THREE YEARS, Do Declare, That I am eighteen years and \_\_\_\_\_ months of age; that I have never been discharged from the United States service on account of disability or by sentence of a court martial, or by order before the expiration of a term of enlistment; and I know of no impediment to my serving honestly and faithfully as a soldier for three years.

GIVEN at Seaman Worth City the 16<sup>th</sup> day of January

Witness: W. H. Burman Noah W Drake

NOTE 1.—This blank will be used for both enlistments and re-enlistments—enlistment of veterans, &c., &c., in the volunteer service. They will be made out in duplicate in all cases—one to accompany the recruiting return of the superintendent (not the recruiting officer) to the Adjutant General, and one to accompany the accounts of the officer who pays bounty, &c. The Regiment and Company in which the soldier last served should be given on the back

NOTE 2.—An enlistment holds to service. A muster-in must, in all cases, precede payment of pay, bounty, pension, &c. A muster-in roll must, in all cases, be filed in the Adjutant General's Office as evidence of muster-in. The mustering officer, commissary, or assistant commissary of musters, as the case may be, will countersign both enlistments as having mustered the soldier into the service of the United States before either of them is given to the disbursing officer.

Discharged \_\_\_\_\_, 18\_\_\_\_  
Reg't of \_\_\_\_\_  
enlistment; last served in Company ( )

No. \_\_\_\_\_  
Noah W Drake  
Volunteered at Seaman Worth City  
January 16 1865  
By W. H. Burman Adjutant  
for 100th Regiment of US Col'd Inf'ty

CONSENT IN CASE OF MINOR.

I, \_\_\_\_\_, Do CERTIFY, That I am \_\_\_\_\_ the \_\_\_\_\_ of \_\_\_\_\_; that the said \_\_\_\_\_ is \_\_\_\_\_ years of age; and I do hereby freely give my CONSENT to his volunteering as a SOLDIER in the ARMY OF THE UNITED STATES for the period of THREE YEARS.

GIVEN at \_\_\_\_\_ the \_\_\_\_\_ day of \_\_\_\_\_

Witness: \_\_\_\_\_

2

*Credited to North Dist Kan 28<sup>th</sup> Subvnt Standard ip. My undate is*

VOLUNTEER ENLISTMENT.

STATE OF *Kansas* TOWN OF *Leavenworth*



I, *Frank W Drake*, born in *Howard County* in the State of *Missouri*, aged *eighteen* years, and by occupation a *farmer*. Do HEREBY ACKNOWLEDGE to have volunteered this *Sixteenth* day of *January*, 1865, to serve as a **Soldier** in the **Army of the United States of America**, for the period of **THREE YEARS**, unless sooner discharged by proper authority: Do also agree to accept such bounty, pay, rations, and clothing, as are, or may be, established by law for volunteers. And I, *Frank W Drake*, do solemnly swear, that I will bear true faith and allegiance to the **United States of America**, and that I will serve them honestly and faithfully against all their enemies or opposers whomsoever; and that I will observe and obey the orders of the President of the United States, and the orders of the officers appointed over me, according to the Rules and Articles of War.

Sworn and subscribed to, at *Leavenworth* this *16<sup>th</sup>* day of *Jan*, 1865, *Frank W Drake*

BEFORE *Lieut N Ford Douglas Secy*  
*1<sup>st</sup> Ind W. S. Cold Cavalry (light)*

I CERTIFY, ON HONOR, That I have carefully examined the above-named Volunteer, agreeably to the General Regulations of the Army, and that, in my opinion, he is free from all bodily defects and mental infirmity, which would in any way disqualify him from performing the duties of a soldier.

*Tiffin Binks*  
*Surgeon Board of Enlistment*  
*North Dist Kansas*  
EXAMINING SURGEON.

I CERTIFY, ON HONOR, That I have minutely inspected the Volunteer *Frank W Drake* previously to his enlistment, and that he was entirely sober when enlisted; that, to the best of my judgment and belief, he is of lawful age; and that, in accepting him as duly qualified to perform the duties of an able-bodied soldier, I have strictly observed the Regulations which govern the recruiting service. This soldier has *grey* eyes, *light* hair, *yellow* complexion, is *five* feet *8* inches high.

*Lieut N Ford Douglas*  
*2nd Battery and Col Art*  
Regiment of *2* Volunteers,  
RECRUITING OFFICER.

*Battery* Mustered into the service of the United States, for three years or during the war, from date of enlistment, in *Company* *2nd* *Regiment of 20<sup>th</sup> Cavalry (Col)* Volunteers, on the *17<sup>th</sup>* day of *January*, 1865, at *Leavenworth Kansas*

*John W. ...*  
*North Dist Kansas*

To Med. Records Section: (Mrs. Fowler)

For medical records of Noah W. Drake, Indpt. Batty. U.S. Colored L. Arty.  
Civil War. Jacket herewith.

10-4-38

Rosafy  
ORD/DEC

Mr. Clark.

No medical records found in the case of Noah W. Drake, Indpt. Btry.  
U.S. Col. Light Arty.

10/5/38

ORD/ef



*Widley, Oly*

Adpt. Batt'y U.S. Col'd L. Art'y

*Private*

*Private*

CARD NUMBERS.

6 2 3 3 6 7 8	26
6 2 3 4 2 1 8	27
6 2 3 4 4 8 4	28
6 2 3 3 7 0 8	29
6 2 3 4 6 4 3	30
9 1 3 3 0 6 7	31
	32
	33
	34
	35
	36
	37
	38
	39
	40
	41
	42
	43
	44
	45
	46
	47
	48
	49
	50

Book Mark: *EB-V-11-P. 513.*

See also

564929 P.O.M.  
S-95625-2 - P.O. MM

W. J. Spencer  
J

*D* | Indpt. Batt'y. | **U.S.C.T.**

*Ely Dudley*

....., Indpt. Batt'y, U. S. Col'd L. Art'y.

Appears on

**Battery Descriptive Book**

of the organization named above.

**DESCRIPTION.**

Age *31* years; height *5* feet *8* inches.

Complexion *Black*

Eyes *Black*; hair *Black*

Where born *Kentucky*

Occupation *Laborer*

**ENLISTMENT.**

When *Feb 28*, 1865.

Where *Fairmont Ky.*

By whom *A Minor*; term *3* y'rs.

Remarks: .....

.....  
 .....  
 .....  
 .....  
 .....  
 .....

*Colbrook*

D | Indpt. Battery. | U.S.C.T.

Ely Dudley

Appears with rank of Priv. on

Muster and Descriptive Roll of a Detachment of U. S. Vols. forwarded

for the Indpt. Batt'y, U. S. Col'd L. Arty. Roll dated

Leavenworth, Mo., Feb. 28, 1865.

Where born Kentucky

Age 35 y'rs; occupation Farmer

When enlisted Feb. 28, 1865.

Where enlisted Leavenworth, Mo.

For what period enlisted 3 years.

Eyes black; hair black

Complexion black; height 5 ft. 8 in.

When mustered in Feb. 28, 1865.

Where mustered in Leavenworth, Mo.

Bounty paid \$100.00; due \$200.00

Where credited

Battery to which assigned

Remarks: Credited to Northern dist. Kas. 25<sup>th</sup> Sub. dist. 4<sup>th</sup> Ward, Leavenworth City. Vol. Recruit & entitled to bounty

Book mark:

E. Thompson

*D* | Indpt. Battery. | **U.S.C.T.**

*Dudley, Ely,*  
*R*, Indpt. Battery, U. S. Col'd L. Art'y.

Appears on

**Battery Muster Roll**

for *Mar & Apr*, 186*5*.

Present or absent *Present*

Stoppage, \$ 100 for

Due Gov't, \$ 100 for

Valuation of horse, \$ 100

Valuation of horse equipments, \$ 100

Remarks:

Book mark:

*Porter*

*D* | Indpt. Battery. | **U.S.C.T.**

*Ch Dudley,*  
*MS*, Indpt. Battery, U. S. Col'd L. Art'y.

Appears on

**Battery Muster Roll**

for *May & June*, 1865.

Present or absent.....

Stoppage, \$.....<sup>100</sup> for.....

Due Gov't, \$.....<sup>100</sup> for.....

Valuation of horse, \$.....<sup>100</sup>

Valuation of horse equipments, \$.....<sup>100</sup>

Remarks: *Discharged*  
*from Hospital by G.O.*  
*No. 44, War Dept, Apr. 28,*  
*65.*

Book mark: *Discharged May 20/65,*  
*over*

*Porter*

JAN. 17

6234484

☆1891☆

*EB, V. 11, P 513,*

*A. J. Batty* U.S.C.T.

*Dudley, Elly*  
*Priv, Co. Indpt Batty Reg't U. S. Col'd 1st Arty*

Appears on a

**Detachment Muster-out Roll**

of the organization named above. Roll dated

*Fort Leavenworth Kan, May 20, 1865.*

Muster-out to date *May 20, 1865.*

Last paid to *Pay due from enlistment*, 186

**Clothing account:**

Last settled *renewed*, 186 ; drawn since \$ 100

Due soldier \$ 100; due U. S. \$ 100

Am't for cloth'g in kind or money adv'd \$ *47* <sup>93</sup>/<sub>100</sub>

Due U. S. for arms, equipments, &c., \$ 100

Bounty paid \$ *100* 100 due \$ *200* 100

Remarks: *Forwarded from Gen Hospital at Fort Leavenworth Kansas and mustered out in compliance with Telegraphic order War Dept Aug 10 May 3<sup>d</sup> 1865*

Book mark:

*G. W. Deadrick*

(349)

Copyist.



*S* | Indpt. Battery. | **U.S.C.T.**

*Dudley Ely,*  
*M*, Indpt. Battery U. S. Col'd Light Art'y.

Appears on **Batt'y Muster-out Roll**, dated  
*W. Lammuth, Ms. July 27 1865.*

Muster-out to date ..... 186 .

Last paid to ..... 186 .

**Clothing account:**

Last settled....., 186 ; drawn since \$~~47~~<sup>43</sup>/<sub>100</sub>

Due soldier \$.....<sup>100</sup>; due U. S. \$.....<sup>100</sup>

Am't for cloth'g in kind or money adv'd \$.....<sup>100</sup>

Due U. S. for arms, equipments, &c., \$.....<sup>100</sup>

Bounty paid \$.....<sup>100</sup>; due \$.....<sup>100</sup>

Remarks: *Discharged on*  
*Surgeon's Cert. of Disability*  
*Apr. 25/65.*

Book mark: *Discharged May 20/65,*  
*over*

*Parter*

JAN. 17

6234643

☆1891☆

*CB. 11. P. 513.*

*Ely Judley*

, Co. \_\_\_\_\_,

*Ind Batt*  
*Reg't* *U.S.C. A*

*17* Enclosures.

Bed Cards .....	Final Statements .....
Burial Records .....	Furloughs or L. of A .....
Certs. of Dis. for Discharge .....	Med. Certificates .....
C. M. Charges .....	Med. Des. Lists .....
Descriptive Lists .....	Orders .....
Discharge Certificates .....	Pris. of War Record .....
Enlistment Papers <i>17</i> .....	Resignations .....

Other papers relating to—

Admission to Hosp'l .....	Furlough or L. of A .....
Casualty Sheet .....	Med. Examination .....
Confinement .....	Misc. Information .....
Contracts .....	Pay or Clothing .....
Death or Effects .....	Personal Reports .....
Desertion .....	Rank .....
Discharge from Hosp'l .....	Transfer to Hosp'l .....
Discharge from Service .....	Transfer to V. R. C. .....
Duty .....	Transportation .....

DECLARATION OF RECRUIT.

I, Dudley Ely, desiring to VOLUNTEER as a Soldier in the Army of the United States, for the term of THREE YEARS. Do Declare, That I am ~~Twenty Eight~~ 30 years and ... months of age; that I have never been discharged from the United States service on account of disability or by sentence of a court martial, or by order before the expiration of a term of enlistment; and I know of no impediment to my serving honestly and faithfully as a soldier for three years.

GIVEN at Leavenworth city Kansas the 28 day of February 1865

Witness: W. L. Cook Dudley Ely mark

NOTE 1.—This blank will be used for both enlistments and re-enlistments—enlistment of veterans, &c., &c., in the volunteer service. They will be made out in duplicate in all cases—one to accompany the recruiting return of the superintendent (not the recruiting officer) to the Adjutant General, and one to accompany the accounts of the officer who pays bounty, &c. The Regiment and Company in which the soldier last served should be given on the back. NOTE 2.—An enlistment holds to service. A muster-in must, in all cases, precede payment of pay, bounty, pension, &c. A muster-in roll must, in all cases, be filed in the Adjutant General's Office as evidence of muster-in. The mustering officer, commissary, or assistant commissary of musters, as the case may be, will countersign both enlistments as having mustered the soldier into the service of the United States before either of them is given to the disbursing officer.

Rec'd from 2nd Aud. Nov. 23d 1892

No. 8 Dudley Ely Volunteered at Leavenworth February 28, 1865. By Capt. G. H. Munner Regt. 1st Cal. Arty Discharged 18

CONSENT IN CASE OF MINOR.

I, ... Do CERTIFY, That I am ... of ... years of age; and I do hereby freely give my CONSENT to his volunteering as a SOLDIER in the ARMY OF THE UNITED STATES for the period of THREE YEARS.

GIVEN at ... the ... day of ...

Witness:

(A. G. O. No. 74 & 76.)

*This receipt has received one hundred dollars advance bounty of the three hundred dollar bounty authorized by an Act of Congress approved Feb 7, 1864, and I warrant to pay from the bounty of the Government the balance of the three hundred dollars.*

*Resided to North Dist Ave 22<sup>nd</sup> Sub Dist 4 Ward Leavenworth City*

VOLUNTEER ENLISTMENT.

STATE OF *Kansas*



TOWN OF

*Leavenworth*

I, *Dudley Ely*, born in \_\_\_\_\_, in the State of *Kentucky*, aged *35* years, and by occupation a *Laborer*, DO HEREBY ACKNOWLEDGE to have volunteered this *Twenty Eighth (28)* day of *February*, 1865, to serve as a **Soldier** in the **Army of the United States of America**, for the period of **THREE YEARS**, unless sooner discharged by proper authority: Do also agree to accept such bounty, pay, rations, and clothing, as are, or may be, established by law for volunteers. And I, *Dudley Ely*, do solemnly swear, that I will bear true faith and allegiance to the **United States of America**, and that I will serve them honestly and faithfully against all their enemies or opposers whomsoever; and that I will observe and obey the orders of the President of the United States, and the orders of the officers appointed over me, according to the Rules and Articles of War.

Sworn and subscribed to, at *Leavenworth* this *28* day of *February*, 1865; } *Dudley Ely* his mark  
BEFORE *P. H. Keiner 2<sup>nd</sup> Lieut.*  
*Ind Battery U.S. Col. 11<sup>th</sup> Art. (Light)*

I CERTIFY, ON HONOR, That I have carefully examined the above-named Volunteer, agreeably to the General Regulations of the Army, and that, in my opinion, he is free from all bodily defects and mental infirmity, which would in any way disqualify him from performing the duties of a soldier.

*J. B. Wicks*  
*Surg. Gen. of Cavalry*  
*West. Mo. Dist. Kansas*  
EXAMINING SURGEON.

I CERTIFY, ON HONOR, That I have minutely inspected the Volunteer *Dudley Ely* previously to his enlistment, and that he was entirely sober when enlisted; that, to the best of my judgment and belief, he is of lawful age; and that, in accepting him as duly qualified to perform the duties of an able-bodied soldier, I have strictly observed the Regulations which govern the recruiting service. This soldier has *Black* eyes, *Black* hair, *Black* complexion, is *5* feet *8* inches high.

*P. H. Keiner 2<sup>nd</sup> Lieut.*  
*Ind Battery U.S. Col. 11<sup>th</sup> Art. (Light)*  
RECRUITING OFFICER.

(A. G. O. No. 74 & 76.)

Mustered into the service of the United States, for three years or during the war, from date of enlistment, in *Company B* of the *8<sup>th</sup> Regt. of Light Volunteers*, on the *28* day of *February*, 1865, at *Leavenworth*

*James A. ...*  
*Capt. & Co. Quar. Master Dist. Kansas*

NOTE 1.—This blank will be used for both enlistments and re-enlistments—enlistment of veterans, &c., &c., in the volunteer service. They will be made out in duplicate in all cases—one to accompany the recruiting return of the superintendent (not the recruiting officer) to the Adjutant General, and one to accompany the accounts of the officer who pays bounty, &c. The Regiment and Company in which the soldier last served should be given on the back.

NOTE 2.—An enlistment holds to service. A muster-in must, in all cases, precede payment of pay, bounty, pension, &c. A muster-in roll must, in all cases, be filed in the Adjutant General's Office as evidence of muster-in. The mustering officer, commissary, or assistant commissary of masters, as the case may be, will countersign both enlistments as having mustered the soldier into the service of the United States before either of them is given to the disbursing officer.

DECLARATION OF RECRUIT.

I, Judley Ely, desiring to VOLUNTEER as a Soldier in the Army of the United States, for the term of THREE YEARS. Do Declare, That I am Thirty five (35) years and \_\_\_\_\_ months of age; that I have never been discharged from the United States service on account of disability or by sentence of a court martial, or by order before the expiration of a term of enlistment; and I know of no impediment to my serving honestly and faithfully as a soldier for three years.

GIVEN at Leavenworth city Kansas the 28 day of February 1865

Witness: W. D. Cook Judley Ely  
mark

Discharged \_\_\_\_\_, 18 \_\_\_\_\_

Reg't of \_\_\_\_\_

enlistment; last served in Company ( ) \_\_\_\_\_

By Went G. H. Minor  
Snackel Regiment W. D. Co., 9th

Volunteered at Leavenworth, Mo February 28, 1865

No. \_\_\_\_\_  
Judley Ely

Joseph Patton Co. 11

CONSENT IN CASE OF MINOR.

I, \_\_\_\_\_, Do CERTIFY, That I am the \_\_\_\_\_ of \_\_\_\_\_; that the said \_\_\_\_\_ is \_\_\_\_\_ years of age; and I do hereby freely give my CONSENT to his volunteering as a SOLDIER in the ARMY OF THE UNITED STATES for the period of THREE YEARS.

GIVEN at \_\_\_\_\_ the \_\_\_\_\_ day of \_\_\_\_\_

Witness: \_\_\_\_\_

*Credited to North Dist War 22<sup>d</sup> Sub. Dist 4 Ward Leavenworth City*

VOLUNTEER ENLISTMENT.

STATE OF

TOWN OF

*Kansas*



*Leavenworth*

I, *Dudley Ely*, born in \_\_\_\_\_, in the State of *Kentucky*, aged *35* years, and by occupation a *Laborer*, DO HEREBY ACKNOWLEDGE to have volunteered this *Twenty eighth (28)* day of *February*, 1865, to serve as a **Soldier** in the **Army of the United States of America**, for the period of **THREE YEARS**, unless sooner discharged by proper authority: Do also agree to accept such bounty, pay, rations, and clothing, as are, or may be, established by law for volunteers. And I, *Dudley Ely*, do solemnly swear, that I will bear true faith and allegiance to the **United States of America**, and that I will serve them honestly and faithfully against all their enemies or opposers whomsoever; and that I will observe and obey the orders of the President of the United States, and the orders of the officers appointed over me, according to the Rules and Articles of War.

Sworn and subscribed to, at *Leavenworth* this *28* day of *February*, 1865, BEFORE *P. H. Minor, 2<sup>d</sup> Lieut.* *Dudley Ely* mark  
*Ind. Baty. U.S. Col 4<sup>th</sup> Arty. (Light)*

I CERTIFY, ON HONOR, That I have carefully examined the above-named Volunteer, agreeably to the General Regulations of the Army, and that, in my opinion, he is free from all bodily defects and mental infirmity, which would in any way disqualify him from performing the duties of a soldier.

*W. H. D. Wick*  
*Surgeon Board of Parallel*  
*War Dept. Dist Kansas*  
EXAMINING SURGEON.

I CERTIFY, ON HONOR, That I have minutely inspected the Volunteer *Dudley Ely* previously to his enlistment, and that he was entirely sober when enlisted; that, to the best of my judgment and belief, he is of lawful age; and that, in accepting him as duly qualified to perform the duties of an able-bodied soldier, I have strictly observed the Regulations which govern the recruiting service. This soldier has *Black* eyes, *Black* hair, *Black* complexion, is *5* feet *8* inches high.

*P. H. Minor 2<sup>d</sup> Lieut*  
*Ind. Baty. U.S. Col 4<sup>th</sup> Arty. (Light)*  
RECRUITING OFFICER.

Mustered into the service of the United States, for three years or during the war, from date of enlistment, in *Company* *Dudley Bally* *Regiment of* *Volunteers*, on the *28* day of *February*, 1865, at *Leavenworth, Mo*

*J. W. ...*  
*Capt. ...*

*Edwards, George*

**Capt. Batt'y U.S. Col'd L. Art'y.**

*Private*      *Private*

**CARD NUMBERS.**

6	233620	26
6	233765	27
6	233913	28
6	234047	29
6	234220	30
6	234387	31
6	234549	32
9	132946	33
		34
10		35
11		36
12		37
12		38
14		39
15		40
16		41
17		42
18		43
19		44
20		45
21		46
22		47
23		48
24		49
25		50

Book Mark: \_\_\_\_\_

See also \_\_\_\_\_



8607449- S.H. (Kans)

W. Spencer  
4

*E* | Indpt. Batt'y. | **U.S.C.T.**

*Alonzo Eddings*

....., Indpt. Batt'y, U. S. Col'd L. Art'y.

Appears on

**Battery Descriptive Book**

of the organization named above.

**DESCRIPTION.**

Age *22* years; height *5* feet *4* inches.

Complexion *Black*

Eyes *Black*; hair *Black*

Where born *Howard Co. Md.*

Occupation *Laborer*

**ENLISTMENT.**

When *Dec. 7*, 186 *4*.

Where *Sumner with Co.*

By whom *A. Mathews*; term *3* y'rs.

Remarks: .....

.....

.....

.....

.....

.....

.....

.....

.....

.....

*Soelbrock*

E

Indpt. Battery.

U.S.C.T.

Alonzo Eddings

Appears with rank of *Priv* on**Muster and Descriptive Roll of a Detachment of U. S. Vols. forwarded**

for the Indpt. Batt'y, U. S. Col'd L. Arty. Roll dated

Leavenworth *Ky*, Dec 7, 1864Where born *Kawand Co. Missouri*Age *22* y'rs; occupation *Laborer*When enlisted *Dec 7*, 1864.Where enlisted *Leavenworth, Ky*For what period enlisted *3* years.Eyes *black*; hair *black*Complexion *black*; height *5* ft. *4* in.When mustered in *Dec 7*, 1864.Where mustered in *Leavenworth, Ky*Bounty paid \$ *100*; due \$ *100*

Where credited

Battery to which assigned

Remarks: *Credited to Northern District  
Kansas, 19<sup>th</sup> Sub-District, 1st  
ward r. Government Reserve  
Leavenworth City, Leavenworth County  
over*

Book mark:

E. L. Hampton

(339)

Copyist.

JAN. 17  
6233620  
Van. Recruit  
to Bounty

★16891★

entitled

*E*

Indpt. Battery.

U.S.C.T.

*Alonzo Eddings*

*Pat*, Indpt. Battery, U. S. Col'd L. Art'y.

Appears on

**Battery Muster-in and Descriptive Roll**

of the organization named above. Roll dated

*Leavenworth Co Dec 23*, 1864.

Where born *Kowan Co, Mo.*

Age *22* y'rs; occupation *Laborer*

When enlisted *Dec 7*, 1864.

Where enlisted *Leavenworth Co*

For what period enlisted *3* years.

Eyes *Blue*; hair *Blue*

Complexion *Blue*; height *5* ft. *4* in.

When mustered in *Dec 7*, 1864.

Where mustered in *Leavenworth*

Bounty paid \$ *100*<sup>00</sup>/<sub>100</sub>; due \$ *200*<sup>00</sup>/<sub>100</sub>

Where credited

Battery to which assigned

Remarks: *C. M. Dist Co  
19th S. D. 1st Ward  
Leavenworth Co.*

Book mark :

*J. S. Schuler*

(856g)

Copyist.

E | Indpt. Battery. | **U.S.C.T.**

Alonzo Eddings  
Pat, Indpt. Battery, U. S. Col'd L. Art'y.

Appears on

**Battery Muster Roll**

for Enlistment to Dec 31, 1864.

Present or absent Present

Stoppage, \$ 100 for

Due Gov't, \$ 100 for

Valuation of horse, \$ 100

Valuation of horse equipments, \$ 100

Remarks:

Book mark:

J. H. Schuster  
(358) Copyist.

E | Indpt. Battery. | **U.S.C.T.**

*Alonzo Eddings*  
*11<sup>th</sup> Corp*, Indpt. Battery, U. S. Col'd L. Art'y.

Appears on

**Battery Muster Roll**

for *Jan 1st*, 186<sup>5</sup>.

Present or absent *Present*

Stoppage, \$ 100 for

Due Gov't, \$ 100 for

Valuation of horse, \$ 100

Valuation of horse equipments, \$ 100

Remarks: *Appointed Corp*  
*Jan 1st 1865 by Maj*  
*P. H. Hunt Chief of Artillery*  
*Dept of Kansas,*

Book mark:

*J. Schreyer*

(358)

Copyist.

*65*

Indpt. Battery. | **U.S.C.T.**

*Alonzo Eddings,*  
*On*, Indpt. Battery, U. S. Col'd L. Art'y.

Appears on

**Battery Muster Roll**

for *Mar, v Apl,* 1865.

Present or absent *Present.*

Stoppage, \$ 100 for

Due Gov't, \$ 100 for

Valuation of horse, \$ 100

Valuation of horse equipments, \$ 100

Remarks:

Book mark:

*Porter*

(358)

Copyist.



*E* | Indpt. Battery. | **U.S.C.T.**

*Alvys Eddings*  
*Pr*, Indpt. Battery, U. S. Col'd L. Art'y.

Appears on

**Battery Muster Roll**

for *May & June*, 1865.

Present or absent *Present*

Stoppage, \$ 100 for

Due Gov't, \$ 100 for

Valuation of horse, \$ 100

Valuation of horse equipments, \$ 100

Remarks:  
\_\_\_\_\_  
\_\_\_\_\_  
\_\_\_\_\_  
\_\_\_\_\_  
\_\_\_\_\_  
\_\_\_\_\_

Book mark: \_\_\_\_\_

*Porter*

*E*

Indpt. Battery.

U.S.C.T.

*George Eddings*

*G*, Indpt. Battery U. S. Col'd Light Art'y.

Appears on **Batt'y Muster-out Roll**, dated

*St. Louis, Mo., July 22, 1865.*

Muster-out to date

*July 22, 1865.*

Last paid to

*Dec. 31, 1864.*

Clothing account:

Last settled....., 186 ; drawn since \$ *63<sup>79</sup>/<sub>100</sub>*,

Due soldier \$.....<sup>100</sup>; due U. S. \$.....<sup>100</sup>

Am't for cloth'g in kind or money adv'd \$.....<sup>100</sup>

Due U. S. for arms, equipments, &c., \$.....<sup>100</sup>

Bounty paid \$ *100* <sup>100</sup>; due \$ *None* <sup>100</sup>,

Remarks: *Due C. Fenton, Sutter,*

*\$10-*

Book mark :.....

*Partey*

Copyist.

*Eddings Alonzo*

, Co. *1st Batt W.S.C.A*  
*Reg't*

*7* Enclosures.

Bed Cards .....	Final Statements .....
Burial Records .....	Furloughs or L. of A. ....
Certs. of Dis. for Discharge .....	Med. Certificates .....
C. M. Charges .....	Med. Des. Lists .....
Descriptive Lists .....	Orders .....
Discharge Certificates .....	Pris. of War Record .....
Enlistment Papers <i>7</i> .....	Resignations .....

Other papers relating to—

Admission to Hosp'l .....	Furlough or L. of A. ....
Casualty Sheet .....	Med. Examination .....
Confinement .....	Misc. Information .....
Contracts .....	Pay or Clothing .....
Death or Effects .....	Personal Reports .....
Desertion .....	Rank .....
Discharge from Hosp'l .....	Transfer to Hosp'l .....
Discharge from Service .....	Transfer to V. R. C. ....
Duty .....	Transportation .....

NOTE 1.—This blank will be used for both enlistments and re-enlistments—enlistment of veterans, &c., &c., in the volunteer service. They will be made out in duplicate in all cases—one to accompany the recruiting return of the superintendent (not the recruiting officer) to the Adjutant General, and one to accompany the accounts of the officer with pay, bounty, &c. The Regiment and Company in which the soldier last served should be given on the back.

NOTE 2.—An enlistment holds to service. A muster-in must, in all cases, precede payment of pay, bounty, pension, &c. A muster-in roll must, in all cases, be filed in the Adjutant General's Office as evidence of muster-in. The mustering officer, commissary, or assistant commissary of musters, as the case may be, will countersign both enlistments as having mustered the soldier into the service of the United States before either of them is given to the disbursing officer.

DECLARATION OF RECRUIT.

I, Alonzo Eddings desiring to VOLUNTEER as a Soldier in the Army of the United States, for the term of THREE YEARS Do Declare, That I am (22) twenty two years and \_\_\_\_\_ months of age; that I have never been discharged from the United States service on account of disability or by sentence of a court-martial, or by order before the expiration of a term of enlistment; and I know of no impediment to my serving honestly and faithfully as a soldier for three years.

GIVEN at \_\_\_\_\_ the seventh day of December 1864

Witness:

W. B. Bingham Alonzo Eddings  
mark

No. \_\_\_\_\_  
2

enlistment; last served in Company ( )  
Co. 1st Regt of U.S. Artillery  
Discharged \_\_\_\_\_ 18 \_\_\_\_\_

Alonzo Eddings  
Volunteered at \_\_\_\_\_  
seventh December 1864  
By Wm. H. Miller Adjutant  
\_\_\_\_\_ Regiment of \_\_\_\_\_

CONSENT IN CASE OF MINOR.

I, \_\_\_\_\_ Do CERTIFY, That I am the \_\_\_\_\_ of \_\_\_\_\_; that the said \_\_\_\_\_ is \_\_\_\_\_ years of age; and I do hereby freely give my CONSENT to his volunteering as a SOLDIER in the ARMY OF THE UNITED STATES for the period of THREE YEARS.

GIVEN at \_\_\_\_\_ the \_\_\_\_\_ day of \_\_\_\_\_

Witness:

per March 17

VOLUNTEER ENLISTMENT.

STATE OF

*Kansas*



TOWN OF

*Leavenworth*

I, *Alonso Eddings* born in *Howard Co*  
in the State of *Missouri* aged *22* years,

and by occupation a *Laborer* Do HEREBY ACKNOWLEDGE to have  
volunteered this *17<sup>th</sup> Sixth* day of *December* 1864,

to serve as a **Soldier** in the **Army of the United States of America**, for the  
period of **THREE YEARS** unless sooner discharged by proper authority: Do also  
agree to accept such bounty, pay, rations, and clothing, as are, or may be, estab-  
lished by law for volunteers. And I, *Alonso Eddings* do  
solemnly swear, that I will bear true faith and allegiance to the **United States  
of America**, and that I will serve them honestly and faithfully against all their  
enemies or opposers whomsoever; and that I will observe and obey the orders of  
the President of the United States, and the orders of the officers appointed over  
me, according to the Rules and Articles of War.

Sworn and subscribed to, at *Leavenworth*  
this *17<sup>th</sup>* day of *December* 1864, *Alonso Eddings*

BEFORE *Wm D Matthews* Lieut  
Recruiting 1<sup>st</sup> Ind U.S. Col Artillery

I CERTIFY, ON HONOR, That I have carefully examined the above-named Volunteer, agreeably  
to the General Regulations of the Army, and that, in my opinion, he is free from all bodily defects and  
mental infirmity, which would in any way disqualify him from performing the duties of a soldier.

*Wiffie Sinks*  
Sur Board of Enrollment  
*Leavenworth* Dist *Kansas*  
EXAMINING SURGEON.

I CERTIFY, ON HONOR, That I have minutely inspected the Volunteer, *Alonso Eddings*  
previously to his enlistment, and that he was entirely sober when enlisted; that, to the best of my  
judgment and belief, he is of lawful age; and that, in accepting him as duly qualified to perform the duties  
of an able-bodied soldier, I have strictly observed the Regulations which govern the recruiting service.  
This soldier has *Black* eyes, *Black* hair, *Black* complexion, is *5* feet  
*4* inches high.

*Wm D Matthews* Lieut  
Recruiting 1<sup>st</sup> Ind, U.S. Col Artillery  
Regiment of *Volunteers*,  
RECRUITING OFFICER.

(A. G. O. No. 74 & 75.)

Mustered into the service of the United States, in *Company* *Anders Battery*  
the *17<sup>th</sup>* day of *December* 1864 at *Leavenworth* *Ks*  
Regt of *W. D. Anderson* *Volunteers*, on  
*Alonso Eddings*  
*Capt 20<sup>th</sup> Mass*  
*Charles S. Smith*

NOTE 1.—This blank will be used for both enlistments and re-enlistments—enlistment of veterans, &c., &c., in the volunteer service. They will be made out in duplicate in all cases—one to accompany the recruiting return of the superintendent (not the recruiting officer) to the Adjutant General, and one to accompany the accounts of the officer who pays bounty, &c. The Regiment and Company in which the soldier last served should be given on the back.

NOTE 2.—An enlistment holds to service. A muster-in must, in all cases, precede payment of pay, bounty, pension, &c. A muster-in roll must, in all cases, be filed in the Adjutant General's Office as evidence of muster-in. The mustering officer, commissary, or assistant commissary of musters, as the case may be, will countersign both enlistments as having mustered the soldier into the service of the United States before either of them is given to the disbursing officer.

Rec'd from 2nd. Aud. Nov. 23d 1892

DECLARATION OF RECRUIT.

*Alonzo Eddings* desiring to VOLUNTEER as a Soldier in the Army of the United States, for the term of THREE YEARS, Do Declare, That I am *22* years and *two* months of age; that I have never been discharged from the United States service on account of disability or by sentence of a court martial, or by order before the expiration of a term of enlistment; and I know of no impediment to my serving honestly and faithfully as a soldier for three years.

GIVEN at \_\_\_\_\_ the *22nd* day of *December* 18*64*

Witness: *W. P. [unclear]* *Alonzo Eddings*

No. *29*  
*Alonzo Eddings*  
 Mustered at *Waverly, Va. 11th Regt.*  
*Seventh December 1864,*  
 By *Wm. H. [unclear]*  
 Regiment of \_\_\_\_\_  
 \_\_\_\_\_  
 \_\_\_\_\_ enlistment; last served in Company ( ) \_\_\_\_\_  
 \_\_\_\_\_ Reg't of \_\_\_\_\_  
 \_\_\_\_\_ Discharged \_\_\_\_\_ 18 \_\_\_\_\_

CONSENT IN CASE OF MINOR.

I, \_\_\_\_\_ Do CERTIFY, That I am the \_\_\_\_\_ of \_\_\_\_\_; that the said \_\_\_\_\_ is \_\_\_\_\_ years of age; and I do hereby freely give my CONSENT to his volunteering as a SOLDIER in the ARMY OF THE UNITED STATES for the period of THREE YEARS.

GIVEN at \_\_\_\_\_ the \_\_\_\_\_ day of \_\_\_\_\_

Witness: \_\_\_\_\_

VOLUNTEER ENLISTMENT.

STATE OF



TOWN OF

Leavenworth, Mo.

I, Alonzo Eddings born in Howard Co  
 in the State of Missouri aged 22 Twenty two years,  
 and by occupation a Laborer. Do HEREBY ACKNOWLEDGE to have  
 volunteered this Seventh day of December 1864,  
 to serve as a Soldier in the Army of the United States of America, for  
 the period of THREE YEARS, unless sooner discharged by proper authority;  
 Do also agree to accept such bounty, pay, rations, and clothing, as are, or may be,  
 established by law for volunteers. And I, Alonzo Eddings do  
 solemnly swear, that I will bear true faith and allegiance to the United States  
of America, and that I will serve them honestly and faithfully against all  
 their enemies or opposers whomsoever; and that I will observe and obey the  
 orders of the President of the United States, and the orders of the officers  
 appointed over me, according to the Rules and Articles of War.

Sworn and subscribed to, at Leavenworth  
 this 7 day of December 1864, } Alonzo Eddings  
 BEFORE Wm D Matthews } his  
Recruiting 1st Ind. U. S. Col Artillery } mark

I CERTIFY, ON HONOR, That I have carefully examined the above-named Volunteer, agreeably  
 to the General Regulations of the Army, and that, in my opinion, he is free from all bodily defects and  
 mental infirmity, which would in any way disqualify him from performing the duties of a soldier.

Jiffie Binks  
Surgeon Board of Enrollment  
North Dixie Kansas  
 EXAMINING SURGEON.

I CERTIFY, ON HONOR, That I have minutely inspected the Volunteer, Alonzo Eddings,  
 previously to his enlistment, and that he was entirely sober when enlisted; that, to the best of my  
 judgment and belief, he is of lawful age; and that, in accepting him as duly qualified to perform the  
 duties of an able-bodied soldier, I have strictly observed the Regulations which govern the recruiting  
 service. This soldier has Black eyes, Black hair, Black complexion, is 5  
 feet 4 inches high.

Wm D Matthews  
Recruiting 1st Ind. U. S. Col Artillery  
Volunteers,  
 Regiment of  
 RECRUITING OFFICER.

(A. G. O. No. 74 & 76.)

Mustered into the service of the United States, for three years or during the war, from date of enlistment, in Company 1st  
Batt U S Art Regiment of Artillery Volunteers, on the 7th day of December, 1864, at Leavenworth, Mo  
Wm D Matthews  
Recruiting 1st Ind. U. S. Col Artillery  
Volunteers,  
 Regiment of

The Bounty fund  
 is from the Provost  
 Marshal's Office  
 of Leavenworth, Mo.  
 Alonzo Eddings  
 Recruiting 1st Ind. U. S. Col Artillery  
 Volunteers,  
 Regiment of

*Amerson, William*

Adpt. Batt'y U.S. Col'd L. Art'y

*Private Private*

CARD NUMBERS.

1	6233696	26
2	6234327	27
3	6234644	28
4	9133070	29
5		30
6		31
7		32
8		33
9		34
10		35
11		36
12		37
13		38
14		39
15		40
16		41
17		42
18		43
19		44
20		45
21		46
22		47
23		48
24		49
25		50

Book Mark:

See also



*E*

Indpt. Batt'y. | **U.S.C.T.**

*William Edmonson*

....., Indpt. Batt'y, U. S. Col'd L. Art'y.

Appears on

**Battery Descriptive Book**

of the organization named above.

**DESCRIPTION.**

Age *46* years; height *5* feet *5* inches.

Complexion *Black*

Eyes *Black*; hair *Black*

Where born *Independence Mo.*

Occupation *Farmer*

**ENLISTMENT.**

When *March 3*, 186*5*.

Where *Ind. with. Ky.*

By whom *Capt McMahon*; term *1* y'rs.

Remarks: .....

.....

.....

.....

.....

.....

.....

.....

.....

.....

*Boalton*

E

Indpt. Battery.

U.S.C.T.

*William Edmonson*

Appears with rank of *Priv* on

**Muster and Descriptive Roll of a Detachment of U. S. Vols. forwarded**

for the Indpt. Batt'y, U. S. Col'd L. Arty. Roll dated

*Leavenworth, Kas, Mch 3, 1865.*

Where born *Independence, Missouri*

Age *46* y'rs; occupation *Farmer*

When enlisted *Mch 3, 1865.*

Where enlisted *Leavenworth, Kansas*

For what period enlisted *1* years.

Eyes *black*; hair *black*

Complexion *black*; height *5* ft. *5* in.

When mustered in *Mch 3, 1865.*

Where mustered in *Leavenworth, Kansas*

Bounty paid \$ *33*<sup>*33*</sup>/<sub>*100*</sub>; due \$ *66*<sup>*67*</sup>/<sub>*100*</sub>

Where credited

Battery to which assigned

Remarks: *Credited to Northern Dist. Kas. 2<sup>d</sup> Sub. Dist. Kickapoo Tp. Leavenworth County. Vol. Recruit & entitled to bounty*

Book mark:

*E. L. Thomsen*

*C*

Indpt. Battery.

U.S.C.T.

*William Edmondson,*

*Pr*, Indpt. Battery, U. S. Col'd L. Art'y.

Appears on

**Battery Muster Roll**

for *May & Apl.*, 1865.

Present or absent

Stoppage, \$ 100 for

Due Gov't, \$ 100 for

Valuation of horse, \$ 100

Valuation of horse equipments, \$ 100

Remarks: *Discharged on  
Surgeons Certificate of  
Disability, Apl. 21/65,*

Book mark:

*Porter*

(358)

Copyist.

*C*

Indpt. Battery.

U.S.C.T.

*William Edmonson,*

*R*, Indpt. Battery U. S. Col'd Light Art'y.

Appears on **Batt'y Muster-out Roll**, dated

*W. Linnworth, Ky, July 27, 1865.*

Muster-out to date ..... 186 .

Last paid to ..... 186 .

Clothing account:

Last settled....., 186 ; drawn since \$*45*<sup>*35*</sup>/<sub>100</sub>,

Due soldier \$.....<sub>100</sub>; due U. S. \$.....<sub>100</sub>

Am't for cloth'g in kind or money adv'd \$.....<sub>100</sub>

Due U. S. for arms, equipments, &c., \$.....<sub>100</sub>

Bounty paid \$.....<sub>100</sub>; due \$.....<sub>100</sub>

Remarks: *Discharged on*  
*Surgeon's Cert. of Disabl.*  
*Apr. 21/65,*

Book mark: *C.D.*

*Porter*

*E. Amerson Williams*

, Co. *1st* <sup>Batt</sup> <sub>Reg't</sub> *W.S.C.A*

*3* Enclosures.

Bed Cards .....	Final Statements .....
Burial Records .....	Furloughs or L. of A .....
Certs. of Dis. for Discharge / .....	Med. Certificates .....
C. M. Charges .....	Med. Des. Lists .....
Descriptive Lists .....	Orders .....
Discharge Certificates .....	Pris. of War Record .....
Enlistment Papers <i>2</i> .....	Resignations .....

Other papers relating to—

Admission to Hosp'l .....	Furlough or L. of A .....
Casualty Sheet .....	Med. Examination .....
Confinement .....	Misc. Information .....
Contracts .....	Pay or Clothing .....
Death or Effects .....	Personal Reports .....
Desertion .....	Rank .....
Discharge from Hosp'l .....	Transfer to Hosp'l .....
Discharge from Service .....	Transfer to V. R. C. .....
Duty .....	Transportation .....

DECLARATION OF RECRUIT.

I, William Edmondson, desiring to VOLUNTEER as a Soldier in the Army of the United States, for the term of ~~THREE YEARS~~ one Do Declare, That I am forty six years and \_\_\_\_\_ months of age; that I have never been discharged from the United States service on account of disability or by sentence of a court martial, or by order before the expiration of a term of enlistment; and I know of no impediment to my serving honestly and faithfully as a soldier for ~~three~~ one years.

GIVEN at Leavenworth Kansas the 30 day of March, 1875

Witness: Wm Stokes Wm Edmondson mark

Rec'd from Mr. A. G. O. No. 74 & 76

NOTE 1.—This blank will be used for both enlistments and re-enlistments—enlistment of volunteers, &c., &c., in the volunteer service. They will be made out in duplicate in all cases—one to accompany the recruiting return of the superintendent (not the recruiting officer) to the Adjutant General, and one to accompany the accounts of the officer who pays bounty, &c. The Regiment and Company in which the soldier last served should be given on the back.

NOTE 2.—An enlistment holds to service. A muster-in must, in all cases, precede payment of pay, bounty, pension, &c. A muster-in roll must, in all cases, be filed in the Adjutant General's Office as evidence of muster-in. The mustering officer, commissary, or assistant commissary of musters, as the case may be, will countersign both enlistments as having mustered the soldier into the service of the United States before either of them is given to the disbursing officer.

Discharged \_\_\_\_\_, 18\_\_\_\_  
enlistment; last served in Company ( )  
Reg't of \_\_\_\_\_

No. 2  
William Edmondson  
Volunteered at Leavenworth Kas  
March 30, 1875  
By Capt Wm Stokes  
Adj't 13th Reg't U.S. Col'd Infantry

CONSENT IN CASE OF MINOR.

I, \_\_\_\_\_, Do CERTIFY, That I am \_\_\_\_\_; that the \_\_\_\_\_ of \_\_\_\_\_; that the \_\_\_\_\_ is \_\_\_\_\_ years of age; and I do hereby freely give my CONSENT to his volunteering as a SOLDIER in the ARMY OF THE UNITED STATES for the period of THREE YEARS.

GIVEN at \_\_\_\_\_ the \_\_\_\_\_ day of \_\_\_\_\_

Witness: \_\_\_\_\_

(A. G. O. No. 74 & 76.)

certified to Northern Dist Kansas 23rd Sub Dist Kickapoo Townships Leavenworth

VOLUNTEER ENLISTMENT.

STATE OF

Kansas

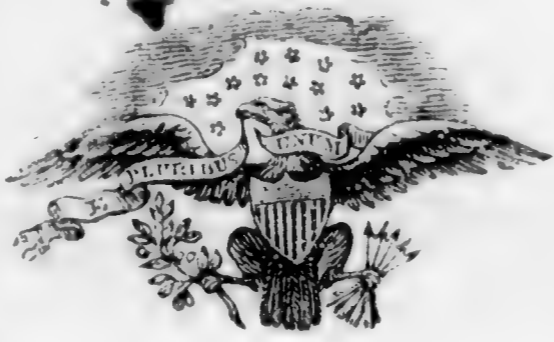

TOWN OF

Leavenworth

I, William Edmonson born in Independence in the State of Missouri, aged forty six years, and by occupation a Farmer, Do HEREBY ACKNOWLEDGE to have volunteered this third day of March, 1865, to serve as a Soldier in the Army of the United States of America, for the period of ~~THREE YEARS~~ <sup>ONE</sup> unless sooner discharged by proper authority: Do also agree to accept such bounty, pay, rations, and clothing, as are, or may be, established by law for volunteers. And I, Wm Edmonson do solemnly swear, that I will bear true faith and allegiance to the United States of America, and that I will serve them honestly and faithfully against all their enemies or opposers whomsoever; and that I will observe and obey the orders of the President of the United States, and the orders of the officers appointed over me, according to the Rules and Articles of War.

Sworn and subscribed to, at Leavenworth Mo, this 3rd day of March, 1865, Wm Edmonson mark BEFORE J. W. Cannon Capt & Pro Marsh. North Dist of Kan.

I CERTIFY, ON HONOR, That I have carefully examined the above-named Volunteer, agreeably to the General Regulations of the Army, and that, in my opinion, he is free from all bodily defects and mental infirmity, which would in any way disqualify him from performing the duties of a soldier.

J. W. Cannon Surgeon Board of Enrollment North Dist. Kansas EXAMINING SURGEON.

I CERTIFY, ON HONOR, That I have minutely inspected the Volunteer Wm Edmonson previously to his enlistment, and that he was entirely sober when enlisted; that, to the best of my judgment and belief, he is of lawful age; and that, in accepting him as duly qualified to perform the duties of an able-bodied soldier, I have strictly observed the Regulations which govern the recruiting service. This soldier has Black eyes, Black hair, Black complexion, is five feet five inches high.

J. W. Cannon Capt & Pro Marsh. North Dist Kansas Regiment of Volunteers. RECRUITING OFFICER.

(A. G. O. No. 74 & 76.)

Mastered into the service of the United States, for 2 years or during the war, from date of enlistment, in Company of 1st Regt. U.S. Artillery 49th Vols. on the 3rd day of March, 1865 at Leavenworth Mo Kan.

Capt. Thomas M. Moore

This recruit has received thirty three dollars, being the amount of first installment of bounty

NOTE 1.—This blank will be used for both enlistments and re-enlistments—enlistment of veterans, &c., &c., in the volunteer service. They will be made out in duplicate in all cases—one to accompany the recruiting return of the recruiting officer (not the recruiting officer) to the Adjutant General, and one to accompany the accounts of the officer who pays bounty, &c. The Regiment and Company in which the soldier last served should be given on the back.

NOTE 2.—An enlistment holds to service. A muster-in must, in all cases, precede payment of pay, bounty, pension, &c. A muster-in roll must, in all cases, be filed in the Adjutant General's Office as evidence of muster-in. The mustering officer, commissary, or assistant commissary of musters, as the case may be, will countersign both enlistments as having mustered the soldier into the service of the United States before either of them is given to the disbursing officer.

DECLARATION OF RECRUIT.

I, William Edmonson, desiring to VOLUNTEER as a Soldier in the Army of the United States, for the term of THREE YEARS. Do Declare, That I am Forty six years and \_\_\_\_\_ months of age; that I have never been discharged from the United States service on account of disability or by sentence of a court martial, or by order before the expiration of a term of enlistment; and I know of no impediment to my serving honestly and faithfully as a soldier for three years.

GIVEN at Leavenworth Kansas the 3<sup>rd</sup> day of March 1865

Witness:

Wm. Holden, Wm. Edmonson  
mark

Paul. Roth says  
No. \_\_\_\_\_  
1-3

William Edmonson  
Volunteered at Leavenworth Kan  
March 3<sup>rd</sup> 1865  
By Capt. M. W. ...  
Adj. Gen. ...

Discharged \_\_\_\_\_, 18\_\_\_\_  
Reg't of \_\_\_\_\_  
enlistment; last served in Company ( )

CONSENT IN CASE OF MINOR.

I, \_\_\_\_\_, Do CERTIFY, That I am \_\_\_\_\_; that the \_\_\_\_\_ of \_\_\_\_\_ is \_\_\_\_\_ years of age; and I do hereby freely give my CONSENT to his volunteering as a SOLDIER in the ARMY OF THE UNITED STATES for the period of THREE YEARS.

GIVEN at \_\_\_\_\_ the \_\_\_\_\_ day of \_\_\_\_\_

Witness:



Credited to Northern Dist Kansas 23<sup>d</sup> Sub Dist Kickapoo Township Leavenworth Co.  
Kickapoo 41

VOLUNTEER ENLISTMENT.

STATE OF

TOWN OF

*Kansas*



*Leavenworth*

I, *William Edmonson*, born in *Independence*  
in the State of *Missouri*, aged *Forty Six* years,  
and by occupation a *Farmer*, Do HEREBY ACKNOWLEDGE to have  
volunteered this *third* day of *March*, 1865,  
to serve as a *Soldier* in the **Army of the United States of America**, for  
the period of ~~THREE~~ *ONE* YEARS, unless sooner discharged by proper authority:  
Do also agree to accept such bounty, pay, rations, and clothing as are, or may be,  
established by law for volunteers. And *William Edmonson*, do  
solemnly swear, that I will bear true faith and allegiance to the **United States**  
**of America**, and that I will serve them honestly and faithfully against all  
their enemies or opposers whomsoever; and that I will observe and obey the  
orders of the President of the United States, and the orders of the officers  
appointed over me, according to the Rules and Articles of War.

Sworn and subscribed to, at *Leavenworth Kas*  
this *3<sup>d</sup>* day of *March*, 1865,  
BEFORE *Amvican* } *Wm Edmonson*  
*Capt Pro Mar North Dist Kan* } *mark*

I CERTIFY, ON HONOR, That I have carefully examined the above-named Volunteer, agreeably  
to the General Regulations of the Army, and that, in my opinion, he is free from all bodily defects and  
mental infirmity, which would in any way disqualify him from performing the duties of a soldier.

*Stiffie Birch*  
*Surgeon in Charge*  
*Amvican* EXAMINING SURGEON.

I CERTIFY, ON HONOR, That I have minutely inspected the Volunteer *Wm Edmonson*  
previously to his enlistment, and that he was entirely sober when enlisted; that, to the best of my  
judgment and belief, he is of lawful age; and that, in accepting him as duly qualified to perform the  
duties of an able-bodied soldier, I have strictly observed the Regulations which govern the recruiting  
service. This soldier has *black* eyes, *black* hair, *black* complexion, is *5'11"*  
feet *11 1/2* inches high.

*Amvican*  
*Capt Pro. Mar. North Dist Kansas*  
Regiment of *Volunteers*

RECRUITING OFFICER.

Mustered into the service of the United States, for *one* year or during the war, from date of enlistment, in Company  
*B* of *Co. A* *Artillery Regt* *Volunteers*, on the *3<sup>d</sup>* day of *March*, 1865, at *Leavenworth*

*Capt Pro Mar North Dist Kansas*

*E. 40, Henderson Co Mo 1865*

CERTIFICATE OF DISABILITY FOR DISCHARGE

In the case of

*1775*  
*Wm Edmonson*

*Private Independent Battery*  
*U.S. Regt of Colored Inf.*

APPROVED

*Geo F Rausch*

SURGEON U.S.A  
MEDICAL DIRECTOR

*Headqrs Dept of the Interior*  
*St Louis Mo April 17 1865*  
*To be Discharged*

*By order of*

*Major Genl Dodge*  
*H J Swain*  
*Asst Adj Genl*

ADJUTANT GENERAL'S OFFICE

*May 15 1865*

Duplicate sent the Pension Office.

Received

*W. E. Office*  
*Headqrs Dept of the Interior*  
*St Louis Mo April 17 1865*  
*A. B.*

# ARMY OF THE UNITED STATES.



## CERTIFICATE OF DISABILITY FOR DISCHARGE.

(To be used, in duplicate, in all cases of discharge on account of disability.)

Independent- *Private William Edmonson* of Captain *H. Ford Douglas*  
 Company, ( *1* ) of the *Colored Artillery* Regiment of United States  
 who was enlisted by *Capt. Mc. Cahon* of  
 the ~~Leavenworth~~ Regiment of *Leavenworth* at *Leavenworth*  
 on the *Thirteenth* day of *March* 1865, to serve *One* year; he was born  
 in *Independence* in the State of *Missouri* is *Forty six*  
 years of age, *Five* feet *6* inches high, *Black* complexion, *Black* eyes,  
*Black* hair, and by occupation when enlisted a *Farmer* During the last two  
 months said soldier has been unfit for duty *60* days. (Here consult directions on Form 12, p. 269, Medical Dept. Gen. Reg.)

*This soldier is crippled in his leg and has had to go with a crutch ever since he joined the Battery*

STATION: *Fort Leavenworth*  
DATE: *April 8th 1865*

*H. Ford Douglas*  
Capt. Commanding Company.

I CERTIFY, that I have carefully examined the said *William Edmonson* of  
 Captain *H. Ford Douglas*'s Company, and find him incapable of performing the duties of a soldier  
 because of (Here consult par. 1134, p. 245, and directions on Form 12, p. 269, Med. Dept. Gen. Reg.)

*Atrophy of right arm, and lameness results of an injury occurring prior to his last enlistment. Previous injuries disability existed prior to his last enlistment Not eligible to Vet R Corps*

*Amos A. ...* Surgeon.  
*Mc. Post Hospital*  
 1865, at *Fort Leavenworth*  
*W. Davis* of the *16th*  
 Commanding the Post.

DISCHARGED, this *21st* day of *April*

NOTE 1.—When a probable case for pension, special care must be taken to state the degree of disability.  
 NOTE 2.—The place where the soldier desires to be addressed may be here added.

Town— County— State—

(DUPLICATES.)

*Approved*  
*D. B. Davis*  
*Surgeon Major*  
*Medical Director D.C.*

*Miss George*

ndpt. Batt'y U.S. Col'd L. Art'y.

*Private Private*

CARD NUMBERS.

<i>6 2 3 3 6 4 6</i>	26
<i>6 2 3 4 0 7 7</i>	27
<i>6 2 3 4 2 2 1</i>	28
<i>6 2 3 4 3 8 8</i>	29
<i>6 2 3 4 5 5 0</i>	30
<i>9 1 3 3 0 9 9</i>	31
	32
	33
	34
	35
	36
	37
	38
	39
	40
	41
	42
	43
	44
	45
	46
	47
	48
	49
	50

Book Mark:

See also

1911 N 024

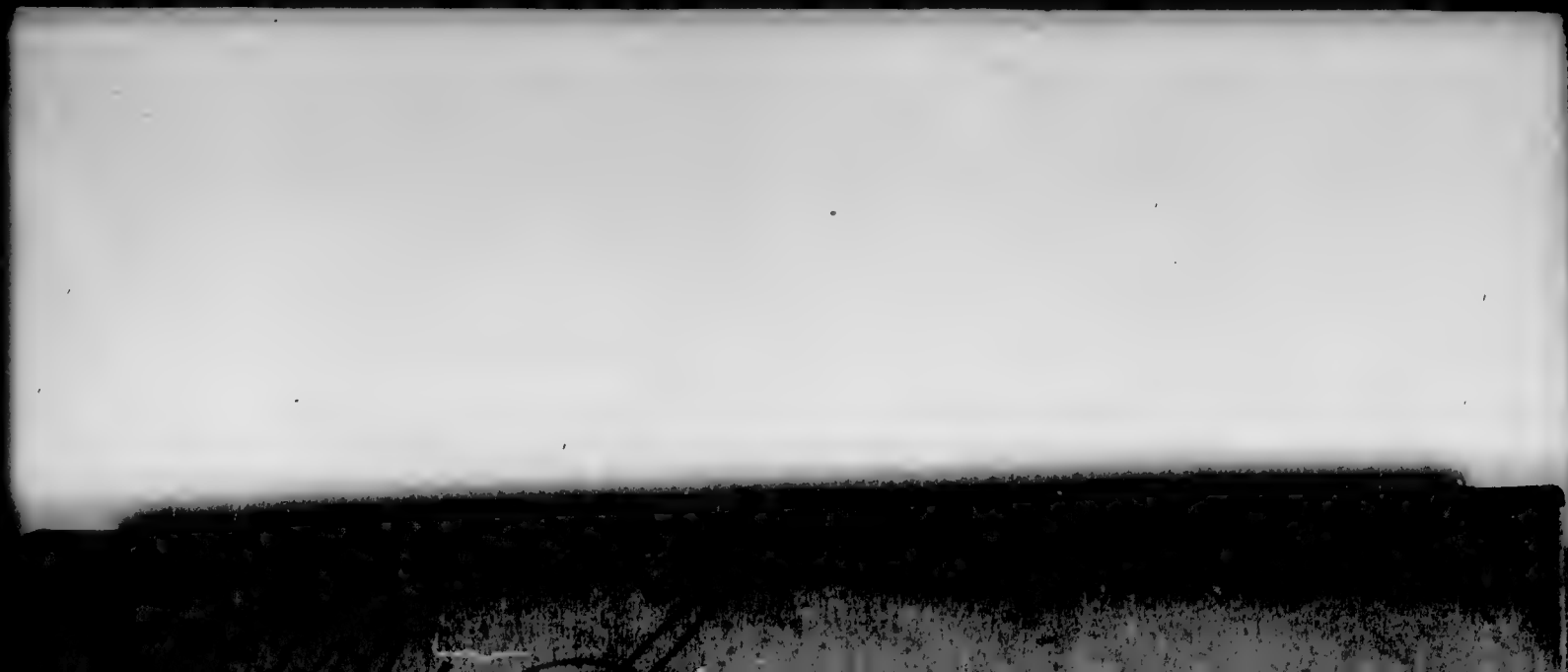

А. 1059622 РО-МУ-7М

В. С. Романов  
г.

E | Indpt. Batt'y. | **U.S.C.T.**

*George Ellis*

....., Indpt. Batt'y, U. S. Col'd L. Art'y.

Appears on

**Battery Descriptive Book**

of the organization named above.

**DESCRIPTION.**

Age *17* years; height *5* feet *2* inches.

Complexion *Yellow*

Eyes *Black*; hair *Black*

Where born *Munroe Co., Mo*

Occupation *Farmer*

**ENLISTMENT.**

When *Jan. 16*, 186*5*.

Where *Lawrence Kas*

By whom *Capt Douglas*, term *3* y'rs.

Remarks: .....

.....

.....

.....

.....

.....

.....

.....

.....

.....

.....

.....

.....

*Shollroot*

E

Indpt. Battery.

U.S.C.T.

George Ellis

Appears with rank of *Priv* on

**Muster and Descriptive Roll of a Detachment of U. S. Vols. forwarded**

for the Indpt. Batt'y, U. S. Col'd L. Arty. Roll dated

*Leavenworth, Mo. Jan. 17, 1865.*

Where born *Clark Co., Ken.*

Age *17* y'rs; occupation *Farmer*

When enlisted *Jan. 16, 1865.*

Where enlisted *Leavenworth, Kans.*

For what period enlisted *3* years.

Eyes *Black*; hair *Black*

Complexion *Yellow*; height *5* ft. *2* in.

When mustered in *Jan. 17, 1865.*

Where mustered in *Leavenworth, Mo.*

Bounty paid \$ *000* <sup>100</sup>; due \$ *300* <sup>100</sup>

Where credited

Battery to which assigned

Remarks: *Credited to South<sup>th</sup> Dist.*

*Kans., 31<sup>st</sup> Sub-district Lawrence,*

*Douglas Co. Volunteer Recruit*

*& entitled to Bounty.*

Book mark:

*E. Tharnton*

(339)

Copyist.



E

Indpt. Battery.

U.S.C.T.

George Ellis

Oct, Indpt. Battery, U. S. Col'd L. Art'y.

Appears on

Battery Muster Roll

for *Jan'y Feb*, 186*5*.

Present or absent *Present*

Stoppage, \$ 100 for

Due Gov't, \$ 100 for

Valuation of horse, \$ 100

Valuation of horse equipments, \$ 100

Remarks: *Security due \$100.*

Book mark:

*J. Schoddy*

(358)

Copyist.

*O* | Indpt. Battery. | **U.S.C.T.**

*George Ellis,*

*Pr*, Indpt. Battery, U. S. Col'd L. Art'y.

Appears on

**Battery Muster Roll**

for *Mar. & Apr*, 1865.

Present or absent *Present,*

Stoppage, \$ 100 for

Due Gov't, \$ 100 for

Valuation of horse, \$ 100

Valuation of horse equipments, \$ 100

Remarks: *Bounty due \$100.00*

Book mark: \_\_\_\_\_

*Parter*

(358)

Copyist.

*O* | Indpt. Battery. | **U.S.C.T.**

*George Ellis,*  
*Pr*, Indpt. Battery, U. S. Col'd L. Art'y.

Appears on

**Battery Muster Roll**

for *May & June*, 186*5*.

Present or absent *Present*.

Stoppage, \$ 100 for

Due Gov't, \$ 100 for

Valuation of horse, \$ 100

Valuation of horse equipments, \$ 100

Remarks:  
-----  
-----  
-----  
-----  
-----  
-----  
-----  
-----  
-----  
-----

Book mark: *100*

*Porter*  
Copyist.

1977 001  
E | Indpt. Battery. | U.S.C.T.

*George Ellis,*  
*Co.*, Indpt. Battery U. S. Col'd Light Art'y.

Appears on **Batt'y Muster-out Roll**, dated  
*At Leavenworth, Mo., July 22, 1865.*

Muster-out to date *July 22, 1865.*

Last paid to *Pay due from enlistment,* 186 .

Clothing account:

Last settled....., 186 ; drawn since \$ *60* <sup>49</sup>/<sub>100</sub>,

Due soldier \$.....<sup>100</sup>; due U. S. \$.....<sup>100</sup>

Am't for cloth'g in kind or money adv'd \$.....<sup>100</sup>

Due U. S. for arms, equipments, &c., \$.....<sup>100</sup>

Bounty paid \$ *None* <sup>100</sup>; due \$ *1 00* <sup>100</sup>,

Remarks:.....  
.....  
.....  
.....  
.....  
.....  
.....

Book mark:.....

(361)

*Partes*  
Copyist.

*Ellis George*

, Co. *1st* *Batt.* *Reg't* *U.S.C.A.*

*2* **Enclosures.**

Bed Cards .....	Final Statements .....
Burial Records .....	Furloughs or L. of A .....
Certs. of Dis. for Discharge .....	Med. Certificates .....
C. M. Charges .....	Med. Des. Lists .....
Descriptive Lists .....	Orders .....
Discharge Certificates .....	Pris. of War Record .....
Enlistment Papers <i>2</i> .....	Resignations .....

**Other papers relating to—**

Admission to Hosp'l .....	Furlough or L. of A .....
Casualty Sheet .....	Med. Examination .....
Confinement .....	Misc. Information .....
Contracts .....	Pay or Clothing .....
Death or Effects .....	Personal Reports .....
Desertion .....	Rank .....
Discharge from Hosp'l .....	Transfer to Hosp'l .....
Discharge from Service .....	Transfer to V. R. C. .....
Duty .....	Transportation .....

NOTE 1.—This blank will be used for both enlistments and re-enlistments—enlistment of veterans, &c., &c., in the volunteer service. They will be made out in duplicate in all cases—one to accompany the recruiting return of the superintendent (not the recruiting officer) to the Adjutant General, and one to accompany the accounts of the officer who pays bounty, &c. The Regiment and Company in which the soldier last served should be given on the back

NOTE 2.—An enlistment holds to service. A muster-in must, in all cases, precede payment of pay, bounty, pension, &c. A muster-in roll must, in all cases, be filed in the Adjutant General's Office as evidence of muster-in. The mustering officer, commissary, or assistant commissary of musters, as the case may be, will countersign both enlistments as having mustered the soldier into the service of the United States before either of them is given to the disbursing officer.

DECLARATION OF RECRUIT

I, George Ellis, desiring to VOLUNTEER as a Soldier in the Army of the United States, for the term of THREE YEARS, Do Declare, That I am sixteen years and \_\_\_\_\_ months of age; that I have never been discharged from the United States service on account of disability or by sentence of a court martial, or by order before the expiration of a term of enlistment; and I know of no impediment to my serving honestly and faithfully as a soldier for three years.

GIVEN at Leavenworth City the 16<sup>th</sup> day of January 1865

Witness:

W. A. Burnham

George Ellis

Discharged \_\_\_\_\_, 18 \_\_\_\_\_

Reg't of \_\_\_\_\_

enlistment; last served in Company ( \_\_\_\_\_ )

No. \_\_\_\_\_  
George Ellis  
 Volunteered at Leavenworth Mo  
January 16, 1865  
By W. A. Burnham  
Private 1st Regt of U.S. Cavalry (8<sup>th</sup>)

CONSENT IN CASE OF MINOR.

I, W. A. Burnham, Do CERTIFY, That I am the Guardian of George Ellis; that the said George Ellis is seventeen years of age; and I do hereby freely give my CONSENT to his volunteering as a SOLDIER in the ARMY OF THE UNITED STATES for the period of THREE YEARS.

GIVEN at Leavenworth City the 16 day of January 1865

Witness:

C. N. O. Clough

W. A. Burnham

*Credited to Southern Dist Kas. 31st Subst Dist Lawrence Douglas Leo*

VOLUNTEER ENLISTMENT.

STATE OF *Kansas* TOWN OF *Lawrence*



I, *George Ellis*, born in *Clark Co* in the State of *Kentucky*, aged *Seventeen* years, and by occupation a *Farmer*, Do HEREBY ACKNOWLEDGE to have volunteered this *Sixteenth* day of *January*, 1865, to serve as a **Soldier** in the **Army of the United States of America**, for the period of **THREE YEARS**, unless sooner discharged by proper authority: Do also agree to accept such bounty, pay, rations, and clothing, as are, or may be, established by law for volunteers. And I, *George Ellis*, do solemnly swear, that I will bear true faith and allegiance to the **United States of America**, and that I will serve them honestly and faithfully against all their enemies or opposers whomsoever; and that I will observe and obey the orders of the President of the United States, and the orders of the officers appointed over me, according to the Rules and Articles of War.

Sworn and subscribed to, at *Lawrence* this *16th* day of *Jan*, 1865, BEFORE *Lieut N Ford Douglas Recruiting Officer 1st Ind U.S. Col- Artillery (Light)*

I CERTIFY, ON HONOR, That I have carefully examined the above-named Volunteer, agreeably to the General Regulations of the Army, and that, in my opinion, he is free from all bodily defects and mental infirmity, which would in any way disqualify him from performing the duties of a soldier.

*Tiffin Binks*  
Surgeon Board of Enrollments  
North West Dist Kansas  
EXAMINING SURGEON.

I CERTIFY, ON HONOR, That I have minutely inspected the Volunteer *George Ellis* previously to his enlistment, and that he was entirely sober when enlisted; that, to the best of my judgment and belief, he is of lawful age; and that, in accepting him as duly qualified to perform the duties of an able-bodied soldier, I have strictly observed the Regulations which govern the recruiting service. This soldier has *black* eyes, *black* hair, *yellow* complexion, is *fine* feet *2* inches high.

*Lieut N Ford Douglas*  
*1st Ind U.S. Col- Artillery*  
RECRUITING OFFICER.

Mustered into the service of the United States, for three years or during the war, from date of enlistment, in *Company A 1st Ind U.S. Col- Artillery*, *Battery* Regiment of *Volunteers*, on the *17th* day of *January*, 1865, at *Lawrence, Kansas*.

*James H. ...*  
*Capt. ...*  
*William ...*

NOTE 1.—This blank will be used for both enlistments and re-enlistments—enlistment of veterans, &c., &c., in the volunteer service. They will be made out in duplicate in all cases—one to accompany the recruiting return of the superintendent (not the recruiting officer) to the Adjutant General, and one to accompany the accounts of the officer who pays bounty, &c. The Regiment and Company in which the soldier last served should be given on the back

NOTE 2.—An enlistment holds to service. A muster-in must, in all cases, precede payment of pay, bounty, pension, &c. A muster-in roll must, in all cases, be filed in the Adjutant General's Office as evidence of muster-in. The mustering officer, commissary, or assistant commissary of musters, as the case may be, will countersign both enlistments as having mustered the soldier into the service of the United States before either of them is given to the disbursing officer.

DECLARATION OF RECRUIT.

I, George Ellis, desiring to VOLUNTEER as a Soldier in the Army of the United States, for the term of THREE YEARS. Do Declare, That I am eighteen years and \_\_\_\_\_ months of age; that I have never been discharged from the United States service on account of disability or by sentence of a court martial, or by order before the expiration of a term of enlistment; and I know of no impediment to my serving honestly and faithfully as a soldier for three years.

GIVEN at Leavenworth City the 16<sup>th</sup> day of January 1865-

Witness: W. A. Burnham George Ellis  
mark

Discharged ..... 18 ..

Rec't of ..

enlistment; last served in Company ( )

No. 9  
George Ellis  
Company of Leavenworth  
January 16 1865  
Reg't of 1st Cavalry  
Regiment of 18<sup>th</sup> Cal (P)

CONSENT IN CASE OF MINOR.

I, W. A. Burnham, Do CERTIFY, That I am the Guardian of George Ellis; that the said George Ellis is seventeen years of age; and I do hereby freely give my CONSENT to his volunteering as a SOLDIER in the ARMY OF THE UNITED STATES for the period of THREE YEARS.

GIVEN at Leavenworth City the 17 day of January 1865-

Witness: W. A. Burnham  
C. N. O. Blue



Credited to Southern Dist Kan. 31st Dist Lt Col Samuel Douglas Co

Louisa Day of Cas 31

VOLUNTEER ENLISTMENT.

STATE OF

Kansas



TOWN OF

Seavenworth

I, George Ellis, born in Clark Co in the State of Kentucky, aged Seventeen years, and by occupation a farmer, Do HEREBY ACKNOWLEDGE to have volunteered this Sixteenth day of January, 1865, to serve as a Soldier in the Army of the United States of America, for the period of THREE YEARS, unless sooner discharged by proper authority: Do also agree to accept such bounty, pay, rations, and clothing, as are, or may be, established by law for volunteers. And I, George Ellis, do solemnly swear, that I will bear true faith and allegiance to the United States of America, and that I will serve them honestly and faithfully against all their enemies or opposers whomsoever; and that I will observe and obey the orders of the President of the United States, and the orders of the officers appointed over me, according to the Rules and Articles of War.

Sworn and subscribed to, at Seavenworth this 16th day of Jan, 1865, before me George Ellis

I CERTIFY, ON HONOR, That I have carefully examined the above-named Volunteer, agreeably to the General Regulations of the Army, and that, in my opinion, he is free from all bodily defects and mental infirmity, which would in any way disqualify him from performing the duties of a soldier.

Jesse Sinks Examining Surgeon

I CERTIFY, ON HONOR, That I have minutely inspected the Volunteer George Ellis previously to his enlistment, and that he was entirely sober when enlisted; that, to the best of my judgment and belief, he is of lawful age; and that, in accepting him as duly qualified to perform the duties of an able-bodied soldier, I have strictly observed the Regulations which govern the recruiting service. This soldier has black eyes, black hair, yellow complexion, is five feet 2 inches high.

Lt Col Samuel Douglas Recruiting Officer

(A. G. O. No. 74 & 76.)

Mustered into the service of the United States, for three years or during the war, from date of enlistment, in 31st Dist Lt Col Samuel Douglas Co, on the 17th day of January, 1865, at Seavenworth Kansas.

George Ellis

*01*  
*Oving Ephraim*  
Indpt. Batt'y U.S. Col'd L. Art'y  
*Private Private*

CARD NUMBERS.

<i>16233668</i>	26
<i>6234222</i>	27
<i>6234389</i>	28
<i>62346-571</i>	29
<i>9133069</i>	30
	31
	32
	33
	34
	35
	36
	37
	38
	39
	40
	41
	42
	43
	44
	45
	46
	47
	48
	49
	50

Book Mark: \_\_\_\_\_

See also \_\_\_\_\_

S. 1940715 PONTM.

W. Penner  
E

*E*

Indpt. Batt'y. | **U.S.C.T.**

*Ephraim Erving*

....., Indpt. Batt'y, U. S. Col'd L. Art'y.

Appears on

**Battery Descriptive Book**

of the organization named above.

**DESCRIPTION.**

Age *56* years; height *5* feet *4* inches.

Complexion *Black*

Eyes *Black*; hair *Black*

Where born *Russville Ky*

Occupation *Labourer*

**ENLISTMENT.**

When *Feb. 27*, 186*5*.

Where *San with Kais.*

By whom *A Minor*; term *3* y'rs.

Remarks: .....

.....  
 .....  
 .....  
 .....  
 .....  
 .....  
 .....

*Shelton*

8

Indpt. Battery.

U.S.C.T.

Ephraim Ewing

Appears with rank of *Priv* on**Muster and Descriptive Roll of a Detachment of U. S. Vols. forwarded**

for the Indpt. Batt'y, U. S. Col'd L. Arty. Roll dated

*Leavenworth, Kans, Feb. 27, 1865.*Where born *Russellville Co., Kans.*Age *56* y'rs; occupation *Lab. and*When enlisted *Feb. 27, 1865.*Where enlisted *Leavenworth, Ks.*For what period enlisted *3* years.Eyes *black*; hair *black*Complexion *black*; height *5 ft. 4 in.*When mustered in *Feb. 27, 1865.*Where mustered in *Leavworth, Ks.*Bounty paid \$ *100* 100; due \$ *200* 100

Where credited

Battery to which assigned

Remarks: *Credited to North<sup>n</sup> dist. Kans. 2<sup>d</sup> Sub. dist. 4<sup>th</sup> Ward. Leavenworth City. Vol. Recruit entitled to bounty.*

Book mark:

*E. L. Thomson*

*O<sup>r</sup>* | Indpt. Battery. | **U.S.C.T.**

*Captain Ewing*  
*On*

, Indpt. Battery, U. S. Col'd L. Art'y.

Appears on

**Battery Muster Roll**

for *Mar + Apr*, 1865.

Present or absent *Present*

Stoppage, \$ 100 for

Due Gov't, \$ 100 for

Valuation of horse, \$ 100

Valuation of horse equipments, \$ 100

Remarks:  
-----  
-----  
-----  
-----  
-----  
-----  
-----  
-----  
-----  
-----

Book mark: -----

*Porter*

(358)

Copyist.

*E* | Indpt. Battery. | **U.S.C.T.**

*Ephraim Ewing,*  
*E*, Indpt. Battery, U. S. Col'd L. Art'y.

Appears on

**Battery Muster Roll**

for *May & June*, 1865.

Present or absent *Present,*

Stoppage, \$ 100 for

Due Gov't, \$ 100 for

Valuation of horse, \$ 100

Valuation of horse equipments, \$ 100

Remarks:  
\_\_\_\_\_  
\_\_\_\_\_  
\_\_\_\_\_  
\_\_\_\_\_  
\_\_\_\_\_  
\_\_\_\_\_  
\_\_\_\_\_

Book mark: \_\_\_\_\_

*Porter*

(358)

Copyist.

*O* | Indpt. Battery. | **U.S.C.T.**

*Phraim Curing,*  
*Pr*, Indpt. Battery U. S. Col'd Light Art'y.

Appears on **Batt'y Muster-out Roll**, dated  
*W. Leavenworth, Kas. July 22, 1865.*

Muster-out to date *July 22*, 1865.

Last paid to *Pay due from enlistment,* 1865.

**Clothing account:**

Last settled....., 186 ; drawn since \$ *51* <sup>84</sup>/<sub>100</sub>,

Due soldier \$.....<sup>100</sup>; due U. S. \$.....<sup>100</sup>

Am't for cloth'g in kind or money adv'd \$.....<sup>100</sup>

Due U. S. for arms, equipments, &c., \$.....<sup>100</sup>

Bounty paid \$ *100* <sup>100</sup>; due \$ *None* <sup>100</sup>,

Remarks:.....  
 .....  
 .....  
 .....  
 .....

Book mark : *2124, 1882,*

*Porter*  
 Copyist.



*Ewing Ephraim*

, Co. *2nd Batt U.S.C.A.*  
Reg't

**7 Enclosures.**

Bed Cards .....	Final Statements .....
Burial Records .....	Furloughs or L. of A. ....
Certs. of Dis. for Discharge .....	Med. Certificates .....
C. M. Charges .....	Med. Des. Lists .....
Descriptive Lists .....	Orders .....
Discharge Certificates .....	Pris. of War Record .....
Enlistment Papers <b>7</b> .....	Resignations .....

Other papers relating to—

Admission to Hosp'l .....	Furlough or L. of A. ....
Casualty Sheet .....	Med. Examination .....
Confinement .....	Misc. Information .....
Contracts .....	Pay or Clothing .....
Death or Effects .....	Personal Reports .....
Desertion .....	Rank .....
Discharge from Hosp'l .....	Transfer to Hosp'l .....
Discharge from Service .....	Transfer to V. R. C. ....
Duty .....	Transportation .....
.....	.....

DECLARATION OF RECRUIT.

I, Ephraim Ewing, desiring to VOLUNTEER as a Soldier in the Army of the United States, for the term of THREE YEARS. Do Declare, That I am Fifty six (56) years and \_\_\_\_\_ months of age; that I have never been discharged from the United States service on account of disability or by sentence of a court martial, or by order before the expiration of a term of enlistment; and I know of no impediment to my serving honestly and faithfully as a soldier for three years.

GIVEN at Leavenworth City Kansas the 27 day of February 1868

Witness: W. Wheat Ephraim Ewing his mark

NOTE 1.—This blank will be used for both enlistments and re-enlistments—enlistment of veterans, &c., &c., in the volunteer service. They will be made out in duplicate in all cases—one to accompany the recruiting return of the superintendent (not the recruiting officer) to the Adjutant General, and one to accompany the accounts of the officer who pays bounty, &c. The Regiment and Company in which the soldier last served should be given on the back  
NOTE 2.—An enlistment holds to service. A muster-in must, in all cases, precede payment of pay, bounty, pension, &c. A muster-in roll must, in all cases, be filed in the Adjutant General's Office as evidence of muster-in. The mustering officer, commissary, or assistant commissary of musters, as the case may be, will countersign both enlistments as having mustered the soldier into the service of the United States before either of them is given to the disbursing officer.

enlistment: last served in Company ( )  
Reg't of \_\_\_\_\_  
Discharged \_\_\_\_\_, 18 \_\_\_\_\_

No. 5  
Ephraim Ewing  
Volunteered at Leavenworth Mo  
February 27th, 1868  
By W. Wheat Adj. Genl.  
for duplicate Recruits of Co. B. 1st Regt. Ark.

CONSENT IN CASE OF MINOR.

I, \_\_\_\_\_, Do CERTIFY, That I am \_\_\_\_\_; that the \_\_\_\_\_ of \_\_\_\_\_; that the said \_\_\_\_\_ is \_\_\_\_\_ years of age; and I do hereby freely give my CONSENT to his volunteering as a SOLDIER in the ARMY OF THE UNITED STATES for the period of THREE YEARS.

GIVEN at \_\_\_\_\_ the \_\_\_\_\_ day of \_\_\_\_\_

Witness: \_\_\_\_\_

(A. G. O. No. 74 & 76.)

Rec'd from 2nd. Aud. Nov. 23d 1892

Resident to North Dist Kansas 22<sup>nd</sup> Sub Dist 4<sup>th</sup> Ward Leavenworth City  
3874

VOLUNTEER ENLISTMENT.

STATE OF



TOWN OF

Leavenworth

I, Ephraim Ewing, born in Russellville County  
in the State of Kentucky, aged 56 years,  
and by occupation a Laborer, Do HEREBY ACKNOWLEDGE to have  
volunteered this Twenty seventh (27) day of February, 1865  
to serve as a **Soldier** in the **Army of the United States of America**, for  
the period of **THREE YEARS**, unless sooner discharged by proper authority:  
Do also agree to accept such bounty, pay, rations, and clothing, as are, or may be,  
established by law for volunteers. And I, Ephraim Ewing, do  
solemnly swear, that I will bear true faith and allegiance to the **United States**  
**of America**, and that I will serve them honestly and faithfully against all  
their enemies or opposers whomsoever; and that I will observe and obey the  
orders of the President of the United States, and the orders of the officers  
appointed over me, according to the Rules and Articles of War.

Sworn and subscribed to, at Leavenworth  
this 27 day of February, 1865,  
BEFORE P. H. Minor 2<sup>nd</sup> Lieut. } Ephraim Ewing  
his mark

Ind. Baty. U.S. Col & Arty. (Light)  
I CERTIFY, ON HONOR, That I have carefully examined the above-named Volunteer, agreeably  
to the General Regulations of the Army, and that, in my opinion, he is free from all bodily defects and  
mental infirmity, which would in any way disqualify him from performing the duties of a soldier.

Tiffin Sinks  
Asst Surgeon Band of Enrollment  
South Dist Kan EXAMINING SURGEON.

I CERTIFY, ON HONOR, That I have minutely inspected the Volunteer Ephraim Ewing  
previously to his enlistment, and that he was entirely sober when enlisted; that, to the best of my  
judgment and belief, he is of lawful age; and that, in accepting him as duly qualified to perform the  
duties of an able-bodied soldier, I have strictly observed the Regulations which govern the recruiting  
service. This soldier has Black eyes, Black hair, Black complexion, is 5  
feet 4 inches high.

P. H. Minor 2<sup>nd</sup> Lieut.  
Ind. Baty. U.S. Col & Arty. (Light)  
RECRUITING OFFICER.

A. O. No. 71 & 76.)

Registered into the service of the United States, for three years or during the war, from date of enlistment, in Company  
Regiment of Light Volunteers, on the 27 day of February 1865; at Leavenworth  
Missouri  
Ind. Baty. U.S. Col & Arty. (Light)

This receipt has received five hundred dollars advance bounty of the three hundred  
dollar bounty authorized by an Act of Congress approved June 4<sup>th</sup> 1864, and circulated  
No 24 from the Provost Marshal's Office

NOTE 1.—This blank will be used for both enlistments and re-enlistments—enlistment of veterans, &c., &c., in the volunteer service. They will be made out in duplicate in all cases—one to accompany the recruiting return of the superintendent (not the recruiting officer) to the Adjutant General, and one to accompany the accounts of the officer who pays bounty, &c. The Regiment and Company in which the soldier last served should be given on the back.

NOTE 2.—An enlistment holds to service. A muster-in must, in all cases, precede payment of pay, bounty, pension, &c. A muster-in roll must, in all cases, be filed in the Adjutant General's Office as evidence of muster-in. The mustering officer, commissary, or assistant commissary of musters, as the case may be, will countersign both enlistments as having mustered the soldier into the service of the United States before either of them is given to the disbursing officer.

DECLARATION OF RECRUIT.

I, Ephraim Ewing, desiring to VOLUNTEER as a Soldier in the Army of the United States, for the term of THREE YEARS, Do Declare, That I am Fifty six (56) years and \_\_\_\_\_ months of age; that I have never been discharged from the United States service on account of disability or by sentence of a court martial, or by order before the expiration of a term of enlistment; and I know of no impediment to my serving honestly and faithfully as a soldier for three years.

GIVEN at Leavenworth City Kansas the 27 day of February 1865

Witness:

W. B. Street Ephraim Ewing  
mark

Discharged \_\_\_\_\_, 18

Regt of \_\_\_\_\_

enlistment; last served in Company ( )

for Shackel Bohly Abel Lee Ady

By E. G. Palmer

Volunteered at Leavenworth Kansas

February 27, 1865

Frank B. Wemyer Bohly Abel Lee Ady

CONSENT IN CASE OF MINOR.

I, \_\_\_\_\_, Do CERTIFY, That I am \_\_\_\_\_; that the \_\_\_\_\_ of \_\_\_\_\_; that the \_\_\_\_\_ is \_\_\_\_\_ years of age; and I do hereby freely give my CONSENT to his volunteering as a SOLDIER in the ARMY OF THE UNITED STATES for the period of THREE YEARS.

GIVEN at \_\_\_\_\_ the \_\_\_\_\_ day of \_\_\_\_\_

Witness:

Credited to North Dist Houses 22<sup>a</sup> Sub Dist 7 March 2000  
H. Ward

VOLUNTEER ENLISTMENT.

STATE OF



TOWN OF

*Kansas*

*Leavenworth*

I, *Ephraim Ewing*, born in *Russellville County*  
in the State of *Kentucky*, aged *56* years,  
and by occupation a *Laborer*, DO HEREBY ACKNOWLEDGE to have  
volunteered this *Twenty Seventh* (27) day of *February*, 1865,  
to serve as a **Soldier** in the **Army of the United States of America**, for  
the period of **THREE YEARS**, unless sooner discharged by proper authority:  
Do also agree to accept such bounty, pay, rations, and clothing, as are, or may be,  
established by law for volunteers. And I, *Ephraim Ewing*, do  
solemnly swear, that I will bear true faith and allegiance to the **United States**  
**of America**, and that I will serve them honestly and faithfully against all  
their enemies or opposers whomsoever; and that I will observe and obey the  
orders of the President of the United States, and the orders of the officers  
appointed over me, according to the Rules and Articles of War.

Sworn and subscribed to, at *Leavenworth*  
this *27* day of *February*, 1865,  
BEFORE *P. H. Minor 2<sup>nd</sup> Lieut.*  
*Ind. Baty. U.S. 10th Art. (Light.)* } *Ephraim Ewing*  
*mark*

I CERTIFY, ON HONOR, That I have carefully examined the above-named Volunteer, agreeably  
to the General Regulations of the Army, and that, in my opinion, he is free from all bodily defects and  
mental infirmity, which would in any way disqualify him from performing the duties of a soldier.

*Tiffin Binks*  
*Surgeon General of Enrollment North Dist Kan*  
EXAMINING SURGEON.

I CERTIFY, ON HONOR, That I have minutely inspected the Volunteer *Ephraim Ewing*  
previously to his enlistment, and that he was entirely sober when enlisted; that, to the best of my  
judgment and belief, he is of lawful age; and that, in accepting him as duly qualified to perform the  
duties of an able-bodied soldier, I have strictly observed the Regulations which govern the recruiting  
service. This soldier has *Black* eyes, *Black* hair, *Black* complexion, is *5*  
feet *4* inches high.

*P. H. Minor 2<sup>nd</sup> Lieut.*  
*Ind. Baty. U.S. 10th Art. (Light.)*  
RECRUITING OFFICER.

U.S. Cavalry Regiment of *Light* Volunteers, on the *27* day of *February* 1865, at *Leavenworth Kan*  
Mustered into the service of the United States, for three years or during the war, from date of enlistment, in Company *B*

*Col. P. H. Minor*  
*North Dist Kansas*

*Ind. P. H. Minor*

*Fields, Calvin*

Adpt. Batt'y U.S. Col'd L. Art'y.

*Private Private*

CARD NUMBERS.

6	2	3	3	7	6	7
6	2	3	3	9	1	5
6	2	3	4	0	7	8
6	2	3	4	2	2	3
6	2	3	4	3	9	0
6	2	3	4	5	5	2
9	1	3	2	9	4	8
10						
11						
12						
13						
14						
15						
16						
17						
18						
19						
20						
21						
22						
23						
24						
25						

- 26
- 27
- 28
- 29
- 30
- 31
- 32
- 33
- 34
- 35
- 36
- 37
- 38
- 39
- 40
- 41
- 42
- 43
- 44
- 45
- 46
- 47
- 48
- 49
- 50

Book Mark:

See also

S-977426-R.O. aff  
S-977424-P.O. aff  
D1171105-P.O. med

W. J. Spencer  
7

*I* | Indpt. Batt'y. | **U.S.C.T.**

*Calvin Fields*

....., Indpt. Batt'y, U. S. Col'd L. Art'y.

Appears on

**Battery Descriptive Book**

of the organization named above.

**DESCRIPTION.**

Age *18* years; height *5* feet *5* inches.

Complexion *Brown*

Eyes *Black*; hair *Black*

Where born *Clay Co. Mo.*

Occupation *Farmer*

**ENLISTMENT.**

When *Aug. 14*, 186*4*.

Where *Wyandotte Co. Ks.*

By whom *Lt Muir*; term *3* y'rs.

Remarks: .....

.....  
 .....  
 .....  
 .....  
 .....  
 .....  
 .....  
 .....

*Holbrook*



*F*

Indpt. Battery.

U.S.C.T.

*Calvin Field*

*Indpt.*, Indpt. Battery, U. S. Col'd L. Art'y.

Appears on

**Battery Muster-in and Descriptive Roll**

of the organization named above. Roll dated

*Severnworth Kas*, 1864.

Where born *Clay Co Mo.*

Age *19* y'rs; occupation *Farmer*

When enlisted *Aug 14*, 1864.

Where enlisted *Wymondott Mo*

For what period enlisted *3* years.

Eyes *Blu*; hair *Blk*

Complexion *Brn*; height *5* ft. *5* in.

When mustered in *Aug 18*, 1864.

Where mustered in *Severnworth Mo*

Bounty paid \$*100*<sup>*00*</sup>/<sub>100</sub>; due \$*20*<sup>*00*</sup>/<sub>100</sub>

Where credited

Battery to which assigned

Remarks: *A M Dist Mo*  
*28<sup>th</sup> Wymondott Kas*

Book mark: *F 101 No. 71*

(356g)

*J. Schuber*

Copyist.

*F* | Indpt. Battery. | **U.S.C.T.**

*Calvin Fields*

*702*, Indpt. Battery, U. S. Col'd L. Art'y.

Appears on

**Battery Muster Roll**

for *Assignment to Det B*, 186 *4*

Present or absent *Present*

Stoppage, \$ 100 for

Due Gov't, \$ 100 for

Valuation of horse, \$ 100

Valuation of horse equipments, \$ 100

Remarks:

Book mark:

*J. Schuster*  
(358) Copyist.

*F* | Indpt. Battery. | **U.S.C.T.**

*Calvin Fields*

*Pat*, Indpt. Battery, U. S. Col'd L. Art'y.

Appears on

**Battery Muster Roll**

for *Jan'y Feb*, 186<sup>*5*</sup>.

Present or absent *Present*

Stoppage, \$ 100 for

Due Gov't, \$ 100 for

Valuation of horse, \$ 100

Valuation of horse equipments, \$ 100

Remarks:

Book mark:

*[Signature]*

(358)

Copyist.

*F* | Indpt. Battery. | **U.S.C.T.**

*Calvin Fields,*  
*A*, Indpt. Battery, U. S. Col'd L. Art'y.

Appears on

**Battery Muster Roll**

for *Mar, & Apr,* 1865.

Present or absent *Present*

Stoppage, \$ \_\_\_\_\_ <sup>100</sup> for \_\_\_\_\_

Due Gov't, \$ \_\_\_\_\_ <sup>100</sup> for \_\_\_\_\_

Valuation of horse, \$ \_\_\_\_\_ <sup>100</sup>

Valuation of horse equipments, \$ \_\_\_\_\_ <sup>100</sup>

Remarks: \_\_\_\_\_  
\_\_\_\_\_  
\_\_\_\_\_  
\_\_\_\_\_  
\_\_\_\_\_  
\_\_\_\_\_

Book mark: \_\_\_\_\_

*Butler*

*F* | Indpt. Battery. | **U.S.C.T.**

*Calvin Fields*

*Pr*, Indpt. Battery, U. S. Col'd L. Art'y.

Appears on

**Battery Muster Roll**

for *May & June*, 1865.

Present or absent *Present*

Stoppage, \$ 100 for

Due Gov't, \$ 100 for

Valuation of horse, \$ 100

Valuation of horse equipments, \$ 100

Remarks:

Book mark:

*Prater*

(358)

Copyist.

*J* | Indpt. Battery. | **U.S.C.T.**

*Calvin Fields,*

*A*, Indpt. Battery U. S. Col'd Light Art'y.

Appears on **Batt'y Muster-out Roll**, dated

*Ft. Leavenworth, Mo., July 22* 1865.

Muster-out to date

*July 22*, 1865.

Last paid to

*Dec. 31*, 1864.

Clothing account:

Last settled....., 186 ; drawn since \$ *69*<sup>*63*</sup>/<sub>100</sub>,

Due soldier \$ 100; due U. S. \$ 100

Am't for cloth'g in kind or money adv'd \$ 100

Due U. S. for arms, equipments, &c., \$ 100

Bounty paid \$ *100* 100; due \$ *None* 100,

Remarks:.....  
 .....  
 .....  
 .....  
 .....  
 .....

Book mark: *F101, Mo. K, 1559, 1882,*

*Parten*

*Fields, Calvin*

*P*, Co. Ind. Batt. U. S. C. A.  
Reg't

*13* Enclosures.

Bed Cards.....	Descriptive Lists.....
Burial Records.....	Final Statements.....
Certs. of Dis. for Discharge.....	Furloughs.....
C. M. Charges.....	Med. Des. Lists.....
Med. Certificates.....	Orders.....

*Enlist.*

Other papers relating to—

Admission to Hosp'l.....	Furlough.....
Casualty Sheet (Officer's).....	Med. Examination.....
Confinement.....	Misc. Information <input checked="" type="checkbox"/>
Contracts.....	Pay or Clothing.....
Death or Effects.....	Personal Reports.....
Desertions.....	Rank.....
Discharge from Hosp'l.....	Transfer to Hosp'l.....
Discharge from Service.....	Transfer to V. R. C. ....
Duty.....	Transportation.....

MICROFILM PUBLICATION M 1836

COMPILED MILITARY SERVICE RECORDS  
OF VOLUNTEER UNION SOLDIERS WHO SERVED WITH  
THE UNITED STATES COLORED TROOPS (USCT)  
INDEPENDENT BATTERY LIGHT ARTILLERY

PERSONAL PAPERS' TARGET SHEET

PLEASE NOTE THE CHECKED INFORMATION ABOUT THE PERSONAL PAPERS IN  
THIS FILE:

NO PERSONAL PAPERS WERE FOUND IN THIS FILE WHEN THE  
RECORDS WERE ARRANGED FOR MICROFILMING.

5 PERSONAL PAPER(S) FOUND IN THIS FILE WHEN THE RECORDS  
WERE ARRANGED FOR MICROFILMING.



DECLARATION OF RECRUIT.

NOTE 1.—This blank will be used for both enlists and re-enlistments—enlistment of veterans, &c., &c., in the volunteer service. They will be made out in duplicate in all cases—one to accompany the recruiting return to the recruiting officer (not the recruiting officer) to the Adjutant General, and one to accompany the accounts of the officer who pays bounty, &c. The Regiment and Company which the soldier last served should be given on the back. NOTE 2.—An enlistment holds to service. A re-in must, in all cases, precede payment of pay, bounty, pension, &c. A muster-in roll must, in all cases, be filed in the Adjutant General's Office as evidence of must. The mustering officer, commissary, or assistant commissary of musters, as the case may be, will countersign both enlistments as having mustered the soldier into the service of the United States before either of them is given to the disbursing officer.

I, Cabrin Fields desiring to VOLUNTEER as a Soldier in the Army of the United States, for the term of THREE YEARS, Do Declare, That I am 18 years and \_\_\_\_\_ months of age; that I have never been discharged from the United States service on account of disability or by sentence of a court martial, or by order before the expiration of a term of enlistment; and I know of no impediment to my serving honestly and faithfully as a soldier for three years.

GIVEN at Wyandotte State of Kansas the 14<sup>th</sup> day of August 1864

Witness: W.A. Dunham Cabrin Fields  
mark

Rec'd from 2nd. Aug. Nov. 23d 1892

Discharged ..... 18  
Reg't of .....  
enlistment; last served in Company ( )

No. 630  
Cabrin Fields  
Volunteered at Wyandotte  
August 14<sup>th</sup> 1864.  
By W. A. Dunham Adjutant  
1st Regt of Artillery

CONSENT IN CASE OF MINOR.

I, ..... Do CERTIFY, That I am the ..... of .....; that the said ..... is ..... years of age; and I do hereby freely give my CONSENT to his volunteering as a SOLDIER in the ARMY OF THE UNITED STATES for the period of THREE YEARS.

GIVEN at ..... the ..... day of .....

Witness: .....

30 32

VOLUNTEER ENLISTMENT.

STATE OF

TOWN OF

*Missouri*  
Kansas



*Wyandott*

*I, Calvin Fields*

born in *Clay Co*

in the State of *Missouri*

aged *18* years,

and by occupation a *Farmer*

DO HEREBY ACKNOWLEDGE to have

volunteered this *14* day of *August* 186*4*

to serve as a **Soldier** in the **Army of the United States of America**, for the period of **THREE YEARS**, unless sooner discharged by proper authority:

Do also agree to accept such bounty, pay, rations, and clothing, as are, or may be, established by law for volunteers. And I, *Calvin Fields*

do solemnly swear, that I will bear true faith and allegiance to the **United States of America**, and that I will serve them honestly and faithfully against all their enemies or opposers whomsoever; and that I will observe and obey the orders of the President of the United States, and the orders of the officers appointed over me, according to the Rules and Articles of War.

Sworn and subscribed to, at *Wyandott*

this *14* day of *Aug* 186*4*

BEFORE *P. B. Minor 2<sup>d</sup> Lieut*

*Recruiting 1<sup>st</sup> U.S. Col. Battery*

*Calvin Fields*  
his mark

I CERTIFY, ON HONOR, That I have carefully examined the above-named Volunteer, agreeably to the General Regulations of the Army, and that, in my opinion, he is free from all bodily defects and mental infirmity, which would in any way disqualify him from performing the duties of a soldier.

*Jiffie Sinks*  
*Surg. Board Enrollment*  
*North Dix Kansas*

EXAMINING SURGEON.

I CERTIFY, ON HONOR, That I have minutely inspected the Volunteer, *Calvin Fields* previously to his enlistment, and that he was entirely sober when enlisted; that, to the best of my judgment and belief, he is of lawful age; and that, in accepting him as duly qualified to perform the duties of an able-bodied soldier, I have strictly observed the Regulations which govern the recruiting service. This soldier has *black* eyes, *black* hair, *Brown* complexion, is *5* feet *5* inches high.

*P. B. Minor 2<sup>d</sup> Lieut Recruiting*  
*1<sup>st</sup> U.S. Col. Battery* Volunteers,  
RECRUITING OFFICER.

Mustered into the service of the United States, for three years or during the war, from date of enlistment, in Company *...* Regiment of *...* Volunteers, on the *18* day of *August*, 186*4*, at *Wyandott, Kansas*

NOTE 1.—This blank will be used for both enlistments and re-enlistments—enlistment of veterans, &c., &c., in the volunteer service. They will be made out in duplicate in all cases—one to accompany the recruiting return of the superintendent (not the recruiting officer) to the Adjutant General, and one to accompany the accounts of the officer who pays bounty, &c. The Regiment and Company in which the soldier last served should be given on the back.

NOTE 2.—An enlistment holds to service. A muster-in must, in all cases, precede payment of pay, bounty, pension, &c. A muster-in roll must, in all cases, be filed in the Adjutant General's Office as evidence of muster-in. The mustering officer, commissary, or assistant commissary of musters, as the case may be, will countersign both enlistments as having mustered the soldier into the service of the United States before either of them is given to the disbursing officer.

DECLARATION OF RECRUIT.

I, Calvin Fields desiring to VOLUNTEER as a Soldier in the Army of the United States, for the term of THREE YEARS, Do Declare, That I am 18 years and \_\_\_\_\_ months of age; that I have never been discharged from the United States service on account of disability or by sentence of a court martial, or by order before the expiration of a term of enlistment; and I know of no impediment to my serving honestly and faithfully as a soldier for three years.

GIVEN at Wyandott State of Kansas the 14<sup>th</sup> day of August 1864

Witness:

W. A. Burnham

Calvin Fields  
male

No. 65

Calvin Fields

Volunteered at Wyandott

August 14<sup>th</sup> 1864

By P. P. Minor 2d Lieut

1st U. S. Regiment Col Battery

..... enlistment; last served in Company ( )

..... Reg't of .....

Discharged ..... 18 .....

CONSENT IN CASE OF MINOR.

I, ..... Do CERTIFY, That I am the ..... of .....; that the said ..... is ..... years of age; and I do hereby freely give my CONSENT to his volunteering as a SOLDIER in the ARMY OF THE UNITED STATES for the period of THREE YEARS.

GIVEN at ..... the ..... day of .....

Witness: .....

3032

VOLUNTEER ENLISTMENT.

STATE OF

Kansas



TOWN OF

Wyandotte

I, Calvin Fields born in Delray Co in the State of Missouri aged 18 years, and by occupation a Farmer Do HEREBY ACKNOWLEDGE to have volunteered this 14th day of August 1864

to serve as a Soldier in the Army of the United States of America, for the period of THREE YEARS, unless sooner discharged by proper authority: Do also agree to accept such bounty, pay, rations, and clothing, as are, or may be, established by law for volunteers. And I, Calvin Fields do solemnly swear, that I will bear true faith and allegiance to the United States of America, and that I will serve them honestly and faithfully against all their enemies or opposers whomsoever; and that I will observe and obey the orders of the President of the United States, and the orders of the officers appointed over me, according to the Rules and Articles of War.

Sworn and subscribed to, at Wyandotte this 14th day of Aug 1864 BEFORE P. B. Minor 2nd Lieut Recruiting U.S. Col Battery Calvin Fields make

I CERTIFY, ON HONOR, That I have carefully examined the above-named Volunteer, agreeably to the General Regulations of the Army, and that, in my opinion, he is free from all bodily defects and mental infirmity, which would in any way disqualify him from performing the duties of a soldier.

Gifford Birko Surg Board enrollment North of Kansas EXAMINING SURGEON.

I CERTIFY, ON HONOR, That I have minutely inspected the Volunteer, Calvin Fields previously to his enlistment, and that he was entirely sober when enlisted; that, to the best of my judgment and belief, he is of lawful age; and that, in accepting him as duly qualified to perform the duties of an able-bodied soldier, I have strictly observed the Regulations which govern the recruiting service. This soldier has black eyes, black hair, Brown complexion, is 5 feet 5 inches high.

P. B. Minor 2nd Lieut Recruiting U.S. Col Battery Volunteers, RECRUITING OFFICER.

Mustered into the service of the United States, for three years or during the war, from date of enlistment, in Company ... Regiment of ... Volunteers, on the 18th day of Aug, 1864, at ...



~~656~~

**ENDORSEMENT.**

No. 101 *K*

APPLICATION OF

*Thos Field*

OF

*Liberty Day Co Mo*

for compensation for service of  
slave *Calvin Fields*

enlisted Oct 14 1864,  
*Independent Batty*  
in Co. 1 *Regiment,*

U. S. Colored Troops.

Received Jan 14 1867,

Compensation awarded,  
\_\_\_\_\_ 186 \_\_\_\_\_,  
\_\_\_\_\_ Dollars.

President Board of Claims.

P. O. Address of Applicant.

*Chipman Haswell*  
*Washington D C*  
*Adlyz*

War Department,

ADJUTANT GENERAL'S OFFICE.

Washington, Jan 30 1867.

*Respectfully returned to the*  
*Commission for the State of*  
*Missouri, with the informa-*  
*tion that Calvin Fields*  
*was enlisted at Wyandott Kans.*  
*August 14, 1864, and was*  
*mustered in as Private Israel Batty*  
*U. S. Colored Batty Aug 18, 1864.*

*9.101. pro. K*

*A. F. Ransom*

Asst. Adj't General.

a compensation for the said slave, under provisions of Section 24, Act approved February 24, 1864, and Section 2, Act approved July 28, 1866.

WARD OF THE BOARD OF CLAIMS.

OFFICE OF THE BOARD OF CLAIMS,

Drafted in the Service of the United States.

\_\_\_\_\_ 186 \_\_\_\_\_  
of \_\_\_\_\_  
\_\_\_\_\_, having proved, under oath \_\_\_\_\_ loyalty to the Con-  
States, and established \_\_\_\_\_ title as to the ownership of  
a slave \_\_\_\_\_ and mustered  
\_\_\_\_\_ day of \_\_\_\_\_ 186 \_\_\_\_\_,  
\_\_\_\_\_ in the service of the United States, in the  
ed Troops, Co. \_\_\_\_\_ the sum of \_\_\_\_\_  
this Board, subject to the approval of the Secretary of War, as

President of the Board.

Member of the Board.

*Rudolph*

Member of the Board.

To \_\_\_\_\_

Chief of the Bureau for the  
Organization of Colored Troops, Washington, D. C.

(Form A.)

CLAIM FOR COMPENSATION FOR ENLISTED SLAVE.

No. I, Thomas Field, a loyal citizen, and a resident of Liberty Township County of Clay State of Missouri do hereby claim compensation, under the provisions of

Section 24, Act approved February 24, 1864, and Section 2, Act approved July 28, 1866, for my slave Calvin Field enlisted October 14<sup>th</sup> 1864, at Wyandotte Kansas by Lieut Miner in the Independent Battery Regiment U. S. Colored Troops, Co. (Light); certificate of which enlistment, and a descriptive list, as required, accompanying this application. I never received any certificate

In proof of my loyalty to the Constitution and Government of the United States, I present the accompanying oath, which I have taken, signed and acknowledged; to be filed with this application, in accordance with requirement of General Order, No. 329, 1863, War Department, Adjutant General's Office.

Thomas Field

Dec 6<sup>th</sup> 1866

OATH OF ALLEGIANCE. I, Thomas Field the owner and claimant, do solemnly swear that the foregoing claim is a just and true claim due to me as master and owner of the said slave, and that the facts alleged in said claim in respect to the enlistment of said slave into the military service of the United States are true.

And I do further swear that I have never joined, or been concerned in any insurrection or rebellion; that I have never borne arms against the United States; that I have never given any aid, countenance, counsel or encouragement to any person or persons engaged, or whom I had reason to believe were about to engage, in insurrection, rebellion or armed hostility against the United States; that I have neither sought, nor accepted, nor attempted to exercise the functions of any office, civil or military, nor to perform any service whatever under any authority, or pretended authority, in hostility to the United States; that I have not yielded a voluntary support to any insurrection, rebellion or pretended government, authority, power or constitution within the United States, hostile thereto. And I do further swear that, to the best of my knowledge and ability, I have supported and defended, and will continue to support and defend, the United States, against all enemies, foreign and domestic, and that I have supported, defended and obeyed, and will continue to support, defend and obey, the Constitution and laws of the United States, that I will bear true faith and allegiance to the same; and that I take this oath freely, without any mental reservation or purpose of evasion. So help me God.

Thomas Field

Sworn to and subscribed before me, at Liberty Mo. this 6<sup>th</sup> day of December 1866.



James L. Clark  
Circuit Court, Clay Co. Missouri

Affidavits of disinterested loyal parties will be required to prove the active loyalty of the claimant during the war.

Ch. K. and sign above

(5-2-15-1)

for the adjustment of such claims, before the Departments at Washington, D. C., where the same may become necessary, and elsewhere, and in his name, place and stead, for him and in his name to ask, demand, recover and receive such compensation as may be awarded as aforesaid, hereby giving and granting unto his said Attorneys full power and authority to do and perform all and every act and thing whatsoever requisite and necessary to be done in and about the premises as full and to all intents and purposes the same as he might or could do were he personally present, hereby ratifying and confirming all his said Attorneys or their substitutes by their appointment shall lawfully do or cause to be done by virtue hereof; and it is understood and agreed that this Power of Attorney cannot be revoked by him without the consent of his Attorneys herein appointed.

(3) Thomas Field

STATE OF Missouri }  
County of Clay } ss.

On this 6<sup>th</sup> day of December 1866, personally appeared before me Clerk of the Circuit Court in and for the county and State aforesaid Thomas Field the claimant above mentioned, and made oath to the foregoing statement by him subscribed, and he further acknowledge the signing and sealing of the foregoing Power of Attorney to be his own free binding act, for the purposes and objects therein contained and set forth; and at the same time also personally appeared the above named James Henshaw and Ambrose M. Griffith William Austin and Mabary Mitchell and made oath to the truth of the statements by them respectively subscribed.

Witness my hand and seal, upon the day and date first above written.



[SEAL.]

15 cts Stamp

(4) James L. Lee Clerk  
Circuit Court Clay Co Missouri

INSTRUCTIONS.

- (1) State all the circumstances connected with obtaining title—when, where and how.
  - (2) Signature of claimant.
  - (3) Signatures of witnesses to ownership.
  - (4) Signatures of witnesses to loyalty.
  - (5) Signature of claimant.
  - (6) Signature of Notary Public or Clerk of Court, authenticated by seal.
- If title is by purchase, state date of bill of sale, and where recorded. When possible, file the bill of sale. If title is by inheritance, state when and from whom the slave was inherited, and where the will is recorded or the administrator was appointed.  
If claimant is a trustee, executor or administrator, he must show by the record proof that he is such.  
Where the same party claims compensation for more than one slave, he must file a separate claim for each.

CHIPMAN, HOSMER & CO.,  
WASHINGTON, D. C.,  
Attorneys for Claimant.

1866, 24th Dec.

For Compensation for Service of Slave.

Affidavits of Ownership and Loyalty, and Power of Attorney, in the Application of Thomas Field.

No. 101



*Thomas Field* claimant for compensation under the Acts of Congress of February 24th, 1864, and July 28th, 1866, for *Calvin Fields* a slave, who was *enlisted* into the military service of the United States upon the *14<sup>th</sup>* day of *October* 186*6* Having been duly sworn declares that at the date of the *enlistment* of said *Calvin Fields* as aforesaid, and as more fully set forth in *his* application, *he was* the lawful owner of said *Calvin Fields* and obtained *his* title to him in the following manner: (1)  
*The mother of said Calvin Fields belonged to the said Thomas Field, and the said Calvin Fields for whom compensation is claimed, was born the property of the said Thomas Field, the claimant.*

(2) *Thomas Field*  
*James Bushaw* a resident of *Clay* County, State of *Missouri* and *Ambrose M. Griffith* a resident of *Clay* County, State of *Missouri* having been duly sworn, declare that they are personally acquainted with *Thomas Field* the claimant for compensation for slave *Calvin Fields* under the Acts of Congress of February 24th, 1864, and July 28, 1866, and know that said *Calvin Fields* at the date of his *enlistment* into the military service of the United States, and for *twelve years* previous thereto was the slave of said *Thomas Field*. They also declare that they have no interest in said claim.

(3) *James Bushaw*  
*Ambrose M. Griffith*  
*William Austin* a resident of *Clay* County, State of *Missouri* and *Mabery Mitchell* a resident of *Clay* County, State of *Missouri* having first been duly sworn, upon their oaths declare that they reside respectively in county of *Clay* State of *Missouri* and county of *Clay* State of *Missouri*; that they are personally acquainted with *Thomas Field* claimant for compensation for *his* slave *Calvin Fields* under the Acts of Congress of February 24, 1864, and July 28, 1866, and that they know that said claimant has firmly and faithfully maintained *his* allegiance and adherence to the Government of the United States, by defending its cause against the Government of the so-called Confederate States of America, in all suitable and practicable ways, and according to *his* ability; they also swear that they have themselves maintained a like adherence and allegiance to the Government of the United States, and that they have no interest in said claim.

*William Austin*  
 (4) *Mabery Mitchell*  
 And the said *Thomas Field* claimant further declares that in consideration of valuable services rendered and to be rendered, *him* hath and doth employ and constitute, as *his* Attorneys, **CHIPMAN, HOSMER & CO.**, Washington, D. C., to prosecute *his* claim for compensation which may be awarded to *him* as owner of said slave, by the Acts of Congress in that regard, before the Board of Claims appointed for the State of *Missouri*

*John*

**1st. Batt'y U.S. Col'd L. Art'y.**

*Private* | *Private*

**CARD NUMBERS.**

6 2 3 3 6 9 2	26
6 2 3 4 2 2 4	27
6 2 3 4 3 9 1	28
6 2 3 4 5 5 3	29
9 1 3 3 0 7 3	30
	31
	32
	33
	34
	35
	36
	37
	38
	39
	40
	41
	42
	43
	44
	45
	46
	47
	48
	49
	50

Book Mark: \_\_\_\_\_

See also \_\_\_\_\_

S-657706 - Jo aff  
S-1011603 Plomow  
Ag. 1373514  
D. 3027983 and wd

ny specimen  
4

*A* | Indpt. Batt'y. | **U.S.C.T.**

*John Field*

....., Indpt. Batt'y, U. S. Col'd L. Art'y.

Appears on

**Battery Descriptive Book**

of the organization named above.

**DESCRIPTION.**

Age *18* years; height *5* feet *6* inches.

Complexion *Black*

Eyes *Black*; hair *Black*

Where born *Platte Co. Missouri*

Occupation *Laborer*

**ENLISTMENT.**

When *Mich. 1*, 186*5*.

Where *Seventh Kansas*.

By whom *Dominos*; term *3* y'rs.

Remarks: .....

*Holbrook*

*A* | Indpt. Battery. | **U.S.C.T.**

*John Fields*

Appears with rank of *Priv* on

**Muster and Descriptive Roll of a Detachment of U. S. Vols. forwarded**

for the Indpt. Batt'y, U. S. Col'd L. Arty. Roll dated

*Leavenworth, Ks, Mch 1, 1865.*

Where born *Platte Co., Missouri*

Age *18* y'rs; occupation *Labourer*

When enlisted *Mch 1, 1865.*

Where enlisted *Leavth, Kans*

For what period enlisted *3* years.

Eyes *black*; hair *black*

Complexion *black*; height *5 ft. 6 in.*

When mustered in *Mch 1, 1865.*

Where mustered in *Leavth, Kans*

Bounty paid \$ *100* <sup>100</sup>; due \$ *200* <sup>100</sup>

Where credited .....

Battery to which assigned .....

Remarks: *Credited to Northm. Dist. Ks*

*22<sup>d</sup> Sub. dist. 4<sup>th</sup> Ward Leavenworth*

*city. vol. Receipts entitled*

*to bounty*

Book mark: .....

*E. L. Thorton*

*H* *Indep Batty* *MS 67*

*John Fields*

*Bn*, Co. *Indep Batty* Reg't *MSC 7*

Appears on

**Battery Muster Roll**

for *Nov & Apr*, 1865.

Present or absent *Present*

Stoppage, \$ 100 for

Due Gov't, \$ 100 for

Valuation of horse, \$ 100

Valuation of horse equipments, \$ 100

Remarks :

Book mark :

(858)

*W. Spencer*

*g* Copyist.

*F* | Indpt. Battery. | **U.S.C.T.**

*John Fields,*  
*Co*, Indpt. Battery, U. S. Col'd L. Art'y.

Appears on

**Battery Muster Roll**

for *May & June*, 186*5*.

Present or absent *Present*.

Stoppage, \$ 100 for

Due Gov't, \$ 100 for

Valuation of horse, \$ 100

Valuation of horse equipments, \$ 100

Remarks:

-----  
-----  
-----  
-----  
-----  
-----  
-----  
-----  
-----

Book mark: -----

*Porter*  
-----  
Copyist.

*F* | Indpt. Battery. | **U.S.C.T.**

*John Fields,*

*R*, Indpt. Battery U. S. Col'd Light Art'y.

Appears on **Batt'y Muster-out Roll**, dated  
*St. Lawrence Co. N.Y. July 22, 1865.*

Muster-out to date *July 22, 1865.*

Last paid to *(Pay due from enlistment)* 186 .

**Clothing account:**

Last settled....., 186 ; drawn since \$ *67* <sup>*33*</sup>/<sub>100</sub>,

Due soldier \$.....<sup>100</sup>; due U. S. \$.....<sup>100</sup>

Am't for cloth'g in kind or money adv'd \$.....<sup>100</sup>

Due U. S. for arms, equipments, &c., \$.....<sup>100</sup>

Bounty paid \$ *100* <sup>100</sup>; due \$ *None* <sup>100</sup>,

Remarks:.....  
.....  
.....  
.....  
.....  
.....  
.....

Book mark:.....

*Parter*  
Copyist.



*Fields John*

Co.

*1st Batt. U.S.C.A. 1st Regt.*

*8* Enclosures.

Bed Cards .....	Final Statements .....
Burial Records .....	Furloughs or L. of A. ....
Certs. of Dis. for Discharge .....	Med. Certificates .....
C. M. Charges .....	Med. Des. Lists .....
Descriptive Lists .....	Orders .....
Discharge Certificates .....	Pris. of War Record .....
Enlistment Papers .....	Resignations .....

Other papers relating to—

Admission to Hosp'l .....	Furlough or L. of A. ....
Casualty Sheet .....	Med. Examination .....
Confinement .....	Misc. Information <i>3</i> .....
Contracts .....	Pay or Clothing .....
Death or Effects .....	Personal Reports .....
Desertion .....	Rank .....
Discharge from Hosp'l .....	Transfer to Hosp'l .....
Discharge from Service .....	Transfer to V. R. C. ....
Duty .....	Transportation .....

DECLARATION OF RECRUIT.

I, John Field, desiring to VOLUNTEER as a Soldier in the Army of the United States, for the term of THREE YEARS. Do Declare, That I am Eighteen (18) years and        months of age; that I have never been discharged from the United States service on account of disability or by sentence of a court martial, or by order before the expiration of a term of enlistment; and I know of no impediment to my serving honestly and faithfully as a soldier for three years.

GIVEN at Leavenworth City Kansas the 1<sup>st</sup> day of March 1865

Witness: Michael Rogers John Field mark

NOTE 1.—This blank will be used for both enlistments and re-enlistments—enlistment of veterans, &c., &c., in the volunteer service. They will be made out in duplicate in all cases—one to accompany the recruiting return of the superintendent (not the recruiting officer) to the Adjutant General, and one to accompany the accounts of the officer who pays bounty, &c. The Regiment and Company in which the soldier last served should be given on the back.

NOTE 2.—An enlistment holds to service. A muster-in must, in all cases, precede payment of pay, bounty, pension, &c. A muster-in roll must, in all cases, be filed in the Adjutant General's Office as evidence of muster-in. The mustering officer, commissary, or assistant commissary of musters, as the case may be, will countersign both enlistments as having mustered the soldier into the service of the United States before either of them is given to the disbursing officer.

Discharged \_\_\_\_\_, 18  
Reg't of \_\_\_\_\_  
enlistment; last served in Company ( )

Volunteered at Leavenworth Kas  
March 1<sup>st</sup> 1865  
By Capt. McQueen for Co. B  
1<sup>st</sup> U.S. Colored Regt.  
of Artillery - Light  
for Adj. Gen. B. B. Loring  
No. 29  
John Field

CONSENT IN CASE OF MINOR.

I, \_\_\_\_\_ Do CERTIFY, That I am \_\_\_\_\_; that the \_\_\_\_\_ of \_\_\_\_\_; that the \_\_\_\_\_ is \_\_\_\_\_ years of age; and I do hereby freely give my CONSENT to his volunteering as a SOLDIER in the ARMY OF THE UNITED STATES for the period of THREE YEARS.

GIVEN at \_\_\_\_\_ the \_\_\_\_\_ day of \_\_\_\_\_

Witness: Michael Rogers

(A. G. O. No. 74 & 76.)

*Credited to Northern Dist Kansas 22<sup>d</sup> Sub Dis 4<sup>th</sup> Ward Leavenworth City*

VOLUNTEER ENLISTMENT.

STATE OF

TOWN OF

*Kansas*



*Leavenworth*

I, *John Field*, born in *Platte Co.* in the State of *Missouri*, aged *18* years, and by occupation a *Labourer*, DO HEREBY ACKNOWLEDGE to have volunteered this *First (1<sup>st</sup>)* day of *March*, 1865, to serve as a **Soldier** in the **Army of the United States of America**, for the period of **THREE YEARS**, unless sooner discharged by proper authority: Do also agree to accept such bounty, pay, rations, and clothing, as are, or may be, established by law for volunteers. And I, *John Field*, do solemnly swear, that I will bear true faith and allegiance to the **United States of America**, and that I will serve them honestly and faithfully against all their enemies or opposers whomsoever; and that I will observe and obey the orders of the President of the United States, and the orders of the officers appointed over me, according to the Rules and Articles of War.

Sworn and subscribed to, at *Leavenworth* this *1<sup>st</sup>* day of *March*, 1865, before *P. M. Minor 2<sup>d</sup> Lieut.* *John Field* mark

*Ind. Baty. U.S. Col. Artillery*  
I CERTIFY, ON HONOR, That I have carefully examined the above-named Volunteer, agreeably to the General Regulations of the Army, and that, in my opinion, he is free from all bodily defects and mental infirmity, which would in any way disqualify him from performing the duties of a soldier.

*William F. Smith*  
*Surgeon Board of Enlistment*  
*Northern Dist Kansas*  
EXAMINING SURGEON.

I CERTIFY, ON HONOR, That I have minutely inspected the Volunteer *John Field* previously to his enlistment, and that he was entirely sober when enlisted; that, to the best of my judgment and belief, he is of lawful age; and that, in accepting him as duly qualified to perform the duties of an able-bodied soldier, I have strictly observed the Regulations which govern the recruiting service. This soldier has *Black* eyes, *Black* hair, *Black* complexion, is *5* feet *6* inches high.

*P. M. Minor 2<sup>d</sup> Lieut.*  
*Ind. Baty. U.S. Col. Art. (Sig.)*  
RECRUITING OFFICER.

(A. G. O. No. 74 & 76.)

*U.S. Colored Regiment of Artillery 1<sup>st</sup> Battalion*  
Mustered into the service of the United States, for three years or during the war, from date of enlistment, in *Company* *1<sup>st</sup>* day of *March*, 1865, at *Leavenworth Kas*

*George A. Smith*  
*Capt. 1<sup>st</sup> Battalion*  
*Northern Dist Kansas*  
*Ind. President's Battery*

DECLARATION OF RECRUIT.

I, John Fields, desiring to VOLUNTEER as a Soldier in the Army of the United States, for the term of THREE YEARS. Do Declare, That I am Eighteen (18) years and        months of age; that I have never been discharged from the United States service on account of disability or by sentence of a court martial, or by order before the expiration of a term of enlistment; and I know of no impediment to my serving honestly and faithfully as a soldier for three years.

GIVEN at Leavenworth City Kansas the 1st day of March 1865

Witness:

Michael Rogers

John's Fields  
mark

Rec'd from 2nd. Aud. Nov. 23d 1892

NOTE 1.—This blank will be used for both enlistments and re-enlistments—enlistment of veterans, &c., &c., in the volunteer service. They will be made out in duplicate in all cases—one to accompany the recruiting return of the superintendent (not the recruiting officer) to the Adjutant General, and one to accompany the accounts of the officer who pays bounty, &c. The Regiment and Company in which the soldier last served should be given on the back.

NOTE 2.—An enlistment holds to service. A muster-in must, in all cases, precede payment of pay, bounty, pension, &c. A muster-in roll must, in all cases, be filed in the Adjutant General's Office as evidence of muster-in. The mustering officer, commissary, or assistant commissary of musters, as the case may be, will countersign both enlistments as having mustered the soldier into the service of the United States before either of them is given to the disbursing officer.

Discharged        18      

Reg't of       

enlistment; last served in Company (        )

Volunteered at Leavenworth Mo  
March 1st 1865  
By Capt. M. Sherman War Northern Dist Mo  
for 1st Regt. U.S. Caval  
for 1st Regt. U.S. Caval  
1st Regt. U.S. Caval

No. 1  
John Fields  
Volunteered at Leavenworth Mo  
March 1st 1865

CONSENT IN CASE OF MINOR.

I,       , Do CERTIFY, That I am        years of age; and I do hereby freely give my CONSENT to his volunteering as a SOLDIER in the ARMY OF THE UNITED STATES for the period of THREE YEARS.

GIVEN at        the        day of       

Witness:

*John Fielder received one hundred dollar advance bounty of the three hundred dollar bounty authorized by act approved July 4, 1864 and received from the U.S. Army on March 19, 1864*

VOLUNTEER ENLISTMENT.

STATE OF

*Kansas*



TOWN OF

*Leavenworth*

I, *John Fielder*, born in *Platte Co.* in the State of *Missouri*, aged *18* years, and by occupation a *Soldier*. Do HEREBY ACKNOWLEDGE to have volunteered this *1st* day of *March*, 1865, to serve as a **Soldier** in the Army of the United States of America, for the period of **THREE YEARS**, unless sooner discharged by proper authority: Do also agree to accept such bounty, pay, rations, and clothing, as are, or may be, established by law for volunteers. And I, *John Fielder*, do solemnly swear, that I will bear true faith and allegiance to the **United States of America**, and that I will serve them honestly and faithfully against all their enemies or opposers whomsoever; and that I will observe and obey the orders of the President of the United States, and the orders of the officers appointed over me, according to the Rules and Articles of War.

Sworn and subscribed to, at *Leavenworth* this *1st* day of *March*, 1865, before *P. H. Minor 2nd Lieut* and *Ind. Baty U.S. Col. Artillery* } *John Fielder* mark

I CERTIFY, ON HONOR, That I have carefully examined the above-named Volunteer, agreeably to the General Regulations of the Army, and that, in my opinion, he is free from all bodily defects and mental infirmity, which would in any way disqualify him from performing the duties of a soldier.

*V. J. Dink*  
*Surgeon General*  
*Northern Dist Kansas*  
EXAMINING SURGEON.

I CERTIFY, ON HONOR, That I have minutely inspected the Volunteer *John Fielder* previously to his enlistment, and that he was entirely sober when enlisted; that, to the best of my judgment and belief, he is of lawful age; and that, in accepting him as duly qualified to perform the duties of an able-bodied soldier, I have strictly observed the Regulations which govern the recruiting service. This soldier has *Black* eyes, *Black* hair, *Black* complexion, is *5* feet *6* inches high.

*P. H. Minor 2nd Lieut*  
*Ind. Baty U.S. Col. Artillery*  
RECRUITING OFFICER.

(2 G. O. No. 74 & 76.)

*U.S. Cavalry*  
Mustered into the service of the United States, for three years or during the war, from date of enlistment, in *Company* *B* *13th Cavalry*  
of *1st* Regiment of *Light* Volunteers, on the *1st* day of *March*, 1865, at *Leavenworth Kansas*

*Capt Geo Mansfield*  
*Northern Dist Kansas*

and I gave my gun to him they took my Bells off  
and confined me in the guard house,  
It was Sers Dodge Post Adjutant that came to  
me and cursed me and tried to take my  
gun away from me,

Geo Beales

Sed Cold Bartly

Statement of  
John Seales Privt Indpt Co<sup>l</sup> Battery

I was on guard on the 16<sup>th</sup> day of May 1865 and was posted by the Corporal of the guard Johnson of the Ind Co<sup>l</sup> Battery) on post next at the Magazine. Being on the second relief I was posted soon after retreat 7 o'clock P. M. I was instructed by the Corporal to not allow any one to come on the parade ground except the Officer of the day, the Officer of the guard the sergeant of the guard and the Corporal of the guard with the relief and further to not allow any one to lean or lay on the fence. Soon after I was posted on guard there was four men come to the fence of the parade ground near the north west corner and leaned on it. I told them repeatedly to get off the fence they called me a damned nigger son of a Bitch and when I would turn my back to walk my Beat they would commence kicking the fence. After carrying on in that way for about half an hour I fired my gun at them but missed them and hit a man that was in Company Quarters opposite to the men that I fired at I did not see the man that was shot it was my intention to hit the men that was on the fence. After I fired there was an Officer come over to me and cursed me and tried to take my gun away from me I told the Officer that I could not give my gun to him he called the Corporal of the guard

#392 P. 162, B. C. P. 62,  
Dist. 16th Kansas 1865  
Fort Leavenworth, Kans  
May 17<sup>th</sup> 1865  
Filed with 64 52

James 1st Lt. H. C.  
Officers Day  
1st Lt. H. C.  
Hemrich Lt. Col.

107. d. G. O. M. 2, 1865.  
Reports that sentinels at  
garrison is instructed not to allow  
or hitching of horses to or  
sitting or lying of persons on  
fence around parade ground  
Last evening a citizen name  
Jaynes got on fence, sentinels  
challenged him, told sentinels  
to go to hell, black out, sentinels  
fired, hitting & wounding Col.  
Jaynes, sentinels named  
John Fields Capt. Inspt Batt.  
May 17<sup>th</sup> 1865 -

Post of Ft Leavenworth  
May 17<sup>th</sup> 1865.  
Respectfully I am to  
the Genl. Commr. It appears  
that this sentinel is not  
to ~~be~~ dismissed therefore  
summarily, that the  
man be released from  
arrest. I believe that  
any sentinel that lies  
into a trap when a  
sentence is given to the  
the Post of the U. S.  
should be dismissed the  
service or mustered out  
for want of common  
sense. Wm. Hemrich  
Lt Col. Commr.

one enclosure  
MAY 17 1865  
U.S. DEPT. OF WAR  
ST. LOUIS

Hd Geo High North Kansas  
Fort Leavenworth May 24<sup>th</sup> 65  
Respy forwarded for  
such action as may  
be deemed proper in  
accordance with  
the communication  
and the endorsement  
of Lt Col Heunels  
Comdy Post Fort Leavenworth

Wm. Hemrich  
1st Lt. H. C.  
Hemrich Lt. Col.



Fort Leavenworth, Kas  
May 17<sup>th</sup> 1863

Colonel,

Sir: I have the honor to report, that the Sentinel at the magazine, in the Parade Ground has instructed, not to allow any horse to be hitched to the fence around the Parade Ground or to allow any person to sit on or lean against said fence.

About sunset, last evening, a citizen, by name, Jaynes, who was an employee of the Quartermaster's Dept., got up on the fence on the West side of the Parade Ground.

The Sentinel challenged him and told him to get off the fence, and repeated the same, six different times when the aggressor told the Sentinel, (so the sentinel says) "to go to hell, you black creep," and at that moment another man got up on the fence; The Sentinel therefore fired his piece, but missed the man, the

The shot was intended for hitting  
and wounding a colored person.  
Said Sentinel's name was John  
Fields, of the Colored Independent  
Battery.

H. E. Turner  
Lieut 15<sup>th</sup> U. S. C. &  
Officer of Day, May 16<sup>th</sup> 1865.

Genl. Col. Hancock's  
Comdg. Post.

May 17, 1865  
John Fields  
Capt. of Col. Battery

C.P.M.G. Fort Leavenworth Kas May 18, 1945

Col. G. Henricks

Commanding Post

Requests the release of Sgt. John Fields. Sgt. C. A. Batley is possessed in the custody of this office

M.P.

Release

*[Handwritten signature]*

now released

May 19, 1945

*[Handwritten signature]*

Post of Ft. Leavenworth  
May 18<sup>th</sup> 1865.

The Dir. Genl. will please  
release Private John Field (alias)  
from the Guardhouse.

Inst. Hermito.  
L. Cpl. Carter.

*Frank*

**apt. Batt'y U.S. Col'd L. Art'y**

*Private* | *Private*

**CARD NUMBERS.**

<i>6 2 3 3 6 6 5</i>	26
<i>2 3 4 2 2 4</i>	27
<i>6 2 3 4 3 9 2</i>	28
<i>6 2 3 4 5 5 4</i>	29
<i>9 1 3 3 0 6 1</i>	30
	31
	32
	33
	34
	35
	36
	37
	38
	39
	40
	41
	42
	43
	44
	45
	46
	47
	48
	49
	50

Book Mark: \_\_\_\_\_

See also \_\_\_\_\_

*F* | Indpt. Batt'y. | **U.S.C.T.**

*Frank Fletcher*

....., Indpt. Batt'y, U. S. Col'd L. Art'y.

Appears on

**Battery Descriptive Book**

of the organization named above.

**DESCRIPTION.**

Age *18* years; height *5* feet *4 1/2* inches.

Complexion *Black*

Eyes *Black*; hair *Black*

Where born *St Louis Co. Mo.*

Occupation *Farmer*

**ENLISTMENT.**

When *Feb. 25*....., 186*5*.

Where *Seavorth A's*

By whom *A Munis*; term *3* y'rs.

Remarks: .....

.....  
 .....  
 .....  
 .....  
 .....  
 .....  
 .....

*Hobbs*

*F* | Indpt. Battery. | **U.S.C.T.**

*Frank Fletcher*

Appears with rank of *Priv* on

**Muster and Descriptive Roll of a Detachment of U. S. Vols. forwarded**

for the Indpt. Batt'y, U. S. Col'd L. Arty. Roll dated

*Leavenworth, Kas, Feb. 25, 1865.*

Where born *St. Louis Co. Missouri*

Age *18* y'rs; occupation *Farmer*

When enlisted *Feb 25*, 1865.

Where enlisted *Leavenworth, Kas.*

For what period enlisted *3* years.

Eyes *black*; hair *black*

Complexion *black*; height *5 ft. 4 1/2 in.*

When mustered in *Feb. 25*, 1865.

Where mustered in *Leavenworth, Kas.*

Bounty paid \$ *100* 100; due \$ *200* 100

Where credited .....

Battery to which assigned .....

Remarks: *Credited to Northern Dist  
Kas. 22 Sub dist. 4th Ward  
Leavenworth City, Vol. Recruit  
& entitled to bounty*

Book mark: .....

*E. L. Thornton*

*F* | Indpt. Battery. | **U.S.C.T.**

*Frank Fletcher,*

*F*....., Indpt. Battery, U. S. Col'd L. Art'y.

Appears on

**Battery Muster Roll**

for *May, & Apr.*....., 186*5*.

Present or absent *Present*.....

Stoppage, \$.....<sup>100</sup> for.....

Due Gov't, \$.....<sup>100</sup> for.....

Valuation of horse, \$.....<sup>100</sup>

Valuation of horse equipments, \$.....<sup>100</sup>

Remarks:.....

Book mark:.....

*Parter*



*F*

Indpt. Battery.

U.S.C.T.

*Frank Fletcher,*

*On*, Indpt. Battery, U. S. Col'd L. Art'y.

Appears on

**Battery Muster Roll**

for *May & June*, 186*5*.

Present or absent *Present,*

Stoppage, \$ 100 for

Due Gov't, \$ 100 for

Valuation of horse, \$ 100

Valuation of horse equipments, \$ 100

Remarks:

Book mark:

*Porter*

*F*

Indpt. Battery.

U.S.C.T.

*Frank Fletcher,*

*In*, Indpt. Battery U. S. Col'd Light Art'y.

Appears on **Batt'y Muster-out Roll**, dated

*Ft. Leavenworth, Kas, July 22, 1865.*

Muster-out to date *July 22,* 1865.

Last paid to *Pay due from enlistment,* 1865.

Clothing account:

Last settled....., 1865 ; drawn since \$ *63<sup>28</sup>* 100,

Due soldier \$..... 100; due U. S. \$..... 100

Am't for cloth'g in kind or money adv'd \$..... 100

Due U. S. for arms, equipments, &c., \$..... 100

Bounty paid \$ *100* 100; due \$ *none* 100,

Remarks:.....

Book mark: *Y 240, P. 138, 77.*

*Porter*

(361)

Copyist.

*Fletcher Frank*

, Co. *1st Bull W.S.A.*  
*Reg't*

*2* Enclosures.

Bed Cards .....	Final Statements .....
Burial Records .....	Furloughs or L. of A. ....
Certs. of Dis. for Discharge .....	Med. Certificates .....
C. M. Charges .....	Med. Des. Lists .....
Descriptive Lists .....	Orders .....
Discharge Certificates .....	Pris. of War Record .....
Enlistment Papers <i>2</i> .....	Resignations .....

Other papers relating to—

Admission to Hosp'l .....	Furlough or L. of A. ....
Casualty Sheet .....	Med. Examination .....
Confinement .....	Misc. Information .....
Contracts .....	Pay or Clothing .....
Death or Effects .....	Personal Reports .....
Desertion .....	Rank .....
Discharge from Hosp'l .....	Transfer to Hosp'l .....
Discharge from Service .....	Transfer to V. R. C. ....
Duty .....	Transportation .....

DECLARATION OF RECRUIT.

I, Frank Fletcher, desiring to VOLUNTEER as a Soldier in the Army of the United States, for the term of THREE YEARS, Do Declare, That I am 18 years and          months of age; that I have never been discharged from the United States service on account of disability or by sentence of a court martial, or by order before the expiration of a term of enlistment; and I know of no impediment to my serving honestly and faithfully as a soldier for three years.

GIVEN at Leavenworth City, Kansas the 25 day of February 1865

Witness: [Signature] Frank Fletcher  
mak

NOTE 1.—This blank will be used for both enlistments and re-enlistments—enlistment of veterans, &c., &c., in the volunteer service. They will be made out in duplicate in all cases—one to accompany the recruiting return of the superintendent (not the recruiting officer) to the Adjutant General, and one to accompany the accounts of the officer who pays bounty, &c. The Regiment and Company in which the soldier last served should be given on the back  
NOTE 2.—An enlistment holds to service. A muster-in must, in all cases, precede payment of pay, bounty, pension, &c. A muster-in roll must, in all cases, be filed in the Adjutant General's Office as evidence of muster-in. The mustering officer, commissary, or assistant commissary of musters, as the case may be, will countersign both enlistments as having mustered the soldier into the service of the United States before either of them is given to the disbursing officer.

Discharged         , 18        

Reg't of         

enlistment; last served in Company ( )

No.           
Frank Fletcher  
Volunteered at Leavenworth Kas  
February 25 1865  
By Cooper & M. M. Brown  
Independent Regiment U.S. Col'd Arty. 2d Lt

Frank Fletcher  
13

CONSENT IN CASE OF MINOR.

I,         , Do CERTIFY, That I am          years of age; and I do hereby freely give my CONSENT to his volunteering as a SOLDIER in the ARMY OF THE UNITED STATES for the period of THREE YEARS.

GIVEN at          the          day of         

Witness:

Credited to Northern Dist Kansas 22<sup>d</sup> Sub Dist. 4<sup>th</sup> Ward Leavenworth City

VOLUNTEER ENLISTMENT.

STATE OF

*Kansas*



TOWN OF

*Leavenworth*

I, *Frank Fletcher*, born in *St Louis County* in the State of *Missouri*, aged *18* years, and by occupation a *Farmer*, DO HEREBY ACKNOWLEDGE to have volunteered this *Twenty fifth 25* day of *February*, 1865, to serve as a **Soldier** in the **Army of the United States of America**, for the period of **THREE YEARS**, unless sooner discharged by proper authority: Do also agree to accept such bounty, pay, rations, and clothing, as are, or may be, established by-law for volunteers. And I, *Frank Fletcher*, do solemnly swear, that I will bear true faith and allegiance to the **United States of America**, and that I will serve them honestly and faithfully against all their enemies or opposers whomsoever; and that I will observe and obey the orders of the President of the United States, and the orders of the officers appointed over me, according to the Rules and Articles of War.

Sworn and subscribed to, at *Leavenworth* this *25* day of *February*, 1865, BEFORE *D. H. Minor 2<sup>d</sup> Lieut And Batty US Col<sup>d</sup> Arty Light* } *Frank Fletcher* his mark

I CERTIFY, ON HONOR, That I have carefully examined the above-named Volunteer, agreeably to the General Regulations of the Army, and that, in my opinion, he is free from all bodily defects and mental infirmity, which would in any way disqualify him from performing the duties of a soldier.

*Jeffrey Binks*  
Surgeon Board of Consultants  
North<sup>th</sup> Dist Kansas  
EXAMINING SURGEON.

I CERTIFY, ON HONOR, That I have minutely inspected the Volunteer *Frank Fletcher* previously to his enlistment, and that he was entirely sober when enlisted; that, to the best of my judgment and belief, he is of lawful age; and that, in accepting him as duly qualified to perform the duties of an able-bodied soldier, I have strictly observed the Regulations which govern the recruiting service. This soldier has *black* eyes, *black* hair, *black* complexion, is *5* feet *4 1/2* inches high.

*D. H. Minor 2<sup>d</sup> Lieut*  
*And Batty US Col<sup>d</sup> Arty Light*  
RECRUITING OFFICER.

(A. G. O. No. 74 & 76.)

U.S. Colored Regiment of Light Volunteers, on the 25<sup>th</sup> day of February 1865, at Leavenworth Mo  
Mustered into the service of the United States, for three years or during the war, from date of enlistment, in ~~Company~~ *Independent Battery*

*Richard P. Brown 1<sup>st</sup> Marshal*  
*Northern Dist Kansas*

DECLARATION OF RECRUIT.

I, Frank Fletcher, desiring to VOLUNTEER as a Soldier in the Army of the United States, for the term of THREE YEARS, Do Declare, That I am 18 years and \_\_\_\_\_ months of age; that I have never been discharged from the United States service on account of disability or by sentence of a court martial, or by order before the expiration of a term of enlistment; and I know of no impediment to my serving honestly and faithfully as a soldier for three years.

GIVEN at Leavenworth City Kansas the 25 day of February 1865

Witness: A. G. Post Frank + Fletcher  
mark

NOTE 1.—This blank will be used for both enlistments and re-enlistments of veterans, &c., &c., in the volunteer service. They will be made out in duplicate in all cases—one to accompany the recruiting return of the superintendent (not the recruiting Agent) and one to accompany the accounts of the officer who pays bounty, &c. The Regiment and Company in which the soldier last served should be given on the back.  
NOTE 2.—An enlistment holds to service. A muster-in must, in all cases, precede payment of pay, bounty, pension, &c. A muster-in roll must, in all cases, be filed in the Adjutant General's Office as evidence of muster-in. The mustering officer, commissary, or assistant commissary of musters, as the case may be, will countersign both enlistments as having mustered the soldier into the service of the United States before either of them is given to the disbursing officer.

Rec'd from 20th Nov. 23d 1892  
Adj. Gen. A. G. Post

Discharged \_\_\_\_\_, 18\_\_\_\_  
Reg't of \_\_\_\_\_  
enlistment; last served in Company ( )

No. 4  
Frank Fletcher  
Volunteered at Leavenworth Kansas  
25 January 25, 1865  
By Joseph P. Post  
Adj. Gen. U.S. Army

CONSENT IN CASE OF MINOR.

I, \_\_\_\_\_, Do CERTIFY, That I am \_\_\_\_\_; that the \_\_\_\_\_ of \_\_\_\_\_; that the \_\_\_\_\_ is \_\_\_\_\_ years of age; and I do hereby freely give my CONSENT to his volunteering as a SOLDIER in the ARMY OF THE UNITED STATES for the period of THREE YEARS.

GIVEN at \_\_\_\_\_ the \_\_\_\_\_ day of \_\_\_\_\_

Witness: \_\_\_\_\_

Redeemed to Northern Dist. Kansas. 22<sup>nd</sup> Sub Dist. 4<sup>th</sup> Ward Leavenworth City.

One recruit has received one hundred dollar advance bounty of three hundred dollar bounty authorized by an Act of Congress approved July 4<sup>th</sup> 1864 and bounty No 27 from the Provost Marshal General of the Army.

VOLUNTEER ENLISTMENT.

STATE OF Kansas



TOWN OF Leavenworth

I, Frank Fletcher, born in St Louis County in the State of Missouri, aged 18 years, and by occupation a Farmer, Do HEREBY ACKNOWLEDGE to have volunteered this Twenty fifth (25) day of February, 1865, to serve as a Soldier in the Army of the United States of America, for the period of THREE YEARS, unless sooner discharged by proper authority: Do also agree to accept such bounty, pay, rations, and clothing, as are, or may be, established by law for volunteers. And I, Frank Fletcher, do solemnly swear, that I will bear true faith and allegiance to the United States of America, and that I will serve them honestly and faithfully against all their enemies or opposers whomsoever; and that I will observe and obey the orders of the President of the United States, and the orders of the officers appointed over me, according to the Rules and Articles of War.

Sworn and subscribed to, at Leavenworth } Frank Fletcher  
this 25 day of February, 1865, } his  
BEFORE P H. Mison 2nd Lt } not  
2nd Battery U.S. Col. 11<sup>th</sup> Artillery

I CERTIFY, ON HONOR, That I have carefully examined the above-named Volunteer, agreeably to the General Regulations of the Army, and that, in my opinion, he is free from all bodily defects and mental infirmity, which would in any way disqualify him from performing the duties of a soldier.

Tiffin Links  
Surg Board of Enrollments  
North Dist Kansas  
EXAMINING SURGEON.

I CERTIFY, ON HONOR, That I have minutely inspected the Volunteer Frank Fletcher previously to his enlistment, and that he was entirely sober when enlisted; that, to the best of my judgment and belief, he is of lawful age; and that, in accepting him as duly qualified to perform the duties of an able-bodied soldier, I have strictly observed the Regulations which govern the recruiting service. This soldier has black eyes, black hair, black complexion, is 5 inches high.

P H. Mison 2nd Lt  
2nd Battery U.S. Col. 11<sup>th</sup> Artillery  
Volunteers,  
RECRUITING OFFICER.

(U. S. No. 74 & 76.)

Mustered into the service of the United States, for three years or during the war, from date of enlistment, in Company Independent Battery U.S. Cavalry 1st Regiment of Light Artillery Volunteers, on the 25 day of February 1865, at Leavenworth Kansas

Provost Marshal  
Northern District Kansas

*James M. F.*

Capt. Batt'y U.S. Col'd L. Art'y.

*Private Private*

CARD NUMBERS.

6 2 3 3 6 1 5	26
6 2 3 3 7 6 9	27
6 2 3 3 9 1 7	28
6 2 3 4 0 8 1	29
6 2 3 4 2 2 7	30
6 2 3 4 3 9 5	31
6 2 3 4 5 5 7	32
9 1 3 2 9 5 0	33
	34
	35
	36
	37
	38
	39
	40
	41
	42
	43
	44
	45
	46
	47
	48
	49
	50

Book Mark:

See also



Rep 354118.

8793167-PO 90

S-1103264-Compton  
A2273727 and w.D.

A4.1867271

SS. Ralph Shumaker  
Alma

Kansas  
1/18/34

W. Spencer  
4

*J* | Indpt. Battery. | **U.S.C.T.**

*James M. F. Forbes*

Appears with rank of *Priv* on

**Muster and Descriptive Roll of a Detachment of U. S. Vols. forwarded**

for the Indpt. Batt'y, U. S. Col'd L. Arty. Roll dated

*Leavenworth, Ks, Dec. 6, 1864.*

Where born *Stanford Co. Ken*

Age *26* y'rs; occupation *Farmer*

When enlisted *Dec 6, 1864.*

Where enlisted *Leavenworth, Ks*

For what period enlisted *3* years.

Eyes *Blk*; hair *Blk*

Complexion *Blk*; height *5* ft. *7* in.

When mustered in *Dec 6, 1864.*

Where mustered in *Leavenworth, Ks*

Bounty paid \$ *100*; due \$ *100*

Where credited

Battery to which assigned

Remarks: *Credited to Northern District, Kansas, 25<sup>th</sup> Sub District, 4<sup>th</sup> Ward, Leavenworth City, Leavenworth County, Vol over*

Book mark:

*E. L. Shannon*

JAN. 17

6233615

CI 891\*

*Recruit & entitled to  
Bounty.*

*A* | Indpt. Battery. | **U.S.C.T.**

*James N. Forbes*

*Sgt*, Indpt. Battery, U. S. Col'd L. Art'y.

Appears on

**Battery Muster-in and Descriptive Roll**

of the organization named above. Roll dated

*Leavenworth Co. Dec 6*, 1864.

Where born *Stamford Co Ky*

Age *26* y'rs; occupation *Farmer*

When enlisted *Dec 6*, 1864.

Where enlisted *Leavenworth Co*

For what period enlisted *3* years.

Eyes *Blk*; hair *Blk*

Complexion *Blk*; height *5* ft. *7* in.

When mustered in *Dec 6*, 1864.

Where mustered in *Leavenworth*

Bounty paid \$ *100<sup>00</sup>*/<sub>100</sub>; due \$ *20<sup>00</sup>*/<sub>100</sub>

Where credited

Battery to which assigned

Remarks: *Co M, Dist Co,*

*22d SD 4th word*

*Leavenworth News*

Book mark:

*J. A. Brady*

*A* | Indpt. Battery. | **U.S.C.T.**

*James J. Forbes*  
*pot*, Indpt. Battery, U. S. Col'd L. Art'y.

Appears on

**Battery Muster Roll**

for *Eight months to Dec 31*, 186*4*

Present or absent *Present*

Stoppage, \$ *100* for

Due Gov't, \$ *100* for

Valuation of horse, \$ *100*

Valuation of horse equipments, \$ *100*

Remarks:

Book mark:

*J. H. Schooley*  
(358) Copyist.

*F* | Indpt. Battery. | **U.S.C.T.**

*James W. Fortes*  
*Fort*, Indpt. Battery, U. S. Col'd L. Art'y.

Appears on

**Battery Muster Roll**

for *Army & Fort*, 186*5*.

Present or absent. *Present*

Stoppage, \$ 100 for

Due Gov't, \$ 100 for

Valuation of horse, \$ 100

Valuation of horse equipments, \$ 100

Remarks:  
\_\_\_\_\_  
\_\_\_\_\_  
\_\_\_\_\_  
\_\_\_\_\_  
\_\_\_\_\_  
\_\_\_\_\_

Book mark: \_\_\_\_\_

*J. Schrey*  
(358) \_\_\_\_\_ Copyist.

*J* | Indpt. Battery. | **U.S.C.T.**

*James W. T. Forbes,*  
*PA*, Indpt. Battery, U. S. Col'd L. Art'y.

Appears on

**Battery Muster Roll**

for *Jan, & Apr*, 186 *3*.

Present or absent *Present*

Stoppage, \$ 100 for

Due Gov't, \$ 100 for

Valuation of horse, \$ 100

Valuation of horse equipments, \$ 100

Remarks:

Book mark:

*Poster*

*J* | Indpt. Battery. | **U.S.C.T.**

*James W. F. Forbes,*  
*Pr*, Indpt. Battery, U. S. Col'd L. Art'y.

Appears on

**Battery Muster Roll**

for *May + June*, 1865.

Present or absent *Present,*

Stoppage, \$ 100 for

Due Gov't, \$ 100 for

Valuation of horse, \$ 100

Valuation of horse equipments, \$ 100

Remarks:

Book mark:

*Porter*



*J* | Indpt. Battery. | **U.S.C.T.**

*James W. F. Forbes*  
Co., Indpt. Battery U. S. Col'd Light Art'y.

Appears on **Batt'y Muster-out Roll**, dated  
*Mt. Leavenworth, Ky July 22, 1865.*

Muster-out to date *July 22, 1865.*

Last paid to *Decr 31, 1864.*

Clothing account:

Last settled....., 186 ; drawn since \$ *63*<sup>36</sup>/<sub>100</sub>,

Due soldier \$.....<sub>100</sub>; due U. S. \$.....<sub>100</sub>

Am't for cloth'g in kind or money adv'd \$.....<sub>100</sub>

Due U. S. for arms, equipments, &c., \$.....<sub>100</sub>

Bounty paid \$ *100*/<sub>100</sub>; due \$ *none*/<sub>100</sub>,

Remarks:.....

Book mark :.....

*Porter*

*J* | Indpt. Batt'y. | **U.S.C.T.**

*James M. J. Forbes*

....., Indpt. Batt'y, U. S. Col'd L. Art'y.

Appears on

**Battery Descriptive Book**  
of the organization named above.

**DESCRIPTION.**

Age *26* years; height *5* feet *7* inches.

Complexion *Black*

Eyes *Black*; hair *Black*

Where born *Stanford Co Ky*

Occupation *Farmer*

**ENLISTMENT.**

When *Dec 6*, 186 *4*

Where *Harrodsburg*

By whom *L Mathews*; term *3* y'rs.

Remarks: .....

.....  
.....  
.....  
.....  
.....  
.....  
.....  
.....  
.....  
.....

*Holbrook*

*Forbes James M.*

*1st* Batt. *U.S.C.A.*  
*Reg't*

, Co. \_\_\_\_\_,

*2*

**Enclosures.**

- |                                    |                            |
|------------------------------------|----------------------------|
| Bed Cards .....                    | Final Statements .....     |
| Burial Records .....               | Furloughs or L. of A ..... |
| Certs. of Dis. for Discharge ..... | Med. Certificates .....    |
| C. M. Charges .....                | Med. Des. Lists .....      |
| Descriptive Lists .....            | Orders .....               |
| Discharge Certificates .....       | Pris. of War Record .....  |
| Enlistment Papers .....            | Resignations .....         |

**Other papers relating to—**

- |                              |                            |
|------------------------------|----------------------------|
| Admission to Hosp'l .....    | Furlough or L. of A .....  |
| Casualty Sheet .....         | Med. Examination .....     |
| Confinement .....            | Misc. Information .....    |
| Contracts .....              | Pay or Clothing .....      |
| Death or Effects .....       | Personal Reports .....     |
| Desertion .....              | Rank .....                 |
| Discharge from Hosp'l .....  | Transfer to Hosp'l .....   |
| Discharge from Service ..... | Transfer to V. R. C. ..... |
| Duty .....                   | Transportation .....       |

DECLARATION OF RECRUIT.

I, James William A Forbes desiring to VOLUNTEER as a Soldier in the Army of the United States, for the term of THREE YEARS, Do Declare, That I am Twenty Six years and ... months of age; that I have never been discharged from the United States service on account of disability or by sentence of a court martial, or by order before the expiration of a term of enlistment; and I know of no impediment to my serving honestly and faithfully as a soldier for three years.

GIVEN at Lawrence, Mo. the Six day of December 1864

Witness: Wm Ford Douglas

James W. A. Forbes, Clerk

NOTE 1.—This blank will be used for both enlistments and re-enlistments—enlistment of veterans, &c., &c., in the volunteer service. They will be made out in duplicate in all cases—one to accompany the recruiting return of the superintendent (not the recruiting officer) to the Adjutant General, and one to accompany the accounts of the officer who pays bounty, &c. The Regiment and Company in which the soldier last served should be given on the back.

NOTE 2.—An enlistment holds to service. A muster-in must, in all cases, precede payment of pay, bounty, pension, &c. A muster-in roll must, in all cases, be filed in the Adjutant General's Office as evidence of muster-in. The mustering officer, commissary, or assistant commissary of musters, as the case may be, will countersign both enlistments as having mustered the soldier into the service of the United States before either of them is given to the disbursing officer.

enlistment; last served in Company ( ) Discharged 18

By ... Recruiting Bureau Battery, U.S. Regiment of ...

Volunteered at Lawrence, Mo. the ... day of ... 1864.

James W. A. Forbes

No. 7

CONSENT IN CASE OF MINOR.

I, ... Do CERTIFY, That I am the ... of ...; that the said ... is ... years of age; and I do hereby freely give my CONSENT to his volunteering as a SOLDIER in the ARMY OF THE UNITED STATES for the period of THREE YEARS.

GIVEN at ... the ... day of ...

Witness: ...

4016d

VOLUNTEER ENLISTMENT.

STATE OF



TOWN OF

Kansas

Leavenworth City

I, James W. F. Forbes born in Stamford Co  
 in the State of Kentucky aged Twenty Six years,  
 and by occupation a Farmer DO HEREBY ACKNOWLEDGE to have  
 volunteered this Sixth day of December 1864  
 to serve as a **Soldier** in the **Army of the United States of America**, for  
 the period of **THREE YEARS**, unless sooner discharged by proper authority:  
 Do also agree to accept such bounty, pay, rations, and clothing, as are, or may be,  
 established by law for volunteers. And I, James W. F. Forbes do  
 solemnly swear, that I will bear true faith and allegiance to the **United States**  
**of America**, and that I will serve them honestly and faithfully against all  
 their enemies or opposers whomsoever; and that I will observe and obey the  
 orders of the President of the United States, and the orders of the officers  
 appointed over me, according to the Rules and Articles of War.

Sworn and subscribed to, at Leavenworth this 6<sup>th</sup> day of Dec 1864  
 BEFORE William & Mathews Recruiting and Colt Artillery  
Recruiting and Colt Artillery

I CERTIFY, ON HONOR, That I have carefully examined the above-named Volunteer, agreeably  
 to the General Regulations of the Army, and that, in my opinion, he is free from all bodily defects and  
 mental infirmity, which would in any way disqualify him from performing the duties of a soldier.

Tiffin Binks  
Surg Board of Enrollment  
North Dist Kansas  
 EXAMINING SURGEON.

I CERTIFY, ON HONOR, That I have minutely inspected the Volunteer, .....  
 previously to his enlistment, and that he was entirely sober when enlisted; that, to the best of my  
 judgment and belief, he is of lawful age; and that, in accepting him as duly qualified to perform the  
 duties of an able-bodied soldier, I have strictly observed the Regulations which govern the recruiting  
 service. This soldier has Black eyes, Black hair, Black complexion, is five  
 feet Seven inches high.

William & Mathews  
Recruiting and Colt Artillery  
 Regiment of ..... Volunteers,  
 RECRUITING OFFICER.

Mustered into the service of the United States, for three years or during the war, from date of enlistment, in Company D  
Battery, U.S. Artillery Regiment of Artillery, 1<sup>st</sup> Volunteers, on the 6<sup>th</sup> day of December, 1864 at Leavenworth  
James W. F. Forbes  
Capt U.S. Artillery  
1<sup>st</sup> Volunteers

DECLARATION OF RECRUIT.

NOTE 1.—This blank will be used for both enlistments and re-enlistments—enlistment of veterans, &c., &c., in the volunteer service. They will be made out in duplicate in all cases—one to accompany the recruiting return of the superintendent (not the recruiting officer) to the Adjutant General, and one to accompany the accounts of the officer who pays bounty, &c. The Regiment and Company in which the soldier last served should be given on the back.

NOTE 2.—An enlistment holds to service. A muster-in must, in all cases, precede payment of pay, bounty, pension, &c. A muster-in roll must, in all cases, be filed in the Adjutant General's Office as evidence of muster-in. The mustering officer, commissary, or assistant commissary of musters, as the case may be, will countersign both enlistments as having mustered the soldier into the service of the United States before either of them is given to the disbursing officer.

Rec'd from 2nd. Aud. Nov. 23d 1892

I, James M. Y. Yerles desiring to VOLUNTEER as a Soldier in the Army of the United States, for the term of THREE YEARS, Do Declare, That I am Twenty Six years and \_\_\_\_\_ months of age; that I have never been discharged from the United States service on account of disability or by sentence of a court martial, or by order before the expiration of a term of enlistment; and I know of no impediment to my serving honestly and faithfully as a soldier for three years.

GIVEN at Leavenworth City the 6 day of December 1892

Witness: By Hand of \_\_\_\_\_

James M. Y. Yerles  
for \_\_\_\_\_

No. 31

James M. Y. Yerles  
Volunteered at Leavenworth

Leavenworth 1864,

By William D. Weather  
Recruiting and Standard Battery  
Regiment of \_\_\_\_\_

\_\_\_\_\_ enlistment; last served in Company ( )

\_\_\_\_\_ Reg't of \_\_\_\_\_

Discharged \_\_\_\_\_ 18 \_\_\_\_\_

CONSENT IN CASE OF MINOR.

I, \_\_\_\_\_ Do CERTIFY, That I am \_\_\_\_\_; that the \_\_\_\_\_ of \_\_\_\_\_; that the said \_\_\_\_\_ is \_\_\_\_\_ years of age; and I do hereby freely give my CONSENT to his volunteering as a SOLDIER in the ARMY OF THE UNITED STATES for the period of THREE YEARS.

GIVEN at \_\_\_\_\_ the \_\_\_\_\_ day of \_\_\_\_\_

Witness: \_\_\_\_\_

VOLUNTEER ENLISTMENT.

STATE OF



TOWN OF

Lancaster City

I, James W. F. Forbes born in Stamford Co-  
 in the State of Kentucky aged Twenty Six years,  
 and by occupation a Farmer Do HEREBY ACKNOWLEDGE to have  
 volunteered this Sixth day of December 1864  
 to serve as a **Soldier** in the **Army of the United States of America**, for  
 the period of **THREE YEARS**; unless sooner discharged by proper authority:  
 Do also agree to accept such bounty, pay, rations, and clothing, as are, or may be,  
 established by law for volunteers. And I, James W. F. Forbes do  
 solemnly swear, that I will bear true faith and allegiance to the **United States**  
**of America**, and that I will serve them honestly and faithfully against all  
 their enemies or opposers whomsoever; and that I will observe and obey the  
 orders of the President of the United States, and the orders of the officers  
 appointed over me, according to the Rules and Articles of War.

Sworn and subscribed to, at Lancaster  
 this Six day of Dec 1864 } James W. F. Forbes  
 BEFORE William S. Matthews 2nd Lieut-  
 +

I CERTIFY, ON HONOR, That I have carefully examined the above-named Volunteer, agreeably  
 to the General Regulations of the Army, and that, in my opinion, he is free from all bodily defects and  
 mental infirmity, which would in any way disqualify him from performing the duties of a soldier.

Tiffie Sinks  
 Surg Board of Enrollment  
 North "Dias Kansas  
 EXAMINING SURGEON.

I CERTIFY, ON HONOR, That I have minutely inspected the Volunteer, James W. F. Forbes  
 previously to his enlistment, and that he was entirely sober when enlisted; that, to the best of my  
 judgment and belief, he is of lawful age; and that, in accepting him as duly qualified to perform the  
 duties of an able-bodied soldier, I have strictly observed the Regulations which govern the recruiting  
 service. This soldier has black eyes, black hair, black complexion, is five  
 feet seven inches high.

William S. Matthews 2nd Lieut  
 Recruiting and Col. 12th  
 Regiment of Volunteers,  
 RECRUITING OFFICER.

Mustered into the service of the United States, for three years or during the war, from date of enlistment, in Company D  
Bally 11th Co d Regiment of Arty Regt Volunteers, on the 6th day of December, 1864, at Lancaster Ks  
James W. F. Forbes  
Capt 11th Co d Regt Arty Volunteers  
William S. Matthews  
2nd Lieut 12th Co d Regt Arty Volunteers

I have examined the above named volunteer and find him to be a free man of lawful age and of sound mind and body and fit for the service of the United States Army.

*Foster, Thomas*

ndpt. Batt'y U.S. Col'd L. Art'y.

*Private Private*

CARD NUMBERS.

6 2 3 3 7 6 6	26
6 2 3 3 9 1 4	27
6 2 3 4 0 7 9	28
6 2 3 4 2 2 5	29
6 2 3 4 3 9 3	30
6 2 3 4 5 5 5	31
9 1 3 2 9 4 7	32
	33
	34
	35
	36
	37
	38
	39
	40
	41
	42
	43
	44
	45
	46
	47
	48
	49
	50

Book Mark: \_\_\_\_\_

See also \_\_\_\_\_



*F* | Indpt. Batt'y. | **U.S.C.T.**

*Thomas Foster*

....., Indpt. Batt'y, U. S. Col'd L. Art'y.

Appears on

**Battery Descriptive Book**

of the organization named above.

**DESCRIPTION.**

Age *46* years; height *5* feet *7* inches.

Complexion *Black*

Eyes *Black*; hair *Black*

Where born *Hamilton Co. Ohio*

Occupation *Cooper*

**ENLISTMENT.**

When *July 23*, 186 *4*

Where *Warren Co. - Pa.*

By whom *H. Matthews*; term *3* y'rs.

Remarks: .....

.....  
 .....  
 .....  
 .....  
 .....  
 .....  
 .....  
 .....

*Holbrook*

*F* | Indpt. Battery. | **U.S.C.T.**

*Thomas Foster*

*Pat*, Indpt. Battery, U. S. Col'd L. Art'y.

Appears on

**Battery Muster-in and Descriptive Roll**

of the organization named above. Roll dated

*Lovenworth Co Mass*, 1864.

Where born *Farmington, Ohio*

Age *44* y'rs; occupation *Cooper*

When enlisted *July 23*, 1864.

Where enlisted *Lovenworth Co.*

For what period enlisted *3* years.

Eyes *Blk*; hair *Blk*

Complexion *Brn*; height *5* ft. *7* in.

When mustered in *July 24*, 1864.

Where mustered in *Lovenworth*

Bounty paid \$ *100*; due \$ *300*<sup>*00*</sup>/<sub>*100*</sub>

Where credited

Battery to which assigned

Remarks: *On H Dist Co,  
19<sup>th</sup> SD, 1<sup>st</sup> Ward  
Lovenworth Co.*

Book mark:

*J. Schindler*

(856g)

Copyist.

*A* | Indpt. Battery. | **U.S.C.T.**

*Thomas Foster*

*Pvt*, Indpt. Battery, U. S. Col'd L. Art'y.

Appears on

**Battery Muster Roll**

for *Attachment to Det 31*, 186 *4*

Present or absent *Absent*

Stoppage, \$ 100 for

Due Gov't, \$ 100 for

Valuation of horse, \$ 100

Valuation of horse equipments, \$ 100

Remarks: *Lies in Hospital  
at Ft. Leavenworth Mo.*

Book mark:

*J. H. Schuler* Copyist.  
(358)

*F*

Indpt. Battery. | **U.S.C.T.**

*Thomas Foster*

*Fat*, Indpt. Battery, U. S. Col'd L. Art'y.

Appears on

**Battery Muster Roll**

for *July 1st*, 186*5*.

Present or absent *Present*

Stoppage, \$ 100 for

Due Gov't, \$ 100 for

Valuation of horse, \$ 100

Valuation of horse equipments, \$ 100

Remarks: *In arrest*

Book mark: \_\_\_\_\_

*J. H. Shirley*  
(358) Copyist.

*F* | Indpt. Battery. | **U.S.C.T.**

*Thomas Foster,*

*A*....., Indpt. Battery, U. S. Col'd L. Art'y.

Appears on

**Battery Muster Roll**

for *May & Apr,*....., 1865.

Present or absent *Present,*.....

Stoppage, \$.....<sup>100</sup> for.....

Due Gov't, \$.....<sup>100</sup> for.....

Valuation of horse, \$.....<sup>100</sup>

Valuation of horse equipments, \$.....<sup>100</sup>

Remarks: *Penalty due \$100.00*

Book mark: .....

*Foster*

*F*

Indpt. Battery.

U.S.C.T.

*Thomas Foster*

*Pr*, Indpt. Battery, U. S. Col'd L. Art'y.

Appears on

**Battery Muster Roll**

for *May & June*, 1865.

Present or absent *Present*

Stoppage, \$ 100 for

Due Gov't, \$ 100 for

Valuation of horse, \$ 100

Valuation of horse equipments, \$ 100

Remarks:

Book mark:

*Baxter*

*F* | Indpt. Battery. | **U.S.C.T.**

*Thomas Foster,*

*M*, Indpt. Battery U. S. Col'd Light Art'y.

Appears on **Batt'y Muster-out Roll**, dated *St. Lawrence Co., N.Y., July 22, 1865.*

Muster-out to date *July 22, 1865.*

Last paid to *Dec. 31, 1864.*

Clothing account:

Last settled....., 186 ; drawn since \$ *39*<sup>*40*</sup>/<sub>100</sub>,

Due soldier \$ 100; due U. S. \$ 100

Am't for cloth'g in kind or money adv'd \$ 100

Due U. S. for arms, equipments, &c., \$ 100

Bounty paid \$ ~~None~~ 100; due \$ 100 100,

Remarks: *Due C. F. Gordon, Sutter,*  
*\$10-*

Book mark:

*Parter*

Copyist.

*Indpt Bathy*

*Foster, Thomas*

....., Co. ...., *2* Reg't *USCLA*

*2* Enclosures.

Bed Cards .....	Final Statements .....
Burial Records .....	Furloughs or L. of A .....
Certs. of Dis. for Discharge .....	Med. Certificates .....
C. M. Charges .....	Med. Des. Lists .....
Descriptive Lists .....	Orders .....
Discharge Certificates .....	Pris. of War Record .....
Enlistment Papers .....	Resignations .....

Other papers relating to—

Admission to Hosp'l .....	Furlough or L. of A .....
Casualty Sheet .....	Med. Examination .....
Confinement .....	Misc. Information .....
Contracts .....	Pay or Clothing .....
Death or Effects .....	Personal Reports .....
Desertion .....	Rank .....
Discharge from Hosp'l .....	Transfer to Hosp'l .....
Discharge from Service .....	Transfer to V. R. C. ....
Duty .....	Transportation .....



DECLARATION OF RECRUIT.

I, Thomas Foster desiring to VOLUNTEER as a Soldier in the Army of the United States, for the term of THREE YEARS Do Declare, That I am 46 years and 0 months of age; that I have never been discharged from the United States service on account of disability or by sentence of a court-martial, or by order before the expiration of a term of enlistment; and I know of no impediment to my serving honestly and faithfully as a soldier for three years.

GIVEN at Leavenworth City State of Kansas the 23<sup>rd</sup> day of July 1864

Witness:

C. H. Langston

Thomas Foster  
mark

NOTE 1.—This blank will be used for both enlistments and re-enlistments—enlistments of veterans, &c., &c., in the volunteer service. They will be made out in duplicate in all cases, one to accompany the recruiting return of the superintendent (not the recruiting officer) to the Adjutant General, and one to accompany the accounts of the officer who pays bounty, &c. The Regiment and Company in which the soldier last served should be given on the back.  
NOTE 2.—An enlistment holds to service. A muster-in must, in all cases, precede payment of pay, bounty, pension, &c. A muster-in roll must, in all cases, be filed in the Adjutant General's Office as evidence of muster-in. The mustering officer, commissary, or assistant commissary of musters, as the case may be, will countersign both enlistments and the muster-in roll before the soldier is given into the service of the United States before either of them is given to the disbursing officer.

X

enlistment; last served in Company ( )  
Reg't of \_\_\_\_\_  
Discharged \_\_\_\_\_ 18\_\_

Volunteered at Leavenworth City  
July 23 1864  
By Spencer Matthews 2<sup>d</sup> Dist  
Rec'd by Capt. H. C. 2<sup>d</sup> Dist

No. 23

CONSENT IN CASE OF MINOR.

I, \_\_\_\_\_ Do CERTIFY, That I am \_\_\_\_\_; that the \_\_\_\_\_ of \_\_\_\_\_ is \_\_\_\_\_ years of age; and I do hereby freely give my CONSENT to his volunteering as a SOLDIER in the ARMY OF THE UNITED STATES for the period of THREE YEARS.

GIVEN at \_\_\_\_\_ the \_\_\_\_\_ day of \_\_\_\_\_

Witness:

VOLUNTEER ENLISTMENT.

STATE OF

*Kansas*



TOWN OF

*Lavenworth City*

I, *Thomas Foster* born in *Hamilton County*

in the State of *Ohio* aged *46* years,

and by occupation a *Cooper* Do HEREBY ACKNOWLEDGE to have

volunteered this *23<sup>rd</sup>* day of *July* 1864,

to serve as a **Soldier** in the **Army of the United States of America**, for the

period of **THREE YEARS** unless sooner discharged by proper authority: Do also

agree to accept such bounty, pay, rations, and clothing, as are, or may be, estab-

lished by law for volunteers. And I, *Thomas Foster* do

solemnly swear, that I will bear true faith and allegiance to the **United States**

**of America**, and that I will serve them honestly and faithfully against all their

enemies or opposers whomsoever; and that I will observe and obey the orders of

the President of the United States, and the orders of the officers appointed over

me, according to the Rules and Articles of War.

Sworn and subscribed to, at *Lavenworth City of this*  
this *23* day of *July* 1864. *Thomas Foster*

BEFORE *Wm. J. Matthews* )  
*Quint-Recruiting Co. 2<sup>nd</sup> W.S. Col. Artillery* )  
*Recruiting Officer*

I CERTIFY, ON HONOR, That I have carefully examined the above-named Volunteer, agreeably to the General Regulations of the Army, and that, in my opinion, he is free from all bodily defects and mental infirmity, which would in any way disqualify him from performing the duties of a soldier.

*Jeffrey Sinks*  
*Surg Board of Enrollment*  
*North West Kansas*  
EXAMINING SURGEON.

I CERTIFY, ON HONOR, That I have minutely inspected the V *er, Thomas Foster*  
previously to his enlistment, and that he was entirely sober when enlisted; that, to the best of my judgment and belief, he is of lawful age; and that, in accepting him as duly qualified to perform the duties of an able-bodied soldier, I have strictly observed the Regulations which govern the recruiting service. This soldier has *Black* eyes, *Black* hair, *Black* complexion, is *5-* feet *5 1/2* inches high.

*Wm. J. Matthews 2<sup>nd</sup> Lieut*  
*Recruiting Co. 2<sup>nd</sup> W.S. Col. Artillery*  
Regiment of *Volunteers,*

RECRUITING OFFICER.

the ..... day of ..... 186 , at .....  
Mustered into the service of the United States, in Company .....  
Regiment of .....  
Volunteers, on

DECLARATION OF RECRUIT.

I, Thomas Foster desiring to VOLUNTEER as a Soldier in the Army of the United States, for the term of THREE YEARS Do Declare, That I am 44 years and 0 months of age; that I have never been discharged from the United States service on account of disability or by sentence of a court-martial, or by order before the expiration of a term of enlistment; and I know of no impediment to my serving honestly and faithfully as a soldier for three years.

GIVEN at Leavenworth City, State of Kansas the 23<sup>rd</sup> day of July 1864

Witness: C. H. Gungerson

Thomas Foster  
recruit

NOTE 1.—This blank will be used for both enlistments and re-enlistments—enlistment of veterans, &c., &c., in the volunteer service. They will be made out in duplicate in all cases—one to accompany the recruiting return of the superintendent (not the recruiting officer) to the Adjutant General, and one to accompany the accounts of the officer who pays bounty, &c. The Regiment and Company in which the soldier last served should be given on the back.  
NOTE 2.—An enlistment holds to service. A muster-in must, in all cases, precede payment of pay, bounty, pension, &c. A muster-in roll must, in all cases, be filed in the Adjutant General's Office as evidence of muster-in. The mustering officer, commissary, or assistant commissary of musters, as the case may be, will countersign both enlistments as having mustered the soldier into the service of the United States before either of them is given to the disbursing officer.

..... enlistment; last served in Company ( )  
..... Reg't of .....  
Discharged ..... 18 .....

No. 4  
Thomas Foster  
Volunteered at Leavenworth City  
July 23 1864,  
By Wm. D. Matthews 2<sup>d</sup> Lieut  
Recruiting Officer 1<sup>st</sup> Reg't Cavalry  
Leavenworth, Kan.

CONSENT IN CASE OF MINOR.

I, ..... Do CERTIFY, That I am the ..... of .....; that the said ..... is ..... years of age; and I do hereby freely give my CONSENT to his volunteering as a SOLDIER in the ARMY OF THE UNITED STATES for the period of THREE YEARS.

GIVEN at ..... the ..... day of .....

Witness: .....

VOLUNTEER ENLISTMENT.

STATE OF

*Kansas*



TOWN OF

*Leavenworth City*

I, *Thomas Foster*

born in *Hamilton County*

in the State of *Ohio* aged *46* years,

and by occupation a *Cooper* Do HEREBY ACKNOWLEDGE to have

volunteered this *23* day of *July* 1864

to serve as a **Soldier** in the **Army of the United States of America**, for the period of **THREE YEARS** unless sooner discharged by proper authority: Do also

agree to accept such bounty, pay, rations, and clothing, as are, or may be, established by law for volunteers. And I, *Thomas Foster* do

solemnly swear, that I will bear true faith and allegiance to the **United States of America**, and that I will serve them honestly and faithfully against all their

enemies or opposers whomsoever; and that I will observe and obey the orders of the President of the United States, and the orders of the officers appointed over

me, according to the Rules and Articles of War.

Sworn and subscribed to, at *Leavenworth City* this *23<sup>o</sup>* day of *July* 1864 *Thomas Foster*

BEFORE *Wm D Matthews 2nd* *Recruiting Co H. 2nd US Col Artillery*

I CERTIFY, ON HONOR, That I have carefully examined the above-named Volunteer, agreeably to the General Regulations of the Army, and that, in my opinion, he is free from all bodily defects and mental infirmity, which would in any way disqualify him from performing the duties of a soldier.

*Jiffie Sink*  
*Sur Board of Enrollment*  
*North Dist Kansas*  
EXAMINING SURGEON.

I CERTIFY, ON HONOR, That I have minutely inspected the Volunteer, previously to his enlistment, and that he was entirely sober when enlisted; that, to the best of my judgment and belief, he is of lawful age; and that, in accepting him as duly qualified to perform the duties of an able-bodied soldier, I have strictly observed the Regulations which govern the recruiting service.

This soldier has *Black* eyes, *Black* hair, *Black* complexion, is *5* feet *7* inches high.

*Wm D Matthews 2nd*  
*Recruiting Co H. 2nd US Col Artillery*  
Volunteers,  
RECRUITING OFFICER.

(A. G. O. No. 74 & 75.)

Mustered into the service of the United States, in Company *H* of *3rd* Regiment of *US Art* *Volunteers*, on the *23* day of *July* 1864, at *Leavenworth* *for 3 years or during the war from date of enlistment organization*

1st Batt'y U.S. Col'd L. Art'y.

Private Private

CARD NUMBERS.

62335-86	26
6233770	27
6233918	28
6234080	29
6234226	30
6234394	31
6234556	32
4132952	33
	34
	35
	36
	37
	38
	39
	40
	41
	42
	43
	44
	45
	46
	47
	48
	49
	50

Book Mark:

See also

*J* | Indpt. Batt'y. | **U.S.C.T.**

*John Fowler*

....., Indpt. Batt'y, U. S. Col'd L. Art'y.

Appears on

**Battery Descriptive Book**

of the organization named above.

**DESCRIPTION.**

Age *24* years; height *5 feet 5 1/2* inches.

Complexion *Black*

Eyes *Black*; hair *Black*

Where born *Bourbon Co. Ky*

Occupation *Farmer*

**ENLISTMENT.**

When *Oct. 26*, 186 *4*

Where *Fort Scott*

By whom *L. Matthews*; term *3* y'rs.

Remarks: .....

.....  
 .....  
 .....  
 .....  
 .....  
 .....  
 .....  
 .....

*Stalbrook*

*F* | Indpt. Battery. | **U.S.C.T.**

*John Fowler*

Appears with rank of *Priv* on

**Muster and Descriptive Roll of a Detachment of U. S. Vols. forwarded**

for the Indpt. Batt'y, U. S. Col'd L. Arty. Roll dated

*Leavenworth, Kans, Nov. 29, 1864.*

Where born *Bowling Co. Ky*

Age *20* y'rs; occupation *Farmer*

When enlisted *Oct 26*, 1864.

Where enlisted *Fr. Scott Co*

For what period enlisted *3* years.

Eyes *Blk*; hair *Blk*

Complexion *Blk*; height *5* ft. *5* in.

When mustered in *Nov. 29*, 1864.

Where mustered in *Leavenworth, Kans*

Bounty paid \$ *100*; due \$ *100*

Where credited

Battery to which assigned

Remarks: *Credited to Southern Dist, Kansas, Fr. Scott, Bowling Co. Vol Recruit & entitled to Bounty*

Book mark:

*E. L. Thornton*

*A* | Indpt. Battery. | **U.S.C.T.**

*John Fowler*  
*Pat*, Indpt. Battery, U. S. Col'd L. Art'y.

Appears on

**Battery Muster-in and Descriptive Roll**

of the organization named above. Roll dated

*Leavenworth Mo Dec 23*, 1864.

Where born *Bourbon Co. Ky*

Age *24* y'rs; occupation *Farmer*

When enlisted *Oct 26*, 1864.

Where enlisted *Fort Scott Mo*

For what period enlisted *3* years.

Eyes *Blu*; hair *Blu*

Complexion *Blu*; height *5* ft. *5 1/2* in.

When mustered in *Nov 29*, 1864.

Where mustered in *Leavenworth*

Bounty paid \$ *100*<sup>00</sup>/<sub>100</sub>; due \$ *200*<sup>00</sup>/<sub>100</sub>

Where credited

Battery to which assigned

Remarks: *Co. I. Dist Mo*

*Fort Scott Bourbon Co. Mo*

Book mark :

*J. H. Sawyer*  
 (856g) Copyist.



*F*

Indpt. Battery.

U.S.C.T.

*John Fowler*  
*Pat*

Indpt. Battery, U. S. Col'd L. Art'y.

Appears on

**Battery Muster Roll**

for *Enlistment to Dec 31, 1864.*

Present or absent *Present*

Stoppage, \$ *100* for

Due Gov't, \$ *100* for

Valuation of horse, \$ *100*

Valuation of horse equipments, \$ *100*

Remarks:

Book mark:

*J. H. Schuler*  
(358) Copyist.

*J* | Indpt. Battery. | **U.S.C.T.**

*John Fowler*  
*Pot*, Indpt. Battery, U. S. Col'd L. Art'y.

Appears on

**Battery Muster Roll**

for *Jimmy Pot*, 186 *5*

Present or absent *Present*

Stoppage, \$ \_\_\_\_\_ *100* for \_\_\_\_\_

Due Gov't, \$ \_\_\_\_\_ *100* for \_\_\_\_\_

Valuation of horse, \$ \_\_\_\_\_ *100*

Valuation of horse equipments, \$ \_\_\_\_\_ *100*

Remarks: \_\_\_\_\_  
\_\_\_\_\_  
\_\_\_\_\_  
\_\_\_\_\_  
\_\_\_\_\_  
\_\_\_\_\_  
\_\_\_\_\_

Book mark: \_\_\_\_\_

*J. S. Shively*  
(358) Copyist.

*F*

Indpt. Battery.

U.S.C.T.

*John Fowler,*  
*Co*

, Indpt. Battery, U. S. Col'd L. Art'y.

Appears on

**Battery Muster Roll**

for *May, & Apr,* 186 *5.*

Present or absent *Present,*

Stoppage, \$ 100 for

Due Gov't, \$ 100 for

Valuation of horse, \$ 100

Valuation of horse equipments, \$ 100

Remarks:

Book mark:

*Butler*

Copyist.

*J* | Indpt. Battery. | **U.S.C.T.**

*John Fowler,*  
*Pr*, Indpt. Battery, U. S. Col'd L. Art'y.

Appears on

**Battery Muster Roll**

for *May & June*, 186*5*.

Present or absent *Present,*

Stoppage, \$ \_\_\_\_\_ <sup>100</sup> for \_\_\_\_\_

Due Gov't, \$ \_\_\_\_\_ <sup>100</sup> for \_\_\_\_\_

Valuation of horse, \$ \_\_\_\_\_ <sup>100</sup>

Valuation of horse equipments, \$ \_\_\_\_\_ <sup>100</sup>

Remarks: \_\_\_\_\_

Book mark: \_\_\_\_\_

*Parter*

(358)

Copyist.

*G* | Indpt. Battery. | **U.S.C.T.**

*John Fowler,*

*Co*, Indpt. Battery U. S. Col'd Light Art'y.

Appears on **Batt'y Muster-out Roll**, dated

*At Leavenworth, Mo, July 22, 1865.*

Muster-out to date *July 22, 1865.*

Last paid to *Dec. 31, 1864.*

Clothing account:

Last settled....., 186 ; drawn since \$ *70* <sup>*71*</sup>/<sub>100</sub>,

Due soldier \$.....<sup>100</sup>; due U. S. \$.....<sup>100</sup>

Am't for cloth'g in kind or money adv'd \$.....<sup>100</sup>

Due U. S. for arms, equipments, &c., \$.....<sup>100</sup>

Bounty paid \$ *100* <sup>100</sup>; due \$ *None* <sup>100</sup>,

Remarks:.....

.....  
.....  
.....  
.....  
.....  
.....  
.....

Book mark:.....

*Porter*

Copyist.

Fowler John

, Co. , 2nd Batt. U.S.C.A. Regt

2 Enclosures.

- |                                    |                            |
|------------------------------------|----------------------------|
| Bed Cards .....                    | Final Statements .....     |
| Burial Records .....               | Furloughs or L. of A. .... |
| Certs. of Dis. for Discharge ..... | Med. Certificates .....    |
| C. M. Charges .....                | Med. Des. Lists .....      |
| Descriptive Lists .....            | Orders .....               |
| Discharge Certificates .....       | Pris. of War Record .....  |
| Enlistment Papers .....            | Resignations .....         |

Other papers relating to—

- |                              |                           |
|------------------------------|---------------------------|
| Admission to Hosp'l .....    | Furlough or L. of A. .... |
| Casualty Sheet .....         | Med. Examination .....    |
| Confinement .....            | Misc. Information .....   |
| Contracts .....              | Pay or Clothing .....     |
| Death or Effects .....       | Personal Reports .....    |
| Desertion .....              | Rank .....                |
| Discharge from Hosp'l .....  | Transfer to Hosp'l .....  |
| Discharge from Service ..... | Transfer to V. R. C. .... |
| Duty .....                   | Transportation .....      |

NOTE 1.—This blank will be used for both enlistments and re-enlistments—enlistment of veterans, &c., &c., in the volunteer service. They will be made out in duplicate in all cases—one to accompany the recruiting return of the superintendent (not the recruiting officer) to the Adjutant General, and one to accompany the accounts of the officer who pays bounty, &c. The Regiment and Company in which the soldier last served should be given on the back.

NOTE 2.—An enlistment holds to service. A muster-in must, in all cases, precede payment of pay, bounty, pension, &c. A muster-in roll must, in all cases, be filed in the Adjutant General's Office as evidence of muster-in. The mustering officer, commissary, or assistant commissary of musters, as the case may be, will countersign both enlistments as having mustered the soldier into the service of the United States before either of them is given to the disbursing officer.

DECLARATION OF RECRUIT.

*John Fowler*

desiring to VOLUNTEER as a Soldier in the Army of the United States, for the term of THREE YEARS, Do Declare, That I am *Twenty two* years and \_\_\_\_\_ months of age; that I have never been discharged from the United States service on account of disability or by sentence of a court martial, or by order before the expiration of a term of enlistment; and I know of no impediment to my serving honestly and faithfully as a soldier for three years.

GIVEN at *Fort Scott, Kansas* the *26* day of *October* 18*64*

Witness:

*Nathl. C. Hanson* *John H. Fowler*  
mark

*[Signature]*

No. ....

*John Fowler*

Volunteered at *San Jacinto Tex*

*October 26* 18*64*

By *Wm. M. Lawrence*

*Adj. Batty* Regiment of *U.S. Cavalry*

enlistment; last served in Company ( )

Reg't of \_\_\_\_\_

Discharged \_\_\_\_\_ 18 \_\_\_\_\_

202

CONSENT IN CASE OF MINOR.

I, \_\_\_\_\_ Do CERTIFY, That I am the \_\_\_\_\_ of \_\_\_\_\_; that the said \_\_\_\_\_ is \_\_\_\_\_ years of age; and I do hereby freely give my CONSENT to his volunteering as a SOLDIER in the ARMY OF THE UNITED STATES for the period of THREE YEARS.

GIVEN at \_\_\_\_\_

the \_\_\_\_\_ day of \_\_\_\_\_

Witness: \_\_\_\_\_

VOLUNTEER ENLISTMENT.

STATE OF

*Kansas*



TOWN OF

*Fort Scott*

I, *John Fowler* born in *Bourbon Co*  
 in the State of *Kentucky* aged *Twenty* years,  
 and by occupation a *Farmer* Do HEREBY ACKNOWLEDGE to have  
 volunteered this *Twenty-Sixth* day of *October* 186*4*,  
 to serve as a **Soldier** in the **Army of the United States of America**, for  
 the period of **THREE YEARS**, unless sooner discharged by proper authority:  
 Do also agree to accept such bounty, pay, rations, and clothing, as are, or may be,  
 established by law for volunteers. And I, *John Fowler* do  
 solemnly swear, that I will bear true faith and allegiance to the **United States**  
**of America**, and that I will serve them honestly and faithfully against all  
 their enemies or opposers whomsoever; and that I will observe and obey the  
 orders of the President of the United States, and the orders of the officers  
 appointed over me, according to the Rules and Articles of War.

Sworn and subscribed to, at *Fort Scott - Ky*  
 this *26<sup>th</sup>* day of *October* 186*4*  
 BEFORE *Wm S Mathews*  
*John X Fowler*  
*MWR*

*2<sup>d</sup> Lt Recy 2<sup>d</sup> Bully U.S. Cavd Army - Sigle*

I CERTIFY, ON HONOR, That I have carefully examined the above-named Volunteer, agreeably to the General Regulations of the Army, and that, in my opinion, he is free from all bodily defects and mental infirmity, which would in any way disqualify him from performing the duties of a soldier.

*Tiffin Binks*  
*Sigle in Bd of Enrollment*  
*Arch Dur Par* EXAMINING SURGEON.

I CERTIFY, ON HONOR, That I have minutely inspected the Volunteer, *John Fowler*  
 previously to his enlistment, and that he was entirely sober when enlisted; that, to the best of my  
 judgment and belief, he is of lawful age; and that, in accepting him as duly qualified to perform the  
 duties of an able-bodied soldier, I have strictly observed the Regulations which govern the recruiting  
 service. This soldier has *black* eyes, *black* hair, *black* complexion, is *five*  
 feet *five*/<sub>8</sub> inches high.

*Wm S Mathews*  
*2<sup>d</sup> Lt Recy 2<sup>d</sup> Bully U.S. Cavd Army - Volunteers, Sigle*  
 RECRUITING OFFICER.

(A. G. O. No. 74 & 76.)

Mustered into the service of the United States, for three years or during the war, from date of enlistment, in Company *the 1<sup>st</sup>*  
*Regiment of* *Army Sigle* Volunteers, on the *26<sup>th</sup>* day of *October* 186*4* at *Fort Scott - Ky*  
*John X Fowler*  
*the 1<sup>st</sup>*  
*Regiment of*  
*Army Sigle*  
*Volunteers*



NOTE 1.—This blank will be used for both enlistments and re-enlistments—enlistment of veterans, &c., &c., in the volunteer service. They will be made out in duplicate in all cases—one to accompany the recruiting return of the superintendent (not the recruiting officer) to the Adjutant General, and one to accompany the accounts of the officer who pays bounty, &c. The Regiment and Company in which the soldier last served should be given on the back.

NOTE 2.—An enlistment holds to service. A muster-in must, in all cases, precede payment of pay, bounty, pension, &c. A muster-in roll must, in all cases, be filed in the Adjutant General's Office as evidence of muster-in. The mustering officer, commissary, or assistant commissary of musters, as the case may be, will countersign both enlistments as having mustered the soldier into the service of the United States before either of them is given to the disbursing officer.

DECLARATION OF RECRUIT.

I, John Fowler desiring to VOLUNTEER as a Soldier in the Army of the United States, for the term of THREE YEARS, Do Declare, That I am Twenty years and \_\_\_\_\_ months of age; that I have never been discharged from the United States service on account of disability or by sentence of a court martial, or by order before the expiration of a term of enlistment; and I know of no impediment to my serving honestly and faithfully as a soldier for three years.

GIVEN at Don Scott Kansas the 26 day of October 1864

Witness: Nash, C. Hanson John Fowler  
mark

No. 322

John Fowler  
Volunteered at Don Scott KS

October 26 1864

By Wm. Matthews 2d Lt. Regt

Ad. Battery - Regiment of U.S. Artillery - 1st

enlistment; last served in Company ( )

Reg't of \_\_\_\_\_

Discharged \_\_\_\_\_ 18 \_\_\_\_\_

Rec'd from 2nd. Aud. Nov. 23d 1892

CONSENT IN CASE OF MINOR.

I, \_\_\_\_\_ Do CERTIFY, That I am \_\_\_\_\_; that the \_\_\_\_\_ of \_\_\_\_\_; that the \_\_\_\_\_ is \_\_\_\_\_ years of age; and I do hereby freely give my CONSENT to his volunteering as a SOLDIER in the ARMY OF THE UNITED STATES for the period of THREE YEARS.

GIVEN at \_\_\_\_\_ the \_\_\_\_\_ day of \_\_\_\_\_

Witness: \_\_\_\_\_

VOLUNTEER ENLISTMENT.

STATE OF



TOWN OF

*Kansas*

*Don Scott*

I, *John Fowler* born in *Bourbon Co*  
in the State of *Kentucky* aged *Twenty* years,  
and by occupation a *Farmer* Do HEREBY ACKNOWLEDGE to have  
volunteered this *Twenty Sixth* day of *October* 1864,  
to serve as a **Soldier** in the **Army of the United States of America**, for  
the period of **THREE YEARS**, unless sooner discharged by proper authority:  
Do also agree to accept such bounty, pay, rations, and clothing, as are, or may be,  
established by law for volunteers. And I, *John Fowler* do  
solemnly swear, that I will bear true faith and allegiance to the **United States**  
**of America**, and that I will serve them honestly and faithfully against all  
their enemies or opposers whomsoever; and that I will observe and obey the  
orders of the President of the United States, and the orders of the officers  
appointed over me, according to the Rules and Articles of War.

Sworn and subscribed to, at *Don Scott*  
this *26* day of *October* 1864  
BEFORE *Wm D Mattheus* } *John Fowler*  
mark

*2d Lt. Reily 2nd Regt U.S. Cavalry, Sigsbee*  
I CERTIFY, ON HONOR, That I have carefully examined the above-named Volunteer, agreeably  
to the General Regulations of the Army, and that, in my opinion, he is free from all bodily defects and  
mental infirmity, which would in any way disqualify him from performing the duties of a soldier.

*Lizzie Bunker*  
*Surgeon Bd of Examiners*  
*Archibald Mac* EXAMINING SURGEON.

I CERTIFY, ON HONOR, That I have minutely inspected the Volunteer, *John Fowler*  
previously to his enlistment, and that he was entirely sober when enlisted; that, to the best of my  
judgment and belief, he is of lawful age; and that, in accepting him as duly qualified to perform the  
duties of an able-bodied soldier, I have strictly observed the Regulations which govern the recruiting  
service. This soldier has *black* eyes, *black* hair, *black* complexion, is *five*  
feet *five* inches high.

*Wm D Mattheus*  
*2d Lt. Reily* Recruiting Officer of *U.S. Cavalry* Volunteers, *Sigsbee*

(A. G. O. No. 74 & 76.)

*Mustered into the service of the United States, for three years or during the war, from date of enlistment, in Company*  
*2d Lt. Reily 2nd Regt U.S. Cavalry, Sigsbee*  
*Volunteers, on the 26 day of October 1864, at*  
*Don Scott*  
*Examined by*  
*John Fowler*  
*Wm D Mattheus*  
*Archibald Mac*  
*John Fowler*  
*Wm D Mattheus*  
*2d Lt. Reily*

*Trasier, Andrew*

Indpt. Batt'y U.S. Col'd L. Art'y

*Private* | *Brook*

CARD NUMBERS.

1	6233768	26
2	6233916	27
3	9132949	28
4		29
5		30
6		31
7		32
8		33
9		34
10		35
11		36
12		37
13		38
14		39
15		40
16		41
17		42
18		43
19		44
20		45
21		46
22		47
23		48
24		49
25		50

Book Mark:

See also

*A* | Indpt. Batt'y. | **U.S.C.T.**

*Andrew Fraser*

....., Indpt. Batt'y, U. S. Col'd L. Art'y.

Appears on

**Battery Descriptive Book**

of the organization named above.

**DESCRIPTION.**

Age *29* years; height *5* feet *8* inches.

Complexion *Black*

Eyes *Black*; hair *Black*

Where born *Jasanna Co. Okla*

Occupation *Laborer*

**ENLISTMENT.**

When *Aug. 15*, 186 *4*

Where *Ferisworth Ok*

By whom *L. Matthews*; term *3* y'rs.

Remarks:

.....  
.....  
.....  
.....  
.....  
.....  
.....  
.....

*Stolbrook*

*F* | Indpt. Battery. | **U.S.C.T.**

*Andrew Masier*

*Pat*, Indpt. Battery, U. S. Col'd L. Art'y.

Appears on

**Battery Muster-in and Descriptive Roll**

of the organization named above. Roll dated

*Leavenworth Mo Dec 3*, 1864.

Where born *Jessamine Mo Ky.*

Age *29* y'rs; occupation *Laborer*

When enlisted *Aug 15*, 1864.

Where enlisted *Leavenworth Mo*

For what period enlisted *3* years.

Eyes *Blu*; hair *Blu*

Complexion *Bro*; height *5-8* in.

When mustered in *Aug 18*, 1864.

Where mustered in *Leavenworth*

Bounty paid \$ *100*; due \$ *30<sup>00</sup>/<sub>100</sub>*

Where credited

Battery to which assigned

Remarks: *En M det Co  
20th I.D. 2nd Ward  
Leavenworth Mo.*

Book mark ;

*J. A. Masier*

*G*

Indpt. Battery.

U.S.C.T.

*Andrew Grasier*

*Pvt*, Indpt. Battery, U. S. Col'd L. Art'y.

Appears on

**Battery Muster Roll**

for *Tullis' front to Dec 31*, 186 *4*.

Present or absent *Absent*

Stoppage, \$ *100* for

Due Gov't, \$ *100* for

Valuation of horse, \$ *100*

Valuation of horse equipments, \$ *100*

Remarks: *Absent without leave*

*Not on Sub Rolls of Batty*

Book mark:

*J. H. Schooley*

(358)

Copyist.

*Frazier Andrew*

, Co. *1st Batt.* *Regt* *U.S.C.A.*

*2* Enclosures.

Bed Cards .....	Final Statements .....
Burial Records .....	Furloughs or L. of A. ....
Certs. of Dis. for Discharge .....	Med. Certificates .....
C. M. Charges .....	Med. Des. Lists .....
Descriptive Lists .....	Orders .....
Discharge Certificates .....	Pris. of War Record .....
Enlistment Papers .....	Resignations .....

Other papers relating to—

Admission to Hosp'l .....	Furlough or L. of A. ....
Casualty Sheet .....	Med. Examination .....
Confinement .....	Misc. Information .....
Contracts .....	Pay or Clothing .....
Death or Effects .....	Personal Reports .....
Desertion .....	Rank .....
Discharge from Hosp'l .....	Transfer to Hosp'l .....
Discharge from Service .....	Transfer to V. R. C. ....
Duty .....	Transportation .....

They will be made out in duplicate in all cases—one to accompany the recruiting return of the superintendent (not the recruiting officer) to the Adjutant General, and one to accompany the accounts of the officer who pays bounty, &c. The Regiment and Company in which the soldier last served should be given on the back.

NOTE 1.—This blank will be used for both enlistments and re-enlistments—enlistment of veterans, &c., &c., in the volunteer service. A muster-in roll must, in all cases, be filed in the Adjutant General's Office as evidence of muster-in. The mustering officer, commissary, or assistant commissary of musters, as the case may be, will countersign both enlistments as having mustered the soldier into the service of the United States before either of them is given to the disbursing officer.

DECLARATION OF RECRUIT.

I, Andrew Frasier desiring to VOLUNTEER as a Soldier in the Army of the United States, for the term of THREE YEARS Do Declare, That I am 25 years and — months of age; that I have never been discharged from the United States service on account of disability or by sentence of a court-martial, or by order before the expiration of a term of enlistment; and I know of no impediment to my serving honestly and faithfully as a soldier for three years.

GIVEN at Severn North State of Penn the 15 day of August 1864

Witness: W. Bushman Andrew Frasier

No. 70

Andrew Frasier  
 Volunteered at Severn North  
August 15 1864  
 By Wm. D. Matthews 2nd Lieut  
5th Regt. Penn. Cav. U.S. Army  
 Regiment of —  
 Discharged — 18—  
 enlistment; last served in Company ( )  
 Reg't of —

CONSENT IN CASE OF MINOR.

I, \_\_\_\_\_ Do CERTIFY, That I am \_\_\_\_\_; that the \_\_\_\_\_ of \_\_\_\_\_; that the \_\_\_\_\_ is \_\_\_\_\_ years of age; and I do hereby freely give my CONSENT to his volunteering as a SOLDIER in the ARMY OF THE UNITED STATES for the period of THREE YEARS.

GIVEN at \_\_\_\_\_ the \_\_\_\_\_ day of \_\_\_\_\_

Witness: \_\_\_\_\_



35-36

VOLUNTEER ENLISTMENT.

STATE OF

*Kansas*



TOWN OF

*Leavenworth*

I, *Andrew Frasier* born in *Jessamine Co*

in the State of *Kentucky* aged *29* years,

and by occupation a *Saloon* Do HEREBY ACKNOWLEDGE to have

volunteered this *15* day of *August* 186*4*,

to serve as a **Soldier** in the **Army of the United States of America**, for the period of **THREE YEARS** unless sooner discharged by proper authority: Do also

agree to accept such bounty, pay, rations, and clothing, as are, or may be, established by law for volunteers. And I, *Andrew Frasier* do

solemnly swear, that I will bear true faith and allegiance to the **United States of America**, and that I will serve them honestly and faithfully against all their

enemies or opposers whomsoever; and that I will observe and obey the orders of the President of the United States, and the orders of the officers appointed over

me, according to the Rules and Articles of War.

Sworn and subscribed to, at *Leavenworth* his *Andrew Frasier*  
this *15* day of *August* 186*4*.

BEFORE *Wm & Matthews 2nd Lieut* *mark*  
*Recruit 1st Ind. U.S. Col Artillery*

I CERTIFY, ON HONOR, That I have carefully examined the above-named Volunteer, agreeably to the General Regulations of the Army, and that, in my opinion, he is free from all bodily defects and mental infirmity, which would in any way disqualify him from performing the duties of a soldier.

*Tiffin Sikes*  
*Surgeon Board enrollment*  
*North West Kansas*  
EXAMINING SURGEON.

I CERTIFY, ON HONOR, That I have minutely inspected the Volunteer, *Andrew Frasier* previously to his enlistment, and that he was entirely sober when enlisted; that, to the best of my judgment and belief, he is of lawful age; and that, in accepting him as duly qualified to perform the duties of an able-bodied soldier, I have strictly observed the Regulations which govern the recruiting service. This soldier has *Black* eyes, *Black* hair, *Black* complexion, is *5* feet *8* inches high.

*Wm & Matthews 2nd Lieut*  
*Recruit 1st Ind U.S. Col Artillery*  
Regiment of *Volunteers,*

RECRUITING OFFICER.

the ..... day of ..... 186 , at ..... Regiment of ..... Volunteers, on

NOTE 1.—This blank will be used for both enlistments and re-enlistments—enlistment of veterans, &c., &c., in the volunteer service. They will be made out in duplicate in all cases—one to accompany the recruiting return of the superintendent (not the recruiting officer) to the Adjutant General, and one to accompany the accounts of the officer who pays bounty, &c. The Regiment and Company in which the soldier last served should be given on the back.

NOTE 2.—An enlistment holds to service. A muster-in must, in all cases, precede payment of pay, bounty, pension, &c. A muster-in roll must, in all cases, be filed in the Adjutant General's Office as evidence of muster-in. The mustering officer, commissary, or assistant commissary of musters, as the case may be, will countersign both enlistments as having mustered the soldier into the service of the United States before either of them is given to the disbursing officer.

DECLARATION OF RECRUIT.

I, Andrew Frasier desiring to VOLUNTEER as a Soldier in the Army of the United States, for the term of THREE YEARS Do Declare, That I am 29 years and — months of age; that I have never been discharged from the United States service on account of disability or by sentence of a court-martial, or by order before the expiration of a term of enlistment; and I know of no impediment to my serving honestly and faithfully as a soldier for three years.

GIVEN at Leavenworth State of Kansas the 15 day of August 1864

Witness: W. A. Buchanan Andrew Frasier

No. 88

Volunteered at Leavenworth Kansas  
August 15th 1864  
By A. D. Matthews Regt. Ills  
1st Regt. of Ills  
enlistment; last served in Company ( )  
Reg't of .....  
Discharged ..... 18 ..

CONSENT IN CASE OF MINOR.

I, ..... Do CERTIFY, That I am the ..... of .....; that the said ..... is ..... years of age; and I do hereby freely give my CONSENT to his volunteering as a SOLDIER in the ARMY OF THE UNITED STATES for the period of THREE YEARS.

GIVEN at ..... the ..... day of .....

Witness: .....

35-36 1/2

VOLUNTEER ENLISTMENT.

STATE OF

*Kansas*



TOWN OF

*Severnworth*

I, *Andrew Frasier* born in *Wessex Co*

in the State of *Kentucky* aged *29* years,

and by occupation a *Labourer* Do HEREBY ACKNOWLEDGE to have

volunteered this *15* day of *August* 1864,

to serve as a **Soldier** in the **Army of the United States of America**, for the

period of **THREE YEARS** unless sooner discharged by proper authority: Do also

agree to accept such bounty, pay, rations, and clothing, as are, or may be, estab-

lished by law for volunteers. And I, *Andrew Frasier* do

solemnly swear, that I will bear true faith and allegiance to the **United States**

**of America**, and that I will serve them honestly and faithfully against all their

enemies or opposers whomsoever; and that I will observe and obey the orders of

the President of the United States, and the orders of the officers appointed over

me, according to the Rules and Articles of War.

Sworn and subscribed to, at *Severnworth*

this *15* day of *August* 1864,

BEFORE *Wm D Matthews 2nd Lieut*

*Recruiting 1st In*

*Andrew Frasier* his mark

I CERTIFY, ON HONOR, That I have carefully examined the above-named Volunteer, agreeably to the General Regulations of the Army, and that, in my opinion, he is free from all bodily defects and mental infirmity, which would in any way disqualify him from performing the duties of a soldier.

*Jiffie Bink*  
*Surgeon General*  
*West Dist Kansas*

EXAMINING SURGEON.

I CERTIFY, ON HONOR, That I have minutely inspected the Volunteer, *Andrew Frasier* previously to his enlistment, and that he was entirely sober when enlisted; that, to the best of my judgment and belief, he is of lawful age; and that, in accepting him as duly qualified to perform the duties of an able-bodied soldier, I have strictly observed the Regulations which govern the recruiting service.

This soldier has *Black* eyes, *Black* hair, *Black* complexion, is *5* feet

*8* inches high.

*Wm D Matthews 2nd Lieut*  
*Recruiting 1st In* *And U.S. Col* *Artillery*  
*Volunteers,*

RECRUITING OFFICER.

(A. G. O. No. 74 & 75.)

the ..... day of ..... 1864, at .....  
Mustered into the service of the United States, in *Company* .....  
Regiment of .....  
Volunteers, on

*Steuwede, Peter*

ndpt. Batt'y U.S. Col'd L. Art'y

*Private Private*

CARD NUMBERS.

6 2 3 3 7 7 5	26
6 2 3 3 9 2 4	27
6 2 3 4 6 6 6	28
9 1 3 3 9 4 6	29
9 8 1 - 0 5 - 1 8 7 5	30
	31
	32
	33
	34
	35
	36
	37
	38
	39
	40
	41
	42
	43
	44
	45
	46
	47
	48
	49
	50

Book Mark: *EB, V. 11, P. 456, & G 81*  
*V. 11, P. 737*

See also

*G* | Indpt. Batt'y. | **U.S.C.T.**

*Peter Gatewood*

....., Indpt. Batt'y, U. S. Col'd L. Art'y.

Appears on

**Battery Descriptive Book**

of the organization named above.

**DESCRIPTION.**

Age *40* years; height *5* feet *8* inches.

Complexion *Black*

Eyes *Black*; hair *Black*

Where born *Fauquier Va.*

Occupation *Laborer*

**ENLISTMENT.**

When *Aug 16*, 186*4*.

Where *Farm in the S's*

By whom *Lt Mathews*; term *3* y'rs.

Remarks: .....

.....

.....

.....

.....

.....

.....

.....

.....

.....

.....

*Stalbrook*

*G* | Indpt. Battery. | **U.S.C.T.**

*Peter Gatewood*

*Pax*, Indpt. Battery, U. S. Col'd L. Art'y.

Appears on

**Battery Muster-in and Descriptive Roll**

of the organization named above. Roll dated

*Lewesmouth Va, Dec 23*, 1864.

Where born *Wamsboro Va*

Age *40* y'rs; occupation *Laborer*

When enlisted *Aug 16*, 1864.

Where enlisted *Lewesmouth Va.*

For what period enlisted *3* years.

Eyes *Blue*; hair *Blue*

Complexion *Brn*; height *5 ft. 8* in.

When mustered in *Aug 18*, 1864.

Where mustered in *Lewesmouth*

Bounty paid \$ *100*; due \$ *300*<sup>*00*</sup>/<sub>*100*</sub>

Where credited

Battery to which assigned

Remarks: *Deserted Sept 24<sup>th</sup> 1864*

Book mark:

*J. H. [Signature]*

(856g)

Copyist.

G | Indpt. Battery. | **U.S.C.T.**

Peter Gatewood

Prvt, Indpt. Battery, U. S. Col'd L. Art'y.

Appears on

**Battery Muster Roll**

for Enlistment to DCB, 186 X

Present or absent Absent

Stoppage, \$ 100 for

Due Gov't, \$ 100 for

Valuation of horse, \$ 100

Valuation of horse equipments, \$ 100

Remarks: Absent without leave

Book mark: Started Sept 24/64

JH Schooley  
(358) Copyist.

JAN. 17

6233924

☆1681☆

EB.V. 11. P. 456. 5281.  
V. 11. C. 75.



*G* | Indpt. Battery. | **U.S.C.T.**

*Peter Gatewood*

*M*, Indpt. Battery U. S. Col'd Light Art'y.

Appears on **Batt'y Muster-out Roll**, dated  
*St. Leavenworth, Mo July 27 1865*.

Muster-out to date \_\_\_\_\_, 186 .

Last paid to \_\_\_\_\_, 186 .

**Clothing account:**

Last settled \_\_\_\_\_, 186 ; drawn since \$ \_\_\_\_\_ 100

Due soldier \$ \_\_\_\_\_ 100; due U. S. \$ \_\_\_\_\_ 100

Am't for cloth'g in kind or money adv'd \$ \_\_\_\_\_ 100

Due U. S. for arms, equipments, &c., \$ \_\_\_\_\_ 100

Bounty paid \$ \_\_\_\_\_ 100; due \$ \_\_\_\_\_ 100

Remarks: \_\_\_\_\_  
\_\_\_\_\_  
\_\_\_\_\_  
\_\_\_\_\_  
\_\_\_\_\_

Book mark: *Deserted Sept. 4/64, -*  
*over*

\_\_\_\_\_  
*Porter*  
\_\_\_\_\_  
Copyist.

JAN. 17

6234666

018910

*Q. N. 11, P. 456, + Q. 81,  
N. 11, Q. 9, 75.*

G. | Supt. Battery | Wgt.  
Lt. Col.

Peter Gatewood

Supt. Battery Wgt. Lt. Col.  
Co. Reg't

**NOTATION.**

EB 11.456. G. 81. C. D. 1875.  
Book mark:

**War Department,**

Adjutant General's Office,

Washington, September 15<sup>th</sup>, 1875.

Assented September 4. 1864.

A. M. Muzzey

*Gatewood Peter*

, Co. *1st Batt* Reg't *U.S.C.A.*

*2* Enclosures.

Bed Cards .....	Final Statements .....
Burial Records .....	Furloughs or L. of A. ....
Certs. of Dis. for Discharge .....	Med. Certificates .....
C. M. Charges .....	Med. Des. Lists .....
Descriptive Lists .....	Orders .....
Discharge Certificates .....	Pris. of War Record .....
Enlistment Papers <i>2</i> .....	Resignations .....

Other papers relating to—

Admission to Hosp'l .....	Furlough or L. of A. ....
Casualty Sheet .....	Med. Examination .....
Confinement .....	Misc. Information .....
Contracts .....	Pay or Clothing .....
Death or Effects .....	Personal Reports .....
Desertion .....	Rank .....
Discharge from Hosp'l .....	Transfer to Hosp'l .....
Discharge from Service .....	Transfer to V. R. C. ....
Duty .....	Transportation .....

NOTE 1.—This blank will be used for both enlistments and re-enlistments—enlistment of veterans, &c., &c., in the volunteer service. They will be made out in duplicate in all cases—one to accompany the recruiting return of the superintendent (not the recruiting officer) to the Adjutant General, and one to accompany the accounts of the officer who pays bounty, &c. The Regiment and Company in which the soldier last served should be given on the back.

NOTE 2.—An enlistment holds to service. A muster-in must, in all cases, precede payment of pay, bounty, pension, &c. A muster-in roll must, in all cases, be filed in the Adjutant General's Office as evidence of muster-in. The mustering officer, commissary, or assistant commissary of musters, as the case may be, will countersign both enlistments as having mustered the soldier into the service of the United States before either of them is given to the disbursing officer.

DECLARATION OF RECRUIT.

I, Peter Gatewood desiring to VOLUNTEER as a Soldier in the Army of the United States, for the term of THREE YEARS Do Declare, That I am 40 years and \_\_\_\_\_ months of age; that I have never been discharged from the United States service on account of disability or by sentence of a court-martial, or by order before the expiration of a term of enlistment; and I know of no impediment to my serving honestly and faithfully as a soldier for three years.

GIVEN at Lavemore State of Kansas the 16<sup>th</sup> day of August 1864

Witness: W. B. Bunchum Peter Gatewood  
man

No. 76

Peter Gatewood

Volunteered at Lavemore

August 16<sup>th</sup> 1864

By Wm. D. Matthews

1<sup>st</sup> Lt. Sigismund of Battery

1<sup>st</sup> Regt. Kansas

enlistment; last served in Company ( )

Reg't of \_\_\_\_\_

Discharged \_\_\_\_\_ 18 \_\_\_\_\_

X

CONSENT IN CASE OF MINOR.

I, \_\_\_\_\_ Do CERTIFY, That I am the \_\_\_\_\_ of \_\_\_\_\_; that the said \_\_\_\_\_ is \_\_\_\_\_ years of age; and I do hereby freely give my CONSENT to his volunteering as a SOLDIER in the ARMY OF THE UNITED STATES for the period of THREE YEARS.

GIVEN at \_\_\_\_\_ the \_\_\_\_\_ day of \_\_\_\_\_

Witness: \_\_\_\_\_

3234

VOLUNTEER ENLISTMENT.

STATE OF

Kansas



TOWN OF

Leavenworth

I, Peter Gatewood born in Hanson Co.

in the State of Virginia aged 40 years,

and by occupation a Laborer. Do HEREBY ACKNOWLEDGE to have

volunteered this 16th day of August 1864,

to serve as a Soldier in the Army of the United States of America, for the period of THREE YEARS unless sooner discharged by proper authority: Do also

agree to accept such bounty, pay, rations, and clothing, as are, or may be, established by law for volunteers. And I, Peter Gatewood do

solemnly swear, that I will bear true faith and allegiance to the United States

of America, and that I will serve them honestly and faithfully against all their

enemies or opposers whomsoever; and that I will observe and obey the orders of the President of the United States, and the orders of the officers appointed over me, according to the Rules and Articles of War.

Sworn and subscribed to, at Leavenworth

this 16th day of August 1864.

BEFORE Wm D Matthews 2nd Lieut

Peter Gatewood mark

Recruiting 1st U.S. Col Battery

I CERTIFY, ON HONOR, That I have carefully examined the above-named Volunteer, agreeably to the General Regulations of the Army, and that, in my opinion, he is free from all bodily defects and mental infirmity, which would in any way disqualify him from performing the duties of a soldier.

Wiffie Simke Surg. Genl. enllment North Dist. Kansas

EXAMINING SURGEON.

I CERTIFY, ON HONOR, That I have minutely inspected the Volunteer, Peter Gatewood previously to his enlistment, and that he was entirely sober when enlisted; that, to the best of my judgment and belief, he is of lawful age; and that, in accepting him as duly qualified to perform the duties of an able-bodied soldier, I have strictly observed the Regulations which govern the recruiting service.

This soldier has black eyes, black hair, black complexion, is 2 feet 9 inches high.

Wm D Matthews 2nd Lieut

1st U. S. Regiment Col. Battery Volunteers,

RECRUITING OFFICER.

the ..... day of ..... 186 , at ..... Regiment of ..... Volunteers, on

**NOTE 1.**—This blank will be used for both enlistments and re-enlistments—enlistment of veterans, &c., &c., in the volunteer service. They will be made out in duplicate in all cases—one to accompany the recruiting return of the superintendent (not the recruiting officer) to the Adjutant General, and one to accompany the accounts of the officer who pays bounty, &c. The Regiment and Company in which the soldier last served should be given on the back.

**NOTE 2.**—An enlistment holds to service. A muster-in must, in all cases, precede payment of pay, bounty, pension, &c. A muster-in roll must, in all cases, be filed in the Adjutant General's Office as evidence of muster-in. The mustering officer, commissary, or assistant commissary of musters, as the case may be, will countersign both enlistments as having mustered the soldier into the service of the United States before either of them is given to the disbursing officer.

DECLARATION OF RECRUIT.

I, Peter Isatewood desiring to VOLUNTEER as a Soldier in the Army of the United States, for the term of THREE YEARS Do Declare, That I am 40 years and \_\_\_\_\_ months of age; that I have never been discharged from the United States service on account of disability or by sentence of a court-martial, or by order before the expiration of a term of enlistment; and I know of no impediment to my serving honestly and faithfully as a soldier for three years.

GIVEN at Leavenworth State of Kansas the 16<sup>th</sup> day of August 1864

Witness: W. A. Burnham Peter Isatewood  
mark

No. 76 577

Peter Isatewood  
Volunteered at Leavenworth  
August 16<sup>th</sup> 1864  
By W. D. Matthews 2<sup>d</sup> Lieut  
1<sup>st</sup> U. S. Regiment of Artillery

\_\_\_\_\_ enlistment; last served in Company ( )  
\_\_\_\_\_ Reg't of \_\_\_\_\_  
Discharged \_\_\_\_\_ 18 \_\_\_\_\_

CONSENT IN CASE OF MINOR.

I, \_\_\_\_\_ Do CERTIFY, That I am the \_\_\_\_\_ of \_\_\_\_\_; that the said \_\_\_\_\_ is \_\_\_\_\_ years of age; and I do hereby freely give my CONSENT to his volunteering as a SOLDIER in the ARMY OF THE UNITED STATES for the period of THREE YEARS.

GIVEN at \_\_\_\_\_ the \_\_\_\_\_ day of \_\_\_\_\_

Witness: \_\_\_\_\_

3234

VOLUNTEER ENLISTMENT.

STATE OF

Kansas



TOWN OF

Leavenworth

I, Peter Gatewood born in Hanson Co

in the State of Virginia aged 40 years,

and by occupation a Laborer DO HEREBY ACKNOWLEDGE to have

volunteered this 16th day of August 1864,

to serve as a Soldier in the Army of the United States of America, for the period of THREE YEARS unless sooner discharged by proper authority: Do also agree to accept such bounty, pay, rations, and clothing, as are, or may be, established by law for volunteers. And I, Peter Gatewood do solemnly swear, that I will bear true faith and allegiance to the United States of America, and that I will serve them honestly and faithfully against all their enemies or opposers whomsoever; and that I will observe and obey the orders of the President of the United States, and the orders of the officers appointed over me, according to the Rules and Articles of War.

Sworn and subscribed to, at Leavenworth

this 16th day of August 1864,

BEFORE Wm D Matthews 2nd Lieut

Peter Gatewood mark

Recruiting 1st U.S. Col Battery

I CERTIFY, ON HONOR, That I have carefully examined the above-named Volunteer, agreeably to the General Regulations of the Army, and that, in my opinion, he is free from all bodily defects and mental infirmity, which would in any way disqualify him from performing the duties of a soldier.

Tiffin Barks

Surg Board enrollment Wm D Matthews 2nd Lieut

EXAMINING SURGEON.

I CERTIFY, ON HONOR, That I have minutely inspected the Volunteer, previously to his enlistment, and that he was entirely sober when enlisted; that, to the best of my judgment and belief, he is of lawful age; and that, in accepting him as duly qualified to perform the duties of an able-bodied soldier, I have strictly observed the Regulations which govern the recruiting service. This soldier has black eyes, black hair, brown complexion, is 5 feet 8 inches high.

Wm D Matthews 2nd Lieut

1st U.S. Col Battery Volunteers,

RECRUITING OFFICER.

the day of 1864, at Mustered into the service of the United States, in Company of the 1st U.S. Col Battery, 1st Regiment of Volunteers, on



*Gibbs, Calvin*

Adpt. Batt'y U.S. Col'd L. Art'y

*Private Private*

CARD NUMBERS.

6 2 3 3 6 2 7	26
6 2 3 3 7 7 6	27
6 2 3 3 9 2 5	28
6 2 3 4 0 8 2	29
6 2 3 4 2 2 9	30
6 2 3 4 3 9 7	31
6 2 3 4 5 5 9	32
9 1 3 2 9 5 7	33
	34
	35
	36
	37
	38
	39
	40
	41
	42
	43
	44
	45
	46
	47
	48
	49
	50

Book Mark:

See also

G | Indpt. Batt'y. | U.S.C.T.

Calvin Gibbs

....., Indpt. Batt'y, U. S. Col'd L. Art'y.

Appears on

**Battery Descriptive Book**

of the organization named above.

**DESCRIPTION.**

Age 21 years; height 5 feet 8 inches.

Complexion Brown

Eyes Brown; hair Brown

Where born Nashville Tenn.

Occupation Laborer

**ENLISTMENT.**

When Dec 12, 1864.

Where At Seav'nth Co

By whom J. Mathens; term 3 y'rs.

Remarks: .....

Holbrook

G | Indpt. Battery. | **U.S.C.T.**

Calvin Gibbes

Appears with rank of *Priv* on

**Muster and Descriptive Roll of a Detachment of U. S. Vols. forwarded**

for the Indpt. Batt'y, U. S. Col'd L. Arty. Roll dated

*Leavenworth, Ks., Dec. 13, 1864.*

Where born *Nashville, Tenn.*

Age *21* y'rs; occupation *Laborer*

When enlisted *Dec 12, 1864.*

Where enlisted *Leavenworth, Ks.*

For what period enlisted *3* years.

Eyes *Brown*; hair *Brown*

Complexion *Brown*; height *5 ft. 8 1/2 in.*

When mustered in *Dec. 13, 1864.*

Where mustered in *Leavenworth, Ks.*

Bounty paid \$ *100*; due \$ *100*

Where credited

Battery to which assigned

Remarks: *Credited to North<sup>m</sup> Dist. Kansas, 19<sup>th</sup> Subdistrict, 1<sup>st</sup> Ward, Leavenworth City, Vol. recruit & entitled to Bounty.*

Book mark:

*E. L. Thornton*

*J* | Indpt. Battery. | **U.S.C.T.**

*Calvin Gibbs*

*Pat*, Indpt. Battery, U. S. Col'd L. Art'y.

Appears on

**Battery Muster-in and Descriptive Roll**

of the organization named above. Roll dated

*Lewenworth Co*, 1864.

Where born *Nashville Tenn*

Age *20* y'rs; occupation *Laborer*

When enlisted *Dec 12*, 1864.

Where enlisted *Lewenworth Co*

For what period enlisted *3* years.

Eyes *Bro*; hair *Bro*

Complexion *43rd*; height *5 ft. 8 1/2 in.*

When mustered in *Dec 13*, 1864.

Where mustered in *Lewenworth Co*

Bounty paid \$*100*<sup>00</sup>/<sub>100</sub>; due \$*200*<sup>00</sup>/<sub>100</sub>

Where credited

Battery to which assigned

Remarks: *A. N. died Co  
19th ID. 1st Regt  
Lewenworth Co,*

Book mark ;

*[Signature]*

(356g)

Copyist.

*G* | Indpt. Battery. | **U.S.C.T.**

*Calvin Gibbs*

*Pvt*, Indpt. Battery, U. S. Col'd L. Art'y.

Appears on

**Battery Muster Roll**

for *Enlistment to Dec 31, 1864*

Present or absent *Present*

Stoppage, \$ *100* for

Due Gov't, \$ *100* for

Valuation of horse, \$ *100*

Valuation of horse equipments, \$ *100*

Remarks:

Book mark:

*J. H. Ashley*  
(358) Copyist.

C 1st Regt Baty 2867

Calvin Gibbs

Sgt, Co Ind/2 Baty 1st Regt 2867

Appears on

**Battery Muster Roll**

for Jan & Feb, 1865.

Present or absent Present

Stoppage, \$ 100 for

Due Gov't, \$ 100 for

Valuation of horse, \$ 100

Valuation of horse equipments, \$ 100

Remarks :

Book mark :

(358)

W. Spenser  
4

Copyist.

*E* | Indpt. Battery. | **U.S.C.T.**

*Calvin Gibbs*

*A*, Indpt. Battery, U. S. Col'd L. Art'y.

Appears on

**Battery Muster Roll**

for *Mar, & Apr,*, 186*5*.

Present or absent *Present,*

Stoppage, \$ 100 for

Due Gov't, \$ 100 for

Valuation of horse, \$ 100

Valuation of horse equipments, \$ 100

Remarks:

Book mark:

*Porter*

*G* | Indpt. Battery. | **U.S.C.T.**

*Catrina Gibbs*

*A*, Indpt. Battery, U. S. Col'd L. Art'y.

Appears on

**Battery Muster Roll**

for *May & June*, 186 *5*.

Present or absent *Present*.

Stoppage, \$ *100* for

Due Gov't, \$ *100* for

Valuation of horse, \$ *100*

Valuation of horse equipments, \$ *100*

Remarks:

Book mark:

*Porter*



*G* | Indpt. Battery. | **U.S.C.T.**

*Calvin Gibbs,*

*A*....., Indpt. Battery U. S. Col'd Light Art'y.

Appears on **Batt'y Muster-out Roll**, dated  
*St. Lawrence Co., July 22, 1865.*

Muster-out to date *July 22*....., 1865.

Last paid to *Dec. 31*....., 1864.

Clothing account:

Last settled....., 186 ; drawn since \$ *57*<sup>*31*</sup>/<sub>100</sub>,

Due soldier \$.....<sub>100</sub>; due U. S. \$.....<sub>100</sub>

Am't for cloth'g in kind or money adv'd \$.....<sub>100</sub>

Due U. S. for arms, equipments, &c., \$.....<sub>100</sub>

Bounty paid \$ *100* <sub>100</sub>; due \$ *none* <sub>100</sub>,

Remarks: *Due C. Fenner, sutler,*  
*\$4-*.....

Book mark :.....

*Porter*

Gibbs Calvin

, Co. , 2nd Batt. U.S.C. A  
Reg't

**Enclosures.**

- |                                    |                            |
|------------------------------------|----------------------------|
| Bed Cards .....                    | Final Statements .....     |
| Burial Records .....               | Furloughs or L. of A. .... |
| Certs. of Dis. for Discharge ..... | Med. Certificates .....    |
| C. M. Charges .....                | Med. Des. Lists .....      |
| Descriptive Lists .....            | Orders .....               |
| Discharge Certificates .....       | Pris. of War Record .....  |
| Enlistment Papers .....            | Resignations .....         |

Other papers relating to—

- |                              |                           |
|------------------------------|---------------------------|
| Admission to Hosp'l .....    | Furlough or L. of A. .... |
| Casualty Sheet .....         | Med. Examination .....    |
| Confinement .....            | Misc. Information .....   |
| Contracts .....              | Pay or Clothing .....     |
| Death or Effects .....       | Personal Reports .....    |
| Desertion .....              | Rank .....                |
| Discharge from Hosp'l .....  | Transfer to Hosp'l .....  |
| Discharge from Service ..... | Transfer to V. R. C. .... |
| Duty .....                   | Transportation .....      |

NOTE 1.—This blank will be used for both enlistments and re-enlistments—enlistment of veterans, &c., &c., in the volunteer service. They will be made out in duplicate in all cases—one to accompany the recruiting return of the superintendent (not the recruiting officer) to the Adjutant General, and one to accompany the accounts of the officer who pays bounty, &c. The Regiment and Company in which the soldier last served should be given on the back.

NOTE 2.—An enlistment holds to service. A muster-in must, in all cases, precede payment of pay, bounty, pension, &c. A muster-in roll must, in all cases, be filed in the Adjutant General's Office as evidence of muster-in. The mustering officer, commissary, or assistant commissary of musters, as the case may be, will countersign both enlistments as having mustered the soldier into the service of the United States before either of them is given to the disbursing officer.

DECLARATION OF RECRUIT.

I, Calvin Gibbs desiring to VOLUNTEER as a Soldier in the Army of the United States, for the term of THREE YEARS, Do Declare, That I am Twenty three years and \_\_\_\_\_ months of age; that I have never been discharged from the United States service on account of disability or by sentence of a court martial, or by order before the expiration of a term of enlistment; and I know of no impediment to my serving honestly and faithfully as a soldier for three years.

GIVEN at Leavenworth State of Kansas the 12<sup>th</sup> day of December 1864

Witness: Benjamin McLean Calvin Gibbs

No. \_\_\_\_\_

Calvin Gibbs

Volunteered at Leavenworth, K  
19<sup>th</sup> December 1864,

By W. S. Matthews  
Judge of the Peace, N. S. C. 1. 1. 1. 1.

Light

enlistment; last served in Company ( )  
1<sup>st</sup> Regt of N. S. C. 1. 1. 1. 1.  
Discharged \_\_\_\_\_ 1864

CONSENT IN CASE OF MINOR.

I, \_\_\_\_\_ Do CERTIFY, That I am the \_\_\_\_\_ of \_\_\_\_\_; that the said \_\_\_\_\_ is \_\_\_\_\_ years of age; and I do hereby freely give my CONSENT to his volunteering as a SOLDIER in the ARMY OF THE UNITED STATES for the period of THREE YEARS.

GIVEN at \_\_\_\_\_ the \_\_\_\_\_ day of \_\_\_\_\_

Witness: \_\_\_\_\_

VOLUNTEER ENLISTMENT.

STATE OF

TOWN OF

*Kansas*



*Leimona*

I, *Calvin gibbes* born in *Mashville* in the State of *Tennessee* aged *Twenty one* years, and by occupation a *laborer*. Do HEREBY ACKNOWLEDGE to have volunteered this *twelfth* day of *December* 1864 to serve as a **Soldier** in the **Army of the United States of America**, for the period of **THREE YEARS**, unless sooner discharged by proper authority: Do also agree to accept such bounty, pay, rations, and clothing, as are, or may be, established by law for volunteers. And I, *Calvin gibbes* do solemnly swear, that I will bear true faith and allegiance to the **United States of America**, and that I will serve them honestly and faithfully against all their enemies or opposers whomsoever; and that I will observe and obey the orders of the President of the United States, and the orders of the officers appointed over me, according to the Rules and Articles of War.

Sworn and subscribed to, at *Leimona* this *12<sup>th</sup>* day of *December* 1864 } *Calvin gibbes*  
BEFORE *William D. Matthews* } *his*  
*Recruiting and US Col's left artillery* } *subscribed*  
*Battery*

I CERTIFY, ON HONOR, That I have carefully examined the above-named Volunteer, agreeably to the General Regulations of the Army, and that, in my opinion, he is free from all bodily defects and mental infirmity, which would in any way disqualify him from performing the duties of a soldier.

*Jiffie Sinks*  
*Surgeon Board of Enrollment*  
*North Dist Kansas*  
EXAMINING SURGEON.

I CERTIFY, ON HONOR, That I have minutely inspected the Volunteer, *Calvin gibbes* previously to his enlistment, and that he was entirely sober when enlisted; that, to the best of my judgment and belief, he is of lawful age; and that, in accepting him as duly qualified to perform the duties of an able-bodied soldier, I have strictly observed the Regulations which govern the recruiting service. This soldier has *Brown* eyes, *Brown* hair, *Brown* complexion, is *5* feet *8 1/2* inches high.

*William D. Matthews*  
*Recruiting and US Col's left artillery*  
Regiment of *Battery* Volunteers,  
RECRUITING OFFICER.

(A. G. O. No. 74 & 76.)

*Battery N.S. Regiment of Col. G. W. (A.S.)*  
Mustered into the service of the United States, for three years or during the war, from date of enlistment, in *Leimona* *Kansas* on the *12<sup>th</sup>* day of *December* 1864, at *Leimona*  
*James A. Brown*  
*Col. General - Mashville*  
*North Dist Kansas*  
*Independent*

NOTE 1.—This blank will be used for both enlistments and re-enlistments—enlistment of veterans, &c., &c., in the volunteer service. They will be made out in duplicate in all cases—one to accompany the recruiting return of the superintendent (not the recruiting officer) to the Adjutant General, and one to accompany the accounts of the officer who pays bounty, &c. The Regiment and Company in which the soldier last served should be given on the back.

NOTE 2.—An enlistment holds to service. A muster-in must, in all cases, precede payment of pay, bounty, pension, &c. A muster-in roll must, in all cases, be filed in the Adjutant General's Office as evidence of muster-in. The mustering officer, commissary, or assistant commissary of musters, as the case may be, will countersign both enlistments as having mustered the soldier into the service of the United States before either of them is given to the disbursing officer.

DECLARATION OF RECRUIT.

I, Calvin Gibbs desiring to VOLUNTEER as a Soldier in the Army of the United States, for the term of THREE YEARS, Do Declare, That I am Twenty Three years and \_\_\_\_\_ months of age; that I have never been discharged from the United States service on account of disability or by sentence of a court martial, or by order before the expiration of a term of enlistment; and I know of no impediment to my serving honestly and faithfully as a soldier for three years.

GIVEN at Leavenworth State of Kansas the 12<sup>th</sup> day of December 1864

Witness: Benjamin Wilson Calvin Gibbs  
mark

No. 597

Calvin Gibbs

Volunteered at Leavenworth

12<sup>th</sup> December 1864

By W. D. Matthews

Indy. Regt. 1st. Dist. 1st. Det.

High

\_\_\_\_\_ enlistment; last served in Company ( )

\_\_\_\_\_ Reg't of \_\_\_\_\_

Discharged \_\_\_\_\_ 18 \_\_\_\_\_

Rec'd from 2nd. Aud. Nov. 23d 1892

CONSENT IN CASE OF MINOR.

I, \_\_\_\_\_ Do CERTIFY, That I am the \_\_\_\_\_ of \_\_\_\_\_; that the said \_\_\_\_\_ is \_\_\_\_\_ years of age; and I do hereby freely give my CONSENT to his volunteering as a SOLDIER in the ARMY OF THE UNITED STATES for the period of THREE YEARS.

GIVEN at \_\_\_\_\_ the \_\_\_\_\_ day of \_\_\_\_\_

Witness: \_\_\_\_\_

1864

VOLUNTEER ENLISTMENT.

STATE OF

TOWN OF

*Kansas*



*Leavenworth*

I, *Calvin gibbes* born in *Nashville*  
 in the State of *Tennessee* aged *Nineteen* years,  
 and by occupation a *Laborer* Do HEREBY ACKNOWLEDGE to have  
 volunteered this *twelfth 12<sup>th</sup>* day of *December* 1864  
 to serve as a **Soldier** in the Army of the **United States of America**, for  
 the period of **THREE YEARS**, unless sooner discharged by proper authority:  
 Do also agree to accept such bounty, pay, rations, and clothing, as are, or may be,  
 established by law for volunteers. And I, *Calvin gibbes* do  
 solemnly swear, that I will bear true faith and allegiance to the **United States**  
**of America**, and that I will serve them honestly and faithfully against all  
 their enemies or opposers whomsoever; and that I will observe and obey the  
 orders of the President of the United States, and the orders of the officers  
 appointed over me, according to the Rules and Articles of War.

Sworn and subscribed to, at *Leavenworth* this *12* day of *December* 1864  
 BEFORE *William D. Matthews, 2nd Lieut*  
*Recruiting 2nd US Colored Light Artillery*

I CERTIFY, ON HONOR, That I have carefully examined the above-named Volunteer, agreeably  
 to the General Regulations of the Army, and that, in my opinion, he is free from all bodily defects and  
 mental infirmity, which would in any way disqualify him from performing the duties of a soldier.

*Jiffie Binkes*  
*Sur Board of Enrollment*  
*North Dist Kansas*  
 EXAMINING SURGEON.

I CERTIFY, ON HONOR, That I have minutely inspected the Volunteer, *Calvin gibbes*  
 previously to his enlistment, and that he was entirely sober when enlisted; that, to the best of my  
 judgment and belief, he is of lawful age; and that, in accepting him as duly qualified to perform the  
 duties of an able-bodied soldier, I have strictly observed the Regulations which govern the recruiting  
 service. This soldier has *Brown* eyes, *Brown* hair, *Brown* complexion, is *5*  
 feet *8 1/2* inches high.

*William D. Matthews, 2nd Lieut*  
*Recruiting 2nd US Col. Light Artillery*  
 Regiment of \_\_\_\_\_ Volunteers,  
 RECRUITING OFFICER.

(A. G. O. No. 74 & 76.)

Mustered into the service of the United States, for three years or during the war, from date of enlistment, in *1st* ~~1st~~ *Independent*  
*3rd* ~~3rd~~ *Regiment* ~~Regiment~~ *of* ~~of~~ *Artillery* ~~Artillery~~ *1st* ~~1st~~ *Division* ~~Division~~ *of* ~~of~~ *the* ~~the~~ *Army* ~~Army~~  
 on the *13<sup>th</sup>* day of *December*, 1864, at *Leavenworth* *Kansas*

I have examined the above named volunteer and find him to be a free man of full age and sound mind and body and fit for military service.

*Subs. Frank*

Indpt. Batt'y U.S. Col'd L. Art'y

*Private Private*

CARD NUMBERS.

<i>6 2 3 3 7 7 4</i>	26
<i>6 2 3 3 9 2 1</i>	27
<i>6 2 3 4 0 8 2</i>	28
<i>6 2 3 4 2 2 8</i>	29
<i>6 2 3 4 3 9 6</i>	30
<i>6 2 3 4 5 5 8</i>	31
<i>9 1 3 2 9 5 5</i>	32
	33
	34
	35
	36
	37
	38
	39
	40
	41
	42
	43
	44
	45
	46
	47
	48
	49
	50

Book Mark: \_\_\_\_\_

See also \_\_\_\_\_

NARA 1009

D1327699 - P. O. Man

My penner  
2



*G* | Indpt. Batt'y. | **U. S. C. T.**

*Frank Gibbs*

....., Indpt. Batt'y, U. S. Col'd L. Art'y.

Appears on

**Battery Descriptive Book**

of the organization named above.

**DESCRIPTION.**

Age *27* years; height *5* feet *6* inches.

Complexion *Black*

Eyes *Black*; hair *Black*

Where born *Rappahannock Va*

Occupation *Laborer*

**ENLISTMENT.**

When *July 23*, 186*4*.

Where *Avon Co & Co*

By whom *G Mathews*; term *3* y'rs.

Remarks: .....

.....  
 .....  
 .....  
 .....  
 .....  
 .....  
 .....

*Steele*

*I* | Indpt. Battery. | **U.S.C.T.**

*Franz Libbs*

*Pvt*, Indpt. Battery, U. S. Col'd L. Art'y.

Appears on

**Battery Muster-in and Descriptive Roll**

of the organization named above. Roll dated

*Leavenworth Kas Dec 23*, 1864.

Where born *Pappahonus Co, Va.*

Age *27* y'rs; occupation *Laborer*

When enlisted *July 23*, 1864.

Where enlisted *Leavenworth Kas*

For what period enlisted *3* years.

Eyes *Blu*; hair *Blk*

Complexion *Blk*; height *5* ft. *6* in.

When mustered in *July 26*, 1864.

Where mustered in *Leavenworth*

Bounty paid \$ *100*<sup>00</sup>/<sub>100</sub>; due \$ *200*<sup>00</sup>/<sub>100</sub>

Where credited

Battery to which assigned

Remarks: *Or. N. dist, Kas  
2<sup>nd</sup> Lt, 3<sup>rd</sup> Ward  
Leavenworth Kas.*

Book mark ;

*A. J. ...*

(856g)

Copyist.

*D* | Indpt. Battery. | **U.S.C.T.**

*Frank Gibbs*

*Pvt*, Indpt. Battery, U. S. Col'd L. Art'y.

Appears on

**Battery Muster Roll**

for *Subst must to Dec 31*, 186*4*.

Present or absent *Present*

Stoppage, \$ *100* for

Due Gov't, \$ *100* for

Valuation of horse, \$ *100*

Valuation of horse equipments, \$ *100*

Remarks: \_\_\_\_\_  
\_\_\_\_\_  
\_\_\_\_\_  
\_\_\_\_\_  
\_\_\_\_\_  
\_\_\_\_\_  
\_\_\_\_\_  
\_\_\_\_\_

Book mark: \_\_\_\_\_

*J. Schoddy*  
(358) Copyist.

*G* | Indpt. Battery. | **U.S.C.T.**

*Frank Gibbs*

*Post*, Indpt. Battery, U. S. Col'd L. Art'y.

Appears on

**Battery Muster Roll**

for *Jan'y Feb*, 186<sup>*5*</sup>.

Present or absent. *Present*

Stoppage, \$ \_\_\_\_\_ <sup>100</sup> for \_\_\_\_\_

Due Gov't, \$ \_\_\_\_\_ <sup>100</sup> for \_\_\_\_\_

Valuation of horse, \$ \_\_\_\_\_ <sup>100</sup>

Valuation of horse equipments, \$ \_\_\_\_\_ <sup>100</sup>

Remarks: \_\_\_\_\_

Book mark: \_\_\_\_\_

*J. Schoddy*  
(358) Copyist.

*G* | Indpt. Battery. | **U.S.C.T.**

*Frank Gibbs*

*On*, Indpt. Battery, U. S. Col'd L. Art'y.

Appears on

**Battery Muster Roll**

for *Mar, & Apr*, 186 5.

Present or absent *Present*

Stoppage, \$ 100 for

Due Gov't, \$ 100 for

Valuation of horse, \$ 100

Valuation of horse equipments, \$ 100

Remarks:

Book mark:

*Porter*

*G* | Indpt. Battery. | **U.S.C.T.**

*Frank Gibbs*

*Pr*, Indpt. Battery, U. S. Col'd L. Art'y.

Appears on

**Battery Muster Roll**

for *May & June*, 186 *5*.

Present or absent *Present*

Stoppage, \$ 100 for

Due Gov't, \$ 100 for

Valuation of horse, \$ 100

Valuation of horse equipments, \$ 100

Remarks:

-----  
-----  
-----  
-----  
-----  
-----  
-----  
-----

Book mark: -----

*Parter*

Copyist.

*G*

Indpt. Battery.

U.S.C.T.

*Frank Gibbs,*

*M*, Indpt. Battery U. S. Col'd Light Art'y.

Appears on **Batt'y Muster-out Roll**, dated

*St. Leavenworth, Mo., July 22, 1865.*

Muster-out to date *July 22, 1865.*

Last paid to *Dec. 31, 1864.*

Clothing account:

Last settled....., 186 ; drawn since \$ *67*<sup>*94*</sup>/<sub>100</sub>,

Due soldier \$ 100; due U. S. \$ 100

Am't for cloth'g in kind or money adv'd \$ 100

Due U. S. for arms, equipments, &c., \$ 100

Bounty paid \$ *100* 100; due \$ *None* 100,

Remarks:.....

Book mark : *1689-83.*

*Porter,*

Copyist.

Gibbs Frank

....., Co. ...., 2 Reg't U.S.C. Cav

2 Enclosures.

Bed Cards .....	Final Statements .....
Burial Records .....	Furloughs or L. of A .....
Certs. of Dis. for Discharge .....	Med. Certificates .....
C. M. Charges .....	Med. Des. Lists .....
Descriptive Lists .....	Orders .....
Discharge Certificates .....	Pris. of War Record .....
Enlistment Papers <i>2</i> .....	Resignations .....

Other papers relating to—

Admission to Hosp'l .....	Furlough or L. of A .....
Casualty Sheet .....	Med. Examination .....
Confinement .....	Misc. Information .....
Contracts .....	Pay or Clothing .....
Death or Effects .....	Personal Reports .....
Desertion .....	Rank .....
Discharge from Hosp'l .....	Transfer to Hosp'l .....
Discharge from Service .....	Transfer to V. R. C. .....
Duty .....	Transportation .....



NOTE 1.—This blank will be used for both enlistments and re-enlistments—enlistment of veterans, &c., &c., in the volunteer service. They will be made out in duplicate in all cases—one to accompany the recruiting return of the superintendent (not the recruiting officer) to the Adjutant General, and one to accompany the accounts of the officer who pays bounty, &c. The Regiment and Company in which the soldier last served should be given on the back.

NOTE 2.—An enlistment holds to service. A muster-in must, in all cases, precede payment of pay, bounty, pension, &c. A muster-in roll must, in all cases, be filed in the Adjutant General's Office as evidence of muster-in. The mustering officer, commissary, or assistant commissary of musters, as the case may be, will countersign both enlistments as having mustered the soldier into the service of the United States before either of them is given to the disbursing officer.

DECLARATION OF RECRUIT.

I, Frank Gibbs desiring to VOLUNTEER as a Soldier in the Army of the United States, for the term of THREE YEARS Do Declare, That I am \_\_\_\_\_ years and \_\_\_\_\_ months of age; that I have never been discharged from the United States service on account of disability or by sentence of a court-martial, or by order before the expiration of a term of enlistment; and I know of no impediment to my serving honestly and faithfully as a soldier for three years.

GIVEN at Lancaster Pa. State of Kansas the \_\_\_\_\_ day of July 1864

Witness: W.A. Burnham Frank Gibbs  
mark

No. 24

Frank Gibbs

Volunteered at Lancaster City

July 23 1864

By Wm. P. Matthews 2nd Lieut.  
Recruiting Co. K. 2nd S. Cal. Cavalry  
art.

enlistment; last served in Company ( )

Reg't of \_\_\_\_\_

Discharged \_\_\_\_\_ 18 \_\_\_\_\_

CONSENT IN CASE OF MINOR.

I, \_\_\_\_\_ Do CERTIFY, That I am the \_\_\_\_\_ of \_\_\_\_\_; that the said \_\_\_\_\_ is \_\_\_\_\_ years of age; and I do hereby freely give my CONSENT to his volunteering as a SOLDIER in the ARMY OF THE UNITED STATES for the period of THREE YEARS.

GIVEN at \_\_\_\_\_ the \_\_\_\_\_ day of \_\_\_\_\_

Witness: \_\_\_\_\_

VOLUNTEER ENLISTMENT.

STATE OF

*Kansas*



TOWN OF

*Leavenworth City*

I, *Frank Gibbs* born in *Rappahannock Co,*

in the State of *Virginia* aged *27* years,  
and by occupation a *Farmer* Do HEREBY ACKNOWLEDGE to have

volunteered this *23* day of *July* 1864,

to serve as a **Soldier** in the **Army of the United States of America**, for the  
period of **THREE YEARS** unless sooner discharged by proper authority: Do also

agree to accept such bounty, pay, rations, and clothing, as are, or may be, estab-  
lished by law for volunteers. And I, *Frank Gibbs* do

solemnly swear, that I will bear true faith and allegiance to the **United States**  
**of America**, and that I will serve them honestly and faithfully against all their

enemies or opposers whomsoever; and that I will observe and obey the orders of  
the President of the United States, and the orders of the officers appointed over

me, according to the Rules and Articles of War.

Sworn and subscribed to, at *Leavenworth* } *his*  
this *23* day of *July* 1864 } *Frank Gibbs*  
BEFORE *Wm D Matthews* } *mark*

*Lieut Recruiting Co 16<sup>th</sup> U.S. Col. Artillery*

I CERTIFY, ON HONOR, That I have carefully examined the above-named Volunteer, agreeably  
to the General Regulations of the Army, and that, in my opinion, he is free from all bodily defects and  
mental infirmity, which would in any way disqualify him from performing the duties of a soldier.

*Jiffie Sims*  
*Sur Board of Enrollment*  
*North Dist Kansas*  
EXAMINING SURGEON.

I CERTIFY, ON HONOR, That I have minutely inspected the Volunteer, *Frank Gibbs*

previously to his enlistment, and that he was entirely sober when enlisted; that, to the best of my  
judgment and belief, he is of lawful age; and that, in accepting him as duly qualified to perform the duties  
of an able-bodied soldier, I have strictly observed the Regulations which govern the recruiting service.

This soldier has *Black* eyes, *Black* hair, *Black* complexion, is *5* feet  
*6* inches high.

*Wm D Matthews* *Lieut*  
*Recruiting Co 16<sup>th</sup> U.S. Col. Artillery*  
Regiment of *Volunteers*

RECRUITING OFFICER.

the ..... day of ..... 1864, at ..... Mustered into the service of the United States, in Company ..... Regiment of ..... Volunteers, on

DECLARATION OF RECRUIT.

I, Frank Gibbs desiring to VOLUNTEER as a Soldier in the Army of the United States, for the term of THREE YEARS Do Declare, That I am years and months of age; that I have never been discharged from the United States service on account of disability or by sentence of a court-martial, or by order before the expiration of a term of enlistment; and I know of no impediment to my serving honestly and faithfully as a soldier for three years.

GIVEN at Leavenworth City, State of Kansas the 23 day of July 1864

Witness: [Signature] Frank Gibbs mark

NOTE 1.—This blank will be used for both enlistments and re-enlistments—enlistment of veterans, &c., &c., in the volunteer service. They will be made out in duplicate in all cases—one to accompany the recruiting return of the superintendent (not the recruiting officer) to the Adjutant General, and one to accompany the accounts of the officer who pays bounty, &c. The Regiment and Company in which the soldier last served should be given on the back. NOTE 2.—An enlistment holds to service. A muster-in must, in all cases, precede payment of pay, bounty, pension, &c. A muster-in roll must, in all cases, be filed in the Adjutant General's Office as evidence of muster-in. The mustering officer, commissary, or assistant commissary of musters, as the case may be, will countersign both enlistments as having mustered the soldier into the service of the United States before either of them is given to the disbursing officer.

Rec'd from 2nd. Aud. Nov. 23d 1892

enlistment; last served in Company ( ) Reg't of Discharged 18

Volunteered at Leavenworth City July 23 1864 By Wm. M. Ma. Thews 2nd Lieut Recruiting Co. K. 2nd Regt. S. Cal. Infantry Regiment of

No. 23

CONSENT IN CASE OF MINOR.

I, Do CERTIFY, That I am the of ; that the said is years of age; and I do hereby freely give my CONSENT to his volunteering as a SOLDIER in the ARMY OF THE UNITED STATES for the period of THREE YEARS.

GIVEN at the day of

Witness:

VOLUNTEER ENLISTMENT.

STATE OF

*Kansas*



TOWN OF

*Leavenworth*

I, *Frank Gibbs*

born in *Wappahannock Co*

in the State of *Virginia* aged *27* years,

and by occupation a *Farmer* Do HEREBY ACKNOWLEDGE to have

volunteered this *23<sup>rd</sup>* day of *July* 186*4*,

to serve as a **Soldier** in the **Army of the United States of America**, for the period of **THREE YEARS** unless sooner discharged by proper authority: Do also agree to accept such bounty, pay, rations, and clothing, as are, or may be, established by law for volunteers. And I, *Frank Gibbs* do solemnly swear, that I will bear true faith and allegiance to the **United States of America**, and that I will serve them honestly and faithfully against all their enemies or opposers whomsoever; and that I will observe and obey the orders of the President of the United States, and the orders of the officers appointed over me, according to the Rules and Articles of War.

Sworn and subscribed to, at *Leavenworth* *Frank Gibbs* his  
this *23<sup>rd</sup>* day of *July 2<sup>nd</sup>* 186*4* *mark*

BEFORE *Wm D Matthews* *1<sup>st</sup> Lieut*  
*Recruiting Co. H. 2<sup>nd</sup> W. S. Col. Artillery*

I CERTIFY, ON HONOR, That I have carefully examined the above-named Volunteer, agreeably to the General Regulations of the Army, and that, in my opinion, he is free from all bodily defects and mental infirmity, which would in any way disqualify him from performing the duties of a soldier.

*Jiffie Sims*  
*Sur. Board of Enrollment*  
*North Dist. Kansas*  
EXAMINING SURGEON.

I CERTIFY, ON HONOR, That I have minutely inspected the Volunteer, *Frank Gibbs* previously to his enlistment, and that he was entirely sober when enlisted; that, to the best of my judgment and belief, he is of lawful age; and that, in accepting him as duly qualified to perform the duties of an able-bodied soldier, I have strictly observed the Regulations which govern the recruiting service. This soldier has *Black* eyes, *Black* hair, *Black* complexion, is *5* feet *6* inches high.

*Wm D Matthews* *1<sup>st</sup> Lieut*  
*Recruiting Co. H. 2<sup>nd</sup> W. S. Col. Artillery*  
Regiment of *Volunteers*

RECRUITING OFFICER.

Mustered into the service of the United States, in *Copper* the *26<sup>th</sup>* day of *July* 186*4*, at *Leavenworth*

Regiment of *1<sup>st</sup> Kansas Heavy Arty*

Volunteers, on *Leavenworth*

*Recruited by Wm D Matthews 1st Lieut Recruiting Co. H. 2nd W.S. Col. Artillery*

*State of Kansas*  
*Leavenworth*  
*July 26th 1864*  
*Frank Gibbs*  
*1st Lieut*  
*Recruiting Co. H. 2nd W.S. Col. Artillery*  
*1st Kansas Heavy Arty*  
*Leavenworth*

*Gordon, Charles*

Adpt. Batt'y U.S. Col'd L. Art'y.

*Private Private*

CARD NUMBERS.

6	2	3	3	4	4	3	26
6	2	3	3	9	2	0	27
6	2	3	4	6	7	0	28
9	1	3	2	9	5	3	29
9	8	0	0	5	1	5	30
							31
							32
							33
							34
							35
							36
							37
							38
							39
							40
							41
							42
							43
							44
							45
							46
							47
							48
							49
							50

Book Mark: *SB, VII, Page 4-80*  
*V. II, de J. 75*

See also

*G* | Indpt. Batt'y. | **U.S.C.T.**

*Charles Gordon*

....., Indpt. Batt'y, U. S. Col'd L. Art'y.

Appears on

**Battery Descriptive Book**  
of the organization named above.

**DESCRIPTION.**

Age *30* years; height *5* feet *3* inches.

Complexion *Brown*

Eyes *Black*; hair *Black*

Where born *Jackson Mo.*

Occupation *Labourer*

**ENLISTMENT.**

When *July 23*, 186 *4*.

Where *Franklin Co. Mo.*

By whom *L. Mathews*; term *3* y'rs.

Remarks: .....

.....  
.....  
.....  
.....  
.....  
.....  
.....  
.....

*Holbrook*

*I* | Indpt. Battery. | **U.S.C.T.**

*Charles Gordon*

*Co*, Indpt. Battery, U. S. Col'd L. Art'y.

Appears on

**Battery Muster-in and Descriptive Roll**

of the organization named above. Roll dated

*Leavenworth Kas*, 1864

Where born *Jackson Co. Mo.*

Age *30* yrs; occupation *Laborer*

When enlisted *July 23*, 1864.

Where enlisted *Leavenworth Kas*

For what period enlisted *3* years.

Eyes *Blk*; hair *Blk*

Complexion *Brn*; height *5* ft. *3* in.

When mustered in *July 26*, 1864.

Where mustered in *Leavenworth*

Bounty paid \$ *100*; due \$ *300*<sup>*00*</sup>/<sub>*100*</sub>

Where credited

Battery to which assigned

Remarks: *Discharged Sept 15*  
*1864*

Book mark :

*J. M. Huskey*

G | Indpt. Battery. | U.S.C.T.

Charles Jordan

POX, Indpt. Battery, U. S. Col'd L. Art'y.

Appears on

Battery Muster Roll

for Enlistment to Dec 31, 1864

Present or absent Absent

Stoppage, \$ 100 for

Due Gov't, \$ 100 for

Valuation of horse, \$ 100

Valuation of horse equipments, \$ 100

Remarks: Absent without  
leave

Book mark: Des. to Sept 12/64  
over

(358) J. H. Ashley Copyist.



NARR 1926

JAN. 17

6233920

☆1891☆

E.B.V. II. P. 456 + 8  
80. V. II. Q. A. 75.

G | Indpt. Battery. | **U.S.C.T.**

Charles Gordon,

A, Indpt. Battery U. S. Col'd Light Art'y.

Appears on **Batt'y Muster-out Roll**, dated

St. Leonards, Va., July 22, 1865.

Muster-out to date \_\_\_\_\_, 186 .

Last paid to \_\_\_\_\_, 186 .

**Clothing account:**

Last settled \_\_\_\_\_, 186 ; drawn since \$ \_\_\_\_\_ 100

Due soldier \$ \_\_\_\_\_ 100; due U. S. \$ \_\_\_\_\_ 100

Am't for cloth'g in kind or money adv'd \$ \_\_\_\_\_ 100

Due U. S. for arms, equipments, &c., \$ \_\_\_\_\_ 100

Bounty paid \$ \_\_\_\_\_ 100; due \$ \_\_\_\_\_ 100

Remarks: \_\_\_\_\_

\_\_\_\_\_

\_\_\_\_\_

\_\_\_\_\_

\_\_\_\_\_

\_\_\_\_\_

Book mark: Deserted Sept. 12, 1864,

over

Pantor

NRRH1828

JAN. 17

6234670

618910

*CR. 11, P. 456, + 8, 80, 4,  
11, C. T. 75,*

G. | Supt. Battery | Wife D.  
Lt. Col.

Charles Gordon.

Supt. Battery | Wife Lt. Col.  
Reg't

**NOTATION.**

E. B. 11.456 G. 80. C. P. 1875.  
Book mark:

**War Department,**

Adjutant General's Office,

Washington, September 15<sup>th</sup>, 1875.

Assented September 12, 1864

A. M. Muzzey.

Copyist.

*Gordon Charles*

Co. *1st* Batt. *U.S.C.A.*  
Regt

*2* Enclosures.

Bed Cards .....	Final Statements .....
Burial Records .....	Furloughs or L. of A. ....
Certs. of Dis. for Discharge .....	Med. Certificates .....
C. M. Charges .....	Med. Des. Lists .....
Descriptive Lists .....	Orders .....
Discharge Certificates .....	Pris. of War Record .....
Enlistment Papers <i>2</i> .....	Resignations .....

Other papers relating to—

Admission to Hosp'l .....	Furlough or L. of A. ....
Casualty Sheet .....	Med. Examination .....
Confinement .....	Misc. Information .....
Contracts .....	Pay or Clothing .....
Death or Effects .....	Personal Reports .....
Desertion .....	Rank .....
Discharge from Hosp'l .....	Transfer to Hosp'l .....
Discharge from Service .....	Transfer to V. R. C. ....
Duty .....	Transportation .....

DECLARATION OF RECRUIT.

I, Charles Gordon desiring to VOLUNTEER as a Soldier in the Army of the United States, for the term of THREE YEARS Do Declare, That I am 30 years ~~and~~ months of age; that I have never been discharged from the United States service on account of disability or by sentence of a court-martial, or by order before the expiration of a term of enlistment; and I know of no impediment to my serving honestly and faithfully as a soldier for three years.

GIVEN at Leavenworth City State of Kansas the 23 day of July 1864

Witness:

W.A. Bunker

Charles Gordon

NOTE 1.—This blank will be used for both enlistments and re-enlistments—enlistment of veterans, &c., &c., in the volunteer service. They will be made out in duplicate in all cases—one to accompany the recruiting return of the superintendent (not the recruiting officer) to the Adjutant General, and one to accompany the accounts of the officer who pays bounty, &c. The Regiment and Company in which the soldier last served should be given on the back.

NOTE 2.—An enlistment holds to service. A muster-in must, in all cases, precede payment of pay, bounty, pension, &c. A muster-in roll must, in all cases, be filed in the Adjutant General's Office as evidence of muster-in. The mustering officer, commissary, or assistant commissary of musters, as the case may be, will countersign both enlistments as having mustered the soldier into the service of the United States before either of them is given to the disbursing officer.

No. 27

Charles Gordon

Volunteered at Leavenworth City

July 23<sup>d</sup> 1864

By Wm. D. Hapstern 2<sup>d</sup> Lieut

Company 60 1<sup>st</sup> Regt. Cavalry

enlistment; last served in Company ( )

Reg't of

Discharged 18

CONSENT IN CASE OF MINOR.

I, \_\_\_\_\_ Do CERTIFY, That I am the \_\_\_\_\_ of \_\_\_\_\_; that the said \_\_\_\_\_ is \_\_\_\_\_ years of age; and I do hereby freely give my CONSENT to his volunteering as a SOLDIER in the ARMY OF THE UNITED STATES for the period of THREE YEARS.

GIVEN at \_\_\_\_\_ the \_\_\_\_\_ day of \_\_\_\_\_

Witness:

VOLUNTEER ENLISTMENT.

STATE OF

*Kansas*



TOWN OF

*Lewards City*

I, *Charles Gordon* born in *Jackson Co.*  
 in the State of *Missouri* aged *30* years,  
 and by occupation a *Labourer* Do HEREBY ACKNOWLEDGE to have  
 volunteered this *23* day of *July* 1864  
 to serve as a **Soldier** in the **Army of the United States of America**, for the  
 period of **THREE YEARS** unless sooner discharged by proper authority: Do also  
 agree to accept such bounty, pay, rations, and clothing, as are, or may be, estab-  
 lished by law for volunteers. And I, *Charles Gordon* do  
 solemnly swear, that I will bear true faith and allegiance to the **United States  
 of America**, and that I will serve them honestly and faithfully against all their  
 enemies or opposers whomsoever; and that I will observe and obey the orders of  
 the President of the United States, and the orders of the officers appointed over  
 me, according to the Rules and Articles of War.

Sworn and subscribed to, at *Lewards City* his  
 this *23* day of *July* 1864 } *Charles Gordon*  
 BEFORE *Wm. D. Matthews* } *mark*  
*Sicr Recruiting Co. C. 2<sup>d</sup> W. S. Col. Artillery*

I CERTIFY, ON HONOR, That I have carefully examined the above-named Volunteer, agreeably  
 to the General Regulations of the Army, and that, in my opinion, he is free from all bodily defects and  
 mental infirmity, which would in any way disqualify him from performing the duties of a soldier.

*Jiffie Sink*  
*Surg. Board of Enrollment*  
*North Dist. Kansas*  
 EXAMINING SURGEON.

I CERTIFY, ON HONOR, That I have minutely inspected the Volunteer *Charles Gordon*  
 previously to his enlistment, and that he was entirely sober when enlisted; that, to the best of my  
 judgment and belief, he is of lawful age; and that, in accepting him as duly qualified to perform the duties  
 of an able-bodied soldier, I have strictly observed the Regulations which govern the recruiting service.  
 This soldier has *Black* eyes, *Black* hair, *Brown* complexion, is *5* feet  
*0* inches high.

*Wm. D. Matthews*  
*Recruiting Co. C. 2<sup>d</sup> W. S. Col. Artillery*  
 Regiment of \_\_\_\_\_ Volunteers,  
 RECRUITING OFFICER.

Mustered into the service of the United States, in Company \_\_\_\_\_, Regiment of \_\_\_\_\_ Volunteers, on  
 the *26<sup>th</sup>* day of *July*, 1864, at \_\_\_\_\_

DECLARATION OF RECRUIT.

I, Charles Gordon desiring to VOLUNTEER as a Soldier in the Army of the United States, for the term of THREE YEARS Do Declare, That I am 30 years and 11 months of age; that I have never been discharged from the United States service on account of disability or by sentence of a court-martial, or by order before the expiration of a term of enlistment; and I know of no impediment to my serving honestly and faithfully as a soldier for three years.

GIVEN at Leavenworth City State of Kansas the 23 day of July 1864

Witness:

W.A. Bunker Charles Gordon

NOTE 1.—This blank will be used for both enlistments and re-enlistments—enlistment of veterans, &c., &c., in the volunteer service. They will be made out in duplicate in all cases—one to accompany the recruiting return of the superintendent (not the recruiting officer) to the Adjutant General, and one to accompany the accounts of the officer who pays bounty, &c. The Regiment and Company in which the soldier last served should be given on the back.

NOTE 2.—An enlistment holds to service. A muster-in must, in all cases, precede payment of pay, bounty, pension, &c. A muster-in roll must, in all cases, be filed in the Adjutant General's Office as evidence of muster-in. The mustering officer, commissary, or assistant commissary of musters, as the case may be, will countersign both enlistments as having mustered the soldier into the service of the United States before either of them is given to the disbursing officer.

enlistment; last served in Company ( ) Reg't of Discharged 18

No. 2721 Charles Gordon Volunteered at Leavenworth City July 23rd 1864 By Wm. D. Matthews 2nd Lieut. Recruiting Capt. W. S. Col. 11th Regiment of

CONSENT IN CASE OF MINOR.

I, Do CERTIFY, That I am the of ; that the said is years of age; and I do hereby freely give my CONSENT to his volunteering as a SOLDIER in the ARMY OF THE UNITED STATES for the period of THREE YEARS.

GIVEN at the day of

Witness:



VOLUNTEER ENLISTMENT.

STATE OF

*Kansas*



TOWN OF

*Levermore City*

I, *Charles Gordon* born in *Jackson Co*  
 in the State of *Missouri* aged *30* years,  
 and by occupation a *Laborer* Do HEREBY ACKNOWLEDGE to have  
 volunteered this *23* day of *July* 1864,  
 to serve as a **Soldier** in the **Army of the United States of America**, for the  
 period of **THREE YEARS** unless sooner discharged by proper authority: Do also  
 agree to accept such bounty, pay, rations, and clothing, as are, or may be, estab-  
 lished by law for volunteers. And I, *Charles Gordon* do  
 solemnly swear, that I will bear true faith and allegiance to the **United States**  
**of America**, and that I will serve them honestly and faithfully against all their  
 enemies or opposers whomsoever; and that I will observe and obey the orders of  
 the President of the United States, and the orders of the officers appointed over  
 me, according to the Rules and Articles of War.

Sworn and subscribed to, at *Levermore City*  
 this *23* day of *July* 1864, *Charles Gordon*  
 BEFORE *Wm D. Matthews* his  
*Sieut Recruiting Co 6th U.S. Col Artillery* witness

I CERTIFY, ON HONOR, That I have carefully examined the above-named Volunteer, agreeably  
 to the General Regulations of the Army, and that, in my opinion, he is free from all bodily defects and  
 mental infirmity, which would in any way disqualify him from performing the duties of a soldier.

*Jiffie Sinks*  
*Sur Board of Enrollment*  
*North West Kansas*  
 EXAMINING SURGEON.

I CERTIFY, ON HONOR, That I have minutely inspected the Volunteer,  
 previously to his enlistment, and that he was entirely sober when enlisted; that, to the best of my  
 judgment and belief, he is of lawful age, and that, in accepting him as duly qualified to perform the duties  
 of an able-bodied soldier, I have strictly observed the Regulations which govern the recruiting service.  
 This soldier has *Black* eyes, *Black* hair, *Brown* complexion, is *5* feet  
*11* inches high.

*Wm D. Matthews* *Sieut*  
*Recruiting Co 6th U.S. Col Artillery*  
 Regiment of \_\_\_\_\_ Volunteers,  
 RECRUITING OFFICER.

Mustered into the service of the United States, in Company \_\_\_\_\_  
 the \_\_\_\_\_ day of \_\_\_\_\_ 1864, at \_\_\_\_\_  
*from date of Company Organization*  
 Regiment of \_\_\_\_\_  
 Volunteers, on \_\_\_\_\_  
*Wm D. Matthews*

*Gray, Gabriel*

ndpt. Batt'y U.S. Col'd L. Art'y.

*Private Sergeant*

CARD NUMBERS.

6 2 3 3 6 5-9	26
6 2 3 4 0 4 0	27
6 2 3 4 1 7 2	28
6 2 3 4 3 4 0	29
6 2 3 4 5 0 4	30
9 1 3 3 0 5 4	31
	32
	33
	34
10	35
11	36
12	37
13	38
14	39
15	40
16	41
17	42
18	43
19	44
20	45
21	46
22	47
23	48
24	49
25	50

Book Mark:

See also

*G* | Indpt. Batt'y. | **U.S.C.T.**

*Gabrial Gray*

....., Indpt. Batt'y, U. S. Col'd L. Art'y.

Appears on

**Battery Descriptive Book**

of the organization named above.

**DESCRIPTION.**

Age *26* years; height *5* feet *7* inches.

Complexion *Black*

Eyes *Black*, hair *Black*

Where born *Afayette Ky.*

Occupation *Labourer*

**ENLISTMENT.**

When *Janis 10*, 1865.

Where *Parvorth K's*

By whom *H. minor*; term *3* y'rs.

Remarks: .....

*Holbrook*

G | Indpt. Battery. | **U.S.C.T.**

Gabriel Gray

Appears with rank of Priv on

**Muster and Descriptive Roll of a Detachment of U. S. Vols. forwarded**

for the Indpt. Batt'y, U. S. Col'd L. Arty. Roll dated

Leavenworth, Kas, Feb. 10, 1865.

Where born La Fayette Co., Ken.

Age 26 y'rs; occupation Laborer

When enlisted Jan. 10, 1865.

Where enlisted Leavenworth, Kas.

For what period enlisted 3 years.

Eyes Black; hair Black

Complexion Black; height 5 ft. 7 in.

When mustered in Feb. 10, 1865.

Where mustered in Leavenworth, Kas.

Bounty paid \$ 100 100; due \$ 200 100

Where credited .....

Battery to which assigned .....

Remarks: Credited to 3rd Dist. Kas. 31st Sub Dist. Lawrence Douglas County. Vol. Recruit & enlisted to bounty.

Book mark: .....

Ed. Thamm

*G* | Indpt. Battery. | **U.S.C.T.**

*Gabriel Gray*

*H<sup>th</sup> Corp*, Indpt. Battery, U. S. Col'd L. Art'y.

Appears on

**Battery Muster Roll**

for *July & Feb*, 186<sup>5</sup>.

Present or absent. *Present*

Stoppage, \$ 100 for

Due Gov't, \$ 100 for

Valuation of horse, \$ 100

Valuation of horse equipments, \$ 100

Remarks:

*Appointed Corp'l  
July 1865 by Major  
P. H. Keenut Chf. Artillery  
Dept. of Kan*

Book mark:

*J. Schrey*

(358)

Copyist.

*G* | Indpt. Battery. | **U.S.C.T.**

*Gabriel Gray*  
*Sgt*, Indpt. Battery, U. S. Col'd L. Art'y.

Appears on

**Battery Muster Roll**

for *Mar, + Apl*, 186 *5*.

Present or absent *Present*.

Stoppage, \$ *100* for

Due Gov't, \$ *100* for

Valuation of horse, \$ *100*

Valuation of horse equipments, \$ *100*

Remarks: *Payanc as Corpel,*  
*to Feby, 1/6.5. Promoted*  
*Sergt, Apl, 19/6.5,*

Book mark:

*Darter*

G

Indpt. Battery.

U.S.C.T.

Gabriel Gray,  
Sgt., Indpt. Battery, U. S. Col'd L. Art'y.

Appears on

**Battery Muster Roll**

for *May & June*, 1865.

Present or absent *Present*

Stoppage, \$ 100 for

Due Gov't, \$ 100 for

Valuation of horse, \$ 100

Valuation of horse equipments, \$ 100

Remarks: *Pay due as Corp'l,  
Feb. 16/65. As Sertgt. from  
Feb. 16/65.*

Book mark:

*Patten*

*G*

Indpt. Battery.

U.S.C.T.

*Gabriel Gray,*

*Sgt*, Indpt. Battery U. S. Col'd Light Art'y.

Appears on **Batt'y Muster-out Roll**, dated

*W. Seaworth, Ms., July 27, 1865.*

Muster-out to date *July 27*, 1865.

Last paid to *Pay due from enlist.,* 186 .

Clothing account:

Last settled....., 186 ; drawn since \$ *55* <sup>*96*</sup>/<sub>100</sub>,

Due soldier \$.....<sup>100</sup>/<sub>100</sub>; due U. S. \$.....<sup>100</sup>/<sub>100</sub>

Am't for cloth'g in kind or money adv'd \$.....<sup>100</sup>/<sub>100</sub>

Due U. S. for arms, equipments, &c., \$.....<sup>100</sup>/<sub>100</sub>

Bounty paid \$ *100* <sup>100</sup>/<sub>100</sub>; due \$ *none* <sup>100</sup>/<sub>100</sub>,

Remarks: *Private from enlistment,*  
*to Jan'y. 1/65, then Corp'l,*  
*to Feb'y, 1"; then Serg't.*

Book mark : .....

*Porter*



*Gray Gabriel*

, Co. *1st Batt* *Reg't* *W.P.C. A*

**7 Enclosures.**

Bed Cards .....	Final Statements .....
Burial Records .....	Furloughs or L. of A .....
Certs. of Dis. for Discharge .....	Med. Certificates .....
C. M. Charges .....	Med. Des. Lists .....
Descriptive Lists .....	Orders .....
Discharge Certificates .....	Pris. of War Record .....
Enlistment Papers <b>7</b> .....	Resignations .....

Other papers relating to—

Admission to Hosp'l .....	Furlough or L. of A .....
Casualty Sheet .....	Med. Examination .....
Confinement .....	Misc. Information .....
Contracts .....	Pay or Clothing .....
Death or Effects .....	Personal Reports .....
Desertion .....	Rank .....
Discharge from Hosp'l .....	Transfer to Hosp'l .....
Discharge from Service .....	Transfer to V. R. C. .....
Duty .....	Transportation .....

NOTE 1.—This blank will be used for both enlistments and re-enlistments—enlistment of veterans, &c., &c., in the volunteer service. They will be made out in duplicate in all cases—one to accompany the recruiting return of the superintendent (not the recruiting officer) to the Adjutant General, and one to accompany the accounts of the officer who pays bounty, &c. The Regiment and Company in which the soldier last served should be given on the back

NOTE 2.—An enlistment holds to service. A muster-in must, in all cases, precede payment of pay, bounty, pension, &c. A muster-in roll must, in all cases, be filed in the Adjutant General's Office as evidence of muster-in. The mustering officer, commissary, or assistant commissary of musters, as the case may be, will countersign both enlistments as having mustered the soldier into the service of the United States before either of them is given to the disbursing officer.

DECLARATION OF RECRUIT.

I, Garbriel Gray, desiring to VOLUNTEER as a Soldier in the Army of the United States, for the term of THREE YEARS, Do Declare, That I am Twenty six years and \_\_\_\_\_ months of age; that I have never been discharged from the United States service on account of disability or by sentence of a court martial, or by order before the expiration of a term of enlistment; and I know of no impediment to my serving honestly and faithfully as a soldier for three years.

GIVEN at Leavenworth State Kansas the Tenth day of January 1863

Witness:

John McScott

Garbriel Gray  
Major

Impleh 130th Regt 8

Discharged \_\_\_\_\_ 18 \_\_\_\_\_

Reg't of \_\_\_\_\_

enlistment; last served in Company ( ) \_\_\_\_\_

No. \_\_\_\_\_  
Garbriel Gray  
Volunteered at Leavenworth State  
January 10<sup>th</sup> 1863  
Batt. 10th  
Regt. 130th  
Infantry  
1st  
Regiment of W. Col. A. C. D.

CONSENT IN CASE OF MINOR.

I, \_\_\_\_\_, Do CERTIFY, That I am the \_\_\_\_\_ of \_\_\_\_\_; that the said \_\_\_\_\_ is \_\_\_\_\_ years of age; and I do hereby freely give my CONSENT to his volunteering as a SOLDIER in the ARMY OF THE UNITED STATES for the period of THREE YEARS.

GIVEN at \_\_\_\_\_ the \_\_\_\_\_ day of \_\_\_\_\_

Witness:

Consented to in them on the 31<sup>st</sup> Sub Dist. Lawrence Douglas County

VOLUNTEER ENLISTMENT.

STATE OF

*Kansas*



TOWN OF

*Lawrence*

I, *Gabriel Gray*, born in *La Fayette Co*  
in the State of *Kentucky*, aged *Twenty six* years,  
and by occupation a *Laborer*, DO HEREBY ACKNOWLEDGE to have  
volunteered this *31<sup>st</sup>* day of *January*, 1865,

to serve as a **Soldier** in the **Army of the United States of America**, for  
the period of **THREE YEARS**, unless sooner discharged by proper authority:  
Do also agree to accept such bounty, pay, rations, and clothing, as are, or may be,  
established by law for volunteers. And I, *Gabriel Gray*, do  
solemnly swear, that I will bear true faith and allegiance to the **United States**  
**of America**, and that I will serve them honestly and faithfully against all  
their enemies or opposers whomsoever; and that I will observe and obey the  
orders of the President of the United States, and the orders of the officers  
appointed over me, according to the Rules and Articles of War.

Sworn and subscribed to, at *Lawrence*  
this *31<sup>st</sup>* day of *January*, 1865, } *Gabriel Gray*  
BEFORE *P. B. Minor* } *his*  
*Recruiting Officer U.S. Artillery* } *mark*

I CERTIFY, ON HONOR, That I have carefully examined the above-named Volunteer, agreeably  
to the General Regulations of the Army, and that, in my opinion, he is free from all bodily defects and  
mental infirmity, which would in any way disqualify him from performing the duties of a soldier.

*J. B. Binks*  
*Surg. Board of Enrollments*  
*North Dist Kansas*  
EXAMINING SURGEON.

I CERTIFY, ON HONOR, That I have minutely inspected the Volunteer *Gabriel Gray*  
previously to his enlistment, and that he was entirely sober when enlisted; that, to the best of my  
judgment and belief, he is of lawful age; and that, in accepting him as duly qualified to perform the  
duties of an able-bodied soldier, I have strictly observed the Regulations which govern the recruiting  
service. This soldier has *Blue* eyes, *Black* hair, *Black* complexion, is *5'*  
feet *7* inches high.

*P. B. Minor*  
*Recruiting Officer U.S. Artillery*  
RECRUITING OFFICER.

Mustered into the service of the United States, for three years or during the war, from date of enlistment, in *Company*  
*Regiment of 103<sup>rd</sup> Col. Cal. Inf. Volunteers*, on the *16<sup>th</sup>* day of *February*, 1865, at *Lawrence, Kas.*  
*James C. Brown*  
*Capt. & Comd. Marshal*  
*Lawrence, Kas.*

NOTE 1.—This blank will be used for both enlistments and re-enlistments—enlistment of veterans, &c., &c., in the volunteer service. They will be made out in duplicate in all cases—one to accompany the recruiting return of the superintendent (not the recruiting officer) to the Adjutant General, and one to accompany the accounts of the officer who pays bounty, &c. The Regiment and Company in which the soldier last served should be given on the back

NOTE 2.—An enlistment holds to service. A muster-in must, in all cases, precede payment of pay, bounty, pension, &c. A muster-in roll must, in all cases, be filed in the Adjutant General's Office as evidence of muster-in. The mustering officer, commissary, or assistant commissary of musters, as the case may be, will countersign both enlistments as having mustered the soldier into the service of the United States before either of them is given to the disbursing officer.

Rec'd from 2nd. Aud. Nov. 23d 1892

DECLARATION OF RECRUIT.

I, Samuel Gray, desiring to VOLUNTEER as a Soldier in the Army of the United States, for the term of THREE YEARS, Do Declare, That I am Seventy Six years and \_\_\_\_\_ months of age; that I have never been discharged from the United States service on account of disability or by sentence of a court martial, or by order before the expiration of a term of enlistment; and I know of no impediment to my serving honestly and faithfully as a soldier for three years.

GIVEN at Leavenworth State of Kansas the Tenth day of January 1892

Witness:

John M. Scott

Samuel Gray

Discharged \_\_\_\_\_, 18\_\_\_\_  
enlistment; last served in Company ( )  
Reg't of \_\_\_\_\_

No. 7  
Samuel Gray  
Volunteered at Leavenworth Mo  
January 10<sup>th</sup> 1865  
1st Regt 2nd Minn  
1st Bn 1st Regt of US Cav artd

CONSENT IN CASE OF MINOR.

I, \_\_\_\_\_, Do CERTIFY, That I am \_\_\_\_\_; that the \_\_\_\_\_ of \_\_\_\_\_ is \_\_\_\_\_ years of age; and I do hereby freely give my CONSENT to his volunteering as a SOLDIER in the ARMY OF THE UNITED STATES for the period of THREE YEARS.

GIVEN at \_\_\_\_\_ the \_\_\_\_\_ day of \_\_\_\_\_

Witness:

(A. G. O. No. 74 & 76.)

Admitted to Southern Dist No 31<sup>st</sup> Sub Dist Lawrence Douglas County

This recruit has received One hundred dollars advance bounty of the three hundred dollars bounty authorized by an Act of Congress approved July 13<sup>th</sup> 1864 and Circular No 2 of from the Provost Marshal General dated July 19<sup>th</sup> 1864

VOLUNTEER ENLISTMENT.

STATE OF



TOWN OF

Kansas

Lawrence

Abner Gray, born in La Fayette in the State of Kentucky, aged Twenty Six years, and by occupation a Laborer, Do HEREBY ACKNOWLEDGE to have volunteered this 10<sup>th</sup> day of January, 1865,

to serve as a Soldier in the Army of the United States of America, for the period of THREE YEARS, unless sooner discharged by proper authority: Do also agree to accept such bounty, pay, rations, and clothing, as are, or may be, established by law for volunteers. And I, Abner Gray, do solemnly swear, that I will bear true faith and allegiance to the United States of America, and that I will serve them honestly and faithfully against all their enemies or opposers whomsoever; and that I will observe and obey the orders of the President of the United States, and the orders of the officers appointed over me, according to the Rules and Articles of War.

Sworn and subscribed to, at Lawrence, this 10<sup>th</sup> day of January, 1865, before me, J. Minor, 2<sup>d</sup> Lieut. Recruiting Officer, 1<sup>st</sup> Battery, U.S. Artillery.

I CERTIFY, ON HONOR, That I have carefully examined the above-named Volunteer, agreeably to the General Regulations of the Army, and that, in my opinion, he is free from all bodily defects and mental infirmity, which would in any way disqualify him from performing the duties of a soldier.

Tiffin Birks, Surg. Board of Commissioners, North Dist Kansas, EXAMINING SURGEON.

I CERTIFY, ON HONOR, That I have minutely inspected the Volunteer Abner Gray previously to his enlistment, and that he was entirely sober when enlisted; that, to the best of my judgment and belief, he is of lawful age; and that, in accepting him as duly qualified to perform the duties of an able-bodied soldier, I have strictly observed the Regulations which govern the recruiting service. This soldier has Black eyes, Black hair, Black complexion, is 5 feet 4 inches high.

J. Minor, 2<sup>d</sup> Lieut. Recruiting Officer, 1<sup>st</sup> Battery, U.S. Artillery.

A. G. O. No. 74 & 76.)

Mustered into the service of the United States, for three years or during the war, from date of enlistment, in 1<sup>st</sup> Battery, Regiment of U.S. Artillery Volunteers, on the 10<sup>th</sup> day of January, 1865, at Lawrence, Kansas.

Arthur M. Marshall, Provost Marshal

*Gray James*

dpt. Batt'y U.S. Col'd L. Art'y.

*Private*

*Private*

CARD NUMBERS.

1	6033771	26
2	6033922	27
3	9132954	28
4		29
5		30
6		31
7		32
8		33
9		34
10		35
11		36
12		37
13		38
14		39
15		40
16		41
17		42
18		43
19		44
20		45 <i>me</i>
21		46
22		47
23		48
24		49
25		50

Book Mark:

See also:

*G* | Indpt. Batt'y. | **U.S.C.T.**

*James Gray*  
 -----, Indpt. Batt'y, U. S. Col'd L. Art'y.

Appears on

**Battery Descriptive Book**  
 of the organization named above.

**DESCRIPTION.**

Age *24* years; height *5* feet *7* inches.

Complexion *Black*

Eyes *Black*; hair *Black*

Where born *Papayatto Mo.*

Occupation *Labourer*

**ENLISTMENT.**

When *Aug 6*, 1864

Where *Parsons Co*

By whom *Lt Mathens*; term *3* y'rs.

Remarks: -----  
 -----  
 -----  
 -----  
 -----  
 -----  
 -----  
 -----  
 -----  
 -----

*Stollbrook*

*G*

Indpt. Battery.

U.S.C.T.

*James Gray*

*Pat*, Indpt. Battery, U. S. Col'd L. Art'y.

Appears on

**Battery Muster-in and Descriptive Roll**

of the organization named above. Roll dated

*Leavenworth Co Dec 23*, 1864.

Where born *Lafayette Co Mo.*

Age *24* y'rs; occupation *Seaman*

When enlisted *Aug 6*, 1864.

Where enlisted *Leavenworth Co.*

For what period enlisted *3* years.

Eyes *Blue*; hair *Blue*

Complexion *Blue*; height *5* ft. *7* in.

When mustered in *Aug 9*, 1864.

Where mustered in *Leavenworth*

Bounty paid \$ *100*; due \$ *100*

Where credited

Battery to which assigned

Remarks: *On M. Dist Co  
2nd I.D. 2d Ward  
Leavenworth Co*

Book mark :

*J. H. Ashley*  
(356g) Copyist.



*G*

Indpt. Battery.

U.S.C.T.

*James Gray*  
*Pvt*

Indpt. Battery, U. S. Col'd L. Art'y.

Appears on

**Battery Muster Roll**

for *Enlistment to Dec 31*, 186 *4*.

Present or absent *Absent*

Stoppage, \$ *100* for

Due Gov't, \$ *100* for

Valuation of horse, \$ *100*

Valuation of horse equipments, \$ *100*

Remarks: *Absent without leave*

*Not born on Enl Rolls of Batty*

Book mark:

*J. H. Scherley*

(358)

Copyist.

*Gray James*

, Co. *2nd Batt* *Reg't* *U.S.C. A.*

*2* **Enclosures.**

Bed Cards .....	Final Statements .....
Burial Records .....	Furloughs or L. of A .....
Certs. of Dis. for Discharge .....	Med. Certificates .....
C. M. Charges .....	Med. Des. Lists .....
Descriptive Lists .....	Orders .....
Discharge Certificates .....	Pris. of War Record .....
Enlistment Papers <i>2</i> .....	Resignations .....

**Other papers relating to—**

Admission to Hosp'l .....	Furlough or L. of A .....
Casualty Sheet .....	Med. Examination .....
Confinement .....	Misc. Information .....
Contracts .....	Pay or Clothing .....
Death or Effects .....	Personal Reports .....
Desertion .....	Rank .....
Discharge from Hosp'l .....	Transfer to Hosp'l .....
Discharge from Service .....	Transfer to V. R. C. .....
Duty .....	Transportation .....

DECLARATION OF RECRUIT.

I, James Gray desiring to VOLUNTEER as a Soldier in the Army of the United States, for the term of THREE YEARS, Do Declare, That I am 24 years and 0 months of age; that I have never been discharged from the United States service on account of disability or by sentence of a court martial, or by order before the expiration of a term of enlistment; and I know of no impediment to my serving honestly and faithfully as a soldier for three years.

GIVEN at Lavenworth City - State of Kansas the 24th day of August 1864

Witness: W. A. Burnham James Gray (mark)

NOTE 1.—This blank will be used for enlistments and re-enlistments—enlistment of veterans, &c. &c., in the volunteer service. They will be made out in duplicate in all cases—one to accompany the recruitment of the superintendent (not the recruiting officer) to the Adjutant General, and one to accompany the accounts of the officer who pays bounty, &c. The Regiment and company in which the soldier last served should be given on the back.  
NOTE 2.—An enlistment holds to serve in the Adjutant General's Office as evidence muster-in. The mustering officer, commissary, or assistant commissary of musters, as the case may be, will countersign both enlistments as having mustered the soldier into service of the United States before either of them is given to the disbursing officer.

No. 53

James Gray

Volunteered at Lavenworth City

August 6th 1864

By Wm. D. Matthews 2nd Lieut 1st Regt. S. Cal. Light Artillery

Regiment of 1st Regt. S. Cal. Light Artillery

enlistment; last served in Company ( )

Reg't of

Discharged 18

CONSENT IN CASE OF MINOR.

I, \_\_\_\_\_ Do CERTIFY, That I am the \_\_\_\_\_ of \_\_\_\_\_; that the said \_\_\_\_\_ is \_\_\_\_\_ years of age; and I do hereby freely give my CONSENT to his volunteering as a SOLDIER in the ARMY OF THE UNITED STATES for the period of THREE YEARS.

GIVEN at \_\_\_\_\_ the \_\_\_\_\_ day of \_\_\_\_\_

Witness: \_\_\_\_\_

VOLUNTEER ENLISTMENT.

STATE OF

TOWN OF

*Kansas*



*Leavenworth City*

I, *James Gray* born in *Lafayette Co*  
 in the State of *Missouri* aged *24* years,  
 and by occupation a *Salver* Do HEREBY ACKNOWLEDGE to have  
 volunteered this *24th* day of *August* 1864,  
 to serve as a **Soldier** in the **Army of the United States of America**, for  
 the period of **THREE YEARS**, unless sooner discharged by proper authority:  
 Do also agree to accept such bounty, pay, rations, and clothing as are, or may be,  
 established by law for volunteers. And *James Gray* do  
 solemnly swear, that I will bear true faith and allegiance to the **United States**  
**of America**, and that I will serve them honestly and faithfully against all  
 their enemies or opposers whomsoever; and that I will observe and obey the  
 orders of the President of the United States, and the orders of the officers  
 appointed over me, according to the Rules and Articles of War.

Sworn and subscribed to, at

this *24th* day of *August* 1864

BEFORE *Wm D Matthews 2nd Lieut*

*Recruiting 1st Ind. U. S. Col Light Artillery*

I CERTIFY, ON HONOR, That I have carefully examined the above-named Volunteer, agreeably to the General Regulations of the Army, and that, in my opinion, he is free from all bodily defects and mental infirmity, which would in any way disqualify him from performing the duties of a soldier.

*Jiffie Simko*  
*Surgeon Board of Enrollment*  
*North 6th Kansas*  
 EXAMINING SURGEON.

I CERTIFY, ON HONOR, That I have minutely inspected the Volunteer, *James Gray*  
 previously to his enlistment, and that he was entirely sober when enlisted; that, to the best of my  
 judgment and belief, he is of lawful age; and that, in accepting him as duly qualified to perform the  
 duties of an able-bodied soldier, I have strictly observed the Regulations which govern the recruiting  
 service. This soldier has *Black* eyes, *Black* hair, *Black* complexion, is *5*  
 feet *7* inches high.

*Wm D Matthews 2nd Lieut*  
*Recruiting 1st Ind. U. S. Col Light Artillery*  
 Regiment of *Volunteers*

RECRUITING OFFICER.

Mustered into the service of the United States, for three years or during the war, from date of enlistment, in Company .....  
 Regiment of ..... Volunteers, on the ..... day of ..... 1864, at .....

NOTE 1.—This blank will be used for both enlistments and re-enlistments—enlistment of veterans, &c., &c., in the volunteer service. They will be made out in duplicate in all cases—one to accompany the recruiting return of the superintendent (not the recruiting officer) to the Adjutant General, and one to accompany the accounts of the officer who pays bounty, &c. The Regiment and Company in which the soldier last served should be given on the back.

NOTE 2.—An enlistment holds to service. A muster-in must, in all cases, precede payment of pay, bounty, pension, &c. A muster-in roll must, in all cases, be filed in the Adjutant General's Office as evidence of muster-in. The mustering officer, commissary, or assistant commissary of musters, as the case may be, will countersign both enlistments as having mustered the soldier into the service of the United States before either of them is given to the disbursing officer.

DECLARATION OF RECRUIT.

I, James Gray desiring to VOLUNTEER as a Soldier in the Army of the United States, for the term of THREE YEARS, Do Declare, That I am 24 years and — months of age; that I have never been discharged from the United States service on account of disability or by sentence of a court martial, or by order before the expiration of a term of enlistment; and I know of no impediment to my serving honestly and faithfully as a soldier for three years.

GIVEN at Leavenworth State of Kansas the sixth day of August 1864

Witness: W. A. Bunker James Gray

Discharged ..... 18 ..

Reg't of ..

enlistment; last served in Company ( )

Regiment of ..

By Wm. Matthews 1864

Volunteered at Leavenworth

James Gray

No. 51

CONSENT IN CASE OF MINOR.

I, ..... Do CERTIFY, That I am the ..... of .....; that the said ..... is ..... years of age; and I do hereby freely give my CONSENT to his volunteering as a SOLDIER in the ARMY OF THE UNITED STATES for the period of THREE YEARS.

GIVEN at ..... the ..... day of ..

Witness: ..

35, 57

VOLUNTEER ENLISTMENT.

STATE OF

TOWN OF

Kansas

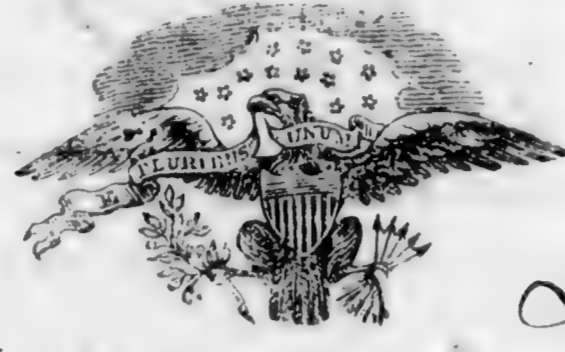

Leavenworth City

I, James Gray born in Lafayette Co. in the State of Missouri aged 24 years, and by occupation a Laborer

Do HEREBY ACKNOWLEDGE to have volunteered this 6th day of August 1864, to serve as a Soldier in the Army of the United States of America, for the period of THREE YEARS, unless sooner discharged by proper authority: Do also agree to accept such bounty, pay, rations, and clothing, as are, or may be, established by law for volunteers. And I, James Gray do solemnly swear, that I will bear true faith and allegiance to the United States of America, and that I will serve them honestly and faithfully against all their enemies or opposers whomsoever; and that I will observe and obey the orders of the President of the United States, and the orders of the officers appointed over me, according to the Rules and Articles of War.

Sworn and subscribed to, at Leavenworth City this 6th day of August 1864, James Gray his mark BEFORE Wm D Matthews 1st Lieut Recruiting 1st Ind U.S. Col Light Cav

I CERTIFY, ON HONOR, That I have carefully examined the above-named Volunteer, agreeably to the General Regulations of the Army, and that, in my opinion, he is free from all bodily defects and mental infirmity, which would in any way disqualify him from performing the duties of a soldier.

Jiffie Sims Surg Board of Enrollment North Dist Kansas EXAMINING SURGEON.

I CERTIFY, ON HONOR, That I have minutely inspected the Volunteer, James Gray previously to his enlistment, and that he was entirely sober when enlisted; that, to the best of my judgment and belief, he is of lawful age; and that, in accepting him as duly qualified to perform the duties of an able-bodied soldier, I have strictly observed the Regulations which govern the recruiting service. This soldier has Black eyes, Black hair, Black complexion, is 5 feet 7 inches high.

Wm D Matthews 1st Lieut Recruiting 1st Ind, U.S. Col Light Cavalry Regiment of Volunteers, RECRUITING OFFICER.

(A. G. O. No. 74 & 76.)

Vertical text on the right side: Mustered into the service of the United States, for three years or during the war, from date of enlistment, in Company... M. D. Matthews (Lieut) on the 6th day of August, 1864, at Leavenworth City, Mo.

*Green, George*

ndpt. Batt'y U.S. Col'd L. Art'y.

*Private*

*Private*

CARD NUMBERS.

1	6233772	26
2	6233919	27
3	9132951	28
4		29
5		30
6		31
7		32
8		33
9		34
10		35
11		36
12		37
13		38
14		39
15		40
16		41
17		42
18		43
19		44
20		45
21		46
22		47
23		48
24		49
25		50

Book Mark:

See also

*G* | Indpt. Batt'y. | **U.S.C.T.**

*George Green*

....., Indpt. Batt'y, U. S. Col'd L. Art'y.

Appears on

**Battery Descriptive Book**

of the organization named above.

**DESCRIPTION.**

Age *26* years; height *5* feet *5* inches.

Complexion *Black*

Eyes *Black*; hair *Black*

Where born *Buckingham Co. Va.*

Occupation *Laborer*

**ENLISTMENT.**

When *July 19*, 186 *4*

Where *Warrenton & Co*

By whom *J. Matheno*; term *3* y'rs.

Remarks: .....

.....

.....

.....

.....

.....

.....

.....

.....

.....

*Holbrook*



*J* | Indpt. Battery. | **U.S.C.T.**

*George Green*

*Pat*, Indpt. Battery, U. S. Col'd L. Art'y.

Appears on

**Battery Muster-in and Descriptive Roll**

of the organization named above. Roll dated

*Leavenworth Mo. Dec 23*, 1864.

Where born *Buckingham Co., Va.*

Age *26* y'rs; occupation *Labourer*

When enlisted *July 19*, 1864.

Where enlisted *Leavenworth Mo.*

For what period enlisted *3* years.

Eyes *Blu*; hair *Blu*

Complexion *Blu*; height *5* ft. *5* in.

When mustered in *July 20*, 1864.

Where mustered in *Leavenworth*

Bounty paid \$ *100*; due \$ *300*<sup>*00*</sup>/<sub>*100*</sub>

Where credited

Battery to which assigned

Remarks: *C. N. Dist Co*

*22<sup>nd</sup> S. D. 4<sup>th</sup> Regt*

*Leavenworth Mo.*

Book mark:

*J. H. Shirley*  
(8569) Copyist.

A | Indpt. Battery. | **U.S.C.T.**

George Green

Co, Indpt. Battery, U. S. Col'd L. Art'y.

Appears on

**Battery Muster Roll**

for Enlistment to Dec 31, 1864

Present or absent Absent

Stoppage, \$ 100 for

Due Gov't, \$ 100 for

Valuation of horse, \$ 100

Valuation of horse equipments, \$ 100

Remarks: Absent without leave

Not on Enl Rolls of Batty

Book mark:

J. H. Schreyer

(358)

Copyist.

*Green, George*

, Co.

*Indp. Bat USCA*

*3*

**Enclosures.**

Bed Cards .....	Final Statements .....
Burial Records .....	Furloughs or L. of A .....
Certs. of Dis. for Discharge .....	Med. Certificates .....
C. M. Charges .....	Med. Des. Lists .....
Descriptive Lists .....	Orders .....
Discharge Certificates .....	Pris. of War Record .....
Enlistment Papers <i>3</i> .....	Resignations .....

**Other papers relating to—**

Admission to Hosp'l .....	Furlough or L. of A .....
Casualty Sheet .....	Med. Examination .....
Confinement .....	Misc. Information .....
Contracts .....	Pay or Clothing .....
Death or Effects .....	Personal Reports .....
Desertion .....	Rank .....
Discharge from Hosp'l .....	Transfer to Hosp'l .....
Discharge from Service .....	Transfer to V. R. C. .....
Duty .....	Transportation .....

NOTE 1.—This blank will be used for both enlistments and re-enlistments—enlistment of veterans, &c., &c., in the volunteer service. They will be made out in duplicate in all cases—one to accompany the recruiting return of the superintendent (not the recruiting officer) to the Adjutant General, and one to accompany the accounts of the officer who pays bounty, &c. The Regiment and Company in which the soldier last served should be given on the back.

NOTE 2.—An enlistment holds to service. A muster-in must, in all cases, precede payment of pay, bounty, pension, &c. A muster-in roll must, in all cases, be filed in the Adjutant General's Office as evidence of muster-in. The mustering officer, commissary, or assistant commissary of musters, as the case may be, will countersign both enlistments as having mustered the soldier into the service of the United States before either of them is given to the disbursing officer.

DECLARATION OF RECRUIT.

I, George Green desiring to VOLUNTEER as a Soldier in the Army of the United States, for the term of THREE YEARS Do Declare, That I am 26 years and months of age; that I have never been discharged from the United States service on account of disability or by sentence of a court martial, or by order before the expiration of a term of enlistment; and I know of no impediment to my serving honestly and faithfully as a soldier for three years.

GIVEN at Leavenworth City - State of Kansas the 15 day of July 1864

Witness:

W. H. Bunker his brother  
George Green  
Mark

No. 13

George Green  
Volunteered at Leavenworth City  
July 15 1864

By Wm. H. Bunker 2nd Lieut -  
Leavenworth Co. K. 2nd U. S. Cav. Artillery  
Regiment of Leavenworth

enlistment; last served in Company ( )

Reg't of \_\_\_\_\_

Discharged \_\_\_\_\_ 1864

Suppl. Bounty W. H. Bunker

CONSENT IN CASE OF MINOR.

I, \_\_\_\_\_ Do CERTIFY, That I am the \_\_\_\_\_ of \_\_\_\_\_; that the said \_\_\_\_\_ is \_\_\_\_\_ years of age; and I do hereby freely give my CONSENT to his volunteering as a SOLDIER in the ARMY OF THE UNITED STATES for the period of THREE YEARS.

GIVEN at \_\_\_\_\_ the \_\_\_\_\_ day of \_\_\_\_\_

Witness: \_\_\_\_\_

VOLUNTEER ENLISTMENT.

STATE OF

TOWN OF

Kansas



Leavenworth City

I, George Green born in Buckingham Co.

~~born~~ of Virginia aged 26 years,  
and by occupation a Labourer Do HEREBY ACKNOWLEDGE to have

volunteered this 19<sup>th</sup> day of July 1864

to serve as a **Soldier** in the **Army of the United States of America**, for  
the period of **THREE YEARS**, unless sooner discharged by proper authority:

Do also agree to accept such bounty, pay, rations, and clothing, as are, or may be,  
established by law for volunteers. And I, George Green do

solemnly swear, that I will bear true faith and allegiance to the **United States**  
**of America**, and that I will serve them honestly and faithfully against all

their enemies or opposers whomsoever; and that I will observe and obey the  
orders of the President of the United States, and the orders of the officers

appointed over me, according to the Rules and Articles of War.

Sworn and subscribed to, at

this 19 day of July 1864

BEFORE

Leavenworth City George Green his  
Wm D Matthews 2nd Lt mark

Lieut Recruiting Co, K, 2nd U.S. Artillery

I CERTIFY, ON HONOR, That I have carefully examined the above-named Volunteer, agreeably  
to the General Regulations of the Army, and that, in my opinion, he is free from all bodily defects and  
mental infirmity, which would in any way disqualify him from performing the duties of a soldier.

Wm D Matthews 2nd Lt  
Recruiting Co K 2nd U.S. Col. Artillery  
EXAMINING SURGEON.

I CERTIFY, ON HONOR, That I have minutely inspected the Volunteer, George Green  
previously to his enlistment, and that he was entirely sober when enlisted; that, to the best of my  
judgment and belief, he is of lawful age; and that, in accepting him as duly qualified to perform the  
duties of an able-bodied soldier, I have strictly observed the Regulations which govern the recruiting  
service. This soldier has Black eyes, Black hair, Black complexion, is 5ft  
feet 5 inches high.

Wm D Matthews 2nd Lt  
Recruiting Co K 2nd U.S. Col. Artillery  
Regiment of Volunteers,  
RECRUITING OFFICER.

Mustered into the service of the United States, for three years or during the war, from date of enlistment, in Company \_\_\_\_\_  
Regiment of \_\_\_\_\_ Volunteers, on the \_\_\_\_\_ day of \_\_\_\_\_, 1864, at \_\_\_\_\_

NOTE 1.—This blank will be used for both enlistments and re-enlistments—enlistment of veterans, &c., &c., in the volunteer service. They will be made out in duplicate in all cases—one to accompany the recruiting return of the superintendent (not the recruiting officer) to the Adjutant General, and one to accompany the accounts of the officer who pays bounty, &c. The Regiment and Company in which the soldier last served should be given on the back.

NOTE 2.—An enlistment holds to service. A muster-in must, in all cases, precede payment of pay, bounty, pension, &c. A muster-in roll must, in all cases, be filed in the Adjutant General's Office as evidence of muster-in. The mustering officer, commissary, or assistant commissary of musters, as the case may be, will countersign both enlistments as having mustered the soldier into the service of the United States before either of them is given to the disbursing officer.

DECLARATION OF RECRUIT.

I, George Green desiring to VOLUNTEER as a Soldier in the Army of the United States, for the term of THREE YEARS Do Declare, That I am 26 years and 0 months of age; that I have never been discharged from the United States service on account of disability or by sentence of a court martial, or by order before the expiration of a term of enlistment; and I know of no impediment to my serving honestly and faithfully as a soldier for three years.

GIVEN at Leavenworth City State of Kansas

the 19 day of July 1869

Witness:

W. H. Bingham George Green  
Mark

No. 13

George Green

Volunteered at Leavenworth Mo. Co.

July 15<sup>th</sup> 1869

By Wm. D. Matthews Adj. Gen.  
Leavenworth Co. K. 2<sup>nd</sup> U.S. Cal. Cavalry  
Regiment of \_\_\_\_\_

Enlistment; last served in Company ( )

Reg't of \_\_\_\_\_

Discharged \_\_\_\_\_ 1869

CONSENT IN CASE OF MINOR.

I, \_\_\_\_\_ Do CERTIFY, That I am \_\_\_\_\_; that the \_\_\_\_\_ of \_\_\_\_\_ years of age; and I said \_\_\_\_\_ is \_\_\_\_\_ do hereby freely give my CONSENT to his volunteering as a SOLDIER in the ARMY OF THE UNITED STATES for the period of THREE YEARS.

GIVEN at \_\_\_\_\_ the \_\_\_\_\_ day of \_\_\_\_\_

Witness:

VOLUNTEER ENLISTMENT.

STATE OF



TOWN OF

Kentucky

Leavenworth City

I, George Green born in Buckingham County  
 in the State of Virginia aged 26 years,  
 and by occupation a Labourer DO HEREBY ACKNOWLEDGE to have  
 volunteered this 19 day of July 1864,  
 to serve as a **Soldier** in the **Army of the United States of America**, for  
 the period of **THREE YEARS**, unless sooner discharged by proper authority:  
 Do also agree to accept such bounty, pay, rations, and clothing, as are, or may be,  
 established by law for volunteers. And I, George Green do  
 solemnly swear, that I will bear true faith and allegiance to the **United States**  
**of America**, and that I will serve them honestly and faithfully against all  
 their enemies or opposers whomsoever; and that I will observe and obey the  
 orders of the President of the United States, and the orders of the officers  
 appointed over me, according to the Rules and Articles of War.

Sworn and subscribed to, at Leavenworth City his George Green  
 this 19 day of July 1864,  
 BEFORE Wm D Matthews } mark

Lieut Recruiting Co, K. U. S. Col. Artillery

I CERTIFY, ON HONOR, That I have carefully examined the above-named Volunteer, agreeably  
 to the General Regulations of the Army, and that, in my opinion, he is free from all bodily defects and  
 mental infirmity, which would in any way disqualify him from performing the duties of a soldier.

Tiffin Links  
 Surg Board of Enrollment  
North Dist Kansas  
 EXAMINING SURGEON.

I CERTIFY, ON HONOR, That I have minutely inspected the Volunteer, George Green  
 previously to his enlistment, and that he was entirely sober when enlisted; that, to the best of my  
 judgment and belief, he is of lawful age; and that, in accepting him as duly qualified to perform the  
 duties of an able-bodied soldier, I have strictly observed the Regulations which govern the recruiting  
 service. This soldier has Black eyes, Black hair, Black complexion, is 5  
 feet 5 inches high.

Wm D Matthews Lieut  
 Recruiting Co K. U. S. Col. Artillery  
 Regiment of \_\_\_\_\_ Volunteers,  
 RECRUITING OFFICER.

Mustered into the service of the United States, for three years or during the war, from date of enlistment, in Company \_\_\_\_\_  
 Regiment of \_\_\_\_\_ Volunteers, on the \_\_\_\_\_ day of \_\_\_\_\_, 1864, at \_\_\_\_\_

NOTE 1.—This blank will be used for both enlistments and re-enlistments—enlistment of veterans, &c., &c., in the volunteer service. They will be made out in duplicate in all cases—one to accompany the recruiting return of the superintendent (not the recruiting officer) to the Adjutant General, and one to accompany the accounts of the officer who pays bounty, &c. The Regiment and Company in which the soldier last served should be given on the back.

NOTE 2.—An enlistment holds to service. A muster-in must, in all cases, precede payment of pay, bounty, pension, &c. A muster-in roll must, in all cases, be filed in the Adjutant General's Office as evidence of muster-in. The mustering officer, commissary, or assistant commissary of musters, as the case may be, will countersign both enlistments as having mustered the soldier into the service of the United States before either of them is given to the disbursing officer.

DECLARATION OF RECRUIT.

I, George Green desiring to VOLUNTEER as a Soldier in the Army of the United States, for the term of THREE YEARS Do Declare, That I am 26 years and 0 months of age; that I have never been discharged from the United States service on account of disability or by sentence of a court martial, or by order before the expiration of a term of enlistment; and I know of no impediment to my serving honestly and faithfully as a soldier for three years.

GIVEN at Leavenworth Ar-States of Kansas the 19<sup>th</sup> day of July 1864

Witness:

W. H. Burnham George Green  
mark

No. 1344

George Green

Volunteered at Leavenworth Ar-

July 19<sup>th</sup> 1864,

By W. H. Burnham

Recruiting Co. K, 2<sup>nd</sup> U.S. Col. Inf.

enlistment; last served in Company ( )

Reg't of \_\_\_\_\_

Discharged \_\_\_\_\_ 1864

CONSENT IN CASE OF MINOR.

I, \_\_\_\_\_ Do CERTIFY, That I am \_\_\_\_\_; that the \_\_\_\_\_ of \_\_\_\_\_; that the \_\_\_\_\_ is \_\_\_\_\_ years of age; and I do hereby freely give my CONSENT to his volunteering as a SOLDIER in the ARMY OF THE UNITED STATES for the period of THREE YEARS.

GIVEN at \_\_\_\_\_

the \_\_\_\_\_ day of \_\_\_\_\_

Witness: \_\_\_\_\_



VOLUNTEER ENLISTMENT.

STATE OF

TOWN OF

Kansas



Lawrence City

I, George Green born in Buckingham County  
 in the State of Virginia aged 26 years,  
 and by occupation a Labourer Do HEREBY ACKNOWLEDGE to have  
 volunteered this 19<sup>th</sup> day of July 1864,  
 to serve as a **Soldier** in the **Army of the United States of America**, for  
 the period of **THREE YEARS**, unless sooner discharged by proper authority:  
 Do also agree to accept such bounty, pay, rations, and clothing, as are, or may be,  
 established by law for volunteers. And I, George Green do  
 solemnly swear, that I will bear true faith and allegiance to the **United States**  
**of America**, and that I will serve them honestly and faithfully against all  
 their enemies or opposers whomsoever; and that I will observe and obey the  
 orders of the President of the United States, and the orders of the officers  
 appointed over me, according to the Rules and Articles of War.

Sworn and subscribed to, at Lawrence City George Green his  
 this 19<sup>th</sup> day of July 1864,  
 BEFORE Wm. D. Matthews 2<sup>nd</sup> Lieut mark  
Recruiting Co, K, 2<sup>nd</sup> U.S. Col. Artillery

I CERTIFY, ON HONOR, That I have carefully examined the above-named Volunteer, agreeably  
 to the General Regulations of the Army, and that, in my opinion, he is free from all bodily defects and  
 mental infirmity, which would in any way disqualify him from performing the duties of a soldier.

Liffin Dinks  
Sur. Board of Enrollment  
North Star Kansas  
 EXAMINING SURGEON.

I CERTIFY, ON HONOR, That I have minutely inspected the Volunteer, George Green  
 previously to his enlistment, and that he was entirely sober when enlisted; that, to the best of my  
 judgment and belief, he is of lawful age; and that, in accepting him as duly qualified to perform the  
 duties of an able-bodied soldier, I have strictly observed the Regulations which govern the recruiting  
 service. This soldier has Black eyes, Black hair, Black complexion, is 5  
 feet 5 inches high.

Wm. D. Matthews 2<sup>nd</sup> Lieut  
Recruiting Co, K, 2<sup>nd</sup> U.S. Col. Artillery  
 Regiment of Volunteers,  
 RECRUITING OFFICER.

(A. G. O. No. 74 & 76.)

Mustered into the service of the United States, for three years or during the war, from date of enlistment, in Company 1st Kansas  
Regiment of Volunteers, on the 19<sup>th</sup> day of July, 1864, at Lawrence, Kansas  
Company 1st Kansas

*Waddo Jackson*

ndpt. Batt'y U.S. Col'd L. Art'y.

*Private Private*

CARD NUMBERS.

1	6233579	26
2	6233788.	27
3	6233937	28
4	6234087	29
5	6234235.	30
6	6234402.	31
7	6234564,	32
8	9132969	33
9		34
10		35
11		36
12		37
13		38
14		39
15		40
16		41
17		42
18		43
19		44
20		45
21		46
22		47
23		48
24		49
25		50

Book Mark:

See also

*JL* | Indpt. Batt'y. | **U.S.C.T.**

*Jackson Heddley*

....., Indpt. Batt'y, U. S. Col'd L. Art'y.

Appears on

**Battery Descriptive Book**

of the organization named above.

**DESCRIPTION.**

Age *43* years; height *5* feet *8* inches.

Complexion *Mulatto*

Eyes *Brown*; hair *Black*

Where born *Scott Co Va.*

Occupation *Farmer*

**ENLISTMENT.**

When *Oct. 10*....., 186 *4*

Where *Warrenton Co.*

By whom *Lt Minor*; term *3* y'rs.

Remarks: .....

.....  
 .....  
 .....  
 .....  
 .....  
 .....  
 .....

*Hollbrook*

H

Indpt. Battery.

U.S.C.T.

Jackson Haddock

Appears with rank of *Priv* on**Muster and Descriptive Roll of a Detachment of U. S. Vols. forwarded**

for the Indpt. Batt'y, U. S. Col'd L. Arty. Roll dated

*Leavenworth, Kans., Oct. 10, 1864.*Where born *Scott Co., Virginia*Age *43* y'rs; occupation *Farmer*When enlisted *Oct 10*, 1864Where enlisted *Leav. City, Kas.*For what period enlisted *3* years.Eyes *Brown*; hair *Black*Complexion *Mulatto*; height *5* ft. *8* in.When mustered in *Oct 10*, 1864Where mustered in *Leav. City, Kans.*Bounty paid \$ *100*; due \$ *100*

Where credited

Battery to which assigned

Remarks: *Credited to 10th Dist of Kans. 19th Sub. Dist. 1st Ward Leav. City. Leav. Co. Volunteer Recruit & entitled to Bounty*

Book mark:

*E. L. Tharnton*

(339)

Copyist.

*No*

Indpt. Battery.

U.S.C.T.

*Jackson Haddox*  
*Pos*, Indpt. Battery, U. S. Col'd L. Art'y.

Appears on

**Battery Muster-in and Descriptive Roll**

of the organization named above. Roll dated

*Leavenworth Mo*, 186*4*.

Where born *Scott Co Va*

Age *43* y'rs; occupation *Farmer*

When enlisted *Oct 10*, 186*4*.

Where enlisted *Leavenworth Mo*

For what period enlisted *3* years.

Eyes *Bro*; hair *Blk*

Complexion *Muloto*; height *5 ft 8* in.

When mustered in *Oct 10*, 186*4*.

Where mustered in *Leavenworth*

Bounty paid \$ *100*<sup>*00*</sup>/<sub>*100*</sub>; due \$ *200*<sup>*00*</sup>/<sub>*100*</sub>

Where credited

Battery to which assigned

Remarks: *A. N. Dist Co*  
*19<sup>th</sup> A. I. 1st Regt*  
*Leavenworth Mo.*

Book mark: *M. 165 mo.*

*J. H. Shirley*  
(356g) Copyist.

76

Indpt. Battery.

U.S.C.T.

Jackson Haddox  
Pot

, Indpt. Battery, U. S. Col'd L. Art'y.

Appears on

**Battery Muster Roll**

for *Enlistment to Dec 31*, 1864.

Present or absent *Present*

Stoppage, \$ 100 for

Due Gov't, \$ 100 for

Valuation of horse, \$ 100

Valuation of horse equipments, \$ 100

Remarks:

Book mark:

*JH Schuly*

(358)

Copyist.

76

Indpt. Battery. | **U.S.C.T.**

Jackson Haddox  
Pot

, Indpt. Battery, U. S. Col'd L. Art'y.

Appears on

**Battery Muster Roll**

for *Jan Feb*, 186<sup>5</sup>.

Present or absent *Present*

Stoppage, \$ 100 for

Due Gov't, \$ 100 for

Valuation of horse, \$ 100

Valuation of horse equipments, \$ 100

Remarks:

Book mark:

*J. S. Schuler*  
(358) Copyist.

*N* | Indpt. Battery. | **U.S.C.T.**

*Jackson Hadden,*  
*Q*, Indpt. Battery, U. S. Col'd L. Art'y.

Appears on

**Battery Muster Roll**

for *May & June*, 1865.

Present or absent *Present*

Stoppage, \$ 100 for

Due Gov't, \$ 100 for

Valuation of horse, \$ 100

Valuation of horse equipments, \$ 100

Remarks:  
\_\_\_\_\_  
\_\_\_\_\_  
\_\_\_\_\_  
\_\_\_\_\_  
\_\_\_\_\_  
\_\_\_\_\_  
\_\_\_\_\_

Book mark: \_\_\_\_\_

*Butler*



*N* | Indpt. Battery. | **U.S.C.T.**

*Jackson Naddy,*  
*Pr*, Indpt. Battery, U. S. Col'd L. Art'y.

Appears on

**Battery Muster Roll**

for *May & June*, 186*5*.

Present or absent *Present*.

Stoppage, \$ 100 for

Due Gov't, \$ 100 for

Valuation of horse, \$ 100

Valuation of horse equipments, \$ 100

Remarks:  
-----  
-----  
-----  
-----  
-----  
-----  
-----  
-----  
-----  
-----

Book mark: -----

-----  
*Porter*  
-----  
(358) Copyist.

*N* | Indpt. Battery. | **U.S.C.T.**

*Jackson Naddy,*  
*Co*, Indpt. Battery U. S. Col'd Light Art'y.

Appears on **Batt'y Muster-out Roll**, dated  
*St. Leonards, Va. July 22*, 1865.

Muster-out to date *July 22*, 1865.

Last paid to *Dec. 31*, 1864.

Clothing account:

Last settled....., 186 ; drawn since \$ *31* <sup>*07*</sup>/<sub>*100*</sub>,

Due soldier \$ <sup>*100*</sup>/<sub>*100*</sub>; due U. S. \$ <sup>*100*</sup>/<sub>*100*</sub>

Am't for cloth'g in kind or money adv'd \$ <sup>*100*</sup>/<sub>*100*</sub>

Due U. S. for arms, equipments, &c., \$ <sup>*100*</sup>/<sub>*100*</sub>

Bounty paid \$ *100* <sup>*100*</sup>/<sub>*100*</sub>; due \$ *None* <sup>*100*</sup>/<sub>*100*</sub>,

Remarks:.....  
.....  
.....  
.....  
.....  
.....  
.....

Book mark: *No. 165. No. K.*

*Parten*

*Haddon Jackson*

, Co. *2nd* Batt. *U.S.C.A.*  
*Reg't*

*3* Enclosures.

Bed Cards .....	Final Statements .....
Burial Records .....	Furloughs or L. of A. ....
Certs. of Dis. for Discharge .....	Med. Certificates .....
C. M. Charges .....	Med. Des. Lists .....
Descriptive Lists .....	Orders .....
Discharge Certificates .....	Pris. of War Record .....
Enlistment Papers <i>2</i> .....	Resignations .....

Other papers relating to—

Admission to Hosp'l .....	Furlough or L. of A. ....
Casualty Sheet .....	Med. Examination .....
Confinement .....	Misc. Information <i>1</i> .....
Contracts .....	Pay or Clothing .....
Death or Effects .....	Personal Reports .....
Desertion .....	Rank .....
Discharge from Hosp'l .....	Transfer to Hosp'l .....
Discharge from Service .....	Transfer to V. R. C. ....
Duty .....	Transportation .....

MICROFILM PUBLICATION M.1836

COMPILED MILITARY SERVICE RECORDS  
OF VOLUNTEER UNION SOLDIERS WHO SERVED WITH  
THE UNITED STATES COLORED TROOPS (USCT)  
INDEPENDENT BATTERY LIGHT ARTILLERY

PERSONAL PAPERS' TARGET SHEET

PLEASE NOTE THE CHECKED INFORMATION ABOUT THE PERSONAL PAPERS IN  
THIS FILE:

- NO PERSONAL PAPERS WERE FOUND IN THIS FILE WHEN THE  
RECORDS WERE ARRANGED FOR MICROFILMING.
- 4 PERSONAL PAPER(S) FOUND IN THIS FILE WHEN THE RECORDS  
WERE ARRANGED FOR MICROFILMING.

DECLARATION OF RECRUIT.

I, Jackson Haddock, desiring to VOLUNTEER as a Soldier in the Army of the United States, for the term of THREE YEARS, Do Declare, That I am 43 years and months of age; that I have never been discharged from the United States service on account of disability or by sentence of a court martial, or by order before the expiration of a term of enlistment; and I know of no impediment to my serving honestly and faithfully as a soldier for three years.

GIVEN at Leavenworth State of Kansas the 10th day of October 1864

Witness:

E. N. O. Clough

Jackson Haddock made

NOTE 1.—This blank will be used for both enlistments and re-enlistments—enlistment of veterans, &c. &c., in the volunteer service. They will be made out in duplicate in all cases—one to accompany the recruiting return of the superintendent (not the recruiting officer) to the Adjutant General, and one to accompany the accounts of the officer who pays bounty, &c. The Regiment and Company in which the soldier last served should be given on the back.

NOTE 2.—An enlistment holds to service. A muster-in must, in all cases, precede payment of pay, bounty, pension, &c. A muster-in roll must, in all cases, be filed in the Adjutant General's Office as evidence of muster-in. The mustering officer, commissary, or assistant commissary of musters, as the case may be, will countersign both enlistments as having mustered the soldier into the service of the United States before either of them is given to the disbursing officer.

CONSENT IN CASE OF MINOR.

I, Do CERTIFY, That I am the of ; that the said is years of age; and I do hereby freely give my CONSENT to his volunteering as a SOLDIER in the ARMY OF THE UNITED STATES for the period of THREE YEARS.

GIVEN at the day of

Witness:

Discharged 18

enlistment; last served in Company ( ) Reg't of

Volunteered at Leavenworth Mo October 10th 1864. By P. N. Quinn 2nd Lt. 1st Regt of U.S. Col. Artillery

Jackson Haddock

No. ....

VOLUNTEER ENLISTMENT.

STATE OF

TOWN OF

*Kansas*



*Leavenworth*

I, *Jackson Haddock* born in *Scott County*  
 in the State of *Virginia* aged *43* years,  
 and by occupation a *Farmer* Do HEREBY ACKNOWLEDGE to have  
 volunteered this *10<sup>th</sup> 2<sup>nd</sup>* day of *October* 1864,  
 to serve as a **Soldier** in the **Army of the United States of America**, for  
 the period of **THREE YEARS**, unless sooner discharged by proper authority:  
 Do also agree to accept such bounty, pay, rations, and clothing, as are, or may be,  
 established by law for volunteers. And I, *Jackson Haddock* do  
 solemnly swear, that I will bear true faith and allegiance to the **United States**  
**of America**, and that I will serve them honestly and faithfully against all  
 their enemies or opposers whomsoever; and that I will observe and obey the  
 orders of the President of the United States, and the orders of the officers  
 appointed over me, according to the Rules and Articles of War.

Sworn and subscribed to, at *Leavenworth*  
 this *10<sup>th</sup>* day of *October* 1864, } *Jackson Haddock*  
 BEFORE *P. H. Minor 2<sup>d</sup> Lieut* } *his*  
*Recruiting Int. Battery U.S. Cav. Artillery* } *mark*

I CERTIFY, ON HONOR, That I have carefully examined the above-named Volunteer, agreeably  
 to the General Regulations of the Army, and that, in my opinion, he is free from all bodily defects and  
 mental infirmity, which would in any way disqualify him from performing the duties of a soldier.

*Stephen Smith*  
*Surgeon Board of Enrollment*  
*North 2<sup>d</sup> Div. Kansas*  
 EXAMINING SURGEON.

I CERTIFY, ON HONOR, That I have minutely inspected the Volunteer, *Jackson Haddock*  
 previously to his enlistment, and that he was entirely sober when enlisted; that, to the best of my  
 judgment and belief, he is of lawful age; and that, in accepting him as duly qualified to perform the  
 duties of an able-bodied soldier, I have strictly observed the Regulations which govern the recruiting  
 service. This soldier has *green* eyes, *black* hair, *Mulatto* complexion, is *5-*  
 feet *8* inches high.

*P. H. Minor 2<sup>d</sup> Lieut.*  
*Int. Battery U.S. Cav. Artillery*  
 RECRUITING OFFICER.

Mustered into the service of the United States, for three years or during the war, from date of enlistment, in *Company* *B* *1<sup>st</sup> Regt*  
*Battery* *Regiment of U.S. Cav. Artillery*, on the *10<sup>th</sup>* day of *October*, 1864, at *Leavenworth Kansas*  
*W. H. Sherman*  
*Chief of Bureau - War Dept.*  
*Wm. H. Sherman*

DECLARATION OF RECRUIT.

I, Jackson Haddock desiring to VOLUNTEER as a Soldier in the Army of the United States, for the term of THREE YEARS, Do Declare, That I am 23 years and months of age; that I have never been discharged from the United States service on account of disability or by sentence of a court martial, or by order before the expiration of a term of enlistment; and I know of no impediment to my serving honestly and faithfully as a soldier for three years.

GIVEN at Leavenworth City State of Kansas the 21th day of October 1864

Witness:

E. O. Olay

Jackson Haddock's mark

NOTE 1.—This blank will be used for both enlistments and re-enlistments—enlistment of veterans, &c., &c., in the volunteer service. They will be made out in duplicate in all cases—one to accompany the recruiting return of the superintendent (not the recruiting officer) to the Adjutant General, and one to accompany the accounts of the officer who pays bounty, &c. The Regiment and Company in which the soldier last served should be given on the back. NOTE 2.—An enlistment holds to service. A muster-in must, in all cases, precede payment of pay, bounty, pension, &c. A muster-in roll must, in all cases, be filed in the Adjutant General's Office as evidence of muster-in. The mustering officer, commissary, or assistant commissary of musters, as the case may be, will countersign both enlistments as having mustered the soldier into the service of the United States before either of them is given to the disbursing officer.

Rec'd from 2nd. Aud. Nov. 23d 1892

Discharged ..... 18  
Reg't of .....  
enlistment; last served in Company ( )

No. 1109  
Jackson Haddock's  
Volunteered at Leavenworth  
October 21th 1864  
By P. H. Minor 2nd Lieut  
and P. H. Minor 1st Lieut

CONSENT IN CASE OF MINOR.

I, \_\_\_\_\_ Do CERTIFY, That I am \_\_\_\_\_; that the the \_\_\_\_\_ of \_\_\_\_\_ is \_\_\_\_\_ years of age; and I said \_\_\_\_\_ do hereby freely give my CONSENT to his volunteering as a SOLDIER in the ARMY OF THE UNITED STATES for the period of THREE YEARS.

GIVEN at \_\_\_\_\_ the \_\_\_\_\_ day of \_\_\_\_\_

Witness:

VOLUNTEER ENLISTMENT.

STATE OF

Kansas

TOWN OF

Leavenworth



I, Jackson Haddock, born in Scott County

in the State of Virginia, aged 43 years,

and by occupation a Farmer. Do HEREBY ACKNOWLEDGE to have

volunteered this 10th day of October 1864,

to serve as a Soldier in the Army of the United States of America, for

the period of THREE YEARS, unless sooner discharged by proper authority:

Do also agree to accept such bounty, pay, rations, and clothing, as are, or may be,

established by law for volunteers. And I, Jackson Haddock, do

solemnly swear, that I will bear true faith and allegiance to the United States

of America, and that I will serve them honestly and faithfully against all

their enemies or opposers whomsoever; and that I will observe and obey the

orders of the President of the United States, and the orders of the officers

appointed over me, according to the Rules and Articles of War.

Sworn and subscribed to, at Leavenworth

this 10th day of October 1864

BEFORE P. H. Minor & Lieut

Recruiting Dist. Batty U.S. Col. Artillery

Jackson Haddock

his mark

I CERTIFY, ON HONOR, That I have carefully examined the above-named Volunteer, agreeably to the General Regulations of the Army, and that, in my opinion, he is free from all bodily defects and mental infirmity, which would in any way disqualify him from performing the duties of a soldier.

Jiffie Sinks  
Surgeon Board of Enrollment  
North Dist. Kas  
EXAMINING SURGEON.

I CERTIFY, ON HONOR, That I minutely inspected the Volunteer, Jackson Haddock

previously to his enlistment, and that he was entirely sober when enlisted; that, to the best of my

judgment and belief, he is of lawful age; and that, in accepting him as duly qualified to perform the

duties of an able-bodied soldier, I have strictly observed the Regulations which govern the recruiting

service. This soldier has brown eyes, black hair, ruddy complexion, is 5

feet 8 inches high.

P. H. Minor & Lieut  
Recruiting Dist. Batty U.S. Col. Artillery  
RECRUITING OFFICER.

Battery U.S. Regiment of Co. Artillery 11th Volunteers, on the 10th day of October 1864, at Leavenworth, Kansas  
Mustered into the service of the United States, for three years or during the war, from date of enlistment, in ~~Company~~ Independent

J. W. Allen  
Capt. & Quartermaster  
Northern District Kansas

Vertical handwritten notes on the left margin, including dates like 'July 19, 1864' and names like 'P. H. Minor'.



for the adjustment of such claims, before the Departments at Washington, D. C., where the same may become necessary, and elsewhere, and in *his* name, place and stead, for *him* and in *his* name to ask, demand, recover and receive such compensation as may be awarded as aforesaid, hereby giving and granting unto *his* said Attorneys full power and authority to do and perform all and every act and thing whatsoever requisite and necessary to be done in and about the premises as full and to all intents and purposes the same as *he* might or could do were *he* personally present, hereby ratifying and confirming all *his* said Attorneys or their substitutes by their appointment shall lawfully do or cause to be done by virtue hereof; and it is understood and agreed that this Power of Attorney cannot be revoked by *him* without the consent of *his* Attorneys herein appointed.

(5) *John P. Miller*

STATE OF *Missouri* } ss.  
County of *Platte*

On this *3rd* day of *November* 186*6*, personally appeared before me *Geo. M. Bell* a *clerk of the Court* in and for the county and State aforesaid *John P. Miller* the claimant above mentioned, and made oath to the foregoing statement by *him* subscribed, and *he* further acknowledged the signing and sealing of the foregoing Power of Attorney to be his own free binding act, for the purposes and objects therein contained and set forth; and at the same time also personally appeared the above named *Moses Boydston* and *John M. Fugate* *Edward M. Dobson* and *Edward Wm A. White* and made oath to the truth of the statements by them respectively subscribed.

Witness my hand and seal, upon the day and date first above written. *at office in Platte City, Mo*  
(6) *Geo. M. Bell Clerk*  
*Platte County Circuit Court*

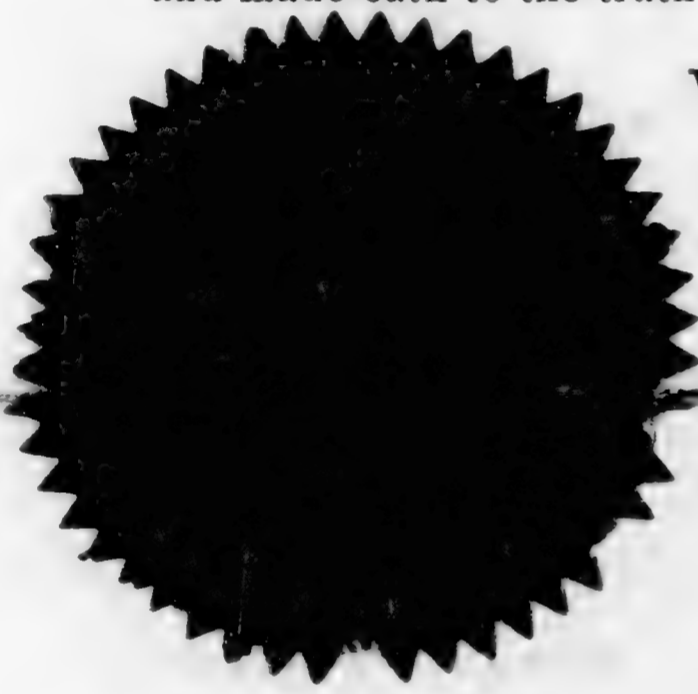

INSTRUCTIONS.

- (1) State all the circumstances connected with obtaining title—when, where and how.
- (2) Signature of claimant.
- (3) Signatures of witnesses to ownership.
- (4) Signatures of witnesses to loyalty.
- (5) Signature of claimant.
- (6) Signature of Notary Public or Clerk of Court, authenticated by seal.

If title is by *purchase*, state date of bill of sale, and where recorded. When possible, file the bill of sale. If title is by inheritance, state when and from whom the slave was inherited, and where the will is recorded or the administrator was appointed.  
If claimant is a trustee, executor or administrator, he must show by the record proof that he is such.  
Where the same party claims compensation for more than one slave, he must file a separate claim for each.

CHIPMAN, HOSMER & CO.,  
WASHINGTON, D. C.,  
*Attorneys for Claimants.*

For Compensation for Service of State.

Attorneys of Ownership and Loyalty, and Power of Attorney, in the Application of  
*John P. Miller*

No. ~~165~~

165-12

*John P. Miller* claimant for compensation under the Acts of Congress of February 24th, 1864, and July 28th, 1866, for *Jackson Haddock* a slave, who was enlisted into the military service of the United States upon the *ninth* day of *October* 1864, having been duly sworn declares that at the date of the enlistment of said *Jackson Haddock* as aforesaid, and as more fully set forth in *his* application, *he was* the lawful owner of said *Jackson Haddock* and obtained *his* title to him in the following manner: (1)

*By purchase from Turner as per bill of sale herewith the bill of sale has been lost & was never recorded. said purchase was made in Platte City Mo. on the 15th day of March 1859.*

(2) *John P. Miller*

*Moses Boydston* a resident of *Platte* County, State of *Missouri* and *John M. Fugate* a resident of *Platte* County, State of *Missouri*

having been duly sworn, declare that they are personally acquainted with *John P. Miller* the claimant for compensation for *his* slave *Jackson Haddock* under the Acts of Congress of February 24th, 1864, and July 28, 1866, and know that said *Jackson Haddock* at the date of his enlistment into the military service of the United States, and for *about five years* previous thereto was the slave of said *John P. Miller*. They also declare that they have no interest in said claim.

(3) *Moses Boydston*  
*John M. Fugate*

*Edward M. Dobson* a resident of *Platte* County, State of *Missouri* and *Wall White* a resident of *Platte* County, State of *Missouri*

having first been duly sworn, upon their oaths declare that they reside respectively in county of *Platte* State of *Missouri* and \_\_\_\_\_ county of *Platte* State of *Missouri*; that they are personally acquainted with

*John P. Miller* claimant for compensation for *his* slave *Jackson Haddock* under the Acts of Congress of February 24, 1864, and July 28, 1866, and that they know that said claimant has firmly and faithfully maintained *his* allegiance and adherence to the Government of the United States, by defending its cause against the Government of the so-called Confederate States of America, in all suitable and practicable ways, and according to *his* ability; they also swear that they have themselves maintained a like adherence and allegiance to the Government of the United States, and that they have no interest in said claim.

*Edward M. Dobson*

And the said *John P. Miller* claimant further declares that in consideration of valuable services rendered and to be rendered, *he* hath and doth employ and constitute, as *his* Attorneys, **CHIPMAN, HOSMER & CO.,** Washington, D. C., to prosecute *his* claim for compensation which may be awarded to *him* as owner of said slave, by the Acts of Congress in that regard, before the Board of Claims appointed for the State of *Missouri*.

**ENDORSEMENT.**

No. ~~157~~ 165 K

APPLICATION OF

John P. Miller

OF

Platte Co. Mo.

for compensation for service of  
slave Jackson Haddock

enlisted Oct 9th 1864

Ind. Batty  
in A Co. Regiment

U. S. Colored Troops. Light Art'y

Received Jan'y 14 1867

Compensation awarded,  
186

Dollars.

President Board of Claims.

P. O. Address of Applicant.

Chapman Hosmer & Co  
Washington DC  
attys

War Department,

ADJUTANT GENERAL'S OFFICE.

Washington, Jan 30 1867.

Respectfully returned to the  
Commission for the State of  
Missouri, with the informa-  
tion that Jackson Haddock  
was enlisted at Graenworth Kans  
October 10 1864, and was  
mustered in as Pvt in Ind. Batty  
U. S. Col. Light Art'y Oct 10 1864.

W. 165: Rec.

A. F. Rowlee

Asst. Adj't General.

a compensation for the said slave, under  
Section 2, Act approved July 28, 1866.

AWARD OF THE BOARD OF CLAIMS.

OFFICE OF THE BOARD OF CLAIMS,

Drafted in the Service of the United States.

186

of

, having proved, under oath loyalty to the Con-

States, and established title as to the ownership of

a slave and mustered

day of 186

in the service of the United States, in the

ored Troops, Co. the sum of

by this Board, subject to the approval of the Secretary of War, as

provisions of Section 24, Act approved February 24, 1864, and

President of the Board.

Member of the Board.

R. A. Marsh Member of the Board.

To

Chief of the Bureau for the  
Organization of Colored Troops, Washington, D. C.

(Form A.)

CLAIM FOR COMPENSATION FOR ENLISTED SLAVE.

No. \_\_\_\_\_  
 I, John P. Miller, a loyal citizen, and a resident  
 of Missouri County of Platte State of  
 \_\_\_\_\_ hereby claim compensation, under the provisions of  
 Section 24, Act approved February 24, 1864, and Section 2, Act approved July 28, 1866, for my slave  
Jackson Haddox enlisted October 9th  
1864, at Leavenworth, Kansas by Lieut. Miller  
 \_\_\_\_\_ in the Independent Battery ~~Regiment~~ U. S. Colored ~~Troops~~,  
Co. Artillery (Light) certificate of which enlistment, and a descriptive list, as required, accompanying this  
 application.

In proof of my loyalty to the Constitution and Government of the United States, I present the accompanying  
 oath, which I have taken, signed and acknowledged; to be filed with this application, in accordance with require-  
 ment of General Order, No. 329, 1863, War Department, Adjutant General's Office.

John P. Miller

November 3rd 1866 .

OATH OF ALLEGIANCE.

I, John P. Miller the owner and claimant, do solemnly swear that the foregoing  
 claim is a just and true claim due to me as master and owner of the said slave, and that the facts alleged in  
 said claim in respect to the enlistment of said slave into the military service of the United  
 States are true. And I do further swear that I have never joined, or been concerned in any insurrection or  
 rebellion; that I have never borne arms against the United States; that I have never given any aid, countenance,  
 counsel or encouragement to any person or persons engaged, or whom I had reason to believe were about to  
 engage, in insurrection, rebellion or armed hostility against the United States: that I have neither sought, nor  
 accepted, nor attempted to exercise the functions of any office, civil or military, nor to perform any service  
 whatever under any authority, or pretended authority, in hostility to the United States; that I have not  
 yielded a voluntary support to any insurrection, rebellion or pretended government, authority, power or consti-  
 tution within the United States, hostile thereto. And I do further swear that, to the best of my knowledge and  
 ability, I have supported and defended, and will continue to support and defend, the United States, against all  
 enemies, foreign and domestic, and that I have supported, defended and obeyed, and will continue to support,  
 defend and obey, the Constitution and laws of the United States, that I will bear true faith and allegiance to the  
 same; and that I take this oath freely, without any mental reservation or purpose of evasion. So help me God.

John P. Miller

Sworn to and subscribed before me, at Platte City, Mo.

this 3rd day of November 1866 .)

with the seal thereof affixed at  
 office Geo. H. Platt Clerk

Platte County Circuit Court

will be required to prove the active loyalty of the claimant during the war.



*Private*  
A. B. Barry U.S. Col'd L. Art'y.

*Private*

CARD NUMBERS.

233603  
233785.  
233934,  
132966

- 26
- 27
- 28
- 29
- 30
- 31
- 32
- 33
- 34
- 35
- 36
- 37
- 38
- 39
- 40
- 41
- 42
- 43
- 44
- 45
- 46
- 47
- 48
- 49
- 50

*me*

Book Mark:

See also

*H* | Indpt. Batt'y. | **U. S. C. T.**

*Edward Abel*

....., Indpt. Batt'y, U. S. Col'd L. Art'y.

Appears on

**Battery Descriptive Book**

of the organization named above.

**DESCRIPTION.**

Age *20* years; height *5* feet *8 1/2* inches.

Complexion *Mulatto*

Eyes *Black*; hair *Black*

Where born *Missouri*

Occupation *Laborer*

**ENLISTMENT.**

When *Dec 13*, 186 *4*

Where *Severnorth D.C.*

By whom *A. Matthews*; term *3* y'rs.

Remarks:

.....  
 .....  
 .....  
 .....  
 .....  
 .....  
 .....

*Hoelbrook*

*H* | Indpt. Battery. | **U.S.C.T.**

*Edward Hall*

Appears with rank of *Priv* on

**Muster and Descriptive Roll of a Detachment of U. S. Vols. forwarded**

for the Indpt. Batt'y, U. S. Col'd L. Arty. Roll dated

*Leavenworth, Kp, Dec. 14, 1864.*

Where born *Unknown Missouri*

Age *20* y'rs; occupation *Labourer*

When enlisted *Dec. 13, 1864.*

Where enlisted *Leavenworth, Kp*

For what period enlisted *3* years.

Eyes *Black*; hair *Blk*

Complexion *Mulatto*; height *5 ft. 8 1/2 in*

When mustered in *Dec 14, 1864.*

Where mustered in *Leavenworth, Kp*

Bounty paid \$ *100*; due \$ *100*

Where credited

Battery to which assigned

Remarks: *Credited to North<sup>n</sup> Dist. Kans. 21st Sub. Dist. 3rd Leavenworth City. Vol. receipt entitled to bounty.*

Book mark:

*E. Thorton*

No | Indpt. Battery. | **U.S.C.T.**

Edward Hall

Indpt. Battery, U. S. Col'd L. Art'y.

Appears on

**Battery Muster-in and Descriptive Roll**

of the organization named above. Roll dated

Leavenworth Mo Dec 3, 1864

Where born

Mo

Age 20 y'rs; occupation

Labourer

When enlisted

Dec 3, 1864

Where enlisted

Leavenworth Mo

For what period enlisted

3

years.

Eyes

Blu

hair

Blu

Complexion

Mulata

height

5 ft. 8 1/2 in.

When mustered in

Dec 14, 1864

Where mustered in

Leavenworth

Bounty paid \$

100

; due \$

300 00/100

Where credited

Battery to which assigned

Remarks:

A. N. Dist No.

2d S. D. 3d Ward

Leavenworth Mo

Book mark :

(856g)

J. H. Crosby

Copyist.



No | Indpt. Battery. | **U.S.C.T.**

Edward Hoall

Pvt, Indpt. Battery, U. S. Col'd L. Art'y.

Appears on

**Battery Muster Roll**

for Lieutenant G. D. B. 31, 1864.

Present or absent *Absent*

Stoppage, \$ 100 for

Due Gov't, \$ 100 for

Valuation of horse, \$ 100

Valuation of horse equipments, \$ 100

Remarks: *Absent without leave*

*Not on Ind Rolls of Batty*

Book mark:

(358)

*J. Scholly*

Copyist.

Hull Edward

, Co. ...., 1st Batt Reg't U.S.C.A

2 Enclosures.

Bed Cards .....	Final Statements .....
Burial Records .....	Furloughs or L. of A .....
Certs. of Dis. for Discharge .....	Med. Certificates .....
C. M. Charges .....	Med. Des. Lists .....
Descriptive Lists .....	Orders .....
Discharge Certificates .....	Pris. of War Record .....
Enlistment Papers ..... 2	Resignations .....

Other papers relating to—

Admission to Hosp'i .....	Furlough or L. of A .....
Casualty Sheet .....	Med. Examination .....
Confinement .....	Misc. Information .....
Contracts .....	Pay or Clothing .....
Death or Effects .....	Personal Reports .....
Desertion .....	Rank .....
Discharge from Hosp'l .....	Transfer to Hosp'l .....
Discharge from Service .....	Transfer to V. R. C. ....
Duty .....	Transportation .....

NOTE 1.—This blank will be used for both enlistments and re-enlistments—enlistment of veterans, &c., &c., in the volunteer service. They will be made out in duplicate in all cases—one to accompany the recruiting return of the superintendent (not the recruiting officer) to the Adjutant General, and one to accompany the accounts of the officer who pays bounty, &c. The Regiment and Company in which the soldier last served should be given on the back.

NOTE 2.—An enlistment holds to service. A muster-in must, in all cases, precede payment of pay, bounty, pension, &c. A muster-in roll must, in all cases, be filed in the Adjutant General's Office as evidence of muster-in. The mustering officer, commissary, or assistant commissary of musters, as the case may be, will countersign both enlistments as having mustered the soldier into the service of the United States before either of them is given to the disbursing officer.

DECLARATION OF RECRUIT.

I, Edward Hall desiring to VOLUNTEER as a Soldier in the Army of the United States, for the term of THREE YEARS, Do Declare, That I am 20 1/2 years and \_\_\_\_\_ months of age; that I have never been discharged from the United States service on account of disability or by sentence of a court martial, or by order before the expiration of a term of enlistment; and I know of no impediment to my serving honestly and faithfully as a soldier for three years.

GIVEN at Leavenworth City the 13<sup>th</sup> day of December 1864

Witness: \_\_\_\_\_  
Edward Hall  
mark

\_\_\_\_\_ enlistment; last served in Company ( )  
 \_\_\_\_\_ Reg't of \_\_\_\_\_  
 Discharged \_\_\_\_\_ 18 \_\_\_\_\_

No. 02  
Edward Hall  
 Volunteered at Leavenworth  
Mo 13<sup>th</sup> day of Dec 1864  
 By Wm M. Matthews 1st Lt  
Regiment of Officers  
1st Regt of Cavalry

CONSENT IN CASE OF MINOR.

I, \_\_\_\_\_ Do CERTIFY, That I am the \_\_\_\_\_ of \_\_\_\_\_; that the said \_\_\_\_\_ is \_\_\_\_\_ years of age; and I do hereby freely give my CONSENT to his volunteering as a SOLDIER in the ARMY OF THE UNITED STATES for the period of THREE YEARS.

GIVEN at \_\_\_\_\_ the \_\_\_\_\_ day of \_\_\_\_\_

Witness: \_\_\_\_\_

B. Ward

VOLUNTEER ENLISTMENT.

STATE OF



TOWN OF

Kansas

Sumnerworth city

I, Edward Hall born in \_\_\_\_\_  
 in the State of Missouri aged twentythree years,  
 and by occupation a labourer Do HEREBY ACKNOWLEDGE to have  
 volunteered this thirteenth day of December 1864  
 to serve as a **Soldier** in the **Army of the United States of America**, for  
 the period of **THREE YEARS**, unless sooner discharged by proper authority:  
 Do also agree to accept such bounty, pay, rations, and clothing, as are, or may be,  
 established by law for volunteers. And I, Edward Hall do  
 solemnly swear, that I will bear true faith and allegiance to the **United States  
 of America**, and that I will serve them honestly and faithfully against all  
 their enemies or opposers whomsoever; and that I will observe and obey the  
 orders of the President of the United States, and the orders of the officers  
 appointed over me, according to the Rules and Articles of War.

Sworn and subscribed to, at Sumnerworth city  
 this 13<sup>th</sup> day of Dec 1864 Edward Hall  
 BEFORE William D Matthews 2nd Lieut mark  
Recruiting and us col left artillery  
(Battery)

I CERTIFY, ON HONOR, That I have carefully examined the above-named Volunteer, agreeably  
 to the General Regulations of the Army, and that, in my opinion, he is free from all bodily defects and  
 mental infirmity, which would in any way disqualify him from performing the duties of a soldier.

Jiffin Sinks  
Sur Board of Enrollment  
Sumnerworth Kansas  
 EXAMINING SURGEON.

I CERTIFY, ON HONOR, That I have minutely inspected the Volunteer, Edward Hall  
 previously to his enlistment, and that he was entirely sober when enlisted; that, to the best of my  
 judgment and belief, he is of lawful age; and that, in accepting him as duly qualified to perform the  
 duties of an able-bodied soldier, I have strictly observed the Regulations which govern the recruiting  
 service. This soldier has black eyes, black hair, mulatto complexion, is \_\_\_\_\_  
 feet 8 1/2 inches high.

William D Matthews 2nd Lieut  
Recruiting and us col left artillery  
(Battery) Volunteers,  
 RECRUITING OFFICER.

(A. G. O. No. 74 & 76.)

Mustered into the service of the United States, for three years or during the war, from date of enlistment, in  
as Col and artillery (81st)  
on the 14 day of December, 1864, at Sumnerworth Kansas  
Independent Battery

Prisoners  
Capt. R. B. Grosbeck  
Sumnerworth Kansas

NOTE 1.—This blank will be used for both enlistments and re-enlistments—enlistment of veterans, &c., &c., in the volunteer service. They will be made out in duplicate in all cases—one to accompany the recruiting return of the superintendent (not the recruiting officer) to the Adjutant General, and one to accompany the accounts of the officer who pays bounty, &c. The Regiment and Company in which the soldier last served should be given on the back.

NOTE 2.—An enlistment holds to service. A muster-in must, in all cases, precede payment of pay, bounty, pension, &c. A muster-in roll must, in all cases, be filed in the Adjutant General's Office as evidence of muster-in. The mustering officer, commissary, or assistant commissary of musters, as the case may be, will countersign both enlistments as having mustered the soldier into the service of the United States before either of them is given to the disbursing officer.

DECLARATION OF RECRUIT.

I, Edward Hall desiring to VOLUNTEER as a Soldier in the Army of the United States, for the term of THREE YEARS, Do Declare, That I am 24 1/2 years and \_\_\_\_\_ months of age; that I have never been discharged from the United States service on account of disability or by sentence of a court martial, or by order before the expiration of a term of enlistment; and I know of no impediment to my serving honestly and faithfully as a soldier for three years.

GIVEN at Savannah City the 13<sup>th</sup> day of December 1864

Witness:

Noah C. Hanson

Edward Hall  
mark

enlistment; last served in Company ( )  
Co. B, 1st Regt of 24<sup>th</sup> Ste. Inds

Discharged \_\_\_\_\_ 18\_\_\_\_

By Wm M. Matthews 1st Lieut  
Regiment of Artillery

Volunteered at Savannah

Edward Hall

No. \_\_\_\_\_

5

CONSENT IN CASE OF MINOR.

I, \_\_\_\_\_ Do CERTIFY, That I am the \_\_\_\_\_ of \_\_\_\_\_; that the said \_\_\_\_\_ is \_\_\_\_\_ years of age; and I do hereby freely give my CONSENT to his volunteering as a SOLDIER in the ARMY OF THE UNITED STATES for the period of THREE YEARS.

GIVEN at \_\_\_\_\_ the \_\_\_\_\_ day of \_\_\_\_\_

Witness:

VOLUNTEER ENLISTMENT.

STATE OF

TOWN OF

Kansas



Leavenworth City

I, Edward Hall born in \_\_\_\_\_  
 in the State of Missouri aged twentyeth 20 years,  
 and by occupation a Labourer Do HEREBY ACKNOWLEDGE to have  
 volunteered this thirteenth 13 day of December 1864  
 to serve as a **Soldier** in the **Army of the United States of America**, for  
 the period of **THREE YEARS**, unless sooner discharged by proper authority:  
 Do also agree to accept such bounty, pay, rations, and clothing, as are, or may be,  
 established by law for volunteers. And I, Edward Hall do  
 solemnly swear, that I will bear true faith and allegiance to the **United States  
 of America**, and that I will serve them honestly and faithfully against all  
 their enemies or opposers whomsoever; and that I will observe and obey the  
 orders of the President of the United States, and the orders of the officers  
 appointed over me, according to the Rules and Articles of War.

Sworn and subscribed to, at Leavenworth City  
 this 13<sup>th</sup> day of December 1864 } Edward Hall  
 BEFORE William D Matthews } Recruiting Officer  
Recruiting Officer } 1st Lieut Artillery  
Battery

I CERTIFY, ON HONOR, That I have carefully examined the above-named Volunteer, agreeably  
 to the General Regulations of the Army, and that, in my opinion, he is free from all bodily defects and  
 mental infirmity, which would in any way disqualify him from performing the duties of a soldier.

Tiffin Binks  
Surgeon Board of Commissioners  
Leavenworth Kansas  
 EXAMINING SURGEON.

I CERTIFY, ON HONOR, That I have minutely inspected the Volunteer, Edward Hall  
 previously to his enlistment, and that he was entirely sober when enlisted; that, to the best of my  
 judgment and belief, he is of lawful age; and that, in accepting him as duly qualified to perform the  
 duties of an able-bodied soldier, I have strictly observed the Regulations which govern the recruiting  
 service. This soldier has black eyes, black hair, mulatto complexion, is 5  
 feet 8 1/2 inches high.

William D Matthews 1st Lieut  
Recruiting Officer } 1st Lieut Artillery  
Battery } Volunteers,  
 Regiment of \_\_\_\_\_ Leavenworth  
 RECRUITING OFFICER.

Mustered into the service of the United States, for three years or during the war, from date of enlistment, in Leavenworth Kansas  
14<sup>th</sup> day of December, 1864, at Leavenworth Kansas  
1st Lieut Artillery  
Battery

*Hamilton, Henry*

ndpt. Batt'y U.S. Col'd L. Art'y

*Private Private*

CARD NUMBERS.

1	6233779.	26
2	6233928.	27
3	6234088.	28
4	6234236.	29
5	6234403.	30
6	6234565.	31
7	9137960	32
8		33
9		34
10		35
11		36
12		37
13		38
14		39
15		40
16		41
17		42
18		43
19		44
20		45
21		46
22		47
23		48
24		49
25		50

Book Mark: \_\_\_\_\_

See also \_\_\_\_\_

*H* | Indpt. Batt'y. | **U.S.C.T.**

*Henry Hamilton*

....., Indpt. Batt'y, U. S. Col'd L. Art'y.

Appears on

**Battery Descriptive Book**

of the organization named above.

**DESCRIPTION.**

Age *27* years; height *5* feet *10* inches.

Complexion *Black*

Eyes *Black*; hair *Black*

Where born *Scott's Key*

Occupation *Laborer*

**ENLISTMENT.**

When *Aug 4*, 186 *4*

Where *Seavorth Is.*

By whom *Lt Mathews*; term *3* y'rs.

Remarks: .....

.....  
.....  
.....  
.....  
.....  
.....  
.....  
.....  
.....

*Holbrook*



*No*

Indpt. Battery. **U.S.C.T.**

*Henry Hamilton*

*Indpt.*, Indpt. Battery, U. S. Col'd L. Art'y.

Appears on

**Battery Muster-in and Descriptive Roll**

of the organization named above. Roll dated

*Government Co Dec 23*, 1864.

Where born *Scott Co Ky*

Age *27* y'rs; occupation *Labor*

When enlisted *July 4*, 1864.

Where enlisted *Government Co*

For what period enlisted *3* years.

Eyes *Blu*; hair *Blu*

Complexion *Blu*; height *5 ft. 10 in.*

When mustered in *July 6*, 1864.

Where mustered in *Government Co*

Bounty paid \$ *100*<sup>00</sup>/<sub>100</sub>; due \$ *200*<sup>00</sup>/<sub>100</sub>

Where credited

Battery to which assigned

Remarks: *A. N. Dist Co*  
*19th Reg 1st Caval*  
*Government Co*

Book mark :

*J. H. [Signature]*

(856g) Copyst.

76

Indpt. Battery.

U.S.C.T.

Henry Hamilton

Private

, Indpt. Battery, U. S. Col'd L. Art'y.

Appears on

**Battery Muster Roll**

for Mustering to Dec 31, 1864

Present or absent Present

Stoppage, \$ 100 for

Due Gov't, \$ 100 for

Valuation of horse, \$ 100

Valuation of horse equipments, \$ 100

Remarks:

Book mark:

J. Schreyer

(358)

Copyist.

No | Indpt. Battery. | **U.S.C.T.**

*Henry Hamilton*  
*Pat*, Indpt. Battery, U. S. Col'd L. Art'y.

Appears on

**Battery Muster Roll**

for *Jan'y Feb*, 186*6*.

Present or absent *Present*

Stoppage, \$ \_\_\_\_\_ <sup>100</sup> for \_\_\_\_\_

Due Gov't, \$ \_\_\_\_\_ <sup>100</sup> for \_\_\_\_\_

Valuation of horse, \$ \_\_\_\_\_ <sup>100</sup>

Valuation of horse equipments, \$ \_\_\_\_\_ <sup>100</sup>

Remarks: \_\_\_\_\_  
\_\_\_\_\_  
\_\_\_\_\_  
\_\_\_\_\_  
\_\_\_\_\_  
\_\_\_\_\_  
\_\_\_\_\_

Book mark: \_\_\_\_\_

(358) *J. W. Ashley* Copyist.

*N* | Indpt. Battery. | **U.S.C.T.**

*Nevins Hamilton,*  
*By* Indpt. Battery, U. S. Col'd L. Art'y.

Appears on

**Battery Muster Roll**

for *Mar. & Apl.*, 1865.

Present or absent *Present*

Stoppage, \$ 100 for

Due Gov't, \$ 100 for

Valuation of horse, \$ 100

Valuation of horse equipments, \$ 100

Remarks:  
-----  
-----  
-----  
-----  
-----  
-----  
-----  
-----  
-----

Book mark: -----

*Parter*

*N* | Indpt. Battery. | **U.S.C.T.**

*Henry Hamilton,*

*H*, Indpt. Battery, U. S. Col'd L. Art'y.

Appears on

**Battery Muster Roll**

for *May & June*, 186 *5*.

Present or absent *Present,*

Stoppage, \$ 100 for

Due Gov't, \$ 100 for

Valuation of horse, \$ 100

Valuation of horse equipments, \$ 100

Remarks:

Book mark:

*Porter*

*N* | Indpt. Battery. | **U.S.C.T.**

*Henry Hamilton,*

*N*, Indpt. Battery U. S. Col'd Light Art'y.

Appears on **Batt'y Muster-out Roll**, dated  
*B. Linnworth, Ky., July 22, 1865.*

Muster-out to date *July 22, 1865.*

Last paid to *Pay due from enlistment, 186*

Clothing account:

Last settled....., 186 ; drawn since \$ *47* <sup>*86*</sup>/<sub>*100*</sub>

Due soldier \$ <sup>*100*</sup>/<sub>*100*</sub>; due U. S. \$ <sup>*100*</sup>/<sub>*100*</sub>

Am't for cloth'g in kind or money adv'd \$ <sup>*100*</sup>/<sub>*100*</sub>

Due U. S. for arms, equipments, &c., \$ <sup>*100*</sup>/<sub>*100*</sub>

Bounty paid \$ *100* <sup>*100*</sup>/<sub>*100*</sub>; due \$ *nine* <sup>*100*</sup>/<sub>*100*</sub>,

Remarks:.....  
.....  
.....  
.....  
.....  
.....

Book mark:.....

*Porter*

Copyist.

*Indict Batty*

*Hamilton, Henry*

Co. *2* Reg't *U.S. P. S. A.*

*4* Enclosures.

Bed Cards .....	Final Statements .....
Burial Records .....	Furloughs or L. of A .....
Certs. of Dis. for Discharge .....	Med. Certificates .....
C. M. Charges .....	Med. Des. Lists .....
Descriptive Lists .....	Orders .....
Discharge Certificates .....	Pris. of War Record .....
Enlistment Papers <i>2</i> .....	Resignations .....

Other papers relating to—

Admission to Hosp'l .....	Furlough or L. of A .....
Casualty Sheet .....	Med. Examination .....
Confinement .....	Misc. Information .....
Contracts .....	Pay or Clothing .....
Death or Effects .....	Personal Reports .....
Desertion .....	Rank .....
Discharge from Hosp'l .....	Transfer to Hosp'l .....
Discharge from Service .....	Transfer to V. R. C. .....
Duty .....	Transportation .....

NOTE 1.—This blank will be used for both enlistments and re-enlistments—enlistment of veterans, &c., &c., in the volunteer service. They will be made out in duplicate in all cases—one to accompany the recruiting return of the superintendent (not the recruiting officer) to the Adjutant General, and one to accompany the accounts of the officer who pays bounty, &c. The Regiment and Company in which the soldier last served should be given on the back.

NOTE 2.—An enlistment holds to service. A muster-in must, in all cases, precede payment of pay, bounty, pension, &c. A muster-in roll must, in all cases, be filed in the Adjutant General's Office as evidence of muster-in. The mustering officer, commissary, or assistant commissary of musters, as the case may be, will countersign both enlistments as having mustered the soldier into the service of the United States before either of them is given to the disbursing officer.

DECLARATION OF RECRUIT.

I, Henry Hamilton desiring to VOLUNTEER as a Soldier in the Army of the United States, for the term of THREE YEARS Do Declare, That I am 27 years and \_\_\_\_\_ months of age; that I have never been discharged from the United States service on account of disability or by sentence of a court-martial, or by order before the expiration of a term of enlistment; and I know of no impediment to my serving honestly and faithfully as a soldier for three years.

GIVEN at Leavenworth State of Kansas the 4<sup>th</sup> day of August 1864

Witness: W. A. Bunker Henry Hamilton

..... enlistment; last served in Company ( )  
Reg't of .....  
Discharged ..... 18 .....

Henry Hamilton  
Volunteered at Leavenworth  
August 1864  
By Wm. A. Bunker 2<sup>d</sup> Lieut. & Commissary  
Recruit Co. K. 2<sup>d</sup> U.S. Cavalry

No. 57

CONSENT IN CASE OF MINOR.

I, ..... Do CERTIFY, That I am the ..... of .....; that the said ..... is ..... years of age; and I do hereby freely give my CONSENT to his volunteering as a SOLDIER in the ARMY OF THE UNITED STATES for the period of THREE YEARS.

GIVEN at ..... the ..... day of .....

Witness: .....



39.59

VOLUNTEER ENLISTMENT.

STATE OF

*Kansas*



TOWN OF

*Seventeenth*

I, *Henry Hamilton* born in *Scott Co*  
 in the State of *Kentucky* aged *27* years,  
 and by occupation a *labourer* Do HEREBY ACKNOWLEDGE to have  
 volunteered this *4<sup>th</sup>* day of *August* 1864  
 to serve as a **Soldier** in the **Army of the United States of America**, for the  
 period of **THREE YEARS** unless sooner discharged by proper authority: Do also  
 agree to accept such bounty, pay, rations, and clothing, as are, or may be, estab-  
 lished by law for volunteers. And I, *Henry Hamilton* do  
 solemnly swear, that I will bear true faith and allegiance to the **United States**  
**of America**, and that I will serve them honestly and faithfully against all their  
 enemies or opposers whomsoever; and that I will observe and obey the orders of  
 the President of the United States, and the orders of the officers appointed over  
 me, according to the Rules and Articles of War.

Sworn and subscribed to, at *Seventeenth*  
 this *4<sup>th</sup>* day of *August* 1864,

*Henry Hamilton*  
 his  
 mark

BEFORE *Wm. D. Matthews 2<sup>nd</sup> Lieut*  
*Recruiting Co 1<sup>st</sup> 2<sup>nd</sup> U.S. Col Artillery*

I CERTIFY, ON HONOR, That I have carefully examined the above-named Volunteer, agreeably  
 to the General Regulations of the Army, and that, in my opinion, he is free from all bodily defects and  
 mental infirmity, which would in any way disqualify him from performing the duties of a soldier.

*Jeffrey Sinks*  
*Surg Board of Enrollment*  
*North 2<sup>nd</sup> Dist Kansas*  
 EXAMINING SURGEON.

I CERTIFY, ON HONOR, That I have minutely inspected the Volunteer, *Henry Hamilton*  
 previously to his enlistment, and that he was entirely sober when enlisted; that, to the best of my  
 judgment and belief, he is of lawful age; and that, in accepting him as duly qualified to perform the duties  
 of an able-bodied soldier, I have strictly observed the Regulations which govern the recruiting service.  
 This soldier has *Black* eyes, *Black* hair, *Black* complexion, is *5* feet  
*10* inches high.

*Wm. D. Matthews 2<sup>nd</sup> Lieut*  
*Recruiting Co 1<sup>st</sup> 2<sup>nd</sup> U.S. Col Artillery*  
 Regiment of *Volunteers,*

RECRUITING OFFICER.

(A. G. O. No. 74 & 75.)

the ..... day of ..... 1864, at .....  
 Mustered into the service of the United States, in Company .....  
 Regiment of .....  
 Volunteers, on

NOTE 1.—This blank will be used for both enlistments and re-enlistments—enlistment of veterans, &c., &c., in the volunteer service. They will be made out in duplicate in all cases—one to accompany the recruiting return of the superintendent (not the recruiting officer) to the Adjutant General, and one to accompany the accounts of the officer who pays bounty, &c. The Regiment and Company in which the soldier last served should be given on the back.

NOTE 2.—An enlistment holds to service. A muster-in must, in all cases, precede payment of pay, bounty, pension, &c. A muster-in roll must, in all cases, be filed in the Adjutant General's Office as evidence of muster-in. The mustering officer, commissary, or assistant commissary of musters, as the case may be, will countersign both enlistments as having mustered the soldier into the service of the United States before either of them is given to the disbursing officer.

DECLARATION OF RECRUIT.

I, Henry Hamilton desiring to VOLUNTEER as a Soldier in the Army of the United States, for the term of THREE YEARS Do Declare, That I am 27 years of age; that I have never been discharged from the United States service on account of disability or by sentence of a court-martial, or by order before the expiration of a term of enlistment; and I know of no impediment to my serving honestly and faithfully as a soldier for three years.

GIVEN at Leavenworth State of Kansas the 4<sup>th</sup> day of August 1864

Witness: W. A. Bushman Henry Hamilton

Rec'd from 2nd. Aud. Nov. 23d 1892

..... enlistment; last served in Company ( )  
..... Reg't of .....  
Discharged ..... 18 .....

No. 36  
Henry Hamilton  
Volunteered at Leavenworth Mo.  
August 1<sup>st</sup> 1864.  
By Wm. D. Prout 2<sup>nd</sup> Lieut  
Recruits Co. K. 2<sup>nd</sup> U.S. Col. Cavalry  
Regiment of .....

CONSENT IN CASE OF MINOR.

I, ..... Do CERTIFY, That I am the ..... of .....; that the said ..... is ..... years of age; and I do hereby freely give my CONSENT to his volunteering as a SOLDIER in the ARMY OF THE UNITED STATES for the period of THREE YEARS.

GIVEN at ..... the ..... day of .....

Witness: .....

VOLUNTEER ENLISTMENT.

STATE OF



TOWN OF

*Kansas*

*Leavenworth*

I, *Henry Hamilton* born in *Scott Co*

in the State of *Virginia* aged *27* years,

and by occupation a *Laborer* Do HEREBY ACKNOWLEDGE to have

volunteered this *4<sup>th</sup>* day of *August* 1864,

to serve as a **Soldier** in the **Army of the United States of America**, for the

period of **THREE YEARS** unless sooner discharged by proper authority: Do also

agree to accept such bounty, pay, rations, and clothing, as are, or may be, estab-

lished by law for volunteers. And I, do

solemnly swear, that I will bear true faith and allegiance to the **United States**

**of America**, and that I will serve them honestly and faithfully against all their

enemies or opposers whomsoever; and that I will observe and obey the orders of

the President of the United States, and the orders of the officers appointed over

me, according to the Rules and Articles of War.

Sworn and subscribed to, at *Leavenworth*

this *4<sup>th</sup>* day of *August* 1864,

BEFORE *Wm D Matthews 2<sup>nd</sup> Lieut*

*Recruiting Co K 2<sup>nd</sup> U.S. Col Artillery*

*his*  
*Henry Hamilton*

I CERTIFY, ON HONOR, That I have carefully examined the above-named Volunteer, agreeably to the General Regulations of the Army, and that, in my opinion, he is free from all bodily defects and mental infirmity, which would in any way disqualify him from performing the duties of a soldier.

*Stiffen Birks*  
*Sur Board of Enrollment*  
*North Dist Kansas*  
EXAMINING SURGEON.

I CERTIFY, ON HONOR, That I have minutely inspected the Volunteer *Henry Hamilton*

previously to his enlistment, and that he was entirely sober when enlisted; that, to the best of my

judgment and belief, he is of lawful age; and that, in accepting him as duly qualified to perform the duties

of an able-bodied soldier, I have strictly observed the Regulations which govern the recruiting service.

This soldier has *Black* eyes, *Black* hair, *Black* complexion, is *3* feet

*10* inches high.

*Wm D Matthews 2<sup>nd</sup> Lieut*  
*Recruiting Co K 2<sup>nd</sup> U.S. Col Artillery*  
Regiment of *Volunteers*,  
RECRUITING OFFICER.

(A. G. O. No. 74 & 75.)

Mustered into the service of the United States, in Company *10<sup>th</sup> Co* Regiment of *1<sup>st</sup> Regt of Colored Inf* Volunteers, on the *6<sup>th</sup>* day of *August*, 1864, at *Leavenworth*  
*not sooner discharged*  
*Wm D Matthews*  
*Recruiting Officer*

W. R. B. 111/1013 074109 Dept-Ku  
 Ft Leavenworth Kansas Jan 31<sup>st</sup> 1865

Bowen Geo. C.

Judge Advocate

Requests that Prisoner Private  
H. Hamilton of Independent  
 Cold Battery, be sent to  
 Court martial at 10.00  
 a.m. Feb 1<sup>st</sup> 1865 for trial

Recd Army Dept Ku Jan 31<sup>st</sup> 1865

Rooms Gen'l Court Martial  
 Ft. Leavenworth, Kansas  
 January 31, 1865

Major:

I would respectfully request that  
 (Prisoner,) Private W. Hamilton of Independent  
 Battery W. S. Colored Artillery, be sent to these  
 rooms, for trial, at 10 A. M. February 1<sup>st</sup> 1865.

Very Respectfully  
 Geo. C. Bowen

2d Lt 2<sup>d</sup> Colorado Cavalry  
 Judge Advocate

Major H. H. Heath  
 Pro Mar Gen'l  
 Dept of Kansas

P. S. Please send (Pris) D. M. Guinn Co "E" 1<sup>st</sup> " "  
 Kansas Vol Cav; also.

Very Respy  
 Geo. C. Bowen  
 J. A.

No 2<sup>d</sup> Dept. Mo C-23  
Office Prov. Mar Gen  
St Louis Mo

L. O. No. 56.

Relative to ~~Drummonds~~<sup>Henry</sup>  
~~Drummond and Gold Battery~~  
~~Johnson Dec 16 1864.~~  
Requested by G. C. Martin

Sgt. Bennett.

Retros per.

HT

Released  
Feb 27 1865

Recd. CRM. Mar 6/65

Head Quarters, Department of the Missouri,

OFFICE OF THE PROVOST MARSHAL GENERAL,

St. Louis, March 1<sup>st</sup> 1865

Special Orders, }  
No. 56 }

EXTRACT:

VIII In compliance with Par 1, G.O. No 54, Co  
Head Quarter Dept, Henry Hamilton, private  
Independent Battery, U. S. Col<sup>d</sup> Art<sup>y</sup>, with be released  
from arrest and returned to duty with his Command  
under the direction of Maj N. H. Heath, Pro Mar -  
dist of Kansas, he having been acquitted on  
the charges preferred.

Maj N. H. Heath,  
Pro Mar Dist of Kansas

J. W. Parker  
Col. & Provost Marshal General

*James M. ...*  
1st Batt'y U.S. Col'd L. Art'y

*Private Private*

CARD NUMBERS.

6233575	26
6233784	27
6233933	28
6234085	29
6234233	30
6234400	31
6234562	32
9132965	33
	34
	35
	36
	37
	38
	39
	40
	41
	42
	43
	44
	45
	46
	47
	48
	49
	50

Book Mark:

See also



S-1162367 - PO m & m

R.P. 503850

D. 1713233 PO. mil.

D. 2770286 and wd

W. Spencer

4

*H* | Indpt. Batt'y. | **U.S.C.T.**

*Benjamin F. Hancock*

....., Indpt. Batt'y, U. S. Col'd L. Art'y.

Appears on

**Battery Descriptive Book**  
of the organization named above.

**DESCRIPTION.**

Age *21* years; height *5* feet *7* inches.

Complexion *Black*

Eyes *Black*; hair *Black*

Where born *Green Co. Ky*

Occupation *Farmer*

**ENLISTMENT.**

When *Sep 29*, 1864.

Where *Paramaribo*

By whom *H. Munir*; term *3* y'rs.

Remarks: .....

*Holbrook*

No

Indpt. Battery.

U.S.C.T.

Benjamin Hancock

Indpt. Battery, U. S. Col'd L. Art'y.

Appears on

Battery Muster-in and Descriptive Roll

of the organization named above. Roll dated

Loveworth Co. Dec 23, 1864.

Where born Green les. Ky

Age 21 y'rs; occupation Farmer

When enlisted Sept 29, 1864.

Where enlisted Loveworth Co

For what period enlisted 3 years.

Eyes Blue; hair Blue

Complexion Blue; height 5 ft. 7 in.

When mustered in Oct 1st, 1864.

Where mustered in Loveworth

Bounty paid \$ 100; due \$ 300 100

Where credited

Battery to which assigned

Remarks: A N Det Co 19th ID 1st Ward Loveworth Co

Book mark :

[Signature]

(850g)

Copyist.

76 | Indpt. Battery. | **U.S.C.T.**

*Benjamin F. Hancock*  
*F. A.*, Indpt. Battery, U. S. Col'd L. Art'y.

Appears on

**Battery Muster Roll**

for *Enlistment to Dec 31, 1864*

Present or absent *Present*

Stoppage, \$ *100* for

Due Gov't, \$ *100* for

Valuation of horse, \$ *100*

Valuation of horse equipments, \$ *100*

Remarks:

Book mark:

*J. W. Scherlock*  
(358) Copyist.

*No*

Indpt. Battery. | **U.S.C.T.**

*Benjamin F. Hancock*

*Pvt*

, Indpt. Battery, U. S. Col'd L. Art'y.

Appears on

**Battery Muster Roll**

for *Jan, Feb*, 186<sup>*5*</sup>.

Present or absent *Present*

Stoppage, \$ \_\_\_\_\_ 100 for \_\_\_\_\_

Due Gov't, \$ \_\_\_\_\_ 100 for \_\_\_\_\_

Valuation of horse, \$ \_\_\_\_\_ 100

Valuation of horse equipments, \$ \_\_\_\_\_ 100

Remarks: \_\_\_\_\_  
\_\_\_\_\_  
\_\_\_\_\_  
\_\_\_\_\_  
\_\_\_\_\_  
\_\_\_\_\_  
\_\_\_\_\_  
\_\_\_\_\_

Book mark: \_\_\_\_\_

*J. A. Schreyer*

(358)

Copyist.

*N* | Indpt. Battery. | **U.S.C.T.**

*Benjamin F Hancock,*  
*B*....., Indpt. Battery, U. S. Col'd L. Art'y.

Appears on

**Battery Muster Roll**

for *Mar, + Apr,*....., 1865.

Present or absent *Present,*.....

Stoppage, \$.....<sup>100</sup> for.....

Due Gov't, \$.....<sup>100</sup> for.....

Valuation of horse, \$.....<sup>100</sup>

Valuation of horse equipments, \$.....<sup>100</sup>

Remarks:.....

Book mark:.....

*Porter*

Copyist.

*N* | Indpt. Battery. | **U.S.C.T.**

*Benjamin Hancock*  
*B*, Indpt. Battery, U. S. Col'd L. Art'y.

Appears on

**Battery Muster Roll**

for *May & June*, 1865.

Present or absent *Present*

Stoppage, \$ 100 for

Due Gov't, \$ 100 for

Valuation of horse, \$ 100

Valuation of horse equipments, \$ 100

Remarks:  
\_\_\_\_\_  
\_\_\_\_\_  
\_\_\_\_\_  
\_\_\_\_\_  
\_\_\_\_\_  
\_\_\_\_\_  
\_\_\_\_\_  
\_\_\_\_\_

Book mark: \_\_\_\_\_

*Pates*  
Copyist.

*N* | Indpt. Battery. | **U.S.C.T.**

*Benjamin F. Hancock,*

*B*, Indpt. Battery U. S. Col'd Light Art'y.

Appears on **Batt'y Muster-out Roll**, dated

*St. Lawrence, N.Y., July 22, 1865.*

Muster-out to date *July 22, 1865.*

Last paid to *Dec. 31, 1864.*

Clothing account:

Last settled....., 186 ; drawn since \$ *34* <sup>*66*</sup>/<sub>100</sub>,

Due soldier \$.....<sup>100</sup>/<sub>100</sub>; due U. S. \$.....<sup>100</sup>/<sub>100</sub>

Am't for cloth'g in kind or money adv'd \$.....<sup>100</sup>/<sub>100</sub>

Due U. S. for arms, equipments, &c., \$.....<sup>100</sup>/<sub>100</sub>

Bounty paid \$ *100* <sup>100</sup>/<sub>100</sub>; due \$ *none* <sup>100</sup>/<sub>100</sub>,

Remarks:.....

.....  
.....  
.....  
.....  
.....  
.....

Book mark:.....

*P. Carter*



*Hancock B. F.*

, Co. \_\_\_\_\_,

*1st Bato*  
*Reg't U. S. C. A*

*2* **Enclosures.**

Bed Cards .....	Final Statements .....
Burial Records .....	Furloughs or L. of A .....
Certs. of Dis. for Discharge .....	Med. Certificates .....
C. M. Charges .....	Med. Des. Lists .....
Descriptive Lists .....	Orders .....
Discharge Certificates .....	Pris. of War Record .....
Enlistment Papers .....	Resignations .....

**Other papers relating to—**

Admission to Hosp'l .....	Furlough or L. of A .....
Casualty Sheet .....	Med. Examination .....
Confinement .....	Misc. Information .....
Contracts .....	Pay or Clothing .....
Death or Effects .....	Personal Reports .....
Desertion .....	Rank .....
Discharge from Hosp'l .....	Transfer to Hosp'l .....
Discharge from Service .....	Transfer to V. R. C. .....
Duty .....	Transportation .....

NOTE 1.—This blank will be used for both enlistments and re-enlistments—enlistment of veterans, &c., &c., in the volunteer service. They will be made out in duplicate in all cases—one to accompany the recruiting return of the superintendent (not the recruiting officer) for the Adjutant General, and one to accompany the reports of the officer who pays bounty, &c. The Regiment and Company in which the soldier last served should be given on the back.

NOTE 2.—An enlistment holds to service. A muster-in must, in all cases, precede payment of pay, bounty, pension, &c. A muster-in roll must, in all cases, be filed in the Adjutant General's Office as evidence of muster-in. The mustering officer, commissary, or assistant commissary of musters, as the case may be, will countersign both enlistments as having mustered the soldier into the service of the United States before either of them is given to the disbursing officer.

DECLARATION OF RECRUIT.

I, Benjamin F Hancock desiring to VOLUNTEER as a Soldier in the Army of the United States, for the term of THREE YEARS, Do Declare, That I am 21 years and \_\_\_\_\_ months of age; that I have never been discharged from the United States service on account of disability or by sentence of a court martial, or by order before the expiration of a term of enlistment; and I know of no impediment to my serving honestly and faithfully as a soldier for three years.

GIVEN at Leavenworth State of Kansas the 29th day of September 1864

Witness:

Ben F Hancock  
mark

No. 85-

B. F. Hancock

Volunteered at Leavenworth

29th September 1864,

By R. H. Minor - 2nd Lieut

1st Battalion of U.S. Col's Cavalry

Clinton Co Mo

enlistment; last served in Company ( )

Reg't of \_\_\_\_\_

Discharged \_\_\_\_\_ 18 \_\_\_\_\_

CONSENT IN CASE OF MINOR.

I, \_\_\_\_\_ Do CERTIFY, That I am the \_\_\_\_\_ of \_\_\_\_\_; that the said \_\_\_\_\_ is \_\_\_\_\_ years of age; and I do hereby freely give my CONSENT to his volunteering as a SOLDIER in the ARMY OF THE UNITED STATES for the period of THREE YEARS.

GIVEN at \_\_\_\_\_ the \_\_\_\_\_ day of \_\_\_\_\_

Witness:

VOLUNTEER ENLISTMENT.

STATE OF

TOWN OF

*Kansas*



*Leavenworth*

I, *Benjamin F. Hancock* born in \_\_\_\_\_  
 in the State of *Kentucky* aged *21* years,  
 and by occupation a *Farmer* Do HEREBY ACKNOWLEDGE to have  
 volunteered this *Twenty ninth* day of *September* 1864,  
 to serve as a **Soldier** in the **Army of the United States of America**, for  
 the period of **THREE YEARS**, unless sooner discharged by proper authority:  
 Do also agree to accept such bounty, pay, rations, and clothing, as are, or may be,  
 established by law for volunteers. And I, *Benjamin F. Hancock* do  
 solemnly swear, that I will bear true faith and allegiance to the **United States  
 of America**, and that I will serve them honestly and faithfully against all  
 their enemies or opposers whomsoever; and that I will observe and obey the  
 orders of the President of the United States, and the orders of the officers  
 appointed over me, according to the Rules and Articles of War.

Sworn and subscribed to, at *Leavenworth* } *Benj. F. Hancock*  
 this *29th* day of *September* 1864, } *his*  
 BEFORE *P. A. Minor 2<sup>d</sup> Lieut* } *make*  
*Recruiting Indt Battery U.S. 6<sup>th</sup> artiller*

I CERTIFY, ON HONOR, That I have carefully examined the above-named Volunteer, agreeably  
 to the General Regulations of the Army, and that, in my opinion, he is free from all bodily defects and  
 mental infirmity, which would in any way disqualify him from performing the duties of a soldier.

*Jiffen Links*  
*Surg. Genl of Enrollment*  
*North Dist Kansas*  
 EXAMINING SURGEON.

I CERTIFY, ON HONOR, That I have minutely inspected the Volunteer, *B. F. Hancock*  
 previously to his enlistment, and that he was entirely sober when enlisted; that, to the best of my  
 judgment and belief, he is of lawful age; and that, in accepting him as duly qualified to perform the  
 duties of an able-bodied soldier, I have strictly observed the Regulations which govern the recruiting  
 service. This soldier has *Black* eyes, *Black* hair, *Black* complexion, is *5'*  
*7"* feet *7"* inches high. *scar on left cheek*  
*P. A. Minor 2<sup>d</sup> Lieut*  
*Indt Battery U.S. 6<sup>th</sup> artiller*  
 RECRUITING OFFICER.

(A. G. O. No. 74 & 76.)

*Benjamin F. Hancock*  
 Mustered into the service of the United States, for three years or during the war, from date of enlistment, in *Company A 1<sup>st</sup> Kansas*  
*Regiment of Col. Frank C. Gilliam's* **Volunteers**, on the *1<sup>st</sup>* day of *October*, 1864, at *Leavenworth, Kansas*  
*J. W. Ashburn*  
*Capt & Provost Marshal*  
*North Dist of Kansas*

NOTE 1.—This Mark will be used for both enlistments and re-enlistments—enlistment of veterans, &c., &c., in the volunteer service. They will be made out in duplicate in all cases—one to accompany the recruiting return of the superintendent (not the recruiting officer) to the Adjutant General, and one to accompany the accounts of the officer who pays bounty, &c. The Regiment and Company in which the soldier last served should be given on the back.

NOTE 2.—An enlistment holds to service. A muster-in must, in all cases, precede payment of pay, bounty, pension, &c. A muster-in roll must, in all cases, be filed in the Adjutant General's Office as evidence of muster-in. The mustering officer, commissary, or assistant commissary of musters, as the case may be, will countersign both enlistments as having mustered the soldier into the service of the United States before either of them is given to the disbursing officer.

DECLARATION OF RECRUIT.

I, Benj F Hancock desiring to VOLUNTEER as a Soldier in the Army of the United States, for the term of THREE YEARS, Do Declare, That I am 21 years and \_\_\_\_\_ months of age; that I have never been discharged from the United States service on account of disability or by sentence of a court martial, or by order before the expiration of a term of enlistment; and I know of no impediment to my serving honestly and faithfully as a soldier for three years.

GIVEN at Leavenworth State of Kansas the 29th day of September 1864

Witness:

Benj F Hancock  
mark

No. ....

12

Benj F Hancock  
Volunteered at Leavenworth  
29th September 1864.  
By P. H. Skinner 2<sup>d</sup> Lieut  
1<sup>st</sup> Regt Cavalry 1<sup>st</sup> Div 1<sup>st</sup> Cavalry

..... enlistment; last served in Company ( )  
..... Reg't of .....

Discharged ..... 18 .....

CONSENT IN CASE OF MINOR.

I, ..... Do CERTIFY, That I am the ..... of .....; that the said ..... is ..... years of age; and I do hereby freely give my CONSENT to his volunteering as a SOLDIER in the ARMY OF THE UNITED STATES for the period of THREE YEARS.

GIVEN at ..... the ..... day of .....

Witness:

VOLUNTEER ENLISTMENT.

STATE OF

Kansas



TOWN OF

Leavenworth

I, B. Franklin Hancock born in \_\_\_\_\_  
 in the State of Kentucky aged 21 years,  
 and by occupation a Farmer Do HEREBY ACKNOWLEDGE to have  
 volunteered this 29th day of September 1864,  
 to serve as a **Soldier** in the **Army of the United States of America**, for  
 the period of **THREE YEARS**, unless sooner discharged by proper authority:  
 Do also agree to accept such bounty, pay, rations, and clothing, as are, or may be,  
 established by law for volunteers. And I, B. Franklin Hancock do  
 solemnly swear, that I will bear true faith and allegiance to the **United States**  
**of America**, and that I will serve them honestly and faithfully against all  
 their enemies or opposers whomsoever; and that I will observe and obey the  
 orders of the President of the United States, and the orders of the officers  
 appointed over me, according to the Rules and Articles of War.

Sworn and subscribed to, at Leavenworth  
 this 29th day of September 1864. B. F. Hancock  
 BEFORE P. H. Minor 2nd Lieut mark  
Recruiting Indt Battery U.S. Cold Artillery

I CERTIFY, ON HONOR, That I have carefully examined the above-named Volunteer, agreeably  
 to the General Regulations of the Army, and that, in my opinion, he is free from all bodily defects and  
 mental infirmity, which would in any way disqualify him from performing the duties of a soldier.

Jeffrey Bisco  
Surg. Major of Cavalry  
North Dist. Kansas  
 EXAMINING SURGEON.

I CERTIFY, ON HONOR, That I have minutely inspected the Volunteer, B. F. Hancock  
 previously to his enlistment, and that he was entirely sober when enlisted; that, to the best of my  
 judgment and belief, he is of lawful age; and that, in accepting him as duly qualified to perform the  
 duties of an able-bodied soldier, I have strictly observed the Regulations which govern the recruiting  
 service. This soldier has black eyes, black hair, black complexion, is 5  
 feet 7 1/2 inches high. Scar on left cheek  
P. H. Minor 2nd Lieut  
Indt Battery U.S. Cold Artillery  
 RECRUITING OFFICER.

Mustered into the service of the United States, for three years or during the war, from date of enlistment, in Company The 1st Kansas  
Battery Regiment of U.S. Cold Artillery Leavenworth on the 1st day of October, 1864 at Leavenworth Kansas

James G. Johnson  
Capt. & Provost-Marshal  
North Dist. Kansas

*Mancock, George W.*  
 ndpt. Batt'y U.S. Col'd L. Art'y  
*Private Private*

CARD NUMBERS.

1	6233576.	26
2	6233783.	27
3	6233932.	28
4	6234084.	29
5	6234232.	30
6	6234399.	31
7	6234561.	32
8	9132964	33
9		34
10		35
11		36
12		37
13		38
14		39
15		40
16		41
17		42
18		43
19		44
20		45
21		46
22		47
23		48
24		49
25		50

Book Mark: \_\_\_\_\_

See also \_\_\_\_\_

S-834627 - P.O. M. + M.  
S-1006133 - P.O. Ret.

S-106076 P.O. aff

S-1068677 P.O. aff

S-1794381 P.O. aff

S-1339719 P.O. aff.

W. S. Spencer  
2

*H* | Indpt. Batt'y. | **U.S.C.T.**

*George W. Hancock*

....., Indpt. Batt'y, U. S. Col'd L. Art'y.

Appears on

**Battery Descriptive Book**

of the organization named above.

**DESCRIPTION.**

Age *18* years; height *5* feet *8* inches.

Complexion *Black*

Eyes *Black*; hair *Black*

Where born *Grandes Pies*

Occupation *Farmer*

**ENLISTMENT.**

When *Sept 29*, 186*4*.

Where *Peareusmith-Is.*

By whom *H Minor*; term *3* y'rs.

Remarks:

.....  
.....  
.....  
.....  
.....  
.....  
.....  
.....  
.....

*Halbrook*  
Copyist.



*H* | Indpt. Battery. | **U.S.C.T.**

*George W. Hancock*

Appears with rank of *Priv* on

**Muster and Descriptive Roll of a Detachment of U. S. Vols. forwarded**

for the Indpt. Batt'y, U. S. Col'd L. Arty. Roll dated

*Leavenworth, Kans., Oct 1, 1864.*

Where born *Green Co., Ken.*

Age *18* y'rs; occupation *Farmer*

When enlisted *Sept. 29, 1864.*

Where enlisted *Leav. City, Kans*

For what period enlisted *3* years.

Eyes *Black*; hair *Black*

Complexion *Black*; height *5* ft. *8* in.

When mustered in *Oct 1, 1864.*

Where mustered in *Leav. City, Kans.*

Bounty paid \$ *100*; due \$ *100*

Where credited

Battery to which assigned

Remarks: *Credited to North Dist. of Kansas, 19th Pub. District, 1st Ward, Leav. City, Vol. Recruit. entitled to Bounty,*

Book mark:

*E. Stanton*

*No* | Indpt. Battery. | **U.S.C.T.**

*George W. Hancock*

*Indpt.*, Indpt. Battery, U. S. Col'd L. Art'y.

Appears on

**Battery Muster-in and Descriptive Roll**

of the organization named above. Roll dated

*Leavenworth Mo Dec 23*, 1864.

Where born *Greenlee Ky*

Age *18* y'rs; occupation *Farmer*

When enlisted *Sept 29*, 1864.

Where enlisted *Leavenworth Mo*

For what period enlisted *3* years.

Eyes *Blu*; hair *Blu*

Complexion *Blu*; height *5 ft. 8 in.*

When mustered in *Oct 1st*, 1864.

Where mustered in *Leavenworth*

Bounty paid \$ *100* <sup>*00*</sup>/<sub>100</sub>; due \$ *200* <sup>*00*</sup>/<sub>100</sub>

Where credited

Battery to which assigned

Remarks: *C. N. Dist Co  
19th S.D. 1st Ward  
Leavenworth Mo,*

Book mark :

*J. H. [Signature]*

(8564)

Copyist.

No | Indpt. Battery. | U.S.C.T.

George W. Hancock

Private, Indpt. Battery, U. S. Col'd L. Art'y.

Appears on

Battery Muster Roll

for Lieutenant's Dress, 1864

Present or absent Present

Stoppage, \$ 100 for

Due Gov't, \$ 100 for

Valuation of horse, \$ 100

Valuation of horse equipments, \$ 100

Remarks:

Book mark:

(358) J. H. Scherwin Copyist.

No | Indpt. Battery. | **U.S.C.T.**

*George W. Hamock*

*Govt*, Indpt. Battery, U. S. Col'd L. Art'y.

Appears on

**Battery Muster Roll**

for *Jan'y Feb*, 186<sup>5</sup>.

Present or absent *Present*

Stoppage, \$ 100 for

Due Gov't, \$ 100 for

Valuation of horse, \$ 100

Valuation of horse equipments, \$ 100

Remarks:

Book mark:

*J. S. Shirley*

(358)

Copyist.

*N* | Indpt. Battery. | **U.S.C.T.**

*George W. Nanceck,*  
*Pr*....., Indpt. Battery, U. S. Col'd L. Art'y.

Appears on

**Battery Muster Roll**

for *Mar + Apr*....., 186 *5*.

Present or absent *Present*.....

Stoppage, \$.....<sup>100</sup> for.....

Due Gov't, \$.....<sup>100</sup> for.....

Valuation of horse, \$.....<sup>100</sup>

Valuation of horse equipments, \$.....<sup>100</sup>

Remarks:.....

Book mark:.....

*Porter*

*N* | Indpt. Battery. | **U.S.C.T.**

*George W. Hancock,*  
*A*....., Indpt. Battery, U. S. Col'd L. Art'y.

Appears on

**Battery Muster Roll**

for *May & June*....., 186*5*.

Present or absent *Present*.....

Stoppage, \$.....<sup>100</sup> for.....

Due Gov't, \$.....<sup>100</sup> for.....

Valuation of horse, \$.....<sup>100</sup>

Valuation of horse equipments, \$.....<sup>100</sup>

Remarks:.....

.....  
.....  
.....  
.....  
.....  
.....  
.....  
.....

Book mark:.....

*Porter*

*N* | Indpt. Battery. | **U.S.C.T.**

*George W. Hancock,*

*M*, Indpt. Battery U. S. Col'd Light Art'y.

Appears on **Batt'y Muster-out Roll**, dated  
*M. Leavenworth's, July 22, 1865.*

Muster-out to date *July 22, 1865.*

Last paid to *Decr 31, 1864.*

Clothing account:

Last settled....., 186 ; drawn since \$ *57*/<sup>*76*</sup>/<sub>*100*</sub>,

Due soldier \$.....<sup>*100*</sup>; due U. S. \$.....<sup>*100*</sup>

Am't for cloth'g in kind or money adv'd \$.....<sup>*100*</sup>

Due U. S. for arms, equipments, &c., \$.....<sup>*100*</sup>

Bounty paid \$ *100* <sup>*100*</sup>; due \$ *None* <sup>*100*</sup>,

Remarks:.....  
.....  
.....  
.....  
.....  
.....  
.....  
.....  
.....

Book mark:.....

*Pates*

*Hancock George H.*

Co.

*1st Batt*  
*Reg't U.S.C.A*

*2* Enclosures.

Bed Cards .....	Final Statements .....
Burial Records .....	Furloughs or L. of A .....
Certs. of Dis. for Discharge .....	Med. Certificates .....
C. M. Charges .....	Med. Des. Lists .....
Descriptive Lists .....	Orders .....
Discharge Certificates .....	Pris. of War Record .....
Enlistment Papers <i>2</i> .....	Resignations .....

Other papers relating to—

Admission to Hosp'l .....	Furlough or L. of A .....
Casualty Sheet .....	Med. Examination .....
Confinement .....	Misc. Information .....
Contracts .....	Pay or Clothing .....
Death or Effects .....	Personal Reports .....
Desertion .....	Rank .....
Discharge from Hosp'l .....	Transfer to Hosp'l .....
Discharge from Service .....	Transfer to V. R. C. .....
Duty .....	Transportation .....
.....	.....



NOTE 1.—This blank will be used for both enlistments and re-enlistments—enlistment of veterans, &c., &c., in the volunteer service. They will be made out in duplicate in all cases—one to accompany the recruiting return of the superintendent (not the recruiting officer) to the Adjutant General, and one to accompany the reports of the officer who pays bounty, &c. The Regiment and Company in which the soldier last served should be given on the back.

NOTE 2.—An enlistment holds to service. A muster-in must, in all cases, precede payment of pay, bounty, pension, &c. A muster-in roll must, in all cases, be filed in the Adjutant General's Office as evidence of muster-in. The mustering officer, commissary, or assistant commissary of musters, as the case may be, will countersign both enlistments as having mustered the soldier into the service of the United States before either of them is given to the disbursing officer.

DECLARATION OF RECRUIT.

I, Geo W Hancock desiring to VOLUNTEER as a Soldier in the Army of the United States, for the term of THREE YEARS, Do Declare, That I am 18 years and \_\_\_\_\_ months of age; that I have never been discharged from the United States service on account of disability or by sentence of a court martial, or by order before the expiration of a term of enlistment; and I know of no impediment to my serving honestly and faithfully as a soldier for three years.

GIVEN at Leavenworth County State of Kansas the 29<sup>th</sup> day of September 1864

Witness:

Geo W Hancock  
his  
marks

No. 84

2613

Geo W Hancock

Volunteered at Leavenworth

29<sup>th</sup> September 1864,

By G H Minor 2<sup>d</sup> Lieut

Indl-Adjutant U.S. 1<sup>st</sup> Artillery

Wm. L. Bohm

enlistment; last served in Company ( )

Reg't of \_\_\_\_\_

Discharged \_\_\_\_\_ 18 .

CONSENT IN CASE OF MINOR.

I, \_\_\_\_\_ Do CERTIFY, That I am the \_\_\_\_\_ of \_\_\_\_\_; that the said \_\_\_\_\_ is \_\_\_\_\_ years of age; and I do hereby freely give my CONSENT to his volunteering as a SOLDIER in the ARMY OF THE UNITED STATES for the period of THREE YEARS.

GIVEN at \_\_\_\_\_ the \_\_\_\_\_ day of \_\_\_\_\_

Witness:

VOLUNTEER ENLISTMENT.

STATE OF

TOWN OF

*Kansas*



*Leavenworth County*

I, *George W. Hancock* born in \_\_\_\_\_  
 in the State of *Kentucky* aged *18* years,  
 and by occupation a *Farmer* Do HEREBY ACKNOWLEDGE to have  
 volunteered this *Twenty ninth* day of *September* 1864,  
 to serve as a **Soldier** in the **Army of the United States of America**, for  
 the period of **THREE YEARS**, unless sooner discharged by proper authority:  
 Do also agree to accept such bounty, pay, rations, and clothing, as are, or may be,  
 established by law for volunteers. And I, *George W. Hancock* do  
 solemnly swear, that I will bear true faith and allegiance to the **United States  
 of America**, and that I will serve them honestly and faithfully against all  
 their enemies or opposers whomsoever; and that I will observe and obey the  
 orders of the President of the United States, and the orders of the officers  
 appointed over me, according to the Rules and Articles of War.

Sworn and subscribed to, at *Leavenworth*  
 this *29<sup>th</sup>* day of *September* 1864, } *George W. Hancock*  
 BEFORE *P. B. Minor 2<sup>nd</sup> Lieut* } *his*  
*Recruiting Inlt Battery U.S. Colored Artillery* } *mark*

I CERTIFY, ON HONOR, That I have carefully examined the above-named Volunteer, agreeably  
 to the General Regulations of the Army, and that, in my opinion, he is free from all bodily defects and  
 mental infirmity, which would in any way disqualify him from performing the duties of a soldier.

*Tiffin Biaks*  
*Surg Board of Enrollment*  
*North Dist Kansas*  
 EXAMINING SURGEON.

I CERTIFY, ON HONOR, That I have minutely inspected the Volunteer *Geo W Hancock*  
 previously to his enlistment, and that he was entirely sober when enlisted; that, to the best of my  
 judgment and belief, he is of lawful age; and that, in accepting him as duly qualified to perform the  
 duties of an able-bodied soldier, I have strictly observed the Regulations which govern the recruiting  
 service. This soldier has *blue* eyes, *black* hair, *black* complexion, is *5*  
 feet *5* inches high.

*P. B. Minor 2<sup>nd</sup> Lieut*  
*Inlt Battery U.S. Colored Artillery*  
 RECRUITING OFFICER.

Mustered into the service of the United States, for three years or during the war, from date of enlistment, in **Company** *The Lincoln*  
*Battery, U.S. Colored Regiment of Artillery (M.I.)* on the *1<sup>st</sup>* day of *October*, 1864 at *Leavenworth Kansas*  
*J. W. Ashman*  
*Capt. Sherman - Marshal*  
*North Dist of Kansas*

NOTE 1.—This blank will be used for both enlistments and re-enlistments—enlistment of veterans, &c., &c. in the volunteer service. They will be made out in duplicate in all cases—one to accompany the recruiting return of the superintendent (not the recruiting officer) to the Adjutant General, and one to accompany the accounts of the officer who pays bounty, &c. The Regiment and Company in which the soldier last served should be given on the back.

NOTE 2.—An enlistment holds to service. A muster-in must, in all cases, precede payment of pay, bounty, pension, &c. A muster-in roll must, in all cases, be filed in the Adjutant General's Office as evidence of muster-in. The mustering officer, commissary, or assistant commissary of musters, as the case may be, will countersign both enlistments as having mustered the soldier into the service of the United States before either of them is given to the disbursing officer.

DECLARATION OF RECRUIT.

I, George W. Hancock desiring to VOLUNTEER as a Soldier in the Army of the United States, for the term of THREE YEARS, Do Declare, That I am 18 years and \_\_\_\_\_ months of age; that I have never been discharged from the United States service on account of disability or by sentence of a court martial, or by order before the expiration of a term of enlistment; and I know of no impediment to my serving honestly and faithfully as a soldier for three years.

GIVEN at Lawrenceville Co. State of Kansas the 29<sup>th</sup> day of September 1864

Witness:

G. W. Hancock  
manly

No. 39

G. W. Hancock

Volunteered at Lawrenceville

29<sup>th</sup> September 1864,

By G. W. Hancock 2<sup>d</sup> Lieut

Under Secretary U.S. Cold Infantry

..... enlistment; last served in Company ( )

Reg't of .....

Discharged ..... 18 .

Rec'd from 2nd. Aud. Nov. 23d 1892

CONSENT IN CASE OF MINOR.

I, ..... Do CERTIFY, That I am the ..... of .....; that the said ..... is ..... years of age; and I do hereby freely give my CONSENT to his volunteering as a SOLDIER in the ARMY OF THE UNITED STATES for the period of THREE YEARS.

GIVEN at ..... the ..... day of .....

Witness:

VOLUNTEER ENLISTMENT.

STATE OF

TOWN OF



*Kansas*

*Leavenworth*

I, *George W. Hancock* born in \_\_\_\_\_  
 in the State of *Kentucky* aged *18* years,  
 and by occupation a *Farmer* Do HEREBY ACKNOWLEDGE to have  
 volunteered this *Twenty ninth* day of *September* 1864  
 to serve as a **Soldier** in the **Army of the United States of America**, for  
 the period of **THREE YEARS**, unless sooner discharged by proper authority:  
 Do also agree to accept such bounty, pay, rations, and clothing, as are, or may be,  
 established by law for volunteers. And I, *George W. Hancock* do  
 solemnly swear, that I will bear true faith and allegiance to the **United States**  
**of America**, and that I will serve them honestly and faithfully against all  
 their enemies or opposers whomsoever; and that I will observe and obey the  
 orders of the President of the United States, and the orders of the officers  
 appointed over me, according to the Rules and Articles of War.

Sworn and subscribed to, at *Leavenworth*  
 this *29th* day of *Sept* 1864, } *George W. Hancock*  
 BEFORE *P. H. Minor 2<sup>nd</sup> Lieut* } *mark*  
*Recruiting Indt Batty U.S. Colored Artillery*

I CERTIFY, ON HONOR, That I have carefully examined the above-named Volunteer, agreeably to the General Regulations of the Army, and that, in my opinion, he is free from all bodily defects and mental infirmity, which would in any way disqualify him from performing the duties of a soldier.

*Wiggins Sims*  
*Surg. Genl. of Enrollment*  
*North Dist. Kansas*  
 EXAMINING SURGEON.

I CERTIFY, ON HONOR, That I have minutely inspected the Volunteer, *George W. Hancock* previously to his enlistment, and that he was entirely sober when enlisted; that, to the best of my judgment and belief, he is of lawful age; and that, in accepting him as duly qualified to perform the duties of an able-bodied soldier, I have strictly observed the Regulations which govern the recruiting service. This soldier has *black* eyes, *black* hair, *black* complexion, is *6-* feet *0* inches high.

*P. H. Minor 2<sup>nd</sup> Lieut*  
*Indt Batty U.S. Colored Artillery*  
 RECRUITING OFFICER

(A. G. O. No. 74 & 76.)

Mustered into the service of the United States, for three years or during the war, from date of enlistment, in *Company* *The Independent*  
*Battery, 1<sup>st</sup> Regt. Cavalry of Artillery (M.) Volunteers* on the *1<sup>st</sup>* day of *October*, 1864 at *Leavenworth* *Kansas*

This record was advanced from the Bureau and No 27 from the

*Wiggins Sims*  
*Capt. & Provost-Marshal*  
*North Dist. of Kansas*

# MICROCOPY

18 18

ROLL

297

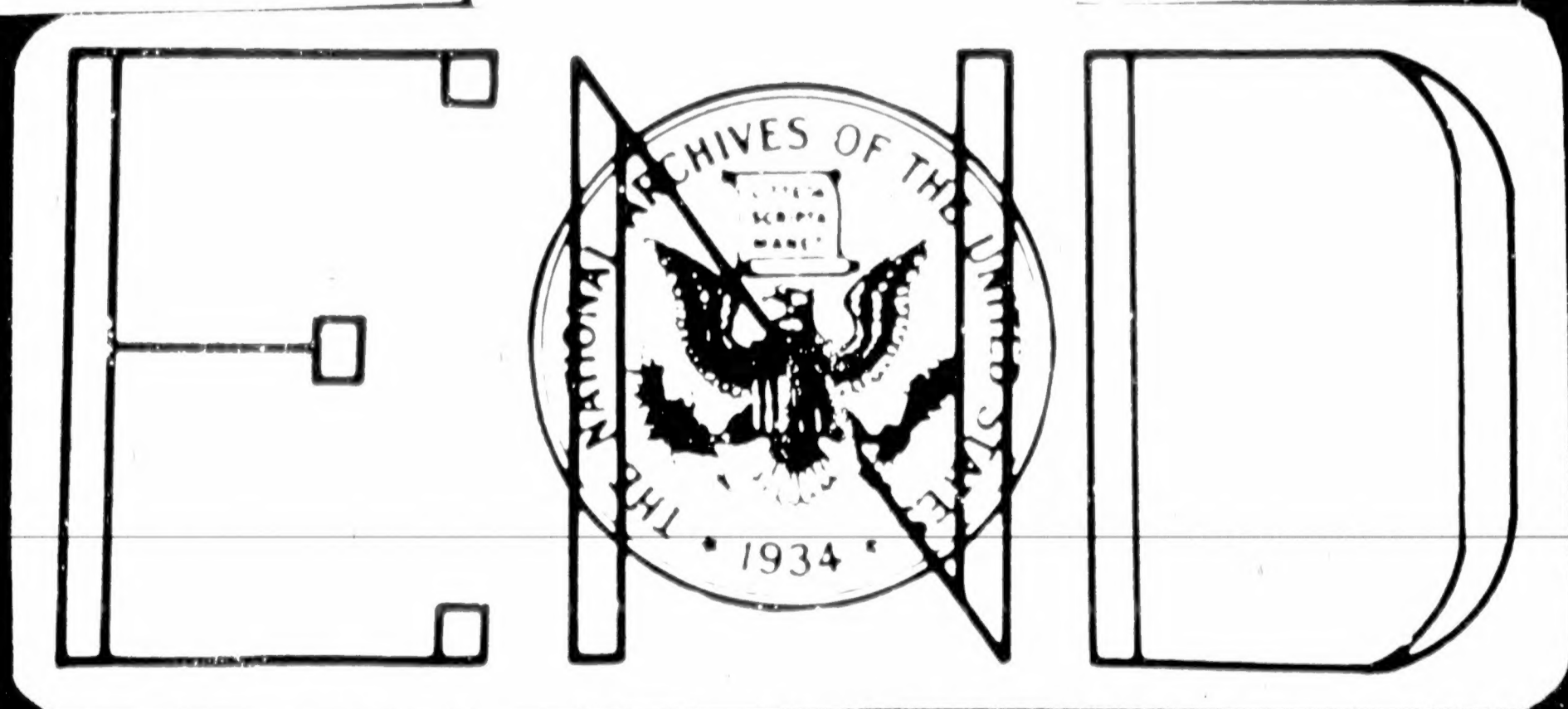

# IMAGE EVALUATION TEST TARGET (QA-3)

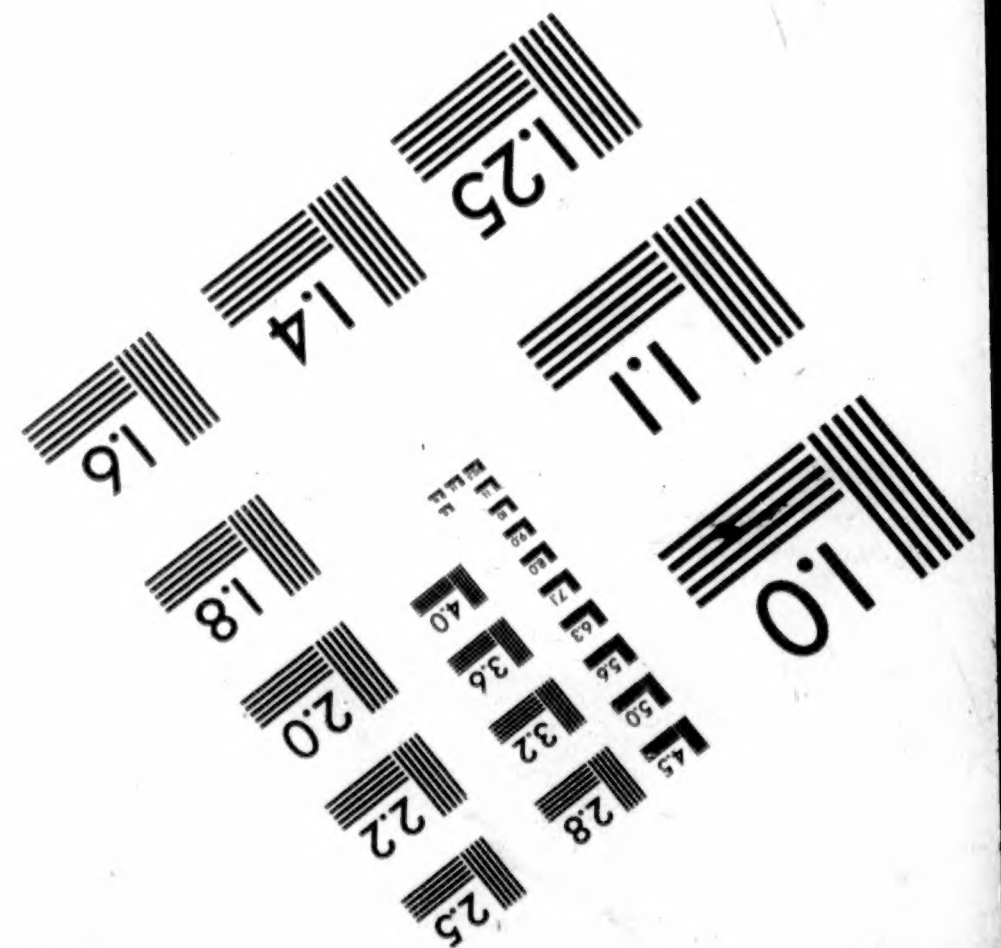
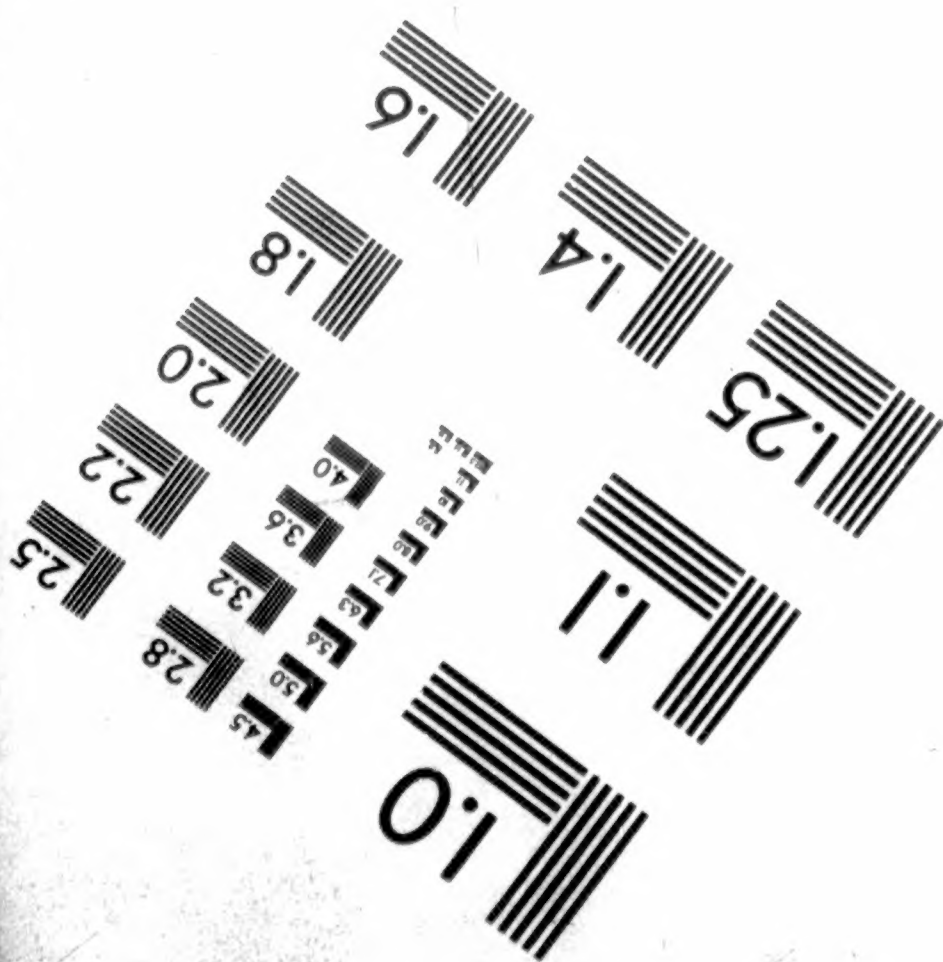
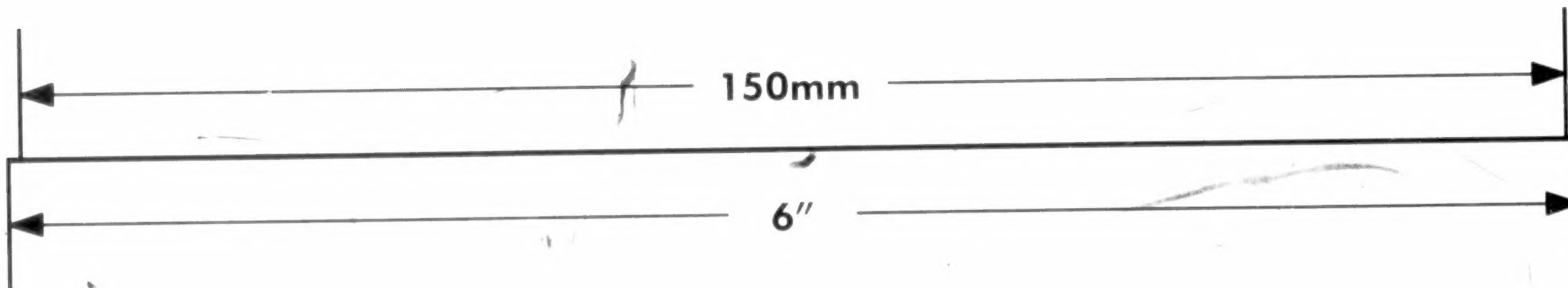
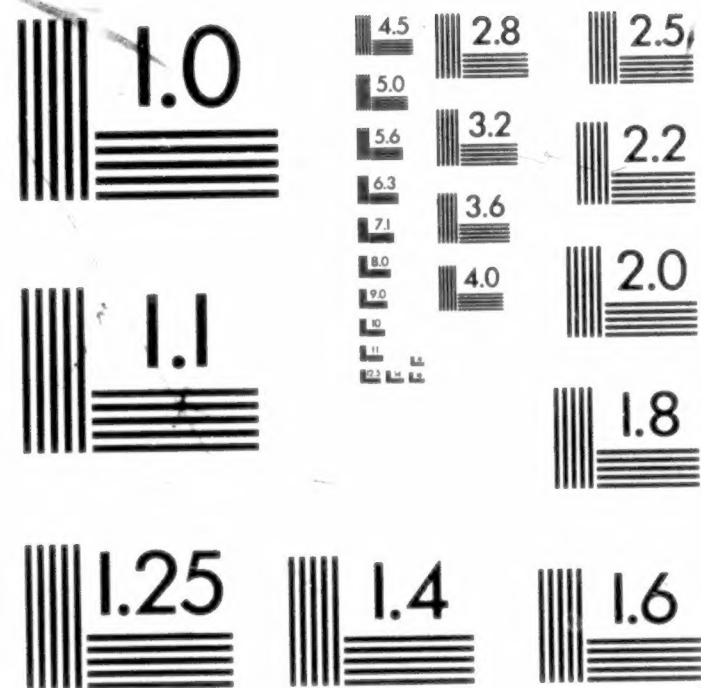
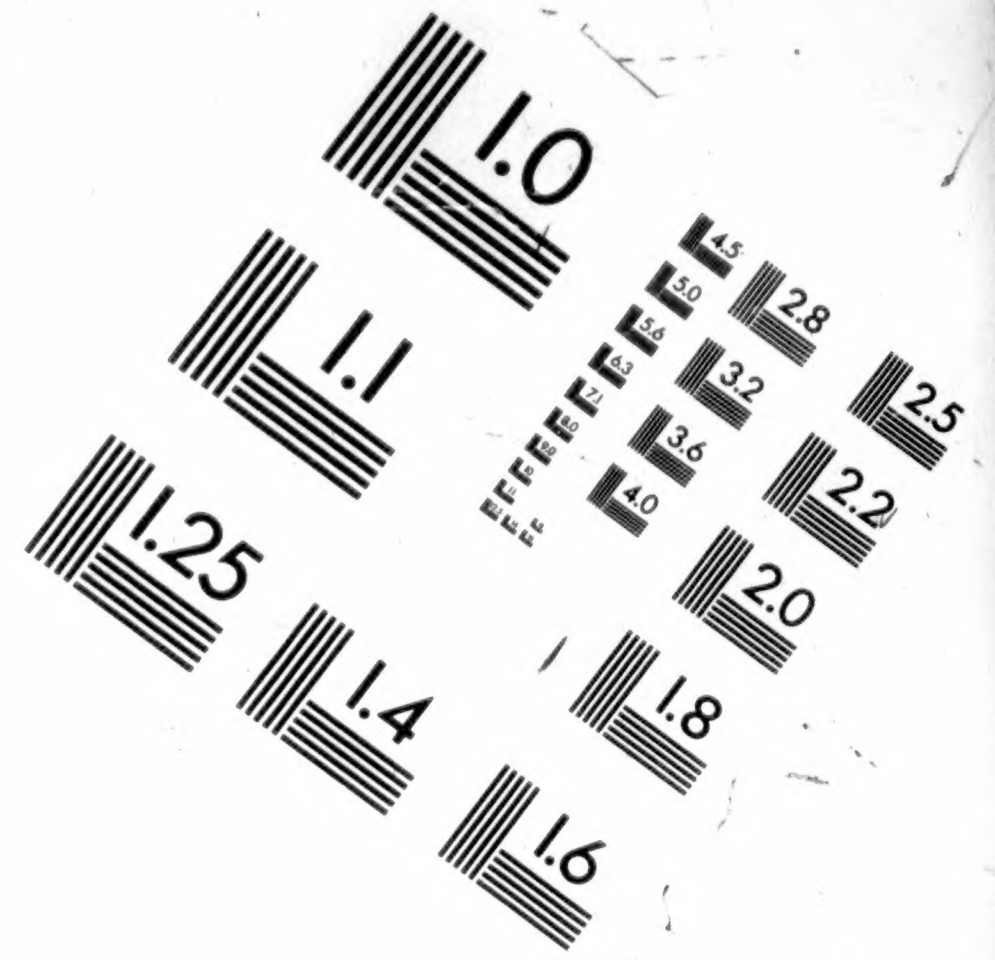
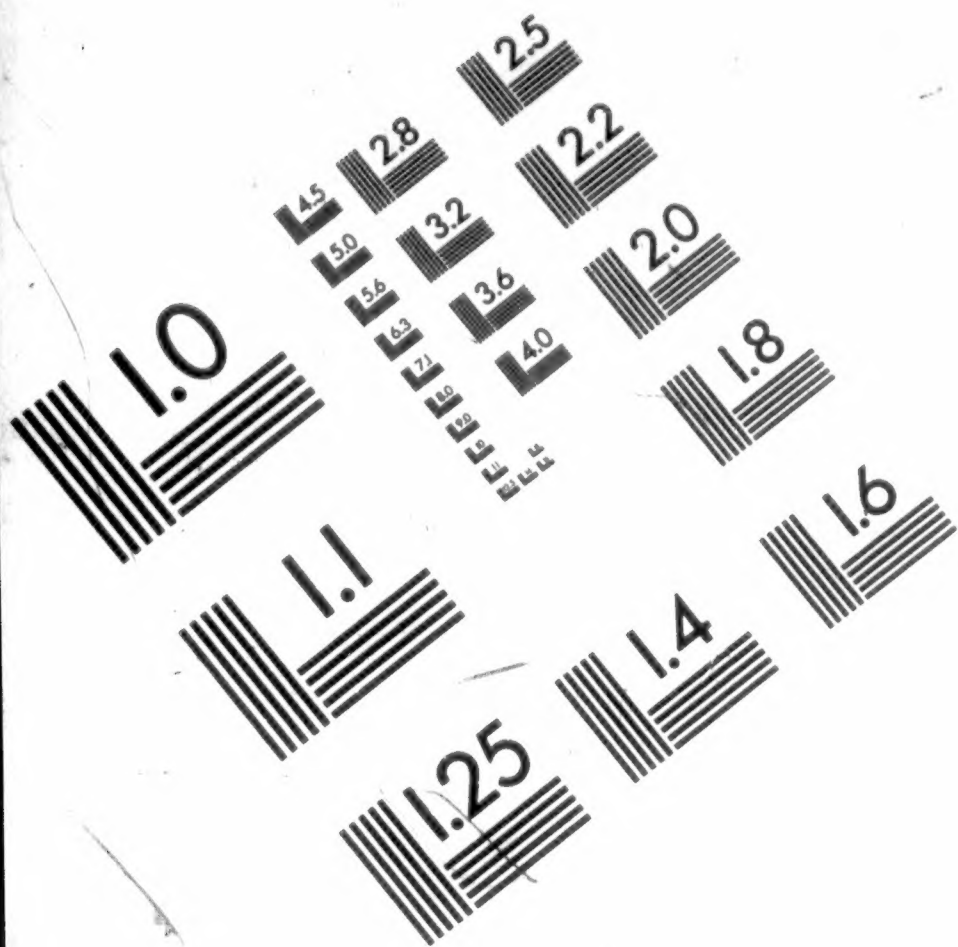

**APPLIED IMAGE, Inc**  
 1653 East Main Street  
 Rochester, NY 14609 USA  
 Phone: 716/482-0300  
 Fax: 716/288-5989

© 1993, Applied Image, Inc., All Rights Reserved

**THE END**

**PLEASE**

**REWIND**